



585-221-102ADD
Issue 2
August, 1993

DEFINITY® Monitor I
Installation Manual Addendum

TO ORDER COPIES OF THIS DOCUMENT

CALL: AT&T Customer Information Center
1 800 432-6600
In Canada: 1 800 255-1242

WRITE: AT&T Customer Information Center
2855 North Franklin Road
P.O. Box 19901
Indianapolis, IN 46219

ORDER: Document No. AT&T 585-221-102ADD
August, 1993

For more information about AT&T documents, see
Business Communications Systems Publications Catalog, 555-000-010

AUDIX is a registered trademark of AT&T.
DATAPHONE is a registered trademark of AT&T.
DEFINITY is a registered trademark of AT&T.
DIMENSION is a registered trademark of AT&T.
Equinox is a registered trademark of Equinox Systems, Inc.
MS-DOS is a registered trademark of Microsoft Corporation.
INFORMIX-SE and INFORMIX-SQL are registered trademarks of Informix Software, Inc.
MEGAPORT is a trademark of Equinox Systems, Inc.
OKIDATA is a registered trademark of Oki Electric Industry Company, Ltd.
UNIX is a registered trademark of UNIX Systems Laboratories, Inc.,
a subsidiary of AT&T.
Philips is a registered trademark of the Phillips Screw Company.
Silent Knight is a registered trademark of Weycross, Inc.

NOTICE

While reasonable efforts were made to ensure that the information in this document was complete and accurate at the time of printing, AT&T can assume no responsibility for any errors. Changes or corrections to the information contained in this document may be incorporated into future reissues.

Prepared by
AT&T GBCS Product Documentation Development
Middletown, NJ 07748-0096

© Copyright 1993
All Rights Reserved

Printed in USA

Contents

1 Introduction

Introduction	1-1
Whats in this Manual?	1-1
Conventions Used in this Manual	1-2
Monitor I Customer Service Phone Number	1-3
The Monitor I Configuration	1-3
Overview - Installation Sequence for 3B2/600	1-7
Overview - Installation Sequence for 6386E/33	1-8
Overview - Installation Sequence for 6386SX/EL	1-9
Overview - Installation Sequence for NCR-3315	1-10
Overview - Installation Sequence for NCR-3332	1-11

2 Installing on a 3B2/600

Installing on a 3B2/600	2-1
Step 1 — Set Up the 3B2/600 and Console	2-2
Step 2 — Install the Additional Hardware	2-4
Step 3 — Load the UNIX Essential Utilities	2-9
Step 4 — Load the Additional Software	2-12
Step 5 — Set Up the Terminals and Modems	2-15
Step 6 — Set Up and Enable the Printer	2-25
Step 7 — Rebuild the UNIX Kernel	2-27
Step 8 — Load the INFORMIX Software	2-30
Step 9 — Add the Monitor I Group and Users	2-32
Step 10 — Load the Monitor I Software	2-34
Step 11 — Enable the System Ports	2-47

3 Installing on the 6386E/33 Model S

Installing on the 6386E/33 Model S	3-1
Step 1 — Set Up the 6386E/33 Model S WGS	3-1
Step 2 — Load the UNIX Essential Utilities	3-5
Step 3 — Load the Additional Software	3-9
Step 4 — Set Up the Terminals and Modems	3-12
Step 5 — Set Up and Enable the Printer	3-22
Step 6 — Rebuild the UNIX Kernel	3-24
Step 7 — Load the INFORMIX Software	3-26
Step 8 — Add the Monitor I Group and Users	3-29

Step 9 — Load the Monitor I Software	3-32
Step 10 — Enable the System Ports	3-45

4 Installing on the 6386SX/EL

Installing on the 6386SX/EL	4-1
Step 1 — Set Up the 6386SX/EL WGS	4-1
Step 2 — Load the UNIX Essential Utilities	4-4
Step 3 — Load the Additional Software	4-8
Step 4 — Set Up the Terminals and Modems	4-10
Step 5 — Set Up and Enable the Printer	4-20
Step 6 — Rebuild the UNIX Kernel	4-23
Step 7 — Load the INFORMIX Software	4-25
Step 8 — Add the Monitor I Group and Users	4-28
Step 9 — Load the Monitor I Software	4-31
Step 10 — Enable the System Ports	4-47

5 Installing on the NCR-3315

Installing on the NCR-3315	5-1
Step 1 — Set Up the NCR-3315 WGS	5-1
Step 2 — Load the UNIX Essential Utilities	5-4
Step 3 — Load the Additional Software	5-8
Step 4 — Set Up the Terminals and Modems	5-10
Step 5 — Set Up and Enable the Printer	5-20
Step 6 — Rebuild the UNIX Kernel	5-23
Step 7 — Load the INFORMIX Software	5-25
Step 8 — Add the Monitor I Group and Users	5-28
Step 9 — Load the Monitor I Software	5-31
Step 10 — Enable the System Ports	5-46

6 Installing on the NCR-3332

Installing on the NCR-3332	6-1
Step 1 — Set Up the NCR-3332 WGS	6-1
Step 2 — Load the UNIX Essential Utilities	6-3
Step 3 — Load the Additional Software	6-6
Step 4 — Set Up the Terminals and Modems	6-8
Step 5 — Set Up and Enable the Printer	6-18
Step 6 — Rebuild the UNIX Kernel	6-21
Step 7 — Load the INFORMIX Software	6-23
Step 8 — Add the Monitor I Group and Users	6-26

Step 9 — Load the Monitor I Software	6-29
Step 10 — Enable the System Ports	6-44

A **Acceptance Testing**

Acceptance Testing	A-1
Monitor I Acceptance Test Cases	A-1

B **Port Configuration Worksheets**

Port Configuration Worksheets	B-1
Port Configuration Worksheet for 3B2/600	B-1
Port Configuration Worksheet for 6386E/33	B-2
Port Configuration Worksheet for 6386SX/EL	B-3
Port Configuration Worksheet for NCR-3315	B-4
Port Configuration Worksheet for NCR-3332	B-5

C **Monitor I Error Messages**

Monitor I Error Messages	C-1
Installation Error Messages	C-1

Index

Introduction

DEFINITY® Monitor I is a system for gathering and analyzing voice and data traffic information on your telecommunications network. Monitor I's menu-driven user interface allows you to gather data about switch resources for the DEFINITY Communications System Generic 2,* the DEFINITY Communications System Generic 1,** and the G3r and G3i switches, as well as System 85, System 75, and DIMENSION®. The G3sv and G3m switches are not specifically referenced throughout this installation guide, but all G3i references include the G3sv and the G3m switches.

See: *An Introduction to DEFINITY Monitor I*, 585-221-010, and the *DEFINITY Monitor I Operations Guide for Generic 3*, 585-221-501† for a description of the Monitor I features.

What's in this Manual?

This manual details the installation of the hardware and software needed to operate DEFINITY Monitor I. The manual is divided into the following chapters:

- | | |
|------------------|---|
| Chapter 1 | "Introduction" provides an overview of the DEFINITY Monitor I configuration and supported software release levels, and outlines the steps required for installing Monitor I on either the 3B2/600, 6386E/33 Model S WGS, 6386SX/EL Model WGS or NCR-3315. |
| Chapter 2 | "Installation on a 3B2/600" provides hardware and software installation procedures needed to run the Monitor I standard features on the 3B2/600. |
| Chapter 3 | "Installing on the 6386E/33" provides hardware and software installation procedures needed to run the Monitor I standard features on the 6386E/33 Model S. |
| Chapter 4 | "Installing on the 6386SX/EL" provides hardware and software installation procedures needed to run the Monitor I standard features on the 6386SX/EL Model. |

* Hereafter abbreviated as DEFINITY Generic 2 or Generic 2.

** Hereafter abbreviated as DEFINITY Generic 1 or Generic 1.

† For information relating to all releases of Generic 2, Generic 1, System 85, System 75 and DIMENSION, please refer to the *DEFINITY Monitor I Operations Manual*, 585-221-703 (December 1992).

- Chapter 5** "Installing on the NCR-3315" provides hardware and software installation procedures needed to run the Monitor I standard features on the NCR-3315.
- Chapter 6** "Installing on the NCR-3332" provides hardware and software installation procedures needed to run the Monitor I standard features on the NCR-3332.
- Appendix A** "Acceptance Testing" contains eight test cases that can be performed after Monitor I is installed.
- Appendix B** "Port Configuration Worksheets" contains samples of the worksheets used to keep track of port assignments.
- Appendix C** "Monitor I Installation Error Messages" lists the error messages you may encounter while installing Monitor I and the actions required to fix the errors.

Conventions Used in this Manual

TABLE 1-1
Table of Conventions

Convention	Meaning
Enter port number pr1 now enabled continue?	This typeface indicates system messages or responses.
<i>cd /etc/.profile</i> <i>installpkg</i> <i>lpstat -t</i>	This typeface indicates a response or entry the user must type.
Edit the etc/password . Access usr/tmp/journal .	The bold typeface applies to files, directories, options, and software references.
<div style="border: 1px solid black; border-radius: 10px; display: inline-block; padding: 2px 10px;">RETURN</div> <div style="border: 1px solid black; border-radius: 10px; display: inline-block; padding: 2px 10px;">ESC</div>	Rounded corners on a key indicate a key on your standard keyboard.
Enter the serial number <i>exactly</i> ...be sure the power is <i>off</i> .	A bold, italicized typeface indicates emphasized information.
Load <filename>	Substitute your filename for the file or software identified in brackets.

Monitor I Customer Service Phone Number

The Monitor I Hotline is located at the Technical Service Center (TSC). The phone number is **1 800 548-8861**.

Note: DO NOT install any hardware or software before calling the TSC.

The Monitor I Configuration

Note: Before you begin installing Monitor I, make sure you have received all the hardware, software, and documentation required for your configuration.

The hardware and software components for a typical system are outlined below.

Hardware Components

The following is a list of the primary hardware components of a standard system.

- AT&T processor (3B2/600, 6386E/33 Model S, 6386SX/EL, NCR-3315 or NCR-3332)
- System console
- Additional Random Access Memory (RAM)
- Remote Management Package (RMP)
- Expanded Input/Output (I/O) Capability Feature card(s), consisting of four asynchronous and one parallel port each
- External Hard Disk Unit
- AT&T 615 Business Communications Terminal (BCT) or AT&T 715 Business Communications System (BCS)
- Modems (The number of modems you need depends on your configuration.)
- Laser or dot matrix printer
- 1 or 3 KVA UPS (Uninterrupted Power Supplies)
- Modular cables and adaptors, as follows.
 - For each printer or terminal accessed through direct-connect or ISN (one port is required for each printer or terminal), you will need the following:
 - One Terminal/Printer modular adaptor (male)
 - One modular RS232C cable (3B2) or 10 conductor modular cable (6386)

- For each printer or terminal accessing the 3B2 or 6386 through a modem (one modem is required for each printer or terminal), you will need the following:
 - One Terminal/Printer modular adaptor (male)
 - One ACU Modem modular adaptor (male)
 - One modular RS232C cable (3B2) or 10 conductor modular cable (6386)
- You will need the following for each modem connected to the 3B2, 6386E/33 or 6386SX/EL used for printer, terminal, or switch access. Multiple printers/modems and terminals/modems can access one modem connected to the 3B2, 6386E/33 or 6386SX/EL. Every two System 85s or every three System 75s can access one modem connected to the 3B2, 6386E/33 or 6386SX/EL.
 - One ACU Modem modular adaptor (male)
 - One modular RS232C cable (3B2) or 10 conductor modular cable (6386)
- You will need the following for the one alarm origination modem connected to the CONTTY port on the 3B2, 6386E/33 or 6386SX/EL:
 - One Terminal/Printer modular adaptor (male)
 - One modular RS232C cable (3B2) or 10 conductor modular cable (6386)
 - The NCR-3315 and the NCR-3332 will use an RJ-45 8-wire cable and adaptors as supplied with its configuration

You will need two small screwdrivers (one Phillips®-head and one flathead) to remove the screws and the cover from the processor and to connect cables.

Software Components

The following is a list of the primary software components necessary for a standard system.

- UNIX® System V Release 3.2.3 Foundation Set and Utilities for the 6386E/33 Model, 6386SX/EL, NCR-3315 and NCR-3332 processors or Release 3.2.1 for the 3B2/600.
- AT&T 513 BCT/System 75 Terminal Emulation cartridge for each 615 BCT terminal if accessing G3i, G1 or System 75 maintenance and administration functions. Note that you may receive a 615 Terminal Emulation cartridge in place of a 513 cartridge; the 615 BCT cartridge can be used in the same way as the 513.
- Enhanced Ports (EPORTS) Utilities
- INFORMIX-SQL® Release 4.0 (3B2/600, 6386E/33, 6386SX/EL, NCR-3315 or NCR-3332)
- INFORMIX-SE® Release 4.0 (3B2/600, 6386E/33, 6386SX/EL, NCR-3315 or NCR-3332)
- DEFINITY Monitor I software
- Remote Management Package (RMP) software, if the 3B2, 6386E/33, or 6386SX/EL are equipped with an RMP card

Documentation

All software and hardware comes with its own documentation, which includes detailed instructions for installing or loading the product. The following manuals should be available for reference during the installation procedure.

3B2/600 Documents

- The packing list included with the 3B2/600 processor
- *AT&T 3B2 Computer Read Me First*
- *AT&T 3B2 Computer UNIX System V Release 3 Owner Operator Manual*
- *AT&T 3B2 Computer UNIX System V Release 3.1 System Administrator's Guide*
- *AT&T 3B2 Computer UNIX System V Release 3.1 System Administrator's Reference Manual*
- *AT&T 3B2 Computer UNIX System V Release 3.2 Release Notes*
- *AT&T 3B2 Computer UNIX System V User's Reference Manual*
- *AT&T 3B2 Computer Expanded Input/Output Capability Manual*
- *AT&T 3B2 Computer Random Access Memory Expansion Manual*
- *AT&T 3B2 Computer SCSI Installation Manual*
- *AT&T 3B2 Computer SCSI Operations Manual*
- *AT&T 3B2 Computer Remote Management Package Manual*

6386E/33 Documents

- The packing list included with the 6386E/33 Model S processor
- *AT&T 6386E/33 Computer Read Me First*
- *AT&T 6386E/33 Work Group System User's Guide*
- *UNIX System V/386 Release 3.2.3 Operations/System Administration Guide*
- *UNIX System V/386 System Administrator's Reference Manual*
- *AT&T 6386E/33 Computer UNIX System V Release 3.2 Release Notes*
- *AT&T 6386E/33 UNIX System V User's Reference Manual*
- *AT&T 6386E/33 Computer Expanded Input/Output Capability Manual*
- *AT&T 6386E/33 Computer Random Access Memory Expansion Manual*
- *AT&T 6386E/33 Computer SCSI Operations Manual*
- *AT&T 6386E/33 Computer Remote Management Package Manual*

NCR-3315 Documents

- *NCR-3315 Technical-Service Manual*
- *NCR-3315 User's Manual*

NCR-3332 Documents

- *NCR System 3000 Model 3332 User's Manual*

Other Documents

- *DATAPHONE® II 2224CEO User's Manual or DATAPHONE II 2224GNN Modem User's Manual*
- *615 BCT User's Guide or 715 BCS User's Guide and Service Manual, or 630/730 Multi-Tasking Graphics Terminal User's Guide*
- *AT&T 572/573/595 Printer User's Guide*
- *513 BCT/System 75 Emulation Cartridge User's Guide*
- *AT&T Intelligent Ports Card Model 900 (IPC-900) User's Guide*

Overview — Installation Sequence for 3B2/600

Table 1-2 lists the steps required to install Monitor I on a 3B2 processor and indicates the chapter containing the appropriate instructions, as well as the approximate time required to complete each step.

TABLE 1-2
3B2/600 Installation

Task	Go To	Time Needed
Set up the 3B2/600 computer and the console.	Chapter 2, Step 1, and instructions in the <i>Read Me First</i> document.	30 minutes
Install the External Hard Disk Unit, and optional AIC card and Silent Knight® Autodialer.	Chapter 2, Step 2	40 minutes
Boot the 3B2 from the UNIX Essential Utilities tape and run the setup program.	Chapter 2, Step 3, and instructions in the <i>Owner Operator Manual</i> .	45 minutes
Install the additional UNIX utilities (from tape) and the optional RMP software (from floppy disk).	Chapter 2, Step 4	40 minutes
Set up and install the modems and additional 615 BCT, 715 BCS, or 730 MTG terminals.	Chapter 2, Step 5	15 minutes per modem or terminal
Set up and enable the printer.	Chapter 2, Step 6	15 minutes
Rebuild the UNIX kernel.	Chapter 2, Step 7	20 minutes
Install the INFORMIX-SQL and INFORMIX-SE software.	Chapter 2, Step 8, and instructions provided with the INFORMIX tapes.	20 minutes
Add the Monitor I group and users.	Chapter 2, Step 9	10 minutes
Install the Monitor I software.	Chapter 2, Step 10	45 minutes
Enable the system ports, including terminal ports and UUCP ports.	Chapter 2, Step 11	5 minutes per port

Use the Port Configuration Worksheet in Appendix B of this manual to note the port assignments of the hardware components in your configuration and the phone lines to which they are attached. You will need this information to enable the ports in Step 11 of Chapter 2.

For information about error messages, refer to the table in Appendix C of this manual.

Overview — Installation Sequence for 6386E/33 Model S

Table 1-3 lists the steps required to install Monitor I on a 6386 processor and indicates the chapter containing the appropriate instructions, as well as the approximate time required to complete each step.

TABLE 1-3
6386E/33 Model S Installation

Task	Go To	Time Needed
Set up the 6386E/33 Model S computer and install the Video Display Controller (VDC600) card, additional memory, Intelligent Ports Card (IPC), keyboard, monitor, mouse, and cables.	Chapter 3, Step 1	60–90 minutes
Run the Setup program, load the UNIX Foundation Set and partition the hard disk.	Chapter 3, Step 2	45 minutes
Load the additional software, including FACE, FMLI, and drivers for the IPC.	Chapter 3, Step 3	60 minutes
Set up and install the modems and additional 615 BCT, 715 BCS, or 730 MTG terminals.	Chapter 3, Step 4	15 minutes per modem or terminal
Set up and enable the printer.	Chapter 3, Step 5	15 minutes
Rebuild the UNIX Kernel.	Chapter 3, Step 6	20 minutes
Install the INFORMIX-SQL and INFORMIX-SE software.	Chapter 3, Step 7, and instructions provided with the INFORMIX tapes.	20 minutes
Add the Monitor I group and users.	Chapter 3, Step 8	10 minutes
Install the Monitor I software.	Chapter 3, Step 9	45 minutes
Enable the system ports, including terminal ports and UUCP ports.	Chapter 3, Step 10	5 minutes per port

Use the Port Configuration Worksheet in Appendix B of this manual to note the port assignments of the hardware components in your configuration and the phone lines to which they are attached. You will need this information to enable the ports in Step 10 of Chapter 3.

For information about error messages, refer to the table in Appendix C of this manual.

Overview — Installation Sequence for 6386SX/EL

Table 1-4 lists the steps required to install Monitor I on a 6386SX/EL processor and indicates the chapter containing the appropriate instructions, as well as the approximate time required to complete each step.

TABLE 1-4
6386SX/EL Installation

Task	Go To	Time Needed
Set up the 6386SX/EL computer and install the additional memory, Intelligent Ports Card (IPC), keyboard, monitor, mouse, and cables.	Chapter 4, Step 1	60–90 minutes
Run the Setup program, load the UNIX Foundation Set, and partition the hard disk.	Chapter 4, Step 2	45 minutes
Load the additional software, including FACE, FMLI, and drivers for the IPC.	Chapter 4, Step 3	60 minutes
Set up and install the modems and additional 615 BCT, 715 BCS, or 730 MTG terminals.	Chapter 4, Step 4	15 minutes per modem or terminal
Set up and enable the printer.	Chapter 4, Step 5	15 minutes
Rebuild the UNIX Kernel.	Chapter 4, Step 6	20 minutes
Install the INFORMIX-SQL and INFORMIX-SE software.	Chapter 4, Step 7, and instructions provided with the INFORMIX tapes.	20 minutes
Add the Monitor I group and users.	Chapter 4, Step 8	10 minutes
Install the Monitor I software.	Chapter 4, Step 9	45 minutes
Enable the system ports, including terminal ports and UUCP ports.	Chapter 4, Step 10	5 minutes per port

Use the Port Configuration Worksheet in Appendix B of this manual to note the port assignments of the hardware components in your configuration and the phone lines to which they are attached. You will need this information to enable the ports in Step 10 of Chapter 4.

For information about error messages, refer to the table in Appendix C of this manual.

Overview — Installation Sequence for NCR-3315

Table 1-5 lists the steps required to install Monitor I on a NCR-3315 processor and indicates the chapter containing the appropriate instructions, as well as the approximate time required to complete each step.

TABLE 1-5
NCR-3315, Installation

Task	Go To	Time Needed
Set up the NCR-3315 computer and install the additional memory, Intelligent Ports Card (IPC), Cartridge Tape Drive, keyboard, monitor, and cables.	Chapter 5, Step 1	60–90 minutes
Run the Setup program, load the UNIX Foundation Set, and partition the hard disk.	Chapter 5, Step 2	45 minutes
Load the additional software, including FACE, FMLI, the Cartridge Tape Utilities, and drivers for the IPC.	Chapter 5, Step 3	60 minutes
Set up and install the modems and additional 615 BCT, 715 BCS, or 730 MTG terminals.	Chapter 5, Step 4	15 minutes per modem or terminal
Set up and enable the printer.	Chapter 5, Step 5	15 minutes
Rebuild the UNIX Kernel.	Chapter 5, Step 6	20 minutes
Install the INFORMIX-SQL and INFORMIX-SE software.	Chapter 5, Step 7, and instructions provided with the INFORMIX tapes.	20 minutes
Add the Monitor I group and users.	Chapter 5, Step 8	10 minutes
Install the Monitor I software.	Chapter 5, Step 9	45 minutes
Enable the system ports, including terminal ports and UUCP ports.	Chapter 5, Step 10	5 minutes per port

Use the Port Configuration Worksheet in Appendix B of this manual to note the port assignments of the hardware components in your configuration and the phone lines to which they are attached. You will need this information to enable the ports in Step 10 of Chapter 5.

For information about error messages, refer to the table in Appendix C of this manual.

Overview — Installation Sequence for NCR-3332

Table 1-6 lists the steps required to install Monitor I on a NCR-3332 processor and indicates the chapter containing the appropriate instructions, as well as the approximate time required to complete each step.

TABLE 1-6
NCR-3332, Installation

Task	Go To	Time Needed
Set up the NCR-3332 computer and install the additional memory, keyboard, monitor, and cables.	Chapter 6, Step 1	60 to 90 minutes
Run the Setup program, load the UNIX Foundation Set, and partition the hard disk.	Chapter 6, Step 2	45 minutes
Load the additional software, including FACE, FMLI, the SCSI Support Package, and drivers for the Equinox.	Chapter 6, Step 3	60 minutes
Set up and install the modems and additional 615 BCT, 715 BCS, or 730 MTG terminals.	Chapter 6, Step 4	15 minutes per modem or terminal
Set up and enable the printer.	Chapter 6, Step 5	15 minutes
Rebuild the UNIX Kernel.	Chapter 6, Step 6	20 minutes
Install the INFORMIX-SQL and INFORMIX-SE software.	Chapter 6, Step 7, and instructions provided with the INFORMIX tapes.	20 minutes
Add the Monitor I group and users.	Chapter 6, Step 8	10 minutes
Install the Monitor I software.	Chapter 6, Step 9	45 minutes
Enable the system ports, including terminal ports and UUCP ports.	Chapter 6, Step 10	5 minutes per port

Use the Port Configuration Worksheet in Appendix B of this manual to note the port assignments of the hardware components in your configuration and the phone lines to which they are attached. You will need this information to enable the ports in Step 10 of Chapter 6.

For information about error messages, refer to the table in Appendix C of this manual.

Installing on a 3B2/600

This section explains how to install the hardware and software required to use DEFINITY Monitor I on the 3B2/600 processor. The entire installation should take approximately five hours; three hours to complete Steps 1 through 4, and two hours to complete Steps 5 through 10.

Figure 2-1 shows a sample DEFINITY Monitor I configuration on the 3B2/600.

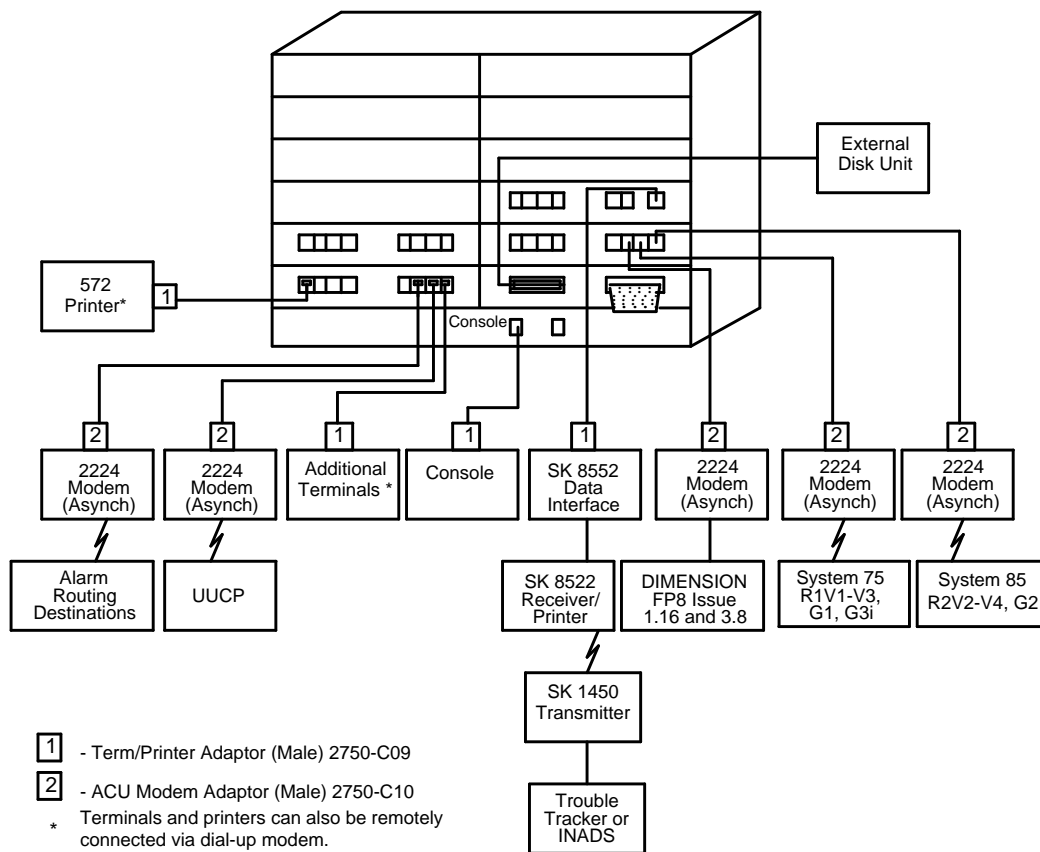

FIGURE 2-1
Sample Monitor I Equipment Configuration on the 3B2/600

Step 1 — Set Up the 3B2/600 and Console

Prerequisites for this Step

Activities

- **DO NOT** install any hardware or software before calling the Technical Support Center (TSC) (1 800 422-6622).
- Make sure that you have received all the components necessary for the Monitor I system.

Documents

- *AT&T 3B2 Computer Read Me First (Read Me First)*
- *AT&T 3B2 UNIX System V Release 3.2.1 Owner/Operator Manual (Owner Manual)*
- *User's Guide - 615 Business Communications Terminal (Terminal Guide) or 715 Business Communications System (BCS) User's Guide and Service Manual Terminal Guide)*

Hardware/Software Components

- The standard 3B2/600 processor, consisting of:
 - System unit
 - 1 4 MB memory card
 - 2 147 MB hard disk drives
 - 1 720 KB floppy disk drive
 - 60 MB cartridge tape drive
 - 3 Enhanced Ports (EPORTS) cards (installed in slots 2, 3, and 4 of the system unit)
 - SCSI (Small Computer Systems Interface) Host Adaptor Card (installed in slot 1 of the system unit) and cable
 - Eight cables
 - Ten connectors
- The recommended console, consisting of:
 - AT&T 615 Business Communications Terminal (BCT) or AT&T 715 Business Communications System (BCS)
 - Keyboard
 - AT&T 513 BCT/System 75 Emulation Cartridge per 615 BCT for accessing G3r, G3i, G1 or System 75 maintenance and administration functions

Procedure 1A — Unpack and Set Up the 3B2/600

- 1 Unpack and set up the 3B2.

See: *Read Me First* for the appropriate steps to unpack and set up the 3B2. The section called "Getting Started" in the *Owner Manual* contains additional information about setting up the computer, as well as basic administration and troubleshooting strategies for the system administrator.

Procedure 1B — Unpack and Set Up the Console

"Step 5 — Set Up the Terminals and Modems" explains the installation procedures for terminals other than the console.

- 1 Unpack and set up the 615 or 715 Console.

See:

- *Read Me First*, which describes how to set up and prepare the console.
 - The *Terminal Guide* to set the console's terminal options to those recommended for the 615 BCT or 715 terminal.
 - "Set Up the Console Terminal" in *Read Me First* to connect the console to the 3B2. (The terminal/printer adaptor is connected to the console port labeled **MAIN** and the other end is connected to the 3B2 port labeled **CONSOLE**.)
- 2 Install the 513 BCT/System 75 Emulation Cartridge by inserting the 513 BCT/System 75 cartridge into the slot on the side of the 615 BCT. Be sure that the cartridge is right side up, with the cartridge label toward the front.

Warning: Check the on/off switch before you install the cartridge to make sure that the power for the 615 terminal is turned *off*. A blank screen is *not* an indicator that the terminal is off, and you will destroy the 513 BCT/System 75 cartridge if you insert or remove it while the terminal is on.

- 3 For the 715 terminal, enter the following settings:
 - Set the emulation mode to: *BCS*
 - Set the UNIX terminal type (TERM) to: *sys75*
 - Set the terminal type for cut-through access from Monitor I to G3r, G3i, G1 and System 75 to: *513*
 - Set the **Swap Delete** option of the 715 terminal to: *yes* (through terminal setup) for BCS.
- 4 For Monitor I operations, change the **Cursor Blink** option to *y* for yes.
- 5 Cut-through access to System 75 R1V1 for maintenance or administration requires that the System 75 be equipped with a pooled modem card that allows asynchronous communications.

Step 2 — Install the Additional Hardware

Prerequisites for this Step

Activities

- Make sure that the 3B2/600 processor, keyboard, and console hardware are set up and connected according to the instructions in Step 1 of this section.

Documents

- *AT&T 3B2 Computer Remote Management Package Manual (RMP Manual)*
- *AT&T 3B2 Computer SCSI Installation Manual (SCSI Manual)*
- *AT&T 3B2 Computer Expanded Input/Output Capability Manual (Ports Manual)*

Hardware/Software Components

- Alarm Interface Card (AIC) and cable
- Expanded Input/Output Capability Ports (EPORTS) card(s)
- 1450 Silent Knight Autodialer
- External Disk Unit, Control cable, and Disk Data cable

Notes: The AIC and cable are part of the Remote Management Package (RMP), which also includes a software diskette. The RMP is a 3B2 feature package that allows administrative and maintenance operations to be performed on a 3B2 computer from a remote location. The RMP also has the ability to output an alarm signal when a machine error is detected. When DEFINITY Monitor I's 3B2 is equipped with an RMP, the processor can forward alarm signals to a designated location (such as AT&T Services or a Trouble Tracker system) through the Silent Knight transmitter. The RMP is required for a 3B2 that will be forwarding its own alarms to the AT&T Technical Support Organization (TSC).

The EPORTS card is a 3B2 feature card that adds four asynchronous ports and one parallel port to the system. The EPORTS card is used for all types of asynchronous communications, including asynchronous alarm reception, alarm routing, UUCP connections, terminal connections, NSD connections and printer connections.

The Silent Knight Autodialer connected to the DEFINITY Monitor I processor is used to send its own hardware alarms to INADS/TSC. Each Silent Knight Autodialer is installed by your AT&T service representative.

Procedure 2A — Install the AIC

Caution: When you install the hardware, be sure to read and follow the instructions and cautions explained in the supporting hardware documentation.

- 1 Remove the cover on the 3B2/600 and install the AIC card.

See: The "Installation and Removal in a 12-Slot 3B2 Computer" instructions in the *RMP Manual* to install the AIC in the next available slot of the 3B2/600.

The RMP software that uses the AIC will be installed in "Step 4 — Load the Additional Software."

Procedure 2B — Install the EPORTS Card(s)

- 1 Install the EPORTS card(s).

See: The "Installation and Removal in a 12-Slot 3B2 Computer" in the *Ports Manual* to install the Ports card(s). This manual also contains information on numbering and assignment of the ports.

- 2 Replace the cover on the 3B2/600.

Figure 2-2 shows the 3B2 processor with the standard cards installed.

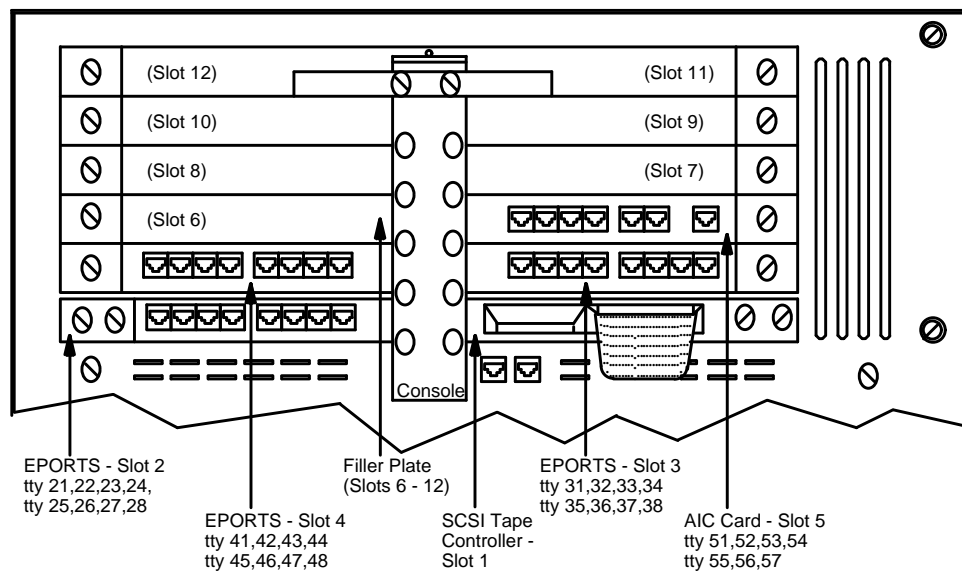

FIGURE 2-2
3B2/600 with Standard Cards

Procedure 2C — Install the 1450 Silent Knight Autodialer

- 1 Unpack the components of the 1450 Silent Knight Autodialer.
See: Figures 2-3 and 2-4 in this section to assist you while installing the Silent Knight Autodialer. Note that the Silent Knight Autodialer channel 1 will be associated with *major* alarms and channel 2 will be associated with *minor* alarms.
- 2 Remove the Silent Knight jumpers 4, 6, and 7.
- 3 Connect a strap between the Silent Knight terminals 3 and 4 and a 15K resistor between the Silent Knight terminals 6 and 11.
- 4 Connect the four-wire modular plug (one end of the two-foot cable) to the Silent Knight as shown in Figure 2-3.
- 5 Connect the telephone line to the Silent Knight terminals 14 (TIP) and 13 (RING) and the modem telephone line to the Silent Knight terminals 16 (TIP) and 15 (RING).
- 6 Set the screws on the Silent Knight to dial the desired location and to identify the ID code of the DEFINITY Monitor I system. The AT&T TSC assigns the ID code.
- 7 Connect the Autodialer to the processor.
- 8 Connect the Transient Protector to the Autodialer.
- 9 Connect to the phone line through an RJ11C jack.

Caution: The connection to the phone line *must* be made through an RJ11C jack. Connection through any other type jack will cause damage to the equipment.

Procedure 2D — Connect the External Disk Unit

- 1 Connect the first external disk unit to the 3B2.
See: The **Task 9** instructions in the *SCSI Manual* to connect the first external disk unit to the 3B2.

Look for the product id on the label on the inside of the 3B2/600 door. If the number ends in G3 or higher (ED-3T023-30,G3), change the **target id** on the External Disk Controller to 4. Otherwise, leave it at the factory setting.
- 2 Connect the additional external disk units.
See: The **Task 11** instructions in the *SCSI Manual* to connect additional external disk units.

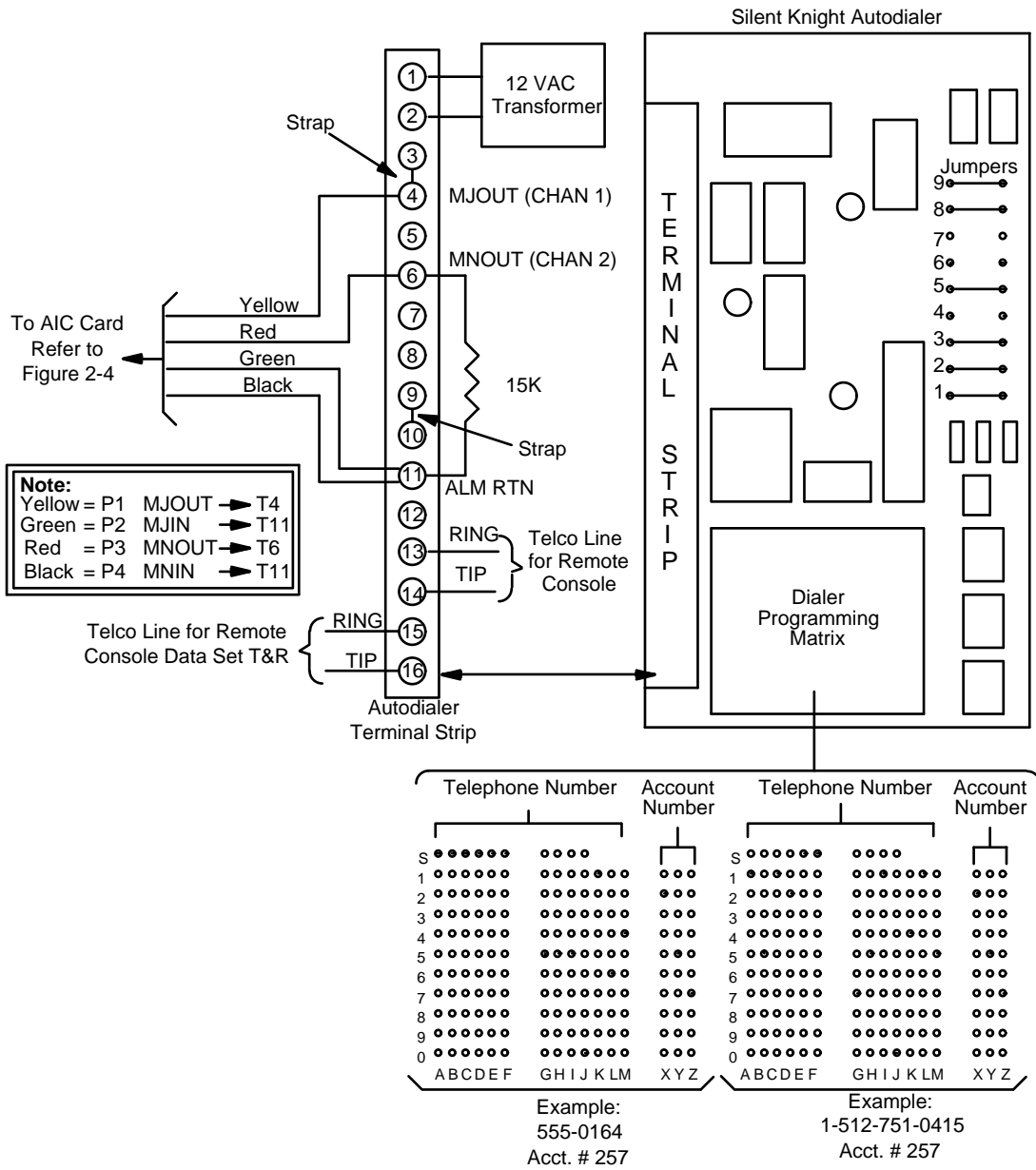

FIGURE 2-3
Autodialer Configuration

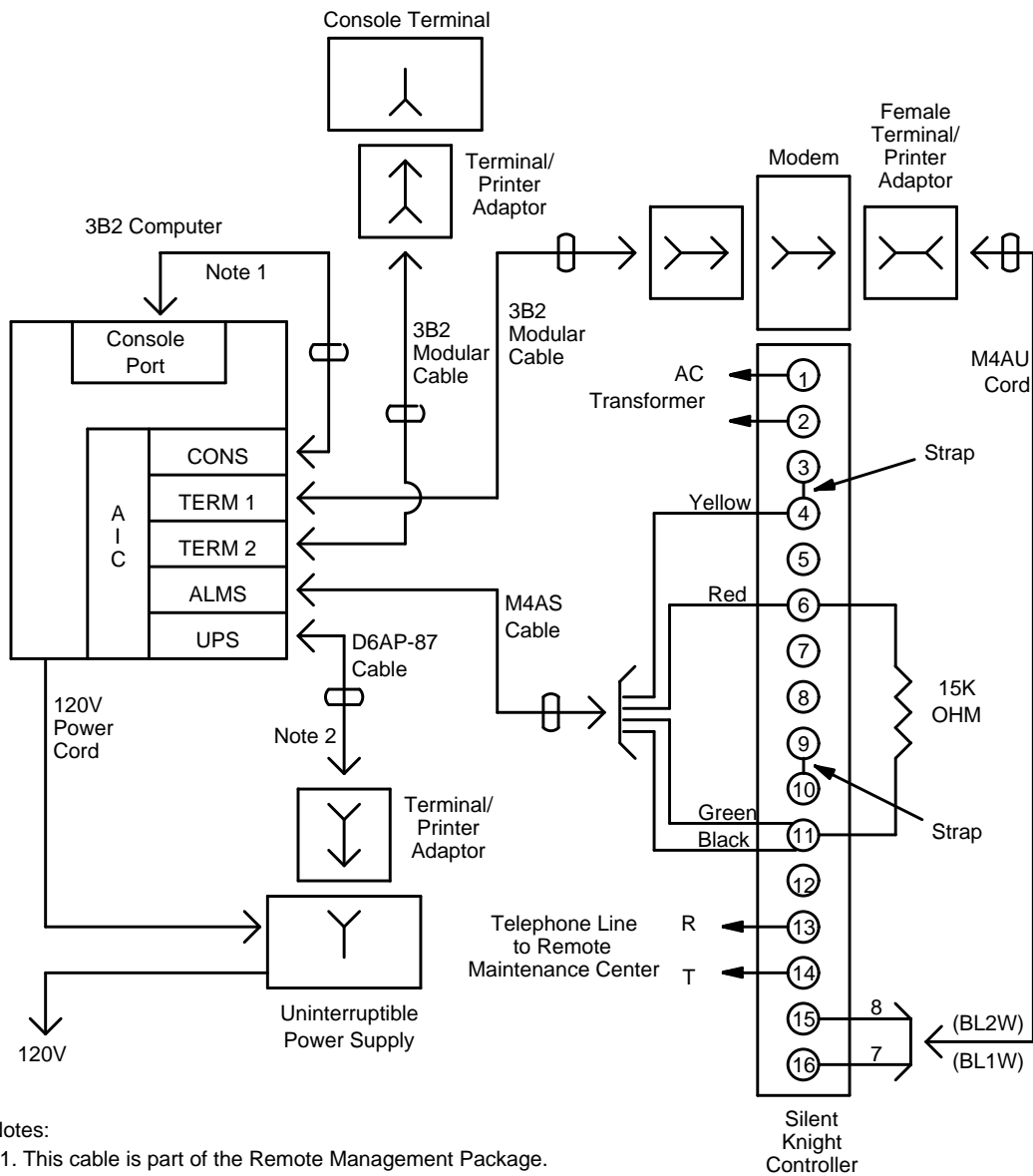

FIGURE 2-4
AIC to Autodialer Configuration

Step 3 — Load the UNIX Essential Utilities

Prerequisites for this Step

Activities

- Make sure that the 3B2 processor, keyboard and console are set up and connected according to Step 1 of this section.
- Make sure that the appropriate cards are installed in the 3B2 according to Step 2 of this section.

Documents

- *AT&T 3B2 Computer UNIX System V Release 3.2.1 Owner Operator Manual (Owner Manual)*
- *AT&T 3B2 Computer UNIX System V Release 3.2.1 Administrator's Guide (Admin Guide)*

Hardware/Software Components

- UNIX Operating System software tape

Procedure 3A — Load the UNIX Essential Utilities

- 1 Turn on the 3B2.

Note: UNIX System V Release 3.2.1 is the operating system supported by Monitor I for the 3B2/600.

Ignore the following messages:

Unknown ID Code for device in slot n

These messages indicate that the hardware in the specified 3B2 slots are undefined. Until the appropriate software is loaded in "Step 4 — Load the Additional Software," these messages are displayed every time the system is booted. The screen prompts you to load the first Essential Utilities tape.

The UNIX Operating System Release number appears after the following message is displayed:

Diagnostics Passed

2 Enter *root* at the prompt:

Console Login:

System Response:

Password:

3 Press RETURN.

See: "Procedure 3.9 — Reload the Operating System, Full System Restore (Default Partition Size)" instructions in the *Admin Manual*.

- Select *1* to specify the SCSI as the load device.
- Select *1* to specify the tape drive as the subdevice.
- Select *1* to specify a full restore.
- Select *1* to specify that the **/usr** file system should be loaded on disk 0 (the first internal hard disk drive).

Refer to Table 2-1 for the initial disk layout.

**TABLE 2-1
Initial Hard Disk Layout**

Disk Number	File System Name	Partition Designation	Block Size
Disk0	/ (root)		26,624
	/swap		65,536
	/sysdump		65,536
	/usr		149,504
Disk1	/usr2		

Procedure 3B — Partition Disk 2

- 1 At the root prompt, enter `sysadm harddisk partition` to begin the hard disk partitioning utility.
- 2 Select `disk 2` to select disk 2 to be partitioned.
- 3 Select `usr2` as the file system name.
- 4 Select the default file system size, which should be the entire second hard disk.

Procedure 3C — Run the Setup Program

- 1 Enter `setup` when the following prompt is displayed:

Console Login

See: The instructions for "Getting Started" in the *Owner Manual*.

Do *not* install user logins at this time; you will do this in "Step 9 — Add the Monitor I Group and Users."

- 2 Set the system clock.
- 3 Assign passwords to the administrative and root logins. This is not required, but it is strongly recommended, especially for the root login.
- 4 Set the **Node Name**. This is the name by which other machines know this one.

Procedure 3D — Change the Firmware Password

- 1 Make a floppy key and change your firmware password.

See: The instructions in "Getting Started" in the *Owner Manual*.

End of procedures for Step 3

Step 4 — Load the Additional Software

Prerequisites for this Step

Activities

- Make sure that the 3B2 processor, keyboard, console, and additional hardware are installed according to Steps 1 and 2 of this section.
- Make sure that the correct version of the Essential Utilities is loaded and the **Setup** program has been run according to Step 3 of this section.
- If the system is in multiuser mode, make sure all other users are logged off.

Documents

- *AT&T 3B2 UNIX System V Release 3.2.1 Owner Operator Manual (Owner Manual)*
- *AT&T 3B2 UNIX System V User's Reference Manual (User's Manual)*

Hardware/Software Components

- Although all the UNIX additional utilities can be loaded, the required software packages are (from SCSI tape):
 - EPORTS
 - directory and file management
 - user environment
 - interprocess communications
 - system administration
 - terminal information (parts 1 and 2)
 - editing
 - line printer spooling
 - basic networking
 - SCSI cartridge tape
 - window utilities (for the 630/730 MTG only)
- Security Administration software
- Ports software (already loaded as part of the Essential Utilities package)
- RMP software, if an AIC was installed in "Step 2 — Install the Additional Hardware"

Procedure 4A — Load the Additional UNIX Utilities

- 1 Log in as *root* at the following prompt:

Console Login:

- 2 Enter *stty erase ^H echoe* to set the backspace key to backspace and erase the character.

This sequence must be entered each time the system is booted. After the system is completely installed, this sequence should be added to the **/etc/profile** .

See: The *Owner Manual* for more details.

- 3 Continue the installation.

See: The "Installation of Utilities" procedures under the "Installation or Removal of Utilities from SCSI Tape" instruction in the "Software Utilities Packages" section in the *Owner Manual*.

The "Software Utilities Packages" section contains additional information about the system administration commands, a description of the packages, and information about dependencies.

- 4 Enter *sysadm tapepkg* to install the UNIX files from SCSI tape.
 - Enter *help* for further information about selecting the packages to install.
- 5 When the Terminal Information Utilities (part 2) is being loaded:
 - Select *1* to install terminfo file(s).
 - Enter *all* when selecting the files to install.
 - Select *done* to complete the installation of the files.
 - Select *0* to terminate installation of the package.

Note: When the Line Printer Spooling Utilities are being loaded, you cannot define the printer to the system until the Monitor I software is loaded.

The system prompts:

Should the disable and enable commands be available to ALL users?

- 6 Enter *n* at the prompt. The current line printer status is displayed on the screen.
- 7 When the Basic Networking Utilities are being loaded, the prompt displays the current name of the system and asks you if you want to change it.
 - Change the system name if desired.

- 8 When the Windowing Utilities are loaded the following prompt is displayed:

How many windowing terminals?

- 9 Enter the number of 630/730 MTGs connected to the processor.

The process is complete when the prompt to remove the cartridge tape is displayed.

Note: To list the utility names after they have been installed, use the `sysadm listpkg` command.

Procedure 4B — Load the Security Administration Utility Package

- 1 Enter `sysadm installpkg` at the prompt.
- 2 Insert the Security Administration diskette when prompted, and press `RETURN`.

Procedure 4C — Continue Loading with the RMP Software

- 1 If an AIC is installed on the 3B2, insert the RMP diskette and press `RETURN` at the prompt:

continue?

Note: Call the Technical Service Center (TSC) at 1 800 548-8861 for your RMP settings. Your TSC engineer will know how to enable the RMP settings.

Procedure 4D — Reboot the System

- 1 Enter `q` to exit the `sysadm` program after all the packages are loaded.
- 2 Enter `cd /` to be sure you are in the root directory.
- 3 Enter `/bin/touch /etc/system` to bring the file dates to the current date.
- 4 Enter `shutdown -i6 -g0 -y` and press `RETURN`.

End of procedures for Step 4

Step 5 — Set Up the Terminals and Modems

Prerequisites for this Step

Activities

- Make sure that the 3B2 processor, keyboard, console, additional cards, and software have been installed according to Steps 1 through 4 of this section.

Documents

- *User's Guide - 615 Business Communications Terminal Guide* or, *715 Business Communications System User's Guide and Service Manual* or *730 Multi-Tasking Graphics Terminal Guide* or *User's Guide - 630 Multi-Graphics Terminal (Terminal Guide)*
- *DATAPHONE II 2224-CEO Modem User's Manual* or *DATAPHONE II 2224-GNN Modem User's Manual (Modem Manual)*

Hardware/Software Components

- 615 BCT(s), or 715 BCS(s), or 630 or 730 MTGs (optional)
- One 513 BCT/System 75 Emulation cartridge per 615 BCT for accessing G3r, G3i, G1, or System 75 maintenance and administration functions
- One or more AT&T modems per communication type
 - Bidirectional 1200/300 baud asynchronous communications modems for UUCP and communication with administered switches
- One modular cable for each terminal or modem to 3B2 connection
- One terminal/printer adaptor for each terminal to modular cable connection
- One male ACU/Modem adaptor for each modem to 3B2 connection
- One EIA shielded cable for the 615 or 715 to modem connection

Procedure 5A — Set Up the Terminals

- 1 Unpack, install and set up the terminal.

See: The "Unpack and Install" (615 BCT or 715 BCS) instructions in the *Terminal Guide*. The *Terminal Guide* also contains the options that need to be set for your terminal.

- 2 Install the 513 BCT/System 75 Emulation Cartridge by inserting the 513 BCT/System 75 cartridge into the slot on the side of the 615 BCT. Be sure that the cartridge is right side up, with the cartridge label toward the front.

Warning: Check the on/off switch before you install the cartridge to make sure that the power for the 615 terminal is turned *off*. A blank screen is *not* an indicator that the terminal is off, and you will destroy the 513 BCT/System 75 cartridge if you insert or remove it while the terminal is on.

- 3 For the 715 terminal, enter the following settings:
 - Set the emulation mode to: *BCS*
 - Set the UNIX terminal type (TERM) to: *sys75*
 - Set the terminal type for cut-through access from Monitor I to G3r, G3i, G1, and System 75 to: *513*
 - Set the **Swap Delete** option of the 715 terminal to: *yes* (through terminal setup) for BCS.
- 4 For Monitor I operations, change the **Cursor Blink** option to *y* for yes.
- 5 Cut-through access to System 75 R1V1 for maintenance or administration requires that the System 75 be equipped with a pooled modem card that allows asynchronous communications.

Procedure 5B — Set Up the Modems

Monitor I supports the 2224-CEO, the 2224-GNN and the AT&T 2400 modems. For either modem, you must set up the hardware switches, as follows.

See: The appropriate *Modem Manual* for complete installation procedures.

Contact the Technical Service Center (TSC) at 1 800 548-8861 to have your modem checked after you have completed the appropriate modem procedures.

2224-CEO Modems

- 1 Remove the CEO modem cover to access the Internal Option switches.

See Figure 2-5 for a diagram of the CEO modem hardware switches.

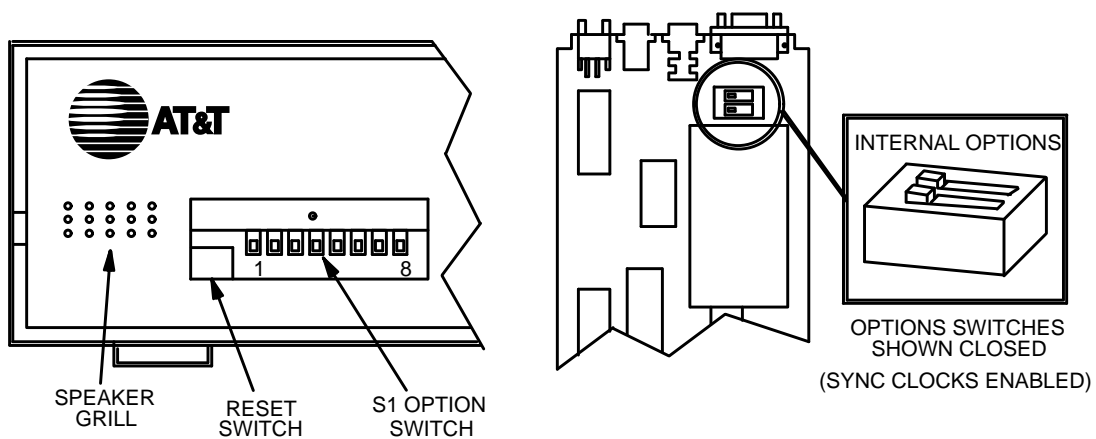

FIGURE 2-5
CEO Modem Hardware

2 To set your modem switches:

- For dial-out or bidirectional 1200/300 baud asynchronous, dialer-enabled modems, set the switches according to Table 2-2.

TABLE 2-2
2224-CEO Dial-Out 1200/300 Asynchronous Communications

Switch	Push	Switch	Push	Switch	Push
1-1	down	1-5	down	int-1	away from number
1-2	down	1-6	up	int-2	away from number
1-3	down	1-7	down		
1-4	down	1-8	down		

- 3 Plug the power cable from the modem into the power outlet.
- 4 Reset the modem by pressing and releasing the RESET switch. This will make your changes effective.

2224-GNN Modems

See Figure 2-6 for a diagram of the GNN modem hardware switches.

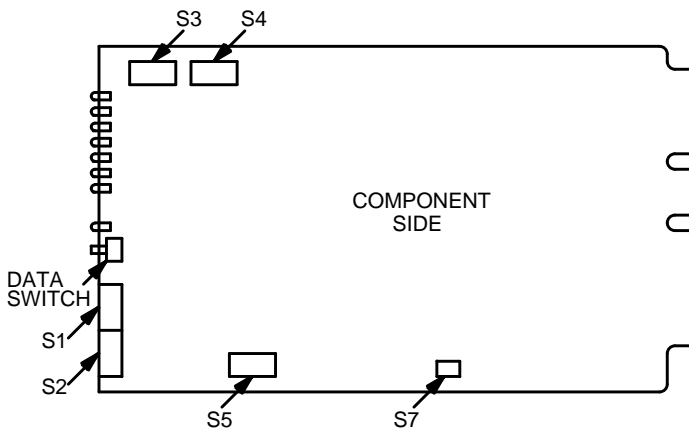

FIGURE 2-6
GNN Modem Hardware

- 1 For dial-out or bidirectional 1200/300 baud asynchronous, dialer-enabled 2224-GNN modems, set the switches according to Table 2-3.

TABLE 2-3
2224-GNN Dial-Out 1200/300 Asynchronous Communications

Switch	Push
1-1	left
1-2	left
1-3	left
1-4	right
1-5	right
1-6	left
1-7	left
1-8	left
2-1	right
2-2	right
2-3	left
2-4	left
2-5	left
2-6	left
2-7	left
2-8	left
3-1	right or up
3-2	right or up
3-3	right or up
3-4	left or down
3-5	left or down
3-6	left or down
3-7	left or down
3-8	left or down

- 2 Reset the modem by removing it from the rack, then putting it back. This will make the changes take effect.

Set Up An AT&T 2400 Modem

The AT&T 2400 modems can arrive from the factory in an unknown state; they can be in a state that will not allow them to communicate with a UNIX system. Therefore, these modems should be configured using a terminal.

Install the AT&T 2400 Modem

Install the AT&T 2400 modem as follows:

- 1 Plug in the modem's power adaptor.
- 2 Connect the modem to the main port of an AT&T 615 Terminal using a straight through male to male RS-232 cable.
- 3 Set the terminal speed to 1200.
- 4 Set the terminal Parity to *EVEN*.
- 5 Set the terminal Send Parity to *NO*.

Set the 2400 Modem Software Options

Set the software options in the 2400 modem using a terminal. The modem can be configured for bidirectional port transmission or product access.

- For a bidirectional transmission, use the sequence of commands provided in Table 2-4, Column 1. AT&T 2400 modems used for bidirectional traffic such as login or UUCP must be locked at one baud rate.
- For a product access configuration, use the sequence of commands provided in Table 2-5, Column 1. AT&T 2400 modems used for product access (various baud rates) must only be used for product access (outgoing only).

TABLE 2-4
AT&T 2400 Modem Bidirectional

Command	Meaning
AT&F	Factory Default
AT&MO	Turn speaker off
AT&QO	Standard Async
ATQ2	Result code in originate only
AT&D2	Enter command mode on DTR dropping
AT&KO	No flow control
AT&C2	CD on for cmd mode, track carrier for data transfer
ATSO=1	Auto Answer
ATS37=6*	Maximum DCE Line Speed**
AT&WO	Write storable parameters of current configuration in memory as profile 0
AT&YO	Specify stored user profile 0 as power up configuration

TABLE 2-5
Configuration of a Product Access Modem

Command	Meaning
AT&F	Factory Default
AT&MO	Turn speaker off
AT&QO	Standard Async
ATQ2	Result code in originate only
AT&D2	Enter command mode on DTR dropping
AT&KO	No flow control
AT&C2	CD on for cmd mode, track carrier for data transfer
ATSO=1	Auto Answer
ATS37=0*	Maximum DCE Line Speed
AT&WO	Write storable parameters of current configuration in memory as profile 0
AT&YO	Specify stored user profile 0 as power up configuration

* Varies across the two configuration tables; all other commands are common for all configurations.

** Set to 5, 1200 baud; set to 6, 2400 baud

Configure the UNIX System

The *Dialers* file of UNIX System V Release 3.2.3 contains the following line:

```
#hayes =,-, "" \M\dAT\r\c OK\r \EATDT\r\c CONNECT \m\c
```

Activate this file by removing the comment symbol, #, at the beginning of the line.

For modems that are to be used for outgoing calls (bidirectional), the procedure for configuring the UNIX System as described in the *Installation Manual* changes as follows:

- In the **Connect to Modem** form of the FACE Menu, set the **Modem Name** field to *Non-Autodialing*.
- The **Devices** files will contain a line corresponding to each modem configured for outgoing calls. The following is a typical entry in this file:

```
ACU ttyh06,M - 1200 Non-Autodialing
```

- For each modem, edit the file by entering a set as shown in the following:

```
ACU ttyh06 - 300 hayes  
ACU ttyh06 - 1200 hayes  
ACU ttyh06 - 2400 hayes
```

End of Procedure

Set the AT&T DataPort 3710 Modem Software Options

Set the software options in the AT&T DataPort 3710 modem using the dialers file described in the next section, "Configure the UNIX system". The modem can be configured for bidirectional port or product access.

- AT&T DataPort 3710 modems used for bidirectional traffic such as login or UUCP must be locked at one baud rate.
- AT&T DataPort 3710 modems used for product access (various baud rates) must only be used for product access (outgoing only).

Configure the UNIX System

The *Dialers* file of the UNIX System V Release 3.2.3 must be added on one consecutive line as follows:

```
ATTparadyne =+,, ""\M\dAT\r\c OK\r AT&FL3Q2&C2&R0\Q0\N1%C0\r\c
OK\r AT&W0&Y0 OK\r \dATDT\r\c 00
```

For modems that are to be used for both incoming and outgoing calls (bidirectional), the procedure for configuring the UNIX System as described in the *Installation Manual* changes as follows:

- In the **Connect to Modem** form of the FACE Menu, set the **Modem Name** field to **HayesSmartm2400**.
- The **Devices** files will contain a line corresponding to each modem configured for outgoing calls. The following is a typical entry in this file:

```
ACU ttyh06 - 1200 ATTparadyne
```

- For each modem, edit the file by entering a set as shown in the following:

```
ACU ttyh06 - 300 ATTparadyne
ACU ttyh06 - 1200 ATTparadyne
```

```
End of Procedure
```

Procedure 5C — Connect the Terminals

- 1 Connect the appropriate terminal/printer adaptor to the port labeled **MAIN** on the back of the terminal.
- 2 Insert the modular cable into the adaptor.
- 3 Insert the other end of the modular cable into an asynchronous port on the Ports card. Attach the red ground connector securely to the **ground** beneath the port.
- 4 Plug the power cable from the terminal into the power outlet.
- 5 Fill in the port number, associated device name, and phone line on the Port Configuration Worksheet in **Appendix B** of this manual.

Procedure 5D — Connect the Modems

- 1 For all other asynchronous modem connections, insert one end of a modular cable into any asynchronous port on the 3B2 Ports or EPORTS cards.
- 2 Attach the red ground connectors securely to the **ground** beneath the port.
- 3 Plug the ACU/Modem adaptor into the RS-232-C port on the back of the modem.
- 4 Insert the other end of the modular cable into the adaptor.
- 5 Connect the modem to the phone line.
- 6 Note the port number, associated device name, and phone line on the Port Configuration Worksheet in **Appendix B** of this manual.

End of procedures for Step 5

Step 6 — Set Up and Enable the Printer

Prerequisites for this Step

Activities

- Make sure the DEFINITY Monitor I system has been installed according to Steps 1 through 5 of this section.

Documents

- *User's Guide AT&T 572/573 Printer (Printer Guide)*
- *AT&T 3B2 Computer UNIX System V Release 3.2.1 System Administrator's Guide (Admin Guide)*

Hardware/Software Components

- AT&T 572 Printer
- AC power cord
- Standard RS232C cable
- Tractor assembly
- Static eliminator

Procedure 6A — Set Up the Printer

- 1 Set up the printer.

See: The *Printer Guide* to set up the printer.

- Set the printer setting, **96 BPS** to *01 9600* for direct connect or *04 1200* for dial-up according to the "Operation Panel and Operational Procedures in Set-Up Mode" in the *Printer Guide*.

Procedure 6B — Connect the Printer Cable

- 1 Use a standard RS232 cable and a TERM/PRINTER adaptor (for a 3B2) to connect the printer to a serial port. Note the port number on the Port Configuration Worksheet.

Procedure 6C — Enable the Printer

- 1 Log in as *root*.

Note: The printer port should not have been enabled.

- 2 Enter */usr/lib/lpshut* and press .

System Response:

```
Line printer scheduler stopped.
```

- 3 For the 572 printer, enter */usr/lib/lpadmin -ppr1 -m5310 -v/dev/ttyxx* and press .

Where: *pr1* is the name you are assigning to the first printer. If you are installing more printers, use different names for each printer.

xx is the port number assigned to the printer.

- 4 Enter */usr/lib/lpsched* and press .

- 5 Enter */usr/lib/accept pr1* and press .

System Response:

```
Destination pr1 now accepting requests.
```

- 6 Enter */usr/lib/lpadmin -dpr1* and press .

- 7 Enter *enable pr1* and press .

System Response:

```
pr1 now enabled.
```

- 8 Enter *lpstat -t* and press .

System Response:

The system responds with the list of printers and their current status; **pr1** should be enabled.

```
End of procedures for Step 6
```

Step 7 — Rebuild the UNIX Kernel

Prerequisites for this Step

Activities

- Make sure that the 3B2 processor, keyboard, console, additional terminals, and modems are installed according to Steps 1, 2, and 5 of this section.
- Make sure that the UNIX Essential Utilities and additional software has been loaded according to Steps 3 and 4 of this section.

Documents

- *AT&T 3B2 UNIX System V Release 3.2.1 Administrator's Guide (Admin Guide)*

Procedure 7A — Change Directories to Where the Kernel Resides

- 1 Log in as *root*.
- 2 Enter `cd /etc/master.d` at the UNIX prompt.

Procedure 7B — Edit the Kernel File

- 1 Set the **TERM** equal to **615**, **715**, **630**, **730**, or **513** for the 615 BCT, 715 BCS, 630 MT, 730 MT, and 513 BCT, respectively, remembering to export the term type. For example, to set the term type for a 615 BCT, enter:

```
TERM=615;export TERM
```

- 2 Using **vi** or **ed**, edit the file named **kernel** :

- Search for **NPROC =** and set the value to **xxx**,

Where: **xxx** equals 30 times the number of MB of RAM in the system.

Change the value for **NPROC** *only* if the value in the file is currently less than **xxx**.

- Search for **MAXUP =** and set it to **80** (MAXUP=80) if the value in the file is currently less than 80.

- Search for **NINODE =** and set the value to **xxx**,

Where: **xxx** equals 100 times the number of MB of RAM in the system.

Change the value for **NINODE** *only* if the value in the file is currently less than **xxx**.

- Search for **NS5INODE =** and set the value to **xxx**,

Where: **xxx** equals 100 times the number of MB of RAM in the system.

Change the value for **NS5INODE** *only* if the value in the file is currently less than **xxx**.

- Search for **NFILE =** and set the value to **xxx**,

Where: **xxx** equals 100 times the number of MB of RAM in the system.

Change the value for **NFILE** *only* if the value in the file is currently less than **xxx**.

- Search for **ULIMIT =** and set the value to **8192**.

- 3 Save your changes and exit the UNIX text editor.

Note: If you do *not* find an entry for a specified parameter in the form of **parameter = xxx**, add the necessary information to the **end** of the file.

These are the suggested minimum parameter settings for Monitor I. If you are running Monitor I as a coresident application you may need to adjust the parameters accordingly.

Procedure 7C — Remake the Kernel

- 1 Enter `cd /boot` at the UNIX prompt and press .
- 2 *Carefully* enter `/etc/mkboot -k KERNEL` and press .

Procedure 7D — Rebuild the Kernel

- 1 Enter `cd /` at the UNIX prompt and press .
- 2 Enter `/etc/shutdown -i5 -g0 -y` and press .

System Response:

A series of intermediate messages is displayed. The system shuts down and runs a self-check program. Eventually the following message is displayed:

FIRMWARE MODE

- 3 Enter the firmware password. The default is **mcp**. If you changed it, enter the correct password.

- If the request is repeated after you have entered the correct password, make sure that your terminal is set for **no parity** and **eight databits**.

System Response:

Enter the name of program to execute []:

- 4 Enter */etc/system* and press **RETURN**.

System Response:

The system prompts you for the device number.

- 5 Select [*1(scsi)*], which is the default device.

System Response:

The system prompts you for the subdevice number.

- 6 Select [*0(disk)*], which is the default subdevice.

Note: The system rebuilds the kernel after the reconfiguration is complete. The system automatically reboots to the multiuser mode after the kernel is rebuilt.

Procedure 7E — Check the Tunable Parameters

- 1 Enter */etc/sysdef* to check the tunable parameters.

End of procedures for Step 7

Step 8 — Load the INFORMIX Software

Prerequisites for this Step

Activities

- Make sure that the 3B2 processor and software have been installed according to Steps 1 through 7 of this section.

Documents

- Instructions included with the INFORMIX-SQL software (*INFORMIX Instructions*)
- *AT&T 3B2 Computer UNIX System V Release 3.2.1 Owner/Operator Manual, System Administration Menus (Owner Manual)*

Hardware/Software Components

- INFORMIX-SQL Release 4.0 software
- INFORMIX-SE Release 4.0 software

Procedure 8A — Add the INFORMIX Group

- 1 Log in as *root*.
- 2 Add the INFORMIX group, using `sysadm addgroup`.
 - **Group Name** — *informix*
 - **Group ID Number** — Use the default group ID number
- 3 Install the entry and exit `sysadm addgroup`.

Procedure 8B — Add the INFORMIX User

- 1 Add the user login ID, *informix*, using `sysadm adduser`.
 - **Login ID** — *informix*
 - **Full Name** — *INFORMIX-SQL*
 - **ID Number** — Use the default ID number
 - **Group Name** — *informix*
 - **User's Login (Home) Directory** — Use the default directory name, */usr/informix*.
- 2 Install the user and select a password. Exit `sysadm adduser`.

Note: When Monitor I is installed, the **informix** login is blocked.

Procedure 8C — Load the INFORMIX-SQL Software

- 1 Load the INFORMIX-SQL software.

See: The "INFORMIX Instructions" to set the directory and path and to load the software.

Procedure 8D — Load the INFORMIX-SE Software

- 1 Load the INFORMIX-SE software.

See: The "INFORMIX Instructions" to set the directory and path and to load the software.

End of procedures for Step 8

Step 9 — Add the Monitor I Group and Users

Prerequisites for this Step

Activities

- Make sure that the 3B2 processor and software have been installed according to Steps 1 through 8 of this section.

Procedure 9A — Add the Monitor I Group

- 1 Log in as *root*.
- 2 Use *sysadm addgroup* to add the Monitor I group.
 - **Group Name** — *traf*
 - **Group ID Number** — Use the default group ID number.

Procedure 9B — Add the Monitor I Users

Note: All Monitor I users should belong to the group named **traf**.

- 1 Use *sysadm adduser* to add the Monitor I users.
 - **User's Full Name** — *Monitor I Administrator*
 - **User's Login ID** — *mtmadm*
 - **User's ID Number** — Select the default user ID number.
 - **Group Name** — *traf*
 - **User's Login (Home) Directory Name** — Enter the directory name as *<directory>/login* name.

Note: Make sure that **<directory>** already exists.

- 2 Install the Monitor I Administrator login and create a password.
- 3 Install another user, *mtmadm1*.

Note: This login is primarily used to facilitate the execution of **cron**. When Monitor I is installed, the **mtmadm1** login is blocked.

- **User's Full Name** — *Dummy login for cron*
- **User's Login ID** — *mtmadm1*
- **User's ID Number** — Use the default user ID number.

- **Group Name** — *traf*
- **User's Login (Home) Directory Name** — Enter the directory name as *<directory>/login name*.

Note: Make sure that **<directory>** already exists.

- 4 Install the dummy login for cron and create a password.
- 5 Use this procedure to add additional logins for Monitor I users, as necessary.

Note: Assign UNIX **at** and **cron** privileges to users who will be scheduling Monitor I reports. Refer to the *User's Manual* for information on **at** and **cron**.

Procedure 9C — Edit the .profile

- 1 Use **vi** or **ed** to edit the **.profile** for each Monitor I user.
- 2 Add the following entry to the **end** of the **.profile** so that each login can use Monitor I:
 . *<directory>/mtm/tools/profile*

Where: **<directory>** is the name of the directory under which you will install Monitor I in **Step 6** of **Procedure 10A**.

Note: If CAFE is used, do not append the **. <directory>/mtm/tools/profile** entry to the user's **.profile**.

- 3 Make sure that the **mtmadm** login also gets a **.profile** configured as listed above.

End of procedures for Step 9

Step 10 — Load the Monitor I Software

Prerequisites for this Step

Activities

- Make sure that you have added the Monitor I group and users, explained in Step 9 of this section.
- Make sure that you have installed INFORMIX-SQL, according to the directions listed in Step 8.
- If you are installing an upgrade (a **warm install**), make sure that no one is using the Monitor I files (directories) and that the Poller and Alarm Manager are not running.
- If you are performing a **warm install**, make sure you do a full backup of Monitor I first. Perform the backup according to the "Back Up Monitor I (3B2/600)" procedure listed in the *DEFINITY Monitor I Operations Guide*.

Documents

- *DEFINITY Monitor I Operations Guide (Ops Guide)*

Hardware/Software Components

- DEFINITY Monitor I installation tape
- Disk Configuration Worksheet obtained from your AT&T Representative

Procedure 10A — Cold Install of Monitor I Software

What? This procedure describes how to do a **cold install** of Monitor I. A cold install is usually done when you are installing Monitor I for the very first time. A **warm install** is done when you are updating existing Monitor I software. See "Procedure 10B — Warm Install of Monitor I Software" for information about warm installs.

In some instances, you may already have Monitor I installed, but you want to remove it and start all over. In this case, you would choose a **cold install** to completely remove the Monitor I directories and databases and reinstall new ones.

How Long? This procedure takes about 30 minutes.

- 1 Log in as *root*.
- 2 Enter *sysadm tapepkg* and press .

System Response:

```
Do you wish to install or remove packages?  
[install remove quit i r q ]
```

- 3 Enter *i* and press .

System Response:

```
Insert the removable medium for the package(s) you want to install  
into the qtape1 drive.  
Press <RETURN> when ready. Type q to quit.
```

- 4 Insert the tape and press to continue the installation.

System Response:

```
Packages available:  
1 DEFINITY Monitor I Release 2.1
```

- 5 Type *1* and press .

System Response:

```
Selection complete ----- installpkg starting.  
Installing DEFINITY Monitor I Release 2.1  
Copyright (c) 1989, 1990, 1991 AT&T  
All Rights Reserved  
Enter type of installation you want (w-warm, c-cold, e-exit):
```

Note: If you choose to exit at this point and you want to restart the installation, you must reinsert the tape. Any time after this point, you can exit and restart without reinserting the tape.

- 6 Type *c* and press .

System Response:

- 7 Enter the directory name then press .

Note: Monitor I will be installed in the directory you specify, under a subdirectory called **mtm**. If this subdirectory does not exist, the system creates it for you.

Example: Entering */usr* or */usr1/traf* will result in Monitor I being installed in the directory **/usr/mtm** or **/usr1/traf/mtm** respectively.

System Response:

Where: **<directory name>** is the name of the directory you specified in the previous step.

- 8 Enter *y* to continue and press .

System Response:

WARNING- Cold installation will remove all Monitor I directories and existing database(s), if any. No one should be using Monitor I during installation. Make sure Monitor I polling system and alarm manager are not running.

Cold installation will proceed, continue? (y/n) :

- 9 Enter *y* to continue and press .

System Response:

```
Select processor type -
Enter 1 for 3B2-600
    2 for 6386E/33 model S
    3 for 6386SX/EL or NCR-3315
```

- 10 Enter *1* and press .

System Response:

```
You are installing on a 3B2-600 processor.
Do you want to continue? (y/n) :
```

- 11 Enter *y* and press .

System Response:

```
Preinstallation checks in progress ....
```

- If preinstallation checks have completed successfully, you will see the following message:

```
Preinstallation checks have completed successfully.
```

- If preinstallation checks did *not* complete successfully, a list of error messages is displayed, followed by this message:

```
Preinstallation checks did not complete successfully.
```

Note: To continue, fix the errors using error message explanations found in **Appendix C** of this manual. Once the errors have been resolved, try installing Monitor I again using this procedure, starting with the **sysadm tapepkg** command in **Step 2**.

If preinstallation checks completed successfully, the following prompt is displayed next:

Do you want to create database place holder(s)? (y/n):

Note: If you enter *n*, the software will be installed, but no placeholders will be created. You can add placeholders after installation is completed by using the **addmount** procedure discussed in "10C — Create Placeholders Using Addmount."

12 Enter *y* to create database placeholders then press **RETURN**.

System Response:

Do you want to use the rotating

Reference: Refer to the DOSS Configuration output for the appropriate response.

- If you answer *n* (no), skip to the system prompt in **Step 14**.
- If you answer *y*, (yes) the following prompts are displayed:

Enter the total number of G2, SYSTEM 85 or FP8 switches?:
Enter the total number of G3r, G3i, G1 or SYSTEM 75 switches?:

13 If you are using the **Rotating Switch Study** feature, enter the correct response to these questions and press **RETURN** to get the next prompt.

System Response:

Are the values entered above correct? (y/n):

- If you answer *n*, (no) the system will again prompt you to enter the total number of switches.

- 14 Once all values are correct, type *y* (yes) then press .

System Response:

Enter the directory to create the database(s), e.g. /usr1 ? :

Reference: Refer to the DOSS Configuration output for the appropriate directory.

- 15 Enter the directory name and press .

Note: The next questions refer to the number of placeholders for databases to be created under each mount point (database directory) for each polling option.

System Response:

How many G2, SYS85 or FP8 (EXTENDED) database(s) ? (0-40) :
How many G2, SYS85 or FP8 (STANDARD) database(s) ? (0-40) :
How many G2, SYS85 or FP8 (DAILY and LIMITED) database(s) ? (0-40) :
How many G1.1 or SYSTEM 75 database(s)? (0-40) :
How many G3r or G3i (EXTENDED) database(s)? (0-40) :
How many G3r or G3i (STANDARD) database(s)? (0-40) :
How many G3r or G3i (DAILY and LIMITED) database(s)? (0-40) :
How many inactive database(s)?

Note: The last prompt, **How many inactive database(s)?** , is only displayed if the **Rotating Switch Study** feature is used.

- 16 Enter the correct response to each of the questions listed above and press to get the next prompt.

Note:

- You *must* enter the correct number of databases for Monitor I to work properly. This information depends on the number of switches being supported and how your disk is sliced. See your Disk Configuration Worksheet for more information.
- Monitor I allows you to repeat this procedure for each mount point (database directory) and polling option per switch type that you have.

System Response:

Are the values entered above correct? (y/n):

- If you answer *n* (no), the system repeats the series of questions listed in **Step 15**.
- 17** Once all values are correct, type *y* (yes) then press .

System Response:

Do you want to create more database place holder(s)? (y/n):

- If you answer *y* (yes), the system returns to the system response in **Step 14** of this procedure.
- 18** Enter *n* (no) and press to continue with the installation.

Note: The system begins copying the files from the tape and a lengthy list of these files appears in a scrolling display. The files displayed on your screen will vary from the partial system listing displayed in the next screen example.

```

Removing existing executables and database(s), if any ...
Copying files from the tape

```

```

.
log
tmp
work
work/pdump
work/polldir
prog
prog/R2V2
prog/R2V2/L1_rep
prog/R2V2/acd_rep
prog/R2V2/covg_rep
.
.
prog/R2V2/iparser
prog/R2V2/clock
.
.
upgrade/d1.1.FL3
.
upgrade/d1.2.GL1
.
.
upgrade/d2.1.AL1/A06tmdb75
.
.
Re-building system 85 R2V5 menu ...
Re-building system 85 R2V4 menu ...
.
.
Re-building system 75 R1V4 menu ...
Re-building system 75 R2V5 menu ...
.
.

```

The following messages appear when the installation completes:

```

All Monitor I files have been installed correctly.
Installation completed successfully.

```

If you *do not* see these messages or if you see error messages during the procedure, look for further information on the errors in `/usr/tmp/journal`. Fix the errors using the error message explanations found in **Appendix C** of this manual, then try installing Monitor I again, starting with the `sysadm tapepkg` command in **Step 2** of this procedure.

```

End of Procedure

```

Procedure 10B — Warm Install of Monitor I Software

- 1 Back up Monitor I according to the "Back Up Monitor I (3B2/600)" procedure listed in the *Monitor I Operations Guide*.
- 2 Follow Steps 1 through 5 of "Procedure 10A — Cold Install of Monitor I Software." Complete Step 2 of this procedure when you see this prompt:

Enter type of installation you want (w-warm, c-cold, e-exit):

- 3 Type *w* and press .

System Response:

**WARNING- No one should be using Monitor I during installation.
Make sure Monitor I polling system and alarm manager are
not running.**

Warm installation will proceed, continue? (y/n) :

- 4 Enter *y* to continue and press .

System Response:

Pre-installation checks in progress

- If pre-installation checks have completed successfully, you will see the following message:

Pre-installation checks have completed successfully.

- If pre-installation checks did *not* complete successfully, a list of error messages is displayed, followed by this message:

Pre-installation checks did not complete successfully.

Note: To continue, fix the errors using error message explanations found in **Appendix C** of this manual. Once the errors have been resolved, try installing Monitor I again using this procedure, starting with the **sysadm tapepkg** command. (See Step 2 of this procedure.)

A lengthy list of files appears on the screen in a scrolling display. After all these files have been installed and some post-installation checking messages appear, the following message is displayed at the completion of the warm installation:

Warm installation completed successfully.

Note: If you do *not* see this message or if you see error messages during the procedure, look for further information on the errors in **/usr/tmp/journal** . Fix the errors, using the error message explanations found in **Appendix C**. Try installing Monitor I again, starting with the **sysadm tapepkg** command. (See **Step 2** of this procedure.)

- 5 As a final post-installation step, restart the poller and alarm manager. Enter **<directory>/mtm/tools/monitor I start** to bring up the Monitor I poller and alarm processes, where **<directory>** is the name of the directory under which you installed Monitor I.

End of Procedure

Procedure 10C — Create Placeholders Using Addmount

Use this procedure to create database placeholders from the UNIX shell, after you have completed the Monitor I installation.

Note: If you have already added placeholders during installation, you will not be able to add additional placeholders from the shell. Also, if you have used the **addmount** procedure previously to add placeholders, you will not be able to execute this procedure a second time.

- 1 Log in as *root*.
- 2 Type `<directory>/mtm/tools/addmount` at the prompt and press .

Where: `<directory>` is the name of the directory under which you installed Monitor I in **Step 7 of Procedure 10A**.

System Response:

Do you want to use the "Rotating Switch Study" feature? (y/n):

Reference: Refer to the DOSS Configuration output for the appropriate response.

- If you answer *n* (no), the following prompt is displayed:

Enter the directory to create the database(s), e.g /usr1 ? :

Continue by skipping to **Step 5** of this procedure.

- If you answer *y* (yes), the following prompts are displayed:

Enter the total number of G2, SYSTEM 85 or FP8 switches?:
Enter the total number of G3r, G3i, G1, or SYSTEM 75 switches?:

- 3 If you are using the **Rotating Switch Study** feature, enter the correct response to these questions and press to get the next prompt.

System Response:

Are the values entered above correct? (y/n):

- If you answer *n* (no), the system will again prompt you to enter the total number of switches.
- 4 Once all values are correct, type *y* (yes) then press .

System Response:

Enter the directory to create the database(s), e.g. /usr1 ? :

Reference: Refer to the DOSS Configuration output for the appropriate directory.

- 5 Enter the directory name and press .

Note: The next questions refer to the number of placeholders for databases to be created under each mount point for each polling option.

System Response:

How many G2, SYS85 or FP8 (EXTENDED) database(s) ? (0-40) :
 How many G2, SYS85 or FP8 (STANDARD) database(s) ? (0-40) :
 How many G2, SYS85 or FP8 (DAILY and LIMITED) database(s) ? (0-40) :
 How many G1 1.1 or SYSTEM 75 database(s)? (0-40) :
 How many G3r or G3i (EXTENDED) database(s)? (0-40) :
 How many G3r or G3i (STANDARD) database(s)? (0-40) :
 How many G3r or G3i (DAILY and LIMITED) database(s)? (0-40) :
 How many inactive database(s)?[

Note: The last prompt, **How many inactive database(s)?** , is only displayed if the **Rotating Switch Study** feature is used.

- 6 Enter the correct response to each of the questions listed above and press to get the next prompt.

Notes:

- You *must* enter the correct number of databases for Monitor I to work correctly. This information depends on the number of switches being supported and how your disk is sliced. See your Disk Configuration Worksheet for more information.
- Monitor I allows you to repeat this procedure for each mount point (database directory) and polling option per switch type that you have.

System Response:

Are the values entered above correct? (y/n):

- If you answer *n* (no), the system returns to the series of questions listed in **Step 5** of this procedure.
- 7 Once all values are correct, type *y* (yes) then press .

System Response:

Do you want to create more database place holder(s)? (y/n):

- If you answer *y*, the system returns to the **System Response** listed in **Step 5** of this procedure.
- 8 Enter *n* to continue the **addmount** procedure.
- 9 Wait for the prompt:

Database place holders successfully created

This message is displayed for each database directory you entered.

Note: If you do not see this message, check **/usr/tmp/addout** for possible errors. Refer to **Appendix C** for Monitor I installation error messages and corrective actions.

End of procedures for Step 10

Step 11 — Enable the System Ports

Prerequisites for this Step

Activities

- Make sure that the 3B2 processor, keyboard, console, terminals, and modems are installed according to Steps 1, 2, and 5 of this section.
- Make sure the Essential Utilities and additional software has been loaded according to Steps 3 and 4 of this section.

Documents

- Refer to the Port Configuration Worksheet in **Appendix B** for a list of configured ports.
- *AT&T 3B2 Computer UNIX System V Release 3.2.1 System Administrator's Guide (Admin Guide)*

Procedure 11A — Enable Bidirectional UUCP Ports

- 1 Log in as *root*.
- 2 Enter *sysadm devicemgmt* at the **root** prompt.
 - Select *2* to add the entry to the **/usr/lib/uucp/Devices** file.
 - Enter the port number (name) to be defined.
- 3 Select *ATT2224G* for all modem types (ATT2224-CEO and/or ATT2224-G).
 - Exit **sysadm devicemgmt**.
- 4 Enter *sysadm portmgmt* at the **root** prompt:
 - Select *2* to modify the port.
 - Select the port to be modified.

System Response:

Do you want the port to be for incoming, outgoing, or bidirectional?
--

- Select *bidirectional*.
- Enter *1200* for the baud rate.

Note: If you have DIMENSION FP8 switches, you will need to edit the **/usr/lib/uucp/Devices** file by creating an additional, identical entry for each ACU

entry with a baud rate of 1200. Then, change the 1200 in the duplicate entry to 300.

- 5 Continue modifying ports or exit `sysadm portmgmt`.

Procedure 11B — Set the CEO Modem Software Options

- 1 Plug the phone cable into the port labeled **Line** on the back of the modem.
- 2 Plug the modem into the power supply.
- 3 Log in as `root`.
- 4 Enter `MTMDIR=<directory>;export MTMDIR`.

Where: `<directory>` is the directory under which Monitor I was loaded in "Step 10 — Load the Monitor I Software."

- 5 Enter `$MTMDIR/tools/ceoconfig`.

System Response:

Enter port number (for example, tty31):

- 6 Enter the port number.

See: **Appendix B** for the port number assigned to the 2224-CEO modem.

System Response:

Testing /dev/<portnumber>
Please wait...
Hardware Switches Set for Dial-Out or Bi-Directional Asynchronous

- If the modem software options are set correctly, the following prompt appears:

<portnumber> Software Options Set Correctly

Perform all tests listed in Appendix A, "Acceptance Testing."

- If the modem software options are set incorrectly, the following prompts appear:

```
Software Options Set Incorrectly for Monitor I
Enter y to set them to the Monitor I configuration
or n to keep current settings (y):
```

7 Enter *y*.

System Response:

```
Setting <portnumber> Software Options to Defaults
Options 1-63 set to default

Option 12 is now y
Option 34 is now 1
Option 36 is now 0
Option 41 is now 0

<portnumber> Software Options Set Correctly
```

Where: <portnumber> is the port number assigned to the 2224-CEO modem.

Note: If these messages are *not* displayed or an error message is displayed, run this procedure again from **Step 5** of **Procedure 11B**.

TABLE 2-6
2224-CEO Modem — Software Options

Option Number	Value	Option Number	Value	Option Number	Value	Option Number	Value
1	y	17	10	33	n	49	N/A
2	y	18	n	34	1	50	N/A
3	y	19	n	35	3	51	n
4	y	20	1	36	0	52	f
5	y	21	0	37	0	53	f
6	N/A	22	:	38	0	54	y
7	y	23	^H	39	5	55	n
8	N/A	24	@	40	N/A	56	y
9	n	25	\$B	41	0	57	N/A
10	n	26	\$:	42	N/A	58	n
11	n	27	n	43	n	59	N/A
12	y	28	n	44	n	60	N/A
13	n	29	0	45	n	61	N/A
14	n	30	n	46	n	62	N/A
15	y	31	y	47	N/A	63	n
16	n	32	I	48	N/A		

Notes: N/A = Not Applicable

Table 2-6 reflects the 2224-CEO modem settings *after* the **ceoconfig** utility is run. This table is for reference purposes only.

End of procedures for Step 11

Installing on the 6386E/33 Model S

This section explains how to install the hardware and software required to use Monitor I on the 6386E/33 Model S processor. The entire installation should take approximately five hours: one hour to complete Step 1 and about four hours to complete Steps 2 through 10.

Step 1 — Set Up the 6386E/33 Model S WGS

Prerequisites for this Step

Activities

- **DO NOT** install any hardware or software before calling the Technical Support Center (TSC) (1 800 548-8861.)
- Make sure you received all the components necessary for the Monitor I system.
- Plan the location and determine the I/O address range, controller memory address range, and Interrupt Request (IRQ) levels of add-on cards in the processor. Table 3-1 lists the default locations and IRQ levels of the add-on cards in the processor. However, the default locations and IRQ recommended may need to be changed if Monitor I is coresident with other applications.

Note: These locations must be unique for each board in the system. Keep a record of the locations and addresses of each board for your reference.

TABLE 3-1
Add-On Cards: Default Location Addresses and IRQ Levels

Card	Slot	IRQ Level	I/O Address	Memory Address
VDC 600	1			
IPC #1	2	14	290	D0000
IPC #2	3	10	2A0	D2000
RMP	5	5	200	CA000
MEM #1	7			
MEM #2	8			

Documents

- *6386E/33 WGS Processor User's Guide (6386 Guide)*
- *6386, 6386E, 6386E/33 Work Group System Memory Expansion Installation Guide (Memory Guide)*
- *AT&T Intelligent Ports Card Model 900 (IPC-900) User's Guide (IPC Guide)*
- *Video Display Controller VDC 600 User's Guide (VDC Guide)*
- *AT&T Work Group System Remote Maintenance Package User's Guide (RMP Guide)*

Hardware/Software Components

- System unit
- AT&T 329D VGA Monitor
- Keyboard
- VDC 600 Video Display Driver card
- Intelligent Ports cards (IPC)
- Memory boards
- Memory Expansion kits
- Remote Maintenance Card

Procedure 1A — Unpack the 6386E/33 and Install the VDC600 Card

- 1 Unpack the processor and remove the cover. Set the jumpers on the memory cards to the default settings and also set the defaults on the dip switches.
See: The "Installing Your System" and "Preparing the System Module" instructions in the "Installation and Care Of Your System" section of the *6386 Guide*.
- 2 Set the dip switches and jumpers on the VDC card to the default settings. Then install the VDC 600.
See: The *VDC Guide* for information on dip switch and jumper settings and the "Installing The Video Display Controller" section in the "Installation and Care of Your System" chapter of the *6386 Guide* for installation instructions.
- 3 Leave the cover off the processor and go to **Procedure 1B — Install the Additional Memory**.

Procedure 1B — Install the Additional Memory

- 1 Install the additional SIMMs.
See: The "Installing System Board SIMMs" instructions in the "Expansion Kits" appendix of the *6386 Guide*.
- 2 Before installing additional memory boards, fill up the SIMM slots on the mother board (a total of 8 MB).
- 3 Install additional memory board(s), if required.
See: The "Memory Expansion Boards" instructions in the Expansion Kits appendix of the *6386 Guide*.
Note: If other applications coresiding on the 6386 require use of specific slots, make sure those slots are left free.

Procedure 1C — Install the Additional Cards

- 1 Set the I/O Starting Address, the Controller Memory Starting Address, and the Interrupt Request Level (IRQ) **shunt** according to Table 3-1. Each IPC must have unique settings. You need to know these settings when you load the IPC software in **Procedure 3B**.
See: The "Hardware Installation" and "Hardware Parameter Settings" sections in the *IPC Guide*.
- 2 Install the IPC in a one-port slot as follows.
See: The "Installing an Expansion Board" instructions in the "Installing Your System" chapter of the *6386 Guide*.
 - Align the IPC-900 board with the selected board slot and insert it into the corresponding connector.
 - Attach the T-adaptor to the IPC-900 board. Make sure it is plugged firmly and completely into the socket.
 - Repeat for additional IPC cards, if supplied. IPC connections must use 10-pin modular cords and 10-pin special adaptors.
- 3 Install the Remote Maintenance Card (RMC).
See: "Setting I/O Addresses" in the *RMP Guide*.
 - Set the dip switches on the card for the correct I/O Starting Address, Controller Memory Starting Address, and Interrupt Request Level (IRQ) according to Table 3-1. Each board must have unique settings. You will need to know the settings when you load the Remote Maintenance Package (RMP) software in **Procedure 3D**.
 - Install the RMC in a one-port slot.

See: "Installing an Expansion Board" in the "Installing Your System" section of the *6386 Guide*.

- Connect the appropriate devices to the ports on the RMC:
 - Connect the Uninterruptible Power Supply to the **UPS** port.
 - Connect the Alarm Interface to the **alarm** port.
 - Connect the remote access modem to the **COM2** port.
- Test the connections to the RMP.

See: "Testing RMP Installation" in the *RMP Guide*.

Procedure 1D — Set Up the Console, Keyboard, Cables and Processor

- 1 Set up and prepare the console.

See:

- The "Connecting the Video Display" instructions in the "Installation and Care of Your System" section of the *6386 Guide*.
- For details on setting up the console terminal, see "Step 4 — Set Up the Terminals and Modems" in this chapter.

- 2 Connect the monitor, keyboard, and power cord to the processor.

See: The "Connecting the Video Display," "Connecting the Keyboard," "Connecting the Mouse," and "Cable Placement" instructions in the "Installing Your System" and "Connecting Modules" sections of the *6386 Guide*.

Note: The 329D console connects to the VDC 600 card, *not* to the parallel printer. The dip switch, jumper, and mother board for the VDC 600 card must use the default settings.

- 3 Replace the covers and connect the processor to the power outlet.

See: The "Connecting the System To a Power Outlet" instructions in the "Installing Your System" section of *6386 Guide*.

End of procedures for Step 1

Step 2 — Load the UNIX Essential Utilities

Prerequisites for this Step

Activities

- Make sure that the 6386E/33 Model S processor, keyboard, and console are set up and connected according to Step 1 of this section.

Documents

- *6386E/33 Model S WGS Processor System Setup and User's Guide (6386 Guide)*
- *UNIX System V/386 Release 3.2.3 Operations/System Administration Guide (Admin Guide)*
- *UNIX System V/386 Release 3.2.3 Release Notes (Release Notes)*

Hardware/Software Components

- Base System Package Disk
- UNIX Operating System Foundation Set software, on cartridge tape

Procedure 2A — Run the Setup Utility

- 1 Configure the base system.

See: The "Getting Started" and "Starting the System" instructions in the *6386 Guide*.

- 2 When running the Setup utility, check to see that the Extended Memory is correct for the amount of memory installed in the system.
 - Press **CTL** - **ALT** - **DEL** to reboot.
 - Wait for the beep.
 - Press **CTL** - **ALT** - **INSERT** to see the current settings for your configuration. The memory size(s) should match the data shown in Table 3-2.

TABLE 3-2
Memory Size

Memory Installed (MB)	Extended Memory (KB)
8	7168
12	11264
16	15360
24	23552
28	27648
32	31744
40	39936

3 Set Console Redirection to the COM2 Port at a speed of 1200 baud.

See: "Setting I/O Redirection" in the *6386 Guide*.

Procedure 2B — Load the UNIX Foundation Set

1 Begin loading the UNIX Foundation Set.

See: The "Boot System to Single-User Mode" instructions in the "Software Installation" section of the *Admin Guide*. Follow the instructions for a SCSI machine.

2 Run the setup and begin partitioning the hard disk as follows.

See: The "Perform Installation Setup" instructions in the Software Installation section of the *Admin Guide*. Follow the setup procedure for a new installation.

- Select *1* to create an MS-DOS® partition.
 - When prompted, enter the amount of hard disk allocated to DOS as *2 percent* (for 300 MB disk).
 - Enter *n* to indicate that the MS-DOS partition is not the active partition.
- 3 Create the UNIX partition as follows.
- Select *1* to create a UNIX partition.
 - Select *1* to indicate that a UNIX System partition is to be created.
 - When prompted, enter the amount of hard disk allocated to UNIX as *98 percent* (for 300 MB disk).
 - Enter *y* to indicate that the UNIX partition is to be active every time the machine is booted.
 - Select *4* to update the disk configuration and exit.

4 Continue partitioning the hard disk.

See: The "Prepare Hard Disk for Surface Analysis" instructions in the Software Installation section of the *Admin Guide*.

5 Complete the hard disk partitioning process as follows.

See: The "Create UNIX System File Systems" instructions in the Software Installation section of the *Admin Guide*.

- Enter *n* to indicate that the default partition allocations are not acceptable.
- Enter *y* at the partition prompt:

Separate root and usr?

- Enter *n* at the partition prompt:

Additional usr2?

- Enter *n* at the partition prompt:

Crash/dump area?

- Enter *36* as the number of cylinders assigned to swap/paging.
- Enter *13* (for the 300 MB disk) as the number of cylinders allocated for the root partition.
- Review the new allocation and make a note of it. Swap/paging and root should have the number of cylinders you assigned, and the balance should be assigned to the **/usr** area. Enter *y* to indicate the allocation is acceptable.
- When you are prompted, remove the diskette from the drive and reboot the system from hard disk.
- After rebooting the system, enter *c* to install the UNIX system from cartridge tape.

6 Load the UNIX essential utilities.

See: The "Install Base System (From Cartridge Tape)" instructions in the Software Installation section of the *Admin Guide*.

7 Assign a root password.

8 Assign an install password.

Procedure 2C — Load Add-On Packages From Tape

Follow the instructions on the Package Selection menu to install the add-on packages from cartridge tape. Select the following for installation:

- 1 Network Support Utilities Package
- 2 Editing Package
- 3 FMLI
- 4 FACE
- 5 FACE Help

Note: The FACE Help package is totally different than the FACE package.

- 6 Press to execute.
- 7 Enter `4` to install all of the Help files.
- 8 Enter `5` to complete (terminate) the Help file installation.

Procedure 2D — Installation Wrap-Up

See: "Installation Wrap-Up for SCSI Machines" in the *Admin Guide*.

- 1 Load the SCSI support package from diskette.
- 2 Follow the instructions on the screen to boot the machine.
- 3 Log in as *root*.

End of procedures for Step 2

Step 3 — Load the Additional Software

Prerequisites for this Step

Activities

- Make sure that the 6386E/33 Model S WGS, keyboard, console, and additional cards are installed according to Step 1 of this section. You need to know the location, memory addresses, and IRQ levels of the boards in the processor.
- Make sure that the correct version of the UNIX Foundation Set is loaded according to Step 2 of this section.

Documents

- *UNIX System V/386 Release 3.2.3 Operations/System Administration Guide (Admin Guide)*
- *Intelligent Ports Card Model 900 (IPC-900) User's Guide (IPC Guide)*
- *AT&T Work Group System Remote Maintenance Package User's Guide (RMP Guide)*

Hardware/Software Components

- UNIX System V/386 Release 3.2.3 Remote Terminal Package
- AT&T IPC UNIX System V 386 Device Driver
- Security Administration Package

When Installing from Diskette

- Use the "Install Optional Add-On Packages (From Diskette)" instructions in the "Software Installation" section of the *Admin Guide* to load the individual software packages.
- If your processor has two disk drives, specify the drive from which you are loading.
- If asked how many diskettes are in the package, count the number of diskettes for the specific package only. Whenever multiple diskettes exist for a specific package, make sure you load these diskettes in sequential order.
- If asked for the diskette type, either look on the diskette for the applicable type or enter: *1.44*.
- If asked to reboot the system, press to skip the reboot process. You do *not* have to reboot after loading each software package; however, you *must* reboot the system after the last package is loaded.

Procedure 3A — Load the Remote Terminal Package

Note: This is *not* the Remote Maintenance Package, which is loaded at a different time.

- 1 Enter *installpkg* at the prompt to load the Remote Terminal Package.
- 2 Enter *1* to install the terminfo files.

Call: The TSC Hotline (1 800 548-8861) to obtain the **terminfo** entry needed to use the 730 terminal and the 615 BCT or 715 BCS with the System 75 Emulation cartridge.

- 3 Enter *all* to load all the terminfo files.
- 4 Enter *done* after the list of files is displayed.
- 5 Enter *0* to complete (terminate) the terminfo file load.

Procedure 3B — Load the IPC Device Driver

Note: Make sure you are using Version 3.0 for the IPC-900.

- 1 Enter *installpkg* at the prompt to load the IPC software.
- 2 Enter the number of IPC cards installed in the system. For each IPC, do the following.
 - Press to select the default (IPC-900) for the type of ports card installed in the system.
 - Enter the Interrupt Request Level (IRQ) of the IPC.

See: Table 3-1 in this guide for the IRQ level required.

- Do one of the following.
 - a Press to select the default starting address of the I/O ports and controller memory.
 - b Enter the appropriate addresses as set on the card during the installation.

See: The "Hardware Parameter Settings" section in the *IPC Guide*.

- 3 Enter *y* to confirm the settings.
- 4 Reboot as instructed.

Procedure 3C — Load the Security Administration Software

- 1 Enter *installpkg* at the prompt to load the Security Administration package.

Procedure 3D — Install the Remote Maintenance Package (UNIX)

If the processor has an RMP, the software must be installed.

See: "Installing the RMP Software" in the *RMP Guide*.

- 1 Select the given Interrupt Request (IRQ) level for the card.
- 2 Press to select the default Starting I/O address and Starting Memory address.

Note: Contact the Technical Service Center (TSC) at 1 800 548-8861 for your RMP settings. Your TSC engineer will know how to enable the RMP settings.

Procedure 3E — Install the Remote Maintenance Package (DOS)

If the processor has an RMP and if you intend to use the Remote Diagnostics software that runs under MS-DOS, the software must be loaded on the DOS partition.

See: "Installing the RMP Software That Runs Under DOS" in the *RMP Guide*.

- 1 Enter *n* at the prompt:

- 2 Enter *y* at the prompt:

- 3 Enter *y* at the prompt:

Step 4 — Set Up the Terminals and Modems

Prerequisites for this Step

Activities

- Make sure that the 6386E/33 Model S processor, keyboard, console and software are set up and connected according to Steps 1 through 3 of this section.

Documents

- *User's Guide - 615 Business Communications Terminal Guide* or, *715 Business Communications System (BCS) User's Guide and Service Manual* or, *730 Multi-Tasking Graphics Terminal Guide (Terminal Guide)*
- *DATAPHONE II 2224-CEO Modem User's Manual* or *DATAPHONE II 2224-GNN Modem Manual (Modem Manual)*
- *Intelligent Ports Card Model 900 (IPC-900) User's Guide (IPC Guide)*

Hardware/Software Components

- 615 BCT(s), or 715 BCS(s), or 630 or 730 MTG(s) [optional]
- One 513 BCT/System 75 Emulation Cartridge per 615 BCT, for accessing G3r, G3i, G1, and System 75 maintenance and administration functions.
- 2224 modem(s) for use with bidirectional 1200/300 baud asynchronous communications for UUCP and communication with administered switches
- 10-pin modular cables with 10-pin special adaptors

Procedure 4A — Set Up the Terminals

- 1 Unpack, install, and set up the terminal.

See: The "Unpack and Install" (615 BCT or 715 BCS) or "Installation" (730) instructions in the *Terminal Guide*.

Note: The 630 or 730 MTG is most effectively used at speeds above 2400 baud, therefore it should not be connected through a modem.

- 2 To make the terminal operational for Monitor I:

- Install the 513 BCT/System 75 Emulation Cartridge by inserting the 513 BCT/System 75 cartridge into the slot on the side of the 615 BCT. Be sure that the cartridge is right side up, with the cartridge label toward the front.

Warning: Check the on/off switch before you install the cartridge to make sure that the power for the 615 terminal is turned *off*. A blank screen is *not* an indicator that the terminal is off, and you will destroy the 513 BCT/System 75 cartridge if you insert or remove it while the terminal is on.

- Follow the instructions in the *Terminal Guide* to enable the cartridge.
- For the 715 terminal, enter the following settings:
 - Set the emulation mode to: *BCS*
 - Set the UNIX terminal type (TERM) to: *sys75*
 - Set the terminal type for cut-through access from Monitor I to G3i, G1, and System 75 to: *513*
 - Set the **Swap Delete** option of the 715 terminal to: *yes* (through terminal setup) for BCS.
- Change the **Cursor Blink** option to *y* for yes.
- Cut-through access to System 75 R1V1 for maintenance or administration requires that the System 75 be equipped with a pooled modem card that allows asynchronous communications.

Procedure 4B — Set Up the Modems

Monitor I supports the 2224-CEO, the 2224-GNN and the AT&T 2400 modems. For either modem, you must set up the hardware switches, as follows.

See: The appropriate *Modem Manual* for complete installation procedures.

Contact the Technical Service Center (TSC) at 1 800 548-8861 to have your modem checked after you have completed the appropriate modem procedures.

AT&T 2400 Modems

Set up an AT&T 2400 modem: The AT&T 2400 modems can arrive from the factory in an unknown state; they can be in a state that will not allow them to communicate with a UNIX system. Therefore, these modems should be configured using a terminal.

2224-CEO Modems

For the 2224-CEO modem:

- 1 Remove the CEO modem cover to access the Internal Option switches. See Figure 3-1 for a diagram of the CEO modem hardware switches.

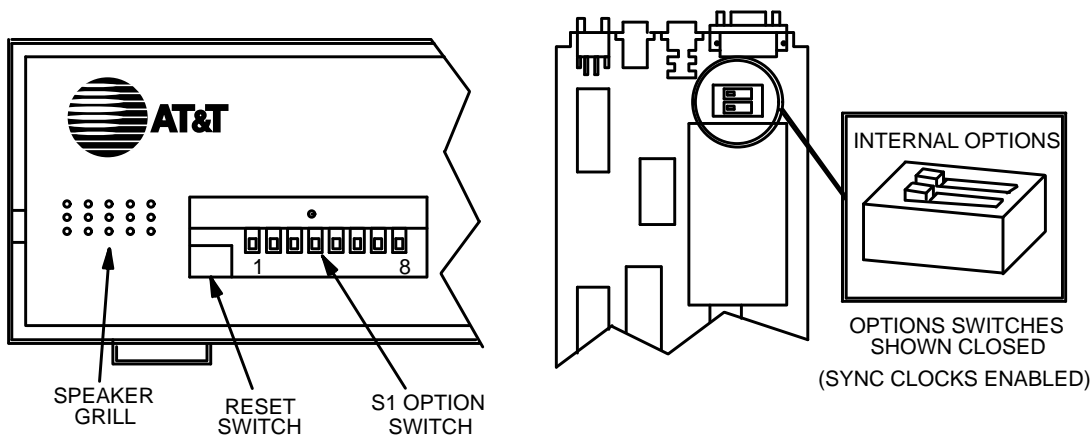

FIGURE 3-1
CEO Modem Hardware Switches

- 2 To set your modem switches:
 - For dial-out or bidirectional 1200/300 baud asynchronous, dialer-enabled modems, set the switches according to Table 3-3.

TABLE 3-3
2224-CEO Dial-Out 1200/300 Asynchronous Communications

Switch	Push	Switch	Push	Switch	Push
1-1	down	1-5	down	internal-1	away from number
1-2	down	1-6	up	internal-2	away from number
1-3	down	1-7	down		
1-4	down	1-8	down		

- 3 Plug the power cable from the modem into the power outlet.
- 4 Reset the modem by pressing and releasing the **RESET** switch. This will make your changes effective.

2224-GNN Modems

See Figure 3-2 for a diagram of the GNN modem hardware switches.

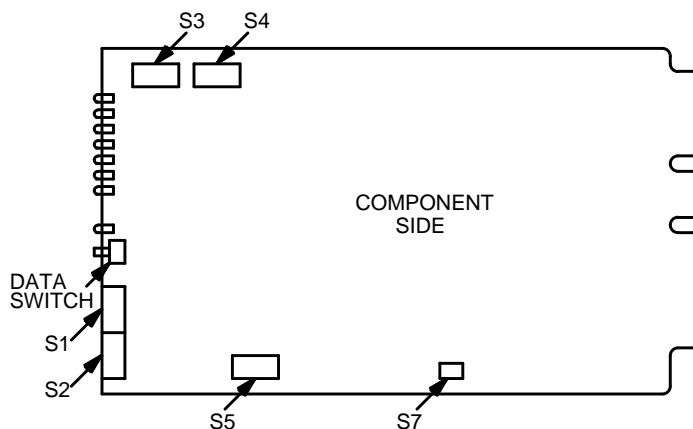

FIGURE 3-2
GNN Modem Hardware

- 1 For dial-out or bidirectional 1200/300 baud asynchronous, dialer enabled 2224-GNN modems, set the switches according to Table 3-4.

TABLE 3-4
2224-GNN Dial-Out 1200/300 Asynchronous Communications

Switch	Push
1-1	left
1-2	left
1-3	left
1-4	right
1-5	right
1-6	left
1-7	left
1-8	left
2-1	right
2-2	right
2-3	left
2-4	left
2-5	left
2-6	left
2-7	left
2-8	left
3-1	right or up
3-2	right or up
3-3	right or up
3-4	left or down
3-5	left or down
3-6	left or down
3-7	left or down
3-8	left or down

- 2 Reset the modem by removing it from the rack, then putting it back. This will make the changes take effect.

Set Up An AT&T 2400 Modem

The AT&T 2400 modems can arrive from the factory in an unknown state; they can be in a state that will not allow them to communicate with a UNIX system. Therefore, these modems should be configured using a terminal.

Install the AT&T 2400 Modem

Install the AT&T 2400 modem as follows:

- 1 Plug in the modem's power adaptor.
- 2 Connect the modem to the main port of an AT&T 615 Terminal using a straight through male to male RS-232 cable.
- 3 Set the terminal speed to 1200.
- 4 Set the terminal Parity to *EVEN*.
- 5 Set the terminal Send Parity to *NO*.

Set the 2400 Modem Software Options

Set the software options in the 2400 modem using a terminal. The modem can be configured for bidirectional port or product access.

- For a bidirectional transmission use the sequence of commands provided in Table 3-5, Column 1. AT&T 2400 modems used for bidirectional traffic such as login or UUCP must be locked at one baud rate.
- For a product access configuration, use the sequence of commands provided in Table 3-6, Column 1. AT&T 2400 modems used for product access (various baud rates) must only be used for product access (outgoing only).

**TABLE 3-5
AT&T 2400 Modem Bidirectional**

Command	Meaning
AT&F	Factory Default
AT&MO	Turn speaker off
AT&QO	Standard Async
ATQ2	Result code in originate only
AT&D2	Enter command mode on DTR dropping
AT&KO	No flow control
AT&C2	CD on for cmd mode, track carrier for data transfer
ATSO=1	Auto Answer
ATS37=6*	Maximum DCE Line Speed**
AT&WO	Write storable parameters of current configuration in memory as profile 0
AT&YO	Specify stored user profile 0 as power up configuration

**TABLE 3-6
Configuration of a Product Access Modem**

Command	Meaning
AT&F	Factory Default
AT&MO	Turn speaker off
AT&QO	Standard Async
ATQ2	Result code in originate only
AT&D2	Enter command mode on DTR dropping
AT&KO	No flow control
AT&C2	CD on for cmd mode, track carrier for data transfer
ATSO=1	Auto Answer
ATS37=0*	Maximum DCE Line Speed
AT&WO	Write storable parameters of current configuration in memory as profile 0
AT&YO	Specify stored user profile 0 as power up configuration

* Varies across the two configuration tables; all other commands are common for all configurations.

** Set to 5, 1200 baud; set to 6, 2400 baud

Configure the UNIX System

The *Dialers* file of UNIX System V Release 3.2.3 contains the following line:

```
#hayes =,-, "" \M\dAT\r\c OK\r \EATDT\r\c CONNECT \m\c
```

Activate this file by removing the comment symbol, #, at the beginning of the line.

For modems that are to be used for outgoing calls (bidirectional), the procedure for configuring the UNIX System as described in the *Installation Manual* changes as follows:

- In the *Connect to Modem* form of the FACE Menu, set the **Modem Name** field to *Non-Autodialing*.
- The **Devices** files will contain a line corresponding to each modem configured for outgoing calls. The following is a typical entry in this file:

```
ACU ttyh06,M - 1200 Non-Autodialing
```

- For each modem, edit the file by entering a set like the following:

```
ACU ttyh06 - 300 hayes  
ACU ttyh06 - 1200 hayes  
ACU ttyh06 - 2400 hayes
```

Set the AT&T DataPort 3710 Modem Software Options

Set the software options in the AT&T DataPort 3710 modem using the dialers file described in the next section, "Configure the UNIX system". The modem can be configured for bidirectional port or product access.

- AT&T DataPort 3710 modems used for bidirectional traffic such as login or UUCP must be locked at one baud rate.
- AT&T DataPort 3710 modems used for product access (various baud rates) must only be used for product access (outgoing only).

Configure the UNIX System

The *Dialers* file of the UNIX System V Release 3.2.3 must be added on one consecutive line as follows:

```
ATTparadyne =+-, ""\M\dAT\r\c OK\r AT&FL3Q2&C2&R0\Q0\N1%C0\r\c  
OK\r AT&W0&Y0 OK\r \dATDT\r\c 00
```

For modems that are to be used for both incoming and outgoing calls (bidirectional), the procedure for configuring the UNIX System as described in the *Installation Manual* changes as follows:

- In the **Connect to Modem** form of the FACE Menu, set the **Modem Name** field to **HayesSmartm2400**.
- The **Devices** files will contain a line corresponding to each modem configured for outgoing calls. The following is a typical entry in this file:

```
ACU ttyh06 - 1200 ATTparadyne
```

- For each modem, edit the file by entering a set as shown in the following:

```
ACU ttyh06 - 300 ATTparadyne  
ACU ttyh06 - 1200 ATTparadyne
```

Procedure 4C — Connect the Terminals

- 1 Find the red **ground lug** on one end of the 10-conductor Modular Cable. Insert that end of the cable into a port on the IPC T-connector and connect the ground lug to the ground slot beneath the port.
- 2 Write the port number, associated device name, and phone line on the Port Configuration Worksheet in **Appendix B** of this manual.
- 3 Connect the other end of the 10-Conductor cable to a terminal/printer adaptor and connect the adapter to the port labeled **MAIN** on the back of the terminal.
- 4 Plug the power cables from the terminals into the power outlet.

Procedure 4D — Connect the Modems

- 1 Connect the 10-Conductor cables from the modems to the IPC serial ports.
- 2 Connect the modems to the phone lines.
- 3 Plug the power cables from the modems into the power outlet.
- 4 Write the port number, associated device name, and phone line on the Port Configuration Worksheet in **Appendix B** of this manual.

End of procedures for Step 4

Step 5 — Set Up and Enable the Printer

Prerequisites for this Step

Activities

- Make sure that the Monitor I system was installed according to Steps 1 through 4 of this section.

Documents

- *User's Guide AT&T 572 Printer* or *User's Guide AT&T 593 Printer (Printer Guide)*
- *UNIX System V/386 Release 3.2.3 Operations/System Administration Guide (Admin Guide)*

Hardware/Software Components

- AT&T 572 or 593 Printer
- AC power cord
- Tractor assembly
- Static eliminator

Procedure 5A — Set Up the Printer

- 1 Set up the printer connection parameters. Make sure the printer setting for the **96 BPS** field is either *01 9600* for direct connect or *04 1200* for dial-up.

See: The "Operation Panel and Operational Procedures in Set-Up Mode" instructions in the *Printer Guide*.

- 2 Use **FACE** to set up the printer parameters.

Procedure 5B — Connect the Printer Cable

- 1 Find the red **ground lug** on one end of the 10-conductor Modular Cable. Insert that end of the cable into a port on the IPC T-connector and connect the ground lug to the ground slot beneath the port.
- 2 Write the port number, associated device name, and phone line on the Port Configuration Worksheet in **Appendix B** of this manual.
- 3 Connect the other end of the 10-Conductor cable to a terminal/printer adaptor and connect the adaptor to the port labeled **MAIN** on the back of the terminal.

Procedure 5C — Enable the Printer

- 1 Log in as *root*.
- 2 Enter */usr/lib/lpshut* at the prompt and press .

System Response:

```
Line printer scheduler stopped
```

- 3 Enter the following for the 572 printer.

```
/usr/lib/lpadmin -ppr1 -m5310 -v/dev/ttyxx
```

Where:

- *xx* is the port number assigned to the printer.
- *pr1* is the name you are assigning to the first printer. If you are installing more printers, use different names for each printer.

- 4 Enter */usr/lib/lpsched* at the prompt and press .
- 5 Enter */usr/lib/accept pr1* at the prompt and press .

System Response:

```
destination pr1 now accepting requests
```

- 6 Enter */usr/lib/lpadmin -dpr1* at the prompt and press .
- 7 Enter *enable pr1* at the prompt and press .

System Response:

```
pr1 now enabled
```

- 8 Enter *lpstat -t* at the prompt and press .

System Response:

The system responds with the list of printers and their current status; **pr1** should be enabled.

```
End of procedures for Step 5
```

Step 6 — Rebuild the UNIX Kernel

Prerequisites for this Step

Activities

- Make sure that the 6386E/33 Model S WGS, keyboard, console, additional terminals, and modems are installed according to Steps 1, 2, and 4 of this section.
- Make sure that the UNIX Foundation Set and additional software were loaded according to Step 3 of this section.
- Make sure that the terminals and modems have been set up and the ports were enabled according to Steps 4 and 5 of this section.

Documents

- *UNIX System V/386 Release 3.2.3 Operations/System Administration Guide (Admin Guide)*

Procedure 6A — Edit the Kernel File

- 1 Using **vi** or **ed**, edit the **/etc/conf/cf.d/mtune** file as follows. These fields are in the fourth column (which is the MAX field).
 - NUMXT = 8
 - MAXUP = 80

- 2 Using **vi** or **ed**, edit the **/etc/conf/cf.d/stune** file using the following suggested minimum parameter settings for Monitor I.

If Monitor I is running with a coresident application and if the other application recommends a different Kernel parameter, set the parameter to the larger of the recommended settings.

If a parameter is *not* found in the file, you must add the entry to the file using the following format.

```
parameter TAB xxx
```

Where: xxx = the value of the parameter.

- NINODE = 100 times the number of RAM in the system or 1300, whichever is lower.

Note: This value should be less than or equal to NS5INODE.

- NS5INODE = 100 times the number of MB of RAM in the system or 1300, whichever is lower.

- NFILE = 100 times the number of MB of RAM in the system or 1300, whichever is lower.
- NPROC = 30 times the number of MB of RAM in the system or 400, whichever is lower.
- MAXUP = 80
- ULIMIT = 8192
- NBUF = 100 times the number of MB of RAM in the system or 2750, whichever is lower.
- NCLIST = 60 times the number of MB of RAM in the system or 1180, whichever is lower.
- NREGION = 100 times the number of MB of RAM in the system or 1200, whichever is lower.
- SHLBMAX = 6
- NUMXT = 8

Procedure 6B — Rebuild the Kernel

- 1 Enter `cd /` at the prompt.
- 2 Enter `/etc/conf/bin/idbuild` at the prompt.

Procedure 6C — Reboot the System

- 1 After the following message is displayed:

UNIX Kernel has been rebuilt

enter `cd /etc/default` to change directories.

- 2 Using `vi` or `ed`, edit the file named `login`.
- 3 Search for `ULIMIT` and change the value to `8192`.
- 4 Save the changes and exit the text editor.
- 5 Change to the root directory: `cd /`.
- 6 Enter `shutdown` to reboot the system.
- 7 When prompted, enter `y` when prompted to continue the shutdown.
- 8 Reboot the system when prompted by pressing `CTL` - `ALT` - `DEL`.

End of procedures for Step 6

Step 7 — Load the INFORMIX Software

Prerequisites for this Step, 6386E/33

Activities

- Make sure that the 6386E/33 Model S processor and software have been installed according to Steps 1 through 7 of this section.
- This step can be completed before the terminals and modems are connected.

Documents

- *UNIX System V/386 Release 3.2.3 Operations/System Administration Guide (Admin Guide)*
- INFORMIX installation instructions

Hardware/Software Components

- INFORMIX-SQL Release 4.0 software
- INFORMIX-SE Release 4.0 software

Procedure 7A — Add the INFORMIX Group

- 1 Log in as *root*.
- 2 Using *vi* or *ed*, edit the System Group file, */etc/group*.
- 3 Add the following to the end of the file:

informix::nnnn:

Where: *nnnn* is the group id, which can be any group number not already used.

- 4 Save the file and exit the UNIX editor.

Procedure 7B — Add the INFORMIX User

- 1 Use *FACE* to add the login, *informix*.
 - **Login Name** — *informix*
 - **Full Name** — *INFORMIX-SQL*
 - **Login ID number** — Use the default login ID number

- **Home Directory** — Enter the directory name as
`<directory>/login_name`
Example: `/usr/informix`
Note: Make sure that the `<directory>` already exists.
 - **System Administration Privileges** — *no*
- 2 Assign a password as instructed.
 - 3 Save the login and exit FACE.
 - 4 Edit the `/etc/passwd` file using `vi` or `ed`.
 - Search for the string: **informix:x:mmmm:1:INFORMIX SQL:/usr/informix:**
Change the `:1:` field to `:nnnn:`,
Where:
 - **nnnn** is the INFORMIX group ID specified in Procedure 7A.
 - **mmmm** is a user ID that is chosen for the INFORMIX user ID.**Example:** `user login name:x:user id:group id: user full name:user full path:`
 - 5 Save and exit the UNIX text editor file.

Procedure 7C — Load the INFORMIX-SQL Software

- 1 Enter `installpkg` at the prompt to load the INFORMIX software from diskette.
- 2 Follow the instructions, insert the diskettes in sequential order, and press `ENTER`.
- 3 Enter the 11-character serial number *exactly* as it appears on the diskette or the Customer Registration card.
- 4 Enter the 6-character serial number KEY *exactly* as it appears on the Customer Registration card.

Procedure 7D — Load the INFORMIX-SE Software

- 1 Enter `installpkg` at the prompt to load the INFORMIX software from diskette.
- 2 Follow the instructions, insert the diskettes in sequential order, and press `ENTER`.
- 3 Enter the 11-character serial number *exactly* as it appears on the diskette or the Customer Registration card.
- 4 Enter the 6-character serial number KEY *exactly* as it appears on the Customer Registration card.

Procedure 7E — Display the Installed Packages

- 1 Enter *displaypkg* at the prompt.
- 2 Make sure the list displayed contains the following software loaded during this installation procedure.
 - Editing Package
 - FACE and FACE HELP Packages
 - FMLI Package
 - INFORMIX-SQL and INFORMIX-SE Software
 - Intelligent Ports Card (IPC) Device Driver Package
 - Network Support Utilities Package
 - Remote Terminal Package
 - Security Administration Package

End of procedures for Step 7

Step 8 — Add the Monitor I Group and Users

Prerequisites for this Step

Activities

- Make sure that the 6386E/33 Model S processor, keyboard, console, additional terminals, and modems are installed according to Steps 1, 2, and 4 of this section.

Documents

- *UNIX System V/386 Release 3.2.3 User's/System Administrator's Reference Manual (Reference Manual)*

Procedure 8A — Add the Monitor I Group

- 1 Log in as *root*.
- 2 At the UNIX prompt, enter *vi /etc/group* to edit the System Group file.
- 3 Add *traf::nnnn:* to the end of the file.

Where: *nnnn* is the group id that is any number not already used.

- 4 Save the file and exit the UNIX *vi* editor.

Procedure 8B — Add the Monitor I Users

- 1 Use **FACE** to add the login, *mtmadm*.
 - **Login Name** — *mtmadm*.
 - **Full Name** — *Monitor I Administrator*.
 - **Login ID number** — Use the default login ID number.
 - **Home Directory** — Enter the directory name as
`<directory>/login_name`

Example: */usr/mtmadm*

Note: Make sure that the `<directory>` already exists.

- **System Administration Privileges** — *no*
- 2 Enter a password for **mtmadm**, as instructed.
 - 3 Remember to save the user login information.
 - 4 Create another login, *mtmadm1*.

Note: This login is primarily used to facilitate the execution of **cron**.

- **Login Name** — *mtmadm1* .
- **Full Name** — *Monitor I cron login* .
- **Login ID number** — Use the default login ID number.
- **Home Directory** — Enter the directory name as
<directory>/login_name

Example: */usr/mtmadm1*

Note: *Make sure that the <directory> already exists.*

- **System Administration Privileges** — *no* .
- 5 Enter a password for **mtmadm1**, as instructed.
 - 6 Remember to save the user login information.
 - 7 Exit FACE and return to the UNIX System.
 - 8 Using **vi** or **ed**, edit the **/etc/passwd** file.
 - Search for the string: **mtmadm:x:mmmm:1:Monitor I Administrator:<directory>**
Change **1** to *:nnnn:* ,
Where: **nnnn** is the Monitor I group id specified in "Procedure 8A — Add the Monitor I Group" and **<directory>** is the home directory for **mtmadm**.
 - Search for the string:
mtmadm1:x:mmmm:1:Monitor I cron login:<directory>
Change **1** to *:nnnn:* ,
Where: **nnnn** is the Monitor I group id specified in "Procedure 8A — Add the Monitor I Group"
<directory> is the home directory for **mtmadm1**.
 - Note:** When Monitor I is installed, the **mtmadm1** login is blocked.
 - 9 Save the file and exit the UNIX text editor.
 - 10 Type *chgrp traf <directory>* at the prompt.
Where: **<directory>** is the home directory of **mtmadm**.
 - 11 Repeat the previous step for **mtmadm1**.
 - 12 Use this procedure to add additional logins for Monitor I users, as necessary.
Note: Assign UNIX **at** and **cron** privileges to users who will be scheduling Monitor I reports. Refer to the *Reference Manual* for information on **at** and **cron**.

Procedure 8C — Edit the .profile

- 1 Use **vi** or **ed** to edit the **.profile** for each Monitor I user.
- 2 Change the **FACEINVOKE** field entry so that users do not have to go through the FACE menu to get to Monitor I. Edit the field so that it reads: **FACEINVOKE = no**.
- 3 Add the following entry to the **end** of the **.profile** so that each login can use Monitor I:

. <directory>/mtm/tools/profile

Where: <directory> is the name of the directory under which you will install Monitor I in **Procedure 9A** of **Step 9**.

Note: If CAFE is used, do not append the **.<directory>/mtm/tools/profile** entry to the users **.profile**.

- 4 Make sure that the **mtmadm** login also gets a **.profile** configured as listed above.

End of procedures for Step 8

Step 9 — Load the Monitor I Software

Prerequisites for this Step

Activities

- Make sure that you have added the Monitor I group and users, explained in Step 8 of this section.
- Make sure that you have installed the INFORMIX-SQL and INFORMIX-SE software, according to the directions listed in Step 7.
- If you are installing an upgrade (a **warm install**), make sure that no one is using the Monitor I files (directories), and that the Poller and Alarm Manager are not running.
- If you are performing a **warm install**, make sure you do a full backup of Monitor I first. Perform the backup according to the "Back Up Monitor I" (6386E/33) procedure listed in the *DEFINITY Monitor I Operations Guide*.

Documents

- *DEFINITY Monitor I Operations Guide (Ops Guide)*

Hardware/Software Components

- DEFINITY Monitor I installation tape
- Disk Configuration Worksheet obtained from your AT&T Representative

Procedure 9A — Cold Install of Monitor I Software

What?

This procedure describes how to do a **cold install** of Monitor I. A cold install is usually done when you are installing Monitor I for the very first time. A **warm install** is done when you are updating existing Monitor I software. See "Procedure 9B — Warm Install of Monitor I Software" for information about warm installs.

In some instances, you may already have Monitor I installed, but you want to remove it and start all over. In this case, you would choose a **cold install** to completely remove the Monitor I directories and databases and reinstall new ones.

How Long?

This procedure takes about 30 minutes to finish.

- 1 Log in as *root*.
- 2 Enter *installpkg* and press .

System Response:

Please indicate the installation medium you intend to use.

**Strike "C" to install from CARTRIDGE TAPE
or "F" to install from FLOPPY DISKETTE.**

- 3 Enter *c* and press .

System Response:

Please insert the cartridge tape into the tape drive.

- 4 Press .

**It is recommended that you re-tension the tape before
attempting the installation, to ensure that the tape is
read without any errors.**

- 5 Press to retension the tape. This will take about three minutes.

System Response:

Packages available for installation:

1. **DEFINITY Monitor I Release 2.1**
2. **Install ALL packages shown above**
3. **Exit, do not install any packages**

- 6 Enter **1** to install Monitor I, press **RETURN**, followed by **ESC**.

System Response:

You have made the following selections:

1. DEFINITY Monitor I Release 2.1

- 7 Press **RETURN** to confirm your selection.

Note: Press **ESC** if you want to redisplay the package selections.

System Response:

REMINDER!

Depending on the packages you are installing, you may be required to provide some input to the installation utility to configure the software for your system.

- 8 Press **RETURN** to continue the installation.

System Response:

Installation in progress --Do not remove the cartridge tape

This message is followed by a copyright message for Monitor I.

System Response:

Enter type of installation you want (w-warm, c-cold, e-exit):

Note: If you choose to exit at this point, and you want to restart installation, you must reinsert the tape. Any time after this point, you can exit and restart without reinserting the tape.

- 9 Type *c* and press .

System Response:

Enter the directory where you want to install Monitor I?:

- 10 Enter the directory name then press .

Note: Monitor I will be installed in the directory you specify, under a subdirectory called **mtm**. If this subdirectory does not exist, the system will now create it for you.

Example: Entering */usr* or */usr1/traf* results in Monitor I being installed in the directory */usr/mtm/* or *usr1/traf/mtm* respectively.

System Response:

Monitor I will be installed under <directory name>/mtm, continue (y/n):

Where: <directory name> is the name of the directory you specified in the previous step.

- 11 Enter *y* to continue and press .

WARNING- Cold installation will remove all Monitor I directories and existing database(s), if any. No one should be using Monitor I during installation. Make sure Monitor I polling system and alarm manager are not running.

Cold installation will proceed, continue? (y/n) :

- 12 Enter *y* and press .

System Response:

```
          Select processor type -  
          Enter 1 for 3B2-600  
            2 for 6386E/33 model S  
            3 for 6386SX/EL or NCR 3315
```

13 Type `2` and press `RETURN`.

System Response:

```
          You are installing on a 6386E/33 model S processor.  
          Do yo want to continue? (y/n) :
```

14 Type `y` and press `RETURN` to continue.

System Response:

```
          Pre-installation checks in progress ....
```

• If pre-installation checks have completed successfully, you will see the following message:

```
          Pre-installation checks have completed successfully.
```

• If pre-installation checks did *not* complete successfully, a list of error messages is displayed, followed by this message:

```
          Pre-installation checks did not complete successfully.
```

Note: To continue, fix the errors using error message explanations found in **Appendix C** of this manual. Once the errors have been resolved, try installing Monitor I again using this procedure, starting with the **installpkg** command in **Step 2**.

If pre-installation checks completed successfully, the following prompt is displayed:

Do you want to create database place holder(s)? (y/n):

Note: If you enter *n*, the software will be installed, but no placeholders will be created. You can add placeholders after installation is completed by using the **addmount** procedure discussed in "9C — Create Placeholders Using Addmount."

- 15 Enter *y* to create database placeholders then press .

System Response:

Do you want to use the "rotating switch study" feature? (y/n):

Reference: Refer to the DOSS Configuration output for the appropriate response.

- If you answer *n*, for the **Rotating Switch Study** feature, the following prompt is displayed:

Enter the directory to create the database(s) e.g. /usr1 ? :

Continue the software load with Step 18 of this procedure.

- If you answer *y*, for the **Rotating Switch Study** feature, the following prompts are displayed:

Enter the total number of G2, SYSTEM 85 or FP8 switches?:
Enter the total number of G3r, G3i, G1 or SYSTEM 75 switches?:

- 16 If you are using the **Rotating Switch Study** feature, enter the correct response to these questions and press to get the next prompt.

System Response:

Are the values entered above correct? (y/n):

- If you answer *n*, the system will again prompt you to enter the total number of switches.

17 Once all values are correct, type *y* then press . System Response:

Enter the directory to create the database(s), e.g. /usr1 ? :

Reference: Refer to the DOSS Configuration output for the appropriate directory.

18 Enter the directory name and press .

Note: The next questions refer to the number of placeholders for databases to be created under each mount point (database directory) for each polling option.

System Response:

How many G2, SYS85 or FP8 (EXTENDED) database(s) ? (0-40) :
How many G2, SYS85 or FP8 (STANDARD) database(s) ? (0-40) :
How many G2, SYS85 or FP8 (DAILY and LIMITED) database(s) ? (0-40) :
How many G1 1.1 or SYSTEM 75 database(s)? (0-40) :
How many G3r or G3i (EXTENDED) database(s)? (0-40) :
How many G3r or G3i (STANDARD) database(s)? (0-40) :
How many G3r or G3i (DAILY and LIMITED) database(s)? (0-40) :
How many inactive database(s)?

Note: The last prompt, **How many inactive database(s)?** , is only displayed if the **Rotating Switch Study** feature is used.

19 Enter the correct response to each of the questions listed above and press to get the next prompt.

Note:

- You *must* enter the correct number of databases for Monitor I to work properly. This information depends on the number of switches being supported and how your disk is sliced. See your Disk Configuration Worksheet for more information.
- Monitor I allows you to repeat this procedure for each mount point (database directory) and polling option per switch type that you have.

System Response:

Are the values entered above correct? (y/n):

- If you answer *n* , the system repeats the series of questions listed in **Step 19** of this procedure.

- 20 Once all values are correct, type *y* then press .

System Response:

Do you want to create more database place holder(s)? (y/n):

- If you answer *y*, the system returns to the response in **Step 19** of this procedure.
- 21 Enter *n* and press to continue with the installation.

Note: The system begins copying the files from the tape and a lengthy list of these files appears in a scrolling display. The files displayed on your screen will vary from the partial system listing displayed in the next screen example.

```
Copying files from the tape
log
tmp
work
work/pdump
work/pollidir
prog
prog/R2V2
prog/R2V2/L1_rep
prog/R2V2/acd_rep
prog/R2V2/covg_rep
.
.
prog/R2V2/iparser
prog/R2V2/clock
.
.
upgrade/d1.1.FL3
.
upgrade/d1.2.GL1
.
.
upgrade/d2.1.AL1/A06tmdb75
.
.
Re-building system 85 R2V5 menu ...
Re-building system 85 R2V4 menu ...
.
.
Re-building system 75 R1V4 menu ...
Re-building system 75 R2V5 menu ...
.
.
```

The following messages appear when the installation completes:

**All Monitor I files have been installed correctly.
Installation completed successfully.**

If you do *not* see these messages or if you see error messages during the procedure, look for further information on the errors in **/usr/tmp/journal** . Fix the errors using the error message explanations found in **Appendix C** of this manual, then try installing Monitor I again, starting with the **installpkg** command in **Step 2 of Procedure 9A**.

End of Cold Install Procedure

Procedure 9B — Warm Install of Monitor I Software

- 1 Back up Monitor I according to the "Back Up Monitor I (6386E/33)" procedure listed in the *Monitor I Operations Guide*.
- 2 Follow Steps 1 through 8 of "Procedure 9A — Cold Install of Monitor I Software."

Complete Step 2 of this procedure when you see this prompt:

Enter type of installation you want (w-warm, c-cold, e-exit):

- 3 Type *w* and press .

System Response:

**WARNING- No one should be using Monitor I during installation.
Make sure Monitor I polling system and alarm manager are
not running.**

Warm installation will proceed, continue? (y/n) :

- 4 Enter *y* to continue and press **RETURN**.

System Response:

Pre-installation checks in progress

- If pre-installation checks have completed successfully, you will see the following message:

Pre-installation checks have completed successfully.

- If pre-installation checks did *not* complete successfully, a list of error messages is displayed, followed by this message:

Pre-installation checks did not complete successfully.

Note: To continue, fix the errors using error message explanations found in **Appendix C** of this manual. Once the errors have been resolved, try installing Monitor I again using this procedure, starting with the **installpkg** command in **Step 2** of this procedure.

A lengthy list of files appears on the screen in a scrolling display. After all these files have been installed and some post-installation checking messages appear, the following message is displayed at the completion of the warm installation:

Warm installation completed successfully.

Note: If you do *not* see this message or if you see error messages during the procedure, look for further information on the errors in **/usr/tmp/journal**. Fix the errors, using the error message explanations found in **Appendix C**. Try installing Monitor I again, starting with the **installpkg** command in **Step 2** of this procedure.

- 5 As a final post-installation step, restart the poller and alarm manager. Enter **<directory>/mtm/tools/monitorI start** to bring up the Monitor I poller and alarm processes, where **<directory>** is the name of the directory under which you installed Monitor I.

End of Warm Install Procedure

Procedure 9C — Create Placeholders Using Addmount

Use this procedure to create database placeholders from the UNIX shell, after you have completed the Monitor I installation.

Note: If you have already added placeholders during installation, you will not be able to add additional placeholders from the shell. Also, if you have used the **addmount** procedure previously to add placeholders, you will not be able to execute this procedure a second time.

- 1 Log in as *root*.
- 2 Type `<directory>/mtm/tools/addmount` at the prompt and press .

Where: `<directory>` is the name of the directory under which you installed Monitor I in **Step 10** of **Procedure 9A**.

System Response:

Do you want to use the "rotating switch study" feature? (y/n):

Reference: Refer to the DOSS Configuration output for the appropriate response.

- If you answer *n*, for the **Rotating Switch Study** feature, the following prompt is displayed:

Enter the directory to create the database(s), e.g /usr1 ? :

Skip to Step 5 of this procedure.

- If you answer *y*, for the **Rotating Switch Study** feature, the following prompts are displayed:

Enter the total number of G2, SYSTEM 85 or FP8 switches?:
Enter the total number of G3r, G3i, G1 or SYSTEM 75 switches?:

- 3 If you are using the **Rotating Switch Study** feature, enter the correct response to these questions and press to get the next prompt.

System Response:

Are the values entered above correct? (y/n):

- If you answer *n*, the system will again prompt you to enter the total number of switches.
- 4 Once all values are correct, type *y* then press .

System Response:

Enter the directory to create the database(s), e.g. /usr1 ? :

Reference: Refer to the DOSS Configuration output for the appropriate directory.

- 5 Enter the directory name and press .

Note: The next questions refer to the number of placeholders for databases to be created under each mount point (database directory) for each polling option.

System Response:

How many G2, SYS85 or FP8 (EXTENDED) database(s) ? (0-40) :
 How many G2, SYS85 or FP8 (STANDARD) database(s) ? (0-40) :
 How many G2, SYS85 or FP8 (DAILY and LIMITED) database(s) ? (0-40) :
 How many G1 1.1 or SYSTEM 75 database(s)? (0-40) :
 How many G3r or G3i (EXTENDED) database(s)? (0-40) :
 How many G3r or G3i (STANDARD) database(s)? (0-40) :
 How many G3r or G3i (DAILY and LIMITED) database(s)? (0-40) :
 How many inactive database(s)?

Note: The last prompt **How many inactive database(s)?** is only displayed if the **Rotating Switch Study** feature is used.

- 6 Enter the correct response to each of the questions listed above and press to get the next prompt.

Note:

- You *must* enter the correct number of databases for Monitor I to work correctly. This information depends on the number of switches being supported and how your disk is sliced. See your Disk Configuration Worksheet for more information.
- Monitor I allows you to repeat this procedure for each mount point (database directory) and polling option per switch type that you have.

System Response:

Are the values entered above correct? (y/n):

- If you answer *n*, the system returns to the series of questions listed in **Step 5** of this procedure.

- 7 Once all values are correct, type *y* then press .

System Response:

Do you want to create more database place holder(s)? (y/n):

- If you answer *y*, the system returns to the **System Response** listed in **Step 4** of this procedure.

- 8 Enter *n* to continue the **addmount** procedure.

- 9 Wait for the prompt:

Database place holders successfully created

You will see this message for each database directory you entered.

Note: If you do not see this message, check **/usr/tmp/addout** for possible errors. Refer to **Appendix C** for Monitor I installation error messages and corrective actions.

End of procedures for Step 9

Step 10 — Enable the System Ports

Prerequisites for this Step

Activities

- Make sure the 6386E/33 Model S processor, keyboard, console, additional terminals, and modems are installed according to Steps 1, 2, and 4 of this section.
- Make sure the UNIX Foundation Set and additional software has been loaded according to Step 3 of this section.
- Make sure the terminals and modems were set up according to Step 4 of this section.

Documents

- Refer to the Port Configuration Worksheet in **Appendix B** for a list of configured ports.
- *Intelligent Ports Card Model 900 (IPC-900) User's Guide (IPC Guide)*

Procedure 10A — Enable Bidirectional Ports

- 1 Log in as *root*.
- 2 Enter *face* at the prompt.
- 3 Enter the following selections:

```

Administrative Menu
└─ Peripheral Setup
   └─ Serial Ports Setup

```

- 4 Use , *Choices* to make the next set of selections.

- An outgoing or bidirectional port to enable.
- **Device Type** = *MODEM*
- **Device Speed** = *1200*

Note: If you have DIMENSION FP8 switches, you will need to edit the `/usr/lib/uucp/Devices` file by creating an additional, identical entry for each ACU entry with a baud rate of 1200. Then, change the 1200 in the duplicate entry to *300*.

- **Flow Control** = *hardware*
- 5 Press to save the port selections.

- 6 From window 5, use `F2`, *Choices* to select the following.
 - **Modem Type** = *AT&T 2224B* for all modem types (AT&T 2224-CEO and AT&T 2224-GNN, and also see the AT&T 2400 Modem section)
 - **Device Connection** = Both incoming and outgoing calls (bidirectional)
- 7 Press `F3` to save the options.
- 8 Exit FACE.

Procedure 10B — Set the CEO Modem Software Options

- 1 Plug the phone cable into the port labeled **Line** on the back of the modem.
- 2 Plug the modem into the power supply.
- 3 Log in as *root*.
- 4 Enter `MTMDIR=<directory>;export MTMDIR`.

Where: `<directory>` is the directory under which Monitor I was loaded in "Step 9 — Load the Monitor I Software."

- 5 Enter `$MTMDIR/tools/ceoconfig`.

System Response:

Enter port number (e.g. tty31):

- 6 Enter the port number.

Reference: **Appendix B** for the port number assigned to the 2224-CEO modem.

System Response:

Testing /dev/<portnumber>
Please wait...
Hardware Switches Set for Dial-Out or Bi-Directional
Asynchronous

- If the modem software options are set correctly, the following prompt is displayed next:

`<portnumber>` **Software Options Set Correctly**

Perform all tests listed in **Appendix A — Acceptance Testing**.

- If the modem software options are set incorrectly, the following prompts are displayed:

```
Software Options Set Incorrectly for Monitor I
Enter y to set them to the Monitor I configuration
or n to keep current settings (y):
```

7 Enter *y*.

System Response:

```
Setting <portnumber> Software Options to Defaults
Options 1-63 set to default
Option 12 is now y
Option 34 is now 1
Option 36 is now 0
Option 41 is now 0

<portnumber> Software Options Set Correctly
```

Where: <portnumber> is the port number assigned to the 2224-CEO modem.

Note: If these messages are *not* displayed or an error message is displayed, run this procedure again from **Step 5 of Procedure 10B**.

TABLE 3-7
2224-CEO Modem — Software Options

Option Number	Value	Option Number	Value	Option Number	Value	Option Number	Value
1	y	17	10	33	n	49	N/A
2	y	18	n	34	1	50	N/A
3	y	19	n	35	3	51	n
4	y	20	1	36	0	52	f
5	y	21	0	37	0	53	f
6	N/A	22	:	38	0	54	y
7	y	23	^H	39	5	55	n
8	N/A	24	@	40	N/A	56	y
9	n	25	\$B	41	0	57	N/A
10	n	26	\$:	42	N/A	58	n
11	n	27	n	43	n	59	N/A
12	y	28	n	44	n	60	N/A
13	n	29	0	45	n	61	N/A
14	n	30	n	46	n	62	N/A
15	y	31	y	47	N/A	63	n
16	n	32	I	48	N/A		

Notes: N/A = Not Applicable

Table 3-7 reflects the 2224-CEO modem settings *after* the **ceoconfig** utility is run. This table is for reference purposes only.

End of procedures for Step 10

Installing on the 6386SX/EL

This section explains how to install the hardware and software required to use Monitor I on the 6386SX/EL processor. The entire installation should take approximately five hours: one hour to complete Step 1 and about four hours to complete Steps 2 through 10.

Step 1 — Set Up the 6386SX/EL WGS

Prerequisites for this Step

Activities

- **DO NOT** install any hardware or software before calling the TSC (1 800 548-8861).
- Make sure you received all the components necessary for the Monitor I system.
- Plan the location and determine the I/O address range, controller memory address range, and Interrupt Request (IRQ) levels of add-on cards in the processor. Table 4-1 lists the default locations and IRQ levels of the add-on cards in the processor. However, the default locations and IRQ recommended may need to be changed if Monitor I is coresident with other applications.

Note: These locations must be unique for each board in the system. Keep a record of the locations and addresses of each board for your reference.

TABLE 4-1
Add-On Cards: Default Location Addresses and IRQ Levels

Card	Slot	IRQ Level	I/O Address	Memory Address
IPC #1	1	10	290	D0000
TAPE	2	5	288	

Documents

- *6386SX/EL WGS Processor User's Guide (6386SX/EL Guide)*
- *6386SX/EL WGS Service Manual (Service Manual)*

- *6386SX/EL WGS Hardware Reference Manual (Reference Manual)*
- *AT&T Intelligent Ports Card Model 900 (IPC-900) User's Guide (IPC Guide)*
- *AT&T Work Group System Remote Maintenance Package User's Guide (RMP Guide)*

Hardware/Software Components

- AT&T 329D VGA Monitor
- AT&T 101-key Keyboard
- AT&T three-button mouse
- Intelligent Ports cards (IPC)
- Memory boards
- Memory Expansion kits
- Remote Maintenance Card

Procedure 1A — Install the Additional Memory

- 1 Install the additional SIMMs.

See: The "Installing Expansion Board" instructions in Chapter 4, "Installing System Options" of the *6386SX/EL Guide*.

- 2 Before installing additional memory boards, fill up the SIMM slots on the mother board (a total of 8 MB).

- 3 Install additional memory board(s), if required.

See: The "Memory Expansion Boards" instructions in the Expansion Kits appendix of the *6386SX/EL Guide*.

Note: If other applications coresiding on the 6386SX/EL require use of specific slots, make sure those slots are left free.

Procedure 1B — Install the Additional Cards

- 1 Set the I/O Starting Address, the Controller Memory Starting Address, and the Interrupt Request Level (IRQ) **shunt** according to Table 4-1. Each IPC must have unique settings. You need to know these settings when you load the IPC software in Procedure 3B of this chapter.

See: The "Hardware Installation" and "Hardware Parameter Settings" sections in the *IPC Guide*.

- 2 Install the IPC in a one-port slot as follows.

See: The "Installing an Expansion Board" instructions in the *Installing Your System* chapter of the *6386SX/EL Guide*.

- Align the IPC-900 board with the selected board slot and insert it into the corresponding connector.
- Attach the T-adaptor to the IPC-900 board. Make sure it is plugged firmly and completely into the socket.
- Repeat for additional IPC cards, if supplied. IPC connections must use 10-pin modular cords and 10-pin special adaptors.

Procedure 1C — Set Up the Console, Keyboard, Cables and Processor

- 1 Set up and prepare the console.

See:

- The "Connect the System Components" instructions in Chapter 1, "Getting Started" of the *6386SX/EL Guide*.
- For details on setting up the console terminal, see "Step 4 — Set Up the Terminals and Modems" in this chapter.

- 2 Connect the monitor, keyboard, and power cord to the processor.

Reference: The "Connect the Keyboard and Video Display" and "Connect Other Peripherals" instructions in Chapter 1, "Getting Started" of the *6386SX/EL Guide*.

- 3 Replace the covers and connect the processor to the power outlet.

Reference: "Connect the System to a Power Outlet" instructions in Chapter 1, "Getting Started" of the *6386SX/EL Guide*.

End of procedures for Step 1

Step 2 — Load the UNIX Essential Utilities

Prerequisites for this Step

Activities

- Make sure that the 6386SX/EL processor, keyboard, and console are set up and connected according to Step 1 of this section.

Documents

- *6386SX/EL WGS Processor User's Guide (6386SX/EL Guide)*
- *UNIX System V/386 Release 3.2.3 Operations/System Administration Guide (Admin Guide)*
- *UNIX System V/386 Release 3.2.3 Release Notes (Release Notes)*

Hardware/Software Components

- Base System Package Disk
- UNIX Operating System Foundation Set software, on cartridge tape

Procedure 2A — Run the Setup Utility

- 1 Configure the base system.

Reference: The "Getting Started" and "Operating Your System" instructions in the *6386SX/EL Guide*.

- 2 When running the Setup utility, check to see that the Extended Memory is correct for the amount of memory installed in the system.
 - Press **CTL** - **ALT** - **DEL** to reboot.
 - Wait for the beep.
 - Press **CTL** - **ALT** - **INSERT** to see the current settings for your configuration. The memory size(s) should match the data shown in Table 4-2.

TABLE 4-2
Memory size, 6386SX/EL

Memory Installed (MB)	Extended Memory (KB)
8	7552

- 3 Set Console Redirection to the COM2 Port at a speed of 1200 baud.

See: "Setting I/O Redirection" in the *6386SX/EL Guide*.

Procedure 2B — Load the UNIX Foundation Set

- 1 Begin loading the UNIX Foundation Set.

See: The "Boot System to Single-User Mode" instructions in the "Software Installation" section of the *Admin Guide*.

- 2 Run the setup and begin partitioning the hard disk as follows.

See: The "Perform Installation Setup" instructions in the Software Installation section of the *Admin Guide*. Follow the setup procedure for a new installation.

- Select *1* to create an MS-DOS partition.
 - When prompted, enter the amount of hard disk allocated to DOS as *5 percent* (for 100 MB disk).
 - Enter *n* to indicate that the MS-DOS partition is not the active partition.
- 3 Create the UNIX partition as follows.
- Select *1* to create a UNIX partition.
 - Select *1* to indicate that a UNIX System partition is to be created.
 - When prompted, enter the amount of hard disk allocated to UNIX as *95 percent* (for 100 MB disk).
 - Enter *y* to indicate that the UNIX partition is to be active every time the machine is booted.
 - Select *4* to update the disk configuration and exit.
- 4 Continue partitioning the hard disk.
- See:** The "Prepare Hard Disk for Surface Analysis" instructions in the Software Installation section of the *Admin Guide*.

5 Complete the hard disk partitioning process as follows.

See: The "Create UNIX System File Systems" instructions in the Software Installation section of the *Admin Guide*.

- Enter *n* to indicate that the default partition allocations are not acceptable.
- Enter *y* at the partition prompt:

Separate root and usr?

- Enter *n* at the next partition prompt:

Additional usr2?

- Enter *n* at the next partition prompt:

Crash/dump area?

- Enter *61* as the number of cylinders assigned to swap/paging.
- Enter *76* (for the 100 MB disk) as the number of cylinders allocated for the root partition.
- Review the new allocation and make a note of it. Swap/paging and root should have the number of cylinders you assigned, and the balance should be assigned to the */usr* area. Enter *y* to indicate the allocation is acceptable.
- When you are prompted, remove the diskette from the drive and reboot the system from hard disk.
- After rebooting the system, enter *c* to install the UNIX system from cartridge tape.

6 Load the UNIX essential utilities.

See: The "Install Base System (From Cartridge Tape)" instructions in the Software Installation section of the *Admin Guide*.

7 Assign a root password.

8 Assign an install password.

Procedure 2C — Load Add-On Packages From Tape

Follow the instructions on the Package Selection menu to install the add-on packages from cartridge tape. Select the following for installation:

- 1 *Editing Package*
- 2 *FMLI*
- 3 *FACE*
- 4 *FACE Help*

Note: The FACE Help package is totally different than the FACE package.

- 5 Press to execute.
- 6 Press to continue.
- 7 Enter *4* to install all of the Help files.
- 8 Enter *5* to complete (terminate) the Help file installation.
- 9 Continue the installation with the cartridge tape utilities.

See: Table 4-1 for the appropriate IRQ load.

- 10 Reboot the system.

End of procedures for Step 2

Step 3 — Load the Additional Software

Prerequisites for this Step

Activities

- Make sure that the 6386SX/EL WGS, keyboard, console, and additional cards are installed according to Step 1 of this section. You need to know the location, memory addresses, and IRQ levels of the boards in the processor.
- Make sure that the correct version of the UNIX Foundation Set is loaded according to Step 2 of this section.

Documents

- *UNIX System V/386 Release 3.2.3 Operations/System Administration Guide (Admin Guide)*
- *Intelligent Ports Card Model 900 (IPC-900) User's Guide (IPC Guide)*
- *AT&T Work Group System Remote Maintenance Package User's Guide (RMP Guide)*

Hardware/Software Components

- UNIX System V/386 Release 3.2.3 Remote Terminal Package
- AT&T IPC UNIX System V 386 Device Driver
- Security Administration Package

When Installing from Diskette

- Use the "Install Optional Add-On Packages (From Diskette)" instructions in the "Software Installation" section of the *Admin Guide* to load the individual software packages.
- If your processor has two disk drives, specify the drive from which you are loading.
- If asked how many diskettes are in the package, count the number of diskettes for the specific package only. Whenever multiple diskettes exist for a specific package, make sure you load these diskettes in sequential order.
- If asked for the diskette type, either look on the diskette for the applicable type or enter *1.44*.
- If asked to reboot the system, press to skip the reboot process. You do *not* have to reboot after loading each software package; however, you *must* reboot the system after the last package is loaded.

Procedure 3A — Load the Remote Terminal Package

Note: This is *not* the Remote Maintenance Package, which is loaded at a different time.

- 1 Enter *installpkg* at the prompt to load the Remote Terminal Package.
- 2 Enter *1* to install the terminfo files.

Call: The TSC Hotline (1 800 548-8861) to obtain the **terminfo** entry needed to use the 730 terminal and the 615 BCT with the System 75 Emulation cartridge. (For the 715 BCS, use "BCS" as the emulation mode and "513" for the terminal type when cutting through from G3i, G1, or System 75 to AUDIX.)

- 3 Enter *all* to load all the terminfo files.
- 4 Enter *done* after the list of files is displayed.
- 5 Enter *0* to complete (terminate) the terminfo file load.

Procedure 3B — Load the IPC Device Driver

Note: Make sure you are using Version 3.0 for the IPC-900.

- 1 Enter *installpkg* at the prompt to load the IPC software.
- 2 Enter the number of IPC cards installed in the system. For each IPC, do the following.
 - Press to select the default (IPC-900) for the type of ports card installed in the system.
 - Enter the Interrupt Request Level (IRQ) of the IPC.

See: Table 4-1 in this guide for the IRQ level required.

- Do one of the following:
 - a Press to select the default starting address of the I/O ports and controller memory.
 - b Enter the appropriate addresses as set on the card during the installation.

See: The "Hardware Parameter Settings" section in the *IPC Guide*.

- 3 Enter *y* to confirm the settings.
- 4 Reboot as instructed.

End of procedures for Step 3

Step 4 — Set Up the Terminals and Modems

Prerequisites for this Step

Activities

- Make sure that the 6386SX/EL processor, keyboard, console and software are set up and connected according to Steps 1 through 3 of this section.

Documents

- *User's Guide - 615 Business Communications Terminal Guide*, or *715 Business Communications System (BCS) User's Guide and Service Manual*, or *730 Multi-Tasking Graphics Terminal Guide (Terminal Guide)*
- *DATAPHONE II 2224-CEO Modem User's Manual* or *DATAPHONE II 2224-GNN Modem Manual (Modem Manual)*
- *Intelligent Ports Card Model 900 (IPC-900) User's Guide (IPC Guide)*

Hardware/Software Components

- 615 BCT(s), 715 BCS(s), or 630 or 730 MTG(s) [optional]
- One 513 BCT/System 75 Emulation Cartridge per 615 BCT for accessing G3i, G1, or System 75 maintenance and administration functions
- 2224 modem(s) for use with bidirectional 1200/300 baud asynchronous communications for UUCP and communication with administered switches
- 10-pin modular cables with 10-pin special adaptors

Procedure 4A — Set Up the Terminals

- 1 Unpack, install, and set up the terminal.

See: The "Unpack and Install" (615 BCT or 715 BCS) or "Installation" (730) instructions in the *Terminal Guide*.

Note: The 630 or 730 MTG is most effectively used at speeds above 2400 baud, therefore it should not be connected through a modem.

- 2 To make the terminal operational for Monitor I:

- Install the 513 BCT/System 75 Emulation Cartridge by inserting the 513 BCT/System 75 cartridge into the slot on the side of the 615 BCT. Be sure that the cartridge is right side up, with the cartridge label toward the front.

Warning: Check the on/off switch before you install the cartridge to make sure that the power for the 615 terminal is turned *off*. A blank screen is *not* an indicator that the terminal is off, and you will destroy the 513 BCT/System 75 cartridge if you insert or remove it while the terminal is on.

- Follow the instructions in the *Terminal Guide* to enable the cartridge.
- For the 715 terminal, enter the following settings:
 - Set the emulation mode to: *BCS*
 - Set the UNIX terminal type (TERM) to: *sys75*
 - Set the terminal type for cut-through access from Monitor I to G3i, G1, and System 75 to: *513*
 - Set the **Swap Delete** option of the 715 terminal to: *yes* (through terminal setup) for BCS.
- Change the **Cursor Blink** option to *y* for yes.
- Cut-through access to System 75 R1V1 for maintenance or administration requires that the System 75 be equipped with a pooled modem card that allows asynchronous communications.

Procedure 4B — Set Up the Modems

Monitor I supports the 2224-CEO, 2224-GNN and AT&T 2400 modems. For either modem, you must set up the hardware switches, as follows.

See: The appropriate *Modem Manual* for complete installation procedures.

Contact the Technical Service Center (TSC) at 1 800 548-8861 to have your modem checked after you have completed the appropriate modem procedures.

2224-CEO Modems

For the 2224-CEO modem:

- 1 Remove the CEO modem cover to access the Internal Option switches.
See Figure 4-1 for a diagram of the CEO modem hardware switches.

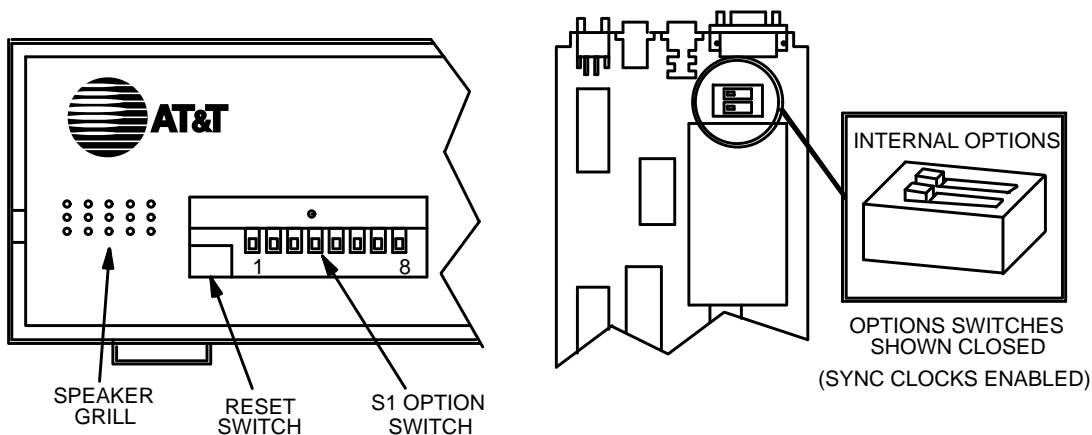

FIGURE 4-1
CEO Modem Hardware Switches

- 2 To set your modem switches:
 - For dial-out or bidirectional 1200/300 baud asynchronous, dialer-enabled modems, set the switches according to Table 4-3.

TABLE 4-3
2224-CEO Dial-Out 1200/300 Asynchronous Communications

Switch	Push	Switch	Push	Switch	Push
1-1	down	1-5	down	internal-1	away from number
1-2	down	1-6	up	internal-2	away from number
1-3	down	1-7	down		
1-4	down	1-8	down		

- 3 Plug the power cable from the modem into the power outlet.
- 4 Reset the modem by pressing and releasing the **RESET** switch. This makes your changes effective.

2224-GNN Modems

See Figure 4-2 for a diagram of the GNN modem hardware switches.

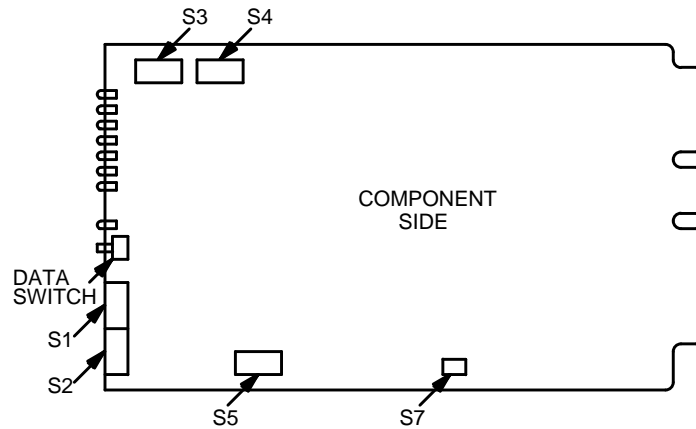

FIGURE 4-2
GNN Modem Hardware

- 1 For dial-out or bidirectional 1200/300 baud asynchronous, dialer-enabled 2224-GNN modems, set the switches according to Table 4-4.

TABLE 4-4
2224-GNN Dial-Out 1200/300 Asynchronous Communications

Switch	Push
1-1	left
1-2	left
1-3	left
1-4	right
1-5	right
1-6	left
1-7	left
1-8	left
2-1	right
2-2	right
2-3	left
2-4	left
2-5	left
2-6	left
2-7	left
2-8	left
3-1	right or up
3-2	right or up
3-3	right or up
3-4	left or down
3-5	left or down
3-6	left or down
3-7	left or down
3-8	left or down

- 2 Reset the modem by removing it from the rack, then putting it back. This makes the changes take effect.

Set Up An AT&T 2400 Modem

The AT&T 2400 modems can arrive from the factory in an unknown state; they can be in a state that will not allow them to communicate with a UNIX system. Therefore, these modems should be configured using a terminal.

Install the AT&T 2400 Modem

Install the AT&T 2400 modem as follows:

- 1 Plug in the modem's power adaptor.
- 2 Connect the modem to the main port of an AT&T 615 Terminal using a straight through male to male RS-232 cable.
- 3 Set the terminal speed to 1200.
- 4 Set the terminal Parity to *EVEN*.
- 5 Set the terminal Send Parity to *NO*.

Set the 2400 Modem Software Options

Set the software options in the 2400 modem using a terminal. The modem can be configured for bidirectional port transmission or product access.

- For a bidirectional transmission, use the sequence of commands provided in Table 4-5, Column 1. AT&T 2400 modems used for bidirectional traffic such as login or UUCP must be locked at one baud rate.
- For a product access configuration, use the sequence of commands provided in Table 4-6, Column 1. AT&T 2400 modems used for product access (various baud rates) must only be used for product access (outgoing only).

**TABLE 4-5
AT&T 2400 Modem Bidirectional**

Command	Meaning
AT&F	Factory Default
AT&MO	Turn speaker off
AT&QO	Standard Async
ATQ2	Result code in originate only
AT&D2	Enter command mode on DTR dropping
AT&KO	No flow control
AT&C2	CD on for cmd mode, track carrier for data transfer
ATSO=1	Auto Answer
ATS37=6*	Maximum DCE Line Speed**
AT&WO	Write storable parameters of current configuration in memory as profile 0
AT&YO	Specify stored user profile 0 as power up configuration

**TABLE 4-6
Configuration of a Product Access Modem**

Command	Meaning
AT&F	Factory Default
AT&MO	Turn speaker off
AT&QO	Standard Async
ATQ2	Result code in originate only
AT&D2	Enter command mode on DTR dropping
AT&KO	No flow control
AT&C2	CD on for cmd mode, track carrier for data transfer
ATSO=1	Auto Answer
ATS37=0*	Maximum DCE Line Speed
AT&WO	Write storable parameters of current configuration in memory as profile 0
AT&YO	Specify stored user profile 0 as power up configuration

* Varies across the two configuration tables; all other commands are common for all configurations.

** Set to 5, 1200 baud; set to 6, 2400 baud

Configure the UNIX System

The *Dialers* file of UNIX System V Release 3.2.3 contains the following line:

```
hayes =,-, "" \M\dATr\c OKr \EATDT\TTr\c CONNECT \m\c
```

Activate this file by removing the comment symbol, #, at the beginning of the line.

For modems that are to be used for outgoing calls (bidirectional), the procedure for configuring the UNIX System as described in the *Installation Manual* changes as follows:

- In the *Connect to Modem* form of the FACE Menu, set the **Modem Name** field to *Non-Autodialing*.
- The **Devices** files will contain a line corresponding to each modem configured for outgoing calls. The following is a typical entry in this file:

```
ACU ttyh06,M - 1200 Non-Autodialing lsp 2p
```

- For each modem, edit the file by entering a set like the following:

```
ACU ttyh06 - 300 hayes  
ACU ttyh06 - 1200 hayes  
ACU ttyh06 - 2400 hayes
```

```
End of Procedure
```

Set the AT&T DataPort 3710 Modem Software Options

Set the software options in the AT&T DataPort 3710 modem using the dialers file described in the next section, "Configure the UNIX system". The modem can be configured for bidirectional port or product access.

- AT&T DataPort 3710 modems used for bidirectional traffic such as login or UUCP must be locked at one baud rate.
- AT&T DataPort 3710 modems used for product access (various baud rates) must only be used for product access (outgoing only).

Configure the UNIX System

The *Dialers* file of the UNIX System V Release 3.2.3 must be added on one consecutive line as follows:

```
ATTparadyne =+,, ""\M\dAT\r\c OK\r AT&FL3Q2&C2&R0\Q0\N1%C0\r\c  
OK\r AT&W0&Y0 OK\r \dATDT\r\c 00
```

For modems that are to be used for both incoming and outgoing calls (bidirectional), the procedure for configuring the UNIX System as described in the *Installation Manual* changes as follows:

- In the **Connect to Modem** form of the FACE Menu, set the **Modem Name** field to **HayesSmartm2400**.
- The **Devices** files will contain a line corresponding to each modem configured for outgoing calls. The following is a typical entry in this file:

```
ACU ttyh06 - 1200 ATTparadyne
```

- For each modem, edit the file by entering a set as shown in the following:

```
ACU ttyh06 - 300 ATTparadyne  
ACU ttyh06 - 1200 ATTparadyne
```

```
End of Procedure
```

Procedure 4C — Connect the Terminals

- 1 Find the red ground lug on one end of the 10-conductor Modular Cable. Insert that end of the cable into a port on the IPC T-connector and connect the ground lug to the ground slot beneath the port.
- 2 Write the port number, associated device name, and phone line on the Port Configuration Worksheet in **Appendix B** of this manual.
- 3 Connect the other end of the 10-conductor cable to a terminal/printer adaptor and connect the adapter to the port labeled **MAIN** on the back of the terminal.
- 4 Plug the power cables from the terminals into the power outlet.

Procedure 4D — Connect the Modems

- 1 Connect the 10-conductor cables from the modems to the IPC serial ports.
- 2 Connect the modems to the phone lines.
- 3 Plug the power cables from the modems into the power outlet.
- 4 Write the port number, associated device name, and phone line on the Port Configuration Worksheet in **Appendix B** of this manual.

End of procedures for Step 4

Step 5 — Set Up and Enable the Printer

Prerequisites for this Step

Activities

- Make sure that the Monitor I system was installed according to Steps 1 through 4 of this section.

Documents

- *User's Guide AT&T 570 Printer* or *User's Guide AT&T 593 Printer (Printer Guide)*
- UNIX System V/386 Release 3.2.3 Operations/System Administration Guide (*Admin Guide*)

Hardware/Software Components

- AT&T 570 or 593 Printer
- AC power cord
- Tractor assembly
- Static eliminator

Procedure 5A — Set Up the Printer

- 1 Set up the printer connection parameters.

See: The "Operation Panel and Operational Procedures in Set-Up Mode" instructions in the *Printer Guide*.

- 2 Use **FACE** to set up the printer parameters.

Procedure 5B — Connect the Printer Cable

- 1 Connect one end of the parallel printer cable to the printer and the other end to the parallel port on the processor.
- 2 Write the port number and associated device name on the Port Configuration Worksheet in **Appendix B** of this manual.

Procedure 5C — Enable the Printer

- 1 Log in as *root*.
- 2 At the prompt, enter *face* and press .
- 3 Enter the following menu selections:

```
System Administration
├─ Peripheral Setup
│   └─ Printer Setup
│       └─ Parallel Printer Port Setup
```

System Response:

- 4 Enter the appropriate printer type, either *AT&T570* or *AT&T593* and press .

System Response:

- 5 Enter the name of the printer and press .

Example: *pr1*

System Response:

- 6 Select the default, *yes*.
- 7 Press to save the values.
- 8 Press to continue with this procedure.
- 9 Press three times to return to the **FACE** main menu.
- 10 Select *exit* then press to exit from the **FACE** main menu.

11 At the next prompt, enter: *lpstat -t*

System Response:

Information about the printer you enabled (for example, pr1) is displayed.

End of procedures for Step 5

Step 6 — Rebuild the UNIX Kernel

Prerequisites for this Step

Activities

- Make sure that the 6386SX/EL WGS, keyboard, console, additional terminals, and modems are installed according to Steps 1, 2, and 4 of this section.
- Make sure that the UNIX Foundation Set and additional software were loaded according to Step 3 of this section.
- Make sure that the terminals and modems have been set up and the ports were enabled according to Steps 4 and 5 of this section.

Documents

- *UNIX System V/386 Release 3.2.3 Operations/System Administration Guide (Admin Guide)*

Procedure 6A — Edit the Kernel File

- 1 Using **vi** or **ed**, edit the **/etc/conf/cf.d/mtune** file with the information listed below. These fields are in the fourth column (which is the MAX field).
 - NUMXT = 8
 - MAXUP = 80

- 2 Using **vi** or **ed**, edit the **/etc/conf/cf.d/stune** file using the following suggested minimum parameter settings for Monitor I.

If Monitor I is running with a coresident application and if the other application recommends a different Kernel parameter, set the parameter to the larger of the recommended settings. If a parameter is *not* found in the file, you must add the entry to the file using the following format.

```
parameter TAB xxx
```

Where: xxx = the value of the parameter.

- NINODE = 100 times the number of MB of RAM in the system or 1300, whichever is lower.

Note: This value should be less than or equal to NS5INODE.
- NS5INODE = 100 times the number of MB of RAM in the system or 1300, whichever is lower.
- NFILE = 100 times the number of MB of RAM in the system or 1300, whichever is lower.
- NPROC = 30 times the number of MB of RAM in the system or 400, whichever is lower.
- MAXUP = 80

- `ULIMIT = 8192`
- `NBUF = 100` times the number of MB of RAM in the system or 2750, whichever is lower.
- `NCLIST = 60` times the number of MB of RAM in the system or 1180, whichever is lower.
- `NREGION = 100` times the number of MB of RAM in the system or 1200, whichever is lower.
- `SHLBMAX = 6`
- `NUMXT = 8`

Procedure 6B — Rebuild the Kernel

- 1 Enter `cd /` at the prompt.
- 2 Enter `/etc/conf/bin/idbuild` at the prompt.

Procedure 6C — Reboot the System

- 1 When you see the following message:

UNIX Kernel has been rebuilt

enter the following to change directories: `cd /etc/default`.

- 2 Using `vi` or `ed`, edit the file named **login**.
- 3 Search for **ULIMIT** and change the value to `8192`.
- 4 Save the changes and exit the text editor.
- 5 Change to the root directory: `cd /`.
- 6 Enter `shutdown` to reboot the system.
- 7 When prompted, enter `y` to continue the shutdown.
- 8 Reboot the system when prompted by pressing `CTL` - `ALT` - `DEL`.

End of procedures for Step 6

Step 7 — Load the INFORMIX Software

Prerequisites for this Step

Activities

- Make sure that the 6386SX/EL processor and software have been installed according to Steps 1 through 7 of this section.
- This step can be completed before the terminals and modems are connected.

Documents

- *UNIX System V/386 Release 3.2.3 Operations/System Administration Guide (Admin Guide)*
- INFORMIX installation instructions

Hardware/Software Components

- INFORMIX-SQL Release 4.0 software
- INFORMIX-SE Release 4.0 software

Procedure 7A — Add the INFORMIX Group

- 1 Log in as *root*.
- 2 Using *vi* or *ed*, edit the System Group file, */etc/group*.
- 3 Add the following to the end of the file:

```
informix::nnnn:
```

Where: *nnnn* is the group id, which can be any group number not already used.

- 4 Save the file and exit the UNIX editor.

Procedure 7B — Add the INFORMIX User

- 1 Use **FACE** to add the login, *informix*.
 - **Login Name** — *informix*
 - **Full Name** — *INFORMIX-SQL*
 - **Login ID number** — Use the default login ID number.
 - **Home Directory** — Enter the directory name as:

```
<directory>/login_name
```

Example: */usr/informix*

Note: Make sure that the <directory> already exists.

- **System Administration Privileges** — *no*.
- 2 Assign a password as instructed.
 - 3 Save the login and exit FACE.
 - 4 Edit the */etc/passwd* file using **vi** or **ed**.
 - Search for the string: **informix:x:mmmm:1:INFORMIX SQL:/usr/informix:**
Change the **:1:** field to **:nnnn:**

Where: **nnnn** is the INFORMIX group ID specified in Procedure 7A and **mmmm** is a user ID that is chosen for the INFORMIX user ID.

Example:

user login name:x:user id:group id: user full name:user full path:

- 5 Save and exit the UNIX text editor file.

Procedure 7C — Load the INFORMIX-SQL Software

- 1 Enter *installpkg* at the prompt to load the INFORMIX software from diskette.
- 2 Follow the instructions, insert the diskettes in sequential order, and press .
- 3 Enter the 11-character serial number *exactly* as it appears on the diskette or the Customer Registration card.
- 4 Enter the 6-character serial number KEY *exactly* as it appears on the Customer Registration card.

Procedure 7D — Load the INFORMIX-SE Software

- 1 Enter *installpkg* at the prompt to load the INFORMIX software from diskette.
- 2 Follow the instructions, insert the diskettes in sequential order, and press .
- 3 Enter the 11-character serial number *exactly* as it appears on the diskette or the Customer Registration card.
- 4 Enter the 6-character serial number KEY *exactly* as it appears on the Customer Registration card.

Procedure 7E — Display the Installed Packages

- 1 Enter *displaypkg* at the prompt.
- 2 Make sure the list displayed contains the following software loaded during this installation procedure.
 - Cartridge Tape Utilities
 - Editing Package
 - FACE and FACE HELP Packages
 - FMLI Package
 - INFORMIX-SE Software
 - INFORMIX-SQL Software
 - Intelligent Ports Card (IPC) Device Driver Package
 - Remote Terminal Package

End of procedures for Step 7

Step 8 — Add the Monitor I Group and Users

Prerequisites for this Step

Activities

- Make sure that the 6386SX/EL processor, keyboard, console, additional terminals, and modems are installed according to Steps 1, 2, and 4 of this section.

Documents

- *UNIX System V/386 Release 3.2.3 User's/System Administrator's Reference Manual (Reference Manual)*

Procedure 8A — Add the Monitor I Group

- 1 Log in as *root*.
- 2 At the UNIX prompt, enter *vi /etc/group, 6386SX/EL* to edit the System Group file.
- 3 Add *traf::nnnn:* to the end of the file.

Where: *nnnn* is the group id that is any number not already used.

- 4 Save the file and exit the UNIX *vi* editor.

Procedure 8B — Add the Monitor I Users

- 1 Use **FACE** to add the login, **mtmadm**.
 - **Login Name** — *mtmadm*
 - **Full Name** — *Monitor I Administrator*
 - **Login ID number** — Use the default login ID number.
 - **Home Directory** — Enter the directory name as:
<directory>/login_name

Example: */usr/mtmadm*

Note: Make sure that the *<directory>* already exists.

- **System Administration Privileges** — *no*.
- 2 Enter a password for **mtmadm**, as instructed.
 - 3 Remember to save the user login information.
 - 4 Create another login, **mtmadm1**.

Note: This login is primarily used to facilitate the execution of **cron**.

- **Login Name** — *mtmadm1*
- **Full Name** — *Monitor I cron login*
- **Login ID number** — Use the default login ID number.
- **Home Directory** — Enter the directory name as
<directory>/login_name

Example: */usr/mtmadm1*

Note: Make sure that the **<directory>** already exists.

- **System Administration Privileges** — *no*.
- 5 Enter a password for **mtmadm1**, as instructed.
 - 6 Remember to save the user login information.
 - 7 Exit FACE and return to the UNIX System.
 - 8 Using **vi** or **ed**, edit the **/etc/passwd** file.

- Search for the string:
mtmadm:x:mmmm:1:Monitor I Administrator:<directory>
- Change **:1:** to **:nnnn:**

Where: **nnnn** is the Monitor I group id specified in "Procedure 8A — Add the Monitor I Group" and **<directory>** is the home directory for **mtmadm**.

- Search for the string:
mtmadm1:x:mmmm:1:Monitor I cron login:<directory>
- Change **:1:** to **:nnnn:**

Where: **nnnn** is the Monitor I group id specified in "Procedure 8A — Add the Monitor I Group" and **<directory>** is the home directory for **mtmadm1**.

Note: When Monitor I is installed, the **mtmadm1** login is blocked.

- 9 Save the file and exit the UNIX text editor.
- 10 Type **chgrp traf <directory>** at the prompt.

Where: **<directory>** is the home directory of **mtmadm**.

- 11 Repeat the previous step for **mtmadm1**.
- 12 Use this procedure to add additional logins for Monitor I users, as necessary.

Note: Assign UNIX **at** and **cron** privileges to users who will be scheduling Monitor I reports. Refer to the *Reference Manual* for information on **at** and **cron**.

Procedure 8C — Edit the .profile

- 1 Use **vi** or **ed** to edit the **.profile** for each Monitor I user.
- 2 Change the **FACEINVOKE** field entry so that users do not have to go through the FACE menu to get to Monitor I. Edit the field so that it reads: *FACEINVOKE = no* .
- 3 Add the following entry to the **end** of the **.profile** so that each login can use Monitor I:
 . <directory>/mtm/tools/profile

Where: <directory> is the name of the directory under which you will be installing Monitor I in **Step 11** of **Procedure 9A**.

Note: If CAFE is used, do not append the **.<directory>/mtm/tools/profile** entry to the users **.profile**.

- 4 Make sure that the **mtmadm** login also gets a **.profile** configured as listed above.

End of procedures for Step 8

Step 9 — Load the Monitor I Software

Prerequisites for this Step

Activities

- Make sure that you have added the Monitor I group and users, explained in Step 8 of this chapter.
- Make sure that you have installed INFORMIX, according to the directions listed in Step 7.
- If you are installing an upgrade (a **warm install**), make sure that no one is using the Monitor I files (directories), and that the Poller and Alarm Manager are not running.
- If you are performing a **warm install**, make sure you do a full backup of Monitor I first. Perform the backup according to the "Back Up Monitor I" (6386SX/EL) procedure listed in the *DEFINITY Monitor I Operations Guide*.

Documents

- *DEFINITY Monitor I Operations Guide (Ops Guide)*

Hardware/Software Components

- DEFINITY Monitor I installation tape
- Disk Configuration Worksheet obtained from your AT&T Representative

Procedure 9A — Cold Install of Monitor I Software

What?

This procedure describes how to do a **cold install** of Monitor I. A cold install is usually done when you are installing Monitor I for the very first time. A **warm install** is done when you are updating existing Monitor I software. See **Procedure 9B — Warm Install of Monitor I Software** for information about warm installs.

In some instances, you may already have Monitor I installed, but you want to remove it and start all over. In this case, you would choose a **cold install** to completely remove the Monitor I directories and databases and reinstall new ones.

How Long?

This procedure takes about 30 minutes to finish.

- 1 Log in as *root*.
- 2 Enter *installpkg* and press .

System Response:

**Please indicate the installation medium you intend to use.
Strike "C" to install from CARTRIDGE TAPE
or "F" to install from FLOPPY DISKETTE.**

- 3 Enter *c* and press .

System Response:

Please insert the cartridge tape into the tape drive.

- 4 Press .

It is recommended that you re-tension the tape before attempting the installation, to ensure that the tape is read without any errors.

- 5 Press to retension the tape. This takes about three minutes.

System Response:

Packages available for installation:

1. **DEFINITY Monitor I Release 2.1**
2. **Install ALL packages shown above**
3. **Exit, do not install any packages**

- 6 Enter **1** to install Monitor I, press **RETURN**, followed by **ESC**.

System Response:

You have made the following selections:

1. **DEFINITY Monitor I Release 2.1**

- 7 Press **RETURN** to confirm your selection.

Note: Press **ESC** if you want to redisplay the package selections.

System Response:

REMINDER!

Depending on the packages you are installing, you may be required to provide some input to the installation utility to configure the software for your system.

- 8 Press **RETURN** to continue the installation.

System Response:

Installation in progress --Do not remove the cartridge tape

This message is followed by a copyright message for Monitor I.

System Response:

Enter type of installation you want (w-warm, c-cold, e-exit):

Note: If you choose to exit at this point and you want to restart installation, you must reinsert the tape. Any time after this point, you can exit and restart without reinserting the tape.

- 9 Type *c* and press .

System Response:

Enter the directory where you want to install Monitor I? (/usr) :

- 10 Enter the default, */usr*, or the the directory of your choice, then press .

Note: Monitor I will be installed in the directory you specify, under a subdirectory called **mtm**. If this subdirectory does not exist, the system will now create it for you.

Example: Entering */usr* or */usr1/traf* results in Monitor I being installed in the directory */usr/mtm* or */usr1/traf/mtm* respectively.

System Response:

Monitor I will be installed under <directory name>/mtm, continue ? (y/n):

Where: <directory name> is the name of the directory you specified in the previous step.

- 11 Enter *y* to continue and press .

System Response:

WARNING- Cold installation will remove all Monitor I directories and existing database(s), if any. No one should be using Monitor I during installation. Make sure Monitor I polling system and alarm manager are not running.

Cold installation will proceed, continue? (y/n) :

- 12 Enter *y* to continue and press .

System Response:

Select processor type -
Enter 1 for 3B2-600
2 for 6386E/33 model S
3 for 6386SX/EL or NCR 3315

13 Enter **3** and press **RETURN**. System Response:

You are installing on a 6386SX/EL or NCR 3315 processor.
Do you want to continue? (y/n) :

14 Enter **y** and press **RETURN**.

System Response:

Enter switch type(s) separated by ','
(G3r, G3i, G2, G1, SYS85, SYS75, FP8, or ALL) :

If you select *ALL* the system response screen shown in Step 15 is displayed. If you select individual switches, the system also prompts you to select the releases you want for each switch selection.

- G3r:

Enter issue(s) for G3r switch separated by ','
(1):

- G3i:

Enter issue(s) for G3i switch separated by ','
(1):

- G2:

Enter release(s) for G2 switch separated by ','
(2.1, 2.2):

- G1:

Enter release(s) for G1 switch separated by ','
(1.1):

- SYS85:

Enter release(s) for SYS 85 switch separated by ','
(R2V4, R2V3, R2V2):

- SYS75:

Enter release(s) for SYS75 switch separated by ','
(R1V3, R1V2, R1V1):

- FP8:

Enter release(s) for FP8 switch separated by ','
(3.8, 1.16):

15 Enter the switch type(s) and releases you want to install then press **RETURN**.

System Response:

Pre-installation checks in progress

- If pre-installation checks have completed successfully, the following message is displayed:

Pre-installation checks have completed successfully.

- If pre-installation checks did *not* complete successfully, a list of error messages is displayed, followed by this message:

Pre-installation checks did not complete successfully.

Note: To continue, fix the errors using error message explanations found in **Appendix C** of this manual. Once the errors have been resolved, try installing Monitor I again using this procedure, starting with the **installpkg** command in **Step 2**.

If pre-installation checks completed successfully, the following prompt is displayed:

Do you want to create database place holder(s)? (y/n):

Note: If you enter *n*, the software is installed, but no placeholders are created. You can add placeholders after installation is completed by using the **addmount** procedure discussed in "9C — Create Placeholders Using Addmount."

- 16 Enter *y* to create database placeholders then press .

System Response:

Do you want to use the "Rotating Switch Study" feature? (y/n):

Reference: Refer to the DOSS Configuration output for the appropriate response.

- If you answer *n*, the following prompt is displayed:

Enter the directory to create the database(s) e.g. /usr1 ? :

Continue the software load with Step 19 of this procedure.

- If you answer *y*, the following prompts are displayed:

Enter the total number of G2, SYSTEM 85 or FP8 switches?:

Enter the total number of G3r, G3i, G1 or SYSTEM 75 switches?:

- 17 If you are using the **Rotating Switch Study** feature, enter the correct response to these questions and press to get the next prompt.

System Response:

Are the values entered above correct? (y/n):

- If you answer *n*, the system again prompts you to enter the total number of switches.
- 18 Once all values are correct, type *y* then press .

System Response:

Enter the directory to create the database(s), e.g. /usr1 ? :

Reference: Refer to the DOSS Configuration output for the appropriate directory.

- 19 Enter the directory name and press .

Note: The next questions refer to the number of placeholders for databases to be created under each mount point (database directory) for each polling option.

System Response:

How many G2, SYS85 or FP8 (EXTENDED) database(s) ? (0-40) :
How many G2, SYS85 or FP8 (STANDARD) database(s) ? (0-40) :
How many G2, SYS85 or FP8 (DAILY and LIMITED) database(s) ? (0-40) :
How many G1 1.1 or SYSTEM 75 database(s)? (0-40) :
How many G3r or G3i (EXTENDED) database(s)? (0-40) :
How many G3r or G3i (STANDARD) database(s)? (0-40) :
How many G3r or G3i (DAILY and LIMITED) database(s)? (0-40) :
How many inactive database(s)?

Note: The last prompt, **How many inactive database(s)?**, is only displayed if the **Rotating Switch Study** feature is used.

- 20 Enter the correct response to each of the questions listed above and press to get the next prompt.

Note:

- You *must* enter the correct number of databases for Monitor I to work properly. This information depends on the number of switches being supported and how your disk is sliced. See your Disk Configuration Worksheet for more information.
- Monitor I allows you to repeat this procedure for each mount point (database directory) and polling option per switch type that you have.

System Response:

Are the values entered above correct? (y/n):

- If you answer *n*, the system repeats the series of questions listed in **Step 19** of this procedure.

- 21 Once all values are correct, type *y* then press .

System Response:

Do you want to create more database place holder(s)? (y/n):

- If you answer *y*, the system returns to the response in **Step 18** of this procedure.

22 Enter *n* and press **RETURN** to continue with the installation.

Note: The system begins copying the files from the tape and a lengthy list of these files appears in a scrolling display. The files displayed on your screen may vary from the partial system listing displayed in the next screen example.

```
.
.
Copying files from the tape
log
tmp
work
work/pdump
work/pollidir
prog
prog/R2V2
prog/R2V2/L1_rep
prog/R2V2/acd_rep
prog/R2V2/covg_rep
.
.
.
prog/R2V2/iparser
prog/R2V2/clock
.
.
```

The following messages appear when the installation completes:

**All Monitor I files have been installed correctly.
Installation completed successfully.**

If you *do not* see these messages or if you see error messages during the procedure, look for further information on the errors in **/usr/tmp/journal**. Fix the errors using the error message explanations found in **Appendix C** of this manual, then try installing Monitor I again, starting with the **installpkg** command in **Step 2** of this procedure.

End of Cold Install Procedure

Procedure 9B — Warm Install of Monitor I Software

- 1 Backup Monitor I according to the "Backing Up Monitor I" procedure listed in the *Monitor I Operations Guide*.
- 2 Follow Steps 1 through 8 of "Procedure 9A — Cold Install of Monitor I Software." Complete Step 2 of this procedure when you see this prompt:

Enter type of installation you want (w-warm, c-cold, e-exit):

- 3 Type *w* at the prompt and press .

System Response:

**WARNING- No one should be using Monitor I during installation.
Make sure Monitor I polling system and alarm manager are
not running.
Warm installation will proceed, continue? (y/n) :**

- 4 Enter *y* to continue and press .

System Response:

Pre-installation checks in progress

- If pre-installation checks have completed successfully, the following message is displayed:

Pre-installation checks have completed successfully.

- If pre-installation checks did *not* complete successfully, a list of error messages is displayed, followed by this message:

Pre-installation checks did not complete successfully.

Note: To continue, fix the errors using error message explanations found in **Appendix C** of this manual. Once the errors have been resolved, try installing Monitor I again using this procedure, starting with the **installpkg** command in **Step 2** of this procedure.

A lengthy list of files appears on the screen in a scrolling display. After all these files have been installed and some post-installation checking messages appear, the following message is displayed at the completion of the warm installation:

Warm installation completed successfully.

Note: If you do *not* see this message or if you see error messages during the procedure, look for further information on the errors in **/usr/tmp/journal**. Fix the errors, using the error message explanations found in **Appendix C**. Try installing Monitor I again, starting with the **installpkg** command in **Step 2** of this procedure.

- 5 As a final post-installation step, restart the poller and alarm manager. Enter **<directory>/mtm/tools/monitor I start** to bring up the Monitor I poller and alarm processes, where **<directory>** is the name of the directory under which you installed Monitor I.

End of Warm Install Procedure

Procedure 9C — Create Placeholders Using Addmount

Use this procedure to create database placeholders from the UNIX shell, after you have completed the Monitor I installation.

Note: If you have already added placeholders during installation, you will not be able to add additional placeholders from the shell. Also, if you have used the **addmount** procedure previously to add placeholders, you will not be able to execute this procedure a second time.

- 1 Log in as *root*.
- 2 Type `<directory>/mtm/tools/addmount` at the prompt and press .

Where: `<directory>` is the name of the directory under which you installed Monitor I in **Step 9 of Procedure 9A**.

System Response:

Do you want to use the "Rotating Switch Study" feature? (y/n):

Reference: Refer to the DOSS Configuration output for the appropriate response.

- If you answer *n*, the following prompt is displayed:

Enter the directory to create the database(s), e.g /usr1 ? :

Continue the software load with Step 5 of this procedure.

- If you answer *y*, the following prompts are displayed:

Enter the total number of G2, SYSTEM 85 or FP8 switches?:

Enter the total number of G3r, G3i, G1 or SYSTEM 75 switches?:

- 3 If you are using the **Rotating Switch Study** feature, enter the correct response to these questions and press to get the next prompt.

System Response:

Are the values entered above correct? (y/n):

- If you answer *n*, the system again prompts you to enter the total number of switches.
- 4 Once all values are correct, type *y* then press .

System Response:

Enter the directory to create the database(s), e.g. /usr1 ? :

Reference: Refer to the DOSS Configuration output for the appropriate directory.

- 5 Enter the directory name and press .

Note: The next questions refer to the number of placeholders for databases to be created under each mount point for each polling option.

System Response:

How many G2, SYS85 or FP8 (EXTENDED) database(s) ? (0-40) :
 How many G2, SYS85 or FP8 (STANDARD) database(s) ? (0-40) :
 How many G2, SYS85 or FP8 (DAILY and LIMITED) database(s) ? (0-40) :
 How many G1 1.1 or SYSTEM 75 database(s)? (0-40) :
 How many G3r or G3i (EXTENDED) database(s)? (0-40) :
 How many G3r or G3i (STANDARD) database(s)? (0-40) :
 How many G3r or G3i (DAILY and LIMITED) database(s)? (0-40) :
 How many inactive database(s)?

Note: The last prompt **How many inactive database(s)?** is only displayed if the **Rotating Switch Study** feature is used.

- 6 Enter the correct response to each of the questions listed above and press to get the next prompt.

Note:

- You *must* enter the correct number of databases for Monitor I to work correctly. This information depends on the number of switches being supported and how your disk is sliced. See your Disk Configuration Worksheet for more information.
- Monitor I allows you to repeat this procedure for each mount point (database directory) and polling option per switch type that you have.

System Response:

Are the values entered above correct? (y/n):

- If you answer *n*, the system returns to the series of questions listed in **Step 5** of this procedure.
- 7 Once all values are correct, type *y* then press .

System Response:

Do you want to create more database place holder(s)? (y/n):

- If you answer *y*, the system returns to the **System Response** listed in **Step 4** of this procedure.
- 8 Enter *n* to continue the **addmount** procedure.
- 9 The following message is displayed for each database directory you entered:

Database place holders successfully created

Note: If you do not see this message, check **/usr/tmp/addout** for possible errors. Refer to **Appendix C** for Monitor I installation error messages and corrective actions.

End of procedures for Step 9

Step 10 — Enable the System Ports

Prerequisites for this Step

Activities

- Make sure the 6386SX/EL processor, keyboard, console, additional terminals, and modems are installed according to Steps 1, 2, and 4 of this section.
- Make sure the UNIX Foundation Set and additional software has been loaded according to Step 3 of this section.
- Make sure the terminals and modems were set up according to Step 4 of this section.

Documents

- Refer to the Port Configuration Worksheet in **Appendix B** for a list of configured ports.
- *Intelligent Ports Card Model 900 (IPC-900) User's Guide (IPC Guide)*

Procedure 10A — Enable Bidirectional Ports

- 1 Log in as *root*.
- 2 Enter *face* at the prompt.
- 3 Enter the following selections:

```

Administrative Menu
└─ Peripheral Setup
   └─ Serial Ports Setup

```

- 4 Use **F2**, *Choices* to select the following.
 - An outgoing or bidirectional port to enable.
 - **Device Type** = *MODEM*
 - **Device Speed** = *1200*

Note: If you have DIMENSION FP8 switches, you need to edit the `/usr/lib/uucp/Devices` file by creating an additional, identical entry for each ACU entry with a baud rate of 1200. Then, change the 1200 in the duplicate entry to 300.

- **Flow Control** = *hardware*
- 5 Press **F3** to save the port selections.
 - 6 From window 5, use **F2**, *Choices* to select the following:
 - **Modem Type** = *AT&T 2224B* for all modem types (AT&T 2400, AT&T 2224-CEO and AT&T 2224-GNN)

- **Device Connection** = Both incoming and outgoing calls (bidirectional)
- 7 Press **F3** to save the options.
 - 8 Exit FACE.

Procedure 10B — Set the CEO Modem Software Options

- 1 Plug the phone cable into the port labeled **Line** on the back of the modem.
- 2 Plug the modem into the power supply.
- 3 Log in as *root*.
- 4 Enter *MTMDIR=<directory>;export MTMDIR*.

Where: *<directory>* is the directory under which Monitor I was loaded in "Step 9 — Load the Monitor I Software."

- 5 Enter *\$MTMDIR/tools/ceoconfig*
System Response:

Enter port number (e.g. tty31):

- 6 Enter the port number.

Reference: **Appendix B** for the port number assigned to the 2224-CEO modem.

System Response:

Testing /dev/<portnumber>
Please wait...
Hardware Switches Set for Dial-Out or Bi-Directional Asynchronous

- If the modem software options are set correctly, the following prompt is displayed:

<portnumber> Software Options Set Correctly

Perform all tests listed in Appendix A, "Acceptance Testing."

- If the modem software options are set incorrectly, the following prompts are displayed:

```
Software Options Set Incorrectly for Monitor I
Enter y to set them to the Monitor I configuration
or n to keep current settings (y):
```

7 Enter *y*.

System Response:

```
Setting <portnumber> Software Options to Defaults
Options 1-63 set to default
Option 12 is now y
Option 34 is now 1
Option 36 is now 0
Option 41 is now 0

<portnumber> Software Options Set Correctly
```

Where: <portnumber> is the port number assigned to the 2224-CEO modem.

Note: If these messages are *not* displayed or an error message is displayed, run this procedure again from **Step 5 of Procedure 10B**.

TABLE 4-7
2224-CEO Modem — Software Options

Option Number	Value	Option Number	Value	Option Number	Value	Option Number	Value
1	y	17	10	33	n	49	N/A
2	y	18	n	34	1	50	N/A
3	y	19	n	35	3	51	n
4	y	20	1	36	0	52	f
5	y	21	0	37	0	53	f
6	N/A	22	:	38	0	54	y
7	y	23	^H	39	5	55	n
8	N/A	24	@	40	N/A	56	y
9	n	25	\$B	41	0	57	N/A
10	n	26	\$:	42	N/A	58	n
11	n	27	n	43	n	59	N/A
12	y	28	n	44	n	60	N/A
13	n	29	0	45	n	61	N/A
14	n	30	n	46	n	62	N/A
15	y	31	y	47	N/A	63	n
16	n	32	I	48	N/A		

Notes: N/A = Not Applicable

Table 4-7 reflects the 2224-CEO modem settings *after* the **ceoconfig** utility is run. This table is for reference purposes only.

End of procedures for Step 10

Installing on the NCR-3315

This section explains how to install the hardware and software required to use Monitor I on the NCR-3315 processor. The entire installation should take approximately five hours: one hour to complete Step 1 and about four hours to complete Steps 2 through 10.

Step 1 — Set Up the NCR-3315 WGS

Prerequisites for this Step

Activities

- **DO NOT** install any hardware or software before calling the TSC (1 800 548-8861).
- Make sure you received all the components necessary for the Monitor I system.
- Plan the location and determine the I/O address range, controller memory address range, and Interrupt Request (IRQ) levels of add-on cards in the processor. Table 5-1 lists the default locations and IRQ levels of the add-on cards in the processor. However, the default locations and IRQ recommended may need to be changed if Monitor I is coresident with other applications.

Note: These locations must be unique for each board in the system. Keep a record of the locations and addresses of each board for your reference.

TABLE 5-1
Add-On Cards: Default Location Addresses and IRQ Levels

Card	Slot	IRQ Level	I/O Address	Memory Address
IPC #1	1	11	290	D0000
TAPE	2	5	288	

Documents

- *NCR-3315 Technical-Service Manual*
- *NCR-3315 User's Manual*

- *AT&T Intelligent Ports Card Model 900 (IPC-900) User's Guide (IPC Guide)*
- *AT&T Work Group System Remote Maintenance Package User's Guide (RMP Guide)*

Hardware/Software Components

- System Unit
- VGA Color Monitor and keyboard for the NCR-3315
- Memory Expansion Unit
 - (1) 4 MB Kit
 - (2) 1 MB Kit
- Intelligent Ports Card (IPC)
- Streaming Tape Drive

Procedure 1A — Install the Additional Memory

- 1 Install the additional SIMMs.

See: The appropriate section in the *NCR-3315 User's Manual*.

- 2 Before installing additional memory boards, fill up the SIMM slots on the mother board (a total of 12 MB).
- 3 Install additional memory board(s), if required.

See: The appropriate section in the *NCR-3315 User's Manual*.

Note: If other applications coresiding on the NCR-3315 require use of specific slots, make sure those slots are left free.

Procedure 1B — Install the Additional Cards

- 1 Set the I/O Starting Address, the Controller Memory Starting Address, and the Interrupt Request Level (IRQ) **shunt** according to Table 5-1. Each IPC must have unique settings. You need to know these settings when you load the IPC software in Procedure 3B of this chapter.

See: The "Hardware Installation" and "Hardware Parameter Settings" sections in the *IPC Guide*.

- 2 Install the IPC in a one-port slot as follows.

See: The appropriate sections in the *NCR-3315 User's Manual*.

- Follow the "Installing an Expansion Board" instructions in the "Installation and Care of Your System" chapter of the appropriate *System Guide* to install the IPC in a one-port slot. On the IPC, set the IRQ "SHUNT" to *IRQ11*. This is the interrupt of the IPC; it is necessary to know this when loading the IPC software.
- Align the IPC-900 board with the selected board slot and insert it into the corresponding connector.
- Attach the T-adaptor to the IPC-900 board. Make sure it is plugged firmly and completely into the socket.
- Repeat for additional IPC cards, if supplied. IPC connections must use 10-pin modular cords and 10-pin special adaptors.
- Follow the "Installing a Streaming Tape Controller Board" and "Installing a Streaming Tape Unit" instructions in the Expansion Kits appendix of the appropriate *System Guide* to install the Streaming Tape Controller card and drive (use holes "D" and "K" to attach the rails to the tape drive). On the Tape Drive Controller card, set the IRQ jumper to 5 (default). This is the interrupt of the Tape Drive Controller; it is necessary to know this when loading the Cartridge Utility software.

Procedure 1C — Set Up the Console, Keyboard, Cables and Processor

- 1 Set up and prepare the console.

See:

- The appropriate section in the *NCR-3315 User's Manual*.
- For details on setting up the console terminal, see "Step 4 — Set Up the Terminals and Modems" in this chapter.

- 2 Connect the monitor, keyboard, and power cord to the processor.

See: The appropriate section in the *NCR-3315 User's Manual*.

- 3 Replace the covers and connect the processor to the power outlet.

See: The appropriate section in the *NCR-3315 User's Manual*.

End of procedures for Step 1

Step 2 — Load the UNIX Essential Utilities

Prerequisites for this Step

Activities

- Make sure that the NCR-3315 processor, keyboard, and console are set up and connected according to Step 1 of this section.

Documents

- *NCR-3315 User's Manual*
- *UNIX System V/386 Release 3.2.3 Operations/System Administration Guide (Admin Guide)*
- *UNIX System V/386 Release 3.2.3 Release Notes (Release Notes)*

Hardware/Software Components

- Base System Package Disk
- UNIX Operating System Foundation Set software, on cartridge tape.

Procedure 2A — Run the Setup Utility

- 1 Configure the base system.

Reference: The appropriate section of the *NCR-3315 User's Manual*.

- 2 When running the Setup utility, check to see that the Extended Memory is correct for the amount of memory installed in the system.
 - Press **CTL** - **ALT** - **DEL** to reboot.
 - Wait for the beep.
 - Press **CTL** - **ALT** - **INSERT** to see the current settings for your configuration. The memory size(s) should match the data shown in Table 5-2.

TABLE 5-2
Memory size, NCR-3315

Memory Installed (MB)	Extended Memory (KB)
8	7552

3 Set **Console Redirection** to the **COM2** Port at a speed of 1200 baud.

See: The appropriate section in the *NCR-3315 User's Manual*.

Procedure 2B — Load the UNIX Foundation Set

1 Begin loading the UNIX Foundation Set.

See: The "Boot System to Single-User Mode" instructions in the "Software Installation" section of the *Admin Guide*.

2 Run the setup and begin partitioning the hard disk as follows.

See: The "Perform Installation Setup" instructions in the Software Installation section of the *Admin Guide*. Follow the setup procedure for a new installation.

- Select *1* to create an MS-DOS partition.
- When prompted, enter the amount of hard disk allocated to DOS as *5 percent* (for 100 MB disk).
- Enter *n* to indicate that the MS-DOS partition is not the active partition.

3 Create the UNIX partition as follows.

- Select *1* to create a UNIX partition.
- Select *1* to indicate that a UNIX System partition is to be created.
- When prompted, enter the amount of hard disk allocated to UNIX as *95 percent* (for 100 MB disk).
- Enter *y* to indicate that the UNIX partition is to be active every time the machine is booted.
- Select *4* to update the disk configuration and exit.

4 Continue partitioning the hard disk.

See: The "Prepare Hard Disk for Surface Analysis" instructions in the Software Installation section of the *Admin Guide*.

5 Complete the hard disk partitioning process as follows.

See: The "Create UNIX System File Systems" instructions in the Software Installation section of the *Admin Guide*.

- Enter *n* to indicate that the default partition allocations are not acceptable.
- Enter *y* at the partition prompt:

Separate root and usr?

- Enter *n* at the next partition prompt:

Additional usr2?

- Enter *n* at the next partition prompt:

Crash/dump area?

- Enter *61* as the number of cylinders assigned to swap/paging.
 - Enter *76* (for the 100 MB disk) as the number of cylinders allocated for the root partition.
 - Review the new allocation and make a note of it. Swap/paging and root should have the number of cylinders you assigned, and the balance should be assigned to the **/usr** area. Enter *y* to indicate the allocation is acceptable.
 - When you are prompted, remove the diskette from the drive and reboot the system from hard disk.
 - After rebooting the system, enter *c* to install the UNIX system from cartridge tape.
- 6 Load the UNIX essential utilities.
- See:** The "Install Base System (From Cartridge Tape)" instructions in the Software Installation section of the *Admin Guide*.
- 7 Assign a root password.
- 8 Assign an install password.

Procedure 2C — Load Add-On Packages From Tape

Follow the instructions on the Package Selection menu to install the add-on packages from cartridge tape. Select the following for installation:

- 1 *Editing Package*
- 2 *FMLI*
- 3 *FACE*
- 4 *FACE Help*

Note: The FACE Help package is totally different than the FACE package.

- 5 Press to execute.
- 6 Press to continue.
- 7 Enter *4* to install all of the Help files.
- 8 Enter *5* to complete (terminate) the Help file installation.
- 9 Continue the installation with the cartridge tape utilities.

See: Table 5-1 for the appropriate IRQ load.

- 10 Reboot the system.

End of procedures for Step 2

Step 3 — Load the Additional Software

Prerequisites for this Step

Activities

- Make sure that the NCR-3315 WGS, keyboard, console, and additional cards are installed according to Step 1 of this section. You need to know the location, memory addresses, and IRQ levels of the boards in the processor.
- Make sure that the correct version of the UNIX Foundation Set is loaded according to Step 2 of this section.

Documents

- *UNIX System V/386 Release 3.2.3 Operations/System Administration Guide (Admin Guide)*
- *Intelligent Ports Card Model 900 (IPC-900) User's Guide (IPC Guide)*
- *AT&T Work Group System Remote Maintenance Package User's Guide (RMP Guide)*

Hardware/Software Components

- UNIX System V/386 Release 3.2.3 Remote Terminal Package
- AT&T IPC UNIX System V 386 Device Driver
- Security Administration Package

When Installing from Diskette

- Use the "Install Optional Add-On Packages (From Diskette)" instructions in the "Software Installation" section of the *Admin Guide* to load the individual software packages.
- If your processor has two disk drives, specify the drive from which you are loading.
- If asked how many diskettes are in the package, count the number of diskettes for the specific package only. Whenever multiple diskettes exist for a specific package, make sure you load these diskettes in sequential order.
- If asked for the diskette type, either look on the diskette for the applicable type or enter *1.44*.
- If asked to reboot the system, press to skip the reboot process. You do *not* have to reboot after loading each software package; however, you *must* reboot the system after the last package is loaded.

Note: The NCR-3315 machine will not work with the GPSC-AT card.

Procedure 3A — Load the Remote Terminal Package

Note: This is *not* the Remote Maintenance Package, which is loaded at a different time.

- 1 Enter *installpkg* at the prompt to load the Remote Terminal Package.
- 2 Enter *1* to install the terminfo files.

Call: The TSC Hotline (1 800 548-8861) to obtain the **terminfo** entry needed to use the 730 terminal and the 615 BCT with the System 75 Emulation cartridge. (For the 715 BCS, use "BCS" as the emulation mode and "513" for the terminal type when cutting through from G3r, G3i, G1, or System 75 to AUDIX™.)

- 3 Enter *all* to load all the terminfo files.
- 4 Enter *done* after the list of files is displayed.
- 5 Enter *0* to complete (terminate) the terminfo file load.

Procedure 3B — Load the IPC Device Driver

Note: Make sure you are using Version 3.0 (or higher) for the IPC-900.

- 1 Enter *installpkg* at the prompt to load the IPC software.
- 2 Enter the number of IPC cards installed in the system. For each IPC, do the following.
 - Press to select the default (IPC-900) for the type of ports card installed in the system.
 - Enter the Interrupt Request Level (IRQ) of the IPC.

See: Table 5-1 in this guide for the IRQ level required. (The IRQ for the NCR-3315 is 11).

- Do one of the following:
 - a Press to select the default starting address of the I/O ports and controller memory.
 - b Enter the appropriate addresses as set on the card during the installation.

See: The "Hardware Parameter Settings" section in the *IPC Guide*.

- 3 Enter *y* to confirm the settings.
- 4 Reboot as instructed.

End of procedures for Step 3

Step 4 — Set Up the Terminals and Modems

Prerequisites for this Step

Activities

- Make sure that the NCR-3315 processor, keyboard, console and software are set up and connected according to Steps 1 through 3 of this section.

Documents

- User's Guide - 615 Business Communications Terminal Guide, or 715 Business Communications System (BCS) User's Guide and Service Manual, or 730 Multi-Tasking Graphics Terminal Guide (*Terminal Guide*)
- DATAPHONE II 2224-CEO Modem User's Manual or DATAPHONE II 2224-GNN Modem Manual (*Modem Manual*)
- Intelligent Ports Card Model 900 (IPC-900) User's Guide (*IPC Guide*)

Hardware/Software Components

- 615 BCT(s), 715 BCS(s), or 630 or 730 MTG(s) [optional]
- One 513 BCT/System 75 Emulation Cartridge per 615 BCT for accessing G3r, G3i, G1, or System 75 maintenance and administration functions
- 2224 modem(s) for use with bidirectional 1200/300 baud asynchronous communications for UUCP and communication with administered switches
- 10-pin modular cables with 10-pin special adaptors

Procedure 4A — Set Up the Terminals

- 1 Unpack, install, and set up the terminal.

See: The "Unpack and Install" (615 BCT or 715 BCS) or "Installation" (730) instructions in the *Terminal Guide*.

Note: The 630 or 730 MTG is most effectively used at speeds above 2400 baud, therefore it should not be connected through a modem.

- 2 To make the terminal operational for Monitor I:

- Install the 513 BCT/System 75 Emulation Cartridge by inserting the 513 BCT/System 75 cartridge into the slot on the side of the 615 BCT. Be sure that the cartridge is right side up, with the cartridge label toward the front.

Warning: Check the on/off switch before you install the cartridge to make sure that the power for the 615 terminal is turned *off*. A blank screen is *not* an indicator that the terminal is off, and you will destroy the 513 BCT/System 75 cartridge if you insert or remove it while the terminal is on.

- Follow the instructions in the *Terminal Guide* to enable the cartridge.
- For the 715 terminal, enter the following settings:
 - Set the emulation mode to: *BCS*
 - Set the UNIX terminal type (TERM) to: *sys75*
 - Set the terminal type for cut-through access from Monitor I to G3r, G3i, G1, and System 75 to: *513*
 - Set the **Swap Delete** option of the 715 terminal to: *yes* (through terminal setup) for BCS.
- Change the **Cursor Blink** option to *y* for yes.
- Cut-through access to System 75 R1V1 for maintenance or administration requires that the System 75 be equipped with a pooled modem card that allows asynchronous communications.

Procedure 4B — Set Up the Modems

Monitor I supports the 2224-CEO, 2224-GNN modems and AT&T 2400. For either modem, you must set up the hardware switches, as follows.

See: The appropriate *Modem Manual* for complete installation procedures.

Contact the Technical Service Center (TSC) at 1 800 548-8861 to have your modem checked after you have completed the appropriate modem procedures.

2224-CEO Modems

For the 2224-CEO modem:

- 1 Remove the CEO modem cover to access the Internal Option switches. See Figure 5-1 for a diagram of the CEO modem hardware switches.

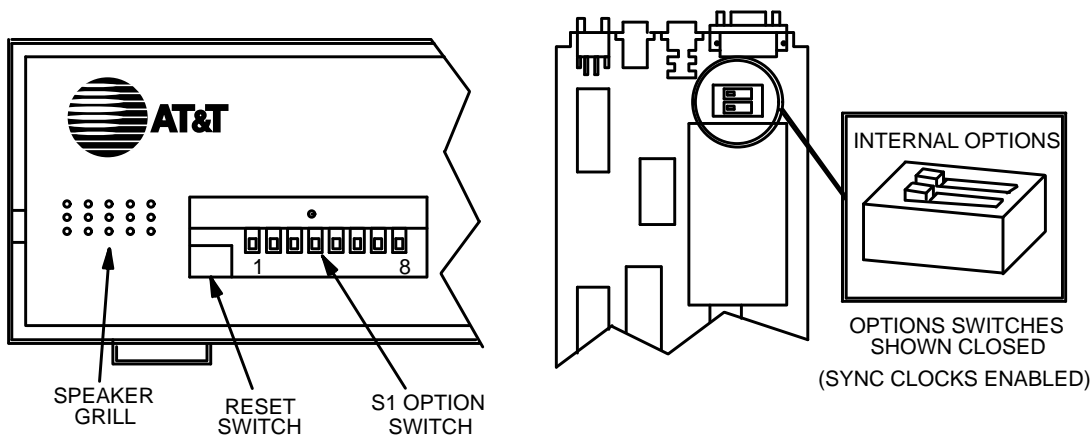

FIGURE 5-1
CEO Modem Hardware Switches

- 2 To set your modem switches:
 - For dial-out or bidirectional 1200/300 baud asynchronous, dialer-enabled modems, set the switches according to Table 5-3.

TABLE 5-3
2224-CEO Dial-Out 1200/300 Asynchronous Communications

Switch	Push	Switch	Push	Switch	Push
1-1	down	1-5	down	internal-1	away from number
1-2	down	1-6	up	internal-2	away from number
1-3	down	1-7	down		
1-4	down	1-8	down		

- 3 Plug the power cable from the modem into the power outlet.
- 4 Reset the modem by pressing and releasing the **RESET** switch. This makes your changes effective.

2224-GNN Modems

See Figure 5-2 for a diagram of the GNN modem hardware switches.

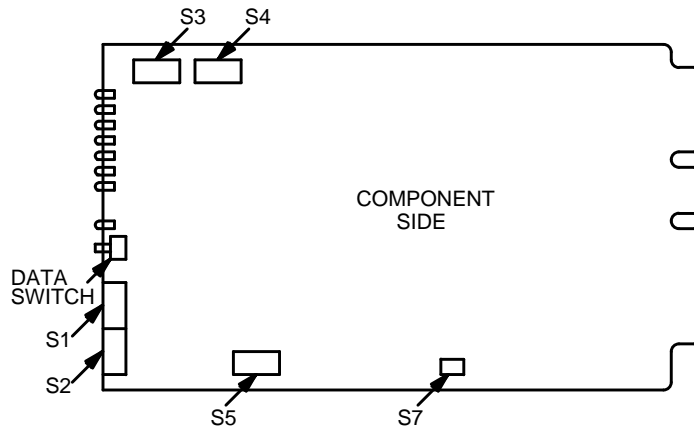

FIGURE 5-2
GNN Modem Hardware

- 1 For dial-out or bidirectional 1200/300 baud asynchronous, dialer-enabled 2224-GNN modems, set the switches according to Table 5-4.

TABLE 5-4
2224-GNN Dial-Out 1200/300 Asynchronous Communications

Switch	Push
1-1	left
1-2	left
1-3	left
1-4	right
1-5	right
1-6	left
1-7	left
1-8	left
2-1	right
2-2	right
2-3	left
2-4	left
2-5	left
2-6	left
2-7	left
2-8	left
3-1	right or up
3-2	right or up
3-3	right or up
3-4	left or down
3-5	left or down
3-6	left or down
3-7	left or down
3-8	left or down

- 2 Reset the modem by removing it from the rack, then putting it back. This makes the changes take effect.

Set Up An AT&T 2400 Modem

The AT&T 2400 modems can arrive from the factory in an unknown state; they can be in a state that will not allow them to communicate with a UNIX system. Therefore, these modems should be configured using a terminal.

Install the AT&T 2400 Modem

Install the AT&T 2400 modem as follows:

- 1 Plug in the modem's power adaptor.
- 2 Connect the modem to the main port of an AT&T 615 Terminal using a straight through male to male RS-232 cable.
- 3 Set the terminal speed to 1200.
- 4 Set the terminal Parity to *EVEN*.
- 5 Set the terminal Send Parity to *NO*.

Set the 2400 Modem Software Options

Set the software options in the 2400 modem using a terminal. The modem can be configured for bidirectional port transmission or product access.

- For a bidirectional transmission use the sequence of commands provided in Table 5-5, Column 1. AT&T 2400 modems used for bidirectional traffic such as login or UUCP must be locked at one baud rate.
- For a product access configuration, use the sequence of commands provided in Table 5-6, Column 1. AT&T 2400 modems used for product access (various baud rates) must only be used for product access (outgoing only).

**TABLE 5-5
AT&T 2400 Modem Bidirectional**

Command	Meaning
AT&F	Factory Default
AT&MO	Turn speaker off
AT&QO	Standard Async
ATQ2	Result code in originate only
AT&D2	Enter command mode on DTR dropping
AT&KO	No flow control
AT&C2	CD on for cmd mode, track carrier for data transfer
ATSO=1	Auto Answer
ATS37=6*	Maximum DCE Line Speed**
AT&WO	Write storable parameters of current configuration in memory as profile 0
AT&YO	Specify stored user profile 0 as power up configuration

**TABLE 5-6
Configuration of a Product Access Modem**

Command	Meaning
AT&F	Factory Default
AT&MO	Turn speaker off
AT&QO	Standard Async
ATQ2	Result code in originate only
AT&D2	Enter command mode on DTR dropping
AT&KO	No flow control
AT&C2	CD on for cmd mode, track carrier for data transfer
ATSO=1	Auto Answer
ATS37=0*	Maximum DCE Line Speed
AT&WO	Write storable parameters of current configuration in memory as profile 0
AT&YO	Specify stored user profile 0 as power up configuration

* Varies across the two configuration tables; all other commands are common for all configurations.

** Set to 5, 1200 baud; set to 6, 2400 baud

Configure the UNIX System

The *Dialers* file of UNIX System V Release 3.2.3 contains the following line:

```
#hayes =,-, "" \M\dAT\r\c OK\r \EATDT\r\c CONNECT \m\c"
```

Activate this file by removing the comment symbol, #, at the beginning of the line.

For modems that are to be used for outgoing calls (bidirectional), change the procedure for configuring the UNIX System as described in the *Installation Manual* as follows:

- In the *Connect to Modem* form of the FACE Menu, set the **Modem Name** field to *Non-Autodialing*.
- The **Devices** files will contain a line corresponding to each modem configured for outgoing calls. The following is a typical entry in this file:

```
ACU ttyh06,M - 1200 Non-Autodialing
```

- For each modem, edit the file by entering a set like the following:

```
ACU ttyh06 - 300 hayes  
ACU ttyh06 - 1200 hayes  
ACU ttyh06 - 2400 hayes
```

End of Procedure

Set the AT&T DataPort 3710 Modem Software Options

Set the software options in the AT&T DataPort 3710 modem using the dialers file described in the next section, "Configure the UNIX system". The modem can be configured for bidirectional port or product access.

- AT&T DataPort 3710 modems used for bidirectional traffic such as login or UUCP must be locked at one baud rate.
- AT&T DataPort 3710 modems used for product access (various baud rates) must only be used for product access (outgoing only).

Configure the UNIX System

The *Dialers* file of the UNIX System V Release 3.2.3 must be added on one consecutive line as follows:

```
ATTparadyne =+,, ""\M\dAT\r\c OK\r AT&FL3Q2&C2&R0\Q0\N1%C0\r\c  
OK\r AT&W0&Y0 OK\r \dATDT\r\c 00
```

For modems that are to be used for both incoming and outgoing calls (bidirectional), the procedure for configuring the UNIX System as described in the *Installation Manual* changes as follows:

- In the **Connect to Modem** form of the FACE Menu, set the **Modem Name** field to **HayesSmartm2400**.
- The **Devices** files will contain a line corresponding to each modem configured for outgoing calls. The following is a typical entry in this file:

```
ACU ttyh06 - 1200 ATTparadyne
```

- For each modem, edit the file by entering a set as shown in the following:

```
ACU ttyh06 - 300 ATTparadyne  
ACU ttyh06 - 1200 ATTparadyne
```

```
End of Procedure
```

Procedure 4C — Connect the Terminals

- 1 Find the red ground lug on one end of the 10-conductor Modular Cable. Insert that end of the cable into a port on the IPC T-connector and connect the ground lug to the ground slot beneath the port.
- 2 Write the port number, associated device name, and phone line on the Port Configuration Worksheet in **Appendix B** of this manual.
- 3 Connect the other end of the 10-conductor cable to a terminal/printer adaptor and connect the adapter to the port labeled **MAIN** on the back of the terminal.
- 4 Plug the power cables from the terminals into the power outlet.

Procedure 4D — Connect the Modems

- 1 Connect the 10-conductor cables from the modems to the IPC serial ports.
- 2 Connect the modems to the phone lines.
- 3 Plug the power cables from the modems into the power outlet.
- 4 Write the port number, associated device name, and phone line on the Port Configuration Worksheet in **Appendix B** of this manual.

End of procedures for Step 4

Step 5 — Set Up and Enable the Printer

Prerequisites for this Step

Activities

- Make sure that the Monitor I system was installed according to Steps 1 through 4 of this section.

Documents

- *User's Guide AT&T 570 Printer* or *User's Guide AT&T 593 Printer (Printer Guide)*
- *UNIX System V/386 Release 3.2.3 Operations/System Administration Guide (Admin Guide)*

Hardware/Software Components

- AT&T 570 or 593 Printer
- AC power cord
- Tractor assembly
- Static eliminator

Procedure 5A — Set Up the Printer

- 1 Set up the printer connection parameters.

See: The "Operation Panel and Operational Procedures in Set-Up Mode" instructions in the *Printer Guide*.

- 2 Use **FACE** to set up the printer parameters.

Procedure 5B — Connect the Printer Cable

- 1 Connect one end of the parallel printer cable to the printer and the other end to the parallel port on the processor.
- 2 Write the port number and associated device name on the Port Configuration Worksheet in **Appendix B** of this manual.

Procedure 5C — Enable the Printer

- 1 Log in as *root*.
- 2 At the prompt, enter *face* and press .
- 3 Enter the following menu selections:

```
System Administration
├─ Peripheral Setup
│   └─ Printer Setup
│       └─ Parallel Printer Port Setup
```

System Response:

- 4 Enter the appropriate printer type, either *AT&T570* or *AT&T593* and press .

System Response:

- 5 Enter the name of the printer and press .

Example: *pr1*

System Response:

- 6 Select the default, *yes*.
- 7 Press to save the values.
- 8 Press to continue with this procedure.
- 9 Press three times to return to the **FACE** main menu.
- 10 Select *exit* then press to exit from the **FACE** main menu.

11 At the next prompt, enter: *lpstat -t*

System Response:

Information about the printer you enabled (for example, pr1) is displayed.

End of procedures for Step 5

Step 6 — Rebuild the UNIX Kernel

Prerequisites for this Step

Activities

- Make sure that the NCR-3315 WGS, keyboard, console, additional terminals, and modems are installed according to Steps 1, 2, and 4 of this section.
- Make sure that the UNIX Foundation Set and additional software were loaded according to Step 3 of this section.
- Make sure that the terminals and modems have been set up and the ports were enabled according to Steps 4 and 5 of this section.

Documents

- *UNIX System V/386 Release 3.2.3 Operations/System Administration Guide (Admin Guide)*

Procedure 6A — Edit the Kernel File

- 1 Using **vi** or **ed**, edit the **/etc/conf/cf.d/mtune** file with the information listed below. These fields are in the fourth column (which is the MAX field).
 - NUMXT = 8
 - MAXUP = 80

- 2 Using **vi** or **ed**, edit the **/etc/conf/cf.d/stune** file using the following suggested minimum parameter settings for Monitor I.

If Monitor I is running with a coresident application and if the other application recommends a different Kernel parameter, set the parameter to the larger of the recommended settings. If a parameter is *not* found in the file, you must add the entry to the file using the following format.

parameter TAB *xxx*

Where: *xxx* = the value of the parameter.

- NINODE = 100 times the number of MB of RAM in the system or 1300, whichever is lower.

Note: This value should be less than or equal to NS5INODE.
- NS5INODE = 100 times the number of MB of RAM in the system or 1300, whichever is lower.
- NFILE = 100 times the number of MB of RAM in the system or 1300, whichever is lower.
- NPROC = 30 times the number of MB of RAM in the system or 400, whichever is lower.
- MAXUP = 80

- `ULIMIT = 8192`
- `NBUF = 100` times the number of MB of RAM in the system or 2750, whichever is lower.
- `NCLIST = 60` times the number of MB of RAM in the system or 1180, whichever is lower.
- `NREGION = 100` times the number of MB of RAM in the system or 1200, whichever is lower.
- `SHLBMAX = 6`
- `NUMXT = 8`

Procedure 6B — Rebuild the Kernel

- 1 Enter `cd /` at the prompt.
- 2 Enter `/etc/conf/bin/idbuild` at the prompt.

Procedure 6C — Reboot the System

- 1 When you see the following message:

UNIX Kernel has been rebuilt

enter the following to change directories: `cd /etc/default`.

- 2 Using `vi` or `ed`, edit the file named `login`.
- 3 Search for `ULIMIT` and change the value to `8192`.
- 4 Save the changes and exit the text editor.
- 5 Change to the root directory: `cd /`.
- 6 Enter `shutdown` to reboot the system.
- 7 When prompted, enter `y` to continue the shutdown.
- 8 Reboot the system when prompted by pressing `CTL` - `ALT` - `DEL`.

End of procedures for Step 6

Step 7 — Load the INFORMIX Software

Prerequisites for this Step

Activities

- Make sure that the NCR-3315 processor and software have been installed according to Steps 1 through 7 of this section.
- This step can be completed before the terminals and modems are connected.

Documents

- *UNIX System V/386 Release 3.2.3 Operations/System Administration Guide (Admin Guide)*
- *INFORMIX installation instructions*

Hardware/Software Components

- INFORMIX-SQL Release 4.0 software
- INFORMIX-SE Release 4.0 software

Procedure 7A — Add the INFORMIX Group

- 1 Log in as *root*.
- 2 Using *vi* or *ed*, edit the System Group file, */etc/group*.
- 3 Add the following to the end of the file:

informix::nnnn:

Where: *nnnn* is the group id, which can be any group number not already used.

- 4 Save the file and exit the UNIX editor.

Procedure 7B — Add the INFORMIX User

- 1 Use **FACE** to add the login, *informix*.
 - **Login Name** — *informix*
 - **Full Name** — *INFORMIX-SQL*
 - **Login ID number** — Use the default login ID number.

- **Home Directory** — Enter the directory name as:
<directory>/login_name
Example: */usr/informix*
Note: Make sure that the **<directory>** already exists.
 - **System Administration Privileges** — *no*.
- 2 Assign a password as instructed.
 - 3 Save the login and exit FACE.
 - 4 Edit the **/etc/passwd** file using **vi** or **ed**.
 - Search for the string: **informix:x:mmmm:1:INFORMIX SQL:/usr/informix:**
Change the **:1:** field to **:nnnn:**
Where: **nnnn** is the INFORMIX group ID specified in Procedure 7A and **mmmm** is a user ID that is chosen for the INFORMIX user ID.
Example:
user login name:x:user id:group id: user full name:user full path:
 - 5 Save and exit the UNIX text editor file.

Procedure 7C — Load the INFORMIX-SQL Software

- 1 Enter *installpkg* at the prompt to load the INFORMIX software from diskette.
- 2 Follow the instructions, insert the diskettes in sequential order, and press .
- 3 Enter the 11-character serial number *exactly* as it appears on the diskette or the Customer Registration card.
- 4 Enter the 6-character serial number KEY *exactly* as it appears on the Customer Registration card.

Procedure 7D — Load the INFORMIX-SE Software

- 1 Enter *installpkg* at the prompt to load the INFORMIX software from diskette.
- 2 Follow the instructions, insert the diskettes in sequential order, and press .
- 3 Enter the 11-character serial number *exactly* as it appears on the diskette or the Customer Registration card.
- 4 Enter the 6-character serial number KEY *exactly* as it appears on the Customer Registration card.

Procedure 7E — Display the Installed Packages

- 1 Enter *displaypkg* at the prompt.
- 2 Make sure the list displayed contains the following software loaded during this installation procedure.
 - Cartridge Tape Utilities
 - Editing Package
 - FACE and FACE HELP Packages
 - FMLI Package
 - INFORMIX-SE Software
 - INFORMIX-SQL Software
 - Intelligent Ports Card (IPC) Device Driver Package
 - Remote Terminal Package

End of procedures for Step 7

Step 8 — Add the Monitor I Group and Users

Prerequisites for this Step

Activities

- Make sure that the 6386SX/EL processor, keyboard, console, additional terminals, and modems are installed according to Steps 1, 2, and 4 of this section.

Documents

- *UNIX System V/386 Release 3.2.3 User's/System Administrator's Reference Manual (Reference Manual)*

Procedure 8A — Add the Monitor I Group

- 1 Log in as *root*.
- 2 At the UNIX prompt, enter *vi /etc/group, 6386SX/EL* to edit the System Group file.
- 3 Add *traf::nnnn:* to the end of the file.

Where: *nnnn* is the group id that is any number not already used.

- 4 Save the file and exit the UNIX *vi* editor.

Procedure 8B — Add the Monitor I Users

- 1 Use **FACE** to add the login, **mtmadm**.
 - **Login Name** — *mtmadm*
 - **Full Name** — *Monitor I Administrator*
 - **Login ID number** — Use the default login ID number.
 - **Home Directory** — Enter the directory name as:
<directory>/login_name

Example: */usr/mtmadm*.

Note: Make sure that the *<directory>* already exists.

- **System Administration Privileges** — *no*.
- 2 Enter a password for **mtmadm**, as instructed.
 - 3 Remember to save the user login information.
 - 4 Create another login, **mtmadm1**.

Note: This login is primarily used to facilitate the execution of **cron**.

- **Login Name** — *mtmadm1*
- **Full Name** — *Monitor I cron login*
- **Login ID number** — Use the default login ID number.
- **Home Directory** — Enter the directory name as
 <directory>/login_name

Example: */usr/mtmadm1*

Note: Make sure that the <directory> already exists.

- **System Administration Privileges** — *no*.
- 5 Enter a password for **mtmadm1**, as instructed.
 - 6 Remember to save the user login information.
 - 7 Exit FACE and return to the UNIX System.
 - 8 Using **vi** or **ed**, edit the **/etc/passwd** file.
 - Search for the string:
 mtmadm:x:mmmm:1:Monitor I Administrator:<directory>
 - Change **:1:** to **:nnnn:**
 Where: **nnnn** is the Monitor I group id specified in "Procedure 8A — Add the Monitor I Group" and <directory> is the home directory for **mtmadm**.
 - Search for the string:
 mtmadm1:x:mmmm:1:Monitor I cron login:<directory>
 - Change **:1:** to **:nnnn:**
 Where: **nnnn** is the Monitor I group id specified in "Procedure 8A — Add the Monitor I Group" and <directory> is the home directory for **mtmadm1**.
- Note:** When Monitor I is installed, the **mtmadm1** login is blocked.
- 9 Save the file and exit the UNIX text editor.
 - 10 Type *chgrp traf <directory>* at the prompt.
 Where: <directory> is the home directory of **mtmadm**.
 - 11 Repeat the previous step for **mtmadm1**.
 - 12 Use this procedure to add additional logins for Monitor I users, as necessary.
 Note: Assign UNIX **at** and **cron** privileges to users who will be scheduling Monitor I reports. Refer to the *Reference Manual* for information on **at** and **cron**.

Procedure 8C — Edit the .profile

- 1 Use **vi** or **ed** to edit the **.profile** for each Monitor I user.
- 2 Change the **FACEINVOKE** field entry so that users do not have to go through the FACE menu to get to Monitor I. Edit the field so that it reads: *FACEINVOKE = no* .
- 3 Add the following entry to the **end** of the **.profile** so that each login can use Monitor I:
 . <directory>/mtm/tools/profile

Where: <directory> is the name of the directory under which you will be installing Monitor I in **Step 11** of **Procedure 9A**.

Note: If CAFE is used, do not append the **.<directory>/mtm/tools/profile** entry to the users **.profile**.

- 4 Make sure that the **mtmadm** login also gets a **.profile** configured as listed above.

End of procedures for Step 8

Step 9 — Load the Monitor I Software

Prerequisites for this Step

Activities

- Make sure that you have added the Monitor I group and users, explained in Step 8 of this chapter.
- Make sure that you have installed INFORMIX, according to the directions listed in Step 7.
- If you are installing an upgrade (a **warm install**), make sure that no one is using the Monitor I files (directories), and that the Poller and Alarm Manager are not running.
- If you are performing a **warm install**, make sure you do a full backup of Monitor I first. Perform the backup according to the "Back Up Monitor I" (6386SX/EL) procedure listed in the *DEFINITY Monitor I Operations Guide*.

Documents

- *DEFINITY Monitor I Operations Guide (Ops Guide)*

Hardware/Software Components

- DEFINITY Monitor I installation tape
- Disk Configuration Worksheet obtained from your AT&T Representative

Procedure 9A — Cold Install of Monitor I Software

What?

This procedure describes how to do a **cold install** of Monitor I. A cold install is usually done when you are installing Monitor I for the very first time. A **warm install** is done when you are updating existing Monitor I software. See **Procedure 9B — Warm Install of Monitor I Software** for information about warm installs.

In some instances, you may already have Monitor I installed, but you want to remove it and start all over. In this case, you would choose a **cold install** to completely remove the Monitor I directories and databases and reinstall new ones.

How Long?

This procedure takes about 30 minutes to finish.

- 1 Log in as *root*.
- 2 Enter *installpkg* and press .

System Response:

**Please indicate the installation medium you intend to use.
Strike "C" to install from CARTRIDGE TAPE
or "F" to install from FLOPPY DISKETTE.**

- 3 Enter *c* and press .

System Response:

Please insert the cartridge tape into the tape drive.

- 4 Press .

It is recommended that you re-tension the tape before attempting the installation, to ensure that the tape is read without any errors.

- 5 Press to retension the tape. This takes about three minutes.

System Response:

Packages available for installation:

1. **DEFINITY Monitor I Release 3.0**
2. **Install ALL packages shown above**
3. **Exit, do not install any packages**

- 6 Enter **1** to install Monitor I, press **RETURN**, followed by **ESC**. System Response:

You have made the following selections:

1. **DEFINITY Monitor I Release 3.0**

- 7 Press **RETURN** to confirm your selection.

Note: Press **ESC** if you want to redisplay the package selections.

System Response:

REMINDER!

Depending on the packages you are installing, you may be required to provide some input to the installation utility to configure the software for your system.

- 8 Press **RETURN** to continue the installation.

System Response:

Installation in progress --Do not remove the cartridge tape

This message is followed by a copyright message for Monitor I.

System Response:

Enter type of installation you want (w-warm, c-cold, e-exit):

Note: If you choose to exit at this point and you want to restart installation, you must reinsert the tape. Any time after this point, you can exit and restart without reinserting the tape.

- 9 Type *c* and press .

System Response:

Enter the directory where you want to install Monitor I? (/usr) :

- 10 Enter the default, */usr*, or the the directory of your choice, then press .

Note: Monitor I will be installed in the directory you specify, under a subdirectory called **mtm**. If this subdirectory does not exist, the system will now create it for you.

Example: Entering */usr* or */usr1/traf* results in Monitor I being installed in the directory */usr/mtm* or */usr1/traf/mtm* respectively.

System Response:

Monitor I will be installed under <directory name>/mtm, continue ? (y/n):

Where: <directory name> is the name of the directory you specified in the previous step.

- 11 Enter *y* to continue and press .

System Response:

WARNING- Cold installation will remove all Monitor I directories and existing database(s), if any. No one should be using Monitor I during installation. Make sure Monitor I polling system and alarm manager are not running.

Cold installation will proceed, continue? (y/n) :

- 12 Enter *y* to continue and press **RETURN**.

System Response:

Select processor type -
Enter 1 for 3B2-600
2 for 6386E/33 model S
3 for 6386SX/EL or NCR 3315

- 13 Enter *3* and press **RETURN**.

System Response:

You are installing on a 6386SX/EL or NCR 3315 processor.
Do you want to continue? (y/n) :

- 14 Enter *y* and press **RETURN**.

System Response:

Enter switch type(s) separated by ','
(G3r, G3i, G2, G1, SYS85, SYS75, FP8, or ALL) :

If you select *ALL* the system response screen shown in Step 15 is displayed. If you select individual switches, the system also prompts you to select the releases you want for each switch selection.

- G3r:

Enter issue(s) for G3r switch separated by ','
(1):

- G3i:

Enter issue(s) for G3i switch separated by ','
(1):

- G2:

Enter release(s) for G2 switch separated by ','
(2.1, 2.2):

- G1:

Enter release(s) for G1 switch separated by ','
(1.1):

- SYS85:

Enter release(s) for SYS 85 switch separated by ','
(R2V4, R2V3, R2V2):

- SYS75:

Enter release(s) for SYS75 switch separated by ','
(R1V3, R1V2, R1V1):

- FP8:

Enter release(s) for FP8 switch separated by ','
(3.8, 1.16):

15 Enter the switch type(s) and releases you want to install then press .

System Response:

Pre-installation checks in progress

- If pre-installation checks have completed successfully, the following message is displayed:

Pre-installation checks have completed successfully.

- If pre-installation checks did *not* complete successfully, a list of error messages is displayed, followed by this message:

Pre-installation checks did not complete successfully.

Note: To continue, fix the errors using error message explanations found in **Appendix C** of this manual. Once the errors have been resolved, try installing Monitor I again using this procedure, starting with the **installpkg** command in **Step 2**.

If pre-installation checks completed successfully, the following prompt is displayed:

Do you want to create database place holder(s)? (y/n):

Note: If you enter *n*, the software is installed, but no placeholders are created. You can add placeholders after installation is completed by using the **addmount** procedure discussed in "9C — Create Placeholders Using Addmount."

- 16 Enter *y* to create database placeholders then press .

System Response:

Do you want to use the "Rotating Switch Study" feature? (y/n):

Reference: Refer to the DOSS Configuration output for the appropriate response.

- If you answer *n*, the following prompt is displayed:

Enter the directory to create the database(s) e.g. /usr1 ? :

Continue the software load with Step 19 of this procedure.

- If you answer *y*, the following prompts are displayed:

Enter the total number of G2, SYSTEM 85 or FP8 switches?:

Enter the total number of G3r, G3i, G1 or SYSTEM 75 switches?:

- 17 If you are using the **Rotating Switch Study** feature, enter the correct response to these questions and press to get the next prompt.

System Response:

Are the values entered above correct? (y/n):

- If you answer *n*, the system again prompts you to enter the total number of switches.
- 18 Once all values are correct, type *y* then press .

System Response:

Enter the directory to create the database(s), e.g. /usr1 ? :

Reference: Refer to the DOSS Configuration output for the appropriate directory.

- 19 Enter the directory name and press .

Note: The next questions refer to the number of placeholders for databases to be created under each mount point (database directory) for each polling option.

System Response:

```

How many G2, SYS85 or FP8 (EXTENDED) database(s) ? (0-40) :
How many G2, SYS85 or FP8 (STANDARD) database(s) ? (0-40) :
How many G2, SYS85 or FP8 (DAILY and LIMITED) database(s) ? (0-40) :
How many G1 1.1 or SYSTEM 75 database(s)? (0-40) :
How many G3r or G3i (EXTENDED) database(s)? (0-40) :
How many G3r or G3i (STANDARD) database(s)? (0-40) :
How many G3r or G3i (DAILY and LIMITED) database(s)? (0-40) :
How many inactive database(s)?

```

Note: The last prompt, **How many inactive database(s)?** , is only displayed if the **Rotating Switch Study** feature is used.

- 20 Enter the correct response to each of the questions listed above and press to get the next prompt.

Note:

- You *must* enter the correct number of databases for Monitor I to work properly. This information depends on the number of switches being supported and how your disk is sliced. See your Disk Configuration Worksheet for more information.
- Monitor I allows you to repeat this procedure for each mount point (database directory) and polling option per switch type that you have.

System Response:

```
Are the values entered above correct? (y/n):
```

- If you answer *n* , the system repeats the series of questions listed in **Step 19** of this procedure.
- 21 Once all values are correct, type *y* then press .

System Response:

```
Do you want to create more database place holder(s)? (y/n):
```

- If you answer *y* , the system returns to the response in **Step 18** of this procedure.

22 Enter *n* and press **RETURN** to continue with the installation.

Note: The system begins copying the files from the tape and a lengthy list of these files appears in a scrolling display. The files displayed on your screen may vary from the partial system listing displayed in the next screen example.

```
.
.
Copying files from the tape
log
tmp
work
work/pdump
work/polldir
prog
prog/R2V2
prog/R2V2/L1_rep
prog/R2V2/acd_rep
prog/R2V2/covg_rep
.
.
.
prog/R2V2/iparser
prog/R2V2/clock
.
.
```

The following messages appear when the installation completes:

```
All Monitor I files have been installed correctly.
Installation completed successfully.
```

If you *do not* see these messages or if you see error messages during the procedure, look for further information on the errors in **/usr/tmp/journal**. Fix the errors using the error message explanations found in **Appendix C** of this manual, then try installing Monitor I again, starting with the **installpkg** command in **Step 2** of this procedure.

End of Cold Install Procedure

Procedure 9B — Warm Install of Monitor I Software

- 1 Backup Monitor I according to the "Backing Up Monitor I" procedure listed in the *Monitor I Operations Guide*.
- 2 Follow Steps 1 through 8 of "Procedure 9A — Cold Install of Monitor I Software." Complete Step 2 of this procedure when you see this prompt:

```
Enter type of installation you want (w-warm, c-cold, e-exit):
```

- 3 Type `w` at the prompt and press `RETURN`.

System Response:

```
WARNING- No one should be using Monitor I during installation.
Make sure Monitor I polling system and alarm manager are
not running.
Warm installation will proceed, continue? (y/n) :
```

- 4 Enter `y` to continue and press `RETURN`.

System Response:

```
Pre-installation checks in progress ....
```

- If pre-installation checks have completed successfully, the following message is displayed:

```
Pre-installation checks have completed successfully.
```

- If pre-installation checks did *not* complete successfully, a list of error messages is displayed, followed by this message:

```
Pre-installation checks did not complete successfully.
```

Note: To continue, fix the errors using error message explanations found in **Appendix C** of this manual. Once the errors have been resolved, try installing Monitor I again using this procedure, starting with the `installpkg` command in **Step 2** of this procedure.

A lengthy list of files appears on the screen in a scrolling display. After all these files have been installed and some post-installation checking messages appear, the following message is displayed at the completion of the warm installation:

Warm installation completed successfully.

Note: If you do *not* see this message or if you see error messages during the procedure, look for further information on the errors in **/usr/tmp/journal** . Fix the errors, using the error message explanations found in **Appendix C**. Try installing Monitor I again, starting with the **installpkg** command in **Step 2** of this procedure.

- 5 As a final post-installation step, restart the poller and alarm manager. Enter **<directory>/mtm/tools/monitor I start** to bring up the Monitor I poller and alarm processes, where **<directory>** is the name of the directory under which you installed Monitor I.

End of Warm Install Procedure

Procedure 9C — Create Placeholders Using Addmount

Use this procedure to create database placeholders from the UNIX shell, after you have completed the Monitor I installation.

Note: If you have already added placeholders during installation, you will not be able to add additional placeholders from the shell. Also, if you have used the **addmount** procedure previously to add placeholders, you will not be able to execute this procedure a second time.

- 1 Log in as *root*.
- 2 Type `<directory>/mtm/tools/addmount` at the prompt and press .

Where: `<directory>` is the name of the directory under which you installed Monitor I in **Step 9 of Procedure 9A**.

System Response:

Do you want to use the "Rotating Switch Study" feature? (y/n):

Reference: Refer to the DOSS Configuration output for the appropriate response.

- If you answer *n*, the following prompt is displayed:

Enter the directory to create the database(s), e.g /usr1 ? :

Continue the software load with Step 5 of this procedure.

- If you answer *y*, the following prompts are displayed:

Enter the total number of G2, SYSTEM 85 or FP8 switches?:

Enter the total number of G3r, G3i, G1 or SYSTEM 75 switches?:

- 3 If you are using the **Rotating Switch Study** feature, enter the correct response to these questions and press to get the next prompt.

System Response:

Are the values entered above correct? (y/n):

- If you answer *n*, the system again prompts you to enter the total number of switches.
- 4 Once all values are correct, type *y* then press .

System Response:

Enter the directory to create the database(s), e.g. /usr1 ? :

Reference: Refer to the DOSS Configuration output for the appropriate directory.

- 5 Enter the directory name and press .

Note: The next questions refer to the number of placeholders for databases to be created under each mount point for each polling option.

System Response:

How many G2, SYS85 or FP8 (EXTENDED) database(s) ? (0-40) :
How many G2, SYS85 or FP8 (STANDARD) database(s) ? (0-40) :
How many G2, SYS85 or FP8 (DAILY and LIMITED) database(s) ? (0-40) :
How many G1 1.1 or SYSTEM 75 database(s)? (0-40) :
How many G3r or G3i (EXTENDED) database(s)? (0-40) :
How many G3r or G3i (STANDARD) database(s)? (0-40) :
How many G3r or G3i (DAILY and LIMITED) database(s)? (0-40) :
How many inactive database(s)?

Note: The last prompt **How many inactive database(s)?** is only displayed if the **Rotating Switch Study** feature is used.

- 6 Enter the correct response to each of the questions listed above and press to get the next prompt.

Note:

- You *must* enter the correct number of databases for Monitor I to work correctly. This information depends on the number of switches being supported and how your disk is sliced. See your Disk Configuration Worksheet for more information.
- Monitor I allows you to repeat this procedure for each mount point (database directory) and polling option per switch type that you have.

System Response:

Are the values entered above correct? (y/n):

- If you answer *n*, the system returns to the series of questions listed in **Step 5** of this procedure.
- 7 Once all values are correct, type *y* then press .

System Response:

Do you want to create more database place holder(s)? (y/n):

- If you answer *y*, the system returns to the **System Response** listed in **Step 4** of this procedure.
- 8 Enter *n* to continue the **addmount** procedure.
- 9 The following message is displayed for each database directory you entered:

Database place holders successfully created

Note: If you do not see this message, check `/usr/tmp/addout` for possible errors. Refer to **Appendix C** for Monitor I installation error messages and corrective actions.

End of procedures for Step 9

Step 10 — Enable the System Ports

Prerequisites for this Step

Activities

- Make sure the 6386SX/EL processor, keyboard, console, additional terminals, and modems are installed according to Steps 1, 2, and 4 of this section.
- Make sure the UNIX Foundation Set and additional software has been loaded according to Step 3 of this section.
- Make sure the terminals and modems were set up according to Step 4 of this section.

Documents

- Refer to the Port Configuration Worksheet in **Appendix B** for a list of configured ports.
- *Intelligent Ports Card Model 900 (IPC-900) User's Guide (IPC Guide)*

Procedure 10A — Enable Bidirectional Ports

- 1 Log in as *root*.
- 2 Enter *face* at the prompt.
- 3 Enter the following selections:

```
Administrative Menu
└─ Peripheral Setup
   └─ Serial Ports Setup
```

- 4 Use **[F2]**, *Choices* to select the following.
 - An outgoing or bidirectional port to enable.
 - **Device Type** = *MODEM*
 - **Device Speed** = *1200*

Note: If you have DIMENSION FP8 switches, you need to edit the */usr/lib/uucp/Devices* file by creating an additional, identical entry for each ACU entry with a baud rate of 1200. Then, change the 1200 in the duplicate entry to 300.

- **Flow Control** = *hardware*
- 5 Press **[F3]** to save the port selections.
 - 6 From window 5, use **[F2]**, *Choices* to select the following:
 - **Modem Type** = *AT&T 2224B* for all modem types (AT&T 2400, AT&T 2224-CEO and AT&T 2224-GNN)

- **Device Connection** = Both incoming and outgoing calls (bidirectional)
- 7 Press `F3` to save the options.
 - 8 Exit FACE.

Procedure 10B — Set the CEO Modem Software Options

- 1 Plug the phone cable into the port labeled **Line** on the back of the modem.
- 2 Plug the modem into the power supply.
- 3 Log in as *root*.
- 4 Enter `MTMDIR=<directory>;export MTMDIR`.

Where: `<directory>` is the directory under which Monitor I was loaded in "Step 9 — Load the Monitor I Software."

- 5 Enter `$MTMDIR/tools/ceoconfig`
System Response:

Enter port number (e.g. tty31):

- 6 Enter the port number.

Reference: **Appendix B** for the port number assigned to the 2224-CEO modem.

System Response:

Testing /dev/<portnumber>
Please wait...
Hardware Switches Set for Dial-Out or Bi-Directional Asynchronous

- If the modem software options are set correctly, the following prompt is displayed:

<portnumber> Software Options Set Correctly

Perform all tests listed in Appendix A, "Acceptance Testing."

- If the modem software options are set incorrectly, the following prompts are displayed:

```
Software Options Set Incorrectly for Monitor I
Enter y to set them to the Monitor I configuration
or n to keep current settings (y):
```

7 Enter *y*.

System Response:

```
Setting <portnumber> Software Options to Defaults
Options 1-63 set to default
Option 12 is now y
Option 34 is now 1
Option 36 is now 0
Option 41 is now 0

<portnumber> Software Options Set Correctly
```

Where: <portnumber> is the port number assigned to the 2224-CEO modem.

Note: If these messages are *not* displayed or an error message is displayed, run this procedure again from **Step 5** of **Procedure 10B**.

TABLE 5-7
2224-CEO Modem — Software Options

Option Number	Value	Option Number	Value	Option Number	Value	Option Number	Value
1	y	17	10	33	n	49	N/A
2	y	18	n	34	1	50	N/A
3	y	19	n	35	3	51	n
4	y	20	1	36	0	52	f
5	y	21	0	37	0	53	f
6	N/A	22	:	38	0	54	y
7	y	23	^H	39	5	55	n
8	N/A	24	@	40	N/A	56	y
9	n	25	\$B	41	0	57	N/A
10	n	26	\$\$:	42	N/A	58	n
11	n	27	n	43	n	59	N/A
12	y	28	n	44	n	60	N/A
13	n	29	0	45	n	61	N/A
14	n	30	n	46	n	62	N/A
15	y	31	y	47	N/A	63	n
16	n	32	I	48	N/A		

Notes: N/A = Not Applicable

Table 5-7 reflects the 2224-CEO modem settings *after* the **ceoconfig** utility is run. This table is for reference purposes only.

End of procedures for Step 10

Installing on the NCR-3332

This section explains how to install the hardware and software required to use Monitor I on the NCR-3332 processor. The entire installation should take approximately five hours: one hour to complete Step 1 and about four hours to complete Steps 2 through 10.

Step 1 — Set Up the NCR-3332 WGS

Prerequisites for this Step

Activities

- **DO NOT** install any hardware or software before calling the TSC at 1 800 548-8861.
- Make sure you received all the components necessary for the Monitor I system.

Documents

- *NCR System 3000 Model 3332 User's Manual*
- *MEGAPORT XP Expandable High Performance Serial I/O Subsystem Hardware Reference Manual*
- *UNIX & XENIX Device Drivers for MEGAPORT Software Reference Manual*

Hardware/Software Components

- System Unit
- VGA Color Monitor and keyboard for the NCR-3332

Procedure 1A — Set Up the Console, Keyboard, Cables and Processor

- 1 Set up and prepare the console.

See:

- The appropriate section in the *NCR-3332 User's Manual*.
- For details on setting up the console terminal, see "Step 4 — Set Up the Terminals and Modems" in this chapter.

- 2 Connect the monitor, keyboard, and power cord to the processor.

See: The appropriate section in the *NCR-3332 User's Manual*.

- 3 Replace the covers and connect the processor to the power outlet.

See: The appropriate section in the *NCR-3332 User's Manual*.

End of procedures for Step 1

Step 2 — Load the UNIX Essential Utilities

Prerequisites for this Step

Activities

- Make sure that the NCR-3332 processor, keyboard, and console are set up and connected according to Step 1 of this section.

Documents

- *NCR System 3000 Model 3332 User's Manual*
- *UNIX System V/386 Release 3.2.3 Operations/System Administration Guide (Admin Guide)*
- *UNIX System V/386 Release 3.2.3 Release Notes (Release Notes)*

Hardware/Software Components

- Base System Package Disk
- UNIX Operating System Foundation Set software, on cartridge tape.

Procedure 2A — Load the UNIX Foundation Set

- 1 Begin loading the UNIX Foundation Set.

See: The "Boot System to Single-User Mode" instructions in the "Software Installation" section of the *Admin Guide*.

- 2 Run the setup and begin partitioning the hard disk as follows.

See: The "Perform Installation Setup" instructions in the Software Installation section of the *Admin Guide*. Follow the setup procedure for a new installation.

- Select *1* to create an MS-DOS partition.
 - When prompted, enter the amount of hard disk allocated to DOS as *1 percent* (for 525 MB disk).
 - Enter *n* to indicate that the MS-DOS partition is not the active partition.
- 3 Create the UNIX partition as follows.
 - Select *1* to create a UNIX partition.
 - Select *1* to indicate that a UNIX System partition is to be created.
 - When prompted, enter the amount of hard disk allocated to UNIX as *99 percent* (for 525 MB disk).

- Enter *y* to indicate that the UNIX partition is to be active every time the machine is booted.
- Select *4* to update the disk configuration and exit.

4 Continue partitioning the hard disk.

See: The "Prepare Hard Disk for Surface Analysis" instructions in the Software Installation section of the *Admin Guide*.

5 Complete the hard disk partitioning process as follows.

See: The "Create UNIX System File Systems" instructions in the Software Installation section of the *Admin Guide*.

- Enter *n* to indicate that the default partition allocations are not acceptable.
- Enter *y* at the partition prompt:

Separate root and usr?

- Enter *n* at the next partition prompt:

Additional usr??

- Enter *n* at the next partition prompt:

Crash/dump area?

- Enter *32* as the number of megabytes assigned to swap/paging.
 - Enter *32* (for the 525 MB disk) as the number of megabytes allocated for the root partition.
 - Review the new allocation and make a note of it. Swap/paging and root should have the number of megabytes you assigned, and the balance should be assigned to the **/usr** area. Enter *y* to indicate the allocation is acceptable.
 - When you are prompted, remove the diskette from the drive and reboot the system from hard disk.
 - After rebooting the system, enter *c* to install the UNIX system from cartridge tape.
- 6 Load the UNIX essential utilities.

See: The "Install Base System (From Cartridge Tape)" instructions in the Software Installation section of the *Admin Guide*.

- 7 Assign a root password.
- 8 Assign an install password.

Procedure 2B — Load Add-On Packages from Tape

Follow the instructions on the Package Selection menu to install the add-on packages from cartridge tape. Select the following for installation:

- 1 *Editing Package*
- 2 *FMLI*
- 3 *FACE*
- 4 *FACE Help*

Note: The FACE Help package is totally different than the FACE package.

- 5 Press to execute.
- 6 Press to continue.
- 7 Enter *4* to install all of the Help files.
- 8 Enter *5* to complete (terminate) the Help file installation.
- 9 Continue the installation with the cartridge tape utilities.
- 10 Reboot the system.

End of procedures for Step 2

Step 3 — Load the Additional Software

Prerequisites for this Step

Activities

- Make sure that the NCR-3332 WGS, keyboard, console, and additional cards are installed according to Step 1 of this section. You need to know the location and memory addresses of the boards in the processor.
- Make sure that the correct version of the UNIX Foundation Set is loaded according to Step 2 of this section.

Documents

- *UNIX System V/386 Release 3.2.3 Operations/System Administration Guide (Admin Guide)*

Hardware/Software Components

- UNIX System V/386 Release 3.2.3 Remote Terminal Package
- Equinox MEGAPORT Device Driver
- Security Administration Package

When Installing from Diskette

- Use the "Install Optional Add-On Packages (From Diskette)" instructions in the "Software Installation" section of the *Admin Guide* to load the individual software packages.
- If your processor has two disk drives, specify the drive from which you are loading.
- If asked how many diskettes are in the package, count the number of diskettes for the specific package only. Whenever multiple diskettes exist for a specific package, make sure you load these diskettes in sequential order.
- If asked for the diskette type, either look on the diskette for the applicable type or enter *1.44*.
- If asked to reboot the system, press to skip the reboot process. You do *not* have to reboot after loading each software package; however, you *must* reboot the system after the last package is loaded.

Procedure 3A — Load the Remote Terminal Package

Note: This is *not* the Remote Maintenance Package, which is loaded at a different time.

- 1 Enter *installpkg* at the prompt to load the Remote Terminal Package.
- 2 Enter *1* to install the terminfo files.

Call: The TSC Hotline, 1 800 548-8861, to obtain the **terminfo** entry needed to use the 730 terminal and the 615 BCT with the System 75 Emulation cartridge. (For the 715 BCS, use "BCS" as the emulation mode and "513" for the terminal type when cutting through from G3r, G3i, G1, or System 75 to AUDIX®.)

- 3 Enter *all* to load all the terminfo files.
- 4 Enter *done* after the list of files is displayed.
- 5 Enter *0* to complete (terminate) the terminfo file load.

Procedure 3B — Load the Equinox Device Driver

Refer to the Equinox Device Driver documentation for instructions.

End of procedures for Step 3

Step 4 — Set Up the Terminals and Modems

Prerequisites for this Step

Activities

- Make sure that the NCR-3332 processor, keyboard, console and software are set up and connected according to Steps 1 through 3 of this section.

Documents

- User's Guide - 615 Business Communications Terminal Guide, or 715 Business Communications System (BCS) User's Guide and Service Manual, or 730 Multi-Tasking Graphics Terminal Guide (*Terminal Guide*)
- DATAPHONE II 2224-CEO Modem User's Manual or DATAPHONE II 2224-GNN Modem Manual (*Modem Manual*)

Hardware/Software Components

- 615 BCT(s), 715 BCS(s), or 630 or 730 MTG(s) [optional]
- One 513 BCT/System 75 Emulation Cartridge per 615 BCT for accessing G3r, G3i, G1, or System 75 maintenance and administration functions
- 2224 modem(s) for use with bidirectional 1200/300 baud asynchronous communications for UUCP and communication with administered switches
- Modular cables with special adaptors

Procedure 4A — Set Up the Terminals

- 1 Unpack, install, and set up the terminal.

See: The "Unpack and Install" (615 BCT or 715 BCS) or "Installation" (730) instructions in the *Terminal Guide*.

Note: The 630 or 730 MTG is most effectively used at speeds above 2400 baud, therefore it should not be connected through a modem.

- 2 To make the terminal operational for Monitor I:

- Install the 513 BCT/System 75 Emulation Cartridge by inserting the 513 BCT/System 75 cartridge into the slot on the side of the 615 BCT. Be sure that the cartridge is right side up, with the cartridge label toward the front.

Warning: Check the on/off switch before you install the cartridge to make sure that the power for the 615 terminal is turned *off*. A blank screen is *not* an indicator that the terminal is off, and you will destroy the 513 BCT/System 75 cartridge if you insert or remove it while the terminal is on.

- Follow the instructions in the *Terminal Guide* to enable the cartridge.
- For the 715 terminal, enter the following settings:
 - Set the emulation mode to: *BCS*
 - Set the UNIX terminal type (TERM) to: *sys75*
 - Set the terminal type for cut-through access from Monitor I to G3r, G3i, G1, and System 75 to: *513*
 - Set the **Swap Delete** option of the 715 terminal to: *yes* (through terminal setup) for BCS.
- Change the **Cursor Blink** option to *y* for yes.
- Cut-through access to System 75 R1V1 for maintenance or administration requires that the System 75 be equipped with a pooled modem card that allows asynchronous communications.

Procedure 4B — Set Up the Modems

Monitor I supports the 2224-CEO, 2224-GNN, AT&T 2400 and AT&T DataPort 3710 modems. For either modem, you must set up the hardware switches, as follows.

See: The appropriate *Modem Manual* for complete installation procedures.

Contact the Technical Service Center (TSC) at 1 800 548-8861 to have your modem checked after you have completed the appropriate modem procedures.

2224-CEO Modems

For the 2224-CEO modem:

- 1 Remove the CEO modem cover to access the Internal Option switches.
See Figure 6-1 for a diagram of the CEO modem hardware switches.

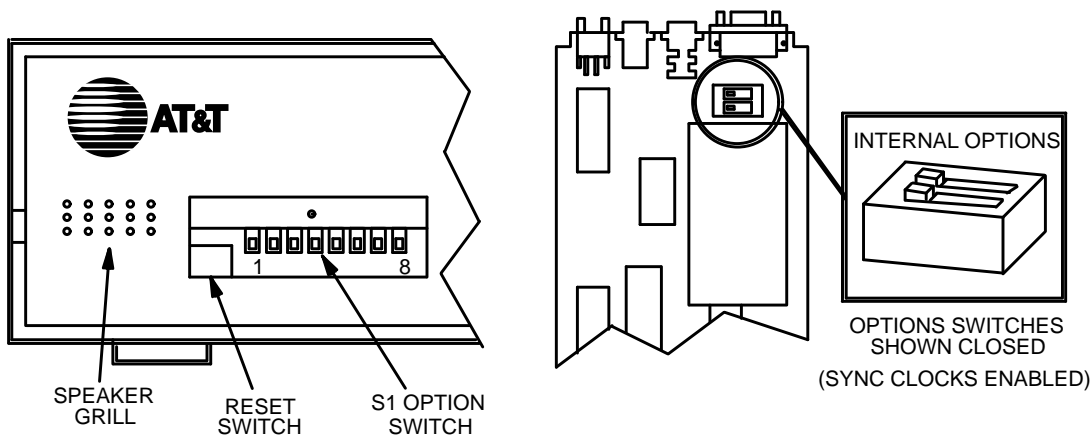

FIGURE 6-1
CEO Modem Hardware Switches

- 2 To set your modem switches:
 - For dial-out or bidirectional 1200/300 baud asynchronous, dialer-enabled modems, set the switches according to Table 6-1.

TABLE 6-1
2224-CEO Dial-Out 1200/300 Asynchronous Communications

Switch	Push	Switch	Push	Switch	Push
1-1	down	1-5	down	internal-1	away from number
1-2	down	1-6	up	internal-2	away from number
1-3	down	1-7	down		
1-4	down	1-8	down		

- 3 Plug the power cable from the modem into the power outlet.
- 4 Reset the modem by pressing and releasing the **RESET** switch. This makes your changes effective.

2224-GNN Modems

See Figure 6-2 for a diagram of the GNN modem hardware switches.

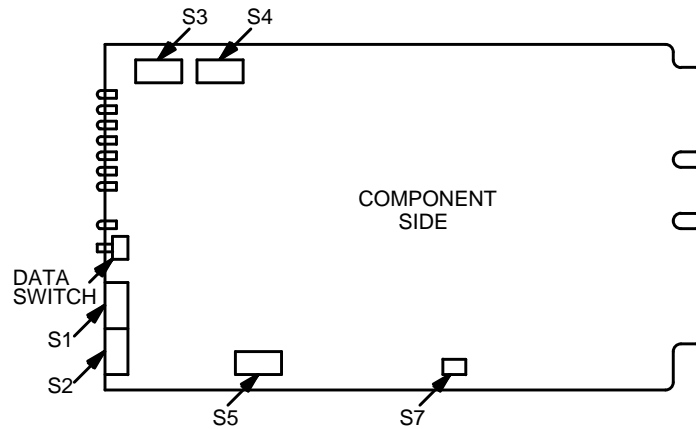

FIGURE 6-2
GNN Modem Hardware

- 1 For dial-out or bidirectional 1200/300 baud asynchronous, dialer-enabled 2224-GNN modems, set the switches according to Table 6-2.

TABLE 6-2
2224-GNN Dial-Out 1200/300 Asynchronous Communications

Switch	Push
1-1	left
1-2	left
1-3	left
1-4	right
1-5	right
1-6	left
1-7	left
1-8	left
2-1	right
2-2	right
2-3	left
2-4	left
2-5	left
2-6	left
2-7	left
2-8	left
3-1	right or up
3-2	right or up
3-3	right or up
3-4	left or down
3-5	left or down
3-6	left or down
3-7	left or down
3-8	left or down

- 2 Reset the modem by removing it from the rack, then putting it back. This makes the changes take effect.

Set Up An AT&T 2400 Modem

The AT&T 2400 modems can arrive from the factory in an unknown state; they can be in a state that will not allow them to communicate with a UNIX system. Therefore, these modems should be configured using a terminal.

Install the AT&T 2400 Modem

Install the AT&T 2400 modem as follows:

- 1 Plug in the modem's power adaptor.
- 2 Connect the modem to the main port of an AT&T 615 Terminal using a straight through male to male RS-232 cable.
- 3 Set the terminal speed to 1200.
- 4 Set the terminal Parity to *EVEN*.
- 5 Set the terminal Send Parity to *NO*.

Set the 2400 Modem Software Options

Set the software options in the 2400 modem using a terminal. The modem can be configured for bidirectional port transmission or product access.

- For a bidirectional transmission use the sequence of commands provided in Table 6-3, Column 1. AT&T 2400 modems used for bidirectional traffic such as login or UUCP must be locked at one baud rate.
- For a product access configuration, use the sequence of commands provided in Table 6-4, Column 1. AT&T 2400 modems used for product access (various baud rates) must only be used for product access (outgoing only).

TABLE 6-3
AT&T 2400 Modem Bidirectional

Command	Meaning
AT&F	Factory Default
AT&MO	Turn speaker off
AT&QO	Standard Async
ATQ2	Result code in originate only
AT&D2	Enter command mode on DTR dropping
AT&KO	No flow control
AT&C2	CD on for cmd mode, track carrier for data transfer
ATSO=1	Auto Answer
ATS37=6*	Maximum DCE Line Speed**
AT&WO	Write storable parameters of current configuration in memory as profile 0
AT&YO	Specify stored user profile 0 as power up configuration

TABLE 6-4
Configuration of a Product Access Modem (Outgoing Only)

Command	Meaning
AT&F	Factory Default
AT&MO	Turn speaker off
AT&QO	Standard Async
ATQ2	Result code in originate only
AT&D2	Enter command mode on DTR dropping
AT&KO	No flow control
AT&C2	CD on for cmd mode, track carrier for data transfer
ATSO=1	Auto Answer
ATS37=0*	Maximum DCE Line Speed
AT&WO	Write storable parameters of current configuration in memory as profile 0
AT&YO	Specify stored user profile 0 as power up configuration

* Varies across the two configuration tables; all other commands are common for all configurations.

** Set to 5, 1200 baud; set to 6, 2400 baud

* Varies across the two configuration tables; all other commands are common for all configurations.

Configure the UNIX System

The *Dialers* file of UNIX System V Release 3.2.3 contains the following line:

```
#hayes =,-, "" \M\dAT\r\c OK\r \EATDT\r\c CONNECT \m\c
```

Activate this file by removing the comment symbol, #, at the beginning of the line.

For modems that are to be used for outgoing calls (bidirectional), change the procedure for configuring the UNIX System as described in the *Installation Manual* as follows:

- In the *Connect to Modem* form of the FACE Menu, set the **Modem Name** field to *Non-Autodialing*.
- The **Devices** files will contain a line corresponding to each modem configured for outgoing calls. The following is a typical entry in this file:

```
ACU ttyh06,M - 1200 Non-Autodialing
```

- For each modem, edit the file by entering a set like the following:

```
ACU ttyh06 - 300 hayes  
ACU ttyh06 - 1200 hayes  
ACU ttyh06 - 2400 hayes
```

End of Procedure

Set the AT&T DataPort 3710 Modem Software Options

Set the software options in the AT&T DataPort 3710 modem using the dialers file described in the next section, "Configure the UNIX System". The modem can be configured for bidirectional port or product access.

- AT&T DataPort 3710 modems used for bidirectional traffic such as login or UUCP must be locked at one baud rate.
- AT&T DataPort 3710 modems used for product access (various baud rates) must only be used for product access (outgoing only).

Configure the UNIX System

The *Dialers* file of the UNIX System V Release 3.2.3 must be added on one consecutive line as follows:

```
ATTparadyne =+-, ""\M\dAT\r\c OK\r AT&FL3Q2&C2&R0\Q0\N1%C0\r\c
OK\r AT&W0&Y0 OK\r \dATDT\r\c 00
```

For modems that are to be used for both incoming and outgoing calls (bidirectional), the procedure for configuring the UNIX System as described in the *Installation Manual* changes as follows:

- In the **Connect to Modem** form of the FACE Menu, set the **Modem Name** field to **HayesSmartm2400**.
- The **Devices** files will contain a line corresponding to each modem configured for outgoing calls. The following is a typical entry in this file:

```
ACU ttyh06 - 1200 ATTparadyne
```

- For each modem, edit the file by entering a set as shown in the following:

```
ACU ttyh06 - 300 ATTparadyne
ACU ttyh06 - 1200 ATTparadyne
```

```
End of Procedure
```

Procedure 4C — Connect the Terminals

- 1 Connect your terminal to the Equinox card.
- 2 Write the port number, associated device name, and phone line on the Port Configuration Worksheet in **Appendix B** of this manual.
- 3 Plug the power cables from the terminals into the power outlet.

Procedure 4D — Connect the Modems

- 1 Connect the cables from the modems to the Equinox serial ports.
- 2 Connect the modems to the phone lines.
- 3 Plug the power cables from the modems into the power outlet.
- 4 Write the port number, associated device name, and phone line on the Port Configuration Worksheet in **Appendix B** of this manual.

End of procedures for Step 4

Step 5 — Set Up and Enable the Printer

Prerequisites for this Step

Activities

- Make sure that the Monitor I system was installed according to Steps 1 through 4 of this section.

Documents

- *User's Guide AT&T 570 Printer, User's Guide AT&T 593 Printer or User's Guide AT&T 595 Printer (Printer Guide)*
- *Printer Documentation for Okidata-ML184*
- *UNIX System V/386 Release 3.2.3 Operations/System Administration Guide (Admin Guide)*

Hardware/Software Components

- AT&T 570, 593 or 595 Printer or Okidata-ML184 Printer
- AC power cord
- Tractor assembly
- Static eliminator

Procedure 5A — Set Up the Printer

- 1 Set up the printer connection parameters.

See: The "Operation Panel and Operational Procedures in Set-Up Mode" instructions in the *Printer Guide*.

- 2 Use **FACE** to set up the printer parameters.

Procedure 5B — Connect the Printer Cable

- 1 Connect one end of the parallel printer cable to the printer and the other end to the parallel port on the processor.
- 2 Write the port number and associated device name on the Port Configuration Worksheet in **Appendix B** of this manual.

Procedure 5C — Enable the Printer

- 1 Log in as *root*.
- 2 At the prompt, enter *face* and press .
- 3 Enter the following menu selections:

```

System Administration
└─ Peripheral Setup
    └─ Printer Setup
        └─ Parallel Printer Port Setup
  
```

System Response:

Printer type:

- 4 Enter the appropriate printer type, either *AT&T570*, *AT&T593*, *AT&T595* or *Okidata-ML* and press .

System Response:

Printer Name:

- 5 Enter the name of the printer and press .

Example: *pr1*

System Response:

Should filter be used?

- 6 Select the default, *yes*.
- 7 Press to save the values.
- 8 Press to continue with this procedure.
- 9 Press three times to return to the **FACE** main menu.
- 10 Select *exit* then press to exit from the **FACE** main menu.

11 At the next prompt, enter: *lpstat -t*

System Response:

Information about the printer you enabled (for example, pr1) is displayed.

End of procedures for Step 5

Step 6 — Rebuild the UNIX Kernel

Prerequisites for this Step

Activities

- Make sure that the NCR-3332 WGS, keyboard, console, additional terminals, and modems are installed according to Steps 1, 2, and 4 of this section.
- Make sure that the UNIX Foundation Set and additional software were loaded according to Step 3 of this section.
- Make sure that the terminals and modems have been set up and the ports were enabled according to Steps 4 and 5 of this section.

Documents

- *UNIX System V/386 Release 3.2.3 Operations/System Administration Guide (Admin Guide)*

Procedure 6A — Edit the Kernel File

- 1 Using **vi** or **ed**, edit the **/etc/conf/cf.d/mtune** file with the information listed below. These fields are in the fourth column (which is the MAX field).
 - NUMXT = 8
 - MAXUP = 80

- 2 Using **vi** or **ed**, edit the **/etc/conf/cf.d/stune** file using the following suggested minimum parameter settings for Monitor I.

If Monitor I is running with a coresident application and if the other application recommends a different Kernel parameter, set the parameter to the larger of the recommended settings. If a parameter is *not* found in the file, you must add the entry to the file using the following format.

parameter TAB *xxx*

Where: *xxx* = the value of the parameter.

- NINODE = 100 times the number of MB of RAM in the system or 1300, whichever is lower.

Note: This value should be less than or equal to NS5INODE.
- NS5INODE = 100 times the number of MB of RAM in the system or 1300, whichever is lower.
- NFILE = 100 times the number of MB of RAM in the system or 1300, whichever is lower.
- NPROC = 30 times the number of MB of RAM in the system or 400, whichever is lower.
- MAXUP = 80

- `ULIMIT = 8192`
- `NBUF = 100` times the number of MB of RAM in the system or 2750, whichever is lower.
- `NCLIST = 60` times the number of MB of RAM in the system or 1180, whichever is lower.
- `NREGION = 100` times the number of MB of RAM in the system or 1200, whichever is lower.
- `SHLBMAX = 6`
- `NUMXT = 8`

Procedure 6B — Rebuild the Kernel

- 1 Enter `cd /` at the prompt.
- 2 Enter `/etc/conf/bin/idbuild` at the prompt.

Procedure 6C — Reboot the System

- 1 When you see the following message:

UNIX Kernel has been rebuilt

enter the following to change directories: `cd /etc/default`.

- 2 Using `vi` or `ed`, edit the file named **login**.
- 3 Search for **ULIMIT** and change the value to `8192`.
- 4 Save the changes and exit the text editor.
- 5 Change to the root directory: `cd /`.
- 6 Enter `shutdown` to reboot the system.
- 7 When prompted, enter `y` to continue the shutdown.
- 8 Reboot the system when prompted by pressing `CTL` - `ALT` - `DEL`.

End of procedures for Step 6

Step 7 — Load the INFORMIX Software

Prerequisites for this Step

Activities

- Make sure that the NCR-3332 processor and software have been installed according to Steps 1 through 7 of this section.
- This step can be completed before the terminals and modems are connected.

Documents

- *UNIX System V/386 Release 3.2.3 Operations/System Administration Guide (Admin Guide)*
- *INFORMIX installation instructions*

Hardware/Software Components

- INFORMIX-SQL Release 4.0 software
- INFORMIX-SE Release 4.0 software

Procedure 7A — Add the INFORMIX Group

- 1 Log in as *root*.
- 2 Using *vi* or *ed*, edit the System Group file, */etc/group*.
- 3 Add the following to the end of the file:

informix::nnnn:

Where: *nnnn* is the group id, which can be any group number not already used.

- 4 Save the file and exit the UNIX editor.

Procedure 7B — Add the INFORMIX User

- 1 Use **FACE** to add the login, *informix*.
 - **Login Name** — *informix*
 - **Full Name** — *INFORMIX-SQL*
 - **Login ID number** — Use the default login ID number.

- **Home Directory** — Enter the directory name as:
<directory>/login_name
Example: */usr/informix*
Note: Make sure that the **<directory>** already exists.
 - **System Administration Privileges** — *no*.
- 2 Assign a password as instructed.
 - 3 Save the login and exit FACE.
 - 4 Edit the **/etc/passwd** file using **vi** or **ed**.
 - Search for the string: **informix:x:mmmm:1:INFORMIX SQL:/usr/informix:**
Change the **:1:** field to **:nnnn:**
Where: **nnnn** is the INFORMIX group ID specified in Procedure 7A and **mmmm** is a user ID that is chosen for the INFORMIX user ID.
Example:
user login name:x:user id:group id: user full name:user full path:
 - 5 Save and exit the UNIX text editor file.

Procedure 7C — Load the INFORMIX-SQL Software

- 1 Enter *installpkg* at the prompt to load the INFORMIX software from diskette.
- 2 Follow the instructions, insert the diskettes in sequential order, and press .
- 3 Enter the 11-character serial number *exactly* as it appears on the diskette or the Customer Registration card.
- 4 Enter the 6-character serial number KEY *exactly* as it appears on the Customer Registration card.

Procedure 7D — Load the INFORMIX-SE Software

- 1 Enter *installpkg* at the prompt to load the INFORMIX software from diskette.
- 2 Follow the instructions, insert the diskettes in sequential order, and press .
- 3 Enter the 11-character serial number *exactly* as it appears on the diskette or the Customer Registration card.
- 4 Enter the 6-character serial number KEY *exactly* as it appears on the Customer Registration card.

Procedure 7E — Display the Installed Packages

- 1 Enter *displaypkg* at the prompt.
- 2 Make sure the list displayed contains the following software loaded during this installation procedure.
 - SCSI Support Package V2.3
 - Editing Package
 - FACE and FACE HELP Packages
 - FMLI Package
 - INFORMIX-SE Software
 - INFORMIX-SQL Software
 - Equinox MEGAPORT Device Driver, Version 2.4.4

End of procedures for Step 7

Step 8 — Add the Monitor I Group and Users

Prerequisites for this Step

Activities

- Make sure that the NCR-3332 processor, keyboard, console, additional terminals, and modems are installed according to Steps 1, 2, and 4 of this section.

Documents

- *UNIX System V/386 Release 3.2.3 User's/System Administrator's Reference Manual (Reference Manual)*

Procedure 8A — Add the Monitor I Group

- 1 Log in as *root*.
- 2 At the UNIX prompt, enter *vi /etc/group* to edit the System Group file.
- 3 Add *traf::nnnn:* to the end of the file.

Where: *nnnn* is the group id that is any number not already used.

- 4 Save the file and exit the UNIX *vi* editor.

Procedure 8B — Add the Monitor I Users

- 1 Use **FACE** to add the login, **mtmadm**.
 - **Login Name** — *mtmadm*
 - **Full Name** — *Monitor I Administrator*
 - **Login ID number** — Use the default login ID number.
 - **Home Directory** — Enter the directory name as:
<directory>/login_name

Example: */usr/mtmadm*.

Note: Make sure that the *<directory>* already exists.

- **System Administration Privileges** — *no*.
- 2 Enter a password for **mtmadm**, as instructed.
 - 3 Remember to save the user login information.
 - 4 Create another login, **mtmadm1**.

Note: This login is primarily used to facilitate the execution of **cron**.

- **Login Name** — *mtmadm1*
- **Full Name** — *Monitor I cron login*
- **Login ID number** — Use the default login ID number.
- **Home Directory** — Enter the directory name as
 <directory>/login_name

Example: */usr/mtmadm1*

Note: Make sure that the <directory> already exists.

- **System Administration Privileges** — *no*.
- 5 Enter a password for **mtmadm1**, as instructed.
 - 6 Remember to save the user login information.
 - 7 Exit FACE and return to the UNIX System.
 - 8 Using **vi** or **ed**, edit the **/etc/passwd** file.
 - Search for the string:
 mtmadm:x:mmmm:1:Monitor I Administrator:<directory>
 - Change **:1:** to **:nnnn:**
 Where: **nnnn** is the Monitor I group id specified in "Procedure 8A — Add the Monitor I Group" and <directory> is the home directory for **mtmadm**.
 - Search for the string:
 mtmadm1:x:mmmm:1:Monitor I cron login:<directory>
 - Change **:1:** to **:nnnn:**
 Where: **nnnn** is the Monitor I group id specified in "Procedure 8A — Add the Monitor I Group" and <directory> is the home directory for **mtmadm1**.
- Note:** When Monitor I is installed, the **mtmadm1** login is blocked.
- 9 Save the file and exit the UNIX text editor.
 - 10 Type *chgrp traf <directory>* at the prompt.
 Where: <directory> is the home directory of **mtmadm**.
 - 11 Repeat the previous step for **mtmadm1**.
 - 12 Use this procedure to add additional logins for Monitor I users, as necessary.
 Note: Assign UNIX **at** and **cron** privileges to users who will be scheduling Monitor I reports. Refer to the *Reference Manual* for information on **at** and **cron**.

Procedure 8C — Edit the .profile

- 1 Use **vi** or **ed** to edit the **.profile** for each Monitor I user.
- 2 Change the **FACEINVOKE** field entry so that users do not have to go through the FACE menu to get to Monitor I. Edit the field so that it reads: *FACEINVOKE = no* .
- 3 Add the following entry to the **end** of the **.profile** so that each login can use Monitor I:

. <directory>/mtm/tools/profile

Where: <directory> is the name of the directory under which you will be installing Monitor I in **Step 11** of **Procedure 9A**.

Note: If CAFE is used, do not append the **.<directory>/mtm/tools/profile** entry to the users **.profile**.

- 4 Make sure that the **mtmadm** login also gets a **.profile** configured as listed above.

End of procedures for Step 8

Step 9 — Load the Monitor I Software

Prerequisites for this Step

Activities

- Make sure that you have added the Monitor I group and users, explained in Step 8 of this chapter.
- Make sure that you have installed INFORMIX, according to the directions listed in Step 7.
- If you are installing an upgrade (a **warm install**), make sure that no one is using the Monitor I files (directories), and that the Poller and Alarm Manager are not running.
- If you are performing a **warm install**, make sure you do a full backup of Monitor I first. Perform the backup according to the "Back Up Monitor I" procedure listed in the *DEFINITY Monitor I Operations Guide*.

Documents

- *DEFINITY Monitor I Operations Guide (Ops Guide)*

Hardware/Software Components

- DEFINITY Monitor I installation tape
- Disk Configuration Worksheet obtained from your AT&T Representative

Procedure 9A — Cold Install of Monitor I Software

What?

This procedure describes how to do a **cold install** of Monitor I. A cold install is usually done when you are installing Monitor I for the very first time. A **warm install** is done when you are updating existing Monitor I software. See **Procedure 9B — Warm Install of Monitor I Software** for information about warm installs.

In some instances, you may already have Monitor I installed, but you want to remove it and start all over. In this case, you would choose a **cold install** to completely remove the Monitor I directories and databases and reinstall new ones.

How Long?

This procedure takes about 30 minutes to finish.

- 1 Log in as *root*.
- 2 Enter *installpkg* and press .

System Response:

**Please indicate the installation medium you intend to use.
Strike "C" to install from CARTRIDGE TAPE
or "F" to install from FLOPPY DISKETTE.**

- 3 Enter *c* and press .

System Response:

Please insert the cartridge tape into the tape drive.

- 4 Press .

It is recommended that you re-tension the tape before attempting the installation, to ensure that the tape is read without any errors.

- 5 Press to retension the tape. This takes about three minutes.

System Response:

Packages available for installation:

1. **DEFINITY Monitor I Release 3.0**
2. **Install ALL packages shown above**
3. **Exit, do not install any packages**

- 6 Enter **1** to install Monitor I, press **RETURN**, followed by **ESC**. System Response:

You have made the following selections:

1. **DEFINITY Monitor I Release 3.0**

- 7 Press **RETURN** to confirm your selection.

Note: Press **ESC** if you want to redisplay the package selections.

System Response:

REMINDER!

Depending on the packages you are installing, you may be required to provide some input to the installation utility to configure the software for your system.

- 8 Press **RETURN** to continue the installation.

System Response:

Installation in progress --Do not remove the cartridge tape

This message is followed by a copyright message for Monitor I.

System Response:

Enter type of installation you want (w-warm, c-cold, e-exit):

Note: If you choose to exit at this point and you want to restart installation, you must reinsert the tape. Any time after this point, you can exit and restart without reinserting the tape.

- 9 Type *c* and press .

System Response:

Enter the directory where you want to install Monitor I? (/usr) :

- 10 Enter the default, */usr*, or the the directory of your choice, then press .

Note: Monitor I will be installed in the directory you specify, under a subdirectory called **mtm**. If this subdirectory does not exist, the system will now create it for you.

Example: Entering */usr* or */usr1/traf* results in Monitor I being installed in the directory */usr/mtm* or */usr1/traf/mtm* respectively.

System Response:

Monitor I will be installed under <directory name>/mtm, continue ? (y/n):

Where: <directory name> is the name of the directory you specified in the previous step.

- 11 Enter *y* to continue and press .

System Response:

WARNING- Cold installation will remove all Monitor I directories and existing database(s), if any. No one should be using Monitor I during installation. Make sure Monitor I polling system and alarm manager are not running.

Cold installation will proceed, continue? (y/n) :

12 Enter *y* to continue and press **RETURN**.

System Response:

Select processor type -
Enter 1 for 3B2-600
2 for 6386E/33 model S
3 for 6386SX/EL or NCR 3315/3332

13 Enter *3* and press **RETURN**.

System Response:

You are installing on a 6386SX/EL or NCR 3315/3332 processor.
Do you want to continue? (y/n) :

14 Enter *y* and press **RETURN**.

System Response:

Enter switch type(s) separated by ','
(G3r, G3i, G2, G1, SYS85, SYS75, FP8, or ALL) :

If you select *ALL* the system response screen shown in Step 15 is displayed. If you select individual switches, the system also prompts you to select the releases you want for each switch selection.

- G3r:

Enter issue(s) for G3r switch separated by ','
(1):

- G3i:

Enter issue(s) for G3i switch separated by ','
(1):

- G2:

Enter release(s) for G2 switch separated by ','
(2.1, 2.2):

- G1:

Enter release(s) for G1 switch separated by ','
(1.1):

- SYS85:

Enter release(s) for SYS 85 switch separated by ','
(R2V4, R2V3, R2V2):

- SYS75:

Enter release(s) for SYS75 switch separated by ','
(R1V3, R1V2, R1V1):

- FP8:

Enter release(s) for FP8 switch separated by ','
(3.8, 1.16):

15 Enter the switch type(s) and releases you want to install then press **RETURN** .

System Response:

Preinstallation checks in progress

- If preinstallation checks have completed successfully, the following message is displayed:

Preinstallation checks have completed successfully.

- If preinstallation checks did *not* complete successfully, a list of error messages is displayed, followed by this message:

Preinstallation checks did not complete successfully.

Note: To continue, fix the errors using error message explanations found in **Appendix C** of this manual. Once the errors have been resolved, try installing Monitor I again using this procedure, starting with the **installpkg** command in **Step 2**.

If pre-installation checks completed successfully, the following prompt is displayed:

Do you want to create database place holder(s)? (y/n):

Note: If you enter *n*, the software is installed, but no placeholders are created. You can add placeholders after installation is completed by using the **addmount** procedure discussed in "9C — Create Placeholders Using Addmount."

- 16 Enter *y* to create database placeholders then press .

System Response:

Do you want to use the "Rotating Switch Study" feature? (y/n):

Reference: Refer to the DOSS Configuration output for the appropriate response.

- If you answer *n*, the following prompt is displayed:

Enter the directory to create the database(s) e.g. /usr1 ? :

Continue the software load with Step 19 of this procedure.

- If you answer *y*, the following prompts are displayed:

Enter the total number of G2, SYSTEM 85 or FP8 switches?:

Enter the total number of G3r, G3i, G1 or SYSTEM 75 switches?:

- 17 If you are using the **Rotating Switch Study** feature, enter the correct response to these questions and press to get the next prompt.

System Response:

Are the values entered above correct? (y/n):

- If you answer *n*, the system again prompts you to enter the total number of switches.
- 18 Once all values are correct, type *y* then press .

System Response:

Enter the directory to create the database(s), e.g. /usr1 ? :

Reference: Refer to the DOSS Configuration output for the appropriate directory.

- 19 Enter the directory name and press .

Note: The next questions refer to the number of placeholders for databases to be created under each mount point (database directory) for each polling option.

System Response:

How many G2, SYS85 or FP8 (EXTENDED) database(s) ? (0-40) :
 How many G2, SYS85 or FP8 (STANDARD) database(s) ? (0-40) :
 How many G2, SYS85 or FP8 (DAILY and LIMITED) database(s) ? (0-40) :
 How many G1 1.1 or SYSTEM 75 database(s)? (0-40) :
 How many G3r or G3i (EXTENDED) database(s)? (0-40) :
 How many G3r or G3i (STANDARD) database(s)? (0-40) :
 How many G3r or G3i (DAILY and LIMITED) database(s)? (0-40) :
 How many inactive database(s)?

Note: The last prompt, **How many inactive database(s)?** , is only displayed if the **Rotating Switch Study** feature is used.

- 20 Enter the correct response to each of the questions listed above and press to get the next prompt.

Note:

- You *must* enter the correct number of databases for Monitor I to work properly. This information depends on the number of switches being supported and how your disk is sliced. See your Disk Configuration Worksheet for more information.
- Monitor I allows you to repeat this procedure for each mount point (database directory) and polling option per switch type that you have.

System Response:

Are the values entered above correct? (y/n):

- If you answer *n* , the system repeats the series of questions listed in **Step 19** of this procedure.

- 21 Once all values are correct, type *y* then press .

System Response:

Do you want to create more database place holder(s)? (y/n):

- If you answer *y* , the system returns to the response in **Step 18** of this procedure.

22 Enter *n* and press **RETURN** to continue with the installation.

Note: The system begins copying the files from the tape and a lengthy list of these files appears in a scrolling display. The files displayed on your screen may vary from the partial system listing displayed in the next screen example.

```
.  
.
Copying files from the tape
log
tmp
work
work/pdump
work/polldir
prog
prog/R2V2
prog/R2V2/L1_rep
prog/R2V2/acd_rep
prog/R2V2/covg_rep
.
.
.
prog/R2V2/iparser
prog/R2V2/clock
.
.
```

The following messages appear when the installation completes:

```
All Monitor I files have been installed correctly.
Installation completed successfully.
```

If you *do not* see these messages or if you see error messages during the procedure, look for further information on the errors in **/usr/tmp/journal**. Fix the errors using the error message explanations found in **Appendix C** of this manual, then try installing Monitor I again, starting with the **installpkg** command in **Step 2** of this procedure.

End of Cold Install Procedure

Procedure 9B — Warm Install of Monitor I Software

- 1 Backup Monitor I according to the "Backing Up Monitor I" procedure listed in the *Monitor I Operations Guide*.
- 2 Follow Steps 1 through 8 of "Procedure 9A — Cold Install of Monitor I Software." Complete Step 2 of this procedure when you see this prompt:

```
Enter type of installation you want (w-warm, c-cold, e-exit):
```

- 3 Type *w* at the prompt and press .

System Response:

```
WARNING- No one should be using Monitor I during installation.
Make sure Monitor I polling system and alarm manager are
not running.
Warm installation will proceed, continue? (y/n) :
```

- 4 Enter *y* to continue and press .

System Response:

```
Preinstallation checks in progress ....
```

- If pre-installation checks have completed successfully, the following message is displayed:

```
Preinstallation checks have completed successfully.
```

- If preinstallation checks did *not* complete successfully, a list of error messages is displayed, followed by this message:

```
Preinstallation checks did not complete successfully.
```

Note: To continue, fix the errors using error message explanations found in **Appendix C** of this manual. Once the errors have been resolved, try installing Monitor I again using this procedure, starting with the **installpkg** command in **Step 2** of this procedure.

A lengthy list of files appears on the screen in a scrolling display. After all these files have been installed and some post-installation checking messages appear, the following message is displayed at the completion of the warm installation:

Warm installation completed successfully.

Note: If you do *not* see this message or if you see error messages during the procedure, look for further information on the errors in **/usr/tmp/journal** . Fix the errors, using the error message explanations found in **Appendix C**. Try installing Monitor I again, starting with the **installpkg** command in **Step 2** of this procedure.

- 5 As a final post-installation step, restart the poller and alarm manager. Enter **<directory>/mtm/tools/monitor I start** to bring up the Monitor I poller and alarm processes, where **<directory>** is the name of the directory under which you installed Monitor I.

End of Warm Install Procedure

Procedure 9C — Create Placeholders Using Addmount

Use this procedure to create database placeholders from the UNIX shell, after you have completed the Monitor I installation.

Note: If you have already added placeholders during installation, you will not be able to add additional placeholders from the shell. Also, if you have used the **addmount** procedure previously to add placeholders, you will not be able to execute this procedure a second time.

- 1 Log in as *root*.
- 2 Type `<directory>/mtm/tools/addmount` at the prompt and press .

Where: `<directory>` is the name of the directory under which you installed Monitor I in **Step 9 of Procedure 9A**.

System Response:

Do you want to use the "Rotating Switch Study" feature? (y/n):

Reference: Refer to the DOSS Configuration output for the appropriate response.

- If you answer *n*, the following prompt is displayed:

Enter the directory to create the database(s), e.g /usr1 ? :

Continue the software load with Step 5 of this procedure.

- If you answer *y*, the following prompts are displayed:

Enter the total number of G2, SYSTEM 85 or FP8 switches?:

Enter the total number of G3r, G3i, G1 or SYSTEM 75 switches?:

- 3 If you are using the **Rotating Switch Study** feature, enter the correct response to these questions and press to get the next prompt.

System Response:

Are the values entered above correct? (y/n):

- If you answer *n*, the system again prompts you to enter the total number of switches.
- 4 Once all values are correct, type *y* then press .

System Response:

Enter the directory to create the database(s), e.g. /usr1 ? :

Reference: Refer to the DOSS Configuration output for the appropriate directory.

- 5 Enter the directory name and press .

Note: The next questions refer to the number of placeholders for databases to be created under each mount point for each polling option.

System Response:

How many G2, SYS85 or FP8 (EXTENDED) database(s) ? (0-40) :
How many G2, SYS85 or FP8 (STANDARD) database(s) ? (0-40) :
How many G2, SYS85 or FP8 (DAILY and LIMITED) database(s) ? (0-40) :
How many G1 1.1 or SYSTEM 75 database(s)? (0-40) :
How many G3r or G3i (EXTENDED) database(s)? (0-40) :
How many G3r or G3i (STANDARD) database(s)? (0-40) :
How many G3r or G3i (DAILY and LIMITED) database(s)? (0-40) :
How many inactive database(s)?

Note: The last prompt **How many inactive database(s)?** is only displayed if the **Rotating Switch Study** feature is used.

- 6 Enter the correct response to each of the questions listed above and press to get the next prompt.

Note:

- You *must* enter the correct number of databases for Monitor I to work correctly. This information depends on the number of switches being supported and how your disk is sliced. See your Disk Configuration Worksheet for more information.
- Monitor I allows you to repeat this procedure for each mount point (database directory) and polling option per switch type that you have.

System Response:

Are the values entered above correct? (y/n):

- If you answer *n*, the system returns to the series of questions listed in **Step 5** of this procedure.
- 7 Once all values are correct, type *y* then press .

System Response:

Do you want to create more database place holder(s)? (y/n):

- If you answer *y*, the system returns to the **System Response** listed in **Step 4** of this procedure.
- 8 Enter *n* to continue the **addmount** procedure.
- 9 The following message is displayed for each database directory you entered:

Database place holders successfully created

Note: If you do not see this message, check `/usr/tmp/addout` for possible errors. Refer to **Appendix C** for Monitor I installation error messages and corrective actions.

End of procedures for Step 9

Step 10 — Enable the System Ports

Prerequisites for this Step

Activities

- Make sure the NCR-3332 processor, keyboard, console, additional terminals, and modems are installed according to Steps 1, 2, and 4 of this section.
- Make sure the UNIX Foundation Set and additional software has been loaded according to Step 3 of this section.
- Make sure the terminals and modems were set up according to Step 4 of this section.

Documents

- Refer to the Port Configuration Worksheet in **Appendix B** for a list of configured ports.
- Equinox User Documentation

Procedure 10A — Enable Bidirectional Ports

- 1 Log in as *root*.
- 2 Enter *cd /etc* at the prompt.
- 3 Edit the "inittab" file:
Enter the following line for each modem:
EaA:23:respawn:/usr/lib/uucp/uugetty -r -t60 tyaA 1200
- 4 Make sure the "devices file" has an entry for each tty port activated.

TABLE 6-5
2224-CEO Modem — Software Options

Option Number	Value	Option Number	Value	Option Number	Value	Option Number	Value
1	y	17	10	33	n	49	N/A
2	y	18	n	34	1	50	N/A
3	y	19	n	35	3	51	n
4	y	20	1	36	0	52	f
5	y	21	0	37	0	53	f
6	N/A	22	:	38	0	54	y
7	y	23	^H	39	5	55	n
8	N/A	24	@	40	N/A	56	y
9	n	25	\$B	41	0	57	N/A
10	n	26	\$:	42	N/A	58	n
11	n	27	n	43	n	59	N/A
12	y	28	n	44	n	60	N/A
13	n	29	0	45	n	61	N/A
14	n	30	n	46	n	62	N/A
15	y	31	y	47	N/A	63	n
16	n	32	I	48	N/A		

Notes: N/A = Not Applicable

This table is for reference purposes only.

End of procedures for Step 10

Acceptance Testing

Monitor I Acceptance Test Cases

The following test cases should be executed for Monitor I acceptance testing and only after **cold** installation of Monitor I is complete. The placeholders for the databases should already be created, either during installation or by running the **addmount** command before executing these test cases. The test cases are designed to ensure that:

- 1 All Monitor I files are installed correctly.
- 2 The uucp files are set up correctly for Monitor I and switch communication.
- 3 The link to INADS is set up correctly for the Monitor I alarming feature to work.

Two tools are provided for automated testing of Monitor I installation and alarming features. The total time to execute all eleven test cases should be around two hours. The test cases should be executed in the order presented and under the **mtmadm** login.

Test Case 1

This test is executed as part of the post-installation check. The script checks size, permissions and ownerships of all Monitor I files and directories.

Test Outline

- 1 Enter the type of installation.
 - For a cold installation, type:

```
su root -c "<directory>/mtm/tools/sanchk -c"
```

and press .
 - For a warm installation, type:

```
su root -c "<directory>/mtm/tools/sanchk -w"
```

and press .

Where: **<directory>** is the directory under which Monitor I was installed.

System Response:

Enter password for root

- 2 Enter this password.
- 3 To check for errors, type: `/usr/tmp/sanout`

Expected Results

Wait for this message:

All Monitor I files have been installed correctly.

Test Case 2

This test verifies if the correct number of placeholders for the databases have been created under each database directory (for example: */usr/mtm/db1*). The number of databases for each database directory depends on the disk configuration.

Test Outline

1 Type `cat $MTMDIR/tools/dbmap` and press `RETURN`.

Note: Execute the following steps for each directory listed in the **dbmap** file.

2 Type `cd <directory>`

Where: `<directory>` is the directory listed in the **dbmap** file.

3 Type `ls -d tmdb*.e/wc -l` and press `RETURN`.

4 Type `ls -d tmdb*.s/wc -l` and press `RETURN`.

5 Type `ls -d tmdb*.l/wc -l` and press `RETURN`.

6 Type `ls -d tmdb*.75e/wc -l` and press `RETURN`.

7 Type `ls -d tmdb*.75s/wc -l` and press `RETURN`.

8 Type `ls -d tmdb*.75l/wc -l` and press `RETURN`.

9 If the **Rotating Switch Study** is being used, type `ls -d tmdb*.i/wc -l` and press `RETURN`.

Expected Results

The output of the **ls** command should be equal to the number of databases to be created (input during cold installation or during execution of the **addmount** program) for the following databases (respectively):

- G2 or SYSTEM 85 or FP8 extended
- G2 or SYSTEM 85 or FP8 standard
- G2 or SYSTEM 85 or FP8 limited or daily
- G3r or G3i extended

- G3r or G3i standard
- G3r or G3i limited or daily and G1 1.1 and System 75
- Inactive

See: Your DOSS configuration output.

Test Case 3

This test case should only be run if the **Rotating Switch Study** feature is being used.

Test Outline

- 1 Type `cd $MTMDIR/prog/common` and press .
- 2 Type: `cat rotenvlist|egrep "TMROTATE/^TMMAXDB/^TMMAXDB75"` and press .

Expected Results

TMROTATE should be set to `y`. The values for TMMAXDB and TMMAXDB75 should be equal to the values entered for *total G2 or SYSTEM 85 or FP8* switches, and *total G3r, G3i, G1, or SYSTEM 75* switches respectively. The above values are entered during installation or during execution of the **addmount** program.

Test Case 4

Test Outline

- 1 Type `ps -eaf|grep cron` and press .

Expected Results

The `/etc/cron` should be running and owned by **root**.

Test Case 5

This test verifies that mail for **mtmadm1** is being forwarded to **mtmadm**.

Test Outline

- 1 Type *mail mtmadm1* and press .
- 2 Type a message, for example, *Mail test* and press .
- 3 Press - .
- 4 Type *mail* and press .
- 5 Type *d* and press .

Expected Results

Mail for **mtmadm** shows up in the message for **mtmadm1**.

Test Case 6

This test verifies that **KERNEL** parameters are reconfigured correctly for Monitor I.

Test Outline

- 1 Type */etc/sysdef/egrep "NPROC|MAXUP|NINODE|NS5INODE|NFILE"* and press .
- 2 Type *ulimit* and press .

Expected Results

The output of the **sysdef** command should be checked against the values entered previously.
The output of the **ulimit** command should be **8192**.

See: **Chapter 2** for the 3B2 installation, **Chapter 3** for 6386E/33 Model S installation, and **Chapter 4** for 6386SX/EL installation in this manual.

Test Case 7

This test should be executed if System 85 and/or DIMENSION switches are to be supported. This test verifies that **uucp** files are set up correctly for Monitor I and switch (System 85 and DIMENSION) communication. You need a live System 85 and/or a DIMENSION switch not held up in ADMIN or MAINTENANCE mode for testing this script.

Test Outline

- 1 Add a System 85 (any release) and a DIMENSION (any release) switch (refer to the Security Information for Monitor I).
- 2 Type *mtm* and press to access the Monitor I main menu.
- 3 Enter the System 85 target name.
- 4 Type *6* and press to access the **Utilities Menu**.
- 5 Type *2* and press to select **Display Switch Time** option.
- 6 Type *y* and press to continue.
- 7 Repeat steps 1–4 for your DIMENSION target.

Expected Results

The current switch and machine time, date, day, and time zone are displayed.

Test Case 8

This test should be executed if a System 75 switch is to be supported. This test verifies that **uucp** files are set up correctly for Monitor I and switch (System 75) communication.

Test Outline

- 1 Add a System 75 switch (refer to the Security Information for Monitor I).
- 2 Type *mtm* and press to access the Monitor I **Main Menu**.
- 3 Enter the System 75 target name.
- 4 Type *4* and press to access the **Utilities Menu**.

- 5 Type `2` and press `RETURN` to select the **System 75 Cut-through** option.
- 6 Enter login name and password. Select the default terminal type.
- 7 To log off the System 75 switch, type: *logoff* at the prompt:

enter command

Expected Results

You should be successfully logged on to the System 75 switch.

Test Case 9

This test verifies that Monitor I polling and alarm manager can be brought up successfully.

Test Outline

- 1 Type `cd /etc/init.d` and press `RETURN`.
- 2 Type `sh monitorl start` and press `RETURN`.
- 3 Type `ps -eaf|grep mtm` and press `RETURN`.

Expected Results

The `ps` command shows two processes—`mtmguard` and `mtmalarm`—running.

Test Case 10

This test verifies that Monitor I polling and alarm manager can be brought down successfully.

Test Outline

- 1 Type `cd /etc/init.d` and press `RETURN`.
- 2 Type `sh monitorl stop` and press `RETURN`.
- 3 Type `ps -eaf|grep mtm` and press `RETURN`.

Expected Results

The `ps` command does not show the above two processes.

Test Case 11

This test should be executed if the INADS system is available and with **cold** Monitor I installations only. This test verifies that the Monitor I alarms can be sent successfully to INADS. This test should be executed between 20 minutes after the hour and 10 minutes before the hour.

Test Outline

- 1 Enter INADS destination name and telephone number (refer to the Security Information for Monitor I).
- 2 Register Monitor I product ID in INADS system. The product ID should be 10 digits long, beginning with the numeral 8.
- 3 Type *mtm* and press to access the Monitor I main menu.
- 4 Enter the System 75, System 85, or DIMENSION target name.
- 5 If your target name is a System 85 or DIMENSION switch, type *5* and press . For anything else, type *3* and press to access the **Administrative Menu**.
- 6 Type *5* and press to access the **Administrative Menu**.
- 7 Type *2* and press to access the **Alarm Destination** screen.
- 8 Enter Monitor I Alarm ID, which has been registered as the Monitor I product ID in the INADS system.
- 9 Enter Switch Target Alarm ID, which is the Switch (PBX) ID.
- 10 Type *!sh* to get the UNIX System prompt.
- 11 At the UNIX prompt, type *\$MTMDIR/tools/in_alarms* and press .
- 12 Wait for 10 minutes.
- 13 Log in to INADS and check if you have received alarms.

Expected Results

There should be one alarm for the Monitor I product ID in the INADS System.

Port Configuration Worksheets

Port Configuration Worksheet for 3B2/600

Slot:Board	Port	Port Name	Device Connected	Phone Line
	CONSOLE1	console		
	CONSOLE2	contty		
1: SCSI Tape				
2: EPorts	Serial 1	tty21		
	Serial 2	tty22		
	Serial 3	tty23		
	Serial 4	tty24		
	Serial 5	tty25		
	Serial 6	tty26		
	Serial 7	tty27		
	Serial 8	tty28		
3: EPorts	Serial 1	tty31		
	Serial 2	tty32		
	Serial 3	tty33		
	Serial 4	tty34		
	Serial 5	tty35		
	Serial 6	tty36		
	Serial 7	tty37		
	Serial 8	tty38		
4: EPorts	Serial 1	tty41		
	Serial 2	tty42		
	Serial 3	tty43		
	Serial 4	tty44		
	Serial 5	tty45		
	Serial 6	tty46		
	Serial 7	tty47		
	Serial 8	tty48		
5: RMP Card				
	3B2 Console	tty51		
	Remote Terminal	tty52		
	Remote Terminal	tty53		
	Alarm Output	tty54		
	UPS Input	tty55		
	Remote Alarm	tty56		
	Remote Alarm	tty57		

Port Configuration Worksheet for 6386E/33

Slot:Board	Port	Port Name	Device Connected	Phone Line
	COM1	tty00		
	COM2	tty01		
	LPT1	lp		
1: SCSI Tape				
2: IPC BOARD I	Serial 1	ttyh01		
	Serial 2	ttyh02		
	Serial 3	ttyh03		
	Serial 4	ttyh04		
	Serial 5	ttyh05		
	Serial 6	ttyh06		
	Serial 7	ttyh07		
	Serial 8	ttyh08		

Port Configuration Worksheet for 6386SX/EL

Slot:Board	Port	Port Name	Device Connected	Phone Line
	COM1	tty00		
	COM2	tty01		
	LPT1	lp		
1: IPC BOARD I	Serial 1	ttyh01		
	Serial 2	ttyh02		
	Serial 3	ttyh03		
	Serial 4	ttyh04		
	Serial 5	ttyh05		
	Serial 6	ttyh06		
	Serial 7	ttyh07		
	Serial 8	ttyh08		

Port Configuration Worksheet for NCR-3315

Slot:Board	Port	Port Name	Device Connected	Phone Line
	COM1	tty00		
	COM2	tty01		
	LPT1	lp		
1: IPC BOARD I	Serial 1	ttyh01		
	Serial 2	ttyh02		
	Serial 3	ttyh03		
	Serial 4	ttyh04		
	Serial 5	ttyh05		
	Serial 6	ttyh06		
	Serial 7	ttyh07		
	Serial 8	ttyh08		

Port Configuration Worksheet for NCR-3332

Slot:Board	Port	Port Name*	Device Connected	Phone Line
	COM1	tty00		
	COM2	tty01		
	LPT1	lp		
1: Equinox BOARD I	Serial 1	ttyaA		
	Serial 2	ttyaB		
	Serial 3	ttyaC		
	Serial 4	ttyaD		
	Serial 5	ttyaE		
	Serial 6	ttyaF		
	Serial 7	ttyaG		
	Serial 8	ttyaH		

* The port name for a bidirectional transmission is written in upper case (ttyaA), while the name for an outgoing transmission is written in lower case (ttyaa).

Monitor I Error Messages

Installation Error Messages

The DEFINITY Monitor I installation error messages are listed below, along with the recommended action for each message.

Error Message	Recommended Action
<i>All database place holders could not be created successfully.</i>	Call customer support.
<i>Can not block mtmadm1 and informix login.</i>	/etc/passwd and/or /etc/shadow files should have at least read permission for the owner.
<i>Compilation may not have completed successfully.</i>	Check /usr/tmp/journal to find the names of the database(s) and the forms that could not be compiled. Call customer support.
<i>DEFINITY Monitor I software not installed.</i>	You must do cold installation first before warm installation can be done.
<i>/etc/init.d directory does not exist.</i>	Check with your system administrator.
<i>/etc/rc0.d directory does not exist.</i>	Check with your system administrator.
<i>/etc/rc2.d directory does not exist.</i>	Check with your system administrator.
<i>INFORMIX DBMS should be installed before installing monitor I.</i>	Refer to the step that describes how to install INFORMIX.
<i>informix is not a valid group id</i>	Refer to the procedure that describes how to add the informix group.
<i>informix is not a valid user id.</i>	Refer to the procedure that describes how to add the informix user.
<i>informix login does not belong to group 'informix'.</i>	Modify <i>informix</i> login to belong to group <i>informix</i> .

Error Message	Recommended Action
<i>Installation may not have completed successfully.</i>	All Monitor I files and directories are not installed correctly or placeholders for directories could not be created successfully. Check /usr/tmp/journal to find the errors.
<i>Insufficient space in <directory>.</i>	At least xxxxx free blocks required in directory where Monitor I is installed before Monitor I installation can continue.
<i>Monitor I files/databases are in use.</i>	No one should be in Monitor I directories or using Monitor I databases. Ask all Monitor I users to log off. Check the output of ps -eaf to see that no Monitor I process is running. Wait for the Monitor I processes to finish.
<i>mtmadm is not a valid user id.</i>	Refer to the step that describes how to add Monitor I users.
<i>mtmadm1 is not a valid user id.</i>	Refer to the step that describes how to add Monitor I users.
<i>mtmadm login does not belong to group traf.</i>	Modify mtmadm login to belong to group traf .
<i>mtmadm1 login does not belong to group traf.</i>	Modify mtmadm1 login to belong to group traf.
<i>Must be root to install Monitor I software.</i>	Log in as root before starting installation.
<i>Not enough free space in root file system.</i>	At least 500 free blocks required in root file system before Monitor I installation can continue.
<i>Not enough free space in usr file system.</i>	At least 500 free blocks required in usr file system before Monitor I installation can continue.
<i>termcap file not found.</i>	Termcap file is missing from /etc and /usr/informix/etc . INFORMIX software may not have been installed correctly.

Monitor I Installation Error Messages (Cont'd)

Error Message	Recommended Action
<p><i>The release currently installed in your machine is more recent than the one in the tape.</i></p>	<p>You are trying to install an old release over a newer release.</p>
<p><i>This program can be executed only once.</i></p>	<p>Addmount can be executed only once after cold installation.</p>
<p><i>Unable to bring down the Monitor I alarm manager.</i></p>	<p>Log in as <i>mtmadm</i> and type <i>alarmend</i>.</p>
<p><i>Unable to bring down the Monitor I polling system.</i></p>	<p>Log in as <i>mtmadm</i> and type <i>pollend</i>.</p>
<p><i>Unable to copy Monitor I software from tape.</i></p>	<p>Clean the tape drive and restart installation. If the error persists, then the tape is bad. You have to reorder a new one.</p>
<p><i>Unable to create directory <i>x</i> under <i>y</i>. Execute addmount after fixing the problem.</i></p>	<p>Check to see if there is a file called <i>x</i> under directory <i>y</i>. Remove file <i>x</i> if it exists. Execute addmount again as root.</p>
<p><i>/usr/lib/cron/cron.allow file is missing.</i></p>	<p>Check with your system administrator.</p>
<p><i>/usr/mail directory does not exist.</i></p>	<p>Check with your system administrator.</p>
<p><i>/usr/options directory missing.</i></p>	<p>Check with your system administrator.</p>
<p><i>/usr/spool/cron/crontabs directory does not exist.</i></p>	<p>Check with your system administrator.</p>
<p><i>/usr/tmp directory does not exist.</i></p>	<p>Create a directory called <i>tmp</i> under usr.</p>
<p><i>Warm Installation aborted. Fatal error during upgrade. Check usr/tmp/journal.</i></p>	<p>Upgrade scripts cannot be executed successfully for some of the databases. Check usr/tmp/journal to find out the database(s) and nature of errors. Call customer support if need be.</p>
<p><i>Warm installation may not have completed successfully.</i></p>	<p>All Monitor I files and directories are not installed correctly or compilation did not complete successfully. Check usr/tmp/journal to find the errors.</p>

Index

- 10-conductor cables
 - 6386E/33, 3-21
 - 6386SX/EL, 4-19
 - NCR-3315, 5-19
 - NCR-3332, 6-17
- 2224-CEO modem
 - set
 - hardware switches
 - 6386E/33, 3-13
 - 6386SX/EL, 4-12
 - NCR-3315, 5-11
 - NCR-3332, 6-9
 - software options
 - 3B2/600, 2-48
 - 6386E/33, 3-46
 - setting
 - software options
 - 6386SX/EL, 4-48, 5-47
 - setup
 - 6386E/33, 3-13
 - 6386SX/EL, 4-11
 - NCR-3315, 5-11
 - NCR-3332, 6-9
- 2224-CEO Modem — Software Option
 - 6386SX/EL, 4-50, 5-49, 6-45
- 2224-CEO Modem — software options
 - 3B2/600, 2-50
- 2224-GNN modem
 - setup
 - 6386E/33, 3-13
 - 6386SX/EL, 4-11
 - NCR-3315, 5-11
 - NCR-3332, 6-9
- 2400 AT&T Modem
 - setting up, 3-17, 4-15, 5-15, 6-13
 - 3B2/600, 2-20
- 2400 Modem software options, 2-20, 3-17, 4-15, 5-15, 6-13
- 329D console
 - 6386E/33, 3-4
- 3315
 - G1
 - administration, 5-10
 - INFORMIX
 - group
 - creating, 5-25
 - User
 - creating, 5-25
 - Kernel
 - UNIX
 - rebuilding, 5-23
- 2224-CEO modem
 - set
 - hardware switches, 5-11
 - setup, 5-11
- 2224-GNN modem
 - setup, 5-11
- 513 Terminal Emulation cartridge, 5-10
- 572 Printer, 5-20
- 615 BCT
 - setup, 5-10
- 715 BCS
 - setup, 5-10
- 730 MTG
 - setup, 5-10
- 730 terminal, 5-9
- add on cards
 - install
 - NCR-3315, 5-2
- additional memory
 - install, 5-2
- AT&T 2400 modem
 - setup, 5-11
- cable
 - printer
 - connect, 5-20
- console
 - setup, 5-3
- crash/dump partition, 5-6
- cursor options, 5-11
- expansion kits, 5-2
- FACE
 - load, 5-7
- FMLI
 - load, 5-7
- Foundation set
 - UNIX, 5-4
- G3r, G3i administration, 5-10
- hardware
 - install additional cards, 5-2
- INFORMIX
 - loading, 5-25
- Intelligent Ports Card, 5-3
- IRQ levels, 5-1
- keyboard
 - connecting, 5-3
- memory
 - extended
 - check, 5-5
- modems
 - setup, 5-10, 5-11
- mouse
 - connecting, 5-3
- MS-DOS
 - create partition, 5-5
 - partitioning hard disk, 5-5

password
 root, 5-6
port(s)
 numbers, 5-19
power outlet
 connect, 5-3
printer
 enabling, 5-21
 setup, 5-20
processor
 reboot, 5-8
Remote Terminal Package
 load, 5-9
root partition, 5-6
 setup, 5-1
Setup utility
 UNIX, 5-4
SIMMs
 install, 5-2
 software
 load additional, 5-8
surface analysis
 preparing hard disk, 5-5
swap/paging partition, 5-6
System 75
 administration, 5-10
system board
 install, 5-2
terminals
 connecting, 5-19
 setup, 5-10
terminfo entries, 5-9
UNIX
 create partition, 5-5
UNIX,
 editing package, 5-7
 foundation set, 5-5
 install base system, 5-6
 Kernel
 rebuilding, 5-23
 loading, 5-4
 Setup utility, 5-4
 usr partition, 5-6
3315 Installation, 5-1
3332
users
 adding, 6-26
G1
 administration, 6-8
INFORMIX
 group
 creating, 6-23
 User
 creating, 6-23
Kernel
 UNIX
 rebuilding, 6-21
mtmadm1 login
 Monitor I, 6-27
2224-CEO modem
 setup, 6-9
2224-GNN modem
 setup, 6-9
513 Terminal Emulation cartridge, 6-8
615 BCT
 setup, 6-8
715 BCS
 setup, 6-8
730 MTG
 setup, 6-8
730 terminal, 6-7
AT&T 2400 modem
 setup, 6-9
console
 setup, 6-2
crash/dump partition, 6-4
cron login, 6-27
cursor options, 6-9
disk
 partitioning, 6-3
FACE
 load, 6-5
FMLI
 load, 6-5
Foundation set
 UNIX, 6-3
G3r
 G3i administration, 6-8
INFORMIX
 loading, 6-23
installation, 6-1
keyboard
 connecting, 6-2
modems
 setup, 6-8, 6-9
mouse
 connecting, 6-2
MS-DOS
 create partition, 6-3
partition
 crash/dump, 6-4
partitioning hard disk, 6-3
password
 root, 6-5
port(s)
 bidirectional, 6-44
 enabling, 6-44
 numbers, 6-17
power outlet
 connect, 6-2
printer
 enabling, 6-19
 setup, 6-18
printers, 6-18
processor
 reboot, 6-6
Remote Terminal Package
 load, 6-7
root partition, 6-4
 setup, 6-1
software
 load additional, 6-6

- surface analysis
 - preparing hard disk, 6-4
- swap/paging partition, 6-4
- System 75
 - administration, 6-8
- terminals
 - connecting, 6-17
 - setup, 6-8
- terminfo entries, 6-7
- UNIX
 - create partition, 6-3
- UNIX editing package, 6-5
- UNIX
 - foundation set, 6-3
 - install base system, 6-4
 - Kernel
 - rebuilding, 6-21
 - loading, 6-3
 - usr partition, 6-4
- 3710 AT&T DataPort Modem
 - installing, 5-18
 - setting up, 3-20, 4-18, 5-18, 6-16
 - 3B2/600, 2-23
- 3710 AT&T DataPort modem
 - software options, 5-18, 6-16
- 3B2/600
 - 2224-CEO Modem — software options, 2-50
 - 2224-CEO modem
 - set, 2-48
 - 2400 AT&T Modem
 - setting up, 2-20
 - 2400 Modem software options, 2-20
 - 513 Terminal Emulation cartridge, 2-15
 - 572 Printer, 2-25
 - 715 terminal options, 2-3, 2-16
 - add the Monitor I Group, 2-32
 - add the Monitor I Users, 2-32
 - additional hardware, 2-4
 - AIC, 2-4
 - alarms from, 2-4
 - Asynchronous Communications, 2-15
 - AT&T 2400 Modem Bidirectional, 2-21
 - Basic Networking Utilities, 2-13
 - bidirectional ports, 2-47
 - cold installation of Monitor I software, 2-34
 - Configuration of a Product Access Modem, 2-21
 - console, 2-3
 - database place holders, 2-39
 - documentation, 1-5
 - EDT (Equipped Device Table), 2-9
 - enabling system ports, 2-47
 - EPORTS card, 2-4
 - install, 2-5
 - at** command, 2-33
 - cron** command, 2-33
 - lpadmin** command, 2-26
 - lpstat** command, 2-26
 - GNN Modem hardware, 2-18
 - hardware components, 2-2
 - hardware connectivity, 2-1
 - INFORMIX group
 - adding, 2-30
 - INFORMIX
 - installing, 2-30
 - installation errors, 2-41
 - installation overview, 1-7
 - installing UNIX, 2-13
 - Line Printer Spooling Utilities, 2-13
 - modem setup, 2-17
 - modems
 - connecting, 2-24
 - Monitor I software
 - warm installation, 2-42
 - passwords, 2-11
 - port configuration worksheet, B-1
 - post-installation steps, 2-43
 - printer cable connection, 2-25
 - processor
 - installing, 2-2
 - RMP, 2-4
 - RMP card, 2-5
 - RMP utilities, 2-14
 - root logins, 2-11
 - rotating switch study, 2-38, 2-44
 - Silent Knight autodialer, 2-4
 - successful installation
 - checking, 2-41
 - terminal emulation
 - 513, 2-3
 - terminal options, 2-3
 - terminal setup, 2-15
 - terminals
 - connecting, 2-24
 - terminfo files, 2-13
 - tty lines, 2-5
 - tunable parameters
 - changing, 2-27
 - UNIX documents, 2-9
 - UNIX hardware and software, 2-12
 - Unix installation
 - disk partitioning, 2-10
 - UNIX
 - installing, 2-9
 - UNIX Setup program, 2-11
 - unpacking procedure, 2-3
 - Windowing Utilities, 2-14
- 3B2/600,
 - documents, 2-2
 - logins, 2-11
 - Security Administration Utilities, 2-14
 - shutdown, 2-14
- 513 Terminal Emulation cartridge, 1-4
 - 3B2/600, 2-3, 2-15
 - 6386E/33, 3-12
 - 6386SX/EL, 4-10
 - NCR-3315, 5-10
 - NCR-3332, 6-8
- 572 Printer
 - 3B2/600, 2-25
 - 6386E/33, 3-22
 - 6386SX/EL, 4-20
 - NCR-3315, 5-20

- NCR-3332, 6-18
- 593 Printer
 - 6386E/33, 3-22
- 595 Printer
 - NCR-3332, 6-18
- 610 BCT
 - setting up
 - 3B2/600, 2-15
- 615 BCT
 - setting up
 - for the 3B2/600, 2-3
 - setup
 - 6386E/33, 3-12
 - 6386SX/EL, 4-10
 - NCR-3315, 5-10
 - NCR-3332, 6-8
- 615 Terminal Emulation cartridge, 1-4
- 6386E/33
 - 2224-CEO modem
 - setup, 3-13
 - 2224-GNN modem
 - setup, 3-13
 - 329D console, 3-4
 - 513 Terminal Emulation cartridge, 3-12
 - 572 Printer, 3-22
 - 593 Printer, 3-22
 - 615 BCT setup, 3-12
 - 730 MTG setup, 3-12
 - 730 terminal, 3-10
 - additional software
 - loading, 3-9
 - alarm interface, 3-4
 - cable
 - printer
 - connecting, 3-22
 - cold installation of Monitor I, 3-32
 - console
 - setting up, 3-4
 - creating partition
 - MS-DOS, 3-6
 - cursor options
 - on console, 3-13
 - documentation, 1-5
 - DOSS Configuration, 3-37
 - Editing package
 - loading, 3-8
 - extended memory
 - checking, 3-6
 - at** command, 3-30
 - chgrp traf** command, 3-30
 - cron** command, 3-30
 - cron** login, 3-30
 - displaypkg** command, 3-28
 - installpkg** command, 3-10, 3-27
 - lpadmin** command, 3-23
 - lpsched** command, 3-23
 - lpstat** command, 3-23
 - mtmadm1** login
 - Monitor I, 3-30
 - mtmadm** login
 - Monitor I, 3-29

- .profile**
 - editing, 3-30
- FACE
 - loading, 3-8
 - using, 3-29
- FMLI
 - loading, 3-8
- G1 administration, 3-12
- G3i administration, 3-12
- hard disk partitioning, 3-6
- hardware
 - installing additional cards, 3-3
- INFORMIX
 - group
 - adding, 3-26
 - loading, 3-26
 - user
 - adding, 3-26
- INFORMIX-SE
 - loading, 3-27
- INFORMIX-SQL
 - loading, 3-27
- installation, 3-1
- installation overview, 1-8
- installation prerequisites, 3-1
- IPC Device Driver
 - loading, 3-10
- IPC-900
 - installing, 3-3
- IRQ, 3-3
- IRQ levels, 3-1
- Kernel, UNIX
 - rebuild, 3-24
- keyboard
 - connection, 3-4
- login for Monitor I
 - mtmadm**, 3-29
- memory chips
 - installing, 3-2
- memory
 - expansion kits
 - installing, 3-3
 - extended, 3-6
- modem setup
 - 2224-GNN, 3-13
- modems
 - connecting, 3-21
 - setup, 3-12
- mouse
 - connection, 3-4
- Network Support Utilities
 - loading, 3-8
- password
 - root, 3-7
- polling options, 3-38
- port configuration worksheet, B-2
- port(s)
 - numbers, 3-21
- power outlet
 - connection, 3-4
- printer

- setup, 3-22
- remote access modem, 3-4
- Remote Maintenance Card (RMC), 3-3
- Remote Terminal Package
 - loading, 3-10
- RMP connection testing, 3-4
- root password, 3-7
- rotating switch feature
 - installing, 3-37
- Security Administration
 - loading, 3-10
- setup, 3-1
- SIMMs
 - installation, 3-3
- software
 - check installed packages, 3-28
- surface analysis
 - preparing hard disk, 3-7
- System 75
 - administration, 3-12
- system board
 - installation, 3-3
- T-adapter
 - IPC card, 3-3
- terminal emulation
 - 513, 3-12
- terminal options, 3-13
- terminals
 - connecting, 3-21
 - setup, 3-12
- Uninterruptible power supply (UPS), 3-4
- UNIX base system
 - installing, 3-7
- UNIX
 - creating partition, 3-6
 - foundation set, 3-6
 - loading, 3-5
 - rebuild kernel, 3-24
 - Setup utility, 3-5
- unpacking, 3-2
- users
 - adding, 3-29
- VDC 600 card, 3-4
- VDC card
 - installing, 3-2
- warm installation of Monitor I, 3-40
- worksheet
 - disk configuration
 - checking, 3-38
- 6386SX/EL
 - G1 administration, 4-10
- INFORMIX
 - group
 - creating, 4-25
 - User
 - creating, 4-25
- Kernel
 - UNIX
 - rebuilding, 4-23
- mtmadm1 login
 - Monitor I, 4-29, 5-29
- 2224-CEO modem
 - setting
 - software options, 4-48, 5-47
 - setup, 4-11
- 2224-GNN modem
 - setup, 4-11
- 513 Terminal Emulation cartridge, 4-10
- 572 Printer, 4-20
- 615 BCT
 - setup, 4-10
- 715 BCS
 - setup, 4-10
- 730 MTG
 - setup, 4-10
- 730 terminal, 4-9
- add on cards
 - install
 - 6386SX/EL, 4-2
- additional memory
 - install, 4-2
- console
 - setup, 4-3
- crash/dump partition, 4-6
- cron login, 4-29, 5-29
- cursor options, 4-11
- disk
 - partitioning, 4-5
- expansion kits, 4-2
- FACE
 - load, 4-7
 - using, 4-28, 5-28
- FMLI
 - load, 4-7
- Foundation set
 - UNIX, 4-4, 4-5
- G3i administration, 4-10
- hardware
 - install additional cards, 4-2
- INFORMIX
 - loading, 4-25
- installation, 4-1
- installation overview, 1-9
- Intelligent Ports Card, 4-3
- IRQ levels, 4-1
- keyboard
 - connecting, 4-3
- memory
 - extended
 - check, 4-5
- modems
 - flow control, 4-47, 5-46
 - setup, 4-10, 4-11
- mouse
 - connecting, 4-3
- MS-DOS
 - create partition, 4-5
- partition
 - crash/dump, 4-6
 - partitioning hard disk, 4-5
- password
 - root, 4-6

port configuration worksheet, B-3
port(s)
 bidirectional, 4-47, 5-46
 enabling, 4-47, 5-46
 numbers, 4-19
power outlet
 connect, 4-3
printer
 enabling, 4-21
 setup, 4-20
processor
 reboot, 4-8
Remote Terminal Package
 load, 4-9
root partition, 4-6
setup, 4-1
Setup utility
 UNIX, 4-4
SIMMs
 install, 4-2
software
 load additional, 4-8
surface analysis
 preparing hard disk, 4-5
swap/paging partition, 4-6
System 75
 administration, 4-10
system board
 install, 4-2
T-adaptor
 IPC card, 4-3
terminals
 connecting, 4-19
 setup, 4-10
terminfo entries, 4-9
UNIX
 create partition, 4-5
 editing package, 4-7
 foundation set, 4-5
 install base system, 4-6
 Kernel
 rebuilding, 4-23
 loading, 4-4
 Setup utility, 4-4
 users
 adding, 4-28, 5-28
 usr partition, 4-6
710 AT&T DataPort modem
 installing, 6-16
715 BCS
 setting up
 3B2/600, 2-3
 6386E/33, 3-12
 6386SX/EL, 4-10
 NCR-3315, 5-10
 NCR-3332, 6-8
715 terminal emulation options
 6386SX/EL, 4-11
 NCR-3315, 5-11
 NCR-3332, 6-9
715 terminal options

 3B2/600, 2-3, 2-16
 6386E/33, 3-13
 6386SX/EL, 4-11
 NCR-3315, 5-11
 NCR-3332, 6-9
730 MTG
 setup
 6386E/33, 3-12
 6386SX/EL, 4-10
 NCR-3315, 5-10
 NCR-3332, 6-8
730 terminal
 6386E/33, 3-10
 6386SX/EL, 4-9
 NCR-3315, 5-9
 NCR-3332, 6-7

A
Acceptance testing
 6386E/33, 3-46
Add INFORMIX
 group
 6386E/33, 3-26
 user
 6386E/33, 3-26
Add on cards
 install
 6386SX/EL, 4-2
 NCR-3315, 5-2
Add users
 Monitor I
 6386E/33, 3-29
 6386SX/EL, 4-28, 5-28
 NCR-3332, 6-26
Additional hardware 3B2/600, 2-4
Additional memory
 install
 6386SX/EL, 4-2
 NCR-3315, 5-2
 6386E/33, 3-3
Additional utilities
 3B2/600, 2-13
Addmount command
 3B2/600, 2-44
Add-on cards
 installing
 6386E/33, 3-3
AIC card
 3B2/600, 2-4, 2-5
Alarm interface
 6386E/33, 3-4
Alarm Interface Card (AIC)
 3B2/600, 2-4
Alarm manager and polling activated
 test case, A-6
Alarm manager and polling deactivated
 test case, A-6
Alarms sent to INADS
 test case, A-7
Asynchronous Communications

3B2/600, 2-15
at command
 3B2/600, 2-33
 6386E/33, 3-30
 6386SX/EL, 4-29, 5-29, 6-27
 AT&T 2400 modem
 installing, 3-17, 4-15, 5-15, 6-13
 setup
 3B2/600, 2-20
 NCR-3315, 5-11
 NCR-3332, 6-9
 software options, 2-20, 3-17, 4-15, 5-15, 6-13
 AT&T 2400 Modem Bidirectional, 2-21, 3-18, 4-16, 5-16, 6-14
 AT&T 572 Printer
 3B2/600, 2-25
 6386E/33, 3-22
 6386SX/EL, 4-20
 NCR-3315, 5-20
 NCR-3332, 6-18
 AT&T 593 Printer
 6386E/33, 3-22
 6386SX/EL, 4-20
 NCR-3315, 5-20
 NCR-3332, 6-18
 AT&T 595 Printer
 NCR-3332, 6-18
 AT&T DataPort 3710 modem
 installing, 3-20, 4-18, 5-18, 6-16
 3B2/600, 2-23
 software options, 2-23, 3-20, 4-18, 5-18, 6-16
 3B2/600, 2-23, 3-20, 4-18, 5-18, 6-16
 Autodialer configuration
 3B2/600, 2-7

B

Basic Networking Utilities
 3B2/600, 2-13
 Bidirectional ports
 3B2/600, 2-47
 6386E/33, 3-45
 6386SX/EL, 4-47, 5-46
 NCR-3332, 6-44
 Board
 Equinox, B-5

C

Cable
 printer
 connect
 6386SX/EL, 4-20
 NCR-3315, 5-20
 NCR-3332, 6-18
 connecting
 6386E/33, 3-22
 Cafe
 3B2/600, 2-33
 Card
 customer registration
 6386E/33, 3-27

VDC 600
 6386E/33, 3-4
 Change
 tunable parameters
 3B2/600, 2-27
 Check
 extended memory
 6386E/33, 3-6
 6386SX/EL, 4-5
 NCR-3315, 5-5
 installed software packages
 6386E/33, 3-28
 6386SX/EL, 4-27
 NCR-3315, 5-27
 NCR-3332, 6-25
chgrp traf command
 6386E/33, 3-30
 6386SX/EL, 4-29, 5-29, 6-27
 Cold installation
 Monitor I
 6386E/33, 3-32
 3B2/600, 2-34
 Command(s)
Addmount
 3B2/600, 2-44
at
 3B2/600, 2-33
 6386E/33, 3-30
 6386SX/EL, 4-29, 5-29, 6-27
chgrp traf
 6386E/33, 3-30
 6386SX/EL, 4-29, 5-29, 6-27
cron
 3B2/600, 2-33
 6386E/33, 3-30
 6386SX/EL, 4-29, 5-29, 6-27
displaypkg
 6386E/33, 3-28
 6386SX/EL, 4-27
 NCR-3315, 5-27
 NCR-3332, 6-25
installpkg
 6386E/33, 3-10, 3-27
 6386SX/EL, 4-9, 4-26, 5-9
 NCR-3315, 5-9, 5-26
 NCR-3332, 6-7, 6-24
lpadmin
 3B2/600, 2-26
 6386E/33, 3-23
lpsched
 6386E/33, 3-23
lpstat
 3B2/600, 2-26
 6386E/33, 3-23
 Configuration
 autodialer
 3B2/600, 2-7
 Configuration of a Product Access Modem, 2-21,
 3-18, 4-16, 5-16, 6-14
 Configuring ports
 3B2/600, 1-7

-
- 6386E/33, 1-8
 - 6386SX/EL, 1-9
 - NCR-3315, 1-10
 - NCR-3332, 1-11
 - Connect
 - keyboard
 - 6386SX/EL, 4-3
 - NCR-3315, 5-3
 - NCR-3332, 6-2
 - modems
 - 6386E/33, 3-21
 - 6386SX/EL, 4-19
 - NCR-3315, 5-19
 - NCR-3332, 6-17
 - mouse
 - 6386SX/EL, 4-3
 - NCR-3315, 5-3
 - NCR-3332, 6-2
 - printer cable
 - 6386E/33, 3-22
 - 6386SX/EL, 4-20
 - NCR-3315, 5-20
 - NCR-3332, 6-18
 - processor to power outlet
 - 6386SX/EL, 4-3
 - NCR-3315, 5-3
 - NCR-3332, 6-2
 - terminals
 - 6386E/33, 3-21
 - 6386SX/EL, 4-19
 - NCR-3315, 5-19
 - NCR-3332, 6-17
 - Connecting modems
 - 3B2/600, 2-24
 - Connection
 - keyboard
 - 6386E/33, 3-4
 - mouse
 - 6386E/33, 3-4
 - processor to power outlet
 - 6386E/33, 3-4
 - Connection testing
 - RMP
 - 6386E/33, 3-4
 - Connectivity diagram
 - 3B2/600, 2-1
 - Console
 - 3B2/600, 2-3
 - setting up
 - 6386E/33, 3-4
 - setup
 - 6386SX/EL, 4-3
 - NCR-3315, 5-3
 - NCR-3332, 6-2
 - unpack
 - 6386SX/EL, 4-3
 - NCR-3315, 5-3
 - NCR-3332, 6-2
 - unpacking
 - 6386E/33, 3-4
 - Conventions
 - documentation, 1-2
 - Crash/dump partition
 - 6386E/33, 3-7
 - 6386SX/EL, 4-6
 - NCR-3315, 5-6
 - NCR-3332, 6-4
 - Create INFORMIX
 - group
 - 6386SX/EL, 4-25
 - NCR-3315, 5-25
 - NCR-3332, 6-23
 - INFORMIX groups
 - 3B2/600, 2-30
 - INFORMIX
 - User
 - 6386SX/EL, 4-25
 - NCR-3315, 5-25
 - NCR-3332, 6-23
 - Create partition
 - MS-DOS
 - 6386E/33, 3-6
 - 6386SX/EL, 4-5
 - NCR-3315, 5-5
 - NCR-3332, 6-3
 - UNIX
 - 6386E/33, 3-6
 - 6386SX/EL, 4-5
 - NCR-3315, 5-5
 - NCR-3332, 6-3
 - cron login
 - 6386E/33, 3-30
 - 6386SX/EL, 4-29, 5-29
 - NCR-3332, 6-27
 - cron** command
 - 6386SX/EL, 4-29, 5-29, 6-27
 - 3B2/600, 2-33
 - 6386E/33, 3-30
 - cursor blink**
 - terminal option
 - 6386E/33, 3-13
 - Cursor options
 - on console
 - 3B2/600, 2-3, 2-16
 - 6386E/33, 3-13
 - 6386SX/EL, 4-11
 - NCR-3315, 5-11
 - NCR-3332, 6-9
 - Customer registration card
 - 6386E/33, 3-27
 - Customer service hotline number, 1-3
 - D**
 - Daily and limited polling option
 - 6386E/33, 3-38, 3-43
 - Database switch
 - specifying capacity
 - 6386E/33, 3-42
 - Database place holders
 - 3B2/600, 2-39
 - Default system printer

- enable
 - 6386E/33, 3-23
 - 3B2/600, 2-26
- DEFINITY Monitor I
 - definition, 1-1
- Device type and speed
 - modems
 - 6386E/33, 3-45
 - 6386SX/EL, 4-47, 5-46
- Disk
 - partitioning
 - 6386E/33, 3-6
 - 6386SX/EL, 4-5
 - NCR-3315, 5-5
 - NCR-3332, 6-3
 - Disk configuration worksheet
 - checking
 - 6386E/33, 3-38
 - displaypkg** command
 - 6386E/33, 3-28
 - 6386SX/EL, 4-27
 - NCR-3315, 5-27
 - NCR-3332, 6-25
 - Documentation
 - 6386E/33, 1-5
 - conventions, 1-2
 - list of supporting, 1-5
 - miscellaneous, 1-6
 - NCR-3315, 1-6
 - NCR-3332, 1-6
 - 3B2/600 processor, 2-2
 - DOSS Configuration
 - 6386E/33, 3-37, 3-42
- E**
- Edit
 - UNIX kernel
 - 6386E/33, 3-24
 - 6386SX/EL, 4-23
 - NCR-3315, 5-23
 - NCR-3332, 6-21
 - Edit the **/etc/passwd** file
 - 6386E/33, 3-30
 - 6386SX/EL, 4-29, 5-29, 6-27
 - Edit the System Group file
 - 6386E/33, 3-29
 - 6386SX/EL, 4-28, 5-28
 - NCR-3332, 6-26
 - Editing **.profile**
 - 6386E/33, 3-30
 - Editing package
 - 6386E/33, 3-8
 - 6386SX/EL, 4-7
 - NCR-3315, 5-7
 - NCR-3332, 6-5
 - EDT (Equipped Device Table)
 - 3B2/600, 2-9
 - Emulation
 - terminal
 - 513
 - 3B2/600, 2-3, 2-15
 - 6386E/33, 3-12
 - 6386SX/EL, 4-10
 - NCR-3315, 5-10
 - NCR-3332, 6-8
 - 715
 - 6386SX/EL, 4-11
 - NCR-3315, 5-11
 - NCR-3332, 6-9
 - Enable
 - default printer
 - 6386E/33, 3-23
 - printer
 - 6386E/33, 3-23
 - 6386SX/EL, 4-21
 - NCR-3315, 5-21
 - NCR-3332, 6-19
 - Enable ports
 - 3B2/600, 2-47
 - 6386E/33, 3-45
 - 6386SX/EL, 4-47, 5-46
 - NCR-3332, 6-44
 - Enabling default printer
 - 3B2/600, 2-26
 - EPORTS card
 - 3B2/600, 2-4
 - install
 - 3B2/600, 2-5
 - Equinox Board, B-5
 - Equinox Device Driver
 - load
 - NCR-3332, 6-7
 - Equipped Device Table (EDT)
 - 3B2/600, 2-9
 - Essential utilities
 - UNIX
 - 3B2/600, 2-9
 - /etc/cron owned by root
 - test case, A-3
 - /etc/group file
 - edit
 - 6386SX/EL, 4-28, 5-28
 - 6386E/33, 3-29
 - NCR-3332, 6-26
 - /etc/passwd** file
 - edit
 - 6386SX/EL, 4-29, 5-29, 6-27
 - 6386E/33, 3-30
 - Expanded ports card
 - 3B2/600, 2-4
 - Expansion board
 - install
 - 6386SX/EL, 4-3
 - NCR-3315, 5-3
 - installing
 - 6386E/33, 3-3
 - Expansion kits
 - 6386E/33, 3-3
 - 6386SX/EL, 4-2, 5-2
 - Extended memory
 - check

- 6386SX/EL, 4-5
- NCR-3315, 5-5
- checking
 - 6386E/33, 3-6
- Extended polling option
 - 6386E/33, 3-38, 3-43
- External disk unit
 - installation
 - 3B2/600, 2-6

F

FACE

- for adding logins
 - 6386E/33, 3-29
- load
 - 6386SX/EL, 4-7
 - NCR-3315, 5-7
 - NCR-3332, 6-5
 - 6386E/33, 3-8

FACE Help

- Load
 - 6386E/33, 3-8
 - 6386SX/EL, 4-7
 - NCR-3315, 5-7
 - NCR-3332, 6-5

513 Terminal Emulation cartridge, 1-4

- 3B2/600, 2-3, 2-15
- 6386E/33, 3-12
- 6386SX/EL, 4-10
- NCR-3315, 5-10
- NCR-3332, 6-8

Flow control

- modems
 - 6386E/33, 3-45
 - 6386SX/EL, 4-47, 5-46

FMLI

- load
 - 6386SX/EL, 4-7
 - NCR-3315, 5-7
 - NCR-3332, 6-5
 - 6386E/33, 3-8

Foundation set

- UNIX
 - 6386E/33, 3-5, 3-6
 - 6386SX/EL, 4-4, 4-5
 - NCR-3315, 5-4, 5-5
 - NCR-3332, 6-3

G

G1

- administration
 - 3B2/600, 2-3, 2-15
 - 6386E/33, 3-12
 - 6386SX/EL, 4-10
 - NCR-3315, 5-10
 - NCR-3332, 6-8
- cartridge with 730 terminal
 - 6386SX/EL, 4-9
 - NCR-3315, 5-9

- NCR-3332, 6-7

G3i

- administration
 - for the 6386E/32, 3-12
 - for the 6386SX/EL, 4-10
- cartridge with 730 terminal
 - 6386SX/EL, 4-9

G3r, G3i

- administration
 - 3B2/600, 2-3
 - for the 3B2/600, 2-15
 - for the NCR-3315, 5-10
 - for the NCR-3332, 6-8
- cartridge with 730 terminal
 - NCR-3315, 5-9
 - NCR-3332, 6-7

GNN Modem hardware

- 3B2/600, 2-18

Group

INFORMIX

- adding
 - 3B2/600, 2-30
 - 6386E/33, 3-26
 - 6386SX/EL, 4-25
 - NCR-3315, 5-25
 - NCR-3332, 6-23

H

Hard disk

- partitioning
 - 6386E/33, 3-6
 - 6386SX/EL, 4-5
 - NCR-3315, 5-5
 - NCR-3332, 6-3

Hardware

- additional
 - 3B2/600, 2-4
- connectivity overview
 - 3B2/600, 2-1
- in standard configuration
 - 3B2/600, 2-2
- Install additional cards
 - 6386SX/EL, 4-2
 - NCR-3315, 5-2
- installation for the 3B2/600, 2-2
- installing additional cards
 - 6386E/33, 3-3

Hardware components, 1-3

Helpline

- TSC, 3-10, 4-9, 5-9, 6-7

Hotline phone number, 1-3

I

INADS

- alarms sent to
 - test case, A-7

INFORMIX

- group
 - creating

- 6386E/33, 3-26
- 6386SX/EL, 4-25
- NCR-3315, 5-25
- NCR-3332, 6-23
- installing
 - 3B2/600, 2-30
- load
 - 6386E/33, 3-26
 - 6386SX/EL, 4-25
 - NCR-3315, 5-25
 - NCR-3332, 6-23
- user
 - adding
 - 6386E/33, 3-26
 - 6386SX/EL, 4-25
 - NCR-3315, 5-25
 - NCR-3332, 6-23
 - user and group
 - 3B2/600, 2-30
- INFORMIX group
 - adding
 - 3B2/600, 2-30
- INFORMIX-SE
 - load
 - 6386SX/EL, 4-26
 - NCR-3315, 5-26
 - NCR-3332, 6-24
 - 6386E/33, 3-27
- INFORMIX-SE software
 - 3B2/600, 2-31
- INFORMIX-SQL
 - load
 - 6386SX/EL, 4-26
 - NCR-3315, 5-26
 - NCR-3332, 6-24
 - 6386E/33, 3-27
- INFORMIX-SQL software
 - 3B2/600, 2-30
- Install
 - 572 Printer
 - 6386SX/EL, 4-20
 - NCR-3315, 5-20
 - add on cards
 - 6386SX/EL, 4-2
 - NCR-3315, 5-2
 - additional memory
 - 6386SX/EL, 4-2
 - NCR-3315, 5-2
 - AT&T 572 Printer
 - 6386SX/EL, 4-20
 - NCR-3315, 5-20
 - NCR-3332, 6-18
 - AT&T 593 Printer
 - 6386SX/EL, 4-20
 - NCR-3315, 5-20
 - NCR-3332, 6-18
 - EPORTS card
 - 3B2/600, 2-5
 - expansion board
 - 6386SX/EL, 4-3
 - NCR-3315, 5-3
- IPC-900
 - 6386SX/EL, 4-3
 - NCR-3315, 5-3
- memory chips
 - 6386E/33, 3-2
- memory expansion kits
 - install
 - 6386SX/EL, 4-2
 - NCR-3315, 5-2
- Okidata-ML184 Printer
 - NCR-3332, 6-18
- printer
 - 6386SX/EL, 4-20
 - NCR-3315, 5-20
 - NCR-3332, 6-18
- SIMMs
 - 6386SX/EL, 4-2
 - NCR-3315, 5-2
- system board
 - 6386E/33, 3-3
 - 6386SX/EL, 4-2
 - NCR-3315, 5-2
- UNIX base system
 - 6386SX/EL, 4-6
 - NCR-3315, 5-6
 - NCR-3332, 6-4
- VDC card
 - 6386E/33, 3-2
- Installation
 - 3B2/600 processor, 2-2
 - 572 Printer
 - 6386E/33, 3-22
 - 6386E/33, 3-1
 - additional memory
 - 6386E/33, 3-3
 - AT&T 572 Printer
 - 6386E/33, 3-22
 - AT&T 593 Printer
 - 6386E/33, 3-22
 - cold
 - 6386E/33, 3-32
 - expansion board
 - 6386E/33, 3-3
 - IPC-900
 - 6386E/33, 3-3
 - memory expansion kits
 - 6386E/33, 3-3
 - printer
 - 6386E/33, 3-22
 - SIMMs
 - 6386E/33, 3-3
 - UNIX base system
 - 6386E/33, 3-7
 - warm
 - 6386E/33, 3-40
- Installation errors
 - 3B2/600, 2-41
- Installation overview
 - 3B2/600, 1-7
 - 6386E/33, 1-8
 - 6386SX/EL, 1-9

NCR-3315, 1-10
 NCR-3332, 1-11
 Installation prerequisites
 3B2/600, 2-2
 6386E/33, 3-1
 Installation time
 3B2/600, 2-1
 Installing
 6386SX/EL, 4-1
 add on cards
 6386E/33, 3-3
 NCR-3315, 5-1
 NCR-3332, 6-1
 Installing INFORMIX
 3B2/600, 2-30
 Installing the software
 3B2/600, 2-12
 Installing UNIX
 3B2/600, 2-9, 2-13
installpkg command
 6386E/33, 3-10, 3-27
 6386SX/EL, 4-9, 4-26, 5-9
 NCR-3315, 5-9, 5-26
 NCR-3332, 6-7, 6-24
 Intelligent ports card
 6386E/33, 3-3
 6386SX/EL, 4-3
 NCR-3315, 5-3
 Interrupt request level (IRQ)
 6386E/33, 3-3
 6386E/33, 3-1
 6386SX/EL, 4-1
 NCR-3315, 5-1
 IPC Device Driver
 load
 6386SX/EL, 4-9
 NCR-3315, 5-9
 loading
 6386E/33, 3-10
 IPC-900
 install
 6386SX/EL, 4-3
 NCR-3315, 5-3
 installing
 6386E/33, 3-3
 IRQ levels
 6386E/33, 3-3
 6386E/33, 3-1
 6386SX/EL, 4-1
 NCR-3315, 5-1

K

Kernel
 UNIX
 edit
 6386E/33, 3-24
 6386SX/EL, 4-23
 NCR-3315, 5-23
 NCR-3332, 6-21
 rebuild

 6386E/33, 3-24, 3-25
 6386SX/EL, 4-23, 4-24
 NCR-3315, 5-23, 5-24
 NCR-3332, 6-21, 6-22
 KERNEL reconfiguration
 test case, A-4
 Keyboard
 connecting
 6386SX/EL, 4-3
 NCR-3315, 5-3
 NCR-3332, 6-2
 connection
 6386E/33, 3-4
 Keys
 In this manual, 1-2

L

Line printer administration commands
 3B2/600, 2-26
 6386E/33, 3-23
 Line Printer Spooling Utilities
 3B2/600, 2-13
 List
 printer names
 6386E/33, 3-23
 Load
 additional software
 6386E/33, 3-9
 6386SX/EL, 4-8
 NCR-3315, 5-8
 NCR-3332, 6-6
 INFORMIX
 6386E/33, 3-26
 6386SX/EL, 4-25
 NCR-3315, 5-25
 NCR-3332, 6-23
 INFORMIX-SE
 6386E/33, 3-27
 6386SX/EL, 4-26
 NCR-3315, 5-26
 NCR-3332, 6-24
 INFORMIX-SQL
 6386E/33, 3-27
 6386SX/EL, 4-26
 NCR-3315, 5-26
 NCR-3332, 6-24
 Security Administration
 6386E/33, 3-10
 UNIX
 6386SX/EL, 4-4
 UNIX foundation set
 6386E/33, 3-5
 6386SX/EL, 4-4
 NCR-3315, 5-4
 NCR-3332, 6-3
 UNIX
 NCR-3315, 5-4
 NCR-3332, 6-3
 Loading
 UNIX

6386E/33, 3-5

Login for cron
 6386SX/EL, 4-29, 5-29
 NCR-3332, 6-27
 6386E/33, 3-30

Login for Monitor I
 mtmadm
 6386E/33, 3-29
 6386SX/EL, 4-28, 5-28
 NCR-3332, 6-26
 mtmadml
 6386E/33, 3-30
 6386SX/EL, 4-29, 5-29
 NCR-3332, 6-27

Logins
 3B2/600, 2-11
 root
 3B2/600, 2-11

lpadmin command
 3B2/600, 2-26
 6386E/33, 3-23

lpsched command
 6386E/33, 3-23

lpstat command
 3B2/600, 2-26
 6386E/33, 3-23

M

Mail forwarding
 test case, A-4

Manuals
 3B2/600, 2-2
 reference, 1-5

Memory
 expansion kits
 install
 6386SX/EL, 4-2
 NCR-3315, 5-2
 6386E/33, 3-3
 extended
 6386E/33, 3-6
 6386SX/EL, 4-5
 NCR-3315, 5-5

Memory chips
 installing
 6386E/33, 3-2

Modems
 2224-CEO
 set
 hardware switches, 3-13, 4-12, 5-11, 6-9
 software options, 2-48 3-46, 4-48, 5-47
 setup
 6386E/33, 3-13
 6386SX/EL, 4-11
 NCR-3315, 5-11
 NCR-3332, 6-9
 2224-GNN
 setup
 6386E/33, 3-13
 6386SX/EL, 4-11

NCR-3315, 5-11
 NCR-3332, 6-9

Modem(s)
 AT&T 2400
 configuring the UNIX System, 2-22,
 3-19, 3-20, 4-17, 4-18, 5-17, 5-18, 6-15, 6-16
 installing, 3-17, 4-15, 5-15, 6-13
 3B2/600, 2-20
 set hardware switches, 3-13
 set software options, 2-20, 3-17, 4-15, 5-15, 6-13
 setup
 NCR-3315, 5-11
 NCR-3332, 6-9
 AT&T DataPort 3710
 installing, 3-20, 4-18, 5-18, 6-16
 3B2/600, 2-23
 setting software options, 3-20, 4-18, 5-18, 6-16
 3B2/600, 2-23

connect
 6386SX/EL, 4-19
 NCR-3315, 5-19
 NCR-3332, 6-17

connecting
 3B2/600, 2-24
 6386E/33, 3-21

flow control
 6386E/33, 3-45
 6386SX/EL, 4-47, 5-46

setting up
 3B2/600, 2-17

setup
 6386E/33, 3-12, 3-13
 6386SX/EL, 4-10, 4-11
 NCR-3315, 5-10, 5-11
 NCR-3332, 6-8, 6-9

Monitor I
 add users
 6386E/33, 3-29
 6386SX/EL, 4-28, 5-28
 NCR-3332, 6-26
 cold installation on the 6386E/33, 3-32
 warm installation
 6386E/33, 3-40

Monitor I hardware, 1-3

Monitor I software
 warm installation
 3B2/600, 2-42

Mouse
 connecting
 6386SX/EL, 4-3
 NCR-3315, 5-3
 NCR-3332, 6-2
 6386E/33, 3-4

MS-DOS
 create partition
 6386SX/EL, 4-5
 NCR-3315, 5-5
 NCR-3332, 6-3
 6386E/33, 3-6

mtmadm login
 Monitor I

- 6386E/33, 3-29
- 6386SX/EL, 4-28, 5-28
- NCR-3332, 6-26
- mtmadm1 login
- Monitor I
 - 6386E/33, 3-30
 - 6386SX/EL, 4-29, 5-29
 - NCR-3332, 6-27
- mtmadm1 mail is forwarded to mtmadm
- test case, A-4

N

- Names
 - printer
 - list
 - 6386E/33, 3-23
- NCR-3315
 - 2224-CEO modem
 - set
 - hardware switches, 5-11
 - G1
 - administration, 5-10
- INFORMIX
 - group
 - creating, 5-25
 - User
 - creating, 5-25
- Installation, 5-1
- Kernel
 - UNIX
 - rebuilding, 5-23
- 2224-CEO modem
 - setup, 5-11
- 2224-GNN modem
 - setup, 5-11
- 513 Terminal Emulation cartridge, 5-10
- 572 Printer, 5-20
- 615 BCT
 - setup, 5-10
- 715 BCS
 - setup, 5-10
- 730 MTG
 - setup, 5-10
- 730 terminal, 5-9
- add on cards
 - install
 - NCR-3315, 5-2
- additional memory
 - install, 5-2
- AT&T 2400 modem
 - setup, 5-11
- Cable
 - printer
 - connect, 5-20
- console
 - setup, 5-3
- crash/dump partition, 5-6
- cursor options, 5-11
- disk
 - partitioning, 5-5
- documentation, 1-6
- expansion kits, 5-2
- FACE
 - load, 5-7
- FMLI
 - load, 5-7
- Foundation set
 - UNIX, 5-4, 5-5
- G3r
 - G3i administration, 5-10
- hardware
 - install additional cards, 5-2
- INFORMIX
 - loading, 5-25
- installation overview, 1-10
- Intelligent Ports Card, 5-3
- IRQ levels, 5-1
- keyboard
 - connecting, 5-3
- memory
 - extended
 - check, 5-5
- modems
 - setup, 5-10, 5-11
- mouse
 - connecting, 5-3
- MS-DOS
 - create partition, 5-5
- partition
 - crash/dump, 5-6
- partitioning hard disk, 5-5
- password
 - root, 5-6
- port configuration worksheet, B-4
- port(s)
 - numbers, 5-19
- power outlet
 - connect, 5-3
- printer
 - enabling, 5-21
 - setup, 5-20
- processor
 - reboot, 5-8
- Remote Terminal Package
 - load, 5-9
- root partition, 5-6
- setup, 5-1
- Setup utility
 - UNIX, 5-4
- SIMMs
 - install, 5-2
- software
 - load additional, 5-8
- surface analysis
 - preparing hard disk, 5-5
- swap/paging partition, 5-6
- System 75
 - administration, 5-10
- system board
 - install, 5-2
- T-adapter

- IPC card, 5-3
- terminals
 - connecting, 5-19
 - setup, 5-10
- terminfo entries, 5-9
- UNIX
 - create partition, 5-5
 - editing package, 5-7
 - foundation set, 5-5
 - install base system, 5-6
 - Kernel
 - rebuilding, 5-23
 - loading, 5-4
 - Setup utility, 5-4
 - usr partition, 5-6
- NCR-3332
 - G1 administration, 6-8
 - INFORMIX
 - group
 - creating, 6-23
 - User
 - creating, 6-23
 - Kernel
 - UNIX
 - rebuilding, 6-21
 - mtmadm1 login
 - Monitor I, 6-27
 - 2224-CEO modem
 - setup, 6-9
 - 2224-GNN modem
 - setup, 6-9
 - 513 Terminal Emulation cartridge, 6-8
 - 615 BCT
 - setup, 6-8
 - 715 BCS
 - setup, 6-8
 - 730 MTG
 - setup, 6-8
 - 730 terminal, 6-7
 - AT&T 2400 modem
 - setup, 6-9
 - console
 - setup, 6-2
 - crash/dump partition, 6-4
 - cron login, 6-27
 - cursor options, 6-9
 - disk
 - partitioning, 6-3
 - documentation, 1-6
 - FACE
 - load, 6-5
 - using, 6-26
 - FMLI
 - load, 6-5
 - Foundation set
 - UNIX, 6-3
 - G3r, G3i administration, 6-8
 - INFORMIX
 - loading, 6-23
 - installation, 6-1
 - installation overview, 1-11
 - keyboard
 - connecting, 6-2
 - modems
 - setup, 6-8, 6-9
 - mouse
 - connecting, 6-2
 - MS-DOS
 - create partition, 6-3
 - partition
 - crash/dump, 6-4
 - partitioning hard disk, 6-3
 - password
 - root, 6-5
 - port configuration worksheet, B-5
 - port(s)
 - enabling, 6-44
 - NCR-3332, 6-44
 - numbers, 6-17
 - power outlet
 - connect, 6-2
 - printer
 - enabling, 6-19
 - setup, 6-18
 - printers, 6-18
 - processor
 - reboot, 6-6
 - Remote Terminal Package
 - load, 6-7
 - root partition, 6-4
 - setup, 6-1
 - software
 - load additional, 6-6
 - surface analysis
 - preparing hard disk, 6-4
 - swap/paging partition, 6-4
 - System 75
 - administration, 6-8
 - terminals
 - connecting, 6-17
 - setup, 6-8
 - terminfo entries, 6-7
 - UNIX
 - create partition, 6-3
 - editing package, 6-5
 - foundation set, 6-3
 - install base system, 6-4
 - Kernel
 - rebuilding, 6-21
 - loading, 6-3
 - users
 - adding, 6-26
 - usr partition, 6-4
- Network Support Utilities
 - loading
 - 6386E/33, 3-8

O

- Okidata-ML174 Printer
 - NCR-3332, 6-18
- Option(s)

-
- Cursor Blink
 - 3B2/600, 2-16
 - polling
 - 6386E/33, 3-38, 3-43
 - Swap Delete
 - 3B2/600, 2-16
 - terminal
 - Cursor Blink
 - 3B2/600, 2-3
 - 6386SX/EL, 4-11
 - NCR-3315, 5-11
 - NCR-3332, 6-9
 - 6386E/33, 3-13
 - swap delete
 - 6386E/33, 3-13
 - 3B2/600, 2-3
 - 6386SX/EL, 4-11
 - NCR-3315, 5-11
 - NCR-3332, 6-9
- P**
- Partition
 - crash/dump
 - 6386SX/EL, 4-6
 - NCR-3315, 5-6
 - NCR-3332, 6-4
 - 6386E/33, 3-7
 - root**
 - 6386E/33, 3-7
 - usr**
 - 6386E/33, 3-7
 - root
 - 6386SX/EL, 4-6
 - NCR-3315, 5-6
 - NCR-3332, 6-4
 - swap/paging
 - 6386E/33, 3-7
 - 6386SX/EL, 4-6
 - NCR-3315, 5-6
 - NCR-3332, 6-4
 - usr
 - 6386SX/EL, 4-6
 - NCR-3315, 5-6
 - NCR-3332, 6-4
 - Partitioning hard disk
 - 6386E/33, 3-6
 - 6386SX/EL, 4-5
 - NCR-3315, 5-5
 - NCR-3332, 6-3
 - Password
 - root
 - 6386E/33, 3-7
 - 6386SX/EL, 4-6
 - NCR-3315, 5-6
 - NCR-3332, 6-5
 - Passwords
 - for system administration logins
 - 3B2/600, 2-11
 - Place holder verification
 - test case, A-2
 - Place holders
 - creating
 - 3B2/600, 2-44
 - Polling and alarm manager activated
 - test case, A-6
 - Polling and alarm manager deactivated
 - test case, A-6
 - Polling options
 - 6386E/33, 3-38, 3-43
 - Port configuration(s)
 - 3B2/600, 1-7
 - 6386E/33, 1-8
 - 6386SX/EL, 1-9
 - NCR-3315, 1-10
 - NCR-3332, 1-11
 - Port configuration worksheet(s)
 - 3B2/600, B-1
 - 6386E/33, B-2
 - 6386SX/EL, B-3
 - NCR-3315, B-4
 - NCR-3332, B-5
 - Port number software options
 - 6386E/33, 3-47
 - Port(s)
 - bidirectional
 - 3B2/600, 2-47
 - 6386E/33, 3-45
 - 6386SX/EL, 4-47, 5-46
 - NCR-3332, 6-44
 - enabling
 - 3B2/600, 2-47
 - 6386E/33, 3-45
 - 6386SX/EL, 4-47, 5-46
 - NCR-3332, 6-44
 - numbers
 - 6386E/33, 3-21
 - 6386SX/EL, 4-19
 - NCR-3315, 5-19
 - NCR-3332, 6-17
 - serial
 - 6386E/33, 3-45
 - 6386SX/EL, 4-47, 5-46
 - Post-installation check
 - test case, A-1
 - Post-installation steps
 - 3B2/600, 2-43
 - Power outlet
 - connect
 - 6386SX/EL, 4-3
 - NCR-3315, 5-3
 - NCR-3332, 6-2
 - connection
 - 6386E/33, 3-4
 - Print queue
 - 6386E/33, 3-23
 - Printer
 - cable
 - connect
 - 6386SX/EL, 4-20
 - NCR-3315, 5-20
 - NCR-3332, 6-18

- connecting
 - 6386E/33, 3-22
- default
 - 6386E/33, 3-23
- enable
 - 6386SX/EL, 4-21
 - NCR-3315, 5-21
 - NCR-3332, 6-19
- enabling
 - 6386E/33, 3-23
- install
 - 6386SX/EL, 4-20
 - NCR-3315, 5-20
 - NCR-3332, 6-18
 - 3B2/600, 2-25
 - 6386E/33, 3-22
- names
 - list
 - 6386E/33, 3-23
- setup
 - 6386E/33, 3-22
 - 6386SX/EL, 4-20
 - NCR-3315, 5-20
 - NCR-3332, 6-18
- Printer cable connection
 - 3B2/600, 2-25
- Printer names
 - listing
 - 3B2/600, 2-26
- Printer(s)
 - 572
 - 3B2/600, 2-25
 - 6386E/33, 3-22
 - 6386SX/EL, 4-20
 - NCR-3315, 5-20
 - 593
 - 6386E/33, 3-22
 - 6386SX/EL, 4-20
 - NCR-3315, 5-20
 - AT&T 572
 - NCR-3332, 6-18
 - AT&T 593
 - NCR-3332, 6-18
 - AT&T 595
 - NCR-3332, 6-18
 - Okidata-ML184, 6-18
- Procedure(s)
 - Add the INFORMIX Group
 - 3B2/600, 2-30
 - 6386E/33, 3-26
 - Add the INFORMIX User
 - 3B2/600, 2-30
 - 6386E/33, 3-26
 - Add the Monitor I Group
 - 3B2/600, 2-32
 - 6386E/33, 3-29
 - Add the Monitor I Users
 - 3B2/600, 2-32
 - 6386E/33, 3-29
 - Change the Firmware Password
 - 3B2/600, 2-11
 - Check the Tunable Parameters
 - 3B2/600, 2-29
 - Cold Install of Monitor I Software
 - 3B2/600, 2-35
 - 6386E/33, 3-32
 - Connect the External Disk Unit
 - 3B2/600, 2-6
 - Connect the Modems
 - 3B2/600, 2-24
 - 6386E/33, 3-21
 - Connect the Printer Cable
 - 6386E/33, 3-22
 - Connect the Terminals
 - 3B2/600, 2-24
 - 6386E/33, 3-21
 - Create Place Holders Using Addmount
 - 3B2/600, 2-44
 - 6386E/33, 3-42
 - Display the Installed Packages
 - 6386E/33, 3-28
 - Edit the **.profile**
 - 6386E/33, 3-31
 - Edit the Kernel File
 - 3B2/600, 2-27
 - 6386E/33, 3-24
 - Edit the .profile
 - 3B2/600, 2-33
 - Enable Bidirectional Ports
 - 6386E/33, 3-45
 - Enable Bidirectional UUCP Ports
 - 3B2, 2-47
 - Enable the Printer
 - 3B2/600, 2-26
 - 6386E/33, 3-23
 - Install the Additional Cards
 - 6386E/33, 3-3
 - Install the Additional Memory
 - 6386E/33, 3-3
 - Install the AIC
 - 3B2/600, 2-5
 - Install the EPORTS Card(s)
 - 3B2/600, 2-5
 - Installation Wrap-Up
 - 6386E/33, 3-8
 - Load Add-On Packages From Tape
 - 6386E/33, 3-8
 - Load the INFORMIX-SE Software
 - 3B2/600, 2-31
 - 6386E/33, 3-27
 - Load the INFORMIX-SQL Software
 - 3B2/600, 2-31
 - 6386E/33, 3-27
 - Load the IPC Device Driver
 - 6386E/33, 3-10
 - Load the Remote Terminal Package
 - 6386E/33, 3-10
 - Load the Security Administration Software
 - 6386E/33, 3-10
 - Load the UNIX Essential Utilities
 - 3B2/600, 2-9
 - Load the UNIX Foundation Set

- 6386E/33, 3-6
- Partition Disk 2
 - 3B2/600, 2-11
- Reboot the System
 - 3B2/600, 2-14
 - 6386E/33, 3-25
- Rebuild the Kernel
 - 3B2/600, 2-28
 - 6386E/33, 3-25
- Remake the Kernel
 - 3B2/600, 2-28
- Run the Setup Program
 - 3B2/600, 2-11
- Run the Setup Utility
 - 6386E/33, 3-5
- Set the CEO Modem Software Options
 - 3B2/600, 2-48
- Set Up the Modems
 - 3B2/600, 2-17
 - 6386E/33, 3-13, 3-14
- Set Up the Printer
 - 3B2/600, 2-25
 - 6386E/33, 3-22
- Set Up the Terminals
 - 3B2/600, 2-15
 - 6386E/33, 3-12
- Unpack and Set Up the 3B2/600, 2-3
- Unpack and Set Up the Console
 - 3B2/600, 2-3
- Warm Install of Monitor I Software
 - 3B2/600, 2-42
 - 6386E/33, 3-40
- Connect the Printer Cable
 - 3B2/600, 2-25
- Processor
 - 3B2/600
 - installing, 2-2
 - reboot
 - 6386E/33, 3-9, 3-25
 - 6386SX/EL, 4-8, 4-24
 - NCR-3315, 5-8, 5-24
 - NCR-3332, 6-6, 6-22
- editing**
 - 6386E/33, 3-30**

Q

- Queue
 - printer
 - 3B2/600, 2-26
 - 6386E/33, 3-23

R

- Reboot
 - processor
 - 6386E/33, 3-9, 3-25
 - 6386SX/EL, 4-8, 4-24
 - NCR-3315, 5-8, 5-24
 - NCR-3332, 6-6, 6-22
 - 3B2/600, 2-14

- Rebuild
 - UNIX kernel
 - 6386E/33, 3-24, 3-25
 - 6386SX/EL, 4-23, 4-24
 - NCR-3315, 5-23, 5-24
 - NCR-3332, 6-21, 6-22
- Remote access modem
 - 6386E/33, 3-4
- Remote Maintenance Card (RMC)
 - 6386E/33, 3-3
- Remote Management Package (RMP)
 - 3B2/600, 2-4, 2-5
- Remote Terminal Package
 - load
 - 6386SX/EL, 4-9
 - NCR-3315, 5-9
 - NCR-3332, 6-7
 - loading
 - 6386E/33, 3-10
- RMC
 - 6386E/33, 3-3
- RMP
 - 3B2/600, 2-4
- RMP card
 - 3B2/600, 2-5
- RMP connection testing
 - 6386E/33, 3-4
- RMP utilities
 - 3B2/600, 2-14
- Root login
 - 3B2/600, 2-11
- Root password
 - 6386E/33, 3-7
 - 6386SX/EL, 4-6
 - NCR-3315, 5-6
 - NCR-3332, 6-5
- root** partition
 - 6386E/33, 3-7
- Rotating switch feature
 - 3B2/600, 2-38, 2-44
 - installing
 - 6386E/33, 3-42, 3-43
 - 6386E/33, 3-37
 - test case, A-3

S

- Security Administration
 - loading
 - 6386E/33, 3-10
- Security Administration Utilities
 - 3B2/600, 2-14
- Serial ports
 - 6386E/33, 3-45
 - 6386SX/EL, 4-47, 5-46
- Set
 - 2224-CEO modem
 - hardware switches
 - 6386E/33, 3-13
 - 6386SX/EL, 4-12
 - NCR-3315, 5-11

- NCR-3332, 6-9
- software options
 - 3B2/600, 2-48
 - 6386E/33, 3-46
 - 6386SX/EL, 4-48, 5-47
- Setting up modem switches
 - 3B2/600, 2-17
- Setup
 - 2224-CEO modems
 - 6386E/33, 3-13
 - 6386SX/EL, 4-11
 - NCR-3315, 5-11
 - NCR-3332, 6-9
 - 2224-GNN modems
 - 6386E/33, 3-13
 - 6386SX/EL, 4-11
 - NCR-3315, 5-11
 - NCR-3332, 6-9
 - 615 BCT
 - 6386E/33, 3-12
 - 6386SX/EL, 4-10
 - NCR-3315, 5-10
 - NCR-3332, 6-8
 - 6386E/33 processor, 3-1
 - 6386SX/EL processor, 4-1
 - 730 MTG
 - 6386E/33, 3-12
 - 6386SX/EL, 4-10
 - NCR-3315, 5-10
 - NCR-3332, 6-8
 - AT&T 2400 modems
 - NCR-3315, 5-11
 - NCR-3332, 6-9
 - console
 - 6386E/33, 3-4
 - 6386SX/EL, 4-3
 - NCR-3315, 5-3
 - NCR-3332, 6-2
 - modems
 - 6386E/33, 3-12, 3-13
 - 6386SX/EL, 4-10, 4-11
 - NCR-3315, 5-10, 5-11
 - NCR-3332, 6-8, 6-9
 - NCR-3315 processor, 5-1
 - NCR-3332 processor, 6-1
 - printer 6386E/33, 3-22
 - printer
 - 6386E/33, 3-22
 - 6386SX/EL, 4-20
 - NCR-3315, 5-20
 - NCR-3332, 6-18
 - terminals
 - 6386E/33, 3-12
 - 6386SX/EL, 4-10
 - NCR-3315, 5-10
 - NCR-3332, 6-8
- Setup program for the 3B2/600, 2-11
- Setup utility
 - UNIX
 - 6386E/33, 3-5
 - 6386SX/EL, 4-4
 - NCR-3315, 5-4
- 715
 - setup
 - 6386E/33, 3-12
- 715 BCS
 - setting up
 - 3B2/600, 2-3
 - 6386SX/EL, 4-10
 - NCR-3315, 5-10
 - NCR-3332, 6-8
- 715 terminal emulation
 - 6386SX/EL, 4-11
 - NCR-3315, 5-11
 - NCR-3332, 6-9
- 715 terminal options
 - 3B2/600, 2-3, 2-16
 - 6386E/33, 3-13
 - 6386SX/EL, 4-11
 - NCR-3315, 5-11
 - NCR-3332, 6-9
- 730 MTG
 - setup
 - 6386E/33, 3-12
 - 6386SX/EL, 4-10
 - NCR-3315, 5-10
 - NCR-3332, 6-8
- 730 terminal
 - 6386E/33, 3-10
 - 6386SX/EL, 4-9
 - NCR-3315, 5-9
 - NCR-3332, 6-7
- Shutdown
 - 3B2/600, 2-14
- Silent Knight autodialer
 - 3B2/600, 2-4
- SIMMs
 - install
 - 6386SX/EL, 4-2
 - NCR-3315, 5-2
 - 6386E/33, 3-3
- 615 BCT
 - setting up
 - for the 3B2/600, 2-3
 - setup
 - 6386E/33, 3-12
 - 6386SX/EL, 4-10
 - NCR-3315, 5-10
 - NCR-3332, 6-8
- 615 Terminal Emulation cartridge, 1-4
- 6386 SX/EL
 - port configuration worksheet, B-3
- 6386/33E
 - installation overview, 1-8
- 6386E/33
 - 2224-CEO modem
 - setup, 3-13
 - 2224-GNN modem
 - setup, 3-13
 - 329D console, 3-4
 - 513 Terminal Emulation cartridge, 3-12
 - 572 Printer, 3-22

593 Printer, 3-22
 615 BCT setup, 3-12
 730 MTG setup, 3-12
 730 terminal, 3-10
 additional software
 loading, 3-9
 alarm interface, 3-4
 cable
 printer
 connecting, 3-22
 cold installation of Monitor I, 3-32
 console
 setting up, 3-4
 creating partition
 MS-DOS, 3-6
 cursor options
 on console, 3-13
 documentation, 1-5
 DOSS Configuration, 3-37
 Editing package
 loading, 3-8
 extended memory
 checking, 3-6
at command, 3-30
chgrp traf command, 3-30
cron command, 3-30
cron login, 3-30
displaypkg command, 3-28
installpkg command, 3-10, 3-27
lpadmin command, 3-23
lpsched command, 3-23
lpstat command, 3-23
mtmadm1 login
 Monitor I, 3-30
mtmadm login
 Monitor I, 3-29
.profile
 editing, 3-30
 FACE
 loading, 3-8
 using, 3-29
 FMLI
 loading, 3-8
 G1
 administration, 3-12
 G3r
 G3i
 administration, 3-12
 hard disk partitioning, 3-6
 hardware
 installing additional cards, 3-3
 INFORMIX
 Group
 adding, 3-26
 loading, 3-26
 user
 adding, 3-26
 INFORMIX-SE
 loading, 3-27
 INFORMIX-SQL
 loading, 3-27
 installation, 3-1
 installation prerequisites, 3-1
 IPC Device driver
 loading, 3-10
 IPC-900
 installing, 3-3
 IRQ, 3-3
 IRQ levels, 3-1
 Kernel
 UNIX
 rebuild, 3-24
 keyboard
 connection, 3-4
 login for Monitor I
 mtmadm, 3-29
 memory chips
 installing, 3-2
 memory
 expansion kits
 installing, 3-3
 extended, 3-6
 modem setup
 2224-CEO, 3-13
 modems
 connecting, 3-21
 setup, 3-12
 mouse
 connection, 3-4
 Network Support Utilities
 loading, 3-8
 password
 root, 3-7
 polling options, 3-38
 port configuration worksheet, B-2
 power outlet
 connection, 3-4
 printer
 setup, 3-22
 remote access modem, 3-4
 Remote Maintenance Card (RMC), 3-3
 Remote Terminal Package
 loading, 3-10
 RMP connection testing, 3-4
 root password, 3-7
 rotating switch feature
 installing, 3-37
 Security Administration
 loading, 3-10
 setup, 3-1
 SIMMs
 installation, 3-3
 software
 check installed packages, 3-28
 surface analysis
 preparing hard disk, 3-7
 System 75
 administration, 3-12
 system board
 installation, 3-3
 T-adaptor
 IPC card, 3-3

- terminal emulation
 - 513, 3-12
- terminal options, 3-13
- terminals
 - connecting, 3-21
 - setup, 3-12
- Uninterruptible power supply (UPS), 3-4
- UNIX base system
 - installing, 3-7
- UNIX
 - creating partition, 3-6
 - foundation set, 3-6
 - loading, 3-5
 - rebuild kernel, 3-24
 - Setup utility, 3-5
- unpacking, 3-2
- users
 - adding, 3-29
- VDC 600 card, 3-4
- VDC card
 - installing, 3-2
- warm installation of Monitor I, 3-40
- worksheet
 - disk configuration
 - checking, 3-38
- 6386SX/EL
 - G1
 - administration, 4-10
 - INFORMIX
 - group
 - creating, 4-25
 - User
 - creating, 4-25
 - Kernel
 - UNIX
 - rebuilding, 4-23
 - mtmadm1 login
 - Monitor I, 4-29, 5-29
 - 2224-CEO modem
 - setting
 - software options, 4-48, 5-47
 - setup, 4-11
 - 2224-GNN modem
 - setup, 4-11
 - 513 Terminal Emulation cartridge, 4-10
 - 572 Printer, 4-20
 - 615 BCT
 - setup, 4-10
 - 715 BCS
 - setup, 4-10
 - 730 MTG
 - setup, 4-10
 - 730 terminal, 4-9
 - add on cards
 - install
 - 6386SX/EL, 4-2
 - additional memory
 - install, 4-2
 - console
 - setup, 4-3
 - crash/dump partition, 4-6
 - cron login, 4-29, 5-29
 - cursor options, 4-11
 - disk
 - partitioning, 4-5
 - expansion kits, 4-2
 - FACE
 - load, 4-7
 - using, 4-28, 5-28
 - FMLI
 - load, 4-7
 - Foundation set
 - UNIX, 4-4, 4-5
 - G3i administration, 4-10
 - hardware
 - install additional cards, 4-2
 - INFORMIX
 - loading, 4-25
 - installation overview, 1-9
 - Intelligent Ports Card, 4-3
 - IRQ levels, 4-1
 - keyboard
 - connecting, 4-3
 - memory
 - extended
 - check, 4-5
 - modems
 - flow control, 4-47, 5-46
 - setup, 4-10, 4-11
 - mouse
 - connecting, 4-3
 - MS-DOS
 - create partition, 4-5
 - partition
 - crash/dump, 4-6
 - partitioning hard disk, 4-5
 - password
 - root, 4-6
 - port(s)
 - bidirectional, 4-47, 5-46
 - enabling, 4-47, 5-46
 - numbers, 4-19
 - power outlet
 - connect, 4-3
 - printer
 - enabling, 4-21
 - setup, 4-20
 - processor
 - reboot, 4-8
 - Remote Terminal Package
 - load, 4-9
 - root partition, 4-6
 - setup, 4-1
 - Setup utility
 - UNIX, 4-4
 - SIMMs
 - install, 4-2
 - software
 - load additional, 4-8
 - surface analysis
 - preparing hard disk, 4-5
 - swap/paging partition, 4-6

- System 75
 - administration, 4-10
- system board
 - install, 4-2
- terminals
 - connecting, 4-19
 - setup, 4-10
- terminfo entries, 4-9
- UNIX
 - create partition, 4-5
 - editing package, 4-7
 - foundation set, 4-5
 - install base system, 4-6
 - Kernel
 - rebuilding, 4-23
 - loading, 4-4
 - Setup utility, 4-4
- users
 - adding, 4-28, 5-28
 - usr partition, 4-6
- 6386SX/EL Installation, 4-1
- Software
 - check installed packages
 - 6386E/33, 3-28
 - 6386SX/EL, 4-27
 - NCR-3315, 5-27
 - NCR-3332, 6-25
 - for RMP
 - 3B2/600, 2-14
 - installation
 - 3B2/600, 2-12
 - installing INFORMIX
 - 3B2/600, 2-30
 - Load additional
 - 6386E/33, 3-9
 - 6386SX/EL, 4-8
 - NCR-3315, 5-8
 - NCR-3332, 6-6
 - load
 - editing package
 - 6386SX/EL, 4-7
 - NCR-3315, 5-7
 - NCR-3332, 6-5
 - Equinox Device Driver
 - NCR-3332, 6-7
 - FACE
 - 6386SX/EL, 4-7
 - NCR-3315, 5-7
 - NCR-3332, 6-5
 - FACE Help
 - 6386E/33, 3-8
 - 6386SX/EL, 4-7
 - NCR-3315, 5-7
 - NCR-3332, 6-5
 - FMLI
 - 6386SX/EL, 4-7
 - NCR-3315, 5-7
 - NCR-3332, 6-5
 - INFORMIX
 - 6386E/33, 3-26
 - 6386SX/EL, 4-25
 - NCR-3315, 5-25
 - NCR-3332, 6-23
 - INFORMIX-SE
 - 6386SX/EL, 4-26
 - NCR-3315, 5-26
 - NCR-3332, 6-24
 - INFORMIX-SQL
 - 6386SX/EL, 4-26
 - NCR-3315, 5-26
 - NCR-3332, 6-24
 - IPC Device Driver
 - 6386SX/EL, 4-9
 - NCR-3315, 5-9
 - Remote Terminal Package
 - 6386SX/EL, 4-9
 - NCR-3315, 5-9
 - NCR-3332, 6-7
 - loading
 - Editing Package
 - 6386E/33, 3-8
 - loading FACE
 - 6386E/33, 3-8
 - loading
 - FMLI
 - 6386E/33, 3-8
 - INFORMIX-SE
 - 6386E/33, 3-27
 - INFORMIX-SQL
 - 6386E/33, 3-27
 - IPC Device Driver
 - 6386E/33, 3-10
 - Network Support Utilities
 - 6386E/33, 3-8
 - Remote Terminal Package
 - 6386E/33, 3-10
 - Security Administration
 - 6386E/33, 3-10
 - Software components, 1-4
 - Software
 - INFORMIX-SE
 - loading
 - 3B2/600, 2-31
 - INFORMIX-SQL
 - loading
 - 3B2/600, 2-30
 - Standard configuration
 - hardware components
 - 3B2/600, 2-2
 - Standard polling option
 - 6386E/33, 3-38, 3-43
 - Step(s)
 - Add the Monitor I Group and Users
 - 3B2/600, 2-32
 - 6386E/33, 3-29
 - Enable the System Ports
 - 3B2/600, 2-47
 - 6386E/33, 3-45
 - Install the Additional Hardware
 - 3B2/600, 2-4
 - Load the Additional Software
 - 3B2/600, 2-12

- 6386E/33, 3-9
- Load the INFORMIX Software
 - 3B2/600, 2-30
 - 6386E/33, 3-26
- Load the Monitor I Software
 - 3B2/600, 2-34
 - 6386E/33, 3-32
- Load the UNIX Essential Utilities
 - 3B2/600, 2-9
 - 6386E/33, 3-5
- Rebuild the UNIX Kernel 3B2/600, 2-27
- Rebuild the UNIX Kernel
 - 6386E/33, 3-24
- Set Up and Enable the Printer
 - 3B2/600, 2-25
 - 6386E/33, 3-22
- Set Up the 3B2/600 and Console, 2-2
- Set Up the 6386E/33 Model S WGS, 3-1
- Set Up the Terminals and Modems
 - 3B2/600, 2-15
 - 6386E/33, 3-12
- Surface analysis
 - preparing hard disk
 - 6386E/33, 3-7
 - 6386SX/EL, 4-5
 - NCR-3315, 5-5
 - NCR-3332, 6-4
- Swap Delete option
 - 3B2/600, 2-3, 2-16
 - 6386SX/EL, 4-11
 - NCR-3315, 5-11
 - NCR-3332, 6-9
 - 6386E/33, 3-13
- Swap/paging partition
 - 6386SX/EL, 4-6
 - NCR-3315, 5-6
 - NCR-3332, 6-4
 - 6386E/33, 3-7
- Switch
 - database capacity
 - specifying
 - 6386E/33, 3-42
- System 75
 - administration
 - 3B2/600, 2-3
 - for the 3B2/600, 2-15
 - for the 6386E/33, 3-12
 - for the 6386SX/EL, 4-10
 - for the NCR-3315, 5-10
 - for the NCR-3332, 6-8
 - cartridge with 730 terminal
 - 6386E/33, 3-10
 - 6386SX/EL, 4-9
 - NCR-3315, 5-9
 - NCR-3332, 6-7
- System board
 - install
 - 6386SX/EL, 4-2
 - NCR-3315, 5-2
 - installation
 - 6386E/33, 3-3

- System group file
 - edit
 - 6386E/33, 3-29
 - 6386SX/EL, 4-28, 5-28
 - NCR-3332, 6-26
- System ports
 - enabling
 - 3B2/600, 2-47

T

- Table(s)
 - Add-on cards: Default Location Addresses and IRQ Levels
 - 6386E/33, 3-1
 - 2224-CEO Dial-Out 1200/300 Asynchronous Communications
 - 6386E/33, 3-14
 - 2224-GNN Dial-Out 1200/300 Asynchronous Communications
 - 6386E/33, 3-16
- T-adaptor
 - IPC card
 - 6386E/33, 3-3
 - 6386SX/EL, 4-3, 5-3
- Technical Service Center (TSC), 1-3, 5-1
- Technical Support Center (TSC), 1-3, 2-2, 3-1, 5-1, 6-1
- 10-conductor cables
 - 6386SX/EL, 4-19
 - NCR-3315, 5-19
 - NCR-3332, 6-17
- Terminal
 - 730
 - 6386E/33, 3-10
 - 6386SX/EL, 4-9
 - NCR-3315, 5-9
 - NCR-3332, 6-7
- Terminal emulation
 - 513
 - 3B2/600, 2-3, 2-15
 - 6386E/33, 3-12
 - 6386SX/EL, 4-10
 - NCR-3315, 5-10
 - NCR-3332, 6-8
 - 715
 - 6386SX/EL, 4-11
 - NCR-3315, 5-11
 - NCR-3332, 6-9
- Terminal Information Utilities
 - 3B2/600, 2-13
- Terminal options
 - 3B2/600, 2-3, 2-16
 - 6386E/33, 3-13
 - 6386SX/EL, 4-11
 - NCR-3315, 5-11
 - NCR-3332, 6-9
- Terminals
 - connect
 - 6386SX/EL, 4-19
 - NCR-3315, 5-19
 - NCR-3332, 6-17
 - connecting
 - 3B2/600, 2-24
 - 6386E/33, 3-21

- setting up
 - 3B2/600, 2-15
- setup
 - 3B2/600, 2-3
 - 6386E/33, 3-12
 - 6386SX/EL, 4-10
 - NCR-3315, 5-10
 - NCR-3332, 6-8
- terminfo entries
 - 6386SX/EL, 4-9
 - NCR-3315, 5-9
 - NCR-3332, 6-7
 - 3B2/600, 2-13
 - 6386E/33, 3-10
- Test case
 - activate polling and alarm manager, A-6
 - alarms sent to INADS, A-7
 - deactivate polling and alarm manager, A-6
 - /etc/cron owned by root, A-3
 - KERNEL reconfiguration, A-4
 - mail forwarding, A-4
 - mtmadm1 mail is forwarded to mtmadm, A-4
 - placeholder verification, A-2
 - post-installation check, A-1
 - rotating switch study, A-3
 - uucp files, A-5
- Tests
 - acceptance
 - 6386E/33, 3-46
- 3315
 - G1
 - administration, 5-10
 - INFORMIX
 - group
 - creating, 5-25
 - User
 - creating, 5-25
 - Kernel
 - UNIX
 - rebuilding, 5-23
 - 2224-CEO modem
 - set
 - hardware switches, 5-11
 - setup, 5-11
 - 2224-GNN modem
 - setup, 5-11
 - 513 Terminal Emulation cartridge, 5-10
 - 572 Printer, 5-20
 - 615 BCT
 - setup, 5-10
 - 715 BCS
 - setup, 5-10
 - 730 MTG
 - setup, 5-10
 - 730 terminal, 5-9
 - add on cards
 - install
 - NCR-3315, 5-2
 - additional memory
 - install, 5-2
 - AT&T 2400 modem
 - setup, 5-11
 - Cable
 - printer
 - connect, 5-20
 - console
 - setup, 5-3
 - crash/dump partition, 5-6
 - cursor options, 5-11
 - disk
 - partitioning, 5-5
 - expansion kits, 5-2
 - FACE
 - load, 5-7
 - FMLI
 - load, 5-7
 - Foundation set
 - UNIX, 5-4, 5-5
 - G3r
 - G3i administration, 5-10
 - hardware
 - install additional cards, 5-2
 - INFORMIX
 - loading, 5-25
 - installation overview, 1-10
 - Intelligent Ports Card, 5-3
 - IRQ levels, 5-1
 - keyboard
 - connecting, 5-3
 - memory
 - extended
 - check, 5-5
 - modems
 - setup, 5-10, 5-11
 - mouse
 - connecting, 5-3
 - MS-DOS
 - create partition, 5-5
 - partition
 - crash/dump, 5-6
 - partitioning hard disk, 5-5
 - password
 - root, 5-6
 - port(s)
 - numbers, 5-19
 - power outlet
 - connect, 5-3
 - printer
 - enabling, 5-21
 - setup, 5-20
 - processor
 - reboot, 5-8
 - Remote Terminal Package
 - load, 5-9
 - root partition, 5-6
 - setup, 5-1
 - Setup utility
 - UNIX, 5-4
 - SIMMs
 - install, 5-2
 - software
 - load additional, 5-8

- surface analysis
 - preparing hard disk, 5-5
- swap/paging partition, 5-6
- System 75
 - administration, 5-10
- system board
 - install, 5-2
- terminals
 - connecting, 5-19
 - setup, 5-10
- terminfo entries, 5-9
- UNIX
 - create partition, 5-5
 - editing package, 5-7
 - foundation set, 5-5
 - install base system, 5-6
 - Kernel
 - rebuilding, 5-23
 - loading, 5-4
 - Setup utility, 5-4
 - usr partition, 5-6
- 3315 Installation, 5-1
- 3332
 - FACE
 - using, 6-26
 - users
 - adding, 6-26
 - G1
 - administration, 6-8
 - INFORMIX
 - group
 - creating, 6-23
 - User
 - creating, 6-23
 - Kernel
 - UNIX
 - rebuilding, 6-21
 - mtmadm1 login
 - Monitor I, 6-27
 - 2224-CEO modem
 - setup, 6-9
 - 2224-GNN modem
 - setup, 6-9
 - 513 Terminal Emulation cartridge, 6-8
 - 615 BCT
 - setup, 6-8
 - 715 BCS
 - setup, 6-8
 - 730 MTG
 - setup, 6-8
 - 730 terminal, 6-7
 - AT&T 2400 modem
 - setup, 6-9
 - console
 - setup, 6-2
 - crash/dump partition, 6-4
 - cron login, 6-27
 - cursor options, 6-9
 - disk
 - partitioning, 6-3
 - FACE
 - load, 6-5
 - FMLI
 - load, 6-5
 - Foundation set
 - UNIX, 6-3
 - G3r, G3i administration, 6-8
 - INFORMIX
 - loading, 6-23
 - installation, 6-1
 - installation overview, 1-11
 - keyboard
 - connecting, 6-2
 - modems
 - setup, 6-8, 6-9
 - mouse
 - connecting, 6-2
 - MS-DOS
 - create partition, 6-3
 - partition
 - crash/dump, 6-4
 - partitioning hard disk, 6-3
 - password
 - root, 6-5
 - port(s)
 - bidirectional, 6-44
 - enabling, 6-44
 - numbers, 6-17
 - power outlet
 - connect, 6-2
 - printer
 - enabling, 6-19
 - setup, 6-18
 - printers, 6-18
 - processor
 - reboot, 6-6
 - Remote Terminal Package
 - load, 6-7
 - root partition, 6-4
 - setup, 6-1
 - software
 - load additional, 6-6
 - surface analysis
 - preparing hard disk, 6-4
 - swap/paging partition, 6-4
 - System 75
 - administration, 6-8
 - terminals
 - connecting, 6-17
 - setup, 6-8
 - terminfo entries, 6-7
 - UNIX
 - create partition, 6-3
 - editing package, 6-5
 - foundation set, 6-3
 - install base system, 6-4
 - Kernel
 - rebuilding, 6-21
 - loading, 6-3
 - usr partition, 6-4
 - 3710 AT&T DataPort modem
 - installing, 3-20, 4-18, 5-18, 6-16

- 3B2/600, 2-23
- setting up, 3-20, 4-18, 5-18, 6-16
- 3B2/600, 2-23
- software options, 3-20, 4-18, 5-18, 6-16
- 3B2/600, 2-23
- 329D console
 - 6386E/33, 3-4
- 3B2/600
 - 2224-CEO Modem — software options, 2-50
 - 2224-CEO modem
 - set, 2-48
 - 2400 AT&T Modem
 - setting up, 2-20
 - 2400 Modem software options, 2-20
 - 513 Terminal Emulation cartridge, 2-15
 - 572 Printer, 2-25
 - 715 terminal options, 2-3, 2-16
 - add the Monitor I Group, 2-32
 - ADd the Monitor I Users, 2-32
 - additional hardware, 2-4
 - AIC, 2-4
 - alarms from, 2-4
 - Asynchronous Communications, 2-15
 - AT&T 2400 Modem Bidirectional, 2-21
 - Basic Networking Utilities, 2-13
 - bidirectional ports, 2-47
 - cold installation of Monitor I software, 2-34
 - Configuration of a Product Access Modem, 2-21
 - console, 2-3
 - database place holders, 2-39
 - EDT (Equipped Device Table), 2-9
 - enabling system ports, 2-47
 - EPORTS card, 2-4
 - install, 2-5
 - at** command, 2-33
 - cron** command, 2-33
 - lpadmin** command, 2-26
 - lpstat** command, 2-26
 - GNN Modem hardware, 2-18
 - hardware connectivity, 2-1
 - INFORMIX group
 - adding, 2-30
 - INFORMIX
 - installing, 2-30
 - installation errors, 2-41
 - installation overview, 1-7
 - installing UNIX, 2-13
 - Line Printer Spooling Utilities, 2-13
 - modem setup, 2-17
 - modems
 - connecting, 2-24
 - Monitor I software
 - warm installation, 2-42
 - passwords, 2-11
 - printer cable connection, 2-25
 - processor
 - installing, 2-2
 - RMP, 2-4
 - RMP card, 2-5
 - RMP utilities, 2-14
 - root logins, 2-11

- rotating switch study, 2-38
- Silent Knight autodialer, 2-4
- successful installation
 - checking, 2-41
- terminal emulation
 - 513, 2-3
- terminal options, 2-3, 2-16
- terminal setup, 2-15
- terminals
 - connecting, 2-24
- terminfo files, 2-13
- tty lines, 2-5
- tunable parameters
 - changing, 2-27
- UNIX documents, 2-9
- UNIX hardware and software, 2-12
- Unix installation
 - disk partitioning, 2-10
- UNIX
 - installing, 2-9
 - UNIX setup program, 2-11
 - unpacking procedure, 2-3
 - Windowing Utilities, 2-14
- 3B2/600
 - documents, 2-2
 - hardware components, 2-2
 - logins, 2-11
 - Security Administration Utilities, 2-14
 - shutdown, 2-14
 - post-installation steps, 2-43
 - rotating switch study, 2-44
 - port configuration worksheet, B-1
- TSC, 4-1
- TSC Helpline, 3-10, 4-9, 5-9, 6-7
- TSC (Technical Support Center), 1-3, 5-1, 2-2, 3-1, 6-1
- tty lines
 - 3B2/600, 2-5
- Tunable parameters
 - changing
 - 3B2/600, 2-27
 - checking
 - 3B2/600, 2-29
- 2400 AT&T modem
 - installing, 3-17, 4-15, 5-15, 6-13
 - 3B2/600, 2-20
 - setting up, 3-17, 4-15, 5-15, 6-13
 - setting up. 3B2/600, 2-20
 - software options, 2-20, 3-17, 4-15, 5-15, 6-13
- Typeface
 - In this manual, 1-2

U

- Uninterruptible power supply (UPS)
 - 6386E/33, 3-4
- UNIX
 - additional utilities
 - 3B2/600, 2-13
 - create partition
 - 6386SX/EL, 4-5
 - NCR-3315, 5-5

- NCR-3332, 6-3
- 6386E/33, 3-6
- edit kernel
 - 6386E/33, 3-24
 - 6386SX/EL, 4-23
 - NCR-3315, 5-23
 - NCR-3332, 6-21
- Essential utilities
 - 3B2/600, 2-9
- foundation set
 - 6386E/33, 3-5, 3-6
 - 6386SX/EL, 4-4, 4-5
 - NCR-3315, 5-4, 5-5
 - NCR-3332, 6-3
- install base system
 - 6386SX/EL, 4-6
 - NCR-3315, 5-6
 - NCR-3332, 6-4
- installing
 - 3B2/600, 2-9, 2-13
- installing base system
 - 6386E/33, 3-7
- kernel
 - edit
 - 6386E/33, 3-24
 - 6386SX/EL, 4-23
 - NCR-3315, 5-23
 - NCR-3332, 6-21
 - kernel
 - rebuild
 - 6386E/33, 3-24, 3-25
 - 6386SX/EL, 4-23, 4-24
 - NCR-3315, 5-23, 5-24
 - NCR-3332, 6-21, 6-22
- load
 - 6386E/33, 3-5
 - editing package
 - 6386SX/EL, 4-7
 - NCR-3315, 5-7
 - NCR-3332, 6-5
 - Equinox Device Driver, 6-7
 - FACE
 - 6386SX/EL, 4-7
- Load
 - FACE Help
 - 6386E/33, 3-8
 - 6386SX/EL, 4-7
 - NCR-3315, 5-7
 - NCR-3332, 6-5
 - FACE
 - NCR-3315, 5-7
 - NCR-3332, 6-5
 - FMLI
 - 6386SX/EL, 4-7
 - NCR-3315, 5-7
 - NCR-3332, 6-5
 - IPC Device Driver, 4-9, 5-9
 - Remote Terminal Package
 - 6386SX/EL, 4-9
 - NCR-3315, 5-9
 - NCR-3332, 6-7
- loading
 - 6386SX/EL, 4-4
 - Editing Package
 - 6386E/33, 3-8
- loading FACE
 - 6386E/33, 3-8
- loading
 - FMLI
 - 6386E/33, 3-8
 - for the 3B2/600, 2-9
 - IPC Device Driver
 - 6386E/33, 3-10
 - NCR-3315, 5-4
 - NCR-3332, 6-3
 - Network Support Utilities
 - 6386E/33, 3-8
 - Remote Terminal Package
 - 6386E/33, 3-10
 - Security Administration
 - 6386E/33, 3-10
- rebuild kernel
 - 6386E/33, 3-24, 3-25
 - 6386SX/EL, 4-23, 4-24
 - NCR-3315, 5-23, 5-24
 - NCR-3332, 6-21, 6-22
- running Setup for the 3B2/600, 2-11
- Setup utility
 - 6386E/33, 3-5
 - 6386SX/EL, 4-4
 - NCR-3315, 5-4
- UNIX command
 - at**
 - 3B2/600, 2-33
 - cron**
 - 3B2/600, 2-33
- UNIX documents
 - for the 3B2/600, 2-9
- UNIX hardware and software
 - 3B2/600, 2-12
- UNIX installation for the 3B2/600
 - disk partitioning, 2-10
- Unpack
 - console
 - 6386SX/EL, 4-3
 - NCR-3315, 5-3
 - NCR-3332, 6-2
 - 6386E/33, 3-2
 - 6386E/33, 3-4
- UPS
 - 6386E/33, 3-4
- User
 - INFORMIX
 - adding
 - 3B2/600, 2-30
 - 6386E/33, 3-26
 - 6386SX/EL, 4-25
 - NCR-3315, 5-25
 - NCR-3332, 6-23
- User IDs
 - 3B2/600, 2-11
- Users

- adding
 - 6386E/33, 3-29
 - 6386SX/EL, 4-28, 5-28
 - NCR-3332, 6-26
- Using FACE
 - 6386E/33, 3-29
 - 6386SX/EL, 4-28, 5-28
 - NCR-3332, 6-26
- usr partition
 - 6386SX/EL, 4-6
 - NCR-3315, 5-6
 - NCR-3332, 6-4
 - 6386E/33, 3-7
- Utilities
 - RMP
 - 3B2/600, 2-14
 - UNIX
 - additional
 - 3B2/600, 2-13
 - essential
 - 3B2/600, 2-9
- uucp files
 - test case, A-5

V

- VDC 600 card
 - 6386E/33, 3-4
- VDC card
 - installing
 - 6386E/33, 3-2

W

- Warm installation
 - Monitor I
 - 6386E/33, 3-40
- Windowing Utilities
 - 3B2/600, 2-14
- Worksheet
 - disk configuration
 - checking
 - 6386E/33, 3-38
 - port configuration
 - 3B2/600, B-1
 - 6386E/33, B-2
 - 6386SX/EL, B-3
 - NCR-3315, B-4
 - NCR-3332, B-5