

# AT&T Standard Plant Training Course

---

Trainee Workbook

Unit 8C

DYNATEL™ 500 Cable Locator

---

PTC No. 157

Cable Repair



UNIT 8C - DYNATEL 500 CABLE LOCATOR

OBJECTIVES

WHEN YOU COMPLETE THIS UNIT YOU WILL BE ABLE TO USE THE DYNATEL 500 CABLE LOCATOR TO:

- LOCATE THE PATH AND DEPTH OF BOTH CABLES AND SERVICE DROPS.
  
- LOCATE BUTT SPLICES, SLACK LOOPS AND UNKNOWN LATERALS.
  
- IDENTIFY CABLES AND CONDUCTORS.

-AND-

- LOCATE CLEAR OR SEVERED CABLE ENDS.

IN ADDITION YOU WILL BE ABLE TO DO FIELD MAINTENANCE ON THE 500.

## DYNATEL 500 CABLE LOCATOR

CONTENTS	PAGE
1. GENERAL .....	1
2. DESCRIPTION .....	2
3. OPERATION .....	4
4. APPLICATIONS .....	11
5. BATTERY OPERATION AND REPLACEMENT .....	13

### 1. GENERAL

1.01 This section covers the description, use and battery replacement of the Dynatel 500 Cable Locator (Fig 1).

1.02 This portable, battery-operated tone set locates the path of buried or underground (UG) cables. Applications include locating butt splices, slack loops, unknown laterals, service drops, and encapsulated closures. The cable locator can also be used for positive cable or conductor identification, for finding the depth of buried or UG cables accurately, and for finding clear or severed cable ends.

1.03 The 500 locates cables without taking them out of service. The transmitter generates a high-frequency tone that can be put on a cable or pair without opening it or noising it up. The tone does not interfere with signals or conversations already on the cable, and it is not sensitive to a-c power-induced noise. The transmitter has two power ranges: normal (for most applications), and high. Power level can be selected for soil conditions or cable length. Ground connections are generally unnecessary for the transmitter setup, and no connections are required for the receiver, which can be operated with one hand at normal walking speeds.

1.04 The tone receiver is a very sensitive, tuned unit that receives only the signal from the transmitter. The receiver output can be heard either through the built-in loudspeaker, or through headphones. In addition, the receiver meter indicates the strength of the tone. The volume knob controls the speaker output level, the headphone output level, and the meter sensitivity. Headphones are optional with the Dynatel 500.

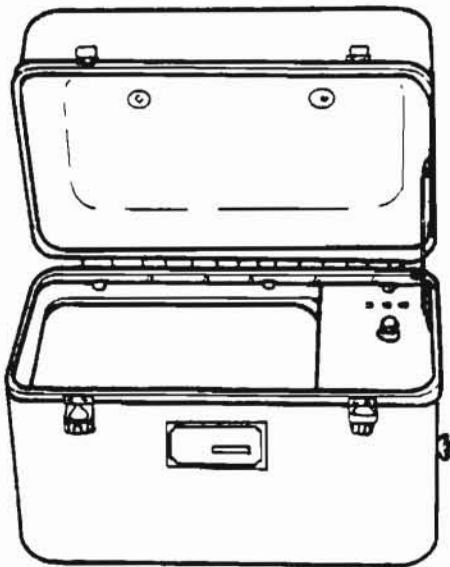

A. TRANSMITTER UNIT

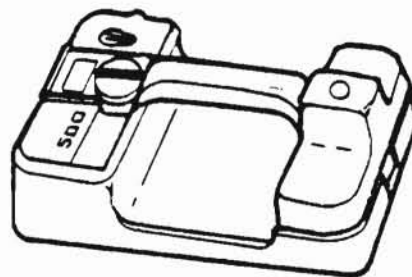

B. RECEIVER UNIT

Fig. 1 - Dynatel Cable Locator

## 2. DESCRIPTION

**2.01** The Cable Locator consists of a transmitter, receiver, and accessory units (Fig. 2). The transmitter and receiver are made of durable yellow fiberglass for light weight and high visibility, and water-resistance in wet-weather operation. For compact storage and carrying, the receiver and accessory units fit into the transmitter case when not in use.

**2.02** The TRANSMITTER has a single switch located on the panel next to the accessory storage well, as shown in Fig. 3 and described below:

(a) The TRANSMITTER output selector is a 4-position switch for testing batteries and setting the transmitter output power level. The selector performs the following functions:

**OFF:** Turns off transmitter power.

**NORMAL:** Sets transmitter output power at NORMAL level. Use this level for maximum battery life.

**HIGH:** Selects HIGH transmitter output level. Use this position for HIGH transmitter output power; for lead sheath cables, cable location over long distances, etc. High power operation reduces battery life. See also Paragraph 5.05.

**BAT TEST:** Battery test position; spring-return, momentary-contact switch puts load on the transmitter batteries. See Section 5.

(b) The Transmitter output connector (not shown) is a standard phone jack.

(c) The BATTERY TEST indicator is used with the BATTERY test position of the TRANSMITTER output selector (above). See Section 5 for battery test procedure.

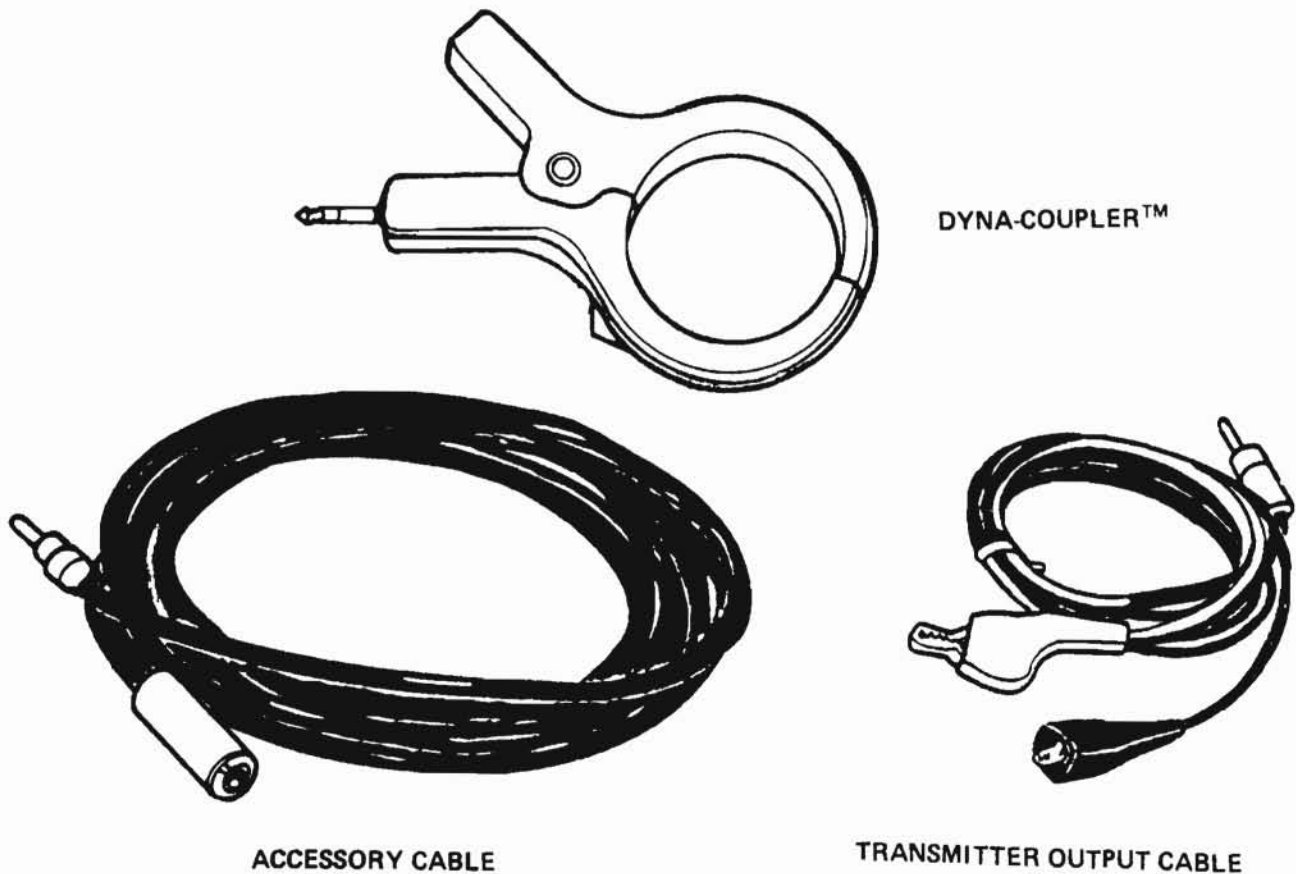

Fig. 2 - Dynatel 500 Accessories

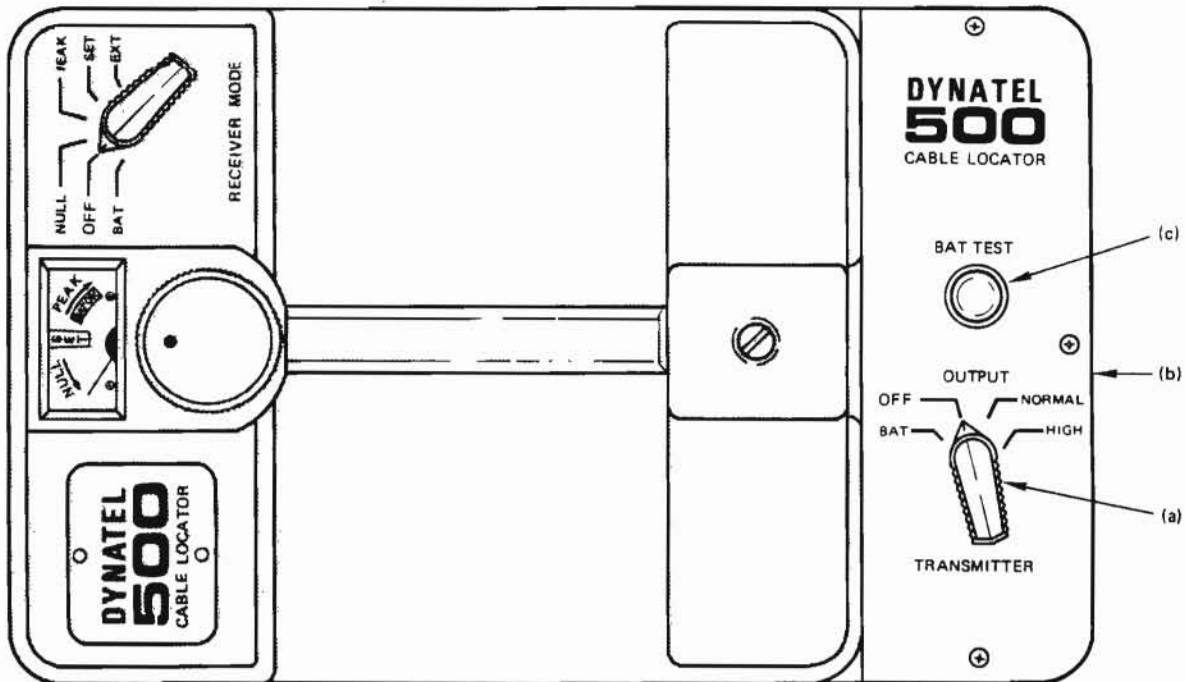

Fig. 3 – Transmitter Unit Panel. Functions are Keyed to Text in Paragraph 2.02.

#### RECEIVER FUNCTIONS

2.03 The Receiver Functions are shown in Fig. 4, and described below:

(a) The RECEIVER MODE selector is a 6-position switch that controls the receiver operating modes. The selector performs the following functions:

- OFF: Turns off receiver power.
- BAT: Battery test position; momentary-contact, spring-return switch puts load on receiver batteries. See Section 5 for battery test procedures.
- NULL: Selects receiver NULL mode operation; for use in cable location. See Paragraph 3.08. In NULL mode, receiver meter reading and the tone from the loudspeaker both decrease sharply when receiver is directly over the cable.
- PEAK: Sets receiver for PEAK mode operation; for use in cable location. See Paragraph 3.14. In PEAK mode, both

the tone from the loudspeaker and the meter reading are the highest when the receiver is directly over the cable. This is not as sharp (definite) an indication as the NULL. Note that for best results in PEAK mode, the receiver handle must be PARALLEL to the cable.

SET: SET mode operation is used for cable depth location. See Paragraph 3.16.

EXT: EXT position used for operation of receiver with Dyna-Coupler™. See Paragraph 3.18.

(b) The Receiver Signal Level Meter indicates the strength of the tone being received. Needle deflects to the right for strong signal (PEAK); needle deflects to the left for NULL or weak signal. Yellow center zone (SET) is for cable depth finding (SET mode). BAT OK zone is used for battery testing.

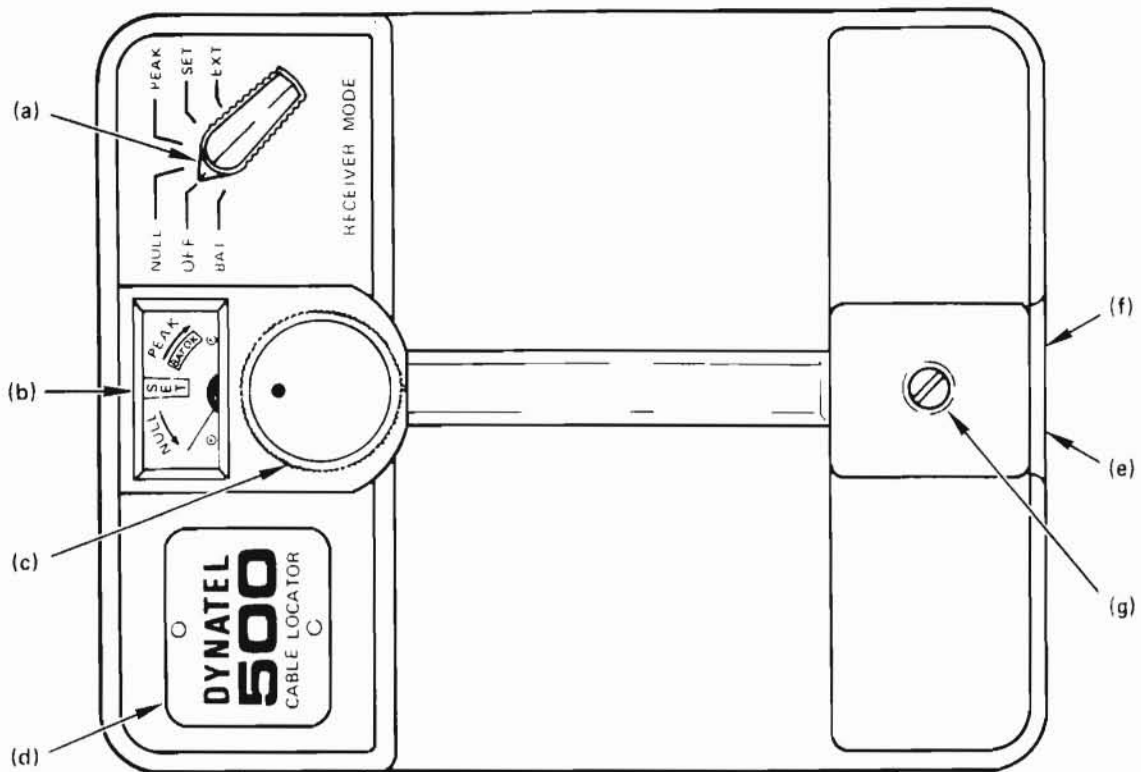

Fig. 4 – Receiver Unit Panel. Functions are Keyed to Text in Paragraph 2.03.

- (c) The Volume Control Knob controls the meter sensitivity, loudness of tone from the receiver loudspeaker, and the headphone output level at the headphone jack.
- (d) The Loudspeaker provides an audible tone level indication. An overlapping cover protects the speaker in wet weather.
- (e) The PHONE Jack (not shown) is an output connector for use with a 600-ohm headset (optional).
- (f) The EXT Jack (not shown) is a signal input jack for use with Dyna-Coupler™ (in EXT mode).
- (g) The Battery Access Cover Screw secures the battery access cover. For the battery changing procedure, see Section 5.

### 3. OPERATION

#### TRANSMITTER SETUP

**3.01 GENERAL.** There are three ways for the transmitter to put tone on a cable: by induction, by direct connection, or with the special Dyna-Coupler™. Instructions for all three methods are included in the following paragraphs. Remove the receiver unit from the transmitter carrying case; close the carrying case in rain or snow.

**3.02 INDUCTION.** Set the transmitter on the ground over the cable, and turn it ON. The transmitter case handle must be parallel to the cable run. No access to the cable is necessary.

*Note:* To ensure accuracy, observe the following precautions:

- a) Do not use the receiver within 25-50 ft of the transmitter.

b) Be certain that the transmitter is placed over the cable to be located. Use the Dyna-Coupler™ or a direct connection if other cables or pipes are in the same area.

**3.03 DYNA-COUPLER™.** If access to the cable is available, this is the easiest and most accurate way to put tone on only one cable. Connect the coupler assembly to the Transmitter Output Jack with the 12-foot cable assembly (Fig. 5). Then open the coupler jaws and place them around the desired cable (or conductor). The tone will be loudest on just that one cable. It is unnecessary to remove common bonding or ground, or to open the cable or conductor.

*Note:* Be sure the Dyna-Coupler™ jaws are fully closed all the way around the cable. If the jaws do not close around the cable, very little tone will be on the cable. If the jaws do not close, the cable is too big. There is no minimum cable size.

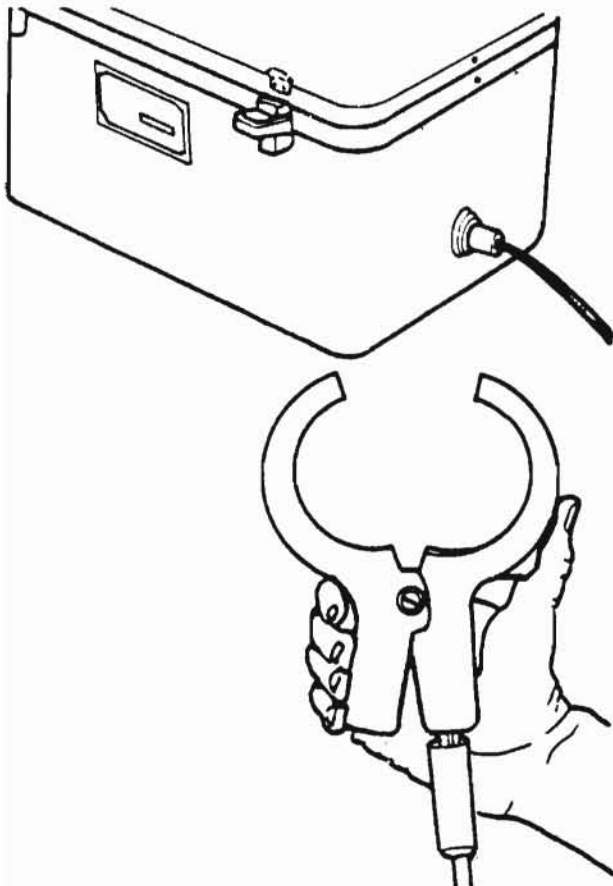

Fig. 5 - Opened Dyna-Coupler™. In the background, the Coupler Cable is shown connected to the Transmitter Output Jack.

**3.04** For best results, do not use the Dyna-Coupler™ on a cable that is clear at both ends. Connect a jumper between one of the conductors (or the sheath) and ground. If no ground point is available, or if the cable length is short, use a direct connection to the sheath or to one conductor. See Paragraph 3.05.

**3.05 DIRECT CONNECTION.** Connect the phone plug on the 5-foot output cable to the TRANSMITTER OUTPUT jack, then connect the red clip lead of the output cable to the cable shield. If the cable is not shielded, open any one conductor in the cable, and connect the red clip lead to that conductor. Keep the black clip lead clear. Then set the transmitter on the ground. If the transmitter cannot be placed on the ground, then connect the black clip to ground. This completes the transmitter setup instructions. See Section 4, Special Applications, for suggestions on using the Cable Locator.

#### CABLE LOCATOR OPERATION

**3.06 TRANSMITTER.** The only transmitter control is the TRANSMITTER output selector. Turn the transmitter ON by turning the selector either to NORMAL or HIGH. See also Section 2. The NORMAL and the HIGH positions on the TRANSMITTER output selector determine the transmitter output power. For most situations, set the switch to NORMAL. Use HIGH power only for extra power, such as locating cable paths over very long distances, in very wet ground when the signal falls off rapidly, or when the soil is sandy and dry, and it is difficult to put tone on the cable.

**3.07 RECEIVER.** The receiver has only two controls: a VOLUME control and a RECEIVER MODE selector. See Section 2. To turn the receiver ON, set the RECEIVER MODE selector to any one of the four positions clockwise from OFF.

#### CABLE LOCATION PROCEDURE

##### NULL MODE

**3.08** Generally, the NULL mode is the most sensitive and accurate. In NULL mode, the tone received is least when the receiver is directly over the cable; the loudspeaker is the quietest, and the meter indicates a null (the needle goes to the left side of the meter). When the receiver is moved to either side of the cable, the tone from the loudspeaker increases, and the meter needle swings to the right. See also Section 2.

**3.09** To operate in NULL mode, set the RECEIVER MODE selector to NULL, and bring the receiver into the general area of the cable. The cable can then be located by moving the receiver to the point where the tone is minimum, and the level meter is NULL. FOR BEST RESULTS, HOLD THE RECEIVER LEVEL. When the cable has been located, it can be followed with the receiver in NULL mode. See Fig. 6.

**3.10** The control knob at the front end of the handle controls both the loudspeaker volume and the meter sensitivity. Cable location accuracy is increased by turning up the volume control (this also increases the meter sensitivity). As the volume control is increased, the null becomes sharper.

**3.11** The receiver is most sensitive in NULL mode. However, if the tone is put on the cable by induction, and the cable is in a joint trench, or there are aerial cables nearby, the pulling effect may make the cable location inaccurate.

**3.12** For best results, put the tone directly on the cable with the Dyna-Coupler™ or with a direct connection. This eliminates the possibility of the receiver indicating a null in the wrong position. Another possibility is to double check the cable position by switching from NULL mode to PEAK mode. THIS IS ALWAYS RECOMMENDED WHEN USING NULL MODE.

**3.13** When using the induction method, do not attempt to locate cable in the immediate vicinity of the transmitter. If it is necessary to use the receiver in an area near the transmitter, then the transmitter should be moved down the cable.

#### PEAK MODE

**3.14** To operate the receiver in PEAK mode, set the RECEIVER MODE selector to PEAK. In this mode, the tone from the receiver is the loudest when the receiver is right over the cable. Similarly,



A

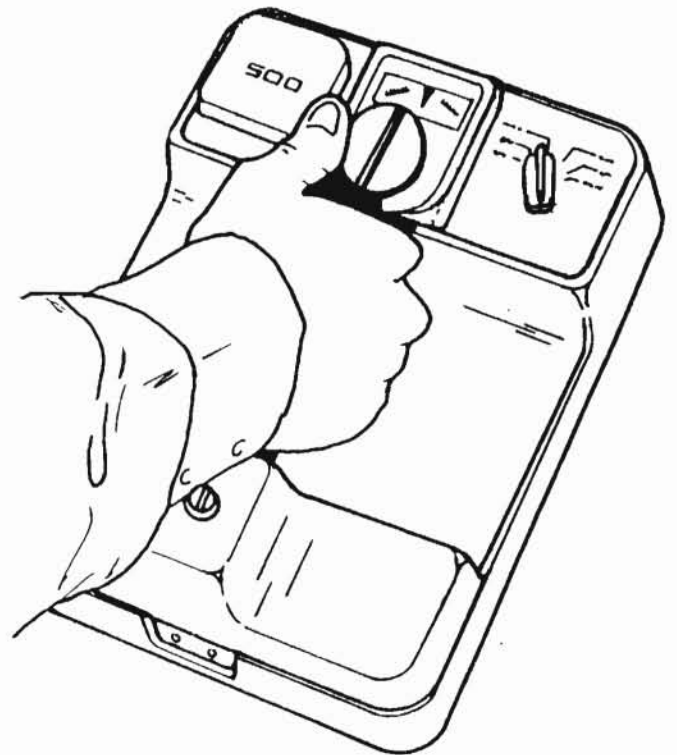

B

Fig. 6 - A. Receiver Unit in operation.

B. Receiver Unit in NULL mode; note thumb operation of Volume Control Knob.



the meter indication is the highest when the receiver is right over the cable. Use the volume control knob to control receiver sensitivity.

*Note:* When using the receiver in PEAK mode, be sure that the handle is PARALLEL to the cable run. If you turn the handle so that it is ACROSS the cable run, the receiver output will decrease, and it won't be as accurate. See Fig. 7.

3.15 Note that while the PEAK mode is not quite as sensitive as NULL mode, it may allow faster cable path location, and it is convenient for certain applications described in Section 4.

### FINDING CABLE DEPTH

3.16 To find the depth of a buried or underground cable, use the following procedure:

- 1) With the receiver in PEAK mode and the receiver handle in line with the cable path, carefully locate the cable position; then place the receiver on the ground directly over the cable.
- 2) Put the RECEIVER MODE selector in SET, and adjust the receiver VOLUME control so that the meter needle is centered on the meter in the yellow area labeled SET.

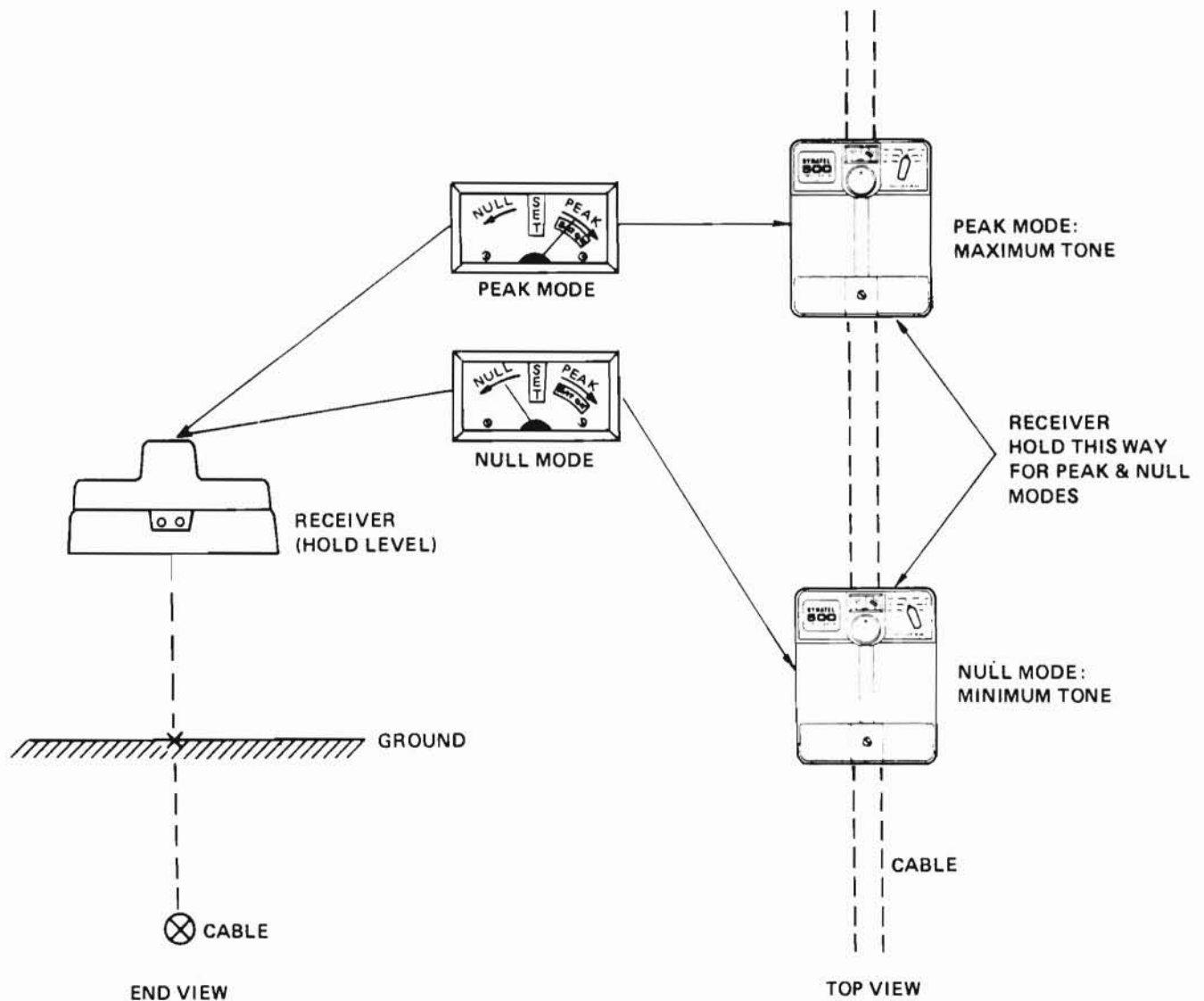

Fig. 7 - Cable Location for Peak & Null Modes.

3) Set the **RECEIVER MODE** selector to **PEAK**. Note that the meter reading and the tone from the loudspeaker will both increase.

4) Raise the receiver straight up from the ground until the meter needle returns to the **SET** area on the dial.

5) Measure the distance from the bottom of the receiver to ground. This is equal to the depth of the cable below the surface of the ground. See Fig. 8.

6) To locate the depth of underground cable in a duct, be sure to subtract the diameter of the duct from the depth of the cable. This helps prevent damage to the duct.

**3.17** The above cable depth location technique is limited by how high the operator can hold the receiver. If the cable goes under a drainage ditch, for example, it may be too deep to use the above method. In this case, use the following triangulation method:

1) With the transmitter in **NULL** mode, locate the cable position. Double check it in **PEAK** mode.

2) Mark the position on the ground.

3) Hold the receiver so that the handle is **PARALLEL** to the cable path, and the bottom of the receiver is at 45 degrees relative to the ground. See Fig. 9.

4) Walk to one side of the cable until receiver indicates a **NULL** again.

5) Mark the position on the ground beneath the receiver.

6) The distance between the first mark and the second mark equals the depth of the cable.

**Note:** The accuracy of this method depends on two things:

a) The handle of the receiver must be parallel with the cable path, and it must be level.

b) The bottom of the receiver must be held at exactly 45 degrees.

If the receiver is held incorrectly, the cable depth measurement may be incorrect.

### **CABLE/CONDUCTOR IDENTIFICATION**

**3.18** By putting tone on the cable to be identified, the Dyna-Coupler™ can then be used with the receiver positively identifying the conductor or cable with the tone. Use the following procedure:

1) Put the tone on the cable. Use either a Dyna-Coupler™, or make a direct connection. See Paragraphs 3.03 and 3.05.

**Notes:** a) If a Dyna-Coupler™ is used to put the tone on the cable, then a second coupler will be required for cable identification.

b) For underground or buried cable, put the coupler between any common bonding point, and the point where the cable goes underground.

2) With the coupler cable, connect the Dyna-Coupler™ to the receiver **EXT** input jack. Set the **RECEIVER MODE** selector to **EXT**. See Fig. 10.

3) To identify the cable, place the Receiver Dyna-Coupler™ around each cable one at a time to locate the one with the greatest tone. This identifies the cable positively.

1) FIRST THIS...

PLACE RECEIVER ON GROUND  
OVER CABLE (SEE PARA. 3.16).  
SET RECEIVER MODE TO SET.  
ADJUST THE VOLUME CONTROL SO  
THE METER INDICATES SET.

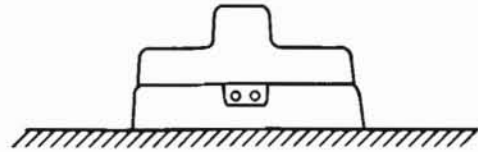

⊗ CABLE

2) THEN THIS...

SET RECEIVER MODE TO PEAK.  
LIFT RECEIVER UNTIL METER  
NEEDLE RETURNS TO SET.

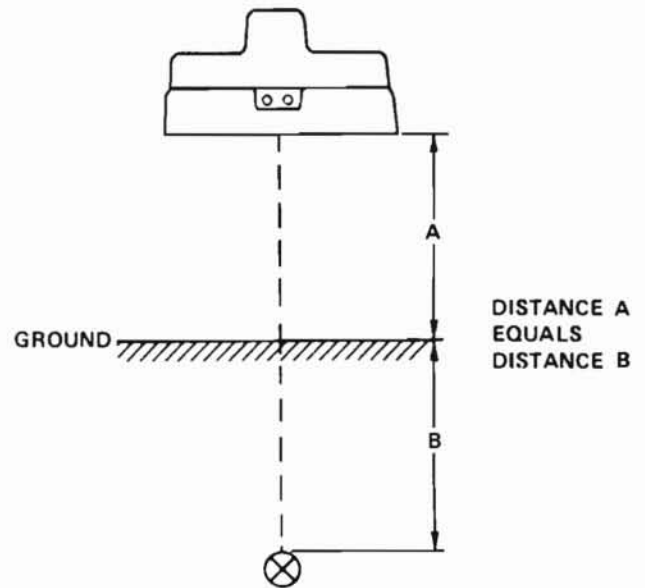
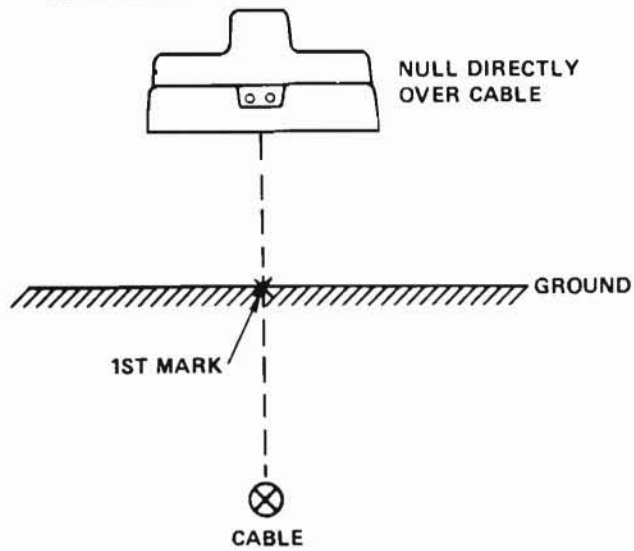

Fig. 8 - Cable Depth Location

1) FIRST THIS . . .  
SET RECEIVER MODE TO NULL.



2) THEN THIS . . .

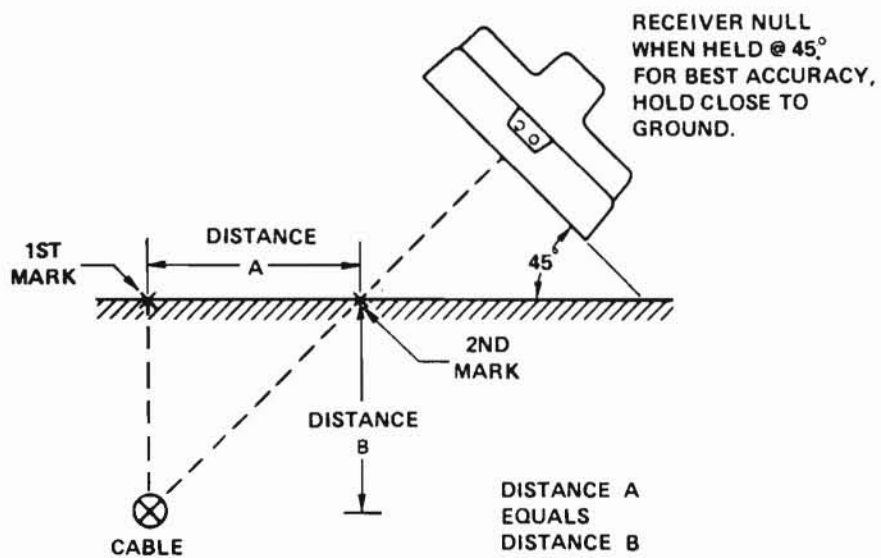

Fig. 9 - Cable Depth Location (Triangulation Method)

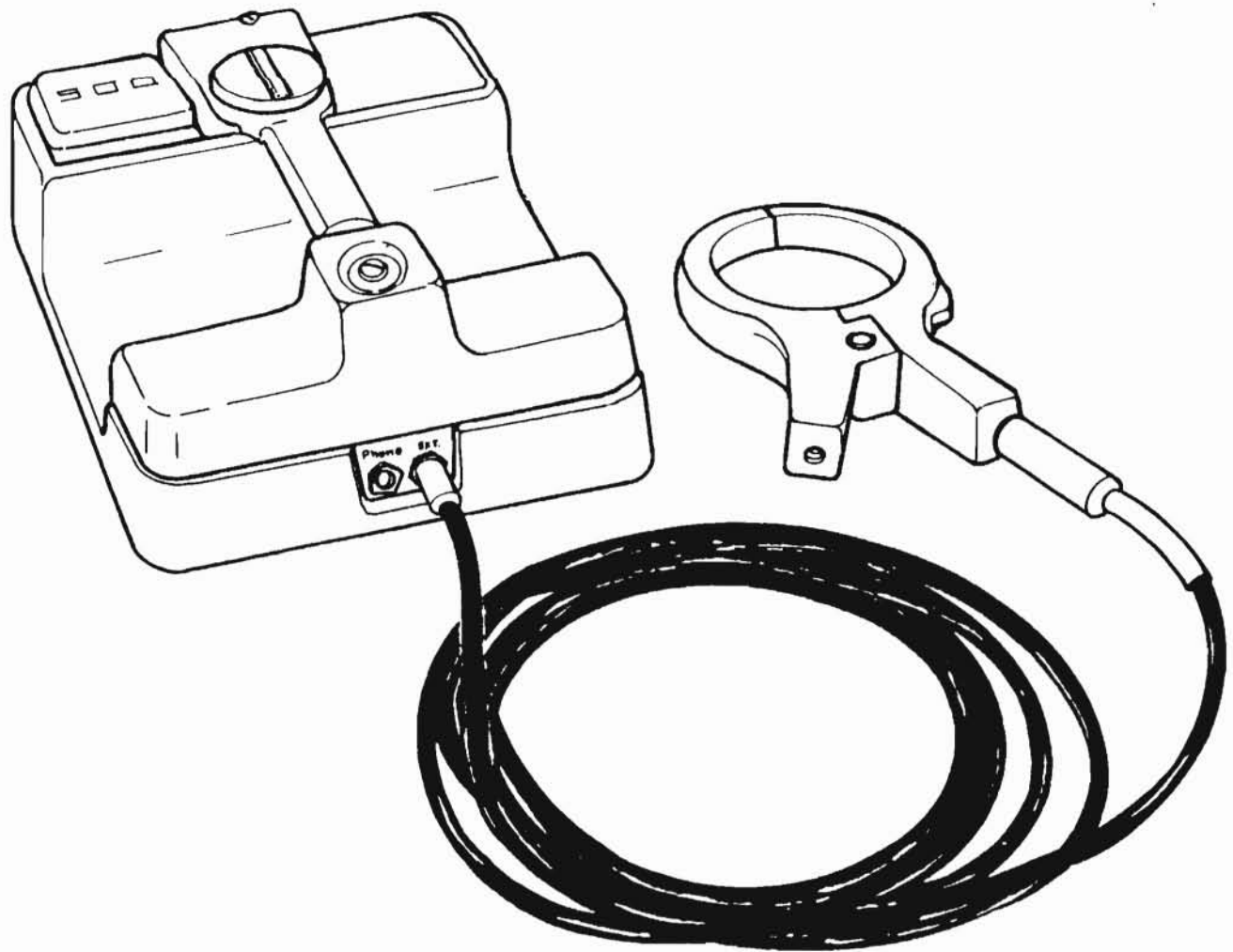

Fig. 10 – Receiver Setup for Cable Identification

#### 4. APPLICATIONS

##### CABLE LOCATION APPLICATIONS

**4.01** For best results, review Sections 2 and 3 for basic operation and cable location techniques. Once the basic operating techniques are understood, the Dynatel 500 will be extremely useful in the following situations.

**4.02 SLACK LOOPS AND BUTT SPLICES.** To find slack loops or butt splices, first locate and mark the path of the cable. Then set the RECEIVER MODE selector to PEAK, and retrace the cable path. HOLD THE RECEIVER SO THAT THE HANDLE IS PERPENDICULAR TO THE

CABLE PATH, and the tone from the receiver is minimum (see Fig. 11). When the receiver passes over a slack loop or a butt splice, the tone from the receiver will increase, and the meter needle will go to the right. This indicates a sudden curve in the cable path, and it could be a butt splice or a loop.

*Note:* The receiver can sense loops and butt splices only if the handle is held perpendicular to the cable path; if it is parallel, the receiver senses the cable itself, and misses the loops, etc.

This method also locates buried closures with laterals. Whenever a slack loop or a splice is located, it is also a good idea to check it for unknown laterals. See Paragraph 4.03.

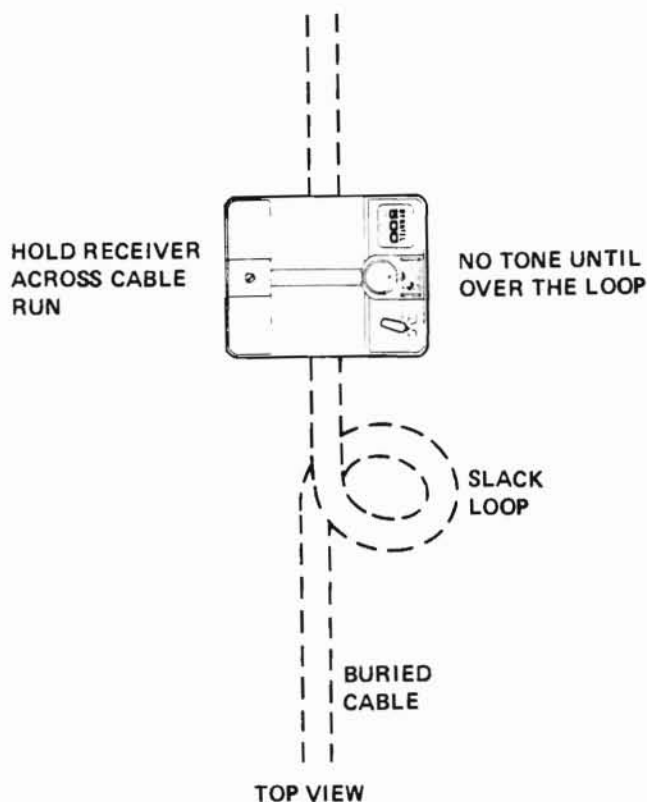

Fig. 11 – Slack Loop or Butt Splice Location

**4.03 UNKNOWN LATERALS.** To check for unknown laterals from a closure, first set up the transmitter and locate any splices or loops as outlined in Paragraph 4.02. Mark each splice or loop.

**4.04** To find laterals, splices or drops from any of the places marked, switch the receiver to PEAK mode. Then walk about 10 to 25 ft away from the mark, and circle the mark. BE SURE TO HOLD THE RECEIVER SO THAT THE METER END OF THE HANDLE POINTS AWAY FROM THE MARK. If the receiver is held any other way, it may miss any laterals or service drops. See Fig. 12.

**4.05** The receiver will remain relatively quiet until it crosses a lateral. The tone will be loudest directly over the lateral. There may be more than one lateral, so be sure to walk all the way around the mark. After all laterals are located, the paths can be located and marked.

**4.06 LOCATING CABLES FROM PEDESTALS OR ACCESSIBLE CLOSURES.** To locate cables or service drops coming out of ready access closures or pedestals, use the Dyna-Coupler™ to put tone on the one cable to be located. BE SURE TO PLACE THE COUPLER BETWEEN THE

COMMON BOND AND THE POINT WHERE THE CABLE GOES UNDERGROUND. Set the transmitter power to NORMAL, unless the cable is to be traced a long distance.

**4.07** To locate the cable, set the RECEIVER MODE selector to PEAK. Then circle the closure at a distance of 10 to 15 feet. BE SURE TO HOLD THE RECEIVER SO THAT THE METER-END OF THE HANDLE POINTS AWAY FROM THE CLOSURE. If the receiver is held any other way, it may miss the cable.

**4.08** The receiver will remain relatively quiet until it crosses a cable. The tone will be loudest when the receiver is directly over the cable. Note that the meter will also point to the right of the scale. There may be more than one cable, so be sure to walk all the way around the mark. The strongest meter signal indicates the proper cable; its path can then be located.

**4.09 SERVICE DROP PATH LOCATION.** To locate the path of a service drop from a house or other building, use the standard cable location procedure. In this case, it may be more convenient to make a direct connection to the service drop at the protector. Connect the transmitter output cable (red clip) to the protector, and place the transmitter on the ground (or connect the black clip to ground). Set the transmitter output power to NORMAL. Then locate the cable path using the standard NULL or PEAK mode techniques outlined in Section 3.

**4.10 CLEAR END LOCATION.** To find the clear or severed end of a cable or service drop, put the tone on the cable with the transmitter. If the cable is bonded at one end, or otherwise connected, put the Dyna-Coupler™ around the cable between the bonding (or connecting) point, and the point where the cable goes underground. If the cable is clear at both ends, the direct-connection is suggested. Set the receiver in PEAK mode and follow the cable path until the tone suddenly decreases. That will be the clear (or severed) end of the cable.

#### CABLE CONNECTION TIPS

**4.11 RISERS.** To locate a cable going underground from a riser, use the Dyna-Coupler™. Reach above the U-guard and pull the cable away from the pole, and place the Coupler around the cable. Once the coupler is connected between the transmitter and the riser, turn the transmitter on to the NORMAL power mode. The path of the cable can now be located.

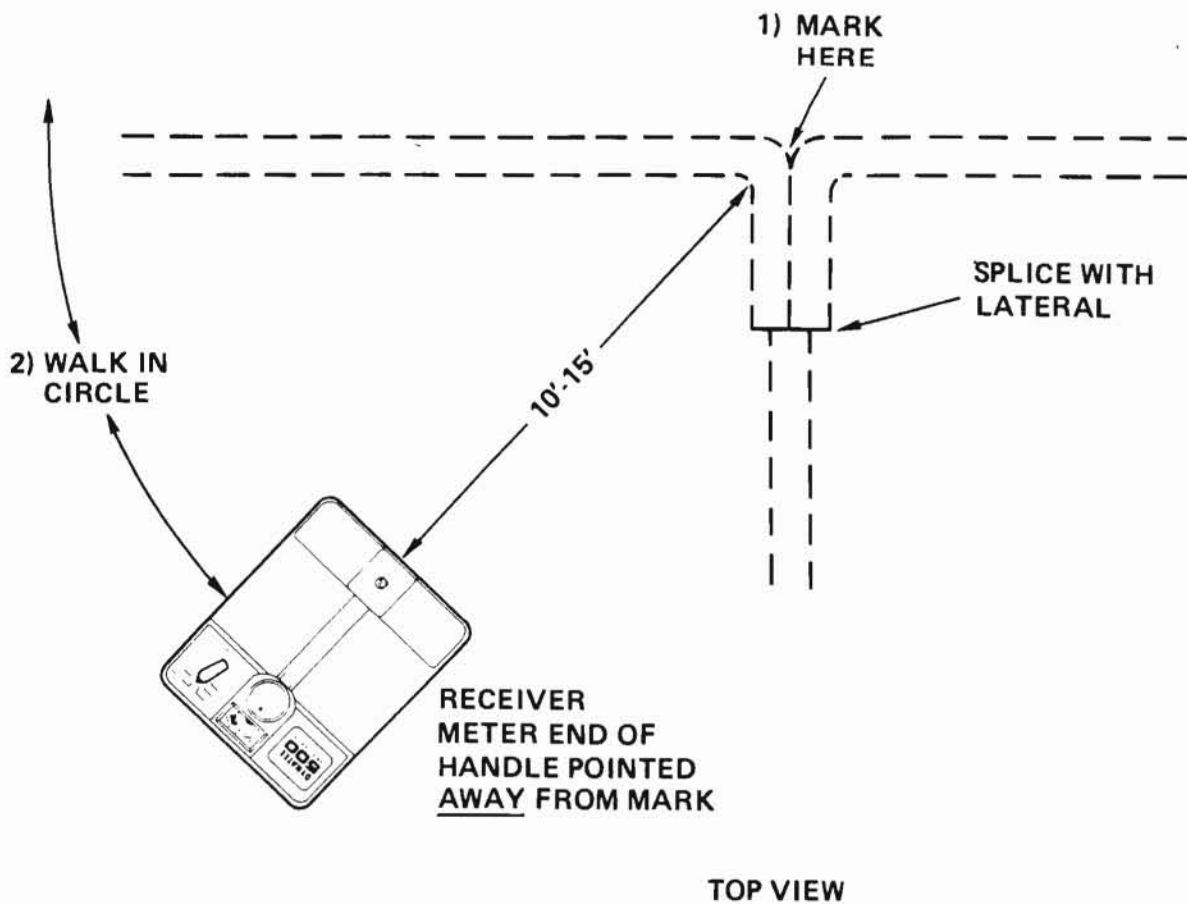

Fig. 12 – Locating Laterals, Drops from Splice, Encapsulation, Riser, etc.

**4.12 PRESSURIZED CABLES.** To put tone on a pressurized buried or toll cable, locate a pressure valve. Then make a direct connection from the transmitter to the valve. Use the transmitter output cable, and connect the red clip lead to the valve assembly. For best results, place the transmitter as far away from the valve assembly as possible. It may be necessary to use the Coupler cable assembly (12 ft) as a cable extension. See Paragraph 3.05.

## 5. BATTERY OPERATION AND REPLACEMENT

### BATTERY TESTS

**5.01 TRANSMITTER.** The TRANSMITTER output selector has a momentary-contact BAT TEST position. To check the batteries, hold the switch fully counter-clockwise for 5 to 10 seconds. The batteries are good if the BAT TEST light turns ON. (See Section 2.) As the batteries age and the light gets dimmer, the transmitter output

power decreases. When the light is barely visible, replace the batteries. Note that the transmitter will operate, if necessary on low batteries.

**5.02 RECEIVER.** Remove the receiver from the transmitter case and hold the RECEIVER MODE selector fully counter-clockwise for 5 to 10 seconds. The meter should indicate BAT OK; if not, replace the batteries.

### BATTERY REPLACEMENT

**5.03 TRANSMITTER.** The transmitter uses two 6-volt carbon-zinc lantern cells. See Table A for replacement types. To change the transmitter batteries, use the following procedure:

- (a) For access to the transmitter battery compartment, take the receiver out of the transmitter. The batteries are located in the bottom of the carrying case, beneath a plastic storage tray. The storage tray is retained by four

screw fasteners. Release the fasteners and lift the storage tray out of the transmitter carrying case. See Fig. 13.

(b) Disconnect each battery; lift it from the case, and replace it with a fresh battery. Place new batteries in the battery compartment in the same position as the old batteries. Be sure to connect the red wire to the (+) positive terminal, and the black wire to the (-) negative terminal on each battery. Always replace both batteries at the same time.

**Note:** The transmitter has a protection circuit that prevents damage if the leads are connected incorrectly; however, **THE TRANSMITTER WILL NOT OPERATE IF THE BATTERIES ARE CONNECTED INCORRECTLY.**

(c) After the batteries have been placed, replace the storage tray, and fasten the quick-release fasteners.

**Table A**  
**Cable Locator Replacement Batteries**

Unit*	Voltage	NEDA	Eveready	Burgess
Transmitter	6V	915	510S	F4BP
Receiver	9V	1602	246	2N6

\*Each unit requires two batteries.

**5.04 RECEIVER.** The receiver uses two 9-volt carbon-zinc batteries, which are located under the access cover at the opposite end of the Receiver from the controls. See Table A for replacement types. To change the batteries, use the following procedure:

- (a) Loosen the battery access cover screw, and remove the access cover (see Paragraph 2.03 (g) ).
- (b) Disconnect each battery; lift it from the receiver, and replace it with a fresh battery. Always replace both batteries at the same time.
- (d) Replace the battery access cover, and tighten the cover screw.

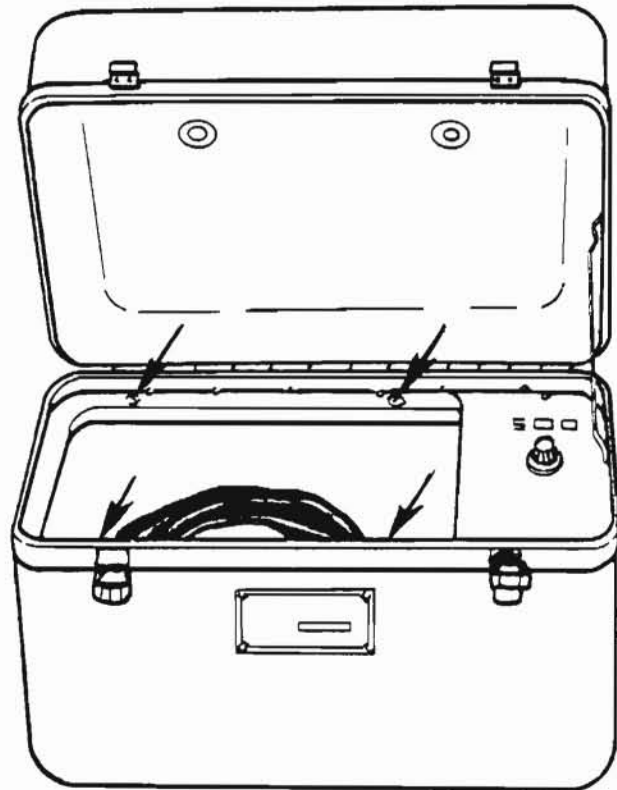

**Fig. 13 – Transmitter Battery Access.** For access, release ¼-turn screws (arrows); lift out plastic storage well.



PROGRESS TEST NO. 1

ANSWER THE FOLLOWING QUESTIONS. IF YOU NEED HELP, YOU MAY USE PARAGRAPHS 3.01 THROUGH 3.05 ON PAGES 5 AND 6 OF YOUR WORKBOOK. DO NOT USE YOUR SET USAGE GUIDE.

1. INDUCTION IS THE EASIEST WAY TO PUT THE TONE SIGNAL ON A CABLE. HOWEVER, THERE ARE TWO CONDITIONS WHEN YOU SHOULD NOT USE INDUCTION. LIST THEM BELOW.

(1) WITHIN 25 TO 50 FT OF TRANSMITTER

(2) OTHER UNDERGROUND UTILITIES

2. THERE ARE TWO IMPORTANT THINGS TO REMEMBER WHEN SETTING UP THE TRANSMITTER FOR INDUCTION.

(1) SET THE TRANSMITTER CASE ON THE GROUND DIRECTLY OVER THE CABLE.

WHAT IS THE OTHER?

(2) HANDLE PARALLEL TO CABLE

3. WHY MUST THE TIPS OF THE JAWS OF A DYNA-COUPLER BE TOUCHING WHEN USING IT TO PUT A TONE SIGNAL ON A CABLE?

TO INDUCE TONE

4. WHEN USING A DIRECT CONNECTION TO A SHIELDED CABLE, WHICH LEAD OF THE SHORT ACCESSORY CABLE IS NOT USED?

GRND

---

---

5. WHAT MUST BE DONE TO USE THE DIRECT CONNECTION METHOD ON A CABLE WITHOUT A SHIELD?

RED TO CONDUCTOR

---

---

---

END OF PROGRESS TEST. WHEN YOU HAVE WRITTEN ALL YOUR ANSWERS, RESTART THE TAPE.

UNIT 8C - WORK ASSIGNMENT NO. 1

READ ALL INSTRUCTIONS BEFORE PROCEEDING.

- 1 - ASK YOUR ADMINISTRATOR TO ASSIGN A BURIED CABLE THAT YOU CAN USE FOR THIS WORK ASSIGNMENT.
- 2 - TAKE YOUR 500 CABLE LOCATOR TO THE WORK AREA.
- 3 - PLACE TONE ON THE BURIED CABLE AT PEDISTAL A. USE THE DYNA-COUPLER. MAKE SURE THAT YOU ARE ON THE CABLE BETWEEN PEDISTAL A AND PEDISTAL B.
- 4 - USE "PEAK". TRACE THE CABLE PATH BETWEEN PEDISTAL B AND PEDISTAL C.
- 5 - MARK THE CABLE PATH WITH FLAGS EVERY 4 FEET.
- 6 - RETRACE THE CABLE PATH IN "NULL".
- 7 - AFTER YOU MARK THE CABLE PATH, MEASURE THE DEPTH OF THE CABLE AT THE MID-POINT BETWEEN PEDISTAL B AND PEDISTAL C. PLACE A FLAG TO ONE SIDE OF THE CABLE PATH TO SHOW HOW DEEP THE CABLE IS BURIED. (THE FLAG SHOULD BE AS FAR TO THE SIDE AS THE CABLE IS DEEP.)

8 - YOU MAY USE YOUR WORKBOOK.

9 - ASK YOUR ADMINISTRATOR TO CHECK YOUR WORK BEFORE YOU REMOVE YOUR FLAGS. YOUR ADMINISTRATOR WILL TELL YOU HOW ACCURATELY YOU HAVE LOCATED THE CABLE AND DEPTH.

10- WHEN YOU ARE TOLD TO PROCEED, BRING YOUR EQUIPMENT BACK INSIDE, THEN RESTART THE TAPE.

11- IF YOU HAVE ANY QUESTIONS ABOUT WHAT YOU ARE TO DO, ASK YOUR ADMINISTRATOR FOR HELP NOW!

WHEN YOU FEEL YOU UNDERSTAND THESE INSTRUCTIONS, PROCEED.

WITH THE TONE ON THE RING SIDE OF PAIR 4,

WHICH CABLE IS THE TONE ON? (CHECK ONE)

CABLE X

CABLE Y

CABLE Z

WHICH WIRE? (CHECK ONE)

GREEN

RED

YELLOW

BLACK

WHEN YOU HAVE ANSWERED THE  
QUESTIONS, TURN YOUR TRANS-  
MITTER AND RECEIVER "OFF";  
THEN RESTART THE TAPE.

UNIT 8C - WORK ASSIGNMENT NO. 2

READ ALL INSTRUCTIONS BEFORE PROCEEDING.

- 1 - ASK YOUR ADMINISTRATOR FOR THE COIL OF STATION WIRE TO BE USED FOR WORK ASSIGNMENT NO. 2.
- 2 - YOUR ADMINISTRATOR WILL TELL YOU WHERE THE COIL OF STATION WIRE IS TO BE PLACED OUTSIDE.
- 3 - TAKE YOUR 500 LOCATOR AND THE WIRE TO THE AREA YOUR ADMINISTRATOR HAS ASSIGNED TO YOU.
- 4 - LAY THE WIRE ON THE GROUND AS SHOWN ON THE NEXT PAGE.
- 5 - TRACE THE PATH IN "PEAK" THEN TURN THE RECEIVER  $90^{\circ}$  AND CHECK FOR THE SLACK LOOP.
- 6 - WHEN YOU ARE SATISFIED THAT YOU KNOW HOW THE 500 REACTS TO SLACK LOOPS, TELL YOUR ADMINISTRATOR THAT YOU HAVE COMPLETED THIS WORK ASSIGNMENT.

WORK ASSIGNMENT NO. 2

