

IC-04A/AT/E

430MHz FM TRANSCEIVER

INSTRUCTION MANUAL

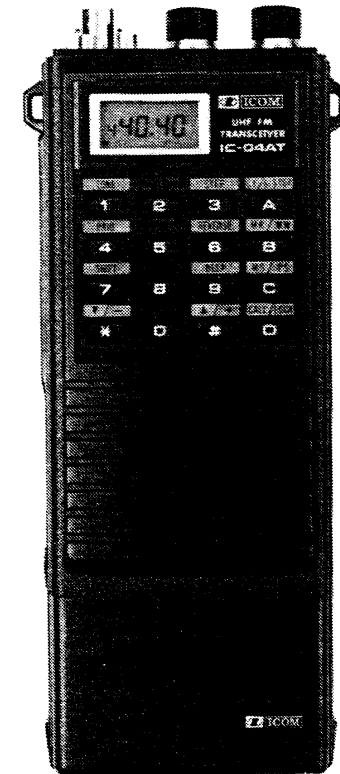

TABLE OF CONTENTS

I. FEATURES.....	1
II. SPECIFICATIONS	2
III. ACCESSORIES.....	4
IV. PRE-OPERATION	5
V. CONTROL FUNCTIONS.....	11
VI. OPERATION	18
KEY FUNCTION.....	18
DIAL MODE	20
MEMORY CHANNEL MODE.....	30
PRIORITY FUNCTION.....	33
LOCK FUNCTION.....	34
SCANNING OPERATIONS.....	35
RECEIVING.....	38
TRANSMITTING	39
VII. INSIDE VIEWS	41
VIII. TROUBLESHOOTING.....	43
IX. BLOCK DIAGRAM	46
- X. OPTIONS	47
XI. SCHEMATIC DIAGRAM.....	SEPARATE

SECTION I FEATURES

SYNTHESIZED HANDHELD TRANSCEIVER

This small, light weight handheld transceiver comes in handy for use any time, whether outdoors, in a car, or at home. The operation frequency can be entered by pushing the front panel keys as well as can be set the frequency step rate, duplex offset frequency and subaudible tone (IC-04AT only).

MULTI-PURPOSE SCANNING

Memory scan allows you to monitor all memory channels. Programmed scan provides scanning between two programmed frequencies. Auto-stop is provided and stops scanning when a signal is received, and resume when the signal goes away.

10 MEMORY CHANNELS

The IC-04A/AT/E has ten memory channels and each channel stores the operating frequency as well as duplex/simplex, duplex offset and subaudible tone frequency (IC-04AT only) for your operating convenience.

EASY-TO-READ DISPLAY

This set employs an easy-to-read LCD display. This displays the operation frequency as well as the memory channel number, duplex mode, scan mode, lock function, tone encoder enable indication, etc.

In addition an S/Rf meter is provided with in-lined dots on the LCD readout across the bottom of the display.

DUAL POWER LEVEL

Transmitter output can be switched easily to either of two levels; 2.5W output HIGH for long distances and 0.5W LOW for short distances. Battery consumption will be minimized in the LOW power mode. The IC-BP7 power pack as an option gives 5W output and standard aluminum case back provides superior heat sinking when the unit is run at that level.

VARIOUS ACCESSORIES AVAILABLE

All IC-4 series accessories are compatible with the IC-04 series plus there are new options such as the IC-BP7 and IC-BP8 battery packs and the HS-10 headset with PTT switch box and VOX unit options.

SECTION II SPECIFICATIONS

GENERAL

Number of Semiconductors	Transistor	47 (04AT: 53, 04E: 48)
	FET	1
	IC	10 (04AT: 13, 04E: 11)
	Diode	38 (04AT: 46, 04E: 39)
Frequency Coverage	04A/AT; 440 ~ 450MHz (Australian version: 430 ~ 440MHz) 04E; 430 ~ 440MHz	
Frequency Readout	6 digit 5KHz readout, LCD Display	
Frequency Resolution	04A/AT; 5KHz steps (other steps such as 10KHz, 15KHz, 20KHz and 25KHz are programmable and available by pushing the UP/DOWN buttons) 04E; 12.5KHz steps (25KHz steps are programmable)	
Frequency Control	Digital PLL Synthesizer with key input	
Frequency Stability	Within 0.001% in range of $-10^{\circ}\text{C} \sim +60^{\circ}\text{C}$	
Memory Channels	10 Channels	
Scanning	Programmed Scan and Memory Channel Scan available	
Usable Temperature	$-10^{\circ}\text{C} \sim +60^{\circ}\text{C}$	
Antenna Impedance	50 ohms unbalanced	
Power Supply Requirement	DC 8.4V with attendant power pack IC-BP3 DC 5.5V ~ 16V negative grounded is acceptable.	
Current Drain at 8.4V	Transmitting: HIGH (2.5W)	Approx. 1.25A
	LOW (0.5W)	Approx. 0.55A
	Receiving: At max audio output	Approx. 150mA
	Squelched	Approx. 45mA

Dimensions 116.5mm(H) x 65mm(W) x 35mm(D) Without power pack
Attendant power pack, IC-BP3 39mm(H) x 65mm(W) x 35mm(D)
Weight 515g (IC-04A: 495g) including power pack, IC-BP3 and flexible antenna

TRANSMITTER

Output power HIGH: 2.5W at 8.4V (5W at 13.2V)
LOW: 0.5W at 8.4V ~ 13.2V
Emission mode 16F₃ (F3E 16K0)
Modulation system Variable reactance frequency modulation
Max. frequency deviation ±5KHz
Spurious emission More than 60dB below carrier
Microphone Built-in Electret condenser microphone
Optional Speaker-microphone (IC-HM9) and Headset (HS-10) can be used
Operating mode Simplex
Duplex (Any in-band frequency separation programmable)

RECEIVER

Receiving system Double-conversion superheterodyne
Modulation acceptance 16F₃ (F3E 16K0)
Intermediate frequencies 1st: 21.8MHz 2nd: 455KHz
Sensitivity Less than 0.3μV for 12dB SINAD
Less than 0.4μV for 20dB Noise quieting
Squelch sensitivity Less than 0.1μV
Spurious response rejection ratio More than 60dB
Selectivity More than ±7.5KHz at -6dB point
Less than ±15KHz at -60dB point
Audio output power More than 500mW (at 8 ohms 10% distortion)
Audio output impedance 8 ohms

SECTION III ACCESSORIES

Carefully remove your transceiver from the packing carton and examine it for signs of shipping damage. Should any be apparent, notify the delivering carrier or dealer immediately, stating the full extent of the damage. It is recommended you keep the shipping cartons. In the event storage, moving, or reshipment becomes necessary, they come in handy. Various accessories are packed with the transceiver. Make sure you have not overlooked anything.

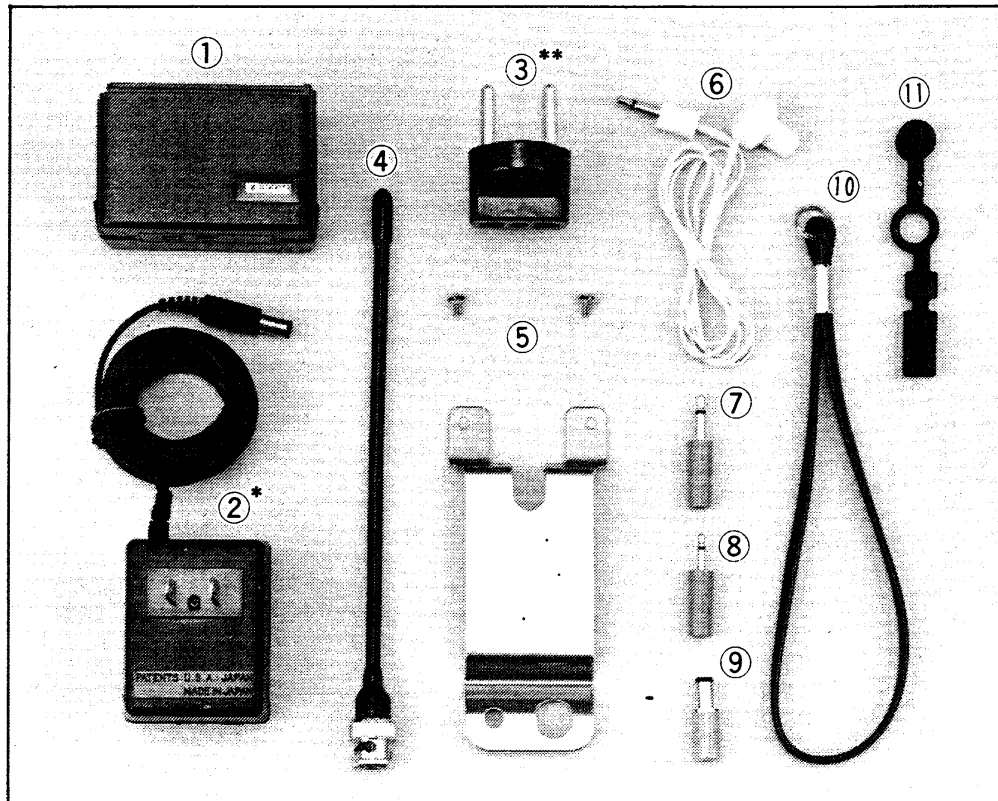

- | | |
|--|---|
| 1. Power pack IC-BP3
(Attached to the set.) | 1 |
| 2. Wall charger* | 1 |
| 3. AC Conversion plug** | 1 |
| 4. Flexible antenna | 1 |
| 5. Belt clip. | 1 |
| 6. Earphone. | 1 |
| 7. Earphone plug | 1 |
| 8. Microphone plug | 1 |
| 9. DC Power plug | 1 |
| 10. Hand-strap | 1 |
| 11. Rainproof cap. | 1 |
- * BC-25U for 117V
BC-26E for 240V
** Supplied only for 240V version.

SECTION IV PRE-OPERATION

BATTERY INSTALLATION

When using Nickel-Cadmium power pack IC-BP3:

The IC-BP3 is a rechargeable Nickel-Cadmium power pack, and it can be slipped onto or off the set very easily. It has a connector for a charger charge-current control circuit, reverse polarity protection circuit and charge indicator LED in its own pack. You can use the supplied BC-25U/26E wall charger or similar simple wall charger, or a car battery by using optional cable IC-CP1 for recharging. Before use, the power pack should be charged about 15 hours, because the battery may have discharged.

After charging is completed, the batteries can be used in the same manner as dry cells. However, the voltage of Nickel-Cadmium batteries drops rapidly just before they are exhausted, so when the battery exhausting indicator on the frequency display is indicated, be sure to immediately stop using it, and recharge the batteries again.

HOW TO CHARGE (When using Nickel-Cadmium power pack IC-BP3)

1. Use the supplied wall charge BC-25U/26E or a stable power source with an output voltage of DC 13.8V and current capacity over 50mA, or use a 12V car battery with optional charger cable IC-CP1. (Output voltage of 12 ~ 15V can be used, but output voltage near the specified voltage should be used.)
2. The power switch of the transceiver must be OFF, or remove the power pack from the transceiver.
3. Connect the output plug of the wall charger (BC-25U/26E), or other power source, to the charger socket of the power pack. (When charging Nickel-Cadmium batteries in the IC-BP4 power pack,

you should use the BC-30/BC-35 charger only.)

The charge indicator LED of the power pack is lit, which shows that the charger is working.

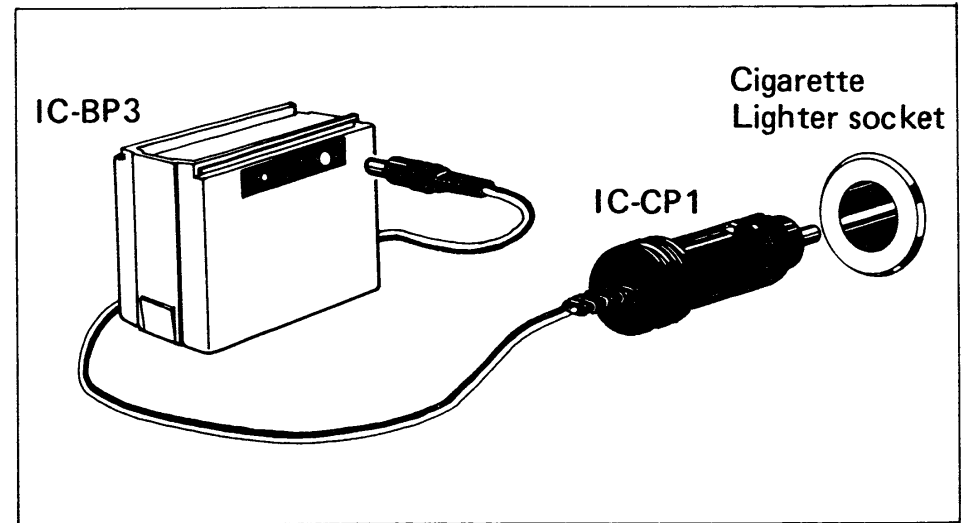
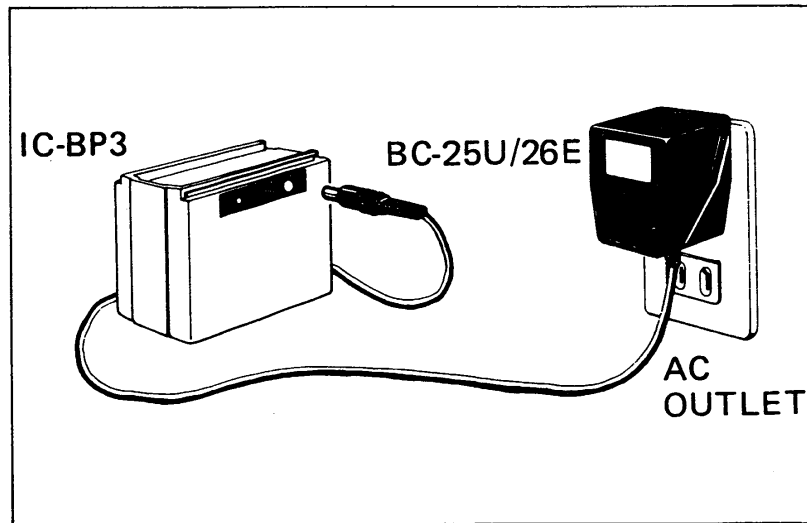

4. It takes about 15 hours to charge the batteries completely. This charger is designed for 0.1C (10-hour rate current), but charge for 15 hours in order to compensate for any unbalance of the batteries.

You should charge the batteries for 15 hours when you have not used them for a long time or after buying them.

5. Charge between 0°C and 40°C.
6. Avoid continuing charging as much as possible after full charging, (15 hours). If excess charging is repeated, efficiency of the power pack is reduced.
7. After charging, unplug the power source from the charger socket of the power pack. The transceiver and the power pack are now ready for operation.

When using the alkaline power pack IC-BP4:

Place the power switch in the OFF position. Remove the power pack from the bottom of the set by pushing the pack in the indicated direction while sliding the lock button upward. Separate the pack into two parts (chassis and case) as follows:

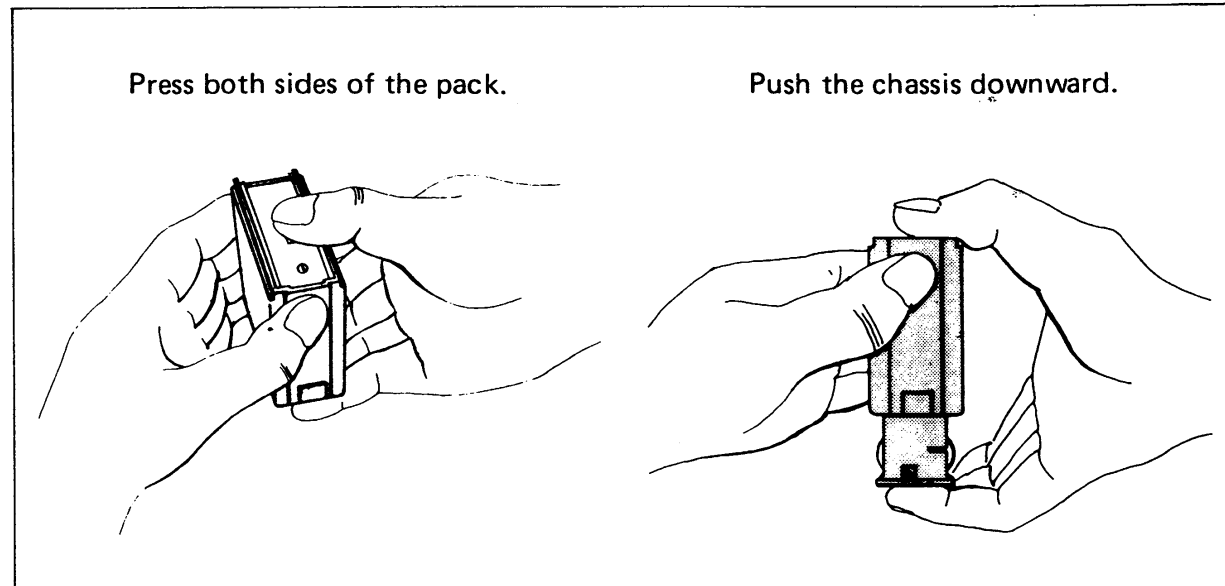
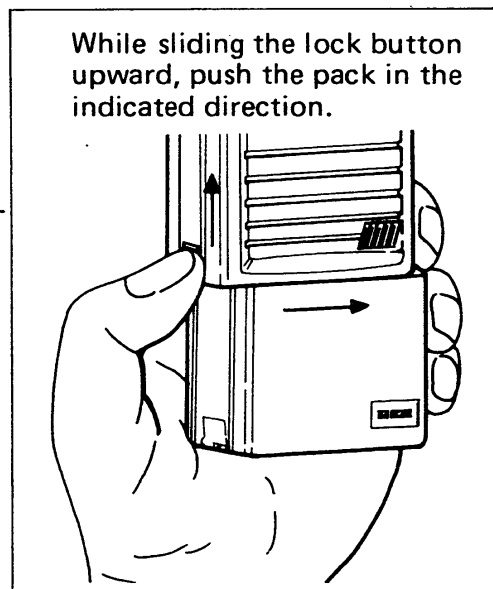

The chassis holds six AA type batteries. Install batteries into each holder, according to indicated polarity. With the batteries properly in place, carefully replace the pack and slip it onto the set with the reverse procedures.

Also, AA type Nickel-Cadmium, rechargeable batteries can be used. But the charger for them should be the optional BC-30/BC-35 charger.

WHEN TO REPLACE BATTERIES (When using alkaline batteries)

When the battery exhausting indicator is indicated during transmission, the batteries are exhausted. Use batteries of the same type, for mixed type might cause leakage. Replace worn batteries with a complete new set. If used with old batteries, the life of new ones might be shortened. Battery life is shortened more by transmitting than by receiving, since several times more current is drawn during transmission. To prolong battery life, therefore, practice the followings:

- * Try to minimize the transmit period.
- * Reduce volume during reception.
- * Be sure to cut off power source when set is not used.

More working hours are available if high-performance batteries are employed.

EXTERNAL POWER SOURCE

For use at home or in a car, please use the external power source which assures you of stable communication without concern about battery consumption.

1. Use either a regulated power supply or car battery of 13.8V DC and of over 1.5A current capability. (Though this transceiver may work at 5.5V to 16V DC, use it preferably at the rated voltage.) (The output power will be 5 watts.)
2. Correctly connect the external supply as shown in the figure. If polarity is reversed, source power is cut off by the protection circuit and the unit will not operate.
3. When the transceiver is kept out of use for a prolonged period, the unit is operated for extended periods by external power only, or when the batteries are exhausted, etc., remove the batteries to protect the unit from possible damage by battery leakage (when using IC-BP4 with alkaline batteries).



FOR OUTDOOR USE

1. Attach the supplied power pack. (Refer to "BATTERY INSTALLATION")
2. Attach the supplied hand strap and belt clip through the fixture on the body (as shown in the drawings.).
3. Attach the flexible rubber antenna.

ATTACHMENT OF HAND STRAP AND BELT CLIP

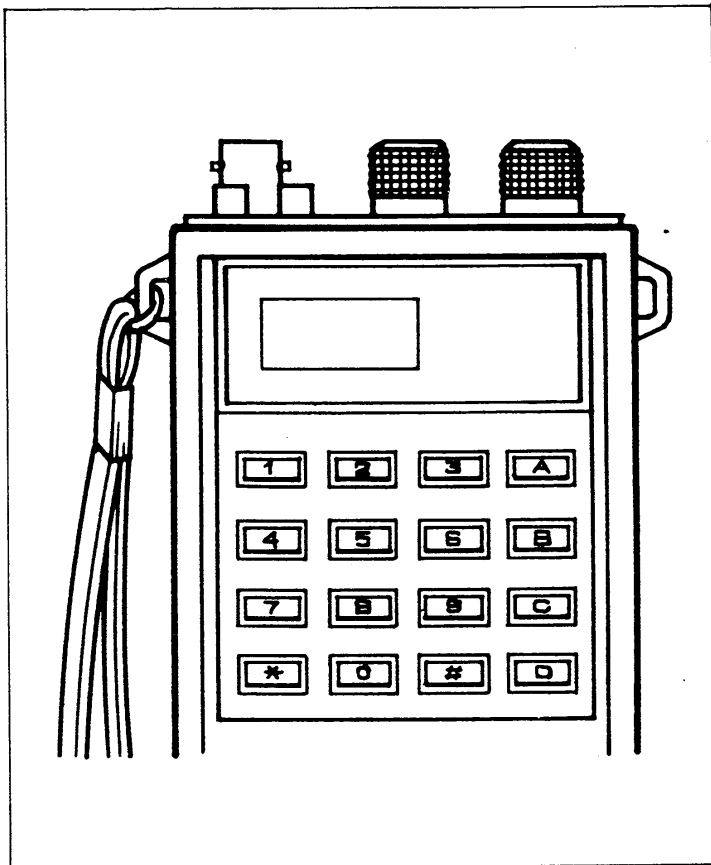

- Attach the belt clip on the back cover with 2 screws supplied.

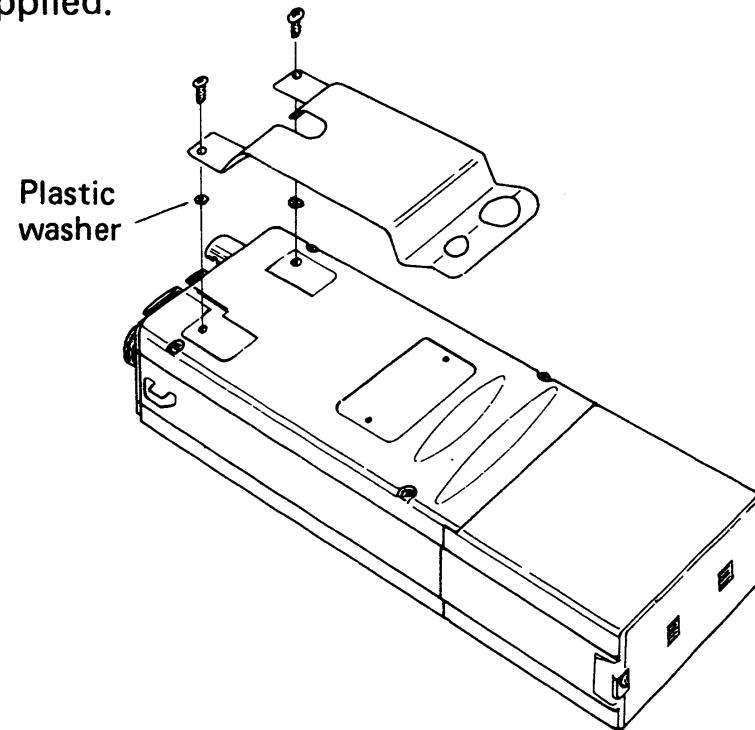

FOR USE IN THE CAR

1. Avoid using the unit near the outlet of heaters, air-conditioners, etc.
2. Install the unit in a convenient place to avoid disrupting safe driving.
3. For the best power source, connect to the car battery through a fuse (2A).
4. Firmly ground to the car body a mobile antenna (e.g. whip antenna) that requires it.

FOR FIXED USE

1. Avoid installing the unit in places exposed to rain, water splash, direct sunshine, dust, vibration, or heat.
2. An external antenna should be used for indoor operation. The use of the flexible antenna indoors may cause TVI, BCI, Hi-Fi interference, malfunction of stabilized DC power supply, etc. When using an external antenna, be sure to remove the flexible antenna.
3. For fixed use, an external power supply is more economical than batteries.

EXTERNAL ANTENNA

1. Select a high performance antenna (a multi-element beam or gain antenna) and set it up in the highest possible position.
2. Use a 50 ohm antenna and coaxial cable.
3. On UHF, the power loss in the antenna cable is large, so use a cable with the lowest possible loss and make it as short as possible.
4. Use a BNC plug for connection to the unit.

SECTION V CONTROL FUNCTIONS

TOP PANEL

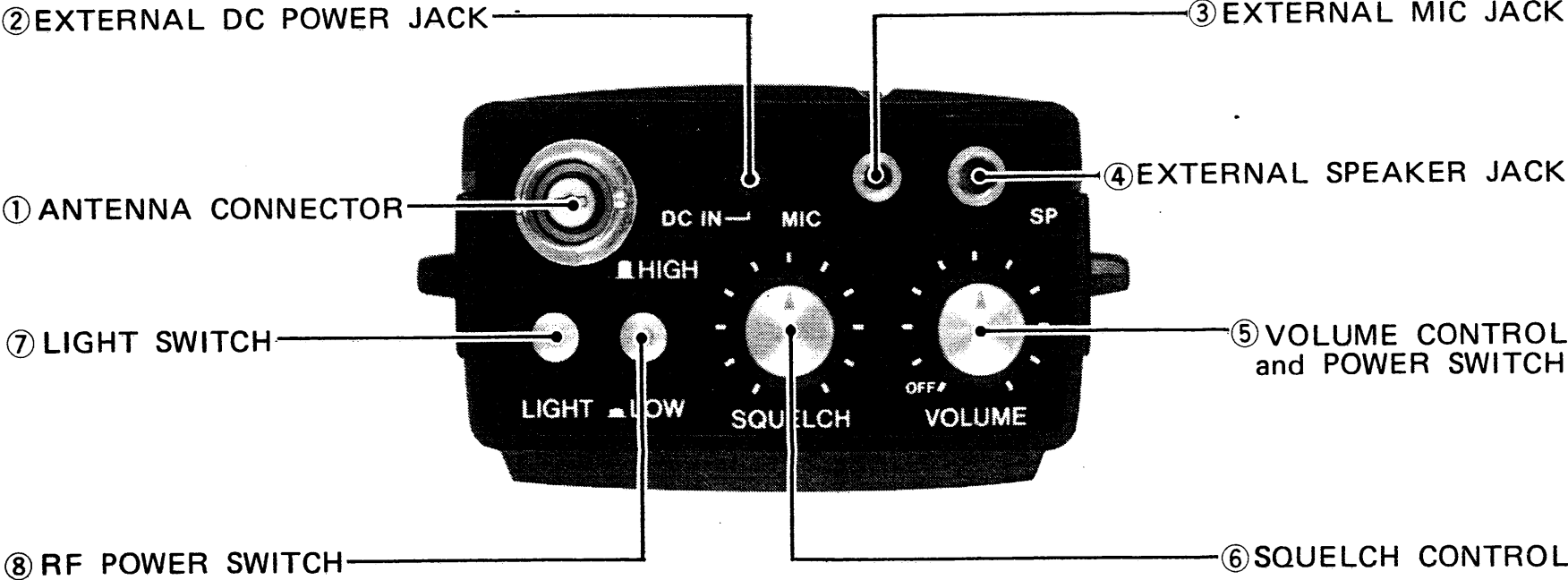

FRONT PANEL

REAR PANEL

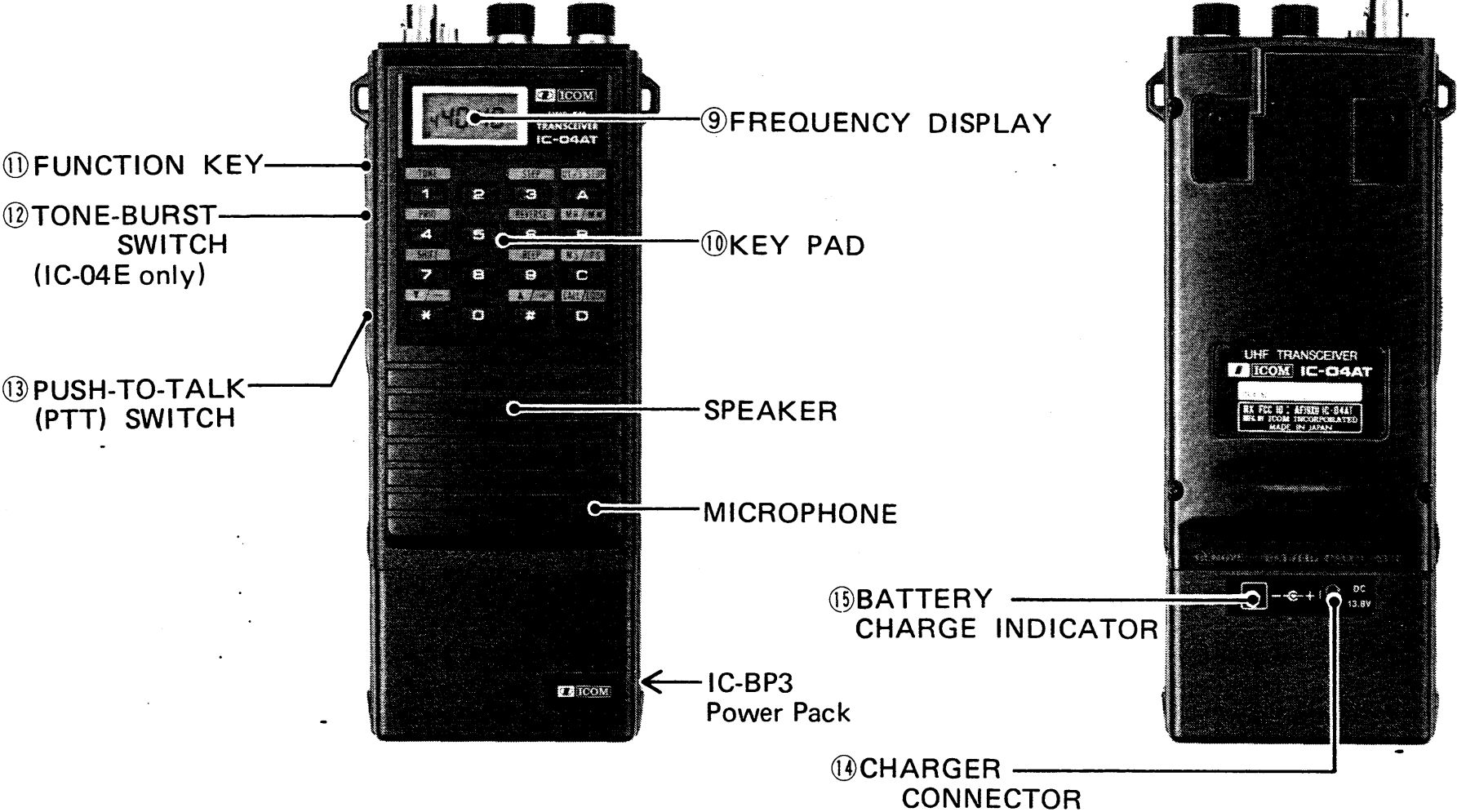

1. ANTENNA CONNECTOR

Connect the supplied flexible antenna. An external antenna can be used using a BNC connector.

2. EXTERNAL DC POWER JACK

A voltage regulated DC power supply with an output of 5.5volts ~ 13.8 volts can be connected here, instead of using the battery pack attached. Inserting the power plug into this jack, disables the attached power pack.

3. EXTERNAL MIC JACK

When an external microphone is used, connect it to this jack. See the schematic for the proper hookup. When the external microphone is connected the built-in microphone does not function. The optional speaker-microphone, IC-HM9 and headset HS-10 with VOX unit, HS-10SA or PTT switch box, HS-10SB can also be used.

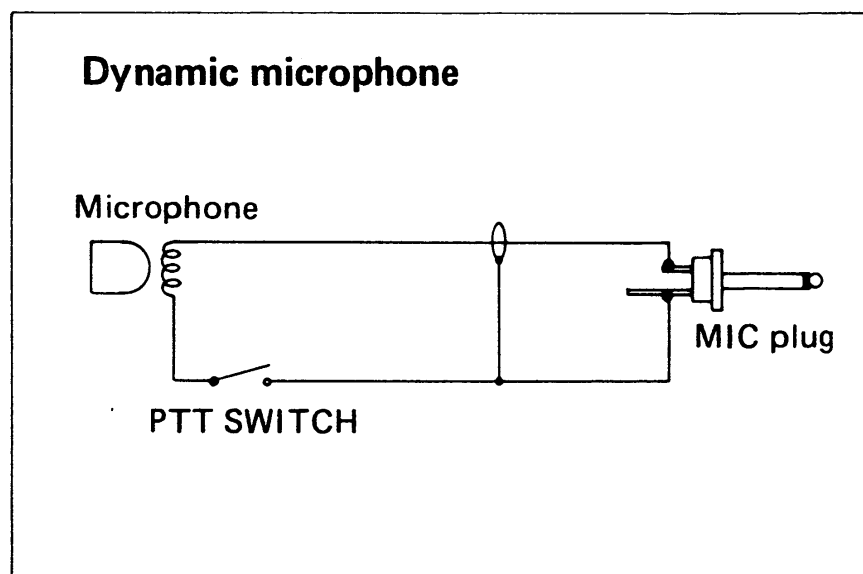
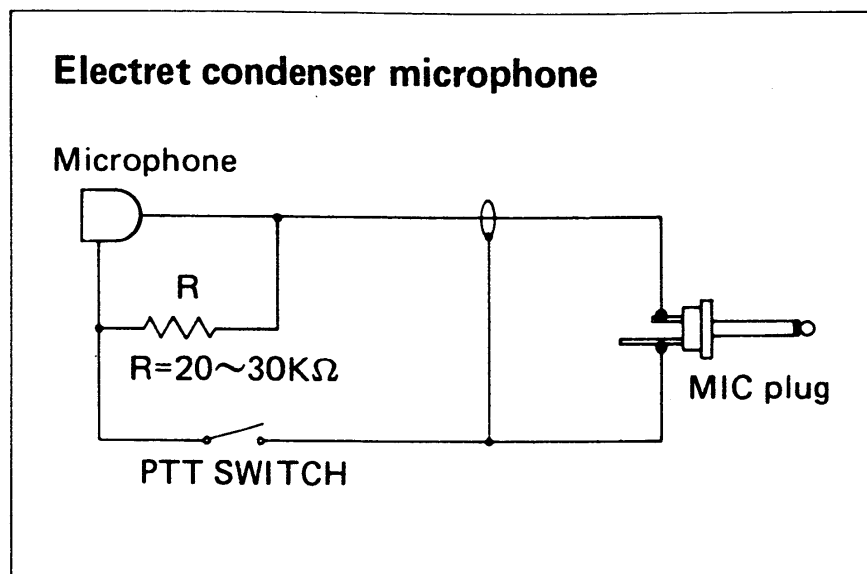

4. EXTERNAL SPEAKER JACK

When an external speaker (or an earphone) is used, connect it to this jack. Use a speaker with an impedance of 8 ohms. When the external speaker is connected the built-in speaker does not function.

5. VOLUME CONTROL and POWER SWITCH

When this control is turned completely counterclockwise, the power is OFF. By turning the control clockwise beyond the "click", the unit is turned ON and the audio level increases by further rotating it clockwise.

6. SQUELCH CONTROL

Sets the squelch threshold level. To turn OFF the squelch function, rotate this control completely counterclockwise. To set the threshold level higher, rotate the control clockwise.

7. LIGHT SWITCH

When this switch is in the locked in position, the frequency display is lit up and can be seen the displayed informations in the dark. When using a battery power pack to power the IC-04A/AT/E, keep this switch in out position to save power.

8. RF POWER SWITCH

Switches the output power of the set HIGH and LOW. In the HIGH (out) position, the output power is 2.5 watts at 8.4 volts. In the LOW (locked in) position, the output power is 0.5 watts at any voltage.

9. FREQUENCY DISPLAY

Indicates not only the operating frequency but also several functions as follows;

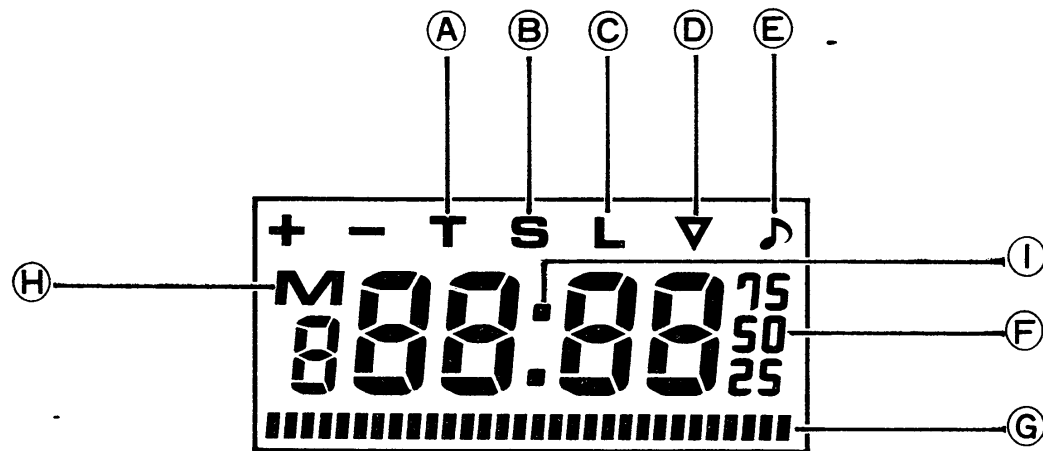

- A TRANSMIT INDICATOR: "T" is indicated when the set is in the transmit mode.
- B SCAN INDICATOR: "S" is indicated when the set is in a scan mode.
- C LOCK INDICATOR: "L" is indicated when the operating frequency is locked by pushing the "D" key while the "FUNC" key is depressed. At this time, any key pushing will be canceled, except "FUNC" and "D" (LOCK) key pushing to clear the lock function.
- D BATTERY CONDITION INDICATOR: "▽" is indicated just before the battery is exhausted in the transmit mode. When the "▽" is indicated, stop to use the set and recharge the battery pack or replace the battery pack with a charged one. (When using IC-BP4 battery pack, replace the exhausted batteries in the pack with new batteries.)

- E TONE ENCODER INDICATOR: "T" is indicated when the subaudible audio tone encoder is actuated by pushing "1" (TONE) key while the "FUNC" key is depressed. (IC-04AT only)
- F FREQUENCY DISPLAY: Indicates the operating frequency with 5 digits between 100MHz and 10KHz, and a small "50" means 5KHz (IC-04E: "75" means 7.5KHz and "25" means 2.5KHz.) (In the memory channel mode, the 100MHz digit shows memory channel number.)
- G S/RF INDICATOR: Indicates Signal strength and RF output level with a dotted bar. The RF output level meter functions only as a relative output meter and does not indicate the wattage. These functions are switched automatically when T/R switching is made.
- H MEMORY MODE INDICATOR: "M" is indicated when the set is in the memory mode and while memory writing.
- I PRIORITY FUNCTION INDICATOR: "•" is indicated when the set is in the priority function.

10. KEY PAD

This key pad has 16 keys consisting of ten numerical keys and six code keys. Most keys have dual functions.

The primary functions are available by just pushing each key. The ten numerical keys function to set digit indicated on each key. The other keys function to set functions indicated above each key with letters on gray colored base.

The secondary functions are available by pushing each key while the "FUNC" key on the side is depressing. Each function is indicated above the key with letters on olive colored base.

11. FUNCTION KEY

By depressing this key, the secondary function of each key can be selected.

12. TONE-BURST SWITCH (IC-04E only)

Most repeaters require a 1750Hz tone-burst for initial access. Depressing this switch for the required period for a repeater, puts the set in the transmit mode and the tone-burst generator actuates and you can access the repeater. (The other versions function as a Push-To-Talk switch.)

13. PUSH-TO-TALK (PTT) SWITCH

For transmission, press this switch and talk into the microphone with normal voice. The internal microphone is of the electret-condenser type and provides good pickup for all voice levels.

14. CHARGER CONNECTOR

Connects to the output plug of the supplied wall charger BC-25U/26E or other suitable power source.

15. BATTERY CHARGE INDICATOR

Lights during battery charging.

SECTION VI OPERATION

KEY FUNCTION

Most keys have dual functions. To set the secondary function, depress the "FUNC" key located on the side, until the key input for desired function has been completed.

KEY	PRIMARY FUNCTION		SECONDARY FUNCTION	
	SYMBOL	FUNCTION	SYMBOL	FUNCTION
1	1	Sets the digit of 1.	TONE	Sets a desired subaudible tone or turns off the tone. Push this key then desired tone number keys. (To turn off the function, push "00" as the tone number.)
2	2	Sets the digit of 2.	-----	-----
3	3	Sets the digit of 3.	STEP	Sets a desired frequency steps. Push this key, then one of the step keys which are defined to the "1" - "5" keys.
4	4	Sets the digit of 4.	PRIO	Sets the priority function. To turn off this function, push the "A" key without depressing the "FUNC" key.
5	5	Sets the digit of 5.	-----	-----
6	6	Sets the digit of 6.	REVERSE	In the duplex mode, the receive frequency and transmit frequency are exchanged with each other.

KEY	PRIMARY FUNCTION		SECONDARY FUNCTION	
	SYMBOL	FUNCTION	SYMBOL	FUNCTION
7	7	Sets the digit of 7. -	SHIFT	Sets a desired receive/transmit frequency separation. Push this switch, "*" key for "-" duplex or "#" key for "+" duplex, then desired separation frequency in four digits.
8	8	Sets the digit of 8.	-----	-----
9	9	Sets the digit of 9.	BEEP	Turns on and off the beep tone which makes a tone when a key has been pushed.
0	0	Sets the digit of 0.	-----	-----
*	▼	Decreases the operating frequency with specified steps, or operating channel number.	-	Sets the "-" duplex mode when pushed following the "SHIFT" (7) key.
#	▲	Increases the operating frequency with specified steps, or operating channel number.	+	Sets the "+" duplex mode when pushed following the "SHIFT" (7) key.
A	CL/SSTOP	<p>Clears entering number, and recall previous frequency or clears previous number to "00".</p> <p>Clears the memory channel mode and the DIAL mode is available.</p> <p>Clears the priority function.</p> <p>Clears any scan function and the operating frequency or memory channel stops on the displayed one.</p>	-----	-----

KEY	PRIMARY FUNCTION		SECONDARY FUNCTION	
	SYMBOL	FUNCTION	SYMBOL	FUNCTION
B	MR	Sets the radio in the memory channel mode. Push the key, then a desired channel number "0" ~ "9"	MW	Writes the displayed frequency into a memory channel. Push the key, then a desired channel number the displayed frequency will be written.
C	MS	Sets the radio in the memory scan mode. Scans all memories.	PS	Sets the radio in the programmed scan mode. Scans frequency between the frequencies memorized in the channel 0 and channel 9 with specified steps.
D	CALL	Call the frequency memorized in the MEMORY CHANNEL 1. At this time, any key pushing is canceled except the "A" key to clear this function.	LOCK	Cancels any key pushing to prevent accidental key pushing. To clear this function, push this key again while depressing the "FUNC" key.

DIAL MODE

The following functions are available only in the DIAL MODE;

1. Setting frequency
2. Setting tone encoder frequency (IC-04AT only)
3. Setting frequency step rate
4. Setting duplex frequency separation

5. Memory writing (memorizing a frequency into a memory channel)
6. Turning the beep tone ON/OFF
7. Starting the programmed scan function

1. SETTING FREQUENCY

To set an operation frequency, push four digit keys representing the frequency desired, beginning with the MHz and ending with the KHz digit. (IC-04E: three digit keys beginning with the MHz and ending with the 10KHz digit).

If illegal digits or out of band frequency have been entered, the entered ones are canceled and the previous operation frequency will be recalled.

When wrong key has been pushed, push the "A" (CL) key, the entered digits are canceled and the previous operation frequency will be recalled.







The last digit key pushing enters the following frequency.

KEY	1	2	3	4	5	6	7	8	9	0	REMARKS
IC-04A	/	/	/	/	5	/	/	/	/	0	KHz
IC-04AT	/	/	/	/	5	/	/	/	/	0	KHz
IC-04E	12.5	25.0	37.5	/	50.0	62.5	75.0	87.5	/	00.0	KHz

NOTE: Key entering of a key indicated with "/" is canceled and the previous operation frequency will be recalled.



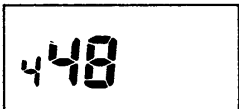
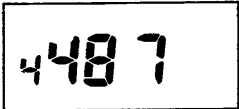

FOR EXAMPLE (for IC-04A/AT):

When setting at 448.75MHz;

Push key				
Display				

FOR EXAMPLE (for IC-04E):

When setting at 438.6875MHz;

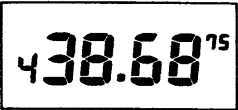
Push key			
Display			

With each push of the "*" (▼) or "#" (▲) key, the operation frequency will be changed one increment up or down with specified frequency step rate (described later) respectively.

In the same way, by depressing the key continuously, the operation frequency will be changed up or down continuously.

At this time, the duplex frequency separation and tone encoder frequency which have been set before (if any), will be cleared.

FOR EXAMPLE (for IC-04A/AT):

When the frequency step rate is set at 5KHz;

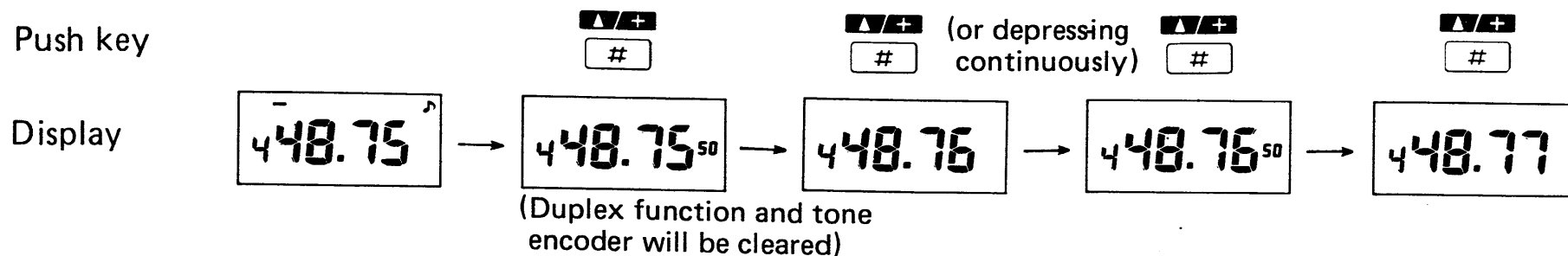

FOR EXAMPLE (for IC-04E):

When the frequency step rate is set at 12.5KHz;

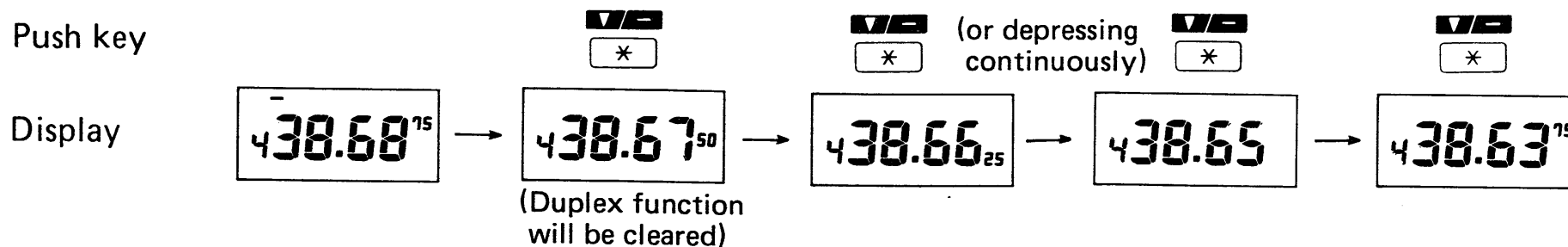

2. SETTING TONE ENCODER FREQUENCY (IC-04AT only)

To set the tone encoder frequency, while depressing the "FUNC" key, push the "1" (TONE) key then two digit keys for tone number (for example; for tone number 12, push "1" and "2" keys.). The tone frequency for each number is shown in the following chart.

To turn off the tone encoder, push the "0" key twice ("00") as the tone number.

If illegal number (a number that is not shown in the chart) has been entered, the number is canceled and the previous number (when the tone encoder is turned off, the number is "00") will be recalled.

TONE NO.	FREQUENCY (Hz)	TONE NO.	FREQUENCY (Hz)	TONE NO.	FREQUENCY (Hz)	TONE NO.	FREQUENCY (Hz)
01	67.0	16	114.8	31	192.8	46	1700.0
02	71.9	17	118.8	32	203.5	47	1750.0
03	74.4	18	123.0	33	210.7	48	1800.0
04	77.0	19	127.3	34	218.1	49	1300.0
05	79.7	20	131.8	35	225.7	50	2000.0
06	82.5	21	136.8	36	233.6	51	2200.0
07	85.4	22	141.3	37	241.8	52	2975.0
08	88.5	23	146.2	38	250.3	53	2550.0
09	91.5	24	151.4	39	500.0	54	2295.0
10	94.8	25	156.7	40	600.0	55	2125.0
11	97.4	26	162.3	41	700.0
12	100.0	27	167.9	42	800.0
13	103.5	28	173.8	43	900.0
14	107.2	29	179.9	44	1000.0
15	110.9	30	186.2	45	1600.0

3. SETTING FREQUENCY STEP RATE

To set the frequency step rate, depress and hold the "FUNC" key, push the "3" (STEP) key then a key to determine the step rate.

The frequency step rate defined to each key is shown in the following chart.

If illegal number (a number that is not shown in the chart) has been entered, the number is canceled and the previous rate number will be recalled.

KEY/DISPLAY	1	2	3	4	5	6	7	8	9	0	REMARKS
IC-04A	5.0	10.0	15.0	20.0	25.0	/	/	/	/	/	KHz
IC-04AT	5.0	10.0	15.0	20.0	25.0	/	/	/	/	/	KHz
IC-04E	/	12.5	/	25.0	/	/	/	/	/	/	KHz

NOTE: Key entering of a key indicated with “/” is canceled and the previous frequency step rate will be recalled.

4. SETTING DUPLEX FREQUENCY SEPARATION

To set the duplex function and its frequency separation, while depressing the “FUNC” key, push the “7” (SHIFT) key, the “*” (–) or “#” (+) key according to the input/output frequency of the repeater you wish to access, then four digit keys of MHz to KHz digits of the desired frequency separation (IC-04E: three digit keys of MHz to 10KHz of the desired frequency separation).

The last digit entering has some limitation, the same as the “SETTING FREQUENCY” so refer to the chart on page 21.

If illegal digits have been entered, the entered ones are canceled and the previous frequency separation will be recalled. (When the duplex function is not turned on, the display will show “0.00”.)

When a wrong key has been pushed, push the "A" (CL) key, the entered digits are canceled and the previous frequency separation will be recalled.

FOR EXAMPLE (for IC-04A/AT)

When setting the frequency separation at +5.00MHz;

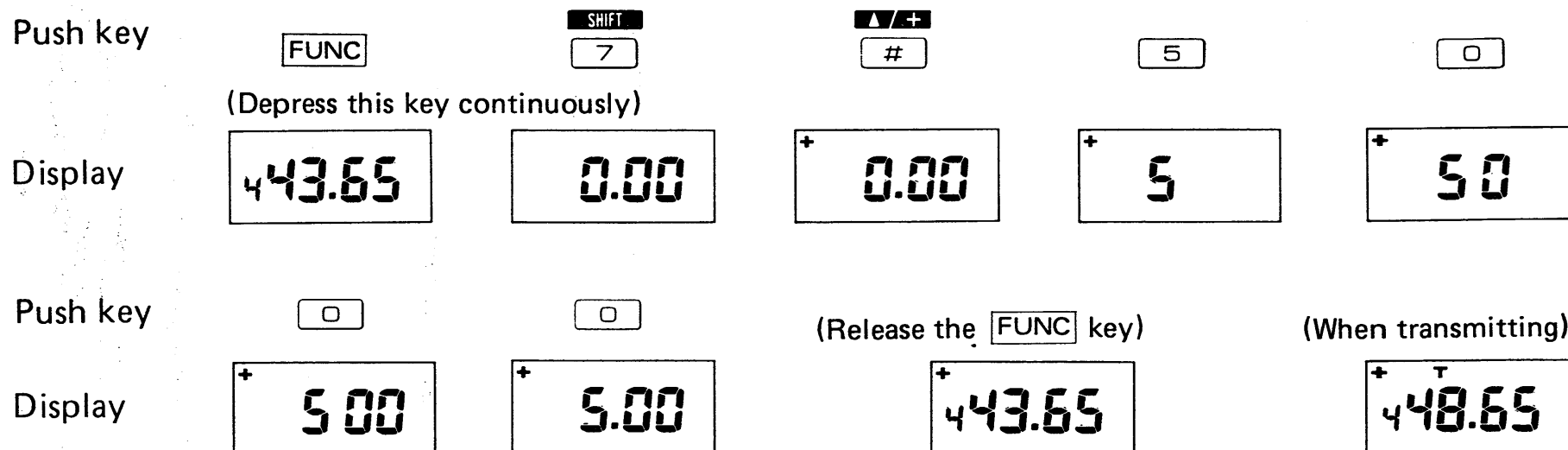

FOR EXAMPLE (for IC-04E)

When setting the frequency separation at -1.6MHz;

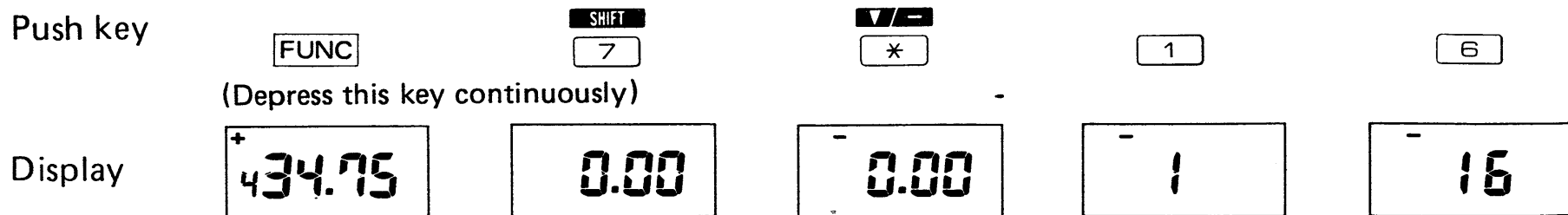

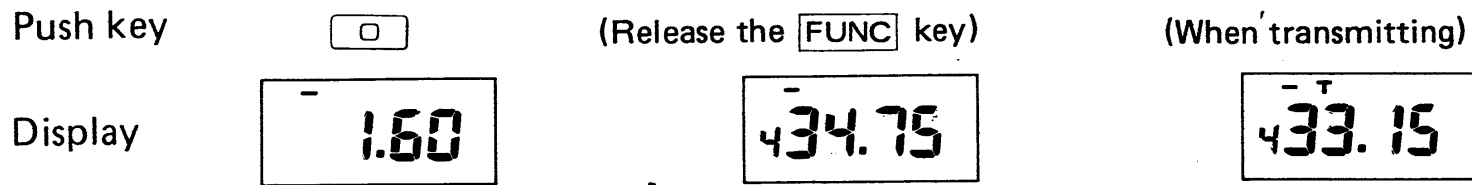

When changing the duplex direction (+duplex to -duplex or vice versa) with the previous frequency separation, while depressing the "FUNC" key, push the "7" (SHIFT) key then the "*" (-) or "#" (+) key depending on your desire.

FOR EXAMPLE:

When changing the frequency separation from -1.6MHz to +1.6MHz;

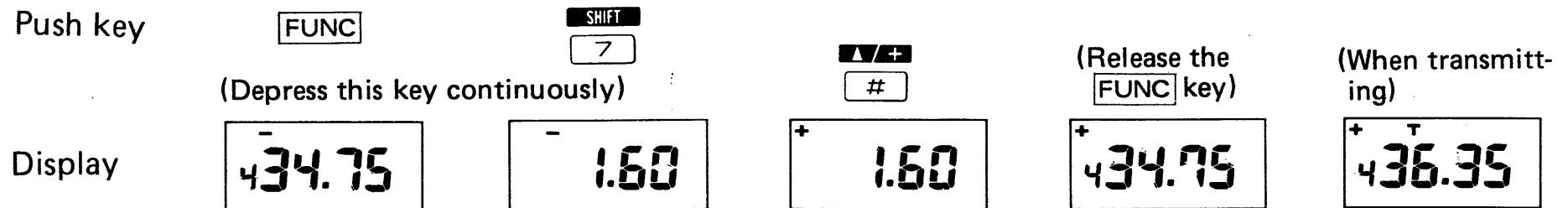

To exchange the receive frequency and expecting transmit frequency or vice versa, while depressing the "FUNC" key, just push the "6" (REVERSE) key, and the receive frequency and expecting transmit frequency will be exchanged and the duplex direction will be reversed.

FOR EXAMPLE:

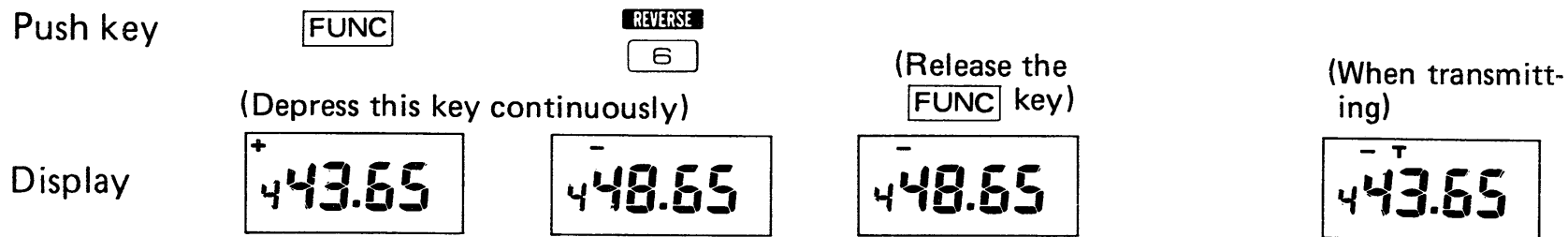

5. MEMORY WRITING

To memorize a frequency (duplex mode, its frequency separation and tone number of the tone encoder (IC-04AT only), if any) into memory channel, set the desired frequency (and duplex mode, etc., if any) with the procedures described before. Then, while pushing the "FUNC" key, push the "B" (MEMORY WRITE) key then a digit key which has the same number as the memory channel number to memorize.

FOR EXAMPLE:

When memorizing 448.65MHz and -5.0MHz duplex frequency separation into the memory channel 7 (M7).

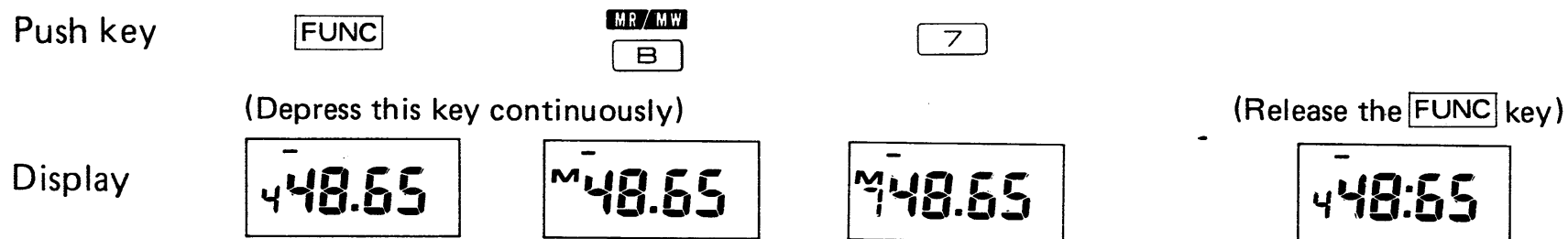

The memorized frequency can be recalled easily by pushing the "B" (MEMORY READ) key and the channel number key (described later).

The set has 10 memory channels, memory channel 1 ~ Memory channel 0. There are some special channels as follows;

M1 (memory channel 1)

The frequency memorized in M1 can be recalled by just pushing the "D" (CALL) key.

The frequency offset for duplex operation (and the tone number of the tone encoder: IC-04AT only) memorized into M1 will be the offset and tone applied to memory channels M2 ~ M6. That is memory channels 1 ~ 6 will have the same offset and tone entered M1. The memory channels M7 ~ M0 may have independent offsets and tones.

M9 (memory channel 9) and M0 (memory channel 0)

The frequencies memorized in M9 (MEMORY CHANNEL 9) and M0 (MEMORY CHANNEL 0) will be the high and low edges of the programmed scanning range. Regardless of which channel the higher frequency is memorized in, the scan starts from the frequency memorized in the memory channel 0. (If the same frequency is memorized in the memory channels 9 and 0 or their difference is less than the frequency step rate, the scan will not start.)

6. TURNING THE BEEP TONE ON/OFF

Each push of the "9" (BEEP) key while depressing the "FUNC" key turns the beep tone ON and OFF alternately. The beep tone is made by pushing any key when it is turned ON. The volume of the beep tone can be adjusted by turning the VOLUME control the same as the receiver audio volume control.

7. STARTING THE PROGRAMMED SCAN FUNCTION

By pushing the "C" (PS) key while depressing the "FUNC" key, the programmed scan is started. The programmed scan scans between the frequencies memorized in the memory channels 9 and 0. More detail is described later.

MEMORY CHANNEL MODE

1. MEMORY READ

To recall a frequency memorized in a memory channel, push the "B" (MR) key then a digit key of the same number as the memory channel which has memorized the desired frequency. The duplex mode and/or tone number (IC-04AT only) also can be recalled at the same time if they have been memorized.

FOR EXAMPLE:

When recalling the frequency memorized in the memory channel 7;

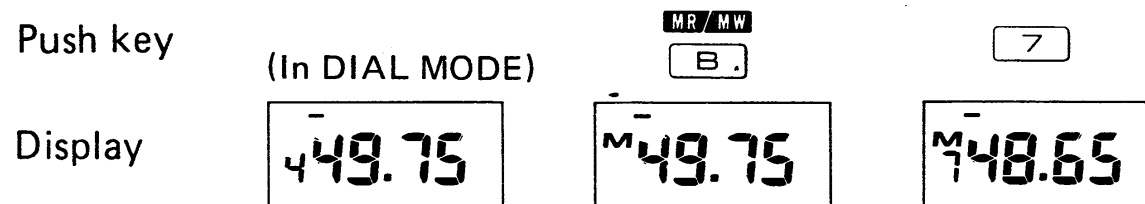

After this, the other memory channels can be recalled by just pushing the digit key of the memory channel number.

FOR EXAMPLE:

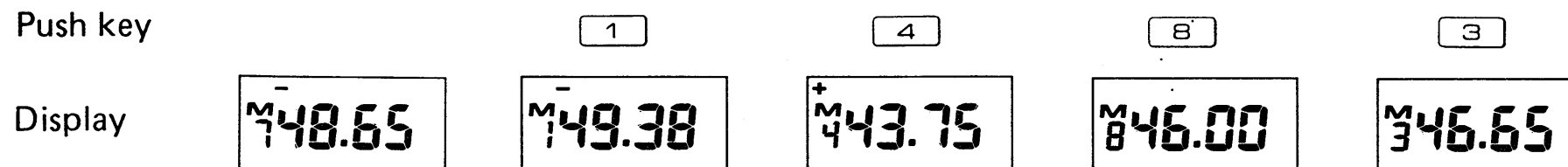

Each push or continuous push of the "*" (DOWN) key, decreases the memory channel number in order, and displays channel number and contents of each memory channel on the frequency display.

FOR EXAMPLE:

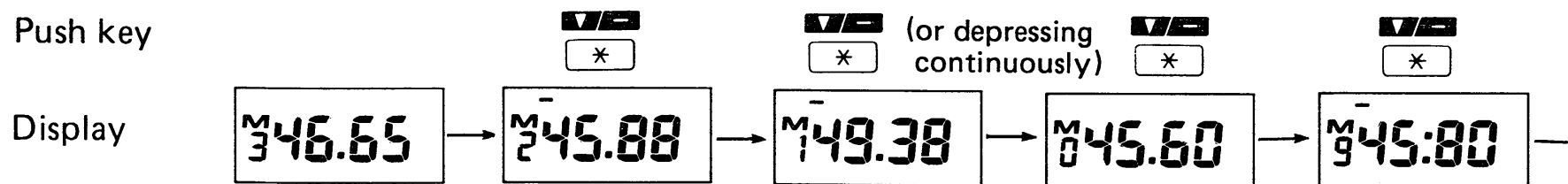

Each push or continuous push of the "#" (UP) key, increases the memory channel number in order, and displays channel number and contents of each memory channel on the frequency display.

FOR EXAMPLE:

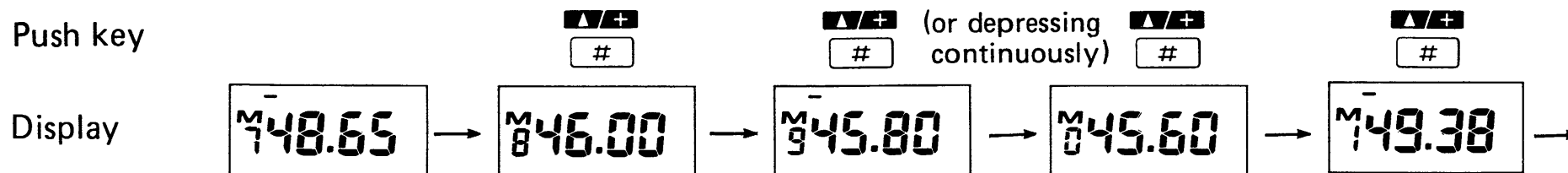

By pushing the "A" (CL) key, the MEMORY CHANNEL MODE is cleared and the set returns in the DIAL MODE. At this time the frequency (duplex mode and tone number, if any) displayed previously in the MEMORY CHANNEL MODE will be kept.

In the MEMORY CHANNEL MODE, all secondary functions except the PRIORITY and LOCK functions are disabled.

2. CALL KEY

When the set is in either MEMORY CHANNEL MODE or DIAL MODE by pushing the "D" (CALL) key, the frequency (and duplex mode and tone number, if any) memorized in the memory channel 1 (M1) is recalled and displayed on the frequency display.

At this time, all key functions (both the primary and secondary functions) except the CLEAR and LOCK functions are disabled.

To clear the CALL KEY function, just push the "A" (CL) key and the frequency (and duplex mode and tone number, if any), and memory channel number (if in the MEMORY CHANNEL MODE) previously displayed are recalled on the frequency display.

FOR EXAMPLE:

Push key

CALL/LOCK

D

CL/S-STOP

A

Display

346.65

449.75

346.65

PRIORITY FUNCTION

This feature allows you to check on your favorite frequency, such as a local repeater or calling channel, for activity while operating on a dial frequency or memory channel. It allows you to check if the frequency is busy or empty.

The following steps are taken to utilize the PRIORITY FUNCTION.

1. Memorize your favorite frequency into the memory channel 1.
2. Set the desired operating frequency by pushing keys or select a memory channel which has been memorized the desired operating frequency.
3. Push the "4" (PRIO) key while depressing the "FUNC" key, and the set receives on the operating frequency a period of five seconds and on the priority channel (memory channel 1 memorized with your favorite frequency) one second. Then repeats this function until the PRIORITY FUNCTION is cleared. At this time, a point is indicated above the decimal point to show the set is in the PRIORITY FUNCTION.
4. In the PRIORITY FUNCTION, all key functions (both the primary and secondary functions) except the "A" (CL) key function are disabled.

5. If the set is turned to transmit mode, during the priority function, the transmit frequency will be the operating frequency in the SIMPLEX mode, or its expecting transmit frequency in the DUPLEX mode. When returned to the receive mode, the priority function will be continued.
6. To clear the PRIORITY FUNCTION just push the "A" (CL) key.

FOR EXAMPLE:

When the contents of M1 are 445.68MHz and -5.0MHz duplex and desired operating frequency is 445.52MHz with -5.0MHz duplex;

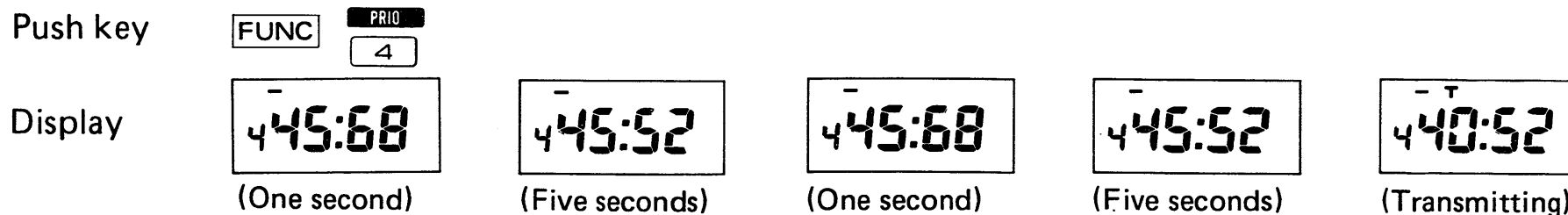

LOCK FUNCTION

This function provides to prevent a mis-operation by an accidental key pushing. This function is available both in the DIAL MODE and MEMORY CHANNEL MODE.

By pushing the "D" (LOCK) key while depressing the "FUNC" key, the displayed frequency (and other data, if any) is fixed, and the letter "L" is displayed above the 100KHz digit to show the LOCK FUNCTION is actuated. At this time, the all key functions are disabled.

To clear the LOCK function, push the "D" (LOCK) key again while depressing the "FUNC" key.

SCANNING OPERATIONS

The IC-04A/AT/E provides MEMORY SCAN and PROGRAMMED SCAN operations.

1. MEMORY SCAN

This is to scan the all ten memory channels in order continuously.

- A. Memorize ten desired frequencies into the memory channels 1 ~ 0 each. If your desired frequencies are less than ten, we recommend you to memorize the same frequency into several memory channels.
- B. To start the scan, just push the "C" (MS) key, and the letter "S" is displayed above the 1MHz digit on the frequency display and the scan starts.
(The scan will start when the set is either in the DIAL MODE or in the MEMORY CHANNEL MODE).
- C. If the SQUELCH is engaged, the scan stops when the squelch is opened and a signal is received. The scan will resume after the signal goes away.
- D. To resume the scan when the scan stops on a signal, push the "C" (MS) key, and the displayed memory channel changes to the upper channel. If the upper channel is no signal the scan will resume.
- E. If the set is turned to transmit mode, during the scan function, the transmit frequency will be the frequency (memory channel) displayed on the frequency display at the moment. At this time, the scan function is cleared and the frequency (memory channel) is locked.
- F. To clear the scan function, push the "A" (CL) key, and the scan stops on the memory channel displayed and the letter "S" on the frequency display goes out.
- G. When the set is in this scan mode, all key functions except the "A" (CL) key and the "C" (MS) key functions are disabled.

FOR EXAMPLE:

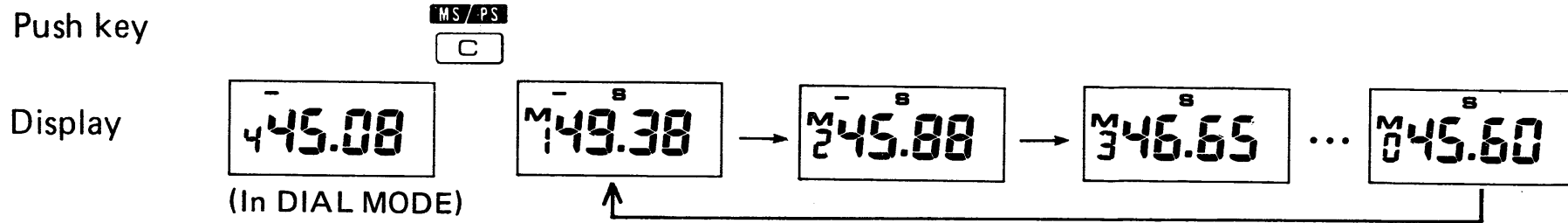

2. PROGRAMMED SCAN

This is used to scan between two desired frequencies, which are memorized in the memory channels 9 and 0.

- A. Memorize the frequencies of the high edge and low edge of the desired scanning range into the memory channels 9 and 0. Regardless of which channel the high edge frequency is memorized in, the scan starts from the frequency memorized in the memory channel 0. If the same frequency is memorized both in the memory channels 9 and 0, the scan will not start.
- B. Set the IC-04A/AT/E in the DIAL MODE. The PROGRAMMED SCAN will not start from the MEMORY CHANNEL MODE.
- C. Push the "C" (PS) key, while depressing the "FUNC" key, and the scan starts from the frequency memorized in the memory channel 0 to the frequency memorized in the channel 9. The scanning frequency increments depend on the frequency step rate setting.
- D. When the scanning frequency reaches the frequency memorized in the memory channel 9, it automatically returns to the frequency memorized in the memory channel 0 and continues scanning to provide endless scanning operation.

- E. While the SQUELCH is engaged, the squelch opening as a signal is received will stop the scanning automatically to lock onto the frequency.
- F. To resume the scan when the scan stops on a signal, push the "C" (MS) key and the displayed frequency changes one increment. If the new frequency is no signal the scan will resume.
- G. If the set is turned to transmit mode, during the scan function, the transmit frequency will be the frequency displayed on the frequency display at the moment. At this time, the scan function is cleared and the frequency is locked.
- H. To clear the scan function, push the "A" (CL) key, and the scan stops on the frequency displayed and the letter "S" on the frequency display goes out.
- I. When the set is in this scan mode, all key functions except the "A" (CL) key and the "C" (PS) key, functions are disabled.

FOR EXAMPLE:

When 445.600MHz is memorized in the memory channel 0 and 445.800MHz in the memory channel 9, and the frequency step rate is set at 25KHz;

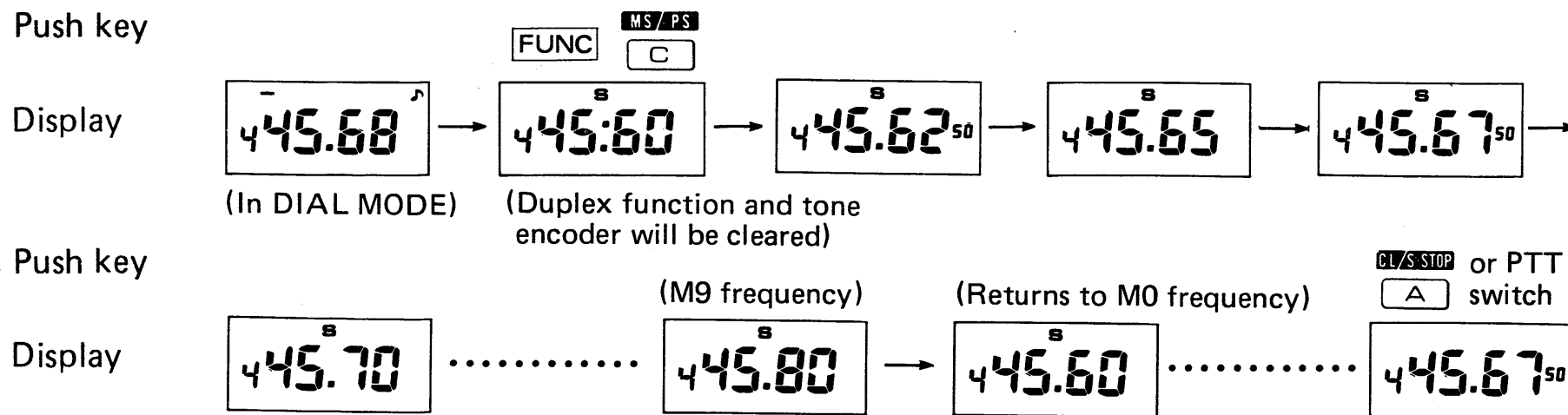

RECEIVING

Make sure the VOLUME CONTROL and POWER SWITCH is in the OFF position, and before turning the power ON, confirm as follows:

1. Make sure the power pack is properly charged and attached to the set.
2. Make sure the supplied flexible antenna is properly set.

When an external antenna is employed, make sure the coaxial line is of the correct impedance (50 ohms) and is neither shorted nor opened, and is firmly connected to the antenna connector.

Set the controls and switches as follows:

- | | | |
|---|---------------------------------|--|
| ⑤ | VOLUME CONTROL and POWER SWITCH | Completely counterclockwise (OFF position) |
| ⑥ | SQUELCH CONTROL | Completely counterclockwise |
| ⑦ | LIGHT SWITCH | OFF (out) |
- (Others may be at any position or setting.)

Turn the VOLUME CONTROL and POWER SWITCH clockwise to click on. A frequency will be shown on the FREQUENCY DISPLAY. Slowly turn the VOLUME CONTROL clockwise to a comfortable level. Set the desired frequency by pushing keys. When a signal is received, the S/RF INDICATOR will show its signal strength.

If no signal can be heard but only noise, turn the SQUELCH CONTROL clockwise until the noise from the speaker stops and set it just below this threshold. (When adjusting the squelch control setting, if some communication signals can be heard, change the operating frequency where only noise can be heard.) The transceiver will now remain silent until an incoming signal is received which opens the squelch. If the squelch is unstable due to the reception of weak signals or mobile stations, adjust the squelch control further until the proper threshold is obtained.

For frequency setting, memory channel operation and scan operation refer to the above chapters.

TRANSMITTING

For SIMPLEX operation, make sure neither “+” nor “-” is displayed on the frequency display. If “+” or “-” is displayed, the set is in the DUPLEX mode, so push the “#” (UP) key then “*” (DOWN) key to clear the DUPLEX function.

For DUPLEX operation, set the frequency separation according to the repeater’s input/output frequencies.

If the lower output power (0.5 watts) is sufficient, push the RF POWER SWITCH in.

Depress the PTT (Push-To-Talk) switch on the side and the transceiver will transmit. At the same time, the letter “T” is displayed above the 1MHz digit on the frequency display and the S/RF INDICATOR will provide an indication of relative power output of the transmitter.

Speaker into the microphone with your normal speech level for the proper microphone level.

To return to the receive mode just release the PTT switch.

If you need a tone-burst for initial access of the repeater, depress the TONE-BURST SWITCH on the side for required period. (IC-04E only: The tone-burst periods vary individually from 100 milliseconds to 2 seconds.)

If you need a subaudible tone to access a repeater, set the tone number suitable for the repeater (IC-04AT only). Refer to the "SETTING TONE ENCODER FREQUENCY" on page 23.

If you need DTMF tones (the same tones as telephone dialing tones) to access a repeater or make auto-phone-patch, etc., push a digit key while depressing the PTT switch, then continue to push digit keys without depressing the PTT switch. After pushing a digit key, the transmit mode will be kept about one second. (IC-04AT only).

When the frequency display is blinking during transmitting, the PLL (Phase-Locked-Loop) is unlocked. (This time the transmitter is muted and any signals are not transmitted.) This may be caused by exhausting the battery, so check the power pack first.

CPU RESETTING

This set employs a microcomputer (CPU) to control frequency, offset frequency, offset direction, scanning, display, etc.

The CPU has a program to initialize the operating condition of the set. However, sometimes an abnormal figures may be displayed on the display or the display fails to illuminate, or the keypad does not function.

This may be caused by a program runaway and is not an equipment malfunction. When this occurs, it may be solved with the following simple procedure:

1. Turn OFF the power switch.
2. While depressing the FUNCTION KEY on the side, turn ON the power switch.
3. The CPU will be reset and the set will work normally. However, note that the frequencies, offset frequencies, offset directions and/or tone numbers, etc. previously memorized in the memory channels will be erased.

SECTION VII INSIDE VIEWS

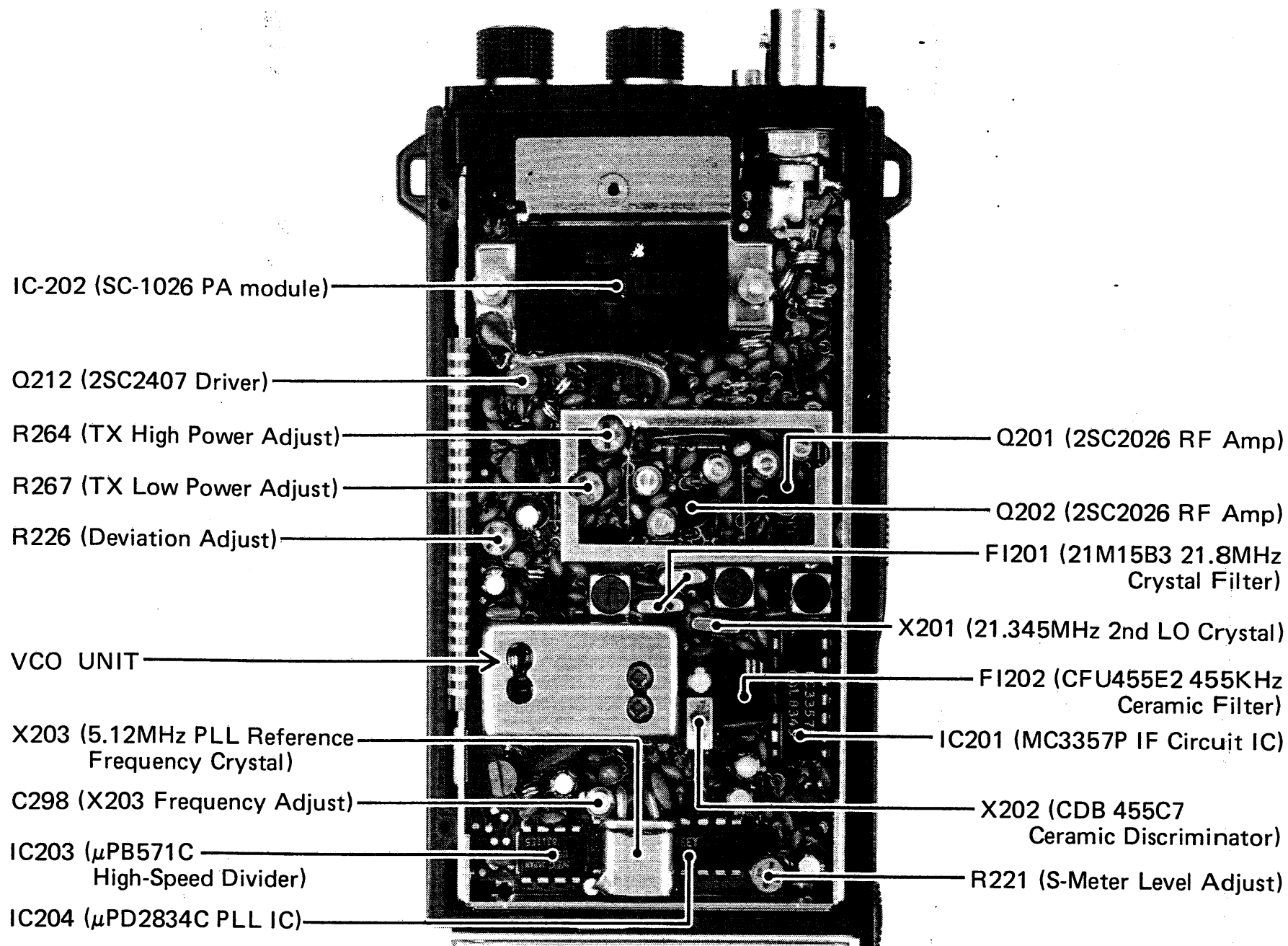

R510 (Subaudible
Tone Level Adj.)

R507 (DTMF
Level Adj.)

IC503 (S-7116A
Subaudible Tone
Gene IC)

IC501 (LR4087
DTMF Osc.)

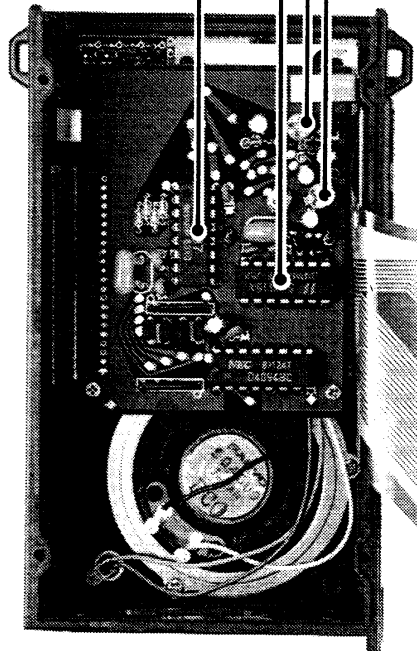

IC-04AT
(with the DTMF unit)

IC401
(HD44795 CPU)

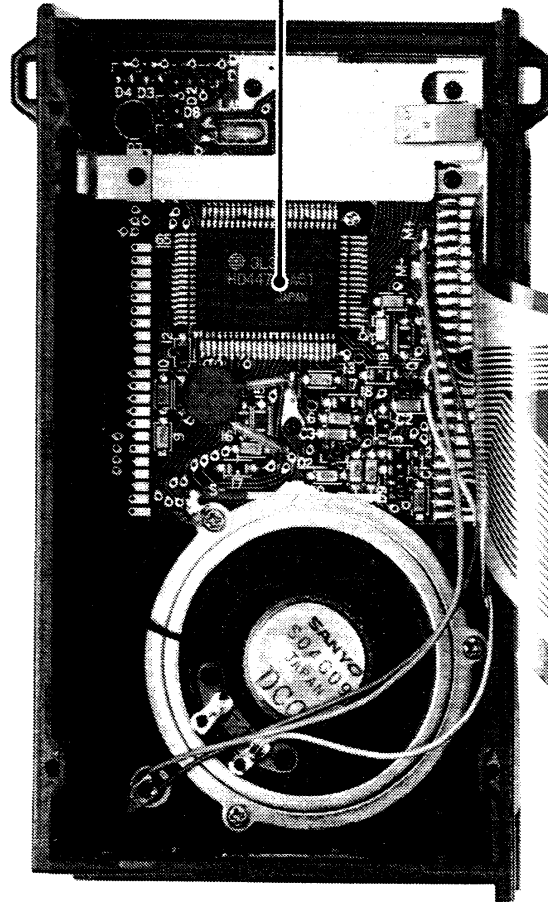

(When the DTMF unit or
Tone-Burst unit is removed.)

RL101 (Power Source
Switching Relay)

R132 (Volume Control
and Power Switch)

R126 (Squelch Control)

IC101 (μ PC358C AF
Low-Pass Filter)

IC105 (TA75393P Battery
Exhausted Detector)

IC102 (TC4071BP T/R
Control)

IC103 (TC4069UBP Beep
Osc. Squelch Control)

BT101 (Memory
Backup Battery)

S102 (CPU Reset Switch)

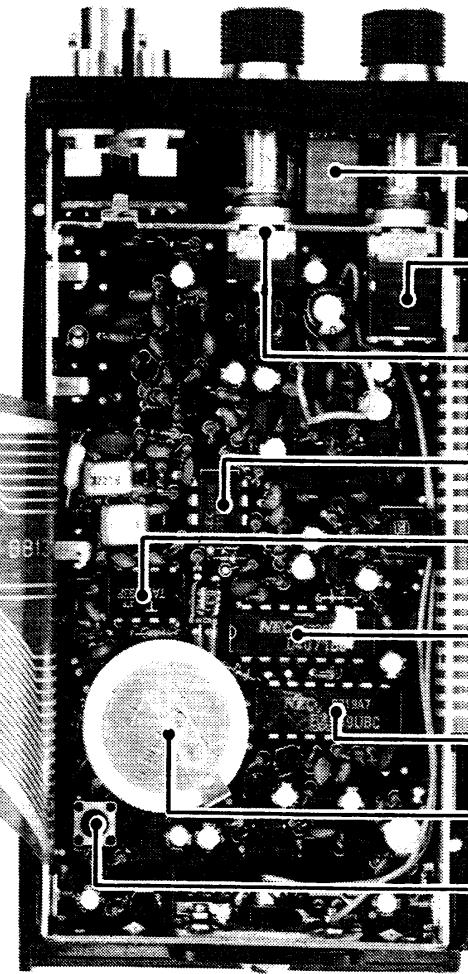

SECTION VIII TROUBLESHOOTING

Your IC-04A/AT/E has been tested very carefully at the factory before shipping. The chart below has been designed to help you correct any problems which are not equipment malfunctions. If you are not able to locate the problem and/or solve it through use of this chart, please contact your dealer or the nearest ICOM service center for assistance.

Problem	Possible Cause	Solution
1. Power does not come ON when the switch is turned.	<p>Bad connection of the power pack.</p> <p>Reverse polarity of the battery (when using IC-BP4)</p> <p>The battery has been exhausted.</p>	<p>Check the connection of the power pack and correct any problems.</p> <p>Make sure of the polarity of each battery and replace them into the pack.</p> <p>Replace the battery with a new one or recharge it.</p>
2. No sound comes from the speaker.	<p>VOLUME CONTROL knob is completely counterclockwise.</p> <p>The unit is in the transmit mode, by the PTT switch.</p>	<p>Turn the knob clockwise to a suitable level.</p> <p>Put the unit in the receive mode.</p>

Problem	Possible Cause	Solution
<p>2. No sound comes from the speaker. (Continued)</p>	<p>SQUELCH setting is turned too far clockwise.</p> <p>External speaker (or earphone) is in use.</p> <p>The battery has been exhausted.</p>	<p>Turn the SQUELCH CONTROL counterclockwise until noise can be heard and reset it just below the threshold.</p> <p>Check if the external speaker plug is inserted properly or if the external speaker cable is cut.</p> <p>Replace the battery with a new one or recharge it.</p>
<p>3. Sensitivity is low and only strong signals are audible.</p>	<p>Bad connection of the flexible antenna.</p> <p>The antenna feed line is cut or shorted. (When using an external antenna.)</p>	<p>Check the connection of the antenna and correct any problems.</p> <p>Check the feed line and correct any improper condition.</p>
<p>4. No or low RF output.</p>	<p>RF Power switch is set at the Low position.</p> <p>The battery has been exhausted.</p> <p>The antenna feed line is cut or shorted.</p>	<p>Set the RF Power switch to the High position.</p> <p>Replace the battery with a new one or recharge it.</p> <p>Check the antenna feed line and correct any problems.</p>

Problem	Possible Cause	Solution
5. No modulation. (When using external microphone.)	Bad connection of the MIC connector.	Check the connection of the MIC connector and correct any problems.
6. The receive mode functions properly and your signals are transmitted, but you are unable to make a contact with another station.	<p>The set is in DUPLEX mode. (When desiring SIMPLEX mode.)</p> <p>The set is in SIMPLEX mode. (When desiring DUPLEX mode.)</p> <p>Improper frequency separation or input/output frequencies of the repeater.</p>	<p>Clear the DUPLEX mode by pushing “#” key then “*” key in the DIAL mode.</p> <p>Set the proper frequency separation according to the repeater input/output frequencies.</p> <p>Set the proper frequency separation according to the repeater input/output frequencies.</p>
7. The programmed scan does not function.	<p>The set is in the MEMORY CHANNEL mode.</p> <p>The frequencies memorized in the M9 and M0 are the same, or their difference is less than the frequency step rate.</p>	<p>Push the “A” key to set in DIAL mode.</p> <p>Memorize frequencies which their difference is more than the frequency step rate into the M9 and M0.</p>
8. All key functions are disabled.	<p>The LOCK function is engaged.</p> <p>The CALL KEY function is engaged.</p>	<p>Clear the LOCK function by pushing the “D” key while depressing the “FUNC” key.</p> <p>Clear the CALL KEY function by pushing the “A” key.</p>

SECTION IX BLOCK DIAGRAM

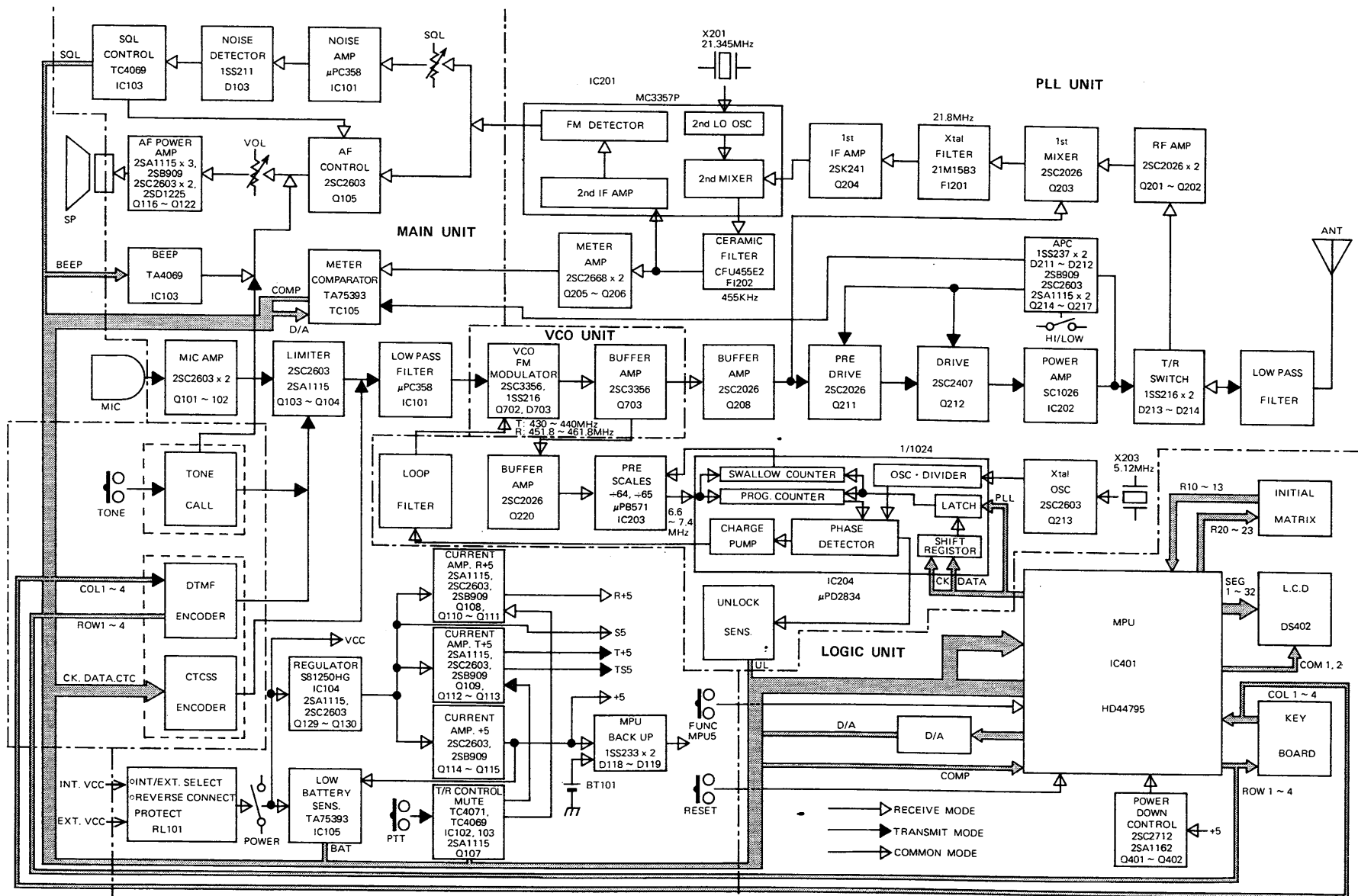

SECTION X OPTIONS

We have prepared a variety of options for the transceiver IC-04A/AT/E in order to enlarge its use.

1. IC-BP2 Nickel-Cadmium Power Pack

This power pack has six AA type 450mAH Nickel-Cadmium batteries (7.2V) and provides 2W output power for the IC-04A/AT/E with attendant longer use capability. Recharge time, when using the BC-30/BC-35 is 1.5 hours.

2. IC-BP4 Battery Case

This case will accept dry batteries, zinc or alkaline, for 2.5W output, or Nickel-Cadmium for 2W output power. It holds six cells. When Nickel-Cadmium are installed the BC-30/BC-35 can be used to recharge the batteries.

3. IC-BP5 Nickel-Cadmium Power Pack

This power pack has nine AA type 450mAH Nickel-Cadmium batteries (10.8V) and provides 4W output power for the IC-04A/AT/E with attendant longer use capability. Recharge time, when using the BC-30/BC-35 is 1.5 hours.

4. IC-BP7 Nickel-Cadmium Power Pack

This power pack has eleven AA type 425mAH Nickel-Cadmium batteries (13.2V) and provides 5W output power for the IC-04A/AT/E. Recharge time, when using the BC-35 is 1.5 hours, when using the BC-16U/E, wall charger, is 15 hours.

5. IC-BP8 Nickel-Cadmium Power Pack

This power pack has seven 800mAH Nickel-Cadmium batteries (8.4V) and provides 2.5W output power for the IC-04A/AT/E with attendant longer use capability. Recharge time, when using the BC-30/BC-35 is 3 hours, when using the BC-16U/E, wall charger, is 15 hours.

6. BC-16U/E Wall Charger for IC-BP7/8

This wall charger is for the Nickel-Cadmium power packs IC-BP7 and IC-BP8. Recharge time is about 15 hours.

7. BC-30 Nickel-Cadmium Battery Charger

A convenient set-in type charger for Nickel-Cadmium power packs. Two charging rates are provided, high speed and regular rate. This charger is compatible with any type of Nickel-Cadmium power packs except IC-BP7.

8. BC-35 Nickel-Cadmium Battery Charger

A convenient set-in type charger for Nickel-Cadmium power packs. Two charging rates are provided, high speed and regular rate. This charger is compatible with any type of Nickel-Cadmium power packs including IC-BP7.

9. IC-CP1 Power Cable for Cigarette Lighter

A handy way to operate with a car battery as well as to recharge the Nickel-Cadmium power packs (IC-BP3/7/8) while mobile, plugs in the cigarette lighter socket.

10. IC-HM9 Speaker/Microphone

A handy speaker and microphone in one unit. Clips on the clothing and operates as both speaker and microphone when plugged in the unit.

11. HS-10 Headset (with HS-10SA VOX Unit or HS-10SB PTT Switch Box)

A set of a headphone and arm mounted microphone provides hand-free operation. The HS-10SA, VOX Unit, provides automatic transmit/receive switching with your voice.

The HS-10SB, PTT Switch Box, provides both Push-To-Talk switch and locked switch functions.

12. Letherette Case, LC-11/LC-12/LC-14

A soft letherette case designed specifically for the IC-04A/AT/E as a convenient, protective case when the set is used outdoors. The LC-11 is for using the set with battery pack IC-BP2/BP3/BP4, the LC-12 is for using with IC-BP5 and the LC-14 is for using with IC-BP7/IC-BP8.



ICOM INCORPORATED

1-6-19, KAMI KURATSUKURI, HIRANO-KU,
OSAKA JAPAN

A-0570
Printed in Japan