

NOTICE

READ YOUR OPERATORS
MANUAL BEFORE APPLYING
POWER.

Thank you,
TeleVideo® Systems, Inc.



CAUTION

This product has been manufactured under strict static control conditions to prevent damage to static sensitive components. Please use static control precautions in servicing of this equipment. Field service or maintenance personnel should be properly grounded before servicing equipment.

WARNING!

Do not open the terminal case as shown in this manual unless you are a qualified technician. Opening the case exposes you to potential shock hazards.

If you are installing this terminal outside the United States, you will need an adaptor between the power cord and the wall outlet or an ac cord approved in the country in which the terminal is being installed.

*TeleVideo[®]
Display Terminal
Operator's Manual*



 TeleVideo Systems, Inc.

**TELEVIDEO®
955 VIDEO DISPLAY TERMINAL
OPERATOR'S MANUAL**

TeleVideo Document 131969-00-B
11 September 1985

Copyright

Copyright (c) 1985 by TeleVideo Systems, Inc. All rights reserved. No part of this publication may be reproduced, transmitted, transcribed, stored in a retrieval system, or translated into any language or computer language, in any form or by any means, electronic, mechanical, magnetic, optical, chemical, manual, or otherwise, without the prior written permission of TeleVideo Systems, Inc., 1170 Morse Avenue P.O. Box 3568 Sunnyvale, CA 94088-3568 800/521-4897

Disclaimer

TeleVideo Systems, Inc. makes no representations or warranties with respect to this manual. Further, TeleVideo Systems, Inc. reserves the right to make changes in the specifications of the product described within this manual at any time without notice and without obligation of TeleVideo Systems, Inc. to notify any person of such revision or changes.

FCC Class A Warning

This peripheral equipment generates, uses, and can radiate radio frequency energy. If not installed and used in accordance with the instruction manual, it may cause interference with radio emissions. This peripheral equipment has been tested and found to comply with the limits for a Class A computing device, pursuant to Subpart J of Part 15 of FCC Rules, which are designed to provide reasonable protection against radio frequency interference when operated in a commercial environment. Operation of this equipment in a residential area is likely to cause interference, in which case the user at his own risk and expense will be required to correct the interference. The use of nonshielded I/O cables may not guarantee compliance with FCC RFI limits.

TeleVideo is a registered trademark of TeleVideo Systems, Inc.

**Televideo Systems, Inc., 1170 Morse Avenue P.O. Box 3568
Sunnyvale, CA 94088-3568 800/521-4897**



TABLE OF CONTENTS

INTRODUCTION	xi
MEET THE 955 TERMINAL	xi
Built-in Features	xi
Options	xi
USING THIS MANUAL	xii
1. INSTALLATION	1
INSPECTING THE TERMINAL	1
SELECTING A GOOD LOCATION	1
INSTALLING THE TERMINAL	2
Connecting the Keyboard	3
Connecting the Terminal to the Computer System	4
Connecting the Terminal to a Printer	5
PLUGGING IN AND TURNING ON THE TERMINAL	6
INSTALLATION SUMMARY	6
2. SETTING OPERATING VALUES	7
HOW SET UP WORKS	7
Set Up Summary	7
Set Up Categories	8
THE SET UP MENUS	9
Main Menu	9
Other Set Up Menus	10
3. OPERATING THE TERMINAL	25
THE KEYBOARD	25
Character Keys	25
Editing Keys	26
Special Keys	30
Function Keys	32
OPERATING THE TERMINAL FROM THE KEYBOARD	32
Resetting the Terminal	32
Editing and Communication Modes	33
Editing and Sending Data	34
SCREEN APPEARANCE	35
The Cursor	35
Screen Saver	35
The Status Line	36

Contents

4. MAINTENANCE AND ASSISTANCE	39
TROUBLESHOOTING	39
Troubleshooting Table	39
Running the Self Test	41
Checking the Line Fuse	42
IF YOU NEED ASSISTANCE	43
Technical Support	44
Customer Service	44
Service Under Warranty	44
Shipping the Terminal	44
5. PROGRAMMING THE 955	45
ENTERING COMMANDS	45
Command Descriptions	46
Using Commands in Your Programs	46
Entering Commands From the Keyboard	47
VERIFYING OPERATIONS	47
Self Test	47
Monitor Mode	48
CHANGING OPERATING VALUES	49
Terminal Operating Modes	49
Variable Operating Values	50
Saving Operating Values	50
Programming Compatibility Mode	51
Changing the Screen Refresh Rate	52
Resetting the Terminal	52
RUNNING A PROGRAM	54
6. CONTROLLING THE TERMINAL'S OPERATION	55
KEYBOARD AND BELL	55
Keyboard Repeat Mode	55
Locking/Unlocking the Keyboard	55
Locking Four Terminal Keys	56
Editing Key Mode	56
Keyclick	56
Sounding the Bell	56
Selecting the Bell Column	57
Margin Bell Mode	57
SCREEN APPEARANCE	57
Screen Saver	57
Screen Visibility	58
Screen Background	58
Visual Attributes	58
Attribute Space Mode	60
Normal Intensity Mode	60
Attribute Base Mode	60
Selecting the Status Line Attribute	61
Cursor Style	61
Columns per Line Mode	61

CHARACTER SETS AND BLOCK GRAPHICS	62
Selecting a Character Set	62
Special Graphics Mode	62
Multinational Character Set	63
Data Word Mode	64
Block Graphics	64
Optional Graphics Firmware	65
7. EDITING	67
EDITING MODES	67
Autowrap Mode	67
New Line Mode	67
DOWN Key Mode	68
Write Protect and Protect Modes	68
ADDITIONAL SCREEN MEMORY	71
Selecting the Number of Lines per Page	72
Autopage Mode	73
Moving to Another Page	74
SCROLLING	75
Controlling the Rate of Scrolling	75
Defining a Scrolling Region	76
Line Lock	76
CURSOR CONTROL	78
Line Feed and Reverse Line Feed	78
Directional Cursor Movement	80
Addressing the Cursor	83
Reading the Cursor	84
Addressing the Cursor in Decimal Units	85
Cursor Home	85
Reading the Cursor in Decimal Units	85
TAB STOPS	86
Setting a Column of Tab Stops	86
Moving the Cursor to a Tab Stop	87
Clearing Typewriter Tab Stop(s)	88
Clearing Field Tab Stop(s)	88
EDITING DATA	89
Line and Page Edit	89
Insert and Replace Mode	89
The Replacement Character	90
Inserting Data	90
Deleting Data	91
Erasing Data	93
Clearing Data	94

8. COMMUNICATIONS	97
CHANGING PORT OPERATING VALUES	97
SETTING UP COMMUNICATIONS WITH THE COMPUTER	98
Selecting a Handshaking Protocol	98
Receive Buffer Fill Limit	99
Transmission Control Mode	99
Selecting the Transmit Delay Rate	100
Communication Modes	100
Setting the Communication Mode	102
SENDING SCREEN DATA	102
Delimiters	102
Reprogramming Delimiters	103
Data Markers	103
Sending Text	104
LOADING AND SENDING MESSAGES	107
Sending the Terminal's Identification	108
The Answerback Message	108
Displaying the Bottom Information Line's Contents	108
Selecting Both Information Lines' Contents	109
Loading the User Messages	109
Sending the Information Line Contents	111
THE FUNCT KEY	111
PRINTING	112
Print Commands	112
Page Print Flip Mode	116
Printer Handshaking Protocols	116
Page Print Terminator	118
9. REPROGRAMMABLE KEYS	119
FUNCTION KEYS	119
Selecting the Function Key Set	121
Reprogramming Function Keys	121
Saving the Contents of the Function Keys	124
Invoking a Function Key	124
REPROGRAMMING EDITING KEYS	125
The SEND Key	125
One Editing Key	125
All Editing Keys	128

Contents

APPENDICES

A	SPECIFICATIONS	A-1
B	STATEMENT OF LIMITED WARRANTY	A-4
C	ASCII CODE TABLES	A-5
D	MONITOR MODE CONTROL CHARACTERS	A-7
E	CURSOR COORDINATES	A-8
F	FOREIGN CHARACTER SETS	A-9
G	MULTINATIONAL CHARACTER SET	A-14
H	CONTROL CODES AND ESCAPE SEQUENCES	A-16
I	CALCULATOR MODE	A-23

GLOSSARY	G-1
----------	-----

INDEX	X-1
-------	-----

QUICK REFERENCE GUIDE	Q-1
-----------------------	-----

LIST OF FIGURES

1-1	Comfortable Terminal Lighting	2
1-2	Ideal Terminal Placement	2
1-3	955 Terminal, Front View	3
1-4	955 Terminal, Rear View	3
1-5	Pin Numbers (25-Pin RS-232 Connector)	4
2-1	Main Menu	9
2-2	Main Port Menus	10
2-3	Print Communications Menu	14
2-4	Screen Menus	16
2-5	Keyboard Menus	19
2-6	Programming Menus	22
3-1	Character Keys	26
3-2	Editing Keys	26
3-3	Special Keys	31
3-4	Data Sent by the Unshifted SEND Key	34
3-5	Data Sent by the Shifted SEND Key	34
3-6	955 Status Line	36
4-1	Location of the Line Fuse	43
4-2	Good Fuse	43
4-3	Burned-Out Fuse	43
5-1	Typical Monitor Mode Display	48
6-1	Special Graphics and Multinational Characters	63
6-2	Display with Three Blocks of Graphics	65
7-1	Effect of Line Feed and Carriage Return Commands	68
7-2	Sample Protected Form with Spaces Left for Data Entry	70
7-3	Partial Page of Memory Displayed on the Screen	72
7-4	Dividing Memory into Pages	73
7-5	Cursor Movement in Autopage Mode	74
7-6	Cursor Movement Between Adjacent Pages	74
7-7	Scrolling Movement Within a Scrolling Region	77
7-8	Setting Field Tab Stops	87
7-9	Deleting Data	92
7-10	Erasing Data	93
8-1	Data Flow in Communication Modes	101
8-2	Print Modes	113
F-1	U.S. ASCII Keyboard Layout	A-9
F-2	U.K. Keyboard Layout	A-10
F-3	French Keyboard Layout	A-10
F-4	German Keyboard Layout	A-11
F-5	Spanish Keyboard Layout	A-11
F-6	Finnish Keyboard Layout	A-12
F-7	Norwegian Keyboard Layout	A-12
F-8	Italian Keyboard Layout	A-13

LIST OF TABLES

1-1	RS-232C Computer (DTE) Interface Connector Assignments	5
1-2	RS-232C Printer (DCE) Interface Connector Assignments	5
2-1	Set Up Categories	8
2-2	Main Set Up Menu	9
2-3	Main Port Set Up Menus	11
2-4	Printer Port Set Up Menu	14
2-5	Screen Set Up Menus	17
2-6	Keyboard Set Up Menus	20
2-7	Programming Set Up Menus	22
3-1	Editing Keys	27
3-2	Special Keys	31
3-4	PRINT Key Operation	35
3-5	Status Line Values	36
4-1	Troubleshooting Terminal Problems	39
5-1	Command Elements	46
5-2	Effects of Compatibility Mode	51
5-3	Summary of Reset Methods	53
6-1	Effects of Visual Attributes	59
7-1	Effects of Protect Mode	69
7-2	Data Loss Due to Scrolling	75
7-3	Effect of Line Feed Code on Cursor Movement	78
7-4	Effect of Reverse Line Feed Code on Cursor Movement	79
7-5	Effect of Cursor Movement Commands	81
7-6	Effect of Protect Mode on Tabulation Commands	87
7-7	Effect of Protect Mode on Insert Commands	91
7-8	Effect of Protect Mode on Delete Commands	92
7-9	Clear Commands	95
8-1	Communication Modes	100
8-2	Default Delimiter Values	103
8-3	Send Commands	105
8-4	Print Commands	114
8-5	Printer Port Handshaking Protocols	116
9-1	Set One Default Function Key Codes	120
9-2	Set Two Default Function Key Codes	120
9-3	Default and Ps Values of Unshifted Editing Keys	126
9-4	Default and Ps Values of Shifted Editing Keys	127
C-1	ASCII Code Chart	A-5
C-2	ASCII Control Character Abbreviations	A-6
F-1	Character Set Comparison	A-9
H-1	Control Codes	A-16
H-2	Escape Sequences	A-17
H-3	ESC [Commands	A-21
H-4	Terminal Operating Modes	A-22
H-5	Variable Operating Values	A-22



INTRODUCTION

MEET THE 955 TERMINAL

TeleVideo's 955 terminal is designed with quality, dependability, and user convenience in mind. It is fully code compatible with TeleVideo's 925/950 family of terminals, but also offers such innovative features as a high-resolution screen with amber color option, 64 function keys, and two operator information lines.

Built-in Features

TeleVideo's 955 terminal is a "smart" terminal with many built-in features:

- Full 925/950 programming compatibility
- Tilt-and-swivel case
- High-resolution screen
- 14-inch, 80/132-column display
- Easy-to-use set up menus
- Switchable space/no-space visual attributes
- Top and bottom operator information lines
- Two sets of 32 programmable function keys
- Reprogrammable editing keys
- Special graphics and multinational character sets

Options

The following options are available:

- RS-422 communication interface
- One or three additional pages of memory
- Tektronix 4010/4014-compatible graphics
- Eight foreign-language character sets
- No-cost amber screen
- 20 mA current loop
- Function key overlays
- Blank keycaps
- WordStar(tm)-CP/M(r) EPROM and keyboard overlay

Contact your distributor or TeleVideo's spare parts department to order any options.

USING THIS MANUAL

The first chapters of the manual contain general user information. Chapters 1 through 3 describe how to install the terminal, change operating values in the set up menus, and control the terminal from the keyboard. Chapter 4 lists troubleshooting procedures and tells you how to obtain service.

Chapters 5 through 9 are for programmers. They explain how the terminal operates and all the programming commands.

At the back of the manual is reference material: appendices, glossary, index, and a programmer's quick reference guide.

1. INSTALLATION

This chapter tells you how to install the terminal. The end of the chapter summarizes the installation steps.

INSPECTING THE TERMINAL

WARNING! Do not open the terminal case. Opening the case exposes you to potential shock hazards. If you wish to inspect the interior of your terminal, have a qualified technician open the case and discharge the voltage for you.

After you unpack the terminal, keep the shipping carton and packing material in case you move or ship the terminal again.

In the packing carton you should find (in addition to this manual):

- The terminal
- A keyboard
- A coiled keyboard cable
- A power cable.

Inspect the keyboard, cabinet, and video screen for shipping damage. If anything is missing or damaged, contact your distributor or dealer.

SELECTING A GOOD LOCATION

Make sure the site you have chosen for the terminal has 4 inches (10.2 cm) of clearance for ventilation on all sides.

The orientation of the terminal's screen can greatly affect your comfort. Reflections and bright light are the most common causes of eye strain. Choose a site with indirect lighting, away from windows and other sources of bright light, as Figure 1-1 shows.

You can avoid fatigue by selecting furniture whose design is conducive to good working posture and placing the terminal at the correct height. The keyboard should be lower than the terminal screen.

Figure 1-2 shows the ideal relationship between the terminal and the operator.

**Figure 1-1
Comfortable Terminal Lighting**

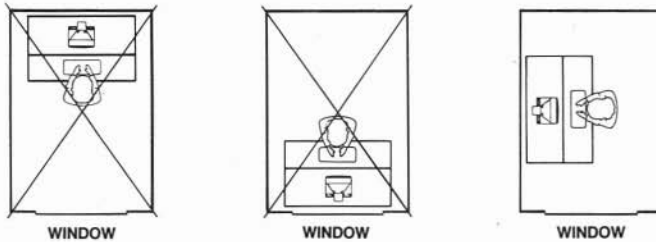

**Figure 1-2
Ideal Terminal Placement**



INSTALLING THE TERMINAL

NOTE! Tests performed on TeleVideo terminals by Underwriters Laboratories indicate they emit virtually no radiation and pose no health hazard.

Now you are ready to plug in the keyboard and connect your terminal to a computer and printer. Figures 1-3 and 1-4 show front and rear views of the 955 terminal with ports, switches and connectors marked.

Connecting the Keyboard

Plug the ends of the coiled keyboard cable into the front of the keyboard case and the front of the terminal (Figure 1-3).

Figure 1-3
955 Terminal, Front View

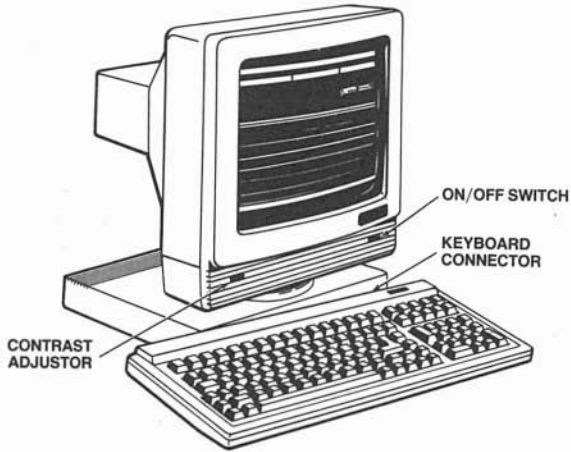
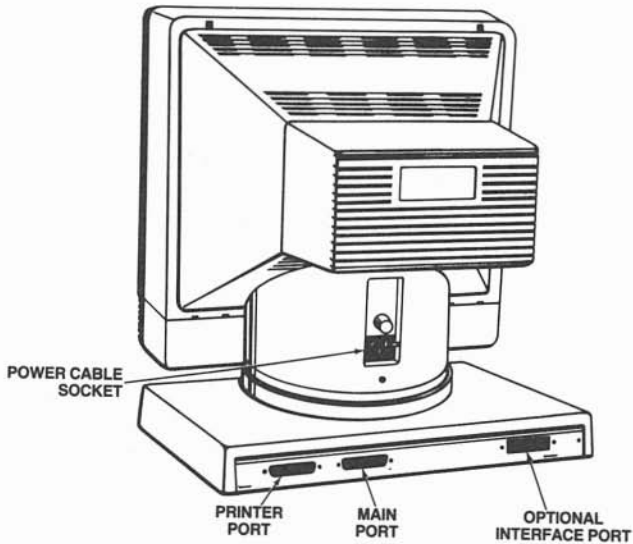

Figure 1-4
955 Terminal, Rear View



Connecting the Terminal to the Computer System

Before you connect the terminal, make sure its voltage is the same as your electrical outlet's. Your terminal should carry a label stating whether its setting is 115 volt or 230 volt ac power. If you want to change the voltage setting, call the TeleVideo Customer Service Department for instructions.

Before you connect the terminal to the computer, measure the distance between them. If the distance is less than 50 feet, you can use an RS-232C interface (with a 25-pin connector) between the terminal and the computer.

For distances more than 50 feet, consult your dealer or call TeleVideo's Peripherals Technical Support Department for help in selecting the correct interface. See the section on assistance in Chapter 4 for information about calling TeleVideo.

If you use the RS-232C interface, follow these steps:

1. Compare the suggested pin connector assignments, listed in Table 1-1, with those required by your computer. Figure 1-5 shows the terminal's pin connector numbers. If necessary, change the interface cable's pin assignments (or ask your service technician to do it for you).
2. Connect the interface cable to the terminal's main port and the computer's RS-232C port.

NOTE! Not all computers have a one-to-one pin compatibility with standard RS-232C pin assignments. Typically, pins 2, 3, and 7 are required to transmit data between the terminal and the computer. If your computer fails to operate properly, call the computer manufacturer for assistance in wiring the interface cable.

Figure 1-5
Pin Numbers (25-Pin RS-232 Connector)

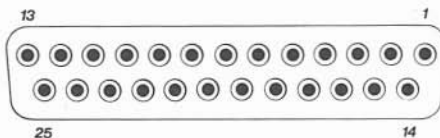

Table 1-1
RS-232C Computer (DTE) Interface Connector Assignments

Pin No.	Signal Name*	Direction
1	Frame Ground	
2**	Transmit Data	Output
3**	Receive Data	Input
4	Request to Send	Output
5	Clear to Send	Input
6	Data Set Ready	Input
7**	Signal Ground	
8	Data Carrier Detect	Input
20	Data Terminal Ready	Output

*Refer to the EIA's Standard RS-232C for signal definitions.

**The terminal requires these signals.

Connecting the Terminal to a Printer

1. Check your printer's pin connector against the terminal's printer port pin assignments, shown in Table 1-2.
2. Connect an RS-232C interface cable to the printer port (Figure 1-4) and to an RS-232C-compatible serial printer.

NOTE! Not all printers have a one-to-one pin compatibility with standard RS-232C pin assignments. To transmit data from the terminal to the printer, you need only pins 3, 7, and 2 and/or 20. If your printer fails to operate properly, call the printer manufacturer.

Table 1-2
RS-232C Printer (DCE) Interface Connector Assignments

Pin No.	Signal Name*	Direction
1	Frame Ground	
2	Receive Data	Input
3	Transmit Data	Output
6	Data Set Ready	Output
7	Signal Ground	
11**	Printer Busy	
20	Data Terminal Ready	Input

*Reference EIA Standard RS-232C for signal definitions.

**Nonstandard handshaking signal used by several printers such as Epson, Texas Instruments, and Okidata. To use pin 11 instead of pin 20, call your service technician.

PLUGGING IN AND TURNING ON THE TERMINAL

Now you are ready to plug in the terminal and turn it on.

1. Plug the power cable into the terminal and into a grounded wall outlet. See Figure 1-4 for the location of the power cable outlet at the rear of the terminal.

In the United States, use a 3-prong electrical outlet with a National Electrical Manufacturers Association (NEMA) Standard 5-15R rating. If you use a two-prong adapter, ground it with a pigtail.

2. Push the white dot on the ON/OFF switch on the right side of the grooved panel below the screen (Figure 1-3).
3. Listen for the terminal's bell, after about a second, and look for the cursor in the top left corner of the screen after 10 to 15 seconds. If the screen remains dark, go to step 5.
4. Adjust the angle of the terminal by pushing on the case until you can see the screen easily.
5. Adjust the screen contrast with the roller on the left side of the grooved panel below the screen (Figure 1-3).

INSTALLATION SUMMARY

1. Unpack and inspect the terminal.
2. Plug the keyboard cable into the terminal and keyboard.
3. Check that the unit has the correct voltage (115 or 230).
4. Connect the appropriate interface cable between the computer system and the terminal.
5. Attach a printer interface cable (if you are connecting a printer to the terminal).
6. Plug the power cord into the terminal and wall outlet.
7. Turn on the terminal, listen for the beep, watch for the cursor, and adjust the tilt and screen contrast.

Before using the terminal, check its operating values, as described in the following chapter.

2. SETTING OPERATING VALUES

When you turn on the 905, it is ready to operate. Its **factory default** operating values are set when it is manufactured. This chapter tells how to reset the default values.

NOTE! You can change all set up values with programming commands. See Chapter 5.

HOW SET UP WORKS

To change the 955's operating values, select new values from the set up menus. Each has an instruction line at the top of the screen and a selection line at the bottom to guide you.

Set Up Summary

1. Press SET UP (shifted NO SCROLL). The main menu appears. You can enter set up any time, but if the computer is sending data, the screen stops receiving incoming data until you leave set up.

NOTE! If the SET UP key has been disabled by a programming command (see Chapter 6), you cannot enter set up. The terminal's bell sounds and the main menu does not appear.

2. Press the UP and DOWN keys to display different set up menus.
3. Press the LEFT and RIGHT keys to move from field to field in each menu.
4. Press the space bar to flip through the values in each field. When the desired value appears, simply move to the next field or menu (or leave set up).

NOTE! The main menu has action fields. Pressing the space bar triggers the action.

Setting Operating Values

5. When you finish selecting set up values, press SET UP to return to normal operation. The message

SAVE? Y/N

appears on the screen.

6. Press Y to save your new values in nonvolatile memory. If you press any other key, the values you selected are lost when you turn the power off or reset the terminal.

Set Up Categories

Table 2-1 describes the 955's six set up categories.

Table 2-1
Set Up Categories

Category	Controls
Main	Access to other menus, plus monitor mode and reset to factory default values.
Main communi- cations (two menus)	Communication with the computer. Some values must match your computer's operating values for proper communication. If you are unsure of the values to select, consult your computer's documentation.
Print communi- cations	Communication with the printer. Some values must match your printer's operating values. If you are unsure of the values to select, consult your printer's documentation.
Screen (two menus)	Screen display characteristics. Some features are a matter of personal preference (such as cursor style), while others should be chosen to suit your application program.
Keyboard (two menus)	Character sets, how certain keys operate, and the codes they transmit.
Programming (two menus)	Loading and sending function key messages; reprogramming the answerback message.

THE SET UP MENUS

Now you are ready to select your operating values.

Main Menu

Figure 2-1 shows the main menu, and Table 2-2 describes it.

**Figure 2-1
Main Menu**

MAIN MENU	CURSOR key to move	SPACE BAR to select	SET-UP to exit			
MAIN	PRINT	SCREEN	KEY BD	PROGRAM	MONT	DEFAULT

**Table 2-2
Main Set Up Menu**

Field	Action
MAIN	Displays the first main port category menu
PRINT	Displays the printer port menu
SCREEN	Displays the first screen category menu
KEY BD	Displays the first keyboard category menu
PROGRAM	Displays the first programming category menu
MONT	Normally blank. Enables monitor mode. The terminal displays control characters on the screen but does not act on them.
DEFAULT	Clears the screen and returns all current operating values (volatile and nonvolatile) to factory default.

STOP! Pressing the space bar in this field erases all operating values changed from default.

Other Set Up Menus

Figures 2-2 through 2-6 show the set up menus for each category, with the default values of each field (where applicable).

Tables 2-3 through 2-7 describe the selections in each field. Values that must match the operating values of your computer or printer are shown in bold print.

**Figure 2-2
Main Port Menus**

MENU 1

MAIN PORT 1	CURSOR key to move	SPACE BAR to change	SET-UP to exit		
BAUD 9600	WORD 8	PRTY NO	STOP 1	COMM FDX	HAND X-ON

MENU 2

MAIN PORT 2	CURSOR key to move	SPACE BAR to change	SET-UP to exit		
BSIZ 32	XDLY NO	XCTR OFF	COMP 950	DATA 7	IMDM OFF

Setting Operating Values

Table 2-3
Main Port Set Up Menus

Field*	Values	Effect
BAUD	50	Selects the speed at which data flows to the computer through the RS-232C main (computer) port.
	75	
	110	
	135	
	150	
	300	
	600	
	1200	
	1800	
	2400	
	3600	
	4800	
	7200	
9600		
19.2		
38.4		
WORD structure	8	Computer port transmits/accepts only 8-bit data words to/from computer.
	7	Computer port transmits/accepts only 7-bit data words to/from computer.
PaRiTY	NO	Terminal does not add or check for parity.
	ODD	Parity is odd (transmitted and received).
	EVEN	Parity is even (transmitted and received).
	MARK	Parity is mark (transmitted).
	SPACe	Parity is space (transmitted).

*Values of fields shown in bold print must match the computer's values before communication can occur.

Setting Operating Values

Table 2-3 Continued
Main Port Set Up Menus

Field*	Selections	Effect
STOP bits	1	A bit (always with a value of one) sent to signal that a character has been sent.
	2	Two bits (both ones) sent to signal that a character has been sent.
COMM unication mode	FDX	Permits simultaneous transmission and reception of information. Keyboard entries are sent only to the computer.
	HDX	Sends keyboard entries to the computer and to the screen.
	BLK	Sends keyboard entries to the screen only; permits block transmission to computer. Terminal may receive data from computer.
	LOC	Sends keyboard entries to the screen only. No communication with computer.
HAND shaking protocol	X-ON	Terminal controls the receipt of data with X-On/X-Off signals to the computer.
	DTR	Terminal controls the receipt of data by lowering and raising the voltage on the DTR line to the computer.
	BOTH	Terminal sends X-On/X-Off signals and also changes the DTR line voltage.
	NO	Terminal does not establish handshaking signals with the computer.

*Values of fields shown in bold print must match the computer's values before communication can occur.

Setting Operating Values

Table 2-3 Continued
Main Port Set Up Menus

Field*	Selections	Effect
Buffer SIZE	16	Selects the receive buffer's fill limit when the terminal sends the X-Off code or lowers the DTR line.
	32	
	64	
	128	
XDLY (transmit delay rate)	NO	Selects the number of character delays per character transmitted. Does not change the baud rate.
	1-7	
XCTR (transmit control)	OFF	Terminal does not accept X-On/X-Off signals from the computer.
	ON	Terminal accepts X-On/X-Off signals from the computer.
COMP- atibility	950	Terminal commands are 950 compatible. See Table 5-2 for details.
	955	Terminal commands are unique to 955 terminal. See Table 5-2 for details.
DATA	7	Terminal reads only the first seven bits of data words from the computer.
	8	Terminal reads all eight bits of data words from the computer.
IMDM (Internal modem)	OFF	Internal modem is off. Always select this value if no modem is installed.
	ON	Internal modem is on. Turning on the internal modem turns off main port communication.

*Values of fields shown in bold print must match the computer's values before communication can occur.

Figure 2-3
Print Communications Menu

PRINT PORT	CURSOR key to move	SPACE BAR to change	SET-UP to exit		
~					
BAUD 1200	WORD 8	PRTY NO	STOP 1	PMOD	FLIP ON

Table 2-4
Printer Port Set Up Menu

Field*	Values	Effect
BAUD	50	Selects the speed at which data flows to the printer through the terminal's RS-232C printer port.
	75	
	110	
	135	
	150	
	300	
	600	
	1200	
	1800	
	2400	
	3600	
4800		
7200		
9600		
19.2		
WORD structure	8	Printer port sends only 8-bit words to the printer.
	7	Printer port sends only 7-bit words to the printer.

*Values of fields shown in bold print must match the printer's values before communication can occur.

Table 2-4 Continued
Printer Port Set Up Menu

Field*		Selections Effect
PaRiTY	NO	Terminal does not add or check for parity.
	ODD	Parity is odd (transmitted and received).
	EVEN	Parity is even (transmitted and received).
	MARK	Parity is mark (transmitted).
	SPACE	Parity is space (transmitted).
STOP bits	1	A bit (always a one) sent to signal that a character has been sent.
	2	Two bits (both ones) sent to signal that a character has been sent.
PMOD	blank	No print mode
	TRSP	Turns on transparent print mode. Terminal does not display data on its screen that flows from the main through the printer port. (Existing screen data is undisturbed.) Main and printer port baud rates may differ.
	COPY	Turns on copy (extension) print mode. Terminal sends (copies) all data from the computer to the printer, as well as displaying it on the screen and acting on any commands in the data stream. Main and printer port baud rates may differ.
	BDir	Turns on bidirectional print mode. Same as copy print (above), but terminal can also pass data from printer to computer.

*Values of fields shown in bold print must match the printer's values before communication can occur.

Table 2-4 Continued
Printer Port Set Up Menu

Field	Selections	Effect
FLIP	ON	If optional memory is installed, screen flips to next page of memory and continues updating when the terminal receives a page print command.
	OFF	When the terminal receives a page print command, the screen stops updating and the current page remains displayed.

Figure 2-4
Screen Menus

MENU 1

SCREEN FORM	CURSOR key to move	SPACE BAR to change	SET-UP to exit		
COLM 80	SCRL JUMP	TOP NO	BOIM STAT	WRAP ON	TOB OFF

MENU 2

SCREEN ATTR	CURSOR key to move	SPACE BAR to change	SET-UP to exit		
BACK DARK	CURS BBLK	ATTR SPAC	BASE LINE	NORM FULL	STAT REV

Table 2-5
Screen Set Up Menus

Field	Values	Effect
COLM	132	132 columns per line appear on screen
	80	80 columns per line appear on screen.
SCRL	JUMP	Data scrolls onto the screen at the same rate it comes from the computer.
	NORMAL	Scroll rate is 4 lines per second.
	SLOW	Scroll rate is 2 lines per second.
	FAST	Scroll rate is 8 lines per second.
TOP line	NO	Screen's top line is blank during normal operation.
	STAT	Status line appears on the screen's top line.
	USR1	User message 1 appears on the screen's top line.
	USR2	User message 2 appears on the screen's top line.
BOTM line	STAT	Status line appears on the screen's bottom line during normal operation.
	NO	Screen's bottom line is blank.
	USR1	User line 1 appears on the screen's bottom line.
	USR2	User line 2 appears on the screen's bottom line.
WRAP	ON	Cursor wraps to the start of the next line.
	OFF	Cursor does not wrap to the next line.

Setting Operating Values

**Table 2-5 Continued
Screen Set Up Menus**

Field	Values	Effect
TOB (time out blank)	OFF	Screen remains on, even while terminal is idle.
	10	When the terminal receives no data for 10, 20, or 30 minutes, screen blanks and the status line displays PRESS ANY KEY TO MAKE SCREEN APPEAR.
	20	
	30	
BACKground	DARK	Screen background is dark with light characters.
	LITE	Screen background is light with dark characters.
CURSor	BBLK	Cursor is a blinking block.
	SBLK	Cursor is a steady block.
	BUND	Cursor is a blinking underline.
	SUND	Cursor is a steady underline.
	NO	Cursor is not visible.
ATTRibute	SPACE	Visual attributes occupy a space (are embedded) on the screen.
	NOSP	Visual attributes do not occupy a space (are not embedded).
BASE	LINE	Visual attributes affect data from the cursor to the end of the line.
	PAGE	Visual attributes affect data from the cursor to the end of the page.
NORMal	FULL	Normal screen intensity is full. Write protected fields appear in half intensity.
	HALF	Normal screen intensity is half. Write protected fields appear in full intensity.

**Table 2-5 Continued
Screen Set Up Menus**

Field	Values	Effect
STATus line	REV	Status line appears in reverse visual attribute.
	NORM	Status line appears in normal visual attribute.
	ULIN	Status line appears in underlined visual attribute.
	RLIN	Status line appears in reverse underlined visual attribute.

**Figure 2-5
Keyboard Menus**

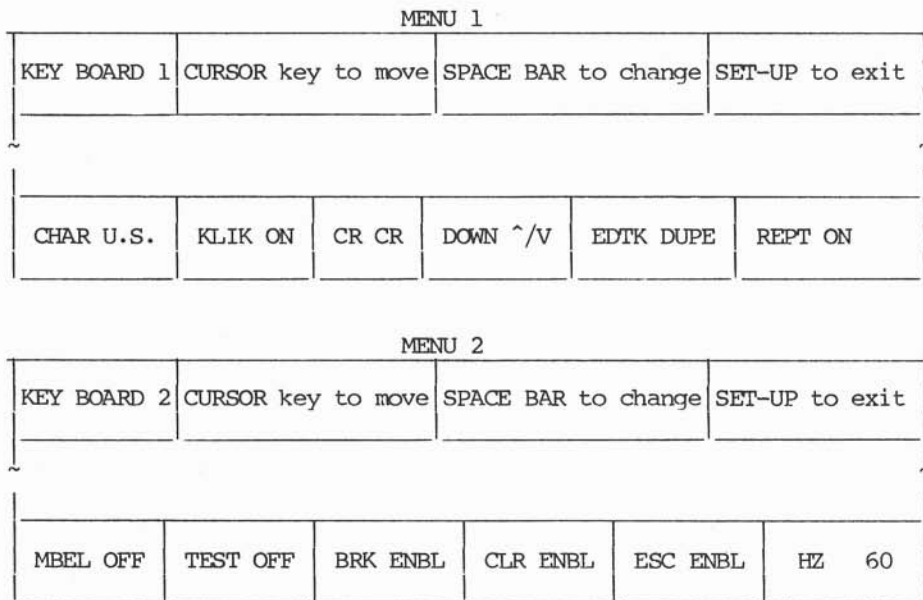

Setting Operating Values

Table 2-6
Keyboard Set Up Menus

Field	Values	Effect
CHAR	U.S.	Character set is U.S. ASCII.
	U.K.	Character set is U.K. English.
	FRENch	Character set is French.*
	GERMan	Character set is German.*
	SPANish	Character set is Spanish.*
	FINNish	Character set is Finnish.*
	NORWegian	Character set is Norwegian.*
	ITALian	Character set is Italian.*
KLIK	ON	Most keys click when pressed.
	OFF	Keys are silent when pressed.
CR	CR	Carriage return code causes a carriage return only.**
	CRLF	Carriage return code causes a line feed and then a carriage return.**
DOWN	~/V	DOWN key sends CTRL V (cursor down).
	~/J	DOWN key sends CTRL J (line feed).**
EDTK	DUPE	Editing key codes go to the computer in full or half duplex modes.
	LOCE	Editing key codes go to the terminal only, even in conversational modes.

*You must install an optional character set EPROM to select characters sets other than U.S. or U.K.

**Computers may use a line feed code as a delimiter, add a line feed to each carriage return, or add a carriage return to each line feed. Consult your computer's documentation.

**Table 2-6 Continued
Keyboard Set Up Menus**

Field	Values	Effect
REPT	ON	Most keys repeat.
	OFF	No keys repeat.
MBEL	ON	Bell sounds when the cursor reaches the margin bell column (default 72) when entering keyboard data.
	OFF	Margin bell does not sound.
TEST	OFF	Self test does not run on power-on.
	ON	Self test runs on power-up.
BRK	EN	The BREAK key functions when pressed.
	DIS	The BREAK key must be pressed with CTRL to send a break signal.
CLR	EN	The CLEAR SPACE key functions.
	DIS	The CLEAR SPACE key is disabled.
ESC	EN	The ESC key functions.
	DIS	The ESC key is disabled.
Hertz	60	Screen refreshes at 60 hertz (U.S. power systems).
	50	Screen refreshes at 50 hertz (most international power systems).

Figure 2-6
Programming Menus

MENU 1			
FUNCTION KEY	any F key to select	CE key to reprogram	ENTER key to stop
~			
SAVE OFF	FSET 1	F1 = 2 XXXXXXXXXXXXXXXXXXXXXXXX	
~			
MENU 2			
ANSWER BACK	CE key to reprogram	normal key to load	ENTER key to stop
~			
ANSR = XXXXXXXXXXXXXXXXXXXX			

Table 2-7
Programming Set Up Menus

Field	Values	Effect
SAVE	OFF	Contents of function keys are not stored in nonvolatile memory. Keys return to factory default values when you turn off power.
	ON	Contents of function keys are stored in nonvolatile (permanent) memory.
FSET	1	Selects function key set one.
	2	Selects function key set two.

Table 2-7 Continued
Programming Set Up Menus

Field	Values	Effect
FXX	1-16 s1-s16	Pressing any function key (unshifted or shifted) displays its number (1-16 or s1-s16) and contents in the set up menu. Press the CE key to reprogram the function key message destination and contents. STOP! Pressing CE clears the current destination variable and message.
1/2/3	1 2 3	Message goes to the computer. Message goes to the terminal. Message goes to host and terminal.
<message>	XXXXXXXX	Enter a new message (characters or commands) at the keyboard. The keys have a total memory capacity of 256 bytes, which can be distributed any way among the keys. You can enter up to 256 bytes; however, only the first 37 show in the menu line. See Chapter 9 for more instructions on loading the function keys. NOTE! If you attempt to load data into a function key when the memory is full, existing messages are destroyed, starting with shifted key F16 and working backward. When all messages are destroyed from key s16 down to the key you are loading, the bell sounds and the terminal does not accept any more data. If you make a mistake, press ENTER, then CE. This restarts the process. Press ENTER to end the loading and leave the field or exit set up.

Setting Operating Values

Table 2-7 Continued
Programming Set Up Menus

Field	Values	Effect
ANSR =	XXXXXXXX XXXXXXXX	<p>Press the CE key to clear the current answerback message. You can enter any 16 bytes of characters or commands from the keyboard as a new message.</p> <p>If you make a mistake, press ENTER, then CE. This starts the process again.</p> <p>Pressing ENTER ends the loading. Until you press ENTER, you cannot move out of the field or exit set up.</p>

3. OPERATING THE TERMINAL

This chapter describes the keys and how to operate the terminal from the keyboard. The end of the chapter describes messages that appear in the status line.

THE KEYBOARD

The keyboard contains character keys, editing keys, special keys, and function keys.

NOTE! The names and functions of shifted and unshifted keys are often different. For example, the shifted NO SCROLL key is called SET UP.

If you press a character key for more than one-half second, the key repeats, sending its code again. Most special keys also repeat when held down for more than one-half second. Function keys do not repeat.

Character Keys

The unshaded keys in Figure 3-1 are character keys. They include all alphabetic characters (A through Z), the space bar, numbers (0 through 9), punctuation marks, and symbols.

NOTE! When you press a character key, its code may go to the computer, but not to the terminal's screen, depending on your communication mode. See the section later in this chapter about communication modes.

Figure 3-1
Character Keys

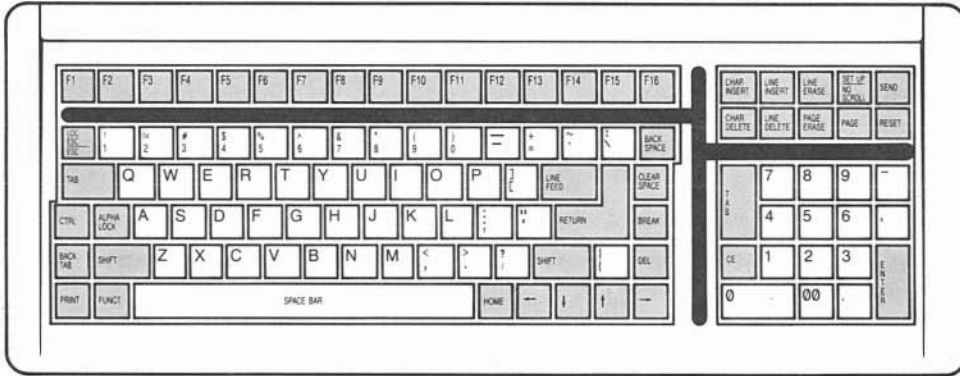

Editing Keys

Editing keys do not display characters. They command the terminal to do editing operations. Figure 3-2 shows the editing keys and Table 3-1 describes their operation. Keys repeat unless noted.

See Table 9-3 and 9-4 for a summary of editing key operations and codes.

Figure 3-2
Editing Keys

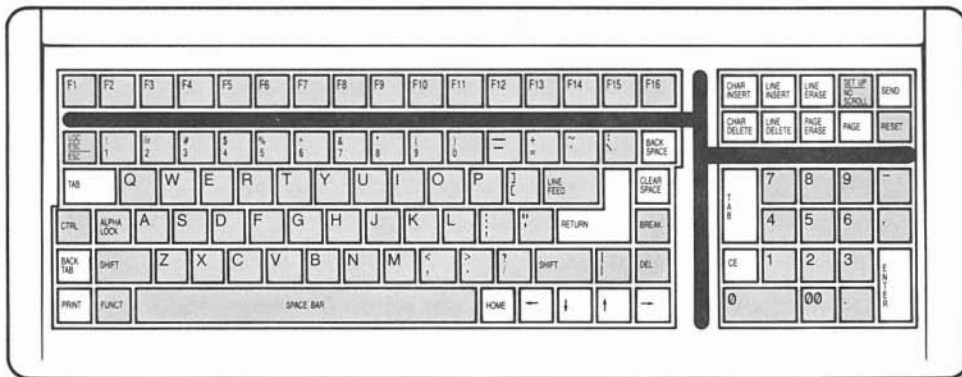

Table 3-1
Editing Keys

Key	Effect
BACK SPACE*	Moves the cursor left one character. Same as LEFT key.
BACK TAB	Returns the cursor to the previous typewriter tab stop or to the first column if no tab stop is set (if protect mode is off) or to the start of the current or previous unprotected field (a field tab stop if protect mode is on).
Shifted BACK TAB	Clears the typewriter tab stop at the cursor location.
CE (clear entry)	Replaces all data in the current tab field with replacement characters. With protect mode off, clears data between typewriter tab stops and moves the cursor back to the beginning of the current tab field. Clears the entire line if it has no tab stops. With protect mode on, clears all data in the cursor's unprotected field. Does not repeat.
Shifted CE	Clears all typewriter tab stops. Does not repeat.
CHAR DELETE	Deletes the cursor character and shifts all succeeding characters one position to the left until they reach the end of the line or page (depending on the setting of line/page edit mode) or a write-protected field. Adds replacement character(s) at the end of the shifted text.
Shifted CHAR DELETE	Enables replace mode (disables insert mode).
CHAR INSERT	Adds a replacement character at the cursor position, shifting all succeeding characters right one position. Shifted characters are lost at the end of the line or page (depending on the setting of line/page edit mode) or at a protected field.
Shifted CHAR INSERT	Enables insert mode (disables replace mode).

*Not affected by editing key mode and not reprogrammable.

Table 3-1 Continued
Editing Keys

Key Name	Effect
CLEAR SPACE	Replaces all unprotected characters on the page with replacement characters.
Shifted CLEAR SPACE	Turns off half intensity and protect mode. Replaces all data with null characters.
LEFT	Moves cursor left one character. Can wrap the cursor around to the previous line.
UP	Moves the cursor up one line within the same column until it reaches the top line.
Shifted UP	Reverse line feed. Moves the cursor up to the previous line within the same column. Once it reaches the page's first line, data scrolls down one line.
DOWN	Moves the cursor down one line within the same column.
Shifted DOWN	Same effect as LINE FEED key.
RIGHT	Moves the cursor right one position. Can wrap the cursor to the next line.
ENTER	Sends a carriage return code to the computer. Does not repeat.
Shifted ENTER	Sends carriage return and line feed codes. Does not repeat.
HOME	Moves the cursor to the current page's first unprotected character position (called home position and usually column one of line one). Does not repeat.
LINE DELETE	Removes the current line and shifts lines below it up one line. Fills the last line of the page with a line of replacement characters. Ignored while protect mode is on.

Table 3-1 Continued
Editing Keys

Key Name	Effect
LINE ERASE	Replaces data from the cursor to the end of the line or the beginning of the next protected field (whichever comes first) with replacement characters. With protect mode on, the effect is limited to the current field.
Shifted LINE ERASE	Replaces data from the cursor to the end of the line with null characters. With protect mode on, the effect is limited to the current field.
LINE FEED*	Moves the cursor down one line within the current column. Affected by protect mode.
LINE INSERT	Adds a line of replacement characters on the cursor line. Data below that line shifts down one line. If the cursor is on the page's last line when the terminal receives this code, that line is lost. Has no effect when protect mode is on.
PAGE	Displays next page of memory (if additional memory is installed). Does not repeat.
Shifted PAGE	Displays previous page of memory (if additional memory is installed).
PAGE ERASE	Replaces unprotected data between the cursor and the end of the page with replacement characters.
Shifted PAGE ERASE	Replaces unprotected data between the cursor and the end of the page with null characters.
PRINT	Prints the current page; replaces special graphics and write-protected characters with space characters. Sends carriage return, line feed, and null characters to the printer after each line. Does not repeat.

*Not affected by editing key mode and not reprogrammable.

Table 3-1 Continued
Editing Keys

Key Name	Effect
Shifted PRINT	Prints everything on the current page. Pages are unformatted (unless formatted automatically by printer) because carriage return, line feed, and null characters are not sent to the printer after each line. Does not repeat.
RETURN*	Sends a carriage return code to the computer. Does not repeat.
SEND	Sends contents of current page to the computer. Does not repeat.
Shifted SEND	Sends contents of cursor line to the computer. Does not repeat.
TAB	If protect mode is off, moves the cursor forward to the next typewriter tab stop. If protect mode is on, moves it to the next field tab stop (start of the next unprotected field).
Shifted TAB**	Sets tab stop at cursor position.

*Not affected by editing key mode and not reprogrammable.

**The unshifted TAB keys on the main keypad and accounting keypad are interchangeable: They transmit the same default codes and have the same function. However, the shifted TAB key on the main keypad transmits the code ESC 1 (set tab), while the shifted numeric keypad TAB key functions same as the unshifted key.

Special Keys

Figure 3-3 shows the special keys, and Table 3-2 explains their effect.

Figure 3-3
Special Keys

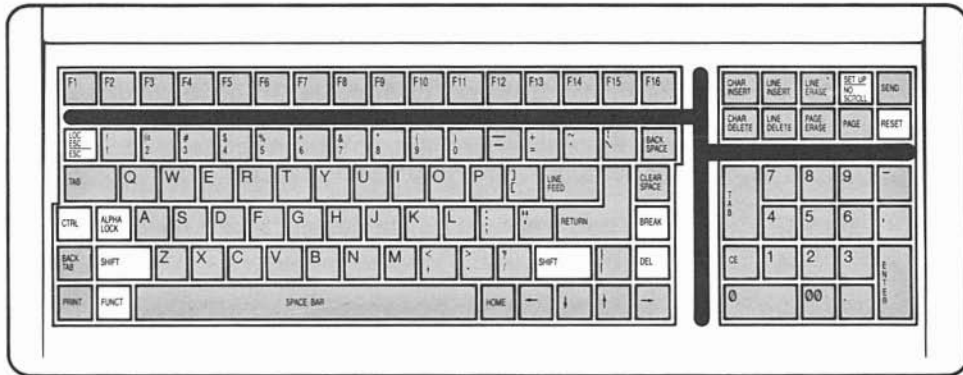

Table 3-2
Special Keys

Key	Effect
ALPHA LOCK	Capitalizes all alphabetic keys, but does not select the upper characters or functions of other keys.
BREAK	Sends a break signal , used in programs, when pressed alone (if enabled) or with CTRL (if disabled). May disconnect a modem.
CTRL	Partially resets the terminal when pressed with CTRL and SHIFT. See the section in this chapter on resetting the terminal for details.
DEL	Pressed with some character keys to send operating commands (control characters). Pressed with other special keys to reset the terminal.
ESC	Has no default function and displays no character. Operation determined solely by application program.
	When pressed immediately before pressing a character key, causes the character key to send an operating command (escape sequence).

Table 3-2 Continued
Special Keys

Key	Effect
FUNCT	Pressed with character keys to send a set of codes whose operation is determined solely by a program.
LOC ESC	When pressed instead of ESC, sends escape sequences from the keyboard to the terminal only.
NO SCROLL	Halts data coming in to the screen from the computer until pressed again.
RESET	Resets the terminal when pressed with CTRL.
SET UP (shifted NO SCROLL)	Displays the first set up line. Press again to leave set up lines and save set up values.
SHIFT	Capitalizes letters and selects the upper characters or functions of other keys.

Function Keys

The 16 unshifted and shifted function keys at the top of the keyboard send a set of codes to the computer that programmers can use. You can program four messages into each key either in set up or by a programming sequence. See Chapter 9 for more information about the function keys.

OPERATING THE TERMINAL FROM THE KEYBOARD

This section tells you how to reset the terminal and how to edit data and send it to the computer and printer.

Resetting the Terminal

To **reset** the terminal, press CTRL RESET. This is the same as turning the terminal off and back on again. All operating values return to the last values saved in nonvolatile memory.

Pressing CTRL SHIFT BREAK partially resets the terminal. It turns off the print mode, write protect, and protect modes; returns the terminal from block or local mode to the previous conversational mode; restores communication between the terminal and the computer (if previously halted); unlocks the keyboard; and sounds the bell.

Editing and Communication Modes

Before you try to enter data or use the editing keys, you should understand the effects of the terminal's **communication modes** and **editing key mode**.

The 955 has four communication modes:

- Full duplex
- Half duplex
- Block
- Local

When you turn on half duplex or full duplex communication modes (in set up or with a programming command), key codes go immediately to the computer.

In **full duplex** mode, key codes go only to the computer and not to the screen, unless your computer sends back (echos) the key codes or the terminal is in **local editing key mode** (described below). Data does not appear on the screen when you press character keys, and the editing keys do not move the cursor or control screen data.

In **half duplex** mode, the terminal sends key codes to the computer and the terminal's screen. Data appears on the screen when you press the character keys, and the editing keys affect the cursor and screen display.

In **block** communication mode, data goes from the keyboard to the screen. Pressing SEND transmits screen data to the computer. The terminal can receive data from the computer any time.

In **local** communication mode, the terminal has no communication with the computer.

Editing key mode affects only the editing keys. In **local editing** mode, editing key codes go **only** to the screen, even when the terminal is in half or full duplex mode. If you are in full duplex communication mode, you can turn on local editing key mode (in set up or with a programming command) to ensure that the editing keys can control screen data. In **duplex editing** mode, the destination of editing key codes is controlled solely by the communication mode.

See Chapters 6 and 8 for more information about editing key and communication modes.

Editing and Sending Data

The editing keys (Table 3-1) move the cursor, change data on the screen, and send data to the computer and printer.

NOTE! If the editing keys do not function as described in Table 3-1, check the terminal's communication and editing key modes, described in the previous section.

In block mode, the unshifted SEND key sends all data in the page, from the home position through (including) the cursor position. See Figure 3-4.

Figure 3-4
Data Sent by the Unshifted SEND Key

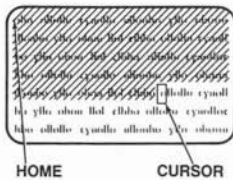

The shifted SEND key sends all data on the cursor line, starting at the first column position and including the cursor position. See Figure 3-5.

Figure 3-5
Data Sent by the Shifted SEND Key

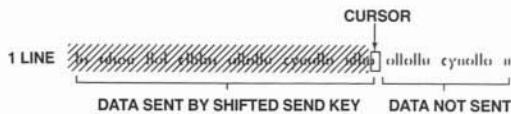

Chapter 9 explains how to reprogram the SEND key.

Pressing the PRINT key prints the contents of the screen. This is called **page print**. During a page print, the screen does not accept new data from the computer or keyboard. When the page print finishes, data again flows onto the screen.

NOTE! If your terminal has more than one page of memory, the display flips to the second page during a page print and the screen continues to accept data.

Table 3-4 explains the action of the print key. See Chapter 8 for more information about printing.

Table 3-4
PRINT Key Operation

PRINT Key	Sends to Printer
Unshifted	All unprotected characters on the page. Sends space characters for protected characters. Printing is formatted : Sends a carriage return and line feed control character after each line.
Shifted	All characters on the page. Printing is unformatted : Sends no formatting control characters in the transmission.

SCREEN APPEARANCE

When you turn on the terminal, you see the **cursor** and the **status line**.

The Cursor

The cursor is a contrasting rectangular block or underline (selected in set up) that indicates the position of the next entered character. The cursor can be invisible, steady, or blinking.

You can move the cursor with the UP, LEFT, DOWN, RIGHT, TAB, BACK TAB, HOME, LINE FEED, RETURN, ENTER, or BACK SPACE keys (described in Table 3-1).

Screen Saver

The terminal's screen-saver feature blanks the screen after 10, 20, or 30 minutes (selected in set up or by a programming command) of inactivity. Blanking the screen conserves the phosphor coating inside the face of the screen.

When the screen blanks, the status line displays the message PRESS ANY KEY TO MAKE SCREEN APPEAR.

The Status Line

In normal operation the bottom line displays the status line. This line summarizes the current operating characteristics. Many fields are normally blank, and information appears only when appropriate.

Figure 3-6 shows status line messages, and Table 3-5 lists all possible messages for each field.

**Figure 3-6
955 Status Line**

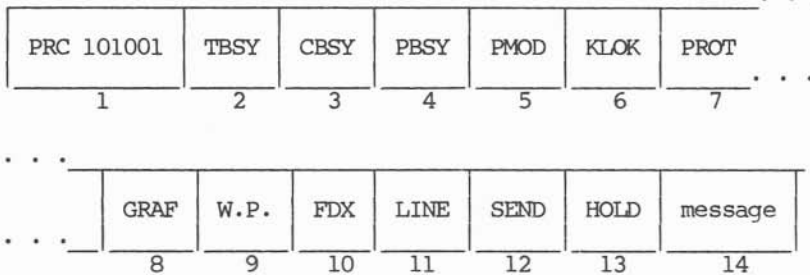

**Table 3-5
Status Line Values**

Field	Values	Description
1	P R C	P = Page of memory (1-4) R = Row (1-96) C = Column (1-132)
2	TBSY	Terminal busy, displayed when terminal's receive buffer reaches its fill limit.
3	CBSY	Computer busy, displayed when computer sends X-Off to the terminal.
	P3ER	Port 3 error, indicating an invalid voltage level on main port connector pins 6 (DSR) and 8 (DCD). (Disconnect the pins.)
4	PBSY	Printer busy, displayed when terminal receives X-Off from printer or voltage drops on DTR line.

Table 3-5 Continued
Status Line Values

Field	Values	Description
5	mode	Displays terminal print mode or operation: UFPG = Unformatted page print operation FMPG = Formatted page print operation TRSP = Buffered transparent print COPY = Buffered copy (extension) print BDIR = Buffered bidirectional print
6	KLOK	Keyboard locked/unlocked (blank)
7	PROT	Protect mode on/off (blank)
8	GRAF	Graphics mode on/off (blank)
9	W.P.	Write protect mode on/off (blank)
10	FDX/HDX/ BLK/LOC	Communication mode: full duplex/half duplex/block/local
11	LINE/ PAGE	Line or page edit mode
12	SEND	Displays SEND when terminal is sending data in block mode
13	HOLD	Displays HOLD when NO SCROLL key is engaged (screen updating is halted)
14	message	Displays seven-character user-programmable message.



4. MAINTENANCE AND ASSISTANCE

This chapter tells you what to check before placing a service call. It also shows you how to change the line fuse and obtain assistance.

TROUBLESHOOTING

Before placing a service call, find the symptom in Table 4-1 and try the solution listed there. The last part of this section tells you how to change the line fuse.

Troubleshooting Table

Table 4-1 lists a variety of terminal problems and simple solutions.

Table 4-1
Troubleshooting Terminal Problems

Symptom	Possible Solution
Terminal dead (no bell; no cursor)	Unplug power cord and plug in both ends again
	Check and replace line fuse
	Turn on power switch
Terminal does not go on line	Check power select switch setting
	Make sure system is "up"
	Disconnect all cables and check for damage, then reattach
	Reset the terminal
	Make sure the terminal is not in block mode (check set up menu)
Check the baud rate	

Table 4-1 Continued
Troubleshooting Terminal Problems

Symptom	Possible Solution
Terminal does not go on line	Check RS-232C (computer) port interface cables:
	Pins 1 and 7 must be grounded
	Pin 2 must be connected to computer receiver
	Pin 3 must be connected to the computer transmitter
	Pins 5, 6, and 8 must be driven by +12 volt dc power or be disconnected
	Turn on the modem
Cursor does not appear	Connect a different modem
	Check handset's position in modem cradle
	Adjust screen brightness
Computer does not respond while on line	Set parity, word structure, and stop bits to match computer's requirements
No keyboard response	Unplug and reattach both ends of keyboard cable
	STOP! This may reset the terminal, which would clear the screen.
	Change to half duplex communication mode
Keyboard locked up	Review all set up line values
	Reset the terminal

Table 4-1 Continued
Troubleshooting Terminal Problems

Symptom	Possible Solution
Printer does not print correctly	<p data-bbox="502 331 1188 388">Check baud rate, parity and word structure of main port in set up</p> <p data-bbox="502 414 959 444">Check print mode and command</p> <p data-bbox="502 470 1188 527">Check baud rate, parity and word structure of printer port in set up</p> <p data-bbox="502 553 1103 583">Check printer cable's pin assignments</p> <p data-bbox="583 609 1157 666">Pins 4 and 20 must be driven by +12 volt dc power or disconnected</p> <p data-bbox="583 692 1139 749">Pin 3 must be connected to printer data input</p> <p data-bbox="583 775 1170 847">Pin 2 must be connected to printer data output for operation with X-On/X-Off control</p>
Escape and control codes do not function as expected	<p data-bbox="502 881 1157 911">Check escape sequences and control codes</p> <p data-bbox="502 937 1188 1013">Make sure upper- and lowercase letters are entered correctly. Is a one used instead of a lowercase L? Zero for uppercase O?</p> <p data-bbox="502 1041 1072 1098">Make sure the ALPHA LOCK key is not engaged.</p> <p data-bbox="502 1124 1188 1229">Disconnect the interface from the terminal's computer port; connect computer port's pins 2 and 3; try operating in full duplex</p> <p data-bbox="502 1256 1059 1286">Try ESC sequences with LOC ESC key</p>
Display is wavy or beep sounds unusual	Change hertz setting

Running the Self Test

You can verify proper operation of the terminal's video display circuitry by running a self test. The test shows all displayable characters and visual attributes.

STOP! Running the self test clears the screen.

1. Press (in sequence):

SET UP 1

2. Watch for the test screen to appear.
3. Check the screen:

Four lines should blink.

All characters should be displayed.

Each character should be formed properly.

You should not see any extra dots and no dots should be missing.

The screen should contain all the visual attributes and some decreased intensity characters.

4. Press **SET UP** to stop the test. You can clear the test from the screen with the **CLEAR SPACE** key.

Checking the Line Fuse

To check the line fuse:

1. Turn off the power and unplug the terminal's power cord (either from the terminal or from the wall outlet).
2. Remove the fuse holder by unscrewing it counterclockwise (Figure 4-1).
3. Slip the glass fuse out of the holder and examine it.

If the thin wire inside the fuse is intact (Figure 4-2), the fuse should be functional. If the thin strip is broken and/or the glass is slightly black (Figure 4-3), the fuse has blown and must be replaced. (A totally black fuse can indicate a problem with the power outlet. If that happens, call your service technician.)

Figure 4-1
Location of the Line Fuse

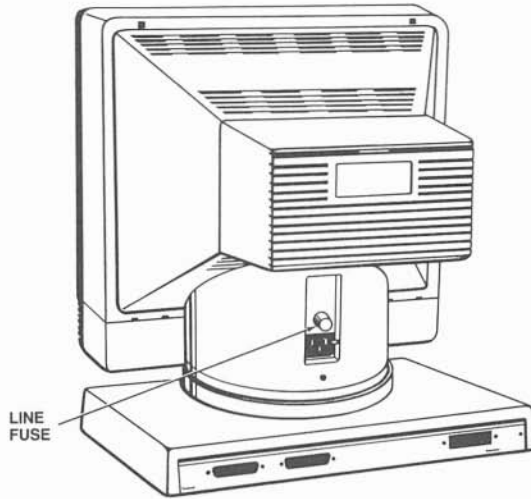

Figure 4-2
Good Fuse

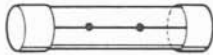

Figure 4-3
Burned-Out Fuse



4. Replace a blown fuse with a 1.5-ampere, slow-blow fuse for 115-volt applications or a 0.75-ampere, slow-blow fuse for 230-volt applications.
5. Replace and tighten the fuse holder.
6. Plug in the terminal power cord.

If the newly replaced fuse blows out immediately, do not replace it again. Call your service technician.

IF YOU NEED ASSISTANCE

TeleVideo's toll-free number for service calls is 800/521-4897 (in California, 800/821-3774). Or call 408/971-0255.

Before calling, check to make sure the terminal is plugged in, all cables are connected to the correct ports, and all operating parameters are set correctly (go back to Chapter 2 if you need to review them).

Ask for the Applications Support Department or the Technical Support Department, depending on your questions. Try to place the terminal by the phone. Have the terminal's serial number, found on the rear of the case, and this manual at hand.

If the line is busy, try again or leave a message with the TeleVideo operator. Your call will be returned as soon as possible.

Applications Support

Ask for the Applications Support Department when you want to know more about a feature, how to use the terminal in a particular environment, or when you need marketing information. Call between 8:30 a.m. and 5:30 p.m., Pacific time, Monday through Friday (except holidays).

Technical Support

Call Technical Support for help with hardware problems or to return the terminal for repair. You can reach the Technical Support Department between 7:00 a.m. and 5:30 p.m., Pacific time, Monday through Friday (except holidays).

Service Under Warranty

The terminal is covered by a limited warranty (see Appendix B). No warranty registration is required. If you need service while the terminal is covered by the limited warranty, call the Technical Support Department.

Shipping the Terminal

Should you need to ship the terminal, ask your service technician to check the integrity of the cabling and the security of the internal mounting hardware. Repack the terminal, using either the original TeleVideo shipping container or other suitable materials.

5. PROGRAMMING THE 955

The following chapters are for programmers. They explain the commands that let you control the terminal in a computer program or from the keyboard.

The terminal responds to a wide range of commands you can include in your programs. Turn to the Quick Reference Guide at the back of the manual for a summary of commands. Incorporating these commands in your programs can make your job faster and easier.

The terminal's editing keys transmit the same codes as certain programming commands. Many programs using the terminal's built-in features can be made interactive. You can write a program that calls on the operator to press an editing key to attain certain results.

If you want to change the function of any editing key to suit your particular application, you can reprogram the key, or keys. See Chapter 9 for instructions on how to reprogram editing keys.

We hope you take advantage of the terminal's many features to help you in all your programming and data handling jobs. If you have any questions or problems this manual cannot answer, TeleVideo's Technical Support personnel are ready to assist you by telephone.

ENTERING COMMANDS

Programming commands cause the terminal to perform an operation, such as moving the cursor, sending the contents of the screen to the printer, or changing an operating mode. You can send them from the host or enter them at the keyboard.

NOTE! When you enter commands from the keyboard, use the LOC ESC key instead of ESC, or put the terminal into local or block communication mode.

Command Descriptions

Command descriptions in this manual have up to five elements. Table 5-1 lists each element and its meaning.

**Table 5-1
Command Elements**

Element	Meaning
Statement	Function of the command
Keyboard entry	How the command is entered at the keyboard (escape sequence or control code)
Key	Key (if any) that sends the same code and performs the same function
DEFAULT =	Terminal's factory default state (if applicable)*
SET UP	Function or value can also be selected in set up mode (if applicable)

Variables in commands are usually shown as **Pn** or **Ps**. **Pn** represents a decimal value and **Ps** a selective value. Variable choices and their effects are listed in the descriptive text following each command.*

*The terminal's **factory default** state is not necessarily the same as the **default value** of a command. If you enter a command without its variable, the command **defaults** to the lowest variable value (zero or one). The resulting state or function may not be the factory default condition.

Using Commands in Your Programs

The 955 terminal responds to control codes and escape sequences regardless of your programming language's format and syntax. How you incorporate commands into your programs depends on your programming language. The multitude of languages and syntaxes recognized by each language makes it impossible to show you how to incorporate commands in each program. If you need help with the proper syntax, refer to the documentation for your programming language.

The Appendix C shows the ASCII characters and corresponding numeric values in various systems.

Entering Commands From the Keyboard

To make sure the terminal receives commands from the keyboard, put the terminal in local or block communication mode. Then the terminal responds to commands from the keyboard, and no commands go to the computer.

If the terminal is in a conversational communication mode, commands go to the computer. How your computer then acts on them depends on your program.

You can send escape sequences to the terminal during a conversational communication mode by entering the commands with the LOC ESC key instead of ESC.

When you enter commands at the keyboard, make sure the ALPHA LOCK key is not locked. Enter the characters exactly as shown so the commands work as described. Notice whether the command requires an upper- or lowercase character, a number one or a lowercase L, a zero or an uppercase O.

Commands are printed in this manual with a space between the characters. Do **not** type this space as part of the sequence; it is included only for clarity. For example, the sequence

ESC c

involves pressing only the ESC key followed by a lowercase c.

Always press the CTRL key first and hold it down while you press the other key (as you would the SHIFT key). Always press **and release** the ESC key before pressing the next key.

VERIFYING OPERATIONS

Self Test

Run the self test

ESC V

This command starts the self test described in Chapter 4. If you send this command while the terminal is in set up mode, nothing happens. After you run the test, you can clear the screen by pressing the CLEAR SPACE key or sending a clear command (described in Chapter 7).

NOTE! Depending on your communication mode, you may want to run the test and clear the screen from the keyboard, entering programming commands with the LOC ESC key.

Monitor Mode

Monitor mode on
Monitor mode off

SET UP
DEFAULT = Off
ESC U
ESC X
or ESC u

Mode on The terminal displays command characters (control characters and escape sequences) on the screen, instead of acting on them.

Mode off Terminal processes commands normally.

Figure 5-1 shows a typical monitor mode display. Seeing command characters on the screen can help you easily debug a program.

Appendix D shows how control characters appear in monitor mode. For example, the ASCII character SOH (entered as CTRL A in the program) appears on the screen during monitor mode as S with a subscript H. Escape sequences include an E with a subscript C for the ESC character. And a null character appears as N subscript L.

If you want to display a control character without putting the terminal in monitor mode, enter an escape character (or press ESC) just before the control character.

Figure 5-1
Typical Monitor Mode Display

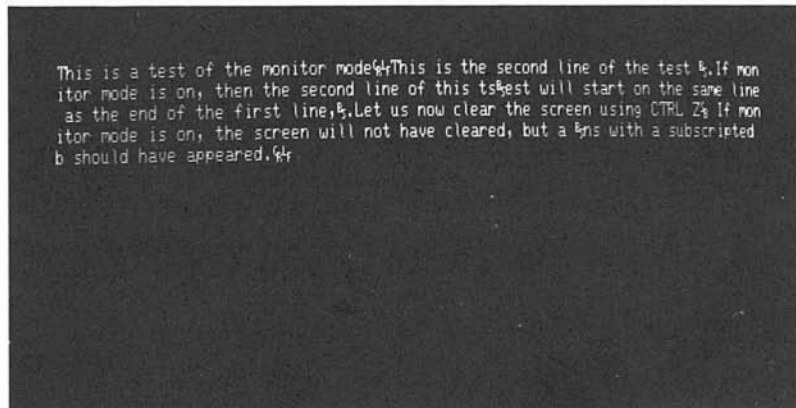

CHANGING OPERATING VALUES

Chapter 2 shows how to change the terminal's operating values in a series of set up menus and then save the new operating values in the terminal's nonvolatile memory. This section explains the commands that let you change many set up values.

Changing set up values with a command only saves the new values in temporary memory. This section also gives the commands to save current set up values in nonvolatile memory and to return to nonvolatile memory or factory default values.

Terminal Operating Modes**SET UP**

Set terminal operating mode(s)

ESC [= Ps h

Reset terminal operating mode(s)

ESC [= Ps l

Ps	Mode	Set	Reset
0	Transmission control	On	Off*
1	Data word	8 bits	7 bits*
2	Attribute base	Page*	Line
3	Columns per line	132	80*
4	Margin bell	On	Off*
5	Normal intensity	Half	Full*
6	New line	LF/CR	CR*
7	Autowrap	On*	Off
8	Auto repeat	On*	Off
9	DOWN key	CTRL J	CTRL V*
10	Function key	Nonvolatile*	Temporary
11	SET UP key	Enabled*	Disabled
12	ESC key	Enabled*	Disabled
13	CLEAR SPACE key	Enabled*	Disabled
14	BREAK key	Enabled*	Disabled
15	Page print flip	On*	Off
16	Screen refresh rate	50 Hz	60 Hz*

*Factory default setting.

Operating mode commands are in pairs: One sets (enables) the function and the other resets (disables) it. You can set or reset operating modes singly or in strings, separating the Ps values by semicolons.

You can also change all these modes in set up. Changing them with a command does not save the new value in nonvolatile memory.

Operating modes affect how the terminal responds to action commands or codes from operating keys. Each mode is described in the section that contains other related commands. See the table of contents and index for specific subjects.

Variable Operating Values**SET UP**

Select a terminal operating value

ESC [p1 ; p2 v

p1 Terminal Function

- 0 Transmit delay rate
- 1 Handshaking protocol
- 2 Receive buffer fill limit
- 3 Status line attribute
- 4 Top information line
- 5 Bottom information line
- 6 Scroll rate
- 7 Function key set
- 8 Screen saver time
- 9 Character set
- 10 Programming compatibility mode

p2 = An operating value variable for each p1 function.

This set of commands lets you change terminal operating values while running a program. You can also change all these values in set up. Changing them with a command does not save the new value in nonvolatile memory.

Each terminal function is described in the section that contains other related commands. See the table of contents and index for specific subjects.

Saving Operating Values

Save current set up values in nonvolatile memory

ESC [0 ; 1 }

This command saves in nonvolatile memory the current settings of the modes and operating values you can change both in set up and by an operating command. It does not affect modes and values (such as protect mode) you cannot change in set up.

Programming Compatibility Mode**SET UP****Select programming compatibility mode****DEFAULT Ps = 1****ESC [10 ; Ps v**

Ps	Terminal
0	955
1	950

This mode changes the operation of certain commands. Table 5-2 lists the commands and how they are affected.

Table 5-2
Effects of Compatibility Mode

Command	955 Mode	950 Mode
ESC p1 p2 <message> CTRL Y	Reprogram function keys using unique 955 p1 values	Reprogram function keys using 950 p1 values
ESC 0 Ps p1 p2 p3	Reprogram any one editing key with any three bytes	Reprogram the SEND key with one of six send commands
ESC +	Clear all to replacement characters (reset protect and write protect modes)	Clear unprotected to replacement characters (do not reset protect and write protect modes)
ESC ,	Clear unprotected to write protected space characters (reset protect mode)	Clear unprotected to write protected space characters (do not reset protect mode)
ESC G Ps	Designating an embedded attribute when the cursor is in a protected field moves the cursor to the next unprotected position and then changes the attribute.	Designating an embedded attribute when the cursor is in a protected field changes the attribute at the cursor position and destroys the character in that position.
ESC M	Terminal returns 10-byte identification 955<sp>R.0,m<CR>	Terminal returns 6-byte identification R.0,m<CR>

Changing the Screen Refresh Rate

Screen refresh rate is 60 Hz
Screen refresh rate is 50 Hz

SET UP
DEFAULT = 60 Hz
ESC [= 16 l
ESC [= 16 h

Some power systems, usually international systems, may require 50 Hz to avoid screen flicker.

Resetting the Terminal

Reset the terminal's operating values to factory default values **ESC ~ 0**

Reset the terminal's operating values to nonvolatile memory values **ESC ~ 1**
key **CTRL RESET**

Reset function keys to factory default values **ESC ~ 2**

Reset editing keys to factory default values **ESC ~ 3**

STOP! The **ESC ~ 0** command erases any reprogramming you may have loaded into nonvolatile memory.

These commands void any values previously changed by commands from the keyboard or computer.

Table 5-3 summarizes methods for resetting some or all terminal operating values. Be careful when you reset the terminal: You can lose operating values you have reprogrammed or selected in set up.

Table 5-3
Summary of Reset Methods

Command/ Key Sequence	Clears Screen?	Actions
ESC ~ 0	Yes	Resets software and returns non-volatile memory to factory default values. STOP! This sequence permanently destroys any reprogrammed values in nonvolatile memory.
CTRL RESET or ESC ~ 1 or power off and back on	Yes	Returns the terminal to nonvolatile memory values (including latest set up line values and reprogrammed function keys, editing keys, and answerback code). Unlocks the keyboard.
ESC ~ 2	No	Restores codes sent by function keys to factory default values.
ESC ~ 3	No	Restores codes sent by editing keys to factory default values.
CTRL SHIFT BREAK	No	Turns off print, write protect, and protect modes. Returns the terminal from block or local mode to the previous conversational mode. Restores communication between terminal and host (if previously halted). Unlocks the keyboard and sounds the terminal's bell.
CTRL BREAK or BREAK	No	Sends a break signal , which brings the transmit data line to a space (low) condition for 250 milliseconds. Has no effect on screen display and does not reset any operating values.

RUNNING A PROGRAM

Execute a user-installed program

ESC z

You can install your own program in external ROM. It must start at hex address 30 00 and contain less than 8 Kbytes, and the first byte must be hex 55. If the terminal finds a program at 30 00 when it receives this command, it jumps to address 30 01 and executes the program.

6. CONTROLLING THE TERMINAL'S OPERATION

The commands in this chapter let you change many aspects of the terminal's operating appearance. You can control such features as keyboard operation, the terminal's bell, the appearance of the screen and the cursor, the number of columns displayed on the screen, and the terminal's character sets. Many of the features can also be controlled in set up.

KEYBOARD AND BELL

You can control many keyboard and bell features with the commands in this section.

Keyboard Repeat Mode

SET UP
DEFAULT = On
ESC [= 8 h
ESC [= 8 l

Keyboard repeat on
Keyboard repeat off

Repeat on Keys repeat when pressed for one-half second, except CLEAR SPACE, HOME, SEND, PAGE, CE, ENTER, RETURN, ESC, LOC ESC, DEL and the function keys.

Repeat off No keys repeat.

Locking/Unlocking the Keyboard

DEFAULT = Unlock
ESC #
ESC "

Lock (disable) the keyboard
Unlock (enable) the keyboard

This command **locks** or **disables** most of the keys while running a program. You can use this feature to keep the operator from entering data while the program builds a special form. However, even while the keyboard is locked, the FUNCT, LOC ESC, BREAK, SET UP, NO SCROLL and function keys still operate.

To unlock the keyboard for the operator, send ESC " from the computer. Or the operator can press CTRL SHIFT BREAK, CTRL RESET or LOC ESC ", or turn the power off and back on again. See Table 5-3 for other effects of these resets.

Controlling the Terminal's Operation

Locking Four Terminal Keys

Lock (disable) key(s)
Unlock (enable) key(s)

SET UP
DEFAULT = Unlocked
ESC [= Ps l
ESC [= Ps h

Ps	Key
11	SET UP
12	ESC
13	CLEAR SPACE
14	BREAK

Key(s) enabled Permits an operator full use of the four keys.

Key(s) disabled Prevents an operator from possibly disrupting a program's functioning by pressing the key(s).

Editing Key Mode

Enable local editing key mode
Enable duplex editing key mode

SET UP
ESC k
ESC l

Duplex mode Codes from editing keys are transmitted just as character key codes are. The communication mode determines where the terminal sends these codes.

Local mode Editing keys change only the screen. They do not send a code to the computer.

Editing key mode affects the keys listed in Table 3-1, except those noted. They are also reprogrammable (see Chapter 9).

Keyclick

Keyclick on
Keyclick off

SET UP
DEFAULT = On
ESC >
ESC <

These commands define whether or not the keys click when they are pressed.

Sounding the Bell

Sound the terminal's bell

CTRL G

Use this command in a program to sound the terminal's bell.

Selecting the Bell Column**Load the margin bell column****CTRL W**

This command sets the margin bell column at the current cursor location. The margin bell sounds when the cursor reaches the margin bell column during data entry from the keyboard. The column value is not saved in nonvolatile memory: After reset or power off, the margin bell column returns to its default value of 72 (in 80-column mode) or 124 (in 132-column mode).

Margin Bell Mode**SET UP**
Margin bell on
Margin bell off
DEFAULT = Off
ESC [= 4 h
ESC [= 4 l

Bell on Margin bell sounds when the cursor reaches the margin bell column when data is entered from the keyboard.

Bell off Margin bell does not sound when the cursor reaches the margin bell column.

SCREEN APPEARANCE

Screen display commands let you choose the appearance of the screen. You can select the color (light or dark) of the screen, the cursor style, the number of columns per line, and the visual attributes (the appearance of characters on the screen).

Screen Saver**SET UP****Select screen saver time**
DEFAULT Ps = 0
ESC [8 ; Ps v

Ps	Effect
-----------	---------------

0	No screen saver
1	Screen blanks after 10 minutes idle
2	Screen blanks after 20 minutes idle
3	Screen blanks after 30 minutes idle

If the terminal is idle (no data received from the keyboard or computer) for 10, 20 or 30 minutes, the screen blanks and the words **PRESS ANY KEY TO MAKE SCREEN APPEAR** appear in the bottom information line.

Controlling the Terminal's Operation

Screen Visibility

	DEFAULT = On
Turn screen on	ESC n
Turn screen off	ESC o

These commands determine whether or not the screen can display data.

Screen Background	SET UP
	DEFAULT = Dark
Light background with dark characters	ESC b
Dark background with light characters	ESC d

The screen's background is either light with dark characters or dark with light characters.

Remember that you can also change the background in the set up line. What the screen background command does depends on the background chosen there. If the terminal receives a command that is the same as the current background, no change occurs.

Visual Attributes

Define visual attribute(s)	DEFAULT Ps = 0
	ESC G Ps

Ps	Visual Attribute
0	Normal (default) video
1	Invisible normal video
2	Blink
3	Invisible blink
4	Reverse current background
5	Invisible reverse
6	Reverse and blink
7	Invisible reverse and blink
8	Underline
9	Invisible underline
:	Underline and blink
;	Invisible underline and blink
<	Reverse and underline
=	Invisible reverse and underline
>	Reverse and underline and blink
?	Invisible reverse and underline and blink

Visual attributes are automatically write-protected characters, so they are protected when ever you enable protect mode.

Controlling the Terminal's Operation

Attributes affect all subsequent characters up to the place where you change the attribute again or the end of the line or page, whichever comes first (depending on the attribute mode you have selected).

Whether or not the attribute occupies a character space depends on your choice of attribute space mode (in set up or with the ESC F Ps command below).

Default attribute values are normal video, character space, page based.

To set a visual attribute, place the cursor where (if the attribute does not occupy a space) or one position before (if the attribute occupies a space) you want the attribute to start, then enter the appropriate escape sequence.

NOTE! See Table 5-2 for an explanation of the effect of 950 and 955 programming modes on embedded visual attributes.

Changing how characters appear can dramatically change the screen's appearance. Table 6-1 describes the effects of visual attributes.

Table 6-1
Effects of Visual Attributes

Name	Effect
Normal video	Restores background of screen to value in set up line (either dark or light).
Reverse video	Changes screen's background to reverse of current background. If screen background was dark with light characters, it is now light with dark characters.
Underline	Creates a solid line below character(s).
Blink	Causes character(s) to blink.
Invisible	Makes all subsequent data entered invisible (although cursor is still visible and data is transmitted to computer). Often used to enter a password, payroll, or other sensitive information.

Controlling the Terminal's Operation

Attribute Space Mode	SET UP
	DEFAULT = Space
Attributes occupy a character space	ESC F 0
Attributes do not occupy a character space	ESC F 1

Character space attributes Visual attributes occupy a character space (are embedded). Entering a character in that space destroys the attribute (unless protect mode is on, since attributes are write-protected).

NOTE! See Table 5-2 for an explanation of the effect of 950 and 955 programming modes on embedded visual attributes.

No space attributes Visual attributes do not occupy a character space (are not embedded). The first character you enter, **where the attribute starts or any place else on the page**, does not destroy the attribute. But **after you enter that first character**, entering a character where the attribute starts destroys the attribute. Since attributes are write protected, you can avoid destroying them by turning on protect mode when you want to re-enter a character where an attribute starts.

Normal Intensity Mode	SET UP
	DEFAULT = Full
Half intensity mode	ESC [= 5 h
Full intensity mode	ESC [= 5 l

Half intensity Normal visual attribute is half intensity. Write protected characters entered subsequently appear in full intensity.

Full intensity Normal visual attribute is full intensity. Write protected characters appear in half intensity.

Attribute Base Mode	SET UP
	DEFAULT = Page
Page base attribute mode	ESC [= 2 h
Line base attribute mode	ESC [= 2 l

Page base Visual attributes affect data from the place you change them to the end of the page.

Line base Visual attributes affect data from the place you change them to the end of the line.

Controlling the Terminal's Operation

Selecting the Status Line Attribute **SET UP**
 DEFAULT Ps = 1
Select the status line visual attribute(s) **ESC [3 ; Ps v**

Ps	Attribute(s)
0	Normal
1	Reverse
2	Normal underline
3	Reverse underline

This command lets you control the appearance of the status line, normally displayed on the screen's bottom line. See Chapter 8 for more information about the status line.

Cursor Style **SET UP**
 DEFAULT Ps = 1
Select cursor style **ESC . Ps**

Ps	Cursor Style
0	Cursor not displayed
1	Blinking block cursor
2	Steady block cursor
3	Blinking underline cursor
4	Steady underline cursor

This command remains in effect until you change it with another command, change the set up line, or turn off the terminal.

Columns per Line Mode **SET UP**
 DEFAULT = 80
Enable 132 columns per line **ESC [= 3 h**
Enable 80 columns per line **ESC [= 3 l**

132 columns Each display line contains 132 columns.

80 columns Each display line contains 80 columns. If you change from 132 columns to 80 columns, data in columns 81 through 132 remains in memory. The cursor also remains in its current position, even when that column is beyond the right margin of the screen, and you can enter data in the undisplayed columns.

Changing from one column mode to another does not clear the screen.

CHARACTER SETS AND BLOCK GRAPHICS

The 955 has U.S. and U.K. ASCII, special graphics, and multinational characters. An optional EPROM supplies six foreign character sets.

Selecting a Character Set

SET UP
DEFAULT Ps = 0
ESC [9 ; Ps v

Select a character set

Ps	Character Set
0	U.S. ASCII
1	U.K. ASCII
2	French
3	German
4	Spanish
5	Finnish
6	Norwegian
7	Italian

Resident character sets are U.S. ASCII and U.K. The other sets are available when you install an optional character set EPROM. You can also order a set of keycaps for any character set. Appendix F shows all the character sets.

Special Graphics Mode

DEFAULT = Off
ESC \$
ESC %

Special graphics mode on
Special graphics mode off

Graphics mode on The terminal converts alphanumeric characters to 32 special graphics characters. The first 16 are compatible with the 950 terminal graphics characters. Figure 6-1 shows the 32 characters and keys you press to produce them. (The first character is a space, which occupies a position but does not display a character.)

Graphics characters are automatically write protected. Protect mode and visual attribute and intensity commands affect them as they would any other write-protected character.

NOTE! The 32 special graphics characters are contained in the character generator at positions hex 80 to 9F. When you enable 8-bit data word mode you can send these characters from the computer with that code range; however, sending those codes from the host may cause software incompatibilities.

Graphics mode off Alphanumeric keys produce ASCII characters.

Controlling the Terminal's Operation

Data Word Mode	SET UP
	DEFAULT = 7 bits
Read 7-bit data words	ESC [= 1 l
Read 8-bit data words	ESC [= 1 h

7-bit words The terminal ignores (masks) the eighth data bit in each byte received from the computer.

8-bit words The terminal reads the eighth data bit in each byte received from the computer. See Figure 6-1 or Appendix G for the characters the terminal generates when it receives codes from hex A1 to FE. (Although the special graphics characters are contained in the terminal's character generator at positions 80 through 9F, generating them by sending those codes from the host may cause software incompatibilities.)

Block Graphics

Define block graphics area up to 80 columns wide	ESC H w h
Define block graphics area 81 to 132 columns wide	ESC H ~ w h

w = An ASCII character from Appendix E representing the length in character positions of the horizontal line that starts at the cursor and extends to the right.

To calculate **w** for a line longer than 80 character positions, subtract 80 from the length and find the corresponding ASCII character.

h = An ASCII character from Appendix E representing the height in character positions of the vertical line that starts at the cursor and extends down.

The **w** and **h** values define the outside dimensions of the rectangle.

You can outline one or more areas with horizontal and vertical lines. Figure 6-2 shows how the screen might appear with three overlapping blocks.

NOTE! Block graphics are limited by the length of the page and the defined scrolling region. If the block extends beyond the limits of the display, only part of it is visible. Entering values greater than the page results in a block that ends at the right or bottom margin.

Figure 6-2
Display with Three Blocks of Graphics

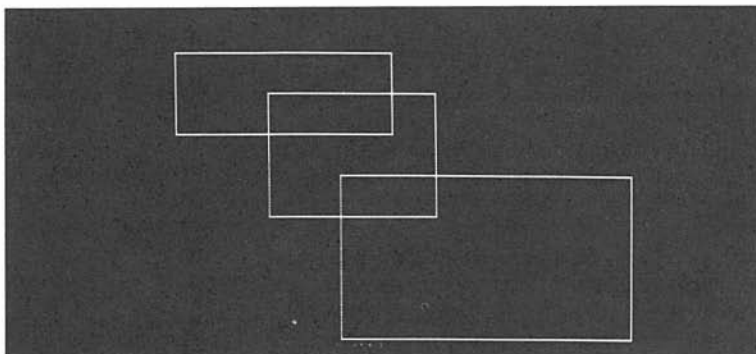

To create a block graphics area:

1. Position the cursor where you want the top left corner before entering the sequence.

NOTE! Executing this sequence does not move the cursor.

2. Define the width and height of the area with

ESC H w h

or

ESC H ~ w h

where w defines the width in character positions and h is the height in lines, as described above.

Special graphics mode does not affect block graphics.

Optional Graphics Firmware

Enable optional graphics firmware

ESC m

This command works only if you have an optional graphics board installed in your terminal.



7. EDITING

Editing commands affect cursor movement and your ability to change data on the screen.

EDITING MODES

Editing modes affect the action of many editing commands, some of which can cause loss of data. If you are unsure about the setting of a mode or the effect of a command, experiment on data you don't mind losing.

Autowrap Mode

SET UP
DEFAULT = On
ESC [= 7 h
ESC [= 7 l

Autowrap mode on
Autowrap mode off

Autowrap on The cursor wraps to the start of the next line if you enter a character when the cursor is on the current line's last position. Protect and autopage modes affect cursor movement in autowrap mode; see the sections about those modes for information on their effect.

Autowrap off Each character entered after the cursor reaches the line's last unprotected position replaces the previous one.

Autowrap mode does not change the effect of the cursor movement keys and commands.

New Line Mode

SET UP
DEFAULT = Off
ESC [= 6 h
ESC [= 6 l

New line mode on
New line mode off

New line on When the terminal receives a CTRL M (carriage return) code, either from the computer or from the RETURN key, the cursor moves down one line and then to the start of the line (LF/CR), as if it had received a CTRL _ (new line) code.

New line off Carriage return code causes only a carriage return.

NOTE! A line feed and then a carriage return command can cause different cursor movements from a carriage return and then a line feed command, depending on the setting of protect mode. A line feed command causes the cursor to enter a protected field; a carriage return does not. See Figure 7-1.

Figure 7-1
Effect of Line Feed and Carriage Return Commands

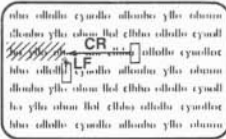

CR/LF

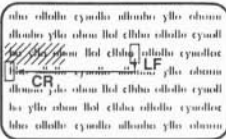

LF/CR

DOWN Key Mode

SET UP
DEFAULT = CTRL V
ESC [= 9 h
ESC [= 9 l

DOWN key sends CTRL J
DOWN key sends CTRL V

CTRL J DOWN key sends a line feed (CTRL J) code. The key actually sends the code in the memory of the shifted DOWN key.

CTRL V DOWN key sends a cursor down (CTRL V) code.

See Chapter 9 for other commands to reprogram the DOWN key.

Write Protect and Protect Modes

DEFAULT = Off
ESC)
ESC (

Turn on write protect mode
Turn off write protect mode

Turn on protect mode
Turn off protect mode

ESC &
ESC '

After you enable write protect mode, data you enter becomes a **write-protected field**. It appears in half intensity unless you have changed the normal intensity attribute.

Graphics characters and visual attributes are automatically write protected, so when you enable protect mode, they are protected.

When protect mode is on, cursor movement commands cannot cause data to scroll off the page and be lost. Only the insert character(s) command can cause loss of unprotected data.

NOTE! You can destroy protected data when the terminal is in 950 programming compatibility mode by changing an embedded visual attribute when the cursor is in a protected field. The new visual attribute destroys the character at the cursor position. The cursor then moves to the first unprotected position following the protected field.

The cursor can be anywhere when you turn on protect mode.

Table 7-1 describes the effects of protect mode.

Table 7-1
Effects of Protect Mode

Function	Effect
Data entry	No data, even unprotected, can scroll off the page. The cursor skips over protected fields during data entry.
Cursor movement	Cursor movement commands cannot cause protected or unprotected data to scroll off the page. Cursor up and down commands can move the cursor into a protected field but cursor right and left commands cause the cursor to skip over a protected field.
Editing	Enabling protect mode automatically enables line edit mode. When protect mode is on, the terminal ignores the command to enable page edit mode. Editing commands affect only unprotected data.
Tabulation	The first unprotected position after a protected field becomes a field tab stop. Pressing the TAB key or sending a tab command moves the cursor to the first field tab stop following a protected field.

Protect mode lets you

Protect designated areas from change

Control transmission of those areas

You can create forms with permanent (protected) headings and blank areas for an operator to fill in later. Figure 7-2 shows a typical form. Protecting the headings keeps them from being accidentally deleted or changed.

Creating protected data, such as a form, takes two steps:

Turn on **write protect** mode and enter the data you want to protect.

Turn on **protect mode** to guard all that data.

Figure 7-2
Sample Protected Form with Spaces Left for Data Entry

Sales Order ----- Sales Order Form Date: / /

Bill Company Name: _____ Ship Company Name: _____
 to: Address: _____ to: Address: _____
 City, State: _____ City, State: _____
 Zip Code: _____ Zip Code: _____

Item	Qty	Part Number and Description	Unit Price	Total Cost
1				
2				
3				
4				
5				
6				
7				
8				
9				
10				

Terms Net ___ Days Purchase Order Number: Subtotal:
 F.O.B.: Sales Contact: Tax:
 Shipper: Other Comments: TOTAL:

1. Position the cursor where you want to enter the first protected character.

2. Enter

ESC)

to activate write protect mode.

NOTE! You must turn on write protect mode **before** entering data to be protected.

3. Enter the information to be protected in that screen area. You can include visual attributes in the data. Whether the visual attribute occupies a position depends on whether you are using positioned or nonpositioned visual attributes.

4. Proofread the entry and correct it if necessary.

5. Enter

ESC (

to turn off write protect mode.

6. Move the cursor to the next area to be write protected and repeat the first 5 steps.

7. After you correctly enter all areas to be protected, protect the **whole form** from change by turning on protect mode.

ADDITIONAL SCREEN MEMORY

This section pertains only to terminals containing additional pages of memory. You can order kits from the TeleVideo spare parts department for one or three additional pages of memory. The default value of each page of memory is 24 lines. The commands in this section tell you how to configure the terminal's memory for 48 or 96 lines per page.

The term **page** (i.e., document) refers to an amount of memory. Not to be confused with page, **screen** refers to the face of the tube on which data appears. The **display** is the amount of data that can be viewed on the screen at one time--the viewable region.

Since the screen displays 24 lines at a time, the display you see on the screen may not contain the entire page. See Figure 7-3.

Figure 7-3
Partial Page of Memory Displayed on the Screen

```

la olam lal ellbu allallo cyuallo al
allallo cyuallo allolamo ylio olam lal c
la cyuallo allolamo ylio olam lal ellb
la olam lal ellbu allallo cyuallo al
olam allallo cyuallo allolamo ylio olam
allolamo ylio olam lal ellbu allallo cyual
la ylio olam lal ellbu allallo cyuallo
olam allallo cyuallo allolamo ylio olam
allolamo ylio olam lal ellbu allallo cyual
la ylio olam lal ellbu allallo cyuallo
olam allallo cyuallo allolamo ylio olam
la cyuallo allolamo ylio olam lal ellb
la olam lal ellbu allallo cyuallo al
allallo cyuallo allolamo ylio olam lal c
  
```

Selecting the Number of Lines per Page

DEFAULT = 24
 ESC \ Ps

Define number of lines on each page

Ps is a value for the lines per page.

Ps	Lines per page	Number of Pages	
		Four-Page Memory	Two-Page Memory
1	24	4	2
2	48	2	1
3	96	1	-

STOP! When you execute this command, the terminal:

- Clears all pages of memory
- Fills all pages with space characters
- Displays page one with the cursor on the home position
- Redefines the scrolling region as the entire 24 lines of the display

If your terminal contains three extra pages of memory, you can divide the terminal's total screen memory into one, two, or four pages.

If it contains only one extra page of memory, you can configure it as two 24-line pages or one 48-line page.

Without additional memory, the single page contains 24 lines.

Figure 7-4 shows the terminal's memory divided into pages.

Figure 7-4
Dividing Memory into Pages

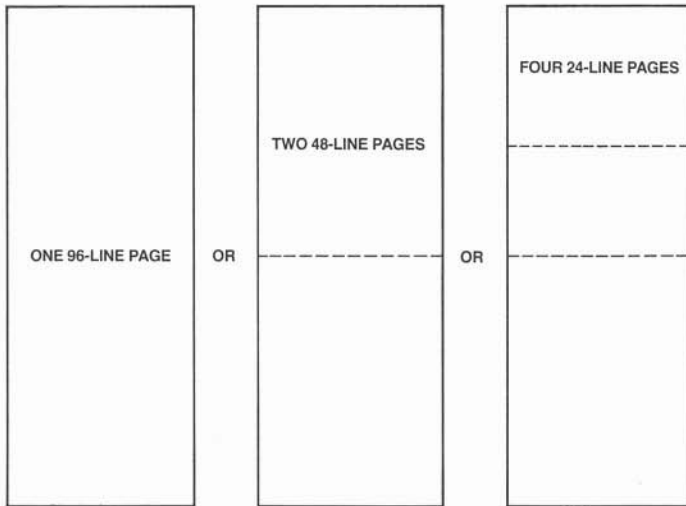

Autopage Mode

Autopage mode on
 Autopage mode off

DEFAULT = Off
ESC v
ESC w

Autopage on A new page in the terminal's memory moves onto the screen when the terminal receives a command to move the cursor beyond the current page.

A line feed or reverse line feed command moves the cursor to the first or last line of an adjoining page (while remaining in the same column position.) See Figure 7-5.

A cursor right, cursor left, or cursor addressing command displays the adjoining page when the cursor reaches the beginning or end of a page. When the cursor reaches the end of the last page, it returns to the beginning of the first page.

Data on a page that moves off the screen is not cleared. When you return to that page, your data reappears.

Autopage off Directional cursor movement commands cannot move the cursor out of the current page or cause a new page to be displayed. However, a cursor addressing command can display a new page.

Figure 7-5
Cursor Movement in Autopage Mode

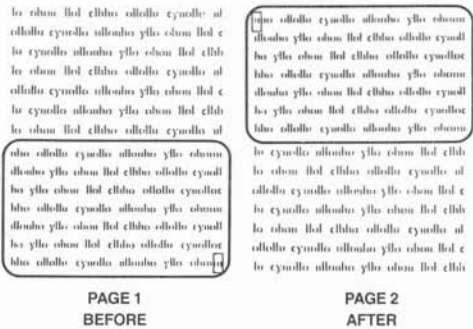

Moving to Another Page

Display the previous page

ESC J
key SHIFT PAGE

Display the next page

ESC K

Display page Pn

key PAGE
ESC [1 ; Pn }

Pn = A decimal value from 0 through 3

NOTE! The terminal can contain up to four pages of memory. The page numbers, however, are 0 through 3.

If you have already displayed the next or previous page, the cursor returns to its last location there after a next or previous page command. Otherwise, the cursor goes to the first unprotected (home) position. See Figure 7-6.

The command to display page Pn lets you move to any page in memory regardless of the page now displayed. The status of autopage mode is irrelevant.

Figure 7-6
Cursor Movement Between Adjacent Pages

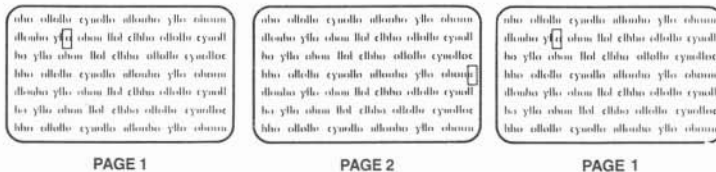

SCROLLING

Scrolling is the movement of the display (the screen area) through a page of memory on the screen. If your terminal has additional memory and your page size is greater than 24 lines, you can scroll the display up or down on the screen and view other parts of the **current page** with the all the cursor movement keys and commands and with the alphanumeric keys, i.e., by entering data.

NOTE! When protect mode is disabled, data entry from the computer or keyboard, as well as certain editing keys and commands, can cause the display to scroll into empty memory, resulting in a loss of data. Table 7-2 lists the keys and commands, and Figure 7-7 illustrates data loss from scrolling. To prevent loss of data, enable protect mode.

Table 7-2
Data Loss Due to Scrolling

Key	Command	Function
LINE FEED SHIFT DOWN	CTRL J	Line feed
SHIFT UP	ESC j	Reverse line feed
RIGHT	CTRL L	Cursor right
All character	--	Data entry from computer or keyboard

Controlling the Rate of Scrolling

Display scrolls smoothly at 4 lines per second

SET UP
DEFAULT Ps = 0
ESC 8

Display scrolls at the rate of received data

ESC 9

Select scroll rate

ESC [6 ; Ps v

Ps	Effect
0	Jump scroll
1	Display scrolls at 4 lines per second (normal)
2	Display scrolls at 2 lines per second (slow)
3	Display scrolls at 8 lines per second (fast)

The terminal's scrolling can be smooth or jump. Smooth scrolling moves the display at an even rate, regardless of how fast the terminal receives data. Jump scrolling displays data at the rate it is received.

NOTE! The terminal cannot control the scroll rate (smooth scroll) if you have not enabled a handshaking protocol (X-On/X-Off or DTR).

Defining a Scrolling Region

Define a scrolling region ESC [Pt ; Pb r

Pt = The (decimal) number of the first (top) line in the scrolling region

Pb = The (decimal) number of the last (bottom) line in the scrolling region

To control the lines through which the display can scroll, turn autopage mode off and define a scrolling region. This fixes certain lines on the screen, while permitting the display to move through the rest of the page.

NOTE! You cannot change data outside the scrolling region. It remains fixed on the screen, although the display can move through data within the scrolling region. Remember that changing the number of lines per page redefines the scrolling region as the whole screen.

Figure 7-7 shows how data is lost when the display scrolls up through one page of memory.

Line Lock

	DEFAULT = Disabled
Enable line lock	ESC ! 1
Disable line lock	ESC ! 2

You can lock selected lines on the screen with this command so they remain fixed, regardless of whether the display scrolls through the remaining lines. However, no more than 23 of the 24 lines on the screen may be locked.

The cursor must be in the line you intend to lock.

Disabling line lock unlocks all the lines on the screen.

Figure 7-7
Scrolling Movement Within a Scrolling Region

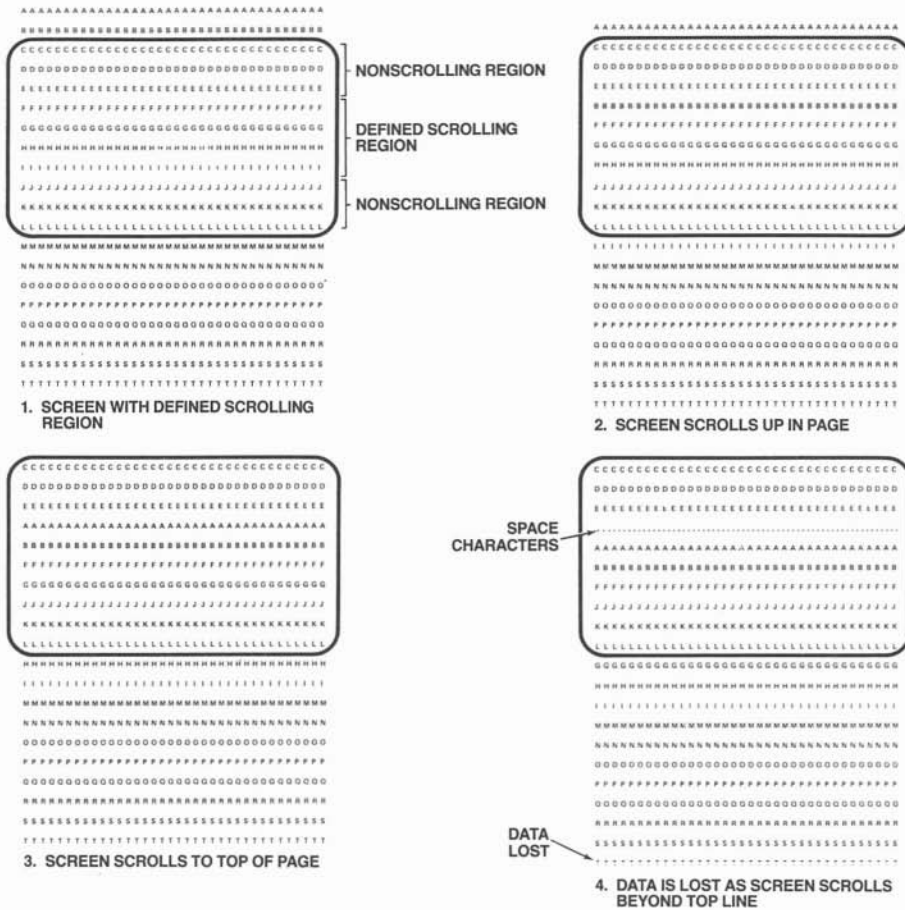

CURSOR CONTROL

You can control the movement of the cursor from the keyboard and by programming commands. Many cursor movements are affected by protect and autopage modes. The tables that follow each set of commands explain how they are affected.

Line Feed and Reverse Line Feed**Line feed**

CTRL J
key LINE FEED
key SHIFT DOWN
key DOWN*

Reverse line feed

ESC j
key SHIFT UP

*Depends on DOWN key mode selection.

A line feed code moves the cursor down one line without moving it sideways. A reverse line feed code moves it up. Autopage and protect modes can affect where the cursor goes after the terminal receives a line feed or reverse line feed code. Tables 7-3 and 7-4 summarize these effects.

STOP! Under certain conditions, line feed and reverse line feed codes may result in the loss of data. These conditions are described in the following tables.

Table 7-3
Effect of Line Feed Code on Cursor Movement

Modes		Effect
Auto-page*	Protect	
Off	On	The cursor moves down one line in the same column. If the cursor is at the bottom of the display and the page is configured for more than 24 lines, data rolls up one line. If the cursor is at the bottom of the page, it wraps around to the top line.

*If additional memory is installed.

Table 7-3 Continued
Effect of Line Feed Code on Cursor Movement

Modes		Effect
Auto- page*	Pro- tect	
Off	Off	Same as protect mode on, except if the cursor is at the bottom of the page, the display scrolls up one line. The page's top line is lost, and a new bottom line of space characters appears.
On	On/ Off	The cursor moves down to the next line. When it reaches that page's last line, it advances to the first line on the next page.

*If additional memory is installed.

Table 7-4
Effect of Reverse Line Feed Code on Cursor Movement

Modes		Effect
Auto- page*	Pro- tect	
Off	On	The cursor moves up one line. When it reaches the page's top line, it does not move any farther.
	Off	When the cursor reaches the page's top line, data scrolls down. A new top line filled with space characters appears, and the old bottom line is lost.
On Off	On/	When the cursor reaches the first line of the page, it returns to the last line of the previous page. If the cursor is on the first line of the first page, it does not move.

*If additional memory is installed.

Directional Cursor Movement

Move the cursor up	CTRL K key UP ESC [Pn A
Move the cursor down	CTRL V key DOWN* ESC [Pn B
Move the cursor right	CTRL L key RIGHT ESC [Pn C key SHIFT RIGHT
Move the cursor left	CTRL H key LEFT key BACK SPACE ESC [Pn D key SHIFT LEFT
New line (line feed/carriage return)	CTRL key SHIFT ENTER
Carriage return*	CTRL M key ENTER key RETURN

Pn = A decimal value specifying the number of moves.

*Depends on DOWN key mode selection.

The cursor right and left commands move the cursor over a protected field; the cursor up and down commands do not.

The cursor up and down commands do not move the cursor beyond the top or bottom of the page, and the ESC [Pn commands do not move the cursor beyond the beginning or end of the line. However, the cursor right and left control codes wrap the cursor around.

Table 7-5 summarizes the effect of the cursor movement commands.

Table 7-5
Effect of Cursor Movement Commands

Command	Modes		Effect
	Auto- page*	Pro- tect	
Cursor up CTRL K ESC [Pn A	Off/ On	Off/ On	Moves the cursor up within the present column until it reaches the top of the page. Additional commands have no effect.
Cursor down CTRL V ESC [Pn B	Off/ On	Off/ On	Moves the cursor down within column. When it reaches the last line of the page, subsequent commands have no effect.
Cursor left CTRL H ESC [Pn D	Off/ On	Off/ On	Moves the cursor left to an unprotected position. Wraps the cursor from the line's first unprotected position to the previous line's last unprotected position.
	Off	Off/ On	The cursor does not move beyond the page's first unprotected position.
	On	Off/ On	Wraps the cursor from a page's first unprotected position to the previous page's last unprotected position. The cursor does not move beyond the first page's first unprotected position.
Cursor right CTRL L ESC [Pn C	Off	Off	The cursor moves right to an unprotected position. A CTRL L command wraps the cursor from a line's last position to the next line's first position.

If the cursor is on the last column of the page's last line, a CTRL L causes data to scroll up one line. The page's first line is lost, and a new bottom line of space characters appears.

Table 7-5 Continued
Effect of Cursor Movement Commands

Command	Modes		Effect
	Auto- page*	Pro- tect	
Cursor right	Off	On	If the cursor is on a page's last unprotected position, CTRL L wraps it around to the same page's first unprotected position.
	On	Off/ On	If the cursor is on a page's last unprotected position, CTRL L advances it to the next page's first unprotected position. If it is on the on the last page, it advances to the first page's first unprotected position.
New line (CTRL _)	Off/ On	Off/ On	Same as line feed and then carriage return (CTRL J and CTRL M). Moves the cursor to the first unprotected position on the next line.
Car- riage return (CTRL M)	Off/ On	Off/ On	Moves the cursor to the current line's first unprotected position.**
	Off/ On	On	If the cursor is on the line's only unprotected position, it does not move.

*If additional memory is installed.

**When line feed/carriage return has been selected, performs a line feed, then a carriage return.

Addressing the Cursor

Address (send) cursor to page, row, and columns 1 through 80	ESC - p r c
Address (send) cursor to page, row, and columns 81 through 132	ESC - p r ~ c
Address (send) cursor to row and columns 1 through 80 in current page	ESC = r c
Address (send) cursor to row and columns 81 through 132 in current page	ESC = r ~ c

p Page

0 One
1 Two
3 Three
3 Four

r = An ASCII character from the cursor coordinate table (Appendix E) for the row (line).

c = An ASCII character from Appendix E for the column. To calculate the value of c for columns 81-132, subtract 80 from the column number and find the corresponding ASCII character.

These commands, called **addressing** or **loading** the cursor, let the computer move the cursor to a specific location within the terminal's memory. When the cursor is in 80-column mode, you can address the cursor to an undisplayed memory area in columns 81 through 132 with this command and enter data there.

NOTE! If your computer inserts nulls between characters, addressing the cursor moves it to an unpredictable position.

For example,

ESC = (Q

sends the cursor to row 9, column 50 of the current page.

ESC = (~ Q

sends the cursor to row 9, column 130 of the current page.

Reading the Cursor

Read cursor's page, row, and column position	ESC /
Read cursor's row and column position	ESC ?

These commands tell the terminal to report (i.e., read) the cursor's current position to the computer.

The terminal responds with ASCII characters representing page, row and column, followed by a CR character. The page number is reported as one of the following values:

Value	Page
0	One
1	Two
2	Three
3	Four

Row and column positions are values from Appendix E.

If the cursor location lies from column 81 to column 132, the report will include a ~ between the row and column values. To calculate the column value, add 80 to the column number from Appendix E.

For example, the terminal would respond to the command

ESC ?

from the computer with

(Q CR

to indicate the cursor position is row 9, column 50 of the current page, or

(~ Q CR

to indicate a position of row 9, column 130.

Addressing the Cursor in Decimal Units

Address the cursor to line and column of ESC [P1 ; Pc H
 the current page in decimal units or ESC [P1 ; Pc f

P1 = A decimal value with one or two digits for the row
 (line).

Pc = A decimal value with one, two or three digits for
 the column.

This command sends the cursor to a designated line and column within the current page.

If the cursor address is in a nonexistent area, the command moves the cursor to the current line's right or bottom margin.

If you enter no variables, the cursor moves to home position.

Cursor Home

Move cursor to home position CTRL ^
 key HOME
 or ESC [H
 key SHIFT HOME

This command moves the cursor to the page's first unprotected position (usually home position, row 1 and column 1). It has no effect if the cursor is already there.

Reading the Cursor in Decimal Units

Read cursor's page, line, and column ESC [? 6 n
 position in decimal units
 Read cursor's line and column position ESC [6 n
 in decimal units

The terminal responds in the format ESC [Pp ; P1 ; Pc R or ESC [P1 ; P1 R. Page, line, and column are decimal units.

TAB STOPS

The terminal has two types of tab stops:

Typewriter (recognized only when protect mode is off)

Field (recognized only when protect mode is on)

Setting a Column of Tab Stops

Set field (protect mode on) or typewriter ESC 1
 (protect mode off) tab stops key SHIFT TAB*

*Main keypad only.

STOP! This command can destroy data during protect mode.

Turning protect mode on automatically sets field tab stops at the first unprotected position after each protected field.

Sending ESC 1 during protect mode creates a column of protected space characters at the cursor position, **destroying the characters that occupy that column.** The column extends down from the cursor line until it encounters a protected character.

The first unprotected position **after** the protected space character in each line becomes a field tab stop. The cursor moves from the new protected space character to the new field tab stop. See Figure 7-8.

After protect mode is turned off, the protected column remains as write-protected space characters.

When protect mode is off, sending ESC 1 creates a tab stop in every line on the screen **at the cursor's current column position.**

Be sure you enter a number one in the command. A lowercase L turns on duplex edit mode.

Figure 7-8
Setting Field Tab Stops

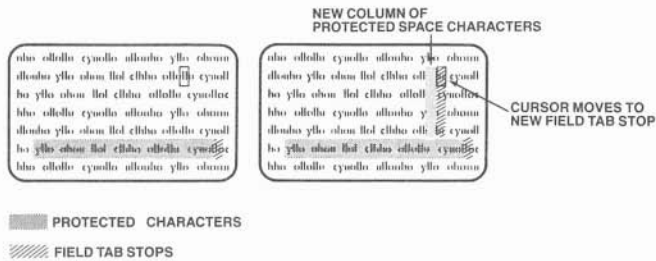

Moving the Cursor to a Tab Stop

Move cursor forward to next typewriter or field tab stop **CTRL I**
key TAB

Move cursor forward to next field tab stop (protect mode on) **ESC i**

Move cursor backward to previous typewriter or field tab stop **ESC I**
key BACK TAB

All tabulation commands are affected by protect mode. When protect mode is off, CTRL I and ESC I move the cursor to a typewriter tab stop; when it is on, they move it to a field tab stop. And when protect mode is off, ESC i has no effect. Table 7-6 describes how protect mode affects tabulation commands.

Table 7-6
Effect of Protect Mode on Tabulation Commands

Command	Protect Mode	Effect
Tab forward (CTRL I)	Off	Moves the cursor to the next typewriter tab stop. If no more tab stops exist, the cursor does not move.
	On	Moves the cursor to the first position in the next unprotected field (next field tab stop). If no more unprotected fields exist, the cursor returns to the first unprotected position on the same page or the next page (if additional memory is installed and autopage mode is on).

Table 7-6 Continued
Effect of Protect Mode on Tabulation Commands

Command	Protect Mode	Effect
Tab backward (ESC I)	Off	Moves the cursor back to the previous typewriter tab stop. If the cursor is already on the line's first tab position or if no other tabs stops exist, the cursor moves to the first column of the line.
	On	Moves the cursor back to the first position in the current or previous unprotected field. If the page has no previous unprotected positions, the cursor does not move, or it returns to the last unprotected field on the previous page (if the terminal has additional memory and autopage mode is on).

Clearing Typewriter Tab Stop(s)

Clear typewriter tab stop at cursor location	ESC 2 key SHIFT BACK TAB
Clear all typewriter tab stops	ESC 3 key SHIFT CE

Protect mode does not affect these commands. The cursor's position is irrelevant when you clear all tab stops.

Clearing Field Tab Stop(s)

Field tab stops are not cleared with a command. However, you can disable them by turning protect mode off. When you turn it on again, you restore the previous field tab stops.

EDITING DATA

You can edit data in five ways:

Write over existing text

Insert character(s) (singly or a line)

Delete a character or a line of existing text

Erase existing text (leaving replacement or null characters in its place)

Clear data

The terminal must be in replace mode to write over existing text.

Line and Page Edit

Enable page edit mode

DEFAULT = Line

ESC N

Enable line edit mode

ESC O

Line edit mode When you insert or delete characters, existing data on moves forward or backward only on the current line. Data pushed beyond the end of the line is lost. The terminal automatically enables line edit mode when you turn on protect mode.

Page edit mode Existing data wraps around from line to line. Data moves to the end of the page before it is lost. When protect mode is on, the terminal ignores the command to enable page edit mode.

Insert and Replace Mode

Enable insert mode

ESC q

key SHIFT CHAR INSERT

Enable replace mode

ESC r

key SHIFT CHAR DELETE

Insert mode Existing data is pushed aside (to the right) by new data as you enter it. Data pushed to the end of the line or page is lost (depending on whether the terminal is in line or page edit mode).

Replace mode New data replaces (writes over) existing data as you enter it.

The Replacement Character

Load a replacement character

DEFAULT Ps = Space
ESC e Ps

Ps = Any ASCII character.

Some editing commands replace data with a predefined replacement character. You can reprogram this character as any ASCII character. This command lets you replace data with characters such as an underline or asterisk.

Inserting DataInsert a replacement character at
the cursor positionESC Q
key CHAR INSERTInsert Pn replacement characters
starting at the cursor

ESC [Pn @

Insert a line of replacement characters
on the current lineESC E
key LINE INSERTInsert Pn lines of replacement characters
starting at the cursor line

ESC [Pn L

Pn = A decimal value

Table 7-7 describes how protect mode affects the action of insert commands.

Table 7-7
Effect of Protect Mode on Insert Commands

Command	Protect Mode	Effect
Insert character (ESC Q) or characters (ESC [Pn @)	Off	Enters replacement character(s) at the cursor position and moves the existing characters right, starting at the cursor. Data pushed past the last line or page position is lost.
	On	Same as above, but only unprotected characters in the current field move. Characters reaching the first protected position or the end of the line (whichever comes first) are lost.
Insert line (ESC E) or lines (ESC [Pn L)	Off	Inserts line(s) of replacement characters starting at the current line; moves all following lines down. Cursor moves to column one of the first inserted line. Lines pushed off the page are lost.
	On	No action.

Deleting Data

Delete character at cursor position	ESC W key CHAR DELETE
Delete Pn characters starting at the cursor position	ESC [Pn P
Delete current line and replace with replacement characters	ESC R key LINE DELETE
Delete Pn lines, starting at cursor line, and replace with replacement characters	ESC [Pn M

Pn = A decimal value.

Deleting **removes** unprotected data only, starting at the cursor position, and pulls the remaining characters back to the cursor position. Replacement characters appear at the end of the line or the page.

Figure 7-9 shows what happens when you delete data in a line.

Figure 7-9
Deleting Data

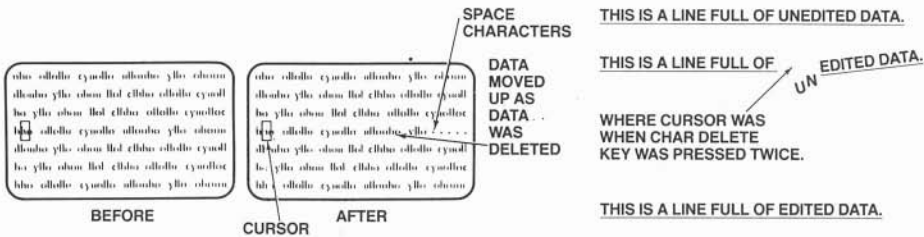

Table 7-8 describes how protect mode affects the action of delete commands.

Table 7-8
Effect of Protect Mode on Delete Commands

Command	Protect Mode	Effect
Delete a character (ESC W) or characters (ESC [Pn P)	Off	Deletes character(s) starting at the cursor; pulls the following characters left.
	On	Same as protect off except only unprotected characters within the cursor's field are deleted.
Delete a line (ESC R) or lines (ESC [Pn M)	Off	Deletes line(s) starting at the cursor line and moves remaining lines up. Moves the cursor back to the first remaining line's first position.
	On	No action.

Erasing Data

Erase from the cursor to end of line; replace with replacement characters	ESC T key LINE ERASE
Erase in the current line; replace with with replacement characters	ESC [Ps K
Erase from the cursor to end of line; replace with null characters	ESC t key SHIFT LINE ERASE
Erase from the cursor to end of page; replace with replacement characters	ESC Y key PAGE ERASE
Erase in the page; replace with replacment characters	ESC [Ps J
Erase from the cursor to end of page; replace with null characters	ESC y key SHIFT PAGE ERASE

Ps Amount Erased

- 0 From cursor to end of line/field or page
- 1 Start of line/field or home position to cursor
- 2 Entire (unprotected) line/field or page

Erasing **replaces** unprotected characters **only** with null or replacement characters, as shown in Figure 7-10. The cursor and existing data do not move.

NOTE! Write protected characters are not protected until you enable protect mode. To avoid losing write protected data, enable protect mode before sending an erase command.

Figure 7-10
Erasing Data

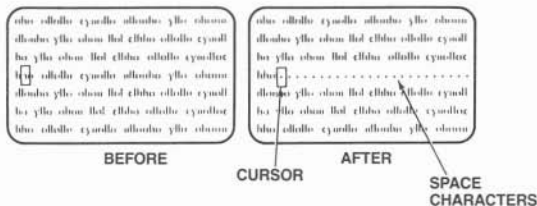

Clearing Data

Clear current unprotected field and replace with replacement characters. Return cursor to beginning of field (protect mode on); or clear current tab field or whole line and move cursor to beginning of current tab field or line (protect mode off)

CTRL X
key CE

Clear all characters and replace with null characters (reset protect and write protect modes)

ESC *
key SHIFT CLEAR SPACE

955 mode: Clear all characters and replace with replacement characters (reset protect and write protect modes)
950 mode: Clear unprotected characters and replace with replacement characters (do not reset write protect and protect modes)

ESC +

955 mode: Clear unprotected characters and replace with write protected space characters (reset protect mode)
950 mode: Clear unprotected characters and replace with write protected space characters (do not reset protect mode)

ESC ,

Clear unprotected characters and replace with replacement characters

ESC ;
or CTRL Z
key CLEAR SPACE

Clear unprotected characters and replace with null characters

ESC :

When you clear data, you replace data with space, null or replacement characters. The cursor moves to the home position (or, if protect mode is on, to the page's first unprotected position). Unlike the previous editing commands, clearing data does not depend on the cursor's position; what you clear depends only on the command you give or the key you press.

Table 7-9 summarizes the actions of clear commands.

Table 7-9
Clear Commands

Command	Effect
Clear field to replacement characters (CTRL X)	<p>If protect mode is off and typewriter tab stops are set, clears all characters between the typewriter tab stops before and after the cursor to replacement characters. The cursor moves to the beginning of that field.</p> <p>If no typewriter tab stops exist, replaces the current line with replacement characters and returns the cursor to the beginning of the line.</p> <p>If protect mode is on, clears the unprotected cursor field. The cursor moves to the beginning of that field.</p>
Clear all to null characters (ESC *)	Changes all data to null characters. Moves the cursor to home position. Turns off protect and write protect modes, if on. (Initial cursor position is irrelevant.)
Clear all to replacement characters (955 compatibility ESC +)	Changes all data to replacement characters. Moves the cursor to home position. Turns off protect and write protect modes, if on. (Initial cursor position is irrelevant.)
Clear unprotected to write protected space characters (ESC ,)	<p>955 compatibility: Changes unprotected data to write-protected space characters. Moves the cursor to home position. Turns off protect mode, if on. (Initial cursor position is) irrelevant.)</p> <p>950 compatibility: Changes unprotected data to write protected space characters. Moves the cursor to home position. Does not reset protect mode. (Initial cursor position is irrelevant.)</p>

Table 7-9 Continued
Clear Commands

Command	Effect
Clear all unprotected to replacement characters (ESC ; or CTRL Z or 950 compatibility ESC +)	Changes all unprotected data to replacement characters. Moves the cursor to the first unprotected position. (Cursor's initial position is irrelevant.) Does not reset protect mode.
Clear all unprotected to null characters (ESC :)	Changes all unprotected data to null characters. Moves the cursor to the first unprotected position. (Cursor's initial position is irrelevant.)

8. COMMUNICATIONS

This chapter tells you how to set the terminal's operating values so it can communicate with a computer and printer. It also explains how to send data from the screen and how to load and send special messages.

CHANGING PORT OPERATING VALUES

Select main port operating values
Select printer port operating values

p1	Baud Rate
1	50
2	75
3	110
4	135
5	150
6	300
7	600
8	1200

SET UP

ESC { p1 p2 p3 p4
ESC } p1 p2 p3 p4

p1	Baud Rate
9	1800
:	2400
;	3600
<	4800
=	7200
>	9600
?	19200
@	38400*

*Main port only.

p2 Stop Bits

0	1
1	2

p3 Parity

0	No
1	Odd (receive/transmit)
3	Even (receive/transmit)
5	Mark
7	Space

p4 Word Length

0	8 bits
1	7 bits

This command temporarily changes the operating values of either of the terminal's RS-232C ports. Unless you save the new values in nonvolatile memory (see Chapter 5), they are lost when you turn off the power.

An an example, if you enter

```
ESC { < 0 3 1
```

the computer port's values become

```
Baud rate      4800
Stop bits      One
Parity         Even
Word length    7 bits
```

SETTING UP COMMUNICATIONS WITH THE COMPUTER

Before the terminal can send and receive data, you must set its handshaking protocol and data word and communication modes.

Selecting a Handshaking Protocol

```
SET UP
DEFAULT Ps = 1
CTRL N
CTRL O
```

Disable X-On/X-Off; enable DTR line

Enable X-On/X-Off; disable DTR line

Select the terminal's handshaking protocol

```
ESC [ 1 ; Ps v
```

Ps	Protocol
0	No protocol
1	X-On/X-Off
2	DTR
3	Both protocols

Sometimes the computer sends data faster than the terminal or its printer can receive it. Part of the data may be lost. The terminal sends signals to the computer called **handshaking protocols** to prevent this data loss. You can use X-On/X-Off or Data Terminal Ready (DTR) as the handshaking protocol between the terminal and the computer. (Or you can select both.)

The terminal's 256-character receive buffer holds data received through the computer port. If you enable the X-On/X-Off handshaking protocol, the terminal transmits the ASCII X-Off control character to the computer (asking it to stop sending data) as soon as the buffer's fill limit (selected in set up or with a command in this section) is reached.

When only 16 characters remain in the receive buffer after the screen has been updated, the terminal sends the computer an X-On character (telling it to resume data transmission to the terminal). While X-On/X-Off is enabled, voltage on the DTR line remains high.

Disabling X-On/X-Off activates the DTR line. Voltage on the DTR line drops when the receive buffer (from the computer port) reaches its fill limit. When only 16 characters remain in the receive buffer, the terminal raises voltage on the DTR line, signaling the computer that it may resume sending data.

Receive Buffer Fill Limit

SET UP

Select the receive buffer fill limit

DEFAULT Ps = 0

ESC [2 ; Ps v

Ps	Fill Limit (Bytes)
0	16
1	32
2	64
3	128

This command selects the byte capacity remaining in the terminal's receive buffer when the terminal sends the X-Off code to the computer or lowers the voltage on the DTR line.

Transmission Control Mode

SET UP

Transmission control on
Transmission control off

DEFAULT = Off

ESC [= 0 h

ESC [= 0 l

Transmission control on The terminal accepts X-On/X-Off signals from the computer. If the terminal sends data faster than the computer can receive it, the computer sends X-Off to tell the terminal to stop sending data. When the computer's receive buffer empties the computer sends X-On.

Transmission control off The terminal ignores X-On/X-Off signals from the computer.

Selecting the Transmit Delay Rate	SET UP
Select the character transmit delay rate	DEFAULT = 0
	ESC [0 ; Pn v

Pn = 0 to 7 character delays per character transmitted

This command causes the terminal to insert delays in the character transmit rate. The delays can range from zero to seven character delays per character transmitted.

NOTE! This command does not change the baud rate.

Communication Modes

Communication modes determine when and where data from the keyboard goes and how interaction with the computer takes place. You can change the current communication mode in the set up menus or with programming commands.

The 955 has four communication modes:

- Block
- Local
- Half duplex (conversational)
- Full duplex (conversational)

Table 8-1 describes each communication mode, and Figure 8-1 shows how data flows in each mode.

Table 8-1
Communication Modes

Name	Effect
Block	In block mode the terminal first sends data only to the screen, so you can edit it before sending it to the computer. Block mode sends data faster than the conversational modes because the terminal transmits faster than you can enter data on the keyboard. The terminal can receive data from the computer in block mode.
Local	The terminal's main (computer) port is turned off. All commands and keyboard entries go only to the terminal's screen, and the terminal cannot receive any data from the computer.

**Table 8-1 Continued
Communication Modes**

Name	Effect
Half duplex	The terminal sends keyboard entries to the screen and to the computer at the same time. Although it is a conversational mode, it does not permit the terminal to transmit and receive simultaneously.
Full duplex	The terminal sends keyboard entries only to the computer. If the computer is programmed to act on a code generated by a keyboard entry, it may echo the result back to the terminal. The terminal can transmit and receive simultaneously.

**Figure 8-1
Data Flow in Communication Modes**

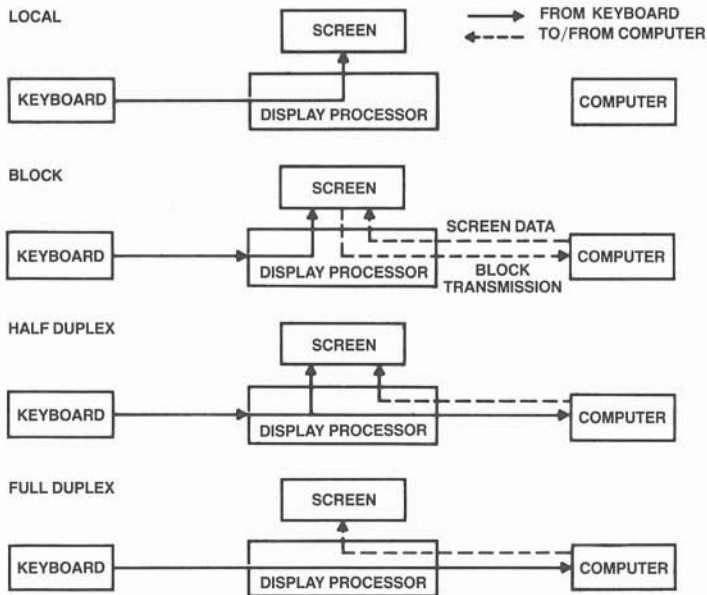

Setting the Communication Mode

Block mode on
Local mode on

SET UP
DEFAULT = FDX
ESC B
ESC c

Half duplex mode on
Full duplex mode on

ESC D H
ESC D F

Return to previous conversational mode (half or full duplex) from block or local mode

ESC C

These commands let you move from one communication mode to another while you are running a program. The terminal returns to the communication mode selected in set up after you turn it off and back on or reset it.

SENDING SCREEN DATA

During full or half duplex mode, data entered on the keyboard goes to the computer immediately. But during block mode, sending it to the computer is a separate step. You can either press the shifted/unshifted SEND key or enter an escape sequence to send specific data.

You cannot send data to the computer in local mode.

Delimiters

Delimiters are data separators that tell the computer how much data the terminal has sent (a field, a line), or they can indicate the end of the transmission. Some transmission commands cause the terminal to automatically add delimiters for the beginning and end or in place of a field, the end of a line, or the end of the transmission. Unless you reprogram these delimiters, the terminal sends the control characters listed in Table 8-2.

NOTE! The terminal does not transmit nulls in the delimiter code to the computer.

Table 8-2
Default Delimiter Values

Delimiter	ASCII Character	Byte Value (in hex)
Field separator	FS NUL	1C 00
Start protect field	ESC)	1B 29
End protect field	ESC (1B 28
End of line	US NUL	1F 00
Termination	CR NUL	0D 00

Reprogramming Delimiters

Reprogram delimiter characters ESC x Ps p1 p2

Ps	Delimiter
0	Field separator
1	End of line
2	Start of protected field
3	End of protected field
4	Message terminator

p1 and p2 are ASCII characters

This command changes the delimiter characters stored in nonvolatile memory. It lets you define the line, field, and termination delimiters included when the terminal sends a screen data.

If you don't want any delimiters, program p1 and p2 as null characters. The terminal does not send null characters to the host in a delimiter.

Data Markers

You can define the amount of data affected by some of the send commands by including a start of text (STX) character where you want data transmission to begin and an end of text (ETX) character where you want it to stop. Because these markers are ASCII control characters, they occupy a character position. To insert the characters, put the the terminal in monitor mode or enter ESC CTRL B (for STX) or ESC CTRL C (for ETX).

Sending Text

Send unprotected characters in cursor line up to and including cursor	ESC 4
Send unprotected page up to and including cursor	ESC 5
Send entire line of data up to and including cursor	ESC 6 key SHIFT SEND
Send entire page up to and including cursor	ESC 7 key SEND
Send unprotected message between start of text (STX)* and end of text (ETX)**	ESC S
Send whole message between start of text (STX)* and end of text (ETX)**	ESC s

*If no STX character is present, text starts at home position.
 **If no ETX character is present, sends through end of the page.

These commands define the quantity and type of data sent to the computer. If the data contains more than one set of STX and ETX characters, the STX character above and nearest the cursor and the following ETX character affect data transmission.

Table 8-3 describes the effect of send commands. Turn back to Table 8-2 for default delimiter values.

Table 8-3
Send Commands

Command	Effect
Send unprotected line (ESC 4)	Sends all unprotected data on the line between and including column one and the cursor. Delimiters --Sends a field separator in place of each protected field and a termination character after the transmission.
Send unprotected page (ESC 5)	Sends unprotected data between and including the page's first unprotected position and the cursor. Delimiters --Sends a field separator for each protected field, line delimiter after each line, and a termination character after the transmission.
Send entire line (ESC 6)	Sends all data between and including first and cursor positions. Delimiters --Sends a termination character after the transmission. Brackets protected fields with start and end protected field delimiters.*
Send entire page (ESC 7)	Sends all data between and including home and cursor positions. Delimiters --Sends line delimiter after each line and a termination character after the transmission. Brackets protected fields with start and end protected field delimiters.*

*When protect mode is on, a field of graphics characters is bracketed by ESC \$ and ESC %, and the terminal sends ESC G Ps for visual attributes.

Table 8-3 Continued
Send Commands

Command	Effect
Send unprotected message (ESC S)	<p>Sends all unprotected data between either STX character (if the cursor follows an STX character) or first unprotected position (if the cursor is before the STX character) and ETX character. Cursor moves to ETX character.</p> <p>If the page has no STX character, sends all unprotected characters starting at the first unprotected position and continuing until the ETX character. Moves cursor to ETX character.</p> <p>If the page has no ETX character, sends all unprotected data between either the STX character (if cursor follows STX character) or the first unprotected position (if the cursor is before the STX character) and the end of the page. Moves the cursor to the first unprotected position. If the page has no STX or ETX characters, sends all unprotected data.</p> <p>Delimiters--Sends a field separator in place of each protected field, line delimiter after each line, and a termination character after the transmission.</p>

Table 8-3 Continued
Send Commands

Command	Effect
Send entire message (ESC s)	Sends all data between the STX character (if the cursor follows the STX character) or home (if the page lacks an STX character or the cursor is before the STX character) and the ETX character. Moves the cursor to the ETX character.
	If page has no ETX character, the terminal sends all data between either the STX character (if the cursor follows the STX character) or home (if the cursor is before the STX character) and the end of the page. Moves the cursor to the home or first unprotected position.
	If page has no STX or ETX character, sends everything. Moves the cursor to home or the first unprotected position.
	Delimiters --Sends a line delimiter after each line and a termination character after the transmission. Each protected field is bracketed by start and end protected field delimiters.*

*When protect mode is on, a field of graphics characters is bracketed by ESC \$ and ESC %, and the terminal sends ESC G Ps for visual attributes.

LOADING AND SENDING MESSAGES

The 955 terminal can display two information lines. The first is at the top of your screen, above the 24 data display lines, and the other is at the bottom of the screen. Normally, the top line is blank and the bottom line displays the status line.

The 955 can store two separate user messages in memory, plus a small status line message. You can display either user message on either information line.

The commands in this section tell you how to load and display information line and identification messages and how to send them to the computer.

Sending the Terminal's Identification**Send terminal's identification****ESC M**

When the terminal receives this command, it returns an identification message to the computer. The message content depends on the terminal compatibility mode:

Mode	Bytes	Message
955	10	955<space>R.0,m<CR>
950	6	R.0,m<CR>

R = Firmware revision level

0 = Firmware revision sublevel

m = Memory size in Kbytes:

0	2 Kbytes
1	4 Kbytes
3	8 Kbytes

The Answerback Message**SET UP****Program the answerback message****ESC ^ <text>****CTRL Y****Send the answerback message****CTRL E**

You can reprogram the terminal's answerback message. The text can contain up to 16 ASCII control or display characters. To include CTRL Y or CTRL P as a display character in the text, rather than a command, precede it with CTRL P (which is not counted as a character in the text). The terminal stores the reprogrammed message in nonvolatile memory.

The default message is blank.

Displaying the Bottom Information Line's Contents

Display user message one on the screen's bottom line **ESC g**

Display the status line on the screen's bottom line **ESC h**

These commands let you choose the type of information displayed on the screen's bottom line.

Selecting Both Information Lines' Contents

SET UP
 DEFAULT Ps = 0/1
 ESC [4 ; Ps v
 ESC [5 ; Ps v

Select the contents of the top information line

Select the contents of the bottom information line

Ps	Type of Information
0	Blank
1	Status line
2	User message one
3	User message two

Loading the User Messages

Load text into user message one

ESC f <text>
 CTRL M

Load text into a user message

ESC _ p1 p2
 <text> CTRL M

p1 User Message

0	Message field in status line
1	User message one
2	User message two

p2 Effect

0	Clears the message before loading
1	Writes over existing message

NOTE! The status line message is saved in the terminal's nonvolatile memory. The user messages, however, are not. When you turn off the power or reset the terminal, they are lost.

You can enter 79 or 131 display characters and commands in the user messages. Like the screen's other display lines, the information lines contain 80 or 132 character positions. The first character is always the current visual attribute (default is reverse video). You can change this visual attribute, but you cannot write over it with a display character.

The status line message contains seven characters.

If you want to change only part of the message, enter a value of 1 for p2, then move the cursor to the first character you want to change. To move the cursor within the message, enter the command CTRL I Pc or CTRL I ~ Pc (for column positions 81-132), where Pc is a column position value from Appendix E.

Until you enter text in the user messages, they are blank (except for the visual attribute in the first character position).

The following example shows how to enter text into user message one on the bottom information line:

1. Display user message one on the bottom information line (if you want to see the message as you enter it) with

ESC g

or

ESC [5 ; 2 v

2. Enter the command

ESC f

or

ESC _ 1 0

to clear the previous text and start loading new text into user message one.

3. Change the visual attribute in the first character position if desired. The default attribute is steady characters in reverse video.
4. Enter up to 79 or 131 characters of text. If you displayed the user message before entering text, you can see the message on the information line as you enter it. However, the cursor does not enter the line during the data entry.
5. You can also include visual attributes (described in the previous chapter) any place in the message with the command ESC G Ps. Remember to count these commands as part of the text characters.

6. Enter

CTRL M

to end the message.

Sending the Information Line Contents**Send the information line contents****ESC Z Ps****Ps Information Line Contents**

0	User message one
1	Status line
2	User message two

You can send either user message or the status line to the computer with this command.

THE FUNCT KEY

The FUNCT key transmits the ASCII code of the next alphanumeric key pressed. That code is bracketed by the SOH (start of header) and carriage return (CR) ASCII control characters (shown in the ASCII Code Chart in Appendix C).

Using the FUNCT key is similar to using the SHIFT key. For example, if your word processing program requires the sequence **SOH C CR**, you would hold down the FUNCT key while you press C.

The FUNCT key only works with alphanumeric (character) keys; don't press an editing key with the FUNCT key.

Because the terminal only transmits the codes to the computer (it does not echo them to the screen), the communication mode in effect is irrelevant.

NOTE! You may need to program your computer's input/output string routine to catch the entire string and then process it. (If you are using an interrupt-driven computer, you do not need to worry about data being lost.)

PRINTING

If you connect a printer to the terminal, you can print data from the computer or the terminal's screen memory. The terminal's print modes determine how data is transmitted through the terminal.

For information about buffered printing, see the section on printer handshaking protocols.

Print Commands	SET UP
	DEFAULT = Off
Buffered copy print mode on	ESC @
Buffered copy print mode off	ESC A
Buffered transparent print mode on	ESC `
Buffered transparent print mode off	ESC a
Buffered bidirectional print mode on	CTRL R
Buffered bidirectional print mode off	CTRL T
Print unprotected formatted page	ESC P
Print all unformatted page	key PRINT
	ESC L
	key SHIFT PRINT
Page print	ESC [0 ; Ps i

Ps	Amount Printed
0	Formatted all
1	Formatted unprotected
4	Unformatted all
5	Unformatted unprotected

All print modes are mutually exclusive; you can only enable one at a time. The terminal responds to a page print command during any print mode (page print is a command, not a mode.)

Figure 8-2 shows the flow of data in print modes and Table 8-4 describes print modes and commands.

Figure 8-2
Print Modes

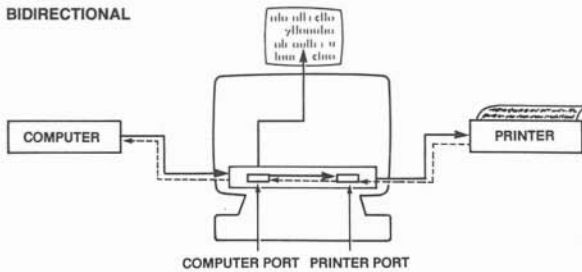
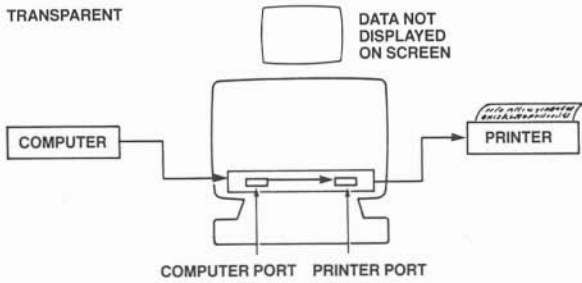
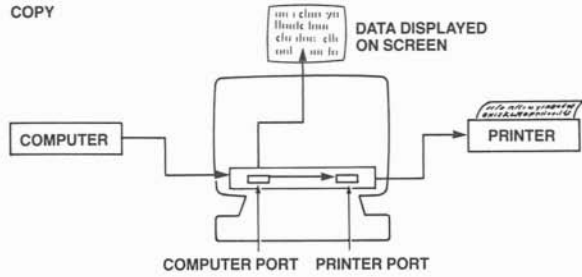

Table 8-4
Print Commands

Mode/Command	Effect
Buffered copy print	All data from the computer or the keyboard goes to both the screen and the printer. Computer and printer baud rates can differ.
	When the terminal receives the command to disable buffered copy mode, incoming data goes to the screen only. Data in the terminal's print buffer continues going to the printer until the print buffer is empty.
Buffered transparent print	Data from the computer or keyboard passes through the terminal to the printer without being displayed on the screen. During transparent print, you cannot edit the existing screen display. Computer and printer baud rates can differ.
	When the terminal receives the command to disable buffered copy mode, data from the computer or keyboard again goes to the screen. Data in the terminal's print buffer continues going to the printer until the print buffer is empty.
Buffered bidirectional print	Data can pass both directions through the terminal. Data from the computer or keyboard also goes to the screen; data from the printer passes through the terminal to the computer but is not displayed on the screen. Computer and printer baud rates may differ.
	When the terminal receives the command to disable bidirectional printing, the screen continues to display incoming data. The terminal no longer transmits data from the printer to the host, and printing stops after the terminal's print buffer empties.

Table 8-4
Print Commands Continued

Mode/Command	Effect
Page print	<p>Prints the contents of the screen memory (page) from the first character position through the cursor position. Sends space characters in place of graphics characters.</p> <p>With one page of memory, screen updating (from keyboard or computer) halts during transmission. The terminal sends ACK to the computer after transmission, and screen updating resumes.</p> <p>Whether or not the terminal displays the next page of memory (if optional memory is installed) during a page print depends on your selection of flip or no flip mode in set up or by a programming command. See the section on page print flip mode following this table.</p>
Formatted all (ESC [0 ; 0 i)	Sends all characters. Adds CR, LF, and null characters after each line.
Formatted unprotected (ESC P or ESC [0 ; 1 i)	Adds CR, LF and null characters after each line. Protected data is replaced by space characters.
Unformatted all (ESC L or ESC [0 ; 4 i)	Sends all characters. Does not add CR, LF, and null characters.
Unformatted unprotected (ESC [0 ; 5 i)	Same as above, but protected data is replaced by space characters.

Page Print Flip Mode

SET UP
DEFAULT = On
ESC [= 15 h
ESC [= 15 l

Page print flip on
 Page print flip off

Flip on If additional pages of memory are installed in the terminal, the display flips to the next page during page print. The screen continues to accept data from the computer or keyboard.

Flip off The current page of memory remains displayed, and screen updating halts during transmission.

Printer Handshaking Protocols

The 955 responds to both X-On/X-Off and DTR handshaking signals from a printer (or other device, such as a modem) connected to the terminal's printer port **except** under certain conditions during bidirectional print mode. Table 8-5 describes how printer port handshaking protocols operate in each print mode and the conditions that may cause the printer to lose data.

NOTE! No protocol exists between the main and printer port buffers. Data flows from the main port buffer into the printer port buffer at the same rate as the flow of data from the printer port buffer to the printer.

Table 8-5
Printer Port Handshaking Protocols

Mode/Command Handshaking Protocol

Buffered copy	If the printer or other device sends X-Off or lowers its DTR line voltage, the terminal stops sending data. After both the printer port buffer and main port buffer fill, the terminal signals the host to stop sending data. Handshaking signals are exchanged between the host and the main port buffer only. Signals are not passed through the printer port or from the printer port buffer to the host.
---------------	--

When the receive buffer empties, the terminal signals the computer to resume sending data.

Table 8-5 Continued
Printer Port Handshaking Protocols

Mode/Command	Handshaking Protocol
Buffered transparent	<p>If the printer or other device sends X-Off or lowers its DTR line voltage, the terminal stops sending data. When the printer port buffer fills, the terminal sends X-Off to the computer, no matter what the main port handshaking protocol is. If the computer does not respond to the X-Off from the printer port buffer and the receive buffer fills, the terminal then sends the main port handshaking protocol signal the computer to stop sending data (X-Off or DTR line low).</p> <p>When the receive buffer empties, the terminal signals the computer to resume sending data. If the host ignores the receive buffer signal, the terminal sends X-On when the printer port buffer empties.</p>
Buffered bidirectional	<p>If the terminal receives X-On/X-Off codes from the device attached to the printer port, its response depends on the protocol established between the terminal and host:</p> <p>If the host-terminal protocol is X-On/X-Off, the terminal recognizes X-Off from the printer as a handshaking signal, rather than passing it through to the host as data, and stops sending data to the printer until the printer sends X-On. When the printer and main port buffers fill, the terminal then signals the host to stop sending data.</p> <p>If the host-terminal protocol is not X-On/X-Off, the terminal passes X-On/X-Off signals from the printer to the host as data. If the host does not respond to X-Off from the printer by stopping the flow of data, the printer may lose data.</p> <p>If the printer lowers the DTR line voltage, the terminal always stops sending data, regardless of the host-terminal protocol. When the printer and main port buffers fill, the terminal signals the host to stop sending data.</p>

Table 8-5 Continued
Printer Port Handshaking Protocols

Mode/Command	Handshaking Protocol
Page print	<p>When all data has been sent to the printer port, the terminal sends the ASCII character ACK to the computer, signalling the end of the operation.</p> <p>If the printer sends X-Off to the terminal or lowers the DTR line voltage during page print, the terminal stops sending data to the printer until the printer sends X-On or raises the DTR line voltage.</p>

Page Print Terminator

Define the page print terminator

DEFAULT = ACK
ESC p Ps

Ps = Any ASCII character

This reprograms the ASCII character the terminal sends to the computer after each page print to signal the end of the transmission. The terminal saves the reprogrammed value in nonvolatile memory.

9. REPROGRAMMABLE KEYS

This chapter gives the default codes of the editing keys and function keys and tells you how to reprogram them. When you change the contents of these keys, their new contents are saved in nonvolatile memory. The reset commands in Chapter 5 can return the keys to default values without changing other operating values.

FUNCTION KEYS

You can invoke a total of 64 function keys on the 955. The terminal has 16 keys and each key, shifted and unshifted, has two sets of memory. You can select the current function key set in set up or by a programming command. Tables 9-1 and 9-2 list the default sequences sent by each function key.

NOTE! Function key codes are transmitted sequentially (as fast as the current baud rate permits). If a function key is pressed while the terminal is sending other data, the terminal sends the function key code after it sends the data. If your computer cannot accept codes at that speed, you can select a character transmit delay rate in set up or with a command, modify your software program, lower the baud rate to the computer, or change the handshaking protocol between the terminal and computer.

Table 9-1
Set One Default Function Key Codes

Unshifted Key	Code*	Shifted Key	Code*
F1	SOH @ CR	F17	SOH ` CR
F2	SOH A CR	F18	SOH a CR
F3	SOH B CR	F19	SOH b CR
F4	SOH C CR	F20	SOH c CR
F5	SOH D CR	F21	SOH d CR
F6	SOH E CR	F22	SOH e CR
F7	SOH F CR	F23	SOH f CR
F8	SOH G CR	F24	SOH g CR
F9	SOH H CR	F25	SOH h CR
F10	SOH I CR	F26	SOH i CR
F11	SOH J CR	F27	SOH j CR
F12	SOH K CR	F28	SOH k CR
F13	SOH L CR	F29	SOH l CR
F14	SOH M CR	F30	SOH m CR
F15	SOH N CR	F31	SOH n CR
F16	SOH O CR	F32	SOH o CR

Table 9-2
Set Two Default Function Key Codes

Unshifted Key	Code*	Shifted Key	Code*
F1	SOH P CR	F17	SOH p CR
F2	SOH Q CR	F18	SOH q CR
F3	SOH R CR	F19	SOH r CR
F4	SOH S CR	F20	SOH s CR
F5	SOH T CR	F21	SOH t CR
F6	SOH U CR	F22	SOH u CR
F7	SOH V CR	F23	SOH v CR
F8	SOH W CR	F24	SOH w CR
F9	SOH X CR	F25	SOH x CR
F10	SOH Y CR	F26	SOH y CR
F11	SOH Z CR	F27	SOH z CR
F12	SOH [CR	F28	SOH { CR
F13	SOH \ CR	F29	SOH CR
F14	SOH] CR	F30	SOH } CR
F15	SOH ^ CR	F31	SOH ~ CR
F16	SOH _ CR	F32	SOH ` CR

*Refer to the ASCII code chart in Appendix C.

Reprogrammable Keys

Selecting the Function Key Set

Select function key set

Ps	Set
0	One
1	Two

SET UP
 DEFAULT Ps = 0
 ESC [7 ; Ps v

This command determines the current function key set.

Reprogramming Function Keys

Reprogram a function key

SET UP
 ESC | p1 p2
 <message> CTRL Y

Key	950-Compatible p1		955-Compatible p1	
	Unshifted	Shifted	Unshifted	Shifted
F1	1	<	1	A
F2	2	=	2	B
F3	3	>	3	C
F4	4	?	4	D
F5	5	@	5	E
F6	6	A	6	F
F7	7	B	7	G
F8	8	C	8	H
F9	9	D	9	I
F10	:	E	:	J
F11	;	F	;	K
F12	G	L	<	L
F13	H	M	=	M
F14	I	N	>	N
F15	J	O	?	O
F16	K	P	@	P

p1 Both Modes

<space> Clear entire current function key set memory
 0 Load function keys in sequence from F1

p2 Message Destination

1 Send message to computer
 2 Send message to terminal
 3 Send message to both computer and terminal

Reprogrammable Keys

The message can contain any combination of display and control characters. Precede CTRL Y, CTRL P, or CTRL \ by CTRL P to embed those characters in the message.

You can program up to 256 bytes into any one function key, but the each function key set's combined total cannot exceed 256.

When p1 = 0, bracket each key's message with the delimiters FS (hex 1C). Your command would look like this:

```
ESC | 0 p2 <message F1> FS p2 <message F2> FS p2 <message  
F3> FS p2 <message F4> FS ... p2 <message Fn> CTRL Y
```

NOTE! You can only load a total of 256 bytes. If you do not clear the keys before you start and your message exceeds the remaining number of unused bytes, the terminal destroys the existing messages, starting with shifted F16 and working backward, first through the shifted and then the unshifted keys (from highest to lowest p1 value). If you continue to load a message into a key after the existing messages in all keys with a higher p1 value have been destroyed, the message no longer loads into the function key memory. Instead, it is displayed on the screen.

If p1 = a space character (hex 20), you can omit the remaining command sequence (p2 <message> CTRL Y). You only need to enter

```
ESC | <space>
```

The value of p2 determines the destination of the message. If you send it to the screen, the computer cannot act on it. If you send it only to the computer, the message cannot appear on the screen, unless the computer echoes it back to the terminal. Think about where the message should go and enter the appropriate p2.

For example, let's program shifted function key F1 to tell the terminal to move the cursor to the end of the page, display the user line (which has been loaded with a message reminding the operator to turn on the printer), and print the contents of the page on a printer connected to the terminal. The message to the operator appears on the user line while the messages to the terminal are stored as escape sequences.

NOTE! This example assumes you are programming the function keys from the keyboard, so you are instructed to press LOC ESC to start the sequence. If you programmed the keys from the host, you would send the ESC control character.

Reprogrammable Keys

1. Press

LOC ESC |

to start the programming sequence.

2. Press

<

to specify the shifted F1 key (950 compatible).

3. Press

2

to send the message to the terminal. Everything entered after this and before the terminating CTRL Y is considered part of the message.

4. Press

ESC = 7 o

where 7 and o are the values of the last row (line) and column position.

When the terminal receives this sequence, it moves the cursor to the end of the page. This defines the amount to be printed.

5. Press

ESC g

to display user message one on the bottom line.

6. Press

ESC P

to start a page print.

7. Press

CTRL Y

to end the program contained by the shifted F1 key.

Reprogrammable Keys

To calculate the bytes in this example, let's look at the entire command. Remember, you only count the bytes in the message portion of the command.

```
ESC | < 2 ESC = 7 o ESC g ESC P CTRL Y
```

Now let's tally the bytes.

Bytes	Entry	Bytes	Entry
1	ESC	1	ESC
1	=	1	g
1	7	1	ESC
1	o	1	P

The message contains 8 bytes.

Now whenever the shifted F1 key is pressed, the terminal moves the cursor to the end of the page, displays the user line, and prints the contents of the screen.

Saving the Contents of the Function Keys

Save function key reprogramming in nonvolatile memory
Do not save function key reprogramming in nonvolatile memory

```
SET UP  
DEFAULT = No save  
ESC [ = 10 h  
ESC [ = 10 l
```

Temporary keys Contents of the function keys are not saved in permanent memory. Keys return to factory default values when you reset the terminal or turn the power off.

Nonvolatile keys Reprogrammed contents of the function keys are saved in permanent (nonvolatile) memory.

Invoking a Function Key

Invoke a function key

```
ESC [ Pn |
```

Pn	Function Key
1-16	Unshifted 1-16
17-32	Shifted 1-16

This command calls from memory the contents of a function key in the current set, as if you had pressed the key on the keyboard.

REPROGRAMMING EDITING KEYS

You can reprogram the codes sent by the editing keys with the commands in this section.

The SEND Key

Reprogram the SEND key

ESC 0 Ps p1

Ps	Key
1	Unshifted
2	Shifted
p1	Code
4	ESC 4
5	ESC 5
6	ESC 6
7	ESC 7
S	ESC S
s	ESC s

This command lets you reprogram the unshifted and shifted SEND keys when the terminal is set for 950 compatibility. Turn back to Table 8-3 for an explanation of each code's effect.

One Editing Key

Reprogram any individual editing key

ESC 0 Ps p1 p2 p3

Ps = An ASCII character from Tables 9-3 and 9-4 representing the editing key

p1, p2, and p3 are any three ASCII characters

This command lets you change the code the terminal sends from any one editing key when the terminal is set for 955 compatibility. Nulls can be included but are not transmitted.

NOTE! If you programmed the unshifted DOWN key to send CTRL J (in set up or by the programming command in Chapter 7), the unshifted key sends the code in the shifted DOWN key memory. So the unshifted DOWN key sends whatever code you reprogram into the shifted DOWN key.

Table 9-3
Default and Ps Values of Unshifted Editing Keys

Ps	Key	Function	Factory Default Values	
			Hex	ASCII
@	HOME	Cursor home	1E 00 00	RS NUL NUL
A	DOWN	Cursor down	16 00 00	SYN NUL NUL
B	UP	Cursor up	0B 00 00	VT NUL NUL
C	LEFT	Cursor left	08 00 00	BS NUL NUL
D	RIGHT	Cursor right	0C 00 00	FF NUL NUL
E	TAB*	Tab cursor	09 00 00	HT NUL NUL
F	BACK TAB	Back tab	1B 49 00	ESC I NUL
G	CLEAR SPACE	Clear unprotected to spaces	1A 00 00	SUB NUL NUL
H	PRINT	Formatted unprotected	1B 50 00	ESC P NUL
I	CHAR INSERT	Insert character	1B 51 00	ESC Q NUL
J	CHAR DELETE	Delete character	1B 57 00	ESC W NUL
K	LINE INSERT	Insert line	1B 45 00	ESC E NUL
L	LINE DELETE	Delete line	1B 52 00	ESC R NUL
M	LINE ERASE	Erase line with spaces	1B 54 00	ESC T NUL
N	PAGE ERASE	Erase page with spaces	1B 59 00	ESC Y NUL
O	PAGE	Next page	1B 4B 00	ESC K NUL
P	SEND	Send page	1B 37 00	ESC 7 NUL
Q	TAB**	Tab cursor	09 00 00	HT NUL NUL
R	CE	Clear entry	18 00 00	CAN NUL NUL
S	ENTER	Carriage return	0D 00 00	CR NUL NUL

*On alphanumeric section of keyboard

**On accounting keypad

Table 9-4
Default and Ps Values of Shifted Editing Keys

Ps	Key	Function	Factory Default Values			
			Hex		ASCII	
`	HOME	Cursor home	1B	5B	48	ESC [H
a	DOWN	Line feed	0A	00	00	LF NUL NUL
b	UP	Reverse line feed	1B	6A	00	ESC j NUL
c	LEFT	Cursor left	1B	5B	44	ESC [D
d	RIGHT	Cursor right	1B	5B	43	ESC [C
e	TAB*	Set tab	1B	31	00	ESC 1 NUL
f	BACK TAB	Clear tab	1B	32	00	ESC 2 NUL
g	CLEAR SPACE	Clear all to nulls	1B	2A	00	ESC * NUL
h	PRINT	Unformatted all	1B	4C	00	ESC L NUL
i	CHAR INSERT	Insert mode	1B	71	00	ESC q NUL
j	CHAR DELETE	Replace mode	1B	72	00	ESC r NUL
k	LINE INSERT	Page edit mode	1B	4E	00	ESC N NUL
l	LINE DELETE	Line edit mode	1B	4F	00	ESC O NUL
m	LINE ERASE	Erase line with nulls	1B	74	00	ESC t NUL
n	PAGE ERASE	Erase page with nulls	1B	79	00	ESC y NUL
o	PAGE	Previous page	1B	4A	00	ESC J NUL
p	SEND	Send line	1B	36	00	ESC 6 NUL
q	TAB**	Tab cursor	09	00	00	HT NUL NUL
r	CE	Clear tab stops	1B	33	00	ESC 3 NUL
s	ENTER	Carriage return and line feed	0D	0A	00	CR LF NUL

*On alphanumeric section of keyboard

**On accounting keypad

All Editing Keys

Reprogram all editing keys

ESC] Ps
p1 ... p60

Ps	Key
0	Unshifted
1	Shifted

pn = Three ASCII characters each for all editing keys

This command lets you change the function of all the editing keys in Tables 9-3 and 9-4 by changing the codes they send. You must enter values for three ASCII characters for all 20 editing keys, in the order they are listed in the tables.

To reprogram both shifted and unshifted editing keys, send the command twice with different Ps values.

Use this command when you want to reprogram most or all editing keys; use the previous command when you want to change only one key at a time.

To illustrate how this command functions, let's reverse the effect of the shifted UP and DOWN keys. After the terminal receives this command, the shifted DOWN key causes a reverse line feed and the shifted UP key will cause a line feed.

1. Press

ESC] 1

to start the programming sequence. Everything entered after this is considered part of the program.

2. Enter, in a string without spaces, the following codes for shifted keys:

RS NUL NUL (This leaves the HOME key unchanged.)

LF NUL NUL (This changes the DOWN key's function.)

ESC j NUL (This changes the UP key's function.)

3. Now continue entering three bytes of code apiece for the remaining editing keys.

APPENDICES

- A Specifications
- B Statement of Limited Warranty
- C ASCII Code Tables
- D Monitor Mode Control Characters
- E Cursor Coordinates
- F Foreign Character Sets
- G Multinational Character Set
- H Control Codes and Escape Sequences
- I Calculator Mode



APPENDIX A SPECIFICATIONS

Part Number	132135-00
Case	Touch tilt (-5 to +15 degrees); swivel (270 degrees); front-mounted power switch, brightness adjustment, and keyboard connector
Screen	14 inches measured diagonally; P31 green nonglare phosphor; screen saver; selectable on/off and background color
Display Format	24 80- or 132-column lines; 25th and 26th information lines; 10 set up menus; self test screen
Character Formation	7 x 9 dot matrix; 9 x 14 character cell
Character Sets	US ASCII and UK standard (96 upper- and lowercase display with descenders, 32 control); 32 special graphics; 96 multinational
Visual Attributes	Space/no space; combinable; blink, blank, underline, reverse field-based; full/half intensity character-based; block graphics
Cursor Attributes	Block (blinking or steady), underline (blinking or steady), none
Cursor Control	Home, up, down, right, left (single and multiple movement commands); carriage return, line feed, reverse line feed, new line; next page, previous page; typewriter and field tabs (forward and backward); address, read
Editing	Character/line insert/delete; line/page/field erase; field/page clear; smooth or normal scroll, definable scrolling region, line lock; protect mode; insert/replace and page/line edit modes; programmable replacement character

Appendices

Reprogramming	64 function keys (two sets of 16 unshifted and shifted) and 20 editing keys, 950 or 955 compatible; answerback; status line message field; information lines; send and print delimiters					
Communications Modes	Conversational (full or half duplex), block, local; monitor; local or duplex edit					
Communications Interface	RS-232C 256-character buffered transmit/receive computer port; RS-232C 256-character buffered printer port; long-distance communications option port; selectable character transmit delay rate					
Communications Protocol	X-On/X-Off or Data Terminal Ready at either RS-232C port					
Word Structure	7 or 8 data bits; 1 or 2 stop bits; 10- or 11-bit word					
Parity	Odd, even, mark, space, or none					
Baud Rates	16 main port (50-38.4Kb) 15 printer port (50 to 19,200 Kb)					
Print Capabilities	Formatted/unformatted page print; buffered copy or transparent print					
Keyboard	Detached, slim-line, typewriter-style with sculptured keycaps; sealed key switches; N-key rollover with ghost key lockout; accounting-style numeric keypad with TAB and ENTER keys; on/off repeat and keyclick; selectable key disable					
Power Requirements	115/230 volt ac, 50/60 Hz					
Dimensions						
	Height		Width		Depth	
	(in.)	(cm)	(in.)	(cm)	(in.)	(cm)
Cabinet	15.0	38.1	12.8	32.5	12.8	32.5
Keyboard	1.8	4.6	17.8	45.2	7.3	18.4

Weight

Net 26 pounds 13 ounces

Shipping 33 pounds 12 ounces

Environmental Requirements

Ventilation 4 inches minimum on all sides

Temperature Operating: 32 degrees F (0 degrees C)
to 113 degrees F (45 degrees C).
Storage: -40 degrees F (-40 degrees C)
to 149 degrees F (65 degrees C)

Relative humidity Operating: 10%-85% noncondensing.
Nonoperating: 10%-85% noncondensing.

Maximum power 40 watts

Option board

Dimensions 8.25 in. x 8 in.

**Available power
(maximum)** 5V 1 amp
+12V 100 mA
-12V 0 amp

Options

20 mA current loop
Neutral fuse
24 or 72 extra lines of screen memory
Amber screen
Long-distance communication interface
Internal modem
EPROM containing French, German,
Spanish, Finnish, Norwegian, and
Italian character sets
Foreign character set keycaps

APPENDIX B STATEMENT OF LIMITED WARRANTY

TeleVideo Systems, Inc. ("TeleVideo") warrants to its distributors, systems houses, end users, and OEMs ("Buyer"), that products manufactured by TeleVideo are free from defects in materials and workmanship. TeleVideo's obligations under this warranty are limited to repairing or replacing, at TeleVideo's option, the part or parts of the products which prove defective in material or workmanship within 15 months after shipment by TeleVideo. Buyer must pass along to its initial customer or user ("Customer") a minimum of 12 months' coverage within this 15-month warranty period, provided that Buyer gives TeleVideo prompt notice of any defect and satisfactory proof thereof.

Products may be returned by Buyer only after a Return Material Authorization number ("RMA") has been obtained from TeleVideo by telephone or in writing. Buyer will prepay all freight charges to return any products to the repair facility designated by TeleVideo and include the RMA number on the shipping container. TeleVideo will, at its option, either repair the defective products or parts or deliver replacements for defective products or parts on an exchange basis to Buyer, freight prepaid to the Buyer. Products returned to TeleVideo under this warranty will become the property of TeleVideo. With respect to any product or part thereof not manufactured by TeleVideo, only the warranty, if any, given by the manufacturer thereof, applies.

EXCLUSIONS

This limited warranty does not cover losses or damage which occurs in shipment to or from Buyer, or are due to, (1) improper installation or maintenance, misuse, neglect, or any cause other than ordinary commercial or industrial application, or (2) adjustment, repair, or modifications by other than TeleVideo-authorized personnel, or (3) improper environment, excessive or inadequate heating or air conditioning and electrical power failures, surges, or other irregularities, or (4) any statements made about TeleVideo's products by salesmen, dealers, distributors or agents, unless confirmed in writing by a TeleVideo officer.

If the firmware or hardware is altered or modified by the Buyer, this firmware and hardware is not covered within this limited warranty and the Buyer bears sole responsibility and liability for that firmware and hardware.

THE FOREGOING TELEVIDEO LIMITED WARRANTY IS IN LIEU OF ALL OTHER WARRANTIES, WHETHER ORAL, WRITTEN, EXPRESSED, IMPLIED, OR STATUTORY. IMPLIED WARRANTIES OF MERCHANTABILITY AND FITNESS FOR A PARTICULAR PURPOSE DO NOT APPLY. TELEVIDEO'S WARRANTY OBLIGATIONS AND DISTRIBUTOR'S REMEDIES HEREUNDER ARE SOLELY AND EXCLUSIVELY AS STATED HEREIN.

TELEVIDEO'S LIABILITY, WHETHER BASED ON CONTRACT, TORT, WARRANTY, STRICT LIABILITY, OR ANY OTHER THEORY, SHALL NOT EXCEED THE PRICE OF THE INDIVIDUAL UNIT WHOSE DEFECT OR DAMAGE IS THE BASIS OF THE CLAIM. IN NO EVENT SHALL TELEVIDEO BE LIABLE FOR ANY LOSS OF PROFITS, LOSS OF USE OF FACILITIES OR EQUIPMENT, OR OTHER INDIRECT, INCIDENTAL OR CONSEQUENTIAL DAMAGES.

APPENDIX C ASCII CODE TABLES

Table C-1
ASCII Code Chart

BITS	7 6 5 4 3 2 1				0 0 0		0 0 1		0 1 0		0 1 1		1 0 0		1 0 1		1 1 0		1 1 1			
	4	3	2	1	Column		0		1		2		3		4		5		6		7	
					↓ Row	0	1	2	3	4	5	6	7									
0	0	0	0	0	0	NUL	000	DLE	20	SP	40	0	@	100	P	120	,	140	p	160		
0	0	0	0	1	1	SOH	001	DC1 (XON)	21	!	41	1	A	101	Q	121	a	141	q	161		
0	0	1	0	0	2	STX	010	DC2	22	"	42	2	B	102	R	122	b	142	r	162		
0	0	1	1	0	3	ETX	011	DC3 (XOFF)	23	#	43	3	C	103	S	123	c	143	s	163		
0	1	0	0	0	4	EOT	100	DC4	24	\$	44	4	D	104	T	124	d	144	t	164		
0	1	0	1	0	5	ENQ	101	NAK	25	%	45	5	E	105	U	125	e	145	u	165		
0	1	1	0	0	6	ACK	110	SYN ↓	26	&	46	6	F	106	V	126	f	146	v	166		
0	1	1	1	0	7	BEL	111	ETB	27	'	47	7	G	107	W	127	g	147	w	167		
1	0	0	0	0	8	BS ←	100	CAN	30	(50	8	H	110	X	130	h	150	x	170		
1	0	0	1	0	9	HT	101	EM	31)	51	9	I	111	Y	131	i	151	y	171		
1	0	1	0	0	A(10)	LF	110	SUB	32	*	52	:	J	112	Z	132	j	152	z	172		
1	0	1	1	0	B(11)	VT ↓	110	ESC	33	+	53	;	K	113	[133	k	153	{	173		
1	1	0	0	0	C(12)	FF →	100	FS	34	,	54	<	L	114	\	134	l	154		174		
1	1	0	1	0	D(13)	CR	101	GS	35	-	55	=	M	115]	135	m	155	}	175		
1	1	1	0	0	E(14)	SO	110	RS	36	.	56	>	N	116	^	136	n	156	~	176		
1	1	1	1	0	F(15)	SI	111	US	37	/	57	?	O	117	_	137	o	157		177		

KEY

ESC	33 27 1B	OCTAL DECIMAL HEX
-----	----------------	-------------------------

Table C-2
ASCII Control Character Abbreviations

NUL	null	FF	form feed	CAN	cancel
SOH	start of heading	CR	carriage return	EM	end of medium
STX	start of text	SO	shift out	SUB	substitute
ETX	end of text	SI	shift in	ESC	escape
EOT	end of transmission	DLE	data link escape	FS	file separator
ENQ	enquiry	DC1	device control 1	GS	group separator
ACK	acknowledge	DC2	device control 2	RS	record separator
BEL	bell	DC3	device control 3	US	unit separator
BS	backspace	DC4	device control 4	SP	space
HT	horizontal tabulation	NAK	negative acknowledge	DEL	delete
LF	linefeed	SYN	synchronous idle		
VT	vertical tabulation	ETB	end of transmission block		

APPENDIX D MONITOR MODE CONTROL CHARACTERS

Control Code	ASCII Character	Hex Value	Character Displayed
CTRL @	NUL	00	N _L
CTRL A	SOH	01	S _H
CTRL B	STX	02	S _X
CTRL C	ETX	03	E _X
CTRL D	EOT	04	E _T
CTRL E	ENQ	05	E _Q
CTRL F	ACK	06	A _K
CTRL G	BEL	07	B _L
CTRL H	BS	08	B _S
CTRL I	HT	09	H _T
CTRL J	LF	0A	L _F
CTRL K	VT	0B	V _T
CTRL L	FF	0C	F _F
CTRL M	CR	0D	C _R
CTRL N	SO	0E	S _O
CTRL O	SI	0F	S _I
CTRL P	DLE	10	D _L
CTRL Q	DC1	11	D ₁
CTRL R	DC 2	12	D ₂
CTRL S	DC 3	13	D ₃
CTRL T	DC 4	14	D ₄
CTRL U	NAK	15	N _K
CTRL V	SYN	16	S _Y
CTRL W	ETB	17	E _B
CTRL X	CAN	18	C _N
CTRL Y	EM	19	E _M
CTRL Z	SUB	1A	S _B
CTRL [ESC	1B	E _C
CTRL \	FS	1C	F _S
CTRL]	GS	1D	G _S
CTRL ^	RS	1E	R _S
CTRL _	US	1F	U _S
DEL	DEL	7F	⌘

APPENDIX E CURSOR COORDINATES

Row/ Column	ASCII Code Transmitted	Row/ Column	ASCII Code Transmitted	Row/ Column	ASCII Code Transmitted	Row/ Column	ASCII Code Transmitted
1	Space	28	;	55	V	82	q
2	!	29	<	56	W	83	r
3	"	30	=	57	X	84	s
4	#	31	>	58	Y	85	t
5	\$	32	?	59	Z	86	u
6	%	33	@	60	[87	v
7	&	34	A	61	\	88	w
8	'	35	B	62]	89	x
9	(36	C	63	^	90	y
10)	37	D	64	_	91	z
11	*	38	E	65	`	92	{
12	+	39	F	66	a	93	⋮
13	,	40	G	67	b	94	}
14	-	41	H	68	c	95	~
15	.	42	I	69	d	96	DEL
16	/	43	J	70	e		
17	0	44	K	71	f		
18	1	45	L	72	g		
19	2	46	M	73	h		
20	3	47	N	74	i		
21	4	48	O	75	j		
22	5	49	P	76	k		
23	6	50	Q	77	l		
24	7	51	R	78	m		
25	8	52	S	79	n		
26	9	53	T	80	o		
27	:	54	U	81	p		

APPENDIX F FOREIGN CHARACTER SETS

Table F-1
Character Set Comparison

HEX CODE	23	40	5B	5C	5D	5E	60	7B	7C	7D	7E
USASCII	#	@	[\]	^	.	{		}	-
U.K.	£										
GERMAN		§	Ä	Ö	Ü			ä	ö	ü	ß
FRENCH	£	à	°	ç	§	^	é	é	ù	è	"
SPANISH			í	Ñ	¿		°	ñ	ç		
NORWEGIAN		"	Æ	Ø	Å			æ	ø	å	
FINNISH			Ä	Ö	Å			ä	ö	å	
ITALIAN	£	à	ò	#	§		@	é	ù	è	ì

NOTE! The French accent characters at positions 5E and 7E hex and the Spanish accent character at position 60 hex create composed characters. If the character following the accent is an upper- or lowercase vowel, the terminal displays the accent over the vowel. If any other character follows an accent, the terminal ignores the accent and displays the character.

Figure F-1
U.S. ASCII Keyboard Layout

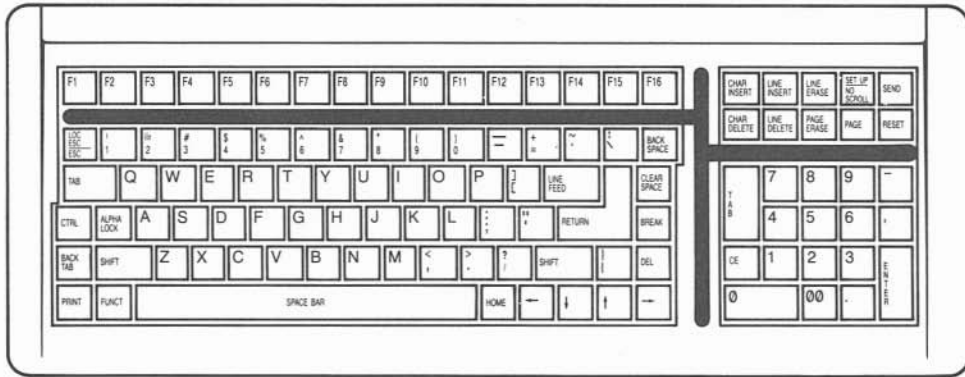

Figure F-2
U.K. Keyboard Layout

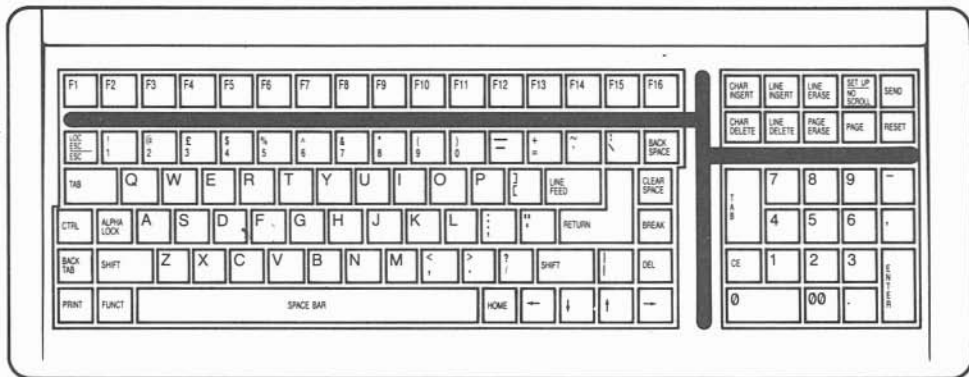

Figure F-3
German Keyboard Layout

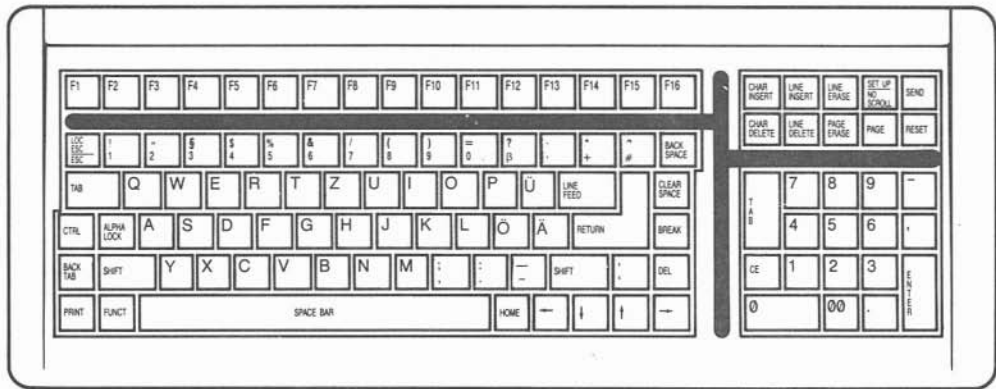

Figure F-4
French Keyboard Layout

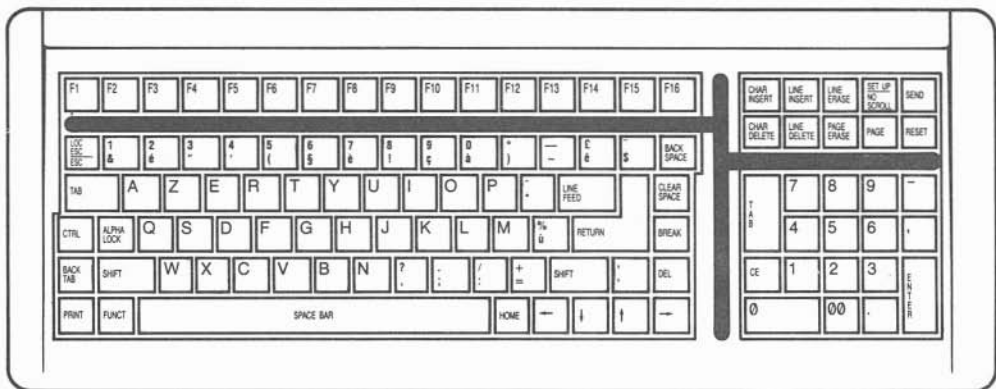

Figure F-5
Spanish Keyboard Layout

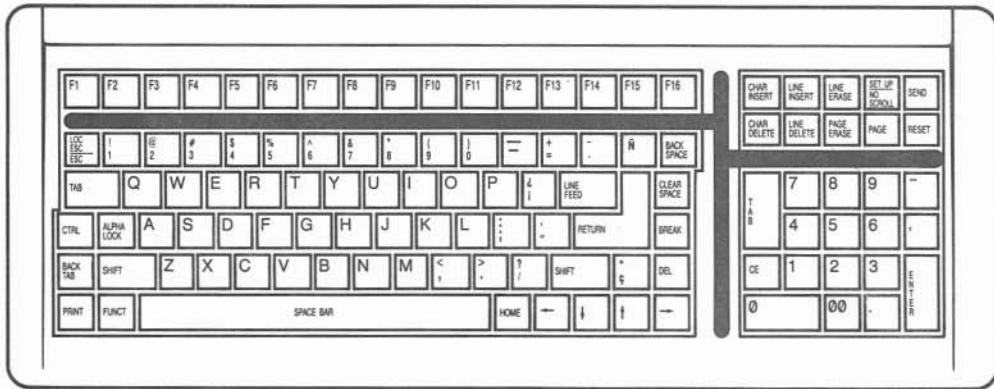

Figure F-6
Norwegian Keyboard Layout

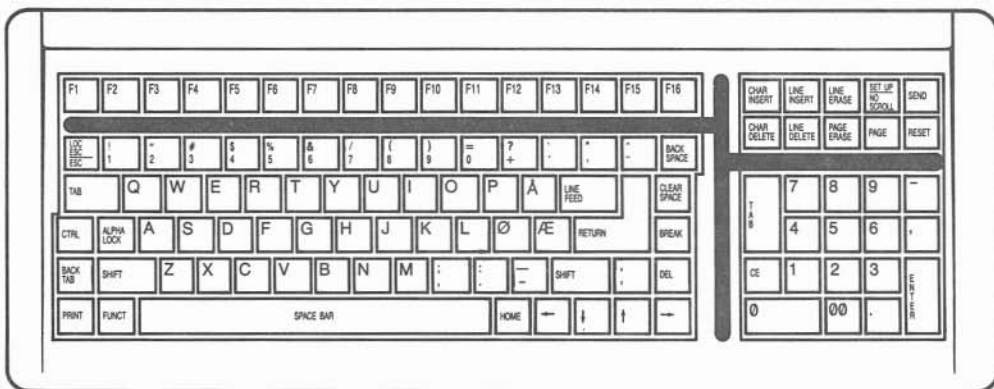

Figure F-7
Finnish Keyboard Layout

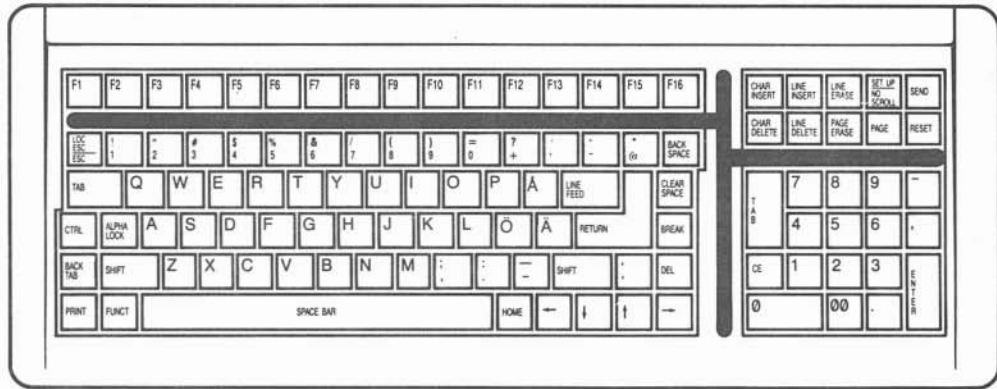
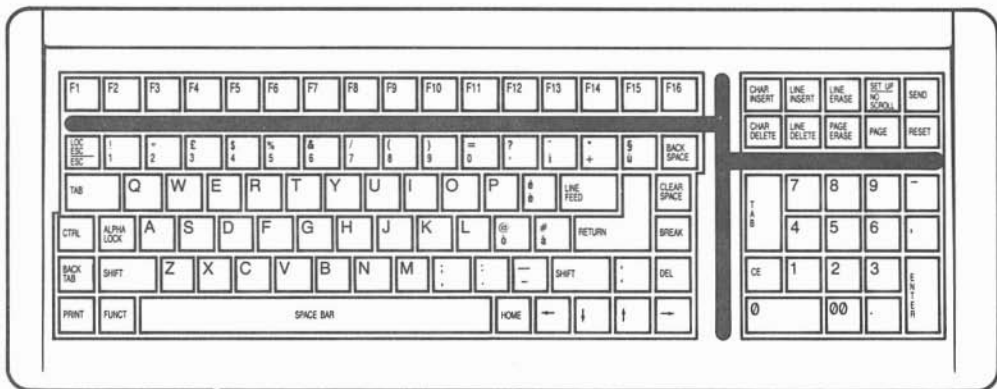

Figure F-8
Italian Keyboard Layout



APPENDIX G MULTINATIONAL CHARACTER SET

ASCII Character	Multi-national Character	Hex Value	ASCII Character	Multi-national Character	Hex Value
!	ı	21	K	Ë	4B
"	ç	22	L	ì	4C
#	£	23	M	í	4D
\$	¥	24	N	î	4E
%	®	25	O	ï	4F
&	©	26	P	ı	50
'	§	27	Q	Ñ	51
(œ	28	R	Ò	52
)	©	29	S	Ó	53
*	à	2A	T	Ô	54
+	á	2B	U	Õ	55
,	â	2C	V	Ö	56
-	ã	2D	W	Ø	57
.	ä	2E	X	Œ	58
/	å	2F	Y	Œ	59
0	æ	30	Z	Ÿ	5A
1	ø	31	[Ù	5B
2	ı	32	\	Ú	5C
3	ı	33]	Û	5D
4	ı	34	^	Ü	5E
5	ı	35	_	Ý	5F
6	ı	36	`	ß	60
7	ı	37	a	à	61
8	ı	38	b	á	62
9	ı	39	c	â	63
:	ı	3A	d	ã	64
;	ı	3B	e	ä	65
<	ı	3C	f	å	66
=	ı	3D	g	æ	67
>	ı	3E	h	ç	68
?	ı	3F	i	è	69
@	ı	40	j	é	6A
A	ı	41	k	ê	6B
B	ı	42	l	ë	6C
C	ı	43	m	ì	6D
D	ı	44	n	í	6E
E	ı	45	o	î	6F
F	ı	46	p	ı	70
G	ı	47	q	ı	71
H	ı	48	r	ı	72
I	ı	49	s	ı	73
J	ı	4A	t	ı	74

Appendices

ASCII Character	Multi-national Character	Hex Value	ASCII Character	Multi-national Character	Hex Value
u	õ	75	z	ú	7A
v	ö	76	{	û	7B
w	œ	77		ü	7C
x	ø	78	}	ÿ	7D
y	ù	79	~	..	7E

APPENDIX H CONTROL CODES AND ESCAPE SEQUENCES

Table H-1
Control Codes

Command	Function	Key
CTRL E	Send the answerback message	
CTRL G	Sound the bell	
CTRL H	Move the cursor left	LEFT
CTRL I	Move cursor forward to next typewriter or field tab stop	or BACK SPACE TAB
CTRL J	Line feed	LINE FEED or SHIFT DOWN
CTRL K	Move the cursor up	UP
CTRL L	Move the cursor right	RIGHT
CTRL M	Carriage return	RETURN or ENTER
CTRL N	Disable X-On/X-Off; enable DTR line	
CTRL O	Enable X-On/X-Off; disable DTR line	
CTRL R	Buffered bidirectional print mode on	
CTRL T	Buffered bidirectional print mode off	
CTRL U	Select a character from the multinational character set	
CTRL V	Move the cursor down	DOWN
CTRL W	Load the margin bell column	
CTRL X	Clear current unprotected field and replace with replacement characters. Return cursor to beginning of field (protect mode on); or clear current tab field or whole line and move cursor to beginning of current tab field or line (protect mode off)	CE
CTRL [Send ESC character to introduce escape sequence	ESC
CTRL Z	Clear unprotected characters and replace with replacement characters	CLEAR SPACE
CTRL ^	Move cursor to home position	HOME
CTRL _	New line (line feed/carriage return)	SHIFT ENTER

Table H-2
Escape Sequences

Command	Function	Key
ESC ! 1	Enable line lock	
ESC ! 2	Disable line lock	
ESC "	Unlock (enable) the keyboard	
ESC #	Lock (disable) the keyboard	
ESC \$	Special graphics mode on	
ESC %	Special graphics mode off	
ESC &	Turn on protect mode	
ESC '	Turn off protect mode	
ESC (Turn off write protect mode	
ESC)	Turn on write protect mode	
ESC *	Clear all characters and replace with null characters (reset protect and write protect modes)	SHIFT CLEAR SPACE
ESC +	955 mode: Clear all to replacement characters (reset protect and write protect modes) 950 mode: Clear unprotected to replacement characters	
ESC ,	955 mode: Clear unprotected to write protected space characters (reset protect mode) 950 mode: Clear unprotected to write protected space characters (do not reset protect mode)	
ESC -	Address (send) cursor to page, row, and columns 1 through 80	
p r c		
ESC -	Address (send) cursor to page, row, and columns 81 through 132	
p r ~ c		
ESC . Ps	Select cursor style	
ESC /	Read cursor's page, row, and column	
ESC 0	Reprogram the SEND key (950 mode)	
Ps p1		
ESC 0 Ps	Reprogram any individual editing key (955 mode)	
p1 p2 p3		
ESC 1	Create column of tab stops at the current column	SHIFT TAB
ESC 2	Clear typewriter tab stop at cursor location	SHIFT BACK TAB
ESC 3	Clear all typewriter tab stops	SHIFT CE
ESC 4	Send unprotected characters in cursor line up to and including cursor	
ESC 5	Send unprotected page up to and including cursor	

Table H-2 Continued
Escape Sequences

Command	Function	Key
ESC 6	Send entire line of data up to and including cursor	SHIFT SEND
ESC 7	Send entire page up to and including cursor	SEND
ESC 8	Data scrolls smoothly at 4 lines per second	
ESC 9	Data scrolls at the rate received	
ESC :	Clear unprotected characters and replace with null characters	
ESC ;	Clear unprotected characters and replace with replacement characters	CLEAR SPACE
ESC <	Keyclick off	
ESC = r c	Address (send) cursor to row and columns 1 through 80 in current page	
ESC = r ~ c	Address (send) cursor to row and columns 81 through 132 in current page	
ESC >	Keyclick on	
ESC ?	Read cursor's row and column position	
ESC @	Buffered copy print mode on	
ESC A	Buffered copy print mode off	
ESC B	Block mode on	
ESC C	Return to previous conversational mode from block or local mode	
ESC D H	Half duplex mode on	
ESC D F	Full duplex mode on	
ESC E	Insert a line of replacement characters on the current line	LINE INSERT
ESC F 0	Attributes occupy a character space	
ESC F 1	Attributes do not occupy a space	
ESC G Ps	Define visual attribute(s)	
ESC H w h	Define block graphics area	
ESC I	Move cursor backward to previous typewriter or field tab stop	BACK TAB
ESC J	Display the previous page	SHIFT PAGE
ESC K	Display the next page	PAGE
ESC L	Print all unformatted page	SHIFT PRINT
ESC M	Send terminal's identification	
ESC N	Enable page edit mode	
ESC O	Enable line edit mode	
ESC P	Print unprotected formatted page	PRINT
ESC Q	Insert a replacement character at the cursor position	CHAR INSERT

Table H-2 Continued
Escape Sequences

Command	Function	Key
ESC R	Delete current line and replace with replacement characters	LINE DELETE
ESC S	Send unprotected message between start of text (STX) and end of text (ETX)	
ESC T	Erase from the cursor to end of line; replace with replacement characters	LINE ERASE
ESC U	Monitor mode on	
ESC V	Run the self test	
ESC W	Delete character at cursor position	CHAR DELETE
ESC X	Monitor mode off	
ESC Y	Erase from the cursor to end of page; replace with replacement characters	PAGE ERASE
ESC Z Ps	Send the information line contents	
ESC [Command sequence introducer	
ESC \ Ps	Define number of lines on each page	
ESC] Ps	Reprogram all editing keys	
ESC ^	Program the answerback message	
<text>	CTRL Y	
ESC	Load text into a user message	
p1 p2	<text> CTRL M	
ESC `	Buffered transparent print mode on	
ESC a	Buffered transparent print mode off	
ESC b	Light background with dark characters	
ESC c	Local mode on	
ESC d	Dark background with light characters	
ESC e Ps	Load a replacement character	
ESC f	Load text into user message one	
<text>	CTRL M	
ESC g	Display user message one on the screen's bottom line	
ESC h	Display the status line on the screen's bottom line	
ESC i	Move cursor forward to next field tab stop (protect mode on)	
ESC j	Reverse line feed	SHIFT UP
ESC k	Enable local editing key mode	
ESC l	Enable duplex editing key mode	
ESC m	Enable optional graphics firmware	
ESC n	Turn screen on	
ESC o	Turn screen off	
ESC p Ps	Define the page print terminator	

Table H-2 Continued
Escape Sequences

Command	Function	Key
ESC q	Enable insert mode	SHIFT CHAR INSERT
ESC r	Enable replace mode	SHIFT CHAR DELETE
ESC s	Send whole message between start of text (STX) and end of text (ETX)	
ESC t	Erase from the cursor to end of line; replace with null characters	SHIFT LINE ERASE
ESC u	Monitor mode off	
ESC v	Autopage mode on	
ESC w	Autopage mode off	
ESC x	Reprogram delimiter code	
Ps p1 p2		
ESC y	Erase from the cursor to end of page; replace with null characters	SHIFT PAGE ERASE
ESC z	Execute a program	
ESC { p1 p2 p3 p4	Select main port operating values	
ESC	Reprogram a function key	
p1 p2	<message> CTRL Y	
ESC } p1 p2 p3 p4	Select printer port operating values	
ESC ~ 0	Reset terminal to factory default values	
ESC ~ 1	Reset terminal to nonvolatile memory values	CTRL RESET
ESC ~ 2	Reset function keys to factory default values	
ESC ~ 3	Reset editing keys to factory default values	

Table H-3
ESC [Commands

Sequence	Function	Key
Pn @	Insert Pn replacement characters starting at the cursor	
Pn A	Move the cursor up	UP
Pn B	Move the cursor down	DOWN
Pn C	Move the cursor right	SHIFT RIGHT
Pn D	Move the cursor left	SHIFT LEFT
H	Address the cursor home	SHIFT HOME
Pl ; Pc H	Address the cursor to line and column of the current page in decimal units	
Ps J	Erase unprotected characters in the page; replace with replacement characters	
Ps K	Erase unprotected characters in the current line; replace with replacement characters	
Pn L	Insert Pn lines of replacement characters starting at the cursor line	
Pn M	Delete Pn lines, starting at cursor line, and replace with replacement characters	
Pn P	Delete Pn characters starting at the cursor position	
Pl ; Pc f	Address the cursor to line and column of the current page in decimal units	
O ; Ps i	Page print	
6 n	Read cursor's line and column position in decimal units	
? 6 n	Read cursor's page, line, and column position in decimal units	
Pt ; Pb r	Define a scrolling region	
Pn	Invoke a function key	
O ; 1 }	Save current set up values in nonvolatile memory	
1 ; Pn }	Display page Pn	

Table H-4
Terminal Operating Modes

Command	State
ESC [= Ps h	Set terminal operating mode(s)
ESC [= Ps l	Reset terminal operating mode(s)

Ps	Mode	Set	Reset
0	Transmission control	On	Off
1	Data bits	8-bit	7-bit
2	Attribute base	Page	Line
3	Columns per line	132	80
4	Margin bell	On	Off
5	Normal intensity	Half	Full
6	New line mode	On	Off
7	Autowrap mode	On	Off
8	Keyboard repeat	On	Off
9	DOWN key	CTRL J	CTRL V
10	Function key	Save	No save
11	SET UP key	Enabled	Disabled
12	ESC key	Enabled	Disabled
13	CLEAR SPACE key	Enabled	Disabled
14	BREAK key	Enabled	Disabled
15	Page print flip	On	Off
16	Screen refresh rate	50 Hz	60 Hz

Table H-5
Variable Operating Values

Command	Function
ESC [p1 ; p2 v	Select a terminal operating value

p1	Function
0	Select character transmit delay rate
1	Select terminal's handshaking protocol
2	Select receive buffer fill limit
3	Select status line visual attribute(s)
4	Select top information line's contents
5	Select bottom information line's contents
6	Select scroll rate
7	Select function key set
8	Select screen saver time
9	Select a character set
10	Select reprogramming compatibility mode

APPENDIX I CALCULATOR MODE

This appendix describes the operation of calculator mode.

1. Type ESC z on the keyboard. If the terminal is in a conversational mode (full or half duplex), press LOC ESC instead of ESC.
2. A blank status line appears on the screen's 25th line.
Enter up to six digits (from either the keyboard or the numeric keypad), type an operand (+, -, * or /), enter another set of up to six digits, and type =. The answer will be a maximum of six digits.
3. To erase an entry, press RETURN on the keyboard or ENTER on the keypad.
4. Press ESC to leave calculator mode. Then send ESC h to the terminal to return to the previous 25th line display.

EXAMPLES**Addition**

To add 123456 and 123456:

Type:	123456 + 123456 =	Answer:	246912
-------	-------------------	---------	--------

If the answer is greater than six digits, the status line displays OVERFLOW.

Subtraction

To subtract 123456 from 246912:

Type:	246912 - 123456 =	Answer:	123456
-------	-------------------	---------	--------

Subtracting a larger number from a smaller number results in a negative answer.

Multiplication

To multiply 123456 by 2:

Type: 123456 * 2 = Answer: 246912

Division

To divide 246912 by 2:

Type: 246912 / 2 = Answer: 123456

If you divide by zero, the screen displays ERROR.

Any answer with a decimal will be truncated. For example:
4.13 displays as 4.

GLOSSARY

ACK An ASCII character (hex 06) meaning acknowledgement. Usually sent by the terminal to the computer to indicate page print or some local function is finished.

address Noun: A number identifying a unique location in the computer's memory where information is stored. Similar to a post office box number. Verb: To send something to a particular location. The computer can **address** the cursor to a specific line and column position on the screen.

alphanumeric characters Alphabetic, numeric, and special data symbols. The standard ASCII character set includes 96 alphanumeric characters. See **character, display characters**.

answerback A programmable response sent to the computer upon request. Can identify a particular terminal when several terminals are connected to a computer, since each terminal's answerback can be unique. If 25 955 terminals are connected to the computer, the fifth 955 terminal could be programmed to reply, "955 5." Answerback codes are also used with modems.

applications program A program to accomplish a specific task, such as word processing, financial analysis, or retrieval of corporate data. See **program, software**.

ASCII Acronym: **American Standard Code for Information Interchange**, pronounced **ask-key**. A standard set of characters used in most data transmission applications in the United States. An ASCII character is expressed as a group of 7 bits. The 128 ASCII characters (found in Appendix C) are divided into 96 alphanumeric (display) and 32 control characters. See **alphanumeric characters, control characters**.

autowrap A mode that automatically moves the cursor to the beginning of the next line after it reaches the end of the current line during data entry.

baud rate The number of binary bits transmitted per second.

bidirectional print A communication mode that enables two-way communication between devices attached to the computer and printer ports. Both devices must have the same baud rate, parity, word structure, and stop bits.

bit Acronym: **binary digit**. The simplest unit of data; always a one or a zero (meaning yes/no, on/off). A group of bits (usually seven or eight) that represents a character is called a byte. See **byte**, **character**.

block mode A communication mode that sends text entered from the keyboard only to the screen until you signal the terminal to send it as a block to the computer.

break signal A signal sent by the BREAK key that holds the communication line (pin 2 of the main RS-232C connector) in the 0 state (low) for 250 milliseconds. It does not affect the terminal's operation and no character appears on the screen. How your computer responds to the signal depends entirely on its programming. A break signal can cause a modem to disconnect.

buffer A temporary data storage location in the terminal's memory. Can be used to compensate for differences in transmission rates or temporarily store characters until the computer or printer can accept them. Buffers let data flow from the computer to the terminal at a different baud rate than from the terminal to the printer. See **handshaking protocol**, **DTR**, **X-On/X-Off**.

buffered print A print mode (either transparent or extension) that stores data in the terminal's buffer(s) when the computer sends data faster than the printer can receive it. See **transparent print**, **extension print**, **buffer**.

byte A group of bits (usually eight) representing a character. See **bit**.

character A unique, transmittable data symbol. See **display character**, **control character**.

character keys The keys that send display (alphanumeric) characters to the terminal and/or computer.

connector The device (plug or jack) at the end of the cable and the electrical interface (port) of the computer, terminal, printer, etc. RS-232 connectors are commonly D-shaped and contain pins (male connector) or holes (female connector). The number of pins varies between equipment manufacturers. TeleVideo terminals have 25-pin female connectors.

control characters Characters that send a command to the terminal, rather than being displayed on the screen. The standard ASCII control characters are in the range of hex 00 to 1F. See the ASCII Control Chart in Appendix C.

conversational mode A communication mode that lets data flow interactively from one communication device to another. See **full duplex**, **half duplex**.

copy print See **extension print**.

CRT Acronym: cathode ray tube. An electronic vacuum tube, like a TV picture tube, that displays images. See **screen**.

cursor A marker showing where the next character should appear on the screen. Can be blinking or steady, a block or an underline, or invisible.

current loop A method of sending data as 20-milliampere current pulses over a serial line (up to 700 meters). Although usually slower than RS-232, it permits accurate communication over longer distances. Either the computer or the terminal may be able to supply the current. The configuration chosen (active or passive) depends on whether the terminal or computer is supplying the power. If the terminal supplies the current, configure the terminal's current loop for active; if the computer supplies the current, configure the terminal for passive. To determine correct configuration, think of a person holding a garden hose with a nozzle on the end. If the house supplies the water pressure to the hose and the person merely opens the nozzle, the house is the active device and the person is passive device. However, if opening and closing the nozzle causes water to flow from (i.e., suctioned out of) a holding tank within the house, the person is the active device and the house is the passive device.

CTS Acronym: Clear to Send. A signal on a dedicated RS-232 line indicating that the computer is ready to receive more data from the terminal.

data Information that can be coded into bits, to be stored in a computer or terminal's memory and transmitted between devices.

DCD Acronym: **Data Carrier Detected**. A signal on a dedicated RS-232 line that indicates whether or not the data carrier in the phone system is active and the device at the other end of the phone line is available.

DCE Acronym: **Data Communications Equipment**. Usually the computer or the equipment connected to it.

default A value or instruction in effect until otherwise defined.

delete To eliminate (destroy) data stored in certain memory locations. See **erase**.

delimiter A code transmitted at the end of a predefined area (field) of data. Could be a field, end of line, or end of text delimiter.

descender That part of a lowercase character that hangs below the main body of the character. The tail of the lowercase **y** is a descender. A terminal with true descenders (such as TeleVideo's) displays the tail below the main line of text.

DIP Switches Acronym: **Dual In-Line Package**. A panel of very small switches.

display The amount of data that can be viewed on the terminal screen at one time. See **page**, **screen**.

display characters Characters that appear on the terminal's screen, including alphanumeric and graphic symbols. See **characters**, **alphanumeric characters**, **graphics characters**.

download To copy (read) data from the computer into the terminal's memory.

DSR Acronym: **Data Set Ready**. A signal on a dedicated RS-232 line indicating when the data coming from the computer is meant for your terminal (or another terminal on a network).

DTE Acronym: **Data Terminal Equipment**. Equipment that supports data transmission from a terminal.

DTR Acronym: **Data Terminal Ready**. A handshaking protocol that controls the flow of data between the terminal and the computer or printer by lowering and raising the voltage on pin 20 (the DTR line) in the RS-232C connector. See **handshaking protocol**, **X-On/X-Off**, **buffer**.

duplex Bidirectional communication. See **conversational mode**, **half duplex**, **full duplex**, **editing mode**.

echo To send back received data. For example, in full duplex communication mode, the computer must echo back data it receives from the terminal before that data can be displayed on the screen.

editing key mode A mode determines the destination of editing key codes. In local editing mode, editing key codes affect only data on the screen, even in conversational communication modes. In duplex editing mode, codes go to the computer (in conversational communication modes). See **mode**.

EM Acronym: **End of Message**. An ASCII control character (hex 19) sometimes marking the end of a block transmission.

EPROM Acronym: **Erasable, Programmable ROM**. A read-only memory chip that can be erased and reprogrammed.

erase To replace data in certain memory locations with replacement characters. See **delete**, **replacement character**.

escape sequence A command introduced by an ASCII escape character (hex 1B) that controls terminal operations.

ETX Acronym: **End of Text**. An ASCII character (hex 03) that marks the end of a block transmission message.

extension print A print mode that sends data from the computer to the printer and the screen at the same time. Sometimes called **copy print**. See **transparent print**, **page print**.

field A group of characters affected in the same way by commands (e.g., a write-protected field).

firmware A program embedded on a chip, usually called an EPROM, inside the terminal that tells the terminal how to operate. See **program**.

formatted Screen data that includes the delimiters that signal the line ends (e.g., CR, LF, and null) and end of the transmission. See **delimiter**, **page print**.

full duplex A communication mode that lets the terminal and computer transmit and receive simultaneously. Data from the computer is not displayed on the screen unless the computer echoes it back. See **echo**.

function keys Keys that send preset escape sequences whose application is user definable. Many TeleVideo terminals have reprogrammable function keys.

graphics characters Special non-ASCII characters used to draw lines, figures, and graphs.

half duplex An interactive communication mode that lets the terminal transmit and receive data in separate, consecutive operations. Key codes go to both the computer and the screen.

handshaking protocol Prearranged signals the computer and the peripherals send when they are ready to send or receive data. They prevent data loss when the other device is not able to accept or handle more data at that time. They can be ASCII control characters (X-On/X-Off) in the data stream or they can be raised or lowered voltage on RS-232C lines dedicated to that purpose (DTR). See **DTR**, **X-On/X-Off**, **DCD**, **DSR**.

hardware The physical components of a system, such as computer, terminals, cables, printers, modems.

hertz A unit of frequency (of electrical waves) equal to one cycle per second. If the frequency rate of the terminal does not match the frequency rate of the incoming alternating current, the display may waver. Abbreviated Hz.

hexadecimal A numbering system with a base of 16 (digits 0-9 and A-F). Commonly used by programmers to indicate locations and contents of a computer's memory. Abbreviated hex. See the ASCII Code Chart in Appendix C.

home The first character position on the page (line 1, column 1). Pressing HOME moves the cursor to this position.

information line Contrasting lines at the top and bottom of the screen that do not display screen data. They can display the status or set up lines, the user's message or nothing. See **status line**, **set up menu**.

insert To add data within existing data, which is usually moved to the right at the point of insertion to make room for the new data.

interface An interaction or connection between devices in a computer system (i.e., the computer and peripherals). See **current loop**, **RS-232C**, **RS-422**.

interface cable A cable with connectors that can be plugged into the port connectors of the components in a system, thus linking the various devices. See **connector**, **RS-232C**, **interface**.

keyboard An arrangement of keys, similar to a typewriter's, on which an operator can enter data, send commands, and operate the terminal.

load To program information into memory.

local editing mode See **editing key mode**.

local mode A mode that disconnects the terminal and computer. Keyboard entries go only to the screen. See **block mode**, **conversational mode**.

menu A displayed list of operating values from which the operator can make selections.

message line See **information line**.

millisecond 1/1000 of a second.

mode An operating state that controls how the terminal operates or reacts to commands. For instance, in monitor mode, the terminal displays all characters (including control codes and escape sequences), not just alphanumeric characters. The terminal can be in several modes at the same time, e.g., protect and duplex edit modes.

modem Acronym: **modulator/demodulator**) An electronic device that changes digital signals (bits) to analog signals (tones), or vice versa. A modem translates digital signals from a computer to analog signals, which can be sent across telephone wires. The modem at the other end translates the analog signals back to digital signals and passes them on to the other computer.

monitor Hardware: A video screen on which you can see computer output and input.

monitor mode A mode in which the screen displays all ASCII characters (control and alphanumeric) and does not act on command characters.

N-key rollover A keyboard feature that lets you type faster than the keyboard can transmit without locking up or missing a character. You can strike a series of keys virtually simultaneously, and the characters will be transmitted in the order in which the keys are pressed.

nonvolatile memory A permanent memory storage area not affected by loss of power. This memory is backed up by a lithium battery.

null An ASCII character (hex 00) that occupies no space and is not transmitted.

operating parameter A value (constant or selectable) that determines terminal operating characteristics, such as the speed of data transmission, the status of an operating mode, and operating appearance (dark or light screen background). See **mode**.

page The amount of available screen memory. Can range from 24 to 96 lines, depending on your terminal's configuration. Since the screen displays 24 lines at a time, you may not see the entire page. See **display**, **screen**.

page print A print command that sends data on the terminal's screen to the printer. Can be formatted or unformatted. See **formatted**, **unformatted**.

parameter See **operating parameter**.

parity A method of checking received data bits to ensure they are complete and accurate. If two devices are connected, the parity setting for both devices must be the same. See **start bit**, **stop bit**.

peripheral External equipment connected to a computer. The most common peripherals are terminals, disk drives, printers, modems, and cassette-tape recorders.

permanent memory See **nonvolatile memory**.

port The location at which data goes in and out of the device, usually the physical connector into which interface cables are plugged. See **connector**, **RS-232C**, **interface**.

program A set of commands that control a computer or terminal. There are three kinds of programs: firmware, which is burned into the EPROMs that control the system; applications, which accomplish specific tasks; and the operating system, which controls the overall operation of the system, directing the firmware and applications programs. See **firmware**, **applications program**, **software**.

protect mode A mode that protects specific data fields from any data entry or editing. Block mode transmission can exclude or include these areas.

RAM Acronym: **Random-Access Memory**. The changeable part of the computer or terminal's memory that can be read and written into during normal operation. It is erased (lost) when power to the RAM chip is turned off. RAM is used in all computers to store the instructions of programs being run. See **ROM**.

read the cursor Report the cursor's position and content to the computer.

refresh To change or update the screen with new data.

replacement character The character that occupies the position previously occupied by an erased character. Unless you define it, it is a space character. See **delete**, **erase**, **space character**.

resolution The sharpness of the characters on the display. When a character contains a lot of small dots (pixels), it is much sharper than a character containing only a few large dots.

reverse video A terminal feature that produces the opposite combination of characters and background from the one usually employed (i.e., light characters on a dark background if normally characters are dark on a light background).

ROM Acronym: **Read-Only Memory**. A memory chip which, after manufacture, can be read but not written or altered. Used to store permanent instructions.

RS-232C A standard technical specification written by the Electronic Industry Association for data sent as voltage pulses over a serial cable at distances up to 50 feet (although shielded wires allow greater length). See **interface**, **current loop**, **RS-422**.

RS-422 A technical specification for high-speed communication between the computer and a peripheral. When used, sends data faster than RS-232C while allowing the peripheral to be located up to 4,000 feet from the computer. See **interface**, **current loop**, **RS-232C**.

RTS Acronym: Request to Send. A line whose voltage changes to control data flow between computer, terminal, and printer. See **handshaking protocol**.

screen The terminal viewing area that shows 24 lines of data and two information lines. See **display**, **page**.

screen saver A feature that causes the screen to go blank when no data entry or editing occurs for a fixed time span (e.g., 10, 20, or 30 minutes), thus preventing the display pattern from being burned into the phosphor. To redisplay the screen, press any key. No data is lost.

screen updating Data changing on the terminal's screen as new data is received from the computer.

scroll The action that moves the display (screen area) up or down in the page so you can see more than 24 lines on that page of memory. The direction, rate, and evenness of the scrolling can be controlled. See **page**, **display**, **screen**.

scrolling region The area in a page of memory through which the display can scroll. Movement of the cursor is limited to the scrolling region.

self-test A procedure that causes the terminal (or a program or peripheral) to check its own operation.

serial transmission A method of sending one bit of data at a time in a stream. See **RS-232C**.

set up A terminal mode that lets the operator change the terminal's operating values from the keyboard.

set up menu Lines displayed on the terminal's top and bottom information lines during set up mode. Set up menus list all terminal operating values that can be changed from the keyboard. See **information line**.

software Various programs, including the operating system and the applications programs, that can be loaded into the terminal. See **firmware, program, system**.

SOH Acronym: **Start of Header**. An ASCII character (hex 01) that frames the start of block of data to be transmitted. See **EM**.

space character An ASCII alphanumeric character (hex 20) that occupies a character position on the screen and in the terminal's memory. Not the same as a null, which looks like a space but contains nothing (i.e., is a void) and does not occupy memory space. The terminal transmits space characters, while it does not transmit null characters. See **null**.

special keys Keys that do not send display characters or editing commands, used for a variety of purposes in controlling the terminal.

status line A line appearing on the top or bottom information line that describes the terminal's current operating conditions.

start bit The bit that signals the beginning of data transmission. It is always a one (1). See **parity, stop bit**.

stop bit The bit that signals the end of data transmission. It is always a one (1). The terminal can use either one or two stop bits, depending on the computer's requirements. See **parity, start bit**.

STX Acronym: **Start of Text**. An ASCII character (hex 02) signalling that text transmission follows.

system The computer, the peripheral devices (such as terminals, printers, and modems), and the programs that work together to accomplish various tasks.

tab stop A preset position to which the cursor goes when the TAB key is pressed or the terminal receives the tab command. Tab stops can be changed or deleted on command.

transmit To send data between one system component (such as the computer) and another (such as the terminal).

transparent print A print mode that sends all data received by the terminal to the printer without displaying it on the screen. See **extension print**, **bidirectional print**, **page print**.

unformatted Screen data that contains no delimiters marking line ends. See **delimiter**.

VDT Acronym: **video display terminal**. A terminal containing a cathode ray tube on which information received from the computer or keyboard can be displayed. Different than a terminal that uses a printer to display data. Video display terminals include a keyboard, while printer terminals may not.

visual attributes The aspects of a character's appearance on the screen. The character can be steady or blinking, full or half intensity, visible or blank (invisible), normal or reverse video, and underlined.

word structure The arrangement of bits in each piece of transmitted data. Consists of a start bit, the data bits, a parity bit (optional) and one or two stop bits.

X-On/X-Off A handshaking protocol in which the terminal and computer or printer recognize the ASCII control characters X-On (hex 11) and X-Off (hex 13) as signals to regulate data flow. See **handshaking protocol**, **DTR**.

QUICK REFERENCE GUIDE

VERIFYING OPERATIONS

Run the self test	ESC V
Monitor mode on	ESC U
Monitor mode off	ESC X
	or ESC u

CHANGING OPERATING VALUES

Set terminal operating mode(s)	ESC [= Ps h
Reset terminal operating mode(s)	ESC [= Ps l
Select a terminal operating value	ESC [p1 ; p2 v
Select 955 programming compatibility mode	ESC [10 ; 0 v
Select 950 programming compatibility mode	ESC [10 ; 1 v
Screen refresh rate is 60 Hz	ESC [= 16 l
Screen refresh rate is 50 Hz	ESC [= 16 h
Reset the terminal's operating values to factory default values	ESC ~ 0
Reset the terminal's operating values to nonvolatile memory values	ESC ~ 1
Reset function keys to factory default values	ESC ~ 2
Reset editing keys to factory default values	ESC ~ 3

RUNNING A PROGRAM

Execute a user-installed program	ESC z
----------------------------------	-------

KEYBOARD AND BELL

Lock (disable) the keyboard	ESC #
Unlock (enable) the keyboard	ESC "
Lock (disable) SET UP key	ESC [= 11 l
Unlock (enable) SET UP key	ESC [= 11 h
Lock (disable) ESC key	ESC [= 12 l
Unlock (enable) ESC key	ESC [= 12 h
Lock (disable) CLEAR SPACE key	ESC [= 13 l
Unlock (enable) CLEAR SPACE key	ESC [= 13 h
Lock (disable) BREAK key	ESC [= 14 l
Unlock (enable) BREAK key	ESC [= 14 h

KEYBOARD AND BELL

Enable local editing key mode	ESC k
Enable duplex editing key mode	ESC l
Keyboard repeat on	ESC [= 8 h
Keyboard repeat off	ESC [= 8 l
Keyclick on	ESC >
Keyclick off	ESC <
Load the margin bell column	CTRL W
Margin bell on	ESC [= 4 h
Margin bell off	ESC [= 4 l
Sound the terminal's bell	CTRL G

SCREEN APPEARANCE

Select screen saver time	ESC [8 ; Ps v
Turn screen on	ESC n
Turn screen off	ESC o
Light background with dark characters	ESC b
Dark background with light characters	ESC d
Define visual attribute(s)	ESC G Ps
Attributes occupy a character space	ESC F 0
Attributes do not occupy a character space	ESC F 1
Half intensity mode	ESC [= 5 h
Full intensity mode	ESC [= 5 l
Page base attribute mode	ESC [= 2 h
Line base attribute mode	ESC [= 2 l
Select the status line visual attribute(s)	ESC [3 ; Ps v
Select cursor style	ESC . Ps
Enable 132 columns per line	ESC [= 3 h
Enable 80 columns per line	ESC [= 3 l

CHARACTER SETS AND BLOCK GRAPHICS

Select a character set	ESC [9 ; Ps v
Special graphics mode on	ESC \$
Special graphics mode off	ESC %
Select a character from the multinational set	CTRL U Ps
Read 7-bit data words	ESC [= 1 l
Read 8-bit data words	ESC [= 1 h
Define block graphics area	ESC H w h
Enable optional graphics firmware	ESC m

EDITING MODES

Autowrap mode on	ESC [= 7 h
Autowrap mode off	ESC [= 7 l
New line mode on	ESC [= 6 h
New line mode off	ESC [= 6 l
DOWN key sends CTRL J	ESC [= 9 h
DOWN key sends CTRL V	ESC [= 9 l
Turn on write protect mode	ESC)
Turn off write protect mode	ESC (
Turn on protect mode	ESC &
Turn off protect mode	ESC '

ADDITIONAL SCREEN MEMORY

Define number of lines on each page	ESC \ Ps
Autopage mode on	ESC v
Autopage mode off	ESC w
Display the previous page	ESC J
Display the next page	ESC K
Display page Pn	ESC [1 ; Pn }

SCROLLING

Data scrolls smoothly at 4 lines per second	ESC 8
Data scrolls at the rate received	ESC 9
Select scroll rate	ESC [6 ; Ps v
Define a scrolling region	ESC [Pt ; Pb r
Enable line lock	ESC ! 1
Disable line lock	ESC ! 2

TAB STOPS

Create column of tab stops at the current column	ESC 1
Move cursor forward to next typewriter or field tab stop	CTRL I
Move cursor forward to next field tab stop (protect mode on)	ESC i
Move cursor backward to previous typewriter or field tab stop	ESC I
Clear typewriter tab stop at cursor location	ESC 2
Clear all typewriter tab stops	ESC 3

CURSOR CONTROL

Line feed	CTRL J
Reverse line feed	ESC j
Move the cursor up	CTRL K
	ESC [Pn A
Move the cursor down	CTRL V
	ESC [Pn B
Move the cursor right	CTRL L
	ESC [Pn C
Move the cursor left	CTRL H
	ESC [Pn D
New line (line feed/carriage return)	CTRL
Carriage return	CTRL M
Address (send) cursor to page, row, and columns 1 through 80	ESC - p r c
Address (send) cursor to page, row, and columns 81 through 132	ESC - p r ~ c
Address (send) cursor to row and columns 1 through 80 in current page	ESC = r c
Address (send) cursor to row and columns 81 through 132 in current page	ESC = r ~ c
Read cursor's page, row, and column position	ESC /
Read cursor's row and column position	ESC ?
Address the cursor to line and column of the current page in decimal units	or ESC [P1 ; Pc H
Move cursor to home position	or ESC [P1 ; Pc f
	CTRL ^
	or ESC [H
Read cursor's page, line, and column position in decimal units	ESC [? 6 n
Read cursor's line and column position in decimal units	ESC [6 n

EDITING DATA

Enable page edit mode	ESC N
Enable line edit mode	ESC O
Enable insert mode	ESC q
Enable replace mode	ESC r
Load a replacement character	ESC e Ps
Insert a replacement character at the cursor position	ESC Q
Insert Pn replacement characters starting at the cursor	ESC [Pn @
Insert a line of replacement characters on the current line	ESC E
Insert Pn lines of replacement characters starting at the cursor line	ESC [Pn L
Delete character at cursor position	ESC W
Delete Pn characters starting at the cursor position	ESC [Pn P
Delete current line and replace with replacement characters	ESC R
Delete Pn lines, starting at cursor line, and replace with replacement characters	ESC [Pn M
Erase from the cursor to end of line; replace with replacement characters	ESC T
Erase in the current line; replace with replacement characters	ESC [Ps K
Erase from the cursor to end of line; replace with null characters	ESC t
Erase from the cursor to end of page; replace with replacement characters	ESC Y
Erase in the page; replace with replacement characters	ESC [Ps J
Erase from the cursor to end of page; replace with null characters	ESC y
Clear current unprotected field and replace with replacement characters. Return cursor to beginning of field (protect mode on); or clear current tab field or whole line and move cursor to beginning of current tab field or line (protect mode off)	CTRL X

EDITING DATA

Clear all characters and replace with null characters (reset protect and write protect modes) ESC *

955 mode: Clear all characters and replace with replacement characters (reset protect and write protect modes) ESC +
 950 mode: Clear unprotected characters and replace with replacement characters (do not reset write protect and protect modes)

955 mode: Clear unprotected characters and replace with write protected space characters (reset protect mode) ESC ,
 950 mode: Clear unprotected characters and replace with write protected space characters (do not reset protect mode)

Clear unprotected characters and replace with replacement characters ESC ;
 or CTRL Z
 Clear unprotected characters and replace with null characters ESC :

CHANGING PORT OPERATING VALUES

Select main port operating values ESC { p1 p2 p3 p4
 Select printer port operating values ESC } p1 p2 p3 p4

SETTING UP COMMUNICATIONS WITH THE COMPUTER

Disable X-On/X-Off; enable DTR line CTRL N
 Enable X-On/X-Off; disable DTR line CTRL O
 Select the terminal's handshaking protocol ESC [1 ; Ps v
 Select the receive buffer fill limit ESC [2 ; Ps v
 Transmission control on ESC [= 0 h
 Transmission control off ESC [= 0 l
 Select the character transmit delay rate ESC [0 ; Pn v
 Block mode on ESC B
 Local mode on ESC c
 Half duplex mode on ESC D H
 Full duplex mode on ESC D F
 Return to previous conversational mode ESC C

SENDING SCREEN DATA

Reprogram delimiter characters	ESC x Ps p1 p2
Send unprotected characters in cursor line up to and including cursor	ESC 4
Send unprotected page up to and including cursor	ESC 5
Send entire line of data up to and including cursor	ESC 6
Send entire page up to and including cursor	ESC 7
Send unprotected message between start of text (STX) and end of text (ETX)	ESC S
Send whole message between start of text (STX) and end of text (ETX)	ESC s

LOADING AND SENDING MESSAGES

Send terminal's identification	ESC M
Program the answerback message	ESC ^ <text> CTRL Y
Send the answerback message	CTRL E
Display user message one on the screen's bottom line	ESC g
Display the status line on the screen's bottom line	ESC h
Select the contents of the top information line	ESC [4 ; Ps v
Select the contents of the bottom information line	ESC [5 ; Ps v
Load text into user message one	ESC f <text> CTRL M
Load text into a user message	ESC _ p1 p2 <text> CTRL M
Send the information line contents	ESC Z Ps

PRINTING

Buffered copy print mode on	ESC @
Buffered copy print mode off	ESC A
Buffered transparent print mode on	ESC `
Buffered transparent print mode off	ESC a
Buffered bidirectional print mode on	CTRL R
Buffered bidirectional print mode off	CTRL T
Print unprotected formatted page	ESC P
Print all unformatted page	ESC L
Page print	ESC [0 ; Ps i
Page print flip on	ESC [= 15 h
Page print flip off	ESC [= 15 l
Define the page print terminator	ESC p Ps

FUNCTION KEYS

Select function key set one	ESC [7 ; 0 v
Select function key set two	ESC [7 ; 1 v
Reprogram a function key	ESC p1 p2 <message> CTRL Y
Save function key reprogramming in nonvolatile memory	ESC [= 10 h
Do not save function key reprogramming in nonvolatile memory	ESC [= 10 l
Invoke a function key	ESC [Pn

REPROGRAMMING EDITING KEYS

Reprogram the SEND key (950 mode)	ESC 0 Ps p1
Reprogram any individual editing key (955 mode)	ESC 0 Ps p1 p2 p3
Reprogram all editing keys	ESC] Ps p1 ... p60

INDEX

- Addressing the cursor, 83, 85
- ALPHA LOCK key, 31, 41
- Answerback message, 24, 108
- Appearance of screen, see
Screen appearance
- ASCII character set, 62
- ASCII characters, A-5
 - as delimiter, 102
 - as print terminator, 120
 - as replacement character, 90
 - as reprogrammed edit key codes, 125, 128
 - as text markers, 103
 - in answerback message, 108
 - in cursor addressing command, 83
 - in cursor position report, 84
 - in FUNCT key transmission, 111
- Assistance, 39, 44
- Attribute base mode, 59-60
- Attributes, see Visual attributes
- Autopage mode, 73, 76
 - effects of, 74, 78-79, 81-82
- Autowrap mode, 17, 67
- BACK SPACE key, 27, 80
- BACK TAB key, 27, 87-88, 126-127
- Background of screen, 18, 58
- Baud rate, 13, 100, 114, 119
 - selecting, 11, 14, 97
- Bell, 6
 - margin column, 21, 57
 - not sounding, 39
 - programming, 56
- Bidirectional print mode, 15, 112
- Block
 - graphics, 64
 - mode, 12, 100, 102
- Bottom information line, see Information lines
- BREAK key, 31, 53, 55
 - disabling, 21, 56
- Buffered print modes, 112, 114
- Buffers, 99, 114, 116-118
 - fill limit of receive, 13, 99
- Cables, 4-5
- Carriage return, 20, 80
- CE key, 27, 88, 94, 126-127
- CHAR DELETE key, 27, 91, 126-127
- CHAR INSERT key, 27, 90, 126-127
- Character keys, 25
 - pressed with FUNCT key, 111
- Character sets, 62-63,
 - foreign, A-9
 - multinational, A-14
 - selecting in set up, 20
- Character(s)
 - ASCII, 83-84, 90, 102-103, 108, 111, 118, 125, 128, A-5
 - delimiter, 102
 - ETX, 103
 - graphics, 62, 68-69
 - sending, 105, 107
 - null, 28-29, 83, 89-90, 93-94
 - print termination, 114, 118
 - replacement, 27-29, 89-94
 - space, 94
 - STX, 103
 - transmit delay rate, 13, 100, 119
 - write protected, 58, 62

- CLEAR SPACE key, 28, 42, 47, 94, 126-127
 - disabling, 21, 56
- Clearing
 - data, 89, 94
 - pages of memory, 72
 - tab stops, 88
- Columns per line mode, 17, 61, 83
- Commands, 45-46
 - changing operating values with, 49
 - displaying in monitor mode, 48
 - effect of protect mode on editing, 69
 - summary, A-16
- Communication, 97
 - modes, 12, 33, 100, 102
 - with computer, 98
 - with printer, 112
- Compatibility
 - of pin connectors, 4-5
 - programming, 51
 - terminal model, 13
- Computer
 - communication with, 98
 - no response from, 40
 - port, 4
 - changing values, 98
 - set up menu, 10
- Connectors, 4-5
- Control characters, 45
 - abbreviations, A-6
 - displaying, 48, A-7
 - functioning incorrectly, 41
 - summary, A-16
- Conversational modes, 100, 102
- Copy print mode, 15, 112-114
- CTRL key, 31
- Current loop, 4
- Current memory, 8, 49, 98
- Cursor
 - absence of, 39-40
 - addressing, 83, 85
 - appearance, 6, 18, 35, 61
 - coordinate table, 64, 83-84, 110
 - movement
 - affected by mode/command, 67-69, 73-74, 78, 87, 94, 105-107
 - commands, 78, 80
 - in set up fields, 7
 - with keys, 35
 - position report, 84
 - reading, 84-85
 - undisplayed, 61
- Customer service, 44
- Damage from shipping, 1
- Data
 - clearing, 89, 94
 - deleting, 89, 92
 - editing, 89
 - from the keyboard, 34
 - entry
 - effect of protect mode, 69
 - preventing, 55
 - protected, 71
 - erasing, 89, 93
 - inserting, 89-91
 - loss of, 67, 72, 75, 78, 86, 90-92, 111
 - preventing, 70, 98
 - scrolling, 18, 75-76
 - sending, 102, 104
 - effect of commands, 105-107
 - from the keyboard, 33
 - transmission markers, 103
 - word
 - mode, 13, 63-64
 - structure, 11, 14, 97

- Data Terminal Ready, 12, 76, 98-99, 116
- Default values, 7, 46
 - editing key codes, 126-127
 - function key codes, 120
 - in set up menus, 10
 - of attributes, 59
 - of delimiters, 102
 - resetting the terminal to, 52
- Defined scrolling region, 64, 72, 76
- DEL key, 31
- Deleting data, 89, 92
- Delimiters, 102
 - in transmitted data, 105, 107
 - reprogramming, 103
- Disabling
 - BREAK key, 21, 56
 - CLEAR SPACE key, 21, 56
 - ESC key, 21, 56
 - SET UP key, 7, 56
 - the keyboard, 55
- Display, see also Screen
 - definition, 71
 - wavy, 41
- DOWN key, 7, 28, 78, 80, 126-127
 - mode, 20, 68
- DTR, see Data Terminal Ready
- Duplex editing key mode, 56
- Edit mode, 69, 89
- Editing
 - effect of protect mode, 69
 - data, 89
 - from the keyboard, 34
 - key mode, 20, 56
 - keys, 26, 34, 125, 127
 - pressed with FUNCT key, 111
 - modes, 33, 67
- Enabling the keyboard, 55
- ENTER key, 28, 80, 126-127
- Erasing data, 89, 93
- ESC key, 31
 - disabling, 21, 56
- Escape sequences, 45
 - displaying in monitor mode, 48
 - functioning incorrectly, 41
 - summary, A-16
- ETX character, 103
- Field
 - protected, 80
 - tab stops, 86-88
- Fill limit of receive buffer, 13, 99
- Flip page mode, 16, 115-116
- Foreign characters, 20, 62, A-9
- Formatted printing, 34, 112, 115
- Full duplex mode, 12, 100, 102
- Full intensity, 18, 60
- FUNCT key, 32, 55, 111
- Function keys, 22, 32, 55, 119-121, 124
- Fuse, 42
- Graphics
 - block, 64
 - characters, 62, 68-69
 - sending, 105, 107
 - optional firmware, 65
- Half duplex mode, 12, 100, 102
- Half intensity, 18, 60, 68-69
- Handshaking protocols, 76, 116, 119
 - selecting, 12, 98
- Hazard
 - electric shock, 1
 - X-ray emissions, 2
- Hertz setting, 21, 41, 52
- HOME key, 28, 85, 126-127
- Home position, 85, 94
- Identification message, 108
- Information lines, 17, 107
 - displaying contents, 108
 - sending, 111
- Insert mode, 27, 89
- Inserting data, 89-91

Inspecting and installing
 the terminal, 1-6
 summary, 6
 Intensity, 18, 60
 half, 68-69
 Interfaces, 4-5

Jump scroll, 17, 75-76

Key(s)

ALPHA LOCK, 31, 41
 BACK SPACE, 27, 80
 BACK TAB, 27, 87-88, 126-127
 BREAK, 31, 53, 55
 disabling, 21, 56
 CE, 27, 88, 94, 126-127
 CHAR DELETE, 27, 91, 126-127
 CHAR INSERT, 27, 90, 126-127
 character, 25
 pressed with FUNCT key, 111
 CLEAR SPACE, 28, 42, 47,
 94, 126-127
 disabling, 21, 56
 CTRL, 31
 cursor movement, 35
 DEL, 31
 disabling, 21
 DOWN, 7, 20, 28, 68, 78,
 80, 126-127
 editing, 26, 34, 56,
 125-128
 pressed with FUNCT key,
 111
 ENTER, 28, 80, 126-127
 ESC, 31
 disabling, 21, 56
 FUNCT, 32, 55, 111
 function, 32, 55, 119-122,
 124
 HOME, 28, 85, 126-127
 LEFT, 7, 28, 80, 126-127
 LINE DELETE, 28, 126-127
 LINE ERASE, 29, 93, 126-127
 LINE FEED, 28-29, 75, 78
 LINE INSERT, 29, 90,
 126-127
 LOC ESC, 32, 41, 47, 55
 names of shifted, 25

Key(s)

NO SCROLL, 32, 55
 PAGE, 29, 74, 126-127
 PAGE ERASE, 29, 93, 126-127
 PRINT, 29, 34, 112, 126-127
 repeat action, 21, 25, 55
 reprogramming, 119
 RESET, 32, 53, 55
 RETURN, 30, 80
 RIGHT, 7, 28, 75, 126-127
 SEND, 30, 33, 102, 126-127
 reprogramming, 125
 sending command codes, 46
 SET UP, 7, 32, 55
 disabling, 7, 56
 SHIFT, 32, 111
 space bar, 8
 TAB, 30, 69, 86-87, 126-127
 UP, 7, 28, 78, 80, 126-127
 Keyboard, 25
 connecting to terminal, 3
 enabling/disabling, 55
 entering commands at, 46-47
 functioning incorrectly, 40
 repeat mode, 21, 55
 set up menu, 19
 Keyclick, 20, 56

LEFT key, 7, 28, 80, 126-127
 Lighting of terminal, 1
 Limited warranty, A-4
 LINE DELETE key, 28, 126-127
 Line edit mode, 69, 89
 LINE ERASE key, 29, 93, 126-127
 Line feed, 20, 78
 LINE FEED key, 28-29, 75, 78
 Line fuse, 42
 LINE INSERT key, 29, 90,
 126-127
 Line lock command, 76

Line(s)

columns per, 17, 61, 83
 information, 17, 107-108,
 111
 number per page, 72, 75-76
 status, 17, 36, 107-109, 111
 visual attributes, 19, 61
 Line-based visual attributes,
 18, 60

- Loading messages, 109
 - see also Addressing
- LOC ESC key, 32, 41, 47, 55
- Local editing key mode, 56
- Local mode, 12, 100, 102
- Locking, see Disabling
- Locking lines, 76
- Losing data, see Data loss
- Main
 - port, see Computer port
 - set up menu, 9
- Margin bell, 57
- Memory
 - additional, 16, 29, 71, 75, 78-79, 82-85, 155-116
 - clearing, 72
 - dividing into pages, 72
 - saving in, 8, 50, 51, 98, 109, 118-119, 124
- Menus
 - keyboard, 19
 - main port, 10
 - main set up, 9
 - printer port, 14
 - programming, 22
 - screen, 16
 - set up, 7-9
- Message(s), 107, 109
 - answerback, 24
 - user, 17
- Mode(s)
 - attribute base, 59-60
 - autopage, 73-74, 76
 - effects of, 78-79, 81-82
 - autowrap, 17, 67
 - bidirectional, 15, 112, 114
 - block, 12, 100, 102
 - print, 61, 112-114
 - columns per line, 17, 61, 83
 - communication, 12, 33, 100
 - conversational, 100, 102
 - copy print, 15, 112, 114
 - data word, 63-64
 - DOWN key, 20, 68
 - editing, 33, 67
 - editing key, 20, 56
 - full duplex, 12, 100, 102
 - half duplex, 12, 100, 102
 - insert, 27
 - insert/replace, 89
 - keyboard repeat, 21, 55
 - line/page edit, 89
 - effect of protect mode, 69
 - local, 12, 100, 102
 - margin bell, 57
 - monitor, 48
 - new line, 20, 67
 - normal intensity, 60
 - operating, 49
 - page print flip, 16, 115-116
 - print, 15, 112, 114
 - programming compatibility, 51
 - protect, 64, 68-69
 - affected by clear commands, 94
 - effects of, 69, 78-79, 81-82, 86-93, 105-107
 - replace, 27, 89
 - special graphics, 62
 - transmit control, 99
 - transparent print, 15, 112, 114
 - visual attribute space, 18, 60
 - write protect, 68-69, 86
 - affected by clear commands, 94
- Modem, 13
- Monitor mode, 48
- Multinational character set, 63, A-14
- New line, 80
 - mode, 20, 67
- New page, 74
- NO SCROLL key, 32, 55
- Nonvolatile memory, 50-52
 - saving values in, 8, 98
- Normal intensity mode, 18, 60
- Normal scroll, see Smooth scroll
- Null characters, 28-29, 83, 89-90, 93-94

- Operating modes, 49
- Operating values, 7-8, 50-51
 - saving, 98
- Page edit mode, 69, 89
- PAGE ERASE key, 29, 93, 126-127
- PAGE key, 29, 74, 126-127
- Page print, 16, 29, 34, 112-116
- Page(s)
 - lines per, 64, 75-76, 78
 - of additional memory, 16, 29, 71-72, 75, 78-79, 82-85, 115-116
- Page-based visual attributes, 18, 60
- Parity, 11, 15, 97
 - matching computer's?, 40
- Pin connector assignments, 4-5
- Ports, see Computer, Printer
- Power
 - off state
 - resetting the terminal to, 52
 - unlocking keyboard, 55
 - voltage setting, 4
- Print
 - buffer, 99, 114, 116-118
 - modes, 15, 112, 114
 - page, 34, 112, 114
 - termination character, 114, 118
- PRINT key, 29, 34, 112, 126-127
- Printer, 5
 - communication with, 112
 - port, 5
 - changing values, 98
 - handshaking protocols, 116-118
 - set up menu, 14
- Printing, 112
 - formatted/unformatted, 115
 - from the keyboard, 34
 - incorrect, 41
- Program
 - incorporating commands in, 46
 - running user-installed, 54
- Programming
 - commands, see Commands
 - compatibility mode, 51
 - languages, 46
 - set up menu, 22
- Protect mode, 64, 68-70
 - affected by clear commands, 94
 - effects of, 69, 78-82, 86-93, 105-107
 - entering data, 71
- Protocols, see Handshaking protocols
- Reading the cursor, 84-85
- Receive buffer, 99, 116-118
 - fill limit, 13, 99
- Received data control, 12
- Repeat action of keys, 21, 25, 55
- Replace mode, 27, 89
- Replacement characters, 27-29, 89-94
- Reprogramming keys, 119-120, 122-125, 127-128
- RESET key, 32, 53, 55
- Resetting the terminal, 52, 55
 - from the keyboard, 32
- RETURN key, 30, 80
- Return Material Authorization (RMA), A-4
- Reverse line feed, 78
- RIGHT key, 7, 28, 75, 126-127
- RS-232C interface, 4-5
- Screen
 - appearance, 17-18, 35, 57
 - blurry, 41
 - columns per line mode, 17, 61, 83
 - contrast adjustment, 6
 - definition, 71
 - saver, see Time out blank
 - set up menu, 17

- Scrolling, 17, 75-76
 - region, 64, 72, 76
- Self test, 21, 42, 47
- SEND key, 30, 33, 102, 126-127
 - reprogramming, 125
- Sending
 - answerback message, 108
 - data, 102, 104
 - effect of commands, 105-107
 - from the keyboard, 33
 - FUNCT key codes, 111
 - function key codes, 119
 - graphics characters, 105, 107
 - identification message, 108
 - information line contents, 111
 - status line contents, 111
 - user messages, 111
 - visual attributes, 105, 107
- Service, 44
 - calls, 39
- Set up, 7-9
 - changing values with
 - commands, 46, 49
 - keyboard menu, 19
 - main menu, 9
 - main port menu, 10
 - printer port menu, 14
 - programming menu, 22
 - screen menu, 16
- SET UP key, 7, 32, 55-56
- SHIFT key, 32, 111
- Shipping the terminal, 44
- Shock hazard, 1
- Smooth scroll, 17, 75-76
- Space
 - bar key, 7
 - characters, 94
 - occupied by visual
 - attributes, 19, 59-60
- Special graphics characters,
 - see Graphics
- Special graphics mode, 62
- Specifications, A-1
- Status line, 17, 36, 107-108
 - visual attributes, 19, 61
- Stop bits, 12, 15, 97
 - matching computer's?, 40
- STX character, 103
- TAB key, 30, 69, 86-87, 126-127
- Tab stops, 86-88
 - clearing data between, 95
- Tabulation, 86-88
 - effect of protect mode, 69
- Technical assistance, 44
- Terminal
 - commands, 45
 - functioning incorrectly, 39-40
 - fuse, 42
 - identification, 108
 - illustration of, 3
 - inspection and installation, 1-6
 - summary, 6
 - model compatibility, 13
 - operating modes, 49
 - operating values, 7
 - operation from keyboard, 32
 - programming compatibility, 51
 - resetting, 32, 52, 55
 - shipping, 44
 - specifications, A-1
- Termination character after
 - page print, 118
- Time out blank, 18, 35, 57
- Top information line, see
 - Information lines
- Transmit
 - control mode, 13, 99
 - delay rate, 14, 100, 119
- Transmitting, see Sending
- Transparent print mode, 15, 112, 114
- Troubleshooting, 39
- Typewriter tab stops, 86-88
- Unformatted printing, 34, 112, 115
- Unlocking, see Enabling

Index

UP key, 7, 28, 78, 80, 126-127
User messages, 17, 107-109,
111
Variables
 in commands, 46
 operating value, 50
Ventilation of terminal, 1
Visibility of screen, 58
Visual attributes, 18, 58, 60
 in user messages, 109
 protected, 68-69
 sending, 105, 107
Voltage setting, 4
Warranty, see Limited
 Warranty
Word structure, 11, 14, 97
 matching computer's?, 40
Write protect mode, 68-69, 86
 effect of clear commands, 94
Write protected
 field, 68-69
 graphics characters, 62
 tab stop column, 86
 visual attributes, 58
X-On/X-Off, 12, 76, 98-99, 116
X-ray emissions, 2

055
955
955

 **TeleVideo Systems, Inc.**

*1170 Morse Avenue
P.O. Box 3568
Sunnyvale, CA 94088-3568*