

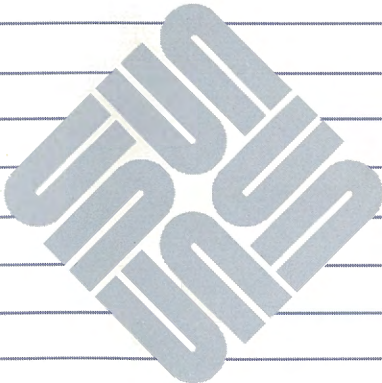

16 Channel Asynchronous Line Multiplexer-2 Field Service Manual and Installation Notes





16 Channel Asynchronous Line Multiplexer-2 Field Service Manual and Installation Notes

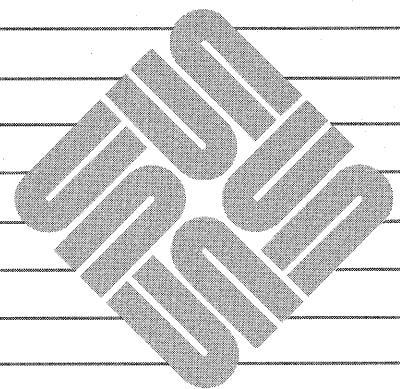

Credits and Trademarks

Multibus is a trademark of Intel Corporation.

VMEbus is a trademark of Motorola, Inc.

Sun Microsystems and **Sun Workstation** are registered trademarks of Sun Microsystems, Incorporated. **Sun-2, Sun2 Sun-2/xxx, Sun-3, Sun3, Sun-3/xxx, Deskside, SunStation, SunCore, SunWindows, and DVMA** are trademarks of Sun Microsystems, Incorporated.

UNIX is a trademark of AT&T Bell Laboratories.

This equipment generates, uses, and can radiate radio frequency energy and if not installed and used in accordance with the instructions manual, may cause interference to radio communications. It has been tested and found to comply with the limits for a Class A computing device pursuant to Subpart J of Part 15 of FCC Rules, which are designed to provide reasonable protection against such interference when operated in a commercial environment. Operation of this equipment in a residential area is likely to cause interference in which case the user at his own expense will be required to take whatever measures may be required to correct the interference.

Copyright © 1987 by Sun Microsystems, Inc.

This publication is protected by Federal Copyright Law, with all rights reserved. No part of this publication may be reproduced, stored in a retrieval system, translated, transcribed, or transmitted, in any form, or by any means manual, electric, electronic, electro-magnetic, mechanical, chemical, optical, or otherwise, without prior explicit written permission from Sun Microsystems.

Contents

Chapter 1	Inspection and Unpacking	3
1.1.	Inspection	3
1.2.	Unpacking	3
Chapter 2	General Description and Cautions	7
2.1.	General Description	7
	Test Equipment	7
2.2.	Important Cautions during Installation	8
	Power Off Caution	8
	Electrostatic Discharge Caution	8
	Springfinger Caution	8
Chapter 3	Board Location and Installation Instructions	13
3.1.	Tools Required	13
3.2.	Board Location and Addressing	13
3.3.	Board Installation	13
	Graceful Power-Down	13
	Installation	13
3.4.	System Hardware Configuration	15
	Board Removal (if necessary)	16
	Installation of Additional Controller Board(s)	16
3.5.	Operating System Configuration	16
Chapter 4	Device Connector Assembly — Rack Installation	19

Chapter 5 Device Connector Assembly — Wall or Floor Mounting	23
Chapter 6 Connecting External Devices to the ALM-2	27
Chapter 7 RS-232 Loopback Diagnostics	33
7.1. Tools Required	33
7.2. RS-232 Loopback Connectors	33
7.3. The RS-232 Loopback Program	33
Software Requirements	34
Running the RS-232 Loopback Program	34
Loopback Status Messages	34
Test Completion	35
Chapter 8 Printer Port Loopback Diagnostics	39
8.1. Tools Required	39
8.2. Printer Port Loopback Connectors	39
8.3. The Printer Port Loopback Program	39
Software Requirements	39
Running the Printer Port Loopback Program	39
Test Completion	40
Appendix A Support Aids	43
A.1. Software System Configuration Aids	43
/dev File System Modifications	43
Results of the Previous Step	44

Figures

Figure 1-1 Unpacking the ALM-2	4
Figure 3-1 Backplane Jumper Locations	15
Figure 4-1 DCA Assembly - Rack Mount	19
Figure 4-2 DCA Installation - Rack Mount	20
Figure 5-1 DCA Assembly - Floor or Wall Mount	23
Figure 6-1 Connecting External Devices to the ALM-2	27





Tables

Table 6-1 ALM-2 to DCA Data Cable Pinouts	28
Table 6-2 ALM-2 to DCA Data Cable Pinouts <i>Continued</i>	29
Table 6-3 Printer Port Pinouts	30
Table A-1 Field Replaceable Units for the ALM-2	43



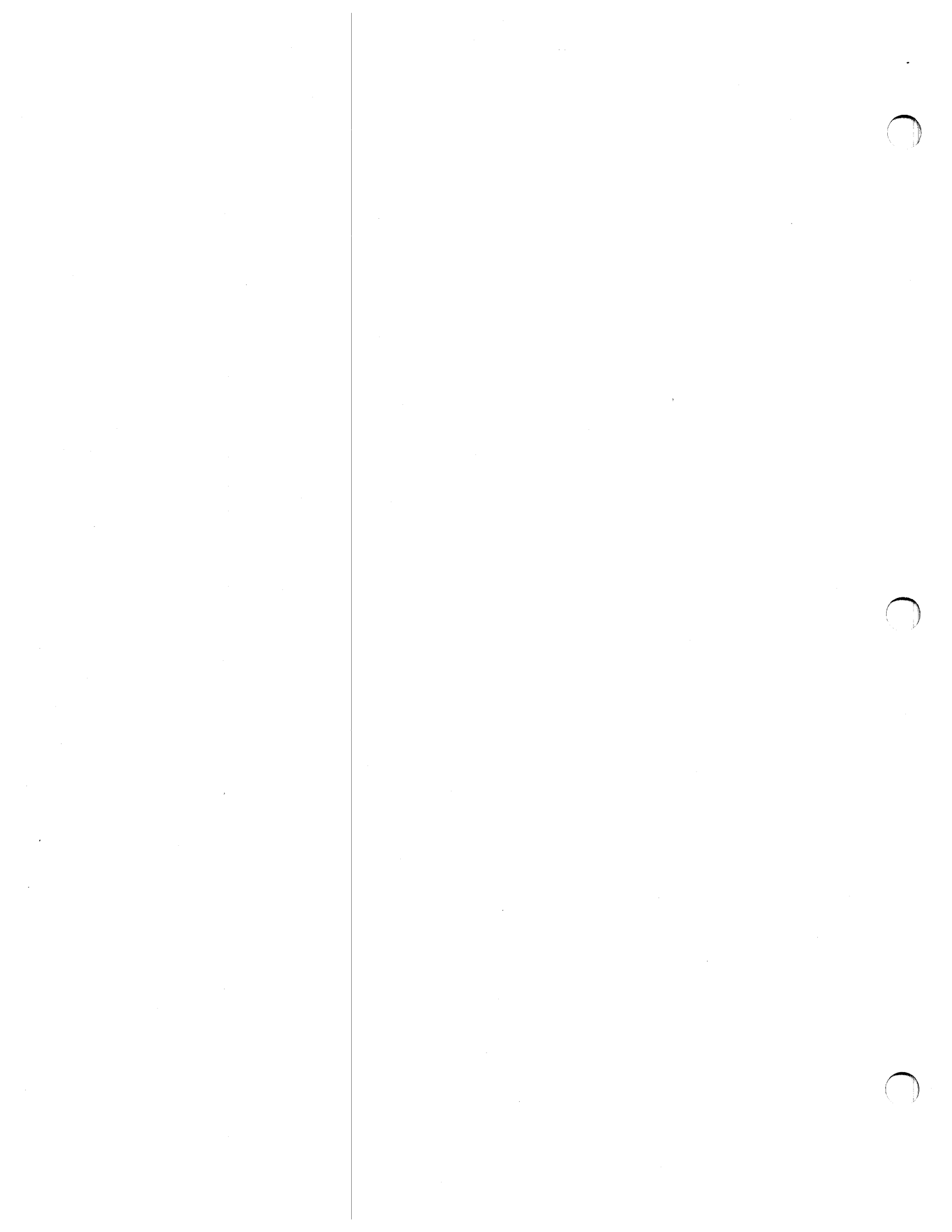

Preface

Purpose

This manual contains information about the installation and use of the 16 Channel Asynchronous Line Multiplexer-2. It also contains an Appendix containing data intended for Sun Customer Service Engineers.

Other Documentation You Will Need

- Card Cage Slot Assignments and Backplane Configuration Procedures
Sun P/N 813-2004-XX
- Card Cage Slot Assignments and Backplane Configuration Procedures for the 16 Channel Asynchronous Line Multiplexer-2
Sun P/N 813-2045-XX
- 16 Channel Asynchronous Line Multiplexer-2 Configuration Procedures
Sun P/N 813-2042-XX
- Installation Manual Addendum for the Sun-3/180 Rackmounted System
Sun P/N 800-1362-XX
- Installing UNIX on the Sun Workstation
Sun P/N 800-1158-XX
- System Administration for the Sun Workstation
Sun P/N 800-1323-XX
- Sun System Diagnostics Manual
Sun P/N 800-2111-XX





Inspection and Unpacking

Inspection and Unpacking	3
1.1. Inspection	3
1.2. Unpacking	3

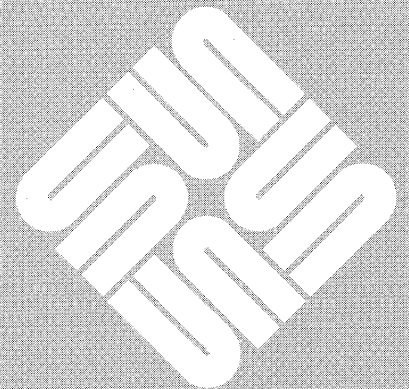



Inspection and Unpacking

1.1. Inspection

When you receive your shipment, inspect all shipping cartons *immediately* for any evidence of damage. If any carton is severely damaged, request that the carrier's agent be present when the carton is opened. If the carrier's agent is not present when a carton is opened and the contents are found to be damaged, keep all contents and packing materials for the agent's inspection.

1.2. Unpacking

The Figure on the following page shows the Packing Box in its most complex and complete configuration. You would receive this box if you ordered the ALM-2 as a separate addition to your Sun Logic Enclosure. If you already have an ALM-2 (or other related equipment), you may receive an abbreviated version of this Packing Box.

Save the packing materials for future use.

Figure 1-1 Unpacking the ALM-2

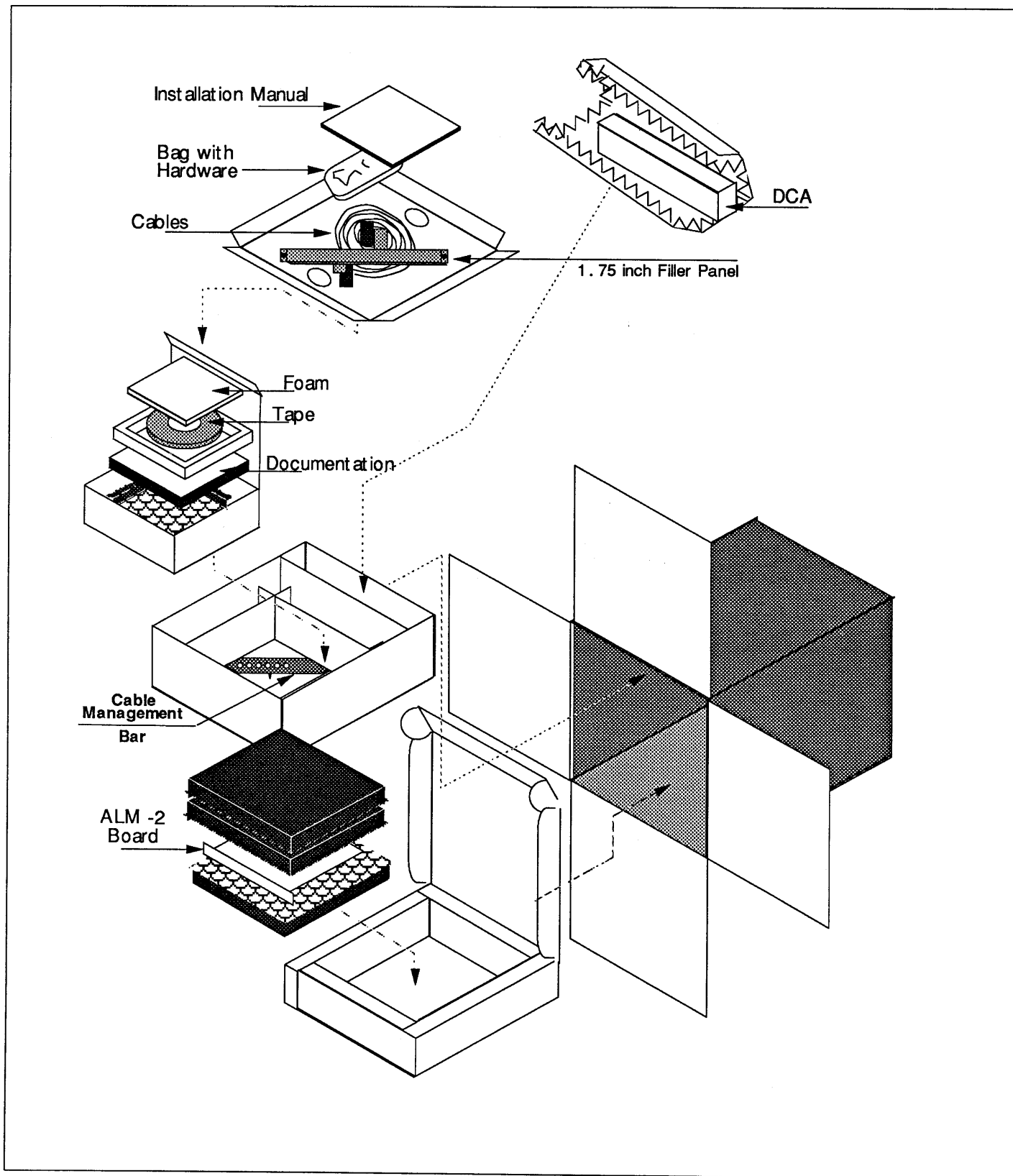

General Description and Cautions

General Description and Cautions	7
2.1. General Description	7
Test Equipment	7
2.2. Important Cautions during Installation	8
Power Off Caution	8
Electrostatic Discharge Caution	8
Springfinger Caution	8

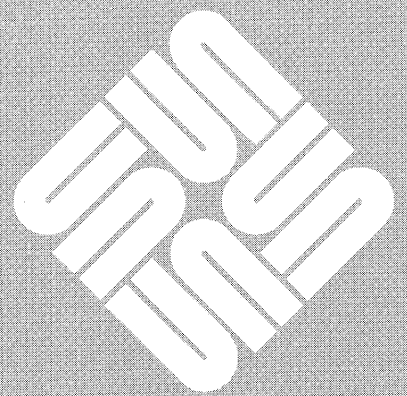



General Description and Cautions

2.1. General Description

The 16 Channel Asynchronous Line Multiplexer-2 (ALM-2) is a serial communications subsystem assembly. It provides an interface between the VME bus and the sixteen RS-232-C serial ports and the single (Centronics compatible) parallel printer port.

The ALM-2 consists of a Controller board, a Device Connector Assembly (DCA), and two Data cables to connect the Controller board to the DCA.

- The ALM-2 Controller board provides the interface between the VME bus and the DCA. The Controller board also has a Centronics compatible parallel printer port.
- The rack or wall mountable DCA has sixteen RS-232-C/RS-423 ports for connection to customer equipment, and two Data ports for connection to the Controller board.
- The two Data cables are 2.4 meters in length, and connect the Controller board to the DCA (a cable is not provided for the printer port).

The ALM-2 is a slave-only VME device, and uses Direct Memory Access from its on-board RAM to communicate with the serial ports. It uses full-duplex signalling, and has a maximum data transfer rate of 19200 baud (for RS-232) or 38400 baud (for RS-423) on all 16 serial channels. Asynchronous devices using the RS-232-C standard signal levels can be connected to the ALM-2 assembly. Sun software can configure each channel separately to work with serial devices at any of the following baud rates:

50, 75, 110, 134.5, 150, 300, 600, 1200, 1800, 2400, 4800, 9600, 19200 and 38400.

Test Equipment

Loopback Connectors are provided for the RS-232 ports, and a special Loopback Connector is provided for the Printer port.

2.2. Important Cautions during Installation

Power Off Caution

Turn off the power and disconnect the power cord from the Logic Enclosure before inserting or removing any boards.

Electrostatic Discharge Caution

Electrostatic Discharge Caution — Some of the devices on Sun boards are very sensitive to electrostatic discharge (they can be permanently damaged). An electrostatic charge can build up in the human body and then discharge when you touch the board.

Before handling any board, make sure that you have placed your hand on a conductive surface that is grounded to a common earth ground, (such as the metal screws on an AC receptacle cover) to discharge the static electricity present in your body.

Springfinger Caution

Springfinger Caution — Springfingers are metal strips that are installed between the edge of the PC board and the outer panel to reduce RFI emissions. Serrated metal “fingers” protrude from either side of the strip.

If a board **WITH** springfingers is installed next to a board **WITHOUT** springfingers, the insulator shield on the outside of the fingers **MUST** be present to prevent possible shorting of component leads to the springfingers.

Installation of a board **WITHOUT** springfingers may affect RFI emissions and may therefore affect FCC compliance. Sun will no longer be responsible for FCC compliance if non-springfingered boards are added to a system originally shipped **WITH** springfingers and FCC approval.

If a logic enclosure contains boards **WITH** and **WITHOUT** springfingers, use the following guidelines:

- Before removing a board **WITHOUT** springfingers, remove the board below it (or to the left of it for pedestal mode) if that board is equipped **WITH** springfingers and an outer insulator shield.
- Replace any filler panel equipped **WITH** springfingers by pulling out the air restrictor panel far enough to allow the springfingers to lay against the filler panel. Push both units into place simultaneously, and secure with the appropriate fasteners. This procedure makes replacement of the filler panels easier, and reduces the possibility of damage to the springfingers.
- Always install a board **WITHOUT** springfingers first, and then replace the board **WITH** springfingers and insulator shield in the slot below it (or to the left).

If a board **WITH** springfingers is installed next to a board or filler panel also equipped **WITH** springfingers, the outside insulator shields should be removed.

Ensure that the insulator strip between the inner side of the springfingers and the PC board is intact at all times.

When removing and replacing boards with springfingers, check the condition of the insulator strip/shield(s) and replace if damaged.

Call 800 USA-4SUN with any questions, or for information on how to obtain additional insulator strips or shields.

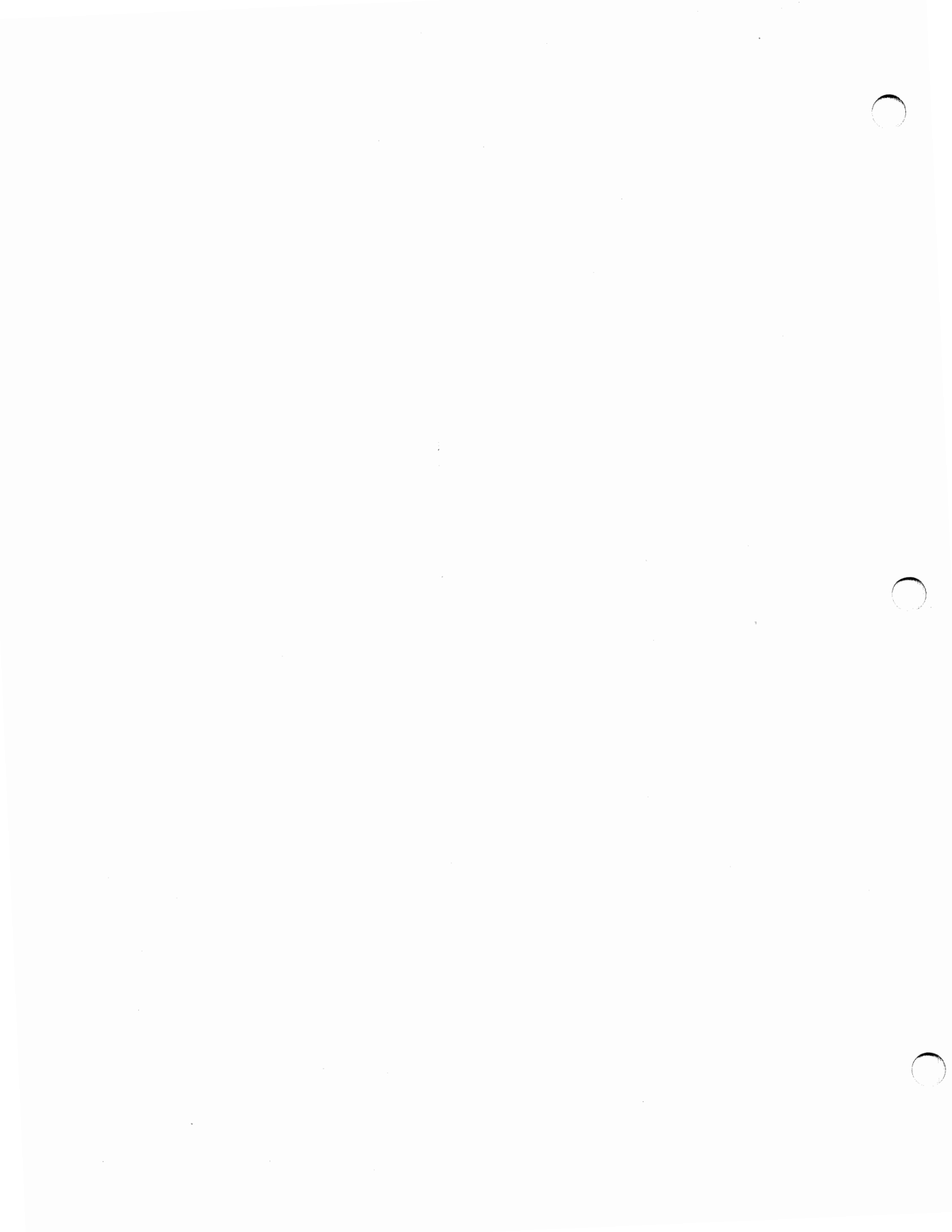

Board Location and Installation Instructions

Board Location and Installation Instructions	13
3.1. Tools Required	13
3.2. Board Location and Addressing	13
3.3. Board Installation	13
Graceful Power-Down	13
Installation	13
3.4. System Hardware Configuration	15
Board Removal (if necessary)	16
Installation of Additional Controller Board(s)	16
3.5. Operating System Configuration	16

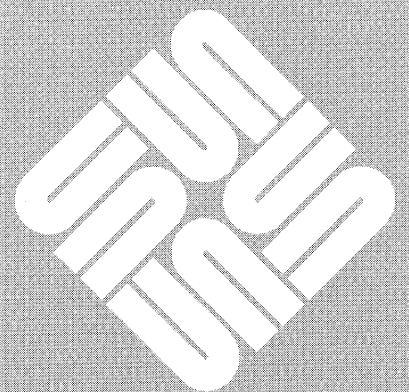



Board Location and Installation Instructions

3.1. Tools Required

The following tools will be needed to install the ALM-2 Controller Board:

- Set of Metric hexagonal (Allen) wrenches, including 2.5mm.
- Phillips screwdrivers #1 and #2.
- Standard blade screwdriver.

3.2. Board Location and Addressing

Refer to the *Card Cage Slot Assignments and Backplane Configuration Procedures for the 16 Channel Asynchronous Line Multiplexer-2* for information and cautions about Logic Enclosure backplane jumpering and location of the ALM-2 Controller Board in your particular Sun system.

3.3. Board Installation

Graceful Power-Down

If the system is running and you want to power-down, ensure that the system administrator has performed the following steps.

1. Warned clients or other workstation users to log out.
2. As super-user, entered a command such as:

```
/etc/halt or /etc/fasthalt
```

The program called by this command ensures that all data in the buffers is written to the disk before UNIX is halted.

When UNIX is halted, you may turn the system power off.

Installation

1. Power-down the Sun Logic Enclosure, and unplug the AC Line cord.
2. Remove the anti-static bag from the Controller board.
3. Refer to the *16 Channel Asynchronous Line Multiplexer-2 Configuration Procedures*, and verify that the jumper and switch settings are set to the correct positions for your application.

4. Using the *Card Cage Slot Assignments and Backplane Configuration Procedures for the 16 Channel Asynchronous Line Multiplexer-2*, choose the target slot in the Logic Enclosure card cage. Using the 2.5mm hexagonal wrench, remove the filler panel on the rear of the card cage corresponding to the target slot (save the screws). For Sun-3 models, remove the air restrictor also.
5. Insert the ALM-2 Controller Board into the the cardcage so that the component side faces towards the right (when viewed from the rear). The board should slide into the cardcage slot with little resistance and fit snugly when seated into the backplane connectors. While a moderate amount of force is required to seat the board, anything in excess of this is cause for inspection. Check the cardcage slot for any obvious obstructions, and both the board and the backplane for damage (bent connector pins, etc.).
6. Using the hex head screws from step 4, secure the board to the card cage.

3.4. System Hardware Configuration

1. Power-down the system, and unplug the AC Line cord.
2. Gain access to the solder side of the cardcage backplane in order to check the backplane jumpers (Correct location of the system backplane jumpers is described in the *Card Cage Slot Assignments and Backplane Configuration Procedures for the 16 Channel Asynchronous Line Multiplexer-2*).

■ If you have a pedestal-type system, unsnap the front bezel and unfasten the four screws holding the hinged power supply panel in place. Insert a large, flat-blade screwdriver in the openings between the panel and the sides of the pedestal to release the panel from the pedestal. Gently lower the power supply tray.

■ If the system is rackmounted, unsnap the bezel and remove the 12 screws that secure the RFI shield. Ensure that all backplane jumpers are configured as indicated in the *Cardcage Slot Assignments and Backplane Configuration Procedures* and the special *Cardcage Slot Assignments and Backplane Configuration Procedures for the 16 Channel Asynchronous Line Multiplexer-2*.

Figure 3-1 illustrates the backplane jumpers.

Figure 3-1 *Backplane Jumper Locations*

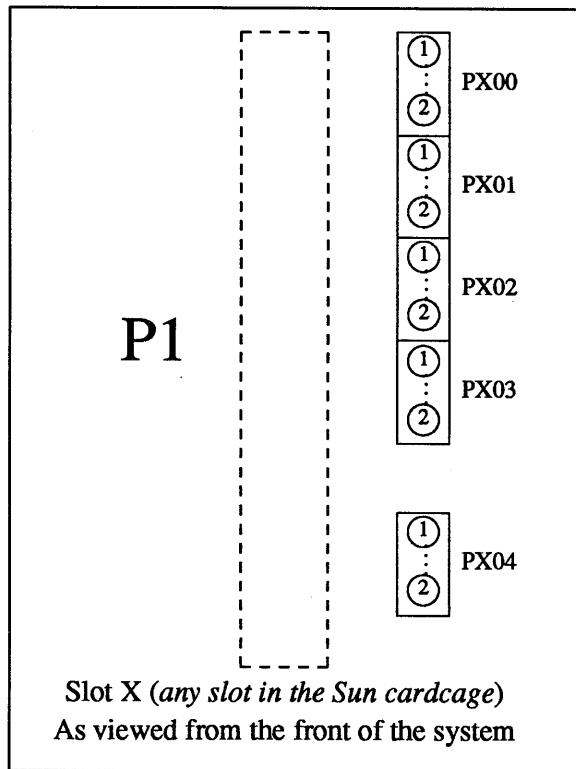

3. Close up the host system Logic Enclosure.

Board Removal (if necessary)

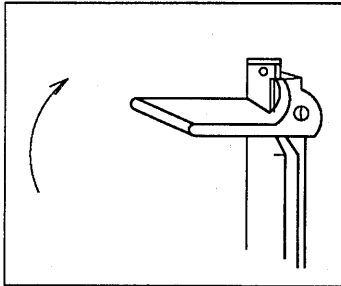

Extraction Lever

If it is necessary to remove a board from the Sun Logic Enclosure, perform the following steps:

1. Refer to the Subsection entitled *Graceful Power-Down* of Section 3.3 , and power-down the workstation.
2. Using a 2.5mm hex wrench, remove the screws securing the board assembly to the cardcage.
3. Referring to the drawing in the left margin, press the PC Board Extraction Levers (located at the top and bottom rear edge of the board assembly) outward. This should initiate board removal.
4. Pull out on the board assembly until it is free of the Logic Enclosure (remember to heed the Electrostatic Discharge Caution when handling the board assembly).

Installation of Additional Controller Board(s)

Repeat Sections 3.2, 3.3, and 3.4 to install each additional Controller.

Pay particular attention to the VME address setting and to the location of the Controller Board in the Logic Enclosure.

3.5. Operating System Configuration

Refer to *Installing UNIX on the Sun Workstation* for information about the changes you will need to make to your operating system.

Device Connector Assembly — Rack Installation

Device Connector Assembly — Rack Installation 19

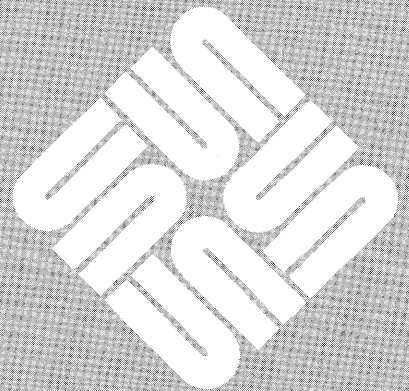

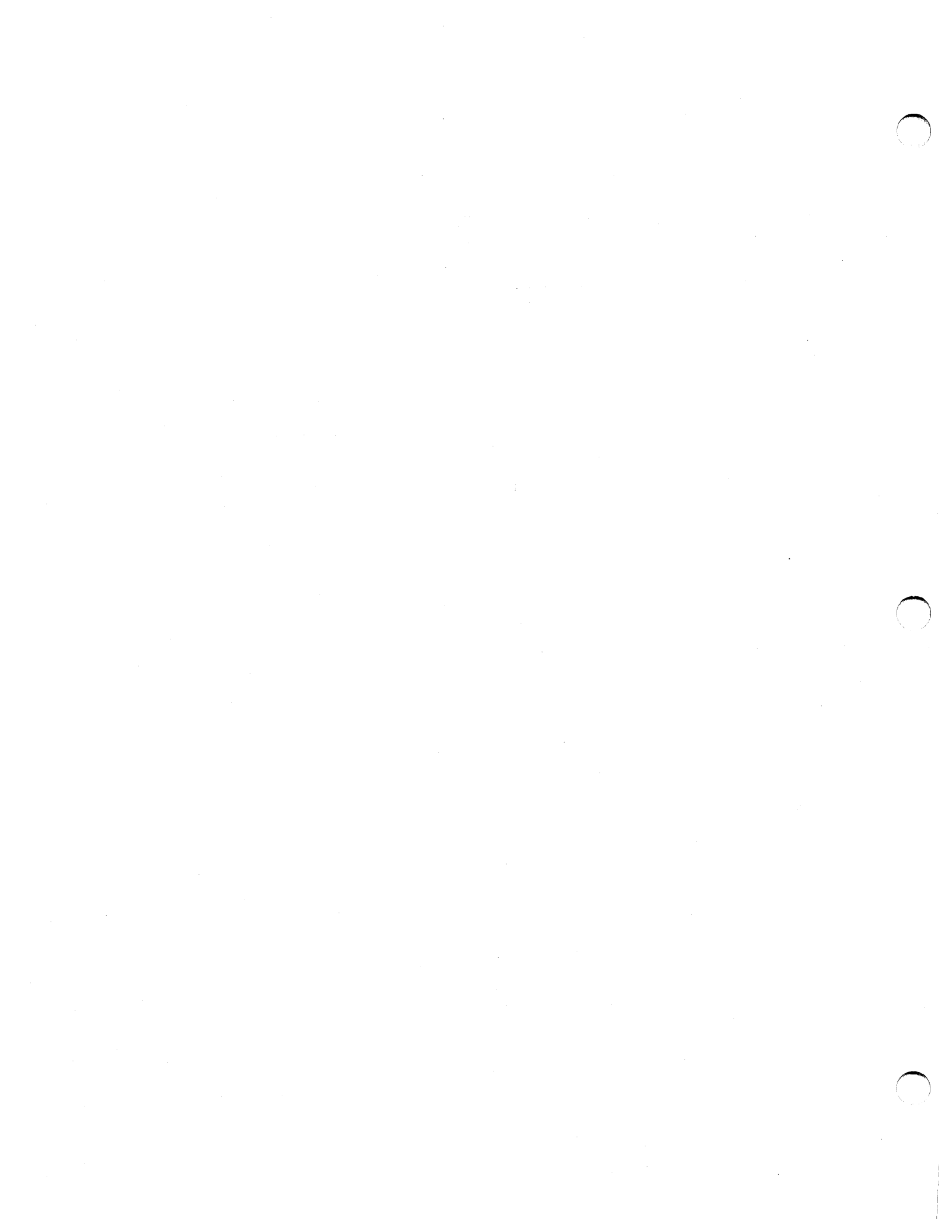

Device Connector Assembly — Rack Installation

If you are going to install the Device Connector Assembly (DCA) into a Sun Rack, perform the following instructions.

1. Using four 8mm M3 screws, attach the long brackets to the DCA as shown in Figure 4-1.
2. Remove the highest available filler panel from the rear of the rack (see Figure 4-2).

NOTE *The DCA is 5 1/4 inches high, and a large percentage of Sun-3 Racks have 7 inch filler panels; therefore, a 1 3/4 inch filler panel (with 2 mounting screws) is shipped with the ALM-2 to cover this extra space. If you have one of the newest Sun Racks, it will have 5 1/4 inch filler panels, and you may discard the 1 3/4 inch filler panel.*

NOTE *If there is no space in the rear of the Rack for the DCA (for example, if there are already three ALM-1s installed), see Chapter 5 — Device Connector Assembly — Wall or Floor Mounting for alternative mounting instructions.*

Figure 4-1 DCA Assembly - Rack Mount

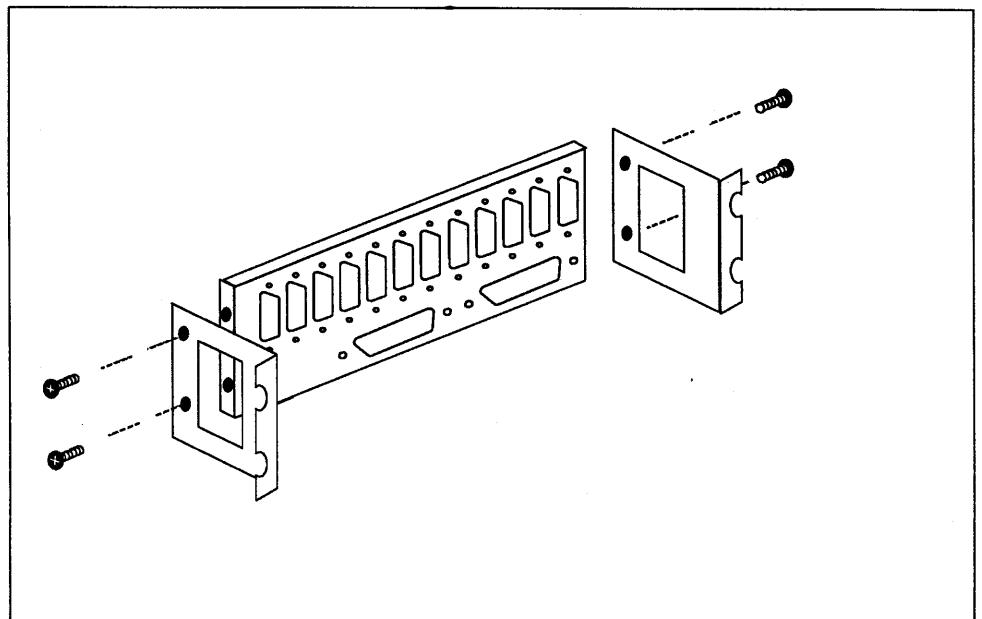

- Using four 10-32 oval head screws, secure the DCA to the rack in the space made available by removing the filler panel in Step 2.

Figure 4-2 *DCA Installation - Rack Mount*

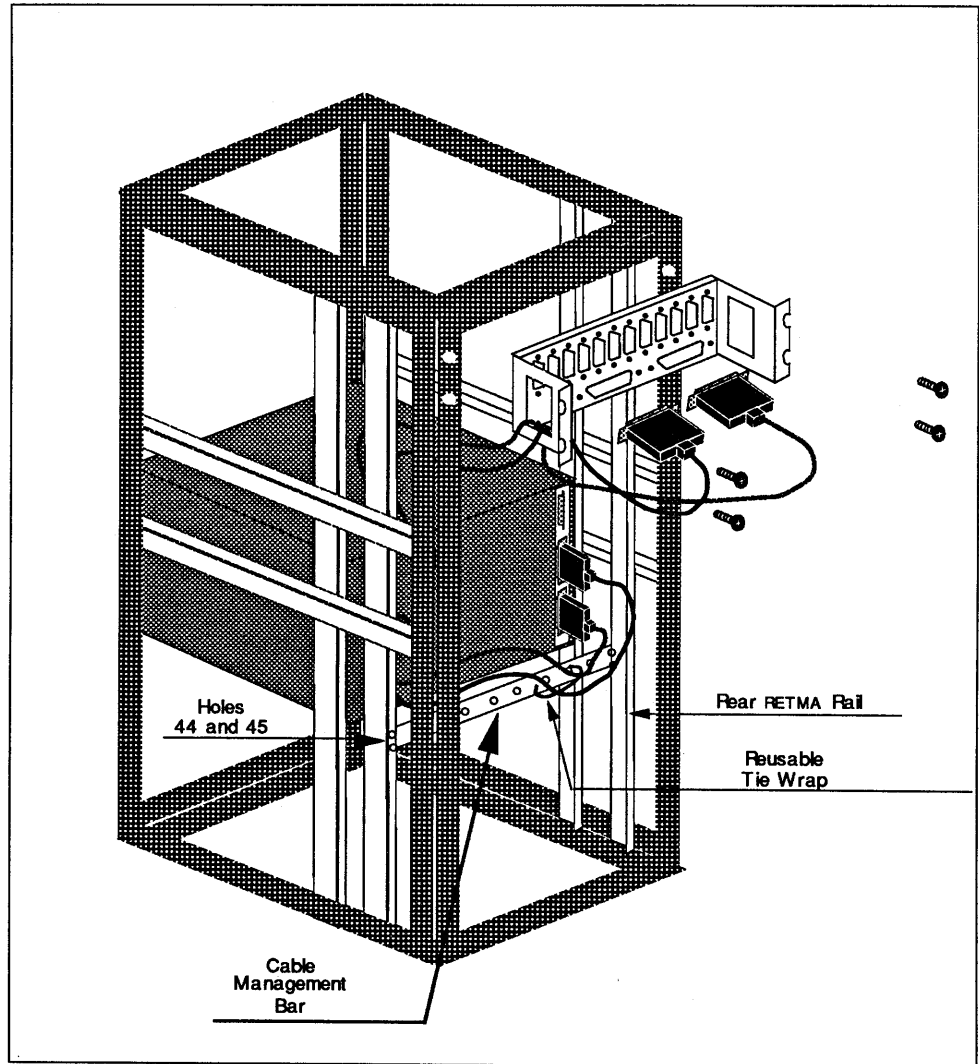

NOTE *The Data cables referred to in Steps 4 and 5 must be routed down the LEFT side of the Rack (when viewed from the rear). Figure 4-2 shows the correct cable routing.*

- Connect a 50-Pin Data cable from the connector labelled **SYSTEM CONN A** on the DCA to the connector labelled **SYSTEM CONN A** on the Controller Board.
- Connect a 50-Pin Data cable from the connector labelled **SYSTEM CONN B** on the DCA to the connector labelled **SYSTEM CONN B** on the Controller Board.
- Repeat Steps 1 through 5 for each additional DCA.

Device Connector Assembly — Wall or Floor Mounting

Device Connector Assembly — Wall or Floor Mounting 23

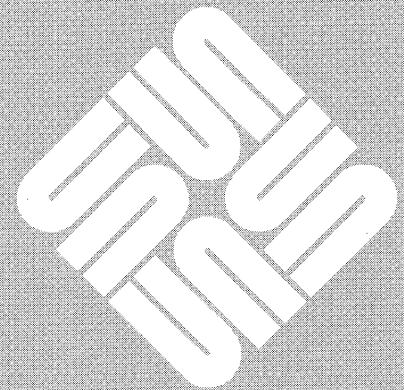



Device Connector Assembly — Wall or Floor Mounting

If it is not applicable or possible to mount the DCA into a Rack (a Pedestal or DeskTop installation, or if the rear of the Rack is full), then it may be installed onto the wall or floor. To mount the DCA to the wall or floor, perform the following steps.

1. Using the four 8mm M3 screws provided, attach the short brackets to the Device Connector Assembly (DCA) as shown in Figure 5-1.
2. Using mounting screws appropriate for your application, secure the DCA to the wall or floor by inserting your mounting screws through the four slots in the mounting bracket and into the wall or floor.

CAUTION Before installing the DCA, select a location that will provide physical safety for the DCA, the cables and, above all, any personnel working in the area.

Figure 5-1 *DCA Assembly - Floor or Wall Mount*

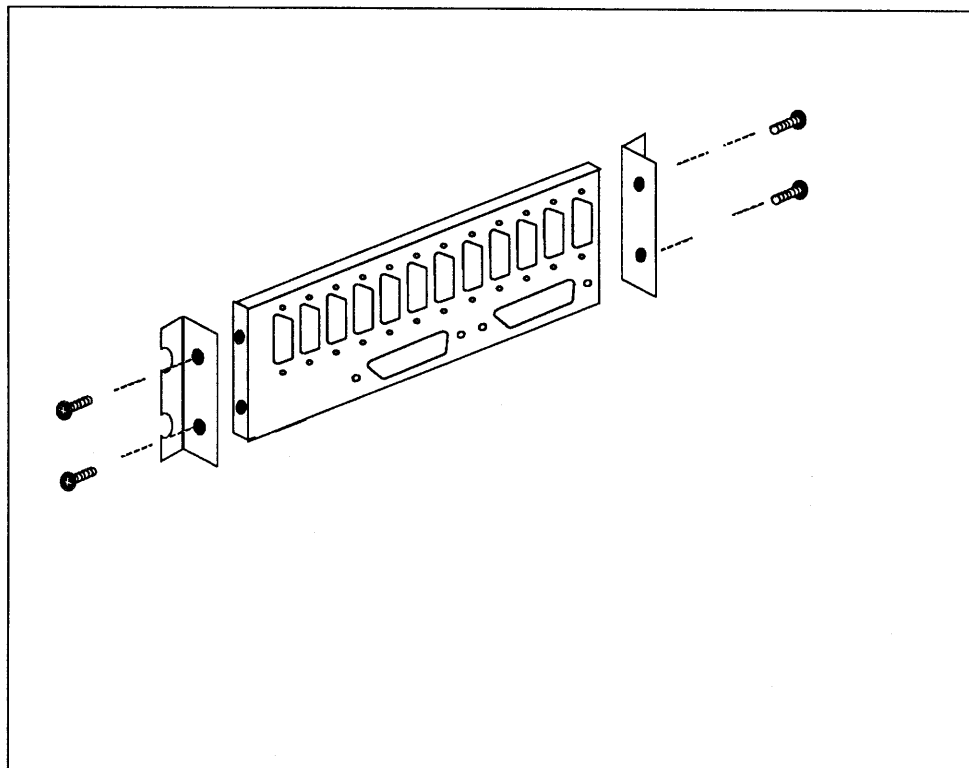

3. Connect a 50-Pin Data cable from the connector labelled **SYSTEM CONN A** on the DCA to the connector labelled **SYSTEM CONN A** on the Controller Board.
4. Connect a 50-Pin Data cable from the connector labelled **SYSTEM CONN B** on the DCA to the connector labelled **SYSTEM CONN B** on the Controller Board.
5. Repeat Steps 1 through 4 for each additional DCA.

Connecting External Devices to the ALM-2

Connecting External Devices to the ALM-2 27

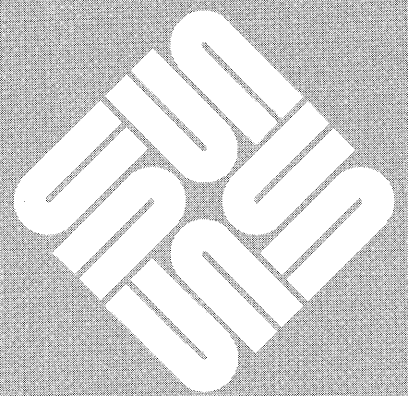

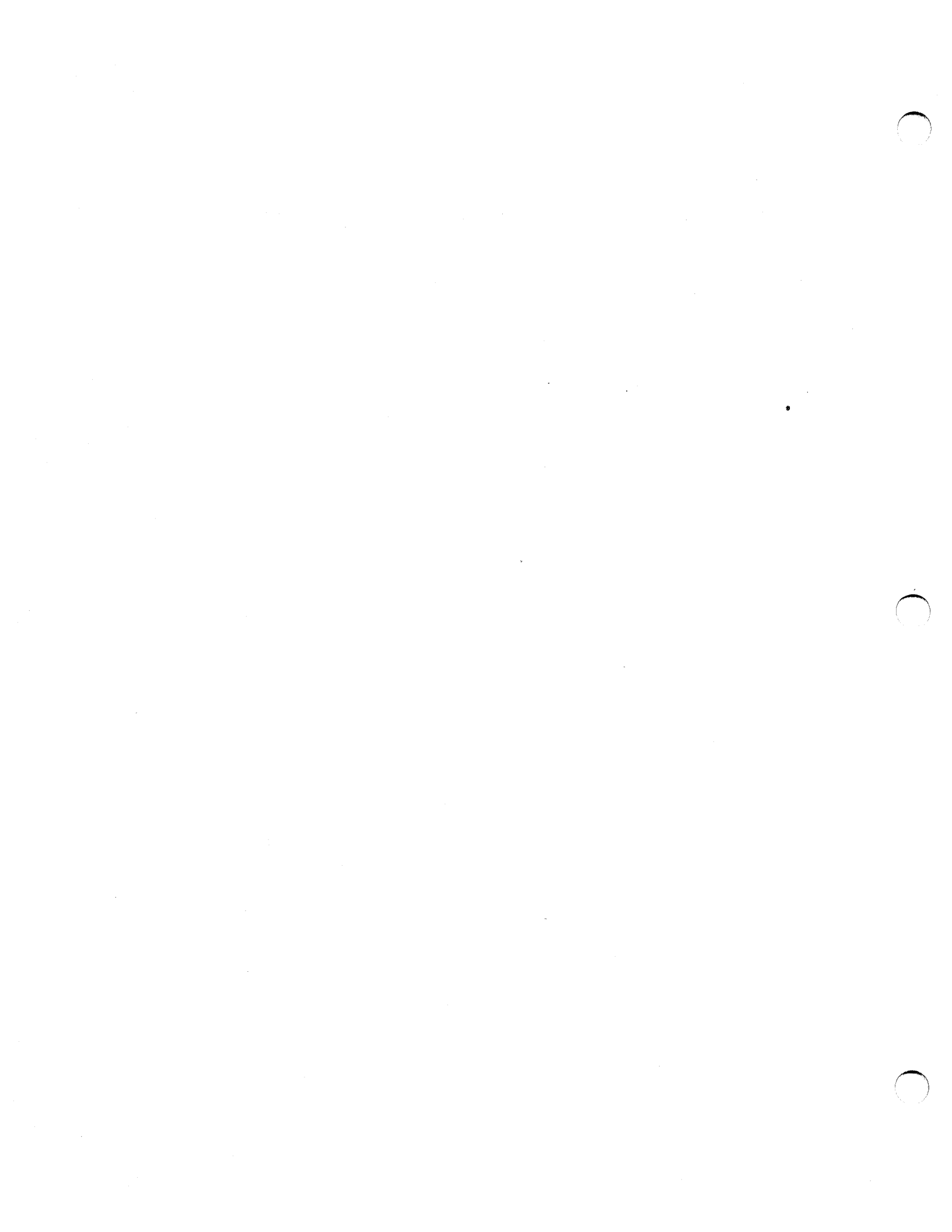

Connecting External Devices to the ALM-2

The ALM-2 ports are configured as Data Terminal Equipment (DTE) ports (as are most ASCII terminals). These ports are designed to communicate with other Data Terminal Equipment as well as Data Communication Equipment (DCE) using RS-232 signalling conventions. Figure 6-1 shows examples of how the ALM-2's DCA ports connect to various types of DTE and DCE devices. Tables 6-1, 6-2 and 6-3 show the connector pinouts for cables that connect directly to the ALM-2.

Figure 6-1 *Connecting External Devices to the ALM-2*

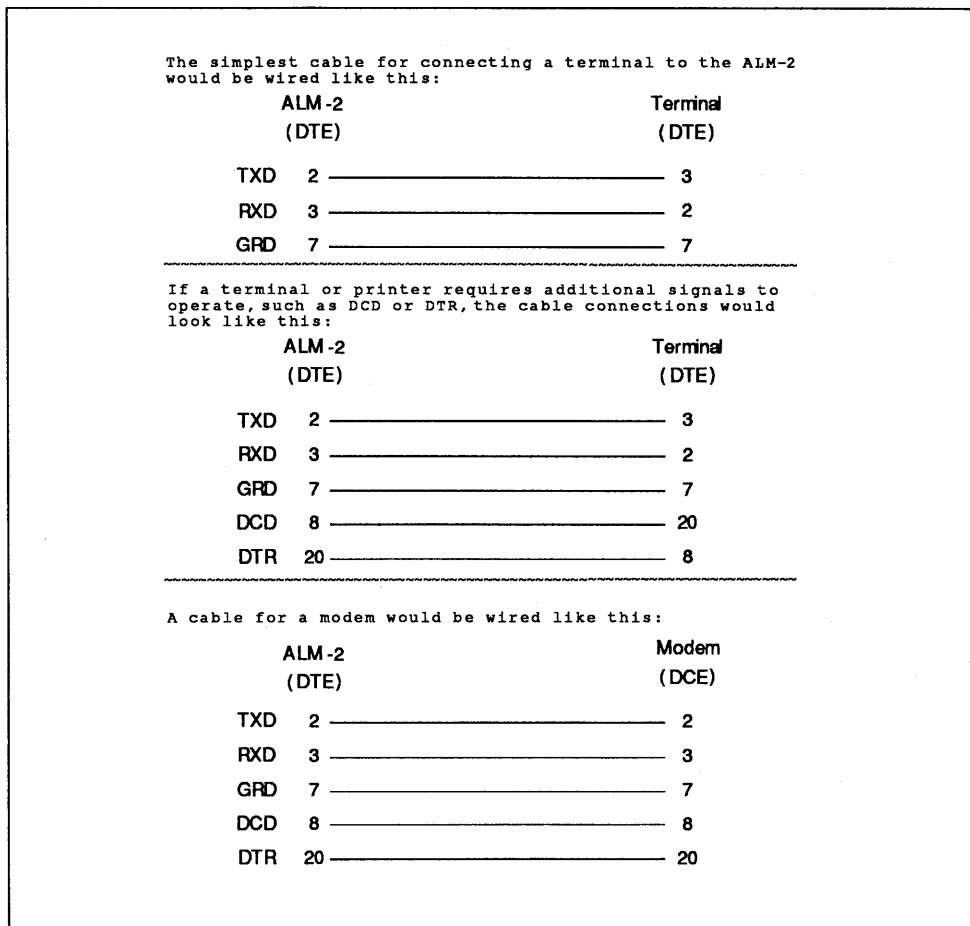

Table 6-1 ALM-2 to DCA Data Cable Pinouts

Pin assignments for the Data Cable Connected between the ALM-2 and the DCA			
Cable Pin Number		System Conn. A	System Conn. B
		Signal Name	Signal Name
1	} *	GND	GND
34		TXDØ	TXD6
18	}	RXDØ	RXD6
2		DCDØ	DCD6
35	}	DTRØ	DTR6
19		GND	GND
3	}	TXD1	TXD7
36		RDX1	RDX7
20	}	DCD1	DCD7
4		DTR1	DTR7
37	}	GND	GND
21		TXD2	TXD8
5	}	RXD2	RXD8
38		DCD2	DCD8
22	}	DTR2	DTR8
6		GND	GND
39	}	TXD3	TXD9
23		RXD3	RXD9
7	}	DCD3	DCD9
40		DTR3	DTR9
24	}	GND	GND
8		TXD4	TXD1Ø
41	}	RXD4	RXD1Ø
25		DCD4	DCD1Ø
9	}	DTR4	DTR1Ø
42		GND	GND

* The symbol } stands for a twisted cable pair.

Table 6-2 ALM-2 to DCA Data Cable Pinouts Continued ...

Pin assignments for the Data Cable Connected between the ALM-2 and the DCA			
Cable Pin Number		System Conn. A	System Conn. B
		Signal Name	Signal Name
26	} *	TXD5	TXD11
10		RXD5	RXD11
43	}	DCD5	DCD11
27		DTR5	DTR11
11	}	RTSØ	GND
44		CTSØ	TXD12
28	}	DSRØ	RXD12
12		TXCØ	DCD12
45	}	RXCØ	DTR12
29		RTS1	GND
13	}	CTS1	TXD13
46		DSR1	RXD13
30	}	TXC1	DCD13
14		RXC1	DTR13
47	}	RTS2	GND
31		CTS2	TXD14
15	}	DSR2	RXD14
48		TXC2	DCD14
32	}	RXC2	DTR14
16		RTS3	GND
49	}	CTS3	TXD15
33		DSR3	RXD15
17	}	TXC3	DCD15
50		RXC3	DTR15

* The symbol } stands for a twisted cable pair.

Table 6-3 *Printer Port Pinouts*

Pin Assignments for the Parallel Printer Port (DB25 Connector)	
<i>Pin Number</i>	<i>Signal Name</i>
1	STRB
2	DATA BIT 0
3	DATA BIT 1
4	DATA BIT 2
5	DATA BIT 3
6	DATA BIT 4
7	DATA BIT 5
8	DATA BIT 6
9	DATA BIT 7
10	ACK
12	PE
13	SLCT
18 thru 24	GND

RS-232 Loopback Diagnostics

RS-232 Loopback Diagnostics	33
7.1. Tools Required	33
7.2. RS-232 Loopback Connectors	33
7.3. The RS-232 Loopback Program	33
Software Requirements	34
Running the RS-232 Loopback Program	34
Loopback Status Messages	34
Test Completion	35

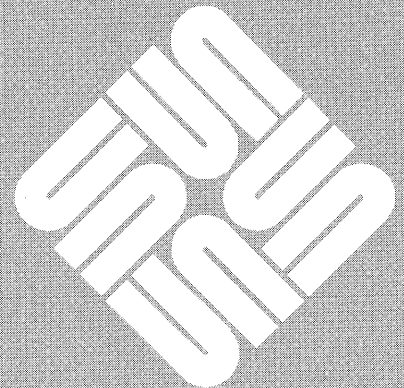

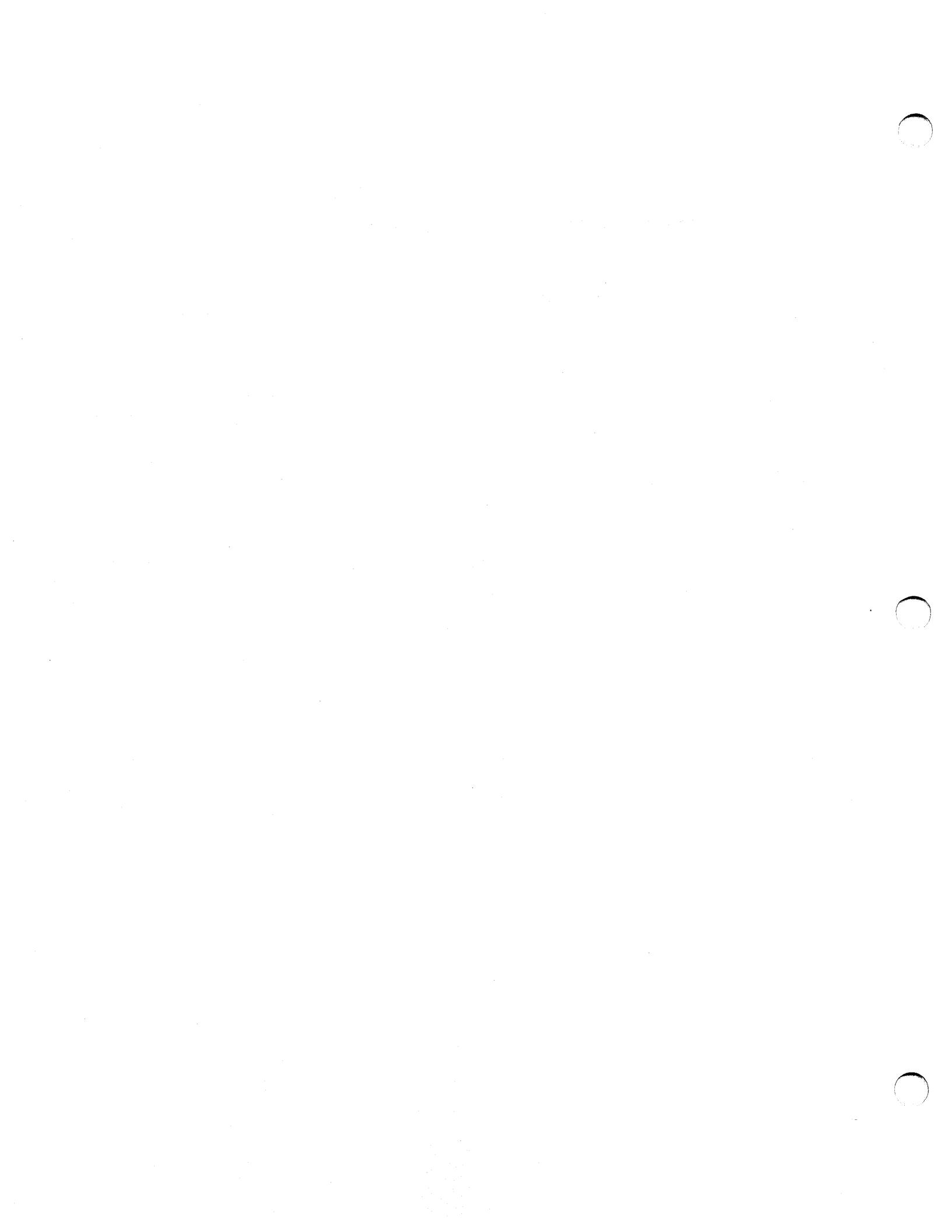

RS-232 Loopback Diagnostics

7.1. Tools Required

- ALM-2 RS-232 Loopback Connectors (ALM-1 loopback connectors will *not* work.).

7.2. RS-232 Loopback Connectors

The RS-232 Loopback Connector is a 25-Pin Sub-D connector that has its outputs wired back to its inputs. Therefore, the data that is written to the serial port is immediately read back (and *should* be exactly the same).

NOTE The ALM-2 RS-232 Loopback Connector and the Printer Port Loopback Connector look very similar. The RS-232 Loopback Connector can be recognized by the fact that it has only three wires connected to six pins. The Printer Port Loopback Connector has ten wires connected to twenty pins.

An RS-232 Loopback Connector is wired as follows:

- Pin 2 is connected to Pin 3
- Pin 4 is connected to Pin 5
- Pin 8 is connected to Pin 20

7.3. The RS-232 Loopback Program

Used in conjunction with the RS-232 Loopback Connectors, this Loopback Program compares the data being written to the serial ports with the data being read back from them. If the data does not match or is not present, the test will stop and an error message will be reported.

The program sets the input mode to RAW (unprocessed), and sends the the numbers 0 through 255 (in a binary code) to the serial port(s). The program will write to all the serial ports, or it will write to individual ports as specified by the user.

Software Requirements

NOTE *In the following descriptions and procedures the # is shown before commands you are to enter. This symbol represents the 'single user' system prompt. Do not enter this symbol as a part of the command.*

The RS-232 Loopback Program runs under control of the UNIX operating system. To avoid conflicts with UNIX system login or shell processing, the file /etc/ttys should be copied. To copy the file, enter the command

```
# cp /etc/ttys /etc/ttys-
```

Now that the original file has been copied, edit /etc/ttys and change the file status for each port you wish to test to 0. For example:

```
12ttyh0
should be changed to
02ttyh0.
```

If this step is not performed, UNIX will 'steal' characters when it attempts to process commands, and the test will fail.

After you have finished editing /etc/ttys, you need to notify 'init' that the new /etc/ttys file is ready for the loopback test. Enter the command:

```
# kill -1 1
```

Running the RS-232 Loopback Program

To run the RS-232 Loopback Program you need to do two things.

First, insert the RS-232 Loopback connector into the DCA port(s) to be tested. Second, enter the command `loopback` followed by the name of the port (device) that you wish to test. For example, to test port 0 of the ALM-2, you would enter the line:

```
# loopback /dev/ttyh0
```

NOTE *Be sure that you enter the port name exactly as it appears in the directory /dev*

If no ports are named after the `loopback` command, you will be asked to name one.

Loopback Status Messages

The RS-232 Loopback Program can generate four types of status messages. Three of the messages indicate errors; the fourth type of message indicates that the program has run successfully.

For example, if the test on port zero is successful, the message /dev/ttyh0 tested OK will be displayed.

The three error messages are:

```
[port] does not exist
[port] does not respond
[port] data does not match
```

The does not exist error message will occur if the program cannot find the port. The following are some probable causes of this condition.

- The specified port is not found in the `/dev` directory.
- The major device number of the `/dev` directory is incorrect.
- The ALM-2 is not configured in the kernel.

The `does not respond` error message will occur if data was sent to the port but no data returned. The following are some probable causes of this condition.

- The port on the DCA may be broken.
- The RS-232 loopback connector may be missing or broken.
- The Data cable between the ALM-2 and the DCA may be poorly connected or broken.

The `data does not match` error message will occur if the data read back from the port does not match the data written to it (the command `XOR` will list the bits that are different). The following are some probable causes of this condition.

- A 'noisy' Data cable.
- A framing error.
- The `/etc/ttys` file status is incorrect.

Test Completion

After completing the Loopback test(s), it is *very important* that you restore the `/etc/ttys` file to its original content. To do this, simply enter the command

```
# mv /etc/ttys- /etc/ttys
```

Once the `/etc/ttys` file is restored to its original state, you need to notify 'init' that this has been done. Enter the command:

```
# kill -1 1
```

Remove any RS-232 Loopback Connectors from the DCA.

The RS-232 Loopback test is now complete.

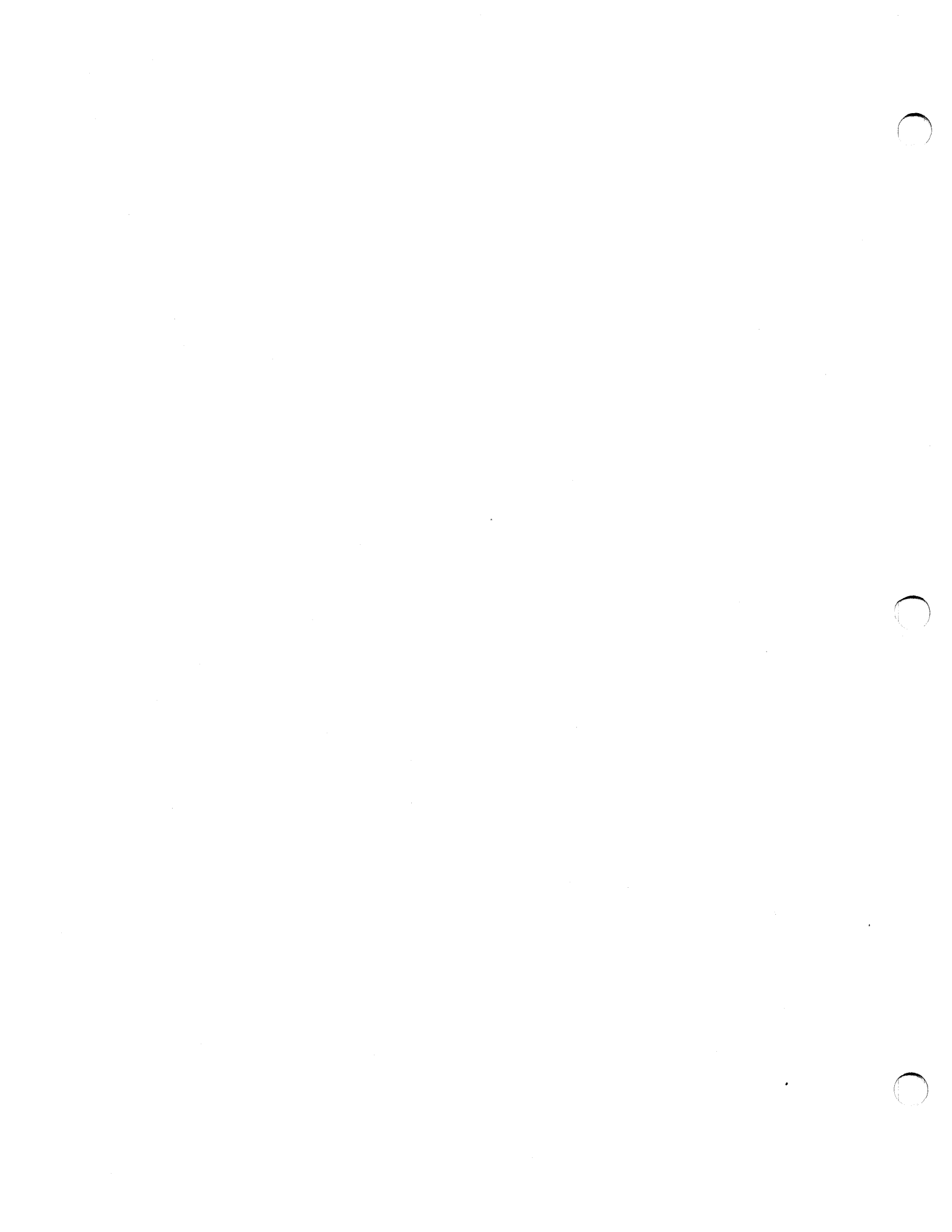

Printer Port Loopback Diagnostics

Printer Port Loopback Diagnostics	39
8.1. Tools Required	39
8.2. Printer Port Loopback Connectors	39
8.3. The Printer Port Loopback Program	39
Software Requirements	39
Running the Printer Port Loopback Program	39
Test Completion	40

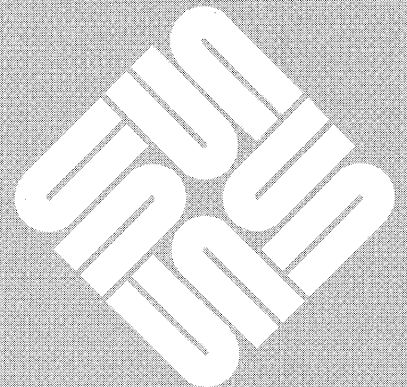

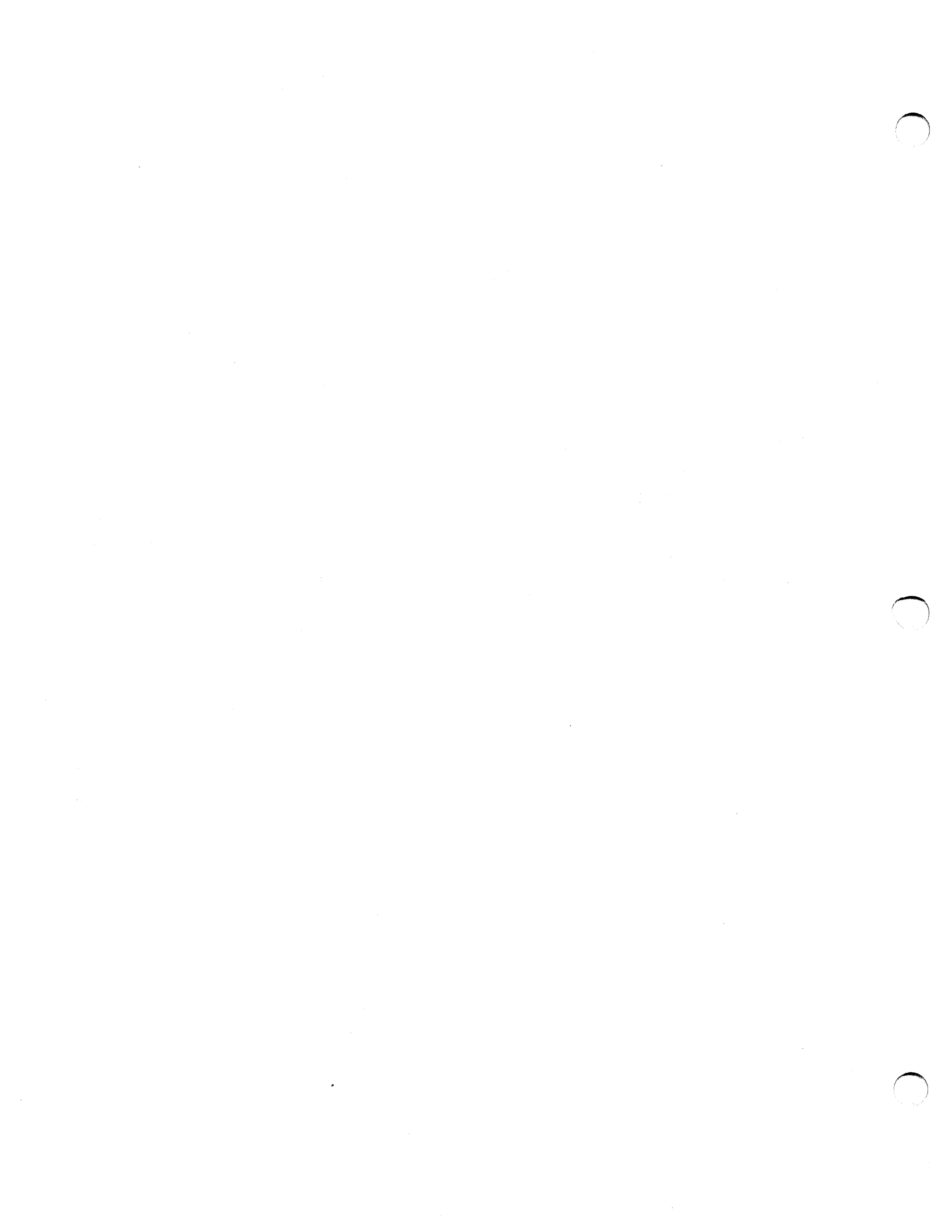

Printer Port Loopback Diagnostics

8.1. Tools Required

- ALM-2 Printer Port Loopback Connector (ALM-1 connectors will *not* work).

8.2. Printer Port Loopback Connectors

The Printer Port Loopback Connector is a 25-Pin Sub-D connector that has its output routed back to its input. Therefore, the data that is written to the printer port is immediately read back (and *should* be exactly the same).

NOTE The ALM-2 Printer Port Loopback Connector and the RS-232 Loopback Connector look very similar. The Printer Port Loopback Connector can be recognized by the fact that it has ten wires connected to twenty pins. The RS-232 Loopback Connector has only three wires connected to six pins.

8.3. The Printer Port Loopback Program

Used in conjunction with the Printer Port Loopback Connector, the Printer Port Loopback Program compares the data being written to the printer port with the data being read back from it. If the data does not match or is not present, the test will stop and an error message will be reported.

Software Requirements

The only software requirement is that you be running Sun software release 3.5 or later. With the 3.5 software release you will have received a manual entitled *Sun System Diagnostics Manual* (Sun P/N 800-2111-XX). This manual describes in great detail how to run the system diagnostics, and the ALM-2 printer port loopback program is a part of these system diagnostics.

Running the Printer Port Loopback Program

To run the Printer Port Loopback Program perform the following steps.

1. Read the *Sun System Diagnostics Manual* carefully.
2. Insert the Printer Port Loopback connector into the printer port on the ALM-2's back panel.
3. After having read the *Sun System Diagnostics Manual*, select the Options menu from the System Diagnostics Main menu.
4. Select the intervention tests from the Options menu.
5. Select **pp** (printer port) from among the intervention tests.

Test Completion

After completing the Printer Port Loopback test, remove any Printer Port Loopback Connectors from the ALM-2's back panel.

The Printer Port Loopback test is now complete.

A

Support Aids

Support Aids	43
A.1. Software System Configuration Aids	43
/dev File System Modifications	43
Results of the Previous Step	44

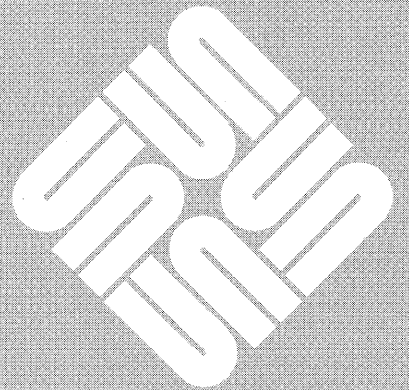



Support Aids

Table A-1 *Field Replaceable Units for the ALM-2*

List of Field Replaceable Units (FRUs)	
<i>FRU Name</i>	<i>Part Number</i>
ALM-2 Controller	501-1203
DCA External Connector Box	540-1526
DCA Cable (controller to DCA EX. Connector Box)	530-1334
RS232 Loopback Cable (test equipment)	540-1558
Printer Loopback Connector (test equipment)	540-1560

A.1. Software System Configuration Aids

Although the SunOS UNIX system software distributed to you does support the ALM-2 board, there is still a small amount of system configuration that must be performed before you can use the ALM-2 in your system.

The steps described below create special device entries in the `/dev` file system. It is absolutely necessary that you perform these steps before using your ALM-2 board(s).

`/dev` File System Modifications

After installing your system software and configuring your kernel as described in *Installing UNIX on the Sun Workstation*, use the command

```
hostname% cd /dev
```

to change to the `/dev` directory.

Determine how many ALM-2 boards are present in your system. (There will be between 1 and 4.) Run MAKEDEV with arguments corresponding to the boards in your system. Examples are shown below:

NOTE The command MAKEDEV is used to create the necessary special device entries for Sun standard and optional hardware. Also, the ALM-2 is known internally to the system as mcp.

If there are four boards in your system:

```
hostname# MAKEDEV mcp0 mcp1 mcp2 mcp3
```

If there are only two:

```
hostname# MAKEDEV mcp0 mcp1
```

Results of the Previous Step

The previous step will have created a set of device entries of the form /dev/ttyxy

where x will be one of the letters *h*, *i*, *j*, or *k*. These letters refer to each ALM-2 board: *h* refers to the first board (mcp0), *i* refers to the second board, and so on. *y* is a hexadecimal digit (in the range 0-9 a-f) which specifies which of the sixteen serial lines on an ALM-2 board is being accessed. Thus the third serial line on the third board is /dev/ttyj2, and the twelfth serial line on the first board is /dev/ttyhb.

For more information on installing modems, configuring terminal lines, and so on, refer to *System Administration for the Sun Workstation—Adding Hardware to Your System*.

Revision History

Dash Number	Revision	Date	Comments
01	1	March 13, 1987	Review Copy
01	2	April 10, 1987	Review Copy
01	3	June 6, 1987	Review Copy
02	50	September 11, 1987	Inclusion of Field Service Data
05	A	December 7, 1987	Production Release

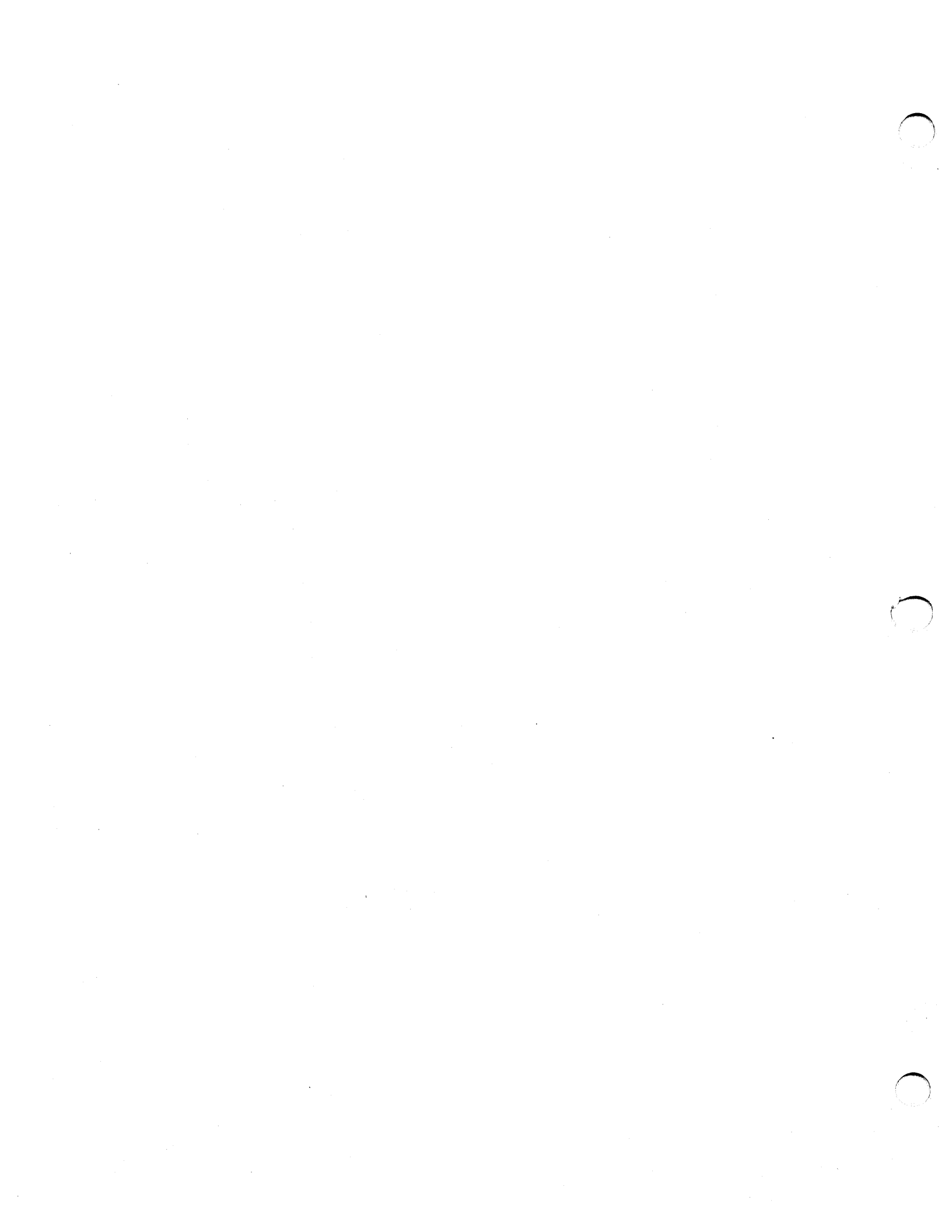



Corporate Headquarters

Sun Microsystems, Inc.
2550 Garcia Avenue
Mountain View, CA 94043
415 960-1300
TLX 37-29639

For U.S. Sales Office

locations, call:
800 821-4643
In CA: 800 821-4642

European Headquarters

Sun Microsystems Europe, Inc.
Sun House
31-41 Pembroke Broadway
Camberley
Surrey GU15 3XD
England
0276 62111
TLX 859017

Australia: (02) 436 4699

Canada: 416 477-6745

France: (1) 46 30 23 24

Germany: (089) 95094-0

Japan: (03) 221-7021

Nordic Countries: (08) 764 78 10

Switzerland: (1) 82 89 555

The Netherlands: 02155 24888

UK: 0276 62111

**Europe, Middle East, and Africa,
call European Headquarters:**
0276 62111

**Elsewhere in the world,
call Corporate Headquarters:**
415 960-1300
Intercontinental Sales

