

The Complete Microcomputer System

MAY 1976
\$1.00

CONTENTS

Introduction	2
Hardware Features	3
Specifications	3
Basic IMSAI 8080 Systems	4
Options and Components	5
Memories	6
Multiprocessors and Shared Memory	7
Interfaces	8
Peripheral Devices	10
Software	12
Documentation	13
Typical System Configurations	14
Warranty	15

IMSAI 8080 THE PROFESSIONAL, AFFORDABLE COMPUTER SYSTEM

Here's a high-quality microprocessor-based system that gives you the performance and flexibility you demand at a price you can afford. Whether you're a cost/performance-conscious OEM, or an uncompromising experimenter, IMSAI 8080 should be your affordable choice.

The computer, using Intel's 8080A chip, makes up to 64K words (bytes) of memory directly accessible. With a basic machine cycle of 0.5 microsecond, and with as many as 256 I/O ports directly accessible, this is definitely a high-capability machine.

The computer is backed by a family of options and peripheral devices and interfaces to do just about any job... serial and line printers, a video terminal, tape cassette, disk or teletypewriter.

It's modular, so you can easily add to your IMSAI 8080 system.

Basic software furnished includes a resident monitor, assembler, text editor, loader and debugger. There's a wide range of high-level system software available to registered IMSAI 8080 owners at very low cost.

While the computer is designed as a high-quality commercial computer, there's no compromise in quality or value if you purchase it as a kit. You can get it together and bring it up in 10 to 20 hours, depending on your experience. Plug-in modularity minimizes solder connections to speed assembly and enhance reliability.

Your IMSAI 8080 computer will be supported by complete documentation including:

- IMSAI 8080 System User's Manual
- Intel 8080 Microprocessor System User's Manual, describing the Intel devices and instruction set
- An Introduction to Microcomputers, textbook on the programming and architecture of microcomputer systems

Your computer is backed by a 90-day warranty, and full factory service at moderate cost.

Whether your IMSAI 8080 computer is to be used up-front, or hidden in your dedicated application, you'll find it the right system to start with, and the best to grow with.

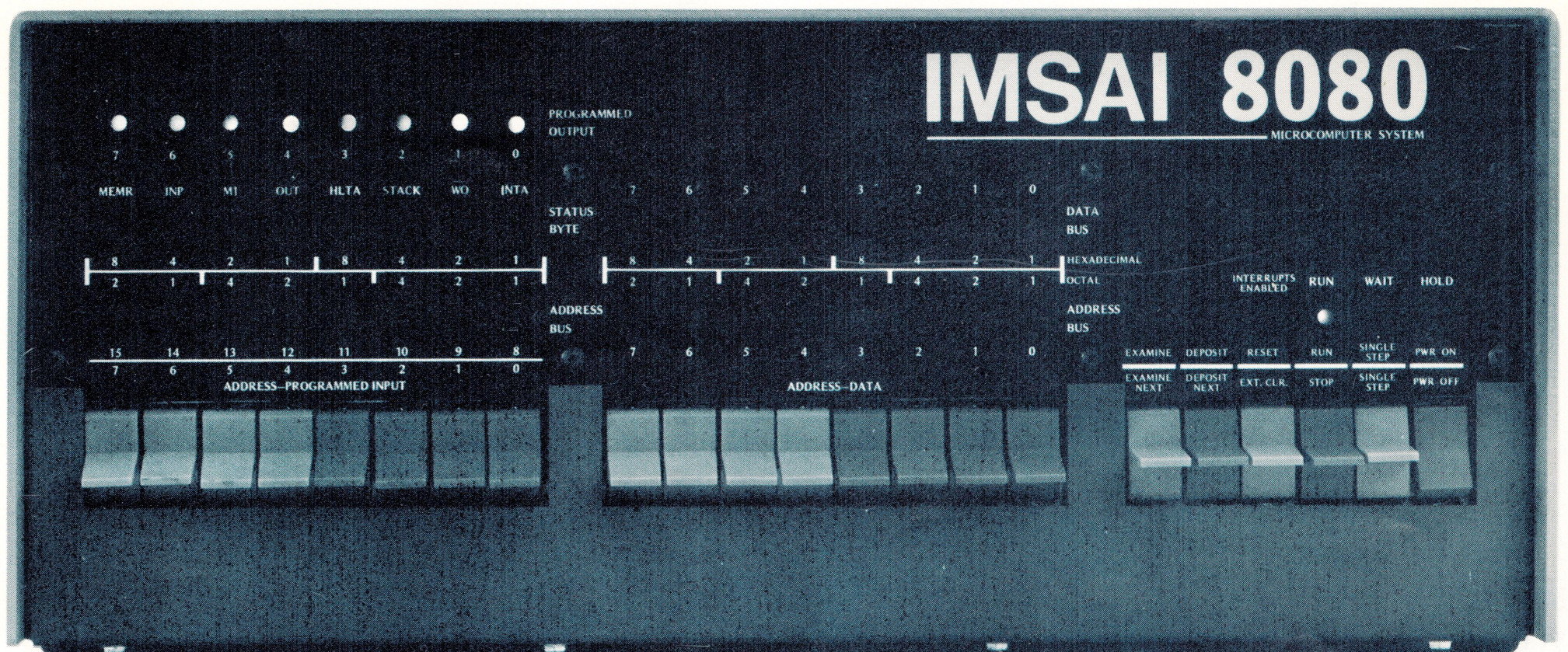

OUTSTANDING HARDWARE FEATURES

Front Panel

- Handsome and functional, with sharp, readable legends behind acrylic panel
- All indicators long-life LED's . . . panel filter enhances contrast
- Eight extra LED's programmed as an output port
- Easy-to-use paddle handle switches
- Easily customized for private labeling

Mechanical

- Sturdy card-cage construction . . . holds up to 22 cards
- Straight-through backplane design . . . no special-purpose slots
- Short backplane sections available
- Flat cable interconnections throughout
- Absolute minimum of point-to-point wiring . . . no point-to-point wiring to front panel permits easy panel removal
- Rack-mount cabinet available
- Pc boards double-sided with plated-through holes and solder mask
- Pc boards of glass-fiber reinforced epoxy laminate
- Pc board contact fingers gold-plated over nickel

Electrical

- Front panel circuits make one-shot timing links non-critical
- Latest LSI and MSI components . . . minimizes package count
- Heavy-current tri-state bus drivers

Power Supply

- Heavy-duty supply . . . 28 amperes for system expansion
- Power regulated on-board by IC devices with thermal current limits
- Generous ceramic disk power decoupling capacitors . . . dipped tantalum capacitors for board decoupling

System

- Designed from the beginning for multi-processor, shared memory capability
- Software drivers available for all IMSAI 8080 peripherals

SPECIFICATIONS

Processor Intel 8080A

Memory (directly addressable):
65,536 words
Word Size: One byte (8 bits)
Register Instruction Cycle Time:
2 microseconds
Basic Machine Cycle Time:
0.5 microsecond
Number of Input/Output Ports: 256
Machine Instruction Set: 78 basic instructions, 174 including variants
Nested Subroutine Calls: Number limited only by memory size
Interrupts: Eight hardware levels (with optional PIC-8 board)
Registers: Six plus stack pointer, program counter, accumulator and status register
Memory Type: Semiconductor (1K x 1 bit chips)

Cabinet

Custom aluminum case with acrylic front panel
Dimensions: 19½ in. wide, 17 in. deep, 7 in. high (rack mount option available)
Front Panel Switches: Paddle handle

Power

Requirements: 120V, 50-60 Hz, single phase, less than 50 Watts (basic system)
Maximum Power Capability: Up to 500 Watts in a large system

Interconnections

Back panel accommodates ten EIA-type 25-pin connectors. Opening and cable clamp furnished for flat cables to exit from cabinet. Flat cables used throughout.

CHOOSE FROM ONE OF THE BASIC IMSAI 8080 MICROCOMPUTER SYSTEMS

I-8080

The standard microcomputer includes:

- Front panel and control board (CP-A)
- Chassis with 22-slot card cage
- Sturdy, attractive dust cover (DC)
- Microprocessor board (MPU-A)
- 28-ampere power supply (PS-28)
- Mother Board with six board slots
- Two 100-pin edge connectors with card edge guides (EXPM)
- IMSAI 8080 System User's Manual
- Intel 8080 Microprocessor System User's Manual
- An Introduction to Microcomputers
- Software including monitor, assembler, editor, loader and debugger (punched paper tape and source listings)

Mother Board

Card-to-card spacing on the Mother Board is $\frac{3}{4}$ -inch, except for the first position reserved for the front panel board or any other board in dedicated applications.

Additional four-slot Mother Board sections (EXP-4) may be added to accommodate connectors, and are connected to other Mother Board sections by jumpers between through-plated holes. A full-length, 22-slot Mother Board (EXP-22) is also available and may be ordered initially in place of the six-slot board.

Heavy power traces handle the large currents that exist in a heavily loaded backplane. High-quality connectors have gold-plated contacts for reliability and long life.

Front Panel

The CP-A Board forms the operator's panel. It includes switches, indicators and logic needed for manual operation. The panel is completely self-contained and plugs directly into the first Mother Board slot. Or it may be connected through an extender board to any available slot in the Mother Board. When the first slot is not used for the front panel, that slot may be used by another board, such as the Parallel I/O Board with its LED indicators visible.

Front panel facilities include:

- 16 address/data switches
- 16 LED address indicators
- 8 LED data bus indicators
- 8 LED programmed output bit indicators
- 6 control function switches
- 8 LED status indicators (including control indicators for INTERRUPT ENABLED, RUN, WAIT and HOLD)

The front panel includes logic that

drives the programmed output indicators, and reads the input byte from the high-order address switches. DATA BUS indicators show data either read or written by the processor.

Indicators are wide-angle LED's behind a contrast-enhancing acrylic panel assembly. Photographically produced panel markings are crisp and explicit and can never wear off. Bit positions are numbered and labeled for both hexadecimal and octal notation. Special labels may be easily inserted to identify special functions for the programmed output LED's.

Switches are high-quality units, with paddle handles color-coded for easy, error-free operation.

Power Supply

The Power Supply (PS-28) is designed for use with pc boards having on-board regulators. Outputs are +10V and $\pm 18V$ at no load, and approximately +7V and $\pm 15.8V$ at full load.

A Power Supply pc board contains rectifiers and 120V ac switching and fusing functions. The board provides terminals for switched ac power, both fused and unfused, for a ventilating fan and auxiliary power outlets on the back panel. When the computer is supplied without the front panel, an ac power switch is mounted on the Power Supply Board.

A custom-built transformer and large, conservatively rated filter capacitors are mounted on the chassis.

Processor Board

The Processor Board (MPU-A) contains the Intel 8080A Microprocessor chip, clock crystal oscillator and clock drivers, status signal latches and bidirectional bus drivers, as well as on-board power

supply voltage regulators.

The bus arrangement and board connector are designed so that the MPU-A board may be used directly in the MITS Altair M8800 Microcomputer system.

The 2-MHz, 2-phase non-overlapping clock for the processor chip is provided by an 18-MHz crystal and 8224 clock driver. An 8212 chip latches status signals. Two 8216 tri-state, bidirectional bus drivers interface the processor chip with the IMSAI 8080 data buses. Other tri-state bus drivers drive address, status and control lines.

The MPU-A board receives $\pm 16V$ and +8V supply voltages and uses on-board regulators to obtain required voltage levels.

The board edge connector has 100 pins on 0.125-inch centers, with 50 pins on each side. Except for gold-plated contact fingers, circuit traces are tin-lead plated for easier, more reliable solder connections.

The board includes a power-on reset circuit, plus pull-up resistors so that without the front panel, power-on reset will start the program at location zero.

Multiple microprocessor boards are able to share memory and run identical or different programs in parallel.

I-8080-1K

Same as basic I-8080 system with the addition of 1K RAM memory on a RAM 4A-1 board. Board may be expanded later by adding up to three MM02-1 memory chip sets. Requires edge connector EXPM.

I-8080-OEM

Basic I-8080 system computer less front panel. Power on/off switch is provided.

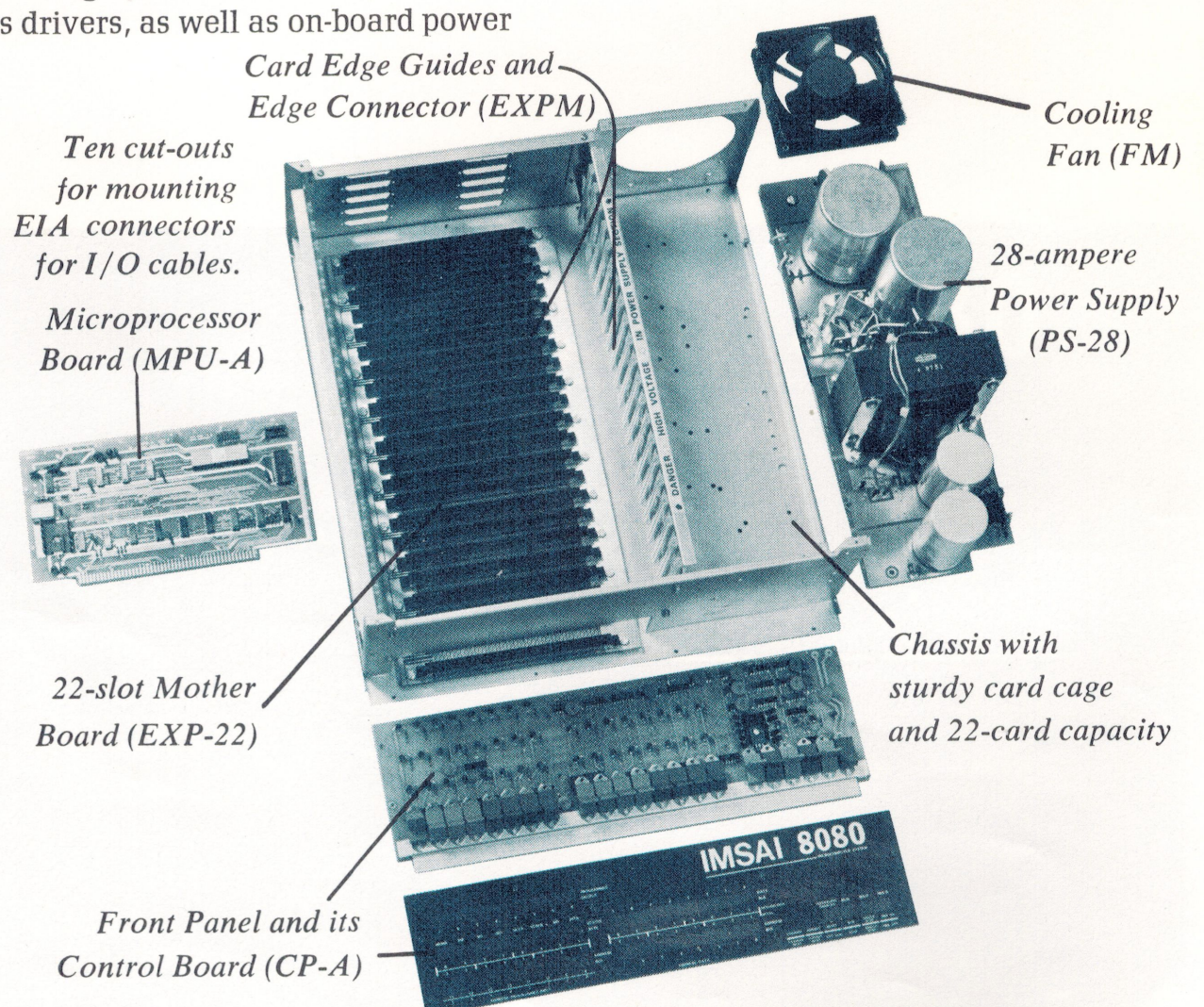

YOUR CHOICE OF OPTIONS AND COMPONENTS FOR THE BASIC SYSTEM

Rack Mount *RM*

This hardware lets you mount the computer chassis in a standard 19-inch electronics rack. It consists of side panels that bolt to the inner sides of the cabinet and support the chassis. A special dust cover is provided in place of the standard dust cover, as well as a modified front panel sheet metal escutcheon. This option must be ordered in conjunction with the basic computer system.

22-Slot Mother Board *EXP-22*

Twenty-two-slot Mother Board replaces all other Mother Board sections in the computer, offering maximum expansion capability. Reduced price available if ordered with basic system. Edge connectors must be ordered separately.

4-Slot Mother Board Expander *EXP-4*

Four-slot Mother Board Expander to increase the number of available slots beyond the six-slot board in the basic system. Bus lines must be wire-jumpered and soldered to existing Mother Board sections. Computer will accommodate up to four EXP-4 boards. Edge connectors must be ordered separately.

Edge Connector *EXPM*

Connects a pc board in the computer to the Mother Board. Consists of a 100-pin edge connector to be soldered to Mother Board, plus two card-edge guides that attach to side of the card cage. Extra edge connectors may be ordered with the basic system to permit easy future expansion.

Priority Interrupt/Interval Clock Board *PIC-8*

The PIC-8 board lets your processor perform jobs between interrupts, without the need to continually poll devices to see if any require service.

Priority interrupt logic on this board monitors the eight priority interrupt lines on the computer Mother Board. It can service either single or multiple interrupt requests. When enabled and it receives an interrupt request, the PIC-8 determines if the request priority is higher than the software-controlled present priority and, if it is, issues a restart instruction that directs the system to the appropriate one of eight priority-controlled restart locations.

For multiple interrupt requests, the PIC-8 determines the highest-priority request and processes it normally.

Note that the system does not store inactive requests, and that a peripheral device must hold its interrupt request until it is acknowledged by the

microprocessor.

The present-priority status register may be set by software to any desired value to prevent generation of low-priority interrupts until the register is reset to a lower value. The status register may be set to permit all levels of interrupt to occur.

The PIC-8 board also includes a clock circuit which generates program-controlled interrupts at intervals preset from 0.1 millisecond to 1 second. Any three rates may be jumper-selected, selecting from rates of 0.1, 0.2, 1.0, 2.0, 10, 20, 100, 200 or 1000 milliseconds. Any one of the three selected rates, or none, may be selected by the program.

One bit of the DATA OUTPUT port is connected to a transistor and jumper pads to provide a special-purpose program-controlled output. The circuit board also provides five 16-pin DIP hole patterns with power and ground decoupling for special circuits of your own design. Hole patterns are drilled for wire-wrap sockets. There is room on the board to mount a small speaker driven by the aforementioned transistor or other circuits of your own design.

An edge connector EXPM is required to install the PIC-8 board.

General Purpose Prototype Board *GP-88*

This board may be used to develop and build your own custom circuits. It offers space for up to 31 16-pin DIP devices and two 40-pin DIP's. Or three 24-pin DIP's may be installed in the two 40-pin spaces. Hole patterns are drilled for wire-wrap sockets.

The board is supplied with an on-board regulator and tantalum decoupling capacitor. An edge connector EXPM is required to install the board.

Extender Board *EXT*

The Extender Board plugs into an edge connector on the Mother Board and is used to extend a functional circuit board out of the card cage for access to circuits. End pins are marked at every fifth pin for fast identification.

Using the Extender Board, the front panel/control board may be attached to any slot in the chassis. Requires edge connector EXPM.

Cooling Fan *FM*

Muffin-type fan that may be installed at rear of computer chassis. It is recommended when there are 10 or more boards in the chassis.

Front Panel *CP-A*

The standard front panel and control card. Requires edge connector EXPM.

Power Supply *PS-28*

The standard IMSAI 8080 power supply providing 28 amperes at +7V dc minimum, and 3 amperes each at +15.8V and -15.8V minimum. Operates from 120V, 50-60 Hz power.

Dust Cover *DC*

The standard IMSAI dust cover normally delivered with the IMSAI 8080 computer.

Microprocessor Board *MPU-A*

This is the Microprocessor Board that is part of the basic computer. Requires edge connector EXPM.

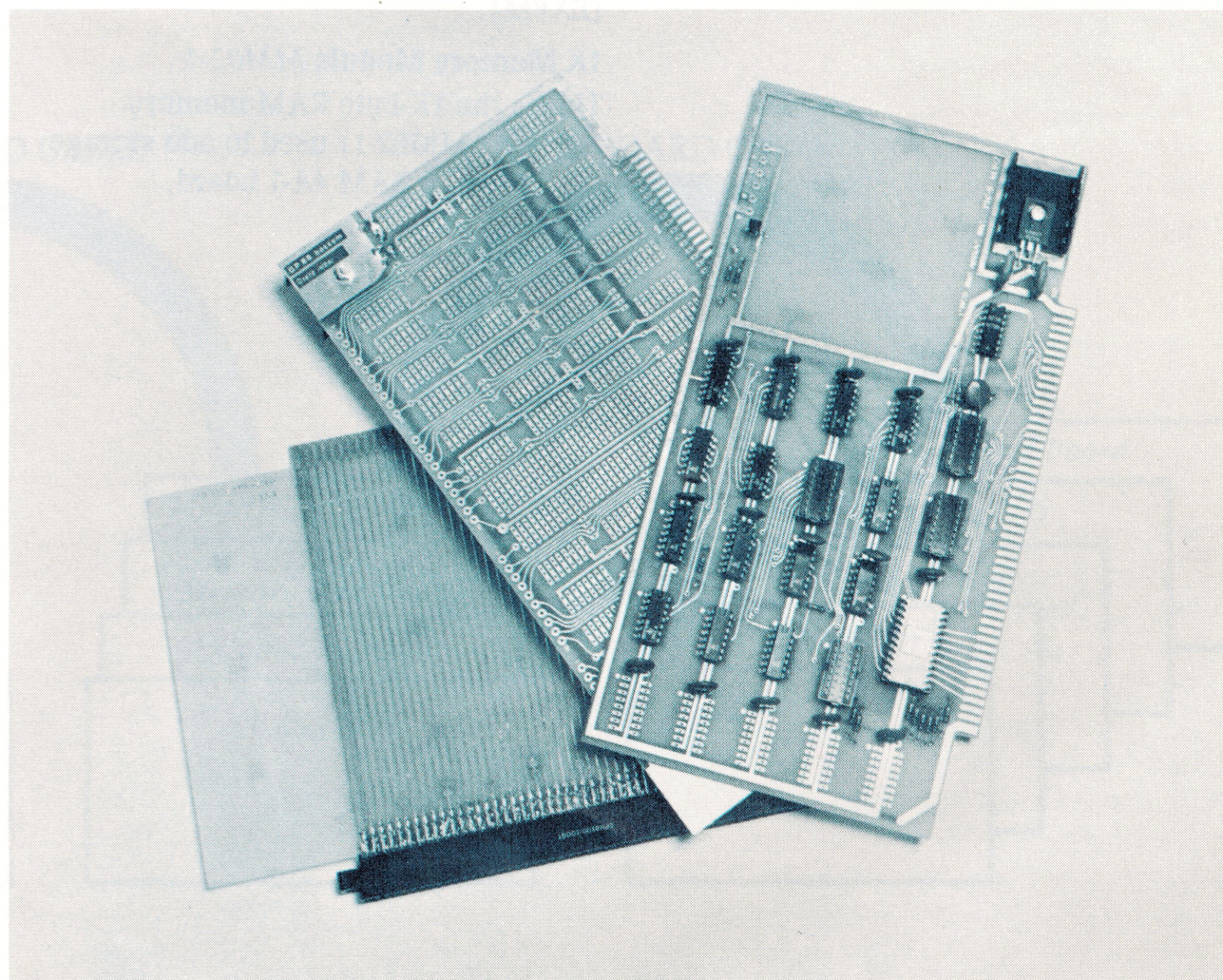

Extender Board EXT, General Purpose Prototype Board GP-88, Priority Interrupt Board PIC-8

MEMORIES WITH UNMATCHED PERFORMANCE

4K Random Access Memory *RAM 4A-4*

The basic memory is the 4K Random Access Memory (RAM 4A-4). This board stores 4096 bytes of changeable information, either programs or data. Information may come from a computer program, a peripheral device, or the front panel switches.

RAM 4A-4 offers a number of unique features to make program development easier. A powerful memory write-protect feature lets you protect 1K-byte blocks of data under program or front panel control. The program can test for the protect status of any 1K-byte block, and an interrupt is generated when a protected block is illegally accessed.

The board has two LED indicators for each 1K-byte block. One is lit when the block is write-protected, and the other is lit when the block is being accessed for reading or writing.

Storage is static using 2102-type chips (no refresh cycle) with a cycle time of 500 nanoseconds. The board

address can be jumper-selected to any 4K block of the computer's 64K-byte address space. The memory is fast enough so that no wait cycles are required. If you use slower memory chips a wait cycle can be generated.

Tri-state bus drivers and three fully decoupled on-card voltage regulators are used.

The board also includes a battery backup circuit (battery not included) to save memory contents when ac power is turned off. Each RAM 4A-4 board requires one edge connector (EXPM).

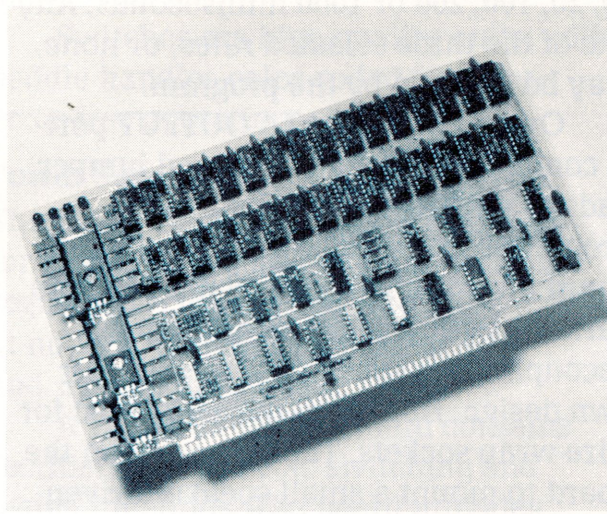

4K Random Access Memory *RAM 4A-4* 1K Random Access Memory *RAM 4A-1*

The 1K Random Access Memory (RAM 4A-1) stores 1K bytes of information. Except for memory capacity, it has the same specifications as the RAM 4A-4 board. As your needs increase you can add memory capacity up to 4K, in 1K increments, by adding MM02-1 memory modules. This board is available only with the IMSAI I-8080-1K computer system.

Requires one edge connector (EXPM).

1K Memory Module *MM02-1*

This is the 1K-byte RAM memory module (MM02-1) used to add storage capacity to a RAM 4A-1 board.

8111 Memory Module *M11-1*

This 8111-type 1K-byte memory module (M11-1) is used to add storage capacity to the RAM 4-1 board, now discontinued.

Read Only Memory *PROM 4-4*

This board (PROM 4-4) provides non-volatile program storage that cannot be changed by the computer or erased when power is turned off. Use a PROM board for programs that are run frequently. For example, IMSAI provides the BASIC language in PROM.

The board contains 16 Intel 1702A, or equivalent, EPROM chips in sockets. They may be erased by ultraviolet light and can be reprogrammed electrically by a PROM programmer unit. Each device stores 256 bytes for a total of 4K bytes on the board. Each of the 16 PROM sockets is individually addressable and PROM's operate independent of each other. Thus, memory space may be structured by simply arranging PROM's in appropriate sockets. The board address is jumper-selected to any 4K block of the computer's 64K memory space.

A user-selectable memory-read delay (0 to 3 machine cycles) allows most efficient use of fast or slow PROM chips. The chips supplied have an access time of 1000 nanoseconds.

The board includes tri-state bus drivers and fully decoupled supply voltage regulators. An EXPM edge connector is required to install the board.

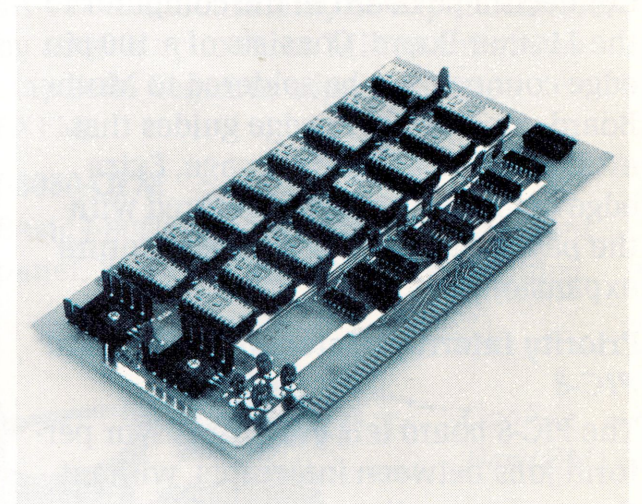

Read Only Memory *PROM 4-4*

512 Bytes PROM Memory *PROM 4-512*

This is a memory board (PROM 4-512) with only two PROM chips that provide 512 bytes of PROM storage. The board may be fully populated, in 512-byte increments, up to 4K bytes by adding 512 Byte Memory Module (MM702-5) sets. An EXPM edge connector is required.

512 Bytes PROM Memory Module *MM702-5*

This is a set of PROM chips (MM702-5) to add 512 bytes of storage to a PROM 4-512 board.

MULTIPROCESSORS AND SHARED MEMORY FOR ULTIMATE FLEXIBILITY

When you design your system to utilize multiple processor boards (MPU-A) sharing the same physical memory, you simply order the Shared Memory Facility (SMF). The SMF is a low-cost facility allowing up to six processors to communicate via a shared memory, and allowing any processor to access several shared memory systems. I/O interfaces can also be shared when selected as memory addresses instead of port numbers.

Each processor is allowed up to 64K bytes of its own local memory, less the amount of memory in the shared block. The shared memory may be up to 64K bytes.

The SMF includes:

- MABP-3 Access Port (bus multiplexer) board
- MAPT-6 Shared Memory Controller board

Both boards are connected to a special Mother Board section (Shared Memory Bus) in a standard IMSAI 8080 chassis. Memory boards shared by the processors are also plugged into this section.

The SMF is completed by Bus boards plugged into the Mother Board of each processor, and cables connecting the Bus boards to the MABP-3 boards on the Shared Memory Bus.

A separate front panel may be connected (through an extender board) to each processor. The processors may be

contained in separate cabinets connected only by the Bus board and associated cable.

Access Port Board *MABP-3*

This bus multiplexer board consists of three identical ports used to switch information between one of three processors and the Shared Memory Bus. Two MABP-3 boards are used to make a six-way switch controlled by the MAPT-6 Shared Memory Controller board.

The MABP-3 board contains three complete sets of logic, each comprising an address decoder, request latch and bus buffers. When two boards are used in a system, they provide a six-way bus switch in which the six processor ports differ only in their priority assigned on the MAPT-6 board.

To any processor, then, access to information in shared memory is the same as access to any other memory space except that it may need to wait while the SMF services higher priority requests.

An EXPM edge connector is needed to install each MABP-3 board.

Shared Memory Controller Board *MAPT-6*

This board performs timing and control functions of the Shared Memory Facility. Logic includes a latched priority encoder which generates the signal PORT SELECT I, where I is the processor presently with highest priority. This signal enables related bus drivers on the MABP-3 boards to perform bus switching.

Other logic elements form a sequential logic network to generate signals controlling the memory. These signals

include SYNC, which substitutes for the SYNC signal normally generated by the processor during a fetch cycle, and which may be used for other system functions.

An EXPM edge connector is needed to install the MAPT-6 board.

Bus Board *BB*

Each processor sharing memory requires a Bus Board and cable to connect its bus to the MABP-3 board. Order either an 8-inch cable (BB CABLE-8) or 18-inch cable (BB CABLE-18), depending on the length required.

An EXPM edge connector is needed to install each Bus board.

8-inch Cable *BB CABLE-8*

This 8-inch flat cable, with 50-pin edge connectors, connects a Bus board to a MABP-3 board.

18-inch Cable *BB CABLE-18*

This 18-inch flat cable, with 50-pin card edge connectors, is used to connect a Bus board to a MABP-3 board when a BB CABLE-8 unit is not long enough.

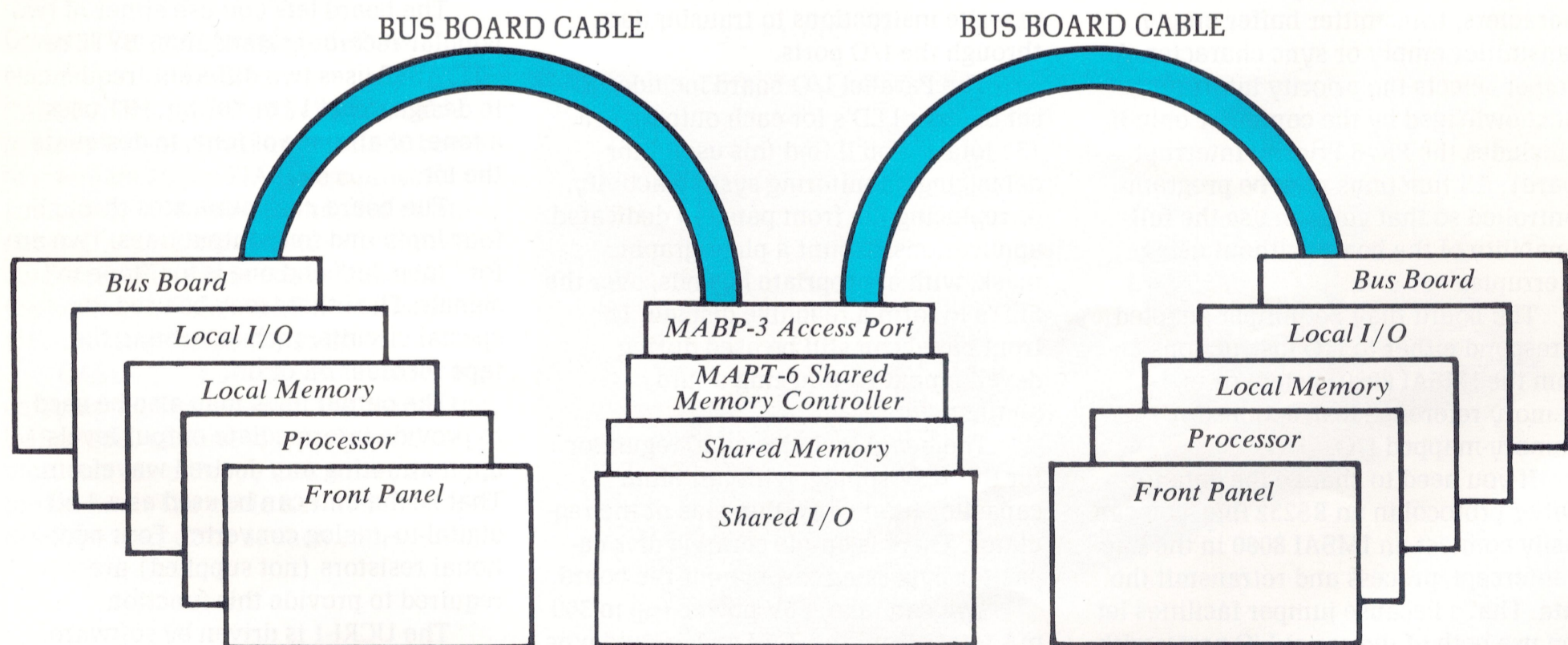

MULTIPROCESSORS AND SHARED MEMORY

INTERFACE BOARDS TO LET THE COMPUTER COMMUNICATE WITH INPUT/OUTPUT DEVICES

Serial I/O Interface *SIO 2-2*

The SIO 2-2 Serial I/O Interface board contains two identical ports, each permitting the computer to communicate with most peripheral devices through an RS232 or current loop interface. The two ports are independent. Each may operate through either the current loop or RS232 mode, and will operate in full-duplex or half-duplex with all control signals.

You can run synchronous or asynchronous lines, full- or half-duplex, at any baud rate up to 9600 baud (asynchronous) or 56,000 baud (synchronous). Baud rates up to 9600 (asynchronous) or 38,400 (synchronous) are selected by jumpers on the board. Asynchronous baud rates are 75, 110, 150, 300, 600, 1200, 2400, 4800 and 9600. Synchronous rates are 1200, 2400, 4800, 9600, 19,200 and 38,400. Other rates are made possible using the SIOC board which mounts directly on the SIO board.

Control lines for each input include DSR, DTR, RTS, CTS and Carrier Detect. RS232 receivers and drivers are also provided for clocks in synchronous operations. Jumpers permit using the board as either the receiving (terminal) end of a communication line or the originating (computer) end.

Each interface is structured around an Intel 8251 USART chip. This chip allows extensive program control of I/O functions including control line and sync character selection, and error-condition sensing and recovery. The board generates interrupts for received characters, transmitter buffer empty, transmitter empty or sync character. A jumper selects the priority interrupt (acknowledged by the computer only if it includes the PIC-8 Priority Interrupt board). All functions may be program-controlled so that you can use the full capability of the board without using interrupts.

The board may be jumper-adapted to respond either to I/O instructions from the IMSAI 8080 system or to memory reference instructions for memory-mapped I/O.

If you need to change the data format or protocol in an RS232 line, you can easily connect an IMSAI 8080 in the line to intercept, process and retransmit the data. That's because jumper facilities let you use both of the serial I/O ports, with control lines connected together.

Connector fingers on the upper edge of the board accommodate two flat cables (CABLE A) to connect directly to 25-pin EIA-type connectors, one for each

port. No hand wiring is required to receive or originate an RS232 line.

An edge connector EXPM is needed to install the SIO 2-2 board. One or two cables (CABLE A) are optional.

Serial I/O Interface Board *SIO 2-1*

This is, essentially, an SIO 2-2 board containing chips for a single port. You can add another port later with the SIOM module.

Serial I/O Module *SIOM*

This set of components adds the second I/O port to an SIO 2-1 board.

Serial I/O Clock Board *SIOC*

This piggyback board attaches to a SIO board to provide any non-standard baud rate from 1 baud to 56K baud. The SIOC board is needed for *each port* using a non-standard baud rate.

Parallel I/O Interface *PIO 4-4*

Use the Parallel I/O board as a custom TTL-level interface to peripheral devices.

The board provides four 8-bit input ports, and four 8-bit output ports. Each input and output port has its own latch and hand-shaking logic for conventional parallel transfer.

Hand-shaking logic on any I/O port will generate an interrupt, with the priority level of the interrupt selected on the board. (Note that the processor will not respond to the interrupt unless the computer contains the PIC-8 Priority Interrupt board.)

The ports are addressed by four sequential addresses jumper-selected to be in the 256 I/O address space. You may also address the board with memory-mapped I/O, using normal memory read or write instructions to transfer data through the I/O ports.

The Parallel I/O board includes a set of eight LED's for each output port (32 total). You'll find this useful for debugging, monitoring system activity, or replacing the front panel in dedicated applications. Mount a photographic mask, with appropriate legends, over the LED's to form a readable display. The front panel can still be used during development by plugging it into another slot.

The board includes an IC regulator for the +5V supply, with tantalum capacitor filters on either side of the regulator. There is ample ceramic disk capacitor bypassing throughout the board.

You can take +5V power (up to 300 mA total) from the +5V and ground pins on the I/O port connectors of a fully utilized board. For each unused port, an additional 100 mA may be drawn from the board. If, for example, you are using four output ports and only two input ports,

500 mA is available from the board.

On the top of the board, fingers accommodate two 50-pin connectors (25 pins per side on 0.1-inch centers), one for input ports, and one for output ports.

An edge connector EXPM is needed to install the Parallel I/O board. PIO cables for input and output are optional.

Parallel I/O Board *PIO 4-1*

This is a PIO 4-4 board containing components for one 8-bit input and one 8-bit output port. Expand it later with 1, 2 or 3 sets of components by adding PIOM sets. Requires edge connector EXPM. PIO cables for input and output are optional.

Parallel I/O Module *PIOM*

This is a set of components to add a single port to a PIO 4-1 board.

Cable *PIO Cable*

This cable connects parallel I/O signals between the Parallel I/O board and the rear of the IMSAI 8080 chassis. An edge connector attaches to the upper edge of the board and the cable divides into two 25-pin EIA-type female connectors which attach to the rear of the chassis.

One PIO CABLE is used for all inputs and a second for all outputs.

Universal Tape Cassette Recorder Interface *UCRI-1*

An audio tape cassette recorder is an inexpensive data storage medium. The UCRI-1 board modulates and demodulates an audio signal to read or write digital data. The board is connected to the tape recorder by two patch cords with RCA-type phone jacks (not supplied).

The board lets you use either of two popular recording standards: BYTE or HIT. BYTE uses two different frequencies to designate a "1" or "0" bit. HIT uses a tone, or absence of tone, to designate the bit.

The board communicates through four input and four output lines. Two are for "tape out" and one is for "tape in" signals. The others may be used for special circuits, such as turning the tape recorder on or off.

The output lines may also be used to provide intermediate output levels approximating any desired waveform. That is, the unit can be used as a 4-bit digital-to-analog converter. Four additional resistors (not supplied) are required to provide this function.

The UCRI-1 is driven by software. HIT standard software is furnished on punched paper tape, with source listings provided for reference.

An edge connector EXPM is needed to install the UCRI-1 board.

Interface Master Board IFM

This will satisfy your need for an "intelligent" peripheral controller to get the best efficiency from your IMSAI 8080 system. It contains its own Intel 8080A microprocessor, a driver program in EPROM and a RAM buffer.

Data is transferred between computer memory and the peripheral device at high speed by direct memory access (DMA).

The EPROM program depends on the type of peripheral device you are to control. An IFM board is only available with the interface board for a specific peripheral device. Order an edge connector EXPM for installing the IFM board.

DEC PDP 11/45 DMA Interface PDP/DMA

This interface allows a Digital Equipment Corporation PDP 11/45 computer to communicate with an IMSAI 8080 computer at DMA speeds. It consists of a board that is inserted into a PDP 11/45 chassis, a board set for the IMSAI 8080 chassis, and an interconnecting cable. This feature allows IMSAI 8080 computers to be attached to a PDP 11/45 computer as satellite processors, yet be directly accessible to a PDP 11/45 program via its UNIBUS®. The IMSAI 8080 satellite processors may be used as work stations with terminals attached, nodes in a communications network, or as parallel processing units.

Please contact the factory for additional information.

Disk Drive Interface HDIF

This interface enables the connection of a Disk-50, -80 or -200 drive to an IMSAI 8080 computer.

Please contact the factory for additional information.

General Purpose Interface Cables CABLE A, CABLE C

CABLE A is a 15-inch, flat ribbon cable to carry signals from an interface board to a female 25-pin EIA-type connector (included) attaching to the rear of the chassis. A card edge connector (included) on the other end attaches to the pc board. Use CABLE A with SIO, FIF and LIF interface boards.

CABLE C is a 5-foot ribbon cable for carrying signals between the rear of the IMSAI 8080 cabinet to a peripheral device, such as a floppy disk drive, modem or terminal. The cable has a male 25-pin EIA-type connector at each end.

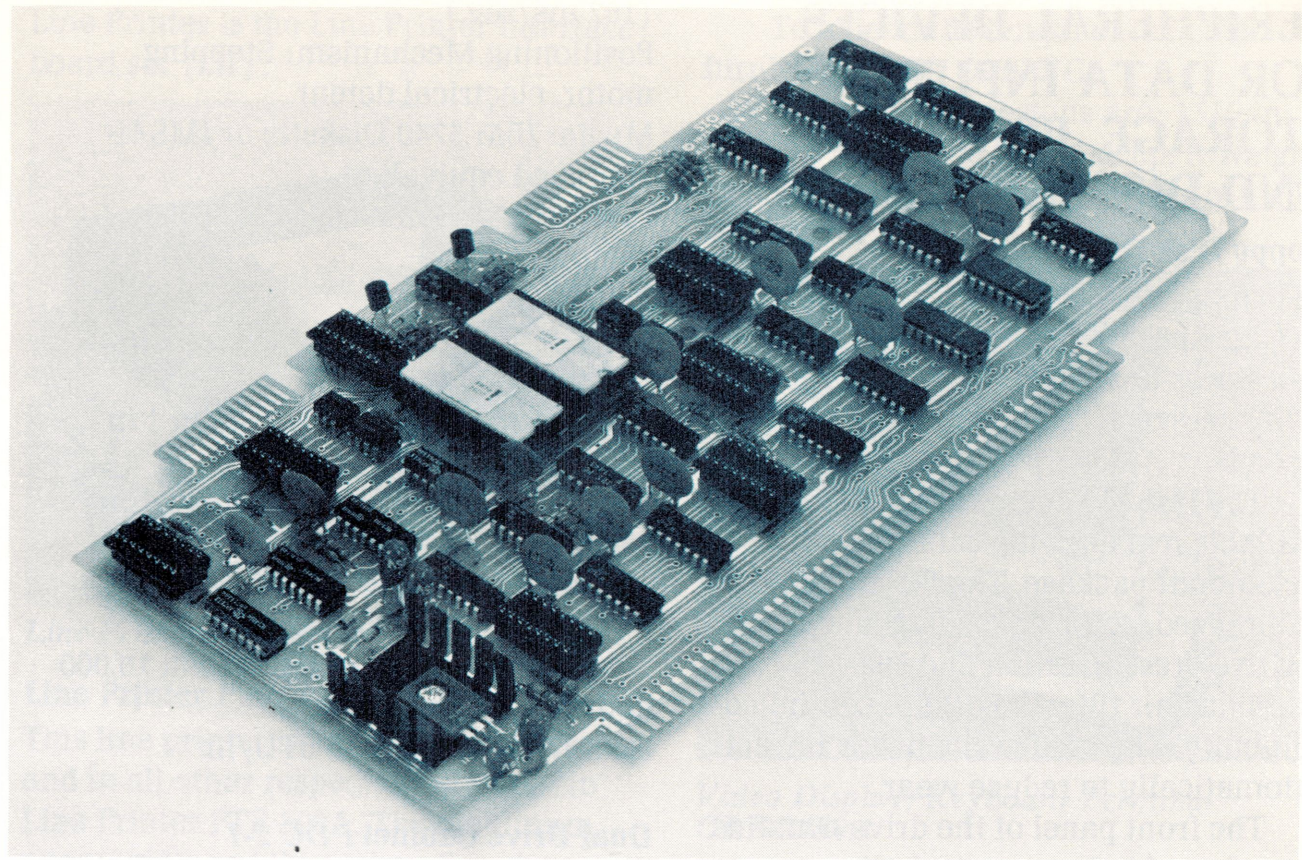

Serial I/O Interface SIO 2-2

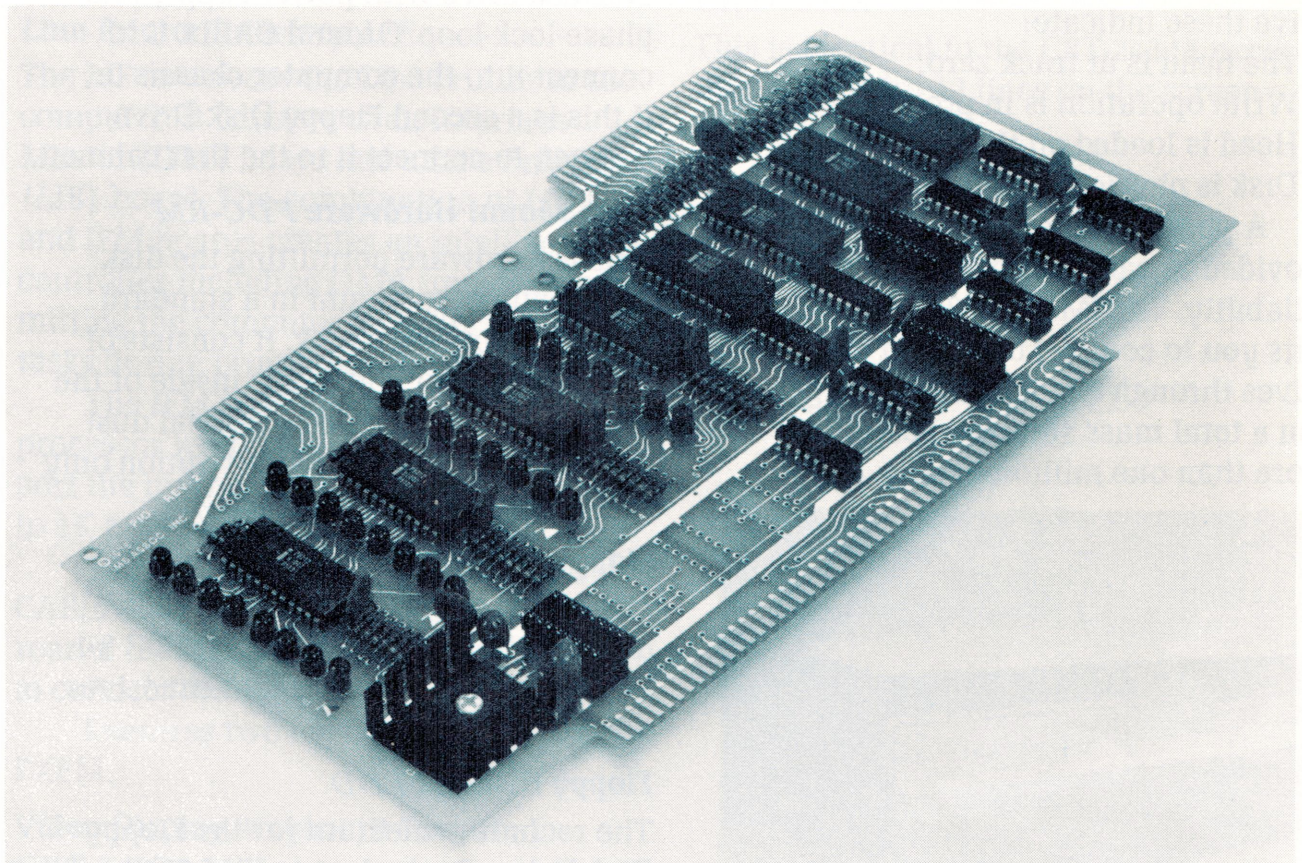

Parallel I/O Interface PIO 4-4

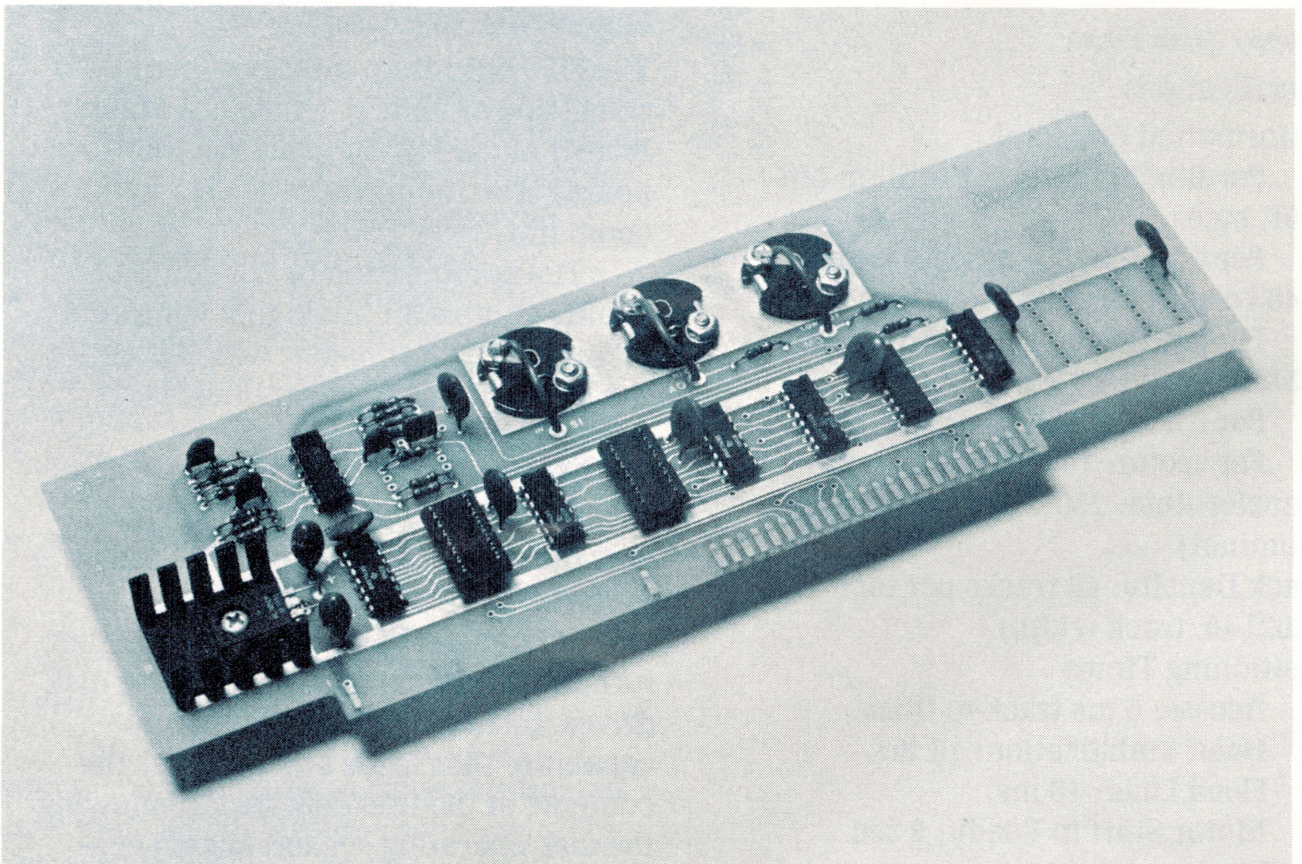

Universal Tape Cassette Recorder Interface UCRI-1

PERIPHERAL DEVICES FOR DATA INPUT, STORAGE, PRINTING AND DISPLAY

Floppy Disk Drive

The Floppy Disk Drive is recommended for high-speed, mass data storage. Each disk stores up to 243K bytes of data, with average access time of 100 milliseconds.

The IMSAI Floppy Disk Drive is available in a desk-top cabinet or in a rack-mount package. The drive is built on a rugged, compact casting, and uses positive pressurization and self-contained air filters to assure continued reliability. The read/write heads retract automatically to reduce wear.

The front panel of the drive contains a number of indicators, including READY and SELECTED. For the selected drive these indicate:

- The head is at track zero.
- Write operation is in progress.
- Head is loaded on the disk.
- Disk is physically write-enabled.

A phase-lock-loop data separator is provided in each cabinet for increased reliability. The IMSAI 8080 system permits you to connect up to four disk drives through a single interface, giving you a total mass storage capacity of more than one million bytes.



Floppy Disk Drive

Specifications

Unformatted Capacity

Per flexible disk: 3.2 million bits/
400K bytes

Per track: 41.7K bits/5K bytes

3740 Format Capacity

Per flexible disk: 1.9 million bits/
243K bytes

Per track: 26.6K bits/3.3K bytes

Per sector: 1024 bits/128 bytes

Transfer Rate: 250K bits per second
(nominal)

Track Density: 48 tracks per inch
(0.021-in. track width)

Positioning Times

Access: 6 ms track-to-track

Head Stabilization: 10 ms

Head Load: 16 ms

Motor Start to Ready: 2 sec

maximum

Rotational Speed: 360 rpm \pm 2.4%

(167 ms/rev.)

Positioning Mechanism: Stepping
motor, electrical detent

Media: IBM 3740 Diskette or IMSAI-
approved equivalent

Dimensions: Same as IMSAI 8080
computer

Reliability

Read Error, soft: Less than 1 in
 10^9 bits

Read Error, hard: Less than 1 in
 10^{12} bits

Positioning Error: Less than 1 in
 10^6 accesses

MTBF: Better than 5000 hr

MTTR: Less than 30 min

Component Life: More than 10,000
hours on all components

Heat Dissipation: 275 BTU/hr

Dual Drive Cabinet FDC 2-1

This is a dual-drive cabinet containing one disk drive with power supply and phase-lock-loop. Order a CABLE C to connect it to the computer chassis or, if this is a second Floppy Disk Drive cabinet, to connect it to the first cabinet.

Rack Mount Hardware FDC-RM

This is hardware permitting the disk drive cabinet to mount in a standard 19-inch electronics rack. It consists of side panels that bolt to the inside of the electronics cabinet and a special dust cover. Order the rack mount option only in conjunction with an FDC 2-1.

Floppy Disk Drive FDC

Disk drive and power supply to add a drive to the dual-drive cabinet FDC 2-1. Includes a cable to interconnect drives within the cabinet.

Floppy Diskette FDD

The recording medium for the Floppy Disk Drive. Equivalent to IBM 3740 Diskette.

Floppy Disk Interface FIF

The FIF board is an interface/controller consisting of an IFM (Interface Master Board) and a FIB (Floppy Disk Interface board) which interface the disk to the computer.

The combination of FIB and IFM boards creates an intelligent controller including DMA transfer, which permits the computer to perform other tasks during disk operations.

The IFM board uses its own 8080A processor which is programmed to support the floppy disk system. The program is stored in 1K byte EPROM chips and can be changed to support different data formats and densities on the floppy disk drives. Included is a disk bootstrap capability that reads and executes the contents of the first disk sector, allowing the disk operating system to gain control after turning on the computer.

A single FIF interface will control

up to four disk drives in a daisy chain signal bus, and can write-protect drives under software control. Commands include Read Clock and Data Bits, Write Sector, Read Sector, Verify Sector, Format Track, Write Deleted Data Sector Mark, Write Protect, Write Enable and Restore Drive.

Logical and physical track addresses may be different. Cyclic redundancy checks are performed automatically. When an error is detected in reading or writing, the logic automatically retries up to 10 times.

The FIF board is furnished with a CABLE A to connect the board to the rear of the computer chassis and a CABLE C to connect the chassis to the Floppy Disk Drive cabinet.

Two edge connectors EXPM are required.

Disk Drives Disk-50, Disk-80, Disk-200

You can specify 3330-type disk drives with 50, 80 or 200-megabyte capacities. Each drive is supplied with Disk Drive Interface HDIF.

Please contact the factory for additional information.

Serial Printer PTR-30A

This serial printer produces letter-quality copy and will operate in the plot mode to produce graphs. Print fonts are changeable, and two-color ribbons are available.

The printer operates at a rate of 30 characters per second, using the Hy-Type I daisy-wheel printer mechanism. It will space up, down, right or left. Tabs are program-controlled and operate at high speed in either direction. The platen is 132 characters wide.

The printer includes a power supply. A software driver program listing is furnished with the printer to facilitate normal character printing and plotting. The driver routine uses about 512 bytes of memory.

The required interface is the PIO 4-1 with an installed Parallel I/O Module (PIOM) and two PIO cables.

A 10-foot round cable is furnished to interconnect the printer with three male 25-pin EIA-type connectors to the rear of the computer chassis.

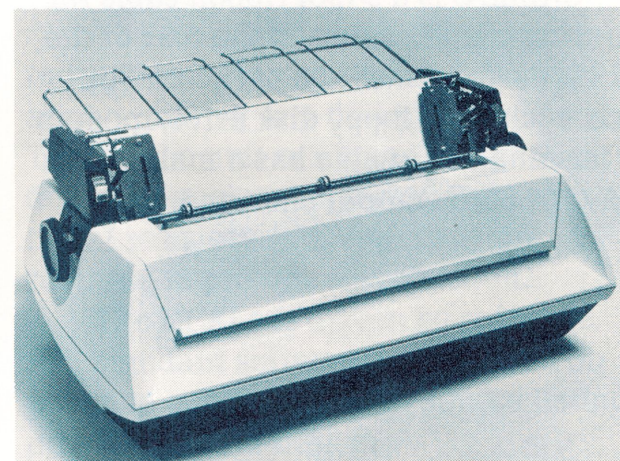

Serial Printer PTR-30A

Specifications

Print Speed: 30 characters per second (average text)
Character Set: 96 characters
Print Line: 132 columns
Form Width: 15 inches maximum
Carriage Return Time: 400 ms maximum for 132 columns
Tabulation: Right and left, direct to column address
Tabulation Speed: 400 ms maximum for 132 columns
Column Spacing: 60 positions per inch (nominal)
Paper Feed: Bidirectional
Paper Feed Spacing: 48 positions per inch (nominal)
Paper Feed Speed: 4 inches per second plus 50 ms settling delay
Dimensions: 8½ in. high, 22½ in. wide, 13½ in. deep
Weight: 30 lb

Tractor Feed Option PTR-30A-TF

This option for the PTR-30A printer provides greater paper control when using multipart forms. It also provides better registration when backing-up a line and overprinting.

Line Printer PTR-300A

The Line Printer prints up to 314 lines of 80-column material per minute. The unit is ruggedly built and produces a high-quality copy on standard fan-folded or rolled forms from 4 to 9¾ inches wide. Multipart forms may have up to six parts. Form width and length are operator-adjustable to permit the printer to handle a variety of forms.

The standard USASCII 63-character set is provided. Character spacing is 10 characters per inch and 6 lines per inch, operator-adjustable to 3 lines per inch.

The printer mechanism uses individual type pallets in an endless revolving carrier belt. This system gives you high-speed operation along with the good character quality and changeability advantages of an impact typebox printer.

Automatic Character Substitution: The printer may be made to print either the upper-case equivalent of a received lower-case character, or the substitute character ☐.

Parity Error Indication: The printer prints the substitute character for a character received with an even parity error. The printer is easily changed to operate with odd parity or none.

Test Character Generation: A switch inside the printer may be used to test the printer mechanism by printing the substitute character ☐ in all printable positions of consecutive lines.

The printer includes power supply and a 10-foot flat cable terminated by a 25-pin EIA-type connector which connects to the rear of the computer chassis. The required interface for the

Line Printer is the Line Printer Interface board set (LIF).

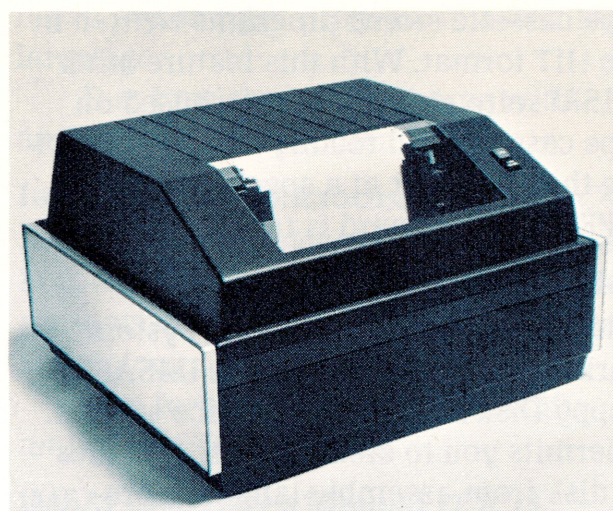

Line Printer PTR-300A

Line Printer PTR-300B

This line printer is 132 columns wide and in all other respects equivalent to Line Printer PTR-300A. The maximum paper width is 14¾ inches. Requires interface board set LIF.

Line Printer Interface LIF

The LIF interfaces the Line Printer to the computer. It consists of an Interface Master (IFM) board and a Line Printer (LIB) board. The combination of LIB and IFM boards creates an intelligent controller including DMA transfer, permitting the computer to perform other tasks during printer operations.

The IFM board uses its own 8080A processor which is programmed to support the printer. The program is stored in 1K byte PROM chips.

The LIF board is furnished with a CABLE A to connect the board to the rear of the computer chassis and a cable to connect the chassis to the Line Printer.

Requires two edge connectors
EXPM.

Video Display/Keyboard Terminal CRT-2480A

The Video Terminal is a high-quality 24-line, 80-character-per-line terminal featuring:

- 12-inch (diagonal) CRT with P4 white phosphor and etched non-glare surface
- 59-key keyboard with office typewriter layout and containing all teletypewriter data and control keys
- Displays 64 ASCII characters (upper-case, numeric and punctuation)
- RS232C and current-loop interfaces at standard communications baud rates from 75 to 19,200 baud for full-duplex or half-duplex asynchronous operation
- Automatic scrolling with new data entered at screen bottom
- Variable communications format: word length, parity and stop bits switch-selectable.

The terminal includes a 3-foot round communications cable terminated by a male 25-pin EIA-type connector. The required interface is an SIO 2-2 or SIO 2-1 board.

To extend the length of the cable furnished, order CABLE C.

Terminal dimensions are: 13½ in. high, 15½ in. wide, 19 in. deep. It weighs 25 pounds and requires 80 Watts of 115V ac power.



Video Display/Keyboard Terminal CRT-2480A

Video Display/Keyboard Terminal CRT-1280A

This is identical to the CRT-2480A except that it provides 12 lines on the screen instead of 24 lines.

SOFTWARE FOR DEVELOPING YOUR PROGRAMS

Software now available includes a monitor/executive (Self-Contained System), Tape Cassette Operating System, Disk Operating System, three BASIC language interpreters and bootstrap loaders for paper tape and tape cassette.

Self-Contained System PGM-1A

This package contains an assembler, editor, debugger, loader and monitor. It has commands to modify memory, dump memory contents, manage memory-located files, list a file, execute a program and use breakpoints.

Programs are read from paper tape by a bootstrap loader program keyed into the computer at the front panel or by a bootstrap on an EPROM card (PGM-4A). The entire package is memory-resident and requires 4K bytes of memory plus 2K bytes for buffers. Generally, at least 8K of memory is needed to store the package and user-created programs.

The package is furnished on paper tape with source listing, along with the basic computer system. It is also available on tape cassette and diskette. The Tape Cassette Operating System also provides the package in EPROM, for use with or without the tape cassette and its interface.

Operating instructions and source listings are contained in the IMSAI 8080 User's Manual.

Tape Cassette Operating System PGM-2A

This package contains a version of the Self-Contained System and includes features for reading and writing files stored on a tape cassette in HIT format, and for loading programs from the cassette. The operating system resides in 4K bytes of EPROM at a high memory address. It is also available on paper tape, tape cassette, and diskette. The system may be used with or without the tape cassette facility.

Use of this system requires at least 4K bytes of random access memory (RAM 4A-4), and requires use of a PROM 4-4 board. If the tape cassette recorder is to be used, a UCRI-1 board is also required.

Paper Tape Bootstrap Loader PGM-4A

This is an EPROM bootstrap loader for paper tape programs. It enables a paper tape for any software package to be automatically read by starting the computer at a specified address. This eliminates keying in the bootstrap program at the front panel. A PROM 4-512 board is required to accommodate this function.

Tape Cassette Bootstrap Loader PGM-5A

This is an EPROM bootstrap loader for tape cassette stored programs written in the HIT format. With this feature other IMSAI software may be purchased on tape cassette and readily loaded by starting the computer at a specified address. A PROM 4-512 board is required.

Disk Operating System DOS-A

This powerful Disk Operating System works in association with the IMSAI Floppy Disk Drive and interface system. It permits you to create and access files on disk from assembly-language programs, extended BASIC or a keyboard.

DOS-A is interactive and can be used for overall system control.

Valuable program-development tools include an assembler to produce relocatable code, a linking loader, a new debug program, and a symbol-oriented text editor.

BASIC Language Interpreter BASIC-4A

This compact yet powerful high-level interpretive language requires only 4K bytes of memory. An additional minimum 1K bytes are required for the user's program. This software is available on paper tape, tape cassette, EPROM and diskette. If you choose EPROM you will need to buy a PROM 4-4 board.

Here's a brief specification:

Statements

IF . . . THEN
READ
DATA
INPUT
PRINT
LET
GOTO
GOSUB
RETURN
FOR
NEXT
RESTORE
REM
RANDOMIZE
STOP
END

Functions

RND
SQR
ABS
INT
SGN

Operators

+
-
=
/

Commands

LIST
NEW
RUN

Other features:

- Direct execution of any statement when line number is omitted
- Line numbers from 1 to 9999
- Two-character error code. Example: NX ERROR AT LINE 20
- Results are calculated to precision of six decimal digits.

BASIC Language Interpreter BASIC-8A

This is an expanded version of the BASIC-4A package and requires 8K bytes of memory plus at least 1K byte for the user's program.

BASIC-8A is available on paper tape, tape cassette, EPROM and diskette. If you choose the program on EPROM, you will need two PROM 4-4 boards.

The package includes all the statements and features of BASIC-4A plus the following:

Statements

ON . . . GOTO
ON . . . GOSUB
DIM
CHANGE
DEF
OUT

Commands

CONTINUE
LOAD
PUNCH
CLEAR
SCRATCH

Functions

INP
TAB
SIN (radians or degrees)
COS
TAN
CSC
SEC
COT
ARC/SIN or ASN
ARCCOS or ACS
ARCTAN or ATN
LOG (base e or base 10)
EXP
LEN
VAL
ASC or ASCII
LEFT\$
RIGHT\$
MID\$
CHR\$
INSTR\$
SPACES
NUM\$
STR\$ or STRINGS
+ (string concatenate)

Other features include:

- IF . . . THEN may be followed by any statement, even another IF. For example: IF A=B THEN PRINT A,B.
- Handles strings, string vectors and arrays with length to 255 characters.
- Handles multiple statements per line, separated by \.

- Statements, commands and functions can be abbreviated to three characters.
- \$ may be omitted from string functions.
- OUT will write to any IMSAI 8080 port; IN will read a byte.

BASIC Language Interpreter BASIC-12A

This package is equivalent to the DEC BASIC-PLUS language and is an expansion of BASIC-8A. The language requires 12K bytes of memory, plus at least 1K for user programs.

BASIC-12A will interface with the Disk Operating System DOS-A to let you access files on disk.

The software is available on paper tape, tape cassette, EPROM or diskette. If you choose the program on EPROM, you will need three PROM 4-4 boards.

The reference document for BASIC-12A is DOC-6 (BASIC-PLUS Language Manual).

IMSAI 8080. The instruction set is described in detail. You'll need this book if you are going to program in assembly language.

It is furnished at no charge with an IMSAI 8080 computer.

Introduction to Microcomputers DOC-2

An excellent 460-page book that teaches how a computer is programmed and presents an overview of microcomputer technology.

It is furnished at no charge with an IMSAI 8080 computer.

IMSAI 8080 User's Manual DOC-3

This book contains complete assembly instructions for the IMSAI 8080 computer. Each subassembly or pc board is described in a separate chapter containing a functional description, theory of operation, photographs, assembly drawing, parts list, assembly instructions and a user guide.

The book describes the software package PGM-1A and provides its source listing.

It is furnished at no charge with an IMSAI 8080 computer.

The TTL Data Book DOC-4

This 640-page book contains complete electrical specifications for Texas Instruments TTL circuits including series 54/74, 54H/74H, 54L/74L, 54LS/74LS, 54S/74S; memories, radiation-hardened and beam lead, high-reliability MIL-M-38510 and JAN IC's.

Pinout Handbook DOC-5

This book summarizes the information most often needed to design circuits with 7400-series TTL logic. Pin connection diagrams, functional information, and some electrical specifications are included. Also includes manufacturers' cross reference.

BASIC-PLUS Language Manual DOC-6

This comprehensive reference manual by Digital Equipment Corporation describes the IMSAI Extended BASIC language.

COMPLETE DOCUMENTATION TO SUPPORT THE SYSTEM

Intel 8080 Microcomputer Systems User's Manual DOC-1

This 157-page book describes the design, operation and specifications of many of the MSI and LSI devices used in the



TYPICAL SYSTEM CONFIGURATIONS

While the IMSAI 8080 will handle tough industrial and commercial assignments in sophisticated multiprocessor environments, it's also an ideal low-cost machine for learning computer technology and programming.

But in any application you'll have freedom and flexibility with IMSAI 8080.

Elementary System

The IMSAI I-8080-1K is a valuable instructional tool for learning computer concepts and machine-language programming. You need only:

Computer

*I-8080-1K computer
EXPM edge connector*

Memory

RAM 4A-1 1K memory

You write small yet powerful programs which are entered using front panel switches. Communication between machine and yourself is through the front panel switches and LED's.

BASIC Language System

This system lets you program the computer in the BASIC language which is widely used in educational and commercial applications. A wide range of interesting games may be played and useful problems solved in BASIC.

In this system the machine and you communicate using a Video Display/Keyboard Terminal or optional teletypewriter. Order the following:

Computer

*I-8080 computer
EXPM edge connector (3)*

Memory

*RAM 4A-4 4K memory
PROM 4-4 memory for 4K-byte BASIC*

Software

*BASIC 4A PROM-programmed 4K BASIC
DOC-6 BASIC User's Manual*

I/O

*CRT-1280A or CRT-2480A Video Display/Keyboard Terminal
SIO 2-1 Serial I/O Interface board
CABLE A cable for interface board*

Assembly Language System with Punched Paper Tape

This system lets you program the computer in assembly language from punched paper tape, providing freedom and economy in developing programs. Machine/operator communications are through a teletypewriter equipped with a paper tape reader.

You can also use this configuration for programming when the BASIC language is on paper tape. Order the following:

Computer

*I-8080 computer
EXPM edge connector (3)*

Memory

RAM 4A-4 4K memory (2)

I/O

*SIO 2-1 Serial I/O Interface board
CABLE A cable for interface board*

Assembly Language System with Tape Cassette Data Storage

This configuration has all assembly language programs in PROM memory and uses an audio cassette tape recorder to store data. Order:

Computer

*I-8080 computer
EXPM edge connector (4)*

Memory

*RAM 4A-4 4K memory
PROM 4-4 read only memory for programs*

Software

PGM-2A Tape Cassette Operating System on PROM

I/O

*CRT-1280A or CRT-2480A Video Display/Keyboard Terminal
Audio Tape Cassette Recorder.
UCRI-1 Tape Cassette Interface Board
SIO 2-1 Serial I/O Interface board
CABLE A cable for interface board*

IMSAI 8080 THE AFFORDABLE COMPUTER DESIGNED WITH YOU IN MIND

The IMSAI 8080 computer has been designed and engineered to provide you with a professional, commercial-grade system without compromise. And it's backed by a 90-day warranty to guarantee you satisfaction.

If you decide to purchase a kit version, you will find we have carefully constructed each part so that special training or special tools are not required to assemble the computer. Also, the detailed, step-by-step instructions take the guesswork out of the assembly process. If you order an assembled IMSAI 8080, you will receive a complete system ready to operate. And you will discover the IMSAI 8080 is superior to any comparable OEM computer system on the market today.

Whether you are purchasing an IMSAI 8080 for yourself or on behalf of a company, we are here to answer any questions or help solve any problems you may have. Just call or write us.

Order the affordable computer today, the IMSAI 8080. And discover how it can grow on you.

90-DAY LIMITED WARRANTY

IMS Associates, Incorporated, hereinafter referred to as IMSAI, in recognition of its responsibility to provide quality products, components, and workmanship, warrants its products as follows: All components sold by IMSAI are purchased through normal factory distribution and any part that fails because of defects in workmanship or material will be replaced at no charge for a period of 90 days following the date of purchase. The defective part must be returned post paid to IMSAI within the warranty period. Any malfunctioning module, purchased as a kit and returned to IMSAI within the warranty period, which in the judgement of IMSAI has been assembled with care and not subjected to electrical or mechanical abuse, will be restored to proper operating condition and returned, regardless of cause of malfunction, with a minimal charge to cover postage and handling. Any module purchased as a kit and returned to

IMSAI, which in the judgement of IMSAI is not covered by the above conditions, will be repaired and returned at a cost commensurate with the work required. In no case will this charge exceed \$20.00 without prior notification and approval of the owner. Any module, purchased as an assembled unit, is guaranteed to meet specifications in effect at the time of manufacture for a period of at least 90 days following purchase. These modules are additionally guaranteed against defects in materials or workmanship for the same 90-day period. All warranted factory assembled units returned to IMSAI post paid will be repaired and returned without charge.

This warranty is made in lieu of all other warranties expressed or implied and is limited in any case to the repair or replacement of the module involved. Specifications are subject to change without notice.

IMS

IMS Associates, Inc. 14860 Wicks Boulevard, San Leandro, CA 94577 (415) 483-2093