

Includes

JNLGN 27-2935

File No. 1130-03
Form A27-2723-1

blue

PLEASE RETURN TO
THE INFO ROOM - GSB 319
COMPUTING SERVICES
UNIVERSITY OF ALBERTA

IBM

Systems Reference Library

IBM 1130 Computing System Component Description

IBM 2250 Display Unit Model 4

This publication contains detailed information about IBM 2250 Display Unit Model 4 programming, operations, and special features. The material is presented with the assumption that the reader has read the IBM 1130 Functional Characteristics, Form A26-5881.

The 2250-4 is a programmable display unit that attaches to the 1130 via a storage access channel. It can display lines, points, and characters, under control of a display program in 1130 main storage. Character generation is a program function, giving the user complete flexibility in the generation and use of character sets. Storage addressing and display program decoding and execution are performed by the 2250. A fiber-optic light pen, in conjunction with the display program and the logical capabilities of the 2250, enables the performance of computer-aided graphic design operations by the 2250 operator. Two special features, the alphameric keyboard and the programmed function keyboard, facilitate (1) message entry and editing by the 2250 operator and (2) communication between the 2250 operator and the CPU program.

Second Edition

This is a major revision of, and obsoletes, A27-2723-0 and Technical Newsletters N27-2915 and N27-2918. A new interrupt, called Cycle Steal Check, is added; also, usage of the stroke data Length bit and resetting of the programmed function keyboard indicators by the Reset Display command are redefined. All changes to text are indicated by a vertical line to the left of the change; revised illustrations are denoted by the symbol ● to the left of the caption.

Significant changes or additions to the specifications contained in this publication are continually being made. When using this publication in connection with the operation of IBM equipment, check the latest SRL Newsletter for revisions or contact the local IBM branch office.

Copies of this and other IBM Publications can be obtained through IBM Branch Offices. Address comments concerning the contents of this publication to:
IBM Corporation, Product Publications, Dept. 528, Kingston, New York 12401

CONTENTS

| | | | |
|---|----|--|----|
| INTRODUCTION | 5 | Set Pen Mode (SPM, GNOP) | 25 |
| 2250-4 DISPLAY SECTION | 8 | Start Timer (STMR) | 25 |
| Displays | 9 | Subroutine Linkage Orders | 26 |
| Graphic Mode | 9 | Revert (RVT) | 26 |
| Character Mode | 11 | Store Revert Register (SRVT) | 26 |
| Light Pen | 13 | 2250-4 OPERATIONS WITH THE 1130 | 27 |
| Alphameric Keyboard | 13 | Commands | 27 |
| Programmed Function Keyboard | 15 | Initiate Write | 27 |
| 2250 Operator Control | 16 | Start Regeneration | 27 |
| Metering | 16 | Set Programmed Function Indicators | 27 |
| 2250-4 CHANNEL INTERFACE SECTION | 17 | Read Status | 28 |
| General | 17 | Control | 29 |
| Subroutines | 18 | No Operation | 29 |
| Graphic Subroutines | 18 | Reset Display | 29 |
| Character Generation | 18 | Sense Interrupt | 30 |
| Display Orders | 19 | Sense DSW | 30 |
| Set Graphic Mode (Vector/Point) (SGMV, SGMP). | 19 | Interrupts. | 31 |
| Long Absolute XY (MBA, DBA) | 19 | Order Controlled Interrupt | 31 |
| Short Absolute X/Y (MBAX, MBAY, DBAX, DBAY) | 19 | Keyboard Interrupt | 31 |
| Incremental XY (MBI, DBI). | 19 | Detect Interrupt | 32 |
| Set Character Mode (Basic/Large) (SCMB, SCML). | 20 | Cycle Steal Check | 32 |
| Stroke Data (MBS, DBS) | 21 | Error Recovery Procedures | 32 |
| Character Control Words (CS) | 22 | APPENDIX A. HEXADECIMAL - DECIMAL CONVERSION | 34 |
| Control Orders | 23 | INDEX | 39 |
| Branch and Interrupt Orders | 23 | | |
| Short Branch (GSB). | 23 | | |
| Long Branch/Interrupt (GB, GBE, GBC, GBCE, GI, GIC). | 23 | | |

ILLUSTRATIONS

| | | | | |
|--------------|---|----|---|-----|
| Frontispiece | IBM 2250 Display Unit Model 4 | 9 | Alphameric Keyboard | 14 |
| 1 | Typical 1130/2250-4 System Configurations | 5 | Programmed Function Keyboard with Sensing Switches | 15 |
| 2 | Functional Sections of 2250-4 | 8 | Programmed Function Keyboard with Toggle Switches | 15 |
| 3 | Display Area Coordinate Addressing System | 9 | Decimal-Hexadecimal Conversion Chart for Incremental Orders | 21 |
| 4 | Extended Grid for Incremental Deflection Off Display Area | 10 | Programmed Function Keyboard Overlay for Keyboards with Sensing Switches (Top View) | 28a |
| 5 | Character Grid Coordinate System. | 11 | Programmed Function Keyboard Overlay for Keyboards with Toggle Switches (Top View) | 28a |
| 6 | Strokes That Form the Letter "A" | 12 | Alphameric Keyboard Code Assignments. | 29 |
| 7 | Character Display Characteristics | 12 | | |
| 8 | Fiber Optic Light Pen | 14 | | |

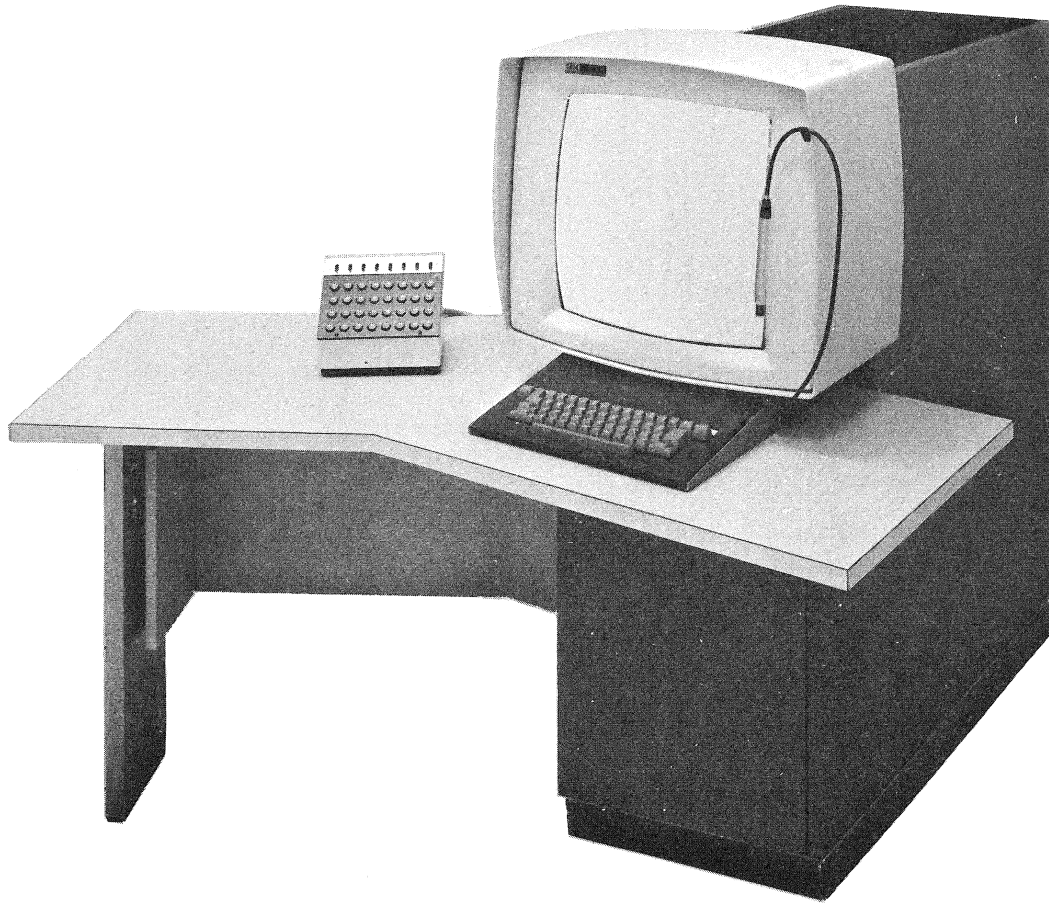

IBM 2250 Display Unit Model 4

The IBM 2250 Display Unit Model 4 (Frontispiece) is a programmable device which attaches to the IBM 1130 computing system and operates under control of a stored program in the 1131 Central Processing Unit (CPU). Two basic 2250-4/1130 system configurations (Figure 1) are available to supplement IBM's display products: (1) a stand-alone configuration, in which the 1130 is the host processor, and (2) a remote configuration, in which the 1130 attaches to IBM System/360 via the 1130 synchronous communications adapter and an IBM 2701 Data Adapter Unit.

The remote configuration, which enables installation of the 2250-4 at a location remote from

the System/360, provides a user situated distant from the central computer convenient access to powerful graphic data processing facilities. In this configuration, the 1130 can function as a dedicated graphics processor, performing unique graphic functions such as light-pen tracking, image selection, and display manipulation. In addition, the central computer would be used for computational operations and for access to large data bases. Thus, the 1130 can (1) respond rapidly to display and conversational functions which, by virtue of their association with the user require fast response (in milliseconds), and (2) refer the computational functions for which the user can tolerate significantly

a. Stand-Alone Configurations

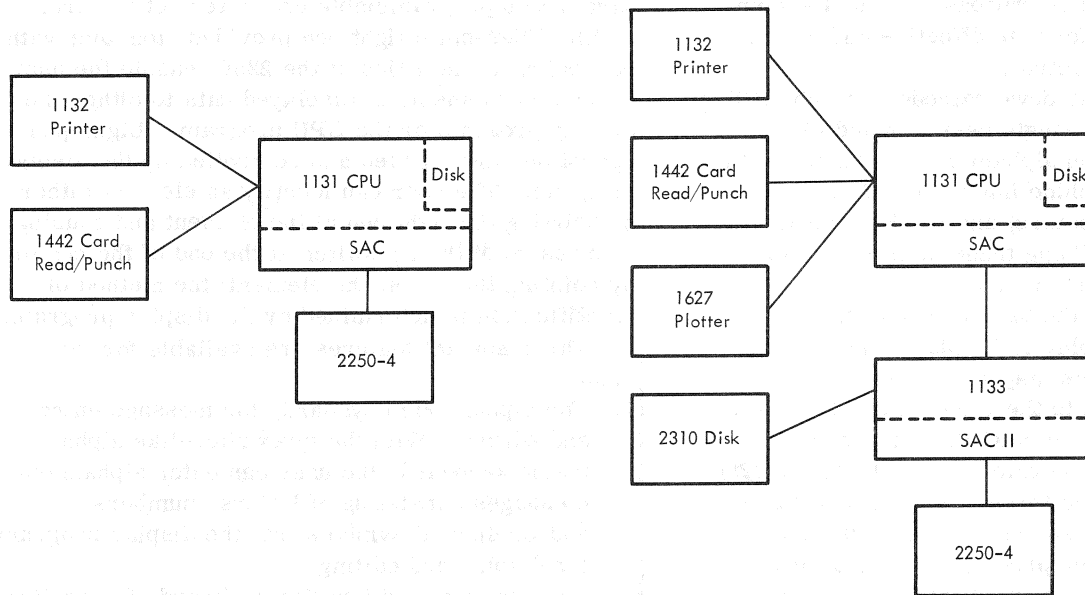

b. Remote Configuration

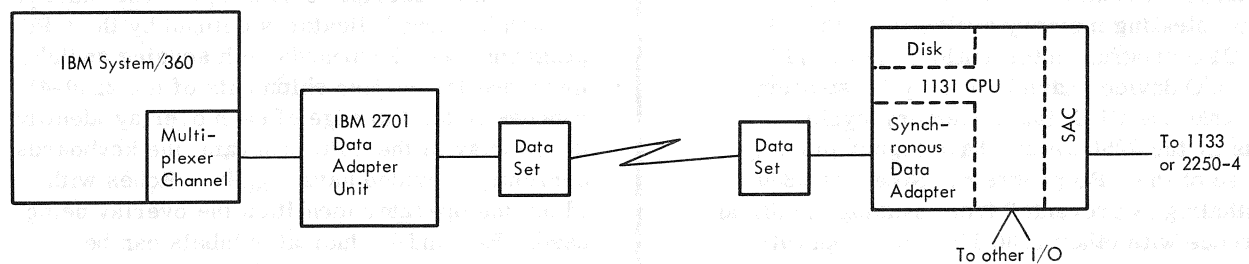

Figure 1. Typical 1130/2250-4 System Configurations

longer delays (in seconds or minutes) to System/360 for execution.

The stand-alone configuration is a low-cost graphic data processing system which makes the advantages of graphic data processing available to more users. In this configuration, the complete graphics application, including unique graphic functions and computational operations, can be performed by the 1130.

In either configuration, the 1130 can function as a general-purpose computing system. It is available with a variety of input/output (I/O) devices and with comprehensive programming support.

The 2250/1130 system offers fast man-machine communication and direct program control. The user can communicate with the computer in his natural technical language during execution of his problem. Logical capabilities in the 2250 enable the CPU program to effectively interpret user actions in connection with displayed images. In addition, the 1130 performs fast interrupt processing, and CPU processing can be overlapped with display program operations. Thus, the combined 1130 and 2250 form an effective and balanced graphic processing system.

The 2250-4 is a sit-down cathode-ray tube (CRT) display console for a single user. In addition to displaying graphic and alphanumeric information, the 2250 offers man-machine interaction through its light pen (standard feature) and two keyboards (special features). Using these facilities, a programmer can furnish computer-aided design capabilities whereby the 2250 user can create, modify, and add graphic and alphanumeric data into the system through the display screen.

The 2250 attaches to the 1130 via a 1130 Storage Access Channel (SAC or SAC II) as shown in Figure 1. The 1130 operates and controls the 2250 through commands and through a display order program sent from CPU storage to the 2250 via SAC. A display program comprising a series of orders (intermixed image and control information) can be sent to the 2250 up to 40 times a second (25ms frame time). This arrangement enables 1130 and 2250 operations to be asynchronous. Once 2250 operations have been started, the 2250 addresses CPU storage as required to execute the display program, stealing memory cycles from the CPU without CPU program intervention. In the 1130 system, I/O devices have higher cycle-stealing priority than the CPU; thus, memory-cycle demands by the 2250 always have higher priority than those of the CPU program. Note that 2250 cycle-stealing is prevented from causing significant interference with other 1130 I/O device operations; devices that operate synchronously with the CPU are assigned higher priority than the 2250 to

eliminate 2250 interference with synchronous operations.

Images in the form of alphanumeric characters, straight lines, and points are displayed on the 12-inch by 12-inch area of the CRT screen. This display area is divided into a 1,024X-by-1,024Y position grid. Points can be plotted at any intersection on this grid, and straight-line segments can be drawn between any two intersections; absolute and incremental positioning can be specified by image information from the display program.

Character generation is a programmable function, giving the user complete flexibility in the generation and use of character sets. Characters represented by their component strokes are stored as subroutines in CPU storage. In addition, the capability to subscript and superscript characters is provided. These capabilities are particularly important in scientific applications that require the display of special symbols (such as Greek alphabets). Inherently upper and lower-case is part of this programmable character set feature.

The fiber-optic light pen provided, together with the logical capabilities of the 2250, enable the user to identify elements of displayed data to either the display program or the CPU program. Light-pen operations are enabled and controlled by the display program. The user can identify an element either by pointing the light pen at the element and causing depression of the tip switch at the end of the pen or by pointing the pen at the element; the method of identification is determined by the display program.

Three special features are available for the 2250:

1. The alphanumeric keyboard, for message entry and editing. With the typewriter-like alphanumeric keyboard, the user can enter alphanumeric messages consisting of letters, numbers, and/or special symbols into the display program for display and editing.
2. The programmed function keyboard, for application flexibility. This keyboard provides communication between the user and a CPU program. The keyboard consists of keys, indicators, and sensing or toggle switches for use with replaceable descriptive overlays. The function of each key and indicator is defined by the CPU program. For keyboards with sensing switches (provided for earlier shipments of the 2250-4), punches in the top edge of each overlay identify the overlay to the CPU program; the keyboards currently provided have toggle switches with which the operator identifies the overlay being used. Key and/or indicator labels can be placed on each overlay to identify the key and indicator functions to the operator. Each key

can be used by the program to initiate a sub-routine associated with the respective overlay, thereby performing the indicated function. For example, depression of a key might result in the enlargement, reduction, or deletion of the displayed image.

3. The display copier attachment feature. This feature permits attachment of an IBM 2285 Display Copier to the 2250. The publication Component Description, IBM 2285 Display Copier, Form A27-2730, contains a functional description of, and operator procedures for, the 2285. The 2285 is a free-standing, non-programmed device; it provides, under 2250 operator control, 8-1/2 by 11-inch paper copies of the 2250 display image. Each copy consists of a black image on a light gray background. The 2285 is located behind the left side of the 2250 reading board; in this position, the 2285 controls, indicators, and hopper (copy receptacle) are easily accessible to the 2250 operator.

Basic power for the 2285 is provided by the 2250. Analog signals are switched from the 2250 to the 2285 during the paper-exposure portion of each copy cycle.

The 1130/2250 system is personalized and compact. Because the 2250 is located close to the 1130, the system can be operated as a single unit. The extended table top on the 2250 provides a convenient workspace for the system user. In addition, the 1131's internal disk drive is easily accessible from the display user position; thus, the user has easy access to removable 2315 disk cartridges, which can be used to retain data and programs relating to his applications.

The logical capabilities of the 2250, combined with the stored program facility provided by the 1130, allow the user great flexibility in designing his "man-machine" interface. The simplicity and versatility of the 1130 and its programming support enable the user to take advantage of this inherent flexibility.

2250-4 DISPLAY SECTION

The 2250-4, under control of the display program in 1130 storage, generates images on the 12-inch by 12-inch usable display area of a 21-inch cathode-ray-tube (CRT). An image can comprise straight lines (vectors), points, and characters.

A visible display is produced when an electron beam in the CRT strikes the phosphor-coated CRT screen, causing the portion of the coating struck by the beam to glow briefly. Normally, the glow fades within a fraction of a second, too soon for the human eye to carefully perceive and identify the image. For this reason, the display must be redrawn continuously (regenerated) at a rate that will cause the display to appear steady and sta-

tionary to the observer. Regeneration is performed automatically under control of the display program.

Storage addressing is performed in the 2250 channel interface section (Figure 2). Once regeneration is started by an 1130 I/O control command, the 2250 channel interface section continuously fetches orders and data from the display program in storage. Orders are decoded in this section, and deflection information is transferred to the 2250 display section, where it is used to draw the appropriate display. Regeneration is accomplished by continuously repeating the display program. Orders and data in the display program can be

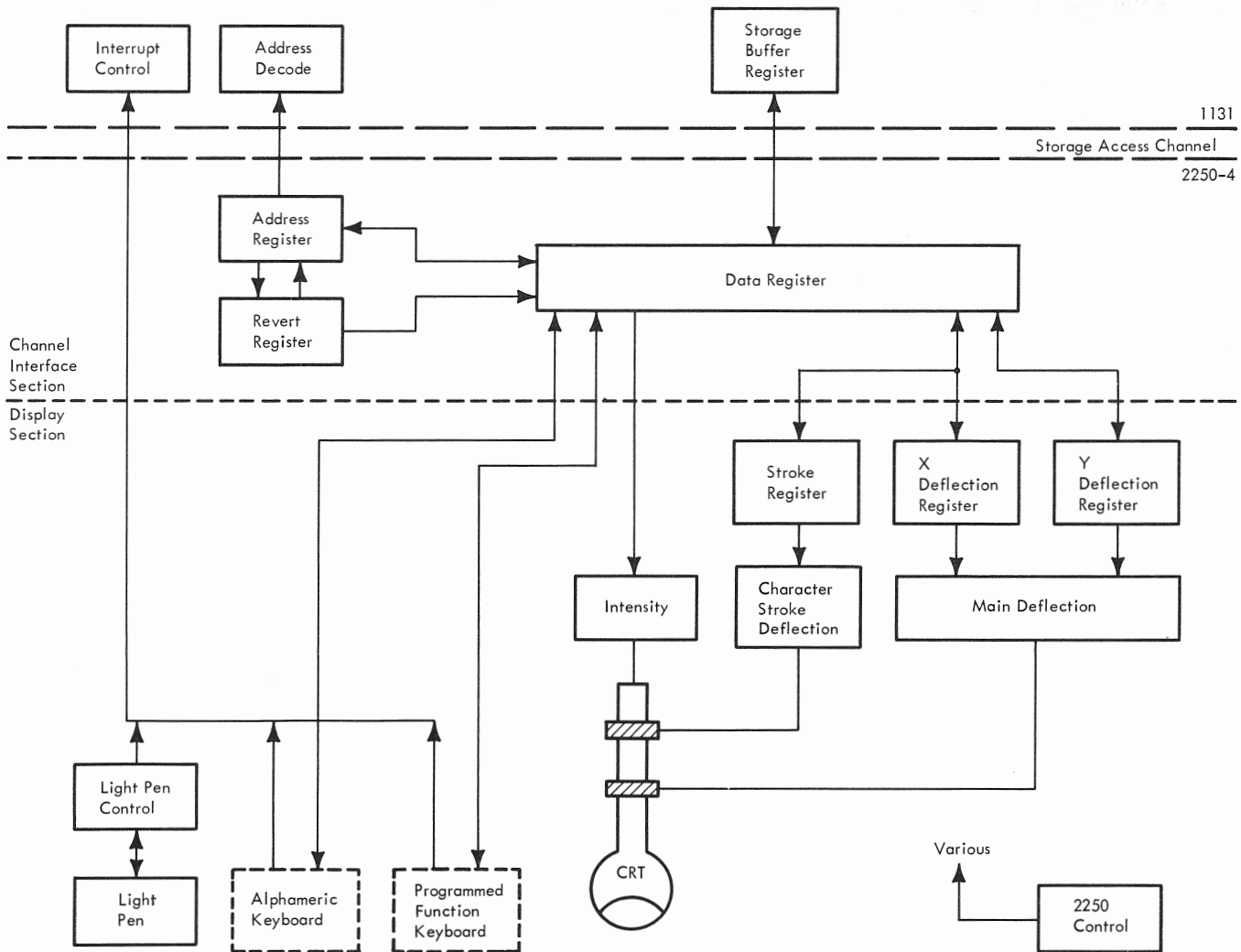

Figure 2. Functional Sections of 2250-4

modified during regeneration, as directed by the CPU program or by the display program itself, to update or change the display.

The 2250 display section also performs various nondisplay services for the user by providing the interface between the user and the problem program with the following devices:

1. Programmed function keyboard. Provides keys and overlays (for user communication to the program) and indicators (for program communication to the user).
2. Alphameric keyboard. Enables the user to change, edit, and/or create character displays. Note that alphameric keyboard key codes can be interpreted by the CPU program and used for control purposes in a manner similar to operations with the programmed function keyboard.
3. Light pen. Provides the means by which the program can identify the storage address of the order that initiated display of a vector, point, or character at which the user is pointing a pen-like device. This information can be used for operations as determined by the display program, by the alphameric keyboard, or by the programmed function keyboard. Thus, the light pen enables the user to enter and manipulate graphic information.

DISPLAYS

Information positioning on the 2250 display area is controlled by a display program in 1130 storage. This program is sent to the 2250, by 16-bit word, via the 1130 storage access channel. Orders in this program specify electron beam deflection to horizontal (X) and vertical (Y) coordinates on a square grid composed of possible electron-beam-deflection end points. This grid, called the "reference grid", covers (logically) the 12-inch by 12-inch display area on the face of the CRT; it comprises 1,024 equally spaced X positions and 1,024 equally spaced Y positions (Figure 3).

Positioning orders in the display program select the X and Y coordinates for each element of a 2250 display (each point, line end point, and character area centroid). The grid of addressable coordinates is called a "raster". The distance between two sequentially addressable lines on the raster is called a "raster unit". Thus, a raster unit represents 1/1,023 of the image (in either the X or the Y direction).

The 2250 can display information in either of two modes: Graphic or Character. Graphic mode is the normal 2250 mode of operation. As such, it is retained through interrupts and Character mode operations, even when it has not been set previously.

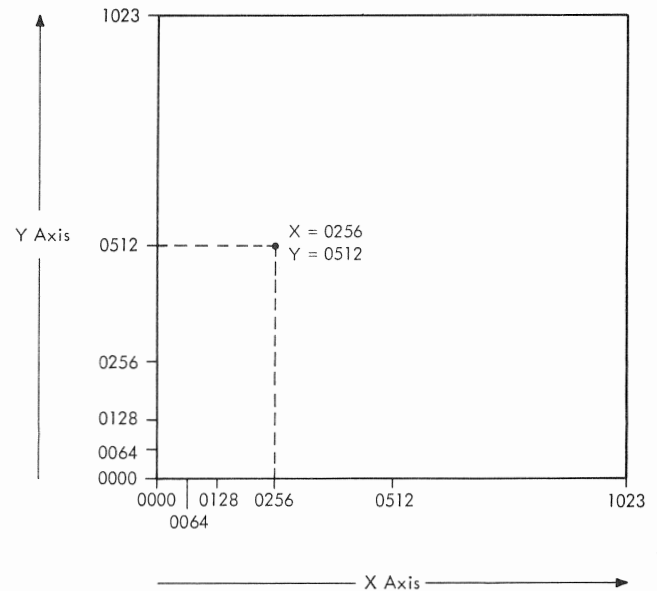

Note: One raster unit = 0.0117 inch, 85 raster units = 1.0 inch, and 1023 raster units = 12 inches.

Figure 3. Display Area Coordinate Addressing System

Graphic Mode

Either vector or point operations can be performed by the 2250 in Graphic mode; if no specific Graphic mode has been set previously by an order from the display program, Vector mode is set automatically. In Graphic mode, the 2250 can receive, from the display program, either (1) electron beam positioning orders, or (2) an order to establish a different mode of operation, such as to set Point mode from Vector mode or to enter Character mode from Graphic mode.

When the 2250 is in Graphic mode, positioning orders from the display program directs electron beam movement (deflection) on the reference grid. Positioning orders address the X, Y coordinates to which the electron beam is to be repositioned. Beam deflection is always from the previously addressed coordinates (where the beam is currently positioned) to the new coordinates. If the 2250 is in Vector mode and a vector is to be displayed, the beam is turned on (unblanked) as it is being repositioned, displaying a line between the current position and the new position specified; in point mode, the beam is unblanked after it has been repositioned, displaying a point at the new position. Points plotted 4 or more raster units apart can be distinguished by the viewer as distinct points.

Positioning orders can also reposition the electron beam without causing a visible line or point to appear on the display. This capability is used to select a starting location for displaying charac-

ters or to start the display of a new set of vectors or points. The positioning order for each vector and point contains a beam control bit, which specifies whether the 2250 is to display the associated vector or point or is to reposition the beam without causing a display.

The positioning order for each deflection specifies not only the new beam position and beam condition; it also specifies the format in which the new position is presented. The new position for each deflection can be presented in any of three formats: long absolute, short absolute, or incremental. Operations performed by the 2250 are different for each type of order.

Long-absolute orders specify the actual X, Y coordinates to which the beam is to be deflected. Each pair of long-absolute order words addresses one pair of coordinates on the reference grid (e.g., X = 0512, Y = 1016). Any grid position can be addressed, and a deflection of any length and in any direction can be specified.

Short-absolute orders specify deflection either in the horizontal (X) direction or in the vertical (Y) direction, but not both. Each short-absolute order addresses one X or Y coordinate on the reference grid; the axis not specified in the data remains unchanged. The beam is deflected horizontally or vertically to the addressed coordinate. For example, if the beam is at position X = 0512, Y = 0512, only four short-absolute orders are needed to draw a box; each order might specify a coordinate as follows:

1. Y = 0612
2. X = 0612
3. Y = 0512
4. X = 0512

Incremental positioning orders specify the amount and direction of beam deflection relative to the current beam position. Each incremental order specifies one increment (up to X = +63 or -64, Y = +63 or -64, a displacement of 0.74 inch) of beam deflection. For example, if the current beam position on the reference grid is X = 0512, Y = 1016, and if an incremental order specifies X = +20, Y = -40, beam deflection will be to position X = 0532, Y = 0976 on the reference grid. Thus, the $\pm X$, $\pm Y$ incremental value is added to the absolute value of the current beam position, resulting in a new absolute value for the new beam position.

When incremental orders cause the beam to move outside the reference grid area, and when a total displacement of 1,024 raster units beyond the perimeter in the X or Y direction is not exceeded, the vectors and/or points so displaced will be blanked and the X and/or Y overflow bit(s) will be set. In this case the X, Y deflection registers will contain the value of a wraparound position; e.g.,

when the beam is moved 10 raster units in the +X direction from position X = 1023, Y = N, the wrap-around position is X = 9, Y = N, and the X overflow bit is set. Unless the overflow limit of 1,024 raster units is exceeded (Figure 4), the displaced beam can be returned to the normal grid area; then, displaying will resume when a positioning order specifies an unblanked deflection that is entirely within the normal display area. This feature allows an image which is generated from incremental data to be automatically cut off or scissored at the screen boundary.

When a portion of an image is blanked because of a beam displacement condition, the display program can return that portion to the visible display area by issuing (1) a long-absolute order, (2) incremental orders in the opposite direction, or (3) one or two short-absolute orders, depending on whether the beam is off in one direction (X or Y) or is off in both directions (X and Y).

Electron beam deflection to the previously addressed coordinate can still be in progress when the next coordinate data is received. When the deflection currently in process is completed, the beam bit is sent to the intensity control section, and the new X, Y coordinates are sent to the main deflection section.

The main deflection section applies X and Y analog values for the current beam position to the deflection coil of the CRT until a new positioning order is received, at which time the analog values start changing to reflect the new position. As the analog values change, the beam moves, causing the

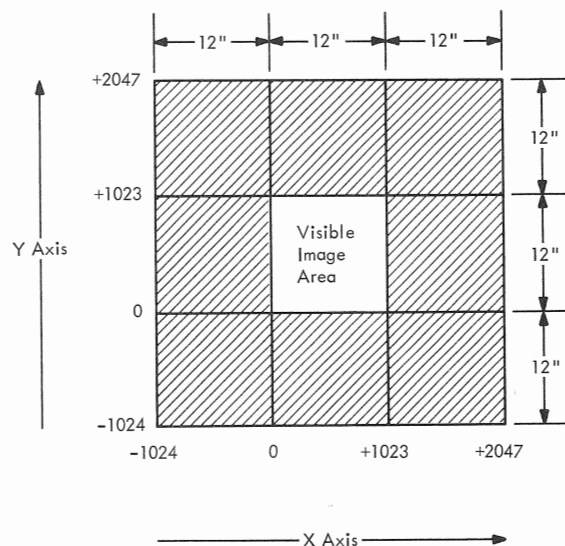

●Figure 4. Extended Grid for Incremental Deflection Off Display Area

image to be displayed. If the beam bit specifies a blanked deflection, the beam moves without being displayed. If the beam bit specifies an unblanked deflection, the electron beam is moved and unblanked as required to display a vector or point.

The X and Y positions registers always contain the absolute X, Y address of the current beam end position in digital form; the contents of these registers can be retrieved to reconstruct the most recent positioning data.

Note that long-absolute, short-absolute, and incremental orders can be intermixed since each is uniquely identified and does not require a mode to be set. In addition, any nongraphic order can be intermixed with graphic data without terminating the Graphic mode (point or vector).

Character Mode

The set of characters that can be displayed by the 2250 in Character mode is defined by the programmer. This character set resides in 1130 storage as a subroutine of the display program and can comprise any number of characters in any font; these characters can be modified at any time during execution of the display program. Characters in this set can be displayed in either of two sizes, basic or large, as determined by the character mode order.

In Character mode, the current X, Y position of the beam on the 1,024-by-1,024 position display area becomes the center of a basic-size or large-size character area, which is maintained throughout one Character mode operation. The program normally places the beam at a starting position on the display area (using a blanked point or vector) before a character display operation is started.

The character area is divided into a grid format of 7X-by-8Y addressable points (Figure 5); note that character grid points do not coincide with the 1,024-by-1,024 points on the reference grid. A character is drawn in this area with a series of high-speed deflections, or "strokes". An average of six such strokes is required to form one upper-case character; lower-case characters may require more strokes. Two stroke end points are specified in each word of stroke data from the display program. Up to 29 stroke words, including control words, can be used to form a character. The character deflection section (Figure 2) converts each stroke end point to X and Y analog signals; these are applied to the high-speed character stroke deflection coil of the CRT.

The main deflection system and the character deflection system operate independently. The main deflection system maintains the current beam

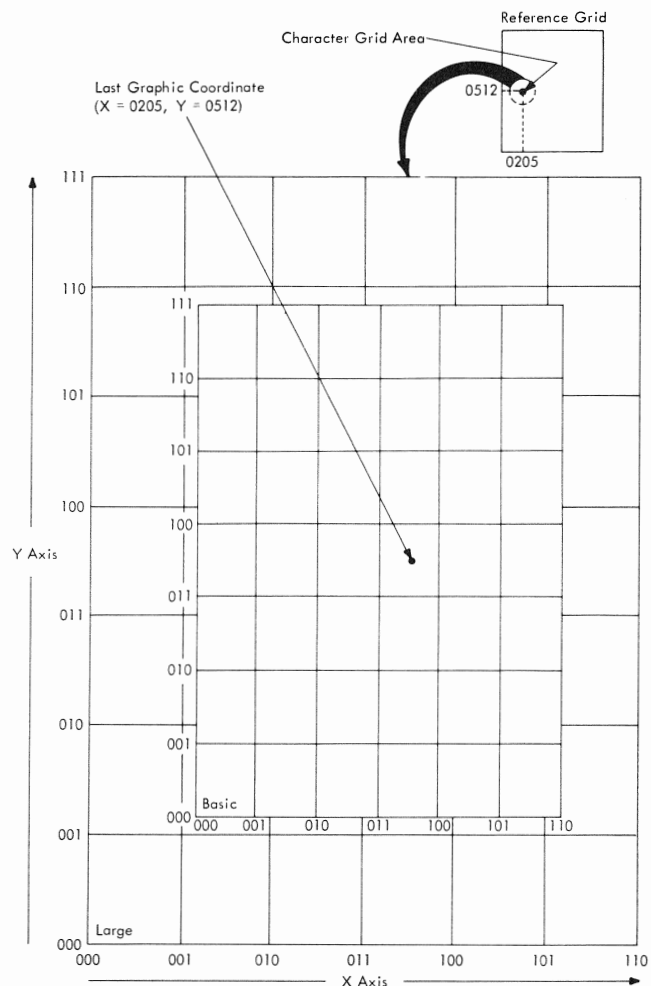
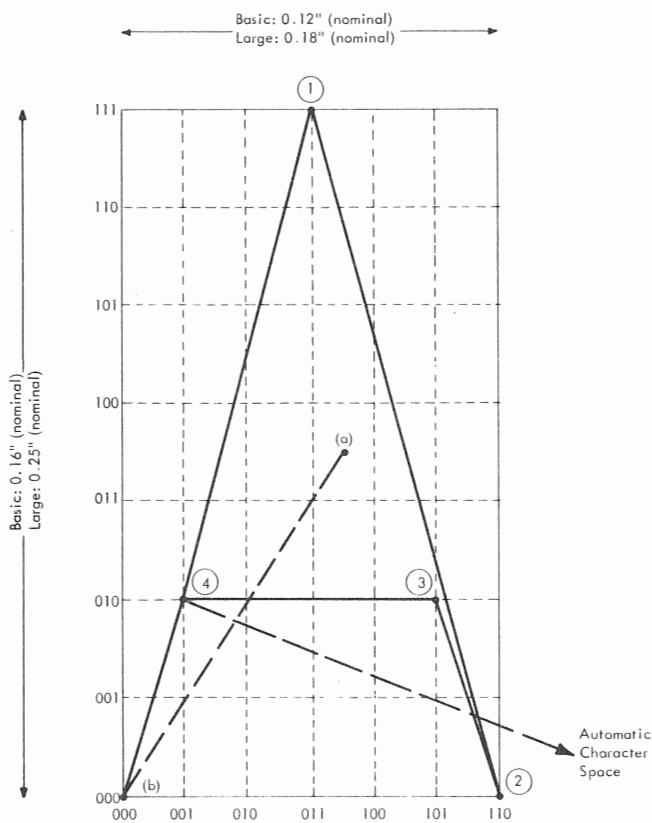

Figure 5. Character Grid Coordinate System

position (the center point of the character grid) by supplying a constant X and Y analog current to the main deflection yoke. At the same time, the character deflection system offsets the beam to position X = 000, Y = 000 of the character grid upon entering Character mode and then forms a character by moving the beam at high speed between various addressed points in the character grid area. Figure 6 illustrates the strokes used to form the character "A".

Figure 7 shows the characteristics of a character display. Character spacing is an automatic function of the 2250. A special bit, called the "revert" bit, is set in the last data word for each character. (The revert bit is used during other operations, as described later in this document.) This bit causes the main deflection system to move the electron beam in the +X direction to the new character area center point. The beam is moved a distance of 14 raster units when displaying basic-size characters or 21 raster units when displaying large-size characters. The program can



- Notes:**
1. Circled numbers refer to the sequence in which the deflection end points are addressed.
 2. Deflection ab occurs automatically upon entering Character mode. Deflection ba occurs when leaving Character mode, in grid position following last character in string.

Figure 6. Strokes That Form the Letter "A"

initiate additional spaces of 14 or 21 raster units each by sending the 2250 one two-stroke character word for each space; this word would specify two blanked strokes and should have the revert bit set. Hence, one space character would result in a distance of 28 or 42 raster units between the center point of the previously specified character area and the center point of the next area.

In addition to stroke words, the program can also send control words to the 2250 during Character mode operations. A control word specifies any one of five functions: new line, null, subscript, superscript, or no-operation. These functions are described in the following paragraphs.

Initial character positioning can be accomplished by an absolute or incremental Graphic mode order. For establishing a method of line spacing, characters that follow a long-absolute order are considered to be "absolutely positioned," and characters that follow an incremental order are "incrementally positioned." Intervening short-absolute orders, though executed, do not establish a method of line spacing; instead, the most recent long-absolute or incremental order is the determining factor.

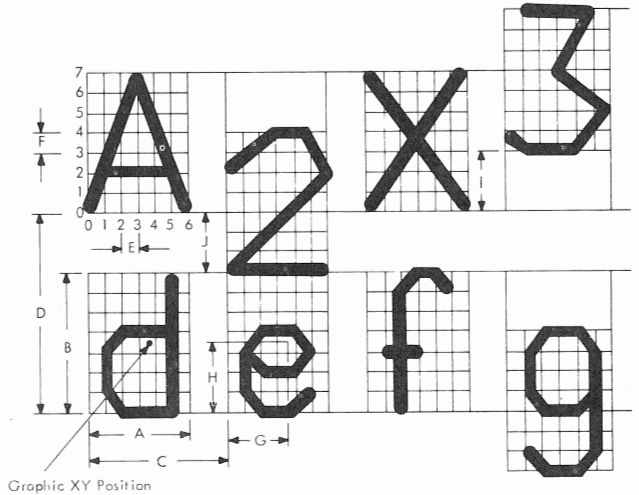

| Legend | Characteristics | Character Size | |
|---------|--|----------------|---------|
| | | Basic | Large |
| | Characters per Line (Max.) | 74 | 49 |
| | Lines per Display (Max.) | 52 | 35 |
| | Number of characters on display (max)* | 3,848 | 1,715 |
| | Character Grid: | | |
| A | Width | 10 RU | 15 RU |
| B | Height | 14 RU | 21 RU |
| C | Character Spacing | 14 RU | 21 RU |
| D | Line Spacing | 20 RU | 30 RU |
| E | Horizontal Character Unit | 1.7 RU | 2.5 RU |
| F | Vertical Character Unit | 2.0 RU | 3.0 RU |
| G | X Offset | 6.0 RU | 9.0 RU |
| H | Y Offset | 7.0 RU | 10.5 RU |
| I and J | Superscript and Subscript Offset | 6 RU | 9 RU |

* Not flicker-free display

Figure 7. Character Display Characteristics

Line spacing is initiated either by the display program or by the 2250. A new line (NL) control word from the display program causes the 2250 to reset the X deflection register to zero and to decrement the Y deflection register by 20 or 30 raster units as determined by character size. Successive NL control words cause successive lines to be stepped. If the Y deflection register underflows (decrements below Y = 0000), and if the characters were absolutely positioned, wraparound occurs so that the new line is positioned at the top of the display area. If underflow occurs during the display of incrementally positioned characters, subsequent lines are positioned below the image area (Figure 4). In addition, subsequent characters are blanked until the beam is returned to the image area, either by a second Y deflection register

underflow (decremented to below $Y = -1024$) or by one or more Graphic mode orders.

Automatic line spacing is performed during display of absolutely positioned characters whenever a character space operation causes the X deflection register to overflow (to increment above $X = +1023$). If an NL control word is not received, the 2250 (1) displays characters to the end of a line, (2) automatically resets the X deflection register to zero, (3) decrements the Y deflection register by 20 or 30 raster units, depending on character size, and (4) continues the display of characters.

Automatic line spacing is not performed when incrementally positioned characters are displayed. In this case, the X deflection register is not reset if overflow occurs during character spacing. Thus, blanked characters are positioned to the right of the display area, in the same line. If the X deflection register overflows a second time (increments beyond $X = 2047$), wraparound occurs; the line of characters reappears at the left side of the visible image area. Note that the Y deflection register is not decremented; thus, line spacing does not occur. When outside the image area, in the X direction, the beam can be returned (1) by an NL control word, (2) by Graphic orders, or (3) by the second X deflection register overflow.

The null control word does not cause a display, does not affect the X, Y position registers, and does not cause character spacing. It can be used as the last word of a character to permit superimposed characters and can be used in character strings to reserve storage space for characters added by the operator.

The subscript control word causes the character grid to be offset downward from its normal position by three vertical character units (Figure 7). The grid remains in this offset position (1) until a character space is performed (initiated by receipt of a stroke word with the revert bit set), (2) until a superscript control function is executed, and (3) until a null control function is executed. The subscript function enables the drawing of subscripts, of lower-case letters that extend below the line, or of strokes (such as underlines) beneath normally positioned characters.

The superscript control word causes the character grid to be offset upward from its normal position by three character units (Figure 7). The grid remains offset until a revert-initiated character space is performed or until a null control function is executed. The superscript function enables the drawing of superscripts and of strokes above normally positioned characters.

Control words that contain undefined codes are no-op'ed. However, a revert bit in these words,

if set, causes execution of the revert function. Thus, no-op's can be used to reserve CPU storage locations for later use by a program.

LIGHT PEN

The light pen, a fiber-optic device (Figure 8), provides two independent inputs to the 2250; light-pen detect status and light-pen switch status. First, the user points the light pen at the section of displayed image he wants to identify to the display program or the CPU program. A light-pen detect can occur whenever light from the CRT beam passes within the light pen field of view. In addition, when the light pen is in the desired position, the user can press the pen tip against the CRT faceplate to activate the tip-switch.

Activation of the light-pen switch and the occurrence of a light-pen detect are independent functions, and their significance is determined by the display program. The display program can disable (or ignore) light-pen detects and ignore switch closures, or it can establish that any one of the following conditions is significant:

1. Light-pen switch closed (detect or no detect).
2. Light-pen detect (switch open or closed).
3. Light pen detect and light pen switch closed.

Following the occurrence of the significant condition(s), the program can interrupt the CPU or can branch operations to a new storage address.

When light-pen detects are enabled (or made significant) by the program, a detect occurs each time the unblanked beam passes within the light pen field of view. This "continuous detects" mode can be used in graphic design operations such as light pen tracking. In addition, the display program can ignore the light pen while certain information (such as a background grid) is being displayed, inhibiting light-pen-initiated operations on that information.

Two small beams of light projected by the light pen appear as two small dots on the CRT faceplate. These dots assist the user in aiming the light pen by "bracketing" the image section that is to be detected.

ALPHAMERIC KEYBOARD

This special feature provides a typewriter-like keyboard with which the user can compose and/or modify messages (on the CRT display area) not protected by the CPU program from keyboard action. Identification (to the user) of the character or character position that can be modified or inserted by the keyboard is a program function.

The keyboard (Figure 9) has 44 character keys and a SHIFT key, which provide a selection of 90 EBCDIC characters (Figure 13). Each alphabetic

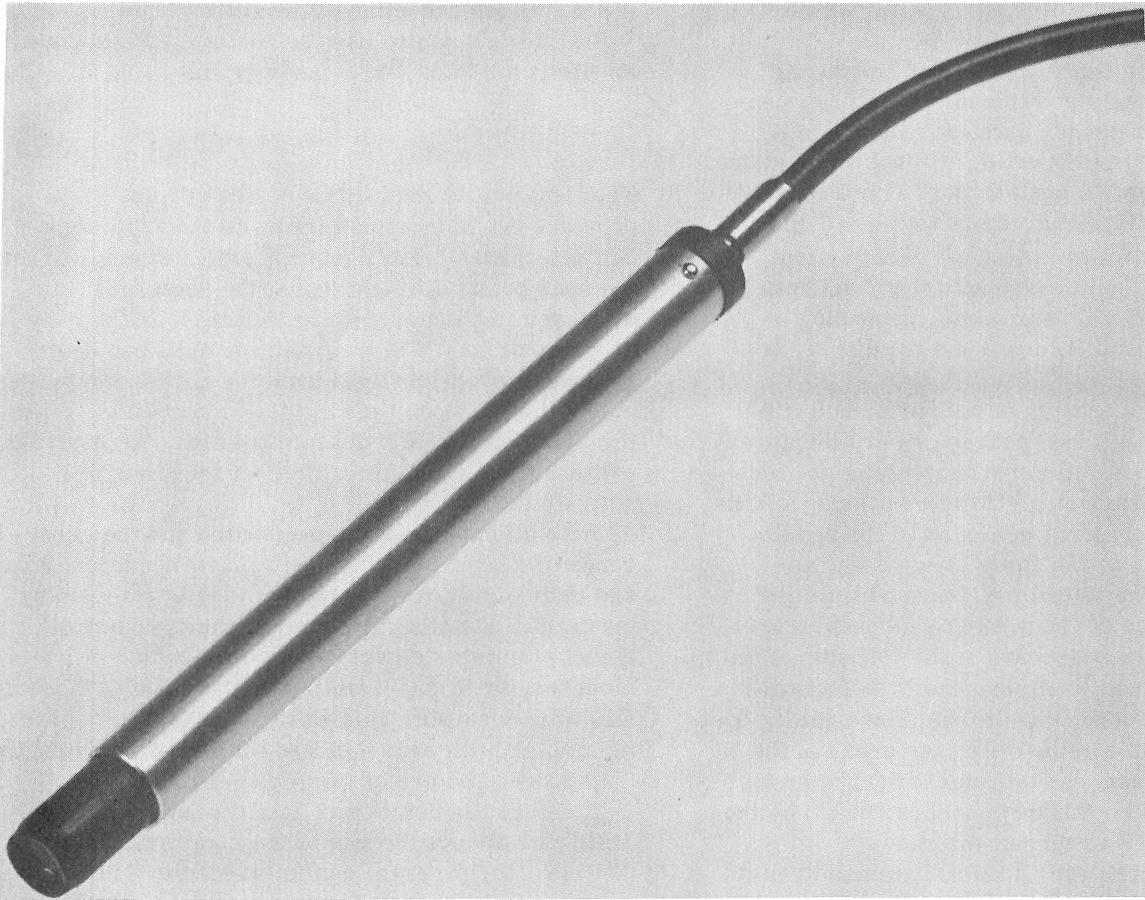

Figure 8. Fiber Optic Light Pen



Figure 9. Alphameric Keyboard

key can provide the upper- or lower-case character as selected by the user. In addition to standard character keys, the following function keys are provided:

SHIFT: When depressed, allows selection of any upper-case alphabetic character or any of the upper characters identified on the dual-character keys. When released, any lower-case alphabetic character or lower dual-character-key character can be selected.

LOCK: Holds SHIFT key in the down position.

ALTN CODING: Allows selection of NULL, END, or CANCEL; when pressed with any other key, generates a null code.

CONTINUE: When held down with a character or control key, the character or control key code is entered once per regeneration cycle until the CONTINUE key is released.

END, CANCEL, ADVANCE, BACKSPACE, and JUMP: The functions of these keys are established by the CPU program. Each key sets a unique bit which can be retrieved by the program.

Each time a key other than SHIFT, LOCK, ALTN CODING, or CONTINUE is depressed, the keyboard locks, regeneration is terminated at completion of the current cycle, and an interrupt is requested. The CPU program can respond to this request by issuing commands to read the key code and to unlock the keyboard.

PROGRAMMED FUNCTION KEYBOARD

Either of two programmed function keyboards may be attached to the 2250-4: the keyboard that was provided for earlier shipments of the 2250-4 (Figure 10), or the keyboard that is currently provided (Figure 10a). Both keyboards contain 32 keys and 32 indicators; the function of each key and indicator is identified by the application program. Functionally, the difference between the two keyboards is the method by which the key functions are identified to the CPU program. The earlier keyboard contains eight sensing switches, which detect a code punched in the top edge of an overlay (Figure 12); 256 unique overlay codes are possible. With the current keyboard, any of 256 possible overlay codes can be indicated to the CPU program by means of eight toggle switches located at the top of the keyboard; this keyboard does not have overlay sensing switches, and the overlay (Figure 12a) does not have punch positions.

The overlays for either keyboard can be marked by such means as typewriter, ball-point pen, and pencil to identify the function of the keys and indicators to the operator; a clear lacquer spray is suggested for fixing the markings on the overlay (to prevent smudging).

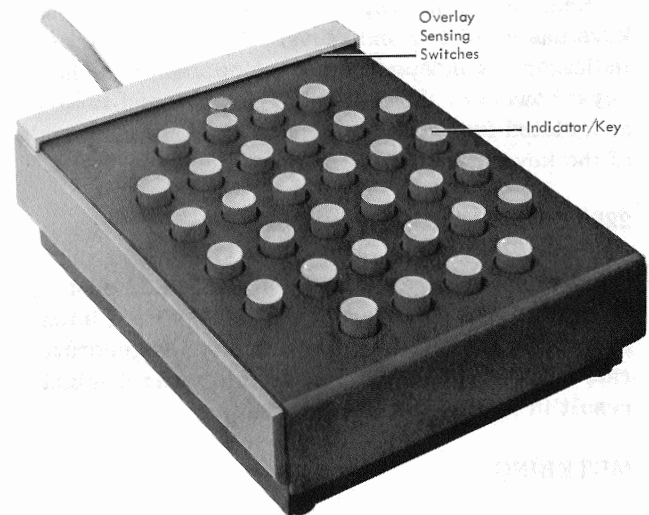

Figure 10. Programmed Function Keyboard with Sensing Switches

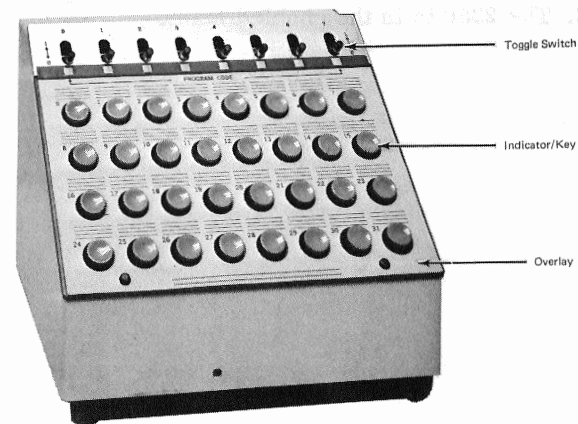

Figure 10a. Programmed Function Keyboard with Toggle Switches

Each key can be used by the program to initiate a subroutine associated with the respective overlay. When a key is pressed, the keyboard is electrically locked (keys can be pressed, but they have no effect), regeneration is stopped, and a CPU interrupt is requested. The CPU program can respond to this interrupt by issuing an I/O Control command (IOCC) to read the key and overlay codes. Then, the CPU program can perform the indicated function and restart the display, thereby unlocking the keyboard. For example, depression of a key might result in the enlargement, reduction, or deletion of a displayed image.

Each of the 32 programmed function keyboard keys has a built-in indicator. Operation of these indicators is independent of the operation of the keys; however, the indicators can be used for associated functions such as informing the operator of the keys that can be, or have been, activated.

2250 OPERATOR CONTROL

The 2250 is equipped with a BRIGHTNESS control with which the operator can adjust the light intensity of the overall display for a given regeneration rate. Improper adjustment of this control might result in faulty light pen operation.

METERING

The 2250 is metered as an assignable unit on the 1130. It contains a usage meter to record customer run time and an Enable/Disable switch. The 2250 records time when all of the following conditions are met:

1. Power is on (controlled at 1131).
2. The 2250 is in the enabled state.

3. The CPU or cycle-steal I/O devices are running (not in CE mode). (Cycle-steal I/O devices include disks, 2501, 1403, 1132, and 2250.)

The Enable/Disable switch allows the 2250 to become logically enabled or disabled. When the 2250 is logically disabled, the usage meter is prevented from recording time and the 2250 is prevented from operating; it is logically disconnected (off-line) from the 1130, and signals are not transmitted across the interface. When the 2250 is enabled, it is on-line, and the usage meter records time.

The Enable/Disable switch setting may be changed at any time. However, the 2250 state does not change until the following conditions occur simultaneously for a minimum period of 400ms:

- (1) the CPU is in the Wait state or in CE mode, and
- (2) all I/O operations (including those of the 2250) are stopped. Note that the usage meter does not record time when the 1130 is in CE mode or when the CPU and cycle-steal I/O devices are not running.

GENERAL

The 2250-4 channel interface section (Figure 2) interfaces the storage access channel and the 2250-4 display section. It decodes and executes orders and commands, addresses CPU storage, and handles data transferred to or from CPU storage. Information transfer across the storage access channel/2250 interface is by 16-bit word.

An address register in the 2250 channel section specifies, to CPU storage, the location at which information will be stored or from which it will be retrieved for 2250 operations. This address register is loaded initially by an Initiate Write (Start Regeneration) command from the CPU program; it can then be stepped automatically by the 2250, altered by the display program, or reloaded

by the CPU program. Thus, display regeneration can be performed without CPU intervention.

The display program consists of display orders, associated data for image generation, and control orders for various nondisplay functions. Table 1 lists the 2250 order set. Undefined order codes received by the 2250 are treated as no-operation orders or are interpreted as data if in the appropriate format.

The CPU program initiates 2250 operations by issuing an Execute I/O (XIO) instruction. The I/O Control command (IOCC) at the effective storage address specified by XIO is then sent to the 2250. If the IOCC is Initiate Write (Start Regeneration), the 2250 fetches display program information from main storage, starting at the IOCC-specified address.

Table 1. 2250-4 Order Set

| Type | Name | Variation(s) | Mnemonic | Comments |
|----------------|---|----------------|----------|------------------------|
| Display Orders | Set Graphic Mode | Vector | SGMV | |
| | | Point | SGMP | |
| | Long Absolute XY | Absolute XY | DBA | Beam on |
| | | Absolute XY | MBA | Beam off |
| | Short Absolute XY | Absolute X | DBAX | Beam on, X deflection |
| | | Absolute X | MBAX | Beam off, X deflection |
| | | Absolute Y | DBAY | Beam on, Y deflection |
| | | Absolute Y | MBAY | Beam off, Y deflection |
| | Incremental XY | Incremental XY | DBI | Beam on |
| | | Incremental XY | MBI | Beam off |
| | Set Character Mode | Basic | SCMB | |
| Large | | SCML | | |
| Data Words | Character Stroke Word (2-stroke mnemonics generate one stroke word) | Stroke | DBS | Beam on |
| | | Stroke | MBS | Beam off |
| | | Control Word | CS | Control code |

| Type | Name | Variation(s) | Mnemonic | Comments |
|-----------------------|-----------------------|--------------------------------|----------|--|
| Control Orders | Short Branch | | GSB | One Word |
| | Long Branch/Interrupt | Unconditional Branch | GB | All variations are two words, and can be coded as 2-word no-op. Long Branches can be direct or indirect. |
| | | | GBE | |
| | | Unconditional Branch, External | GBC | |
| | | Conditional Branch, | GBCE | |
| | | Conditional Branch, External | GI | |
| | | Unconditional Interrupt | GIC | |
| | | Conditional Interrupt | | |
| | Set Pen Mode | Set Pen Mode | SPM | Several options selected by modifiers. |
| | | Graphic No-Operation | GNOP | |
| | Start Timer | | STMR | |
| Revert | | RVT | | |
| Store Revert Register | | SRVT | | |

NOTE: The mnemonics shown are those used by the IBM 1130 Disk Monitor Assembler.

Display program information consists of orders and data. Orders either initiate a 2250 operation or establish a mode. Order-initiated operations include point and vector plotting, branching, and CPU interrupt generation. Two orders, Set Graphic Mode and Set Pen Mode, establish a Graphic mode and a Light Pen mode respectively. The 2250 is always in one of two Graphic modes and in one of four Light Pen modes.

Data is defined as information that does not contain an operation code. Character stroke words are the only data words received by the 2250. Although a character stroke word may contain one or more control bits, these bits are used directly to perform an operation.

SUBROUTINES

Single-level subroutines (linkage from the main order program to the order subroutine and return to the main order program) are used frequently in graphic application. Thus, facilities for a rapid (unconditional) branch to a subroutine and return from the subroutine are provided. Since characters are similar to single-level subroutines, rapid branching significantly reduces character display time.

Orders in the display program enable multiple-level subroutine linkages to be performed. A single-level subroutine facility does not allow characters to be displayed as part of a subroutine, nor does it permit the organization of an image in a hierarchy of graphic segments represented by multiple-level subroutines, as follows:

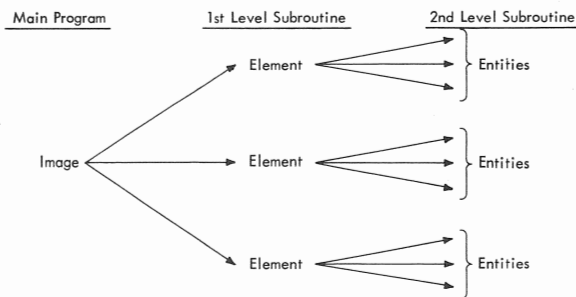

Notes: 1. Examples of elements are elevation, plan, and end-views of a part.
2. Examples of entities are bolt heads, brackets, and supports.

Each graphic sub-picture (element) and each entity can be represented as a subroutine. This is useful in representing display images and performing manipulations on them. The multiple-level subroutine linkage is accomplished by:

1. Storing the return address (i.e., the address of the order following a branch order) in a particular core storage location.
2. Branching indirectly to the location of the return address; thus, the ultimate branch would be the next-higher subroutine level.

Graphic Subroutines

A graphic subroutine is a sequence of display orders which forms a logical element of entity. This method of graphic data organization substantially improves the efficiency of the CPU in the generation of graphic data. For example, the generation program can insert a vector to position the beam and then can provide a linkage to a subroutine representing a logic block in a logic diagram.

Using incremental vectors, the subroutine can generate a display of the logic block about the original reference point; then, linkage can be made back to the main sequence of display orders. The alternative is to require the CPU to place a copy of the logic block orders in the main graphic order sequence every time it appears in the displayed image. Consequently, the graphic subroutine capability substantially reduces storage requirements in instances where an image entity appears repetitively in a display.

In applications where the display images comprise groups of elements (e.g., resistors, capacitors, logic blocks, etc.), graphic subroutines, together with the "defer light pen interrupt" light-pen control order, allow the correlation of a light-pen detect with a group of elements. In many cases, identification of the group is required, rather than the particular element in the group which was detected.

Character Generation

Character generation is a programmable function, allowing the user complete flexibility in the generation and use of character sets. Characters represented by their component strokes are stored in 1130 storage. Up to two character strokes are contained within the 16-bit 1130 word. The character stroke words are organized so that each character can be represented by a subroutine of stroke words. Characters, then, can be drawn by the following general sequence of display orders:

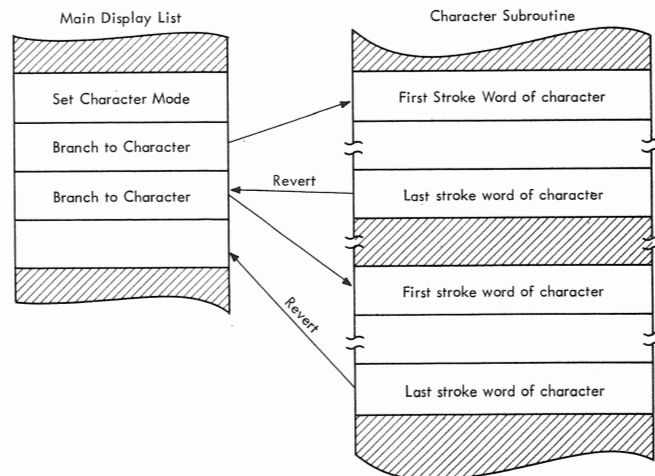

The first branch order transfers program execution to the character stroke words representing the character. The last character stroke word of the character contains the revert bit, which, when decoded, causes an automatic branch back to the main display list. In addition, the beam automatically steps in the +X direction to the next character position. Control codes within the character stroke word are used (1) to suppress spacing, (2) to position the beam to a new line, (3) to position the beam to a point above or below a line to allow certain lower-case letters (such as y and p) to be drawn, and (4) to reserve a location in CPU storage for later use by a program.

If, after branching back from a character subroutine, the next order in the main display list is not a branch order, Graphic mode is re-entered automatically. If a specific Graphic mode (Vector or Point) has been set previously, that mode remains set. Otherwise, Graphic mode (vector) is set automatically. If a branch/interrupt to a noncharacter subroutine is needed immediately after a series of branches to character subroutines, a nonbranch type of order such as Set Pen Mode is inserted after the last branch to the character subroutine. This order causes Character mode to be left and Graphic mode to be re-entered automatically.

DISPLAY ORDERS

Display orders set point mode, return the 2250 to vector mode, or direct the 2250 to position and blank or unblank the electron beam. Display mode operations by the 2250 are described in the preceding section of this publication. In summary, the Set Graphic Mode order specifies the display of vectors or of points under direction of graphic orders from the display program. These orders can be in long absolute, short absolute, and/or incremental format (these formats can be intermixed). The set Character Mode order specifies either basic or large character size; stroke data from a stroke table in the display program directs electron beam movement to form characters.

Programming Note: For improved image accuracy on complete images that are displayed in less than 25ms, the beam should be returned to the center of the display area (X = 512, Y = 512) after the image is displayed.

Set Graphic Mode (Vector/Point) (SGMV, SGMP)

| | | | | | | | | | | | | |
|---|---|---|---|---|----|----|---|-----|--|--|--|------|
| 0 | 0 | 1 | 1 | 0 | 0 | 1 | 0 | 0's | | | | *V/P |
| 0 | 3 | 4 | 7 | 8 | 14 | 15 | | | | | | |

Note: Bit 15 = 0 for vector operations (SGMV), or = 1 for point operations (SGMP)

This order prepares the 2250 to operate with Long Absolute, Short Absolute, and Incremental orders, which can be intermixed. Graphic mode is entered automatically following execution of any order other than a branch that is in a character sequence. The 2250 is placed in the Graphic mode established by the most recent Set Graphic Mode order. If a mode was not established previously, the 2250 is placed in Graphic (Vector) mode.

Long Absolute XY (MBA, DBA)

| | | | | | | | | | | | | | | | |
|-----|---|---|---|---|---|---|--------------|--|--|--|--|--|--|--|----|
| N | 0 | 1 | 0 | B | 0 | 0 | X Coordinate | | | | | | | | |
| N+1 | 0 | 0 | 0 | 0 | 0 | 0 | Y Coordinate | | | | | | | | |
| | 0 | 1 | 2 | 3 | 4 | 5 | 6 | | | | | | | | 15 |

Note: Beam (B) bit = 1 for beam on (DBA), or = 0 for beam off (MBA)

Each Long Absolute XY order identifies one beam deflection end point. Bits 0-2 in the first word identify the order as Long Absolute XY. Bits 6-15 in each word address the actual reference grid coordinates to which the electron beam is to move. A deflection of any length and in any direction can be specified.

A vector or point, as determined by the current 2250 Graphic mode, is displayed if the beam bit is 1, or the beam is repositioned without causing a display if the beam bit is 0.

Short Absolute X/Y (MBAX, MBAY, DBAX, DBAY)

| | | | | | | | | | | | | | | |
|---|---|---|---|-----|---|-------------------|--|--|--|--|--|--|--|----|
| 0 | 1 | 1 | B | X/Y | 0 | X or Y Coordinate | | | | | | | | |
| 0 | 1 | 2 | 3 | 4 | 5 | 6 | | | | | | | | 15 |

Notes: 1. Beam (B) bit = 1 for beam on (DBAX or DBAY), or = 0 for beam off (MBAX or MBAY)
2. X/Y bit = 0 if an X coordinate is in bits 6-15, or = 1 if a Y coordinate is in bits 6-15.

Each one-word Short Absolute X/Y order causes beam deflection either in the horizontal direction or in the vertical direction, whichever is specified by bit 4. Bits 6-15 address the actual X or Y reference grid position to which the electron beam is to be deflected. This order can be used to display a horizontal or vertical line or to display a point, as determined by the current 2250 Graphic mode. It can also be used for electron beam positioning without causing a display, as determined by the beam bit.

Incremental XY (MBI, DBI)

| | | | | | | | | | | | | | | | |
|---|----------------|------------------|--|--|--|--|---|----------------|------------------|----|--|--|--|--|----|
| 1 | S _X | X Increment (ΔX) | | | | | B | S _Y | Y Increment (ΔY) | | | | | | |
| 0 | 1 | 2 | | | | | 7 | 8 | 9 | 10 | | | | | 15 |

Notes: 1. Beam (B) bit = 1 for beam on (DBI), or = 0 for beam off (MBI).
2. Sign (S_X or S_Y) = 1 when associated increment is negative, or = 0 if the increment is positive.

Incremental graphic orders provide the capability of displaying a graphic image by specifying incremental displacement from an absolute beam position. A maximum displacement of +63 or -64 raster units can be specified for X and for Y. Each displacement value can be positive or negative; when negative, the data is presented in 2's complement form. The incremental X and Y values are added to the absolute X and Y values (the current beam position), providing a new absolute value for a new beam position. Figure 11 is a chart that shows conversion from decimal raster units to hexadecimal coding.

The S_X and S_Y bits in each incremental order word are the signs of the X and Y increments, respectively. A 0 sign bit signifies a positive increment, whereas a 1 sign bit signifies a negative increment in 2's complement form. The beam bit is a 1 if a point or vector is to be displayed, or it is a 0 if the beam is to be repositioned without causing a display.

Each incremental deflection starts at the current beam position and ends at an X, Y position determined by the 2250 as follows:

$$X_{\text{new}} = X_{\text{current}} \pm X,$$

$$Y_{\text{new}} = Y_{\text{current}} \pm Y,$$

Note that a string of incremental vectors or points can be moved about the screen without affecting their length or orientation by changing the absolute starting position of the string. For example, a string of incremental orders to form a resistor could be in a subroutine; this string could be used to display the resistor any number of times, anywhere on the screen, as determined by the main program:

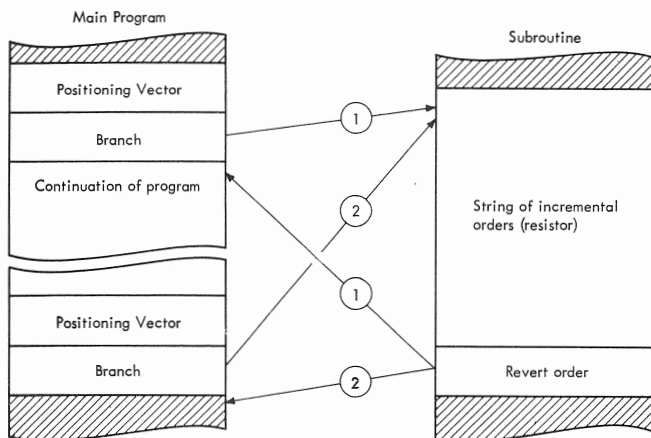

Incremental orders and absolute orders can be intermixed because all are uniquely identified, and a mode need not be set for their operation. Any nongraphic orders can also be inserted between graphic orders without terminating the Graphic mode, as can commands and interrupts.

If an X or Y increment causes the beam to move outside the 1,024 raster-unit image area, the point or entire vector will be blanked, as will all subsequent increments until the beam is returned to the usable image area; both end points of a vector must be on the image area for the vector to be displayed. The beam can be returned in either of two ways: by incremental movement in the opposite direction, or by an absolute positioning operation. If it is returned by an unblanked Long Absolute Vector order, the beam will be moved (blanked) from a wrap-around position to the end point specified in the vector data. Note that if beam displacement outside the image area exceeds +2047 or -1024 (X or Y), the beam may wrap around (may reappear on the opposite side of the usable display area). A Short Absolute X/Y order will return the beam to the image only if it is off-screen in the direction selected by X/Y bit.

Set Character Mode (Basic/Large) (SCMB, SCML)

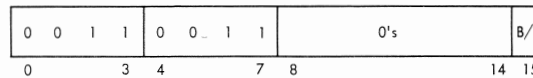

Note: Bit 15 = 0 for basic - size characters (SCMB), or = 1 for large size characters (SCML)

This order places the 2250 in Character mode and specifies that large- or basic-size characters are to be drawn (Figure 7). The set of characters that can be displayed by the 2250 is defined by the programmer. This character set resides in CPU storage as a stroke table or list in the display program. It can comprise any number of characters in any font and can be modified at any time during execution of the display program.

When entering Character mode, the current beam position on the reference grid becomes the center of a character area. (Normally, the program uses a blanked point or vector to establish a starting position before entering Character mode.) This character area is divided into a logical grid of seven X by eight Y addressable positions (Figure 5). A character is drawn in this area with a series of high-speed strokes between addressable positions, as specified by stroke data from the display program. In addition, character control data can be interleaved with stroke data to specify a subscript, superscript, new line, or null function.

Upon entering Character mode, the beam is offset automatically to position X = 0, Y = 0 in the first character area and is spaced automatically to this position in subsequent character areas. The beam is reset to the center of the character area upon leaving Character mode.

In Character mode, only Short Branch and Long Branch/Interrupt orders can be executed without

| 1st Char./ 3rd Char. (Beam on) | 3rd Char. (Beam off) | 2nd/4th Hex Character of Order | | | | | | | | | | | | | | | |
|--------------------------------------|-------------------------|--------------------------------|-----|-----|-----|-----|-----|-----|-----|-----|-----|-----|-----|-----|-----|-----|-----|
| | | 0 | 1 | 2 | 3 | 4 | 5 | 6 | 7 | 8 | 9 | A | B | C | D | E | F |
| 8 | 0 | +0 | +1 | +2 | +3 | +4 | +5 | +6 | +7 | +8 | +9 | +10 | +11 | +12 | +13 | +14 | +15 |
| 9 | 1 | +16 | +17 | +18 | +19 | +20 | +21 | +22 | +23 | +24 | +25 | +26 | +27 | +28 | +29 | +30 | +31 |
| A | 2 | +32 | +33 | +34 | +35 | +36 | +37 | +38 | +39 | +40 | +41 | +42 | +43 | +44 | +45 | +46 | +47 |
| B | 3 | +48 | +49 | +50 | +51 | +52 | +53 | +54 | +55 | +56 | +57 | +58 | +59 | +60 | +61 | +62 | +63 |
| C | 4 | -64 | -63 | -62 | -61 | -60 | -59 | -58 | -57 | -56 | -55 | -54 | -53 | -52 | -51 | -50 | -49 |
| D | 5 | -48 | -47 | -46 | -45 | -44 | -43 | -42 | -41 | -40 | -39 | -38 | -37 | -36 | -35 | -34 | -33 |
| E | 6 | -32 | -31 | -30 | -29 | -28 | -27 | -26 | -25 | -24 | -23 | -22 | -21 | -20 | -19 | -18 | -17 |
| F | 7 | -16 | -15 | -14 | -13 | -12 | -11 | -10 | -9 | -8 | -7 | -6 | -5 | -4 | -3 | -2 | -1 |

Number of Raster Units

Examples:

| ΔX | ΔY | Order Code (Hex) | |
|------------|------------|------------------|----------|
| | | Beam on | Beam off |
| -23 | +27 | E99B | E91B |
| +62 | +6 | BE86 | BE06 |
| -36 | -51 | DCCD | DC4D |
| +63 | -64 | BFC0 | BF40 |

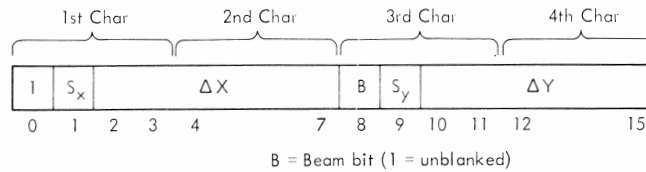

Figure 11. Decimal-Hexadecimal Conversion Chart for Incremental Orders

causing the 2250 to leave Character mode. (For maximum efficiency in generating characters, Short Branch orders should be used because their execution is overlapped with character spacing operations.) The Set Character Mode order should be followed by a branch order pointing to the character subroutine for the first character to be generated. Then, the strokes to form this character are drawn sequentially until a stroke word having the revert bit set is received by the 2250; after both strokes in this word are drawn, control is reverted to the main program location following the branch. If this location also contains a branch order, character generation continues as above. Character mode is terminated when a nonbranch order is decoded in the main order program, allowing the previously selected Graphic mode (vector or point) to continue.

All words in a stroke table are treated as stroke or control data; orders in a stroke table are not decoded. Branches to null strokes can be used to reserve locations in the character string without spacing. If the light pen detects a stroke, the detect status bit is not set (and an interrupt is not requested) until the revert function and spacing are completed.

Programming Notes:

1. A Set Character Mode (basic or large) order establishes Character mode until Character

mode is terminated with a nonbranch/non-interrupt order.

2. If Character mode is not terminated with a nonbranch/noninterrupt order, the order at the branch destination address will be treated as stroke data.

Stroke Data (MBS, DBS)

Each stroke data word contains two stroke endpoint addresses, a beam (B) bit for each stroke, a length (L) bit, and a revert (R) bit:

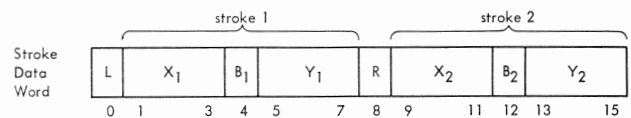

The first stroke addressed by this word is drawn from the current beam position on the character grid to the X_1, Y_1 position; it is intensified if $B_1 = 1$ (DBS). The second stroke is drawn from X_1, Y_1 to X_2, Y_2 and is intensified if $B_2 = 1$. Points can be displayed by positioning the beam with a blanked stroke (MBS) and then addressing one or more unblanked strokes to the current beam position, thereby causing the beam intensification without deflection.

Bit 0 (the L bit) is used to regulate stroke intensity and should be a 1 if either stroke 2 in the

data word is greater than one character unit long. Long and short strokes should not be coded in the same word. Programmed intensity enables the generation of characters that have nearly uniform intensity for all strokes, regardless of the stroke lengths. Visual inspection of a character for uniform intensity might be necessary to verify the setting of a length bit. The user should experiment with this control to achieve optimum results.

Bit 8, the revert bit, is set to identify the last data word of a character. After the two strokes in this last word are drawn, control of the 2250 reverts from the character stroke table back to the main program. Also, the beam is stepped 14 or 21 raster units in the +X direction to position X = 0, Y = 0 of the next character area. Note that a one-word character that specifies two blanked strokes with the revert bit set could be used as a space character to obtain additional space (in multiples of 14 or 21 raster units) between characters.

As an example of how stroke data can be used to form a character, consider the letter "A" shown in Figure 6. This letter could be drawn from two data words, as follows:

| | L | X ₁ | B ₁ | Y ₁ | R | X ₂ | B ₂ | Y ₂ | |
|--------------------|---|----------------|----------------|----------------|---|----------------|----------------|----------------|----|
| First Word | 1 | 0 | 1 | 1 | 1 | 1 | 1 | 0 | 1 |
| Second (last) Word | 1 | 1 | 0 | 1 | 0 | 0 | 1 | 0 | 1 |
| | 0 | 1 | 3 | 4 | 5 | 7 | 8 | 9 | 11 |
| | | | | | | | | | 12 |
| | | | | | | | | | 13 |
| | | | | | | | | | 15 |

Either the display program or the 2250 can initiate line spacing. Program-initiated line spacing is described under Character Control Words following this discussion. The 2250 initiates line spacing automatically only if the characters were initially positioned by a Long Absolute Graphic (Point or Vector) order (were absolutely positioned). When the X deflection register overflows (increments past 1023), it is reset to 0, and the Y deflection register is decremented 20 or 30 raster units to a new line.

If the characters were incrementally positioned, line spacing is not performed when the X deflection register overflows. The line continues to the right of the image area, and all characters are blanked until the X deflection register overflows a second time (increments past X = 2047), at which time wraparound occurs; then, characters are again displayed in the same line on the image area, starting at the left side. Thus, positioning operations for incrementally positioned characters and for incremental graphics are similar. This feature enables any displayed element to be moved anywhere on the image area without causing wrap-

around. Thus, operations can be with a 24-by-24-inch image, of which any 12-by-12-inch square is visible at any one time (see Figure 4).

Programming Note: The most recent Long Absolute or Incremental order determines whether the characters are absolutely positioned or are incrementally positioned. Intervening Short Absolute orders, though executed, are not used for this determination.

Character Control Words (CS)

Any one of five functions can be specified in a character control word: subscript, no-operation, superscript, new line, or null. Coding of the control word is as follows:

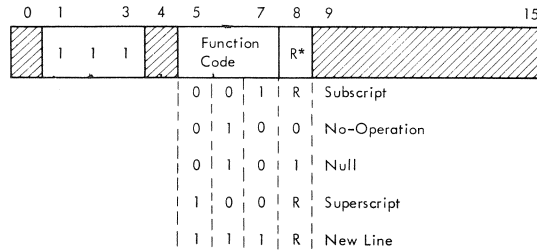

*Revert.

Undefined function codes are treated as no-op's; the revert bit is honored in words with undefined codes. Control words are identified by 1's in bits 1-3.

Subscript. This code causes the character grid to be offset downward from the normal position by three character units (Figure 7). The grid is returned to its normal position following execution of a null control function or of a stroke word with the revert bit set; a superscript control function will move the grid to the superscript position.

Null. This code causes the revert function to be executed; however, character spacing is suppressed. It can be used to reserve locations in the character string without adding character spaces and to superimpose characters when used as the last stroke word of a character.

Superscript. This code causes the character grid to be offset upward from the normal position by three character units (Figure 7) and causes a subscript code anywhere in the stroke table to be ignored. This function enables formation of a superscript, subscript, or normal character from

one set of character data. Word arrangement in storage would be as follows:

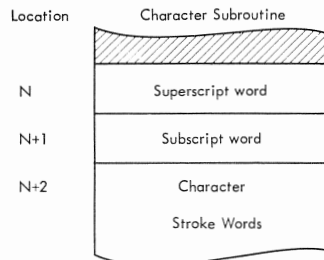

A superscript is drawn from the stroke data when the main program branches to location N; in this case, location N+1 is skipped. A subscript character is drawn when the branch is to location N+1, and a normal character is drawn when the branch is to location N+2. The grid is returned from the superscript position to its normal position following execution of a null function or of a stroke word with the revert bit set.

New Line. This code effects a "carriage return" function by resetting the X deflection register to zero and decrementing the Y deflection register by 20 or 30, according to character size. If the Y deflection register underflows, and if the characters were absolutely positioned, the new line is at the X wraparound position. If the Y deflection register underflows, and if the characters were incrementally positioned, the new line falls below the reference grid area (see Figure 4); in this case, subsequent characters will be blanked until returned to the reference grid area by Graphic orders or by a second underflow.

No-Operation. Reserves locations in the stroke subroutine for later use by the program.

Programming Note: A maximum of 29 stroke and/or control words may be used per character. Exceeding this maximum may result in a Cycle Steal Check interrupt.

CONTROL ORDERS

Control orders are provided for (1) conditional and unconditional branching, (2) conditional and unconditional interrupting of the CPU, (3) light pen control, (4) regeneration rate control, and (5) subroutine linkage.

Branch and Interrupt Orders

A branch order is normally the last order in the main routine of a display program. This order accomplishes display regeneration by branching to the first order in the main routine, resulting in

repeated operation of the display program. Branch orders are also used in Character mode to reference the character stroke table.

Branch orders enable regeneration, logical decision making, character generation, and order subroutines. There are two branch orders: Short Branch and Long Branch/Interrupt. Short Branch is used for unconditional branching within the first 8,192 words of storage, whereas Long Branch/Interrupt is used for conditional or unconditional branching to any location in storage, for interrupting the CPU, and for no-operations (no-op's).

Short Branch (GSB)

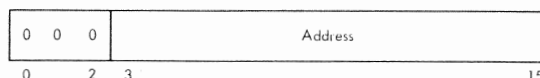

This order causes an unconditional branch to any location within the first 8,192-word block of CPU storage. As it is executed, a full 16-bit return address (address of the location that follows the Short Branch order location in storage) is saved in the revert register. A Store Revert Register order can be used to store the return address in the display program. Either a Revert order, or a character stroke or control word with the revert bit set, will branch operations back to the address specified by the revert register.

Long Branch/Interrupt (GB, GBE, GBC, GBCE, GI, GIC)

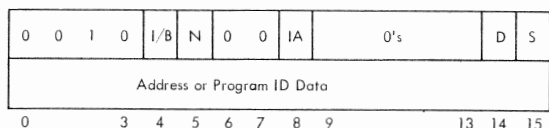

NOTES:

1. I/B bit = 0 for interrupt, or 1 for branch
2. N bit = 1 for 2-word no-op
3. IA bit = 1 for indirect addressing, or 0 for direct addressing
4. D bit = 1 for light pen detect condition
5. S bit = 1 for light pen switch condition

This order can be used for any of the following functions, depending on the configuration of modifier bits in the first word:

| Function | Mnemonic |
|--------------------------------|----------|
| Unconditional Branch | GB |
| Unconditional Branch, External | GBE |
| Conditional Branch | GBC |
| Conditional Branch, External | GBCE |
| Unconditional Interrupt | GI |
| Conditional Interrupt | GIC |

Bits 4 and 5 of the first word identify the order function:

| Bits 4 (I/B) | Bit 5 (N) | Function |
|--------------|-----------|--------------|
| 0 | 0 | Interrupt |
| 1 | 0 | Branch |
| 0 | 1 | 2-word no-op |
| 1 | 1 | 2-word no-op |

If a branch or interrupt function is specified, the configuration of bits 14 and 15 (the D and S bits) determines whether the branch or interrupt is conditional:

| Bit 14 (D) | Bit 15 (S) | Conditions |
|------------|------------|--|
| 0 | 0 | None (unconditional) |
| 0 | 1 | Light pen switch closed; detect or no detect |
| 1 | 0 | Light pen detect; switch open or closed |
| 1 | 1 | Switch closed and detect |

When neither bit is set, the branch or interrupt is unconditional. When either or both bits are set, the detect status bit and/or the light pen switch bit in the device status word (DSW) is tested. If the tested bit(s) is not a 1 (as specified by a 1 in bit 14 and/or 15), the order is handled as a 2-word no-op. If the tested bit(s) is a 1, a branch or interrupt is performed. The detect status bit is reset after it is tested if a branch or interrupt is performed.

An interrupt order (either unconditional or conditional with condition(s) met) stops regeneration of the display program, sets the order controlled interrupt bit (bit 0) in the DSW, and initiates an interrupt request to the CPU. Note that a detect or detect-and-switch-closed interrupt can be initiated only when light pen interrupts are deferred (by a Set Pen Mode order); when light pen interrupts are not deferred, a detect causes an immediate interrupt. The CPU program normally responds to this interrupt with Read Status command, fetching the DSW and other data to determine the cause of the interrupt.

Before a branch order (either unconditional or conditional with condition(s) met) is executed, the status of bit 8 in the first word is checked. If this bit is 0 (direct addressing specified), the order causes a branch to the storage location specified by the address word in the order.

If indirect addressing is specified (bit 8 = 1), the branch destination is specified in the location addressed by the order. For example, if address

N is identified in the second word of this order, the branch is to the location specified by the contents of address N.

When a branch is executed, a 16-bit return address is saved in the revert register. (The return address is the address of the location that follows the Long Branch/Interrupt order location in storage.) This address is used (1) in Character mode when returning from the stroke table to the main program and (2) when executing a Revert order or a Store Revert Register order.

NOTE: A branch order must not specify an address that is beyond the physical limits of CPU storage; if it does, wraparound will occur. (The excess high-order address bits are ignored, and the remaining address bits specify the branch destination.)

When interrupt is specified, the second word of the order can be used by the programmer for specific graphic program identification data. For example, by interpreting a code in this field, the CPU can "simulate" functions not provided by the order set (e.g., Scale, Rotate, Translate, Count, etc.). This facility enables a user to customize the order set according to his application.

Each Conditional and Unconditional Branch External order (GBE and GBCE) causes a branch to an external order program. The second word of the order contains the symbolic name of the external program. The 1130 disk monitor creates a conditional branch (indirect addressing specified) to the named order program.

The following is an example of conditional interrupting in multiple-level subroutines:

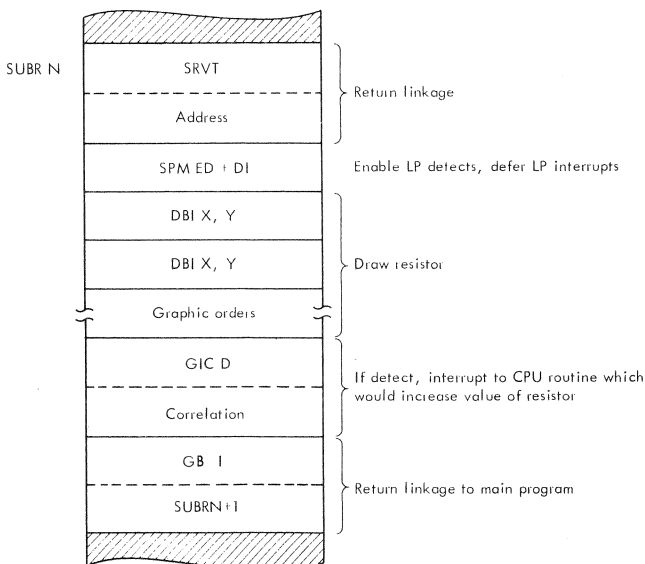

This subroutine example represents a resistor, and a light-pen detect condition indicates that the operator wishes to increase the value of the resistor by a specified amount. If a light-pen detect occurs during execution of this subroutine, a conditional interrupt on detect (GIC D) is taken to a CPU routine, which would increase the value of the resistor. Otherwise, an unconditional branch with indirect addressing specified provides the first leg of a return linkage to the main program. Note that the Set Pen Mode (SPM) order enables light-pen detects (ED) and defers light-pen interrupts (DI). If light-pen interrupts were not deferred, the first detect during execution of this subroutine would cause an immediate interrupt; thus, the conditional interrupt order would not be reached.

An example of how a conditional branch could be used to verify a light-pen detect to a graphic subroutine or entity is as follows:

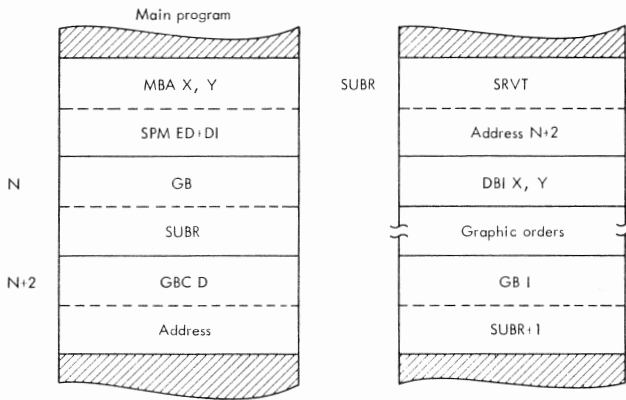

Detects are enabled and light-pen interrupts deferred before branching to the subroutine. After the subroutine is executed, displaying an element or entity, the main program is re-entered, and a conditional branch order (GBC D) is executed. If a light-pen detect occurred during subroutine execution, a branch is executed to a verification subroutine.

Set Pen Mode (SPM, GNOP)

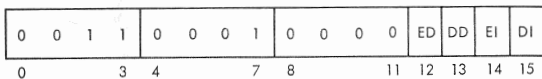

- Notes: 1. Bit 12 = 1 to enable light pen detects.
 2. Bit 13 = 1 to disable light pen detects.
 3. Bit 14 = 1 to enable light pen detect interrupts.
 4. Bit 15 = 1 to defer light pen detects interrupts.

This order establishes the mode of light-pen operation in the 2250. It can enable or disable light-pen detects and can enable or defer interrupts when a detect does occur. Deferred detects can be

tested by Long Branch/Interrupt orders. Note that execution of a Reset Display command also resets Light Pen mode to disable light-pen detects and defer light-pen interrupts and resets the detect interrupt and detect status bits in the DSW.

Light-pen switch operation is independent of light-pen detect circuitry. Switch status is sampled once per regeneration cycle. Long Branch/Interrupt orders, by testing the detect status and light pen switch DSW bits, can branch or interrupt as required to support light-pen operations.

A light pen mode is established by the status of bits 12-15 in the Set Pen Mode order. The possible combinations of these bits and the purpose of each combination are as follows:

- Bits 12-15 = 0 1 X X (Disable Light Pen Detect): Inhibits a detect from setting the DSW detect status bit.
- Bits 12-15 = 1 0 X X (Enable Light Pen Detects): Permits a detect to set the detect status bit.
- Bits 12-15 = 0 0 X X or 1 1 X X: Light Pen Detect mode is not changed.
- Bits 12-15 = X X 0 1 (Defer Light Pen Interrupts): Inhibits a Detect Interrupt from being generated when the DSW detect status bit is set, thereby allowing this status bit to be tested by a Long Branch/Interrupt order.
- Bits 12-15 = X X 1 0 (Enable Light Pen Interrupts): Permits a Detect Interrupt to be generated when the DSW detect status bit is set. If the detect status bit is set when this Set Pen Mode order is decoded, an interrupt is generated immediately. The detect status bit is reset when the detect interrupt bit is set.
- Bits 12-15 = X X 0 0 or X X 1 1: Light pen interrupt mode is not changed.
- Bits 12-15 = 0000, 0011, 1100, 1111 (No Operation): The order is treated as a one-word no-op.

Programming Note: The configuration of all 0's in bits 8-15 of the Set Pen Mode order is reserved for the one-word no-op (GNOP) order.

Start Timer (STMR)

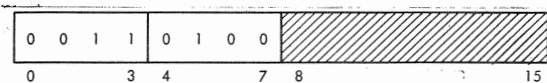

This order prevents the 2250 from using unnecessary storage cycles when executing a short display program, thereby freeing storage cycles for other programs. It is used with a branch order to control regeneration. (The branch order is necessary

to loop from the end of the display program to the beginning, thereby maintaining continuous regeneration without CPU program intervention.) The Start Timer order causes a 25ms timer to be tested. If the timer is running, storage accessing for information following the Start Timer order is delayed. When the timer stops, completing the current 25ms time period, it is restarted, and storage accessing automatically is resumed.

The Start Timer order should be included in each regeneration sequence. The regeneration rate is variable up to a rate of 40cps (25ms frame time) and is determined by the regeneration timer or by the amount of displayed information. (Messages that require less than 25ms to regenerate are displayed at the maximum rate of 40cps.) Note that a flicker-free display image can be obtained with a regeneration rate of 35 to 40cps.

The Start Timer order also allows keyboard interrupts and initiates testing of the light-pen switch. An alphameric or programmed function keyboard interrupt can be generated only during execution of a Start Timer order.

Programming Notes:

1. Failure to use a Start Timer order in a short display program may result in damage to the CRT screen or in variable intensity.
2. The Start Timer order should be used as the first order in a sequence of graphic orders that generates a particular display.

Subroutine Linkage Orders

Subroutine linkage in the display program is accomplished by means of a revert register. Each time a branch order is executed, a return address is saved in the revert register. This address points to the storage location following the location that contains the branch order. The return address is used by two orders: Revert and Store Revert Register.

Revert (RVT)

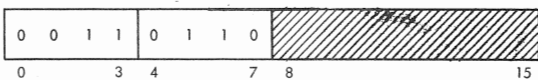

This order causes the revert register contents (the return address) to be loaded into the address register. It is used to return from a single-level subroutine, as follows:

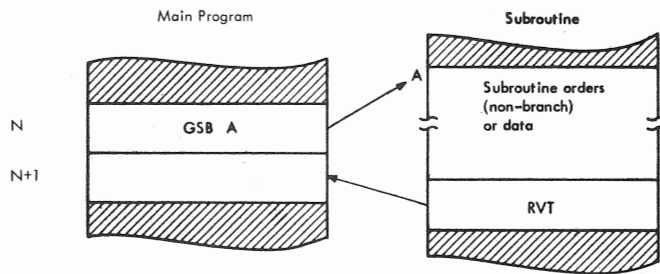

In this example, address N+1 is placed in the revert register as the Short Branch order is executed. This address is then placed in the address register when the Revert order is executed, effecting a return of operations to address N+1. Note that the same function is performed when the revert bit is set in a character data stroke word.

Store Revert Register (SRVT)

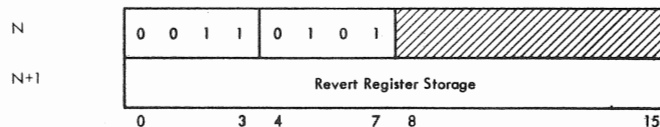

This order causes the revert register contents to be placed into storage as the second word of this order. It is used when more than one branch is to be executed before returning to the main program (i.e., for multilevel subroutines). For example, a Store Revert Register order would be executed before a second branch is issued. After the second branch, a third branch, with indirect addressing specified, can be used to return by way of the stored revert register contents as follows:

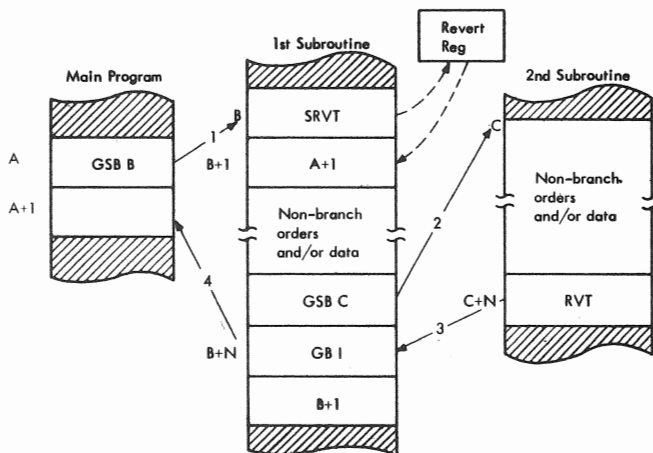

Since the revert register contents can be modified only by a branch order, interrupted subroutines can be restarted at the point of interrupt.

COMMANDS

The CPU uses I/O control commands (IOCC's) to control 2250-4 operations. An IOCC consists of two words, as follows:

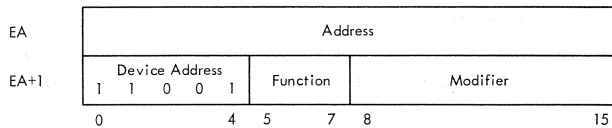

The first word is at an even storage address and contains a 16-bit storage address. An IOCC must be at an even effective address (EA). The second word of the IOCC, stored in the next sequential location, is divided into three control fields: (1) the device address (25 decimal for the 2250-4), (2) the command function code, and (3) the command modifier code. When an Execute I/O (XIO) instruction is executed, the odd word of the IOCC is sent to the 2250, via the storage access channel, before the even word.

Seven functional commands can be executed by the 2250:

| Function | | Modifier | |
|-----------------|------|--------------------|----------|
| Name | Code | Name | Code |
| Initiate Write | 101 | Start Regeneration | 0--000-- |
| Initiate Write | 101 | Set PF Indicators | 1--000-- |
| Initiate Read | 110 | Read Status | ---000-- |
| Control | 100 | No Operation | 0--000-- |
| Control | 100 | Reset Display | 1--000-- |
| Sense Interrupt | 011 | Sense Interrupt | ----- |
| Sense Device | 111 | Sense DSW | ---000-R |

Notes:

1. A dash (-) in the Modifier Code represents a bit that is not decoded by the 2250.
2. The "R" in the modifier code for Sense DSW is a 1 to reset interrupt request.

Command modifier bits 11, 12, and 13 must be 0's; unassigned modifier bits are not decoded. Unassigned function codes are treated as no-operation commands by the 2250. The execution time of each command is equal to the Execute I/O instruction time plus one core storage cycle time for each cycle steal required for data transfer.

Initiate Write

Both Initiate Write commands (Start Regeneration

and Set Programmed Function Indicators) cause the corresponding even IOCC word (a 16-bit CPU storage address) to be loaded into the 2250 address register. Words are then accessed from CPU storage by cycle stealing, starting at this address. An Initiate Write command can be executed only when the 2250 is not busy (not regenerating) and is treated as a no-operation command when the 2250 is busy. A Reset Display command can be used to stop regeneration.

Start Regeneration

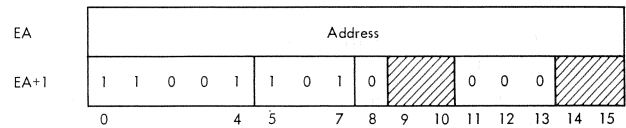

This command starts execution of the display program at the address specified in the even command word. Regeneration continues under control of orders in the display program until terminated by a Reset Display command or by a 2250 interrupt; the busy bit in the DSW is set during regeneration. The Start Regeneration command also clears the interrupt status indicators (DSW bits 0-2) and, if the keyboard interrupt bit is set, unlocks the 2250 keyboards, resets the data available bit, and clears Read Status command response words 4 and 5.

Set Programmed Function Indicators

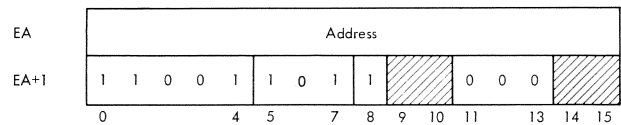

This command is used to load the programmed function keyboard indicators with the contents of two consecutive words in CPU storage; the first of these two words is specified by the address word of this command. Two cycle-steal operations are performed.

Each bit in the two indicator words corresponds to one programmed function keyboard indicator, as follows:

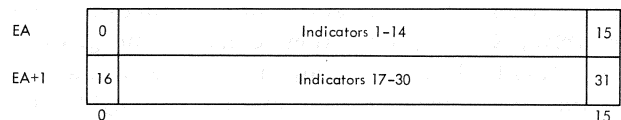

All 1 bits cause their associated indicators to light, and all 0 bits cause their associated indicators to be

turned off. No interrupts are generated.

All programmed function indicators are turned off by a power-on reset (generated when 1130 power is turned on) and by a manual reset (generated when the 1131 RESET pushbutton is pressed). When a Reset Display command is executed, the even word of the Reset Display IOCC (at EA) is imaged twice, once in indicators 0-15 and once in indicators 16-31.

Read Status

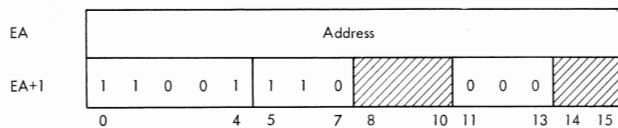

This command causes six words of 2250 status information to be placed, by cycle-stealing, into CPU storage, starting at the address specified in the command. The original contents of the 2250 address register are saved (as the first word of status information) before the command address word is loaded but are not restored after execution of the command.

A Read Status command is normally issued immediately after a Sense Interrupt command in response to a 2250 interrupt; however, it can be executed any time the 2250 is not busy. Interrupts are not generated by the Read Status command, and the 2250 interrupt request is reset (if set). The six words of status information read by this command are as follows:

| | | | | | | | | | | | | | | | | |
|-----------|---------------------------------------|---|---|----------------|---------------------------|---|----|--------------|--------------|---|----|----|----|----|----|----|
| Stored EA | Original Contents of 2250 Address Reg | | | | | | | | | | | | | | | |
| EA+1 | Device Status Word | | | | | | | | | | | | | | | |
| EA+2 | 0's | | | O _X | X Deflection Reg Contents | | | | | | | | | | | |
| EA+3 | 0's | | | O _Y | Y Deflection Reg Contents | | | | | | | | | | | |
| EA+4 | DA | 0 | 0 | PF Key Code | | | | Overlay Code | | | | | | | | |
| EA+5 | DA | 0 | 0 | E | C | A | BK | J | A/N Key Code | | | | | | | |
| | 0 | 1 | 2 | 3 | 4 | 5 | 6 | 7 | 8 | 9 | 10 | 11 | 12 | 13 | 14 | 15 |

Legend: O_X = X Overflow A = Advance Key
 O_Y = Y Overflow BK = Backspace Key
 DA = Data Available J = Jump Key
 E = End Key PF = Programmed Function Keyboard
 C = Cancel Key A/N = Alphameric Keyboard

These words reflect the status of the address register, DSW, X and Y deflection registers, programmed function keyboard, and alphameric keyboard at the time of the preceding interrupt. If a keyboard is not attached to the 2250 or does not have data available, the appropriate data available bit (bit 0) will be a zero. The DSW contents are defined in the Sense DSW command description. The address

register contents in the first word of this response, to be meaningful, may require modification as specified by address displacement bits 14 and 15 in the DSW. The Read Status response is further described in the Interrupts section of this document.

A deflection register overflow bit is 1 only when the beam is outside the visible image area; the beam is always blanked in this case. The beam can be moved outside the image area only during Incremental Graphic mode operations or during incrementally positioned Character mode operation. Once outside the image area, Short Absolute orders can move the beam without returning it to the image area.

In Incremental mode, the beam can be returned to the image area (Figure 4) by issuing (1) a Long Absolute Graphic mode order, (2) Incremental Graphic mode orders in the reverse direction, (3) one Short Absolute Graphic mode order if the beam is off the screen either vertically or horizontally (one overflow bit is set), or (4) two Short Absolute Graphic mode orders (both overflow bits are set). In Character mode, the beam can be returned by issuing a new line character control word (if the X overflow bit is set and execution of a new line function will not cause Y underflow) or by the same methods described in the preceding sentence for Incremental mode.

Keyboard data might be either in word 4 or in word 5 of the status information but not in both words at the same time. Bit 0 is set to 1 if data is available in the word. When one of the 32 programmed function keyboard keys has been depressed, bits 3-7 of word 4 contain a five-bit binary key code which corresponds to the depressed key. In addition, bits 8-15 contain an eight-bit binary code which represents one of 256 possible keyboard overlays.

Figures 12 and 12a are drawings of overlays for sensing-switch keyboards and for toggle-switch keyboards, respectively. The circles on these overlays represent the holes through which the key/indicators protrude. The number at the upper left of each circle is the code of the associated key/indicator; the binary configuration of this code for a key that has been depressed is used in bits 3-7 of word 4 as follows:

| Depressed Key | Key Code (bits 3-7) |
|---------------|---------------------|
| 0 | 0 0 0 0 0 |
| 1 | 0 0 0 0 1 |
| 30 | 1 1 1 1 0 |
| 31 | 1 1 1 1 1 |

Located at the top edge of overlays for sensing-switch keyboards are notch positions, numbered 0 through 7. Bits 8-15 of word 4 are a direct image of the notches in the overlay being used; each 1-bit

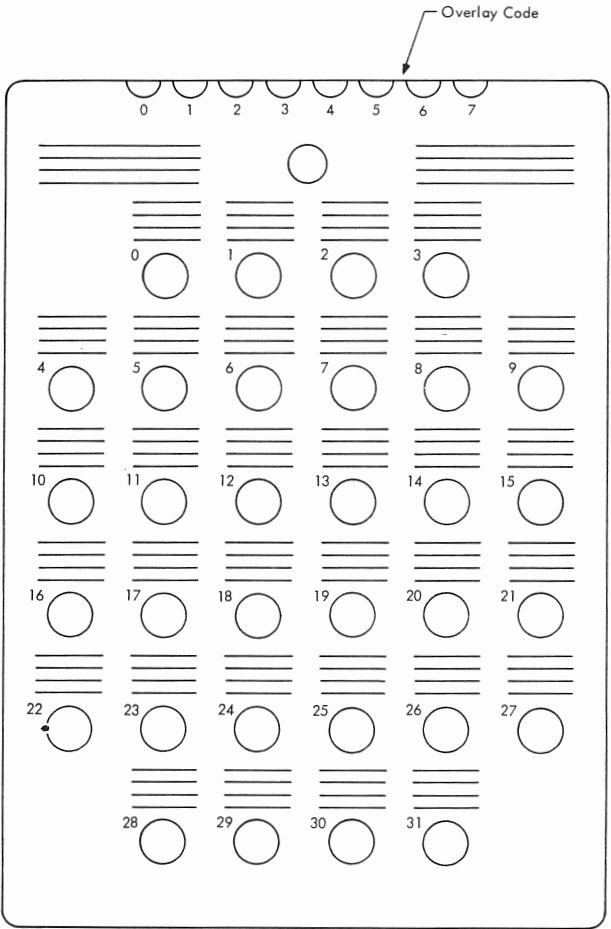

Figure 12. Programmed Function Keyboard Overlay for Keyboards with Sensing Switches (Top View)

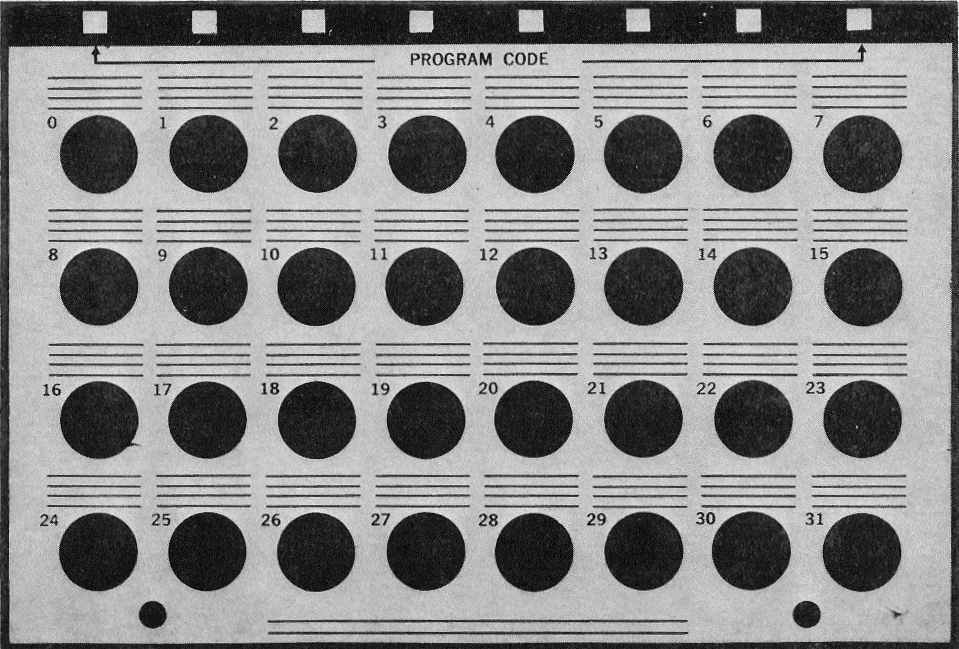

Figure 12a. Programmed Function Keyboard Overlay for Keyboards with Toggle Switches (Top View)



represents a notch in the corresponding overlay position. For a toggle-switch keyboard, bits 8-15 of word 4 are a direct image of the toggle switch settings (Figure 10a); each 1-bit represents a toggle switch that is in the up position. The correlation of notches and toggle-switch settings to the overlay code in word 4, bits 8-15, is as follows:

| Switch(es) Up or Overlay Notch(es) | Overlay Code (Bits 8-15) |
|---------------------------------------|--------------------------|
| None | 0 0 0 0 0 0 0 0 |
| 7 | 0 0 0 0 0 0 0 1 |
| 6 | 0 0 0 0 0 0 1 0 |
| 6, 7 | 0 0 0 0 0 0 1 1 |
| <hr/> | |
| 0-6 | 1 1 1 1 1 1 1 0 |
| 0-7 or | |
| No Overlay | 1 1 1 1 1 1 1 1 |

When an alphameric keyboard key has been depressed, word 5 of the status information identifies the depressed key and bit 0 is set to 1. Bits 3-7 identify the END, CANCEL, ADVANCE, BACK-SPACE, and JUMP keys, respectively. If all of these bits are zero, a character key is identified by a code in bits 8-15. If any of bits 3-7 is a one, bits 8 to 15 will be zero. Figure 13 shows the possible codes (in hexadecimal) that can be in bits

8-15; bits 8-11 contain the first hexadecimal character, and bits 12-15 contain the second. For example, the code for "w" (A6) is 1010 0110 in bits 8-15.

Control

During control command execution, the 2250 address register is not loaded by an address from the IOCC, cycle steals are not used, and interrupts are not generated.

No-Operation

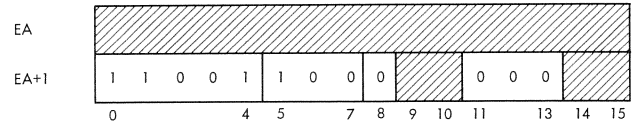

This command is ignored by the 2250. It is reserved as a no-operation and will not be assigned a function in the future.

Reset Display

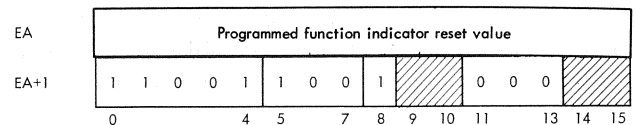

| Key Codes (Hexadecimal) (see note) | | | | | | | | | | | | | | | | |
|------------------------------------|------------|---|---|---|----|----|---|---|---|---|---|---|---|---|---|---|
| Bits | Bits 0 - 3 | | | | | | | | | | | | | | | |
| | 0 | 1 | 2 | 3 | 4 | 5 | 6 | 7 | 8 | 9 | A | B | C | D | E | F |
| 0 | NUL | | | | SP | & | - | | | | | | | | | 0 |
| 1 | | | | | | / | | a | j | | | A | J | | | 1 |
| 2 | | | | | | | | b | k | s | | B | K | S | | 2 |
| 3 | | | | | | | | c | l | t | | C | L | T | | 3 |
| 4 | | | | | | | | d | m | u | | D | M | U | | 4 |
| 5 | | | | | | | | e | n | v | | E | N | V | | 5 |
| 6 | | | | | | | | f | o | w | | F | O | W | | 6 |
| 7 | | | | | | | | g | p | x | | G | P | X | | 7 |
| 8 | | | | | | | | h | q | y | | H | Q | Y | | 8 |
| 9 | | | | | | | | i | r | z | | I | R | Z | | 9 |
| A | | | | | ¢ | ! | | : | | | | | | | | |
| B | | | | | . | \$ | , | # | | | | | | | | |
| C | | | | | < | * | % | @ | | | | | | | | |
| D | | | | | (|) | _ | ' | | | | | | | | |
| E | | | | | + | ; | > | = | | | | | | | | |
| F | | | | | | ~ | ? | " | | | | | | | | |

Legend:
 SP - Space
 NUL - Null

Examples:
 Character Code
 A C1
 9 F9
 % 6C
 NUL 00

Note
 Character code assignments other than those shown within the heavily outlined portions of the chart above are undefined. The characters that would be indicated by these codes are not specified. Also, a character that would be indicated by the 2250 Model 4 for a given undefined character code may be different for other devices. IBM reserves the right to change at any time the character indicated by the 2250 for an undefined character code.

Figure 13. Alphameric Keyboard Code Assignments

This command immediately stops regeneration and generates a unit reset in the 2250, causing all registers, controls, and keyboards to be reset. Zero is the reset state of all registers except the X and Y deflection registers, which are reset to 512 each (the center of the reference grid). The Display mode is reset to Graphic mode (vector), and light-pen control is reset to the disable-detects and defer-interrupts condition. In addition, all pending interrupts are cleared, and the 2250 is made not busy. In addition, the bit configuration in the even word of the Reset Display IOCC (at EA) is imaged twice in the programmed function indicators, once in indicators 0-15, and again in indicators 16-31; thus each 1-bit lights two indicators, and each 0-bit clears two.

Sense Interrupt

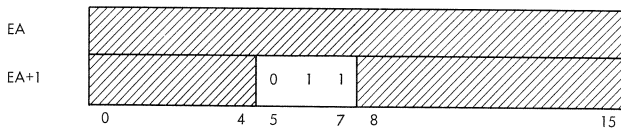

The 2250 executes this command (1) if the 2250 is requesting an interrupt and (2) if interrupt level 3 is active in the 1130. If these conditions are met, the 2250 sends the following word to the 1131:

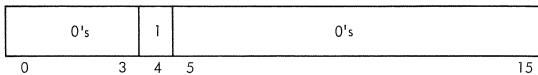

At the 1131 accumulator, bit 4 is logically OR'ed into the level-3 interrupt level status word with bits from other devices with level-3 interrupts pending. The 1130 program responds to this interrupt (if the 2250 has highest priority) with a Read Status command to identify the interrupting condition. If an interrupt is not pending, or if interrupt level 3 is not active, the 2250 handles the Sense Interrupt command as a no-operation. Note that device address bits 0 to 4 are ignored at all times.

Sense DSW

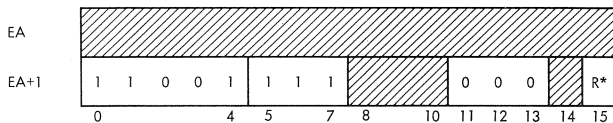

* Reset (R): If set to 1, causes interrupt request to be reset.

This command causes the 2250 to send a device status word (DSW) to the 1131, where it is loaded into the accumulator. Cycle steals are not used, and interrupts are not generated. If the 2250 is

regenerating (is busy), only bit 8 of the DSW is set. When the 2250 is not busy, the DSW contents describe the control status of the 2250, as follows:

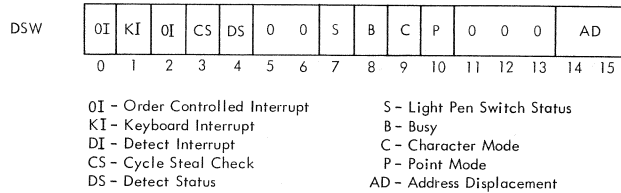

Table 2 gives the meaning of these bits.

Table 2. Interpretation of DSW

| Bit(s) | Name | Indication |
|--------|----------------------------|---|
| 0 | Order Controlled Interrupt | Long Branch/Interrupt order caused the interrupt. |
| 1 | Keyboard Interrupt | A key has been depressed on either keyboard, and data is available. |
| 2 | Detect Interrupt | Light pen has detected a point, vector, or character with interrupts enabled. |
| 3 | Cycle Steal Check | 32 consecutive cycles have been stolen due to program error or machine failure. |
| 4 | Detect Status | Light pen has detected a point, vector, or character with interrupts deferred. This bit is reset whenever it is tested successfully or when DSW bit 2 is set. |
| 5, 6 | Reserved (must be 0's) | |
| 7 | Light Pen Switch Status | Light pen switch was closed when last Start Timer order was executed. |
| 8 | Busy | Display is currently regenerating in Cycle Steal mode. This is always 0 if interrupt has occurred and/or display is not regenerating. |
| 9 | Character Mode | A 1 when in Basic or Large Character mode; 0 when in Graphic mode. |
| 10 | Point Mode | Significant if bit 9 = 0; bit 10 = 1 for Point mode, or = 0 for Vector mode. |
| 11-13 | Reserved (must be 0) | |
| 14, 15 | Address Displacement | Indicates number of locations the address register (in first word of read status response) is ahead of address of order being executed when Detect Interrupt occurred. Contains indeterminate value at any other time. Reset to 01. |

NOTE: The DSW is reset to 0001₁₆ by 2250 unit reset; DSW bits 0-4 are reset by a Start Regeneration command. A nonzero DSW indicates the 2250 is logically enabled (on-line).

INTERRUPTS

All interrupts stop regeneration and request a level-3 interrupt. When a Sense Interrupt command is executed and the 2250 has an interrupt, bit 4 is set in the level-3 interrupt level status word at the 1131 accumulator.

Following the interrupt, a Read Status command can be used to read the current contents of significant registers (six words in all) the CPU storage. The 2250 address register contents are in the first word of status information. This address always points the CPU storage location that would have been accessed next if the interrupt had not occurred. The significance of this address depends on the type of interrupt generated. In all cases, the DSW identifies the interrupt cause. The DSW is the second word of status information sent by the 2250 in response to a Read Status command and is the only response to a Sense DSW command. A Shift Left and Count instruction can be used by the 1131 program to interpret the DSW because the leftmost 1-bit identifies the interrupt.

Bits 0-2 of the DSW (the interrupt status) are reset by the next Start Regeneration command; bit 3 is reset only by a Reset Display command. The interrupt request is reset either by the Read Status command or by a Sense DSW command with bit 15 set to 1, whichever occurs first. An interrupt does not affect the current 2250 display mode (Graphic or Character) and does not change the contents of the revert register or the X and Y deflection registers.

Order Controlled Interrupt

A 1 in DSW bit 0 indicates the occurrence of an order controlled interrupt. This interrupt is generated when the 2250 is executing either the Unconditional or Conditional Interrupt variation of the Long Branch/Interrupt order; the Conditional Interrupt variation can cause an interrupt only when the light-pen detect and/or light-pen switch status bits are tested successfully by the order.

Following execution of a Read Status command, the address in the first word of status information points to the second word of the Long Branch/Interrupt order, which may contain an address or other interrupt identification data. Bits 4 and 7 of the DSW indicate the light-pen detect and light-pen

switch status at the time of interrupt; bit 4 is reset after it is tested successfully.

Keyboard Interrupt

A 1 in DSW bit 1 indicates the occurrence of a keyboard interrupt. It is set when a key has been depressed either on the alphameric keyboard or on the programmed function keyboard and the next Start Timer order is decoded. A Read Status command reads the appropriate keyboard (response word 4 or 5). Both keyboards are locked and light-pen detects are inhibited at the time of interrupt; they remain in this condition until a Start Regeneration command is executed.

A keyboard interrupt can occur only during execution of a Start Timer order. If both keyboards are activated simultaneously, the programmed function keyboard is given priority by the 2250, causing the interrupt; in this case, the alphameric keyboard is locked out. Bits 4 and 7 of the DSW indicate the light-pen detect and light-pen switch status at the time of interrupt.

Following depression of an alphameric keyboard key other than SHIFT, LOCK, ALTN CODING, or CONTINUE, or following depression and release of a programmed function keyboard key, the following sequence occurs:

1. A data available bit is set in the DSW, and both keyboards are locked.
2. The next Start Timer order checks the data available bits and, since one is set, requests an interrupt and sets the keyboard interrupt bit in the DSW. At this time, regeneration is stopped, and the address register points to the Start Timer order location +1.
3. The CPU program should respond to this interrupt with a Read Status command. The 2250 response to this command includes the DSW, which identifies the interrupt, and a set data available bit, which identifies the interrupting keyboard and the response word that contains the keyboard information.
4. The next Start Regeneration command resets the keyboard interrupt bit in the DSW, resets both keyboard words in the Read Status command response (because the keyboard interrupt bit is set), and unlocks both keyboards.

Between the setting of a data available bit and receipt of a Start Timer order, if a light-pen or order-controlled interrupt occurs, the interrupt is taken. When regeneration is started, the next Start Timer order will generate the Keyboard Interrupt.

Detect Interrupt

This interrupt is indicated by a 1 in DSW bit 2. It is generated when the 2250 is enabled for light-pen interrupts (by a Set Pen Mode order) and a detect has occurred.

When a detect occurs while the 2250 is not enabled for light pen-interrupts, execution of a Set Pen Mode order to enable interrupts causes an immediate interrupt unless the detect condition is reset before execution of the order. In this case, the address in the first read status response word will be one higher than the address of the Set Pen Mode order; therefore, bits 14 and 15 of the DSW (the address displacement bits) will be 0 and 1 respectively. Note that the detect status bit is always reset by a Detect Interrupt.

If the 2250 is enabled for light-pen detects when a detect occurs, the address in the first read status response word depends on the type of data detected. Bits 9 and 10 of the DSW identify the display mode as Character, Vector, or Point. Bits 14 and 15 of the DSW specify a displacement. This displacement should be subtracted from the read status response word 0 contents to obtain the address of (1) the first, or only, graphic positioning order causing display of the detected element or (2) the branch order to the detected character. Light-pen switch status at the time read status was executed is indicated in DSW bit 7. In addition, the contents of the X and Y deflection registers (read status response words 2 and 3) might be significant.

If the light pen detects a character stroke, the light pen detect DSW bit is not set and the interrupt is not generated (1) until the Revert function, character space, and (if necessary) line space are completed, or (2), if not character space (e.g. a Null character follows), until the beam is repositioned to X = 000, Y = 000 of the character grid.

Cycle Steal Check

This interrupt is indicated by a 1 in DSW bit 3. It is generated after 32 consecutive cycle steals are executed by the 2250; when this occurs, regeneration is stopped, the Busy status bit is reset, cycle steal requests are blocked, and an interrupt is requested. (Note that this limits characters to a maximum of 29 stroke words each, including control words.) Then, since cycle steals are inhibited, the Read Status response to this interrupt will not store any data. However, following an unsuccessful Read Status command, the Sense DSW command can be used to recover the DSW for identification of the interrupt. A Reset Display command or a manual reset must be given to clear the 2250 and prepare it for restarting the display.

ERROR RECOVERY PROCEDURES

Two types of error procedures may be used for 2250 errors. The first is a programmed recovery procedure for errors detected by the program. The second is a manual recovery procedure for errors detected by the operator. Both involve a single retry.

The programmed recovery procedure consists of (1) issuing a Reset Display command and (2) restarting the display at the first order in the display order list. An error halt and optional error recording may follow an unsuccessful retry. This procedure can be used for the following error conditions when detected by the program.

1. 2250 fails to become busy after issuing a Start Regeneration command (DSW bit 8 = 0).
2. 2250 interrupts but remains busy (DSW bit 8 = 1).
3. 2250 interrupts, but no interrupt bits are set (DSW bits 0-3 are 0's).
4. Busy clear, but Read Status command fails to execute (no data transferred).
5. Reset command fails to clear busy or other DSW bits.
6. More than one interrupt bit set at same time.
7. Keyboard interrupt bit set, but no data available bits set in keyboard data words.
8. Both alphameric and programmed function keyboard data available on single interrupt.
9. Cycle Steal Check occurs.

The manual recovery procedure consists of (1) manually resetting the 1130/2250 system and, then, (2) either restarting or reloading the program, depending on the error detected. This procedure should be used for error conditions that can be detected by the operator but not by the program. The following errors require this procedure:

1. Display and CPU stop with the Parity Check light lit on the 1131. This indicates that a location in CPU storage, accessed either by the CPU or by the I/O device, contains bad parity. The program should be reloaded to continue after manually resetting the system.
2. 2250 and/or CPU program hangs up, but not as a result of a programmed stop. The manual procedure in this case is to reset the system and attempt a restart at a start-over point in the program or monitor. If this fails, reload the program.
3. 2250 manual input devices (light pen, alphameric keyboard, or programmed function keyboard) fail to interrupt the CPU and 2250, or the program appears to respond to a key code other than that manually entered. The initial recovery procedure here is to retry the failing input device. If this fails, reset the

system and restart the program at a start-over point in the program or monitor.

4. 2250 displays a distorted or incorrect image on the screen. Reset the system and restart the program at a start-over point in the program or monitor.

An error-recording subroutine may be called in the event of an unsuccessful retry. This subroutine would be callable either by the graphic I/O subroutines or by the user. A Read Status command would be issued by this subroutine to recover 2250 status information; this information could then be printed with a core dump of significant program locations.

Since program errors can cause some, but not all, of the above error conditions, the programmer should recheck his program (if the above procedure fails) before calling the customer engineer.

APPENDIX A: HEXADECIMAL-DECIMAL CONVERSION

The table in this appendix provides for direct conversion of decimal and hexadecimal numbers in these ranges:

Hexadecimal Decimal
000 to FFF 0000 to 4095

For numbers outside the range of the table, add the following values to the table figures:

Hexadecimal Decimal
1000 4096
2000 8192
3000 12288

Hexadecimal Decimal
4000 16384
5000 20480
6000 24576
7000 28672
8000 32768
9000 36864
A000 40960
B000 45056
C000 49152
D000 53248
E000 57344
F000 61440

| | 0 | 1 | 2 | 3 | 4 | 5 | 6 | 7 | 8 | 9 | A | B | C | D | E | F |
|----|------|------|------|------|------|------|------|------|------|------|------|------|------|------|------|------|
| 00 | 0000 | 0001 | 0002 | 0003 | 0004 | 0005 | 0006 | 0007 | 0008 | 0009 | 0010 | 0011 | 0012 | 0013 | 0014 | 0015 |
| 01 | 0016 | 0017 | 0018 | 0019 | 0020 | 0021 | 0022 | 0023 | 0024 | 0025 | 0026 | 0027 | 0028 | 0029 | 0030 | 0031 |
| 02 | 0032 | 0033 | 0034 | 0035 | 0036 | 0037 | 0038 | 0039 | 0040 | 0041 | 0042 | 0043 | 0044 | 0045 | 0046 | 0047 |
| 03 | 0048 | 0049 | 0050 | 0051 | 0052 | 0053 | 0054 | 0055 | 0056 | 0057 | 0058 | 0059 | 0060 | 0061 | 0062 | 0063 |
| 04 | 0064 | 0065 | 0066 | 0067 | 0068 | 0069 | 0070 | 0071 | 0072 | 0073 | 0074 | 0075 | 0076 | 0077 | 0078 | 0079 |
| 05 | 0080 | 0081 | 0082 | 0083 | 0084 | 0085 | 0086 | 0087 | 0088 | 0089 | 0090 | 0091 | 0092 | 0093 | 0094 | 0095 |
| 06 | 0096 | 0097 | 0098 | 0099 | 0100 | 0101 | 0102 | 0103 | 0104 | 0105 | 0106 | 0107 | 0108 | 0109 | 0110 | 0111 |
| 07 | 0112 | 0113 | 0114 | 0115 | 0116 | 0117 | 0118 | 0119 | 0120 | 0121 | 0122 | 0123 | 0124 | 0125 | 0126 | 0127 |
| 08 | 0128 | 0129 | 0130 | 0131 | 0132 | 0133 | 0134 | 0135 | 0136 | 0137 | 0138 | 0139 | 0140 | 0141 | 0142 | 0143 |
| 09 | 0144 | 0145 | 0146 | 0147 | 0148 | 0149 | 0150 | 0151 | 0152 | 0153 | 0154 | 0155 | 0156 | 0157 | 0158 | 0159 |
| 0A | 0160 | 0161 | 0162 | 0163 | 0164 | 0165 | 0166 | 0167 | 0168 | 0169 | 0170 | 0171 | 0172 | 0173 | 0174 | 0175 |
| 0B | 0176 | 0177 | 0178 | 0179 | 0180 | 0181 | 0182 | 0183 | 0184 | 0185 | 0186 | 0187 | 0188 | 0189 | 0190 | 0191 |
| 0C | 0192 | 0193 | 0194 | 0195 | 0196 | 0197 | 0198 | 0199 | 0200 | 0201 | 0202 | 0203 | 0204 | 0205 | 0206 | 0207 |
| 0D | 0208 | 0209 | 0210 | 0211 | 0212 | 0213 | 0214 | 0215 | 0216 | 0217 | 0218 | 0219 | 0220 | 0221 | 0222 | 0223 |
| 0E | 0224 | 0225 | 0226 | 0227 | 0228 | 0229 | 0230 | 0231 | 0232 | 0233 | 0234 | 0235 | 0236 | 0237 | 0238 | 0239 |
| 0F | 0240 | 0241 | 0242 | 0243 | 0244 | 0245 | 0246 | 0247 | 0248 | 0249 | 0250 | 0251 | 0252 | 0253 | 0254 | 0255 |
| 10 | 0256 | 0257 | 0258 | 0259 | 0260 | 0261 | 0262 | 0263 | 0264 | 0265 | 0266 | 0267 | 0268 | 0269 | 0270 | 0271 |
| 11 | 0272 | 0273 | 0274 | 0275 | 0276 | 0277 | 0278 | 0279 | 0280 | 0281 | 0282 | 0283 | 0284 | 0285 | 0286 | 0287 |
| 12 | 0288 | 0289 | 0290 | 0291 | 0292 | 0293 | 0294 | 0295 | 0296 | 0297 | 0298 | 0299 | 0300 | 0301 | 0302 | 0303 |
| 13 | 0304 | 0305 | 0306 | 0307 | 0308 | 0309 | 0310 | 0311 | 0312 | 0313 | 0314 | 0315 | 0316 | 0317 | 0318 | 0319 |
| 14 | 0320 | 0321 | 0322 | 0323 | 0324 | 0325 | 0326 | 0327 | 0328 | 0329 | 0330 | 0331 | 0332 | 0333 | 0334 | 0335 |
| 15 | 0336 | 0337 | 0338 | 0339 | 0340 | 0341 | 0342 | 0343 | 0344 | 0345 | 0346 | 0347 | 0348 | 0349 | 0350 | 0351 |
| 16 | 0352 | 0353 | 0354 | 0355 | 0356 | 0357 | 0358 | 0359 | 0360 | 0361 | 0362 | 0363 | 0364 | 0365 | 0366 | 0367 |
| 17 | 0368 | 0369 | 0370 | 0371 | 0372 | 0373 | 0374 | 0375 | 0376 | 0377 | 0378 | 0379 | 0380 | 0381 | 0382 | 0383 |
| 18 | 0384 | 0385 | 0386 | 0387 | 0388 | 0389 | 0390 | 0391 | 0392 | 0393 | 0394 | 0395 | 0396 | 0397 | 0398 | 0399 |
| 19 | 0400 | 0401 | 0402 | 0403 | 0404 | 0405 | 0406 | 0407 | 0408 | 0409 | 0410 | 0411 | 0412 | 0413 | 0414 | 0415 |
| 1A | 0416 | 0417 | 0418 | 0419 | 0420 | 0421 | 0422 | 0423 | 0424 | 0425 | 0426 | 0427 | 0428 | 0429 | 0430 | 0431 |
| 1B | 0432 | 0433 | 0434 | 0435 | 0436 | 0437 | 0438 | 0439 | 0440 | 0441 | 0442 | 0443 | 0444 | 0445 | 0446 | 0447 |
| 1C | 0448 | 0449 | 0450 | 0451 | 0452 | 0453 | 0454 | 0455 | 0456 | 0457 | 0458 | 0459 | 0460 | 0461 | 0462 | 0463 |
| 1D | 0464 | 0465 | 0466 | 0467 | 0468 | 0469 | 0470 | 0471 | 0472 | 0473 | 0474 | 0475 | 0476 | 0477 | 0478 | 0479 |
| 1E | 0480 | 0481 | 0482 | 0483 | 0484 | 0485 | 0486 | 0487 | 0488 | 0489 | 0490 | 0491 | 0492 | 0493 | 0494 | 0495 |
| 1F | 0496 | 0497 | 0498 | 0499 | 0500 | 0501 | 0502 | 0503 | 0504 | 0505 | 0506 | 0507 | 0508 | 0509 | 0510 | 0511 |

11313

| | 0 | 1 | 2 | 3 | 4 | 5 | 6 | 7 | 8 | 9 | A | B | C | D | E | F |
|----|------|------|------|------|------|------|------|------|------|------|------|------|------|------|------|------|
| 20 | 0512 | 0513 | 0514 | 0515 | 0516 | 0517 | 0518 | 0519 | 0520 | 0521 | 0522 | 0523 | 0524 | 0525 | 0526 | 0527 |
| 21 | 0528 | 0529 | 0530 | 0531 | 0532 | 0533 | 0534 | 0535 | 0536 | 0537 | 0538 | 0539 | 0540 | 0541 | 0542 | 0543 |
| 22 | 0544 | 0545 | 0546 | 0547 | 0548 | 0549 | 0550 | 0551 | 0552 | 0553 | 0554 | 0555 | 0556 | 0557 | 0558 | 0559 |
| 23 | 0560 | 0561 | 0562 | 0563 | 0564 | 0565 | 0566 | 0567 | 0568 | 0569 | 0570 | 0571 | 0572 | 0573 | 0574 | 0575 |
| 24 | 0576 | 0577 | 0578 | 0579 | 0580 | 0581 | 0582 | 0583 | 0584 | 0585 | 0586 | 0587 | 0588 | 0589 | 0590 | 0591 |
| 25 | 0592 | 0593 | 0594 | 0595 | 0596 | 0597 | 0598 | 0599 | 0600 | 0601 | 0602 | 0603 | 0604 | 0605 | 0606 | 0607 |
| 26 | 0608 | 0609 | 0610 | 0611 | 0612 | 0613 | 0614 | 0615 | 0616 | 0617 | 0618 | 0619 | 0620 | 0621 | 0622 | 0623 |
| 27 | 0624 | 0625 | 0626 | 0627 | 0628 | 0629 | 0630 | 0631 | 0632 | 0633 | 0634 | 0635 | 0636 | 0637 | 0638 | 0639 |
| 28 | 0640 | 0641 | 0642 | 0643 | 0644 | 0645 | 0646 | 0647 | 0648 | 0649 | 0650 | 0651 | 0652 | 0653 | 0654 | 0655 |
| 29 | 0656 | 0657 | 0658 | 0659 | 0660 | 0661 | 0662 | 0663 | 0664 | 0665 | 0666 | 0667 | 0668 | 0669 | 0670 | 0671 |
| 2A | 0672 | 0673 | 0674 | 0675 | 0676 | 0677 | 0678 | 0679 | 0680 | 0681 | 0682 | 0683 | 0684 | 0685 | 0686 | 0687 |
| 2B | 0688 | 0689 | 0690 | 0691 | 0692 | 0693 | 0694 | 0695 | 0696 | 0697 | 0698 | 0699 | 0700 | 0701 | 0702 | 0703 |
| 2C | 0704 | 0705 | 0706 | 0707 | 0708 | 0709 | 0710 | 0711 | 0712 | 0713 | 0714 | 0715 | 0716 | 0717 | 0718 | 0719 |
| 2D | 0720 | 0721 | 0722 | 0723 | 0724 | 0725 | 0726 | 0727 | 0728 | 0729 | 0730 | 0731 | 0732 | 0733 | 0734 | 0735 |
| 2E | 0736 | 0737 | 0738 | 0739 | 0740 | 0741 | 0742 | 0743 | 0744 | 0745 | 0746 | 0747 | 0748 | 0749 | 0750 | 0751 |
| 2F | 0752 | 0753 | 0754 | 0755 | 0756 | 0757 | 0758 | 0759 | 0760 | 0761 | 0762 | 0763 | 0764 | 0765 | 0766 | 0767 |
| 30 | 0768 | 0769 | 0770 | 0771 | 0772 | 0773 | 0774 | 0775 | 0776 | 0777 | 0778 | 0779 | 0780 | 0781 | 0782 | 0783 |
| 31 | 0784 | 0785 | 0786 | 0787 | 0788 | 0789 | 0790 | 0791 | 0792 | 0793 | 0794 | 0795 | 0796 | 0797 | 0798 | 0799 |
| 32 | 0800 | 0801 | 0802 | 0803 | 0804 | 0805 | 0806 | 0807 | 0808 | 0809 | 0810 | 0811 | 0812 | 0813 | 0814 | 0815 |
| 33 | 0816 | 0817 | 0818 | 0819 | 0820 | 0821 | 0822 | 0823 | 0824 | 0825 | 0826 | 0827 | 0828 | 0829 | 0830 | 0831 |
| 34 | 0832 | 0833 | 0834 | 0835 | 0836 | 0837 | 0838 | 0839 | 0840 | 0841 | 0842 | 0843 | 0844 | 0845 | 0846 | 0847 |
| 35 | 0848 | 0849 | 0850 | 0851 | 0852 | 0853 | 0854 | 0855 | 0856 | 0857 | 0858 | 0859 | 0860 | 0861 | 0862 | 0863 |
| 36 | 0864 | 0865 | 0866 | 0867 | 0868 | 0869 | 0870 | 0871 | 0872 | 0873 | 0874 | 0875 | 0876 | 0877 | 0878 | 0879 |
| 37 | 0880 | 0881 | 0882 | 0883 | 0884 | 0885 | 0886 | 0887 | 0888 | 0889 | 0890 | 0891 | 0892 | 0893 | 0894 | 0895 |
| 38 | 0896 | 0897 | 0898 | 0899 | 0900 | 0901 | 0902 | 0903 | 0904 | 0905 | 0906 | 0907 | 0908 | 0909 | 0910 | 0911 |
| 39 | 0912 | 0913 | 0914 | 0915 | 0916 | 0917 | 0918 | 0919 | 0920 | 0921 | 0922 | 0923 | 0924 | 0925 | 0926 | 0927 |
| 3A | 0928 | 0929 | 0930 | 0931 | 0932 | 0933 | 0934 | 0935 | 0936 | 0937 | 0938 | 0939 | 0940 | 0941 | 0942 | 0943 |
| 3B | 0944 | 0945 | 0946 | 0947 | 0948 | 0949 | 0950 | 0951 | 0952 | 0953 | 0954 | 0955 | 0956 | 0957 | 0958 | 0959 |
| 3C | 0960 | 0961 | 0962 | 0963 | 0964 | 0965 | 0966 | 0967 | 0968 | 0969 | 0970 | 0971 | 0972 | 0973 | 0974 | 0975 |
| 3D | 0976 | 0977 | 0978 | 0979 | 0980 | 0981 | 0982 | 0983 | 0984 | 0985 | 0986 | 0987 | 0988 | 0989 | 0990 | 0991 |
| 3E | 0992 | 0993 | 0994 | 0995 | 0996 | 0997 | 0998 | 0999 | 1000 | 1001 | 1002 | 1003 | 1004 | 1005 | 1006 | 1007 |
| 3F | 1008 | 1009 | 1010 | 1011 | 1012 | 1013 | 1014 | 1015 | 1016 | 1017 | 1018 | 1019 | 1020 | 1021 | 1022 | 1023 |

| | 0 | 1 | 2 | 3 | 4 | 5 | 6 | 7 | 8 | 9 | A | B | C | D | E | F |
|----|------|------|------|------|------|------|------|------|------|------|------|------|------|------|------|------|
| 40 | 1024 | 1025 | 1026 | 1027 | 1028 | 1029 | 1030 | 1031 | 1032 | 1033 | 1034 | 1035 | 1036 | 1037 | 1038 | 1039 |
| 41 | 1040 | 1041 | 1042 | 1043 | 1044 | 1045 | 1046 | 1047 | 1048 | 1049 | 1050 | 1051 | 1052 | 1053 | 1054 | 1055 |
| 42 | 1056 | 1057 | 1058 | 1059 | 1060 | 1061 | 1062 | 1063 | 1064 | 1065 | 1066 | 1067 | 1068 | 1069 | 1070 | 1071 |
| 43 | 1072 | 1073 | 1074 | 1075 | 1076 | 1077 | 1078 | 1079 | 1080 | 1081 | 1082 | 1083 | 1084 | 1085 | 1086 | 1087 |
| 44 | 1088 | 1089 | 1090 | 1091 | 1092 | 1093 | 1094 | 1095 | 1096 | 1097 | 1098 | 1099 | 1100 | 1101 | 1102 | 1103 |
| 45 | 1104 | 1105 | 1106 | 1107 | 1108 | 1109 | 1110 | 1111 | 1112 | 1113 | 1114 | 1115 | 1116 | 1117 | 1118 | 1119 |
| 46 | 1120 | 1121 | 1122 | 1123 | 1124 | 1125 | 1126 | 1127 | 1128 | 1129 | 1130 | 1131 | 1132 | 1133 | 1134 | 1135 |
| 47 | 1136 | 1137 | 1138 | 1139 | 1140 | 1141 | 1142 | 1143 | 1144 | 1145 | 1146 | 1147 | 1148 | 1149 | 1150 | 1151 |
| 48 | 1152 | 1153 | 1154 | 1155 | 1156 | 1157 | 1158 | 1159 | 1160 | 1161 | 1162 | 1163 | 1164 | 1165 | 1166 | 1167 |
| 49 | 1168 | 1169 | 1170 | 1171 | 1172 | 1173 | 1174 | 1175 | 1176 | 1177 | 1178 | 1179 | 1180 | 1181 | 1182 | 1183 |
| 4A | 1184 | 1185 | 1186 | 1187 | 1188 | 1189 | 1190 | 1191 | 1192 | 1193 | 1194 | 1195 | 1196 | 1197 | 1198 | 1199 |
| 4B | 1200 | 1201 | 1202 | 1203 | 1204 | 1205 | 1206 | 1207 | 1208 | 1209 | 1210 | 1211 | 1212 | 1213 | 1214 | 1215 |
| 4C | 1216 | 1217 | 1218 | 1219 | 1220 | 1221 | 1222 | 1223 | 1224 | 1225 | 1226 | 1227 | 1228 | 1229 | 1230 | 1231 |
| 4D | 1232 | 1233 | 1234 | 1235 | 1236 | 1237 | 1238 | 1239 | 1240 | 1241 | 1242 | 1243 | 1244 | 1245 | 1246 | 1247 |
| 4E | 1248 | 1249 | 1250 | 1251 | 1252 | 1253 | 1254 | 1255 | 1256 | 1257 | 1258 | 1259 | 1260 | 1261 | 1262 | 1263 |
| 4F | 1264 | 1265 | 1266 | 1267 | 1268 | 1269 | 1270 | 1271 | 1272 | 1273 | 1274 | 1275 | 1276 | 1277 | 1278 | 1279 |
| 50 | 1280 | 1281 | 1282 | 1283 | 1284 | 1285 | 1286 | 1287 | 1288 | 1289 | 1290 | 1291 | 1292 | 1293 | 1294 | 1295 |
| 51 | 1296 | 1297 | 1298 | 1299 | 1300 | 1301 | 1302 | 1303 | 1304 | 1305 | 1306 | 1307 | 1308 | 1309 | 1310 | 1311 |
| 52 | 1312 | 1313 | 1314 | 1315 | 1316 | 1317 | 1318 | 1319 | 1320 | 1321 | 1322 | 1323 | 1324 | 1325 | 1326 | 1327 |
| 53 | 1328 | 1329 | 1330 | 1331 | 1332 | 1333 | 1334 | 1335 | 1336 | 1337 | 1338 | 1339 | 1340 | 1341 | 1342 | 1343 |
| 54 | 1344 | 1345 | 1346 | 1347 | 1348 | 1349 | 1350 | 1351 | 1352 | 1353 | 1354 | 1355 | 1356 | 1357 | 1358 | 1359 |
| 55 | 1360 | 1361 | 1362 | 1363 | 1364 | 1365 | 1366 | 1367 | 1368 | 1369 | 1370 | 1371 | 1372 | 1373 | 1374 | 1375 |
| 56 | 1376 | 1377 | 1378 | 1379 | 1380 | 1381 | 1382 | 1383 | 1384 | 1385 | 1386 | 1387 | 1388 | 1389 | 1390 | 1391 |
| 57 | 1392 | 1393 | 1394 | 1395 | 1396 | 1397 | 1398 | 1399 | 1400 | 1401 | 1402 | 1403 | 1404 | 1405 | 1406 | 1407 |
| 58 | 1408 | 1409 | 1410 | 1411 | 1412 | 1413 | 1414 | 1415 | 1416 | 1417 | 1418 | 1419 | 1420 | 1421 | 1422 | 1423 |
| 59 | 1424 | 1425 | 1426 | 1427 | 1428 | 1429 | 1430 | 1431 | 1432 | 1433 | 1434 | 1435 | 1436 | 1437 | 1438 | 1439 |
| 5A | 1440 | 1441 | 1442 | 1443 | 1444 | 1445 | 1446 | 1447 | 1448 | 1449 | 1450 | 1451 | 1452 | 1453 | 1454 | 1455 |
| 5B | 1456 | 1457 | 1458 | 1459 | 1460 | 1461 | 1462 | 1463 | 1464 | 1465 | 1466 | 1467 | 1468 | 1469 | 1470 | 1471 |
| 5C | 1472 | 1473 | 1474 | 1475 | 1476 | 1477 | 1478 | 1479 | 1480 | 1481 | 1482 | 1483 | 1484 | 1485 | 1486 | 1487 |
| 5D | 1488 | 1489 | 1490 | 1491 | 1492 | 1493 | 1494 | 1495 | 1496 | 1497 | 1498 | 1499 | 1500 | 1501 | 1502 | 1503 |
| 5E | 1504 | 1505 | 1506 | 1507 | 1508 | 1509 | 1510 | 1511 | 1512 | 1513 | 1514 | 1515 | 1516 | 1517 | 1518 | 1519 |
| 5F | 1520 | 1521 | 1522 | 1523 | 1524 | 1525 | 1526 | 1527 | 1528 | 1529 | 1530 | 1531 | 1532 | 1533 | 1534 | 1535 |

11314

| | 0 | 1 | 2 | 3 | 4 | 5 | 6 | 7 | 8 | 9 | A | B | C | D | E | F |
|----|------|------|------|------|------|------|------|------|------|------|------|------|------|------|------|------|
| 60 | 1536 | 1537 | 1538 | 1539 | 1540 | 1541 | 1542 | 1543 | 1544 | 1545 | 1546 | 1547 | 1548 | 1549 | 1550 | 1551 |
| 61 | 1552 | 1553 | 1554 | 1555 | 1556 | 1557 | 1558 | 1559 | 1560 | 1561 | 1562 | 1563 | 1564 | 1565 | 1566 | 1567 |
| 62 | 1568 | 1569 | 1570 | 1571 | 1572 | 1573 | 1574 | 1575 | 1576 | 1577 | 1578 | 1579 | 1580 | 1581 | 1582 | 1583 |
| 63 | 1584 | 1585 | 1586 | 1587 | 1588 | 1589 | 1590 | 1591 | 1592 | 1593 | 1594 | 1595 | 1596 | 1597 | 1598 | 1599 |
| 64 | 1600 | 1601 | 1602 | 1603 | 1604 | 1605 | 1606 | 1607 | 1608 | 1609 | 1610 | 1611 | 1612 | 1613 | 1614 | 1615 |
| 65 | 1616 | 1617 | 1618 | 1619 | 1620 | 1621 | 1622 | 1623 | 1624 | 1625 | 1626 | 1627 | 1628 | 1629 | 1630 | 1631 |
| 66 | 1632 | 1633 | 1634 | 1635 | 1636 | 1637 | 1638 | 1639 | 1640 | 1641 | 1642 | 1643 | 1644 | 1645 | 1646 | 1647 |
| 67 | 1648 | 1649 | 1650 | 1651 | 1652 | 1653 | 1654 | 1655 | 1656 | 1657 | 1658 | 1659 | 1660 | 1661 | 1662 | 1663 |
| 68 | 1664 | 1665 | 1666 | 1667 | 1668 | 1669 | 1670 | 1671 | 1672 | 1673 | 1674 | 1675 | 1676 | 1677 | 1678 | 1679 |
| 69 | 1680 | 1681 | 1682 | 1683 | 1684 | 1685 | 1686 | 1687 | 1688 | 1689 | 1690 | 1691 | 1692 | 1693 | 1694 | 1695 |
| 6A | 1696 | 1697 | 1698 | 1699 | 1700 | 1701 | 1702 | 1703 | 1704 | 1705 | 1706 | 1707 | 1708 | 1709 | 1710 | 1711 |
| 6B | 1712 | 1713 | 1714 | 1715 | 1716 | 1717 | 1718 | 1719 | 1720 | 1721 | 1722 | 1723 | 1724 | 1725 | 1726 | 1727 |
| 6C | 1728 | 1729 | 1730 | 1731 | 1732 | 1733 | 1734 | 1735 | 1736 | 1737 | 1738 | 1739 | 1740 | 1741 | 1742 | 1743 |
| 6D | 1744 | 1745 | 1746 | 1747 | 1748 | 1749 | 1750 | 1751 | 1752 | 1753 | 1754 | 1755 | 1756 | 1757 | 1758 | 1759 |
| 6E | 1760 | 1761 | 1762 | 1763 | 1764 | 1765 | 1766 | 1767 | 1768 | 1769 | 1770 | 1771 | 1772 | 1773 | 1774 | 1775 |
| 6F | 1776 | 1777 | 1778 | 1779 | 1780 | 1781 | 1782 | 1783 | 1784 | 1785 | 1786 | 1787 | 1788 | 1789 | 1790 | 1791 |
| 70 | 1792 | 1793 | 1794 | 1795 | 1796 | 1797 | 1798 | 1799 | 1800 | 1801 | 1802 | 1803 | 1804 | 1805 | 1806 | 1807 |
| 71 | 1808 | 1809 | 1810 | 1811 | 1812 | 1813 | 1814 | 1815 | 1816 | 1817 | 1818 | 1819 | 1820 | 1821 | 1822 | 1823 |
| 72 | 1824 | 1825 | 1826 | 1827 | 1828 | 1829 | 1830 | 1831 | 1832 | 1833 | 1834 | 1835 | 1836 | 1837 | 1838 | 1839 |
| 73 | 1840 | 1841 | 1842 | 1843 | 1844 | 1845 | 1846 | 1847 | 1848 | 1849 | 1850 | 1851 | 1852 | 1853 | 1854 | 1855 |
| 74 | 1856 | 1857 | 1858 | 1859 | 1860 | 1861 | 1862 | 1863 | 1864 | 1865 | 1866 | 1867 | 1868 | 1869 | 1870 | 1871 |
| 75 | 1872 | 1873 | 1874 | 1875 | 1876 | 1877 | 1878 | 1879 | 1880 | 1881 | 1882 | 1883 | 1884 | 1885 | 1886 | 1887 |
| 76 | 1888 | 1889 | 1890 | 1891 | 1892 | 1893 | 1894 | 1895 | 1896 | 1897 | 1898 | 1899 | 1900 | 1901 | 1902 | 1903 |
| 77 | 1904 | 1905 | 1906 | 1907 | 1908 | 1909 | 1910 | 1911 | 1912 | 1913 | 1914 | 1915 | 1916 | 1917 | 1918 | 1919 |
| 78 | 1920 | 1921 | 1922 | 1923 | 1924 | 1925 | 1926 | 1927 | 1928 | 1929 | 1930 | 1931 | 1932 | 1933 | 1934 | 1935 |
| 79 | 1936 | 1937 | 1938 | 1939 | 1940 | 1941 | 1942 | 1943 | 1944 | 1945 | 1946 | 1947 | 1948 | 1949 | 1950 | 1951 |
| 7A | 1952 | 1953 | 1954 | 1955 | 1956 | 1957 | 1958 | 1959 | 1960 | 1961 | 1962 | 1963 | 1964 | 1965 | 1966 | 1967 |
| 7B | 1968 | 1969 | 1970 | 1971 | 1972 | 1973 | 1974 | 1975 | 1976 | 1977 | 1978 | 1979 | 1980 | 1981 | 1982 | 1983 |
| 7C | 1984 | 1985 | 1986 | 1987 | 1988 | 1989 | 1990 | 1991 | 1992 | 1993 | 1994 | 1995 | 1996 | 1997 | 1998 | 1999 |
| 7D | 2000 | 2001 | 2002 | 2003 | 2004 | 2005 | 2006 | 2007 | 2008 | 2009 | 2010 | 2011 | 2012 | 2013 | 2014 | 2015 |
| 7E | 2016 | 2017 | 2018 | 2019 | 2020 | 2021 | 2022 | 2023 | 2024 | 2025 | 2026 | 2027 | 2028 | 2029 | 2030 | 2031 |
| 7F | 2032 | 2033 | 2034 | 2035 | 2036 | 2037 | 2038 | 2039 | 2040 | 2041 | 2042 | 2043 | 2044 | 2045 | 2046 | 2047 |

| | 0 | 1 | 2 | 3 | 4 | 5 | 6 | 7 | 8 | 9 | A | B | C | D | E | F |
|----|------|------|------|------|------|------|------|------|------|------|------|------|------|------|------|------|
| 80 | 2048 | 2049 | 2050 | 2051 | 2052 | 2053 | 2054 | 2055 | 2056 | 2057 | 2058 | 2059 | 2060 | 2061 | 2062 | 2063 |
| 81 | 2064 | 2065 | 2066 | 2067 | 2068 | 2069 | 2070 | 2071 | 2072 | 2073 | 2074 | 2075 | 2076 | 2077 | 2078 | 2079 |
| 82 | 2080 | 2081 | 2082 | 2083 | 2084 | 2085 | 2086 | 2087 | 2088 | 2089 | 2090 | 2091 | 2092 | 2093 | 2094 | 2095 |
| 83 | 2096 | 2097 | 2098 | 2099 | 2100 | 2101 | 2102 | 2103 | 2104 | 2105 | 2106 | 2107 | 2108 | 2109 | 2110 | 2111 |
| 84 | 2112 | 2113 | 2114 | 2115 | 2116 | 2117 | 2118 | 2119 | 2120 | 2121 | 2122 | 2123 | 2124 | 2125 | 2126 | 2127 |
| 85 | 2128 | 2129 | 2130 | 2131 | 2132 | 2133 | 2134 | 2135 | 2136 | 2137 | 2138 | 2139 | 2140 | 2141 | 2142 | 2143 |
| 86 | 2144 | 2145 | 2146 | 2147 | 2148 | 2149 | 2150 | 2151 | 2152 | 2153 | 2154 | 2155 | 2156 | 2157 | 2158 | 2159 |
| 87 | 2160 | 2161 | 2162 | 2163 | 2164 | 2165 | 2166 | 2167 | 2168 | 2169 | 2170 | 2171 | 2172 | 2173 | 2174 | 2175 |
| 88 | 2176 | 2177 | 2178 | 2179 | 2180 | 2181 | 2182 | 2183 | 2184 | 2185 | 2186 | 2187 | 2188 | 2189 | 2190 | 2191 |
| 89 | 2192 | 2193 | 2194 | 2195 | 2196 | 2197 | 2198 | 2199 | 2200 | 2201 | 2202 | 2203 | 2204 | 2205 | 2206 | 2207 |
| 8A | 2208 | 2209 | 2210 | 2211 | 2212 | 2213 | 2214 | 2215 | 2216 | 2217 | 2218 | 2219 | 2220 | 2221 | 2222 | 2223 |
| 8B | 2224 | 2225 | 2226 | 2227 | 2228 | 2229 | 2230 | 2231 | 2232 | 2233 | 2234 | 2235 | 2236 | 2237 | 2238 | 2239 |
| 8C | 2240 | 2241 | 2242 | 2243 | 2244 | 2245 | 2246 | 2247 | 2248 | 2249 | 2250 | 2251 | 2252 | 2253 | 2254 | 2255 |
| 8D | 2256 | 2257 | 2258 | 2259 | 2260 | 2261 | 2262 | 2263 | 2264 | 2265 | 2266 | 2267 | 2268 | 2269 | 2270 | 2271 |
| 8E | 2272 | 2273 | 2274 | 2275 | 2276 | 2277 | 2278 | 2279 | 2280 | 2281 | 2282 | 2283 | 2284 | 2285 | 2286 | 2287 |
| 8F | 2288 | 2289 | 2290 | 2291 | 2292 | 2293 | 2294 | 2295 | 2296 | 2297 | 2298 | 2299 | 2300 | 2301 | 2302 | 2303 |
| 90 | 2304 | 2305 | 2306 | 2307 | 2308 | 2309 | 2310 | 2311 | 2312 | 2313 | 2314 | 2315 | 2316 | 2317 | 2318 | 2319 |
| 91 | 2320 | 2321 | 2322 | 2323 | 2324 | 2325 | 2326 | 2327 | 2328 | 2329 | 2330 | 2331 | 2332 | 2333 | 2334 | 2335 |
| 92 | 2336 | 2337 | 2338 | 2339 | 2340 | 2341 | 2342 | 2343 | 2344 | 2345 | 2346 | 2347 | 2348 | 2349 | 2350 | 2351 |
| 93 | 2352 | 2353 | 2354 | 2355 | 2356 | 2357 | 2358 | 2359 | 2360 | 2361 | 2362 | 2363 | 2364 | 2365 | 2366 | 2367 |
| 94 | 2368 | 2369 | 2370 | 2371 | 2372 | 2373 | 2374 | 2375 | 2376 | 2377 | 2378 | 2379 | 2380 | 2381 | 2382 | 2383 |
| 95 | 2384 | 2385 | 2386 | 2387 | 2388 | 2389 | 2390 | 2391 | 2392 | 2393 | 2394 | 2395 | 2396 | 2397 | 2398 | 2399 |
| 96 | 2400 | 2401 | 2402 | 2403 | 2404 | 2405 | 2406 | 2407 | 2408 | 2409 | 2410 | 2411 | 2412 | 2413 | 2414 | 2415 |
| 97 | 2416 | 2417 | 2418 | 2419 | 2420 | 2421 | 2422 | 2423 | 2424 | 2425 | 2426 | 2427 | 2428 | 2429 | 2430 | 2431 |
| 98 | 2432 | 2433 | 2434 | 2435 | 2436 | 2437 | 2438 | 2439 | 2440 | 2441 | 2442 | 2443 | 2444 | 2445 | 2446 | 2447 |
| 99 | 2448 | 2449 | 2450 | 2451 | 2452 | 2453 | 2454 | 2455 | 2456 | 2457 | 2458 | 2459 | 2460 | 2461 | 2462 | 2463 |
| 9A | 2464 | 2465 | 2466 | 2467 | 2468 | 2469 | 2470 | 2471 | 2472 | 2473 | 2474 | 2475 | 2476 | 2477 | 2478 | 2479 |
| 9B | 2480 | 2481 | 2482 | 2483 | 2484 | 2485 | 2486 | 2487 | 2488 | 2489 | 2490 | 2491 | 2492 | 2493 | 2494 | 2495 |
| 9C | 2496 | 2497 | 2498 | 2499 | 2500 | 2501 | 2502 | 2503 | 2504 | 2505 | 2506 | 2507 | 2508 | 2509 | 2510 | 2511 |
| 9D | 2512 | 2513 | 2514 | 2515 | 2516 | 2517 | 2518 | 2519 | 2520 | 2521 | 2522 | 2523 | 2524 | 2525 | 2526 | 2527 |
| 9E | 2528 | 2529 | 2530 | 2531 | 2532 | 2533 | 2534 | 2535 | 2536 | 2537 | 2538 | 2539 | 2540 | 2541 | 2542 | 2543 |
| 9F | 2544 | 2545 | 2546 | 2547 | 2548 | 2549 | 2550 | 2551 | 2552 | 2553 | 2554 | 2555 | 2556 | 2557 | 2558 | 2559 |

| | 0 | 1 | 2 | 3 | 4 | 5 | 6 | 7 | 8 | 9 | A | B | C | D | E | F |
|------|------|------|------|------|------|------|------|------|------|------|------|------|------|------|------|------|
| A0 - | 2560 | 2561 | 2562 | 2563 | 2564 | 2565 | 2566 | 2567 | 2568 | 2569 | 2570 | 2571 | 2572 | 2573 | 2574 | 2575 |
| A1 - | 2576 | 2577 | 2578 | 2579 | 2580 | 2581 | 2582 | 2583 | 2584 | 2585 | 2586 | 2587 | 2588 | 2589 | 2590 | 2591 |
| A2 - | 2592 | 2593 | 2594 | 2595 | 2596 | 2597 | 2598 | 2599 | 2600 | 2601 | 2602 | 2603 | 2604 | 2605 | 2606 | 2607 |
| A3 - | 2608 | 2609 | 2610 | 2611 | 2612 | 2613 | 2614 | 2615 | 2616 | 2617 | 2618 | 2619 | 2620 | 2621 | 2622 | 2623 |
| A4 - | 2624 | 2625 | 2626 | 2627 | 2628 | 2629 | 2630 | 2631 | 2632 | 2633 | 2634 | 2635 | 2636 | 2637 | 2638 | 2639 |
| A5 - | 2640 | 2641 | 2642 | 2643 | 2644 | 2645 | 2646 | 2647 | 2648 | 2649 | 2650 | 2651 | 2652 | 2653 | 2654 | 2655 |
| A6 - | 2656 | 2657 | 2658 | 2659 | 2660 | 2661 | 2662 | 2663 | 2664 | 2665 | 2666 | 2667 | 2668 | 2669 | 2670 | 2671 |
| A7 - | 2672 | 2673 | 2674 | 2675 | 2676 | 2677 | 2678 | 2679 | 2680 | 2681 | 2682 | 2683 | 2684 | 2685 | 2686 | 2687 |
| A8 - | 2688 | 2689 | 2690 | 2691 | 2692 | 2693 | 2694 | 2695 | 2696 | 2697 | 2698 | 2699 | 2700 | 2701 | 2702 | 2703 |
| A9 - | 2704 | 2705 | 2706 | 2707 | 2708 | 2709 | 2710 | 2711 | 2712 | 2713 | 2714 | 2715 | 2716 | 2717 | 2718 | 2719 |
| AA - | 2720 | 2721 | 2722 | 2723 | 2724 | 2725 | 2726 | 2727 | 2728 | 2729 | 2730 | 2731 | 2732 | 2733 | 2734 | 2735 |
| AB - | 2736 | 2737 | 2738 | 2739 | 2740 | 2741 | 2742 | 2743 | 2744 | 2745 | 2746 | 2747 | 2748 | 2749 | 2750 | 2751 |
| AC - | 2752 | 2753 | 2754 | 2755 | 2756 | 2757 | 2758 | 2759 | 2760 | 2761 | 2762 | 2763 | 2764 | 2765 | 2766 | 2767 |
| AD - | 2768 | 2769 | 2770 | 2771 | 2772 | 2773 | 2774 | 2775 | 2776 | 2777 | 2778 | 2779 | 2780 | 2781 | 2782 | 2783 |
| AE - | 2784 | 2785 | 2786 | 2787 | 2788 | 2789 | 2790 | 2791 | 2792 | 2793 | 2794 | 2795 | 2796 | 2797 | 2798 | 2799 |
| AF - | 2800 | 2801 | 2802 | 2803 | 2804 | 2805 | 2806 | 2807 | 2808 | 2809 | 2810 | 2811 | 2812 | 2813 | 2814 | 2815 |
| B0 - | 2816 | 2817 | 2818 | 2819 | 2820 | 2821 | 2822 | 2823 | 2824 | 2825 | 2826 | 2827 | 2828 | 2829 | 2830 | 2831 |
| B1 - | 2832 | 2833 | 2834 | 2835 | 2836 | 2837 | 2838 | 2839 | 2840 | 2841 | 2842 | 2843 | 2844 | 2845 | 2846 | 2847 |
| B2 - | 2848 | 2849 | 2850 | 2851 | 2852 | 2853 | 2854 | 2855 | 2856 | 2857 | 2858 | 2859 | 2860 | 2861 | 2862 | 2863 |
| B3 - | 2864 | 2865 | 2866 | 2867 | 2868 | 2869 | 2870 | 2871 | 2872 | 2873 | 2874 | 2875 | 2876 | 2877 | 2878 | 2879 |
| B4 - | 2880 | 2881 | 2882 | 2883 | 2884 | 2885 | 2886 | 2887 | 2888 | 2889 | 2890 | 2891 | 2892 | 2893 | 2894 | 2895 |
| B5 - | 2896 | 2897 | 2898 | 2899 | 2900 | 2901 | 2902 | 2903 | 2904 | 2905 | 2906 | 2907 | 2908 | 2909 | 2910 | 2911 |
| B6 - | 2912 | 2913 | 2914 | 2915 | 2916 | 2917 | 2918 | 2919 | 2920 | 2921 | 2922 | 2923 | 2924 | 2925 | 2926 | 2927 |
| B7 - | 2928 | 2929 | 2930 | 2931 | 2932 | 2933 | 2934 | 2935 | 2936 | 2937 | 2938 | 2939 | 2940 | 2941 | 2942 | 2943 |
| B8 - | 2944 | 2945 | 2946 | 2947 | 2948 | 2949 | 2950 | 2951 | 2952 | 2953 | 2954 | 2955 | 2956 | 2957 | 2958 | 2959 |
| B9 - | 2960 | 2961 | 2962 | 2963 | 2964 | 2965 | 2966 | 2967 | 2968 | 2969 | 2970 | 2971 | 2972 | 2973 | 2974 | 2975 |
| BA - | 2976 | 2977 | 2978 | 2979 | 2980 | 2981 | 2982 | 2983 | 2984 | 2985 | 2986 | 2987 | 2988 | 2989 | 2990 | 2991 |
| BB - | 2992 | 2993 | 2994 | 2995 | 2996 | 2997 | 2998 | 2999 | 3000 | 3001 | 3002 | 3003 | 3004 | 3005 | 3006 | 3007 |
| BC - | 3008 | 3009 | 3010 | 3011 | 3012 | 3013 | 3014 | 3015 | 3016 | 3017 | 3018 | 3019 | 3020 | 3021 | 3022 | 3023 |
| BD - | 3024 | 3025 | 3026 | 3027 | 3028 | 3029 | 3030 | 3031 | 3032 | 3033 | 3034 | 3035 | 3036 | 3037 | 3038 | 3039 |
| BE - | 3040 | 3041 | 3042 | 3043 | 3044 | 3045 | 3046 | 3047 | 3048 | 3049 | 3050 | 3051 | 3052 | 3053 | 3054 | 3055 |
| BF - | 3056 | 3057 | 3058 | 3059 | 3060 | 3061 | 3062 | 3063 | 3064 | 3065 | 3066 | 3067 | 3068 | 3069 | 3070 | 3071 |

| | 0 | 1 | 2 | 3 | 4 | 5 | 6 | 7 | 8 | 9 | A | B | C | D | E | F |
|------|------|------|------|------|------|------|------|------|------|------|------|------|------|------|------|------|
| C0 - | 3072 | 3073 | 3074 | 3075 | 3076 | 3077 | 3078 | 3079 | 3080 | 3081 | 3082 | 3083 | 3084 | 3085 | 3086 | 3087 |
| C1 - | 3088 | 3089 | 3090 | 3091 | 3092 | 3093 | 3094 | 3095 | 3096 | 3097 | 3098 | 3099 | 3100 | 3101 | 3102 | 3103 |
| C2 - | 3104 | 3105 | 3106 | 3107 | 3108 | 3109 | 3110 | 3111 | 3112 | 3113 | 3114 | 3115 | 3116 | 3117 | 3118 | 3119 |
| C3 - | 3120 | 3121 | 3122 | 3123 | 3124 | 3125 | 3126 | 3127 | 3128 | 3129 | 3130 | 3131 | 3132 | 3133 | 3134 | 3135 |
| C4 - | 3136 | 3137 | 3138 | 3139 | 3140 | 3141 | 3142 | 3143 | 3144 | 3145 | 3146 | 3147 | 3148 | 3149 | 3150 | 3151 |
| C5 - | 3152 | 3153 | 3154 | 3155 | 3156 | 3157 | 3158 | 3159 | 3160 | 3161 | 3162 | 3163 | 3164 | 3165 | 3166 | 3167 |
| C6 - | 3168 | 3169 | 3170 | 3171 | 3172 | 3173 | 3174 | 3175 | 3176 | 3177 | 3178 | 3179 | 3180 | 3181 | 3182 | 3183 |
| C7 - | 3184 | 3185 | 3186 | 3187 | 3188 | 3189 | 3190 | 3191 | 3192 | 3193 | 3194 | 3195 | 3196 | 3197 | 3198 | 3199 |
| C8 - | 3200 | 3201 | 3202 | 3203 | 3204 | 3205 | 3206 | 3207 | 3208 | 3209 | 3210 | 3211 | 3212 | 3213 | 3214 | 3215 |
| C9 - | 3216 | 3217 | 3218 | 3219 | 3220 | 3221 | 3222 | 3223 | 3224 | 3225 | 3226 | 3227 | 3228 | 3229 | 3230 | 3231 |
| CA - | 3232 | 3233 | 3234 | 3235 | 3236 | 3237 | 3238 | 3239 | 3240 | 3241 | 3242 | 3243 | 3244 | 3245 | 3246 | 3247 |
| CB - | 3248 | 3249 | 3250 | 3251 | 3252 | 3253 | 3254 | 3255 | 3256 | 3257 | 3258 | 3259 | 3260 | 3261 | 3262 | 3263 |
| CC - | 3264 | 3265 | 3266 | 3267 | 3268 | 3269 | 3270 | 3271 | 3272 | 3273 | 3274 | 3275 | 3276 | 3277 | 3278 | 3279 |
| CD - | 3280 | 3281 | 3282 | 3283 | 3284 | 3285 | 3286 | 3287 | 3288 | 3289 | 3290 | 3291 | 3292 | 3293 | 3294 | 3295 |
| CE - | 3296 | 3297 | 3298 | 3299 | 3300 | 3301 | 3302 | 3303 | 3304 | 3305 | 3306 | 3307 | 3308 | 3309 | 3310 | 3311 |
| CF - | 3312 | 3313 | 3314 | 3315 | 3316 | 3317 | 3318 | 3319 | 3320 | 3321 | 3322 | 3323 | 3324 | 3325 | 3326 | 3327 |
| D0 - | 3328 | 3329 | 3330 | 3331 | 3332 | 3333 | 3334 | 3335 | 3336 | 3337 | 3338 | 3339 | 3340 | 3341 | 3342 | 3343 |
| D1 - | 3344 | 3345 | 3346 | 3347 | 3348 | 3349 | 3350 | 3351 | 3352 | 3353 | 3354 | 3355 | 3356 | 3357 | 3358 | 3359 |
| D2 - | 3360 | 3361 | 3362 | 3363 | 3364 | 3365 | 3366 | 3367 | 3368 | 3369 | 3370 | 3371 | 3372 | 3373 | 3374 | 3375 |
| D3 - | 3376 | 3377 | 3378 | 3379 | 3380 | 3381 | 3382 | 3383 | 3384 | 3385 | 3386 | 3387 | 3388 | 3389 | 3390 | 3391 |
| D4 - | 3392 | 3393 | 3394 | 3395 | 3396 | 3397 | 3398 | 3399 | 3400 | 3401 | 3402 | 3403 | 3404 | 3405 | 3406 | 3407 |
| D5 - | 3408 | 3409 | 3410 | 3411 | 3412 | 3413 | 3414 | 3415 | 3416 | 3417 | 3418 | 3419 | 3420 | 3421 | 3422 | 3423 |
| D6 - | 3424 | 3425 | 3426 | 3427 | 3428 | 3429 | 3430 | 3431 | 3432 | 3433 | 3434 | 3435 | 3436 | 3437 | 3438 | 3439 |
| D7 - | 3440 | 3441 | 3442 | 3443 | 3444 | 3445 | 3446 | 3447 | 3448 | 3449 | 3450 | 3451 | 3452 | 3453 | 3454 | 3455 |
| D8 - | 3456 | 3457 | 3458 | 3459 | 3460 | 3461 | 3462 | 3463 | 3464 | 3465 | 3466 | 3467 | 3468 | 3469 | 3470 | 3471 |
| D9 - | 3472 | 3473 | 3474 | 3475 | 3476 | 3477 | 3478 | 3479 | 3480 | 3481 | 3482 | 3483 | 3484 | 3485 | 3486 | 3487 |
| DA - | 3488 | 3489 | 3490 | 3491 | 3492 | 3493 | 3494 | 3495 | 3496 | 3497 | 3498 | 3499 | 3500 | 3501 | 3502 | 3503 |
| DB - | 3504 | 3505 | 3506 | 3507 | 3508 | 3509 | 3510 | 3511 | 3512 | 3513 | 3514 | 3515 | 3516 | 3517 | 3518 | 3519 |
| DC - | 3520 | 3521 | 3522 | 3523 | 3524 | 3525 | 3526 | 3527 | 3528 | 3529 | 3530 | 3531 | 3532 | 3533 | 3534 | 3535 |
| DD - | 3536 | 3537 | 3538 | 3539 | 3540 | 3541 | 3542 | 3543 | 3544 | 3545 | 3546 | 3547 | 3548 | 3549 | 3550 | 3551 |
| DE - | 3552 | 3553 | 3554 | 3555 | 3556 | 3557 | 3558 | 3559 | 3560 | 3561 | 3562 | 3563 | 3564 | 3565 | 3566 | 3567 |
| DF - | 3568 | 3569 | 3570 | 3571 | 3572 | 3573 | 3574 | 3575 | 3576 | 3577 | 3578 | 3579 | 3580 | 3581 | 3582 | 3583 |

11316

| | 0 | 1 | 2 | 3 | 4 | 5 | 6 | 7 | 8 | 9 | A | B | C | D | E | F |
|----|------|------|------|------|------|------|------|------|------|------|------|------|------|------|------|------|
| E0 | 3584 | 3585 | 3586 | 3587 | 3588 | 3589 | 3590 | 3591 | 3592 | 3593 | 3594 | 3595 | 3596 | 3597 | 3598 | 3599 |
| E1 | 3600 | 3601 | 3602 | 3603 | 3604 | 3605 | 3606 | 3607 | 3608 | 3609 | 3610 | 3611 | 3612 | 3613 | 3614 | 3615 |
| E2 | 3616 | 3617 | 3618 | 3619 | 3620 | 3621 | 3622 | 3623 | 3624 | 3625 | 3626 | 3627 | 3628 | 3629 | 3630 | 3631 |
| E3 | 3632 | 3633 | 3634 | 3635 | 3636 | 3637 | 3638 | 3639 | 3640 | 3641 | 3642 | 3643 | 3644 | 3645 | 3646 | 3647 |
| E4 | 3648 | 3649 | 3650 | 3651 | 3652 | 3653 | 3654 | 3655 | 3656 | 3657 | 3658 | 3659 | 3660 | 3661 | 3662 | 3663 |
| E5 | 3664 | 3665 | 3666 | 3667 | 3668 | 3669 | 3670 | 3671 | 3672 | 3673 | 3674 | 3675 | 3676 | 3677 | 3678 | 3679 |
| E6 | 3680 | 3681 | 3682 | 3683 | 3684 | 3685 | 3686 | 3687 | 3688 | 3689 | 3690 | 3691 | 3692 | 3693 | 3694 | 3695 |
| E7 | 3696 | 3697 | 3698 | 3699 | 3700 | 3701 | 3702 | 3703 | 3704 | 3705 | 3706 | 3707 | 3708 | 3709 | 3710 | 3711 |
| E8 | 3712 | 3713 | 3714 | 3715 | 3716 | 3717 | 3718 | 3719 | 3720 | 3721 | 3722 | 3723 | 3724 | 3725 | 3726 | 3727 |
| E9 | 3728 | 3729 | 3730 | 3731 | 3732 | 3733 | 3734 | 3735 | 3736 | 3737 | 3738 | 3739 | 3740 | 3741 | 3742 | 3743 |
| EA | 3744 | 3745 | 3746 | 3747 | 3748 | 3749 | 3750 | 3751 | 3752 | 3753 | 3754 | 3755 | 3756 | 3757 | 3758 | 3759 |
| EB | 3760 | 3761 | 3762 | 3763 | 3764 | 3765 | 3766 | 3767 | 3768 | 3769 | 3770 | 3771 | 3772 | 3773 | 3774 | 3775 |
| EC | 3776 | 3777 | 3778 | 3779 | 3780 | 3781 | 3782 | 3783 | 3784 | 3785 | 3786 | 3787 | 3788 | 3789 | 3790 | 3791 |
| ED | 3792 | 3793 | 3794 | 3795 | 3796 | 3797 | 3798 | 3799 | 3800 | 3801 | 3802 | 3803 | 3804 | 3805 | 3806 | 3807 |
| EE | 3808 | 3809 | 3810 | 3811 | 3812 | 3813 | 3814 | 3815 | 3816 | 3817 | 3818 | 3819 | 3820 | 3821 | 3822 | 3823 |
| EF | 3824 | 3825 | 3826 | 3827 | 3828 | 3829 | 3830 | 3831 | 3832 | 3833 | 3834 | 3835 | 3836 | 3837 | 3838 | 3839 |
| F0 | 3840 | 3841 | 3842 | 3843 | 3844 | 3845 | 3846 | 3847 | 3848 | 3849 | 3850 | 3851 | 3852 | 3853 | 3854 | 3855 |
| F1 | 3856 | 3857 | 3858 | 3859 | 3860 | 3861 | 3862 | 3863 | 3864 | 3865 | 3866 | 3867 | 3868 | 3869 | 3870 | 3871 |
| F2 | 3872 | 3873 | 3874 | 3875 | 3876 | 3877 | 3878 | 3879 | 3880 | 3881 | 3882 | 3883 | 3884 | 3885 | 3886 | 3887 |
| F3 | 3888 | 3889 | 3890 | 3891 | 3892 | 3893 | 3894 | 3895 | 3896 | 3897 | 3898 | 3899 | 3900 | 3901 | 3902 | 3903 |
| F4 | 3904 | 3905 | 3906 | 3907 | 3908 | 3909 | 3910 | 3911 | 3912 | 3913 | 3914 | 3915 | 3916 | 3917 | 3918 | 3919 |
| F5 | 3920 | 3921 | 3922 | 3923 | 3924 | 3925 | 3926 | 3927 | 3928 | 3929 | 3930 | 3931 | 3932 | 3933 | 3934 | 3935 |
| F6 | 3936 | 3937 | 3938 | 3939 | 3940 | 3941 | 3942 | 3943 | 3944 | 3945 | 3946 | 3947 | 3948 | 3949 | 3950 | 3951 |
| F7 | 3952 | 3953 | 3954 | 3955 | 3956 | 3957 | 3958 | 3959 | 3960 | 3961 | 3962 | 3963 | 3964 | 3965 | 3966 | 3967 |
| F8 | 3968 | 3969 | 3970 | 3971 | 3972 | 3973 | 3974 | 3975 | 3976 | 3977 | 3978 | 3979 | 3980 | 3981 | 3982 | 3983 |
| F9 | 3984 | 3985 | 3986 | 3987 | 3988 | 3989 | 3990 | 3991 | 3992 | 3993 | 3994 | 3995 | 3996 | 3997 | 3998 | 3999 |
| FA | 4000 | 4001 | 4002 | 4003 | 4004 | 4005 | 4006 | 4007 | 4008 | 4009 | 4010 | 4011 | 4012 | 4013 | 4014 | 4015 |
| FB | 4016 | 4017 | 4018 | 4019 | 4020 | 4021 | 4022 | 4023 | 4024 | 4025 | 4026 | 4027 | 4028 | 4029 | 4030 | 4031 |
| FC | 4032 | 4033 | 4034 | 4035 | 4036 | 4037 | 4038 | 4039 | 4040 | 4041 | 4042 | 4043 | 4044 | 4045 | 4046 | 4047 |
| FD | 4048 | 4049 | 4050 | 4051 | 4052 | 4053 | 4054 | 4055 | 4056 | 4057 | 4058 | 4059 | 4060 | 4061 | 4062 | 4063 |
| FE | 4064 | 4065 | 4066 | 4067 | 4068 | 4069 | 4070 | 4071 | 4072 | 4073 | 4074 | 4075 | 4076 | 4077 | 4078 | 4079 |
| FF | 4080 | 4081 | 4082 | 4083 | 4084 | 4085 | 4086 | 4087 | 4088 | 4089 | 4090 | 4091 | 4092 | 4093 | 4094 | 4095 |

- Absolutely positioned characters, definition 12
- Alphameric keyboard:
 - Functional description 14
 - General 6, 9
 - Key code assignments 29
 - Photograph 14
 - Physical description 13
- Basic data flow and control diagram of 2250-4 8
- Branch and interrupt orders:
 - Long Branch/Interrupt 23
 - Short Branch 23
- BRIGHTNESS operator control 16
- Character control words:
 - General 6
 - New Line (NL) 12, 23
 - No Operation 13, 23
 - Null 13, 22
 - Subscript 13, 22
 - Superscript 13, 22
- Character mode:
 - Absolutely positioned character, definition 12
 - Character deflection system 11
 - Character display characteristics 12
 - Character sizes 11, 20
 - Character spacing 11, 22
 - Control words 12, 22
 - Data 18
 - Grid coordinate system 11
 - Incrementally positioned characters, definition 12
 - Line spacing 12, 13, 22
 - Orders 20
 - Positioning 12, 21
 - Revert bit 11, 21
 - Stroke subroutine 11
 - Strokes 11, 21
 - Strokes that form letter "A" 12
- Character subroutines 18, 23
- Commands:
 - No Operation 29
 - Read Status 28
 - Reset Display 29
 - Sense DSW 30
 - Sense Interrupt 30
 - Set Programmed Function Indicators 27
 - Start Regeneration 27
- Control commands 29
- Control orders:
 - Branch and interrupt 23
 - Set Pen Mode 25
 - Start Timer 25
 - Subroutine linkage 26
- Coordinate addressing system, display area 9
- Cycle steal check interrupt 32, 23, 30
- Data:
 - Definition 18
 - Stroke 21
- Data flow and control diagram, basic 8
- Defer light pen interrupts 25
- Deflection overflow 10
- Device status word (DSW) 30
- Disable light pen detects 25
- Display regeneration:
 - General information 8
 - Start Regeneration command 27
- Electron beam:
 - Blanking and unblanking 9
 - Positioning 9
- 1130 Computing System:
 - Remote configuration 5
 - Stand-alone configuration 5
 - Storage access channels (SAC and SAC II) 5, 6
- Enable light pen detects 25
- Enable light pen interrupts 25
- Error recovery procedures 32
- Examples of order usage in programs:
 - Character control words 23
 - Character generation 18
 - Conditional branch 25
 - Conditional interrupt 24
 - Incremental XY orders 20
 - Revert order 26
 - Store Revert Register order 26
- Execute I/O instruction 17
- Graphic mode:
 - General description 9
 - Orders 19
 - Positioning orders, general 10
- Graphic subroutines 18, 20, 25
- Hierarchy of graphic segments 18
- Incremental XY orders:
 - Decimal-hexadecimal conversion chart 21
 - Extended grid 10
 - Functional description 10
- Incrementally positioned characters, definition 12
- Indicators, programmed function keyboard description 16
- Indirect addressing, long Branch orders 24
- Initiate Read command 28
- Initiate Write commands 27
- Interrupts:
 - Cycle steal check 32, 23, 30
 - Keyboard 31, 30
 - Light-pen detect 32, 30
 - Order-controlled 24, 31, 30
- Keyboard Interrupt 31

Light pen:

- Functional description 13
- General 6, 9
- Inputs to 2250-4 13
- Photograph 14

Light-pen detect interrupt 32

Light Pen mode 13, 25

Line spacing, Character mode 12, 13

Long Absolute XY order 10, 19

Manual recovery procedure 32

Metering of 2250-4 16

Modes:

- Character 11, 20
- Graphic 9, 19
- Light Pen 13, 25

Multiple-level subroutines, general 18, 24, 26

New Line (NL) character control word 12, 23

No Operation:

- Character control word 13, 23
- Command 27
- Order (one word no-op) 25
- Order (two-word no op) 23

Null character control word 13, 22

Operator control (BRIGHTNBSS) 16

Order-controlled interrupt 24, 31

Orders:

- Incremental X/Y 19
- Long Absolute 19
- Long Branch/Interrupt 23
- Mnemonic listing 17
- No operation, one-word 25
- No operation, two-word 24
- Revert 26
- Set Character Mode (Basic/Large):
 - Character control words 22
 - Description 20
 - Stroke data 21
- Set Graphic Mode (Vector/Point) 19
- Set Pen Mode 25
- Short Absolute X/Y 19
- Short Branch 23
- Start Timer 25
- Store Revert Register 26

Overflow, deflection 10

Overlay, programmed function keyboard:

- Coding 29
- Description 15

Point mode 9, 19, 19

Programmed function keyboard:

- Functional description 15
- General 6, 9
- Key and overlay coding 28
- Photograph 15

Programmed recovery procedure 32

Raster unit, definition 9

Read Status command 28

Reset Display command 29

Revert order 26

Sense DSW Command 30

Sense Interrupt command 30

Set Pen Mode order 25

Set Programmed Function Indicator commands 27

Short Absolute X/Y order 10, 19

Single-level subroutines 18, 26

Special features:

- Alphameric keyboard 6, 9
- Programmed function keyboard 6, 9

Start Regeneration command 27

Start Timer Order 25

Storage access channels (SAC or SAC II):

- Store Revert Register order 26

Stroke data 21

Subroutines 18

Subscript character control word 13, 22

Superscript character control word 13, 22

2250-4:

- Channel interface section 17
- Commands 27
- Display section 8
- Functional sections 8
- General description 6
- Main deflection section 10
- Metering 16
- Operations with the 1130 27
- Orders 19
- Storage addressing 8

Vector mode 9, 10, 19

X, Y position registers:

- Contents 11
- Read Status command 28





International Business Machines Corporation
Data Processing Division
112 East Post Road, White Plains, N.Y. 10601
[USA Only]

IBM World Trade Corporation
821 United Nations Plaza, New York, New York 10017
[International]

READER'S COMMENT FORM

Form A27-2723-1

IBM 1130 Computing System Component Description
IBM 2250 Display Unit Model 4

- How did you use this publication?

As a reference source
As a classroom text
As.....

- Based on your own experience, rate this publication . . .

As a reference source:
Very Good Fair Poor Very
Good Poor

As a text:
Very Good Fair Poor Very
Good Poor

- What is your occupation?
- We would appreciate your other comments; please give specific page and line references where appropriate. If you wish a reply, be sure to include your name and address.

• Thank you for your cooperation. No postage necessary if mailed in the U.S.A.

YOUR COMMENTS PLEASE...

This SRL bulletin is one of a series which serves as reference sources for systems analysts, programmers and operators of IBM systems. Your answers to the questions on the back of this form, together with your comments, will help us produce better publications for your use. Each reply will be carefully reviewed by the persons responsible for writing and publishing this material. All comments and suggestions become the property of IBM.

Please note: Requests for copies of publications and for assistance in utilizing your IBM system should be directed to your IBM representative or to the IBM sales office serving your locality.

fold

fold

BUSINESS REPLY MAIL
NO POSTAGE NECESSARY IF MAILED IN THE UNITED STATES

FIRST CLASS
PERMIT NO. 116
KINGSTON, N.Y.



POSTAGE WILL BE PAID BY...

IBM CORPORATION
C.P.O. BOX 120
KINGSTON, N.Y. 12401

ATTENTION: PRODUCT PUBLICATIONS, DEPT. 520

fold

fold



International Business Machines Corporation
Data Processing Division
112 East Post Road, White Plains, N.Y. 10601
[USA Only]

IBM World Trade Corporation
821 United Nations Plaza, New York, New York 10017
[International]