

**Systems**

**Operator's Library:  
IBM System/370  
Model 145  
Operating Procedures**

**IBM**

**Systems**

**Operator's Library:  
IBM System/370  
Model 145  
Operating Procedures**

**IBM**

# PREFACE

This reference manual contains information necessary to operate the following units of the IBM System/370 Model 145:

- IBM 3145 Processing Unit
- IBM 3210 Console Printer-Keyboard
- IBM 3215 Console Printer-Keyboard
- Console File.

Operating information for related software and peripheral devices is not included.

The reader is assumed to have:

1. Basic computer knowledge and experience, or
2. Operated other related data processing equipment, or
3. Previous computer operating experience on a similar system.

The visual index, located at the beginning of this manual, is an aid for quickly locating the controls and indicators described in this publication.

IBM is grateful to the American National Standards Institute (ANSI) for permission to reprint its definitions from the American National Standard Vocabulary for Information Processing (Copyright © 1970 by American National Standards Institute, Incorporated), which was prepared by Subcommittee X3.5 Terminology and Glossary of American National Standards Committee X3.

*Fourth Edition (May, 1973)*

This is a major revision of, and obsoletes, GC38-0015-2 and Technical Newsletter, GN24-0508, dated November 10, 1972. Changes were made in the composition and format to improve the readability and purpose of this publication. Before using this manual, consult the latest Technical Newsletter for the editions that are applicable and current.

Requests for copies of IBM publications should be made to your IBM representative or to the IBM branch office serving your locality.

This manual has been prepared by the IBM System Products Division, Product Publications, Dept. K10, P.O. Box 6, Endicott, N. Y. 13760. A form is provided at the back of this publication for readers' comments. If the form has been removed, comments may be sent to the above address. Comments become the property of IBM.

This publication has five major sections:

- System Control Panel Indicators, Switches, and Keys  
This section describes the purpose of individual indicators, switches, and keys. It does not describe the applications of these facilities beyond normal operating procedures.
- Console File  
This section contains procedures for the handling, insertion, and removal of magnetic disk cartridges.
- Console Printer-Keyboards  
This section contains PR-KB manual operations, initial setup and operator adjustments, maintenance procedures, and descriptions of indicators and controls.
- Operating Procedures  
This section contains procedures for system operation, initialization, and error recovery.
- Handling Abnormal Situations  
This section contains flowcharts and text for your use in analyzing abnormal situations.

Associated publications are:

*IBM System/360 Disk Operating System Operator Communications and Messages*, Order No. GC24-5074.

*IBM System/360 Operating System Messages and Codes*, GC28-6631.

*IBM System/370 Model 145 Functional Characteristics*, GA24-3557.

*IBM System/360 and System/370 Bibliography*, GA22-6822.

*OS/VS Message Library: VS1 System Messages*, GC38-1001.

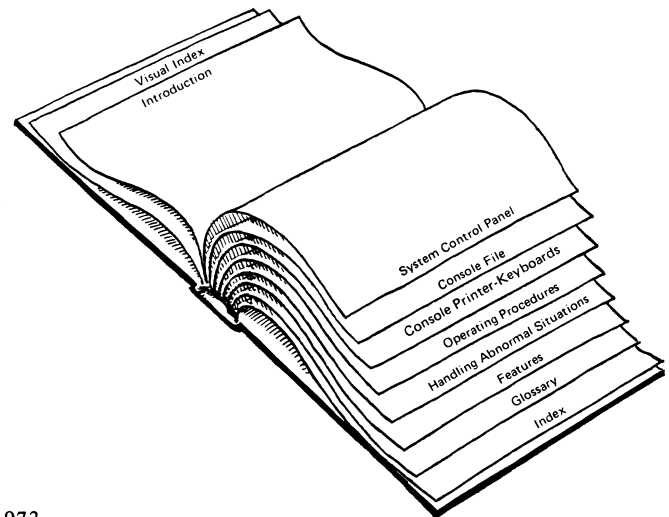

INTRODUCTION

SYSTEM CONTROL PANEL INDICATORS, SWITCHES, and KEYS

CONSOLE FILE

CONSOLE PRINTER—KEYBOARDS

OPERATING PROCEDURES

HANDLING ABNORMAL SITUATIONS

FEATURES

GLOSSARY and INDEX

# VISUAL INDEX

Numbers indicate the pages where descriptive text is found.

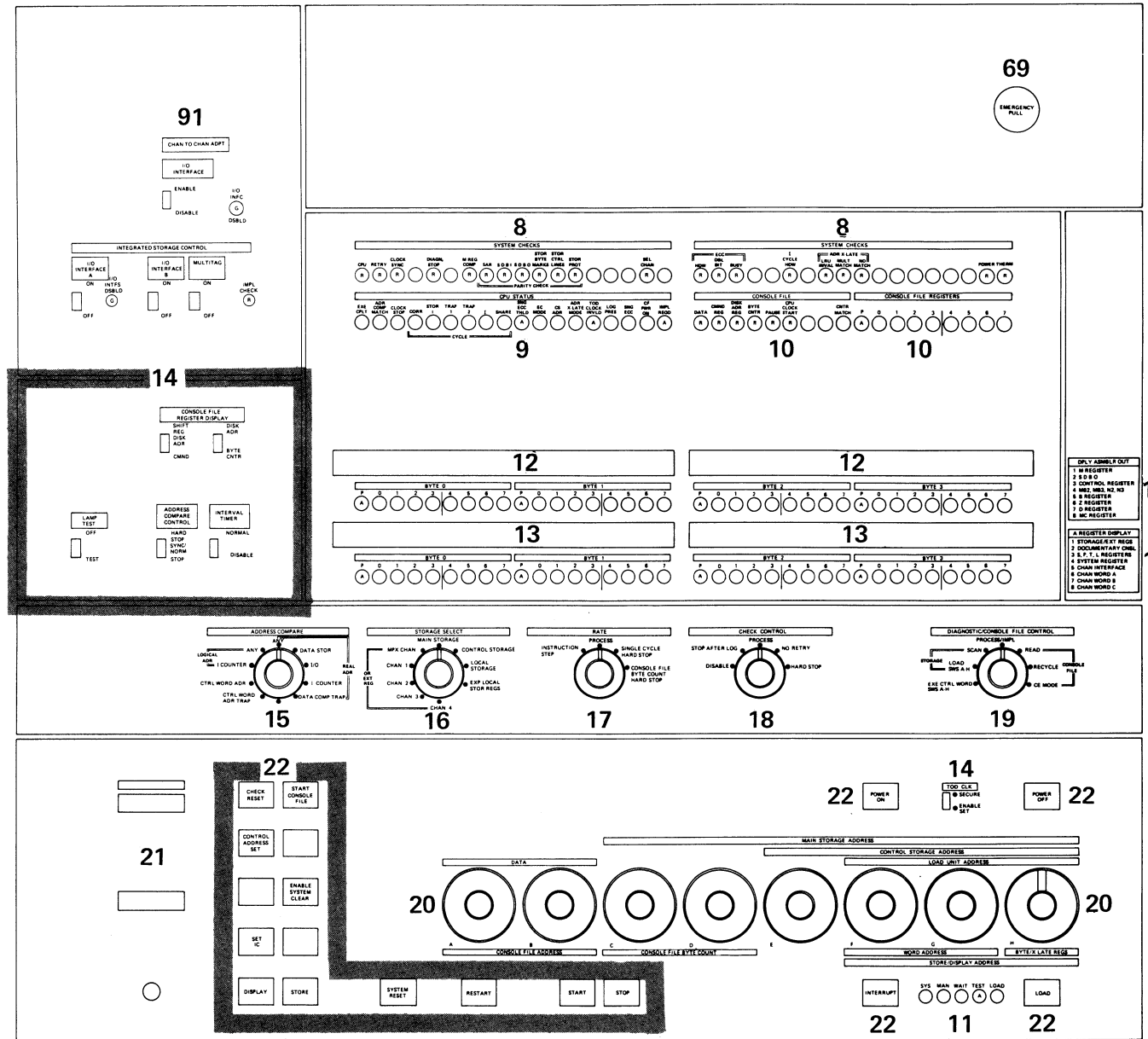

# CONTENTS

<b>Introduction</b> . . . . .	7	Forms Insertion (3215) . . . . .	38
<b>System Control Panel Indicators, Switches, and Keys</b> . . . . .	8	Platen Removal and Replacement (3215) . . . . .	38
System Check Indicators . . . . .	8	Print Element Removal and Replacement (3210) . . . . .	39
System Check Recovery . . . . .	8	Print Element Cleaning (3210) . . . . .	40
Power and Thermal Check Recovery . . . . .	8	<b>Operating Procedures</b> . . . . .	41
CPU Status Indicators . . . . .	9	Console File Cartridge Insertion and Removal . . . . .	41
Console-File Indicators . . . . .	10	Power-On Procedures . . . . .	42
System Indicators . . . . .	11	Initial Microprogram Load (IMPL) (without VS APL Assist Feature) . . . . .	45
Display Assembler Out (DPLY ASMBLR OUT) Roller Switch . . . . .	12	Initial Microprogram Load (IMPL) (with VS APL Assist Feature) . . . . .	47.1
A Register Display Roller Switch . . . . .	13	IMPL Error Recovery . . . . .	48
Toggle Switches . . . . .	14	Console Printer-Keyboard Manual Operations . . . . .	49
Address Compare Switch . . . . .	15	Initial Program Load (IPL) . . . . .	56
Storage Select Switch . . . . .	16	IPL Error Recovery . . . . .	56
Rate Switch . . . . .	17	Set IC (Instruction Counter) . . . . .	57
Check Control Switch . . . . .	18	Instruction Step . . . . .	58
Diagnostic/Console File Control Switch . . . . .	19	Clear Storage . . . . .	59
Rotary Switches A through H . . . . .	20	Data Compare Trap . . . . .	60
Use Meters . . . . .	21	Manual Store/Display Operations . . . . .	62
Keys . . . . .	22	Power-Off Procedures . . . . .	66
Features (Indicators and Switches) . . . . .	24	Emergency Pull Switch . . . . .	69
<b>Console File</b> . . . . .	26	System Test 370 (ST370) . . . . .	70
<b>Cartridge Handling</b> . . . . .	27	System Test 370 (ST370) Operating Procedures . . . . .	72
<b>Console Printer-Keyboards</b> . . . . .	28	System Error Record Editing Program (SEREP) . . . . .	77
Printer Controls (3210) . . . . .	29	<b>Handling Abnormal Situations</b> . . . . .	81
Carriage Controls (3210) . . . . .	30	Handling Abnormal Situations—Introductory Flowchart . . . . .	82
Keyboard (3210 and 3215) . . . . .	31	<b>Features</b> . . . . .	91
Control Keys and Indicators (3210 Model 1 and 3215) . . . . .	32	Integrated File Adapter (IFA) . . . . .	91
Control Keys and Indicators (3210 Model 2) . . . . .	33	Emulators . . . . .	91
Ribbon Removal and Replacement . . . . .	33	Channel-To-Channel Adapter (CTCA) . . . . .	91
Forms Insertion (3210) . . . . .	37	Integrated Storage Control (ISC) . . . . .	91
Platen Removal and Replacement (3210) . . . . .	37	<b>Glossary</b> . . . . .	92
		<b>Index</b> . . . . .	93

## ABBREVIATIONS

ACUM	accumulated	INVAL CHAR	invalid character
ADDR, ADR	address	INVLD	invalid
AM	alter main	IPL	initial program load
AP	alter PSW	ISC	integrated storage control
APL	a programming language	I/O	input or output
AV	alter virtual	LOG-PRES	logout present
CF	console file	MAN	manual
CHAN	channel	MIN	minute
CLAS	class	MS	main storage
CORR	correction	OS	operating system
CPU	central processing unit	PR-KB	printer-keyboard
CTCA	channel-to-channel adapter	PSW	program status word
CU	control unit	PWR	power
DF	display floating-point	RDY	ready
DIAGN	diagnostic	REG	register
DK	display key	REQD	required
DM	display main	SDBO	storage data bus-out
DOS	disk operating system	sec	second
DV	display virtual	SEREP	system error record editing program
EXE	execute	SL	system library
IC	instruction counter	ST370	system test 370 program
IFA	integrated file adapter	SYS	system
IMPL	initial microprogram load	SYS RES	system resident
ind	indicator	THERM	thermal
INFC DSBLD	interface disabled	TOD CLK	time-of-day clock
INTFS DSBLD	interface disabled	VS	virtual storage
INTVN REQD	intervention required		
INVAL ADDR	invalid address		

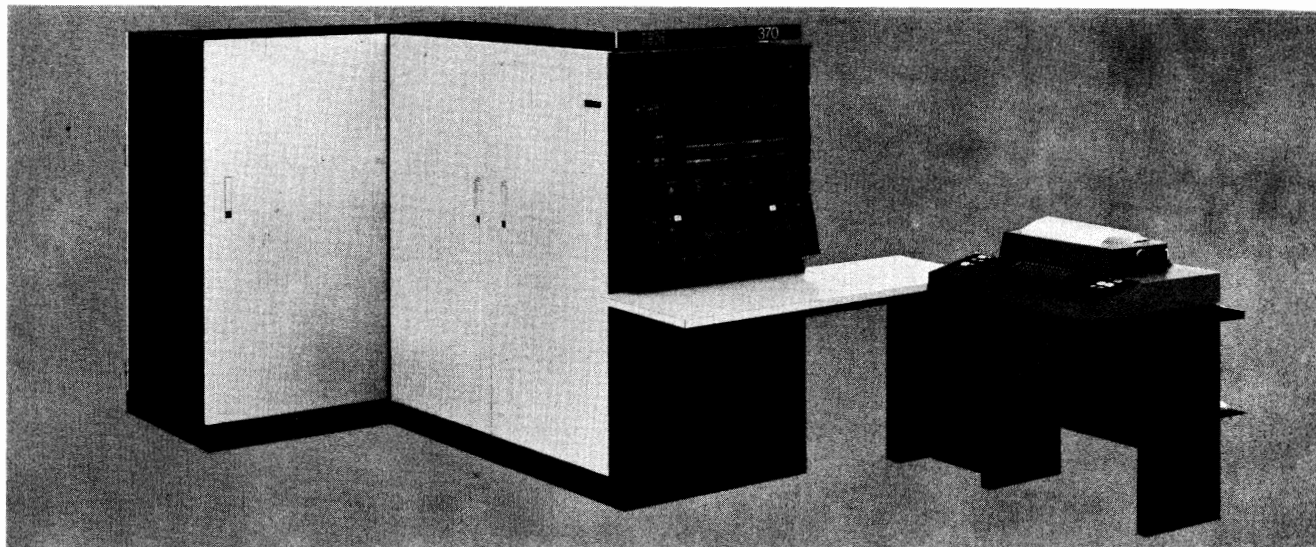

System/370 Model 145 Data Processing System

This manual contains information necessary to operate the System/370 Model 145 Processing Unit and integrated devices, except the Integrated File Adapter (IFA). Order numbers for manuals containing operating procedures for individual input/output devices can be found in the *IBM System/360 and System/370 Bibliography, GA22-6822*. Controls and indicators used only by service personnel are covered in maintenance documentation for the system.

System/370 Model 145 performs data manipulations and input/output operations by executing microprogram routines. The routines executed are determined by the machine language instruction being processed. The Initial Microprogram Load (IMPL) disk contains the 370 microprogram and is inserted into the Console File (CF) before power is applied to the system.

When power is applied to the system and the 370 microprogram is loaded into control storage, the system is ready to load the operating system (OS, DOS, etc.) or a stand-alone program. These programs are loaded by using the

Initial Program Load (IPL) procedure in this manual.

Operating procedures necessary before a problem program can be run are:

1. Disk Cartridge Insertion (IMPL disk)
2. Power-on
3. IMPL (automatic with power-on)
4. IPL the operating system (if required).

Whenever power has been removed from the system, these four procedures must be followed. When power is removed, the contents of control storage and main storage are invalid.

*To help us provide you with better documentation, please use the Reader's Comment Form in the back of this manual.*



# SYSTEM CONTROL PANEL INDICATORS, SWITCHES, and KEYS

## SYSTEM CHECK INDICATORS

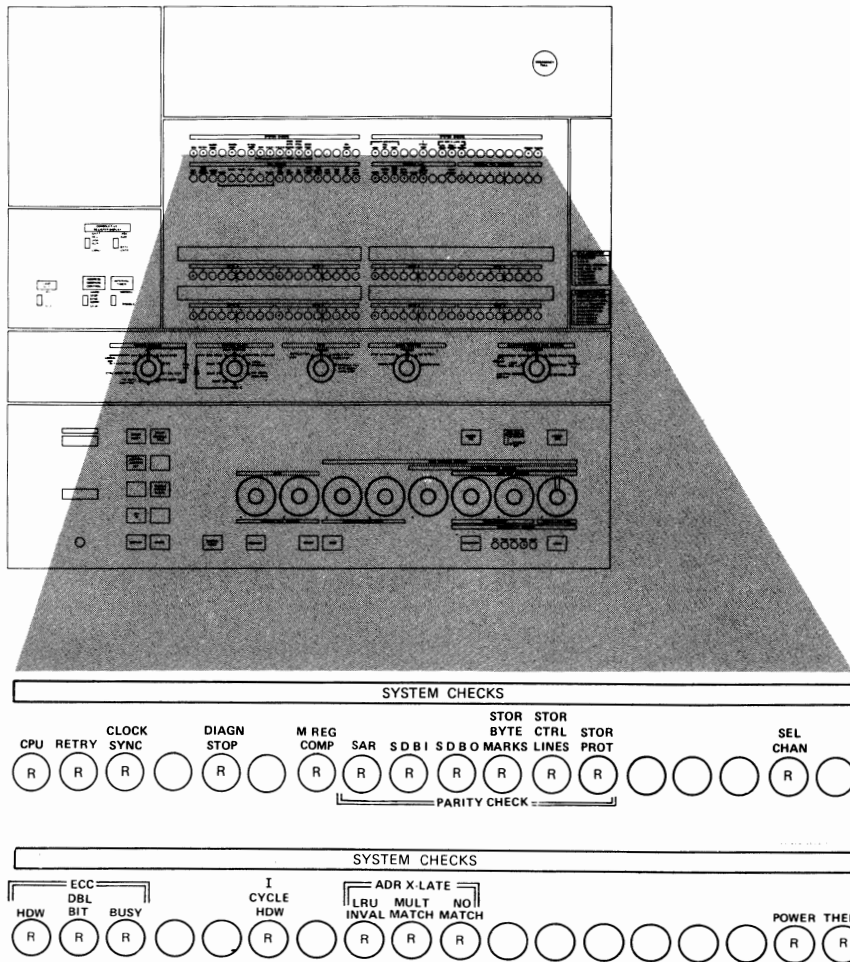

### SYSTEM CHECK RECOVERY

If a system check is indicated, re-IMPL and then re-IPL.  
If the error recurs, see "Handling Abnormal Situations--Introductory Flowchart."

### POWER and THERMAL CHECK RECOVERY

When a power supply failure or overtemperature condition occurs during a system operation, a power-off sequence occurs. The POWER check indicator on alone indicates a

power supply failure. The THERM indicator on along with the POWER check indicator indicates an overtemperature condition.

1. Press CHECK RESET key (resets the indication and allows the POWER ON key to be operative).
2. Press POWER ON key.

If the condition causing the failure was temporary, power will come up normally. If power cannot be restored, see "Handling Abnormal Situations--Introductory Flowchart."

# CPU STATUS INDICATORS

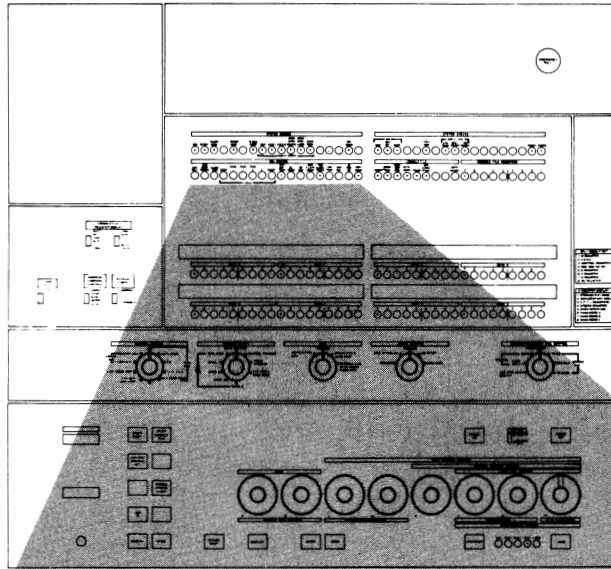

## Service Use

Indicators not described in the chart are for service personnel and are described in maintenance documentation.

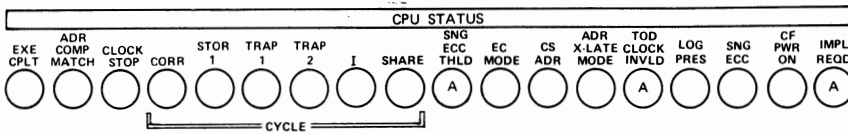

INDICATOR	CONDITION INDICATED
EXE CPLT	CPU stopped state reached as a result of: 1. Pressing the STOP key. 2. The RATE switch being in the INSTRUCTION STEP position. 3. A match being detected while in the address match mode of operation.
ADR COMP MATCH	The address (real or logical) being used to access main storage matches the address set into switches CDEFGH during an address match operation. The action taken by the CPU as a result of the match condition is controlled by the setting of the ADDRESS COMPARE CONTROL switch.
CLOCK STOP	CPU is in a hard-stop condition (CPU clock not running).
TOD CLOCK INVLD	Time-of-day clock is invalid. The indicator is turned off by successfully executing a set clock instruction.
LOG PRES	A log is present in the log area of main storage. When the CHECK CONTROL switch is in the STOP AFTER LOG position and the LOG PRES indicator is on, SEREP may be run.
SNG ECC	One of the data or check bits from storage has been corrected.
CF PWR ON	Power is applied to the console file.
IMPL REQD	An IMPL operation is required.

# CONSOLE-FILE INDICATORS

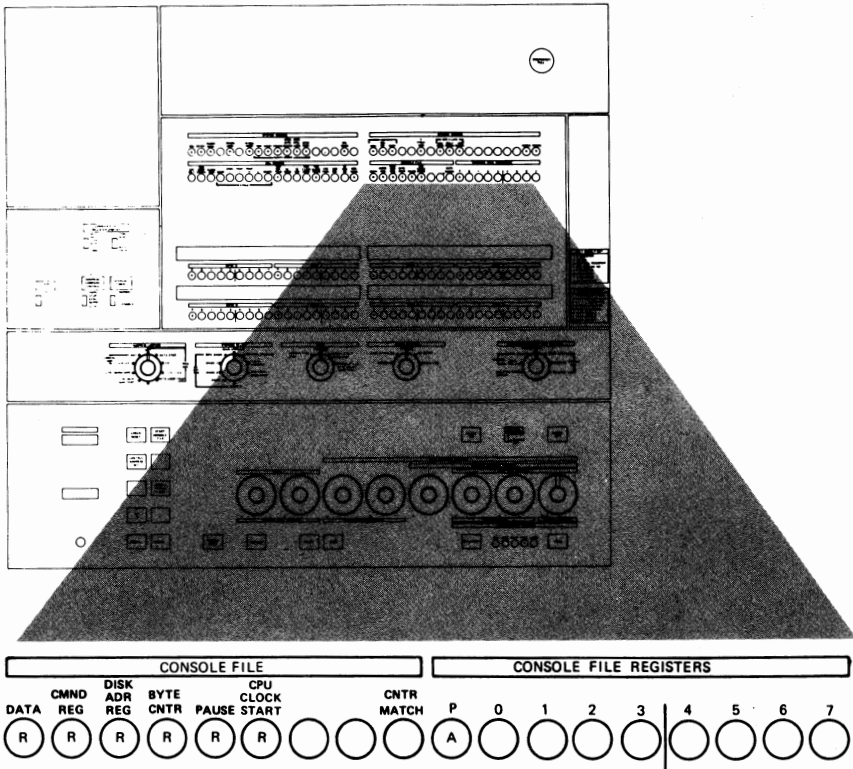

## Operator Use

### CONSOLE FILE CHECKS

Re-IMPL when any console-file check indicator is on. If the error recurs see "Handling Abnormal Situations--Introductory Flowchart."

## Service Use

### CNTR MATCH and CONSOLE FILE REGISTERS

These indicators are used by service personnel, and are described in maintenance documentation.

# SYSTEM INDICATORS

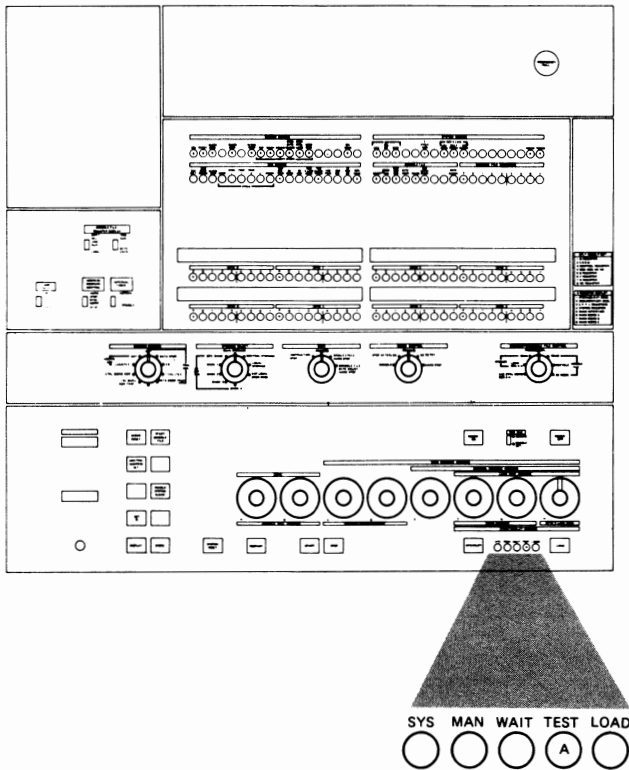

INDICATOR	CONDITION INDICATED
SYS	CPU operations are in progress and either use meter is running.
MAN	CPU clock is stopped or the system is in a soft-stop state. All pending interrupts are handled. Manual store/display operations are possible only when the MAN indicator is on.
WAIT	System is in a wait state (CPU clock running but no instruction processing taking place). If an interrupt occurs, the CPU is taken out of wait state and processing is started under control of the program being executed.
TEST	Any of the following switches are not in the PROCESS or NORMAL position. <ol style="list-style-type: none"> <li>1. RATE</li> <li>2. CHECK CONTROL</li> <li>3. DIAGNOSTIC/CONSOLE FILE CONTROL</li> <li>4. ADDRESS COMPARE CONTROL</li> </ol>
LOAD	Initial Program Load (IPL) is in process. This indicator turns on when LOAD is pressed and turns off when the initial PSW is loaded successfully.

# DISPLAY ASSEMBLER OUT (DPLY ASMBLR OUT) ROLLER SWITCH

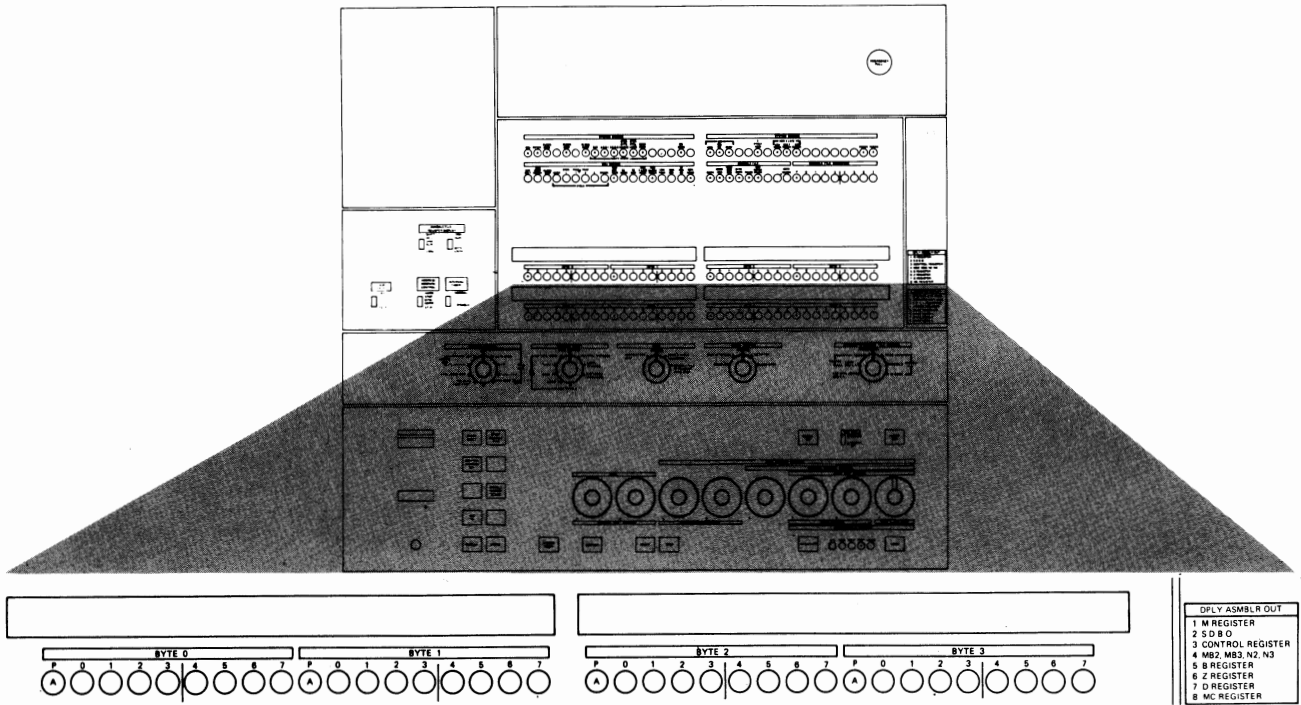

The DPLY ASMBLR OUT roller switch provides a continuous display of the following:

POSITION	INFORMATION DISPLAYED			
	Byte 0	Byte 1	Byte 2	Byte 3
1	M-Register Bytes 1, 2, and 3 (Notes 1 and 2)			
2	Storage Data Bus-Out			
3*	C-Register			
4*	MB-2	MB-3	N2	N3
5*	B-Register			
6*	Z-Register			
7*	D-Register			
8*	MCKA			
Notes:				
1. Storage protect stack key is displayed in bits 0-3 of byte 0.				
2. Bits 0-3 of byte 1 displays the selected channel.				

\*Positions 3 through 8 are for service personnel.

## A REGISTER DISPLAY ROLLER SWITCH

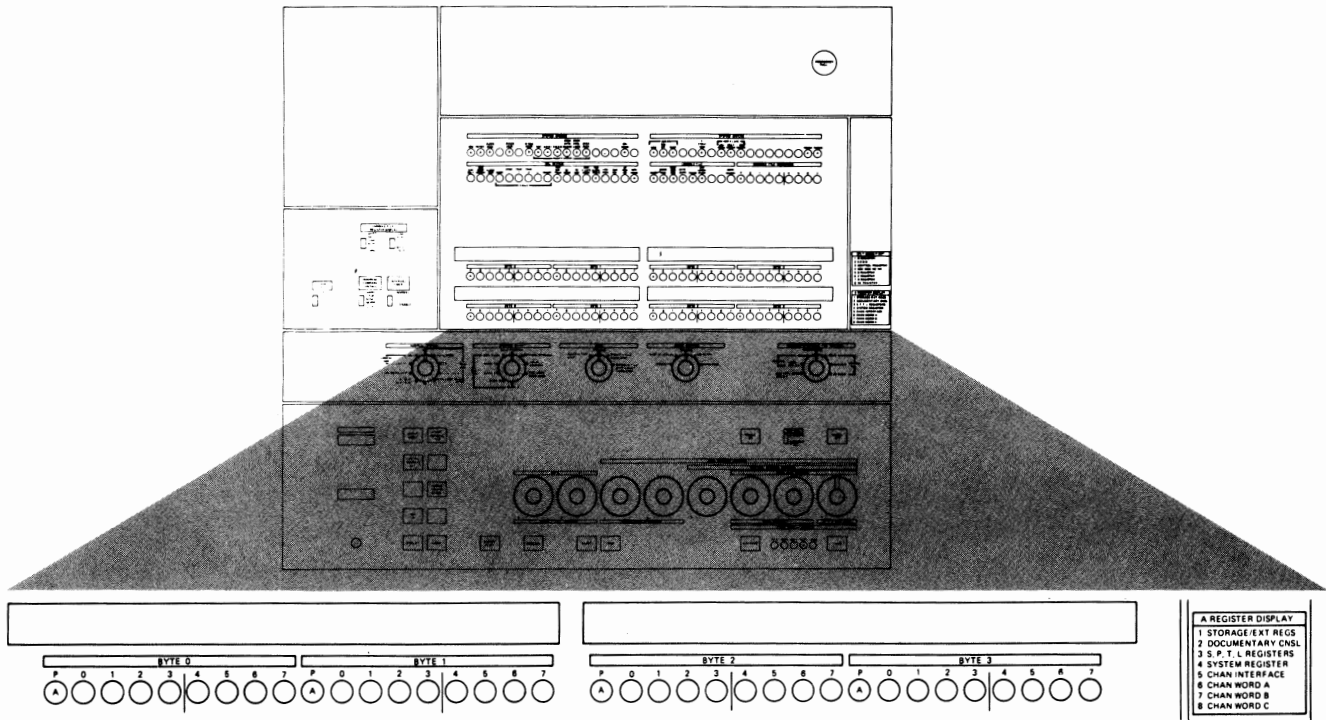

The A REGISTER DISPLAY roller switch is used with the STORAGE SELECT switch to display the following.

POSITION	INFORMATION DISPLAYED			
	Byte 0	Byte 1	Byte 2	Byte 3
1	Storage or External Register (Notes 1 and 2)			
2*	TI-Register	TA-Register	TT-Register	TE-Register
3*	S-Register	P-Register	T-Register	L-Register
4*	System Register Bytes 0, 1, and 2			H-Register
5*	MPX Channel Registers or Selector Channel External Word GTAG (IFA: FTAG)			
6*	Channel Word A (External Word GSTAT) (IFA: FSTAT)			
7*	Channel Word B (External Word GBS) (IFA: FCND)			
8*	Channel Word C (External Word GBUF) (IFA: FBAK)			
Notes:				
1. Position 1 is described in the "Manual Store/Display Operations."				
2. When the CPU is in soft-stop state (MAN indicator on), the indicators display the next instruction address.				

\* Positions 2 through 8 are for service personnel.

## TOGGLE SWITCHES

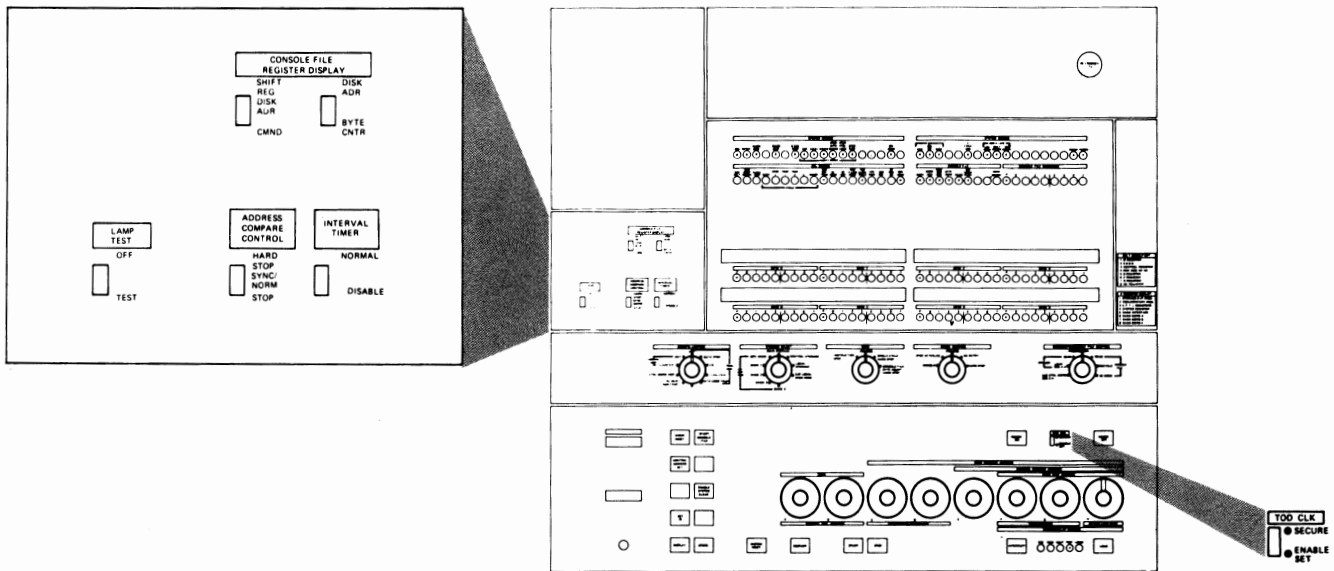

### Lamp Test

All system control-panel and PR-KB indicators should light when the LAMP TEST toggle switch is in the TEST position. This switch can be operated at any time without affecting system operation.

### Interval Timer

#### NORMAL

This position allows a value to be set into or read out of the interval timer location, main storage location 80 (hex 50).

#### DISABLE

This position disables the interval timer. The content of the timer is not available to the data flow for timer functions. Display of timer location 80 (hex 50) in this position shows the last value stored into storage location 80 (hex 50). This value could be the initial timer setting or other program information.

### Time-of-Day Clock (TOD CLK)

#### ENABLE SET

This position enables the set clock instruction to change the value of clock.

#### SECURE

This position allows executing the set clock instruction without affecting the clock value.

### Address Compare Control

This switch is used with the ADDRESS COMPARE and the STORAGE SELECT rotary switches to determine the action taken by the CPU as a result of an address compare match. The CPU should be in manual state (MAN indicator on) before using this switch. (Example: Press STOP key.)

#### SYNC/NORM

This position is the normal operating position. This position also provides a sync pulse for service use, and does not result in a stop on an address match.

#### STOP

This position provides a soft-stop whenever an address match is detected. To restart the CPU, press the START key. With the switch in this position, the TEST indicator is on.

#### HARD STOP

This position is for service personnel and is described in maintenance documentation. With the switch in this position, the TEST indicator is on.

### Console-File Register Display

These switches are used by service personnel and are described in maintenance documentation.

## ADDRESS COMPARE SWITCH

- This switch provides a match when the address used to access main storage matches the address set in rotary switches CDEFGH, and the STORAGE SELECT switch is set to the MAIN STORAGE position.
- The action taken by the CPU as a result of the match condition is determined by the ADDRESS COMPARE CONTROL toggle switch.

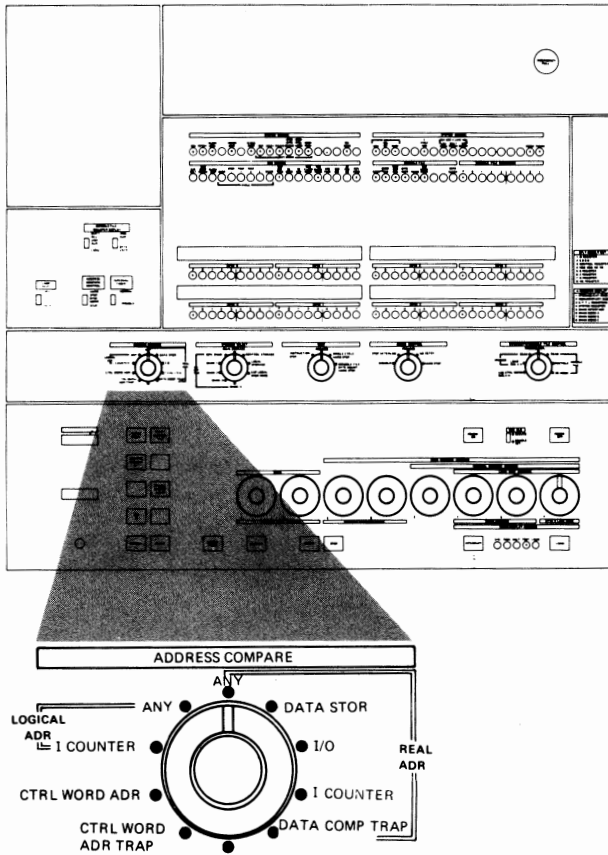

### Operator Use

#### ANY (REAL ADR)

This position is for normal program processing. With the switch in this position, a match occurs for main storage access when the storage address matches the address set in rotary switches CDEFGH.

**Note:** To guarantee a match on instruction addresses, the I-COUNTER positions must be used.

## DATA STOR

This position allows a match when the storage address matches the address set in rotary switches CDEFGH during a data store operation.

## I/O (Input/Output)

This position allows a match when the storage address matches the address set in rotary switches CDEFGH, and the operation is storing or fetching data for an I/O operation.

## I-COUNTER (REAL or LOGICAL ADR)

These positions allow a match when the real or logical main storage address matches the address in rotary switches CDEFGH, and the operation is an instruction fetch from main storage.

**Note:** Significant throughput degradation can occur while processing with this switch set to the I-COUNTER REAL ADR position, and the ADDRESS COMPARE CONTROL switch in the STOP or HARD STOP position.

## DATA COMP TRAP

This position determines which instruction is causing a particular storage byte location to be modified. See "Data Compare Trap."

## ANY (LOGICAL ADR)

This position allows a match when the logical main storage address used to access storage matches the address set in rotary switches CDEFGH.

**Note:** To guarantee a match on instruction addresses, the I-COUNTER positions must be used.

## Service Use

The switch positions not defined are for service personnel and are described in maintenance documentation.



## STORAGE SELECT SWITCH

- This switch selects the proper storage for manual store/display operations. It is also used with ADDRESS COMPARE and ADDRESS COMPARE CONTROL switches for address match functions.
- Store and display functions should be initiated from the PR-KB because that facility cannot cause concurrent I/O operations to overrun. The manual store and display functions should be used only when no I/O operation is in process or when loss of I/O information is unimportant.

## Operator Use

### MAIN STORAGE

This position is for normal program processing and for manual store and display operations of main storage.

### LOCAL STORAGE

This position is for manual store and display of general and floating-point registers.

### Service Use

The switch positions not defined are for service personnel and are described in maintenance documentation.

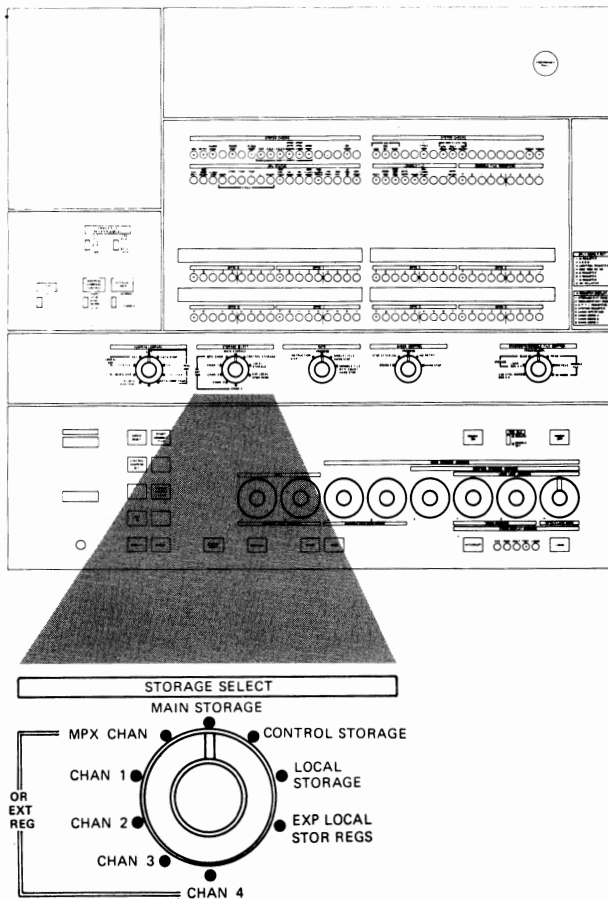

## RATE SWITCH

- This switch controls the rate at which the CPU processes instructions.
- This switch, in any position other than PROCESS, turns on the TEST indicator.

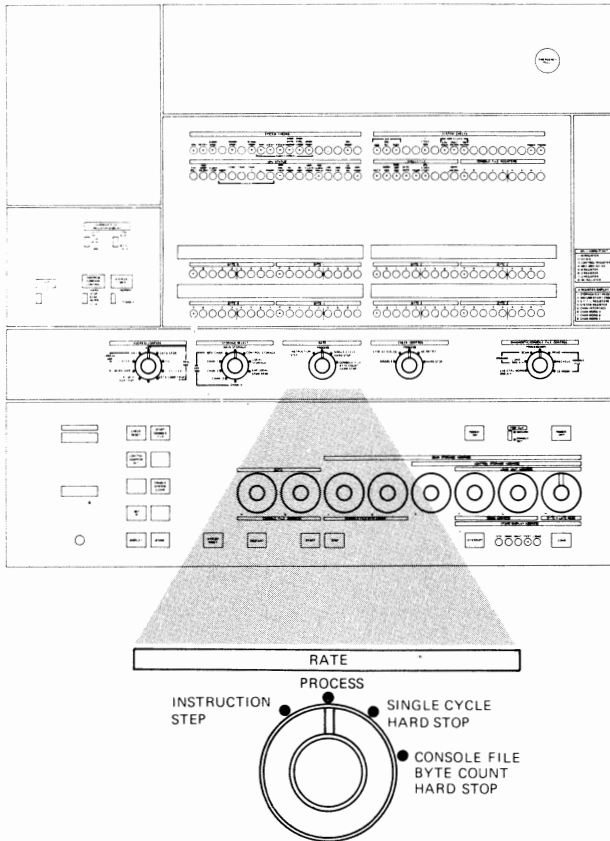

## Operator Use

### PROCESS

This position is for normal program processing.

### INSTRUCTION STEP

In this position, one complete machine language instruction (including all pending interrupts allowed by the system mask) is executed for each operation of the START key. The machine enters the soft-stop state, and the EXE CPLT indicator turns on. The address of the next instruction is displayed in the A REGISTER DISPLAY roller switch, position 1.

### Service Use

The switch positions not defined are for service personnel and are described in maintenance documentation.

## CHECK CONTROL SWITCH

- This switch controls the action taken by the CPU when a machine check occurs.
- This switch, in any position other than PROCESS, turns on the TEST indicator.

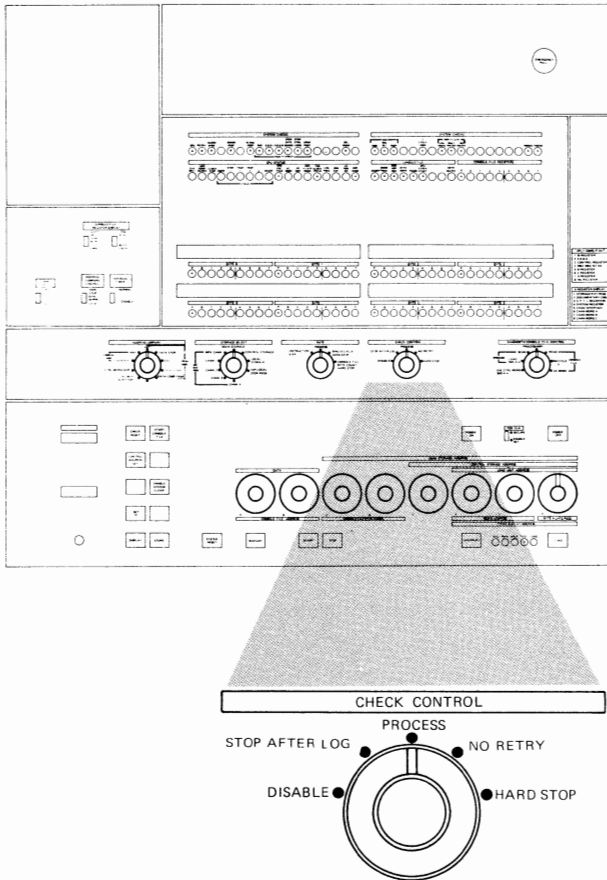

### Operator Use

#### PROCESS

This position is for normal program processing when an operating system with automatic recording of logout data is used.

#### STOP AFTER LOG

This position is for normal program processing when an operating system without automatic recording of logout data is used.

With the switch in this position, a diagnostic logout into main storage locations E8 through IFF (hexadecimal) stops processing and turns on the LOG PRES and RETRY indicators. The diagnostic logout can contain information about a machine check, channel control check, or an interface control check.

After a diagnostic logout, you may run the System Error Record Editing Program (SEREP).

Note: Programs using storage locations E8 through IFF (hexadecimal) are invalid after a diagnostic logout into main storage. To continue processing, you must re-IPL.

### Service Use

The switch positions not defined are for service personnel and are described in maintenance documentation.

## DIAGNOSTIC/CONSOLE FILE CONTROL SWITCH

- The DIAGNOSTIC/CONSOLE FILE CONTROL switch controls console-file and diagnostic functions.
- This switch, in any position other than PROCESS/IMPL, turns on the TEST indicator.

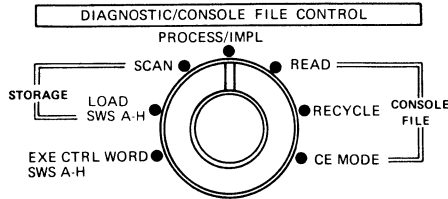
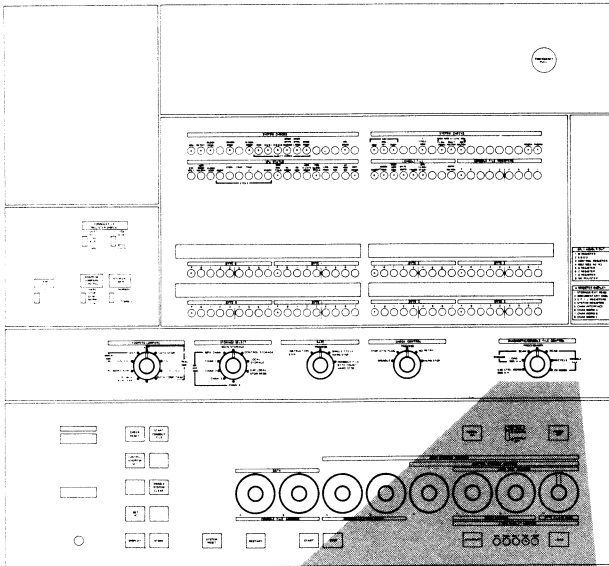

### Operator Use

#### PROCESS/IMPL

This position is for normal program processing and for loading from the console file.

### Service Use

The switch positions not defined are for service personnel and are described in maintenance documentation.

# ROTARY SWITCHES A THROUGH H

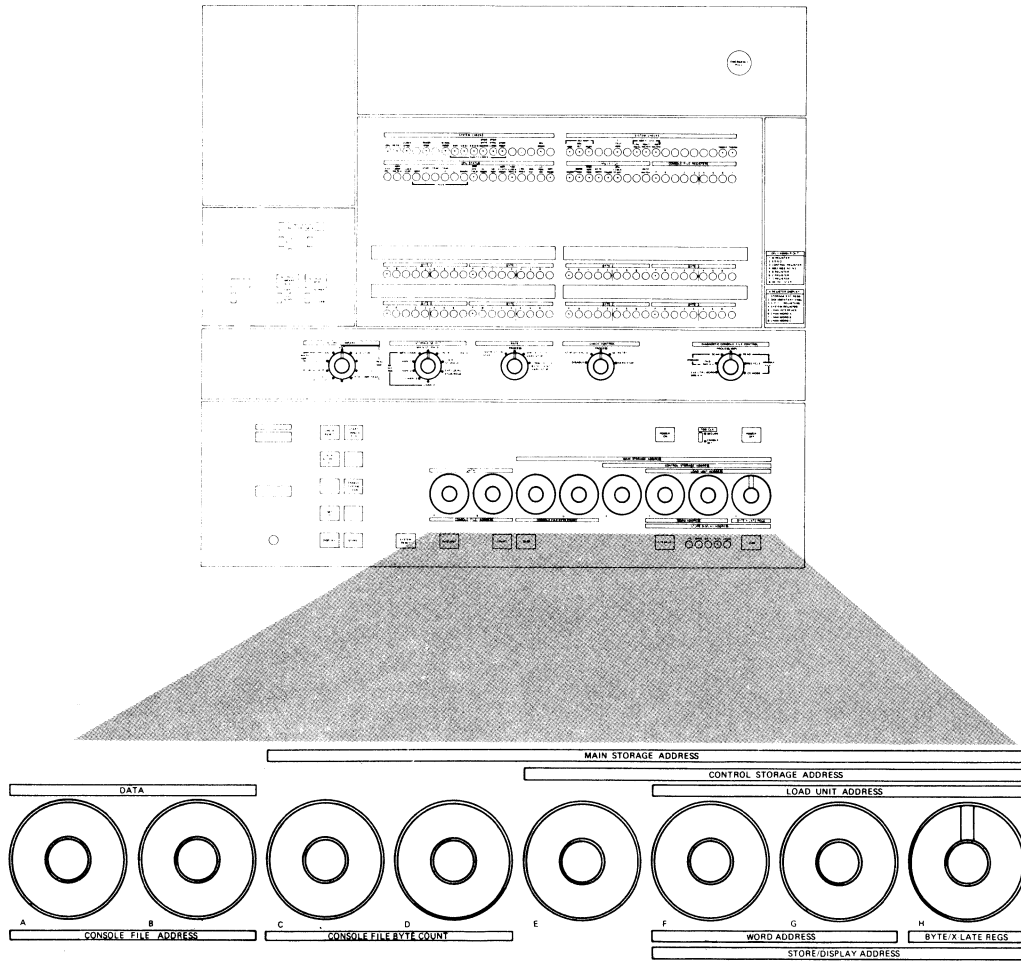

SWITCHES	LABEL	FUNCTION
AB	DATA	Specifies the value of data to be entered on manual store operations.
	CONSOLE FILE ADDRESS	For service personnel and described in maintenance documentation.
CD	CONSOLE FILE BYTE COUNT	For service personnel and described in maintenance documentation.
CDEFGH	MAIN STORAGE ADDRESS	Specifies the main storage address for manual store/display operations and for ADDRESS COMPARE switch functions.
EFGH	CONTROL STORAGE ADDRESS	For service personnel, to specify a control storage address for manual store/display and address compare functions.
FG	WORD ADDRESS	Used to display general and floating-point registers.
FGH	LOAD UNIT ADDRESS	Specifies the load-unit address for IPL operations.
FGH	STORE/DISPLAY ADDRESS	Used to store/display local storage.
H	BYTE/X-LATE REGS	Specifies the byte to be altered during manual store operations.

## USE METERS

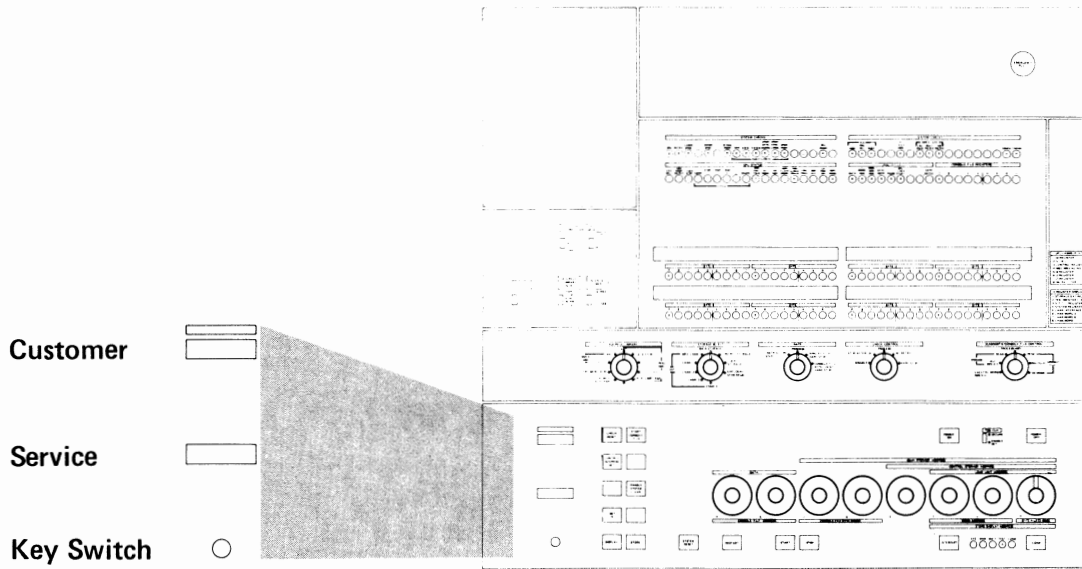

Two direct reading use meters record CPU operating time including manual store and display operations. Either meter runs for a minimum of approximately one second each time it is started. One meter records customer operating time and the other records service operating time. The position of the key switch determines which of the two meters is to record operating time. Your service representative has the key for this switch. Whenever he is performing maintenance on the CPU, he sets the switch to cause the service meter to run.



## KEYS

KEY	FUNCTION
CHECK RESET	Resets all machine check circuitry and POWER and THERM indicators.
START CONSOLE FILE	Starts a console-file read operation.
CONTROL ADDRESS SET	For service personnel; described in maintenance documentation.
ENABLE SYSTEM CLEAR	With SYSTEM RESET or LOAD key clears main storage. (See "Clear Storage.")
SET IC	Loads the contents of rotary CDEFGH into the instruction counter. Instruction processing starts from this address.
DISPLAY	Displays main store, general registers, and floating-point registers. (See "Manual Store/Display Operations.")
STORE	Stores information into main storage or registers. (See "Manual Store/Display Operations.")
SYSTEM RESET*	Resets CPU circuitry. Turns on the IMPL REQD indicator and executes system reset and resident diagnostic micro-programs to check CPU hardware.  Any error detected by system reset turns on the DIAGN STOP indicator. A successful system reset turns off the IMPL REQD indicator and places the system in a soft-stop awaiting your action.
RESTART	Stores the contents of the current PSW in address 8 (hexadecimal) and loads the doubleword starting at address 0 (hexadecimal) as the current PSW. The channels are not reset and processing starts under control of the PSW.
START	With the rotary switches in the normal or PROCESS positions, initiates CPU processing.
STOP	Soft-stops the CPU when the current instruction and pending interrupts are completed. The instruction counter is displayed in the A REGISTER DISPLAY indicators while the CPU is in the soft-stopped state.
INTERRUPT	Requests an external interrupt. The interrupt is taken if programmed and allowed by the system mask.
LOAD**	Starts an IPL operation.
POWER ON	Initiates a power-on sequence.
POWER OFF	Initiates a power-off sequence.

\*The control registers and PSW contents remain unchanged.

\*\*The control registers are set to their initial state, and the PSW is set to all zeros with valid parity.



# FEATURES (INDICATORS and SWITCHES)

## Channel-to-Channel Adapter (CTCA)

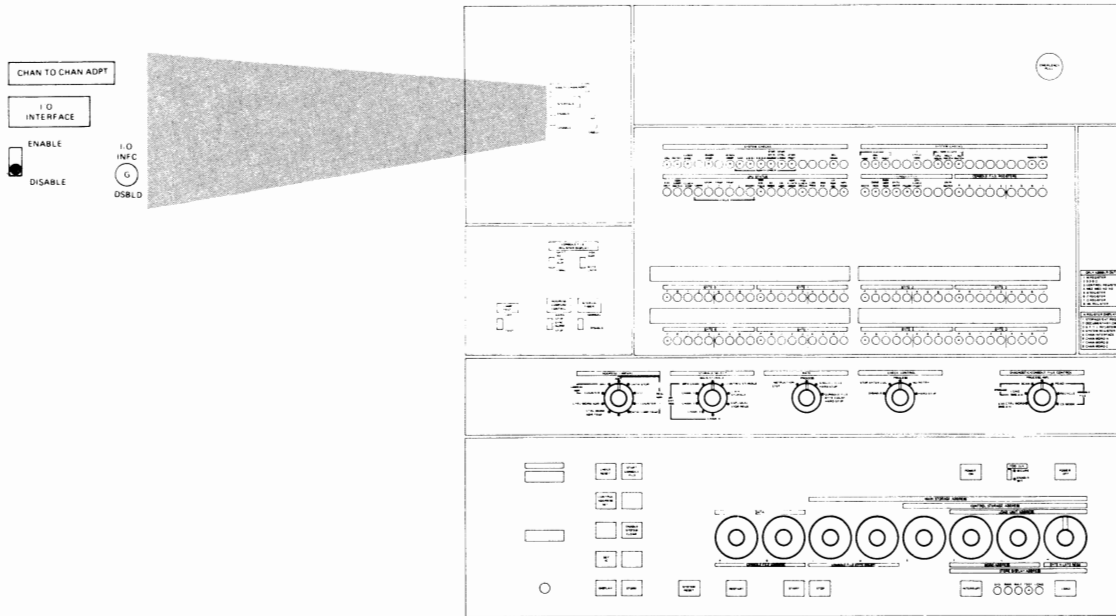

### I/O INFC DSBLD (Indicator)

**ON:** Indicates that the adapter is offline and not available to the program.

**OFF:** Indicates that the adapter is available to the program.

### I/O INTERFACE (Switch)

**ENABLE:** This position makes the adapter available to the program.

**DISABLE:** This position removes the adapter from use by the program.

## FEATURES (INDICATORS and SWITCHES)

### Integrated Storage Control (ISC)

- This feature supports a one-or-two channel application (with or without the two-channel switch special feature). If you have a single channel application, your ISC feature has one (1) function switch (I/O INTERFACE A). The I/O INTERFACE B and MULTITAG switches are non-functional. If you have a two-channel application, your ISC feature has the two-channel-switch special feature, and all feature associated switches are functional.

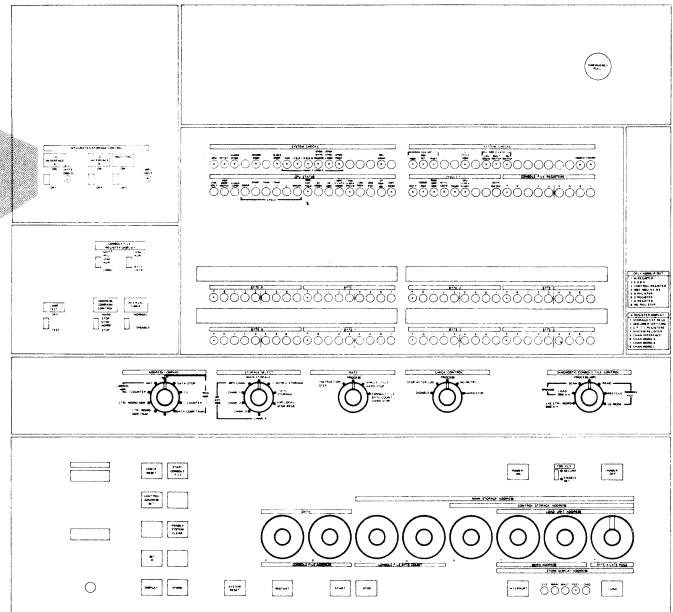
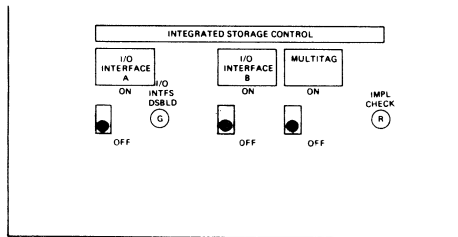

#### ISC (Two-channel switch not installed)

##### I/O INTERFACE A (Switch)

- ON:** This position makes the ISC Feature available to the program.
- OFF:** (ISC not in use) This position removes the ISC from use by the program.
- OFF:** (ISC in use) This position removes the ISC from use by the program only after the system has entered a manual state (MAN indicator on).

##### I/O INTFS DSBLD (Indicator)

- ON:** Indicates that the ISC feature is not available to the program. (I/O INTERFACE A switch is OFF.)
- OFF:** Indicates that the ISC feature is available to the program.

##### I/O INTFS DSBLD (Indicator)

- ON:** Indicates that the ISC feature is not available to any system program. (Both I/O INTERFACE A and B switches are OFF.)
- OFF:** Indicates that the ISC feature is available to the system(s) programs.

#### ISC (Two-channel switch installed)

##### I/O INTERFACE A and B (Switches)

- ON:** This position of switch A or B makes the ISC feature available to the system program using that particular channel interface.
- OFF:** (ISC not in use) This position of switch A or B removes the ISC feature from use by any system program using that particular channel interface.
- OFF:** (ISC in use) This position of switch A or B removes the ISC feature from use by the system program using that respective interface only after that system has entered a manual state (MAN indicator on).

##### MULTITAG (non-functional without two-channel switch)

- Determines how the disk drive will generate device-end.
- ON:** A drive is available after a channel clears the device-end generated by the drive.
- OFF:** A drive is available to either channel after one of the channels clears device-end generated by the drive.

##### IMPL CHECK (Indicator)

Indicates an unsuccessful IMPL operation in the ISC feature.

# CONSOLE FILE

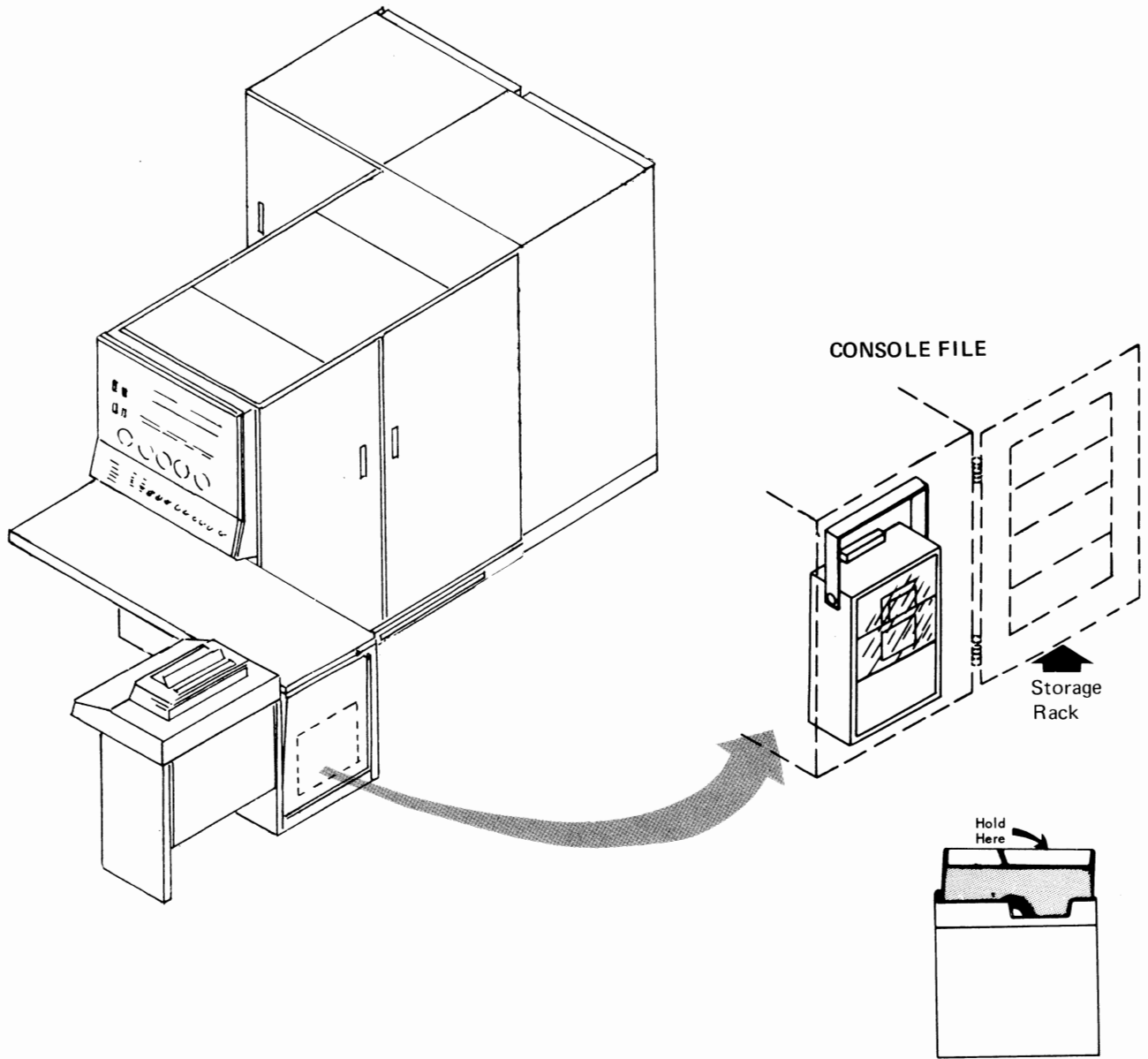

CONSOLE FILE

Storage Rack

Hold Here

DISK CARTRIDGE and ENVELOPE

## CARTRIDGE HANDLING

- The disk cartridge contains information vital to system operation which may not be easily duplicated. **HANDLE THE CARTRIDGE WITH CARE!**

### CAUTIONS

- No pens or pencils. Never write on disk cartridge. Writing pressure damages disk.

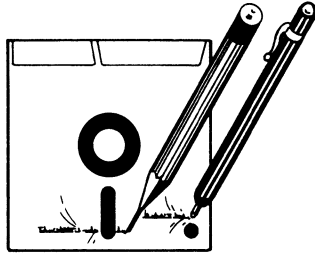

- Replace cartridge envelopes when they become worn, cracked, or distorted.



- No smoking while handling cartridges.

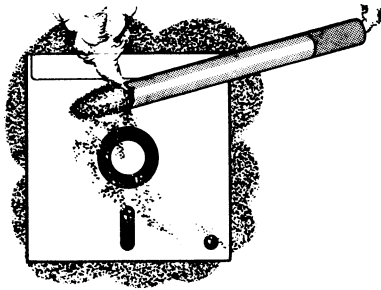

- Keep cartridge away from magnetic fields or from ferromagnetic materials which might be magnetized.

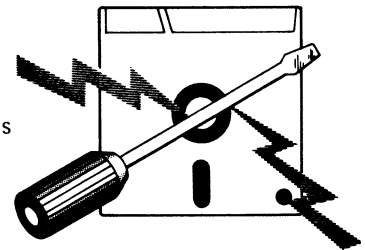

- Return cartridge to envelope whenever it is removed from the console file.

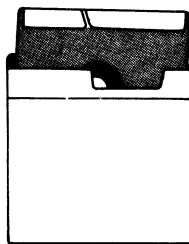

- Do not expose cartridges to heat or sunlight.

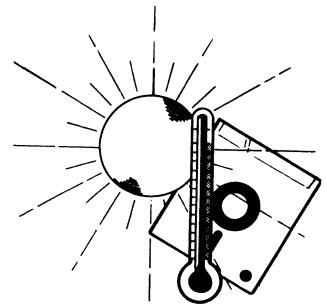

- Do not touch or clean the disk surface.

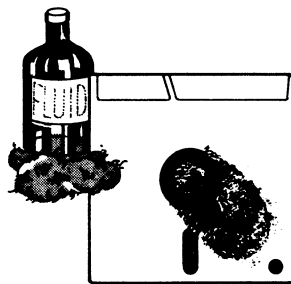

- Store cartridges in their original shipping cartons, or in the storage rack on the access door.

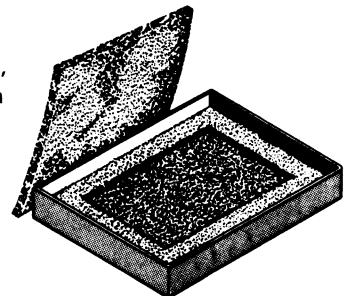

## CONSOLE PRINTER-KEYBOARDS

- The console printer-keyboard is an input/output device that provides alter/display and control functions.

### 3210 CONSOLE PRINTER-KEYBOARD MODEL 1

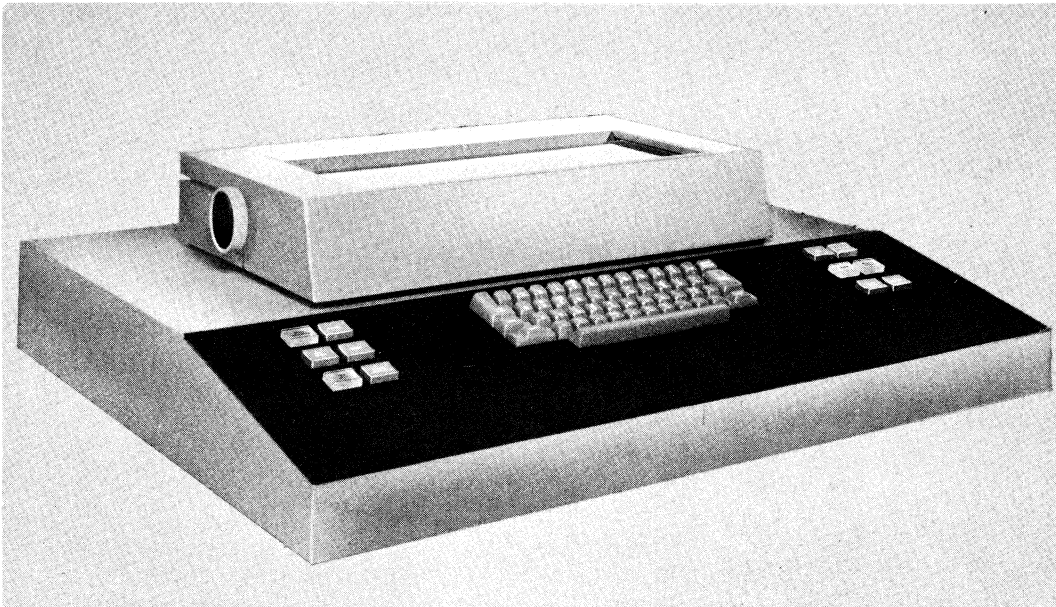

### 3215 CONSOLE PRINTER-KEYBOARD

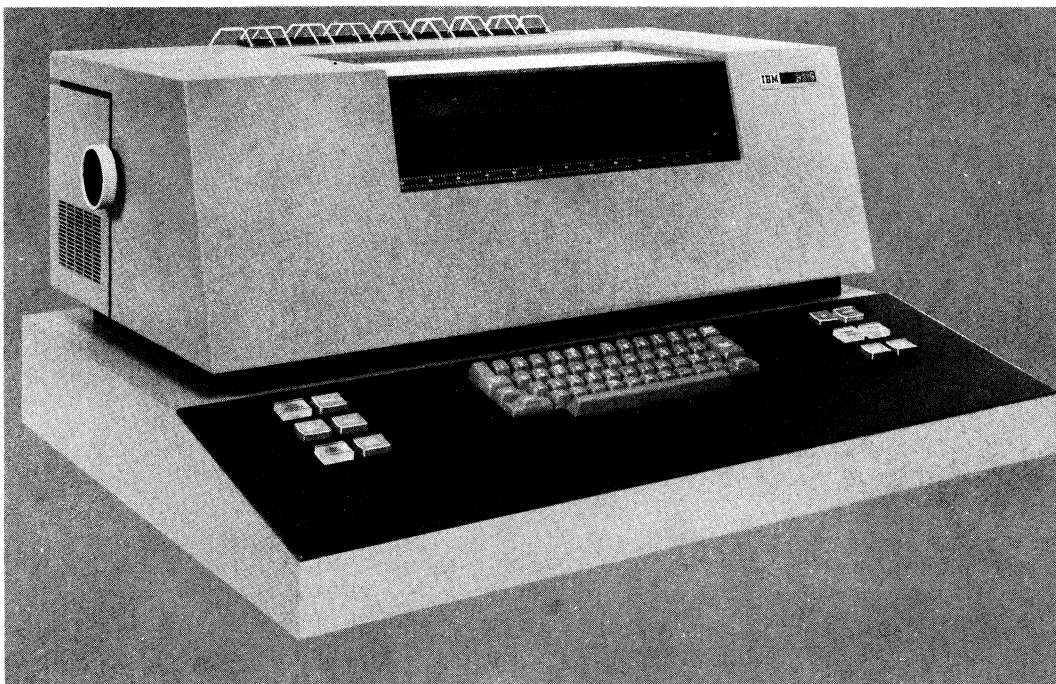

## PRINTER CONTROLS (3210)

### Impression Control Lever

This lever can be positioned in any of five notches. The notch closest to the platen is number 1 and represents the minimum striking force of the print element. The notch farthest from the platen is number 5 and represents the maximum striking force of the print element. You can vary the density of print impression by placing the lever in the appropriate notch.

Note: To change the position of the lever, first move it out of the notch. Then move it forward or backward.

### Ribbon Lift Lever

To provide for ribbon wear distribution you can select either the top or bottom half of the ribbon for printing. When the lever is moved to the left, the bottom half of the ribbon is positioned for printing. When it is moved to the right, the top half is positioned for printing.

### Ribbon Load Lever

This lever latches to the right to keep the ribbon guides raised, for ease in threading the ribbon.

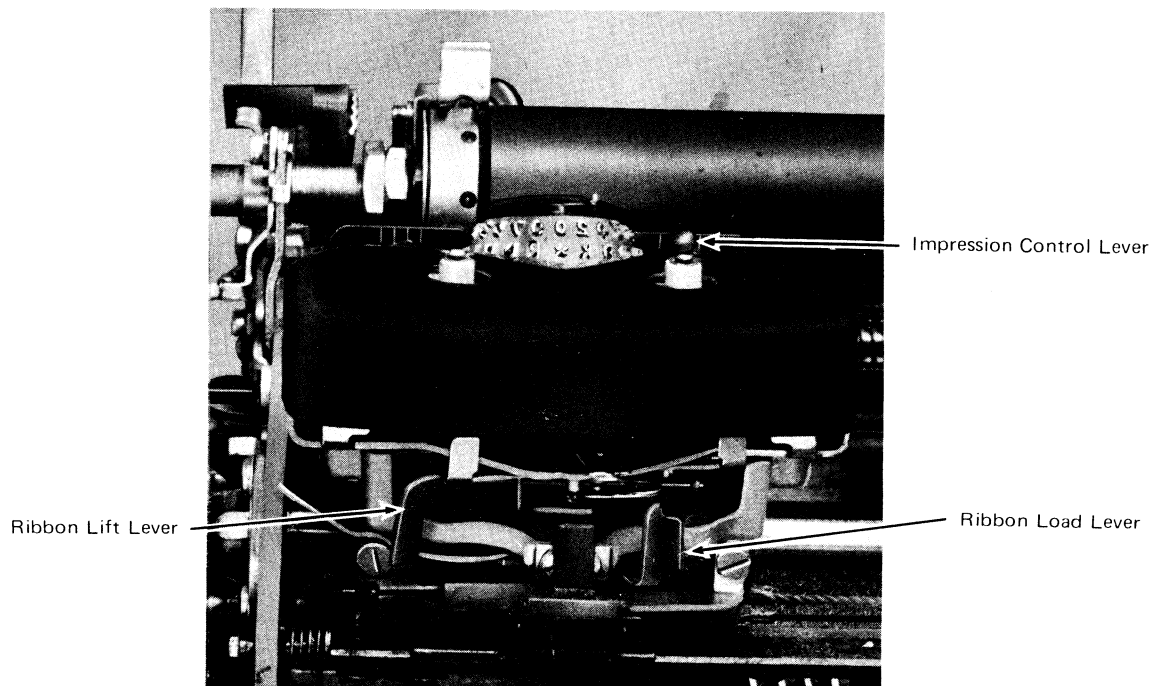

## CARRIAGE CONTROLS (3210)

### Forms Load Lever

When this lever is pulled toward the keyboard, the forms-sensing lever moves away from the platen and permits the forms to be inserted. This turns on INTVN REQD and makes the PR-KB not ready.

### Copy Control Lever

This lever compensates for the thickness of multiple-part forms. When the lever is moved toward the keyboard, the platen moves closer to the print element.

### Platen Knobs

When either knob is rotated, the paper advances. The right platen knob provides fine adjustment to the forms by changing the vertical alignment.

To adjust the vertical alignment, press the right platen knob in and hold it against the spring tension. Turn the knob as required to obtain the desired vertical alignment.

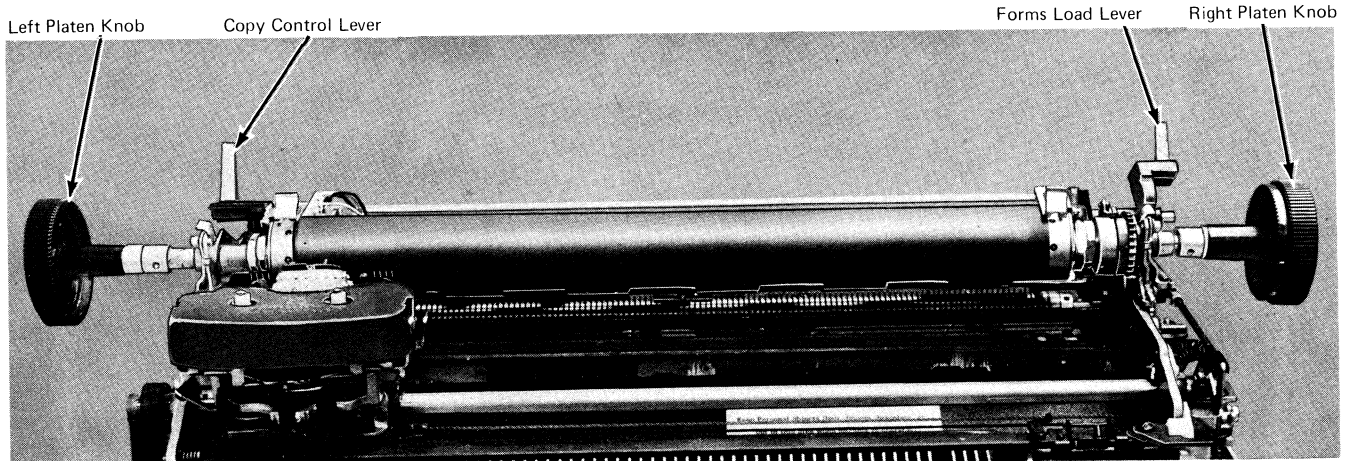





# CONTROL KEYS and INDICATORS (3210 MODEL 1, and 3215)

## LEGEND      INDICATORS      KEYS

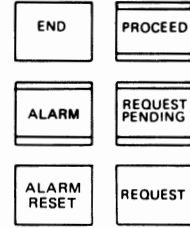
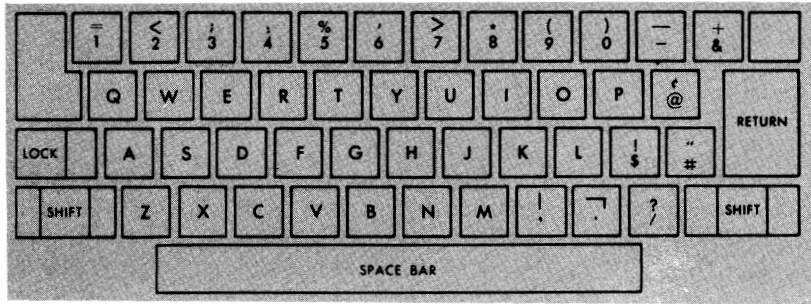
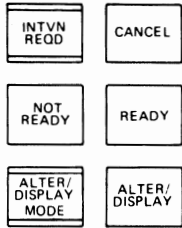

INDICATOR	CONDITION
INTVN REQD	The printer is out of forms, the forms load lever is toward the keyboard, the cover is open, the NOT READY key has been operated, or the 3215 PR-KB is in CE mode.
ALTER/DISPLAY MODE	A request for an alter/display operation was accepted.
ALARM	An alarm command was issued, and manual intervention is required by the operator. If PR-KB is not ready during an IMPL operation, the audible alarm sounds to indicate GO-NO-GO messages.
PROCEED	The PR-KB is ready to accept characters. This indicator is turned on by the ALTER/DISPLAY key, or by a read command.
REQUEST PENDING	A request operation was initiated. This indicator is turned off when the attention status is accepted by the CPU.

KEY	FUNCTION
NOT READY	Places the printer in a not ready condition.
CANCEL	Terminates a read command when you have made an error in data entry. Normally, the program issues the same read command again.
READY	Places the PR-KB in the ready condition.
ALTER/DISPLAY	Requests or ends an alter/display operation. When used to end an alter/display operation, the PR-KB remains in alter/display mode.
END	Terminates a read, write, or alter/display operation.
ALARM RESET	Resets the alarm indicator.
REQUEST	Requests the CPU to initiate a read command to the PR-KB. Under programming control, this allows the operator to enter data.

## CONTROL KEYS and INDICATORS (3210 MODEL 2)

The 3210 Model 2 functions the same as the 3210 Model 1 and 3215 PR-KBs with the following exceptions:

- Alter/display operations can not be performed on the 3210 Model 2. The associated key and indicator are not on this PR-KB.
- A POWER ON key and a POWER OFF key are provided to turn power on and off this PR-KB.

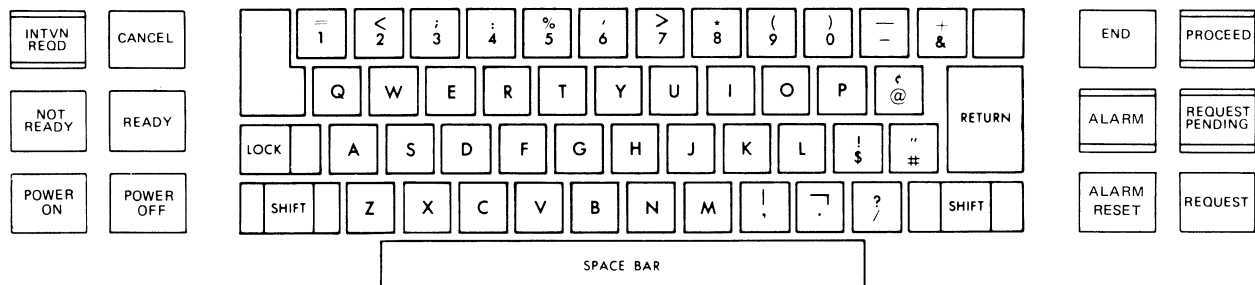

## RIBBON REMOVAL and REPLACEMENT

### 3210 Console Printer-Keyboard

TO REMOVE AND REPLACE A RIBBON:

1. Press the NOT READY key.
2. Raise the top cover.
3. Move the ribbon load lever to the right until latched.
4. Lift the ribbon cartridge up and remove the ribbon from the ribbon guide.
5. Position the new cartridge with the ribbon facing the platen.
6. Slide the ribbon through the slots in the ribbon guides.
7. Position the cartridge on the cartridge posts and press into place.
8. To rewind excess ribbon, turn either cartridge post in the direction of the arrow.
9. Move the ribbon load lever to the left to lower the ribbon guides.

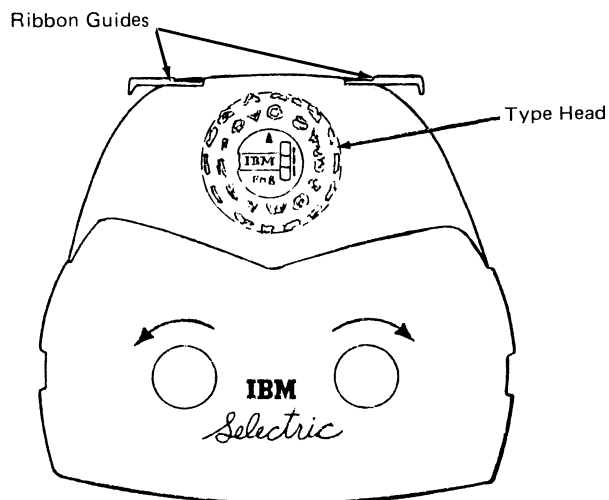

RIBBON THREADING SCHEMATIC

## RIBBON REMOVAL and REPLACEMENT

### 3215 Console Printer-Keyboard

- There are two types of test-switch labels found on the 3215 PR-KBs.
- Either of two types of ribbon cartridges are used on the 3215 PR-KBs.

#### TO REMOVE THE RIBBON CARTRIDGE:

1. Press the NOT-READY key.
2. Raise the printer cover.
3. Set the left test switch to OFFLINE or TEST ON.
4. Set the right test switch to STOP-START *until* print head is centered. Then return switch to OFF KB or OFF/KEYBOARD.
5. Push copy control lever back for maximum distance between print head and platen.
6. Lower safety shield from over print head. Back of shield has ribbon-threading decal for reference.

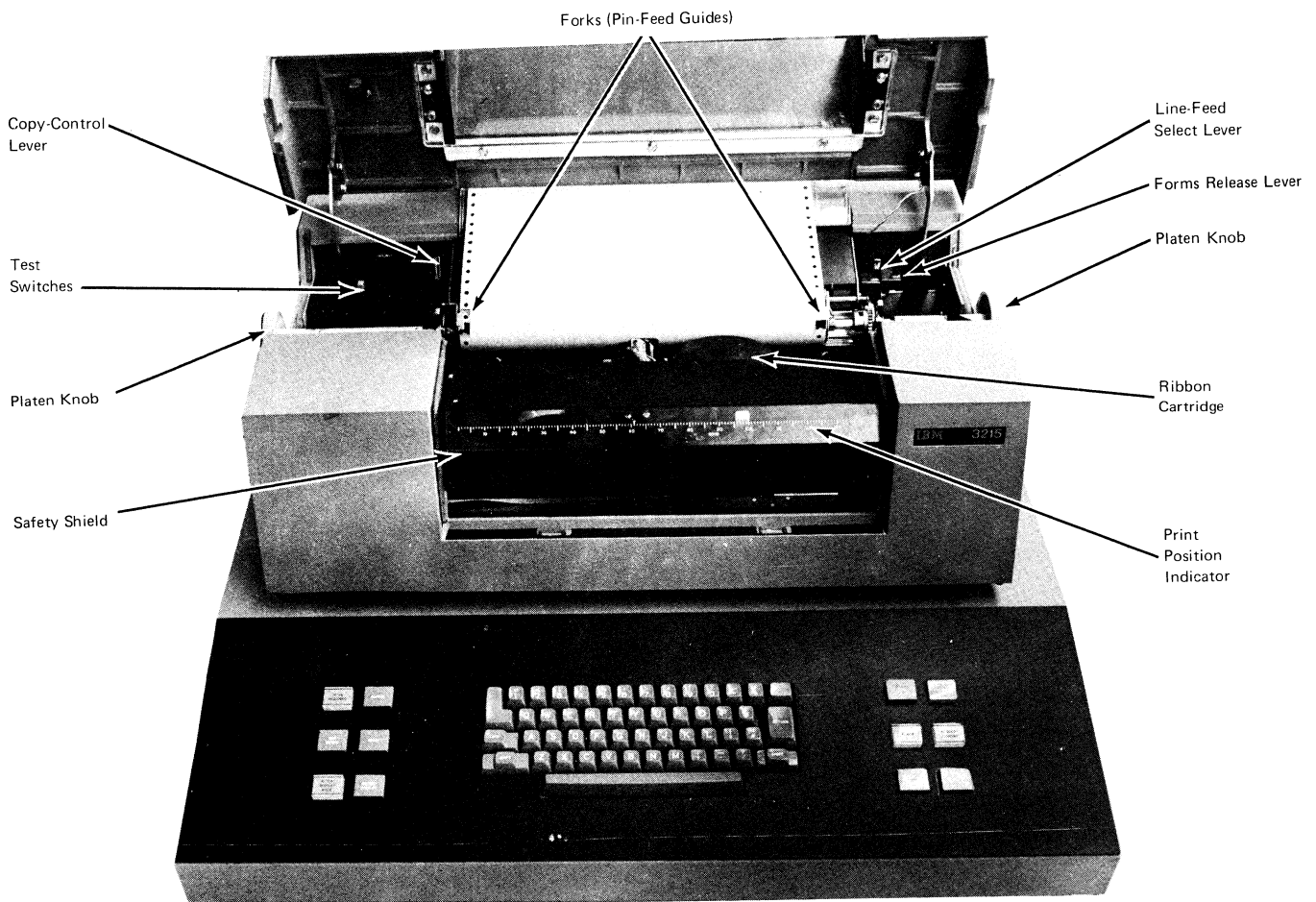

7. Remove ribbon from under plastic guide **1** and from around the guide posts **2** and **3**.
8. With the left hand, pull and hold the ribbon cartridge latch **4** while rotating counterclockwise the ribbon cartridge **5** with the right hand to release the cartridge from the aligning fingers **6**.
9. Lift out the ribbon cartridge. (Rotating the cartridge back and forth facilitates its removal.)

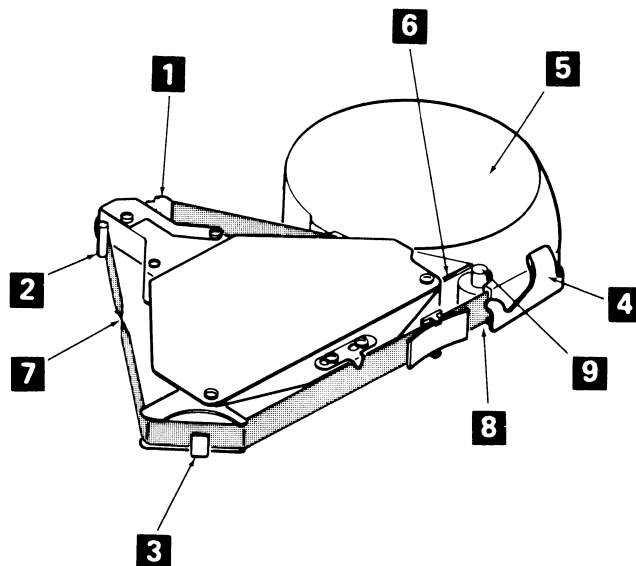

#### TO REPLACE THE RIBBON CARTRIDGE:

##### CAUTION

Do not remove the cardboard loading tab from the ribbon cartridge prior to installing the cartridge. Ribbon damage can occur.

#### REINSTALLING RIBBONS

Note: Ribbon jams may occur when reinstalling a used ribbon unless the following procedure is used:

- a. Perform steps 10 through 15.
  - b. In place of step 16, grasp the ribbon and pull out approximately six inches (15,3 cm) of slack.
  - c. Proceed to step 17.
10. With the left hand, pull and hold the cartridge latch **4**.
  11. Seat the cartridge on the pivot and rotate the cartridge clockwise to engage the aligning fingers **6** with the aligner.
  12. Release the cartridge latch **4**.
  13. Thread the ribbon around the print head. (Be careful not to get oil on the ribbon from the oil wick.) Work the ribbon under the plastic guide **1**, in front of the print head, and back around the front guide post **2**.
  14. Locate the twist **7** in the ribbon between the front and rear guide posts **2** and **3**.
  15. Place the ribbon over the rear guide post **3**.
  16. Remove (and discard) the tab **8** (not shown) protecting the ribbon entrance to the cartridge.
  17. Rotate the drive roll knob **9** counterclockwise to take up the ribbon slack. Continue rotating the knob until ribbon is feeding properly.
  18. Close the safety shield.
  19. Set the copy control lever for the recommended thickness.
  20. Set the right test switch to CONTINUOUS or to START-STOP. Return the switch to OFF KB or OFF/KEYBOARD when the print head begins to return to the left margin.
  21. Set the left test switch to ONLINE or TEST OFF.
  22. Close the printer cover.
  23. Press the READY key on the keyboard.

## RIBBON REMOVAL and REPLACEMENT

### 3215 Console Printer-Keyboard

#### CAUTION

Using a ribbon cartridge not designed for this PR-KB can damage the locating pin.

#### TO REMOVE THE RIBBON CARTRIDGE

1. Press the NOT READY key.
2. Raise the printer cover.
3. Remove the ribbon and cartridge.

#### TO REPLACE THE RIBBON CARTRIDGE

4. Position the hole in the bottom of the cartridge over the locating pin sticking up out of the ribbon feed mechanism, and press the cartridge into place.
5. Thread the ribbon through the ribbon guides following the path shown. Do not twist the ribbon.
6. Rewind any slack in the ribbon by turning the left (front) cartridge post in the direction of the arrow.
7. Lower the printer cover.
8. Press the READY key.

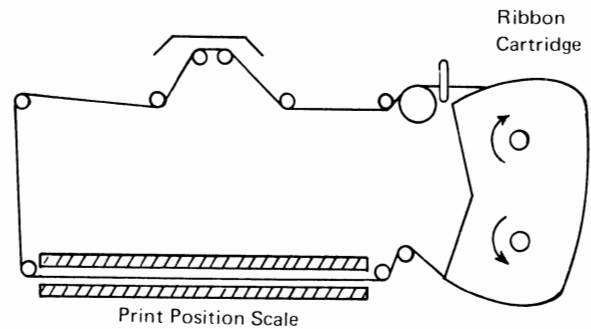

RIBBON THREADING SCHEMATIC

## FORMS INSERTION (3210)

1. Press the CPU STOP key, and then the PR-KB NOT READY key.
2. Place the forms on the lower rack of the forms stand.
3. Raise the top of the printer cover.
4. Move the forms load lever toward the keyboard.
5. Raise the muffler assembly (if installed on your model) and insert the form under the muffler assembly and behind the platen. Manually work the form around the platen until the form appears in the front of the platen. Lower the muffler assembly.
6. Raise the forks (pin-feed guides) on the platen, and insert the form between the guides and platen pins. Align the margin holes with the platen pins and lower the pin-feed guides.
7. Move the forms load lever away from the keyboard (normal operating position).
8. Press in and rotate the right platen knob to vertically align the first print line.
9. Close the printer cover.
10. Press the READY key, and then the CPU START key.

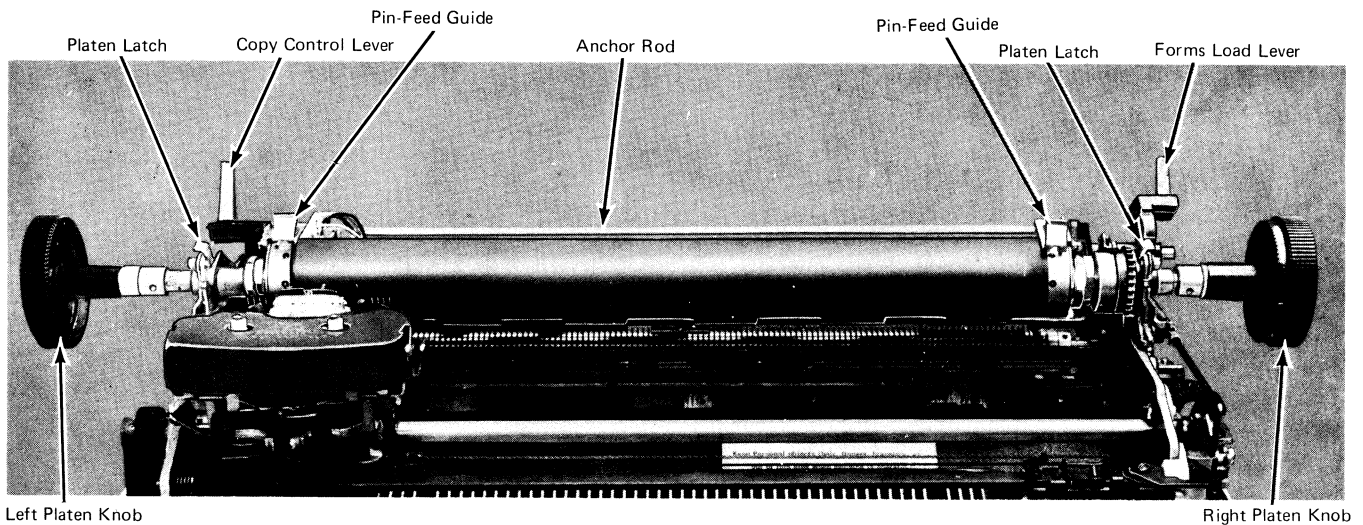

## PLATEN REMOVAL and REPLACEMENT (3210)

### Removal

1. Press the CPU STOP key, and then the PR-KB NOT READY key.
2. Raise the top of the printer cover.
3. Move the forms load lever toward the keyboard, and raise the muffler assembly (if installed on your model).
4. Press down the platen latches at both ends of the platen assembly, and lift the platen out.
2. Align the slots in the pin-feed assemblies so they fit over the anchor rod located behind the platen.
3. Center the end plate in the groove at the right end of the platen shaft.
4. Press the platen into place until it latches, and lower the muffler assembly (if installed on your model). Perform forms insertion procedure if necessary.

### Replacement

1. Position the platen with the ratchet teeth to the right.
5. Move the forms load lever away from the keyboard (normal operating position).
6. Close the printer cover.
7. Press the READY key, and then the CPU START key.

## FORMS INSERTION (3215)

1. Press the CPU STOP key, and then the PR-KB NOT READY key.
2. Raise the top of the printer cover.
3. Place the copy control lever in the forms insertion position (maximum distance from the keyboard).
4. Move the forms release lever toward the keyboard (normal operating position).
5. Raise both platen forks (pin-feed guides).
6. Place the forms on the lower rack of the forms stand.
7. Insert the form into the paper feed slot, and manually work the form around the platen until the form appears in front of the platen.
8. Guide the form between the pin-feed guides and platen pins. Align the margin holes, and lower the pin-feed guides.

9. Set the copy control lever to correspond to the thickness of the forms used.

Position	Type of Form Used
1 ———	1 Part
2 ———	2 or 3 Parts
3 ———	4 Parts
4 ———	5 or 6 Parts
5 ———	Forms Insertion

10. Set the line feed select lever for single or double spacing.
11. Press in and rotate the right platen knob to vertically align the first print line.
12. Rotate either platen knob to feed the form through the exit slot in the printer cover.
13. Close the printer cover.
14. Press the READY key, and then the CPU START key.

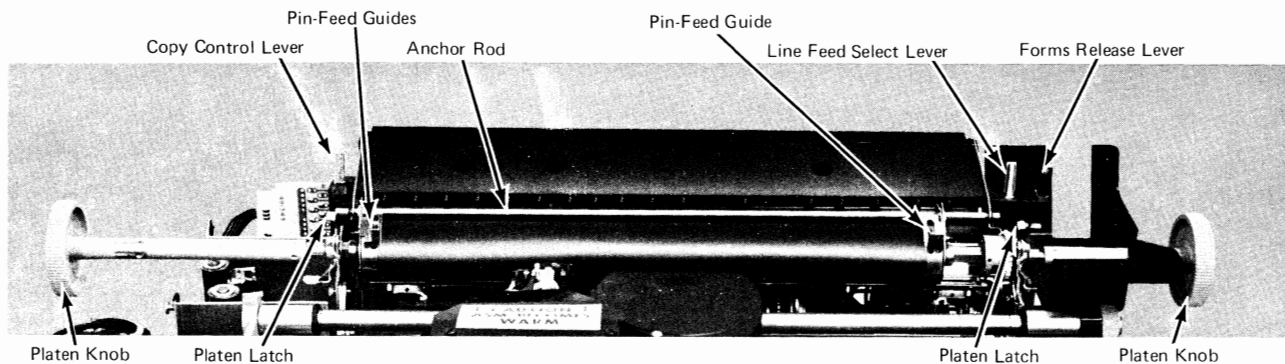

## PLATEN REMOVAL and REPLACEMENT (3215)

### Removal

1. Press the CPU STOP key then the PR-KB NOT READY key.
2. Raise the top of the printer cover.
3. Move the forms release lever toward the keyboard (normal operating position).
4. Set the copy control lever to the forms insertion position (maximum distance from the keyboard).
5. Press down on the platen latches and lift the platen out.

### Replacement

1. Position the platen with the ratchet teeth to the right.
2. Align the slots in the pin-feed assemblies so they fit over the anchor rod located behind the platen.
3. Center the end plate in the groove at the right end of the platen shaft.
4. Press the platen into place until it latches. Perform forms insertion procedure if necessary.
5. Set the copy control lever to correspond to the thickness of the forms used.
6. Move the forms release lever toward the keyboard (normal operating position).
7. Close the printer cover.
8. Press the READY key, then the CPU START key.

## PRINT ELEMENT REMOVAL and REPLACEMENT (3210)

### Removal

1. Press the NOT READY key.
2. Raise the printer cover.
3. Note the direction of the arrow on the print element.
4. Lift the print element release lever.
5. Lift the print element off the print element post.

### Replacement

1. Install the print element on the print element post with the arrow pointing in the same direction it was on removal.
2. Lower the print release lever to lock the print element in place.

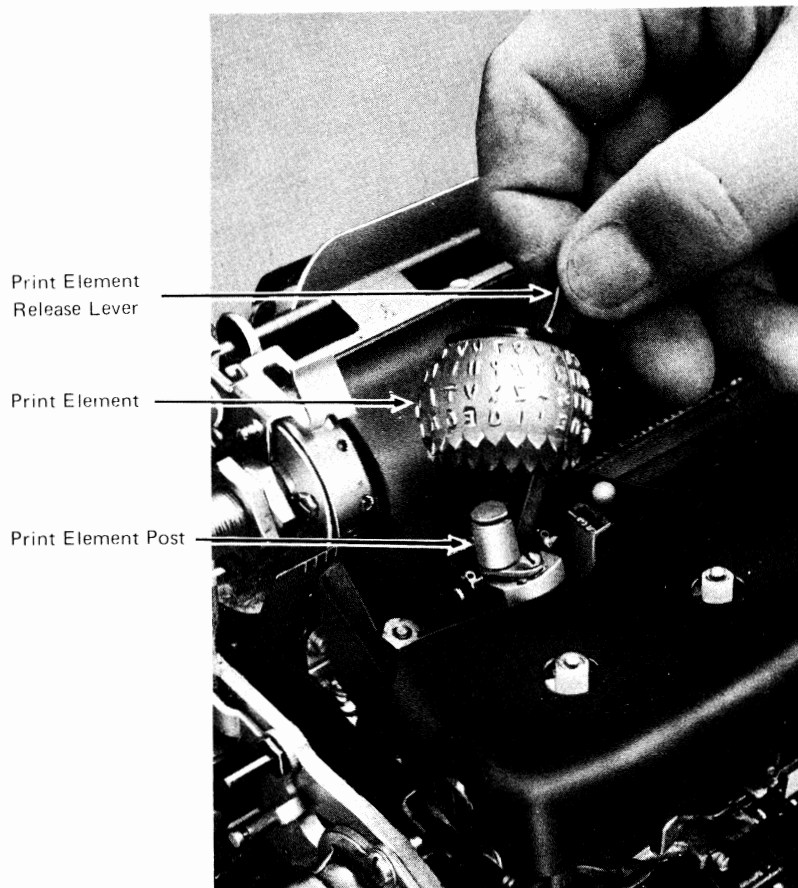



## PRINT ELEMENT CLEANING (3210)

### CAUTION

Do not clean the 3215 print element. Cleaning is done as required by your service representative.

### TO CLEAN THE 3210 PRINT ELEMENT :

1. Press the NOT READY key.
2. Note the direction of the arrow on the print element.
3. Remove the print element.
4. Clip the print element to the end of the dual-purpose brush.
5. Brush away from you and toward the top of the print element using the element brush as shown.
6. Replace the print element with the arrow pointing in the same direction it was on removal.

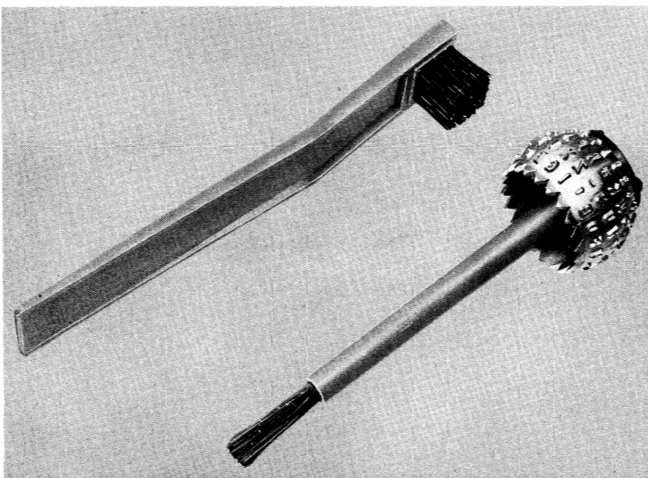

# OPERATING PROCEDURES

## CONSOLE FILE CARTRIDGE INSERTION and REMOVAL

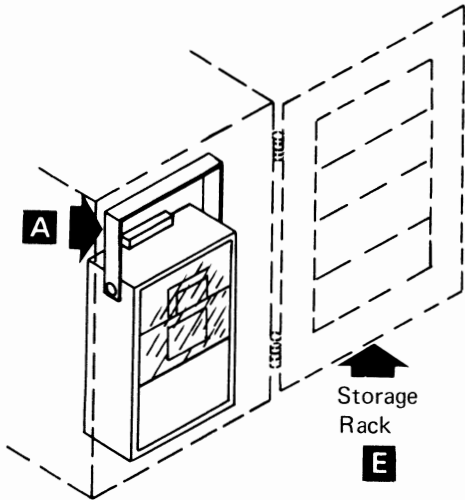

### Insertion

1. Pull handle **A** to open console-file cover.
2. Grasp the cartridge **B** by its white handling area and remove it from its envelope.
3. Lower the cartridge **C** until it is stopped by the locating surfaces.
4. Close cover carefully **D**. The centering cone must slide freely into the center of the disk. If not, check that the cartridge is seated against the locating surfaces and that the cartridge is not damaged.
5. Return the empty carriage envelope to the disk storage rack. **E**

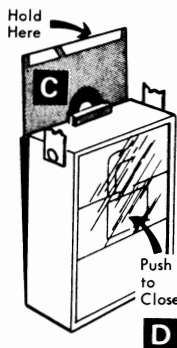
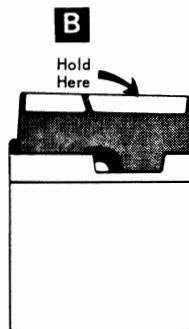

### Removal

1. Pull handle **A** to open console-file cover.
2. Grasp the cartridge **B** by its white handling area and lift it straight up.
3. Slide the cartridge into its envelope and return it to the disk storage rack **E** or to the storage area.

### Storing Cartridges

Before using, acclimate cartridges to the computer room:

If in mailing carton, wait 24 hours.

If not in mailing carton, wait 1 hour.

If mounted on a non-powered file, wait 1/2 hour.

Place cartridges in their envelopes and store them either in the storage rack or in their original mailing cartons. A storage environment should meet the following criteria:

Temperature	40°-100°F (4.4°-37.8°C)
Relative Humidity	8%-80%
Maximum Wet Bulb Temperature	80°F (26.7°C)

### Shipping and Receiving

Ship cartridges inside the original shipping carton. Additional shipping cartons are available at IBM Branch Offices. With the cartridge in place, the package weighs 10 ounces. Be sure to label the package, "DO NOT EXPOSE TO HEAT OR SUNLIGHT."

When receiving cartridges, check for carton and cartridge damage. Save the carton for storing a cartridge and for possible future cartridge shipment.

## POWER-ON PROCEDURES

- 3145 Models H2, HG2, I2, IH2, and J2 have a 3047 Power Unit attached to the system. The 3047 has a POWER ON indicator (white) mounted on a panel at the front of the unit. The indicator is lit when ac input power is applied to the 3047.
- Power-On procedure depends upon the features installed. The following procedures may be used:

### No Features Installed

- 1 Press the POWER-ON key.

Pressing the POWER-ON key initiates a power-on sequence for the CPU and on-line I/O units. The key turns red when pressed and turns white when the power-on sequence is complete.

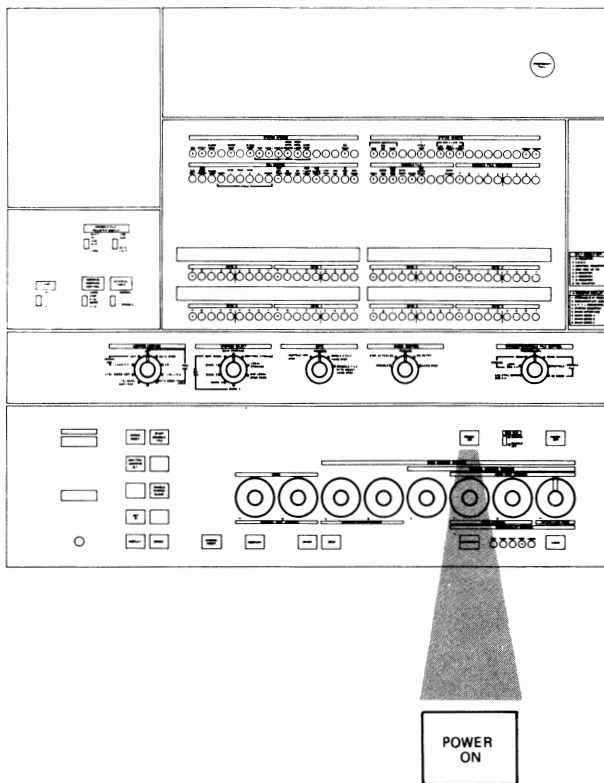

#### Note:

The time required for a power-on sequence is determined by the number and type of I/O units on-line. The contents of storage is not valid after a power-on sequence. Also, an IMPL operation is required. (The IMPL is automatic if the rotary switches are in their normal processing positions, the ADDRESS COMPARE CONTROL switch is set to SYNC/NORM, and the \*370 microprogram disk is mounted on the console-file).

## POWER-ON PROCEDURES

### Channel-to-Channel Adapter (CTCA) Feature Installed

#### 1 Press the POWER ON key.

Pressing the POWER ON key initiates a power-on sequence for the CPU and on-line I/O units. The key turns red when pressed and turns white when the power-on sequence is complete. The time required for a power-on sequence is determined by the number and type of I/O units on-line. The contents of storage is not valid after a power-on sequence. Also, an IMPL operation is required. (The IMPL is automatic if the rotary switches are in their normal processing positions, the ADDRESS COMPARE CONTROL switch is set to SYNC/NORM, and the \*370 microprogram disk is mounted on the console file.)

#### 2 Wait for the I/O INFC DSBLD indicator to turn on.

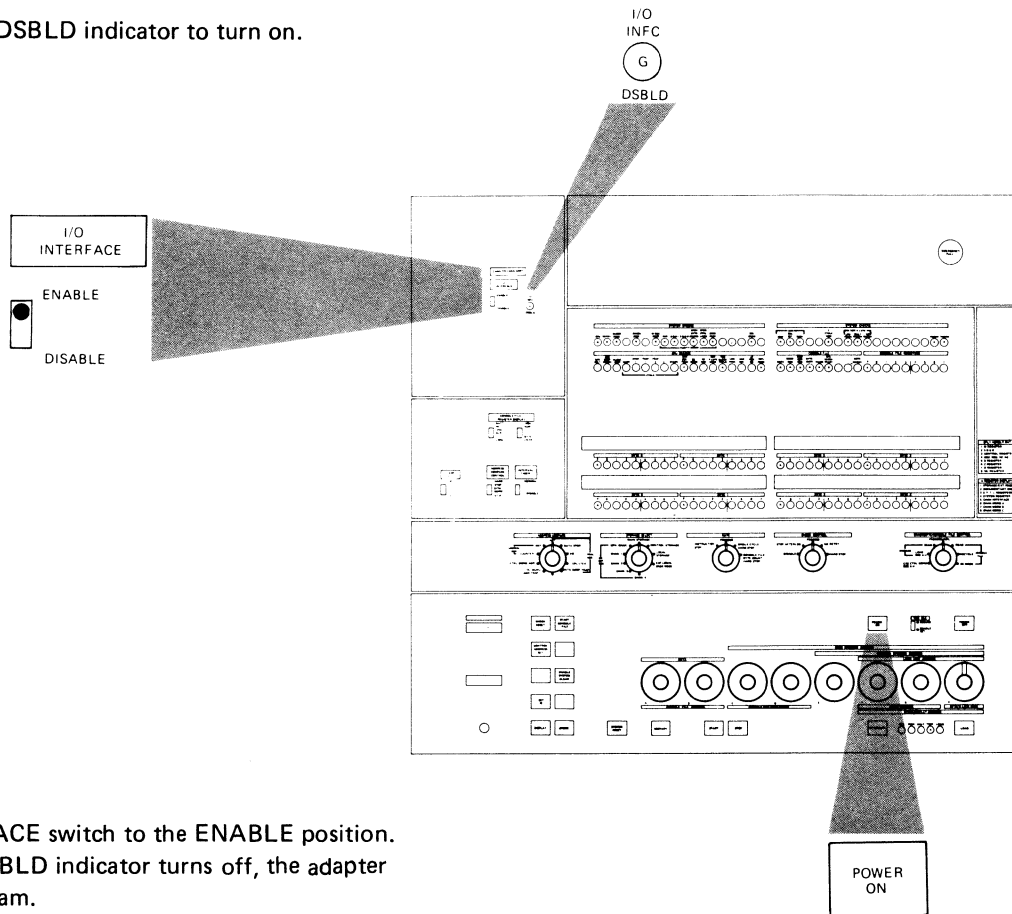

#### 3 Move the I/O INTERFACE switch to the ENABLE position. When the I/O INFC DSBLD indicator turns off, the adapter is available to the program.

## POWER-ON PROCEDURES

### Integrated Storage Control (ISC) Feature Installed

- This procedure has the two-channel-switch special feature included.
- I/O INTERFACE B and MULTITAG switches are non-functional on a single channel ISC application.

#### 1 Press the POWER ON key.

Pressing the POWER ON key initiates a power-on sequence for the CPU and on-line units. The key turns red when pressed and turns white when the power-on sequence is complete. The time required for a power-on sequence is determined by the number and type of I/O units on-line. The contents of storage is not valid after a power-on sequence. Also, an IMPL operation is required. (The IMPL is automatic if the rotary switches are in their normal processing positions, the ADDRESS COMPARE CONTROL switch is set to SYNC/NORM, and the \*370 microprogram disk is mounted on the console file.)

#### 2 Wait for the IMPL REQD indicator to turn off.

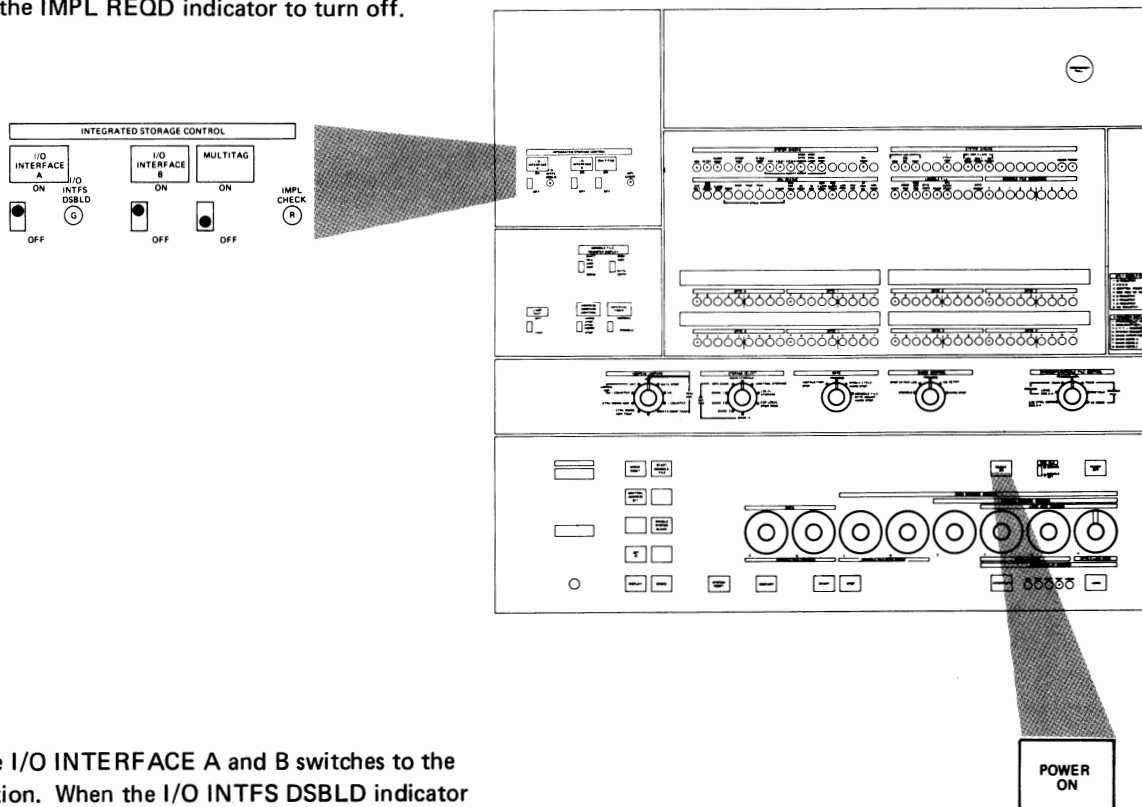

#### 3 Move the I/O INTERFACE A and B switches to the ON position. When the I/O INTFS DSBLD indicator turns off, the ISC is available to the program.

## INITIAL MICROPROGRAM LOAD (IMPL) (without VS APL Assist Feature)

- Ensure that forms are inserted in the console PR-KB and the \*370 microprogram disk is mounted in the console file.

**1** Set all rotary switches to their normal operating positions. Ensure that the ADDRESS COMPARE CONTROL toggle switch is set to SYNC/NORM. Ensure that the ADDRESS COMPARE CONTROL toggle switch is set to SYNC/NORM.

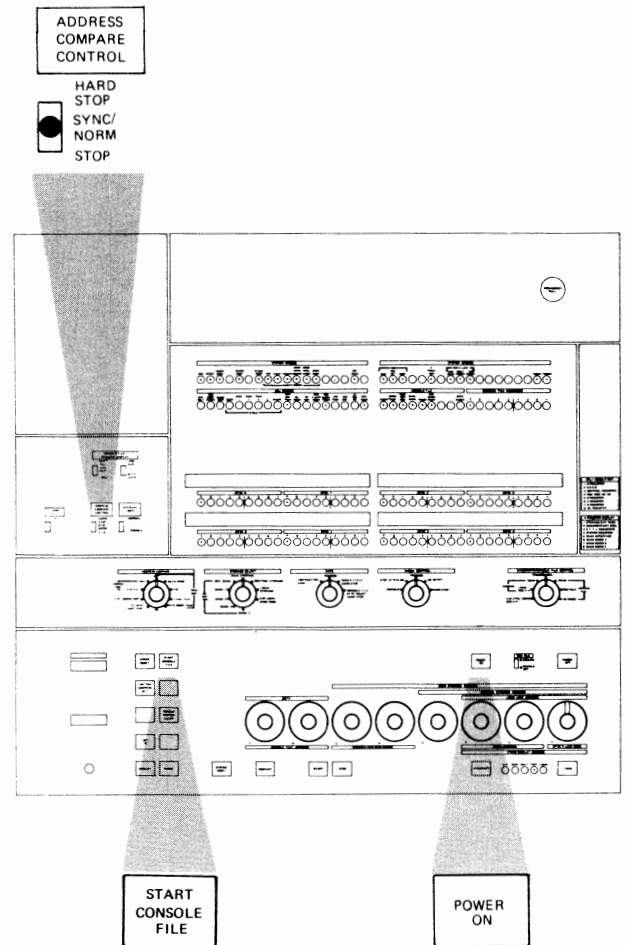

**2** If power is not on, press the POWER ON key. An automatic IMPL occurs. If power is on, press START CONSOLE FILE key to initiate the IMPL.

## INITIAL MICROPROGRAM LOAD (IMPL)

(without VS APL Assist Feature)

**3** The IMPL REQD and CF PWR ON indicators turn on and the START CONSOLE FILE key turns red.

When the console file starts reading, the START CONSOLE FILE key turns white.

The message GO-NO-GO COMPLETE prints on the PR-KB. If the message GO-NO-GO FAILED prints, refer to "IMPL Error Recovery."

**Note:** If the PR-KB is not ready during an IMPL operation, the audible alarm sounds to indicate GO-NO-GO messages.

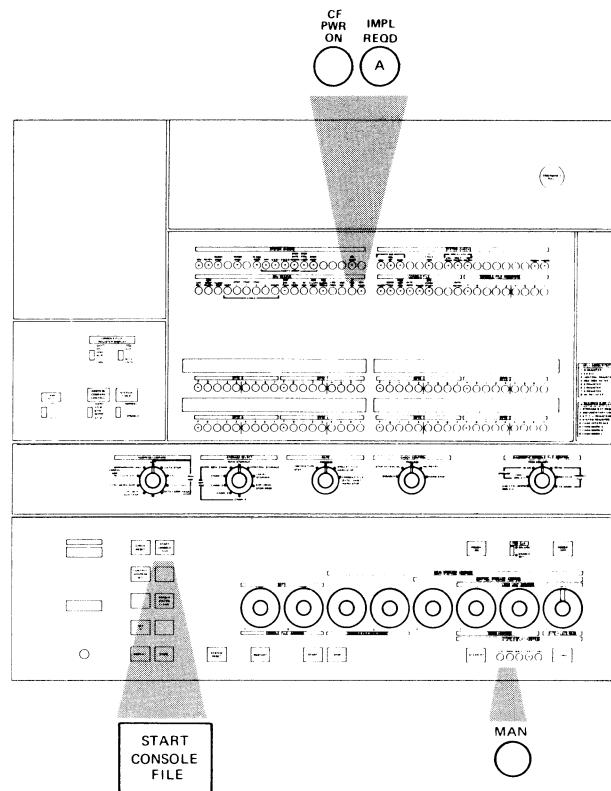

**4** When control storage is loaded, the console file powers off automatically. The CF PWR ON indicator and the START CONSOLE FILE key light turn off.

The system reset routine executes, the IMPL REQD indicator turns off, and the CPU enters the soft-stop state (MAN indicator on).

The IMPL operation takes approximately 35 seconds.

## INITIAL MICROPROGRAM LOAD (IMPL)

(without VS APL Assist Feature)

### 5 Exceptions:

Note 1: If the system has been powered on without the \*370 microprogram disk inserted in the console file, the following procedure must be performed before using the system.

- a. Insert the \*370 microprogram disk in the console file.
- b. Press the START CONSOLE FILE key.
- c. After IMPL is complete, perform a clear storage operation as follows:
  1. Press and hold ENABLE SYSTEM CLEAR key.
  2. Press the SYSTEM RESET or the LOAD key.  
All of main storage is cleared to zeros (hexadecimal 00); control storage is not affected.
  3. Release the ENABLE SYSTEM CLEAR key.

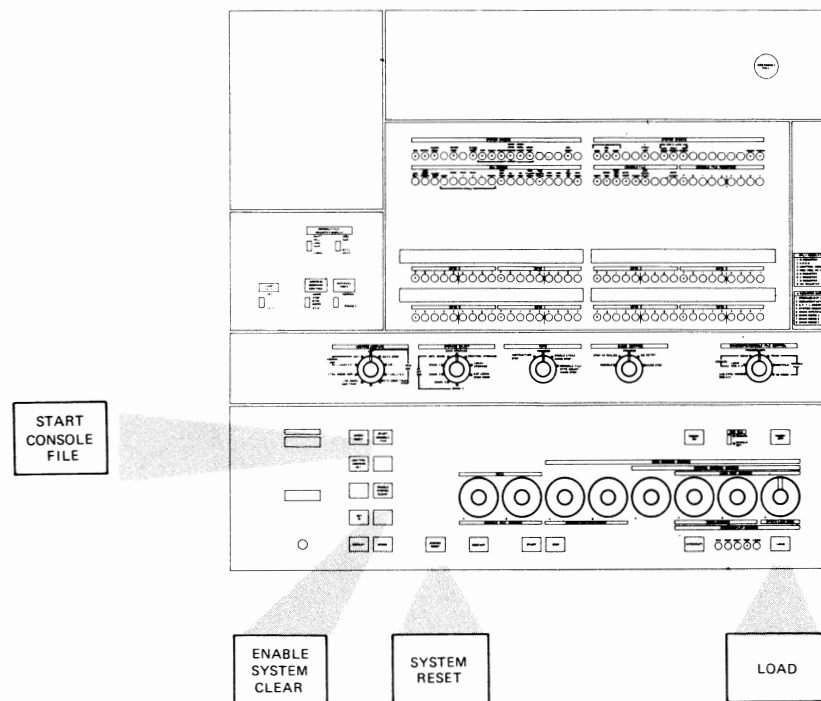

### Note 2: Microprogram Patch Procedure

1. After PR-KB prints GO-NO-GO message, it may print microprogram patch-card IPL procedure.
2. If required, follow microprogram patch-card procedure before you IPL the System Resident (SYS RES) device.



## INITIAL MICROPROGRAM LOAD (IMPL)

(with VS APL Assist Feature)

- Ensure that forms are inserted in the console PR-KB, the PR-KB is in the ready state, and the \*370 micro-program disk that corresponds to the \*APL micro-program disk is mounted in the console file.

**1** Set all rotary switches to their normal operating positions. Ensure that the ADDRESS COMPARE CONTROL toggle switch is set to SYNC/NORM. STOP.

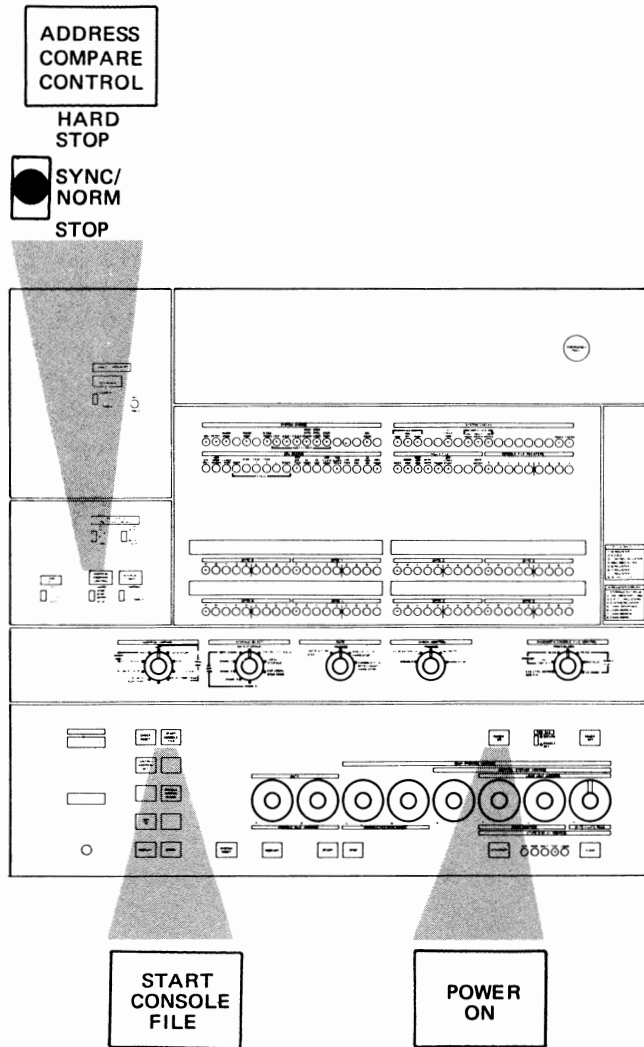

**2** If power is not on, press the POWER ON key. An automatic IMPL occurs. If power is on, press the START CONSOLE FILE key to initiate IMPL.

### INITIAL MICROPROGRAM LOAD (IMPL) (with VS APL Assist Feature)

**3** The IMPL REQD and CF PWR ON indicators turn on and the START CONSOLE FILE key turns red.

When the console file starts reading, the START CONSOLE FILE key turns white.

The message GO-NO-GO COMPLETE prints on the PR-KB. If the message GO-NO-GO FAILED prints, refer to "IMPL Error Recovery."

Note: If the PR-KB is not ready during an IMPL operation, the audible alarm sounds to indicate IMPL messages.

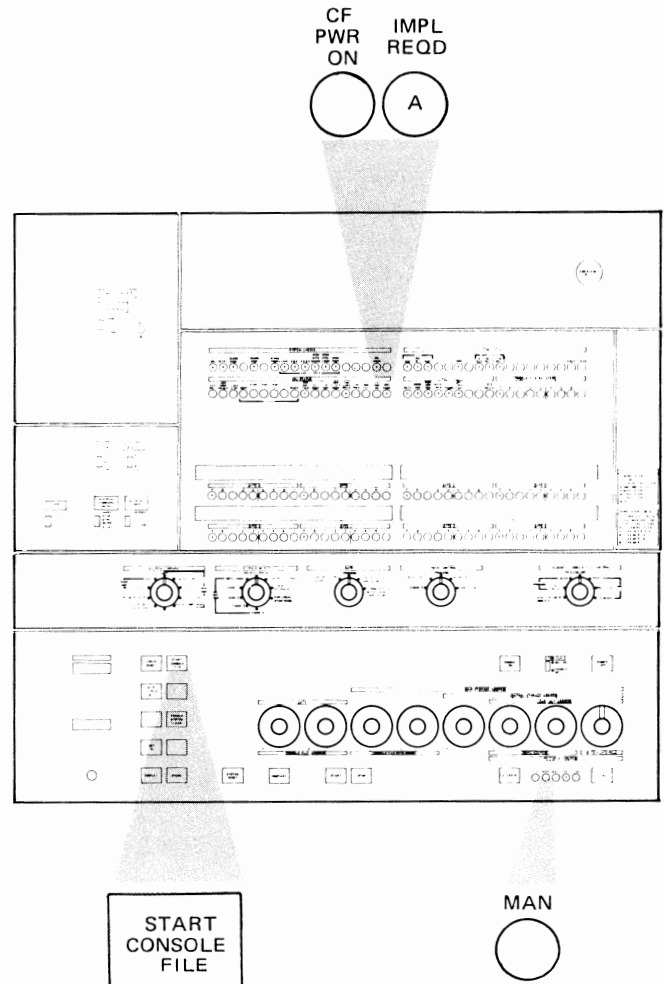

**4** When the first disk is completely read into control storage, the console file powers off automatically. The CF PWR ON indicator and the START CONSOLE FILE key light turn off.

The system reset routine executes, the IMPL REQD indicator turns off, and the CPU enters the soft-stop state (MAN indicator on).

The IMPL operation takes approximately 35 seconds per disk.

## INITIAL MICROPROGRAM LOAD (IMPL)

(with VS APL Assist Feature)

**5** After the \*370 disk has been read, the following message is indicated on the PR-KB:

\*37X MICRO DISK 1 - YOU MUST IMPL

\*APL MICRO DISK

(where \*37X means the proper \*370, \*371, etc. disk that goes with the \*APL coreload) or the console alarm is sounded when intervention required exists on the PR-KB.

The EXE CPLT light is not turned on at this point because the full coreload has not been read into control storage. The microprogram is also prevented from executing I-cycles. Attempts to IPL any programs from devices result in a repeat of the message. (The operator must IMPL the \*APL disk in order to continue.)

**6** Remove the \*370 disk 1 from the console file and insert \*APL disk 2.

**7** Press the START CONSOLE FILE key to read disk 2 into storage.

The IMPL REQD light turns off when the disk starts to read.

Note: If the \*370 disk 1 was not loaded prior to loading disk 2, the message:

THIS MICRO DISK IS \*APL PROPER \*37X DISK  
 MUST BE LOADED FIRST

is indicated. After the message is given, further execution on the system is prevented.

If both disks are loaded properly, the EXE CPLT light turns on and the CF PWR ON light turns off.

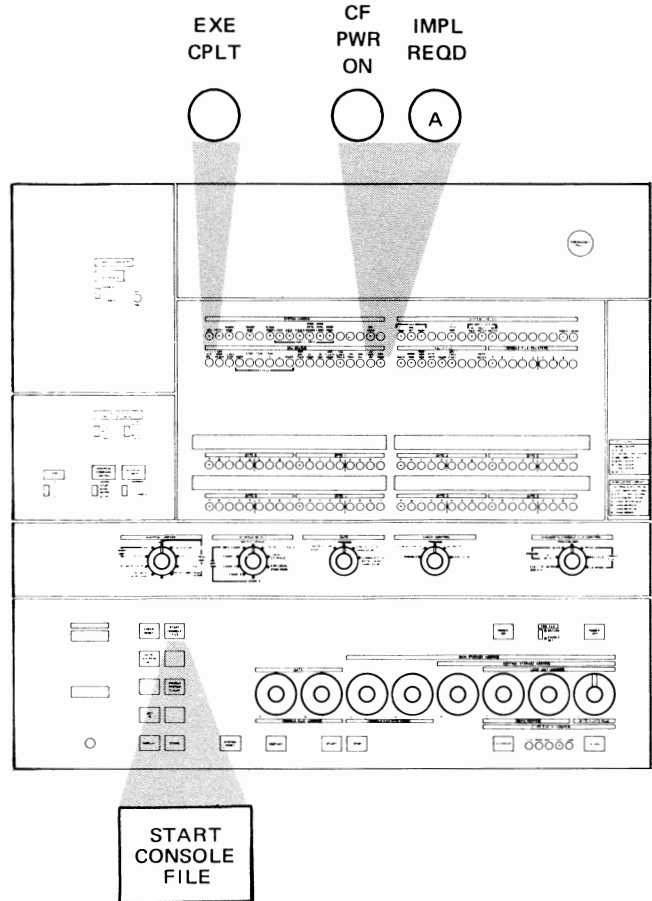

## INITIAL MICROPROGRAM LOAD (IMPL)

(with VS APL Assist Feature)

### 8 Exceptions:

Note 1: If the system has been powered on without the \*370 microprogram disk inserted in the console file, the following procedure must be performed before using the system.

- a. Insert the \*370 microprogram disk in the console file.
- b. Press the START CONSOLE FILE key.
- c. Load the \*APL disk in the console file.
- d. Press the START CONSOLE FILE key.
- e. After IMPL is complete, perform a clear storage operation as follows:
  1. Press and hold the ENABLE SYSTEM CLEAR key.
  2. Press the SYSTEM RESET or the LOAD key. All of main storage is cleared to zeros (hexadecimal 00); control storage is not affected.
  3. Release the ENABLE SYSTEM CLEAR key.

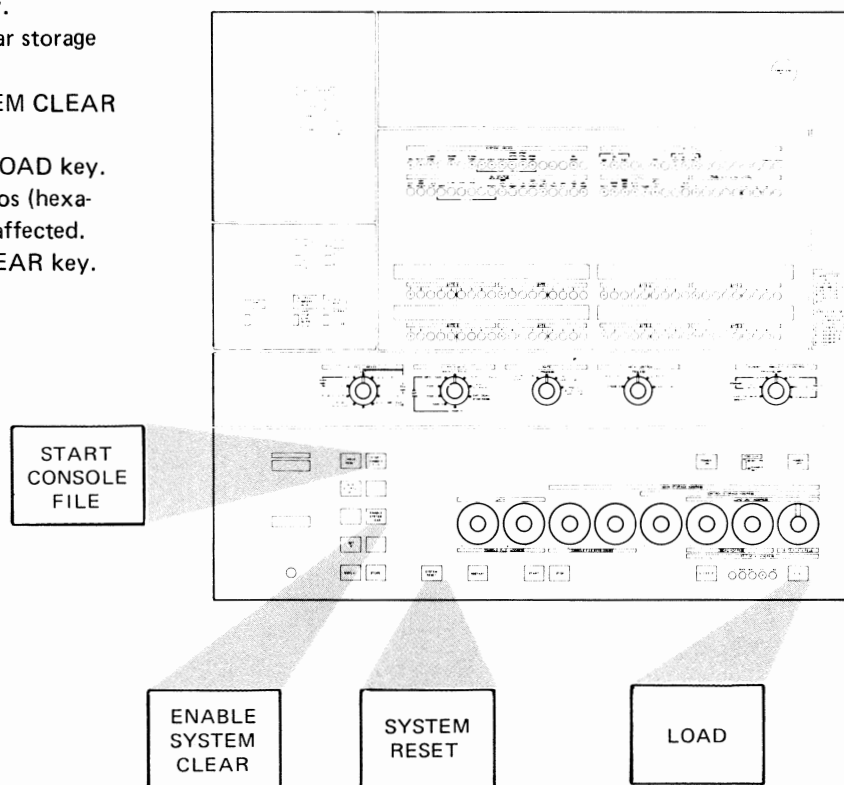

### Note 2: Microprogram Patch Procedure

1. After PR-KB prints the GO-NO-GO message, it may print the microprogram patch-card IPL procedure.
2. If required, follow the microprogram patch-card procedure before you IPL the System Resident (SYS RES) device.

## IMPL ERROR RECOVERY

- Are switches set properly?
- Is \*370 microprogram disk inserted correctly with label upright and facing you?

Attempt to re-IMPL using the START CONSOLE FILE key. If unsuccessful, press the CHECK RESET key and the POWER OFF key. After waiting at least 10 seconds, re-IMPL by pressing the POWER ON key. If the error continues, see "Handling Abnormal Situations-Introductory Flow Chart."

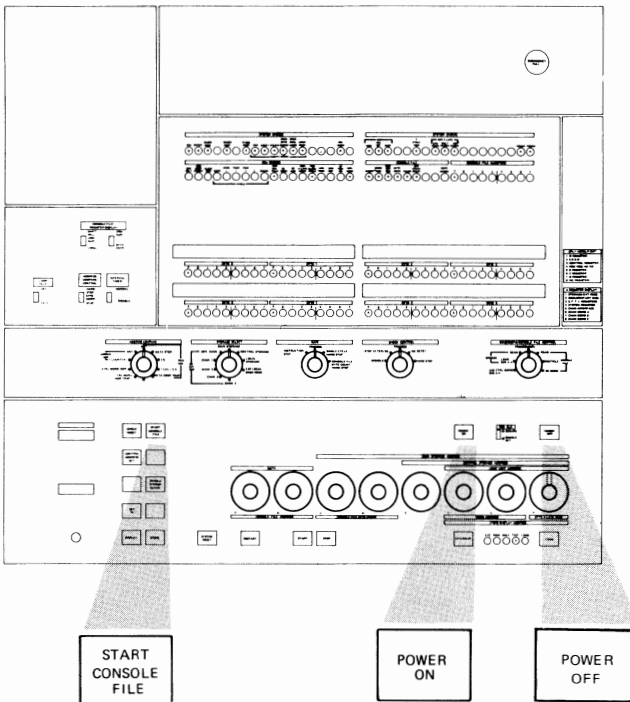

## IMPL Error Indicator Chart

INDICATOR			ERROR CONDITION
START CONSOLE FILE KEY	IMPL REQD	CF PWR ON	
RED	ON	ON	Wrong disk mounted. Disk inserted upside down or backward. Disk not turning.
RED	ON	ON	Error during loading of control storage
RED	ON	OFF	Control storage loaded. Error in execution of system reset.

## CONSOLE PRINTER-KEYBOARD MANUAL OPERATIONS

### Data Entry

During a program-controlled read operation, PROCEED is turned on when the system requires data entry by the operator from the keyboard. The operation is ended by pressing the END key.

### 3210 MODEL 1 CONSOLE PRINTER-KEYBOARD

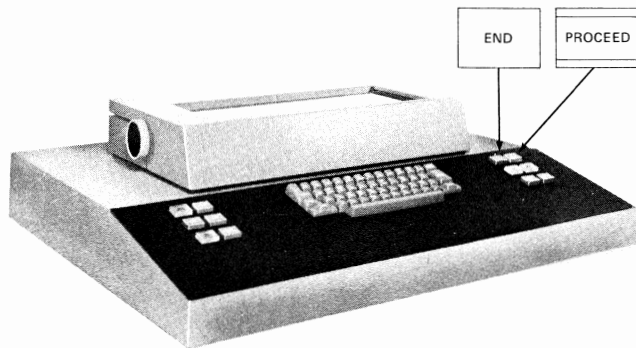

Note: Because of the similarity of the PR-KBs, illustrations of PR-KBs are of the 3210 Model 1.

### Alter/Display Operations

Alter/display operations are performed from the PR-KB. The PR-KB provides a record of the operation, the location(s) accessed, and the data involved.

Display operations print data from storage for operator inspection. The data is not changed.

Alter operations change the data in storage.

## CONSOLE PRINTER-KEYBOARD MANUAL OPERATIONS

### ALTER

Data is entered one hex digit at a time by using the space bar to skip over positions not being altered. The data in the skipped-over positions remains unchanged and prints out each time the spacebar is operated.

To end the alter operation, press the ALTER/DISPLAY or END key.

### DISPLAY

Data is printed starting at the address specified and continues until the ALTER/DISPLAY or END key is pressed.

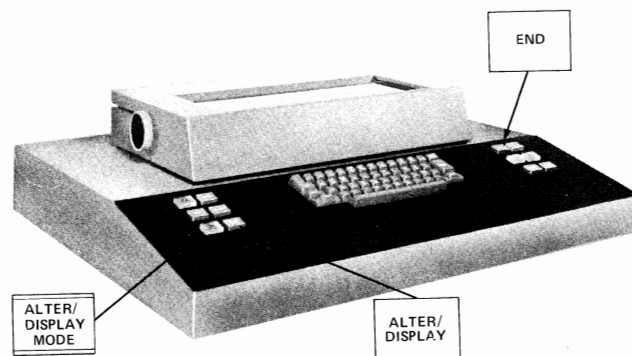

Note: When the operation is ended by the ALTER/DISPLAY key, the PR-KB remains in alter/display mode (ALTER/DISPLAY MODE indicator on).

When the operation is ended by the END key, alter/display mode is terminated.

For alter/display of general and floating-point registers, a wraparound occurs (F to 0 for general registers, and 6 to 0 for floating-point registers).

When addressing main storage, either a word or byte address may be used. If the starting address is not on a word boundary, the PR-KB spaces and aligns at the byte addressed.

# CONSOLE PRINTER-KEYBOARD MANUAL OPERATIONS

## Alter/Display Procedures

Note: Steps 1 through 3 are common for alter and display operations.

- 1 Press the STOP key or set the RATE switch to either INSTRUCTION STEP or SINGLE CYCLE HARD STOP.

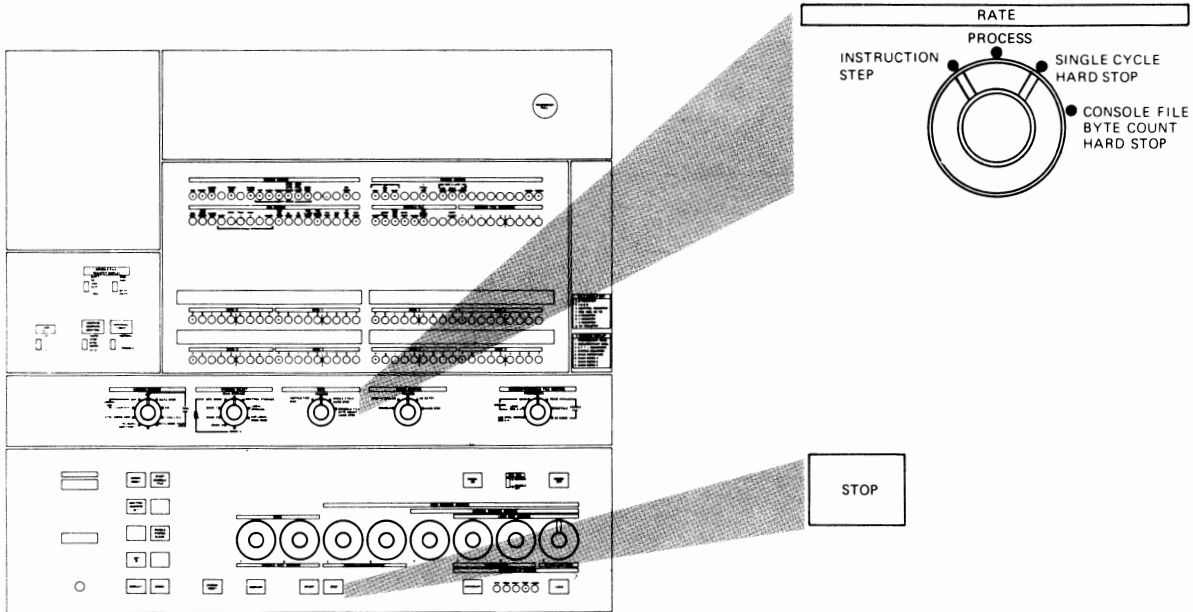

- 2 Press the ALTER/DISPLAY key.
- 3 Wait for both ALTER/DISPLAY MODE and PROCEED indicators to turn on.

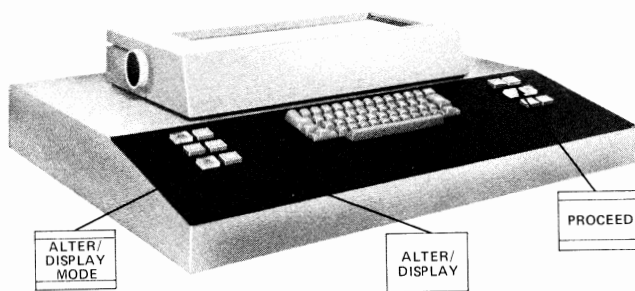



## CONSOLE PRINTER-KEYBOARD MANUAL OPERATIONS

- 4** From the following chart, type the appropriate two-character mnemonic and address of the storage area or register to be altered or displayed.

STORAGE AREA	ALTER MNEMONIC	DISPLAY MNEMONIC	ADDRESS RANGE
MAIN STORAGE	AM	DM	000000-03FFFF*
STORAGE KEY	AK	DK	000000-03FFFF*
CONTROL REGISTER	AC	DC	0-F
GENERAL REGISTER	AG	DG	0-F
FLOATING-POINT REGISTER	AF	DF	0, 2, 4, 6
CURRENT PSW	AP	DP	None required
STORE STATUS	NONE	ST	None required
VIRTUAL STORAGE	AV	DV	000000-FFFFFF
* The upper boundry is movable and depends upon the capacity of main storage.			

- 5** When zeros are typed to the left of the address, a new line operation is started automatically. When zeros are not inserted, press the RETURN key.

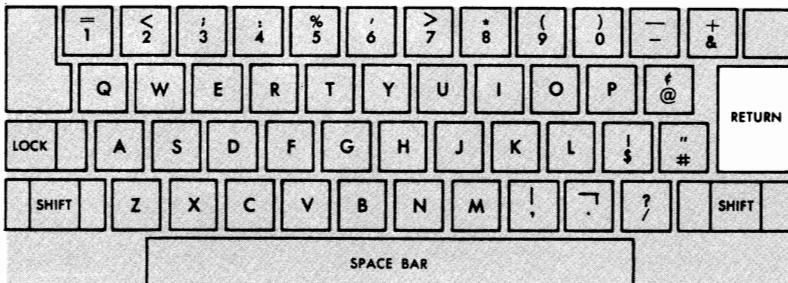

# CONSOLE PRINTER-KEYBOARD MANUAL OPERATIONS

- 6** To continue program processing when the alter or display operation is completed, return the RATE switch to PROCESS and press the START key.

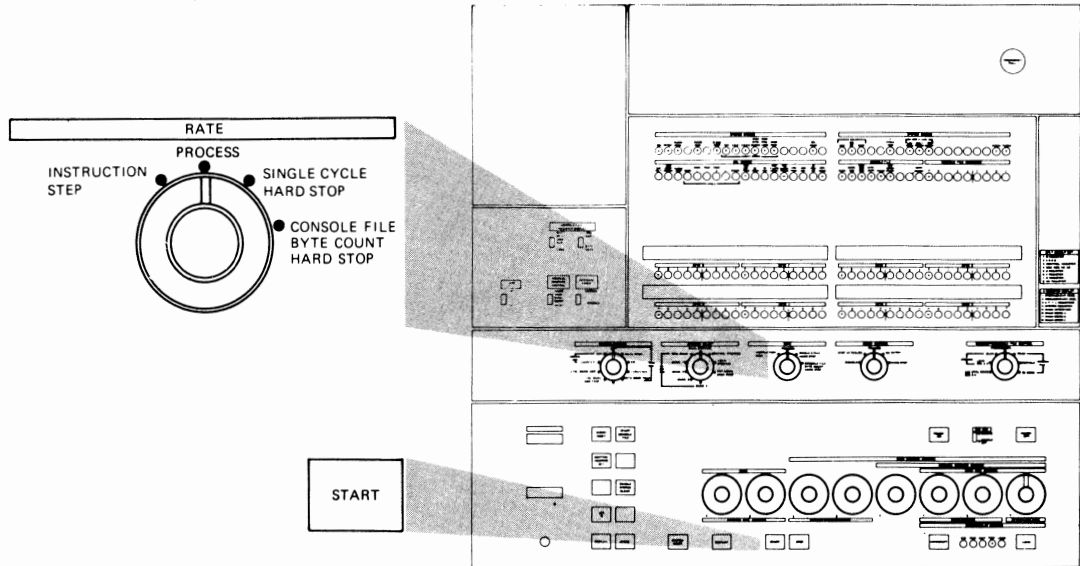

## Alter/Display Examples

- In the following examples, the Xs represent characters displayed or entered and printed by the PR-KB.

### MAIN STORAGE

DM 0008D  
 XXXXXX XXXXXXXX XXXXXXXX-----XX  
 XXXXXXXX XXXXXXXX (Press the ALTER/DISPLAY or END key.)

DM 8D (Press the RETURN key.)  
 XXXXXX XXXXXXXX XXXXXXXX-----XX  
 XXXXXXXX XXXXXXXX (Press the ALTER/DISPLAY or END key.)

AM 480 (Press the RETURN key.)  
 XXXXXXXX XXXX (Press the ALTER/DISPLAY or END key.)

### FLOATING-POINT REGISTER

DF 2  
 XXXXXXXX XXXXXXXX XXXXXXXX-----XX

### STORAGE KEY

DK 009000  
 XXXXXXXX XXXXXXXX XXXXXXXX (Press the ALTER/DISPLAY or END key.)

Each word contains four storage keys.

### CURRENT PSW

AP  
 XXXXXXXX XXXXXXXX

### VIRTUAL STORAGE

Type in logical address: LLLLLL; system types out =  
 RRRRRR (real address).

DV LLLLLL=RRRRRR  
 XXXXXXXX XXXXXXXX XXXXXXXX  
 XXXXXXXX XXXXXXXX (Press ALTER/DISPLAY key.)

AV LLLLLL=RRRRRR  
 XXXXXXXX XXXXXXXX XXXXXXXX  
 XXXXXXXX XXXXXXXX (Press ALTER/DISPLAY key.)

## CONSOLE PRINTER-KEYBOARD MANUAL OPERATIONS

### Alter/Display Error Messages

#### INVAL CHAR

This message prints when one of the following error occurs:

1. The first character of a mnemonic is not A, D, or S.
2. The second character is not M, S, L, K, C, G, F, P, T, or V.  
(S and L are for service personnel.)
3. An invalid hex digit is typed when addressing or altering data.
4. The CANCEL key is pressed.
5. A character with a parity error is detected on the PR-KB bus-in-line.

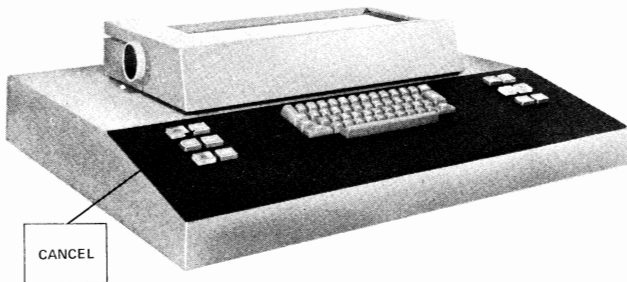

#### INVAL ADDR

Prints when one of the following errors occurs:

1. Invalid starting address.
2. Updated address exceeds the capacity of specified storage.
3. Non-translated logical address. (DV LLLLLL INVAL ADDR).
4. The translated real address exceeds the capacity of main storage. (DV LLLLLL = RRRRRR INVAL ADDR).

## CONSOLE PRINTER-KEYBOARD MANUAL OPERATIONS

### Store Status

- A manually initiated function that places the programmable registers in fixed locations in processor storage.
- The function is initiated by placing the PR-KB in alter/display mode and typing in ST.

### Store Status Procedure

1. Press the STOP key, or place the RATE switch in either INSTRUCTION STEP or SINGLE CYCLE HARD STOP position. This places the CPU in a stopped state.
2. Press the ALTER/DISPLAY key on the PR-KB. The PROCEED light turns on.
3. Type in the mnemonic ST. The function is executed, the carriage on the PR-KB returns, and the CPU exits from the ALTER/DISPLAY mode and returns to a stopped state. (No printout is given.)

The following programmable registers are affected:

- CPU timer
- Clock comparator
- Current PSW
- Floating point registers
- General registers
- Control registers

Note: The fixed storage location addresses for these areas are given in *IBM System/370 Model 145 Functional Characteristics*, GA24-3557.

## INITIAL PROGRAM LOAD (IPL)

**1** Load and ready the System Resident (SYS RES) device.

**2** Dial the address of the IPL device into LOAD UNIT ADDRESS switches F,G,and H.

## IPL ERROR RECOVERY

- Are LOAD UNIT ADDRESS switches F,G,and H correct?
- Is SYS RES device ready?

If setup is correct and IPL errors still occur, see "Handling Abnormal Situations--Introductory Flowchart."

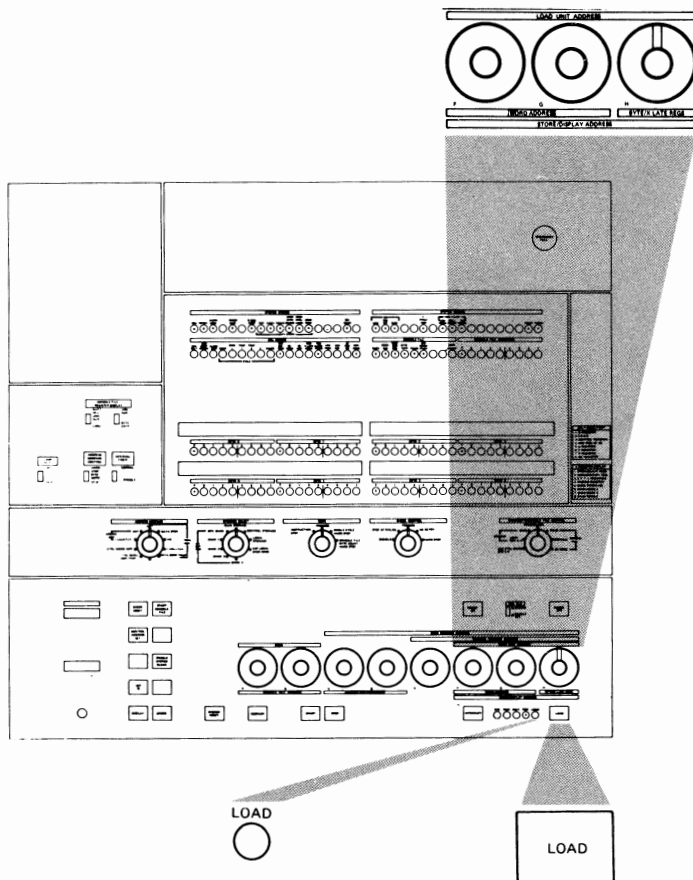

**3** Press the LOAD key.

- After an automatic system reset, the IPL operation starts.
- The LOAD indicator turns on.
- When IPL is complete, the LOAD indicator turns off and the system either executes the program or enters the soft-stop state awaiting your action.

## SET IC (INSTRUCTION COUNTER)

**1** Press the STOP key.

**2** Dial the desired address into MAIN STORAGE ADDRESS switches C, D, E, F, G, and H.

**3** Press the SET IC key.

The set instruction counter operation loads the address from switches C, D, E, F, G, and H into the instruction counter. Instruction processing starts from this address when the START key is pressed.

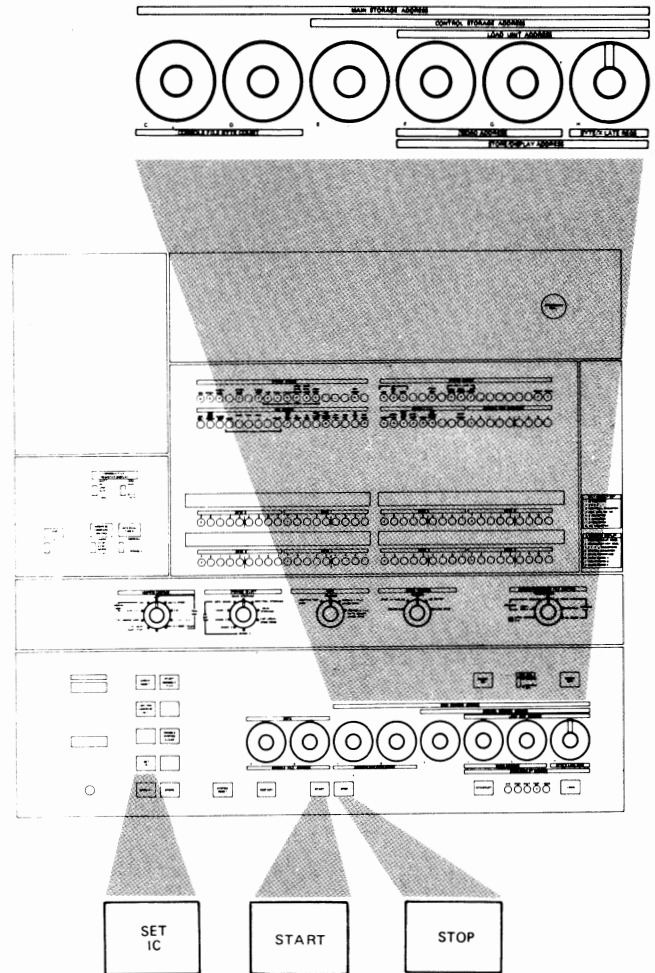

## INSTRUCTION STEP

**1** Press the STOP key.

**2** Set the RATE switch to INSTRUCTION STEP.

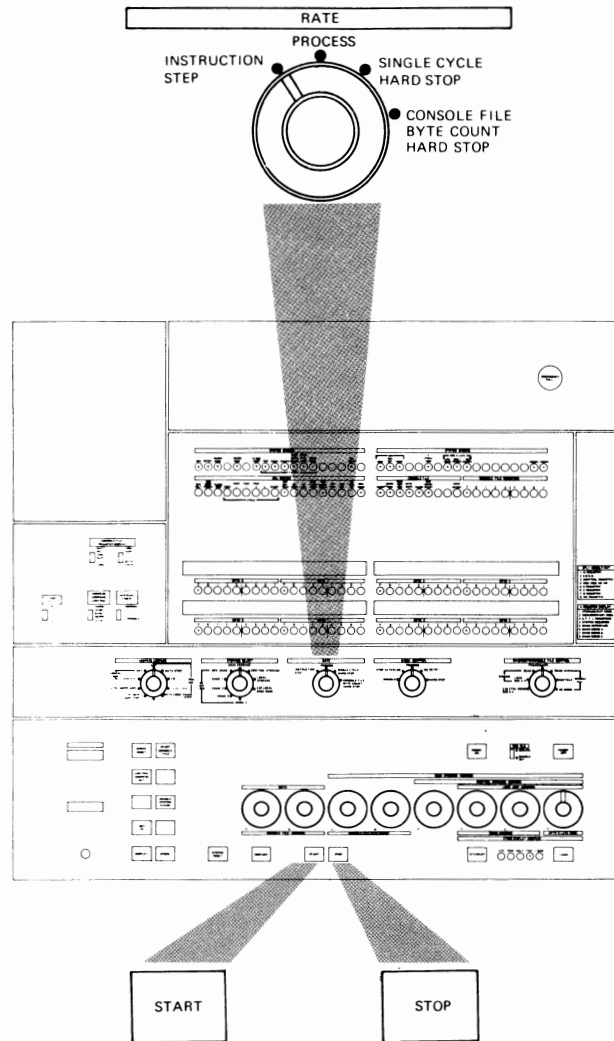

**3** Press the START key.

One machine language instruction is executed for each operation of the START key. The instruction counter (displayed in the A REGISTER DISPLAY indicators) contains the address of the next instruction to be executed.

## CLEAR STORAGE

- Main storage can be cleared to zeros using the following procedure:

**1** Hold the ENABLE SYSTEM CLEAR key in the operated position.

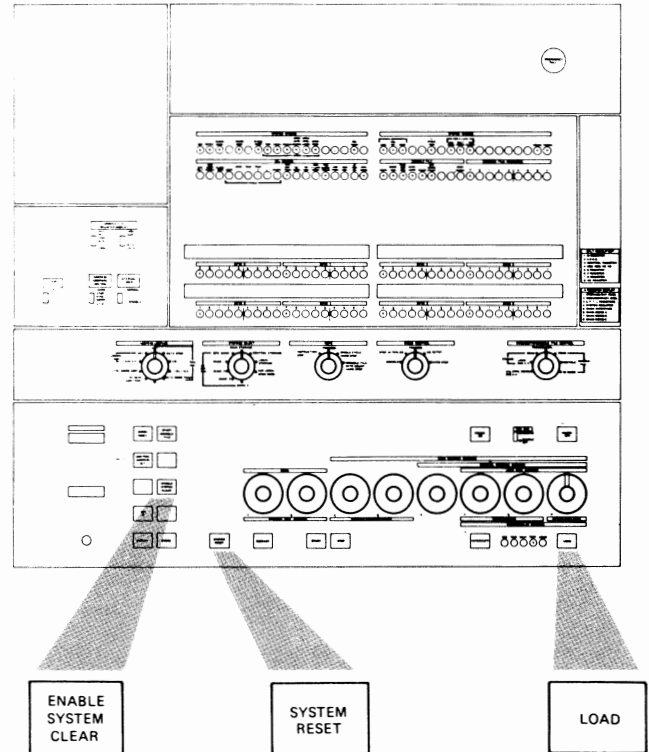

**2** Press the SYSTEM RESET or LOAD key.  
All of main storage is cleared to zeros (hexadecimal 00); control storage is not affected.

**3** Release the ENABLE SYSTEM CLEAR key.



# DATA COMPARE TRAP

**1** Press the STOP key.

**2** Set the ADDRESS COMPARE switch to DATA COMP TRAP.

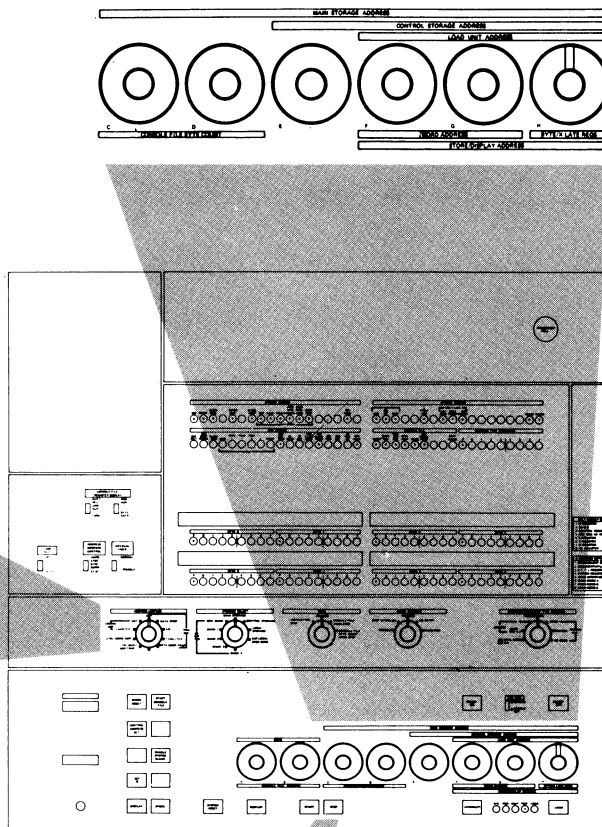
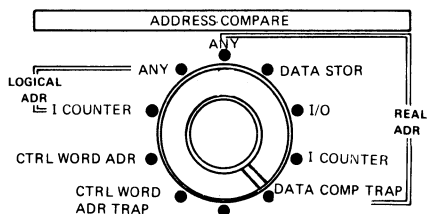

**3** Set the address of the storage byte location being modified in rotary switches C, D, E, F, G, and H.

STOP

## DATA COMPARE TRAP

- 4 Set rotary switches A and B to the desired byte match value.

- 5 Set the ADDRESS COMPARE CONTROL toggle switch to STOP.

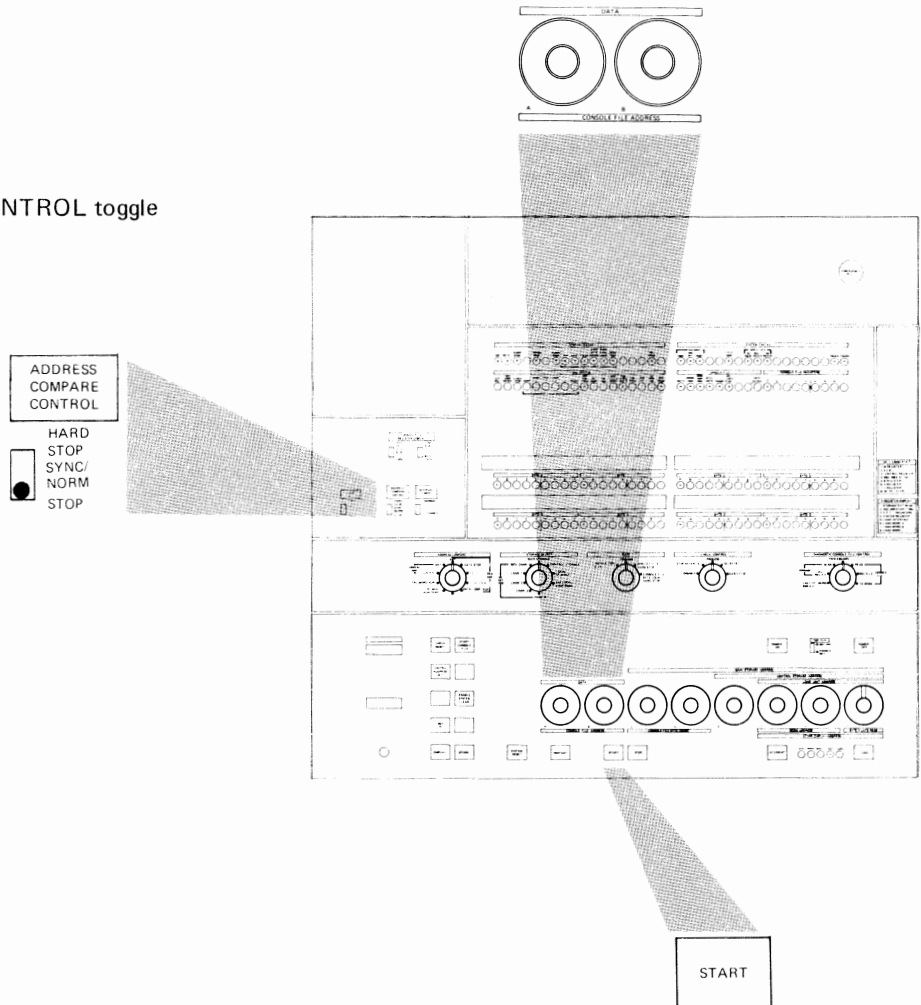

- 6 Press the START key.

When a store operation modifies the specified storage byte location to the value set in switches A and B, the ADR COMP MATCH indicator turns on and the CPU enters a soft-stop state.

To determine the address of the instruction in operation, display the current PSW (refer to "Console Printer-Keyboard Manual Operations") and subtract the current instruction length code from the instruction address in the current PSW.

Note: The instruction found with this procedure may not have modified the data. An I/O data trap occurring during execution of this instruction could have modified the data.

## MANUAL STORE/DISPLAY OPERATIONS

- The MAN indicator must be on for the STORE and DISPLAY keys to be operative. If the CPU is running, press the STOP key to turn on the MAN indicator. If the MAN indicator is on, ignore the remainder of this paragraph. If the CPU is stopped and the MAN indicator is not on, check that the toggle and rotary switches are in the normal positions. If the switches are all in the normal positions, turn the RATE switch to INSTRUCTION STEP and press the START key to turn on the MAN indicator. Return the RATE switch to the normal position and continue the manual store/display operation.

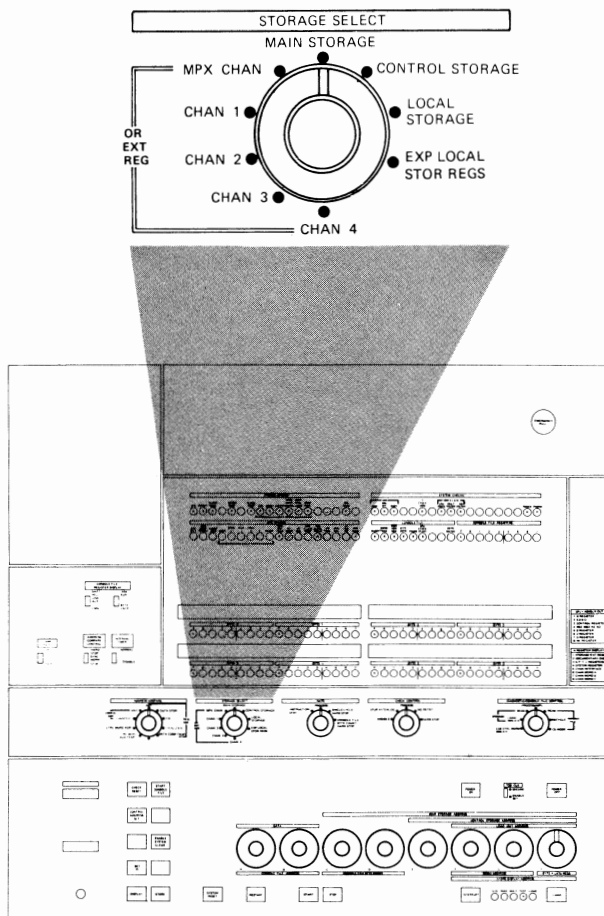

### Main Storage

With the system in manual mode (MAN indicator on), store/display of main storage is performed as follows:

- 1 Set the STORAGE SELECT switch to MAIN STORAGE.
- 2 Set the DPLY ASMBLR OUT roller switch to SDBO (position 2).

DPLY ASMBLR OUT	
1	M REGISTER
2	S D B O
3	CONTROL REGISTER
4	MB2, MB3, N2, N3
5	B REGISTER
6	Z REGISTER
7	D REGISTER
8	MC REGISTER

## MANUAL STORE/DISPLAY OPERATIONS

**3** Dial the desired word address into rotary switches, C, D, E, F, G, and H. For a display operation, proceed to Step 5.

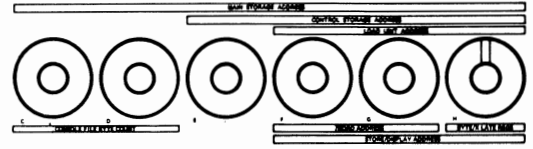

**4** For a store operation, set rotary switches A and B to the hexadecimal byte value to be stored.

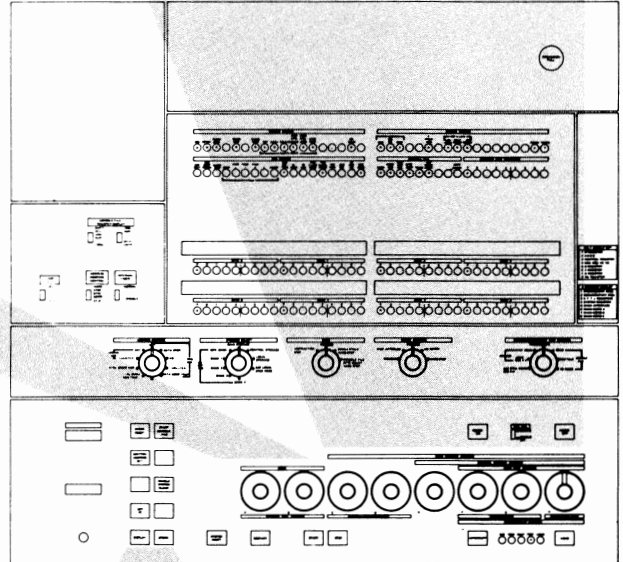
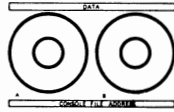

**5** Press the STORE or DISPLAY key.



- The addressed main storage word is displayed in the DPLY ASMBLR OUT roller switch indicators at the end of the store or display operation. Any byte stored is displayed in its stored condition.

# MANUAL STORE/DISPLAY OPERATIONS

## General and Floating-Point Registers

Store or display of these registers is performed as follows:

- 1 Set the STORAGE SELECT switch to LOCAL STORAGE.

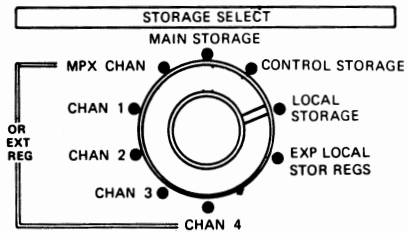

- 2 Dial the word address of the desired register into rotary switches F and G. For a display operation, proceed to Step 5.

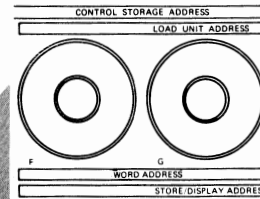
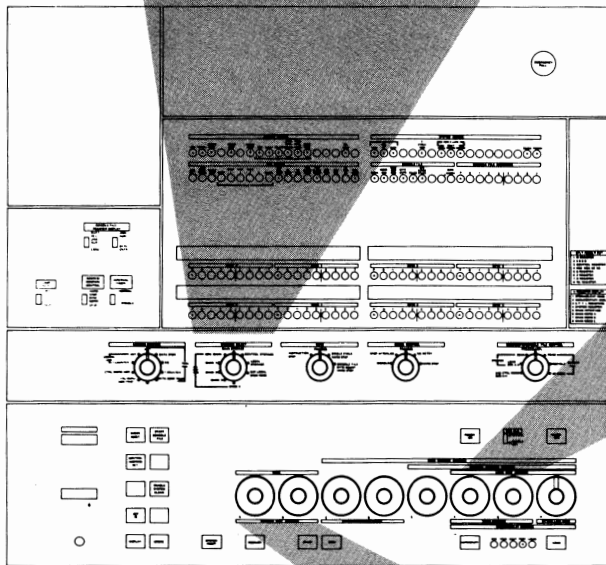

- 3 For store operations, set the value to be stored in switches A and B.

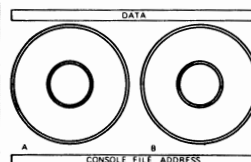

## MANUAL STORE/DISPLAY OPERATIONS

- 4** Set the byte address at which the data is to be stored in switch H (only the two low-order bits of switch H designate the byte). For example, if switch H is set to C (1100 binary), byte zero is selected.

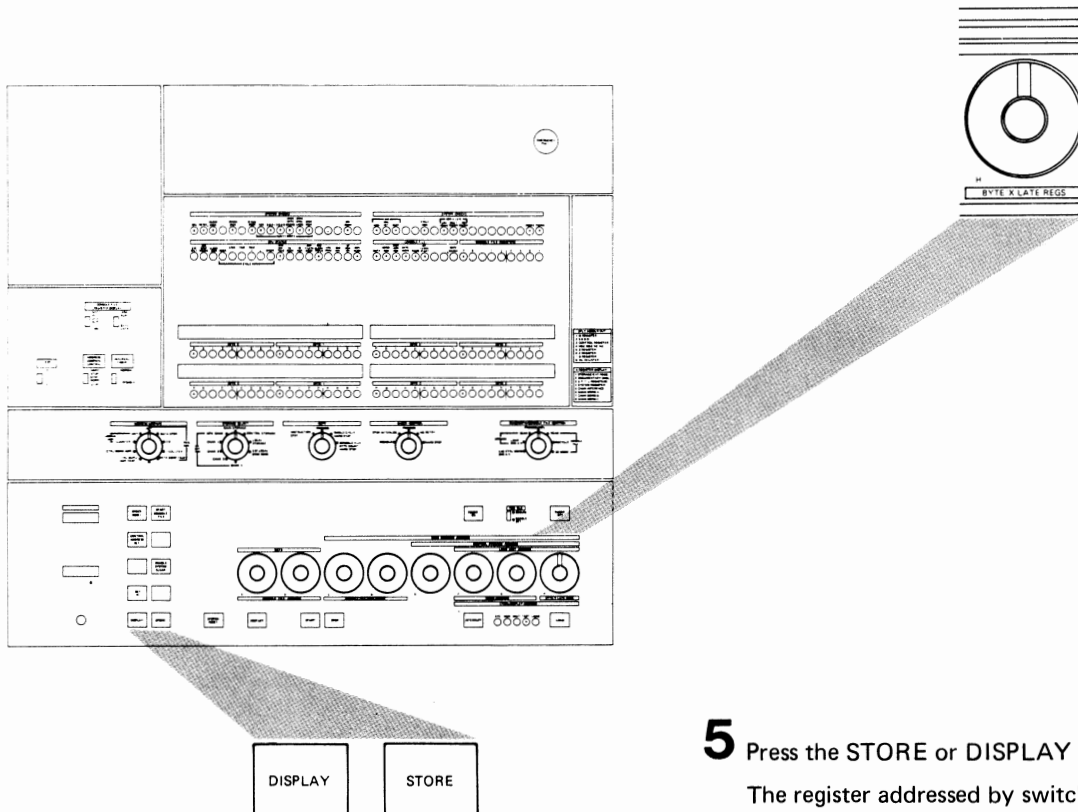

- 5** Press the STORE or DISPLAY key.

The register addressed by switches F and G is displayed in the A REGISTER DISPLAY roller switch indicators at the end of the store or display operation.

WORD ADDR	REGISTER DISPLAYED
00	General Register 0
01	General Register 1
02	General Register 2
03	General Register 3
04	General Register 4
05	General Register 5
06	General Register 6
07	General Register 7
08	General Register 8
09	General Register 9
0A	General Register A
0B	General Register B

WORD ADDR	REGISTER DISPLAYED
0C	General Register C
0D	General Register D
0E	General Register E
0F	General Register F
30	Floating-Point Register 0
31	Floating-Point Register 0
32	Floating-Point Register 2
33	Floating-Point Register 2
34	Floating-Point Register 4
35	Floating-Point Register 4
36	Floating-Point Register 6
37	Floating-Point Register 6

## POWER-OFF PROCEDURES

- Pressing the POWER-OFF key removes power to the CPU and on-line I/O units. Main and control storage information is lost.
- The power-off procedure depends upon the features installed. The following procedures may be used:

### No Features Installed

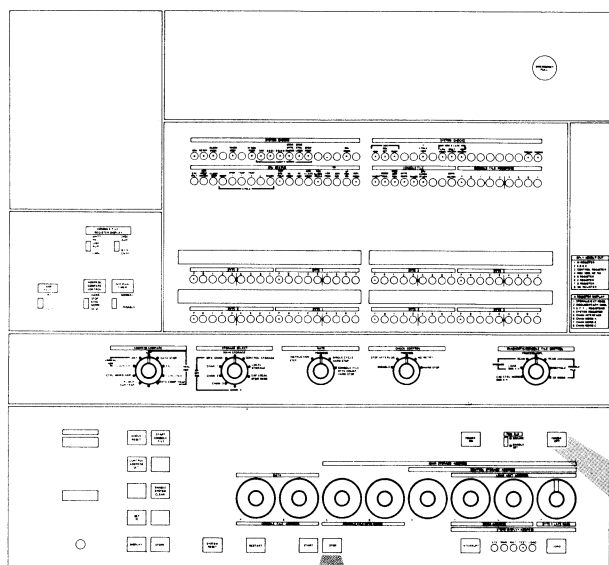

**1** Press the STOP key.



**2** Press the POWER OFF key.

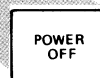

**Note:**

If the system is powered-off, do not turn power back on for at least 10 seconds. If the POWER-ON key is pressed before 10 seconds have elapsed, a power check may occur. This power check condition can be corrected by pressing the CHECK RESET key.

# POWER-OFF PROCEDURES

## Channel-to-Channel Adapter (CTCA) Feature Installed

**1** Inform the operator of the other system that the channel-to-channel adapter is to be removed from use.

**2** Move the I/O INTERFACE switch to the DISABLE position.

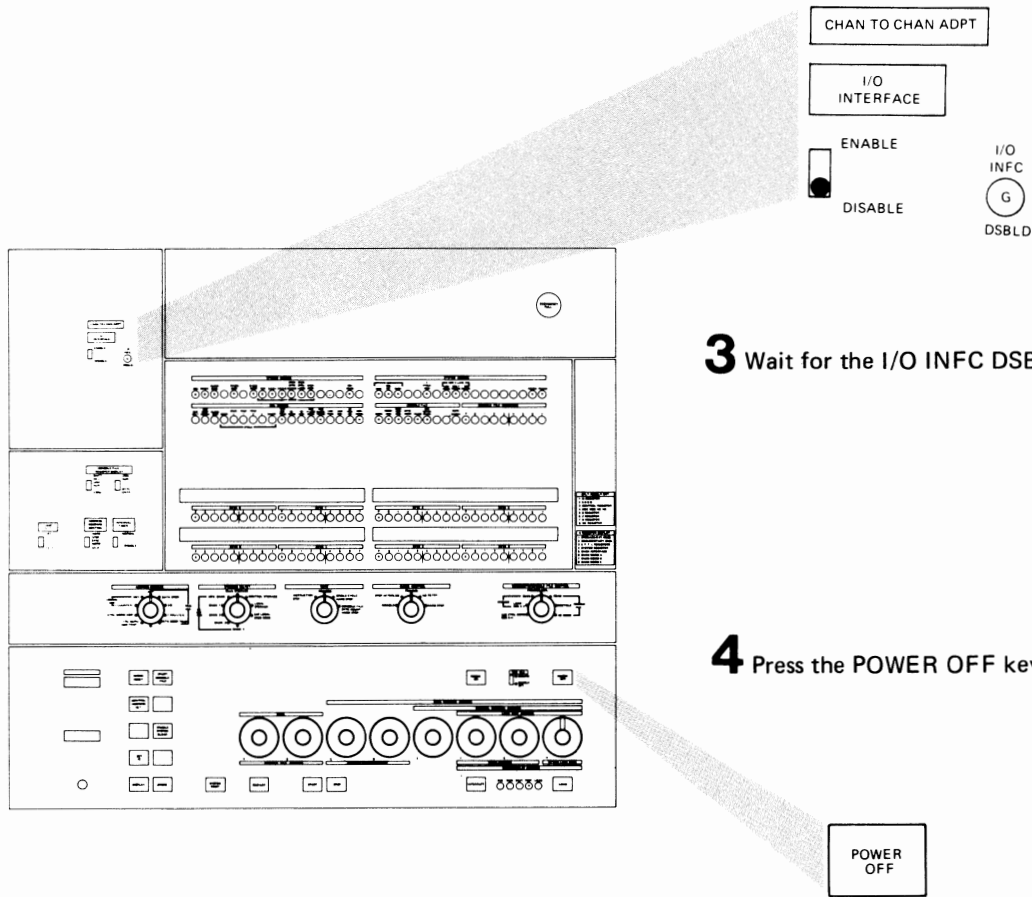

**3** Wait for the I/O INFC DSBLD indicator to turn on.

**4** Press the POWER OFF key.

**Note:**

If the system is powered-off, do not turn power back on for at least 10 seconds. If the POWER-ON key is pressed before 10 seconds have elapsed, a power check may occur. This power check condition can be corrected by pressing the CHECK RESET key.



## POWER-OFF PROCEDURES

### Integrated Storage Control (ISC) Feature Installed

- This procedure has the two-channel-switch special feature included.
- I/O INTERFACE B and MULTITAG switches are non-functional on a single channel ISC application.

**1** Inform the operator of the other system that the ISC feature is to be removed from use.

**2** Move the I/O INTERFACE A and B (switches) to the OFF position.

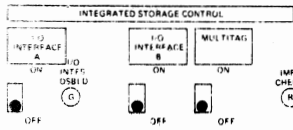

**3** Wait for the I/O INTFS DSBLD indicator to turn on.

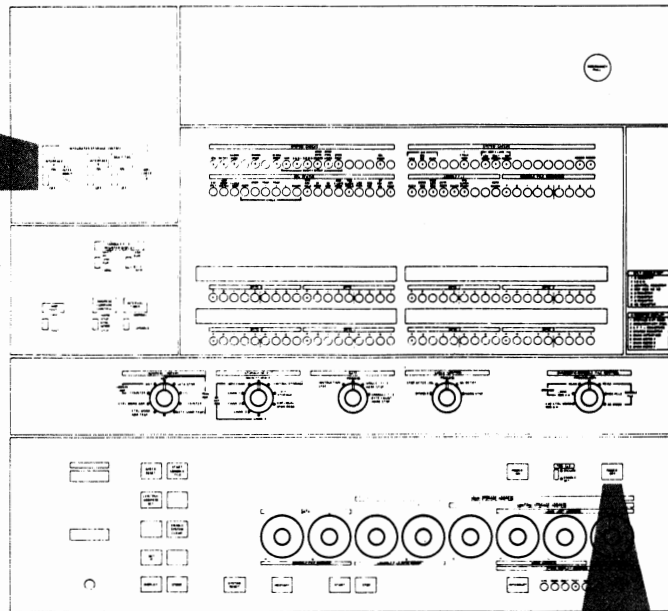

**4** Press the POWER OFF key.

#### Note:

If the system is powered-off, do not turn power back on for at least 10 seconds. If the POWER-ON key is pressed before 10 seconds have elapsed, a power check may occur. This power check condition can be corrected by pressing the CHECK RESET key.

## EMERGENCY PULL SWITCH

- 3145 Models H2, HG2, I2, IH2, and J2 have a 3047 Power Unit attached to the system. The 3047 has an EMERGENCY PULL switch mounted on a panel at the front of the unit. The 3047 EMERGENCY PULL switch functions the same as the switch mounted on the system control panel.
- Pulling either EMERGENCY PULL switch turns off electrical power to the CPU and online I/O units, and makes the POWER ON key ineffective until the EMERGENCY PULL switch is reset by a service representative.

### CAUTION

Either EMERGENCY PULL switch is readily identified by its red knob. Pull the red knob (into the fixed, latched position) in a true emergency only (a system fire or any case of danger to personnel).

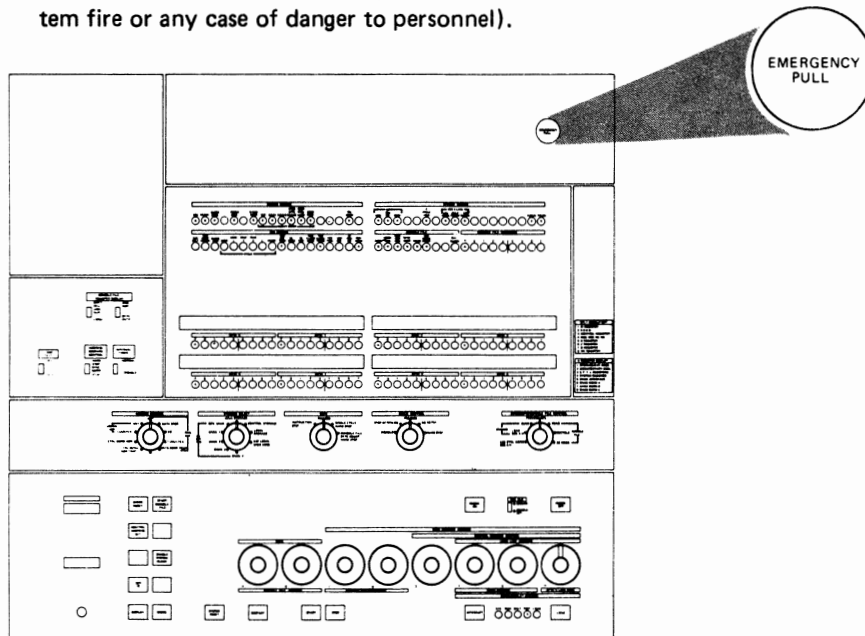

### 3047 Power Unit

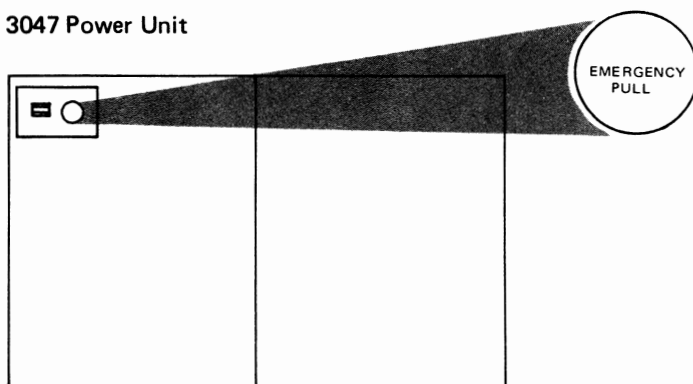

## SYSTEM TEST 370 (ST370)

### Purpose

- Indicates the reliability of the CPU, channel(s), and all I/O devices.
- Identifies the failing device(s), when used to investigate a specific problem.

### Prerequisites

- A completely dedicated system is needed. ST370 does not run under control of an operating system.
- A good \*370 microprogram disk IMPL operation must precede the ST370 test.
- Only devices made ready are tested by ST370.
- "Scratch" or work tapes or disks should be used for testing.

### Run Time

- Minimum time for reliability testing is approximately three minutes. (This gives at least one reliability printout.)
- ST370 must be terminated manually.

### Sources

- If you desire, your service representative can generate a ST370 'load' tape or card deck.

### Program Concepts

- ST370 loads from a 'load' tape or a card deck. The program communicates with the user via the PR-KB. All devices made ready are tested. 'Reliability reports' are printed at intervals on the PR-KB.
- Comparisons made with past ST370 reports may indicate failure trends and the need for scheduling maintenance.
- When ST370 is used to handle an abnormal situation, indicate the results to the dispatcher when you call for service. (Make ST370 results available to your service representative.)
- Recommended running the ST370 for reliability checking; twice weekly.
- ST370 is configuration sensitive. If any system configuration changes take place, have your service representative generate a new ST370 'load' tape or card deck.
- The output device used to print the ST370 messages can be the PR-KB or a Printer (Example: 1403 N1). The "Operating Procedures" in this section use the PR-KB as the output device.

'LOAD'  
Tape

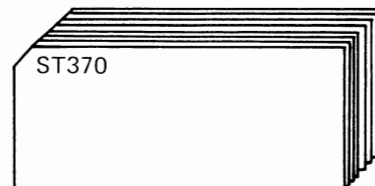

## SYSTEM TEST 370 (ST370)

### I/O Devices

The I/O devices that can be configured and tested by ST370 are:

Disk File and Drum Storage:

2301, 2303, 2305, 2310, 2311, 2314, 2319,  
2321, 3330

Magnetic Tape:

2400, 2415, 2420, 3410, 3420

Punch Card I/O:

1442 N1, 2501, 2520, 2540, 2596, 3505, 3525

Printer:

1403 N1, 1404 N1, 1443 N1, 3211

Displays:

2250, 2260, 3270

Console I/O:

1053, 2702, 2715, 3210, 3215

Magnetic Character Reader:

1259, 1412, 1419

Paper Tape I/O:

1017, 1018, 2671

Transmission Control Devices

2701, 2702, 2715, 3705

Optical Character Readers

1231, 1287 Model 5, 3881

Audio Response Unit

7770

Array Processor

2938

### EXAMPLES

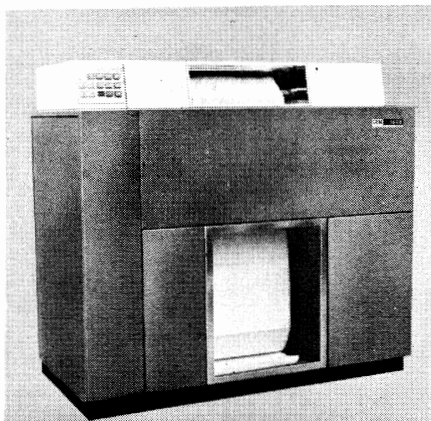

1403 N1 Printer



2311 Disk Storage Drive

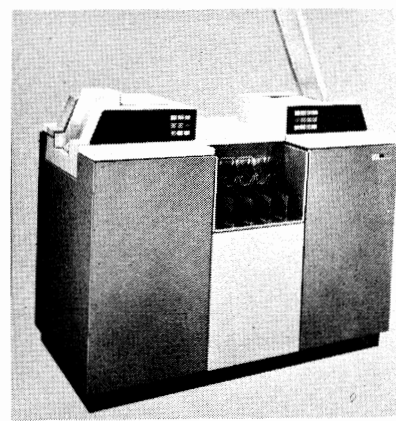

2540 Card Read Punch

# SYSTEM TEST 370 (ST370) OPERATING PROCEDURES

## Loading ST370 from Magnetic Tape

- Set all rotary switches to normal processing positions (indicating marks vertical).
- Set the LOAD UNIT ADDRESS in switches F, G, and H. (Example: 180)
- Load the tape drive with the ST370 'load' tape, and make the drive READY.
- Ready all devices to be tested.

**1** Press the LOAD key.

**2** CPU goes into the wait state (WAIT indicator on).

PR-KB Message:

TO PROCEED PRESS INTERRUPT OR  
TYPE GO

**3** Press the INTERRUPT key.

PR-KB Message:

RUN STARTED

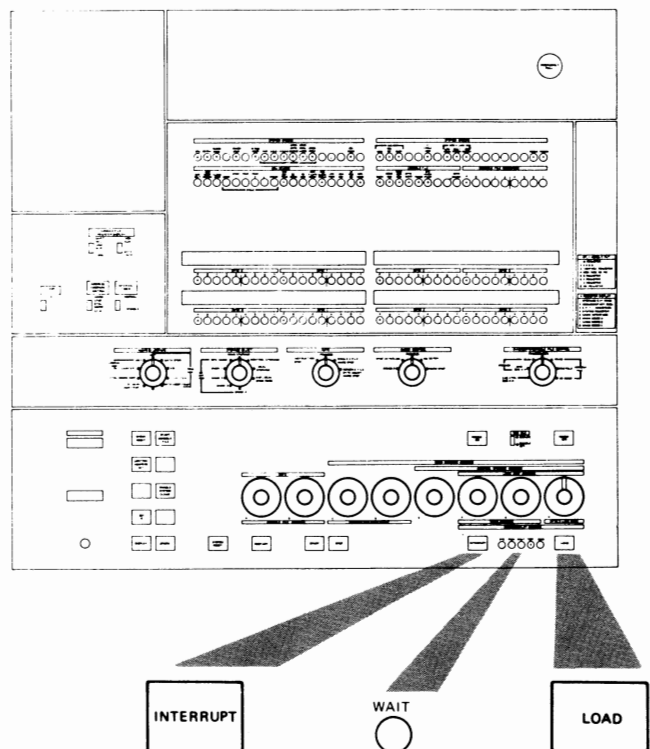

- 4** The first reliability report prints out on the PR-KB approximately three minutes after the INTERRUPT key is pressed.

NOTES:

1. Check the configuration listing to verify that all devices made READY are listed.
2. Reliability reports are printed on the PR-KB approximately every three minutes.

EXAMPLE:

REPORT 01 0003 MIN,00 SEC

	BLOCKS OPERATED	FAILED
I/O	000526	000000
CPU		
FIXED PT	004208	000000
FLOAT PT	004207	000000
DECIMAL	004207	000000
SP TEST	004207	000000

I/O UNITS	BLOCKS	ACUM	NOT			
ADDRESS	CLAS	OPER	FAIL	STAT	RDY	RDY
00000D	PU	0053	0000			X
00000E	PR	0420	0000			X
00001F	KB	0053	0000			X

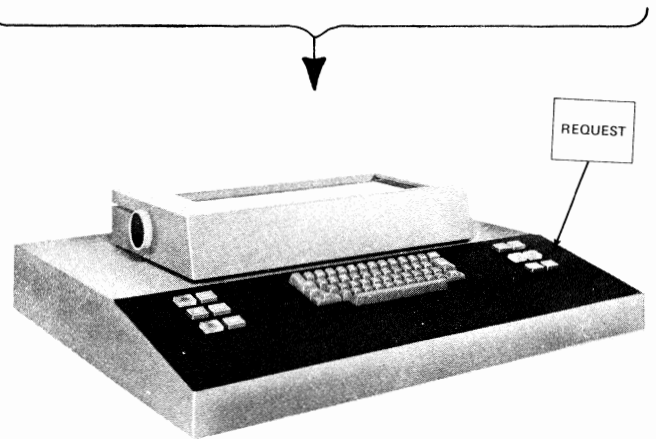

- 5** To terminate ST370, press REQUEST key on the PR-KB.

PR-KB Message:

READY

- 6** Type CANCEL.

PR-KB Message:

RUN CANCELLED

# SYSTEM TEST 370 (ST370) OPERATING PROCEDURES

## Loading ST370 from Punched Cards

- Set all rotary switches to normal processing positions. (indicating marks vertical).
- Set the LOAD UNIT ADDRESS in switches F, G, and H. (Example: 00C)
- Ready the card reader with the ST370 deck.
- Ready all devices to be tested.

**1** Press the LOAD key.

**2** CPU goes into the wait state (WAIT indicator on).

PR-KB Message:

TO PROCEED PRESS INTERRUPT OR  
TYPE GO

**3** Press the INTERRUPT key.

PR-KB Message:

RUN STARTED

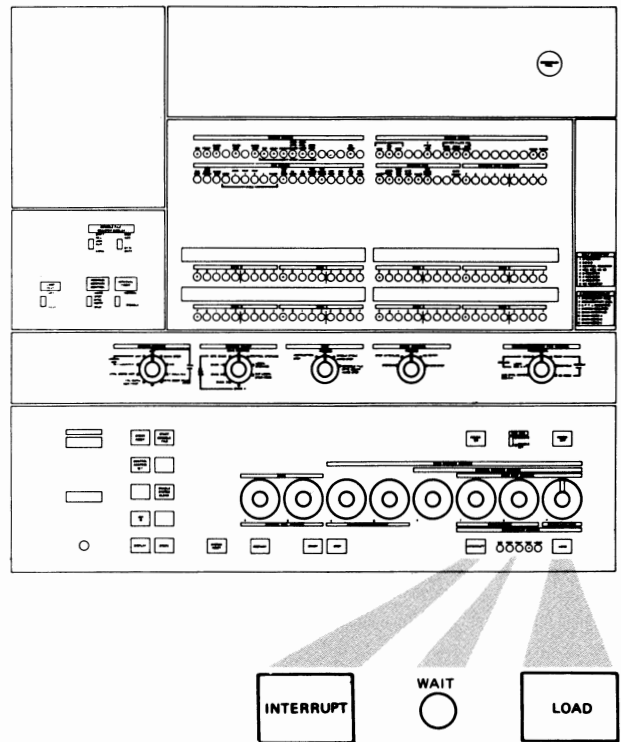

**4** The first reliability report prints out on the PR-KB approximately three minutes after the INTERRUPT key is pressed.

NOTES:

1. Check the configuration listing to verify that all devices made READY are listed.
2. Reliability reports are printed on the PR-KB approximately every three minutes.

EXAMPLE:

REPORT 01 0003 MIN,00 SEC

	BLOCKS OPERATED	FAILED
I/O	000526	000000
CPU		
FIXED PT	004208	000000
FLOAT PT	004207	000000
DECIMAL	004207	000000
SP TEST	004207	000000

I/O UNITS	BLOCKS	ACUM	NOT			
ADDRESS	CLAS	OPER	FAIL	STAT RDY RDY		
00000D	PU	0053	0000			X
00000E	PR	0420	0000			X
00001F	KB	0053	0000			X

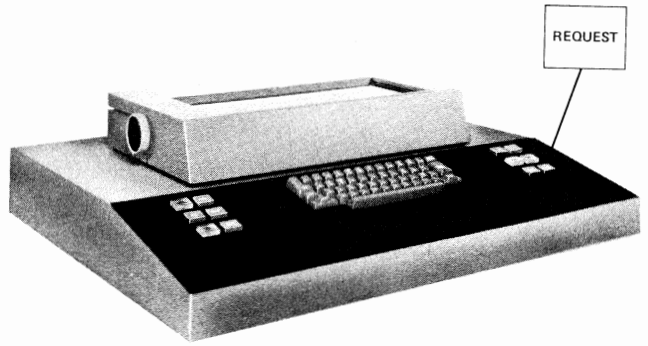
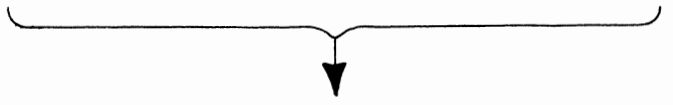

**5** To terminate ST370, press REQUEST key on the PR-KB.

PR-KB Message:

READY

**6** Type CANCEL.

PR-KB Message:

RUN CANCELED



# SYSTEM TEST 370 (ST370) OPERATING PROCEDURES

## Reliability Report Example

REPORT 03—Indicates the number of reports since the start of the test.  
0003 MIN, 00 SEC—Indicates the elapsed time since the last report.

CLOCK—00/00/00—Indicates clock setting at time of report.

I/O BLOCKS—Indicates the total number of I/O blocks operated since the last report.

CPU—Indicates the number of operations and failures against each class of CPU test.

I/O UNITS—Itemizes information about the I/O units (see chart).

```

REPORT 03 0003 MIN, 00 SEC
CLOCK=00/00/00
  BLOCKS OPERATED FAILED
  I/O      000529  000013
  CPU
FIXED PT  005371  000000
FLOAT PT  001020  000000
DECIMAL   000612  000000
SP        000456  000000
  I/O UNITS      BLOCKS ACUM NOT
ADDRESS CLAS OPER FAIL STAT RDY RDY
 00001F TY  0000 0000
 000190 DS  0058 0000 BUSY
 000191 DS  0059 0000
 000193 DS  0057 0013 0E00 *UNIT ERROR*
 000280 TP  0355 0000
 000281 TP  0000 0000
 000282 TP  0000 0000
 000283 TP  0000 0000
  CE,DE,UCK
    
```

### NOTES:

1. This line indicates the failing device. Give the information on this line to the dispatcher when you call for service.
2. The maximum acceptable error percentage varies with the I/O device media used. The percentage figure should be arrived at through discussion with your service representative.

ADDRESS	Unit address of the device
CLAS	Denotes the class of the unit (TP=Tape)
OPER	Indicates the number of I/O blocks run by this unit
FAIL	Number of failures for the unit
ACUM STAT	Total status accumulated by the unit since the last report
NOT RDY	Indicates a change of unit status to not ready
RDY	Indicates a change of unit status to ready
*CHAN ERROR*	Error against the channel
*CU ERROR*	Error against the control unit
*UNIT ERROR*	Error against the unit
BUSY	Indicates an error condition in which the control unit or channel is hung.

## SYSTEM ERROR RECORD EDITING PROGRAM (SEREP)

SEREP is a self-loading program used to retrieve and edit hardware logout information. It provides a hard copy listing of available data pertinent to the error. SEREP does not perform any diagnostic function except to provide edited logout data for the service representative.

### When to Use

SEREP is run after a machine check, channel control check, or interface control check when operating with a control program not using the automatic logging of error data on an external storage device. The system must be run with the CHECK CONTROL switch set to the STOP AFTER LOG position. When a log is present in the log area of storage, the LOG PRES and MAN indicators are on, and SEREP should be run. Save the error data for the service representative.

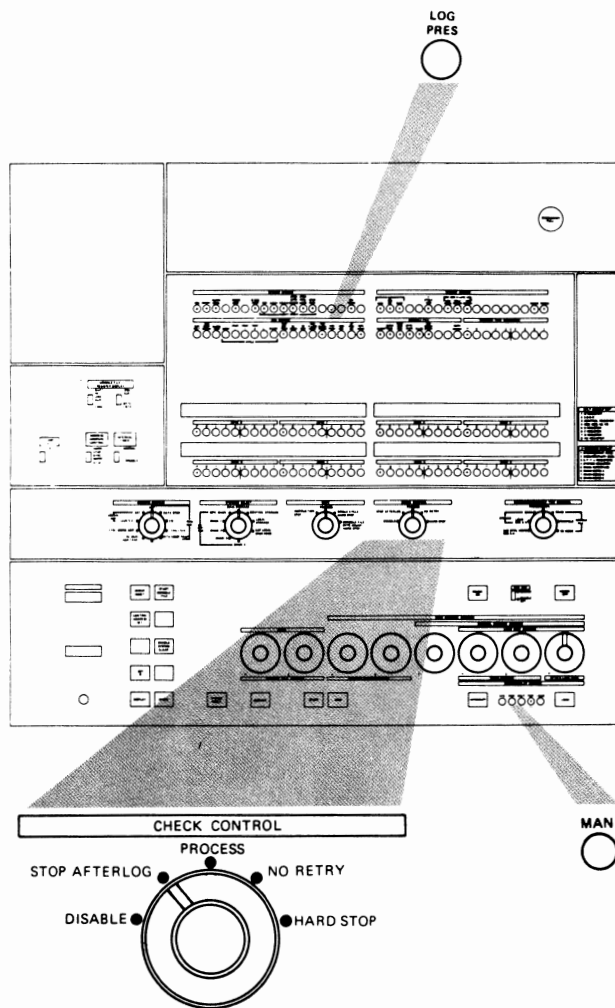

## SYSTEM ERROR RECORD EDITING PROGRAM (SEREP)

### Program Loading

The program is assembled with device address 00E as the output device. If this device is acceptable and available as an output device, it is only necessary to IPL the SEREP deck from the card reader. The output device may be changed in two ways:

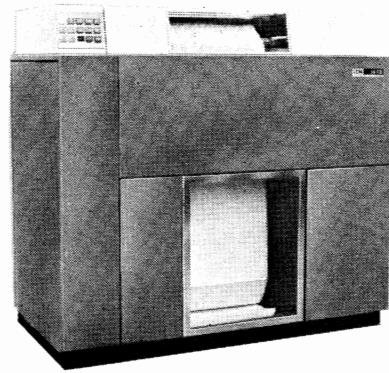

1403 N1 PRINTER  
(ADDRESS 00E)

- 1 Punch the address of the desired output device in columns 67,68, and 69 of the last TXT card (next to the last card in the SEREP deck).

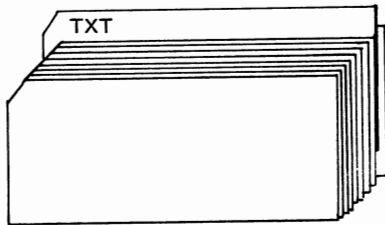

OR

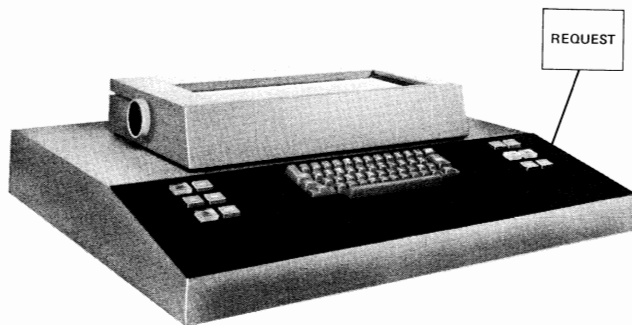

- 2 Reproduce this card, but leave these columns blank. In this case, SEREP goes into the wait state after loading. By causing a not-ready-to-ready interrupt on a device (or by operating the REQUEST key on the PR-KB), that device is assigned as a output device. No other action is required.

- After edit is complete, write the date and time on the first page of the logout.

# SYSTEM ERROR RECORD EDITING PROGRAM (SEREP)

## Normal Program Waits

When no output device is specified, or the specified device is not ready, SEREP enters the wait state after loading.

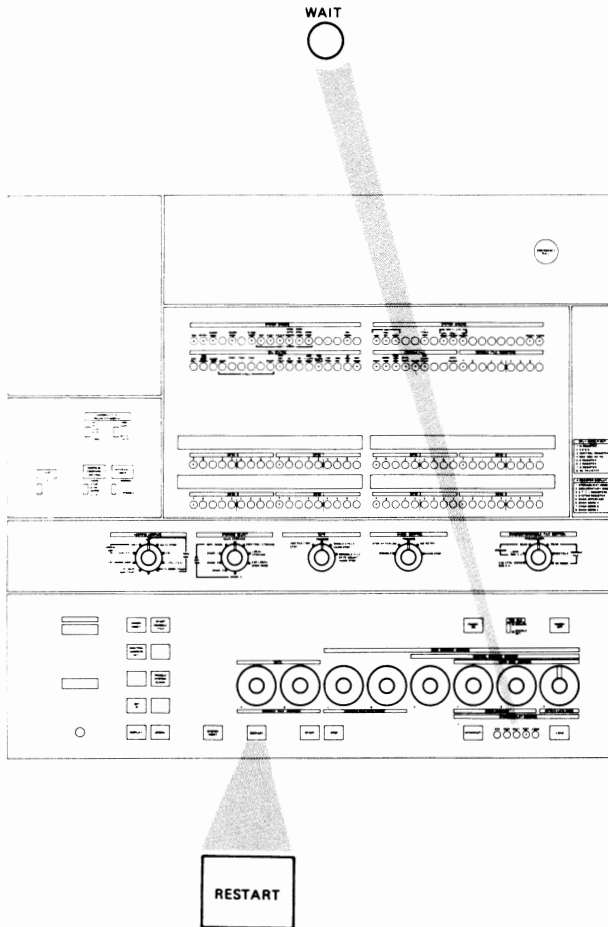

## Error Waits

An unexpected program check during execution of SEREP causes a message to be printed and the system to enter the wait state. Retry is attempted by pressing the RESTART key. Re-IPL because alternation of PSWs by the SEREP program may cause the edit to be erroneous.

## Termination

When logout is complete or if no log is found, a message prints, and the system enters the wait state.

---

Operator's Notes:

---

PLEASE USE THE READER'S COMMENT FORM AT THE BACK OF THE MANUAL.

# HANDLING ABNORMAL SITUATIONS

This section can help you to determine whether a problem exists, and how to handle and report the specific type of error you encounter.

Operator investigation and reporting of abnormal situations reduce overall system down time. The following facilities are used to investigate abnormal situations.

1. Flowcharts (in this section)
2. PR-KB messages
3. System control panel switches and indicators
4. System Test 370 (ST370).

The flowcharts in this section can help you analyze problems that cannot be rectified immediately. These

charts provide systematic checks that help identify a hardware problem from a software or operational problem.

When using the flowcharts, always start with the "Introductory Flowchart." This is an overview of the four major type problems that can be encountered. When used properly, it leads you to a specific problem flow.

You may be able to correct the problem yourself and eliminate system down time. Any information you gather can assist your service representative and shorten system down time.

The flowcharts may direct you to examine PR-KB messages or system indicators and switches. If you are directed to run ST370, examine the reliability printout and relay all pertinent information to the dispatcher when you place a call for service.

# HANDLING ABNORMAL SITUATIONS--INTRODUCTORY FLOWCHART

1. Comply with all OS, DOS, or OS/VS messages before proceeding into flow. (Refer to appropriate Systems Library Manual: DOS, GC24-5074; OS, GC28-6631; OS/VS GC38-1001.)

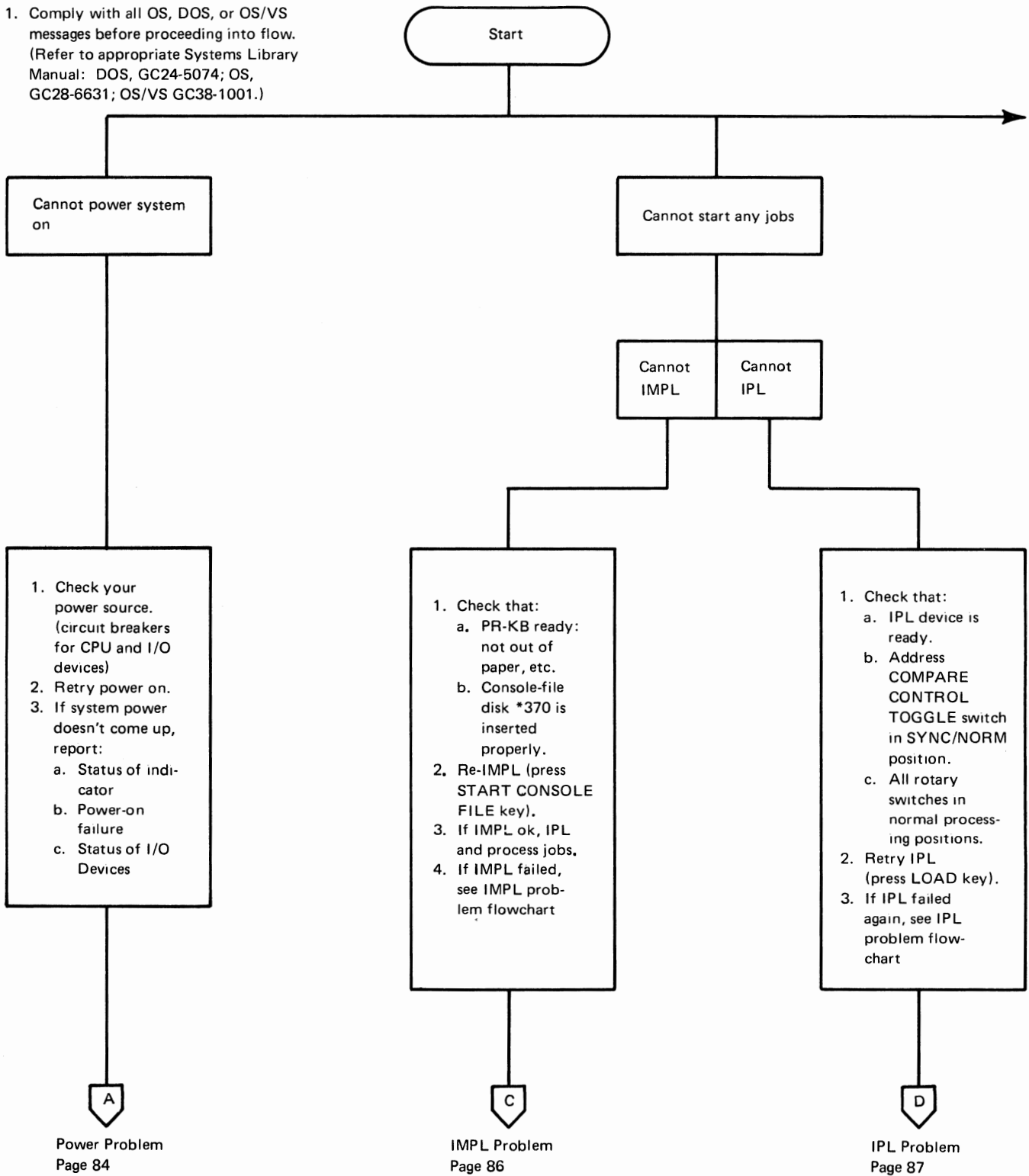

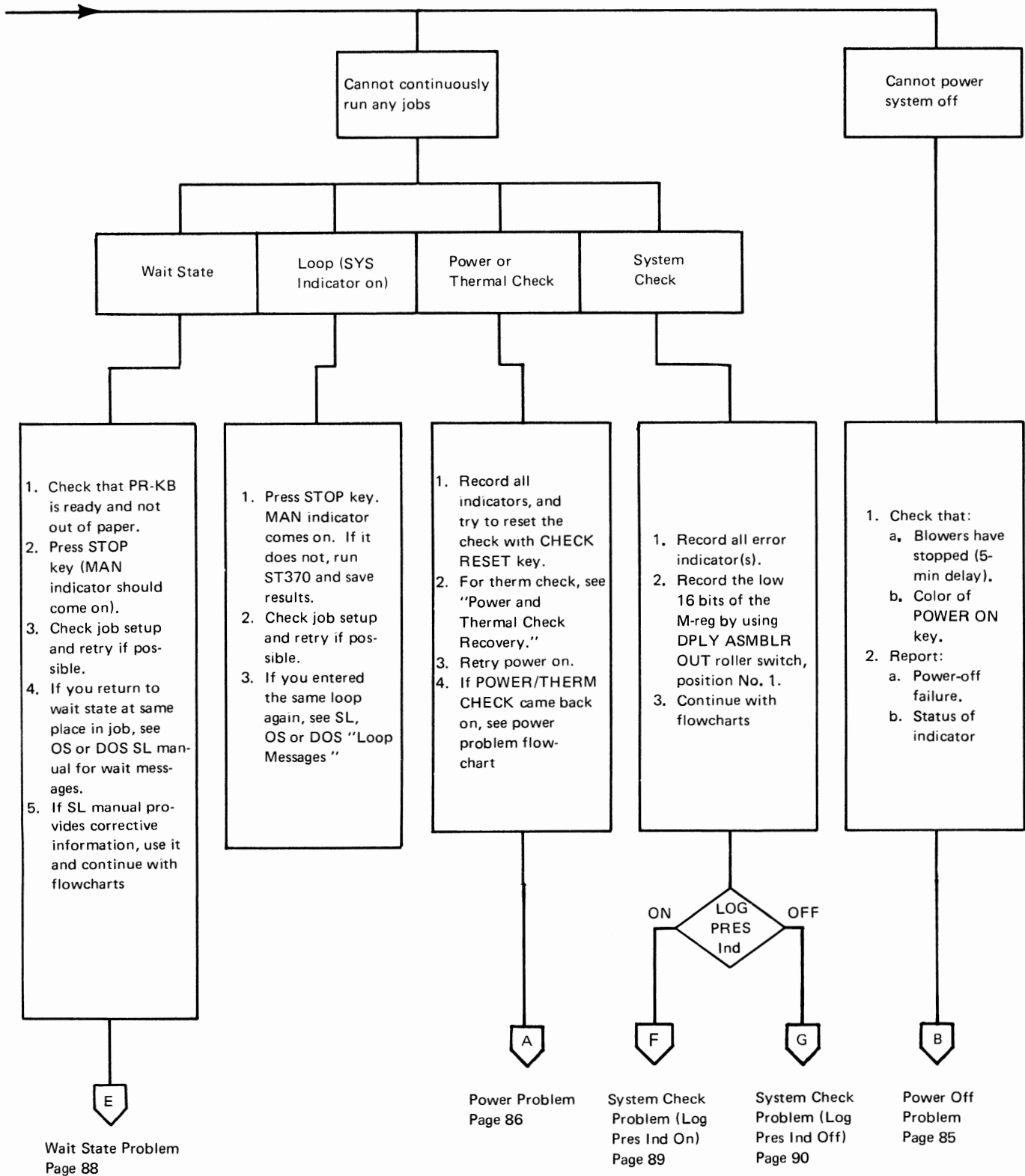



Note:

The power-on sequence takes approximately 45 seconds.

### Power Problem

Pages 82/83

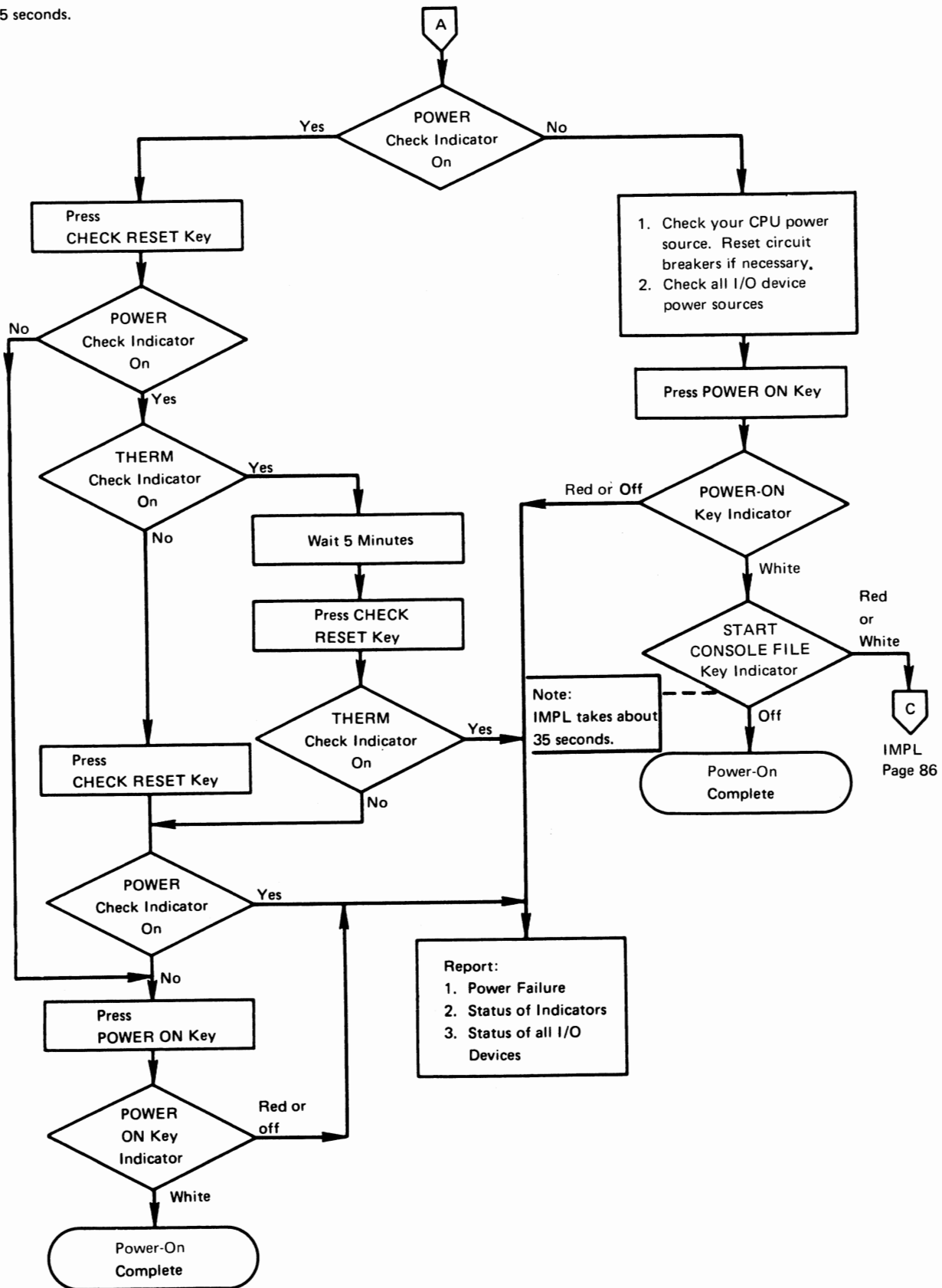

Page 83

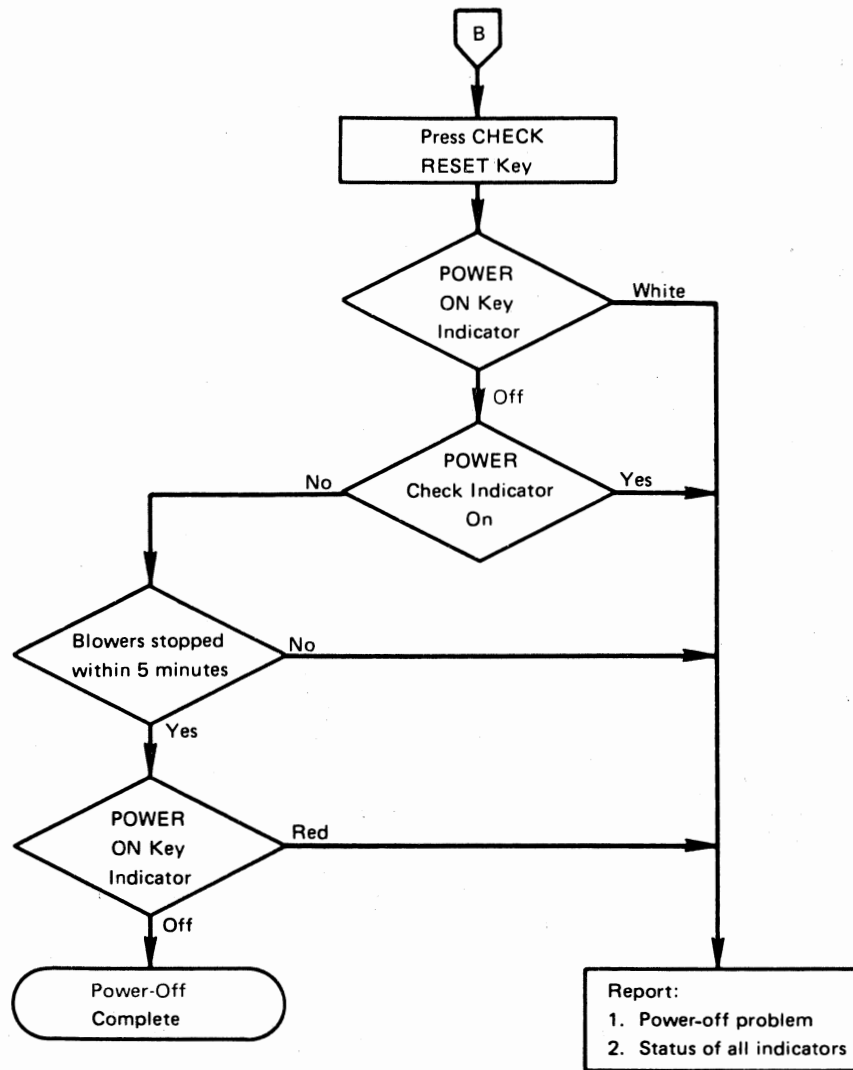



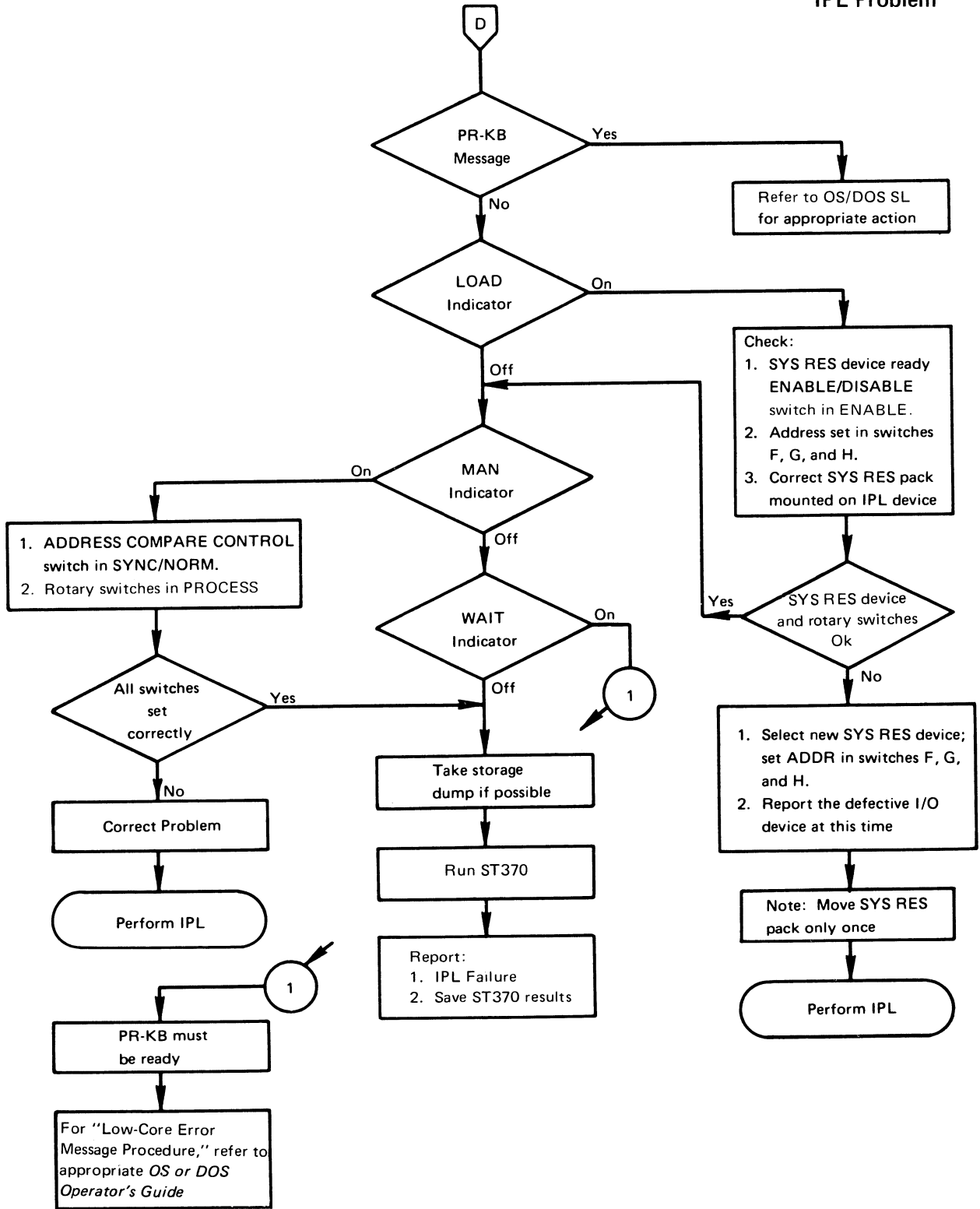

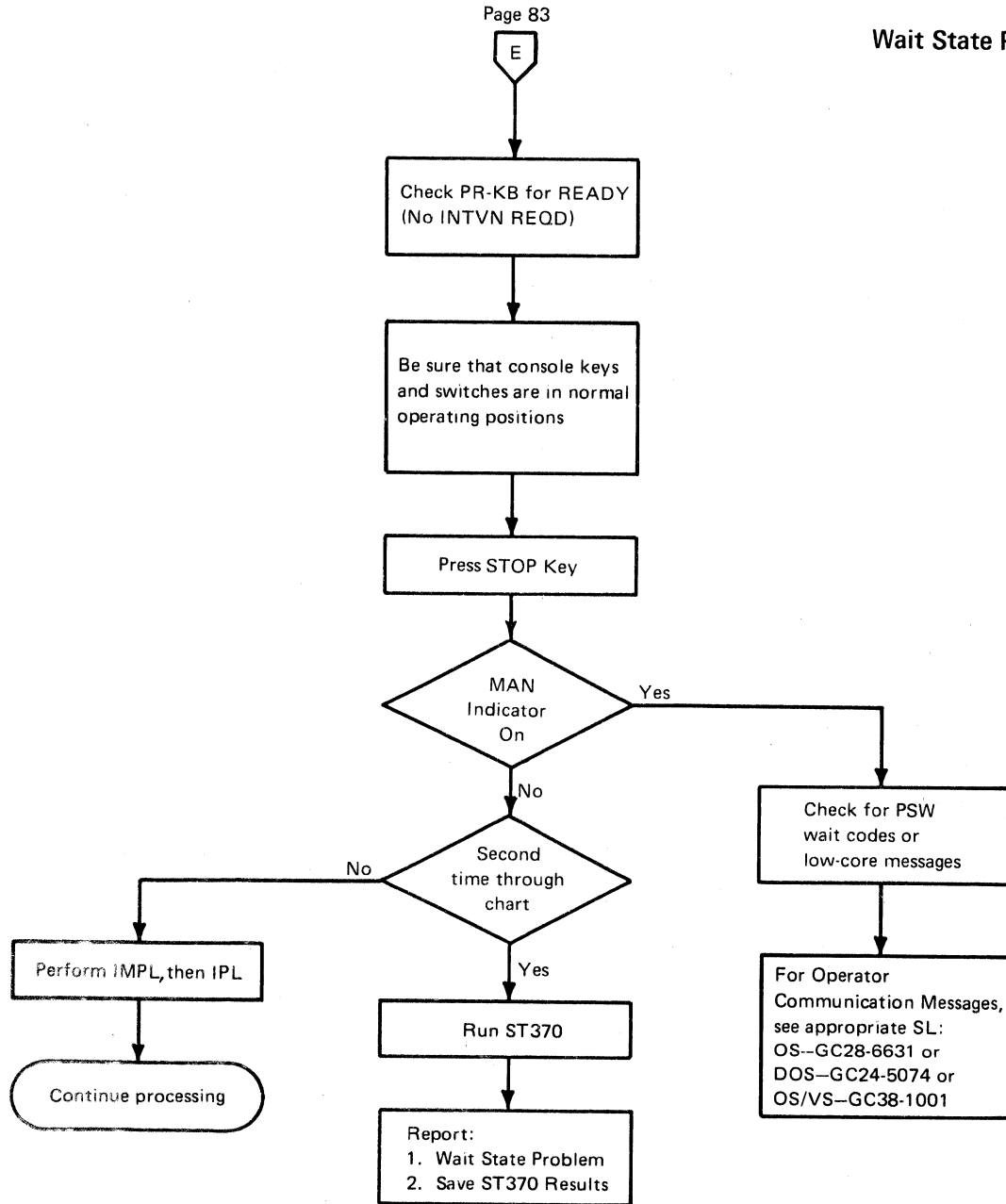

# System Check Problem (LOG PRES Indicator On)

Page 83

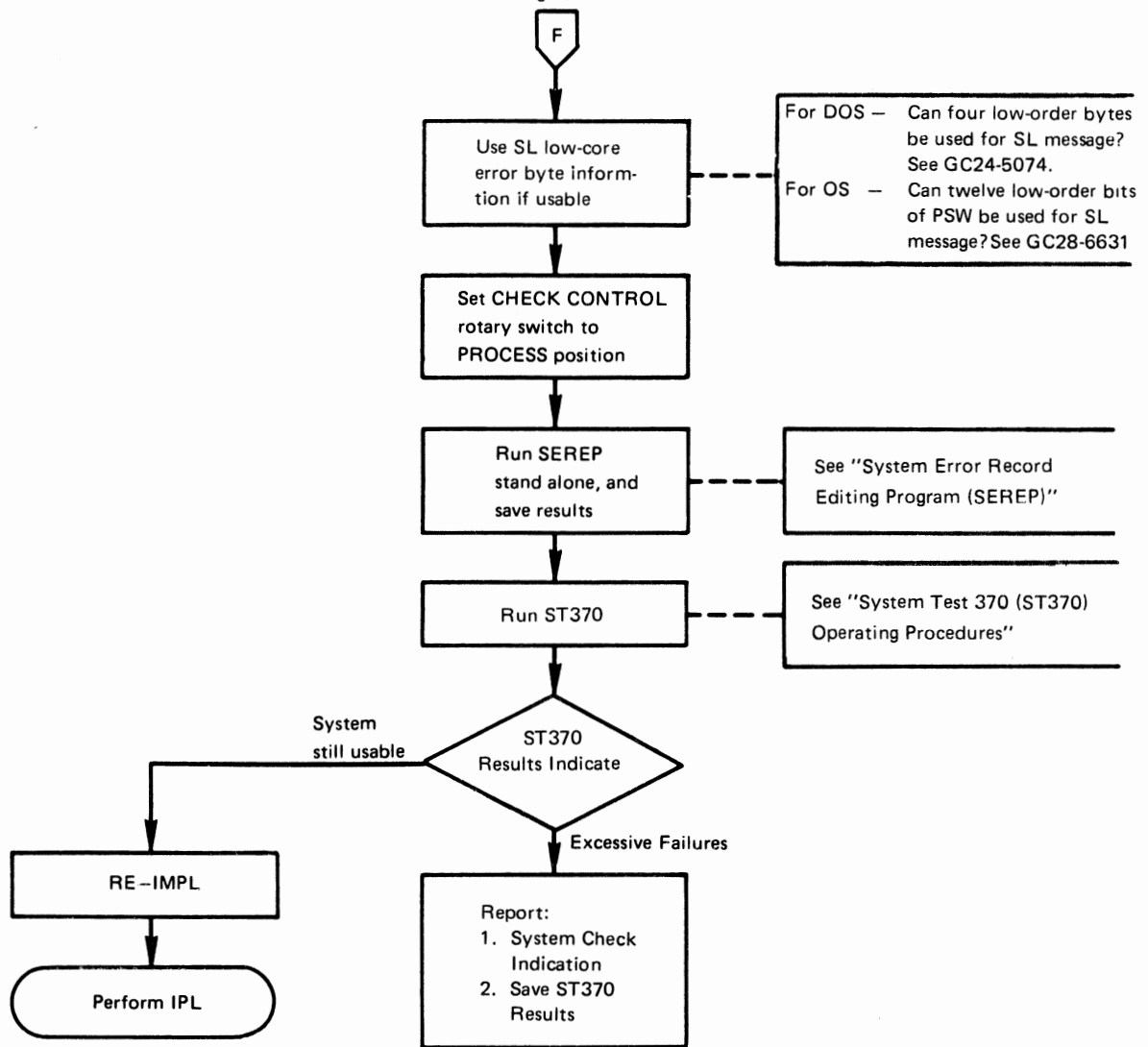

Page 83

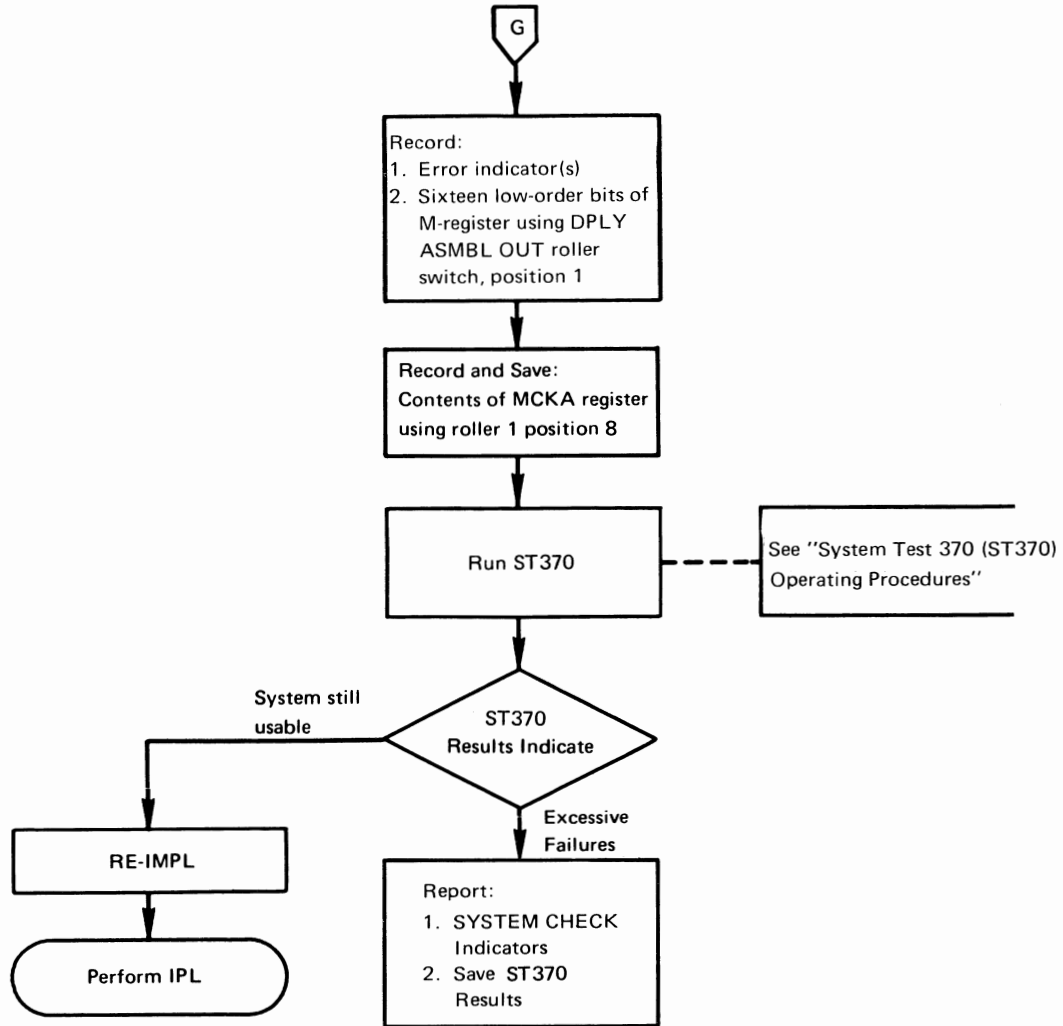

## INTEGRATED FILE ADAPTER (IFA) (3145 MODELS FED, GE, GFD, H, HG, and I)

Operating procedures for the direct access storage devices that attach to the Integrated File Adapter Feature are described in the Operating Procedures Manual for each specific device. For a listing of these manuals, see the *IBM System/360 and System/370 Bibliography*, GA22-6822.

## EMULATORS

Two emulators are available:

1. IBM 1401/1460, 1440
2. IBM 1401/1460, 1440 and IBM 1410/7010

Operating procedures for the system being emulated and operator messages associated with these features are described in the publication for the program being used. For a listing of these manuals, see the *IBM System/360 and System/370 Bibliography*, GA22-6822.

## CHANNEL-TO-CHANNEL ADAPTER (CTCA)

A description of the indicator and switch used with CTCA is found on page 24. The operating procedures are found on the following pages:

Power-On, page 43

Power-Off, page 67

- A description of the CTCA can be found in *IBM System/370 Model 145 Functional Characteristics*, GA24-3557.

## INTEGRATED STORAGE CONTROL (ISC)

A description of the indicators and switches used with ISC is found on page 25.

The operating procedures for ISC are found on the following pages:

Power-On, page 44

Power-Off, page 68

- A description of the ISC feature can be found in *IBM System/370 Model 145 Functional Characteristics*, GA24-3557.



## GLOSSARY

**Hard stop:** A stop in which the CPU clock is stopped. No interrupts can be handled and the CLOCK STOP indicator is on.

**Initial Microprogram Load (IMPL):** An operation that provides for loading the control storage area with the \*370 microprogram or diagnostic programs.

**Logical address:** The calculated effective address of an operand formed by  $B + X + D$ .

**Loop\*:** A sequence of instructions that is executed repeatedly until a terminal condition prevails.

**Program Status Word (PSW):** A doubleword in main storage used to control the order in which instructions are executed, and to hold and indicate the status of the computing system in relation to a particular program.

**Real address:** The actual physical address in main storage.

**Soft stop:** A stop in which the CPU clock continues to run. Interrupts and timer updates are handled if requested and the MAN indicator is on.

**Standalone program:** A program then can be executed independently of an operating system.

**System Error Record Editing Program (SEREP):** A standalone program used on error conditions to edit and print hardware logout information from main storage.

**System Test 370 (ST370):** A standalone program used to identify a failing device(s), when used to investigate a specific problem.

**Virtual Storage:** Addressable space that appears to the user as real storage, from which instructions and data are mapped into real storage locations. The size of virtual storage is limited by the addressing scheme of the computing system and by the amount of auxiliary storage available, rather than by the actual number of real storage locations.

**Wait State:** (1) The condition of a task that depends on one or more events in order to enter the ready condition. (2) The condition of a central processing unit when all operations are suspended.

\* American National Standard Definition

## INDEX

### A

A-register display 58  
A-register display, bytes 0, 1, 2, and 3, indicators 13  
A-register display roller switch 13  
abbreviations 6  
address compare control switch 14  
address compare switch 15  
ADR COMP MATCH, indicator 9  
alarm reset key (PR-KB) 33  
alter (PR-KB) 50  
alter/display error messages  
  INVAL ADDR 54  
  INVAL CHAR 54  
alter/display examples  
  current PSW (AP) 53  
  floating point register (DF) 53  
  main storage (DM or AM) 53  
  storage key (DK) 53  
  virtual storage 53  
alter/display key (PR-KB) 33  
alter/display mnemonic chart 52  
alter/display procedure 51  
alter operation, termination 50  
APL assist (*see* VS APL assist)

### B

byte count switches 20  
byte/X-late regs switch (H) 20

### C

cancel key (PR-KB) 33  
carriage controls (3210 Models 1 and 2, and 3215) 30  
cartridge handling  
  cautions 27  
  storage 41  
  storage rack 26  
CF disk cartridge storage rack 26  
CF PWR ON 9  
channel-to-channel adapter feature  
  indicator and switch 24  
  power-on procedure 43  
  power-off procedure 67  
charts  
  alter/display mnemonic 52  
  CPU status indicators 9  
  general and floating point registers 65  
  IMPL error indicator 48  
  key function, system control panel 23  
  PR-KB indicator condition 32  
  PR-KB key functions 32  
  rotary switches A through H 20  
check control switch 18  
check reset key 23  
checks  
  console file 10  
  system 8  
cleaning, print element (PR-KB) 40  
clear storage 59  
CLOCK STOP, indicator 9  
console file  
  address switches (A and B) 20  
  byte count switches (C and D) 20  
  cartridge insertion and removal 41  
  checks 10  
  disk handling 27  
  IMPL error recovery 48

console file (continued)  
  indicators 10  
  location 26  
  register, indicators 10  
console file disks (CF)  
  \*370 70  
console printer-keyboards 28  
console (PR-KB) key layout  
  3210 Models 1 and 2 32  
  3215 32  
console printer-keyboard manual operations 49  
control address set key 23  
control keys and indicators  
  3210  
    Model 1 32  
    Model 2 33  
  3215 32  
control storage address switches (E-H) 20  
control storage loading (*see* IMPL)  
controls, carriage (3210 and 3215) 30  
copy control lever 30  
counter match and console file registers 10  
CNTR MATCH, indicator 10  
CPU status indicators 9  
CTCA feature  
  indicator 24  
  power-on procedure 43  
  power-off procedure 67  
  switch 24  
current PSW alter/display mnemonics 54  
customer meter 21

### D

data compare trap 60  
data entry (PR-KB) 49  
diagnostic/console file control switch 19  
disk cartridge  
  handling (CF) 27  
  insertion 41  
  removal 41  
  storage 41  
display, A-register roller switch  
  channel word A (GSTAT) 13  
  channel word B (GBS) 13  
  channel word C (GBUF) 13  
  H-register 13  
  IFA: FBAK 13  
  IFA: FCND 13  
  IFA: FSTAT 13  
  L-register 13  
  P-register 13  
  S-register 13  
  storage or external register 13  
  system register bytes 0, 1, and 2 13  
  T-register 13  
  TA-register 13  
  TE-register 13  
  TI-register 13  
  TT-register 13  
  virtual storage 53  
display assembler out, bytes 0,1, 2, and 3, indicators 12  
display assembler out roller switch  
  B-register 12  
  C-register 12  
  D-register 12  
  M-register bytes 1, 2, and 3 12  
  MB-2, MB-3, N2, N3 12

display assembler out roller switch (continued)

MCKA 12  
selected channel 12  
storage data bus-out 12  
Z-register 12  
display key 23  
display (PR-KB) 50

## E

edit program (SEREP) 77  
EMERGENCY PULL switches  
system control panel 69  
3047 power unit 69  
emulators (types of) 91  
enable/disable switch 24  
enable system clear key 23  
END key (PR-KB) 32  
EPO (see EMERGENCY PULL switches)  
error recovery procedures  
handling abnormal situation, flowchart use 81  
IMPL 48  
IPL 56  
power/thermal checks 8  
SEREP 77  
system check 8  
examples, alter/display 53  
EXE CPLT, indicator 9

## F

features  
channel-to-channel adapter (CTCA) 91  
emulators 91  
integrated file adapter (IFA) 91  
integrated storage control (ISC) 91  
floating point registers 53  
flowcharts  
handling abnormal situations, introductory flowchart 82  
IMPL problem 86  
IPL problem 87  
power-off problem 85  
power problem 84  
system check problem, LOG PRES indicator off 90  
system check problem, LOG PRES indicator on 89  
wait state problem 88  
forms  
insertion  
3210 37  
3215 38  
load lever 30  
release lever 38

## G

general and floating point register address charts 65  
glossary 92  
go-no-go messages  
go-no-go complete  
with VS APL assist 47.2  
without VS APL assist 46  
go-no-go failed  
with VS APL assist 47.2  
without VS APL assist 46

## H

handling abnormal situations  
IMPL problem flowchart 86  
IPL problem flowchart 87  
introduction 81  
introductory flowchart 82  
operator's notes 80  
power-off problem, flowchart 85  
power problem, flowchart 84  
system check problem, LOG PRES indicator off, flowchart 90  
system check problem, LOG PRES indicator on, flowchart 89  
handling paper (see forms)

## I

IFA 91  
illustration  
ST370 reliability report 76  
3210 Model 1 (PR-KB) 28  
3215 (PR-KB) 28  
IMPL  
error indicator chart 48  
error recovery 48  
problem, flowchart 86  
procedure  
with VS APL assist 47.1  
without VS APL assist 45  
REQD, indicator 9  
IMPL check, indicator 25  
IMPL error recovery 48  
IMPL REQD indicator 9  
impression control lever (PR-KB) 29  
index, visual 4  
indicators  
ADR COMP MATCH 9  
A-register display, bytes 0, 1, 2, and 3 13  
CF PWR ON 9  
CLOCK STOP 9  
CONSOLE FILE REGISTERS 10  
CNTR MATCH 10  
display assembler out, bytes 0, 1, 2, and 3 12  
EXE CPLT 9  
IMPL REQD 9  
I/O INFC DSBLD 24  
I/O INTFS DSBLD 25  
LOAD 11  
LOG PRES 9  
MAN 11  
POWER ON  
console, key 42  
3047 power unit 42  
SNG ECC 9  
SYS 11  
SYSTEM CHECKS 8  
TEST 11  
TOD CLOCK INVLD 9  
WAIT 11

indicators (PR-KB)  
ALARM 32  
ALTER/DISPLAY MODE 32  
INTVN REQD 32  
PROCEED 32  
REQUEST PENDING 32  
initial microprogram load (IMPL) 45  
initial program load (IPL) 56  
instruction counter 57  
instruction step 58  
integrated storage control, feature 91  
interrupt key 23  
interval timer 14  
introduction 7  
INTVN REQD (PR-KB) 32  
INVAL ADDR (PR-KB) 54  
INVAL CHAR (PR-KB) 54  
I/O devices (ASCP) 74  
I/O INFC DSBLD, indicator 24  
I/O INTERFACE, ENABLE-DISABLE (CTCA) switch 24  
I/O INTFS DSBLD, indicator 25  
I/O INTFS switches, A and B 25  
IPL  
error recovery 56  
problem, flowchart 87  
procedure 56  
ISC feature  
description 25  
indicators 25  
power-on procedure 44  
power-off procedure 68  
switches 25

**K**  
key, function chart 23  
key, function chart (PR-KB)  
lock 31  
return 31  
shift 31  
space bar 31  
key switch 21  
keyboard layout (3210 and 3215) 31  
keys (CPU)  
check reset 23  
control address set 23  
display 23  
enable system clear 23  
interrupt 23  
load 23  
power off 23  
power on 23  
restart 23  
set IC 23  
start 23  
start console file 23  
stop 23  
store 23  
system reset 23  
keys (PR-KB)  
alarm reset 32  
alter/display 32  
cancel 32  
end 32  
not ready 32  
ready 32  
request 32  
keys, system control panel 22  
knob, platen  
3210 30  
3215 37

**L**  
lamp (*see* indicators)  
lamp test, switch 14  
lever (PR-KB)  
copy control 30  
forms load 30  
forms release 38  
impression control 29  
ribbon lift 29  
ribbon load 29  
lights (*see* indicators)  
LOAD indicator 11  
load, key 23  
load unit address switches (F-H) 20  
loading CF disk 41  
loading control storage (*see* IMPL)  
loading programs  
SEREP 78  
ST370 72  
lock key (PR-KB) 31  
log out  
information 77  
program (SEREP) 77  
LOG PRES, indicator 9

**M**  
magnetic disk (*see* console file)  
main storage address switches 20  
main storage alter/display (PR-KB) 51  
MAN, indicator 11  
manual operation (PR-KB) 49  
manual store/display operations  
general and floating point registers 65  
main storage 62  
MAPs (*see* flowcharts)  
messages  
alter/display errors 54  
GO-NO-GO COMPLETE (IMPL)  
with VS APL assist 47.2  
without VS APL assist 46  
GO-NO-GO FAILED (IMPL)  
with VS APL assist 47.2  
without VS APL assist 46  
microprogram patch procedure  
with VS APL assist 47.4  
without VS APL assist 47  
SEREP 77  
ST370 70  
meters  
customer 21  
service 21  
microprogram disk (\*370) 42  
microprogram patch procedure  
with VS APL assist 47.4  
without VS APL assist 47  
mnemonics (PR-KB) 52  
motor generator (*see* 3047 power unit)  
MULTITAG (switch) 25

**N**  
not ready key (PR-KB) 32

**O**  
operating procedures  
alter/display (PR-KB) 51  
clear storage 59  
console-file disk insertion and removal 41  
data compare trap 60  
data entry (PR-KB) 49

operating procedures (continued)

emergency pull switch 69  
IMPL error recovery 48  
initial microprogram load (IMPL)  
  with VS APL assist 47.1  
  without VS APL assist 45  
initial program load (IPL) 56  
instruction step 58  
IPL error recovery 56  
manual store/display operations 62  
power check recovery 8  
power off 66  
power on 41  
SEREP 77  
set IC (instruction counter) 57  
store status 55  
ST370 72  
system check recovery 8  
system error record editing program (SEREP) 77  
thermal check recovery 8  
operator's note page 80

**P**

paper (*see forms*)  
patch card  
  with VS APL assist 47.4  
  without VS APL assist 47  
platen (PR-KB)  
  knobs 30  
  removal  
    3210 37  
    3215 38  
  replacement  
    3210 37  
    3215 38  
printer controls (3210) 29  
PR-KB, manual operations  
  alter 50  
  alter/display 51  
  data entry 49  
  display 50  
  return key 52  
power-off key 23  
power-off problem, flowchart 85  
power-off, procedure 66  
power-on key 23  
power on (procedure) 42  
power problem, flowchart 84  
power and thermal check recovery 8  
print element  
  cleaning (3210) 40  
  removal and replacement (3210) 39  
problem investigation 81  
procedures (*see operating procedures*)  
program description  
  SEREP 77  
  ST370 70  
PSW 23  
pull switch (*see switches*)

**R**

rate switch 17  
ready key (PR-KB) 32  
recovery  
  power check 8  
  system check 8  
  thermal check 8

reliability report illustration (ST370) 76  
removal and replacement  
  platen  
    3210 37  
    3215 38  
  print elements (PR-KB) 39  
  ribbon (PR-KB) 33  
  request key (PR-KB) 32  
  RESET, key 23  
  restart key 23  
  return key (PR-KB) 31  
  ribbon (PR-KB)  
    lift lever 29  
    load lever 29  
    reinstalling (3215) 35  
    replacement 33  
  roller switch  
    A-register display 13  
    display assembler out 12  
  rotary switches (*see switches*)  
  rotary switches A through H, label chart 20

**S**

SEREP  
  description 77  
  error waits 79  
  loading program 78  
  normal program waits 79  
  SEREP (TXT card) 78  
  termination 79  
  when to use 77  
service meter 21  
set IC key (instruction counter) 23  
set IC procedure 57  
shift key (PR-KB) 31  
shipping and receiving (CF) disk cartridges 41  
SNG ECC, indicator 9  
soft stop 11  
spacebar (PR-KB) 31  
start console file key 23  
start key 23  
stop after log 77  
stop key 23  
storage, clear operation 59  
storage select switch 13  
store key 23  
store status 55  
storing (CF) disk cartridges 41  
ST370  
  configured I/O devices tested 71  
  prerequisites 70  
  program concepts 70  
  purpose 70  
  run time 70  
  sources 70  
  termination 70  
switch, key 20  
switches  
  pull, emergency 69  
  roller  
    A-register display 13  
    display assembler out 12  
  rotary  
    A-H 20  
    address compare 15  
    check control 18  
    diagnostic/console-file control 19  
    rate 17  
    storage select 16

switches (continued)

toggle

- address compare control 14
- console-file register display 14
- I/O interface (CTCA) 24
- I/O interface A and B (ISC) 25
  - interval timer 14
  - lamp test 14
  - TOD CLK 14

SYS, indicator 11

SYS RES device

- with VS APL assist 47.4
- without VS APL assist 47

system check

- indicators 8
- problem

LOG PRES indicator off, flowchart 90

LOG PRES indicator on, flowchart 89

recovery 8

system error record editing program (SEREP) 77

system indicators 11

system reset key 23

System Test 370 (ST370) 70

System Test 370 (ST370) operating procedures

loading from 'load' tape 72

loading from punched cards 74

**T**

TEST, indicator 11

thermal check recovery 8

time-of-day clock 14

TOD CLOCK INVLD, indicator 9

toggle switch (*see* switches)

trap, data compare 60

TXT card (SEREP) 78

type ball (*see* print element)

typewriter (*see* console printer-keyboards)

**U**

use meters 21

**V**

visual index 4

virtual storage (*see* display)

VS APL assist IMPL 47.1

**W**

WAIT, indicator 11

wait state problem, flowchart 88

word address switches (F and G) 20

Numeric Index

\*APL microprogram disk 47.1

\*370 microprogram disk

with VS APL assist 47.1

without VS APL assist 45

1401/1460, 1440 emulator 91

1401/1460, 1440 and 1410/7010 emulator 91

3047 Power Unit

EPO switch 69

POWER ON indicator 42

3210 forms insertion 37

3210 platen removal and replacement 37

3210 Model 1 console printer-keyboard 26

3210 Model 1 PR-KB illustration 28

3210 Model 2 printer-keyboard 33

3210 Models 1 and 2 key function chart 31

3215 console printer-keyboard illustration 28

3215 forms insertion 38

3215 key function chart 31

3215 platen removal and replacement 38



READER'S COMMENT FORM

Operator's Library: IBM System/370 Model 145  
Operating Procedures

Order No. GC38-0015-3

- Are you able to find information in this publication easily?
- Are the illustrations adequate, clear, and concise?
- Which of the following are included in your occupational responsibilities?
  - System operating . . . . .
  - Programming . . . . .
  - Supervising . . . . .
  - Instructing . . . . .
  - Maintaining . . . . .
  - Other . . . . .
- We would appreciate your comments; please give specific page and line references where appropriate.

Reply Requested?

Yes

No

NAME . . . . .

STREET . . . . .

CITY . . . . .

STATE . . . . . ZIP CODE . . . . .



GC38-0015-3

**YOUR COMMENTS, PLEASE . . . .**

Your answers to the questions on the back of this form, together with your comments, will help us produce better publications for your use. Each reply will be carefully reviewed by the persons responsible for writing and publishing this material. All comments and suggestions become the property of IBM.

Please note: Requests for copies of publications and for assistance in utilizing your IBM system should be directed to your IBM representative or to the IBM branch office serving your locality.

Cut Along Line

Operator's Library: IBM System/370 Model 145 Operating Procedures (File No. S370-40) Printed in U.S.A. GC38-0015-3

Fold

Fold

FIRST CLASS  
PERMIT NO. 170  
ENDICOTT, N.Y.



**BUSINESS REPLY MAIL**  
NO POSTAGE STAMP NECESSARY IF MAILED IN THE UNITED STATES

POSTAGE WILL BE PAID BY . . . .

IBM Corporation  
Product Publications, K10  
P.O. Box 6  
Endicott, N. Y. 13760

Fold

Fold



**International Business Machines Corporation**  
**Data Processing Division**  
1133 Westchester Avenue, White Plains, New York 10604  
(U.S.A. only)

**IBM World Trade Corporation**  
821 United Nations Plaza, New York, New York 10017  
(International)



International Business Machines Corporation  
Data Processing Division  
1133 Westchester Avenue, White Plains, New York 10604  
(U.S.A. only)

IBM World Trade Corporation  
821 United Nations Plaza, New York, New York 10017  
(International)