

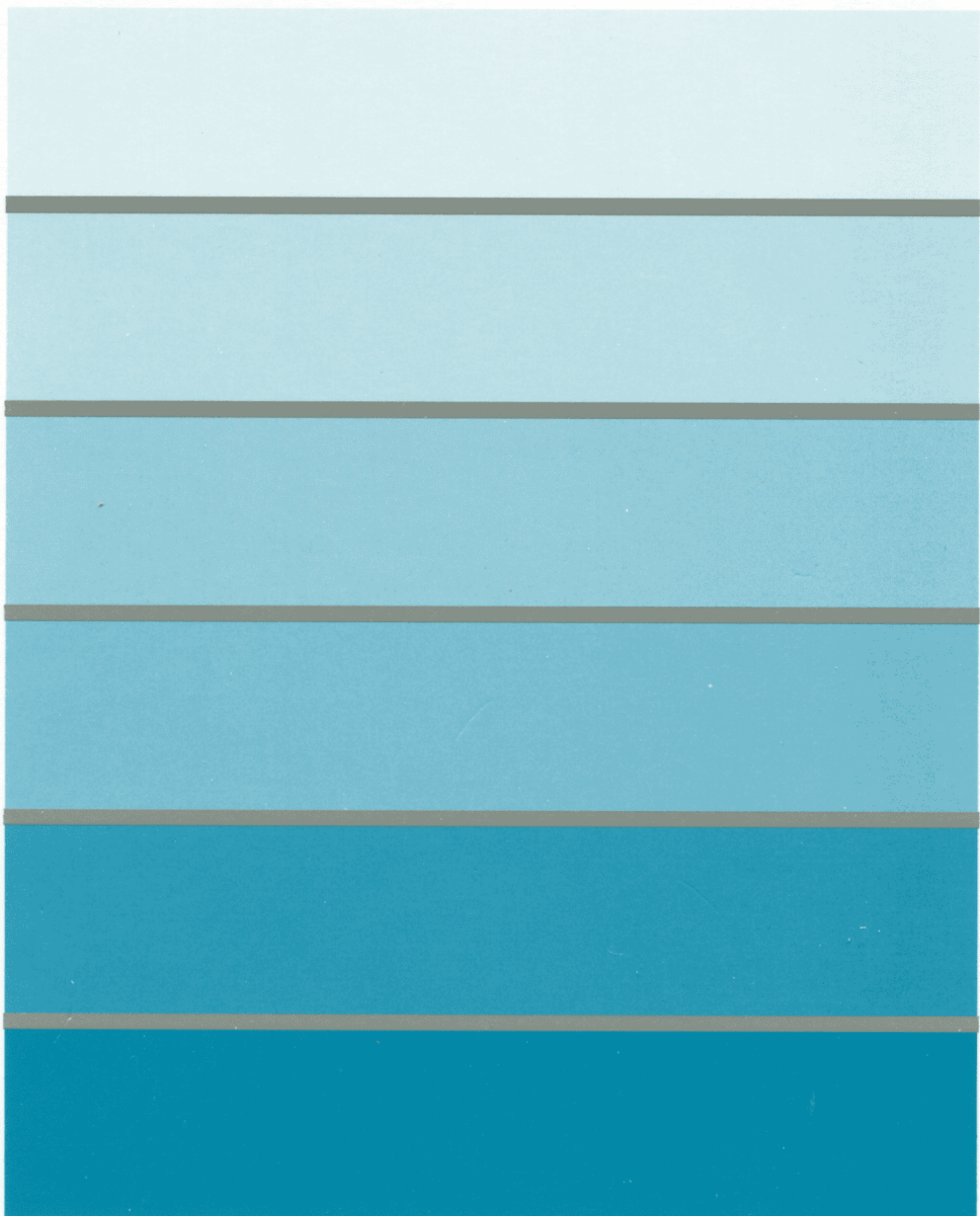

## Planning Guide

Configuration Support B Release 4





---

3174 Establishment Controller

GA27-3862-03

## **Planning Guide**

Configuration Support B Release 4

---

---

---

### **3174 Licensed Internal Code**

Licensed Internal Code remains the property of IBM and is to be used only in accordance with the Agreement for Purchase of IBM Machines or the Agreement for Lease or Rental of IBM Machines, whichever Agreement is applicable.

In this document, the term **3174 microcode** refers to Licensed Internal Code.

### **Fourth Edition (March 1991)**

This major revision obsoletes and replaces GA27-3862-02. See "Summary of Changes" on page xxi for the changes made in this edition. Changes or additions to the text and illustrations are indicated by a vertical line to the left of the change.

Changes are made periodically to the information herein; before using this publication in connection with the operation of IBM systems or equipment, consult your IBM sales representative or the latest *IBM System/370, 30xx, and 4300 Processors Bibliography*, GC20-0001, for the editions that are applicable and current.

References in this publication to IBM products, programs, or services do not imply that IBM intends to make these available in all countries in which IBM operates. Any reference to an IBM licensed program in this publication is not intended to state or imply that only IBM's licensed program may be used. Any functionally equivalent program may be used instead.

Publications are not stocked at the address given below. Requests for IBM publications should be made to your IBM representative or to the IBM branch office serving your locality.

A Reader's Comment Form is provided at the back of this publication. If the form has been removed, address comments to IBM Corporation, Department E02, P.O. Box 12195, Research Triangle Park, N.C., U.S.A. 27709. IBM may use or distribute whatever information you supply in any way it believes appropriate without incurring any obligation to you.

© Copyright International Business Machines Corporation 1989, 1991. All rights reserved.

Note to U.S. Government Users — Documentation related to restricted rights — Use, duplication or disclosure is subject to restrictions set forth in GSA ADP Schedule Contract with IBM Corp.

---

## Choosing the Right Book from the 3174 Library

The 3174 library contains information for installing, customizing, operating, maintaining, and programming the data stream for the 3174 controller. The list below shows the manuals you need to perform these tasks.

### To Find Translations of Safety Notices:

*Safety Notices*, GA27-3824

### To Organize Library Materials:

Binders and Inserts, SBOF-0089

Binder, SX23-0331

Inserts, SX23-0332

### To Become Familiar with the 3174:

*Master Index*, GC30-3515

*3174 Introduction*, GA27-3850

### To Prepare Your Site for the 3174:

*Site Planning*, GA23-0213

*Physical Planning Template*, GX27-2999

### To Set Up and Operate the 3174:

*Models 1L, 1R, 2R, 3R, 11L, 11R, 12L, 12R, and 13R User's Guide*, GA23-0337

*Models 21L, 21R, 22L, and 23R User's Guide*, GA27-3874

*Models 51R, 52R, 53R, 61R, 62R, and 63R User's Guide*, GA23-0333

*Models 81R, 82R, 90R, 91R, and 92R User's Guide*, GA23-0313

### To Plan for and Customize the 3174:

#### Configuration Support A and S

*Planning Guide*, GA27-3844

*Utilities Guide*, GA27-3853

*Central Site Customizing User's Guide*, GA23-0342

*Asynchronous Emulation Adapter Description and Reference*, GA27-3872

#### Configuration Support B

*Planning Guide*, GA27-3862

*Model 90R Tokenway Planning*, GD21-0036

*Utilities Guide*, GA27-3863

*Central Site Customizing User's Guide*, GA27-3868

*Asynchronous Emulation Adapter Description and Reference*, GA27-3872

### To Perform Problem Determination:

*Customer Problem Determination*, GA23-0217

*Status Codes*, GA27-3832



**To Install Features or Convert Models on the 3174:**

*Fixed Disk Installation and Removal Instructions, GA27-3864*  
*Diskette Drive Installation and Removal Instructions, GA23-0263*  
*Device Control Adapters Installation and Removal Instructions, GA23-0265*  
*Model Conversion Instructions, GA23-0295*  
*Token-Ring Network Feature Installation and Removal Instructions, GA23-0329*  
*Storage Expansion Feature Installation and Removal Instructions, GA23-0330*  
*Communication Adapter Installation and Removal Instructions, GA27-3830*  
*Asynchronous Emulation Adapter Installation and Removal Instructions, GA23-0341*  
*Concurrent Communication Adapter Installation and Removal Instructions, GA27-3851*  
*Models 21L, 21R, 22L, and 23R Feature Installation and Removal Instructions, GA27-3875*

**To Use the Asynchronous Emulation Adapter Feature:**

*Asynchronous Emulation Adapter Description and Reference, GA27-3872*  
*Terminal User's Reference for Expanded Functions, GA23-0332*

**To Use the Multiple Logical Terminals Function:**

*Terminal User's Reference for Expanded Functions, GA23-0332*

**To Obtain Data Stream Programming and Reference Information:**

*Functional Description, GA23-0218*  
*Data Stream Programmer's Reference, GA23-0059*  
*Asynchronous Emulation Adapter Description and Reference, GA27-3872*  
*3174 Reference Summary, GX27-3872*  
*3174 Character Set Reference, GA27-3831*  
*3270 X.25 Operation, GA23-0204*

**To Perform Maintenance (Service Personnel):**

*Models 1L, 1R, 2R, 3R, 11L, 11R, 12L, 12R, and 13R Maintenance Information, SY27-2572*  
*Models 21L, 21R, 22L, and 23R Maintenance Information, SY27-0323*  
*Models 51R, 52R, 53R, 61R, 62R, and 63R Maintenance Information, SY27-2573*  
*Models 81R, 82R, 90R, 91R, and 92R Maintenance Information, SY27-2584*  
*CE Reference Summary, SX27-3873*  
*Status Codes, GA27-3832*

**Other Publications**

The following publications are available for the 3174. They are developed by the International Technical Support Center. The intended audience for these books are IBM System Engineers and Customer Network Planners.

*IBM 3174 Establishment Controller Installation Guide, GG24-3061.*

*NetView Distribution Manager Release 2 and 3174 Central Site Change Management Implementation Guide, GG24-3424.*

*IBM 3174 CECP Migration Issues, GG24-3380.*

## Special Notices

The following terms, DENOTED BY AN ASTERISK (\*), used in this publication, are trademarks of the IBM Corporation in the United States and/or other countries:

ANSI 3.64 Terminal	PC/FTTERM Mono
Enterprise Systems Connection	System/370
ESCON	System/390
FTTERM	4201 Proprinter
GDDM	4202 Proprinter XL
NetView	4207 Proprinter X24
PC/FTTERM Color	4208 Proprinter XL24

The following terms, DENOTED BY A DOUBLE ASTERISK (\*\*), used in this publication, are trademarks of other companies:

ADDS Viewpoint A2	Applied Digital Data Systems, Inc.
ADDS Viewpoint/78	Applied Digital Data Systems, Inc.
DEC VT100	Digital Equipment Corporation
DEC VT220	Digital Equipment Corporation
DEC VT240	Digital Equipment Corporation
DEC VT241	Digital Equipment Corporation
DEC VT52	Digital Equipment Corporation
D210	Data General
Esprit Executive 10/78	Esprit Systems, Inc.
Hayes AT	Hayes Microcomputer Products, Inc.
Hazeltine 1500	Hazeltine Systems, Inc.
Hewlett-Packard 2621B	Hewlett-Packard Company
Lear Siegler ADM 3A Dumb Terminal	Lear Siegler, Inc.
Lear Siegler ADM 5 Dumb Terminal	Lear Siegler, Inc.
Lear Siegler ADM 11	Lear Siegler, Inc.
Lear Siegler ADM 12	Lear Siegler, Inc.
Lear Siegler ADM 1178	Lear Siegler, Inc.
Micom	Micom Systems, Inc.
Minitel 1B	France Telecom
Switched Service (UKPSS)	British Telecom
Tektronix 4105	Tektronix, Inc.
Tektronix 4205	Tektronix, Inc.
TELENET	General Telephone and Electronics (GTE) Telenet Communications Corporation
TeleVideo 912	TeleVideo Systems, Inc.
TeleVideo 970	TeleVideo Systems, Inc.
United Kingdom Packet	
WYSE 50/60	Wyse Technology, Inc.

**ES9000 Users:** The 3174 Model 21H used with the ES9000 Models 120, 130, 150, and 170 is the same as a 3174 Model 21L throughout this publication.



---

## Preface

This book replaces the planning information contained in the previous edition. The planning information pertains to Configuration Support B, Release 4. The customizing and utilities procedures related to this book are contained in the *3174 Utilities Guide*, GA27-3863.

This manual briefly introduces the 3174 Establishment Controller and discusses considerations to keep in mind when planning for it. The book supplies the background information required for general and customization planning and explains the procedures for completing the configuration worksheets.

---

## What This Book Will Do for You

This book:

- Introduces you to the 3174 Establishment Controller, its features, model capabilities, and supporting microcode
- Informs you of the planning considerations
- Guides you through the planning process
- Provides you with the information and knowledge required for planning
- Teaches you the microcode customization process
- Aids you in filling out the configuration worksheets
- Gives you a solid plan, which, when implemented, results in a smooth installation and startup.

---

## Who This Book Is For

This book is written for the person who plans for the 3174 Establishment Controller. In various establishments, different people do this job:

- Systems programmers
- Systems analysts
- Systems specialists
- Software specialists
- Communication analysts
- Operations analysts
- Network planners
- Telecommunication specialists.

---

## How to Use This Book

This book has three parts and five appendixes:

**Part 1. Introduction (Chapters 1 and 2):** This part introduces the 3174 Establishment Controller and provides considerations when planning. If you are using this book for the first time, read Part 1.

**Part 2. General Planning (Chapters 3 and 4):** This part contains general planning information that aids in planning for 3174 storage and the host.

**Part 3. Microcode Customization Planning (Chapters 5 through 15):** This part introduces microcode customization and provides the planning information you need to customize the microcode. It describes filling out the configuration worksheets (from Appendix A) and helps you answer the configuration questions.

**Appendix A:** This appendix contains the configuration worksheets. You may want to reproduce them in quantity so that you always have an unused set of worksheets available for planning.

**Appendix B:** Examples of planning for the Asynchronous Emulation Adapter.

**Appendix C:** Examples of planning for the Token-Ring Network.

**Appendix D:** Examples of VTAM/NCP definitions.

**Appendix E:** Examples of using service access points in the Token-Ring Network.

---

## Divider Pages

The following divider pages with tabs are included with this book:

- **Microcode Customization Planning**
- **Worksheet Summary**
- **3174 Configuration Questions Reference.**

These divider pages are printed on card stock and contain specific planning and customizing information. They can be used to section off Part 3 and the Appendixes of this book.

The **Microcode Customization Planning** divider page contains a step-by-step procedure that guides you through microcode customization. We recommend that you use this procedure the first few times that you plan.

The **Worksheet Summary** lists the worksheets you need to fill out for specific features and functions. You can use this summary to plan if you are familiar with microcode customization and have been through the process previously.

The **3174 Configuration Questions Reference** lists the possible responses for each of the configuration questions, the worksheets they appear on, and the page number they appear on in this publication.





---

# Contents

---

## Part 1. Introduction

<b>Chapter 1. Introduction to the 3174 Establishment Controller</b> .....	1-1
The 3174 Establishment Controller .....	1-3
3174 Establishment Controller Models .....	1-4
Features for the 3174 Establishment Controller .....	1-11
Microcode .....	1-13
The 3174 Establishment Controller Library .....	1-14
<b>Chapter 2. Planning Considerations</b> .....	2-1
3174 Establishment Controller Planning .....	2-3
The Site .....	2-3
Controller Storage .....	2-3
Physical Installation .....	2-3
Types of Host Attachment .....	2-4
Multi-Host Support .....	2-6
Terminal Attachment .....	2-10
Display Compatibility Requirements .....	2-12
Host System Planning .....	2-12
Microcode Customization .....	2-12
Microcode Migration .....	2-17
Planning Checklist .....	2-18

---

## Part 2. General Planning

<b>Chapter 3. Planning for Controller Storage</b> .....	3-1
An Overview of Controller Storage Planning .....	3-3
Storage Planning Procedure .....	3-4
Storage Requirements for DSPUs .....	3-5
<b>Chapter 4. Host System and 3174 Planning</b> .....	4-1
An Overview of Host System and 3174 Planning .....	4-3
Considerations for Support of ASCII Graphics .....	4-3
Token-Ring Network 3270 Gateway Considerations .....	4-4
3174 Downstream Physical Units .....	4-11
SNA Considerations for the 3174 .....	4-11
Support of IPDS Printers .....	4-16
Serial Original Equipment Manufacture Interface (SOEMI) Support .....	4-17
Central Site Change Management (CSCM) .....	4-18

---

## Part 3. Microcode Customization Planning

<b>Chapter 5. Microcode Customization Overview</b> .....	5-1
What Is Microcode Customization? .....	5-3
Planning to Reconfigure .....	5-5
Customization Records .....	5-6
Customization Tips .....	5-7

<b>Chapter 6. Planning to Configure</b> .....	6-1
Configuration Questions .....	6-3
<b>Chapter 7. Planning for Port Assignment</b> .....	7-1
An Overview of Port Assignment .....	7-3
Which Response to Question 116 Should You Specify? .....	7-4
Port Assignment Considerations .....	7-4
Who Assigns the Terminals to the Ports? .....	7-6
The Port Assignment Worksheet .....	7-7
Changing Port Assignments .....	7-13
<b>Chapter 8. Planning for Country Extended Code Page</b> .....	8-1
An Overview of Country Extended Code Page .....	8-3
CECP Terminology .....	8-5
CECP and Devices .....	8-5
Entering/Exiting CECP Mode .....	8-8
System Considerations .....	8-8
Local Copy Considerations .....	8-9
Multi-Host Support Considerations .....	8-9
<b>Chapter 9. Planning for Response Time Monitor (RTM)</b> .....	9-1
An Overview of Response Time Monitor .....	9-3
RTM Definition .....	9-3
The RTM Worksheet .....	9-7
How Is Response Time Measured? .....	9-8
Sample Boundary Specifications .....	9-9
Filling Out Worksheet 12—128: RTM .....	9-10
Changing the RTM Specifications .....	9-11
<b>Chapter 10. Planning for X.25</b> .....	10-1
Before You Begin .....	10-3
The X.25 Options Worksheet .....	10-5
Filling In Worksheet 13—X.25 Options .....	10-5
Link Attachment Questions .....	10-6
Host Attachment Questions .....	10-11
Changing the X.25 Options .....	10-19
<b>Chapter 11. Planning for Central Site Change Management</b> .....	11-1
An Overview of Central Site Change Management .....	11-3
The Common SNA Worksheet .....	11-4
Filling In Worksheet 14—Common SNA .....	11-5
<b>Chapter 12. Planning for the Asynchronous Emulation Adapter</b> .....	12-1
An Overview of the Asynchronous Emulation Adapter .....	12-3
AEA Terminology .....	12-4
AEA Concepts .....	12-5
Planning and Setup Tasks .....	12-8
AEA Microcode Customization Planning .....	12-12
AEA Planning Considerations .....	12-15
ASCII Display Stations Supported by the AEA .....	12-17
Filling Out Worksheet 15—3270 Attachment Diagram .....	12-18
Filling Out Worksheet 16—ASCII Attachment Diagram .....	12-24
Numbering the AEA Station Sets on the Attachment Diagrams .....	12-35
Filling Out Worksheet 17—AEA Configure .....	12-37
Filling Out Worksheet 18—AEA Port Set .....	12-41
Filling Out Worksheet 19—AEA Port-to-Port Set Map .....	12-42

Filling Out Worksheet 20—AEA Station Set	12-44
Filling Out Worksheet 21—AEA Default Destination	12-63
Filling Out Worksheet 22—Terminal Tables	12-65
Filling Out Worksheet 23—Inbound Sequence Panels	12-73
Filling Out Worksheet 24—Outbound Sequence Panels	12-76
Filling Out Worksheet 25—Translate Tables	12-77
Filling Out Worksheet 26—Outbound Translate Table Definition	12-80
Filling Out Worksheet 27—Inbound Translate Table Definition	12-81
<b>Chapter 13. Planning to Define Devices</b>	<b>13-1</b>
An Overview of Device Definition	13-3
The Device Definition Worksheet	13-4
Filling In Worksheet 28—Device Definition	13-5
Printer Authorization Matrix (PAM)	13-6
The PAM Worksheet	13-6
A Sample PAM	13-10
Filling Out Worksheet 29—Printer Authorization Matrix (PAM)	13-11
Logical Terminal Assignment (LTA)	13-12
The LTA Worksheet	13-12
A Sample LTA	13-15
LTA Considerations	13-16
Filling Out Worksheet 30—Logical Terminal Assignment (LTA)	13-18
Filling Out Worksheet 31—Prompts for Extended VPD	13-19
<b>Chapter 14. Planning the Token-Ring Network 3270 Gateway</b>	<b>14-1</b>
An Overview of the Token-Ring Network 3270 Gateway	14-3
Overall Planning for Token-Ring Gateway Support	14-3
The Token-Ring Gateway Worksheet	14-6
Filling In Worksheet 32—Token-Ring Gateway	14-7
The Ring Address Assignment Worksheet	14-9
Filling In Worksheet 33—Ring Address Assignment	14-11
The Ring Transmission Definition Worksheet	14-12
Filling In Worksheet 34—Ring Transmission Definition	14-14
<b>Chapter 15. Planning to Modify Keyboards</b>	<b>15-1</b>
An Overview of Modifying Keyboards	15-3
Modify Keyboard Requirements	15-4
Restrictions	15-4
Setting Up the Terminal Keyboards	15-8
Modifying Keyboards for ASCII Emulation	15-8
Two-Language Modification	15-9
Languages Supported on Modifiable Keyboards	15-14
The Keyboard Changes Chart	15-17
Filling Out the Keyboard Worksheets	15-19

---

## Appendixes

<b>Appendix A. Configuration Worksheets</b>	<b>A-1</b>
Worksheet 1—Host Attachment	A-3
Worksheet 2—Multi-Host Definition	A-4
Worksheet 3—BSC	A-5
Worksheet 3S—Secondary BSC	A-6
Worksheet 4—SDLC	A-7
Worksheet 4S—Secondary SDLC	A-8
Worksheet 5—X.25	A-9

Worksheet 5S—Secondary X.25	A-10
Worksheet 6—Non-SNA (Channel)	A-11
Worksheet 7—SNA (Channel)	A-12
Worksheet 7S—Secondary SNA (Channel)	A-13
Worksheet 8—X.21 Switched	A-14
Worksheet 8S—Secondary X.21 Switched	A-15
Worksheet 9—Token-Ring Network	A-16
Worksheet 9S—Secondary Token-Ring Network	A-17
Worksheet 10A—Multiple Logical Terminals	A-18
Worksheet 10B—Multiple Logical Terminals	A-19
Worksheet 10C—Multiple Logical Terminals for AEA	A-20
Worksheet 11A—117: Port Assignment	A-21
Worksheet 11B—117: Port Assignment for AEA	A-22
Worksheet 12—128: RTM	A-23
Worksheet 13—X.25 Options	A-24
Worksheet 13S—Secondary X.25 Options	A-25
Worksheet 14—Common SNA	A-26
Worksheet 15A—3270 Attachment Diagram	A-27
Worksheet 15B—3270 Attachment Diagram	A-28
Worksheet 16—ASCII Attachment Diagram	A-29
Worksheet 17—AEA Configure	A-30
Worksheet 18—AEA Port Set	A-31
Worksheet 19—AEA Port to Port Set Map	A-32
Worksheet 20—AEA Station Set	A-33
Worksheet 21—AEA Default Destination	A-34
Worksheet 22—Terminal Tables Definition	A-35
Worksheet 23A—Inbound Sequence Panels	A-36
Worksheet 23B—Inbound Sequence Panels	A-37
Worksheet 24—Outbound Sequence Panels	A-38
Worksheet 25—Translate Tables Definition	A-39
Worksheet 26—EBCDIC to ASCII Translation (Outbound)	A-40
Worksheet 27—ASCII to EBCDIC Translation (Inbound)	A-41
Worksheet 28—Device Definition	A-42
Worksheet 29—Printer Authorization Matrix (PAM)	A-43
Worksheet 30—Logical Terminal Assignment (LTA)	A-44
Worksheet 31—Extended Vital Product Data (VPD)	A-45
Worksheet 32—Token-Ring Gateway	A-46
Worksheet 33—Ring Address Assignment	A-47
Worksheet 34—Ring Transmission Definition	A-48
Worksheet 35—Storage Requirements	A-49
Non-Katakana Converged Keyboards	A-50
Katakana Converged Keyboards	A-51
Enhanced Keyboard (US)	A-52
Enhanced Keyboard (World Trade)	A-53
Enhanced Keyboard (Katakana)	A-54
<b>Appendix B. AEA Planning Examples</b>	<b>B-1</b>
An Overview of the AEA Planning Examples	B-3
ASCII Terminal Emulation Planning Example	B-4
3270 Terminal Emulation Planning Example	B-17
3270 and ASCII Terminal Emulation Planning Example	B-27

<b>Appendix C. Token-Ring Planning Examples</b> .....	C-1
An Overview of the Token-Ring Planning Examples .....	C-3
Example 1 – Local Gateway and Downstream 3174 Model 13Rs .....	C-3
Example 2 – Remote Gateway .....	C-14
<b>Appendix D. Examples of 3174 VTAM/NCP Definitions</b> .....	D-1
Channel Attached 3174 Definitions (SNA) .....	D-3
Local 3174 Terminal Definition (Non-SNA) .....	D-4
SDLC 3174 Definitions .....	D-5
X.25 Definitions .....	D-9
Definitions for 3174 Token-Ring Network Models .....	D-12
<b>Appendix E. Examples of Using Service Access Points</b> .....	E-1
An Overview of the Service Access Point Examples .....	E-3
<b>List of Abbreviations</b> .....	X-1
<b>Glossary</b> .....	X-7
<b>Index</b> .....	X-25



# Figures

1-1.	The 3174 Establishment Controller	1-3
1-2.	Models 1R, 2R, 3R, 11R, 12L, 12R, and 13R (Models 1L and 11L are similar)	1-4
1-3.	Model 21L	1-5
1-4.	Models 21R, 22L, and 23R	1-5
1-5.	Models 51R, 53R, 61R, 62R, and 63R	1-6
1-6.	Model 90R	1-7
1-7.	Models 91R and 92R	1-7
2-1.	Multiple 3270 Host Access through Concurrent Communication Adapters	2-7
2-2.	ESCON Channel Support	2-8
2-3.	Token-Ring Single Link Multi-Host Support	2-9
2-4.	X.25 Single Link Multi-Host Support	2-10
4-1.	Configuration Example for 3174 Model 1L with the IBM Token-Ring Network 3270 Gateway Feature	4-8
4-2.	Configuration Example for 3174 Model 1R with the IBM Token-Ring Network 3270 Gateway feature	4-10
6-1.	An Example of Worksheet 2 – Multi-Host Definition	6-6
6-2.	An Example of Calculating MLT Storage	6-17
7-1.	An Example of Worksheet 11A – 117: Port Assignment	7-7
9-1.	An Example of Worksheet 12 – 128: RTM	9-7
9-2.	Counters and Boundaries	9-8
10-1.	An Example of Worksheet 13 – X.25 Options	10-5
10-2.	Logical Channel Assignments	10-9
11-1.	An Example of Worksheet 14 – Common SNA	11-4
12-1.	3270 Terminal Emulation Example	12-5
12-2.	ASCII Terminal Emulation Example	12-7
12-3.	Station Sets and Port Sets	12-14
12-4.	The 3270 Response Key	12-18
12-5.	Filling In the Station Type Column on the 3270 Attachment Diagram	12-19
12-6.	Filling In the Default Destination Columns	12-21
12-7.	An Example of 3270 Station Sets	12-22
12-8.	An Example of 3270 Port Sets	12-23
12-9.	ASCII Response Key	12-24
12-10.	Filling In the Station Type Column on the ASCII Attachment Diagram	12-25
12-11.	Filling In the Default Destination Column on the ASCII Attachment Diagram	12-27
12-12.	Filling In the Port Type Column	12-28
12-13.	Filling In the Modem Type Column	12-30
12-14.	Filling In the AEA Station Set Name Column	12-32
12-15.	An Example of AEA Port Sets	12-34
12-16.	An Example of AEA Station Set Numbering	12-35
12-17.	Example of Port-to-Port Set Mapping (Assignment)	12-43
12-18.	Example of the AEA Default Destination Worksheet	12-63
12-19.	Example of User-Defined Terminal (UDT) Selection	12-65
12-20.	Example of User-Defined Terminal Attributes	12-70
12-21.	U1 Inbound Sequences - ASCII Device to 3174 for a DEC VT340	12-73
12-22.	U1 Outbound Sequences - 3174 to ASCII Device for a DEC VT340	12-75
12-23.	User-Defined Translate Table Selection	12-78
12-24.	Outbound Translate Table Defaults for US ASCII, CECP Format	12-80
12-25.	Inbound Translate Table Defaults for US ASCII, CECP Format	12-81



13-1.	An Example of Worksheet 28 – Device Definition	13-4
13-2.	Example of a Worksheet 29 – Printer Authorization Matrix	13-7
13-3.	Example of a PAM Definition	13-10
13-4.	An Example of Worksheet 30 – Logical Terminal Assignment	13-13
13-5.	Example of an LTA Definition	13-15
14-1.	An Example of Worksheet 32 – Token-Ring Gateway	14-6
14-2.	An Example of Worksheet 33 – Ring Address Assignment	14-9
14-3.	An Example of Worksheet 34 – Ring Transmission Definition	14-12
15-1.	Deleting Key Functions	15-11
15-2.	Copying from One Key to Another Key	15-12
15-3.	Example of a Keyboard Changes Chart	15-17
15-4.	Keyboard, Shift, and Function Groups – Keyboard Changes Chart	15-18
15-5.	Example of a Completed Keyboard Changes Chart	15-18
B-1.	ASCII Terminal Emulation—3270 Attachment Diagram	B-6
B-2.	ASCII Terminal Emulation—ASCII Attachment Diagram	B-8
B-3.	AEA Station Set Worksheet—VM SYS 2	B-12
B-4.	AEA Station Set Worksheet—VAX VMS	B-13
B-5.	AEA Station Set Worksheet—PARTS	B-14
B-6.	AEA Station Set Worksheet—3178 TERMS	B-15
B-7.	AEA Default Destination Worksheet—ASCII Terminal Emulation	B-16
B-8.	3270 Terminal Emulation—ASCII Attachment Diagram	B-19
B-9.	AEA Station Set Worksheet—MVS SYSTEM A	B-23
B-10.	AEA Station Set Worksheet—PC FTTERM COLOR	B-24
B-11.	AEA Station Set Worksheet—PC VT100	B-25
B-12.	AEA Default Destination Worksheet – 3270 Terminal Emulation	B-26
B-13.	3270/ASCII Terminal Emulation – 3270 Attachment Diagram	B-29
B-14.	3270/ASCII Terminal Emulation – ASCII Attachment Diagram	B-31
B-15.	AEA Station Set Worksheet—ASCII HOST	B-33
C-1.	Token-Ring Network – Local Gateway and Downstream 3174 13Rs	C-4
C-2.	Worksheet 1 – Local Gateway	C-5
C-3.	Worksheet 7 – Local Gateway	C-6
C-4.	Worksheet 32 – Local Gateway	C-7
C-5.	Worksheet 33 – Local Gateway	C-8
C-6.	Worksheet 34 – Local Gateway	C-9
C-7.	Worksheet 14 – Local Gateway	C-10
C-8.	Worksheet 1 – 3174 Model 13R	C-11
C-9.	Worksheet 9 – 3174 Model 13R	C-12
C-10.	Worksheet 14 – 3174 Model 13R	C-13
C-11.	Token-Ring Network – Remote Gateway	C-15
C-12.	Worksheet 1 – Remote Gateway	C-16
C-13.	Worksheet 4 – Remote Gateway	C-17
C-14.	Worksheet 32 – Remote Gateway	C-18
C-15.	Worksheet 33 – Remote Gateway	C-19
C-16.	Worksheet 34 – Remote Gateway	C-20
C-17.	Worksheet 14 – Remote Gateway	C-21
E-1.	One Gateway for Each Host Connection	E-4
E-2.	Attachment to Multiple Hosts through Non-3174 Gateway without SAPs	E-5
E-3.	Gateway With Multiple Host Connection and SAPs	E-6
E-4.	Gateway With Multiple Host Connection and Multiple SAPs	E-7
E-5.	Combination of Gateway Capabilities	E-8

## **Tables**

1-1.	Features Supported by Models 1L through 23R	1-8
1-2.	Features Supported by Models 51R through 92R	1-9
1-3.	Alternate Configurations	1-10
2-1.	Remote Attachment Adapter Requirements	2-5
3-1.	Base and Maximum Storage Supported in 3174 Models	3-3
3-2.	Storage Requirements for DSPU Combinations (4KB RU Gateway Support)	3-6
3-3.	Storage Requirements for DSPU Combinations (8KB RU Gateway Support)	3-6
4-1.	XID 1 Format	4-15
6-1.	Conversion of BSC Polling Addresses into Controller Addresses	6-10
6-2.	MLT Storage Specification without Multi-Host Support	6-16
6-3.	MLT Storage Specification with Multi-Host Support	6-16
6-4.	Keyboard Languages Supported	6-21
6-5.	CECP Languages Supported	6-22
6-6.	Microcode RPQ Numbers Associated with Keyboards	6-27
6-7.	Host-Channel Attachment Information	6-37
6-8.	Response Selection for Question 317	6-41
6-9.	Response Selection for Question 340	6-42
8-1.	AEA Stations with CECP Support	8-7
12-1.	AEA Station-Type-Specific Questions	12-45
12-2.	IBM and Hayes Modem-Embedded Character Substitutions	12-54
12-3.	Micom Modem-Embedded Character Substitutions	12-54
14-1.	Defaults for F and W by Type selection	14-12
15-1.	Languages Supported on Modifiable Keyboards	15-14
15-2.	Key Function Nomenclature	15-16



---

# Summary of Changes

## Fourth Edition (March 1991)

Information about the following enhancements has been added to this manual for Configuration Support B, Release 4:

- Enterprise Systems Connection (ESCON) Channel attachment
- ESCON Channel Single Link Multi-Host Support
- 8KB RU support
- Enhanced screen support for CUT devices attached to remote 3174s
- New models 12L, 22L, and 23R.
- 3270 Port Expansion Feature

The following customization questions were added for Configuration Support B, Release 4:

- "240: Controller Logical Address"
- "241: RU Maximum Size"

The following customization questions are revised:

- "105: Upper Limit Address"
- "110: Multiple Logical Terminals (MLTs) Storage Support"
- "116: Individual Port Assignment"
- "121: Keyboard Language"
- "126: Miscellaneous Feature Options (B)"
- "220: Alert Function"
- "225: Channel Burst Size"
- "362: X.21 Switched Options"
- "800: Printer Authorization Matrix (PAM)"
- "801: Logical Terminal Assignment (LTA)"
- "908: Link Subsystem Name"
- "911: Ring Speed of the Gateway"
- "940: Ring Address Assignment"
- "941: Ring Transmission Definition"

Other Planning information that is revised:

- Planning for the Asynchronous Emulation Adapter
- Planning for the Token-Ring Gateway
- Planning for Port Assignment.

Technical changes to the text and illustrations are identified by a vertical line to the left of the change.



---

## **Part 1. Introduction**

**Chapter 1. Introduction to the 3174 Establishment Controller**

**Chapter 2. Planning Considerations**





---

## Chapter 1. Introduction to the 3174 Establishment Controller

The 3174 Establishment Controller .....	1-3
3174 Establishment Controller Models .....	1-4
Large-Cluster Controllers .....	1-4
Medium-Cluster Controllers .....	1-6
Small-Cluster Controllers .....	1-7
Features of the 3174 .....	1-8
Alternate Configurations .....	1-10
Features for the 3174 Establishment Controller .....	1-11
Microcode .....	1-13
The 3174 Establishment Controller Library .....	1-14



# The 3174 Establishment Controller

The 3174 Establishment Controller is available in both local (channel-attached) and remote (telecommunication-attached) models. It provides a broad range of connectivity options, workstation and host attachment possibilities, network asset management capabilities, and expandability features.

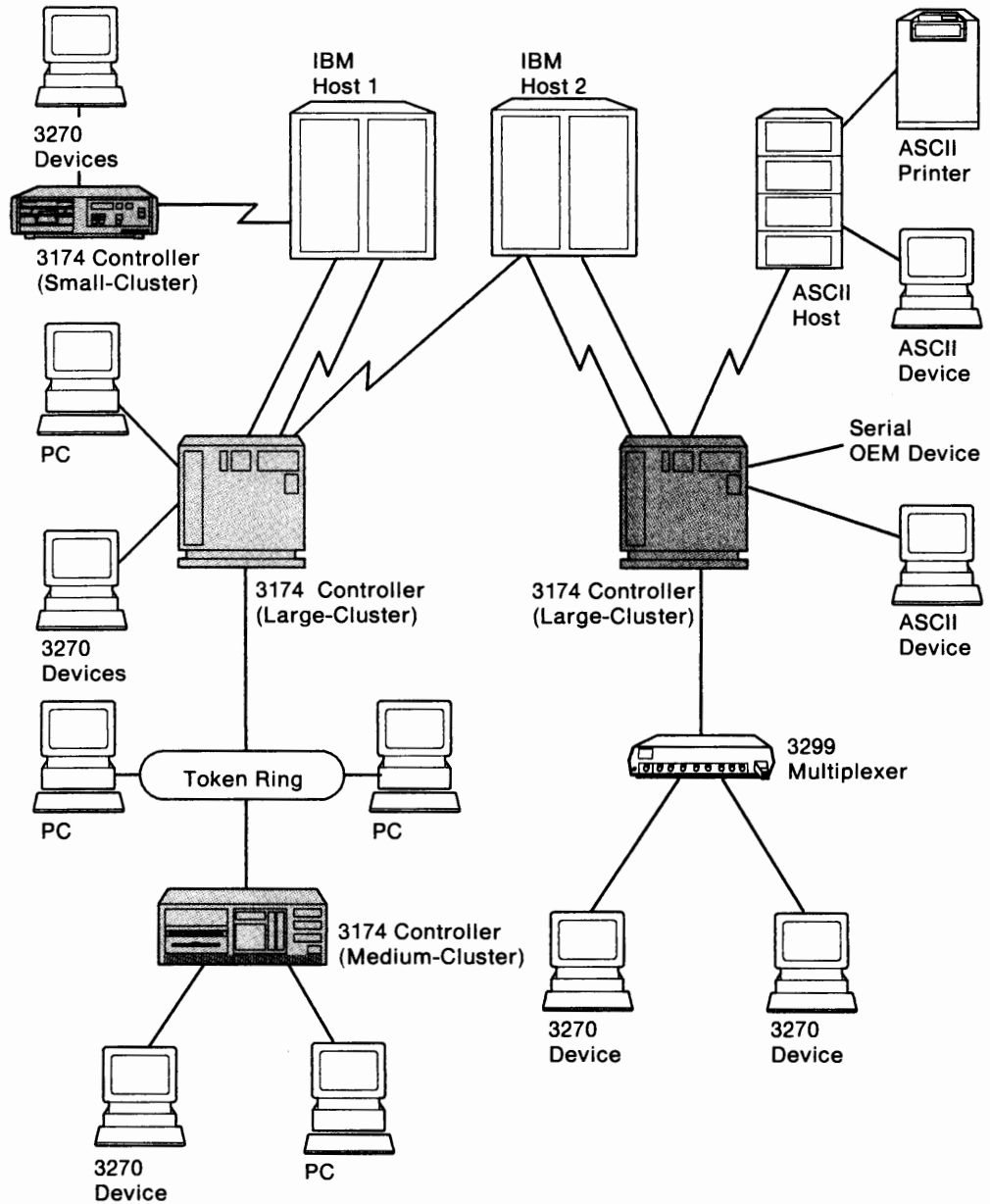

Figure 1-1. The 3174 Establishment Controller

## 3174 Establishment Controller Models

The 3174 Establishment Controller and the display stations and printers that are attached to it are collectively called a *cluster*. Several 3174 Establishment Controller models are available. Each model falls into one of three categories: large-, medium-, or small-cluster controllers. Figures 1-2, 1-3, 1-5, 1-6, and 1-7 illustrate the controller categories and models. The features that each model can support are listed below each model's description.

### Large-Cluster Controllers

Models 1L, 1R, 2R, 3R, 11L, 11R, 12L, 12R, 13R, 21L, 21R, 22L, and 23R are large-cluster controllers. Models 1L, 1R, 2R, and 3R can attach up to thirty-two 3270 devices and/or 24 ASCII devices. Models 11L, 11R, 12L, 12R, 13R, 21L, 21R, 22L, and 23R can attach up to sixty-four 3270 devices and/or 24 ASCII devices.

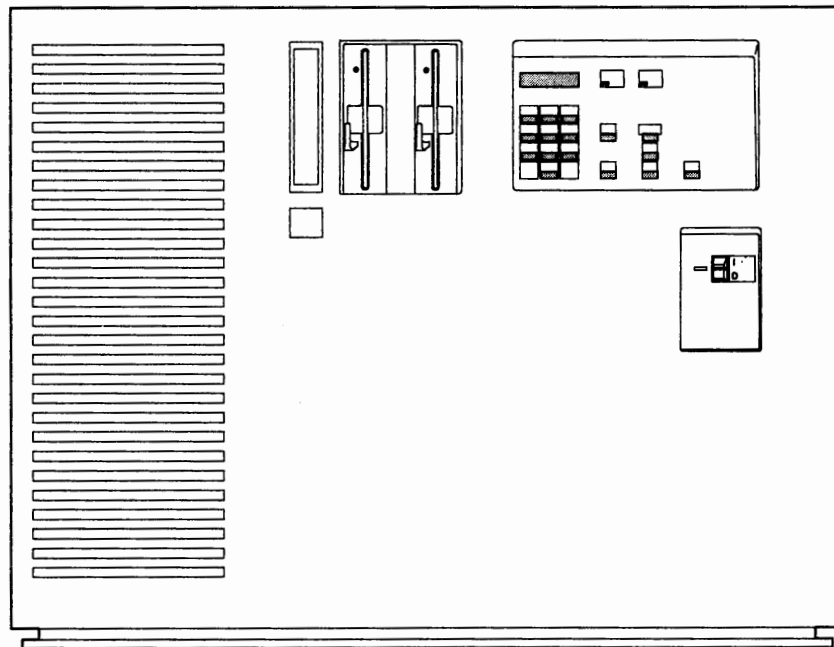

Figure 1-2. Models 1R, 2R, 3R, 11R, 12L, 12R, and 13R (Models 1L and 11L are similar)

**Models 1L and 11L** have a System/370<sup>®</sup>-type channel adapter for Systems Network Architecture (SNA) and non-SNA channel attachment.

**Models 1R and 11R** have a Type 1 Communication Adapter designed for remote operation. They contain EIA 232D/CCITT V.24/V.28 or CCITT V.35 interfaces for SDLC, BSC, or X.25 remote link attachment to a host.

**Models 2R and 12R** have a Type 2 Communication Adapter designed for remote operation. They contain an X.21 interface (CCITT V.11) for SDLC or X.25 remote attachment to a host.

**Models 3R and 13R** are designed for remote connection to a Token-Ring Network. They contain a Token-Ring Adapter and cable for connection to a Token-Ring Network.

**Model 12L** has an Enterprise System Connection\* (ESCON)\* Adapter that allows for SNA and non-SNA channel attachment to the Enterprise Systems Connection Architecture optical I/O interface with fiber optic cables.

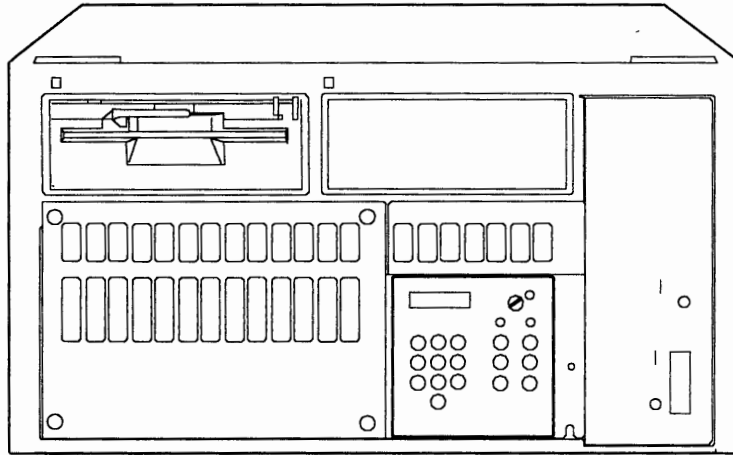

Figure 1-3. Model 21L

**Model 21L** has a System/370-type channel adapter for Systems Network Architecture (SNA) and non-SNA channel attachment. This model is designed for rack-mounted physical configurations.

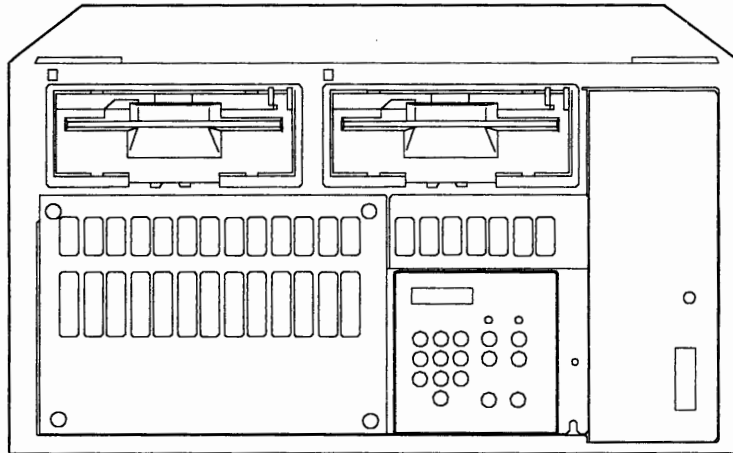

Figure 1-4. Models 21R, 22L, and 23R

**Model 21R** has a Type 1 Communication Adapter designed for remote operation. It contains EIA 232D/CCITT V.24/V.28 and CCITT V.35 interfaces for SDLC, BSC, or X.25 remote link attachment to a host. This model is designed for rack-mounted physical configurations.

**Model 22L** has an Enterprise Systems Connection (ESCON) Adapter that allows for SNA and non-SNA channel attachment to the Enterprise Systems Connection Architecture with fiber optic cables. This model is designed for rack-mounted physical configurations.

**Model 23R** is designed for remote connection to a Token-Ring Network. It has a Token-Ring Adapter and a cable for connection to a Token-Ring Network. It also contains a Type 1 Communication Adapter designed for remote operation and

## The 3174 Establishment Controller

contains EIA 232D/CCITT V.24/V.28 and CCITT V.35 interfaces for SDLC, BSC, or X.25 remote link attachment to a host. This model is designed for rack-mounted physical configurations.

## Medium-Cluster Controllers

Models 51R, 53R, 61R, 62R, and 63R are medium-cluster controllers for attaching up to sixteen 3270 devices and/or eight ASCII devices.

**Note:** Model 52R is not supported for Configuration B microcode because of storage constraints.

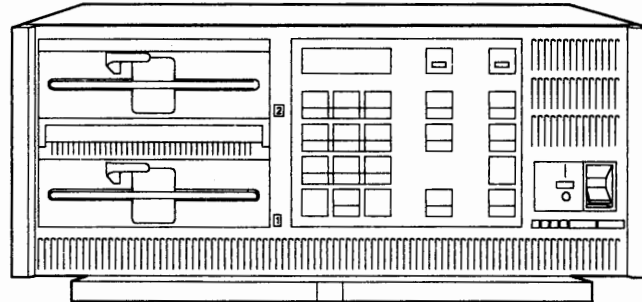

Figure 1-5. Models 51R, 53R, 61R, 62R, and 63R

**Models 51R and 61R** have a Type 1 Communication Adapter designed for remote operation. They contain EIA 232D/CCITT V.24/V.28 or CCITT V.35 interfaces for SDLC, BSC, or X.25 remote link attachment to a host.

**Note:** 51R does not support Multi-Host Token-Ring Gateway. The 51R can, however, provide gateway support to a single host.

**Model 62R** has a Type 2 Communication Adapter designed for remote operation. It contains an X.21 interface (CCITT V.11) for SDLC or X.25 remote link attachment to a host.

**Models 53R and 63R** are designed for remote connection to a Token-Ring Network. They contain a Token-Ring Adapter and cable for connection to a Token-Ring Network.

**Note:** 53R does not support CCAs or AEAs because of feature slot limitations.

## Small-Cluster Controllers

Models 90R, 91R, and 92R are small-cluster controllers for attaching up to eight 3270 devices. There are no additional features supported by these models.

**Note:** Models 81R and 82R are not supported for Configuration B microcode because of storage constraints.

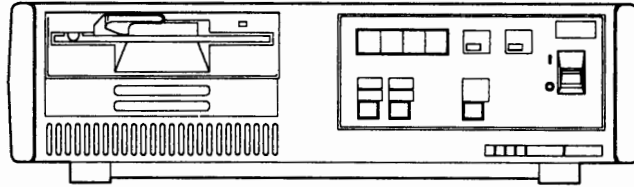

Figure 1-6. Model 90R

**Model 90R** is an IBM Token-Ring Network Gateway controller designed for remote operation. It has a Token-Ring Adapter and a Type 1 Communication Adapter with EIA 232D/CCITT V.24/V.28 or CCITT V.35 interfaces for SDLC remote link attachment to the IBM host.

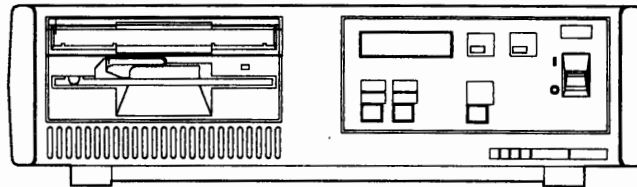

Figure 1-7. Models 91R and 92R

**Model 91R** has a Type 1 Communication Adapter designed for remote operation. It contains EIA 232D/CCITT V.24/V.28 or CCITT V.35 interfaces for SDLC, BSC, or X.25 remote link attachment to the IBM host.

**Model 92R** has a Type 2 Communication Adapter designed for remote operation. It contains an X.21 interface (CCITT V.11) for SDLC or X.25 remote link attachment to the IBM host.



## Features of the 3174

The following tables list, by model, the hardware and combination hardware/microcode features that are supported on the controller. The first table shows large-cluster models; the second table shows medium- and small-cluster models. To support some of the features, many of the models require additional storage. Refer to Chapter 3, "Planning for Controller Storage" on page 3-1 for details. Configuration Support B requires that the controller contain a 2.4MB Diskette Drive, or a Fixed Drive, and at least 2MB of storage.

Table 1-1. Features Supported by Models 1L through 23R													
Feature	1L	1R	2R	3R	11L	11R	12L	12R	13R	21L	21R	22L	23R
1MB Base Storage	B	B	B	B	X	X	X	X	X	X	X	X	X
2MB Base Storage	X	X	X	X	B	B	B	B	B	B	B	B	B
Storage Expansion	O	O	O	O	O	O	O	O	O	O	O	O	O
1.2MB Diskette Drive	B	B	B	B	X	X	X	X	X	X	X	X	X
2.4MB Diskette Drive	O	O	O	O	B	B	B	B	B	B	B	B	B
20MB Fixed Disk	O	O	O	O	O	O	O	O	O	O	O	O	O
Terminal Adapter	B	B	B	B	B	B	B	B	B	B	B	B	B
Terminal Adapter (3270 Port Expansion Feature)	X	X	X	X	O	O	O	O	O	O	O	O	O
Fiber Optic Terminal Adapter	O	O	O	O	O	O	O	O	O	O	O	O	O
Terminal Multiplexer Adapter*	O	O	O	O	O	O	O	O	O	O	O	O	O
Channel Adapter	B	X	X	X	B	X	X	X	X	B	X	X	X
ESCON Adapter	X	X	X	X	X	X	B	X	X	X	X	B	X
Type 1 Communication Adapter	O	B	X	O	O	B	O	X	O	X	B	B	B
Type 2 Communication Adapter	O	X	B	O	O	X	O	B	O	X	X	X	X
Type 3A Communication Adapter (Token-Ring Adapter)	O**	O**	O**	B	O**	O**	O**	O**	B	O**	O	O**	B
Token-Ring 3270 Gateway	O	O	O	X	O	O	O	O	X	O	O	O	X
Asynchronous Emulation Adapter	O	O	O	O	O	O	O	O	O	O	O	O	O
Concurrent Communication Adapter	O	O	O	O	O	O	O	O	O	O	O	O	O
<b>Legend:</b>													
B = Base													
O = Optional													
X = Not Available on this model													
* Although not a feature of the 3174, the 3299 Terminal Multiplexer provides a similar function as the Terminal Multiplexer Adapter and is supported by all models of the 3174.													
** When this adapter is present and you specify the actual model number in question 100, the 3174 can only be customized as a gateway. To use as a Token-Ring attached DSPU, the model designation must be changed during customization. See "Alternate Configurations" on page 1-10.													

Table 1-2. Features Supported by Models 51R through 92R								
Feature	51R	53R	61R	62R	63R	90R	91R	92R
1MB Base Storage	B	B	X	X	X	X	X	X
2MB Base Storage	X	X	B	B	B	B	B	B
Storage Expansion	O	O	O	O	O	X	X	X
1.2MB Diskette Drive	B	B	X	X	X	X	X	X
2.4MB Diskette Drive	O	O	B	B	B	B	B	B
20MB Fixed Disk	O	O	O	O	O	X	X	X
Terminal Adapter	B	B	B	B	B	B	B	B
Terminal Adapter (3270 Port Expansion Feature)	X	X	X	X	X	X	X	X
Fiber Optic Terminal Adapter	X	X	X	X	X	X	X	X
Terminal Multiplexer Adapter*	X	X	X	X	X	X	X	X
Channel Adapter	X	X	X	X	X	X	X	X
ESCON Adapter	X	X	X	X	X	X	X	X
Type 1 Communication Adapter	B	X	B	X	X	B	B	X
Type 2 Communication Adapter	X	X	X	B	X	X	X	B
Type 3A Communication Adapter (Token-Ring Adapter)	O**	B	O**	O**	B	B***	X	X
Token-Ring 3270 Gateway	O	X	O	O	X	B	X	X
Asynchronous Emulation Adapter	O	X	O	O	O	X	X	X
Concurrent Communication Adapter	O	X	O	O	O	X	X	X
<b>Legend:</b>								
B = Base								
O = Optional								
X = Not Available on this model								
* Although not a feature of the 3174, the 3299 Terminal Multiplexer provides a similar function as the Terminal Multiplexer Adapter and is supported by all models of the 3174.								
** When this adapter is present and you specify the actual model number in question 100, the 3174 can only be customized as a gateway. To use as a Token-Ring attached DSPU, the model designation must be changed during customization. See "Alternate Configurations" on page 1-10.								
*** This model can only be customized as a gateway.								

## Alternate Configurations

Many models of the 3174 Establishment Controller can be configured to act as other models; most models require additional hardware to support alternate configurations. Functions not normally supported by a particular model controller may be supported on the controller under an alternate configuration. For example, a Model 13R can only be customized as Token-Ring attached. By installing a Type 1 Communication Adapter and designating Model 11R in question 100, you can customize for functions supported on the Model 11R that are not supported on a Model 13R, such as X.25 or gateway. The models that can be alternately configured are listed below, along with the features and the alternate configurations that can be attained.

Table 1-3. Alternate Configurations. These alternate configurations are for models that can contain, in addition to their primary communication adapter, a Type 1, Type 2, or Type 3A Communication Adapter.		
Primary Configuration	Additional Adapter Type	Alternate Configuration
Model 01L	Type 1 (3040 or 3041)	Model 01R
	Type 2 (3043)	Model 02R
	Type 3A (3044)	Model 03R
Model 01R	Type 3A (3044)	Model 03R
Model 02R	Type 3A (3044)	Model 03R
Model 03R	Type 1 (3040 or 3041)	Model 01R
	Type 2 (3043)	Model 02R
Model 11L	Type 1 (3040 or 3041)	Model 11R
	Type 2 (3043)	Model 12R
	Type 3A (3044)	Model 13R
Model 11R	Type 3A (3044)	Model 13R
Model 12L	Type 1 (3040 or 3041)	Model 11R
	Type 2 (3043)	Model 12R
	Type 3A (3044)	Model 13R
Model 12R	Type 3A (3044)	Model 13R
Model 13R	Type 1 (3040 or 3041)	Model 11R
	Type 2 (3043)	Model 12R
Model 21L	Type 3A (3044)	Model 23R
Model 21R	Type 3A (3044)	Model 23R*
Model 22L	None Required**	Model 21R
	Type 3A (3044)	Model 23R
Model 23R	None Required**	Model 21R
Model 51R	Type 3A (3044)	Model 53R
Model 61R	Type 3A (3044)	Model 63R
Model 62R	Type 3A (3044)	Model 63R
<p>* Model 23R is recommended, but Model 21R can also be used as the model designation for this alternate configuration.</p> <p>** The Type 1 Communication Adapter, required for the alternate configuration, is integrated in the planar board for this model.</p>		

---

## Features for the 3174 Establishment Controller

There are several features for the 3174 Establishment Controller. Tables 1-1 and 1-2 show which features are supported by which controller models. Not all features are supported on all 3174 models.

**Terminal Multiplexer Adapter (TMA)** allows attachment of up to thirty-two 3270 terminals if four TMAs are installed. It attaches to the Terminal Adapter and multiplexes the data streams from eight 3270 devices into a single coaxial cable.

**3299 Terminal Multiplexer** is attached to the Terminal Adapter with a coaxial cable, the IBM Cabling System, or to the Fiber Optic Terminal Adapter using fiber optic cable. It multiplexes the data streams from up to eight or thirty-two 3270 devices into a single cable, depending on the multiplexer model.

**Type 1 Communication Adapter (EIA 232D/CCITT V.24/V.28 or CCITT V.35)** provides a telecommunication path to a host. It supports SDLC, BSC, or X.25 remote link attachment.

**Type 2 Communication Adapter (CCITT X.21/V.11)** provides a telecommunication path to a host. It supports SDLC or X.25 remote attachment.

**16/4 Mbps Token-Ring Adapter** connects the controller to an IBM Token-Ring Network. This adapter is also referred to as the Type 3A Communication Adapter.

**Asynchronous Emulation Adapter (AEA)** allows ASCII terminals to communicate with ASCII hosts, ASCII terminals to emulate 3270 devices and communicate with 3270/IBM hosts, and 3270 terminals attached to the controller to emulate ASCII terminals and communicate with ASCII hosts.

**Type 1 Concurrent Communication Adapter (EIA 232D/CCITT V.24/V.28 or CCITT V.35)** provides a concurrent telecommunication path to another host. It supports SDLC, BSC, or X.25 remote link attachment.

**Type 2 Concurrent Communication Adapter (CCITT X.21/V.11)** provides a concurrent telecommunication path to another host. It supports SDLC or X.25 remote attachment.

**Second diskette drive** has many uses, including, for example, to downstream load microcode to DSL devices and to decrease diskette swapping when performing 3174 utilities.

**Fixed Disk Drive** is used to load and store microcode. If Central Site Change Management is being used, at least one fixed disk drive should be installed on the Central Site Controller.

**Storage Expansion** is available to support additional features and functions not supported by the base storage.

## The 3174 Establishment Controller

**Fiber Optic Terminal Adapter** provides for attaching 3299 Model 32 terminal multiplexers. This adapter attaches to the Terminal Adapter with a coaxial cable and to the 32-port 3299 Terminal Multiplexer with fiber optic cable.

**3270 Port Expansion Feature** allows attachment of 32 additional 3270 terminals. This feature can also attach Terminal Multiplexer Adapters (TMAs) and 3299 multiplexers. The feature provides a new Terminal Adapter and requires Configuration Support B Release 4 microcode.

---

## Microcode

Microcode<sup>1</sup> for the 3174 Establishment Controller is on a purchased diskette. This microcode can be copied from a diskette onto a fixed disk (with the exception of some RPQ microcode on diskettes that can be merged) as separate diskette images. Diskettes and fixed disks are used to load and store the operational microcode and customization data.

In this manual, the word “disk” is used as the generic term for the media (diskette or fixed disk) on which the microcode is stored. You can use several different disks:

**3174 Utility Disk** contains the microcode necessary to run various utilities. This microcode arrives on a 2.4MB diskette and requires 2MB of controller storage to execute.

**3174 Control Disk**, when customized, contains the microcode necessary to make the 3174 Establishment Controller operational. This microcode arrives on a 2.4MB diskette and requires at least 2MB of controller storage to execute.

**3174 Limited Function Utility Disk** is used in networks that are under central site control to limit the number of 3174 utilities that can be performed and prevent unauthorized reconfiguration of the controller. This microcode arrives on a 1.2MB diskette. The diskette is ordered using specify code 9005. (See the *3174 Utilities Guide*, GA27-3863, for more information.)

**RPQ Diskette** contains a request for price quotation (RPQ), an alteration or addition to the functional capabilities the controller provides. An RPQ diskette is requested by a customer. RPQ diskettes can contain the microcode for up to 30 RPQs. Microcode for mergeable RPQs arrives on a 1.2MB diskette; microcode for RPQ Control disks is on a 2.4MB diskette.

**Downstream Load (DSL) Disks** are used for display stations that require the controller to downstream-load its operational microcode; for example, the 3290 Information Panel. The Asynchronous Emulation Adapter (AEA) also requires downstream-loaded microcode. If there are no distributed function terminals (DFTs) in the cluster that require DSL microcode and you are not configuring for the AEA, you do not need a DSL disk. DSL microcode is shipped on a 1.2MB diskette.

For more information on these disks, see the *3174 Utilities Guide*, GA27-3863.

---

<sup>1</sup> Microcode may be classified as IBM Licensed Internal Code. See the 3174 Licensed Internal Code notice at the beginning of this document for more information.

---

## **The 3174 Establishment Controller Library**

Each manual in the 3174 library is written to help you perform a specific *task*. A task consists of the operations you must perform to reach a specific goal. The tasks covered by the 3174 library include:

- Planning
- Installation
- Customization
- Operation
- Maintenance
- Problem determination.

The manuals in the 3174 library are grouped by task on page iii. Contact your IBM representative to order the manuals you need.

## Chapter 2. Planning Considerations

3174 Establishment Controller Planning	2-3
The Site	2-3
Controller Storage	2-3
Physical Installation	2-3
Types of Host Attachment	2-4
S/370 or S/390 Channel	2-4
Token-Ring Network	2-4
ASCII	2-5
Remote Link	2-5
Multi-Host Support	2-6
Link Attachment	2-6
Host Attachment	2-6
Concurrent Communication Adapter	2-7
Single Link Multi-Host Support	2-8
Multi-Host Gateway Support	2-10
Terminal Attachment	2-10
Direct Attachment	2-11
Terminal Multiplexer Adapters (TMAs)	2-11
Fiber Optic Terminal Adapter	2-11
IBM 3299 Terminal Multiplexers	2-11
Asynchronous Emulation Adapter	2-11
Display Compatibility Requirements	2-12
Host System Planning	2-12
Microcode Customization	2-12
Type of Host Attachment	2-13
Multi-Host Support	2-13
Alternate Configurations	2-14
Keyboard Language Support	2-14
Country Extended Code Page (CECP)	2-14
Network Asset Management	2-14
Central Site Control Facility (CSCF)	2-14
User-Defined Terminal Tables (UDTs)	2-15
User-Defined Translate Tables (UDXs)	2-15
Port Assignments	2-15
Device Definition	2-15
Central Site Change Management (CSCM)	2-16
Keyboard Modification	2-16
Multiple Logical Terminal Sessions (MLT)	2-16
Multiple Interactive Sessions	2-16
Downstream Load Microcode	2-16
Response Time Monitor	2-17
Local Format Storage	2-17
Microcode Migration	2-17
Planning Checklist	2-18





---

## 3174 Establishment Controller Planning

Now that you have been introduced to the 3174 Establishment Controller, you are ready to begin planning to meet the needs of your establishment. Although planning is a straightforward process, many things must be considered. This chapter identifies those considerations and provides the “big picture,” which is required in any planning activity.

---

### The Site

Preparing and planning the site for installation of a controller is made up of many tasks, which include several subtasks. The major tasks in planning for the site are:

- Checking the environment
- Ordering the 3174 Establishment Controllers and terminals
- Defining the controller's physical configuration
- Designing the site floor plan
- Determining the controller cabling
- Completing the 3174 cabling worksheets
- Giving the completed worksheets to the setup personnel.

Use the *3174 Site Planning* manual, GA23-0213, during this phase of your installation; it will help you complete these tasks.

---

### Controller Storage

You need to ensure, through planning, that you have sufficient storage for the features and functions that you wish to use. The procedure in Chapter 3, “Planning for Controller Storage,” helps you determine these storage requirements.

Storage capabilities will vary depending on the controller model. In some cases, you can gain additional storage by installing a storage expansion card. These storage expansion cards are customer-installable features.

---

### Physical Installation

The controller is a customer-installable product, so the IBM service representative is needed only to attach the channel interface cables (bus and tag) to Models 1L, 11L, and 21L and set the channel priority switches. Installation of the controller involves:

- Unpacking the controller
- Placing it in the desired location
- Installing any features (such as an AEA, TMAs, and so on)
- Connecting power
- Running tests
- Connecting the communication cables
- Attaching terminals
- Customizing the microcode using completed configuration worksheets
- IMLing (initial microcode loading) the controller.

Refer to the *3174 Site Planning*, GA23-0213, and to the setup procedure in the *3174 User's Guide* when physically installing the controller.

---

### Types of Host Attachment

You need to consider your establishment's needs for host attachment. The attachment capabilities depend on the controller model and features. The following types of host attachment are supported:

- Channel Attachment (S/370, S/390\*)
- ASCII
- Token-Ring Network
- Remote Link (BSC, SDLC, X.25).

#### S/370 or S/390 Channel

Channel attachment is direct attachment to the host using cable and adapter combinations. The 3174 controller supports two types of channel attachment: S/370 and S/390 Attachment, which supports the Enterprise Systems Connection Architecture. Both types support SNA and non-SNA.

#### S/370 Channel

This method of channel attachment uses Channel Interface Cables (bus and tag) and a channel adapter. The System/370-architecture channel interface for SNA and non-SNA is used for attachment. Models 1L, 11L, and 21L are capable of this kind of channel attachment. They have Data-Chaining Interlocked and High Speed Transfer channel operational modes. These can provide channel data rates up to 1.0 and 1.25 megabytes per second (respectively) and 2.5Mbps with data streaming. The allowable distance from the host to the controller is 122 meters (400 feet).

In addition to the channel speed, you should consider burst sizes, priority settings, and unit control words (UCW) when planning for this type of attachment.

#### S/390 Channel

The ESCON Channel Adapter supports S/390 Channel attachment from the host to the controller. This type of attachment supports both SNA and non-SNA. The adapter is available on Models 12L and 22L only.

The allowable distance from the host to the controller is increased from 122 meters (400 feet) to 3 kilometers (1.86 Miles) without an ES Connection Director. If two ES Connection Directors are installed between the host and the controller, the controller can be installed up to 9 kilometers (5.5 miles) from the host.

#### Token-Ring Network

Token-Ring Network attachment is another way to attach controllers to SNA hosts. With this method of attachment, the Token-Ring and a gateway are between the controller and the host. To plan for Token-Ring attachment, use the customization question information in Chapter 6, "Planning to Configure" on page 6-1.

If you will be using your controller as a gateway, use the information in Chapter 14, "Planning the Token-Ring Network 3270 Gateway" on page 14-1, and the examples in Appendix C, "Token-Ring Planning Examples" on page C-1, to plan its configuration.

## ASCII

ASCII attachment is accomplished through the Asynchronous Emulation Adapter (AEA). Before you plan for ASCII attachment, read the 3174 *AEA Description and Reference*, GA27-3872. To plan for ASCII attachment, use Chapter 12, "Planning for the Asynchronous Emulation Adapter" on page 12-1 and Appendix B, "AEA Planning Examples" on page B-1.

## Remote Link

Remote attachment requires communication adapters and Data Circuit Terminating Equipment (DCE) instead of channel adapters.

Table 2-1 illustrates remote link attachment.

Table 2-1. Remote Attachment Adapter Requirements					
Remote Link Attachment					
Model	Primary Link			Secondary Link	
	Type 1 CA	Type 2 CA	Token-Ring Adapter	Type 1 CCA	Type 2 CCA
1L				✓	✓
1R	✓			✓	✓
2R		✓		✓	✓
3R			✓	✓	✓
11L				✓	✓
11R	✓			✓	✓
12L				✓	✓
12R		✓		✓	✓
13R			✓	✓	✓
21L				✓	✓
21R				✓	✓
22L				✓	✓
23R			✓	✓	✓
51R	✓			✓	✓
53R			✓	✓	✓
61R	✓			✓	✓
62R		✓		✓	✓
63R			✓	✓	✓
90R	✓		✓		
91R	✓				
92R		✓			

## Multi-Host Support

The 3174 Establishment Controller can be configured to access multiple 3270 hosts. Using the MLT function, each terminal connected to a 3270 controller port can have up to five host sessions. These sessions may be all to one host or to several hosts. A terminal can access the different hosts through a keying sequence that switches between the sessions and/or hosts.

There are several types of Multi-Host Support:

- An additional link to hosts through a Concurrent Communication Adapter (CCA)
- Single Link Multi-Host Support (Token-Ring, ESCON Channel, X.25)
- Multi-Host Gateway.

Various combinations of Multi-Host Support can be used at the same time. For instance, the ESCON Channel Adapter, Concurrent Communication Adapters and X.25 can be used simultaneously. For information on configuring for multiple hosts, see "Microcode Customization" on page 2-12.

The following terms are used throughout this book in order to differentiate hosts and links:

- Link attachment
- Host attachment.

## Link Attachment

Link attachment refers generally to the physical means of attaching to a host or network (the hardware link). Depending upon its type, the link is considered "primary" or "secondary". (A primary link is typically the link provided by the model you have purchased and does not require any optional features.)

Primary links are provided by:

- Channel Adapter
- ESCON Channel Adapter
- Type 1 Communication Adapter
- Type 2 Communication Adapter
- Token-Ring Adapter.

Secondary links are provided by:

- Type 1 Concurrent Communication Adapter
- Type 2 Concurrent Communication Adapter.

## Host Attachment

Some kinds of link attachment allow multiple hosts to be accessed. Consider one of these hosts the primary host and the others, secondary hosts. Thus, on a primary link, you can have a primary host (1A) and secondary hosts (1B-1H). And on a secondary link you can have a primary host (2A or 3A) and secondary hosts (2B-2D, 3B-3D). The following matrix illustrates this concept:

	Primary Link	Secondary Link
Primary Host	1A	2A, 3A
Secondary Host	1B-1H	2B-2D, 3B-3D

You make primary and secondary host assignments as part of planning for customization. The number/letter combinations are the *host IDs*, by which you identify each host. A host ID is always two characters: the first is a number and indicates the link, the second is a letter and indicates the host. The number **1** and the letter **A** always indicate **primary**. (Thus the 1A host is the primary host on the primary link, and the 2A host is the primary host on a secondary link.)

### Concurrent Communication Adapter

The Concurrent Communication Adapter (CCA) is a hardware feature. It provides access to additional 3270 hosts. It can provide access to one additional host, or it can provide access over an X.25 network to a maximum of four hosts (X.25 Single Link Multi-Host Support).

There are two types of these adapters:

- The Type 1 Concurrent Communication Adapter provides for remote link attachment using BSC, SDLC, and X.25.
- The Type 2 Concurrent Communication Adapter provides for remote link attachment using X.21 and X.25.

The number of Concurrent Communication Adapters that can be installed in a controller varies depending on the controller model:

Model	Number of CCA's
1L, 1R, 2R, 3R, 11L, 11R, 12L, 12R, 13R	2
51R, 63R	1
21L, 21R, 22L, 23R	2
61R, 62R	2

The Model 53R and small-cluster controllers do not support the CCA.

Figure 2-1 illustrates the multiple 3270 hosts that a terminal can access when Concurrent Communication Adapters are present in a controller.

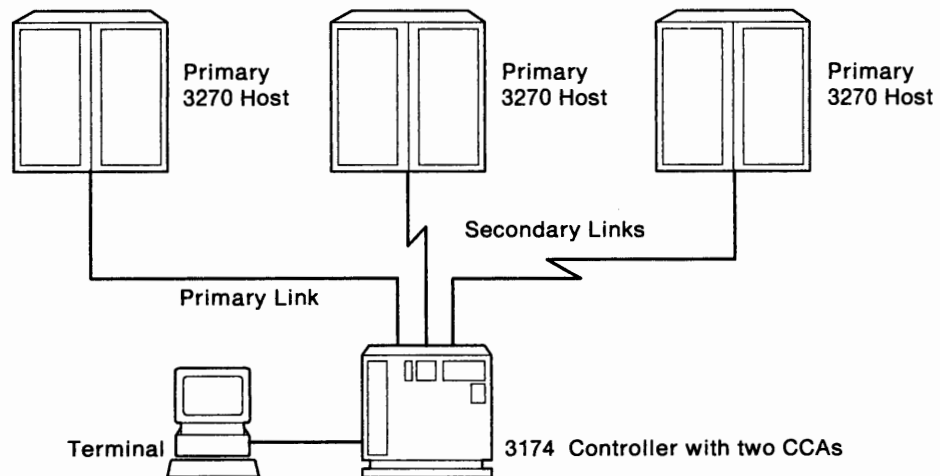

Figure 2-1. Multiple 3270 Host Access through Concurrent Communication Adapters

### Single Link Multi-Host Support

Single Link Multi-Host Support enables terminals attached to a controller to access multiple 3270 hosts on a single physical link. If the link is primary, up to eight hosts can be configured; if the link is secondary, up to four hosts can be configured.

The 3174 Establishment Controller supports three types of Single Link Multi-Host Support. Each is explained in the following sections.

### ESCON Channel

ESCON Channel Support allows you to access up to eight IBM hosts on the primary link through an ES Connection Director connected to a S/390 host. For an illustration of ESCON Channel Support, see Figure 2-2.

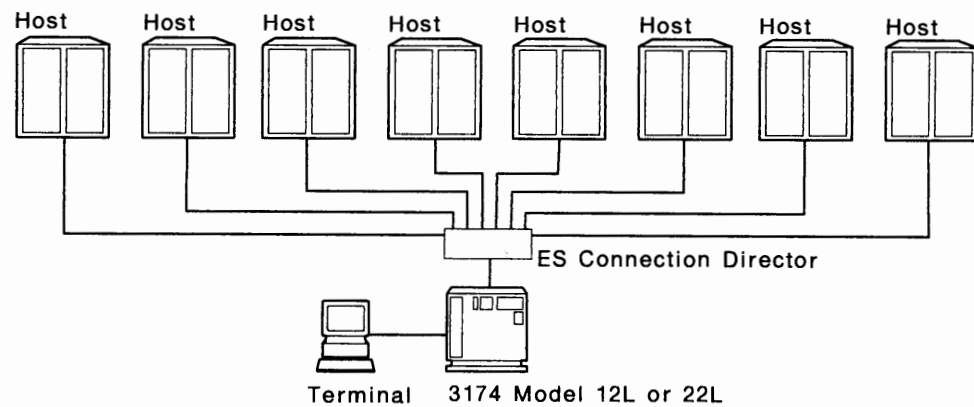

Figure 2-2. ESCON Channel Support

### Token-Ring

This function is for controllers attached to the IBM Token-Ring Network as a downstream physical unit. The single link is the link between the controller and the ring; it is the controller's primary link. Terminals attached to the controller can access multiple 3270 hosts.

The Token-Ring is attached to the hosts through gateways. Each gateway has a unique address. That address is used during the customization of a controller using Token-Ring Single Link Multi-Host Support to identify the path to the gateway. Service Access Points (SAPs), specified in conjunction with the gateway address, identify the different hosts upstream of the gateway.

Models 3R, 13R, 23R, 53R, and 63R support Token-Ring Single Link Multi-Host Support. Controllers configured as a gateway do not. Alternate configurations allow other controllers to appear as one of these models and thus support this function (see Table 1-3 on page 1-10 for more information). Figure 2-3 on page 2-9 illustrates Token-Ring Single Link Multi-Host Support.

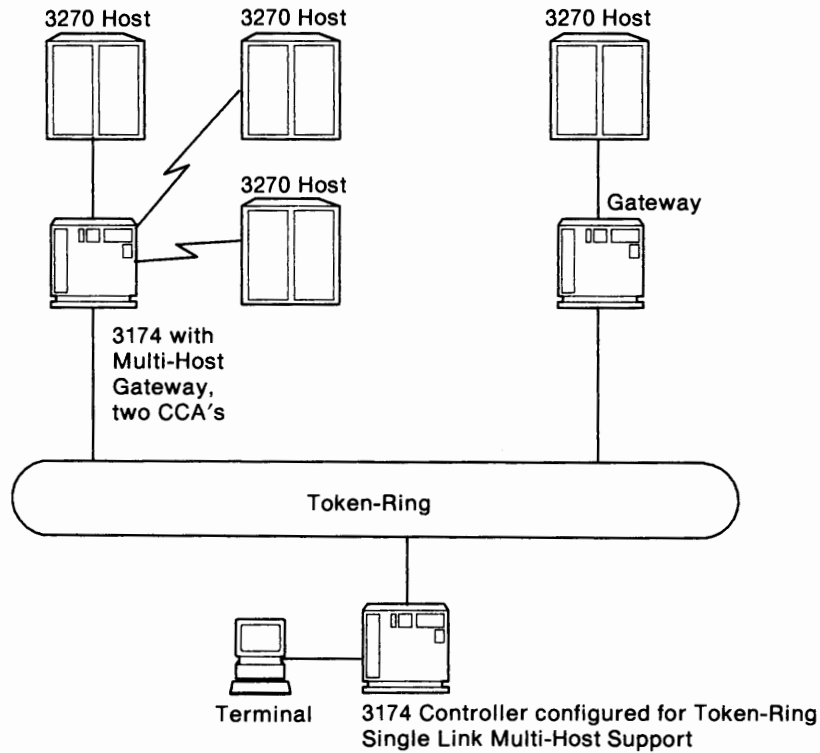

Figure 2-3. Token-Ring Single Link Multi-Host Support

Single Link Multi-Host Support over a Token-Ring means that primary and secondary hosts are accessed through the primary link, supplied by the Token-Ring Adapter. At customization, you can choose which host will be your primary host on the link and which hosts will be the secondary hosts.

## X.25

This function is for controllers attached to X.25 networks. Unlike other types of single link support, X.25 Single Link Multi-Host Support can be accomplished over the primary or secondary link—or both at once.

On a primary link, up to eight hosts can be configured. The link is accomplished using a Type 1 or Type 2 Communication Adapter and X.25 protocol.

On a secondary link, up to four hosts can be configured. The link is accomplished using a Type 1 or Type 2 Concurrent Communication Adapter and X.25 protocol.

Two secondary links can be used on most models of the 3174, making the total number of hosts accessible through secondary links eight. Some controller models support only one CCA (and therefore one secondary link).

Figure 2-4 on page 2-10 illustrates X.25 Single Link Multi-Host Support support through both primary and secondary links.



## Planning Considerations

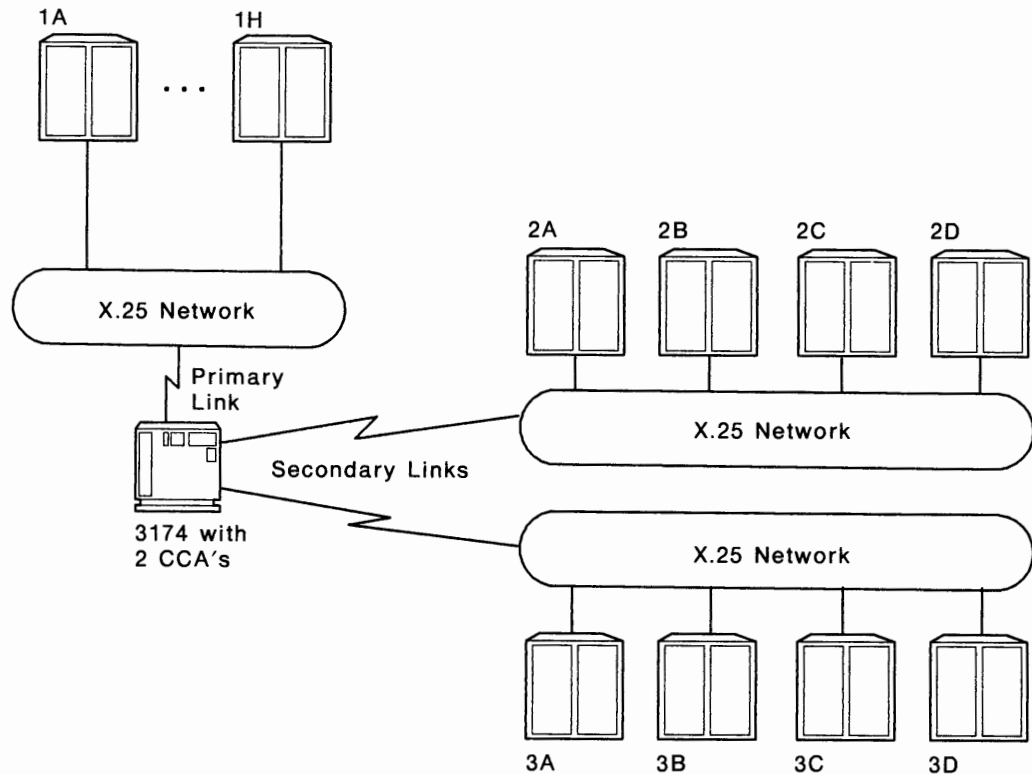

Figure 2-4. X.25 Single Link Multi-Host Support

### Multi-Host Gateway Support

Multi-Host Gateway Support is a microcode function that gives devices on a Token-Ring access to multiple hosts through a gateway controller. The hosts can be attached either on the controller's primary or secondary link, but the link must be local SNA or remote SDLC. For example, Token-Ring devices on a controller customized for ESCON Channel Single Link Multi-Host Support can access any of the eight possible channel-attached hosts.

A particular Token-Ring device, depending on the support provided by the device, may not be able to concurrently access more than one of the gateway's hosts. For example, a Token-Ring device such as a 3174 Model 13R customized for Single Link Multi-Host Support, could access up to 8 hosts through only one 3174 gateway. Figure 2-3 on page 2-9 shows an example of Multi-Host Gateway Support.

---

### Terminal Attachment

Terminals can be attached to the controller in several ways. Some of the attachment methods are restricted to certain controller models. The number of terminals that can be attached also varies from model to model. Attachment methods include:

- Direct
- Terminal Multiplexer Adapters (TMAs)
- Fiber Optic Terminal Adapters
- IBM 3299 Terminal Multiplexers
- Asynchronous Emulation Adapters (AEA).

### Direct Attachment

Terminals can be attached directly to the ports on a Terminal Adapter (TA), which is installed in the controller during its manufacture. Depending on the controller model, a 9-, 4-, or 1-port Terminal Adapter is installed. When the 3270 Port Expansion Feature is present, there will either be a total of eight Terminal Adapter ports or four (three for the first TA, and one for the second) depending on the model type.

### Terminal Multiplexer Adapters (TMAs)

The Terminal Multiplexer Adapter (TMA):

- Multiplexes the data streams from eight 3270 devices into a single coaxial cable
- Can be installed in large-cluster controllers (up to 4 per installed Terminal Adapter)
- Is attached to the Terminal Adapter with a short coaxial cable
- Provides 8 ports, allowing up to 32 terminals to be attached if 4 TMAs are installed or 64 terminals if 8 TMAs are installed.

### Fiber Optic Terminal Adapter

The Fiber Optic Terminal Adapter provides for attaching 3299 Model 32 Terminal Multiplexers by means of fiber optic cable. This adapter attaches to the Terminal Adapter with coaxial cable and to the 32-port 3299 Terminal Multiplexer with fiber optic cable.

### IBM 3299 Terminal Multiplexers

The 3299 Terminal Multiplexer:

- Multiplexes the data streams from up to eight or up to thirty-two 3270 devices into a single cable, depending on the multiplexer model
- Is attached to the Terminal Adapter with a coaxial cable, the IBM Cabling System, or Fiber Optic Cable, depending on the multiplexer model.

### Asynchronous Emulation Adapter

The Asynchronous Emulation Adapter (AEA):

- Allows 3270 emulation from ASCII displays and printers as well as ASCII emulation from 3270 devices
- Has eight communication ports to which ASCII displays, printers, hosts, and modems can be connected
- Supports switched, direct, and non-switched terminal connections.

---

### Display Compatibility Requirements

**3290 compatibility with the host:** If 3290 Information Panels are in the cluster, setup level 3 changes may be required to make the 3290 logical terminals compatible with their definition at the host, so that the host can communicate with them. Check with the system programmer. If setup level 3 changes are required after 3174 customizing is completed, you need to IML the Control disk before switching on the 3290 and going into setup level 3. DSL (downstream load) code is also required to make the 3290 operational. For more information, see the *3290 Information Panel Description and Reference*, GA23-0021.

**Customization compatibility between the IBM 3270 Personal Computer and the 3174 Establishment Controller:** If any 3270 Personal Computers are in the cluster, obtain a copy of the Information Worksheet used for customizing the IBM 3270 Personal Computer system diskette. The information on this worksheet should agree with the responses to the 3174 configuration questions. For more information, see the *IBM 3270 Personal Computer Introduction and Preinstallation Planning*, GA23-0179.

---

### Host System Planning

You need to consider several areas for your host attachment.

- System definitions
- VTAM and NCP definitions
- VSE/SP2 considerations
- Response Unit (RU) size
- OEM ASCII Graphics support
- Failure information
- Response formats
- .SOEMI support
- Central Site Change Management
- VM patches.

When planning to ensure that the host supports your establishment's needs, see Chapter 4, "Host System and 3174 Planning."

---

### Microcode Customization

"Microcode customization" is the term used to describe the process of tailoring the operational code supplied by IBM with the controller to:

- Support the attaching displays and printers
- Support the features installed in the controller
- Identify the methods and protocols of host attachment that the controller will use.

For example, you customize to identify such things as:

- The number of hosts
- The number of ports used
- The addresses assigned to the ports
- Keyboard languages and layouts
- The number of host sessions for terminals
- The support provided for asynchronous communication
- The types of communication protocol.

This customization process consists of many tasks, but can be thought of as:

- Planning the customization
- Completing the worksheets
- Customizing the microcode on the Control disk.

Microcode customization and how to plan for it are explained further in Chapter 5. You should read that chapter before you plan for customization. You must also consider some of these items:

- Type of host attachment
- Multi-Host Support
- Alternate configurations
- Keyboard language support
- Country Extended Code Page
- Network Access Management
- Central Site Control Facility
- User-defined Terminal tables
- User-defined Translate tables
- Port assignments
- Device Definition
- Central Site Change Management
- Keyboard modification
- Multiple sessions for terminals
- Downstream load microcode
- Response Time Monitor
- Local Format Storage.

### Type of Host Attachment

The types of host attachments were described earlier in this chapter. As part of your host attachment, you need to identify during microcode customization planning, the communication protocol you are using:

- BSC
- X.25
- Local Non-SNA
- Local SNA
- X.21 Switched
- Token-Ring Network
- SDLC.

Configuration question “101: Host Attachment” on page 6-5 identifies the protocol or sends you to the information that does.

### Multi-Host Support

As described earlier, there are several types of Multi-Host Support. The desire to configure for multiple 3270 hosts is identified to the microcode by responding to question “101: Host Attachment” with an **M**.

Multi-Host Support requires that you plan the microcode customization by filling out worksheets for each host attachment. You can think of each host attachment as a separate controller configuration. You begin by identifying all the hosts and their characteristics on “Worksheet 2—Multi-Host Definition.” Then you fill out worksheets for the primary link attachment (primary host first). When filling out these worksheets, you will respond to configuration questions that pertain to the entire link, or “controller configuration”. These questions are not repeated on the worksheets for the secondary hosts on the link. After completing the worksheets for the primary host on a link, you fill out worksheets for each secondary host attachment on the link.

You need to consider several things when planning for Multi-Host Support:

- Port Assignments
- Device Definition
- Multiple sessions for terminals

## Planning Considerations

- Storage
- Response Time Monitor
- Type of controller you are configuring.

These are discussed later in this chapter.

## Alternate Configurations

Depending on the types of communication adapters installed, certain models of the 3174 Establishment Controller can be configured to operate as different models. These different configurations are known as *alternate configurations* (see Table 1-3 on page 1-10).

To use one of the controllers listed in Table 1-3 on page 1-10 in an alternate configuration, you must configure a Control disk for each communication protocol.

## Keyboard Language Support

The controller supports many languages. During planning, you will identify the keyboard language you wish to use when responding to configuration question "121: Keyboard Language." The languages supported by the controller are listed in Table 6-4 on page 6-21.

If you have a Concurrent Communication Adapter, you can specify the keyboard language that is to be used with the adapter. This language can be different than the language on your primary host links. For more information, see "139: Concurrent Communication Keyboard Language" on page 6-29.

## Country Extended Code Page (CECP)

In addition to the basic keyboard language support, the controller provides Country Extended Code Page (CECP) support. CECP provides a larger definition of graphic characters and improves multilingual communication. Your response to configuration question 123 on page 6-21 indicates whether you wish to use CECP. If you do, you must also respond to question 121 with one of the CECP languages listed in Table 6-5 on page 6-22.

## Network Asset Management

The Network Asset Management function supports host requests for vital product data from SNA-attached controllers and their devices. (Vital product data is information about a specific display station, such as its location or type.) These are devices that do not support regular vital product data architecture. The data is submitted through the Central Site Control Facility and NetView\*.

## Central Site Control Facility (CSCF)

The Central Site Control Facility enables you to perform online problem determination procedures from remote NetView-supported terminals. This facility eliminates the need to go to a terminal directly attached to the 3174 to perform an online test. Central Site Control Facility is also used for submitting vital product data to a host from an SNA-attached controller or device.

**Note:** CSCF requires NetView Release 3.0 of MVS/XA or VM/SP or higher.

## User-Defined Terminal Tables (UDTs)

User-Defined Terminal tables are one of two groups of tables providing for communication between 3270 hosts and ASCII devices. Terminal tables enable the AEA feature to interpret and send sequences and commands to different ASCII station types emulating 3270 terminals. The AEA microcode provides terminal tables for several commonly used station types; you can define more tables to support other station types.

Refer to “Filling Out Worksheet 22—Terminal Tables” on page 12-65 for an example of terminal table definition.

## User-Defined Translate Tables (UDXs)

User-Defined Translate tables are the second group of tables used for communication between 3270 hosts and ASCII devices. Translate tables provide information about the character set supported by an ASCII station, the language configured for its 3174 controller, and matching symbols in each data stream to equivalent symbols in the other data stream. The AEA feature provides translate tables for commonly used stations; you can define more to support other stations.

Refer to “Filling Out Worksheet 25—Translate Tables” on page 12-77 for an example of translate table definition.

## Port Assignments

You need to identify port assignments for your terminals and printers during your customization planning. This is done by assigning host addresses to ports or by allowing the customizing program to assign them for you. Your response to configuration question 116 identifies how you want host addresses assigned. If you are planning for Multi-Host Support, you need to specify a separate port assignment for each host attachment. The planning information you need, and the responses for question 116, are located in Chapter 7, “Planning for Port Assignment.”

## Device Definition

Device Definition consists of three separate areas:

- Printer Authorization Matrix
- Logical Terminal Assignment
- Extended Vital Product Data (VPD).

The first two areas deal with the assignment of devices that connect to the controller, and each contains defaults for these assignments. The third area deals with setting up information for providing vital product data.

**Printer Authorization Matrix (PAM)** defines which printers the display stations in a cluster can use for local copy, host printing, and shared copy operations. During planning, you complete worksheets that identify the display stations in the PAM for the different copy operations.

**Logical Terminal Assignment (LTA)** identifies which host sessions individual terminals can access and allows you to assign a printer to one host. You do not need an LTA if you are not planning to configure for Multi-Host Support. Port Assignment is used to identify host sessions in such a case.

## Planning Considerations

**Extended Vital Product Data** enables you to plan for sending vital product data from certain attached stations. Vital product data is information about a specific display station, such as its location or model type.

The information you need to complete this phase of planning is located in Chapter 13, "Planning to Define Devices."

## Central Site Change Management (CSCM)

By customizing for Central Site Change Management (CSCM), you can centrally distribute the customization information to the rest of the controllers in the network. This provides convenience and control.

Read the *Central Site Customizing User's Guide*, GA27-3868, before planning for CSCM. Once you have read that book, you can plan for CSCM using the information in Chapter 11 of this manual.

## Keyboard Modification

The purpose of modifying keyboards is to create unique keyboard layouts that meet specific user applications. If you require layouts that are not standard, the information in Chapter 15, "Planning to Modify Keyboards," helps you plan for modified layouts.

## Multiple Logical Terminal Sessions (MLT)

Multiple Logical Terminals (MLT) allows a terminal to have multiple sessions with one or more hosts. It is supported for both 3270 and ASCII terminals. Terminals can access different applications through a key sequence that switches between the different sessions.

## Multiple Interactive Sessions

The 3174 Establishment Controller supports multiple sessions on some devices without using MLT support. The Multiple Interactive Sessions (MIS) capability allows DFT display stations to operate as multiple logical terminals. Refer to "Port Assignment Considerations" on page 7-4 for additional information about MIS.

Address assignment for multiple sessions is accomplished through customization questions 116 and 117. When assigning addresses to ports supporting DFTs, you should check the device's supporting documentation for information about the number and type of sessions supported for that DFT.

## Downstream Load Microcode

Downstream Load (DSL) microcode is required for devices and features that need additional microcode to operate, for example, the IBM 3290 Display Panel and the Asynchronous Emulation Adapter. A DSL disk stores the diagnostics, bringup code, and operational microcode for displays and features that require additional microcode to operate.

You need to identify if there are any devices in your configuration that require DSL microcode. If there is more than one type of these devices, you need to perform the procedure for merging DSL code in the *3174 Utilities Guide*, GA27-3863.

## Response Time Monitor

The Response Time Monitor (RTM) function is a tool for network management, used to measure and evaluate response times. Response times can be measured for all display terminals that attach to the controller, but distributed function terminals (DFTs) require a special interface. See the *3174 Functional Description*, GA23-0218.

RTM is defined by the response given to configuration question 127, which is explained in Chapter 9, "Planning for Response Time Monitor (RTM)."

## Local Format Storage

Local Format Storage (LFS) provides for host-controlled loading of formats into 3174 storage and for presenting the formats. This feature is supported on any CUT device or any ASCII device operating in CUT emulation mode.

This feature helps improve system response time by enabling the 3174 to display stored formats when requested, thus relieving the host of repeatedly transmitting the format data to the controller.

LFS is defined by the response given to configuration question 179, which is explained in Chapter 6, "Planning to Configure."

---

## Microcode Migration

Periodically, IBM makes available upgraded versions of the Utility and Control diskettes that include new functions, such as the ability to handle a new type of display station. Each upgrade is assigned a microcode release level.

When migrating from one release of microcode to the next, consider:

- Microcode Upgrade utility
- RPQs
- Downstream Load code
- Patches
- Configuration questions not supported in the previous release
- Keyboard modification.

Chapter 5, "Microcode Customization Overview," contains more information on these considerations.



## Planning Considerations

### Planning Checklist

This Checklist is suggested for new installations. Your controller may not require all the steps indicated, or it may require additional steps. You can modify the checklist to meet your controller's requirements.

Step	Date Scheduled	Responsible		Date Completed	Action
		Customer	IBM		
1		✓			Designate the persons in your organization who will be responsible for all phases of the 3174 controller installation.
2		✓	✓		Review this planning checklist with the designated persons.
3		✓			Review appropriate tasks with the site planner. The site planner should read the site planning manual for information and instructions.
4		✓			Work with the site planner to develop a schedule for installation and to make sure appropriate communication equipment has been ordered.
5		✓	✓		Review the installation schedule with the site planner and the IBM representative.
6		✓	✓		Define your configuration needs. Work with your IBM representative and other appropriate persons to arrive at the desired configuration.
7		✓			Order supplies as determined in Step 6.
8		✓			Review information on the 3174 library in this manual and order the desired manuals through your IBM representative.
9		✓			Develop a training program for employees.
10		✓			Review the progress of the installation schedule. Identify and resolve any schedule conflicts.
11		✓	✓		Review the 3174 controller configuration with your IBM representative to make sure the new configuration continues to meet your needs.
12		✓			Check with the site planner to verify arrival of equipment and completion of site preparation.
13		✓			Complete the configuration worksheets.
14		✓			Make sure all the necessary information (such as configuration information, customizing worksheets, and so on) is available for appropriate personnel.
15		✓	✓		Verify that setup and customization have been done and machines are operational.

---

## **Part 2. General Planning**

**Chapter 3. Planning for Storage**

**Chapter 4. Host System and 3174 Planning**



---

# Chapter 3. Planning for Controller Storage

- An Overview of Controller Storage Planning ..... 3-3
- Storage Planning Procedure ..... 3-4
- Storage Requirements for DSPUs ..... 3-5



## An Overview of Controller Storage Planning

Before you start planning, you need:

- “Worksheet 35—Storage Requirements” on page A-49.
- A knowledge of the features and functions that will be included in your configuration, including any RPQs.
- To know the amount of storage installed in your controller. Table 3-1 shows base and maximum storage amounts supported by each controller model. Base storage is the minimum amount of storage that can ship in the controller; maximum storage is the largest amount of storage that can be reached using combinations of storage expansion features.

**Important:** 2MB is the minimum amount of storage required to support Configuration Support B microcode.

Table 3-1. Base and Maximum Storage Supported in 3174 Models

Model	Base Storage	Maximum Storage
1L, 1R, 2R, 3R	1MB	4MB
11L, 11R, 12L, 12R, 13R	2MB	6MB
21L, 21R, 22L, 23R	2MB	6MB
51R, 53R	1MB	3MB
61R, 62R, 63R	2MB	6MB
90R, 91R, 92R	2MB	2MB

Certain functions may require that storage expansion features be installed in the controller. You need to plan for controller storage if your configuration includes any of the following:

- Token-Ring 3270 Gateway function
  - Multiple Logical Terminals
  - Central Site Change Management
  - Asynchronous Emulation Adapter
  - Local Format Storage
  - AEA Large Screen Support
  - Multi-host Support
  - 3270 Port Expansion Feature
  - RPQs with additional storage requirements.
- (See your RPQ documentation to determine if additional storage is needed.)

If sufficient storage is **not** installed in the controller to support these features and functions, some support for the functions you planned is deconfigured (function does not operate or operates at a lower level) once the controller has been customized and IMLed. If support is deconfigured, the 3174 logs information about the features and functions for which deconfigure occurred.

**Note:** If you have not planned for microcode customization, you may wish to do so before planning your controller’s storage. While planning microcode customization, you identify the features and functions required for your configuration.

---

### Storage Planning Procedure

**Planner:** Use the following steps to determine how much storage is required your controller's configuration.

- Step 1** Locate and make a copy of "Worksheet 35—Storage Requirements" on page A-49.
- Step 2** Determine the features, functions, and RPQs that your configuration supports. A Base configuration requires at least 1661MB.
- a. Single Link Multi-Host Support over the ESCON Channel with 4KB RU ability requires the same storage per host function as for single link controllers without ESCON Channel attachment.  
  
Use the storage numbers for 4KB RU Support (Local Models) in Table 3-2 on page 3-6 for ESCON Channel Gateway Support using 4KB RU ability.
  - b. Determine your storage requirement for MLT support for all 3270 and ASCII terminals. See "Determining MLT Storage Requirements" on page 6-14.
  - c. If you are planning for AEA MLT, please note that the 216KB requirement is *in addition to* the amount of storage required to support MLT. For example, if you plan to have Level 6 of MLT support, and you plan to provide MLT for ASCII terminals, add 1536KB and 216KB into your storage requirement total.
  - d. See "179: Local Format Storage" on page 6-34 for information about local format storage.
  - e. See "Storage Requirements for DSPUs" on page 3-5 for Gateway controllers.
  - f. For RPQs write in the amount of storage required. See the documentation supplied with the RPQs.
  - g. If you are planning for the 3270 Port Expansion Feature and you have included the 159K for Multi-Host Support, then you must use 505K as the storage requirement for the 3270 Port Expansion Feature.
- Step 3** In the Totals column, write in the storage requirements for each feature and function that is supported in your configuration.
- Step 4** After entering all the storage requirements for your configuration into the Totals column, add these figures and write the result next to Total Storage Required at the bottom of the worksheet. (Ensure that you have added in the 1661MB required for Base.)

- Step 5** Consult the following table to determine how much storage (in megabytes) is required to support your configuration. Enter the result on the worksheet next to Storage Required in MB.

If Total Storage Required	MBs Required
= 2048 or less	2MB
= 2049 to 3032	3MB
= 3033 to 4056	4MB
= 4057 to 5080	5MB
= 5081 to 6104	6MB

For example, if the Total Storage Required equals 3150, then 4MB of controller storage is required.

- Step 6** Ensure that your controller contains sufficient storage by comparing the storage requirements for the functions you want configured with the physical amount of storage installed in the controller. If the storage installed in the controller is less than the storage required for the functions you want, you need to add storage or leave some function unconfigured. To obtain additional storage, contact your IBM representative.

## Storage Requirements for DSPUs

Table 3-2 on page 3-6 lists storage requirements according to combinations of downstream physical units (DSPUs) supported on primary and secondary links for 4KB RU Gateway Support. Table 3-3 on page 3-6 lists storage requirements for 8KB RU Gateway Support. The maximum number of DSPUs supported with 8KB RU is 100.

To use these tables, determine whether your configuration will include DSPUs on both primary and secondary (CCA) links or the primary link only or the secondary links only. Then find the line on the chart that contains the lowest range possible that encompasses the number of DSPUs you have.

For example, suppose you plan for DSPUs on primary and secondary links. Find the line in the table that encompasses the number of secondary link DSPUs while still accommodating the number of primary link DSPUs. So, if you were planning for 10 DSPUs on the primary link and 35 on the secondary link of a local model controller, you would need 1024KB of storage. Ten primary link DSPUs fit into the first range of 1-10 under **Primary**, but 35 DSPUs do not fit in the first **CCA** range of 1-32. By going to the next line, you can meet both DSPU requirements and determine that you need 1024KB of storage.

Or suppose you were planning for 95 DSPUs on the primary link and 72 DSPUs on the secondary link of a local model controller. In this case, the primary link DSPUs require the higher range (and the greater amount of storage). Seventy-two secondary link DSPUs fit into the second **CCA** range of 1-72, but 95 DSPUs don't fit in the second **Primary** range of 1-60. By going to the next line, you meet both requirements and determine that you need 1536KB of storage.



## Controller Storage Planning

Table 3-2. Storage Requirements for DSPU Combinations (4KB RU Gateway Support). Values are in KB (1024 bytes).				
DSPUs				Storage Required
Primary Only	CCAs Only	Primary and CCAs		
		Primary	CCAs	
(Local Models)				
1 – 28	1 – 100	1 – 20	1 – 32	512
29 – 72	1 – 100	1 – 60	1 – 72	1024
73 – 116	1 – 100	1 – 95	1 – 100	1536
117 – 140	1 – 100	1 – 130	1 – 100	2048
141 – 200	1 – 100	1 – 180	1 – 100	2560
201 – 250	1 – 100	1 – 230	1 – 100	3072
(Remote Models)				
1 – 72	1 – 100	1 – 40	1 – 50	512
73 – 140	1 – 100	1 – 116	1 – 100	1024
141 – 250	1 – 100	1 – 200	1 – 100	1536

Table 3-3. Storage Requirements for DSPU Combinations (8KB RU Gateway Support). Values are in KB (1024 bytes).				
DSPUs				Storage Required
Primary Only	CCAs Only	Primary and CCAs		
		Primary	CCAs	
(Local Models)				
1 – 20	1 – 100	1 – 12	1 – 32	512
21 – 50		1 – 38	1 – 72	1024
51 – 80		1 – 59	1 – 100	1536
81 – 100		1 – 90	1 – 100	2048

---

## Chapter 4. Host System and 3174 Planning

An Overview of Host System and 3174 Planning .....	4-3
Considerations for Support of ASCII Graphics .....	4-3
IBM GDDM ASCII Graphics Support .....	4-3
Other Support .....	4-4
Token-Ring Network 3270 Gateway Considerations .....	4-4
Segmenting .....	4-5
System Definitions Used with the Gateway Function .....	4-5
3174 Downstream Physical Units .....	4-11
SNA Considerations for the 3174 .....	4-11
How LU-1 Pacing Overruns are Handled .....	4-11
SNA SSCP/PU Sessions .....	4-11
Alerts .....	4-12
3174 REQMS/RECFMS Support .....	4-13
Response/Request Unit (RU) Size .....	4-14
BIND Extensions .....	4-15
Support of IPDS Printers .....	4-16
SNA Protocol .....	4-16
BSC and Channel Protocol .....	4-16
Serial Original Equipment Manufacture Interface (SOEMI) Support .....	4-17
Sense ID Command for Non-SNA Channel Attachment .....	4-17
Central Site Change Management (CSCM) .....	4-18
Microcode Requirements .....	4-18
System Software Requirements .....	4-18
CSCM VTAM Definitions .....	4-18



---

## An Overview of Host System and 3174 Planning

You must consider several things when planning for the host to ensure that it supports your network. This chapter notes host programming considerations for the IBM 3174 Establishment Controller, offers tips for coding macros, and provides information on planning and customizing Downstream Physical Units (DSPUs).

It is assumed that you have data stream and host programming experience. This chapter offers information on coding but does not explain programming operations. Some of the terminology used in this chapter can be found in the glossary, but if you need detailed information, you may need to refer to your host application documentation and the *3174 Functional Description*, GA23-0218.

The following areas should be considered for your host applications:

- System definitions
- VTAM and NCP definitions
- VSE/SP2 considerations
- Response Unit (RU) size
- OEM ASCII Graphics support
- Failure information
- Response formats
- SOEMI support
- Central Site Change Management
- VM patches.

In addition to this chapter, Appendix D contains examples of VTAM/NCP definitions for the 3174.

---

## Considerations for Support of ASCII Graphics

If you are planning to customize for supporting ASCII graphics workstations, certain prerequisites apply to your system. They are listed in "IBM GDDM ASCII Graphics Support."

Several of the prerequisite items provide the ability to perform functions other than ASCII graphics (such as file transfer). "Other Support" on page 4-4 explains this information.

### IBM GDDM ASCII Graphics Support

ASCII graphics refers to the ability of GDDM\* to drive ASCII workstations using an LU2 OEM data structured field in a 3270 data stream. The function of the 3174 controller in this mode is to transparently pass data between the host and the ASCII device. This capability is sometimes referred to as LU2 transparency.

If your host is running a Virtual Machine/System Product (VM/SP) release, *and* you are planning customization for a 3174 to support OEM ASCII graphics workstations along with IBM GDDM, you need:

- VM/SP Release 6 or later
- APAR #VM37424 for VM/SP Release 6
- An IBM GDDM release that supports OEM ASCII graphics functions (see note).

**Note:** IBM intends to provide GDDM drivers for specific OEM ASCII graphics workstations attached to the 3174.

If the host is **not** running a VM/SP release, you need an IBM GDDM release that supports OEM ASCII graphics functions (see note).

If an ASCII device is to participate in OEM ASCII graphics support, the device must be supported in two ways: it must be a standard ASCII graphics device (support can be through a User-Defined Terminal table), and it must be supported by the appropriate IBM GDDM release. If graphics support is provided through a User-Defined Terminal table, you must provide a Graphics Query Reply attribute at UDT customization. (See "Filling Out Worksheet 22—Terminal Tables" on page 12-65 for more information about the Graphics Query Reply.)

## Other Support

You may be planning for graphics support other than ASCII graphics, or for plotter use, or for file transfer programs. If this is the case, certain prerequisites apply to your system.

If your host is running a Virtual Machine/System Product (VM/SP) release, *and* the 3174 for which you are planning customization supports LU2 Transparency (the application uses Write-Structured Fields or OEM data-structured fields with a device), you need:

- VM/SP Release 6 or later
- APAR #VM37424 for VM/SP Release 6
- Your own file transfer, plotter, or graphics support programs in the host and/or workstation.

**Note:** In order for a 3174 ASCII device to participate in LU2 Transparency, the device must be supported by the application. Also, the User-defined Terminal table used with the device must have a Graphics Query Reply attribute specified.

---

## Token-Ring Network 3270 Gateway Considerations

To communicate with a host, devices attached to a Token-Ring Network often use a gateway to convert Token-Ring protocols and frames to certain SNA protocols and request units. A 3174 Model 1L, 1R, 2R, or 51R with the Token-Ring 3270 Gateway Feature and customized for gateway serves this function. A Model 11L, 12L, 11R, 12R, 21L, 21R, 22L, 61R, 62R, or 90R with a Token-Ring Adapter and customized for gateway serves this function.

A 3174 Establishment Controller with the IBM Token-Ring Network 3270 Gateway function is defined at the host as an SNA channel-attached or telecommunication-attached controller.

Each 3174 Model 3R, 13R, 23R, 53R, and 63R that is attached to the Token-Ring Network is also defined as an SNA channel-attached or telecommunication-attached controller. These controllers appear to the host system as downstream physical units (DSPUs).

When the 3174 Gateway is customized, a list of Token-Ring addresses of the devices to be serviced by the gateway is defined. If downstream physical units (DSPUs) have to be added or deleted, the gateway customization must be updated to reflect the new configuration.

A single 3174 controller can provide gateway functions to more than one host using the Multi-Host Gateway support. In this case, each host attachment should be customized as a separate gateway. For each host, you must define the list of Token-Ring addresses that are to be routed to that host.

The 3270 Token-Ring Gateway is supported by:

- ACF/VTAM under VM, MVS, and VSE
- NetView Version 1 or higher.

## Segmenting

Sometimes request/response units (RUs) sent to network terminals are too large for optimal transfer over the connecting link. In such cases, the information units are divided into smaller elements to facilitate transmission over the link. This process is called *segmenting*.

The gateway performs outbound and inbound segmenting when:

- The size of an outbound RU exceeds the frame size customized for the DSPU. (See configuration questions “940: Ring Address Assignment” on page 14-9 and “941: Ring Transmission Definition” on page 14-13.)
- The inbound frame from a DSPU to a local gateway exceeds the host read channel program size or 1032 bytes, whichever is smaller.
- The inbound frame from a DSPU to a remote gateway exceeds 457 bytes.

## System Definitions Used with the Gateway Function

The following sections provide coding tips for macros and show valid system definitions for use with the Gateway function.

### MVS/SP Definitions

An IODEVICE macro must be coded for the 3174 Model 1L, 11L, 12L, 21L, and 22L gateway and for each DSPU. The macro should be coded as follows:

- The UNIT parameter of the IODEVICE macro must be coded

```
3174/3791L - for Models 1L, 11L, and 21L
3174      - for Models 12L and 22L
```

Code the UNIT parameter 3270 for Local non-SNA controllers.

- The ADDRESS parameter of the IODEVICE macro allows specification of multiple Token-Ring-attached devices.
- A single IODEVICE macro should be coded, with the ADDRESS parameter specifying multiple devices. (Note that XA systems require IOCP generation and use the IODEVICE and CTLUNIT macros.)

### VM/SP Definitions

The following examples are valid definitions for the 3174 Models 1L, 11L, 12L, 21L, and 22L acting as Token-Ring 3270 Gateways and for the ring-attached downstream physical units (PUs). These definitions can be used if the gateway is attached to a virtual guest machine (for example, VSE/VCNA), or if the gateway feature is attached to the native VTAM directly under VM.

**Note:** The definition examples in this chapter are valid as of the release of this manual. However, they depend on release levels of the associated macros and may not work for your code. They are intended only as examples.

### For the Gateway:

```
RDEVICE ADDRESS=E40,DEVTYPE=3705,ADAPTER=TYPE4,MODEL=H8, *  
CPTYPE=NCP
```

### For the Downstream Physical Units (DSPUs):

```
RDEVICE ADDRESS=E41,DEVTYPE=3705,ADAPTER=TYPE4,MODEL=H8 *  
CPTYPE=NCP  
RDEVICE ADDRESS=E42,DEVTYPE=3705,ADAPTER=TYPE4,MODEL=H8 *  
CPTYPE=NCP  
RDEVICE ADDRESS=E43,DEVTYPE=3705,ADAPTER=TYPE4,MODEL=H8 *  
CPTYPE=NCP  
RDEVICE ADDRESS=E44,DEVTYPE=3705,ADAPTER=TYPE4,MODEL=H8 *  
CPTYPE=NCP  
RDEVICE ADDRESS=E45,DEVTYPE=3705,ADAPTER=TYPE4,MODEL=H8 *  
CPTYPE=NCP
```

### For the Gateway:

```
RCTLUNIT ADDRESS=E40,CUTYPE=3705,FEATURE=16-DEVICE  
RCHANNEL ADDRESS=E,CHTYPE=BLKMPXR
```

### Tips for coding macros:

- The FEATURE parameter of the RCTLUNIT macro specifies the maximum number of Token-Ring-attached cluster controllers or workstations supported by a single 3174 Model 1L, 11L, 12L, 21L, or 22L with the gateway feature installed. The value given in the FEATURE parameter must be a multiple of 16. For the maximum number of workstations or controllers supported by the gateway feature, the parameter must be coded:

FEATURE =  $n$ -DEVICE where  $n$  stands for the maximum number of nodes plus 1 ( $n$  must be a multiple of 16).

- The value given in the ADDRESS parameter of the RCTLUNIT macro must end with 0, as in ADDRESS = 5C0.
- The RCTLUNIT macro defines the 3174 Model 1L, 11L, 12L, 21L, or 22L as CUTYPE = 3705.
- The RDEVICE macro defines the 3174 Model 1L, 11L, 12L, 21L, or 22L and each Token-Ring-attached node as DEVTYPE = 3705.
- In the IODEVICE macro, each 3174 Model 1L, 11L, 12L, 21L, or 22L and each Token-Ring-attached device are defined as follows:

```
3791L - for Models 1L, 11L, and 21L  
3174 - for Models 12L and 22L
```

A RDEVICE macro must be coded for the gateway itself and for each Token-Ring-attached cluster controller or workstation (PU).

**Note:** If there are more DSPU definitions in the 3174 gateway than VM RDEVICE macro definitions, attempts to bring up the gateway will lead to a VTAM hang-up.

**VSE Definition**

VSE/SP2.1 does not automatically recognize and generate ADD statements for a locally attached 3174 Model 1L, 11L, 12L, 21L, or 22L. You must manually include ADD statements as in the following example:

**For the gateway:**

```
ADD CUU,3791L,EML (SNA)
ADD CUU,3277,EML (NON-SNA)
```

**For the DSPUs:**

```
ADD E41,3791L,EML
ADD E42,3791L,EML
ADD E43,3791L,EML
ADD E44,3791L,EML
ADD E45,3791L,EML
```

The emulation parameter (EML) is necessary to inform VSE/SP2.1 that the 3174 Model 1L, 11L, 12L, 21L, or 22L is to be handled as a 3274 Model A41.

**Channel Type UCW Definition**

For a 3174 gateway, unit control words (UCWs) must be set up according to the channel type:

Channel	3174 SNA	3174 Non-SNA	3174 Model 1L, 11L, or 21L with Gateway
370 byte	Nonshared	Nonshared	Nonshared
370 block	Nonshared	Shared	Shared

**VTAM Definition**

If  $n$  Token-Ring nodes are supported through a single 3174 Establishment Controller with the 3270 Gateway feature, perform the VTAM system definition as if there were  $n + 1$  SNA or SDLC controllers attached. For VTAM Version 3.1.1, the SECNET parameter of the PU macro must be set to YES (SECNET = YES) for all  $n$  downstream physical units, but not for the 3270 Gateway feature itself.

A subchannel or SDLC address must be defined for each workstation or cluster controller attached to a Token-Ring Network. The 3174 Establishment Controller with the 3270 Gateway feature that is being defined must also have a subchannel or an SDLC address assigned, and it must be the lowest subchannel or SDLC address in the ring. *These addresses must be contiguous.*

**Note:** These subchannel addresses must be a subset of or in a range equal to those defined in the IOCP and host system generation.

**VTAM Definition Example:** Figure 4-1 on page 4-8 illustrates the system definition parameters used in defining a 3174 Model 1L with the gateway feature and a Token-Ring-attached 3174 Model 3R to an MVS/VTAM host system. Related customization questions are also illustrated. In this example, the I-frame size of 2042 bytes is used. The default of 1033 bytes is used for the inbound frame size. Note that the VTAM IOBUF size and the MAXBFRU on the PU macros were chosen to accommodate an inbound frame of this size. Defaults were used for window sizes and the MAXIN value for the Model 3R.



Example Configuration<sup>1</sup> Definition Considerations

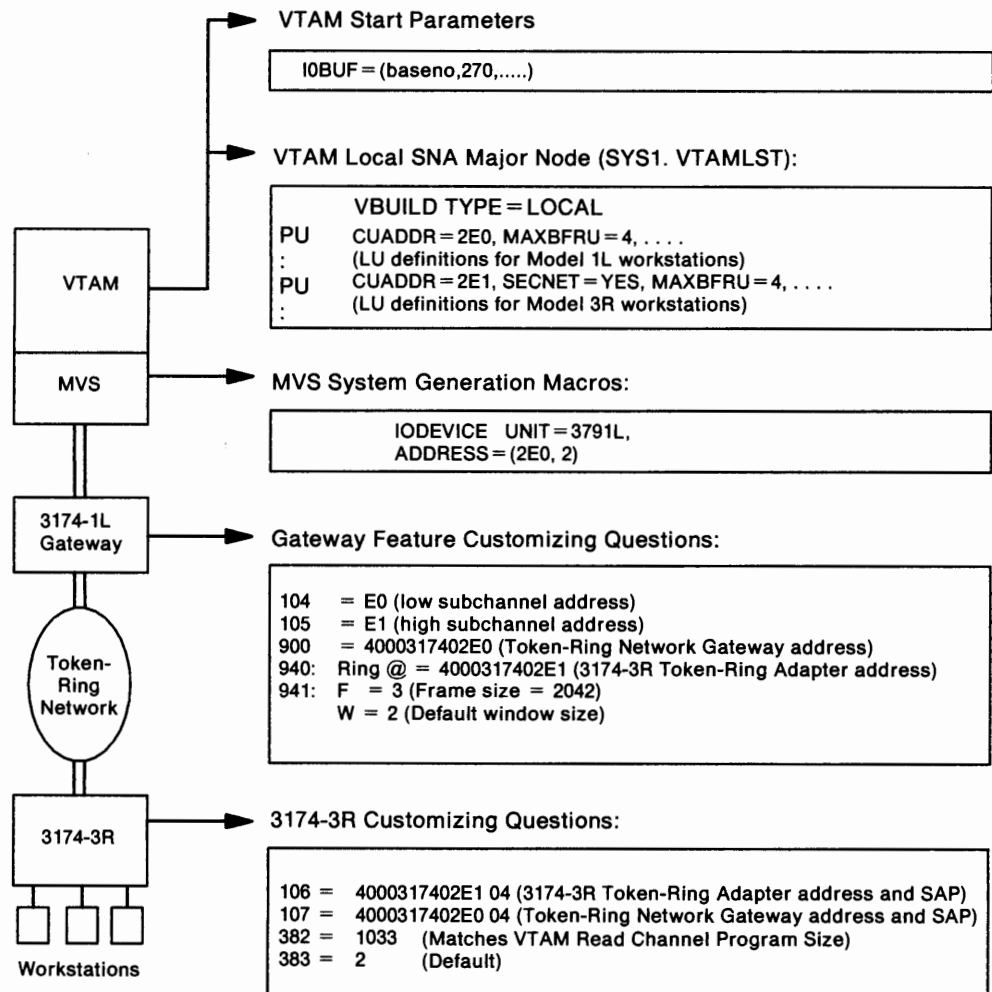

<sup>1</sup> 3174 Model 1L Attachment to an MVS Host at Channel Address 2E0 with One 3174 Model 3R Attached to the Token-Ring Network

Figure 4-1. Configuration Example for 3174 Model 1L with the IBM Token-Ring Network 3270 Gateway Feature

## NCP Definition

Generally, NCP definitions follow the same guidelines as the VTAM definitions described in “VTAM Definition” on page 4-7. Some coding tips for NCP are listed below:

- A PU macro should be defined for each ring-attached PU; in addition, one PU macro is needed for the 3174 controller with the gateway feature.
- The addresses in the PU macro should match those defined in VTAM and, therefore, are contiguous.
- Segmenting is done by the 3174 when the MAXDATA parameter is set to a value greater than the F value specified for question 941 in gateway customization.
- The SERVLIM parameter on the LINE macro directly affects the speed at which the SDLC links are established with PUs defined at the gateway. This parameter specifies the number of complete regular scans of the normal (active links) service order table before one line on the status (inactive links) service order table is serviced.

The status service order table is scanned more frequently with a low value for the SERVLIM parameter than with a high value. With a low value specified, or by taking the default, the links are established more quickly, but performance is degraded for active links by processing the status service order table more frequently. With a high value specified, performance for active links is less affected, but the speed at which new links are established is reduced.

- The 3174 gateway can operate on an NCP line that is set up for simultaneous send and receive mode of operation: DUPLEX=FULL on the GROUP macro, ADDRESS=(xxxx,FULL) on the LINE macro. However, each PU associated with the gateway must be defined for alternate send and receive operation (DATMODE=HALF) on the PU macro. This combination of attributes allows the NCP to send data to one DSPU while receiving data from another DSPU and should improve overall performance.
- The NCP can be configured to perform Group Polling to the PUs associated with a 3174 gateway. Configuring this way improves performance by reducing the amount of unproductive polling by the NCP. Group Polling is activated at the NCP by defining a common group poll address for the DSPUs (GP3174 option of the NCP PU or LINE macro).

Not all versions of NCP support Group Polling. Refer to “912: Group Poll Address” on page 14-8 for more information.

Figure 4-2 on page 4-10 shows that the NCP MAXDATA size of 521 is used. The Token-Ring frame size (response to question 941 for the gateway and response to question 380 for the Model 3R) are set to accommodate this frame size; the NCP MAXDATA frame size and the Token-Ring frame size do *not* need to match. Defaults were used for window sizes.

Example Configuration\* Definition Considerations

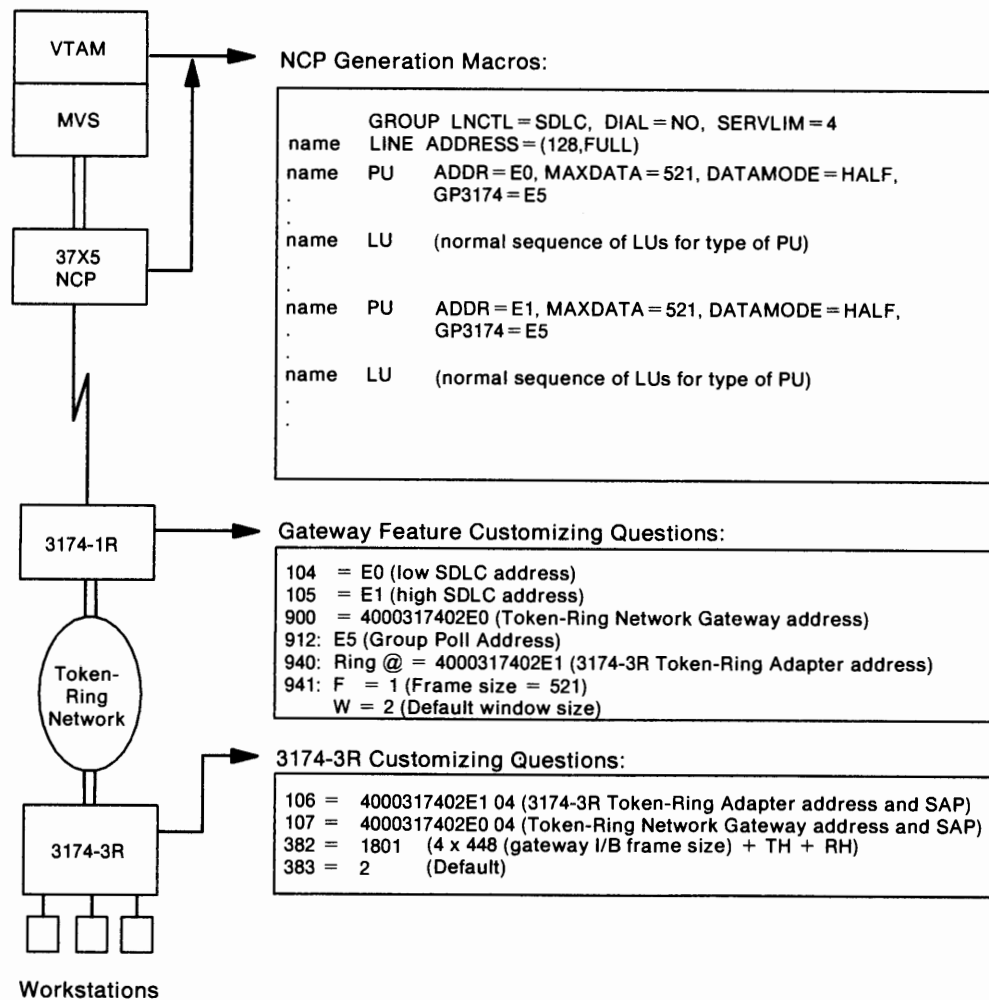

\*3174 Model 1R attachment to an NCP with one 3174 Model 3R attached to the Token-Ring Network

Figure 4-2. Configuration Example for 3174 Model 1R with the IBM Token-Ring Network 3270 Gateway feature

---

## 3174 Downstream Physical Units

IBM 3174 Models 3R, 13R, 23R, 53R, and 63R attach to the Token-Ring Network and communicate with a host through a gateway. Because these models communicate with a host through a gateway, they are referred to as downstream physical units (DSPUs).

The gateway can be an IBM 3174, 3720/3725/3745, AS/400, or 9370. However, host definitions for the 3174 DSPU differ according to the gateway type.

A DSPU appears to the host access methods and applications as a PU type 2.0. When using Single Link Multi-Host Support, a 3174 may appear as multiple (up to eight) DSPUs.

During the customization of DSPUs, you respond to configuration questions that define the address of the gateway and the characteristics of the link. These configuration questions are listed below. However, there are other questions that must be given consideration when customizing your DSPU. For more information on the configuration questions, see Chapter 6, "Planning to Configure."

- "100: 3174 Model Designation"
- "101: Host Attachment"
- "106: Token-Ring Network Address and Service Access Point of the 3174"
- "107: Token-Ring Network Address and Service Access Point of the Gateway"
- "215: Physical Unit Identification"
- "382: Maximum Ring I-Frame Size"
- "383: Token-Ring Network Maximum Out"
- "384: Ring Speed of the Token-Ring Network."

Appendix C provides examples of planning for gateways and DSPUs.

---

## SNA Considerations for the 3174

### How LU-1 Pacing Overruns are Handled

For the 3174, device dependencies occur because a printer is slower than the display. You can control this discrepancy through the use of *pacing*. When you define your system definition, you can establish a pacing count that determines the number of normal flow request RUs that flow before a pacing response is required to allow the next group of  $n$  RUs to continue. This pacing protocol ensures that waiting RUs or chains are not stacked in the 3174 link buffers.

When the 3174 detects a pacing overrun, it rejects the chain on which the overrun was detected with a -R(0801), purges the printer buffer, and sends UNBIND type 0F (Cleanup) to the host to terminate the session.

### SNA SSCP/PU Sessions

The 3174 and the host system use SSCP/PU sessions to allow exchange of information between the access method application and the 3174. The 3174 operates with duplex protocols on the SSCP/PU session in compliance with SNA.

### Alerts

Alerts are high-priority events requiring immediate attention. The 3174 SNA alert function sends problem determination information, collected by the 3174 controller or entered by an operator, to the hardware monitor component of the NetView program.

When Single Link Multi-Host Support has been configured, you can designate any of the hosts on the primary link as the 3174 alert control point. A host designated as such receives hardware and microcode alerts. For more information, see configuration question "221: 3174 Alert Control Point" on page 6-36.

### Machine Type Identification

When NetView receives an alert, it uses the machine type number to identify the source of the alert.

The type number is "3174" and will be included as 4 bytes of EBCDIC data in controller alerts and as 2 bytes of hexadecimal data when a sense ID is issued.

### Error Identification Data

In addition to the error code (nnn) associated with the type of controller failure, the 3174 is able to supply information that can be correlated to the part number and card location of the failing field replaceable unit (FRU) or FRU group. The information is in the form of TYPE and LOCATION data. TYPE data either is derived from 1 byte of information supplied by each card or is assigned by the controller for other failing components, such as cables. This information indicates both the type and change level of the card. TYPE data is 4 characters long. LOCATION data is 2 characters long and indicates the location of the failing FRU.

The 3174 also provides additional failure information on certain classes of SNA data stream errors. This information is called *error detail* and is returned as an additional qualifier.

The 3174 requires certain programs at the specified levels for central site problem determination.

- For all models, except those with the optional IBM Token-Ring Network 3270 Gateway feature, the following programs are required:
  - NPDA Version 3 Release 2 with:
    - APAR PP43332 (PTF UP90223) for MVS/370
    - APAR PP43337 (PTF UP90224) for MVS/XA
    - APAR VM22413 (PTF UV90110) for VM
    - No Program Temporary Fixes (PTFs) required for VSE.
  - NetView program.
- For 3174 Establishment Controllers with the optional IBM Token-Ring Network 3270 Gateway feature, the NetView program is required.
- The Response Time Monitor, a base IBM 3174 function, is supported by NLDM, Release 2, for VM/SP (with or without HPO).

## 3174 REQMS/RECFMS Support

The Request Maintenance Statistics (REQMS) command is sent by the SSCP to a 3174 when the Network Problem Determination Application (NPDA) requests PU performance statistics. In return, the 3174 sends a Record Formatted Maintenance Statistics (RECFMS) response. This RECFMS data is recorded at the host by the Network Communications Control Facility (NCCF).

The following table shows what types of REQMS commands are supported. The 3174 rejects unsupported REQMS commands with the negative response X'080C'.

REQMS Type	3174 Support:			
	SDLC	X.25	SNA Channel	Token-Ring Network
1	✓	✓		
2	✓			
3	✓			
5	✓	✓	✓	✓

The formats for the 3174 RECFMS can be found in *Customer Problem Determination*, GA23-0217.

### Node ID Block Number for RECFMS

The 3174 returns a block number of X'048' (decimal 72) in RECFMS headers. The block number of X'048' has been assigned by architecture and is authorized for use in RECFMS only. The block number for XID is X'017'.

### NetView RECFMS

The CTRL command allows the NetView operator to retrieve link test results, summary error counter, and release level data from 3174 SNA controllers. When the NetView operator issues a CTRL command, the NetView program formats a Request Maintenance Statistics (REQMS) record and sends it to the specified controller. The 3174 responds to the request by sending to the NetView program an RECFMS record containing the information requested by the operator; the NetView program displays this information to the requesting operator. For more information about issuing the CTRL and REQMS commands, refer to *NetView Operation*, SC30-3364. For more information about viewing RECFMS data, refer to the *NetView Hardware Problem Determination Reference*, SC30-3366.

### Response/Request Unit (RU) Size

#### SNA Channel Attachment

Inbound and outbound RU sizes depend on several things:

- configuration environment
- 3174 model
- method of device attachment.

The maximum RU sizes for Models 12L and 22L are 8192 bytes inbound and 8192 bytes outbound.

For all other 3174 channel models, the maximum RU sizes are 4096 bytes outbound and 2048 bytes inbound.

**Initialization Parameters:** The 3174 requires that the host channel program accommodate an inbound RU of 256 bytes. The channel control word (CCW) carrying the *connect* function will be rejected with unit-check status (sense = NI) unless the following criteria are met.

The *size* of the host buffer cannot be less than 78 bytes or greater than 1066 bytes. The *size* of the host buffer multiplied by the *number* of host buffers must be large enough to accommodate:

- The Link Header (LH) (4 bytes minimum, 32 bytes maximum)
- The Transmission Header (TH)
- The Request Header (RH)
- At least 256 bytes of data (RU).

Using ACF/VTAM as an example, the *size of host buffers* comes from the ACF/VTAM START option specifying the *bufsize* value of the IOBUF buffer pool for OS/VS systems (LFBUF for DOS/VS systems).

The *number of host buffers* comes from the MAXBFRU operand of the physical unit (PU) statement defining the controller under a Local SNA Major Node (VBUILD TYPE = LOCAL).

## SDLC/X.25 Attachments

The maximum outbound RU size within a segment for the 3174 is 512 bytes.

### XID 1 Support

To allow the primary station to determine that the 3174 has the capability to support a 512-byte RU size, XID 1 is supported. See Table 4-1 for the hexadecimal value and meaning of each byte.

Table 4-1. XID 1 Format		
Byte	Value	Meaning
0	X'12'	ID format/PU type
1	X'14'	Length
2–5	X'017-----'	Block number (bits 0–11), ID number (bits 12–31, determined by customization)
6,7	X'0000'	Reserved
8	X'00' (SDLC) X'01' (X.25)	Link station and connection protocol flags (00 = half-duplex, 01 = duplex)
9	X'10'	Link station segment assembly
10,11	X'0209'	Maximum I-field length: 521 bytes
12	X'00'	SNA link profile
13	X'00'	Initialization mode option (SIM and RIM are not supported)
14,15	X'0000'	Reserved
16	X'07' (SDLC) X'01' – '07' (X.25)	Modulus 8, the number of I-frames received before acknowledgment. Determined by customization variable.
17	X'00'	Reserved
18	X'01'	Length of controller address
19	X'__'	Controller address (determined by customization)

**Note:** XID 1 for the 3174 X.21 Short-Hold Mode function is the same as defined by the 3274 X.21 Short-Hold Mode RPQ.

## BIND Extensions

You should be aware of information on BIND extensions. See the *3174 Functional Description* for this information.



---

### Support of IPDS Printers

This section lists host programming notes related to the support of Intelligent Printer Data Stream (IPDS) printers. For detailed information about IPDS printers, refer to the *3174 Functional Description*.

#### SNA Protocol

- IPDS printers operating with Systems Network Architecture (SNA) protocol are identified as logical units type 1 (LU-1).
- The BIND command sent to establish an LU-1 session in which IPDS will be used must indicate "FM Headers Allowed" (byte 6, bit 1 = 1).
- If End Bracket (EB) is used with a function management (FM) data chain containing IPDS structured fields, IPDS mode will be implicitly terminated following the processing of "last-in-chain," *resulting in the loss of printer-generated IPDS ACK/NACKs occurring at "last-in-chain."*

To prevent this loss, EB should never be used to terminate IPDS mode. Instead, an FMH-1 containing DESSEL = EDS, DSP = IPDS should be used. If the bracket is also to be terminated, EB may be used in the chain carrying the FMH-1.

- A printer placed in LU-1 IPDS mode by receipt of an FMH(BDS, IPDS) may generate a NACK (for an IR, EC, or other exception condition) before CD is received. If this condition occurs, the controller sends SIGNAL (00010000) to the host application as a request for "send state." If CD is not received before an FMH(EDS) is received, the controller returns a negative response (1005) to the FMH(EDS) RU, meaning "Send-state requested following receipt of FMH(BDS), but CD not received prior to the receipt of FMH(EDS)."

#### BSC and Channel Protocol

The following items deal with host acknowledgment of an ACK/NACK reply.

- For the inbound transmission of an IPDS ACK/NACK reply at *data chain end* or *data chain only* (or implied only), valid host acknowledgments are the same as allowed for inbound transmission of Query Reply—for example, an E/W or E/W Alternate (with or without a WCC) or a WSF (with or without structured fields).
- For inbound transmission of an IPDS ACK after *data chain start* but before *data chain end*, the only valid acknowledgments are WSF, E/W (WCC = Reset), and E/W Alternate (WCC = Reset).

Using the WSF command with *data chain continue* or *data chain end* as the host acknowledgment allows continuation of the in-chain state and IPDS mode.

- Using the E/W (WCC = Reset) or E/W Alternate (WCC = Reset) command as the host acknowledgment will result in **termination of the in-chain state and IPDS mode**.

Refer to the appropriate product description manual for additional information, for example, the *4224 Printer Product and Programming* manual, GC31-2551.

---

## Serial Original Equipment Manufacture Interface (SOEMI) Support

Serial Original Equipment Manufacture Interface (SOEMI) support is included in the 3174 base function. This function is available with the non-SNA channel attachment only (Models 1L, 11L, 12L, 21L, and 22L). The SOEMI function extends device-attachment capabilities to a variety of industry devices of independent manufacturers, for engineering, scientific, and manufacturing environments. A protocol based on structured fields provides you with programming flexibility.

The SOEMI support does not affect the operation of devices attached to other ports of the controller. On a Write command (X'01'), the 3174 presents channel-end (CE) status after the command and data have been accepted, followed by device end (DE) when the controller is free to process other commands.

On the 4361 Workstation adapter, CE and DE are presented together on a Write command.

### Sense ID Command for Non-SNA Channel Attachment

The Sense ID command requests data transfer to the host. The 3174 controller sends 4 bytes of data, which contain the controller type and model, for all device addresses except those to which the SOEMI is attached.

For SOEMI addresses, 7 bytes of data are sent with the attached device type and model contained in bytes 4–6.

For Models 12L and 22L, the bytes of data are:

- For all addresses except SOEMI: X'FF 31 74 ID 00 00 00 00 40 72 00 60'
- For all SOEMI addresses: X'FF 31 74 ID BA 00 01 00 40 72 00 60'.

For other models, the bytes of data are:

- For all addresses except SOEMI: X'FF 31 74 1D'
- For SOEMI addresses: X'FF 31 74 1D BA 00 01'.

---

## Central Site Change Management (CSCM)

CSCM provides the facility to electronically distribute 3174 microcode and customizing data to the 3174s in an SNA network. It operates in conjunction with NetView Distribution Manager (NetView DM), which is an application program running on ACF/VTAM in an S/370 processor. The architected SNA protocols used to carry the data through the network include:

- LU Type 6.2
- SNA File Services
- SNA Management Services
- SNA Distribution Services (SNA/DS).

For detailed information on CSCM, see the *Central Site Customizing User's Guide*, GA27-3868.

**Note:** CSCM is supported only on the primary host on the primary link. However, the customization data and/or microcode for other host attachments can be distributed through the primary host's attachment.

### Microcode Requirements

The central site library controller and the network controllers must be at microcode release A4.0/S4.0 or higher.

### System Software Requirements

NetView DM Version 1, Release 2 or higher, may be installed on any IBM processor capable of operating with MVS, ACF/VTAM, or ACF/TCAM.

For more information on NetView DM, see *IBM NetView Distribution Manager*:

- *Planning*, SH19-6589
- *Operation*, SH19-6592
- *Diagnosis*, LY19-6293
- *Installation*, SH19-6590
- *User's Guide*, SH19-6602
- *Messages and Codes*, SH19-6595
- *General Information*, GH19-6587.

### CSCM VTAM Definitions

Network and LU names must be defined in VTAM and the 3174 microcode. In addition, LU names must also be defined in NetView DM. You define these names in the 3174 microcode when you respond to "501: Network ID (NETID)" and "502: Logical Unit Name (LUNAME)."

The Network ID is used to identify a given network and is defined in the VTAM start parameters. These parameters are kept in the SYS1.VTAMLST in the member ATCSTRxx (xx is any two installation-defined characters, normally 00). The Network ID is defined by the statement "NETID=." The name specified for the Network ID in VTAM and in the 3174 microcode must match (see page 11-5 for valid naming conventions).

LU names are used to identify a controller within a network. For VTAM, they are defined in the SYS1.VTAMLST (see "3174 PU/LU Specifications for PU3174" on page D-6 for an example of a CSCM LU definition). In NetView DM, they are defined during the node definition. The name specified for the LU name in VTAM, the 3174 microcode, and NetView DM, must match (see page 11-6 for valid naming conventions).

---

## **Part 3. Microcode Customization Planning**

**Chapter 5. Microcode Customization Overview**

**Chapter 6. Planning to Configure**

**Chapter 7. Planning for Port Assignment**

**Chapter 8. Planning for Country Extended Code Page**

**Chapter 9. Planning for Response Time Monitor**

**Chapter 10. Planning for X.25**

**Chapter 11. Planning for Central Site Change Management**

**Chapter 12. Planning for the Asynchronous Emulation Adapter**

**Chapter 13. Planning to Define Devices**

**Chapter 14. Planning for the Token-Ring 3270 Gateway**

**Chapter 15. Planning to Modify Keyboards**



---

## Chapter 5. Microcode Customization Overview

What Is Microcode Customization? .....	5-3
Planning the Customization .....	5-3
Completing the Worksheets .....	5-4
Customizing the Control Disk .....	5-5
Planning to Reconfigure .....	5-5
Port Assignment .....	5-5
RTM .....	5-5
X.25 Options .....	5-5
Customization Records .....	5-6
Local Copy .....	5-6
Configuration Worksheets .....	5-6
Duplicate Diskettes .....	5-6
Customization Tips .....	5-7
Using the Copy Procedure to Manage Customization Data .....	5-7
Pattern Control Diskettes .....	5-8
Central Site Customizing .....	5-8
Microcode Migration .....	5-9



---

## What Is Microcode Customization?

Microcode customization consists of many tasks that, when completed, result in a Control disk that is customized to:

- Support the attaching displays and printers
- Support the features installed in the controller
- Identify the methods and protocols of host attachment that the controller will use.

For example, you customize the Control disk for such things as:

- The number of hosts
- The number of ports used
- The addresses assigned to the ports
- Keyboard languages and layouts
- The number of host sessions for terminals
- The support provided for asynchronous communication
- The types of communication protocol.

The major tasks that must be completed to customize a Control disk are:

- Planning the customization
- Completing the worksheets
- Running the customization utilities.

In order to get the “big picture” of Microcode Customization and a description of the many features and functions that can be customized, refer to “Microcode Customization” on page 2-12.

## Planning the Customization

There are two suggested methods that you can use to plan. Both are described on divider tabs and either method will guide you through the planning process.

- The divider page labeled “**Microcode Customization Planning**” has a step-by-step procedure printed on it that will guide you through the microcode customization process. It is highly recommended that you follow this procedure the first few times that you plan.
- The divider page labeled “**Worksheet Summary**” lists the worksheets that must be filled out to plan the specific areas of your configuration. This method is suggested for those who are familiar with microcode customization planning and have been through the process previously.

Planning the microcode customization involves reading the information in the planning chapters and completing the required worksheets. When planning, you select responses to configuration questions that define the hardware and software configuration in the cluster, the functions the controller provides, and the methods of host attachment. Then, you record the responses you select on the configuration worksheets, which are in Appendix A.



## Microcode Customization

There are several planning phases that make up microcode customization:

- Planning to Configure
- Planning for Port Assignment
- Planning for CECF
- Planning for Response Time Monitor
- Planning for X.25
- Planning for Central Site Change Management
- Planning for the Asynchronous Emulation Adapter
- Planning to Define Devices
- Planning for the Token-Ring 3270 Gateway
- Planning to Modify Keyboards.

The first planning phase, "Planning to Configure," is required the rest are optional. Each planning phase has a chapter devoted to it, which contains the information you need for planning the phase. Chapters 6 through 15 contain this planning information.

## Completing the Worksheets

The worksheets are provided to help plan and record customizing information. Blank copies of these worksheets are located in Appendix A. You are authorized to make as many copies as you need. However, to avoid confusion, copy only the worksheets you will be using. The information printed on the divider page labeled "Worksheet Summary" helps you determine which of the worksheets are needed for your configuration.

On the configuration worksheets, the only questions presented are those that apply to the specific configuration for which you are planning. The configuration questions are numbered (098, 099, 100, and so on) and cover all 3174 model types and host attachments.

As customizing planner, you record responses to the configuration questions on these worksheets. The customizer in turn uses the completed worksheets to fill in the customization panels displayed during the customization utilities.

Only read the questions shown on the worksheet. Select your responses, and write them in the boxes. Some questions have a default response printed under the box. To tell the customizer the default is to be used, circle it and leave the box blank. (The microcode automatically supplies the default unless you specify a different choice.)

138 -    
  Circle default response

Each worksheet tells you where to find the planning information, has a list of the question numbers, and provides a short description of each question.

After you have completed all the worksheets required for your configuration, give the completed worksheets to the person who customizes the Control disk. The *3174 Utilities Guide* explains how to enter this configuration information on the disk.

## Customizing the Control Disk

Customizing is performed at a display station attached to port 26-00 of the controller. This display station is referred to as a “customizing display station.”

When a Control disk is customized, options are selected from the “Master Menu” and the “Customize Control Disk Menu” (see the *3174 Utilities Guide*). Initially, the Configure option is selected and performed. In addition, there may be a need to select and perform one or more of these customizing options:

- Merge DSL
- Copy Files
- Microcode Upgrade
- Media Management
- Define Devices
- Identify Customizing Keyboard
- Merge RPQ
- Modify Keyboards
- Define AEA
- Initializing a Fixed Disk.

The *3174 Utilities Guide* contains more information and the procedures for performing these options.

As the procedures for customizing the Control disk are performed, a series of panels appearing on the screen display a number of questions. The customizer types in the responses to those questions using the information recorded on the configuration worksheets. The 3174 writes these responses to the Control disk. After a Control disk has been customized, it can be reconfigured if the hardware or software configuration is changed.

---

## Planning to Reconfigure

At a later date, you may want to reconfigure (change some responses to the configuration questions). The planning process for reconfiguring and configuring is the same, except for the following:

- Port Assignment
- RTM
- X.25 Options.

### Port Assignment

If you have changes to make to the Port Assignment, see “Changing Port Assignments” in Chapter 7. The table under that heading explains how to fill out “Worksheet 11—117: Port Assignment”.

### RTM

If you have changes to make to the Response Time Monitor, see “Changing the RTM Specifications” in Chapter 9. The table under that heading explains how to fill out the RTM Worksheet.

### X.25 Options

If you have changes to make to the X.25 Options, see “Changing the X.25 Options” in Chapter 10. The table under that heading explains how to fill out the X.25 Options Worksheet.

---

### Customization Records

Setting up a record-keeping system now can save you time later. If you do the customizing for dozens—or hundreds—of controllers, it is recommended that you keep several records of the controller customizations. You can use one or more of the following methods to keep records of your customization:

- Local copy
- Configuration worksheets
- Duplicate diskettes
- Central Site Customizing procedure.

#### Local Copy

The local copy function is an easy-to-use tool for keeping records. You can have the customizer print a copy of each customization panel on the display screen as soon as the responses have been entered and verified. Then you can organize a set of these customization records in controller serial number order and keep them together in a binder or in a file drawer.

It is recommended that you store a copy of these records in or near the controller. When there is a problem with the controller, the controller operator and the IBM service representative need these records.

The *3174 Utilities Guide* contains the procedure for printing a local copy.

#### Configuration Worksheets

If you do not plan to have the customizer use the local copy function, you can keep records by photocopying the completed worksheets. You can organize these customization records in order according to their controller serial numbers and keep them together in a binder or in a file drawer.

#### Duplicate Diskettes

Making a duplicate of each Utility and Control disk is highly recommended. The duplicate diskette can be used as a backup for the original disk.

To make a duplicate Utility or Control diskette, use the Full Copy or Copy Customizing Data option. The procedure for these Copy options is in the *3174 Utilities Guide*.

You should identify any diskettes that you duplicate. Affix a label to the upper portion of the diskette. The label identifies the diskette type by name. In addition, you may wish to write a unique designation of your own on the label.

---

## Customization Tips

There are several methods that you can use to manage customization data, speed up customizing, and make customizing easier:

- Using the Copy procedure to manage customization data
- Pattern Control diskettes
- Central Site Customizing
- Microcode Migration.

### Using the Copy Procedure to Manage Customization Data

You can manage your customization data by using the Copy procedure and mailing the diskettes to your remote sites.

If you distribute your customization data on diskettes, there are several situations when you will be concerned with the management of the diskettes in your network:

- When controllers are initially installed
- When Microcode Upgrade diskettes are received
- When changes are made to existing configurations.

These situations require that you perform the Customize Control Disk procedure, or the Microcode Upgrade procedure, or combinations of both. The *3174 Utilities Guide* contains these procedures.

The following method is suggested if you have one or more of the above situations and wish to use the copy procedure to manage customization data.

- Step 1** Prepare a master diskette. If possible, test the master diskette by performing an IML on it and running a controller with it before copies are made. Be sure to resolve all problems before making copies.
- Step 2** Use the Copy function to make copies for the other 3174 controllers in your network. (Some configuration questions are unique to a given controller. Be sure to tailor each copy for its intended controller.) Complete and attach a diskette identification label to each copy.
- Step 3** Use a reusable shipping container to send the customized diskettes to the controller for which they were made. Enclose copies of the completed panels or the worksheets that were used for customizing. You may want to include a note to the location personnel telling them to insert the diskette, close the diskette drive, and perform an IML on their controller. Also instruct them to return the reusable shipping container, with the old diskettes, to your machine's location.
- Step 4** Maintain a record of the diskettes in your network to show the diskette type and release level, and the date that the diskette was installed.

For additional information on the IML and Copy Files procedures, see the *3174 Utilities Guide*.

### Pattern Control Diskettes

To speed up customizing, you can have the customizer create "pattern" Control diskettes. A pattern Control diskette contains a standard hardware and software configuration used for more than one cluster. Once a pattern diskette is created, copies can be made by performing the Copy procedure in the *3174 Utilities Guide*.

For example, one pattern diskette could apply to clusters that have the following configuration:

- 3174 Model 1R
- SDLC protocol
- No distributed function terminals (DFTs)
- No port assignment table
- No Printer Authorization Matrix (PAM)
- Control microcode at the current microcode release level.

Another pattern diskette could be made for clusters that have this configuration:

- 3174 Model 1L
- Local non-SNA host attachment
- Display stations with modifiable keyboards
- A port assignment table
- A PAM with printers used for local copy assigned to ports 26-01,26-02, and 26-03.
- Control microcode at the current microcode release level.

### Central Site Customizing

Central Site Customizing is an option that can be chosen from the "Master Menu" (see the *3174 Utilities Guide*). By choosing this option, controller microcode can be tailored for each controller in a network at the central site.

There are several advantages to using the Central Site Customizing option:

- You can manage customizing throughout the network by generating customized Control disks from a central database.
- You can minimize the need for customizing expertise throughout the network by concentrating it at the central site.
- You can save customizing time by relying on a few trained people located at the central site who are thoroughly familiar with customizing, especially Central Site Customizing.
- Record-keeping is enhanced because information can be quickly and easily retrieved from the database. Also, updating of the database is easy to accomplish.

Central Site Customizing is intended primarily for customers whose networks contain more than 25 controllers, but it may be used in smaller networks as well. See the *Central Site Customizing User's Guide*, GA27-3868, for more information.

## **Microcode Migration**

At some date, you may want to upgrade the Control and Utility microcode that you are currently using. Upgraded microcode can provide you with increased support or function, such as the ability to handle a new type of display or printer. Each upgraded version of microcode is assigned a new release level.

Migrating from one release level to another requires that you use the Microcode Upgrade utility. (The *3174 Utilities Guide* describes the Microcode Upgrade procedure.) Microcode Upgrade transfers the customization data from an already-customized Control disk onto a higher-level Control disk. This utility saves you time, because you do not have to plan again or respond to the configuration questions that were supported by the previous release of microcode.

There are however, several things to keep in mind when planning for Microcode Upgrade. These tasks must be performed on the new Control disk after the upgrade:

- Responding to questions not supported in the previous release
- Merging RPQs
- Merging DSL microcode
- Copying patches.

The procedures for performing these tasks are in the *3174 Utilities Guide*.

Another consideration is the effect of Microcode Upgrade on modified keyboard layouts for some keyboard models. If you have modified a Converged (122-key) keyboard or an Enhanced Typewriter keyboard and plan to upgrade the modified layouts, you may want to do further keyboard modification after the upgrade. "Restrictions" on page 15-4 contains specific information about Microcode Upgrade and keyboard modification. If you decide to perform further keyboard modification, Chapter 15, "Planning to Modify Keyboards" contains the information you need.



## Chapter 6. Planning to Configure

Configuration Questions	6-3
098: Online Test Password	6-3
099: Product Assistance Data	6-4
100: 3174 Model Designation	6-4
101: Host Attachment	6-5
104: Controller Address	6-9
105: Upper Limit Address	6-11
106: Token-Ring Network Address and Service Access Point of the 3174	6-12
107: Token-Ring Network Address and Service Access Point of the Gateway	6-13
108: Unique Machine Identifier	6-13
110: Multiple Logical Terminals (MLTs) Storage Support	6-14
116: Individual Port Assignment	6-18
117: Port Assignment	6-19
118: Port Address	6-20
121: Keyboard Language	6-20
123: Country Extended Code Page Support	6-21
125: Miscellaneous Feature Options (A)	6-22
126: Miscellaneous Feature Options (B)	6-24
127: Response Time Monitor (RTM) Definition	6-25
128: RTM Boundaries and Interface Specification	6-25
132: Alternate Base Keyboard Selection	6-25
136: Standard Keyboard Layouts	6-27
137: Modified Keyboard Layouts	6-28
138: Standard Keypad Layouts	6-28
139: Concurrent Communication Keyboard Language	6-29
141: Magnetic Character Set	6-29
150: Token-Ring Network Gateway	6-30
165: Compressed Program Symbols	6-30
166: Attribute Select Keypad	6-30
168: Additional Extension-Mode Key Definition (Personal Computers)	6-31
173: Distributed Function Terminal (DFT) Options	6-31
175: Distributed Function Terminal (DFT) Password	6-33
176: BSC Enhanced Communication Option: Distributed Function Terminals	6-33
179: Local Format Storage	6-34
213: Between Bracket Printer Sharing	6-34
215: Physical Unit Identification	6-35
220: Alert Function	6-35
221: 3174 Alert Control Point	6-36
222: Support of Command Retry	6-36
223: Attention Delay Value	6-37
224: Mode of Data Transfer	6-38
225: Channel Burst Size	6-38
240: Controller Logical Address	6-39
241: RU Maximum Size	6-39
310: Connect-Data-Set-to-Line (CDSTL) Operation	6-39
313: NRZ or NRZI Encoding	6-40
317: Telecommunication Facilities	6-40
318: Full- or Half-Speed Transmission	6-41
332: X.25 Options	6-42
340: RTS Control Response Options	6-42



360: X.21 Switched Retry	6-43
361: X.21 Switched Retry Timing	6-43
362: X.21 Switched Options	6-43
365: X.21 Data Transfer Delay	6-45
367: X.21 Switched Short-Hold Mode	6-46
368: X.21 Switched Short-Hold Mode Dial Number	6-46
370: Maximum Inbound I-Frame Size	6-46
371: X.21 Switched Dial Digits	6-46
372: Autocall/Autodisconnect	6-47
382: Maximum Ring I-Frame Size	6-47
383: Token-Ring Network Maximum Out	6-48
384: Ring Speed of the Token-Ring Network	6-48

---

## Configuration Questions

Before you start planning, you need:

- The configuration worksheets in Appendix A. These worksheets help to determine which configuration questions you should answer.
- Completed site planning worksheets.
- Information about the display stations and printers you want to attach to the controller.
- Information from your system programmer about responses to some of the configuration questions.
- The *3174 Character Set Reference*, GA27-3831, if you plan to change keyboard layouts.

Some, but not all, of the following configuration questions appear on the worksheets you are instructed to fill out while performing the procedure printed on the divider page labeled "Microcode Customization Planning." The questions that appear depend on the types of host communication (your response to "101: Host Attachment" on page 6-5). Read and respond to only the questions that appear on the worksheets.

*Planner: The following information for questions 098, 099, 100, and 101 is needed to complete step 1 of the procedure printed on the divider page labeled "Microcode Customization Planning." **You must answer questions 100 and 101.** Locate "Worksheet 1—Host Attachment" on page A-3. Write your responses to questions 098, 099, 100, and 101 on the worksheet.*

### 098: Online Test Password

*Response:* Up to eight alphanumeric characters.

The default response is underscores.

A response to this question is optional. This password is used to invoke certain online tests such as AEA Wrap and RAS IML.

This password must not be the same as a standard NetView or VTAM command (as defined by a CLIST). If a password duplicating a command is defined, NetView will recognize it when online tests are invoked through CSCF. NetView will execute the password as a command, and the online test will never be executed.

When responding to this question with a password, do not precede the password with blanks and do not enter blanks between characters.

**099: Product Assistance Data**

*Response:* Up to 68 alphanumeric characters.

A response to this question is optional. It is designed to provide you with a way to record the names and telephone numbers of a person to contact if there is a problem with the controller. You may leave blanks wherever you have not written an alphanumeric character.

**100: 3174 Model Designation**

*Response:*

01L	12R	53R
01R	13R	61R
02R	21L	62R
03R	21R	63R
11L	22L	90R
11R	23R	91R
12L	51R	92R.

Enter the actual model number or the alternate configuration model number of the controller you plan to customize.

The default response is XXX.

**Notes:**

1. All models that have the Token-Ring 3270 Gateway feature installed can be customized as the gateway controller in the primary or alternate configuration.
2. There are two Type 3 (Token-Ring) Communication Adapters. The 4Mbps Token-Ring Adapter and the Type 3A, or 16/4Mbps Token-Ring Adapter (3044).
3. The 3174 Model 21H is used *only* on the ES9000 and should be customized as a 21L. It is functionally the same as a Model 21L.

**Note:** For alternate configurations, only one set of configuration parameters and microcode can be easily managed with Central Site Change Management. This is due to a requirement that both controller configurations must have the same Network ID and LU names.

You can convert from one host connection type to another using Central Site Change Management, provided you have taken the appropriate measures to accommodate the restrictions defined above. However, because coordination of 3174 and VTAM changes can be complex, we do not recommend the use of alternate configurations in a Central Site Change Management environment.

## 101: Host Attachment

Response:

- |                       |                          |
|-----------------------|--------------------------|
| 1 = BSC               | 5 = SNA (Channel)        |
| 2 = SDLC (See notes)  | 6 = SDLC (X.21 Switched) |
| 3 = X.25              | 7 = Token-Ring Network   |
| 4 = Non-SNA (Channel) | M = Multi-Host Support.  |

The default response is X.

### Notes:

1. To use the Token-Ring 3270 Gateway feature, respond with 2, 5, or M.
2. Option 2 (SDLC) represents SDLC architecture on V.24/V.35 interfaces (either switched or leased) **or** SDLC architecture on X.21 interface that is *nonswitched*. If you want X.21 *switched*, use option 6.
3. A sheet of X.21 and X.25 Keyboard Labels (Order No. SX23-0285) may be shipped with the 3174 controller. Provide one set of these labels from the sheet for each display station keyboard using X.21 or X.25 host attachment.
4. If you are configuring for a Model 12L or Model 22L, respond with 4, 5, or M.

Responding with **M** indicates that you wish to have multiple 3270 host attachments. Before you continue planning, read "Multi-Host Support" on page 2-6 and "Microcode Customization" on page 2-12, if you have not done so already.

Multi-Host Support requires that you plan the microcode customization by filling out worksheets for each host attachment. Think of each attachment to a host as a separate controller configuration.

## Planning to Configure

If you respond with **M**, fill out "Worksheet 2—Multi-Host Definition" (Figure 6-1). This worksheet is used to identify the hosts and their characteristics.

Multi-Host Definition					
Host ID	Adapter Type	Host Attach	Hardware Group	Include In IML	Host Descriptor
1A		—			_____
2A	—	—	—	—	_____
3A	—	—	—	—	_____
—					_____
—					_____
—					_____
—					_____
—					_____
—					_____
—					_____
—					_____
—					_____
—					_____
—					_____
—					_____
—					_____
—					_____

Figure 6-1. An Example of Worksheet 2 – Multi-Host Definition

The columns on "Worksheet 2—Multi-Host Definition" are described below.

### Host ID

A two-character identifier for each of the hosts. The first character is numeric and identifies the specific host link. The second character is alphabetic and identifies one of multiple hosts on that link.

A host ID beginning with the number "1" represents a host on the primary link. There can be only one primary link between a controller and upstream hosts, but up to eight hosts can be accessed over that primary link, depending on the configuration. The second character in the host ID differentiates between the hosts (A-H).

A host ID beginning with a "2" or "3" represents a host on a secondary link. A secondary link uses Concurrent Communication Adapters (CCAs), and some 3174 models can have two secondary links. Up to four hosts can be accessed over one secondary link, depending on the configuration. The second character in the host ID differentiates between the hosts (A-D).

Regardless of whether it is on a primary link or a secondary link, only one primary host can be configured for each link. The letter "A" in the host ID identifies the primary host. Therefore, the primary hosts are identified as 1A, 2A, and 3A. Secondary hosts are identified as 1B, 1C, 1D, 1E, 1F, 1G, 1H, 2B, 2C, 2D, 3B, 3C, and 3D.

**Note:** When planning for Single Link Multi-Host Support, prioritize the hosts by alphabetic order (xA hosts have highest priority, then all other hosts on that link).

**Adapter Type**

This field is for Concurrent Communication Adapters. It identifies the adapter type:

- 1 = Type 1 Concurrent Communication Adapter
- 2 = Type 2 Concurrent Communication Adapter.

See "Concurrent Communication Adapter" on page 2-7 if you need more information on the adapter types.

**Host Attach**

This identifies the type of host attachment for each link. The primary host on the primary link (1A) has the following possibilities:

- 1 = BSC
- 2 = SDLC
- 3 = X.25
- 4 = Non-SNA (Channel)
- 5 = SNA (Channel)
- 6 = SDLC (X.21 Switched)
- 7 = Token-Ring Network.

**Notes:**

1. Respond with 3, 5, or 7 for Single Link Multi-Host Support.
2. To use the Token-Ring 3270 Gateway feature, respond with 2 or 5.

The primary hosts on secondary links (Host IDs 2A and 3A) have the following possibilities:

**Type 1 CCA:**

- 1 = BSC
- 2 = SDLC (see note)
- 3 = X.25

**Type 2 CCA:**

- 2 = SDLC
- 3 = X.25
- 6 = SDLC (X.21 Switched)

**Notes:**

1. Respond with 3 for Single Link Multi-Host Support.
2. Respond with 2 if planning for Token-Ring 3270 Gateway support.

**Hardware Group**

The possible responses to these fields are hardware groups 51 and 52. You determine your response by identifying how the CCAs are physically plugged into the available card slots. Card slots are numbered; the CCA plugged into the card slot with the lowest number is assigned hardware group 51.

If you use only one CCA, it must be assigned hardware group 51.

## Planning to Configure

### Include in IML

This field specifies whether a host is to be included in the IML (initial microcode load). Possible responses are:

- 0 = No
- 1 = Yes.

If you only want to use a host at certain times, fill out the worksheets for the host attachment and have the customizer respond to this field with 1. Once the customization data has been entered for the host, the response can be changed to 0. When you want to use the host, change the 0 to 1 and re-IML the controller.

**Note:** To use secondary hosts on secondary links, you must include the primary hosts (2A and 3A) on those links in the IML. The primary host on the primary link is included by default.

### Host Descriptor

This optional field is used to describe each host. The description can contain up to 20 characters. If filled in, the description appears in the operator information area (OIA) of displays accessing the host.

The proper functioning of devices that are emulating control unit terminals (CUTs) may depend on the display of the following indicators:

- ASCII device emulation mode
- Programmable Symbol Indicators
- Character Set, Color, and Highlighting
- Shift Indicators
- Caps Lock area
- Extended Graphics.

The Host Descriptor may overlay these indicators. In such a case, you can ensure proper functioning by not specifying a Host Descriptor.

*Planner: If your response to question 101 was:*

- 1, 2, 3, 4, 5, 6, or 7, return to the divider page labeled "Microcode Customization Planning." See step 2 to determine the next worksheet you need to fill out.
- "M," return to the divider page labeled "Microcode Customization Planning." See step 3 to determine the next worksheet you need to fill out.

## 104: Controller Address

*Response:* The two-character hexadecimal address.

The default response is XX.

Ask the system programmer at the host system location for this hexadecimal address. The host system recognizes this as the input/output (I/O) address.

**For BSC:** Obtain the polling address (in hexadecimal) for this controller from the system programmer at the host site. *Be sure that it is the polling address, and not the line address.* Use Table 6-1 on page 6-10 to convert the BSC polling address to the controller address (for example, if the BSC address [EBCDIC] is 4E, then the controller address is 14). Do **not** convert the hexadecimal address to a decimal number, and be sure to ask the system programmer if the address is EBCDIC or ASCII.

Because it is standard practice to send the address twice, the system programmer may give you a "double address" (for example, 4040). Use only the first two digits (for example, 40).

**For SDLC:** If the host access consists of VTAM/NCP, specify the controller address on the ADDR operand of the NCP's PU statement.

**For X.25:** This is the X.25 secondary station address.

**For Non-SNA (Channel):** The host system recognizes this as the lower (base) I/O address of the range of I/O addresses assigned to the terminals attached to the controller. If 16 or fewer devices (including ASCII) are attached, the following controller addresses are valid: 00, 10, 20, 30, 40, 50, 60, 70, 80, 90, A0, B0, C0, D0, E0, F0. If more than 16 devices (including ASCII) are attached, the following controller addresses are valid: 00, 20, 40, 60, 80, A0, C0, E0.

**For SNA (Channel):** This controller address represents the I/O address of the SNA physical unit.

**For Token-Ring 3270 Gateway:** The host system recognizes this as the lower (base) I/O address.

**For X.21 Switched:** If the host access consists of VTAM/NCP, specify the controller address on the ADDR operand of VTAM's switched PU statement.



Table 6-1. Conversion of BSC Polling Addresses into Controller Addresses		
BSC Hexadecimal Polling Address		
EBCDIC	ASCII	Controller Address
40	20	00
C1	41	01
C2	42	02
C3	43	03
C4	44	04
C5	45	05
C6	46	06
C7	47	07
C8	48	08
C9	49	09
4A	5B	10
4B	2E	11
4C	3C	12
4D	28	13
4E	2B	14
4F	21	15
50	26	16
D1	4A	17
D2	4B	18
D3	4C	19
D4	4D	20
D5	4E	21
D6	4F	22
D7	50	23
D8	51	24
D9	52	25
5A	5D	26
5B	24	27
5C	2A	28
5D	29	29
5E	3B	30
5F	5E	31

## 105: Upper Limit Address

*Response:* Two-character hexadecimal address. The system programmer at the host system location will supply this address.

**For SDLC and SNA (Channel) without the Token-Ring 3270 Gateway Feature:** 00 is the only valid response.

**For Non-SNA:** The upper limit address indicates the range of consecutive I/O addresses assigned to the terminals attached to the controller.

**Note:** For Non-SNA, if this response is 00, the response to question 116 cannot be 0. If this response is nonzero, the response to question 116 must be 0.

**For the Token-Ring 3270 Gateway:** The upper limit address indicates the range of consecutive subchannel addresses (for local models) or SDLC station addresses (for remote models) assigned to the Token-Ring Downstream Physical Units (DSPUs) communicating to this host through the gateway controller. You must also define an address for the controller you are customizing. For local models, these addresses must be defined contiguously at the host access method.

Controllers that have Concurrent Communications Adapters installed can support up to 50 DSPUs on each CCA.

As an example: You have a Token-Ring Network with 40 DSPUs. The address of the controller you are customizing is 10. Your response to question 104 would be 10, since that is the lower limit in the range of addresses. To find the upper limit add the number of devices (in hexadecimal). There are 40 devices (28 hexadecimal). Therefore the upper limit address is 38. See the following example.

### Example

<p>Decimal 40 (number of devices) = 28 hexadecimal</p> <p>10 hexadecimal (the controller address)            + 28 hexadecimal (number of devices)</p> <hr/> <p>= 38 hexadecimal (the upper limit address)</p>
---

### DSPU Restrictions

The number of DSPUs supported by your Gateway depends on the kind of Token-Ring Adapter installed and whether or not you are using 8KB RUs. The total number of DSPUs shown apply for all gateway configurations, including multi-host gateway, regardless of the number of host attachments.

**4MB Token-Ring Adapter:** Up to 140 DSPUs are supported. Your response to question 105, minus your response to question 104, cannot be greater than X'8C' (140 decimal).

**16/4 MB Token-Ring Adapter / 4KB RU Maximum:** Up to 250 DSPUs are supported (except for Model 1L, which will only support 140 DSPUs). Your response to question 105, minus your response to question 104 cannot be greater than X'FA' (250 decimal).

**16/4 MB Token-Ring Adapter / 8KB RU Maximum:** Up to 100 DSPUs are supported. Your response to question 105, minus your response to question 104 cannot be greater than X'64'.

## 106: Token-Ring Network Address and Service Access Point of the 3174

*Planner: Questions 106 and 107 apply to 3174 controllers without the 3270 Gateway feature that attach to the Token-Ring Network.*

*Response: A 12-character hexadecimal address and a 2-character hexadecimal service access point.*

**Address:**

The address can be either a locally administered address, a universal address, or all zeros. A locally administered address is in the following format:

4000 XYYY YYYY

where X and Y are the user-assigned portion of the locally administered address. Note that X should not be greater than X'7'.

A universal address is in the following format:

WWWW WWZZ ZZZZ

W = the ID of the adapter manufacturer (for example, IBM's ID is 10005A).

Z = the unique address portion of this adapter's universal address.

**Warning:** When the product permits you to enter either type of address, the suggested choice is a locally administered address. If the universal address is used and the Token-Ring Adapter is replaced, the 3174, as well as the gateway, will have to be recustomized with the new address.

**Service Access Point:**

The default is 04. If you are not using Single Link Multi-Host Support, respond with the default. Your response must be a multiple of 4 ranging from X'04' to X'EC'.

When using Single Link Multi-Host Support, you can access additional hosts through a single gateway (if supported) by specifying additional service access points (SAPs). Usage of the SAP depends on the capabilities of the gateways. If you are using Single Link Multi-Host Support, you may have to specify a SAP other than the default. See Appendix E for examples of using the SAP.

**Notes:**

1. The universal address is used if you respond with all zeros.
2. When filling in the worksheets for secondary hosts on the primary link (1B–1H), the address portion of this question does not have to be answered. The response provided for the primary host (1A) is automatically transferred to the secondary hosts during the customizing procedures.
3. If the gateway that you are using is a 372x, you must define the Token-Ring Network addresses as locally administered addresses using dial digits (digits that can be dialed on the telephone) 0 through 9 **only**. The 372x should be connected by way of telephone lines.
4. The response to question 106 and 107 cannot be the same.

Ask your network planner for this address and service access point.

## 107: Token-Ring Network Address and Service Access Point of the Gateway

*Response:* A 12-character hexadecimal address and a 2-character hexadecimal service access point.

### Address:

The address can be either a locally administered address or a universal address. A locally administered address is in the following format:

4000 XYYY YYYY

where X and Y are the user-assigned portion of the locally administered address. Note that X should not be greater than X'7'.

A universal address is in the following format:

WWW WWZZ ZZZZ

W = the ID of the adapter manufacturer (for example, IBM's ID is 1000 5A).

Z = is the unique address portion of this adapter's universal address.

### Service Access Point:

The default is 04. If you are not using Single Link Multi-Host Support, respond with the default. Your response must be a multiple of 4 ranging from X'04' to X'EC'.

When using Single Link Multi-Host Support, you can access additional hosts through a single gateway (if supported) by specifying additional service access points (SAPs). Usage of the SAP depends on the capabilities of the gateways. If you are using Single Link Multi-Host Support, you may have to specify a SAP other than the default. See Appendix E for examples of using the SAP.

### Notes:

1. If the gateway that you are using is a 372x, you must define the Token-Ring Network addresses as locally administered addresses using dial digits (digits that can be dialed on the telephone) 0 through 9 **only**. The 372x expects to be connected by way of telephone lines.
2. The response to this question cannot be all zeros, nor can it be the same as the response to question 106.

Ask your network planner for this address and service access point.

## 108: Unique Machine Identifier

*Response:* Seven alphanumeric characters. We recommend that you use the controller's serial number as the unique machine identifier. The serial number is located on the front panel of the controller and consists of 7 alphanumeric characters.

If the controller's serial number is not available or you prefer not to use it, you may enter your own unique machine identifier of 7 alphanumeric characters. You may enter 0–9, A–Z, null, or space for the 7 characters.

### 110: Multiple Logical Terminals (MLTs) Storage Support

*Planner: This question has two parts. You must provide a nonzero response to this question if you are planning for Multi-Host Support (question 101 = M). In answering this question, you are allocating MLT storage for all host IDs on this link. The 3174 Model 90R does not support MLT.*

The default response is 0 0000 which is no MLT.

A nonzero response to either part of this question allows you to configure control unit terminal (CUT) display stations or ASCII display stations emulating CUT displays to use multiple host sessions. If you respond to either part of this question with a nonzero value, the other part of the question must be zero.

*Response to first part of question: 0 0000*

Nonzero response: 1 to 8 allocates a preset amount of 3174 storage to support MLT. The preset amount ranges from 64KB to 2688KB.

	Host ID	Valid Nonzero Response
Models 1L through 23R	1A	1 to 8
Models 51R, 53R, 61R, 62R, 63R	1A	1 to 8
Models 91R, 92R	1A	1 or 2
Concurrent Communication Adapters	2x and 3x	1 or 2

*Response to second part of question: 0 0000*

Nonzero response: 0001 – 2784 allocates that amount of 3174 storage in kilobytes to support MLT.

Valid responses are:

	Host ID	Minimum Response	Maximum Response
Models 1L through 23R	1A	0001 KB	2784 KB
Models 51R, 53R, 61R, 62R, 63R	1A	0001 KB	2784 KB
91R, 92R	1A	0001 KB	0128 KB
Concurrent Communication Adapters	2x and 3x	0001 KB	0128 KB

See “Determining MLT Storage Requirements” if you wish to specify a nonzero response to either part of question 110.

### Determining MLT Storage Requirements

To determine what your MLT storage requirements are, fill in the following worksheets as required for your configuration:

- Worksheet 10A (Ports 26-00 – 26-31)
- Worksheet 10B (Ports 27-00 – 27-31)
- Worksheet 10C (Ports 21-00 – 23-07).

These worksheets are located in Appendix A, “Configuration Worksheets.”

The following steps explain how to fill out each worksheet.

**Step 1** In the Device Type/Screen Size column, specify the device and screen size for each controller port that has a CUT or ASCII display attached to it (for example, CUT 24 × 80).

3270 Devices with the Extended Function Feature (Feature 6) can support different screen sizes. For these devices, the SNA host can send down a Bind command to change the screen size. Therefore, you must ensure there is enough storage for the largest screen that could be selected on the Bind. For example, the device might be set up to support 24 × 80 and the Bind command could change this to 32 × 80. (If your host applications do not support screen size changes, set Q126 Bit 5 = 1 and select the storage amount required for the screen size that the device will be set up for).

The following shows which setup options display station users must select in order to get the Extended Function Feature:

- 3180 displays — Model IDs 6-9
- 3191, 3192 displays — the Extended Function Model IDs (i.e. 2+, 3+, 4+, or 5+)
- 3471 (Model B), 3472 (all models except G) displays — a keyboard type other than 78EMU (3278 Emulation Mode).

**Step 2** **For 3270 Devices only:** In the EAB? column, specify whether the CUT display stations have extended attribute buffers (EABs). Specify a “Y” or “N” (Yes or No).

**Step 3** In the Number of Sessions column, specify the number of host sessions for the listed devices. *The maximum is 5 sessions.*

If you are calculating the MLT level for:

- A primary link (Host ID 1A), include both the 3270 host sessions for that link and ASCII host sessions.
- A secondary link (Host ID 2A or 3A), include only 3270 host sessions for that link.

**Notes:**

- a. Each 3270 host session requires a host address. Local Non-SNA and BSC controllers are permitted a maximum of 32 host addresses.
- b. You not have to add any storage for printer sessions or Distributed Function Terminals (DFTs).

**Step 4** To determine how much storage to reserve for each listed device, refer to:

- Table 6-2 on page 6-16 if you are not using Multi-Host Support.
- Table 6-3 on page 6-16 if you are using Multi-Host Support.

*Write in the amount of storage required for each device in the MLT Storage Required column.*

Table 6-2. MLT Storage Specification without Multi-Host Support. Values are in KB (1024 bytes).					
Cut or ASCII Device Screen Size	Number of Sessions				
	1	2	3	4	5
CUT/24 × 80	0	0	2	4	6
CUT/24 × 80 with EAB	0	4	8	12	16
ASCII/24 × 80	0	0	2	4	6
ASCII/30 × 80	0	4	8	12	16
ASCII/32 × 80					
CUT/32 × 80					
CUT/43 × 80					
CUT/27 × 132	0	12	20	28	36
CUT/32 × 80 with EAB					
CUT/43 × 80 with EAB					
CUT/27 × 132 with EAB					

**Note:** If you are planning storage for ASCII Tektronix 4205s or UDT tables for which transparency is being defined, you must add additional storage. Base the additional storage amounts on screen size. If the display is 24 × 80, add 2KB more of storage; if the display is 30 × 80 or 32 × 80, add 4KB more of storage. If you are planning for only one logical session on an ASCII display station, no additional storage is required. This applies regardless of Multi-Host Support.

Table 6-3. MLT Storage Specification with Multi-Host Support. Values are in KB (1024 bytes).					
CUT or ASCII Device Screen Size	Number of Sessions				
	1	2	3	4	5
CUT/24 × 80	0	0	0	0	2
CUT/24 × 80 with EAB	0	0	4	8	12
ASCII/24 × 80	0	0	2	4	6
CUT/32 × 80	0	0	4	8	12
CUT/43 × 80					
CUT/27 × 132					
ASCII/30 × 80	0	4	8	12	16
ASCII/32 × 80					
CUT/32 × 80 with EAB	0	8	16	24	32
CUT/43 × 80 with EAB					
CUT/27 × 132 with EAB					

**Step 5** After calculating the amount of storage each device requires for MLT support, add these amounts to determine the total amount of MLT storage required. *Write this amount on the totals line at the bottom of the MLT Storage Required column.*

**Step 6** If you filled out more than one worksheet, add the amount from the totals line of each worksheet to arrive at the total amount of MLT storage you require.

- If you wish to specify an exact amount of MLT storage, write the amount with leading zeroes next to question 110 on the host attachment worksheet.
- If you wish to specify an MLT level, use the following chart and *considering future expansion*, determine which level of MLT support you should select.

If the total storage required is	Select MLT level
1KB to 64KB	1
65KB to 128KB	2
129KB to 512KB	3
513KB to 896KB	4
897KB to 1152KB	5
1153KB to 1536KB	6
1537KB to 2048KB	7
2049KB to 2688KB	8

Figure 6-2 shows an example of an MLT Worksheet that was completed using the values from Table 6-3.

Controller Port Number	Device Type/Screen Size	EAB? Y/N	Number of Sessions	MLT Storage Required
26-00	CUT/24 × 80	Y	3	4
26-01	DFT/variable	N	3	0
26-02	CUT/24 × 80	N	5	2
26-03	CUT/43 × 80	Y	4	24
26-04	CUT/32 × 80	N	5	12
26-05	CUT/27 × 132	Y	4	24
26-06	CUT/43 × 80	Y	5	32
26-07	CUT/24 × 80	N	3	0
21-01	ASCII/30 × 80	N	2	0
21-02	ASCII/24 × 80	N	5	2
Total MLT Storage Required:				100

Figure 6-2. An Example of Calculating MLT Storage

In this example, 100KB is the total amount of storage required. Level 1 reserves only up to 64KB and would therefore be insufficient. Level 2 of MLT reserves up to 128KB, which would be sufficient, but considering eventual expansion, you may decide to choose Level 3 support (512KB) or higher.



### MLT-Related Considerations

- If your response to either part of question 110 is nonzero, you cannot respond to question 116 with 0 on the worksheet for the primary host attachment.
- For information on port addressing of the Multiple Logical Terminals (MLTs), see Chapter 7, "Planning for Port Assignment."
- If you are configuring for Multi-Host Support, see Chapter 13 for information on defining host sessions for terminals.
- If you are using MLT on ASCII devices, you must answer question 703 with a 1.

### 116: Individual Port Assignment

*Response:* One to four alphanumeric digits.

The four digits of this response are grouped into two pairs. The first (leftmost) pair represents the assignment of 3270 addresses. The second pair represents the assignment of AEA addresses.

**Note:** Depending on your configuration, you may not be specifying all four digits; you may have a one, two, or four-digit response. However, placement of the digits is crucial, so please read the following description carefully.

The default response is 0.

For Port Assignment, you define addresses for terminals attached to the Terminal Adapter, not for PCs or controllers attached to the Token-Ring. Therefore, if you want to customize for any devices that are not attached to the Token-Ring, you should plan to customize for Port Assignment.

If your response is **0**, **1**, or **2**, write your response in the leftmost box and leave the second box blank.

- 0 = 1 address per 3270 port; individual addresses are automatically assigned.
- 1 = You assign the number of addresses for each port; individual addresses are automatically assigned.
- 2 = You assign the individual addresses.
- SX = X is the number of addresses per 3270 port; individual addresses are automatically assigned. X is 1 to 5.
- AY = Y is the number of addresses per AEA port; individual addresses are automatically assigned. Y is 1 to 5.

#### Enter 0 if you:

- Want one 3270 address per port automatically assigned.
- Do not want to plan for port assignment.
- Do not want any AEA addresses assigned.

#### Enter 1 or 2 if you:

- Plan to assign port addresses on a port-by-port basis.
- Answered either part of question 110 with a nonzero response.
- Plan to have ASCII devices access 3270 hosts (AEA must be present).
- Plan to use DFTs with multiple interactive sessions. (The 3290 Information Panel and the 3270 Personal Computer are some of the DFTs with multiple interactive sessions capability.)

**Enter SX if you:**

- Want to specify the number of addresses (1 to 5) to be assigned to each 3270 port.
- Want to specify the same number of addresses for all 3270 ports and have the individual addresses automatically assigned.
- Do not plan to have ASCII devices access 3270 hosts.
- Answered either part of question 110 with a nonzero response.
- Plan to use DFTs with multiple interactive sessions.

Responses S1—S5 are allowed only on SNA host attachments.

The above responses do not result in AEA port address assignment. To plan for assignment of AEA addresses:

**Enter SX AY if you:**

- Want to specify the number of addresses to be assigned to each 3270 port and the number of addresses to be assigned to each AEA port.
- Want to specify the same number of addresses for both 3270 and AEA ports ( $X = Y$ ).
- Want to have the individual addresses automatically assigned.
- Answered questions 110 and 703 with nonzero responses.
- Plan to have ASCII devices access 3270 hosts.

**Important:**

1. The maximum number of addresses that can be assigned is 253. The customizing utility prioritizes the assignment of addresses. Be sure that the number of addresses you select in this question does not exceed 253. Otherwise, either some ports do not get any addresses or they get fewer addresses than you requested.
2. Do not respond to the AY part of this question if:
  - The host is non-SNA
  - The 3174 model number is 53R, 90R, 91R, or 92R.
3. If the response to question 101 = M, the second part of question 116 appears only for the 1A primary host.

See Chapter 7, "Planning for Port Assignment," if you require more information to determine your response.

## 117: Port Assignment

This is a panel that appears during the Configure procedure if you respond to question 116 with 1 or 2. Chapter 7, "Planning for Port Assignment," contains the planning information you need to fill out the worksheet for this panel.

### 118: Port Address

This panel appears on the screen after the 117 panel if you opt to assign your own addresses; if you select automatic address assignment, this panel appears after the customizer responds to question 116. It displays the assigned port addresses in hexadecimal. The customizer cannot enter information on this panel.

### 121: Keyboard Language

**Planner:** *The response given for this question must correspond to that given when defining translate tables. See "Worksheet 25—Translate Tables Definition" on page A-39 for information. If the responses differ, unpredictable results may occur.*

*If you plan to answer question "123: Country Extended Code Page Support" with a 1 (CECP Support), you **must** use one of the valid CECP languages in Table 6-5 on page 6-22 when responding to this question.*

**Response:** Two digits that represent the keyboard language that will be used in this cluster.

The default response is 01 (U.S. English).

**Notes:**

1. The *3174 Character Set Reference*, GA27-3831, contains the code pages for the supported languages.
2. The keyboard languages listed in bold type in Table 6-4 can be used for communication to ASCII devices. For more information, see "Terminal Tables and Translate Tables" on page 12-16.
3. If one of the languages shown in regular type (not intended for support of ASCII devices) is selected for ASCII communication, the language provided will be U.S. English.

Table 6-4. Keyboard Languages Supported

<b>01 = English (U.S.)<sup>1</sup></b>	<b>28 = Portuguese</b>
02 = English (U.S.) ASCII-7 <sup>(1)(2)</sup>	<b>29 = Canadian Bilingual<sup>1</sup></b>
<b>03 = Austrian/German</b>	<b>30 = French</b>
04 = Belgian	33 = English (U.S.) ASCII-International <sup>3</sup>
05 = Brazilian	34 = English (U.S.) ASCII-8 <sup>4</sup>
<b>07 = Danish</b>	35 = Cyrillic
<b>09 = Finnish</b>	36 = Greek
14 = International	37 = Icelandic
<b>15 = Italian</b>	38 = ROECE <sup>5</sup> Latin
16 = Japanese English	39 = Turkish
17 = Japanese Katakana	40 = Yugoslavic
<b>19 = Spanish</b>	<b>41 = Swiss-French (New)</b>
<b>21 = Spanish-Speaking</b>	<b>42 = Swiss-German (New)</b>
<b>22 = English (UK)</b>	<b>43 = Belgian (New)</b>
<b>23 = Norwegian</b>	46 = Thai
<b>24 = Swedish</b>	<b>47 = Netherlands</b>
25 = EBCDIC World Trade	48 = New Greek

<sup>1</sup> Alternate Keyboard Selection (132) is valid only with these languages.

<sup>2</sup> Available on remote models only. Does not support Extended Data Stream.

<sup>3</sup> Available only on BSC, local SNA, and local non-SNA.

<sup>4</sup> Available only on SDLC and X.25.

<sup>5</sup> Regional Office for Eastern and Central Europe.

## 123: Country Extended Code Page Support

*Response:*

- 0 = No CECP Support
- 1 = CECP Support (see Note 1).

The default response is 0.

If you respond to this question with a 1 (CECP Support), a larger definition of graphic characters than previous code pages will be supported, and the ability for multilingual communication will be improved.

**Warning:** Answering this question with a 1 can result in a loss of data integrity and cause unexpected characters to appear on the screen. You should read Chapter 8, "Planning for Country Extended Code Page," before responding to this question with a 1.

**Warning:** Answering this question with a 1 results in a loss of the Mono Case function on 3192 Models C, D, and F.

### Notes:

1. You must answer question 121 with one of the valid CECP (Country Extended Code Page) languages from Table 6-5 on page 6-22 if you plan to respond to question 123 with a 1.
2. If you respond to this question with a 1 and to question 139 with 00 or 01 for the CCA host attachment, CECP code pages are used for CCA-attached hosts.
3. See Chapter 8, "Planning for Country Extended Code Page," for the supported devices.
4. ASCII devices customized for CECP support cannot provide the Field Mark or Dup characters.

## Planning to Configure

The languages supported by CECF are listed in Table 6-5 on page 6-22. Beside each language name is the 2-digit response that is used when responding to "121: Keyboard Language."

Table 6-5. CECF Languages Supported

01 = English (U.S.)	24 = Swedish
03 = Austrian/German	28 = Portuguese
07 = Danish	29 = Canadian Bilingual
09 = Finnish	30 = French
15 = Italian	37 = Icelandic
19 = Spanish	41 = Swiss French (New)
21 = Spanish-Speaking	42 = Swiss German (New)
22 = English (UK)	43 = Belgian (New)
23 = Norwegian	47 = Netherlands

**Note:** The *3174 Character Set Reference*, GA27-3831, contains the code pages for the supported languages.

## 125: Miscellaneous Feature Options (A)

*Response:* Eight digits (0 or 1).

- 0 = No
- 1 = Yes.

The default response is 00000000.

Specify digits 1–8 as either a 0 or 1. Digits are numbered from left to right.

**Note:** Digits 3 and 5 through 7 cannot be specified on the worksheets for secondary host attachments.

Digit	Description
1	Dual-Function Clear Key
2	Unsupported Control Code Translate
3	Clicker Option
4	Command Chaining
5	PS Load Altered Screen
6	File Transfer Aid
7	Background Alarm
8	Deferred Keystroking (Remote SNA Only)

**Digit 1 - Dual-Function Clear Key:** Specify this digit as 1 to prevent the Clear key from putting a 3278, 3279, or 3180 display station into the default screen size mode.

**Warning:** Specifying this digit as 1 causes the Clear key to operate contrary to the definition given in the *IBM 3270 Information Display System Data Stream Programmer's Reference*, GA23-0059. Host applications written to conform with the *Data Stream Programmer's Reference* may react unpredictably.

**Digit 2 - Unsupported Control Code Translate:** Specify this digit as 1 to translate the following interface codes into a hyphen character (EBCDIC X'60'):

- 01 through 04, 06, 07, 09, 0A, 0B, 0E, 0F, 10, 14, 16, 17, 18, 1A, 1B, 1F
- 20 through 27, 2A, 2B, 2D, 2E, 2F
- 30 through 3B, and 3D.

During READ operations, the hyphen character code returns to the host instead of the original code.

### Notes:

1. Additionally, interface codes 3F and FF are replaced by hyphens on devices without the Extended Attribute Buffer (EAB).
2. The above codes are reserved for future use in the IBM 3270 Data Stream. Host applications that transmit these codes as data with a write-type command or within an outbound 3270DS structured field are not in conformance with the *Data Stream Programmer's Reference* and may encounter unpredictable results.

Specifying this digit as 0 (default) causes the controller to reject the interface codes and display a PROG 402 in the operator information area of the display station, which receives a message containing one of the unsupported interface codes. Pressing the RESET key clears the PROG 402 from the screen. Also, an Erase Write or Erase Write Alternate command from the host application clears the PROG 402 from the screen.

### Digit 3 - Clicker Option:

- 0 = Keyboard clicker is *off* when the display station is turned on.
- 1 = Keyboard clicker is *on* when the display station is turned on.

### Digit 4 - Command Chaining:

- 0 = Command Chaining is on.
- 1 = Command Chaining is off.

Performance may be downgraded if you specify this digit as a 1.

**Digit 5 - PS Load Altered Screen:** Specifying a 1 inhibits screen flashing during a load PS.

**Digit 6 - File Transfer Aid:** The operation of DFT devices is not affected by this option.

A response of 1 is required for:

- Operation of the IBM Personal Computer with an IBM 3278/79 emulation card or equivalent performing file transfer. This includes the IBM 3270 Personal Computer operating in CUT mode.
- Operation of the 3814 Switching Management System.
- Operation on the AEA using FTTERM\* (IBM File Transfer/Terminal Emulator Program or OS 2 Extended Addition File Transfer).

If 1 is specified, the operation of other CUT (non-IBM PC) devices may be degraded.

### Digit 7 - Background Alarm:

- 0 = Background alarm is allowed.
- 1 = Background alarm is disabled for background sessions.

This option has effect only when question 110 (MLT) has been configured with a nonzero response.

Each MLT display has one foreground session and one or more background sessions. The foreground session is the one currently displayed on the terminal screen; the others are background sessions. Host updates to background sessions may include sounding the alarm. This option allows the background alarms to be disabled.

**Note:** This alarm is automatically disabled if digit 6 (File Transfer Aid) receives a response of 1.

### **Digit 8 - Deferred Keystroking - Remote SNA:**

0 = Deferred keystrokes are discarded between segments within a request unit (RU).

1 = Deferred keystrokes are processed between segments within a request unit (RU).

**Note:** Performance is degraded if you respond to this question with a 1.

## **126: Miscellaneous Feature Options (B)**

*Response:* Eight digits (0 or 1).

0 = No

1 = Yes (See note).

**Note:** For Digit 3, specifying 0 causes Type Ahead to remain enabled; specifying 1 causes Type Ahead to be disabled.

The default response is 00000000.

<b>Digit</b>	<b>Description</b>
1	Reserved
2	Coax Timeout Period
3	Type Ahead
4	Enhanced Screen Support for 3270 CUT Devices (SNA only)
5	Bind Support
6	Reserved
7	Reserved
8	Reserved

**Digit 1 - Reserved:** The first digit is reserved.

**Digit 2 - Coax Timeout Period:** The Coax Timeout Period is used by the controller to ensure timely responses from attached devices. Specifying the second digit as 1 increases the timeout period from 50 microseconds (the default) to 100 microseconds.

Specify 1 for the second digit if:

- You have devices attached through products that increase the coax delay past 50 microseconds (for example, a 5209 Link Protocol Converter).
- Original Equipment manufacturer (OEM) multiplexers or devices are attached to the controller.

**Warning:** If you operate in a stressful keystroking environment (many devices, rapid keystroking) and you have the AEA feature, specifying this digit as 1 may result in lost keystrokes.

**Digit 3 - Type Ahead:** Specifying a 1 inhibits the Type Ahead function on 3270 CUT and ASCII terminals. Specifying a 0 allows the Type Ahead function. This function allows buffering of keystrokes for the display while the controller is waiting for the host to respond or unlock the keyboard.

**Digit 4 - Enhanced Screen Support for 3270 CUT Terminals (SNA Only):** When set to a 1, the 3174 sends data to a terminal after a complete SNA chain is received. When set to a 0 the 3174 sends data to a terminal after complete segments are received. If the host link is operating at a slow speed, data sent to a terminal in segments can cause choppy screen presentation.

**Digit 5 - Bind Support:** This applies *only* to SNA Hosts on the 3174 and affects *only* CUT devices with Extended Function Feature (EFF), also known as Feature 6, and with multiple sessions.

If a 0 (default) is specified, the 3174 will accept a Bind to a device with EFF that specifies a screen larger than the device had been defined when set up. For example, a 3472 set up as a Model 2 (24 x 80) will have a Bind specifying a screen size of 43 x 80 accepted.

If a 1 is specified, the 3174 will handle devices with EFF the same as it handles devices without EFF relative to Bind processing. For example, the Bind is only accepted if the number of rows is less than or equal to the rows in the model size.

**Note:** The answer to this question will affect the amount of MLT storage that is required for devices with the Extended Function Feature. Refer to "110: Multiple Logical Terminals (MLTs) Storage Support" on page 6-14 for more information about MLT storage and the Extended Function Feature.

**Digits 6 through 8 - Reserved:** These digits are reserved.

## 127: Response Time Monitor (RTM) Definition

*Response:* Two digits. If one digit is zero, the other must also be zero.

The default response is 00 (no RTM support).

**Note:** If your response to this question is nonzero, you **must** fill out "Worksheet 12-128: RTM."

Turn to Chapter 9 for information on planning for RTM, how to fill out the worksheet, and the possible responses to question 127. Your system programmer will help you select your responses.

## 128: RTM Boundaries and Interface Specification

During the Configure procedure, this host-related panel appears if your response to question 127 was nonzero. Chapter 9, "Planning for Response Time Monitor (RTM)," has the planning information you need to fill out the worksheet for this panel.

## 132: Alternate Base Keyboard Selection

**Planner:** This question is valid only if question 121 was given a response of 01 or 29.



## Planning to Configure

*Response:* Four digits (A value of 0, 1, or 2 for each).

- 0 = No
- 1 = Yes (keyboard without numeric lock)
- 2 = Yes (keyboard with numeric lock—valid for 8K1038 and 8K1158 keyboards only).

The default response is 0000.

**Note:** For a description of numeric lock, see “Numeric Lock Feature Option” in the *3174 Functional Description, GA23-0218*.

Your response to question 132 specifies the alternate keyboard layouts (if any) that you want configured in the system. If you leave question 132 set to the default, the layout of the keyboards attached to the controller is used.

Base keyboards 8K0808 and 8K0932 are mutually exclusive and replace the standard Base Typewriter keyboards. Base keyboard emulators use the Base Typewriter layout in their emulation; therefore, any change to the Base Typewriter layout affects the Base keyboard emulators. For this reason, ASCII display stations used for 3270 terminal emulation (or any other emulators) may lose some of their functions.

Base keyboard 8K1038 can be used in addition to the other Base keyboards. Base keyboard 8K1158 replaces all of the standard Base APL keyboards.

To determine which keyboards you have, refer to Table 6-6 on page 6-27, which lists the microcode RPQs associated with the different keyboards. For visual identification of keyboards 8K0808, 8K0932, 8K1038, or 8K1158, refer to the *3174 Character Set Reference*.

<b>Digit</b>	<b>Description</b>
1	8K0808 Base Keyboard
2	8K0932 Base Keyboard (3178-C4)
3	8K1038 Base Keyboard (3178-C3)
4	8K1158 Base Keyboard

**Notes:**

1. Base keyboards 8K0808, 8K0932, 8K1038, and 8K1158 do not require RPQ microcode to operate.
2. Responding with a 1 to digit 3 (8K1038) and digit 4 (8K1158) results in the PF keys being operational in the lower shift position.

Table 6-6. Microcode RPQ Numbers Associated with Keyboards		
Microcode RPQ Numbers	Supported?	Response
8K0809	Yes	First digit = 1
8K1162	Yes	First digit = 1
8K0931	Yes	Second digit = 1
8K1034	No	See 8K1230
8K1035	No	See 8K1255
8K1163	Yes	Second digit = 1
8K1164	No	For Typewriter keyboard see 8K1230
	Yes	For APL keyboard fourth digit = 1
8K1165	No	For Typewriter keyboard see 8K1255
	Yes	For APL keyboard fourth digit = 2
8K1166	No	See 8K1164
8K1230	Yes	Third digit = 1
8K1231	No	See 8K1255
8K1245	No	See 8K1255
8K1255	Yes	Third digit = 2

### 136: Standard Keyboard Layouts

**Planner:** Answer questions 136, 137, and 138 only if the 3174 cluster includes a display station that has a Converged or Enhanced keyboard that is operating in native mode. For additional information on modifying keyboards, see Chapter 15, "Planning to Modify Keyboards."

Most keyboards are modifiable in native mode; see your terminal user's guide for instructions on setting up your terminal.

Response: Four digits (0 or 1).

- 0 = No
- 1 = Yes.

The default response is 0000.

Digit	Description
1	Converged Typewriter keyboard
2	Converged APL keyboard
3	Converged Data Entry keyboard
4	Enhanced Typewriter keyboard

By using the Modify Keyboards procedure, you can create as many as four modified versions of these layouts. However, the total number of keyboard layouts (standard and modified) that you select to use for any cluster cannot exceed 4 (a combination of responses to questions 136 and 137).

Your response to this question specifies the standard keyboard layouts that you want configured in the system. Enter a 1 in the response field for each standard keyboard layout that you want configured in the system. If you specify all four standard keyboard layouts here (response = 1111), you cannot select any modified keyboard layouts in question 137.

For illustrations of the standard layouts, refer to the *3174 Character Set Reference*.

### 137: Modified Keyboard Layouts

*Response:* Four digits (0 or 1).

- 0 = No
- 1 = Yes.

The default response is 0000.

**See the “Planner” note under question 136.**

Digit	Description
1	Keyboard ID: A
2	Keyboard ID: B
3	Keyboard ID: C
4	Keyboard ID: D

Your response to question 137 specifies the modified keyboard layouts that you want configured in the system. Each layout consists of a keyboard/keypad combination that you can identify with the letter A, B, C, or D. You define the modified layout that the keyboard ID represents by performing the Modify Keyboards procedure in the *3174 Utilities Guide*. See Chapter 15, “Planning to Modify Keyboards,” for directions for defining a modified layout.

Enter a 1 in the response field for the IDs that you either plan to define or have already defined. This configures the layout assigned that ID in the system.

**Note:** The total number of keyboard layouts selected in questions 136 and 137 cannot exceed 4.

### 138: Standard Keypad Layouts

*Planner:* This question applies only to standard, Converged, or Enhanced keyboards in native mode (see your terminal user’s guide). If the keyboard is being operated in emulation mode, this question does not apply for these display stations.

*Response:*

- 0 = National Language Numeric Keypad
- 1 = Data Entry Keypad
- 2 = Program Function Keypad.

The default response is 0.

**See the “Planner” note on page 6-27.**

These responses specify the type of keypad to be used with the standard keyboard layouts you selected in question 136. If you selected one to four types of keyboard layouts in question 136, you can select one keypad here to be used with all of them.

For visual identification of these keypads, see “Numeric Keypads” in the *3174 Character Set Reference*.

## 139: Concurrent Communication Keyboard Language

**Planner:** This question applies only to host attachments through Concurrent Communication Adapters.

**Response:**

- 00 = Same language used for the 1A host
- 01 = English (U.S.)
- 02 = English (U.S.) ASCII-7.

The default response is 00.

Your response specifies the keyboard language that is to be used for all host attachments through a Concurrent Communication Adapter.

**Notes:**

1. You must respond to question 139 with 00 if you did not respond to question 121 with 01 or 02 while planning for the primary link attachment.
2. You must respond to question 139 with 01 if the communication protocol of your secondary link attachment is X.21 and you responded to question 121 with 02 while planning for the primary link attachment.
3. You cannot respond to question 139 with 02 if the communication protocol of your secondary link attachment is X.21 and you responded to question 121 with 01 while planning for the primary link attachment.
4. You cannot send compressed Program Symbols data (question 165 = 1) if you respond to question 139 with 02.
5. If you provide a nonzero response to question 139, DFT devices cannot communicate with the 3270 host attached through the Concurrent Communication Adapter.
6. If you modify a keyboard for the language used on the primary host attachment on this link, when that workstation operates in a logical terminal session on the CCA, it will **not** have the modified keyboard; it will have the standard (unmodified) one *if a different language was selected when responding to this question.*

## 141: Magnetic Character Set

**Response:**

- A = None
- B = Numeric
- C = Alphanumeric (auto entry for secure data only)
- D = Alphanumeric (auto entry for all data).

The default response is A.

Your response specifies the type of magnetic character set (if any) that has been installed.

**Note:** Your response must be A if your response to question 121 was 35 (Cyrillic), 38 (ROECE), 40 (Yugoslavic), or 46 (Thai).

## 150: Token-Ring Network Gateway

*Response:*

- 0 = This controller does not act as a gateway to this host.
- 1 = This controller does act as a gateway to this host.

The default response is 0.

Your response specifies whether or not the controller you are planning for will act as a gateway to the host you are attaching to.

**Note:** You cannot respond to this question with a 1 if your response to question 105 is 00.

If you respond with 1, fill out "Worksheet 32—Token-Ring Gateway," "Worksheet 33—Ring Address Assignment," and "Worksheet 34—Ring Transmission Definition."

## 165: Compressed Program Symbols

*Response:*

- 0 = Do not send compressed Programmed Symbols data.
- 1 = Send compressed Programmed Symbols data.

The recommended setting for 3174 remote models is 1.

The recommended setting for 3174 local models is 0.

**Note:** If you are planning a secondary host attachment through a Concurrent Communication Adapter, you cannot respond to question 165 with 1 if you responded to question 139 with 02.

Compressing data on a locally attached 3174 could degrade performance. For distributed function terminals, you do not need to specify a 1. For more information on compressed Programmed Symbols data, see the *3174 Functional Description*, GA23-0218.

## 166: Attribute Select Keypad

*Response:*

- A = Attribute Select Keypad not in use
- B = Attribute Select Keypad in use **without** numeric lock
- C = Attribute Select Keypad in use **with** numeric lock.

The default response is A.

For visual identification of the Attribute Select Keypad, see the *3174 Character Set Reference*.

**Note:** Your response must be A if your response to question 121 was 35 (Cyrillic), 38 (ROECE Latin), 40 (Yugoslavic), or 46 (Thai).

## 168: Additional Extension-Mode Key Definition (Personal Computers)

**Planner:** Answer this question only if the 3174 has personal computers (PCs) attached that use 3270 CUT mode emulation programs **and** either:

- The MLT function will be used, or
- The ASCII emulation function will be used.

**Response:**

- 0 = No additional extension-mode key is defined
- 1 = Home key is the additional extension-mode key
- 2 = Print ID key is the additional extension-mode key.

The default response is 0.

Many 3270 terminal emulation programs that run on PCs do not completely emulate all the keystrokes available on a 3278 or 3279 CUT display station; for example, many key sequences that require an ALT Shift are ignored by the emulation program and are not sent to the 3174. Therefore, an additional extension mode (similar to an ALT Shift) is required so that PCs with 3270 emulation programs can use the 3174 MLT change-screen and ASCII-emulation functions.

The response to this question defines an additional key used to enter keyboard extension mode. For possible alternatives to defining this additional extension-mode key, see the *3174 Terminal User's Reference for Expanded Functions*, GA23-0332.

A response of 1 or 2 to this question changes the function of either the Home key or the Print ID key on 3278 and 3279 keyboards as well as on keyboards that emulate the 3278 or 3279 keyboards. For that reason, do not specify a nonzero response unless the additional function is required to support a PC 3270 emulation program providing CUT mode operation. If the Home key is selected as the additional extension-mode key, access to the Home function is changed; the Home key must be pressed twice to return the cursor to Home. The Print ID key is affected in the same way if it is selected as the additional extension-mode key.

The Home key is the recommended extension-mode key; Home is normally an unshifted key on PC keyboards and provides easier operator access.

**Note:** This question affects all Base keyboards (for example, 3278 or 3279 keyboards) and all keyboards emulating 3278 type keyboards. It does not affect IBM Converged or Enhanced keyboards unless those keyboards are used in 3278 or 3279 emulation mode.

## 173: Distributed Function Terminal (DFT) Options

**Response:** Eight digits (0 or 1).

- 0 = No
- 1 = Yes.

The default response is 00000000. Digits are numbered from left to right. The DFT devices include:

- IBM 3179 G Color Graphic Display Station
- IBM 3192 G Color Graphics Display Station
- IBM 3193 Display Station

## Planning to Configure

- IBM 3194 Display Terminal
- IBM 3290 Information Panel
- IBM 3270 Personal Computer
- IBM InfoWindow Graphics-5 3472 Display Station.

If you do not have one of these devices, use the default.

Digit	Description
1	Enable Local Copy Format Controls
2	Automatic Form Feed before Local Copy
3	Automatic Form Feed after Local Copy
4	Reserved
5	Reserved
6	Field Intensity Option
7	Field Intensity Option
8	Update Panel before Allowing Buffer Change

**Digit 1 - Enable Local Copy Format Controls:** DFT devices generate an SNA-character-string data stream to perform a local copy operation to a printer. If the printer does not have Save/Restore Format capability and is operated in shared mode (in shared mode, local copy operation is permitted between brackets of a host communication), there is a possibility that the local copy operation will destroy the format controls established by the host program. Appropriate specification of this digit establishes format controls. If a printer supports Save/Restore Format, this option has no effect: the DFT device will send format controls.

If this digit is set to 0 (default), the DFT device will not send format controls to a printer that lacks Save/Restore Format capability. Set this digit to 0 for those operating environments where the host program does not reestablish format controls with each Begin Bracket. This is true for SNA only. Note that the format of the local copy output depends on the format controls established by the operator and/or host program.

When this digit is set to 1, the DFT device will send format controls to the printer even though the printer lacks Save/Restore capability. This enables the local copy output to duplicate, as closely as possible, the character image being copied from the DFT device. Set this digit to 1 for those operating environments where the printer is not operated in shared mode and/or the host program reestablishes format controls with each Begin Bracket.

**Digit 2 - Automatic Form Feed before Local Copy:**

- Specify this digit as 0 if you do *not* want the printer to generate an automatic form feed before a local copy operation is performed via the DFT data stream.
- Specify this digit as 1 if you want the printer to generate an automatic form feed before a local copy is performed via the DFT data stream.

**Digit 3 - Automatic Form Feed after Local Copy:**

- Specify this digit as 1 if you want to generate an automatic form feed after a local copy operation is performed via the DFT data stream.
- Specify this digit as 0 if you do *not* want to generate an automatic form feed after a local copy operation is performed via the DFT data stream.

**Digits 4 and 5 - Reserved:** The fourth and fifth digits are reserved and defaulted to 0.

**Digits 6 and 7 - Field Intensity Options - 3290:** Use the sixth and seventh digits to specify the field intensity option.

- Specify these digits as either 00 or 11 if you want the 3290 to underscore all fields carrying the field intensity attribute.
- Specify these digits as 01 if you do *not* want the 3290 to underscore or display in reverse video the fields carrying the field intensity attribute.
- Specify these digits as 10 if you want the 3290 to display in reverse video the fields carrying the field intensity attribute.

**Digit 8 - Update Panel before Allowing Buffer Change - 3290:** Specify this digit as 0 if you want the 3290 to suspend panel updating to process a host transmission. If this digit is set to 0, under high-data-rate conditions the host messages placed in the display buffer may be overlaid with new data before they are displayed on the panel.

When this digit is set to 1, the contents of the display buffer must be displayed on the panel before new data can be placed in the display buffer. Set this digit to 1 when the 3290s are being used as system consoles or for other applications where potentially high message rates are possible and the user must visually interpret all data sent by the host.

## 175: Distributed Function Terminal (DFT) Password

*Response:* A six-digit numeric password.

Define a six-digit password. This password is used in 3290 setup level 3 every time permanent changes are made to the 3290 logical terminal definition table. The default is 000000. For more information, see the *3290 Information Panel Description and Reference*, GA23-0021, or the *3290-2 Information Panel Description and Reference*, GA23-0241.

## 176: BSC Enhanced Communication Option: Distributed Function Terminals

*Response:*

- 0 = No
- 1 = Yes.

The default response is 0.

To specify a 1, you must have distributed function terminals attached to the 3174.

In addition:

- Your system programmer should confirm that your host system is capable of handling enhanced 3270 BSC protocols in response to outbound transmissions of BSC WACK (wait before transmit acknowledgment).
- You use one of the following IBM licensed programs, which support BSC WACK:
  - ACF/NCP Version 1, Release 2 or higher (CICS/VS and IMS/VS using VTAM or TCAM and ACF/NCP are supported)
  - ACF/VTAM with Communication Adapter Support (4331, 4361, and 9370)
  - CICS/VS Version 1, Release 6 and higher using BTAM
  - VM/370 SP, Release 3 and higher.



## Planning to Configure

If you use IMS/VS with BTAM, TCAM, or ACF/TCAM with the Communication Controller's Emulation Program (EP), you must specify 0.

Consult with your system programmer for this information. Be sure that the licensed programs you use are at compatible release levels and support the required display functions.

### 179: Local Format Storage

*Response:* Three digits.

The default response is 0 0 0.

#### **Digit 1 - Enable Local Format Storage (LFS) feature:**

- 0 = No LFS feature.
- 1 = Formats can be loaded to an LFS storage buffer, which is reserved for this host.
- 2 = This response is valid only for hosts other than 1A. If this digit is specified, that host can present formats. The 1A host manages the formats.
- 3 = This response is valid only for hosts other than 1A. If this digit is specified, that host can present formats *and* load them into its own storage buffer or just present formats that are managed by host 1A.

**Note:** If the response for this digit is a 2 or 3 for hosts other than 1A, the LFS feature must be enabled on the 1A host.

#### **Digit 2 - Mode of Operation for Operator-selected Formats:**

- 0 = Operator-selected formats is disabled for this host.
- 1 = Operator-selected formats is enabled for this host.

This response must be 0 if the LFS feature is not selected (digit 1 = 0).

#### **Digit 3 - Amount of storage to be allocated for Format Storage on each Host Connection:**

- 0 = No storage allocated
- 1 = 64K
- 2 = 128K
- 3 = 256K
- 4 = 512K
- 5 = 1024K\*
- 6 = 1536K.

The response for this digit must be 0 if digit 1 is 0 or 2.

The response for this digit must **not** be 0 if digit 1 is 1 or 3.

\*If this option is specified on a controller with 3MB of storage installed, the actual local format storage available is 984KB.

### 213: Between Bracket Printer Sharing

*Response:*

- 0 = No Between Bracket Printer Sharing
- 1 = Between Bracket Printer Sharing allowed.

The default response is 1.

Select 0 if you are not using local copy or if all printers on the Printer Authorization Matrix are defined in "local mode" (you do not want the host to use the local copy

printers for direct print operations). Select 1 if some printers on the Printer Authorization Matrix are defined in “shared mode” (some printers are shared for both local copy and host printing).

For more information on local copy, see Chapter 13, “Planning to Define Devices.”

## 215: Physical Unit Identification

*Response:* Five alphanumeric characters.

The default response is 00000.

The physical unit identification (PUID) is a 5-character hexadecimal code; the only valid characters are A–F and 0–9. Each PUID in a network should be unique.

You can obtain the PUID from the system programmer. The PUID identifies the controller to the host in response to an XID command. The PUID is required for switched connections.

## 220: Alert Function

*Response:*

- 0 = No alert function
- 1 = Alert function without operator-generated alert message capability
- 2 = Alert function with operator-generated alert message capability from port 0 of HG 26 or HG 27 only
- 3 = Alert function with operator-generated alert message capability from all ports.<sup>1</sup>

The default response is 0.

If you are planning to specify Ring Error Monitor (905 = 1), you should select 1, 2, or 3 for this question.

Alert is an SNA-only function that requires the NetView program, Version 1.1 or higher, at the host. If Alert has been specified, the 3174 will attempt to send, to the host, alert data for all errors that have not affected the integrity of the host adapter, the 3174 processor, control storage, or the control program itself. The 3174 sends alert data, based on the controller status codes it generates, in a session between a system services control point (SSCP) and a physical unit (PU). The alert information flows through the Network Communication Control Facility (NCCF) to the NetView program. The NetView program determines which alert data is significant and maintains a data base of alert information based on the filters in effect for devices throughout the network. The NetView program data base is used for problem determination and failure isolation.

An operator-generated alert message is a skeleton message called up by an operator, who fills it in with installation-specific information. For an operator-generated alert message to be processed correctly, the NetView program at the host must be set up to receive the message. See the *3174 Functional Description* for details on sending an operator-generated alert message.

---

<sup>1</sup> Distributed function terminals cannot issue an operator-generated alert message.

### 221: 3174 Alert Control Point

**Planner:** *This question applies only to hosts on the primary link through Single Link Multi-Host support.*

**Response:**

0 = This host is not the alert control point for the 3174.

1 = This host is the alert control point for the 3174.

The default response is 0.

Your response determines whether or not the host you are planning for will be the alert control point. A host designated as the alert control point receives hardware, microcode, and LU-LU alerts. A host not designated as such only receives alerts pertaining to LU-LU sessions.

**Notes:**

1. Only one host can be designated as the alert control point.
2. The primary host becomes the alert control point when question 220 = nonzero for the primary host and question 220 = nonzero and question 221 = 0 for all secondary hosts on the link.
3. If question 220 = nonzero for any secondary host attachment and 220 = 0 for the primary host, then an alert control point must be designated (question 221).
4. If question 221 = 1, then your response to question 220 must be nonzero.
5. If there is not enough controller storage to support a secondary host that has been designated as the alert control point, then the secondary host is deconfigured. The primary host becomes the alert control point by default.

### 222: Support of Command Retry

**Planner:** *Configuration questions 222, 223, 224, and 225 pertain only to 3174 Models 1L, 11L, and 21L. If you are planning for a remote 3174 model, continue with question 310.*

*Table 6-7 on page 6-37 lists the customizing parameters and host systems for which the 3174 Models 1L, 11L, and 21L are supported. The information in this table applies to SNA and non-SNA attachments. Refer to Table 6-7 when answering questions 222, 224, and 225.*

**Response:**

0 = No support of command retry

1 = Support of command retry.

The default response is 0.

Select the command retry option only if the 3174 is connected to a channel equipped with the command retry feature. The system programmer can supply this information. With this function, when certain error conditions are detected, the 3174 can request the channel to retry a command.

The following information explains the contents of Table 6-7.

**Command Retry:**

If command retry is enabled, the 3174 initiates a retry request for all Bus Out parity checks detected during write data transfer sequences.

**Data Transfer Modes:**

The channel adapter in the 3174 can transfer data in these different modes:

- Data Chained Interlocked (DCI) – Interlocked single tag
- High-Speed Transfer (HST) – Interlocked double tag
- Data Streaming – 1.25Mbps or 2.5Mbps.

**Channel Burst Size:**

The 3174 transfers data in an interlocked mode at a rate of 1.25 megabytes, or 0.8 microsecond per byte. The channel burst size default value is 32. The consequences of specifying larger burst sizes can be determined only by calculating the critical wait times of other controllers and devices attached to the same byte multiplexer channel. Exceeding the wait times of the other devices may cause them to overrun and/or otherwise degrade their performance. Consult with your account systems engineer if you are not able to determine what burst size should be set.

The burst size selected for operation on a block multiplexer channel does not affect the data transfer rate, because a block channel forces burst mode.

Table 6-7. Host-Channel Attachment Information

Host System and Channel Type	Command Retry (Question 222)	Mode of Data Transfer (Question 224)	Channel Burst Size (Question 225)
4331 Byte Multiplexer	No	High-Speed Transfer	32
4331 Block Multiplexer	Yes	High-Speed Transfer	NA
4341 Byte Multiplexer	Yes	High-Speed Transfer	32
4341 Block Multiplexer	Yes	High-Speed Transfer	NA
4361 Byte Multiplexer	Yes	High-Speed Transfer	32
4361 Block Multiplexer	Yes	High-Speed Transfer	NA
4381 Byte Multiplexer	Yes	High-Speed Transfer	32
4381 Block Multiplexer	Yes	High-Speed Transfer	NA
303x Byte Multiplexer	No	Normal Transfer	32
303x Block Multiplexer	Yes	High-Speed Transfer	NA
308x Byte Multiplexer	No	High-Speed Transfer	32
308x Block Multiplexer	Yes	High-Speed Transfer	NA
3090 Byte Multiplexer	No	High-Speed Transfer	32
3090 Block Multiplexer	Yes	High-Speed Transfer	NA

**223: Attention Delay Value**

*Response:* A two-digit number that represents the delay value in whole milliseconds. The response range is 10–99.

The default response is 10.

**See the “Planner” note on page 6-36.**

## Planning to Configure

The attention delay function increases the probability of including more than one path information unit (PIU) per read channel program and reduces the number of unsolicited attentions presented to the channel. This function queues inbound data during the specified delay period and then presents one attention at the end of the delay period. The system programmer can supply this information.

**Note:** Attention delay is not implemented for the Token-Ring Network 3270 Gateway function. Any response entered for this question has no effect when the gateway feature is used.

### 224: Mode of Data Transfer

*Response:*

- 0 = Interlocked mode; normal data transfer
- 1 = Data streaming mode; 1.25Mbps
- 2 = Interlocked mode; high-speed data transfer
- 3 = Data streaming mode; 2.5Mbps.

The default response is 2.

**See the "Planner" note on page 6-36.**

Select option 2 if the 3174 connects to a channel equipped with the high-speed transfer feature. The system programmer can supply this information.

### 225: Channel Burst Size

**Planner:** *This question is applicable for byte multiplexer channel operation only:*

*Response:*

- |                         |                          |
|-------------------------|--------------------------|
| 0 = 002 bytes per burst | 4 = 032 bytes per burst  |
| 1 = 004 bytes per burst | 5 = 064 bytes per burst  |
| 2 = 008 bytes per burst | 6 = 256 bytes per burst  |
| 3 = 016 bytes per burst | 7 = 512 bytes per burst. |

The default response is 4.

**See the "Planner" note on page 6-36.**

For byte multiplexer channel attachment, a response of 7 provides optimal 3174 performance. A lower value may be required, however, for overall byte multiplexer channel operation when other controllers share the same channel. See a system programmer familiar with system tuning for assistance in selecting an appropriate value for the system configuration.

**Planner:** *If you are filling out*

- *Worksheet 3, 3S, 4, 4S, 5, 5S, 7, 7S, 8, 8S, 9, or 9S, continue responding to the following configuration questions that appear on your worksheet.*
- *"Worksheet 6—Non-SNA (Channel)," return to the divider page labeled "Microcode Customization Planning." See step 4 to determine the next worksheet to fill out.*

*You may also refer to the divider page labeled "Worksheet Summary" to determine where to proceed next.*

*Keep records of your configuration using one of the methods described under "Customization Records" on page 5-6.*

## 240: Controller Logical Address

**Planner:** *This question applies to Models 12L and 22L only.*

**Response:** A single alphanumeric character in the range of 0-9 and A-F.

The default response is 0 on the 1A host; on other hosts, the default response is X. If you are customizing for a controller other than a Model 12L or 22L, take the default response to this question.

This address identifies the logical controller to its upstream host.

**Note:** This value needs to correspond to the CUADD parameter of the CNTLUNIT macro of the IOCP.

**Planner:** *If you are filling out*

- *Worksheet 7S, you have completed this worksheet. Return to the divider page labeled "Microcode Customization Planning." See step 5 to determine if there are additional worksheets to be filled out.*
- *Worksheet 3, 3S, 4, 4S, 5, 5S, 7, 8, 8S, 9, or 9S, continue responding to the following configuration questions that appear on your worksheet.*

## 241: RU Maximum Size

**Planner:** *This question applies to Models 12L and 22L only.*

**Response:**

- 0 = 4KB RU maximum
- 1 = 8KB RU maximum.

The default response is 0.

This question defines the maximum amount of data that can be received in a single RU across the ESCON Channel. If you are customizing a controller other than a Model 12L or 22L, take the default response to this question.

**Planner:** *If you are filling out "Worksheet 7—SNA (Channel)" on page A-12, you have completed this worksheet. Return to the step that instructed you to fill out this worksheet and determine where to proceed next.*

## 310: Connect-Data-Set-to-Line (CDSTL) Operation

**Response:**

- 0 = Operation on a nonswitched line, **or**  
Operation on a switched line in the US or Canada, **or**  
Operation in data terminal ready/data set ready (DTR/DSR) mode in countries other than Canada, **or**  
Connection via the CCITT V.35 interface, **or**  
Connection using X.21 or X.25
- 1 = Connection on a switched line via the CCITT 108.1 interface operating in the connect-data-set-to-line (CDSTL) mode.

The default response is 0.

### 313: NRZ or NRZI Encoding

*Response:*

- 0 = Use nonreturn to zero (NRZ) encoding
- 1 = Use nonreturn to zero inverted (NRZI) encoding.

The default response is 0.

This parameter must be compatible with the host system communication controller and/or the modem. Specify NRZI encoding only for SDLC host communication. Ask the system programmer which response you should specify.

### 317: Telecommunication Facilities

*Response:*

- 0 = Nonswitched facilities
- 1 = Half-duplex SNBU operation (IBM Modems 3872, 3875, or equivalent<sup>2</sup> only)
- 2 = Switched networks.

The default response is 0.

**Notes:**

1. Respond to question 317 with the default if your connection to the host does not require a modem.
2. You cannot respond with 1 for a host attachment through a Concurrent Communication Adapter.
3. A response of 1 is not valid for Models 11R, 12R, 21R, 61R, 62R, 90R, 91R, and 92R.
4. A response of 2 is not valid for BSC host attachment.

To respond to this question, you need to know:

- Whether the modem in your installation is operating in *duplex* or *half-duplex* in its primary facility, **and**
- Whether the modem is operating in *duplex* or *half-duplex* in its secondary facility, **and**
- The type of communication line that is being used (nonswitched or switched).

Use Table 6-8 on page 6-41 to determine your response.

---

<sup>2</sup> Half-duplex SNBU operation provided by modems other than IBM 3872, 3875 or equivalent is supported. In this case, respond to questions 317 and 340 with 0 on a separate Customized Control disk. IML this backup control disk when the primary operation fails.

Table 6-8. Response Selection for Question 317

Primary Modem Operation	Secondary Modem Operation	Communication Line Type	Response	Further Requirements
Duplex	Duplex	Nonswitched	0	None
Half-duplex	Half-duplex	Nonswitched	0	None
Duplex	Half-duplex	Nonswitched	0	Backup Control Disk*
Duplex or Half-duplex	Duplex or Half-duplex	Switched	2	None

\*On the backup Control disk, respond to question 340 with a 0.  
 For IBM 3872, 3875, or equivalent modems, respond to question 317 with a 1.  
 Otherwise, responses to all other customization questions should be the same on both Control disks.

**0 = Nonswitched facilities:** Select this response for operation via modem or direct-connection attachment to certain hosts or communication controllers such as a 3710, 3720, 3721, 3725, 3726, 4361, or 8100 where a modem is not required.

**1 = Half-duplex SNBU operation:** Select this response for the backup Control disk configuration when the 3872, 3875, or equivalent modem supports half-duplex RTS protocol on the secondary facility and supports full-duplex RTS protocol on the primary facility. For modems other than 3872, 3875, or equivalent, select 0 as your response.

**2 = Switched networks:** Select this response for operation in point-to-point mode on the public switched telephone network (PSTN). (A response of 2 is not valid for links using BSC or the gateway function or for Model 90R controllers.)

### 318: Full- or Half-Speed Transmission

*Response:*

- 0 = Full-Speed Transmission
- 1 = Half-Speed Transmission.

The default response is 0.

Enter a 0 if full-speed transmission operation is desired. Enter a 1 if half-speed transmission operation is desired.

If the speed capability can be controlled by the local or host modem, it is recommended that a 0 be entered and that the modem control the speed. (This parameter must be compatible with the host system communication controller and/or the modem.)

If the 3174 controls the capability to operate in either full-speed or half-speed mode, two Control disks can be generated, one for full-speed operation and one for half-speed operation. (See the Copy procedure in the *3174 Utilities Guide*, GA27-3863.) To switch speeds, IML the other Control disk.

**Note:** To determine if the operating speed can be controlled by the modem, refer to the documentation for your modem.



### 332: X.25 Options

This host-related panel appears during the Configure procedure if your response to question 101 was 3 or if you have multi-host support. The responses entered on this panel customize the microcode for primary hosts (1A, 2A, and 3A) for X.25 support. Chapter 10, "Planning for X.25," contains the planning information needed to fill out "Worksheet 13—X.25 Options" on page A-24.

This panel will appear considerably different for secondary hosts than for primary hosts. For these hosts (1B-1H, 2B-2D, and 3B-3D), the panel contains a subset of X.25 questions and goes with "Worksheet 13S—Secondary X.25 Options" on page A-25. Chapter 10, "Planning for X.25," contains the necessary information.

### 340: RTS Control Response Options

*Response:*

- 0 = Controlled Request-to-Send (RTS)
- 1 = Permanent Request-to-Send
- 2 = BSC special controlled Request-to-Send.

The default response is 0.

To respond to this question, you need to know:

- Whether the modem in your installation is operating in *duplex* or *half-duplex* in its primary facility, **and**
- Whether the modem is operating in *duplex* or *half-duplex* in its secondary facility, **and**
- The type of communication line that is being used (nonswitched or switched)
- Whether your network is SDLC or BSC.

Use Table 6-9 to select your response.

Table 6-9. Response Selection for Question 340

Primary Modem Operation	Secondary Modem Operation	Protocol	Response	Further Requirements
Duplex	Duplex	SDLC or BSC	1	None
Half-duplex	Half-duplex	SDLC or BSC	0	None
Half-duplex	Half-duplex	BSC	2 <sup>1</sup>	None
Duplex	Half-duplex	SDLC or BSC	1	Backup Control Disk <sup>2</sup>

<sup>1</sup>If the host modems use the NEW SYNC feature, selecting 2 may cause transmission errors.

If you are in doubt about whether your host modems use the NEW SYNC feature, enter a 0.

<sup>2</sup>On the backup Control disk, respond to question 340 with a 0; for IBM 3872, 3875, or equivalent modems, respond to question 317 with a 1. Otherwise, responses to all other customization questions should be the same on both Control disks.

**Planner:** If you are filling out

- *Worksheet 4, 4S, 5, 5S, 8, 8S, 9, or 9S, continue responding to the following configuration questions that appear on your worksheet.*
- *“Worksheet 3—BSC,” return to the divider page labeled “Microcode Customization Planning.” See step 4 to determine the next worksheet to fill out.*
- *“Worksheet 3S—Secondary BSC,” return to the divider page labeled “Microcode Customization Planning.” See step 5 to determine if you need to fill out worksheets for additional host attachments before continuing with the next step.*

*You may also refer to the divider page labeled “Worksheet Summary” to determine where to proceed next.*

*Keep records of your configuration using one of the methods described under “Customization Records” on page 5-6.*

### 360: X.21 Switched Retry

*Response:*

- 00 = X.21 Switched feature not in use, or Retry not in use
- 01 – 99 = Number of times to retry an incoming or outgoing call after the initial attempt is unsuccessful.

The default response is 00. You must use a two-digit response. Where necessary, use a leading zero (for example, 04 for 4 retries).

### 361: X.21 Switched Retry Timing

*Response:*

- 00 = X.21 Switched feature not in use, or Retry not in use
- 01 – 20 = Two-digit number that specifies the number of seconds between the retries specified in question 360.

The default response is 00. You must use a two-digit response. Where necessary, use a leading zero (03 for 3 seconds).

### 362: X.21 Switched Options

*Response:* Eight digits (0 or 1). 0 = No 1 = Yes

The response to this question determines how X.21 keyboard options can be used from terminals attached to the 3174. You should use the default response of 00000000 if you are not using the X.21 Switched feature. The digits, numbered from left to right, represent a different X.21 function:

Digit	Description
1	Direct Key
2	Dial Key
3	Local and Communicate Keys
4	Disconnect Key
5	Reserved
6	Delayed Disconnect function
7	DCE Supported for Direct Calls
8	DCE Supported for Addressed Calls

**Digit 1 - Direct Key:** Used to initiate a direct call through the X.21 switched network.

0 = The Direct Key can be used only from a terminal on port 0 of HG 26 or HG 27, and only if digit 7 = 1.

1 = The Direct Key can be used from any port, but only if digit 7 = 1.

**Digit 2 - Dial Key:** Used to initiate an addressed call through the X.21 switched network.

0 = The Dial Key can be used only from a terminal on port 0 of HG 26 or HG 27, and only if digit 8 = 1.

1 = The Dial Key can be used from any port, but only if digit 8 = 1.

**Digit 3 - Local and Communicate Keys:** Used to manage the 3174's interface to the DCE of the X.21 network. The Local Key takes the 3174 off-line from the network, and prevents any incoming or outgoing call. The Communicate Key puts the controller back on-line.

0 = The Local and Communicate Keys can be used only from a terminal on port 0 of HG 26 or HG 27.

1 = The Local and Communicate Keys can be used from any port.

**Digit 4 - Disconnect Key:** Used to terminate a call.

0 = The Disconnect Key can be used only from a terminal on port 0 of HG 26 or HG 27.

1 = The Disconnect Key can be used from any port.

**Digit 5 - Reserved**

**Digit 6 - Delayed Disconnect function**

0 = When the Disconnect Key is pressed, the 3174 breaks the connection immediately.

1 = If there are any active (bound) SNA sessions, the Disconnect Key must be pressed twice before the 3174 breaks the connection.

**Digit 7 - DCE Supported for Direct Calls**

0 = The X.21 Switched connection cannot be made using direct calling. This means that the Direct Key cannot be used from any port.

1 = The X.21 Switched connection can be made using direct calling. The Direct Key may be used from port 0 of HG 26 or HG 27, and from any other port if digit 1 = 1.

**Digit 8 - DCE Supported for Addressed Calls**

0 = The X.21 Switched connection cannot be made using addressed calling. This means that the Dial Key cannot be used from any port.

1 = The X.21 Switched connection can be made using addressed calling. The Dial Key may be used from port 0 of HG 26 or HG 27, and from any other port if digit 2 = 1.

To use the X.21 Switched feature, you must specify either or both of the seventh and eighth digits as 1. Your choice depends on the functions that your X.21 network provides.

Example 1: Selecting 00000111 allows an operator at port 0 of HG 26 or HG 27 to use all the X.21 keys, and requires that operator to press the Disconnect Key twice to break the connection when SNA sessions are active. No X.21 keys can be used on ports other than 0.

Example 2: Selecting 01110001 prevents direct calling from any port, but allows all ports to use all other X.21 keys. Delayed disconnect (digit 6) is not selected; when an operator presses the Disconnect Key, the 3174 breaks the connection immediately, regardless of the state of SNA sessions.

### 365: X.21 Data Transfer Delay

**Planner:** When filling out "Worksheet 4—SDLC" or "Worksheet 5—X.25," respond to this question **only** if your response to question 100 is 2R, 12R, 62R, or 92R.

When filling out "Worksheet 4S—Secondary SDLC" or "Worksheet 5S—Secondary X.25," respond to this question **only** if the adapter type specified for this host (on worksheet 2) is the Type 2 Concurrent Communication Adapter.

**Response:**

- 0 = Not applicable
- 1 = No delay
- 2 = Data Transfer Delay (X.21 nonswitched only).

The default response is 0.

**Select 1 for:**

- X.21 switched operation, or
- X.21 leased operation if the DTE connection at the host end of the network is through an X.21 interface (for example, not through X.21 bis).

**Select 2 when:**

- The DTE connection at the host end of the network is through X.21 bis, or
- The 3174 connection to the network is through an "X.21 multipoint" DCE.

Response 2 provides a delay of 24-bit times in the transition from the X.21 Data state to the X.21 Data Transfer state. This delay prevents loss of data in the attachments described above.

**Planner:** If you are filling out

- *Worksheet 4, 4S, 8, 8S, 9, or 9S, continue responding to the following configuration questions that appear on your worksheet.*
- *"Worksheet 5—X.25," fill out "Worksheet 13—X.25 Options" and "Worksheet 14—Common SNA." The information you need to fill out these worksheets is in Chapter 10 and Chapter 11.*
- *"Worksheet 5S—Secondary X.25," fill out "Worksheet 13S—Secondary X.25 Options." The information you need to fill out this worksheet is in Chapter 10.*

## Planning to Configure

You may also refer to the divider page labeled "Worksheet Summary" to determine where to proceed next.

Keep records of your configuration using one of the methods described under "Customization Records" on page 5-6.

### 367: X.21 Switched Short-Hold Mode

*Response:*

- 0 = No
- 1 = Yes.

Short-Hold Mode is an automatic facility that disconnects the X.21 switched link between a primary station and a secondary station whenever there is a break in the data traffic. It reconnects the link as soon as there is more data to send.

### 368: X.21 Switched Short-Hold Mode Dial Number

*Response:* Up to 14 numeric characters.

Enter the dial number of the 3174. This field must be completed if the response to question 367 is equal to 1. If the response to this question does not fill the entire field, leave underscores or blanks wherever you have not written a character.

### 370: Maximum Inbound I-Frame Size

*Response:*

- 0 = 265-byte Maximum I-Frame
- 1 = 521-byte Maximum I-Frame.

The default response is 0.

When large amounts of data are being transmitted, network performance and speed can be improved by responding to this question with a 1.

The I-Frame size includes the length of the transmission header (TH) and request or response header (RH). For example, if the maximum length of a request unit (RU) segment is 512, then the I-frame size is 521 (512 + 9 for the TH and RH).

**Note:** Maximum Inbound I-Frame Size refers to the maximum size of the I-Frame that the 3174 controller sends to the host.

### 371: X.21 Switched Dial Digits

*Response:* A maximum of thirty-one numeric digits (0-9).

These digits are the number by which the host is called if the Autocall function is enabled for *dial* autocall. If Autocall is enabled as *direct* (372 is 2 x), no response to this question is required. If, however, question 372 is *dial* (372 is 1 x), you must respond to this question.

The default response is underscores.

**372: Autocall/Autodisconnect**

*Response:* Two digits

The default response is 0 0.

**Digit 1 - Enable Autocall function:**

- 0 = No autocall
- 1 = Enable DIAL autocall
- 2 = Enable DIRECT autocall (X.21 switched only).

If this digit is 1 or 2 and the 3174 is not already connected to the host, the 3174 will attempt to make the switched connection to the host whenever a new logical terminal becomes active. This may be when a device powers on or when a logical terminal is first reached in the change screen sequence.

**Digit 2 - Enable Autodisconnect function:**

- 0 = No autodisconnect
- 1 = Enable autodisconnect.

If this digit is 1, the 3174 will break the switched connection to the host when the last logical terminal becomes inactive or powers off.

The Autocall and Autodisconnect functions are independent of one another: you can enable or disable one without the other.

**Planner:** *If you are filling out:*

- *“Worksheet 9—Token-Ring Network” or “Worksheet 9S—Secondary Token-Ring Network,” continue responding to the following configuration questions.*
- *“Worksheet 4—SDLC” or “Worksheet 8—X.21 Switched,” fill out “Worksheet 14—Common SNA.” The information you need to fill out this worksheet is in Chapter 11.*
- *“Worksheet 4S—Secondary SDLC” or “Worksheet 8S—Secondary X.21 Switched,” return to the divider page labeled “Microcode Customization Planning.” See step 5 to determine if you need to fill out worksheets for additional host attachments before continuing with the next step.*

*You may also refer to the divider page labeled “Worksheet Summary” to determine where to proceed next.*

*Keep records of your configuration using one of the methods described under “Customization Records” on page 5-6.*

**382: Maximum Ring I-Frame Size**

*Response:* Four numeric characters.

The default response is 0521.

- For controllers with a 4Mbps Token-Ring Adapter installed, a valid response ranges from 265 to 2042 bytes.
- For controllers with a 16/4Mbps Token-Ring Adapter installed, a valid response ranges from 265 to 2057 bytes.

Where necessary, use a leading zero (0521 for 521 bytes).

### Notes:

1. The response to this question depends on your gateway and ring configuration.
2. In responding to this question, you need to consider the route by which data will flow. If at link activation time there does not exist a route to the gateway that supports the specified I-frame size, then the I-frame size is downgraded to the maximum supported on the available route. When a downgrade takes place, a unique status code appears on the operator panel and an error is written in the 3174 event log.
3. The I-frame size should include the length of the transmission header (TH) and response header (RH). For example, if the maximum length of an RU segment is 1024, the I-frame size specified should be 1033 (1024 + 9 for the TH and RH).
4. Maximum Ring I-Frame Size refers to the maximum size of the I-Frame that the 3174 controller sends over the ring.

### 383: Token-Ring Network Maximum Out

*Response:* One numeric character.

A valid response ranges from 1 to a maximum of 7.

The default response is 2. This field specifies the maximum number of link level I-frames that the 3174 transmits before waiting for an acknowledgment and may also be referred to as the "transmit window size."

**Note:** The response to this question is dependent upon your gateway and ring configuration.

### 384: Ring Speed of the Token-Ring Network

*Response:*

- 0 = 4Mbps with normal token release
- 1 = 16Mbps with normal token release
- 2 = 16Mbps with early token release.

The default response is 0.

- For controllers with a 4Mbps Token-Ring Adapter installed, 0 is the only valid response.
- For controllers with a 16/4Mbps Token-Ring Adapter installed, 0, 1, or 2 is a valid response. A response of 2 is recommended for large networks.

**Planner:** *This is the end of the regular configuration questions. If you filled out:*

- "Worksheet 9—Token-Ring Network," fill out "Worksheet 14—Common SNA." The information you need to fill out this worksheet is in Chapter 11.
- "Worksheet 9S—Secondary Token-Ring Network," return to the divider page labeled "Microcode Customization Planning." See step 5 to determine if you need to fill out worksheets for additional host attachments before continuing with the next step.

*You may also refer to the divider page labeled "Worksheet Summary" to determine where to proceed next.*

*Keep records of your configuration using one of the methods described under "Customization Records" on page 5-6.*

---

## Chapter 7. Planning for Port Assignment

An Overview of Port Assignment .....	7-3
Which Response to Question 116 Should You Specify? .....	7-4
Port Assignment Considerations .....	7-4
For DFT .....	7-4
For CUT (or CUT Emulation by ASCII Displays) and Printers .....	7-4
For Multi-Host Support .....	7-5
Who Assigns the Terminals to the Ports? .....	7-6
The Port Assignment Worksheet .....	7-7
Completing the Port Assignment Worksheet When 116=1 .....	7-10
Completing the Port Assignment Worksheet When 116=2 .....	7-11
Changing Port Assignments .....	7-13





---

## An Overview of Port Assignment

Before you start planning, you need:

- “Worksheet 11A—117: Port Assignment” on page A-21
- “Worksheet 11B—117: Port Assignment for AEA” on page A-22
- Information about the terminals to be attached to the controller
- Information from the site planner about terminal port assignments
- Information on the number of additional host attachments (if any) that have been configured. Each host attachment requires a separate port assignment.

Depending on your response to question 116, you can either assign ports on an individual basis or let the customizing program assign them for you. If you assign ports on an individual basis, you save host addresses because only those ports that you will use are defined. When planning Port Assignment, you define 3270 host sessions for all types of devices: 3270 display stations and printers, as well as ASCII display stations and printers.

If you let the customizing program assign addresses for you, it assigns addresses for each 3270 port of the controller, even if display stations or printers are not connected to all the ports. The same is true for AEA ports. **When the system is operating in non-SNA, unused addresses take up channel address space.**

If you are not planning to use Multi-Host Support, Port Assignment identifies the number of sessions that each device can have with a host. Up to five sessions with a host can be defined on ports that are used to attach control unit terminals (CUTs) using the Multiple Logical Terminals (MLT) function or distributed function terminals (DFTs) with multiple interactive screen (MIS) capability.

**Planner:** *If you are planning to allow communication with ASCII devices through the Asynchronous Emulation Adapter (AEA), you should plan the AEA configuration before you plan for Port Assignment. For additional information, see Chapter 12, “Planning for the Asynchronous Emulation Adapter.”*

---

## Which Response to Question 116 Should You Specify?

There are many possible responses to question 116. If you need help choosing a response, see "Port Assignment Considerations."

Question 116 enables you to direct the system to make all port assignments, whether for 3270 ports, AEA ports, or both. Or, it lets you make all or part of the assignments yourself.

The response to question 116 can be 1, 2, or 4 digits long. Depending on the response you select, you can assign 3270 ports only or 3270 ports and AEA ports.

"116: Individual Port Assignment" on page 6-18 explains the possible responses in detail. It also gives information about the impact on question 116 of responses to several other customization questions (see the list of notes in question 116).

---

## Port Assignment Considerations

### For DFT

The **multiple interactive sessions capability (MIS)** allows DFT display stations to act as multiple logical terminals. Each logical terminal has its own host address and can interact independently with its own host program. When assigning addresses or allowing the customizing program to assign addresses to ports supporting DFTs, you should check the DFT supporting documentation regarding the number and type of sessions supported for that DFT; for example, a DFT may support only three host sessions and one printer session.

### For CUT (or CUT Emulation by ASCII Displays) and Printers

The **Multiple Logical Terminals (MLT) function** allows CUT displays and ASCII displays emulating CUT displays to act as multiple logical terminals. Each logical terminal has its own host address and can interact independently with its own host program. For CUTs using the MLT function, consult "Worksheets 10A and 10B—Multiple Logical Terminals" to ensure that you do not exceed the amount of storage reserved to support these displays. The "Number of Sessions" column on this worksheet contains the number of planned host sessions for each CUT display. For ASCII devices using MLT, consult "Worksheet 10C—Multiple Logical Terminals for AEA" for this information.

#### 3270 Display Stations and Printers

In order for a 3270 display or printer to communicate with the 3270 host, a 3270 host address must be assigned to the Terminal Adapter (TA) port to which the display or printer is attached.

If a CUT display is using the MLT function, it is able to connect to the 3270 host only on the logical terminals for which a 3270 host address has been assigned.

For a printer attached to a 3270 display station to communicate with a 3270 host, two 3270 host addresses must be assigned to the 3270 port for host 1A. If a second address is not defined, only the 3270 display station can communicate with the 3270 host.

### ASCII Display Stations and Printers

For an ASCII display or printer to communicate with the 3270 host, the display or printer must have a 3270 host address assigned to the AEA port to which it is attached. If you do not assign a 3270 host address, the display user will not be permitted to connect to the 3270 host.

For a printer attached to an ASCII display station to communicate with a 3270 host, two 3270 host addresses must be assigned to the AEA port. If a second address is not defined, only the ASCII display station can communicate with the 3270 host.

### Examples of 3270 Host Addressing Restrictions for the AEA

- If you specify the 3270 host as the first session and the Connection Menu for the next two sessions on "Worksheet 21—AEA Default Destination," a display user is not able to connect to the 3270 host for the two Connection Menu sessions unless you assign 3270 host addresses for those sessions. When 116=1, enter 3 in the IS column; when 116=2, assign host addresses 1, 2, and 3 (see Figure 7-1 on page 7-7).
- If you specify the 3270 host as the first session, the Connection Menu as the second session, and the 3270 host as the third session, you **must** assign a 3270 host address to all three sessions. When 116=1, enter 3 in the IS column; when 116=2, assign host addresses 1, 2, and 3 (see Figure 7-1 on page 7-7). Skipping addresses on a port is not permitted.

## For Multi-Host Support

If you are using Multi-Host Support, a separate port assignment is required for each attachment to a host. All of the addresses that you assign for each port (over all hosts) become a pool of potential host sessions for a device on the port. The host sessions that are presented to a device are defined using Logical Terminal Assignment (described in Chapter 13). Logical Terminal Assignment allows you to choose up to five host sessions (from the pool of potential sessions) for the display attached to the port.

When planning LTA, remember:

- ASCII devices can communicate only with the primary host on the primary link.
- Even with Multi-Host Support, a printer can be assigned only one host session.

---

## **Who Assigns the Terminals to the Ports?**

In some establishments, the person who plans for customizing assigns the terminals to the ports and then communicates the assignments to the site planner. In others, the site planner assigns the terminals to the ports and communicates that information to the person who plans customizing (because that person will be customizing for port assignment or defining the Printer Authorization Matrix).

If you are responsible for assigning terminals to ports, you can record the port assignment data for the site planner on the Cabling Worksheets. These worksheets are included in *3174 Site Planning*. These worksheets are designed to keep records of the port connections and to communicate that information between the site planner and the person who plans customizing.

## The Port Assignment Worksheet

If you respond to question 116 with a 1 or 2, you must fill out “Worksheet 11—117: Port Assignment”. This worksheet has two pages; make sure you get both (11A and 11B). See Figure 7-1 for an example of Worksheet 11A. On the worksheets, you assign the number of host addresses per port connection. The person who customizes uses the completed worksheet to identify these assignments in the microcode.

If you have configured for Multi-Host Support, you can assign addresses to ports 21-00 through 23-07 (ASCII ports), on Worksheet 11B, when filling out the worksheet for host 1A. Assign addresses to ports 27-00 through 27-31 on Worksheet 11A, when filling out the worksheet for hosts 1A through 1H. Addresses can be assigned to ports 26-00 through 26-31 on Worksheet 11A for all hosts.

117: Port Assignment													
Host Addresses						Host Addresses							
Port	IS	1	2	3	4	5	Port	IS	1	2	3	4	5
26-00	___	___	___	___	___	___	26-01	___	___	___	___	___	___
26-02	___	___	___	___	___	___	26-03	___	___	___	___	___	___
26-04	___	___	___	___	___	___	26-05	___	___	___	___	___	___
26-06	___	___	___	___	___	___	26-07	___	___	___	___	___	___
26-08	___	___	___	___	___	___	26-09	___	___	___	___	___	___
26-10	___	___	___	___	___	___	26-11	___	___	___	___	___	___
26-12	___	___	___	___	___	___	26-13	___	___	___	___	___	___
26-14	___	___	___	___	___	___	26-15	___	___	___	___	___	___
26-16	___	___	___	___	___	___	26-17	___	___	___	___	___	___
26-18	___	___	___	___	___	___	26-19	___	___	___	___	___	___
26-20	___	___	___	___	___	___	26-21	___	___	___	___	___	___
26-22	___	___	___	___	___	___	26-23	___	___	___	___	___	___
26-24	___	___	___	___	___	___	26-25	___	___	___	___	___	___
26-26	___	___	___	___	___	___	26-27	___	___	___	___	___	___
26-28	___	___	___	___	___	___	26-29	___	___	___	___	___	___
26-30	___	___	___	___	___	___	26-31	___	___	___	___	___	___
27-00	___	___	___	___	___	___	27-01	___	___	___	___	___	___
27-02	___	___	___	___	___	___	27-03	___	___	___	___	___	___
27-04	___	___	___	___	___	___	27-05	___	___	___	___	___	___
27-06	___	___	___	___	___	___	27-07	___	___	___	___	___	___
27-08	___	___	___	___	___	___	27-09	___	___	___	___	___	___
27-10	___	___	___	___	___	___	27-11	___	___	___	___	___	___
27-12	___	___	___	___	___	___	27-13	___	___	___	___	___	___
27-14	___	___	___	___	___	___	27-15	___	___	___	___	___	___
27-16	___	___	___	___	___	___	27-17	___	___	___	___	___	___
27-18	___	___	___	___	___	___	27-19	___	___	___	___	___	___
27-20	___	___	___	___	___	___	27-21	___	___	___	___	___	___
27-22	___	___	___	___	___	___	27-23	___	___	___	___	___	___
27-24	___	___	___	___	___	___	27-25	___	___	___	___	___	___
27-26	___	___	___	___	___	___	27-27	___	___	___	___	___	___
27-28	___	___	___	___	___	___	27-29	___	___	___	___	___	___
27-30	___	___	___	___	___	___	27-31	___	___	___	___	___	___

Figure 7-1. An Example of Worksheet 11A – 117: Port Assignment

## Planning for Port Assignment

There are two procedures for filling out this worksheet. If you:

- Specified that 116=1, use the procedure on page 7-10.
- Specified that 116=2, use the procedure on page 7-11.

The columns on this worksheet are described below.

<b>Port</b>	<p>This column lists the port numbers, beginning with port 26-00. The prefix "26" indicates direct or indirect connection to the Terminal Adapter (TA), identified by Hardware Group 26. The prefix "27" indicates direct or indirect connection to the Terminal Adapter, identified by Hardware Group 27.</p> <ul style="list-style-type: none"><li>• For Models 51R, 61R, 62R, and 63R, you can assign addresses only to ports 26-00 through 26-15 on Worksheet 11A, and to ports 21-00 through 21-07 on Worksheet 11B.</li><li>• For Model 53R, you can assign addresses only to ports 26-00 through 26-15 on Worksheet 11A.</li><li>• For Models 90R, 91R and 92R, you can assign addresses only to ports 26-00 through 26-07 on Worksheet 11A.</li><li>• For Models 11L, 11R, 12L, 13R, 21L, 21R, 22L, and 23R, you can assign addresses to ports 26-00 through 27-31 (if you have a second Terminal Adapter) on Worksheet 11A and to ports 21-00 through 23-07 on Worksheet 11B.</li></ul>
<b>IS</b>	<p>This column defines the number of 3270 host addresses to be assigned to each port. For a display using the MLT function, this number must correspond to the number of logical terminals requiring connections to the 3270 host. The default for port 26-00 and port 27-00 is a 1; The default can be changed to a number between 1 and 5 for all 26-xx or 27-xx ports.</p>
<b>Host Addresses</b>	<p>These columns define the primary and secondary addresses of a host. The addresses are used to route information to and from the display stations and printers assigned to the ports. The first column (1) represents the host's primary address. The remaining columns (2–5) represent the host's secondary addresses for displays using the MLT function or the address of a host addressable printer (printer attached to a display). (Use column 2 for host addressable printers on worksheets for host 1A.) The combined total of primary and secondary host addresses should equal the number of 3270 host sessions.</p> <p>The following indicates how the host addresses will be assigned.</p> <p><i>The scheme for response 0 is as follows:</i></p> <ul style="list-style-type: none"><li>• Assign one address to each of the first (HG 26) 32 Terminal Adapter ports, by increasing port number.</li><li>• Assign one address to each of the second (HG 27) 32 Terminal Adapter ports, by increasing port number.</li></ul> <p><i>The scheme for response SX is as follows:</i></p> <ul style="list-style-type: none"><li>• Assign one address to each of the first (HG 26) 32 Terminal Adapter ports, by increasing port number.</li></ul>

## Planning for Port Assignment

- Assign remaining addresses to each of the first 32 Terminal Adapter ports, by increasing port number.
- Assign one address to each of the second (HG 27) 32 Terminal Adapter ports, by increasing port number.
- Assign remaining addresses to each of the second 32 Terminal Adapter ports, by increasing port number.

*The 1/SX AY scheme is expanded as follows:*

- Assign one address to each of the first (HG 26) 32 Terminal Adapter ports by increasing port number.
- Assign one address to each of the 24 AEA ports, by increasing port number.
- Assign remaining addresses to each of the first 32 Terminal Adapter ports by increasing port number.
- Assign remaining addresses to each of the 24 AEA ports, by increasing port number.
- Assign one address to each of the second (HG 27) 32 Terminal Adapter ports, by increasing port number.
- Assign remaining addresses to each of the second 32 Terminal Adapter ports, by increasing port number.

*The primary and secondary addresses (1–5) correspond to the “LT1–LT5” response columns on “Worksheet 21—AEA Default Destination.”*



### Completing the Port Assignment Worksheet When 116 = 1

If your response to question 116 is 1, you select the ports you will use and define the number of host addresses per port. The 3174 customizing program automatically assigns the primary and secondary addresses of the host.

**Note:** If you have not read the previous information in this chapter, you need to do so before you begin to fill out the worksheet.

**Step 1** Locate and make a copy of "Worksheet 11—117: Port Assignment". This worksheet has two pages; make sure you get both (11A and 11B). If you have configured for Multi-Host Support, you need to identify which host these port assignments are for by writing the host identifier in the Host ID field on the top of the worksheet. If you are filling out these worksheets for a secondary host attachment, you can assign addresses to ports 27-00 through 27-31 on worksheet 11A for hosts 1A through 1H, but you can only assign addresses to ports 21-00 through 23-07 for host 1A on worksheet 11B.

Addresses can be assigned to ports 26-00 through 26-31 for all hosts.

**Step 2** In the IS column, write the number of host addresses you want assigned (0 to 5) next to each port. Write a number next to each port. If you do not want to use a port for a 3270 host session, be sure to write a 0.

**Note:** This number must represent the total number of 3270 host sessions desired to support the CUT, DFT, or ASCII device.

In the following example, DFTs or CUTs (with MLT support) are assigned to all Terminal Adapter ports (HG 26), and ports 27-00 through 27-04 on the Terminal Adapter (HG 27). Ports with an entry of zero in the IS column will not be used for 3270 host sessions.

117: Port Assignment													
Host Addresses						Host Addresses							
Port	IS	1	2	3	4	5	Port	IS	1	2	3	4	5
26-00	2	—	—	—	—	—	26-01	3	—	—	—	—	—
26-02	4	—	—	—	—	—	26-03	3	—	—	—	—	—
26-04	3	—	—	—	—	—	26-05	2	—	—	—	—	—
26-06	3	—	—	—	—	—	26-07	2	—	—	—	—	—
26-08	3	—	—	—	—	—	26-09	3	—	—	—	—	—
⋮						⋮							
27-00	2	—	—	—	—	—	27-01	2	—	—	—	—	—
27-02	4	—	—	—	—	—	27-03	5	—	—	—	—	—
27-04	3	—	—	—	—	—	27-05	0	—	—	—	—	—
27-06	0	—	—	—	—	—	27-07	0	—	—	—	—	—

**Step 3** Do not exceed the port assignment limitations for your protocol:

- For SNA protocol (SNA Local, SDLC, X.25, X.21 Switched, Token-Ring Network), up to 253 addresses in the range from 2 to 254 are permitted.
- For non-SNA protocol (non-SNA Local or BSC), the addresses range from 0 to 31.

**Note:** If you define a Printer Authorization Matrix, check that the printers (with the exception of local copy printers) are assigned addresses on Worksheets 11A and 11B.

**Planner:** You have completed “Worksheet 11A—117: Port Assignment” and “Worksheet 11B—117: Port Assignment for AEA.”

*Return to the divider page labeled “Microcode Customization Planning.” Refer to the step that instructed you to fill out Worksheets 11A and 11B to determine if there are additional worksheets you need to fill out before continuing with the next step. You may also refer to the divider page labeled “Worksheet Summary” to determine where to proceed next.*

*Keep records of your configuration by using one of the methods described under “Customization Records” on page 5-6.*

*If you need to communicate these port assignments to the site planner, use the Cabling Worksheets in 3174 Site Planning, which explain how to enter the port assignments on the worksheet.*

### Completing the Port Assignment Worksheet When 116 = 2

If your response to question 116 is 2, you assign (in decimal values) the host addresses (primary and secondary) that you want to use for each port. Then, the customizing program automatically generates the IS field.

**Note:** If you have not read the previous information in this chapter, you need to do so before you begin to fill out the worksheet.

**Step 1** Locate and make a copy of “Worksheet 11—117: Port Assignment”. This worksheet has two pages; make sure you get both (11A and 11B). If you have configured for Multi-Host Support, you need to identify which host these port assignments are for by writing the host identifier in the Host ID field on the top of the worksheet. If you are filling out these worksheets for a secondary host attachment, you can assign addresses to ports 27-00 through 27-31 on worksheet 11A for hosts 1A through 1H, but you can only assign addresses to ports 21-00 through 23-07 for host 1A on worksheet 11B.

Addresses can be assigned to ports 26-00 through 26-31 for all hosts.

**Step 2** Under the host address column headings, write the addresses in decimal values. When you assign host addresses to a port, assign them to consecutive columns: 1, 2, 3, 4, and 5. You can skip addresses between ports, or skip ports, but you **cannot** skip over host address columns. For example, you cannot assign addresses to columns 1, 3, and 4, but not to column 2. The addresses themselves do not need to be sequential, but be careful not to repeat any addresses. For example, 7, 9, 5, 15 is an acceptable sequence, but 7,

## Planning for Port Assignment

9, 5, 9 is not. If there is no address to specify, leave the field empty on the worksheet.

In the following example, DFTs or CUTs (with MLT support) are assigned to Terminal Adapter ports 26-00 through 26-09 on HG 26, and to Terminal Adapter ports 27-00 through 27-04 on HG 27. No terminal is assigned to ports 27-05, 27-06, or 27-07.

117: Port Assignment													
Host Addresses						Host Addresses							
Port	IS	1	2	3	4	5	Port	IS	1	2	3	4	5
26-00		2	3				26-01		20	21			
26-02		5	7	8	9		26-03		22	23			
26-04		10	11				26-05		24	25			
26-06		12	13	14	15	16	26-07		26	27	28		
26-08		18	33				26-09		29	30	31	32	
27-00		36	37				27-01		38				
27-02		41					27-03		50	52			
27-04		53					27-05						
27-06							27-07						

**Step 3** Do not exceed the port assignment limitations for your protocol:

- For SNA protocol (SNA Local, SDLC, X.25, X.21 Switched, and Token-Ring Network), up to 253 addresses in the range from 2 to 254 are permitted.
- For non-SNA protocol (non-SNA Local or BSC), the addresses range from 0 to 31.

**Note:** If you define a Printer Authorization Matrix, check that the printers (with the exception of local copy printers) are assigned addresses on Worksheets 11A and 11B.

**Planner:** You have completed "Worksheet 11A—117: Port Assignment" and "Worksheet 11B—117: Port Assignment for AEA."

Return to the divider page labeled "Microcode Customization Planning." Refer to the step that instructed you to fill out Worksheets 11A and 11B to determine if there are additional worksheets you need to fill out before continuing with the next step. You may also refer to the divider page labeled "Worksheet Summary" to determine where to proceed next.

Keep records of your configuration by using one of the methods described under "Customization Records" on page 5-6.

If you need to communicate these port assignments to the site planner, use the Cabling Worksheets in 3174 Site Planning, which explain how to enter the port assignments on the worksheet.

## Changing Port Assignments

If you change your response to question 116, refer to the following table, which explains how to fill out Worksheet 11 (both pages 11A and 11B).

Change in 116		
Was	Now	Change to Worksheet
0	1	Fill in the IS column.
0	2	Fill in the host address columns (1–5) with decimal values.
1	0	None. The customizing program automatically assigns new addresses.
1	2	In the host address columns (1–5), you can add new addresses or you can delete or replace the previous assigned addresses (use decimal values).
2	0	None. The customizing program automatically assigns new addresses.
2	1	Fill in the IS columns with new values.
S1–S5	S1–S5	None. The customizing program automatically assigns new addresses. (Remember, a maximum of 253 addresses can be assigned. See "116: Individual Port Assignment" on page 6-18.)
S1 A1–S5 A5	S1 A1–S5 A5	None. The customizing program automatically assigns new addresses. (Remember, a maximum of 253 addresses can be assigned. See "116: Individual Port Assignment" on page 6-18.)



---

## Chapter 8. Planning for Country Extended Code Page

An Overview of Country Extended Code Page .....	8-3
Code Pages .....	8-4
Character Sets .....	8-4
Base Support .....	8-4
CECP Terminology .....	8-5
CECP and Devices .....	8-5
Printers and Displays .....	8-5
Keyboards .....	8-6
ASCII Devices .....	8-6
Entering/Exiting CECP Mode .....	8-8
Setup Mode .....	8-8
System Considerations .....	8-8
Host Filters .....	8-8
Host Use of Previously Undefined I/O code points .....	8-8
Data Integrity .....	8-9
Local Copy Considerations .....	8-9
Multi-Host Support Considerations .....	8-9



---

## An Overview of Country Extended Code Page

Country Extended Code Page (CECP) allows the terminal user to display and print an expanded set of characters. This expanded set of characters is an extension of the Base support provided for each CECP language (see Table 6-5 on page 6-22 for the supported languages).

For example, the French Base support, which contains 105 graphic characters, under CECP expands to 190 graphic characters plus a space. The Base support, a subset of CECP support, remains the same.

Without CECP, communication is restricted to the character set of a given language. For example, a keyboard customized for German is restricted to only the characters and punctuation necessary for German. CECP provides the flexibility to communicate in another language—French, for example.

With CECP, a German keyboard can be modified to contain the same characters as a French keyboard. The system provides two means of keyboard modification: the Keyboard Definition Utility (KDU) and the Extended Graphics function. KDU is a utility for creating unique keyboard layouts to meet the needs of specific applications. The Extended Graphics function provides support of additional characters on the keyboard that can be made active by pressing one key (ExGr). The additional characters must have been previously assigned.

CECP enables all languages to support one universal set of characters, Character Set 697. Characters from other languages can then be entered, displayed, printed and sent to the host.

You select CECP for your controller through the customization process. When you fill out the worksheets for customizing the microcode, you respond to question "123: Country Extended Code Page Support" (see page 6-21) to indicate support or nonsupport of CECP.

**Warning:** Installation of CECP may cause a loss of data integrity in data bases and applications. Therefore, it is important to read "System Considerations" on page 8-8 before customizing for CECP.

To understand CECP, it is helpful to learn of:

- Code pages
- Character sets
- Base support.



### Code Pages

A *code page* is an assignment of graphic characters and control function meanings to all code points in the page. To understand this, consider a 1-byte (8-bit) binary code. Such a code consists of 0's and 1's that can be arranged in up to 256 different patterns. Each pattern is a *code point*. Each code point is assigned a meaning, either as a character or as a control function. An arrangement of code points and their meanings together make up a *code page*. (Refer to the *3174 Character Set Reference*, GA27-3831, to view the supported code pages.)

In addition, the code page serves as the I/O interface between a host and a controller. It is divided into two parts: commands and graphic characters.

*Commands* are control instructions to devices that define how devices should format data for presentation. Commands are the same for each language. Commands take up 64 code point positions (from 00 to 3F) in a code page.

*Graphic characters* are the characters that are displayed or printed on a device. These graphic characters are assigned to positions 40 through FE in each country's code page. But, within these positions, the location of the characters can be different from one language to another. Also, within existing code pages, the supported characters can differ between languages. (For example, the French code page supports E-accent grave; the German does not. They both contain the character !, but that character is assigned a different position on each page.)

### Character Sets

A *character set* is the collection of graphic characters required to support a specific language. In addition to supporting a language's character set, the 3174 controller supports the "space." Base character sets may differ in size. For example, the French character set contains 105 characters and the German character set contains 94 characters.

For CECP, one universal character set has been defined. It contains the 190 graphic characters plus a space required to support all CECP languages. It is known as *Character Set 697*. In this book, references to Character Set 697 include the character set and the space.

### Base Support

Prior to CECP, each language defined a character set that consists of 94 to 161 graphic characters. The code points that have been defined to represent these graphic characters make up a *subset* of the code points available on the whole page. For each country, this subset is known as its *Base* support. The remaining code points, those not assigned a graphic character, are undefined and unsupported.

## CECP Terminology

CECP has its own terminology. Some of the more commonly used terms are explained below. These terms are also defined in the glossary at the back of this book.

<b>Base data set</b>	A data set that does not contain CECP-unique graphics.
<b>CECP-capable device</b>	A device that has the necessary features to support CECP, which are enabled.
<b>CECP Character Set</b>	A collection of symbols in Character Set 697 required for CECP languages.
<b>CECP data set</b>	A data set that contains at least one CECP-unique graphic.
<b>CECP-unique graphic</b>	A graphic that is in the CECP character set and not in the Base support.
<b>Synonym</b>	A code point that is supported only by a device that contains an extended attribute buffer (EAB). For devices without an EAB, synonyms are translated to hyphens.

## CECP and Devices

The following devices will support CECP when attached to a 3174 Establishment Controller customized for a CECP language:

- 3191 Control Unit Terminals, Models D, E, and L
- 3192 Control Unit Terminals, Models C, D, F, L, and W
- 3812-2 printer
- 4224 printers
- 4234 printers
- 6262 printers
- ASCII devices (displays and printers).
- 3471 Control Unit Terminals (Model B)
- 3472 Control Unit Terminals (all Models except Model G).

**Warning:** The use of CECP will result in a loss of the Mono Case function on 3192 Models C, D, and F.

## Printers and Displays

There are two versions of character set 697. CECP-capable printers support character set 697 Version 0, while CECP-capable displays support Version 1. The support provided by each version is the same, with the exception of 4 characters. The differences in the characters are shown in the table below.

Version 0	Version 1
Dotless "i" <i>l</i>	Superscript 1      ¹
Florin symbol <i>f</i>	Copyright symbol      ©
Numeric space	Divide symbol      ÷
Double underscore      =	Multiply symbol      ×

## Planning for CECP

### Unique Printer Considerations

CECP mode of operation does not support Intelligent Printer Data Stream (IPDS), since IPDS manages the character set within the data stream. CECP mode of operation also does not support a printer attached to a port on the Asynchronous Emulation Adapter (AEA).

### Keyboards

CECP extended characters are supported on the IBM Enhanced Keyboards and the IBM Converged Keyboards.

On these keyboards, any of the characters on a CECP code page may be defined by using the Keyboard Definition Utility (KDU). The characters can be assigned to the upper shift, lower shift, or alternate shift position of keys on the keyboards.

#### Notes:

1. When using KDU, you may need to refer to the code pages in the *3174 Character Set Reference*, GA27-3831.
2. A CECP-capable display with an IBM Converged Keyboard that is used in 3278 Emulation mode is not supported as a CECP-capable display.
3. CECP-unique graphics will be presented correctly only on a CECP-capable display.
4. For CECP countries, when the Acute, Grave, Circumflex, Diaeresis, Cedilla, and Degree/Overcircle accents are added to a Typewriter or APL keyboard, they become "nonescaping keys." A nonescaping key is a key that allows a character to be typed without the imprint position being changed. These keys are intended to be combined with other characters in a two-keystroke sequence to create accented characters. If the accent is to be used by itself, the two-keystroke sequence **must** be the accent and space.

### ASCII Devices

The Asynchronous Emulation Adapter supports CECP languages in both ASCII and 3270 Emulation. They are in addition to U.S.A. English. For a list of the languages, see Table 6-4 on page 6-21. For support of a language *not* provided by the AEA, the AEA allows construction of User-Defined Translate tables and User-Defined Terminal tables. Chapter 12, "Planning for the Asynchronous Emulation Adapter" explains these tables.

Different ASCII displays support different CECP languages (all are subsets of the set of CECP-supported languages).

**Note:** When in ASCII Emulation, the system always has CECP support, regardless of the response to question 123 (CECP support).

Language	ASCII Stations						
	IBM 3101	IBM 3151/61	FTTERM	DEC VT100**	DEC VT220**	DEC VT240**	Tektronix 4205**
Austrian/ German (03)	✓	✓	✓	✓	✓	✓	✓
Belgian (43)		✓	✓	✓	✓	✓	
Canadian bilingual (29)		✓	✓	✓	✓	✓	
Danish (07)		✓	✓	✓	✓	✓	✓
English (UK) (22)	✓	✓	✓	✓	✓	✓	✓
English (US) (01)	✓	✓	✓	✓	✓	✓	✓
Finnish (09)		✓	✓	✓	✓	✓	
French (30)	✓	✓	✓	✓	✓	✓	✓
Icelandic (37)		✓	✓	✓	✓	✓	
Italian (15)	✓	✓	✓	✓	✓	✓	
Netherlands (47)				✓	✓	✓	
Norwegian (23)		✓	✓	✓	✓	✓	✓
Portuguese (28)		✓	✓				
Spanish (19)	✓	✓	✓	✓	✓	✓	
Spanish- speaking (21)	✓	✓	✓	✓	✓	✓	
Swedish (24)		✓	✓	✓	✓	✓	✓
Swiss French (41)		✓	✓	✓	✓	✓	
Swiss German (42)		✓	✓	✓	✓	✓	

**Notes:**

1. CS1 and CS2 are supported for French, German, Canadian, Italian, Spanish, Spanish-speaking, English (UK and US) on the IBM 3151/61.
2. ISO 8859/1.2 is supported for all languages except Dutch on the IBM 3151/61.
3. FTTERM is supported through ISO 8859/1.2.
4. DEC VT220 keyboards D, E, and F are supported for Danish, Norwegian, and UK English.
5. ISO 8859/1.2 and CS1 and CS2 are supported on the 3101 as provided by 316X displays.

---

## Entering/Exiting CECF Mode

If a device is CECF-capable, the controller places the device in CECF mode whenever connected to an IBM host session. Printers remain in CECF mode unless data is being copied from a device that is not CECF-capable. These printers return to CECF mode after the copy operation is complete.

## Setup Mode

Display setup mode may allow the enabling of the CECF feature. For example, on a 3191 or 3192, valid model IDs for CECF support are 2+, 3+, 4+, or 5+. Models 3471 (Model B), and 3472 (all models except G) support CECF if the keyboard type is not 78EMU (3278 emulation).

---

## System Considerations

You may need to consider whether host programs accept CECF data before customizing for CECF. When CECF is supported, conventions may need to be adopted. IBM host applications, vendor applications, and in-house applications may be affected.

CECF generally doubles the number of valid I/O code points generated from a keyboard and sent inbound. It is your responsibility to ensure that host programs and data bases can accept CECF data. Be careful of the following:

- Host filters
- Host use of previously defined I/O code points
- Data integrity.

You may be required to keep track of which data sets will or will not be CECF.

## Host Filters

Filters in host programs could generate undesired results. The filters might reject or translate some CECF-unique graphic code points from their original values to incorrect values. This might cause data loss, a program check, or undetected, erroneous alteration of data.

## Host Use of Previously Undefined I/O code points

Since a user could not directly enter previously undefined character code points, a host program could be using those code points for other purposes without causing conflicts before CECF support. However, with CECF support, host usage of these previously undefined code points may now result in conflict with the CECF usage.

One example would be if a host application (such as a data base manager) used the previously undefined character code points as control codes (such as end of file markers).

Another example would be a host application that used the previously undefined character code points as values for a special font (such as APL).

## Data Integrity

When the host properly manages CECF data, the data can generally be sent to either CECF-capable devices or devices that are not CECF-capable. Devices that are not CECF-capable present the data in the best manner they can. Care must be exercised when critical data is sent to a display that does not contain an extended attribute buffer (EAB), for example, a 3191 Model A or B. These displays physically cannot store nine I/O code points which vary per language. These nine I/O code points are called *synonyms*.

**Warning:** If synonyms are sent to a device that does not contain an EAB, they are translated to hyphens. If this data is read back by the host, the original CECF data that corresponded with these I/O code points is lost.

When unexpected hyphens appear, there is one primary action you should take. At the device on which the unexpected hyphens appear, make sure that the work being done is *not* filed or saved. Thus the altered code points will not be transmitted back to the host to overwrite the correct data. The *3174 Character Set Reference*, GA27-3831, shows the synonyms for each CECF code page.

**Note:** You can avoid problems by ensuring that CECF data sets are accessed only by CECF devices.

---

## Local Copy Considerations

In a Local Copy operation, a display is the source of the operation and a printer is the target. If the source is CECF-capable and the target is not, CECF-unique characters do not print properly. For all other combinations of source and target, characters prints correctly.

Most local copy operations are limited to displays and printers that are both operating in either 3270 or 3270 emulation mode. But a 3270 display that is operating in ASCII emulation mode can perform a local copy to its target printer if the printer is operating in 3270 mode.

---

## Multi-Host Support Considerations

CECF support can be specified only for the primary host on the primary link. If you are using Single Link Multi-Host Support and CECF is selected for the primary host, then all hosts on that link must use CECF code pages. CECF code pages must also be used for Concurrent Communication Adapter (CCA)-attached hosts if the primary host on the primary link is using CECF *and* question 139=00 or 01 for the CCA host attachment. (For information on question "139: Concurrent Communication Keyboard Language," see page 6-29.) CECF is not supported for hosts on secondary links unless such support is provided on the primary link.



---

## Chapter 9. Planning for Response Time Monitor (RTM)

An Overview of Response Time Monitor .....	9-3
RTM Definition .....	9-3
First-Digit Response .....	9-4
Second-Digit Response .....	9-5
The RTM Worksheet .....	9-7
How Is Response Time Measured? .....	9-8
Sample Boundary Specifications .....	9-9
Valid Boundaries .....	9-9
Invalid Boundaries .....	9-9
Filling Out Worksheet 12—128: RTM .....	9-10
Changing the RTM Specifications .....	9-11





---

## An Overview of Response Time Monitor

Before you start planning, you need:

- “Worksheet 12—128: RTM” on page A-23
- Information from your system programmer to select your responses.

The Response Time Monitor (RTM) function is a tool for network management, used to measure and evaluate response times. The RTM function measures and records the response time from the recognition of the inbound Attention Identifier (AID) request in the 3174 until the end of the transaction. Depending on how the 3174 controller is customized, RTM information can be obtained either by a network management application in the host or by a controller display station operator, or both.

Response times can be measured for all display terminals that attach to the 3174, but DFT terminals require a special interface. For a detailed description of the RTM function and the distributed function terminal (DFT) interface, see the *3174 Functional Description*.

The display of response times at the 3174 cluster level does not require any host programming support. However, RTM has a host interface for SNA communication. Host programming support (Network Logical Display Manager, Release 2 or higher) is available for setting RTM parameters from a host and for collecting and displaying RTM information at a NetView or Network Communication Control Facility (NCCF) operator station.

For BSC and non-SNA channel communication, response times are displayed only at the 3174 cluster level.

**Note:** DFTs do not support RTM while in session with a secondary host that is attached through a Concurrent Communication Adapter.

---

## RTM Definition

RTM is defined in your two-digit response to question 127. The first digit asks whether you have host support for RTM and its nature. Even without host support, you can use RTM as a valuable network management tool.

Your second-digit response asks for the point at which you wish to measure response times. It's up to you to decide which point of measurement is most meaningful. If you specify a zero (“no RTM support”) for one digit of your response, the other digit must also be zero.

### First-Digit Response

The first digit of your response to question 127 determines whether RTM is configured with host support and where the RTM data is displayed.

0 = No RTM support (default).

1 = RTM without host support. On port 26-00 or port 27-00 only, the operator can:

- Display RTM log information in Test mode<sup>1</sup>
- Display the Last Transaction Time indicator
- Reset the RTM data via the /4,1 Test.

2 = RTM without host support. On all ports, the operator can:

- Display RTM log information in Test mode<sup>1</sup>
- Display the Last Transaction Time indicator
- Reset the RTM data via the /4,1 test.

3 = RTM with host support (Local [SNA], SDLC, X.25, Token-Ring Network). You cannot display RTM log information or the Last Transaction Time indicator on any port at the 3174 cluster level. The host may alter the authorization to display RTM log information at any time.

4 = RTM with host support (Local [SNA], SDLC, X.25, Token-Ring Network). On port 26-00 or port 27-00 only, the operator can:

- Display RTM log information in Test mode<sup>1</sup>
- Display the Last Transaction Time indicator.

The host may alter the authorization to display RTM log information at any time.

5 = RTM with host support (Local [SNA], SDLC, X.25, Token-Ring Network). On all ports, the operator can:

- Display RTM log information in Test mode<sup>1</sup>
- Display the Last Transaction Time indicator.

The host may alter the authorization to display RTM log information at any time.

---

<sup>1</sup> DFT terminals cannot display the RTM log.

## Second-Digit Response

The second digit of your response to question 127 determines what is measured.

- 0 = No RTM support (default).
- 1 = **First Character:** The measurement is terminated when the first command of the next outbound message is written to the terminal. This command can be:
  - Write, Erase/Write, or Erase/Write Alternate
  - Erase All Unprotected
  - Load Programmed Symbols
  - Erase Reset
  - Set Window Origin
  - Activate Partition
  - Create Partition
  - Destroy Partition
  - Reset Partition
  - BSC Copy.

**Note:** A Write with or without data terminates the RTM measurement. The foregoing are examples of outbound communication that could possibly be expected to modify the contents of the presentation space.

- 2 = **Keyboard Unlocked:** For SNA devices, measurement is terminated when the next outbound operation (other than a Read) to the terminal contains a Change Direction/End Bracket (CD/EB) or explicit or implicit keyboard restore (WCC = keyboard restore or EAU command):

In non-SNA:

- For terminals such as the 3278 or 3279 display stations, measurement is terminated:
  - On end of transmission (EOT) for BSC. Exception: Upon receipt of a BSC Copy command, the measurement is terminated on the *from* device, once the screen image has been stored in the controller. At this point, the *from* device is available for the operator to use. The *to* device in the BSC Copy still has the measurement terminated at EOT.
  - On end of command chain.
- For distributed function terminals, such as the 3290 Information Panel, the 3179 Color Graphics Display Station, and the IBM 3270 Personal Computer, measurement is terminated upon receipt of a Terminate Chained Command Sequence (TCCS).

- 3 = **CD/EB:** This definition is valid only in an SNA environment. The measurement is terminated upon receipt of a Change Direction (CD) or End Bracket (EB), which puts the terminal into a Send or Contention state, respectively. This is usually equivalent to a "time-to-last-character."

**Notes:**

1. EB or CD received in an exception response request or in a definite response causes the last in chain (LIC) segment to terminate the measurement.
  2. CD in conjunction with a Read does not stop the timer.
- 4 = **Last Character:** This definition measures from the pressing of an AID key to receipt of the last character of the last message prior to the pressing of the next AID key.

In non-SNA:

For terminals such as the 3278 or 3279 display stations, measurement is terminated:

- On end of transmission (EOT) for BSC. Exception: Upon receipt of a BSC Copy command, the measurement is terminated on the *from* device, once the screen image has been stored in the controller. At this point, the *from* device is available for the operator to use. The *to* device in the BSC Copy still has the measurement terminated at EOT.
- On end of command chain.

In SNA:

- Measurement is terminated on receipt of CD/EB (Change Direction or End Bracket).

**Note:** This new transaction-end definition applies only to attached CUT-mode terminals. RTM support is disabled for DFT devices if this new RTM type is selected by the host or during 3174 customization. DFT devices do not support this new transaction-end definition.

## The RTM Worksheet

If you specified a nonzero response to question 127, you must fill out "Worksheet 12—128: RTM" (Figure 9-1). There are two versions of the 128: RTM Definition panel on this worksheet.

The version (A or B) that you fill out depends on your first-digit response to question 127.

- Fill out Version A if your first-digit response is 1 or 2. It allows you to specify the time boundaries for the RTM counters.
- Fill out Version B if your first-digit response is 3, 4, or 5. It allows you to specify a flag for setting the host interface status and to specify the boundaries for the RTM counters.

The procedure on page 9-10 helps you fill out "Worksheet 12—128: RTM."

**Default Values**

---

**Version A**

---

**128: RTM Definition**

<b>B1</b>	<input type="checkbox"/> 00	<input type="checkbox"/> 01	<input type="checkbox"/> 0
<b>B2</b>	<input type="checkbox"/> 00	<input type="checkbox"/> 02	<input type="checkbox"/> 0
<b>B3</b>	<input type="checkbox"/> 00	<input type="checkbox"/> 05	<input type="checkbox"/> 0
<b>B4</b>	<input type="checkbox"/> 00	<input type="checkbox"/> 10	<input type="checkbox"/> 0

---

**Version B**

---

**128: RTM Definition**

<b>F1</b>	<input type="checkbox"/>	<input type="checkbox"/>	<input type="checkbox"/>	<input type="checkbox"/>	<input type="checkbox"/>	<input type="checkbox"/>	<input type="checkbox"/>	<input type="checkbox"/>	<input type="checkbox"/>
	0	0	0	0	0	0	0	0	0
<b>B1</b>	<input type="checkbox"/> 00	<input type="checkbox"/> 01	<input type="checkbox"/> 0						
<b>B2</b>	<input type="checkbox"/> 00	<input type="checkbox"/> 02	<input type="checkbox"/> 0						
<b>B3</b>	<input type="checkbox"/> 00	<input type="checkbox"/> 05	<input type="checkbox"/> 0						
<b>B4</b>	<input type="checkbox"/> 00	<input type="checkbox"/> 10	<input type="checkbox"/> 0						

---

Figure 9-1. An Example of Worksheet 12 – 128: RTM

The fields on this worksheet are described below.

**F1** The host interface status, an eight-digit field, is used only when host support is specified. (See the procedure on page 9-10 for a description of the digits.) This field cannot contain blanks; specify a 0 instead.

**B1 – B4** These fields specify the boundary — the maximum time associated with each RTM counter. Time is specified in minutes, seconds, and tenths of a second; for example, 11:35.3 is 11 minutes, 35 and 3/10 seconds. See “Sample Boundary Specifications” on page 9-9 for examples that illustrate both valid and invalid boundary specifications. This field cannot contain blanks; specify a 0 instead.

**Default responses** The defaults are printed under the boxes on the worksheet, and are automatically supplied by the microcode.

---

## How Is Response Time Measured?

When you customize for RTM support, a series of five counters (see Figure 9-2) is allocated for each display or logical terminal.

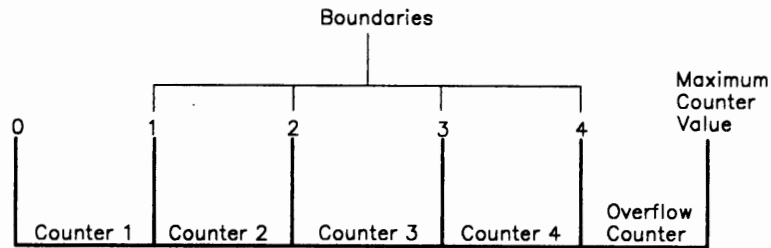

Figure 9-2. Counters and Boundaries

The counters represent the intervals of time into which response times can be categorized. You can set up as many as four counters and specify the maximum amount of time in the interval, or boundary, associated with each. If a response time is less than or equal to a particular boundary (for example, boundary 3), the counter associated with that boundary (counter 3) is incremented at the end of the transaction. If the response time does not fit within any of the boundaries, it is categorized in the fifth, or overflow, counter. If you specify any one of the first four boundaries as the maximum, the counter following that boundary becomes the overflow counter and the subsequent counters are ignored. The maximum *counter* value is 65535. The counter does not wrap around when this value is reached.

## Sample Boundary Specifications

The following examples illustrate both valid and invalid specification of boundaries (B1, B2, B3, and B4).

### Valid Boundaries

B1 - 00 : 02 . 1  
 B2 - 00 : 03 . 2  
 B3 - 00 : 05 . 5  
 B4 - 00 : 07 . 7

Each response time of 2.1 seconds or less increases the first counter.

Each response time exceeding 2.1 seconds but less than or equal to 3.2 seconds increases the second counter.

Each response time exceeding 3.2 seconds but less than or equal to 5.5 seconds increases the third counter.

Each response time exceeding 5.5 seconds but less than or equal to 7.7 seconds increases the fourth counter.

Each response time exceeding 7.7 seconds increases the fifth counter.

### Invalid Boundaries

#### Example 1: Boundary Values Not in Ascending Order

B1 - 00 : 02 . 0  
 B2 - 00 : 05 . 7  
B3 - 00 : 04 . 5  
 B4 - 00 : 06 . 8

#### Example 2: A Zero Entry for Field B1

B1 - 00 : 00 . 0  
 B2 - 00 : 00 . 1  
 B3 - 00 : 00 . 2  
 B4 - 00 : 00 . 3

#### Example 3: Nonzero Entry after the Maximum Boundary Value

B1 - 00 : 01 . 0  
 B2 - 27 : 18 . 3  
B3 - 10 : 15 . 4  
B4 - 20 : 10 . 5

#### Example 4: The Seconds Field Exceeds 59

B1 - 00 : 01 . 0  
 B2 - 00 : 10 . 0  
 B3 - 00 : 30 . 0  
B4 - 00 : 61 . 0



## Filling Out Worksheet 12—128: RTM

**Step 1** Locate “Worksheet 12—128: RTM” on page A-23. If you have configured for Multi-Host Support, you need to identify which host these RTM boundaries are for by writing the host identifier in the Host ID field on the top of the worksheet.

**Step 2** Enter your responses on the worksheet.

- If you want to use the defaults, circle “Default Values.” You have completed the worksheet. Go to the “Planner” note on page 9-11.
- If your first-digit response to question 127 was:
  - 1 or 2, circle “Version A.”
  - 3, 4, or 5, circle “Version B.”

**Step 3** Specify the boundaries (B1—B4) in Version A or B. The rules for specifying boundaries are:

- Specify the time in minutes, seconds, and tenths of a second; for example, 11:35.3 is 11 minutes, 35 and 3/10 seconds.
- Do not specify a zero entry (00 : 00.0) for field B1.
- Specify from one to four boundaries, in sequence of ascending value. Do not embed a zero entry between two nonzero entries.
- The maximum boundary you can specify is 27:18.3. Any entries after the maximum value **must** be zero.
- The maximum entry you can specify in the seconds field is 59 seconds.

Version A is complete once you have specified the boundaries.

**Step 4** For Version B, fill out the eight-digit status flag field. Respond with 0 or 1:

- 0 = No; turns off the function associated with the bit position.
- 1 = Yes; turns on the function associated with the bit position.

Digit	Description
1	RTM Enabled. If the default (0) is used, RTM will remain off unless turned on by host support.
2	3174 transmits unsolicited RTM data when an UNBIND is processed (LU-LU)
3	3174 transmits unsolicited RTM data if counter overflows
4	3174 sends alert if counter overflows
5	Reserved. Set to 0.
6	Reserved. Set to 0.
7	Reserved. Set to 0.
8	Reserved. Set to 0.

**Note:** If you specify host support in question 127 but let the defaults for the status flag field stand, RTM statistics are not kept for any device unless a host application enables the RTM function.

**Planner:** You have completed “Worksheet 12—128: RTM.”

Return to the divider page labeled “Microcode Customization Planning.” Refer to the step that instructed you to fill out Worksheet 12 to determine if there are additional worksheets you need to fill out before continuing with next step. You may also refer to the divider page labeled “Worksheet Summary” to determine where to proceed next.

Keep records of your configuration by using one of the methods described under “Customization Records” on page 5-6.

---

## Changing the RTM Specifications

If you change your first-digit response to question 127, refer to the following table, which explains how to fill out “Worksheet 12—128: RTM.”

Change in 127		
Was	Now	Change on Worksheet
1	2	Record the changed responses on Version A of the 128 panel.
2	1	Record the changed responses on Version A of the 128 panel.
3, 4, 5	1, 2	Fill out Version A of the 128 panel.
1, 2	3, 4, 5	Fill out Version B of the 128 panel.
3, 4, 5	3, 4, 5	Record the changed responses on Version B of the 128 panel.



## Chapter 10. Planning for X.25

Before You Begin	10-3
Overview	10-3
X.25 and Microcode Upgrade	10-4
The X.25 Options Worksheet	10-5
Filling In Worksheet 13—X.25 Options	10-5
Link Attachment Questions	10-6
400: Network Type	10-6
424: 3174 DTE Address	10-6
431: Packet Sequence Numbering	10-7
433: K-Maximum Out	10-7
434: Nonstandard Default Packet Size	10-7
435: Nonstandard Default Window Size	10-8
450: Link Level Transmit Timeout	10-8
451: Number of Retries	10-8
Logical Channel Numbering	10-8
461: Lowest Incoming Channel	10-9
462: Highest Incoming Channel	10-9
463: Lowest Two-Way Channel	10-9
464: Highest Two-Way Channel	10-9
465: Lowest Outgoing Channel	10-10
466: Highest Outgoing Channel	10-10
Host Attachment Questions	10-11
401: Circuit Type	10-11
402: Logical Channel Identifier	10-11
409: X.25 Keyboard Support Options	10-11
The Connection Identifier (CID)	10-12
420: Incoming Call Options	10-13
421: Outgoing Call Options	10-14
423: Host DTE Address (HNAD)	10-15
430: Negotiated Packet Size (NPKT) or PVC Packet Size	10-16
432: Negotiated Window Size (NWND) or PVC Window Size	10-16
440: Throughput Class Negotiation (TCLS)	10-16
441: Closed User Group (CUG)	10-17
442: Recognized Private Operating Agency (RPOA)	10-17
452: Connection Identifier (CID)	10-17
453: Connection Options	10-18
Changing the X.25 Options	10-19



## Before You Begin

Before you start planning, you need:

- “Worksheet 13—X.25 Options” on page A-24
- The X.25 network subscription.

*This chapter is presented differently from other customizing chapters. For X.25, the questions are grouped logically instead of numerically. There are two groups: questions relating to virtual circuit definition (host) and questions relating to subscription definition (links). The table below lists the questions in numeric order. Page references help you find each question easily.*

<b>X.25 Questions-Numerical Listing</b>	
<b>Question:</b>	<b>Page:</b>
<b>400:</b> Network Type	Page 10-6
<b>401:</b> Circuit Type	Page 10-11
<b>402:</b> Logical Channel	Page 10-11
<b>409:</b> X.25 Keyboard Support Options	Page 10-11
<b>420:</b> Incoming Call Options	Page 10-13
<b>421:</b> Outgoing Call Options	Page 10-14
<b>423:</b> Host DTE Address	Page 10-15
<b>424:</b> 3174 DTE Address	Page 10-6
<b>430:</b> Negotiated Packet Size	Page 10-16
<b>431:</b> Packet Sequence Numbering	Page 10-7
<b>432:</b> Negotiated Window Size	Page 10-16
<b>433:</b> K-Maximum Out	Page 10-7
<b>434:</b> Nonstandard Default Packet Size	Page 10-7
<b>435:</b> Nonstandard Default Window Size	Page 10-8
<b>440:</b> Throughput Class	Page 10-16
<b>441:</b> Closed User Group	Page 10-17
<b>442:</b> Recognized Private Operating Agency	Page 10-17
<b>450:</b> Link Level Transmit Timeout	Page 10-8
<b>451:</b> Number of Retries	Page 10-8
<b>452:</b> Connection Identifier	Page 10-17
<b>453:</b> Connection Options	Page 10-18
<b>461:</b> Lowest Incoming Channel	Page 10-9
<b>462:</b> Highest Incoming Channel	Page 10-9
<b>463:</b> Lowest Two-Way Channel	Page 10-9
<b>464:</b> Highest Two-Way Channel	Page 10-9
<b>465:</b> Lowest Outgoing Channel	Page 10-10
<b>466:</b> Highest Outgoing Channel	Page 10-10

## Overview

The CCITT Recommendation X.25 defines the packet formats and control procedures for the exchange of packets between data terminal equipment (DTE) and data-circuit-terminating equipment (DCE) for switched virtual circuits (SVCs) and permanent virtual circuits (PVCs). The control procedures include establishing and clearing of calls, data transfer, flow control, and error recovery.

## Planning for X.25

Customizing for X.25 involves defining the unique aspects of your X.25 network subscription to the 3174 controller. You need a copy of your firm's X.25 network subscription to complete the X.25 worksheet.

An X.25 network subscription can include optional user facilities. The 3174 controller supports the following facilities for SVCs and provides customizing questions for them:

- Closed User Group
- Negotiated Window Size
- Negotiated Packet Size
- Nonstandard Default Window Size
- Nonstandard Default Packet Size
- Recognized Private Operating Agency
- Reverse Charge
- Throughput Class.

An operator, however, can modify customized values for certain X.25 facilities during the Dial procedure. To allow the operator to change values during the Dial procedure, for question 409 ("X.25 Keyboard Support Options") you *must* set the sixth digit equal to 0 ("Dial Screen Display").

### X.25 and Microcode Upgrade

If you used X.25 with earlier levels of 3174 microcode, be aware that the meanings of some X.25 questions have changed. Also, due to expanded X.25 support, several questions have been added.

If you plan to use the Microcode Upgrade utility to update your microcode, the utility will handle the necessary changes for you. If you do *not* plan to use the upgrade utility, please read this chapter carefully; it explains changes to the X.25 panels.

## The X.25 Options Worksheet

If you are configuring for primary hosts, you must fill out "Worksheet 13—X.25 Options" (Figure 10-1); if you are configuring for secondary hosts, you must fill out "Worksheet 13S—Secondary X.25 Options."

\_\_\_\_\_ 332: X.25 Options \_\_\_\_\_

400 - <input type="text"/> 0 0	401 - <input type="text"/> 4	402 - <input type="text"/> <u>        </u>	
409 - <input type="text"/> 1 0 1 0 0 1 0 0	420 - <input type="text"/> 0 0 0 0 0 0 0 0	421 - <input type="text"/> 0 0 0 0 0 0 0 0	
423 - <input type="text"/> <u>                                </u>	424 - <input type="text"/> <u>                                </u>		
430 - <input type="text"/> 1	431 - <input type="text"/> 1	432 - <input type="text"/> 0 2	433 - <input type="text"/> 2
434 - <input type="text"/> 1	435 - <input type="text"/> 0 2		
440 - <input type="text"/> 9	441 - <input type="text"/> <u>        </u>	442 - <input type="text"/> <u>        </u>	
450 - <input type="text"/> X X X X	451 - <input type="text"/> X X	452 - <input type="text"/> <u>                                </u>	453 - <input type="text"/> 0 0 0 0 0 0 0 0
461 - <input type="text"/> <u>        </u>	462 - <input type="text"/> <u>        </u>	463 - <input type="text"/> <u>        </u>	464 - <input type="text"/> <u>        </u>
		465 - <input type="text"/> <u>        </u>	466 - <input type="text"/> <u>        </u>

Figure 10-1. An Example of Worksheet 13—X.25 Options

The areas on this worksheet are described below.

- Default responses**    The microcode automatically supplies the default response unless you specify a different response during customization. If there is a default value for a facility to which you do not subscribe, leave the default value unchanged.
  
- X**                        You must respond to this question. No default is supplied.
  
- Underscore**            This question is a sequel to a previous question. Your response to the previous question dictates whether you need to respond to the sequel. For example, if your response to question 401 (circuit type) is 1 (permanent virtual circuit), no response is necessary for question 423 (host and DTE address). When you do not want to specify a response on the worksheet, circle the underscores. The person who customizes can leave the underscore unchanged in the response field.

## Filling In Worksheet 13—X.25 Options

**Planner:** The following questions appear on "Worksheet 13—X.25 Options" and some of them appear on Worksheet 13S. If you are filling out a worksheet for a primary host link, locate "Worksheet 13—X.25 Options" on page A-24. (If you have configured for Multi-Host Support, identify which host these X.25 options are for in the Host ID field on the top of the worksheet.) If you are filling out a worksheet for a secondary host link, locate "Worksheet 13S—Secondary X.25 Options" on



page A-25. Identify which host these X.25 options are for. Write your responses to the following questions on the worksheet.

---

## Link Attachment Questions

The following questions pertain to link attachment. They appear on primary host panels only.

### 400: Network Type

*Response:* Four numeric characters.

The four digits of this response are divided into three parts. The first two digits represent the network type. The third digit represents the network level. The fourth digit represents the type of diagnostic codes the 3174 should send for the link.

The possible responses are shown below. The digits shown in bold type are the digits to which the possible responses apply.

**00** 0 0: (First two digits)

00 = CCITT-recommended network with announced IBM support, not DATANET-1.

01 = Connection is to the Netherlands DATANET-1.

If IBM has announced X.25 support for your country's network and it is not DATANET-1, use the default (00).

00 **0** 0: (Third digit)

0 = The network supports CCITT Recommendation X.25, 1980 level

1 = The network supports CCITT Recommendation X.25, 1984 level and beyond.

00 0 **0**: (Fourth digit)

0 = The 3174 should use SNA diagnostic codes for errors that are reported to the network.

1 = The 3174 should use ISO diagnostic codes.

The default response to this question is 00 0 0.

### 424: 3174 DTE Address

*Response:* A maximum of 15 numeric characters (0 through 9).

The default response is underscores.

This field contains the local DTE address for the 3174. Enter a maximum of 15 digits for the number, leaving blanks or underscores wherever you have not written a numeric character.

For any hosts on this link, if the first digit of your response to question 421 (Outgoing Call Options) is 1 and the response to question 401 (Circuit Type) is 3 or 4, then you must respond to this question. Otherwise, circle the default (underscore) on the worksheet.

### 431: Packet Sequence Numbering

*Response:*

- 0 = Modulo 8
- 1 = Modulo 128.

The default response is 0.

Your response determines whether the extended packet sequence numbering facility is to be used. Refer to your network subscription information to determine your response. The response to this question can affect responses to questions 432 (Negotiated Window Size) and 435 (Nonstandard Default Window Size).

### 433: K-Maximum Out

*Response:* Maximum number of link level I-frames. The response can be a value of 1 – 7.

The default response is 2.

This field specifies the maximum number of outstanding link level I-frames that the 3174 transmits before waiting for an acknowledgment. Your network subscription information indicates the correct response.

### 434: Nonstandard Default Packet Size

*Response:*

- 0 = 64-byte packet
- 1 = 128-byte packet
- 2 = 256-byte packet
- 3 = 512-byte packet.

The default response is 1.

This field contains the default packet size to which you subscribed in your X.25 network agreement. This value is used to select the packet size for an SVC when packet size negotiation is not used.

The table below shows the relationship of packet sizes to Path Information Unit (PIU) sizes.

PIU Size Inbound (Q370)	Packet Size	Number of Data Packets for Maximum PIU
If Q370 = 0, max PIU = 265	64	5
	128	3
	256	2
	512	1
If Q370 = 1, max PIU = 521	64	9
	128	5
	256	3
	512	2

**Note:** In Configuration Support B, Release 3 microcode and higher, questions 434 and 435 do not apply to PVCs. The microcode upgrade process makes the necessary changes during an upgrade from Release B2.

### 435: Nonstandard Default Window Size

*Response:*

- 01 – 07 = Range for modulo 8 (if question 431 equals 0)
- 01 – 11 = Range for modulo 128 (if question 431 equals 1).

The default response is 02.

This field contains the default packet window size value subscribed to in your X.25 network agreement. This value is used to select the window size for an SVC when window size negotiation is not used.

**Note:** In Configuration Support B, Release 3 microcode and higher, questions 434 and 435 do not apply to PVCs. The microcode upgrade process makes the necessary changes during an upgrade from Release B2.

### 450: Link Level Transmit Timeout

*Response:* A value in the range 0001 – 2540.

You must respond to this question. No default is supplied.

This is the value referred to as  $T_1$  or  $T_p$ . It is specified in 0.1-second intervals and set to the value required by each individual network. Refer to your network subscription for the value you should use. The 3174 timer will be  $\pm 20\%$  of the value specified. For values greater than 25.0 seconds (0250 input), the lower (tenths) digit is ignored. For example, 0277 is treated as 27 seconds.

### 451: Number of Retries

*Response:* A value in the range 01 – 99.

You must respond to this question. No default is supplied.

Set this value (referred to as  $N_p$  or  $N_2$ ) to the number of retries required by the individual network. Refer to your network subscription for this information.

### Logical Channel Numbering

**Planner:** Questions 461 through 466 describe the logical channel numbering of your network subscription. Responses to the questions determine valid ranges for incoming and outgoing calls. Figure 10-2 shows how these questions relate to one another in establishing channel ranges.

Figure 10-2 shows channel range pairs. Pairs must be in ascending order, and the total number of channels and PVCs cannot exceed 255.

The outside delimiters of the channel ranges can be used (i.e. some networks use 0, and some assign Highest Outgoing Channel (HOC) to be 4095). If there are no PVCs, the pairs must still be relative, but the Lowest Incoming Channel (LIC) could be 1 while Highest Incoming Channel (HIC) is 255.

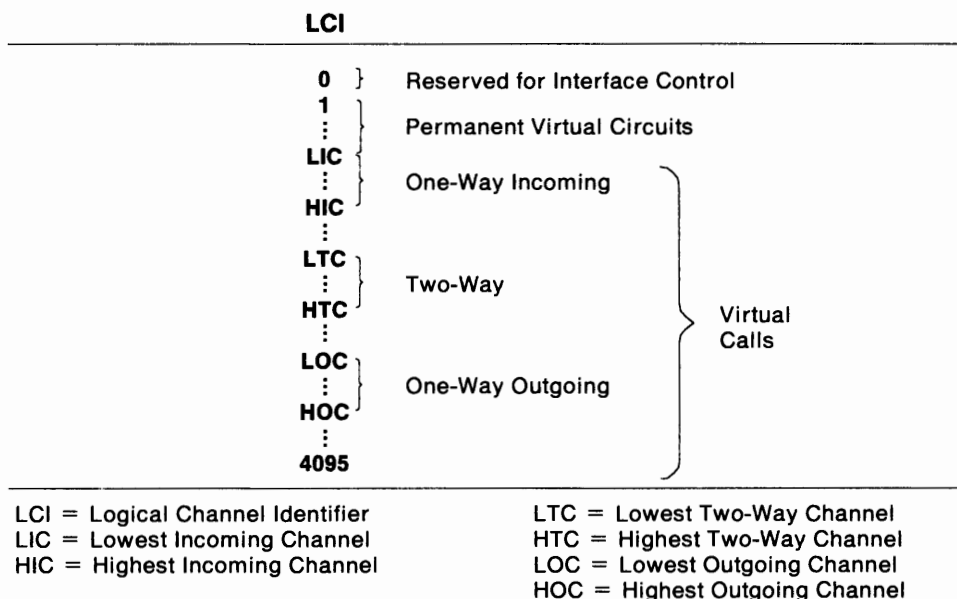

Figure 10-2. Logical Channel Assignments

### 461: Lowest Incoming Channel

*Response:* A value in the range 0000-4095.

The response to this question is optional. If specified, this response should match the lowest number Logical Channel Number (LCN) in the network subscription that is reserved for calls incoming from the network. If you do not use Incoming Call Channels, do not enter a response for this question.

### 462: Highest Incoming Channel

*Response:* A value in the range 0000-4095.

The response to this question is optional. If specified, this response should match the highest number LCN in the network subscription that is reserved for calls incoming from the network. If you do not use Incoming Call Channels, do not enter a response for this question.

### 463:Lowest Two-Way Channel

*Response:* A value in the range 0000-4095.

The response to this question is optional. If specified, this response should match the lowest number LCN in the network subscription that is reserved for incoming or outgoing network calls. If you do not use Two-Way Channels, do not enter a response for this question.

### 464:Highest Two-Way Channel

*Response:* A value in the range 0000-4095.

The response to this question is optional. If specified, this response should match the highest number LCN in the network subscription that is reserved for incoming or outgoing network calls. If you do not use Two-Way Channels, do not enter a response for this question.

**465: Lowest Outgoing Channel**

*Response:* A value in the range 0000-4095.

The response to this question is optional. If specified, this response should match the lowest number LCN in the network subscription that is reserved for outgoing network calls. If you do not use Outgoing Call Channels, do not enter a response for this question.

**466: Highest Outgoing Channel**

*Response:* A value in the range 0000-4095.

The response to this question is optional. If specified, this response should match the highest number LCN in the network subscription that is reserved for outgoing network calls. If you do not use Outgoing Call Channels, do not enter a response for this question.

---

## Host Attachment Questions

The following questions define X.25 characteristics for individual hosts (virtual circuits).

### 401: Circuit Type

*Response:*

- 1 = Permanent virtual circuit (PVC)
- 2 = Incoming call (from host) only (SVC)
- 3 = Outgoing call (to host) only (SVC)
- 4 = Two-way call (SVC).

This input field indicates the type of circuit for this host. Refer to your subscription information for your response. A permanent virtual circuit (PVC) is a permanent logical connection between two DTEs, analogous to a point-to-point SDLC nonswitched connection. It requires no call setup or clearing by the DTE. A switched virtual circuit (SVC) is a temporary logical connection between two DTEs, analogous to a point-to-point switched line.

### 402: Logical Channel Identifier

*Response:*

0000 – 4095.

This decimal value is the channel identifier for the PVC circuit specified in question 401 and must be specified only when the response to question 401 is 1. Refer to your subscription information for your channel identifier.

### 409: X.25 Keyboard Support Options

*Response:* Eight digits (0 or 1).

- 0 = No
- 1 = Yes.

The default response is 10100100. Digits are numbered from left to right.

This field allows you to choose how to use X.25 Extension Mode keys for this particular host. Keyboards on distributed function terminals cannot be used for initiating or terminating an X.25 connection. The X.25 keys are Extension, DIAL, LOCAL, COMM (Communicate), and DISC (Disconnect). For more information about the function of these keys, see the *3174 Functional Description, GA23-0218*.

Typically, the device attached to port 0 of HG 26 or HG 27 has access to all the X.25 Extension Mode keys. During customization, however, you can assign the keys to all ports, or certain keys can be deleted. You may also customize for automatic dial and disconnect support (question 372), which can eliminate the need for use of the X.25 Extension Mode keys.

To allow the operator to change customized values for certain X.25 facilities on a per-call basis during the Dial procedure, set the sixth digit (Dial Screen Display) equal to 0.

**Note:** If the response to question 401 is 1, the first, second, and sixth digits have no meaning and are ignored.

<b>Digit</b>	<b>Description</b>
1	X.25 DISC Key
2	X.25 DISC Key
3	X.25 LOCAL and COMM
4	X.25 LOCAL and COMM
5	X.25 Keys
6	Dial Screen Display
7	Disconnect/Local Mode Operation
8	Reserved

**Digits 1 and 2 - X.25 DISC Key:**

- 00 = X.25 DISC key is not supported.
- 01 = X.25 DISC key is supported only on port 0 of HG 26 or HG 27, regardless of how the fifth digit (X.25 Keys) is specified.
- 10 = Default – X.25 DISC is supported according to how the fifth digit (X.25 Keys) is specified.
- 11 = Invalid.

**Digits 3 and 4 - X.25 LOCAL and COMM Keys:**

- 00 = X.25 LOCAL and COMM keys are not supported.
- 01 = X.25 LOCAL and COMM keys are supported only on port 0 of HG 26 or HG 27, regardless of how the fifth digit (X.25 Keys) is specified.
- 10 = Default – X.25 LOCAL and COMM keys are supported according to how the fifth digit (X.25 Keys) is specified.
- 11 = Invalid.

**Digit 5 - X.25 Keys:**

- 0 = Default – X.25 keys are supported only on port 0 of HG 26 or HG 27.
- 1 = X.25 keys are supported on all ports (except those with a DFT attached).

**Digit 6 - Dial Screen Display:**

- 0 = Display all fields on the Dial screen. This allows the operator to change customized or default values on a per-call basis.
- 1 = Default – Display only the HNAD field on the Dial screen. This allows the operator to enter only the number to be called.

**Digit 7 - Disconnect/Local Mode Operation:**

- 0 = Default – If no SNA sessions are active, pressing the DISC (SVC) or LOCAL (PVC) key performs the disconnect or local mode operation. If any sessions are active, pressing the key once inhibits the rest of the keyboard. Pressing the key twice initiates the operation.
- 1 = The DISC (SVC) or LOCAL (PVC) key immediately performs the disconnect or local mode operation, regardless of active sessions.

**Digit 8 - Reserved:** This digit is reserved and defaulted to 0.

## The Connection Identifier (CID)

In prior levels of 3174 configuration support, a one-to-one correspondence existed between a host DTE and a controller DTE. Each DTE was identified by a unique address. When an SVC was used, DTE addresses were sufficient to identify the DTEs initiating and receiving each call.

With X.25 Single Link Multi-Host Support this is no longer the case. One controller may communicate with several hosts simultaneously; or one controller may establish several sessions simultaneously with one host. If the controller has several sessions with one host, DTE addresses are not sufficient to identify sending and receiving DTEs. For instance, suppose one controller is to have several sessions with one host. To the host, each session appears as a separate controller. If the host issues a call to the 3174, the Incoming Call packet will contain the host's DTE address, but the 3174 cannot determine for which session the call is intended. A further means of identifying separate sessions (host or controller) within one DTE address is required.

To do this, the Connection Identifier (CID) portion of the call request packet is used. It is an 8-character field that you can use to identify the correct PU; it is used in conjunction with the DTE address to uniquely identify the session. The 3174 requires you to use the CID if two or more PUs on a link are associated with the same host system, and the host system is going to be calling the controller. If the controller will be calling the host, check with your host system administrator to determine whether use of CIDs is necessary.

If you are customizing for only one host, the CID can be specified for Call Packet verification *instead* of the host address.

Questions 420, 421, 423, 424, and 452 enable you to specify the remote DTE's address and CID and contain more explanation of these fields.

## 420: Incoming Call Options

**Response:** Eight digits (0 or 1).

- 0 = No
- 1 = Yes.

The default response is 00000000. Digits are numbered from left to right.

Your response specifies how to process fields in an incoming call. Many of the choices refer to optional facilities; refer to your network subscription information before selecting your response.

If you are planning for X.25 Single Link Multi-Host Support, you may be required to answer digits 1 and 6 with a 1 if more than one of your host definitions allows incoming calls (401 = 2 or 4). You must answer digit 1 with 1 for all such hosts and supply correct DTE addresses for question 423. If any of these host connections are to the same host DTE (responses to 423 are not unique), then you must answer digit 6 with a 1 and supply a unique CID for question 452.

If the X.25 keyboard support option (question 409) specifies that the Dial screen will display all the fields (sixth digit is 0), the operator can change any values selected for incoming call options by using the Dial panel.



Digit	Description
1	Host DTE Address
2	Reverse-Charge Facility
3	Reverse-Charge Facility
4	Negotiated Packet Size Facility
5	Negotiated Window Size Facility
6	Connection Identifier
7	Throughput Class
8	Reserved

**Digit 1 - Host DTE Address:** This digit specifies whether to validate the host (calling) DTE address on incoming calls.

**Digits 2 and 3 - Reverse-Charge Facility:** These digits specify how to handle calls with the reverse-charge facility.

- 00 = Do not accept calls that include the reverse-charge facility.
- 01 = Accept calls with the reverse-charge facility equal to reverse charge requested.
- 10 = Accept calls with the reverse-charge facility equal to reverse charge *not* requested.
- 11 = Accept calls with the reverse-charge facility whether reverse charges are requested or not.

**Digit 4 - Negotiated Packet Size Facility:** This digit specifies whether to accept Incoming Call packets that include the negotiated packet size facility.

**Digit 5 - Negotiated Window Size Facility:** This digit specifies whether to accept Incoming Call packets that include the negotiated window size facility.

**Digit 6 - Connection Identifier:** This digit specifies whether to validate the Connection Identifier (CID) on incoming calls.

**Digit 7 - Throughput Class Negotiation:** This digit specifies whether to accept Incoming Call packets that include the Throughput Class facility.

**Digit 8 - Reserved:** This digit is reserved and defaulted to 0.

## 421: Outgoing Call Options

*Response:* Eight digits (0 or 1).

- 0 = No
- 1 = Yes.

The default response is 00000000. Digits are numbered from left to right.

Your response specifies the fields to include in an outgoing Call Request packet. Many of the choices refer to optional facilities. Refer to your network subscription information before selecting your responses.

If the X.25 keyboard support option (question 409) specifies that the Dial screen display all fields (sixth digit is 0), an operator can change any values selected for outgoing call options during a Dial session on a per-call basis.

Digit	Description
1	3174 DTE Address
2	Reverse-Charge Facility
3	Reverse-Charge Facility
4	Negotiated Packet Size Facility
5	Negotiated Window Size Facility
6	Connection Identifier
7	Throughput Class
8	Reserved

**Digit 1 - 3174 DTE Address:** This digit specifies whether to supply the 3174 (calling) DTE address in the Call Request packet.

**Digits 2 and 3 - Reverse-Charge Facility:** These digits specify how to handle calls with the reverse-charge facility.

- 00 = Do not include the reverse-charge facility in the Call Request packet.
- 01 = Request reverse charge via the reverse-charge facility.
- 10 = Request *no* reverse charge via the reverse-charge facility.
- 11 = Invalid response.

**Digit 4 - Negotiated Packet Size Facility:** The response for this digit specifies whether the negotiated packet size facility field will be included in the Call Request packet.

**Digit 5 - Negotiated Window Size Facility:** This digit specifies whether to include the negotiated window size facility field in the Call Request packet.

**Digit 6 - Connection Identifier:** This digit specifies whether to include the CID in the Call Request packet.

**Digit 7 - Throughput Class:** This digit specifies whether to include the Throughput Class facility in the Call Request packet.

**Digit 8 - Reserved:** This digit is reserved and is defaulted to 0.

### 423: Host DTE Address (HNAD)

*Response:* A maximum of 15 digits (0 through 9).

This field contains the host network data terminating equipment (DTE) address, which is a unique address identifying this DTE to the network. Enter a maximum of 15 digits for the telephone number, leaving blanks or underscores wherever you have not written a numeric character.

You must respond to this question if question 401 (Circuit Type) is 2 *and* digit one of 420 (Incoming Call Options) is 1. Or, if question 401 is 3 or 4, you must respond to this question. Otherwise, circle the default (underscore) on the worksheet.

### 430: Negotiated Packet Size (NPKT) or PVC Packet Size

*Response:*

- 0 = 64-byte packet
- 1 = 128-byte packet
- 2 = 256-byte packet
- 3 = 512-byte packet.

The default response is 1.

**For SVCs** Your response to this question defines the negotiated packet size facility. This is an optional facility; refer to your subscription information to see if a response is required. This question is related to questions 420 (Incoming Call Options) and 421 (Outgoing Call Options). The fourth digit of both of those questions enables the negotiated packet size facility. In question 420, if the fourth digit is 1, the response you select here sets the size limit to which the controller may negotiate when accepting an incoming call. In question 421, if the fourth digit is 1, the response you select here will be requested in the Call Request Packet.

**For PVCs** This question has a little different meaning for PVCs than for SVCs. If you are configuring for PVCs, *the packet size is not negotiated but remains constant at the value you select here*. If you are configuring for SVCs, the value you select for this question is a *limit* on variable packet sizes.

### 432: Negotiated Window Size (NWND) or PVC Window Size

*Response:*

- 01 – 07 = Range for modulo 8 (if question 431 equals 0)
- 01 – 11 = Range for modulo 128 (if question 431 equals 1).

**For SVCs** This field is used for the negotiated window size facility. It is an optional field. Refer to your network subscription for information to determine your response. In question 420 (Incoming Call Options), if the fifth digit is 1, the response selected here sets the size limit to which the controller may negotiate when processing an incoming call. In question 421 (Outgoing Call Options), if the fifth digit is 1, the response selected here will be requested in the Call Request Packet.

**For PVCs** This question has a little different meaning for PVCs than for SVCs. If you are configuring for PVCs, *the window size is not negotiated but remains constant at the value you select here*. If you are configuring for SVCs, the value you select for this question is a *limit* on variable window sizes.

### 440: Throughput Class Negotiation (TCLS)

*Response:*

- |              |                 |
|--------------|-----------------|
| 3 = 75 bps   | 9 = 4800 bps    |
| 4 = 150 bps  | A = 9600 bps    |
| 5 = 300 bps  | B = 19 200 bps  |
| 6 = 600 bps  | C = 48 000 bps  |
| 7 = 1200 bps | D = 64 000 bps. |
| 8 = 2400 bps |                 |

The default response is 9.

Throughput Class is a network facility that sets priority for packets. Refer to your network subscription information for the response to this question.

In question 421 (Outgoing Call Options), if the seventh digit is 1 (include the Throughput Class facility in the Call Request packet), this field supplies the value. In question 420 (Incoming Call Options), if the seventh digit is 1 (accept Throughput Class on an incoming Call Request packet), the 3174 accepts the requested value if it is less than or equal to the customized value. If not, the customized value is returned.

#### 441: Closed User Group (CUG)

*Response:*

00 – 99 = Include closed user group facility in outgoing Call Request packet.

A response to this question is optional.

Consult your network subscription information for your response. Enter a value to be included in the closed user group facility in an outgoing Call Request packet. If the field is left with underscores, blanks, or nulls, the closed user group facility is not included in the outgoing Call Request packet.

An operator can enter this value on a per-call basis, overriding default or customized values.

**Note:** If the response is a number with fewer than two digits, use a leading zero. For example, if your response is 6, enter 06 on the worksheet. If there is no response for this question, circle the underscore (default) on the worksheet.

#### 442: Recognized Private Operating Agency (RPOA)

*Response:*

0000 – 9999 = Recognized private operating agency.

A response to this question is optional. Enter a value for the recognized private operating agency facility if this applies to your system. If the field is left with underscores, this facility is not included in the outgoing Call Request packet.

An operator can enter this value on a per-call basis, overriding default or customized values.

**Note:** If the response is a number with fewer than four digits, use leading zeros. For example, if your response is 57, enter 0057 on the worksheet. If there is no response for this question, circle the underscore (default) on the worksheet.

#### 452: Connection Identifier (CID)

*Response:* This identifier can have up to 8 numeric characters (0–9), alphabetic characters (A–Z), or blanks. Refer to “The Connection Identifier (CID)” on page 10-12 for information about the connection identifier and its use with the DTE.

**Note:** For 3174 customizing you must enter alphanumeric characters for this response. In the host SYSGEN procedure, however, you may be required to enter hexadecimal characters for this same CID password. (For example, hexadecimal characters are required for the NCP Packet Switching Interface [NPSI] SYSGEN.) Check the appropriate host documentation to determine SYSGEN requirements.

## 453: Connection Options

*Response:* Eight digits (0 or 1).

The default response is 00000000. Digits are numbered from left to right.

Digit	Description
1	Level of CCITT X.25 architecture supported
2	Diagnostic code type
3-8	Reserved

### **Digit 1 - CCITT X.25 Architecture Level:**

- 0 = 1980
- 1 = 1984 and beyond

### **Digit 2 - Diagnostic Code Type:**

- 0 = SNA
- 1 = ISO

This digit identifies what type of diagnostic codes the 3174 should use for Clear Request or Reset Request packets when breaking the connection with the remote DTE.

**Digit 3-8 — Reserved.** Digits 3 through 8 are reserved.

**Planner:** *You have completed the X.25 Options Worksheet.*

- *If you filled out "Worksheet 5—X.25" previously, fill out "Worksheet 14—Common SNA." (Chapter 11 contains the information needed to fill out this worksheet.) If you have already filled out Worksheet 14, return to the divider page labeled "Microcode Customization Planning." See step 4 to determine the next worksheet you need to fill out.*
- *If you filled out "Worksheet 5S—Secondary X.25" previously, return to the divider page labeled "Microcode Customization Planning." See step 5 to determine if you need to fill out worksheets for additional host attachments before continuing with the next step.*

*You may also refer to the divider page labeled "Worksheet Summary" to determine where to proceed next.*

*Keep records of your configuration by using one of the methods described under "Customization Records" on page 5-6.*

## Changing the X.25 Options

If you have changes to make to the X.25 Options, refer to the following table, which explains how to fill out "Worksheet 13—X.25 Options" on page A-24.

Change in 101	Change on Worksheet
Your previous response was $101 = 3$ , and you did not change it.	The 332 panel that appears on the screen displays the previous responses. Enter your changed responses to the 332 panel on the worksheet.
You changed your previous response to $101 = 3$ .	<p>The panel that appears on the screen displays response fields filled with Xs, underscores, and default responses. See "Filling In Worksheet 13—X.25 Options" (on page 10-5) for instructions on filling out that panel on the configuration worksheet.</p> <p>If you have changes to make to a previously customized 332 panel, enter your changed responses on the 332: X.25 Options panel on the configuration worksheet. Reread the description of the question. Check whether the changed response requires you to change a response to another question.</p>



---

## Chapter 11. Planning for Central Site Change Management

An Overview of Central Site Change Management .....	11-3
The Common SNA Worksheet .....	11-4
Filling In Worksheet 14—Common SNA .....	11-5
500: CSCM Unique .....	11-5
501: Network ID (NETID) .....	11-5
502: Logical Unit Name (LUNAME) .....	11-6





---

## An Overview of Central Site Change Management

Before you start planning, you need:

- “Worksheet 14—Common SNA” on page A-26
- Information from your host system programmer about responses to questions 501 and 502.

Central Site Change Management (CSCM) offers many advantages. By centrally customizing the controllers, you can reduce the errors that often occur during customization because one person and one location are doing the customizing for all the controllers in the network. If you are using the NetView Distribution Manager (NetView DM) software package, the customization data and/or microcode can be electronically distributed to the SNA Network Site Controllers and then remotely IMLed from the host. This decreases the need for trained personnel at each controller.

Before planning for and answering the questions for CSCM, you should become familiar with the *Central Site Customizing User's Guide*, GA27-3868.

If you plan to configure for CSCM, you need to ensure that your controller contains sufficient storage. The “Storage Planning Procedure” on page 3-4 helps you determine your storage requirements.

**Note:** CSCM is supported only on the primary host on the primary link (1A). However, the customization data and/or microcode for other host attachments can be distributed through the primary host's attachment.

## The Common SNA Worksheet

Your response to question 101: Host Attachment determines whether or not you must fill out “Worksheet 14—Common SNA” (Figure 11-1). If your response to question 101 was one of the following or if you responded to question 101 with M and you are using one of the following protocols, fill out the Common SNA worksheet.

- 2—SDLC
- 3—X.25
- 5—Local SNA
- 6—X.21 Switched
- 7—Token-Ring Network.

On the worksheet, you respond to the questions that are discussed in this chapter.

The diagram shows a rectangular box representing the worksheet. At the top center, the text "Common SNA" is written. Below this, there are three input fields. On the left, the number "500" is followed by a small square box, and the number "0" is written below it. In the center, the number "501" is followed by a horizontal row of eight small square boxes. On the right, the number "502" is followed by another horizontal row of eight small square boxes. The entire content is enclosed in a thin black border.

Figure 11-1. An Example of Worksheet 14 – Common SNA

## Filling In Worksheet 14—Common SNA

**Planner:** The following questions appear on “Worksheet 14—Common SNA.” Locate “Worksheet 14—Common SNA” on page A-26. Write your responses to the questions on the worksheet.

### 500: CSCM Unique

*Response:*

- 0 = CSCM is not in use.
- 1 = CSCM is in use as a Network Site Controller.
- 2 = CSCM is in use as a Central Site Controller.

The default is 0.

**Note:** A response of 2 is not valid for 3174 models using the Token-Ring Network 3270 Gateway feature or Models 91R and 92R.

**If you:**

- Do not want to use CSCM, leave this question set to its default.
- Wish to use CSCM and the controller you are planning the customization for is a Network Site Controller, respond with 1.
- Wish to use CSCM and the controller you are planning the customization for is the Central Site Controller, respond with 2.
- Respond to this question with a 1 or 2, you must respond to questions 501: Network ID and 502: LUNAME.

### 501: Network ID (NETID)

This name is used in an SNA network that is using the SNA Network Interconnection function. It identifies the network of the controller you are planning to customize, and distinguishes that network from the other networks.

The Network ID name should be unique for each network. Provide the same response to this question for each controller within a given network.

*Response:* Up to 8 alphanumeric characters (first character must be alphabetic and no blanks/spaces between characters are allowed). See the following example.

**Example**

<p>NETCONTA (valid) NW CONTA (invalid)</p>
--

The default is blanks.

The name specified should be obtained from or coordinated with the host system programmer.

## 502: Logical Unit Name (LUNAME)

The LUNAME identifies a controller that is using change management. Specify a unique name for each controller within a given network.

*Response:* Up to 8 alphanumeric characters (first character must be alphabetic and no blanks/spaces between characters are allowed). See the following example.

**Example**

```
NETWKL06 (valid)
LU6 NETW (invalid)
```

The default is blanks.

The name specified should be obtained from or coordinated with the host system programmer.

**Planner:** *You have completed "Worksheet 14—Common SNA."*

*Return to the divider page labeled "Microcode Customization Planning." Refer to the step that instructed you to fill out Worksheet 14 to determine if there are additional worksheets that you need to fill out before continuing with the next step. You may also refer to the divider page labeled "Worksheet Summary" to determine where to proceed next.*

*Keep records of your configuration by using one of the methods described under "Customization Records" on page 5-6.*

---

## Chapter 12. Planning for the Asynchronous Emulation Adapter

An Overview of the Asynchronous Emulation Adapter	12-3
AEA Terminology	12-4
AEA Concepts	12-5
Planning and Setup Tasks	12-8
Analyze Your Communication Requirements	12-8
Create a System Specification	12-8
Things to Do	12-9
AEA Microcode Customization Planning	12-12
Station Sets and Port Sets	12-13
AEA Planning Considerations	12-15
MLT	12-15
Storage	12-16
Multi-Host Support	12-16
Terminal Tables and Translate Tables	12-16
ASCII Display Stations Supported by the AEA	12-17
Filling Out Worksheet 15—3270 Attachment Diagram	12-18
Filling Out Worksheet 16—ASCII Attachment Diagram	12-24
Numbering the AEA Station Sets on the Attachment Diagrams	12-35
Filling Out Worksheet 17—AEA Configure	12-37
700: Configure the AEA Feature	12-37
702: Control Key Assignment	12-37
703: Request MLT for AEA	12-37
710: Miscellaneous ASCII Feature Options (A)	12-38
711: Miscellaneous ASCII Feature Options (B)	12-39
712: Miscellaneous ASCII Feature Options (C)	12-39
713: Miscellaneous ASCII Feature Options (D)	12-40
Filling Out Worksheet 18—AEA Port Set	12-41
Filling Out Worksheet 19—AEA Port-to-Port Set Map	12-42
Filling Out Worksheet 20—AEA Station Set	12-44
721: Station Set Name	12-46
722: Station Type	12-46
723: Port Set Name	12-47
725: Host Connection Menu Option	12-47
731: Flow Control Type	12-48
732: XON/XOFF Transmission Resumption	12-48
733: Line Speed	12-49
734: Line Speed (ASCII Host Upper Limit)	12-49
735: Parity	12-50
736: Stop Bits	12-50
737: Maximum Modem Line Speed	12-50
741: Switched Disconnect Timeout (3270 Hosts Only)	12-51
742: Inactivity Timeout	12-51
743: Prompt for Universal/Specific Keyboard Map	12-52
744: Number of Bits per Character	12-52
745: ASCII Display Character Set	12-52
746: Translate Option	12-53
751: Data Stream Supported by the ASCII Host	12-53
752: ASCII Host Phone Number	12-53
761: Auto XON/XOFF (DEC VT100/VT220 Data Stream)	12-56
762: Wraparound Option (DEC VT100/VT220 Data Stream)	12-56

763: New Line Option (DEC VT100/VT220 Data Stream) . . . . .	12-56
764: Margin Bell (DEC VT100/VT220 Data Stream) . . . . .	12-57
765: DEC Host ASCII Character Set (DEC VT100/VT220 Data Stream) . . . . .	12-57
771: Automatic Line Feed for Cursor Control (IBM 3101 Data Stream) . . . . .	12-57
772: Carriage Return/Carriage Return—Line Feed Selection (IBM 3101 Data Stream) . . . . .	12-57
773: Automatic New Line for Cursor Control (IBM 3101 Data Stream) . . . . .	12-58
774: Scrolling (IBM 3101 Data Stream) . . . . .	12-58
775: Line Turnaround Character (IBM 3101 Data Stream) . . . . .	12-58
776: IBM ASCII Host Character Set . . . . .	12-58
781: Attached Printer Prompt . . . . .	12-58
782: Use of Form Feed . . . . .	12-59
783: Page Length . . . . .	12-59
784: Printer Character Set . . . . .	12-59
785: ASCII Printer Options . . . . .	12-60
786: Page Width . . . . .	12-61
787: LU 1 SCS Transparency Translation . . . . .	12-61
Filling Out Worksheet 21—AEA Default Destination . . . . .	12-62
Filling Out Worksheet 22—Terminal Tables . . . . .	12-64
Section One: Identifying Each Table . . . . .	12-64
Section Two: Selecting Attributes for Tables . . . . .	12-66
Defaults . . . . .	12-71
Filling Out Worksheet 23—Inbound Sequence Panels . . . . .	12-72
ASCII Inbound Sequences . . . . .	12-72
Filling Out Worksheet 24—Outbound Sequence Panels . . . . .	12-75
ASCII Outbound Sequences . . . . .	12-75
Filling Out Worksheet 25—Translate Tables . . . . .	12-76
Filling Out Worksheet 26—Outbound Translate Table Definition . . . . .	12-79
EBCDIC Outbound Sequences . . . . .	12-79
Defaults . . . . .	12-79
Filling Out Worksheet 27—Inbound Translate Table Definition . . . . .	12-80
ASCII Inbound Sequences . . . . .	12-80

---

## An Overview of the Asynchronous Emulation Adapter

Before you start planning, you need:

- Worksheets 15 through 27 from Appendix A
- Documentation supporting the ASCII display stations, printers, and hosts you plan to use or attach (for example, ASCII display station and host setup or customizing records).

The Asynchronous Emulation Adapter (AEA) allows:

- 3270 displays and/or printers to communicate with ASCII hosts
- ASCII displays and/or printers to communicate with IBM hosts
- ASCII displays and/or printers to communicate with ASCII hosts.

The Asynchronous Emulation Adapter provides three major modes of operation:

**3270 Terminal Emulation** allows ASCII terminals to emulate an IBM 3178 Display Station Model C2, 3279 Color Display Station Model 2A, or 3287 Printer Model 2 for connection to an IBM host.

**Note:** When configured for Multi-Host Support, terminals involved in 3270 emulation can communicate only with the primary host on the primary link.

**ASCII Terminal Emulation** allows an IBM 3270 display station to emulate an IBM 3101 Display Station, or a Digital Equipment Corporation (DEC) VT100 or VT220, or a Data General D210\*, and allows an IBM 3270 printer to emulate an ASCII printer. 3270 terminals can thereby connect to ASCII hosts or public data networks.

**ASCII Pass-Through** allows ASCII terminals to connect through the 3174 Establishment Controller to ASCII hosts or to public data networks.

**Note:** To use the AEA, you need the AEA microcode that was supplied with the adapter and a second disk drive or fixed disk to download the microcode. You may need to plan for merging the AEA microcode onto a DSL disk; see the *3174 Utilities Guide*, GA27-3863, for the Merge DSL procedure.



---

## AEA Terminology

The following terms are used throughout this chapter.

**Connection Menu** A list of all available host connections as defined by station names during customizing. The display station users may select alternate host connections from this list provided they have customized authorization.

**Terminal Type Menu** A list of all the available names and terminal types for the port to which you are currently connected. Names and terminal types are taken from the station sets defined during customization.

**Default Destination** A host to which a terminal or printer is connected when it is initially turned on. *If a host is not defined as the default destination for a display station, the Connection Menu is displayed.*

**Note:** A default destination is required for printers.

**AEA station** A 3270 or ASCII display station, printer, or host that is involved in asynchronous communication through the AEA.

**AEA station set** One or more AEA stations with the same attributes<sup>1</sup>, such as:

- Station type (for example, 3270 display station or DEC VT100 display station)
- Default destination (for example, the IBM 3270 host or an ASCII host)
- Flow control, line speed, parity, and various other attributes, described later in this chapter.

Station set names for host stations will appear on the connection menu for all devices with AEA access. Station set names for terminals will appear in the terminal type menu, provided that more than one station set is defined.

**AEA port set** One or more controller ports that have the same physical characteristics such as port type (switched, direct, nonswitched), speed, parity, and so on. A port set supports one or more station sets. All ports in a port set provide access to the same station sets.

**Note:** Station sets supported by a port set must have the same default destination and different station types.

**Port pools** A group of ports (a port set) that offers multiple access points to the same resource. When the controller receives a request to connect to a host, it scans the port set for a non-busy (available) port. If one is found, it is selected as the port through which the connection is processed.

---

<sup>1</sup> For customizing purposes, two stations have the same attributes if all the station set questions have the same answers.

## AEA Concepts

To plan and set up a communication network, you should be familiar with network components and configurations. In this section are examples of 3270 and ASCII Terminal Emulation with the basic components required for data communication. These examples should help you understand the concepts and functions of asynchronous communication with the AEA feature.

**Example 1:** This example (see Figure 12-1) shows a 3270 Terminal Emulation configuration in which a remote ASCII terminal accesses an IBM host by connecting over telephone lines to the 3174. The components of the configuration are labeled, and the specific AEA terms that apply to these components are shown below, in **bold**.

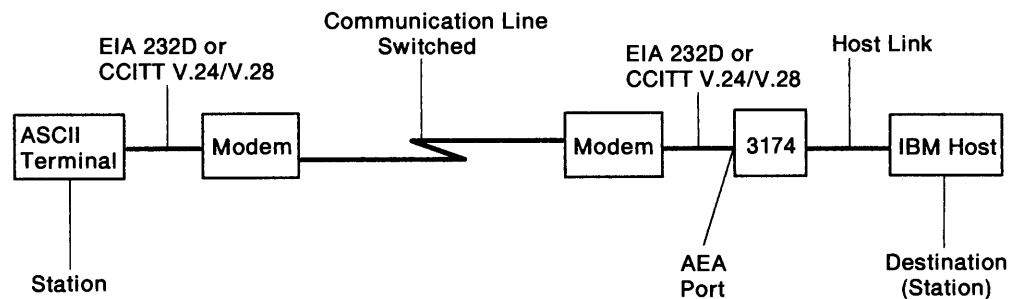

Figure 12-1. 3270 Terminal Emulation Example

The **ASCII terminal** is called a *station*. In general, any display, printer, or host (IBM or ASCII) involved in asynchronous communication through the AEA is called a *station*. In AEA customizing, ASCII terminal stations are identified by a range of characteristics, including *station type* (such as IBM 3101, DEC VT100, Hewlett-Packard 2621B\*\*), *destination* (in this case, the IBM host), *flow control type* (in this case, XON/XOFF), *line speed*, and *parity*.

**Modems** convert the digital signals from terminals or computers to analog communication signals at one end of the line, and convert the analog communication signals back to digital signals at the other end of the line. In AEA customizing, the modem attached to an AEA port is identified by its *modem type*; the four modem type designations are *Hayes*, *Micom*\*\*, *IBM*, and *Other*. Limited-distance modems (LDM) do not have a modem type designation. The Hayes, Micom, IBM, or equivalent auto-call modems are required only for dialing out from the 3174 controller to an ASCII host or public data network. In Figure 12-1, an auto-call modem would be useful at the terminal end of the line; at the 3174 end of the line, an auto-call modem is not required to process calls coming in to the 3174 controller. The modem attached to the remote ASCII terminal must use the same speed and modulation technique as the associated modem attached to the AEA port. Also, the remote modem's type is not relevant to AEA configuration.

The AEA feature supports nonswitched-line, switched-line, and limited-distance modems that provide duplex asynchronous operation and equal transmit and receive speeds, and that conform to EIA 232D/CCITT V.24/V.28 specifications. The AEA feature also supports auto-call<sup>2</sup> modems that conform to the EIA 232D/CCITT V.24/V.28 specifications and to the IBM Attention Command Set (AT), the Hayes AT command set, the Microm auto-dial procedure and other autodial modems, or the AEA manual calling<sup>3</sup> requirement.

The **Communication line** provides a data path between modems. In this example, the communication line is a *switched* line. Switched lines (also called dial lines) use the same equipment and transmission lines that are used for voice (telephone) communication. A connection must be established between the terminal and the host before data can be transmitted. To establish a connection with the IBM host, the remote ASCII terminal user must dial (call) the 3174 just as with voice communication. A user dials the 3174 phone number either by using a telephone connected to the nearby modem, or by using a communication application program and either selecting the number from an automatic call directory or entering the dial digits at the keyboard.

The 3174 then makes the IBM host connection, either immediately or after selection from the Connection Menu.

ASCII terminals can also be connected to the 3174 either *directly* or via *nonswitched* lines. In Figure 12-1 on page 12-5, if the ASCII terminal is no more than 15 meters (50 feet) away from the 3174, it can be connected directly to an AEA port; the two modems and the communication line are not needed for direct connection.

Unlike switched lines, nonswitched lines (also called leased lines or dedicated lines) do not require dialing to establish communication; the line is permanently connected instead of being routed through switching equipment.

Be aware that for nonswitched connections the AEA does not determine whether the connecting device is present or not. While this provides a more flexible interface, connections are sometimes made to nonexistent or powered-off devices. For ASCII host lines, if the user gets a nonswitched connection where the ASCII host is powered off or not connected, the characters will not be echoed (the ASCII host is responsible for character echoing). The user should return to the Connection Menu, disconnect, and try the connection again. This time the AEA will try another host line if one is defined and available.

In Example 1, an **AEA port** connects a modem to the 3174. In AEA customizing, ports are identified by their *port type*; the port type reflects the kind of communication line or connection supported between the terminal and the 3174; the port types that can be used by ASCII stations are designated *Switched*, *Direct*, and *Nonswitched*. The AEA port type in Figure 12-1 on page 12-5 is a *switched* port.

---

<sup>2</sup> An auto-call modem accepts dial digits from the AEA over the data leads. In AEA operation, auto-call is a feature whereby dial digits (an ASCII host phone number) are stored in the 3174 Establishment Controller. These digits are sent to the auto-call modem when the user requests a connection to the ASCII host.

<sup>3</sup> In AEA operation, manual calling means that the terminal user enters the modem commands and dial digits from the keyboard in order to initiate a connection to an ASCII host.

In general, a **destination** is a host to which a terminal user has access. A *default destination* can be specified while planning for the AEA; the default destination is the host to which an ASCII terminal is connected when the user calls into an AEA port on the 3174. If a default destination is not specified, or if the default destination cannot be connected, the user is presented with a *Connection Menu* that consists of a list of host destinations from which the user can select a particular host or application.

**Example 2:** This example (see Figure 12-2) shows an ASCII Terminal Emulation configuration in which a 3270 terminal accesses a remote ASCII host. The components of the configuration are labeled, and the specific AEA terms that apply to these components are shown below, in **bold**; only those components that differ from the 3270 Terminal Emulation example are described.

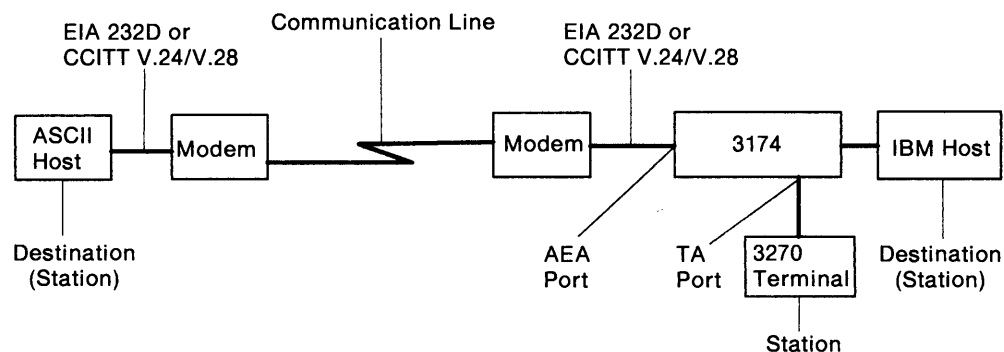

Figure 12-2. ASCII Terminal Emulation Example

In AEA customizing, a **3270 terminal** involved in asynchronous communication is also called a *station*. 3270 terminal stations are identified by their station type (display station or printer) and their destination configuration.

The port type of coax is designated for **Terminal Adapter (TA) ports** that connect 3270 terminal stations.

The modem attached to an **AEA port** used for calling out to an ASCII host over switched lines must be a Hayes, Micom, IBM, or equivalent auto-call modem.

The default destination in this case is the host to which a 3270 terminal station is connected when the user switches on the terminal, or toggles the Normal/Test switch. As in the previous example, if a default destination is not specified, the user is presented at connection time with a Connection Menu. In this example, the IBM host could be the default destination; the ASCII host would then have been reached through the Connection Menu.

---

### Planning and Setup Tasks

You must coordinate customizing and site planning activities. Those responsible for customizing the 3174 and for site planning must plan and implement their activities together.

#### Analyze Your Communication Requirements

You must identify which 3270 and ASCII stations attach to the 3174. In addition, you must decide how the ASCII stations will be connected to the 3174; ASCII stations can be connected either directly or through switched (dialed) or nonswitched telecommunication lines.

When choosing what kind of lines to use, consider that although auto-call modems are more expensive than ordinary modems, switched lines requiring auto-call modems are less expensive to rent and use than nonswitched lines. Over time, the expense of auto-call modems will be recovered by the savings realized on switched line costs.

Nonswitched lines are used to provide immediate access to a dedicated resource and to provide users with more reliable data communication. Nonswitched lines may be conditioned by the common carrier (the company that supplies communication services) to reduce transmission errors and signal distortion, and to increase the speed capability of the line. Switched lines cannot be conditioned.

You must carefully evaluate your communication requirements when deciding on switched or nonswitched lines.

Remember that each asynchronous communication line can support only one session at a time. Therefore, if you have eight users of an ASCII host, and they all need to be connected all day to the same resource, your controller will require eight communication lines to that resource. This may be an unlikely circumstance, so you need to perform a traffic analysis to compute how many lines are required to support the users of a particular resource. For these eight users, you need to evaluate the amount of connect-time per user per hour. You may find that three or four AEA ports are sufficient to prevent an *all ports busy* condition.

#### Create a System Specification

Planners must work from an overall 3174 controller specification or layout plan. You should provide such a controller specification that consists of 3174 Attachment Diagrams that identify all the attached 3270 (synchronous) and/or ASCII (asynchronous) displays, printers, and hosts. The 3270 and ASCII Attachment Diagrams are in Appendix A, "Configuration Worksheets." The diagrams account for a controller that has up to sixty-four 3270 devices connected to the Terminal Adapters (direct-attached or through a multiplexer), and up to 24 ASCII devices (local and remote terminals or hosts). These diagrams provide much of the information required to fill out configuration worksheets.

## Things to Do

You can proceed to the tasks below after you have:

- Identified all the 3270 and ASCII attachments that will use the AEA feature
- Resolved your data communication requirements
- Ordered the AEA feature.

Skip any tasks that do not pertain to your situation.

1. Copy and fill out the 3174 Attachment Diagrams from Appendix A and give copies to those responsible for customizing the 3174 controller and preparing the site.
2. Order communication lines.
3. Subscribe to an information service.
4. Order cables.
5. Order modems.
6. Order test equipment.
7. Prepare the site.
8. Plan for and customize the microcode to support the AEA.
9. Set up AEA hardware (when not installed at the IBM facility).
10. Check out the system – Phase 1 (3174 hardware checkout).
11. Check out the system – Phase 2 (customization checkout).
12. Check out the system – Phase 3 (operational checkout).

## Fill Out the 3174 Attachment Diagrams

The 3174 Attachment Diagrams are provided so that you can identify all the 3270 and ASCII displays, printers, and hosts that will be connected to the 3174 Establishment Controller. Follow the instructions that accompany each attachment diagram, and use the completed attachment diagrams to complete the customizing and site planning worksheets.

## Things to Order

**Order Communication Lines:** Contact your communication service (either the telephone company or your in-house communication department), and order the number and kind of communication lines that meet your data communication requirements.

**Subscribe to an Information Service:** Information services provide databases that meet various information needs. These services advertise in many trade magazines and journals. If your establishment requires an information service, call and request a subscription. The service will provide you with the resource phone number, a user ID and password, and asynchronous communication protocol configuration information. This information will include such items as line speed, parity, number of stop bits, and host data stream type (VT100 or 3101). You will use this information when customizing the AEA ports that will access this information service.

**Order Cables:** IBM does not provide cables with the AEA feature. You must order or assemble these cables. The cable's wiring must conform to the cabling specification described in *3174 Site Planning*, GA23-0213. Make sure that your vendor provides cables that match this specification.

## Planning for the AEA

**Order Modems:** For auto-dialing out from the 3174 over switched lines, use Hayes, Micom, IBM, or equivalent intelligent modems. The documentation provided with these modems describes how to configure the modem for your specific operations. For answering calls from remote ASCII terminals, ordinary switched modems can be used. Refer to the *3174 Terminal User's Reference for Expanded Functions*, GA23-0332, for modem specifications and configuration switch settings. For nonswitched connections over in-house wiring, limited-distance modems can be used.

**Order Test Equipment:** The following equipment may be needed to monitor or test AEA operation:

- Test headset or test telephone to check telecommunication lines to remote sites.
- Datascope and a break-out box to examine leads.
- EIA connector gender changer. To run cable wrap tests with the wrap plug supplied with the AEA feature, you may need a connector that changes the gender of the end of the cable.

### Prepare the Site

Refer to *3174 Site Planning*, GA23-0213, for such details of site preparation as modem power and equipment rack space requirements. Plan also to terminate the telecommunication lines somewhere near the modems.

Site planning worksheets must be filled out in accordance with the 3174 Attachment Diagrams.

### Plan for and Customize the Microcode to Support the AEA

Some of the major customizing activities required for AEA operation are described under "AEA Microcode Customization Planning" on page 12-12. Refer to that section for this information. The configuration worksheets must be filled out in accordance with the 3174 Attachment Diagrams.

### Set Up AEA Hardware

The 3174 must be accessible from the front and back to install the AEA, the back panels, and a ground strap. Customer installation and checkout instructions are provided with the AEA feature.

### System Checkout

System checkout consists of three phases:

1. Customer installation and cable checkout
2. Customization and modem checkout
3. Operational checkout.

#### Phase 1 – Customer Installation and Cable Checkout

1. After hardware setup is completed, run offline diagnostics (Alt 2 IML and Alt 1 IML tests) as described in the customer installation instructions that accompany the AEA feature. These tests verify the proper operation of the 3174 and the AEA.
2. Attach cables to the AEA ports.

3. Check the continuity of cables. For cables wired for connection to a modem, the wrap plug is attached to the end of a cable. ALT 1 IML wrap tests are run on the selected AEA port<sup>4</sup> (refer to the *3174 User's Guide* for test procedures). The procedure should be repeated for each cable. You should repair or replace any cable attached to a port that failed a wrap test and run the test again.

### Phase 2 – Customization and Modem Checkout

1. Connect cables to modems, limited-distance modems, or “null modems.”<sup>5</sup>
2. Connect communication lines to the modems.
3. Connect ASCII stations to the other end of the communication line.
4. IML the 3174 with customized microcode.
5. Configure and test the modems using online test 12 (refer to the *Customer Problem Determination*, GA23-0217, for more information).

**Phase 3 – Operational Checkout:** In this phase, with all stations attached and the 3174 IMLed, exercise normal 3270 communications and any AEA modes of operation that apply.

1. Sign on from 3270 display stations, and try to access the IBM host. This step verifies normal terminal/computer operations.
2. If applicable, turn on a directly attached ASCII display station, and check for the Connection Menu<sup>6</sup>, terminal type prompt, or IBM host screen, whichever applies. (Press carriage return; or press carriage return, type a period (.), then press carriage return again.)

Try to access the IBM host; communication between an ASCII terminal and an IBM host exercises 3270 Terminal Emulation.

3. From a 3270 display station (if ASCII Terminal Emulation is configured), request the Connection Menu (if necessary), and verify that the IBM and ASCII hosts are listed. Try to access an ASCII host.
4. Request a connection to the IBM host from a supported remote ASCII display station, or one configured to emulate a supported station. Communication between the ASCII terminal and the IBM host exercises 3270 Terminal Emulation and all the hardware components of remote access.
5. If applicable, request a connection to an ASCII host from an ASCII display station to exercise ASCII Pass-Through.

---

<sup>4</sup> Wrap tests work only on cables wired for connection to modems; wrap tests do not work on cables wired for direct connection of terminals or computers.

<sup>5</sup> A null modem is a device with two 25-pin D-shell connectors that attaches to the station end of a standard, straight-through, pin-for-pin EIA 232D/CCITT V.24/V.28 cable. The null modem does the crossing-over of the appropriate leads required for the direct connection of a terminal or computer to an AEA port (see *3174 Site Planning*, GA23-0213).

<sup>6</sup> Refer to the *3174 Terminal User's Reference for Expanded Functions* for Connection Menu procedures.



---

## AEA Microcode Customization Planning

The controller requires information about the stations attached to the AEA. Unlike coax-attached stations, most of this information must be provided through customizing because ASCII stations do not have a standardized way of identifying themselves to the controller at connection time. Information about the AEA ports, their use by 3270 stations, and the ASCII stations must be provided to the controller through customizing.

Planning for customizing the 3174 Establishment Controller to support the Asynchronous Emulation Adapter involves:

- Configuring for the AEA
- Specifying what default destinations display stations and printers will have
- Assigning display stations, printers, or hosts to groups called *station sets*
- Assigning station sets to *port sets* (a port or group of ports)
- Mapping (assigning) the ports supporting the station sets to the port sets
- Defining terminal tables and translate tables.

**Note:** When ASCII display stations with attached printers are defined with unique port assignment entries, host applications can communicate with both at the same time through the same port.

AEA configuration planning involves grouping devices and ports with similar attributes into sets. This process is used to reduce the amount of information that would normally have to be keyed in. For example, instead of keying in the information for each display station attached to the controller, you key in the information *once* for a group of display stations with the same characteristics.

To group the devices and assign them to sets, you need specific information about the display stations, printers, and hosts, and the ports they are attached to:

- What types they are (for example, 3270 or ASCII)
- What their characteristics are (for example, the line speed they require)
- Which ports they are attached to
- How they are attached to the controller
- What host the printers will default to when they are turned on
- Whether the display stations will default to a specific host session or the Connection Menu when they are turned on (for 3270 display stations when the MLT function has been configured, you also need to know what additional default destinations must be specified).

Using this information, you are guided through three worksheets: "Worksheets 15A and 15B—3270 Attachment Diagram", and "Worksheet 16—ASCII Attachment Diagram." You may have already received completed diagrams; if you have, you may proceed to "Numbering the AEA Station Sets on the Attachment Diagrams" on page 12-35 when you are ready.

You use the three completed attachment diagrams to complete the AEA worksheets.

**The three diagrams are an important aid in planning the AEA configuration.**

Starting on page 12-18, you are guided through the procedures for filling out the attachment diagrams and the AEA worksheets. Examples of how to fill out the worksheets are provided in these procedures. Additional planning examples are provided in Appendix B, "AEA Planning Examples."

## Station Sets and Port Sets

In many instances, much of the information about stations and ports is the same for groups of stations and ports. Customizing provides a way to put stations and ports into *station sets* and *port sets*, respectively, and to assign station and port characteristics on a "set" basis. All members of a set share the same characteristics.

### Examples

1. Eight ports on a single AEA are to be used to connect to IBM 3163 display stations over in-house lines running at 9600 bps. The display stations can be grouped into a station set that defines the common station type, line speed, parity, default destination, and other station characteristics. The ports can be grouped into a port set that defines the common port type as *nonswitched*. The station set would be assigned to the port set.
2. Twelve ports (eight on one AEA, four on another) are to be used to provide access to a public database through auto-dialing IBM modems. The ASCII host that has the public database would be a station set that defines the host's attributes, such as the phone number for the host, line speed, parity, and flow control type. The ports can be grouped into a single port set (named, for example, "CALL OUT") that defines the common port type as *switched*, and the common modem type as *IBM*.
3. If VT100s, 3163s, and PCs emulating 3101s all called in to a pool of 20 AEA ports, they would be defined in three station sets all pointing at the same port set: "CALL IN."
4. A switched port set may be used for both incoming calls from displays and for outgoing calls to hosts. The port sets, CALL OUT and CALL IN (in examples 2 and 3), could be combined into one port set, "IN OUT."

Defining port sets and station sets for fixed connections (coax, nonswitched, or direct ports) is usually straightforward: ports that connect stations with the same attributes are assigned to a port set, and stations of the same type are described in a single station set that is assigned to that port set.

Figure 12-3 on page 12-14 shows an example of station set and port set groupings. There are two station sets in the figure: one of ASCII displays and one of ASCII printers. There are also two port sets, made up of groups according to port type.

In this example, each station set connects to one of the port sets; however, if both station sets connected to switched ports, the port set containing switched ports would connect both station sets.

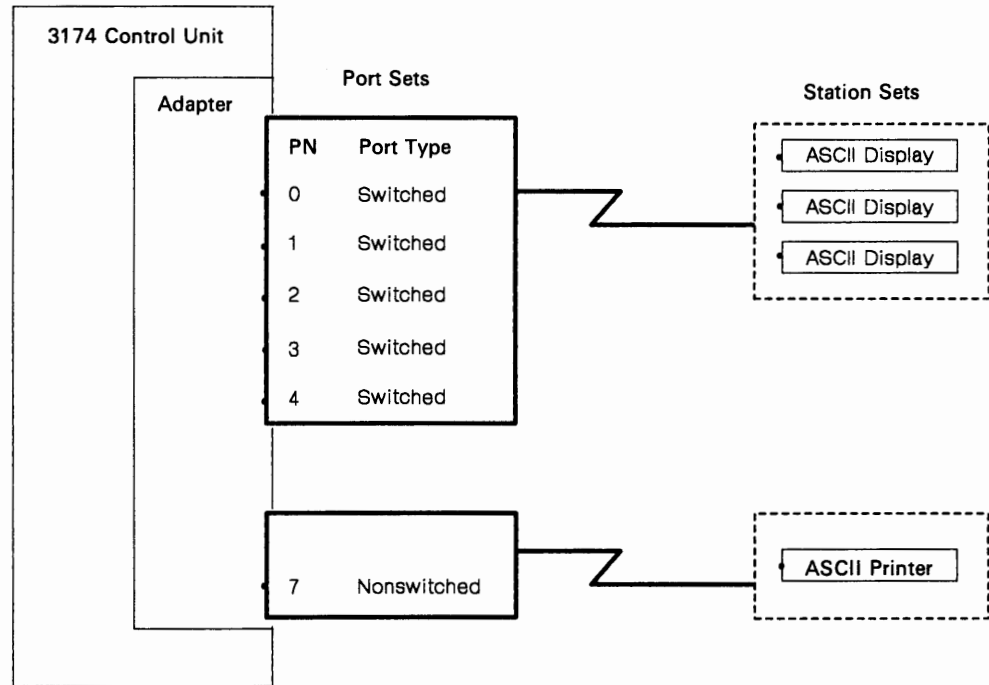

Figure 12-3. Station Sets and Port Sets

**Notes:**

1. Station sets supported by a port set must have the same default destination.
2. Separate port sets must be defined for ASCII printer station sets and ASCII terminal station sets that are connected to the AEA either directly or over nonswitched lines.

Switched connections offer a wider range of possible configurations; this makes customization for switched connections more complex. Again, stations that have the same attributes are defined in a station set. Several different station sets can be assigned to a single port set. The port set thus becomes a pool of ports that can be used by stations of different types.

When defining port sets, remember that the controller distinguishes the station sets within a port set by their station type. This has several specific implications:

- Display station sets assigned to one port set **must** have different station types. When a display station calls in, the controller determines its station set by the user's response to the station type prompt.
- Display station sets assigned to one port set **must** have identical attachment parameters (such as speed, parity, stop bits, and number of bits per character); they must all use the same speed/parity or autobaud so that the controller knows what to expect when stations call in.
- ASCII Host Station sets assigned to one port set **do not** require identical attachment parameters (speed, parity, or stop bits) within a port set.
- Printers and display stations **must** be in different port sets. When a call arrives, the controller must know whether the call is made from a display or a printer. The printer cannot respond to a station type prompt.

- A display with an attached printer is treated as a display; however, you must inform the 3174 that the display has an attached printer at the time of connection.

In general, assigning as many ports as possible into a single switched port set improves the probability of a port being available. For example, if an eight-port pool for outgoing calls to hosts and an eight-port pool for incoming calls from display stations are combined into one 16-port pool, the outgoing calls can use any available (idle) ports that had been formerly assigned to the incoming port pool. Conversely, the incoming calls can use any available ports that had been formerly assigned to the outgoing port pool.

A reason for limiting the size of port sets is to reduce terminal prompting; if two station sets with different line speeds are assigned to the same port set (line speed must be specified in customizing as *auto*), users are required to enter autobaud sequences and to respond to a station type prompt. These steps can be avoided if separate port sets are defined for the different station sets.

The station set names for hosts appear in the Connection Menu<sup>7</sup>. If more than one display station type can connect to a port, their station set names appear in a *terminal type menu* when the display station connects to the 3174. Users of the system need to understand these station set names, so station set names should be chosen that are self-explanatory. For example, "VAX System 4" is more specific and understandable than "A-Host."

---

## AEA Planning Considerations

The following sections discuss what you should consider when planning for the AEA.

### MLT

*MLT* is a 3174 function that allows 3270 CUT or ASCII display stations to access multiple host sessions. If ASCII MLT support is configured, a display user can interact with, and connect to, up to five host sessions. The host sessions are to the 3270 host 1A and one or more ASCII hosts. 3270 MLT support also enables the display user to interact with, and connect to, up to five host sessions. The sessions are to one or more IBM hosts (through the primary or secondary host links), one or more ASCII hosts, or both. Configuring the AEA to support the MLT function requires planning for special station and port set definitions and host access.

If MLT has been configured, display stations can have as many as five default destinations defined. The default destination configuration (the number and order of default destinations) is specified on a station-set basis; for each default destination configuration, you need to define a station set and associated port set.

If you specify an ASCII host as a default destination, the host connection is established when the display station is turned on; an AEA port supporting that host is dedicated to the display station. In dedicating an AEA port supporting that host, access to that host for other display stations and printers will be limited to the remaining ports supporting that host.

---

<sup>7</sup> If Multi-Host Support is used, the Host Descriptor, if defined, appears instead of the station set name for the 3270 hosts.

## Planning for the AEA

For more information regarding the MLT function, see Chapter 6, "Planning to Configure" and Chapter 7, "Planning for Port Assignment."

## Storage

The overall storage of the controller must be sufficient to support the AEA and any other function that you may want configured. Under certain functional configurations, AEA will be deconfigured during IML if the controller does not contain sufficient storage to support the AEA and any other functions you have configured.

The "Storage Planning Procedure" on page 3-4 helps you to determine the storage requirements for the AEA and any other functions you are planning to configure.

## Multi-Host Support

If you have configured for Multi-Host Support, then a Logical Terminal Assignment (LTA) is defined to identify which hosts each 3270 display and printer can access. The LTA is defined either through planning or with defaults that are determined when the device is turned on. The LTA determines which logical terminals (LTs) may be used to access ASCII hosts. If the LTA entry for an LT indicates a host session for a CCA-attached host (Host ID 2A-2D or 3A-3D), then the Connection Menu and ASCII hosts cannot be accessed from that LT. The default destination for that LT is ignored; only the session indicated in the LTA is used. However, if the LTA entry for an LT indicates a host session with a host on the primary link (Host ID 1A—1H), then the AEA Default Destination determines whether the LT is first assigned to the Connection Menu, an ASCII host, or a 3270 host. If the AEA Default Destination indicates a 3270 host, then the host session for the LT is the one indicated by the LTA entry.

**Note:** ASCII devices cannot use Multi-Host Support; therefore, LTA is not used for ASCII devices.

## Terminal Tables and Translate Tables

The AEA provides a means for interpreting data from any device and sending data that can be understood by the device. With ASCII stations, this can be difficult, because many ASCII stations communicate using widely varying command sequences. Other factors are the character set that the device supports and the language for which the 3174 is configured. For example, the command sequence for clearing the screen of one station type may have a different effect on another station type. Or a symbol interpreted one way at a 3270 host may be interpreted differently at the ASCII device.

The AEA solves this difficulty by enabling you to define special tables for communicating between 3270 hosts and ASCII station types. There are two types of user-defined tables: *User-Defined Terminal tables (UDT tables)* and *User-Defined Translate tables (UDX tables)*. Each can be defined for inbound and outbound communication.

UDT tables enable the AEA to interpret and send sequences and commands to different ASCII station types in 3270 emulation. These tables map ASCII keyboard sequences to 3270 commands and 3270 sequences to ASCII commands. The AEA provides terminal tables for several commonly used station types; you can define more tables to support other station types.

UDX tables provide information about the character set supported by that station type, the language configured for its 3174 controller, and matching symbols in each

data stream to equivalent symbols in the other data stream. The AEA provides translate tables for several commonly used station types; you can define more tables to support other station types.

The AEA provides several terminal and translate tables that are already defined. If your devices match the station types of these tables and you do not wish to change the tables at all, you can use them for your system. In this case, the necessary information is provided as default values on the customization panels; the customizer simply uses the default values.

For more information on terminal and translate tables, see "Filling Out Worksheet 22—Terminal Tables" and "Filling Out Worksheet 25—Translate Tables."

---

## ASCII Display Stations Supported by the AEA

The following list of ASCII display stations are supported by the AEA:

- ADDS Viewpoint A2\*\*
- ADDS Viewpoint/78\*\*
- Hazeltine 1500\*\*
- Esprit Executive 10/78\*\*
- Hewlett-Packard 2621B
- IBM 3101
- IBM 3151
- IBM 3161
- IBM 3162
- IBM 3163
- IBM 3164
- Cypress, Cedar, and Juniper terminals
- Lear Siegler ADM 3A Dumb Terminal\*\*
- Lear Siegler ADM 5\*\*
- Lear Siegler ADM 11\*\*
- Lear Siegler ADM 1178\*\*
- Lear Siegler ADM 12\*\*
- ANSI 3.64 terminal\*
- TeleVideo 912\*\*
- TeleVideo 970\*\*
- DEC VT52\*\*
- DEC VT100
- DEC VT220
- DEC VT240
- DEC VT241\*\*
- Personal Computers running FTTERM
- Tektronix 4205
- WYSE 50/60\*\*
- Minitel 1B\*\*.

**Planner:** *The following procedures for filling out the Attachment Diagrams (3270 and ASCII) are the first step in planning for the AEA. The information on these Attachment Diagrams (when complete) will be used to fill out the remaining AEA worksheets.*

## Filling Out Worksheet 15—3270 Attachment Diagram

Locate and remove “Worksheet 15—3270 Attachment Diagram”. This worksheet has two pages; make sure you get both (15A and 15B). The following steps guide you through the worksheet. **Read all these steps before filling out the worksheet.** Throughout these steps, an example configuration is provided. The example is designed to show a variety of connection possibilities and the resulting AEA configuration. This example configuration does not use Multi-Host Support. (You can find additional AEA planning examples in Appendix B.)

**The examples shown are for HG 26. Worksheet 15B is for HG 27. You will fill out Worksheet 15B exactly the same for hardware group 26.** The example configuration consists of:

- Hosts:
  - An IBM host named “VMSYS2”
  - Two ASCII hosts named “VAX VMS” and “PARTS”
- ASCII terminal emulation:
  - 3270 display stations accessing the IBM and ASCII hosts
  - 3270 printers accessing the IBM host
  - Use of the MLT function
- 3270 terminal emulation
  - IBM 3151 display stations accessing the IBM host
  - DEC VT100 display stations accessing the IBM host
  - Televideo 912 display stations accessing the IBM host.

**Step 1** Fill in the host Station Set Name and Station Set Number columns.

In the response key on the top of the worksheet, fill in a name for each host you want your attached 3270 and ASCII display stations and printers to be able to access. See Figure 12-4.

	Station Set Name	=	Station Set Number
IBM Host =	VMSYS2	=	1
ASCII Host =	VAX VMS	=	2
ASCII Host =	PARTS	=	3
ASCII Host =		=	
ASCII Host =		=	
ASCII Host =		=	
ASCII Host =		=	
ASCII Host =		=	

Figure 12-4. The 3270 Response Key

**Note:** When Multi-Host Support is used, the “3270 Host” station set is used for all the 3270 hosts that have been configured.

*The name may be up to 24 characters long, and up to 28 ASCII hosts may be defined as station sets. The station set for IBM hosts has already been numbered Station Set Number 1. Number each*

additional host sequentially (for example, the next host would be *Station Set Number 2*). Use the back of the photocopied worksheet for additional ASCII hosts.

**When naming the hosts, use easily recognized names as they will appear in the Connection Menu.** Figure 12-4 gives an example of how to fill in these columns.

**Step 2** Fill in the Station Type column.

Refer to the completed site planning worksheets to determine what kind of device (a display station or printer) is attached to each of the controller ports. Use the Station Type abbreviations listed in the response key to fill in the Station Type column for each port of the 3270 Terminal Adapter. The Station Type column is used to indicate whether a printer or a display station is attached to the controller port. Figure 12-5 gives an example of how to fill in this column on the worksheet.

3270 Attachment Diagram		Station Set Name	Station Set Number	Default Destinations					Station Type
Terminal Adapter Name	Port Set Name	Station Set Name		LT1	LT2	LT3	LT4	LT5	
HG-26	26-00		IBM Host = VMSYS2 = 1						3D
	26-01		ASCII Host = VAX VMS = 2						3D
	26-02		ASCII Host = PARTS = 3						
	26-03		ASCII Host =						
	26-04		ASCII Host =						
	26-05		ASCII Host =						
	26-06		ASCII Host =						
	26-07		ASCII Host =						
	26-08		ASCII Host =						
	26-09		ASCII Host =						
	26-10		ASCII Host =						
	26-11		ASCII Host =						
	26-12		ASCII Host =						
	26-13		ASCII Host =						
	26-14		ASCII Host =						
	26-15		ASCII Host =						
	26-16		ASCII Host =						
	26-17								
	26-18								3D
	26-19								
	26-20								
	26-21								
	26-22								
	26-23								
	26-24								
	26-25								
	26-26								
	26-27								
	26-28								
	26-29								
	26-30								
	26-31								

Figure 12-5. Filling In the Station Type Column on the 3270 Attachment Diagram

In Figure 12-5, ports 26-00 through 26-16 are all the same Station Type – 3D – which indicates they are 3270 display stations. Ports 26-17 through 26-19 are all Station Type 3P, which indicates they are 3270 printers. Ports 26-20 through 26-31 are Station Type 3D, which indicates they are 3270 display stations.



### **Step 3** Fill in the Default Destination columns.

The Default Destination columns are used to indicate the initial default destinations of the display stations and printers attached to the 3174 Establishment Controller. In the case of 3270 display stations (when MLT has been configured), they list the concurrent default destinations. For printers, you must specify a host. For display stations, you may or may not specify a host. *If you do not specify a host, write in CM for Connection Menu.* "CM" indicates the 3270 display will have the Connection Menu displayed after powering on.

If you specify an ASCII host as a default destination, the host connection is established when the display station or printer is initially turned on; an AEA port supporting that host is dedicated to the display station or printer. In dedicating an AEA port supporting an ASCII host, access to that host for other displays and printers will be limited to the remaining ports supporting the host. It is recommended that you specify an ASCII host as a default destination only if that ASCII host will be the sole host connection for the display station or printer. *CM for Connection Menu* should be indicated for all display stations that will require occasional access to ASCII hosts. If the Connection Menu is not the default destination, you will be able to display the Connection Menu on the display station by use of the Connection Menu key sequence.

Fill in Default Destination column 1 with either a host station set number (listed in the response key) to indicate a specific host session or *CM* to indicate the Connection Menu.

Fill in Default Destination columns 2 through 5 for display stations, only if MLT has been configured. Write in either a host station set number (from the response key) to indicate a specific host session or *CM* to indicate the Connection Menu for each concurrent default destination.

#### **Notes:**

- a. If you have 3270 display stations with more than one default destination, it is recommended that you put IBM host sessions first, because of Port Assignment restrictions. See Chapter 7 if you need additional information regarding Port Assignment.
- b. When Multi-Host Support is used, the Default Destination entries are ignored for logical terminals that are assigned (using Logical Terminal Assignment) to hosts 2A-2D and 3A-3D. See "Multi-Host Support" on page 12-16 for more information.
- c. For 3270 or ASCII display sessions with an attached printer, the default destination for the printer LT is ignored. Instead, a 3270 host connection is assumed.

Figure 12-6 on page 12-21 gives an example of how to fill in the Default Destination columns on the 3270 Attachment Diagram.

### 3270 Attachment Diagram

Station Set Name	Station Set Number
IBM Host = VMSYS2	= 1
ASCII Host = VAX VMS	= 2
ASCII Host = PARTS	= 3
ASCII Host =	=
ASCII Host =	=
ASCII Host =	=
ASCII Host =	=
ASCII Host =	=
ASCII Host =	=
ASCII Host =	=

Note:  
For 3270 Stations  
Port Type = Coax = 1

3270 Display=3D Printer=3P
----------------------------------

Terminal Adapter HG-26	Port Set Name	Station Set Name	Default Destinations					Station Type
			LT1	LT2	LT3	LT4	LT5	
26-00			1	CM				3D
26-01			↓	↓				↓
26-02			↓	↓				↓
26-03			↓	↓				↓
26-04			↓	↓				↓
26-05			↓	↓				↓
26-06			↓	↓				↓
26-07			↓	↓				↓
26-08			↓	↓				↓
26-09			↓	↓				↓
26-10			↓	↓				↓
26-11			↓	↓				↓
26-12			↓	↓				↓
26-13			↓	↓				↓
26-14			↓	↓				↓
26-15			↓	↓				↓
26-16			↓	↓				↓
26-17			1					3P
26-18			↓					↓
26-19			↓					↓
26-20			CM					3D
26-21			↓					↓
26-22			↓					↓
26-23			↓					↓
26-24			↓					↓
26-25			↓					↓
26-26			↓					↓
26-27			↓					↓
26-28			↓					↓
26-29			↓					↓
26-30			↓					↓
26-31			↓					↓

Figure 12-6. Filling In the Default Destination Columns

In Figure 12-6, display stations at ports 26-00 through 26-16 have been given the IBM host as their first default destination and then the Connection Menu. The printers on ports 26-17 through 26-19 have been given the IBM host as their default destination. The display stations on ports 26-20 through 26-31 have been given the Connection Menu.

**Step 4** Fill in the Station Set Name column.

To fill in the Station Set Name column, sort the Station Types listed in the Station Type column into the two main types: printers and display stations. *The name may be up to 24 characters long.*

**Printers**

Sort the printers into groups with the same default destination. Name each **group** and put the corresponding name in the Station Set Name column for each printer in the group.

**Display stations**

Sort the display stations into groups with the same default destinations and in the same order. Name each **group** and put the corresponding name in the Station Set Name column for each display station in the group.

Figure 12-7 gives an example of how to group the 3270 stations into station sets.

3270 Attachment Diagram		Station Set Name	Station Set Number	Default Destinations					Station Type
Terminal Adapter HG-26	Port Set Name	Station Set Name		LT1	LT2	LT3	LT4	LT5	
26-00		3270 Displays 1	IBM Host = VMSYS2 = 1		1	CM			3D
26-01			ASCII Host = VAX VMS = 2						
26-02			ASCII Host = PARTS = 3						
26-03			ASCII Host =						
26-04			ASCII Host =						
26-05			ASCII Host =						
26-06			ASCII Host =						
26-07			ASCII Host =						
26-08			ASCII Host =						
26-09			ASCII Host =						
26-10			ASCII Host =						
26-11			ASCII Host =						
26-12			ASCII Host =						
26-13			ASCII Host =						
26-14			ASCII Host =						
26-15			ASCII Host =						
26-16			3270 Printers						
26-17		IBM Host =			1				
26-18		ASCII Host =							
26-19		3270 Displays 2							
26-20			IBM Host =		CM				3D
26-21			ASCII Host =						
26-22			ASCII Host =						
26-23			ASCII Host =						
26-24			ASCII Host =						
26-25			ASCII Host =						
26-26			ASCII Host =						
26-27			ASCII Host =						
26-28			ASCII Host =						
26-29			ASCII Host =						
26-30			ASCII Host =						
26-31		ASCII Host =							

Figure 12-7. An Example of 3270 Station Sets

In Figure 12-7, display stations at ports 26-00 through 26-16 have been given the IBM host as their first default destination and then the Connection Menu. This group has been named **3270 Displays 1**. The printers attached to ports 26-17 through 26-19 have the IBM 3270 Host as their default destination. This group has been named **3270 Printers**. The display stations on ports 26-20 through 26-31 have been given only the Connection Menu. This group has been named **3270 Displays 2**. The display stations have been grouped and assigned to two different

station sets because one group has only one default destination and the other group has a default destination and the Connection Menu (two host sessions).

**Step 5** Fill in the Port Set Name column.

The station sets you named can now be assigned to individual port sets.

Assign a port set name to each of the station sets and write the name in the Port Set Name column for the station set assigned to that port set. *The name may be up to 8 characters long.* Figure 12-8 gives an example of how to sort the station sets and assign them to port sets.

3270 Attachment Diagram		Station Set Name	Station Set Number	Default Destinations					Station Type
Terminal Adapter HG-26	Port Set Name	Station Set Name		LT1	LT2	LT3	LT4	LT5	
			IBM Host = VMSYS2 = 1						
			ASCII Host = VAX VMS = 2						
			ASCII Host = PARTS = 3						
			ASCII Host =						
			ASCII Host =						
			ASCII Host =						
			ASCII Host =						
			ASCII Host =						
			ASCII Host =						
			ASCII Host =						
			3270 Display=3D Printer=3P						
			Note: For 3270 Stations Port Type = Coax = 1						
26-00	3270D1	3270 Displays 1		1	CM				3D
26-01									
26-02									
26-03									
26-04									
26-05									
26-06									
26-07									
26-08									
26-09									
26-10									
26-11									
26-12									
26-13									
26-14									
26-15									
26-16									
26-17	3270P	3270 Printers		1					3P
26-18									
26-19									
26-20	3270D2	3270 Displays 2		CM					3D
26-21									
26-22									
26-23									
26-24									
26-25									
26-26									
26-27									
26-28									
26-29									
26-30									
26-31									

Figure 12-8. An Example of 3270 Port Sets

In Figure 12-8, station set 3270 Displays 1 becomes a port set named **3270D1**. Station set 3270 Displays 2 becomes a port set named **3270D2**; this station set must be assigned to a different port set because it has only one default destination (host session). The station set **3270 Printers** has been assigned to port set 3270P.

**Planner:** You have completed the 3270 Attachment Diagrams. Proceed to "Filling Out Worksheet 16—ASCII Attachment Diagram."

## Filling Out Worksheet 16—ASCII Attachment Diagram

Locate and remove “Worksheet 16—ASCII Attachment Diagram” on page A-29. The following steps guide you through the worksheet.

**Step 1** Fill in the host Station Set Name and Station Set Number columns.

Copy the station set names and numbers listed in the response key of the 3270 Attachment Diagrams into the response key for the ASCII Attachment Diagram (see Figure 12-9). *The name may be up to 24 characters long.* Figure 12-9 gives an example of how to fill in these columns.

	Station Set Name	Station Set Number
IBM Host =	VMSYS2	= 1
ASCII Host =	VAX VMS	= 2
ASCII Host =	PARTS	= 3
ASCII Host =		=
ASCII Host =		=
ASCII Host =		=
ASCII Host =		=
ASCII Host =		=

Figure 12-9. ASCII Response Key

In Figure 12-9, the IBM host has been named **VM SYS 2** and has been numbered **Station Set Number 1**. The two ASCII hosts have been named **VAX VMS** and **PARTS** and numbered **Station Set 2** and **Station Set 3**.

**Step 2** Fill in the Station Type column.

Using the Station type abbreviations listed at the bottom of the worksheet, fill in the Station Type column for each port of the AEA.

**Notes:**

- a. If several different Station Types will be attached through a modem pool that allows them to access a range of ports, list the Station Types for that range of ports in the Station Type column. A modem pool consists of one or more modems of the same type (for example, three Hayes modems) which are used by several display stations, printers, or hosts to access several controller ports.
- b. Be sure to fill in the Station Type column for any ASCII hosts listed in the response key.

Figure 12-10 gives an example of how to fill in this column on the worksheets.

ASCII Attachment Diagram		Station Set Name		Station Set Number	See Station Type Table below
Switched=2	Hayes = 1	IBM Host = VMSYS2		= 1	
Direct =3	Micom=2	ASCII Host = VAX VMS		= 2	
Non-switched =4	IBM =3	ASCII Host = PARTS		= 3	
	Other =4	ASCII Host =		=	
		ASCII Host =		=	
		ASCII Host =		=	
		ASCII Host =		=	
		ASCII Host =		=	
		ASCII Host =		=	
		ASCII Host =		=	
		ASCII Host =		=	
Port Type	Modem Type	Port Set Name	Station Set Name	Default Destination	Station Type
<b>AEA HG-21</b>					
21-00					V1 I1 T1
21-01					
21-02					
21-03					
21-04					
21-05					
21-06					
21-07					
<b>AEA HG-22</b>					
22-00					AH
22-01					
22-02					
22-03					
22-04					
22-05					
22-06					
22-07					
<b>AEA HG-23</b>					
23-00					
23-01					
23-02					
23-03					
23-04					
23-05					
23-06					
23-07					
<b>Station Type Table</b>					
ASCII Host	= AH	FTTERM (Monochrome)	= FM Lear Siegler 1178	= L7 Televideo 912	= T1
ASCII Plotter	= AL	Hewlett Packard 2621 B	= H2 IBM 3162 Model 870	= R8 Televideo 970	= T7
ASCII Printer	= AP	IBM 3101	= I1 ROLM Cypress, Cedar, Juniper	= R1 DEC VT100	= V1
ADDS Viewpoint A-1,A-2	= A2	IBM 3151, 3161, 3162, 3163	= 12 ANSI 3.64 Terminal	= S1 DEC VT241	= V2
ADDS Viewpoint 78	= A7	IBM 3151,3161,3162,3163	= 13 UDT5	= U5 DEC VT52	= V5
Esprit Hazeltine 1500	= E1	IBM 3164	= 14 UDT6	= U6 DEC VT220	= V6
Esprit Executive 78	= E7	Lear Siegler ADM 11/12	= L1	Tektronix 4205	= X4
FTTERM (Color)	= FC	Lear Siegler ADM 3A/5	= L3	WYSE 50/60	= W1
UDT1	= U1	UDT3	= U3	Minitel 1B	= M1
UDT2	= U2	UDT4	= U4		

Figure 12-10. Filling In the Station Type Column on the ASCII Attachment Diagram

In Figure 12-10, ports 21-00 through 21-07 have a variety of ASCII display stations, which will be accessing them through this range of ports. The responses listed at the bottom of the worksheet indicate that the **V1** indicates DEC VT100 display stations, the **I1** indicates IBM 3101 display stations, and the **T1** indicates TeleVideo 912 display stations. The ASCII host named **VAX VMS** will be using ports 22-00 through 22-04 to communicate and has been indicated with a station type of **AH**. The other ASCII host (named **PARTS**) will be using ports 22-05 through 22-07 and has also been indicated by an **AH** in the station type column.

### **Step 3** Fill in the Default Destination column.

The Default Destination Column is used to indicate a specific host session or the Connection Menu. The Station Type dictates whether a host or the Connection menu may be specified:

- For printers, a host must be specified.
- For display stations, you may or may not specify a host. *If you do not specify a host, write in CM.*
- For display stations with a printer, only the default destination for the display can be specified
- For hosts, do not specify a default destination.
- For 3270 or ASCII display sessions with an attached printer, the default destination for the printer LT is ignored. Instead a 3270 host connection is assumed.

Fill in the Default Destination column for each printer and display station with either a host station set number (from the response key) or *CM* to indicate Connection Menu.

If you specify an ASCII host as a default destination, the host connection is established when the display station or printer is initially turned on; an AEA port supporting that host is dedicated to the display station or printer. In dedicating an AEA port supporting an ASCII host, access to that host for other display stations and printers will be limited to the remaining ports supporting the host. It is recommended that you specify an ASCII host as a default destination only if that ASCII host will be the sole host connection for the display station or printer. *CM* for Connection Menu should be indicated for all display stations that will require occasional access to ASCII hosts. Figure 12-11 on page 12-27 gives an example of how to fill in the Default Destination column on the ASCII Attachment Diagram.

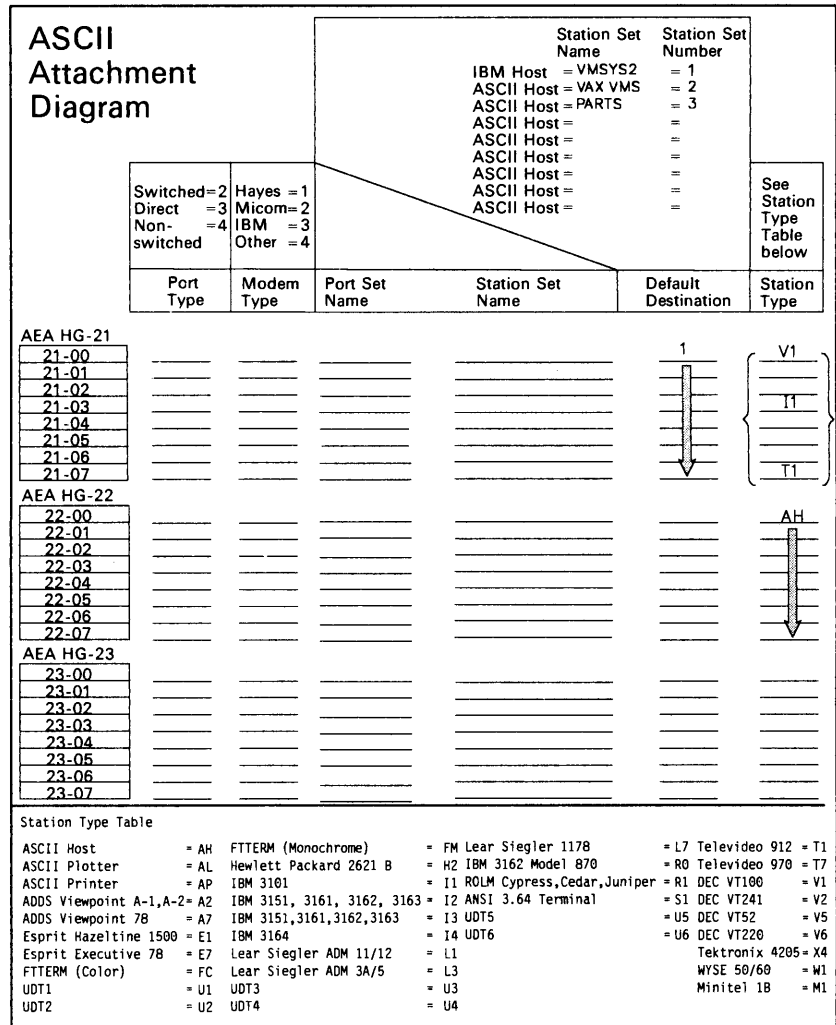

Figure 12-11. Filling In the Default Destination Column on the ASCII Attachment Diagram

In Figure 12-11, all the display stations in the range of ports (21-00 through 21-07) have been given the IBM Host as their default destination; the IBM Host has been indicated by 1, that being the number assigned to it in the response key.



**Step 4** Fill in the Port Type.

This column specifies what type of physical connection will be used to attach the display stations, printers, and hosts to the AEA ports.

Using the Port Type abbreviations listed in the response key, fill in the Port Type column for each of the AEA ports. The following list defines the three possible responses:

- 2 = Switched – Connection is made through modems attached to the Public Telephone network.
- 3 = Direct – Connection is made through null modems or by using a DTE cable.
- 4 = Nonswitched – Connection is made through privately owned or leased lines or by using a DTE cable.

Figure 12-12 gives an example of how to fill in this column on the worksheets.

### ASCII Attachment Diagram

			Station Set Name IBM Host = VMSYS2 = 1 ASCII Host = VAX VMS = 2 ASCII Host = PARTS = 3 ASCII Host = = ASCII Host = = ASCII Host = = ASCII Host = = ASCII Host = = ASCII Host = =	Station Set Number = 1 = 2 = 3 = = = = =	
Switched=2 Direct =3 Non-switched =4	Hayes =1 Micom=2 IBM =3 Other =4			See Station Type Table below	
Port Type	Modem Type	Port Set Name	Station Set Name	Default Destination	Station Type

<b>AEA HG-21</b>					
21-00	2			1	V1
21-01	↓			↓	I1
21-02	↓			↓	T1
21-03	↓			↓	
21-04	↓			↓	
21-05	↓			↓	
21-06	↓			↓	
21-07	↓			↓	
<b>AEA HG-22</b>					
22-00	2				AH
22-01	↓				↓
22-02	↓				↓
22-03	↓				↓
22-04	↓				↓
22-05	↓				↓
22-06	↓				↓
22-07	↓				↓
<b>AEA HG-23</b>					
23-00					
23-01					
23-02					
23-03					
23-04					
23-05					
23-06					
23-07					

Station Type Table					
ASCII Host	= AH	FTTERM (Monochrome)	= FM Lear Siegler 1178	= L7 Televideo 912	= T1
ASCII Plotter	= AL	Hewlett Packard 2621 B	= H2 IBM 3162 Model 870	= R0 Televideo 970	= T7
ASCII Printer	= AP	IBM 3101	= I1 ROLM Cypress,Cedar,Juniper	= R1 DEC VT100	= V1
ADDS Viewpoint A-1,A-2	= A2	IBM 3151, 3161, 3162, 3163	= I2 ANSI 3.64 Terminal	= S1 DEC VT241	= V2
ADDS Viewpoint 78	= A7	IBM 3151,3161,3162,3163	= I3 UDT5	= U5 DEC VT52	= V5
Esprit Hazeltine 1500	= E1	IBM 3164	= I4 UDT6	= U6 DEC VT220	= V6
Esprit Executive 78	= E7	Lear Siegler ADM 11/12	= L1	Tektronix 4205	= X4
FTTERM (Color)	= FC	Lear Siegler ADM 3A/5	= L3	MYSE 50/60	= W1
UDT1	= U1	UDT3	= U3	Minitel 1B	= M1
UDT2	= U2	UDT4	= U4		

Figure 12-12. Filling In the Port Type Column

In Figure 12-12 on page 12-28, ports 21-00 through 21-07 all have the same Port Type – 2 – which indicates that the display stations are connected through switched lines. Ports 22-00 through 22-04 have a Port Type of 2, which indicates that this ASCII host is also connected through switched lines. Ports 22-05 through 22-07 have a port type of 3, which indicates that this ASCII host is connected through direct lines.

**Step 5** Fill in the Modem Type.

This column specifies what type of modem will be used for the display station, printer, or host on AEA ports using switched lines (having a port type of 2); the modem specified is the modem attached to the controller.

Using the Modem Type abbreviations listed in the response key, fill in the Modem Type column for any AEA ports with a port type of 2. The following list defines the four possible responses:

- 1 = Hayes (or Hayes-compatible)
- 2 = Micom (or Micom-compatible)
- 3 = IBM
- 4 = Other (modems that meet the AEA specifications).

Figure 12-13 gives an example of how to fill in this column on the worksheets.

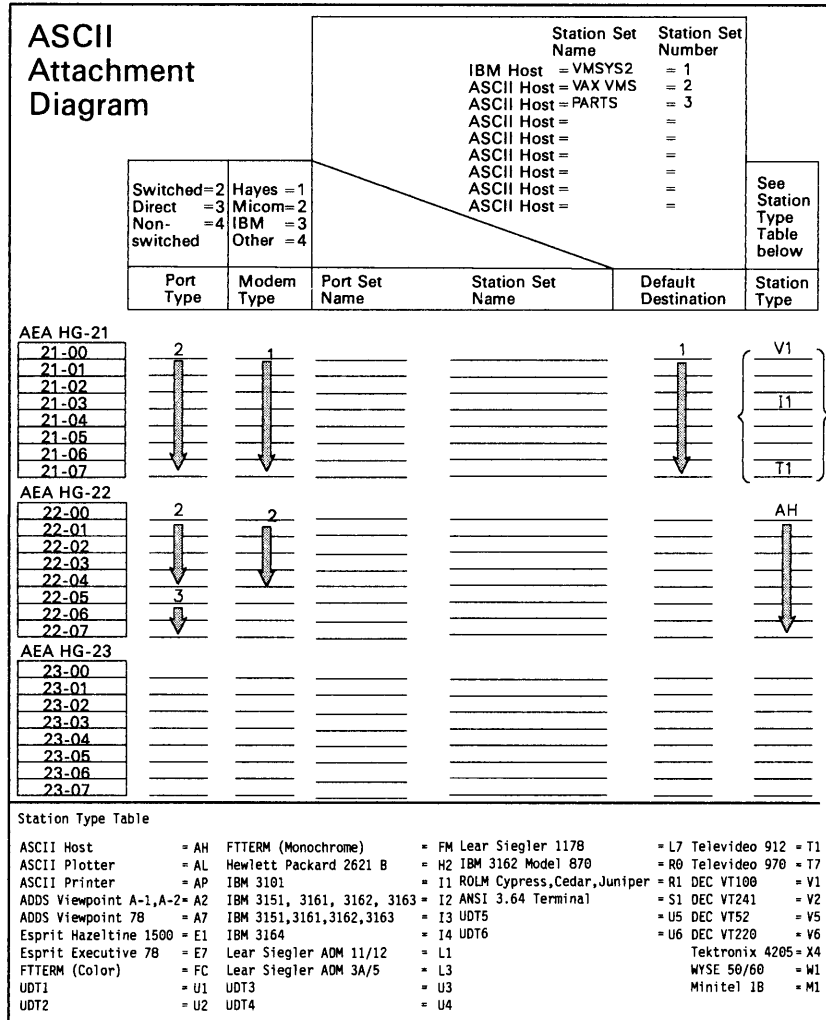

Figure 12-13. Filling In the Modem Type Column

In Figure 12-13, ports 21-00 through 21-07 have the same Modem Type – 1 – which indicates that these display stations all communicate using Hayes modems. Ports 22-00 through 22-04 have a modem type of 2, which indicates that this ASCII host communicates through Micom modems. The ASCII host on ports 22-05 through 22-07 has a port type of 3, which indicates that it is connected through direct lines and therefore does not use a modem.

**Step 6** Fill in the Station Set Name column.

To fill in the AEA Station Set column, sort the station types listed in the Station Type column into three main types: hosts, printers, and display stations.

**Hosts**

Write the station set names for each AEA host (found in the response key) in the Station Set Name column of the AEA ports over which the host will communicate.

**Printers**

Sort the printers into groups that have the same port type, modem type, and default destination responses. Name each group and write the corresponding name in the Station Set Name column for each printer in the group.

**Display stations**

Sort the display stations into groups (station sets) that have the same station type, port type, modem type, and default destination responses. Name each group and write the corresponding name in the Station Set Name column for each display station in the group. **Use a name that the display station user can recognize.** If more than one AEA station set of different display stations is assigned to an AEA port set, the display station users will be prompted to identify their display station; the station set names assigned to that port set will be displayed and the display station user will select from the list.

*The name can be up to 24 characters long.* Figure 12-14 gives an example of how to sort the stations into station sets.

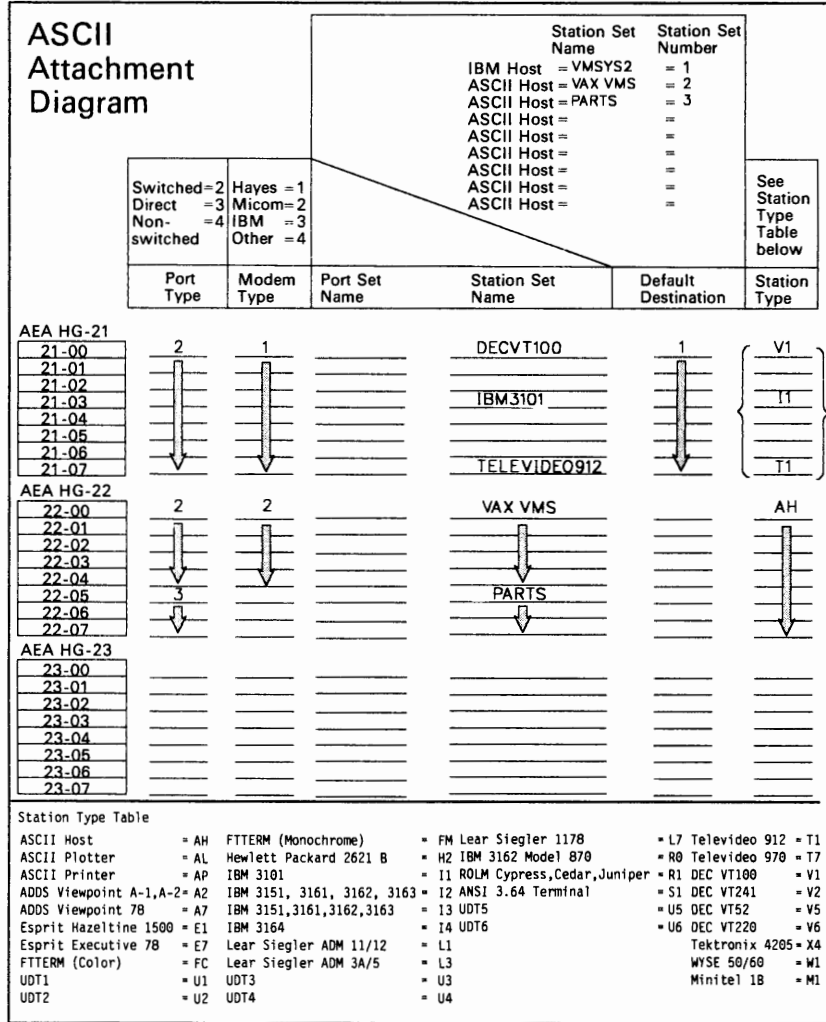

Figure 12-14. Filling In the AEA Station Set Name Column

In Figure 12-14, the display stations on the range of ports from 21-00 through 21-07 have the same port type, modem type, and default destination responses; they have been assigned to individual station sets because their station types differ. The display stations with station type V1 have been assigned to station set DECVT100; the display stations with station type I1 have been assigned to station set IBM3101, and the display stations with station type T1 have been assigned to station set TELEVIDEO912. The two ASCII hosts have already been named **VAX VMS** and **PARTS**, and the names have been written in the Station Set Name column.

**Step 7** Fill in the Port Set Name column.

To fill in this column, sort the station sets into three groups: station sets made up of display stations, printers, and hosts.

**Station sets made up of display stations**

Sort these station sets into groups that have the same port type, modem type, and default destination. Name each group and write the corresponding name in the Port Set Name column for each station set assigned to that port set.

**Station sets made up of printers**

Assign each printer station set to an individual port set and name the port set. Write the corresponding name in the Port Set Name column for each station set.

**Station sets made up of hosts**

Sort the host station sets into groups with the same port and modem type. Name each group and write the corresponding name in the Port Set Name column for each station set assigned to that port set.

**Note:** ASCII host station sets and display station sets can be assigned to the same port set if they have the same port and modem type. This results in more efficient use of the modems.

*A port set name can be up to 8 characters long. Figure 12-15 gives an example of how to sort the station sets and assign them to port sets.*

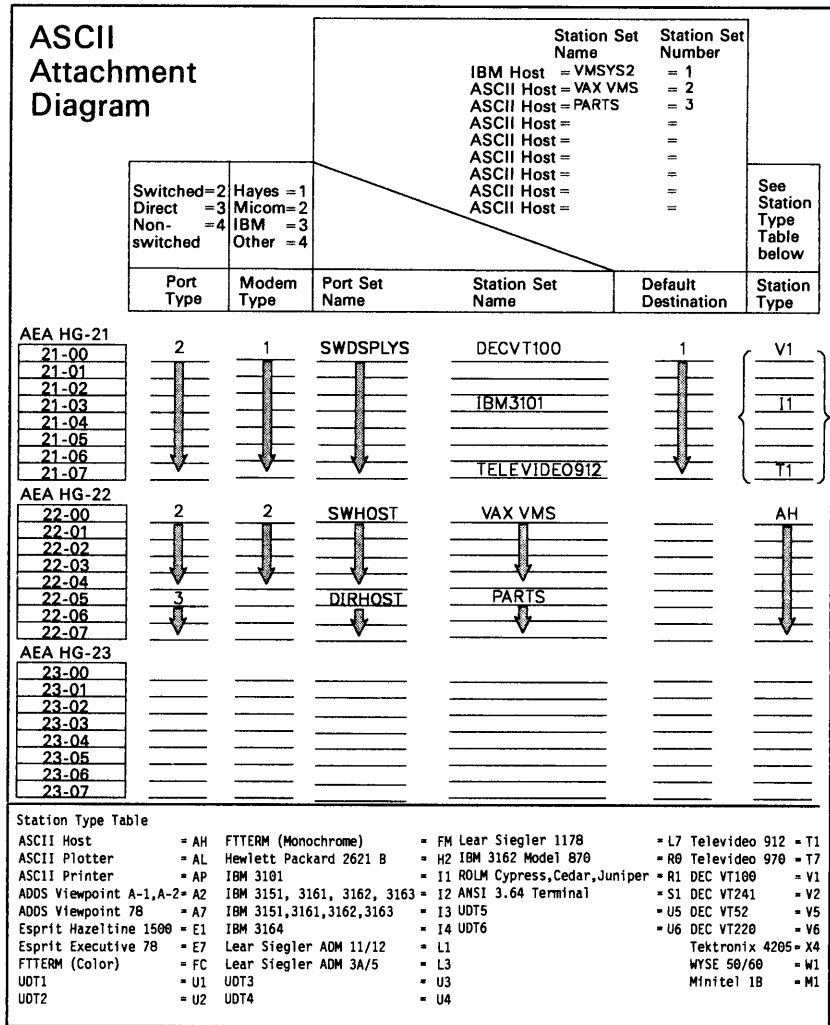

Figure 12-15. An Example of AEA Port Sets

In Figure 12-15, the station sets DECVT100, IBM3101, and TELEVIDEO912 can be assigned to the same port set because their station types are different and their port and modem types are the same; they have both been assigned to port set SWDSPLYS. The first ASCII host station set, named **VAX VMS**, cannot be assigned to the same port set as the second ASCII host station set, named **PARTS**, because their port types differ; station set VAX VMS has been assigned to port set SWHOST and station set PARTS has been assigned to port set DIRHOST.

**Planner:** You have completed the ASCII Attachment Diagram. Proceed to "Numbering the AEA Station Sets on the Attachment Diagrams" on page 12-35.

## Numbering the AEA Station Sets on the Attachment Diagrams

The host station sets have already been numbered in the response keys. Start numbering the station sets sequentially on the 3270 Attachment Diagram from the last number you assigned to a host in the response key. For example, if the last host was numbered 3, number the next station set 4. When you have completed numbering the station sets on the 3270 Attachment Diagram, number the station sets on the ASCII Attachment Diagram using the next sequential number.

Number each station set **once** and then write that number beside the station set name each time the name occurs. Figure 12-16 gives an example of how to number the station sets.

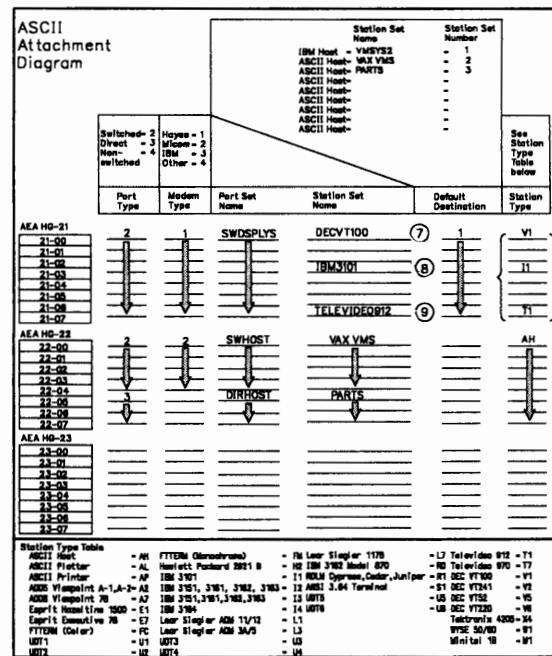
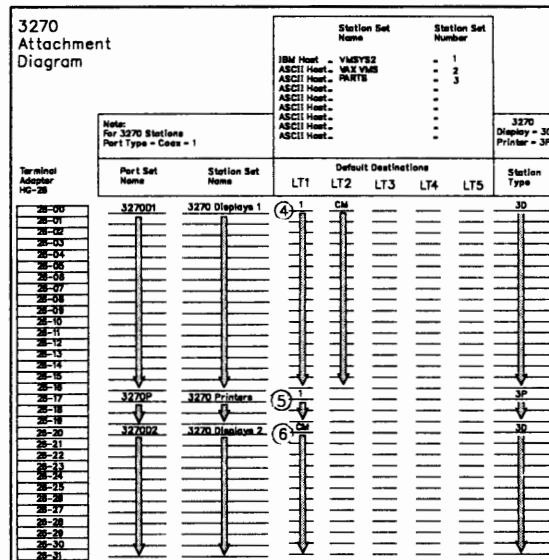

Figure 12-16. An Example of AEA Station Set Numbering



## Planning for the AEA

In Figure 12-16 on page 12-35, the IBM 3270 Host and two ASCII hosts have been numbered 1, 2, and 3. The 3270 Attachment Diagrams have already been completed, and three station sets have been numbered; station set **3270 Displays 1** has been numbered 4, station set **3270 Printers** has been numbered 5, and station set **3270 Displays 2** has been numbered 6. On the ASCII Attachment Diagram, the AEA station set **DECVT100** has been numbered 7, the station set **IBM3101** has been numbered 8, and the station set **TELEVIDEO912** has been numbered 9.

**Planner:** *You have finished the first step in completing the remaining AEA worksheets. Use the three worksheets you just completed and the following information to fill out Worksheets 17 through 27. Worksheets 17 through 27 are needed by the person customizing the 3174 Establishment Controller to support the AEA.*

*Remove Worksheets 17 through 27 from Appendix A and read all of the following information before filling them out. These worksheets should be filled out in their numerical order.*

---

## Filling Out Worksheet 17—AEA Configure

Following is a description of the questions on the worksheet and the possible responses. Read these descriptions and write your responses on the worksheet.

### 700: Configure the AEA Feature

*Response:*

- 0 = Turns off the AEA feature and maintains any AEA configuration data previously stored.
- 1 = Initiates Configure or Reconfigure procedure for the AEA feature and turns on the AEA.

The default response is 0.

**Note:** The microcode upgrade process defaults this question to a 0 during upgrade from Release B2.

### 702: Control Key Assignment

*Response:*

- 0 = Use the ALT key to provide the control function for ASCII Emulation users.
- 1 = Use the control key to provide the control function for ASCII emulation users.

The default response is 1.

If you select 0, the same end-user keyboard interface is provided as in 3174 Configuration Support B1.

**Notes:**

1. Option 0 is valid only for U.S.A. English.
2. If option 0 is selected, DEC VT220 and Data General D210 emulation are not permitted.
3. When option 0 is selected, KDU mappings are ignored during ASCII Emulation; the keyboard diverts back to its normal layout.
4. The microcode upgrade process defaults this question to a 1 during upgrade from Release B2.

### 703: Request MLT for AEA

*Response:*

- 0 = No AEA MLT support.
- 1 = Request AEA MLT support.

The default response is 0.

If this question = 1 and question 700 = 1, then question 110 cannot = 0.

## 710: Miscellaneous ASCII Feature Options (A)

*Response:* Eight digits (0 or 1).

- 0 = No
- 1 = Yes.

The default response is 00000000.

Digits are numbered from left to right.

Digit	Description
1	Reverse Video Option
2	Automatic New Line After End of Print
3	DSR Timing for Activating Connections
4	DSR Timing for Deactivating Connections
5	Printer Keyboard Option
6	Status Line Update Option
7	Reserved
8	Reserved

**Digit 1 - Reverse Video Blanks-to-Hyphens Option:** For 3270 displays *without* EABs, specifying this bit as 1 results in reverse video blanks displaying as hyphens.

**Digit 2 - Automatic New Line After End of Print:** Specifying this bit as a 1 results in an automatic new line only if the column pointer is in a position other than column 1. Specifying this bit as a 0 results in an automatic new line regardless of where the column pointer is located.

**Digit 3 - DSR Timing for Activating Connections:** Specifying this bit as a 1 results in the AEA recognizing that a connection has been established on switched or direct ports if DSR remains high for 500 milliseconds in response to the AEA raising DTR and RTS. This allows for faster connections on lines where the leads are stable.

When this bit is specified as a 0, DSR must remain high for two seconds in response to the AEA raising DTR and RTS.

For additional information on port activation, see the 3174 *AEA Description and Reference*.

**Digit 4 - DSR Timing For Deactivating Connections:** When this bit is specified as a 1, the AEA will not immediately deactivate a connection for a direct or switched port when DSR drops. Instead, it will time how long DSR remains low. If it is low for less than two seconds, the connection will remain active. If it is low for more than two seconds, the connection will be deactivated.

When this bit is specified as a 0, the AEA will deactivate a connection for direct and switched ports as soon as DSR drops.

For additional information on port deactivation, see the 3174 *AEA Description and Reference*, GA27-3872.

**Digit 5 - Printer Keyboard Option:** When this bit is set, it causes the AEA to ignore all inputs from the ASCII printer except the pacing data.

**Digit 6 - Status Line Update Option:** When this bit is set, it causes the AEA to update the status line after it finishes updating the data portion of the screen.

**Digits 7 through 8 - Reserved:** These digits are reserved.

## 711: Miscellaneous ASCII Feature Options (B)

*Response:* Eight digits (0 or 1).

- 0 = No
- 1 = Yes.

The default response is 00000000.

Digits are numbered from left to right.

**Note:** This customization question is reserved for use in defining non-standard feature options.

Digit	Description
1	Send TERMSELF when Device Disconnect
2	SLU Capability Vector of Notify = 00
3	Reserved
4	Reserved
5	Reserved
6	Reserved
7	Reserved
8	Reserved

**Digit 1 - Send TERMSELF when Device Disconnects:** Specifying this bit as a 1 results in TERMSELF being sent when a device in session with a 3270 SNA host application disconnects.

Specifying this bit as a 0 results in an UNBIND being sent when a device in session with a 3270 SNA host application disconnects.

**Digit 2 - SLU Capability of Power Off Request:** Specifying this bit as a 1 results in a value of X'00' for the Secondary LU capability byte of control vector X'0C' for Power Off Notify requests. This prevents a SNA host application from retaining data between sessions.

Specifying this bit as a 0 results in a value of X'10' for the Secondary LU capability byte of control vector X'0C' for a Power Off Notify Request.

**Digits 3 through 8 - Reserved:** These digits are reserved.

## 712: Miscellaneous ASCII Feature Options (C)

*Response:* Eight digits (0 or 1).

- 0 = No
- 1 = Yes.

The default response is 00000000.

Digits are numbered from left to right.

**Note:** This customization question is reserved for use in defining non-standard feature options.

Digit	Description
1	Reserved
2	Reserved
3	Reserved
4	Reserved
5	Reserved
6	Reserved
7	Reserved
8	Reserved

**713: Miscellaneous ASCII Feature Options (D)**

*Response:* Eight digits (0 or 1).

- 0 = No
- 1 = Yes.

The default response is 00000000.

Digits are numbered from left to right.

**Note:** This customization question is reserved for use in defining non-standard feature options.

Digit	Description
1	Reserved
2	Reserved
3	Reserved
4	Reserved
5	Reserved
6	Reserved
7	Reserved
8	Reserved

## Filling Out Worksheet 18—AEA Port Set

Following is a list of the different response areas for the worksheet and information on where the responses can be found on the 3270 and ASCII Attachment Diagrams. *Fill in the response areas for each unique port set name.*

<b>Name</b>	<p>Port Set Name column of the worksheets.</p> <p>Be sure to list all the port set names you wrote in on “Worksheet 15A—3270 Attachment Diagram,” “Worksheet 15B—3270 Attachment Diagram,” and “Worksheet 16—ASCII Attachment Diagram.” <i>A maximum of 16 is allowed.</i></p>
<b>Session Limit</b>	<p>Total number of default destinations (and CMs) listed for the port sets on the 3270 Attachment Diagram. Put the number of default destinations for each port set beside the corresponding port set name on “Worksheet 18—AEA Port Set.”</p> <p>If the number of host addresses is less than the session limit when questions 117 and 118 are being answered, those sessions without host addresses will not be permitted to access the 3270 (IBM host). However, access to ASCII hosts will be permitted. If the address defined for questions 117 and 118 exceeds the session limit number, those addresses will be unused by the controller since no device will have a session corresponding to those addresses.</p> <p><b>Note:</b> 3270 and ASCII port sets can have one to five session limits. If a port set is defined without a session limit, the system defaults the limit to 1.</p>
<b>Port Type</b>	<p>Port Type column of the ASCII Attachment Diagram.</p> <p><b>For 3270 port sets, respond with a 1.</b></p> <p>1 = 3270 Port Set.                  2 = Switched – Connection is made through modems attached to the public telephone network.                  3 = Direct – Connection is made through null modems.                  4 = Nonswitched – Connection is made through privately owned or leased lines.</p> <p><b>Note:</b> For nonswitched ports, the AEA will assume the device is attached and will not recognize that the device is powered off.</p>
<b>Modem Type</b>	<p>Modem Type column of the ASCII Attachment Diagram.</p> <p><b>For 3270 port sets, do not respond to this question.</b></p> <p>1 = Hayes (or Hayes-compatible)                  2 = Micom (or Micom-compatible)                  3 = IBM                  4 = Other (modems that meet the AEA specifications).</p> <p><b>Note:</b> Not all of the models made by Hayes, Micom, and IBM are supported. For the modem models and command sets that are supported, see the <i>3174 Terminal User’s Reference for Expanded Functions</i>, GA23-0332.</p>

**Password** 8-character response for which the user is prompted. This password is not required. If no password is entered on the AEA Port Set panel, no prompt is given.

---

### Filling Out Worksheet 19—AEA Port-to-Port Set Map

Refer to the 3270 and ASCII Attachment Diagrams and determine which controller ports support each port set. On “Worksheet 19—AEA Port to Port Set Map,” indicate these ports by writing the number of the port set in the corresponding response area for each controller port. (The port sets are numbered on “Worksheet 18—AEA Port Set.”) Figure 12-17 on page 12-43 gives an example of mapping (assigning) the controller ports to the port sets.

In Figure 12-17 on page 12-43, port set 1 is named **3270D1**, port set 2 is **3270P**, port set 3 is **3270D2**, port set 4 is **SWDSPLYS**, port set 5 is **SWHOST**, and port set 6 is **DIRHOST**. Using the numbers of the port sets, you **assign** the 3174 ports to the specific port sets.

In the example:

- 3174 ports 26-00 through 26-16 have been assigned to port set 1 (3270D1).
- Ports 26-17 through 26-19 have been assigned to port set 2 (3270P).
- Ports 26-20 through 26-31 have been assigned to port set 3 (3270D2).
- Ports 27-00 through 27-31 have **not** been assigned to a port set.
- Ports 21-00 through 21-07 have been assigned to port set 4 (SWDSPLYS).
- Ports 22-00 through 22-04 have been assigned to port set 5 (SWHOST).
- Ports 22-05 through 22-07 have been assigned to port set 6 (DIRHOST).

AEA Port Set					
	Name	Session Limit	Port Type	Modem Type	Password
1	<b>3270D1</b>	<b>2</b>	<b>1</b>	—	_____
2	<b>3270P</b>	<b>1</b>	<b>1</b>	—	_____
3	<b>3270D2</b>	<b>1</b>	<b>1</b>	—	_____
4	<b>SWDSPLYS</b>	—	<b>2</b>	<b>1</b>	_____
5	<b>SWHOST</b>	—	<b>2</b>	<b>2</b>	_____
6	<b>DIRHOST</b>	—	<b>3</b>	—	_____
7	_____	—	—	—	_____
8	_____	—	—	—	_____
9	_____	—	—	—	_____
10	_____	—	—	—	_____
11	_____	—	—	—	_____
12	_____	—	—	—	_____
13	_____	—	—	—	_____
14	_____	—	—	—	_____
15	_____	—	—	—	_____
16	_____	—	—	—	_____

AEA Port to Port Set Map								
3270 Ports	0	1	2	3	4	5	6	7
26-00 to 26-07	<b>1</b>	<b>1</b>	<b>1</b>	<b>1</b>	<b>1</b>	<b>1</b>	<b>1</b>	<b>1</b>
26-08 to 26-15	<b>1</b>	<b>1</b>	<b>1</b>	<b>1</b>	<b>1</b>	<b>1</b>	<b>1</b>	<b>1</b>
26-16 to 26-23	<b>1</b>	<b>2</b>	<b>2</b>	<b>2</b>	<b>3</b>	<b>3</b>	<b>3</b>	<b>3</b>
26-24 to 26-31	<b>3</b>	<b>3</b>	<b>3</b>	<b>3</b>	<b>3</b>	<b>3</b>	<b>3</b>	<b>3</b>
27-00 to 27-07	—	—	—	—	—	—	—	—
27-08 to 27-15	—	—	—	—	—	—	—	—
27-16 to 27-23	—	—	—	—	—	—	—	—
27-24 to 27-31	—	—	—	—	—	—	—	—
AEA Ports	0	1	2	3	4	5	6	7
21-00 to 21-07	<b>4</b>	<b>4</b>	<b>4</b>	<b>4</b>	<b>4</b>	<b>4</b>	<b>4</b>	<b>4</b>
22-00 to 22-07	<b>5</b>	<b>5</b>	<b>5</b>	<b>5</b>	<b>5</b>	<b>6</b>	<b>6</b>	<b>6</b>
23-00 to 23-07	—	—	—	—	—	—	—	—

Figure 12-17. Example of Port-to-Port Set Mapping (Assignment)



---

## Filling Out Worksheet 20—AEA Station Set

Each AEA Station Set Worksheet represents a single station set. Make copies of this worksheet, one worksheet for each station set. To fill out these worksheets, refer to the numbers you assigned each station set on the 3270 and ASCII Attachment Diagrams. The first station sets are the host station sets (numbered in the response key). **Station sets must have only one number assigned.**

Using the numbers assigned to each station set, write the number in the response area to the left of question 721 on the Station Set Worksheets. You fill out the Station Set Worksheets in the order in which you numbered them.

Proceed to Table 12-1 on page 12-45. This table contains the questions applicable for each station type. Beginning with station set 1 (the IBM host), answer the questions listed under 3270 host; the questions can be found immediately following the chart.

**After you have completed all the AEA Station Set Worksheets, continue with “Filling Out Worksheet 21—AEA Default Destination” on page 12-63.**

Table 12-1 on page 12-45 lists the questions that must be answered for each type of display station, host, and printer. If a  $\checkmark$  appears beneath the station type, answer that question. For example, answer questions 721, 722, and 723 for a station set made up of 3270 printers.

Question	ASCII Stations				3270 Stations			
	Host	Display Station	Printer	Display Station/Printer	Host	Display Station	Printer	Display Station/Printer
721: Station Set Name	✓	✓	✓	✓	✓	✓	✓	✓
722: Station Type	✓	✓	✓	✓	✓	✓	✓	✓
723: Port Set Name	✓	✓	✓	✓		✓	✓	✓
725: Host Connection Menu Option		✓		✓		✓		✓
731: Flow Control	✓	✓	✓	✓				
732: XON/XOFF Transmission Resumption	✓	✓	✓	✓				
733: Line Speed	✓	✓	✓	✓				
734: Line Speed (Host Upper Limit)	✓							
735: Parity	✓	✓	✓	✓				
736: Stop Bits	✓	✓	✓	✓				
737: Maximum Modem Line Speed	✓	✓	✓	✓				
741: Switched Disconnect Timeout								
742: Inactivity Timeout	✓	✓	✓	✓				
743: Prompt for Universal/Specific Keyboard Map		✓		✓				
744: Number of Bits per Character	✓	✓	✓	✓				
745: ASCII Display Character Set		✓		✓				
746: Translate Option		✓		✓				
751: Data Stream Supported by the ASCII Host	✓							
752: ASCII Host Phone Number	✓							
761: Auto XON/XOFF (DEC VT100/VT220)	✓							
762: Wraparound Option (DEC VT100/VT220)	✓							
763: New Line Option (DEC VT100/VT220)	✓							
764: Margin Bell Option (DEC VT100/VT220)	✓							
765: DEC Host ASCII Character Set (DEC VT100/VT220 Data Stream)	✓							
771: Automatic Line Feed for Cursor Control (IBM 3101)	✓							
772: Carriage Return/ Carriage Return—Line Feed Selection	✓							
773: Automatic New Line for Cursor Control (IBM 3101)	✓							
774: Scrolling (IBM 3101)	✓							
775: Line Turnaround Character	✓							
776: IBM ASCII Host Character Set	✓							
781: Shared Printer Prompt				✓				
782: Use of Form Feed			✓	✓				
783: Page Length			✓	✓				
784: Printer Character Set			✓	✓				
785: ASCII Printer Options			✓	✓				
786: Page Width			✓	✓				
787: LU 1 SCS Transparency Translation			✓	✓				

## 721: Station Set Name

*Response:* Up to 24 alphanumeric characters (blanks are permitted).

Fill in this response area with the station set name from the Station Set Name column on the attachment diagram. This name represents a group of display stations, printers, or hosts with the same attributes. When naming station sets made up of displays, use a name the display station users can recognize as representing their display stations. If more than one station set of different ASCII display stations is assigned to a port set, the display station users will be prompted to identify their display station; the station set names assigned to that port set will be displayed and the display station user will select from the list.

## 722: Station Type

*Response:*

Station Set Type	ASCII Respond With	3270 Respond With
Host	AH	3H
Plotter	AL	
Printer	AP	3P
Display Station:		3D
ADDS Viewpoint A1 and A2	A2	
ADDS Viewpoint/78	A7	
Esprit Executive 10/78	E7	
Hazeltime 1500	E1	
FTTERM Color* (IBM File Transfer/Terminal Emulator Program)	FC	
FTTERM Monochrome* (IBM File Transfer/Terminal Emulator Program)	FM	
Hewlett-Packard 2621B	H2	
IBM 3101	I1	
IBM 3151, 3161, 3162, 3163	I2	
IBM 3151, 3161, 3162, 3163	I3	
IBM 3164	I4	
IBM 3151, 3161, 3162, or 3163 with 3708 cartridge	I5	
Lear Siegler ADM 11 or ADM 12	L1	
Lear Siegler ADM 3A or ADM 5	L3	
Lear Siegler ADM 11/78	L7	
IBM 3162 Model 870	R0	
Cypress, Cedar, and Juniper terminals	R1	
ANSI 3.64 terminal	S1	
TeleVideo 912	T1	
TeleVideo 970	T7	
DEC VT100	V1	
DEC VT241	V2	
DEC VT52	V5	
DEC VT220	V6	
Tektronix 4205	X4	
WYSE 50/60	W1	

Minitel 1B	M1
User-Defined Terminal table 1	U1
User-Defined Terminal table 2	U2
User-Defined Terminal table 3	U3
User-Defined Terminal table 4	U4
User-Defined Terminal table 5	U5
User-Defined Terminal table 6	U6

Fill in this response area with the station type listed for this station set in the Station Type column of the applicable attachment diagram.

**723: Port Set Name**

*Response:* Up to 8 alphanumeric characters (blanks permitted).

Fill in this response area with the port set name listed for this station set on the applicable attachment diagram.

This name represents the port set to which this station set has been assigned.

**725: Host Connection Menu Option**

*Response:*

- 0 = The display station users in this station set will not be allowed to select alternative host connections from the Host Connection Menu. They can access only the connection defined in their Default Destination.
- 1 = The display station users in this station set will be allowed to select alternative host connections from the Host Connection Menu.

The default response is 1.

**Planner:** Use the following sources of input while gathering information needed to respond to the remaining questions:

- Persons responsible for setting up ASCII hosts
- ASCII host, display station, and printer customizing records
- ASCII device-supporting documentation
- External database documentation (for example, subscription information for remote ASCII databases).

## 731: Flow Control Type

*Response:*

- 0 = None
- 1 = XON/XOFF
- 2 = DTR (applicable only for nonswitched port types)
- 3 = RFS (applicable only for direct port types).

The default response is 1.

Your response specifies the type of flow control to be used between the controller and the ASCII host, display station, or printer.

- 0 = None**            The AEA will not recognize or apply any type of flow control.
- 1 = XON/XOFF**      The AEA will transmit and receive control codes XON and XOFF for data flow control. XOFF is used to halt data transmission. XON is used to allow data transmission to resume.

If this type of flow control is selected for an ASCII host using the D210 data stream, the flow control is one-directional for ASCII terminal emulation. The AEA sends XON/XOFF to the ASCII host to resume or halt the transmission of data. However, if the AEA receives an XON or XOFF control code from the ASCII host, it handles the control code as if it were a normal character and will not use it for pacing.

- 2 = DTR**            When the AEA detects a drop of the signal on the Data Set Ready (DSR) lead, it will stop sending data. To stop data transmission from an attached device, the AEA will drop the signal on the Data Terminal Ready (DTR) lead, which is cabled to the attached device's DSR lead.
- 3 = RFS**            When the AEA recognizes lead changes in Ready for Sending (RFS), it starts or stops sending data. To start or stop data transmission from an attached device, the AEA changes the signal on the Request To Send (RTS) lead.

**Note:** The correct flow control is required; if an incorrect response is made to this question, overrun errors can result. The DTE cable wiring diagram in *3174 Site Planning*, GA23-0213, must be followed exactly for DTR or RFS flow control to function properly.

Refer to the host, display station, or printer setup information for your response.

## 732: XON/XOFF Transmission Resumption

*Response:*

- 1 = Resume after any character is received.
- 2 = Resume only after XON is received.

The default response is 1.

If XON/XOFF is used, the response to this question indicates the signal the controller must receive to resume transmitting after it has received XOFF. Your response specifies whether transmission will be resumed only after XON is received by the adapter, or after any character is sent to the adapter.

You should use the default, because this precludes display station "hangups" caused by an accidental transmission of XOFF.

### 733: Line Speed

*Response:* 0 through 7.

0 = Autobaud/Autoparity	4 = 2400 bps
1 = 300 bps	5 = 4800 bps
2 = 600 bps	6 = 9600 bps
3 = 1200 bps	7 = 19 200 bps.

The default response is 0 and cannot be specified for a host or printer.

Autobaud/Autoparity (0), indicates the AEA will determine the speed and parity of the connecting terminal from the first three characters received. The user must type in CR.CR (carriage return, period, carriage return).

If you are answering this question for a host that supports a range of speeds (for example, 300 to 1200 bits per second), your response should be the lower limit (in this example, 300 bits per second).

If the line speed for the host is not a range, but a specific number (for example, 2400 bits per second), respond to this question and *skip* the next question, 734.

**Note:** If *Autobaud (0)* is not specified, all terminals assigned to the same port set must be set at the same speed. If the line speed specified is incorrect, response to transmissions may be absent or garbled.

### 734: Line Speed (ASCII Host Upper Limit)

*Planner:* This question applies only to ASCII hosts that support autobaud and have a range, as described in question 733. If you responded to question 733 with a specific speed (for example, 2400 bits per second), do not respond to question 734.

*Response:*

2 = 600 bps	5 = 4800 bps
3 = 1200 bps	6 = 9600 bps
4 = 2400 bps	7 = 19 200 bps.

There is no default response for this question.

This field specifies the host's upper-limit line speed.

**Notes:**

1. If the host supports autobaud and has a range, the response to this question is the upper limit of the range and must be greater than the response to question 733. Question 733 should **not** be answered as Autobaud (0) for ASCII hosts, but should indicate the lowest data rate supported by both the ASCII host and the AEA.
2. Ensure that the speed you specify for question 734 is not higher than the speed you plan to specify for question 737. Setting 734 higher than 737 will prevent dialing out.

### 735: Parity

*Response:*

- |                         |           |
|-------------------------|-----------|
| 0 = Autobaud/Autoparity | 3 = None  |
| 1 = Odd                 | 4 = Space |
| 2 = Even                | 5 = Mark. |

The default response is 0 and applies only to display stations; it cannot be used for hosts or printers.

If Autobaud is specified in question 733, then Autoparity (0) must be specified here.

**Note:** If *Autobaud (0)* is not specified, all terminals assigned to the same port set must be set at the same speed.

Your response specifies the parity and is required for ASCII hosts and printers. (See the Glossary for a definition of *parity*.)

**Notes:**

1. If the parity specified is incorrect, response to transmissions will be absent or garbled.
2. Because of hardware limitations, 8-bit Mark and Space parity is not supported.
3. If your device is sending 7 bits no-parity, and autobaud/autoparity is customized on the AEA, you should also configure your device to send two stop bits. Your response to question 736 must be 1 (1 stop bit) to insure the correct parity on the AEA.

### 736: Stop Bits

*Response:*

- 1 = 1 stop bit
- 2 = 2 stop bits.

The default response is 1.

Your response specifies whether the ASCII characters sent or received require 1 or 2 stop bits. If the number of stop bits specified is incorrect, response to transmissions may be absent or garbled.

### 737: Maximum Modem Line Speed

*Response:*

- |              |                 |
|--------------|-----------------|
| 1 = 300 bps  | 5 = 4800 bps    |
| 2 = 600 bps  | 6 = 9600 bps    |
| 3 = 1200 bps | 7 = 19 200 bps. |
| 4 = 2400 bps |                 |

There is no default response for this question.

**Notes:**

1. A response must be given if you are using a Hayes or IBM modem on switched lines and responded to question 733 with a 0.
2. Ensure that the speed you specified for question 734 is not higher than the speed you specify for question 737. Setting 734 higher than 737 will prevent dialing out.

**Hayes and IBM modem users:** If *Autobaud (0)* is specified in question 733, the answer to question 737 will determine the speed that commands are transmitted to your modem. To get the full use of the modem, respond to this question with the highest speed the attached modem it is capable of supporting.

## **741: Switched Disconnect Timeout (3270 Hosts Only)**

**Planner:** *This question applies only to 3270 hosts using BSC or local non-SNA protocols.*

**Response:** A three-digit number ranging from 000 to 254, representing a number of minutes (use leading zeros).

The default response is 000.

This question provides additional security function in the event of disconnection of a switched-line ASCII terminal. The response to this question specifies how long (in minutes), after the disconnection, the AEA port associated with this address should be held unavailable to take advantage of a host session timeout security feature. Ask your IBM host system programmer for this response.

## **742: Inactivity Timeout**

**Response:** Value from 000 to 254, representing a number of minutes (use leading zeros).

The default response is 015. A response of 0 indicates that the device may remain inactive for an indefinite period (no inactivity timeout set).

A nonzero response to this question defines the time an AEA port may remain idle before the connection is broken and the port made available to other users. The timer is reset when data is received from ASCII display stations or hosts. For printer connections, the timer is reset whenever data is sent to the printer.

In deciding what response to make to this question, consider relating time that a display station remains inactive to lost resource. Your response should be made considering the following:

- Line (phone) cost
- Importance of this station set's access
- Port value (access of other display stations).

This question decides the amount of time allowed for a display station, printer, or host to remain idle before the connection is broken.



### 743: Prompt for Universal/Specific Keyboard Map

*Response:*

- 0 = Do not display prompt.
- 1 = Display prompt.

The default response is 1.

This question decides whether the terminal user is prompted with a choice of using the specific map supporting the display station or a universal map that supports all the terminal types supported by the AEA. A response of 0 indicates the user will be using the specific keyboard map and should not be prompted for a choice.

The specific keyboard map takes advantage of keyboard nomenclature (for example, cursor movement keys) and is recommended if only a few different types of ASCII display stations are in use.

The universal keyboard map is constant for all ASCII display stations and is recommended if many different display stations will be used by the same display station user.

### 744: Number of Bits per Character

*Response:*

- 0 = 7 bits per character
- 1 = 8 bits per character

The default response is 0.

If question 735 is answered with a 3, option 0 indicates a start bit, 7 data bits, and either 1 or 2 stop bits. If question 735 is answered with a 3, option 1 indicates 8 data bits and no parity bit.

If question 735 is answered with anything other than a 3, the frame includes the parity bit.

**Note:** Because of hardware limitations, 8-bit Mark and Space parity is not supported.

This question must be answered the same for all stations in a port set.

### 745: ASCII Display Character Set

*Response:*

- 0 = US ASCII
- 1 = IBM 3101 CS1
- 2 = IBM 316x CS1 and CS2
- 3 = ISO 8859/1.2
- 4 = DEC MCS (requires 8-bit option for question 744)
- 5 = DEC NRC

The default response is 0.

This question applies only to ASCII displays.

If you are planning for devices that support multiple languages through the AEA, only options 1 through 5 apply.

If you are planning for devices that support one language through the AEA, only option 1 applies.

**Notes:**

1. If the controller will be configured for U.S.A. English **and** the station type supports the appropriate character set, options 1 through 5 are valid.
2. The answer given to this question may determine which predefined translate table is used for transmitting and receiving data. See question 746.

**746: Translate Option**

*Response:*

- 0 = Default table (US ASCII, CS1, CS1/2, ISO 8859, MCS, NRC)
- 1 = User-Defined Translate table 1
- 2 = User-Defined Translate table 2
- 3 = User-Defined Translate table 3

The default response is 0.

These two digits specify the translate tables to be used for transmitting and receiving data. The first (leftmost) digit specifies the transmit table. The second digit specifies the receive table.

You can define up to three of your own translate tables or use the default table provided by the AEA. For instructions on planning for your own table definitions, see “Filling Out Worksheet 25—Translate Tables” on page 12-77.

If you select to use a table provided by the AEA, your response to question 745 determines which default table will be used.

**751: Data Stream Supported by the ASCII Host**

*Response:*

- 1 = Host uses VT100 data stream.
- 2 = Host uses 3101 data stream.
- 3 = Host uses Data General D210 data stream (U.S.A. English only).
- 4 = Host uses a VT220 data stream, 7-bit control.
- 5 = Host uses a VT220 data stream 8-bit control.

There is no default for this question. This entry is required for ASCII hosts.

**752: ASCII Host Phone Number**

*Planner:* A response to this question is required if this host is the default destination of a printer and the Port Type is switched (a response of 2 on “Worksheet 16—ASCII Attachment Diagram” or “Worksheet 18—AEA Port Set”).

*Response:* Up to 48 alphanumeric characters.

This field contains the phone number of the ASCII host. This number will be sent to an autodial modem when a connection to this host is requested. This phone number can contain control characters the modem uses to perform certain operations (for example, “wait for second dial tone”).

Certain modem control characters that are not usually allowed during customizing have substitutes provided. Other control characters can be inserted into the dial string by coding the hexadecimal representation of the required ASCII character (for example, X'52' = R).

See Table 12-2 for the modem control characters that must be substituted for IBM or Hayes modems; see Table 12-3 for the modem control characters that must be substituted for Micom modems.

**Notes:**

1. If you are accessing a public database, refer to your subscription information for your response.
2. Refer to the modem supporting documentation for information on the specific modem requirements and information on control characters.
3. If the Port Type for this station set has been defined as switched (2) and this number is **not** specified, the display station user will be required to send the dial digits to the modem from his display station keyboard (perform a manual dial operation).
4. ATD does not have to be entered. The controller automatically supplies the ATD when dialing the number for Hayes and IBM modems.

Table 12-2. IBM and Hayes Modem-Embedded Character Substitutions

IBM and Hayes Embedded Character	3174 Customization Substitution
P	P
T	T
,	W

The control characters used by IBM and Hayes modems are as follows:

- , – Pause (usually to allow for second dial tone)
- P – Switch to pulse dialing
- T – Switch to tone dialing
- 0 through 9 – Numbers supported.

Table 12-3. Micom Modem-Embedded Character Substitutions

Micom Embedded Character	3174 Customization Substitution
\$	P
&	T
K	K

The control characters used by Micom modems are as follows:

- \$ – Switch to pulse dialing
- & – Switch to tone dialing
- K – Wait for second dial tone
- 0 through 9 – Numbers supported.

Example 1 illustrates control character substitution. In the example, "WW" is used to generate ",", in the dial string. There is no substitute for the "R" in the dial string; therefore, the hexadecimal code X'52' is used to generate "R". The Hayes string shown in the example would become the following string:

T9,,P1234567R

**Example 1**

T9 WW P123 4567 X52



The hexadecimal code (translates to the character R)

The substituted control characters (translates to the characters ,,)

**Note:** Spaces are not required between the characters.

If you have a modem type of "other," the phone number can be any character A-Z or 0-9; the 3174 sends the ASCII hexadecimal equivalents for each character to the modems. To generate characters other than A-Z or 0-9, use the hexadecimal X to indicate that the two characters following it are ASCII data and are not to be translated.

The phone number shown below is for a modem type of "other." It contains no control characters or substitutions.

ATDT1,,8005551212

This phone number is generated by the string shown in Example 2. The characters ,, in the dial string are generated by the hexadecimal code X'2B'.

**Example 2**

ATDT 1 X2BX2B 800 555 1212

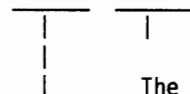

The hexadecimal code (translates to the characters ,,)

The modem orders

### 761: Auto XON/XOFF (DEC VT100/VT220 Data Stream)

*Planner:* Questions 761 through 765 apply to ASCII host stations that use a DEC VT100/VT220 data stream. They define the VT100/VT220 setup options the host expects the VT100/VT220 to use.

Refer to DEC VT100/VT220 setup information and to supporting documentation for currently operating local VT100/VT220 display stations. The DEC VT100/VT220 host expects these options to have been set up on the terminals. You may also want to see the 3174 Terminal User's Reference for Expanded Functions, GA23-0332.

*Response:*

- 0 = Auto XON/XOFF disabled
- 1 = Auto XON/XOFF enabled.

The default response is 1.

This field specifies whether Auto XON/XOFF is activated.

### 762: Wraparound Option (DEC VT100/VT220 Data Stream)

*Response:*

- 0 = Wraparound option disabled
- 1 = Wraparound option enabled.

The default response is 1.

This field identifies whether the wraparound option is operational. If you leave this question set to its default (1), a new line will be generated when a character is typed after the cursor has reached the right margin.

### 763: New Line Option (DEC VT100/VT220 Data Stream)

*Response:*

- 0 = New line option disabled
- 1 = New line option enabled.

The default response is 1.

This field identifies whether carriage return alone, or both carriage return and line feed will occur.

If the new line option is enabled, pressing the Return key will result in a carriage return and line feed. The receipt of a line feed will also result in a carriage return and line feed.

### **764: Margin Bell (DEC VT100/VT220 Data Stream)**

*Response:*

- 0 = Margin bell disabled
- 1 = Margin bell enabled.

The default response is 1.

This field identifies whether the margin bell is operational. If you leave this question set to its default (1), an audible alarm will be generated when the cursor reaches the 72nd position.

### **765: DEC Host ASCII Character Set (DEC VT100/VT220 Data Stream)**

*Response:*

- 0 = DEC NRC
- 1 = DEC MCS

The default response is 0.

This field identifies the character set used by the ASCII host using the DEC VT100 or DEC VT220 data stream.

### **771: Automatic Line Feed for Cursor Control (IBM 3101 Data Stream)**

*Questions 771 through 776 apply to ASCII host stations that use the IBM 3101 data stream. They define the 3101 setup option that the host expects the 3101s to use.*

*Refer to the setup information for the currently functioning 3101 terminal and to the IBM 3101 Display Terminal Description, GA18-2033, for information to answer the following questions.*

*Response:*

- 0 = Automatic line feed disabled
- 1 = Automatic line feed enabled.

The default response is 1.

This field identifies whether the automatic line feed is operational. If you leave this question set to its default (1), the receipt of a carriage return will result in a carriage return and line feed.

### **772: Carriage Return/Carriage Return—Line Feed Selection (IBM 3101 Data Stream)**

*Response:*

- 0 = Carriage Return
- 1 = Carriage Return and Line Feed.

The default response is 1.

This field identifies whether carriage return alone, or both carriage return and line feed, will occur.

### **773: Automatic New Line for Cursor Control (IBM 3101 Data Stream)**

*Response:*

- 0 = Automatic new line disabled
- 1 = Automatic new line enabled.

The default response is 1.

This field identifies whether the cursor will automatically move to the first character position on the next line after it reaches the 80th position.

### **774: Scrolling (IBM 3101 Data Stream)**

*Response:*

- 0 = Scrolling disabled
- 1 = Scrolling enabled.

The default response is 1.

This field identifies whether scrolling will be supported for the display stations.

### **775: Line Turnaround Character (IBM 3101 Data Stream)**

*Response:*

- 0 = EOT (end of transmission)
- 1 = CR (carriage return)
- 2 = XOFF (transmitter off)
- 3 = ETX (end of text).

The default response is 1.

This field identifies the line turnaround character.

### **776: IBM ASCII Host Character Set**

*Response:*

- 1 = ISO - 8859/1.2
- 2 = IBM 3101 CS1
- 3 = IBM 316x CS1 and CS2

The default response is 1.

### **781: Attached Printer Prompt**

*Planner:* Questions 781 through 787 apply to ASCII printers. They define printer attributes.

*Response:*

- 0 = No
- 1 = Yes
- 2 = Assumed (no prompt but printer attachment is assumed).

The default response is 0.

Some ASCII displays allow for attachment of a printer. The printer can be managed by the AEA as a separate device on the same line. For instance, printing can be accomplished from the ASCII display or initiated from the host.

**Note:** Display stations with attached printers will not operate if you do not respond to question 781 with a 1.

If you respond to this question with a 1 (Yes), the following prompt will appear at connection time.

```
DO YOU HAVE A PRINTER ATTACHED TO THIS TERMINAL?
(1=YES, 0=NO) =====> _
```

When the prompt appears, users of ASCII display stations with attached printers can decide whether or not to let the AEA manage the attached printers. System prints will be allowed to print on the attached printer if a second host address is assigned to the port and the user responds with yes to the prompt.

## 782: Use of Form Feed

*Response:*

- 0 = Printer does not support form feed
- 1 = Printer supports form feed.

The default response is 0.

This field identifies whether a printer can perform a form feed.

## 783: Page Length

*Response:* Value from 001 to 255 (use leading zeros).

The default response is 066.

This field defines the page length for an attached printer. If the printer does not support form feed, this count will be used to emulate form feeds in 3270 data streams.

## 784: Printer Character Set

*Response:*

- 1 = US ASCII
- 2 = ISO - 8859/1.2
- 3 = DEC MCS
- 4 = PC code page 850
- 5 = User-Defined Translate table 1
- 6 = User-Defined Translate table 2
- 7 = User-Defined Translate table 3

The default response is 1.

The AEA provides translate tables for printers. If you choose not to use one of the supplied tables, you can define your own (options 5, 6, and 7). See "Filling Out Worksheet 25—Translate Tables" on page 12-77 for more information.



## 785: ASCII Printer Options

*Response:* Eight digits (0 or 1).

- 0 = No
- 1 = Yes.

The default response is 11111000. Digits are numbered from left to right.

Digit	Description
1	Options
2	Options
3	Options
4	Options
5	Options
6	Options
7	Options
8	Reserved

**Note:** These options apply to LU3 (DSC/DSE) datastream and local copies. The 3174 treats a local copy as if it were an LU3 (DSC/DSE) print.

### Digit 1 - Options:

- 0 = A carriage return (CR) at maximum print position (MPP) +1 performs a new line (NL) function.
- 1 = A CR at MPP+1 performs a CR. The NL function is suppressed.

### Digit 2 - Options:

- 0 = A NL at MPP+1 performs two NL operations.
- 1 = A NL at MPP+1 performs one NL operation.

### Digit 3 - Options:

- 0 = An FF (Form Feed) followed by data takes up a print position. This causes a space to be printed in the first print position of the first print line on the next page. The print element will be left at the second print position of the first print line on the next page.
- 1 = An FF followed by data does not take up a print position. Therefore, no space is printed and the print element is left at the first print position of the first print line on the next page.

**Digit 4 - Options:** Note that this option is affected by Option 7.

If Option 7 is configured for a 1, then Option 4 is overridden.

If Option 7 is configured for a 0 then the following descriptions apply.

- 0 = When an FF is in the last buffer position of the print buffer, the FF operation moves the print element to the second print position of the first line of the next page and the execution of the FF ends the print. Because Option 7 is configured for a 0, an automatic NL operation moves the print element to the first print position of the second line. The result is a blank line at the top of the new page.

1 = When an FF is in the last buffer position, the FF is executed but no print position is used by the FF character. Therefore, the print element is positioned in the first print position of the first line on the next page. The automatic NL is suppressed and there is no blank line at the top of the new page.

**Digit 5 - Options:** (Only valid for LU3 (DSC/DSE) formatted prints)

- 0 = Lines that contain only non-printable fields or nulls are suppressed. Attributes, CR, NL and end-of-message (EM) are treated as nulls.
- 1 = Null lines are printed as blanks. CR, NL and EM are honored.

**Digit 6 - Options:**

- 0 = The FF is valid only in column 1 or at MPP+1; otherwise it is printed as a space.
- 1 = An FF is valid in any buffer position.

Refer to the tables below for details.

**Digit 7 - Options:**

- 0 = At the completion of a print operation, an automatic NL is executed.
- 1 = At the completion of a print operation, an automatic FF is executed.

When this option is configured for a 1, option 4 is overridden.

If you would like an FF after Local Copy, digit 7 must be configured as a 1. However, note that this will cause an FF after LU3 (DSC/DSE) print as well.

Assume the FF is at the end of the print and valid because it meets one or the other of the conditions for validity stated in Option 6.

- If Option 4 and Option 7 are configured for a 0 then the FF results in the print element being moved to the first print position of the second line of the new page.
- If Option 4 or Option 7 is configured for a 1 then the FF results in the print element being moved to the first print position of the first line of the new page.

Assume the FF is at the end of the print and invalid because Option 6 is configured for a 0 and the FF is not in column 1 or at MPP+1.

- Option 4 is ignored.
- If Option 7 is configured for a 0 then an automatic NL is executed at the completion of the print operation.
- If Option 7 is configured for a 1 then an automatic FF is executed at the completion of the print operation.

**Digit 8 - Reserved:**

## Planning for the AEA

### 786: Page Width

*Response:* Value from 001 to 255 (use leading zeros).

The default response is 132.

### 787: LU 1 SCS Transparency Translation

*Response:*

0 = LU 1 transparent data is not translated.

1 = LU 1 transparent data is translated.

The default response is 0.

This question determines how the printer LU 1 SCS transparency data is to be translated. If translation of data is selected, the table selected in question 784 is used.

If option 0 is selected, transparent data is passed through to the ASCII printer and should be in a format that is compatible with the printer.

## Filling Out Worksheet 21—AEA Default Destination

The LT1 at the top of this worksheet corresponds to the Default Destination column on the ASCII Attachment Diagram and the Default Destination 1 column on the 3270 Attachment Diagram. LT2 through LT5 correspond to the Default Destination columns LT2 through LT5 on the 3270 Attachment Diagram.

The station set numbers on “Worksheet 21—AEA Default Destination” correspond to the station set numbers on the 3270 and ASCII Attachment Diagrams.

There are considerations for the Default Destination when Multi-Host Support has been configured. Read the discussion on Multi-Host support under “AEA Planning Considerations” on page 12-15 if you have not done so already.

- ASCII Attachment Diagram

The default destinations for each station set have already been specified in the Default Destination columns on the ASCII Attachment Diagram.

For each station set number found on the ASCII Attachment Diagram, write in the Default Destination column responses for that station set number in the LT1 through LT5 columns of the AEA Default Destination worksheet. *If CM (for Connection Menu) is indicated for any default destination, leave the corresponding LT column on the AEA Default Destination worksheet blank for that station number.*

**Note:** The session limit for ASCII printers is always 1.

- 3270 Attachment Diagrams

The default destinations for each station set have already been specified in the Default Destination columns on the 3270 Attachment Diagrams.

For each station set number found on the 3270 Attachment Diagrams, write in the Default Destination column responses for that station set number in the LT1 through LT5 columns of the AEA Default Destination Worksheet. *If CM (for Connection Menu) is indicated for any default destination, leave the corresponding LT column on the AEA Default Destination Worksheet blank for that station set number.*

See Figure 12-18 on page 12-64 for an example of how to complete this worksheet.

# Planning for the AEA

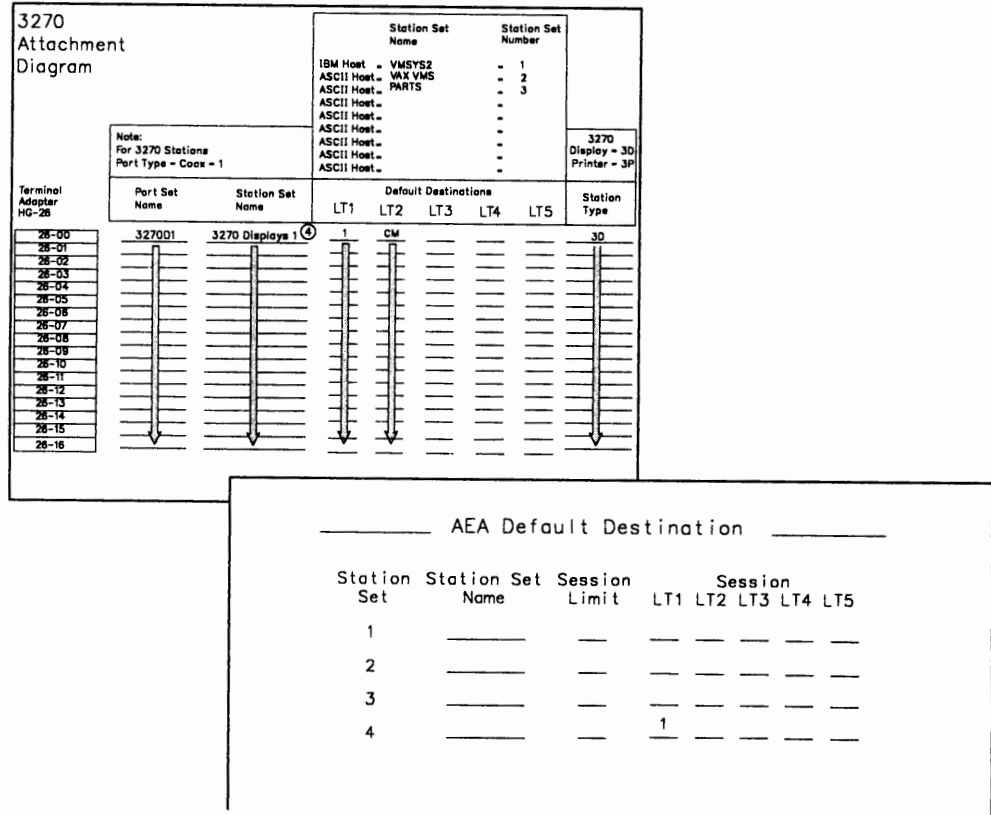

Figure 12-18. Example of the AEA Default Destination Worksheet

In Figure 12-18, the display stations in Station Set Number 4 have a 1 in the Default Destination 1 column and CM in the Default Destination 2 column on the 3270 Attachment Diagrams. On the AEA Default Destination Worksheet, beside Station Set 4, a 1 is written in the LT1 column and nothing is listed in the LT2 column; a blank represents CM.

---

## Filling Out Worksheet 22—Terminal Tables

**Planner:** *The following procedures explain how to complete a set of worksheets for one User-Defined Terminal table. Worksheets 22-24 pertain to terminal tables definition; before filling them out, make a set of copies for each terminal table being defined.*

Locate and remove Worksheet 22. Using the descriptions given below, fill in each response area on the worksheet.

Note that this worksheet is divided into two sections. Each section represents a separate customization panel.

### Section One: Identifying Each Table

The text below describes the responses needed for the first panel of UDT customization. This panel enables you to identify your UDT tables.

You can define your own tables or copy, modify, and rename tables that are already defined. Details about how to do this are provided in the following text.

#### Number

Number is the number of the UDT table being defined. The number must be in the range U1—U6. This field is required, and a maximum of six tables can be defined.

**Note:** If you build a new table by using another as a model and changing its values, save the changes under a new name unless you want to overwrite the model table. Default tables used as models are not overwritten. If you use a default table as a model, whether you make any changes or not, and then you file it away, the table is filed under the UDT number you selected, and the default one left intact.

#### Name

Name is a mnemonic name that helps you differentiate among the six tables. It can be up to 14 characters long, using any combination of supported characters. Once a UDT has been defined (and filed), its name is displayed on the customizing panel to the right of the table number that it describes.

This field is optional, but if the UDT table is new or previously defined and no name is given, the model name is defaulted to the model number.

**Model**

Model is a defined table, used as a model for the one you are creating. The list below contains names and IDs of terminal tables already supported. Tables U1-U6 are user-defined. Any existing UDT can be used as a model.

- U1.UDT-1
- U2.UDT-2
- U3.UDT-3
- U4.UDT-4
- U5.UDT-5
- U6.UDT-6
- I1. IBM 3101
- I3. IBM 3151/61/62/63
- I4. IBM 3164
- FC. FTTERM Color
- V1. DEC VT100
- V2. DEC VT241
- V5. DEC VT52
- V6. DEC VT220
- H2. HP 2621B
- L3. LS ADM 3A
- T1. Televideo 912
- T7. Televideo 970
- W1. WYSE 50/60
- X4. Tektronix 4205

If you wish to use a table as a model, enter the ID of that table in the space provided on the worksheet. If no model is specified at customization, underscores appears in place of default values on subsequent panels.

Figure 12-19 gives an example of UDT selection. In the example, Table U1 is defined under the name DEC VT340. A defined table is being used as a model; it is Table V2, which contains default values for a DEC VT241 station type.

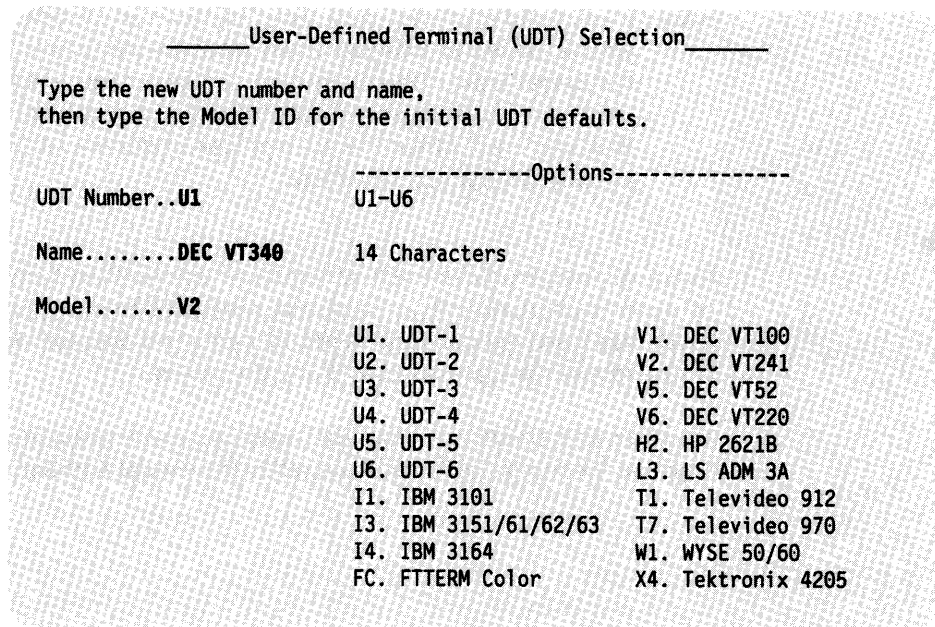

Figure 12-19. Example of User-Defined Terminal (UDT) Selection

## Section Two: Selecting Attributes for Tables

This section describes the responses needed for defining the terminal table you have selected. If you select a model terminal table, those attribute values associated with this model appear on the panel as defaults.

### Attributes

The attributes are of the station type for which the table is being built. The second part of Worksheet 22 lists possible attributes of this station type. Complete the columns to the right of the Attributes list with appropriate responses.

#### Last Line Reserved for Status

Yes = Station type supports a status line.

No = Station type does not support a status line.

Indicates whether or not station supports an accessible status line (usually line 25). If you specify **No** for this attribute, the Status Line Character Set, Status Line Clear Option, and Use Cursor Seq on Status Line attributes are not applied to the table being built.

But responses to these attributes still must be given (or the default values used). Blanks can be entered as responses, or any of the valid entries described below can be entered. If anything other than blanks or valid entries are used as responses, an error condition results.

**Status Line Character Set** Valid entries are 0, 1, or 2. Each entry choice is listed and explained below.

0 = Indicates that the status line characters are translated using the standard translation. This means that no special characters appear on the status line for this station. This option should be used for all stations with a status line that is turned on and off.

1 = Indicates that the station supports special characters on the status line.

2 = Indicates that special characters are supported on the status line as in option 1. This support corresponds to that provided by the Televideo 970 display station.

**Status Line Clear Option** Valid entries are 0, 1, 2, and 3. Each entry choice is listed and explained below. These options only apply if the terminal's last line is reserved for status.

0 = The status line is not erased when a screen is cleared or on status line entry.

1 = The status line entry sequence also erases the status line and the complete status line must be rewritten.

2 = The clear screen command also erases the status line. The status line must be rewritten when the screen is cleared.

3 = Status line is cleared on both a screen clear and on status line entry. In both cases, the status line must be rewritten.

#### Use Cursor Seq on Status Line

Yes = The station's normal Set Cursor command can be used on the status line.

No = Set Cursor cannot be used.

For example, if no cursor sequence is supported on a status line, then in order to write the clock symbol in columns 11 and 12 of the line, the entire line up to that point must be rewritten.



**Scrolling On**

- Yes = The screen will scroll if a character is sent to the last screen position.
- No = Character entry to the last screen position does not cause scrolling.

Indicates whether or not the station type is configured for scrolling ahead. If **Yes** is specified, the 3174 controller will not send characters to the last screen position.

**Cursor Wraps at End of Line**

- Yes = Cursor wraps from column 80 to column 1 of next line.
- No = The cursor does not wrap unless a Set Cursor command is sent.

**Color Supported**

- Yes = Color is supported on this station.
- No = Color is not supported on this station.

**Cursor Class** A decimal number from 0 to 5 that indicates how the Set Cursor command is formatted. The number represents a sequence of hexadecimal digits that are required for the station to perform a Set Cursor function. (Set Cursor and Cursor Sequence are described below.)

The Cursor Sequence attribute contains the actual hexadecimal sequence represented by this number. The following text gives more information about the Cursor Sequence attribute.

**Cursor Sequence** This attribute is a sequence of hexadecimal digits, two to five pairs long, which directs the station to perform a Set Cursor function. The sequences are shown below, each according to the Cursor Class value that represents it. The actual position numbers (line and column) are not included in the example sequences. Each sequence should be read left to right.

Cursor Class 0 is:

- Cursor sequence introducer, made up of any three ASCII characters
- The line number, made up of ASCII characters representing decimals
- An ASCII character separator
- The column number, made up of ASCII characters representing decimals
- An ASCII character trailer.

For example, to position the cursor at line 10, column 21, the sequence might be:

ESC & a 1 0 y 2 1 C ... (the sequence)  
1B 26 61 31 30 79 32 31 43 ..... (in hex)

For a station that supports this cursor class, the entry for this example would be 1B26617943.

Cursor Class 1 is:

- Escape character
- Left bracket
- The line number, made up of ASCII characters representing decimals
- An ASCII character separator
- The column number, made up of ASCII characters representing decimals
- An ASCII character trailer.

An example sequence might be:

```
ESC 1b 1 0 ; 2 1 H ... (the sequence)
1B 5B 31 30 3B 32 31 48 ..... (in hex)
```

For a station that supports this cursor class, the entry for this example would be 1B5B3B48.

Cursor Class 2 is:

- Any two ASCII characters
- The line number, in hexadecimal plus X'20'
- The column number, in hexadecimal plus X'20'.

This sequence contains no separators or trailers. An example might be:

```
ESC A X'2A' X'35' ... (the sequence)
1B 41 2A 35 ..... (in hex)
```

For a station that supports this cursor class, the entry for this example would be 1B41.

Cursor Class 3 is:

- One or two ASCII characters
- The column number, in hexadecimal
- The line number, in hexadecimal.

This sequence could have either one of two pairs of introducers, for example:

```
ESC A X'15' X'0A' ... (the sequence)
1B 41 15 0A ..... (in hex)
```

For a station that supports this cursor class, the entry for this example would be 1B41. If only one character is required, that character should be entered.

Cursor Class 4 is

- One or two ASCII characters
- The column number, in hexadecimal plus X'20'
- The line number, in hexadecimal plus X'20'.

This sequence could contain either one or two pairs of introducers. An example might be:

```
ESC A X'35' X'2A' ... (the sequence)
1B 41 35 2A ..... (in hex)
```

For a station that supports this cursor class, the entry for this example would be 1B41. If only one character is required, that character should be entered.

Cursor Class 5 is:

- Any two ASCII characters
- The line number, in hexadecimal
- The column number, in hexadecimal.

This sequence has two pairs of introducers; for example:

```
ESC A X'05' X'15' ... (the sequence)
1B 41 0A 15 ..... (in hex)
```

For a station that supports this cursor class, the entry for this example would be 1B41.

**Note:** Cursor classes 3 and 5 use absolute addressing for the cursor. For this reason, XON/XOFF pacing should not be used. Addressing line or column X'11' or X'13' would be interpreted as XON or XOFF.

Refer to your station documentation for information about cursor sequence selection.

### Alternate Screen Size

- 0 = Screen size is 24 x 80 lines/column
- 1 = Screen size is 30 x 80 lines/column
- 2 = Screen size is 32 x 80 lines/column.

Sets the size of the station screen. The station's physical screen size must be at least as large as the options selected here. For information about planning for storage, see "Storage Planning Procedure" on page 3-4.

**Graphics Query Reply** An entry made for this attribute indicates that the device supports graphics and that OEM auxiliary data is passed through to and from the device. The host sends a Read Partition Query X'8F' to the display, and the device responds with a Character Set Query Reply indicating graphics support. A Character Set Query Reply is sent for ASCII devices only if this attribute is specified.

The response specifying Graphics Query Reply must be 8 characters long. The lack of a response in this field indicates that the device does not support graphics; in such a case, Graphic Input Wait Time, Graphics Input Ending Sequence, and Graphics Input Length do not need to be filled in. If a response *is* given for this field, a response must also be given for the Graphics Input Length field. The other two graphics attribute fields are still optional. (Any combination of the next three fields is valid, but the entries should match the capabilities of the device and application.)

**Graphics Input Wait Time** An entry here indicates the number of 100-millisecond intervals that this device will wait between transmissions to the 3174. After a specified time interval, if no additional data has been received, the controller sends what data it already has to the host.

This response must be a value between 0 and 99. A 0 response indicates that no timeout applies.

**Graphics Input Ending Sequence** This entry consists of ASCII hexadecimal codes. A maximum of five pairs of them can be entered. If a matching sequence of these characters is received while the station is in Graphics Input mode, the data

received is sent to the host. If this space is left blank, (no response is entered), no search is made for a sequence.

**Graphics Input Length** This entry indicates the maximum number of characters that can be received during Graphics Input mode before data is sent to the host. The value can be from 1 to 128. If a response is entered for the Graphics Query Reply attribute, this field is required.

Figure 12-20 on page 12-71 shows an example of attribute selection. This example shows the default values that would appear for the selections made in Figure 12-19 on page 12-66. They are the default values for station type DEC VT241 (model table V2).

\_\_\_\_\_U1 User-Defined Terminal Attributes\_\_\_\_\_

Tab to the Selection, then type the option.

	Selection	Options
Last Line Reserved for Status	N	Y=Yes    N=No
Status Line Character Set . .	0	0-2
Status Line Clear Option	0	0-3
Use Cursor Seq on Status Line	N	Y=Yes    N=No
Scrolling On . . . . .	N	Y=Yes    N=No
Cursor Wraps at End of Line .	N	Y=Yes    N=No
Color Supported . . . . .	Y	Y=Yes    N=No
Cursor Class . . . . .	1	0-5
Cursor Sequence . . . . .	1B5B3B48	ASCII hex codes
Alternate Screen Size . . . .	0	0-2
Graphics Query Reply . . . .	<b>DEC340</b>	8 Characters
Graphics Input Wait Time . .	2	0-99 (milliseconds)
Graphics Input Ending Seq . .	5D0D	ASCII hex codes
Graphics Input Length . . . .	128	1-128 Bytes

Figure 12-20. Example of User-Defined Terminal Attributes

### Defaults

When a model table is used, the values for that model type appear in the response areas during customization and can be referred to as default values.

When planning to customize these tables for your establishment, you may choose to use a model, with default values, and modify those responses for your configuration. For each response being changed, write the new one in the corresponding response area of the worksheet.

Write only those responses that are *changed* in the response areas of the worksheets. You may wish to leave blanks for responses not being modified.

At any time during customization of these panels, if the customizer wishes to show default values, he presses PF4 (Default key). This key refreshes all screens of the panel and shows the original default responses. If a model table is not used, the customization panels display underscores.

Remember, the ASCII sequences are to be entered in hexadecimal. Blanks between hexadecimal characters in a field are not allowed. To see default values for each of the 14 predefined terminal tables, refer to the *IBM 3174 Establishment Controller AEA Description and Reference*.

---

## Filling Out Worksheet 23—Inbound Sequence Panels

Locate and remove Worksheet 23. This worksheet has two pages; make sure you get both (23A and 23B). Using the information provided below, fill in the appropriate response areas on the worksheet.

Because the Inbound Sequence Panel is extensive, it may require several screens to be displayed entirely. This is called *windowing*. The portion of the panel seen in each window differs according to the station type used for customizing. Worksheet 23 shows all panel entries grouped over two pages.

### ASCII Inbound Sequences

Worksheet 23 shows the AEA-supported 3270 functions. The response areas are for ASCII command sequences the terminal sends inbound to the 3174. The command sequences must be in hexadecimal.

Each 3270 function can be invoked using one of two ASCII sequences: **primary** or **alternate**. The primary command sequence is the one the device should use to accomplish the function; the alternate sequence provides a second method for accomplishing the same function. It can be used for such situations as wanting to use two keys to perform the same function.

No sequence can duplicate another one, primary or alternate. Duplicate sequences are defined as sequences having no differing hexadecimal codes or those that are subsets of others. For example, 1B5B2A and 1B5B are duplicate sequences, whereas 1B5B4A and 1B5B2A are not. Sequence 1B5B is a subset of 1B5B2A.

Figure 12-21 shows the Inbound Sequence Panel with default values for the model table selected in Figure 12-19 on page 12-66 (model table V2). Notice that a primary sequence and an alternate sequence are not necessary for each 3270 function.

\_\_\_\_\_ U1 Inbound Sequences - ASCII Device to 3174 \_\_\_\_\_

Type the ASCII Sequence(s) for each 3270 function.

3270 Function	ASCII Sequence from Terminal	
	Primary	Alternate
PF1 . . . . .	1B4F71	1B31
PF2 . . . . .	1B4F72	1B32
PF3 . . . . .	1B4F73	1B33
PF4 . . . . .	1B4F74	1B34
PF5 . . . . .	1B4F75	1B35
PF6 . . . . .	1B4F76	1B36
PF7 . . . . .	1B4F77	1B37
PF8 . . . . .	1B4F78	1B38
PF9 . . . . .	1B4F79	1B39
PF10 . . . . .	1B4F50	1B30
PF11 . . . . .	1B4F51	1B20
PF12 . . . . .	1B4F52	1B3D
PF13 . . . . .	1B5B31377E	1B21
PF14 . . . . .	1B5B31387E	1B40
PF15 . . . . .	1B5B31397E	1B23
PF16 . . . . .	1B5B31307E	1B24
PF17 . . . . .	1B5B32327E	1B25
PF18 . . . . .	1B5B32337E	1B5E
PF19 . . . . .	1B5B32347E	1B26
PF20 . . . . .	1B5B32357E	1B2A
PF21 . . . . .	1B5B32367E	1B28
PF22 . . . . .	1B5B32387E	1B29
PF23 . . . . .	1B5B32397E	1B5F
PF24 . . . . .	1B5B33317E	1B2B
PA1 . . . . .	1B5B33327E	1B2C
PA2 . . . . .	1B5B33337E	1B2E
PA3 . . . . .	1B5B33347E	1B2F
ATTN . . . . .	01	_____
SysRq . . . . .	1B5B367E	1B73
Reset . . . . .	12	_____
Dev Cancel . . . . .	18	_____
Enter . . . . .	0D	_____
Clear Screen . . . . .	03	_____
Cursor Select . . . . .	0B	_____
Cursor Up . . . . .	1B5B41	_____
Cursor Down . . . . .	1B5B42	0A
Cursor Left . . . . .	1B5B44	_____
Cursor Right . . . . .	1B5B43	_____
Tab . . . . .	09	_____
Backtab . . . . .	1B5B317E	_____
Newline . . . . .	1B5B347E	_____
Home . . . . .	08	1B68
Change Screen . . . . .	19	_____

Figure 12-21 (Part 1 of 2). U1 Inbound Sequences - ASCII Device to 3174 for a DEC VT340

U1 Inbound Sequences - ASCII Device to 3174

Type the ASCII Sequence(s) for each 3270 function.

3270 Function	ASCII Sequence from Terminal	
	Primary	Alternate
Ex Sel . . . .	02	1862
Field Mark. .	06	_____
Dup . . . . .	04	_____
Erase EOF . .	05	_____
Erase Input .	1858337E	1869
Insert . . . .	1858337E	187F
Delete . . . .	7F	_____
Print . . . . .	10	_____
Ident . . . . .	1A	1864
Status ON/OFF	17	183F
Refresh . . . .	1858357E	1872
Fast Left . . .	16	_____
Fast Right . .	15	_____
Suspend Print	0C	186F
Resume Print	07	1870
Test . . . . .	14	1874
File Tran En	_____	_____
File Tran Dis	_____	_____
ECHO . . . . .	_____	_____
ECHO . . . . .	_____	_____
ECHO . . . . .	_____	_____

Figure 12-21 (Part 2 of 2). U1 Inbound Sequences - ASCII Device to 3174 for a DEC VT340



## Filling Out Worksheet 24—Outbound Sequence Panels

Locate and remove Worksheet 24. Using the information provided below, fill in the appropriate response areas on the worksheet.

### ASCII Outbound Sequences

This worksheet shows the 3270 functions that you can define for your ASCII devices to support. The response areas correspond to the command sequences that are sent outbound from the 3174 to the station. The command sequences are entered in hexadecimal. Only one outbound ASCII sequence can be defined for each 3270 function.

Remember, default sequence values appear if a model table is used. Refer to "Defaults" on page 12-72 for more information about default values.

Figure 12-22 shows the Outbound Sequence Panel, including default values for the model table selected in Figure 12-19 (model table V2).

U1 Outbound Sequences - 3174 to ASCII Device	
Type the ASCII sequence for each function.	
Function	ASCII Sequence to the Terminal
Term Init Seq	<b>1B5B3F313B383B32681B5B3F333B37 6C1B3D1B5B30711B5B481B5B4A1B5B 3469</b>
Term Exit Seq	<b>1B5B481B5B4A</b>
Erase EOL	1B5B4B
Clear Screen	1B5B4A
Cursor Up	1B5B41
Cursor Down	1B5B42
Cursor Left	1B5B44
Cursor Right	1B5B43
Status On	
Status Off	
Bell	07
Dim Unprot	1B5B306D
Highlt Unprot	1B5B303B316D
Dim Protec	1B5B306D
Highlt Protec	1B5B303B316D
Transparency On	
Transparency Off	
Alpha Clear	
Start Printer	1B5B3569
Stop Printer	1B5B3469

Figure 12-22. U1 Outbound Sequences - 3174 to ASCII Device for a DEC VT340

## Filling Out Worksheet 25—Translate Tables

**Planner:** The following procedures explain how to complete a set of worksheets for one User-Defined Translate table. Worksheets 22-24 pertain to translate tables definition; before filling them out, make a set of copies for each translate table being defined.

Locate and remove Worksheet 25. Using the descriptions given below, fill in each response area on the worksheet.

The text below describes the responses needed for the first panel of UDX customization. This panel enables you to identify your UDX tables. You can define your own tables or copy, modify, and rename tables that are already defined. Details about how to do this are provided below.

**Number** The number of the UDX being defined. The number must be in the range 1—3. This field is required and a maximum of three tables can be defined.

**Note:** If you build a new table by using another as a model and changing its values, save the changes under a new name unless you want to overwrite the model table. Default tables used as models are not overwritten. If you use a default table as a model, whether you make any changes or not, and then you file it away, the table is filed under the UDX number you selected and the default one is left intact.

**Name** A mnemonic name that helps you differentiate between the three tables. It can be up to 14 characters long, using any combination of supported characters. Once a UDX has been defined (and filed), its name is displayed on the customizing panel to the right of the table number that it describes.

This field is optional, but if no name is entered, the customizing procedure assigns a default name. If the table is new or previously defined and no name is given, the model name is defaulted to the model number.

**Language** A two-digit language ID. This ID is that of the keyboard language used for default UDX translation. The languages and their IDs are listed below.

- 01 U.S.A. English
- 03 German
- 07 Danish
- 09 Finnish
- 15 Italian
- 19 Spanish
- 21 Spanish speaking
- 22 UK English
- 23 Norwegian
- 24 Swedish
- 28 Portuguese
- 29 Canadian Bilingual
- 30 French
- 41 Swiss French
- 42 Swiss German
- 43 Belgian
- 47 Netherlands.

The response for this field should match that given for question 121. It is not a requirement but is strongly recommended, as unpredictable results may occur otherwise.

A response to this item *is* required if any of default tables 4-9 are selected as models. (See the description of the model field on 12-78.) The default value is 01.

**CECP**

A single digit response that indicates yes (Y) or no (N). Placing a "Y" in this response field indicates that the CECP code page for this language is used.

The response for this field should match that given for question 123 of customization. It is not a requirement but is strongly recommended, as undesirable results may occur otherwise.

A response is required for this item if any of default tables 4-9 are selected as models. (See the description of the Model field, below.) The default value is N.

**Model**

A defined table, used as a model for the one you are creating. The list below contains names and IDs of translate tables already supported. Tables UDX-1, UDX-2, and UDX-3 are user-defined. Any existing UDX can be used as a model.

If you wish to use a table as a model, enter the ID of that table in the space provided on the worksheet. If no model is specified at customization, underscores appear in place of default values on subsequent panels.

1. UDX-1
2. UDX-2
3. UDX-3
4. Standard US ASCII to EBCDIC
5. DEC MCS 8-bit Character Table
6. DEC NRC 7-bit Character Table
7. ISO 8859/1.2 7/8-bit Character Table
8. 3101 CS1 Character Set Table
9. 31XX CS1/CS2 SI/SO Character Table

Figure 12-23 on page 12-79 shows an example of UDX table selection. In the example, table 1 is being defined and given the name EngASCII. It provides CECP support. Default table 4 is selected as the model. Table 4 contains the character translation sequences for Standard US ASCII to EBCDIC conversion; these sequences appear as defaults.

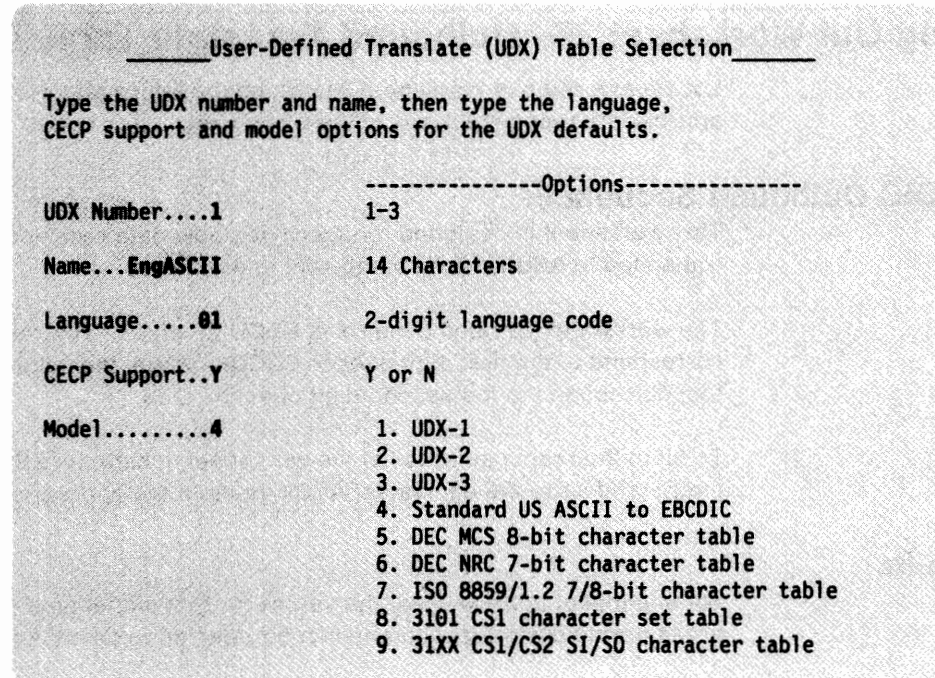

Figure 12-23. User-Defined Translate Table Selection. This figure shows an example panel identifying a User-Defined Translate table as supporting U.S.A. English, CECP, and using standard US ASCII to EBCDIC translation.

Each language supported for UDX translation has a unique character set. The hexadecimal values in the translate table correspond to characters in the set. The *3174 Character Set Reference*, GA27-3831 shows the character sets for each language.

---

## Filling Out Worksheet 26—Outbound Translate Table Definition

Locate and remove Worksheet 26. Using the information provided below, fill in the appropriate response areas of the worksheet.

### EBCDIC Outbound Sequences

This worksheet is designed for specifying how data received from the host is translated to ASCII before being sent to the device.

The worksheet contains a matrix of EBCDIC values. The row numbers (on the left) correspond to the first digit of each EBCDIC value; the column numbers (across the top) correspond to the second digit of each value.

To fill in the response areas of the worksheet, locate the EBCDIC values using the matrix and write the equivalent ASCII value in the appropriate response area.

### Defaults

When a model table is used, the values for that model type appear in the response areas during customization and can be referred to as default values.

When planning to customize these tables for your establishment, you may choose to use a model, with default values. Modify those responses for your configuration. For each response being changed, write the new one in the corresponding response area of the worksheet.

Write only those responses that are *changed* in the response areas of the worksheets. You may wish to leave blanks for responses not being modified.

At any time during customization of these panels, if the customizer wishes to show default values for a sequence, he presses PF4 (Default key). This key refreshes all screens of the panel and shows the original default responses. If a model table is not used, the customization panels display underscores.

Remember, the ASCII sequences are to be entered in hexadecimal. Blanks between hexadecimal characters in a field are not allowed. To see default values for each of the 6 predefined translate tables, refer to the *IBM 3174 Establishment Controller AEA Description and Reference*.

Figure 12-24 on page 12-81 shows the an example of the Outbound (EBCDIC to ASCII) Translation Panel. The example shows the default values for model table 4.

Outbound Translate Table Defaults for US ASCII, CECP Format

	0	1	2	3	4	5	6	7	8	9	A	B	C	D	E	F
0	20	20	20	20	20	20	20	20	20	20	20	20	20	20	20	20
1	20	20	20	20	20	20	20	20	20	20	20	20	20	20	20	20
2	20	20	20	20	20	20	20	20	20	20	20	20	20	20	20	20
3	20	20	20	20	20	20	20	20	20	20	20	20	20	20	20	20
4	20	20	20	20	20	20	20	20	20	20	58	2E	3C	28	28	7C
5	26	20	20	20	20	20	20	20	20	20	21	24	2A	29	38	5E
6	2D	2F	20	20	20	20	20	20	20	20	50	2C	25	5F	3E	3F
7	20	20	20	20	20	20	20	20	20	60	3A	23	40	27	30	22
8	20	61	62	63	64	65	66	67	68	69	20	20	20	20	20	20
9	20	6A	6B	6C	6D	6E	6F	70	71	72	20	20	20	20	20	20
A	20	7E	73	74	75	76	77	78	79	7A	20	20	20	20	20	20
B	20	20	20	20	20	20	20	20	20	20	20	20	20	20	20	20
C	7B	41	42	43	44	45	46	47	48	49	20	20	20	20	20	20
D	7D	4A	4B	4C	4D	4E	4F	50	51	52	20	20	20	20	20	20
E	5C	20	53	54	55	56	57	58	59	5A	3B	20	20	20	20	20
F	30	31	32	33	34	35	36	37	38	39	2A	20	20	20	20	20

Figure 12-24. Outbound Translate Table Defaults for US ASCII, CECP Format

**Note:** When 8-bit codes are entered in this table and the port for which the UDT applies is configured as 7-bit, it is assumed that the terminal or printer supports Shift-in and Shift-out.

## Filling Out Worksheet 27—Inbound Translate Table Definition

Locate and remove Worksheet 27. Using the information provided below, fill in the appropriate response areas of the worksheet.

### ASCII Inbound Sequences

This worksheet is designed for specifying how data received from the device is translated to EBCDIC before being sent on to the host.

The worksheet contains a matrix of ASCII values. The row numbers (on the left) correspond to the first digit of each ASCII value; the column numbers (across the top) correspond to the second digit of each value.

To fill in the response areas of the worksheet, locate the ASCII values using the matrix and write the equivalent EBCDIC value in the appropriate response area.

Figure 12-25 on page 12-82 shows an example of the Inbound (ASCII to EBCDIC) Translation Panel. The example shows the default values for model table 4.

## Planning for the AEA

Inbound Translate Table Defaults for US ASCII, CECF Format																
	0	1	2	3	4	5	6	7	8	9	A	B	C	D	E	F
0	00	40	40	40	40	40	40	40	40	B9	CA	CA	41	B9	40	40
1	40	40	40	40	40	40	40	40	40	E1	9F	40	40	40	40	CA
2	40	5A	7F	7B	5B	6C	50	7D	40	5D	5C	4E	6B	60	4B	61
3	F0	F1	F2	F3	F4	F5	F6	F7	F8	F9	7A	5E	4C	7E	6E	6F
4	7C	C1	C2	C3	C4	C5	C6	C7	C8	C9	D1	D2	D3	D4	D5	D6
5	07	D8	D9	E2	E3	E4	E5	E6	E7	E8	E9	8A	E0	8B	80	60
6	79	81	82	83	84	85	86	87	88	89	91	92	93	94	95	96
7	97	98	99	A2	A3	A4	A5	A6	A7	A8	A9	CD	4F	D0	A1	40
8	00	00	00	00	00	00	00	00	00	00	00	00	00	00	00	00
9	00	00	00	00	00	00	00	00	00	00	00	00	00	00	00	00
A	00	00	00	00	00	00	00	00	00	00	00	00	00	00	00	00
B	00	00	00	00	00	00	00	00	00	00	00	00	00	00	00	00
C	00	00	00	00	00	00	00	00	00	00	00	00	00	00	00	00
D	00	00	00	00	00	00	00	00	00	00	00	00	00	00	00	00
E	00	00	00	00	00	00	00	00	00	00	00	00	00	00	00	00
F	00	00	00	00	00	00	00	00	00	00	00	00	00	00	00	00

Figure 12-25. Inbound Translate Table Defaults for US ASCII, CECF Format

**Planner:** You have completed the worksheets required for AEA planning.

Return to the divider page labeled "Microcode Customization Planning." See step 7 to determine if there are additional worksheets that you need to fill out to complete the planning process. You may also refer to the divider page labeled "Worksheet Summary" to determine where to proceed next.

Keep records of your configuration by using one of the methods described under "Customization Records" on page 5-6.

---

## Chapter 13. Planning to Define Devices

An Overview of Device Definition .....	13-3
The Device Definition Worksheet .....	13-4
Filling In Worksheet 28—Device Definition .....	13-5
800: Printer Authorization Matrix (PAM) .....	13-5
801: Logical Terminal Assignment (LTA) .....	13-5
802: Prompts for Extended Vital Product Data (VPD) .....	13-6
Printer Authorization Matrix (PAM) .....	13-6
The PAM Worksheet .....	13-6
A Sample PAM .....	13-10
Filling Out Worksheet 29—Printer Authorization Matrix (PAM) .....	13-11
Logical Terminal Assignment (LTA) .....	13-12
The LTA Worksheet .....	13-12
A Sample LTA .....	13-15
LTA Considerations .....	13-16
For CUTs .....	13-16
For DFTs .....	13-16
For DFT-Es .....	13-17
For Printers .....	13-17
Filling Out Worksheet 30—Logical Terminal Assignment (LTA) .....	13-18
Filling Out Worksheet 31—Prompts for Extended VPD .....	13-19





---

## An Overview of Device Definition

Before you start planning, you need the following:

- Information from the site planner about which terminals and printers are attached to which ports
- “Worksheet 28—Device Definition” on page A-42
- “Worksheet 29—Printer Authorization Matrix (PAM)” on page A-43
- “Worksheet 30—Logical Terminal Assignment (LTA)” on page A-44
- “Worksheet 31—Extended Vital Product Data (VPD)” on page A-45
- You may need the completed Port Assignment Worksheets.

Device Definition consists of three separate areas:

- Printer Authorization Matrix (PAM)
- Logical Terminal Assignment (LTA)
- Prompts for Extended Vital Product Data (VPD).

All three deal with the assignment of devices that connect to the controller, and each contains default values for these assignments.

**Printer Authorization Matrix** defines which printers the display stations in a cluster can use for local copy, host printing, and shared copy operations. During planning, you complete worksheets that identify the display stations in the PAM for the different copy operations.

**Note:** If you have already planned for the Asynchronous Emulation Adapter (AEA), refer to the AEA Worksheets for information on AEA printer port assignments. If you have not planned the AEA, you may wish to do so before defining the Printer Authorization Matrix. The information you need for planning the AEA is in Chapter 12.

**Logical Terminal Assignment** identifies which host sessions each display station can access. An LTA is needed only if you are planning to configure for Multi-Host Support.

**Notes:**

1. If you have not planned for Port Assignment, you may want to do so before planning the LTA. It is during Port Assignment that devices actually get assigned host addresses. Each 3270 host requires a separate port assignment.
2. If you are planning to configure for Multi-Host support, you need to do both Logical Terminal Assignment and Port Assignment.

**Extended Vital Product Data** enables the customizer to define the vital product data (VPD) that is sent from 3471 (Model B) and 3472 (all models except G) displays upon request. The information that is entered by the customizer is submitted by that display station upon the controller's request. This information is used primarily for trouble-shooting.

---

## The Device Definition Worksheet

When planning for device definition, you need to fill out “Worksheet 28—Device Definition” (Figure 13-1). This worksheet contains three configuration questions that the customizer encounters while performing the Define Devices utility. Your responses to these questions determine whether you want to define the PAM, LTA, Extended VPD, or all three.

\_\_\_\_\_ Device Definition \_\_\_\_\_

800 Printer Authorization Matrix (PAM) -	<input type="checkbox"/>	<input type="checkbox"/>
	0	0
801 Logical Terminal Assignment (LTA) -	<input type="checkbox"/>	
	0	
802 Prompts for Extended VPD -	<input type="checkbox"/>	
	0	

Figure 13-1. An Example of Worksheet 28—Device Definition

## Filling In Worksheet 28 – Device Definition

Locate “Worksheet 28—Device Definition” on page A-42. Using the following information, write your responses to the questions on the worksheet.

### 800: Printer Authorization Matrix (PAM)

*Response:*

- 00 = Do not define the PAM.
- 10 = Define the PAM. Printers on HG 27 **cannot** be defined on the PAM.
- 11 = Define the PAM. Printers on HG 27 **can** be defined on the PAM.

The default response is 00.

**Notes:**

1. If you leave this question set to the default, previously defined PAM data is not included when the controller is IMLed and the local copy function will be unavailable.
2. Values specified for PRINT ID or Printer Assignment will differ depending on the response.
  - If question 800 = 10, the terminal user will specify either a value, 1-55, that represents the HG 26 or AEA printer port number, or a value, 70-85, that represents the printer class number.
  - If question 800 = 11, the terminal user will specify either a value, 1-47, that represents the PAM entry number, or a value, 70-85, that represents the printer class number.

For more information on PRINT IDs or Printer Assignments, see Chapter 4 in the *3174 Functional Description, GA23-0218*.

If you need more information to determine your response, see “Printer Authorization Matrix (PAM)” on page 13-6.

### 801: Logical Terminal Assignment (LTA)

*Response:*

- 0 = Do not define the LTA. (Previously defined LTA data will not be included when the controller is IMLed.)
- 1 = Define the LTA for port 26-00; copy to the remaining ports.  
Define the LTA for port 27-00; copy to the remaining ports.
- 2 = Define the LTA for individual ports.

The default response is 0.

**Note:** HG 27 ports are not allowed to access CCA host sessions (2x, 3x).

If you need more information to determine your response, see “Logical Terminal Assignment (LTA)” on page 13-12.

### 802: Prompts for Extended Vital Product Data (VPD)

*Response:*

- 0 = Disable Extended VPD
- 1 = Enable Extended VPD

The default response is 0.

If you need more information to determine your response, see "Filling Out Worksheet 31 – Prompts for Extended VPD" on page 13-19.

**Planner:**

- If you answered question "800: Printer Authorization Matrix (PAM)" with a 1 as the first digit, fill out "Worksheet 29—Printer Authorization Matrix (PAM)." The information you need to fill out this worksheet starts on page 13-6.
- If you answered question "801: Logical Terminal Assignment (LTA)" with a nonzero response, fill out "Worksheet 30—Logical Terminal Assignment (LTA)." The information you need to fill out this worksheet starts on page 13-12.
- If you answered question "802: Prompts for Extended Vital Product Data (VPD)," fill out "Worksheet 31—Extended Vital Product Data (VPD)." The information you need to fill out this worksheet can be found on page 13-19.

---

## Printer Authorization Matrix (PAM)

The Printer Authorization Matrix (PAM) defines which printers the display stations in a cluster can use for local copy, host printing, and shared copy operations. A local copy transfers data directly from the display buffer to the printer buffer, and the data is printed. During a host print operation, data is sent from the host to the printer. Shared copy means that both local copy and host printing operations can be performed. Printers that will be used for host printing operations only need not be entered in the matrix.

When defining a printer for local copies, its capabilities should match those of the source display, especially the capabilities for APL/Text handling and support of the Extended Highlighting, Color, and Programmed Symbols functions. If the print buffer is at least as large as the display buffer, a copy request can be handled. However, if the other capabilities do not match, the printout may be degraded, depending on the contents of the display buffer when the copy request is serviced.

---

## The PAM Worksheet

"Worksheet 29—Printer Authorization Matrix (PAM)" (Figure 13-2 on page 13-7) helps you define which display stations will use which printers. Use the procedure on page 13-11 to fill in this worksheet.

PAM Definition										
Entry	Printer Port		Mode	Class						
				7		8				
				0	1	2	3	HG 21	HG 22	HG 23
1	--	--	---	0	1	2	3	0	1	2
2	--	--	---	0	1	2	3	0	1	2
3	--	--	---	0	1	2	3	0	1	2
4	--	--	---	0	1	2	3	0	1	2
5	--	--	---	0	1	2	3	0	1	2
6	--	--	---	0	1	2	3	0	1	2
7	--	--	---	0	1	2	3	0	1	2
8	--	--	---	0	1	2	3	0	1	2

Entry	3270 Display Ports						ASCII Display Ports					
	0	1	2	3	HG 21	HG 22	0	1	2	3	HG 23	
1	26	27	26	27	26	27	0	1	2	3	0	
2	26	27	26	27	26	27	0	1	2	3	0	
3	26	27	26	27	26	27	0	1	2	3	0	
4	26	27	26	27	26	27	0	1	2	3	0	
5	26	27	26	27	26	27	0	1	2	3	0	
6	26	27	26	27	26	27	0	1	2	3	0	
7	26	27	26	27	26	27	0	1	2	3	0	
8	26	27	26	27	26	27	0	1	2	3	0	

Figure 13-2. Example of a Worksheet 29 – Printer Authorization Matrix

The following describes the areas on this worksheet.

**Entry** The PAM Entry is sequential numbering from 1 to 47, with 47 being the maximum number of printer assignments allowed.

The Entry field appears twice on the worksheet. In the top half of the worksheet, next to each printer you have identified, you define the Printer Port, Mode, and Class. In the bottom half of the worksheet, you write in the same PAM Entry numbers and identify the ports of the displays that will use the printer.

**Printer Port** In this column, you identify the port number for the printer. Include the two-digit hardware group number prefix: 26, 21, 22, 23, or 27 if question 800 = 11. You cannot assign a local copy printer to port 26-00.

If you have planned for individual port assignment, ensure that the assigned addresses on “Worksheet 11–117: Port Assignment” (Parts A and B) and the AEA Configure Worksheets (17 through 27) are consistent with the printer assignments defined here. The exception to this requirement is local-copy printers; they do not require a host address.

**Mode** This column is used to define the mode in which the printer will operate:

- 0 = Host
- 1 = Local
- 2 = Shared.

**Host mode** means the printer is under host (system) control. Since host control is the default mode for each printer if no matrix is defined, it is unnecessary to include a printer on the PAM if it will operate in host mode. When in host mode, the printer is protected from local copies, unless it is operating with BSC protocols. (The BSC Copy command does not use the PAM; it is directed to the to device and specifies the *from* device as a command parameter.)

**Local mode** means the printer is used only for local-copy functions regardless of host attachment or communication protocol. The display operator initiates a local copy by using the Print key; if the display is operating in SNA, the host can initiate a local copy from the display buffer. However, the host cannot use the printer for direct-print operations.

**Shared mode** means the printer performs both host-directed printing operations and local-copy operations. The efficiency of local-copy operations in shared mode depends on the communication protocol.

In SNA, a printer defined in shared mode may be used for local copy under either of these conditions:

- When the printer is not in session with a primary logical unit (PLU) in the host
- When Between Bracket Printer Sharing (question 213) has been specified in the microcode and the printer is not in bracket state with the PLU in the host.

In non-SNA, shared mode is a less efficient choice for local copy operations. Host application sessions are longer, so there are fewer opportunities for a local copy between host communications.

When operating a printer in shared mode, the user must assume responsibility for the integrity of the printed data by following installation rules and proper programming practices.

### **Class**

In this area, you enter an **X** (capital letter) under the class or classes defined for the printer.

You may want to group printers into classes, based, for example, on (1) physical characteristics (type font, character set, type of forms mounted), (2) location, or (3) security. You can assign a class number ranging from 70 through 85. In your installation, class 72 may identify all printers with yellow paper. In any configuration, a single printer may be in one class, several, or none.

If you wanted to group several printers in class 72 and authorize the display on port 26-08 to use any of them, you would enter an **X** under Display Port 26-08 on the line for each printer in class 72. If the display then attempted a local copy with a class 72 printer already in use, the local copy would automatically be sent to another available printer in that same class.

Before performing a local copy, the display operator selects a particular printer by class by first selecting the IDENT function on the keyboard and then keying in the authorized class number (70 through 85) next to the printer symbol on the bottom of the screen.

**Display Port** Your response in this field defines which displays may use each printer. You can assign more than one display to use the same printer for local copy or shared copy operations.

Write an **X** under the port for each display authorized to use a particular printer.

**Notes:**

1. Displays cannot perform local copies on printers that have ASCII hosts designated as their default destination on "Worksheet 21—AEA Default Destination."
2. Local copy printers can be assigned to display stations on HG 27 even if question 800 = 10.



## A Sample PAM

A sample Printer Authorization Matrix is defined in Figure 13-3.

PAM Definition														
Entry	Printer Port		Mode	Class										
	7	8		0	1	2	3	4	5	6	7			
				7	8	0	1	2	3	4	5	6	7	8
1	26	02	2											
2	26	04	1	X										
3	21	02	1											
4	26	06	1	X										
5	21	03	2	X										
6	--	--	--											
7	--	--	--											
8	--	--	--											

3270 Display Ports											ASCII Display Ports												
Entry	0			1			2			3			HG 21			HG 22			HG 23				
	0	1	2	0	1	2	0	1	2	0	1	2	0	1	2	0	1	2	0	1	2		
1		X			X	XXX																	
2		X	X																				
3			X																				
4					X	X																	
5						X	X	X															
6																							
7																							
8																							

Figure 13-3. Example of a PAM Definition

**Entry 1:** This printer is cabled to port 26-02. It operates in shared mode (2). It has no class designation. The displays at ports 26-01, 26-13, 26-15, 26-16, 26-17, 27-00, and 27-02 all use this printer.

**Entry 2:** This printer operates in local mode (1). It is designated in class 71 because it prints output on continuous forms. The displays at ports 26-07, 26-08, and 26-09 all use this printer. These displays are also authorized to use the printer attached to port 26-06 (as defined in Entry 4), and the printer attached to port 21-03 (as defined in entry 5), which are also in class 71.

**Entry 3:** This printer operates in local mode (1). It has no class designation. The displays at ports 26-03, 26-10, 26-11, and 26-12 all use this printer.

**Entry 4:** This printer operates in local mode (1) and is designated in class 71. The displays at ports 26-07, 26-08, and 26-09 are authorized to use this printer, as well as the printer at port 26-04 (as defined in Entry 2), and the printer at port 21-03 (as defined in Entry 5).

**Entry 5:** This printer operates in shared mode (2) and is designated in class 71 because it prints output on continuous forms. The displays at ports 21-04, 21-05, 26-07, 26-08, and 26-09 are authorized to use this printer.

**Notes:**

1. A printer assigned on the PAM must have a 3270 host designated as its default destination. See Chapter 12, "Planning for the Asynchronous Emulation Adapter" on page 12-1 for more information.
2. The Sample PAM has restrictions or different specifications depending on your response to question 800.
  - If question 800 = 10,
    - HG 27 cannot be used when designating a printer port.
    - The PRINT ID or Printer Assignment to be used for the local copy printers defined in our sample PAM on the previous page is:
      - 02 on display stations 26-01, 26-13, 26-15, 26-16, 26-17, 27-00, and 27-02 representing port number 26-02 (PAM Entry 1).
      - 71 on display stations 26-07, 26-08, 26-09, 21-04, and 21-05 representing the class number 71 (PAM Entries 2, 4, and 5).
      - 34 on display stations 26-03, 26-10, 26-11, and 26-12 representing port number 21-02 (PAM Entry 3).
  - If question 800 = 11,
    - HG 27 can be used when designating a printer port.
    - The PRINT ID or Printer Assignment to be used for the local copy printers defined in our sample PAM on the previous page is:
      - 01 on display stations 26-01, 26-13, 26-15, 26-16, 26-17, 27-00, and 27-02 representing the actual PAM Entry number.
      - 71 on display stations 26-07, 26-08, 26-09, 21-04, and 21-05 representing class number 71 (PAM Entry 2, 4, and 5).
      - 03 on display stations 26-03, 26-10, 26-11, and 26-12 representing the actual PAM Entry number.

---

## Filling Out Worksheet 29—Printer Authorization Matrix (PAM)

**Planner:** *If you have not read the previous information in this chapter, you need to do so before you begin to fill out the worksheet.*

**Step 1** Locate "Worksheet 29—Printer Authorization Matrix (PAM)" on page A-43. Make copies of this worksheet (one for every five printer assignments).

**Step 2** Decide to which ports you are attaching the printers and displays.

**Step 3** Enter your responses in these fields:

**Entry:** Sequentially number the PAM Entries on the top half of the worksheet. Transfer the same numbers to the entries on the bottom half.

**Printer Port:** Write the four-digit number of the port to which the printer is attached (for example, 26-18 or 21-02). You cannot assign a printer to port 26-00.

**Mode:** Write the number of the mode in which the printer will operate.

**Class:** Write an **X** under the number that identifies the class(es) defined for the printer. If no class is defined, leave this blank.

**Display Port:** Write an **X** under the ports of the displays authorized to use this particular printer.

**Step 4** Finish entering the information for those printers that you want to authorize for local copy.

**Planner:** You have completed "Worksheet 29—Printer Authorization Matrix (PAM)" on page A-43.

If you answered question 801 with a nonzero response, proceed to page 13-12 to begin planning the Logical Terminal Assignments. If you do not plan on making Logical Terminal Assignments, return to the divider page labeled "Microcode Customization Planning" and see step 9. You may also refer to the divider page labeled "Worksheet Summary" to determine where to proceed next.

Keep records of your configuration using one of the methods described under "Customization Records" on page 5-6.

---

## Logical Terminal Assignment (LTA)

Logical Terminal Assignment (LTA) is used when Multi-Host Support has been configured for a controller. The LTA allows you to assign up to five host sessions for each terminal and one host session for each printer attached to a 3270 controller port. Terminals can have all of their sessions with one host or each session can be with a different host. Each session for a terminal is seen by the host as communication between it and a physical terminal. By assigning up to five host sessions for each terminal, you are using one terminal as if it were five physical terminals. In other words, one physical terminal becomes five logical terminals.

For each 3270 controller port, there are five logical terminal (LT) fields on the Logical Terminal Assignment Worksheet. In these LT fields, you identify the host sessions that a terminal can access. Host sessions are presented on a terminal in the order that they are defined. Ports for which an LTA is not specified receive default assignments that are determined when a 3270 device is turned on.

When planning for LTA, remember:

- ASCII devices can communicate only with the primary host on the primary link.
- Even with Multi-Host Support, a printer can be assigned only one host session.
- CCA host sessions (2x, 3x) are not allowed on HG 27.

---

## The LTA Worksheet

"Worksheet 30—Logical Terminal Assignment (LTA)" (Figure 13-4 on page 13-13) helps you define the hosts with which display stations can have sessions. Use the procedure on page 13-18 to fill in this worksheet. This example only shows a small portion of the ports on HG 27.

———— Logical Terminal Assignment ————

Port	LT1	LT2	LT3	LT4	LT5	Port	LT1	LT2	LT3	LT4	LT5
26-00	—	—	—	—	—	26-01	—	—	—	—	—
26-02	—	—	—	—	—	26-03	—	—	—	—	—
26-04	—	—	—	—	—	26-05	—	—	—	—	—
26-06	—	—	—	—	—	26-07	—	—	—	—	—
26-08	—	—	—	—	—	26-09	—	—	—	—	—
26-10	—	—	—	—	—	26 11	—	—	—	—	—
26-12	—	—	—	—	—	26-13	—	—	—	—	—
26-14	—	—	—	—	—	26-15	—	—	—	—	—
26-16	—	—	—	—	—	26-17	—	—	—	—	—
26-18	—	—	—	—	—	26-19	—	—	—	—	—
26-20	—	—	—	—	—	26-21	—	—	—	—	—
26-22	—	—	—	—	—	26-23	—	—	—	—	—
26-24	—	—	—	—	—	26-25	—	—	—	—	—
26-26	—	—	—	—	—	26-27	—	—	—	—	—
26-28	—	—	—	—	—	26-29	—	—	—	—	—
26-30	—	—	—	—	—	26-31	—	—	—	—	—
27-00	—	—	—	—	—	27-01	—	—	—	—	—
27-02	—	—	—	—	—	27-03	—	—	—	—	—
27-04	—	—	—	—	—	27-05	—	—	—	—	—
27-06	—	—	—	—	—	27-07	—	—	—	—	—

Figure 13-4. An Example of Worksheet 30 – Logical Terminal Assignment

The following describes the areas on the worksheet.

**Port** This column lists the physical 3270 port numbers, beginning with port 26-00. The prefix "26" indicates direct or indirect connection to the Terminal Adapter (TA), identified by Hardware Group 26. The prefix "27" indicates direct or indirect connection to the Terminal Adapter identified by Hardware Group 27.

**LT1—LT5** In each of these columns, you identify host sessions for the logical terminals (LTs) assigned to the 3270 controller ports. Your response to each field consists of a two-part entry. The first part of your response determines which host the LT is assigned to. For this part of your response, enter the two-character host identifier (this information appears on "Worksheet 2—Multi-Host Definition").

The second part of your response is optional. It determines which host address is to be used for the LT. For this part of your response, you write in the port assignment entry number (1—5 which corresponds to your logical session number) that you wish to be assigned to the LT. (The port assignment entries are assigned when you fill out "Worksheet 11—117: Port Assignment" [Parts A and B] for each host attachment.) If you decide to leave this part of your response blank, it will be assigned sequentially during the Configure utility.

For example, assume you write in the following values for a particular port:

1A2 2A\_ 2A3 2A\_ 1A\_

After the customizer types in these responses and presses ENTER, the following values are displayed on his screen.

1A2 2A1 2A3 2A2 1A1

You cannot skip LTs or enter duplicate entries for a port. The following example is invalid for both of these reasons:

LT1 LT2 LT3 LT4 LT5  
1A1 1A1 \_\_\_ 2A1 1B1

**Notes:**

1. In some cases, the LTA overrides assignments made in the AEA Default Destination. If you have configured for the AEA, see the discussion of Multi-Host Support under "AEA Planning Considerations" on page 12-15.
2. 3174 online tests must be performed from a CUT display. To ensure that all tests can be performed, select a port that has a CUT attached to it and assign at least one LT to each host link. For example, if you had Host IDs 1A, 2A, 3A, 1B, 1C, 1D, 1E, and 1F, the following would fill this requirement.

LT1 LT2 LT3 LT4 LT5  
1C 2A 3A \_\_\_ \_\_\_

You should make this assignment to port 26-00 because some tests are only performed from this port.

3. Host 2X or 3X cannot be assigned to HG 27.

## A Sample LTA

A sample Logical Terminal Assignment is defined in Figure 13-5.

Logical Terminal Assignment											
Port	LT1	LT2	LT3	LT4	LT5	Port	LT1	LT2	LT3	LT4	LT5
26-00	1A1	2A1	3A1	---	---	26-01	1A1	1A2	1A3	1A4	1A5
26-02	1A1	---	---	---	---	26-03	1A	1A	2A	2A	3A
26-04	1A	1A	2A	2A	3A	26-05	1A	1A	2A	2A	3A
26-06	2A1	2A3	3A3	3A4	3A2	26-07	2A4	2A5	3A1	3A2	3A5
26-08	1A	1B	1C	1D	1E	26-09	1A	1B	1C	1D	1E
26-10	1A	1B	1C	1D	1E	26-11	1A	1B	1C	1D	1E
26-12	1A	1B	1C	1D	1E	26-13	1A	1B	1C	1D	1E
26-14	2A	2A	2A	2A	2A	26-15	2A	2A	2A	2A	2A
26-16	3A	3A	3A	3A	3A	26-17	3A	3A	3A	3A	3A
26-18	---	---	---	---	---	26-19	---	---	---	---	---
26-20	---	---	---	---	---	26-21	---	---	---	---	---
26-22	---	---	---	---	---	26-23	---	---	---	---	---
26-24	---	---	---	---	---	26-25	---	---	---	---	---
26-26	---	---	---	---	---	26-27	---	---	---	---	---
26-28	---	---	---	---	---	26-29	---	---	---	---	---
26-30	---	---	---	---	---	26-31	---	---	---	---	---

Figure 13-5. Example of an LTA Definition

In the overall configuration involving this LTA, we have two secondary links, through Concurrent Communication Adapters, each with one host. We also have a primary link configured for Single Link Multi-Host Support with access to five hosts on the link. This configuration yields the following Host Identifiers: 1A, 2A, 3A, 1B, 1C, 1D, and 1E. The hosts accessed through the primary link are identified by 1A, 1B, 1C, 1D, and 1E. The hosts on the secondary links are identified by 2A and 3A. A separate Port Assignment was previously defined for each of these hosts.

**Port 26-00:** A CUT is attached to this port and access to each host link was defined to allow 3174 online tests to be run.

**Port 26-01:** The attached terminal has five LT sessions with the primary host.

**Port 26-02:** A 3270 printer is connected to this port and assigned to the primary host (1A).

**Ports 26-03, -04, -05:** Displays attached to these ports each have their first two LT sessions assigned to the primary host on the primary link. The third and fourth LT sessions are assigned to the primary host on the secondary link (identified by 2A), and the fifth LT session is assigned to the primary host on the secondary link 3A.

**Ports 26-06, -07:** The displays on these ports both have their first two LT sessions with the 2A host and the remaining sessions with the 3A host. However, the port assignment entry numbers vary.

## Planning to Define Devices

**Ports 26-08—26-13:** On these ports, LT sessions for attached displays have been defined for all the hosts accessed through the Single Link Multi-Host Support function.

**Ports 26-14—26-17:** Displays attached to these ports are assigned LT sessions with only one host, 2A or 3A.

**Ports 26-18—26-31:** Default LTAs will be made to these ports when the devices attached to them are turned on.

Refer to the Multi-Host Support chapter in the 3174 *Functional Description* for additional information about defaulting.

---

## LTA Considerations

### For CUTs

In order for a local copy to be performed from a specific LT, the display must be authorized in the PAM to use the selected printer and the host session for the LT must be associated with the same host link as the printer. For example, an LT whose host session is on host 1A may do a local copy to a printer that is assigned to host 1D. The same LT may not do a local copy to a printer that is assigned to host 2A or 3A.

Session 1A2 is used for an attached printer session. If 1A2 is specified on the LTA panel, then the corresponding LT will not be available to the display. If 1A2 does not appear in the LTA and there are less than five LTs filled in, the display will have all sessions specified on the LTA and the printer will use session 1A2. If 1A2 does not appear on the LTA and five LTs are filled in for the port, then the display will only be able to access the first four sessions and the printer will be assigned session 1A2. The LT5 session will not be used because the maximum number of sessions (both display and attached printers) is limited to five.

### For DFTs

**Local Copy:** In order for a local copy to be performed from an LT, the display must be authorized in the PAM to use the selected 3270 printer. A local copy will be allowed only to 3270 printers that are assigned to the primary host link, or to ASCII printers in FPC mode. For example, an LT whose host session is on host 2B may do a local copy to a printer that is assigned to hosts 1A—1H. The same LT may not do a local copy to a printer that is assigned to host 2A or 3A.

**Multi-Host Support:** In order for a DFT to communicate with hosts on a secondary link (Host ID 2A-2D, 3A-3D), the primary link must be configured for SNA (Local SNA, SDLC, X.25, Token-Ring Network, or X.21 Switched) and the secondary links must be configured for SNA (SDLC, X.25 or X.21 Switched). If the primary link is *not* configured for SNA, but the secondary links *are*, then the LTA is ignored and all sessions are assigned to the primary host on the primary link. If the primary link *is* configured for SNA, but the secondary links are *not*, then sessions defined with the secondary hosts cannot be used.

### **For DFT-Es**

You specify the information for the DFT mode sessions in the LTA. The CUT mode sessions are defaulted. The considerations for the DFT mode sessions are the same as those for normal DFT devices. Refer to the Multi-Host Support chapter in the 3174 *Functional Description* for additional information about defaulting.

### **For Printers**

When planning for LTA, remember that, even with multi-host support, a printer can be assigned only one host session.



---

## Filling Out Worksheet 30 – Logical Terminal Assignment (LTA)

**Planner:** *If you have not read the previous information in this chapter, you need to do so before you begin to fill out the worksheet.*

- Step 1** Locate and make a copy of “Worksheet 30—Logical Terminal Assignment (LTA)” on page A-44.
- Step 2** Decide which ports will receive LTAs. Ports that are not defined will receive default LTAs when the devices attached to them are turned on.
- If you specified that 801 = 1, then you need to define the LTAs only to port 26-00 and port 27-00; the control microcode will make the same assignments for the remaining controller ports.
- Step 3** For each port that you wish to make LT assignments to, write in the identifiers of the hosts that you wish to have sessions with under the LT1 – LT5 columns. The order in which you assign these identifiers determines the session sequence of the attached terminal. For example, a host assigned to LT1 will be the terminal’s first session and host assigned to LT2 will be the terminal’s second session. If you wish to specify which address for a host is to be used for the LT, write in the port assignment entry number 1 – 5 next to the host’s identifier. (These optional port assignment entries are assigned automatically during customizing if you do not specify them here.)
- When you assign host sessions to a port, do not skip LT entries. For example, while making assignments to LT1, LT2, LT3, and LT4 is valid, making assignments to LT1, LT3, and LT4 is not.
- Step 4** Do not exceed the port limitations of your controller:
- For Models 1L, 1R, 2R, and 3R, you can make assignments to ports 26-00 through 26-31 only.
  - For Models 11L, 11R, 12L, 12R, 13R, 21L, 21R, 22L, and 23R, you can make assignments to all the ports on the worksheet if you have a second Terminal Adapter (HG 27).
  - For Models 51R, 53R, 61R, 62R, and 63R, you can make assignments to ports 26-00 through 26-15 only.

**Planner:** *You have completed “Worksheet 30—Logical Terminal Assignment (LTA).”*

*Return to the divider page labeled “Microcode Customization Planning” and see step 9. You may also refer to the divider page labeled “Worksheet Summary” to determine where to proceed next.*

*Keep records of your configuration by using one of the methods described under “Customization Records” on page 5-6.*

---

## Filling Out Worksheet 31 – Prompts for Extended VPD

*Planner: If you have not read the previous information in this chapter, you need to do so before you begin to fill out the worksheet.*

**Step 1** Locate “Worksheet 31—Extended Vital Product Data (VPD)” on page A-45. Make a copy of this worksheet.

**Step 2** For each 3471 (model B) and 3472 (all models except G) station that will have a VPD label, enter the label information on one label line of the worksheet.

The requirements for each label are:

- Each label can be a maximum of 15 characters.
- Valid characters for each label are **A–Z** and **0–9**. Spaces between characters are also allowed.

**Note:** Do not use underscores in the labels, the system stores them as blanks.

If question 802=1, Extended VPD is enabled. At customization, the customizer is prompted by a panel that resembles worksheet 31. He will enter those labels that you have written on the worksheet on the panel. Then, when the 3472 user invokes Extended VPD Setup or /5 or /6, he will see the labels and can type data next to them.



---

## Chapter 14. Planning the Token-Ring Network 3270 Gateway

An Overview of the Token-Ring Network 3270 Gateway .....	14-3
Overall Planning for Token-Ring Gateway Support .....	14-3
The Token-Ring Gateway Worksheet .....	14-6
Filling In Worksheet 32 – Token-Ring Gateway .....	14-7
900: Token-Ring Network Address and SAP for the Gateway .....	14-7
905: Ring Error Monitor (REM) .....	14-7
908: Link Subsystem Name .....	14-7
911: Ring Speed of the Gateway .....	14-8
912: Group Poll Address .....	14-8
The Ring Address Assignment Worksheet .....	14-9
940: Ring Address Assignment .....	14-9
Filling In Worksheet 33 – Ring Address Assignment .....	14-11
The Ring Transmission Definition Worksheet .....	14-12
941: Ring Transmission Definition .....	14-13
Filling In Worksheet 34 – Ring Transmission Definition .....	14-14



---

## An Overview of the Token-Ring Network 3270 Gateway

Before you start planning, you need the following:

- “Worksheet 32—Token-Ring Gateway” on page A-46
- “Worksheet 33—Ring Address Assignment” on page A-47
- “Worksheet 34—Ring Transmission Definition” on page A-48.

This chapter describes additional questions you answer to customize your 3174 controller for Token-Ring Network gateway support. This chapter also presents an overall strategy to plan for your 3174 gateway. Appendix C contains planning examples for local and remote gateways. Refer to these examples while planning for the microcode customization of your 3174 gateway controller.

---

## Overall Planning for Token-Ring Gateway Support

The following information is intended as general planning steps for implementing Token-Ring Network gateway support as provided by the 3174 Establishment Controller. Depending on the devices and host access method, you need to consult other documentation to obtain further details. See the list of related publications in the preface of this book.

**Step 1** Order the appropriate 3174 documentation.

**Step 2** Identify a profile of the user equipment attaching to the gateway:

- Identify host application requirements.
- Identify personal computer (PC) product requirements for attaching to the Token-Ring Network.
- Identify physical Token-Ring configuration changes.
- Identify items such as additional cables, 8228 Multistation Access Units, Token-Ring Adapters for PCs, and copper/optical fiber repeaters as required for your Token-Ring Network.
- Plan for universally administered or locally administered addresses for the PCs and other attaching devices.
- If the PCs will use the IBM PC 3270 Emulation Program Version 3, decide if the users will be standalone or network station users supported by PC gateway. Also decide if you require the program’s Extended Support offering.
- Define a starting (test) Token-Ring configuration.
- Define a production Token-Ring configuration.
- Plan for any future increases in the number of attaching Token-Ring devices.
- Plan for a backup of the gateway controller.
- Consider installing the IBM LAN Manager program for ring diagnostics and the IBM Token-Ring Network Trace and Performance Program. If you decide on installing either or both of these programs, you must order, install, and test them.

**Step 3** Document the relationship between VTAM, the 3174 gateway, and the attaching devices.

### For Gateway connections to channel-attached hosts:

- Choose a consecutive channel address range that supports the 3174 gateway and attached devices.
- Choose an address range that allows for future growth of your Token-Ring Network and keep a record of the range.
- Choose the VTAM Physical Unit (PU) and Logical Unit (LU) naming convention and keep a record of the names.
- Plan for universally and locally administered addresses for the devices attaching to the gateway.
- Define the service access point (SAP) addresses used by the Token-Ring devices and keep a record of these addresses.

### For 3174 Gateway connections to telecommunication attached hosts:

- Choose the SDLC address range that supports the 3174 gateway and attached devices.
- Since the 3174 is in a multidrop configuration on the communication link, ensure that the consecutive SDLC address range allows room for future growth of your Token-Ring Network. Keep a record of this address range.
- Choose the VTAM Physical Unit (PU) and Logical Unit (LU) naming convention and keep a record of the names.
- Plan for universally and locally administered addresses for the devices attaching to the gateway.
- Define the service access point (SAP) addresses used by the Token-Ring devices and keep a record of these addresses.

**Step 4** Order the required 3174 and features that meet your needs.

**Step 5** Prepare the host operating system for the 3174 gateway.

### For Gateway connections to channel-attached hosts:

- For the 3174 host address range:
  - If the host is an I/O control program (IOCP) processor, define the 3174 as a single controller with multiple addresses (one CNTLUIT statement normally, with shared set to YB).
  - If the host is not an IOCP processor, schedule a service representative to set the unit control words (UCWs) to shared.
- For VM systems:
  - Define each device (channel addresses) as a separate 3725 or 3705 RDEVICE macro.
  - Define controllers as single unit with Feature = 144-DEVICE.

### For Gateway connections to telecommunication attached hosts:

Order and install the following as required for your network:

- Communication lines
- Modems
- 37xx or Integrated Communication Adapter hardware
- VTAM APARS for 9370 (VM - VM26635, VSE - DY35217)
- Because you have a half-duplex multidrop configuration, create VTAM/NCP definitions for a multidrop configuration.

### **Step 6** Prepare VTAM for the 3174 gateway.

- If you are migrating to a new release of VTAM, perform the migration before you install the gateway.
- Decide if you want the ring error monitor (REM) function of the 3174. If so, you need ACF/VTAM Version 3.1.1 or higher for NetView support.
- If your current version of ACF/VTAM is no longer supported, migrate to a supported version.
- Verify that the VTAM buffers meet the 3174 requirement of greater than or equal to 78 bytes and the number of bytes is even.
- RU sizes must be less than or equal to 8KB inbound and 8KB outbound for 3174 Models 12L and 22L. Question 241 must be 1 if 8KB outbound is selected; question 241 must be 0 if 4KB outbound is selected.
- RU sizes must be less than or equal to 4KB inbound and 4KB outbound for 3174 Models 1L, 11L, and 21L.
- Order and apply any necessary program temporary fixes (PTFs).

### **Step 7** Define the Token-Ring devices to VTAM and/or NCP.

- Ensure Logmode entries for the LUs exist within the Logmode tables.
- RU sizes must be less than or equal to 2KB inbound and 4KB outbound for 3174 Models 3R, 13R, 21R, 23R, 53R, and 63R.  
  
If the gateway is a Model 12L or 22L, the RU sizes must be less than or equal to 2KB inbound and 8KB outbound. However, desirable RU sizes are greater than or equal to 1KB inbound and greater than 1KB outbound.
- For non-3174 Token-Ring devices, the maximum RU sizes are 4KB inbound and 4KB outbound.  
  
If the gateway is a Model 12L or 22L, the RU sizes must be less than or equal to 8KB inbound and 8KB outbound for non-3174 Token-Ring devices.
- Verify printers on PCs have the correct LU1 or LU3 Logmode entries.



**For 3174 Gateway Models 1L, 11L, 12L, 21L, and 22L:**

Define the 3174 and its non-Token-Ring devices within VTAM Local SNA major node.

- Verify the MAXBFRU is sufficient for the 3174. Ability to handle 1KB is recommended.
- Verify the defined addresses are within the 3174 gateway address range.

**For 3174 Gateway Models 1R, 2R, 11R, 12R, 21R, 51R, 61R, 62R, and 90R:**

Define a major node and NCP definition of a pseudo-multidrop line. Refer to "NCP Definition" on page 4-9 for more information.

- Step 8** Install and customize the 3174 gateway.
- Step 9** Customize the devices attaching to the Token-Ring Network.
- Step 10** Activate the 3174 gateway and Token-Ring-attached devices to the host.

## The Token-Ring Gateway Worksheet

If your response to question 150 was 1, you must fill out "Worksheet 32—Token-Ring Gateway" (Figure 14-1). On the worksheet, you respond to configuration questions using the information in this chapter.

Token-Ring Gateway													
900 -	<table border="1" style="width: 100%; border-collapse: collapse;"> <tr> <td style="width: 25%;"> </td> <td style="width: 25%;"> </td> <td style="width: 25%;"> </td> <td style="width: 25%;"> </td> </tr> <tr> <td style="text-align: center;">X X X X</td> <td style="text-align: center;">X X X X</td> <td style="text-align: center;">X X X X</td> <td style="text-align: center;">0 4</td> </tr> </table>					X X X X	X X X X	X X X X	0 4	905 -	<table border="1" style="width: 50%; border-collapse: collapse;"> <tr> <td style="width: 50%;"> </td> </tr> <tr> <td style="text-align: center;">1</td> </tr> </table>		1
X X X X	X X X X	X X X X	0 4										
1													
		908 -	<table border="1" style="width: 100%; border-collapse: collapse;"> <tr> <td style="width: 25%;"> </td> <td style="width: 25%;"> </td> <td style="width: 25%;"> </td> <td style="width: 25%;"> </td> </tr> <tr> <td style="text-align: center;">I</td> <td style="text-align: center;">B</td> <td style="text-align: center;">M</td> <td style="text-align: center;">L</td> </tr> </table>					I	B	M	L		
I	B	M	L										
		911 -	<table border="1" style="width: 50%; border-collapse: collapse;"> <tr> <td style="width: 50%;"> </td> </tr> <tr> <td style="text-align: center;">0</td> </tr> </table>		0								
0													
		912 -	<table border="1" style="width: 50%; border-collapse: collapse;"> <tr> <td style="width: 25%;"> </td> <td style="width: 25%;"> </td> </tr> <tr> <td style="text-align: center;">0</td> <td style="text-align: center;">0</td> </tr> </table>			0	0						
0	0												

Figure 14-1. An Example of Worksheet 32—Token-Ring Gateway

---

## Filling In Worksheet 32 – Token-Ring Gateway

Locate “Worksheet 32—Token-Ring Gateway” on page A-46. Using the following information, write your responses to the questions on the worksheet.

*Planner:* As you step through Token-Ring Gateway planning, if Multi-Host Gateway is configured, remember that the responses to questions 900, 905, 908, and 911 **must be the same for all hosts with the exception of the SAP.**

The SAP field is defined in question 900 and must be unique for each host.

### 900: Token-Ring Network Address and SAP for the Gateway

*Response:* Twelve-character hexadecimal address and two-character SAP.

This address and SAP must be a locally administered address in the following format:

4000 XYYY YYYY 04

where X and Y are the user-assigned portion of the locally administered address. Note that X should not be greater than hex 7.

The default value for the SAP is 04; this must be replaced with your own value.

**Note:** The response for this question cannot be all zeros.

Ask your network planner for this address.

### 905: Ring Error Monitor (REM)

*Response:*

0 = No  
1 = Yes.

The default response is 1.

For the ring that it is on, the ring error monitor (REM) performs integration and analysis of the nonrandom or error conditions on a real-time basis. REM then derives information indicating the fault domain (the two consecutive adapters and the media between them) most likely to be causing the failure, and provides this information to the host communication and systems management (C&SM) when error thresholds have been exceeded.

### 908: Link Subsystem Name

*Response:* Up to eight alphanumeric characters.

The default response is “IBMLAN”, which appears on the panel.

The link subsystem name identifies which controller an alert is from when an alert is sent to the host.

When responding to this question with a password, do not enter blanks between characters.

### 911: Ring Speed of the Gateway

*Response:*

- 0 = 4Mbps with normal token release
- 1 = 16Mbps with normal token release
- 2 = 16Mbps with early token release.

The default response is 0.

For controllers with a 4Mbps Token-Ring Adapter installed, respond with 0. For controllers with a 16/4Mbps Token-Ring Adapter installed, you may select any response. A response of 2 is recommended for large networks, but a 2 is valid only if the host is accessed via an ESCON Channel Adapter with 8 KB RU (question 241 = 1).

When you have 8KB RU support (question 241 = 1), the response to this question cannot be 0.

**Note:** If you want to have devices on your ring running both early and normal token release, you must respond to this question with 2. If you select 0 or 1, your ring can only operate with normal token release.

### 912: Group Poll Address

*Planner:* Group polling is used only for SDLC attachments. Do not answer this question if your host attachment is Local SNA.

*Response:* Two-character hexadecimal group poll address that is not in the range specified for questions 104 and 105, but not equal to X'FF'.

The default response is 00 (no group polling).

The address specified (if any) must be coordinated with the host system programmer.

Group polling results in faster response times for end users by decreasing the number of SDLC polls on the network.

**Restrictions:**

- One of the following must be installed at the host:
  - NCP Version 4 Release 3.1
  - NCP Version 5 Release 2.1
  - SSP Version 3 Release 4.1

Each of the above requires Small Programming Enhancements (SPEs). Contact your IBM representative for the SPEs required.

- SDLC-attached 3174s without the Gateway feature cannot use group polling.

*Planner:* You have completed "Worksheet 32—Token-Ring Gateway." Continue with filling out "Worksheet 33—Ring Address Assignment."

# The Ring Address Assignment Worksheet

“Worksheet 33—Ring Address Assignment” (Figure 14-2) helps you set up the one-to-one correspondence between the subchannel addresses and the Token-Ring Network address of attaching products. Use the procedure on page 14-11 to fill out this worksheet.

\_\_\_\_\_ 940: Ring Address Assignment \_\_\_\_\_

S	Ring	SAP	T		S	Ring	SAP	T
<input type="checkbox"/>	<input type="checkbox"/> <input type="checkbox"/> <input type="checkbox"/> <input type="checkbox"/> <input type="checkbox"/> <input type="checkbox"/> <input type="checkbox"/> <input type="checkbox"/> <input type="checkbox"/> <input type="checkbox"/>	<input type="checkbox"/>	<input type="checkbox"/>	0 4 0	<input type="checkbox"/>	<input type="checkbox"/> <input type="checkbox"/> <input type="checkbox"/> <input type="checkbox"/> <input type="checkbox"/> <input type="checkbox"/> <input type="checkbox"/> <input type="checkbox"/> <input type="checkbox"/>	<input type="checkbox"/>	<input type="checkbox"/>
<input type="checkbox"/>	<input type="checkbox"/> <input type="checkbox"/> <input type="checkbox"/> <input type="checkbox"/> <input type="checkbox"/> <input type="checkbox"/> <input type="checkbox"/> <input type="checkbox"/> <input type="checkbox"/> <input type="checkbox"/>	<input type="checkbox"/>	<input type="checkbox"/>	0 4 0	<input type="checkbox"/>	<input type="checkbox"/> <input type="checkbox"/> <input type="checkbox"/> <input type="checkbox"/> <input type="checkbox"/> <input type="checkbox"/> <input type="checkbox"/> <input type="checkbox"/> <input type="checkbox"/>	<input type="checkbox"/>	<input type="checkbox"/>
<input type="checkbox"/>	<input type="checkbox"/> <input type="checkbox"/> <input type="checkbox"/> <input type="checkbox"/> <input type="checkbox"/> <input type="checkbox"/> <input type="checkbox"/> <input type="checkbox"/> <input type="checkbox"/> <input type="checkbox"/>	<input type="checkbox"/>	<input type="checkbox"/>	0 4 0	<input type="checkbox"/>	<input type="checkbox"/> <input type="checkbox"/> <input type="checkbox"/> <input type="checkbox"/> <input type="checkbox"/> <input type="checkbox"/> <input type="checkbox"/> <input type="checkbox"/> <input type="checkbox"/>	<input type="checkbox"/>	<input type="checkbox"/>
<input type="checkbox"/>	<input type="checkbox"/> <input type="checkbox"/> <input type="checkbox"/> <input type="checkbox"/> <input type="checkbox"/> <input type="checkbox"/> <input type="checkbox"/> <input type="checkbox"/> <input type="checkbox"/> <input type="checkbox"/>	<input type="checkbox"/>	<input type="checkbox"/>	0 4 0	<input type="checkbox"/>	<input type="checkbox"/> <input type="checkbox"/> <input type="checkbox"/> <input type="checkbox"/> <input type="checkbox"/> <input type="checkbox"/> <input type="checkbox"/> <input type="checkbox"/> <input type="checkbox"/>	<input type="checkbox"/>	<input type="checkbox"/>
<input type="checkbox"/>	<input type="checkbox"/> <input type="checkbox"/> <input type="checkbox"/> <input type="checkbox"/> <input type="checkbox"/> <input type="checkbox"/> <input type="checkbox"/> <input type="checkbox"/> <input type="checkbox"/> <input type="checkbox"/>	<input type="checkbox"/>	<input type="checkbox"/>	0 4 0	<input type="checkbox"/>	<input type="checkbox"/> <input type="checkbox"/> <input type="checkbox"/> <input type="checkbox"/> <input type="checkbox"/> <input type="checkbox"/> <input type="checkbox"/> <input type="checkbox"/> <input type="checkbox"/>	<input type="checkbox"/>	<input type="checkbox"/>
<input type="checkbox"/>	<input type="checkbox"/> <input type="checkbox"/> <input type="checkbox"/> <input type="checkbox"/> <input type="checkbox"/> <input type="checkbox"/> <input type="checkbox"/> <input type="checkbox"/> <input type="checkbox"/> <input type="checkbox"/>	<input type="checkbox"/>	<input type="checkbox"/>	0 4 0	<input type="checkbox"/>	<input type="checkbox"/> <input type="checkbox"/> <input type="checkbox"/> <input type="checkbox"/> <input type="checkbox"/> <input type="checkbox"/> <input type="checkbox"/> <input type="checkbox"/> <input type="checkbox"/>	<input type="checkbox"/>	<input type="checkbox"/>
<input type="checkbox"/>	<input type="checkbox"/> <input type="checkbox"/> <input type="checkbox"/> <input type="checkbox"/> <input type="checkbox"/> <input type="checkbox"/> <input type="checkbox"/> <input type="checkbox"/> <input type="checkbox"/> <input type="checkbox"/>	<input type="checkbox"/>	<input type="checkbox"/>	0 4 0	<input type="checkbox"/>	<input type="checkbox"/> <input type="checkbox"/> <input type="checkbox"/> <input type="checkbox"/> <input type="checkbox"/> <input type="checkbox"/> <input type="checkbox"/> <input type="checkbox"/> <input type="checkbox"/>	<input type="checkbox"/>	<input type="checkbox"/>
<input type="checkbox"/>	<input type="checkbox"/> <input type="checkbox"/> <input type="checkbox"/> <input type="checkbox"/> <input type="checkbox"/> <input type="checkbox"/> <input type="checkbox"/> <input type="checkbox"/> <input type="checkbox"/> <input type="checkbox"/>	<input type="checkbox"/>	<input type="checkbox"/>	0 4 0	<input type="checkbox"/>	<input type="checkbox"/> <input type="checkbox"/> <input type="checkbox"/> <input type="checkbox"/> <input type="checkbox"/> <input type="checkbox"/> <input type="checkbox"/> <input type="checkbox"/> <input type="checkbox"/>	<input type="checkbox"/>	<input type="checkbox"/>
<input type="checkbox"/>	<input type="checkbox"/> <input type="checkbox"/> <input type="checkbox"/> <input type="checkbox"/> <input type="checkbox"/> <input type="checkbox"/> <input type="checkbox"/> <input type="checkbox"/> <input type="checkbox"/> <input type="checkbox"/>	<input type="checkbox"/>	<input type="checkbox"/>	0 4 0	<input type="checkbox"/>	<input type="checkbox"/> <input type="checkbox"/> <input type="checkbox"/> <input type="checkbox"/> <input type="checkbox"/> <input type="checkbox"/> <input type="checkbox"/> <input type="checkbox"/> <input type="checkbox"/>	<input type="checkbox"/>	<input type="checkbox"/>
<input type="checkbox"/>	<input type="checkbox"/> <input type="checkbox"/> <input type="checkbox"/> <input type="checkbox"/> <input type="checkbox"/> <input type="checkbox"/> <input type="checkbox"/> <input type="checkbox"/> <input type="checkbox"/> <input type="checkbox"/>	<input type="checkbox"/>	<input type="checkbox"/>	0 4 0	<input type="checkbox"/>	<input type="checkbox"/> <input type="checkbox"/> <input type="checkbox"/> <input type="checkbox"/> <input type="checkbox"/> <input type="checkbox"/> <input type="checkbox"/> <input type="checkbox"/> <input type="checkbox"/>	<input type="checkbox"/>	<input type="checkbox"/>
<input type="checkbox"/>	<input type="checkbox"/> <input type="checkbox"/> <input type="checkbox"/> <input type="checkbox"/> <input type="checkbox"/> <input type="checkbox"/> <input type="checkbox"/> <input type="checkbox"/> <input type="checkbox"/> <input type="checkbox"/>	<input type="checkbox"/>	<input type="checkbox"/>	0 4 0	<input type="checkbox"/>	<input type="checkbox"/> <input type="checkbox"/> <input type="checkbox"/> <input type="checkbox"/> <input type="checkbox"/> <input type="checkbox"/> <input type="checkbox"/> <input type="checkbox"/> <input type="checkbox"/>	<input type="checkbox"/>	<input type="checkbox"/>
<input type="checkbox"/>	<input type="checkbox"/> <input type="checkbox"/> <input type="checkbox"/> <input type="checkbox"/> <input type="checkbox"/> <input type="checkbox"/> <input type="checkbox"/> <input type="checkbox"/> <input type="checkbox"/> <input type="checkbox"/>	<input type="checkbox"/>	<input type="checkbox"/>	0 4 0	<input type="checkbox"/>	<input type="checkbox"/> <input type="checkbox"/> <input type="checkbox"/> <input type="checkbox"/> <input type="checkbox"/> <input type="checkbox"/> <input type="checkbox"/> <input type="checkbox"/> <input type="checkbox"/>	<input type="checkbox"/>	<input type="checkbox"/>
<input type="checkbox"/>	<input type="checkbox"/> <input type="checkbox"/> <input type="checkbox"/> <input type="checkbox"/> <input type="checkbox"/> <input type="checkbox"/> <input type="checkbox"/> <input type="checkbox"/> <input type="checkbox"/> <input type="checkbox"/>	<input type="checkbox"/>	<input type="checkbox"/>	0 4 0	<input type="checkbox"/>	<input type="checkbox"/> <input type="checkbox"/> <input type="checkbox"/> <input type="checkbox"/> <input type="checkbox"/> <input type="checkbox"/> <input type="checkbox"/> <input type="checkbox"/> <input type="checkbox"/>	<input type="checkbox"/>	<input type="checkbox"/>
<input type="checkbox"/>	<input type="checkbox"/> <input type="checkbox"/> <input type="checkbox"/> <input type="checkbox"/> <input type="checkbox"/> <input type="checkbox"/> <input type="checkbox"/> <input type="checkbox"/> <input type="checkbox"/> <input type="checkbox"/>	<input type="checkbox"/>	<input type="checkbox"/>	0 4 0	<input type="checkbox"/>	<input type="checkbox"/> <input type="checkbox"/> <input type="checkbox"/> <input type="checkbox"/> <input type="checkbox"/> <input type="checkbox"/> <input type="checkbox"/> <input type="checkbox"/> <input type="checkbox"/>	<input type="checkbox"/>	<input type="checkbox"/>
<input type="checkbox"/>	<input type="checkbox"/> <input type="checkbox"/> <input type="checkbox"/> <input type="checkbox"/> <input type="checkbox"/> <input type="checkbox"/> <input type="checkbox"/> <input type="checkbox"/> <input type="checkbox"/> <input type="checkbox"/>	<input type="checkbox"/>	<input type="checkbox"/>	0 4 0	<input type="checkbox"/>	<input type="checkbox"/> <input type="checkbox"/> <input type="checkbox"/> <input type="checkbox"/> <input type="checkbox"/> <input type="checkbox"/> <input type="checkbox"/> <input type="checkbox"/> <input type="checkbox"/>	<input type="checkbox"/>	<input type="checkbox"/>
<input type="checkbox"/>	<input type="checkbox"/> <input type="checkbox"/> <input type="checkbox"/> <input type="checkbox"/> <input type="checkbox"/> <input type="checkbox"/> <input type="checkbox"/> <input type="checkbox"/> <input type="checkbox"/> <input type="checkbox"/>	<input type="checkbox"/>	<input type="checkbox"/>	0 4 0	<input type="checkbox"/>	<input type="checkbox"/> <input type="checkbox"/> <input type="checkbox"/> <input type="checkbox"/> <input type="checkbox"/> <input type="checkbox"/> <input type="checkbox"/> <input type="checkbox"/> <input type="checkbox"/>	<input type="checkbox"/>	<input type="checkbox"/>
<input type="checkbox"/>	<input type="checkbox"/> <input type="checkbox"/> <input type="checkbox"/> <input type="checkbox"/> <input type="checkbox"/> <input type="checkbox"/> <input type="checkbox"/> <input type="checkbox"/> <input type="checkbox"/> <input type="checkbox"/>	<input type="checkbox"/>	<input type="checkbox"/>	0 4 0	<input type="checkbox"/>	<input type="checkbox"/> <input type="checkbox"/> <input type="checkbox"/> <input type="checkbox"/> <input type="checkbox"/> <input type="checkbox"/> <input type="checkbox"/> <input type="checkbox"/> <input type="checkbox"/>	<input type="checkbox"/>	<input type="checkbox"/>
<input type="checkbox"/>	<input type="checkbox"/> <input type="checkbox"/> <input type="checkbox"/> <input type="checkbox"/> <input type="checkbox"/> <input type="checkbox"/> <input type="checkbox"/> <input type="checkbox"/> <input type="checkbox"/> <input type="checkbox"/>	<input type="checkbox"/>	<input type="checkbox"/>	0 4 0	<input type="checkbox"/>	<input type="checkbox"/> <input type="checkbox"/> <input type="checkbox"/> <input type="checkbox"/> <input type="checkbox"/> <input type="checkbox"/> <input type="checkbox"/> <input type="checkbox"/> <input type="checkbox"/>	<input type="checkbox"/>	<input type="checkbox"/>
<input type="checkbox"/>	<input type="checkbox"/> <input type="checkbox"/> <input type="checkbox"/> <input type="checkbox"/> <input type="checkbox"/> <input type="checkbox"/> <input type="checkbox"/> <input type="checkbox"/> <input type="checkbox"/> <input type="checkbox"/>	<input type="checkbox"/>	<input type="checkbox"/>	0 4 0	<input type="checkbox"/>	<input type="checkbox"/> <input type="checkbox"/> <input type="checkbox"/> <input type="checkbox"/> <input type="checkbox"/> <input type="checkbox"/> <input type="checkbox"/> <input type="checkbox"/> <input type="checkbox"/>	<input type="checkbox"/>	<input type="checkbox"/>
<input type="checkbox"/>	<input type="checkbox"/> <input type="checkbox"/> <input type="checkbox"/> <input type="checkbox"/> <input type="checkbox"/> <input type="checkbox"/> <input type="checkbox"/> <input type="checkbox"/> <input type="checkbox"/> <input type="checkbox"/>	<input type="checkbox"/>	<input type="checkbox"/>	0 4 0	<input type="checkbox"/>	<input type="checkbox"/> <input type="checkbox"/> <input type="checkbox"/> <input type="checkbox"/> <input type="checkbox"/> <input type="checkbox"/> <input type="checkbox"/> <input type="checkbox"/> <input type="checkbox"/>	<input type="checkbox"/>	<input type="checkbox"/>
<input type="checkbox"/>	<input type="checkbox"/> <input type="checkbox"/> <input type="checkbox"/> <input type="checkbox"/> <input type="checkbox"/> <input type="checkbox"/> <input type="checkbox"/> <input type="checkbox"/> <input type="checkbox"/> <input type="checkbox"/>	<input type="checkbox"/>	<input type="checkbox"/>	0 4 0	<input type="checkbox"/>	<input type="checkbox"/> <input type="checkbox"/> <input type="checkbox"/> <input type="checkbox"/> <input type="checkbox"/> <input type="checkbox"/> <input type="checkbox"/> <input type="checkbox"/> <input type="checkbox"/>	<input type="checkbox"/>	<input type="checkbox"/>
<input type="checkbox"/>	<input type="checkbox"/> <input type="checkbox"/> <input type="checkbox"/> <input type="checkbox"/> <input type="checkbox"/> <input type="checkbox"/> <input type="checkbox"/> <input type="checkbox"/> <input type="checkbox"/> <input type="checkbox"/>	<input type="checkbox"/>	<input type="checkbox"/>	0 4 0	<input type="checkbox"/>	<input type="checkbox"/> <input type="checkbox"/> <input type="checkbox"/> <input type="checkbox"/> <input type="checkbox"/> <input type="checkbox"/> <input type="checkbox"/> <input type="checkbox"/> <input type="checkbox"/>	<input type="checkbox"/>	<input type="checkbox"/>
<input type="checkbox"/>	<input type="checkbox"/> <input type="checkbox"/> <input type="checkbox"/> <input type="checkbox"/> <input type="checkbox"/> <input type="checkbox"/> <input type="checkbox"/> <input type="checkbox"/> <input type="checkbox"/> <input type="checkbox"/>	<input type="checkbox"/>	<input type="checkbox"/>	0 4 0	<input type="checkbox"/>	<input type="checkbox"/> <input type="checkbox"/> <input type="checkbox"/> <input type="checkbox"/> <input type="checkbox"/> <input type="checkbox"/> <input type="checkbox"/> <input type="checkbox"/> <input type="checkbox"/>	<input type="checkbox"/>	<input type="checkbox"/>
<input type="checkbox"/>	<input type="checkbox"/> <input type="checkbox"/> <input type="checkbox"/> <input type="checkbox"/> <input type="checkbox"/> <input type="checkbox"/> <input type="checkbox"/> <input type="checkbox"/> <input type="checkbox"/> <input type="checkbox"/>	<input type="checkbox"/>	<input type="checkbox"/>	0 4 0	<input type="checkbox"/>	<input type="checkbox"/> <input type="checkbox"/> <input type="checkbox"/> <input type="checkbox"/> <input type="checkbox"/> <input type="checkbox"/> <input type="checkbox"/> <input type="checkbox"/> <input type="checkbox"/>	<input type="checkbox"/>	<input type="checkbox"/>
<input type="checkbox"/>	<input type="checkbox"/> <input type="checkbox"/> <input type="checkbox"/> <input type="checkbox"/> <input type="checkbox"/> <input type="checkbox"/> <input type="checkbox"/> <input type="checkbox"/> <input type="checkbox"/> <input type="checkbox"/>	<input type="checkbox"/>	<input type="checkbox"/>	0 4 0	<input type="checkbox"/>	<input type="checkbox"/> <input type="checkbox"/> <input type="checkbox"/> <input type="checkbox"/> <input type="checkbox"/> <input type="checkbox"/> <input type="checkbox"/> <input type="checkbox"/> <input type="checkbox"/>	<input type="checkbox"/>	<input type="checkbox"/>

Figure 14-2. An Example of Worksheet 33 – Ring Address Assignment

## 940: Ring Address Assignment

The following information defines the columns on the Ring Address Assignment worksheet.

- S** Contains the addresses within the range of addresses defined in questions 104 and 105. This information is supplied automatically when the Ring Address Assignment panel is presented during the Configure utility.

**Ring** This column defines the Token-Ring Network addresses of the DSPUs (downstream physical units).

*Response:* Twelve-character hexadecimal address.

The address can be either a locally administered address or a universal address. A locally administered address is in the following format:

4000 XYYY YYYY

where X and Y are the user-assigned portion of the locally administered address. Note that X should not be greater than hex 7.

A universal address is in the following format:

WWWW WWZZ ZZZZ

where:

W = The ID of the adapter manufacturer (for example, IBM's ID is 1000 5A)

Z = The unique address portion of this adapter's universal address.

**Note:** The combination of the Ring and SAP must be unique. See the publications for ring-attached products for addressing specifications.

**Important:** When the product permits you to enter either type of address, the suggested choice is locally administered. If the universal address is used and the Token-Ring Adapter is replaced, that product, as well as the gateway, will have to be recustomized with the new address.

**SAP** This column defines the service access point (SAP) ID. Some attaching products, including a 3174 that is configured for Single Link Multi-Host Support, may appear as multiple SNA physical units and therefore have multiple SAP addresses and a single-ring address. See the publications for ring-attached products for more information.

*Response:* Two hexadecimal characters.

This must be a multiple of 4 in the range of hex 04 to hex EC.

The default is 04.

**T** This is the type of the device.

*Response:*

0 = workstation

1 = 3174 Establishment Controller

2 = 8KB RU devices

The default is 0.

Response 2 is valid only if question 241 is 1 (8KB RU). The selection will determine the default values for I-frame size and maximum out (transmit window size) on the Ring Transmission Definition panel.

Consult your network planner for this information.

## Filling In Worksheet 33 – Ring Address Assignment

Refer to the descriptions of the columns under “940: Ring Address Assignment” on page 14-9 if you need information to fill in a field on this worksheet.

**Step 1** Locate “Worksheet 33—Ring Address Assignment” on page A-47. Depending on the number of DSPUs, you may need to make from one to eight copies of this worksheet.

**Step 2** Skip the first Ring entry. The response to question 900 (Gateway address) will automatically fill this entry during customization.

In the remaining Ring columns, enter from left to right (to be consistent with the cursor movement on the customizer’s screen) the 12-character hexadecimal address of each attaching device.

**Step 3** Fill in the SAP columns or circle the default for each attaching device.

*Response:* Two hexadecimal characters.

This must be a multiple of 4 in the range of hex 04 to hex EC.

The default is 04.

**Step 4** Fill in the T columns or circle the default for each device.

*Response:*

0 = workstation

1 = 3174 Establishment Controller

2 = 8KB RU devices

The default is 0.

**Planner:** You have completed “Worksheet 33—Ring Address Assignment.” Continue with “Worksheet 34—Ring Transmission Definition” on page A-48.

## The Ring Transmission Definition Worksheet

“Worksheet 34—Ring Transmission Definition” (Figure 14-3) helps you define the transmit I-frame size and maximum-out for each DSPU. Use the procedure on page 14-14 to fill out this worksheet.

\_\_\_ 941: Ring Transmission Definition \_\_\_

S	Ring	SAP	F	W	S	Ring	SAP	F	W
<input type="checkbox"/>	<input type="checkbox"/>	<input type="checkbox"/>	<input type="checkbox"/>	<input type="checkbox"/>	<input type="checkbox"/>	<input type="checkbox"/>	<input type="checkbox"/>	<input type="checkbox"/>	<input type="checkbox"/>
<input type="checkbox"/>	<input type="checkbox"/>	0 4	<input type="checkbox"/>	<input type="checkbox"/>	<input type="checkbox"/>	<input type="checkbox"/>	0 4	<input type="checkbox"/>	<input type="checkbox"/>
<input type="checkbox"/>	<input type="checkbox"/>	0 4	<input type="checkbox"/>	<input type="checkbox"/>	<input type="checkbox"/>	<input type="checkbox"/>	0 4	<input type="checkbox"/>	<input type="checkbox"/>
<input type="checkbox"/>	<input type="checkbox"/>	0 4	<input type="checkbox"/>	<input type="checkbox"/>	<input type="checkbox"/>	<input type="checkbox"/>	0 4	<input type="checkbox"/>	<input type="checkbox"/>
<input type="checkbox"/>	<input type="checkbox"/>	0 4	<input type="checkbox"/>	<input type="checkbox"/>	<input type="checkbox"/>	<input type="checkbox"/>	0 4	<input type="checkbox"/>	<input type="checkbox"/>
<input type="checkbox"/>	<input type="checkbox"/>	0 4	<input type="checkbox"/>	<input type="checkbox"/>	<input type="checkbox"/>	<input type="checkbox"/>	0 4	<input type="checkbox"/>	<input type="checkbox"/>
<input type="checkbox"/>	<input type="checkbox"/>	0 4	<input type="checkbox"/>	<input type="checkbox"/>	<input type="checkbox"/>	<input type="checkbox"/>	0 4	<input type="checkbox"/>	<input type="checkbox"/>
<input type="checkbox"/>	<input type="checkbox"/>	0 4	<input type="checkbox"/>	<input type="checkbox"/>	<input type="checkbox"/>	<input type="checkbox"/>	0 4	<input type="checkbox"/>	<input type="checkbox"/>
<input type="checkbox"/>	<input type="checkbox"/>	0 4	<input type="checkbox"/>	<input type="checkbox"/>	<input type="checkbox"/>	<input type="checkbox"/>	0 4	<input type="checkbox"/>	<input type="checkbox"/>
<input type="checkbox"/>	<input type="checkbox"/>	0 4	<input type="checkbox"/>	<input type="checkbox"/>	<input type="checkbox"/>	<input type="checkbox"/>	0 4	<input type="checkbox"/>	<input type="checkbox"/>
<input type="checkbox"/>	<input type="checkbox"/>	0 4	<input type="checkbox"/>	<input type="checkbox"/>	<input type="checkbox"/>	<input type="checkbox"/>	0 4	<input type="checkbox"/>	<input type="checkbox"/>
<input type="checkbox"/>	<input type="checkbox"/>	0 4	<input type="checkbox"/>	<input type="checkbox"/>	<input type="checkbox"/>	<input type="checkbox"/>	0 4	<input type="checkbox"/>	<input type="checkbox"/>
<input type="checkbox"/>	<input type="checkbox"/>	0 4	<input type="checkbox"/>	<input type="checkbox"/>	<input type="checkbox"/>	<input type="checkbox"/>	0 4	<input type="checkbox"/>	<input type="checkbox"/>
<input type="checkbox"/>	<input type="checkbox"/>	0 4	<input type="checkbox"/>	<input type="checkbox"/>	<input type="checkbox"/>	<input type="checkbox"/>	0 4	<input type="checkbox"/>	<input type="checkbox"/>
<input type="checkbox"/>	<input type="checkbox"/>	0 4	<input type="checkbox"/>	<input type="checkbox"/>	<input type="checkbox"/>	<input type="checkbox"/>	0 4	<input type="checkbox"/>	<input type="checkbox"/>
<input type="checkbox"/>	<input type="checkbox"/>	0 4	<input type="checkbox"/>	<input type="checkbox"/>	<input type="checkbox"/>	<input type="checkbox"/>	0 4	<input type="checkbox"/>	<input type="checkbox"/>
<input type="checkbox"/>	<input type="checkbox"/>	0 4	<input type="checkbox"/>	<input type="checkbox"/>	<input type="checkbox"/>	<input type="checkbox"/>	0 4	<input type="checkbox"/>	<input type="checkbox"/>
<input type="checkbox"/>	<input type="checkbox"/>	0 4	<input type="checkbox"/>	<input type="checkbox"/>	<input type="checkbox"/>	<input type="checkbox"/>	0 4	<input type="checkbox"/>	<input type="checkbox"/>
<input type="checkbox"/>	<input type="checkbox"/>	0 4	<input type="checkbox"/>	<input type="checkbox"/>	<input type="checkbox"/>	<input type="checkbox"/>	0 4	<input type="checkbox"/>	<input type="checkbox"/>

Figure 14-3. An Example of Worksheet 34 – Ring Transmission Definition

The F and W columns are the only unique fields between the 940 and 941 panels. The defaults for F and W depend on the value assigned to T (type) on the Ring Address Assignment Worksheet. These defaults are listed by type selection in Table 14-1.

Table 14-1. Defaults for F and W by Type selection

Type	I-Frame	Maximum-Out
0 (workstation)	0 (265 bytes)	2
1 (controller)	3 (2042 bytes)	2
2 (8KB RU device)	5 (8201 bytes)	2

## 941: Ring Transmission Definition

The following information defines the F and W fields.

**F** Transmit I-frame size.

*Response:*

- 0 = 265 bytes
- 1 = 521 bytes
- 2 = 1033 bytes
- 3 = 2042 bytes
- 4 = 4105 bytes
- 5 = 8201 bytes

The value specified for the T (type) field on the Ring Address Assignment Worksheet determines the default. These defaults are listed in Table 14-1 on page 14-12.

**Notes:**

1. Response 4 is valid only for controllers that have a 16/4Mbps Token-Ring Gateway Adapter installed.
2. Response 5 is valid for either a controller with a 16/4Mbps Token-Ring Gateway Adapter installed or a controller that is running with ESCON Channel attachment.
3. In responding to this question, you need to consider the route by which data will flow. If at link activation time there does not exist a route to the gateway that supports the specified I-frame size, then the I-frame size is downgraded to the maximum supported on the available route. When a downgrade takes place, a unique status code appears on the operator panel and an error is written in the 3174 event log.
4. The values for the maximum I-frame size include the additional bytes for the SNA header.

**W** Maximum-Out (transmit window size) – the number of transmits before waiting to receive an acknowledgment.

*Response:* One numeric character.

A valid response ranges from 1 to a maximum of 7.

The value specified for the T (type) field on the Ring Address Assignment Worksheet determines the default. These defaults are listed in Table 14-1 on page 14-12.

Consult your network planner for this information.



---

## Filling In Worksheet 34 – Ring Transmission Definition

Refer to the descriptions of the columns under “941: Ring Transmission Definition” on page 14-13 if you need information to fill in a field on this worksheet.

**Step 1** Locate “Worksheet 34—Ring Transmission Definition” on page A-48. Depending on the number of DSPUs, you may need to make from one to eight copies of this worksheet.

**Step 2** Duplicate the Ring entries from the Ring Address Assignment Worksheet.

**Step 3** Duplicate the SAP responses from the Ring Address Assignment Worksheet.

**Step 4** Fill in the F columns for each attaching device.

*Response:*

- 0 = 265 bytes
- 1 = 521 bytes
- 2 = 1033 bytes
- 3 = 2042 bytes
- 4 = 4105 bytes (Applies to Models 12L or 22L Gateway)
- 5 = 8201 bytes (Applies to Models 12L or 22L Gateway)

**Note:** The Token-Ring must be running with a 16/4Mbps Token-Ring Adapter or the 8192-byte RU size will not be supported.

**Step 5** In the W columns for each attaching device, enter the number of transmits before waiting to receive an acknowledgment.

*Response:* One numeric character. A valid response ranges from 1 to a maximum of 7.

Consult your network planner for this information.

**Planner:** You have completed “Worksheet 34—Ring Transmission Definition.” Return to the divider page labeled “Microcode Customization Planning.” See step 4 to determine if you need to fill out additional worksheets before you continue. You may also refer to the divider page labeled “Worksheet Summary” to determine where to proceed next.

Keep records of your configuration by using one of the methods described under “Customization Records” on page 5-6.

---

## Chapter 15. Planning to Modify Keyboards

An Overview of Modifying Keyboards .....	15-3
Modify Keyboard Requirements .....	15-4
Restrictions .....	15-4
General .....	15-4
Local Functions .....	15-6
APL .....	15-7
Nomenclature Presentation .....	15-7
Setting Up the Terminal Keyboards .....	15-8
Modifying Keyboards for ASCII Emulation .....	15-8
Two-Language Modification .....	15-9
Examples of Two-Language Modification .....	15-10
Languages Supported on Modifiable Keyboards .....	15-14
The Keyboard Changes Chart .....	15-17
Keyboard, Shift, and Function Groups .....	15-18
A Sample Keyboard Changes Chart .....	15-18
Filling Out the Keyboard Worksheets .....	15-19



---

## An Overview of Modifying Keyboards

Before you start planning, you need the following:

- The Keyboard Layout Worksheets in Appendix A
- The *3174 Character Set Reference*, GA27-3831, for visual identification of keyboard layouts and for code page graphics.

The purpose of the Modify Keyboards procedure is to create unique keyboard layouts that meet specific user applications. These modified layouts can be used on IBM display stations with modifiable keyboards.

Keyboards can be modified for both 3270 sessions and ASCII Emulation. This chapter presents keyboard modification procedures based on use in 3270 sessions. Procedures for ASCII Emulation are similar; an explanation is provided. See "Modifying Keyboards for ASCII Emulation" in this chapter.

During microcode customization planning, you can select which standard keyboard layout (question 136) and which of the four possible modified keyboard layouts (question 137) are to be included in the 3174. The maximum number of standard and modified keyboards that can be configured is four.

Most characters, symbols, and functions can be relocated, duplicated, or deleted from almost any key position. However, there are restrictions, as explained under "Restrictions" on page 15-4. For two-language keyboards, modifying the secondary language nomenclature on the two-language keyboard will, in some cases, also affect the primary nomenclature. These occurrences are described in detail under "Two-Language Modification" on page 15-9.

The 3174 supports a PA3 function for the Converged (also referred to as *122-key keyboard*) and Enhanced Typewriter keyboards. The PA3 key, which is sometimes unlabeled, allows a third program attention key to be supported by an application. You should check with your system programmer to determine if any application already has a function associated with the PA3 key. If the system programmer determines that pressing the (unlabeled) PA3 key initiates an undesirable action, you should instruct the customizer to use the Modify Keyboard procedure to remove the PA3 key from the keyboard.

**Note:** To modify the keyboard on a 3290 Information Panel or 3179 Color Display Station, see *3290 Information Panel Description and Reference*, GA23-0021, and *3179 G Color Display Station Description*, GA18-2261.

---

## Modify Keyboard Requirements

To use modified keyboards, it is necessary to answer question "137: Modified Keyboard Layouts" on page 6-28 (see page 6-28) on the applicable Host Attachment Worksheet.

Although as many as four modified keyboard layouts can be defined, the total number of standard and modified keyboard layouts (question numbers 136 and 137) cannot exceed 4. For example, if three standard keyboards are selected, then only one of the four modified keyboards can be selected.

---

## Restrictions

The restrictions are grouped into four categories:

- General
- Local Functions
- APL
- Nomenclature Presentation.

### General

- If you modify a keyboard for the language used on the primary host link, the display station will not get the modified keyboard when operating in a logical terminal session if the following are true: (1) the logical terminal session is on a secondary host *and* (2) the secondary host is not configured for the same language as the primary host on the primary link. If the secondary and primary hosts on the same link are configured for the same language, the display station will get the modified keyboard.
- If you have a keyboard with the Numeric Lock feature and you are planning to modify any of these functions:

Change Screen	Reset
Attention	Cursor Blink
System Request	Alternate Cursor
Test Request	Clicker
Device Cancel	Extended Select.
Insert	

then consult the Numeric Lock feature section of *3174 Functional Description*, , GA23-0218. This is particularly important if you plan to move the function to a key that will not be used in ALT shift or one that will not provide these functions in both lower and upper shift modes.

- A maximum of four keyboard layouts are identified by this procedure.
- The following are mandatory key functions and **must** be included on the modified keyboard layouts:

Alternate shift	Test
Enter	System request
Reset	Upshift or downshift.
Device cancel	

**Exceptions:**

For the Katakana Converged keyboards: The Japanese English upper and lower shift key functions are mandatory key functions and **must** be included on the modified keyboard layout.

For the Greek, Cyrillic, and Thai modifiable keyboards: The Latin shift key function is a mandatory key function and **must** be included on the modified keyboard layout.

- A make/break key cannot be copied to a non-make/break key, nor can a non-make/break key be copied to a make/break key.

The make/break keys are:

Shift Lock	ENTER (on main keyboard only)
Upshift (two keys)	Downshift (Data Entry keyboard only)
RESET/DEV CNCL	CONTROL (3471/72 only).
ALT (two keys)	

- **Do not** place any of the following functions anywhere on key 69 while modifying Converged keyboards for Models 3179, 3180, 3191, and 3192. (See the keyboard worksheets in Appendix A for the position of key 69.)

Shift Lock	ALT
Upshift	Downshift
RESET/DEV CNCL	CONTROL.

- **Do not** place any of the following functions anywhere on key 64 while modifying a Converged keyboard for a Model 3180. (See the keyboard worksheets in Appendix A for the position of key 64.)

Shift Lock	ALT
Upshift	Downshift
RESET/DEV CNCL	

- For CEEC countries, when the Acute, Grave, Circumflex, Diaeresis, Cedilla, and Degree/Overcircle accents are added to a Typewriter or APL keyboard, they become “nonescaping keys.” A nonescaping key is a key that allows a character to be typed without the imprint position being changed. These keys are intended to be combined with other characters in a two-keystroke sequence to create accented characters. If the accent is to be used by itself, the two-keystroke sequence **must** be the accent and space.
- For languages that have Extended Graphics support (all CEEC languages except Icelandic), the Caps Lock and Shift Lock functions cannot be modified in full-key mode. The Caps Lock and Shift Lock functions can be moved around within the original key in single-shift mode. They cannot be deleted, copied, or exchanged with another key. All shifts of the modified key must contain the Caps Lock or Shift Lock function, in any arrangement.

**Note:** Modifying keyboards does not affect the Extended Select or Extended Graphics keyboard functions.

For languages without Extended Graphics support, Caps Lock and Shift Lock functions can be moved to another key in full-shift mode and moved around within a key in single-shift mode. However, all shifts of the modified key must contain the Caps Lock or Shift Lock function, in any arrangement.

## Planning to Modify Keyboards

- Reset and Device Cancel functions can be moved to another key in full-shift mode and moved around within a key in single-shift mode. However, all shifts of the modified key must contain the Reset or Device Cancel function, in any arrangement.
- “Fwd” and “Back” (the scroll forward and backward functions) can be moved, but they are not operative for all modifiable keyboards.
- For languages that have Extended Graphics support (all CECF languages except Icelandic), the Up-shift, Down-shift, and Alt-shift keys cannot be modified.
- For languages that do not have Extended Graphics support, the Up-shift, Down-shift, and Alt-shift keys cannot be modified in a single shift change.
- On Typewriter and APL keyboards with the keyboard numeric lock feature, the keyboard is automatically downshifted when the cursor enters a numeric field; on Data Entry keyboards, the keyboard is automatically upshifted. You must keep this in mind when modifying a keyboard with this feature, because the automatic shifting remains in effect regardless of keyboard layout modification. For example, when a Typewriter keyboard layout has been modified, if any numbers are moved from downshift to upshift key locations, the operator must override the automatic downshift in a numeric lock field (by pressing the Shift key) before keying in the upshift numbers.
- Only characters resident in the I/O interface code page for the language that was selected can be added to the keyboard. For example, only the characters from the Cyrillic I/O interface code page can be used to add a character to the keyboard while you are modifying Cyrillic keyboards.
- When modifying a Converged keyboard for a 3471 or 3472, change it so that **only** the following functions are listed on key 69 (see the keyboard worksheets in Appendix A for the position of key 69). Or, delete all functions from that key:

Shift Lock/Caps	ALT
Lock	Downshift (Data entry keyboard)
Upshift	CONTROL
RESET/DEV CNCL	ENTER.

## Local Functions

- Keyboard local functions are not displayed and are not modifiable.
- Extended Select key functions (including Entry Assist, X.21, and X.25) cannot be modified.
- Local keys (for example, SETUP, RECORD, and PLAY keys) on modifiable keyboards do not send signals to the 3174. (See your terminal user’s guide to find out if your terminal’s keyboard has local keys.) Any key functions that are moved to these “local” key locations will not be recognized by the 3174. This restriction does not apply to modifiable keyboards that do not implement these local keys.
- The procedure will not prevent moving functions to or from the keys associated with the local key functions. When a modifiable keyboard is performing a local function, however, all key functions revert to the positions of the standard keyboard. For example, assume that the ALT key function was exchanged with the ENTER key. During setup mode, then, the original ALT key (now labeled ENTER) must be pressed when the “Alternate” function is required.

## APL

- Not all display stations with modifiable keyboards support the APL keyboard.
- The display station connected to port 26-00 must have an APL read-only storage (ROS) to modify APL characters.
- A display station must have an APL2 ROS in order to display APL2 characters correctly.
- APL key functions cannot be exchanged with Typewriter key functions.
- Characters resident in an I/O interface code page cannot be added to the APL layer on the Converged APL keyboard.

## Nomenclature Presentation

- When a key nomenclature of  $n$  characters (where  $n > 3$ ) is moved to a key of less-than- $n$  characters, the nomenclature is truncated. For example, exchanging the Print key with the letter Q key causes Pri to be displayed on the new "print" key.
- The display station connected to port 26-00 must have a primary language read-only storage (ROS) to display the corresponding primary language characters. However, these characters are modifiable whether the primary language ROS is present or not. (This note applies to Katakana, Greek, Turkish, Icelandic, ROECE, Yugoslavic, Cyrillic, and Thai.)
- For CECP characters to be supported, the controller must be customized for CECP, and displays that support CECP must be used. See Chapter 8, "Planning for Country Extended Code Page," for the devices that support CECP.
- For any CECP language, characters that are unique to the CECP ROS may not be displayed correctly unless the display being used has a CECP ROS.

For additional information on keyboard restrictions, refer to the *3174 Utilities Guide*, GA27-3863.



---

### Setting Up the Terminal Keyboards

After customizing has been performed, the user of a display station with a modifiable keyboard can select which keyboard layout to use. For a modified keyboard layout, the user must change the keyboard to match the layout sheet by changing the keytops or by affixing stick-on labels. Depending on the type of display station, the user identifies the keyboard layout to the 3174 either by switches mounted on the bottom of the keyboard or by a local-mode procedure.

The users of display stations with modifiable keyboards need to know which keyboard layouts have been customized for their controller. Copies of the modified keyboard layouts should be given to these users so that they can set up their keyboards.

Instructions on how to set up a modified keyboard layout are in the operator's guide for each display station with a modifiable keyboard.

The customer is responsible for all changes he makes to the keyboard. That is, before submitting a keyboard for exchange or repair, the customer should remove all special keytops he has installed on his keyboard, because he will receive a keyboard with the standard key layout in return for any keyboard submitted for exchange or maintenance.

---

### Modifying Keyboards for ASCII Emulation

Converged and Enhanced keyboards are used in ASCII Emulation. Each keyboard type can be modified (and its layout changed) for both 3270 *and* ASCII Emulation sessions at once. The Keyboard Definition Utility allows you to make changes for 3270 sessions, then the system matches equivalent ASCII functions to 3270 ones. Modified keyboards can only be used in ASCII Emulation if question 702 = 1.

So, to modify a function used in ASCII Emulation mode, use keyboard maps to find the 3270 function that matches the ASCII function you want to change (the one already on that key). Then, using KDU, change the 3270 function to the one that matches the ASCII function you want supported. See the *3174 Terminal User's Reference for Expanded Function* for the keyboard maps that match ASCII-3270 equivalent functions.

For example, suppose you have a Converged keyboard which emulates a 3101. On the keyboard map, you see that the 3270 function matching ASCII ERASE EOS is Cursor Sel. So you use KDU to move the Cursor Sel function to the key you want ERASE EOS to be supported on. Then, when you power on that workstation, identify it as using a modified keyboard layout. From that point on, when the workstation is used in 3270 session, Cursor Sel is in the new location; when the workstation is used in ASCII Emulation session, the ERASE EOS function is in the new location also.

---

## Two-Language Modification

**Code Page Considerations:** In some two-language code pages, there may be a character that is duplicated between the primary and secondary languages. While modifying the secondary language keyboard, you may use only the secondary language's characters. While modifying the primary language keyboard, you may use only the primary language's characters. For example, a Latin (secondary language) capital A and a Greek (primary language) capital alpha look similar, but the Latin A is hex C1, and the Greek alpha is hex 41.

**Hidden Keyboard Considerations:** When the primary language code is specified on the master panel of this procedure, the keyboard layouts of two languages—for instance, the Katakana keyboard layout and the Japanese English keyboard layout—can be displayed.

There are occasions when a modification made to the primary language (Katakana, Greek, Cyrillic, and Thai) keyboard layout will also be made to the secondary language keyboard layout. For example, if the Katakana keyboard layout is displayed and PF7 is deleted, the PF7 on the hidden (Japanese English) keyboard layout may also be deleted. The reverse is also true. When a modification is made to both languages, an indication is displayed on the display screen. (This indication and how to move between the keyboard layouts are explained in the *3174 Utilities Guide*, GA27-3863.)

A two-language modification will occur (unless you are modifying a keyboard where the keyboard group selection is equal to a 1, meaning APL only) in the following circumstances:

- When you are modifying function keys on the keyboard; for example, program function keys, control keys, and shift keys. With some exceptions, most of these keys appear gray on the keyboard.

If you are modifying a graphic key, a two-language modification will **not** occur. Graphic keys produce alphanumeric and national characters on the screen. With some exceptions, these are the white keys on the keyboard.

- If you are copying a character from an I/O interface code table, two-language modification will **not** occur.
- If the modification involves the full key (both upper and lower shift positions), and the upper and lower shift positions on the displayed keyboard layout and on the hidden keyboard layout are the same. See "Examples of Two-Language Modification" on page 15-10 for illustrations of this condition.
- When the modification involves a single-shift (either the upper shift, lower shift, or alt shift position) key, and the corresponding keys on both the displayed keyboard and the hidden keyboard are the same. See "Examples of Two-Language Modification" for illustrations of this condition.

### Examples of Two-Language Modification

The examples in Figures 15-1 and 15-2 illustrate cases when a two-language modification will and will not occur. They use the Japanese English keyboard layout as the displayed keyboard and the Katakana keyboard layout as the hidden keyboard. However, the same result would occur regardless of which keyboard is hidden or displayed. The keyboard layouts used in the examples represent the control keys on the left side of the Typewriter keyboard. The characters displayed on the boxes, however, do not represent any real function; they are used here for illustration only.

The same applies to Latin-Greek, Latin-Cyrillic, and Latin-Thai language keyboard layouts.

### Deleting Key Functions

The first and second sets of boxes on the left in Figure 15-1 represent the layout of function keys on the left side of the Japanese English Typewriter keyboard that is displayed on the screen. They show the keyboard **before** and **after** the Modify Keyboard procedure was used to delete a key function. The third and fourth sets of boxes, on the right, represent the corresponding keys on the hidden (Katakana) Typewriter keyboard layout. They show what can happen to the hidden keyboard when keys are deleted on the displayed keyboard.

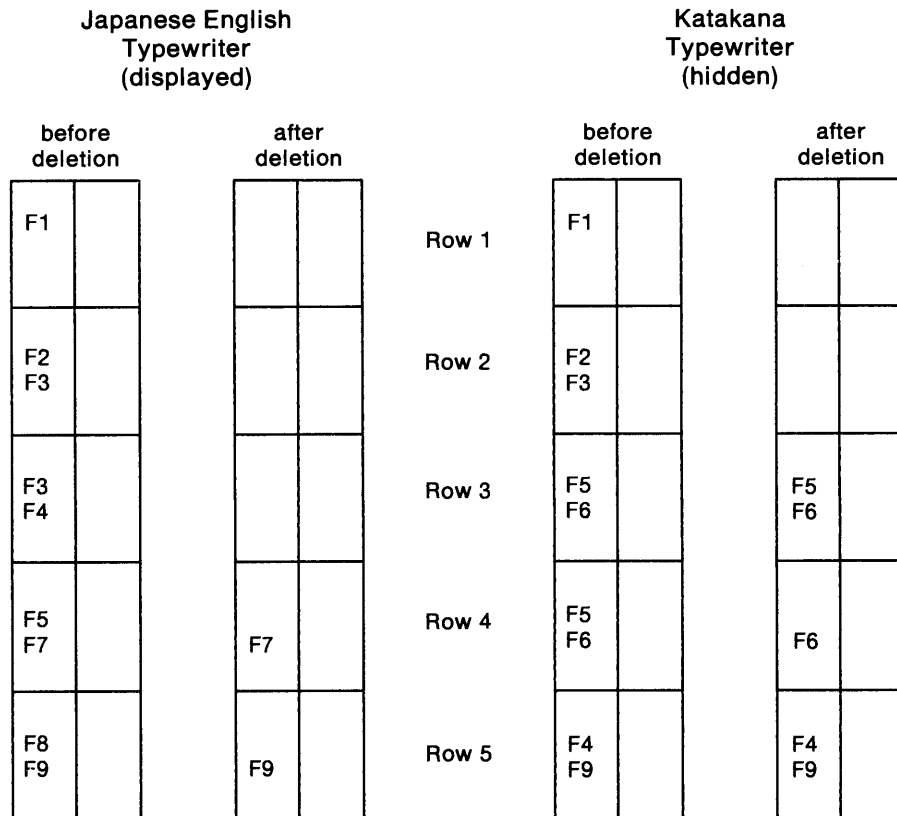

- Row 1:** Full-key deletion; both the displayed and hidden keyboards are modified because they are functionally the same.
- Row 2:** Full-key deletion; both the displayed and hidden keyboards are modified because they are functionally the same.
- Row 3:** Full-key deletion; the key on the displayed keyboard and the corresponding key on the hidden keyboard are functionally different. The hidden key is not modified.
- Row 4:** Single-shift deletion of the upper shift function occurs on both keyboards because the upper shift functions of both keys are the same.
- Row 5:** Single-shift deletion; the upper shift function of the key on the displayed keyboard is functionally different from the corresponding key on the hidden keyboard. The hidden keyboard is not modified.

Figure 15-1. Deleting Key Functions

## Planning to Modify Keyboards

### Copying from One Key to Another Key

The following examples also apply when you are exchanging the functions of two keys.

The first and second sets of boxes on the left in Figure 15-2 represent function keys on the Japanese English Typewriter keyboard layout that is displayed on the screen. They show the **before** and **after** states of copying a key function to the neighboring key. The third and fourth sets of boxes represent the corresponding keys on the hidden (Katakana) Typewriter keyboard layout. They show what will happen to the hidden keyboard when keys are copied on the displayed keyboard.

Japanese English Typewriter (displayed)			Katakana Typewriter (hidden)	
before copy	after copy		before copy	after copy
F1		Row 1	F1	F1
F2 F3 F9	F2 F3 F9	Row 2	F2 F3 (F9)	F2 F3 (F9)
F4 F5	F4 F5	Row 3	F4 F6	F4 F6
F8 F9	F8 F9	Row 4	F8 F9	F6 F7

- Row 1:** Full-key copy; both the displayed and hidden keyboards are modified because they are functionally the same. The function in the alternate location is copied to the Katakana keyboard, but is not displayed.
- Row 2:** Full-key copy; both the displayed and hidden keyboards are modified because they are functionally the same in the upper and lower positions. The function in the alternate location is copied to the Katakana keyboard, but is not displayed.
- Row 3:** Full-key copy; the key on the hidden keyboard is not modified, because the corresponding keys are not functionally the same in both upper and lower shift positions.
- Row 4:** Full-key copy; the corresponding keys on the hidden keyboard are not modified, because the target key (the key being copied to) is functionally different from the target key on the displayed keyboard.

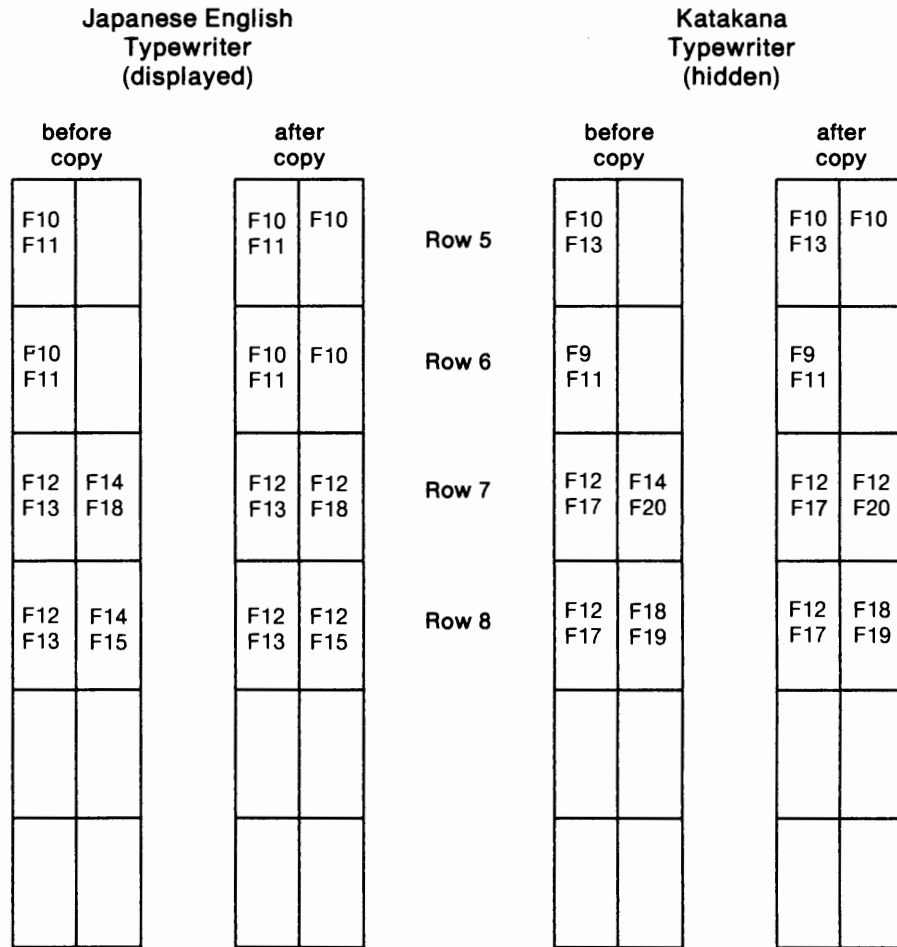

- Row 5:** Single-shift copy of the upper shift function; the corresponding keys on the hidden keyboard are modified because the upper positions of both keys are functionally the same.
- Row 6:** Single-shift copy of the upper shift function; the corresponding keys on the hidden keyboard are not modified, because the upper position of the corresponding key on the hidden keyboard is functionally different from the corresponding key on the displayed keyboard.
- Row 7:** Single-shift copy of the upper shift function; the corresponding keys on the hidden keyboard are modified because the upper position of the target key (the key being copied to) is functionally the same as the corresponding key on the displayed keyboard.
- Row 8:** Single-shift copy of the upper shift function; the keys on the hidden keyboard are not modified, because the upper position of the target key (the key being copied to) is functionally different from the corresponding key on the displayed keyboard.

Figure 15-2 (Part 2 of 2). Copying from One Key to Another Key

## Languages Supported on Modifiable Keyboards

Table 15-1. Languages Supported on Modifiable Keyboards					
Keyboard Language	Converged Keyboards			Enhanced Keyboard	Response
	Typewriter	Data Entry	APL	Typewriter	
English (U.S.A.)	✓	✓	✓	✓	01
English (U.S.A.) ASCII-7	✓				02 <sup>1</sup>
Austrian/German	✓	✓	✓	✓	03
Belgian	✓		✓		04
Danish	✓	✓	✓	✓	07
Finnish	✓	✓	✓	✓	09
Italian	✓	✓	✓	✓	15
Japanese Katakana	✓	✓	✓	✓	17
Spanish	✓		✓	✓	19
Spanish-Speaking	✓	✓	✓	✓	21
English (UK)	✓	✓	✓	✓	22
Norwegian	✓	✓	✓	✓	23
Swedish	✓	✓	✓	✓	24
Portuguese	✓	✓	✓	✓	28
Canadian Bilingual	✓	✓	✓	✓	29
French	✓	✓	✓	✓	30
English (U.S.A.) ASCII-International	✓		✓		33 <sup>2</sup>
English (U.S.A.) ASCII-8	✓				34 <sup>3</sup>
Cyrillic	✓			✓	35
Greek	✓			✓	36
Icelandic	✓			✓	37
ROECE <sup>4</sup> Latin	✓			✓	38
Turkish	✓			✓	39
Yugoslavic	✓			✓	40
Swiss French (New)	✓		✓	✓	41
Swiss German (New)	✓		✓	✓	42
Belgian (New)	✓		✓	✓	43
Thai				✓	46
Netherlands	✓	✓	✓	✓	47
New Greek	✓			✓	48

<sup>1</sup>Available on remote models only.  
Does not support Extended Data Stream.

<sup>2</sup>Available on BSC, Local SNA, and Local Non-SNA only.

<sup>3</sup>Available on SDLC and X.25 only.

<sup>4</sup>Regional Office for Eastern and Central Europe.

**Note:** The *3174 Character Set Reference*, GA27-3831, contains the code pages for the supported languages.

Each of the languages supported by the Modify Keyboard procedure uses the key function nomenclature of one of the following languages:

- English
  - Belgian
  - Cyrillic
  - Danish
  - Finnish
  - Greek
  - Icelandic
  - Netherlands
  - New Belgium
  - Norwegian
  - Portuguese
  - ROECE
  - Swedish
  - Thai
  - Turkish
  - Yugoslavic
  - UK English
  - US English
- French
  - Canadian (Bilingual)
  - French (AZERTY 105)
  - New Swiss/French
- German
  - Austrian/German
  - New Swiss/German
- Italian
  - Italian
- Spanish
  - Spanish
  - Spanish-speaking
- Japanese
  - Katakana.

For example, when a keyboard panel for a Finnish keyboard is displayed, the key function is displayed in English. Table 15-2 on page 15-16 lists the key functions and the corresponding displays.



# Planning to Modify Keyboards

Table 15-2. Key Function Nomenclature					
Key Function	Key Function Display				
	English	French	German	Italian	Spanish
Attention	Attn	Attn	Abruf	Attn	Atenc
Clear	Clear	EfEcr	Losch	Annul	Borra
System Request	SysRq	Syst	S-Abf	Sist	PtSis
Cursor Select	CrSel	SelCr	AwPos	SelCr	SelCr
Erase Input	ErInp	EfEnt	E-Lo	ImCan	BorEn
Erase to End of Field	ErEOF	EfFZn	LoFld	FCCan	BrFDC
Extend Select	ExSel	2eSel	ErAus	EsSel	ExSel
Print	Print	Impr	Druck	Stamp	Impr
Ident	Ident	Ident	Ident	Ident	Ident
Test	Test	Test	Test	Prova	Prba
Shift Lock	ShLck	VrMaj	UmVer	FMaiu	BlMay
Up Shift	UpSh	Maj	UmObn	Maius	Mayus
Reset	Reset	Rest	Grdst	Ripr	Rest
Device Cancel	DvCnl	AnnOp	Eh-Lo	AnTrs	CancD
Alternate Shift	Alt	FnSel	Alt	Altrn	Altva
Space	Space	Esp	Leer	Spaz	Espac
Enter	Enter	Entr	DatFr	Invio	Intro
Home	CrHom	Posl	GrPos	Posiz	IncCr
Cursor Down	CrDwn	CrBas	UnPos	CrGiu	BajCr
Cursor Up	CrUp	CrHt	ObPos	CrSu	SubCr
Insert	Ins	Inser	Eifug	Inser	Inser
Delete	Del	Suppr	Z-Lo	Canc	Supr
Delete Word	WdDel	SpMot	W-Lo	PCanc	SupP1
Duplicate	Dup	Repro	Dup	Dup	Dup
Field Mark	FldMk	FinZn	FeldM	MC	MCamp
PA1—PA3	PA1—PA3	AP1—AP3	PA1—PA3	AP1—AP3	AP1—AP3
Cursor Blink	CrBnk	ClgCr	BIPos	IntCr	ParCr
Alternate Cursor	CrAlt	TypCr	UPos	CAlt	CrAlt
Clicker (On/Off)	Click	Clic	Klick	Segn	Clic
PF1—PF24	P1—P24	P1—P24	P1—P24	F1—F24	F1—F24
Down Shift	DwnSh	Min	UmUnt	Minus	Minus
Window Forward	Fwd	Avant	Vorw	Avant	Avnce
Change Screen	ChgSc	ChgSc	ChgSc	ChgSc	Chgsc
Window Back	Back	Arr	Ruck	Indtr	Retro
Backspace	<--	<--	<--	<--	<--
Carrier Return	<-	<-	<-	<-	<-
Tab Right	->	->	->	->	->
Tab Left	<-	<-	<-	<-	<-
Fast Cursor Left	<<<--	<<<--	<<<--	<<<--	<<<--
Fast Cursor Right	-->>	-->>	-->>	-->>	-->>
Cursor Left	<-	<-	<-	<-	<-
Cursor Right	->	->	->	->	->
Capslock	CapLk	CapLk	CapLk	CapLk	CapLk

## The Keyboard Changes Chart

An example of a Keyboard Changes Chart can be seen in Figure 15-3. This chart appears on keyboard worksheets 1 through 5. Use the procedure on page 15-19 to fill out the keyboard worksheets.

Keyboard			Shift		Function					From Key		I/O Interface		To Key	
0	1	2	3	4	5	6	7	8	Shift	Character	Code	Character	Shift	Character	

Figure 15-3. Example of a Keyboard Changes Chart

The columns are defined below.

- 0, 1, 2, 3, 4, 5, 6, 7, 8**                      Numbers indicating the keyboard, shift, and function groups (see Figure 15-4 on page 15-18.)
- From Key Shift**                              Designates which shift positions of the key should be moved, deleted, or copied.
- From Key Character**                        Designates the character or function on the *From* key that will be deleted, moved, copied, or exchanged.
- I/O Interface Code**                         A hexadecimal code that represents a character not normally on the keyboard. These codes can be found in the I/O Interface Code Character tables of the *3174 Character Set Reference*, GA27-3831.
- I/O Interface Code Character**             A character that is not normally on the keyboard, but that can be added through the use of hexadecimal codes entered in the Modify Keyboards files of the controller.
- To Key Shift**                                 Designates which shift positions on the *To* key will receive the *From* key character or the I/O interface code character.
- To Key Character**                         Designates the character or function on the *To* key that will be exchanged with the *From* key character, that will be replaced by the *From* key character or I/O interface code character, or that indicates the *To* key position on the keyboard.

## Planning to Modify Keyboards

### Keyboard, Shift, and Function Groups

<b>0, 1, 2 – Keyboard Group</b>	
0 =	The desired change is on a Converged Typewriter, Converged Data Entry, Enhanced Typewriter, or the typewriter functions on a Converged APL keyboard.
1 =	The desired change applies only to the APL key functions on a Converged APL keyboard.
2 =	The desired change applies to both the typewriter and APL functions a Converged APL keyboard.
<b>3, 4 – Shift Group</b>	
3 =	Full-key change (includes alternate, upper, and lower shifts).
4 =	Single-shift change.
<b>5, 6, 7, 8 – Function Group</b>	
5 =	Copy from I/O interface code table.
6 =	Exchange two functions.
7 =	Copy a function to another key.
8 =	Delete a key function.

Figure 15-4. Keyboard, Shift, and Function Groups – Keyboard Changes Chart

### A Sample Keyboard Changes Chart

Use the following example as a reference when filling out the Keyboard Changes Chart.

**Example:** In this example, the planner has already specified on the top portion of the worksheet that the keyboard is Non-Katakana, Typewriter, PF, and a new layout.

In the following Keyboard Changes Chart, the planner has indicated on the first row that he wishes:

- To change a Converged Typewriter, Converged Data Entry, or Enhanced Typewriter keyboard
- To make a single-shift change
- To exchange two functions
- To perform an exchange of the X key (uppershift position) with the A key (uppershift position).

In the second row the planner has indicated that he wishes:

- To change a Converged Typewriter, Converged Data Entry, or Enhanced Typewriter keyboard
- To make a single-shift change
- To copy a character from the I/O interface code table
- To copy the plus (+) key from the I/O Interface character table (hex 4E) to replace the Z key (alternate position).

Keyboard			Shift		Function				From Key		I/O Interface		To Key	
0	1	2	3	4	5	6	7	8	Shift	Character	Code	Character	Shift	Character
✓				✓		✓			Upper	X			Upper	A
✓				✓	✓						4E	+	Alternate	Z

Figure 15-5. Example of a Completed Keyboard Changes Chart

## Filling Out the Keyboard Worksheets

Use the following steps to plan your modified keyboards. Be sure to review "Restrictions" on page 15-4. The restrictions listed may apply to the changes you wish to make.

**Step 1** Locate the worksheets you plan to use. There are five Keyboard Layout Worksheets:

- Converged Non-Katakana
- Converged Katakana
- Enhanced (US)
- Enhanced (World Trade)
- Enhanced (Katakana).

Remove the worksheets you plan to use from Appendix A. The keyboard users will need copies of the completed worksheets to set up their keyboards. Duplicate the worksheets as needed, but be sure to keep one blank copy of each worksheet for future planning.

**Step 2** At the top of the worksheet, circle the keyboard ID. The keyboard IDs represent the modified or unmodified keyboards for which the controller has been configured. To determine which IDs are to be supported, check the response to configuration question 137 on your host related worksheet.

**Step 3** Specify whether this is a New Layout or Update. If you are planning changes to a keyboard that already exists in the Modify Keyboard tables (within the microcode files), check the box indicating "Update." If you are planning to enter a new keyboard into the Modify Keyboard tables, check the box indicating "New Layout."

**Step 4** **Planner:** *This step does not apply to Enhanced keyboards. If you are modifying an Enhanced keyboard, proceed to step 5.*

Put a check in the "Keyboard Type" box that applies to the keyboard you are modifying: Typewriter, Data Entry, or APL.

**Step 5** Put a check in the "Keypad Type" box that applies to the keyboard you are modifying: National Language Numeric, Data Entry, or Program Function (PF).

**Step 6** Put in the appropriate language number (found in Table 15-1 on page 15-14) on the line beside "Keyboard Language," which is located just above the Keyboard Changes Chart on the worksheet.

**Warning:** If you specify a keyboard language that has characters **unique** to APL2 and CECP, you need to ensure that a device capable of supporting those characters will be used. If you use a device that does not support those characters, they may be misrepresented or displayed as blanks.

## Planning to Modify Keyboards

**Step 7** Using the information in Figure 15-4 on page 15-18 and the description of the Keyboard Changes Chart columns on page 15-17, fill in the Keyboard Changes Chart (located at the bottom of the worksheet) with the modifications you plan to make.

- a. Place a ✓ in the Keyboard, Shift, and Function group columns. Using Figure 15-4 on page 15-18 as a reference, determine which number applies for **each** group. Place a ✓ in the column under the appropriate numbers. **You must choose one number from each group.**
- b. Designate Upper Shift, Lower Shift, Alternate, or All in the **From** Key Shift Column. The *From* key is the key you will be moving, copying, or deleting.

**Note:** In the case where you will be copying a character from the I/O Interface Code Characters chart, see step 7d.

After you have determined which shift of the character should be changed, indicate the shift or "All" (in the case where you wish to change the entire key) in the shift column for the *From* key.

- c. Write in the character or function for the **From** key. Write in the appropriate character (for example, "A") or function (for example, the "Forward" function), in the Character column for the *From* key.
- d. **Planner:** *This step applies only if you are copying an I/O Interface Code from the I/O Interface Code tables. If you are not copying an I/O Interface Code, skip this step.*

Write in the I/O Interface Code and character. The I/O Interface Code Characters are characters that are not standard on the keyboard. To allow the character to be used on the keyboard you are modifying, you must copy the character from the I/O Interface Code Character tables. These tables are located within the Modify Keyboard files, but must be indicated to the Modify Keyboards program by a hexadecimal code. (The hexadecimal codes can be found in the *3174 Character Set Reference*, GA27-3831.)

After determining which I/O interface code character you wish to copy from the I/O Interface Code Tables, write the hexadecimal code given for that character, **and** the actual character you want copied, in the applicable columns of the Keyboard Changes Chart.

- e. Designate Upper Shift, Lower Shift, Alternate, or All in the **To** Key Shift Column. The *To* key is the key to which you are copying or moving the character or function.

The shift indicates which shift position on the *To* key will receive the *From* key character or the I/O interface code character.

**Note:** Be sure to review "Restrictions" on page 15-4.

- f. Write in the Character or Function for the *To* key. In the event that you wish to have characters, functions, or an entire key exchanged or replaced, you will want to indicate which character, function, or entire key you wish to exchange with the *From* key. Write in the appropriate character (for example, "A") or function (for example, the "Forward" function), in the Character column for the *To* key.

**Note:** In the event that the *To* key does not have a character or function on the shift position to which you plan to move the *From* key character, use one of the characters or functions on the *To* key, to identify the *To* key's location.

**Step 8** On the keyboard worksheet, indicate with an X which keys will be affected by the Modify Keyboards changes; this will help the person performing the actual procedure to locate the affected keys quickly.

**Step 9** Give a copy of the completed worksheets to the customizer.

When you have completed filling out all the worksheets, give a copy of each worksheet to the person who will perform the Modify Keyboard procedure. Information on how to perform the actual procedure can be found in the *3174 Utilities Guide*, GA27-3863.

**Planner:** *You have completed planning for Modified Keyboards.*

*Return to the divider page labeled "Microcode Customization Planning." See step 7 to determine if there are additional worksheets you need to fill out to complete the planning process. You may also refer to the divider page labeled "Worksheet Summary" to determine where to proceed next.*

*Keep records of your modifications using one of the methods described under "Customization Records" on page 5-6.*



---

# Appendixes

**Appendix A. Configuration Worksheets**

**Appendix B. AEA Planning Examples**

**Appendix C. Token-Ring Planning Examples**

**Appendix D. Examples of 3174 VTAM/NCP Definitions**

**Appendix E. Examples of Using Service Access Points**





## Appendix A. Configuration Worksheets

Worksheet 1—Host Attachment	A-3
Worksheet 2—Multi-Host Definition	A-4
Worksheet 3—BSC	A-5
Worksheet 3S—Secondary BSC	A-6
Worksheet 4—SDLC	A-7
Worksheet 4S—Secondary SDLC	A-8
Worksheet 5—X.25	A-9
Worksheet 5S—Secondary X.25	A-10
Worksheet 6—Non-SNA (Channel)	A-11
Worksheet 7—SNA (Channel)	A-12
Worksheet 7S—Secondary SNA (Channel)	A-13
Worksheet 8—X.21 Switched	A-14
Worksheet 8S—Secondary X.21 Switched	A-15
Worksheet 9—Token-Ring Network	A-16
Worksheet 9S—Secondary Token-Ring Network	A-17
Worksheet 10A—Multiple Logical Terminals	A-18
Worksheet 10B—Multiple Logical Terminals	A-19
Worksheet 10C—Multiple Logical Terminals for AEA	A-20
Worksheet 11A—117: Port Assignment	A-21
Worksheet 11B—117: Port Assignment for AEA	A-22
Worksheet 12—128: RTM	A-23
Worksheet 13—X.25 Options	A-24
Worksheet 13S—Secondary X.25 Options	A-25
Worksheet 14—Common SNA	A-26
Worksheet 15A—3270 Attachment Diagram	A-27
Worksheet 15B—3270 Attachment Diagram	A-28
Worksheet 16—ASCII Attachment Diagram	A-29
Worksheet 17—AEA Configure	A-30
Worksheet 18—AEA Port Set	A-31
Worksheet 19—AEA Port to Port Set Map	A-32
Worksheet 20—AEA Station Set	A-33
Worksheet 21—AEA Default Destination	A-34
Worksheet 22—Terminal Tables Definition	A-35
Section One: Identifying Each Table	A-35
Section Two: Selecting Attributes for Tables	A-35
Worksheet 23A—Inbound Sequence Panels	A-36
Worksheet 23B—Inbound Sequence Panels	A-37
Worksheet 24—Outbound Sequence Panels	A-38
Worksheet 25—Translate Tables Definition	A-39
Worksheet 26—EBCDIC to ASCII Translation (Outbound)	A-40
Worksheet 27—ASCII to EBCDIC Translation (Inbound)	A-41
Worksheet 28—Device Definition	A-42
Worksheet 29—Printer Authorization Matrix (PAM)	A-43
Worksheet 30—Logical Terminal Assignment (LTA)	A-44
Worksheet 31—Extended Vital Product Data (VPD)	A-45
Worksheet 32—Token-Ring Gateway	A-46
Worksheet 33—Ring Address Assignment	A-47
Worksheet 34—Ring Transmission Definition	A-48
Worksheet 35—Storage Requirements	A-49
Non-Katakana Converged Keyboards	A-50
Katakana Converged Keyboards	A-51
Enhanced Keyboard (US)	A-52

Enhanced Keyboard (World Trade) .....	A-53
Enhanced Keyboard (Katakana) .....	A-54

**Permission to Copy**

You are authorized to copy the worksheets in this appendix. Make as many copies of these worksheets as you need to plan for customizing. Save the blank originals for later planning.

---

# Worksheet 1—Host Attachment

Date: \_\_\_\_\_  
Serial: \_\_\_\_\_  
Customized by: \_\_\_\_\_

Model: \_\_\_\_\_  
Location: \_\_\_\_\_  
Telephone: \_\_\_\_\_

Chapter 6 of the *3174 Planning Guide* contains the planning information you need.

---

\_\_\_\_\_ MODEL/ATTACH \_\_\_\_\_

098 -

099 -

100 -

X X X

101 -

X

- 
- 098: Online Test Password
  - 099: Product Assistance Data
  - 100: 3174 Model Designation
  - 101: Host Attachment

---

## Worksheet 2—Multi-Host Definition

Chapter 6 of the *3174 Planning Guide* contains the planning information you need.

---

### \_\_\_\_\_ Multi-Host Definition \_\_\_\_\_

Host ID	Adapter Type	Host Attach	Hardware Group	Include In IML	Host Descriptor
1A		—			_____
2A	—	—	—	—	_____
3A	—	—	—	—	_____
—				—	_____
—				—	_____
—				—	_____
—				—	_____
—				—	_____
—				—	_____
—				—	_____
—				—	_____
—				—	_____
—				—	_____
—				—	_____
—				—	_____
—				—	_____

---

# Worksheet 3—BSC

Chapter 6 of the 3174 Planning Guide contains the planning information you need.

Host ID: \_\_\_\_\_

## \_\_\_\_\_ BSC \_\_\_\_\_

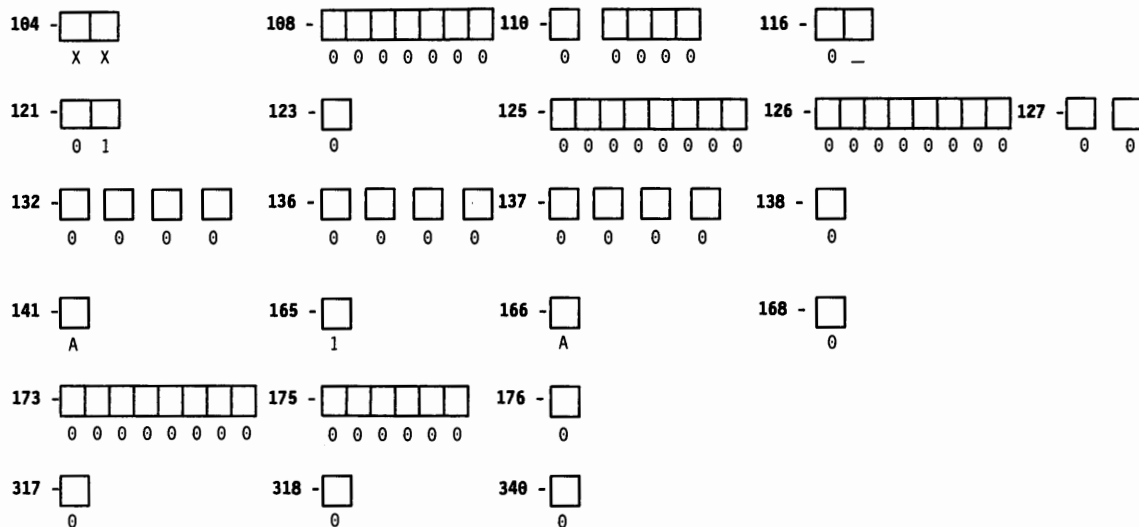

- |  |   |
|--|---|
| 104: Controller Address                | 138: Standard Keypad Layouts                  |
| 108: Unique Machine Identifier         | 141: Magnetic Character Set                   |
| 110: MLT Configuration Level           | 165: Compressed Program Symbols               |
| 116: Individual Port Assignment        | 166: Attribute Select Keypad                  |
| 121: Keyboard Language                 | 168: Additional Extension-Mode Key Definition |
| 123: CECF Support                      | 173: DFT Options                              |
| 125: Miscellaneous Feature Options (A) | 175: DFT Password                             |
| 126: Miscellaneous Feature Options (B) | 176: BSC Enhanced Communication: DFTs         |
| 127: RTM Definition                    | 317: Telecommunication Facilities             |
| 132: Alternate Keyboard Selection      | 318: Full- or Half-Speed Transmission         |
| 136: Standard Keyboard Layouts         | 340: RTS Control Options                      |
| 137: Modified Keyboard Layouts         |   |

# Worksheet 3S—Secondary BSC

Chapter 6 of the 3174 Planning Guide contains the planning information you need.

Host ID: \_\_\_\_\_

\_\_\_\_\_ BSC \_\_\_\_\_

104 - <input type="text"/> <input type="text"/> X X	110 - <input type="text"/> <input type="text"/> <input type="text"/> <input type="text"/> 0 0 0 0 0	116 - <input type="text"/> <input type="text"/> 0 _
	125 - <input type="text"/> <input type="text"/> * <input type="text"/> * <input type="text"/> * <input type="text"/> * <input type="text"/> * <input type="text"/> 0 0 0	127 - <input type="text"/> <input type="text"/> 0 0
		139 - <input type="text"/> <input type="text"/> 0 0
	165 - <input type="text"/> 1	
	176 - <input type="text"/> 0	
317 - <input type="text"/> 0	318 - <input type="text"/> 0	340 - <input type="text"/> 0

- |  |                                       |
|--|---------------------------------------|
| 104: Controller Address                | 165: Compressed Program Symbols       |
| 110: MLT Configuration Level           | 176: BSC Enhanced Communication: DFTs |
| 116: Individual Port Assignment        | 317: Telecommunication Facilities     |
| 125: Miscellaneous Feature Options (A) | 318: Full- or Half-Speed Transmission |
| 127: RTM Definition                    | 340: RTS Control Options              |
| 139: CCA Keyboard Language             |                                       |

\*Responses cannot be entered. Responses provided on the worksheet for the primary host on the primary link fill these fields automatically during the customizing procedures.

# Worksheet 4—SDLC

Chapter 6 of the 3174 Planning Guide contains the planning information you need.

Host ID: \_\_\_\_\_

————— SDLC —————

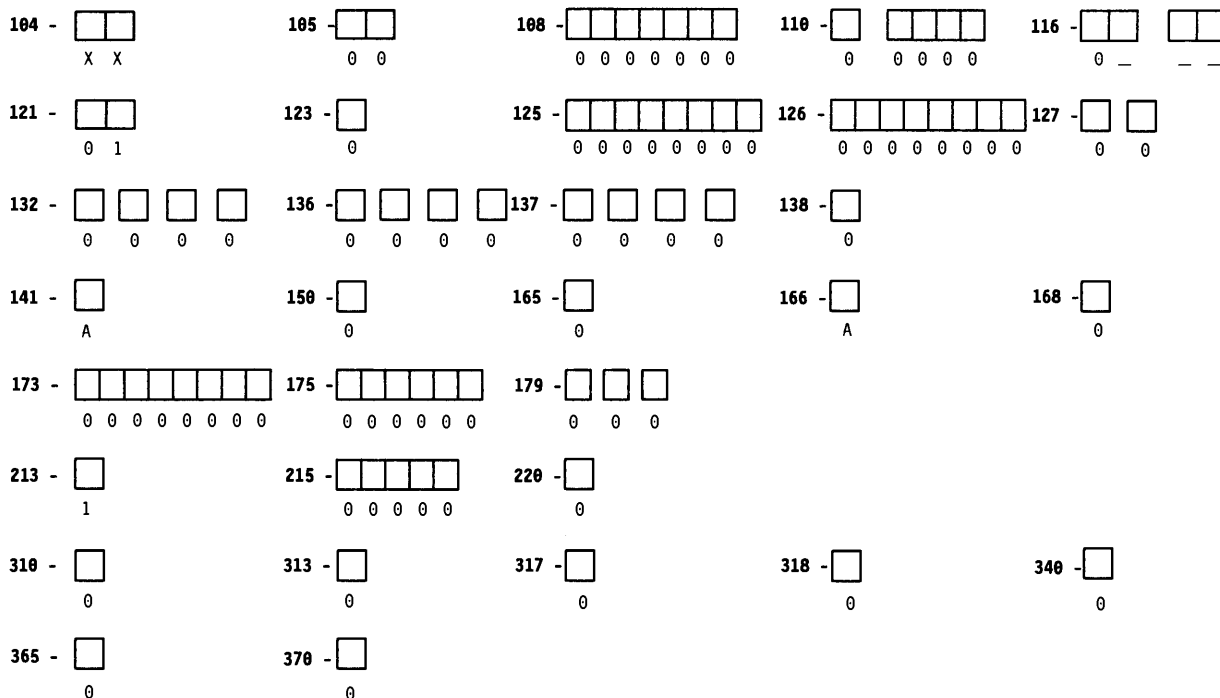

- |  |   |
|--|---|
| <ul style="list-style-type: none"> <li>104: Controller Address</li> <li>105: Upper Limit Address</li> <li>108: Unique Machine Identifier</li> <li>110: MLT Configuration Level</li> <li>116: Individual Port Assignment</li> <li>121: Keyboard Language</li> <li>123: CECF Support</li> <li>125: Miscellaneous Feature Options (A)</li> <li>126: Miscellaneous Feature Options (B)</li> <li>127: RTM Definition</li> <li>132: Alternate Keyboard Selection</li> <li>136: Standard Keyboard Layouts</li> <li>137: Modified Keyboard Layouts</li> <li>138: Standard Keypad Layouts</li> <li>141: Magnetic Character Set</li> <li>150: Token-Ring Network Gateway Controller</li> </ul> | <ul style="list-style-type: none"> <li>155: Compressed Program Symbols</li> <li>166: Attribute Select Keypad</li> <li>168: Additional Extension-Mode Key Definition</li> <li>173: DFT Options</li> <li>175: DFT Password</li> <li>179: Local Format Storage</li> <li>213: Between Bracket Printer Sharing</li> <li>215: Physical Unit Identification</li> <li>220: Alert Function</li> <li>310: Connect-Data-Set-to-Line Operation</li> <li>313: NRZ or NRZI Encoding</li> <li>317: Telecommunication Facilities</li> <li>318: Full- or Half Speed Transmission</li> <li>340: RTS Control Options</li> <li>365: X.21 Switched Host DTE Connection</li> <li>370: Maximum Inbound I-Frame Size</li> </ul> |
|--|---|



## Worksheet 4S—Secondary SDLC

Chapter 6 of the 3174 Planning Guide contains the planning information you need.

Host ID: \_\_\_\_\_

\_\_\_\_\_ SDLC \_\_\_\_\_

104 -    
X X

105 -    
0 0

110 -       
0 0 0 0 0

116 -    
0 -

125 -   \*  \*  \*  \*  \*   
0 0 0

127 -    
0 0

150 -   
0

165 -   
1

139 -    
0 0

179 -     
0 0 0

213 -   
1

215 -        
0 0 0 0 0

220 -   
0

310 -   
0

313 -   
0

317 -   
0

318 -   
0

340 -   
0

365 -   
0

370 -   
0

- |  |   |
|--|---|
| 104: Controller address                        | 213: Between Bracket Printer Sharing    |
| 105: Upper Limit Address<br>Controller Address | 215: Physical Unit Identification       |
| 110: MLT Configuration Level                   | 220: Alert Function                     |
| 116: Individual Port Assignment                | 310: Connect-Data-Set-to-Line Operation |
| 125: Miscellaneous Feature Options (A)         | 313: NRZ or NRZI Encoding               |
| 127: RTM Definition                            | 317: Telecommunication Facilities       |
| 139: CCA Keyboard Language                     | 318: Full- or Half-Speed Transmission   |
| 150: Token-Ring Network Gateway Controller     | 340: RTS Control Options                |
| 165: Compressed Program Symbols                | 365: X.21 Data Transfer Delay           |
| 179: Local Format Storage                      | 370: Maximum Inbound I-Frame Size       |

\*Responses cannot be entered. Responses provided on the worksheet for the primary host attachment on the primary link fill these fields automatically during the customizing procedures.

## Worksheet 5—X.25

Chapter 6 of the 3174 Planning Guide contains the planning information you need.

Host ID: \_\_\_\_\_

### X.25

184 - <input type="checkbox"/> <input type="checkbox"/> X X	188 - <input type="checkbox"/> <input type="checkbox"/> <input type="checkbox"/> <input type="checkbox"/> <input type="checkbox"/> <input type="checkbox"/> <input type="checkbox"/> <input type="checkbox"/> <input type="checkbox"/> 0 0 0 0 0 0 0 0	110 - <input type="checkbox"/> <input type="checkbox"/> <input type="checkbox"/> <input type="checkbox"/> <input type="checkbox"/> 0 0 0 0 0	116 - <input type="checkbox"/> <input type="checkbox"/> <input type="checkbox"/> <input type="checkbox"/> 0 _ _ _
121 - <input type="checkbox"/> <input type="checkbox"/> 0 1	123 - <input type="checkbox"/> 0	125 - <input type="checkbox"/> <input type="checkbox"/> <input type="checkbox"/> <input type="checkbox"/> <input type="checkbox"/> <input type="checkbox"/> <input type="checkbox"/> <input type="checkbox"/> <input type="checkbox"/> <input type="checkbox"/> 0 0 0 0 0 0 0 0 0 0	126 - <input type="checkbox"/> <input type="checkbox"/> <input type="checkbox"/> <input type="checkbox"/> <input type="checkbox"/> <input type="checkbox"/> <input type="checkbox"/> <input type="checkbox"/> <input type="checkbox"/> <input type="checkbox"/> 0 0 0 0 0 0 0 0 0 0
127 - <input type="checkbox"/> <input type="checkbox"/> 0 0	132 - <input type="checkbox"/> <input type="checkbox"/> <input type="checkbox"/> <input type="checkbox"/> 0 0 0 0	136 - <input type="checkbox"/> <input type="checkbox"/> <input type="checkbox"/> <input type="checkbox"/> 0 0 0 0	137 - <input type="checkbox"/> <input type="checkbox"/> <input type="checkbox"/> <input type="checkbox"/> 0 0 0 0
138 - <input type="checkbox"/> 0	141 - <input type="checkbox"/> A	165 - <input type="checkbox"/> 1	166 - <input type="checkbox"/> A
168 - <input type="checkbox"/> 0	173 - <input type="checkbox"/> <input type="checkbox"/> <input type="checkbox"/> <input type="checkbox"/> <input type="checkbox"/> <input type="checkbox"/> <input type="checkbox"/> <input type="checkbox"/> <input type="checkbox"/> 0 0 0 0 0 0 0 0 0 0	175 - <input type="checkbox"/> <input type="checkbox"/> <input type="checkbox"/> <input type="checkbox"/> <input type="checkbox"/> <input type="checkbox"/> <input type="checkbox"/> <input type="checkbox"/> 0 0 0 0 0 0 0 0	179 - <input type="checkbox"/> <input type="checkbox"/> <input type="checkbox"/> 0 0 0
213 - <input type="checkbox"/> 1	215 - <input type="checkbox"/> <input type="checkbox"/> <input type="checkbox"/> <input type="checkbox"/> <input type="checkbox"/> <input type="checkbox"/> 0 0 0 0 0 0	220 - <input type="checkbox"/> 0	365 - <input type="checkbox"/> 0
		370 - <input type="checkbox"/> 0	372 - <input type="checkbox"/> <input type="checkbox"/> 0 0

- |   |   |
|---|---|
| <ul style="list-style-type: none"> <li>104: Controller Address</li> <li>108: Unique Machine Identifier</li> <li>110: MLT Configuration Level</li> <li>116: Individual Port Assignment</li> <li>121: Keyboard Language</li> <li>123: CECF Support</li> <li>125: Miscellaneous Feature Options (A)</li> <li>126: Miscellaneous Feature Options (B)</li> <li>127: RTM Definition</li> <li>132: Alternate Keyboard Selection</li> <li>136: Standard Keyboard Layouts</li> <li>137: Modified Keyboard Layouts</li> <li>138: Standard Keypad Layouts</li> </ul> | <ul style="list-style-type: none"> <li>141: Magnetic Character Set</li> <li>165: Compressed Program Symbols</li> <li>166: Attribute Select Keypad</li> <li>168: Additional Extension-Mode Key Definition</li> <li>173: DFT Options</li> <li>175: DFT Password</li> <li>179: Local Format Storage</li> <li>213: Between Bracket Printer Sharing</li> <li>215: Physical Unit Identification</li> <li>220: Alert Function</li> <li>365: X.21 Data Transfer Delay</li> <li>370: Maximum Inbound I-Frame Size</li> <li>372: Autocall/Autodisconnect</li> </ul> |
|---|---|

# Worksheet 5S—Secondary X.25

Chapter 6 of the 3174 Planning Guide contains the planning information you need.

Host ID: \_\_\_\_\_

X.25

184 -    
X X

110 -       
0 0 0 0 0

116 -    
0 \_

125 -   \* \* \* \* \*   
0 0 0

127 -    
0 0

139 -    
0 0

165 -   
1

179 -     
0 0 0

213 -   
1

215 -        
0 0 0 0 0

220 -   
0

221 -   
0

365 -   
0

370 -   
0

372 -    
0 0

- |  |                                      |
|--|--------------------------------------|
| 104: Controller Address                | 213: Between Bracket Printer Sharing |
| 110: MLT Configuration Level           | 215: Physical Unit Identification    |
| 116: Individual Port Assignment        | 220: Alert Function                  |
| 125: Miscellaneous Feature Options (A) | 221: 3174 Alert Control Point        |
| 127: RTM Definition                    | 365: X.21 Data Transfer Delay        |
| 139: CCA Keyboard Language             | 370: Maximum Inbound I-Frame Size    |
| 165: Compressed Program Symbols        | 372: Autocall/Autodisconnect         |
| 179: Local Format Storage              |                                      |

\*Responses cannot be entered. Responses provided on the worksheet for the primary host on the primary link fill these fields automatically during the customizing procedures. If you are configuring for secondary hosts or links, some of the questions shown on this worksheet may not apply to your configuration.

## Worksheet 6—Non-SNA (Channel)

Chapter 6 of the 3174 Planning Guide contains the planning information you need.

Host ID: \_\_\_\_\_

\_\_\_\_\_ Local (Non-SNA) \_\_\_\_\_

104 - <input type="checkbox"/> <input type="checkbox"/> X X	105 - <input type="checkbox"/> <input type="checkbox"/> X X	108 - <input type="checkbox"/> <input type="checkbox"/> <input type="checkbox"/> <input type="checkbox"/> <input type="checkbox"/> <input type="checkbox"/> <input type="checkbox"/> <input type="checkbox"/> 0 0 0 0 0 0 0 0	110 - <input type="checkbox"/> <input type="checkbox"/> <input type="checkbox"/> <input type="checkbox"/> <input type="checkbox"/> 0 0 0 0 0 0	116 - <input type="checkbox"/> <input type="checkbox"/> 0 -
121 - <input type="checkbox"/> <input type="checkbox"/> 0 1	123 - <input type="checkbox"/> 0	125 - <input type="checkbox"/> <input type="checkbox"/> <input type="checkbox"/> <input type="checkbox"/> <input type="checkbox"/> <input type="checkbox"/> <input type="checkbox"/> <input type="checkbox"/> <input type="checkbox"/> <input type="checkbox"/> 0 0 0 0 0 0 0 0 0 0	126 - <input type="checkbox"/> <input type="checkbox"/> <input type="checkbox"/> <input type="checkbox"/> <input type="checkbox"/> <input type="checkbox"/> <input type="checkbox"/> <input type="checkbox"/> <input type="checkbox"/> <input type="checkbox"/> <input type="checkbox"/> <input type="checkbox"/> 0 0 0 0 0 0 0 0 0 0 0 0	127 - <input type="checkbox"/> <input type="checkbox"/> 0 0
132 - <input type="checkbox"/> <input type="checkbox"/> <input type="checkbox"/> <input type="checkbox"/> 0 0 0 0	136 - <input type="checkbox"/> <input type="checkbox"/> <input type="checkbox"/> <input type="checkbox"/> <input type="checkbox"/> 0 0 0 0 0	137 - <input type="checkbox"/> <input type="checkbox"/> <input type="checkbox"/> <input type="checkbox"/> <input type="checkbox"/> 0 0 0 0 0	138 - <input type="checkbox"/> 0	
141 - <input type="checkbox"/> A	165 - <input type="checkbox"/> 0	166 - <input type="checkbox"/> A	168 - <input type="checkbox"/> 0	
173 - <input type="checkbox"/> <input type="checkbox"/> <input type="checkbox"/> <input type="checkbox"/> <input type="checkbox"/> <input type="checkbox"/> <input type="checkbox"/> <input type="checkbox"/> <input type="checkbox"/> <input type="checkbox"/> <input type="checkbox"/> 0 0 0 0 0 0 0 0 0 0	175 - <input type="checkbox"/> <input type="checkbox"/> <input type="checkbox"/> <input type="checkbox"/> <input type="checkbox"/> <input type="checkbox"/> <input type="checkbox"/> <input type="checkbox"/> 0 0 0 0 0 0 0 0			
222 - <input type="checkbox"/> 0	224 - <input type="checkbox"/> 2	225 - <input type="checkbox"/> 4		

- |  |   |
|--|---|
| 104: Controller Address                | 137: Modified Keyboard Layouts                |
| 105: Upper Limit Address               | 138: Standard Keypad Layouts                  |
| 108: Unique Machine Identifier         | 141: Magnetic Character Set                   |
| 110: MLT Configuration Level           | 165: Compressed Program Symbols               |
| 116: Individual Port Assignment        | 166: Attribute Select Keypad                  |
| 121: Keyboard Language                 | 168: Additional Extension-Mode Key Definition |
| 123: CECF Support                      | 173: DFT Options                              |
| 125: Miscellaneous Feature Options (A) | 175: DFT Password                             |
| 126: Miscellaneous Feature Options (B) | 222: Support of Command Retry                 |
| 127: RTM Definition                    | 224: Mode of Data Transfer                    |
| 132: Alternate Keyboard Selection      | 225: Channel Burst Size                       |
| 136: Standard Keyboard Layouts         |   |

## Worksheet 7—SNA (Channel)

Chapter 6 of the 3174 Planning Guide contains the planning information you need.

Host ID: \_\_\_\_\_

———— Local (S N A) ————

104 - <input type="text"/> <input type="text"/> X X	105 - <input type="text"/> <input type="text"/> 0 0	108 - <input type="text"/> <input type="text"/> <input type="text"/> <input type="text"/> <input type="text"/> <input type="text"/> <input type="text"/> <input type="text"/> 0 0 0 0 0 0 0 0	110 - <input type="text"/> <input type="text"/> <input type="text"/> <input type="text"/> <input type="text"/> <input type="text"/> 0 0 0 0 0 0	116 - <input type="text"/> <input type="text"/> <input type="text"/> <input type="text"/> 0 - - -
121 - <input type="text"/> <input type="text"/> 0 1	123 - <input type="text"/> 0	125 - <input type="text"/> <input type="text"/> <input type="text"/> <input type="text"/> <input type="text"/> <input type="text"/> <input type="text"/> <input type="text"/> <input type="text"/> <input type="text"/> <input type="text"/> <input type="text"/> 0 0 0 0 0 0 0 0 0 0	126 - <input type="text"/> <input type="text"/> <input type="text"/> <input type="text"/> <input type="text"/> <input type="text"/> <input type="text"/> <input type="text"/> <input type="text"/> <input type="text"/> <input type="text"/> <input type="text"/> <input type="text"/> 0 0 0 0 0 0 0 0 0 0	127 - <input type="text"/> <input type="text"/> 0 0
132 - <input type="text"/> <input type="text"/> <input type="text"/> <input type="text"/> 0 0 0 0	136 - <input type="text"/> <input type="text"/> <input type="text"/> <input type="text"/> <input type="text"/> <input type="text"/> 0 0 0 0 0	137 - <input type="text"/> <input type="text"/> <input type="text"/> <input type="text"/> <input type="text"/> <input type="text"/> 0 0 0 0 0	138 - <input type="text"/> 0	
141 - <input type="text"/> A	150 - <input type="text"/> 0	165 - <input type="text"/> 0	166 - <input type="text"/> A	168 - <input type="text"/> 0
173 - <input type="text"/> <input type="text"/> <input type="text"/> <input type="text"/> <input type="text"/> <input type="text"/> <input type="text"/> <input type="text"/> <input type="text"/> <input type="text"/> <input type="text"/> <input type="text"/> <input type="text"/> <input type="text"/> <input type="text"/> <input type="text"/> 0 0 0 0 0 0 0 0 0 0	175 - <input type="text"/> <input type="text"/> <input type="text"/> <input type="text"/> <input type="text"/> <input type="text"/> <input type="text"/> <input type="text"/> <input type="text"/> <input type="text"/> <input type="text"/> <input type="text"/> <input type="text"/> <input type="text"/> <input type="text"/> 0 0 0 0 0 0 0 0	179 - <input type="text"/> <input type="text"/> <input type="text"/> 0 0 0		
213 - <input type="text"/> 1	215 - <input type="text"/> <input type="text"/> <input type="text"/> <input type="text"/> <input type="text"/> <input type="text"/> <input type="text"/> <input type="text"/> 0 0 0 0 0 0	220 - <input type="text"/> 0	240 - <input type="text"/> 0	241 - <input type="text"/> 0
222 - <input type="text"/> 0	223 - <input type="text"/> <input type="text"/> 1 0	224 - <input type="text"/> 2	225 - <input type="text"/> 4	

- |  |   |
|--|---|
| 104: Controller Address                    | 165: Compressed Program Symbols               |
| 105: Upper Limit Address                   | 166: Attribute Select Keypad                  |
| 108: Unique Machine Identifier             | 168: Additional Extension-Mode Key Definition |
| 110: MLT Configuration Level               | 173: Distributed Function Terminal Options    |
| 116: Individual Port Assignment            | 175: Distributed Function Terminal Password   |
| 121: Keyboard Language                     | 179: Local Format Storage                     |
| 123: CECF Support                          | 213: Between Bracket Printer Sharing          |
| 125: Miscellaneous Feature Options (A)     | 215: Physical Unit Identification             |
| 126: Miscellaneous Feature Options (B)     | 220: Alert Function                           |
| 127: RTM Definition                        | 222: Support of Command Retry                 |
| 132: Alternate Keyboard Selection          | 223: Attention Delay Value                    |
| 136: Standard Keyboard Layouts             | 224: Mode of Data Transfer                    |
| 137: Modified Keyboard Layouts             | 225: Channel Burst Size                       |
| 138: Standard Keypad Layouts               | 240: Controller Logical Address               |
| 141: Magnetic Character Set                | 241: RU Maximum Size                          |
| 150: Token-Ring Network Gateway Controller |   |

## Worksheet 7S—Secondary SNA (Channel)

Chapter 6 of the 3174 *Planning Guide* contains the planning information you need.

Host ID: \_\_\_\_\_

\_\_\_\_\_ Local (S N A) \_\_\_\_\_

184 -    
X X

185 -    
0 0

116 -    
0 -

125 -          
0 0 \* \* \* \* \* 0

127 -    
0 0

158 -   
0

165 -   
0

179 -     
0 0 0

215 -       
0 0 0 0 0

220 -   
0

221 -   
0

240 -   
X

- |  |                                   |
|--|-----------------------------------|
| 104: Controller Address                | 165: Compressed Program Symbols   |
| 105: Upper Limit Address               | 179: Local Format Storage         |
| 116: Individual Port Assignment        | 215: Physical Unit Identification |
| 125: Miscellaneous Feature Options (A) | 220: Alert Function               |
| 127: RTM Definition                    | 221: Alert Control Point          |
| 150: Token-Ring Gateway Controller     | 240: Controller Logical Address   |

# Worksheet 8—X.21 Switched

Chapter 6 of the *3174 Planning Guide* contains the planning information you need.

Host ID: \_\_\_\_\_

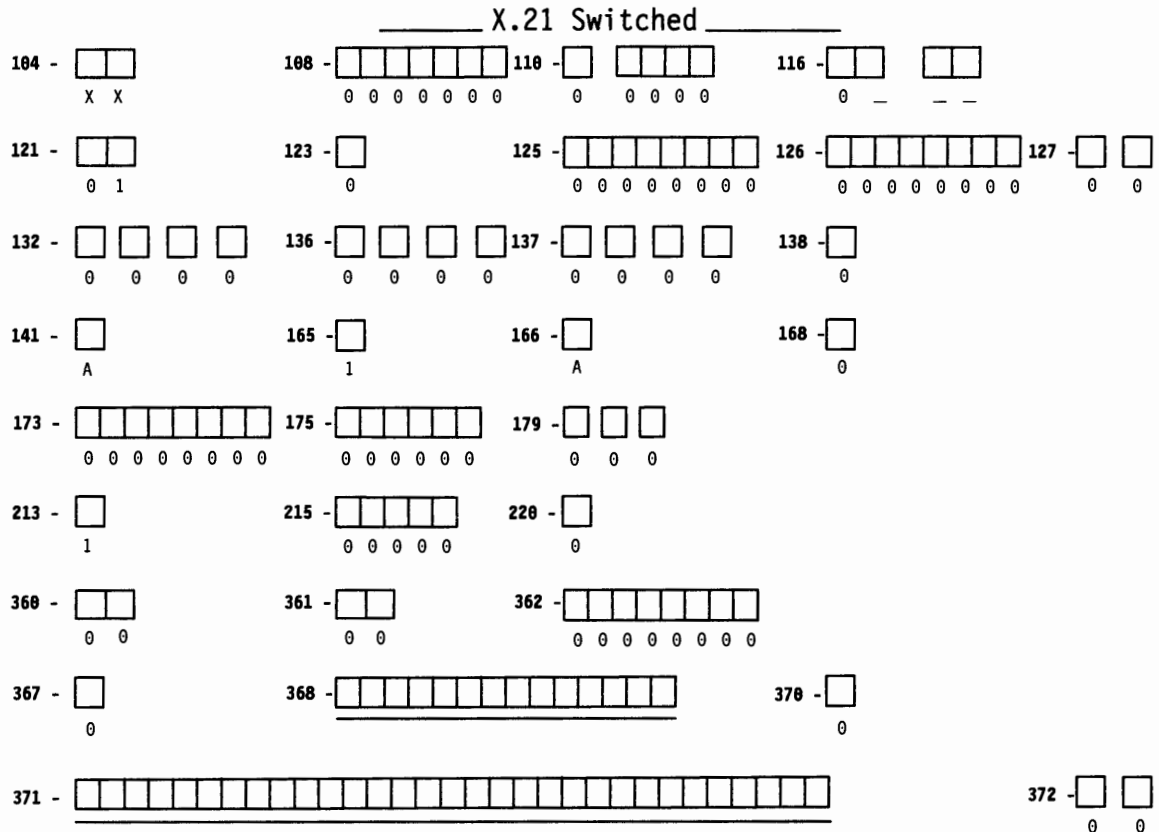

- |  |  |
|--|--|
| 104: Controller Address                | 168: Additional Extension-Mode Key Definition  |
| 108: Unique Machine Identifier         | 173: DFT Options                               |
| 110: MLT Configuration Level           | 175: DFT Password                              |
| 116: Individual Port Assignment        | 179: Local Format Storage                      |
| 121: Keyboard Language                 | 213: Between Bracket Printer Sharing           |
| 123: CECP Support                      | 215: Physical Unit Identification              |
| 125: Miscellaneous Feature Options (A) | 220: Alert Function                            |
| 126: Miscellaneous Feature Options (B) | 360: X.21 Switched Retry                       |
| 127: RTM Definition                    | 361: X.21 Switched Retry Timing                |
| 132: Alternate Keyboard Selection      | 362: X.21 Switched Options                     |
| 136: Standard Keyboard Layouts         | 367: X.21 Switched Short-Hold Mode             |
| 137: Modified Keyboard Layouts         | 368: X.21 Switched Short-Hold Mode Dial Number |
| 138: Standard Keypad Layouts           | 370: Maximum Inbound I-Frame Size              |
| 141: Magnetic Character Set            | 371: X.21 Switched Dial Digits                 |
| 165: Compressed Program Symbols        | 372: Autocall/Autodisconnect                   |
| 166: Attribute Select Keypad           |  |





# Worksheet 9—Token-Ring Network

Chapter 6 of the 3174 Planning Guide contains the planning information you need.

Host ID: \_\_\_\_\_

## \_\_\_\_\_ Token-Ring Network \_\_\_\_\_

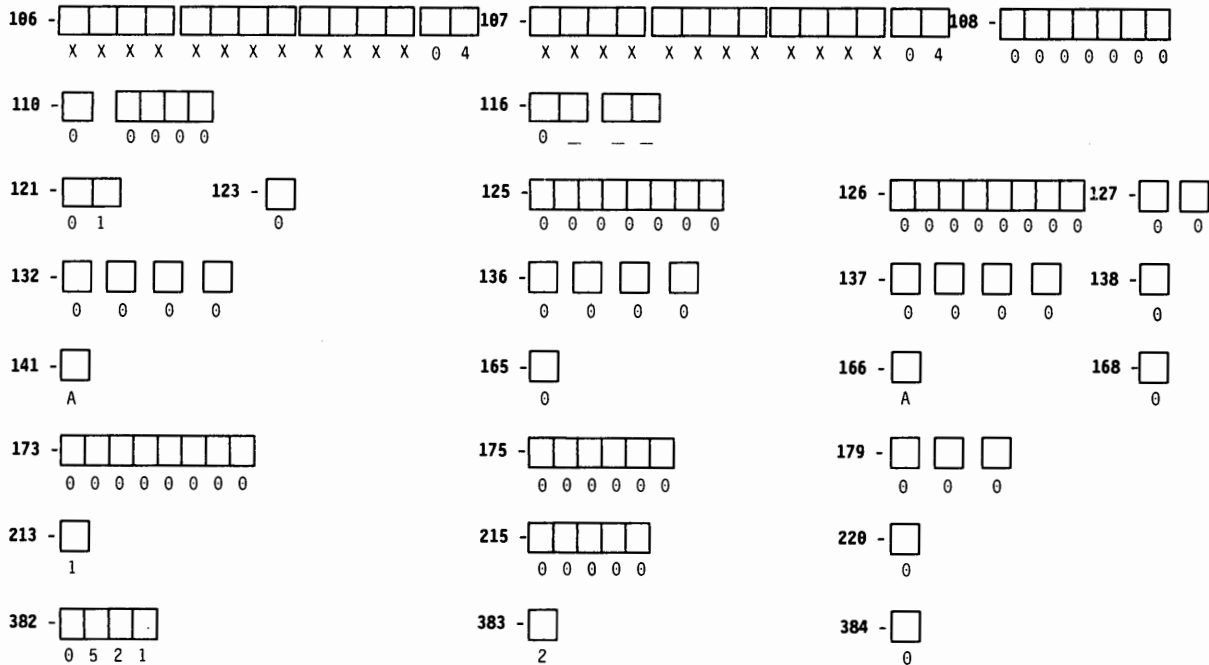

- |   |   |
|---|---|
| 106: Token-Ring Network—3174 Address/SAP    | 141: Magnetic Character Set                   |
| 107: Token-Ring Network—Gateway Address/SAP | 165: Compressed Program Symbols               |
| 108: Unique Machine Identifier              | 166: Attribute Select Keypad                  |
| 110: MLT Configuration level                | 168: Additional Extension-Mode Key Definition |
| 116: Individual Port Assignment             | 173: DFT Options                              |
| 121: Keyboard Language                      | 175: DFT Password                             |
| 123: CECF Support                           | 179: Local Format Storage                     |
| 125: Miscellaneous Feature Options (A)      | 213: Between Bracket Printer Sharing          |
| 126: Miscellaneous Feature Options (B)      | 215: Physical Unit Identification             |
| 127: RTM Definition                         | 220: Alert Function                           |
| 132: Alternate Keyboard Selection           | 382: Maximum Inbound I-Frame Size             |
| 136: Standard Keyboard Layouts              | 383: Token-Ring Network Maximum Out           |
| 137: Modified Keyboard Layouts              | 384: Ring Speed of the Token-Ring Network     |
| 138: Standard Keypad Layouts                |   |

# Worksheet 9S—Secondary Token-Ring Network

Chapter 6 of the 3174 Planning Guide contains the planning information you need.

Host ID: \_\_\_\_\_

## \_\_\_\_\_ Token-Ring Network \_\_\_\_\_

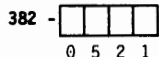
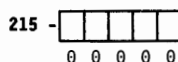
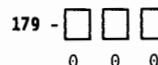
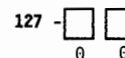
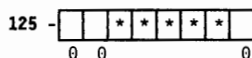
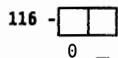
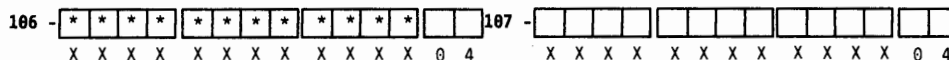

- 106: Token-Ring Network – Address/SAP
- 107: Token-Ring Network – Gateway Address/SAP
- 116: Individual Port Assignment
- 125: Miscellaneous Feature Options (A)
- 127: RTM Definition
- 165: Compressed Program Symbols

- 179: Local Format Storage
- 215: Physical Unit Identification
- 220: Alert Function
- 221: 3174 Alert Control Point
- 382: Maximum Inbound I-Frame Size
- 383: Token-Ring Network Maximum Out

\*Responses cannot be entered. Responses provided on the worksheet for the primary host attachment for the primary link fill these fields automatically during the customizing procedures.

## Worksheet 10A—Multiple Logical Terminals

Chapter 6 of the 3174 Planning Guide contains the planning information you need.

Controller Port Number	Device Type/Screen Size	EAB? Y/N	Number of Sessions	MLT Storage Required
26-00				
26-01				
26-02				
26-03				
26-04				
26-05				
26-06				
26-07				
26-08				
26-09				
26-10				
26-11				
26-12				
26-13				
26-14				
26-15				
26-16				
26-17				
26-18				
26-19				
26-20				
26-21				
26-22				
26-23				
26-24				
26-25				
26-26				
26-27				
26-28				
26-29				
26-30				
26-31				
Subtotal (if HG 27 and ASCII) MLT Storage required:				
Total (if HG 26 only) MLT Storage required:				

## Worksheet 10B—Multiple Logical Terminals

Chapter 6 of the 3174 Planning Guide contains the planning information you need.

Controller Port Number	Device Type/Screen Size	EAB? Y/N	Number of Sessions	MLT Storage Required
27-00				
27-01				
27-02				
27-03				
27-04				
27-05				
27-06				
27-07				
27-08				
27-09				
27-10				
27-11				
27-12				
27-13				
27-14				
27-15				
27-16				
27-17				
27-18				
27-19				
27-20				
27-21				
27-22				
27-23				
27-24				
27-25				
27-26				
27-27				
27-28				
27-29				
27-30				
27-31				
Subtotal (if 3270 and ASCII) MLT Storage required:				
Total (if 3270 only) MLT Storage required:				

**Worksheet 10C—Multiple Logical Terminals for AEA**

Chapter 6 of the *3174 Planning Guide* contains the planning information you need.

AEA Port Number	Device Type/Screen Size	Number of Sessions	MLT Storage Required
21-00			
21-01			
21-02			
21-03			
21-04			
21-05			
21-06			
21-07			
22-00			
22-01			
22-02			
22-03			
22-04			
22-05			
22-06			
22-07			
23-00			
23-01			
23-02			
23-03			
23-04			
23-05			
23-06			
23-07			
Subtotal (amount for ASCII devices only) required: Total MLT Storage required for 3270 and AEA ports:			

# Worksheet 11A—117: Port Assignment

Chapter 7 of the 3174 Planning Guide contains the planning information you need.

Host ID: \_\_\_\_\_

## 117: Port Assignment

Host Addresses							Host Addresses						
Port	IS	1	2	3	4	5	Port	IS	1	2	3	4	5
26-00	_____	_____	_____	_____	_____	_____	26-01	_____	_____	_____	_____	_____	_____
26-02	_____	_____	_____	_____	_____	_____	26-03	_____	_____	_____	_____	_____	_____
26-04	_____	_____	_____	_____	_____	_____	26-05	_____	_____	_____	_____	_____	_____
26-06	_____	_____	_____	_____	_____	_____	26-07	_____	_____	_____	_____	_____	_____
26-08	_____	_____	_____	_____	_____	_____	26-09	_____	_____	_____	_____	_____	_____
26-10	_____	_____	_____	_____	_____	_____	26 11	_____	_____	_____	_____	_____	_____
26-12	_____	_____	_____	_____	_____	_____	26-13	_____	_____	_____	_____	_____	_____
26-14	_____	_____	_____	_____	_____	_____	26-15	_____	_____	_____	_____	_____	_____
26-16	_____	_____	_____	_____	_____	_____	26-17	_____	_____	_____	_____	_____	_____
26-18	_____	_____	_____	_____	_____	_____	26-19	_____	_____	_____	_____	_____	_____
26-20	_____	_____	_____	_____	_____	_____	26-21	_____	_____	_____	_____	_____	_____
26-22	_____	_____	_____	_____	_____	_____	26-23	_____	_____	_____	_____	_____	_____
26-24	_____	_____	_____	_____	_____	_____	26-25	_____	_____	_____	_____	_____	_____
26-26	_____	_____	_____	_____	_____	_____	26-27	_____	_____	_____	_____	_____	_____
26-28	_____	_____	_____	_____	_____	_____	26-29	_____	_____	_____	_____	_____	_____
26-30	_____	_____	_____	_____	_____	_____	26-31	_____	_____	_____	_____	_____	_____
27-00	_____	_____	_____	_____	_____	_____	27-01	_____	_____	_____	_____	_____	_____
27-02	_____	_____	_____	_____	_____	_____	27-03	_____	_____	_____	_____	_____	_____
27-04	_____	_____	_____	_____	_____	_____	27-05	_____	_____	_____	_____	_____	_____
27-06	_____	_____	_____	_____	_____	_____	27-07	_____	_____	_____	_____	_____	_____
27-08	_____	_____	_____	_____	_____	_____	27-09	_____	_____	_____	_____	_____	_____
27-10	_____	_____	_____	_____	_____	_____	27-11	_____	_____	_____	_____	_____	_____
27-12	_____	_____	_____	_____	_____	_____	27-13	_____	_____	_____	_____	_____	_____
27-14	_____	_____	_____	_____	_____	_____	27-15	_____	_____	_____	_____	_____	_____
27-16	_____	_____	_____	_____	_____	_____	27-17	_____	_____	_____	_____	_____	_____
27-18	_____	_____	_____	_____	_____	_____	27-19	_____	_____	_____	_____	_____	_____
27-20	_____	_____	_____	_____	_____	_____	27-21	_____	_____	_____	_____	_____	_____
27-22	_____	_____	_____	_____	_____	_____	27-23	_____	_____	_____	_____	_____	_____
27-24	_____	_____	_____	_____	_____	_____	27-25	_____	_____	_____	_____	_____	_____
27-26	_____	_____	_____	_____	_____	_____	27-27	_____	_____	_____	_____	_____	_____
27-28	_____	_____	_____	_____	_____	_____	27-29	_____	_____	_____	_____	_____	_____
27-30	_____	_____	_____	_____	_____	_____	27-31	_____	_____	_____	_____	_____	_____

**Note:** Remember that the first column (1) represents the host's primary address.

---

## Worksheet 11B—117: Port Assignment for AEA

Chapter 7 of the *3174 Planning Guide* contains the planning information you need.

Host ID: \_\_\_\_\_

---

### \_\_\_\_\_117: Port Assignment \_\_\_\_\_

Host Addresses						Host Addresses							
Port	IS	1	2	3	4	5	Port	IS	1	2	3	4	5
21-00	_____	_____	_____	_____	_____	_____	21-01	_____	_____	_____	_____	_____	_____
21-02	_____	_____	_____	_____	_____	_____	21-03	_____	_____	_____	_____	_____	_____
21-04	_____	_____	_____	_____	_____	_____	21-05	_____	_____	_____	_____	_____	_____
21-06	_____	_____	_____	_____	_____	_____	21-07	_____	_____	_____	_____	_____	_____
22-00	_____	_____	_____	_____	_____	_____	22-01	_____	_____	_____	_____	_____	_____
22-02	_____	_____	_____	_____	_____	_____	22-03	_____	_____	_____	_____	_____	_____
22-04	_____	_____	_____	_____	_____	_____	22-05	_____	_____	_____	_____	_____	_____
22-06	_____	_____	_____	_____	_____	_____	22-07	_____	_____	_____	_____	_____	_____
23-00	_____	_____	_____	_____	_____	_____	23-01	_____	_____	_____	_____	_____	_____
23-02	_____	_____	_____	_____	_____	_____	23-03	_____	_____	_____	_____	_____	_____
23-04	_____	_____	_____	_____	_____	_____	23-05	_____	_____	_____	_____	_____	_____
23-06	_____	_____	_____	_____	_____	_____	23-07	_____	_____	_____	_____	_____	_____

---

## Worksheet 12—128: RTM

*Planner: Chapter 9 of the 3174 Planning Guide contains the planning information you need.*

**Host ID:** \_\_\_\_\_

*Circle the name that indicates the response you want to specify. If you circle Version A or Version B, write your responses on the corresponding panel.*

### Default Values

#### Version A

---

#### 128: RTM Definition

<b>B1</b>	<input type="checkbox"/> 00	<input type="checkbox"/> 01	<input type="checkbox"/> 0
<b>B2</b>	<input type="checkbox"/> 00	<input type="checkbox"/> 02	<input type="checkbox"/> 0
<b>B3</b>	<input type="checkbox"/> 00	<input type="checkbox"/> 05	<input type="checkbox"/> 0
<b>B4</b>	<input type="checkbox"/> 00	<input type="checkbox"/> 10	<input type="checkbox"/> 0

---

#### Version B

#### 128: RTM Definition

<b>F1</b>	<input type="checkbox"/>	<input type="checkbox"/>	<input type="checkbox"/>	<input type="checkbox"/>	<input type="checkbox"/>	<input type="checkbox"/>	<input type="checkbox"/>	<input type="checkbox"/>	<input type="checkbox"/>
	0	0	0	0	0	0	0	0	0
<b>B1</b>	<input type="checkbox"/> 00	<input type="checkbox"/> 01	<input type="checkbox"/> 0						
<b>B2</b>	<input type="checkbox"/> 00	<input type="checkbox"/> 02	<input type="checkbox"/> 0						
<b>B3</b>	<input type="checkbox"/> 00	<input type="checkbox"/> 05	<input type="checkbox"/> 0						
<b>B4</b>	<input type="checkbox"/> 00	<input type="checkbox"/> 10	<input type="checkbox"/> 0						



## Worksheet 13—X.25 Options

Chapter 10 of the 3174 *Planning Guide* contains the planning information you need.

Host ID: \_\_\_\_\_

### \_\_\_\_\_ 332: X.25 Options \_\_\_\_\_

400 -      
0 0 0 0

401 -   
4

402 -      
\_\_\_\_\_

409 -          
1 0 0 1 0 0 1 0 0

420 -            
0 0 0 0 0 0 0 0 0

421 -            
0 0 0 0 0 0 0 0 0

423 -                  
\_\_\_\_\_

424 -                  
\_\_\_\_\_

430 -   
1

431 -   
1

432 -    
0 2

433 -   
2

434 -   
1

435 -    
0 2

440 -   
9

441 -    
\_\_\_\_\_

442 -      
\_\_\_\_\_

450 -      
X X X X

451 -    
X X

452 -          
\_\_\_\_\_

453 -            
0 0 0 0 0 0 0 0

461 -      
\_\_\_\_\_

462 -      
\_\_\_\_\_

463 -      
\_\_\_\_\_

464 -      
\_\_\_\_\_

465 -      
\_\_\_\_\_

466 -      
\_\_\_\_\_

- |                                      |  |
|--------------------------------------|--|
| 400: Network Type                    | 440: Throughput Class Negotiation        |
| 401: Circuit Type                    | 441: Closed User Group                   |
| 402: Logical Channel Identifier      | 442: Recognized Private Operating Agency |
| 409: X.25 Keyboard Support Options   | 450: Link Level Transmit Timeout         |
| 420: Incoming Call Options           | 451: Number of Retries                   |
| 421: Outgoing Call Options           | 452: Connection Identifier Password      |
| 423: Host DTE Address                | 453: Connection Options                  |
| 424: 3174 DTE Address                | 461: Lowest Incoming Channel             |
| 430: Negotiated Packet Size          | 462: Highest Incoming Channel            |
| 431: Packet Sequence Numbering       | 463: Lowest Two-Way Channel              |
| 432: Negotiated Window Size          | 464: Highest Two-Way Channel             |
| 433: K-Maximum Out                   | 465: Lowest Outgoing Channel             |
| 434: Nonstandard Default Packet Size | 466: Highest Outgoing Channel            |
| 435: Nonstandard Default Window Size |  |

# Worksheet 13S—Secondary X.25 Options

Chapter 10 of the 3174 Planning Guide contains the planning information you need.

Host ID: \_\_\_\_\_

## \_\_\_\_\_ 332: X.25 Options \_\_\_\_\_

	481 - <input type="checkbox"/> 4	482 - <input type="checkbox"/> <input type="checkbox"/> <input type="checkbox"/> <input type="checkbox"/> <input type="checkbox"/> X X X X	
489 - <input type="checkbox"/> <input type="checkbox"/> <input type="checkbox"/> <input type="checkbox"/> <input type="checkbox"/> <input type="checkbox"/> <input type="checkbox"/> <input type="checkbox"/> 1 0 1 0 0 1 0 0	420 - <input type="checkbox"/> <input type="checkbox"/> <input type="checkbox"/> <input type="checkbox"/> <input type="checkbox"/> <input type="checkbox"/> <input type="checkbox"/> <input type="checkbox"/> 0 0 0 0 0 0 0 0	421 - <input type="checkbox"/> <input type="checkbox"/> <input type="checkbox"/> <input type="checkbox"/> <input type="checkbox"/> <input type="checkbox"/> <input type="checkbox"/> <input type="checkbox"/> 0 0 0 0 0 0 0 0	
423 - <input type="checkbox"/> <input type="checkbox"/> <input type="checkbox"/> <input type="checkbox"/> <input type="checkbox"/> <input type="checkbox"/> <input type="checkbox"/> <input type="checkbox"/> <input type="checkbox"/> <input type="checkbox"/> <input type="checkbox"/> <input type="checkbox"/> <input type="checkbox"/> <input type="checkbox"/> _____			
438 - <input type="checkbox"/> 1	432 - <input type="checkbox"/> <input type="checkbox"/> 0 2		
448 - <input type="checkbox"/> 9	441 - <input type="checkbox"/> <input type="checkbox"/> _____	442 - <input type="checkbox"/> <input type="checkbox"/> <input type="checkbox"/> <input type="checkbox"/> _____	
	452 - <input type="checkbox"/> <input type="checkbox"/> <input type="checkbox"/> <input type="checkbox"/> <input type="checkbox"/> <input type="checkbox"/> <input type="checkbox"/> _____	453 - <input type="checkbox"/> <input type="checkbox"/> <input type="checkbox"/> <input type="checkbox"/> <input type="checkbox"/> <input type="checkbox"/> <input type="checkbox"/> <input type="checkbox"/> 0 0 0 0 0 0 0 0	

- |                                    |  |
|------------------------------------|--|
| 401: Circuit Type                  | 432: Negotiated Window Size              |
| 402: Logical Channel Identifier    | 440: Throughput Class Negotiation        |
| 409: X.25 Keyboard Support Options | 441: Closed User Group                   |
| 420: Incoming Call Options         | 442: Recognized Private Operating Agency |
| 421: Outgoing Call Options         | 452: Connection Identifier Password      |
| 423: Host DTE Address              | 453: Connection Options                  |
| 430: Negotiated Packet Size        |  |

---

## Worksheet 14—Common SNA

Chapter 11 of the *3174 Planning Guide* contains the planning information you need.

---

Common SNA

500 - <input style="width: 30px; height: 15px;" type="text"/>	501 - <table border="1" style="display: inline-table; border-collapse: collapse;"><tr><td style="width: 15px; height: 15px;"></td><td style="width: 15px; height: 15px;"></td><td style="width: 15px; height: 15px;"></td><td style="width: 15px; height: 15px;"></td><td style="width: 15px; height: 15px;"></td><td style="width: 15px; height: 15px;"></td><td style="width: 15px; height: 15px;"></td><td style="width: 15px; height: 15px;"></td></tr></table>									502 - <table border="1" style="display: inline-table; border-collapse: collapse;"><tr><td style="width: 15px; height: 15px;"></td><td style="width: 15px; height: 15px;"></td><td style="width: 15px; height: 15px;"></td><td style="width: 15px; height: 15px;"></td><td style="width: 15px; height: 15px;"></td><td style="width: 15px; height: 15px;"></td><td style="width: 15px; height: 15px;"></td><td style="width: 15px; height: 15px;"></td></tr></table>								
0																		

---

- 500: CSCM Unique
- 501: Network ID (NETID)
- 502: Logical Unit Name (LUNAME)

# Worksheet 15A—3270 Attachment Diagram

Chapter 12 of the 3174 Planning Guide contains the planning information you need.

Terminal Adapter HG-26	Port Set Name	Station Set Name	Default Destinations					Station Type
			LT1	LT2	LT3	LT4	LT5	
26-00								
26-01								
26-02								
26-03								
26-04								
26-05								
26-06								
26-07								
26-08								
26-09								
26-10								
26-11								
26-12								
26-13								
26-14								
26-15								
26-16								
26-17								
26-18								
26-19								
26-20								
26-21								
26-22								
26-23								
26-24								
26-25								
26-26								
26-27								
26-28								
26-29								
26-30								
26-31								

Station Set Name	Station Set Number
IBM Host =	= 1
ASCII Host =	=
ASCII Host =	=
ASCII Host =	=
ASCII Host =	=
ASCII Host =	=
ASCII Host =	=
ASCII Host =	=
ASCII Host =	=

Note:  
For 3270 Stations  
Port Type = Coax = 1

3270  
Display = 3D  
Printer = 3P

## Worksheet 15B—3270 Attachment Diagram

Chapter 12 of the 3174 *Planning Guide* contains the planning information you need.

Terminal Adapter HG-27	Port Set Name	Station Set Name	Default Destinations					Station Type
			LT1	LT2	LT3	LT4	LT5	
27-00								
27-01								
27-02								
27-03								
27-04								
27-05								
27-06								
27-07								
27-08								
27-09								
27-10								
27-11								
27-12								
27-13								
27-14								
27-15								
27-16								
27-17								
27-18								
27-19								
27-20								
27-21								
27-22								
27-23								
27-24								
27-25								
27-26								
27-27								
27-28								
27-29								
27-30								
27-31								

Note: For 3270 Stations Port Type = Coax = 1	Station Set Name	Station Set Number	3270 Display = 3D Printer = 3P
	IBM Host =	= 1	
	ASCII Host =	=	
	ASCII Host =	=	
	ASCII Host =	=	
	ASCII Host =	=	
	ASCII Host =	=	
	ASCII Host =	=	
	ASCII Host =	=	
	ASCII Host =	=	

# Worksheet 16—ASCII Attachment Diagram

Chapter 12 of the 3174 Planning Guide contains the planning information you need.

Switched = 2 Direct = 3 Non-switched = 4		Hayes * = 1 Micom = 2 IBM = 3 Other = 4		Station Set Name IBM Host = ASCII Host = ASCII Host = ASCII Host = ASCII Host = ASCII Host = ASCII Host = ASCII Host = ASCII Host =	Station Set Number = 1 = = = = = = =	See Station Type Table below
Port Type	Modem Type	Port Set Name	Station Set Name	Default Destination	Station Type	

**AEA HG-21**

21-00					
21-01					
21-02					
21-03					
21-04					
21-05					
21-06					
21-07					

**AEA HG-22**

22-00					
22-01					
22-02					
22-03					
22-04					
22-05					
22-06					
22-07					

**AEA HG-23**

23-00					
23-01					
23-02					
23-03					
23-04					
23-05					
23-06					
23-07					

**Station Type Table \***

ASCII Host = AH FTTERM (Monochrome)	= FM Lear Siegler 1178	= L7 Televideo 912 = T1
ASCII Plotter = AL Hewlett Packard 2621 B	= H2 IBM 3162 Model 870	= R0 Televideo 970 = T7
ASCII Printer = AP IBM 3101	= I1 ROLM Cypress, Cedar, Juniper	= R1 DEC VT100 = V1
ADDS Viewpoint A-1,A-2 = A2 IBM 3151, 3161, 3162, 3163	= I2 ANSI 3.64 Terminal	= S1 DEC VT241 = V2
ADDS Viewpoint 78 = A7 IBM 3151,3161,3162,3163	= I3 UDT5	= U5 DEC VT52 = V5
Esprit Hazeltine 1500 = E1 IBM 3164	= I4 UDT6	= U6 DEC VT220 = V6
Esprit Executive 78 = E7 Lear Siegler ADM 11/12	= L1	= Tektronix 4205 = X4
FTTERM (Color) = FC Lear Siegler ADM 3A/5	= L3	= WYSE 50/60 = W1
UDT1 = U1 UDT3	= U3	= Minitel 1B = M1
UDT2 = U2 UDT4	= U4	

\*Trademark acknowledgments can be found in "Special Notices" on page v.

---

## Worksheet 17—AEA Configure

Chapter 12 of the *3174 Planning Guide* contains the planning information you need.

---

\_\_\_\_\_ AEA Configure \_\_\_\_\_

700 -   
0

702 -   
1

703 -   
0

710 - 

<input type="checkbox"/>	<input type="checkbox"/>	<input type="checkbox"/>	<input type="checkbox"/>	<input type="checkbox"/>	<input type="checkbox"/>	<input type="checkbox"/>	<input type="checkbox"/>	<input type="checkbox"/>	<input type="checkbox"/>
--------------------------	--------------------------	--------------------------	--------------------------	--------------------------	--------------------------	--------------------------	--------------------------	--------------------------	--------------------------

  
0 0 0 0 0 0 0 0

711 - 

<input type="checkbox"/>	<input type="checkbox"/>	<input type="checkbox"/>	<input type="checkbox"/>	<input type="checkbox"/>	<input type="checkbox"/>	<input type="checkbox"/>	<input type="checkbox"/>	<input type="checkbox"/>	<input type="checkbox"/>
--------------------------	--------------------------	--------------------------	--------------------------	--------------------------	--------------------------	--------------------------	--------------------------	--------------------------	--------------------------

  
0 0 0 0 0 0 0 0

712 - 

<input type="checkbox"/>	<input type="checkbox"/>	<input type="checkbox"/>	<input type="checkbox"/>	<input type="checkbox"/>	<input type="checkbox"/>	<input type="checkbox"/>	<input type="checkbox"/>	<input type="checkbox"/>	<input type="checkbox"/>
--------------------------	--------------------------	--------------------------	--------------------------	--------------------------	--------------------------	--------------------------	--------------------------	--------------------------	--------------------------

  
0 0 0 0 0 0 0 0

713 - 

<input type="checkbox"/>	<input type="checkbox"/>	<input type="checkbox"/>	<input type="checkbox"/>	<input type="checkbox"/>	<input type="checkbox"/>	<input type="checkbox"/>	<input type="checkbox"/>	<input type="checkbox"/>	<input type="checkbox"/>
--------------------------	--------------------------	--------------------------	--------------------------	--------------------------	--------------------------	--------------------------	--------------------------	--------------------------	--------------------------

  
0 0 0 0 0 0 0 0

---

700: Configure the AEA Feature

702: Control Key Assignment

703: Request MLT for AEA

710: Miscellaneous ASCII Feature Options (A)

711: Miscellaneous ASCII Feature Options (B)

712: Miscellaneous ASCII Feature Options (C)

713: Miscellaneous ASCII Feature Options (D)

## Worksheet 18—AEA Port Set

Chapter 12 of the *3174 Planning Guide* contains the planning information you need.

### \_\_\_\_\_ AEA Port Set \_\_\_\_\_

	Name	Session Limit	Port Type	Modem Type	Password
1	_____	_____	_____	_____	_____
2	_____	_____	_____	_____	_____
3	_____	_____	_____	_____	_____
4	_____	_____	_____	_____	_____
5	_____	_____	_____	_____	_____
6	_____	_____	_____	_____	_____
7	_____	_____	_____	_____	_____
8	_____	_____	_____	_____	_____
9	_____	_____	_____	_____	_____
10	_____	_____	_____	_____	_____
11	_____	_____	_____	_____	_____
12	_____	_____	_____	_____	_____
13	_____	_____	_____	_____	_____
14	_____	_____	_____	_____	_____
15	_____	_____	_____	_____	_____
16	_____	_____	_____	_____	_____



---

## Worksheet 19—AEA Port to Port Set Map

Chapter 12 of the *3174 Planning Guide* contains the planning information you need.

---

	AEA Port to Port Set Map							
	0	1	2	3	4	5	6	7
3270 Ports								
26-00 to 26-07	—	—	—	—	—	—	—	—
26-08 to 26-15	—	—	—	—	—	—	—	—
26-16 to 26-23	—	—	—	—	—	—	—	—
26-24 to 26-31	—	—	—	—	—	—	—	—
27-00 to 27-07	—	—	—	—	—	—	—	—
27-08 to 27-15	—	—	—	—	—	—	—	—
27-16 to 27-23	—	—	—	—	—	—	—	—
27-24 to 27-31	—	—	—	—	—	—	—	—
AEA Ports								
21-00 to 21-07	—	—	—	—	—	—	—	—
22-00 to 22-07	—	—	—	—	—	—	—	—
23-00 to 23-07	—	—	—	—	—	—	—	—

---



---

## Worksheet 21—AEA Default Destination

Chapter 12 of the 3174 *Planning Guide* contains the planning information you need.

---

### AEA Default Destination

Station Set	Station Set Name	Session Limit	Session				
			LT1	LT2	LT3	LT4	LT5
1	_____	_____	_____	_____	_____	_____	_____
2	_____	_____	_____	_____	_____	_____	_____
3	_____	_____	_____	_____	_____	_____	_____
4	_____	_____	_____	_____	_____	_____	_____
5	_____	_____	_____	_____	_____	_____	_____
6	_____	_____	_____	_____	_____	_____	_____
7	_____	_____	_____	_____	_____	_____	_____
8	_____	_____	_____	_____	_____	_____	_____
9	_____	_____	_____	_____	_____	_____	_____
10	_____	_____	_____	_____	_____	_____	_____
11	_____	_____	_____	_____	_____	_____	_____
12	_____	_____	_____	_____	_____	_____	_____
13	_____	_____	_____	_____	_____	_____	_____
14	_____	_____	_____	_____	_____	_____	_____
15	_____	_____	_____	_____	_____	_____	_____
16	_____	_____	_____	_____	_____	_____	_____
17	_____	_____	_____	_____	_____	_____	_____
18	_____	_____	_____	_____	_____	_____	_____
19	_____	_____	_____	_____	_____	_____	_____
20	_____	_____	_____	_____	_____	_____	_____
21	_____	_____	_____	_____	_____	_____	_____
22	_____	_____	_____	_____	_____	_____	_____
23	_____	_____	_____	_____	_____	_____	_____
24	_____	_____	_____	_____	_____	_____	_____
25	_____	_____	_____	_____	_____	_____	_____
26	_____	_____	_____	_____	_____	_____	_____
27	_____	_____	_____	_____	_____	_____	_____
28	_____	_____	_____	_____	_____	_____	_____
29	_____	_____	_____	_____	_____	_____	_____
30	_____	_____	_____	_____	_____	_____	_____

---

---

## Worksheet 22—Terminal Tables Definition

Chapter 12 of the *3174 Planning Guide* contains the planning information you need.

UDT Number: \_\_\_\_\_

### Section One: Identifying Each Table

---

\_\_\_\_ AEA User-Defined Terminal Table Definition \_\_\_\_

UDT Number \_\_\_\_\_

Name \_\_\_\_\_

Model \_\_\_\_\_

### Section Two: Selecting Attributes for Tables

#### Attributes of Station Type:

Last line reserved for Status	_____
Status line Character Set	_____
Status line Clear Option	_____
Use Cursor Seq on Status Line	_____
Scrolling on	_____
Cursor wraps at end of line	_____
Color supported	_____
Cursor class	_____
Cursor sequence	_____
Alternate Screen size	_____
Graphics Query Reply	_____
Graphics Input wait time	_____
Graphics Input ending seq	_____
Graphics Input length	_____

---

---

## Worksheet 23A—Inbound Sequence Panels

Chapter 12 of the 3174 *Planning Guide* contains the planning information you need.

---

\_\_\_\_\_ Inbound Sequence Panels \_\_\_\_\_

UDT Number: _____	3270 Function	ASCII Sequence from Terminal	
		Primary	Alternate
	PF1	_____	_____
	PF2	_____	_____
	PF3	_____	_____
	PF4	_____	_____
	PF5	_____	_____
	PF6	_____	_____
	PF7	_____	_____
	PF8	_____	_____
	PF9	_____	_____
	PF10	_____	_____
	PF11	_____	_____
	PF12	_____	_____
	PF13	_____	_____
	PF14	_____	_____
	PF15	_____	_____
	PF16	_____	_____
	PF17	_____	_____
	PF18	_____	_____
	PF19	_____	_____
	PF20	_____	_____
	PF21	_____	_____
	PF22	_____	_____
	PF23	_____	_____
	PF24	_____	_____
	PA1	_____	_____
	PA2	_____	_____
	PA3	_____	_____
	ATTN	_____	_____
	SysRq	_____	_____
	Reset	_____	_____
	Dev Cancel	_____	_____
	Enter	_____	_____

---

---

## Worksheet 23B—Inbound Sequence Panels

Chapter 12 of the *3174 Planning Guide* contains the planning information you need.

---

\_\_\_\_\_ Inbound Sequence Panels (Continued) \_\_\_\_\_

UDT Number: _____	3278 Function	ASCII Sequence from Terminal	
		Primary	Alternate
	Clear Screen	_____	_____
	Cursor Select	_____	_____
	Cursor Up	_____	_____
	Cursor Down	_____	_____
	Cursor Left	_____	_____
	Cursor Right	_____	_____
	Tab	_____	_____
	Backtab	_____	_____
	Newline	_____	_____
	Home	_____	_____
	Change Screen	_____	_____
	Ex Sel	_____	_____
	Field Mark	_____	_____
	Dup	_____	_____
	Erase EOF	_____	_____
	Erase Input	_____	_____
	Insert	_____	_____
	Delete	_____	_____
	Print	_____	_____
	Ident	_____	_____
	Status ON/OFF	_____	_____
	Refresh	_____	_____
	Fast Left	_____	_____
	Fast Right	_____	_____
	Suspend Print	_____	_____
	Resume Print	_____	_____
	Test	_____	_____
	File Tran En	_____	_____
	File Tran Dis	_____	_____
	ECHO	_____	_____
	ECHO	_____	_____
	ECHO	_____	_____

---

---

## Worksheet 24—Outbound Sequence Panels

Chapter 12 of the 3174 *Planning Guide* contains the planning information you need.

UDT Number: \_\_\_\_\_

---

\_\_\_\_\_ Outbound Sequence Panel \_\_\_\_\_

Function	ASCII Sequence to the Terminal
Term Init Seq	_____
	_____
	_____
	_____
	_____
	_____
Term Exit Seq	_____
	_____
Erase EOL	_____
Clear Screen	_____
Cursor Up	_____
Cursor Down	_____
Cursor Left	_____
Cursor Right	_____
Status On	_____
Status Off	_____
Bell	_____
Dim Unprot	_____
Highlit Unprot	_____
Dim Protec	_____
Highlit Protec	_____
Transparency On	_____
Transparency Off	_____
Alpha Clear	_____
Start Printer	_____
Stop Printer	_____

---

---

## Worksheet 25—Translate Tables Definition

Chapter 12 of the *3174 Planning Guide* contains the planning information you need.

**UDX Number:** \_\_\_\_\_

---

\_\_\_\_\_ AEA User Translate Table Definition \_\_\_\_\_

UDX Number \_\_\_\_\_

Name \_\_\_\_\_

Language \_\_\_\_\_

CECP Support \_\_\_\_\_

Model \_\_\_\_\_

---



---

## Worksheet 26—EBCDIC to ASCII Translation (Outbound)

Chapter 12 of the 3174 *Planning Guide* contains the planning information you need.

UDX Number: \_\_\_\_\_

---

\_\_\_\_\_ UDX Translation - EBCDIC to ASCII \_\_\_\_\_

	0	1	2	3	4	5	6	7	8	9	A	B	C	D	E	F
0	_____	_____	_____	_____	_____	_____	_____	_____	_____	_____	_____	_____	_____	_____	_____	_____
1	_____	_____	_____	_____	_____	_____	_____	_____	_____	_____	_____	_____	_____	_____	_____	_____
2	_____	_____	_____	_____	_____	_____	_____	_____	_____	_____	_____	_____	_____	_____	_____	_____
3	_____	_____	_____	_____	_____	_____	_____	_____	_____	_____	_____	_____	_____	_____	_____	_____
4	_____	_____	_____	_____	_____	_____	_____	_____	_____	_____	_____	_____	_____	_____	_____	_____
5	_____	_____	_____	_____	_____	_____	_____	_____	_____	_____	_____	_____	_____	_____	_____	_____
6	_____	_____	_____	_____	_____	_____	_____	_____	_____	_____	_____	_____	_____	_____	_____	_____
7	_____	_____	_____	_____	_____	_____	_____	_____	_____	_____	_____	_____	_____	_____	_____	_____
8	_____	_____	_____	_____	_____	_____	_____	_____	_____	_____	_____	_____	_____	_____	_____	_____
9	_____	_____	_____	_____	_____	_____	_____	_____	_____	_____	_____	_____	_____	_____	_____	_____
A	_____	_____	_____	_____	_____	_____	_____	_____	_____	_____	_____	_____	_____	_____	_____	_____
B	_____	_____	_____	_____	_____	_____	_____	_____	_____	_____	_____	_____	_____	_____	_____	_____
C	_____	_____	_____	_____	_____	_____	_____	_____	_____	_____	_____	_____	_____	_____	_____	_____
D	_____	_____	_____	_____	_____	_____	_____	_____	_____	_____	_____	_____	_____	_____	_____	_____
E	_____	_____	_____	_____	_____	_____	_____	_____	_____	_____	_____	_____	_____	_____	_____	_____
F	_____	_____	_____	_____	_____	_____	_____	_____	_____	_____	_____	_____	_____	_____	_____	_____

---

## Worksheet 27—ASCII to EBCDIC Translation (Inbound)

Chapter 12 of the *3174 Planning Guide* contains the planning information you need.

UDX Number: \_\_\_\_\_

---

\_\_\_\_\_ UDX Translation - ASCII to EBCDIC \_\_\_\_\_

	0	1	2	3	4	5	6	7	8	9	A	B	C	D	E	F
0	_____	_____	_____	_____	_____	_____	_____	_____	_____	_____	_____	_____	_____	_____	_____	_____
1	_____	_____	_____	_____	_____	_____	_____	_____	_____	_____	_____	_____	_____	_____	_____	_____
2	_____	_____	_____	_____	_____	_____	_____	_____	_____	_____	_____	_____	_____	_____	_____	_____
3	_____	_____	_____	_____	_____	_____	_____	_____	_____	_____	_____	_____	_____	_____	_____	_____
4	_____	_____	_____	_____	_____	_____	_____	_____	_____	_____	_____	_____	_____	_____	_____	_____
5	_____	_____	_____	_____	_____	_____	_____	_____	_____	_____	_____	_____	_____	_____	_____	_____
6	_____	_____	_____	_____	_____	_____	_____	_____	_____	_____	_____	_____	_____	_____	_____	_____
7	_____	_____	_____	_____	_____	_____	_____	_____	_____	_____	_____	_____	_____	_____	_____	_____
8	_____	_____	_____	_____	_____	_____	_____	_____	_____	_____	_____	_____	_____	_____	_____	_____
9	_____	_____	_____	_____	_____	_____	_____	_____	_____	_____	_____	_____	_____	_____	_____	_____
A	_____	_____	_____	_____	_____	_____	_____	_____	_____	_____	_____	_____	_____	_____	_____	_____
B	_____	_____	_____	_____	_____	_____	_____	_____	_____	_____	_____	_____	_____	_____	_____	_____
C	_____	_____	_____	_____	_____	_____	_____	_____	_____	_____	_____	_____	_____	_____	_____	_____
D	_____	_____	_____	_____	_____	_____	_____	_____	_____	_____	_____	_____	_____	_____	_____	_____
E	_____	_____	_____	_____	_____	_____	_____	_____	_____	_____	_____	_____	_____	_____	_____	_____
F	_____	_____	_____	_____	_____	_____	_____	_____	_____	_____	_____	_____	_____	_____	_____	_____

---

---

**Worksheet 28—Device Definition**

Chapter 13 of the *3174 Planning Guide* contains the planning information you need.

---

\_\_\_\_\_ Device Definition \_\_\_\_\_

- 800 Printer Authorization Matrix (PAM) -    
0 0
- 801 Logical Terminal Assignment (LTA) -   
0
- 802 Prompts for Extended VPD -   
0

## Worksheet 29—Printer Authorization Matrix (PAM)

Chapter 13 of the 3174 Planning Guide contains the planning information you need.

Entry	Printer Port		Mode	PAM Definition																	
				Class					Class												
				7		8			7		8										
		01234		56789			012345														
—	—	—	—	—	—	—	—	—	—	—	—	—	—	—	—	—	—	—	—	—	—
—	—	—	—	—	—	—	—	—	—	—	—	—	—	—	—	—	—	—	—	—	—
—	—	—	—	—	—	—	—	—	—	—	—	—	—	—	—	—	—	—	—	—	—
—	—	—	—	—	—	—	—	—	—	—	—	—	—	—	—	—	—	—	—	—	—
—	—	—	—	—	—	—	—	—	—	—	—	—	—	—	—	—	—	—	—	—	—
—	—	—	—	—	—	—	—	—	—	—	—	—	—	—	—	—	—	—	—	—	—
—	—	—	—	—	—	—	—	—	—	—	—	—	—	—	—	—	—	—	—	—	—
—	—	—	—	—	—	—	—	—	—	—	—	—	—	—	—	—	—	—	—	—	—
—	—	—	—	—	—	—	—	—	—	—	—	—	—	—	—	—	—	—	—	—	—

### 3270 Display Ports

### ASCII Display Ports

Entry	0		1		2		3		HG 21		HG 22		HG 23	
	01234	56789	01234	56789	01234	56789	01	01	01234567	01234567	01234567	01234567	01234567	
—	26	.....	.....	.....	.....	.....	.....	..	.....	.....	.....	.....	.....	
—	27	.....	.....	.....	.....	.....	.....	..	.....	.....	.....	.....	.....	
—	26	.....	.....	.....	.....	.....	.....	..	.....	.....	.....	.....	.....	
—	27	.....	.....	.....	.....	.....	.....	..	.....	.....	.....	.....	.....	
—	26	.....	.....	.....	.....	.....	.....	..	.....	.....	.....	.....	.....	
—	27	.....	.....	.....	.....	.....	.....	..	.....	.....	.....	.....	.....	
—	26	.....	.....	.....	.....	.....	.....	..	.....	.....	.....	.....	.....	
—	27	.....	.....	.....	.....	.....	.....	..	.....	.....	.....	.....	.....	
—	26	.....	.....	.....	.....	.....	.....	..	.....	.....	.....	.....	.....	
—	27	.....	.....	.....	.....	.....	.....	..	.....	.....	.....	.....	.....	
—	26	.....	.....	.....	.....	.....	.....	..	.....	.....	.....	.....	.....	
—	27	.....	.....	.....	.....	.....	.....	..	.....	.....	.....	.....	.....	
—	26	.....	.....	.....	.....	.....	.....	..	.....	.....	.....	.....	.....	
—	27	.....	.....	.....	.....	.....	.....	..	.....	.....	.....	.....	.....	

---

## Worksheet 30—Logical Terminal Assignment (LTA)

Chapter 13 of the *3174 Planning Guide* contains the planning information you need.

---

### \_\_\_\_\_ Logical Terminal Assignment \_\_\_\_\_

Port	LT1	LT2	LT3	LT4	LT5	Port	LT1	LT2	LT3	LT4	LT5
26-00	___	___	___	___	___	26-01	___	___	___	___	___
26-02	___	___	___	___	___	26-03	___	___	___	___	___
26-04	___	___	___	___	___	26-05	___	___	___	___	___
26-06	___	___	___	___	___	26-07	___	___	___	___	___
26-08	___	___	___	___	___	26-09	___	___	___	___	___
26-10	___	___	___	___	___	26 11	___	___	___	___	___
26-12	___	___	___	___	___	26-13	___	___	___	___	___
26-14	___	___	___	___	___	26-15	___	___	___	___	___
26-16	___	___	___	___	___	26-17	___	___	___	___	___
26-18	___	___	___	___	___	26-19	___	___	___	___	___
26-20	___	___	___	___	___	26-21	___	___	___	___	___
26-22	___	___	___	___	___	26-23	___	___	___	___	___
26-24	___	___	___	___	___	26-25	___	___	___	___	___
26-26	___	___	___	___	___	26-27	___	___	___	___	___
26-28	___	___	___	___	___	26-29	___	___	___	___	___
26-30	___	___	___	___	___	26-31	___	___	___	___	___
27-00	___	___	___	___	___	27-01	___	___	___	___	___
27-02	___	___	___	___	___	27-03	___	___	___	___	___
27-04	___	___	___	___	___	27-05	___	___	___	___	___
27-06	___	___	___	___	___	27-07	___	___	___	___	___
27-08	___	___	___	___	___	27-09	___	___	___	___	___
27-10	___	___	___	___	___	26 11	___	___	___	___	___
27-12	___	___	___	___	___	27-13	___	___	___	___	___
27-14	___	___	___	___	___	27-15	___	___	___	___	___
27-16	___	___	___	___	___	27-17	___	___	___	___	___
27-18	___	___	___	___	___	27-19	___	___	___	___	___
27-20	___	___	___	___	___	27-21	___	___	___	___	___
27-22	___	___	___	___	___	27-23	___	___	___	___	___
27-24	___	___	___	___	___	27-25	___	___	___	___	___
27-26	___	___	___	___	___	27-27	___	___	___	___	___
27-28	___	___	___	___	___	27-29	___	___	___	___	___
27-30	___	___	___	___	___	27-31	___	___	___	___	___

---

---

## Worksheet 31—Extended Vital Product Data (VPD)

Chapter 13 of the *3174 Planning Guide* contains the planning information you need.

---

\_\_\_\_\_ Extended Vital Product Data \_\_\_\_\_

Label Descriptions

- 1 \_\_\_\_\_
  - 2 \_\_\_\_\_
  - 3 \_\_\_\_\_
  - 4 \_\_\_\_\_
  - 5 \_\_\_\_\_
  - 6 \_\_\_\_\_
  - 7 \_\_\_\_\_
  - 8 \_\_\_\_\_
-

---

## Worksheet 32—Token-Ring Gateway

Chapter 14 of the *3174 Planning Guide* contains the planning information you need.

---

### \_\_\_\_\_Token-Ring Gateway\_\_\_\_\_

900 -   
X X X X X X X X X X X X X X X X 0 4

905 -   
1

908 -   
I B M L A N

911 -   
0

912 -   
0 0

---

900: Token-Ring Network – Gateway Address/SAP  
905: Ring Error Monitor  
908: Link Subsystem Name

911: Ring Speed of the Gateway  
912: Group Poll Address

# Worksheet 33—Ring Address Assignment

Chapter 14 of the 3174 Planning Guide contains the planning information you need.

## \_\_\_\_\_940: Ring Address Assignment\_\_\_\_\_

S	Ring	Address	SAP	T	S	Ring	Address	SAP	T
<input type="text"/>	<input type="text"/>	<input type="text"/>	<input type="text"/>	<input type="text"/>	<input type="text"/>	<input type="text"/>	<input type="text"/>	<input type="text"/>	<input type="text"/>
			0 4	0				0 4	0
<input type="text"/>	<input type="text"/>	<input type="text"/>	<input type="text"/>	<input type="text"/>	<input type="text"/>	<input type="text"/>	<input type="text"/>	<input type="text"/>	<input type="text"/>
			0 4	0				0 4	0
<input type="text"/>	<input type="text"/>	<input type="text"/>	<input type="text"/>	<input type="text"/>	<input type="text"/>	<input type="text"/>	<input type="text"/>	<input type="text"/>	<input type="text"/>
			0 4	0				0 4	0
<input type="text"/>	<input type="text"/>	<input type="text"/>	<input type="text"/>	<input type="text"/>	<input type="text"/>	<input type="text"/>	<input type="text"/>	<input type="text"/>	<input type="text"/>
			0 4	0				0 4	0
<input type="text"/>	<input type="text"/>	<input type="text"/>	<input type="text"/>	<input type="text"/>	<input type="text"/>	<input type="text"/>	<input type="text"/>	<input type="text"/>	<input type="text"/>
			0 4	0				0 4	0
<input type="text"/>	<input type="text"/>	<input type="text"/>	<input type="text"/>	<input type="text"/>	<input type="text"/>	<input type="text"/>	<input type="text"/>	<input type="text"/>	<input type="text"/>
			0 4	0				0 4	0
<input type="text"/>	<input type="text"/>	<input type="text"/>	<input type="text"/>	<input type="text"/>	<input type="text"/>	<input type="text"/>	<input type="text"/>	<input type="text"/>	<input type="text"/>
			0 4	0				0 4	0
<input type="text"/>	<input type="text"/>	<input type="text"/>	<input type="text"/>	<input type="text"/>	<input type="text"/>	<input type="text"/>	<input type="text"/>	<input type="text"/>	<input type="text"/>
			0 4	0				0 4	0
<input type="text"/>	<input type="text"/>	<input type="text"/>	<input type="text"/>	<input type="text"/>	<input type="text"/>	<input type="text"/>	<input type="text"/>	<input type="text"/>	<input type="text"/>
			0 4	0				0 4	0
<input type="text"/>	<input type="text"/>	<input type="text"/>	<input type="text"/>	<input type="text"/>	<input type="text"/>	<input type="text"/>	<input type="text"/>	<input type="text"/>	<input type="text"/>
			0 4	0				0 4	0
<input type="text"/>	<input type="text"/>	<input type="text"/>	<input type="text"/>	<input type="text"/>	<input type="text"/>	<input type="text"/>	<input type="text"/>	<input type="text"/>	<input type="text"/>
			0 4	0				0 4	0
<input type="text"/>	<input type="text"/>	<input type="text"/>	<input type="text"/>	<input type="text"/>	<input type="text"/>	<input type="text"/>	<input type="text"/>	<input type="text"/>	<input type="text"/>
			0 4	0				0 4	0
<input type="text"/>	<input type="text"/>	<input type="text"/>	<input type="text"/>	<input type="text"/>	<input type="text"/>	<input type="text"/>	<input type="text"/>	<input type="text"/>	<input type="text"/>
			0 4	0				0 4	0



# Worksheet 34—Ring Transmission Definition

Chapter 14 of the 3174 Planning Guide contains the planning information you need.

## \_\_\_\_\_ 941: Ring Transmission Definition \_\_\_\_\_

S	Ring	Address	SAP	F	W	S	Ring	Address	SAP	F	W
<input type="text"/>	<input type="text"/>	<input type="text"/>	<input type="text"/> 0 4						<input type="text"/>		
<input type="text"/>	<input type="text"/>	<input type="text"/>	<input type="text"/> 0 4	<input type="checkbox"/>	<input type="checkbox"/>	<input type="text"/>	<input type="text"/>	<input type="text"/>	<input type="text"/> 0 4	<input type="checkbox"/>	<input type="checkbox"/>
<input type="text"/>	<input type="text"/>	<input type="text"/>	<input type="text"/> 0 4	<input type="checkbox"/>	<input type="checkbox"/>	<input type="text"/>	<input type="text"/>	<input type="text"/>	<input type="text"/> 0 4	<input type="checkbox"/>	<input type="checkbox"/>
<input type="text"/>	<input type="text"/>	<input type="text"/>	<input type="text"/> 0 4	<input type="checkbox"/>	<input type="checkbox"/>	<input type="text"/>	<input type="text"/>	<input type="text"/>	<input type="text"/> 0 4	<input type="checkbox"/>	<input type="checkbox"/>
<input type="text"/>	<input type="text"/>	<input type="text"/>	<input type="text"/> 0 4	<input type="checkbox"/>	<input type="checkbox"/>	<input type="text"/>	<input type="text"/>	<input type="text"/>	<input type="text"/> 0 4	<input type="checkbox"/>	<input type="checkbox"/>
<input type="text"/>	<input type="text"/>	<input type="text"/>	<input type="text"/> 0 4	<input type="checkbox"/>	<input type="checkbox"/>	<input type="text"/>	<input type="text"/>	<input type="text"/>	<input type="text"/> 0 4	<input type="checkbox"/>	<input type="checkbox"/>
<input type="text"/>	<input type="text"/>	<input type="text"/>	<input type="text"/> 0 4	<input type="checkbox"/>	<input type="checkbox"/>	<input type="text"/>	<input type="text"/>	<input type="text"/>	<input type="text"/> 0 4	<input type="checkbox"/>	<input type="checkbox"/>
<input type="text"/>	<input type="text"/>	<input type="text"/>	<input type="text"/> 0 4	<input type="checkbox"/>	<input type="checkbox"/>	<input type="text"/>	<input type="text"/>	<input type="text"/>	<input type="text"/> 0 4	<input type="checkbox"/>	<input type="checkbox"/>
<input type="text"/>	<input type="text"/>	<input type="text"/>	<input type="text"/> 0 4	<input type="checkbox"/>	<input type="checkbox"/>	<input type="text"/>	<input type="text"/>	<input type="text"/>	<input type="text"/> 0 4	<input type="checkbox"/>	<input type="checkbox"/>
<input type="text"/>	<input type="text"/>	<input type="text"/>	<input type="text"/> 0 4	<input type="checkbox"/>	<input type="checkbox"/>	<input type="text"/>	<input type="text"/>	<input type="text"/>	<input type="text"/> 0 4	<input type="checkbox"/>	<input type="checkbox"/>
<input type="text"/>	<input type="text"/>	<input type="text"/>	<input type="text"/> 0 4	<input type="checkbox"/>	<input type="checkbox"/>	<input type="text"/>	<input type="text"/>	<input type="text"/>	<input type="text"/> 0 4	<input type="checkbox"/>	<input type="checkbox"/>
<input type="text"/>	<input type="text"/>	<input type="text"/>	<input type="text"/> 0 4	<input type="checkbox"/>	<input type="checkbox"/>	<input type="text"/>	<input type="text"/>	<input type="text"/>	<input type="text"/> 0 4	<input type="checkbox"/>	<input type="checkbox"/>
<input type="text"/>	<input type="text"/>	<input type="text"/>	<input type="text"/> 0 4	<input type="checkbox"/>	<input type="checkbox"/>	<input type="text"/>	<input type="text"/>	<input type="text"/>	<input type="text"/> 0 4	<input type="checkbox"/>	<input type="checkbox"/>
<input type="text"/>	<input type="text"/>	<input type="text"/>	<input type="text"/> 0 4	<input type="checkbox"/>	<input type="checkbox"/>	<input type="text"/>	<input type="text"/>	<input type="text"/>	<input type="text"/> 0 4	<input type="checkbox"/>	<input type="checkbox"/>
<input type="text"/>	<input type="text"/>	<input type="text"/>	<input type="text"/> 0 4	<input type="checkbox"/>	<input type="checkbox"/>	<input type="text"/>	<input type="text"/>	<input type="text"/>	<input type="text"/> 0 4	<input type="checkbox"/>	<input type="checkbox"/>
<input type="text"/>	<input type="text"/>	<input type="text"/>	<input type="text"/> 0 4	<input type="checkbox"/>	<input type="checkbox"/>	<input type="text"/>	<input type="text"/>	<input type="text"/>	<input type="text"/> 0 4	<input type="checkbox"/>	<input type="checkbox"/>
<input type="text"/>	<input type="text"/>	<input type="text"/>	<input type="text"/> 0 4	<input type="checkbox"/>	<input type="checkbox"/>	<input type="text"/>	<input type="text"/>	<input type="text"/>	<input type="text"/> 0 4	<input type="checkbox"/>	<input type="checkbox"/>

## Worksheet 35—Storage Requirements

Chapter 3 of the *3174 Planning Guide* contains the procedure for filling out this worksheet. Values are in KB (1024 bytes). **Select only one value from each group.**

Function	Requires	Totals:
Base	1661	1661
Asynchronous Emulation Adapter (one or more)	309	
Large-Screen Support	48	
Multiple Logical Terminals	216	
Multi-Host Support (CCA and/or Single Link Multi-Host Support)	159	
Single Link Multi-Host Support		
2 Hosts on the link	54	
3 Hosts on the link	108	
4 Hosts on the link	162	
5 Hosts on the link	216	
6 Hosts on the link	270	
7 Hosts on the link	324	
8 Hosts on the link	378	
Multiple Logical Terminals (Level or Exact Amount)		
Level 1	64	
Level 2	128	
Level 3	512	
Level 4	896	
Level 5	1152	
Level 6	1536	
Level 7	2048	
Level 8	2688	
Exact Amount		
Central Site Change Management		
Network Site Controller	186	
Central Site Controller	186	
Central Site Controller (1 Fixed Disk Drive)	266	
Central Site Controller (2 Fixed Disk Drives)	346	
3270 Port Expansion Feature		
Without Multi-Host Support present	377	
With Multi-Host Support present	505	
Local Format Storage		
Level 1	77	
Level 2	141	
Level 3	269	
Level 4	525	
Level 5	1037	
Level 6	1548	
RPQ Storage		
DSPU Combinations—Local Models		
Refer to Table 3-2 on page 3-6 to figure your totals.		
DSPU Combinations—Remote Models		
Refer to Table 3-2 on page 3-6 to figure your totals.		
	<b>Total Storage Required:</b>	
	<b>Storage Required in MBs:</b>	

## Non-Katakana Converged Keyboards

Chapter 15 of the *3174 Planning Guide* contains the planning information you need.

**Language:** \_\_\_\_\_  
**Keyboard ID:** A B C D  
 (circle one)

**Modify Field:**  
 1 = New Layout  
 2 = Update

**Keyboard Type:**  
 1 = Typewriter  
 2 = Data Entry  
 3 = APL

**Keypad Type:**  
 0 = National Language Numeric  
 1 = Data Entry  
 2 = Program Function (PF)

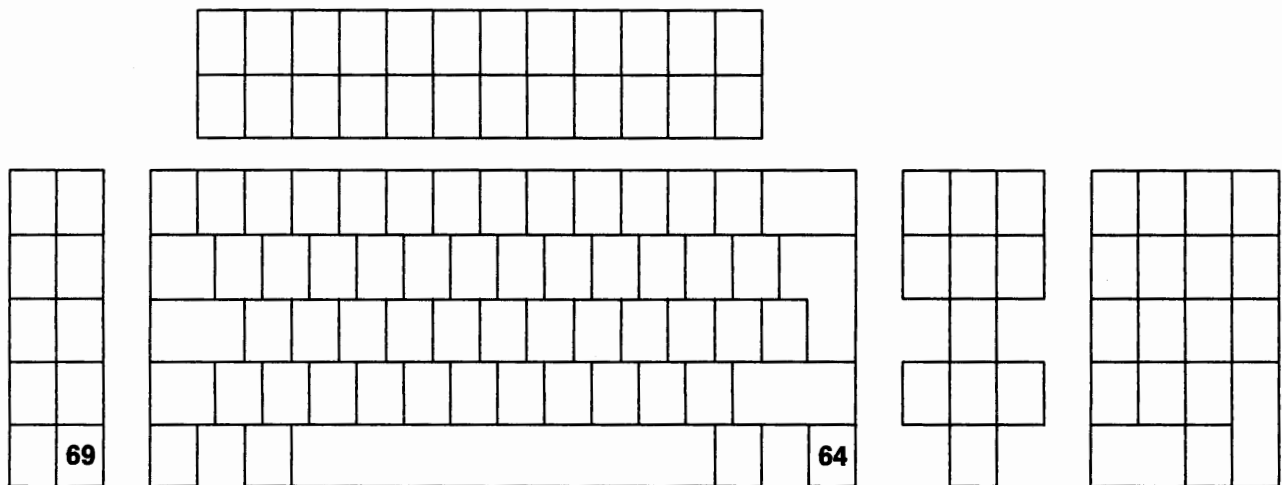

Keyboard			Shift		Function			From Key		I/O Interface		To Key		
0	1	2	3	4	5	6	7	8	Shift	Character	Code	Character	Shift	Character

- 0, 1, 2 - Keyboard Group**
- 0 = The desired change is on a Converged Typewriter, Converged Data Entry, Enhanced Typewriter, or the typewriter functions on a Converged APL keyboard.
  - 1 = The desired change applies only to the APL key functions on a Converged APL keyboard.
  - 2 = The desired change applies to both the typewriter and APL functions on a Converged APL keyboard.
- 3, 4 - Shift Group**
- 3 = Full-key change (includes alternate, upper, and lower shifts).
  - 4 = Single-shift change.
- 5, 6, 7, 8 - Function Group**
- 5 = Copy from I/O interface code table.
  - 6 = Exchange two functions.
  - 7 = Copy a function to another key.
  - 8 = Delete a key function.

# Katakana Converged Keyboards

Chapter 15 of the 3174 Planning Guide contains the planning information you need.

Language: \_\_\_\_\_ Keyboard ID: A B C D Modify Field:  1 = New Layout  2 = Update Keyboard Type:  1 = Typewriter  2 = Data Entry  3 = APL Keypad Type:  0 = National Language Numeric  1 = Data Entry  2 = Program Function (PF)

(circle one)

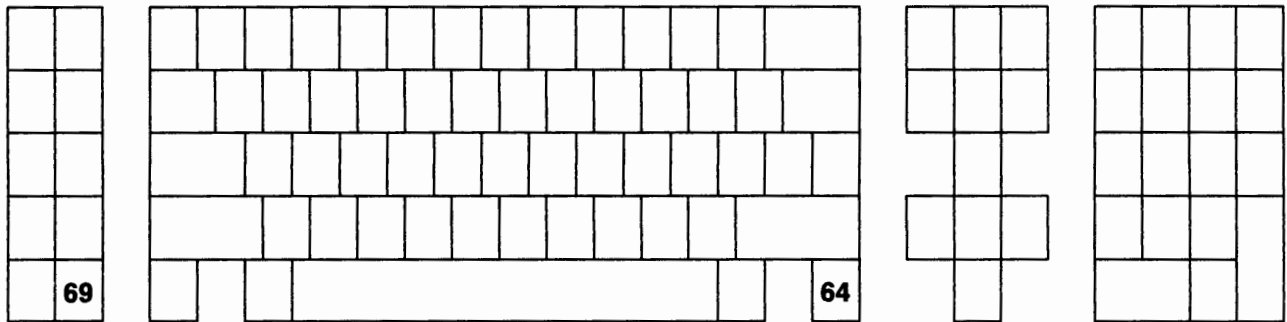
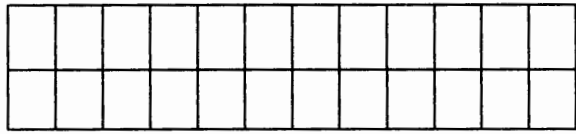

Keyboard		Shift		Function				From Key		I/O Interface		To Key		
0	1	2	3	4	5	6	7	8	Shift	Character	Code	Character	Shift	Character

**0, 1, 2 - Keyboard Group**

- 0 = The desired change is on a Converged Typewriter, Converged Data Entry, Enhanced Typewriter, or the typewriter functions on a Converged APL keyboard.
- 1 = The desired change applies only to the APL key functions on a Converged APL keyboard.
- 2 = The desired change applies to both the typewriter and APL functions on a Converged APL keyboard.

**3, 4 - Shift Group**

- 3 = Full-key change (includes alternate, upper, and lower shifts).
- 4 = Single-shift change.

**5, 6, 7, 8 - Function Group**

- 5 = Copy from I/O interface code table.
- 6 = Exchange two functions.
- 7 = Copy a function to another key.
- 8 = Delete a key function.

# Keyboard Layout Worksheet 3

## Enhanced Keyboard (US)

Chapter 15 of the 3174 Planning Guide contains the planning information you need.

**Language:** \_\_\_\_\_  
**Keyboard ID:** A B C D  
 (circle one)  
**Modify Field:**  
 1 = New Layout  
 2 = Update  
**Keyboard Type:**  
 4 = Typewriter  
**Keypad Type:**  
 0 = National Language Numeric  
 1 = Data Entry  
 2 = Program Function (PF)

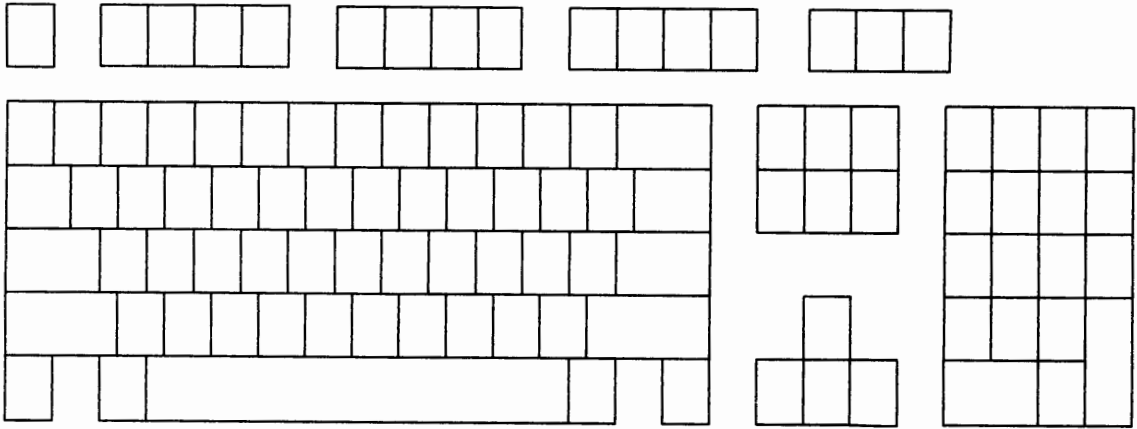

Keyboard			Shift		Function				From Key		I/O Interface		To Key	
0	1	2	3	4	5	6	7	8	Shift	Character	Code	Character	Shift	Character

- 0, 1, 2 - Keyboard Group**
- 0 = The desired change is on a Converged Typewriter, Converged Data Entry, Enhanced Typewriter, or the typewriter functions on a Converged APL keyboard.
  - 1 = The desired change applies only to the APL key functions on a Converged APL keyboard.
  - 2 = The desired change applies to both the typewriter and APL functions on a Converged APL keyboard.
- 3, 4 - Shift Group**
- 3 = Full-key change (includes alternate, upper, and lower shifts).
  - 4 = Single-shift change.
- 5, 6, 7, 8 - Function Group**
- 5 = Copy from I/O interface code table.
  - 6 = Exchange two functions.
  - 7 = Copy a function to another key.
  - 8 = Delete a key function.

## Enhanced Keyboard (World Trade)

Chapter 15 of the 3174 Planning Guide contains the planning information you need.

**Language:** \_\_\_\_\_  
**Keyboard ID:** A B C D (circle one)  
**Modify Field:**  1 = New Layout  2 = Update  
**Keyboard Type:**  4 = Typewriter  
**Keypad Type:**  0 = National Language Numeric  1 = Data Entry  2 = Program Function (PF)

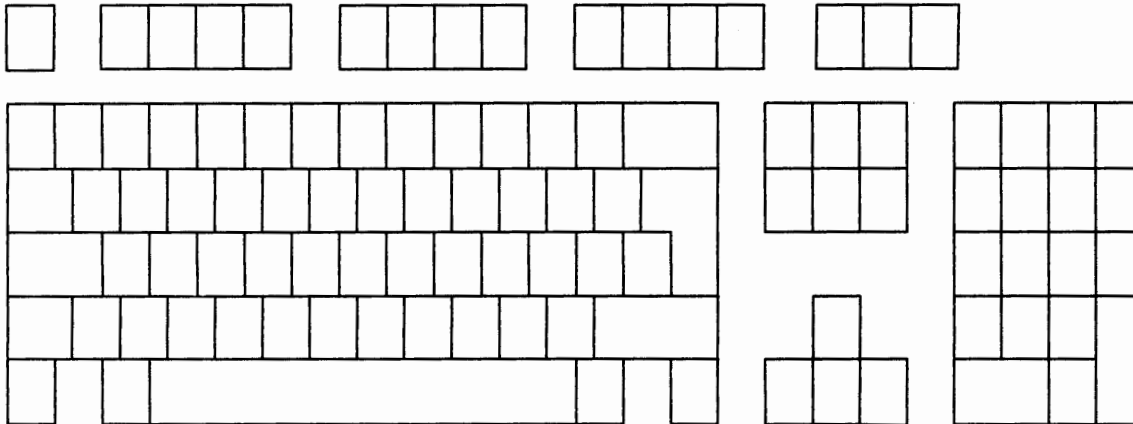

Keyboard		Shift		Function				From Key		I/O Interface		To Key		
0	1	2	3	4	5	6	7	8	Shift	Character	Code	Character	Shift	Character

### 0, 1, 2 - Keyboard Group

- 0 = The desired change is on a Converged Typewriter, Converged Data Entry, Enhanced Typewriter, or the typewriter functions on a Converged APL keyboard.
- 1 = The desired change applies only to the APL key functions on a Converged APL keyboard.
- 2 = The desired change applies to both the typewriter and APL functions on a Converged APL keyboard.

### 3, 4 - Shift Group

- 3 = Full-key change (includes alternate, upper, and lower shifts).
- 4 = Single-shift change.

### 5, 6, 7, 8 - Function Group

- 5 = Copy from I/O interface code table.
- 6 = Exchange two functions.
- 7 = Copy a function to another key.
- 8 = Delete a key function.

## Enhanced Keyboard (Katakana)

Chapter 15 of the 3174 Planning Guide contains the planning information you need.

**Language:** \_\_\_\_\_  
**Keyboard ID:** A B C D (circle one)  
**Modify Field:**  1 = New Layout  2 = Update  4 = Typewriter  
**Keypad Type:**  0 = National Language Numeric  1 = Data Entry  2 = Program Function (PF)

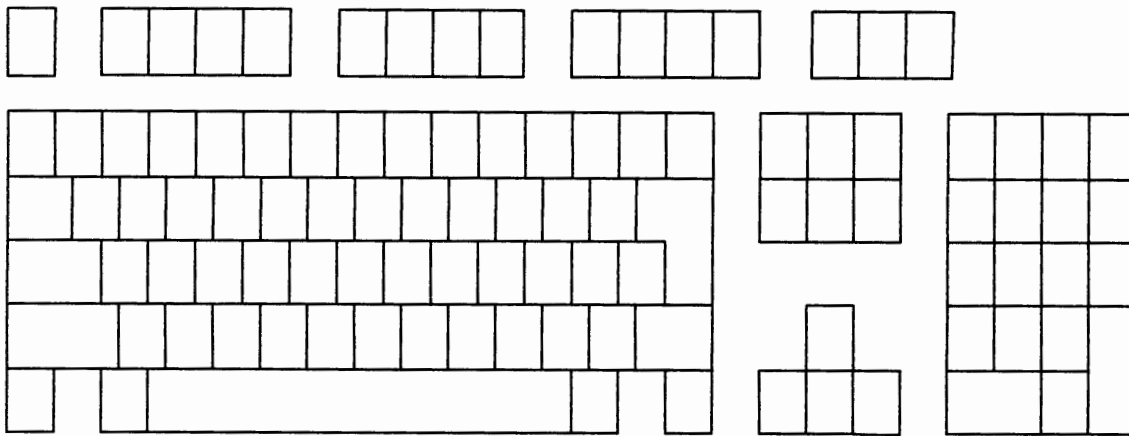

Keyboard			Shift		Function				From Key		I/O Interface		To Key	
0	1	2	3	4	5	6	7	8	Shift	Character	Code	Character	Shift	Character

**0, 1, 2 - Keyboard Group**

- 0 = The desired change is on a Converged Typewriter, Converged Data Entry, Enhanced Typewriter, or the typewriter functions on a Converged APL keyboard.
- 1 = The desired change applies only to the APL key functions on a Converged APL keyboard.
- 2 = The desired change applies to both the typewriter and APL functions on a Converged APL keyboard.

**3, 4 - Shift Group**

- 3 = Full-key change (includes alternate, upper, and lower shifts).
- 4 = Single-shift change.

**5, 6, 7, 8 - Function Group**

- 5 = Copy from I/O interface code table.
- 6 = Exchange two functions.
- 7 = Copy a function to another key.
- 8 = Delete a key function.

---

## Appendix B. AEA Planning Examples

An Overview of the AEA Planning Examples .....	B-3
ASCII Terminal Emulation Planning Example .....	B-4
System Description and Communication Requirements .....	B-4
What We Have to Do .....	B-4
Specific Design Qualifications .....	B-4
Hardware Requirements .....	B-4
3174 Attachment Diagrams .....	B-5
Hardware Setup .....	B-7
Customization Requirements .....	B-9
3270 Terminal Emulation Planning Example .....	B-17
System Description and Requirements .....	B-17
What We Have to Do .....	B-17
Specific Design Qualifications .....	B-17
Hardware Requirements .....	B-18
3174 Attachment Diagrams .....	B-18
Hardware Setup .....	B-18
Customization Requirements .....	B-20
3270 and ASCII Terminal Emulation Planning Example .....	B-27
System Description and Requirements .....	B-27
What We Have to Do .....	B-27
Specific Design Qualifications .....	B-27
Hardware Requirements .....	B-27
3174 Attachment Diagrams .....	B-27
Additional Customizing Requirements .....	B-32





---

## An Overview of the AEA Planning Examples

In the following examples, we present sample computer environments with data communication requirements that are satisfied by the addition of Asynchronous Emulation Adapters (AEA).

- The first example examines ASCII Terminal Emulation; 3270 terminals require access to a nearby ASCII host.
- The second example examines 3270 Terminal Emulation; remote ASCII terminals require access to an IBM host.
- The third example examines both ASCII Terminal Emulation and 3270 Terminal Emulation.

We start with an overall description of the computer environment and the communication requirements. We analyze the requirements for the entire system, divide the load across several controllers as homogeneously as possible, state specific design qualifications, and then concentrate on how to plan the customization of **one** of those controllers. This controller is a piece of the overall system solution; however, its physical layout and customization represent a model or prototype that must be put into effect at each controller equipped for asynchronous communication.

The following design conventions are observed throughout these examples:

- When applicable, asynchronous traffic is distributed across several 3174 Establishment Controllers; this convention optimizes resource availability and improves the consistency of overall system performance. The even distribution of asynchronous traffic across controllers may also serve to expedite and standardize customizing of the affected controllers; if the controllers are physically and functionally equivalent, then only one controller needs to be manually customized; copies of the customization can be made and used (with minor modifications, such as the channel address) on the other controllers.
- Ports that serve the same function are grouped together; this simplifies the planning, drawing, and understanding of the controller's configuration.
- Room for system expansion is provided.

---

## **ASCII Terminal Emulation Planning Example**

In this example, we set up communication between 3270 terminals and a local ASCII host. The 3270 terminals can also access an IBM host.

### **System Description and Communication Requirements**

One hundred twenty 3178 display terminals are connected to an IBM 3090 with a VM operating system. Forty-five 3270 terminal users scattered throughout the building need access to a DEC host in the engineering department on the third floor. About one hour per terminal per day is spent using the DEC application called *VAX VMS*. Occasionally, a few of the terminals will need an application called *PARTS*. Both applications support VT100s.

### **What We Have to Do**

- Design a configuration that uses the AEA feature to meet this requirement.
- Decide what connection mechanism to use, how many lines are needed, what controllers are affected, and how many AEA features to install.
- Allow for some expansion in the future.
- Fill out the 3174 Attachment Diagrams and use them to complete the Site Planning and Customization worksheets.
- Enter the data into customization panels.
- IML a customized controller, and check out the system.

### **Specific Design Qualifications**

ASCII traffic will be distributed across three controllers; each controller will support 15 ASCII users.

Traffic analysis indicates that five AEA ports per controller will provide an acceptable level of port availability for the 15 users of *VAX VMS*. Remember, one port supports only one ASCII host session at a time. The Idle Time-Out can be increased (default = 15 minutes), because port availability should not be a problem.

*VAX VMS* and *PARTS* are considered different destinations; these applications control their own ports. On one controller (C1), two additional ports are allocated to *PARTS*. The other two controllers (C2 and C3) will not have any ports allocated to *PARTS*.

Limited-distance (nonswitched) modems are capable of handling communication between the controllers and the DEC host.

### **Hardware Requirements**

- 17 DEC ports (seven for C1 users, and five each for C2 and C3 users) and 17 cables
- 17 limited-distance modem pairs
- 17 twisted-pair cable runs to connect LDM pairs
- Three Asynchronous Emulation Adapters and 17 cables.

## 3174 Attachment Diagrams

Once we have determined the number of ports needed, the modem types, and the method of connecting stations to the AEA ports, we can diagram the layout of the system and identify station sets and port sets. A system layout consists of a 3270 Attachment Diagram and an ASCII Attachment Diagram. These diagrams are a useful reference for both site planning and customization activities.

See Figures B-1 and B-2 for sample attachment diagrams for the first controller (C1). We have filled in portions of the diagrams; these portions are printed in bold italic. The diagrams have been filled in by (1) identifying the stations and station sets, (2) identifying the ports and port sets, and then (3) indicating the assignment of station sets to port sets.

## 3270 Attachment Diagram

For the 3270 Attachment Diagram, we have:

1. Written in the names of the available hosts (VM SYS 2, VAX VMS, and PARTS) and numbered VAX VMS and PARTS as station sets 2 and 3, respectively.
2. Written in the 3270 station type (3D) and drawn an arrow down to Terminal Adapter port 14 to show that these ports are used by the 3270 displays that require access to the DEC host.  
**Note:** Terminal Adapter/Multiplexer ports 15–31 do not have access to the DEC host; they operate as they did before the addition of the AEA feature.
3. Written in the Default Destinations (1 = VM SYS 2). The arrow shows that all 3270 displays have the same number and sequence of Default Destinations.
4. Added brackets around those stations of the same type and default destination configuration, and assigned these stations the station set name 3178 TERMS.
5. Added brackets around the ports to which the 3178 display stations are connected, and assigned these ports the port set name PSA3178.
6. Added an arrow to show that the station set 3178 TERMS is served by port set PSA3178.

**Note:** This example only shows terminals attached to HG 26.

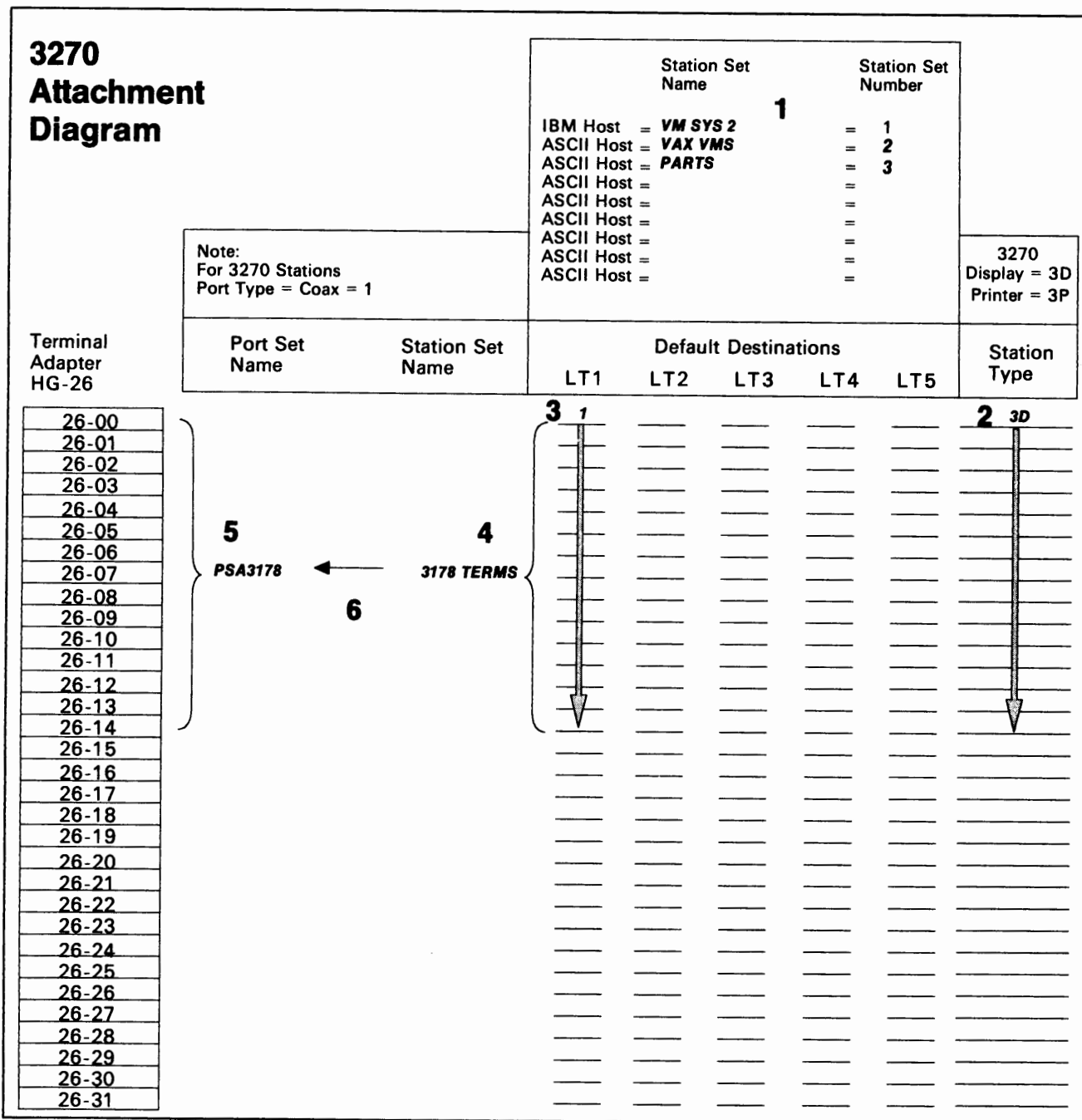

Figure B-1. ASCII Terminal Emulation—3270 Attachment Diagram

### ASCII Attachment Diagram

For the ASCII Attachment Diagram, we have:

1. Written in the names of the available hosts (VMSYS2, VAX VMS, and PARTS), and numbered VAX VMS and PARTS as station sets 2 and 3, respectively.
2. Written in the ASCII station types (AH and AH); default destination does not apply (NA).
3. Added brackets around each AH, and assigned the station set names VAX VMS and PARTS. These names will be displayed in the Connection Menu, so they should be understandable by the application users.
4. Written in the port type (4) for AEA ports 21-00 through 21-04, and 21-06 and 21-07.

**Note:** Limited-distance modems are not assigned a Modem Type (NA).

5. Added a bracket around each group of AEA ports that have the same Port Type and Default Destination; all ports in our system have the same Port Type and Default Destination, but five ports (21-00 through 21-04) have been allocated to VAX VMS, and two ports (21-06 and 21-07) have been allocated to PARTS. These two groups of ports must be in different port sets; we have assigned them the port set names PSVAXVMS and PSPARTS.
6. Added arrows to show that station sets VAX VMS and PARTS are served by port sets PSVAXVMS and PSPARTS, respectively.

### Hardware Setup

The major tasks required for hardware setup are:

1. Rewire the three controllers so that the fifteen 3270 terminals that require access to the DEC host are connected to ports 00 through 14 on each controller.
2. Install one AEA in C1, C2, and C3. Follow the setup and checkout procedures in the setup instructions provided with the AEA feature.
3. Set up and check out cables, limited-distance modems, twisted-pair cabling, and any required distribution frame cross-connections.

**Planning Example – ASCII Terminal Emulation**

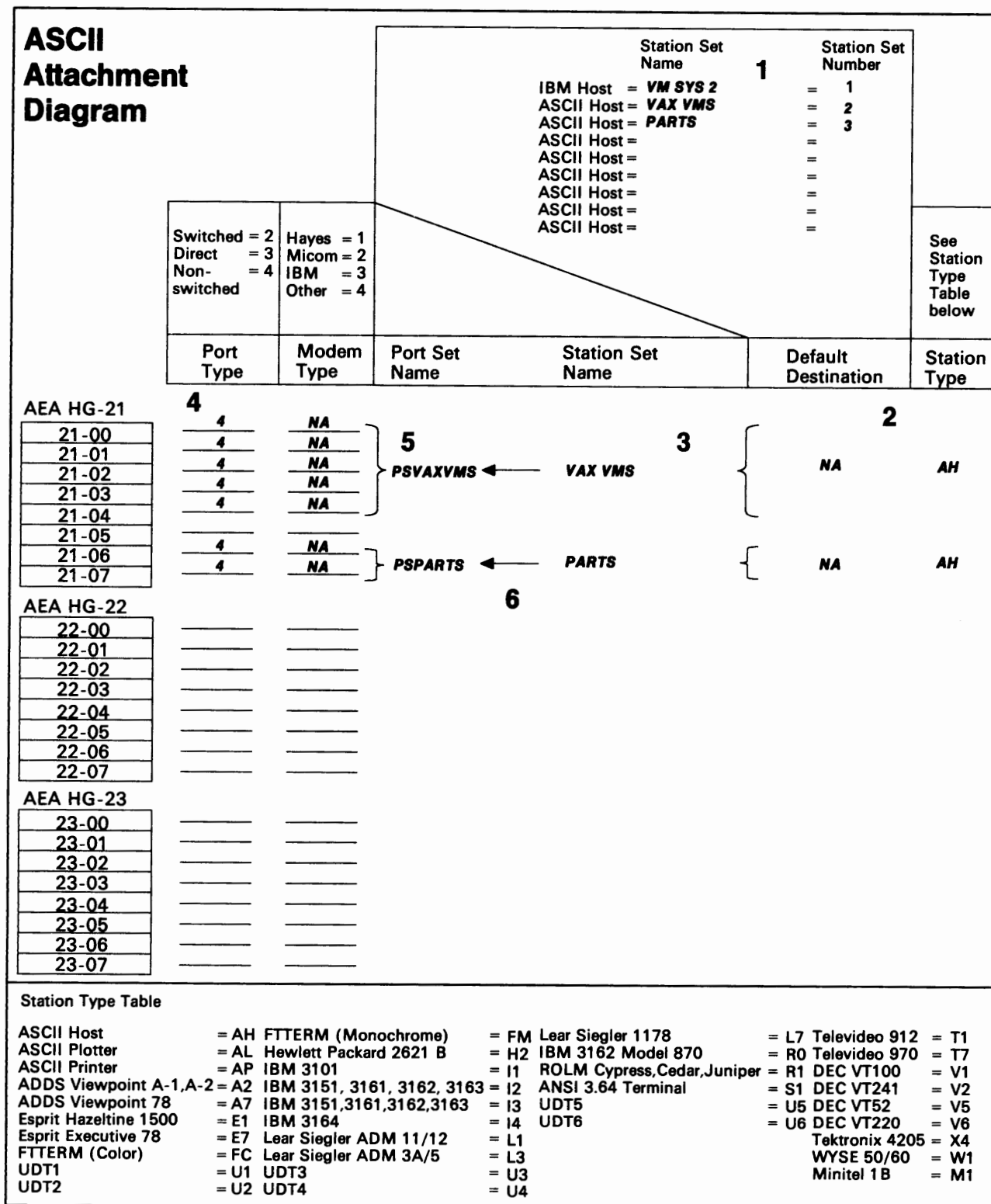

Figure B-2. ASCII Terminal Emulation—ASCII Attachment Diagram

### Customization Requirements

The AEA customization worksheets for C1 are shown here. The customization for C2 and C3 differ from that for C1 only in that devices on C2 and C3 will not have access to PARTS.

Using the 3174 Attachment Diagrams as a guide, we have filled out the following worksheets:

- AEA Configuration
- AEA Port Set
- AEA Port to Port Set Map
- AEA Station Set
- AEA Default Destination.

When a default response for a configuration question did not meet the requirements of our network, an alternate response was written on the worksheet. Use of the default response was indicated by circling it.

**Note:** Most defaults were chosen to simplify the examples; they do not imply a recommendation.

For detailed information on how to fill out the worksheets, refer to Chapter 12, "Planning for the Asynchronous Emulation Adapter."

### AEA Configure Worksheet

On the following worksheet, we have filled in question 700 with a 1.

\_\_\_\_\_ AEA Configure \_\_\_\_\_

700 -   
0

702 -   
①

703 -   
②

710 -   
② ② ② ② ② ② ② ②

711 -   
② ② ② ② ② ② ② ②

712 -   
② ② ② ② ② ② ② ②

713 -   
② ② ② ② ② ② ② ②



## Planning Example – ASCII Terminal Emulation

### AEA Port Set Worksheet

Shown below are names of Port Sets. These Port Set names are arbitrary but must consist of no more than 8 characters (including blanks). For 3270 stations, port type is always 1 (coax) and modem type is irrelevant. The 3174 Attachment Diagrams indicate that we have three port sets:

- PSA3178
- PSVAXVMS
- PSPARTS.

**PSA3178:** Is the port set for Terminal Adapter ports that require access to the DEC host. Session Limit is 1, Port Type is 1 (coax), and Modem Type is irrelevant. Note that PSA3178 is port set 1.

**PSVAXVMS:** Is the port set for AEA ports attached to the VAX VMS application on the DEC host. Session Limit is irrelevant, Port Type is 4 (nonswitched), and because we are using limited-distance modems, Modem Type need not be specified. Note that PSVAXVMS is port set 2.

**PSPARTS:** Is the port set for AEA ports attached to the PARTS application on the DEC host. Session Limit is irrelevant, Port Type is 4 (nonswitched), and Modem Type need not be specified. Note that PSPARTS is port set 3.

AEA Port Set					
	Name	Session Limit	Port Type	Modem Type	Password
1	<u>PSA3178</u>	<u>1</u>	<u>1</u>	—	_____
2	<u>PSVAXVMS</u>	<u>0</u>	<u>4</u>	—	_____
3	<u>PSPARTS</u>	<u>0</u>	<u>4</u>	—	_____
4	_____	—	—	—	_____
5	_____	—	—	—	_____
6	_____	—	—	—	_____
7	_____	—	—	—	_____
8	_____	—	—	—	_____
9	_____	—	—	—	_____
10	_____	—	—	—	_____
11	_____	—	—	—	_____
12	_____	—	—	—	_____
13	_____	—	—	—	_____
14	_____	—	—	—	_____
15	_____	—	—	—	_____
16	_____	—	—	—	_____

**AEA Port to Port Set Map Worksheet**

On the worksheet shown below, we have assigned ports to a port set by writing the number of the port set (1, 2, or 3) on the line corresponding to the port number that is to be in a particular port set. We have filled in:

- 1 for those ports in PSA3178  
Terminal Adapter ports 0–7 and 8–14 are mapped to port set PSA3178.
- 2 for those ports in PSVAXVMS  
AEA ports 0–4 are mapped to port set PSVAXVMS.
- 3 for those ports in PSPARTS.  
AEA ports 6 and 7 are mapped to port set PSPARTS.

AEA Port to Port Set Map								
3270 Ports	0	1	2	3	4	5	6	7
26-00 to 26-07	<u>1</u>	<u>1</u>	<u>1</u>	<u>1</u>	<u>1</u>	<u>1</u>	<u>1</u>	<u>1</u>
26-08 to 26-15	<u>1</u>	<u>1</u>	<u>1</u>	<u>1</u>	<u>1</u>	<u>1</u>	<u>1</u>	—
26-16 to 26-23	—	—	—	—	—	—	—	—
26-24 to 26-31	—	—	—	—	—	—	—	—
27-00 to 27-07	—	—	—	—	—	—	—	—
27-08 to 27-15	—	—	—	—	—	—	—	—
27-16 to 27-23	—	—	—	—	—	—	—	—
27-24 to 27-31	—	—	—	—	—	—	—	—
AEA Ports	0	1	2	3	4	5	6	7
21-00 to 21-07	<u>2</u>	<u>2</u>	<u>2</u>	<u>2</u>	<u>2</u>	—	<u>3</u>	<u>3</u>
22-00 to 22-07	—	—	—	—	—	—	—	—
23-00 to 23-07	—	—	—	—	—	—	—	—

**AEA Station Set Worksheets**

Referring to the 3174 Attachment Diagrams, we see that we have four station sets: VM SYS 2, VAX VMS, PARTS, and 3178 TERMS. An AEA station set worksheet has been filled out for each station set (Figures B-3 through B-6).

**VM SYS 2:** The IBM host must be assigned to a station set. In Figure B-3, we have filled in the worksheet number (1) in the upper left corner of the worksheet, and have written in responses to the following configuration questions:

- 721** Station set name. We have specified **VM SYS 2** as the name of the IBM host station set; it will appear in the Connection Menu.
- 722** Station type. We have specified **3H** as the IBM (3270) host station type.

AEA Station Set																		
1	721	VM SYS 2	722	3H	723	<table border="1" style="width: 100%; height: 15px;"> <tr> <td> </td><td> </td><td> </td><td> </td><td> </td><td> </td><td> </td><td> </td><td> </td><td> </td> </tr> </table>											725	1
	731	732	733	734	735	736	737											
	1	1	8	-	8	1	-											
	741	742	743	744	745	746												
	8 8 8	8 1 5	1	8	8	8 8												
	751	752																
	-																	
	761	762	763	764	765													
	1	1	1	1	8													
	771	772	773	774	775	776												
	1	1	1	1	2	1												
	781	782	783	784	785	786	787											
	8	8	8 6 6	1	1 1 1 1 0 0 0	1 3 2	8											

Figure B-3. AEA Station Set Worksheet—VM SYS 2

**VAX VMS:** This is a DEC application that represents a unique destination. In Figure B-4 we have filled in the worksheet number (2) in the upper left corner of the worksheet, and have written in responses to the following configuration questions:

- 721** Station set name. We have specified **VAX VMS** as the name for this station set; it will appear in the Connection Menu.
- 722** Station type. We have specified **AH** for the ASCII host station type.
- 723** Port set name. We have specified **PSVAXVMS** as the port set associated with station set VAX VMS.
- 733** Line speed. We have specified **6** to indicate a line speed of 9600 bps.
- 735** Parity. We have specified **1** to indicate that odd parity will be used.
- 742** Idle time-out. We have increased the idle time-out (default = 15 minutes) to **30** minutes because port availability will not be a problem.
- 751** Data stream supported by the ASCII host. We have specified **1** to indicate that the ASCII host supports VT100 data stream.
- 764** Margin bell. We have specified **0** because margin bell is not useful with the applications that will be used.

AEA Station Set														
2	721 -	VAX VMS					722 -	AH	723 -	PSVAXVMS			725 -	8
731 -	1	732 -	1	733 -	6	734 -	0	735 -	1	736 -	1	737 -		
741 -	8	742 -	0	743 -	1	744 -	8	745 -	8	746 -	8	747 -	8	
751 -	1													
761 -	1	762 -	1	763 -	1	764 -	0	765 -	8					
771 -	1	772 -	1	773 -	1	774 -	1	775 -	2	776 -	1			
781 -	8	782 -	8	783 -	8	784 -	1	785 -	1	786 -	1	787 -	8	

Figure B-4. AEA Station Set Worksheet—VAX VMS

## Planning Example – ASCII Terminal Emulation

**PARTS:** This is another DEC application that represents a unique destination. In Figure B-5, we have filled in the worksheet number (3) in the upper left corner of the worksheet and have written in responses to the following configuration questions:

- 721** Station set name. We have specified **PARTS** as the name of the station set; this name will appear in the Connection Menu.
- 722** Station type. We have specified **AH** for the ASCII host station type.
- 723** Port set name. We have specified **PSPARTS** as the port set associated with station set PARTS.
- 733** Line speed. We have specified **6** to indicate a line speed of 9600 bps.
- 735** Parity. We have specified **1** to indicate that odd parity will be used.
- 742** Idle time-out. We have increased the idle time-out to **30** minutes to allow users more time to do other things.
- 751** Data stream supported by the ASCII host. We have specified **1** to indicate that the ASCII host supports VT100 data stream.
- 762** Wraparound option. We have specified a **0** because wraparound is not a useful function when using the PARTS application.

AEA Station Set									
<u>3</u>	721 - PARTS	722 - AH	723 - PSPARTS	725 -					
				①					
731 -	732 -	733 - 6	734 -	735 - 1	736 -	737 -			
①	①	8	⊖	8	①				
741 -	742 - 030	743 -	744 -	745 -	746 -				
⓪ ⓪ ⓪	8 1 5	①	⓪	⓪	⓪ ⓪				
751 -	752 -								
761 -	762 - 0	763 -	764 -	765 -					
①	1	①	①	⓪					
771 -	772 -	773 -	774 -	775 -	776 -				
①	①	①	①	②	①				
781 -	782 -	783 -	784 -	785 -	786 -	787 -			
⓪	⓪	⓪ ⓪ ⓪	①	1 1 1 1 0 0 0	① 3 2	⓪			

Figure B-5. AEA Station Set Worksheet—PARTS

**3178 TERMS:** This station set consists of those 3178 terminals with access to DEC applications. In Figure B-6, we have filled in the worksheet number (4) in the upper left corner of the worksheet and have written in responses to the following configuration questions:

- 721** Station set name. We have specified **3178 TERMS** as the name of the station set.
- 722** Station type. We have specified **3D** for the 3270 display station type.
- 723** Port set name. We have specified **PSA3178** as the port set associated with station set 3178 TERMS.

AEA Station Set									
4	721 - 3178 TERMS		722 - 3D	723 - PSA3178		725 -			
731 -	732 -	733 -	734 -	735 -	736 -	737 -			
741 -	742 -	743 -	744 -	745 -	746 -				
751 -									
761 -	762 -	763 -	764 -	765 -					
771 -	772 -	773 -	774 -	775 -	776 -				
781 -	782 -	783 -	784 -	785 -	786 -	787 -			

Figure B-6. AEA Station Set Worksheet—3178 TERMS

**AEA Default Destination Worksheet**

On this worksheet, we have specified the IBM host, VM SYS 2, as AEA station set number 1; we have filled in the other station set names in the order that we had defined them on the AEA Station Set worksheets. In addition, we have added a 1 at the intersection of LT1 (logical terminal 1) and 3178 TERMS to indicate that when stations in station set 3178 TERMS are turned on, they will be connected to AEA Station Set Number 1, VM SYS 2.

AEA Default Destination							
Station Set	Station Set Name	Session Limit	Session				
			LT1	LT2	LT3	LT4	LT5
1	<u>VM SYS 2</u>	—	—	—	—	—	
2	<u>VAX VMS</u>	—	—	—	—	—	
3	<u>PARTS</u>	—	—	—	—	—	
4	<u>3178 TERMS</u>	<u>1</u>	<u>1</u>	—	—	—	
5	_____	—	—	—	—	—	
6	_____	—	—	—	—	—	
7	_____	—	—	—	—	—	
8	_____	—	—	—	—	—	
9	_____	—	—	—	—	—	
10	_____	—	—	—	—	—	
11	_____	—	—	—	—	—	
12	_____	—	—	—	—	—	
13	_____	—	—	—	—	—	
14	_____	—	—	—	—	—	
15	_____	—	—	—	—	—	

Figure B-7. AEA Default Destination Worksheet—ASCII Terminal Emulation

This is the end of the section describing filling out the worksheets. Refer to Chapter 12, "Planning for the Asynchronous Emulation Adapter," for more information.

---

## 3270 Terminal Emulation Planning Example

In this example, we will set up communication between remote ASCII terminals and a channel-attached IBM host.

### System Description and Requirements

A large MVS/VTAM/TSO/IMS installation supports four hundred 3270 displays of various types on three mainframes. Night-time access is needed to two of the mainframes for 40 system programmers who have PCs with 5842 modems at home. Use of this service will be infrequent but intensive when needed. Twelve of the PCs use FTTERM and have color monitors, and attached printers. A VT100 emulator will be used with the other PCs.

### What We Have to Do

- Design a configuration that uses the AEA feature to meet this requirement.
- Decide what connection mechanism to use, how many lines are needed, what controllers will be affected, and how many AEA features to install.
- Outline operational and security procedures.
- Complete Site Planning and Customization worksheets to implement your solution.
- Enter the data into customization panels.
- IML a customized controller and check out the system.

### Specific Design Qualifications

1. To support the possibility that all 40 users may need IBM host access at the same time, we need to provide 40 AEA ports. Allowing for growth, we will need six AEAs.
2. ASCII traffic will be distributed across six controllers: three of the controllers are connected to one IBM host, and three are connected to the other IBM host. Therefore, each set of three controllers will support 20 ASCII users.
3. One AEA port is needed for each ASCII user. Therefore, for 40 users, seven ports per AEA will support the traffic. To provide room for system growth, we will configure eight AEA ports, but use only six or seven.
4. Switched communication is supported by IBM 5842 auto-call modems attached to the AEA ports.
5. IBM hosts are SNA hosts, so there are no host address limitations.



### Hardware Requirements

- Six Asynchronous Emulation Adapters (one per controller)
- 40 cables
- 40 modems
- 40 telephone circuits.

### 3174 Attachment Diagrams

Once we have determined the number of ports needed, the modem types, and the method of connecting stations to the AEA ports, we can diagram the layout of the system and identify station sets and port sets. A system layout consists of a 3270 Attachment Diagram and an ASCII Attachment Diagram. However, because the 3270 terminals are not involved in this configuration, we need only to fill out an ASCII Attachment Diagram. These diagrams are a useful reference for both site planning and customization activities.

See Figure B-8 on page B-19 for a sample ASCII Attachment Diagram. We have filled in portions of this diagram; these portions are printed in ***bold italic***. The diagram has been filled in by (1) identifying the stations and station sets, (2) identifying the ports and port sets, and then (3) indicating the assignment of station sets to port sets.

### ASCII Attachment Diagram

For the ASCII Attachment Diagram, we have:

1. Written in the name of the available host, MVS SYS A. The host is already numbered as Station Set 1.
2. Written in the ASCII station types: FC and V1. FC is the station type for the group of FTTERM PC terminals, and V1 is the station type for the group of PC's running VT100 terminal emulators.
3. Written in the Default Destination: 1 = MVS SYS A.
4. Added brackets around those stations of the same type and default destination, and assigned these stations the Station Set names PC FTTERM COLOR and PC VT100.
5. Written in the Port Type (2) and Modem Type (3) for AEA ports 21-00 through 21-07; the arrows indicate the repetition of the previous Port or Modem Type.
6. Added a bracket around this group of AEA ports with the same Port Type, Modem Type, and Default Destination and assigned it the Port Set name, DIALINT.
7. Drawn a switched-line, phone network symbol, and added arrows to show that Station Sets PC FTTERM COLOR and PC VT00 are served by the switched ports of Port Set, DIALINT.

### Hardware Setup

Listed are the major tasks required for hardware setup:

1. Install one AEA in each of six controllers (C1 through C6). Follow the setup and checkout procedures in the setup instructions provided with the AEA feature.
2. Set up and check out cables, modems, and telephone connections.

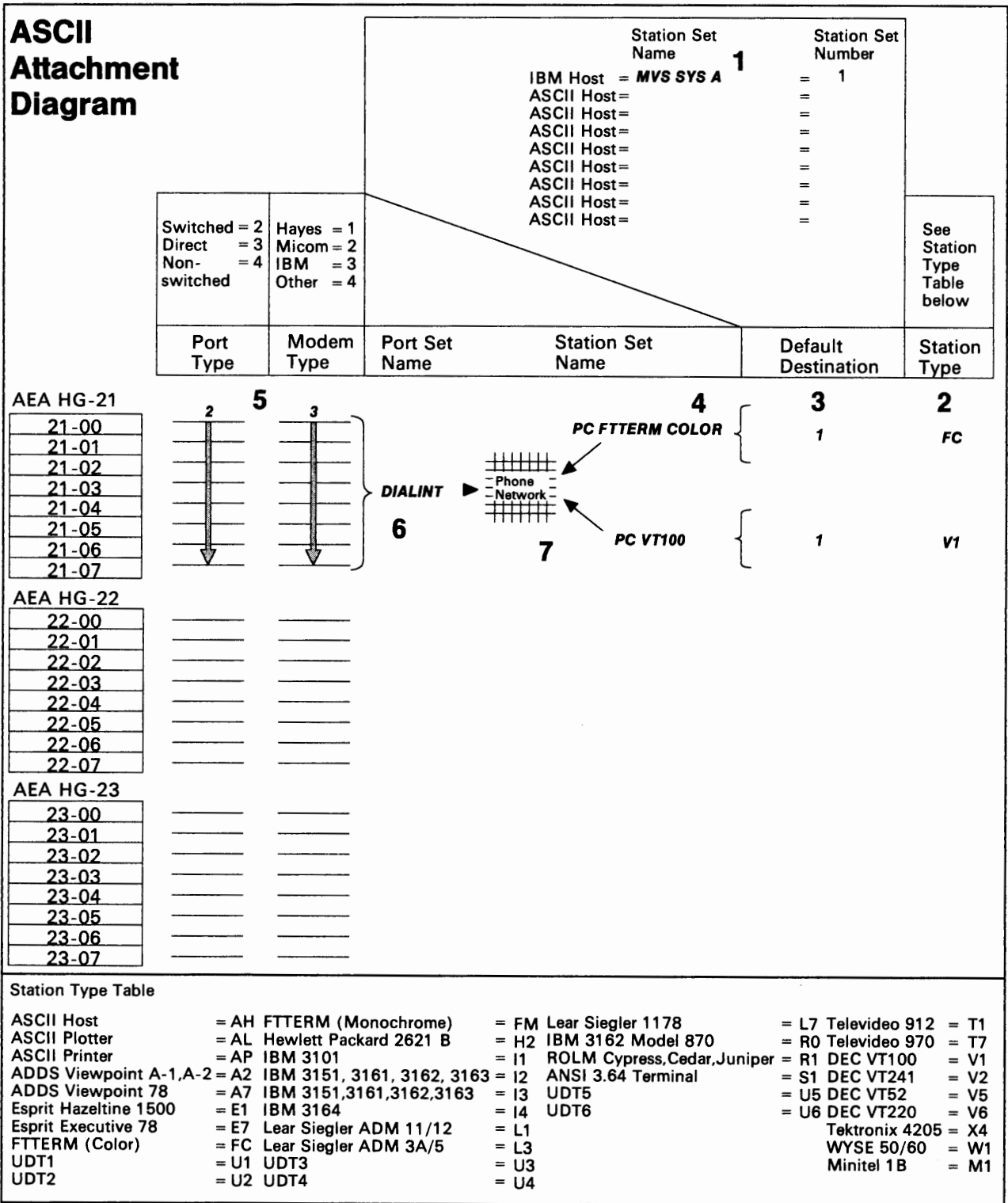

Figure B-8. 3270 Terminal Emulation—ASCII Attachment Diagram

### Customization Requirements

The AEA customization worksheets for C1 are shown below. The customization for C2 through C6 is identical to that for C1.

Using the ASCII Attachment Diagram, we have filled out the following worksheets:

- AEA Configuration
- AEA Port Set
- AEA Port to Port Set Map
- AEA Station Set
- AEA Default Destination.

When a default response for a configuration question did not meet the requirements of our network, an alternate response was written on the worksheet. Use of the default response was indicated by circling it.

**Note:** Most defaults were chosen to simplify the examples; they do not imply a recommendation.

**Note:** An ASCII terminal emulating a 3270 terminal requires a 3270 host address. Therefore, the Port Assignment Worksheet must also be filled out. For attached printer support each port must be assigned two host addresses and the controller must be configured for Multiple Logical Terminals (MLT) support. Refer to Chapter 7 for information on the Port Assignment Worksheet.

For detailed information on how to fill out the worksheets, refer to Chapter 12, "Planning for the Asynchronous Emulation Adapter."

### AEA Configure Worksheet

On the following worksheet, we have filled in question 700 with a 1.

_____ AEA Configure _____	
700 -	<input type="checkbox"/> 1 <input type="checkbox"/> 0
702 -	<input type="checkbox"/> <input type="checkbox"/> 1
703 -	<input type="checkbox"/> <input type="checkbox"/> 0
710 -	<input type="checkbox"/> <input type="checkbox"/> <input type="checkbox"/> <input type="checkbox"/> <input type="checkbox"/> <input type="checkbox"/> <input type="checkbox"/> <input type="checkbox"/> <input type="checkbox"/> <input type="checkbox"/> <input type="checkbox"/> <input type="checkbox"/> <input type="checkbox"/> <input type="checkbox"/> <input type="checkbox"/> <input type="checkbox"/> <input type="checkbox"/> <input type="checkbox"/> <input type="checkbox"/> <input type="checkbox"/> 0 <input type="checkbox"/> 0 <input type="checkbox"/> 0 <input type="checkbox"/> 0 <input type="checkbox"/> 0 <input type="checkbox"/> 0 <input type="checkbox"/> 0 <input type="checkbox"/> 0
711 -	<input type="checkbox"/> <input type="checkbox"/> <input type="checkbox"/> <input type="checkbox"/> <input type="checkbox"/> <input type="checkbox"/> <input type="checkbox"/> <input type="checkbox"/> <input type="checkbox"/> <input type="checkbox"/> <input type="checkbox"/> <input type="checkbox"/> <input type="checkbox"/> <input type="checkbox"/> <input type="checkbox"/> <input type="checkbox"/> <input type="checkbox"/> <input type="checkbox"/> <input type="checkbox"/> <input type="checkbox"/> 0 <input type="checkbox"/> 0 <input type="checkbox"/> 0 <input type="checkbox"/> 0 <input type="checkbox"/> 0 <input type="checkbox"/> 0 <input type="checkbox"/> 0 <input type="checkbox"/> 0
712 -	<input type="checkbox"/> <input type="checkbox"/> <input type="checkbox"/> <input type="checkbox"/> <input type="checkbox"/> <input type="checkbox"/> <input type="checkbox"/> <input type="checkbox"/> <input type="checkbox"/> <input type="checkbox"/> <input type="checkbox"/> <input type="checkbox"/> <input type="checkbox"/> <input type="checkbox"/> <input type="checkbox"/> <input type="checkbox"/> <input type="checkbox"/> <input type="checkbox"/> <input type="checkbox"/> <input type="checkbox"/> 0 <input type="checkbox"/> 0 <input type="checkbox"/> 0 <input type="checkbox"/> 0 <input type="checkbox"/> 0 <input type="checkbox"/> 0 <input type="checkbox"/> 0 <input type="checkbox"/> 0
713 -	<input type="checkbox"/> <input type="checkbox"/> <input type="checkbox"/> <input type="checkbox"/> <input type="checkbox"/> <input type="checkbox"/> <input type="checkbox"/> <input type="checkbox"/> <input type="checkbox"/> <input type="checkbox"/> <input type="checkbox"/> <input type="checkbox"/> <input type="checkbox"/> <input type="checkbox"/> <input type="checkbox"/> <input type="checkbox"/> <input type="checkbox"/> <input type="checkbox"/> <input type="checkbox"/> <input type="checkbox"/> 0 <input type="checkbox"/> 0 <input type="checkbox"/> 0 <input type="checkbox"/> 0 <input type="checkbox"/> 0 <input type="checkbox"/> 0 <input type="checkbox"/> 0 <input type="checkbox"/> 0

**AEA Port Set Worksheet**

Shown below is a Port Set name. This Port Set name is arbitrary, but must consist of no more than 8 characters (including blanks). The ASCII Attachment Diagram indicates that we have one port set which is named DIALINT.

**DIALINT:** Is the port set for the AEA ports used by remote ASCII terminals. Session limit is 1 (even though some devices may have an attached printer), Port Type is 2 (switched), and Modem Type is 3 (IBM). Note that DIALINT is port set 1.

AEA Port Set					
	Name	Session Limit	Port Type	Modem Type	Password
1	<b>DIALINT</b>	<b>1</b>	<b>2</b>	<b>3</b>	_____
2	_____	—	—	—	_____
3	_____	—	—	—	_____
4	_____	—	—	—	_____
5	_____	—	—	—	_____
6	_____	—	—	—	_____
7	_____	—	—	—	_____
8	_____	—	—	—	_____
9	_____	—	—	—	_____
10	_____	—	—	—	_____
11	_____	—	—	—	_____
12	_____	—	—	—	_____
13	_____	—	—	—	_____
14	_____	—	—	—	_____
15	_____	—	—	—	_____
16	_____	—	—	—	_____

## Planning Example – 3270 Terminal Emulation

### AEA Port to Port Set Map Worksheet

On the worksheet shown below, we have assigned ports to a port set by writing the number of the port set (1) on the line corresponding to the port number that is in the particular port set. We have filled in 1 for ports 0-7 in Port Set DIALINT.

AEA Port to Port Set Map								
3270 Ports	0	1	2	3	4	5	6	7
26-00 to 26-07	—	—	—	—	—	—	—	—
26-08 to 26-15	—	—	—	—	—	—	—	—
26-16 to 26-23	—	—	—	—	—	—	—	—
26-24 to 26-31	—	—	—	—	—	—	—	—
27-00 to 27-07	—	—	—	—	—	—	—	—
27-08 to 27-15	—	—	—	—	—	—	—	—
27-16 to 27-23	—	—	—	—	—	—	—	—
27-24 to 27-31	—	—	—	—	—	—	—	—
AEA Ports	0	1	2	3	4	5	6	7
21-00 to 21-07	<u>1</u>	<u>1</u>	<u>1</u>	<u>1</u>	<u>1</u>	<u>1</u>	<u>1</u>	<u>1</u>
22-00 to 22-07	—	—	—	—	—	—	—	—
23-00 to 23-07	—	—	—	—	—	—	—	—

**AEA Station Set Worksheets**

Referring to the 3174 ASCII Attachment Diagram, we see that we have three station sets: MVS SYS A, PC FTTERM COLOR, and PC VT100. An AEA Station Set Worksheet must be filled out for each station set (Figures B-9 through B-11).

**MVS SYS A:** The IBM host must be assigned to a Station Set. In Figure B-9 we have filled in the worksheet number (1) in the upper left corner of the worksheet and have written in responses to the following configuration questions:

**721** Station set name. We have specified **MVS SYS A** as the name of the IBM host station set; it will appear in the Connection Menu.

**722** Station type. We have specified **3H** as the IBM (3270) host station type.

AEA Station Set							
<b>1</b>	721 - <u>MVS SYS A</u>		722 - <input type="text" value="3H"/>	723 - <input type="text" value=""/>		725 - <input type="text" value="1"/>	
731 - <input type="text" value="1"/>	732 - <input type="text" value="1"/>	733 - <input type="text" value="9"/>	734 - <input type="text" value="0"/>	735 - <input type="text" value="9"/>	736 - <input type="text" value="1"/>	737 - <input type="text" value=""/>	
741 - <input type="text" value="000"/>	742 - <input type="text" value="015"/>	743 - <input type="text" value="1"/>	744 - <input type="text" value="0"/>	745 - <input type="text" value="0"/>	746 - <input type="text" value="00"/>		
751 - <input type="text" value="0"/>	752 - <input type="text" value=""/>						
761 - <input type="text" value="0"/>	762 - <input type="text" value="1"/>	763 - <input type="text" value="1"/>	764 - <input type="text" value="1"/>	765 - <input type="text" value="0"/>			
771 - <input type="text" value="1"/>	772 - <input type="text" value="1"/>	773 - <input type="text" value="1"/>	774 - <input type="text" value="1"/>	775 - <input type="text" value="0"/>	776 - <input type="text" value="1"/>		
781 - <input type="text" value="1"/>	782 - <input type="text" value="1"/>	783 - <input type="text" value="066"/>	784 - <input type="text" value="1"/>	785 - <input type="text" value="1111000"/>	786 - <input type="text" value="132"/>	787 - <input type="text" value="0"/>	

Figure B-9. AEA Station Set Worksheet—MVS SYSTEM A

## Planning Example – 3270 Terminal Emulation

**PC FTTERM COLOR:** This is the remote PC with a color monitor and attached printer running FTTERM that requires access to MVS SYS A. In Figure B-10, we have filled in the worksheet number (2) in the upper left corner of the worksheet and have written in responses to the following configuration questions:

**Note:** We have accepted the default values for questions 733 (line speed = autobaud) and 735 (parity = auto) because calls will be coming in at different speeds.

- 721** Station set name. We have specified **PC FTTERM COLOR** as the name of the station set.
- 722** Station type. We have specified **FC** as station type to indicate that these IBM PCs are using FTTERM with color displays.
- 723** Port set name. We have specified **DIALINT** as the port set associated with station set PC FTTERM COLOR.
- 737** Maximum modem line speed. We have specified a **4** to indicate a maximum modem line speed of 2400 bps (maximum speed supported by the IBM 5842).
- 742** Idle time-out. We have increased the idle time-out (default = 15 minutes) to **60** minutes because port availability will not be a problem; a separate port is provided for each user.
- 781** Attached printer prompt. We have responded to this question with a **1**, causing the user to be asked whether he has an attached printer.

DO YOU HAVE A PRINTER ATTACHED TO THIS TERMINAL?  
(1 = YES, 0 = NO) =====> \_

The user's answer to this prompt will determine whether or not the AEA will manage the attached printer.

AEA Station Set																	
2	721 -	PC FTTERM COLOR			722 -	FC	723 -	DIALINT		725 -							
											①						
	731 -		732 -		733 -		734 -		735 -		736 -		737 -	4			
		①		①		⑧		①		⑧		①		—			
	741 -		742 -	060		743 -		744 -		745 -		746 -					
		⑧ ⑧ ⑧		⑧ 1 5		①		⑧		⑧		⑧	⑧				
	751 -		_____														
	761 -		762 -		763 -		764 -		765 -								
		①		①		①		①		⑧							
	771 -		772 -		773 -		774 -		775 -		776 -						
		①		①		①		①		②		①					
	781 -	1	782 -		783 -	066		784 -		785 -	1111000			786 -		787 -	
		⑧		⑧		⑧ 6 6		①			① 1 1 1 0 0 0			① 3 2			⑧

Figure B-10. AEA Station Set Worksheet—PC FTTERM COLOR

## Planning Example – 3270 Terminal Emulation

**PC VT100:** These are the remote PCs running a DEC VT100 Emulation Program that require access to MVS SYS A. In Figure B-11 we have filled in the worksheet number (3) in the upper left corner of the worksheet, and have written in responses to the following configuration questions:

**Note:** Questions 733 and 735 are left at their default values. All display stations assigned to the same port set must have the same settings for line speed, parity, and stop bits.

- 721** Station set name. We have specified **PC VT100** as the name of the station set.
- 722** Station type. We have specified **V1** as station type to indicate that these are PCs running a VT100 Emulation Program.
- 723** Port set name. We have specified **DIALINT** as the port set associated with station set PC VT100.
- 737** Maximum modem line speed. We have specified a **4** to indicate a maximum modem line speed of 2400 bps (maximum speed for this station set), VT100.
- 742** Idle time-out. We have increased the idle time-out (default = 15 minutes) to **60** minutes because port availability will not be a problem; a separate port is provided for each user.

AEA Station Set									
3	721 - PC VT100	722 - V1	723 - DIALINT	725 - 1					
731 - 1	732 - 1	733 - 8	734 - 1	735 - 8	736 - 1	737 - 4			
741 - 8 8 8	742 - 0 6 0	743 - 1	744 - 8	745 - 8	746 - 8 8				
751 -	752 -								
761 - 1	762 - 1	763 - 1	764 - 1	765 - 8					
771 - 1	772 - 1	773 - 1	774 - 1	775 - 2	776 - 1				
781 - 8	782 - 8	783 - 8 6 6	784 - 1	785 - 1 1 1 1 1 0 0 0	786 - 1 3 2	787 - 8			

Figure B-11. AEA Station Set Worksheet—PC VT100



**AEA Default Destination Worksheet**

On this worksheet, we have specified the IBM host, MVS SYS A, as AEA station set number 1. We have filled in the other station set names in the order that we defined them on the AEA Station Set worksheets. We have added a 1 at the intersections of LT1 and PC FTTERM COLOR and LT1 and PC VT100 to indicate that, when stations in these station sets dial in to the controller, they will be connected to the AEA station set number 1, MVS SYS A.

AEA Default Destination							
Station Set	Station Set Name	Session Limit	Session				
			LT1	LT2	LT3	LT4	LT5
1	<b>MVS SYS A</b>						
2	<b>PC FTTERM COLOR</b>	<b>1</b>	<b>1</b>				
3	<b>PC VT100</b>	<b>1</b>	<b>1</b>				
4							
5							
6							
7							
8							
9							
10							
11							
12							
13							
14							
15							

Figure B-12. AEA Default Destination Worksheet – 3270 Terminal Emulation

This is the end of the section describing filling out the worksheets. Refer to Chapter 12, "Planning for the Asynchronous Emulation Adapter," for more information.

---

## 3270 and ASCII Terminal Emulation Planning Example

### System Description and Requirements

A VMPROFS system with channel-attached 3274s has a large number of another manufacturer's (OEM) protocol converters attached over BSC lines. 3270 terminals are attached to the 3274s; locally attached ASCII display stations emulating ADDS Viewpoint 78s and dial-in VT220 displays (emulating VT100s) are attached to the OEM protocol converters. Local non-SNA 3274s are to be replaced by 3174s. In so doing, some of the OEM protocol converters will be replaced by AEA features; only the VT220s will be connected to the AEAs. In addition, a number of inexpensive ASCII printers are needed to be used for local copy near some of the 3270 displays. Communication also needs to be set up between the 3270 terminals and a remote information service (INFOSERV). Finally, dial-out communication needs to be set up between the 3270 terminals and a remote ASCII host.

### What We Have to Do

Design a representative controller configuration that addresses these requirements; complete only the 3174 Attachment Diagrams for one controller (C1).

### Specific Design Qualifications

- Six controllers are required to distribute data traffic evenly.
- VT220s will be prompted for a password.
- Systems analysis shows that the information service and the VT220s can be supported by 12 switched AEA ports per controller; these ports will be used by 3270 terminals to dial out to the information service, or by remote VT220s to dial in to the IBM host. In addition, 12 AEA ports will be used for local ASCII printers.

### Hardware Requirements

- Three AEA cards (provides 18 ports)
- Twelve auto-call modems (per controller) to support dialing out to the information service and dialing in from the VT220s
- Twelve limited-distance modem pairs per controller for ASCII printers
- Twenty-four cables per controller for LDMs and auto-call modems
- Twisted-pair wiring to each ASCII printer.

### 3174 Attachment Diagrams

Once we have determined the number of ports needed, the modem types, and the method of connecting stations to the AEA ports, we can diagram the layout of the system and identify station sets and port sets. A system layout consists of a 3270 Attachment Diagram and an ASCII Attachment Diagram. These diagrams are a useful reference for both site planning and customization activities.

See Figures B-13 and B-14 for sample attachment diagrams for C1. The diagrams have been filled in by (1) identifying the stations and station sets, (2) identifying the ports and port sets, and then (3) indicating the assignment of station sets to port sets.

### 3270 Attachment Diagram

For the 3270 Attachment Diagram, we have:

1. Written in the names of the available hosts (VMPROFS and INFOSERV), and numbered INFOSERV as station set 2.
2. Written in the 3270 station type (3D), and drawn an arrow down to Terminal Adapter port 27 to show that these ports are used by 3270 displays.
3. Written in the Default Destination (1 = VMPROFS). The arrows show that all 3270 displays have the same default destination.
4. Added a bracket around these stations of the same type and default destination configuration, and assigned to them the station set name 3270 TERMS.
5. Added brackets around the ports to which the 3270 display stations are connected, and assigned these ports the port set name PS3270.
6. Added an arrow to show that the station set 3270 TERMS is served by port set PS3270.

**Note:** This example only shows terminals attached to HG 26.

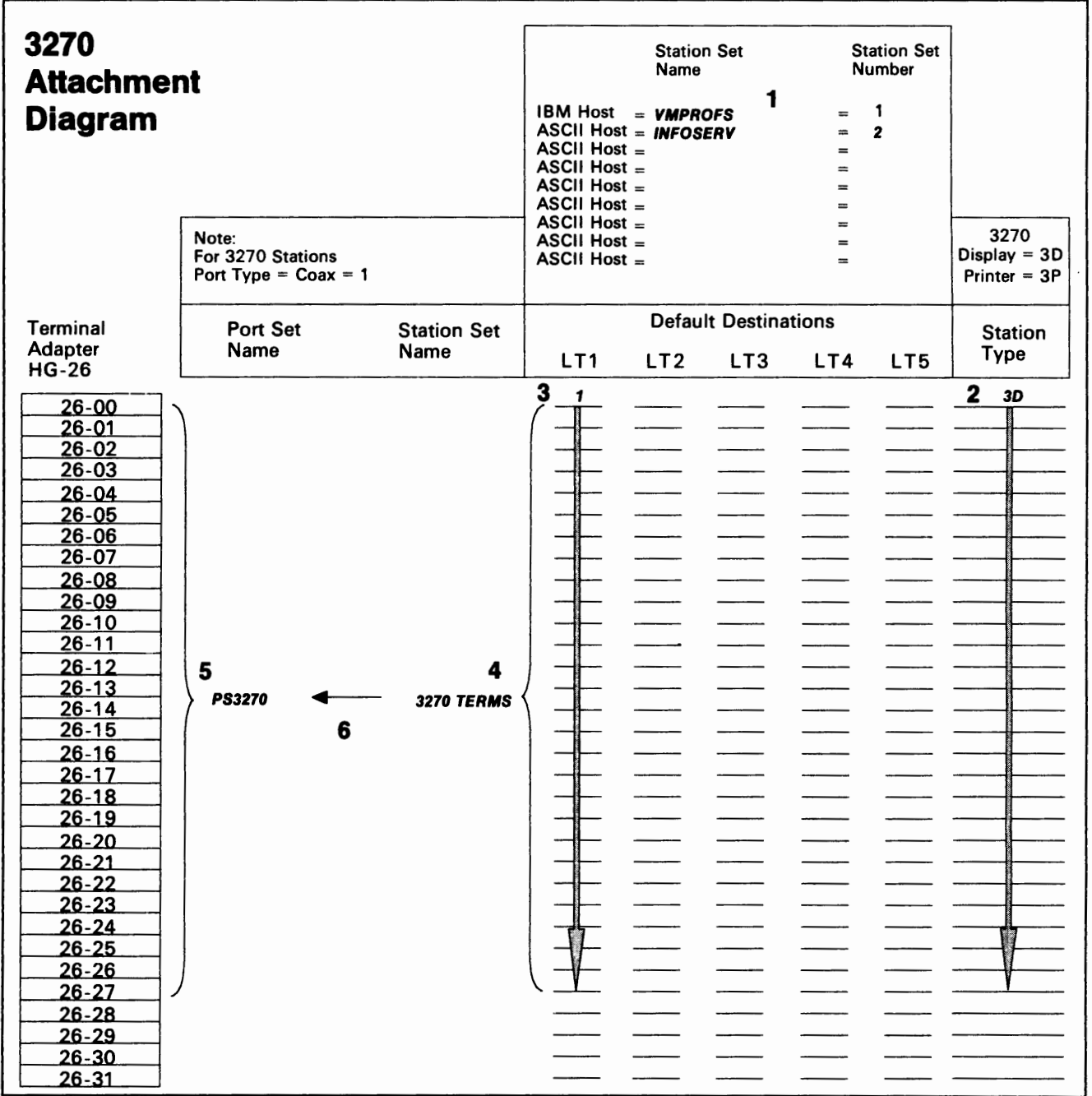

Figure B-13. 3270/ASCII Terminal Emulation – 3270 Attachment Diagram

### ASCII Attachment Diagram

For the ASCII Attachment Diagram, we have:

1. Written in the names of the available hosts (VMPROFS and INFOSERV), and numbered INFOSERV as station set 2.
2. Written in the ASCII station types (AH, V1, and AP); V1 is the station type for the group of VT220 terminals, and AP is the station type for the 12 ASCII printers.
3. Written in the Default Destination (1 = VMPROFS); default destination does not apply (NA) to an AH.
4. Added brackets around those stations of the same type and default destination, and assigned these stations the station set names INFOSERV, VT220, and LOCPRTR.
5. Written in the Port Type (2) and Modem Type (3) for AEA ports 21-00 through 22-03 (12 ports); the arrows indicate the repetition of the previous Port or Modem Type.
6. Written in the Port Type (4) and Modem Type (not applicable) for AEA ports 22-04 through 23-07 (12 ports); the arrows indicate the repetition of the previous Port or Modem Type.
7. Added a bracket around each group of AEA ports that have the same Port Type, Modem Type, and Default Destination and assigned each group a port set name: INFODIAL for ports 21-00–21-05, IBMDIAL for ports 21-06–22-03, and PRTR for ports 22-04–23-07.
8. Added arrows to show that the station sets INFOSERV and VT220 are serviced by the switched ports of port sets INFODIAL and IBMDIAL respectively.
9. Added an arrow to show that Station Set LOCPRTR is served by the nonswitched ports of port set PRTR.

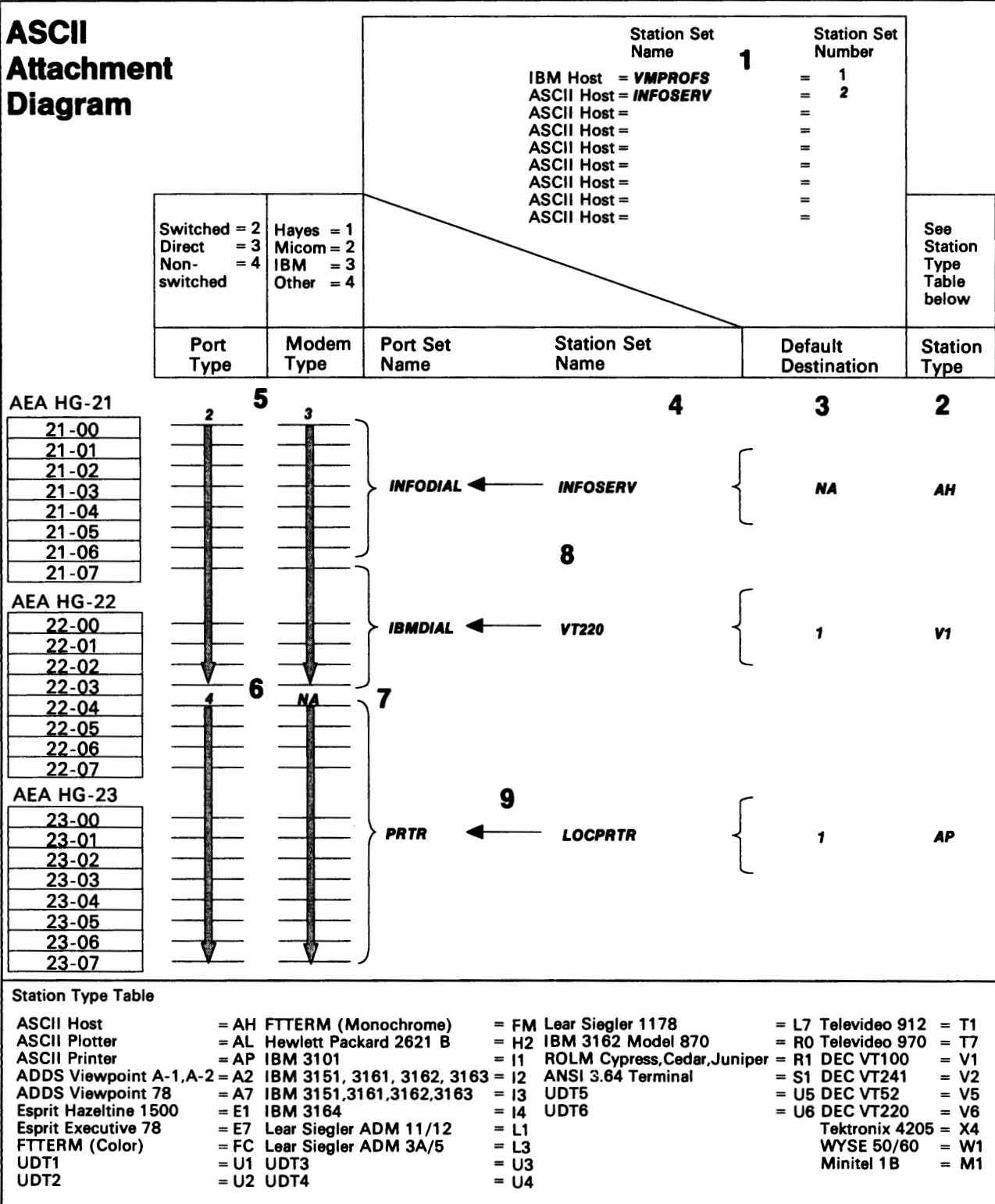

Figure B-14. 3270/ASCII Terminal Emulation – ASCII Attachment Diagram

## **Additional Customizing Requirements**

To provide system security on the dial-in ports (VT220s only), a password could be specified on the AEA Configuration worksheet, question 701. Additionally, on the AEA Station Set worksheet, you could restrict the stations in the VT220 station set from using the Connection Menu; the VT220s would have access only to the IBM host.

When a default response for a configuration question on the AEA Station Set worksheet did not meet the requirements of our network, an alternate response was specified. Use of the default response was indicated by circling it.

**Note:** Most defaults were chosen to simplify the examples; they do not imply a recommendation.

To assign the ASCII printers to 3270 terminals, you will have to define the printer authorization matrix (PAM). Refer to Chapter 13, "Planning to Define Devices," for more information.

**AEA Station Set Worksheet**

**INFOSERVE:** The controller dialing out to a remote host requires access to a modem operating at 1200bps. In Figure B-15, we have filled in the worksheet number (1) in the upper left corner of the worksheet and have written in responses to the following configuration questions:

- 721** Station set name. We have specified **ASCII HOST** as the name of the station set.
- 722** Station type. We have specified **AH** as station type to indicate that this station can dial out to an ASCII host.
- 723** Port set name. We have specified **INFODIAL** as the port set associated with station set ASCII HOST.
- 733** Line speed. We have specified **3** to indicate a line speed of 1200 bps.
- 735** Parity. We have specified **4** to indicate that space parity will be used.
- 742** Idle time-out. We have specified **60** minutes for idle time-out because port availability will not be a problem; a separate port is required for each user.
- 751** Data stream support by the ASCII host. We have specified **1** to indicate that the ASCII host supports VT100 data stream.
- 752** ASCII host phone number. We have specified (as an example only) the phone number of the ASCII host. This number will be sent to an auto-call modem when a connection to this host is requested. This dial string can contain control characters the modem uses to perform certain operations (for example, "wait for second dial tone").

AEA Station Set									
1	721 - ASCII HOST	722 - AH	723 - INFODIAL	725 -					
	731 -	732 -	733 - 3	734 -	735 - 4	736 -	737 -		
	741 -	742 - 060	743 -	744 -	745 -	746 -			
	751 -	752 - T9ww1ww234w5678901							
	761 -	762 -	763 -	764 -	765 -				
	771 -	772 -	773 -	774 -	775 -	776 -			
	781 -	782 -	783 -	784 -	785 -	786 -	787 -		

Figure B-15. AEA Station Set Worksheet—ASCII HOST

This is the end of the section describing filling out the worksheets. Refer to Chapter 12, "Planning for the Asynchronous Emulation Adapter," for more information.





---

# Appendix C. Token-Ring Planning Examples

- An Overview of the Token-Ring Planning Examples ..... C-3
- Example 1 – Local Gateway and Downstream 3174 Model 13Rs ..... C-3
  - Worksheets for the Local Gateway ..... C-5
  - Worksheets for the 3174 13Rs ..... C-11
- Example 2 – Remote Gateway ..... C-14
  - Worksheets for the Remote Gateway ..... C-16



---

## An Overview of the Token-Ring Planning Examples

In the following planning examples, we present sample computer environments with data communication requirements that are managed through a Token-Ring Network. The first planning example shows the configuration of a local gateway and three downstream 3174 Model 13Rs. The second planning example shows the configuration of a remote gateway.

In each example, we start with the overall description of the computer environment and provide a diagram of the network. Then, the completed planning worksheets for the controllers in the network are presented and explained.

---

### Example 1 – Local Gateway and Downstream 3174 Model 13Rs

A sales organization on the east coast is housed in a two-story building. On the first floor, administrative personnel carry out the day-to-day duties of entering sales orders and administrative records using personal computers. On the second floor, the sales representatives require access to product, availability, and cost data.

In Figure C-1 on page C-4, we have a network that meets these needs. The network consists of:

- A host
- A 3174 Model 11L being used as the 3270 gateway controller
- A terminal attached to the 3270 gateway controller for running online tests
- A backbone ring on the second floor running at 16Mbps
- Three 3174 Model 13Rs attached to the backbone ring, each controlling twenty 3270 terminals
- A bridge connecting the two Token-Ring Networks
- A local ring on the first floor running at 4Mbps
- Fifteen IBM personal computers attached to the local ring.

# Token-Ring Planning Examples

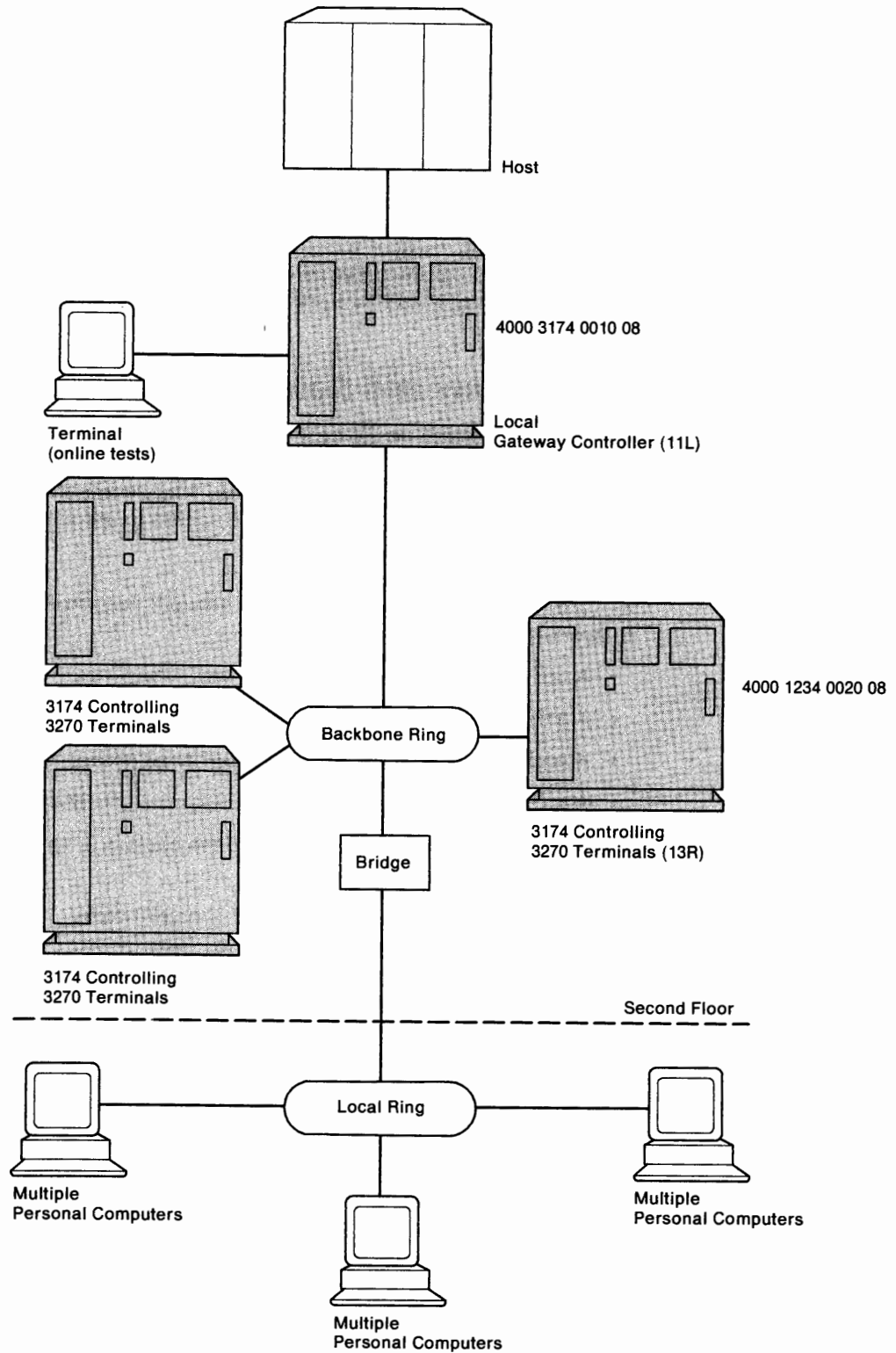

Figure C-1. Token-Ring Network – Local Gateway and Downstream 3174 13Rs

## Worksheets for the Local Gateway

To plan for the local gateway, we have responded to configuration questions on the following worksheets:

- “Worksheet 1—Host Attachment”
- “Worksheet 7—SNA (Channel)”
- “Worksheet 32—Token-Ring Gateway”
- “Worksheet 33—Ring Address Assignment”
- “Worksheet 34—Ring Transmission Definition”
- “Worksheet 14—Common SNA.”

When a default response for a configuration question did not meet the requirements of our network, an alternate response was written on the worksheet. Use of the default response was indicated by circling it.

**Note:** Most defaults were chosen to simplify the examples; they do not imply a recommendation.

### Host Attachment Worksheet – Local Gateway

On worksheet 1 (Figure C-2), we have written in responses to the following configuration questions:

- 098** Online Test Password. We have taken the default underscores.
- 099** Product assistance data. We have indicated that the **Systems Analysts** at telephone number **919-999-9999** should be contacted if there is a problem with the controller.
- 100** Model number. We have specified **11L**, the gateway’s model number.
- 101** Host attachment. A response of **5** was given to indicate that local SNA is the protocol being used.

Chapter 6 contains additional information on the configuration questions that appear on this worksheet.

\_\_\_\_\_ MODEL/ATTACH \_\_\_\_\_

098 -

099 -

100 -   
X X X

101 -   
X

Figure C-2. Worksheet 1 – Local Gateway

# Token-Ring Planning Examples

## Local (SNA) Worksheet – Local Gateway

On worksheet 7 (Figure C-3), we have written in responses to the following configuration questions:

- 104** Controller address. We have assigned the lower SDLC address X'10' to the gateway.
- 105** Upper limit address. We specified X'2E' as the highest SDLC address that can be assigned to the Token-Ring-attached devices. The responses to questions 104 and 105 provide a range of 31 addresses, allowing for future expansion.
- 108** Unique machine identifier. We have written in the Gateway's serial number **1234567** as the identifier.
- 150** Token-Ring Network Gateway Controller. A **1** was specified to identify this controller as the gateway.
- 215** Physical unit identification. We have specified **EB001** as the host's identifier for our Gateway.
- 220** Alert function. A response of **2** has been given, allowing an operator to send alert messages from port 0.
- 222** Support of command retry. A response of **1** has been given to indicate that commands are retried when error conditions are detected.
- 225** Channel burst size. We have responded with **7** to indicate 512 bytes per burst.

Chapter 6 contains additional information on the configuration questions that appear on this worksheet.

### Local (SNA)

104 - <input type="text" value="10"/>	105 - <input type="text" value="2E"/>	108 - <input type="text" value="1234567"/>	110 - <input type="text" value="00000000"/>	116 - <input type="text" value="00000000"/>
X X	0 0	0 0 0 0 0 0 0 0	0 0 0 0 0 0 0 0	0 0 0 0 0 0 0 0
121 - <input type="text" value="01"/>	123 - <input type="text" value="0"/>	125 - <input type="text" value="0000000000"/>	126 - <input type="text" value="0000000000"/>	127 - <input type="text" value="00"/>
132 - <input type="text" value="0000"/>	136 - <input type="text" value="0000"/>	137 - <input type="text" value="0000"/>	138 - <input type="text" value="0"/>	
141 - <input type="text" value="A"/>	150 - <input type="text" value="1"/>	165 - <input type="text" value="0"/>	166 - <input type="text" value="A"/>	168 - <input type="text" value="0"/>
173 - <input type="text" value="0000000000"/>	175 - <input type="text" value="00000000"/>	179 - <input type="text" value="000"/>		
213 - <input type="text" value="1"/>	215 - <input type="text" value="EB001"/>	220 - <input type="text" value="2"/>	221 - <input type="text" value="0"/>	
0	0 0 0 0 0	0	0	
222 - <input type="text" value="1"/>	223 - <input type="text" value="10"/>	224 - <input type="text" value="2"/>	225 - <input type="text" value="7"/>	
0	1 0	2	4	

Figure C-3. Worksheet 7 – Local Gateway

**Token-Ring Gateway Worksheet – Local Gateway**

On worksheet 32 (Figure C-4), we have written in responses to the following configuration questions:

- 900** Token-Ring Network address and SAP for the gateway. The locally administered address **4000 3174 0010 08** was assigned to the gateway. The SAP is **08**.
- 908** Link subsystem name. We have written in **GATE01**. The host will use this name to identify any alerts sent from the gateway.
- 911** Ring speed of the gateway. A response of **2** has been given to indicate that the backbone ring is running at 16Mbps with early token release.

Chapter 14 contains additional information on the questions that appear on this worksheet.

\_\_\_\_\_ Token-Ring Gateway \_\_\_\_\_

<p>900 - <table border="1" style="display: inline-table; border-collapse: collapse; text-align: center;"> <tr><td>4</td><td>0</td><td>0</td><td>0</td></tr> <tr><td>X</td><td>X</td><td>X</td><td>X</td></tr> </table> <table border="1" style="display: inline-table; border-collapse: collapse; text-align: center;"> <tr><td>3</td><td>1</td><td>7</td><td>4</td></tr> <tr><td>X</td><td>X</td><td>X</td><td>X</td></tr> </table> <table border="1" style="display: inline-table; border-collapse: collapse; text-align: center;"> <tr><td>0</td><td>0</td><td>1</td><td>0</td></tr> <tr><td>X</td><td>X</td><td>X</td><td>X</td></tr> </table> <table border="1" style="display: inline-table; border-collapse: collapse; text-align: center;"> <tr><td>0</td><td>8</td></tr> <tr><td>0</td><td>4</td></tr> </table> </p>	4	0	0	0	X	X	X	X	3	1	7	4	X	X	X	X	0	0	1	0	X	X	X	X	0	8	0	4	<p>905 - <table border="1" style="display: inline-table; border-collapse: collapse; text-align: center;"> <tr><td> </td></tr> <tr><td>1</td></tr> </table></p>		1	<p>908 - <table border="1" style="display: inline-table; border-collapse: collapse; text-align: center;"> <tr><td>G</td><td>A</td><td>T</td><td>E</td><td>0</td><td>1</td><td> </td><td> </td></tr> <tr><td>I</td><td>B</td><td>M</td><td>L</td><td>A</td><td>N</td><td> </td><td> </td></tr> </table></p>	G	A	T	E	0	1			I	B	M	L	A	N			
4	0	0	0																																														
X	X	X	X																																														
3	1	7	4																																														
X	X	X	X																																														
0	0	1	0																																														
X	X	X	X																																														
0	8																																																
0	4																																																
1																																																	
G	A	T	E	0	1																																												
I	B	M	L	A	N																																												
<p>911 - <table border="1" style="display: inline-table; border-collapse: collapse; text-align: center;"> <tr><td>2</td></tr> <tr><td>0</td></tr> </table></p>	2	0	<p>912 - <table border="1" style="display: inline-table; border-collapse: collapse; text-align: center;"> <tr><td> </td><td> </td></tr> <tr><td>0</td><td>0</td></tr> </table></p>			0	0																																										
2																																																	
0																																																	
0	0																																																

Figure C-4. Worksheet 32 – Local Gateway



## Token-Ring Planning Examples

### 940: Ring Address Assignment Worksheet – Local Gateway

On worksheet 33 (Figure C-5), we have:

- Left the S columns blank. The range of I/O addresses defined in questions 104 and 105 will fill these columns automatically during customization.
- Left the first Ring entry blank. The response to question 900 (gateway address) will automatically fill this entry during customization.

In the remaining Ring columns, we have entered the locally administered addresses of the attaching devices. To be consistent with the cursor movement on the customizer's screen, these addresses were entered from left to right. We chose to include the device types and I/O addresses in our addressing scheme.

- We entered 08 as the value for the SAP columns.
- In the T (type) columns, we circled the default (workstation) for each personal computer and wrote in a 1 (controller) for each 3174 13R.

Chapter 14 contains additional information pertaining to the columns on this worksheet.

_____940: Ring Address Assignment_____					_____940: Ring Address Assignment_____									
S	Ring				SAP	T	S	Ring				SAP	T	
	4	0	0	0	7	2	3	4	0	0	1	7	08	
	4	0	0	0	7	2	3	4	0	0	1	3	08	
	4	0	0	0	7	2	3	4	0	0	1	5	08	
	4	0	0	0	7	2	3	4	0	0	1	7	08	
	4	0	0	0	7	2	3	4	0	0	1	9	08	
	4	0	0	0	7	2	3	4	0	0	1	B	08	
	4	0	0	0	7	2	3	4	0	0	1	D	08	
	4	0	0	0	7	2	3	4	0	0	1	F	08	
	4	0	0	0	3	1	7	4	0	0	2	7	08	1
	4	0	0	0	0	0	0	0	0	0	2	3	08	
	4	0	0	0	0	0	0	0	0	0	2	5	08	
	4	0	0	0	0	0	0	0	0	0	2	7	08	
	4	0	0	0	0	0	0	0	0	0	2	9	08	
	4	0	0	0	0	0	0	0	0	0	2	B	08	
	4	0	0	0	0	0	0	0	0	0	2	D	08	

Figure C-5. Worksheet 33 – Local Gateway

**941: Ring Transmission Definition Worksheet – Local Gateway**

On worksheet 34 (Figure C-6), we have:

- Duplicated our Ring entries from the previous worksheet.
- Taken the 08 for the SAP columns.
- Made entries into the F (transmit I-frame size) columns:
  - For our personal computers, we have written a 0 (the default for workstations) to indicate 265-byte I-frame transmissions.
  - For our 3174 13Rs, we have written a 4 to indicate 4105-byte I-frame transmissions (these controllers have 16/4Mbps Token-Ring Adapters).
- Written responses in the W (maximum-out) columns. We have specified a 2 for all of the W entries to indicate the maximum number of transmissions allowed before an acknowledgment.

Chapter 14 contains additional information pertaining to the columns on this worksheet.

941: Ring Transmission Definition																
S	Ring				SAP	F	W	S	Ring				SAP	F	W	
	4	0	0	0	1	2	3	4	0	0	1	7	0	8	0	2
	4	0	0	0	1	2	3	4	0	0	1	3	0	8	0	2
	4	0	0	0	1	2	3	4	0	0	1	5	0	8	0	2
	4	0	0	0	1	2	3	4	0	0	1	7	0	8	0	2
	4	0	0	0	1	2	3	4	0	0	1	9	0	8	0	2
	4	0	0	0	1	2	3	4	0	0	1	B	0	8	0	2
	4	0	0	0	1	2	3	4	0	0	1	D	0	8	0	2
	4	0	0	0	1	2	3	4	0	0	1	F	0	8	0	2
	4	0	0	0	3	1	7	4	0	0	2	7	0	8	4	2
	4	0	0	0	0	0	0	0	0	0	2	3	0	8	0	2
	4	0	0	0	0	0	0	0	0	0	2	5	0	8	0	2
	4	0	0	0	0	0	0	0	0	0	2	7	0	8	0	2
	4	0	0	0	0	0	0	0	0	0	2	9	0	8	0	2
	4	0	0	0	0	0	0	0	0	0	2	B	0	8	0	2
	4	0	0	0	0	0	0	0	0	0	2	D	0	8	0	2

Figure C-6. Worksheet 34 – Local Gateway

## Token-Ring Planning Examples

### Common SNA Worksheet – Local Gateway

On worksheet 14 (Figure C-7), we have circled the defaults for configuration questions 500, 501, and 502. Although the Central Site Change Management (CSCM) function will not be used, we filled out this worksheet because it appears on the customizer's screen during the Configure procedure.

Chapter 11 contains information on the configuration questions that appear on this worksheet. The *Central Site Customizing User's Guide*, GA27-3868, contains information on CSCM.

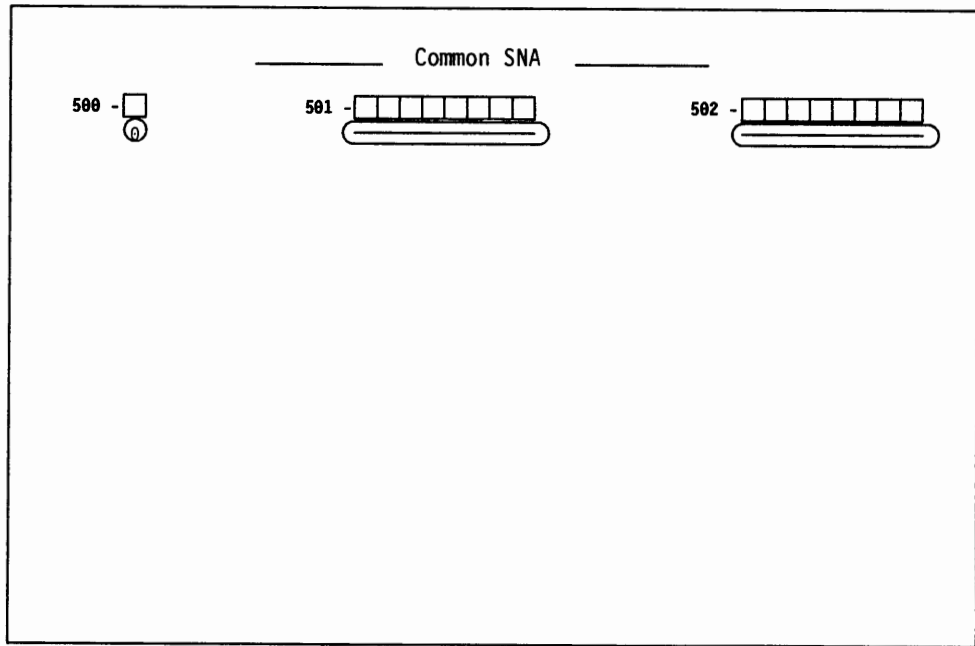

Figure C-7. Worksheet 14 – Local Gateway

## Worksheets for the 3174 13Rs

Although there are actually three 3174 Model 13Rs, the worksheets for only one are shown. Except for questions 106, 108, and 215, the worksheets for the other 3174 13Rs are identical.

To plan for the 3174 Model 13R, we have responded to configuration questions on the following worksheets:

- "Worksheet 1—Host Attachment"
- "Worksheet 9—Token-Ring Network"
- "Worksheet 14—Common SNA."

When a default response for a configuration question did not meet the requirements of our network, an alternate response was written on the worksheet. Use of the default response was indicated by circling it.

**Note:** Most defaults were chosen to simplify the examples; they do not imply a recommendation.

### Host Attachment Worksheet – 3174 Model 13R

On worksheet 1 (Figure C-8), we have written in responses to the following configuration questions:

- 098** Online Test Password. We have taken the default underscores.
- 099** Product assistance data. We have indicated that the **Systems Analysts** at telephone number **919-999-9999** should be contacted if there is a problem with the controller.
- 100** Model number. We have specified **13R**, this controller's model number.
- 101** Host attachment. A response of **7** was given to indicate the Token-Ring Network.

Chapter 6 contains additional information on the configuration questions that appear on this worksheet.

\_\_\_\_\_MODEL/ATTACH\_\_\_\_\_

098 -

099 -

100 -   
X X X

101 -   
X

Figure C-8. Worksheet 1 – 3174 Model 13R

## Token-Ring Planning Examples

### Token-Ring Network Worksheet – 3174 Model 13R

On worksheet 9 (Figure C-9), we have written in responses to the following configuration questions:

- 106** Token-Ring Network address and service access point of the 3174. The locally administered address **4000 3174 0020** was assigned to this controller and a SAP of 08.
- 107** Token-Ring Network address and service access point of the gateway. We have written in the gateway's address, **4000 3174 0010** with a SAP of 08.
- 108** Unique machine identifier. We have written in this controller's serial number **2345678** as the identifier.
- 215** Physical unit identification. We have specified **EB002** as the host's identifier for this controller.
- 220** Alert function. A response of **3** has been given, allowing operators to send alert messages from all ports.
- 380** Maximum receive I-frame size. We indicated that **4105** bytes is the maximum I-frame size that can be received.
- 384** Ring speed of the Token-Ring Network. We responded with a **2** to indicate a 16Mbps ring speed with early token release.

Chapter 6 contains additional information on the configuration questions that appear on this worksheet.

\_\_\_\_\_ Token-Ring Network \_\_\_\_\_

<p>186 - <b>40003174002008</b> X X X X X X X X X X X X X X 0 4</p> <p>110 - <input type="checkbox"/> <input type="checkbox"/> <input type="checkbox"/> <input type="checkbox"/> ① 0 0 0 0</p> <p>121 - <input type="checkbox"/> <input type="checkbox"/>      123 - <input type="checkbox"/> ① 0 1                      ①</p> <p>132 - <input type="checkbox"/> <input type="checkbox"/> <input type="checkbox"/> <input type="checkbox"/> 0 0 0 0</p> <p>141 - <input type="checkbox"/> A</p> <p>173 - <input type="checkbox"/> <input type="checkbox"/> <input type="checkbox"/> <input type="checkbox"/> <input type="checkbox"/> <input type="checkbox"/> <input type="checkbox"/> <input type="checkbox"/> 0 0 0 0 0 0 0 0</p> <p>213 - <input type="checkbox"/> ①</p> <p>382 - <input type="checkbox"/> <input type="checkbox"/> <input type="checkbox"/> <input type="checkbox"/> 0 5 2 1</p>	<p>187 - <b>40003174001008</b> X X X X X X X X X X X X X X 0 4</p> <p>116 - <input type="checkbox"/> <input type="checkbox"/> <input type="checkbox"/> ① --</p> <p>125 - <input type="checkbox"/> <input type="checkbox"/> <input type="checkbox"/> <input type="checkbox"/> <input type="checkbox"/> <input type="checkbox"/> <input type="checkbox"/> <input type="checkbox"/> <input type="checkbox"/> <input type="checkbox"/> 0 0 0 0 0 0 0 0 0 0</p> <p>136 - <input type="checkbox"/> <input type="checkbox"/> <input type="checkbox"/> <input type="checkbox"/> <input type="checkbox"/> 0 0 0 0 0</p> <p>165 - <input type="checkbox"/> ①</p> <p>175 - <input type="checkbox"/> <input type="checkbox"/> <input type="checkbox"/> <input type="checkbox"/> <input type="checkbox"/> <input type="checkbox"/> <input type="checkbox"/> <input type="checkbox"/> 0 0 0 0 0 0 0 0</p> <p>215 - <b>EB002</b> 0 0 0 0 0</p> <p>383 - <input type="checkbox"/> ②</p>	<p>188 - <b>2345678</b> 0 0 0 0 0 0 0 0</p> <p>126 - <input type="checkbox"/> <input type="checkbox"/> <input type="checkbox"/> <input type="checkbox"/> <input type="checkbox"/> <input type="checkbox"/> <input type="checkbox"/> <input type="checkbox"/> <input type="checkbox"/> <input type="checkbox"/>      127 - <input type="checkbox"/> <input type="checkbox"/> 0 0 0 0 0 0 0 0 0 0                      0 0</p> <p>137 - <input type="checkbox"/> <input type="checkbox"/> <input type="checkbox"/> <input type="checkbox"/> <input type="checkbox"/>      138 - <input type="checkbox"/> 0 0 0 0 0                                      ①</p> <p>166 - <input type="checkbox"/>      168 - <input type="checkbox"/> A                                      ①</p> <p>179 - <input type="checkbox"/> <input type="checkbox"/> <input type="checkbox"/> 0 0 0</p> <p>220 - <b>3</b> 0</p> <p>384 - <b>2</b> 0</p>
--	---	--

Figure C-9. Worksheet 9 – 3174 Model 13R

**Common SNA Worksheet – 3174 Model 13R**

On worksheet 14 (Figure C-10), we have circled the defaults for questions 500, 501, and 502. Although the Central Site Change Management (CSCM) function will not be used, we filled out this worksheet because it appears on the customizer's screen during the Configure procedure.

Chapter 11 contains information on the configuration questions that appear on this worksheet. The *Central Site Customizing User's Guide*, GA27-3868, contains information on CSCM.

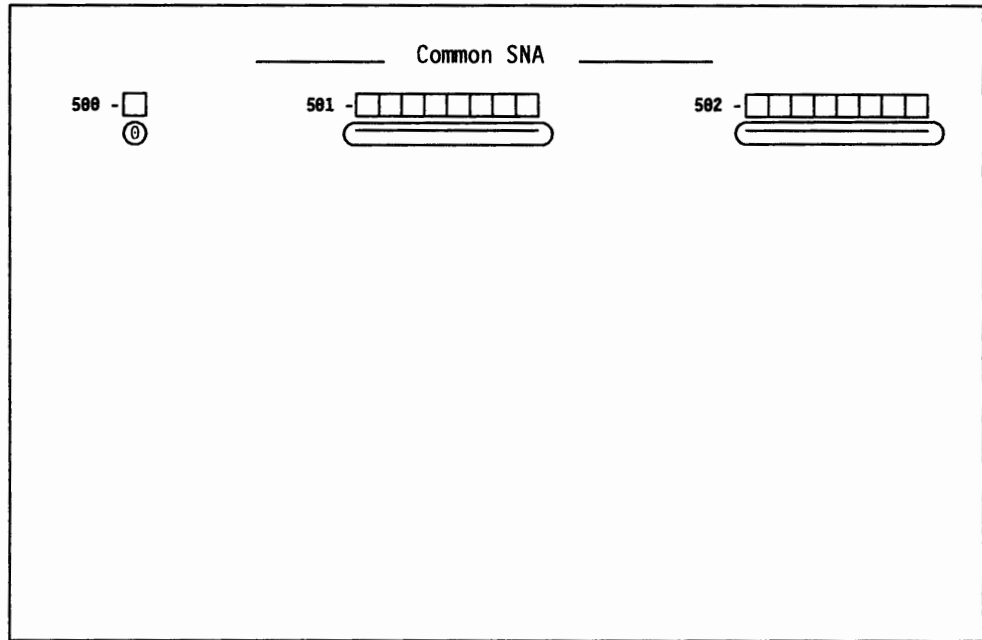

Figure C-10. Worksheet 14 – 3174 Model 13R

---

### Example 2 – Remote Gateway

A large insurance company needs to pass information and claims records between its headquarters and branch offices. To accomplish this, the branch offices require access to a host at headquarters.

This insurance company has chosen to concentrate its customizing expertise at the headquarters location. Therefore, Central Site Change Management (CSCM) is used throughout each of the networks.

In Figure C-11 on page C-15, we have a typical network of the branch offices. The network consists of:

- A host
- A 3725 communications controller
- Two modems on both ends of the telecommunication link
- A 3174 Model 1R being used as the remote 3270 gateway controller. The gateway controller also supports several terminals
- A backbone ring running at 4Mbps
- Ten IBM personal computers attached to the backbone ring.

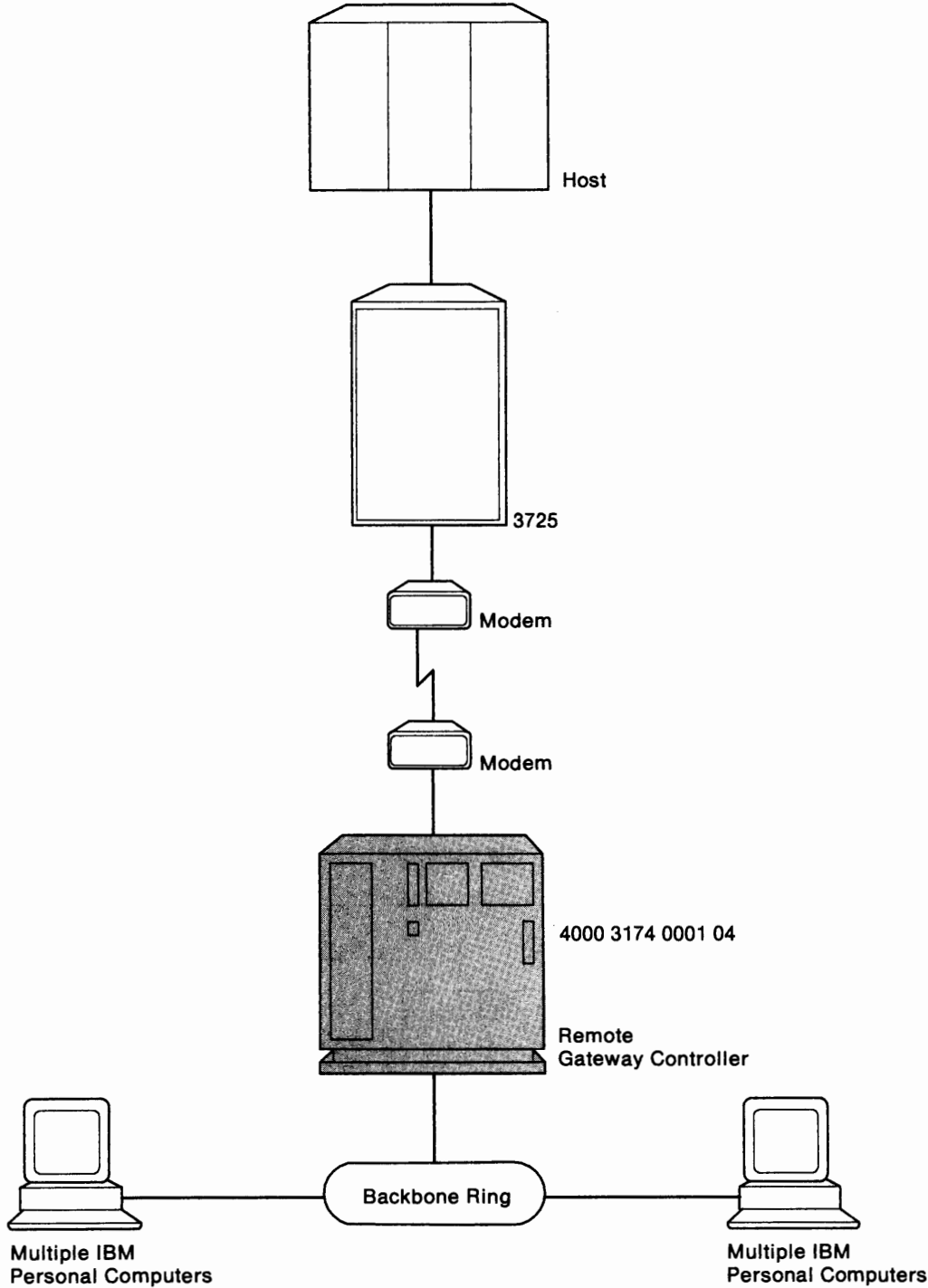

Figure C-11. Token-Ring Network – Remote Gateway



### Worksheets for the Remote Gateway

To plan for the remote gateway, we have responded to configuration questions on the following worksheets:

- “Worksheet 1—Host Attachment”
- “Worksheet 4—SDLC”
- “Worksheet 32—Token-Ring Gateway”
- “Worksheet 33—Ring Address Assignment”
- “Worksheet 34—Ring Transmission Definition”
- “Worksheet 14—Common SNA.”

When a default response for a configuration question did not meet the requirements of our network, an alternate response was written on the worksheet. Use of the default response was indicated by circling it.

**Note:** Most defaults were chosen to simplify the examples; they do not imply a recommendation.

### Host Attachment Worksheet – Remote Gateway

On worksheet 1 (Figure C-12), we have written in responses to the following configuration questions:

- 098 Online Test Password. We have taken the default underscores.
- 099 Product assistance data. We have indicated that the **Service Department at Headquarters** should be contacted if there is a problem with the controller.
- 100 Model number. We have specified **01R**, the gateway’s model number.
- 101 Host attachment. A response of **2** was given to indicate that SDLC is the protocol being used.

Chapter 6 contains additional information on the configuration questions that appear on this worksheet.

_____ MODEL/ATTACH _____																																																											
098 -	<table border="1" style="width: 100%; height: 15px;"> <tr> <td style="width: 10%;"></td><td style="width: 10%;"></td><td style="width: 10%;"></td><td style="width: 10%;"></td><td style="width: 10%;"></td><td style="width: 10%;"></td><td style="width: 10%;"></td><td style="width: 10%;"></td><td style="width: 10%;"></td><td style="width: 10%;"></td> </tr> </table>																																																										
099 -	<table border="1" style="width: 100%; height: 15px;"> <tr> <td style="width: 10%;">C</td><td style="width: 10%;">O</td><td style="width: 10%;">N</td><td style="width: 10%;">T</td><td style="width: 10%;">A</td><td style="width: 10%;">C</td><td style="width: 10%;">T</td><td style="width: 10%;">T</td><td style="width: 10%;">H</td><td style="width: 10%;">E</td><td style="width: 10%;">S</td><td style="width: 10%;">E</td><td style="width: 10%;">R</td><td style="width: 10%;">V</td><td style="width: 10%;">I</td><td style="width: 10%;">C</td><td style="width: 10%;">E</td><td style="width: 10%;">D</td><td style="width: 10%;">E</td><td style="width: 10%;">P</td><td style="width: 10%;">A</td><td style="width: 10%;">R</td><td style="width: 10%;">T</td><td style="width: 10%;">M</td><td style="width: 10%;">E</td><td style="width: 10%;">N</td><td style="width: 10%;">T</td><td style="width: 10%;">A</td><td style="width: 10%;">T</td> </tr> </table> <table border="1" style="width: 100%; height: 15px; margin-top: 5px;"> <tr> <td style="width: 10%;">H</td><td style="width: 10%;">E</td><td style="width: 10%;">A</td><td style="width: 10%;">D</td><td style="width: 10%;">Q</td><td style="width: 10%;">U</td><td style="width: 10%;">A</td><td style="width: 10%;">R</td><td style="width: 10%;">T</td><td style="width: 10%;">E</td><td style="width: 10%;">R</td><td style="width: 10%;">S</td><td style="width: 10%;"></td><td style="width: 10%;"></td><td style="width: 10%;"></td><td style="width: 10%;"></td><td style="width: 10%;"></td><td style="width: 10%;"></td><td style="width: 10%;"></td><td style="width: 10%;"></td><td style="width: 10%;"></td><td style="width: 10%;"></td><td style="width: 10%;"></td><td style="width: 10%;"></td><td style="width: 10%;"></td><td style="width: 10%;"></td><td style="width: 10%;"></td><td style="width: 10%;"></td><td style="width: 10%;"></td> </tr> </table>	C	O	N	T	A	C	T	T	H	E	S	E	R	V	I	C	E	D	E	P	A	R	T	M	E	N	T	A	T	H	E	A	D	Q	U	A	R	T	E	R	S																	
C	O	N	T	A	C	T	T	H	E	S	E	R	V	I	C	E	D	E	P	A	R	T	M	E	N	T	A	T																															
H	E	A	D	Q	U	A	R	T	E	R	S																																																
100 -	<table border="1" style="width: 100%; height: 15px;"> <tr> <td style="width: 10%; text-align: center;">0</td><td style="width: 10%; text-align: center;">1</td><td style="width: 10%; text-align: center;">R</td> </tr> </table> <p style="text-align: center;">X X X</p>	0	1	R																																																							
0	1	R																																																									
101 -	<table border="1" style="width: 100%; height: 15px;"> <tr> <td style="width: 10%; text-align: center;">2</td> </tr> </table> <p style="text-align: center;">X</p>	2																																																									
2																																																											

Figure C-12. Worksheet 1 – Remote Gateway

**SDLC Worksheet – Remote Gateway**

On worksheet 4 (Figure C-13), we have written in responses to the following configuration questions:

- 104** Controller address. We have assigned the lower I/O address X'01' to the gateway.
- 105** Upper limit address. We specified X'14' as the highest I/O address that can be assigned to the Token-Ring-attached devices. The responses to questions 104 and 105 provide a range of 20 addresses, allowing for future expansion.
- 108** Unique machine identifier. We have written in the gateway's serial number **3456789** as the identifier.
- 150** Token-Ring Network Gateway Controller. A **1** was specified to identify this controller as the gateway.
- 215** Physical unit identification. We have specified **EB005** as the host's identifier for our gateway.
- 220** Alert function. A response of **2** has been given, allowing an operator to send alert messages from port 0.
- 340** RTS control response options. The gateway is communicating with the host through modems that are operating in duplex mode in their primary and secondary facilities. Therefore, **1** was specified to indicate use of permanent request-to-send (RTS).

Chapter 6 contains additional information on the configuration questions that appear on this worksheet.

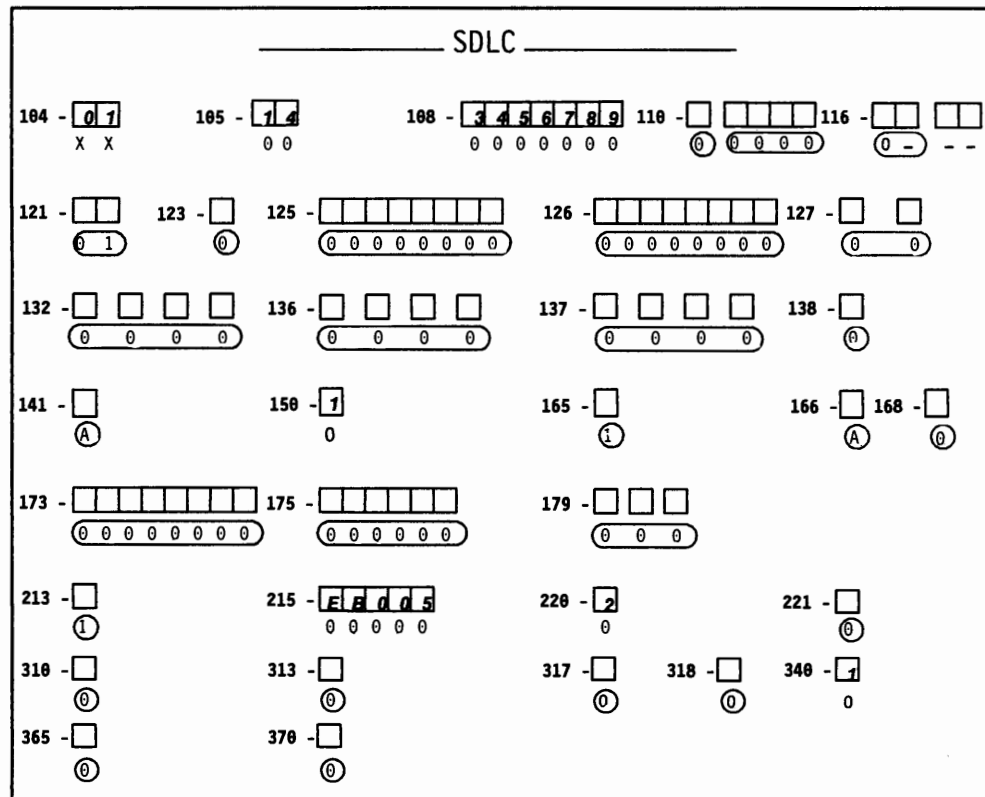

Figure C-13. Worksheet 4 – Remote Gateway

## Token-Ring Planning Examples

### Token-Ring Gateway Worksheet – Remote Gateway

On worksheet 32 (Figure C-14), we have written in responses to the following configuration questions:

- 900** Token-Ring Network address for the gateway. The locally administered address **4000 3174 0001** was assigned to the gateway. The default SAP was used.
- 908** Link subsystem name. We have written in **GATE02**. The host will use this name to identify any alerts sent from this gateway.

Chapter 14 contains additional information on the configuration questions that appear on this worksheet.

_____ Token-Ring Gateway _____																																																
900 - <table border="1" style="display: inline-table; border-collapse: collapse;"><tr><td style="width: 20px; text-align: center;">4</td><td style="width: 20px; text-align: center;">0</td><td style="width: 20px; text-align: center;">0</td><td style="width: 20px; text-align: center;">0</td><td style="width: 20px; text-align: center;">3</td><td style="width: 20px; text-align: center;">1</td><td style="width: 20px; text-align: center;">7</td><td style="width: 20px; text-align: center;">4</td><td style="width: 20px; text-align: center;">0</td><td style="width: 20px; text-align: center;">0</td><td style="width: 20px; text-align: center;">0</td><td style="width: 20px; text-align: center;">1</td><td style="width: 20px; text-align: center;"> </td><td style="width: 20px; text-align: center;"> </td></tr><tr><td style="text-align: center;">X</td><td style="text-align: center;">X</td><td style="text-align: center;">X</td><td style="text-align: center;">X</td><td style="text-align: center;">X</td><td style="text-align: center;">X</td><td style="text-align: center;">X</td><td style="text-align: center;">X</td><td style="text-align: center;">X</td><td style="text-align: center;">X</td><td style="text-align: center;">X</td><td style="text-align: center;">X</td><td style="text-align: center;">(0 4)</td><td style="text-align: center;"> </td></tr></table>	4	0	0	0	3	1	7	4	0	0	0	1			X	X	X	X	X	X	X	X	X	X	X	X	(0 4)		905 - <table border="1" style="display: inline-table; border-collapse: collapse;"><tr><td style="width: 20px; text-align: center;"> </td></tr><tr><td style="text-align: center;">(1)</td></tr></table>		(1)	908 - <table border="1" style="display: inline-table; border-collapse: collapse;"><tr><td style="width: 20px; text-align: center;">G</td><td style="width: 20px; text-align: center;">A</td><td style="width: 20px; text-align: center;">T</td><td style="width: 20px; text-align: center;">E</td><td style="width: 20px; text-align: center;">0</td><td style="width: 20px; text-align: center;">2</td><td style="width: 20px; text-align: center;"> </td><td style="width: 20px; text-align: center;"> </td></tr><tr><td style="text-align: center;">I</td><td style="text-align: center;">B</td><td style="text-align: center;">M</td><td style="text-align: center;">L</td><td style="text-align: center;">A</td><td style="text-align: center;">N</td><td style="text-align: center;"> </td><td style="text-align: center;"> </td></tr></table>	G	A	T	E	0	2			I	B	M	L	A	N		
4	0	0	0	3	1	7	4	0	0	0	1																																					
X	X	X	X	X	X	X	X	X	X	X	X	(0 4)																																				
(1)																																																
G	A	T	E	0	2																																											
I	B	M	L	A	N																																											
911 - <table border="1" style="display: inline-table; border-collapse: collapse;"><tr><td style="width: 20px; text-align: center;"> </td></tr><tr><td style="text-align: center;">(0)</td></tr></table>		(0)	912 - <table border="1" style="display: inline-table; border-collapse: collapse;"><tr><td style="width: 20px; text-align: center;"> </td><td style="width: 20px; text-align: center;"> </td></tr><tr><td style="text-align: center;">(0 0)</td></tr></table>			(0 0)																																										
(0)																																																
(0 0)																																																

Figure C-14. Worksheet 32 – Remote Gateway

**940: Ring Address Assignment Worksheet – Remote Gateway**

On worksheet 33 (Figure C-15), we have:

- Left the S columns blank. The range of I/O addresses defined in questions 104 and 105 will fill these columns automatically during customization.
- Left the first Ring entry blank. The response to question 900 (gateway address) will automatically fill this entry during customization.

In the remaining Ring columns, we have entered the locally administered addresses of the attaching devices. To be consistent with the cursor movement on the customizer's screen, these addresses were entered from left to right. We chose to include the device types and I/O addresses in our addressing scheme.

- Circled the defaults for the SAP (service access point) columns.
- In the T (type) columns, we circled the default (workstation) for each IBM personal computer.

Chapter 14 contains additional information pertaining to the columns on this worksheet.

\_\_\_ 940: Ring Address Assignment \_\_\_

S	Ring	SAP	T	S	Ring	SAP	T
	4000 1234 0002	04	0		4000 1234 0003	04	0
	4000 1234 0004	04	0		4000 1234 0005	04	0
	4000 1234 0006	04	0		4000 1234 0007	04	0
	4000 1234 0008	04	0		4000 1234 0009	04	0
	4000 1234 000A	04	0		4000 1234 000B	04	0
	4000 1234 000C	04	0		4000 1234 000D	04	0
	4000 1234 000E	04	0		4000 1234 000F	04	0
	4000 1234 0010	04	0		4000 1234 0011	04	0
	4000 1234 0012	04	0		4000 1234 0013	04	0
		04	0			04	0
		04	0			04	0
		04	0			04	0
		04	0			04	0
		04	0			04	0
		04	0			04	0
		04	0			04	0
		04	0			04	0
		04	0			04	0
		04	0			04	0
		04	0			04	0

Figure C-15. Worksheet 33 – Remote Gateway

# Token-Ring Planning Examples

## 941: Ring Transmission Definition Worksheet – Remote Gateway

On worksheet 34 (Figure C-16), we have:

- Duplicated our Ring entries from the previous worksheet.
- Circled the defaults for the SAP (service access point) columns.
- Written 0s (the default for workstations) into the F (transmit I-frame size) columns to indicate 265-byte I-frame transmissions.
- Written 2s (the default for workstations) into the W (maximum-out) columns to indicate the maximum number of transmissions allowed before and an acknowledgment.

Chapter 14 contains additional information pertaining to the columns on this worksheet.

\_\_\_\_\_941: Ring Transmission Definition\_\_\_\_\_

S	Ring	Address	SAP	F	W	S	Ring	Address	SAP	F	W
<input type="checkbox"/>	<input type="checkbox"/>	<input type="checkbox"/>	<input type="checkbox"/>	<input type="checkbox"/>	<input type="checkbox"/>	<input type="checkbox"/>	<input type="checkbox"/>	<input type="checkbox"/>	<input type="checkbox"/>	<input type="checkbox"/>	<input type="checkbox"/>
<input type="checkbox"/>	4000	1234	0002	0	2	<input type="checkbox"/>	4000	1234	0003	0	2
<input type="checkbox"/>	4000	1234	0004	0	2	<input type="checkbox"/>	4000	1234	0005	0	2
<input type="checkbox"/>	4000	1234	0006	0	2	<input type="checkbox"/>	4000	1234	0007	0	2
<input type="checkbox"/>	4000	1234	0008	0	2	<input type="checkbox"/>	4000	1234	0009	0	2
<input type="checkbox"/>	4000	1234	000A	0	2	<input type="checkbox"/>	4000	1234	000B	0	2
<input type="checkbox"/>	4000	1234	000C	0	2	<input type="checkbox"/>	4000	1234	000D	0	2
<input type="checkbox"/>	4000	1234	000E	0	2	<input type="checkbox"/>	4000	1234	000F	0	2
<input type="checkbox"/>	4000	1234	0010	0	2	<input type="checkbox"/>	4000	1234	0011	0	2
<input type="checkbox"/>	4000	1234	0012	0	2	<input type="checkbox"/>	4000	1234	0013	0	2
<input type="checkbox"/>	4000	1234	0014	0	2	<input type="checkbox"/>	<input type="checkbox"/>	<input type="checkbox"/>	<input type="checkbox"/>	<input type="checkbox"/>	<input type="checkbox"/>
<input type="checkbox"/>	<input type="checkbox"/>	<input type="checkbox"/>	<input type="checkbox"/>	<input type="checkbox"/>	<input type="checkbox"/>	<input type="checkbox"/>	<input type="checkbox"/>	<input type="checkbox"/>	<input type="checkbox"/>	<input type="checkbox"/>	<input type="checkbox"/>
<input type="checkbox"/>	<input type="checkbox"/>	<input type="checkbox"/>	<input type="checkbox"/>	<input type="checkbox"/>	<input type="checkbox"/>	<input type="checkbox"/>	<input type="checkbox"/>	<input type="checkbox"/>	<input type="checkbox"/>	<input type="checkbox"/>	<input type="checkbox"/>
<input type="checkbox"/>	<input type="checkbox"/>	<input type="checkbox"/>	<input type="checkbox"/>	<input type="checkbox"/>	<input type="checkbox"/>	<input type="checkbox"/>	<input type="checkbox"/>	<input type="checkbox"/>	<input type="checkbox"/>	<input type="checkbox"/>	<input type="checkbox"/>
<input type="checkbox"/>	<input type="checkbox"/>	<input type="checkbox"/>	<input type="checkbox"/>	<input type="checkbox"/>	<input type="checkbox"/>	<input type="checkbox"/>	<input type="checkbox"/>	<input type="checkbox"/>	<input type="checkbox"/>	<input type="checkbox"/>	<input type="checkbox"/>
<input type="checkbox"/>	<input type="checkbox"/>	<input type="checkbox"/>	<input type="checkbox"/>	<input type="checkbox"/>	<input type="checkbox"/>	<input type="checkbox"/>	<input type="checkbox"/>	<input type="checkbox"/>	<input type="checkbox"/>	<input type="checkbox"/>	<input type="checkbox"/>
<input type="checkbox"/>	<input type="checkbox"/>	<input type="checkbox"/>	<input type="checkbox"/>	<input type="checkbox"/>	<input type="checkbox"/>	<input type="checkbox"/>	<input type="checkbox"/>	<input type="checkbox"/>	<input type="checkbox"/>	<input type="checkbox"/>	<input type="checkbox"/>
<input type="checkbox"/>	<input type="checkbox"/>	<input type="checkbox"/>	<input type="checkbox"/>	<input type="checkbox"/>	<input type="checkbox"/>	<input type="checkbox"/>	<input type="checkbox"/>	<input type="checkbox"/>	<input type="checkbox"/>	<input type="checkbox"/>	<input type="checkbox"/>

Figure C-16. Worksheet 34 – Remote Gateway

**Common SNA Worksheet – Remote Gateway**

On worksheet 14 (Figure C-17), we have written in responses to the following configuration questions:

- 500** CSCM unique. A response of **2** was given to indicate that the remote Gateway is operating as a network site controller using CSCM.
- 501** Network ID. We have written in **NETCONTA** to identify the network that our controller is in.
- 502** Logical unit name. We have specified the name **S050600A** to identify our controller within the network.

Chapter 11 contains additional information on the configuration questions that appear on this worksheet. The *Central Site Customizing User's Guide*, GA27-3868, contains information on CSCM.

Common SNA		
500 - <input type="text" value="2"/>	501 - <input type="text" value="NETCONTA"/>	502 - <input type="text" value="S050600A"/>
0		

Figure C-17. Worksheet 14 – Remote Gateway



---

## Appendix D. Examples of 3174 VTAM/NCP Definitions

Channel Attached 3174 Definitions (SNA) .....	D-3
Local 3174 Terminal Definition (Non-SNA) .....	D-4
SDLC 3174 Definitions .....	D-5
SDLC Group Specification for 3174 .....	D-5
Line Macro for SDLC 3174 .....	D-5
SDLC Service Macro Specifications Remote 3174 .....	D-5
3174 PU/LU Specifications for PU3174 .....	D-6
Specifications for a Gateway with Group Poll .....	D-7
X.25 Definitions .....	D-9
Definitions for 3174 Token-Ring Network Models .....	D-12
VTAM Definitions for 3174 DSPUs .....	D-12
NCP Definitions for 3174 DSPU .....	D-13
VSE/VTAM Definitions .....	D-14





This appendix contains VTAM and NCP definition examples for devices attached to a SDLC link, to an X.25 connection, to the Token-Ring Network, and examples for channel-attached SNA-3270 and non-SNA-3270 devices.

---

## Channel Attached 3174 Definitions (SNA)

### PU DEFINITION

---

#### LOCAL 3174 DEFINITIONS

---

```

LOCCOLOR VBUILD  TYPE=LOCAL
LOCAPU  PU  CUADDR=5E, ISTATUS=ACTIVE, PUTYPE=2, MAXBFRU=10,      *
          MODETAB=MT327X
    
```

### LU DEFINITION

```

LOCCSCM LU  LOCADDR=1, ENCR=NONE, DLOGMOD=BATCH, ISTATUS=ACTIVE, SSCPFM=FSS
LOC791  LU  LOCADDR=2, VPACING=4, DLOGMOD=T3279M3, USSTAB=US327X
LOC32872 LU LOCADDR=3, VPACING=4, DLOGMOD=T3287M2C
LOC793  LU  LOCADDR=4, VPACING=4, DLOGMOD=T3279M2, USSTAB=US327X
LOC794  LU  LOCADDR=5, VPACING=4, DLOGMOD=T3279M2, USSTAB=US327X
LOC795  LU  LOCADDR=6, VPACING=4, DLOGMOD=T3279M4E, USSTAB=US327X
LOC32876 LU LOCADDR=7, VPACING=4, DLOGMOD=T3287M2C, USSTAB=US327X
LOC32877 LU LOCADDR=8, VPACING=4, DLOGMOD=T3287M2C
LOC798  LU  LOCADDR=9, VPACING=4, DLOGMOD=T3279M4, USSTAB=US327X
    
```

### **Notes:**

1. LOCCSCM is a dependent LU 6.2 for GSCM.
2. The *ACF/VTAM Installation* manual, ST27-0439, describes how local SNA major nodes are defined.

---

**Local 3174 Terminal Definition (Non-SNA)**

---



---

 LOCAL 3270 TERMINAL DEFINITION
 

---

```

    LBUILD
H11L420 LOCAL CUADDR=420,TERM=3277,                                X
        MODETAB=AMODETAB,LOGAPPL=SAMON11,USSTAB=US3270,          X
        ISTATUS=ACTIVE,SPAN=(SPH111),DLOGMOD=M2BSCNQ
*
        STATOPT=('3277 420 -SYS3')
H11L421 LOCAL CUADDR=421,TERM=3277,                                X
        MODETAB=AMODETAB,LOGAPPL=SAMON11,USSTAB=US3270,          X
        ISTATUS=ACTIVE,SPAN=(SPH111),DLOGMOD=M2BSCNQ
*
        STATOPT=('3277 420 -SYS3')
.
.
.
H11L42F LOCAL CUADDR=42F,TERM=3286,FEATUR2=(MODEL2),             X
        MODETAB=AMODETAB,ISTATUS=INACTIVE,                       X
        SPAN=(SPH11L)
*
        STATOPT=('3286 42F -SYS3')
H11L430 LOCAL CUADDR=430,TERM=3277,                                X
        MODETAB=AMODETAB,USSTAB=US3270,LOGAPPL=SAMON11,          X
        ISTATUS=ACTIVE,SPAN=(SPH11L),DLOGMOD=M3BSCQ
*
        STATOPT=('3277 430 -SYS3')
H11L431 LOCAL CUADDR=431,TERM=3277,                                X
        MODETAB=AMODETAB,USSTAB=US3270,LOGAPPL=SAMON11,          X
        ISTATUS=ACTIVE,SPAN=(SPH11L),DLOGMOD=M3BSCQ
*
        STATOPT=('3277 431 -SYS3')
H11L436 LOCAL CUADDR=436,TERM=3277,                                X
        MODETAB=AMODETAB,USSTAB=US3270,DLOGMOD=M3BSCNQ,          X
        ISTATUS=ACTIVE,SPAN=(SPH11L)
*
        STATOPT=('3277 436 -SYS3')
H11L437 LOCAL CUADDR=437,TERM=3277,                                X
        MODETAB=AMODETAB,USSTAB=US3270,DLOGMOD=M3BSCNQ,          X
        ISTATUS=ACTIVE,SPAN=(SPH11L)
*
        STATOPT=('3277 437 -SYS3')
.
.
.

```

**Note:** The *ACF/VTAM Installation* manual, ST27-0439, describes the definition and filing of local terminals.

**SDLC 3174 Definitions**

**SDLC Group Specification for 3174**

GSDL (definition model)

GROUP MACRO SPECIFICATIONS FOR SDLC LINES				
G13S1	GROUP	LNCTL=SDLC,	SYNCHRONOUS DATA LINK	X
		DUPLEX=FULL,	REQUEST TO SEND ALWAYS UP	X
		NRZI=YES,		X
		REPLYTO=1,	1 SECOND FOR SDLC	X
		RETRIES=(7,4,5),	7 RETRIES PER SECOND FOR 5 TIMES	X
		TYPE=NCP	NCP ONLY	

**Line Macro for SDLC 3174**

LSD3174 (definition model)

SDLC 3174				
	LINE	MACRO SPECIFICATION	SDLC LINK 000 MODEM	
L13000	LINE	ADDRESS=(000,FULL),	FULL DUPLEX	X
		ATTACH=MODEM,	MODEM ATTACH	X
		OWNER=M11,		X
		ANS=CONTINUE,	DON'T BREAK CROSS DOMAIN SESSIONS	X
		CLOCKING=EXT,	MODEM ATTACHED	X
		NRZI=YES,		X
		ISTATUS=ACTIVE,		X
		DUPLEX=FULL,	REQUEST TO SEND ALWAYS UP	X
		ETRATIO=30,	DEFAULT	X
		MAXPU=1,	ALLOW NO MORE THAN 1 PU ON LINE	X
		SERVLIM=10,		X
		SRT=(,64),		X
		SPEED=9600,		X
		STATOPT='3174 LINE'		

**Note:** This example could also be used for a gateway controller, except that the MAXPU value would be greater than 1.

**SDLC Service Macro Specifications Remote 3174**

SERVICE (definition model)

SERVICE MACRO SPECIFICATION FOR SDLC (LINE 000)	
SERVICE ORDER=(P13000A),	X
MAXLIST=1	

3174 PU/LU Specifications for PU3174

CBS3174 (definition model)

SERVICE MACRO SPECIFICATION FOR SDLC (LINE 000)				
P13000A	PU	ADDR=C1, DATMODE=HALF, MAXDATA=265, MAXLU=64, MAXOUT=7, PACING=0 PASSLIM=8, PUDR=YES, PUTYPE=2, RETRIES=(7,4,5), DISCNT=(NO), ISTATUS=ACTIVE, VPACING=0	CLUSTER ADDRESS = C1  MAXIMUM AMOUNT OF DATA MAXIMUM LUS ON THIS PU MAX SDLC FRAMES BEFORE RESPONSE PACING SET BY BIND IMAGE  7 RETRIES PER SECOND FOR 5 TIMES (V) VTAM (V) VTAM (V) VTAM	X X X X X X X X X X X X
*				
T130CSCM	LU	LOCADDR=01, DLOGMOD=BATCH, ENCR=NONE, SSCPFM=FSS, ISTATUS=ACTIVE	DEPENDENT 6.2 LU FOR CSCM RECOMMENDED LOGMODE TITLE ENTRY  (V) VTAM	X X X X
*				
T1300002	LU	LOCADDR=02, MODETAB=AMODETAB, DLOGMOD=M2SDLCNQ, ISTATUS=ACTIVE	3278  (V) VTAM	X X X
*				
T1300003	LU	LOCADDR=03, MODETAB=AMODETAB, DLOGMOD=M2SDLCNQ, ISTATUS=ACTIVE	3278  (V) VTAM	X X X
*				
T1300004	LU	LOCADDR=04, MODETAB=AMODETAB, DLOGMOD=M3278SCS, ISTATUS=ACTIVE	3287  (V) VTAM	X X X
*				
T1300005	LU	LOCADDR=05, MODETAB=AMODETAB, DLOGMOD=M2SDLCNQ, ISTATUS=ACTIVE	3179G  (V) VTAM	X X X
*				
T1300006	LU	LOCADDR=06 MODETAB=MTPSPC, DLOGMOD=PCMODE, ISTATUS=ACTIVE	3270PC  (V) VTAM	X X X
*				
T1300007	LU	LOCADDR=07 MODETAB=MTPSPC, DLOGMOD=PCMODE, ISTATUS=ACTIVE	3270PC  (V) VTAM	X X X
*				

Specifications for a Gateway with Group Poll

Refer to "SDLC Group Specification for 3174" and "Line Macro for SDLC 3174" on page D-5 for information on group specification.

CBS3174 (definition model)

SERVICE MACRO SPECIFICATION FOR SDLC (LINE 000)				
P13000A	PU	ADDR=C1, DATMODE=HALF, MAXDATA=265, MAXLU=64, MAXOUT=7, PACING=0, PASSLIM=8, PUDR=YES, GP3174=C5, PUTYPE=2, RETRIES=(7,4,5), DISCNT=(NO), ISTATUS=ACTIVE, VPACING=0	CLUSTER ADDRESS = C1  MAXIMUM AMOUNT OF DATA MAXIMUM LUS ON THIS PU MAX SDLC FRAMES BEFORE RESPONSE PACING SET BY BIND IMAGE  GROUP POLL ADDRESS  7 RETRIES PER SECOND FOR 5 TIMES (V) VTAM (V) VTAM (V) VTAM	X X X X X X X X X X X X X X X X
*				
T130CSCM	LU	LOCADDR=01, DLOGMOD=BATCH, ENCR=NONE, SSCPFM=FSS, ISTATUS=ACTIVE	DEPENDENT 6.2 LU FOR CSCM RECOMMENDED LOGMODE TITLE ENTRY  (V) VTAM	X X X X X
*				
T1300002	LU	LOCADDR=02, MODETAB=AMODETAB, DLOGMOD=M2SDLCNQ, ISTATUS=ACTIVE	3278  (V) VTAM	X X X X
*				
T1300003	LU	LOCADDR=03, MODETAB=AMODETAB, DLOGMOD=M2SDLCNQ, ISTATUS=ACTIVE	3278  (V) VTAM	X X X X
*				
P14000A	PU	ADDR=C2, DATMODE=HALF, MAXDATA=265, MAXLU=64, MAXOUT=7, PACING=0, PASSLIM=8, PUDR=YES, GP3174=C5, PUTYPE=2, RETRIES=(7,4,5), DISCNT=(NO), ISTATUS=ACTIVE, VPACING=0	CLUSTER ADDRESS = C1  MAXIMUM AMOUNT OF DATA MAXIMUM LUS ON THIS PU MAX SDLC FRAMES BEFORE RESPONSE PACING SET BY BIND IMAGE  GROUP POLL ADDRESS  7 RETRIES PER SECOND FOR 5 TIMES (V) VTAM (V) VTAM (V) VTAM	X X X X X X X X X X X X X X X
*				

# VTAM/NCP Definition Examples

T140CSCM LU	LOCADDR=01, DLOGMOD=BATCH, ENCR=NONE, SSCPFM=FSS, ISTATUS=ACTIVE	DEPENDENT 6.2 LU FOR CSCM RECOMMENDED LOGMODE TITLE ENTRY  (V) VTAM	X X X X
*			
T1400002 LU	LOCADDR=02, MODETAB=AMODETAB, DLOGMOD=M2SDLCNQ, ISTATUS=ACTIVE	3278  (V) VTAM	X X X
*			
T1400003 LU	LOCADDR=03, MODETAB=AMODETAB, DLOGMOD=M2SDLCNQ, ISTATUS=ACTIVE	3278  (V) VTAM	X X X
*			

## X.25 Definitions

VTAM and NPSI Release 4.2 definitions used in testing 3174 functions.

---

X.25 NPSI R 4.2 STAGE1 INPUT

\* THIS GENERATION IS FOR 1 MCH LINK. FOR:

\* CPU TO 3174 PVC AND SVC; WITH QLLC CONTROL FOR BOTH.

\* X25BUILD - THIS MACRO DESCRIBES THE GENERATION PROCESS.

---

X25R41	X25BUILD	IDNUMH=01,	ID FOR NON-SNA SWITCHED SUPPORT	C
		MAXPIU=4K,	MAXIMUM PIU LENGTH	C
		MCHCNT=1,	1 MCH LINK DEFINED	C
		MODEL=3725,	3725	C
		SNAP=NO,	SNAP FACILITY OFF	C
		SRCHI=X25BLK1,	STAGE 2 OUTPUT MEMBER NAME (1 = GENNO)	C
		SRCLO=X25TBL1,	STAGE 2 OUTPUT MEMBER NAME (1 - GENNO)	C
		SCRPRFX=X25,	STAGE 2 OUTPUT TABLES & BLOCKS PREFIX	C
		VERSION=V4,	NPSI RELEASE 4.2 ONLY	C
		TYPYSYS=OS	MVS 3.8 WITH ACF/VTAM V3	

---

X25 NET - DESCRIBES THE PPSN.

---

NETX25	X25NET	DM=YES,	LAPB DM COMMAND	C
		NETTYP=1,	TYPE 1 TYMNET NETWORK	C
		CPHINDX=2,	2 ENTRIES IN VIRTUAL CIRCUIT TABLE	C
		OUHINDX=1	1 ENTRY IN THE OPTIONAL FACILITY TABLE	

---

X25VCCPT - VIRTUAL CIRCUIT CONNECTION PARAMETERS TABLE.

---

X25VCCPT	INDEX=1,	TABLE ENTRY NUMBER	C
	MAXPKTL=128,	MAXIMUM PACKET LENGTH EXCL PACKET HDR	C
	INSLOW=(25,0),	FREE BUFFER PERCENTAGE	C
	VWINDOW=2	PACKET TRANSMIT/RECEIVE WINDOW SIZE	

---

X25OUFTT - SVC USER FACILITIES AND CALL USER DATA TABLE.

---

X25OUFT	INDEX=1	TABLE ENTRY NUMBER	
---------	---------	--------------------	--

---

X25MCH - DESCRIBE THE PHYSICAL MULTICHANNEL LINK.  
DTE END 15

---

X25MCH	ADDRESS=15,	3725 FDX LINE ADDRESS	C
	FRMLGTH=259,	MAXIMUM FRAME LENGTH (+3 BYTE PKT HDR)	C
	LCGDEF=0(20),	LOGICAL CHAN GRP 0, UP TO CHAN 12	C
	MWINDOW=7,	LINK ACCESS FRAME WINDOW SIZE (HDLC)	C
	ANS=STOP,	AUTO NETWORK SHUTDOWN DECISION	C
	ENABLT0=3,	ENABLE TO 3 SECONDS	C
	DSABLTO=3,	DISABLE TO 3 SECONDS	C
	DBIT=NO,	DELIVERY CONFIRMATION BIT SUPPORTED	C
	GATE=NO,	GATE OR DATE FUNCTION SUPPORT	C
	SUBADDR=NO,	SUBADDRESSING	C
	LCNO=NOTUSED,	LOGICAL CHANNEL 0 NOT USED	C
	LLCLIST=(LLC3),	SVC'S TYPES SUPPORTED	C
	NDRETRY=2,	NP/TP SEQUENCE EXECUTED	C
	NPRETRY=10,	I OR U FRAME TIMEOUT RECOVERY	C
	PAD=INTEG,	PAD FUNCTION SUPPORTED	C
	TRAN=ODD,	NO TRANSLATION IF NO PAD FUNCTION	C
	PKTMDL=8,	MODULO 8 PACKET NUMBERING	C
	STATION=DTE,	NETWORK CONNECTION	C
	SPEED=9600,	PHYSICAL LINK SPEED	C



# VTAM/NCP Definition Examples

	TDTIMER=2, TPTIME=3.0	TIME (SECS) BETWEEN ND RETRANSMISSIONS X25 T1 TIMER IN SECS	C
<hr/>			
X25LCG - DESCRIBE THE LOGICAL CHANNEL GROUP.			
<hr/>			
	X25LCG LCGN=0	LOGICAL CHANNEL GROUP NUMBER	
<hr/>			
PU/LU MACRO SPECIFICATION FOR 3174 LOGICAL CHANNEL 4 (PVC)			
<hr/>			
XL15004	X25LINE LCN=1, DSTNODE=BNN, LLC=LLC3, TYPE=P, VCCINDX=1		C C C C
*			
XP15004	X25PU PUTTYPE=2, ADDR=C1, MAXDATA=265, PASSLIM=7, MAXOUT=7, ISTATUS=ACTIVE, SSCPFM=USSSCS, MODETAB=MT3274C2, DLOGMOD=T3278M2, USSTAB=US327X	ATTACH TO AN X.25/SNA 3174 STATION ADDRESS DEPENDANT ON PU CONSTRAINTS MAXIMUM PIU SEGMENTS IN TRANSMISSION MAXIMUM SDLC FRAMES BEFORE LINK RESP ACTIVATE AT INITIALIZATION LOGON FORMAT MODE TABLE REFERENCE FOR VTAM MODE TABLE REFERENCE FOR VTAM USS TABLE REFERENCE FOR VTAM	C C C C C C C C
*			
XT1541	X25LU LOCADDR=2, ISTATUS=ACTIVE	ADDRESS OF LU ACTIVATE WITH PU	C
XT1542	X25LU LOCADDR=3, ISTATUS=INACTIVE	ADDRESS OF LU ACTIVATE WITH PU	C
<hr/>			
X25VC - DESCRIBE RESERVE PVCS			
<hr/>			
X25VC	LCN=(2,10), TYPE=P, VCCINDX=1, LLC=LLC0	LOGICAL CHANNELS WITHIN A GROUP V C TYPE - P=PERMANENT, S=SWITCHED INDEX IN CONNECTION PARAMETER TABLE LOGICAL LINK CONTROL	C C C
<hr/>			
X25VC - DESCRIBE THE SWITCHED VIRTUAL CIRCUITS			
<hr/>			
X25VC	LCN=(11,20), NCPGRP=X25S01B, TYPE=S, VCCINDX=1, CALL=INOUT, OUFINDX=1	LOGICAL CHANNELS WITHIN A GROUP TO ASSOCIATE WITH VTAM PATH STMT V C TYPE - P=PERMANENT, S=SWITCHED INDEX IN CONNECTION PARAMETER TABLE INCOMING AND OUTGOING CALLS ACCEPTED INDEX IN USER TABLE	C C C C C
<hr/>			
X25END - NPSI GENERATION END, NAME MEMBERS FOR STAGE 2 OUTPUT.			
<hr/>			
X25END	INCPRFX=X25, LSTUACB=YES, NCPSTG1=X25NCP1, X25VTAM=YES, INCHI=X25HJI1, INCL2HI=X25HII1, INCINIT=X25INI1, INCL2LO=X25LOI1, ORDINIT=X25INO1, ORDHI=X25HJO1, ORDL2HI=X25HIO1, ORDL2LO=X25LO1,	STAGE 2 OUTPUT MEMBERS PREFIX NPSI SUPPLY LASTUACB MACRO STAGE 2 OUTPUT MEMBER NAME (1 = GENNO) VTAM ACCEPT ADDRESS=NONE & AUTO=YES STAGE 2 OUTPUT MEMBER NAME (1 = GENNO) STAGE 2 OUTPUT MEMBER NAME (1 = GENNO) STAGE 2 OUTPUT MEMBER NAME (1 = GENNO) STAGE 2 OUTPUT MEMBER NAME (1 = GENNO) STAGE 2 OUTPUT MEMBER NAME (1 = GENNO) STAGE 2 OUTPUT MEMBER NAME (1 = GENNO) STAGE 2 OUTPUT MEMBER NAME (1 = GENNO) STAGE 2 OUTPUT MEMBER NAME (1 = GENNO) STAGE 2 OUTPUT MEMBER NAME (1 = GENNO)	C C C C C C C C C C C
END			
<hr/>			

In an ACF/VTAM switched major node:

X3174	VBUILD	MAXGRP=5, MAXNO=12, TYPE=SWNET	REQUIRED REQUIRED REQUIRED	X X
*				
XP3174	PU	ADDR=C1, IDBLK=017, IDNUM=A0076, DISCONT=YES, MAXDATA=265, MAXOUT=7, PASSLIM=7, MODETAB=MT3274C2, MAXPATPH=6, VPACING=0, PUTYPE=2, SSCPFM=USSSCS, DLOGMOD=T3278M2, USSTAB=US327X	Same as 3274 user defined	X X X X X X X X X X X X
*				
PAT3174	PATH	DIALNO=31060019833, GRPNM=X25S01B, GID=2, PID=21	Host DTE address, LLC type 3 association to NCP/NPSI group	X X X
*				
XT3174	LU	LOCADDR=2		
XT3174A	LU	LOCADDR=3		

## Definitions for 3174 Token-Ring Network Models

The following sections describe how 3174 x3R models are defined at the host when using NCP/Token-Ring Interconnect (NTRI) instead of the 3174 gateway function.

### VTAM Definitions for 3174 DSPUs

VTAM definitions used for a Switched Major Node for downstream 3174s.

---

```

*
          VTAM SWITCHED MAJOR NODE FOR NTRI WITH 3174
*
E13SW9  VBUILD  MAXGRP=5,          REQUIRED          X
          MAXNO=12,              REQUIRED          X
          TYPE=SWNET             REQUIRED
**
E13PS09  PU      ADDR=13,          COULD BE ANYTHING (NOT USED)  X
          IDBLK=017,             3274/3174 BURNED IN          X
          IDNUM=A0001,           SEE CUSTOMIZATION # 215      X
          DISCNT=NO,             X
          MAXOUT=1,              X
          MODETAB=AMODETAB,       X
          MAXPATH=2,             X
          VPACING=0,             X
          PUTYPE=2,              X
          SSCPFM=USSSCS,         X
          DLOGMOD=M2SDLCQ,       X
          USSTAB=US327X
**
E13D0901 PATH  DIALNO=0004400043301002, TO 3174 MODEL          X
          GRPNM=EG22L01,        LOGICAL GROUP OF TIC 1      X
          GID=1,                 X
          PID=1
**
E13D0902 PATH  DIALNO=0004400033301004, TO PC WITH 3270 EMULATION  X
          GRPNM=EG22L02,        LOGICAL GROUP OF TIC 2      X
          GID=1,                 X
          PID=2,                 X
          USE=NO                  INITIALLY INACTIVE          X
**
E13L0902 LU    LOCADDR=2          FOR A DISPLAY
E13L0903 LU    LOCADDR=3          FOR A DISPLAY/PRINTER
E13L0904 LU    LOCADDR=4          FOR A DISPLAY/PRINTER
-
-
-

```

---

**NCP Definitions for 3174 DSPU**

G22XLLL GROUP LNCTL=SDLC,REPLYTO=1				
L22000	LINE	ADDRESS=(00,FULL),	LINE ADDRESS	X
		ATTACH=DIR3725,	INN LINK	X
		CLOCKING=EXT,	REQUIRED FOR DIRECT	X
		DUPLEX=FULL,	MODEM STRAPPING IS FULL	X
		MONLINK=YES,	MONITOR LINK FOR ACTPU	X
		NRZI=YES,		X
		PAUSE=0.1,		X
		SDLCST=(SDL22PRI,SDL22SEC),		X
		RETRIES=(7,3,5),		X
		SERVLIM=254,		X
		ISTATUS=ACTIVE	INITIAL STATUS	
PU MACRO SPECIFICATION FOR THE ADJACENT 3720 SA12				
P22000	PU	MAXOUT=7,	MAX PIU'S SENT BEFORE RESP REQ	X
		PUTYPE=4,	PHYSICAL UNIT TYPE LOCAL 3720	X
		ISTATUS=ACTIVE,	INITIAL STATUS	X
		TGN=8,	TRANSMISSION GROUP 8	X
		ANS=CONTINUE	DON'T BREAK THE X-DOMAIN SESSIONS	
PHYSICAL GROUP FOR TIC 1				
EG22P01	GROUP	ECLTYPE=PHYSICAL,	TIC DEFINITION	X
		PUDR=NO,		X
		STATOPT='NTRI TIC1'		
EL22017	LINE	ADDRESS=(17,FULL),	TIC ADDRESS	X
		PORTADD=0,	FIRST TIC	X
		LOCADD=400012201001,	LOCAL ADMIN. ADDRESS OF TIC	X
		RCVBUFC=4095,	NTRI RECEIVE BUFFER	X
		MAXTSL=1108	NTRI TRANSMIT DATA CAPACITY	
EP22017	PU	ADDR=01		
EU22017	LU	ISTATUS=INACTIVE,		X
		LOCADDR=0		
LOGICAL GROUP FOR TIC 1				
EG22L01	GROUP	ECLTYPE=LOGICAL,	DEFINE TERMINALS IN THE RING	X
		AUTOGEN=20,	LOGICAL CONNECTIONS	X
		MAXLU=20,	NUMBER OF LOGICAL UNITS	X
		PHYPORT=0,	FIRST TIC	X
		CALL=INOUT,	DIAL IN / DIAL OUT POSSIBILITY	X
		DIAL=YES,		X
		LINEADD=YES,		X
		LINEAUT=YES,		X
		MAXPU=1,		X
		PUTYPE=2		

## VTAM/NCP Definition Examples

### VSE/VTAM Definitions

The following is an example of a typical VSE/VTAM B-book for a local SNA major node containing a gateway and two DSPUs.

```
CATALOG SNA3174.B
SNA3174  VBUILD TYPE=LOCAL

SNAE40  PU    CUADDR=E40,MODETAB=MODE3290,          GATEWAY          X
          PUTYPE=2, ISTATUS=ACTIVE,MAXBFRU=1
VSE3L000 LU   LOCADDR=2,                              X
          SSCPFM=USSSCS,USSTAB=USSTAB,PACING=1,VPACING=2, X
          ISTATUS=ACTIVE,LOGAPPL=MWTC,DLOGMOD=GMOD3E
VSE3L001 LU   LOCADDR=3,                              X
          SSCPFM=USSSCS,USSTAB=USSTAB,PACING=1,VPACING=2, X
          ISTATUS=ACTIVE,LOGAPPL=MWTC,DLOGMOD=GMOD3E
          LU    ...
SNAE41  PU    CUADDR=E41,MODETAB=MODE3290,          DSPU 1           X
          PUTYPE=2, ISTATUS=ACTIVE,MAXBFRU=1
VSE3L100 LU   LOCADDR=2,                              X
          SSCPFM=USSSCS,USSTAB=USSTAB,PACING=1,VPACING=2, X
          ISTATUS=ACTIVE,LOGAPPL=MWTC,DLOGMOD=GMOD3E
VSE3L101 LU   LOCADDR=3,                              X
          SSCPFM=USSSCS,USSTAB=USSTAB,PACING=1,VPACING=2, X
          ISTATUS=ACTIVE,LOGAPPL=MWTC,DLOGMOD=GMOD3E
          LU    ...
SNAE42  PU    CUADDR=E42,MODETAB=MODE3290,          DSPU 2           X
          PUTYPE=2, ISTATUS=ACTIVE,MAXBFRU=1
VSE3L200 LU   LOCADDR=2,                              X
          SSCPFM=USSSCS,USSTAB=USSTAB,PACING=1,VPACING=2, X
          ISTATUS=ACTIVE,LOGAPPL=MWTC,DLOGMOD=GMOD3E
VSE3L201 LU   LOCADDR=3,                              X
          SSCPFM=USSSCS,USSTAB=USSTAB,PACING=1,VPACING=2, X
          ISTATUS=ACTIVE,LOGAPPL=MWTC,DLOGMOD=GMOD3E
          LU    ...
```

---

## Appendix E. Examples of Using Service Access Points

An Overview of the Service Access Point Examples .....	E-3
Gateway Supports Single Host Connection .....	E-4
Non-3174 Gateway with Multiple Host Connections and SAPs .....	E-5
Gateway Supports Multiple Host Connection and SAPs .....	E-6
Gateway Supports Multiple Host Connection and SAPs with the ESCON Channel .....	E-7
Combination of Gateway Capabilities .....	E-8



---

## An Overview of the Service Access Point Examples

Service access points (SAPs) are used when the gateway supports access to multiple hosts. If you are using Single Link Multi-Host Support, you can access additional hosts through a single gateway (if supported) by specifying additional service access points (SAPs). Usage of the SAP depends on the capabilities of the gateways.

The following examples are provided to help you respond to the SAP portion of configuration questions "106: Token-Ring Network Address and Service Access Point of the 3174" and "107: Token-Ring Network Address and Service Access Point of the Gateway." Each example assumes that you are using Single Link Multi-Host Support to access additional hosts. Look at each example and use the ones that most closely resemble your network. Examples are provided for the following:

- A gateway that supports a single host connection
- A non-3174 gateway that supports multiple host connections
- A gateway that supports multiple host connections and SAPs
- A gateway that supports multiple host connections through the Model 12L ESCON Channel
- A combination of gateway capabilities.

When trying to understand SAPs, it may help to think of an apartment building. The building has one common street address and the apartments within the building are identified with unique numbers. These unique apartment numbers can be equated to SAPs.



### Gateway Supports Single Host Connection

Figure E-1 shows the usage of SAPs in its simplest form. Each gateway supports only one host connection and SAP.

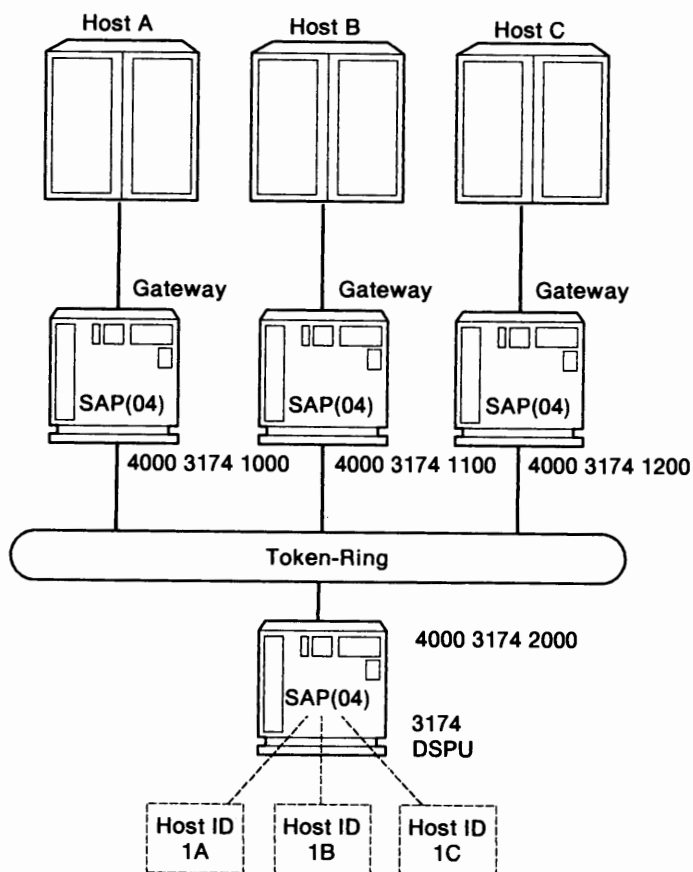

Figure E-1. One Gateway for Each Host Connection

The following table shows responses to configuration questions 106 and 107 for the network in Figure E-1. The **address portions** of these responses are used for example purposes only; they do not imply a recommendation.

Host ID	106: 3174		107: Gateway	
	Address	SAP	Address	SAP
1A	400031742000	04	400031741000	04
1B	400031742000	04	400031741100	04
1C	400031742000	04	400031741200	04

### Non-3174 Gateway with Multiple Host Connections and SAPs

Figure E-2 shows attachment to multiple hosts through a non-3174 gateway that does not support SAPs.

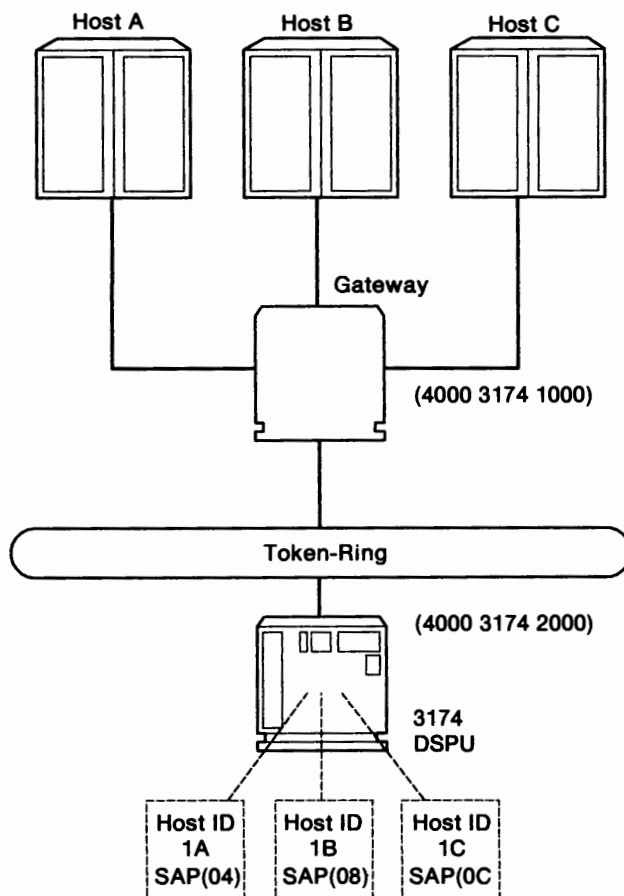

Figure E-2. Attachment to Multiple Hosts through Non-3174 Gateway without SAPs

The following table shows responses to configuration questions 106 and 107 for the network in Figure E-1 on page E-4. The **address portions** of these responses are used for example purposes only; they do not imply a recommendation.

Host ID	106: 3174		107: Gateway	
	Address	SAP	Address	SAP
1A	400031742000	04	400031741000	04
1B	400031742000	08	400031741000	04
1C	400031742000	0C	400031741000	04

### Gateway Supports Multiple Host Connection and SAPs

Figure E-3 shows attachment to multiple hosts through a gateway that supports three SAPs.

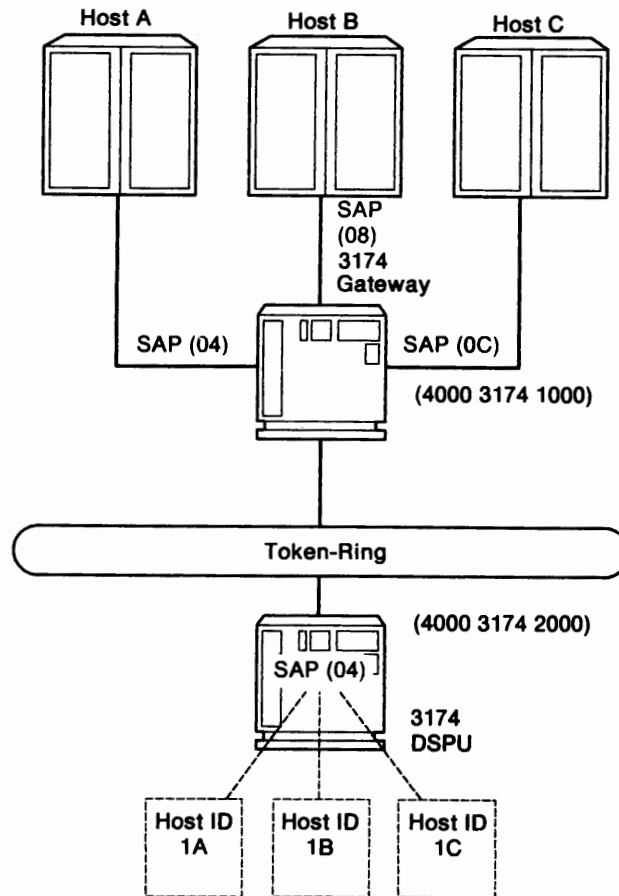

Figure E-3. Gateway With Multiple Host Connection and SAPs

The following table shows responses to configuration questions 106 and 107 for the network in Figure E-3. The **address portions** of these responses are used for example purposes only; they do not imply a recommendation.

Host ID	106: 3174		107: Gateway	
	Address	SAP	Address	SAP
1A	400031742000	04	400031741000	04
1B	400031742000	04	400031741000	08
1C	400031742000	04	400031741000	0C

## Gateway Supports Multiple Host Connection and SAPs with the ESCON Channel

The Model 12L supports multiple host connections and SAPs. Figure E-4 shows attachment to multiple hosts through the Model 12L and ESCON Channel Director.

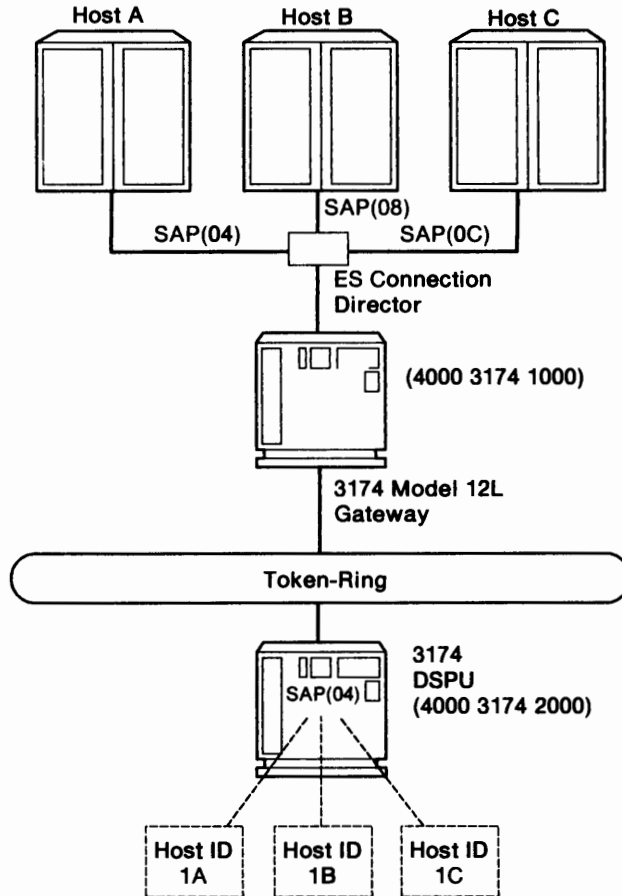

Figure E-4. Gateway With Multiple Host Connection and Multiple SAPs

The following table shows responses to configuration questions 106 and 107 for the network in Figure E-4. The **address portions** of these responses are used for example purposes only; they do not imply a recommendation.

Host ID	106: 3174		107: Gateway	
	Address	SAP	Address	SAP
1A	400031742000	04	400031741000	04
1B	400031742000	04	400031741000	08
1C	400031742000	04	400031741000	0C

### Combination of Gateway Capabilities

Figure E-5 shows the usage of SAPs in a network that consists of all three of the previous examples.

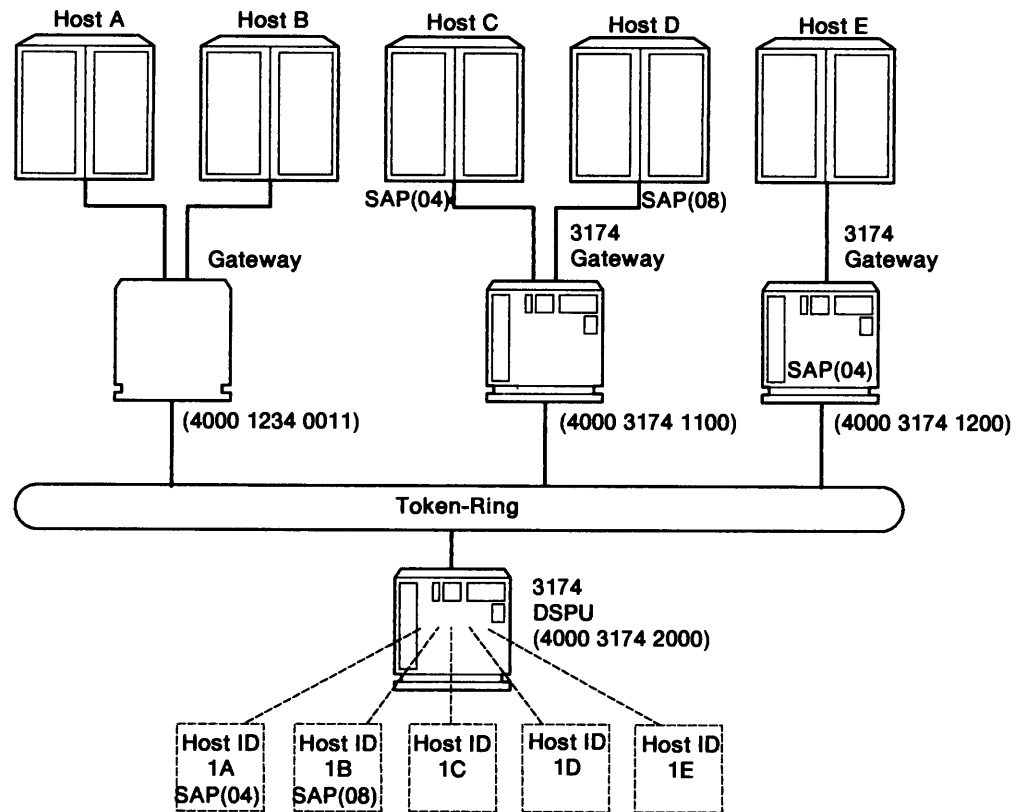

Figure E-5. Combination of Gateway Capabilities

The following table shows responses to configuration questions 106 and 107 for the network in Figure E-5. The **address portions** of these responses are used for example purposes only; they do not imply a recommendation.

Host ID	106: 3174		107: Gateway	
	Address	SAP	Address	SAP
1A	400031742000	04	400012340011	04
1B	400031742000	08	400012340011	04
1C	400031742000	04	400031741100	04
1D	400031742000	04	400031741100	08
1E	400031742000	04	400031741200	04

---

## List of Abbreviations

### A

**A.** (1) Ampere. (2) Angstrom.

**AC.** Alternating current.

**ACF/TCAM.** Advanced Communications Function for the Telecommunications Access Method.

**ACF/VTAM.** Advanced Communications Function for the Virtual Telecommunications Access Method.

**ACK.** Acknowledge.

**ACTPU.** Activate Physical Unit.

**AEA.** Asynchronous Emulation Adapter.

**AID.** Attention identifier.

**Alt.** Alternate.

**ANSI.** American National Standards Institute.

**APAR.** Authorized program analysis report.

**APL.** A Programming Language.

**ASCII.** American National Standard Code for Information Interchange.

**ATTN.** Attention.

### B

**B.** Busy.

**BB.** Begin bracket.

**BIS.** Bracket initiation stopped

**bps.** Bits per second.

**BSC.** Binary synchronous communication.

### C

**C.** Celsius.

**CA.** Character attributes.

**C&D.** Cause and diagnostic (codes)

**CC.** (1) Control check. (2) Chain Command (flag).

**CCA.** Concurrent Communication Adapter.

**CCITT.** International Telegraph and Telephone Consultative Committee.

**CCW.** Channel command word.

**CD.** Change direction.

**CE.** (1) IBM Customer Engineer. (2) Correctable error. (3) Channel-end.

**CECP.** Country extended code page.

**ChgSc.** Change screen.

**CICS.** Customer Information Control System.

**CICS/VS.** Customer Information Control System/Virtual Storage.

**CID.** Connection identifier.

**CMS.** Conversational monitor system.

**cncl.** Cancel.

**coax.** Coaxial (cable).

**comm.** Communication.

**CR.** (1) Command Reject. (2) Carriage return.

**CSCF.** Central Site Control Facility.

**CSCM.** Central Site Change Management.

**CUG.** Closed user group.

**CUT.** Control unit terminal.

### D

**D.** Display.

**DCE.** Data circuit-terminating equipment.

**DE.** Device-end.

**dec.** Decimal.

**DEL.** The delete character.

**dev.** Device.

**Dev Cncl.** Device Cancel.

**DFT.** (1) Distributed function terminal.  
(2) Diagnostic function test.

**DISC.** Disconnect.

**DM.** (1) Disconnect mode. (2) Distribution Manager.

**DOS.** Disk Operating System.

**DSL.** (1) Downstream load. (2) Data set label.

**DSPU.** Downstream physical unit.

**DSR.** Data set ready.

**DTE.** Data terminal equipment.

**DTR.** Data terminal ready.

**dup, DUP.** Duplicate.

## **E**

**EAB.** Extended Attribute Buffer.

**EAU.** Erase All Unprotected.

**EB.** End bracket.

**EBCDIC.** Extended Binary-Coded Decimal Interchange Code.

**EC.** Engineering change.

**EIA.** Electronic Industries Association.

**EOF.** End of field.

**EOT.** End-of-transmission character.

**ESC.** Escape.

**ESCON.** Enterprise Systems Connection.

**ETX.** End of Text.

**E/W.** Erase/Write.

**EX.** Exception (response).

## **F**

**F.** Fahrenheit.

**FA.** Field attribute.

**FF.** Form Feed.

**FM.** (1) Frequency modulation. (2) Function management. (3) Field mark.

**FMH.** Function management header.

**FRU.** Field-replaceable unit.

## **G**

**GDDM.** Graphical Data Display Manager.

## **H**

**H.** Height.

**HDLC.** High-level data link control.

**hex.** Hexadecimal.

**HG.** Hardware group.

**HNAD.** Host network (DTE) address.

## **I**

**I.** Information (format).

**ID.** (1) Identification. (2) Identifier.

**Ident.** Identification.

**IML.** Initial microcode load.

**In.** Inch (or inches).

**INS.** Insert.

**I/O.** Input/output.

**IOCP.** Input/output control program.

**IPDS.** Intelligent Printer Data Stream.

**IR.** Intervention Required.

**ISO.** International Organization for Standardization.

## **K**

**k.** 1000.

**K.** 1024.

**Kb.** Kilobit.

**KB.** Kilobyte.

**KDU.** Keyboard Definition Utility

## **L**

**L.** Left.

**LAN.** Local area network.

**LAPB.** Link access procedure balanced.

**LFS.** Local Format Storage.

**LFU.** Limited Function Utility.

**LH.** Link header.

**LIB.** Library.

**LIC.** Last in chain.

**LLC.** Logical link control.

**LT.** Logical terminal.

**LTA.** Logical terminal assignment.

**LU.** Logical unit.

## **M**

**m.** Meter (or meters).

**MAP.** Maintenance analysis procedure.

**max.** Maximum.

**MB.** Megabyte.

**Mbps.** Megabits per second.

**min.** Minimum, minute.

**MIS.** Multiple interactive sessions.

**MLT.** Multiple Logical Terminals.

**modem.** Modulator-demodulator.

**MPP.** Maximum print position.

**MVS.** Multiple virtual storage.

## **N**

**NCCF.** Network Communications Control Facility.

**NCP.** Network Control Program.

**NI.** Not initialized.

**NL.** New Line.

**NLDM.** Network Logical Data Manager.

**No.** Number.

**NPDA.** Network Problem Determination Application.

**NPKT.** Negotiated packet size.

**NRZ.** Nonreturn to zero.

**NRZI.** Nonreturn to zero inverted.

**NTRI.** NCP Token-Ring Interconnection.

**NUM.** Numeric.

**NWND.** Negotiated window size.

## **O**

**OEM.** Original equipment manufacturer.

**OIA.** Operator information area.

## **P**

**P.** (1) Printer. (2) Protected.

**PA.** (1) Program access. (2) Program attention.

**PAM.** Printer authorization matrix.

**PC.** Personal computer.

**pF.** Picofarad.

**PF.** Program function.

**PID.** Product-set ID.

**PIU.** Path information unit.

**PLU.** Primary logical unit.

**PS.** Programmed symbols.

**PU.** Physical unit.

**PUID.** Physical unit identification.

**PVC.** Permanent virtual circuit.

## **Q**

**QLLC.** Qualified logical link control.



## R

**R.** (1) Rear. (2) row. (3) riser.

**RECFMS.** Record Formatted Maintenance Statistics.

**REM.** Ring error monitor.

**Req.** Request.

**REQMS.** Request Maintenance Statistics.

**resp.** Response.

**RFS.** Ready-For-Sending.

**RH.** Request/response header.

**ROS.** Read-only storage.

**RPOA.** Recognized Private Operating Agency.

**RPQ.** Request for price quotation.

**R/R.** Request/response.

**RTM.** Response Time Monitor.

**RTS.** Request to send.

**RU.** Request/response unit.

## S

**S.** Sequenced (format), side.

**SAP.** Service access point.

**SCS.** SNA character string.

**SDLC.** Synchronous Data Link Control.

**SI.** Suppress Index.

**SLU.** Secondary logical unit.

**SNA.** Systems Network Architecture.

**SNBU.** Switched network backup.

**SOEMI.** Serial Original Equipment Manufacturer Interface.

**SP.** (1) Space. (2) Specific Poll.

**SSCP.** System services control point.

**SVC.** Switched virtual circuit.

**SYSGEN.** System generation.

## T

**TA.** Terminal adapter.

**TCLS.** Throughput class negotiation.

**TH.** Transmission header.

**TMA.** Terminal Multiplexer Adapter.

**TP.** Teleprocessing.

## U

**U.** Unprotected.

**UCW.** Unit control word.

**UDT.** User defined terminal tables.

**UDX.** User defined translate tables.

**UKPSS.** United Kingdom Packet Switched Service.

**U.S.** United States.

**US.** (1) Unit specify (2) Unit separator.

## V

**V.** Volt.

**VM.** Virtual machine.

**VM/SP.** Virtual machine/System Product.

**VPD.** Vital Product Data.

**VS.** Virtual storage.

**VSE.** Virtual storage extended.

**VTAM.** Virtual Telecommunications Access Method.

## W

**WACK.** Wait before transmit positive acknowledgement.

**WCC.** Write control character.

**WE.** Western Electric.

**WSF.** Write Structured Field.

# **X**

**XON.** Transmitter on.

**X.25.** Packet-switched networks.

**XID.** Exchange station identification.

**XOFF.** Transmitter off.



---

# Glossary

## A

**access method.** A technique for moving data between main storage and input/output devices.

**acknowledgment.** The transmission, by a receiver, of acknowledge characters as an affirmative response to a sender.

**active.** (1) Able to communicate on the network. A token-ring network adapter is active if it is able to transmit and receive on the network. (2) Operational. (3) Pertaining to a node or device that is connected or is available for connection to another node or device. (4) Currently transmitting or receiving.

**active logical terminal (LT).** In MLT, the currently displayed logical terminal. Synonymous with *foreground logical terminal*. Contrast with *background logical terminal*.

**adapter.** (1) A general term for a device that provides some transitional function between two or more devices. (2) In a local area network, within a communicating device, a circuit card with its associated software that enables the device to communicate over the network.

**address.** (1) A value that identifies a register, a particular part of storage, a data source, or a data sink. The value is represented by one or more characters. (2) To refer to a device or an item of data by its address. (3) In word processing, the location, identified by an address code, of a specific section of the recording medium or storage. (4) The location in the storage of a computer where data is stored. (5) In data communication, the unique code assigned to each device or workstation connected to a network.

**Advanced Communications Function for the Telecommunications Access Method (ACF/TCAM).**

(1) An IBM licensed program that provides single domain network capability and, optionally, multiple-domain capability. ACF/VTAM runs under MVS and OS/VS1 and provides message queuing. (2) An IBM licensed program that provides queued message-handling.

**Note:** TCAM, Versions 1 and 2, are telecommunications access methods, but TCAM, Version 3, is a message-handling subsystem.

**AEA.** See *Asynchronous Emulation Adapter*.

**AEA port.** A communication connector on the Asynchronous Emulation Adapter (AEA).

**AEA port set.** (1) One or more 3174 ports that support individual AEA station sets; they must have the same port (connection) type and modem type, but different station types. (2) One or more 3174 station sets that have different station types, but the same port type, modem type, and number of default destinations.

**AEA station.** A 3270 or ASCII display station, printer, or host that communicates through the Asynchronous Emulation Adapter.

**AEA station set.** (1) One or more AEA stations that have the same attributes, for example, line speed and parity. (2) One or more AEA stations that share the same characteristics of station type, port type, modem type, and default destination.

**alert.** (1) For IBM LAN management products, a notification indicating a possible security violation, a persistent error condition, or an interruption or potential interruption in the flow of data around the network. See also *network management vector transport*. (2) In SNA, a record sent to a system problem management focal point to communicate the existence of an alert condition. (3) In the NetView program, a high-priority event that warrants immediate attention. This data base record is generated for certain event types that are defined by user-constructed filters.

**alternate cursor.** (1) An image reversal of each dot in the character cell at the cursor position. (2) A cursor other than the one displayed on the display surface at power on time.

**alternate 1 initial microcode load (Alt 1 IML).** The initiating procedure for running specific adapter tests, starting customizing, or doing a normal IML.

**alternate 2 initial microcode load (Alt 2 IML).** The initiating procedure for running a general 3174 controller test.

**American National Standard Code for Information Interchange (ASCII).** The standard code, using a coded character set consisting of 7-bit coded characters (8 bits including parity check), used for information interchange among data processing systems, data communication systems, and associated equipment. The ASCII set consists of control characters and graphics characters.

**APAR.** Authorized program analysis report. A report of a problem caused by a suspected defect in a current unaltered release of a program.

**application.** (1) The use to which an information processing system is put, for example, a payroll

application, an airline reservation application, or a network application. (2) A collection of software components used to perform specific types of work on a computer.

**application program.** (1) A program written for or by a user that applies to the user's work. Some application programs receive support and services from a special kind of application program called a network application program. (2) A program used to connect and communicate with stations in a network, enabling users to perform application-oriented activities.

**ASCII emulation.** The ability of a 3270 display station or printer to communicate with an ASCII host using the DEC VT100, DEC VT220, Data General D210, or IBM 3101 data stream.

**ASCII pass-through.** The transmission of unmodified data between ASCII display stations or printers and an ASCII host or public data network.

**asynchronous.** (1) Pertaining to two or more processes that do not depend upon the occurrence of a specific event such as a common timing signal. (2) In Fiber Distributed Data Interface (FDDI) rings, a type of data traffic that does not need bounded access delay to the medium and guaranteed throughput.

**Asynchronous Emulation Adapter (AEA).** In the 3174 Establishment Controller, an adapter that enables an ASCII terminal to communicate with a 3270 host using the 3270 data stream, an ASCII terminal to communicate with an ASCII host through the 3174, and a 3270 terminal to communicate with an ASCII host using data streams, such as the DEC VT100, DEC VT220, Data General D210, or IBM 3101 data streams.

**attach.** To make a device part of a network logically.

**attaching device.** Any device that is physically connected to a network and can communicate over the network.

**attention (ATTN).** An occurrence external to an operation that could cause an interruption of the operation.

**attention identifier (AID).** (1) A code in the inbound 3270 data stream that identifies the source or type of data that follows. (2) A character in a data stream indicating that the user has pressed a key, such as ENTER, that requests an action by the system.

**attention key.** A function key on terminals that, when pressed, causes an I/O interruption in the processing unit.

**attribute.** (1) A characteristic. (2) A terminal display language or transformation definition language (TDL) keyword that specifies a particular quality for the TDL object with which it is associated.

**audible alarm.** (1) An alarm that is sounded when designated events occur that require operator attention or intervention before system operation can continue. (2) A special feature that sounds a short, audible tone automatically when a character is entered from the keyboard into the next-to-last character position on the screen. The tone can also be sounded under program control.

**automatic answering.** (1) Answering in which the called data terminal equipment (DTE) automatically responds to the calling signal.

**Note:** The call may be established whether or not the called DTE is attended.

(2) A machine feature that permits a station to respond without operator action to a call it receives over a switched line. See also *manual answering*. Contrast with *automatic calling*.

**autobaud.** In the 3174 AEA feature, the process of determining the line speed and parity settings of a connecting display station from a specific sequence of characters (CR . CR) entered from the keyboard. ASCII hosts may also support automatic speed and parity detection, but the character sequence they require may differ.

**auto-call.** See *automatic calling*.

**automatic calling.** (1) Calling in which the elements of the selection signal are entered into the data network contiguously at the full data signaling rate. (2) A machine feature that permits a station to initiate a connection with another station over a switched line without operator action. (3) See also *manual calling*. Contrast with *automatic answering*.

## B

**backbone.** In a multiple-ring local area network, a high-speed link to which the rings are connected by means of bridges. A backbone may be configured as a bus or as a ring.

**backbone ring.** A ring that interconnects ring networks.

**background logical terminal (LT).** In MLT, any logical terminal that is not currently displayed. Contrast with *active logical terminal (LT)*.

**Base data set.** A data set that contains only those characters contained in a country's base character set. A base character set may or may not be a subset of CECP.

**batch.** A program or operation that is performed with little or no interaction between the user and the system. Contrast with *interactive*.

**binary synchronous communication (BSC).** A form of telecommunication line control that uses a standard set of transmission control characters and control character sequences, for binary synchronous transmission of binary-coded data between stations. Contrast with *synchronous data link control (SDLC)*.

**bind command.** A command used to start a session and to define the characteristics of that session. Contrast with *unbind command*.

**bits per second (bps).** The rate at which bits are transmitted per second.

**bracket.** In SNA, one or more chains of request units (RUs) and their responses, which are exchanged between two LU-LU half-sessions and represent a transaction between them. A bracket must be completed before another bracket can be started. Examples of brackets are data base inquiries/replies, update transactions, and remote job entry output sequences to workstations.

**bridge.** (1) An attaching device that connects two LAN segments to allow the transfer of information from one LAN segment to the other. A bridge may connect the LAN segments directly by network adapters and software in a single device, or may connect network adapters in two separate devices through software and use of a telecommunications link between the two adapters. (2) A functional unit that connects two LANs that use the same logical link control (LLC) procedures but may use the same or different medium access control (MAC) procedures. Contrast with *gateway* and *router*.

**buffer.** (1) A portion of storage used to hold input or output data temporarily. (2) A routine or storage used to compensate for a difference in data rate or time of occurrence of events, when transferring data from one device to another.

**burst.** (1) In data communication, a sequence of signals counted as one unit in accordance with some specific criterion or measure. (2) To separate continuous-form paper into discrete sheets.

**bus.** (1) In a processor, a physical facility on which data is transferred to all destinations, but from which only addressed destinations may read in accordance with appropriate conventions. (2) A network configuration in which nodes are interconnected through a bidirectional transmission medium. (3) One or more conductors used for transmitting signals or power.

**byte.** (1) A string that consists of a number of bits, treated as a unit, and representing a character. (2) A binary character operated upon as a unit and usually shorter than a computer word. (3) A string that consists of a particular number of bits, usually 8, that is

treated as a unit, and that represents a character.

(4) A group of 8 adjacent binary digits that represent one extended binary-coded decimal interchange code (EBCDIC) character.

## C

**card.** In the 3174 Establishment Controller, a unit of electronic circuitry contained in a plastic casing (or cassette) and providing the controller with a specialized function, for example, a Terminal Adapter or an Encrypt/Decrypt Adapter.

**carrier.** A wave or pulse train that may be varied by a signal bearing information to be transmitted over a communication system.

**CECP-capable device.** A device that supports the Country Extended Code Page.

**CECP character set.** A collection of symbols in Character Set 697 required for CECP languages.

**CECP data set.** A data set that contains any CECP-unique graphic.

**CECP-unique graphic.** A graphic symbol that is in the CECP character set and not in the base character set.

**Central site change management (CSCM).** A function of the 3174 microcode that tracks the microcode for each controller in a network and, in conjunction with NetView DM, electronically distributes and retrieves microcode changes for each controller.

**Central Site Controller.** The controller that contains the central site library for all of the controllers in a network.

**central site customizing.** The process of tailoring the 3174 Licensed Internal Code for each controller in a network, at the central site.

**central site library.** One or more Library disks that contain customizing data and label information for the controllers in a network.

**channel.** (1) A functional unit, controlled by a host computer, that handles the transfer of data between processor storage and local peripheral equipment. (2) A path along which signals can be sent. (3) The portion of a storage medium that is accessible to a given reading or writing station. (4) In broadband transmission, a designation of a frequency band 6 MHz wide.

**channel-attached.** Pertaining to attachment of devices directly by data channels (I/O channels) to a computer. Synonym for *local*. Contrast with *telecommunication-attached*.

**character position.** (1) A location on the screen at which one character can be displayed. (2) An addressed location in the buffer at which 1 character can be stored.

**character set.** (1) A defined collection of characters. (2) A group of characters used for a specific reason, for example, the set of characters a printer can print. (3) The collection of graphic characters required to support a specific language.

**cluster.** A station that consists of a control unit (a cluster controller) and the terminals attached to it.

**cluster controller.** A device that can control the input/output operations of more than one device connected to it. A cluster controller may be controlled by a program stored and executed in the unit, for example, the IBM 3174 Establishment Controller. Or, it may be entirely controlled by hardware, for example, the IBM 3272 Control Unit. See also *cluster* and *cluster controller node*. Synonymous with *cluster control unit*.

**cluster controller node.** A peripheral node that can control a variety of devices. See also *host node*, *Network Control Program (NCP) node*, and *terminal node*.

**cluster control unit.** Synonym for cluster controller.

**coaxial cable.** A cable consisting of one conductor, usually a small copper tube or wire, within and insulated from another conductor of larger diameter, usually copper tubing or copper braid.

**code page.** An assignment of graphic characters and control function meanings to all code points.

**code point.** A 1-byte code representing one of 256 potential characters.

**command.** (1) A request for performance of an operation or execution of a program. (2) A character string from a source external to a system that represents a request for system action.

**command retry.** A channel and control unit procedure that causes a command to be retried without requiring an I/O interruption.

**communication adapter.** (1) A circuit card with associated software that enables a processor, controller, or other device to be connected to a network. (2) See *EIA communication adapter, V.35 communication adapter*, and *X.21 communication adapter*.

**communication controller.** (1) A device that directs the transmission of data over the data links of a network; its operation may be controlled by a program processed in a processor to which the controller is connected or by a program executed within the device.

(2) A type of communication control unit whose operations are controlled by one or more programs stored and executed in the unit. It manages the details of line control and the routing of data through a network. (3) See also *cluster controller*, *communication controller node*, and *transmission control unit*.

**communication controller node.** A subarea node that does not contain a system services control point (SSCP).

**communication link.** Physical (hardware) link.

**communication management host.** In ACF/TCAM, the host in a communication management configuration that performs all network-control functions in the network except control of locally attached stations of data hosts.

**component.** (1) Hardware or software that is part of a functional unit. (2) A functional part of an operating system, for example, the scheduler or supervisor. (3) In systems with VSAM, a named, cataloged collection of stored records, such as the data component or index component of a key-sequenced file or alternate index. (4) In System/38 graphics, the representation of a data group on a chart. (5) See *terminal component* and *solid state component*.

**Concurrent Communication Adapter (CCA).** In the 3174 Establishment Controller, a communication adapter that, along with the necessary microcode, provides terminals attached to the 3174 the ability to concurrently access an additional 3270 host.

**configuration.** The arrangement of a computer system or network as defined by the nature, number, and chief characteristics of its functional units. More specifically, the term *configuration* may refer to a hardware configuration or a software configuration. See also *system configuration*.

**configuration parameters.** Variables in a configuration definition, the values of which characterize the relationship of a product, such as a bridge, to other products in the same network.

**Connection Menu.** A menu on the screen of a display station attached to the 3174 Establishment Controller, from which a user can select an available host.

**connector.** A means of establishing electrical flow.

**control character.** (1) A character whose occurrence in a particular context specifies a control function. (2) A character used to specify that a control unit is to perform a particular operation.

**control codes.** (1) Code points and their assigned control function meanings. (2) The hexadecimal values hex 00 through hex 3F, and hex FF in the 3270

data stream. ASCII control codes are the hexadecimal values hex 00 through hex 1F and 7F.

**Control (CTL) disk.** A customized diskette or fixed disk containing the microcode that describes a particular controller's attached terminals, and its method of attachment to the host.

**Control (CTL) diskette.** A customized diskette containing the microcode that describes a particular controller's attached terminals, and its method of attachment to the host.

**control function.** Synonym for *control operation*.

**controller.** A unit that controls input/output operations for one or more devices.

**control operation.** An action that affects the recording, processing, transmission, or interpretation of data; for example, starting or stopping a process, carriage return, font change, rewind, and end of transmission. Synonymous with *control function*.

**control unit.** A general term for any device that provides common functions for other devices or mechanisms. Synonym for controller.

**control unit terminal (CUT).** A terminal that relies on the 3174 to interpret the data stream. Examples are the 3178, 3179, 3278 Model 2, and 3279 Model S2A.

**control unit terminal (CUT) mode.** A host-interactive mode that enables an IBM 3270 Personal Computer customized in this mode to run only one session emulating a 3178, 3179, 3278 Model 2, or 3279 Model S2A.

**conversion.** (1) In programming languages, the transformation between values that represent the same data item but belong to different data types. Information may be lost as a result of conversion because accuracy of data representation varies among different data types. (2) The process of changing from one method of data processing to another or from one data processing system to another. (3) The process of changing from one form of representation to another, for example, to change from decimal representation to binary representation.

**copy operation.** An operation that copies the contents of the buffer from one terminal to another terminal attached to the same control unit.

**country extended code page (CECP).** A function of the 3174 microcode that provides for a code page containing additional code points beyond those available with Table 5A code pages. CECP is supported by a universal character set, Character Set 697, which contains 190 characters.

**create.** In 3174 central site customizing, to create a library member for a network controller, and store the customizing data for that library member on a Library diskette.

**cursor.** (1) A movable, visible mark used to indicate the position at which the next operation will occur on a display surface. (2) A unique symbol that identifies a character position in a screen display, usually the character position at which the next character to be entered from the keyboard will be displayed.

**Customer Information Control System (CICS).** An IBM licensed program that enables transactions entered at remote terminals to be processed concurrently by user-written application programs. It includes facilities for building, using, and maintaining data bases.

**customization.** Procedures that tailor the control unit microcode to fit the various types of display stations and printers and the method of host attachment that a particular control unit will handle.

**customizing display station.** A display station used to perform the customizing procedures; this display station must be attached to port 26-00 of the controller. Only these display stations can be used for customizing: a 3178, a 3179 Model 1 operating in native or 3279-emulation mode, a 3180 operating in native or 3278-emulation mode, a 3191, a 3192, a 3194 operating in control unit terminal (CUT) mode, a 3270 Personal Computer with 3278/3279 emulation, operating in CUT mode, a 3278 (except Model 1), a 3279, a 5550 family operating in CUT mode, a 6150 RT Personal Computer, and a 6151 RT Personal Computer.

**customizing keyboard.** A keyboard used to type in the customizing responses; this keyboard must be a Typewriter, Data Entry, APL (with APL off), or Text (with Text off) keyboard with a QWERTY layout. (On a QWERTY layout, the first six characters on the left side of the top row of alphabetic characters are Q, W, E, R, T, Y.)

## D

**data.** (1) A representation of facts, concepts, or instructions in a formalized manner suitable for communication, interpretation, or processing by human or automatic means. (2) Any representations such as characters or analog quantities to which meaning is or might be assigned.

**data base.** A set of data, part or the whole of another set of data, that consists of at least one file, and that is sufficient for a given purpose or for a given data processing system.

**data chaining.** In synchronous data link control (SDLC) data transmission, the chaining together of scattered



segments of storage data to assemble a complete SDLC frame.

**data circuit.** (1) A pair of associated transmit and receive channels that provide a means of two-way data communication. (2) In SNA, see also *link connection*.

**Notes:**

1. Between data-switching exchanges, the data circuit may include data circuit-terminating equipment (DCE), depending on the type of interface used at the data-switching exchange.
2. Between a data station and a data-switching exchange or data concentrator, the data circuit includes the data-terminating equipment at the data station end. It may also include equipment similar to a DCE at the data-switching exchange or data-concentrator location.

**data circuit-terminating equipment (DCE).** In a data station, the equipment that provides the signal conversion and coding between the data terminal equipment (DTE) and the line.

**Data Entry keyboard.** A keyboard layout designed for data entry applications.

**data frame.** See *frame*.

**data host.** In an ACF/TCAM communication management configuration, a host that is dedicated to processing applications and does not control network resources, except for its locally attached devices. See also *communication management host*.

**data link.** (1) Any physical link, such as a wire or a telephone circuit, that connects one or more remote terminals to a communication control unit, or connects one communication control unit with another. (2) The assembly of parts of two data terminal equipment (DTE) devices that are controlled by a link protocol, and the interconnecting data circuit, that enable data to be transferred from a data source to a data sink. (3) In SNA, see also *link*.

**Note:** A telecommunication line is only the physical medium of transmission. A data link includes the physical medium of transmission, the protocol, and associated devices and programs; it is both physical and logical.

**data stream.** (1) All data transmitted through a data channel in a single read or write operation. (2) A continuous stream of data elements being transmitted, or intended for transmission, in character or binary-digit form, using a defined format. See also *data stream format*.

**data streaming.** A protocol for transmitting data on a channel. In this protocol, the sender maintains the channel in a transmit state for an extended length of time.

**data stream format.** In SNA, the format of the data elements (end-user data) in the request unit (RU). See also *3270 data stream* and *SNA character string (SCS)*.

**data terminal equipment (DTE).** (1) That part of a data station that serves as a data source, data receiver, or both. (2) Equipment that sends or receives data, or both.

**Data Terminal Ready (DTR) flow control.** A procedure for a communicating device to signal its readiness to receive data by raising the DTR lead on an EIA 232D interface.

**data transfer.** (1) The result of the transmission of data signals from any data source to a data receiver. (2) The movement, or copying, of data from one location and the storage of the data at another location.

**deconfigure.** In 3174, the ability of the controller to disable functions or features to a partially operating or non-operating state, when the configuration of the control disk requires more 3174 storage than is available.

**default.** Pertaining to an attribute, value, or option that is assumed when none is explicitly specified.

**default destination.** A destination for display stations and printers that is defined in AEA customization.

**default response.** A response supplied by the customizing utility if a different response is not specified during customization.

**destination.** Any point or location, such as a node, station, or a particular terminal, to which information is to be sent.

**device.** (1) A mechanical, electrical, or electronic contrivance with a specific purpose. (2) An input/output unit such as a terminal, display, or printer.

**diagnostics.** Modules or tests used by computer users and service personnel to diagnose hardware problems.

**disk.** A direct-access data storage medium, which may be either flexible (diskette) or hard (fixed disk).

**diskette.** A flexible magnetic disk enclosed in a protective container.

**diskette drive.** The mechanism used to seek, read, and write data on diskettes.

**display field.** (1) An area in the display buffer that contains a set of characters that can be manipulated or operated upon as a unit. (2) A group of consecutive characters (in the buffer) that starts with an attribute character (defining the characteristics of the field) and contains one or more alphanumeric characters. The

field continues to, but does not include, the next attribute character.

**display station.** An input/output device containing a display screen and an attached keyboard that allows a user to send information to or receive information from the system.

**distributed function terminal (DFT).** A programmable terminal that can perform operations previously performed by the control unit. These terminals can interpret the 3270 data stream themselves. Examples are the IBM 3270 Personal Computer and the 3290 Information Panel.

**distributed function terminal (DFT) mode.** A host-interactive mode that enables an IBM 3270 Information Display System customized in this mode to run as many as four host sessions. The sessions can emulate a 3178, 3179, 3278 Model 2, or 3279 Model S2A.

**downstream.** (1) In the direction of data flow or toward the destination of transmission. (2) From the processor toward an attached unit or end user. (3) Contrast with *upstream*.

**downstream load (DSL).** The capability of a distributed function terminal to receive its control program from the control unit to which it is attached. A disk containing the terminal's control program is loaded into the control unit.

**downstream physical unit (DSPU).** A controller or a workstation downstream from a gateway that is attached to a host.

**drop.** A cable that leads from a faceplate to the distribution panel in a wiring closet. When the IBM Cabling System is used with the IBM Token-Ring Network, a drop may form part of a lobe. See also *lobe*.

**duplex.** Pertaining to communication in which data can be sent and received at the same time. Synonymous with *full duplex*.

## E

**Early Token Release (ETR).** In token-ring and Fiber Distributed Data Interface (FDDI) networks, a function that allows a transmitting adapter to release a new token as soon as it has completed frame transmission, whether or not the frame header has returned to that adapter.

**EBCDIC.** Extended binary-coded decimal interchange code. A coded character set consisting of 8-bit coded characters.

**EIA communication adapter.** A communication adapter conforming to EIA standards that can combine and send information on two lines at speeds up to 19.2 kbps.

**EIA 232D.** An electrical interface defined by the Electronics Industries Association for establishing connections and controlling data flow between data terminal equipment and data communication equipment. The interface has been adapted to allow communication between DTEs.

**emulate.** To imitate one system with another, primarily by hardware, so that the imitating system accepts the same data, executes the same computer programs, and achieves the same results as the imitated computer system.

**emulation.** (1) The imitation of all or part of one system by another, primarily by hardware, so that the imitating system accepts the same data, executes the same programs, and achieves the same results as the imitated computer system. (2) The use of programming techniques and special machine features to permit a computing system to execute programs written for another system. (3) Imitation; for example, imitation of a computer or device. (4) See *terminal emulation*. (5) Contrast with *simulation*.

**enabled.** (1) On a LAN, pertaining to an adapter or device that is active, operational, and able to receive frames from the network. (2) Pertaining to a state of a processing unit that allows the occurrence of certain types of interruptions. (3) Pertaining to the state in which a transmission control unit or an audio response unit can accept incoming calls on a line.

**equipment rack.** A metal stand for mounting components.

**Erase All Unprotected (EAU) command.** A 3270 data stream command that erases all unprotected fields and inserts nulls.

**Enterprise Systems Connection Adapter (ESCON Adapter).** In 3174, this adapter allows the controller to communicate with an IBM S/390\* host through an Enterprise Systems Connection Channel using optical fiber cable.

**event.** (1) An occurrence or happening. (2) An occurrence of significance to a task; for example the completion of an asynchronous operation, such as an input/output operation.

**extended attribute buffer (EAB).** The buffer in which the extended field attributes are stored. Examples of extended field attributes are:

- Extended highlighting
- Color (blue, red, pink, green, turquoise, yellow, white)

- Character sets
- Transparency

**extended binary-coded decimal interchange code (EBCDIC).** A coded character set consisting of 8-bit coded characters.

**extended highlighting.** (1) A function that provides blink, reverse video, and underscore for emphasizing fields or characters on devices supporting extended field attributes and character attributes. (2) An attribute type in the extended field attribute and character attribute. (3) An attribute passed between session partners in the Start Field Extended, Modify Field, and Set Attribute orders.

## F

**fault.** An accidental condition that causes a functional unit to fail to perform its required function.

**fault domain.** (1) In IBM LAN problem determination, the portion of a network that is expected to be involved with an indicated error. (2) The segment of a token-ring network between a station and its nearest active upstream neighbor (NAUN).

**feature.** A part of an IBM product that may be ordered separately by the customer.

**fiber.** See *optical fiber*.

**fiber optics.** The branch of optical technology concerned with the transmission of radiant power through fibers made of transparent materials such as glass, fused silica, and plastic.

### Notes:

1. Telecommunication applications of fiber optics use optical fibers. Either a single discrete fiber or a nonspatially aligned fiber bundle may be used for each information channel. Such fibers are often called *optical fibers* to differentiate them from fibers used in noncommunication applications.
2. Various industrial and medical applications use (typically high-loss) flexible fiber bundles in which individual fibers are spatially aligned, permitting optical relay of an image.
3. Some specialized industrial applications use rigid (fused) aligned fiber bundles for image transfer.

**fiber optic cable.** See *optical cable*.

**Fiber Optic Terminal Adapter (FTA).** In 3174, this adapter allows a 3299 Model 032 to be attached to the 3174 using optical fiber cable.

**field.** See *display field*.

**file.** A named set of records stored or processed as a unit.

**fixed disk.** A rigid magnetic disk used in a fixed disk drive.

**fixed disk drive.** A disk storage device that reads and writes on rigid magnetic disks.

**flag.** (1) An indicator or parameter that shows the setting of a switch. (2) Any of various types of indicators used for identification, for example, a wordmark. (3) A character that signals the occurrence of some condition, such as the end of a word. (4) Deprecated term for *mark*.

**flow control.** (1) In data communication, control of the data transfer rate. (2) In SNA, the process of managing the rate at which data traffic passes between components of the network. The purpose of flow control is to optimize the rate of flow of message units with minimum congestion in the network, that is, neither to overflow the buffers at the receiver or at intermediate routing nodes nor to leave the receiver waiting for more message units. (3) The methods used to control the flow of information across a network.

**foreground logical terminal (LT).** Synonym for *active logical terminal (LT)*.

**frame.** (1) The unit of transmission in some LANs, including the IBM Token-Ring Network and the IBM PC Network. It includes delimiters, control characters, information, and checking characters. On a token-ring network, a frame is created from a token when the token has data appended to it. On a token bus network (IBM PC Network), all frames including the token frame contain a preamble, start delimiter, control address, optional data and checking characters, end delimiter, and are followed by a minimum silence period. (2) A housing for machine elements. (3) In synchronous data link control (SDLC), the vehicle for every command, every response, and all information that is transmitted using SDLC procedures. Each frame begins and ends with a flag.

**full duplex.** Synonym for *duplex*.

**function.** In NetView DM, a function is the specification of a transmission activity on a resource or group of resources. Functions are grouped into phases. In CSCM, resources are known as data objects.

## G

**gateway.** A device and its associated software that interconnect networks or systems of different architectures. The connection is usually made above the reference model network layer. For example, a gateway allows LANs access to System/370 host computers. Contrast with *bridge* and *router*.

**generate.** In 3174 central site customizing, to write a Control diskette containing the customizing data for a particular controller. Also, to print a mailing address label and a diskette label for a particular controller.

**get.** In 3174 central site customizing, to select the type of data you want and store it in working copy.

**group.** (1) A set of related records that have the same value for a particular field in all records. (2) A collection of users who can share access authorities for protected resources. (3) A list of names that are known together by a single name.

## H

**half-duplex.** In data communication, pertaining to transmission in only one direction at a time. Contrast with *duplex*.

**hexadecimal.** (1) Pertaining to a selection, choice, or condition that has 16 possible values or states. (2) Pertaining to a fixed-radix numeration system, with radix of 16. (3) Pertaining to a numbering system with base of 16; valid numbers use the digits 0 through 9 and characters A through F, where A represents 10 and F represents 15.

**hexadecimal number.** The 1-byte hexadecimal equivalent of an EBCDIC character.

**host access method.** The access method that controls communication with a domain.

**host attachment.** A mode of SNA communication in which the processor acts as a secondary SNA device.

**host interface.** Interface between a network and the host computer.

**host logical unit (LU).** An SNA logical unit (LU) located in a host processor, for example, an ACF/VTAM application program.

**host mode.** The operating mode of an HASP main processor communicating with an HASP workstation.

**host node.** (1) A node at which a host processor is located. (2) In SNA, a subarea node that contains a system services control point (SSCP); for example, a System/370 computer with OS/VS2 and ACF/TCAM.

**host system.** (1) A data processing system used to prepare programs and operating environments for use on another computer or controller. (2) The data processing system to which a network is connected and with which the system can communicate. (3) The controlling or highest-level system in a data communication configuration; for example, a System/38 is the host system for the workstations connected to it.

**IBM Cabling System.** A permanently installed wiring system that eliminates the need to rewire when terminals are moved from one location to another within an office complex. It allows transmission of data at very high speeds and is the foundation for installing a local area network.

**initial microcode load (IML).** The action of loading the operational microcode.

**input mode.** A mode in which records can be read from a file.

**input/output (I/O).** (1) Pertaining to a device whose parts can perform an input process and an output process at the same time. (2) Pertaining to a functional unit or channel involved in an input process, output process, or both, concurrently or not, and to the data involved in such a process. (3) Pertaining to input, output, or both.

**interactive.** Pertaining to a program or system that alternately accepts input and then responds. An interactive system is conversational, that is, a continuous dialog exists between user and system. Contrast with *batch*.

**interface.** (1) A shared boundary between two functional units, defined by functional characteristics, common physical interconnection characteristics, signal characteristics, and other characteristics as appropriate. (2) A shared boundary. An interface may be a hardware component to link two devices or a portion of storage or registers accessed by two or more computer programs. (3) Hardware, software, or both, that links systems, programs, or devices.

**International Organization for Standardization (ISO).** An organization of national standards bodies from various countries established to promote development of standards to facilitate international exchange of goods and services, and develop cooperation in intellectual, scientific, technological, and economic activity.

## K

**keyboard definition.** A customizing procedure for defining a maximum of four modified keyboard layouts for modifiable keyboards only. Most characters, symbols, and functions can be relocated, duplicated, or deleted from almost any keyboard position. Synonym for *modify keyboard*.

**kilobit (Kb).** One thousand binary digits.

**kilobyte (KB).** 1024 bytes for processor and data storage (memory) size; otherwise, 1000 bytes.

## L

**large cluster.** In 3174, the specific models of the controller that support attachment of up to 64 IBM 3270 Terminals.

**layer.** (1) One of the seven levels of the Open Systems Interconnection reference model. (2) In open systems architecture, a collection of related functions that comprise one level of hierarchy of functions. Each layer specifies its own functions and assumes that lower level functions are provided. (3) In SNA, a grouping of related functions that are logically separate from the functions of other layers. Implementation of the functions in one layer can be changed without affecting functions in other layers.

**leased line.** Synonym for *nonswitched line*.

**Library (LIB) diskette.** A diskette that contains customizing data for some or all of the controllers in a network.

**Limited Function Utility (LFU) diskette.** A diskette that contains the microcode to run only a limited number of utilities. These are: Diagnostics, Copy Files, Encrypt/Decrypt Master Key, Identify Customizing Keyboard, and Media Management. The Limited Function Utility diskette is used mainly in networks that are under central site control.

**line speed.** (1) The rate at which data is transmitted from one point to another over a telecommunication line. (2) The number of binary digits that can be sent over a telecommunication line in 1 second, expressed in bits per second (bps).

**link.** (1) The logical connection between nodes including the end-to-end link control procedures. (2) The combination of physical media, protocols, and programming that connects devices on a network. (3) In computer programming, the part of a program, in some cases a single instruction or an address, that passes control and parameters between separate portions of the computer program. (4) To interconnect items of data or portions of one or more computer programs. (5) In SNA, the combination of the link connection and link stations joining network nodes.

**link connection.** (1) All physical components and protocol machines that lie between the communicating link stations of a link. The link connection may include a switched or leased physical data circuit, a LAN, or an X.25 virtual circuit. In SNA, the physical equipment providing two-way communication and error correction and detection between one link station and one or more other link stations.

**link station.** (1) A specific place in a service access point (SAP) that enables an adapter to communicate

with another adapter. (2) A protocol machine in a node that manages the elements of procedure required for the exchange of data traffic with another communicating link station. (3) A logical point within a SAP that enables an adapter to establish connection-oriented communication with another adapter. (4) In SNA, the combination of hardware and software that allows a node to attach to and provide control for a link.

**lobe.** In the IBM Token-Ring Network, the section of cable (which may consist of several cable segments) that connects an attaching device to an access unit.

**local.** Pertaining to a device accessed directly without use of a telecommunication line. Synonym for *channel-attached*. Contrast with *remote*.

**local area network (LAN).** A computer network located on a user's premises within a limited geographical area.

**Note:** Communication within a local area network is not subject to external regulations; however, communication across the LAN boundary may be subject to some form of regulation.

**local format storage.** In 3174, this function allows the controller to store pre-defined formatted screens and subsequently be viewed by a terminal user. The formatted screens are downloaded from the host into the 3174.

**locally administered address.** An adapter address that the user can assign to override the universally administered address. Contrast with *universally administered address*.

**location.** With reference to a 3174, a place within the 3174 chassis where a particular card or adapter is inserted.

**logical connection.** In a network, devices that can communicate or work with one another because they share the same protocol. See also *physical connection*.

**logical link control (LLC) sublayer.** One of two sublayers of the ISO Open Systems Interconnection data link layer (which corresponds to the SNA data link control layer), proposed for LANs by the IEEE Project 802 Committee on Local Area Networks and the European Computer Manufacturers Association (ECMA). It includes those functions unique to the particular link control procedures that are associated with the attached node and are independent of the medium; this allows different logical link protocols to coexist on the same network without interfering with each other. The LLC sublayer uses services provided by the medium access control (MAC) sublayer and provides services to the network layer.

**logical terminal (LT).** In MLT, one of five sessions available to share one display station.

**logical unit (LU).** In SNA, a port through which an end user accesses the SNA network in order to communicate with another end user and through which the end user accesses the functions provided by system services control points (SSCPs). An LU can support at least two sessions, one with an SSCP and one with another LU, and may be capable of supporting many sessions with other logical units.

**LU-6.2.** An abbreviation for LU-LU session type 6. In SNA, a type of session between two programs in a distributed processing environment, using the SNA character string or a structured field data stream; for example, the NetView DM/3174 implementation of microcode distribution and management.

## M

**main storage.** Program-addressable storage from which instructions and other data can be loaded directly into registers for subsequent processing.

**maintenance analysis procedure (MAP).** A maintenance document that gives an IBM service representative a step-by-step procedure for tracing a symptom to the cause of a failure.

**make-break key.** On a control unit terminal (CUT) device, a key that sends a signal to the control unit, invoking a function, both when the key is first pressed down (make) and again when it is released (break).

**manual answering.** (1) Answering in which a call is established only if the called user signals a readiness to receive the call by means of a manual operation. (2) Operator actions to prepare a station to receive a call on a switched line. Contrast with *automatic answering*.

**manual calling.** (1) Calling that permits the entry of selection signals from a calling data station at an undefined character rate. (2) Operator actions to place a call over a switched line. Contrast with *automatic calling*.

**mark.** A symbol or symbols that indicate the beginning or the end of a field, a word, an item of data or a set of data such as a file, record, or block.

**medium.** A physical carrier of electrical or optical energy.

**medium cluster.** In 3174, the specific models of the controller that support attachment of up to 16 IBM 3270 Terminals.

**megabit (Mb).** A unit of measure for throughput. 1 megabit = 1 048 576 bits.

**megabyte (MB).** A unit of measure for data. 1 megabyte = 1 048 576 bytes.

**memory.** Program-addressable storage from which instructions and other data can be loaded directly into registers for subsequent execution or processing. Synonymous with *main storage*.

**microcode.** (1) One or more microinstructions. (2) A code, representing the instructions of an instruction set, that is implemented in a part of storage that is not program-addressable. (3) To design, write, and also to test one or more microinstructions.

**modem (modulator/demodulator).** A device that converts digital data from a computer to an analog signal that can be transmitted on a telecommunication line, and converts the analog signal received to data for the computer.

**modify keyboard..** Synonym for *keyboard definition*.

**modulation.** (1) The process by which a characteristic of a signal is varied according to a characteristic of another signal. (2) The process by which a message signal is impressed upon a carrier signal so that the carrier is altered to represent the message signal.

**multidrop (network).** A network configuration in which there are one or more intermediate nodes on the path between a central node and an endpoint node.

**multi-host support.** In the 3174 Establishment Controller, the ability of a terminal to access more than one host at a time.

**multiple logical terminal (MLT).** In the 3174, a function that provides a CUT-attached, fixed-function display station with the ability to interact with as many as five host sessions. Each session is processed as though it were a separate display station.

**multiport.** Pertaining to communication among more than two stations over a single telecommunication line.

## N

**name.** An alphanumeric term that identifies a data set, statement, program, or cataloged procedure.

**native mode.** A 3179 or 3180 operational mode that uses the full capabilities of those models' display and keyboard.

**NetView.** A host-based IBM licensed program that provides communication network management (CNM) or communications and systems management (C&SM) services. It supersedes NCCF, NPDA, NLDM, and NPM.

**network.** (1) A configuration of data processing devices and software connected for information interchange. (2) An arrangement of nodes and connecting branches. Connections are made between data stations.

**Network Control Program (NCP) node.** In SNA products, a subarea node that contains an ACF/NCP program but not a system services control point (SSCP).

**network management vector transport.** The portion of an alert transport frame that contains the alert message.

**Network Problem Determination Application (NPDA).** An IBM licensed program that helps the user identify network problems from a central control point using interactive display techniques.

**Network Site Controller.** In 3174, any 3174 that is configured for central site change management, but does not contain the central site library. Contrast with *central site controller*.

**node.** (1) Any device, attached to a network, that transmits and/or receives data. (2) An endpoint of a link, or a junction common to two or more links in a network. (3) In a network, a point where one or more functional units interconnect transmission lines.

**nonescaping key.** A key that allows a character to be typed without the imprint position being changed.

**nonswitched line.** (1) A connection between systems or devices that does not have to be made by dialing. Contrast with *switched line*. (2) A telecommunication line on which connections do not have to be established by dialing. Synonymous with *leased line*.

**NRZI.** (1) Non-return-to-zero inverted transmission. (2) Non-return-to-reference transmission in which the zeros are represented by a bit cell boundary transition in the information signal, and ones are represented by the absence of a bit cell boundary transition.

**null modem.** A device with two 25-pin D-shell connectors that attaches to the station end of a standard, straight-through, pin-for-pin EIA 232D cable. The null modem does the crossing-over of the appropriate EIA 232D leads required for the direct connection of a terminal or computer to an AEA port.

## O

**online test.** A diagnostic test or data collection program that is run without interrupting the normal operation of the 3174 and its associated terminals.

**operator information area (OIA).** The area below the line near the bottom of the display area where graphics

and alphanumeric characters are displayed to define the status of the terminal or the system to the operator.

**optical cable.** A fiber, multiple fibers, or a fiber bundle in a structure built to meet optical, mechanical, and environmental specifications.

**optical fiber.** Any filament made of dielectric materials that guides light, regardless of its ability to send signals. See also *fiber optics*.

**option.** (1) A specification in a statement, a selection from a menu, or a setting of a switch, that may be used to influence the execution of a program. (2) A hardware or software function that may be selected or enabled as part of a configuration process. (3) A piece of hardware (such as a network adapter) that can be installed in a device to modify or enhance device function.

**original equipment manufacturer (OEM).** A manufacturer of equipment that may be marketed by another manufacturer.

## P

**padding.** (1) A technique by which a receiving station controls the rate of transmission of a sending station to prevent overrun. (2) In SNA, a technique by which a receiving component controls the rate of transmission of a sending component to prevent overrun or congestion.

**packet.** (1) In data communication, a sequence of binary digits, including data and control signals, that is transmitted and switched as a composite whole. (2) Synonymous with *data frame*. Contrast with *frame*.

**parallel.** (1) Pertaining to a process in which all events occur within the same interval of time, each handled by a separate but similar functional unit; for example, the parallel transmission of the bits of a computer word along the lines of an internal bus. (2) Pertaining to concurrent or simultaneous operation of two or more devices or to concurrent performance of two or more activities in a single device. (3) Pertaining to concurrent or simultaneous occurrence of two or more related activities in multiple devices or channels. (4) Pertaining to the simultaneity of two or more processes. (5) Pertaining to the simultaneous processing of the individual parts of a whole, such as the bits of a character and the characters of a word, using separate facilities for the various parts. (6) Contrast with *serial*.

**parameter.** (1) A variable that is given a constant value for a specified application and that may denote the application. (2) An item in a menu for which the user specifies a value or for which the system provides a value when the menu is interpreted. (3) Data passed between programs or procedures.

**parity.** (1) A transmission error-checking scheme in which an extra bit is added to some unit of data, usually a byte, in order to make the total number of one bits even or odd. For the AEA feature, odd, even, mark, space, or no-parity coding is supported. No-parity means that no parity bit is sent or expected. Mark and space mean that the parity position is always set to one or zero, respectively, and that received parity is not checked. (2) The state of being either even-numbered or odd-numbered.

**parity bit.** (1) A binary digit appended to a group of binary digits to make the sum of all the digits, including the appended binary digit, either odd or even as pre-established. (2) A check bit appended to an array of binary digits to make the sum of all the binary digits, including the check bit, always odd or always even.

**parity (even).** A condition when the sum of all of the digits in an array of binary digits is even.

**parity (odd).** A condition when the sum of all of the digits in an array of binary digits is odd.

**password.** In computer security, a string of characters known to the computer system and a user, who must specify it to gain full or limited access to a system and to the data stored within it.

**path.** In a network, a route between any two nodes.

**physical connection.** (1) A connection that establishes an electrical circuit. (2) In ACF/VTAM, a point-to-point connection or multipoint connection.

**physical unit (PU).** In SNA, the component that manages and monitors the resources of a node, such as attached links and adjacent link stations, as requested by a system services control point (SSCP) via an SSCP-SSCP session.

**polling.** (1) On a multipoint connection or a point-to-point connection, the process whereby data stations are invited one at a time to transmit. (2) Interrogation of devices for such purposes as to avoid contention, to determine operational status, or to determine readiness to send or receive data.

**port.** (1) An access point for data entry or exit. (2) A connector on a device to which cables for other devices such as display stations and printers are attached.

**Port Expansion Feature.** In 3174, an optional feature that allows up to 32 additional 3270 type terminals to be attached. This feature provides a new terminal adapter for specific large-cluster models of the 3174.

**port pools.** A port set that offers multiple access points to the same resource.

**primary logical unit (PLU).** In SNA, the logical unit (LU) that contains the primary half-session for a particular LU-LU session. Contrast with *secondary logical unit*.

**printer authorization matrix (PAM).** A matrix stored in the controller that establishes printer assignment and classification.

**program access (PA) key.** On a display device keyboard, a key that produces a call to a program that performs display operations. See also *program function (PF) key*.

**program attention key.** On a display device keyboard, a key that produces an interruption to solicit program action. See also *program access (PA) key* and *program function (PF) key*.

**program function (PF) key.** On a display device keyboard, a key that passes a signal to a program to call for a particular display operation. See also *program access (PA) key*.

**programmable symbols (PS).** Customer-defined symbols. There are a maximum of 190 symbols in a programmed symbol set.

**programmed symbols (PS).** In the 3270 Information Display System, an optional feature that stores up to six user-definable, program-loadable character sets of 190 characters each in terminal read/write storage for display or printing by the terminal.

**protocol.** (1) A set of semantic and syntactic rules that determines the behavior of functional units in achieving communication. (2) In SNA, the meanings of and the sequencing rules for requests and responses used for managing the network, transferring data, and synchronizing the states of network components. (3) A specification for the format and relative timing of information exchanged between communicating parties.

**put.** In 3174 central site customizing, to store data from the working copy into a library member.

## R

**remote.** Pertaining to a system, program, or device that is accessed through a telecommunication line.

**remove.** (1) To take an attaching device off a network. (2) To stop an adapter from participating in passing data on a network.

**request for price quotation (RPQ).** An alteration or addition to the functional capabilities that the controller provides.



**response field.** On a display device, a specified area on the display space where the user can enter, modify, or erase response data.

**Response Time Monitor (RTM).** A network management tool that measures and records the transaction times of inbound host attention (AID) operations from display stations that communicate with the host.

**ring network.** A network configuration in which a series of attaching devices is connected by unidirectional transmission links to form a closed path. A ring of an IBM Token-Ring Network is referred to as a LAN segment or as a Token-Ring Network segment.

**router.** An attaching device that connects two LAN segments, which use similar or different architectures, at the reference model network layer. Contrast with *bridge* and *gateway*.

## S

**scroll.** To move all or part of the display image vertically or horizontally to display data that cannot be observed within a single display image.

**secondary logical unit (SLU).** In SNA, the logical unit (LU) that contains the secondary half-session for a particular LU-LU session. Contrast with *primary logical unit*.

**segment.** A section of cable between components or devices on the network. A segment may consist of a single patch cable, multiple patch cables connected, or a combination of building cable and patch cables connected.

**serial.** (1) Pertaining to a process in which all events occur one after the other; for example, serial transmission of the bits of a character according to V24 CCITT protocol. (2) Pertaining to the sequential or consecutive occurrence of two or more related activities in a single device or channel. (3) Pertaining to the sequential processing of the individual parts of a whole, such as the bits of a character or the characters of a word, using the same facilities for successive parts. (4) Contrast with *parallel*.

**service access point (SAP).** (1) A logical point made available by an adapter where information can be received and transmitted. A single SAP can have many links terminating in it. (2) In Open Systems Interconnection (OSI) architecture, the logical point at which an  $n + 1$ -layer entity acquires the services of the  $n$ -layer. For LANs, the  $n$ -layer is assumed to be data link control (DLC). A single SAP can have many links terminating in it. These link "end-points" are represented in DLC by link stations.

**session.** (1) In network architecture, an association of facilities necessary for establishing, maintaining, and releasing connections for communication between stations. (2) In MLT, synonymous with logical terminal (LT). (3) In SNA, a logical connection between two network addressable units that can be activated, tailored to provide various protocols, and deactivated as requested.

**session limit.** In 3174, the total number of logical terminals or defined AEA default destinations for an AEA port set.

**simulation.** (1) The representation of selected characteristics of the behavior of one physical or abstract system by another system. In a digital computer system, simulation is done by software; for example, (a) the representation of physical phenomena by means of operations performed by a computer system, and (b) the representation of operations of a computer system by those of another computer system. (2) Contrast with *emulation*.

**single link multi-host support.** In the 3174 Establishment Controller, the ability of a terminal to access multiple hosts over a single physical link connected to the IBM Token-Ring Network, an X.25 Network, or an Enterprise Systems Connection Director.

**small cluster.** In 3174, the specific models of the controller that support attachment of up to 8 IBM 3270 Terminals.

**SNA character string (SCS).** A character string composed of EBCDIC controls, optionally intermixed with end-user data, that is carried within a request/response unit.

**solid-state component.** A component whose operation depends on control of electric or magnetic phenomena in solids, for example, a transistor, crystal diode, or ferrite core.

**sort.** In 3174 central site customizing, to arrange a list of library members according to date, name, or microcode level.

**station.** (1) An input or output point of a system that uses telecommunication facilities; for example, one or more systems, computers, terminals, devices, and associated programs at a particular location that can send or receive data over a telecommunication line. (2) A location in a device at which an operation is performed, for example, a read station. (3) In SNA, a link station.

**stop bit.** Synonym for *stop signal*.

**stop signal.** In start-stop transmission, a signal at the end of a character that prepares the receiving device

for reception of a subsequent character. Synonymous with *stop bit*.

**storage.** A unit into which recorded text can be entered, in which it can be retained and processed, and from which it can be retrieved. See also *memory*.

**structured field.** A data stream format that permits variable-length data and controls to be parsed into its components without having to scan every byte.

**subsystem.** A secondary or subordinate system, or programming support, usually capable of operating independently of or asynchronously with a controlling system. The 3174 and its attached terminals are an example of a subsystem.

**Suppress Index (SI) order.** An order that generates the suppress index character, valid only for the 3288 Model 2 printer. This character inhibits a line index to allow overprinting.

**switched line.** A telecommunication line in which the connection is established by dialing. Contrast with *nonswitched line*.

**synchronous.** (1) Pertaining to two or more processes that depend on the occurrences of a specific event, such as common timing signal. (2) Occurring with a regular or predictable time relationship.

**Synchronous Data Link Control (SDLC).** A discipline conforming to subsets of the Advance Data Communication Control Procedures (ADCCP) of the American National Standards Institute (ANSI) and High-level Data Link Control (HDLC) of the International Organization for Standardization, for managing synchronous, code-transparent, serial-by-bit information transfer over a link connection. Transmission exchanges may be duplex or half-duplex over switched or nonswitched links. The configuration of the link connection may be point-to-point, multipoint, or loop. See also *binary synchronous communication (BSC)*.

**synonym.** A code point that is supported only by a device that contains an extended attribute buffer (EAB). For devices without an EAB, synonyms are translated to hyphens.

**system configuration.** A process that specifies the devices and programs that form a particular data processing system.

**system generation (SYSGEN).** The process of selecting optional parts of an operating system and of creating a particular operation system tailored to the requirements of a data processing installation. System generation enables a host computer to identify and communicate with the I/O devices connected to it.

**Systems Network Architecture (SNA).** The description of the logical structure, formats, protocols, and operational sequences for transmitting information units through, and controlling the configuration and operation of, networks.

**system services control point (SSCP).** In SNA, the focal point within an SNA network for managing the configuration, coordinating network operator and problem determination requests, and providing directory support and other session services for end users of the network. Multiple SSCPs, cooperating as peers, can divide the network into domains of control, with each SSCP having a hierarchical control relationship to the physical units (PUs) and logical units (LUs) within its domain.

## T

**telecommunication-attached.** Pertaining to the attachment of devices by teleprocessing lines to a host processor. Synonym for *remote*. Contrast with *channel-attached*.

**telecommunication control unit.** See *communication controller*.

**terminal.** In data communication, a device, usually equipped with a keyboard and display device, capable of sending and receiving information.

**terminal adapter (TA).** In 3174, an adapter that provides control for a maximum of 32 terminals per adapter. The maximum number of terminals that can be connected depends on the model of the 3174.

**terminal component.** A separately addressable part of a terminal that performs an input or output function, such as the display component of a keyboard-display device or a printer component of a keyboard-printer device.

**terminal emulation.** The capability of a microcomputer, personal computer, 3270 CUT mode display station, 3270 printer, ASCII display station, or ASCII printer to operate as if it were a particular type of terminal linked to a processing unit and to access data.

**terminal multiplexer.** A device, such as the 3299 Terminal Multiplexer, for interleaving the signals for many devices onto a single cable.

**terminal multiplexer adapter (TMA).** This adapter is connected to the terminal adapter in the 3174 and provides control for a maximum of eight terminals.

**terminal node.** (1) In a hierarchical data base, a node that has no subordinate records or segments. (2) In SNA products, a peripheral node that is not user-programmable and has less processing capability than a cluster controller node. Examples are nodes

consisting of the IBM 3277 Data Station, 3767 Communication Terminal, 3614 Consumer Transaction Facility, and 3624 Consumer Transaction Facility.

**terminal port.** (1) In a network, the functional unit of a node through which data can enter or leave the network. (2) The part of a processor that is dedicated to a single data channel for the purpose of receiving data from or transferring data to one or more external or remote devices.

**terminal type menu.** A list of all the available names and terminal types for a given port.

**time-out.** (1) An event that occurs at the end of a predetermined period of time that began at the occurrence of another specified event. (2) A time interval allotted for certain operations to occur; for example, response to polling or addressing before system operation is interrupted and must be restarted. (3) A terminal feature that logs off a user if an entry is not made within a specified period of time.

**to drive.** The drive that receives the transferred data.

**token.** A sequence of bits passed from one device to another on the token-ring network that signifies permission to transmit over the network. It consists of a starting delimiter, an access control field, and an end delimiter. The access control field contains a bit that indicates to a receiving device that the token is ready to accept information. If a device has data to send along the network, it appends the data to the token. When data is appended, the token then becomes a frame. See *frame*.

**token ring.** A network with a ring topology that passes tokens from one attaching device (node) to another. A node that is ready to send can capture a token and insert data for transmission.

**token-ring network.** (1) A ring network that allows unidirectional data transmission between data stations by a token-passing procedure over one transmission medium so that the transmitted data returns to and is removed by the transmitting station. The IBM Token-Ring Network is a baseband LAN with a star-wired ring topology that passes tokens from network adapter to network adapter. (2) A network that uses a ring topology, in which tokens are passed in a sequence from node to node. A node that is ready to send can capture the token and insert data for transmission. (3) A group of interconnected token rings.

**trace.** (1) A record of the execution of a computer program. It exhibits the sequences in which the instructions were executed. (2) A record of the frames and bytes transmitted on a network.

**transaction.** In an SNA network, an exchange between two programs that usually involves a specific set of

initial input data that causes the execution of a specific task or job. Examples of transactions include the entry of a customer's deposit that results in the updating of the customer's balance, and the transfer of a message to one or more destination points.

**translate table.** A table that defines the translation of ASCII to EBCDIC and EBCDIC to ASCII and that allows the use of special characters and nonstandard codes.

**transmission control unit (TCU).** A communication control unit whose operations are controlled solely by programmed instructions from the computing system to which the unit is attached. No program is stored or executed in the unit, for example, the IBM 2702 and 2703 Transmission Controls. Contrast with *communication controller*. Synonymous with *telecommunication control unit*.

**transmitter.** See *universal receiver-transmitter*.

**transparency.** See *transparent*

**transparent.** (1) Pertaining to operations or data that are of no significance to the user. (2) In data transmission, pertaining to information not recognized by the receiving program or device as transmission control characters.

**type.** In the 3174 Establishment Controller, the identifying number of a card. For example, 9150 is a type number of the terminal adapter in the 3174.

**type 1 communication adapter.** The 3174 adapter that supports communication between the 3174 (and its terminals) and a host over telecommunication links using any of these interfaces: (a) EIA 232D/V.24 and V.35 for SNA/SDLC, (b) BSC, and (c) X.25. The user selects the appropriate interface.

**type 2 communication adapter.** The 3174 adapter that supports communication between the 3174 (and its terminals) and a host over telecommunication links using either the X.21 interface for SNA/SDLC or the X.25 interface. The user selects the interface.

## U

**unbind.** In SNA, to deactivate a session between logical units.

**unbind command.** A command used to reset the protocols for a session. Contrast with *bind command*.

**universal receiver-transmitter.** A circuit used in asynchronous, synchronous, or synchronous/asynchronous data communication applications to provide all the necessary logic to recover data in a serial-in parallel-out fashion and to transmit data in a parallel-in serial-out fashion. It is usually duplex; that is, it can transmit and receive

simultaneously with the option to handle various data word lengths.

**universally administered address.** The address permanently encoded in an adapter at the time of manufacture. All universally administered addresses are unique. Contrast with *locally administered address*.

**update.** In 3174 central site customizing, to tailor a library member's customizing data, in working copy, and put it back to the library disk.

**upgrade.** In 3174 central site customizing, to select a library member and upgrade its data to the microcode level of the Central Site Customizing Utility disk.

**upstream.** (1) In the direction opposite to data flow or toward the source of transmission. (2) Toward the processor from an attached unit or end user. (3) Contrast with *downstream*.

**Utility disk.** A diskette or fixed disk that contains the microcode necessary to run various utilities, for example, to copy portions of a diskette for a backup diskette.

## V

**V.35 communication adapter.** A communication adapter that can combine and send information on one line at speeds up to 64 kbps, and conforms to the CCITT V.35 standard.

**variable.** (1) In computer programming, a character or group of characters that refers to a value and, in the execution of a computer program, corresponds to an address. (2) A quantity that can assume any of a given set of values.

**vector.** One or more related fields of data, in a specified format. A quantity usually characterized by an ordered set of numbers.

**version.** A separate IBM-licensed program, based on an existing IBM-licensed program, that usually has significant new code or new function.

**virtual circuit.** Synonym for *virtual connection*.

**virtual connection.** (1) A connection between two nodes on the network that is established using the transport layer and that provides reliable data between nodes. (2) A logical connection established between two data terminal equipment (DTE) devices. Synonymous with *virtual circuit*.

**virtual machine (VM).** A functional simulation of a computer and its associated devices. Each virtual machine is controlled by a suitable operating system,

for example, a conversational monitor system. VM controls concurrent execution of multiple virtual machines on one host computer.

**virtual storage (VS).** (1) The storage space that may be regarded as addressable main storage by the user of a computer system in which virtual addresses are mapped into real addresses. The size of virtual storage is limited by the addressing scheme of the computer system and by the amount of auxiliary storage available, not by the actual number of main storage locations. (2) Addressable space that is apparent to the user as the processor storage space, from which the instructions and the data are mapped into the processor storage locations.

## W

**workstation.** (1) An I/O device that allows either transmission of data or the reception of data (or both) from a host system, as needed to perform a job: for example, a display station or printer. (2) A configuration of I/O equipment at which an operator works. (3) A terminal or microcomputer, usually one connected to a mainframe or network, at which a user can perform tasks.

**wraparound.** The continuation of an operation (for example, a read operation or a cursor movement operation) from the last character position in a buffer to the first character position in the buffer.

**wrap test.** A test that checks attachment or control unit circuitry without checking the mechanism itself by returning the output of the mechanism as input. For example, when unrecoverable communication adapter or machine errors occur, a wrap test can transmit a specific character pattern to or through the modem in a loop and then compare the character pattern received with the pattern transmitted.

**write.** To make a permanent or transient recording of data in a storage device or on a data medium.

**write control character (WCC).** A character used in conjunction with a Write command to specify that a particular operation, or combination of operations, is to be performed at a display station or printer.

**Write Structured Field (WSF) command.** A command used to transmit data in structured field format.

## X

**X.21.** In data communication, a recommendation of the International Telegraph and Telephone Consultative Committee (CCITT) that defines the interface between data terminal equipment and public data networks for digital leases and circuit switched synchronous services.

**X.21 communication adapter.** A communication adapter that can combine and send information on one line at speeds up to 64 kbps, and that conforms to CCITT X.21 standards.

**X.25.** In data communication, a recommendation of the CCITT that defines the interface between data terminal equipment and packet switching networks.

### 3

**3270 data stream.** (1) The commands, control codes, orders, attributes, and data or structured fields for 3270 devices, that are transmitted inbound to an application program or outbound to a terminal. (2) Data being transferred from or to an allocated primary or tertiary device, or to the host system, as a continuous stream of

data and 3270 Information Display System control elements in character form.

**3270 emulation.** The use of a program that allows a device or system such as a personal computer or a System/38 to operate in conjunction with a host system as if it were a 3270-series display station or control unit.

**3270 Port Expansion Feature.** In 3174, a second terminal adapter and the required microcode that allows the 3174 to support an additional 32 terminals. This adapter is available only on large cluster models of the 3174.

# Index

## A

- access to dial key 6-44
- access to direct key 6-44
- ACF/NCP 6-33
- ACF/VTAM 6-33
- additional extension mode key definition for personal computers (168) 6-31
- additional storage requirements
  - asynchronous emulation adapter (AEA) 3-3
  - central site change management (CSCM) 3-3
  - concurrent communication adapter (CCA) 3-3
  - multiple logical terminals (MLT) 3-3
  - single link multi-host support 3-3
  - token-ring 3270 gateway 3-3
  - worksheet A-49
- address
  - calls, DCE 6-44
  - controller (104) 6-9
  - data terminal equipment 10-6
  - gateway, token-ring network (900) 14-7
  - hexadecimal polling 6-9
  - host DTE 10-14, 10-15
  - locally administered 6-12, 6-13, 14-10
  - polling 6-9
  - port (118) 6-20
  - ring assignment (940) 14-9
  - token-ring attached 3174s (106) 6-12
  - token-ring gateway (107) 6-13
  - universal 6-12, 6-13, 14-10
  - upper limit (105) 6-11
  - 3174 DTE 10-15
- AEA configuration questions 6-3
  - 098 online test password 6-3
  - 179 local format storage 6-34
  - 700 configure the AEA feature 12-37
  - 702 assign control key 12-37
  - 703 request MLT for AEA 12-37
  - 710 ASCII feature options (A) 12-38
  - 711 ASCII feature options (B) 12-39
  - 712 ASCII feature options (C) 12-39
  - 713 ASCII feature options (D) 12-40
  - 744 number of bits per character 12-52
  - 745 ASCII display character set 12-52
  - 746 Translate Option 12-53
  - 765 DEC host ASCII character set 12-57
  - 776 IBM ASCII host character set 12-58
  - 784 printer character set 12-59
  - 785 ASCII printer options 12-60
  - 786 page width 12-62
  - 787 LU 1 SCS transparency translation 12-62
- AEA configure worksheet 12-37
- AEA default destination worksheet 12-63
  - UDT worksheets 12-65
    - inbound sequence panels 12-73
    - outbound sequence panels 12-76
      - selection and attributes 12-65
- AEA planning examples B-1
  - ASCII terminal emulation B-4
    - 3270 and ASCII terminal emulation B-27
    - 3270 terminal emulation B-17
- AEA port set worksheet 12-41
- AEA port-to-port set map worksheet 12-42
- AEA station set questions 12-46
  - 721 station set name 12-46
  - 722 station type 12-46
  - 723 port set name 12-47
  - 725 host connection menu option 12-47
  - 731 flow control type 12-48
  - 732 XON/XOFF transmission resumption 12-48
  - 733 line speed 12-49
  - 734 line speed, ASCII host upper limit 12-49
  - 735 parity 12-50
  - 736 stop bits 12-50
  - 737 maximum modem line speed 12-50
  - 741 switched disconnect timeout 12-51
  - 742 inactivity timeout 12-51
  - 743 prompt for universal/specific keyboard map 12-52
  - 751 data stream supported by the ASCII host 12-53
  - 752 ASCII host phone number 12-53
  - 761 auto XON/XOFF 12-56
  - 762 wraparound option 12-56
  - 763 new line option 12-56
  - 764 margin bell 12-57
  - 771 automatic line feed for cursor control 12-57
  - 772 carriage return/carriage return - line feed selection 12-57
  - 773 automatic new line for cursor control 12-58
  - 774 scrolling 12-58
  - 775 line turnaround character 12-58
  - 781 attached printer prompt 12-58
  - 782 use of form feed 12-59
  - 783 page length 12-59
- AEA station set worksheet 12-44
- AEA worksheet examples
  - AEA Configure B-9, B-20
  - AEA Default Destination B-16, B-26
  - AEA Port Set B-10, B-21
  - AEA Port to Port Set Map B-11, B-22
  - AEA Station Set B-12, B-23, B-33
  - ASCII Attachment Diagram B-7, B-18, B-30
  - 3270 Attachment Diagram B-5, B-28
- AEA worksheets, completing
  - AEA Configure 12-37
  - AEA Default Destination 12-63
  - AEA Port Set 12-41

AEA worksheets, completing (*continued*)  
   AEA Port-to-Port Set Map 12-42  
   AEA Station Set 12-44  
   ASCII Attachment Diagram 12-24  
   Inbound Sequence Panels 12-73  
   Inbound Translate Table Definition 12-81  
   numbering station sets 12-35  
   Outbound Sequence Panels 12-76  
   Outbound Translate Tables Definition 12-80  
   Terminal Tables 12-65  
   Translate Tables 12-77  
   3270 Attachment Diagram 12-18  
 aid, file transfer 6-23  
 alarm, background 6-23  
 alert 4-12  
   error ID data 4-12  
   function (220) 6-35  
   machine type ID 4-12  
   operator-generated 6-35  
   3174 control point (221) 6-36  
 alternate base keyboard selection (132) 6-26  
 alternate configurations 2-14  
 APL keyboard  
   response for 6-27  
   restrictions 15-7  
 APL2, warning 15-19  
 ASCII  
   attached printer prompt 12-58  
   attachment 2-5  
   data stream supported by the host 12-53  
   display stations supported 12-17  
   display stations with attached printers 12-58  
   emulation modes 12-3  
   feature options (A) 12-38  
   feature options (B) 12-39  
   feature options (C) 12-39  
   feature options (D) 12-40  
   host phone number 12-53  
   host station using  
     IBM 3101 data stream 12-57  
     using DECVT100/VT220 data stream 12-56  
   individual port assignment 6-18  
   line speed, host upper limit 12-49  
   pass-through 12-3  
   printer options 12-60  
   station type 12-46  
 ASCII Attachment Diagram 12-24  
 ASCII display character set (745) 12-52  
 ASCII Emulation  
   modifying keyboards 15-8  
 ASCII graphics support 4-3  
 assign control key (702) 12-37  
 assignment  
   individual port (116) 6-18  
   of ports 7-3  
   port (117) 6-19  
 assignment, logical terminals 13-12  
 assistance data, product (099) 6-4  
 Asynchronous Emulation Adapter (AEA) 12-1  
   *See also* AEA  
   adapter description 1-11  
   ASCII Attachment Diagram worksheet A-29  
   ASCII emulation models 12-3  
   ASCII terminal emulation 12-3  
   ASCII to EBCDIC Translation A-41  
   assigning devices to sets 12-12  
   cables 12-9  
   communication line 12-6  
   communication requirements, analyzing 12-8  
   concepts of 12-5  
   configuration example. 12-5, 12-7  
   Configure worksheet A-30  
   connection menu 12-4  
   considerations 12-15  
   customization description 12-12  
   default destination 12-4, 12-7  
   Default Destination worksheet A-34  
   description of 12-3  
   destination 12-7  
   direct connection 12-6  
   display stations supported 12-17  
   EBCDIC to ASCII Translation A-40  
   embedded character substitution 12-54  
   Extended Vital Product Data A-45  
   fixed connections 12-13  
   hardware setup 12-10  
   Inbound Sequence Panels A-36, A-37  
   information service 12-9  
   line conditioning 12-8  
   microcode customization 12-10  
   MLT considerations 12-15  
   modem type 12-41  
   modems 12-5  
   modems, ordering 12-10  
   modes of operation 12-3  
   Multi-Host considerations 12-16  
   name, port set 12-41  
   naming station sets 12-15  
   nonswitched lines 12-6  
   null modem 12-11  
   Outbound Sequence Panels A-38  
   pass-through 12-3  
   password 12-42  
   planning and setup 12-8  
   planning examples B-1  
   planning for 12-1  
   planning tasks 12-12  
   port 12-6  
   port assignment considerations 7-4  
   port pools 12-4  
   port set 12-4  
   Port Set worksheet A-31  
   port sets, examples of 12-13  
   Port to Port Set Map worksheet A-32  
   port type 12-41

## Asynchronous Emulation Adapter (AEA) (continued)

- session limit 12-41
- session support 12-8
- site preparation 12-10
- station 12-4, 12-5
- station set 12-4
- Station Set worksheet A-33
- station sets, examples of 12-13
- station type questions, list of 12-45
- storage considerations 12-16
- storage requirements 3-3
- switched connections 12-14
- switched lines 12-6
- system checkout 12-10
- system specification, creating 12-8
- task list 12-9
- terminal attachment 2-11
- terminal connections 12-3
- terminal tables and translate tables 12-16
- Terminal Tables Definition worksheet A-35
- terminal type menu 12-4
- terminology 12-4
- test equipment 12-10
- things to order 12-9
- traffic analysis 12-8
- Translate Tables Definition A-39
- wrap plug 12-10
- wrap tests 12-10
- 3270 Attachment Diagram worksheet A-27, A-28
- 3270 emulation models 12-3
- 3270 terminal emulation 12-3
- attached printer prompt (781) 12-58
- attachment
  - multiple host 2-6
    - Concurrent Communication Adapter 2-7
    - ESCON Channel 2-8
    - Token-Ring Single Link Multi-Host Support 2-8
    - X.25 Single Link Multi-Host Support 2-9
- terminal 2-10
  - AEA adapter 2-11
  - direct 2-11
  - multiplexer adapters 2-11
- types of 2-4
  - ASCII 2-5
  - remote link 2-5
  - S/370 channel 2-4
  - S/390 channel 2-4
  - token-ring 2-4

attachment diagram

- ASCII, filling out 12-24
- numbering 12-35
- 3270, filling out 12-18

attachment, host (101) 6-5

attention delay value (223) 6-37

attribute select keypad (166) 6-30

attributes for terminal tables 12-67

Austrian/German, language code 6-20

auto XON/XOFF (761) 12-56

automatic form feed 6-32

automatic line feed for cursor control (771) 12-57

automatic new line for cursor control (773) 12-58

## B

background alarm 6-23

base keyboards

- 8K0808 6-26
- 8K0932 6-26
- 8K1038 6-26
- 8K1158 6-26

base support, CECP 8-4

Belgian (New), language code 6-20

Belgian, language code 6-20

bell, margin (764) 12-57

between bracket sharing (213) 6-34

bind extensions 4-15

bits, stop (736) 12-50

block number, RECFMS 4-13

boundary values, RTM 9-9

Brazilian, language code 6-20

BSC (binary synchronous communication)

- as host attachment 6-5
- converting polling address 6-9
- enhanced communication (176) 6-33
- protocol for IPDS printers 4-16
- secondary worksheet A-6
- special controlled request-to-send 6-42
- worksheet A-5

buffer, display 6-33

burst size, channel

- information on 6-37
- question for (225) 6-38

## C

cables 12-9

calls

- address 6-44
- direct 6-44

Canadian Bilingual, language code 6-20

carriage return/carriage return - line feed selection (772) 12-57

CECP

- See country extended code page

central site change management configuration questions 11-5

- 500 CSCM unique 11-5
- 501 network ID (NETID) 11-5
- 502 logical unit name (LUNAME) 11-6

central site change management (CSCM) 2-16

- at the host 4-18
- central site controller 11-5
- completing the worksheet 11-5
- considerations 2-16
- description of 11-3



central site change management (CSCM) *(continued)*  
 description of worksheet 11-4  
 host configuration 11-4  
 microcode requirements 4-18  
 Multi-Host Support restrictions 4-18, 11-3  
 network site controller 11-5  
 planning 11-1  
 storage requirements 3-3  
 system software requirements 4-18  
 VTAM definitions 4-18

chaining, command 6-23

changing  
 X.25 options 10-19

channel burst size  
 information on 6-37  
 question for (225) 6-38

channel RU sizes, SNA 4-14

channels, logical 10-8

channel, IPDS printers 4-16

character  
 set, magnetic (141) 6-29  
 string, translated 12-55  
 substitution, embedded 12-54

character sets, CECP 8-4  
 version 0 8-5  
 version 1 8-5

checklist, planning  
 for AEA 12-9  
 for Token-Ring Gateway 14-3  
 for 3174 2-18

CICS/VS 6-33

CID (connection identifier) 10-17

circuit type (401) 10-11

class negotiation, throughput class (440) 10-16

clear key, dual-function 6-22

clicker option 6-23

closed user group (441) 10-17

coax timeout period 6-24

code pages 8-4

COMM key, X.25 10-12

command chaining 6-23

command retry (222) 6-36

commands, CECP 8-4

Common SNA worksheet A-26

communicate key, local 6-44

communication line, AEA 12-6

communication, BSC enhanced 6-33

compatibility requirements, display 2-12

compressed program symbols (165) 6-30

Concurrent Communication Adapter (CCA)  
 CECP considerations 8-9  
 CECP restrictions 6-21  
 keyboard language 2-14, 6-29  
 storage requirements 3-3  
 type 1, description of 1-11  
 type 2, description of 1-11  
 what it does 2-7

configuration questions 6-3  
 autocal/autodisconnect 6-47  
 098 Online Test Password 6-3  
 099 product assistance data 6-4  
 100 model designation 6-4  
 101 host attachments 6-5  
 104 controller address 6-9  
 105 upper limit address 6-11  
 106 Token-Ring Network address and SAP of the 3174 6-12  
 107 Token-Ring Network address and SAP of the gateway 6-13  
 108 unique machine identifier 6-13  
 110 MLT storage 6-14  
 116 individual port assignment 6-18  
 117: port assignment 6-19  
 118 port address 6-20  
 121 keyboard language and character set 6-20  
 123 country extended code page (CECP) support 6-21  
 125 miscellaneous feature options (A) 6-22  
 126 miscellaneous feature options (B) 6-24  
 127 response time monitor definition 9-3  
 127 Response Time Monitor (RTM) definition 6-25  
 128 RTM boundaries and interface 6-25  
 132 alternate base keyboard selection 6-26  
 136 standard keyboard layouts 6-27  
 137 modified keyboard layouts 6-28  
 138 standard keypad layouts 6-28  
 139 concurrent communication keyboard language 6-29  
 141 magnetic character set 6-29  
 150 Token-Ring Network Gateway 6-30  
 165 compressed program symbols 6-30  
 166 attribute select keypad 6-30  
 168 additional extension mode key definition (personal computers) 6-31  
 173 3179G options 6-31  
 173 3290 options 6-31  
 175 3179G password 6-33  
 175 3290 password 6-33  
 176 BSC enhanced communications 6-33  
 179 local format storage 6-34  
 213 between bracket sharing 6-34  
 215 physical unit identification 6-35  
 220 alert function 6-35  
 221 alert control point, 3174 6-36  
 222 command retry 6-36  
 223 attention delay value 6-37  
 224 mode of data transfer 6-38  
 225 channel burst size 6-38  
 240 Controller Logical Address 6-39  
 241 RU Maximum Size 6-39  
 310 connect data set to line operation 6-39  
 313 NRZ or NRZI encoding 6-40  
 317 telecommunication facilities 6-40  
 318 full- or half-speed transmission 6-41  
 332 X.25 options 6-42

configuration questions (*continued*)

- 340 request-to-send control options 6-42
- 360 X.21 switched retry 6-43
- 361 X.21 switched retry timing 6-43
- 362 X.21 switched options 6-43
- 365 X.21 data transfer delay 6-45
- 367 X.21 switched short-hold mode 6-46
- 368 X.21 switched short-hold mode dial number 6-46
- 370 maximum inbound I-frame size 6-46
- 371 X.21 switched dial digits 6-46
- 382 maximum ring I-frame size 6-47
- 383 Token-Ring network maximum out 6-48
- 384 Ring Speed of the Token-Ring Network 6-48
- 400 network type 10-6
- 401 circuit type 10-11
- 402 logical channel identifier 10-11
- 409 X.25 keyboard support options 10-11
- 420 incoming call options 10-13
- 421 outgoing call options 10-14
- 423 host DTE address 10-15
- 424 3174 DTE address 10-6
- 430 negotiate packet size 10-16
- 431 packet sequence numbering 10-7
- 432 negotiated window size 10-16
- 433 K-maximum out 10-7
- 434 nonstandard default packet size 10-7
- 435 nonstandard default window size 10-8
- 440 throughput class negotiation 10-16
- 441 closed user group 10-17
- 442 recognized private operating agency 10-17
- 450 link level transmit timeout 10-8
- 451 number of retries 10-8
- 452 connection identifier 10-17
- 453 connection options 10-18
- 461 lowest incoming channel 10-9
- 462 highest incoming channel 10-9
- 463 lowest two-way channel 10-9
- 464 highest two-way channel 10-9
- 465 lowest outgoing channel 10-10
- 466 highest outgoing channel 10-10
- 500 CSCM unique 11-5
- 501 network ID (NETID) 11-5
- 502 logical unit name (LUNAME) 11-6
- 700 configure the AEA feature 12-37
- 702 control key assignment 12-37
- 703 request MLT for AEA 12-37
- 710 ASCII feature options (A) 12-38
- 711 ASCII feature options (B) 12-39
- 712 ASCII feature options (C) 12-39
- 713 ASCII feature options (D) 12-40
- 721 station set name 12-46
- 723 port set name 12-47
- 725 host connection menu option 12-47
- 731 flow control type 12-48
- 732 XON/XOFF transmission resumption 12-48
- 733 line speed 12-49
- 734 line speed, ASCII host upper limit 12-49

configuration questions (*continued*)

- 735 parity 12-50
- 736 stop bits 12-50
- 737 maximum modem line speed 12-50
- 741 switched disconnect timeout 12-51
- 742 inactivity timeout 12-51
- 743 prompt for universal/specific keyboard map 12-52
- 744 number of bits per character 12-52
- 745 ASCII display character set 12-52
- 746 Translate Option 12-53
- 751 data stream supported by the ASCII host 12-53
- 752 ASCII host phone number 12-53
- 761 auto XON/XOFF 12-56
- 762 wraparound option 12-56
- 763 new line option 12-56
- 764 margin bell 12-57
- 765 DEC host ASCII character set 12-57
- 771 automatic line feed for cursor control 12-57
- 772 carriage retrun/carriage return - line feed selection 12-57
- 772 station type 12-46
- 773 automatic new line for cursor control 12-58
- 774 scrolling 12-58
- 775 line turnaround character 12-58
- 776 IBM ASCII Host Character Set 12-58
- 781 attached printer prompt 12-58
- 782 use of form feed 12-59
- 783 page length 12-59
- 784 printer character set 12-59
- 785 ASCII printer options 12-60
- 786 page width 12-62
- 787 LU 1 SCS transparency translation 12-62
- 800 Printer Authorization Matrix (PAM) 13-5
- 801 Logical Terminal Assignment (LTA) 13-5
- 802 prompts for extended VPD 13-6
- 900 Token-Ring Network address for the Gateway 14-7
- 905 ring error monitor 14-7
- 908 link subsystem name 14-7
- 911 Ring Speed of the Token-Ring Gateway 14-8
- 912 Group Poll Address 14-8
- 940 ring address assignment 14-9
- 941 ring transmission definition 14-13
- configuration worksheets A-3
- configuration worksheets, description of 5-4
- configure the AEA feature (700) 12-37
- connect data set to line operation (310) 6-39
- Connection Identifier 10-14, 10-15
  - explanation 10-12
  - related questions
    - 420 10-13
    - 421 10-14
    - 423 10-15
- connection identifier (452) 10-17
- connection menu 12-4
- connection options 10-18

- considerations
  - AEA 12-15
  - at host for SNA 4-11
  - at host for the gateway 4-4
  - CECP 8-8
  - controller storage 2-3, 3-3
  - data integrity, CECP 8-9
  - display compatibility 2-12
  - host filters, CECP 8-8
  - host system planning 2-12, 4-3
  - local copy, CECP 8-9
  - microcode customization 2-12
  - microcode migration 2-17
  - MLT 6-18
  - Multi-Host Support 2-6
  - multi-hosts, CECP 8-9
  - physical installation 2-3
  - port assignment 7-4
  - terminal attachment 2-10
  - the site 2-3
  - types of host attachment 2-4
  - undefined code points, CECP 8-8
- Control disk
  - description of 1-13
  - how to customize 5-5
  - upgrading 5-9
- controlled request-to-send 6-42
- controller address(104) 6-9
- Controller Logical Address
  - logical address, controller (240) 6-39
- controller storage
  - planning for 3-1
  - worksheet A-49
- copy format controls, enable local copy 6-32
- copying from one key to another 15-12
- country extended code page (CECP) 6-21
  - base support 8-4
  - character sets 8-4
  - code pages 8-4
  - commands 8-4
  - considerations for Multi-Host Support 8-9
  - data integrity 8-9
  - data integrity warning 6-21
  - displays with 8-5
  - entering and exiting 8-8
  - graphic characters 8-4
  - host filters 8-8
  - keyboards with 8-6
  - languages supported 6-21
  - local copy 8-9
  - mode 8-8
  - overview of 8-3
  - planning for 8-1
  - printers with 8-5
  - restriction for Multi-Host Support 6-21
  - setup mode 8-8
  - support (123) 6-21
  - supported devices 8-5
- country extended code page (CECP) (*continued*)
  - synonym warning 8-9
  - system considerations 8-8
  - terminology 8-5
  - undefined code points 8-8
  - unique characters, warning 15-19
  - unique printer considerations 8-6
  - warning, data integrity 8-3
- CUG (closed user group) 10-17
- cursor control
  - automatic line feed (771) 12-57
  - automatic new line (773) 12-58
- customization 2-12
  - alternate configurations 2-14
  - central site control facility 2-14
  - considerations 2-12
  - country extended code page support 2-14
  - CSCM 2-16
  - data management 5-7
  - defining devices 2-15
  - description of 5-3
  - downstream load 2-16
  - how to plan 5-3
  - keyboard language 2-14
  - keyboard modification 2-16
  - local format storage 2-17
  - Multi-Host Support 2-13
  - multiple logical terminal sessions 2-16
  - network asset management 2-14
  - on the Control disk 5-5
  - planning 5-3
  - planning with worksheets 5-4
  - port assignment 2-15
  - reconfiguring 5-5
  - records 5-6
  - release migration 5-9
  - response time monitor 2-17
  - tips for 5-7
  - types of host attachment 2-13
  - upgrading 5-9
  - user-defined terminal tables 2-15
  - user-defined translate tables 2-15
  - using CSCM 5-8
  - using pattern diskettes 5-8
- CUT port assignment considerations 7-4
- Cyrillic, language code 6-20

## D

- Danish, language code 6-20
- data entry keyboard, response for 6-27
- data entry keypad, response for 6-28
- data integrity, CECP 8-9
- data stream
  - DECVT100/VT220, questions 12-56
  - IBM 3101 questions 12-57
- data stream supported by the ASCII host (751) 12-53

- data transfer delay, X.21 (365) 6-45
- data transfer modes 6-37
- data transfer (224) 6-38
- DCE supported for
  - addressed calls 6-44
  - direct calls 6-44
- DEC host ASCII character set (765) 12-57
- DECVT100/VT220 data stream, questions 12-56
  - 761 auto XON/XOFF 12-56
  - 762 wraparound option 12-56
  - 763 new line option 12-56
  - 764 margin bell 12-57
- default destination 12-4
- default destination, AEA 12-7
- default packet size, nonstandard (434) 10-7
- deferred keystroking (remote SNA) 6-24
- Define Devices 13-1
  - completing the worksheet 13-5
  - description of 13-3
  - planning 13-1
  - printers 13-6
  - terminals 13-12
  - worksheet A-42
  - worksheet description 13-4
- definition
  - additional extension-mode key (168) 6-31
  - Response Time Monitor (127) 6-25, 9-3
  - ring transmission (941) 14-13
  - VTAM/NCP, examples of D-1
- delay value, attention (223) 6-37
- delayed disconnect function 6-44
- deleting key functions 15-11
- designation, model (100) 6-4
- destination, AEA 12-7
- determining MLT storage requirements 6-14
- device definition
  - considerations 2-15
  - Extended Vital Product Data 2-15
  - logical terminal assignment 2-15
  - printer authorization matrix 2-15
- Device Definition questions 13-5
  - 800 Printer Authorization Matrix 13-5
  - 801 Logical Terminal Assignment 13-5
  - 802 prompts for extended VPD 13-6
- devices, CECP-capable 8-5
- devices, port assignment (116)
  - ASCII, DFT devices 6-18
  - automatic 6-18, 6-19
- DFT
  - See distributed function terminal
- dial key 6-44
- dial screen display 10-12
- direct calls, DCE 6-44
- direct connection, AEA 12-6
- direct key 6-44
  - dial 6-44
- direct terminal attachment 2-11

- DISC key, X.25 10-12
- disconnect key 6-44
- disconnect timeout, switched (741) 12-51
- disconnect/local mode operation 10-12
- diskettes
  - for record-keeping 5-6
  - management of 5-7
  - pattern 5-8
- disks
  - Control 1-13
  - DSL (downstream load) 1-13
  - how to customize 5-5
  - kinds of 1-13
  - LFU (limited function utility) 1-13
  - RPQ (request for price quotation) 1-13
  - Utility 1-13
- display buffer 6-33
- display compatibility requirements 2-12
- display stations supported by AEA 12-17
- displays with CECP 8-5
- display, dial screen 10-12
- distributed function terminal (DFT) 6-31
  - automatic form feed after local copy 6-32
  - automatic form feed before local copy 6-32
  - automatic port assignment 6-19
  - BSC enhanced communication (176) 6-33
  - enable local copy format controls 6-32
  - field intensity, 3290 6-33
  - individual port assignment 6-18
  - options (173) 6-31
  - port assignment considerations 7-4
  - update panel before allowing buffer change 6-33
- downstream physical units (DSPUs) 4-11
  - configuration questions for 4-11
- drives, reason for
  - fixed disk 1-11
  - second diskette 1-11
- DSL (downstream load)
  - considerations 2-16
  - disk description 1-13
- DTE (data terminal equipment)
  - host address 10-14, 10-15
  - 3174 address 10-6, 10-15
- dual-function clear key 6-22

## E

- early token release 6-48, 14-8
- EBCDIC World Trade, language code 6-20
- embedded character substitution
  - Hayes 12-54
  - IBM 12-54
  - Micom 12-54
- emulation
  - ASCII terminal 12-3
  - asynchronous considerations 12-15
  - asynchronous overview 12-12
  - asynchronous planning 12-1

- emulation (*continued*)
  - asynchronous planning tasks 12-12
  - 3270 terminal 12-3
- enable local copy format controls 6-32
- encoding, NRZ or NRZI (313) 6-40
- English (UK), language code 6-20
- English (U.S.) ASCII-International, language code 6-20
- English (U.S.) ASCII-7, language code 6-20
- English (U.S.) ASCII-8, language code 6-20
- English (U.S.), language code 6-20
- enhanced keyboard
  - Katakana worksheet A-54
  - US worksheet A-52
  - World Trade worksheet A-53
- enhanced typewriter keyboard
  - response for 6-27
- entering CECP mode 8-8
- error identification data 4-12
- error monitor, ring (905) 14-7
- ES Connection Director 2-4, 2-8
- establishment controller
  - considerations for 2-3
  - description of 1-3
  - feature descriptions 1-11
  - large-cluster controllers 1-4
  - medium-cluster
    - table of features 1-8
  - medium-cluster controllers 1-6
  - models 1-4
  - planning 2-3
  - small-cluster
    - 81R, 82R 1-7
    - 90R 1-7
    - 91R, 92R 1-7
  - table of features 1-8
- examples
  - planning AEA B-1
  - planning for LTA 13-15
  - planning for PAM 13-10
  - planning Token-Ring Network C-1
  - using service access points E-1
  - VTAM/NCP definitions D-1
- exiting CECP mode 8-8
- extended code page support 6-21
- Extended VPD
  - completing the worksheet 13-19
- extension mode key for PCs 6-31
- extensions, bind 4-15

## F

- facilities, nonswitched 6-41
- facilities, telecommunication (317) 6-40
- facility
  - negotiated packet size 10-14, 10-15
  - negotiated window size 10-14, 10-15
  - reverse-charge 10-14, 10-15

- features
  - chart, by models 1-8
  - description of 1-11
  - for large-cluster controllers 1-4
- Fiber Optic Terminal adapter
  - description of 1-12
  - models supported 1-8
- field description
  - Common SNA worksheet 11-4
  - Keyboard Changes Chart 15-17
  - Logical Terminal Assignment worksheet 13-14
  - Multi-Host Definition 6-6
  - Printer Authorization Matrix worksheet 13-7
  - Ring Address Assignment worksheet 14-9
  - Token-Ring Gateway worksheet 14-6
  - 117: Port Assignment worksheet 7-7
  - 128: RTM worksheet 9-7
  - 332: X.25 Options worksheet 10-5
- field intensity 6-33
- file transfer aid 6-23
- filling out
  - Common SNA worksheet 11-5
  - Device Definition worksheet 13-5
  - keyboard worksheets 15-19
  - Logical Terminal Assignment worksheet 13-18
  - MLT worksheet 6-14
  - Port Assignment worksheet, (116=1) 7-10
  - Port Assignment worksheet, (116=2) 7-11
  - Printer Authorization Matrix worksheet 13-11
  - Prompts for Extended VPD 13-19
  - Ring Address Assignment worksheet 14-11
  - Ring Transmission Definition worksheet 14-14
  - Token-Ring Gateway worksheet 14-7
  - 128: RTM worksheet 9-10
  - 332: X.25 Options worksheet 10-5
- Filling out AEA Configure worksheet 12-37
- Finnish, language code 6-20
- fixed connections, AEA 12-13
- flow control type (731) 12-48
- form feed
  - local copy 6-32
  - use of (782) 12-59
- French, language code 6-20
- full- or half-speed transmission (318) 6-41
- function group 15-18
- functions
  - chart, by cluster group 1-8
- function, alert (220) 6-35

## G

- gateway controller, Token-Ring Network (150) 6-30
- Gateway, address for 14-7
- GDDM and ASCII graphics 4-3
- general restrictions, keyboard 15-4
- graphic characters, CECP 8-4
- Greek, language code 6-20

group  
  function 15-18  
  keyboard 15-18  
  shift 15-18  
group poll address 14-8

## H

half-duplex SNBU operation 6-41  
hardware setup, AEA 12-10  
hexadecimal polling address 6-9  
high speed data transfer 6-38  
HNAD (host network (DTE) address) 10-15  
host attachment  
  ASCII 2-5  
  Concurrent Communication Adapter 2-7  
  ESCON Channel 2-8  
  identifying to microcode 2-13  
  multiple 2-6, 2-13  
  remote link 2-5  
  S/370 channel 2-4  
  S/390 channel 2-4  
  token-ring 2-4  
  Token-Ring Single Link Multi-Host Support 2-8  
  types of 2-4  
  X.25 Single Link Multi-Host Support 2-9  
Host Attachment worksheet A-3  
host attachment (101) 6-5  
host configuration, CSCM 11-4  
host connection menu option (725) 12-47  
host DTE address 10-14  
host DTE address (423) 10-15  
host filters, CECF 8-8  
host mode, printer 13-8  
host planning 4-1  
  alerts 4-12  
  bind extensions 4-15  
  BSC protocol for IPDS printers 4-16  
  channel protocol for IPDS printers 4-16  
  coding macros 4-6  
  CSCM 4-18  
  CSCM microcode requirements 4-18  
  CSCM system software requirements 4-18  
  CSCM VTAM definitions 4-18  
  downstream physical units 4-11  
  error ID data 4-12  
  gateway considerations 4-4  
  IPDS printer support 4-16  
  LU-1 pacing overruns 4-11  
  machine type ID 4-12  
  MVS/SP for gateway 4-5  
  NCP for gateway 4-9  
  NetView, RECFMS 4-13  
  node ID block number, RECFMS 4-13  
  overview of 4-3  
  REQMS/RECFMS support 4-13  
  RU sizes 4-14  
  SDLC/X.25 attachment 4-15

host planning (*continued*)  
  segmenting 4-5  
  sense ID command, non-SNA 4-17  
  SNA channel attachment 4-14  
  SNA considerations 4-11  
  SNA protocol for IPDS printers 4-16  
  SNA SSCP/PU sessions 4-11  
  SOEMI support 4-17  
  system definitions, gateway 4-5  
  unit control words for gateway 4-7  
  VM/SP for gateway 4-5  
  VSE for gateway 4-7  
  VTAM for gateway 4-7  
  VTAM hang-up 4-6  
host printing operations 13-6  
host system considerations 2-12, 4-3  
hot key, personal computers (168) 6-31

## I

I-frame size  
  maximum inbound (370) 6-46  
  maximum ring (382) 6-47  
  transmit (941) 14-13  
IBM ASCII host character set (776) 12-58  
IBM 3101 data stream, questions 12-57  
  771 automatic line feed for cursor control 12-57  
  772 carriage return/carriage return - line feed  
    selection 12-57  
  773 automatic new line for cursor control 12-58  
  774 scrolling 12-58  
  775 line turnaround character 12-58  
Icelandic, language code 6-20  
identification, physical unit (215) 6-35  
identifier, connection 10-14, 10-15  
identifier, logical channel (402) 10-11  
identifier, machine (108) 6-13  
IDs, keyboard 6-28  
ID, network (501) 11-5  
IMS/VS 6-33  
inactivity timeout (742) 12-51  
inbound sequence panels, UDT 12-73  
inbound translation, UDX 12-81  
incoming channel 10-9  
  highest 10-9  
  lowest 10-9  
individual port assignment (116) 6-18  
information service, AEA 12-9  
intensity  
  3290 6-33  
International, language code 6-20  
IPDS printer support 4-16  
  BSC and channel protocol 4-16  
  SNA protocol 4-16  
Italian, language code 6-20  
I/O addresses (S) 14-9

## J

Japanese English, language code 6-20  
Japanese Katakana, language code 6-20

## K

K-maximum out (433) 10-7

### key

copying 15-12  
disconnect 6-44  
function nomenclature 15-15  
local communicate 6-44  
X.25 10-12  
X.25 DISC 10-12  
X.25 LOCAL and COMM 10-12

key function nomenclature 15-15

### keyboard

additional extension mode key definition (168) 6-31  
alternate selection (132) 6-26  
APL 6-27  
data entry 6-27  
enhanced typewriter 6-27  
IDs 6-28  
language for concurrent communication 6-29  
languages for 6-20  
languages supported 6-20, 15-14  
selection, modified layouts (137) 6-28  
selection, standard layouts (136) 6-27  
types of 6-27  
typewriter 6-27  
with CECP 8-6  
X.21 switched options (362) 6-43

### Keyboard Changes Chart

example of 15-18  
field description 15-17

keyboard group 15-18

keyboard language considerations 2-14

keyboard modification 15-1

APL restrictions 15-7  
completing the worksheets 15-19  
copying from one key to another 15-12  
customizing questions to answer 15-4  
deleting key functions 15-11  
description of 15-3  
Enhanced (Katakana) worksheet A-54  
Enhanced (US) worksheet A-52  
Enhanced (World Trade) worksheet A-53  
function group 15-18  
general restrictions 15-4  
Katakana Converged worksheet A-51  
key function nomenclature 15-15  
Keyboard Changes Chart example 15-18  
keyboard changes chart, description of 15-17  
keyboard group 15-18  
keyboards supported 15-14  
languages supported 15-14  
local function restrictions 15-6

### keyboard modification (*continued*)

nomenclature presentation restrictions 15-7  
Non-Katakana Converged worksheet A-50  
planning considerations 2-16  
planning for 15-1  
planning procedure 15-19  
setting up terminal keyboards 15-8  
shift group 15-18  
two-language modification 15-9  
two-language modification, examples of 15-10  
types of worksheets 15-19

### keyboard worksheets

Enhanced (Katakana) A-54  
Enhanced (US) A-52  
Enhanced (World Trade) A-53  
Katakana Converged A-51  
Non-Katakana Converged A-50

### keyboards

ASCII Emulation 15-8

### keyboards, base

8K0808 6-26  
8K0932 6-26  
8K1038 6-26  
8K1158 6-26

### keypad

Attribute Select (166) 6-30  
data entry 6-28  
national language numeric 6-28  
program function 6-28  
selection, standard layouts (138) 6-28

keystroking, deferred 6-24

## L

language support, considerations 2-14

languages supported 6-20, 15-14

languages, CECP only 6-21

language, keyboard (121) 6-20

### large-cluster controllers

table of features 1-8  
2R and 12R 1-4  
21R 1-5  
23R 1-5  
3R and 13R 1-4

### layouts

modified keyboards (137) 6-28  
standard keyboards (136) 6-27  
standard keypads (138) 6-28

length, page (783) 12-59

### Limited Function Utility Disk

description of 1-13

line conditioning, AEA 12-8

line feed selection, carriage return/carriage return  
(772) 12-57

line speed (733) 12-49

line speed, ASCII host upper limit (734) 12-49

line speed, maximum modem (737) 12-50

- line turnaround character (775) 12-58
- link level transmit timeout (450) 10-8
- link subsystem name (908) 14-7
- local copy
  - for record-keeping 5-6
  - format controls 6-32
  - with automatic form feed after 6-32
  - with automatic form feed before 6-32
- local copy operations 13-6
- local copy, CECF 8-9
- local format storage (179) 6-34
- local function restrictions, keyboard 15-6
- LOCAL key, X.25 10-12
- local mode, printer 13-8
- local non-SNA 6-5
- local SNA 6-5
- locally administered address 14-10
- local, communicate key 6-44
- logical channel identifier (402) 10-11
- logical channels
  - description 10-8
  - numbering 10-8
- Logical Terminal Assignment (LTA) 13-12
  - completing the worksheet 13-18
  - considerations 13-16
  - description of 13-12
  - example of 13-15
  - planning 13-12
  - worksheet A-44
  - worksheet description 13-12
  - worksheet fields 13-14
- logical unit name (LUNAME) (502) 11-6
- LU 1 SCS transparency translation (787) 12-62
- LU-1 pacing overruns 4-11

## M

- machine type identification 4-12
- machine, unique identifier (108) 6-13
- magnetic character set (141) 6-29
- management of customization data 5-7
- management of diskettes 5-7
- management, central site 11-3
- margin bell (764) 12-57
- maximum
  - inbound I-frame size (370) 6-46
  - modem line speed (737) 12-50
  - out 14-13
  - ring I-frame size (382) 6-47
  - Token-Ring Network out (383) 6-48
- measurement of response time 9-8
- medium-cluster controllers
  - table of supported features 1-8
- memory requirements
  - asynchronous emulation adapter (AEA) 3-3, 12-16
  - central site change management (CSCM) 3-3
  - concurrent communication adapter (CCA) 3-3
  - ESCON Channel 3-4

- memory requirements (*continued*)
  - level support, MLT 3-4
  - MLT level support 3-4
  - multiple logical terminals (MLT) 3-3
  - single link multi-host support 3-3
  - token-ring 3270 gateway 3-3
  - worksheet A-49
- menu option, host connection (725) 12-47
- methods of record-keeping 5-6
  - using a printer 5-6
  - using diskettes 5-6
  - using worksheets 5-6
- microcode
  - Control 1-13
  - DSL (downstream load) 1-13
  - kinds of 1-13
  - LFU (limited function utility) 1-13
  - migration 2-17, 5-9
  - requirements, CSCM 4-18
  - RPQ (request for price quotation) 1-13
  - Utility 1-13
- microcode customization 2-12
  - alternate configurations 2-14
  - central site control facility 2-14
  - considerations 2-12
  - country extended code page support 2-14
  - CSCM 2-16
  - data management 5-7
  - defining devices 2-15
  - description of 5-3
  - downstream load 2-16
  - how to plan 5-3
  - keyboard language 2-14
  - keyboard modification 2-16
  - local format storage 2-17
  - Multi-Host Support 2-13
  - multiple logical terminal sessions 2-16
  - network asset management 2-14
  - on the Control disk 5-5
  - planning 5-3
  - planning with worksheets 5-4
  - port assignment 2-15
  - reconfiguring 5-5
  - records 5-6
  - release migration 5-9
  - response time monitor 2-17
  - tips for 5-7
  - types of host attachment 2-13
  - upgrading 5-9
  - user-defined terminal tables 2-15
  - user-defined translate tables 2-15
  - using CSCM 5-8
  - using pattern diskettes 5-8
- microcode upgrade
  - X.25 10-4
- migration, microcode 2-17, 5-9
- miscellaneous ASCII feature options (710) 12-38



- miscellaneous ASCII feature options (711) 12-39
- miscellaneous ASCII feature options (712) 12-39
- miscellaneous ASCII feature options (713) 12-40
- miscellaneous feature options (125) 6-22
  - background alarm 6-23
  - clicker option 6-23
  - command chaining 6-23
  - deferred keystroking (remote SNA) 6-24
  - dual-function clear key 6-22
  - file transfer aid 6-23
  - PS load altered screen 6-23
  - unsupported control code translate 6-22
- miscellaneous feature options (126) 6-24
  - coax timeout period 6-24
- MLT (multiple logical terminals) 6-14
  - completing the worksheet 6-14
  - considerations 2-16
  - considerations with AEA 12-15
  - description of 6-14
  - determining requirements 6-14
  - related considerations 6-18
  - storage requirements 3-3
  - storage (110) 6-14
  - worksheet A-18, A-19
  - worksheet C A-20
- mode of data transfer (224) 6-38
- model descriptions
  - 1R and 11R 1-4
  - 12L 1-4
  - 2R and 12R 1-4
  - 21R 1-5
  - 22L 1-5
  - 23R 1-5
  - 3R and 13R 1-4
  - 51R and 61R 1-6
  - 53R and 63R 1-6
  - 62R 1-6
- model designation (100) 6-4
- model-descriptions
  - 1L and 11L 1-4
  - 1R and 11R 1-4
  - 12L and 12R 1-4
  - 2R and 12R 1-4
  - 21L and 21R 1-4
  - 22L 1-4
  - 23R 1-4
  - 3R and 13R 1-4
- models feature chart 1-8
- modem
  - Hayes embedded character substitution 12-54
  - IBM embedded character substitution 12-54
  - Micom embedded character substitution 12-54
  - translated character 12-55
  - translated character string 12-55
- modems, AEA 12-5
- modes, data transfer 6-37
- modifiable keyboard
  - modified layouts (137) 6-28
- modifiable keyboard (*continued*)
  - standard layouts (136) 6-27
- modification
  - examples of two-language 15-10
  - two-language 15-9
- modified keyboard layouts (137) 6-28
- Modify Keyboards 15-1
  - APL restrictions 15-7
  - completing the worksheets 15-19
  - considerations 2-16
  - copying from one key to another 15-12
  - customizing questions to answer 15-4
  - deleting key functions 15-11
  - description of 15-3
  - Enhanced (Katakana) worksheet A-54
  - Enhanced (US) worksheet A-52
  - Enhanced (World Trade) worksheet A-53
  - function group 15-18
  - general restrictions 15-4
  - Katakana Converged worksheet A-51
  - key function nomenclature 15-15
  - Keyboard Changes Chart example 15-18
  - keyboard changes chart, description of 15-17
  - keyboard group 15-18
  - keyboards supported 15-14
  - languages supported 15-14
  - local function restrictions 15-6
  - nomenclature presentation restrictions 15-7
  - Non-Katakana Converged worksheet A-50
  - planning for 15-1
  - planning procedure 15-19
  - setting up terminal keyboards 15-8
  - shift group 15-18
  - two-language modification 15-9
  - two-language modification, examples of 15-10
  - types of worksheets 15-19
- Modulo 8 and 128 10-7
- monitor, ring error (905) 14-7
- multi-host gateway support 2-10
- Multi-Host Support
  - CECP considerations 8-9
  - CECP restrictions 6-21
  - Concurrent Communication Adapter 2-7
  - CSCM restrictions 4-18, 11-3
  - customizing for 2-13
  - description of 2-6
  - description of worksheet 6-6
  - ESCON Channel 2-8
  - host definition worksheet A-4
  - keyboard language 2-14
  - port assignment considerations 7-5
  - response for 6-5
  - service access point examples E-1
  - things to consider 2-13
  - Token-Ring Single Link 2-8
  - with AEA 12-16
  - X.25 2-9

multiplexer adapters, terminal attachment 1-11, 2-11  
MVS/SP definition, gateway 4-5

## N

national language numeric keypad, response for 6-28  
NCP definition, gateway 4-9  
NCP/VTAM definitions, 3174 D-1  
    channel attached 3174 (SNA) D-3  
    examples of D-1  
    local 3174 terminal (Non-SNA) D-4  
    SDLC D-5  
    Token-Ring Network D-12  
    X.25 D-9  
negotiated packet size facility 10-14, 10-15  
negotiated packet size (430) 10-16  
negotiated window size facility 10-14, 10-15  
negotiated window size (432) 10-16  
negotiated, throughput class 10-14  
Netherlands, language code 6-20  
NetView, RECFMS 4-13  
network diskettes, management of 5-7  
network ID, NETID (501) 11-5  
network site controller 11-5  
network subscription 10-3  
network type (400) 10-6  
networks, switched 6-41  
New Greek, language code 6-20  
new line option (763) 12-56  
nomenclature presentation restrictions,  
    keyboard 15-7  
nomenclature, key function 15-15  
non-SNA sense ID command 4-17  
Non-SNA (Channel) worksheet A-11  
nonreturn to zero inverted (NRZI) 6-40  
nonreturn to zero (NRZ) 6-40  
nonstandard default packet size (434) 10-7  
nonstandard default window size (435) 10-8  
nonswitched facilities 6-41  
nonswitched lines, AEA 12-6  
normal data transfer 6-38  
normal token release 6-48, 14-8  
Norwegian, language code 6-20  
NPKT (negotiated packet size) 10-16  
NRZ or NRZI encoding (313) 6-40  
NRZ (nonreturn to zero) 6-40  
NRZI (nonreturn to zero inverted) 6-40  
null modem 12-11  
number of bits per character (744) 12-52  
number of retries (451) 10-8  
numbering AEA Attachment Diagrams 12-35  
numbering, packet sequence (431) 10-7  
NWND (negotiated window size) 10-16

## O

online test password (098) 6-3

operation  
    connect-data-set-to-line (310) 6-39  
    disconnect/local mode, X.25 10-12  
    half-duplex SNBU 6-41  
operator-generated alert 6-35  
option  
    ASCII printer 12-60  
    clicker 6-23  
    direct 6-44  
    distributed function terminals 6-31  
    field intensity 6-33  
    incoming call (420) 10-13  
    miscellaneous ASCII feature (710) 12-38  
    miscellaneous ASCII feature (711) 12-39  
    miscellaneous ASCII feature (712) 12-39  
    miscellaneous ASCII feature (713) 12-40  
    miscellaneous feature (125) 6-22  
    miscellaneous feature (126) 6-24  
    new line (763) 12-56  
    outgoing call (421) 10-14  
    RTS control response (340) 6-42  
    wraparound (762) 12-56  
    X.21 switched (362) 6-43  
    X.25 keyboard support (409) 10-11  
    X.25 (3320) 6-42  
outbound sequence panels, UDT 12-76  
    UDX worksheets 12-77  
        inbound translation 12-81  
        outbound translation 12-80  
        selection 12-77  
outbound translation, UDX 12-80  
outgoing channel  
    highest 10-10  
    lowest 10-10

## P

packet sequence numbering (431) 10-7  
packet size facility, negotiated 10-14, 10-15  
packet size, negotiated (430) 10-16  
page length (783) 12-59  
page width (786) 12-62  
parity (735) 12-50  
password  
    3179G 6-33  
    3290 6-33  
pattern diskette 5-8  
PA3 key, warning 15-3  
permanent request-to-send 6-42  
personal computers, additional extension-mode key  
    definition (168) 6-31  
phone number, ASCII host (752) 12-53  
physical installation considerations 2-3  
physical unit identification (215) 6-35  
planning  
    AEA 12-1  
    AEA examples B-1  
    AEA tasks 12-12

- planning (*continued*)
  - central site change management 11-1
  - define devices 13-1
  - for CECP 8-1
  - for controller storage 3-1
  - for port assignment 7-1
  - for the host 4-1
  - how to 5-3
  - logical terminal assignment (LTA) 13-12
  - modify keyboards 15-1
  - parts of the process 5-3
  - phases 5-3
  - printer authorization matrix (PAM) 13-6
  - reconfigure 5-5
  - response time monitor (RTM) 9-1
  - steps for storage 3-4
  - strategy for gateway 14-3
  - to configure 6-1
  - token-ring examples C-1
  - token-ring network 3270 gateway 14-1
  - using worksheets 5-4
  - what's involved 5-3
  - X.25 10-1
- planning checklist
  - for AEA 12-9
  - for Token-Ring Gateway 14-3
  - for 3174 2-18
- planning considerations 2-3
  - controller storage 2-3, 3-3
  - display compatibility 2-12
  - host system planning 2-12, 4-3
  - microcode customization 2-12
  - microcode migration 2-17
  - Multi-Host Support 2-6
  - physical installation 2-3
  - site preparation 2-3
  - terminal attachment 2-10
  - types of host attachment 2-4
- polling address 6-9
- polling, group 14-8
- port address (118) 6-20
- port assignment
  - AEA considerations 7-4
  - cabling worksheets 7-6
  - changing port assignments 7-13
  - completing the worksheet (116=1) 7-10
  - completing the worksheet (116=2) 7-11
  - considerations 2-15
  - CUT devices using MLT function 7-4
  - description of 7-3
  - description of worksheet 7-7
  - DFT considerations 7-4
  - Multi-Host Support considerations 7-5
  - planning for 7-1
  - question 116 response descriptions 7-4
  - worksheet A-21, A-22
- port assignment, individual (116)
  - ASCII, DFT devices 6-18
  - automatic 6-18, 6-19
- port assignment, individual (116) (*continued*)
  - port pools, AEA 12-4
  - port set name (723) 12-47
  - port set, AEA 12-4
  - Portuguese, language code 6-20
  - port, AEA 12-6
  - printer
    - ASCII options 12-60
    - host mode 13-8
    - local mode 13-8
    - shared mode 13-8
  - Printer Authorization Matrix (PAM) 13-6
    - completing the worksheet 13-11
    - description of 13-6
    - example of 13-10
    - host mode 13-8
    - host printing 13-6
    - local copy 13-6
    - local mode 13-8
    - planning 13-6
    - shared copy 13-6
    - shared mode 13-8
    - worksheet A-43
    - worksheet description 13-6
    - worksheet fields 13-7
      - class 13-8
      - display port 13-9
      - entry 13-7
      - mode 13-7
      - printer port 13-7
  - printer character set (784) 12-59
  - printer considerations, CECP 8-6
  - printer support, IPDS 4-16
    - BSC and channel protocol 4-16
    - SNA protocol 4-16
  - printers with CECP 8-5
  - printer, for record-keeping 5-6
  - private operating agency, recognized (442) 10-17
  - procedure
    - filling out Common SNA worksheet 11-5
    - filling out Device Definition worksheet 13-5
    - filling out keyboard worksheets 15-19
    - filling out MLT worksheet 6-14
    - filling out PAM worksheet 13-11
    - filling out Ring Address Assignment worksheet 14-11
    - filling out Ring Transmission Definition worksheet 14-14
    - filling out RTM worksheet 9-10
    - filling out the extended VPD worksheet 13-19
    - filling out the LTA worksheet 13-18
    - filling out X.25 Options worksheet 10-5
    - filling out 117: Port Assignment worksheet (116=1) 7-10
    - filling out 117: Port Assignment worksheet (116=2) 7-11
    - storage planning 3-4

product assistance data (099) 6-4  
program function keypad, response for 6-28  
program symbols, compressed (165) 6-30  
prompt for attached printer (781) 12-58  
prompt for universal/specific keyboard map  
(743) 12-52  
PS load altered screen 6-23  
PSTN (public switched telephone network) 6-41  
publications  
    choosing one iii  
    3174 library 1-14  
purpose of record-keeping 5-6

## Q

questions for  
    DECVT100/VT220 data stream 12-56  
    IBM 3101 data stream 12-57

## R

REFMS for NetView 4-13  
recognized private operating agency (442) 10-17  
reconfigure, planning 5-5  
record-keeping, methods of 5-6  
    using a printer 5-6  
    using diskettes 5-6  
    using worksheets 5-6  
remote link attachment 2-5  
REQMS/REFMS support 4-13  
    NetView, REFMS 4-13  
    node ID block number, REFMS 4-13  
request MLT for AEA (703) 12-37  
request-to-send control options (340) 6-42  
Response Time Monitor (RTM)  
    boundaries and interface (128) 6-25  
    changing specifications 9-11  
    completing the worksheet 9-10  
    considerations 2-17  
    defining 9-3  
    definition (127) 6-25  
    description of 9-3  
    description of worksheet 9-7  
    first-digit response 9-4  
    how its measured 9-8  
    planning for 9-1  
    sample boundaries 9-9  
    second-digit response 9-5  
    worksheet A-23  
restrictions for modifying keyboards 15-4  
    APL 15-7  
    general 15-4  
    local functions 15-6  
    nomenclature presentation 15-7  
retries, number of (451) 10-8  
retry  
    X.21 switched timing (361) 6-43  
    X.21 switched (360) 6-43

retry, command (222) 6-36  
reverse-charge facility 10-14, 10-15  
ring  
    maximum I-frame size (382) 6-47  
ring address assignment (940) 14-9  
ring addresses (Ring) 14-10  
ring error monitor (905) 14-7  
ring speed of the Token-Ring Gateway (911) 14-8  
ring speed of the Token-Ring Network (384) 6-48  
ring transmission definition (941) 14-13  
ROECE Latin, language code 6-20  
RPOA (recognized private operating agency) 10-17  
RPQ (request for price quotation) diskette  
    description of 1-13  
RTM  
    See Response Time Monitor  
RU Maximum Size  
    Size, Maximum RU (241) 6-39  
RU sizes 4-14  
    SDLC/X.25 attachment 4-15  
    SNA channel attachment 4-14  
RU sizes, SDLC/X.25 4-15

## S

S (I/O addresses) 14-9  
screen, PS load altered 6-23  
scrolling (774) 12-58  
SDLC secondary worksheet A-8  
SDLC worksheet A-7  
SDLC (Synchronous Data Link Control) 6-5  
Secondary SNA (Channel) worksheet A-13  
security  
    connection identifier 10-17  
    DFT password 6-33  
segmenting 4-5  
selection, alternate base keyboard (132) 6-26  
sense ID command, non-SNA 4-17  
serial original equipment manufacturer interface  
(SOEMI) 4-17  
    sense ID command, non-SNA 4-17  
service access point  
    examples of using E-1  
    token-ring attached 3174s (106) 6-12  
    token-ring gateway (107) 6-13  
service access point (SAP) 14-10  
session support, AEA 12-8  
setting up terminal keyboards 15-8  
setup mode, CECP 8-8  
shared copy operations 13-6  
shared mode, printer 13-8  
sharing, between bracket (213) 6-34  
shift group 15-18  
short-hold mode dial number, X.21 switched  
(368) 6-46  
short-hold mode, X.21 switched (367) 6-46  
Single Link Multi-Host Support  
    CECP considerations 8-9

## Single Link Multi-Host Support (*continued*)

- CECP restrictions 6-21
- description of 2-8
- ESCON Channel 2-8
- service access point examples E-1
- storage requirements 3-3
- Token-Ring 2-8, 2-9
- site preparation considerations 2-3
- site preparation, AEA 12-10
- small-cluster controllers
  - descriptions
    - 90R 1-7
    - 91R 1-7
    - 92R 1-7
- SNA considerations 4-11
- SNA protocol for IPDS printers 4-16
- SNA RU sizes 4-14
  - channel attachment 4-14
  - SDLC/X.25 attachment 4-15
- SNA SSCP/PU sessions 4-11
- SNA (Channel) worksheet A-12
- SNA (systems network architecture) 9-3
- SNBU (switched network backup) 6-41
- SOEMI support 4-17
  - sense ID command, non-SNA 4-17
- Spanish-Speaking, language code 6-20
- Spanish, language code 6-20
- specification change, RTM 9-11
- specification, RTM boundaries and interface (128) 6-25
- specifying keyboard language, warning 15-19
- speed, ASCII host upper limit (734) 12-49
- speed, line (733) 12-49
- speed, ring 6-48, 14-8
- standard keypad layouts (138) 6-28
- standard layouts, keypads (138) 6-28
- standard layouts, modifiable keyboards (136) 6-27
- station set name (721) 12-46
- station set, AEA 12-4
- station type
  - ASCII 12-46
  - 3270 12-46
- station type (722) 12-46
- station, AEA 12-4, 12-5
- stop bits (736) 12-50
- storage considerations 2-3, 3-3
- storage expansion feature, description of 1-11
- storage requirements 3-3
  - asynchronous emulation adapter (AEA) 3-3, 12-16
  - central site change management (CSCM) 3-3
  - concurrent communication adapter (CCA) 3-3
  - multiple logical terminals (MLT) 3-3
  - single link multi-host support 3-3
  - token-ring 3270 gateway 3-3
- storage, MLT (110) 6-14
- subscription, network 10-3
- subsystem name, link (908) 14-7

## support

- country extended code page 6-21
- keyboards 15-14
- languages 6-20, 15-14
- Swedish, language code 6-20
- Swiss French (New), language code 6-20
- Swiss German (New), language code 6-20
- switched connections, AEA 12-14
- switched disconnect timeout (741) 12-51
- switched lines, AEA 12-6
- switched networks 6-41
- symbols, compressed program (165) 6-30
- synonyms 8-9
  - warning 8-9
  - what you can do 8-9
- system checkout, AEA 12-10
- system considerations, CECP 8-8
- system definitions, gateway 4-5
  - coding macros 4-6
  - MVS/SP 4-5
  - NCP 4-9
  - unit control words 4-7
  - VM/SP 4-5
  - VSE 4-7
  - VTAM 4-7
- system software requirements, CSCM 4-18
- S/370 channel attachment 2-4
  - cables 2-4
- S/390 channel attachment 2-4

## T

- TCLS (throughput class negotiation) 10-16
- telecommunication facilities (317) 6-40
- terminal assignment, logical 13-12
- terminal attachment
  - AEA adapter 2-11
  - considerations 2-10
  - direct 2-11
  - Fiber Optic Terminal Adapter 2-11
  - multiplexer adapters 1-11, 2-11
- terminal equipment address 10-6
- terminal keyboards
  - setting up 15-8
- terminal multiplexer adapter, description of 1-11
- terminal options, DFT 6-31
- terminal table attributes 12-67
- terminal type menu, AEA 12-4
- terminology, AEA 12-4
- terminology, CECP 8-5
- test equipment, AEA 12-10
- Thai, language code 6-20
- throughput class 10-15
- throughput class negotiation 10-14
- throughput class negotiation (440) 10-16
- time measurement, response 9-8
- timeout, coax 6-24

- timeout, inactivity (742) 12-51
- timeout, switched disconnect (741) 12-51
- token-ring attachment 2-4
- Token-Ring Gateway worksheets, completing
  - Ring Address Assignment 14-11
  - Ring Transmission Definition 14-14
  - Token-Ring Gateway 14-7
- Token-Ring Network 6-5
  - adapter description 1-11
  - address and SAP of the gateway (107) 6-13
  - address and SAP of the 3174 (106) 6-12
  - early token release 6-48
  - gateway controller (150) 6-30
  - maximum out (383) 6-48
  - normal token release 6-48
  - planning examples C-1
  - ring I-frame size (382) 6-47
  - ring speed (384) 6-48
  - secondary worksheet A-17
  - service access point, gateway (107) 6-13
  - service access point, 3174 (106) 6-12
  - using SAPs E-1
  - worksheet A-16
  - 3174 address warning 6-12
- Token-Ring Network Gateway questions 14-7
  - 900 address for the Gateway 14-7
  - 905 ring error monitor 14-7
  - 908 link subsystem name 14-7
  - 911 Ring Speed of the Token-Ring Gateway 14-8
  - 912 Group Poll Address 14-8
  - 940 ring address assignment 14-9
  - 941 ring transmission definition 14-13
- Token-Ring Network 3270 Gateway 14-1
  - address assignment worksheet description 14-9
  - early token release 14-8
  - gateway identification (150) 6-30
  - gateway worksheet description 14-6
  - host macro coding 4-6
  - host support 4-4
  - I/O addresses (S) 14-9
  - maximum out 14-13
  - MVS/SP definitions 4-5
  - NCP definition 4-9
  - normal token release 14-8
  - overall planning of 14-3
  - planning 14-1
  - Ring Address Assignment worksheet A-47
  - ring addresses (Ring) 14-10
  - Ring Transmission Definition worksheet A-48
  - segmenting 4-5
  - service access point (SAP) 14-10
  - storage requirements 3-3
  - system definitions 4-5
  - Token-Ring Gateway worksheet A-46
  - transmission definition worksheet
    - description 14-12
  - transmit I-frame 14-13
  - type (T) 14-10
- Token-Ring Network 3270 Gateway (*continued*)
  - unit control word definitions 4-7
  - VM/SP definitions 4-5
  - VSE definitions 4-7
  - VTAM definition 4-7
  - VTAM hang-up 4-6
- Token-Ring planning examples C-1
  - downstream 3174 worksheets C-11
  - downstream 3174s C-3
  - local gateway C-3
  - local gateway worksheets C-5
  - overview C-3
  - remote gateway C-14
  - remote gateway worksheets C-16
- Token-Ring worksheet examples
  - Common SNA C-10, C-13, C-21
  - Local (SNA) C-6
  - Model/Attach C-5, C-11, C-16
  - Ring Address Assignment C-8, C-19
  - Ring Transmission Definition C-9, C-20
  - SDLC C-17
  - Token-Ring Gateway C-7, C-18
  - Token-Ring Network C-12
- traffic analysis, AEA 12-8
- transfer delay, X.21 data (365) 6-45
- transfer, data mode (224) 6-38
- Translate Option (746) 12-53
- translated character string 12-55
- translated modem character 12-55
- translate, unsupported control code 6-22
- transmission
  - full- or half-speed 6-41
  - resumption trigger, XON/XOFF (732) 12-48
- transmit I-frame size 14-13
- transmit timeout, link level (450) 10-8
- transmit window size 14-13
- Turkish, language code 6-20
- turnaround character, line (775) 12-58
- two-language modification 15-9
  - examples of 15-10
- two-way channel 10-9
  - highest 10-9
  - lowest 10-9
- type of flow control (731) 12-48
- type 1 communication adapter, description of 1-11
- type 2 communication adapter, description of 1-11
- type (T) 14-10
- typewriter keyboard, response for 6-27

## U

- UDTs 12-65
- UDXs 12-77
- undefined code points, CECP 8-8
- unique characters, warning
  - APL2 15-19
  - CECP 15-19

- unique machine identifier (108) 6-13
- unit control word, gateway 4-7
- unit name, logical (502) 11-6
- universal address 14-10
- universal/specific keyboard map, prompt for (743) 12-52
- unlabeled PA3 key, warning 15-3
- unsupported control code translate 6-22
- update panel before allowing buffer change 6-33
- upgrading microcode 5-9
- upper limit address (105) 6-11
- use of form feed (782) 12-59
- user group, closed (441) 10-17
- User-Defined Terminal tables 12-65
  - considerations for AEA planning 12-16
  - general description 12-16
  - how to define 12-65
  - IBM-provided 12-66
- User-Defined Translate tables 12-77
  - considerations for AEA planning 12-16
  - general description 12-16
  - how to define 12-77
- Utility disk
  - description of 1-13
  - upgrading 5-9

## V

- VM/SP definition, gateway 4-5
- VSE definition, gateway 4-7
- VTAM definition, gateway 4-7
- VTAM hang-up 4-6
- VTAM/NCP definitions, 3174 D-1
  - channel attached 3174 (SNA) D-3
  - examples of D-1
  - local 3174 terminal (Non-SNA) D-4
  - SDLC D-5
  - Token-Ring Network D-12
  - X.25 D-9

## W

- WACK (wait before transmit positive acknowledgment) 6-33
- warning
  - about synonyms, CECF 8-9
  - APL2 15-19
  - CECF 15-19
  - data integrity, CECF 6-21, 8-3
  - dual function clear key 6-22
  - PA3 key 15-3
  - specifying keyboard language 15-19
  - 106 Token-Ring network address of the 3174 6-12
- window size facility, negotiated 10-14, 10-15
- window size, negotiated (432) 10-16
- window size, nonstandard default (435) 10-8
- window size, transmit 14-13

## worksheet description

- all of 5-4
- Common SNA 11-4
- Device Definition 13-4
- for record-keeping 5-6
- keyboard changes chart 15-17
- Logical Terminal Assignment 13-12
- Multi-Host Definition 6-6
- Port Assignment 7-7
- Printer Authorization Matrix 13-6
- Response Time Monitor 9-7
- Ring Address Assignment 14-9
- Ring Transmission Definition 14-12
- Token-Ring Gateway 14-6
- X.25 Options 10-5

## worksheets

- AEA Configure A-30
- AEA Default Destination A-34
- AEA Port Set A-31
- AEA Port to Port Set Map A-32
- AEA Station Set A-33
- ASCII Attachment Diagram A-29
- ASCII to EBCDIC Translation (for UDX) A-41
- BSC A-5
- Common SNA A-26
- Device Definition A-42
- EBCDIC to ASCII Translation (for UDX) A-40
- Enhanced Keyboard (Katakana) A-54
- Enhanced Keyboard (US) A-52
- Enhanced Keyboard (World Trade) A-53
- Extended Vital Product Data A-45
- Host Attachment A-3
- Inbound Sequence Panels (for UDT) A-36, A-37
- Katakana Converged Keyboard A-51
- Logical Terminal Assignment A-44
- Multi-Host Definition A-4
- Multiple Logical Terminals A-18, A-19
- Multiple Logical Terminals on AEA A-20
- Non-Katakana Converged Keyboard A-50
- Non-SNA (Channel) A-11
- Outbound Sequence Panels (for UDT) A-38
- Port Assignment A-21, A-22
- Printer Authorization Matrix A-43
- Ring Address Assignment A-47
- Ring Transmission Definition A-48
- SDLC A-7
- Secondary BSC A-6
- Secondary SDLC A-8
- Secondary SNA (Channel) A-13
- Secondary Token-Ring Network A-17
- Secondary X.21 Switched A-15
- secondary X.25 A-10
- secondary X.25 options A-25
- SNA (Channel) A-12
- Storage Requirements A-49
- Terminal Tables Definition (for UDT) A-35
- Token-Ring Gateway A-46
- Token-Ring Network A-16

## worksheets (*continued*)

Translate Tables Definition (for UDX) A-39

X.21 Switched A-14

X.25 A-9

X.25 Options A-24

128: Response Time Monitor A-23

3270 Attachment Diagram A-27, A-28

wrap plug 12-10

wrap tests 12-10

wraparound option (762) 12-56

## X

XON/XOFF transmission resumption (732) 12-48

XON/XOFF, auto (761) 12-56

X.21

data transfer delay (365) 6-45

response for host attachment 6-5

X.21 switched

options (362) 6-43

DCE supported for addressed calls 6-44

DCE supported for direct calls 6-44

disconnect key 6-44

local, communicate key 6-44

retry timing (361) 6-43

retry (360) 6-43

secondary worksheet A-15

short-hold mode dial number (368) 6-46

short-hold mode (367) 6-46

worksheet A-14

X.25

changing options 10-19

completing worksheet 10-5

description of worksheet 10-5

DISC key 10-12

keys 10-12

LOCAL and COMM keys 10-12

Options worksheet A-24, A-25

options (332) 6-42

planning for 10-1

response for host attachment 6-5

secondary worksheet A-10

worksheet A-9

X.25 configuration questions 10-6

400 network type 10-6

401 circuit type 10-11

402 logical channel identifier 10-11

409 X.25 keyboard support options 10-11

420 incoming call options 10-13

421 outgoing call options 10-14

423 host DTE address 10-15

424 3174 DTE address 10-6

430 negotiated packet size 10-16

431 packet sequence numbering 10-7

432 negotiated window size 10-16

433 K-maximum out 10-7

434 nonstandard default packet size 10-7

435 nonstandard default window size 10-8

X.25 configuration questions (*continued*)

440 throughput class negotiation 10-16

441 closed user group 10-17

442 recognized private operating agency 10-17

450 link level transmit timeout 10-8

451 number of retries 10-8

452 connection identifier 10-17

453 connection options 10-18

461 lowest incoming channel 10-9

462 highest incoming channel 10-9

463 lowest two-way channel 10-9

464 highest two-way channel 10-9

465 lowest outgoing channel 10-10

466 highest outgoing channel 10-10

X.25 incoming call options (420) 10-13

connection identifier 10-14

host DTE address 10-14

negotiated packet size facility 10-14

negotiated window size facility 10-14

reverse-charge facility 10-14

throughput class negotiation 10-14

X.25 keyboard support options (409) 10-11

dial screen display 10-12

disconnect/local mode operation 10-12

X.25 DISC key 10-12

X.25 keys 10-12

X.25 LOCAL and COMM keys 10-12

X.25 outgoing call options (421) 10-14

connection identifier 10-15

negotiated packet size facility 10-15

negotiated window size facility 10-15

reverse-charge facility 10-15

throughput class 10-15

3174 DTE address 10-15

X.25 Networks

logical channels 10-8

planning for

before you begin 10-3

## Y

Yugoslavic, language code 6-20

## Numerics

106 Token-Ring network address of the 3174,  
warning 6-12

117: port assignment 6-19

118: port address 6-20

3174 compatibility

with 3270 Information Display System 2-12

with 3290 Information Panel 2-12

3174 control point, alert (221) 6-36

3174 controller

See establishment controller

3174 DTE address 10-15

3174 DTE address (424) 10-6



- 3174 Establishment Controller
  - considerations for 2-3
  - description of 1-3
  - feature descriptions 1-11
  - large-cluster controllers 1-4
  - medium-cluster controllers 1-6
  - models 1-4
  - planning 2-3
  - small-cluster controllers 1-7
  - table of features 1-8
- 3174 VTAM/NCP definitions D-1
  - channel attached 3174 (SNA) D-3
  - examples of D-1
  - local 3174 terminal (Non-SNA) D-4
  - SDLC D-5
  - Token-Ring Network D-12
  - X.25 D-9
- 3179G options (173) 6-31
- 3179G password (175) 6-33
- 3270 Information Display System
  - compatibility with 3174 2-12
- 3270 Port Expansion Feature, description of 1-12
- 3270 station type
  - display station 12-46
  - host 12-46
  - printer 12-46
- 3290 field intensity 6-33
- 3290 Information Panel
  - compatibility with 3174 2-12
- 3290 options (173) 6-31
- 3290 password (175) 6-33
- 3299 terminal multiplexer, description of 1-11
- 8K0808 keyboard 6-26
- 8K0932 keyboard 6-26
- 8K1038 keyboard 6-26
- 8K1158 keyboard 6-26

---

# Reader's Comments

**IBM 3174 Establishment Controller Planning Guide  
Configuration Support B Release 4  
Publication No. GA27-3862-03**

Use this form to tell us what you think about this manual. If you have found errors in it, or if you want to express your opinion about it (such as organization, subject matter, appearance) or make suggestions for improvement, this is the form to use.

To request additional publications, or to ask questions or make comments about the functions of IBM products or systems, you should talk to your IBM representative or to your IBM authorized remarketer. This form is provided for comments about the information in this manual and the way it is presented.

When you send comments to IBM, you grant IBM a nonexclusive right to use or distribute your comments in any way it believes appropriate without incurring any obligation to you.

Be sure to print your name and address below if you would like a reply.

---

---

---

---

---

---

---

---

---

---

---

---

---

---

---

---

---

---

---

---

---

---

---

---

---

---

---

---

---

---

---

Name \_\_\_\_\_

Address \_\_\_\_\_

Company or Organization \_\_\_\_\_

\_\_\_\_\_

Phone No. \_\_\_\_\_

\_\_\_\_\_



Fold and Tape

Please do not staple

Fold and Tape



NO POSTAGE  
NECESSARY  
IF MAILED IN THE  
UNITED STATES



# BUSINESS REPLY MAIL

FIRST CLASS MAIL PERMIT NO. 40 ARMONK, NEW YORK

POSTAGE WILL BE PAID BY ADDRESSEE

International Business Machines Corporation  
Information Development  
Department E02  
P.O. Box 12195  
Research Triangle Park, North Carolina 27709-9990



Fold and Tape

Please do not staple

Fold and Tape

## Microcode Customization Planning

Read Part 1 and Chapter 5 of this book if you are planning microcode customization for the first time. If you are experienced at planning microcode customization, you may want to skim those chapters before you begin the following procedure.

**Planner:** During this procedure, you leave these steps and go to the planning sections of this book that contain the information you need to fill out the worksheets. Once the worksheets that are required for a step are completed, return to this procedure to complete the next step.

The worksheets are located in Appendix A. Each worksheet directs you to the chapter that contains the planning information you need.

**Step 1** Fill out "Worksheet 1—Host Attachment" on page A-3. The information you need to fill out this worksheet starts on page 6-4.

**Step 2** On Worksheet 1 you specified a response to question 101. Depending on that response, fill out one of the following worksheets:

If Question 101-Host Attachment	Fill Out Worksheets
= 1 - BSC	3
= 2 - SDLC	4, 14
= 3 - X.25	5, 13, 14
= 4 - Non-SNA (Channel)	6
= 5 - SNA (Channel)	7, 14
= 6 - X.21 Switched	8, 14
= 7 - Token-Ring Network	9, 14
= M - Multi-Host Support	2

The information you need to fill out worksheets 3—9 starts on page 6-9. When filling out Worksheet 2, start on page 6-5.

**Planner:** If you did not fill out Worksheet 2, proceed to step 4.

**Step 3** Complete this step **only** if you filled out Worksheet 2.

Depending on the response you specified in the "Host Attach" field for the primary host on the primary link (1A), fill out one of the worksheets in the following table.

If the Primary Host's Attachment Field	Fill Out Worksheets
= 1 - BSC	3
= 2 - SDLC	4, 14
= 3 - X.25	5, 13, 14
= 4 - Non-SNA (Channel)	6
= 5 - SNA (Channel)	7, 14
= 6 - X.21 Switched	8, 14
= 7 - Token-Ring Network	9, 14

Write in **1A** in the "Host ID" field on the top of the worksheet.

**Step 4** Consult the following table to determine if you have responded to a question that requires additional planning. If not, read the following "**Planner**" note to determine where to proceed.



If on Worksheets	Question	Fill Out Worksheets
3 through 9	116 = 1 or 2	11A & 11B
3 through 9	127 = nonzero	12
4 or 7	150 = 1	32, 33, 34

**Planner:** If you are *not* planning for Multi-Host Support, go to step 7. If you are planning for Multi-Host Support, complete the remaining steps.

- Step 5** Each additional host attachment requires separate worksheets. The worksheets that you fill out depend on the link attachment and on the communication protocol. For each additional host attachment, fill out the worksheets indicated. (Be sure to include the host identifier on each worksheet.)

If the Communication Protocol Is	Fill Out Worksheets
BSC	3S
SDLC and/or X.21 Nonswitched	4S
X.25	5S, 13S
SNA (Channel)	7S
X.21 Switched	8S
Token-Ring Network	9S

- Step 6** For each worksheet you filled out in step 5, consult the following table to determine if you have responded to a question that requires additional planning. (If not, go to step 7.) Be sure to include the host identifier on each worksheet.

If on Worksheets	Question	Fill Out Worksheet
3S, 4S, 5S, 7S, 8S, or 9S	116 = 1 or 2	11A & 11B
3S, 4S, 5S, 7S, 8S, or 9S	127 = nonzero	12
4S, 7S	150 = 1	32, 33, 34

- Step 7** If you wish to have one or both of the following features supported, fill out the worksheets indicated.

To Support	Fill Out Worksheets
Asynchronous Emulation Adapter	15 through 27
Modified Keyboards	Keyboard 1–5

- Step 8** If you wish to Define Devices, fill out Worksheet 28. Depending on responses specified on Worksheet 28, fill out the worksheets indicated.

To Define	Fill Out Worksheets
Printer Authorization Matrix (PAM)	29
Logical Terminal Assignment (LTA)	30
Extended Vital Product Data (Extended VPD)	31

- Step 9** Give the completed worksheets to the person who will customize the Control disk. If you have planned for Multi-Host Support, group the worksheets by their host identifier before giving them to the customizer.

## Worksheet Summary

If you are familiar with the microcode customization process, you can use this summary to plan your configuration. The worksheets that must be filled out to plan the specific areas of your configuration are listed below. The worksheets, which are located in Appendix A, tell you where to find the planning information you need.

All configurations require that you fill out **Worksheet 1**.

### Type of Host Attachment

Attachment Type	Worksheets
BSC	3
SDLC and/or X.21 Nonswitched with Gateway	4, 14 4, 14, 32, 33, 34
X.25	5, 13, 14
Non-SNA (Channel)	6
SNA (Channel)	7, 14
with Gateway	7, 14, 32, 33, 34
X.21 Switched	8, 14
Token-Ring Network	9, 14
Multiple Hosts (Primary host on primary link requires worksheets for one of the above.)	2

### Additional Host Attachment

Attachment Type	Worksheets
BSC	3S
SDLC and/or X.21 Nonswitched with Gateway	4S 4S, 32, 33, 34
X.25	5S, 13 or 13S
SNA (Channel)	7S
with Gateway	7S, 32, 33, 34
X.21 Switched	8S
Token-Ring Network	9S

### Additional Areas

Area	Worksheets
Multiple Logical Terminals	10
Port Assignment	11A & 11B
Response Time Monitor	12
Asynchronous Emulation Adapter	15 through 27
Device Definition (PAM, LTA, and Extended VPD)	28 through 31
Controller Storage	35
Modified Keyboards	Keyboard 1—5

### Customizing Procedures

You may need to have the customizer:

- Merge RPQs
- Merge DSL
- Copy Files
- Perform Microcode Upgrade
- Perform Media Management
- Identify Customizing Keyboard.

See the *3174 Utilities Guide*, GA27-3863, for these additional procedures.



## 3174 Configuration Questions Reference

Configuration Questions—Worksheet 1	
Question:	Response:
<b>098:</b> Online Test Password (Page 6-3)	Up to 8 alphanumeric characters
<b>099:</b> Product Assistance Data (Page 6-4)	Up to 68 alphanumeric characters
<b>100:</b> 3174 Model Designation (Page 6-4)	3174 Model Number
<b>101:</b> Host Attachment (Page 6-5)	(1-7, M) Host attachment type

Configuration Questions—Worksheets 3 through 9S	
Question:	Response:
<b>104:</b> Controller Address (Page 6-9)	Two-character hexadecimal address
<b>105:</b> Upper Limit Address (Page 6-11)	Two-character hexadecimal address
<b>106:</b> Token-Ring Network Address and SAP - 3174 (Page 6-12)	A hexadecimal address and service access point
<b>107:</b> Token-Ring Network Address and SAP - Gateway (Page 6-13)	A hexadecimal address and service access point
<b>108:</b> Unique Machine Identifier (Page 6-13)	Seven alphanumeric characters
<b>110:</b> MLT Storage Support (Page 6-14)	Level 0–8 or exact MLT storage amount
<b>116:</b> Individual Port Assignment (Page 6-18)	One, two, or four alphanumeric characters
<b>Note:</b> 0, 1, SX, and SXAY provide automatic assignment.	
<b>117:</b> Port Assignment	Panel (See page 6-19)
<b>118:</b> Port Address	Panel (See page 6-20)
<b>121:</b> Keyboard Language (Page 6-20)	Two-digit language code
<b>123:</b> Country Extended Code Page Support (Page 6-21)	0 = No CECP 1 = CECP
<b>125:</b> Miscellaneous Feature Options (A) (Page 6-22)	Eight digits (0 or 1)
<b>126:</b> Miscellaneous Feature Options (B) (Page 6-24)	Eight digits (0 or 1)
<b>127:</b> RTM Definition (Page 6-25)	Two digits
<b>128:</b> Boundaries and Interface Specification	Panel (See page 6-25)
<b>132:</b> Alternate Base Keyboard Selection (Page 6-25)	Four digits (0, 1, or 2)
<b>136:</b> Standard Keyboard Layouts (Page 6-27)	Four digits (0 or 1)
<b>137:</b> Modified Keyboard Layouts (Page 6-28)	Four digits (0 or 1)

Configuration Questions—Worksheets 3 through 9S	
Question:	Response:
<b>138:</b> Standard Keypad Layouts (Page 6-28)	0 = National Language Numeric 1 = Data Entry 2 = Program Function
<b>139:</b> Concurrent Communication Keyboard Language (Page 6-29)	00 = Same language as primary host on that link 01 = English (U.S.A.) 02 = English (U.S.A.) ASCII-7.
<b>141:</b> Magnetic Character Set (Page 6-29)	A = None B = Numeric C = Alphanumeric (auto entry; secure data) D = Alphanumeric (auto entry; all data)
<b>150:</b> Token-Ring Network Gateway Controller (Page 6-30)	0 = Not a gateway controller 1 = Gateway controller
<b>165:</b> Compressed Program Symbols (Page 6-30)	0 = Compressed PS data not sent 1 = Compressed PS data sent
<b>166:</b> Attribute Select Keypad (Page 6-30)	A = Attribute Select Keypad not in use B = Attribute Select Keypad in use without numeric lock C = Attribute Select Keypad in use with numeric lock
<b>168:</b> Additional Extension-Mode Key Definition (Page 6-31)	0 = None 1 = Home key 2 = Print ID key
<b>173:</b> DFT Options (Page 6-31)	Eight digits (0-No or 1-Yes)
<b>175:</b> DFT Password (Page 6-33)	Six numeric digits
<b>176:</b> BSC Enhanced Communication (Page 6-33)	0 = No 1 = Yes
<b>179:</b> Local Format Storage (Page 6-34)	Three digits (0, 1, 2, or 3)
<b>213:</b> Between Bracket Printer Sharing (Page 6-34)	0 = No 1 = Yes
<b>215:</b> PU Identification (Page 6-35)	Five alphanumeric characters
<b>220:</b> Alert Function (Page 6-35)	0 = None 1 = No operator-generated alert message capability 2 = Operator-generated alert message capability from port 26-00 and 27-00 3 = Operator-generated alert message capability; all ports
<b>221:</b> 3174 Alert Control Point (Page 6-36)	0 = This host is not the alert control point for the 3174. 1 = This host is the alert control point for the 3174.
<b>222:</b> Support of Command Retry (Page 6-36)	0 = No 1 = Yes
<b>223:</b> Attention Delay Value (Page 6-37)	Two digits (whole milliseconds)



Configuration Questions—Worksheets 3 through 9S	
Question:	Response:
<b>224:</b> Mode of Data Transfer (Page 6-38)	0 = Interlocked mode; normal data transfer 1 = Data streaming mode; 1.25Mbps 2 = Interlocked mode; high-speed data transfer 3 = Data streaming mode; 2.5Mbps
<b>225:</b> Channel Burst Size (Page 6-38)	0 = 002 bytes per burst 1 = 004 bytes per burst 2 = 008 bytes per burst 3 = 016 bytes per burst 4 = 032 bytes per burst 5 = 064 bytes per burst 6 = 256 bytes per burst 7 = 512 bytes per burst
<b>240:</b> Controller Logical Address (Page 6-39)	One alphanumeric digit (from 0-9, A-F)
<b>241:</b> RU Maximum Size (Page 6-39)	0 = 4KB RU 1 = 8KB RU
<b>310:</b> CDSTL Operation (Page 6-39)	0 = Operation: Nonswitched, or switched line (US or Canada), or in DTR/DSR mode (not Canada). 1 = Connection on a switched line via the CCITT 108.1 interface operating in the CDSTL mode.
<b>313:</b> NRZ or NRZI Encoding (Page 6-40)	0 = Nonreturn to zero encoding 1 = Nonreturn to zero inverted encoding
<b>317:</b> Telecommunication Facilities (Page 6-40)	0 = Nonswitched facilities 1 = Half-duplex SNBU operation 2 = Switched networks
<b>318:</b> Full- or Half-Speed Transmission (Page 6-41)	0 = Full-speed Transmission 1 = Half-speed Transmission
<b>332:</b> X.25 Options (Page 6-42)	Panel (See Chapter 10)
<b>340:</b> RTS Control Response (Page 6-42)	0 = Controlled RTS 1 = Permanent RTS 2 = BSC special controlled RTS
<b>360:</b> X.21 Switched Retry (Page 6-43)	00 = Switched feature or Retry not in use 01-99 = Number of times to retry an incoming or outgoing call
<b>361:</b> X.21 Switched Retry Timing (Page 6-43)	00 = Switched feature not in use, or Retry not in use 01-20 = Number of seconds between retries
<b>362:</b> X.21 Switched Options (Page 6-43)	Eight digits (0-No and 1-Yes)
<b>365:</b> X.21 Data Transfer Delay (Page 6-45)	0 = N/A 1 = No delay 2 = Data Transfer Delay
<b>367:</b> X.21 Switched Short-Hold Mode (Page 6-46)	0 = No 1 = Yes
<b>368:</b> X.21 Switched Short-Hold Mode Dial Number (Page 6-46)	Up to 14 numeric characters (dial number of the 3174)

Configuration Questions—Worksheets 3 through 9S	
Question:	Response:
<b>370:</b> Maximum Inbound I-Frame Size (Page 6-46)	0 = 265-byte Maximum I-Frame 1 = 521-byte Maximum I-Frame
<b>371:</b> X.21 Switched Dial Digits (Page 6-46)	Thirty-one numeric digits (0-9)
<b>372:</b> Autocall/Autodisconnect (Page 6-47)	Two numeric digits (0, 1, or 2)
<b>382:</b> Maximum Ring I-Frame Size (Page 6-47)	Four numeric characters <ul style="list-style-type: none"> <li>From 265 to 2042 bytes for 4Mbps Token-Ring Adapters</li> <li>From 265 to 2057 bytes for 16/4Mbps Token-Ring Adapters</li> </ul>
<b>383:</b> Token-Ring Network Maximum Out (Page 6-48)	One numeric character (from 1 to 7)
<b>384:</b> Ring Speed of the Token-Ring Network (Page 6-48)	0 = 4Mbps - Normal token release 1 = 16Mbps - Normal token release 2 = 16Mbps - Early token release

X.25 Options—Worksheet 13	
Question:	Response:
<b>400:</b> Network Type (Page 10-6)	Four numeric digits (0 or 1)
<b>401:</b> Circuit Type (Page 10-11)	1 = Permanent virtual circuit (PVC) 2 = Incoming call (from host) only (SVC) 3 = Outgoing call (to host) only (SVC) 4 = Two-way call (SVC).
<b>402:</b> Logical Channel Identifier (Page 10-11)	0000 – 4095. Channel identifier for PVC circuit specified in question 401.
<b>409:</b> X.25 Keyboard Support Options (Page 10-11)	Eight digits (0-No or 1-Yes)
<b>420:</b> Incoming Call Options (Page 10-13)	Eight digits (0-No or 1-Yes)
<b>421:</b> Outgoing Call Options (Page 10-14)	Eight digits (0-No or 1-Yes)
<b>423:</b> Host DTE Address (Page 10-15)	Up to 15 numeric digits.
<b>424:</b> 3174 DTE Address (Page 10-6)	Up to 15 numeric digits.
<b>430:</b> Negotiated Packet Size (Page 10-16)	0 = 64-byte packet 1 = 128-byte packet 2 = 256-byte packet 3 = 512-byte packet
<b>431:</b> Packet Sequence Numbering (Page 10-7)	0 = Modulo 8 1 = Modulo 128.
<b>432:</b> Negotiated Window Size (Page 10-16)	01-07 = Modulo 8 range (if 431 = 0) 01-11 = Modulo 128 range (if 431 = 1).



**X.25 Options—Worksheet 13**

Question:	Response:
<b>433:</b> K-Maximum Out (Page 10-7)	1 - 7. Maximum number of link level I-frames.
<b>434:</b> Nonstandard Default Packet Size (Page 10-7)	0 = 64-byte packet 1 = 128-byte packet 2 = 256-byte packet 3 = 512-byte packet
<b>435:</b> Nonstandard Default Window Size (Page 10-8)	01-07 = Modulo 8 range (if 431 = 0) 01-11 = Modulo 128 range (if 431 = 1).
<b>440:</b> Throughput Class Negotiation (Page 10-16)	One digit (3-9 or A-D)
<b>441:</b> Closed User Group (Page 10-17)	00-99. Include CUG facility in outgoing Call Request packet.
<b>442:</b> Recognized Private Operating Agency (Page 10-17)	0000-9999 = RPOA
<b>450:</b> Link Level Transmit Timeout (Page 10-8)	0001-2540. Specified in 0.1-second intervals.
<b>451:</b> Number of Retries (Page 10-8)	01-99. Number of retries required by the network.
<b>452:</b> Connection Identifier (Page 10-17)	Eight-character maximum (0-9, A-Z or blanks).
<b>453:</b> Connection Options (Page 10-18)	Eight digits (0 or 1)
<b>461:</b> Lowest Incoming Channel (Page 10-9)	0000-4095
<b>462:</b> Highest Incoming Channel (Page 10-9)	0000-4095
<b>463:</b> Lowest Two-Way Channel (Page 10-9)	0000-4095
<b>464:</b> Highest Two-Way Channel (Page 10-9)	0000-4095
<b>465:</b> Lowest Outgoing Channel (Page 10-10)	0000-4095
<b>466:</b> Highest Outgoing Channel (Page 10-10)	0000-4095

**CSCM Questions—Worksheet 14**

Question:	Response:
<b>500:</b> CSCM Unique (Page 11-5)	0 = No CSCM 1 = CSCM in use as a Network Site Controller. 2 = CSCM in use as a Central Site Controller.
<b>501:</b> Network ID (Page 11-5)	Up to eight alphanumeric characters (first character must be uppercase alphabetic; no spaces/blanks).
<b>502:</b> Logical Unit Name (Page 11-6)	Up to eight alphanumeric characters (first character must be uppercase alphabetic; no spaces/blanks).

**AEA Configure Questions—Worksheet 17**

Question:	Response:
<b>700:</b> Configure the AEA Feature (Page 12-37)	0 = Turns off AEA and keeps previously stored configuration data. 1 = Turns on AEA and initiates the AEA Configure or Reconfigure procedure.
<b>702:</b> Control Key Assignment (Page 12-37)	Single digit (0 or 1)
<b>703:</b> Request MLT for AEA (Page 12-37)	Single digit (0 or 1)
<b>710:</b> Miscellaneous ASCII Feature Options (A) (Page 12-38)	Eight digits (0-No or 1-Yes)
<b>711:</b> Miscellaneous ASCII Feature Options (B) (Page 12-39)	Eight digits (0-No or 1-Yes)
<b>712:</b> Miscellaneous ASCII Feature Options (C) (Page 12-39)	Eight digits (0-No or 1-Yes)
<b>713:</b> Miscellaneous ASCII Feature Options (D) (Page 12-40)	Eight digits (0-No or 1-Yes)

**AEA Station Set Questions—Worksheet 20**

Question:	Response:
<b>721:</b> Station Set Name (Page 12-46)	Up to 24 alphanumeric characters (blanks permitted).
<b>722:</b> Station Type	For responses see 12-46.
<b>723:</b> Port Set Name (Page 12-47)	Up to eight alphanumeric characters (blanks permitted).
<b>725:</b> Host Connection Menu Option (Page 12-47)	0 = Users can only select the defined Default Destination from the Host Connection Menu. 1 = Users can select alternate host connections from the Host Connection Menu.
<b>731:</b> Flow Control Type (Page 12-48)	0 = None 1 = XON/XOFF 2 = DTR (for nonswitched port types) 3 = RFS (for direct port types)
<b>732:</b> XON/XOFF Transmission Resumption Trigger (Page 12-48)	1 = Resume after any character is received 2 = Resume only after XON is received.
<b>733:</b> Line Speed (Page 12-49)	0 = Autobaud/Autoparity 1 = 300 bps 2 = 600 bps 3 = 1200 bps 4 = 2400 bps 5 = 4800 bps 6 = 9600 bps 7 = 19 200 bps
<b>734:</b> Line Speed (ASCII Host Upper Limit) (Page 12-49)	2 = 600 bps 3 = 1200 bps 4 = 2400 bps 5 = 4800 bps 6 = 9600 bps 7 = 19 200 bps



**AEA Station Set Questions—Worksheet 20**

Question:	Response:
<b>735:</b> Parity (Page 12-50)	0 = Autobaud/Autoparity 1 = Odd 2 = Even 3 = None 4 = Space 5 = Mark
<b>736:</b> Stop Bits (Page 12-50)	1 = 1 stop bit 2 = 2 stop bits
<b>737:</b> Maximum Modem Line Speed (Page 12-50)	1 = 300 bps 2 = 600 bps 3 = 1200 bps 4 = 2400 bps 5 = 4800 bps 6 = 9600 bps 7 = 19 200 bps
<b>741:</b> Switched Disconnect Timeout (3270 Host Only) (Page 12-51)	Three-digit number ranging from 000 to 254. Represents a number of minutes (use leading zeros).
<b>742:</b> Inactivity Timeout (Page 12-51)	Value from 0 to 254. Represents a number of minutes (use leading zeros).
<b>743:</b> Prompt for Universal/Specific Keyboard Map (Page 12-52)	0 = Do not display prompt 1 = Display prompt
<b>744:</b> Number of Bits per Character (Page 12-52)	0 = 7 bits per character 1 = 8 bits per character
<b>745:</b> ASCII Display Character Set (Page 12-52)	0 = US ASCII 1 = IBM 3101 CS1 2 = IBM 316x CS1 and CS2 3 = ISO 8859/1.2 4 = DEC MCS 5 = DEC NRC
<b>746:</b> Translate Option (Page 12-53)	0 = Default table 1 = UDX-1 2 = UDX-2 3 = UDX-3
<b>751:</b> Data Stream Supported by the ASCII Host (Page 12-53)	1 = VT100 data stream 2 = 3101 data stream 3 = Data General D210 data stream 4 = VT220 data stream 7-bit control 5 = VT220 data stream 8-bit control
<b>752:</b> ASCII Host Phone Number (Page 12-53)	Up to 48 alphanumeric characters. Phone number of the ASCII host.
<b>761:</b> Auto XON/XOFF (DEC VT100/VT220) (Page 12-56)	0 = Disabled 1 = Enabled
<b>762:</b> Wraparound Option (DEC VT100/VT220) (Page 12-56)	0 = Disabled 1 = Enabled
<b>763:</b> New Line Option (DEC VT100/VT220) (Page 12-56)	0 = Disabled 1 = Enabled
<b>764:</b> Margin Bell (DEC VT100/VT220) (Page 12-57)	0 = Disabled 1 = Enabled
<b>765:</b> DEC Host ASCII Character Set (DEC VT100/VT220) (Page 12-57)	0 = DEC NRC 1 = DEC MCS

**AEA Station Set Questions—Worksheet 20**

Question:	Response:
<b>771:</b> Automatic Line Feed for Cursor Control (IBM 3101) (Page 12-57)	0 = Disabled 1 = Enabled
<b>772:</b> Carriage Return/Carriage Return-Line Feed Selection (IBM 3101) (Page 12-57)	0 = Carriage Return 1 = Carriage Return and Line Feed
<b>773:</b> Automatic New Line for Cursor Control (IBM 3101) (Page 12-58)	0 = Disabled 1 = Enabled
<b>774:</b> Scrolling (IBM 3101) (Page 12-58)	0 = Disabled 1 = Enabled
<b>775:</b> Line Turnaround Character (IBM 3101) (Page 12-58)	0 = EOT 1 = CR 2 = XOFF 3 = ETX
<b>776:</b> IBM ASCII Host Character Set (Page 12-58)	0 = ISO - 8859/1.2 1 = IBM 3101 CS1 2 = IBM 316x CS1 and CS2
<b>781:</b> Attached Printer Prompt (Page 12-58)	0 = No 1 = Yes 2 = Assumed (no prompt)
<b>782:</b> Use of Form Feed (Page 12-59)	0 = Printer does not support form feed 1 = Printer supports form feed
<b>783:</b> Page Length (Page 12-59)	Value from 1 to 255 (use leading zeros).
<b>784:</b> Printer Character Set (Page 12-59)	1 = US ASCII 2 = ISO - 8859/1.2 3 = DEC MCS 4 = PC code page 850 5 = UDX-1 6 = UDX-2 7 = UDX-3
<b>785:</b> ASCII Printer Options (Page 12-60)	Eight digits (0-No or 1-Yes)
<b>786:</b> Page Width (Page 12-62)	Value from 001 to 255
<b>787:</b> LU 1 SCS Transparency Translation (Page 12-62)	0 = LU 1 transparent data is not translated 1 = LU 1 transparent data is translated

**Device Definition Questions—Worksheet 22**

Question:	Response:
<b>800:</b> Printer Authorization Matrix (Page 13-5)	00 = Do not define the PAM 10 = Define the PAM. Printers on HG 27 cannot be defined on the PAM 11 = Define the PAM. Printers on HG 27 can be defined on the PAM
<b>801:</b> Logical Terminal Assignment (Page 13-5)	0 = Do not define the LTA 1 = Define the LTA for port 26-00 and 27-00 2 = Define the LTA for individual ports.

**Device Definition Questions—Worksheet 22**

<b>Question:</b>	<b>Response:</b>
<b>802:</b> Prompts for Extended Vital Product Data (VPD) (Page 13-6)	0 = Do not define Extended VPD 1 = Define Extended VPD

**Token-Ring 3270 Gateway Questions—Worksheet 25**

<b>Question:</b>	<b>Response:</b>
<b>900:</b> Token-Ring Network Address for the Gateway (Page 14-7)	12-character hexadecimal address and 2-character SAP. (Should be locally administered)
<b>905:</b> Ring Error Monitor (Page 14-7)	0 = No 1 = Yes
<b>908:</b> Link Subsystem Name (Page 14-7)	Eight alphanumeric characters
<b>911:</b> Ring Speed of the Token-Ring 3270 Gateway (Page 14-8)	One digit (0-2)
<b>912:</b> Group Poll Address (Page 14-8)	Two-character hexadecimal address
<b>940:</b> Ring Address Assignment	Panel (See page 14-9)
<b>941:</b> Ring Transmission Definition	Panel (See page 14-13)





Part Number  
39F9256

File Number  
36/38/370/4300/8100/3174-09

GA27-3862-03



Printed in U.S.A.