

# QX-10 OPERATIONS MANUAL



**EPSON**  
EPSON AMERICA, INC.

# QX-10 OPERATIONS MANUAL



Copyright © 1983 by Epson America, Inc.  
3415 Kashiwa St.  
Torrance, CA 90505

All rights reserved. No part of this publication may be reproduced, stored in a retrieval system, or transmitted, in any form or by any means, electronic, mechanical, photocopying, recording or otherwise, without the prior written permission of Epson America, Inc. No patent liability is assumed with respect to the use of information contained herein. While every precaution has been taken in the preparation of this book, Epson America, Inc. assumes no responsibility for errors or omissions. Neither is any liability assumed for damages resulting from the use of the information contained herein.

No. QD-001

Printed in the United States of America

VALDOCS and HASCI are trademarks of  
Rising Star Industries, 24050 Madison St., Suite 113, Torrance, CA 90505.

Centronics\* is a registered trademark of Centronics Data Computer Corp.

TPM\* is a registered trademark of Computer Design Labs

CP/M\* is a registered trademark of Digital Research

### **Federal Communications Commission Radio Frequency Interference Statement**

This equipment generates and uses radio frequency energy and if not installed and used properly, that is, in strict accordance with the manufacturer's instructions, may cause interference to radio and television reception. It has been type tested and found to comply with the limits for a Class B computing device in accordance with the specifications in Subpart J of Part 15 of FCC Rules, which are designed to provide reasonable protection against such interference in a residential installation. However, there is no guarantee that interference will not occur in a particular installation. If this equipment does cause interference to radio or television reception, which can be determined by turning the equipment off and on, the user is encouraged to try to correct the interference by one or more of the following measures:

- Reorient the receiving antenna
- Relocate the computer with respect to the receiver
- Move the computer away from the receiver
- Plug the computer into a different outlet so that the computer and receiver are on different branch circuits

If necessary, the user should consult the dealer or an experienced radio/television technician for additional suggestions. The user may find the following booklet prepared by the Federal Communications Commission helpful:

"How to Identify and Resolve Radio-TV Interference Problems". This booklet is available from the US Government Printing Office, Washington, D.C., 20402, Stock No. 004-000-00345-4.

## **CHAPTER 1** **Getting Started**

Unpacking	1-1
Getting Hooked Up	1-3
Power	1-8
What's Booting?	1-9
Caring for Your Diskettes	1-10
Inserting Diskettes	1-13

## **CHAPTER 2** **QX-10 Components**

The Microprocessor	2-1
The QX-10 Memory	2-2
Programs	2-3
The Operating System	2-3
The QX-10 Keyboard	2-3
The Video Monitor	2-5
Other Features	2-6

## **CHAPTER 3** **Installing External Devices and Option Cards**

External Devices	3-1
Installation Procedures	3-2
Installing Option Cards	3-3

## **CHAPTER 4** **Troubleshooting**

## **APPENDIXES**

A. ASCII CP/M Character Codes	A-1
B. ASCII TPM Character Codes	B-1
C. HASCI CP/M Character Codes	C-1
D. HASCI TPM Character Codes	D-1

## **INDEX**

# CHAPTER 1

# Getting Started

---

Getting started with your QX-10 won't take very long at all. Even though there's a good deal of material to go through in this chapter, it's all simple and straightforward. In fact, you'll probably be up and running in half an hour or less! In that short time, you'll be able to learn everything you need to know about unpacking your QX-10, hooking up its different units, powering it up, caring for floppy disks, and inserting them correctly. Let's get going!

## Unpacking

---

When you opened the carton marked "Open Me First," you found this and other manuals and some diskettes. (You should also have three other cartons.)

Before unpacking the cartons, make sure the location you've selected for the QX-10 has everything needed to get the best performance. Check it for:

**1. A flat, hard surface.** Soft surfaces like beds and carpeted floors can hinder the free air circulation that the QX-10 needs, as well as attract static electricity which can erase floppy disks and possibly wreak havoc on some circuitry.

**2. Free air circulation.** In a typical arrangement, the QX-10 measures about twenty-one inches wide and twenty-four inches deep (slightly more desk space than a typewriter). Not only should air be able to circulate *under* the system; you'll want a few clear inches *behind* it, so there's enough air for its ventilation system to work to best advantage.

3. **Environmental conditions:** It's important to keep your computer shielded from extremes in temperature and humidity. Avoid direct sunlight, heater ducts, and other hot areas. Also, don't use the QX-10 in damp areas—excessive humidity can hinder operation.

4. **A double three-prong 115-volt grounded outlet.** You'll need one outlet for the main unit and another for an Epson printer (or other additional equipment). Using this type of outlet helps to prevent static charges. Most importantly, *make sure* the socket is grounded!

5. **Clearance from other electrical appliances.** Keep your QX-10 away from anything that generates magnetic fields. This may come as a surprise, but just about everything that plugs into an electrical outlet can generate a magnetic field that could cause problems! Even your telephone can upset things if it's kept too close to your equipment or the floppy disks.

Once you're sure you have the ideal place to set up the QX-10, carefully open the other three cartons. Use a small, sharp tool (such as a pocketknife) to cut the tape, and use it with a little caution. Your QX-10 is well packaged, but there's no reason to risk scratching its case. You'll find the QX-10 monitor, keyboard, and main unit wrapped in clear plastic and snugly packed in Styrofoam packing. With each unit you'll also find a cable and a registration card.

Fill out the registration cards at the time of purchase and mail them to Epson. With your registration cards on file, Epson can provide continuing hardware and software support to help you in using your QX-10.

Be sure to keep the cartons (and the Styrofoam packing) in case you should ever need to ship your QX-10. And, by the way, inspect your QX-10 components before assembly and, if anything looks damaged or otherwise wrong, return it to the dealer.



## Getting Hooked Up

Now that all of the boxes are unpacked, it's time to put the parts together into a working system. Start with the main unit. That's the one that looks like this:

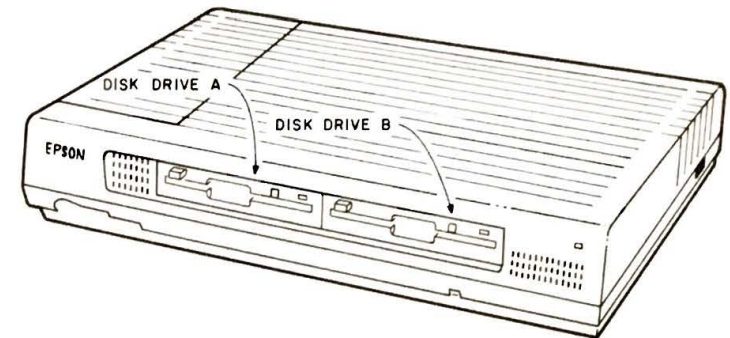

Place it on the flat surface with the front facing you, as shown.

Remove the paper shipping diskettes from the two diskette drives (marked A and B) by pushing the button labeled "PUSH" located at the left side of each drive. When you push it, the button will pop out, as will the edge of the paper diskette. Carefully pull out both paper diskettes and save them along with the other shipping materials.

Now turn the main unit around so that the back is facing you, like so:

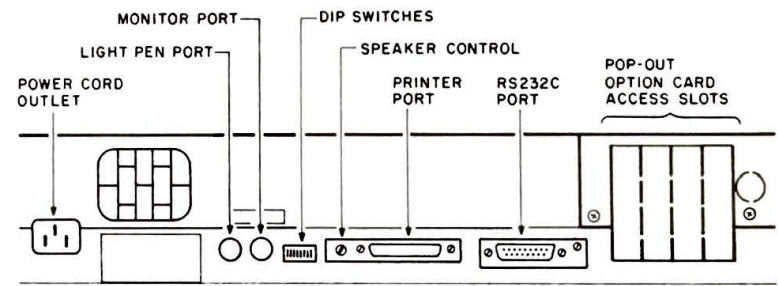

You'll be using two of the outlets on the back of the QX-10. The power cord will go into the large, rectangular outlet on the left-hand side, labeled, "CAUTION: DISCONNECT INPUT POWER BEFORE SERVICING." The round outlet labeled "MONITOR" is where the monitor cable will go.

The power switch is on the side of the main unit, around the corner from the power outlet. It has two positions, "OFF" on the left and "ON" on the right.

**IMPORTANT:** Be sure the power switch is off before you hook up the QX-10.

Plug the rectangular end of the power cord into the QX-10 power receptacle and the other end into a three-prong, 115-volt *grounded* wall outlet as described earlier.

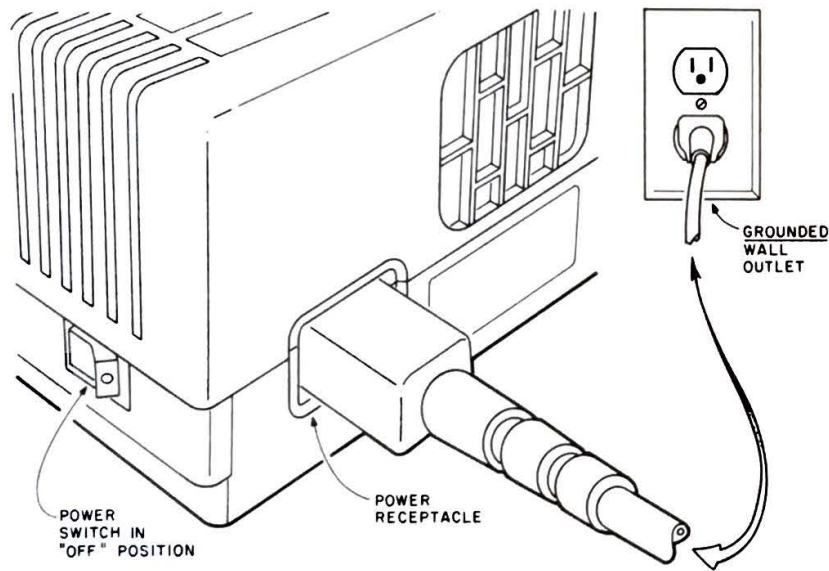

Now, set the CRT monitor on top of the main unit so that the back is also facing you.

The knob located at the bottom left of the monitor controls screen brightness (which you may wish to adjust later). To the right of this control is the monitor port to which one end of the monitor cable will be connected.

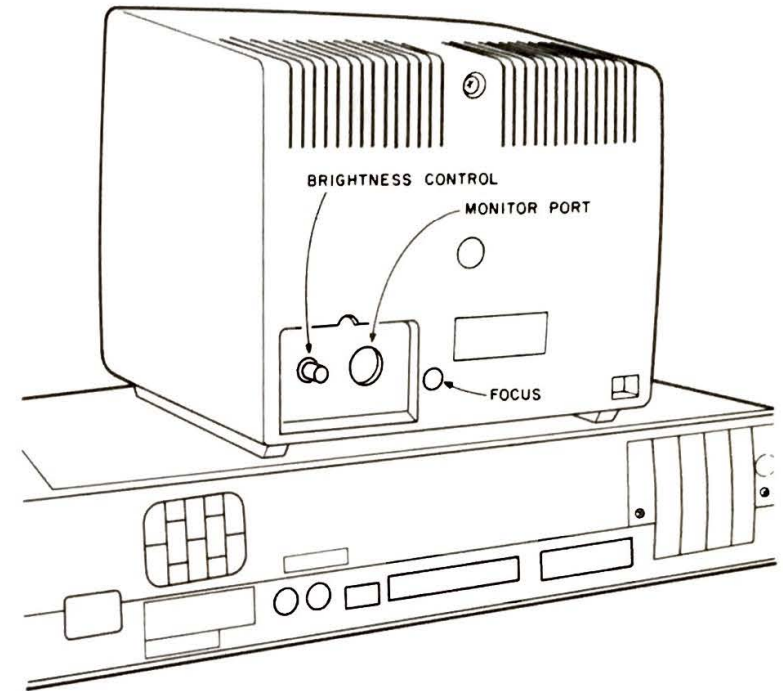

The monitor cable is fairly short, with two different DIN plugs. These plugs differ only in the number of pins: the end that connects to the back of the monitor has seven pins, and the end that hooks into the main unit has eight pins.

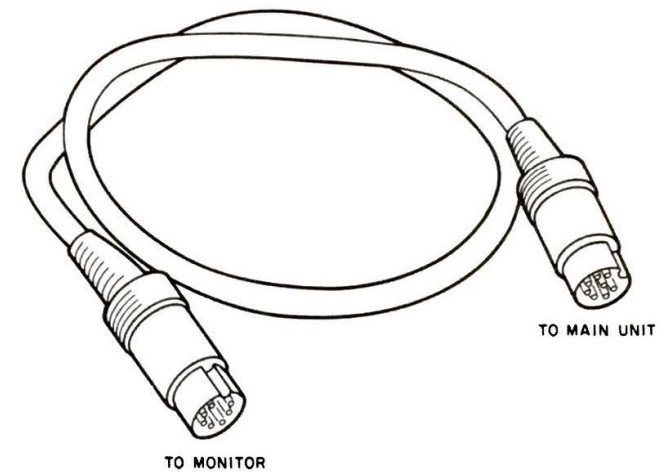

Insert the seven-pin plug into the outlet on the monitor and the other end into the round outlet on the back of the main unit, marked "MONITOR."

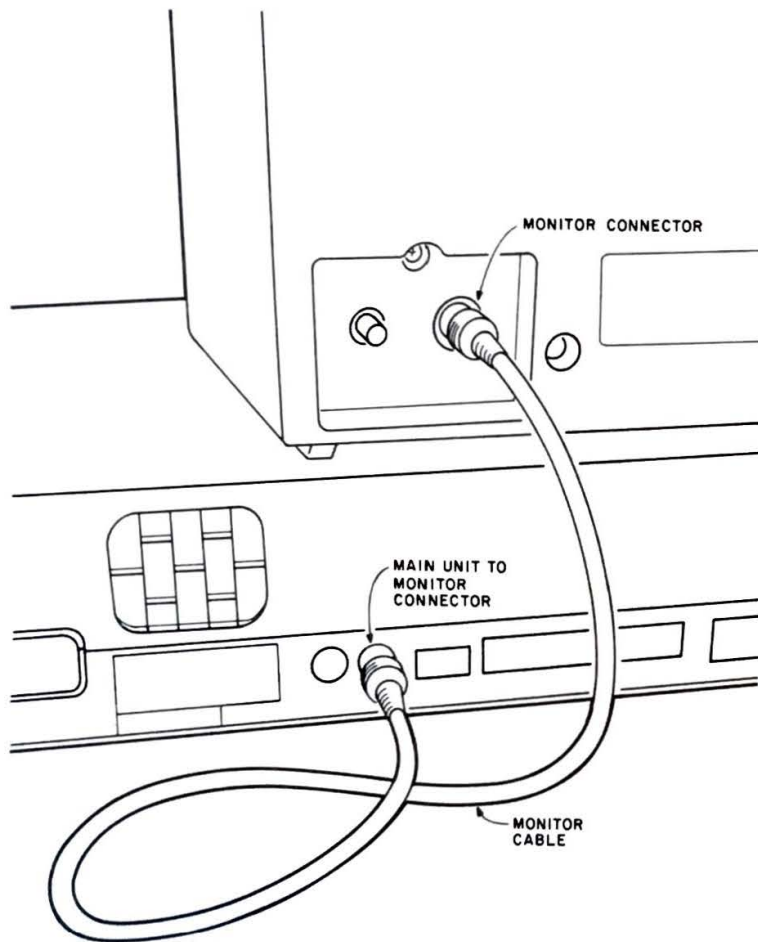

Now turn the main unit and monitor around so they're facing you.

The keyboard cable for either the ASCII keyboard or the HASCI keyboard is coiled and looks like a phone cord. Both ends of this cable are the same: each has eight pins and a small flap that's used to unplug the cable. Push either end of the cable into the round outlet on the back of the keyboard. (Be sure to get it all the way in.) Then plug the other end into the round outlet on the back of the left front side of the main unit, below the Epson logo.

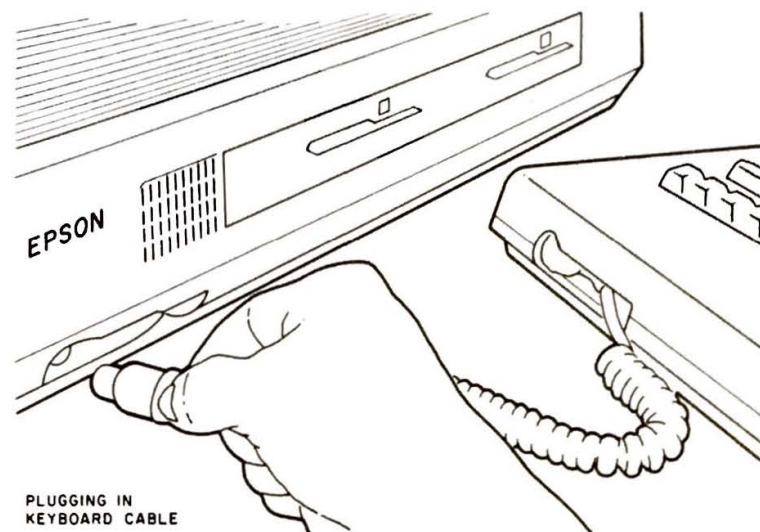

PLUGGING IN  
KEYBOARD CABLE

Some people like to use the QX-10 with the keyboard on their laps, and others like to set it on a firm surface. But your options don't end there! You can also select the angle of your keyboard.

Changing the angle of the keyboard is simple. First, turn it over. There are two legs at the back. You can adjust these so that the keyboard will tilt. Turn the legs a quarter turn in either direction (this will unlock them) and pull them toward you.

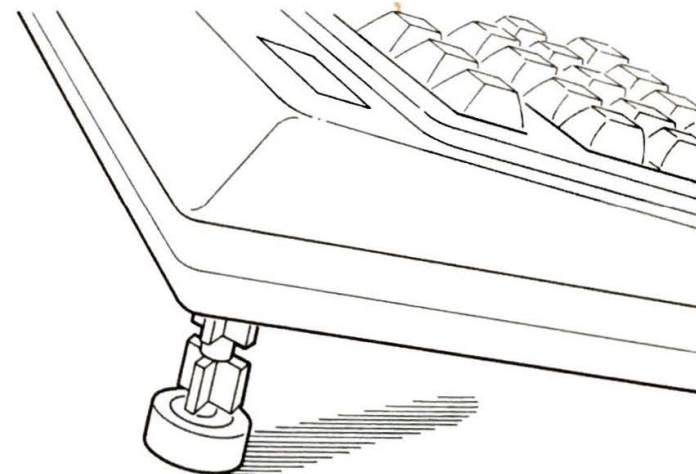

ADJUSTABLE KEYBOARD LEGS



When the legs are extended, turn them a quarter turn in either direction to lock them. Now turn the keyboard right side up and try it for comfort. If it seems too high, you can try the midway position by unlocking the legs and pushing them into the keyboard until the notch on the legs is even with the bottom of the keyboard and then locking them into place as before. Experiment to find the position that is most comfortable for you!

You are now hooked up and about to turn on your QX-10 for the very first time—pretty exciting, isn't it?

## Power

Don't touch that power switch yet! First, take a minute to read through these rules of thumb:

1. NEVER UNPLUG ANY CABLE WHILE THE SWITCH IS ON.
2. NEVER TRY TO OPEN THE DISK DRIVES WHILE THE DISK IS TURNING.
3. NEVER OPEN THE CASE WITH THE POWER CABLE PLUGGED IN.

To turn the power ON, simply press the power switch to the "ON" position. To turn the power OFF, just press the other end of the switch.

Once you've powered up the computer, the small red light near the top right corner of the main unit will come on and you'll hear the cooling fan start up. You may also notice a number of small red lights on your keyboard blink on, then off, indicating that the internal self-diagnostic check is proceeding.

The small red light to the right of drive A will also come on and the message "INSERT DISKETTE" will appear on the monitor screen. (If any other message appears, see Chapter 4, "Troubleshooting.")

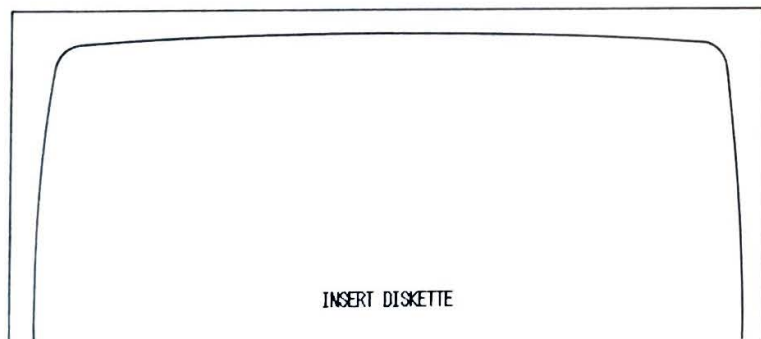

If the brightness on the screen isn't the way you like it, reach around the right side of the monitor until you feel the control knob near the bottom. Turning the knob clockwise will increase the brightness; turning it counterclockwise will decrease it. You can experiment a bit to find the most comfortable brightness for you.

Before beginning work on your QX-10, you'll need to understand the concept of "booting," so let's proceed!

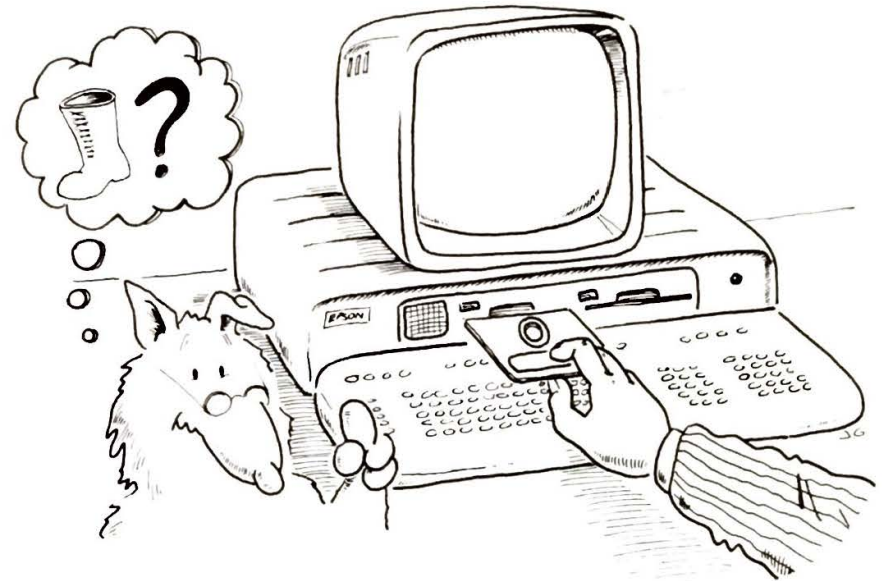

## What's Booting?

"Booting" is the term used to describe the process of transferring or "loading" the operating system from the diskette to the QX-10's memory.

There are two kinds of booting: "warm" and "cold." A cold boot is what you're about to undertake—the machine has just been powered up, and no program has been loaded. A "warm" boot takes place when the computer has been running one program and then another disk is loaded. The two procedures are identical except that with a warm boot, the reset button is pressed after the diskette has been inserted. This button is located at the front of the unit, just underneath diskette drive door B.

### Drive A/Drive B

Booting is always done from drive A, which is the one on the left. (After that, you can choose to change to drive B.)

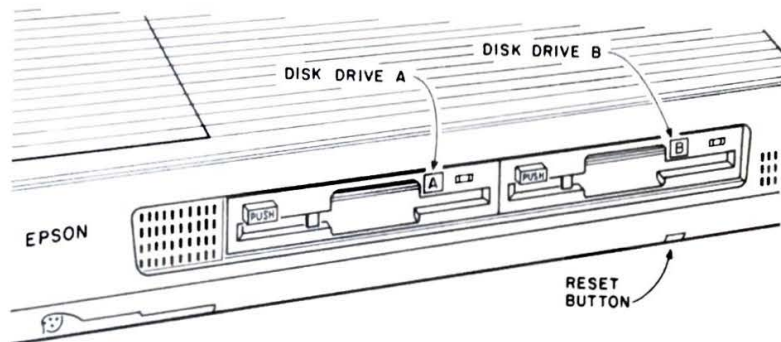

That part of the drive visible at the front of the main unit includes the slot where you insert diskettes, the button labeled “PUSH,” and the “in use” light.

You’ll be working with two kinds of diskettes: *system* diskettes and *data* diskettes. System diskettes carry the information that tells the QX-10 how to perform specific operations—as, for example, when you boot up using the Valdocs System diskette. Data diskettes are where the QX-10 stores information that you created while using the software on the system diskette. Using Valdocs as an example, you’d store a document (a letter or even a novel!) that you created using Valdocs on a data diskette.

## Caring for Your Diskettes

Floppy disks are wondrous things. Where else can you hold the equivalent of hundreds of pages of text in an easily portable package smaller than a “golden oldie?” Floppy disks — or diskettes, as they’re often called — are not indestructible. Before we go any further, we need to talk about handling, storing, and using floppy disks.

Floppy disks are like records made out of recording tape. And just as it’s possible to destroy a tape, it’s possible to destroy a floppy disk or lose some of its data. Floppy disks store data as hundreds of thousands of magnetized areas. It should be pointed out that for best results you should buy only high-quality diskettes. The extra cost is worth it in terms of quality and reliability.

It’s *essential* that you handle and use floppy disks properly. Don’t worry; all that’s required are a few simple precautions:

1. **Make Backup Copies Often:** There’s no better way to protect your data than to have a spare copy tucked away in a safe place. If it’s particularly important data, you might even want to have more than one copy. Some people even keep their backups in a safe deposit box.

You should buy yourself a box or two of floppy disks. (They should be 40-track, soft-sector, double-sided, double-density.)

Even though disks hold quite a bit of data, you’ll be surprised at how quickly you’ll fill them up—especially if you’re adamant about making backups.

Looking at the top surface of the diskette, you’ll notice that the right edge has a small rectangular notch. When this notch is covered by the adhesive write-protect tabs that are included in the diskette package, the diskette will accept no new information. That is, it is protected from being written over. If, on the other hand, this notch is exposed, you can write new data onto the diskette.

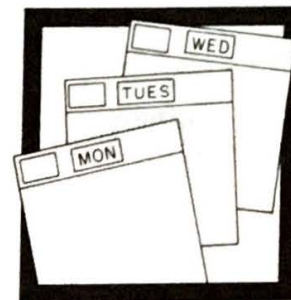

**IMPORTANT:** You should make *two* backup copies of your system disk. Put the original away in a safe place, preferably *not* in the same room as your computer. You can use one of the backups as a “working master” — from which to make additional backup copies. Use the second system backup as your day-to-day “working” disk.

If you'll be using your QX-10 on a regular basis, we strongly suggest that you make backup copies of your disks *every day*. Most professional computer users do. A little precaution now can save you a great deal of aggravation later. One of the easiest ways to make backups is to have seven backup disks, each marked with a day of the week. At the end of each day, all you have to do is take the disk marked for that day and copy your data to it. For specific backup instructions, refer to the operating manual of the system you are using.

If you're still unconvinced, just remember Murphy's Law. If anything can go wrong it *will*. There are all sorts of ways to lose important data. Lightning might hit the power line, causing a power surge which may make the computer write random information all over the disk. Your children might decide to play disk jockey. You might spill coffee on a disk or even (heaven forbid!) drop a hot ash on the disk surface, causing it to melt. The only way to protect yourself is to have backups. Get in the habit of making backups *right away*.

**2. Don't Touch Those Diskettes!** (No, we don't mean you have to wear gloves.) Just make sure you don't touch the magnetic surface of the diskette—the areas that show through the holes of the disk package. The oils on your fingers can play havoc with data. Handle disks *only* by their protective jackets, keep them in their protective envelopes when they're not in use, and keep them stored in protective cases or other dust proof containers.

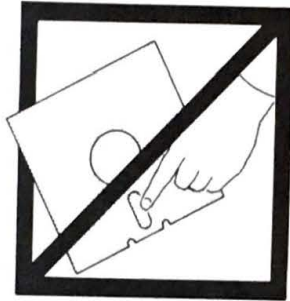

Just like phonograph records, diskettes hate dirt, dust, fingerprints, grime, or spilled coffee. On records, these things are a nuisance, but on diskettes they can spell disaster. Once again, *make backups!*

**3. Don't Force the Merchandise:** Floppy disks are flexible, but that doesn't mean you can bend, fold, spindle, or mutilate them. Any physical abuse can damage the magnetic coating, and there goes your data.



Another important point: *never* force a disk into the disk drive. If it won't slide in easily, something's wrong. There may be a diskette already in the slot, and you could end up damaging both of them.

#### 4. Beware the Magnetic Field:

Remember that floppy disks store their data magnetically, just like tapes. You probably won't be running a horseshoe magnet over the surface of the disk, but you should be aware that there are many sources of magnetism in and around the home or office. The fact is that just about everything that uses electricity generates magnetism. Electric typewriters (why would you need one of those?), television sets, fans, speaker magnets, and telephones (which are often placed near a computer) all generate magnetic fields. Keep your diskettes away from them!

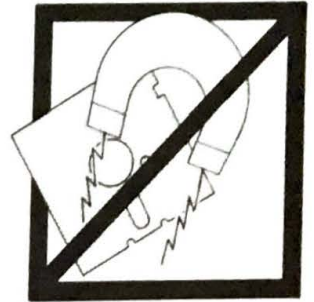

**5. Keep It Comfortable:** When it comes to temperature, treat your diskettes like people. Room temperature is best. If you leave your diskettes in a locked car in the middle of the summer or the dead of a northern winter, you're asking for trouble.\* The optimum temperature range is 50-90 degrees Fahrenheit.

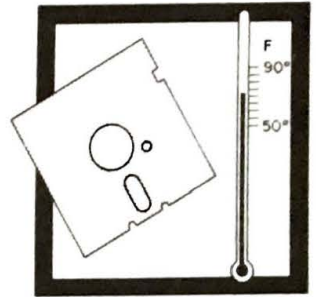

## Inserting Diskettes

Choose the system diskette that you wish to start with, and remove it from the paper envelope. Remember, don't touch the exposed surfaces!

Gently slide the system diskette into drive A, with the oval-shaped window inserted first, and the label facing up. Slide the diskette in as far as it goes easily. Don't bend it or force it in any way. If it doesn't seem to be going in correctly, take it out and try again.

You'll notice that when it's almost all the way in, the diskette meets with some resistance. Now give it one more gentle push and it will go in all the way (you will hear a soft snap). Press the button marked "PUSH." The monitor will now display a screen.

The only other thing to remember is *not* to open a drive while the red light is on. If the computer is reading the diskette, it probably won't do

\*Exception: If you must leave diskettes in a car, the trunk is probably best because it's more insulated and temperatures will be more moderate.

any harm to open the drive, but if you open it while writing onto the diskette, you will lose data and possibly render the diskette unusable.

That's it! Your QX-10 is up and running!

## CHAPTER 2

# QX-10

# Components

---

If you've worked with computers before, you may find that much of the information in this manual will come as no surprise. If, on the other hand, you are new to computers, you may wonder if you have what it takes to master the QX-10. Relax, and rest assured that you do. In fact, it will be fun to look back a week or so after you've begun working on the QX-10 and amaze yourself with the progress you've shown!

Although the QX-10 is the result of years of highly technical research, you don't have to be technically minded to use and enjoy this marvelous electronic tool. What follows is a description of the technical components and capabilities of the QX-10, expressed in as nontechnical a language as possible.

### The Microprocessor

---

When you sit down and begin working on the QX-10, you are facing a compact machine that only a few years ago would have been a much larger unit. One of the reasons for the QX-10's compactness is that the "brain" of the computer—called a *microprocessor*—is amazingly small. It's so small, in fact, that you'd need a pair of tweezers to pick it up. Consisting of a tiny "chip," this little integrated circuit, a product of the modern technological boom, can process thousands of bursts of information in a fraction of a second. Electrical current speeds through the chip's microscopic electronic circuits and is translated into video displays or a variety of other actions, both visible and invisible. The microprocessor, dubbed the *Z80*, enables your QX-10 to operate with great speed and accuracy, without taking up much desk space.

## Bits and Bytes

A computer's operation and capacity is expressed in terms of *bits* and *bytes*. The concept of bits and bytes is quite technical, but it can be understood generally as follows:

A bit is a unit of computer information. (Physically, it consists of a microscopic electrical "switch" that can be closed or open, representing the alternatives of yes and no, on or off, and so forth.) The word "bit" itself is derived from the words "binary digit," and you would need to wrestle with complicated computer theory to fully comprehend bits, but for our purposes all we need to know is that bits combine to form *bytes*. No one knows for certain where the word "byte" originated, but a byte is a group of eight bits that functions as a character or symbol that the computer can "understand." The Z80 microprocessor is referred to as an "8-bit microprocessor."

The QX-10 microprocessor can combine bytes in a multitude of ways. As an example, one byte can have a numerical value of zero to 255. Suppose you have commanded the computer to store a byte that has the value of the number 44, and another with the value of the number 56. If you make an entry that commands the computer to add these two bytes together, it will retrieve the two from their respective storage slots and create a new byte with the value of 100, which it will then store in memory.

## The QX-10 Memory

Unlike the human brain, the QX-10 has a limit to the amount of information it can store in its memory. On the other hand, while people at times have trouble recalling facts, the QX-10's stored data is always accessible upon demand. You'll remember that information is stored as bytes. A thousand and twenty-four bytes (1024) is referred to as a *kilobyte*. Your QX-10 has either 64 kilobytes (64K) or 256 kilobytes (256K), depending on the model. (**NOTE:** Although "kilo" means exactly a thousand, it is used for convenience to denote 1,024 bytes; "64K" is 65,536 bytes, for instance.)

The QX-10 uses "RAM"—random access memory. This is memory that can be both written into and read. Normally, RAM is lost when a computer is switched off, but the QX-10 has *CMOS* RAM, which enables it to retain entered data when power is turned off. (More about this later.)

## Programs

Almost everyone who's heard of a computer has also heard the terms "program" or "programmer" associated with computers. What *is* a program?

A *program* is a set of instructions that direct the computer to perform a particular task. An *application program* is designed for specific types of projects, such as word processing or general ledger. Programs can be short and simple or long and complicated.

An *operating system* can be defined as all software, taken as a whole, that allows a total system to operate. Necessary for multi-processing, an operating system controls application programs, interfaces with peripheral devices, and performs other functions, such as moving the cursor around the screen at your command.

## The Operating System

Your QX-10 has either a *CP/M* operating system or a *TPM* operating system. TPM will run *any* application program written for CP/M. However, application programs written for TPM will not necessarily run on a CP/M system.

## The QX-10 Keyboard

If your QX-10 has the TPM operating system, then you probably also have the *HASCI* keyboard. HASCI (pronounced "has-key") is short for "Human Applications Standard Computer Interface." It is a streamlined keyboard similar to a standard typewriter keyboard. There are some additional keys not found on a typewriter, but they are conveniently placed and easy to use. The HASCI keyboard is used with the Valdocs word-processing system or any other software package.

The *ASCII* keyboard (pronounced "ask-ee") is not as streamlined as the HASCI, but it is the one most computer programmers are used to working with. (ASCII stands for "American Standard Code for Information Interchange." This keyboard is not designed to be used with Valdocs.)

One way in which the HASCI and ASCII keyboards differ is in the four sets of keys at the top of the keyboard. On the HASCI keyboard, you

will find four system control keys, five file control keys, four applications keys, and four tpestyle keys—all labeled in English and programmed to perform as labeled. For example, the "COPY DISK" key, when pressed, copies one disk to a second disk. The "DRAW" key accesses the QX-10's graphics capability.

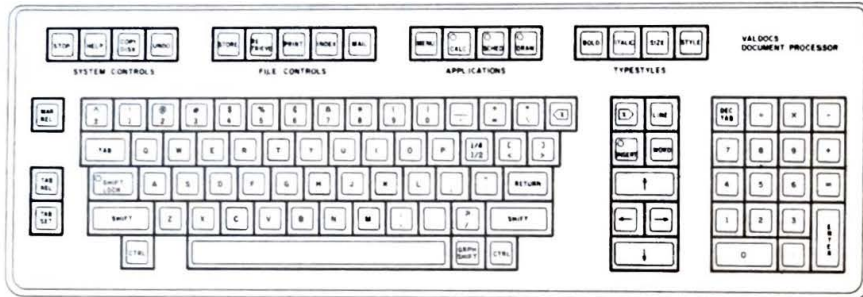

On the ASCII keyboard are ten function keys marked F1, F2, F3, and so forth; a set of four keys labeled "BREAK," "PAUSE," "HELP," "SCRN DUMP;" and another set of four labeled "SF1," "SF2," "SF3," and "SF4."

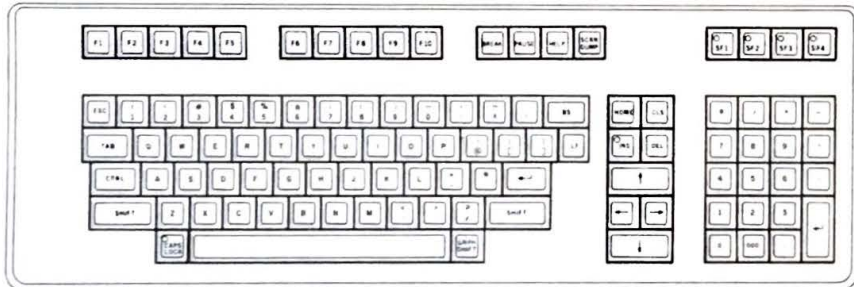

**NOTE:** Appendixes A through D in the back of this manual show the QX-10 character codes for ASCII CP/M and TPM, and HASCI CP/M and TPM. Refer to these if you switch to a different keyboard or computer.

## The Video Monitor

Your QX-10 has a special video monitor (also called a CRT, for cathode ray tube). The video monitor is described as having "dedicated" RAM memory. This means that the video memory, either 32,000 bytes or 128,000 bytes, is "dedicated" to working only for the monitor. This is an advanced concept, because it allows two modes, characters and graphics, to be displayed simultaneously. The video board rests "piggyback" on the main memory located inside the main unit.

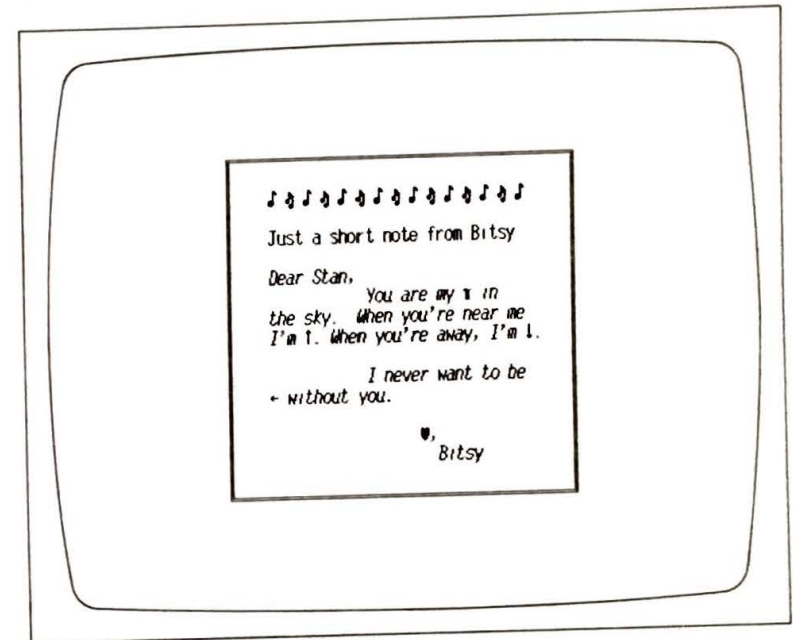

The video screen will be 25 lines deep by 80 characters across when you're doing nongraphic work. The same screen will be transformed into a very fine resolution screen when the graphics mode is employed. Graphics displays are composed of tiny dots, called *pixels* (for "picture elements") and the QX-10 screen can display 640 × 400 pixels, producing a sharp, clear image.

Besides displaying both characters and graphics, the QX-10 monitor has other special features. For instance, every character can be made to blink, show in reverse video, or increase in light intensity. The monitor can also zoom and pan like a TV camera. In addition, when you are using Valdocs, you can choose from many different font styles.

## Other Features

### ROM

The QX-10 also has from 2,000 to 8,000 bytes of "ROM," or "read only memory." This is memory that cannot be altered and contains instructions for starting up the computer. All ROM patterns have been permanently stored and when you turn the QX-10 off, the ROM will remain in storage and will perform the same each time you switch on the unit.

For instance, when the power is turned on and the message "INSERT DISKETTE" appears on the monitor, it is being retrieved from ROM and will continue to do so.

### Direct Memory Access Controllers

Also contained in the QX-10 system are two direct memory access controllers, or *DMAs*. Put simply, these control the memory space and how it is used. Such jobs as moving data from diskette to microprocessor or from a port to the microprocessor and back again are controlled by the *DMAs* without bothering the microprocessor—thus speeding up operations considerably.

### Serial Port

One *serial port* is available to connect external devices to the QX-10 while the other port is used by the keyboard. The ports are standard RS232C two-way. Devices such as serial printers, single-line modems, monitors, and other computers can be connected to the QX-10 through the serial port.

### Centronics-Compatible Parallel Port

The parallel port is a standard Centronics-compatible port where more external devices can be connected (such as parallel printers or plotters). Instead of going through a single port cable one bit at a time, data goes through eight different wires simultaneously, so that it moves one byte at a time—quite a bit faster than through a serial port.

### CMOS RAM Memory

Another special feature of the QX-10 is its CMOS RAM memory. The CMOS (for "complementary metal oxide semiconductor") memory contains 2048 bytes and uses very little power. The internal nickel-cadmium battery that powers CMOS RAM automatically recharges when power is on. This allows CMOS RAM to retain the 2K of memory even when the computer is turned off or unplugged—a welcome feature. The CMOS RAM will continue to function for several weeks with power off.

### Clock Calendar

Your QX-10 contains a clock/calendar that also uses the CMOS technology. Instructions for setting the clock calendar are contained in your software documentation. Once you set the time and date, the QX-10 will maintain both accurately.

### Light Pen Interface

Another convenient feature is an interface for a light pen, a device used for tracing a diagram or object, thus drawing a picture on the graphics screen display.

### Option Cards

There is space in the QX-10 for five peripheral, or "option," cards. These are special printed circuit boards that you can install in your QX-10 for adding special devices and features. For example, you'll need a card to make a direct-connect modem work, or a joystick, or a hard disk. In Chapter 3, you'll learn how to install option cards.

If this deluge of information seems a bit too much right now, don't worry. You'll have time to explore the capabilities and features of the QX-10 as you use it. The ease of operation and many useful features of the QX-10 are what will make owning and using this finest of computers a real joy.

# CHAPTER 3

## Installing External Devices and Option Cards

### External Devices

External devices are available to connect to your QX-10 through ports built into the back of the main unit. These include such devices as printers, modems (for computer-to-computer communication over telephone lines), and speech synthesizers.

#### External Device Ports

There are three external device ports on the back of the main unit: a light pen port, a Centronics-compatible parallel port (labeled "PRINTER"), and an RS232C serial port. The RS232C port may also be used for a printer, but because it relays data at a slower rate than the parallel connection, it is generally not the preferred choice for printing.

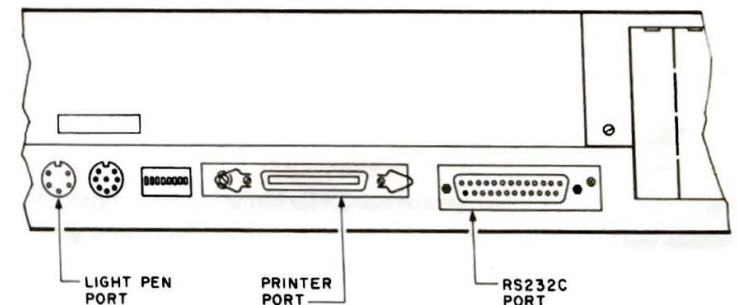



## Installation Procedures

### Preliminary Steps

**IMPORTANT:** Turn the power switch to "OFF."

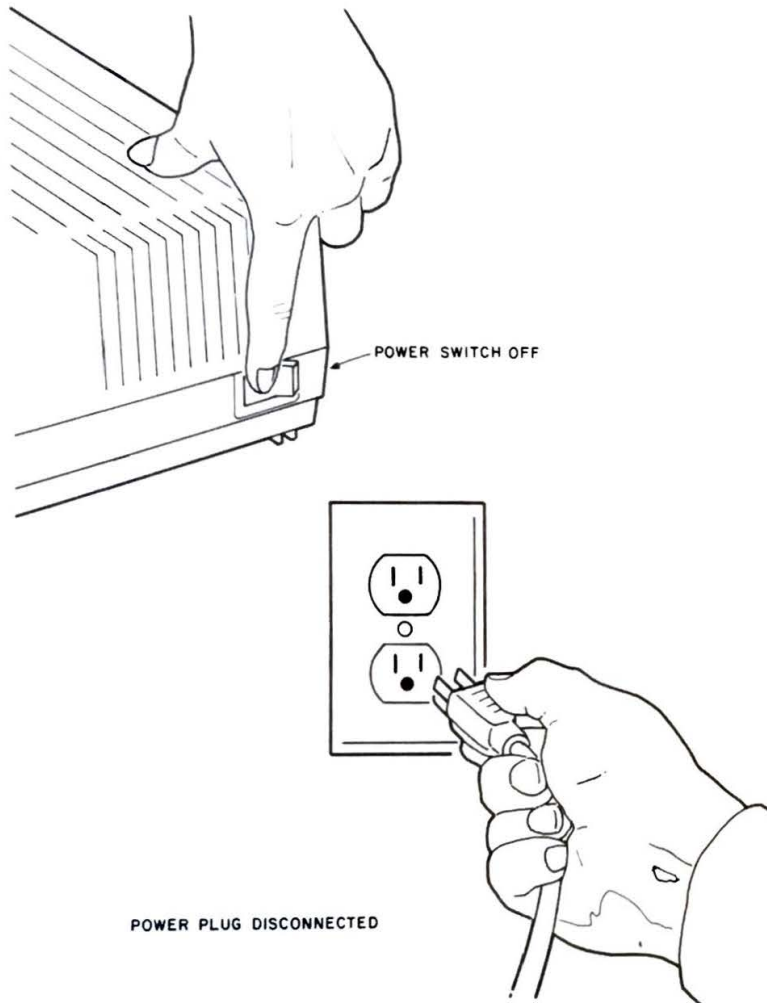

Check the manual for the external device to determine the correct connecting port.

Turn the main unit around so that the back is facing you. Unplug the power cord from the wall outlet.

### Checking the Cable

All ports on the back of the main unit are female; you'll be plugging the male end of the connecting cable into the main unit. Here are some examples of how the male ends of the cables will look for each type:

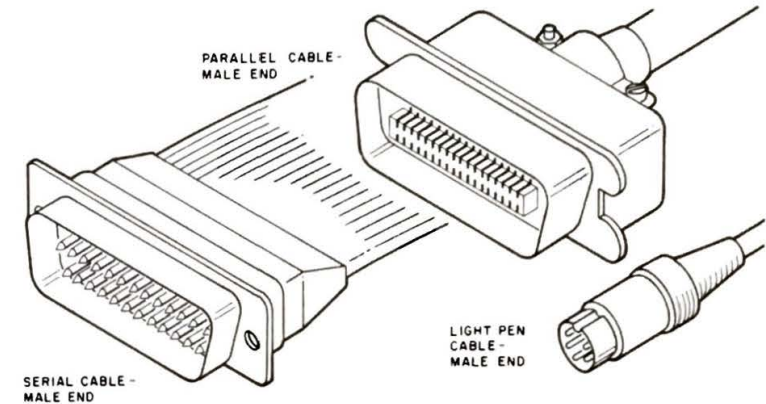

### Plugging In

Plug in the male end. Be careful! Connector prongs are easily bent. If the cable end doesn't go in easily, it is probably upside down. Make sure you have the cable end right side up and try it again.

Once the cable end is in, push it gently to make sure that it is in all the way. If you are attaching a parallel cable, fasten the wire loops over each side of the plug to secure it. If it is a serial cable, tighten the screws on each side of the plug.

### Powering Up

Check to make sure the power switch is in the OFF position. Then plug the power cord into the wall outlet. You are now ready to power up, and follow the procedure in your manual for connecting your external device.

## Installing Option Cards

Option cards, like external devices, are accessories that you add to increase the versatility of your QX-10. But they are installed internally. Some option cards are equipped with outlets for external devices, while others are designed to be used with built-in outlets and standard external devices.

For cards with built-in outlets, you'll need to remove one of the pop-out access panels on the back of the main unit. Otherwise, the installation procedure is the same for both types.

- CHECKLIST:**
- 1) Option card
  - 2) Option card manual
  - 3) Phillips screwdriver

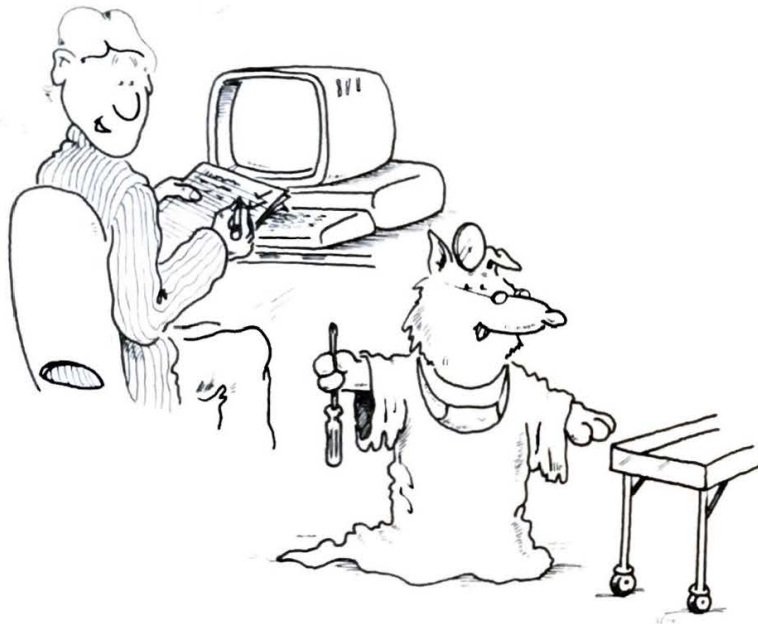

### Powering Down

First, turn the power switch to "OFF." Turn the main unit around so that the back is facing you. Unplug the power cord from the wall outlet.

**WARNING!** Never open the QX-10 while it is plugged into a wall outlet!

### Removing the Option Cards Cover

Unscrew the Phillips screws on each side of the option access slots.

The lift-off cover is completely detachable. To remove it, tilt it up and away from you. There are two hingelike protrusions on the front end.

After the top is raised as far as it will go, pull it up to disconnect it. Set the cover aside.

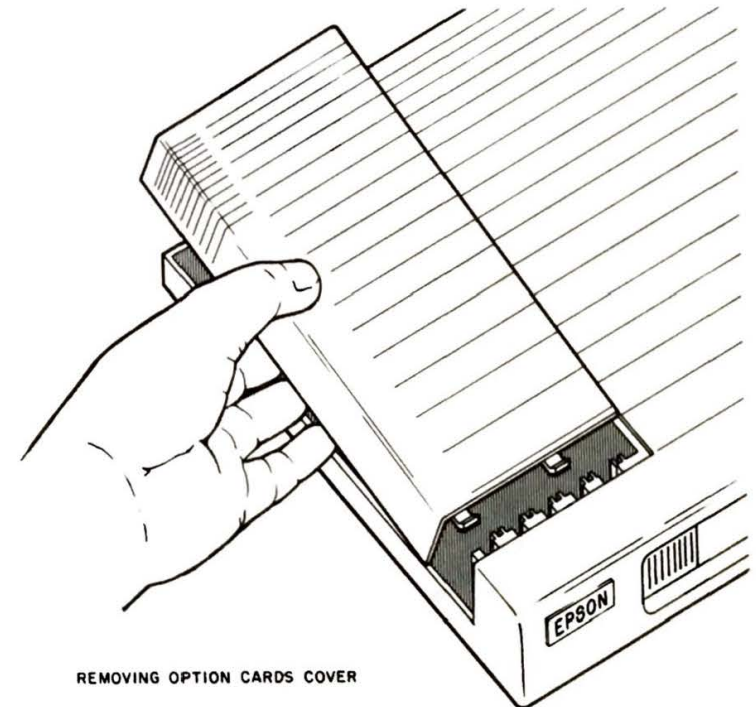
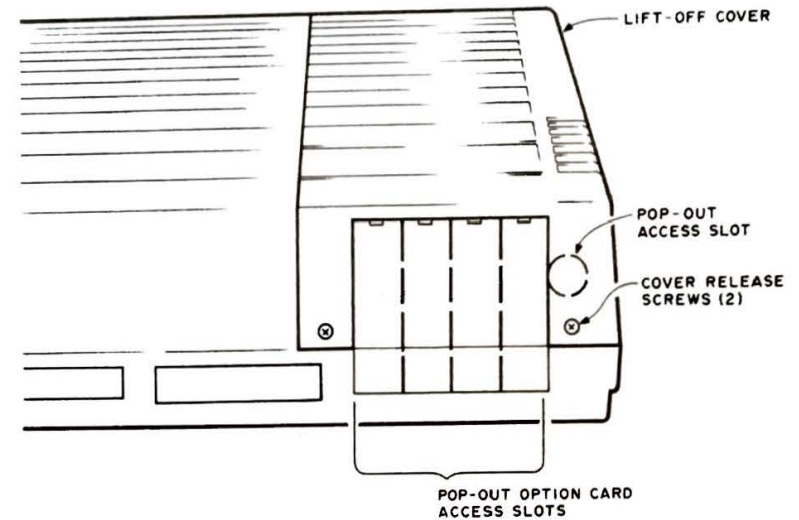

REMOVING OPTION CARDS COVER

### QX-10 Interior

The interior of the option card well will look like this:

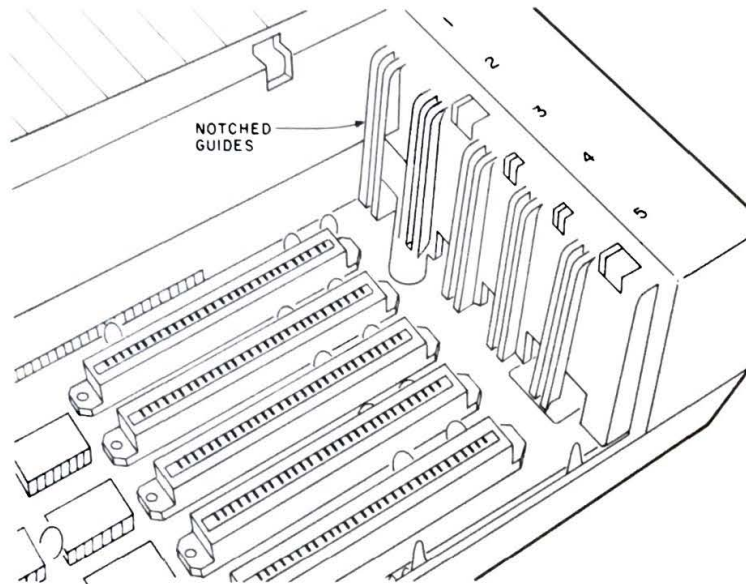

### Removing the Shipping Brace

The black metal plate is a shipping brace. It is easily removed by unscrewing the small Phillips screw on the inside. Store the screw and the brace in a safe place.

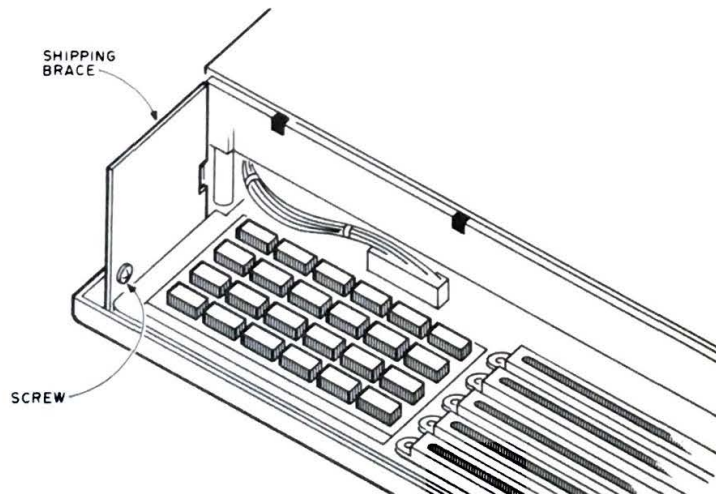

### Selecting the Correct Slot

You need to decide which slot the option card should go in. For most option cards, it makes no difference. But check the option card manual anyway, because occasionally the card requires a specific slot. Also, slot number 5 is fitted with a round pop-out access hole on the back of the main unit, while slots 1 through 4 have vertical pop-out access slots. If the option card comes with a round outlet, you'll probably want to install it in slot number 5.

### Unpacking and Handling the Option Card

Carefully remove the option card from its carton. (Save both the box and packing materials.) *Hold the card only by its edges.* The backing is quite rigid but the soldering and electronic components attached to the card are very delicate. Dropping the card or hitting it against a hard surface may damage it. Touching any of the contact pins (which look like metal fringe on the bottom of the card) should also be avoided, because dirt or grease will impair proper contact with the QX-10.

Even though they are usually designed to fit only one way, it's a good idea to examine the card first. The contact pins should be pointing down and the components should be on the left side when you're facing the back of the main unit. When the option card comes with its own outlet, the side with the outlet goes into the back of the main unit. The contact pins will fit into one of the five different connector slots.

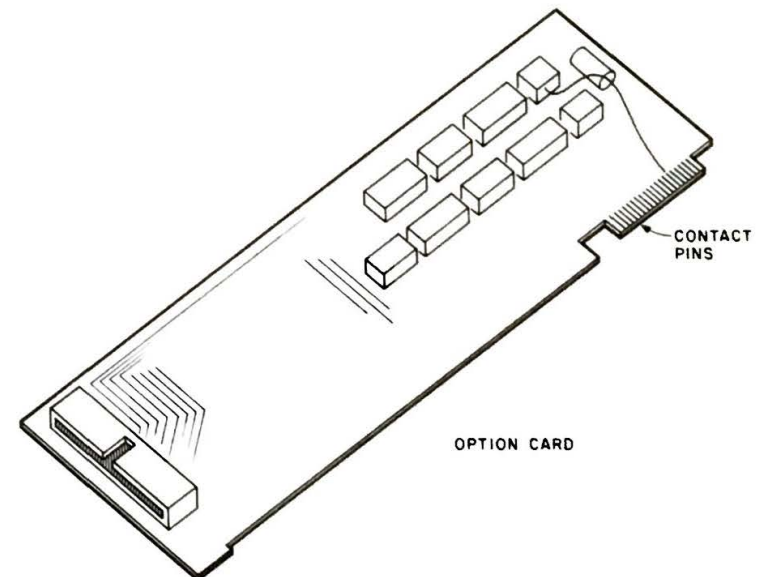

### Inserting the Option Card

Now slide the card down into the proper slot, fitting the front end of the card into the corresponding notched guide on the front wall. Once the connector pins are seated in the connector slot, push a little more firmly to insert fully.

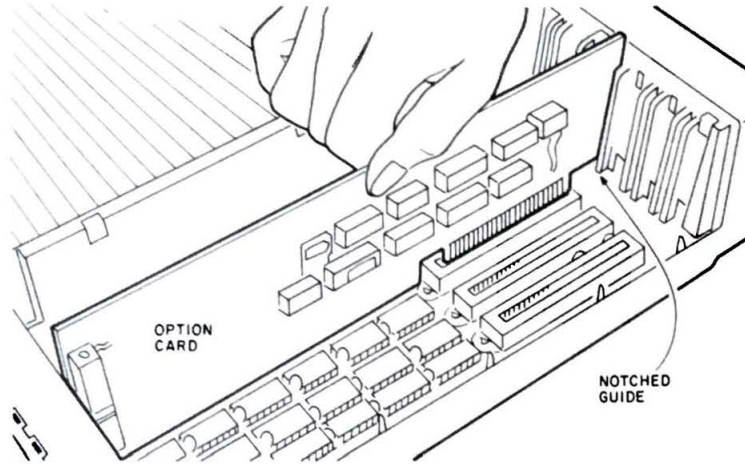

If the option card didn't go in smoothly, pull it out and try sliding it in again, being sure to keep it straight in the notched guide.

### Removing an Access Slot

If the card has its own built-in outlet, remove the pop-out access slot on the back of the main unit. To do this, pull the panel of four access slots up to remove them from the main unit. Snap off the selected access

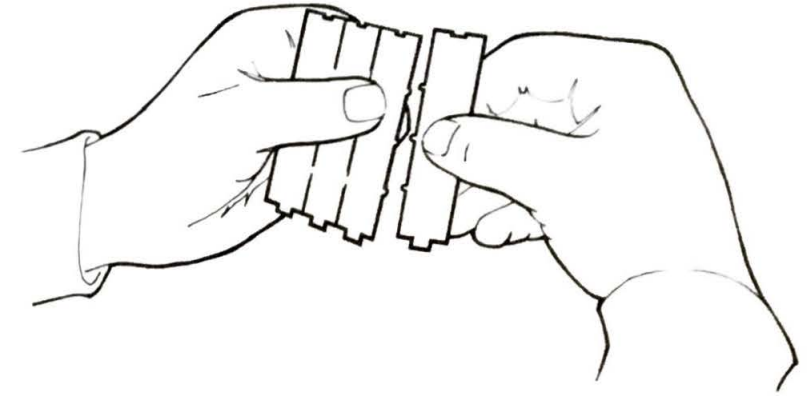
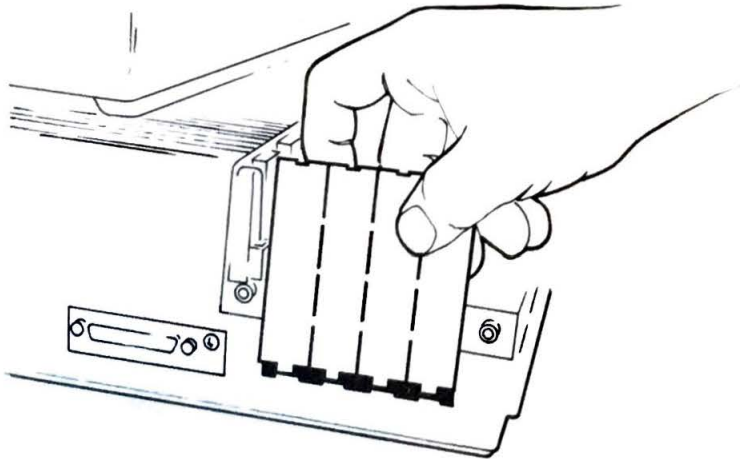

slot while gripping the neighboring access slot(s) with your other hand. Now slide the remaining access slots back into place.

### Replacing the Cover

With the cover in a vertical position, fit the two hinges into their holes on the front of the main unit, then lower the cover. It should fit snugly. Replace the screws on the lower back end to secure the cover to the main unit.

### Powering Up

**IMPORTANT:** Check that the power switch is "OFF." Then, plug the power cable into the wall outlet. Turn the main unit back toward the front. You are now ready to power up and inform your QX-10 that it has just received a new option card. The instruction guide for your option card should tell you how to do this.

**CAUTION:** Always wait at least five seconds after switching off power before switching power back on. Failure to wait can damage your computer.

### Removing Option Cards

Follow the instructions for powering down and removing the cover. Then, detach any cables connected to the option card. Slide the card straight up and out of the notched guides.

Be sure to rewrap the card (preferably with the original packing), and place it inside a carton for safe storage.

Replace the cover as described previously, then follow the procedure for powering up and inform the QX-10 of what you've just removed by using the appropriate procedure for your operating system.

# CHAPTER 4

## Troubleshooting

---

There really isn't very much that can go wrong with your QX-10. It has been especially well-constructed, internally and externally, to be problem-free and damage-resistant.

Then why read this chapter? Because occasionally, even with the QX-10, things can go wrong. However, the chances are that the error will be yours—it may be that you are still mastering a new software package or option or that you have encountered a bug in the software.

In this chapter we'll go through the most common problems you'll encounter, describing them in the order that they're most likely to occur.

### **Procedure?**

If it's a new procedure, chances are you may not yet fully understand it. Check the manual and go through the procedure again, step by step.

### **Diskette Problem?**

Have you been treating your diskettes right? If you read the section in Chapter 1 on how to take care of them, then your diskettes probably haven't been damaged. But just to make sure, try your backup diskette to see if you get the same kind of problems. If you're getting bad results from one diskette, and not from its backup, then your diskette has probably been damaged.

Or are you having problems with a brand new diskette that you're trying to format or copy onto? Chances are good that you've purchased a bad diskette that slipped past the manufacturer's quality control check. Try another one from the same box. Does the second one work correctly? If so, the first one was probably bad. Save it and take it back to the

supplier; they'll refund your money. Now if the second (and the rest) all give you the same undesirable results, go troubleshooting somewhere else—because the odds are good that you'll never buy a box of diskettes with more than one lemon in it.

### Booting Problems?

Drive A looks exactly like drive B; the only difference is that A is on the left side and B is on the right side. *However, you can only boot up from drive A.* So, pop out your software and double-check.

Or, if this is a warm boot, did you remember to press the "RESET" button after inserting the diskette?

### Bugs?

"Bugs," in computerese, refer mostly to imperfections in software. These bugs are minor flaws that the people who wrote the program couldn't foresee. You usually find them by trying out a routine in a slightly different manner than that planned by the programmers. Instead of getting the desired results, you get something you weren't expecting: you find a "bug."



Here are a few ways to find out whether you've got a real bug or not: First, if you have tried this routine many times before, and always successfully, then most likely it is not a bug. Look for another cause of trouble.

A good approach is to start over from the very beginning. Remove the diskette. Turn off the machine, then re-boot your software diskette. Now try your routine again, after checking the manual and following the suggested steps. Are you getting the expected results now?

If you are, and if the way you tried it before was really a logical approach, but a different one than that given by the manual, try it again. Are your results still unacceptable?

If they still aren't what you were expecting, you've probably found a "bug." Most software firms are delighted to learn about any bugs and are continually debugging their software, so you might consider letting them know what you've found. Also, sometimes updated copies of the same software are available for a minimal cost.

### Crossed Wires?

If you have just set up your QX-10 and it isn't behaving, double-check the cables. Are the connections tight?

And are they *correct*? Is the keyboard cable going into the *front* of the main unit? It is possible to plug the keyboard cable into the monitor outlet on the *back* of the main unit, but then neither the monitor nor the keyboard work.



### Dip Switch Problems?

There is a bank of eight dip switches on the back of the main unit, between the monitor outlet and the speaker volume knob.

Some software (such as Valdocs) may not work at all should the dip switches be set incorrectly, or the software may give you a message on the monitor as to which switch(es) should be changed. However, when they are used, the software manual will specify the positions of the switches.

**NOTE:** For Valdocs to operate correctly, switches must be as pictured below.

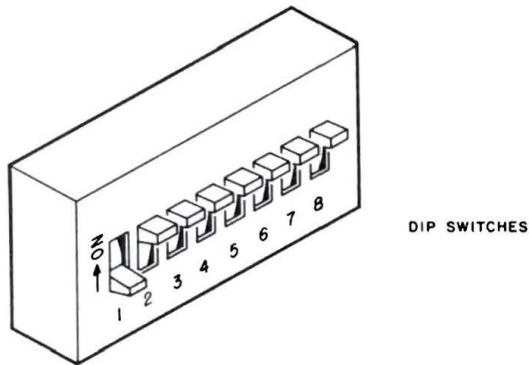

#### Printer Problem?

If your printer has been up and running for some time, working compatibly with your software, and then you find that suddenly all your printing is coming out wrong, or not coming out at all, blame it on your printer and check the troubleshooting section of its manual.

On the other hand, if your printer has just been installed, but is not working correctly, you probably have a communication problem that should be resolved by rechecking the printer manual.

#### Options?

If you have just installed an option card, and you're not getting the kind of results you had expected, double-check the following: Is the option board inserted correctly? Did you follow the procedure in the option board manual? If you answer "yes" to both those questions, you may be able to save a trip back to the dealer who sold you the board by first calling and describing the situation to your sales rep.

#### Static?

Static electricity could possibly affect your QX-10, causing both diskettes and CMOS memory to lose data.

Static electricity is rarely this powerful, but if you were, for instance, to turn on a negative ion generator next to your QX-10, you could wipe out CMOS or diskette memory.

#### Battery Low?

Your CMOS battery can last several weeks with the QX-10 power off. However, it is automatically recharged each time you power up the QX-10. When it starts getting low, the real-time clock may start giving you the wrong date and time. *Don't try to change the battery yourself.* Take your QX-10 back to your Epson dealer. The dealer will first save your CMOS RAM contents before installing the new battery, if you wish.

#### Hardware Problems? (Least Likely)

Your QX-10 is reliable, so don't be surprised if you never have any hardware problems. One reason is that the only moving parts are in the disk drives, and nonmoving parts hardly ever malfunction, especially when you are caring for your QX-10 properly.

Furthermore, each time you turn on your QX-10, it will give itself a self-diagnosis. Then, one of the following four things will happen:

1. When everything is A-OK, your screen will read "INSERT DISKETTE."
2. When there is an abnormality somewhere, and it's time to call your Epson service center, you'll hear a buzzer and get the message "DIAGNOSTIC CODE 0001" with a three-character suffix.
3. When there is an error in memory, you'll get the buzzer and the message, "DIAGNOSTIC CODE 0002."
4. When there is something defective with the CPU, you may or may not get the Diagnostic Code 0001, and you may or may not get the buzzer. Check the small red light on the front right-hand side of the main unit. If it is not lit, then the CPU is probably defective.

**WARNINGS!** Neither the monitor nor the keyboard should ever be opened except by a trained QX-10 service specialist. This is also true for the main unit, except for the cover on the left side that protects the option card slots. You'll need to open it to install or remove option cards.

**IMPORTANT:** Do not open cover until power is off!

If you do have problems you can't solve yourself, call your Epson dealer or Epson service center.

# APPENDIX A

## ASCII CP/M

### Character Codes

Shaded Keys = Keypad Keys

Values are valid in all modes except where noted.

GS = Graph Shift    GSS = Graph Shift Shifted    ^ = CTRL Key    (S) = Shift Key

DECIMAL	HEXADECIMAL	CHARACTER OR FUNCTION	WHAT YOU TYPE
0	00	—	—
1	01	—	^ a
2	02	—	^ b
3	03	—	^ c
4	04	—	^ d
5	05	—	^ e
6	06	—	^ f
7	07	—	^ g
8	08	BS	BS or ^ h
9	09	TAB	TAB or ^ I or ^ TAB
10	0A	LF	LF or ^ J or ^ LF
11	0B	—	^ k
12	0C	—	^ l
13	0D	—	—
14	0E	—	^ n
15	0F	—	^ o
16	10	—	^ p
17	11	—	^ q
18	12	—	^ r
19	13	—	^ s
20	14	—	^ t
21	15	—	^ u
22	16	—	^ v
23	17	—	^ w
24	18	—	^ x
25	19	—	^ y
26	1A	—	—
27	1B	ESC	ESC or ^ [
28	1C	—	—
29	1D	—	^ ]
30	1E	—	^ \
31	1F	—	—



DECIMAL	HEXADECIMAL	CHARACTER OR FUNCTION	WHAT YOU TYPE
32	20	CR	CR or $\wedge \leftarrow$ or $\wedge m$
33	21		or $\wedge 1$
34	22	"	" or $\wedge 2$
35	23	#	# or $\wedge 3$
36	24	\$	\$ or $\wedge 4$
37	25	%	% or $\wedge 5$
38	26	&	& or $\wedge 6$ or $\wedge 7$
39	27	'	'
40	28	(	( or $\wedge 9$
41	29	)	) or $\wedge 0$
42	2A	*	* or $\wedge 8$ or $\wedge *$
43	2B	+	+ or $\wedge +$
44	2C	,	, or $\wedge ,$ or $\wedge \wedge$
45	2D	-	- or $\wedge -$
46	2E	.	. or $\wedge .$ or $\wedge \wedge$
47	2F	/	/ or $\wedge /$
48	30	0	00 or $\wedge 0$
49	31	1	11 or $\wedge 1$
50	32	2	22 or $\wedge 2$
51	33	3	33 or $\wedge 3$
52	34	4	44 or $\wedge 4$
53	35	5	55 or $\wedge 5$
54	36	6	66 or $\wedge 6$
55	37	7	77 or $\wedge 7$
56	38	8	88 or $\wedge 8$
57	39	9	99 or $\wedge 9$
58	3A	:	: or $\wedge :$
59	3B	;	;
60	3C	<	<
61	3D	=	= or $\wedge =$
62	3E	>	>
63	3F	?	?
64	40	@	@ or $\wedge 2$
65	41	A	A
66	42	B	B
67	43	C	C
68	44	D	D
69	45	E	E
70	46	F	F
71	47	G	G
72	48	H	H
73	49	I	I
74	4A	J	J
75	4B	K	K
76	4C	L	L
77	4D	M	M
78	4E	N	N
79	4F	O	O
80	50	P	P
81	51	Q	Q
82	52	R	R

DECIMAL	HEXADECIMAL	CHARACTER OR FUNCTION	WHAT YOU TYPE
83	53	S	S
84	54	T	T
85	55	U	U
86	56	V	V
87	57	W	W
88	58	X	X
89	59	Y	Y
90	5A	Z	Z
91	5B	—	—
92	5C	—	—
93	5D	—	—
94	5E	ESC	(S) ESC or $\wedge$ ESC
95	5F	—	—
96	60	,	,
97	61	a	a
98	62	b	b
99	63	c	c
100	64	d	d
101	65	e	e
102	66	f	f
103	67	g	g
104	68	h	h
105	69	i	i
106	6A	j	j
107	6B	k	k
108	6C	l	l
109	6D	m	m
110	6E	n	n
111	6F	o	o
112	70	p	p
113	71	q	q
114	72	r	r
115	73	s	s
116	74	t	t
117	75	u	u
118	76	v	v
119	77	w	w
120	78	x	x
121	79	y	y
122	7A	z	z
123	7B	[	[ (GS)
124	7C	^	^ (GS)
125	7D	]	] (GS)
126	7E	\	\ (GS)
127	7F	Delete 1 character	DEL BS (GS) (GSS)
128	80	F1	F1 or $\wedge$ F1
129	81	F2	F2 or $\wedge$ F2
130	82	F3	F3 or $\wedge$ F3
131	83	F4	F4 or $\wedge$ F4
132	84	F6	F6 or $\wedge$ F6
133	85	F7	F7 or $\wedge$ F7

DECIMAL	HEXADECIMAL	CHARACTER OR FUNCTION	WHAT YOU TYPE
134	86	F8	F8 or ^F8
135	87	F9	F9 or ^F9
136	88	BREAK	BREAK or ^BREAK
137	89	PAUSE	PAUSE or ^PAUSE
138	8A	HELP	HELP or ^HELP
139	8B	SCREEN DUMP	SCRN DUMP OR ^S.D.
140	8C	F10	F10 or ^F10
141	8D	F5	F5 or ^F5
142	8E	—	—
143	8F	SF1	SF1 or ^SF1
144	90	SF2	SF2 or ^SF2
145	91	SF3	SF3 or ^SF3
146	92	SF4	SF4 or ^SF4
147	93	—	—
148	94	Home cursor	HOME or ^HOME
149	95	Clear screen	(S) CLS or ^CLS
150	96	Insert character	INS or ^INS
151	97	Delete	DEL (GS) or ^DEL
152	98	Move cursor up	(S) ↑ or
153	99	Move cursor left	(S) ←
154	9A	Move cursor right	(S) →
155	9B	Move cursor down	(S) ↓
156	9C	Move cursor up	↑ or ^↑
157	9D	Move cursor left	← or ^←
158	9E	Move cursor right	→ or ^→
159	9F	Move cursor down	↓ or ^↓
160	A0	ESC	ESC (GS)
161	A1	1	1 (GS)
162	A2	2	2 (GS)
163	A3	3	3 (GS)
164	A4	4	4 (GS)
165	A5	5	5 (GS)
166	A6	q	q (GS)
167	A7	w	w (GS)
168	A8	W	W (GSS)
169	A9	\$	\$ (GSS)
170	AA	%	% (GSS)
171	AB	x	x (GS)
172	AC	ESC	ESC (GSS)
173	AD	!	! (GSS)
174	AE	"	" (GSS)
175	AF	#	# (GSS)
176	B0	e	e (GS)
177	B1	r	r (GS)
178	B2	s	s (GS)
179	B3	S	S (GSS)
180	B4	D	D (GSS)
181	B5	X	X (GSS)
182	B6	F	F (GSS)
183	B7	f	f (GS)

DECIMAL	HEXADECIMAL	CHARACTER OR FUNCTION	WHAT YOU TYPE
184	B8	Q	Q (GSS)
185	B9	E	E (GSS)
186	BA	R	R (GSS)
187	BB	—	—
188	BC	d	d (GS)
189	BD	—	—
190	BE	—	—
191	BF	—	—
192	C0	:	: (GSS)
193	C1	*	* (GSS)
194	C2	{	{ (GSS)
195	C3	}	} (GSS)
196	C4	—	6
197	C5	B	B (GSS)
198	C6	=	= (GSS)
199	C7	-	- (GSS)
200	C8	.	. (GS)
201	C9	'	' (GS)
202	CA	<	< (GSS)
203	CB	>	> (GSS)
204	CC	a	a (GS)
205	CD	A	A (GSS)
206	CE	z	z (GS)
207	CF	Z	Z (GSS)
208	D0	c	c (GS)
209	D1	v	v (GS)
210	D2	b	b (GS)
211	D3	n	n (GS)
212	D4	C	C (GSS)
213	D5	V	V (GSS)
214	D6	N	N (GSS)
215	D7	@	@ (GS)
216	D8	'	' (GSS)
217	D9	.	.
218	DA	:	: (GSS)
219	DB	l	l (GSS)
220	DC	K	K (GSS)
221	DD	7	7 (GS)
222	DE	i	i (GS)
223	DF	k	k (GS)
224	E0	H	H (GSS)
225	E1	h	h (GS)
226	E2	t	t (GS)
227	E3	g	g (GS)
228	E4	&	& (GSS)
229	E5	M	M (GSS)
230	E6	6	-6 (GS)
231	E7	m	m (GS)
232	E8	j	j (GS)
233	E9	u	u (GS)
234	EA	(	( (GSS)

DECIMAL	HEXADECIMAL	CHARACTER OR FUNCTION	WHAT YOU TYPE
235	EB	O	O (GSS)
236	EC	L	L (GSS)
237	ED	—	—
238	EE	O	O (GS)
239	EF	I	I (GS)
240	F0	Y	Y (GSS)
241	F1	y	y (GS)
242	F2	T	T (GSS)
243	F3	G	G (GSS)
244	F4	—	— (GSS)
245	F5	?	? (GSS)
246	F6	0	0 (GS)
247	F7	/	/
248	F8	J	J (GSS)
249	F9	u	U (GSS)
250	FA	)	) (GSS)
251	FB	P	p (GSS)
252	FC	+	+ (GSS)
253	FD	9	9 (GS)
254	FE	P	P (GS)
255	FF	.	.(GS)

Notes: CNTRL ^ and CNTRL @ keys have no function. CNTRL Z creates infinite loop.

# APPENDIX B

## ASCII TPM

### Character Codes

Shaded Keys = Keypad Keys

Values are valid in all modes except where noted.

GS = Graph Shift GSS = Graph Shift Shifted ^ = CTRL Key (S) = Shift Key

DECIMAL	HEXADECIMAL	CHARACTER OR FUNCTION	WHAT YOU TYPE
0	00	—	—
1	01	—	^ a
2	02	—	^ b
3	03	—	^ c
4	04	—	^ d
5	05	—	^ e
6	06	—	^ f
7	07	—	^ g
8	08	BS	BS or ^ h
9	09	TAB	TAB or ^ I
10	0A	LF	LF or ^ J
11	0B	—	^ k
12	0C	—	^ l
13	0D	—	—
14	0E	—	^ n
15	0F	—	^ o
16	10	—	^ p
17	11	—	^ q
18	12	—	^ r
19	13	—	^ s
20	14	—	^ t
21	15	—	^ u
22	16	—	^ v
23	17	—	^ w
24	18	—	^ x
25	19	—	^ y
26	1A	—	—
27	1B	—	^ [
28	1C	—	—
29	1D	—	^ ]
30	1E	—	^ \
31	1F	—	—

DECIMAL	HEXADECIMAL	CHARACTER OR FUNCTION	WHAT YOU TYPE
32	20	RET	← or ^ m or ^ ←
33	21	!	! or ^ 1
34	22	"	" or ^ 2
35	23	#	# or ^ 3
36	24	\$	\$ or ^ 4
37	25	%	% or ^ 5
38	26	&	& or ^ 6 or ^ 7
39	27	'	'
40	28	(	( or ^ 9
41	29	)	) or ^ 0
42	2A	*	* or ^ 8 or ^ *
43	2B	+	+ or ^ +
44	2C	,	,
45	2D	-	- or ^ -
46	2E	.	.
47	2F	/	/ or ^ /
48	30	0	0 0
49	31	1	1 1
50	32	2	2 2
51	33	3	3 3
52	34	4	4 4
53	35	5	5 5
54	36	6	6 6
55	37	7	7 7
56	38	8	8 8
57	39	9	9 9
58	3A	:	:
59	3B	;	;
60	3C	<	<
61	3D	=	=
62	3E	>	>
63	3F	?	? or ^ /
64	40	@	@ or ^ 2
65	41	A	A
66	42	B	B
67	43	C	C
68	44	D	D
69	45	E	E
70	46	F	F
71	47	G	G
72	48	H	H
73	49	I	I
74	4A	J	J
75	4B	K	K
76	4C	L	L
77	4D	M	M
78	4E	N	N
79	4F	O	O
80	50	P	P
81	51	Q	Q
82	52	R	R

DECIMAL	HEXADECIMAL	CHARACTER OR FUNCTION	WHAT YOU TYPE
83	53	S	S
84	54	T	T
85	55	U	U
86	56	V	V
87	57	W	W
88	58	X	X
89	59	Y	Y
90	5A	Z	Z
91	5B	[	[
92	5C	\	\
93	5D	]	]
94	5E	^ or ESC	^ or ^ ESC
95	5F	_	_
96	60	~ or -	~ or -(GS)
97	61	a	a
98	62	b	b
99	63	c	c
100	64	d	d
101	65	e	e
102	66	f	f
103	67	g	g
104	68	h	h
105	69	i	i
106	6A	j	j
107	6B	k	k
108	6C	l	l
109	6D	m	m
110	6E	n	n
111	6F	o or DEL	o
112	70	p	p
113	71	q	q
114	72	r	r
115	73	s	s
116	74	t	t
117	75	u	u
118	76	v	v
119	77	w	w
120	78	x	x
121	79	y	y
122	7A	z	z
123	7B	{ or [	{ or [(GS)
124	7C	^	^ (GS)
125	7D	} or ]	} or ] (GS)
126	7E	~ or \	~ or \ (GS)
127	7F	DEL or BS	DEL or ^ BS
128	80	F1	F1
129	81	F2	F2
130	82	F3	F3
131	83	F4	F4
132	84	F6	F6
133	85	F7	F7

DECIMAL	HEXADECIMAL	CHARACTER OR FUNCTION	WHAT YOU TYPE
134	86	F8	F8
135	87	F9	F9
136	88	BREAK	BREAK
137	89	PAUSE	PAUSE
138	8A	HELP	HELP
139	8B	SCREEN DUMP	SCRN DUMP
140	8C	F10	F10
141	8D	F5	F5
142	8E	—	—
143	8F	SF1	SF1
144	90	SF2	SF2
145	91	SF3	SF3
146	92	SF4	SF4
147	93	—	—
148	94	HOME	HOME
149	95	CLS	⌘ CLS
150	96	INS	INS
151	97	DEL	DEL (GS)
152	98	Move cursor up	(S) ↑
153	99	Move cursor left	(S) ←
154	9A	Move cursor right	(S) →
155	9B	Move cursor down	(S) ↓
156	9C	Move cursor up	↑
157	9D	Move cursor left	←
158	9E	Move cursor right	→
159	9F	Move cursor down	↓
160	A0	ESC	ESC (GS)
161	A1	1	1 (GS)
162	A2	2	2 (GS)
163	A3	3	3 (GS)
164	A4	4	4 (GS)
165	A5	5	5 (GS)
166	A6	q	q (GS)
167	A7	w	w(GS)
168	A8	W	W (GSS)
169	A9	\$	\$ (GSS)
170	AA	%	% (GSS)
171	AB	X	X (GS)
172	AC	ESC	ESC (GSS)
173	AD	!	! (GSS)
174	AE	"	" (GSS)
175	AF	#	# (GSS)
176	B0	e	e (GS)
177	B1	r	r (GS)
178	B2	s	s (GS)
179	B3	S	S (GSS)
180	B4	D	D (GSS)
181	B5	X	X (GSS)
182	B6	F	F (GSS)
183	B7	f	f (GS)
184	B8	Q	Q (GSS)

DECIMAL	HEXADECIMAL	CHARACTER OR FUNCTION	WHAT YOU TYPE
185	B9	E	E (GSS)
186	BA	R	R (GSS)
187	BB	—	—
188	BC	d	d (GS)
189	BD	—	—
190	BE	—	—
191	BF	—	—
192	C0	:	: (GSS)
193	C1	*	* (GSS)
194	C2	{	{ (GSS)
195	C3	}	} (GSS)
196	C4	—	—
197	C5	B	B (GSS)
198	C6	=	= (GSS)
199	C7	-	- (GSS)
200	C8	.	. (GS)
201	C9	(	(GS)
202	CA	<	< (GSS)
203	CB	>	> (GSS)
204	CC	a	a (GS)
205	CD	A	A (GSS)
206	CE	z	z (GS)
207	CF	—	—
208	D0	c	c (GS)
209	D1	v	v (GS)
210	D2	b	b (GS)
211	D3	n	n (GS)
212	D4	C	C (GSS)
213	D5	V	V (GSS)
214	D6	N	N (GSS)
215	D7	@	@ (GS)
216	D8	'	' (GSS)
217	D9	:	: (GS)
218	DA	'	' (GSS)
219	DB	l	l (GSS)
220	DC	K	K (GSS)
221	DD	7	7 (GS)
222	DE	i	i (GS)
223	DF	k	k (GS)
224	E0	H	H (GSS)
225	E1	h	h (GS)
226	E2	t	t (GS)
227	E3	g	g (GS)
228	E4	&	& (GSS)
229	E5	M	M (GSS)
230	E6	6	6 (GS)
231	E7	m	m (GS)
232	E8	j	j (GS)
233	E9	u	u (GS)
234	EA	(	( (GSS)
235	EB	O	O (GSS)

DECIMAL	HEXADECIMAL	CHARACTER OR FUNCTION	WHAT YOU TYPE
236	EC	L	L (GSS)
237	ED	8 or Z	8 (GS) or Z (GSS)
238	EE	o	o (GS)
239	EF	l	l (GS)
240	F0	Y	Y (GSS)
241	F1	y	y (GS)
242	F2	T	T (GSS)
243	F3	G	G (GSS)
244	F4	—	— (GSS)
245	F5	?	? (GSS)
246	F6	—	—
247	F7	—	—
248	F8	J	J (GSS)
249	F9	U	U (GSS)
250	FA	)	) (GSS)
251	FB	P	P (GSS)
252	FC	+	+ (GSS)
253	FD	9	9 (GS)
254	FE	p	p (GS)
255	FF	.	. (GS)

Notes: CNTRL Z creates infinite loop.  
 CNTRL F1 clears screen.  
 CNTRL ^ takes you to monitor.  
 CNTRL @ does nothing.

# APPENDIX C

## HASCI CP/M

### Character Codes

Shaded Keys = Keypad Keys

Values are valid in all modes except where noted.

GS = Graph Shift    GSS = Graph Shift Shifted    ^ = CTRL Key    (S) = Shift Key

DECIMAL	HEXADECIMAL	CHARACTER OR FUNCTION	WHAT YOU TYPE
0	00	—	—
1	01	—	^ a
2	02	—	^ b
3	03	—	^ c
4	04	—	^ d
5	05	—	^ e
6	06	—	^ f
7	07	—	^ g
8	08	—	^ h
9	09	TAB	TAB or ^ i
10	0A	DEC.TAB	DEC.TAB or ^ j
11	0B	—	^ k
12	0C	—	^ l
13	0D	—	—
14	0E	—	^ n
15	0F	—	^ o
16	10	—	^ p
17	11	—	^ q
18	12	—	^ r
19	13	—	^ s
20	14	—	^ t
21	15	—	^ u
22	16	—	^ v
23	17	—	^ w
24	18	—	^ x
25	19	—	^ y
26	1A	—	—
27	1B	MAR REL	MAR REL
28	1C	—	—
29	1D	—	^ >
30	1E	—	^ +
31	1F	—	^

DECIMAL	HEXADECIMAL	CHARACTER OR FUNCTION	WHAT YOU TYPE
32	20	RETURN	RETURN or ^m
33	21	!	! or ^1
34	22	"	" or ^'
35	23	#	# or ^3
36	24	\$	\$ or ^4
37	25	%	% or ^5
38	26	&	& or ^7
39	27	'	' or ^
40	28	(	( or ^9
41	29	)	) or ^0
42	2A	x or *	x or * or ^8
43	2B	+ +	+ + or ^ =
44	2C	.	. or ^.
45	2D	- -	- - or ^ -
46	2E	..	.. or ^..
47	2F	/	/
48	30	0 0	0 0 or ^ 0
49	31	1 1	1 1 or ^ 1
50	32	2 2	2 2 or ^ 2
51	33	3 3	3 3 or ^ 3
52	34	4 4	4 4 or ^ 4
53	35	5 5	5 5 or ^ 5
54	36	6 6	6 6 or ^ 6
55	37	7 7	7 7 or ^ 7
56	38	8 8	8 8 or ^ 8
57	39	9 9	9 9 or ^ 9
58	3A	.	. or ^.
59	3B	,	,
60	3C	<	<
61	3D	= =	= = or =
62	3E	>	>
63	3F	? >	? or ^/
64	40	@	@
65	41	A	A
66	42	B	B
67	43	C	C
68	44	D	D
69	45	E	E
70	46	F	F
71	47	G	G
72	48	H	H
73	49	I	I
74	4A	J	J
75	4B	K	K
76	4C	L	L
77	4D	M	M
78	4E	N	N
79	4F	O	O
80	50	P	P
81	51	Q	Q
82	52	R	R

DECIMAL	HEXADECIMAL	CHARACTER OR FUNCTION	WHAT YOU TYPE
83	53	S	S
84	54	T	T
85	55	U	U
86	56	V	V
87	57	W	W
88	58	X	X
89	59	Y	Y
90	5A	Z	Z
91	5B	[	[
92	5C	\	\
93	5D	]	]
94	5E	^	^
95	5F	_	_
96	60	.	.
97	61	a	a
98	62	b	b
99	63	c	c
100	64	d	d
101	65	e	e
102	66	f	f
103	67	g	g
104	68	h	h
105	69	i	i
106	6A	j	j
107	6B	k	k
108	6C	l	l
109	6D	m	m
110	6E	n	n
111	6F	o	o
112	70	p	p
113	71	q	q
114	72	r	r
115	73	s	s
116	74	t	t
117	75	u	u
118	76	v	v
119	77	w	w
120	78	x	x
121	79	y	y
122	7A	z	z
123	7B	<	< (GS)
124	7C	=	= (GS)
125	7D	>	> (GS)
126	7E	\	\ (GS)
127	7F	Delete backward	<input type="button" value="⏪"/>
128	80	Stop function	STOP
129	81	Get HELP screen	HELP
130	82	Copy disk file(s)	COPY DISK
131	83	Cancel last action	UNDO
132	84	Store file	STORE
133	85	Retrieve file	RETRIEVE

DECIMAL	HEXADECIMAL	CHARACTER OR FUNCTION	WHAT YOU TYPE
134	86	Get PRINT menu	PRINT
135	87	Display file index	INDEX
136	88	Get main menu	MENU
137	89	Get calculator	CALC
138	8A	Get scheduler	SCHED
139	8B	Drawing function	DRAW
140	8C	Get mail function	MAIL
141	8D	—	—
142	8E	Print in bold type	BOLD
143	8F	Print in italic type	ITALIC
144	90	Select print size	SIZE
145	91	Choose typestyle	STYLE
146	92	Set tabs	TAB SET
147	93	Release tabs	TAB REL
148	94	Delete forward	⌫
149	95	Delete line	LINE
150	96	Insert character(s)	INSERT
151	97	Move to next word	WORD
152	98	Move cursor up	(S) ↑
153	99	Move cursor left	(S) ←
154	9A	Move cursor right	(S) →
155	9B	Move cursor down	(S) ↓
156	9C	Move cursor up	↑
157	9D	Move cursor left	←
158	9E	Move cursor right	→
159	9F	Move cursor down	↓
160	A0	±	± (GS)
161	A1	1	1 (GS)
162	A2	2	2 (GS)
163	A3	3	3 (GS)
164	A4	4	4 (GS)
165	A5	5	5 (GS)
166	A6	q	q (GS)
167	A7	w	w (GS)
168	A8	W	W (GSS)
169	A9	\$	\$ (GSS)
170	AA	%	% (GSS)
171	AB	x	x (GS)
172	AC	^	^ (GSS)
173	AD	!	! (GSS)
174	AE	@	@ (GSS)
175	AF	#	# (GSS)
176	B0	e	e (GS)
177	B1	r	r (GS)
178	B2	s	s (GS)
179	B3	S	S (GSS)
180	B4	D	D (GSS)
181	B5	X	X (GSS)
182	B6	F	F (GSS)
183	B7	f	f (GS)

DECIMAL	HEXADECIMAL	CHARACTER OR FUNCTION	WHAT YOU TYPE
184	B8	Q	Q (GSS)
185	B9	E	E (GSS)
186	BA	R	R (GSS)
187	BB	±	±
188	BC	± or d	± or d (GS)
189	BD	°	°
190	BE	½	½
191	BF	¼	¼
192	C0	°	° (GSS)
193	C1	"	" (GSS)
194	C2	[	[ (GSS)
195	C3	]	] (GSS)
196	C4	¢	¢
197	C5	B	B (GSS)
198	C6	—	— (GSS)
199	C7	+	+ (GSS)
200	C8	.	. (GS)
201	C9	.	. (GS)
202	CA	.	. (GSS)
203	CB	.	. (GSS)
204	CC	a	a (GS)
205	CD	A	A (GSS)
206	CE	z	z (GS)
207	CF	—	—
208	D0	c	c (GS)
209	D1	v	v (GS)
210	D2	b	b (GS)
211	D3	n	n (GS)
212	D4	C	C (GSS)
213	D5	V	V (GSS)
214	D6	N	N (GSS)
215	D7	½	½ (GS)
216	D8	¼	¼ (GSS)
217	D9	.	. (GS)
218	DA	&	& (GSS)
219	DB	l	l (GSS)
220	DC	K	K (GSS)
221	DD	7	7 (GS)
222	DE	l	l (GS)
223	DF	k	k (GS)
224	E0	H	H (GSS)
225	E1	h	h (GS)
226	E2	t	t (GS)
227	E3	g	g (GS)
228	E4	¢	¢ (GSS)
229	E5	M	M (GSS)
230	E6	6	6 (GS)
231	E7	m	m (GS)
232	E8	J	J (GS)
233	E9	u	u (GS)
234	EA	*	* (GSS)



DECIMAL	HEXADECIMAL	CHARACTER OR FUNCTION	WHAT YOU TYPE
235	EB	O	O (GSS)
236	EC	L	L (GSS)
237	ED	8 or Z	8 (GS) or Z(GSS)
238	EE	o	o (GS)
239	EF	l	l (GS)
240	F0	Y	y (GS) or Y (GSS)
241	F1	y	y (GS)
242	F2	T	T (GSS)
243	F3	G	G (GSS)
244	F4	)	) (GSS)
245	F5	?	? (GSS)
246	F6	0	0 (GS)
247	F7	/	/ (GS)
248	F8	J	J (GSS)
249	F9	U	U (GSS)
250	FA	(	( (GSS)
251	FB	P	P (GSS)
252	FC	.	. (GSS)
253	FD	9	9 (GS)
254	FE	p	p (GS)
255	FF	:	: (GS)

Notes: CNTRL BOLD, CNTRL 2, CNTRL \, and CNTRL ½ keys do nothing. CNTRL Z key creates infinite loop.

# APPENDIX D

## HASCI TPM

### Character Codes

Shaded Keys = Keypad Keys

Values are valid in all modes except where noted.

GS = Graph Shift GSS = Graph Shift Shifted

^ = CTRL Key (S) = Shift Key

DECIMAL	HEXADECIMAL	CHARACTER OR FUNCTION	WHAT YOU TYPE
0	00	—	—
1	01	—	^ a
2	02	—	^ b
3	03	—	^ c
4	04	—	^ d
5	05	—	^ e
6	06	—	^ f
7	07	—	^ g
8	08	—	^ h
9	09	TAB	TAB or ^ I
10	0A	DEC. TAB	DEC. TAB or ^ j
11	0B	—	^ k or ^ m
12	0C	—	^ l
13	0D	—	—
14	0E	—	^ n
15	0F	—	^ o
16	10	—	^ p
17	11	—	^ q
18	12	—	^ r
19	13	—	^ s
20	14	—	^ t
21	15	—	^ u
22	16	—	^ v
23	17	—	^ w
24	18	—	^ x
25	19	—	^ y
26	1A	—	—
27	1B	MAR REL	MAR REL
28	1C	—	—
29	1D	—	^ >
30	1E	—	^ ±
31	1F	—	^ —

DECIMAL	HEXADECIMAL	CHARACTER OR FUNCTION	WHAT YOU TYPE
32	20	RETURN	RETURN
33	21	!	!
34	22	"	" or ^
35	23	#	# or ^ 3
36	24	\$	\$ or ^ 4
37	25	%	% or ^ 5
38	26	&	& or ^ 7
39	27	'	'
40	28	(	( or ^ 9
41	29	)	) or ^ 0
42	2A	X or *	X or * or ^ 8
43	2B	+	+ or ^ =
44	2C	,	, or ^ .
45	2D	-	- or ^ _
46	2E	.	. or ^ ,
47	2F	/	/
48	30	0	0 or ^ 0
49	31	1	1 or ^ 1
50	32	2	2 or ^ 2
51	33	3	3 or ^ 3
52	34	4	4 or ^ 4
53	35	5	5 or ^ 5
54	36	6	6 or ^ 6
55	37	7	7 or ^ 7
56	38	8	8 or ^ 8
57	39	9	9 or ^ 9
58	3A	:	: or ^ ;
59	3B	;	;
60	3C	<	< or ^ =
61	3D	=	= or ^ <
62	3E	>	>
63	3F	^	^ /
64	40	@	@
65	41	A	A
66	42	B	B
67	43	C	C
68	44	D	D
69	45	E	E
70	46	F	F
71	47	G	G
72	48	H	H
73	49	I	I
74	4A	J	J
75	4B	K	K
76	4C	L	L
77	4D	M	M
78	4E	N	N
79	4F	O	O
80	50	P	P
81	51	Q	Q
82	52	R	R

DECIMAL	HEXADECIMAL	CHARACTER OR FUNCTION	WHAT YOU TYPE
83	53	S	S
84	54	T	T
85	55	U	U
86	56	V	V
87	57	W	W
88	58	X	X
89	59	Y	Y
90	5A	Z	Z
91	5B	[	[
92	5C	\	\
93	5D	]	]
94	5E	^	^
95	5F	_	_
96	60	—	— (GSS)
97	61	a	a
98	62	b	b
99	63	c	c
100	64	d	d
101	65	e	e
102	66	f	f
103	67	g	g
104	68	h	h
105	69	i	i
106	6A	j	j
107	6B	k	k
108	6C	l	l
109	6D	m	m
110	6E	n	n
111	6F	o	o
112	70	p	p
113	71	q	q
114	72	r	r
115	73	s	s
116	74	t	t
117	75	u	u
118	76	v	v
119	77	w	w
120	78	x	x
121	79	y	y
122	7A	z	z
123	7B	<	< (GS)
124	7C	=	= (GS)
125	7D	>	> (GS)
126	7E	\	\ (GS)
127	7F	Delete backward	⏪ or ⏩
128	80	Stop function	STOP
129	81	Get HELP screen	HELP
130	82	Copy disk file(s)	COPY DISK
131	83	Cancel last action	UNDO
132	84	Store file	STORE
133	85	Retrieve file	RETRIEVE

DECIMAL	HEXADECIMAL	CHARACTER OR FUNCTION	WHAT YOU TYPE
134	86	Get PRINT menu	PRINT
135	87	Display file index	INDEX
136	88	Get main menu	MENU
137	89	Get calculator	CALC
138	8A	Get scheduler	SCHED
139	8B	Drawing function	DRAW
140	8C	Get mail function	MAIL
141	8D	—	—
142	8E	Print in bold type	BOLD
143	8F	Print in italic type	ITALIC
144	90	Select print size	SIZE
145	91	Choose typestyle	STYLE
146	92	Set tabs	TAB SET
147	93	Release tabs	TAB REL
148	94	Delete forward	⏩
149	95	Delete line	LINE
150	96	Insert character(s)	INSERT
151	97	Move to next word	WORD
152	98	Move cursor up	(S) ↑
153	99	Move cursor left	(S) ←
154	9A	Move cursor right	(S) →
155	9B	Move cursor down	(S) ↓
156	9C	Move cursor up	↑
157	9D	Move cursor left	←
158	9E	Move cursor right	→
159	9F	Move cursor down	↓
160	A0	±	± (GS)
161	A1	1	1 (GS)
162	A2	2	2 (GS)
163	A3	3	3 (GS)
164	A4	4	4 (GS)
165	A5	5	5 (GS)
166	A6	q	q (GS)
167	A7	w	w (GS)
168	A8	W	W (GSS)
169	A9	\$	\$ (GSS)
170	AA	%	% (GSS)
171	AB	x	x (GS)
172	AC	^	^ (GSS)
173	AD	!	! (GSS)
174	AE	@	@ (GSS)
175	AF	#	# (GSS)
176	B0	e	e (GS)
177	B1	r	r (GS)
178	B2	s	s (GS)
179	B3	S	S (GSS)
180	B4	D	D (GSS)
181	B5	X	X (GSS)
182	B6	F	F (GSS)
183	B7	f	f (GS)

DECIMAL	HEXADECIMAL	CHARACTER OR FUNCTION	WHAT YOU TYPE
184	B8	Q	Q (GSS)
185	B9	E	E (GSS)
186	BA	R	R (GSS)
187	BB	±	±
188	BC	± or d	± or d (GS)
189	BD	°	°
190	BE	1/2	1/2
191	BF	1/4	1/4
192	C0	°	° (GSS)
193	C1	—	—
194	C2	[	[ (GSS)
195	C3	]	] (GSS)
196	C4	€	€
197	C5	B	B (GSS)
198	C6	—	— (GSS)
199	C7	+	+ (GSS)
200	C8	.	. (GS)
201	C9	.	(GS)
202	CA	.	(GSS)
203	CB	.	(GSS)
204	CC	a	a (GS)
205	CD	A	A (GSS)
206	CE	z	z (GS)
207	CF	Z	Z (GSS)
208	D0	c	c (GS)
209	D1	v	v (GS)
210	D2	b	b (GS)
211	D3	n	n (GS)
212	D4	C	C (GSS)
213	D5	V	V (GSS)
214	D6	N	N (GSS)
215	D7	1/2	1/2 (GS)
216	D8	1/4	1/4 (GSS)
217	D9	.	(GS)
218	DA	&	& (GSS)
219	DB	l	l (GSS)
220	DC	K	K (GSS)
221	DD	7	7 (GS)
222	DE	i	i (GS)
223	DF	k	k (GS)
224	E0	H	H (GSS)
225	E1	h	h (GS)
226	E2	l	l (GS)
227	E3	g	g (GS)
228	E4	€	€ (GSS)
229	E5	M	M (GSS)
230	E6	6	6 (GS)
231	E7	m	m (GS)
232	E8	J	J (GS)
233	E9	u	u (GS)
234	EA	*	* (GSS)

DECIMAL	HEXADECIMAL	CHARACTER OR FUNCTION	WHAT YOU TYPE
235	EB	O	O (GSS)
236	EC	L	L (GSS)
237	ED	8	8 (GS)
238	EE	o	o (GS)
239	EF	l	l (GS)
240	F0	Y	Y (GSS)
241	F1	y	y (GS)
242	F2	T	T (GSS)
243	F3	G	G (GSS)
244	F4	)	) (GSS)
245	F5	?	? (GSS)
246	F6	0	0 (GS)
247	F7	/	/ (GS)
248	F8	J	J (GSS)
249	F9	U	U (GSS)
250	FA	(	( (GSS)
251	FB	P	P (GSS)
252	FC	.	(GSS)
253	FD	9	9 (GS)
254	FE	p	p (GS)
255	FF	:	: (GS)

Notes: CNTRL STOP clears screen.  
 CNTRL BOLD, CNTRL 2, CNTRL ½ do nothing.  
 CNTRL \ takes you to monitor.  
 CNTRL Z creates infinite loop.

# INDEX

- Air circulation, need for, 1-1
- Angle of keyboard, selecting, 1-7 — 1-8
- Application program, definition of, 2-3
- ASCII keyboard, 2-3 — 2-4
  - function keys on, 2-4
- Backup copies, need for, 1-11 — 1-12
- Binary digit, 2-2
- Bit, definition of, 2-2
- Booting, 1-9 — 1-10
  - cold, 1-9
  - definition of, 1-9
  - problems when, 4-2
  - warm, 1-9
  - warm, procedure for, 1-9
- Brightness of screen,
  - adjustment, 1-9
  - location of control, 1-4
- Bugs, in programs,
  - checking for, 4-2 — 4-3
  - definition of, 4-2
- Byte,
  - definition of, 2-2
  - numerical value of, 2-2
- Chip, 2-1
- Clock/calendar, QX-10, 2-7
- CMOS battery, 4-5
  - replacing, 4-5
- CMOS RAM memory, 2-2, 2-6
  - saving, 4-5
- Components, QX-10,
  - connecting, 1-3 — 1-8
  - CRT monitor, 1-4 — 1-6
  - main unit, 1-3 — 1-4
- Cooling fan on QX-10, 1-8
- CPU, problem in, 4-5
- CRT (cathode ray tube), 2-5
- CRT monitor, 1-4 — 1-6
  - brightness control of, 1-4, 1-9
- Data diskette, definition of, 1-10
- Diagnostic check, internal, 1-8, 4-5
- Dimensions of QX-10, 1-1
- DIN plugs on monitor cable, 1-5 — 1-6
- Dip switches, 4-3 — 4-4
- Direct memory access controller (DMA), definition of, 2-6
- Diskette drives, removing paper shipping diskettes from, 1-3
- Diskette problems, 4-1 — 4-2
- Environmental conditions needed by QX-10, 1-2
- External device ports,
  - Centronics-compatible parallel, 3-1
  - light pen, 3-1
  - RS232C serial, 3-1
- External devices,
  - examples of, 3-1
  - installation of, 3-2 — 3-3
  - using ports to connect, 3-1
- Floppy disks,
  - backup copies,
    - reason for, 1-11 — 1-12
  - buying, 1-11
  - caring for, 1-10 — 1-13
  - compared to
    - phonograph records, 1-10
  - how data is stored on, 1-10
  - how to handle, 1-12
  - quality, need for, 1-10
  - small rectangular notch on, 1-11
- Graphics capability of QX-10, 2-4
  - using "DRAW" key to access, 2-4
- Hardware problems, 4-5
  - buzzer, meaning of, 4-5
  - CPU, 4-5
  - "DIAGNOSTIC CODE 0001" message, 4-5
  - "DIAGNOSTIC CODE 0002" message, 4-5
  - memory error, 4-5
- HASCI keyboard, 2-3 — 2-4
  - applications keys on, 2-4
  - "COPY DISK" key, 2-4
  - "DRAW" key, 2-4
  - file control keys on, 2-4
  - system control keys on, 2-4
  - typestyle keys on, 2-4

- “INSERT DISKETTE” message, 1-8, 2-6, 4-5
- Integrated circuit, 2-1
- “In use” light, 1-10
- Keyboard, QX-10, 2-3 — 2-4
  - ASCII, 2-3
  - comparison, ASCII and HASCI, 2-3 — 2-4
  - HASCI, 2-3
  - repair of, 4-5
- Keyboard cable, 1-6
- Kilobyte, definition of, 2-2
- Light pen interface, 2-7
- Magnetic fields,
  - hazards of, 1-2, 1-13
  - sources of, 1-13
- Main unit, connecting to system, 1-3 — 1-4
  - power cord for, 1-3
- Memory, in QX-10, 2-2
  - CMOS, 4-4 — 4-5
  - CMOS RAM, 2-2, 2-6
  - compared to human brain, 2-2
  - “dedicated” RAM, 2-5
  - error in, 4-5
  - random access (RAM), 2-2
  - read only (ROM), 2-6
- Microprocessor, 2-1 — 2-2
  - 8-bit, 2-2
  - Z80, 2-1, 2-2
- Monitor cable, 1-4 — 1-5
  - DIN plugs on, 1-5 — 1-6
  - “MONITOR” outlet for, 1-3
- Monitor port, 1-4
- Monitor, repair of, 4-5
- Murphy’s Law, 1-12
- Operating system,
  - CP/M, 2-3
  - definition of, 2-3
  - TPM, 2-3
- Option card,
  - contact pins on, 3-7
  - definition of, 2-7
  - insertion of, 3-8
  - installation of, 3-3 — 3-9
  - problems, 4-4
  - removal of, 3-9
  - slot for, selection of, 3-7
  - unpacking and handling, 3-7
  - uses for, 2-7
- Outlets needed,
  - for Epson printer, 1-2
  - for QX-10, 1-2
- Parallel cable, how to attach, 3-3
- Parallel port,
  - Centronics-compatible, 2-6, 3-1
  - compared to serial port, 2-6
  - definition, 2-6
  - devices used with, 2-6
- Peripheral card, *see* Option card
- Pixels, definition of, 2-5
- Powering up, 1-8 — 1-9
  - warning regarding, 3-9
- Printer problems, 4-4
- Problems,
  - battery, 4-5
  - booting, 4-2
  - bugs in program, 4-2 — 4-3
  - cable, 4-3
  - dip switch, 4-3 — 4-4
  - diskette, 4-1 — 4-2
  - hardware, 4-5
  - option card, 4-4
  - printer, 4-4
  - static, 4-4 — 4-5
- Program,
  - application, 2-3
  - definition of, 2-3
- “PUSH” button on diskette drive, 1-3, 1-10, 1-13
- RAM (random access memory),
  - CMOS, 2-2, 2-6
  - definition of, 2-2
- Red light,
  - on drive A, 1-8, 1-10, 1-13
  - on main unit, 1-8, 4-5
- Registration cards, filling out, 1-2
- Reset button on diskette drive B, 1-9
  - use in warm boot, 1-9
- ROM (read only memory), 2-6
- Rules for operation of computer, 1-8
- Serial cable, how to attach, 3-3
- Serial port,
  - devices used with, 2-6
  - RS232C, 2-6, 3-1
- Static electricity,
  - hazards of, 1-1, 4-4 — 4-5
  - negative ion generator as source of, 4-5
  - prevention of, 1-2

- System diskette,
  - definition of, 1-10
  - insertion of, 1-13 — 1-14
  - making backup copies of, 1-11
- Temperature, optimum, for QX-10, 1-13
- Unpacking the QX-10, 1-1 — 1-2
- Valdocs System diskette, 1-10
- Valdocs word-processing system, 2-3
  - font styles with, 2-5
- Video monitor, QX-10, 2-5
  - brightness control on, 1-4, 1-9
  - special features of, 2-5
- Video screen,
  - graphics mode on, 2-5
  - used for nongraphic work, 2-5
- Write-protect tabs, 1-11
- Z80 microprocessor, 2-1, 2-2