

# **COMBINED NEWSLETTER**

---

**January 1984**

**Volume 1 Number 2**

---



**PERSONAL COMPUTERS**

**OFFICE AUTOMATION**

**GRAPHICS**

**COBOL**

**DIBOL**

# CHAIRMAN'S CHAT ...

DECUS  
OFFICE AUTOMATION  
SPECIAL INTEREST GROUP

22 November 1983

## CHAIRMAN'S CHAT

The Las Vegas Symposia was another successful forum. Unfortunately, the successes were primarily in the conference rooms and not in the casinos. It does appear though that most OA SIG members had enough money to get home.

Interest in office automation from DECmates to VAX All-In-1 continues to grow as evidenced by the overflowing crowds at most of the OA sessions. Armed with the strength of our attendance figures, Pauline Kuntz, our symposia coordinator, and I will work even harder to get larger rooms for Cincinnati. While we're on the subject, I want to thank Pauline for her singular efforts in creating the excellent slate of seminars we offered in Las Vegas. We can all make her job easier for the Spring Symposia if we submit our participation intentions early. If nothing else, let Pauline know what subjects you'd like covered at the Symposia.

Our proposed OA SIG Operating Procedures have been approved by the SIG Steering Committee. We're including them in this issue so we can get your comments before putting them into effect. Please call or write Margaret Drake, our newsletter editor, or myself by February 15, 1984. We'll incorporate appropriate comments and take a vote at our business meeting in Cincinnati.

It is also time to start thinking about elections for the three key positions in the OA SIG Steering Committee, i.e., Chairman, symposia coordinator, and newsletter editor. We incumbents have been pleased to serve you. However, we don't want to monopolize the organization. Therefore, elections will also be a topic at our next symposia business meeting.

Remember, we are trying to build an organization that is responsive to your needs. We are always glad to hear your questions and comments.

Have a good day.



Tom Orlowski

Margaret Drake  
7703 Floyd Curl Drive  
San Antonio, TX 78284  
(512) 691-6105

T. J. Orlowski  
HQDA TAGO (DAAG-ID)  
2461 Eisenhower Ave (Rm 1156)  
Alexandria, VA 22331  
(703) 325-6161/2



# SYMPOSIUM COORDINATES ....

By Pauline Kuntz

The Las Vegas DECUS Symposium has taken its place in the halls of history. Office Automation presented 36 sessions -- 19 User presentations, 17 Digital sponsored, 5 Birds of a Feather requested sessions, an All-In-One working Group Session and a Hospitality Hour in the OA suite. Twenty-four of the 2,498 members of the OA SIG actively contributed to these presentations. At least OA participants left Las Vegas as winners.

Many thanks to Phill Swanson who made it possible for all of us to share in the jackpot of the first OA Magic session. Our thanks also to Jim McCord, DIBOL Sig, who provided the equipment and Gary Shepherd who made the video cassette recording. For copies of the videocassette, contact Pauline Kuntz, UTHSCSA, 7703 Floyd Curl Drive, San Antonio, TX 78284.

Now we face east and Cincinnati. We need presenters, session chairmen, panel members, and someone to operate the camera to record our OA Magic session as well as other OA sessions. We also need someone to serve as emcee of the OA Magic session.

Some suggested sessions for Cincinnati follow:

- OA System Manager's Panel
- Lessons Learned -- Technician
  - User
  - Software
  - Hardware
- Legal Implications of Software Licenses
- Communication Issues Relating to OA
- "Guess" vs. Actual User Needs of OA
- Sharing of User Developed OA Software
- All-In-One Implementation Helps -- Pre, Actual and Post Videotex
- Message Router
- Business Graphics
- Approaches to Training OA Users
- Timesharing
- MASS II
- OA Ergonomics

What are your suggestions? Do you have specific areas you would like a Digital representative to address? I need all suggestions by early January so that we can confirm and submit abstracts by the January 20 deadline. Scheduling takes place in late February.

DECUS continually confirms that people working together can accomplish a superabundance. The system works and I enjoy the complexity of the OA scheduling process. My chief concern is that the presentations are representative of the desires of all of the Office Automation Special Interest Group membership. I look forward to hearing from you. You can telephone me at (512) 691-7351 or write to me at: The University of Texas Health Science Center at San Antonio, 7703 Floyd Curl Drive, San Antonio, TX 78284.

## STEERING COMMITTEE ....

CHAIRMAN:

thomas j. orlowski  
(703) 325-6161/2

SYMPOSIUM COORDINATOR:

pauline f. kuntz  
(512) 691-7351

NEWSLETTER EDITOR:

margaret drake  
(512) 691-6105

ASST. SYMPOSIUM COORDINATOR:

phillip j. metzler  
(602) 261-6581

ASSISTANT EDITOR:

dwight h. person  
(504) 527-5525

PRESENTATION RECRUITER:

fred gerkin  
(201) 564-4095

ASSISTANT EDITOR:

ray kaplan  
(602) 626-3116

12-BIT EDITOR:

bob hassinger  
(617) 435-3452

AREA COORDINATORS

PERSONAL COMPUTERS:

david e. solomon  
(313) 769-8500

SIG LIAISONS

GRAPHICS:

bill kramer  
(302) 453-6031

STANDALONES:

loretta ammons  
(916) 752-3524

VAX:

douglas j. wilson  
(617) 253-2041

PRO/KNOWLEDGE WORKER:

tom j. green  
(415) 422-6231

DIBOL AND 12-BIT:

lawrence h. eisenberg  
(213) 788-0354

DEC COUNTERPART:

dick hill  
(603) 884-3960

ruth k. koolish  
(312) 724-9280

bob hassinger  
(617) 435-3452

# THE FORUM ...

DRAFT

## OFFICE AUTOMATION SPECIAL INTEREST GROUP

### OPERATING PROCEDURES

#### Article I

##### Name

- 1.0 The name of the organization is the Office Automation Special Interest Group (OA SIG).

#### Article II

##### Purpose

- 2.0 The OA SIG is established under the bylaws of the DECUS/U. S. Chapter to:
  1. Provide a forum for managers, technicians, and users to exchange ideas, programs, and any other items of common interest.
  2. Provide feedback to Digital Equipment Corporation (DEC) on all matters concerning office automation related software products, services, policies, and all DEC manufactured computers, peripheral equipment, and other products and services.

#### Article III

##### Membership

- 3.0 Membership requirements:
  1. Any DECUS members using or interested in office automation and its related products, equipment or services is qualified to be a member.
  2. Any person qualified to be a member will be accepted as a member upon submitting a request to DECUS U.S. Chapter.
- 3.1 Rights of members:
  1. Members shall be eligible to participate in SIG activities and be members of the Steering Committee.

2. Any bonafide member of the OA SIG may bring a motion before a meeting of the SIG Steering Committee.

#### Article IV Steering Committee

##### 4.0 General

1. The OA SIG shall be administered by the Steering Committee.
2. The Steering Committee shall consist of at least three officers. Other officers may be elected or appointed as the need arises.
3. Liaison officers to other SIGs may be appointed as voting members of the Steering Committee at any time deemed necessary by the SIG Chairman.
4. Any member of the OA SIG may be on the Steering Committee and the Steering Committee shall be composed solely of members.
5. The Chairman may act independently on all matters, and shall inform and consult with the Steering Committee as (s)he sees fit. A majority vote of the remaining members shall be required to override decisions of the chairman.

##### 4.1 Steering Committee Officers

1. The Chairman will be elected by simple majority vote of SIG members present at the SIG business meeting at Symposia.
2. The Steering Committee Officers shall serve for two years, and with the exception of the Chairman will be elected by the steering committee. The Chairman will service for two years and may serve consecutive terms only if (s)he runs for reelection in a regularly scheduled election.
3. The officers are the Chairman, the Newsletter Editor. and the Symposia Coordinator.

##### 4.2 At-Large Members

1. The chairman may appoint members of the Steering Committee as necessary when it is not practical to conduct an election by the entire steering committee.

2. At large members may be appointed by a majority vote of the steering committee.

#### 4.3 Past Officer Members

To assist in the in the transfer of responsibilities to new officers, past officers, when eligible, will remain as members of the Steering Committee for one year.

#### 4.4 Duties of the Chairman

1. The Chairman is the chief executive officer of the SIG, and shall chair all steering committee and business meetings and be responsible for directing all activities of the SIG between meetings of the steering committee. The Chairman's actions are subject to review by the Steering Committee. The Chairman may be recalled for cause by simple majority vote of no confidence by the members.
2. The Chairman shall appoint steering committee members after coordination with the serving members of the Steering Committee.

#### 4.5 Duties of the Symposia Coordinator

1. The Symposia coordinator is responsible for the encouragement of Symposia participation, and scheduling of OA sessions at DECUS Symposia.
2. In the event that the position of Chairman becomes vacant, the Symposia Coordinator shall temporarily assume all duties of the Chairman except that of Steering Committee appointments until a permanent Chairman is elected.

#### 4.6 Duties of the Newsletter Editor

1. The Newsletter Editor shall edit and publish the SIG newsletter.
2. In the event that both the position of Chairman and Symposia Coordinator become vacant, the Newsletter Editor shall temporarily assume all duties of the Chairman except that of Steering Committee appointments until a permanent Chairman is elected.

#### 4.7 Vacancy in Office

1. Should the Chairman vacate his(her) office by resignation, disability, or ineligibility or impeachment, a new Chairman shall be elected by a majority vote of the remaining members of the steering committee. The new Chairman will serve out the old Chairman's term and must then run for reelection at the regularly scheduled election, if (s)he desires to continue in office.
2. Should any other officer vacate his(her) office by resignation, disability, or ineligibility or impeachment, the Chairman shall appoint a replacement.

### Article V Elections

#### 5.0 Election of Officers

1. The Chairman and Newsletter Editor shall be elected by the steering committee at the first steering committee meeting in every even numbered year.
2. The Symposia coordinator will be elected in odd numbered years.
3. Special elections may be held at any time necessary.

#### 5.1 Appointment of at-large members

1. The at-large members appointed by the chairman are intended to assist the chairman in discharging his or her duties.
2. The at-large members appointed by vote of the steering committee shall be elected by the officers at the first steering committee meeting in every odd numbered year.

#### 5.2 Past Officer members

Outgoing officers, unless ineligible or elected as an officer or appointed as an at-large member, or impeached from office shall become a past officer member of the steering committee for one year.

### 5.3 Impeachment of Officers

In accordance with Article III, The Steering Committee will accept any motion to remove an officer of the OA SIG. The motion will be presented in the next Newsletter along with the comments of the remaining Steering Committee members and a request that members file a vote on the motion within 30 days. Should a majority of respondents comprising at least 1/4th of the membership at the time of the Newsletters distribution agree to the removal, the officer is impeached, and must be replaced by election by the members, as described below.

### 5.4 Nominations

Should an officer be impeached, or all three of the key Steering Committee officer positions become simultaneously vacant, nominations for that(those) position(s) will be accepted by the Newsletter Editor. or the person designated to function in the nominations committee capacity. The nominees will be contacted, and shall accept by filing a brief statement in their behalf to be published in the next Newsletter. All members may return the ballot published in that copy of the Newsletter. The nominee receiving the most votes will be elected and take office immediately.

## Article VI Meetings

### 6.0 General meetings

Business meeting shall be scheduled at the Spring and Fall DECUS U.S. Chapter symposia.

### 6.1 Steering Committee meetings

The Steering Committee shall meet by phone or electronic mail prior to each general meeting, or at the Chairman's request. and shall also meet at each DECUS U.S. Chapter symposia.

## Article VII Amendments

- 7.0 Amendments to these operating procedures shall be made by a majority vote of the Steering Committee. An amendment will be proposed at one meeting, and voted on in a future meeting, with the proposed amendment published in the Newsletter in the interim.

# HELP OFFERED ....

## Hässle

AB Hässle Subsidiary within the Astra Group

Date

July 27, 1983

Your date

Our reference

L Palmer/eb

Your reference

Mr Tom Orlowski  
HQDA, TAGO  
Attn: DAAG-ID  
2461 Eisenhower Avenue  
Arlington, VA 22331  
USA

Dear Mr Orlowski,

We have routines available that can read/write OS8-floppies on the VAX and also a full PDP8-emulator that allows you to run (the worlds slowest) OS8-system on the VAX.

If you are interested contact me.

Regards,

Lars Palmer *Eva Blysing*  
Data dept /Eva Blysing, secr.

Postal address

AB Hässle  
S-431 83 MÖLNDAL  
Sweden

Office and laboratories

Kärragatan 5  
MÖLNDAL  
Sweden

Telephone

International  
Switchboard  
+ 4631676000  
Indialling  
+ 463167 + ext.no.

Cable address

Abhaessle Gothenburg

Telex

208 10 Haessle S



# ALL-IN-ONE IN ACTION ...

## Introduction to the ALL-IN-1 Working Group

The ALL-IN-1 Working Group has been formed under the Office Automation SIG of DECUS in order to have a group more focused on ALL-IN-1. We hope that having a group devoted to ALL-IN-1 will allow for better communications both within the ALL-IN-1 user community, and between the user community and Digital.

We began our efforts at the Spring '83 DECUS Symposium (held in St. Louis), when Phill Swanson picked up on the idea of creating some type of group for the ALL-IN-1 user community. The idea was quite well-received, and a lot of interest was expressed. Phill's efforts helped bring about the Office Automation Magic session (among others) which provided many of us with some valuable (and humorous) insights into ALL-IN-1.

Due to other professional demands on his time, Phill has asked me to assume the position of Chairperson of the Working Group. As I begin to function in that role, I would like to thank him publicly for his efforts in getting this Working Group off the ground!

For those of you I have not yet met, here is a quick introduction to me, and where I stand in the ALL-IN-1 user community. I work for the Development Computer Center of the Production Test Division (PTD) of GenRad, Incorporated. Our Computer Center houses six VAX-11/780s in addition to many PDP-11s. Two of the VAXes currently use ALL-IN-1 and host a variety of users and applications; the other four systems are devoted to the development of software for products for my Division. In addition, we have a network of VAXes around the country (and around the world) on which we use ALL-IN-1 to support the operations of the company.

The operation of the Working Group so far has been simply to give back to DEC our reactions and findings with respect to the ALL-IN-1 product. They have been fairly interested and responsive to our opinions and ideas, so the Working Group seems already to have made some contribution.

Published elsewhere in this issue is a listing of those people who attended various OA sessions in Las Vegas, and indicated an interest in the ALL-IN-1 Working Group. If you were not there, and are interested, or if you were there, and I have your address wrong (I did the typing, and assume full liability for typos!), please let me know.

Also published elsewhere in this issue is a listing of some of the sessions which we are **proposing** for the Spring '83 Symposium (in Cincinnati). If you have something to contribute to one of these, or would like to propose another session, please contact me.

I would like to thank all of you who have expressed an interest, and tell you that I hope to be able to continue the efforts begun by Phill Swanson to make this Working Group a valuable asset to its members and to DECUS.

I welcome any ideas, suggestions, or comments from you about your ideas for the Working Group (or for corrections on my typing). My address is:

Mitch Brown  
Associate Development Engineer  
GenRad, Incorporated  
Production Test Division  
300 Baker Avenue MS/6  
Concord, MA 01742



Mitch Brown,  
Chairperson, ALL-IN-1 Working Group

Proposed Sessions  
for  
**SPRING 1984 DECUS SYMPOSIUM**  
[ ALL-IN-1 Working Group ]

Implementing ALL-IN-1 -- First Timers  
Implementing ALL-IN-1 V2.0 -- Hints & Kinks  
What ALL-IN-1 V2.0 Is Going To Be  
ALL-IN-1 Questions & Answers  
ALL-IN-1 Performance Update  
The Care and Feeding of an ALL-IN-1 Installation  
    - file re-building  
    - customizing  
ALL-IN-1 Training  
    - case studies on how "...we..." did it  
ALL-IN-1 -- "What I Wish DEC Had Told Me"  
ALL-IN-1 Documentation -- What to Expect From V2.0  
ALL-IN-1 Word Processing -- Features / Functions

## ALL-IN-1 Working Group

### Member Listing

This is a listing of those people who indicated an interest in the ALL-IN-1 Working Group at the '83 Fall Symposium. They are not necessarily experts -- this list is just those who are interested. Some of us are already using ALL-IN-1 on one or more VAXes, and others are still in the preliminary stages of evaluation or installation.

If your address is not shown below and you would like to be included, or if your address is below but is incomplete or in error, please contact Mitch Brown.

#### Alaska:

Harvey Langholtz  
U. S. Coast Guard  
Juneau, AK 99801  
907 - 586 - 7798

#### Arizona:

Richard D. Ortiz, Principal Software Engineer  
GenRad  
Service Products Division  
Phoenix, AZ 85016  
602 - 264 - 2475

Barbara Stallings, Marketing Specialist  
Digital Equipment Corporation  
Phoenix, AZ 85034  
602 - 267 - 1364

Ray Kaplan, Systems Support  
The University of Arizona  
Department of Management Information Systems  
Tucson, AZ 85721  
602 - 621 - 2748

#### California:

Barbara Meyer  
Delco Systems Operations  
Goleta, CA 93117  
805 - 961 - 5673

Richard Rosomoff, VAX System Manager  
The Games Network, Inc.  
Los Angeles, CA 90010  
213 - 932 - 1950

Don Roark  
Corporate Systems  
Lawry's Foods, Inc.  
Los Angeles, CA 90057  
213 - 225 - 2491 (ext. 315)

ALL-IN-1 Working Group

Member Listing

California: (continued)

Howard Cheng, Manager, Planning & Technical Support  
Bechtel Power Corporation  
Los Angeles Power Division  
Norwalk, CA 90650  
213 - 807 - 3819

Terry A. Fleming, Systems Supervisor  
Bechtel Power Corporation  
Norwalk, CA 90650  
213 - 946 - 1811

Vinita C. Mathur, Manager Office Automation  
Bechtel Power Corporation  
Los Angeles Power Division  
Norwalk, CA 90650  
213 - 807 - 2000  
213 - 944 - 9311

Donna L. Oellien, Systems Analyst  
GA Technologies Inc.  
San Diego, CA 92138  
619 - 455 - 3931

Robert M. Randall, Manager  
GA Technologies Inc.  
Computer Services  
San Diego, CA 92138  
619 - 455 - 4456

Erik Freitag, System Manager  
The Crocker Bank  
Business Banking Division  
San Francisco, CA 94103  
415 - 477 - 1772

De Ann Murphy, Office Systems Consultant  
The Crocker Bank  
Business Banking Division  
San Francisco, CA 94104  
983 - 3766

Bob Lunen  
Computer Technology Associates, Inc.  
San Jose, CA 95110  
408 - 295 - 1995

Joe Fleming  
ROLM  
Santa Clara, CA 95050  
408 - 986 - 6429

ALL-IN-1 Working Group

Member Listing

California: (continued)

James D. Smith, Manager Office Automation  
Rockwell International Corporation  
Space Transportation & Systems Group  
Seal Beach, CA  
213 - 594 - 1787

Jack Young, Manager  
Genentech, Inc.  
Office Systems  
South San Francisco, CA 94080  
415 - 952 - 1000

Colorado:

Star James, Supervisor  
U. S. Postal Service  
Management Information Systems  
Denver, CO 80202-9995  
303 - 837 - 3822

Carol Christie, Management Analyst  
U. S. Bureau of Reclamation  
Office of Administrative Systems  
Denver, CO 80225  
303 - 234 - 5195

Richard Quinlan, Senior Systems Engineer  
Rockwell International Corporation  
Energy Systems Group  
Golden, CO 80401  
303 - 497 - 4731

Harry Johns  
Rockwell International  
Golden, CO 80401  
303 - 497 - 2559

Connecticut:

Thomas F. Pepin  
Pfizer Connecticut Data Center  
Systems Support  
Groton, CT 06340  
203 - 441 - 4880

Peter Surovov, Member of Technical Staff  
ITT  
Advanced Technology Center  
Shelton, CT 06484  
203 - 929 - 7341 (ext. 180)

Robert W. Tuttle, Senior Tools Improvement Specialist  
ITT  
Programming  
Stratford, CT 06497  
203 - 375 - 0200

ALL-IN-1 Working Group

Member Listing

D.C.:

Bill Mountjoy  
Public Broadcasting Service  
Washington, DC 20024  
202 - 488 - 5097

Carl F. Para  
Office of Evaluation & Research OP:C:E  
Internal Revenue Service  
Washington, DC 20224

Earl Screven  
Veterans' Administration  
Washington, DC 20420  
202 - 389 - 2305

Richard McKay  
Veterans' Administration  
Washington, DC 20420

Delaware:

Robert L. Welsh, President  
Office Control, Inc.  
Wilmington, DE 19807  
302 - 654 - 2778

Florida:

Michael A. Seay, Telecommunications Engineer  
National Aeronautics and Space Administration  
Video Systems Branch  
Kennedy Space Center, FL 32899  
305 - 867 - 3180

Georgia:

Jim Young  
Lockheed - Georgia Company  
Smyrna, GA 30080  
404 - 425 - 6934

Iowa:

Newton J. Munsar  
Grinnell College  
Grinnell, IA 50112  
515 - 236 - 2570

Illinois:

J. E. Matthews, Manager  
Illinois Bell  
Minicomputer Systems  
Chicago, IL 60606  
312 - 930 - 3660

ALL-IN-1 Working Group

Member Listing

Illinois: (continued)

Cristopher R. Feenstra, Manager  
Bally Manufacturing Corporation  
Technical Support  
Chicago, IL 60631  
312 - 399 - 1300

Indiana:

James T. Welborne, CDP, Data Processing Manager  
Crowe, Chizek and Company  
South Bend, IN 46601  
219 - 232 - 3992

Kansas:

Scott Kailer, Manager  
The Federal Land Bank of Wichita  
Systems and Programming  
Wichita, KS 67202  
316 - 264 - 5371

Kentucky:

Sam Beazly, Manager  
Federal Land Bank of Louisville  
Information Services  
Louisville, KY 40202  
502 - 566 - 7165

Mary Grinnan  
Federal Land Bank of Louisville  
Louisville, KY 40232  
502 - 566 - 7835

Massachusetts:

C. Barnett  
Farm Credit Banks  
Agawam, MA  
413 - 786 - 7600

Robert J. Peterson, Systems Programming Analyst  
The Gillette Company  
Management Information Systems  
Boston, MA 02106  
617 - 463 - 2067

Paul N. Neilson, Technical Manager  
Fidelity Systems  
Boston, MA 02109  
617 - 726 - 9368

Ray Konisky  
Teradyne, Inc  
Boston, MA 02110

ALL-IN-1 Working Group

Member Listing

**Massachusetts:** (continued)

Stephen P. Burke, MIS Manager  
Teradyne, Inc.  
Customer Service Division  
Boston, MA 02111  
617 - 482 - 2700 (ext. 2380)

Linda Le Beau, Timesharing Analyst  
The Gillette Company  
Management Information Systems  
Boston, MA 02199  
617 - 421 - 7234

Richard Petroff, Manager Data Communications  
Boston College  
Department of Computer Services  
Chestnut Hill, MA 02167  
617 - 552 - 8506

Mitch Brown, Associate Development Engineer  
GenRad, Inc.  
Production Test Division  
Concord, MA 01742  
617 - 369 - 4400 (ext. 2010)

John R. Wolfe, Senior Engineer  
General Electric Company  
Medium Steam Turbine Department  
Lynn, MA 01910  
617 - 594 - 3180

**Michigan:**

Lilian Siak  
General Motors - Industrial Relations  
Detroit, MI 48202  
313 - 556 - 3475

Dan W. Prevost  
Cadillac Motor Car  
Detroit, MI 48232  
313 - 554 - 7592

Arvid Martin, Manager, Computer & Information Systems  
GMF Robotics  
Research & Development  
Troy, MI 48098  
313 - 641 - 4133

Neal Strand, Sr. Project Engineer  
General Motors  
Manufacturing Engineering and Development  
Warren, MI 48090-9040  
313 - 575 - 0782



ALL-IN-1 Working Group

Member Listing

**Michigan:** (continued)

Mary L. Marvel-Nelson,  
G. M. Research Labs  
Warren, MI 48090  
313 - 575 - 3219

**Minnesota:**

Barbara Young  
Farm Credit Services  
St. Paul, MN 55121  
612 - 221 - 4827

Earl C. Robinson, Advanced Software Analyst  
Timesharing Services/3M  
St. Paul, MN 55144  
612 - 733 - 3892

**Missouri:**

Thomas E. DeLoyht  
Panhandle Eastern PipeLine Co.  
Kansas City, MO 64141  
816 - 968 - 2905

Jeffrey A. Fox, Programmer Analyst, System Manager  
The Federal Land Bank of St. Louis  
St. Louis, MO 63103  
314 - 342 - 3870

**North Carolina:**

B. C. Lipe  
R. J. Reynolds Industries  
Winston-Salem, NC 27102

**New Hampshire:**

Gilbert S. Fair, Technical Support Manager  
Digital Equipment Corporation  
Office & Information Systems Marketing  
Merrimack, NH 03054  
603 - 884 - 4666

Barbara Liberty  
Digital Equipment Corporation  
Office & Information Systems Marketing  
Merrimack, NH 03054

Gerald J. Croteau, Jr., MIS Systems Manager  
Digital Equipment Corporation  
Commercial OEM  
Merrimack, NH 03054  
603 - 884 - 7162

ALL-IN-1 Working Group

Member Listing

New Jersey:

Terrance L. Stowers, Scientific & Mathematical Services  
Johnson & Johnson  
Management Information Center  
Raritan, NJ 08869  
201 - 524 - 1859

New Mexico:

John G. Miner  
Signetics, Corp  
Albuquerque, NM  
505 - 822 - 7205

Robert K. Umstead  
Computer Technology Associates, Inc.  
Albuquerque, NM 87101  
505 - 242 - 4438

Mike Robles, Supervisor  
Sandia National Laboratories  
Computer Operations  
Division 2631  
Albuquerque, NM 87185  
505 - 844 - 5905

Kim Patterson, Programmer  
New Mexico Junior College  
Hobbs, NM 88240  
505 - 392 - 4510 (ext. 286)

Jim VanHecke  
Los Alamos National Labs  
Los Alamos, NM 87545  
505 - 667 - 4696

Dale Land  
Los Alamos National Labs  
Los Alamos, NM 87545

Nancy Werner  
Los Alamos National Labs  
Los Alamos, NM 87545

Ron Krantz  
Los Alamos National Labs  
Los Alamos, NM 87545

Elise Lee  
Los Alamos National Labs  
Los Alamos, NM 87545

ALL-IN-1 Working Group

Member Listing

Nevada:

Mary Christine Thompson, Word Processing & Forms Management  
Reynolds Electrical & Engineering Co., Inc.  
Las Vegas, NV 89114  
702 - 734 - 3419

New York:

Charles Grotticelli  
Republic National Bank  
New York, NY  
212 - 930 - 6299

Indira Singh  
c/o Bankers Trust  
New York, NY 10015  
212 - 775 - 6634

Louis S. Galterio, Systems Officer  
Bankers Trust Company  
New York, NY 10015  
212 - 775 - 2002

Jeffrey P. Davis, Senior Consultant  
Manufacturers Hanover Leasing Corporation  
Management Information Systems Department  
New York, NY 10017  
212 - 286 - 6985

Karen Friedman  
MHLC  
New York, NY 10017  
212 - 286 - 6907

Lynn-Marie Miehle, Director of Office Automation  
Republic National Bank  
New York, NY 10038  
212 - 930 - 6155

John Bullivant, Manager  
Citicorp International Communications, Inc.  
New York, NY 10043  
212 - 558 - 0814

Bill Knightly  
General Electric  
Schenectady, NY 12345  
518 - 383 - 4988

David Bowers  
AMF, Inc.  
White Plains, NY 10604  
914 - 694 - 2884

ALL-IN-1 Working Group

Member Listing

Ohio:

Valerie Fleming  
Delco Products Division of GM  
Dayton, OH 45401  
513 - 258 - 7875

Frank Hatten  
Goodyear Atomic Corp.  
Piketon, OH 45661  
614 - 289 - 2331 (ext. 5237)

Mark D. Mulias, Manager  
Libbey-Owens-Ford Company  
Automated Office Systems Development  
Toledo, OH 43695  
419 - 247 - 4758

Leon Martin  
U. S. Air Force  
Wright-Patterson AFB, OH 45433  
513 - 255 - 6109

Chris R. Gunning, Lieutenant, USAF  
Computer Systems Development Officer  
U. S. Air Force  
Wright-Patterson AFB, OH 45433  
513 - 255 - 6224

Oregon:

Robert Nesbitt  
Consolidated Freightways  
Portland, OR 97208  
503 - 226 - 4692

Pennsylvania:

Roger C. Devonald  
General Electric Space Systems Division  
Philadelphia, PA 19101

Micheal L. Harper, Senior Systems Analyst  
Aluminum Company of America  
Process Computer Systems  
Pittsburgh, PA 15219  
412 - 553 - 4828

Mark Miller  
Penn. State University  
University Park, PA 16802  
814 - 865 - 1379

Thomas E. Tracy  
Penn. State University  
University Park, PA 16802  
814 - 863 - 0327

ALL-IN-1 Working Group

Member Listing

**Tennessee:**

Dennis M. McCloud  
Oak Ridge National Laboratory  
Oak Ridge, TN 37830

**Texas:**

Ben Brandt, Supervisor  
U. S. Postal Service  
Management Information Systems  
Houston, TX 77210 - 9995  
713 - 226 - 3625

Susan L. Jackson, Programmer III  
USAA  
User Information Center  
San Antonio, TX 78288  
512 - 690 - 2585

**Utah:**

Errol Bartholomew, Regional Data Processing Officer  
U. S. Bureau of Reclamation  
Upper Colorado Region  
Salt Lake City, UT 84147  
801 - 524 - 5595

**Virginia:**

Thomas J. Orlowski, Lieutenant Colonel  
HQ Department of Army  
Chief Information Systems  
Alexandria, VA  
325 - 6161

Thomas B. Mattson, Director  
Center for Naval Analyses  
Computing Services  
Alexandria, VA 22311  
703 - 998 - 3852

James D. Parsells  
CNA  
Alexandria, VA 22311

**Washington:**

Keith Bechard  
Puget Power  
Bellevue, WA 98009  
206 - 451 - 3106

**Wisconsin:**

Joyce Nelson  
Wisconsin Telephone Company  
Milwaukee, WI 53208  
414 - 678 - 3205

# FEATURED ARTICLES ....

## PERSONAL COMPUTERS AS OFFICE NETWORK WORKSTATIONS

R. Rembert Aranda  
Digital Equipment Corporation  
Merrimack, NH

### ABSTRACT

Personal computing is a key element of a sound office automation strategy. Personal Computers are the long-sought office multi-function workstation. Personal Computers generally have lower total costs as office workstations than "dumb" terminals. Hence PC's foster rapid movement towards the important Office Automation goal of a workstation on every office desk.

There are already more personal computers on office desks than either DP terminals or word processors. In fact, the number of personal computers running word processing software already exceeds (and is growing more rapidly than) the number of word processors. It is clear that most office workstations will be personal computers and their technological descendants.

The explosively growing number of PC's is generating an immense latent demand for host/network services which internal DP/MIS organizations are well placed to meet. The host-based services most urgently needed by PC users are Electronic Mail, Data Base Access/manipulation, and Electronic Filing Systems. The role of external services in Office Systems, and the role of Videotex are also discussed.

Most of the functionality required by office workers can and ought to be delivered by PC's. However, connecting the PC to a host or network is a key requirement in office environments. It is a clear trend that office workers find it desirable and convenient to increasingly use their PC's as "intelligent terminals" to hosts and networks.

PC's are a fundamentally different type of computer resource than minis or mainframes. The paper contrasts the type of functionality and software best delivered by PC's with that best delivered by hosts/networks. A model for relating both types is presented, called the Application Space Model. The types of software widely used by personal computers are described, particularly communication software.

### INTRODUCTION

The long-sought multi-function office workstation has arrived, disguised as the personal computer. Personal computing is the most important single force driving office automation. The role of personal computers in office automation (OA) is ill-understood primarily because personal computers have created revolutionary new opportunities and a new computing culture beyond the original (now aged) vision of many DP and OA plans.

The time has come to end the undeclared PC Office War. For the past four years, this undeclared war has been waged in corporate environments between DP/MIS "establishment" forces and PC "revolutionaries". The War is about the redistribution of computing wealth. This is one war in which both sides can be victorious if an armistice is negotiated.

Personal computers are potentially the best thing that ever happened for DP. They offer a means of dramatically improving the return on DP expenditures, and relief from the applications backlog. However, realizing that potential requires that DP/MIS managements significantly redefine their role, and take an active part in encouraging and supporting wide deployment of PC's. This new DP role needs to be oriented to support rather than to control.

During the early years of the Personal Computing Era (1975-1983), DP/MIS and OA managements tended to view the personal computer alternatively as toy or threat, and erected barriers to their widespread deployment. Legions of maverick PC revolutionaries met these barriers by guerrilla warfare including the "creative purchase order". The Creative PO is a surreptitious device that ushers PC's into the organization as "typewriters", "calculators", and "laboratory instruments" among others.

Despite the barriers and prohibitions imposed by much of the computing establishment, there are already more personal computers on office desks than either DP terminals or word processors. And the rate of growth in shipments is substantially larger for PC's than for DP terminals or word processors. For most office workers, personal computers will be the hands-on introduction to office automation.

It is most unlikely that PC's will take over the functions now performed by DP host systems. But it is likely that most of the functionality to be made available to new computer system users over the next five years will be provided by desk-top computing. A significant part of such functionality will be provided by PC's acting as "intelligent terminals" to shared hosts and advanced networks.

Most popular personal computers can serve as terminals to hosts and networks. However, in part because of the cultural rift between DP and PC users, most PC's today are used as stand-alone machines. About a third of office PC's, however, use communication linkages to hosts and networks.

It is a clear trend that office workers find it desirable and convenient to increasingly use their PC's as "intelligent terminals" to hosts and networks. Communication services and data base access are foremost among the needs that make connection to other systems attractive for PC users.

#### PC INSTALLED BASE: CURRENT & FORECAST

About 2 million personal computers have been purchased by US businesses. The overwhelming majority of these are used to handle office work. The United States accounts for about 70% of the PC market, and is likely to remain so for the next five years.

By the end of 1983 the total installed base of personal computers in US offices is estimated to reach about 3 million units. Within five years that installed base will have grown beyond the 10 million mark. The number of office workers in the US is about 40 million. About 40% of US office workers are employed by Fortune 1300 organizations. Over the next five years the number of office workers will grow only modestly, but office worker compensation will grow substantially both in absolute terms and as a proportion of total US salaries.

Fortune 1000 companies are purchasing personal computers in substantial quantities. The installed base of personal computers in Fortune 1000 firms will be about one million units by the end of 1983, and will exceed 5 million units within five years.

Some proportion of the personal computers purchased by US businesses are actually used by office workers at home. In addition more than a half million PC's have been purchased by US households. By the end of 1983, that installed base can be expected to approach 2 million units. Over the next five years this number will have grown beyond 5 million units. The majority of household personal computers will be purchased by office workers and their families, and will be used for office work to a significant extent.

There are already more PC's running word processing software than there are word processors. This fact is

especially interesting because the PC's running word processing are almost exclusively used by managers and professionals rather than secretaries. This is a prime example of the revolutionary power of the PC. Unobtrusively, in less than three years the PC has redefined word processing from a clerical task to a predominantly professional/managerial task.

From the forecast personal computer growth, it is clear that most office workstations will be personal computers and their technological descendants. DP and OA managements urgently need to revise their view of the personal computer from Toy/Threat to Tool, and recognize that the end of the "dumb" terminal and shared logic word processor dominance era is at hand.

#### PERSONAL COMPUTERS: A FUNDAMENTALLY DIFFERENT COMPUTING RESOURCE

The first step to meaningfully defining an office systems role for personal computers is to understand that PC's are different from older shared DP computers in ways more fundamental than scale. That is recognizing that a PC is not just a "little" computer; it's best not to think of it as a computer at all!

It would strike most of us as absurd to define cars as underpowered, low capacity trucks. Though both are motor vehicles, we all know that cars are used for purposes not suitably or economically handled by trucks. And we all know that it is most infrequently that the average motorist finds his car limited and needs a truck instead.

Similarly, to regard PC's as computers because they have the same conceptual system components (CPU, primary storage, disk drives, etc.), turns experience into liability causing us to think of them as "little" or "toy" versions of mainframes and minis. That view prevents a meaningful understanding of their role in the office.

PC's have radically altered the economics of computing, making feasible all sorts of applications which are not economically or conveniently carried out on a shared host. Spreadsheets, Word Processing, and Graphics are convenient examples. This radical change has invalidated much of what is regarded as orthodox wisdom about computer usage and economics.

At the core of a PC's attractiveness is that it provides a user-centered, highly flexible computing environment. The personal computer delivers computing power on the user's terms, without requiring the user to give up autonomy or incur dependence on the overburdened DP department to get his work done. Be its power ever so humble, a PC is a computer the user can call his own.

It is obviously true that personal computers have much less processor power, memory, and storage than mainframes and minis. But all of their resources are available to one person. That means no overhead for the software that administers sharing of one processor, and effectively better response times for many office applications (Reference 1).

At the workstation, the key assessment of a computer's power is not absolute processor power (say in MIPS) but rather processor power minus overhead

divided by the number of users. Sheer response time within an application is for many users the most important measure of a computer's power.

From the user's point of view the power offered by a PC is quite comparable to that delivered by a powerful shared host through a dumb terminal. Indeed, in many cases it is superior. Moreover, unlike traditional timesharing environments, the power delivered by a PC is constant independent of other users' activity. Such constancy is a high value to users.

The user-tailorability of a PC is formidable, wholly beyond what would be possible with a shared computer whose functionality represents a design compromise trading-off the needs of several users. The lead time required to implement a PC application is much shorter than for DP systems, on the order of days or weeks. This enhances user-tailorability by making it not only easy but also fast to change or add to PC functionality.

To press the analogy to automobiles a bit further, a truck is so expensive to own and operate that "idleness" is an enemy to be avoided by scheduling in advance and keeping it rolling. In a car, on the other hand, "idleness" is a fine and valuable thing we call "availability"-- allowing immediate access at the user's whim for whatever purpose he desires. Likewise for computers.

Since the PC is idle (i.e. available) most of the time and PC software is relatively inexpensive, the marginal cost of computing is negligible. This means that new applications can evolve far more easily than in a traditional DP environment where the marginal costs of computing are so high that detailed cost/benefit studies and high level approvals precede the lengthy process of software design and development.

#### END-USER DEVELOPED APPLICATIONS

If the multi-function office PC has one purpose, it is to serve as an Applications Development Machine for non-programmers. The most successful software packages for PC's are not really "applications" at all, but rather "tools" for users to develop their own applications- in lieu of conventional programming.

The user who replaces a stack of paper with PC spreadsheets, and thus a manual process with a computerized process has developed an application. This "application" does not fit our notions of applications development, and compared with procedural language programming environments there are many restrictions. Nonetheless, a user-developed application it is, and much quicker and cheaper than more traditional applications development.

James Martin (Reference 2) has described the crisis confronting DP as a question of coming to grips with end-user computing, and more widely implementing "Applications Development Without Programmers". Martin reports that many of the the requests in the Applications backlog (now running 2-8 years in many large organizations) can be handled by end-user computing tools such as DBMS query languages.

Similarly, (as is argued in Reference 1) PC's can be used to handle many of the requests in the "invisible backlog"-- those unmet application needs that aren't even submitted for DP review. Most of these applications are not good candidates for traditional DP solutions: one shot problems, rush jobs, and small scale, low-payoff problems. Many office applications fall into this category.

The software for personal computers is fundamentally different from that for shared multi-user hosts, as summarized in Table 1, below.

Table 1: A COMPARISON OF TRADITIONAL AND PC SOFTWARE PRODUCTS

	Mainframes & Minis	Personal Computers
Price	high, \$10Ks	low, \$100s
Purchased by	central buyer (DP)	end-user
Distribution channel	direct sales	retail/mail order
Justification level	dept./corp.	individual user
Pay-back period	5-10 years	.5 - 1.0 years
Program size	medium/large	small
Program character	application	tool
Program functionality	wide	narrow
Training requirements	weeks	hours/days
Documentation	paper manuals	on-line
Lead time to use	months/years	days/weeks
Built by	programmers	programmers/users
Modified by	programmers	users
Modification time	slow	fast
Response time	variable	constant
Competitive offerings	few	many
Graphics and color	rare	common
Operating system	h/ware vendor	3rd party/commodity
Number of installations	.1Ks-1Ks	10Ks-100Ks

PC software provides a hierarchical structure for user application development. Software packages like spreadsheets and modelling packages, for example, run by using a combination of base software and "templates". These templates can be created by non-programmers not able or willing to write base software. In turn, the combination of base product plus user-defined templates can be used by a large number of users who are not able or willing to create their own templates (at least initially).

One of the most interesting (and largely unobserved) characteristics of applications software is that of "learning system". That is, the experience of interacting with an on-line system is a learning experience, causing the user to modify his notions about the task being carried out, and the role the computer system should play. The vexed application developer too often perceives this learning as an expression of the "fickle" end-user's avoidable change of heart about requirements. That's too bad, because if we could incorporate such learning into software it would increase its value and usefulness.

PC software aids in seizing the opportunities created by this learning system character in two ways. First the software often allows the user to modify the display and content, quickly. Second, the software is so inexpensive that when the user's view of requirements changes he can afford to throw the package away and get another that more closely fills his evolving requirements.



The use of PC software products as prototypes to develop application requirements yields better, faster, and less expensive results than traditional requirements specification methods.

#### PERSONAL COMPUTER SOFTWARE

Table 2 lists the most widely implemented types of software for office personal computers. The electronic spreadsheet (e.g. Visicalc) is the best known of these. Word processing and data management packages are also frequently found in the office PC user's portfolio. Some survey data (e.g. Reference 3) suggest that the number of PC Word Processing installations is actually larger than the number of PC spreadsheet applications.

Software sales drive the personal computer market. Annual sales of PC software are now at the \$1 Billion level, and will grow to about \$11 billion within five years. Over the period of 1983-1988, US sales will account for about 70% of total PC software sales.

Currently, the average value of the PC user's software portfolio is about \$1,000. "Bootlegging" or pirating of PC software is so common that many packages are estimated to have two to three "pirate" users for every legitimate user. Therefore counts of PC software sales may substantially underestimate the rate of penetration. The size of the average PC user software portfolio will grow significantly over the next two years, in value and number of packages. Inexpensive winchester disks and higher density floppies will promote such portfolio growth.

The last five PC software types listed in Table 2 are not as widely implemented as the first three, but are rapidly gaining in popularity. The last type listed, "User Shells/Integrated Application Environments", exists in two major varieties. The first is "bundled" packages (e.g. Lotus 1-2-3, Context MBA, Visi-On) which incorporate spreadsheet, WP, graphics and sometimes other functionality. The second are packages that allow users to assemble their own integrated system using software packages of his choice. Examples of the latter include Supervyz, Organizr, DesQ, and private videotex packages that allow the PC to act as a single user videotex host.

Table 2: Types of PC Office Software

-----  
 Most Widely Implemented  
 -----

- \*Word Processing
- \*Spreadsheet/Modelling Packages
- \*Data Management
  
- \*Communications/terminal emulation
- \*Graphics Utilities
- \*Vertical (Specialized) Applications
- \*Report/Applications Generators
  
- \*User "Shells"/Integrated Application Environments

Data management packages and personal word processors, are widely used as applications development tools for non-programmers. The data management packages (some of which are honest to goodness DBMS) allow users to define input forms, search/retrieve logic, and report formats. Some PC DBMS packages now have available Application

Generators which allow users to non-procedurally define an application and have the machine generate high-level source code. Even the PC word processor gets used to build applications. The list management modules of WP systems are routinely used to implement crude transaction processing systems; inelegant by DP standards, but attractive to PC users who value speed of implementation and self-reliance.

The wide implementation of data management packages on PC's has readied many end-users for appreciating DBMS packages and DBMS tools (such as query languages) available on minicomputers and mainframes. A similar trend has developed with graphics and color graphics utilities. The widespread use of these tools on PC's has sensitized many users to the value of these capabilities, making what we've traditionally thought of as specialized functionality into a common, standard requirement.

#### PC COMMUNICATIONS SOFTWARE

The proportion of PC's connected to hosts and networks has been increasing steadily over the past three years. About 20%-30% of office PC's are now connected to one or more hosts, directly or with modems.

There is a strong trend towards multi-host use. The "hosts" that PC's may communicate with include other PC's, shared multi-user hosts, and Local Area Network servers.

Personal computer access to hosts and networks typically makes use of communications software such as Z-Term, DECmate CX/DX, Transend, and Poly-TRM. Such software runs on the PC, manipulating the communications port and modems to provide function such as:

- \*"dumb terminal" emulation
- \*uploading of PC local files to the host
- \*downloading host data to local PC files
- \*transmission of files created under different O/S
- \*file compression/decompression for efficient document transmission
- \*error checking/handling routines
- \*menu selection of frequently dialed telephone numbers
- \*automatically dialling host telephone number, with repeated redialling if busy or no answer
- \*definition of PC function keys as "macros", allowing repetitive multiple key sequences to be sent with one keystroke
- \*automatically executing host log-on and log-off sequences
- \*unattended host access and file up/download operations

#### THE ROLE OF PERSONAL COMPUTERS IN OFFICE SYSTEMS

PC's augment rather than compete with DP in providing computer-based services to office workers. It is no more typical for PC's to be used for replacing DP applications than it was for minis to take over mainframe applications. Rather- analogously to the relationship between minis and mainframes- PC's typically serve new users and new uses, which were not previously feasible on economic, technical, or administrative grounds. Judiciously deployed, they can help meet the critical goal of realizing a better return on DP expenditures.

In defining a role for personal computers in advanced office systems, we must consider both the PC's strengths and weaknesses, and to deploy host/network services as a means to augment PC capability and overcome its limitations. In other words, DP host and network services need to be positioned as the logical extension of the functionality delivered by PC's rather than as alternatives to personal computing. In that context, we can describe DP multi-user hosts and networks as "Foundation Systems" supporting PC workstations.

Table 3 summarizes PC strengths and weaknesses. Table 4 summarizes the strengths and weaknesses of Foundation Systems. A conceptual framework for coupling these two fundamentally different types of computing resources follows.

#### THE NEED FOR PC COMMUNICATION LINKAGES

While the merits of PC's as stand-alone machines are becoming relatively well known, it is less frequently observed that although the typical PC user buys a stand-alone machine, most users quickly (6 to 18 months) come to desire functionality that requires connecting the PC to other PC's or to timesharing hosts as an intelligent terminal. There is a synergy between the growth of communication services and the PC installed base. As each grows, it provides a spur for the growth of the other.

Table 3: PC Strengths and Weaknesses

##### STRENGTHS

- +Full control by user over functionality and availability
- +Low cost hardware, low marginal cost of computing
- +Software inexpensive enough, and pay-back period short enough to justify use as "throw-away" prototype
- +Faster response time for many applications than shared hosts
- +Constant processing power, independent of other users' activity
- +Common availability of color and graphics displays
- +Lighter requirements for environment characteristics and hardware maintenance (e.g. temperature, humidity, dust)
- +Very short lead time to implementation

##### WEAKNESSES

- End user must assume system management burden (e.g. media backup)
- Limits on the size of files that can be stored or used
- Limits on the size of application programs that may be executed
- Processor-bound applications may exceed hardware capabilities
- Decentralized data stores may result in multiple, inconsistent data files with attendant data management problems
- Limited software support, though less support is needed
- Software protection mechanisms employed, and other factors may severely limit ability to modify and tailor software, or to share data files among multiple applications

The host-based services most urgently needed by PC users are Electronic Mail, Data Base access, and Electronic Files. Electronic File systems (such as BASIS) allow filing, searching, and retrieval to be automated. This is especially important in view of the rapidly increasing number of documents which have to be handled by office workers.

Electronic-Mail is the host-based service most needed by PC users at present. Albert Crawford (Reference 4) has described the benefits and challenges of implementing large scale Electronic Mail systems, documented as part of the pioneering work of Digital Equipment Corporation. A finding of particular interest is that most electronic mail users access the system hands-on rather than through secretaries or other intermediaries.

Office workers are "team players", devoting 40% to 60% of their typical work day to communications activities. Usually, documents or calculations prepared by office workers are sent to at least one other person. And most documents and data processed by office workers incorporate information earlier processed by their colleagues.

Today this recycling and reprocessing of office information is usually handled by printing hard copy, reproduction, manual filing/searching, and re-keying. PC's linked directly or through a shared host provide

Table 4: Shared Host Strengths and Weaknesses

##### STRENGTHS

- +Implicitly a communications medium or broadcasting facility
- +Very large files can be stored and used by applications; shared file access is easily implemented and administered including access to corporate and departmental DP files
- +Easily implemented shared use of costly peripherals
- +(if networked host) Gateway access to multiple systems
- +Facilitates central control over data and software, strengthening Information Resource Management and auditing
- +Easy use from remote sites with a wide range of "terminals"
- +High productivity software development tools, including high performance non-procedural languages and DBMS
- +Large, stable vendors offering strong, extensive support

##### WEAKNESSES

- Little end-user control functionality and availability
- High hardware/software acquisition and operation costs
- Large software expense imposes life expectancy based on payback period rather than user requirements
- Variable response time/processing power dependent on number and types of other users
- Expensive requirements for environmental control
- Long lead time to operational application
- Difficult to use software requiring extensive user training
- Generally limited to monochrome, text only displays

a faster, easier, and cheaper way. For this reason, it is a key requirement that the PC deployed allow users to exchange as well as to prepare documents.

Communication capabilities on office PC's are important because they allow users to electronically exchange documents, data, and software with co-workers. Such electronic transport takes place at the speed of light, in contrast with the expensive, snail-paced paper workflow in the typical office. Electronic transport also reduces the amount of re-keying, by delivering documents in machine readable form, ready for subsequent processing.

Most (about 75%) of the computer functionality now required by office workers can and ought to be delivered by PC's. But the importance of the 25% balance (delivered by communications with hosts/networks) is far greater than its numerical share suggests. It is, in fact, essential.

Host and network services provide the communications "glue" that improves the efficiency and effectiveness with which a work group can complete tasks that require cooperation and data sharing. A PC user may spend one hour manipulating spreadsheet data, and using a personal word processor to fold the data into a memo, and might then consume only 30 seconds of host connect time uploading the memo to the host that he uses for electronic mail. Though a very small proportion of the total time, the short host connect typically saves recipients four days of waiting, ultimately reflected in the time to complete the total task.

#### ON-LINE DATA BANKS AND EXTERNAL SERVICES

Successfully coupling PC's to hosts and networks requires a re-orientation of the DP/MIS function, from one of control to service/support. Successful DP/MIS organizations will reposition themselves as "Information Utilities" providing PC users advanced computation and communication services.

The timesharing bureaus have on the whole found it easier to recognize and to gear up for seizing this opportunity than have corporate and departmental DP organizations. They will provide vigorous competition to internal DP organizations that do not reposition themselves to meet the latent demand for "information utilities" created by the growth in the PC base.

Coupling to multi-user hosts and networks allows PC users access to existing data stored on corporate and departmental DP hosts. Such access might allow many of the DP applications now geared to periodic large report generation to be re-oriented to on-demand query processing. This would reduce the cost and workload of DP centers, and the amount of incoming paper to be processed by office workers.

In addition to internal DP host connection, an increasing number of PC's are used to access the rapidly growing number of "On-line Data Banks" and "Information Utilities" such as Dow-Jones, CompuServe, Delphi, The Source, Westlaw, LEXIS/NEXIS, and public Videotex services such as Prestel.

The annual sales volume of such on-line services and Value-Added Networks is forecast to exceed \$13 billion by 1990. Communication services (e.g. electronic mail, bulletin boards, and text

conferencing) are the service category of greatest use for current information utilities such as CompuServe and The Source.

External host/network services allow office workers to obtain and send information outside of their organizations nearly as easily as they can within them. This is a key benefit of advanced office systems sometimes underestimated by Local Area Network advocates. Wide Area Networks and Value-Added Networks are of at least equal value to Local area Networks in advanced office systems.

Most electronic mail implementations at present are tackled at the departmental or corporate level. This leaves unsatisfied the need to communicate with individuals not on the mail system. It is desirable that corporate electronic mail systems include customers and suppliers as well as employees. Users can now send mail electronically to correspondents not on their internal systems by using public electronic mail systems such as Telemail, Western Union Mailgrams and USPS E-COM. In Europe relevant PC communication interfaces include Telex and Teletex.

#### APPLICATION SPACE

Technologically-oriented personnel tend to think of PC functionality in hardware terms. By contrast, end-users tend to think of PC functionality in terms of the applications software base available for a given machine. It is necessary to bridge this gap, because the PC market will in all likelihood continue to be software driven.

The author has developed a model for describing user views of Workstation functionality, and the ways users typically evolve in their usage of office system functions. This model, "Application Space" is illustrated in Figure 1.

The Application Space model is a matrix or plane that contains all of the software that exists. The whole of Application Space can be seen as a collection of "power tools" to replace traditional labor-intensive office tools such as paper & pencil. A key property of these power tools is that they operate on "digital" or "electronic" pages rather than paper. Unlike traditional DP applications, PC power tools can typically be used as substitutes for manual tools without having to change workflow or procedures.

FIGURE 1: APPLICATION SPACE

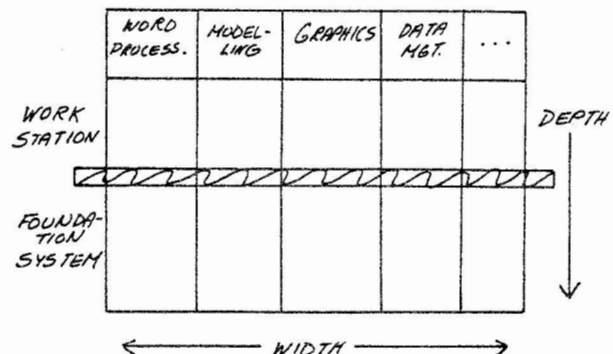

A given PC allows the user a window into this space. The dimensions of the window vary depending on the PC under consideration. To bring some order to the enormous number of items listed on the Applications Space plane, we need some structure.

The first step in structuring Application Space is to divide the plane into columns, each corresponding to an applications category (e.g. those listed in Table 2). We can simply define the "width" of Application Space to be the number of columns.

The second step towards structure is to make entries (names of software products) within each column in such a manner that the lower the entry is made, the more "depth" that is associated with the software item. Depth is synonymous with some good things like computing power, functional richness, and size of files that can be handled. Depth is also synonymous with some not-so-good things like complexity, cost, and longer lead times to implementation.

Both the depth and width of the Application Space window available from a given PC vary significantly for currently available personal computers, and are usually unbalanced. That is, most personal computers are easily characterized as "depth" OR "width" machines.

The width of the window provided by a given PC is important, because it is a measure of how feasible it is to use the machine to explore/experiment and use the machine for applications unintended at the time of original purchase. Depth is important because it is the limit of the power and richness available to users.

The amount of depth required by users is usually a function of experience. Initial requirements are shallow, and width is a more important consideration. But as experience builds, a hunger for depth develops for the most frequently used applications. PC's that can be easily coupled to hosts allow additional depth to be provided by establishing communications with shared hosts and advanced networks. The total number of entries in the window of a particular machine-Variety- is important because it is a measure of the ability to suit individual preferences.

It is desirable to divide Application Space into two sectors: (1) applications locally executed on the PC; and, (2) applications resident on shared multi-user hosts accessible to the PC when it acts as a "dumb" or "intelligent" terminal. In this context, host systems employed are usefully seen as "Foundation Systems" providing support to PC's that augment PC capability by providing extra depth, and a communications medium for PC's to exchange documents, data, and software.

The Workstation and Foundation System sectors of Application Space have fundamentally different characteristics particularly with regard to: price, payback period, length of lead time to implementation, and support/training requirements. These differences are summarized in Tables 1,3 and 4.

#### APPLICATION PATHWAYS

The experience of office workers in using PC's and Foundation Systems can be thought of as "pathways"

through Application Space. Each software product used is a point or step in the pathway.

The ease with which a user can carve his own pathway is a critical factor in the success of OA implementation. To a large extent, this is a function of the amount and variety of products available in the window for a particular machine. The amount of software in the Workstation sector is much greater and more varied than in the Foundation System sector.

It is important that the user be able to take the path most convenient and comfortable for him. A regimented pathway may be necessary in the Foundation System sector, but not in the Workstation sector. This is a value to be exploited.

It is difficult, if not impossible, to pre-determine the pathway to be taken by an user. Even when we retrospectively chart the path for an user we can not reliably expect that other users will choose the same pathway. Therefore the appropriate emphasis for OA functionality planning is not the detailed definition of projected pathways, but rather defining the dimensions (depth and width) of the window required to support particular classes of users.

#### TEAM SOFTWARE

Thus far, we have described Application Space as divided into two sectors, and at present, software runs on either a Workstation or a Foundation System. A third sector, occupying the middle area of Application Space, contains software that runs on both simultaneously. Such software allows the PC and the Foundation System to act as a team, economically delivering a tremendous amount of computing function and power.

Over the next two years, this new class of software, "Team Software" will become prevalent. Team Software packages will feature communication between simultaneously running programs on hosts and PC's at the task-to-task level, without human intervention. Team Software will use programming code considerably more sophisticated than that of early PC software products. And Team Software will incorporate the types of communications software later described in this paper.

The most common initial use of Team Software is likely to be the provision of wider access to departmental and corporate DP files, and "civilizing" interfaces to pre-existing, poorly human factored host-based software. Applications benefitting from unattended operation will also be strong candidates. Third-party Software Houses are particularly well placed to exploit the Team Software opportunities, by buying or making agreements with third-party PC software developers and publishers.

Another early implementation area for Team Software will be systems that accept PC text and graphics files, and convert them to presentation quality, for example, typeset documents and image enhanced color transparencies.

When PC's are connected to Foundation Systems over moderate bandwidth ("9.6Kbaud) or high bandwidth lines, Team Software may be used to implement Electronic Distribution of PC software. In this area, the value-added of Team Software includes

sophisticated error checking and handling techniques. Electronic distribution has many advantages over current methods.

The Team Software approach can also be used to link software running on an all-PC computer team. Multi-PC Team Software will be of particular relevance in Local Area Network server architectures.

Widespread use of Team Software would in all likelihood have a significant impact on operating system choice and development. Short term, it might give a boost to relatively portable operating systems running on both PC's and hosts, such as RSX, Unix, and UCSD-p. Long term, however, a new generation of operating systems geared to supporting Team Software may evolve.

#### STANDARDS

In some ways, the proliferation of PC's has impaired the standard setting and enforcing responsibilities of DP organizations. This is especially true in organizations where no guidelines exist and an uncoordinated multiple vendor PC environment develops.

However, since for the foreseeable future most PC software will be generated by third-party vendors whose primary concern is selling software rather than hardware, strong economic incentives exist for movement towards a level of standards/compatibility beyond that associated with minicomputer and mainframe environments.

Standards are beginning to emerge which will make it easier to use PC's as office network terminals. The key areas where standards are evolving include:

- \*communication protocols/hardware interconnect
- \*inter-application data exchange
- \*graphics
- \*command/user interface
- \*electronic messaging
- \*disk media formats

#### VIDEOTEX

Videotex is a new class of systems designed for use by untrained, non-technical users. Videotex is not yet widely recognized as an important element of office systems strategy. However, Videotex standards are among the most relevant to advanced office systems and personal computing. Office Videotex applications, and their relation to personal computers are described in Reference 5.

Videotex systems have three major uses in advanced office systems. First, to serve as an applications development medium for non-programmers. Second, to serve as "shells" and gateways providing an integrated user interface to software and data, incorporating an application-independent command standard. Third, to serve as a graphics standard- one explicitly allowing documents to mix color graphics, text, and data.

Videotex services will primarily delivered by multi-user Videotex hosts. But in some cases the Videotex "host" will be a PC. Such architectures, and office Videotex uses are described in Reference 1.

Videotex comes in two varieties: Public (analogous to time-sharing service bureaus) and Private (analogous to Departmental or Corporate DP). Most of the publicly discussed Videotex work has been aimed at large scale Public systems intended to serve mass consumers (usually at home) in conjunction with very cheap specialized "dumb" terminals, including TV's with cheap adapters. However, most Videotex activity and revenues over the next three years will be in small scale, Private Videotex systems supporting office workers and using PC's running Videotex terminal emulation software.

#### WORKSTATION COSTS

A key issue in defining an office role for personal computers is acquisition and operating costs. Office systems are aimed at having at least one workstation per office worker (two for workers who are expected to do work from home). Consequently, the total cost per workstation is even more important than in traditional DP and WP systems.

There are approximately 40 million office workers in the US, representing most of the workers classified by the Census Bureau as "White Collar" workers. The average annual cost of an office worker is now more than \$30,000 annually, an increase of about 20% over 1980 costs.

The total number of office workers in the US will remain relatively stable over the 1980's, in contrast to the dramatic growth of this labor force segment over the last century. But the compensation of office workers will continue to rise significantly, becoming an increasing proportion of total US labor force wages.

In 1981, office labor costs in the US were about one trillion dollars, representing about 80% of all office costs. Labor costs are forecast to continue rising over the 1980's, doubling over the period of 1980 to 1990.

Managers account for the largest share of the office labor dollar (40%), followed by professionals (38%), and clerical workers (22%). Therefore, it is important to set the priority on deploying workstations to managers and professionals, rather than clerical workers.

Raymond Panko (Reference 6) estimates that text processing and the telephone account for about half of the non-labor costs (exclusive of office space). About three quarters of text processing costs are consumed by three categories: reproduction (31%), postal delivery (22%), and paper (19%).

When labor costs are factored in, we find that over half of office expenditures are consumed in using paper and the telephone. The rapidly dropping costs of processing and communication technologies, therefore make it increasingly attractive to move towards more technology-intensive office communication environments.

Personal computers are often perceived as too expensive for wide deployment, when compared with DP terminals. The view that personal computers are too expensive misses one of the key issues: a personal computer is often cheaper! Comparisons that show that

)

)

)





## ELECTRONIC FILING AND OFFICE AUTOMATION

By John H. Wright,  
Florida Computer, Inc.

Have you thought there must be a better way to store paper than filing cabinets? Have you spent hours looking for a document and not found it?

Several years ago it was predicted that technology would create a decline in office paper use. It simply has not happened. Paper use is still increasing despite more on-line access to information.

Have you wanted to keep months or years of information on-line, but have not been able to justify the disk expense?

The answer to both these problems, paper storage and long-term on-line access to information, has arrived and is ready to be used with your existing DEC system (PDP-11 or VAX) and All-In-One<sup>TM</sup>.

The answer, a new DEC computer peripheral that plugs into a VT-100 (or compatible terminal through an interface) is Electronic Filing or Micrographic reader/printer. With packaged software, the reader/printer automatically retrieves and displays stored and coded microimages through commands issued at your CRT. And, if you like, with one more key stroke you can even make high quality paper copies.

Sound interesting? OK, how do you start to eliminate that paper jungle of filing cabinets?

First examine the source of those documents in the cabinets. A number probably comes right from your PDP-11 or VAX. Take any financial document and it probably comes from your system. Simply by generating a magnetic tape, you can turn all those pieces of paper into film and keep only a few fields (descriptors) of information together with the film's address on the computer.



Retrieval can be accomplished automatically right from your VT-100. These two processes, converting magnetic tape into film and the computer retrieval of film information, are called computer output microfilm (COM) and computer assisted retrieval (CAR).

There are numerous service bureaus in each city that will convert your magnetic tape to microfilm. If you are in a large company you probably have one in-house.

If your documents are not on magnetic media, you have two alternatives: either utilize a service bureau which specializes in filming, or film it yourself in which case the camera shutter can be controlled by your CRT.

Unlike the computer generated microfilm, each document filmed must be indexed. Screen formatted fields prompt you through a fill-in-the-blank style index which automatically adds the micrographic's address (i.e., cartridge and image number) and enters the information on disk storage.

OK, now you see how you can get your invoices and other documents to microfilm, but how can you retrieve it?

By only knowing one, or a few, fields of information you can use your VT-100 to retrieve a hit list of documents fulfilling that information. With additional information you can narrow the hit list, or you can automatically display the documents on the reader/printer and make a copy of them if you so desire. This can be accomplished without moving from your VT-100.

Yes, the copy reproduced is an exact image that is legally acceptable in a court of law. DEC even microfils manuals because of the savings in publishing cost and storage space. DEC field service has a small manual viewer with them when they visit your site. Almost all companies use microfilm, but now this exciting marriage with the computer has made microfilm retrieval a new office automation product.





## **GENERAL RULES FOR VIDEO TERMINAL USE**

For video terminal operators to be comfortable during a prolonged workday, there are some workstation design considerations that should be noted:

- Make sure the operator's seat promotes good posture through proper seat height and lumbar support adjustments.

To minimize fatigue, especially for prolonged situations, the feet should be placed flat on the floor or footrest with the lower leg approximately vertical. The thighs should be approximately horizontal, with the weight taken on the buttocks, not the thighs. The thighs should not be compressed, particularly behind the knees. Such compression restricts blood flow to the lower legs. The trunk should be vertical, and the body weight on the spine supported by a backrest at the lumbar region.

The upper arms should hang from the shoulder joint comfortably straight down at the sides. The forearms should be positioned at less than 90 degrees (and up to 70 degrees) with the elbow joints taking the load, not the upper arm muscles. The wrists should be flexed or extended no more than 20 degrees. Finally, the head should be inclined downward, but no more than about 15 to 20 degrees. The head should not be twisted, except occasionally.

- Keep multiple reading surfaces at about the same distance from the eyes.
- Adjust the situation so that posture is comfortable, possibly by adjusting seating height or by tilting or setting screen height. (Seat adjustment information is available in Appendix A.)
- Start with an evenly and well lighted working area that generally minimizes reflections, glare, noise, and other distractions.
- The workstation layout should enable the operator to be able to relax the eyes periodically by looking at an object some distance away from the screen.
- Encourage the operator to personalize the working area, and provide places for telephone, cup, personal items and holder for documents.
- Keep frequently used items within the operator's comfortable reach (about 58 cm. [2 ft.]), and enable the operator to change or adjust working position periodically to relax.

## **INSTALLING THE VIDEO TERMINAL**

The video display terminal can be installed for either a seated or standing workstation for data entry, data inquiry or interactive dialogue.

In the DATA ENTRY situation, the operator keys in large amounts of data from source documents and generally does not need to write on these documents. Therefore, the operator should place the document and keyboard in the most comfortable position, while the display screen can be positioned to the side.

In the DATA INQUIRY situation, the operator keys in a few symbols to obtain important information from the display and will probably want to write down information on forms or other documents. Therefore, the display should be placed in the most convenient position while allowing adequate room for writing.

In the INTERACTIVE DIALOGUE situation, both the operator and the computer send and receive information. The operator probably will also want to write on the documents. Therefore, the keyboard, display and documents are of equal importance.

In all three situations, the installation of either a seated or quick-use standing workstation should be done carefully. Most operators will find a workstation that permits adjustments to the general rules for video terminal use listed in the previous section to be both comfortable and functional.

Adjustable seat height and back support, screen tilt, screen swivel, movable keyboard and document holder will permit the use of one workstation by many operators. They will also permit an operator to change position easily from time to time.

### **THE PHYSICAL ENVIRONMENT**

Perhaps the most important element of workstation design is the physical layout surrounding the workstation. Lighting without glare and distractions is key to good operation. Good light can include indirect illumination of the work area as well as direct illumination of the document. Distractions include bright sunlight through windows, noise, movement, heat, humidity, static electricity and activity in adjacent workstations.

#### **LIGHTING**

Most offices are lighted for doing paperwork, not for operating video terminals. Dimmers and individual light adjustments make working at video terminals easier. Lights in and around the work station should be placed so that they minimize the eye's adjustment to different light levels.

##### **Lighting Suggestions:**

- If the workstation has a window, place the video terminal at a right angle to that window.
- Directly lighting the video display will cause reflections and glare, and should be avoided. Instead, adjust the video terminal's brightness controls for comfortable viewing.
- Position screen to avoid reflection and glare, perhaps with a tilt/swivel adjustment.
- Use filters on video screen to help reduce glare and reflections.
- If directly lighting the documents, place light so it does not create glare and reflections on nearby surfaces or on the screen.
- Light from the side or behind the operator to avoid lights shining directly into the operator's eye (and onto the screen).
- Keep the light levels on all work surfaces about equal.
- Use diffusers over any glaring lights.
- Place lighting so that it does not reflect on the video screen (an angle at least 30 degrees above work surfaces and video screen will usually accomplish this).
- Eliminate shiny or polished work surfaces.

#### **ELIMINATING DISCOMFORTS AND DISTRACTIONS**

- Bright lights, especially direct sunlight entering through windows at various times of the work day, can be controlled with curtains at the operator's discretion.
- Noise is always a distraction. A high background sound level (above 65 dbA) is tiring, and sudden noises are both distracting and disturbing. Sound absorbing materials such as curtains, carpeting and acoustic tile help reduce both types of noise. Whenever possible, cover hard work surfaces to make them absorb rather than reflect noise.



)

)

)

## APPENDIX A

Chair adjustment procedure:

1. Place your feet flat on the ground or footrest.
2. If your working table is adjustable, adjust the seat height so that your feet remain flat on the ground or footrest and the angle made between the lower leg and the upper leg is slightly more than 90 degrees.
3. Adjust the height of the work surface so that the lower arm is slightly higher than a horizontal position or angle and the upper arms are vertical.
4. Position the seat's backrest angle from a vertical position (0 degrees), to slightly tilted back (to about six degrees) depending on whether you work sitting forward or alternative between forward and back work positions.
5. If your working table is not adjustable, adjust the seat height to a point where your upper arms become vertical, and then use a footrest which is adjustable in height and inclination. (After Kaplan, A. Selecting a Chair for the Office. *Modern Office Procedures*, September, 1981, p. 127-131).

### Further Information

All types of video display terminals made by DEC have been checked for emission of X radiation. This is done as part of approval by Underwriters Laboratories and Canadian Standards Association, as is indicated by the presence of the UL or SCA label on your product.

The U.S. and Canadian governments have set limits of 0.5 mR/hr (milliroentgens per hour) as a maximum limit for these products. Our tests indicate that levels emitted are below 0.1 mR/hr even during defective operation. We are not able to measure below that level due to the presence of background radiation, which comes from such sources as natural radiation in earth and building materials, cosmic radiation and fallout.

The RF power density including microwave regions, 10 Mhz to 18 Ghz, is below 0.1 mW/cm<sup>2</sup>. Present production of the VT100 and all of the PC series terminals also meet the United States FCC Class A limits for RF radiation, and in West Germany, the VDE 0871 Class B limits. These FCC regulations ensure that equipment such as VDTS do not emit RF radiation that would interfere with the operation of other equipment. Since these standards are far more stringent than RF health exposure standards, we are assured that levels of RF radiation are significantly lower than those recommended by the American National Standards Institute (ANSI) and the Canadian Labour Code and Radio Act.

Ultraviolet emission of our terminals is below 0.2 uW/cm<sup>2</sup> from 200 to 400 nm according to tests by other agencies, well below any known harmful effects. Infrared emission is below 20 uW/cm<sup>2</sup>, considerably less than most heat sources.

There is a recently completed study available from the US bureau of Radiological Health in Rockville, Maryland, titled "An Evaluation of Radiation Emission from Video Display Terminals", HHS publication FDA 81-8153, which descusses this issue in further detail. It comes to the conclusion that "Video display terminals should not pose a radiation risk to those who operate them."

As a result, we see no reason for you to be concerned about radiation from Digital Equipment Corporation's terminals.



# 12-BIT ARTICLES ....

DECUS 12 BIT NEWS

=====

NUMBER 44

DECEMBER 1983

---

Contributions and correspondence should be sent to:

Robert Hassinger, 12 Bit Coordinator  
c/o DECUS MR2-3/E55 ..or.. Liberty Mutual Research Center  
One Iron Way 71 Frankland Road  
Marlboro, MA 01752 Hopkinton, MA 01748

DECUS/Europe contributions are solicited through:

Lars Palmer  
DECUS/Europe 12 Bit News Liaison  
Hassle  
Fack  
S-431 20 MOLNDAL 1  
SWEDEN

(Please include reference to Newsletter number and page when inquiring about material published.)

## NEWSLETTER SUBMISSIONS

Submissions are accepted at all times and are normally used in the next issue to go to press regardless of date of receipt.

Material submitted in machine readable form is particularly desirable because it can be edited and incorporated into the newsletter format more easily. Higher quality reproduction is also possible this way. Contact Bob Hassinger for further details on acceptable media and formats if you plan to make a submission in machine readable form.

## FUTURE DEADLINES

I have been given the following deadlines for the next two issues: February 1 and May 1. These are the dates my material must be in the hands of the person I send it to. In order to make it into those issues, your material must reach me ten days before these dates to cover mailing delays and to give me time to edit and retype it. Machine readable input is greatly appreciated, particularly near deadline time. In some cases it may actually be possible to send your material electronically direct to my system. If you are interested, give me a call.



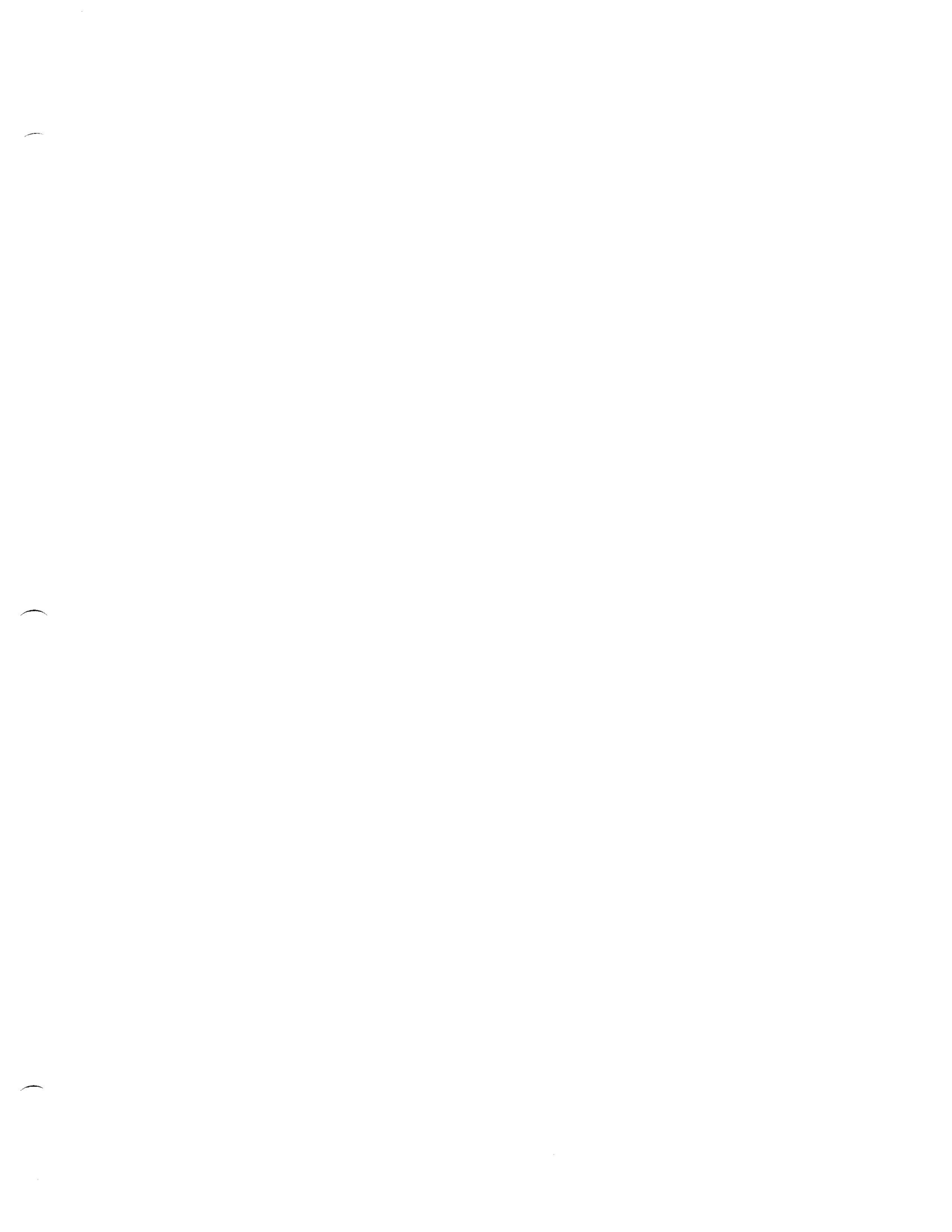

and do I/O through it from BASIC!

Before I gave up on CP/M, I noticed another little quirk. BASIC was very willing to create files that the rest of the CP/M system would not recognize. It looks like BASIC will create file name entries in the directory with illegal characters in them. Apparently BASIC just goes ahead and writes what ever you give it for a name without bothering to do any checking! That would not be too bad if the "manual"s DEC gives you warned you about it but they do not.

Speaking of the "manual"s you get with CP/M and BASIC, they look like something DEC did in 1968 or so. There is a whole set of CP/M commands that are mentioned but not documented. If you look real close you can find a line in the manual that tells you to buy another option to get documentation on those commands. You can not write assembly language programs because of this and the lack of documentation on the machine and the CP/M BIOS (BIOS is sort of like OS/8 device drivers, you always need documentation on it in any CP/M system so you have a chance to deal with problems like this).

The BASIC manual is a classic. You have a generic language section that applies to a great many different versions, then you have a section on extensions for the disk version and disk files, then you go on to another section that discuss differences for the CP/M version then you go back and notice in the generic section that some of the commands have footnotes saying that the command is not in "some" versions and then you notice some more commands that say they are not in the DECmate version.

OK, you say, all new products have problems, we know what to do about that. You check the SPD (Software Product Description - DEC's formal product description for software) to be sure the product is supposed to do what you want then you send in an SPR (Software Performance Report) to get a fix. If that does not work you do a little programming to get around the problem. Maybe write a device driver for example. If this still does not solve the problem you go to your DECUS Special Interest Group. They are supposed to have contacts at DEC for resolving problems.

In this case none of the above works! Take a look at the SPD that comes with CP/M and BASIC. It says there is no support offered with the product and that you buy it "AS IS"! You do not get any SPR forms to send in a complaint. After noting this I reviewed the SPD to see if any limitations were documented. The SPDs turn out to be very non-committal. They don't say you can and they don't say you can't. Based on past experience, any limitation as serious as these would be explicitly mentioned. Since there are no limitations given and since it is the norm for CP/M systems to do these things, it seems reasonable to expect this product would do them.

The only thing left to do was call the WPS hotline. They are really supporting WPS but it was worth a chance since there was no where else to turn. Eventually, after a round of telephone tag, I talked to someone who does try to deal with CP/M questions. She had to go off and check with other people since she really had no background on this level. The answer was yes, BASIC can't do I/O to the COM port - there is no fix available - submit an SPR. Only you do not get SPR service with this product - Catch-22! Also, the telephone support people had no information to offer on the rumored "communication option" either.

As it so happens I AM the DECUS SIG person you would get in touch with to try to get help with a problem like this. Unfortunately, I have been working through DECUS since the DECmate II announcement a year ago last Spring, trying to get DEC to establish a line of communication with us for this sort of thing without success. I spent the last week trying again to make contact with someone in DEC who could address these issues. At deadline time I still have gotten no response.

All the customary means of resolving a product problem have failed. At this point I think potential purchasers of the CP/M option should look very carefully at what is offered and be careful to make no assumptions about it. It looks like DEC has given this CP/M product "a lick and a promise". I can't find anyone inside DEC who knows anything about this CP/M product. It looks like they contracted outside for the product and they have no idea what it is about, what is good or bad about it, and they don't seem to have any way to address problems. The implementation seems to me to be sloppy and poorly engineered - about on a par with the first release of the 4K Disc Monitor for the PDP-8 back in 1968.

These particular limitations may not bother you at all. You may be lucky enough to use an application that runs fine under this system but what I have found makes me very cautious about this product. I think there are likely to be more than the usual number of problems with it and, worst of all, there seems to be no recourse at all for the unlucky purchaser who runs up against one.

If your decision to go with the DECmate II is predicated on the availability of a general programming capability for implementing your own application, as was the case for this lab, you might want to reconsider your decision.

This demonstrates one of the main reasons I advocate making the OS/8 family available on the DECmate II. Unlike the CP/M option, it is an open, modifiable system. If all else fails you can write your own device driver or program that does I/O directly. Even the WPS training disks use OS/8 because of these advantages. Direct screen I/O is particularly good from the OS/8 side. Due to the architecture of the CP/M system on the DECmate II and the undocumented (secret?) nature of the I/O system, you do not have this option with CP/M.

#### NOTE FROM RUDI STANGE

"Ref.: OA SIG Newsletter Volume 1, No. 2 \*\*\* May 1983

"I like to say that I am glad the 12-Bit SIG has the OA Newsletter as a carrier for their concerns. What I appreciate much less is the fact, that they start it with crying and complaining about DEC not producing the old PDP8 anymore. I wonder if anyone of those people still drives the old model T from Henry Ford??? (For him I would make some concessions)!

"When you, Bob, did run the 12-Bit SIG it was flourishing and sprouting like crocusses in April, and as soon as the experts took over, they managed to almost erase the group completely. Well, may be I should not brag, for I belong to the German 12-Bit SIG which seems to be the only one alive and active despite the fact that we could not buy a DECMATE-I because it was not sold in Germany, and the DECMATE-II will only appear early next year on the German market, that is the German Version of it (US versions could be obtained right now).

"DECMATE-II really is much better than any previous PDP8, it runs C/PM programs, Word Processing with Sort, Math, List Processing and real good communications, also it allows access to RX01/RX02's, and it has DIBOL8/11. We will soon have OS/8 on it and a C Compiler, and we can make use of 48 Kilo-Words of memory. It has 2x32 KW, one of it is the usual bank while the second bank functions as control memory, but only half of it is used for such purposes. It also offers some new instructions with the 6120 processor e.g. push and pop. I am really enthusiastic about it.

"Now getting to some requests from the a.m newsletter:

"Mr. Orlowski asks for some means to correspond between the PDP8 and the VAX. We have some WPS8's connected to a VAX via a PAX (Permanent Address Extension) which allows to transfer ASCII code between both machines. Data files could be written in FILEX (available on COS-310) FILEX writes IBM format and accepts OS/8 or COS files which can be read on any machine able to read IBM compatible format.

"Mr. Lee Roberts seems to be dissatisfied with WPS, I can only answer him to try to use something else in order to appreciate WPS8.

"PASCAL-S, Ronald Larkin's remarks on it are (in general) right. I have some instructions on it in German language. Anyone having a DECMATE-II should use PASCAL MT PLUS running under C/PM, (same with BASIC.)

"Dr. John A Hawkinson and Nancy Holley want to do more than just WPS, i.e. patients/customer files, billings, inventory etc. I urgently advise not to use OS/8 for this, the expenses in time and effort would be too much, use DIBOL, it is similar to COBOL but much easier to handle, also faster and elegant. It is runs on all DEC computers and will soon appear for C/PM as I understand. It offers a good Data Base System with easy screen handling. Just try to program the screen in OS/8 and compare it to DIBOL: the statements are e.g.:

DISPLAY(R,C,0)	Position cursor at row R character position C
DISPLAY(R,C,1)	Erase screen starting at row R character C
DISPLAY(R,C,2)	Erase row R starting from character C
DISPLAY(R,C,'ANY TEXT')	Display text in single quotes starting in row R at character position C
DISPLAY(R,C,LOC)	Display contents of LOC starting in row R character position C.

"DIBOL statements are in plain English (like BASIC). DIBOL runs under COS-310. DIBOL is fast and efficient. I have submitted a DIBOL Floppy to DECUS library, containing some subroutines for screen and file handling as well as an example customer file system along with comments for beginners and experts. In case more readers are interested, I am willing to conduct an introductory course to DIBOL via this news letter.

"Bob, I am delighted to see you back aboard, let's start to get the 12 Bit SIG to new horizons."

Rudi's address is c/o Digital Equipment GmbH, Freischütz-Strasse 91, D8000 München 81.

## HELP - DIGITAL SOFTWARE NEWS

Dr. F. E. James sent the following note asking for help:

"In your Fall 1982 12 Bit SIG Newsletter, you made reference to a publication called "Digital Software News". You mentioned that a DEC order number QQF097-2Z would get us twelve months' worth of this service.

"I'd like to tell you that we have attempted to contact DECUS several times in order to get this, and have been in touch with DEC, but we can't find anyone there who knows anything about it. Can you help?"

I told Dr. James that of course he had to go to DEC rather than DECUS but other than that I did not know what the current situation was because we do not have a subscription due to budget problems. Note: the order number was actually QJ097-2Z but that should not have been a problem. Can anyone help? Let me know for the next Newsletter.

Dr. James is at James Investment Research, Inc., PO Box 8, Alpha, Ohio 45301 (513) 426-7640.

## PROBLEMS WITH CROSS ASSEMBLY ON RT-11

Ronald P. Larkin sent the following note:

"Cross-assembly of PDP-8 assembly language programs on an RT-11 system seemed to be an attractive possibility for us. We tried a DECUS program (11-405) but found that this program was not usable for any but the most rudimentary PDP-8 programs. For instance: XLIST is not properly handled, the listing file contains no error messages, literals are not recognized, and the double quote is not recognized. We discovered these problems with a working PAL8 program of 15 lines."

With my DECUS Library Committee hat on, I looked up the program in question to see if I could understand the reason for Ron's problems. I noticed that the abstract states the program is compatible with PAL III (the old paper tape version of PAL) rather than PAL8. I think PAL8 is very close to being a proper superset of PAL III or, in other words, PAL III and DECUS 11-405 handle subsets of PAL8 syntax. I think that at least some of Ron's problems come from using features that were introduced in PAL8 that were not in PAL III. I have not looked at PAL III since the late sixties so I can not say for sure. Can any of you old timers out there help out? Send me a note for the next Newsletter.

Ron is Assistant Wildlife Ecologist, Illinois Department of Energy and Natural Resources, 607 East Peabody Drive, Champaign, IL 61820 (217) 333-6880.

## WINCHESTER DISK CONTROLLER

DEC is not developing any new hardware for the Omnibus machines (8/E, 8/m, etc.) so owners of those machines do not get much chance to take advantage of new peripheral devices like Winchester disks. As a result it was encouraging to see information on a new product that I recently received from CESI.

The CESI MDC8 is a single, hex-wide circuit board that performs data and control functions to a family of SASI disk controllers. The MDC8 and a SASI disk controller allow the addition of families of 5 1/4 and 8 inch Winchester disk drives to Omnibus based systems. Each unit will support two Winchester drives plus two floppy drives. Further information is available from Computer Extensions Systems, Inc., 17511 El Camino Real, #131, Houston, Texas 77058 (713) 488-8830.

NOTE FROM WALLY KALINOWSKI

As I sit here finishing up the last article for the Newsletter, Wally has transmitted a short rundown on what is going on in his area directly into my system. Here is a summary of it. Hopefully we will have details for the next time.

"A new version of TKPLOT was submitted by E. Lynch to DECUS about one month ago. E. Lynch is making great progress on a Symbiont for OS/8. The printer and the plotter now run in the background with no noticeable slowing of the computer running OS/8. There are a few things left to be done though before we will be sending it out to DECUS. When FRTS comes up it occasionally halts. We expect to clear this up tonight. Also, wild cards need to be added to the queue program and also an un-queue.

"Jonathan Easton said that he will definitely have U of M Pascal in DECUS. He expects to have it submitted by Christmas. I will soon get MULTOS/8 (thanks to Bill Haygood) in to DECUS. It is presently configured to run only with RK05 disc as the system. I guess we could maybe find someone out there with time to implement it on a floppy. Speaking of "anyone out there", has anyone modified LOAD (FORTRAN IV) so that more than one library can be used?. Has anyone been able to get it to load more than one module (subroutine) from a single file?

"By the way, I talked to Ian Templeton the other day. He has a circuit drawing for an IEEE488 interface (GPIB) for the PDP/8 along with software which he is willing to share with whoever wants it.

"Well BOB that is more or less it on Louis's and my outline of what we were going to write plus a thing on how the symbiont works but we didn't get to it in time."

Wally Kalinowski  
213 648-5604

RE: WALLY KALINOWSKI'S "CALL TO ARMS"

In the last Newsletter there was a note from Wally Kalinowski and Louis Tribble. They are interested in finding ways for the 12 Bit user community to acquire rights to as much of the existing software for our systems as possible and place it were it will be accessible. A lot of important software is being lost because the people who control it have lost interest or gone on to other things.

Wally and Louis were particularly interested in finding other users who are interested and willing to help. Part of their input for the last Newsletter was a questionnaire you could use to indicate your interest. Unfortunately, Murphy's law is very active in DECUS. The page with the form got swallowed along the way



from East coast to West coast and back to Decus on the East coast. So, I am going to print it here again but I am not going to try to make it a separate, pull out page. That should cut down on the chances of getting lost. Don't worry too much about the money questions at this point. We can do a lot even without any money. (For example a few years back I shelled out one whole dollar and got OS/8 RUNOFF and some other things for the Library.) What we are looking for is an indication of interest and support at this point.

---

12 BIT SOFTWARE PROJECT QUESTIONNAIRE

Name \_\_\_\_\_

and \_\_\_\_\_

Address \_\_\_\_\_

\_\_\_\_\_

Phone \_\_\_\_\_

1) Can you contribute ten dollars? \_\_\_\_\_

2) If you can contribute more, how much? \$ \_\_\_\_\_

3) What mass storage devices do you have? \_\_\_\_\_

4) Can you help distribute, if necessary? \_\_\_\_\_

Comments, suggestions, (offers of help!):

Mail to:

Bob Hassinger  
Liberty Mutual Research Center  
71 Frankland Road  
Hopkinton, MA 01748 USA

---

## Approved 12 bit CMOS-processor with new design

Wolfgang Leber  
Max-Planck-Institut für Hirnforschung  
D 6000 Frankfurt 71  
W-Germany

For a long time only a few CMOS-technology microprocessors have been available. Right from the start, the PDP-8 compatible 12 bit processor of the 6100 family belonged to that group. Now a newly designed and improved version is available. Its development was initiated by a big manufacturer - hence the delay of two or three years for the 6120 being for sale. The fact that a lot of effort was invested in software worldwide seems to be the reason for that development.

To use the 6120 on an established 6100 bus structure it takes a few modifications of control signals because this chip set is not pin-compatible to the 6100 family.

Three enhanced capabilities make the 6120 is different from its predecessors:

1. On chip memory extension control for an address space of 2x 32K words.
2. Something long known to the 8 and 16 bit world: Increase of the instruction set to control two stackpointers.
3. Although the clock frequency is the same, speed is twice as high, which was achieved by an optimized microcode.

While the 6100 line consisted of the following members

- a) 6100 12 bit CPU
- b) 6101 PIE peripheral interface element
- c) 6102 memory extension, DMA, refresh and clock controller
- d) 6103 20 bit input/output,

only two chips have been developed for the 6120 family so far:

- a) 6120 12 bit CPU with memory extension controller
- b) 6121 input/output controller with PDP-8 compatible I/O structure.

An adaption onto the EURO-12 bus used in "12-bit domain" in Europe seemed reasonable because a lot of interfaces have been developed for that bus. The increased functionality of the 6120 promised a denser packaging, too. While three EURO-12 cards were needed before to establish the functions CPU, extended memory control, memory management for 1 MW of memory and control panel monitor, this is now possible on one board.

Some functions used could be implemented by the 6102 which has been developed as a 'super chip' (memory extension, DMA, memory refresh, clock controller). A few instruction incompatibilities and the fact that there was no other manufacturer for this chip put up a lot of problems for some designers.

In addition a long-existing requirement for higher working speed could only be met with special design techniques (10V operating using level converters). The 6120 is now twice as fast as its predecessor at the same clock frequency. The multiplexed bus structure has not been changed basically, it has been increased by two signals though.

Most signals did not change, so that in the following only the differences and increased functions are described in detail. These refer to new or deleted signals or signals whose functions have changed.

1. STARTUP            This input enables to differentiate between starting the program in the control panel memory (as it is done by the 6100) or in the main memory. The start address in both cases is 07777.
  
2. IOCLR             This output gets active if
  - a) a RESET-signal is applied or
  - b) the instruction CAF (clear all flags) is given.This signal corresponds to the EURO-12 signal INIT.
  
3. EMA2              is the lowest order bit of the extended memory address. The two higher-order bits are multiplexed with the C-lines.
  
4. LXDAR             While with the 6100 each address (main memory, panel memory and device addresses) had to be latched with LXPAR there are now separate signals available.
  - a) LXMAR - main memory addresses
  - b) LXPAP - panel memory addresses
  - c) LXDAR - device addresses.Timing was slightly changed, too, but does not influence compatibility (see description of schematics).
  
5. READ              This signal is active when the CPU wants to read data from the bus and is similar to XTA, but with reversed polarity.
  
6. WRITE             This signal is active when the CPU wants to put out data onto the bus and corresponds to XTC for writing operations.
  
7. OUT               This new signal simplifies controlling the bus transceiver. It can be used like XTB.

The signals

LINK, C2, SWSEL and DEVSEL

are not available anymore.

DEVSEL, which used to be necessary for all device operations, can easily be generated by a few gates. With most applications the LINK-bit was not used externally, so there is no real loss. The other signals can be created by control panel firmware.

This part of the schematics shows how bus compatibility with the 6100 can be realized.

The IX-signals are present during the whole cycle. Therefore they are not only used for latching the addresses but also for generating the select signals. Consequently it is very simple to make the same signals on the bus available which exist with the 6100. As there was no difference between main memory-, panel memory- and device addresses before, all three signals can be put together into one signal for the bus. It should be noted that a few signals' polarity has been changed. More difficult is the control of the busreceiver for C-lines and the SKIP-line. Here you find a general difference between both processors. With the 6100 each WRITE is preceded by a READ, which means that so-called dummy READs are added. At this time the control lines are sampled and corresponding functions are executed. The 6120 works differently in that respect. Here a possible READ- follows a WRITE-phase. The control lines are always sampled during the WRITE-phase. Basically the time of sampling does not matter, but incompatibilities can occur when an interface decodes the control signals using the READ/WRITE conditions for the decoding of control signals. In our application all interfaces could be used without modifications. A foreign development made alterations in this part necessary. For the sake of compatibility of both processors it is advisable not to gate the control lines with READ or WRITE.

On the CPU-side you must take care that the bus driver for these signals multiplexed with the extended address line will be controlled with the correct timing. The delay circuit to control the bus receiver is necessary to transmit the C-lines slightly longer than the WRITE-phase. The timing diagram for the a input/output phase illustrates this.

To summarize you can say that the adaption is no basic problem. Tests have shown that - adequate clock frequency provided (10 MHz) - a system is available which allows a higher processing speed than all other versions of the PDP-8 product line ever produced.

In spite of the rather "aged" instruction set (created in 1964) one can see that because of the 6120 the PDP-8 sees its renaissance in the DECmate II personal computer. This is a good example of hardware being built for excellent software and operating system already existing, like WPS-8 and COS-310 and OS/78.

Legends:

Table 1: Suggestion for a circuit to exchange 6100/6102 for a 6120, keeping the original signals and their significations.

Table 2: Signal diagramm of the 6120 during an input/output instruction.

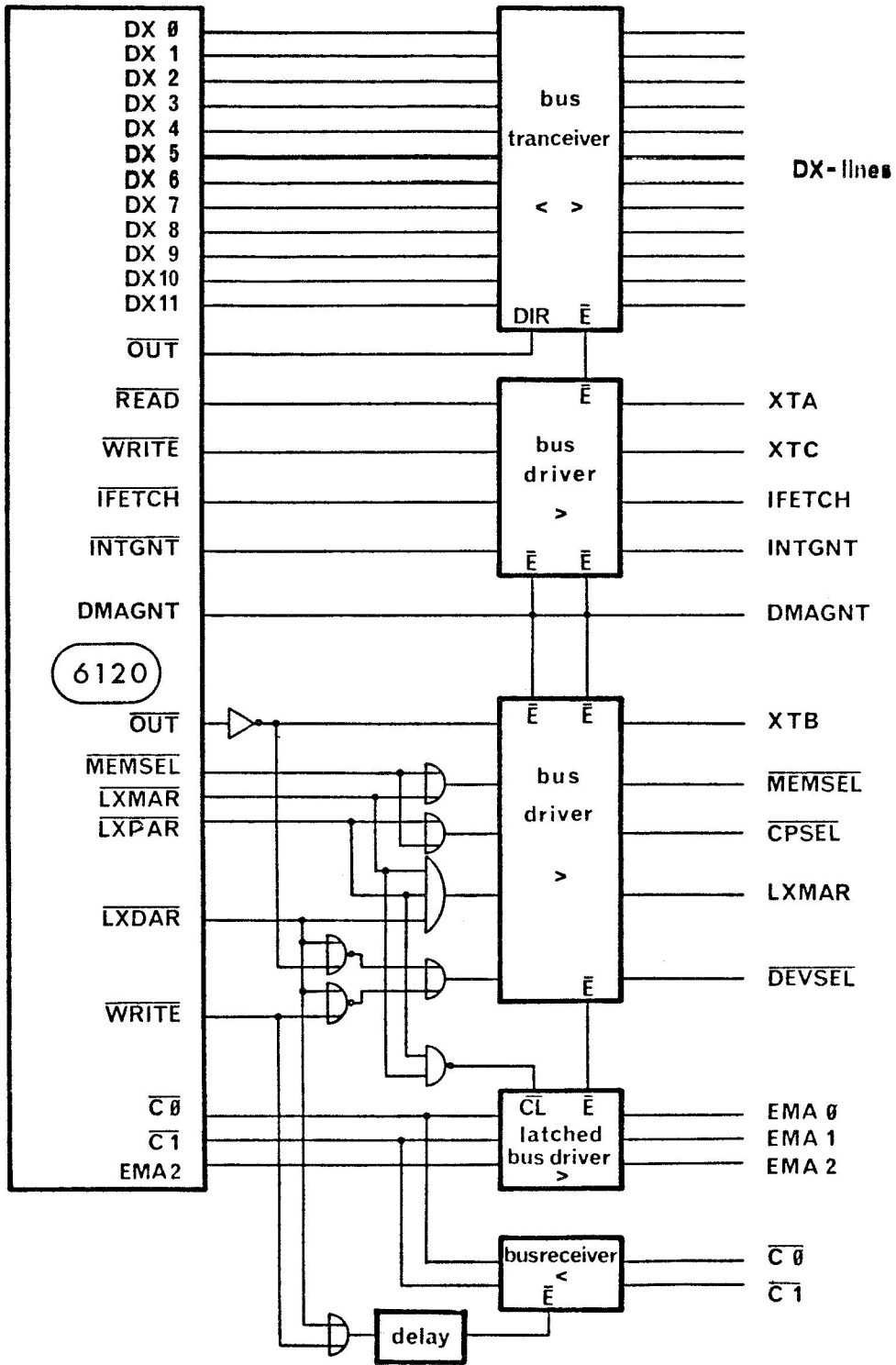

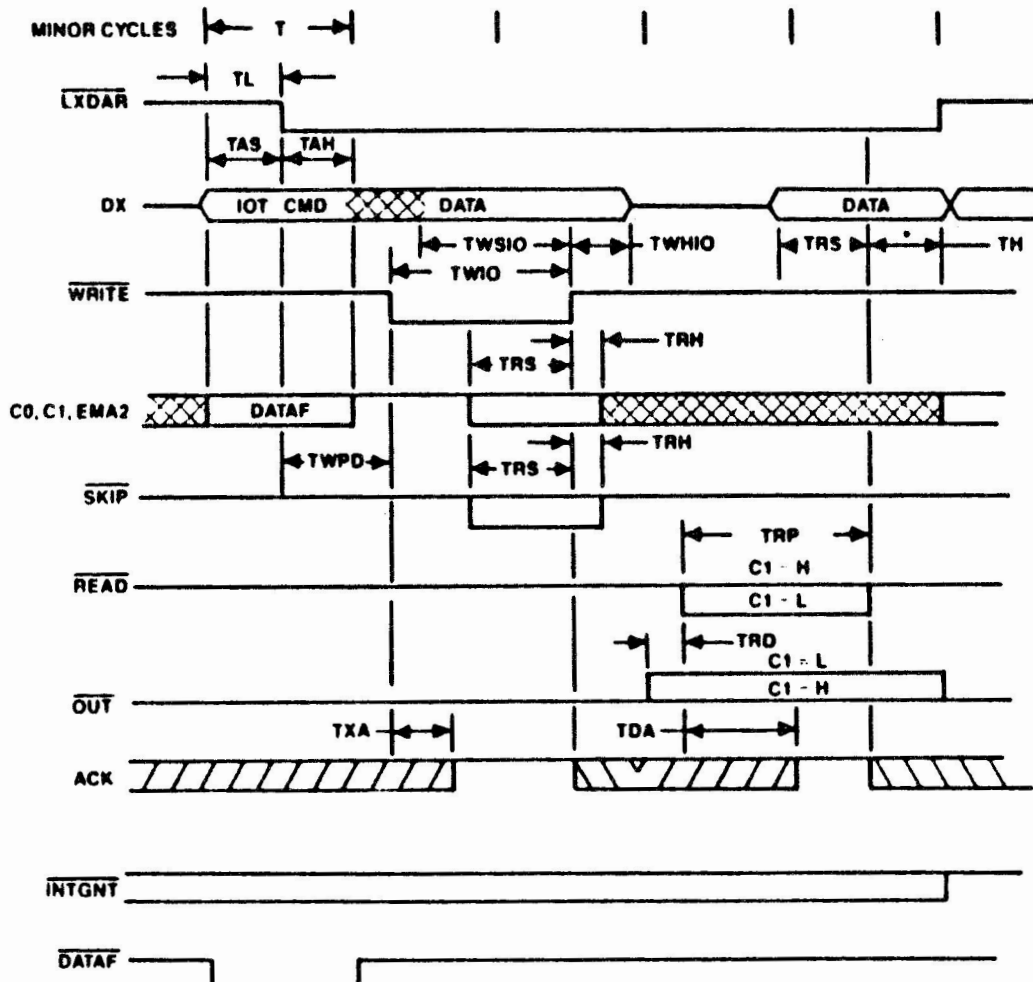

NOTES: Operation is shortened one Minor Cycle if READ is not executed  
 \* Read Data must be held until the rising edge of LX DAR for Read IOTs

EXTERNAL IOT OPERATION

# THE OA TELL-A-GRAM ...

A SIG INFORMATION EXCHANGE

NEEDS:

I WOULD LIKE SOME INFORMATION ON \_\_\_\_\_

\_\_\_\_\_

I WOULD LIKE AN ARTICLE IN THE NEWSLETTER ON \_\_\_\_\_

\_\_\_\_\_

I WOULD LIKE A SYMPOSIUM SESSION ON \_\_\_\_\_

\_\_\_\_\_

OTHER \_\_\_\_\_

NEWSLETTER:

I WILL WRITE AN ARTICLE ON \_\_\_\_\_

OTHER \_\_\_\_\_

SYMPOSIUM:

I WILL MAKE A PRESENTATION (PLEASE CALL PAULINE KUNTZ AT (512) 691-7351)

I WILL CHAIR A SESSION

I WILL "MC" AN OA MAGIC SESSION

I WILL OPERATE A CAMERA/TAPE RECORDER FOR A SESSION

I WILL "MAN" THE OA SUITE FOR A TWO-HOUR BLOCK OF TIME

OTHER \_\_\_\_\_

COMMENTS:

\_\_\_\_\_

\_\_\_\_\_

NAME/TITLE \_\_\_\_\_

ADDRESS/MAIL STOP \_\_\_\_\_

CITY \_\_\_\_\_ STATE \_\_\_\_\_ ZIP \_\_\_\_\_

PLEASE RETURN TO MARGARET DRAKE  
DIRECTOR OF INSTITUTIONAL MANAGEMENT SUPPORT  
UT HEALTH SCIENCE CENTER  
7703 FLOYD CURL DRIVE  
SAN ANTONIO, TEXAS 78284

---

STAMP

MARGARET DRAKE  
DIRECTOR OF INSTITUTIONAL MANAGEMENT SUPPORT  
UT HEALTH SCIENCE CENTER  
7703 FLOYD CURL DRIVE  
SAN ANTONIO, TEXAS 78284

---



# **COMBINED NEWSLETTER**



**GRAPHICS**

**Section Two**



# GAPSIG NEWSLETTER

January 1984

FROM THE EDITOR . . . . .	2
NEW LIBRARY SUBMITTALS . . . . .	3
WANTED . . . . .	9

# PLEA FROM THE EDITOR: HELP!

First, my apologies. I'm sure you have noticed that this newsletter looks a bit different than the previous four issues -- shall we say a giant step backwards? The reason is that my normal resources were not available to me at deadline time due to the moving of our data center. I had to resort to using RUNOFF and a LA120 printer.

Next, an apology about the content. The deadline for having this issue into the DECUS office was only two weeks after the previous issue hit the streets. Hardly enough time for submissions to come knocking on my door. Normally, this would not be a problem, as I generally have articles in the can that I have solicited. Unfortunately, these articles did not arrive in the mail in time for the deadline.

I wish that I could say that things will be back to normal in the next issue. They won't be. I am moving on to a position on the Publications Committee as Newsletter Editor Coordinator, which will pre-empt my position as GAPSIG Newsletter Editor. HELP! I NEED A REPLACEMENT! My new position is a demanding one, requiring much time. I need to forego my duties as GAPSIG Newsletter Editor. I can not do this until a volunteer steps forward to be take my place.

Running the newsletter is not a bad job. Sure, it requires time, but the rewards are well worth the time spent. In the two years that I have been editor, I have made a number of helpful contacts both inside and outside of Digital. I have attended, at DECUS expense, two newsletter editor meetings, both of which were very interesting, to say the least. I have been at, also at DECUS expense, two GAPSIG Steering Committee meetings, where most of the SIG business is conducted. I have chaired sessions at Symposia, which enabled me to set into the Sunday receptions a half hour early. Most important of all, I have met a lot of competent people in the field of computer graphics.

If you have any inklings at all to be editor, please contact me at:

Mike York  
Boeing Computer Services  
P.O. Box 24346 M/S 6R-56  
Seattle, WA 98124  
(206) 342-1422

We need volunteers for other positions too. We have openings for Handout Editor, Symposia Coordinator and various working group coordinators. Don't be shy folks -- this offer won't last long. Please call me at the above address or contact the SIG Chairman at the following address:

Bill Kramer  
Computing Center  
University of Delaware  
192 South Chapel St.  
Newark, DE 19711  
(302) 453-6031

We need your help.

## NEW DECUS LIBRARY SUBMISSIONS

new  
11-629

Roger Williams Collection

Version: May 1983

Author: Rolland D. Everitt, Roger Williams College, Bristol, RI

Operating System: RSTS/E V7.2-04

Source Language: BASIC-PLUS

Other Software Required: MONEY, EDT or other Text Editor

Special Hardware Required: VK100 Terminal for Graphics programs

The following is a brief description of the programs included in this package:

XYPLOT is a two-dimensional cartesian plotting program capable of plotting three simultaneous functions on a GIGI (VK-100) terminal. XYPLOT is a stand-alone program and no other files are required. The user must enter one, two, or three functions in X as program lines within a subroutine. The user may introduce as many new variables as necessary, provided he does not use any of the existing program variables.

ISOMET.BAS is a cartesian plotting program capable of plotting a single function in X and Y on a GIGI (VK100) terminal. The plot appears in isometric projection. The user must enter his function

as one or more program lines defining Z in terms of X and Y. The user may introduce new variables if needed, as long as he does not use any of the existing program variables.

ACOUNT.BAS is a system accounting program which uses the output of the program MONEY as its input file. ACOUNT produces a report page for each project, listing the CPU time, terminal time, percent time spent processing, disk usage, quota, and percent quota used for each PPN in the project. These values are totaled for each project.

SUMMER was designed to be used in conjunction with ACOUNT in an academic environment. The output report, which may be given any name, tabulates the following data for each input report: connect time, CPU time, and disk storage total.

CIPHER.BAS is an encryption/decryption program which can operate on any file including program source code. It is menu-driven and "user friendly". No programming or system knowledge is required for use, except for the ability to enter standard file specs for input and output.

Documentation on magnetic media.

Media (Service Charge Code): Listings (BA), Floppy Diskette (KA)  
600' Mastape (MA), Format: RT-11

\*\*\*\*\*

new  
11-639

Additions to the Roger Williams College Collection

Version: June 1983

Author: Rolland Everitt, Roger Williams College, Bristol, RI

Operating System: RSTS/E V7.2, RT-11

Source Language: BASIC-PLUS

Other Software Required: HELP.BAC, HELP.HLP, QUEMAN, QUMRUN, RPGII  
FORTRAN IV

The following is a brief description of some of the programs on the tape.

GRAPH.FOR is a RSTS/E Fortran IV subroutine which will plot up to five simultaneous functions of one independent variable. The output consists of two files. FTN1.DAT contains the plot, which is 100 columns wide. FTN2.DAT contains the tabulated data for the functions.

FORTRA.HLP, ISOMET.HLP and XYLOT.HLP are text files to be used with the RSTS/E HELP facility. FORTRA.HLP describes the steps for compiling, linking and running a FORTRAN IV program under RSTS/E.

ISOMET.HLP and XYPLOT.HLP describe the capabilities of and method of access to programs ISOMET.BAS and XYPLOT.BAS.

RFGBCP.BAS is a user-friendly program which creates a batch control file for the purpose of compiling, taskbuilding, and running an RPGII program under RSTS/E. The program asks the user if he wants instructions, and prompts him step-by-step if does.

Restrictions: Some users may wish to edit text files to remove references to Roger Williams College.

Documentation on magnetic media.

Media (Service Charge Code): Listing (BA), Floppy Diskette (KA)  
600' Mastape (MA), Format: DOS-11

\*\*\*\*\*

new  
11-633

TREK: A Space Game

Version: May 1983, V1.0-02

Author: Andrew J. Howard, Canberra TAFE, Act, Australia

Operating System: RSTS/E V6C

Source Language: BASIC-PLUS

Memory Required: 16KW

Special Hardware Required: VT52 or VT100 terminal

TREK is a development from SPACWR and uses the direct cursor addressing features of the VT52 and VT100 terminals. It also makes use of the Advanced Video Option of the VT100 terminal. TREK is a game of cunning and skill. You must destroy all the enemy's war fleet before they destroy you. The screen displays updates in real time. The game will run on any terminal, but works best on a VT100 with the advanced option.

Documentation on magnetic media.

Media (Service Charge Code): Write-up (AA), Floppy Diskette (KA),  
Format: RT-11, 600' Mastape (MA),  
Format: DOS-11

\*\*\*\*\*

new  
VAX-58

VIEW 3D: Three Dimensional Viewing Package

Version: November 1982

Author: David Malcolm, University of Newcastle, NSW, Australia

Operating System: VAX/VMS

Source Language: PASCAL

Other Software Required: PASCAL Compiler (DECUS No. 11-346)

Special Hardware Required: Some graphic output terminal required.  
Currently set up for Tektronix terminals working via IGL.

View 3D is a graphics processing package conforming to the following specification:

1. It is for use with line drawing graphics devices; the scene being described by plane polygons and wire lines.
2. It allows hidden line removal; and both parallel and perspective projection.
3. Viewing adjustments may be made interactively.
4. It contains a MACRO object description facility.
5. Text may be generated automatically.
6. It makes use of dynamic memory allocation (lists), to overcome any array size limitations.
7. It uses low level graphical action commands only, for portability.

Restrictions: Known restrictions and problems explained in the User's Manual.

Media (Service Charge Code): Manual (EB), 600' Magtape (MA),  
Format: VAX/ANSI (Blocked at 2048)



\*\*\*\*\*

new  
VAX-59

STATSPLINE Programs

Version: V2.0, June, 1983

Author: John A. Lambert, University of Newcastle, NSW, Australia

Operating System: VAX/VMS

Source Language: FORTRAN IV

Other Software Required: Uses Tektronix IGL plotting routines. Not essential to main programs.

The STATSPLINE package consists of two programs: Histospline and Dataspline.

Histospline smooths a histogram to provide an "estimate" of the underlying probability density curve (a "histospline").

Dataspline similarly transforms a set of individual observations to a "density curve" (a "dataspline"). The program can also handle histograms to produce smoothed histospines.

Printer-plot routines for histograms and curves are included as are plotting routines using Tektronix IGL.

Documentation on magnetic media.

Media (Service Charge Code): 600' Mastape (MA), Format: VAX/ANSI (Blocked at 2048)

\*\*\*\*\*

revision  
VAX-44

KIC2: Integrated Circuit Layout Program

Version: V1.15, April 1983

Author: Ken Keller and Giles Billingsley, University of California at Berkeley, Berkeley, CA

Operating System: VAX/VMS

Source Language: C, PL/1, VAX-11

Memory Required: 1MB Minimum

Special Hardware Required: Graphics terminal, Tektronix 4113, AED 512

KIC2 is a process independent IC artwork editor. It was developed to provide a low-cost alternative to present commercial artwork editors. This program is written in the C-programming language and is designed around a simple data model so that it can perform efficiently on a General Purpose 32 bit computer. KIC2 is in widespread use within the EECS department at Berkeley and has been used for the design of both digital and analog CMOS and NMOS circuits, Josephson function layouts and bipolar technologies.

KIC2 runs on the AED 512 and the Tektronix 4113 Color Graphics terminals which can be connected to a VAX computer.

Changes and Improvements: Directory command is implemented.

Restrictions: U.S. Government export regulations prohibit the distribution of this program outside of the United States without the appropriate export license.

Installation and user documentation available in hard copy only.

Media (Service Charge Code): Manual (EA), 600' Mastape (MA),  
Format: VAX/ANSI (Blocked at 2048)

## **WANTED**

Information from RGL users to help us design our application so we

Terry Milligan  
Intermetrics, Inc.  
5392 Bolsa Avenue  
Huntington Beach, CA 92649

# **COMBINED NEWSLETTER**



**DIBOL**

**Section Three**

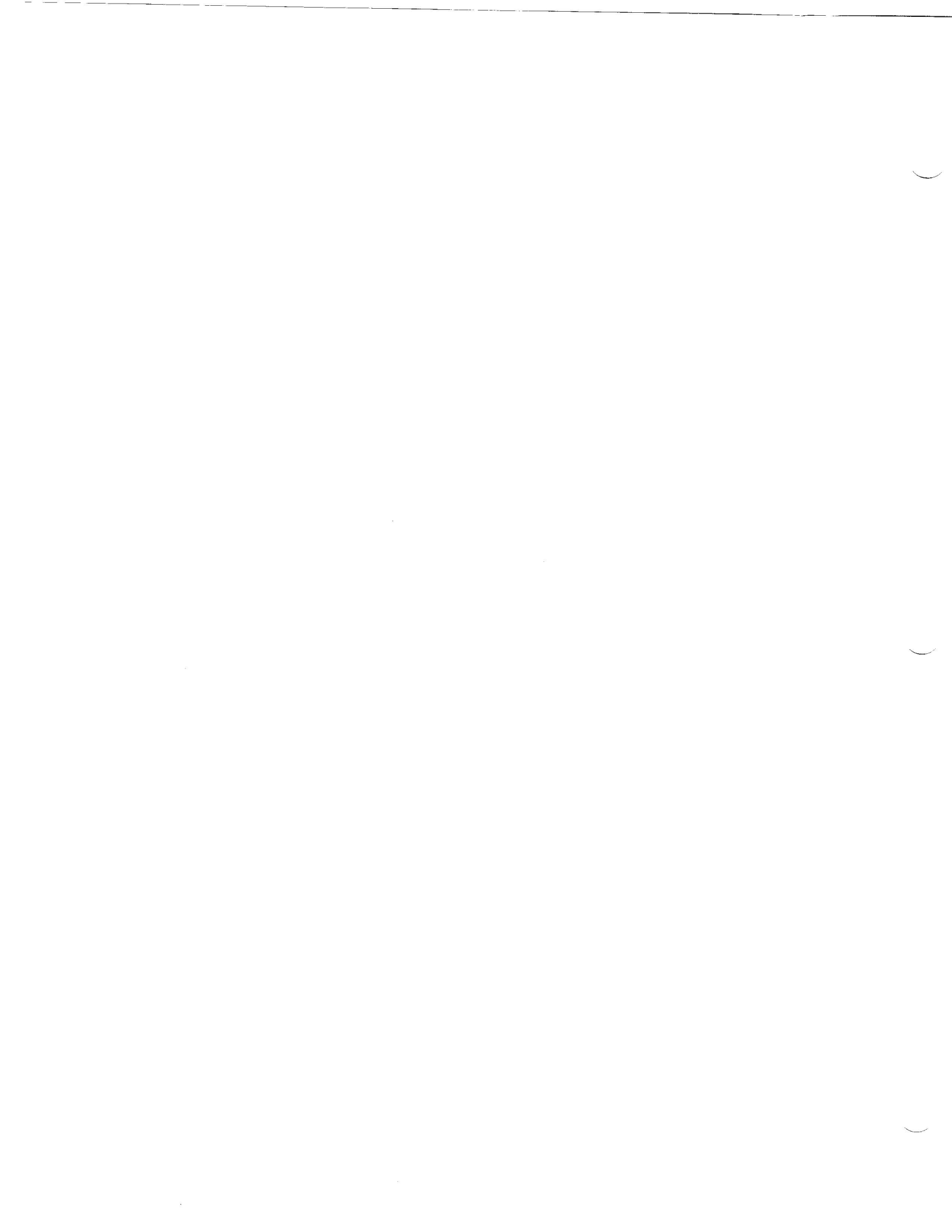

# DIBOL BUSINESS SIG NEWSLETTER

Volume II, Number 4

January 1984

## *in this issue ...*

From the Chair.....	page D2
Editor's Notes.....	page D3
VAX Commercial Language Comparison.....	page D4
Programming Standards.....	page D6
DIBOL 'WISH' LIST.....	page D12
DIBOL Request Ballot.....	page D23
SIG Officers.....	page D24
DECUS Library Order Form.....	page D25
QUERIES AND QUIPS Request Form.....	page D27



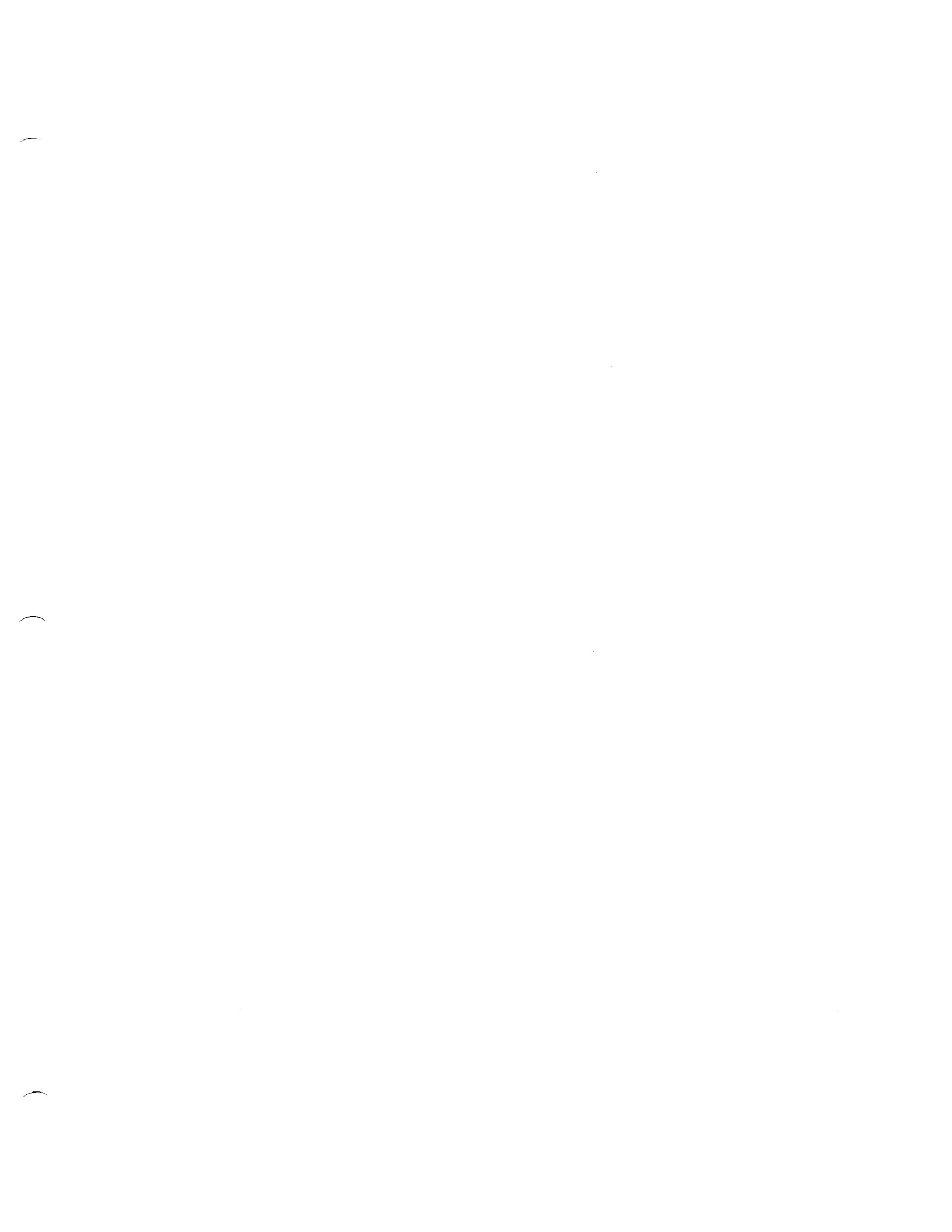

## VAX Commercial Language Comparison

Digital has recently completed a performance comparison of the VAX commercial languages. The benchmark was designed by a Commercial OEM in 1979 to test the relative performance of BASIC, COBOL, and DIBOL. Because so many people have asked for relative performance data, the same comparison has been run on VAX.

This comparison was performed in a "real world" environment. Rather than create a benchmark program that may emphasize arithmetic operations at the expense of I/O operations, the test consists of a typical commercial application written in each of the three languages.

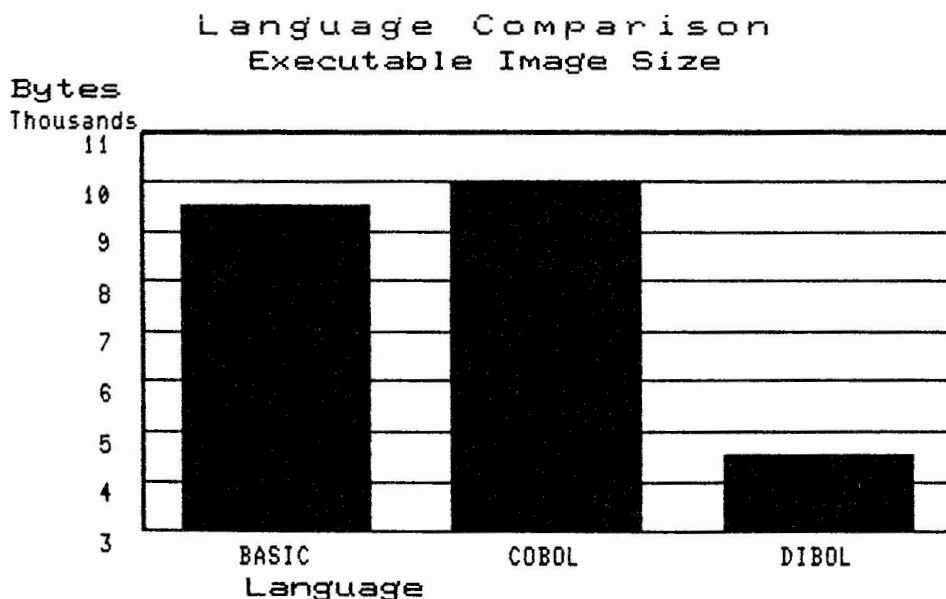

The VAX-11 DIBOL executable image is half the size of COBOL and BASIC. This means it takes less disk space to store DIBOL programs and less memory to run DIBOL programs.

### Compilation Speed

The VAX-11 DIBOL V 2 compiler is over twice as fast as BASIC and over 50% faster than COBOL on the VAX-11/730, VAX-11/750, and VAX-11/780.



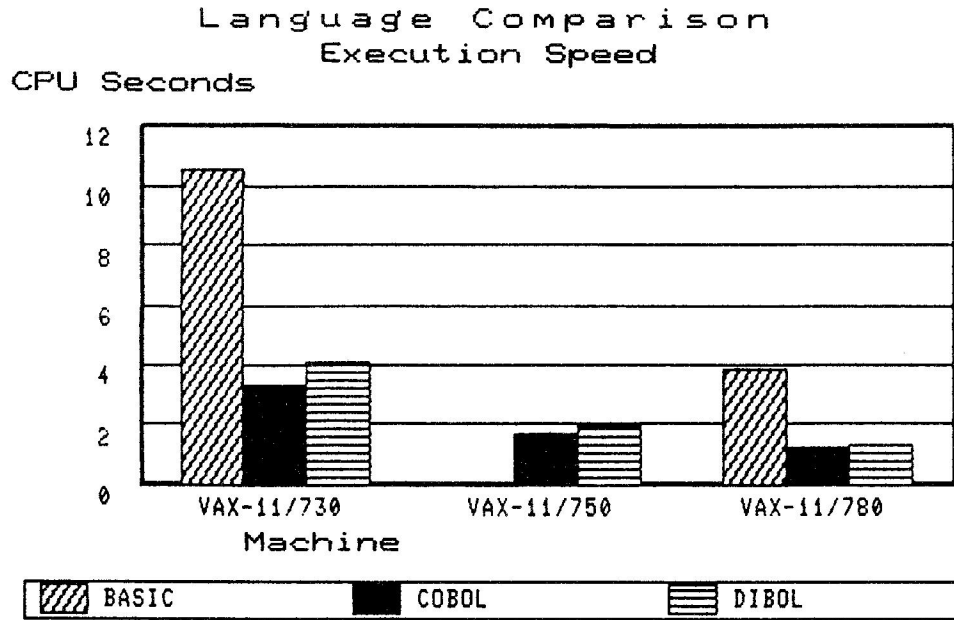

The VAX-11 DIBOL and COBOL programs take the essentially same amount of time to execute. Both DIBOL and COBOL execute over 60% faster than BASIC.

# PROGRAMMING STANDARDS

Submitted by: David P. Hanifin  
 Lee County Electric Cooperative  
 Ft. Myers, FL

## 1) PROGRAM HEADER

The beginning header requirement for a program should be formatted as follows. It should be a separate file called 'PROGRAM NAME'.HST and be the first module pulled into the program at compilation.

```

START ;CCZIP - ZIP CODE MAIL LIST
;*****
;** ORIGINAL PROGRAMMING DATE ; 11/3/82 **
;** PROGRAM NAME ; CCZIP.DBL **
;** PROGRAM VERSION NUMBER ; 00 **
;** PROGRAM REVISION NUMBER ; A **
;** PROGRAM AUTHOR ; KATHY FAUL **
;** PLACE OF PROGRAM ORIGIN ; L.C.E.C. **
;*****
;** PROGRAM DESCRIPTION ; **
;** ZIP CODE MAILING LIST - TOTAL NUMBER OF ALLOCATION CARDS BY **
;** ZIP CODE, SUBTOTALS BY 1ST 3 POSITIONS OF ZIP CODE AND **
;** GRAND TOTALS OF ALL ZIPS. **
;*****
;** SPECIAL PROGRAM INSTRUCTION ; **
;** ** **
;** ** **
;*****
;** REVISION HISTORY ; **
;** ** **
;** REVISION # DATE INITIALS SR#/REASON **
;** ----- ---- - **
;** ** ** **
;** ** **
;*****
    
```

2) FILE DESCRIPTION HEADER

All record descriptions should be formatted as follows:

```

; *****
; *          CAPITAL CREDITS MASTER FILE          *
; *****
; * FILE NAME :                CCMST.ISM          *
; * LOGICAL :                   L:                *
; * FILE ORGANIZATION :        IDX                *
; * RECORD FORMAT :            FIX                *
; * RECORD SIZE :              137                *
; * BUCKET SIZE :              1                  *
; * PRIMARY KEY :              NCTN              *
; * ALTERNATE KEY-1 :          *                  *
; * ALTERNATE KEY-2 :          *                  *
; * ALTERNATE KEY-3 :          *                  *
; *****

```

RECORD CCMST

		<u>;BEG.</u>	<u>END</u>	<u>FIELD DESCRIPTION</u>
NCIN	,D9	;1	9	MEMBER NUMBER
NSSN	,D9	;10	18	SSN
NNAME	,A25	;19	43	CONSUMER NAME
NADD1	,A20	;44	63	ADDRESS LINE 1
NADD2	,A20	;64	83	ADDRESS LINE 2
NCITY	,A13	;84	96	MAILING CITY
NST	,A2	;97	98	MAILING STATE
NZIP	,D5	;99	103	ZIP CODE
NZIP4	,D4	;104	107	ADDT'L ZIP CODE
NIND	,A1	;108	108	RETIREMENT INDICATOR
	,A29	;109	137	RECORD SIZE 137

3) APPLICATION CHANNEL ASSIGNMENTS

Each application will have it's own channel assignments for it's data files. All programs within that application should consistently use their designated channel assignments. All application requiring KB: will open channel 1 for KB: assignment.

```

; *****
; *          I/O CHANNEL ASSIGNMENTS          *
; * CHANNEL          ASSIGNMENT          *
; * 1                KB:                    *
; * 2                CCTAGM.ISM            *
; * 3                CCTAGZ.FIL            *
; * 4                *                      *
; * 5                *                      *
; * 6                PRINT FILE            *
; *****

```

4) PRINT HEADINGS

Headings for printed output will follow a standard format. Information required at the top of each printed report is as follows:

- |                    |                                    |
|--------------------|------------------------------------|
| A) PROGRAM NAME    | ; 1ST LINE OF HEADING-LEFT CORNER  |
| B) L.C.E.C.        | ; 1ST LINE OF HEADING-CENTERED     |
| C) PAGE NO.        | ; 1ST LINE OF HEADING-RIGHT CORNER |
| D) SYSTEM RUN DATE | ; 2ND LINE OF HEADING-LEFT CORNER  |
| E) REPORT NAME     | ; 2ND LINE OF HEADING-CENTERED     |
| F) SYSTEM RUN TIME | ; 2ND LINE OF HEADING-RIGHT CORNER |

5) COMMON VARIABLE USAGE & RECORD SWITCHES

Common variables such as those used for error handling and messages will be used as much as possible. A common area of variable will be used in all programs. Variables used in a record definition, such as CCSW1 & CCSW2 must be commented in detail. See example below.

COMMON

CCPRG	,A6,'CCZIP'	;PROGRAM NAME
CCDES	,A20,'ZIP CODE MAIL LIST'	;PROGRAM DESCRIPTION
CCMES	,A40	;MESSAGE
CCNT	,D7,0000000	;RECORD COUNTER
CONT	,D7	;SAVE COUNTER
CCVER	,D3,010	;CURRENT VERSION NUMBER
CCREV	,A1,'A'	;CURRENT REVISION NUMBER
CCDAT	,A9,'XX-XXX-YY'	;LAST ACCESSED DATE
CCSW1	,D1	;1=SINGLE HT DOUBLE WT ;2=DOUBLE HT DOUBLE WT
CCSW2	,D1	;1=PROCESSING PLEASE WAIT ;2=PRINTING REPORT ;3=PLEASE STAND BY
ERR	,D3	;ERROR NUMBER
LINE	,D4	;ERROR LINE NUMBER

6) MISCELLANEOUS VARIABLES

All miscellaneous variables should be grouped together and commented in detail. \* \* NOTE \* \* for efficient storage of variables, they should all begin with the same letter.

RECORD MISC

CHZIP	,D5	;HOLD ZIP CODE
CNTZIP	,D6	;TOTAL BY ZIP CODE
CNTSUB	,D6	;SUBTOTAL BY 1ST 3 POS
CTOTZC	,D6	;TOTAL FOR ALL ZIP CODES
CMASK	,A6,'ZZZZX'	;MASK FOR ZIPS AND TOTALS
CPAGE	,D3,000	;PAGE COUNTER
CNTLIN	,D2	;LINE COUNTER

7) INDENTATION AND SPACING

The following are guidelines to be followed.

1. Variable data names, record name and labels should be consistent throughout program and preferable start in column 1 to promote readability.
2. Items within record and source code should be preceded by a tab.
3. Skip at least one line between paragraphs.

8) DATE FORMATTING

Unless it is necessary to format date in a different manner, all dates will be stored as YYMMDD.

9) COMMENTING

Internal line commenting should appear next to the following statements and be consistently aligned.

1. 'IF' STATEMENTS
2. 'GOTO' STATEMENTS
3. 'INCR' STATEMENTS
4. 'ONERROR' STATEMENTS
5. 'CALLS' AND 'XCALL' STATEMENTS
6. 'I/O' STATEMENTS SUCH AS 'READ' AND 'WRITE'
7. 'OPEN' AND 'CLOSE' STATEMENTS

Additionally, any code which the programmer feels should be commented. Paragraph commenting will be required prior to each new paragraph label.

10) LOGICALS

No program to be promoted to production will have project programmer number within it's body. Logicals such as 'L:' and 'PRT:' replace 'DB2:[30,100]'. Logical usage will provide greater flexibility and more portability.

11) OPEN/CLOSE STATEMENTS

All 'OPEN' statements and all 'CLOSE' statements will be nested together in the programs. Opens at the beginning and closes at the end.

```
OPEN(3,I,'L:CCTAGZ.FIL')           ;INPUT FILE - CC TAG FILE (ZIP)
OPEN(4,SI,'L:CCMST.ISM')          ;INPUT FILE - CC MASTER FILE
OPEN(5,O,'L:CCZIP.ERR')           ;OUTPUT - RUN TIME ERROR RPT
```

SOURCE CODE

```
CLOSE 3                           ;CLOSE INPUT - CC TAG FILE
CLOSE 4                           ;CLOSE INPUT - CC MASTER FILE
CLOSE 5                           ;CLOSE RUN TIME ERROR FILE
```

## 12) MENUS

All programs will be run from menus and return to menus. Menus will contain the following information:

1. Program name
2. Menu name
3. System date and time
4. Program selection

All menus should be 'PASSWORD' and 'CTRL C' protected. Menu selections should be numerical figures. A program selected from a menu should not 'NORMALLY' exit without returning to a submenu or main menu.

## 13) REVISION BANNER

A revision banner will be displayed prior to a first screen. The information within the revision banner will include:

```
PROGRAM NAME  
VERSION  
REVISION  
LAST ACCESSED DATE  
'PROPERTY OF LCEC'
```

## 14) SUBROUTINE USAGE

A) INTERNAL - Routines should be coded efficiently and be well documented.

B) EXTERNAL - Routines will be provided for each programming language.

```
ex:  LMITR      BANNER/KEYBOARD I/O  
      IMMES     MESSAGE BANNER, REPORTS  
      LMCNT     COUNTER FOR REPORTS  
      LMCRT     CRT HEADER  
      LROUT     ROUTE SELECTION  
      LSCOR     SECURITY ROUTINE  
      INPUT     DATA ENTRY HANDLER
```

## 15) LOCKING/UNLOCKING

Record locking is enforced when files are open in 'SU' mode. All files opened in read only mode will be unlocked as soon as possible. Using the following format:

```
ONERROR ERROR  
READ(2,REC,RC)  
UNLOCK 2  
OFFERROR
```

16) PROGRAM STOPPING

1. Normal stop - Stop statements should always include a logical and either another program name or 'MENU'. EX: STOP 'PRP:MENU'
2. Abnormal stop - Programs which terminate because of error conditions must execute a routine to output the error conditions, terminate the job and log the user off the system. Error number, error line number and program name should be included as part of the error routine.

```

EX:  ERROR,
      XCALL ERROR(ERR,LINE)
      OFFERROR                               ; (1) ENF OF FILE
      IF (ERR.EQ.53.OR.ERR.EQ.1) GOTO CONT   ; (53) KEY NOT SAME
      IF (ERR.EQ.40) GOTO ERR1              ; (40) RECORD LOCKED
      FORMS (5,0)                           ; RUN TIME ERROR REPT
      EMSG (14,16)=ERR                       ; ERROR NUMBER
      EMSG (26,29)=LINE                      ; LINE NUMBER
      WRITES (5,MESG)                       ; WRITE ERROR MSG
      DISPLAY (1,155,' [22:15F',EMSG)       ; DISPLAY ERROR MSG
      GOTO EOF                               ; ON TERMINAL
  
```

```

RECORD MSG
      EMSG ,A48,'ERROR NUMBER      AT LINE      IN PROGRAM      !'
  
```

17) ERROR HANDLING

The following format will be used for error trapping in programs.

```

      ONERROR ERROR
      SERR=1
RK1,  READ (1,REC,E01)
      OFFERROR

'ERROR'      LABEL EXECUTION WILL BRANCH TO.
'SERR'      VALUE USED IN ASSOCIATING THE ERROR WITH ITS
            LOCATION IN THE PROGRAM.
'BK1'      LABEL TO BRANCH BACK TO FROM 'ERROR'.
'OFFERROR'  PREPARES FOR THE NEXT ERROR CONDITION.
  
```

Errors which occur unusually and are not trapped for, will be displayed on the screen for the user and written out to record msg as explained above in program stopping 2) ABNORMAL STOP.

## 18) PROGRAM AND FILE NAMING CONVENTIONS

Under the current operating system, RSTS/E, there are six positions available for the program name.

POSITIONS 1-3 Should be alphabetic reflecting their system.

EX: MAT = MATERIALS, GEL = GENERAL LEDGER

POSITIONS 4-6 Should be numeric and designate program function.

EX: 100 = REPORT, 200 = MENU, 300 = FILE MAINTENANCE

Subroutines should be identified by using 5 or less alphanumeric positions that help identify their function.

### FILE NAME EXTENSIONS

DIBOL SOURCE PROGRAM	.DBL
BASIC SOURCE PROGRAM	.BAS
FORTRAN SOURCE PROGRAM	.FOR
RMS DATA FILE	.ISM
RMS DATA FILE	.REL
RMS DATA FILE	.SEQ
INDIRECT COMMAND FILE	.DEF
EXECUTABLE IMAGE	.EXE
HISTORY OF CHANGES	.HST
COMMAND PROCEDURES	.COM
FILE DEFINITIONS	.REC
COMPLILER LISTING	.LTS
DOCUMENTATION	.DOC
OBJECT FILES	.OBJ
DATATRIEVE DICTIONARY	.DIC
DIRECTORY FILE	.DTR
OUTPUT LOG FILE	.LOG
FMS FORM LIBRARY	.FLB

### APPLICATION EXTENSIONS

REPORT FILES	.RPT OR .PRT
TEMP I/O DATA FILES	.TMP
PERM I/O DATA FILES	.DAT
CUMMULATIVE YTD DATA	.YTD
MONTH END DATA	.JAN
MONTH END DATA	.FEB
MONTH END DATA	.MAR
MONTH END DATA	.APR
MONTH END DATA	.MAY
MONTH END DATA	.JUN
MONTH END DATA	.JUL
MONTH END DATA	.AUG
MONTH END DATA	.SEP
MONTH END DATA	.OCT
MONTH END DATA	.NOV
MONTH END DAT	.DEC

## ~ DIBOL Wish List ~

The wish list is an outgrowth of the DIBOL feedback session that occurs at each U.S. DECUS as well as input from European DIBOL users. Requests for DIBOL language or system specific enhancements are recorded and Digital's response presented. The wish list is updated after each DECUS to include new suggestions and Digital's formal response is given at the next DECUS.

The wish list is divided into two major parts. The first part contains those requests which are being considered by Digital. The second part contains those items which are closed. Requests are added to the second part of the list when they are implemented or when Digital has no plans to implement them.

In this issue the OPEN REQUESTS portion of the wish list will be presented.



## OPEN REQUESTS

### DIBOL Language Enhancements

1.1 through 1.2 Closed.

1.3 Request (5-82): Implement implied decimal arithmetic so DIBOL keeps track of decimal point in arithmetic calculations.

Digital Response: This is under serious consideration.

1.4 Request (5-82): Implement a macro expansion capability in DIBOL which would expand a user statement into multiple DIBOL language statements.

Digital Response: This is under consideration.

1.5 through 1.6 Closed.

1.7 Request (5-82): Implement an OPEN-for-append mode for sequential files in those operating systems where it is meaningful.

Digital Response (5-83): This is already available in VAX-11 DIBOL since operating system features are available to implement this request. It is under serious consideration for other RMS systems.

1.8 Closed.

1.9 Request (12-82): Allow string operations, i.e. subscripting, of array elements.

Digital Response (5-83): This is under consideration along with multi-dimension arrays.

1.10 Closed.

1.11 Request (12-82): Provide a statement that will set many variables to the same values. Possible syntax might be:

```
SET A,B,C,D = 10  
  OR  
A = B = C = D = 10
```

Digital Response (5-83): This is under consideration.

1.12 Request (12-82): Add a FIND statement which would:

- o Search an Indexed file for a given key
- o Perform no actual I/O, but indicate if a record with such a key exists.
- o Move file pointer to found record, so READS could read the next record.

Digital Response (5-83): This is under consideration for RMS systems.

1.13 Closed.

1.14 Request (12-82): Allow returning from a SUBROUTINE by using XRETURN. This would clarify whether returning from internal call in a SUBROUTINE or the SUBROUTINE itself.

Digital Response (5-83): This is under consideration.

1.15 Closed.

1.16 Request (12-82): Allow a binary data type for loops and indexing to provide performance improvements over today's implementation which supports only decimal data types and converts the value to binary upon statement execution.

Digital Response (5-83): This is under serious consideration.

1.17 Closed.

1.18 Request (12-82): Provide a FUNCTION facility similar to FORTRAN or BASIC.

Digital Response (5-83): This is under serious consideration.

1.19 Request (12-82): Provide a multi-dimension array capability.

Digital Response (5-83): This has been discussed at DSO and a syntax has been recommended. This is under consideration.

1.20 through 1.21 Closed.

1.22 Request (3-83 UK): Implement an easy test for alphabetic characters.

Digital Response (5-83): This is under consideration.

1.23 Closed.

1.24 Request (3-83 UK): The VAX compiler should generate machine language code rather than interpretive code.

Digital Response (5-83): This is under serious consideration.

1.25 Request (3-83 UK): Implement a way to resume after an ONERROR

trap.

Digital Response (5-83): This is under consideration.

1.26 Closed.

1.27 Request (5-83): Optionally allow specifying a field without a size when an initial value is included. The DIBOL compiler should make the field the size of the initial value. A possible syntax might be:

```
, A*, 'ABCDEF'
```

which would result in this field being 6 characters long.

Digital Response (9-83): This is under consideration.

1.28 Request (5-83): Add packed decimal data type.

Digital Response (9-83): This is under serious consideration.

1.29 Request (5-83): Stop evaluating the expression in an IF statement as soon as it can be determined that the statement cannot be true. This would allow statements like:

```
IF (D .AND. ARRAY(D).EQ.1) ...
```

without getting a subscript error.

Digital Response (9-83): This capability is presently available if the following syntax is used:

```
IF D  
  BEGIN  
  IF ARRAY(D).EQ.1 ...  
  END
```

The BEGIN-END block is required for this to work. A change that would not require the BEGIN-END block is under serious consideration.

1.30 Request (5-83): Provide a statement to set a variable to some value. Possible syntax might be:

```
CLEAR AFLD TO 'T'
```

which would result in every character position within AFLD containing a 'T'.

Digital Response (9-83): This is under consideration.

1.31 Request (5-83): Provide a statement to do a backward scan on a string for some value.

Digital Response (9-83): VAX-11 DIBOL provides a subroutine for this purpose and this subroutine will be considered for other systems. DSO has defined the syntax for a DIBOL function to perform searches (both forward and backward) and implementation of the DSO function is under consideration.

- 1.32 Request (5-83): Provide a statement to do a table lookup.

Digital Response (9-83): This is under consideration.

- 1.33 Closed.

- 1.34 Request (5-83): Make DIBOL RMS I/O routines more flexible by adding access using key of reference, segmented keys, and RFA.

Digital Response (9-83): Some of the desired functionality is currently provided with external subroutines. Additional RMS I/O enhancements are under consideration.

- 1.35 Request (5-83): Optionally return the job name as well as the job number in the JBNO subroutine.

Digital Response (9-83): A JBNAM external subroutine is available with Professional DIBOL and RSX-11M-PLUS DIBOL. A similar subroutine for other systems is under consideration.

- 1.36 Request (5-83): Provide a WAIT statement like BASIC to automatically log off unattended terminals. After expiration of the time specified on the WAIT statement, any terminal input would cause a trappable error to be generated.

Digital Response (9-83): This is under consideration.

- 1.37 Request (5-83): Add the ability to create resident libraries using DIBOL subroutines.

Digital Response (9-83): This is under serious consideration.

- 1.38 Request (7-83 UK): Provide a subroutine to return the characteristics of an open file. The file size is of particular interest.

Digital Response (9-83): This is under consideration.

- 1.39 Request (7-83 UK): Add user definable literals that can be used anywhere in the program. For example:

SIZE=5 ; Literal definition

FIELD, A'SIZE' ; Literal reference

Digital Response (9-83): This is under serious consideration.

- 1.40 Request (7-83 UK): Add ability to test the value of a user

defined literal (see 1.39) in a conditional compilation statement. For example:

```
SYSTEM=2 ; System (1=CTS-300,2=RSTS/E)
.IF SYSTEM.EQ.1 ; CTS-300?
  FILE, A6,'FILNAM' ; Yes--
.ENDC
.IF SYSTEM.EQ.2 ; RSTS/E?
  FILE, A12,'[10,1]FILNAM' ; Yes--
.ENDC
```

Digital Response (9-83): This is under consideration.

- 1.41 Request (7-83 UK): Add IF-THEN-ELSE type construct for conditional compilation.

Digital Response (9-83): This is under consideration.

- 1.42 Request (7-83 UK): Add OR, AND, and XOR for conditional compilation so that multiple conditions can be tested.

Digital Response (9-83): This is under consideration.

- 1.43 Request (10-83): Add a .SHOW compiler directive to enable/disable listing conditionally uncompiled code and included files.

Digital Response: This is under consideration.

- 1.44 Request (10-83): Allow COMMON data to be defined in subroutines and referenced in a main program or other subroutines.

Digital Response: This is under serious consideration.

- 1.45 Request (10-83): Add more structure to the data division by allowing field redefinition and subfields.

Digital Response: This is under consideration.

- 1.46 Request (10-83): Allow PDP-11 DIBOL programs to call non-DIBOL subroutines by using the R5 calling standard. Also, allow DIBOL subroutines on PDP-11s and VAX to be more easily called by non-DIBOL programs by allowing arguments to be passed by reference and by value.

Digital Response: This is under serious consideration.

- 1.47 Request (10-83): Implement a way for a DIBOL program to set the exit status for the program.

Digital Response: This is under serious consideration.

- 1.48 Request (10-83): Add an EXIT statement to exit BEGIN-END blocks and an EXITLOOP statement to exit FOR, DO-UNTIL, and WHILE.

Digital Response: This is under serious consideration.

- 1.49 Request (10-83): Add a statement that would perform an untested loop such as:

REPEAT statement

Many DIBOL loops are exited when an end-of-file is detected and an untested loop would eliminate the need for constructs such as:

```
WHILE TRUE
  READS (1,RECORD,EOF)
```

or

```
DO
  READS (1,RECORD,EOF)
UNTIL DONE
```

Digital Response: This is under consideration.

- 1.50 Request (10-83): The end-of-file label used with ACCEPT, READS, and RECV does not facilitate good structured programming. Provide a way to execute a BEGIN-END block (or any other statement) when the end-of-file condition is detected. One possible syntax would be to use an asterisk to indicate that the end-of-file statement immediately follows the statement:

```
READS (1,RECORD,*)
  BEGIN
  XCALL ERROR (ERRNUM,ERRLIN)
  IF ERRNUM.EQ.EOF GOTO EOF
  END
```

Digital Response: This is under consideration.

- 1.51 Request (10-83): Allow relational operators in USING match expressions as in the following example:

```
USING VALUE SELECT
  (.LT. 0), statement
  (0),      statement
  (.GT. 0), statement
ENDUSING
```

Digital Response: This is under consideration.

- 1.52 Request (10-83): Add a way to execute a loop using a list of values, such as:

FOR dfield LIST (exp1, exp2, ... expn)  
statement

Digital Response: This is under consideration.

- 1.53 Request (10-83): SEND/RECV only operates between programs running on the same processor. However, with the advent of clustered systems as well as the increasing availability of DECnet, SEND/RECV should be enhanced to handle programs which run on separate processors.

Digital Response: This is under consideration.

- 1.54 Request (10-83): Add enhanced screen handling to make it easier to produce forms and to input the data from a form.

Digital Response: This is under serious consideration.

- 1.55 Request (10-83): Add a qualifier to the OPEN statement to specify that the file must be created contiguously. If the file cannot be created contiguously, then the OPEN will fail and a trappable error will be produced.

Digital Response: This is under serious consideration.

- 1.56 Request (10-83): Implement a way to lock a file (i.e., maintain exclusive access) that will work even when chaining between several programs.

Digital Response: This is under consideration.

- 1.57 Request (10-83): Add a way to create a file with protection.

Digital Response: This is under consideration.

- 1.58 Request (10-83): Add an optional argument to the CLOSE statement which specifies an action to be taken. The actions possible would be:

- 1 Delete the file just created
- 2 Truncate the file
- 3 Print the file
- 4 Submit the file

Digital Response: This is under consideration.

- 1.59 Request (10-83): Provide a way to use an alternate collating sequence (such as the multi-national character set) in relational operations.

Digital Response: This is under serious consideration.

### DIBOL Documentation

2.1 through 2.2 Closed.

2.3 Request (3-83 UK): COS-310 includes a page where the size of the DIBOL code is listed for each instruction. This is useful when programs have to be squeezed to fit. Please include similar documentation for PDP-11 and VAX implementations of DIBOL.

Digital Response (5-83): This is under consideration.

2.4 Closed.

### DIBOL Compiler

3.1 Request (5-82): Produce better error indication when compilation errors occur. Specifically, the error should be able to abort a command file. For example:

- o On RT-11, set the error byte in the monitor communication area to indicate an error.
- o On RSTS/E, preface the error with a question mark.

Digital Response (5-83): This is under consideration.

3.2 through 3.3 Closed.

3.4 Request (5-83): Provide a cross reference listing on RSTS/E.

Digital Response (9-83): This is under consideration for all PDP-11 DIBOL implementations.

3.5 Closed.

### DIBOL Implementations



4.1 COS-310 DIBOL

4.1.1 through 4.1.6 Closed.

4.1.7 Request (5-83): Provide a way to reach the SETUP on the DECmate-II. Running SYSGEN/C to get a system halt is not exactly a friendly way to do this.

Digital Response (9-83): This is under consideration.

4.1.8 Closed.

4.2 Professional DIBOL

No requests.

4.3 CTS-300 DIBOL

4.3.1 through 4.3.9 Closed.

4.4 RSX-11M-PLUS DIBOL

No requests.

4.5 RSTS/E DIBOL

4.5.1 through 4.5.5 Closed.

4.5.6 Request (12-82): Support queuing batch jobs thru LPQUE statement as is done in VAX-11 DIBOL.

Digital Response (5-83): RSTS/E DIBOL can queue batch jobs by chaining to an indirect command file via the "@PK" facility. Although unsupported, RSTS/E has committed support for DIBOL users with the understanding that someday the command file syntax may change.

A system independent way of queuing batch jobs is under consideration.

4.5.7 through 4.5.8 Closed.

4.6 VAX-11 DIBOL

4.6.1 Request (12-82): VAX-11 DIBOL should implement the DETACH statement. It is needed for compatibility. Print programs, for example, need a DETACH to free terminal after selecting printer, start/end range, etc.

Digital Response (5-83): VMS does not have the facility to let DETACH work. VMS developers have it under consideration.

4.6.2 through 4.6.4 Closed.

Utilities

5.1 SORT

5.1.1 Closed.

5.1.2 Request (5-83): Add a parameter to SORT for the number of records already in order and/or add the ability to merge a transaction file into a history file overwriting the pad records. Also, allow SORT to display a message on the terminal.

Digital Response (9-83): This is under consideration.

5.2 DECType

5.2.1 Closed.

5.2.2 Request (3-83 UK): Make DECType and QUILL available on all systems.

Digital Response (5-83): This is under consideration.

5.3 DDT

5.3.1 Request (7-83 UK): Have DDT work with label names in addition to line numbers.

Digital Response (9-83): This is under consideration.

5.3.2 Request (7-83 UK): Add a command to count the number of times a particular statement is executed.

Digital Response (9-83): This is under consideration.

FALL 1983 DIBOL  
REQUEST BALLOT  
QUESTIONNAIRE

DECUS Membership Number \_\_\_\_\_

Installation Delegate ?     Yes     No

Your experience level (circle one):

- 1. Wizard                      2. Expert                      3. Knowledgeable
- 4. normal                      5. Novice

REMINDER:

One ballot per DECUS membership number. Duplicates or ballots without membership number will be discarded.

The total number of points (absolute value) which you allocate on this ballot may not exceed 50 points. No more than 10 points may be given to any single request.

Request Number:

Points:

_____	_____
_____	_____
_____	_____
_____	_____
_____	_____
_____	_____
_____	_____
_____	_____
_____	_____
_____	_____
_____	_____
_____	_____
_____	_____
_____	_____
_____	_____
_____	_____
_____	_____
_____	_____
_____	_____
_____	_____
_____	_____
_____	_____
_____	_____
_____	_____
_____	_____
_____	_____
_____	_____
_____	_____
_____	_____
_____	_____

Please mail to: Mike Daugherty  
Digital Equipment Corporation  
Continental Blvd. MK01-2/H32  
Merrimack, NH 03054

# SIG Officers

\* CHAIRMAN

David L. Wyse  
Projects Unlimited, Inc.  
3680 Wyse Road  
Dayton, OH 45414  
(513) 890-1800 x 233

\* DEC COUNTERPART

Ray Arsenault  
Digital Equipment Corp.  
MK01-2/H32  
Merrimack, NH 03054  
(603) 884-5525

\* VICE CHAIRMAN/SUITE CO-ORDINATOR

David P. "Pat" Hanifin  
Lee County Electric Co-Operative, Inc.  
P.O. Box 3455  
North Fort Meyers, FL 33903-0308  
(813) 995-2121

HANDOUT EDITOR/PC LIASON

Dick Lloyd  
Lloyd Publicity Co.  
2107 North Charles St.  
Baltimore, MD 21218  
(301) 685-6161

\* SYMPOSIA CO-ORDINATOR

Vaughn Nowlin  
P.O. Box 59808  
Dallas, TX 75229  
(214) 351-2917

RT-11 CO-ORDINATOR

Brian Gardner  
Professional Business Systems  
2025 Sheppard Avenue E  
Willowdale, Ont M2J-IV7  
(416) 494-3623

\* LIBRARY CO-ORDINATOR

Ray Evanson  
Paragon Data Systems  
927 East King St.  
Winona, MN 55987  
(507) 452-8833

VAX CO-ORDINATOR

Neil Baldrige  
Comp-U-Share  
3824 50th St.  
Lubbock, TX 79413  
(806) 792-3785

\* PUBLICATION CO-ORDINATOR

Becky Burkes  
Financial Insurance Consultants  
P.O. Box 77  
Covington, LA 70434  
(504) 892-7428

RSTS CO-ORDINATOR

Ralph S. Jacobson  
Data Enterprises  
500 Turnpike St.  
Canton, MA 02021  
(617) 828-4800

\* STANDARDS AND VIDEO TAPING CO-ORDINATOR

Jim McGord Jr.  
Corpne Corporation  
Bluegrass Industrial Park  
Louisville, KY 40299  
(502) 491-4433

PAST CHAIRMAN

Lowell LeFebvre  
Sytek, Incorporated  
19 Church Street  
Berea, Ohio 44017  
(216) 243-1613

\* Denotes SIG Executive Committee



## DECUS LIBRARY ORDER FORM

(Use this form to order DECUS Library programs,  
Catalogs, Proceedings and other DECUS services.)

### HOW TO ORDER:

Please complete the attached order form and return to DECUS Order Processing.

Reference should be made to the CURRENT DECUS Program Library Catalog and Price List.

DECUS Library prices generally change July 1 of every year.

### HOW TO PAY:

Orders for less than \$25.00 must be prepaid and will not be invoiced.

**PREPAID ORDERS:** Orders for less than \$25.00 must be accompanied by a check, or money order made payable to DECUS. PLEASE DO NOT SEND CASH THROUGH THE MAIL.

**PURCHASE ORDERS:** Official company purchase orders, made payable to DECUS, are acceptable for orders of \$25.00 or more and must be accompanied by a completed DECUS order form.

### WHO TO CONTACT:

DECUS Membership Information (617) 467- 4168  
Ordering Information (617) 467- 4135

Orders and related correspondence should be sent to:

DECUS  
Ordering Processing  
One Iron Way, MRO2-1/C11  
Marlboro, MA 01752



Order Processing  
One Iron Way/MRO2-1/C11  
Marlboro, MA 01752  
(617) 467-4135

# DECUS LIBRARY ORDER FORM

(PLEASE DO NOT WRITE IN SHADED AREAS)

LOG NO.

**DECUS**

Please type this form.

Name				Name					
DECUS Membership No.				Company					
Telephone No.				Address					
Date Ordered									
Purchase Order No.									
Please attach purchase order and/or payment				City		State		Zip	
<p>THE DECUS PROGRAM LIBRARY IS A CLEARING HOUSE ONLY; IT DOES NOT SELL, GENERATE OR TEST PROGRAMS. ALL PROGRAMS AND INFORMATION ARE PROVIDED "AS IS".</p> <p>For further information, please refer to your Chapter supplement.</p>						<b>DIGITAL EMPLOYEES ONLY</b>			
						CC Number			
						CC Mgr. Name			
						CC Mgr. Badge No.			
				CC Mgr. Signature					
Line	Qty.	Program ORDER NO.	Media Code(s) (up to 3 per line)		Format (per catalog)	Line Amount (\$)	DECUS USE ONLY		
							Adjustment	Accounting	Order Processing
1		VI84-DIBOL	VE	(\$250)	VHS				Date Rec'd
2		(Fall 84)							Cash
3									Check
4		VI84-DIBS	VC	(\$250)	VHS				Receipt No.
5		(Fall 84)							Additional Payment
6									Date Rec'd
7									Amount
8									Receipt No.
9									Processed by
10									Refund Amount
11		Shipping..1 set \$25							Refund Date
		2 sets Free!							Accounting
12									
13									Invoice <input type="checkbox"/> Yes <input type="checkbox"/> No
SUBTOTAL									No.
ADD POSTAGE (See Price List)									Date
<b>TOTAL CHARGE</b>						Orders for less than \$25. must be prepaid and will not be invoiced!	\$		Amount
<p>THESE COMMODITIES ARE LICENSED BY THE UNITED STATES FOR ULTIMATE DESTINATION: UNITED STATES.</p> <p>DIVERSION CONTRARY TO U.S. LAW PROHIBITED.</p>									Remarks

# Queries & Quips



A SIG Information Interchange

Caption: \_\_\_\_\_

Message: \_\_\_\_\_

\_\_\_\_\_  
\_\_\_\_\_  
\_\_\_\_\_  
\_\_\_\_\_  
\_\_\_\_\_  
\_\_\_\_\_  
\_\_\_\_\_  
\_\_\_\_\_  
\_\_\_\_\_  
\_\_\_\_\_  
\_\_\_\_\_  
\_\_\_\_\_

Contact:

Name: \_\_\_\_\_

Address: \_\_\_\_\_

Telephone: \_\_\_\_\_

Signature \_\_\_\_\_ Date \_\_\_\_\_

MAIL TO: Becky Burkes  
P.O. Box 77  
Covington, LA 70434

