



**The ALTOS  
386 Series 600  
Marketing Guide**

**Altos 386 Series 600 Marketing Guide**

**Altos 386 Series 600**

**August 1989**

# Altos 386 Series 600 Marketing Guide

## Table of Contents

### Section:

I.	System Overview	I-1	
	A.	Series 600 Features and Benefits	I-2
	B.	Series 600 Product Specifications	I-3
	C.	System Architecture	I-5
		System Bus	I-6
		Main Logic Board	I-6
		System Memory	I-7
		Data Storage	I-8
		System Communications	I-8
		Uninterruptible Power Supply	I-9
		Modularity	I-9
		Diagnostics	I-9
	D.	Configurations	I-10
	E.	Operating System	I-11
		Compatibility	I-11
		Honey-Danber UUCP and CU	I-11
		Memory & Hard Disk Requirements	I-11
		Altos System V Features	I-12
		Languages & Communications	I-13
	F.	Warranty & Maintenance	I-14
	G.	Technical Support	I-14
II.	Market Positioning	II-1	
	A.	Market Analysis	II-1
	B.	Marketing Objective	II-3
	C.	Application Software Features	II-4
III.	Competitive Matrices & Benchmarks	III-1	
	A.	Competition	III-2

Altos 386 Series 600 Marketing Guide

I. System Overview

## Altos 386 Series 600 Marketing Guide

### I. System Overview

The Altos 386 Series 600 is a high performance 32-bit system that is based on multiple processor architecture. Specifically designed to serve the 1 to 8 user UNIX environment, the Series 600 is an entry-level Altos system ideal for small businesses.

Based on the high performance multi-user architecture of the Altos Series 1000, the Series 600 incorporates the Intel 80386 processor operating at 25MHz. The system achieves zero wait states with 32KB cache memory, and has an optional Intel 80387 floating point co-processor for fast math-orientated operations.

System performance is further enhanced by a multiprocessor architecture. The CPU board incorporates an Intel 80186 as an intelligent Input/Output (I/O) controller to handle incoming and outgoing communications of peripheral devices. This efficient multiple processor architecture provides an ideal solution for modern office automation and commercial application requirements.

Addressing smaller business environments, the Series 600 has a maximum system connectivity of up to 8 users and total RAM capacity of up to 8MB to efficiently support system users. Base Configurations include 4MB RAM, 1.2MB floppy drive, 90MB or 190MB SCSI hard disk, 125/150MB SCSI tape drive and eight RS-232 ports on the CPU board. Hard disk expansion supports up to 380MB of total disk storage.

The Series 600 is introduced with a full compliment of languages and software applications. System-to-system connectivity capability with current 386-based and previous 286-based Altos products is provided with the standard configuration of a WorkNet port on the Series 600. Through this port, synchronous communications with the 386-based Series 1000 and 2000 and all other 286-based Altos systems are possible with the Series 600 running WorkNet II LAN software. To promote the development of business applications and further increase productivity, all Altos products are available with training, service and support programs.

Offering state-of-the-art performance and software compatibility in a compact floor standing box, the Series 600 is designed for the small UNIX-based business environment.

## Altos 386 Series 600 Marketing Guide

### Series 600 Features and Benefits

<u>Feature</u>	<u>Benefit</u>
* 25MHz, 80386 processor	* High Performance System
* 32KB Cache Memory	* Maintains frequently used information, enabling zero wait states operation
* 4 to 8MB RAM	* Increased RAM capacity for better performance
* 90 to 380MB Internal Mass Storage	* Increased storage capacity to grow with your business environment
* 1.2MB Floppy Drive	* Data exchange with IBM PC/AT Systems
* Standard 125/150MB SCSI Tape Drive	* Convenient and reliable tape backup
* Integral 80186 I/O Processor operating at 7MHz with 128KB Buffer Cache	* Off-loads CPU's workload providing for enhanced system performance
* Eight RS-232 ports on CPU	* Enhanced on-board serial connectivity provided with base system configuration
* 1 serial port configured for WorkNet	* System connectivity to Altos 386-based Series 1000, Series 2000 and all Altos 286-based products

# Altos 386 Series 600 Marketing Guide

## Series 600 Product Specifications

### Main Logic Board

#### CPU Section

Processor:	Intel 32-bit 80386, 25MHz
Co-processor:	Intel 32-bit 80387 (optional)
Cache Memory:	32KB

#### I/O Section

I/O Controller:	Intel 80186
Local Memory:	128KB with byte parity checking
Async Ports:	7
Async/WorkNet Port:	1
Async Speed:	300 - 19.2Kbps
WorkNet LAN Speed:	1.4Mbps
ADMA Controller:	82258
Floppy Controller:	WD37C65 25MHz
SCSI Controller:	WD33C93 25MHz

#### System Memory Section

Addressable RAM:	4MB with byte parity checking
Data Transfer Rate:	Up to 18.3MB/sec
Transfer Word Length:	8, 16, 24, or 32-bit

### Main Memory

RAM:	4MB, up to 8MB
Expansion Sizes:	4MB Boards
Number of RAM Slots:	2

### Floppy Disk Drive

Max. Drive/Chassis:	1
Media Size:	5.25-inch
Media Type:	Double-Sided/Dual-Density
Media Capacity:	1.2MB (formatted)

### Hard Disk

Max. Drive/Chassis:	2 Half-Height or 1 Full-Height
Platter Size:	5.25-inch
Interface:	SCSI
Formatted Sizes:	90MB, 190MB Half-Height Drives
Average Access Times:	29ms, 18ms
Data Transfer Rate:	10Mbps

## Altos 386 Series 600 Marketing Guide

### Tape Drive

Max. Drive/Chassis:	1		
Form Factor:	5.25-inch Half-Height		
Interface:	SCSI		
Media Size:	1/4-inch		
Operating Mode:	90ips, streaming		
Recording Mode:	NRZI		
Capacity:	60MB	125MB	150MB
Format:	QIC-24	QIC-120	QIC-150
Number of Tracks:	9	15	18
Media Type:	DC600A	DC600A	DC6150
Support:	Read Only	Read/Write	Read/Write

### Chassis Specifications

Cabinet:	4 Half-Height Slots		
Number of RAM Slots:	2		
Configuration:	Floorstanding Model		
Height:	20-inches		
Width:	7-inches		
Depth:	20-inches		
Weight:	Approx. 63 lbs.		
Power Supply:	250 Watts		
AC Power Range:	115 VAC	90 to 127 VAC	
(Switch Selectable)	230 VAC	195 to 253 VAC	
Line Frequency Range:	47 to 73Hz		



### System Architecture

The compact system architecture allows for convenient system configuration and service. A variety of specific business requirements are easily addressed with the Series 600 hardware platform. The system supports up to three modular plug-in printed circuit boards and four half-height storage device modules.

The architecture of the Series 600 is a single board computer providing entry-level cost benefits. The CPU, cache memory and the I/O controller reside on the main logic board. This single board CPU design includes the Intel 80386 processor, 32KB cache memory and eight RS-232 ports. An Intel 80387 floating point processor is available as an option. System memory is contained in a single dedicated memory slot with one additional memory slot for expansion. All boards are plug in, and easily slide into the system without the use of ribbon cables.

Internally, the system supports up to two SCSI half-height drives, one SCSI 1/4-inch tape drive and a 5.25-inch floppy drive. The Series 600 component architecture is illustrated in Figure One.

Figure 1

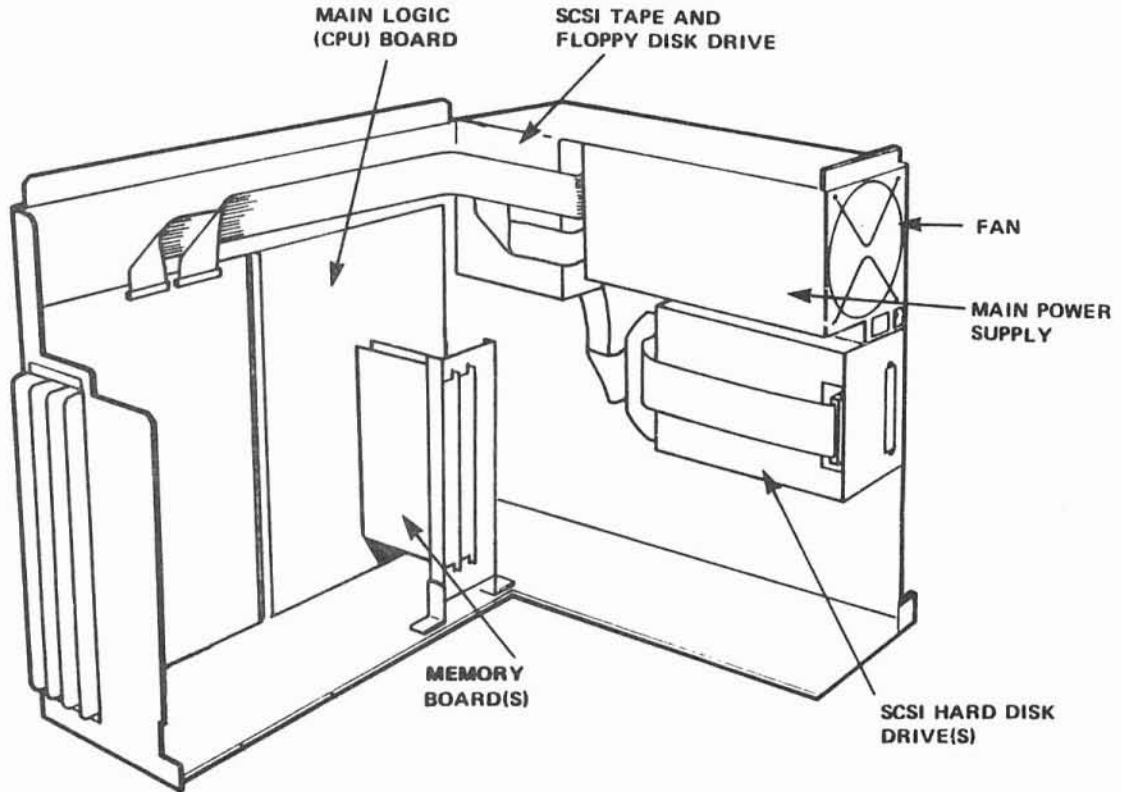

Altos 386 Series 600 Open Rear Panel

## Altos 386 Series 600 Marketing Guide

### System Bus

The system bus is asynchronous and has 32 data lines and 26 address lines that can support a maximum data transfer rate of 20MB per second. While the Series 600 system features are designed to accommodate 8MB of system memory, the system bus can support up to 64MB of memory address space and data transfers can be either 8, 16, 24 or 32-bits wide.

Featuring a unique bus design and SCSI-based peripherals, the Series 600 components (i.e. boards, peripheral devices) are not interchangeable with Altos 286-based products or the 386-based Series 500 and Series 2000.

### Main Logic Board

The main logic board on the Series 600 includes all the following subsystems on one system board.

- \* Main Processor
- \* Input/Output
- \* Controller I/O Bus
- \* Peripheral Control
- \* Communications

This enables the Series 600 to provide powerful advantages of a larger, more expensive system in to a compact, high performance chassis.

### Main Processor Section

The Series 600 is designed with the Intel 32-bit 25MHz 80386 microprocessor, 32KB cache memory and an optional Intel 80387 Floating-Point Numeric Co-processor for fast math oriented operations. An interrupt controller and a calendar clock with battery backup are also contained in the main processor section.

Cache memory efficiently utilizes the full power and speed of the microprocessor by keeping its own copy of data that the processor is most likely to use repeatedly. Since cache memory is much faster than main memory, the CPU can access data and operate more efficiently. At the same time, the large size of the cache and its 2-set design make it less likely that the processor will need to access the main memory and therefore, the system bus. This translates to both, a higher cache "hit" ratio and greater system bus availability for other system functions. Conversely, systems with little or no cache memory force the CPU to wait when accessing the relatively slow main memory.

An efficient high-speed on-chip Memory Management Unit (MMU), designed for high performance in a multi-user, multi-tasking environment, supports Altos' full Demand-Paged Virtual Memory (DPVM).

## Altos 386 Series 600 Marketing Guide

Based on mainframe technology, DPVM is used in the Altos System V/386 operating system to manage and partition main memory. As a program runs, only needed sections are moved into main memory, replacing portions that are not needed. DPVM allows each software application to "see" a uniform, large address space independent of the number of applications running on a system or the actual size of main memory. The MMU maps virtual memory into the actual (physical) memory of the system.

The MMU in conjunction with the Altos System V/386 operating system can support up to 2 Gigabytes of virtual user memory by managing it in 4KB blocks.

### I/O Controller Section

The I/O Controller is based on an Intel 80186 processor with 128KB of buffer memory to off load the SIO burden from the 80386 processor. Data transfer between the I/O Controller (Intel 80186), I/O peripherals, and local 128KB memory is provided by this 16-bit controller bus.

### Peripheral Control Section

The Intel 80186, assisted by an 82258 four-channel ADMA controller, efficiently manages the I/O peripheral devices. Internally, a floppy disk drive, a SCSI tape drive and up to two SCSI-based hard disk drives can be supported.

### Communications Section

The I/O processor is driven by the Intel 80186 microprocessor operating at 7.3MHz with 128KB of local memory. Supporting up to eight RS-232 ports and all communication expansion, the 80186 relieves the CPU of all communication I/O. One of the eight on-board ports may be software configured as an Altos WorkNet LAN port providing system communication to all Altos 286 and 386-based systems except the Altos 386 Series 500.

### System Memory

Entry-level Series 600 configurations come with 4MB RAM occupying one of the two 32-bit dedicated memory slots. Total system memory can be expanded to 8MB. Memory expansion boards come in 4MB boards. The CPU communicates with system memory via a 32-bit bus.

For high performance and reduced cost, the Series 600 takes advantage of Dual In-line Packaging (DIP) RAM. This memory provides similar performance as standard Zigg Zagg In-line Packaging (ZIP) or Single In-line Memory Module (SIMM) memory, but costs less. Main memory in the Series 600 is closely coupled so that all system memory operates at high speed providing a data transfer rate up to 18.3MB per second. System memory is organized into long words of 32-bits, and memory transfers can be made in 8-, 16-, 24-, or 32-bit quantities.

## Altos 386 Series 600 Marketing Guide

### Data Storage

The Altos 386 Series 600 offers flexible data storage. Each standard system includes a 1.2MB floppy disk drive, a 125/150MB SCSI streaming tape drive and a SCSI disk drive.

The floppy disk drive is a dual-speed, double-sided, double-density, 5.25-inch disk drive which uses normal (800KB formatted) capacity or high (1.2MB formatted) capacity disks. Data transfer is at either 250Kbps or 500Kbps.

Standard (formatted) hard disk configurations for the Series 600 come in two sizes. There is a 90MB SCSI half-height drive and 190MB SCSI half-height drive with data transfer rates of 10Mbps. The system can configure two half-height drives for a maximum storage capacity of 380MB.

### Series 600 System Communications

The Series 600 supports a maximum of eight RS-232 ports which are located on the main logic board. One of the eight ports on the main logic board is software configured to support the Altos WorkNet LAN. This enables the Series 600 to connect up to 30 Altos systems. The system does not configure additional serial communication boards.

Figure 2 illustrates the front and rear panels of the Series 600. The rear panel contains eight RS-232 ports on the CPU board and an Uninterruptible Power Supply (UPS) connector. More information on the UPS subsystem is included on the following page.

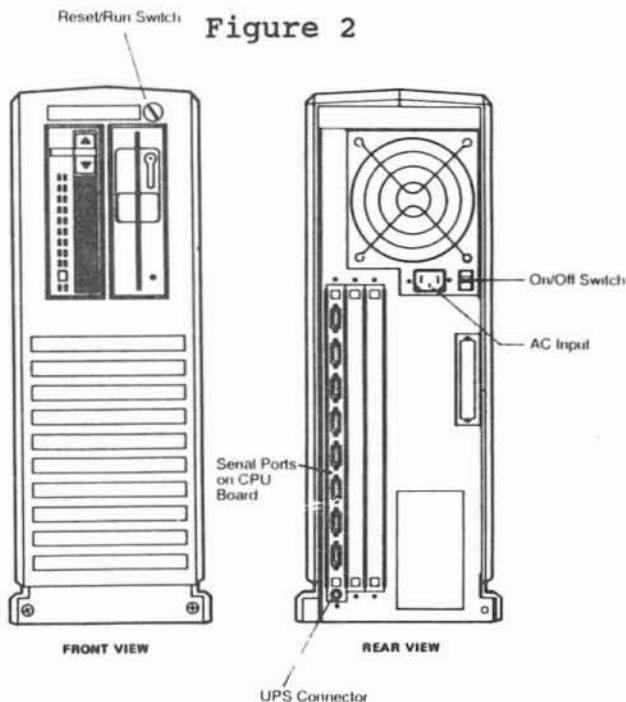

Altos 386 Series 600 Front and Rear Panels

## Altos 386 Series 600 Marketing Guide

### Uninterruptible Power Supply Subsystem

Combined with Altos System V/386, the Uninterruptible Power Supply (UPS) provides extra reliability and file system integrity during power failure for the Series 600. If an AC power line failure occurs for more than 20 milliseconds, the UPS becomes active. During a line failure, the UPS switches to internal battery power and continues to supply full power to the computer system for a normal shutdown, or saving the state of the system.

The UPS option is highly recommended for systems located in areas where the AC power supply is not stable. It is also recommended for systems which are used in transaction processing application environments.

### Modularity and Upgrade Capability

A principle feature of the Series 600 system is its compact cabinet and economical design. The CPU easily slides out of a system slot for service or upgrade while memory expansion is conveniently accomplished by adding an additional board. Modularity enables the Series 600 to easily accommodate a Series 1000 (25 or 33MHz) CPU board. Upgrading to this CPU allows the Series 600 access to all the expansion capabilities of a Series 1000 system including external hard disk and tape support.

System service is easier and at much lower cost since the system was designed around 10 Field Replaceable Units (FRUs) that are hand-pluggable. This modular approach also allows the system to incorporate newer and higher performance technologies (more memory, larger hard drives, etc.) as it becomes available, thus insuring a built-in future to match changing needs.

### Diagnostics

Three major categories of diagnostic tests are provided to help maintain the Series 600 system. A "Power-On Test" confirms the operational status of major system components. A menu-driven "User Confidence Test" allows the non-technical system user to test the full functionality of the system. "Field Service Diagnostics", which can be run locally or executed remotely via a modem by a trained technician, will help isolate failures down to the field replaceable unit. These features help isolate problems easily while system modularity and field replaceability offers quick servicing and maximum system availability to the user.

## Altos 386 Series 600 Marketing Guide

### Configurations

The following are standard configurations for the Altos Series 600. Hardware options should be purchased from Altos.

#### Altos 386 - 6409T

P.N. 540-23275-001

- 80386, 25MHz CPU Board
- Socket for 80387 Floating Point Co-processor
- 32KB Cache memory
- 4MB RAM
- 8 serial ports on CPU board
- 1.2MB 5.25-inch Floppy Drive
- 90MB SCSI Disk
- 125/150MB SCSI Streaming Tape Drive

#### Altos 386 - 6419T

P.N. 540-23275-005

- 80386, 25MHz CPU Board
- Socket for 80387 Floating Point Co-processor
- 32KB Cache memory
- 4MB RAM
- 8 serial ports on CPU board
- 1.2MB 5.25-inch Floppy Drive
- 190MB SCSI Disk
- 125/150MB SCSI Streaming Tape Drive

#### Upgrade Options

- 80387 Floating Point Co-processor, 25MHz
- 4MB RAM Board (DIP Page Mode)
- 90MB SCSI Drive (Half-Height)
- 190MB SCSI Drive (Half-Height)
- Uninterruptible Power Supply (UPS) Subsystem

## Altos 386 Series 600 Marketing Guide

### Operating System

Altos System V/386 continues Altos' technological leadership by offering a powerful UNIX/XENIX merged product. Altos System V/386 combines AT&T's UNIX standards, Microsoft's refinements for commercial use and Altos' UNIX/XENIX merged enhancements. The Altos enhancements take advantage of the Altos system architecture and provide ease of installation, use, and maintenance of Altos systems.

#### Compatibility

Altos System V/386 protects your investment in application software with built-in compatibility with popular operating systems in the market today. Based on the industry standard AT&T UNIX System V Release 3.1, Altos System V/386 provides compatibility with XENIX.

X.OUT and COFF (Common Object File Format) applications are also supported by Altos System V/386. COFF is the standard object and application file format for AT&T's UNIX V.3. System utilities for transferring files between Altos System V/386 and MS-DOS formatted diskettes are also provided.

#### Honey-Danber UUCP and CU

Two communications utilities are part of the Altos System V/386 operating system. The Honey-Danber UUCP and CU communications utilities are included within the Altos System V/386 Run-time System. These industry standard UNIX V.3 file transfer utilities are easy to use and maintain.

#### Memory Requirements

Altos System V/386 requires 2MB of RAM dedicated to the operating system. System performance is highly dependent upon the type of application and the amount of configured RAM. Some applications require more system memory than others. With a minimum 4MB of system configured RAM and a maximum of 8 users, the Series 600 should not have to be expanded in a normal application environment.

#### Hard Disk Requirements

The UNIX System V/386 Runtime occupies approximately 15MB and reserves another 5MB as the default swap area on the hard disk. The UNIX System V/386 Development System uses approximately 6MB of additional hard disk space and the documentor's workbench requires approximately 4MB of additional hard disk space. The Runtime and Development Systems occupy approximately 30MB of total hard disk space.

## Altos 386 Series 600 Marketing Guide

### Altos System V Features

- \* Record and File Locking - Allows an application to lock a file or record to prevent corruption by having more than one user access the file at the same time.
- \* Synchronous "Block Writes" - Features provided to update file and directory information on the hard disk prior to returning control to the application. This feature provides data integrity assurance.
- \* Semaphores and Shared Memory Operations - Semaphores synchronize the process by dividing large programming tasks into several, smaller, concurrently executing tasks, and also provide an exclusive use of a resource or shared variable. Shared memory operations provide a means by which cooperating processes can communicate rapidly.
- \* Symbolic Links - Allows files or directories to be located transparently on different disk drives within a system or even on other systems if they are connected via Altos' WorkNet II LAN or Remote File Sharing (RFS).
- \* Transparent Printer Support - Allows printer support via the auxiliary port of an Altos terminal instead of a system port.
- \* Demand Paged Virtual Memory - Allows programs that are much larger than actual physical memory to be executed. Essential pieces of the program are paged in and out of memory in 4KB page increments.
- \* Altos System V Print Spooler - Allows you to schedule jobs for the printer.
- \* Loadable Device Drivers - Software developers can now add custom drivers to applications without packaging a customized operating system kernel within the product. Thereby, increasing flexibility for customized software support.
- \* Shared Libraries - COFF binaries can share library code in RAM, saving RAM space.
- \* UPS Support - The ability to connect an Uninterruptible Power Supply (UPS) to the system which secures your system against power failure.



## Altos 386 Series 600 Marketing Guide

### Languages

Altos offers an ideal environment for software design, development and maintenance with many different language options including BASIC, C, COBOL, FORTRAN, Pascal, and RPG II.

- \* BBX Progression/2
- \* MBASIC Compiler
- \* MBASIC Interpreter
- \* LPI-BASIC
- \* C
- \* LPI-COBOL
- \* RM/COBOL Version 2
- \* RM/COBOL-85
- \* COBOL/2
- \* LPI FORTRAN
- \* LPI-PASCAL
- \* LPI-RPG II

### Communication Products

#### WorkNet II Local Area Network (LAN)

The Altos WorkNet II LAN combines hardware, which is built into Altos 16-bit and 32-bit systems, and software to transform UNIX systems into a transparent distributed processing environment. Software selectable for network speeds of .8Mbps or 1.4Mbps, WorkNet II can support up to 30 Altos systems. WorkNet II provides a gateway for accessing and sharing data between Altos 8086, 80286 and 80386 based systems.

#### CLEO 3780 Plus (SYNCCable)

The 3780 Plus software package enables your UNIX-based Series 600 system to emulate an IBM 3780 or 2870 RJE Station. With 3780 Plus you can transmit and receive files from any other micro, mini or mainframe computer supporting the 3780/2780 bisynchronous protocol.

#### ASYNc

Altos Async provides a low-cost, easy-to-use data communications. Async can be used with any of the communications ports on the Altos machine. In addition to a menu operated interface, Async provides a simple and reliable file-transfer facility that uses the "modem" protocol for reliable movement of information between systems.

## Altos 386 Series 600 Marketing Guide

### Warranty

All Altos products come with a one year parts and labor warranty. For system maintenance, the customer has three choices in which to depot the system. They may send the system to Altos in San Jose, CA., a regional support center or a Self Servicing Reseller.

### Maintenance

#### Altos On-Site

Altos offers the non-servicing reseller a hardware support solution with the Altos On-Site (AOS) program. Altos has designed and is ultimately responsible for the functionality and operation of this program. Triad and Bunker-Ramo are two reliable and wide spread servicing companies contracted to provide national service for all Altos products. An AOS customer with an Altos hardware problem obtains support by calling their reseller. The reseller takes the initial customer call, solve the software issues, and/or then call Altos On-Site for hardware issues.

The AOS Program features the following services:

- \* 200 Sites/ 300 Field Engineers
- \* One Call Nationwide Support
- \* Committed 4 Hour On-Site Response
- \* Unlimited Trouble Calls
- \* Customized Account History Reports
- \* Remote Diagnostics
- \* Modem Provided with Contract (1200 bps)
- \* Spare Parts Stocked Locally

### Technical Support

Technical support is available in four different programs which are purchased on a yearly basis. Resellers can select the program that best fits their needs. The following services are available to the reseller.

- \* Telephone Technical Support
- \* Consulting & Software Evaluation
- \* Remote Diagnostics
- \* Technical Publication
- \* Software Updates

Altos 386 Series 600 Marketing Guide

II. Market Positioning

## II. Market Positioning

Positioned against the personal computers and Work Group Local Area Networks, the Series 600 falls into the 5 to 8 user segment of the small business environment. Configured to efficiently address 5 to 8 concurrent users, small multi-user systems are designed to offer a lower cost-per-user price advantage over PC networks serving the same number of users. Shared processors and peripherals enable the multi-user computer to provide enhanced system through-put and performance over competing PC networks.

Coupled with a multiprocessor architecture and flexible configurations, the multi-user system provides the business environment with enhanced application processing abilities.

### Market Analysis

#### Small Multiuser Systems in the Small Business Environment

The small business environment as defined by Dataquest, a market research firm, ranges in size from 1 to 99 employees. Configuring 5 to 8 concurrent users, the small multi-user system can efficiently address small businesses employing between 1 to 20 employees.

#### Market Size

Dataquest has provided a four year market forecast for small multi-user systems in the small business environment. The data is available in both units and revenues, and includes average selling price for these systems. The U.S. market data is available in Table 1 & 2.

Table 1  
U.S. Small Multi-user Systems

	<u>1989</u>	<u>1990</u>	<u>1991</u>	<u>1992</u>	<u>CAGR *</u>
Units (x 1000)	264.0	299.5	325.9	351.6	9.5%
Revenues (\$Billions)	4.5	4.9	5.2	5.5	7.0%
Average Selling Price (\$Thousands)	16.5	16.2	15.8	15.5	2.3%

\* (CAGR) Compounded Annually Growth Rate

## Altos 386 Series 600 Marketing Guide

**Table 2**  
**Worldwide Small Multi-user Systems**

	<u>1989</u>	<u>1990</u>	<u>1991</u>	<u>1992</u>	<u>CAGR</u> *
Units (x 1000)	528.7	577.8	628.7	677.7	9.5%
Revenues (\$Billions)	8.0	8.7	9.3	9.8	7.7%
Average Selling Price (\$Thousands)	15.2	15.0	14.8	14.5	1.7%

### Market Base

Altos supports the small business environment which include companies ranging in size from 1 to 99 employees. Designed to support the entire system range in this environment, Altos systems provide total computer support for all business applications (i.e., accounting, payroll, inventory, etc.). By implementing WorkNet, users can network the Series 600 to Altos 286-based products and the Series 1000 and Series 2000 386-based products. With the addition of integrated vertical software solutions on the Altos platform, resellers may support the market base with industry specific applications.

Small businesses ranging from 1 to 50 employees typically consist of 6 to 16 concurrent computer users. The Series 1000 supports up to 32 users by providing enhanced system capabilities including increased disk and memory capacities. Companies ranging in size from 50 to 99 employees represent the 32 to 64 user market which is addressed by the Series 2000 system. Networking the Series 1000 and 2000 systems through Altos WorkNet II LAN provides support for 64+ users.

### Competition

The primary competition for growth in the low-end of the small business environment will come from networked personal computers and other low-end multi-user systems. Big name vendors such as AT&T, Compaq, IBM, Novell, Wyse and 3COM offer LAN solutions consisting of software running on PC hardware platforms. Combined with popular software and graphic-oriented applications, the PC LAN offers an efficient inexpensive computer solution. Prime and NCR support the market by providing entry-level multi-user configurations with multiprocessor architecture and the ability to upgrade system capacities. Refer to Section III of the market guide for more details on competitive information.

\* (CAGR) Compounded Annually Growth Rate

## Altos 386 Series 600 Marketing Guide

### Marketing Objective

Historically, a leader in multi-user system technology, Altos has designed the Series 600 to provide higher performance in the low-end UNIX market. Based on resellers demands for an entry-level multi-user computer extending beyond the 16MHz performance range of the Series 500, the 25MHz Series 600 system integrates the high performance architecture of the Series 1000 with the base user configurations of the Series 500. As a stand-alone system, the Series 600 can easily address up to eight concurrent users with increased system processing and through-put.

Falling into the small business environment category, the Series 600's objective is to create awareness and recognition for Altos' 386-based product family and to position the system as the leading multi-user UNIX-based system.

The Series 600 system offers the reseller an opportunity with Altos to address the market where small businesses are interested in supporting all of their business applications in a single system. (i.e., finance, inventory, sales)

Against the competing vendors such as AT&T, Compaq, IBM, NCR, Prime and Wyse, the Series 600 system is positioned to compete favorably. The Series 600 is a strong contender in this product category when considering price/performance points, an extensive application software base and Altos' commitment to rapid introduction of new and enhanced products.

Positioned at the low-end of the Altos product line, the Series 600 provides support for the following small business requirements.

- \* Industry/Profession Specific Principle Application
- \* Complete and Integrated Office Automation
- \* A Variety of Application Software Packages
- \* Connectivity with the Altos 386 product line

# Altos 386 Series 600 Marketing Guide

## Application Software Features

### A. Application Software Products

#### I. Integration

- \* Altos APEX
- \* Altos Office Manager Tool Kit
- \* Altos Multiview
- \* VP/ix

#### II. Personal Productivity

- \* WordPerfect 4.2
- \* SCO Professional Spreadsheet
- \* SCO FoxBASE+

#### III. Office Automation

- \* Altos Integrated Office (AIO)
- \* Uniplex Word Processor (version 6)
- \* AIO/Uniplex Medical/Legal Spell Corrector
- \* Altos Open Office
- \* Altos Calendar
- \* Altos Mail
- \* Altos ASYNC

#### IV. Database Products

- \* INFORMIX-SQL Development System
- \* INFORMIX-SQL Runtime
- \* INFORMIX-4GL Development System
- \* INFORMIX-4GL Runtime
- \* INFORMIX-4GL Rapid Development System with interactive debug
- \* INFORMIX-4GL Rapid Dev. Runtime System
- \* INFORMIX-Turbo
- \* INFORMIX-ESQL/C Development System
- \* INFORMIX-ESQL/C Runtime
- \* INFORMIX-ESQL/COBOL
- \* Oracle RDBMS
- \* Oracle SQL Forms
- \* Oracle Pro SQL
- \* Oracle Runtime
- \* Easy SQL
- \* SQL Calc
- \* SQL Menu
- \* SQL Net

#### V. Accounting Applications

- \* Solomon III

B. Languages: BASIC, C, COBOL, FORTRAN, PASCAL, RPG II

Altos 386 Series 600 Marketing Guide

III. Competitive Matrices and Benchmarks



## Altos 386 Series 600 Marketing Guide

### III. Competitive Matrices and Benchmarks

The Series 600 has been benchmarked against a variety of different vendors. Operating at 25MHz, the Series 600 is a strong performer when configured with 8MB RAM, 190MB hard disk and running the Altos System V/386 operating system.

Altos subscribes to Neal Nelson & Associates, a third party vendor that specializes in benchmark results for UNIX-based systems. Running eighteen different function tests, Neal Nelson obtains timed results for each system. Systems with the fastest time results are judged to have better benchmark performance. Of the eighteen tests, Altos uses the first three as the best representation of system performance in the business environment.

The first test is designed to simulate a normal business environment with a mix of calculations and hard disk I/O. The second test simulates CPU intensive calculation tasks such as wordprocessing and spreadsheet applications. Of the three tests, Test Two has the fastest times, because it is CPU intensive. Test Three represents disk intensive tasks such as database and accounting applications. The slowest of the three tests, Test Three represents hard disk I/O speed.

Benchmarks are a good sales tool for comparing system performance against other vendors. Variables to take into account when looking at a system-to-system comparison are the number of CPUs, the type of CPU, CPU clock speed, RAM capacity and the hard disk access time. A system having more RAM and/or a faster CPU clock speed will normally have an advantage in the benchmark tests.

The system configuration that is used by Neal Nelson & Associates for competitive systems is determined by the manufacturer. Neal Nelson requests that manufacturers submit a typical configuration, but they do not recommend or suggest a standard configuration. Because of this, a system to system configuration comparison in the benchmark tests may not be identical. Neal Nelson & Associates are located in Chicago, Ill. and the telephone is (312) 332-3242.

The following section contains basic system specification matrices followed by their benchmark results. The matrices include base model configuration, hardware expandability, communication capability and pricing for each system. The matrices are designed to list general system configurations. Actual system configuration in the benchmark tests will probably differ. System configurations are listed in the legend of each benchmark test. In some cases, benchmarks for competitive systems may not be available. Other system benchmarks are not available because they do not run the UNIX operating system.

## Competition

In the five to eight user category, the Altos Series 600 competes primarily against PC Local Area Networks and other multiuser computers. Running the XENIX operating system with enhanced hard disk and memory capacities, the PC provides a relatively inexpensive computing solution for the small business environment. Combined with local area networking, separate PCs may share and access data across a communication network with other PCs and mini/mainframe systems. Entry-level multi-user systems provide inexpensive low-end configurations with built-in expansion capabilities to accommodate future business growth. This enables small firms the ability to easily and cost-effectively upgrade their system's capacities.

Established in the UNIX market as a leader in multiuser system technology, Altos has built a reputation for providing quality, high performance computer systems. The following is a list of Altos strengths and weaknesses against PC LANs and small multi-user systems.

### Altos Strengths

1. The Series 600 multiuser architecture provides better price/performance points over PC LANs for an eight user environment. Shared processor and peripheral (i.e., disk, memory, etc.) architecture enable the Series 600 to offer a lower cost-per-user solution. Each user shares CPU processing power, memory capacity and application base. PC LANs have a file sharing architecture where each PC connected to the network has it's own system components (i.e., CPU, memory, applications). Providing each user with their own PC can be expensive. Designed to support the processing and data input/output needs of multiple users, the Series 600 out-performs the shared architecture of the work group LAN.
2. The Series 600 offers the customer a one stop shop. All system hardware is built and backed by Altos. System components are integrated together to provide optimal performance. This enables the Series 600 to efficiently process the needs for multiple concurrent users. Many PC systems require third party communication boards and operating systems to address the multi-user market. If there is an operating problem with a third-party component, the system vendor will often not take responsibility for system service support. With an Altos system, the customer is assured of complete system support.
3. The high performance system architecture enables the Series 600 to out-perform most similar and larger configured multi-user computers. With it's modular design, the system is capable of upgrading to a Series 1000 CPU board. This enables the Series 600 to match all

## Altos 386 Series 600 Marketing Guide

Enhanced by an extensive base of software available through Altos and other third-party solutions, the Series 600 provides the customer with a total system solution.

### Altos Weaknesses

1. Similar multi-user systems competing against the Series 600 may support larger disk, memory and serial expansion capabilities accommodating business growth in future years.
2. The Series 600 does not offer industry standard local or wide area networking capabilities possessed by many PC LANs and multi-user systems.
3. Against PC Local Area Networks, the Series 600 does not offer PC/AT Bus compatibility. True Graphic-oriented applications will not be available for the system.

The following competitive systems are listed in this section.

AT&T 6386

Compaq 386/33

IBM PS/2-80

NCR Tower 32/200

\* Prime EXL MBX

Wyse 3225

\* Neal Nelson benchmark tests currently not available

## Altos 386 Series 600 Marketing Guide

### Competitive Matrix

	Altos Series 600 Model 6409T	AT&T 6386 Model 374	Compaq 386/33 Model 84	IBM PS/2 Model 80
<b>Number of Users:</b>	1 to 8	1 to 20	1 to 32 (estimated)	1 to 24 (estimated)
<b>System Definition:</b>	80386 32-bit, 25MHz 32KB Cache Memory 80387 FPC (optional) Altos System V 4MB, up to 8MB 1.2MB Floppy 90MB SCSI Disk 125/150MB Tape Drive 8 Serial Ports	80386 32-bit, 20MHz  80387 FPC (optional) UNIX System V 1MB, up to 48MB 1.44MB Floppy 135MB Disk 60MB Tape Drive (optional) 1 Serial, 1 Parallel	80386 32-bit, 33MHz 64KB Cache Memory 80387/WE3167 (opt.) Xenix 2MB, up to 16MB 1.2MB Floppy 84MB ESDI Disk 150MB Tape Drive (optional) 1 Serial, 1 Parallel Enhanced Keyboard VGA Controller	80386 32-bit, 20MHz  80387 FPC (optional) AIX 2MB, up to 16MB 1.44MB Floppy 115MB ESDI Disk 55MB Tape Drive (optional) 1 Serial, 1 Parallel PC Keyboard
<b>Bus Type:</b>	Extended Multibus	AT-Bus	PC/AT-Bus	Micro Channel
<b>Hard Disk Options:</b>	90MB, 190MB	40MB, 68MB, 135MB	84MB, 110MB, 320MB 300MB, 650MB	44MB, 70MB, 115MB 314MB
<b>Internal Drive Capacity:</b>	2 Half-Height Drives	3 Half-Height Drives	2 Half-Height Drives	2 Drives
<b>Max. Configuration:</b>	380MB internal	203MB internal	1.85GB external	628MB internal
<b>System Price:</b>		\$9,025	\$10,499	\$8,995
<b>Option Pricing:</b>		60MB Tp Drive \$2,295 1MB RAM \$850	System Model 320 \$14,499 System Model 650 \$17,999	55MB Tp Drive \$1,795 2MB RAM \$1,395 314MB Disk \$6,495 115MB Disk \$3,495

## Altos 386 Series 600 Marketing Guide

### Competitive Matrix

	Altos Series 600 Model 6409T	NCR Tower Series Model 32/200	Prime EXL Series MBX	Wyse Model 3225
<b>Number of Users:</b>	1 to 8	1 to 4	1 to 33	1 to 24
<b>System Definition:</b>	80386 32-bit, 25MHz 32KB Cache Memory 80387 FPC (optional) Altos System V 4MB, up to 8MB 1.2MB Floppy 90MB SCSI Disk 125/150MB Tape Drive 8 Serial Ports	MC68020 32-bit, 16.67MHz  MC68881 FPC (optional) UNIX System V 1MB, up to 8MB 1.44MB Floppy 51MB Disk 150MB Tape Drive 4 Serial, 1 Parallel	80386 32-bit  80387 FPC (optional) UNIX System V 2MB, up to 16MB 1.2MB Floppy 150MB ESDI Disk 60MB Tape Drive 8 Serial Ports PT 250 Terminal	80386 32-bit, 25Mz 64KB Cache Memory 80387 FPC XENIX 4MB, up to 24MB 1.2MB Floppy 150MB ESDI Disk 150MB Tape Drive 2 Serial, 1 Parallel
<b>Bus Type:</b>	Extended Multibus	Multibus-Compatible	Multibus II	PC/AT-Bus
<b>Hard Disk Options:</b>	90MB, 190MB	22MB, 42MB, 100MB 139MB	94MB, 323MB	150MB, 300MB
<b>Internal Drive Capacity: Max. Configuration:</b>	2 Half-Height Drives 380MB internal	2 Drives 278MB internal	2 Drives 417MB internal	5 Half-Height Drives 450GB internal
<b>System Price:</b>		\$7,290	\$10,540	\$11,054
<b>Option Pricing:</b>				

# Altos Computer Systems

Simulates ' Normal ' Task with Mix of Calculations and Disk I / O

Business Benchmark ( TM ) Neal Nelson & Associates

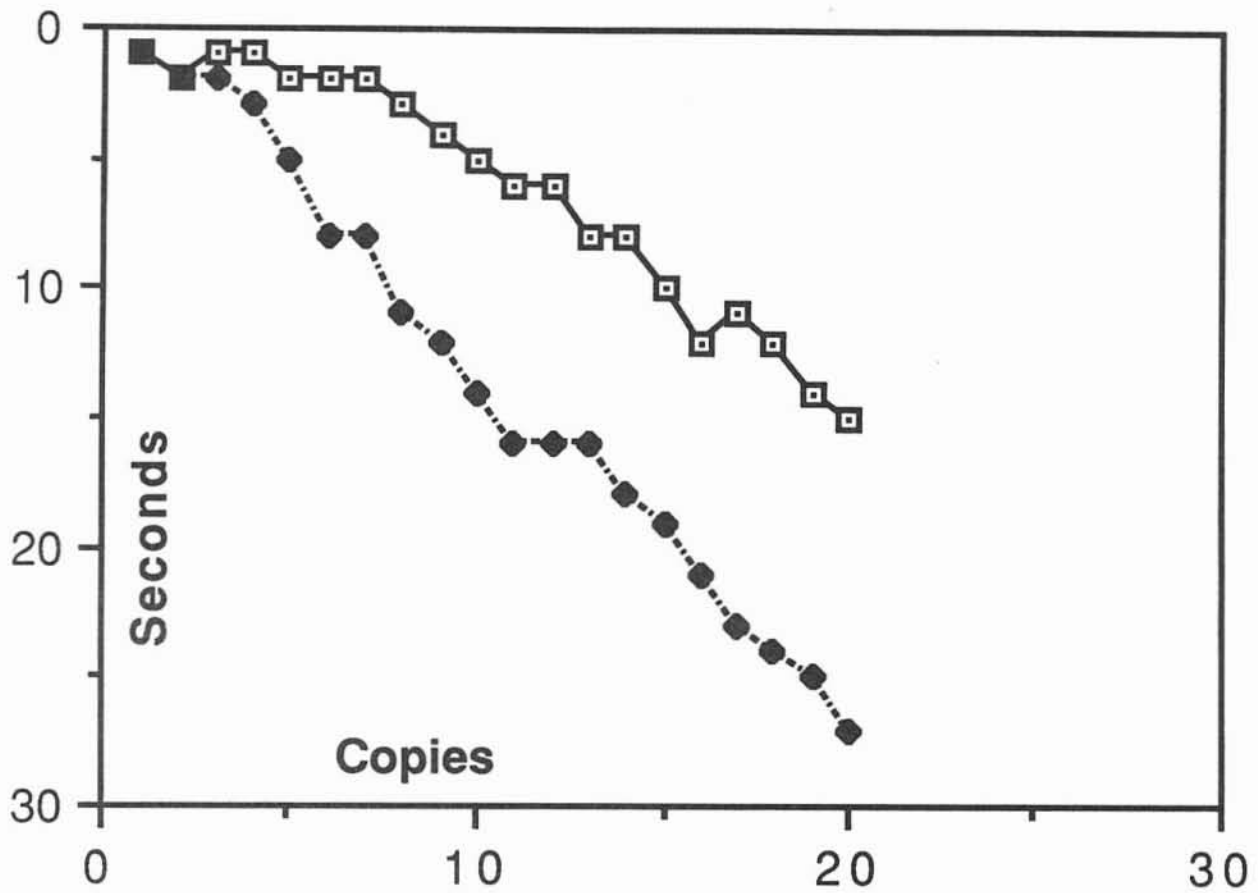

—□— Altos Series 600 ( 80386 / 25MHz / 8MB / 190MB Disk / Altos System 5.3 )

- -◆- - AT&T 6386 ( 80386 / 20MHz / 16MB / 135MB Disk / Unix 5.3.1 )

# Altos Computer Systems

Calculation Intensive Task Like Word Processing or Spread Sheet  
Business Benchmark ( TM ) Neal Nelson & Associates

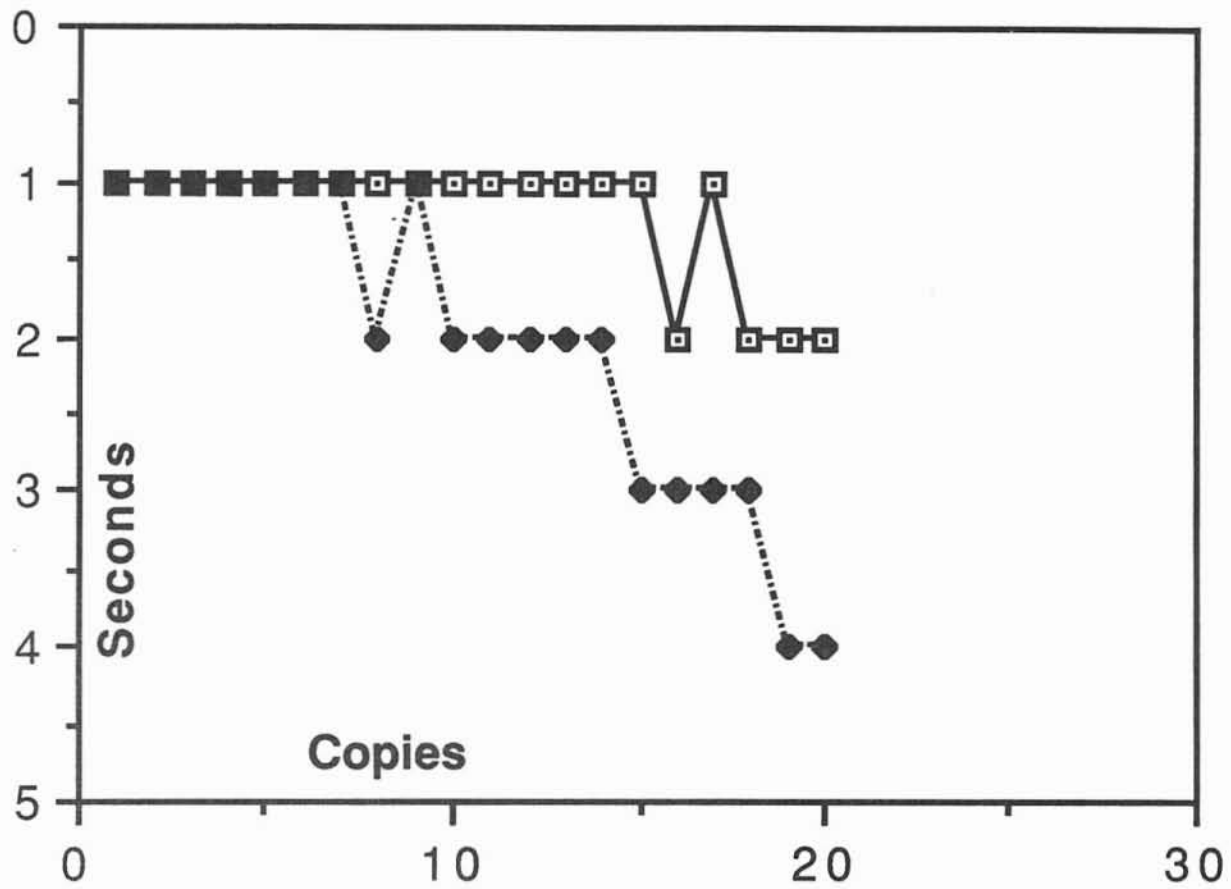

—■— Altos Series 600 ( 80386 / 25MHz / 8MB / 190MB Disk / Altos System 5.3 )

- - -◆- - - AT&T 6386 ( 80386 / 20MHz / 16MB / 135MB Disk / Unix 5.3.1 )

# Altos Computer Systems

Disk Intensive Task Like Data Base or Accounting Applications

Business Benchmark ( TM ) Neal Nelson & Associates

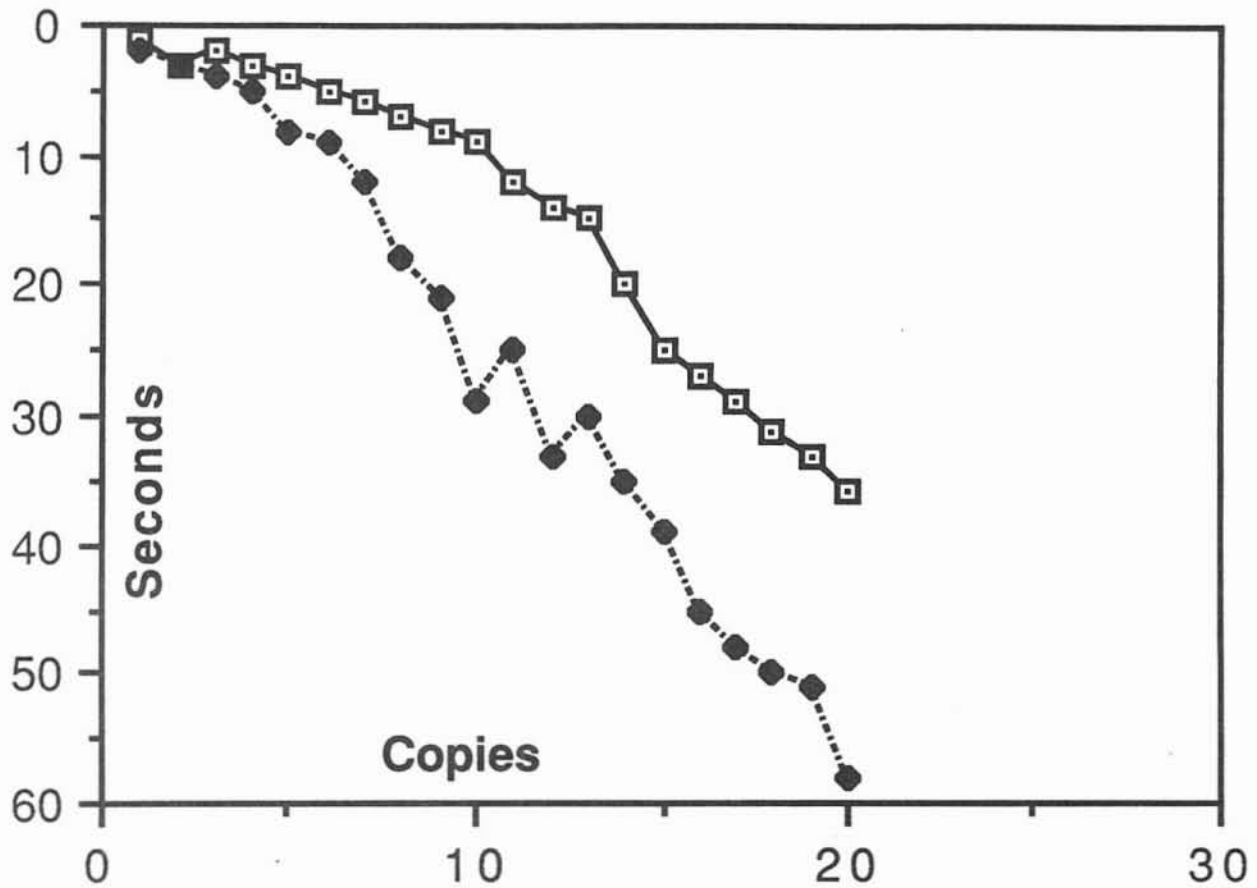

---

—□— Altos Series 600 ( 80386 / 25MHz / 8MB / 190MB Disk / Altos System 5.3 )

-◆- AT&T 6386 ( 80386 / 20MHz / 16MB / 135MB Disk / Unix 5.3.1 )

---



# Altos Computer Systems

Simulates ' Normal ' Task with Mix of Calculations and Disk I / O

Business Benchmark ( TM ) Neal Nelson & Associates

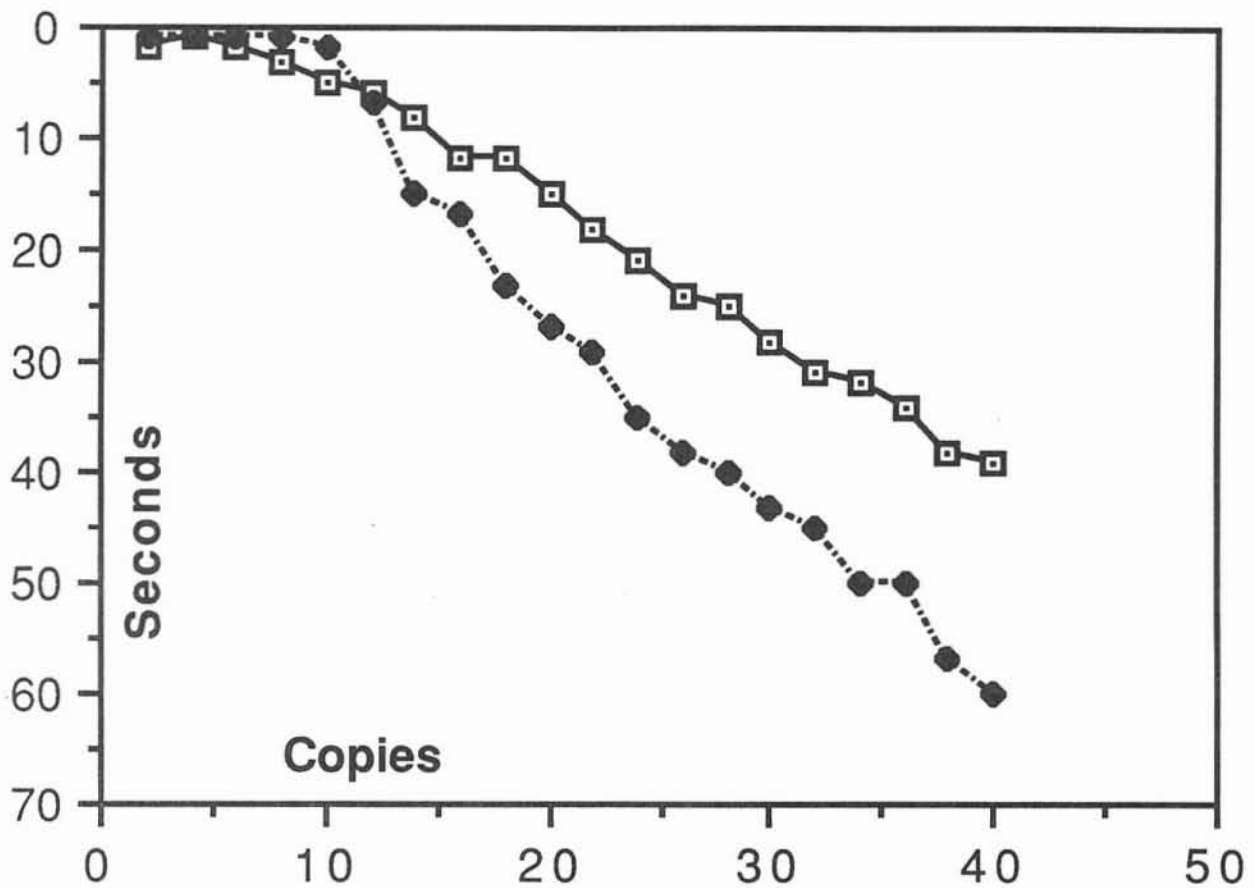

—■— Altos Series 600 (80386/ 25MHz / 8MB /190MB Disk/ Altos System 5.3 )

-◆- Compaq 386/33 (80386/ 33MHz / 16MB / 650MB Disk/ SCO Xenix 386 2.3.1)

# Altos Computer Systems

Calculation Intensive Task Like Word Processing or Spread Sheet

Business Benchmark ( TM ) Neal Nelson & Associates

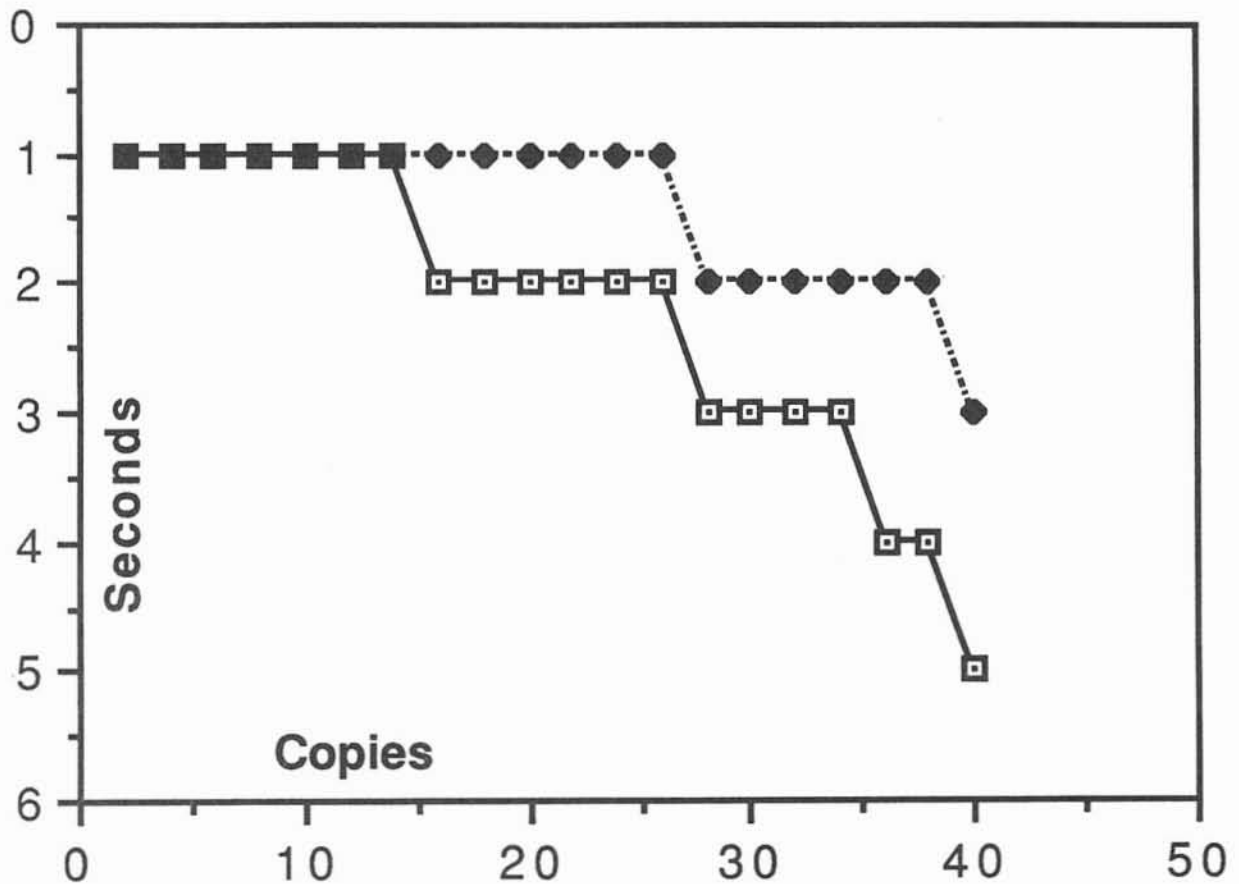

---

—■— Altos Series 600 (80386/ 25MHz/ 8MB /190MB Disk/ Altos System 5.3 )

-◆- Compaq 386/33 (80386/ 33MHz / 16MB / 650MB Disk/ SCO Xenix 386 2.3.1)

---

# Altos Computer Systems

Disk Intensive Task Like Data Base or Accounting Applications

Business Benchmark ( TM ) Neal Nelson & Associates

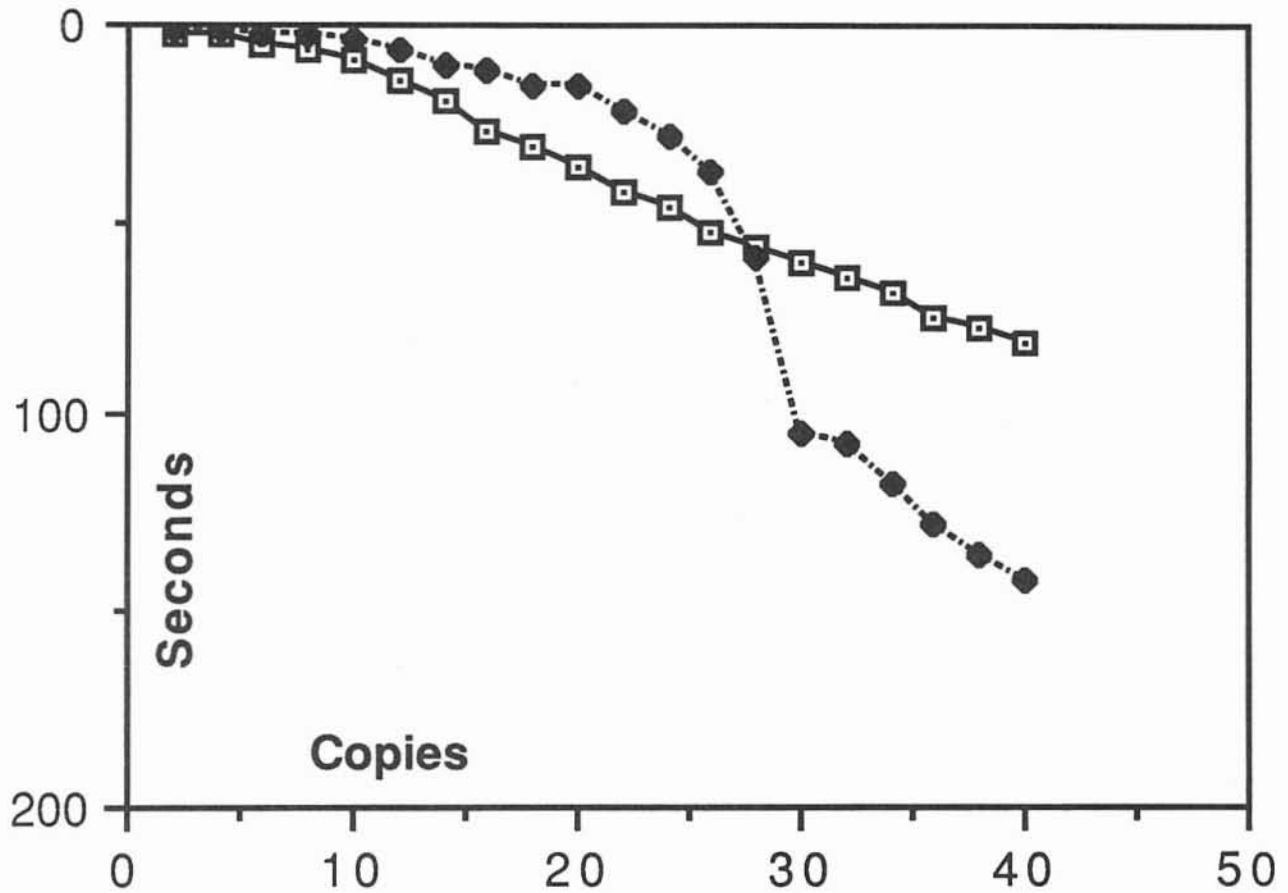

---

—■— Altos Series 600 (80386/ 25MHz / 8MB / 190MB Disk/ Altos System 5.3 )

-◆- Compaq 386/33 (80386/ 33MHz / 16MB / 650MB Disk/ SCO Xenix 386 2.3.1)

---

# Altos Computer Systems

Simulates ' Normal ' Task with Mix of Calculations and Disk I / O

Business Benchmark ( TM ) Neal Nelson & Associates

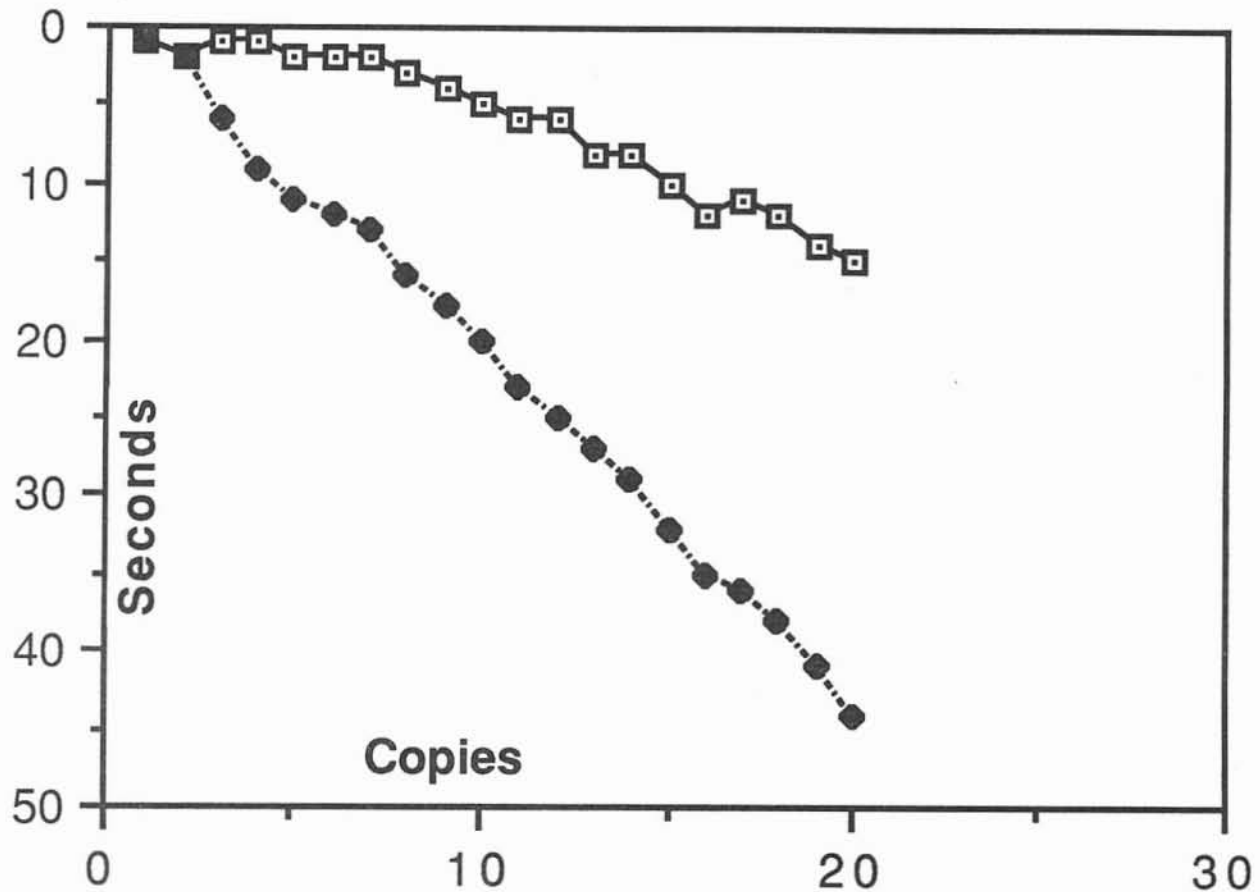

---

—■— Altos Series 600 ( 80386/ 25MHz / 8MB / 190MB Disk/ Altos Sys 5.3 )

-◆- IBM PS/2-80 ( 80386/ 20MHz / 4MB / 115MB Disk/ SCO 386 2.2.2 )

---

# Altos Computer Systems

Calculation Intensive Task Like Word Processing or Spread Sheet  
Business Benchmark ( TM ) Neal Nelson & Associates

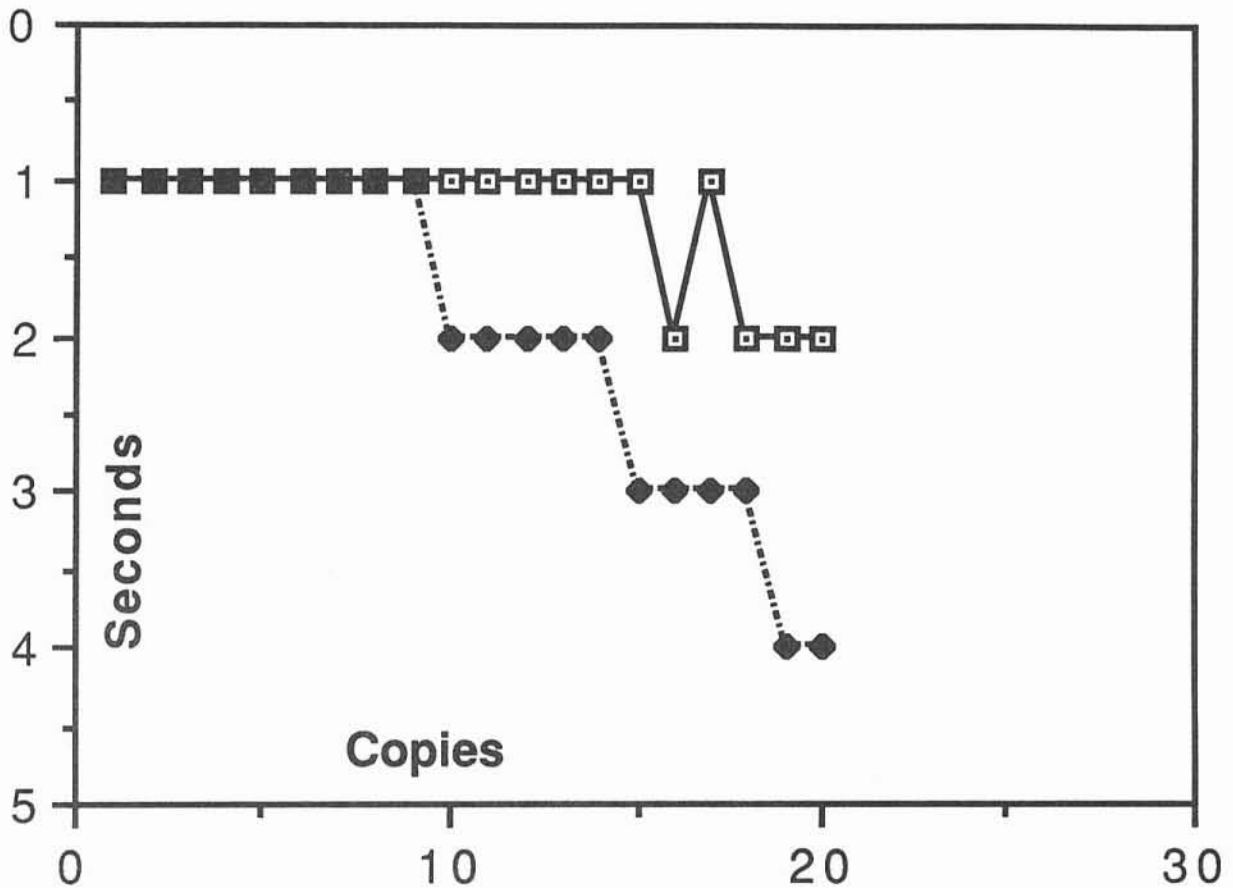

---

—■— Altos Series 600 ( 80386 / 25MHz / 8MB / 190MB Disk / Altos Sys 5.3 )

-◆- IBM PS/2-80 ( 80386 / 20MHz / 4MB / 115MB Disk / SCO 386 2.2.2 )

---

# Altos Computer Systems

Disk Intensive Task Like Data Base or Accounting Applications  
Business Benchmark ( TM ) Neal Nelson & Associates

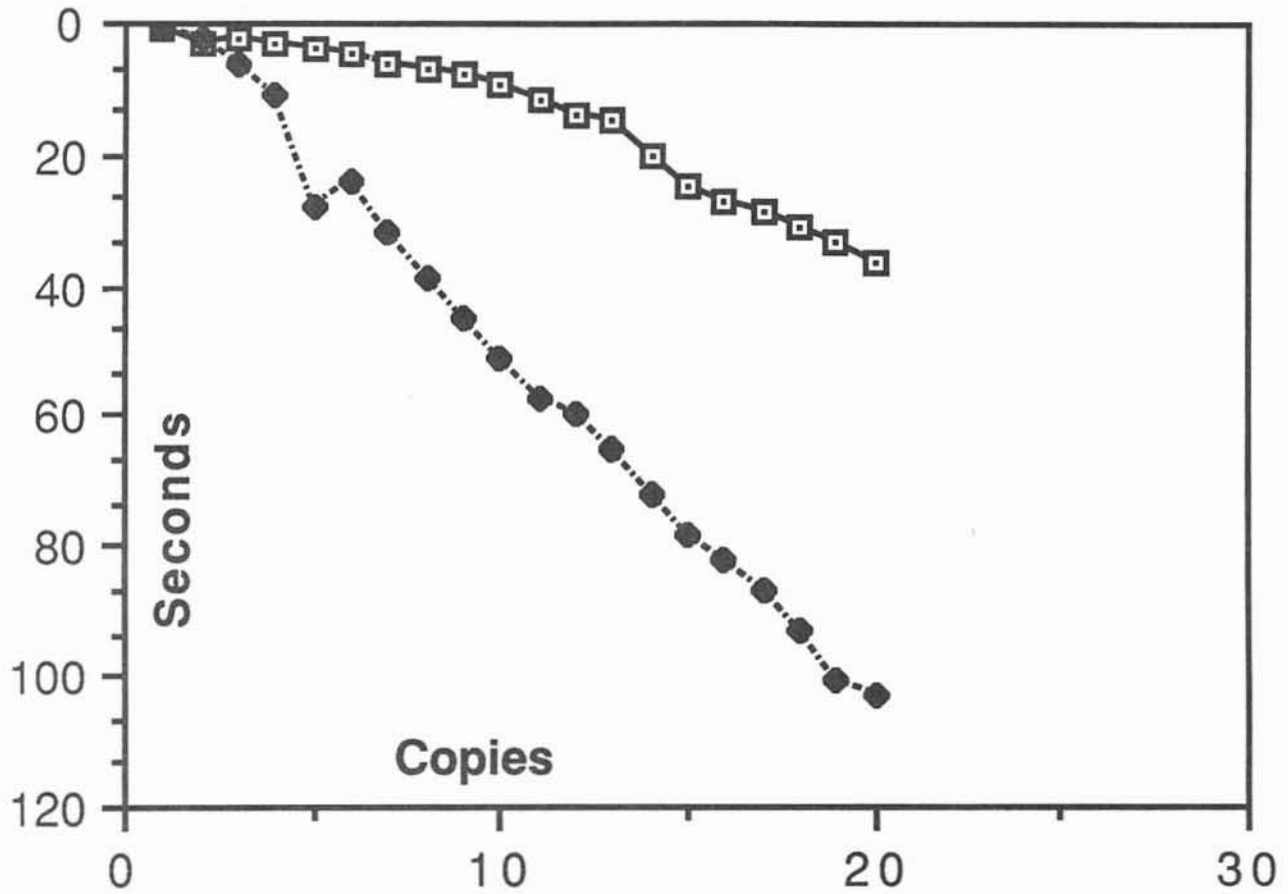

---

— □ — Altos Series 600 ( 80386 / 25MHz / 8MB / 190MB Disk / Altos Sys 5.3 )

- - ◆ - - IBM PS/2-80 ( 80386 / 20MHz / 4MB / 115MB Disk / SCO 386 2.2.2 )

---

# Altos Computer Systems

Simulates ' Normal ' Task with Mix of Calculations and Disk I / O

Business Benchmark ( TM ) Neal Nelson & Associates

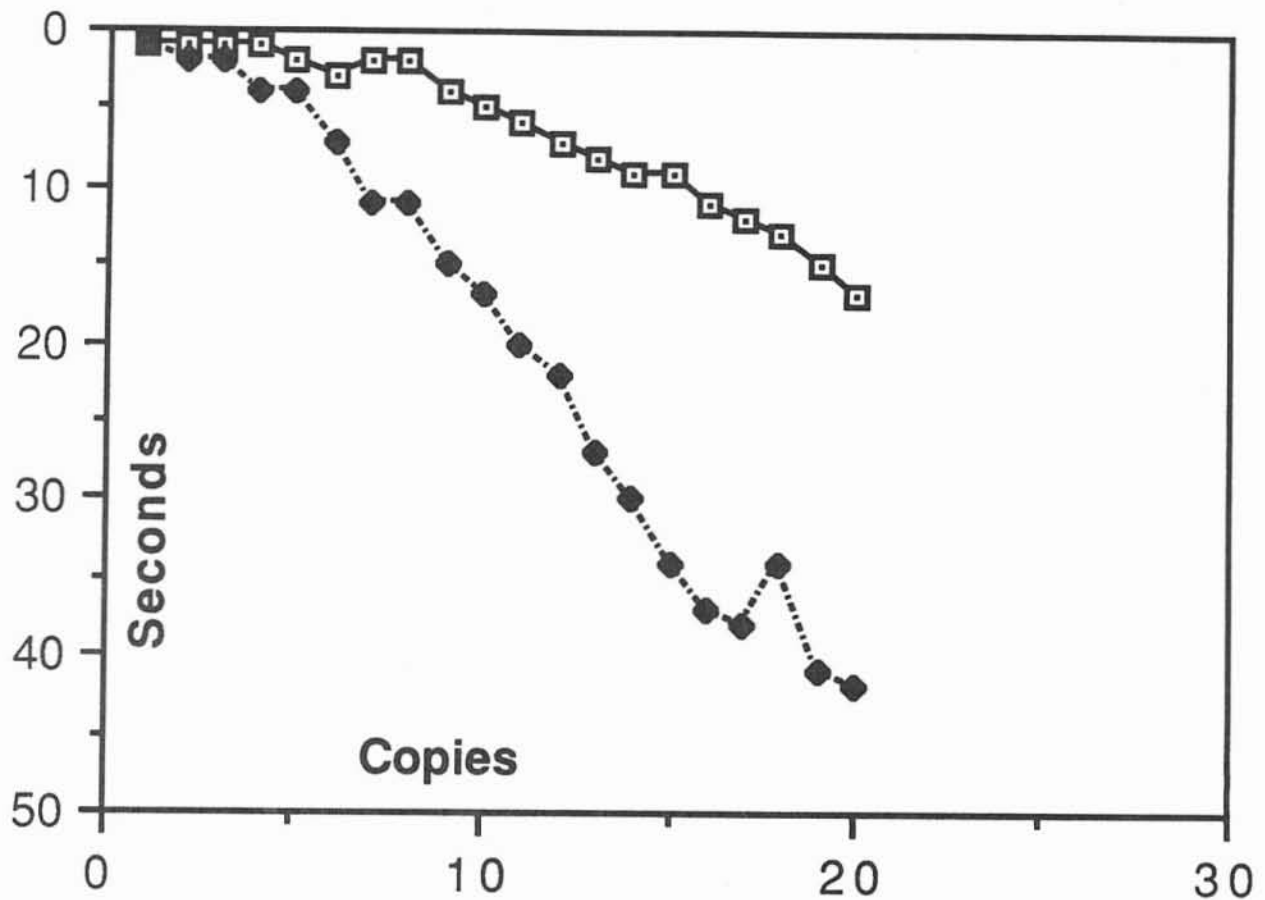

—■— Altos Series 600 (80386/ 25MHz / 8MB / 190MB Disk/ Alfos Sys 5.3 )

- -◆- - NCR 32/200 ( MC68020/ 16.7MHz / 8MB / 100MB Disk/ Unix 5.3 )

# Altos Computer Systems

Calculation Intensive Task Like Word Processing or Spead Sheet  
Business Benchmark ( TM ) Neal Nelson & Associates

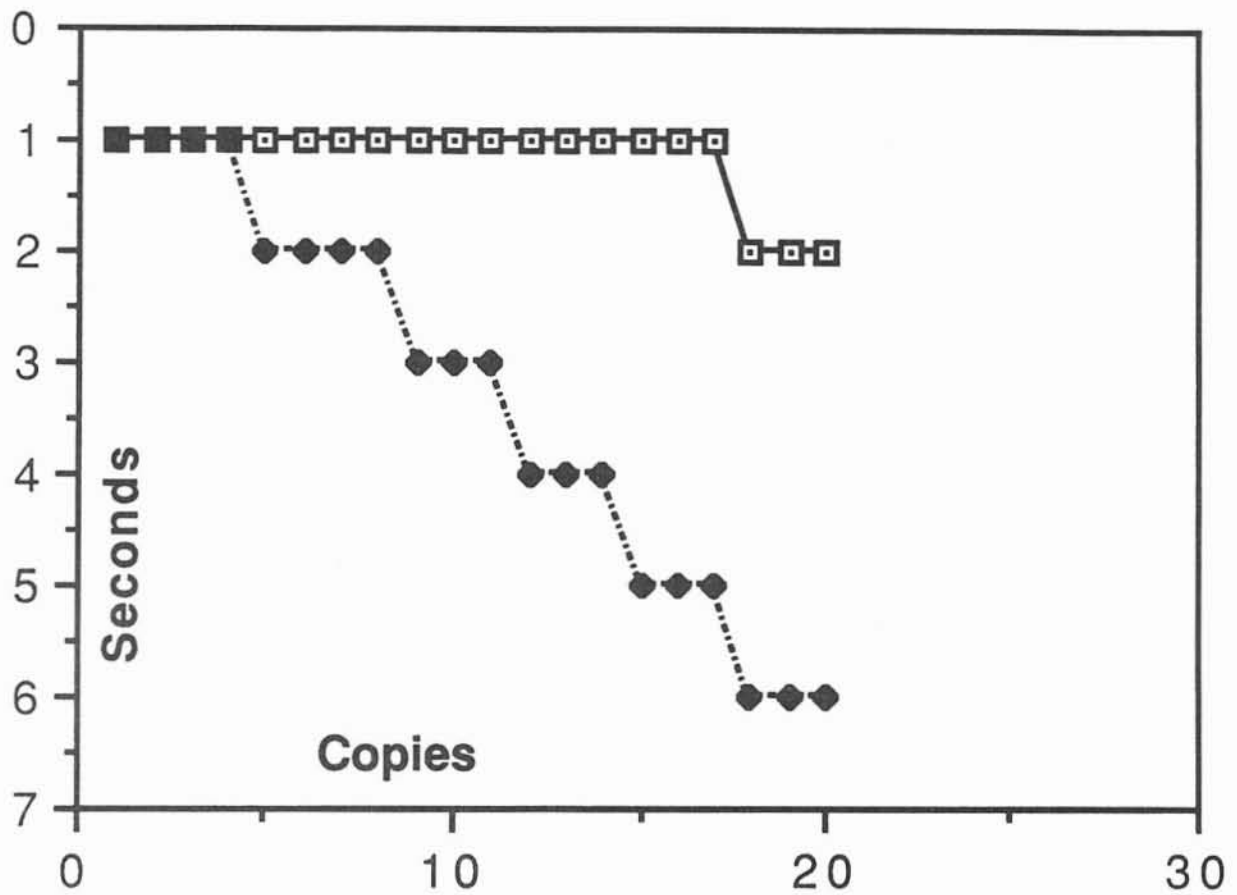

---

—■— Altos Series 600 (80386/ 25MHz / 8MB / 190MB Disk/ Altos Sys 5.3 )

-◆- NCR 32/200 ( MC68020/ 16.7MHz / 8MB / 100MB Disk/ Unix 5.3 )

---



# Altos Computer Systems

Disk Intensive Task Like Data Base or Accounting Applications  
Business Benchmark ( TM ) Neal Nelson & Associates

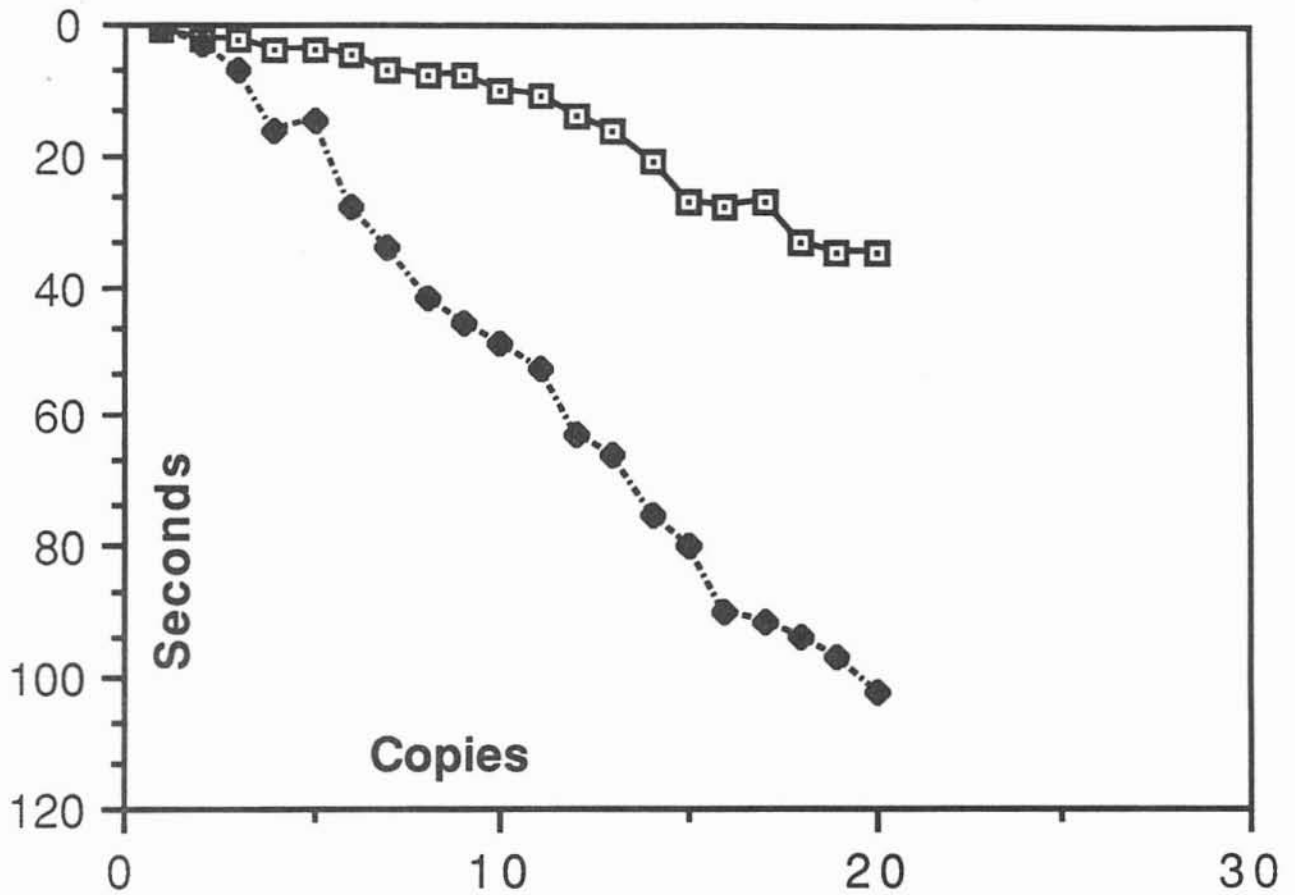

---

—□— Altos Series 600 ( 80386 / 25MHz / 8MB / 190MB Disk / Altos Sys 5.3 )

-◆- NCR 32/200 ( MC68020 / 16.7MHz / 8MB / 100MB Disk / Unix 5.3 )

---

# Altos Computer Systems

Simulates ' Normal ' Task with Mix of Calculations and Disk I / O

Business Benchmark ( TM ) Neal Nelson & Associates

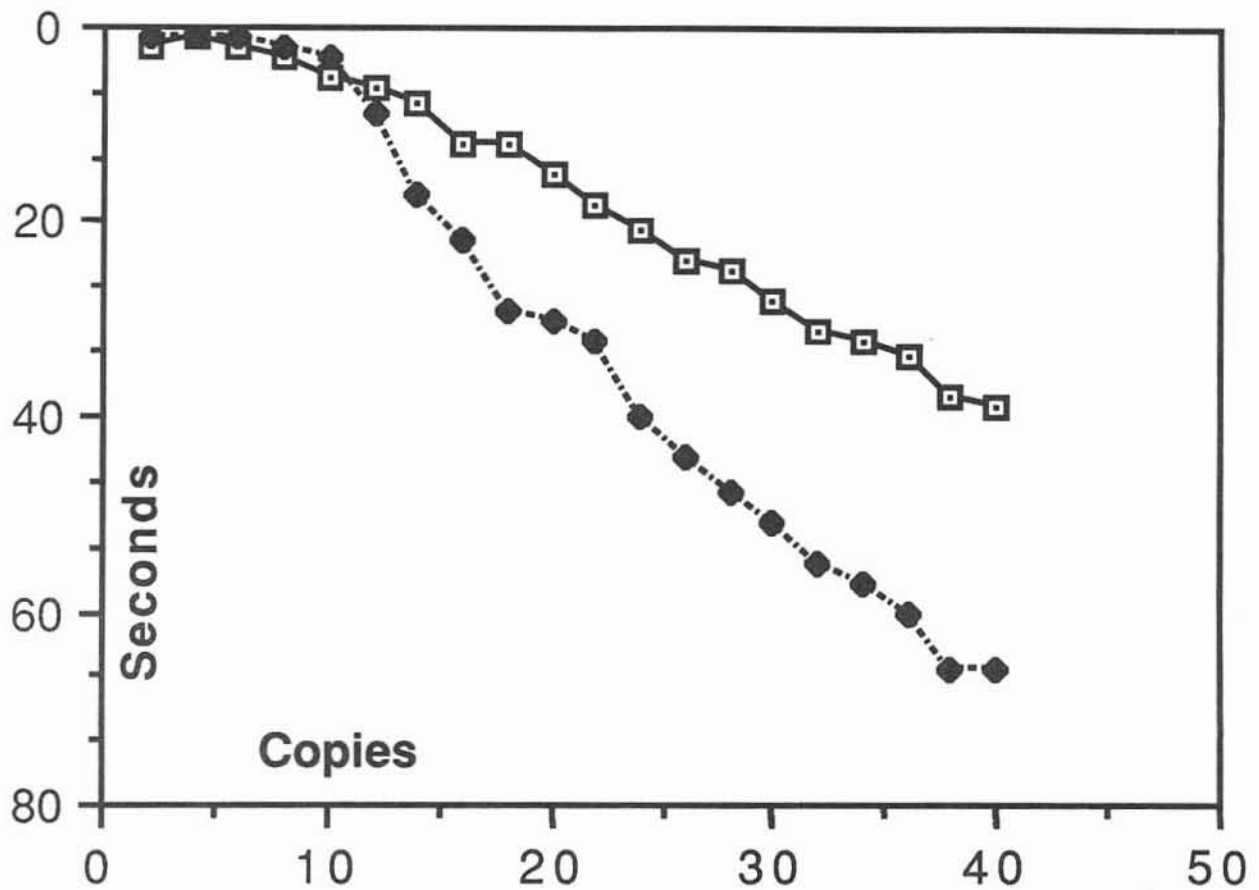

—□— Altos Series 600 ( 80386/ 25MHz / 8MB / 190MB Disk/ Altos System 5.3 )

-◆- Wyse 3225 ( 80386/ 25MHz / 16MB / 150MB Disk/ Xenix 386 2.3 )

# Altos Computer Systems

Calculation Intensive Task Like Word Processing or Spread Sheet  
Business Benchmark ( TM ) Neal Nelson & Associates

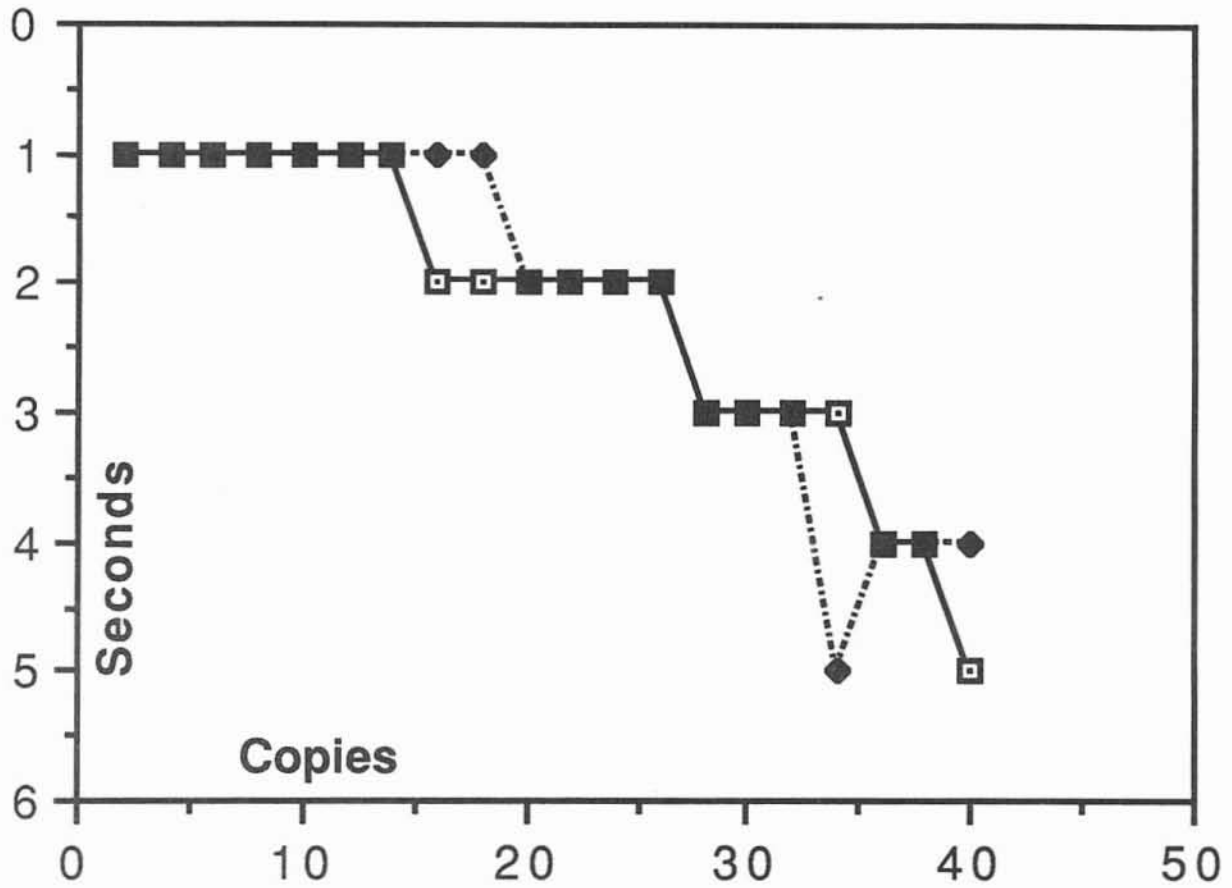

---

—■— Altos Series 600 (80386/ 25MHz / 8MB / 190MB Disk/ Altos System 5.3)

-◆- Wyse 3225 (80386/ 25MHz / 16MB / 150MB Disk/ Xenix 386 2.3)

---

# Altos Computer Systems

Disk Intensive Task Like Data Base or Accounting Applications  
Business Benchmark ( TM ) Neal Nelson & Associates

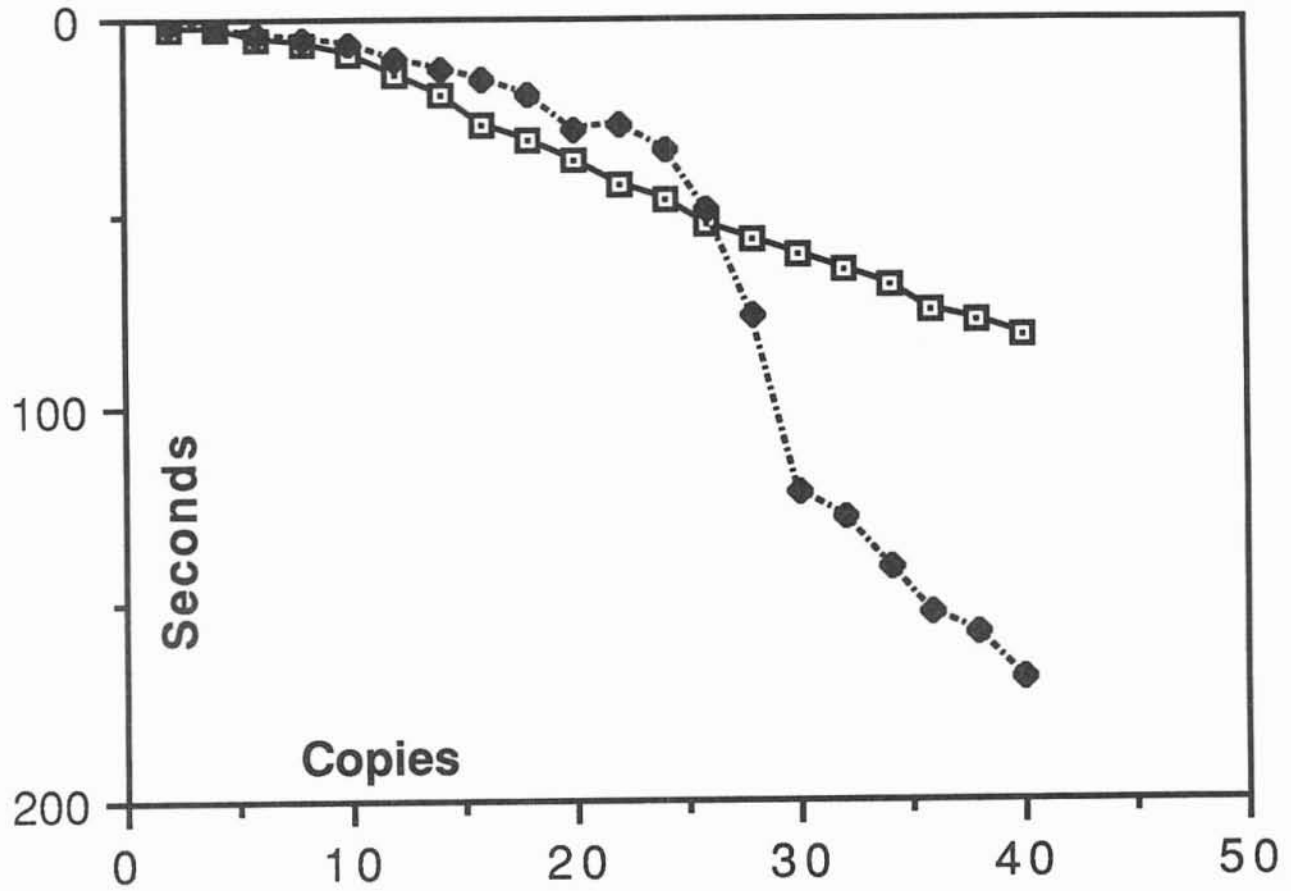

—■— Altos Series 600 ( 80386 / 25MHz / 8MB / 190MB Disk / Altos System 5.3 )

-◆- Wyse 3225 ( 80386 / 25MHz / 16MB / 150MB Disk / Xenix 386 2.3 )



Altos Computer Systems  
2641 Orchard Parkway  
San Jose, California 95134  
(408) 946-6700