

SONY®

VIDEODISC PLAYER

LDP-1000A

OPERATING INSTRUCTIONS

Before operating the unit, please read this manual thoroughly and retain it for future reference.

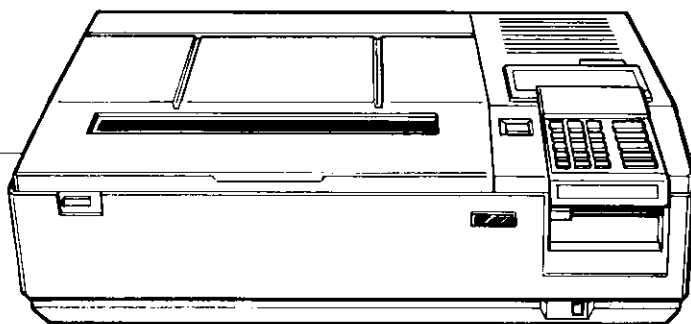

TABLE OF CONTENTS

Precautions.....	3	Operation with control instructions	19
A little about the video disc and the videodisc player	4	Memorizing the segment data	20
Data on the video discs	5	Preparation	20
Location and function of parts and controls	6	Operation	20
Front panel.....	6	To check or to correct the entered data	20
Control unit	7	Before memorizing the control instruction.....	21
Indicating lamps	8	To start entering control instructions	21
Rear panel	9	To end entering control instructions	21
Preparations	10	Memorizing the control instructions	22
To see a picture with a TV receiver	10	To play segments at fast, normal or slow speeds.....	22
To see a picture with a video monitor.....	11	To select audio channel 1 or 2.....	22
Before operation	12	To decide whether to display the index or not.....	22
To open and close the disc compartment lid	12	To play a segment frame-by-frame	23
Remove the cap over the objective lens	12	To obtain a still picture of the beginning of a	
To insert and remove the videodisc	12	particular segment	23
To remotely control the videodisc player	13	Memorizing the control instructions for branching.....	24
Wired remote control.....	13	Using the [GO TO] key.....	24
Wireless remote control.....	13	Using the [INPUT] key	24
How to play a videodisc.....	14	Using the built-in registers.....	24
Operation	14	To check the control instructions entered.....	25
Operation with control instructions	14	To correct the entered control instruction data	25
To select the audio channel to be heard	15	Error message	26
Chapter stop	15	Capacity of data	26
If a normal picture does not appear on the screen	15	To start the operation with control instructions	26
Search operation.....	16	Example of control instructions.....	26
To search for a particular frame (Point search).....	16	Control instruction sheet	26
To search for the beginning of a particular chapter		How the control instructions on the previous page	
(Chapter search).....	16	operate	27
To search for the beginning of a particular segment		Optional connections	28
(Segment search)	16	Stereo system connection	28
To repeat a particular part (Frame repeat search)	17	Connection with a time base corrector	28
To repeat a particular chapter (Chapter repeat search)	17	Connection with an external sync generator	28
To repeat a particular segment (Segment repeat		To transport the LDP-1000A.....	29
search).....	18	Repacking for shipment	29
To search for a frame which has been memorized in		Specifications	30
advance (Memory search)	18	Trouble checks	31
To play at a particular slow speed	18		

OWNER'S RECORD

The model and serial numbers are located at the rear. Record the serial number in the space provided below. Refer to these numbers whenever you call upon your Sony dealer regarding this product.

Model No. LDP-1000A Serial No. _____

WARNING

To prevent fire or shock hazard, do not expose the set to rain or moisture.

To avoid electrical shock, do not open the cabinet. Refer servicing to qualified personnel only.

CAUTION

Use of controls or adjustments or performance of procedures other than those specified herein may result in hazardous radiation exposure.

PRECAUTIONS

- This machine is designed for operation in a horizontal position and only with a 120 V ac, 60 Hz power supply.
- Do not install the set in a location near heat sources, such as radiators or air ducts, or in a place subject to direct sunlight, excessive dust, mechanical vibration or shock.
- Allow adequate air circulation to prevent internal heat buildup. Do not place the set on surfaces (rugs, blankets, etc.) or near materials (curtains, draperies) that may block the ventilation holes.
- After playing a disc, remove it from the compartment if the set will not be used for any length of time. Do not transport the set with a disc in place.
- To disconnect the cord, pull it out by the plug. Never pull the cord itself.
- Should any solid object or liquid fall into the cabinet, unplug the set and have it checked by qualified personnel before operating it any further.
- Do not operate the set right after having transported it from a cold location directly to a warm location or in a room whose temperature rises suddenly, because moisture may condense in the operating section of the set. Wait for about an hour before turning the power on in the new location or let the room temperature rise gradually.
- Clean the cabinet, panel and controls with a dry soft cloth, or soft cloth lightly moistened with a mild detergent solution. Do not use any type of solvent such as alcohol or benzine which may damage the finish.
- Remove the cushion and be sure to save it. When the LDP-1000A is transported or when shock to the compartment lid is expected, be sure to attach the cushion.
- Save the original shipping carton and packing material; they will come in handy if you ever have to ship your set. For maximum protection, repack the set as it was originally packed at the factory.
- If you have any questions about this machine, contact your dealer or your nearest Sony authorized service facility.

LOOSEN THE SHIPPING SCREW UNDERNEATH THE PLAYER.

The shipping screw is screwed down at the factory to secure the mechanism inside the player.

Be sure to turn the shipping screw counterclockwise with a coin or similar object until the screw is loose soon after unpacking.

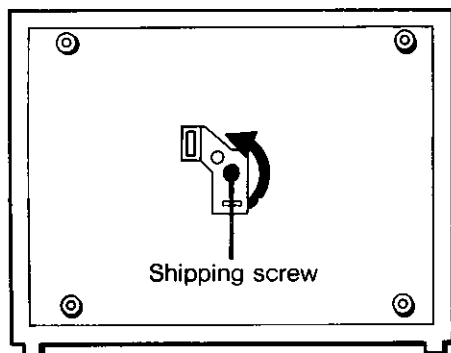

A LITTLE BIT ABOUT THE VIDEO DISC AND THE VIDEODISC PLAYER

A spiral pattern of pits is recorded about 1.1 mm under the surface of the video disc.

In the LDP-1000A videodisc player, a laser beam focuses on the pits and then reflects. Variations in the reflected beam are detected and converted into the video and audio playback signals. The playback picture and sound are obtained by a monitor or a TV receiver connected to the video disc player.

This videodisc system has the following features:

No physical contact between pick-up system and disc

Because a laser beam is employed for signal pick-up, there is no physical contact with the disc, which means no wear. In addition, because the pit pattern is recorded below the surface of the disc, it is not necessary to be constantly on guard against fingerprints and dust, making the video disc easy to handle.

High accuracy insured high-quality picture

Newly-developed CCD chips enable the effects of the time base error and disc eccentricity to be eliminated.

Flexible use of video discs

The brushless spindle motor makes the system set in the standby mode in about 10 seconds after a disc is inserted. The system can play both the CAV* and CLV** video discs. With a CAV disc, the system can play back (or in reverse) at various speeds, can display a still picture and can perform a number of other functions with the aid of a built-in microprocessor.

High speed access

You can locate a particular point on a disc within five seconds. With a CAV disc, a particular frame or segment can be searched for, and with a CAV/CLV disc with chapter data, a particular chapter can be searched for.

* CAV (constant angular velocity) disc

The CAV disc rotates at 1800 r.p.m. and the laser beam moves from the inner part of the disc to the outer. Up to 30 minute playback is possible on one side of the disc. On the disc, up to 54,000 frames can be recorded. Each frame of the playback picture is recorded as one rotation and the frame number is recorded on the track.

With a CAV disc, playback at variable speeds, frame number and play mode display and operations with control instructions are possible.

** CLV (constant linear velocity) disc

The CLV disc rotates at a speed between 1800 r.p.m. and 700 r.p.m. with constant linear velocity. The laser beam moves from inner part of the disc to the outer as with CAV disc. Playback of up to one hour is possible on one side of the disc, though only the normal play, the scan and the search operations are possible. The elapsed playback time can be displayed on the monitor screen.

Remote control of the system is possible

The system's control unit can be detached and used as a wireless remote control unit or with the supplied remote control cable, as a wired remote control unit.

A variety of possible connections

The LDP-1000A is equipped with an RS232C serial interface connector so that it can be connected to a computer. The LDP-1000A is also equipped with SYNC IN and SC IN connectors so that it can be operated in synchronization with the external sync signal and so that a special effects generator can be connected to the LDP-1000A.

DATA ON THE VIDEO DISCS

Frames

A CAV disc has up to 54,000 "frames" which are numbered in sequence. You can search for a particular frame or repeat a particular sequence of frames.

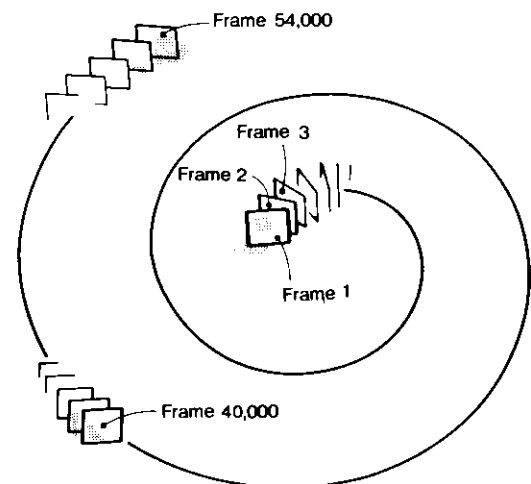

Chapters

There are CAV and CLV discs on which "chapters" are recorded, as the chapter of a book. If a chapter number is displayed after a frame number has been displayed (on a CAV disc) or if playback time is displayed in minutes (on a CLV disc) when you press the [INDEX] key, the disc has chapter data.

You can easily search for a particular chapter and play it back repeatedly.

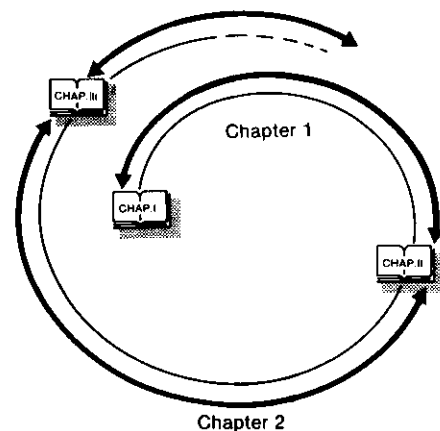

Segments

Using the frame numbers on a CAV disc, you can divide the disc into up to 63 separate segments by designating the beginning and end frame of a sequence.

You can search for a particular segment and play it back repeatedly.

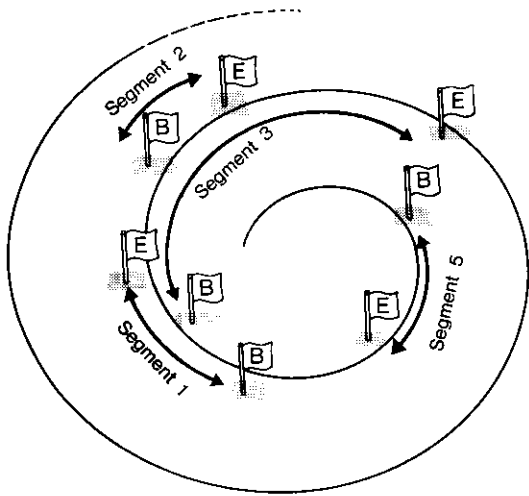

LOCATION AND FUNCTION OF PARTS AND CONTROLS

FRONT PANEL

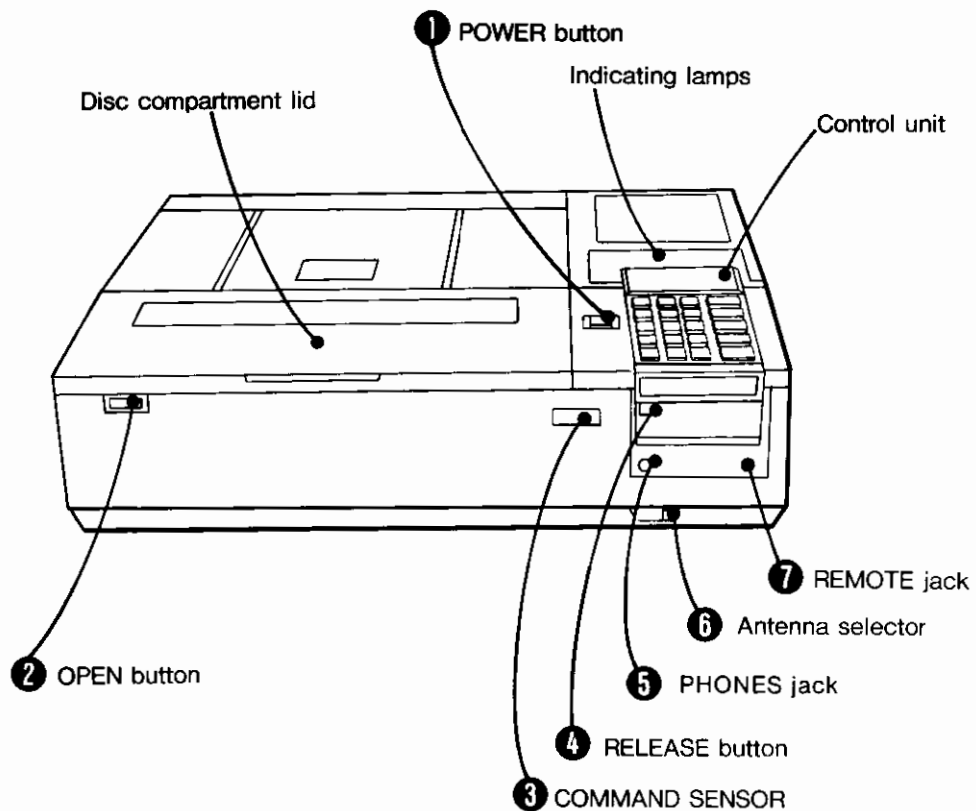

❶ POWER button

Press to turn on the power of the player.
To turn off the power, press the button again.

❷ OPEN button

Press to open the disc compartment lid for insertion or removal of the video disc.

❸ COMMAND SENSOR

The red COMMAND SENSOR lamp will blink to show that the player detects that a key of the control unit has been pressed.

❹ RELEASE button

Press this button while detaching the control unit.

❺ PHONES jack

Connect headphones here to monitor the audio.

❻ Antenna selector

This selector selects the picture on the monitor screen. When you want to watch the program from the disc, set this selector to VDP. When you want to watch the TV program from the antenna, set this selector to ANT.

❼ REMOTE jack (special mini jack)

Connect to the remote jack on the control unit with the remote cable when the control unit is to be used as a wired remote commander.

CONTROL UNIT

- The keys cannot function when using a CLV disc.

The [CE] key clears the last data entered. Press this key when you press an incorrect key.

The [CL] key is the all-clear key. Press this key when you want to cancel an operation using the control instruction keys, such as entering the control instructions, operation with control instructions or check of the entered control instructions.

AUDIO CH-1 and CH-2 keys

Each laser disc has two audio channels, channel 1 and 2. When the player is turned on, both audio channels are turned on. The AUDIO CH-1 and CH-2 lamps will light. To turn the audio channel 1 or 2 off, press the CH-1 or CH-2 key. The appropriate indicating lamp will go off. Pressing the key again turns the audio channel on.

Control instruction keys

These keys are used for the operation with control instructions — memorizing the segment data, memorizing the control instructions, operating the disc with control instructions and so on.

STOP key

Press this key to stop displaying the picture. When another key is pressed, the desired playback mode will start at the point where the STOP key was pressed.

INDEX key

Press to display the play mode, frame number, chapter number and data for control instructions on the monitor screen while playing the CAV disc. When the CLV disc is playing, the time elapsed since the beginning of the program will be displayed, and then chapter number will be displayed if it is recorded. Press this key again to turn the display off.

MENU key

Press this key to see the menu again during playing a CAV disc.

Function keys

SCAN key

Keep holding this key down for high-speed (about 100 times of normal speed) playback. When you release this key, playback will be resumed at normal speed.

FAST key

Press this key for tripple-speed playback.

SLOW key

Press this key for slow-speed ($1/5$ of normal speed) playback.

STEP/STILL key

Press this key for a still picture. If you press this key again and immediately release it, the next frame will be displayed. If you keep the key depressed, the picture will advance frame-by-frame.

PLAY key

Press this key for normal speed playback.

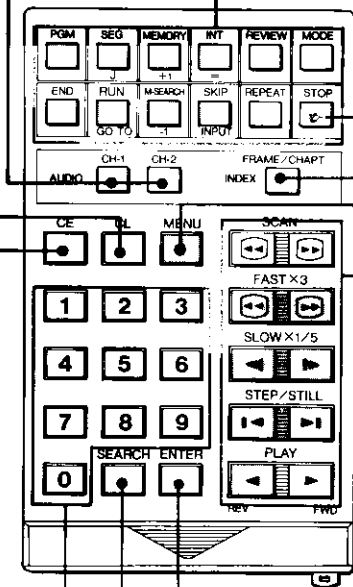

Figure keys

SEARCH key

Press this key for the search operation

ENTER key

Press this key to advance the step to the next during memorizing the segment data or the control instructions or to end the above mentioned operation.

Notes on the function keys

- The right key of the two keys [▶] is for playback and the left key [◀] is for reverse.
- The audio can be monitored only in the forward play mode.
- Press the desired key when you want, no matter what mode the player is in. The player enters into the desired mode.

INDICATING LAMPS

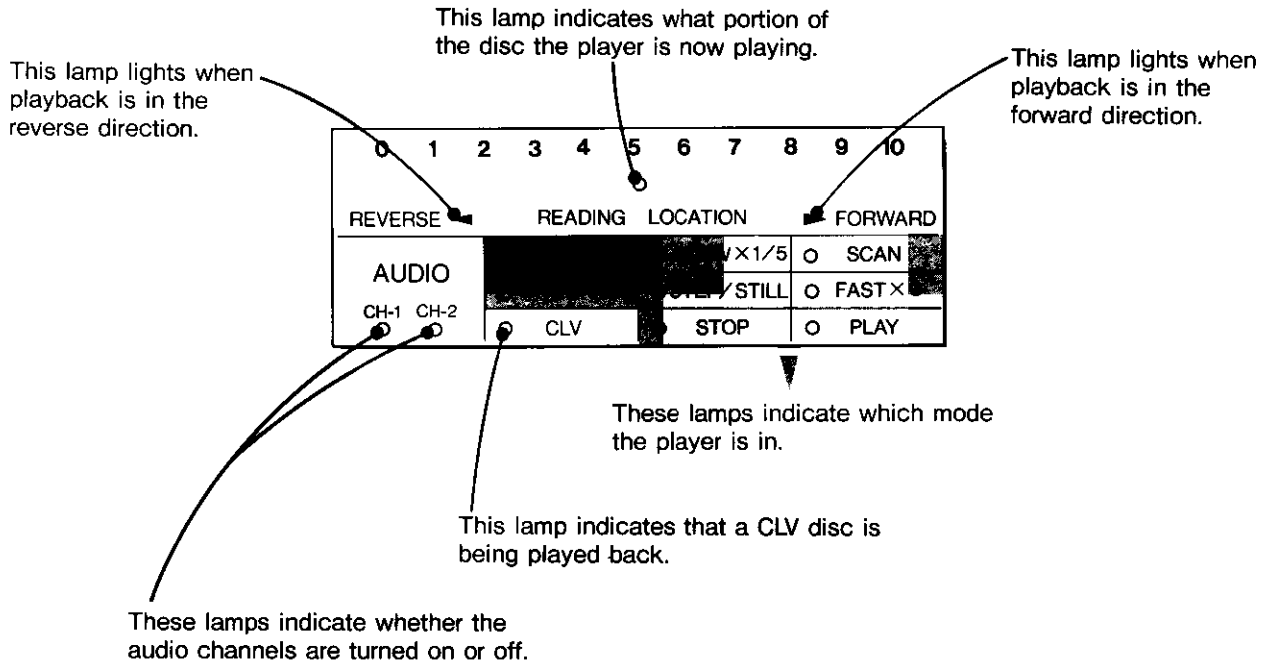

REAR PANEL

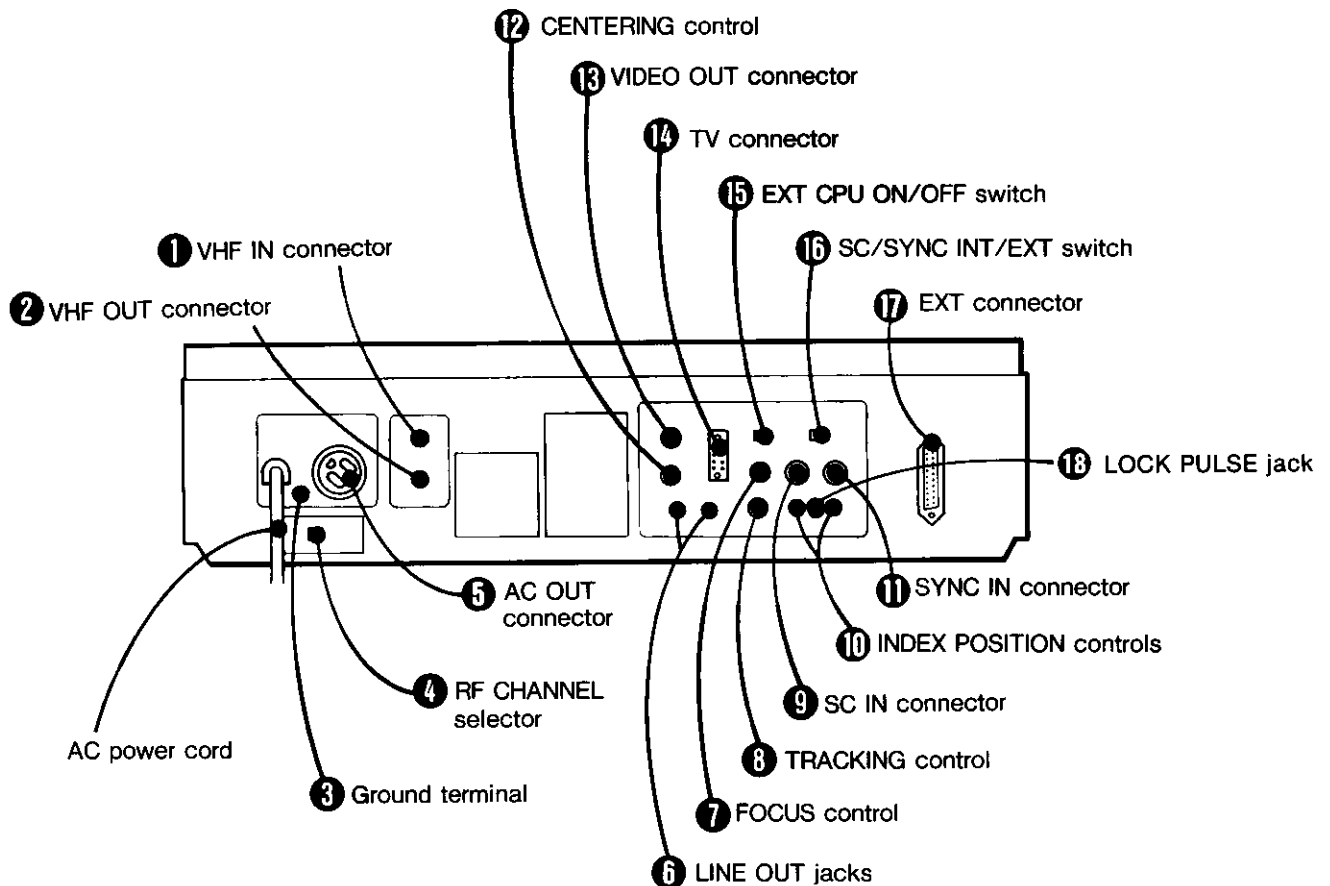

❶ VHF IN connector (F type connector)

Connect the 75-ohm coaxial cable for VHF antenna here. If the antenna cable is a 300-ohm twin lead, use the EAC-25 external antenna connector (optional).

❷ VHF OUT connector (F type connector)

Connect to the VHF antenna connector of the TV receiver. Either of the following signals, selected by the antenna selector on the front, can be supplied.

- VHF TV signal connected to the VHF IN connector
- the program on the disc (which is converted into the VHF signal by the built-in RF unit)

❸ Ground terminal [⚡]

To reduce hum, connect this terminal to an earth ground with a ground wire.

❹ RF CHANNEL* selector

Selects the channel to which the output signal of the VHF OUT connector is fed. Set the selector to channel 3 or 4, which is not active in your area.

* RF (Radio Frequency) channel: The built-in RF unit modulates the playback signal of the disc into the frequency of the VHF channel 3 or 4, which we call the RF channel, so that the picture from the disc can be displayed by the TV receiver.

❺ AC OUT (outlet) connector

This outlet supplies ac power to other video equipment whose power consumption is no more than 400 watts. Power is supplied to the connected equipment regardless of the position of the player's POWER switch.

❻ LINE OUT jacks (phono jacks)

Connect to the line input jacks of audio equipments.

❼ FOCUS control

Normally set this control at the center detent position. If a picture with noise appears on the monitor screen, turn this control until you get the best possible picture. After playing this particular disc, return this control to its center detent position.

❽ TRACKING control

Normally set this control at the center detent position. If a picture with noise appears on the monitor screen, first turn the FOCUS control and then this control until you get the best possible picture. After playing this particular disc, return this control to its center detent position.

❾ SC IN connector (BNC connector)

Connect an external sync generator. The connector accepts 3.58 MHz subcarrier.

❿ INDEX POSITION controls

These controls adjust the position of the index display on the monitor screen. The V control is for the vertical direction and the H is for the horizontal direction.

⓫ SYNC IN connector (BNC connector)

Connect a time base corrector or external sync generator. The connector accepts composite sync signal.

⓬ CENTERING control

If a normal picture does not appear on the monitor screen in the playback mode, turn the control until you get the best possible picture. Normally set this control to the center detent position.

⓭ VIDEO OUT connector (BNC connector)

Connect to the video input of a video monitor or a time base corrector.

⓮ TV connector (8-pin connector)

Connect an 8-pin connector of a video monitor here.

⓯ EXT CPU ON/OFF switch

Normally set this switch to the OFF position.

Only when the player is to be operated by the external computers, remove the stopper, set the switch to ON and reinstall the stopper to keep the switch to the ON position. The any function and control keys on the control unit of the player will not function.

● When you want to operate the LDP-1000A with the external computers, please contact your Sony dealer.

⓰ SC/SYNC INT/EXT switch

When the player is to be operated synchronizing with the internal sync signal, set this switch to the INT position. When the player is to be operated synchronizing with the external sync signal connected to the SYNC IN (and SC IN) connector(s), set this switch to the EXT position. If no external sync signal is supplied to the SYNC IN connector, the player operates synchronizing with the internal sync signal regardless of the switch position.

⓱ EXT connector (RS232C serial interface connector)

Connect the external computers to operate the player.

⓲ LOCK PULSE jack

Use this jack to superimpose characters, pictures or graphic display from the Sony SMC-70 series microcomputer over the playback picture of the video disc. Connect this jack to the optional SMI-7073 RGB superimposer or SMI-7074 NTSC superimposer for the SMC-70 series using the remote cable supplied to the LDP-1000A to obtain a stable superimposition over a still or variable speed picture.

PREPARATIONS

To see a picture, connect a TV receiver or a video monitor to the videodisc player as follows.

If you use a TV receiver, the TV receiver should be adjusted so that it displays a picture from the videodisc player

TO SEE A PICTURE WITH A TV RECIEVER

ANTENNA CONNECTION

Remove the VHF antenna cable from the TV receiver and connect it to the player. Leave the UHF antenna cable connected to the TV receiver.

If your cable is a 75-ohm coaxial type (round) cable, connect it to the VHF IN with an F-type connector (optional).

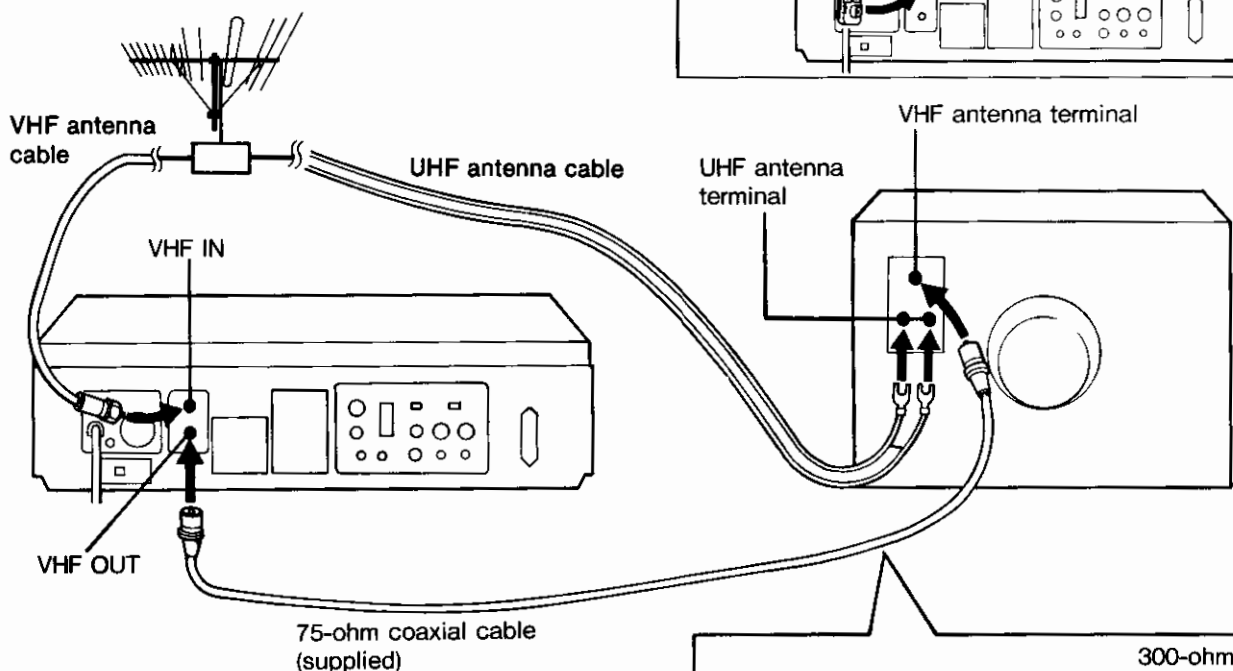

TV CONNECTION

Once the VHF signal connection indicated above is completed, the VHF TV signals as well as the signal from the player can be fed to the TV receiver so that you can also view TV programs in the usual way.

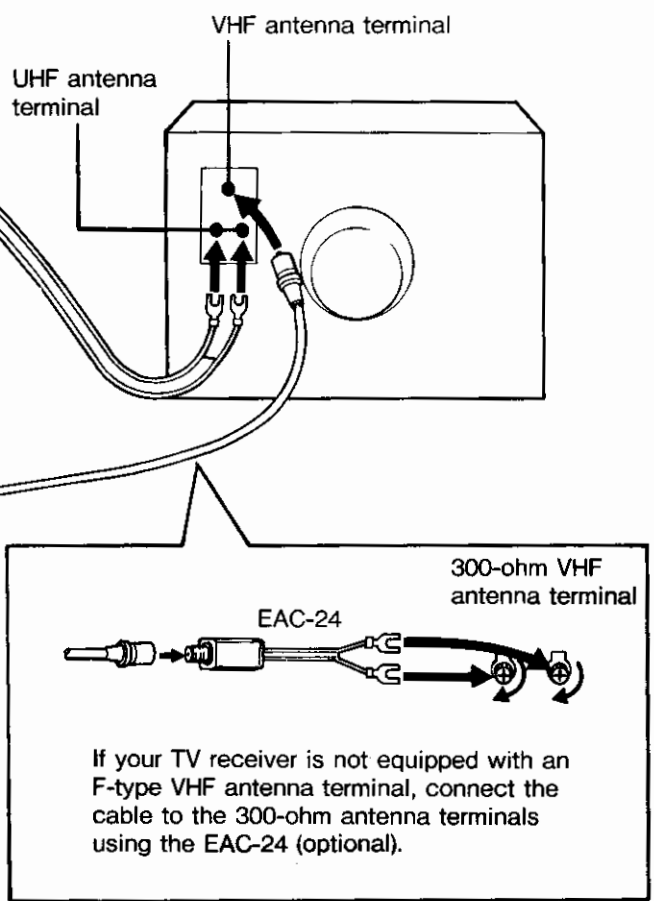
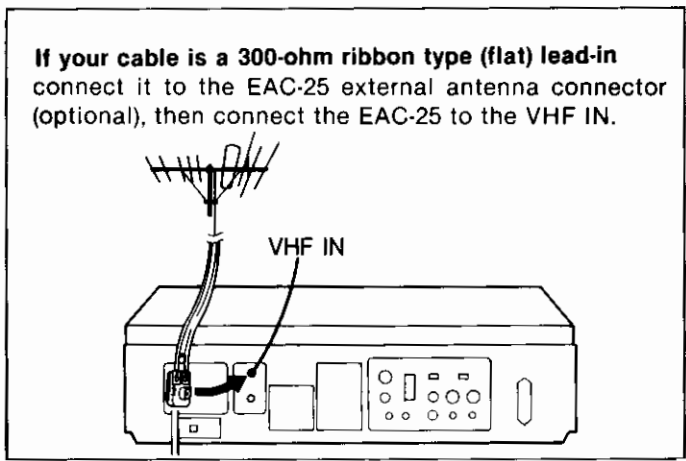

CAUTION

Connection between the LDP-1000A VHF OUT connector and the antenna terminals of a TV receiver should be made only as shown in these instructions. Failure to do so may result in operation that violates the regulations of the Federal Communications Commission regarding the use and operation of rf devices. Never connect the output of the LDP-1000A to an antenna or make simultaneous (parallel) antenna and LDP-1000A connections at the antenna terminals of your receiver.

TV ADJUSTMENT

Adjust your TV receiver to accept the signal from your player in this way;

On the player

1. Set the RF CHANNEL selector located at the rear of the player to CH-3 or CH-4, whichever channel is not active in your area.
2. Set the antenna selector to VDP.
3. Press the POWER button to turn on the player.
4. Press the OPEN button and insert a disc. (See page 12.)

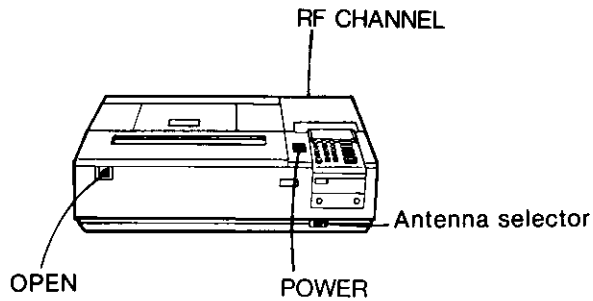

On the TV

5. Turn on the TV.
6. Set the channel on the TV receiver to the VHF channel 3 or 4, depending on the setting of the RF CHANNEL selector. The program of the disc will be displayed on the TV screen.

If a picture does not appear on the TV screen or if the display is not clear, fine tune the channel on the TV.

If your TV receiver has an electronic tuner and does not have a button for VHF channel 3 or 4, adjust a channel select button so that the program of the disc is clearly displayed on the TV screen and the sound is clearly heard.

- For details about TV channel adjustment, see the instruction manual furnished with the TV receiver.

Now the TV receiver has been correctly tuned to receive the signal from the player.

TO SEE A PICTURE WITH A VIDEO MONITOR

Once you connect a monitor, you can watch the playback picture on the monitor screen.

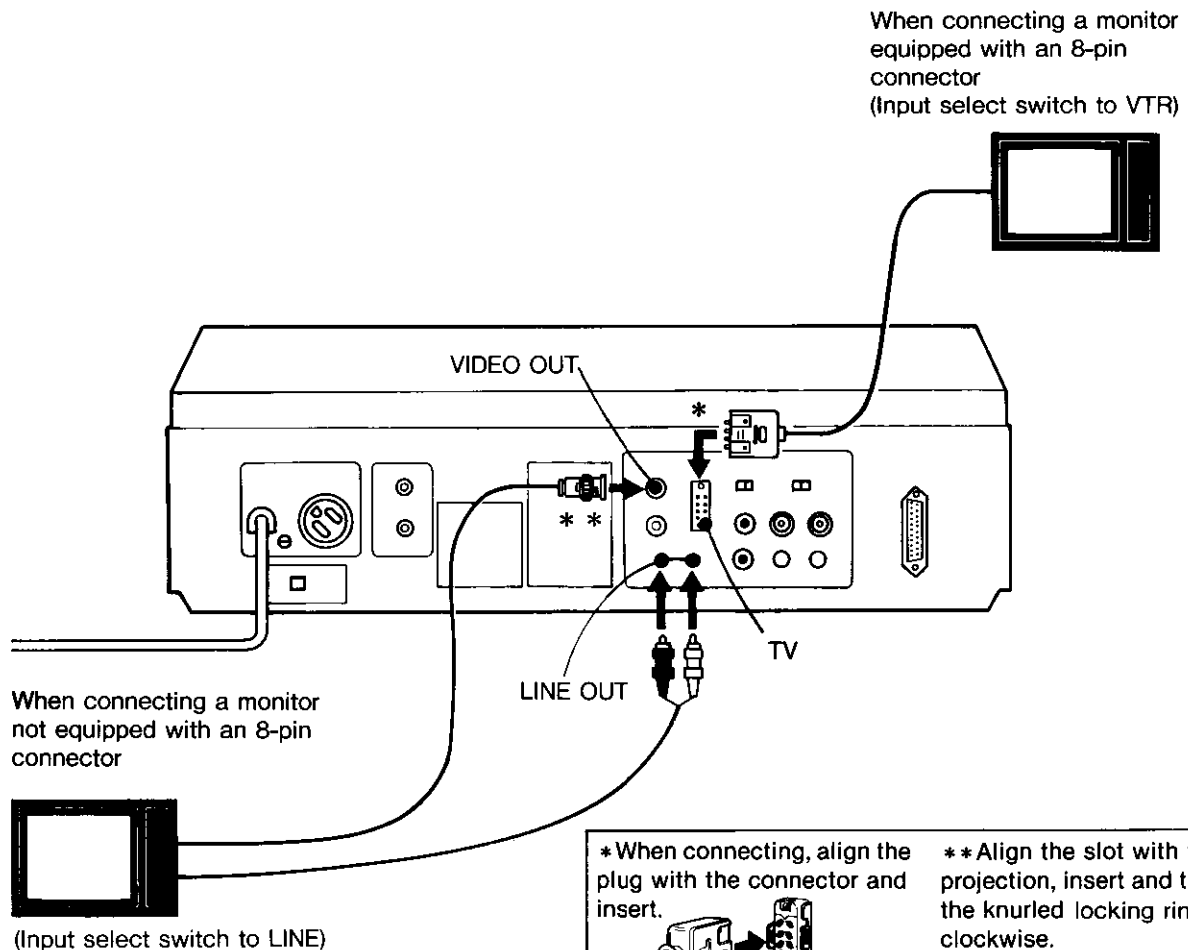

* When connecting, align the plug with the connector and insert.



When disconnecting, press the buttons on the plug and pull.

** Align the slot with the projection, insert and tighten the knurled locking ring clockwise.



BEFORE OPERATION

TO OPEN AND CLOSE THE DISC COMPARTMENT LID

To open

1. Plug the ac power cord into a wall outlet.
2. Press the POWER button.
3. Press the OPEN button.
The lid will unlock and lift up slightly.
4. Lift up the lid all the way. Be careful not to force the lid beyond its normal open position.

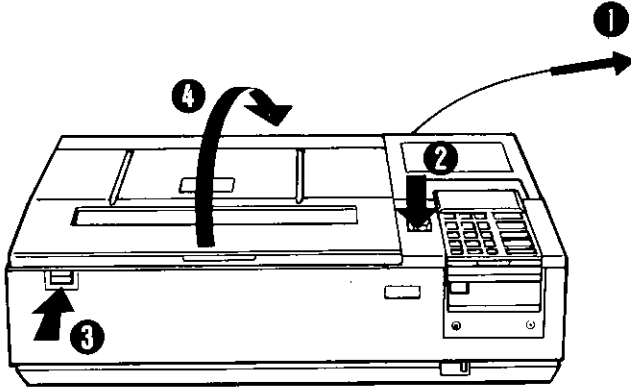

To close

Push the lid down firmly so that the latch locks securely.

If the lid does not open

1. Turn the power off.
 2. While pressing the OPEN button, press the POWER button again.
- If the lid still does not open, contact your Sony dealer.

REMOVE THE CAP OVER THE OBJECTIVE LENS

A cap has been put on the objective lens at the factory to protect the lens from damage and dust. Open the disc compartment lid and remove the cap.

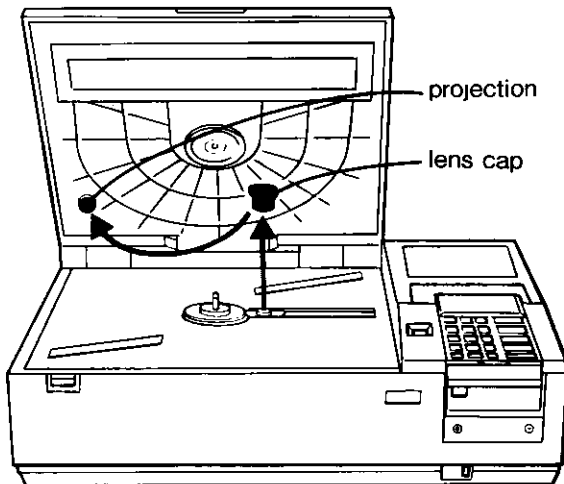

This cap should be saved for the later use when the player is shipped again or is not to be used for an extended period of time. Save the cap by putting it over the projection on the lid.

TO INSERT AND REMOVE THE VIDEO DISC

To insert

1. Open the disc compartment lid.
2. Place the disc with the desired program label up and install it to the center wheel firmly.

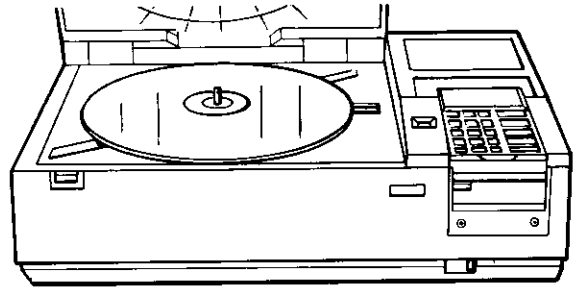

3. Close the lid.

The disc will start rotating. The STANDBY lamp will blink for several seconds, then will go off to show that the player is ready to play.

To remove

1. Press the OPEN button when you want to stop playing the disc, no matter what mode the player is in.
The disc will stop rotating and the lid will unlock and lift up slightly.
2. Lift up the lid all the way.
3. Remove the disc, holding it by the rim.
4. Close the lid

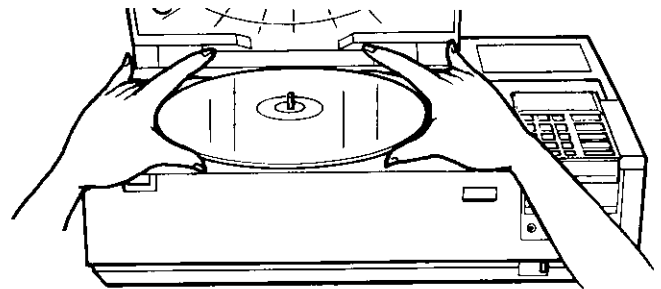

TO REMOTELY CONTROL THE VIDEODISC PLAYER

The control unit can be detached from the player by sliding it toward you while pressing the **RELEASE** button. It can be used either as a wireless or a wired remote control unit.

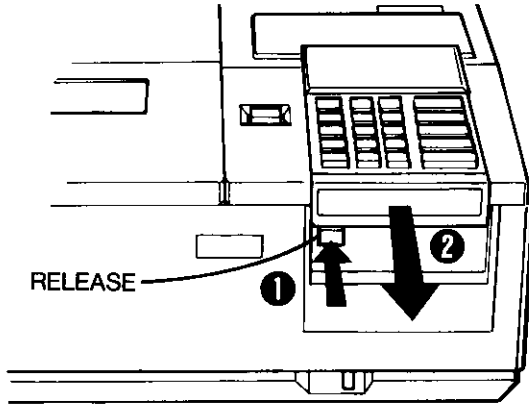

To attach, slide the control unit until it is plugged in firmly.

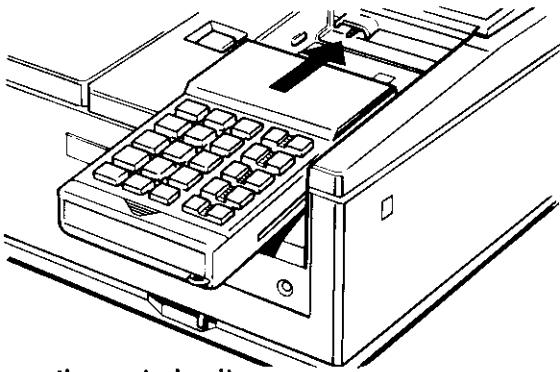

Notes on the control unit

- Keep the control unit away from hot or humid places.
- Avoid dropping any foreign objects into the control unit.
- To avoid a malfunction, do not press two or more function keys simultaneously.

WIRED REMOTE CONTROL

Once the **POWER** button on the player is depressed and the player and the control unit are connected with the supplied remote cable, you can remotely control the player with the control unit detached from the player. Connect the remote cable to the remote jack on the control unit and the **REMOTE** jack on the player.

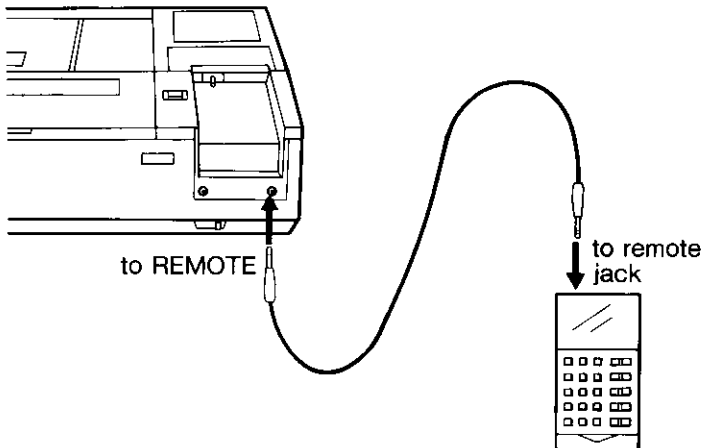

WIRELESS REMOTE CONTROL

Once the **POWER** button on the player is pressed, you can remotely control the player with the detached control unit up to 10 meters (3 feet) away from the player and within the range illustrated below.

The red lamp of the **COMMAND SENSOR** blinks to indicate that a function key has been pressed.

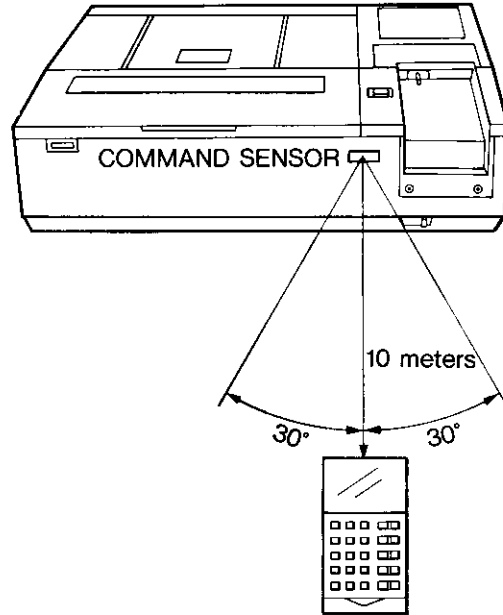

Battery installation

The control unit operates on batteries when it is used without the remote cable. To install the batteries, press down and slide open the battery compartment lid and install the three batteries size AA (IEC designation R6) with the correct polarity. Then close the lid.

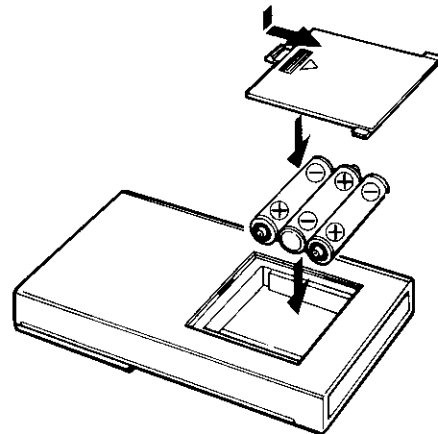

- In normal operation, battery life is over six months. When the batteries are exhausted, the remote control unit will not operate the player properly. When this happens, replace all the batteries.
- If the control unit is not to be used for a long period of time, remove the batteries to avoid damage from possible battery leakage.

HOW TO PLAY A VIDEO DISC

OPERATION

There are three kinds of video discs; a CAV disc having the control instructions, a CAV disc having not the control instructions and a CLV disc. The operation is a little different among discs.

1. Press the POWER button.
2. Press the OPEN button and lift up the lid all the way.
3. Insert a video disc.
4. Close the lid. the STANDBY indicator lights and the disc starts rotating.
 - If you want to display the index on the monitor screen, press the INDEX key.

0 1 2 3 4 5 6 7 8 9 10										
○										
REVERSE ◀	READING	LOCATION								▶ FORWARD
AUDIO	◻ STANDBY	○ SLOW X 1/5								○ SCAN
CH1 CH2	◻ PROGRAM	○ STEP/STILL								○ FAST X 3
○	○ CLV	○ STOP								○ PLAY

0 1 2 3 4 5 6 7 8 9 10										
○										
REVERSE ◀	READING	LOCATION								▶ FORWARD
AUDIO	◻ STANDBY	○ SLOW X 1/5								○ SCAN
CH1 CH2	◻ PROGRAM	○ STEP/STILL								○ FAST X 3
○	○ CLV	○ STOP								○ PLAY

When a CAV disc having the control instructions is played, the PROGRAM and STEP/STILL indicators light 15 seconds after the lid is closed.

The menu will be displayed. Press the keys according to the instructions of the displayed menu.

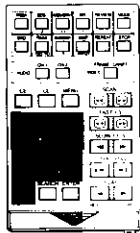

0 1 2 3 4 5 6 7 8 9 10										
○										
REVERSE ◀	READING	LOCATION								▶ FORWARD
AUDIO	◻ STANDBY	○ SLOW X 1/5								○ SCAN
CH1 CH2	◻ PROGRAM	○ STEP/STILL								○ FAST X 3
○	○ CLV	○ STOP								○ PLAY

When a CAV disc having not the control instructions is played, the PLAY indicator lights 15 seconds after the lid is closed.

The playback will automatically begin. You can use any function keys on the control unit.

- For search operation, see page 16.

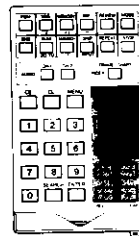

0 1 2 3 4 5 6 7 8 9 10										
○										
REVERSE ◀	READING	LOCATION								▶ FORWARD
AUDIO	◻ STANDBY	○ SLOW X 1/5								○ SCAN
CH1 CH2	◻ PROGRAM	○ STEP/STILL								○ FAST X 3
○	○ CLV	○ STOP								○ PLAY

When a CLV disc is played, the CLV and PLAY indicators light 10 seconds after the lid is closed.

The playback will automatically begin.

- The [SCAN ◀] [SCAN ▶] and forward [PLAY ▶] keys can be used.
- For search operation, see page 16.

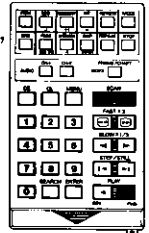

- To stop the playback momentarily, press the STOP key.
- To end the play of the disc, press the OPEN button, and the disc stops rotating and the lid is unlocked.

OPERATION WITH CONTROL INSTRUCTIONS

If "TOO LARGE" is displayed on the screen,

→ The number you have pressed is larger than the instructions on the menu. Wait until the display disappears for a few seconds, and press the correct keys.

To see the menu again,

→ Press the [MENU] key.

- To interrupt the operation with control instructions momentarily, → Press the [INT] key. The playback stops and a still picture is obtained. You can use any function keys on the control unit.

- To return to the operation with control instructions interrupted by the [INT] key, → Press the [END] key, and the original operation will be resumed.

- To stop the operation with the control instructions, → Press the [CL] key or the [END] key. The playback stops and you can press any function buttons.

- To restart the operation with control instructions stopped by the [CL] key or [END] key, → Press the [MENU] key, or press the [PGM] key, then the [RUN] key, and the menu will be displayed.

- To skip to the segment to be played next during the operation with the control instructions, → Press the [SKIP] key

- If, while a segment is playing during the operation with control instructions, you decide to see that segment from the beginning once again, → Press the [REVIEW] key.

TO SELECT THE AUDIO CHANNEL TO BE HEARD

Press the [AUDIO CH-1] or [CH-2] key. When the key is pressed, the sound is cut off, and when the key is pressed again, the sound can be heard.

TO SKIP TO THE NEXT CHAPTER OR REVIEW THE CHAPTER BEING PLAYED (Chapter Stop)

— For a disc with chapter data —

Press the [INDEX] key to display the chapter number and keep the [SCAN] key depressed. (To skip to the next chapter press [SCAN ►]; to return to the beginning of the chapter being played press [SCAN ◀].) When the beginning of the chapter is found, playback stops and a still picture is obtained (CAV disc) or playback starts (CLV disc). Release the [SCAN] key at this point. The CAV disc will start playback. To skip more chapters press [SCAN] again.

IF A NORMAL PICTURE DOES NOT APPEAR ON THE MONITOR SCREEN

Turn the CENTERING control until you get the best possible picture. If the picture still contains noise, adjust the FOCUS control and then the TRACKING control.

- After playing this particular disc, return the FOCUS and TRACKING controls to their center detent position.

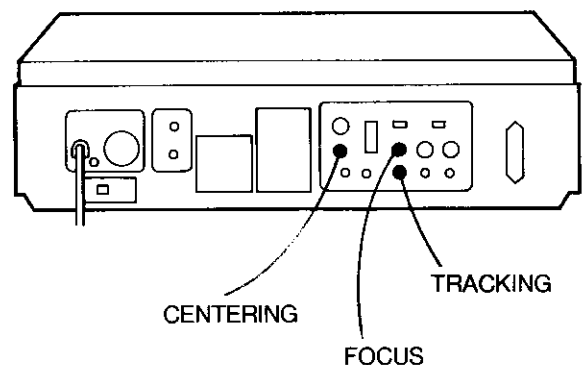

SEARCH OPERATION

TO SEARCH FOR A PARTICULAR POINT (Point Search) (For CAV disc and CLV disc)

On a CLV disc, search for the desired point by frame.

On a CAV disc, search in reference to the elapsed playback time from the beginning of the disc (in minutes).

CAV disc: For example, to search for Frame 2050:

Step	Keys to be pressed	Display
1.	[SEARCH]	SEARCH 00000
2.	[2] [0] [5] [0]	SEARCH 02050
3.	[ENTER]	Frame 2050 will be displayed. (Still picture)

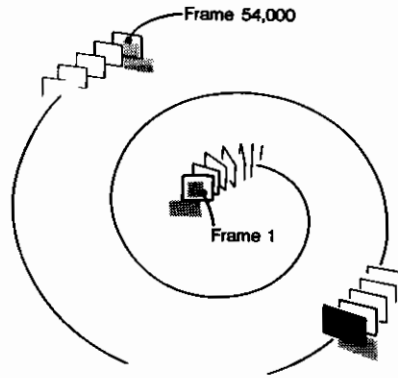

CLV disc: For example, to search for the 25-minute point:

Step	Keys to be pressed	Display
1.	[SEARCH]	SEARCH 00000
2.	[2] [5]	SEARCH 00025
3.	[ENTER]	Playback will begin from the 25-minute point

TO SEARCH FOR THE BEGINNING OF A PARTICULAR CHAPTER (Chapter Search) (For CAV disc and CLV disc)

For example, to search for chapter 3:

Step	Keys to be pressed	Display
1.	[SEARCH]	SEARCH 00000
2.	[MODE]	SEARCH C-001
3.	[3]	SEARCH C-003
4.	[ENTER]	The beginning of Segment 3 will be searched for and the still picture of the first frame will be displayed (CAV disc), or playback starts (CLV disc).

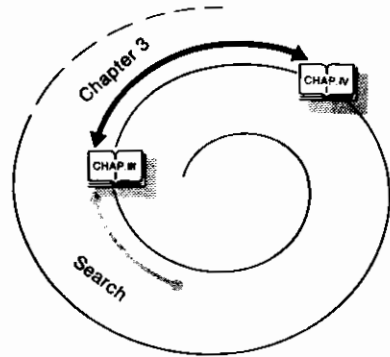

TO SEARCH FOR THE BEGINNING OF A PARTICULAR SEGMENT (Segment Search) (Only for the CAV disc)

To enter the segment data, refer to the "MEMORIZING THE SEGMENT DATA" on page 20.

For example, to search for Segment 10:

Step	Keys to be pressed	Display
1.	[SEARCH]	SEARCH 00000
2.	[MODE]	SEARCH C-001*
3.	[MODE]	SEARCH S-001
4.	[1] [0]	SEARCH S-010
		● To search for Segment 1, skip this step.
5.	[ENTER]	The beginning of Segment 10 will be displayed.

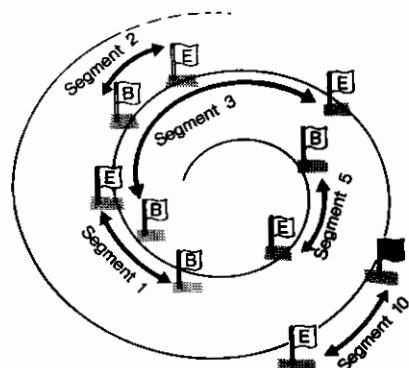

*For a disc with no chapter data, "SEARCH S-001" will be displayed. In this case, skip Step 3.

TO REPEAT A PARTICULAR PART UP TO 15 TIMES (Point Repeat Search) (For CAV disc and CLV disc)

On a CAV disc, playback between any specified two frames at the specified speed can be done repeatedly up to 15 times.

CAV disc: For example, to play from Frame 100 to 170 three times at slow (x1/5) speed:

Step	Keys to be pressed	Display
1.	Search for Frame 100, the starting point.	
2.	[REPEAT]	00000 The frame number of the starting point is memorized.
3.	[1] [7] [0] (frame number of end point)	00170
4.	[SLOW] ● To play at normal speed, skip this step.	SLOW 00170
5.	[ENTER]	REPEAT * 01
6.	[3]* (times to be repeated)	REPEAT * 03
7.	[ENTER]	The part from Frame 100 to Frame 170 will be played back at slow speed three times.

* If [0] is pressed at this point, playback will be repeated until you press the [CL] key.

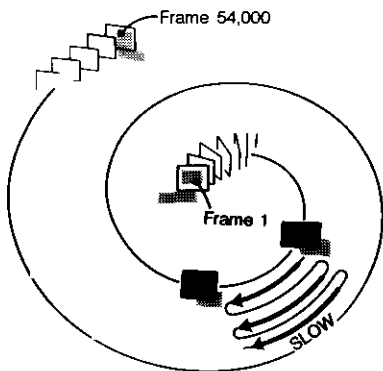

On a CLV disc, playback between any two points specified in minutes from the beginning can be done at normal speed repeatedly up to 15 times.

CLV disc: For example, to play from the 25-minute point to the 40-minute point three times:

Step	Keys to be pressed	Display
1.	Search for the 25-minute point, the starting point.	
2.	[REPEAT]	00000 The starting point in minutes is memorized.
3.	[040] (time of end point)	00040
4.	[ENTER]	REPEAT 01
5.	[3]* (times to be repeated)	REPEAT 03
6.	[ENTER]	The part from the 25-minute point to the 40-minute point will be played back three times. Playback will continue after the playback of this particular part ends.

TO REPEAT A PARTICULAR CHAPTER UP TO 15 TIMES (Chapter Repeat Search) (For CAV disc and CLV disc)

For example, to repeat Chapter 12 twice:

Step	Keys to be pressed	Display
1.	[REPEAT]	REPEAT 00000*
2.	[MODE]	REPEAT C-001
3.	[1] [2] (Chapter number)	REPEAT C-012
4.	[ENTER]	REPEAT * 01
5.	[2] (Times to be repeated)	REPEAT * 02
6.	[ENTER]	Chapter 12 will be played back twice. The CAV disc stops and the CLV disc plays back the next chapter.

* If "REPEAT C-001" is displayed in step 1, skip step 2.

TO REPEAT A PARTICULAR SEGMENT UP TO 15 TIMES (Segment Repeat Search) (Only for the CAV disc)

For example, to repeat Segment 2 for five times at fast (×3) speed:

Step Keys to be pressed

1. Search for a segment to be played.
2. [REPEAT] REPEAT S-001
3. [2] REPEAT S-002
(segment number)
● For Segment 1, skip this step.
4. [FAST] FAST S-002
● To play at normal speed, skip this step.
5. [ENTER] REPEAT * 01
6. [5] REPEAT * 05
(times to be repeated)
7. [ENTER] Segment 2 will be played back five times at fast speed.

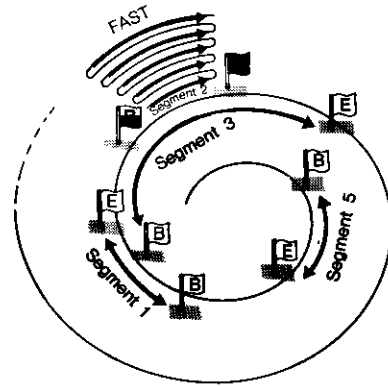

You can start the Segment Repeat Search from any point.

Step Keys to be pressed

1. Search for the frame to start playback.
2. [REPEAT] 00000
3. [MODE] REPEAT S-001*
4. [2] REPEAT S-002
5. [FAST] FAST S-002
6. [ENTER] REPEAT * 01
7. [5] REPEAT * 05
8. [ENTER]

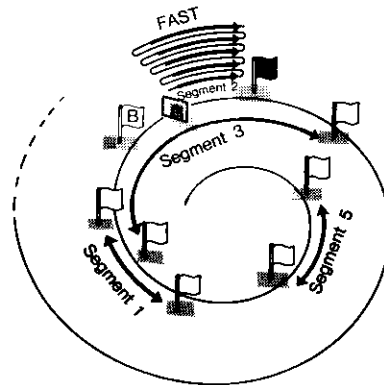

*If the disc has chapter data, "REPEAT C-001" will be displayed. In this case press [MODE] again.

TO SEARCH FOR A FRAME WHICH HAS BEEN MEMORIZED IN ADVANCE (Memory Search) (Only for CAV disc)

1. Play a video disc in any mode.
2. Press the [MEMORY] key at the point you want to see again.
3. Press the [M. SEARCH] key. The point where the [MEMORY] key was pressed will be searched for.

● If the [MEMORY] key has been pressed several times, only the point where the key was last pressed will be searched for.

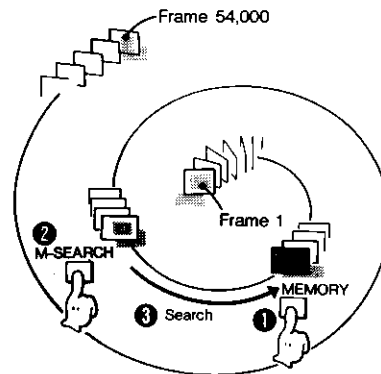

TO PLAY AT PARTICULAR SLOW SPEED (Only for the CAV disc)

You can select a playback speed from 1/1 to 1/255 normal speed by entering the denominator of the desired speed as data for the playback speed. For example, to play at speed 1/30 normal speed, "30" should be pressed:

1. Press the [STEP/STILL ▶] key for forward play or the [STEP/STILL ◀] key for reverse play.
2. Press the [3] and [0] keys (data for the playback speed).
3. Press the [ENTER] key. Playback at a speed 1/30 normal speed will begin.

OPERATION WITH CONTROL INSTRUCTIONS (Using CAV discs)

Using the built-in microprocessor, you can memorize the segment data—the segment number and the beginning and end frame numbers of the segment—in the LDP-1000A and play these segments in any desired order and also at any playback speed—fast (x3), normal, slow (x1/5) or frame-by-frame. It is also possible to jump to another series of playback program during the performance of a series of playback program. This is called “Branching”. The control instructions for playing or branching are stored on numbers 000 to 511 in the memory. These numbers are called “Line Numbers”.

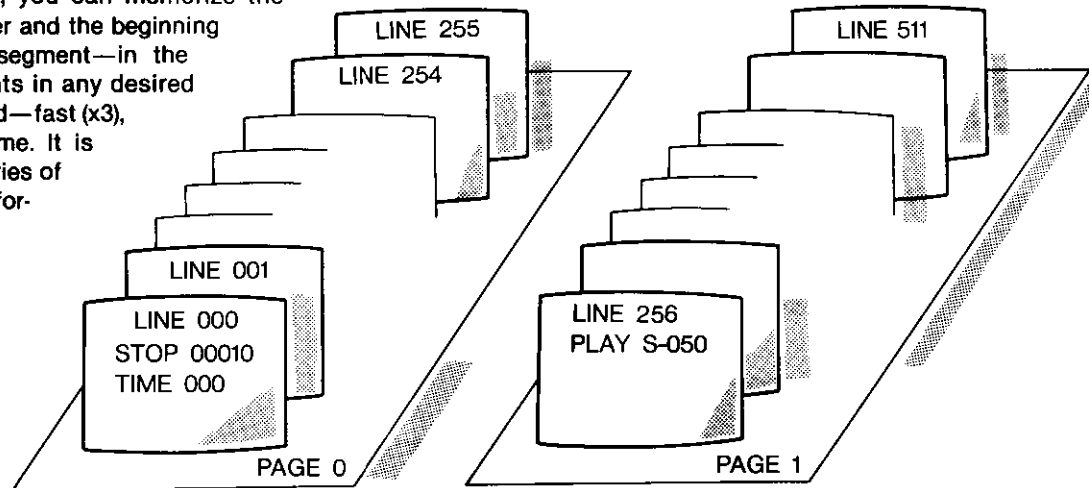

On some CAV discs, the segment data and control instructions are recorded on the beginning portion of the audio channel 2. You can use these data to play the disc, of course, and also play the same disc with another control instructions when you enter the new data by using the control unit of the LDP-1000A.

This part of instruction manual tells you how to memorize the segment data and the control instructions for playing and branching.

MEMORY OF THE DATA TO BE ENTERED

The memory of the entered segment data and control instructions will be kept on the LDP-1000A for three days, or until new data or control instruction is entered.

BEFORE MEMORIZING THE CONTROL INSTRUCTIONS

PREPARATION

1. Make the necessary connections.
2. Press the POWER button.
3. Insert a video disc.
4. Press the INDEX key to display the frame number.

TO START ENTERING CONTROL INSTRUCTIONS

1. Press the [PGM] key. "START AT 000" will be displayed.
2. Press the Line Number to which you want to assign a control instruction. To start from Line 000, skip this step.
3. Press the [ENTER] key. "000 FUNCTION?" will be displayed.

Now the LDP-1000A is ready to memorize the data for control instructions for playing or for branching.

Note:

Because all data is automatically erased from a Line when new data is entered, we recommend checking that there is no data you want to retain stored on a Line before you enter new data on that Line.

TO END ENTERING CONTROL INSTRUCTIONS

When you have finished memorizing the all control instructions for a program, terminate the program with the following method.

Press the [ENTER] key while "000 FUNCTION?" is displayed
"000 END 00000" will appear.

↖line number ↗present frame number

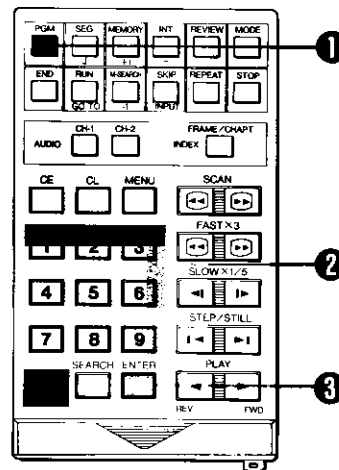

MEMORIZING THE CONTROL INSTRUCTIONS FOR PLAYING

TO PLAY SEGMENTS AT FAST (x3), NORMAL OR SLOW (x1/5) SPEEDS

For example, if you want to enter the control instructions "Play Segment 2 at slow (x1/5) speed" on Line 042, proceed as follows:

Step Keys to be pressed

[PGM] [4] [2] [ENTER]

1. [SLOW]

- For playback at normal speed, skip this step.

042 FUNCTION?

line number

042 SLOW S-001

segment number
to be played
playback speed

2. [2]

- (segment number)
- To play Segment 1,

042 SLOW S-002

3. [ENTER]

044 FUNCTION?

- For the following control instructions, repeat these steps.
- To end entering control instructions, press the [ENTER] key again.

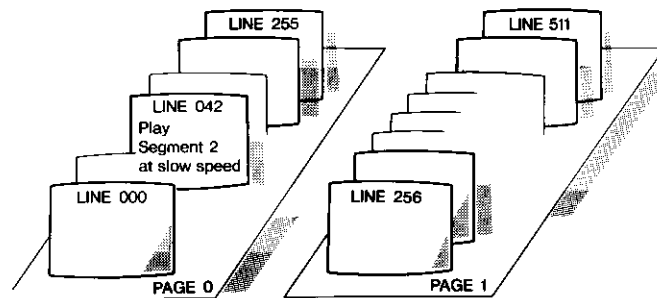

TO SELECT AUDIO CHANNEL 1 OR 2

Both audio channels will be played back in normal operation. However, you can select the audio of either channel 1 or 2 alone in this way:

1. Display the "000 FUNCTION?".
2. Press the [CH-1] key for channel 1 or the [CH-2] key for channel 2.
"000 AUDIO-1 0" or "000 AUDIO-2 0" will be displayed
3. Press one of the following keys:
 - [0] for off (the sound will be cut off)
 - [1] for on (the sound will be heard)
 - [2] for toggle (the mode—on or off—will be changed)
4. Press the [ENTER] key.

TO DECIDE WHETHER TO DISPLAY THE INDEX OR NOT

You can decide whether the index is displayed or not during playing a segment in this way:

1. Display the "000 FUNCTION?".
2. Press the [INDEX] key and the "000 INDEX 0" will be displayed.
3. Press one of the following keys:
 - [0] for off (the index is not displayed)
 - [1] for on (the index is displayed)
 - [2] for toggle (the mode—the index is displayed or not—will be changed)
4. Press the [ENTER] key.

TO PLAY A SEGMENT FRAME-BY-FRAME

The speed at which frames are to be advanced can range from 1/1 to 1/255 normal speed. Enter the denominator of the desired playback speed as data.

For example, if you want to enter the control instructions "Play Segment 55 frame-by-frame at 1/90 normal speed" on Line 100, proceed as follows:

- | Step | Keys to be pressed | Display |
|------|--|-----------------------------------|
| | [PGM] [1] [0] [0][ENTER] | 100 FUNCTION?
↑
line number |
| 1. | [STEP] | 100 STEP S-001 |
| 2. | [5] [5]
(segment number)
● To play Segment 1,
skip this step. | 100 STEP S-055 |
| 3. | [ENTER] | 100 STEP 000 |
| 4. | [9] [0]
(denominator of the
playback speed) | 100 STEP 090 |
| 5. | [ENTER] | 103 FUNCTION? |
- For additional segments, repeat these steps.
 - To end entering control instructions, press the [ENTER] key again.

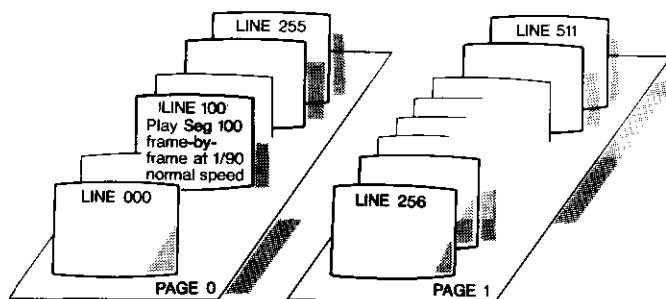

TO OBTAIN A STILL PICTURE OF THE BEGINNING OF A PARTICULAR SEGMENT

For example, if you want to enter the control instructions "Stop at the beginning of Segment 50 for 3 seconds" on Line 70, proceed as follows.

- | Step | Keys to be pressed | Display |
|------|--|-----------------------------------|
| | [PGM] [7] [0][ENTER] | 070 FUNCTION?
↑
line number |
| 1. | [STOP] | 070 STOP S-001 |
| 2. | [5] [0]
(segment number)
● For Segment 1,
skip this step. | 070 STOP S-050 |
| 3. | [ENTER] | 070 TIME 000 |
| 4. | [3]
(number of seconds the
frame is to be displayed) | 070 TIME 003 |
| 5. | [ENTER] | 073 FUNCTION? |
- To end entering control instructions, press the [ENTER] key again.

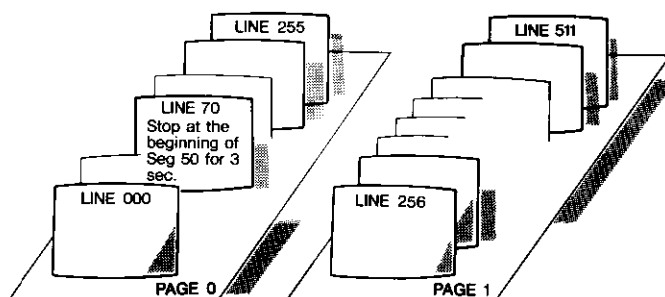

- You can display a specific frame by designating by the frame number as follows. For example, to enter the control instructions "Stop at Frame 1500 for 5 seconds" on Line 456:

- | Step | Keys to be pressed | Display |
|------|---------------------------|----------------|
| | [PGM] [4] [5] [6] [ENTER] | 456 FUNCTION? |
| 1. | [STOP] | 456 STOP S-001 |
| 2. | [MODE] | 456 STOP 00000 |
| 3. | [1] [5] [0] [0] | 456 STOP 01500 |
| 4. | [ENTER] | 456 TIME 000 |
| 5. | [5] | 456 TIME 005 |
| 6. | [ENTER] | 460 FUNCTION? |

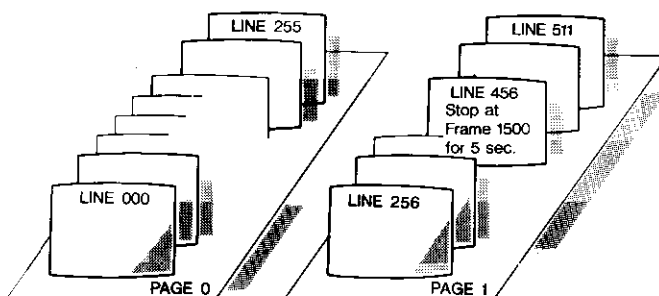

MEMORIZING THE CONTROL INSTRUCTIONS FOR BRANCHING

USING THE [GO TO] KEY

You can jump from one line to another.
For example, if you want to enter control instructions "Jump to Line 001" on Line 418, proceed as follows.

- | Step | Keys to be pressed | |
|------|--|---------------|
| | [PGM] [4] [1] [8] [ENTER] | 418 FUNCTION? |
| 1. | [GO TO (RUN)] | 418 GO TO 000 |
| 2. | [1] | 418 GO TO 001 |
| | (line number to jump to) | |
| | ● If jumping to Line 000 skip this step. | |
| 3. | [ENTER] | 420 FUNCTION? |

● To end entering control instructions, press the [ENTER] key again

● You can jump to any line among Line 000 to Line 511.

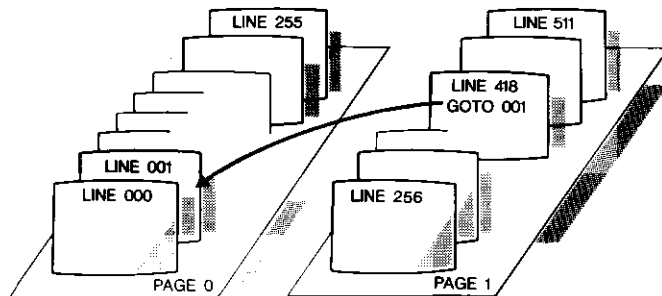

USING THE [INPUT] KEY

Use the [INPUT (SKIP)] key to devise a control instruction which offers the user a choice of which one of up to 9 different lines will follow.

It is possible, for example, to devise a Line 057, in which the user presses figure key 1 the next control instruction will be Line 042 and if he presses figure key 2 the next will be Line 120, and so on. Proceed in this way:

- | Step | Keys to be pressed | |
|------|--------------------------|-----------------|
| | [PGM] [5] [7] [ENTER] | 057 FUNCTION? |
| 1. | [INPUT] | 057 INPUT-1 000 |
| 2. | [4] [2] | 057 INPUT-1 042 |
| | (line number to jump to) | |
| 3. | [ENTER] | 057 INPUT-2 000 |
| 4. | [1] [2] [0] | 057 INPUT-2 120 |
| 5. | [ENTER] | 057 INPUT-3 000 |
| 6. | [ENTER] | 060 FUNCTION? |

● To end entering control instructions, press the [ENTER] key. "000 FUNCTION?" will be displayed.

NOTE

As lines are stored in two groups (which we call "Pages") — from Line 000 to Line 255 on Page 0 and from Line 256 to Line 511 on Page 1, it is not possible to jump from a line on one page to a line on another.

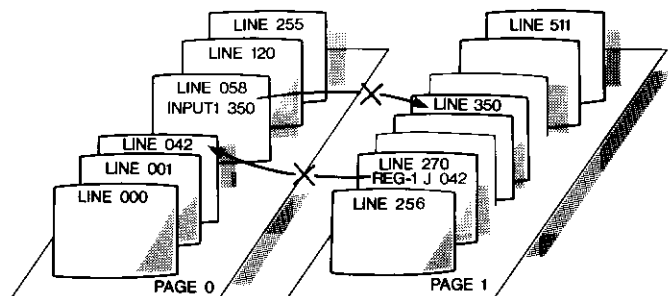

USING THE BUILT-IN REGISTERS

The LDP-1000A has four registers numbered from 0 to 3. The registers count the times a control instruction has been performed. The value memorized on a register decreases by one each time the control instruction is performed. If the value on a register is not 0, the operation returns to the beginning of that control instructions to repeat it until the value becomes 0, at which point the operation goes on to the next control instructions. Using these registers, you can repeat a particular control instructions up to 255 times.

NOTE

Again, it is not possible to jump from a line on one page to a line on another.

For example, if you want to enter control instructions "Play Segment 5 at fast (x3) speed for three times using Register-1" on Line 040, proceed as follows:

Step	Keys to be pressed	Display
	[PGM] [4] [0] [ENTER]	040 FUNCTION?
1.	[= (INT)]	040 REG-0] = 000
2.	[1] (register number) ● To use Register-0, skip this step.	040 REG-1] = 000
3.	[ENTER]	040 REG-1 = 000]
4.	[3]* (times to be played)	040 REG-1 = 003]
5.	[ENTER]	042 FUNCTION?
6.	[FAST] ● To play at normal speed, skip this step.	042 FAST S-001
7.	[5] (segment number) ● To play Segment 1, skip this step.	042 FAST S-005
8.	[ENTER]	044 FUNCTION?
9.	[J]	044 REG-0] J 000
10.	[1] (the same register number as in step 2)	044 REG-1] J 000
11.	[ENTER]	044 REG-1 J 000]
12.	[4] [2] (line number in step 5) ● If the line number is 000, skip this step.	044 REG-1 J 042]
13.	[ENTER]	046 FUNCTION

*If "0" is entered at this point, the register does not function.

● To end entering control instructions, press the [ENTER] key again.

TO CHECK THE CONTROL INSTRUCTIONS ENTERED

1. Press the [PGM] key. "START AT 000" will be displayed
2. Press the line number to be checked. To check Line 000, skip this step.
3. Press the [PGM] key. The data on the selected line will be displayed.

- To check the following control instructions, press the [PGM] key again.
- To end the check, press the [CL] key.

TO CORRECT THE ENTERED CONTROL INSTRUCTION DATA

Call up the line to be corrected and enter the correct data. For example, if you want to change the playback speed of Segment 2 stored on Line 006 from PLAY to SLOW, proceed as follows:

Step	Keys to be pressed	Display
1.	[PGM]	START AT 000
2.	[6] (line number)	START AT 006
3.	[ENTER]	006 FUNCTION?
4.	[SLOW]	006 SLOW S-001
5.	[2] (segment number)	006 SLOW S-002
6.	[ENTER]	008 FUNCTION?
7.	[END]	

● To end the correction, be sure to press the [END] key. If you press the [ENTER] key instead, the control instructions will be terminated at Line 006 and the next control instructions will not be performed.

ERROR MESSAGE

If you press an improper key, one of the following messages will appear on the monitor screen for about 1.5 seconds. When this happens, press the correct key.

INVALID KEY

"INVALID KEY" indicates that the pressed key has no function in the operation of the LDP-1000A.

TOO LARGE

"TOO LARGE" appears in the following situations.

- when a repeat time of more than 16 is entered in the Repeat Search mode.
(The maximum number of repeat times is 15.)
- when a register number of 4 or more is entered.
(The register numbers are from 0 to 3.)
- when you select Line 512 or higher to enter data.
(The lines are numbered from 000 to 511.)
- when a segment number of 64 or higher is entered
(The segments are numbered from 1 to 63.)
- when 256 or higher is entered as data for the register.
(The register can accept data from 1 to 255.)

FORMAT ERROR

When you press a key which designates an impossible operation while checking the control instructions or performing the operation with control instructions "FORMAT ERROR" will appear and operation will be interrupted.

PAGING ERROR

When you enter the control instructions in the LDP-1000A to jump to a Line stored on the other page using the [INPUT] key or [J] key, "PAGING ERROR" will appear. Remember that Lines 000 to 255 are stored on one page and Lines 256 to 511 on the other page and that you cannot jump between pages

MEMORY END

When you enter control instructions over Program 511 during entering control instructions, "MEMORY END" will appear.

CAPACITY OF DATA

Frame numbers: from 1 to 54,000

Segment numbers: from 1 to 63

Line numbers: from 000 to 511 (Line 000 to 255 are stored on Page 0 and Line 256 to 511 are stored on Page 1.)

Inputs: from 1 to 9

Register numbers: from 0 to 3

Values which can be entered on a register: from 1 to 255

(If 0 is entered, the register does not function.)

Times a particular part or segment can be repeated: up to 15

(If 0 is entered, playback will continue until the command to stop is entered.)

Speed for frame-by-frame advance or slow motion: 1/1 to 1/255

TO START THE OPERATION WITH CONTROL INSTRUCTIONS

1. Press the [PGM] key.
2. Press the figure keys of the line number you want to play.
3. Press the [RUN] key, and the operation will begin and continue in sequence to the line on which the end indication is entered.

EXAMPLE OF CONTROL INSTRUCTIONS

CONTROL INSTRUCTION SHEET

Line number	Instruction	Meaning of the instruction
000	STOP 00010 TIME 000	Stop at Frame 10 for 0 second.
004	INPUT-1 010 INPUT-2 040 INPUT-3 070 INPUT-4 100	Jump to Line 010 when [1] is pressed. Jump to Line 040 when [2] is pressed. Jump to Line 070 when [3] is pressed. Jump to Line 100 when [4] is pressed.
009	END	End of the instructions.
010	S-001	Play Segment 1.
011	S-002	Play Segment 2.
012	S-003	Play Segment 3.
013	S-004	Play Segment 4.
014	STOP 00250 TIME 010	Stop at Frame 250 for 10 seconds.
018	GO TO 000	Jump to Line 000
020	END	End of the instructions.
040	REG-1 002	"2" is stored on Register-1.
042	FAST S-005	Play Segment 5 at fast (x3) speed.
044	INPUT-1 070 INPUT-2 050	Jump to Line 070 when [1] is pressed. Jump to Line 050 when [2] is pressed.
047	END	End of the instructions.
050	REG-1 J 054	When the result subtracted one from the value on Register-1 is not 0, jump to Line 054; when it is 0, go to the next instructions.
052	GO TO 070	Jump to Line 070
054	REG-2 002	"2" is stored on Register-2.
056	S-010	Play Segment 10.
057	INPUT-1 042 INPUT-2 120	Jump to Line 042 when [1] is pressed. Jump to Line 120 when [2] is pressed.
060	END	End of the instructions.
120	REG-2 J 056	When the result subtracted one from the value on Register-2 is not 0, jump to Line 056; when it is 0, go to the next instructions.
122	GO TO 010	Jump to Line 010.
⋮		
⋮		
⋮		

HOW THE CONTROL INSTRUCTIONS ON THE PREVIOUS PAGE OPERATES

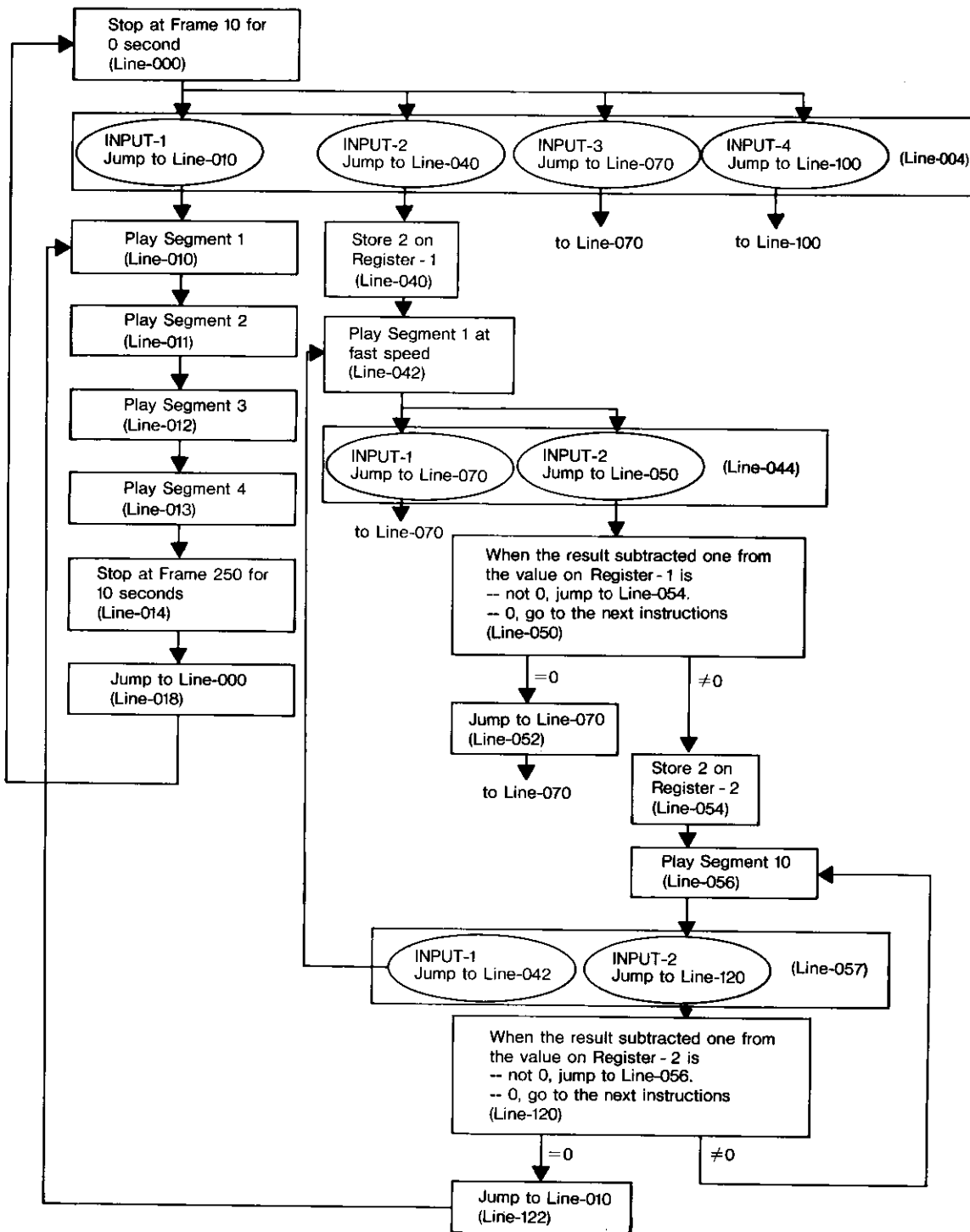

OPTIONAL CONNECTIONS

STEREO SYSTEM CONNECTION

Stereo hi-fi bilingual sound can be reproduced by connecting the stereo system to the LDP-1000A videodisc player. Connect the LINE OUT CH-1/L and CH-2/R on the player to the AUX input (or tape tuner input) jacks on the stereo amplifier or receiver.

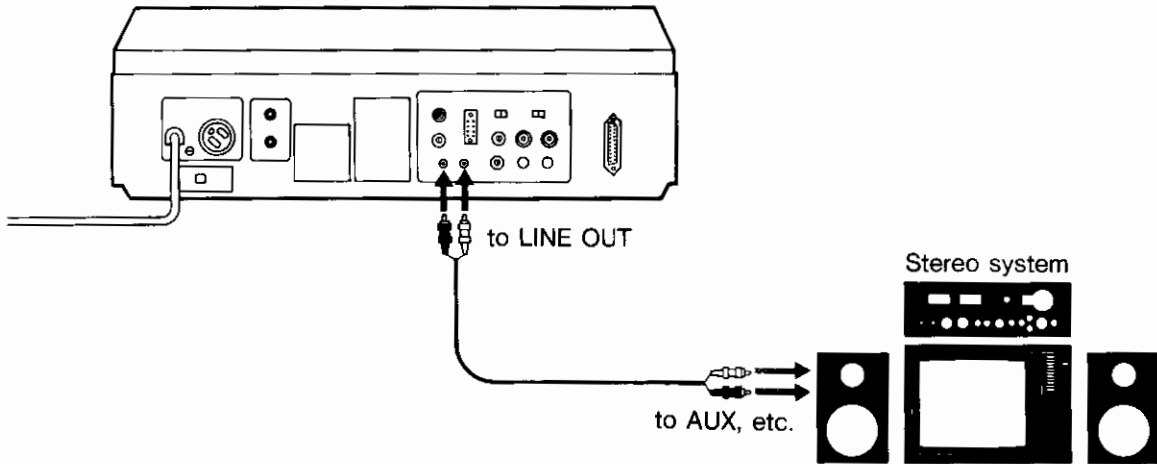

CONNECTION WITH A TIME BASE CORRECTOR

● If a monitor is connected to the LDP-1000A, the color reproduction cannot be obtained on the monitor screen.

*The time base corrector should be the direct mode type such as the Sony BVT-1000, BVT-2000.

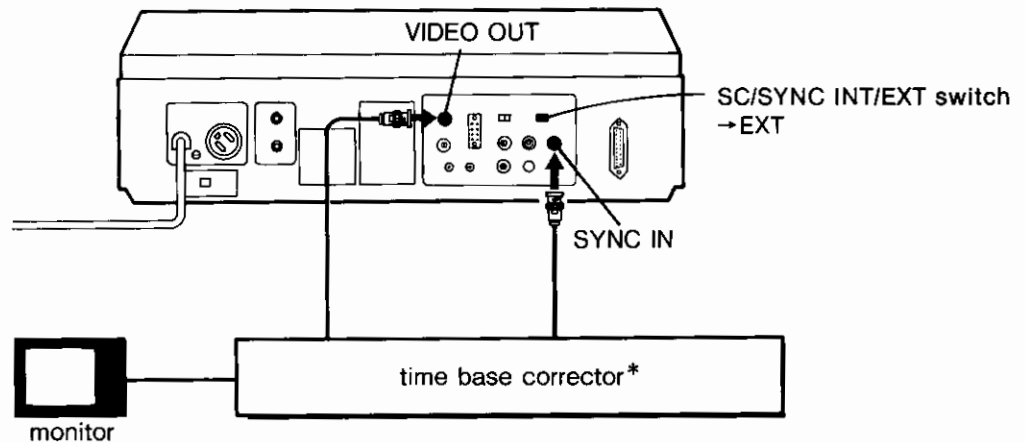

CONNECTION WITH AN EXTERNAL SYNC GENERATOR

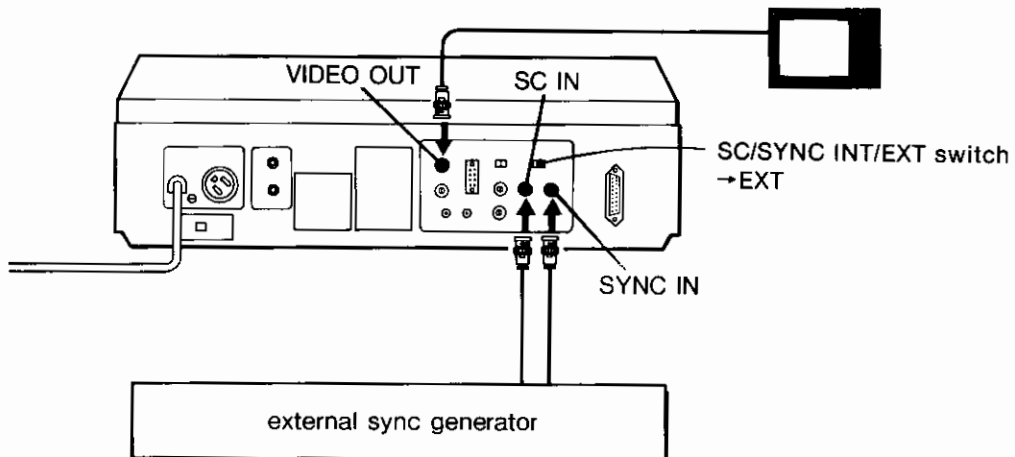

● If the external sync generator is not connected to the SC IN connector, the color reproduction cannot be obtained on the monitor screen.

TO TRANSPORT THE LDP-1000A

1. Place the cap over the objective lens.
2. Turn the adjuster on the bottom until the arrow of the location indicator are aligned.
3. Turn the shipping screw clockwise with a coin or similar object until it is tight.

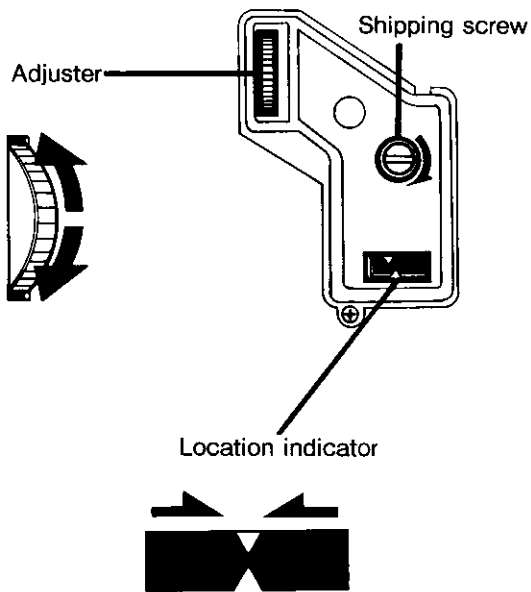

4. Attach the cushion in the disc compartment as illustrated.

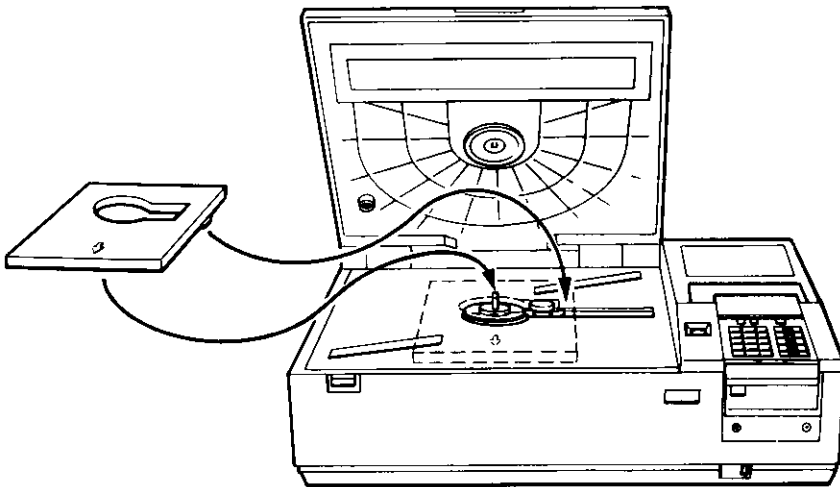

REPACKING FOR SHIPMENT

The packing procedure is subject to change. Refer to the illustration on the original carton for later packing instructions.

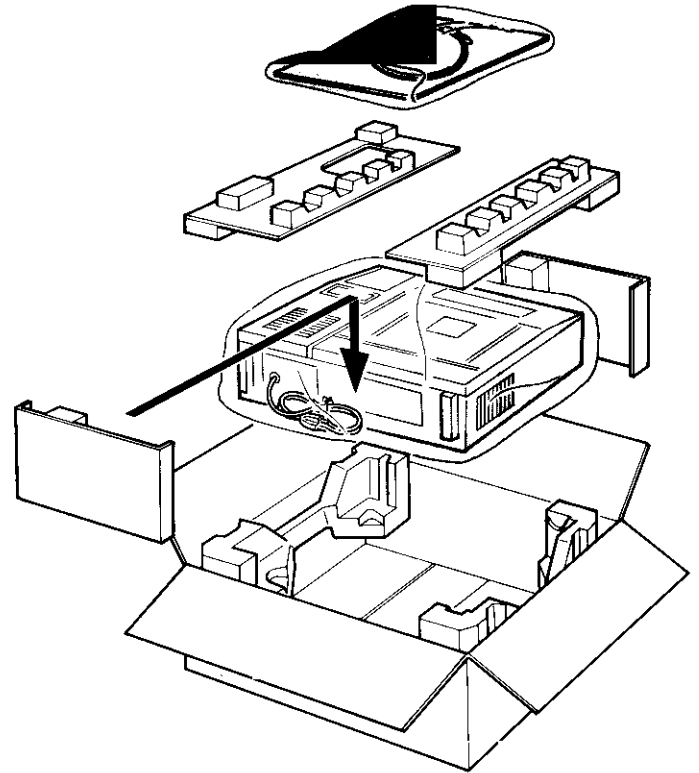

SPECIFICATIONS

General

Pick-up method	Laser beam (reflective)
Laser	He-Ne ($\lambda = 6328\text{\AA}$)
Maximum playing time	CAV: 30 min./side CLV: 60 min./side
Spindle revolution	CAV: 1800 r.p.m. CLV: 1800 r.p.m. (inner circumference) to 700 r.p.m. (outer circumference)

Video

Signal	EIA standards, NTSC color
Output	1.0 V(p-p), 75 ohms unbalanced, sync negative
Resolution	Color: 360 lines
Signal-to-noise ratio	42 dB
VHF output	Channel 3 or 4 (selectable) 75 ohms, unbalanced
Input signals	SYNC 4 V(p-p) \pm 1 V(p-p), 75 ohms SC 2 V(p-p) \pm 0.5 V(p-p), 75 ohms

Audio

Output	LINE OUT: Less than 2 k ohms 0 \pm 2 dB [V] (100% MOD, 47 k ohm load), unbalanced PHONES: 8 ohms, -19 \pm 2 dB [V]
Signal-to-noise ratio	More than 50 dB
Frequency response	40 Hz to 20 kHz (\pm 3 dB)

Others

Power requirements	120 V ac \pm 10%, 60 Hz
AC OUT	Unswitched 120 V ac, max. 400W
Power consumption	110W
Operating temperature	10°C to 35°C (40°F to 95°F)
Dimensions	542 \times 160 \times 415 mm (w/h/d) (21 ³ / ₈ \times 6 ¹ / ₄ \times 16 ³ / ₈ inches)
Weight	19.6 kg (43 lb 3 oz)

Remote control unit RM-1002

Remote control system	Infrared control
Power requirements	4.5 V dc Battery size AA \times 3 (IEC battery designation R6)
Dimensions	91 \times 31 \times 157 mm (w/h/d) (3 ⁵ / ₈ \times 1 ¹ / ₄ \times 6 ¹ / ₄ inches)
Weight	280 g (10 oz) including batteries

Accessories supplied

75-ohm coaxial cable with F-type connectors (1.5m)
Remote cable (2m)

Design and specifications subject to change without notice.

TROUBLE CHECKS

Many apparent malfunctions may be caused by a mis-set control that has been overlooked, or some other equally simple cause.

Should any difficulty arise in operation, check through this list

of symptoms, and cause and remedy. Should the difficulty persist, unplug the unit and contact the dealer from whom this unit was purchased, or a local Sony authorized service station.

Symptom	Cause and remedy
Lid does not open.	<ul style="list-style-type: none"> ● Power cord is not properly plugged into ac outlet. → Connect an ac power cord. ● Power is not turned on. → Press the POWER button. ● Latch is not released. → Press the OPEN button. (See page 12.)
Disc does not rotate.	<ul style="list-style-type: none"> ● Power is not turned on. → Connect the ac power cord to an ac outlet and press the POWER button. ● Lid is not shut completely. → Push lid close firmly so latch locks.
Disc rotates but no picture.	<ul style="list-style-type: none"> ● The shipping screw has not been loosened. → Turn the shipping screw fully counter-clockwise. ● The lens cap is still put on. → Remove the lens cap. ● The unrecorded side is played. → Turn over the disc. ● TV or monitor is not turned on. → Turn the TV or monitor on. ● Wrong connection from player to TV or monitor. → Make correct connections. ● TV set is not tuned to channel 3 or 4. → Set TV to channel 3 or 4 (inactive channel in your area). ● The RF CHANNEL selector is not set properly. → Set the selector to the inactive channel in your area. ● The player is in the standby mode. → Wait for a moment. ● The EXT CPU ON/OFF switch is set to ON. → Set the switch to OFF.
Picture quality is bad.	<ul style="list-style-type: none"> ● Bad connections between player and TV or monitor → Check all connections, particularly F type connector. ● The RF CHANNEL selector setting and the channel selected on the TV are not correspond. → Both TV and player must be set to the same channel (3 or 4) which is not active in your area. ● TV fine tuning has not been adjusted. → Fine tune the TV for optimum picture quality. ● The disc is not installed firmly. → Install the disc firmly. ● Poor disc. → Try playing a different disc. If other discs give good quality, the problem is with the particular disc.
TV no longer receives the broadcasting program after it has been connected to the player.	<ul style="list-style-type: none"> ● The antenna cable has not been connected. → Connect the VHF antenna cable properly. ● The antenna selector on the player is set to VDP. → Set the selector to ANT.
A particular part of a particular disc is not reproduced properly.	<ul style="list-style-type: none"> ● The disc is damaged. → Press the SCAN key to skip over the damaged portion.
The control unit on the player does not work.	<ul style="list-style-type: none"> ● The unit has not been connected firmly. → Install the unit onto the player firmly.
Wireless remote control does not work.	<ul style="list-style-type: none"> ● The batteries in the control unit are exhausted. → Replace the batteries.
Wired remote control does not work.	<ul style="list-style-type: none"> ● Remote control cable is not connected firmly. → Connect the cable to the REMOTE jack on the player and the remote control jack on the control unit firmly.