



**BLONDER
TONGUE**
LABORATORIES, INC.

One Jake Brown Road
Old Bridge, NJ 08857-1000 USA
(800) 523-6049 • (732) 679-4000 • FAX: (732) 679-4353
www.blondertongue.com

INSTRUCTION MANUAL

AP Series

Agile Processor with Emergency Alert System

Model	Stock No.
AP 40-550B	59802
AP 40-750B	59803
AP 60-550B	59817
AP 60-750B	59818

651204800C

The lightning flash with arrow-head symbol within an equilateral triangle is intended to alert you to the presence of uninsulated "dangerous voltage" within the product's enclosure that may be of sufficient magnitude to constitute a risk of electrical shock to persons.



The exclamation point within an equilateral triangle is intended to alert you to the presence of important operating and maintenance (servicing) instructions in the literature accompanying the product.

**TO REDUCE THE RISK OF ELECTRICAL SHOCK, DO NOT REMOVE COVER FROM THIS UNIT.
NO USER-SERVICEABLE PARTS INSIDE. REFER SERVICING TO QUALIFIED SERVICE PERSONNEL.**

WARNING: TO PREVENT FIRE OR SHOCK HAZARD, DO NOT EXPOSE THIS UNIT TO RAIN OR MOISTURE

NOTE TO CATV SYSTEM INSTALLER

This reminder is provided to call the CATV System Installer's attention to Article 820-40 of the NEC that provides guidelines for proper grounding and, in particular, specifies that the cable ground shall be connected to the grounding system of the building, as close to the point of cable entry as practical.

Description

AP Series are frequency agile TV channel processors that provide visual and aural RF carrier outputs on any Broadcast or CATV channel in the full 50 to 550 MHz (AP xx-550B) or 750 MHz (APxx-750B) frequency range from any VHF or UHF RF input source. They have an exceptionally low out of band noise floor that permits the construction of multiple channel headends without auxiliary filtering. Efficient AGC assures a wide dynamic range and dual SAW filters provide superior selectivity.

The processors are available in either 60 dBmV (AP 60-xxx) or 40 dBmV (AP 40-xxx) output versions. DIP switches for setting the input and output frequencies are accessible from the front panel, as are the A/V ratio, output level, FCC aeronautical offset controls and flatness control.

An external IF loop-thru enables the replacement of the standard IF signal with an alternate source of composite IF (such as an "all-call" system) or the insertion of IF scrambling equipment. An on-board carrier substitution generator is automatically activated upon loss of input signal. A high isolation IF switch is included to allow for an EXT IF input which can be used for EAS capability.

Options

- 04 = Sub Band Output
- 12 = Automatic Broadcast Offset Correction
- 14 = On Channelock
- 17 = Sub Band Input (AP 60-xxx)
- 20 = Digital Control, Serial RS-232/TTL Loop

Specifications

RF

Input Frequency Range:
 54 - 806 MHz, CATV - Ch. A-2 to Ch. 117
 Off Air Ch2 to Ch13, Ch 14 to Ch 69

Output Frequency Range
 APxx-550
 Ch. 2 to Ch. 78: 54 - 547.25 MHz
 UHF Ch. 14 to Ch. 27: 471.25 - 547.25 MHz

APxx-750
 Ch. 2 to Ch. 116: 54 - 745.25 MHz
 UHF Ch. 14 to Ch. 60: 471.25 - 747.25 MHz

Input Level Range for <1.0 dB Change At Output:
 -18 to 30 dBmV, (Input A/V = -15dB, C/V = -17dB)

Recommended Operating Input Level Range
 Off Air: -10 to +30 dBmV
 Cable: -10 to +10 dBmV

Standby Signal Threshold: -19 ±2 dBmV

Output Level Control Range
 AP40-xxx: 32 to 42 dBmV
 AP60-xxx: 50 to 60 dBmV

Aural/Visual Ratio Adjustment Range: 0 to -9 dB
 (Factory Set Range to 0 dB)
 Att. of Color Carrier: 1 dB

Output Visual Carrier Freq. Tolerance
 (With Respect to Input Freq.)
 Standard Channels: ±10 KHz
 Aeronautical Channels: ±2.5 KHz

Channel Passband Response
 fv to fv +4.5 MHz: ±1 dB at 0 dB A/V adj
 fv -0.5 to fv +3.75: ±1 dB, at any A/V setting

Adjacent Channel Rejection: -65 dBc
 (Equal Visual Car. and -15 dB A/V Ratio)

In Channel Carrier-To-Noise Ratio:
 VHF Input: 55 dB
 UHF Input: 53 dB

Broadband Noise: -76 dBc

Spurious output:
 (with A/V = -15 dB & C/V = -17 dB)
 In Channel: -58 dBc
 Out of Channel: -64 dBc, 50 to 1,000 MHz

Output Impedance, On Channel:
 75 Ohm, 14 dB Return Loss

IF

IF Loop Level: 35 dBmV@ 45.75 MHz
 IF Output Impedance: 75 Ohm, 12 dB Return Loss
 IF Input Impedance: 75 Ohm, 17 dB Return Loss
 EAS/ALT IF Input Level: 36 dBmV @ 45.75 MHz
 EAS/ALT IF Switch Isolation: >60 dB

General

Power Requirements: 105-129 VAC, 60 Hz, 3/8 A Fuse,
 Slo-Blo.
 Temperature Range: 0° to 50° C

Mechanical

Dimensions
 AP 40: 19 x 1-3/4 x 10 inch., WxHxD
 AP 60: 19 x 1-3/4 x 14-1/4 inch., WxHxD

Shipping Weight
 AP 40: 8 lbs. (Approximate)
 AP 60: 9 lbs. (Approximate)

Signal Connectors
 RF OUT: Type "F"
 IF IN: Type "F"
 IF OUT: Type "F"
 RF IN: Type "F"

EAS/ALT IF Input Control: 3 position terminal strip

Operating Controls - Front Panel

All operating controls and indicators for the processor are located on, or are accessible from the front panel.

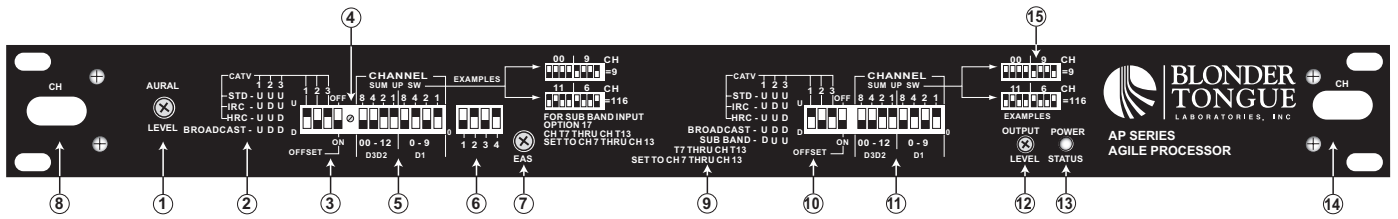

Front Panel View

1. **AURAL LEVEL** - Attenuates amplitude of aural RF carrier relative to visual RF carrier.
2. **OPERATING MODE SWITCH** - Positions 1, 2 & 3 used to select CATV or Broadcast mode.
3. **OFFSET SELECTOR** - Position 4 used to turn FCC Offset ON or OFF.
4. **OFFSET ADJUST** - Variable input frequency offset adjustment.
5. **INPUT CHANNEL SELECTOR** - Switches to select input channel.
6. **SELECTOR SWITCH** - Options
7. **EAS/ALT INDICATOR** - Lights green when EAS/ALT is active.
8. **INPUT CHANNEL LABEL** - Attached by user for reference.
9. **OPERATING MODE SWITCH** - Positions 1, 2 & 3 used to select CATV or Broadcast mode.
10. **OFFSET SELECTOR** - Position 4 used to turn FCC Offset ON or OFF.
11. **OUTPUT CHANNEL SELECTOR** - Switches to select output channel in Standard, HRC, or IRC assignments and broadcast.
12. **OUTPUT LEVEL** - Simultaneously adjusts amplitude of aural and visual carriers.
13. **POWER** - Power ON indicator light.
14. **OUTPUT CHANNEL LABEL** - Attached by user for reference.
15. **CHANNEL SETTING EXAMPLES** - Channels 9 and 116 shown.

Connections - Rear Panel

All connections to the unit are made at the rear panel.

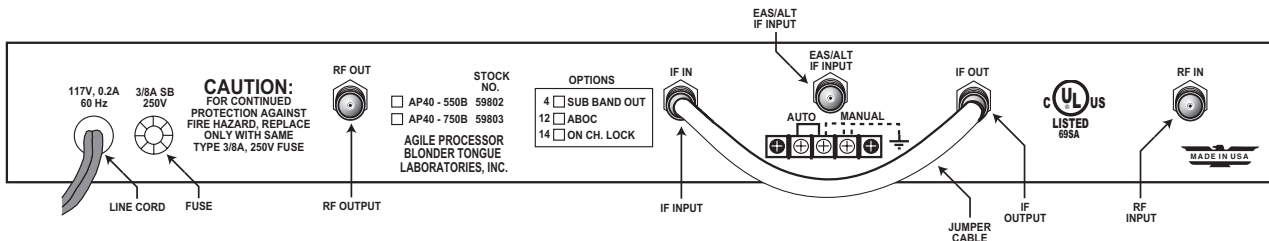

Rear Panel View - AP 40

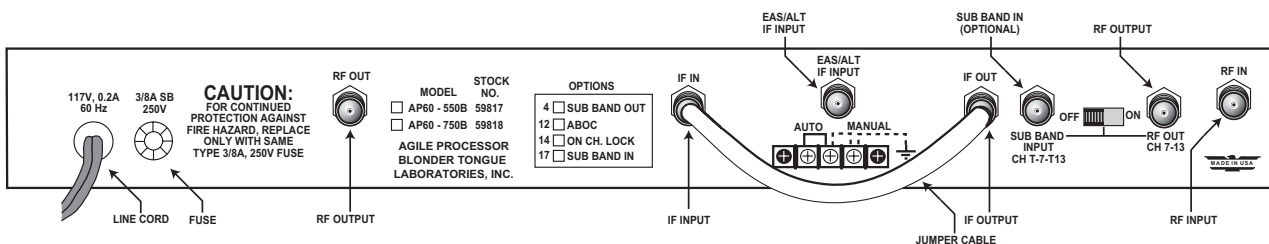

Rear Panel View - AP 60

Installation and Operation

Note to CATV SYSTEM Installer

This reminder is provided to call the CATV System Installer's attention to Article 820-40 of the NEC that provides guidelines for proper grounding and, in particular, specifies that the cable ground shall be connected to the grounding system of the building, as close to the point of cable entry as practical.

Unpacking and Handling

Each unit is shipped with all equipment assembled, wired, factory tested, and then packaged in an appropriate shipping container. Ensure that all accessories are removed from the container and packing material before they are discarded.

Mechanical Inspection

Inspect the front and rear of the equipment for shipping damage. Make sure the equipment is clean, and no wires, cables, or connectors are broken, damaged or loose.

Damage in Shipment

Should damage be discovered after unpacking the system, immediately file a claim with the carrier. A full report of the damage shall be made and a copy forwarded to BLONDER TONGUE Laboratories, Inc. The company will then advise what disposition is to be made of the equipment.

Precautions

Adherence to the initial installation precautions outlined in the Table below will help prevent problems arising during the installation and future maintenance of the unit.

Installation Precautions Table

PRECAUTIONS	REQUIREMENTS
Avoid Heat Buildup	Allow (1) EIA rack space (1 ³ / ₄ ") between powered headend products in the equipment racks.
Ensure easy access to rack wiring.	Allow a minimum of 18 inches behind the equipment rack(s)
Facilitate servicing and maintenance.	Allow a minimum of 36" of clearance in front of the equipment rack(s).
Avoid direct heating or air conditioning.	If unavoidable, use deflector plates.
AC power source outlets.	Locate equipment near sufficient outlets to provide power for test equipment and power tools.
Rack Support.	Make certain rack supports are sufficiently rigid to support racks.
Building leakage.	Beware of dripping water onto equipment from leaky roofs, waveguide roof entries, and cold water pipe condensations.

Returning Product for Repair (or Credit)

A Return Material Authorization (RMA) Number is required on all products returned to Blonder Tongue, regardless if the product is being returned for repair or credit. Before returning product, please contact the Blonder Tongue Service Department at 1-800-523-6049, Ext. 4256 or visit our website: www.blondertongue.com for further information.

Unit Mounting

Mount the unit securely in a standard 19 inch EIA rack, ensuring access to rear connections and front controls. Make sure adequate ventilation exists in the vicinity of the unit.

Preparation for Use

Plug in the 3-prong connector of the AC power cord into a suitable 117 V 60 Hz AC outlet of adequate current carrying capacity. Use appropriate cables (75 Ohm coaxial) to connect the RF Signal source to the RF Input of the unit and the RF output of the unit to the system input. Make sure that the IF coaxial jumper cable is in place, connecting the IF input and the IF output.

Setting The Unit Input/Output Channel

Gently pull both access door retaining clips simultaneously to expose the offset channel selector switches.

Two banks of switches are presented. Switch 1 has 4 positions and Switch 2 has 8 positions. Position 1, 2 & 3 of Switch 1 are used to set the unit operating mode as shown in the Switch 1 table. Position 4 is used to invoke (UP) or revoke (DOWN) the FCC Aeronautical Frequency Offsets.



	SWITCH 1			
	1	2	3	4
STD	<input type="checkbox"/>	<input type="checkbox"/>	<input type="checkbox"/>	<input type="checkbox"/>
IRC	<input type="checkbox"/>	<input type="checkbox"/>	<input type="checkbox"/>	<input type="checkbox"/>
HRC	<input type="checkbox"/>	<input type="checkbox"/>	<input type="checkbox"/>	<input type="checkbox"/>
Broadcast	<input type="checkbox"/>	<input type="checkbox"/>	<input type="checkbox"/>	<input type="checkbox"/>
Sub Band (optional)	<input type="checkbox"/>	<input type="checkbox"/>	<input type="checkbox"/>	<input type="checkbox"/>

Output

	SWITCH 1			
	1	2	3	4
STD	<input type="checkbox"/>	<input type="checkbox"/>	<input type="checkbox"/>	<input type="checkbox"/>
IRC	<input type="checkbox"/>	<input type="checkbox"/>	<input type="checkbox"/>	<input type="checkbox"/>
HRC	<input type="checkbox"/>	<input type="checkbox"/>	<input type="checkbox"/>	<input type="checkbox"/>
Broadcast	<input type="checkbox"/>	<input type="checkbox"/>	<input type="checkbox"/>	<input type="checkbox"/>

Input

Switch 2 is used to set the unit input/output channel number.

Channel setting is accomplished by setting the switch to the desired input/output channel.

Switch 2 is divided into 2 sections, the Tens section and the Ones section.

In each section, there are 4 switches labeled - 8,4,2,1. Each correspond to it's respective numeric value.

A simple chart, shown below, gives the corresponding switch positions for Tens position, 1 to 12 and for the Ones position 0-9.

The user sets the Tens section and the Ones section together to set the desired channel. The arithmetic sum of the values of both the Tens section and the Ones section is equal to the channel number to which the unit is set.

Example: For CH 116, set 11 Tens and 6 ones for 116.
For single digit channels, the Tens switch is set to zero.

	SWITCH 1			
	1	2	3	4
STD	<input type="checkbox"/>	<input type="checkbox"/>	<input type="checkbox"/>	<input type="checkbox"/>
IRC	<input type="checkbox"/>	<input type="checkbox"/>	<input type="checkbox"/>	<input type="checkbox"/>
HRC	<input type="checkbox"/>	<input type="checkbox"/>	<input type="checkbox"/>	<input type="checkbox"/>

Switch 2
Numeric Value Chart

Tens Value	SWITCH 2								Ones Value
	Tens				Ones				
	8	4	2	1	8	4	2	1	
0 =	<input type="checkbox"/>	<input type="checkbox"/>	<input type="checkbox"/>	<input type="checkbox"/>	<input type="checkbox"/>	<input type="checkbox"/>	<input type="checkbox"/>	<input type="checkbox"/>	= 0
10 =	<input type="checkbox"/>	<input type="checkbox"/>	<input type="checkbox"/>	<input type="checkbox"/>	<input type="checkbox"/>	<input type="checkbox"/>	<input type="checkbox"/>	<input type="checkbox"/>	= 1
20 =	<input type="checkbox"/>	<input type="checkbox"/>	<input type="checkbox"/>	<input type="checkbox"/>	<input type="checkbox"/>	<input type="checkbox"/>	<input type="checkbox"/>	<input type="checkbox"/>	= 2
30 =	<input type="checkbox"/>	<input type="checkbox"/>	<input type="checkbox"/>	<input type="checkbox"/>	<input type="checkbox"/>	<input type="checkbox"/>	<input type="checkbox"/>	<input type="checkbox"/>	= 3
40 =	<input type="checkbox"/>	<input type="checkbox"/>	<input type="checkbox"/>	<input type="checkbox"/>	<input type="checkbox"/>	<input type="checkbox"/>	<input type="checkbox"/>	<input type="checkbox"/>	= 4
50 =	<input type="checkbox"/>	<input type="checkbox"/>	<input type="checkbox"/>	<input type="checkbox"/>	<input type="checkbox"/>	<input type="checkbox"/>	<input type="checkbox"/>	<input type="checkbox"/>	= 5
60 =	<input type="checkbox"/>	<input type="checkbox"/>	<input type="checkbox"/>	<input type="checkbox"/>	<input type="checkbox"/>	<input type="checkbox"/>	<input type="checkbox"/>	<input type="checkbox"/>	= 6
70 =	<input type="checkbox"/>	<input type="checkbox"/>	<input type="checkbox"/>	<input type="checkbox"/>	<input type="checkbox"/>	<input type="checkbox"/>	<input type="checkbox"/>	<input type="checkbox"/>	= 7
80 =	<input type="checkbox"/>	<input type="checkbox"/>	<input type="checkbox"/>	<input type="checkbox"/>	<input type="checkbox"/>	<input type="checkbox"/>	<input type="checkbox"/>	<input type="checkbox"/>	= 8
90 =	<input type="checkbox"/>	<input type="checkbox"/>	<input type="checkbox"/>	<input type="checkbox"/>	<input type="checkbox"/>	<input type="checkbox"/>	<input type="checkbox"/>	<input type="checkbox"/>	= 9
100 =	<input type="checkbox"/>	<input type="checkbox"/>	<input type="checkbox"/>	<input type="checkbox"/>					
110 =	<input type="checkbox"/>	<input type="checkbox"/>	<input type="checkbox"/>	<input type="checkbox"/>					
120 =	<input type="checkbox"/>	<input type="checkbox"/>	<input type="checkbox"/>	<input type="checkbox"/>					

Channel Setting Examples

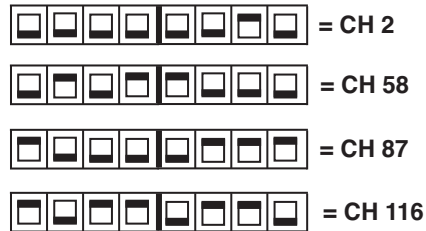

EAS/ALT IF

AUTOMATIC - Connect a jumper to the terminal strip auto position. EAS/ALT will switch on when a +37 dBmV EAS IF signal is detected.

MANUAL - EAS is active with a ground connection on the manual position of the terminal strip
 (Do not insert jumper when manually switching.)

Automatic

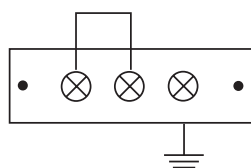

Manual

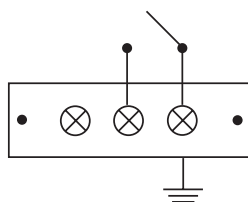

Adjustments

OUTPUT LEVEL

Connect a suitable RF indicator such as a Field Strength Meter (tuned to the visual carrier frequency) or a Spectrum Analyzer to the RF output of the modulator or a system monitor point and adjust the Output Level control to the desired reading of the visual carrier.

A/V CARRIER RATIO

To adjust the aural-to-visual carrier ratio, tune the RF indicator device to the aural carrier frequency and adjust the Aural Level control to obtain the desired aural carrier level. Note that you cannot obtain a ratio smaller (that is, the aural level relatively higher) than that of the incoming RF signal. Recommended ratio is -15 dB.

STANDBY CARRIER THRESHOLD

The Standby Carrier Threshold is factory-set for -19 dBmV. If it is necessary to set the threshold to some other level, proceed as follows before installing the AP Processor in its rack or cabinet.

1. Plug the AP Processor power cord into a 117 VAC, 60 Hz outlet. The green Power LED on the front panel will light. A warmup period of about 30 minutes is required to stabilize the equipment.
2. Set the AP Processor to the desired input and output channels.
3. Connect a television receiver (tuned to the output channel) to the rear-panel RF OUT terminal; use the RF OUT control and attenuators as required to avoid overloading the receiver.
4. Using a variable attenuator and a signal level meter, adjust the input signal to the desired threshold level. Connect the input signal to the RF INPUT terminal.
5. Locate the Threshold Control, R32.
6. Adjust R32 so that the picture just switches between the input signal and the standby carrier. Use the television receiver as an indicator.
7. After making the adjustment, disconnect the power cord and input and output cabling.
8. Install the unit in its mounting location.

Option 4 - Sub-Band Output

Description

Option 4 extends the output frequency range of an AP processor to include sub-band channels T7 through T13. This permits the unit to be used for sub-band via the return path in a two way system or as a LAN processor. All external controls and connectors remain the same as a standard model. Video and Audio specifications for channels T7 through T13 also conform to standard processor performance. RF specifications remain the same except for the following:

Specifications (Typical)

RF Output Frequency Range: All Channels 7.0 - 550/750 MHz

		SWITCH 2							
		Tens				Ones			
CH	Pix/MHz	8	4	2	1	8	4	2	1
T7	7.0	<input type="checkbox"/>	<input type="checkbox"/>	<input type="checkbox"/>	<input type="checkbox"/>	<input type="checkbox"/>	<input type="checkbox"/>	<input type="checkbox"/>	<input type="checkbox"/>
T8	13.0	<input type="checkbox"/>	<input type="checkbox"/>	<input type="checkbox"/>	<input type="checkbox"/>	<input type="checkbox"/>	<input type="checkbox"/>	<input type="checkbox"/>	<input type="checkbox"/>
T9	19.0	<input type="checkbox"/>	<input type="checkbox"/>	<input type="checkbox"/>	<input type="checkbox"/>	<input type="checkbox"/>	<input type="checkbox"/>	<input type="checkbox"/>	<input type="checkbox"/>
T10	25.0	<input type="checkbox"/>	<input type="checkbox"/>	<input type="checkbox"/>	<input type="checkbox"/>	<input type="checkbox"/>	<input type="checkbox"/>	<input type="checkbox"/>	<input type="checkbox"/>
T11	31.0	<input type="checkbox"/>	<input type="checkbox"/>	<input type="checkbox"/>	<input type="checkbox"/>	<input type="checkbox"/>	<input type="checkbox"/>	<input type="checkbox"/>	<input type="checkbox"/>
T12	37.0	<input type="checkbox"/>	<input type="checkbox"/>	<input type="checkbox"/>	<input type="checkbox"/>	<input type="checkbox"/>	<input type="checkbox"/>	<input type="checkbox"/>	<input type="checkbox"/>
T13	43.0	<input type="checkbox"/>	<input type="checkbox"/>	<input type="checkbox"/>	<input type="checkbox"/>	<input type="checkbox"/>	<input type="checkbox"/>	<input type="checkbox"/>	<input type="checkbox"/>



Option 14 - ON CHANNEL LOCK

ON CHANNEL LOCK solves one of the commonly encountered problems of using an Agile Processor in the ON Channel Mode. (e.g. channel 9 VHF input, channel 9 VHF output).

The problem being addressed manifests itself as picture “flutter” similar to the effects of signals reflected from aircraft (although it is caused by a different phenomenon). The flutter most often occurs when the input signal is an off air antenna or antenna/preamplifier combination.

Option 14 is intended to be invoked only when the input is channel 2 - 13 broadcast and the output channel is the same as the input. Do not invoke Option 14 for conversions. Option 14 is invoked by Switch SW3, POSITION 1. Switch SW3, POSITION 1 is found in the bank of front panel accessible input channel selector switches. Place Switch SW3, POSITION 1 down to invoke Option 14, up to disable Option 14. Also switch SW-1 POSITION 4 OFF when using Option 14.

As a reminder, turn “offset adjust” potentiometer fully clockwise when using this processor on the “ON Channel” mode regardless of whether the processor has Option 14 or not.

When setting up a processor for “ON Channel” operation be certain that the switches for the output selector are as required for “ON Channel” operation. Use the following procedure for best results when in the “ON Channel” mode and when using Option 14.

1. Switch SW-1 POSITION 4 is switched OFF when using Option 14 and ON to adjust for frequency offsets.
2. Set Front Panel Offset Adjust Control fully clockwise.
3. Switch SW-3, POSITION 1 is down to invoke Option 14 ON. Move to the up position for Option 14 OFF.

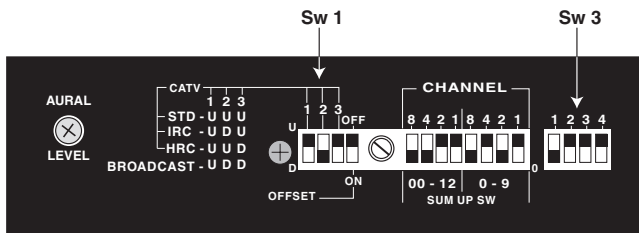

Input Tuning

Option 17 - Sub-Band Input for AP60

Description

The sub-band Option 17 consists of a block converter placed before the product's main RF input. The converter translates the entire T-channel band (5-50 MHz) to the high VHF TV band (173-218 MHz), and presents this as the sub-band converter output on the rear panel. This output is coupled via a short coax jumper to the basic product's RF input. The converter local oscillator operates at a frequency of 168.25 MHz. Therefore, at the output of the converter, standard "T" channels appear as channel "7" for "T-7", channel "8" for "T-8", and so on. Selection of the appropriate T-channel to be processed is made via the front panel input frequency select DIP switches following the channel "7" settings for T-7, channel "8" settings for T-8, and so on.

A complete frequency selector chart is provided below. In addition, one may use the frequency chart supplied with the product by following the settings for standard broadcast channels 7-13 as if they were T-7 through T-13.

The sub-channel converter has a conversion loss of approximately 8 dB. Therefore, a nominal input signal level to the sub-band converter should be between 3 and 23 dBmV to ensure proper operation.

Connections for Sub-Band Options

1. Set the Sub-Band selector located on the back panel to the ON position.
2. Connect the cable containing the Sub-Band channels (T-7 thru T-13) to the Sub-Band input.
3. Using the supplied loop-thru cable, connect the Sub-Band output to the RF input.
4. Set Switch 1 to the STD Mode. Set the AP60 front panel switches (Input Channel Selector) for the desired Sub-Band channel by using the chart below:



	SWITCH 1			
	1	2	3	4
STD	<input type="checkbox"/>	<input type="checkbox"/>	<input type="checkbox"/>	<input type="checkbox"/>
IRC	<input type="checkbox"/>	<input type="checkbox"/>	<input type="checkbox"/>	<input type="checkbox"/>
HRC	<input type="checkbox"/>	<input type="checkbox"/>	<input type="checkbox"/>	<input type="checkbox"/>
Broadcast	<input type="checkbox"/>	<input type="checkbox"/>	<input type="checkbox"/>	<input type="checkbox"/>

	SWITCH 2							
	Tens				Ones			
	8	4	2	1	8	4	2	1
T7	<input type="checkbox"/>	<input type="checkbox"/>	<input type="checkbox"/>	<input type="checkbox"/>	<input type="checkbox"/>	<input type="checkbox"/>	<input type="checkbox"/>	<input type="checkbox"/>
T8	<input type="checkbox"/>	<input type="checkbox"/>	<input type="checkbox"/>	<input type="checkbox"/>	<input type="checkbox"/>	<input type="checkbox"/>	<input type="checkbox"/>	<input type="checkbox"/>
T9	<input type="checkbox"/>	<input type="checkbox"/>	<input type="checkbox"/>	<input type="checkbox"/>	<input type="checkbox"/>	<input type="checkbox"/>	<input type="checkbox"/>	<input type="checkbox"/>
T10	<input type="checkbox"/>	<input type="checkbox"/>	<input type="checkbox"/>	<input type="checkbox"/>	<input type="checkbox"/>	<input type="checkbox"/>	<input type="checkbox"/>	<input type="checkbox"/>
T11	<input type="checkbox"/>	<input type="checkbox"/>	<input type="checkbox"/>	<input type="checkbox"/>	<input type="checkbox"/>	<input type="checkbox"/>	<input type="checkbox"/>	<input type="checkbox"/>
T12	<input type="checkbox"/>	<input type="checkbox"/>	<input type="checkbox"/>	<input type="checkbox"/>	<input type="checkbox"/>	<input type="checkbox"/>	<input type="checkbox"/>	<input type="checkbox"/>
T13	<input type="checkbox"/>	<input type="checkbox"/>	<input type="checkbox"/>	<input type="checkbox"/>	<input type="checkbox"/>	<input type="checkbox"/>	<input type="checkbox"/>	<input type="checkbox"/>

For operation of the AP60 with Non-Sub-Band channels, set the Sub-Band Selector to the OFF position and connect the coax cable from the system to the RF Input on the back panel.

Option 12 - Automatic Broadcast Offset Correction (ABOC)

With the use of Option 12, all input offsets are fully corrected to allow precise control of output offsets. This allows for control of FCC 21005 Offset requirements completely independent of the input offset. Using Option 12, there is no need to measure or determine the input offset frequency whether it is broadcast or from a cable channel. All inputs up to ± 25 KHz offset are fully corrected. Once selected, the output channel will maintain that offset even if the input offset varies. A green Front Panel Indicator shows that the ABOC is on and the input offset has been fully corrected.

Option 12, ABOC should be turned on when using an AP as a converter in the "Off-Channel" mode where the output channel differs from the input channel. The input channel is selected by means of Front Panel DIP switches corresponding to the input channel. The output channel is selected by Front Panel DIP switches and set according to the output channel. ABOC On/Off position controls ABOC operation. With the 4th switch UP the ABOC is activated and the output offset frequency will be maintained independent of the input offset. It is recommended that the ABOC be kept on during "Off-Channel" operation, thus keeping the output offsets controlled.

During "On-Channel" operation, the ABOC should be switched off. In this mode, the output frequency will remain exactly the same as the input frequency.

During "Off-Channel" operation with the ABOC off, the output offset will no longer be accurate but will be a function of the input offset which may be unknown.

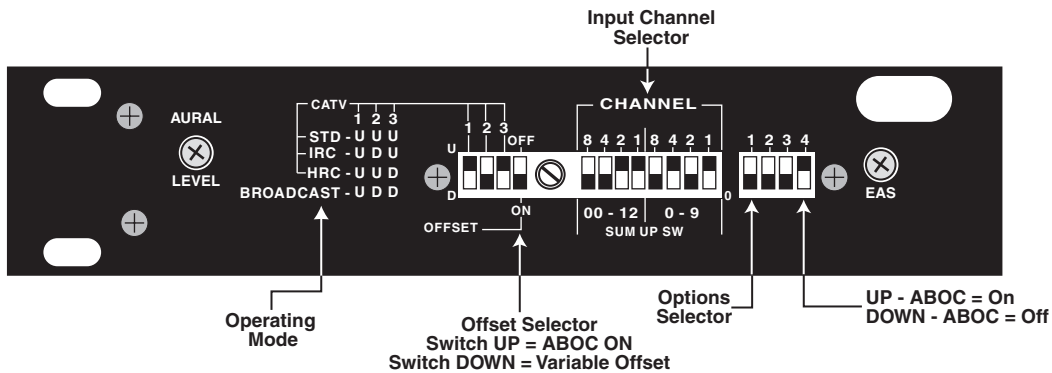

Notes:

1. When ABOC is "ON", the offset switch must be set to "OFF" (UP) position.
2. For "On Channel" operation: ABOC is "OFF" and offset switch is UP.
3. For "Off-Channel" operation: with ABOC off, output offset will not be controlled by the processor but by the input frequency. Offset switch is down, variable offset may be adjusted at the front panel.

Frequency Allocation Tables

EIA Chan.	Standard Video	Incremental Video (IRC)	Harmonic Video (HRC)
02	55.2500	55.2625	54
03	61.2500	61.2625	60
04	67.2500	67.2625	66
01	NA	73.2625	72
05	77.2500	79.2625	78
06	83.2500	85.2625	84
95	91.2500	91.2625	90
96	97.2500	97.2625	96
97	103.2500	103.2625	102
98	109.2750	109.2750	Cannot lock to comb ref: refer to FCC regs
99	115.2750	115.2750	
14	121.2625	121.2625	
15	127.2625	127.2625	126
16	133.2625	133.2625	132
17	139.2500	139.2625	138
18	145.2500	145.2625	144
19	151.2500	151.2625	150
20	157.2500	157.2625	156
21	163.2500	163.2625	162
22	169.2500	169.2625	168
07	175.2500	175.2625	174
08	181.2500	181.2625	180
09	187.2500	187.2625	186
10	193.2500	193.2625	192
11	199.2500	199.2625	198
12	205.2500	205.2625	204
13	211.2500	211.2625	210
23	217.2500	217.2625	216
24	223.2500	223.2625	222
25	229.2625	229.2625	228
26	235.2625	235.2625	234
27	241.2625	241.2625	240
28	247.2625	247.2625	246
29	253.2625	253.2625	252
30	259.2625	259.2625	258
31	265.2625	265.2625	264
32	271.2625	271.2625	270
33	277.2625	277.2625	276
34	283.2625	283.2625	282
35	289.2625	289.2625	288
36	295.2625	295.2625	294
37	301.2625	301.2625	300
38	307.2625	307.2625	306
39	313.2625	313.2625	312
40	319.2625	319.2625	318
41	325.2625	325.2625	324
42	331.2750	331.2750	330
43	337.2625	337.2625	336
44	343.2625	343.2625	342
45	349.2625	349.2625	348
46	355.2625	355.2625	354
47	361.2625	361.2625	360
48	367.2625	367.2625	366
49	373.2625	373.2625	372
50	379.2625	379.2625	378
51	385.2625	385.2625	384
52	391.2625	391.2625	390
53	397.2625	397.2625	396
54	403.2500	403.2625	402
55	409.2500	409.2625	408
56	415.2500	415.2625	414
57	421.2500	421.2625	420
58	427.2500	427.2625	426
59	433.2500	433.2625	432
60	439.2500	439.2625	438
61	445.2500	445.2625	444
62	451.2500	451.2625	450

EIA Chan.	Standard Video	Incremental Video (IRC)	Harmonic Video (HRC)
63	457.2500	457.2625	456
64	463.2500	463.2625	462
65	469.2500	469.2625	468
66	475.2500	475.2625	474
67	481.2500	481.2625	480
68	487.2500	487.2625	486
69	493.2500	493.2625	492
70	499.2500	499.2625	498
71	505.2500	505.2625	504
72	511.2500	511.2625	510
73	517.2500	517.2625	516
74	523.2500	523.2625	522
75	529.2500	529.2625	528
76	535.2500	535.2625	534
77	541.2500	541.2625	540
78	547.2500	547.2625	546
79	553.2500	553.2625	552
80	559.2500	559.2625	558
81	565.2500	565.2625	564
82	571.2500	571.2625	570
83	577.2500	577.2625	576
84	583.2500	583.2625	582
85	589.2500	589.2625	588
86	595.2500	595.2625	594
87	601.2500	601.2625	600
88	607.2500	607.2625	606
89	613.2500	613.2625	612
90	619.2500	619.2625	618
91	625.2500	625.2625	624
92	631.2500	631.2625	630
93	637.2500	637.2625	636
94	643.2500	643.2625	642
100	649.2500	649.2625	648
101	655.2500	655.2625	654
102	661.2500	661.2625	660
103	667.2500	667.2625	666
104	673.2500	673.2625	672
105	679.2500	679.2625	678
106	685.2500	685.2625	684
107	691.2500	691.2625	690
108	697.2500	697.2625	696
109	703.2500	703.2625	702
110	709.2500	709.2625	708
111	715.2500	715.2625	714
112	721.2500	721.2625	720
113	727.2500	727.2625	726
114	733.2500	733.2625	732
115	739.2500	739.2625	738
116	745.2500	745.2625	744

VHF Broadcast Channels	
Channel	Video (MHz)
2	55.25
3	61.25
4	67.25
5	77.25
6	83.25
7	175.25
8	181.25
9	187.25
10	193.25
11	199.25
12	205.25
13	211.25
UHF Broadcast Channels	
Channel	Video (MHz)
14	471.25
15	477.25
16	483.25
17	489.25
18	495.25
19	501.25
20	507.25
21	513.25
22	519.25
23	525.25
24	531.25
25	537.25
26	543.25
27	549.25
28	555.25
29	561.25
30	567.25
31	573.25
32	579.25
33	585.25
34	591.25
35	597.25
36	603.25
37	609.25
38	615.25
39	621.25
40	627.25
41	633.25
42	639.25
43	645.25
44	651.25
45	657.25
46	663.25
47	669.25
48	675.25
49	681.25
50	687.25
51	693.25
52	699.25
53	705.25
54	711.25
55	717.25
56	723.25
57	729.25
58	735.25
59	741.25
60	747.25

Sub Band Channels	
Channel	Standard Video
T7	7
T8	13
T9	19
T10	25
T11	31
T12	37
T13	43
T14	49

Limited Warranty

Blonder Tongue Laboratories, Inc. (BT) will at its sole option, either repair or replace (with a new or factory reconditioned product, as BT may determine) any product manufactured by BT which proves to be defective in materials or workmanship or fails to meet the specifications which are in effect on the date of shipment or such other specifications as may have been expressly agreed upon in writing (i) for a period of one (1) year from the date of original purchase (or such shorter period of time as may be set forth in the license agreement specific to the particular software being licensed), with respect to iCentral™ (hardware and software) and all other software products (including embedded software) licensed from BT, (ii) for a period of one (1) year from the date of original purchase, with respect to all MegaPort™, IPTV products, and fiber optics receivers, transmitters, couplers and integrated receiver/distribution amplifiers (including TRAILBLAZER™, RETRO-LINX™ and TWIN STAR™ products) as well as for DigiCipher® satellite receivers, and (iii) for a period of three (3) years from the date of original purchase, with respect to all other BT products. Notwithstanding the foregoing, in some cases, the warranty on certain proprietary sub-assembly modules manufactured by third-party vendors and contained in BT products and on certain private-label products manufactured by third-parties for resale by BT are of shorter duration or otherwise more limited than the standard BT limited warranty. In such cases, BT's warranty with respect to such third-party proprietary sub-assembly modules and private-label products will be limited to the duration and other terms of such third-party vendor's warranty. In addition, certain products, that are not manufactured but are resold by BT, carry the original OEM warranty for such products. The limited warranty set forth in this paragraph does not apply to any product sold by BT, which at the time of sale constituted a Refurbished/Closeout Product.

(b) BT will at its sole option, either repair or replace (with a new or factory-reconditioned product, as BT may determine) any product sold by BT which at the time of sale constituted a refurbished or closeout item ("Refurbished/Closeout Product"), which proves to be defective in materials or workmanship or fails to meet the specifications which are in effect on the date of shipment or such other specifications as may have been expressly agreed upon in writing, for a period of ninety (90) days from the date of original purchase. Notwithstanding the foregoing, in some cases the warranty on third party software and on certain proprietary sub-assembly modules manufactured by third-party vendors and contained in BT products and on certain private-label products manufactured by third-parties for resale by BT are of shorter duration or otherwise more limited than the BT limited warranty for Refurbished/Closeout Products. In such cases, BT's warranty for Refurbished/Closeout Products constituting such third party software, third-party proprietary sub-assembly modules and private-label products will be limited to the duration and other terms of such third-party vendor's warranty. In addition, notwithstanding the foregoing, (i) certain Refurbished/Closeout Products that are not manufactured (but are resold) by BT, carry the original OEM warranty for such products, which may be longer or shorter than the BT limited warranty for Refurbished/Closeout Products. All sales of Refurbished/Closeout Products are final.

To obtain service under this warranty, the defective product, together with a copy of the sales receipt or other satisfactory proof of purchase and a brief description of the defect, must be shipped freight prepaid to: Blonder Tongue Laboratories, Inc., One Jake Brown Road, Old Bridge, New Jersey 08857.

This warranty does not cover damage resulting from (i) use or installation other than in strict accordance with manufacturer's written instructions, (ii) disassembly or repair by someone other than the manufacturer or a manufacturer-authorized repair center, (iii) misuse, misapplication or abuse, (iv) alteration, (v) lack of reasonable care or (vi) wind, ice, snow, rain, lightning, or any other weather conditions or acts of God.

OTHER THAN THE WARRANTIES SET FORTH ABOVE, BT MAKES NO OTHER WARRANTIES OR REPRESENTATIONS OF ANY KIND, EXPRESS OR IMPLIED, AS TO THE CONDITION, DESCRIPTION, FITNESS FOR A PARTICULAR PURPOSE, MERCHANTABILITY, OR AS TO ANY OTHER MATTER, AND SUCH WARRANTIES SUPERSEDE ANY ORAL OR WRITTEN WARRANTIES OR REPRESENTATIONS MADE OR IMPLIED BY BT OR BY ANY OF BT'S EMPLOYEES OR REPRESENTATIVES, OR IN ANY OF BT'S BROCHURES MANUALS, CATALOGS, LITERATURE OR OTHER MATERIALS. IN ALL CASES, BUYER'S SOLE AND EXCLUSIVE REMEDY AND BT'S SOLE OBLIGATION FOR ANY BREACH OF THE WARRANTIES CONTAINED HEREIN SHALL BE LIMITED TO THE REPAIR OR REPLACEMENT OF THE DEFECTIVE PRODUCT F.O.B. SHIPPING POINT, AS BT IN ITS SOLE DISCRETION SHALL DETERMINE. BT SHALL IN NO EVENT AND UNDER NO CIRCUMSTANCES BE LIABLE OR RESPONSIBLE FOR ANY CONSEQUENTIAL, INDIRECT, INCIDENTAL, PUNITIVE, DIRECT OR SPECIAL DAMAGES BASED UPON BREACH OF WARRANTY, BREACH OF CONTRACT, NEGLIGENCE, STRICT TORT LIABILITY OR OTHERWISE OR ANY OTHER LEGAL THEORY, ARISING DIRECTLY OR INDIRECTLY FROM THE SALE, USE, INSTALLATION OR FAILURE OF ANY PRODUCT ACQUIRED BY BUYER FROM BT.

All claims for shortages, defects, and non-conforming goods must be made by the customer in writing within five (5) days of receipt of merchandise, which writing shall state with particularity all material facts concerning the claim then known to the customer. Upon any such claim, the customer shall hold the goods complained of intact and duly protected, for a period of up to sixty (60) days. Upon the request of BT, the customer shall ship such allegedly non-conforming or defective goods, freight prepaid to BT for examination by BT's inspection department and verification of the defect. BT, at its option, will either repair, replace or issue a credit for products determined to be defective. BT's liability and responsibility for defective products is specifically limited to the defective item or to credit towards the original billing. All such replacements by BT shall be made free of charge f.o.b. the delivery point called for in the original order. Products for which replacement has been made under the provisions of this clause shall become the property of BT. Under no circumstances are products to be returned to BT without BT's prior written authorization. BT reserves the right to scrap any unauthorized returns on a no-credit basis. Any actions for breach of a contract of sale between BT and a customer must be commenced by the customer within thirteen (13) months after the cause of action has accrued. A copy of BT's standard terms and conditions of sale, including the limited warranty, is available from BT upon request. Copies of the limited warranties covering third-party proprietary sub-assembly modules and private-label products manufactured by third-parties are also available from BT on request. DigiCipher® is a registered trademark of Motorola Corp. (Rev 0509)



**BLONDER
TONGUE**
LABORATORIES, INC.

One Jake Brown Road
Old Bridge, NJ 08857-1000 USA
(800) 523-6049 • (732) 679-4000 • FAX: (732) 679-4353
www.blondertongue.com