

THE PROGRAMMER'S CP/M[®] HANDBOOK

Andy Johnson-Laird

Osborne/McGraw-Hill
Berkeley, California

Published by
Osborne/McGraw-Hill
2600 Tenth Street
Berkeley, California 94710
U.S.A.

For information on translations and book distributors outside of the U.S.A.,
please write to Osborne/McGraw-Hill at the above address.

CP/M is a registered trademark of Digital Research, Inc.
CP/M-86, MP/M-86, and MP/M II are trademarks of
Digital Research, Inc.
Z80 is a registered trademark of Zilog, Inc.

THE PROGRAMMER'S CP/M® HANDBOOK

Copyright ©1983 by Osborne/McGraw-Hill. All rights reserved. Printed in the United States of America. Except as permitted under the Copyright Act of 1976, no part of this publication may be reproduced or distributed in any form or by any means, or stored in a data base or retrieval system, without the prior written permission of the publisher, with the exception that the program listings may be entered, stored, and executed in a computer system, but they may not be reproduced for publication.

1234567890 DODO 89876543

ISBN 0-88134-103-7 (Paperback Edition)

ISBN 0-88134-119-3 (Hardcover Edition)

Mary Borchers, Acquisitions Editor
Ralph Baumgartner, Technical Editor
Susan Schwartz, Copy Editor
Judy Wohlfrom, Text Design
Yashi Okita, Cover Design

marcus b

②.

**THE PROGRAMMER'S
CP/M® HANDBOOK**

Dedication

Several years ago I was told that “Perfection is an English education, an American salary, and a Japanese wife.”

Accordingly, I wish to thank the members of Staff at Culford School in England, who gave me the English education, the people who work with me at Johnson-Laird Inc. and Control-C Software and our clients, who give me my American salary, and Mr. and Mrs. Kitagawa, who gave me Kay Kitagawa (who not only married me but took over where my English grammar left off).

A..J-L.

Acknowledgments

Although this book is not authorized or endorsed by Digital Research, I would like to express my thanks to Gary Kildall and Kathy Strutynski of Digital Research, and to Phil Nelson (formerly of Digital Research, now of Victor Technology) for their help in keeping me on the path to truth in this book. I would also like to thank Denise Penrose, Marty McNiff, Mary Borchers, and Ralph Baumgartner at Osborne/McGraw-Hill for their apparently inexhaustible patience.

A.J-L.

Contents

1	Introduction	1
2	The Structure of CP/M	5
3	The CP/M File System	17
4	The Console Command Processor (CCP)	45
5	The BASIC Disk Operating System	67
6	The BASIC Input/Output System	147
7	Building a New CP/M System	183
8	Writing an Enhanced BIOS	209
9	Dealing with Hardware Errors	295
10	Debugging a New CP/M System	319
11	Additional Utility Programs	371
12	Error Messages	449
A	ASCII Character Set	465
B	CP/M Command Summary	469
C	Summary of BDOS Calls	479
D	Summary of BIOS Calls	485
	Index	487

Outline of Contents
Notation
Example Programs on Diskette



Introduction

This book is a sequel to the *Osborne CP/M® User Guide* by Thom Hogan. It is a technical book written mainly for programmers who require a thorough knowledge of the internal structure of CP/M—how the various pieces of CP/M work, how to use CP/M as an operating system, and finally, how to implement CP/M on different computer systems. This book is written for people who

- Have been working with microcomputers that run Digital Research's CP/M operating system.
- Understand the internals of the microprocessor world—bits, bytes, ports, RAM, ROM, and other jargon of the programmer.
- Know how to write in assembly language for the Intel 8080 or Zilog Z80 Central Processing Unit (CPU) chips.

If you don't have this kind of background, start by getting practical experience on a system running CP/M and by reading the following books from Osborne/McGraw-Hill:

- *An Introduction to Microcomputers: Volume 1—Basic Concepts*
This book describes the fundamental concepts and facts that you need to

know about microprocessors in order to program them. If you really need basics, there is a Volume 0 called *The Beginner's Book*.

- *8080A/8085 Assembly Language Programming*
This book covers all aspects of writing programs in 8080 assembly language, giving many examples.
- *Osborne CP/M® User Guide (2nd Edition)*
This book introduces the CP/M operating system. It tells you how to use CP/M as a tool to get things done on a computer.

The book you are reading now deals only with CP/M Version 2.2 for the 8080 or Z80 chips. At the time of writing, new versions of CP/M and MP/M (the multi-user, multi-tasking successor to CP/M) were becoming available. CP/M-86 and MP/M-86 for the Intel 8086 CPU chip and MP/M-II for the 8080 or Z80 chips had been released, with CP/M 3.0 (8080 or Z80) in the wings. The 8086, although related architecturally to the 8080, is different enough to make it impossible to cover in detail in this book; and while MP/M-II and MP/M-86 are similar to CP/M, they have many aspects that cannot be adequately discussed within the scope of this book.

Outline of Contents

This book explains topics as if you were starting from the top of a pyramid. Successive “slices” down the pyramid cover the same material but give more detail.

The first chapter includes a brief outline of the notation used in this book for example programs written in Intel 8080 assembly language and in the C programming language.

Chapter 2 deals with the structure of CP/M, describing its major parts, their positions in memory, and their functions.

Chapter 3 discusses CP/M's file system in as much detail as possible, given its proprietary nature. The directory entry, disk parameter block, and file organization are described.

Chapter 4 covers the Console Command Processor (CCP), examining the way in which you enter command lines, the CP/M commands built into the CCP, how the CCP loads programs, and how it transfers control to these programs.

Chapter 5 begins the programming section. It deals with the system calls your programs can make to the high-level part of CP/M, the Basic Disk Operating System (BDOS).

Chapters 6 through 10 deal with the Basic Input/Output System (BIOS). This is the part of CP/M that is unique to each computer system. It is the part that you as a programmer will write and implement for your own computer system.

Chapter 6 describes a standard implementation of the BIOS.

Chapter 7 describes the mechanism for rebuilding CP/M for a different configuration.

Chapter 8 tells you how to write an enhanced BIOS.

Chapter 9 takes a close look at how to handle hardware errors—how to detect and deal with them, and how to make this task easier for the person using the computer.

Chapter 10 discusses the problems you may face when you try to debug your BIOS code. It includes debugging subroutines and describes techniques that will save you time and suffering.

Chapter 11 describes several utility programs, some that work with the features of the enhanced BIOS in Chapter 8 and some that will work with all CP/M 2 implementations.

Chapter 12 concerns error messages and some oddities that you will discover, sometimes painfully, in CP/M. Messages are explained and some probable causes for strange results are documented.

The appendixes contain “ready-reference” information and summaries of information that you need at your side when designing, coding, and testing programs to run under CP/M or your own BIOS routines.

Notation

When you program your computer, you will be sitting in front of your terminal interacting with CP/M and the utility programs that run under it. The sections that follow describe the notation used to represent the dialog that will appear on your terminal and the output that will appear on your printer.

Console Dialog

This book follows the conventions used in the *Osborne CP/M User Guide*, extended slightly to handle more complex dialogs. In this book

- `<name>` means the ASCII character named between the angle brackets, `<` and `>`. For example, `<BEL>` is the ASCII Bell character, and `<HT>` is the ASCII Horizontal Tab Character. (Refer to Appendix A for the complete ASCII character set.)
- `<cr>` means to press the CARRIAGE RETURN key.
- 123 or a number without a suffix means a decimal number.
- 100B or a number followed by B means a binary number.
- 0A5H or a number followed by H means a hexadecimal number. A hexadecimal number starting with a letter is usually shown with a leading 0 to avoid confusion.

- ^x means to hold the CONTROL (CTRL) key down while pressing the x key.
- Underline is keyboard input you type. Output from the computer is shown without underlining.

Assembly Language Program Examples

This book uses Intel 8080 mnemonics throughout as a “lowest common denominator”—the Z80 CPU contains features absent in the 8080, but not vice versa. Output from Digital Research's ASM Assembler is shown so that you can see the generated object code as well as the source.

High-Level Language Examples

The utility programs described in Chapter 11 are written in C, a programming language which lends itself to describing algorithms clearly without becoming entangled in linguistic bureaucracy. Cryptic expressions have been avoided in favor of those that most clearly show how to solve the problem. Ample comments explain the code.

An excellent book for those who do not know how to program in C is *The C Programming Language* by Brian Kernighan and Dennis Ritchie (Prentice-Hall). Appendix A of this book is the C Reference Manual.

Example Programs on Diskette

Example programs in this book have been assembled with ASM and tested with DDT, Digital Research's Dynamic Debugging Tool. C examples were compiled using Leor Zolman's BDS C Compiler (Version 1.50) and tested using the enhanced BIOS described in Chapter 8.

All of the source code shown in this book is available on a single-sided, single-density, 8-inch diskette (IBM 3740 format). Please do *not* contact Osborne/McGraw-Hill to order this diskette. Call or write

Johnson-Laird, Inc.
Attn: The CP/M Programmer's Handbook Diskette
6441 SW Canyon Court
Portland, OR 97221
Tel: (503) 292-6330

The diskette is available for \$50 plus shipping costs.

CP/M from Digital Research
The Pieces of CP/M
CP/M Diskette Format
Loading CP/M
Console Command Processor
Basic Disk Operating System
Basic Input/Output System
CCP, BDOS, and BIOS
Interactions

2

The Structure of CP/M

This chapter introduces the pieces that make up CP/M—what they are and what they do. This bird's-eye view of CP/M will establish a framework to which later chapters will add more detailed information.

You may have purchased the standard version of CP/M directly from Digital Research, but it is more likely you received CP/M when you bought your micro-processor system or its disk drive system. Or, you may have purchased CP/M separately from a software distributor. In any case, this distributor or the company that made the system or disk drive will have already modified the standard version of CP/M to work on your specific hardware. Most manufacturers' versions of CP/M have more files on their system diskette than are described here for the standard Digital Research release.

Some manufacturers have rewritten all the documentation so that you may not have received any Digital Research CP/M manuals. If this is the case, you should order the complete set from Digital Research, because as a programmer, you will need to have them for reference.

CP/M from Digital Research

Digital Research provides a standard “vanilla-flavored” version of CP/M that will run only on the Intel Microcomputer Development System (MDS). The CP/M package from Digital Research contains seven manuals and an 8-inch, single-sided, single-density standard IBM 3740 format diskette.

The following manuals come with this CP/M system:

- *An Introduction to CP/M Features and Facilities*. This is a brief description of CP/M and the utility programs you will find on the diskette. It describes only CP/M version 1.4.
- *CP/M 2.0 User's Guide*. Digital Research wrote this manual to describe the new features of CP/M 2.0 and the extensions made to existing CP/M 1.4 features.
- *ED: A Context Editor for the CP/M Disk System*. By today's standards, ED is a primitive line editor, but you can still use it to make changes to files containing ASCII text, such as the BIOS source code.
- *CP/M Assembler (ASM)*. ASM is a simple but fast assembler that can be used to translate the BIOS source code on the diskette into machine code. Since ASM is only a bare-bones assembler, many programmers now use its successor, MAC (also from Digital Research).
- *CP/M Dynamic Debugging Tool (DDT)*. DDT is an extremely useful program that allows you to load programs in machine code form and then test them, executing the program either one machine instruction at a time or stopping only when the CPU reaches a specific point in the program.
- *CP/M Alteration Guide*. There are two manuals with this title, one for CP/M version 1.4 and the other for 2.0. Both manuals describe, somewhat cryptically, how to modify CP/M.
- *CP/M Interface Guide*. Again, there are two versions, 1.4 and 2.0. These manuals tell you how to write programs that communicate directly with CP/M.

The diskette supplied by Digital Research has the following files:

ASM.COM

The CP/M assembler.

BIOS.ASM

A source code file containing a sample BIOS for the Intel Microcomputer Development System (MDS). Unless you have the MDS, this file is useful only as an example of a BIOS.

CBIOS.ASM

Another source code file for a BIOS. This one is skeletal: There are gaps so that you can insert code for your computer.

DDT.COM

The Dynamic Debugging Tool program.

DEBLOCK.ASM

A source code file that you will need to use in the BIOS if your computer uses sector sizes other than 128 bytes. It is an example of how to block and deblock 128-byte sectors to and from the sector size you need.

DISKDEF.LIB

A library of source text that you will use if you have a copy of Digital Research's advanced assembler, MAC.

DUMP.ASM

The source for an example program. DUMP reads a CP/M disk file and displays it in hexadecimal form on the console.

DUMP.COM

The actual executable program derived from DUMP.ASM.

ED.COM

The source file editor.

LOAD.COM

A program that takes the machine code file output by the assembler, ASM, and creates another file with the data rearranged so that you can execute the program by just typing its name on the keyboard.

MOVCPM.COM

A program that creates versions of CP/M for different memory sizes.

PIP.COM

A program for copying information from one place to another (PIP is short for Peripheral Interchange Program).

STAT.COM

A program that displays statistics about the CP/M and other information that you have stored on disks.

SUBMIT.COM

A program that you use to enter CP/M commands automatically. It helps you avoid repeated typing of long command sequences.

SYSGEN.COM

A program that writes CP/M onto diskettes.

XSUB.COM

An extended version of the SUBMIT program. The files named previously

fall into two groups: One group is used only to rebuild CP/M, while the other set is general-purpose programming tools.

The Pieces of CP/M

CP/M is composed of the Basic Disk Operating System (BDOS), the Console Command Processor (CCP), and the Basic Input/Output System (BIOS).

On occasion you will see references in CP/M manuals to something called the FDOS, which stands for "Floppy Disk Operating System." This name is given to the portion of CP/M consisting of both the BDOS and BIOS and is a relic passed down from the original version. Since it is rarely necessary to refer to the BDOS and the BIOS combined as a single entity, no further references to the FDOS will be made in this book.

The BDOS and the CCP are the proprietary parts of CP/M. Unless you are willing to pay several thousand dollars, you cannot get the source code for them. You do not need to. CP/M is designed so that all of the code that varies from one machine to another is contained in the BIOS, and you do get the BIOS source code from Digital Research. Several companies make specialized BIOSs for different computer systems. In many cases they, as well as some CP/M hardware manufacturers, do not make the source code for their BIOS available; they have put time and effort into building their BIOS, and they wish to preserve the proprietary nature of what they have done.

You may have to build a special configuration of CP/M for a specific computer. This involves no more than the following four steps:

1. Make a version of the BDOS and CCP for the memory size of your computer.
2. Write a modified version of the BIOS that matches the hardware in your computer.
3. Write a small program to load CP/M into memory when you press the RESET button on your computer.
4. Join all of the pieces together and write them out to a diskette.

These steps will be explained in Chapters 7, 8, and 9.

In the third step, you write a small program that loads CP/M into memory when you press the RESET button on your computer. This program is normally called the bootstrap loader. You may also see it called the "boot" or even the "cold start" loader. "Bootstrap" refers to the idea that when the computer is first turned on, there is no program to execute. The task of getting that very first program into the computer is, conceptually, as difficult as attempting to pick yourself up off the ground by pulling on your own bootstraps. In the early days of computing, this operation was performed by entering instructions manually—setting large banks

of switches (the computer was built to read the switches as soon as it was turned on). Today, microcomputers contain some small fragment of a program in “non-volatile” read-only memory (ROM)—memory that retains data when the computer is turned off. This stored program, usually a Programmable Read Only Memory (PROM) chip, can load your bootstrap program, which in turn loads CP/M.

CP/M Diskette Format

The standard version of CP/M is formatted on an 8-inch, single-sided diskette. Diskettes other than this type will probably have different layouts; hard disks definitely will be different.

The physical format of the standard 8-inch diskette is shown in Figure 2-1. The

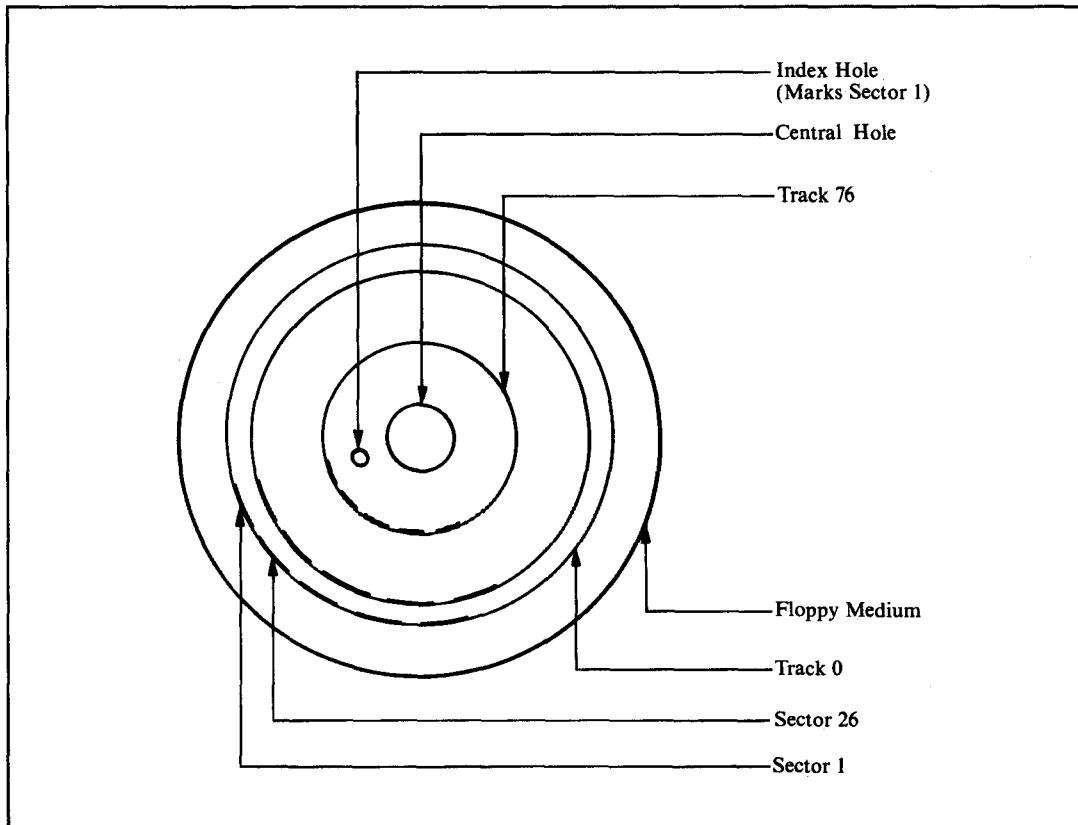

Figure 2-1. Floppy disk layout

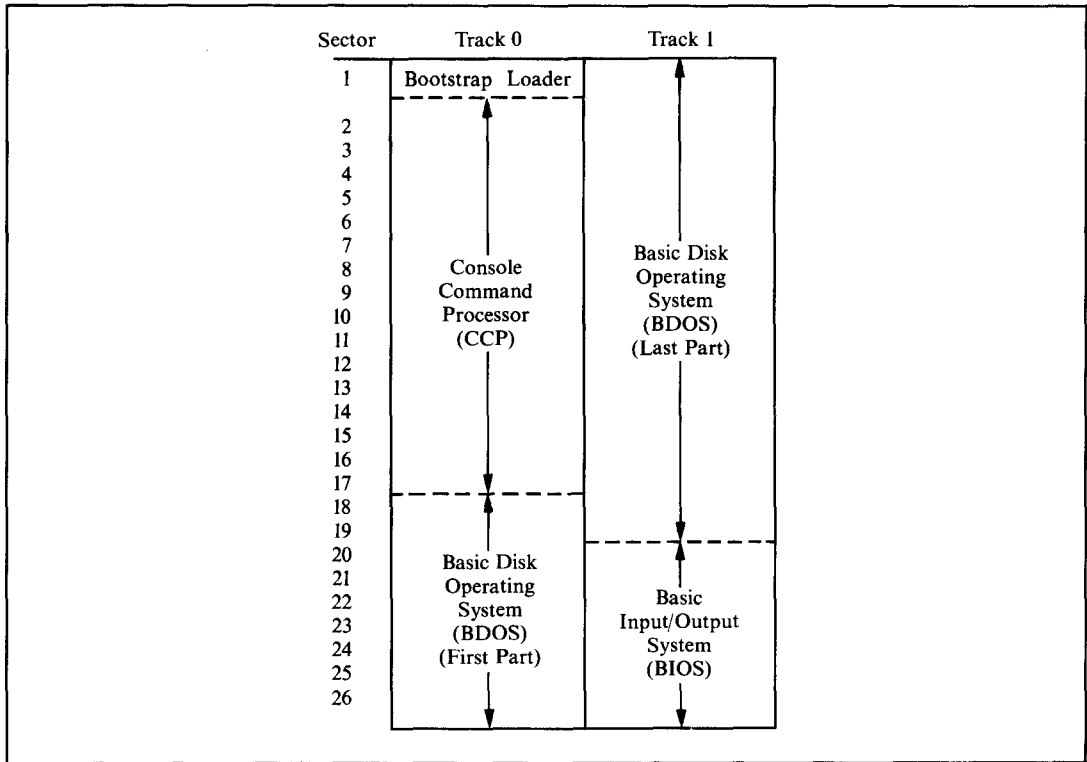

Figure 2-2. Layout of CP/M on tracks 0 and 1 of floppy disk

diskette has a total of 77 concentric tracks numbered from zero (the outermost) to 76 (the innermost). Each of these tracks is divided radially into 26 sectors. These physical sectors are numbered from 1 to 26; physical sector zero does not exist. Each sector has enough space for 128 bytes of data.

Even when CP/M is implemented on a large hard disk with much larger sector sizes, it still works with 128-byte sectors. The BIOS has extra instructions that convert the *real* sectors into CP/M-style 128-byte sectors.

A final note on physical format: The soft-sectored, single-sided, single-density, 8-inch diskette (IBM 3740 format) is the *only* standard format. Any other formats will be unique to the hardware manufacturer that uses them. It is unlikely that you can read a diskette on one manufacturer's computer if it was written on another's, even though the formats appear to be the same. For example, a single-sided, double-density diskette written on an Intel Development System cannot be read on a Digital Microsystems computer even though both use double-density format. If you want to move data from one computer to another, use 8-inch, single-sided, single-density format diskettes, and it *should* work.

In order to see how CP/M is stored on a diskette, consider the first two tracks on the diskette, track 0 and track 1. Figure 2-2 shows how the data is stored on these tracks.

Loading CP/M

The events that occur after you first switch on your computer and put the CP/M diskette into a disk drive are the same as those that occur when you press the RESET button—the computer generates a RESET signal.

The RESET button stops the central processor unit (CPU). All of the internals of the CPU are set to an initial state, and all the registers are cleared to zero. The program counter is also cleared to zero so that when the RESET signal goes away (it only lasts for a few milliseconds), the CPU starts executing instructions at location 0000H in memory.

Memory chips, when they first receive power, cannot be relied upon to contain any particular value. Therefore, hardware designers arrange for some initial instructions to be forced into memory at location 0000H and onward. It is this feat that is like pulling yourself up by your own bootstraps. How can you make the computer obey a particular instruction when there is “nothing” (of any sensible value) inside the machine?

There are two common techniques for placing preliminary instructions into memory:

Force-feeding

With this approach, the hardware engineer assumes that when the RESET signal is applied, some part of the computer system, typically the floppy disk controller, can masquerade as memory. Just before the CPU is unleashed, the floppy disk controller will take control of the computer system and copy a small program into memory at location 0000H and upward. Then the CPU is allowed to start executing instructions at location 0000H. The disk controller preserves the instructions even when power is off because they are stored in nonvolatile PROM-based firmware. These instructions make the disk controller read the first sector of the first track of the system diskette into memory and then transfer control to it.

Shadow ROM

This is a variation of the force-feeding technique. The hardware manufacturer arranges some ROM at location 0000H. There is also some normal read/write memory at location 0000H, but this is electronically disabled when the RESET signal has been activated. The CPU, unleashed at location 0000H, starts to execute the ROM instruction. The first act of the ROM program is to copy itself into read/write memory at some convenient location higher up in memory and transfer control of the machine up to this copy. Then the real memory at location 0000H can be turned on, the ROM turned off, and the first sector on the disk read in.

With either technique, the result is the same. The first sector of the disk is read into memory and control is transferred to the first instruction contained in the sector.

This first sector contains the main CP/M bootstrap program. This program initializes some aspects of the hardware and then reads in the remainder of track 0 and most of the sectors on track 1 (the exact number depends on the overall length of the BIOS itself). The CP/M bootstrap program will contain only the most primitive diskette error handling, trying to read the disk over and over again if the hardware indicates that it is having problems reading a sector.

The bootstrap program loads CP/M to the correct place in memory; the load address is a constant in the bootstrap. If you need to build a version of CP/M that uses more memory, you will need to change this load address inside the bootstrap as well as the address to which the bootstrap will jump when all of CP/M has been read in. This address too is a constant in the bootstrap program.

The bootstrap program transfers control to the first instruction in the BIOS, the cold boot entry point. "Cold" implies that the operation is starting cold from an empty computer.

The cold boot code in the BIOS will set up the hardware in your computer. That is, it programs the various chips that control the speed at which serial ports transmit and receive data. It initializes the serial port chips themselves and generally readies the computer system. Its final act is to transfer control to the first instruction in the BDOS in order to start up CP/M proper.

Once the BDOS receives control, it initializes itself, scans the file directory on the system diskette, and hands over control to the CCP. The CCP then outputs the "A>" prompt to the console and waits for you to enter a command. CP/M is then ready to do your bidding.

At this point, it is worthwhile to review which CP/M parts are in memory, where in memory they are, and what functions they perform.

This overview will look at memory first. Figure 2-3 shows the positions in memory of the Console Command Processor, the Basic Disk Operating System, and the Basic Input/Output System.

By touching upon these major memory components—the CCP, BDOS, and BIOS—this discussion will consider which modules interact with them, how requests for action are passed to them, and what functions they can perform.

Console Command Processor

As you can see in Figure 2-3, the CCP is the first part of CP/M that is encountered going "up" through memory addresses. This is significant when you consider that the CCP is only necessary in between programs. When CP/M is idle, it needs the CCP to interact with you, to accept your next command. Once CP/M has started to execute the command, the CCP is redundant; any console interaction will be handled by the program you are running rather than by the CCP.

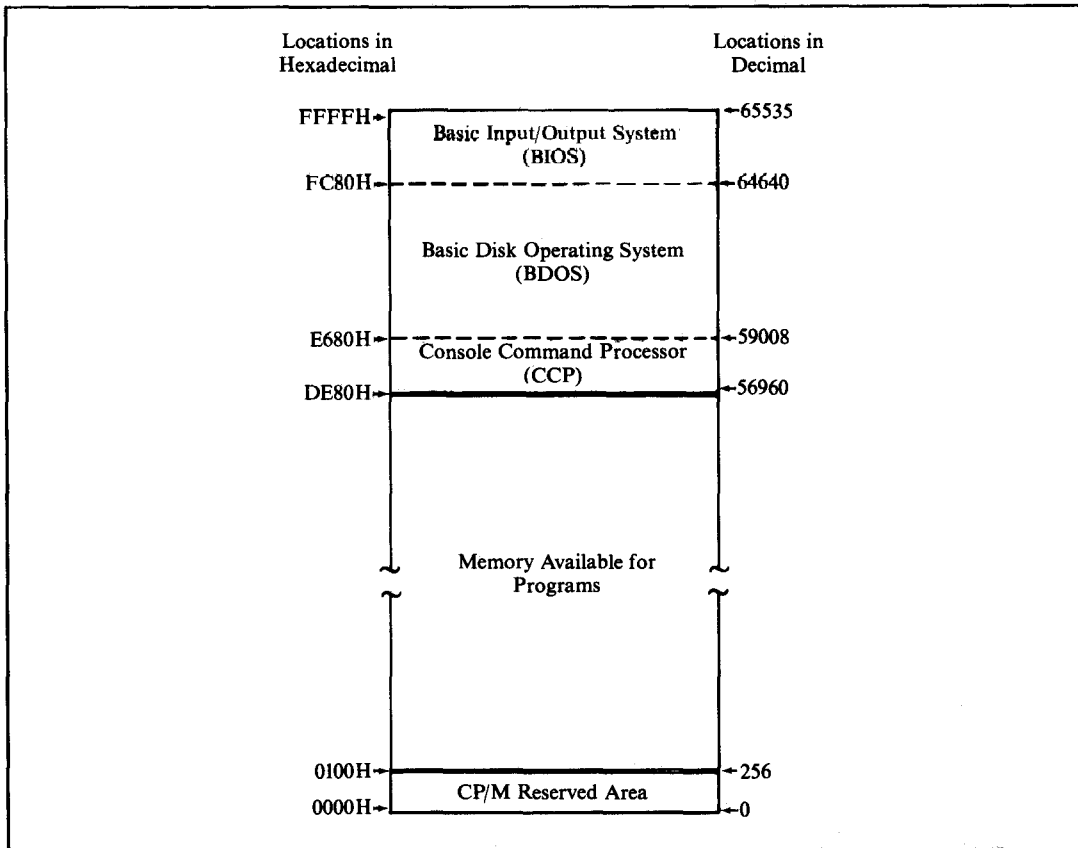

Figure 2-3. Memory layout with CP/M loaded

Therefore, the CCP leads a very jerky existence in memory. It is loaded when you first start CP/M. When you ask CP/M, via the CCP, to execute a program, this program can overwrite the CCP and use the memory occupied by the CCP for its own purposes. When the program you asked for has finished, CP/M needs to reload the CCP, now ready for its interaction with you. This process of reloading the CCP is known as a *warm boot*. In contrast with the cold boot mentioned before, the warm boot is not a complete “start from cold”; it’s just a reloading of the CCP. The BDOS and BIOS are not touched.

How does a program tell CP/M that it has finished and that a warm boot must be executed? By jumping to location 0000H. While the BIOS was initializing itself during the cold boot routine, it put an instruction at location 0000H to jump to the warm boot routine, which is also in the BIOS. Once the BIOS warm boot routine

has reloaded the CCP from the disk, it will transfer control to the CCP. (The cold and warm boot routines are discussed further in Chapter 6.)

This brief description indicates that every command you enter causes a program to be loaded, the CCP to be overwritten, the program to run, and the CCP to be reloaded when the program jumps to location 0000H on completing its task. This is not completely true. Some frequently needed commands reside in the CCP. Using one of these commands means that CP/M does not have to load anything from a diskette; the programs are already in memory as part of the CCP. These commands, known as “intrinsic” or “resident” commands, are listed here with a brief description of what they do. (All of them are described more thoroughly in Chapter 4.) The “resident” commands are

<i>DIR</i>	Displays which files are on a diskette
<i>ERA</i>	Erases files from a diskette
<i>REN</i>	Changes the names of files on diskette
<i>TYPE</i>	Displays the contents of text files on the console
<i>SAVE</i>	Saves some of memory as a file on diskette
<i>USER</i>	Changes User File Group.

Basic Disk Operating System

The BDOS is the heart of CP/M. The CCP and all of the programs that you run under CP/M talk to the BDOS for all their outside contacts. The BDOS performs such tasks as console input/output, printer output, and file management (creating, deleting, and renaming files and reading and writing sectors).

The BDOS performs all of these things in a rather detached way. It is concerned only with the logical tasks at hand rather than the detailed action of getting a sector from a diskette into memory, for example. These “low-level” operations are done by the BDOS in conjunction with the BIOS.

But how does a program work with the BDOS? By another strategically placed jump instruction in memory. Remember that the cold boot placed the jump to the BIOS warm boot routine in location 0000H. At location 0005H, it puts a jump instruction that transfers control up to the first instruction of the BDOS. Thus, any program that transfers control to location 0005H will find its way into the BDOS. Typically, programs make a CALL instruction to location 0005H so that once the BDOS has performed the task at hand, it can return to the calling program at the correct place. The program enlisting the BDOS's help puts special values into several of the CPU registers before it makes the call to location 0005H. These values tell the BDOS what operation is required and the other values needed for the specific operation.

Basic Input/Output System

As mentioned before, the BDOS deals with the input and output of information in a detached way, unencumbered by the physical details of the computer hardware. It is the BIOS that communicates directly with the hardware, the ports, and the peripheral devices wired to them.

This separation of *logical* input/output in the BDOS from the *physical* input/output in the BIOS is one of the major reasons why CP/M is so popular. It means that the same version of CP/M can be adapted for all types of computers, regardless of the oddities of the hardware design. Digital Research will tell you that there are over 200,000 computers in the world running CP/M. Just about all of them are running *identical* copies of the CCP and BDOS. Only the BIOS is different. If you write a program that plays by the rules and only interacts with the BDOS to get things done, it will run on almost all of those 200,000 computers without your having to change a single line of code.

You probably noticed the word “almost” in the last paragraph. Sometimes programmers make demands of the BIOS directly rather than the BDOS. This leads to trouble. The BIOS should be off limits to your program. You need to know what it is and how it works in order to build a customized version of CP/M, but you must *never* write programs that talk directly to the BIOS if you want them to run on other versions of CP/M.

Now that you understand the perils of talking to the BIOS, it is safe to describe how the BDOS communicates with the BIOS. Unlike the BDOS, which has a single entry point and uses a value in a register to specify the function to be performed, the BIOS has several entry points. The first few instructions in the BIOS are all independent entry points, each taking up three bytes of memory. The BDOS will enter the BIOS at the appropriate instruction, depending on the function to be performed. This group of entry points is similar in function to a railroad marshalling yard. It directs the BDOS to the correct destination in the BIOS for the function it needs to have done. The entry point group consists of a series of JUMP instructions, each one three bytes long. The group as a whole is called the BIOS jump table, or jump vector. Each entry point has a predefined meaning. These points are detailed and will be discussed in Chapter 6.

CCP, BDOS, and BIOS Interactions

Figure 2-4 summarizes the functions that the CCP, BDOS, and BIOS perform, the ways in which these parts of CP/M communicate among themselves, and the way in which one of your programs running under CP/M interacts with the BDOS.

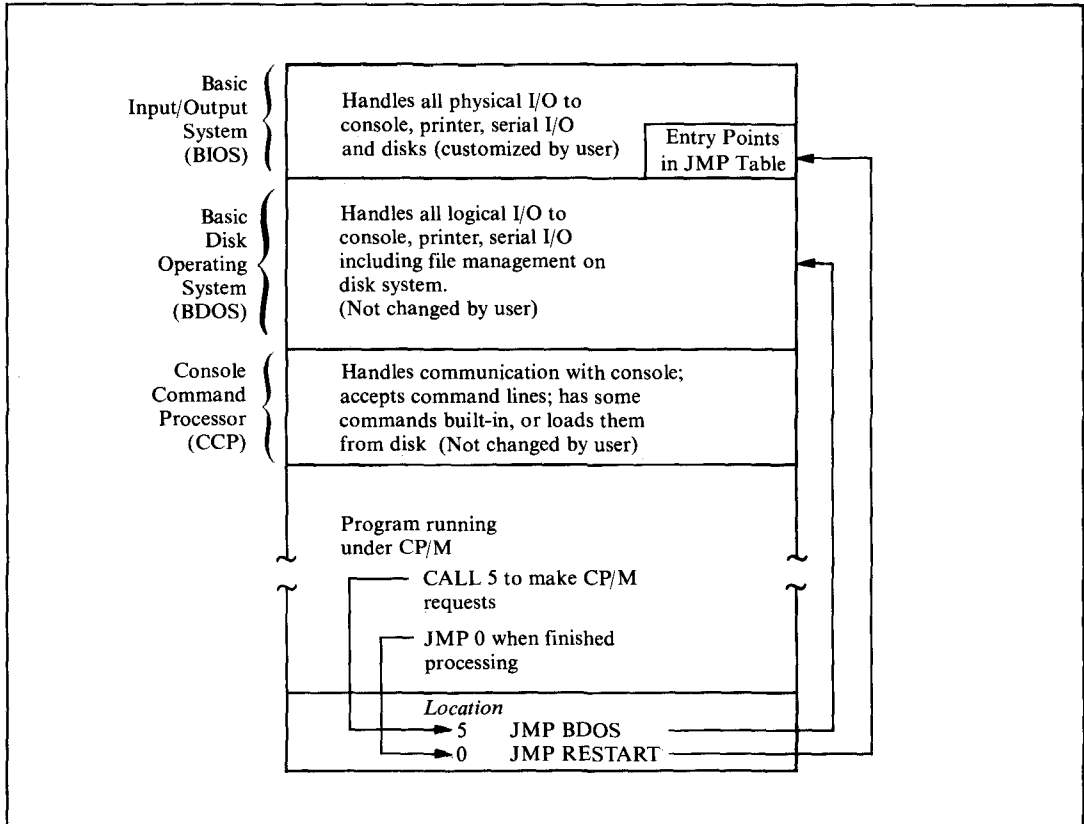

Figure 2-4. CP/M's functional breakdown

How CP/M Views the Disk
The Making of a File
Disk Definition Tables
File Organizations

3

The CP/M File System

This chapter gives you a close look at the CP/M file system. The Basic Disk Operating System (BDOS) is responsible for this file system: It keeps a directory of the files on disk, noting where data are actually stored on the disk. Because the file system automatically keeps track of this information, you can ignore the details of which tracks and sectors on the disk have data for a given file.

How CP/M Views the Disk

To manage files on the disk, CP/M works with the disk in logical terms rather than in physical terms of tracks and sectors. CP/M treats the disk as three major areas.

These are the *reserved area*, which contains the bootstrap program and CP/M itself; the *file directory*, containing one or more entries for each file stored on the disk; and the *data storage area*, which occupies the remainder of the disk. You will

be looking at how CP/M allocates the storage to the files as your programs create them.

The Basic Input/Output System (BIOS) has built-in tables that tell CP/M the respective sizes of the three areas. These are the *disk definition tables*, described later in this chapter.

Allocation Blocks

Rather than work with individual 128-byte sectors, CP/M joins several of these sectors logically to form an allocation block. Typically, an allocation block will contain eight 128-byte sectors (which makes it 1024 or 1K bytes long). This makes for easier disk manipulation because the magnitude of the numbers involved is reduced. For example, a standard 8-inch, single-density, single-sided floppy disk has 1950 128-byte sectors; hard disks may have 120,000 or more. By using allocation blocks that view the disk eight sectors at a time, the number of storage units to be managed is substantially reduced. The total number is important because numeric information is handled as 16-bit integers on the 8080 and Z80 microprocessors, and therefore the largest unsigned number possible is 0FFFFH (65,535 or 64K decimal).

Whenever CP/M refers to a specific allocation block, all that is needed is a simple number. The first allocation block is number 0, the next is number 1, and so on, up to the total remaining capacity of the disk.

The typical allocation block contains 1024 (1K) bytes, or eight 128-byte sectors. For the larger hard disks, the allocation block can be 16,384 (16K) bytes, which is 128 128-byte sectors. CP/M is given the allocation via an entry in the disk definition tables in the BIOS.

The size of the allocation block is not arbitrary, but it is a compromise. The originator of the working BIOS for the system—either the manufacturer or the operating system's designer—chooses the size by considering the total storage capacity of the disk. This choice is tempered by the fact that if a file is created with only a single byte of data in it, that file would be given a complete allocation block. Large allocation blocks can waste disk storage if there are many small files, but they can be useful when a few very large files are called for.

This can be seen better by considering the case of a 1K-byte allocation block. If you create a very small file containing just a single byte of data, you will have allocated an entire allocation block. The remaining 1023 bytes will not be used. You can use them by adding to the file, but when you first create this one-byte file, they will be just so much dead space. This is the problem: Each file on the disk will normally have one partly filled allocation block. If these blocks are very large, the amount of wasted (unused) space can be very large. With 16K-byte blocks, a 10-megabyte disk with only 3 megabytes of data on it could become logically full, with all allocation blocks allocated.

On the other hand, when you use large allocation blocks, CP/M's performance is significantly improved because the BDOS refers to the file directory less

frequently. For example, it can read a 16K-byte file with only a single directory reference.

Therefore, when considering block allocation, keep the following questions in mind:

How big is the logical disk?

With a larger disk, you can tolerate space wasted by incomplete allocation blocks.

What is the mean file size?

If you anticipate many small files, use small allocation blocks so that you have a larger “supply” of blocks. If you anticipate a smaller number of large files, use larger allocation blocks to get faster file operations.

When a file is first created, it is assigned a single allocation block on the disk. Which block is assigned depends on what other files you already have on the disk and which blocks have already been allocated to them. CP/M maintains a table of which blocks are allocated and which are available. As the file accumulates more data, it will fill up the first allocation block. When this happens, CP/M will extend the file and allocate another block to it. Thus, as the file grows, it occupies more blocks. These blocks need not be adjacent to each other on the disk. The file can exist as a series of allocation blocks scattered all over the disk. However, when you need to see the entire file, CP/M presents the allocation blocks in the correct order. Thus, application programs can ignore allocation blocks. CP/M keeps track of which allocation blocks belong to each file through the file directory.

The File Directory

The *file directory* is sandwiched between the reserved area and the data storage area on the disk. The actual size of the directory is defined in the BIOS’s disk definition tables. The directory can have some binary multiple of entries in it, with one or more entries for each file that exists on the disk. For a standard 8-inch floppy diskette, there will be room for 64 directory entries; for a hard disk, 1024 entries would not be unusual. Each directory entry is 32 bytes long.

Simple arithmetic can be used to calculate how much space the directory occupies on a standard floppy diskette. For example, for a floppy disk the formula is $64 \times 32 = 2048$ bytes = 2 allocation blocks of 1024 bytes each.

The directory entry contains the name of the file along with a list of the allocation blocks currently used by the file. Clearly, a single 32-byte directory entry cannot contain all of the allocation blocks necessary for a 5-megabyte file, especially since CP/M uses only 16 bytes of the 32-byte total for storage of allocation block numbers.

Extents

Often CP/M will need to control files that need many allocation blocks. It does this by creating more than one directory entry. Second and subsequent directory

entries have the same file name as the first. One of the other bytes of the directory entry is used to indicate the directory entry sequence number. Each new directory entry brings with it a new supply of bytes that can be used to hold more allocation block numbers. In CP/M jargon, each directory entry is called an *extent*. Because the directory entry for each extent has 16 bytes for storing allocation block numbers, it can store either 16 one-byte numbers or 8 two-byte numbers. Therefore, the total number of allocation blocks possible in each extent is either 8 (for disks with more than 255 allocation blocks) or 16 (for smaller disks).

File Control Blocks

Before CP/M can do anything with a file, it has to have some control information in memory. This information is stored in a *file control block*, or FCB. The FCB has been described as a motel for directory entries—a place for them to reside when they are not at home on the disk. When operations on a file are complete, CP/M transforms the FCB back into a directory entry and rewrites it over the original entry. The FCB is discussed in detail at the end of this chapter.

As a summary, Figure 3-1 shows the relationships between disk sectors, allocation blocks, directory entries, and file control blocks.

The Making of a File

To reinforce what you already know about the CP/M file system, this section takes you on a “walk-through” of the events that occur when a program running under CP/M creates a file, writes data to it, and then *closes* the file.

Assume that a program has been loaded in memory and the CPU is about to start executing it. First, the program will declare space in memory for an FCB and will place some preset values there, the most important of which is the file name. The area in the FCB that will hold the allocation block numbers as they are assigned is initially filled with binary 0's. Because the first allocation block that is available for file data is block 1, an allocation block number of 0 will mean that no blocks have been allocated.

The program starts executing. It makes a call to the BDOS (via location 0005H) requesting that CP/M create a file. It transfers to the BDOS the address in memory of the FCB. The BDOS then locates an available entry in the directory, creates a new entry based on the FCB in the program, and returns to the program, ready to write data to the file. Note that CP/M makes no attempt to see if there is already a file of the same name on the disk. Therefore, most real-world programs precede a request to make a file with a request to delete any existing file of the same name.

The program now starts writing data to the file, 128-byte sector by 128-byte sector. CP/M does not have any provision for writing one byte at a time. It handles data sector-by-sector only, flushing sectors to the disk as they become full.

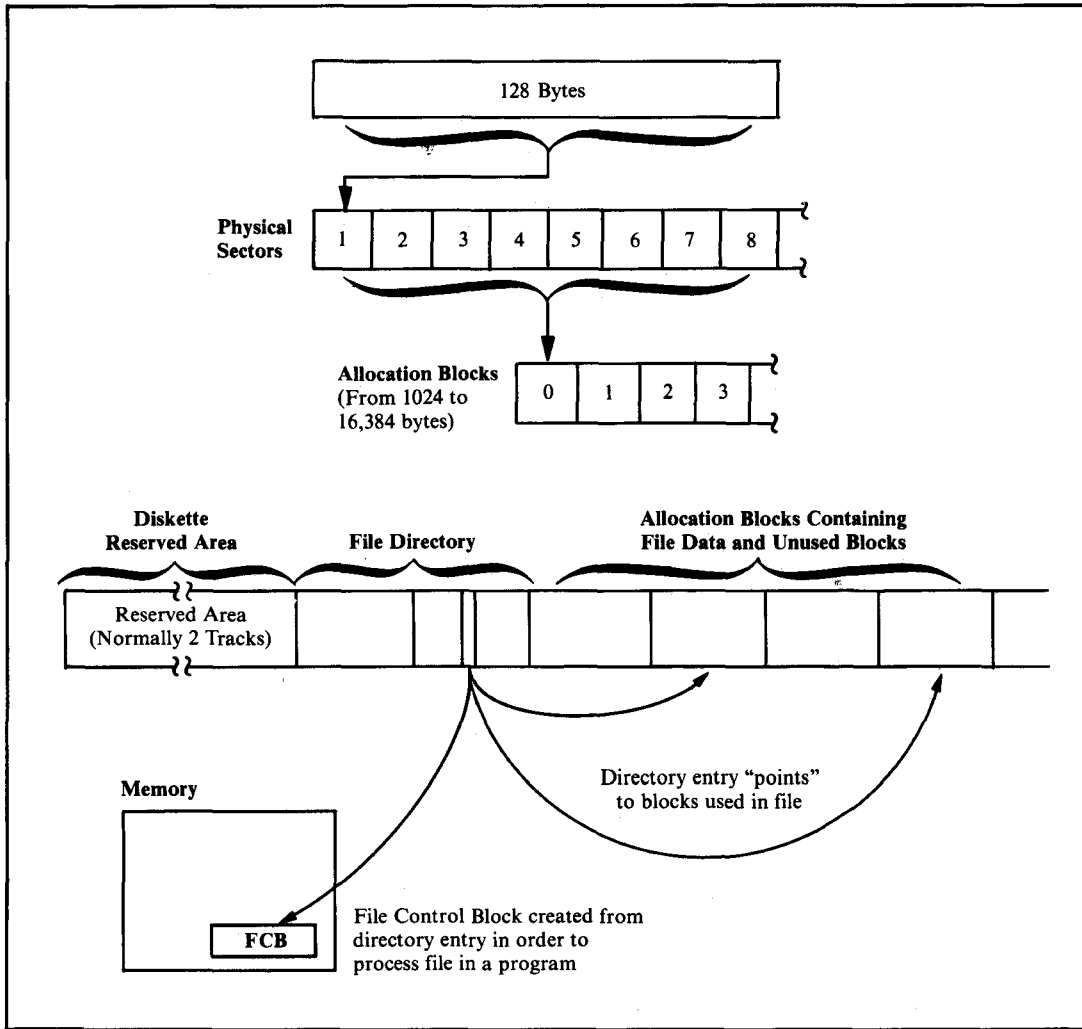

Figure 3-1. The hierarchical relationship between sectors, allocation blocks, directory entries, and FCBs

The first time a program asks CP/M (via a BDOS request) to write a sector onto the file on the disk, the BDOS finds an unused allocation block and assigns it to the file. The number of the allocation block is placed inside the FCB in memory. As each allocation block is filled up, a new allocation block is found and assigned, and its number is added to the list of allocation blocks inside the FCB. Finally, when the FCB has no more room for allocation block numbers, the BDOS

- Writes an updated directory entry out to the disk.

- Seeks out the next spare entry in the directory.
- Resets the FCB in memory to indicate that it is now working on the second extent of the file.
- Clears out the allocation block area in the FCB and waits for the next sector from the program.

Thus the process continues. New extents are automatically opened until the program determines that it is time to finish, writes the last sector out to the disk, and makes a BDOS request to close the file. The BDOS then converts the FCB into a final directory entry and writes to the directory.

Directory Entry

The directory consists of a series of 32-byte entries with one or more entries for each file on the disk. The total number of entries is a binary multiple. The actual number depends on the disk format (it will be 64 for a standard floppy disk and perhaps 2048 for a hard disk).

Figure 3-2 shows the detailed structure of a directory entry. Note that the description is actually Intel 8080 source code for the data definitions you would need in order to manipulate a directory entry. It shows a series of EQU instructions—*equate* instructions, used to assign values or expressions to a label, and in this case used to access an entry. It also shows a series of DS or *define storage* instructions used to declare storage for an entry. The comments on each line describe the function of each of the fields. Where data elements are less than a byte long, the comment identifies which bits are used.

As you study Figure 3-2, you will notice some terminology that as yet has not been discussed. This is described in detail in the sections that follow.

File User Number (Byte 0) The least significant (low order) four bits of byte 0 in the directory entry contain a number in the range 0 to 15. This is the *user number* in which the file belongs. A better name for this field would have been file group number. It works like this: Suppose several users are sharing a computer system with a hard disk that cannot be removed from the system without a lot of trouble. How can each user be sure not to tamper with other users' files? One simple way would be for each to use individual initials as the first characters of any file names. Then each could tell at a glance whether a file was another's and avoid doing anything to anyone else's files. A drawback of this scheme is that valuable character positions would be used in the file name, not to mention the problems resulting if several users had the same initials.

The file user number is prefixed to each file name and can be thought of as part of the name itself. When CP/M is first brought up, User 0 is the default user—the one that will be chosen unless another is designated. Any files created will go into the directory bearing the user number of 0. These files are referred to as being in user area 0. However, with a shared computer system, arrangements must be made

for multiple user areas. The USER command makes this possible. User numbers and areas can range from 0 through 15. For example, a user in area 7 would not be able to get a directory of, access, or erase files in user area 5.

This user-number byte serves a second purpose. If this byte is set to a value of 0E5H, CP/M considers that the file directory entry has been deleted and completely ignores the remaining 31 bytes of data. The number 0E5H was not chosen whimsically. When IBM first defined the standard for floppy diskettes, they chose the binary pattern 11100101 (0E5H) as a good test pattern. A new floppy diskette formatted for use has nothing but bytes of 0E5H on it. Thus, the process of erasing a file is a “logical” deletion, where only the first byte of the directory entry is changed to 0E5H. If you accidentally delete a file (and provided that no other directory activity has occurred) it can be resurrected by simply changing this first byte back to a reasonable user number. This process will be explained in Chapter 11.

File Name and Type (Bytes 1 - 8 and 9 - 11) As you can see from Figure 3-2, the file name in a directory entry is eight bytes long; the file type is three. These two fields are used to name a file unambiguously. A file name can be less than eight characters and the file type less than three, but in these cases, the unused character positions are filled with spaces.

Whenever file names and file types are written together, they are separated by a period. You do not need the period if you are not using the file type (which is the same as saying that the file type is all spaces). Some examples of file names are

```
READ. ME
LONGNAME.TYP
1
1.2
```

0000 =	FDE#USER	EQU	0	;File user number (LS 4 bits)
0001 =	FDE#NAME	EQU	1	;File name (8 bytes)
0009 =	FDE#TYP	EQU	9	;File type
				;Offsets for bits used in type
0009 =	FDE#RD	EQU	9	;Bit 7 = 1 - Read only
000A =	FDE#SYS	EQU	10	;Bit 7 = 1 - System status
000B =	FDE#CHANGE	EQU	11	;Bit 7 = 0 = File Written To
				;
000C =	FDE#EXTENT	EQU	12	;Extent number
				;13, 14 reserved for CP/M
000F =	FDE#RECUSED	EQU	15	;Records used in this extent
0010 =	FDE#ABUSED	EQU	16	;Allocation blocks used
				;
				;
0000	FD#USER:	DS		;File user number
0001	FD#NAME:	DS	8	;File name
0009	FD#TYP:	DS	3	;File type
000C	FD#EXTENT:	DS	1	;Extent
000D	FD#RESV:	DS	2	;Reserved for CP/M
000F	FD#RECUSED:	DS	1	;Records used in this extent
0010	FD#ABUSED:	DS	16	;Allocation blocks used

Figure 3-2. Data declarations for CP/M's file directory entries

A file name and type can contain the characters A through Z, 0 through 9, and some of the so-called "mark" characters such as "/" and "-". You can also use lowercase letters, but be careful. When you enter commands into the system using the CCP, it converts all lowercases to uppercases, so it will never be able to find files that actually have lowercase letters in their directory entries. Avoid using the "mark" characters excessively. Ones you can use are

```
! @ # $ % ( ) - + /
```

Characters that you must not use are

```
< > . , ; : = ? * [ ]
```

These characters are used by CP/M in normal command lines, so using them in file names will cause problems.

You can use odd characters in file names to your advantage. For example, if you create files with nongraphic characters in their names or types, the only way you can access these files will be from within programs. You cannot manipulate these files from the keyboard except by using ambiguous file names (described in the next section). This makes it more difficult to erase files accidentally since you cannot specify their names directly from the console.

Ambiguous File Names CP/M has the capability to refer to one or more file names by using special "wild card" characters in the file names. The "?" is the main wildcard character. Whenever you ask CP/M to do something related to files, it will match a "?" with any character it finds in the file name. In the extreme case, a file name and type of "????????.???" will match with any and all file names.

As another example, all the chapters of this book were held in files called "CHAP1.DOC," "CHAP2.DOC," and so on. They were frequently referred to, however, as "CHAP?.DOC." Why two question marks? If only one had been used, for example, "CHAP?.DOC," CP/M would not have been able to match this with "CHAP10.DOC" nor any other chapter with two digits. The matching that CP/M does is strictly character-by-character.

Because typing question marks can be tedious and special attention must be paid to the exact number entered, a convenient shorthand is available. The asterisk character "*" can be used to mean "as many ?'s as you need to fill out the name or the type field." Thus, "????????.???" can be written "*.*" and "CHAP?.DOC" could also be rewritten "CHAP*.DOC."

The use of "*" is allowed only when you are entering file names from the console. The question mark notation, however, can be used for certain BDOS operations, with the file name and type field in the FCB being set to the "?" as needed.

File Type Conventions Although you are at liberty to think up file names without constraint, file types are subject to convention and, in one or two cases, to the mandate of CP/M itself.

The types that will cause problems if you do not use them correctly are

- .ASM*
Assembly language source for the ASM program
- .MAC*
Macro assembly language
- .HEX*
Hexadecimal file output by assemblers
- .REL*
Relocatable file output by assemblers
- .COM*
Command file executed by entering its name alone
- .PRN*
Print file written to disk as a convenience
- .LIB*
Library file of programs
- .SUB*
Input for CP/M SUBMIT utility program

Examples of conventional file types are

- .C*
C source code
- .PAS*
Pascal source code
- .COB*
COBOL source code
- .FTN*
FORTRAN source code
- .APL*
APL programs
- .TXT*
Text files
- .DOC*
Documentation files
- .INT*
Intermediate files
- .DTA*
Data files

.IDX

Index files

.\$\$\$

Temporary files

The file type is also useful for keeping several copies of the same file, for example, "TEST.001," "TEST.002," and so on.

File Status Each one of the states *Read-Only*, *System*, and *File Changed* requires only a single bit in the directory entry. To avoid using unnecessary space, they have been slotted into the three bytes used for the file type field. Since these bytes are stored as characters in ASCII (which is a seven-bit code), the most significant bit is not used for the file type and thus is available to show status.

Bit 7 of byte 9 shows Read-Only status. As its name implies, if a file is set to be Read-Only, CP/M will not allow any data to be written to the file or the file to be deleted.

If a file is declared to be System status (bit 7 of byte 10), it will not show up when you display the file directory. Nor can the file be copied from one place to another with standard CP/M utilities such as PIP unless you specifically ask the utility to do so. In normal practice, you should set your standard software tools and application programs to be both Read-Only and System status/Read-Only, so that you cannot accidentally delete them, and System status, so that they do not clutter up the directory display.

The File Changed bit (bit 7 of byte 11) is always set to 0 when you close a file to which you have been writing. This can be useful in conjunction with a file backup utility program that sets this bit to 1 whenever it makes a backup copy. Just by scanning the directory, this utility program can determine which files have changed since it was last run. The utility can be made to back up only those files that have changed. This is much easier than having to remember which files you have changed since you last made backup copies.

With a floppy disk system, there is less need to worry about backing up on a file-by-file basis—it is just as easy to copy the whole diskette. This system is useful, however, with a hard disk system with hundreds of files stored on the disk.

File Extent (Byte 12) Each directory entry represents a file extent. Byte 12 in the directory entry identified the extent number. If you have a file of less than 16,384 bytes, you will need only one extent—number 0. If you write more information to this file, more extents will be needed. The extent number increases by 1 as each new extent is created.

The extent number is stored in the file directory because the directory entries are in random sequence. The BDOS must do a sequential search from the top of the directory to be sure of finding any given extent of a file. If the directory is large, as it could be on a hard disk system, this search can take several seconds.

Reserved Bytes 13 and 14 These bytes are used by the proprietary parts of CP/M's file system. From your point of view, they will be set to 0.

Record Number (Byte 15) Byte 15 contains a count of the number of records (128-byte sectors) that have been used in the last partially filled allocation block referenced in this directory entry. Since CP/M creates a file sequentially, only the most recently allocated block is not completely full.

Disk Map (Bytes 16 - 31) Bytes 16-31 store the allocation block numbers used by each extent. There are 16 bytes in this area. If the total number of allocation blocks (as defined by you in the BIOS disk tables) is less than 256, this area can hold as many as 16 allocation block numbers. If you have described the disk as having more than 255 allocation blocks, CP/M uses this area to store eight two-byte values. In this case allocation blocks can take on much larger values.

A directory entry can store either 8 or 16 allocation block numbers. If the file has not yet expanded to require this total number of allocation blocks, the unused positions in the entry are filled with zeros. You may think this would create a problem because it appears that several files will have been allocated block 0 over and over. In fact, there is no problem because the file directory itself always occupies block 0 (and depending on its size several of the blocks following). For all practical purposes, block 0 "does not exist," at least for the storage of file data.

Note that if, by accident, the relationship between files and their allocation blocks is scrambled—that is, either the data in a given block is overwritten, or two or more active directory entries contain the same block number—CP/M cannot access information properly and the disk becomes worthless.

Several commercially available utility programs manipulate the directory. You can use them to inspect and change a damaged directory, reviving accidentally erased files if you need to. There are other utilities you can use to logically remove bad sectors on the disk. These utilities find the bad areas, work backward from the track and sector numbers, and compute the allocation block in which the error occurs. Once the block numbers are known, they create a dummy file, either in user area 15 or, in some cases, in an "impossible" user area (one greater than 15), that appears to "own" all the bad allocation blocks.

A good utility program protects the integrity of the directory by verifying that each allocation block is "owned" by only one directory entry.

Disk Definition Tables

As mentioned previously, the BIOS contains tables telling the BDOS how to view the disk storage devices that are part of the computer system. These tables are built *by you*. If you are using standard 8-inch, single-sided, single-density floppy

diskettes, you can use the examples in the Digital Research manual *CP/M 2 Alteration Guide*. But if you are using some other, more complex system, you must make some careful judgments. Any mistakes in the *disk definition tables* can create serious problems, especially when you try to correct diskettes created using the erroneous tables. You, as a programmer, must ensure the correctness of the tables by being careful.

One other point before looking at table structures: Because the tables exist and define a particular disk “shape” does not mean that such a disk need necessarily be connected to the system. The tables describe *logical* disks, and there is no way for the physical hardware to check whether your disk tables are correct. You may have a computer system with a single hard disk, yet describe the disk as though it were divided into several *logical* disks. CP/M will view each such “disk” independently, and they should be thought of as separate disks.

Disk Parameter Header Table

This table is the starting point in the disk definition tables. It is the topmost structure and contains nothing but the addresses of other structures. There is one entry in this table for each logical disk that you choose to describe. There is an entry point in the BIOS that returns the address of the parameter header table for a specific logical disk.

An example of the code needed to define a disk parameter header table is shown in Figure 3-3.

Sector Skewing (Skewtable) To define sector *skewing*, also called sector *interlacing*, picture a diskette spinning in a disk drive. The sectors in the track over which the head is positioned are passing by the head one after another — sector 1, sector 2, and so on — until the diskette has turned one complete revolution. Then the sequence repeats. A standard 8-inch diskette has 26 sectors on each track, and the disk spins at 360 rpm. One turn of the diskette takes 60/360 seconds, about 166 milliseconds per track, or 6 milliseconds per sector.

Now imagine CP/M loading a program from such a diskette. The BDOS takes a finite amount of time to read and process each sector since it reads only a single sector at a time. It has to make repeated reads to load a program. By the time the BDOS has read and loaded sector n , it will be too late to read sector $n + 1$. This sector will have already passed by the head and will not come around for another 166 milliseconds. Proceeding in this fashion, almost $4\frac{1}{2}$ seconds are needed to read one complete track.

This problem can be solved by simply numbering the sectors *logically* so that there are several physical sectors between each logical sector. This procedure, called *sector skewing* or *interlace*, is shown in Figure 3-4. Note that unlike physical sectors, logical sectors are numbered from 0 to 25.

Figure 3-4 shows the standard CP/M sector interlace for 8-inch, single-sided, single-density floppy diskettes. You see that logical sector 0 has six sectors between

```

DPBASE:                                ;Base of the parameter header
; (used to access the headers)
0000 1000          DW      SKEWTABLE    ;Pointer to logical-to-physical
; sector conversion table
0002 0000          DW      0           ;Scratch pad areas used by CP/M
0004 0000          DW      0
0006 0000          DW      0
0008 2A00          DW      DIRBUF      ;Pointer to Directory Buffer
; work area
000A AA00          DW      DPBO        ;Pointer to disk parameter block
000C B900          DW      WACD        ;Pointer to work area (used to
; check for changed diskettes)
000E C900          DW      ALVECO      ;Pointer to allocation vector
;
;
; The following equates would normally be derived from
; values found in the disk parameter Block.
; They are shown here only for the sake of completeness.
;
003F =            NODE      EQU      63          ;Number of directory entries 1
00F2 =            NOAB      EQU      242         ;Number of allocation blocks
;
; Example data definitions for those objects pointed
; to by the disk parameter header
;
SKEWTABLE:                                ;Sector skew table.
; Indexed by logical sector
0010 01070D13     DB      01,07,13,19        ;Logical sectors 0,1,2,3
0014 19050B11     DB      25,05,11,17        ;4,5,6,7
0018 1703090F     DB      23,03,09,15        ;8,9,10,11
001C 1502080E     DB      21,02,08,14        ;12,13,14,15
0020 141A060C     DB      20,26,06,12        ;16,17,18,19
0024 1218040A     DB      18,24,04,10        ;20,21,22,23
0028 1016         DB      16,22             ;24,25
;
002A             DIRBUF: DS      128         ;Directory buffer
00AA             DPBO:  DS      15          ;Disk parameter block
; This is normally a table of
; constants.
; A dummy definition is shown
; here
00B9             WACD:  DS      (NODE+1)/4    ;Work area to check directory
; Only used for removable media
00C9             ALVECO: DS      (NOAB/8)+1   ;Allocation vector #0
; Needs 1 bit per allocation
; block

```

Figure 3-3. Data declarations for a disk parameter header

it and logical sector 1. There is a similar gap between each of the logical sectors, so that there are six “sector times” (about 38 milliseconds) between two adjacent logical sectors. This gives ample time for the software to access each sector. However, several revolutions of the disk are still necessary to read every sector in turn. In Figure 3-4, the vertical columns of logical sectors show which sectors are read on each successive revolution of the diskette.

The wrong interlace can strongly affect performance. It is not a gradual effect, either; if you “miss” the interlace, the perceived performance will be very slow. In the example given here, six turns of the diskette are needed to read the whole track—this lasts one second as opposed to $4\frac{1}{2}$ without any interlacing. But don’t imagine that you can change the interlace with impunity; files written with one interlace stay that way. You must be sure to read them back with the same interlace with which they were written.

Some disk controllers can simplify this procedure. When you format the diskette, they can write the sector addresses onto the diskette with the interlace already built in. When CP/M requests sector n, the controller's electronics wait until they see the requested sector's header fly by. They then initiate the read or write operation. In this case you can embed the interlace right into the formatting of the diskette.

Because the wrong interlace gives terrible performance, it is easy to know when you have the right one. Some programmers use the time required to format a diskette as the performance criterion to optimize the interlace. This is not good practice because under normal circumstances you will spend very little time formatting diskettes. The time spent loading a program would be a better arbiter, since far more time is spent doing this. You might argue that doing a file update would be even more representative, but most updates produce slow and sporadic disk activity. This kind of disk usage is not suitable for setting the correct interlace.

Hard disks do not present any problem for sector skewing. They spin at 3600 rpm or faster, and at that speed there simply is no interlace that will help. Some

Physical Sector	Logical Sector					
	Pass 1	Pass 2	Pass 3	Pass 4	Pass 5	Pass 6
1	0					
2				13		
3			9			
4						22
5		5				
6					18	
7	1					
8				14		
9			10			
10						23
11		6				
12					19	
13	2					
14				15		
15			11			
16						24
17		7				
18					20	
19	3					
20				16		
21			12			
22						25
23		8				
24					21	
25	4					
26				17		

NOTE: Additional sector between logical sectors 12 and 13

Figure 3-4. Physical to logical sector skewing

tricks can be played to improve the performance of a hard disk — these will be discussed in the section called “Special Considerations for Hard Disks,” later in this chapter.

To better understand these theories, study an example of the standard interlace table, or *skewtable*. Bear in mind that the code that will access this table will first be given a *logical* sector. It will then have to return the appropriate *physical* sector.

Figure 3-5 shows the code for the skew table and the code that can be used to access the table. The table is indexed by a logical sector and the corresponding table entry is the physical sector. You can see that the code assumes that the first *logical* sector assigned by CP/M will be sector number 0. Hence there is no need to subtract 1 from the sector number before using it as a table subscript.

Unused Areas in the Disk Parameter Header Table The three words shown as 0’s in Figure 3-3 are used by CP/M as temporary variables during disk operations.

Directory Buffer (DIRBUF) The *directory buffer* is a 128-byte area used by CP/M to store a sector from the directory while processing directory entries. You only need one directory buffer; it can be shared by all of the logical disks in the system.

Disk Parameter Block (DPB0) The *disk parameter block* describes the particular characteristics of each logical disk. In general, you will need a separate parameter block for each *type* of logical disk. Logical disks can share a parameter block only if their

```

                                SKEWTABLE:
0000 01070D13      DB      01,07,13,19      ;Logical sector
                                ;0,1,2,3
0004 19050B11      DB      25,05,11,17      ;4,5,6,7
0008 1703090F      DB      23,03,09,15      ;8,9,10,11
000C 1502080E      DB      21,02,08,14      ;12,13,14,15
0010 141A060C      DB      20,26,06,12      ;16,17,18,19
0014 1218040A      DB      18,24,04,10      ;20,21,22,23
0018 1016          DB      16,22          ;24,25
                                ;
                                ;
                                The code to translate logical sectors to physical
                                sectors is as follows:
                                ;
                                ; On entry, the logical sector will be transferred from
                                ; CP/M as a 16-bit value in registers BC.
                                ; CP/M also transfers the address of the skew table
                                ; in registers DE (it finds the skew table by looking in
                                ; the disk parameter header entry).
                                ;
                                ; On return, the physical sector will be placed
                                ; in registers HL.
                                ;
                                SECTRAN:
001A EB          XCHG      ;HL -> skew table base address
001B 09          DAD      B      ;HL -> physical sector
                                ;
                                ; entry in skew table
001C 6E          MOV      L,M      ;L = physical sector
001D 60          MOV      H,0      ;HL = Physical Sector
001E C9          RET          ;Return to BDOS

```

Figure 3-5. Data declarations for the standard skewtable for standard diskettes

characteristics are identical. You can, for example, use a single parameter block to describe all of the single-sided, single-density diskette drives that you have in the system. However, you would need another parameter block to describe double-sided, double-density diskette drives. It is also rare to be able to share parameter blocks when a physical hard disk is split up into several logical disks. You will understand why after looking at the contents of a parameter block, described later in this chapter.

Work Area to Check for Changed Diskettes (WACD) One of the major problems that CP/M faces when working with removable media such as floppy diskettes is that the computer operator, without any warning, can open the diskette drive and substitute a different diskette. On early versions of CP/M, this resulted in the newly inserted diskette being overwritten with data from the original diskette.

With the current version of CP/M, you can request that CP/M check if the diskette has been changed. Given this request, CP/M examines the directory entries whenever it has worked on the directory and, if it detects that the diskette has been changed, declares the whole diskette to be Read-Only status and inhibits any further writing to the diskette. This status will be in effect until the next warm boot operation occurs. A warm boot occurs whenever a program terminates or a CONTROL-C is entered to the CCP, resetting the operating system.

The value of WACD is the address of a buffer, or temporary storage area, that CP/M can use to check the directory. The length of this buffer is defined (somewhat out of place) in the disk parameter block.

Allocation Vector (ALVEC0) CP/M views each disk as a set of allocation blocks, assigning blocks to individual files as those files are created or expanded, and relinquishing blocks as files are deleted.

CP/M needs some mechanism for keeping track of which blocks are used and which are free. It uses the *allocation vector* to form a *bit map*, with each bit in the map corresponding to a specific allocation block. The most significant bit (bit 7) in the first byte corresponds to the first allocation block, number 0. Bit 6 corresponds to block 1, and so on for the entire disk.

Whenever you request CP/M to use a logical disk, CP/M will *log in* the disk. This consists of reading down the file directory and, for each active entry or extent, interacting with the allocation blocks “owned” by that particular file extent. For each block number in the extent, the corresponding bit in the allocation vector is set to 1. At the end of this process, the allocation vector will accurately represent a map of which blocks are in use and which are free.

When CP/M goes looking for an unused allocation block, it tries to find one near the last one used, to keep the file from becoming too fragmented.

In order to reserve enough space for the allocation vector, you need to reserve one bit for each allocation block. Computing the number of allocation blocks is discussed in the section “Maximum Allocation Block Number,” later in this chapter.

Disk Parameter Block

The *disk parameter block* in early versions of CP/M was built into the BDOS and was a closely guarded secret of the CP/M file system. To make CP/M adaptable to hard disk systems, Digital Research decided to move the parameter blocks out into the BIOS where everyone could adapt them. Because of the proprietary nature of CP/M's file system, you will still see several odd-looking fields, and you may find the explanation given here somewhat superficial. However, the lack of explanation in no way detracts from your ability to use CP/M as a tool.

Figure 3-6 shows the code necessary to define a parameter block for 8-inch, single-sided diskettes. This table is pointed to by—that is, its address is given in—an entry in the disk parameter header. Each of the entries shown in the disk parameter block is explained in the following sections.

Sectors Per Track This is the number of 128-byte sectors per track. The standard diskette shown in the example has 26 sectors. As you can see, simply telling CP/M that there are 26 sectors per track does not indicate whether the first sector is numbered 0 or 1. CP/M assumes that the first sector is 0; it is left to a sector translate subroutine to decipher which physical sector this corresponds to.

Hard disks normally have sector sizes larger than 128 bytes. This is discussed in the section on considerations for hard disks.

Block Shift, Block Mask, and Extent Mask These mysteriously named fields are used internally by CP/M during disk file operations. The values that you specify for them depend primarily on the size of the allocation block that you want.

Allocation block size can vary from 1024 bytes (1K) to 16,384 bytes (16K). There is a distinct trade-off between these two extremes, as discussed in the section on allocation blocks at the beginning of this chapter.

An allocation block size of 1024 (1K) bytes is suggested for floppy diskettes with capacities up to 1 megabyte, and a block size of 4096 (4K) bytes for larger floppy or hard disks.

		DPBO:		
0000	1A00	DW	26	;Sectors per track
0002	03	DB	3	;Block shift
0003	07	DB	7	;Block mask
0004	03	DB	3	;Extent mask
0005	F200	DW	242	;Max. allocation block number
0007	3F00	DW	63	;Number of directory entries 1
0009	C0	DB	1100#0000B	;Bit map for allocation blocks
000A	00	DB	0000#0000B	; used for directory
000B	1000	DW	16	;No. of bytes in dir. check buffer
000D	0200	DW	2	;No. of tracks before directory

Figure 3-6. Data declarations for the disk parameter block for standard diskettes

If you can define which block size you wish to use, you can now select the values for the block shift and the block mask from Table 3-1.

Table 3-1. Block Shift and Mask Value

Allocation Block Size	Block Shift	Block Mask
1,024	3	7
2,048	4	15
4,096	5	31
8,192	6	63
16,384	7	127

Select your required allocation block size from the left-hand column. This tells you which values of block shift and mask to enter into the disk parameter block.

The last of these three variables, the *extent mask*, depends not only on the block size but also on the total storage capacity of the logical disk. This latter consideration is only important for computing whether or not there will be fewer than 256 allocation blocks on the logical disk. Just divide the chosen allocation block size into the capacity of the logical disk and check whether you will have fewer than 256 blocks.

Keeping this answer and the allocation block size in mind, refer to Table 3-2 for the appropriate value for the extent mask field of the parameter block. Select the appropriate line according to the allocation block size you have chosen. Then, depending on the total number of allocation blocks in the logical disk, select the extent mask from the appropriate column.

Table 3-2. Extent Mask Value

Allocation Block Size	Number of Allocation Blocks	
	1 to 255	256 and Above
1,024	0	(Impossible)
2,048	1	0
4,096	3	1
8,192	7	3
16,384	15	7

Maximum Allocation Block Number This value is the *number* of the last allocation block in the logical disk. As the first block number is 0, this value is *one less* than the total number of allocation blocks on the disk. Where only a partial allocation block exists, the number of blocks is rounded down.

Figure 3-7 has an example for standard 8-inch, single-sided, single-density diskettes. Note that CP/M uses two reserved tracks on this diskette format.

Number of Directory Entries Minus 1 Do not confuse this entry with the number of files that can be stored on the logical disk; it is only the number of *entries* (minus one). Each extent of each file takes one directory entry, so very large files will consume several entries. Also note that the value in the table is *one less* than the number of entries.

On a standard 8-inch diskette, the value is 63 entries. On a hard disk, you may want to use 1023 or even 2047. Remember that CP/M performs a sequential scan down the directory and this takes a noticeable amount of time. Therefore, you should balance the number of logical disks with your estimate of the largest file size that you wish to support.

As a final note, make sure to choose a number of entries that fits evenly into one or more allocation blocks. Each directory entry needs 32 bytes, so you can compute the number of bytes required. Make sure this number can be divided by your chosen allocation block size without a remainder.

Allocation Blocks for the Directory This is a strange value; it is not a number, but a bit map. Looking at Figure 3-6, you see the example value written out in full as a binary value to illustrate how this value is defined. This 16-bit value has a bit set to 1 for each allocation block that is to be used for the file directory.

This value is derived from the number of directory entries you want to have on the disk and the size of the allocation block you want to use. One given, or

Physical characteristics:		Calculate:	
77	Tracks/Diskette	77	Tracks/Diskette
26	Sectors/Track	<u> - 2</u>	Tracks Reserved for CP/M
128	Bytes/Sector	75	Tracks for File Storage
2	Tracks Reserved for CP/M	<u> × 26</u>	Number of Sectors
1024	Bytes/Allocation Block	1950	Sectors for File Storage
		<u> × 128</u>	Bytes per Sector
		249,600	Bytes for File Storage
		<u> ÷ 1024</u>	Bytes/Allocation Block
		243.75	Total Number of Allocation Blocks
		242	Number of the last allocation block (rounded and based on first block being Block 0)

Figure 3-7. Computing the maximum allocation block number for standard diskettes

constant, in this derivation is that the size of each directory entry is 32 bytes.

In the example, 64 entries are required (remember the number shown is one less than the required value). Each entry has 32 bytes. The total number of bytes required for the directory thus is 64 times 32, or 2048 bytes. Dividing this by the allocation block size of 1024 indicates that two allocation blocks must be reserved for the directory. You can see that the example value shows this by setting the two most significant bits of the 16-bit value.

As a word of warning, do not be tempted to declare this value using a DW (define word) pseudo-operation. Doing so will store the value *byte-reversed*.

Size of Buffer for Directory Checking As mentioned before in the discussion of the disk parameter header, CP/M can be requested to check directory entries whenever it is working on the directory. In order to do this, CP/M needs a buffer area, called the *work area to check for changed diskettes*, or WACD, in which it can hold working variables that keep a compressed record of what is on the directory. The length of this buffer area is kept in the disk parameter block; its address is specified in the parameter header. Because CP/M keeps a compressed record of the directory, you need only provide one byte for every four directory entries. You can see in Figure 3-6 that 16 bytes are specified to keep track of the 64 directory entries.

Number of Tracks Before the Directory Figure 3-8 shows the layout of CP/M on a standard floppy diskette. You will see that the first two tracks are reserved, containing the initial bootstrap code and CP/M itself. Hence the example in Figure 3-6, giving the code for a standard floppy disk, shows two reserved tracks (the number of tracks before the directory).

This *track offset value*, as it is sometimes called, provides a convenient method of dividing a physical disk into several logical disks.

Special Considerations for Hard Disks

If you want to run CP/M on a hard disk, you must provide code and build tables that make CP/M work as if it were running on a very large floppy disk. You must even include 128-byte sectors. However, this is not difficult to do.

To adapt hard disks to the 128-byte sector size, you must provide code in the disk driver in your BIOS that will present the illusion of reading and writing 128-byte sectors even though it is really working on sectors of 512 bytes. This code is called the *blocking/deblocking* routine.

If hard disks have sector sizes other than 128 bytes, what of the number of sectors per track, and the number of tracks?

Hard disks come in all sizes. The situation is further confused by the disk controllers, the hardware that controls the disk. In many cases, you can think of the hard disk as just a series of sectors without any tracks at all. The controller, given a *relative* sector number by the BIOS, can translate this sector number into which track, read/write head (if there is more than one platter), and sector are actually being referenced.

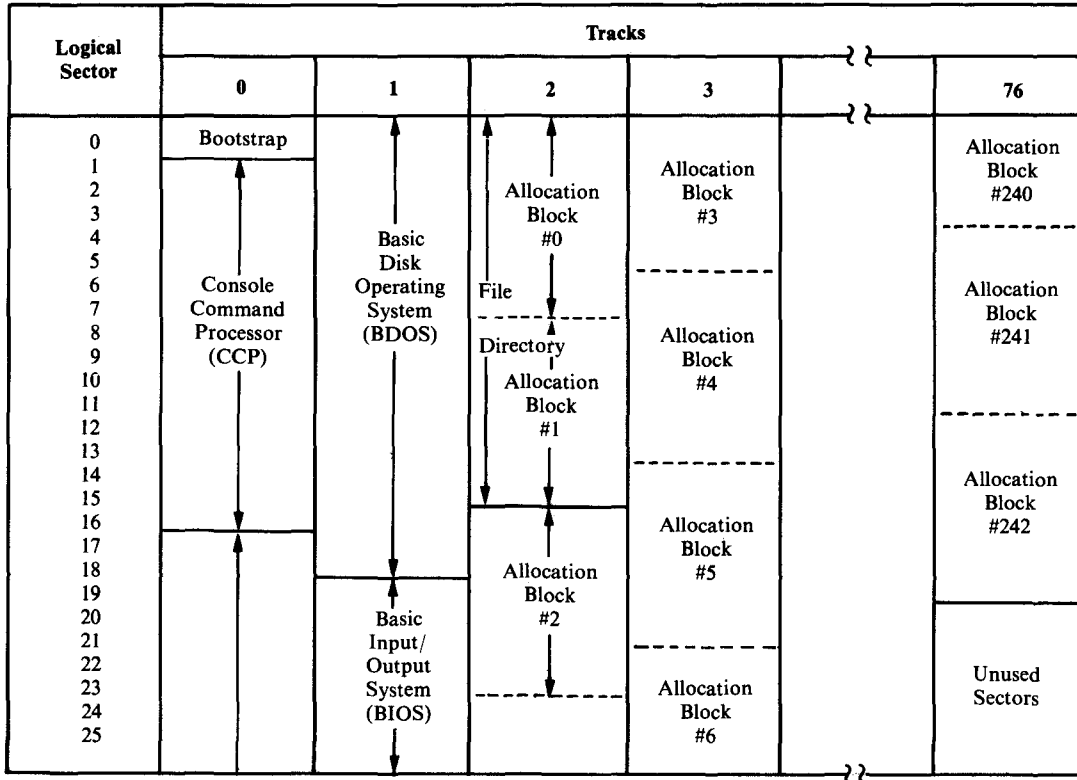

Figure 3-8. Layout of standard diskette

Furthermore, most hard disks rotate so rapidly that there is nothing to be gained by using a sector-skewing algorithm. There is just no way to read more than one physical sector per revolution; there is not enough time.

In many cases it is desirable to divide up a single, physical hard disk into several smaller, logical disks. This is done mainly for performance reasons: Several smaller disks, along with smaller directories, result in faster file operations.

The disk parameter header will have 0's for the skewtable entry and the pointer to the WACD buffer. In general, hard disks *cannot* be changed, at least not without turning off the power and swapping the entire disk drive. If you are using one of the new generation of removable hard disks, you will need to use the directory checking feature of CP/M.

The disk parameter block for a hard disk will be quite different from that used for a floppy diskette. The number of sectors per track needs careful consideration. Remember, this is the number of 128-byte sectors. The conversion from the physical sector size to 128-byte sectors will be done in the disk driver in the BIOS.

If you have a disk controller that works in terms of sectors and tracks, all you need do is compute the number of 128-byte sectors on each track. Multiply the number of physical sectors per track by their size in bytes and then divide the product by 128 to give the result as the number of 128-byte sectors per physical track.

But what of those controllers that view their hard disks as a series of sectors without reference to tracks? They obscure the fact that the sectors are arranged on concentric tracks on the disk's surface. In this case, you can play a trick on CP/M. You can set the "sectors per track" value to the number of 128-byte sectors that will fit into one of the disk's physical sectors. To do this, divide the physical sector size by 128. For example, a 512-byte physical sector size will give an answer of four 128-byte sectors per "track." You can now view the hard disk as having as many "tracks" as there are physical sectors. By using this method, you avoid having to do any kind of arithmetic on CP/M's sector numbers; the "track" number to which CP/M will ask your BIOS to move the disk heads will be the *relative physical sector*. Once the controller has read this physical sector for you, you can look at the 128-byte sector number, which will be 0, 1, 2, or 3 (for a 512-byte physical sector) in order to select which 128 bytes need to be moved in or out of the disk buffer.

The block shift, block mask, and extent mask will be computed as before. Use a 4096-byte allocation block size. This will yield a value of 5 for the block shift, 31 for the block mask, and given that you will have more than 256 allocation blocks for each logical disk, an extent mask value of 1.

The maximum allocation block number will be computed as before. Keep clear in your mind whether you are working with the number of physical sectors (which will be larger than 128 bytes) or with 128-byte sectors when you are computing the storage capacity of each logical disk.

The number of directory entries (less 1) is best set to 511 for logical disks of 1 megabyte and either 1023 or 2047 for larger disks. Remember that under CP/M version 2 you cannot have a logical disk larger than 8 megabytes.

The allocation blocks for the directory are also computed as described for floppy disks.

As a rule, the size of the directory check buffer (WADC) will be set to 0, since there is no need to use this feature on hard disk systems with fixed media.

The number of tracks before the directory (track offset) can be used to divide up the physical disk into smaller logical disks, as shown in Figure 3-9.

There is no rule that says the tracks before a logical disk's directory cannot be used to contain other complete logical disks. You can see this in Figure 3-9. CP/M behaves as if each logical disk starts at track 0 (and indeed they do), but by specifying increasingly larger numbers of tracks before each directory, the logical disks can be staggered across the available space on the physical disk.

Figure 3-10 shows the calculations involved in the first phase of building disk parameter blocks for the hard disk shown in Figure 3-9. The physical characteristics are those imposed by the design of the hard disk. As a programmer, you do not have any control over these; however, you can choose how much of the physical

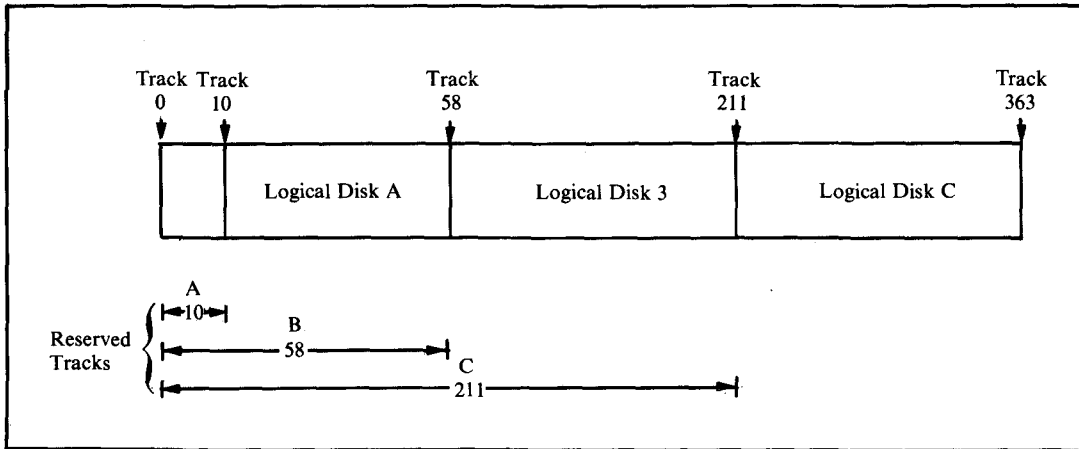

Figure 3-9. Dividing hard disks into logical disks

disk is assigned to each logical disk, the allocation block size, and the number of directory entries. You can see that logical disk A is much smaller than disks B and C, and that B and C are the same size. Disk A will be the systems disk from which most programs will be loaded, so its smaller directory size will make program loading much faster. The allocation block size for disk A is also smaller in order to reduce the amount of space wasted in partially filled allocation blocks.

Figure 3-10 also shows the calculations involved in computing the maximum allocation block number. Again, note that once the total number of allocation blocks has been computed, it is necessary to round it down in the case of any fractional components and then subtract 1 to get the maximum number (the first block being 0).

Figure 3-11 shows the actual values that will be put into the parameter blocks. It is assumed that the disk controller is one of those types that view the physical disk as a series of contiguous sectors and make no reference to tracks; the internal electronics and firmware in the controller take care of these details. For this reason, CP/M is told that each *physical* sector is a “track” in CP/M’s terms. Each “track” has 512 bytes and can therefore store four 128-byte sectors. You can see this is the value that is in the sectors/“track” field.

The block shift and mask values are obtained from Table 3-1, using the allocation block size previously chosen. Then, with both the allocation block size and the maximum number of allocation blocks (see Figure 3-10), the extent mask can be obtained from Table 3-2. You can see in Figure 3-11 that extent mask values of 1 were obtained for all three logical disks even though two different allocation block sizes have been chosen, and even though disk A has less than 256 blocks and disks B and C have more.

Physical Characteristics:			Calculate:		
364	Tracks/Disk		A:	B: and C:	
20	Sectors/Track		48	153	Tracks assigned to Disk
512	Bytes/Sector		<u>×10,240</u>	<u>×10,240</u>	Bytes/Track
10,240	Bytes/Track		491,520	1,566,720	Bytes/Disk
			<u>÷ 2048</u>	<u>÷ 4096</u>	Bytes/Allocation Block
Chosen Logical Characteristics:			240	382.5	Number of Allocation Blocks
			239	381	Maximum Block Number
	Tracks	Allocation Block Size			
Reserved Area	10	n/a			
Disk A:	48	2048			
Disk B:	153	4096			
Disk C:	153	4096			

Figure 3-10. Computing the maximum allocation block number for a hard disk

DPBA:	DPBB:	DPBC:	
4	4	4	;128-byte sectors/"track"
4	5	5	;Block shift
15	31	31	;Block mask
1	1	1	;Extent mask
239	381	381	;Max. all. block #
255	1023	1023	;No. of directory entries
11110000B	11111111B	11111111B	;Bit Map for allocation blocks
00000000B	00000000B	00000000B	; used for directory
0	0	0	;No. of bytes in dir.check buffer
(10)	(58)	(211)	;Actual tracks before directory
200	1160	4220	; "Tracks" before directory

Figure 3-11. Disk parameter tables for a hard disk

The bit map showing how many allocation blocks are required to hold the file directory is computed by multiplying the number of directory entries by 32 and dividing the product by the allocation block size. This yields results of 4 for disk A and 8 for disks B and C. As you can see, the bit maps have the appropriate number of bits set.

Since most of the hard disks on the market today do not have removable media, the lengths of the directory checking buffer are set to 0.

The number of "tracks" before the directory requires a final touch of skull-duggery. Having already indicated to CP/M that each "track" has four sectors, you need to continue in the same vein and express the number of real tracks before the directories in units of 512-byte physical sectors.

As a final note, if you are specifying these parameter blocks for a disk controller that requires you to communicate with it in terms of physical tracks and 128-byte sectors, then the number of sectors per track must be set to 80 (twenty

512-byte sectors per physical track). You would also have to change the number of tracks before the directory by stating the number of physical tracks (shown in parentheses on Figure 3-11).

Adding Additional Information to the Parameter Block

Normally, some additional information must be associated with each logical disk. For example, in a system that has several physical disks, you need to identify where each *logical* disk resides. You may also want to identify some other *physical* parameters, disk drive types, I/O port numbers, and addresses of driver sub-routines.

You may be tempted to extend the disk parameter header entry because there is a separate header entry for each logical disk. But the disk parameter header is exactly 16 bytes long; adding more bytes makes the arithmetic that we need to use in the BIOS awkward. The best place to put these kinds of information is to *prefix* them to the front of each disk parameter block. The label at the front of the block must be left in the same place lest CP/M become confused. Only special additional code that you write will be “smart” enough to look *in front* of the block in order to find the additional parameter information.

File Organizations

CP/M supports two types of files: sequential and random. CP/M views both types as made up of a series of 128-byte *records*. Note that in CP/M's terms, a record is the same as a 128-byte sector. This terminology sometimes gets in the way. It may help to think of 128-byte sectors as *physical* records. Applications programs manipulate *logical* records that bear little or no relation to these physical records. There is code in the applications programs to manipulate logical records.

CP/M does not impose any restrictions on the contents of a file. In many cases, though, certain conventions are used when textual data is stored. Each line of text is terminated by ASCII CARRIAGE RETURN and LINE FEED. The last sector of a text file is filled with ASCII SUB characters; in hexadecimal this is 1AH.

File Control Blocks

In order to get CP/M to work on a file, you need to provide a structure in which both you and the BDOS can keep relevant details about the file, its name and type, and so on. The file control block (FCB) is a derivative of the file directory entry, as you can see in Figure 3-12. This figure shows both a series of equates that can be used to access an entry and a series of DB (define byte) instructions to declare an example.

The first difference you will see between the file directory entry and the FCB is that the very first byte is serving a different purpose. In the FCB, it is used to

specify on which disk the file is to be found. You may recall that in the directory, this byte indicates the user number for a given entry. When you are actually processing files, the current user number is set either by the operator in a command from the console or by a BDOS function call; this predefines which subset of files in the directory will be processed. Therefore, the FCB does not need to keep track of the user number.

The disk number in the FCB's first byte is stored in an odd way. A value of 0 indicates to CP/M that it should look for the file on the current default disk. This default disk is selected either by an entry from the console or by making a specific BDOS call from within a program. In general, the default disk should be preset to the disk that contains the set of programs with which you are working. This avoids unnecessary typing on the keyboard when you want to load a program.

A disk number value other than 0 represents a letter of the alphabet based on a simple codification scheme of A = 1, B = 2, and so on.

As you can see from Figure 3-12, the file name and type must be set to the required values, and for sequential file processing, the remainder of the FCB can be set to zeros. Strictly speaking, the last three bytes of the FCB (the random record number and the random record overflow byte) need not even be declared if you are never going to process the file randomly.

This raises a subtle conceptual point. Random files are only random files because *you* process them randomly. Though this sounds like a truism, what it means is that CP/M's files are not intrinsically random or sequential. What they are depends on how you choose to process them at any given point. Therefore,

0000 =	FCBE#DISK	EQU	0	;Disk drive (0 = default, 1=A)
0001 =	FCBE#NAME	EQU	1	;File name (8 bytes)
0009 =	FCBE#TYP	EQU	9	;File type
				;Offsets for bits used in type
0009 =	FCBE#RO	EQU	9	;Bit 7 = 1 - read only
000A =	FCBE#SYS	EQU	10	;Bit 7 = 1 - system status
000B =	FCBE#CHANGE	EQU	11	;Bit 7 = 0 - file written to
				;
000C =	FCBE#EXTENT	EQU	12	;Extent number
				;13, 14 reserved for CP/M
000F =	FCBE#RECUSED	EQU	15	;Records used in this extent
0010 =	FCBE#ABUSED	EQU	16	;Allocation blocks used
0020 =	FCBE#SEQREC	EQU	32	;Sequential rec. to read/write
0021 =	FCBE#RANREC	EQU	33	;Random rec. to read/write
0023 =	FCBE#RANRECO	EQU	35	;Random rec. overflow byte (MS)
				;
				;
0000 00	FCB#DISK:	DB	0	;Search on default disk drive
0001 46494C454E	FCB#NAME:	DB	'FILENAME'	;File name
0009 545950	FCB#TYP:	DB	'TYP'	;File type
000C 00	FCB#EXTENT:	DB	0	;Extent
000D 0000	FCB#RESV:	DB	0,0	;Reserved for CP/M
000F 00	FCB#RECUSED:	DB	0	;Records used in this extent
0010 0000000000	FCB#ABUSED:	DB	0,0,0,0,0,0,0,0	;Allocation blocks used
0018 0000000000		DB	0,0,0,0,0,0,0,0	
0020 00	FCB#SEQREC:	DB	0	;Sequential rec. to read/write
0021 0000	FCB#RANREC:	DW	0	;Random rec. to read/write
0023 00	FCB#RANRECO:	DB	0	;Random rec. overflow byte (MS)

Figure 3-12. Data declarations for the FCB

while the manner in which you process them will be different, there is nothing special built into the file that predicates how it will be used.

Sequential Files

A sequential file begins at the beginning and ends at the end. You can view it as a contiguous series of 128-byte “records.”

In order to create a sequential file, you must declare a file control block with the required file name and type and request the BDOS to *create* the file. You can then request the BDOS to write, “record” by “record” (really 128-byte sector by 128-byte sector) into the file. The BDOS will take care of opening up new extents as it needs to. When you have written out all the data, you must make a BDOS request to close the file.

To read an existing file, you also need an FCB with the required file name and type declared. You then make a BDOS request to open the file for processing and a series of Read Sequential requests, each one bringing in the next “record” until either your program detects an end of file condition (by examining the data coming in from the file) or the BDOS discovers that there are no more sectors in the file to read. There is no need to close a file from which you have been reading data — but *do close it*. This is not necessary if you are going to run the program only under CP/M, but it is necessary if you want to run under MP/M (the multiuser version of CP/M).

What if you need to append further information to an existing file? One option is to create a new file, copy the existing file to the new one, and then start adding data to the end of the new file. Fortunately, with CP/M this is not necessary. In the FCB used to read a file, the name and the type were specified, but you can also specify the extent number. If you do, the BDOS will proceed to open (if it can find it) the extent number that you are asking for. If the BDOS opens the extent successfully, all you need do is check if the number of records used in the extent (held in the field FCB\$RECUSED) is less than 128 (80H). This indicates the extent is not full. By taking this record number and placing it into the FCB\$SEQREC (sequential record number) byte in the FCB, you can make CP/M *jump ahead* and start writing from the effective end of the file.

Random Files

Random files use a simple variation of the technique described above. The main difference is that the random record number must be set in the FCB. The BDOS automatically keeps track of file extents during Read/Write Random requests. (These requests are explained more fully in Chapter 5.)

Conceptually, random files need a small mind-twist. After creating a file as described earlier, you must set the random record number in the FCB before each Write Random request. This is the two-byte value called FCB\$RANREC in Figure 3-12. Then, when you give the Write Random request to the BDOS, it will

look at the record number; compute in which extent the record must exist; if necessary, create the directory entry for the extent; and finally, write out the data record. Using this scheme, you can dart backward and forward in the file putting records at random throughout the file space, with CP/M creating the necessary directory entries each time you venture into a part of the file that has not yet been written to.

The same technique is used to read a file randomly. You set the random record number in the FCB and then give a system call to the BDOS to open the correct extent and read the data. The BDOS will return an error if it cannot find the required extent or if the particular record is nonexistent.

Problems lie in wait for the unwary. Before starting to do any random reading or writing, you must open up the file at extent 0 even though this extent may not contain any data records. For a new file, this can be done with the Create File request, and for an existing file with the normal Open File request. If you create a *sparse* file, one that has gaps in between the data, you may have some problems manipulating the file. It will appear to have several extents, each one being partially full. This will fool some programs that normally process sequential files; they don't expect to see a partial extent except at the end of a file, and may treat the wrong spot as the end.

Functions of the CCP
Editing the CCP Command Line
Built-In Commands
Program Loading
Base Page
Memory Dumps of the Base Page
Processing the Command Tail
Available Memory
Communicating with the BIOS
Returning to CP/M

4

The Console Command Processor (CCP)

The Console Command Processor processes commands that you enter from the console. As you may recall from the brief overview in Chapter 2, the CCP is loaded into memory immediately below the BDOS. In practice, many programs deliberately overwrite the CCP in order to use the memory it normally occupies. This gives these programs an additional 800H bytes (2K bytes).

When one of these “transient programs” terminates, it relinquishes control to the BIOS, which in turn reloads a fresh copy of the CCP from the system tracks of the disk back into memory and then transfers control to it. Consequently, the CCP leads a sporadic existence—an endless series of being loaded into memory, accepting a command from you at the console, being overwritten by the program

you requested to be loaded, and then being brought back into memory when the program terminates.

This chapter discusses what the CCP does for you in those brief periods when it is in memory.

Functions of the CCP

Simply put, once the CCP has control of the machine, so do you. The CCP announces its presence by displaying a prompt of two characters: a letter of the alphabet for the current default disk drive and a “greater than” sign. In the example A>, the A tells you that the default disk drive is currently set to be logical drive A, and the “>,” that the message was output by the CCP.

Once you see the prompt, the CCP is ready for you to enter a command line. A command line consists of two major parts: the name of the command and, optionally, some values for the command. This last part is known as the *command tail*.

The command itself can be one of two things: either the name of a file or the name of one of the frequently used commands built into the CCP.

If you enter the name of one of the built-in commands, the CCP does not need to go out to the disk system in order to load the command for execution. The executable code is already inside the CCP.

If the name of the command you entered does not match any of the built-in commands (the CCP has a table of their names), the CCP will search the appropriate logical disk drive for a file with a matching name and a file type of “COM” (which is short for command). You do not enter “.COM” when invoking a command—the CCP assumes a file type of “COM.”

If you do not precede the name of the COM file with a logical disk drive specification, the CCP will search the current default drive. If you have prefixed the COM file's name with a specific logical drive, the CCP will look only on that drive for the program. For example, the command MYPROG will cause the CCP to look for a file called “MYPROG.COM” on the current default drive, whereas C:MYPROG would make the CCP search only on drive C.

If you enter a command name that matches neither the CCP's built-in command table nor the name of any COM file on the specified disk, the CCP will output the command name followed by a question mark, indicating it is unable to find the file.

Editing the CCP Command Line

The CCP uses a line buffer to store what you type until you strike either a CARRIAGE RETURN or a LINE FEED. If you make an error or change your mind, you can modify the incomplete command, even to the point of discarding it.

You edit the command line by entering *control characters* from the console. Control characters are designated either by the combination of keys required to generate them from the keyboard or by their official name in the ASCII character set. For example, CONTROL-J is also known as CARRIAGE RETURN or CR.

Whenever CP/M has to represent control characters, the convention is to indicate the “control” aspect of a character with a caret (“^”). For example, CONTROL-A will appear as “^A”, CONTROL-Z as “^Z”, and so on. But if you press the CONTROL key with the normal shift key and the “6” key, this will produce a CONTROL-^ or “^^”. The representation of control keys with the caret is only necessary when outputting to the console or the printer — internally, these characters are held as their appropriate binary values.

CONTROL-C: Warm Boot If you enter a CONTROL-C as the first character of a command line, the CCP will initiate a warm boot operation. This operation resets CP/M completely, including the disk system. A fresh copy of the CCP is loaded into memory and the file directory of the current default disk drive is scanned, rebuilding the allocation bit map held in the BIOS (as discussed in Chapter 3).

The only time you would initiate a warm boot operation is after you have changed a diskette (or a disk, if you have removable media hard disks). Thus, CP/M will reset the disk system.

Note that a CONTROL-C only initiates a warm boot if it is the first character on a command line. If you enter it in any other position, the CCP will just echo it to the screen as “^C”. If you have already entered several characters on a command line, use CONTROL-U or CONTROL-X to cancel the line, and then use CONTROL-C to initiate a warm boot. You can tell a warm boot has occurred because there will be a noticeable pause after the CONTROL-C before the next prompt is displayed. The system needs a finite length of time to scan the file directory and rebuild the allocation bit map.

CONTROL-E: Physical End-of-Line The CONTROL-E command is a relic of the days of the teletype and terminals that did not perform an automatic carriage return and line feed when the cursor went off the screen to the right. When you type a CONTROL-E, CP/M sends a CARRIAGE RETURN/LINE FEED command to the console, but does not start to execute the command line you have typed thus far. CONTROL-E is, in effect, a *physical* end-of-line, not a *logical* one.

As you can see, you will need to use this command only if your terminal either overprints (if it is a hard copy device) or does not wrap around when the cursor gets to the right-hand end of the line.

CONTROL-H: Backspace The CONTROL-H command is the ASCII backspace character. When you type it, the CCP will “destructively” backspace the cursor. Use it to correct typing errors you discover before you finish entering the command line. The last character you typed will disappear from the screen. The CCP does this by sending a three-character sequence of backspace, space, backspace to the console.

The CCP ignores attempts to backspace over its own prompt. It also takes care of backspacing over control characters that take two character positions on the line. The CCP sends the character sequence backspace, backspace, space, space, backspace, backspace, erasing both characters.

CONTROL-J: Line Feed/CONTROL-M: Carriage Return The CONTROL-J command is the ASCII LINE FEED character; CONTROL-M is the CARRIAGE RETURN. Both of these characters terminate the command line. The CCP will then execute the command.

CONTROL-P: Printer Echo The CONTROL-P command is used to turn on and off a feature called *printer echo*. When it is turned on, every character sent to the console is also sent to CP/M's list device. You can use this command to get a hard copy of information that normally goes only to the console.

CONTROL-P is a "toggle." The first time you type CONTROL-P it turns on printer echo; the next time you type CONTROL-P it turns off printer echo. Whenever CP/M does a warm boot, printer echo is turned off.

There is no easy way to know whether printer echo is on or off. Try typing a few CARRIAGE RETURNS, and see whether the printer responds; if it does not, type CONTROL-P and try again.

One of the shortcomings in most CP/M implementations is that the printer drivers (the software in the BIOS that controls or "drives" the printer) do not behave very intelligently if the printer is switched off or not ready when you or your program asks it to print. Under these circumstances, the software will wait forever and the system will appear to be dead. So if you "hang" the system in this way when you type a CONTROL-P, check that the printer is turned on and ready. Otherwise, you may have to reset the entire system.

CONTROL-R: Repeat Command Line The CONTROL-R command makes the CCP repeat or retype the current input line. The CCP outputs a "#" character, a CARRIAGE RETURN/LINE FEED, and then the entire contents of the command line buffer. This is a useful feature if you are working on a teletype or other hard copy terminal and have used the RUB or DEL characters. Since these characters do not destructively delete a character, you can get a visually confusing line of text on the terminal. The CONTROL-R character gives you a fresh copy of the line without any of the logically deleted characters cluttering it up. In this way you can see exactly what you have typed into the command line buffer.

See the discussion of the RUB and DEL characters for an example of CONTROL-R in use.

CONTROL-S: Stop Screen Output The CONTROL-S command is the ASCII XOFF (also called DC3) character; XOFF is an abbreviation for "Transmit Off." Typing CONTROL-S will temporarily stop output to the console. In a standard version of

CP/M, the CCP will resume output when *any* character is entered (including another CONTROL-S) from the console. Thus, you can use CONTROL-S as a toggle switch to turn console output on and off.

In some implementations of CP/M, the console driver itself (the low-level code in the BIOS that controls the console) will be maintaining a communication protocol with the console; therefore, a better way of resuming console output after pausing with a CONTROL-S is to use CONTROL-Q, the ASCII XON or “Transmit On” character. Entering a CONTROL-Q instead of relying on the fact that *any* character may be used to continue the output is a fail-safe measure.

The commands CONTROL-S and CONTROL-Q are most useful when you have large amounts of data on the screen. By “riding” the CONTROL-S and CONTROL-Q keys, you can let the data come to the screen in small bursts that you can easily scan.

CONTROL-U or CONTROL-X: Undo Command Line The commands CONTROL-U and CONTROL-X perform the same function: They erase the current partially entered command line so that you can undo any mistakes and start over. The CONTROL-U command was originally intended for hard copy terminals. The CCP outputs a “#” character, then a CARRIAGE RETURN/LINE FEED, and then some blanks to leave the cursor lined up and ready for you to enter the next command line. It leaves what you originally entered in the previous line on the screen. The CONTROL-X command is more suited to screens; the CCP destructively backspaces to the beginning of the command line so that you can reenter it.

RUB or DEL: Delete Last Character The rubout or delete function (keys marked RUB, RUBOUT, DEL, or DELETE) nondestructively deletes the last character that you typed. That is, it deletes the last character from the command line buffer and echoes it back to the console.

Here is an example of a command line with the last few characters deleted using the RUB key:

```
A>RUN PAYROLLLLORYAPSALES
          ^^^^^^^
          DELeted
```

You can see that the command line very quickly becomes unreadable. If you lose track of what are data characters and what has been deleted, you can use CONTROL-R to get a fresh copy of what is in the command line buffer.

The example above would then appear as follows:

```
A>RUN PAYROLLLLORYAPSALES#
  RUN SALES_
```

The “#” character is output by the CCP to indicate that the line has been

repeated. The “_” represents the position of the cursor, which is now ready to continue with the command line.

Built-In Commands

When you enter a command line and press either CARRIAGE RETURN or LINE FEED, the CCP will check if the command name is one of the set of built-in commands. (It has a small table of command names embedded in it, against which the entered command name is checked.) If the command name matches a built-in one, the CCP executes the command immediately.

The next few sections describe the built-in commands that are available; however, refer to *Osborne CP/M User Guide*, second edition by Thom Hogan (Berkeley: Osborne/McGraw-Hill, 1982) for a more comprehensive discussion with examples of the various forms of each command.

X: — Changing Default Disk Drives The default drive is the currently active drive that CP/M uses for all file access whenever you do not nominate a specific drive. If you wish to change the default drive, simply enter the new default drive's identifying letter followed by a colon. The CCP responds by changing the name of the disk that appears in the prompt line.

On hard disks, this simple operation may take a second or two to complete because the BDOS, requested by the CCP to log in the drive, must read through the disk directory and rebuild the allocation vector for the disk. If you have a diskette or a disk that is removable, changing it and performing a warm boot has the same effect of refreshing CP/M's image of which allocation blocks are used and which are available. It takes longer on a hard disk because, as a rule, the directories are much larger.

DIR — Directory of Files In its simplest form, the DIR command displays a listing of the files set to Directory status in the current user number (or file group) on the current default drive. Therefore, when you do not ask for any files after the DIR command, a file name of “*.*” is assumed. This is a total wildcard, so all files that have not been given System status will be displayed. This is the only built-in command where an omitted file name reference expands to “all file names, all file types.”

You can display the directory of a different drive by specifying the drive in the same command line as the DIR command.

You can qualify the files you want displayed by entering a unique or ambiguous file name or extension. Only those files that match the given file name specification will be displayed, and even then, only those files that are not set to System status will appear on the screen. (The standard CP/M utility program STAT can be used to change files from SYS to DIR status.)

Another side effect of the DIR command and files that are SYS status is best illustrated by an example. Imagine that the current logical drive B has two files on it called SYSFILE (which has SYS status) and NONSYS (which does not). Look at the following console dialog, in which user input is underlined:

```
B>DIR<cr>
B: NONSYS                SYSFILE does not show
B>DIR JUNK<cr>
NO FILE                 JUNK does not exist
B>DIR SYSFILE<cr>
B>_
```

Do you see the problem? If a file is not on the disk, the CCP will display NO FILE (or NOT FOUND in earlier versions of CP/M). However, if the file *does* exist but is a SYS file, the CCP does not display it because of its status; nor does the CCP say NO FILE. Instead it quietly returns to the prompt. This can be confusing if you are searching for a file that happens to be set to SYS status. The only safe way to find out if the file does exist is to use the STAT utility.

ERA — Erase a File The ERA command logically removes files from the disk (*logically* because only the file directory is affected; the actual data blocks are not changed).

The logical delete changes the first byte of each directory entry belonging to a file to a value of 0E5H. As you may recall from the discussion on the file directory entry in Chapter 3, this first byte usually contains the file user number. If it is set to 0E5H, it marks the entry as being deleted.

ERA makes a complete pass down the file directory to logically delete all of the extents of the file.

Unlike DIR, the ERA command does not assume “all files, all types” if you omit a file name. If it did, it would be all too easy to erase all of your files by accident. You must enter “*.*” to erase all files, and even then, you must reassure the CCP that you really want to erase all of them from the disk. The actual dialog looks like the following:

```
A>era b:*.*<cr>
ALL (Y/N)?y<cr>
A>_
```

If you change your mind at the last minute, you can press “n” and the CCP will not erase any files.

One flaw in CP/M is that the ERA command only asks for confirmation when you attempt to erase all of your files using a name such as “*.*” or “*.???”. Consider the impact of the following command:

```
A>ERA *.C???<cr>
A>_
```

The CCP with no hesitation has wiped out all files that have a file type starting with the letter “C” in the current user number on logical disk A.

If you need to use an ambiguous file name in an ERA command, check which files you will delete by first using a STAT command with exactly the same ambiguous file name. STAT will show you all the files that match the ambiguous name, even those with SYS status that would not be displayed by a DIR command.

There are several utility programs on the market with names like UNERA or WHOOPS, which take an ambiguous file name and reinstate the files that you may have accidentally erased. A design for a version of UNERASE is discussed in Chapter 11.

If you attempt to erase a file that is not on the specified drive, the CCP will respond with a NO FILE message.

REN — Rename a File The REN command renames a file, changing the file name, the file type, or both. In order to rename, you need to enter two file names, the new name and the current file name.

To remember the correct name format, think of the phrase *new = old*. The actual command syntax is

```
A>ren newfile.typ=oldfile.typ<cr>
A>_
```

You can use a logical disk drive letter to specify on which drive the file exists. If you specify the drive, you only need to enter it on one of the file names. If you enter the drive with both file names, it must be the same letter for both.

Unlike the previous built-in command, REN cannot be used with ambiguous file names. If you try, the CCP echoes back the ambiguous names and a question mark, as in the following dialog:

```
A>ren chap*.doc=chapter*.doc<cr>
CHAP*.DOC=CHAPTER*.DOC?
A>_
```

If the REN command cannot find the old file, it will respond NO FILE. If the new file already exists, the message FILE EXISTS will be displayed. If you receive a FILE EXISTS message and want to check that the new file does exist, remember that it is better to use the STAT command than DIR. The extant file may be declared to be SYS status and therefore will not appear if you use the DIR command.

TYPE — Type a Text File The TYPE command copies the specified file to the console. You cannot use ambiguous file names, and you will need to press CONTROL-S if the file has more data than can fill one screen. With the TYPE command, the data in the file will fly past on the screen unless you stop the display by pressing CONTROL-S. Be careful, because if you type any other character, the TYPE command will abort and return control to the CCP.

Once you have had time to see what is displayed on the screen, you can press CONTROL-Q to resume the output of data to the console. With standard CP/M implementations, you will discover that any character can be used to restart the flow of data; however, use CONTROL-Q as a fail-safe measure. CONTROL-S (X-OFF) and CONTROL-Q (X-ON) conform to the standard protocol which should be used.

If you need to get hard copy output of the contents of the file, you should type a CONTROL-P command before you press the CARRIAGE RETURN at the end of the TYPE command line.

As you may have inferred, the TYPE command should only be used to output ASCII text files. If for some reason you use the TYPE command with a file that contains binary information, strange characters will appear on the screen. In fact, you may program your terminal into some state that can only be remedied by turning the power off and then on again. The general rule therefore is *only* use the TYPE command with ASCII text files.

SAVE — Save Memory Image on Disk The SAVE command is the hardest of the CCP's commands to explain. It is more useful to the programmer than to a typical end user. The format of this command is

```
A>SAVE n FILENAME.TYP<cr>
A>_
```

The SAVE command creates a file of the specified name and type (or overwrites an existing file of this name and type), and writes into it the specified number *n* of memory pages. A page in CP/M is 256 (100H) bytes. The SAVE command starts writing out memory from location 100H, the start of the Transient Program Area (TPA). Before you use this command, you will normally have loaded a program into the TPA. The SAVE command does just what its name implies: It saves an image of the program onto a disk file.

More often than not, when you use the SAVE command the file type will be ".COM." With the file saved in this way, the CCP will be able to load and execute the file.

USER — Change User Numbers As mentioned before, the directory of each logical disk consists of several directories that are physically interwoven but logically separated by the user number. When you use a specific user number, those files that were created when you were in another user number are logically not available to you.

The USER command provides a way for you to move from one user number to another. The command format is

```
A>USER n<cr>
A>_
```

where *n* can be any number from 0 to 15. Any other number will provoke the CCP to echoing back your entry, followed by a question mark.

But once you have switched back and forth between user numbers several times, it is easy to become confused about which user number you are in. The STAT command can be used to find the current user number. If you are in a user number that does not make a copy of STAT available to you however, all you can do is use the USER command to set yourself to another user number. You cannot find out which user number you were in; you can only tell the system the user number you want to go to.

In the custom BIOS systems discussed later, there is a way of displaying the current user number each time a warm boot occurs. If you are building a system in which you plan to utilize CP/M's user number features, you should give this display of the current user number serious thought. If you are in the wrong user number and erase files, you can create serious problems.

Some implementations of CP/M have modified the CCP so that the prompt shows the current user number as well as the default drive (similar to the prompt used in MP/M). However, this use of a nonstandard CCP is not a good practice. As a rule, customization should be confined to the BIOS.

Program Loading

The first area to consider when loading a program is the first 100H bytes of memory, called the *base page*. Several fields — units in this area of memory — are set to predetermined values before a program takes control.

To aid in this discussion, imagine a program called COPYFILE that copies one file to another. This program expects you to specify the source and destination file names on the command line. A typical command would read

```
A>copyfile tofile.typ fromfile.typ display
```

Notice the word “display.” COPYFILE will, if you specify the “display” option, output the contents of the source file (“fromfile.typ”) on the console as the transfer takes place.

When you press the CARRIAGE RETURN key at the end of the command line, the CCP will search the current default drive (“A” in the example) and load a file called COPYFILE.COM into memory starting at location 100H. The CCP then transfers control to location 100H — just past the base page — and COPYFILE starts executing.

Base Page

The base page normally starts from location 0000H in memory, but where there is other material in low memory addresses, it may start at a higher address. Figure 4-1 shows the assembly language code you will need to access the base page. RAM is assumed to start at location 0000H in this example.

```

0000 =    RAM      EQU    0      ;Start of RAM (and the base page)
                                ;You may need to change this to
                                ; some other value (e.g. 4300H)

0000      ;          ORG    RAM    ;Set location counter to RAM base
0000      WARMBOOT: DS    3      ;Contains a JMP to warm boot entry
                                ; in BIOS Jump vector table

                                ;
0002 =    BIOSPAGE EQU    RAM+2  ;BIOS Jump vector page

                                ;
0003      IOBYTE:  DS    1      ;Input/output redirection byte

                                ;
0004      CURUSER: DS    1      ;Current user (bits 7-4)
0004 =    CURDISK: EQU    CURUSER ;Default logical disk (bits 3-0)

                                ;
0005      BDOSE:   DS    3      ;Contains a JMP to BDOS entry
0007 =    TOPRAM   EQU    BDOSE+2 ;Top page of usable RAM

                                ;
0005C     ;          ORG    RAM+5CH ;Bypass unused locations

005C      FCB1:    DS    16     ;File control block #1
                                ;Note: if you use this FCB here
                                ; you will overwrite FCB2 below.

                                ;
006C      FCB2:    DS    16     ;File control block #2
                                ;You must move this to another
                                ; place before using it

                                ;
0080     ;          ORG    RAM+80H ;Bypass unused locations

                                ;
0080      COMTAIL: DS    1      ;Complete command tail
                                ;Count of the number of chars
                                ; in command tail (CR not incl.)
0081      COMTAIL#COUNT: DS 127 ;Characters in command tail
                                ; converted to uppercase and
                                ; without trailing carriage ret.

                                ;
0080     ;          ORG    RAM+80H ;Redefine command tail area

                                ;
0080      DMABUFFER: DS 128     ;Default "DMA" address used
                                ; as a 128-byte record buffer

                                ;
0100     ;          ORG    RAM+100H ;Bypass unused locations
                                ;Start of transient program area
                                ; into which programs are loaded.

```

Figure 4-1. Base page data declarations

Some versions of CP/M, such as the early Heathkit/Zenith system, have ROM from location 0000H to 42FFH. Digital Research, responding to market pressure, produced a version of CP/M that assumed RAM starting at 4300H. If you have one of these systems, you must add 4300H to all addresses in the following paragraphs *except* for those that refer to addresses at the top of memory. These will not be affected by the presence of ROM in low memory.

The individual values used in fields in the base page are described in the following sections.

Warmboot The three-byte *warmboot* field contains an instruction to jump up to the high end of RAM. This JMP instruction transfers control into the BIOS and triggers a warm boot operation. As mentioned before, a warm boot causes CP/M to reload the CCP and rebuild the allocation vector for the current default disk. If you need

to cause a warm boot from within one of your assembly language programs, code

```
JMP 0           ;Warm Boot
```

BIOSPAGE The BIOS has several different entry points; however, they are all clustered together at the beginning of the BIOS. The first few instructions of the BIOS look like the following:

```
JMP ENTRY1
JMP ENTRY2
JMP ENTRY3      ;and so on
```

Because of the way CP/M is put together, the first jump instruction *always* starts on a page boundary. Remember that a page is 256 (100H) bytes of memory, so a page boundary is an address where the least significant eight bits are zero. For example, the BIOS jump vector (as this set of JMPs is called) may start at an address such as F200H or E600H. The exact address is determined by the size of the BIOS.

By looking at the BIOSPAGE, the most significant byte of the address in the warmboot JMP instruction, the page address of the BIOS jump vector can be determined.

IOBYTE CP/M is based on a philosophy of separating the *physical* world from CP/M's own *logical* view of the world. This philosophy also applies to the character-oriented devices that CP/M supports.

The IOBYTE consists of four two-bit fields that can be used to assign a physical device to each of the logical ones. It is important to understand that the IOBYTE itself is just a passive data structure. Actual assignment occurs only when the physical device drivers examine the IOBYTE, interpreting its contents and selecting the correct physical drive for the cooperation of the BIOS. These device drivers are the low-level (that is, close to machine language) code in the BIOS that actually interfaces and controls the physical device.

The four *logical* devices that CP/M knows about are

1. *The console.* This is the device through which you communicate with CP/M. It is normally a terminal with a screen and a keyboard. The console is a bidirectional device: It can be used as a source for information (input) and a destination to which you can send information (output).

In CP/M terminology, the console is known by the symbolic name of "CON:". Note the ":"—this differentiates the device name from a disk file that might be called "CON."

2. *The list device.* This is normally a printer of some sort and is used to make hard copy listings. CP/M views the printer as an output device only. This creates problems for printers that need to tell CP/M they are busy, but this

problem can be remedied by adding code to the low-level printer driver. CP/M's name for this logical device is "LST:".

3. *The paper tape reader.* It is unusual to find a paper tape reader in use today. Originally, CP/M ran on an Intel Microcomputer Development System called the MDS-800, and this system had a paper tape reader. This device can be used only as a source for information. CP/M calls this logical device "RDR:".

4. *The paper tape punch.* This, too, is a relic from CP/M's early days and the MDS-800. In this case, the punch can be used only for output. The logical device name used by CP/M is "PUN:".

The physical arrangement of the IOBYTE fields is shown in Figure 4-2.

Each two-bit field can take on one of four values: 00, 01, 10, and 11. The particular value can be interpreted by the BIOS to mean a specific physical device, as shown in Table 4-1.

Although the actual interpretation of the IOBYTE is performed by the BIOS, the STAT utility can set the IOBYTE using the logical and physical device names, and PIP (Peripheral Interchange Program) can be used to copy data from one device to another. In addition, you can write a program that simply changes the

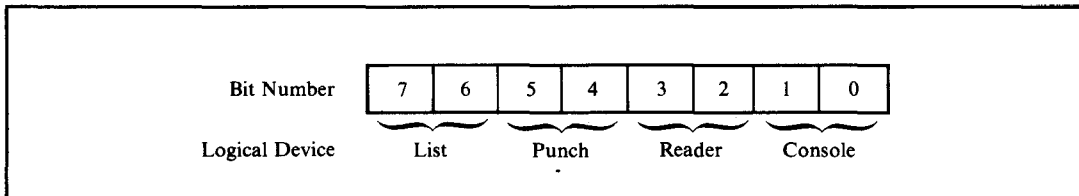

Figure 4-2. Arrangement of the IOBYTE

Table 4-1. IOBYTE Values

Logical Device	Physical Device			
	00	01	10	11
Console (CON:)	TTY:	CRT:	BAT:	UC1:
Reader (RDR:)	TTY:	PTR:	UR1:	UR2:
Punch (PUN:)	TTY:	PTP:	UP1:	UP2:
List (LST:)	TTY:	CRT:	LPT:	UL1:

contents of the IOBYTE. But be careful: Changes in the IOBYTE take effect immediately.

The values in the IOBYTE have the following meanings:

Console (CON:)

- 00 Teletype driver (TTY:)
This driver is assumed to be connected to a hard copy device being used as the main console.
- 01 CRT driver (CRT:)
The driver is assumed to be connected to a CRT terminal.
- 10 Batch mode (BAT:)
This is a rather special case. It is assumed that appropriate drivers will be called so that console input comes from the logical reader (RDR:) and console output is sent to the logical list device (LST:).
- 11 User defined console (UC1:)
Meaning depends on the individual BIOS implementation. If, for example, you have a high-resolution graphics screen, you could arrange for this setting of the IOBYTE to direct console output to it. You might make console input come in from some graphic tablet, joystick, or other device.

Reader (RDR:)

- 00 Teletype driver (TTY:)
This refers to the paper tape reader device that was often found on teletype consoles.
- 01 Paper tape reader (PTR:)
This presumes some kind of high-speed input device connected to the system. Modern systems rarely have such a device, so this setting is often used to connect the logical reader to the input side of a communications line.
- 10 User defined reader #1 (UR1:)
- 11 User defined reader #2 (UR2:)
Both of these settings can be used to direct the physical driver to some other specialized devices. These values are included only because they would otherwise have been unassigned. They are rarely used.

Punch (PUN:)

- 00 Teletype driver (TTY:)
This refers to the paper tape punch that was often found on teletype consoles.
- 01 Paper tape punch (PTP:)

This presumes that there is some kind of high-speed paper tape punch connected to the system. Again, this is rarely the case, so this setting is often used to connect the logical punch to the output side of a communications line.

- 10 User defined punch #1 (UP1:)
- 11 User defined punch #2 (UP2:)
These two settings correspond to the two user defined readers, but they are practically never used.

List (LST:)

- 00 Teletype driver (TTY:)
Output will be printed on a teletype.
- 01 CRT driver (CRT:)
Output will be directed to the screen on a CRT terminal.
- 10 Line printer driver (LPT:)
Output will go to a high-speed printing device. Although the name *line printer* implies a specific type of hardware, it can be any kind of printer.
- 11 User defined list device (UL1:)
Whoever writes the BIOS can arrange for this setting to cause logical list device output to go to a device other than the main printer.

To repeat: The IOBYTE is not actually used by the main body of CP/M. It is just a passive data structure that can be manipulated by the STAT utility. Whether the IOBYTE has any effect depends entirely on the particular BIOS implementation.

CURUSER The CURUSER field is the most significant four bits (high order nibble) of its byte. It contains the currently selected user number set by the CCP USER command, by a specific call to the BDOS, or by a program setting this nibble to the required value. This last way of changing user numbers may cause compatibility problems with future versions of CP/M, so use it only under controlled conditions.

CURDISK The CURDISK field is the least significant four bits of the byte it shares with CURUSER. It contains a value of 0 if the current disk is A:, 1 if it is B:, and so on. The CURDISK field can be set from the CCP, by a request to the BDOS, or by a program altering this field. The caveat given for CURUSER regarding compatibility also applies here.

BDOSE This three-byte field contains an instruction to jump to the entry point of the BDOS. Whenever you want the BDOS to do something, you can transfer the request to the BDOS by placing the appropriate values in registers and making a CALL to this JMP instruction. By using a CALL, the return address will be

placed on the stack. The subsequent JUMP to the BDOS does not put any additional information onto the stack, which operates on a last-in, first-out basis; so when the system returns from the BDOS, it will return directly to your program.

TOPRAM Because the BDOS, like the BIOS, starts on a page boundary, the most significant byte of the address of the BDOS entry tells you in which page the BDOS starts. You must subtract 1 from the value in TOPRAM to get the highest page number that you can use in your program. Note that when you use this technique, you assume that the CCP will be overwritten since it resides in memory just below the BDOS.

FCB1 and FCB2 As a convenience, the CCP takes the first two parameters that appear in the command tail (see next section), attempts to parse them as though they were file names, and places the results in FCB1 and FCB2. The results, in this context, mean that the logical disk letter is converted to its FCB representation, and the file name and type, converted to uppercase, are placed in the FCB in the correct bytes. In addition, any use of "*" in the file name is expanded to one or more question marks. For example, a file name of "abc*.*" will be converted to a name of "ABC?????" and type of "??".

Notice that FCB2 starts only 16 bytes above FCB1, yet a normal FCB is at least 33 bytes long (36 bytes if you want to use random access). In many cases, programs only require a single file name. Therefore, you can proceed to use FCB1 straight away, not caring that FCB2 will be overwritten.

In the case of the COPYFILE program example on previous pages, two file names are required. Before FCB1 can be used, the 16 bytes of FCB2 must be moved into a skeleton FCB that is declared in the body of COPYFILE itself.

COMTAIL The command tail is everything on the command line *other* than the command name itself. For example, the command tail in the COPYFILE command line is shown here:

```
A>copyfile tofile.type fromfile.typ display
```

The CCP takes the command tail (converted to uppercase) and stores it in the COMTAIL area.

COMTAIL\$COUNT This is a single-byte binary count of the number of characters in the command tail. The count does *not* include a trailing CARRIAGE RETURN or a blank between the command name and the command tail. For example, if you enter the command line

```
A>PRINT ABC*.*
```

the COMTAIL\$COUNT will be six, which is the number of characters in the string "ABC*.*".

COMTAIL\$CHARS These are the actual characters in the command tail. This field is not blank-filled, so you must use the COMTAIL\$COUNT in order to detect the end of the command tail.

DMA\$BUFFER In Figure 4-1, the DMA\$BUFFER is actually the same area of memory as the COMTAIL. This is a space-saving trick that works because most programs process the contents of the command tail before they do any disk input or output.

The DMA\$BUFFER is a sector buffer (hence it has a length of 128 bytes). The use of the acronym DMA (direct memory access) refers back to the Intel MDS-800. This system had hardware that could move data to and from diskettes by going directly to memory, bypassing the CPU completely. The term is still used even though you may have a computer system that does not use DMA for its disk I/O. You can substitute the idea of "the address to/from which data is read/written" in place of the DMA concept.

You can request CP/M to use a DMA address other than DMA\$BUFFER, but whenever the CCP is in control, the DMA address will be set back here.

TPA This is the *transient program area* into which the CCP loads programs. The TPA extends up to the base of the BDOS.

The TPA is also the starting address for the memory image that is saved on disk whenever you use the CCP SAVE command.

Memory Dumps of the Base Page

The following are printouts showing the contents of the base page (the first 100H bytes of memory) as the COPYFILE program will see it.

This is an example of the first 16 bytes of memory:

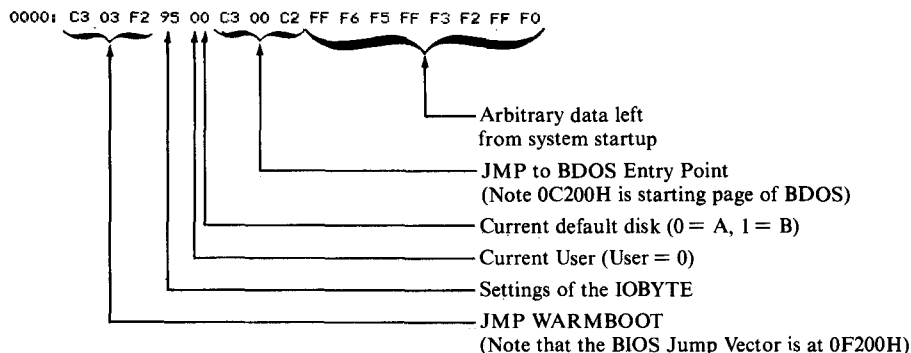

The command line, as you recall, was

```
A>copyfile tofile.typ fromfile.typ display
```

The FCB1 and FCB2 areas will be set by the CCP as follows:

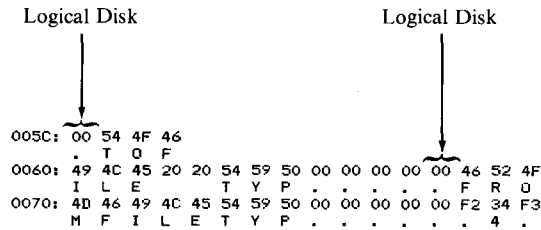

Since the logical disks were not specified in the file names in the command line, the CCP has set the disk code in both FCB1 and FCB2 to 00H, meaning "use the default disk." The file name and type have been converted to uppercase, separated, and put into the FCBs in their appointed places.

The complete command tail has been stored in COMTAIL as follows:

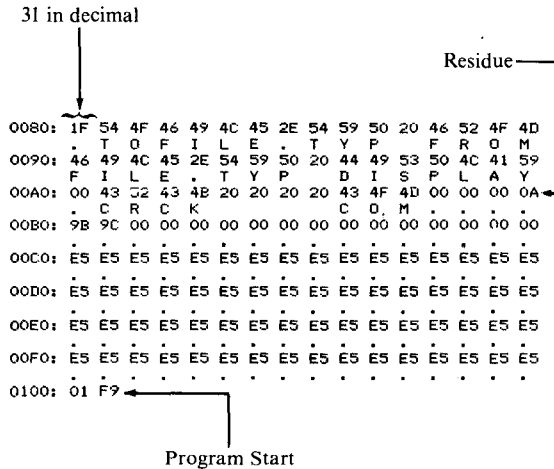

You can see that the command tail length is 01FH (31 decimal). This is followed immediately by the command tail characters themselves. Note that the command tail stops at location 9FH. The remainder of the data that you can see is the residue of some previous directory operation by the CCP. You can see the file name CRCK.COM in a directory entry, followed by several 0E5Hs that are unused directory space.

Finally, at location 0100H are the first two bytes of the program.

Processing the Command Tail

One of the first problems facing you if you write a program that can accept parameters from the command tail is to process the command tail itself, isolating each of the parameters. You should use a standard subroutine to do this. This subroutine splits the command line into individual parameters and returns a count of the number of parameters, as well as a pointer to a table of addresses. Each address in this table points in turn to a null-byte-terminated string. Each parameter is placed in a separate string.

Figure 4-3 contains the listing of this subroutine, CTP (Command Tail Processor).

```

0100          ORG    100H
0100 CD3601  START: CALL  CTP    ;Test bed for CTP
0103 00          NOP
                ; Remainder of your program

                ;
                ; This subroutine breaks the command tail apart, placing
                ; each value in a separate string area.
                ;
                ; Return parameters:
                ; A = 0 - No error (Z flag set)
                ; B = Count of number of Parameters
                ; HL -> Table of addresses
                ; Each address points to a null-byte-
                ; terminated parameter string.
                ; If too many parameters are specified, then A = TMP
                ; If a given parameter is too long, then A = PTL
                ; and D points to the first character of the
                ; offending parameter in the COMTAIL area.
                ;
0080 = COMTAIL EQU    80H    ;Command tail in base page
0080 = COMTAIL$COUNT EQU  COMTAIL ;Count of chars. in command tail
0001 = CTP$TMP EQU    1     ;Too many parameters error code
0002 = CTP$PTL EQU    2     ;Parameter too long error code
                ;
                ; PTABLE: ;Table of pointers to parameters
0104 0C01          DW    P1    ; Parameter 1
0106 1A01          DW    P2    ; Parameter 2
0108 2801          DW    P3    ; Parameter 3
                ; <--- Add more parameter addresses here
010A 0000          DW    0     ; Terminator
                ;
                ; Parameter strings.
                ; The first byte is 0 so that unused parameters appear
                ; to be null strings.
                ; The last byte of each is a 0 and is used to detect
                ; a parameter that is too long.
010C 0001010101P1: DB    0,1,1,1,1,1,1,1,1,1,1,1,1,1,1,0 ;Param. 1 & terminator
011A 0001010101P2: DB    0,1,1,1,1,1,1,1,1,1,1,1,1,1,1,0 ;Param. 2 & terminator
0128 0001010101P3: DB    0,1,1,1,1,1,1,1,1,1,1,1,1,1,1,0 ;Param. 3 & terminator
                ; <--- Add more parameter strings here
                ;
                ; CTP:
0136 210401        LXI    H,PTABLE ;Main entry point <<<<<
0139 0E00          MVI    C,0     ;HL -> table of addresses
013B 3A8000        LDA    COMTAIL$COUNT ;Set parameter count
013E B7           ORA    A         ;Character count
013F C8           RZ           ;Check if any params.
0140 E8           PUSH   H         ;Exit (return params. already set)
0141 47           MOV    B,A       ;Save on top of stack for later
0142 218100        LXI    H,COMTAIL+1 ;B = COMTAIL char. count
                ;HL -> Command tail chars.

```

Figure 4-3. Command Tail Processor (CTP)

```

CTP*NEXTP:
0145 E3      XTHL                ;Next parameter loop
                                ;HL -> Table of addresses
                                ;Top of stack = COMTAIL ptr.
0146 5E      MOV      E,M        ;Get LS byte of param. addr.
0147 23      INX      H          ;Update address pointer
0148 56      MOV      D,M        ;Get MS byte of param. addr.
                                ;DE -> Parameter string (or is 0)
0149 7A      MOV      A,D        ;Get copy of MS byte of addr.
014A B3      ORA      E          ;Combine MS and LS byte
014B CA8001  JZ      CTP*TMPX      ;Too many parameters--exit
014E 23      INX      H          ;Update pointer to next address
014F E3      XTHL                ;HL -> comtail
                                ;Top of stack--update addr. ptr.
                                ;At this point, we have
                                ; HL -> next byte in command tail
                                ; DE -> first byte of next parameter string

CTP*SKIPB:
0150 7E      MOV      A,M        ;Get next parameter byte
0151 23      INX      H          ;Update command tail ptr.
0152 05      DCR      B          ;Check if characters still remain
0153 FA7301  MB      CTPX        ;No, so exit
0156 FE20      CPI      / /        ;Check if blank
0158 CA5001  JZ      CTP*SKIPB    ;Yes, so skip blanks
015B 0C      INR      C          ;Increment parameter counter

CTP*NEXTC:
015C 12      STAX     D          ;Store in parameter string
015D 13      INX     D          ;Update parameter string ptr.
015E 1A      LDAX     D          ;Check next byte
015F B7      ORA     A          ;Check if terminator
0160 CA7A01  JZ      CTP*PTLX      ;Parameter too long exit
0163 AF      XRA     A          ;Float a 00-byte at end of param.
0164 12      STAX     D          ;Store in param. string
0165 7E      MOV     A,M        ;Get next character from tail
0166 23      INX     H          ;Update command tail pointer
0167 05      DCR     B          ;Check if characters still remain
0168 FA7301  JM      CTPX        ;No, so exit
016B FE20      CPI     / /        ;Check if parameter terminator
016D CA4501  JZ      CTP*NEXTP      ;Yes, so move to next parameter
0170 C35C01  JMP     CTP*NEXTC          ;No, so store it in param. string

;
CTPX:
0173 AF      XRA     A          ;Normal exit
                                ;A = 0 & Z-flag set

;
CTPCX:
0174 E1      POP     H          ;Balance stack
0175 210401  LXI     H,PTABLE          ;Return ptr. to param. addr. table
0178 B7      ORA     A          ;Ensure Z-flag set appropriately
0179 C9      RET

;
CTP*PTLX:
017A 3E02      MVI     A,CTP*PTL          ;Parameter too long exit
017C EB      XCHG          ;Set error code
017D C37401  JMP     CTPCX          ;DE -> offending parameter
                                ;Common exit

;
CTP*TMPX:
0180 3E01      MVI     A,CTP*TMP          ;Too many parameters exit
0182 C37401  JMP     CTPCX          ;Set error code
                                ;Common exit

;
0185      END     START

```

Figure 4-3. Command Tail Processor (CTP) (continued)

Available Memory

Many programs need to use all of available memory, and so very early in the program they need to set the stack pointer to the top end of the available RAM. As mentioned before, the CCP can be overwritten as it will be reloaded on the next warm boot.

Figure 4-4 shows the code used to set the stack pointer. This code determines the amount of memory in the TPA and sets the stack pointer to the top of available RAM.

Communicating with the BIOS

If you are writing a utility program to interact with a customized BIOS, there will be occasions where you need to make a *direct* BIOS call. However, if your program ends up on a system running Digital Research's MP/M Operating System, you will have serious problems if you try to call the BIOS directly. Among other things, you will crash the operating system.

If you need to make such a call and you are aware of the dangers of using direct BIOS calls, Figure 4-5 shows you one way to do it.

Remember that the first instructions in the BIOS are the jump vector—a sequence of JMP instructions one after the other. Before you can make a direct call, you need to know the *relative page offset* of the particular JMP instruction you want to go to. The BIOS jump vector always starts on a page boundary, so all you need to know is the least significant byte of its address.

```

0007 =      TOPRAM EQU    7      ;Most significant byte of
          ;                      BDOS entry point
0000 3A0700      LDA    TOPRAM ;Get MS byte of BDOS entry point
0003 3D          DCR    A      ;Back off one page
0004 2EFF        MVI    L,OFFH ;Set LS byte of final address
0006 67          MOV    H,A    ;HL = XXXFH
0007 F9          SPHL         ;Set stack pointer from HL

```

Figure 4-4. Setting stack pointer to top of available RAM

```

          ; Use this technique only for CP/M utility programs.
          ; MP/M programs do not permit this.
0009 =      CONIN  EQU    09H    ;Get console input character
          ;                      ; (It's the 4th jump in the vector)
0002 =      BIOSPAGE EQU    2    ;Address of BIOS page
          ;
          ; At this point you make a direct CONIN
          ; CALL...
          ;
0000 2E09        MVI    L,CONIN ;Get LS byte of CONIN entry point
0002 CD0500      CALL   BIOS    ;Go to BIOS entry subroutine
          ; ... the rest of your program...
          ;
          ; BIOS:
0005 3A0200      LDA    BIOSPAGE;Get BIOS jump vector page
0008 67          MOV    H,A    ;HL -> entry point
          ; (You set LS byte before coming here)
0009 E9          PCHL         ;"Jump" to BIOS
          ; Your return address is already
          ; on the stack

```

Figure 4-5. Making a direct BIOS call

```

; Note: This example assumes you have not
; overwritten the CCP.
;
0100          ORG    100H    ;Start at TPA
          START:
0100 210000    LXI    H,0    ;Save CCP's stack pointer
0103 39        DAD    SP    ;By adding it to 0 in HL
0104 220F01    SHLD   CCP*STACK
0107 314101    LXI    SP,LOCAL*STACK
;
; The main body of your program is here
;
; ... and when you are ready to return
; to the CCP...
010A 2A0F01    LHLD   CCP*STACK    ;Get CCP's stack pointer
010D F9        SPHL           ;Restore SP
010E C9        RET           ;Return to the CCP
;
010F          CCP*STACK:    DS    2    ;Save area for CCP SP
0111          LOCAL*STACK: DS    48   ;Local stack
0141          END    START

```

Figure 4-6. Returning to CCP at program end

Returning to CP/M

Once your program has run, you will need to return control back to CP/M. If your program has not overwritten the CCP and has left the stack pointer as it was when your program was entered, you can return directly to the CCP using a RET instruction.

Figure 4-6 shows how a normal program would do this if you use a local stack, one within the program. The CCP stack is too small; it has room for only 24 16-bit values.

The advantage of returning directly to the CCP is speed. This is true especially on a hard disk system, where the time needed to perform a warm boot is quite noticeable.

If your program has overwritten the CCP, you have no option but to transfer control to location 0000H and let the warm boot occur. To do this, all you need do is execute

```
EXIT:    JMP    0        ;Warm Boot
```

(As a hint, if you are testing a program and it suddenly exits back to CP/M, the odds are that it has inadvertently blundered to location 0000H and executed a warm boot.)

What the BDOS Does
BDOS Function Calls
Naming Conventions
Making a BDOS Function Request

5

The Basic Disk Operating System

The Basic Disk Operating System is the real heart of CP/M. Unlike the Console Command Processor, it must be in memory all the time. It provides all of the input/output services to CP/M programs, including the CCP.

As a general rule, unless you are writing a system-dependent utility program, you should use the BDOS for *all* of your program's input/output. If you circumvent the BDOS you will probably create problems for yourself later.

What the BDOS Does

The BDOS does all of the system input/output for you. These services can be grouped into two types of functions:

Simple Byte-by-Byte I/O

This is sending and receiving data between the computer system and its logical devices—the console, the “reader” and “punch” (or their substitutes), and the printer.

Disk File I/O

This covers such tasks as creating new files, deleting old files, opening existing files, and reading and writing 128-byte long “records” to and from these files.

The remainder of this chapter explains each of the BDOS functions, shows how to make each operating system request, and gives additional information for each function. You should also refer to Digital Research's manual, *CP/M 2 Interface Guide*, for their standard description of these functions.

BDOS Function Calls

The BDOS function calls are described in the order of their function code numbers. Figure 5-1 summarizes these calls.

Naming Conventions

In practice, whenever you write programs that make BDOS calls, you should include a series of equates for the BDOS function code numbers. We shall be making reference to these values in subsequent examples, so they are shown in Figure 5-2 as they will appear in the programs.

The function names used to define the equates in Figure 5-2 are shorter than those in Figure 5-1 to strike a balance between the abbreviated function names used in Digital Research's documentation and the need for clearer function descriptions.

Making a BDOS Function Request

All BDOS functions are requested by issuing a CALL instruction to location 0005H. You can also request a function by transferring control to location 0005H with the return address on the stack.

In order to tell the BDOS what you need it to do, you must arrange for the internal registers of the CPU to contain the required information before the CALL instruction is executed.

Function Code	Description
Simple Byte-by-Byte I/O	
0	Overall system and BDOS reset
1	Read a byte from the console keyboard
2	Write a byte to the console screen
3	Read a byte from the logical reader device
4	Write a byte to the logical punch device
5	Write a byte to the logical list device
6	Direct console I/O (no CCP-style editing)
7*	Read the current setting of the IOBYTE
8*	Set a new value of the IOBYTE
9	Send a "\$"-terminated string to the console
10	Read a string from the console into a buffer
11	Check if a console key is waiting to be read
12	Return the CP/M version number
Disk File I/O	
13	Reset disk system
14	Select specified logical disk drive
15	Open specified file for reading/ writing
16	Close specified file after reading/ writing
17	Search file directory for first match with filename
18	Search file directory for next match with filename
19	Delete (erase) file
20	Read the next "record" sequentially
21	Write the next "record" sequentially
22	Create a new file with the specified name
23	Rename a file to a new name
24	Indicate which logical disks are active
25	Return the current default disk drive number
26	Set the DMA address (read/ write address)
27	Return the address of an allocation vector
28*	Set specified logical disk drive to Read-Only status
29	Indicate which disks are currently Read-Only status
30	Set specified file to System or Read-Only status
31	Return address of disk parameter block (DPB)
32*	Set/Get the current user number
33	Read a "record" randomly
34	Write a "record" randomly
35	Return logical file size (even for random files)
36	Set record number for the next random read/ write
37	Reset specified drive
40	Write a "record" randomly with zero fill

*These do not work under MP/M.

Figure 5-1. BDOS function calls

0000 =	B\$SYSRESET	EQU	0	;System Reset
0001 =	B\$CONIN	EQU	1	;Read Console Byte
0002 =	B\$CONOUT	EQU	2	;Write Console Byte
0003 =	B\$READIN	EQU	3	;Read "Reader" Byte
0004 =	B\$PUNOUT	EQU	4	;Write "Punch" Byte
0005 =	B\$LISTOUT	EQU	5	;Write Printer Byte
0006 =	B\$DIRCONIO	EQU	6	;Direct Console I/O
0007 =	B\$GETIO	EQU	7	;Get IOBYTE
0008 =	B\$SETIO	EQU	8	;Set IOBYTE
0009 =	B\$PRINTS	EQU	9	;Print Console String
000A =	B\$READCONS	EQU	10	;Read Console String
000B =	B\$CONST	EQU	11	;Read Console Status
000C =	B\$GETVER	EQU	12	;Get CP/M Version Number
000D =	B\$DSKRESET	EQU	13	;Disk System Reset
000E =	B\$SELDISK	EQU	14	;Select Disk
000F =	B\$OPEN	EQU	15	;Open File
0010 =	B\$CLOSE	EQU	16	;Close File
0011 =	B\$SEARCHF	EQU	17	;Search for First Name Match
0012 =	B\$SEARCHN	EQU	18	;Search for Next Name Match
0013 =	B\$ERASE	EQU	19	;Erase (delete) File
0014 =	B\$READSEQ	EQU	20	;Read Sequential
0015 =	B\$WRITESEQ	EQU	21	;Write Sequential
0016 =	B\$CREATE	EQU	22	;Create File
0017 =	B\$RENAME	EQU	23	;Rename File
0018 =	B\$GETACTDSK	EQU	24	;Get Active (Logged-in) Disks
0019 =	B\$GETCURDSK	EQU	25	;Get Current Default Disk
001A =	B\$SETDMA	EQU	26	;Set DMA (Read/Write) Address
001B =	B\$GETALVEC	EQU	27	;Get Allocation Vector Address
001C =	B\$SETDSKRO	EQU	28	;Set Disk to Read Only
001D =	B\$GETRODSKS	EQU	29	;Get Read Only Disks
001E =	B\$SETFAT	EQU	30	;Set File Attributes
001F =	B\$GETDPB	EQU	31	;Get Disk Parameter Block Address
0020 =	B\$SETGETUN	EQU	32	;Set/Get User Number
0021 =	B\$READRAN	EQU	33	;Read Random
0022 =	B\$WRITERAN	EQU	34	;Write Random
0023 =	B\$GETFSIZ	EQU	35	;Get File Size
0024 =	B\$SETRANREC	EQU	36	;Set Random Record Number
0025 =	B\$RESETD	EQU	37	;Reset Drive
0028 =	B\$WRITERANZ	EQU	40	;Write Random with Zero-Fill

Figure 5-2. Equates for BDOS function code numbers

The function code number of the specific function call you want performed must be in register C.

If you need to hand a single-byte value to the BDOS, such as a character to be sent to the console, then you must arrange for this value to be in register E. If the value you wish to pass to the BDOS is a 16-bit value, such as the address of a buffer or a file control block (FCB), this value must be in register pair DE.

When the BDOS hands back a single-byte value, such as a keyboard character or a return code indicating the success or failure of the function you requested, it will be returned in register A. When the BDOS returns a 16-bit value, it will be in register pair HL.

On return from the BDOS, registers A and L will contain the same value, as will registers B and H. This odd convention stems from CP/M's origins in PL/M (Programming Language/Microprocessor), a language used by Intel on their MDS system. Thus, PL/M laid the foundations for what are known as "register calling conventions."

Purpose The system reset function makes CP/M do a complete reset, exactly the same as the warm boot function invoked when you transfer control to the WARM-BOOT point (refer to Figure 4-1).

In addition to resetting the BDOS, this function reloads the CCP, rebuilds the allocation vectors for the currently logged disks, sets the DMA address (used by CP/M to address the disk read/write buffer) to 80H, marks all disks as being Read/Write status, and transfers control to the CCP. The CCP then outputs its prompt to the console.

Notes This function is most useful when you are working in a high-level language that does not permit a jump instruction to an absolute address in memory. Use it when your program has finished and you need to return control back to CP/M.

Function 1: Read Console Byte

Function Code: C = 01H
 Entry Parameters: None
 Exit Parameters: A = Data byte from console

Example

```

0001 =      B*CONIN      EQU    1      ;Console input
0005 =      BDOS        EQU    5      ;BDOS entry

0000 0E01      MVI      C,B*CONIN    ;Get function code
0002 CD0500      CALL      BDOS

```

Purpose This function reads the next byte of data from the console keyboard and puts it into register A. If the character input is a graphic character, it will be echoed back to the console. The only control characters that are echoed are CARRIAGE RETURN, LINE FEED, BACKSPACE, and TAB. In the case of a TAB character, the BDOS outputs as many spaces as are required to move the cursor to the next multiple of eight columns. All of the other control characters, including CONTROL-C, are input but are not echoed.

This function also checks for CONTROL-S (XOFF) to see if console output should be suspended, and for CONTROL-P (printer echo toggle) to see if console output should also be sent to the list device. If CONTROL-S is found, further output will be suspended until you type another character. CONTROL-P will enable the echoing of console output the first time it is pressed and disable it the second time.

If there is no incoming data character, this function will wait until there is one.

Notes This function often hinders rather than helps, because it echoes the input. Whenever you need console input at the byte-by-byte level, you will usually want to suppress this echo back to the console. For instance, you may know that the "console" is actually a communications line such as a modem. You may be trying to accept a password that should not be echoed back. Or you may need to read a

cursor control character that would cause an undesirable side effect on the terminal if echoed there.

In addition, if you need more than a single character from the console, your program will be easier to use if the person at the console can take full advantage of the CCP-style line editing. This can best be done by using the Read Console String function (code 10, 0AH).

Read Console String also is more useful for single character input, especially when you are expecting a “Y” or “N” (yes or no) response. If you use the Read Console Byte function, the operator will have only one chance to enter the data. When you use Read Console String, however, users have the chance to type one character, change their minds, backspace, and type another character.

Function 2: Write Console Byte

Function Code: C = 02H

Entry Parameters: E = Data byte to be output

Exit Parameters: None

Example

```

0002 =      B*CONOUT      EQU      2      ;Write Console Byte
0005 =      BDOS         EQU      5      ;BDOS entry

0000 0E02          MVI      C,B*CONOUT    ;Function code
0002 1E2A          MVI      E,'*'        ;E = data byte to be output
0004 CD0300       CALL     BDOS

```

Purpose This function outputs the data byte in register E to the console. As with function 1, if the data byte is a TAB character, it will be expanded by the BDOS to the next column that is a multiple of eight. The BDOS also checks to see if there is an incoming character, and if there is, checks to see if it is a CONTROL-S (in which case console output is suspended) or CONTROL-P (in which case echoing of console output to the printer is toggled on or off).

Notes You may have problems using this function to output cursor-addressing control sequences to the console. If you try to output a true binary cursor address to position 9, the BDOS will interpret this as a TAB character (ASCII code 9) and dutifully replace it with zero to eight blanks. If you need to output binary values, you must set the most significant bit of the character (use an ORI 80H, for example) so that it will not be taken as the ASCII TAB.

Here are two general-purpose subroutines that you will need for outputting messages. The first one, shown in Figure 5-3, outputs a null-byte-terminated message from a specified address. The second, in Figure 5-4, does essentially the same thing *except* that the message string follows immediately after the call to the subroutine.

```

;MSGOUT (message out)
;Output null-byte-terminated message.

;Calling sequence
; MESSAGE: DB 'Message',0
;
; LXI H,MESSAGE
; CALL MSGOUT

;Exit Parameters
; HL -> Null byte terminator

0002 = B$CONOUT EQU 2 ;Write Console Byte
0005 = BDOS EQU 5 ;BDOS entry point

MSGOUT:
0000 7E MOV A,M ;Get next byte for output
0001 B7 ORA A
0002 C8 RZ ;Return when null-byte
0003 23 INX H ;Update message pointer
0004 E5 PUSH H ;Save updated pointer
0005 5F MOV E,A ;Ready for BDOS
0006 0E02 MVI C,B$CONOUT
0008 CD0500 CALL BDOS
000B E1 POP H ;Recover message pointer
000C C30000 JMP MSGOUT ;Go back for next character

```

Figure 5-3. Write console byte example, output null-byte terminated message from specified address

```

;MSGOUTI (message out in-line)
;Output null-byte-terminated message that
;follows the CALL to MSGOUTI.

;Calling sequence
; CALL MSGOUTI
; DB 'Message',0
; ... next instruction

;Exit Parameters
; HL -> instruction following message

0002 = B$CONOUT EQU 2 ;Write Console Byte
0005 = BDOS EQU 5 ;BDOS entry point

MSGOUTI:
0000 E1 POP H ;HL -> message
0001 7E MOV A,M ;Get next data byte
0002 23 INX H ;Update message pointer
0003 B7 ORA A ;Check if null byte
0004 C20800 JNZ MSGOUTIC ;No, continue
0007 E9 PCHL ;Yes, return to next instruction
; after in-line message

MSGOUTIC:
0008 E5 PUSH H ;Save message pointer
0009 5F MOV E,A ;Ready for BDOS
000A 0E02 MVI C,B$CONOUT ;Function code
000C CD0500 CALL BDOS
000F C30000 JMP MSGOUTI ;Go back for next char.

```

Figure 5-4. Write console byte example, output null-byte terminated message following call to subroutine

Function 3: Read "Reader" Byte

Function Code: C = 03H
 Entry Parameters: None
 Exit Parameters: A = Character input

Example

```

0003 =      B$READIN      EQU    3      ;Read "Reader" Byte
0005 =      BDOS          EQU    5      ;BDOS entry

0000 0E03          MVI    C,B$READIN    ;Function code
0002 CD0500        CALL   BDOS          ;A = reader byte
  
```

Purpose

This function reads the next character from the logical "reader" device into register A. In practice, the physical device that is accessed depends entirely on how your BIOS is configured. In some systems, there is no reader at all; this function will return some arbitrary value such as 1AH (the ASCII CONTROL-Z character, used by CP/M to denote "End of File").

Control is not returned to the calling program until a character has been read.

Notes

Since the physical device (if any) used when you issue this request depends entirely on your particular BIOS, there can be no default standard for all CP/M implementations. This is one of the weaker parts of the BDOS.

You should "connect" the reader device by means of BIOS software to a serial port that can be used for communication with another system. This is only a partial solution to the problem, however, because this function call does not return control to your program until an incoming character has been received. There is no direct way that you can "poll" the reader device to see if an incoming character has been received. Once you make this function call, you lose control until the next character arrives; there is no function corresponding to the Read Console Status (function code 11, 0BH) that will simply read status and return to your program.

One possible solution is to build a timer into the BIOS reader driver that returns control to your program with a dummy value in A if a specified period of time goes by with no incoming character. But this brings up the problem of what dummy value to use. If you ever intend to send and receive files containing pure binary information, there is no character in ASCII that you might not encounter in a legitimate context. Therefore, any dummy character you might choose could also be true data.

The most cunning solution is to arrange for one setting of the IOBYTE (which controls logical-device-to-physical-device mapping) to connect the console to the serial communication line. This done, you can make use of the Read Console Status function, which will return not the physical console status but the serial line status. Your program can then act appropriately if no characters are received within a specified time. Figure 5-11 shows a subroutine that uses this technique in the Set IOBYTE function (code 8, 08H).

Figure 5-5 shows an example subroutine to read lines of data from the reader device. It reads characters from the reader, stacking them in memory until either a LINE FEED or a specified number of characters has been received. Note that CARRIAGE RETURNS are ignored, and the input line is terminated by a byte of 00H. The convention of 00H-byte terminated strings and no CARRIAGE RETURNS is used because it makes for much easier program logic. It also conforms to the conventions of the C language.

```

;RL#RDR
;Read line from reader device.
;Carriage returns are ignored, and input terminates
;when specified number of characters have been read
;or a line feed is input.

;Note: Potential weakness is that there is no
;timeout in this subroutine. It will wait forever
;if no more characters arrive at the reader device.

;Calling sequence
;   LXI   H,BUFFER
;   LXI   B,MAXCOUNT
;   CALL  RL#RDR

;Exit Parameters
;   HL -> 00H byte terminating string
;   BC = residual count (0 if max. chars.read)
;   E = last character read

0003 = B#READIN EQU 3 ;Reader input
0005 = BDOS EQU 5 ;BDOS entry point

000D = CR EQU 0DH ;Carriage return
000A = LF EQU 0AH ;Line feed (terminator)

RL#RDR:
0000 79 MOV A,C ;Check if count 0
0001 B0 ORA B ;If count 0 on entry, fake
0002 5F MOV E,A ;last char. read (00H)
0003 CA2000 JZ RL#RDRX ;Yes, exit
0006 C5 PUSH B ;Save max. chars. count
0007 E5 PUSH H ;Save buffer pointer

RL#RDRI: ;Loop back here to ignore
0008 0E03 MVI C,B#READIN
000A CD0500 CALL BDOS ;A = character input
000D 5F MOV E,A ;Preserve copy of chars.
000E FE0D CPI CR ;Check if carriage return
0010 CA0800 JZ RL#RDRI ;Yes, ignore it
0013 E1 POP H ;Recover buffer pointer
0014 C1 POP B ;Recover max. Count
0015 FE0A CPI LF ;Check if line feed
0017 CA2000 JZ RL#RDRX ;Yes, exit
001A 77 MOV M,A ;No, store char. in buffer
001B 23 INX H ;Update buffer pointer
001C 0B DCX B ;Downdate count
001D C30000 JMP RL#RDR ;Loop back for next char.

RL#RDRX:
0020 3600 MVI M,0 ;Null-byte-terminate buffer
0022 C9 RET

```

Figure 5-5. Read line from reader device

Function 4: Write "Punch" Byte

Function Code: C = 04H
 Entry Parameters: E = Byte to be output
 Exit Parameters: None

Example

```

0004 =      B#PUNOUT      EQU    4      ;Write "Punch" Byte
0005 =      BDOS         EQU    5

0000 0E04          MVI    C,B#PUNOUT    ;Function code
0002 1E2A          MVI    E,'*'        ;Data byte to output
0004 CD0500        CALL   BDOS
  
```

Purpose This function is a counterpart to the Read "Reader" Byte described above. It outputs the specified character from register E to the logical punch device. Again, the actual physical device used, if any, is determined by the BIOS. There is no set standard for this device; in some systems the punch device is a "bit bucket," so called because it absorbs all data that you output to it.

Notes The problems and possible solutions discussed under the Read "Reader" Byte function call also apply here. One difference, of course, is that this function outputs data, so the problem of an indefinite loop waiting for the next character is less likely to occur. However, if your punch device is connected to a communications line, and if the output hardware is not ready, the BIOS line driver will wait forever. Unfortunately, there is no legitimate way to deal with this problem since the BDOS does not have a function call that checks whether a logical device is ready for output.

Figure 5-6 shows a useful subroutine that outputs a 00H-byte terminated string to the punch. Wherever it encounters a LINE FEED, it inserts a CARRIAGE RETURN into the output data.

Function 5: Write List Byte

Function Code: C = 05H
 Entry Parameters: E = Byte to be output
 Exit Parameters: None

Example

```

0005 =      B#LSTOUT      EQU    5      ;Write List Byte
0005 =      BDOS         EQU    5

0000 0E05          MVI    C,B#LSTOUT    ;Function code
0002 1E2A          MVI    E,'*'        ;Data byte to output
0004 CD0500        CALL   BDOS
  
```

Purpose This function outputs the specified byte in register E to the logical list device. As with the reader and the punch, the physical device used depends entirely on the BIOS.

```

;WL$PUN
;Write line to punch device. Output terminates
;when a 00H byte is encountered.
;A carriage return is output when a line feed is
;encountered.

;Calling sequence
;   LXI   H,BUFFER
;   CALL WL$PUN

;Exit parameters
;   HL -> 00H byte terminator

0004 =   B$PUNOUT   EQU   4
0005 =   BDOS      EQU   5

000D =   CR        EQU   0DH   ;Carriage return
000A =   LF        EQU   0AH   ;Line feed

WL$PUN:
0000 E5       PUSH   H           ;Save buffer pointer
0001 7E       MOV    A,M         ;Get next character
0002 B7       ORA    A           ;Check if 00H
0003 CA2000  JZ     WL$PUNX      ;Yes, exit
0006 FE0A     CPI    LF         ;Check if line feed
0008 CC1600  CZ     WL$PUNLF     ;Yes, O/P CR
000B 5F       MOV    E,A         ;Character to be output
000C 0E04     MVI    C,B$PUNOUT   ;Function code
000E CD0500  CALL  BDOS          ;Output character
0011 E1       POP    H           ;Recover buffer pointer
0012 23       INX   H           ;Increment to next char.
0013 C30000  JMP    WL$PUN          ;Output next char

WL$PUNLF:
0016 0E04     MVI    C,B$PUNOUT   ;Line feed encountered
0018 1E0D     MVI    E,CR         ;Function code
001A CD0500  CALL  BDOS          ;Output a CR
001D 3E0A     MVI    A,LF         ;Recreate line feed
001F C9       RET                    ;Output LF

WL$PUNX:
0020 E1       POP    H           ;Exit
0021 C9       RET                    ;Balance the stack

```

Figure 5-6. Write line to punch device

Notes

One of the major problems associated with this function is that it does not deal with error conditions very intelligently. You cannot be sure which physical device will be used as the logical list device, and most standard BIOS implementations will cause your program to wait forever if the printer is not ready or has run out of paper. The BDOS has no provision to return any kind of error status to indicate that there is a problem with the list device. Therefore, the BIOS will have to be changed in order to handle this situation.

Figure 5-7 is a subroutine which outputs data to the list device. As you can see, this is essentially a repeat of Figure 5-6, which performs the same function for the logical punch device.

```

;WL$LST
;Write line to list device. Output terminates
;when a 00H byte is encountered.
;A carriage return is output when a line feed is
;encountered.

;Calling sequence
;   LXI   H,BUFFER
;   CALL  WL$LST

;Exit parameters
;   HL -> 00H byte terminator

0005 =   B$LSTOUT   EQU    5
0005 =   BDOS      EQU    5

000D =   CR        EQU    0DH   ;Carriage return
000A =   LF        EQU    0AH   ;Line feed

WL$LST:
0000 E5          PUSH   H           ;Save buffer pointer
0001 7E          MOV    A,M         ;Get next character
0002 B7          ORA    A           ;Check if 00H
0003 CA2000      JZ     WL$LSTX     ;Yes, exit
0006 FE0A        CPI    LF         ;Check if line feed
0008 CC1600      CZ     WL$LSTLF    ;Yes, O/P CR
000B 5F          MOV    E,A         ;Character to be output
000C 0E05        MVI    C,B$LSTOUT   ;Function code
000E CD0500      CALL   BDOS         ;Output character
0011 E1          POP    H           ;Recover buffer pointer
0012 23          INX   H           ;Update to next char.
0013 C30000      JMP    WL$LST         ;Output next char.

WL$LSTLF:
0016 0E05        MVI    C,B$LSTOUT   ;Function code
0018 1E0D        MVI    E,CR         ;Output a CR
001A CD0500      CALL   BDOS
001D 3E0A        MVI    A,LF         ;Recreate line feed
001F C9          RET              ;Output LF

WL$LSTX:
0020 E1          POP    H           ;Exit
0021 C9          RET              ;Balance the stack

```

Figure 5-7. Write line to list device

Function 6: Direct Console I/O

Function Code: C = 06H
Entry Parameters: E = 0FFH for Input
E = Other than 0FFH for output
Exit Parameters: A = Input byte or status

Example

```

0006 =   B$DIRCONIO EQU    6   ;Direct (raw) Console I/O
0005 =   BDOS      EQU    5   ;BDOS entry point

;Example of console input

0000 0E06        MVI    C,B$DIRCONIO ;Function code
0002 1E0F        MVI    E,0FFH     ;0FFH means input
0004 CD0500      CALL   BDOS         ;A = 00 if no char. waiting
;A = NZ if character input

```

```

                                ;Example of console output
0007 0E06                      MVI    C,B$DIRCONIO  ;Function code
0009 1E2A                      MVI    E,'*'      ;Not OFFH means output char.
000B CD0500                   CALL   BDOS

```

Purpose This function serves double duty: it both inputs and outputs characters from the console. However, it bypasses the normal control characters and line editing features (such as CONTROL-P and CONTROL-S) normally associated with console I/O. Hence the name “direct” (or “unadorned” as Digital Research describes it). If the value in register E is *not* 0FFH, then E contains a valid ASCII character that is output to the console. The logic used is most easily understood when written in pseudo-code:

```

if this is an input request (E = OFFH)
{
  if console status indicates a character is waiting
  {
    read the char from the console and
    return to caller with char in A
  }
  else (no input character waiting) and
  return to caller with A = 00
}
else (output request)
{
  output the char in E to the console and
  return to caller
}

```

Notes This function works well provided you never have to send a value of 0FFH or expect to receive a value of 00H. If you do need to send or receive pure binary data, you cannot use this function, since these values are likely to be part of the data stream.

To understand why you might want to send and receive binary data, remember that the logical “reader” does not have any method for you to check its status to see if an incoming character has arrived. All you can do is attempt to read a character (Read Reader Byte, function code 3). However, the BDOS will not give control back to you until a character arrives (which could be a very long time). One possibility is to logically assign the console to a communications line by the use of the IOBYTE (or some similar means) and then use this Direct I/O call to send and receive data to and from the line. Then you could indeed “poll” the communications line and avoid having your program go into an indefinite wait for an incoming character. An example subroutine using this technique is shown in Figure 5-11 under Set IOBYTE (function code 8).

Figure 5-8 shows a subroutine that uses the Direct Console Input and Output. Because this example is more complex than any shown so far, the code used to check the subroutine has also been included.

Function 7: Get IOBYTE Setting

```

Function Code:  C = 07H
Entry Parameters: None
Exit Parameters: A = IOBYTE current value

```

```

;-----
;TESTBED CODE
;Because of the complexity of this subroutine, the
; actual testbed code has been left in this example.
; It assumes that DDT or ZSID
; will be used for checkout.
;-----

0100          IF      1          ;Change to IF 0 to disable testbed
0100          ORG    100H
0100 C31101    JMP     START     ;Bypass "variables" setup by DDT

0103 00      OPTIONS:  DB      0          ;Option flags
0104 41454900 TERMS:   DB      'A','E','I',0 ;Terminators
0108 05      BUFFER   DB      5          ;Max. characters in buffer
0109 00      DB      0          ;Actual count
010A 6363636363 DB      99,99,99,99,99 ;Data bytes
010F 6363    DB      99,99

START:
0111 210801    LXI    H,BUFFER   ;Get address of buffer
0114 110401    LXI    D,TERMS    ;Address of terminator table
0117 3A0301    LDA    OPTIONS    ;Get options set by DDT
011A 47        MOV    B,A        ;Put in correct register
011B CD2B01    CALL   RCS        ;Enter subroutine
011E CD3800    CALL   38H        ;Force DDT breakpoint
0121 C31101    JMP     START     ;Test again
                                ;End of testbed
                                ENDF

;RCS: Read console string (using raw input)
;Reads a string of characters into a memory
; buffer using raw input.

;Supports options:
;   o to echo characters or not (when echoing,
;     a carriage return will be echoed followed
;     by line feed)
;   o warm boot on input of control-C or not
;   o terminating input either on:
;     o max. no of chars input
;     o matching terminator character

; Calling Sequence
;   LXI    H,BUFFER
;   Buffer has structure:
;           BUFFER: DB      10      Max. size
;                   DB      0       Actual Read
;                   DS     10+1    Buffer area
;   MVI    B,OPTIONS    Options required
;                   (see equates)
;   LXI    D,TERMS     Pointer to 00H-byte
;                   terminated Chars,
;                   any one of which is a
;                   terminator.
;   CALL   RCS

; Exit Parameters
;   BUFFER: Updated with data bytes and actual
;           character count input.
;           (Does not include the terminator).
;   A = Terminating Code
;   0 = Maximum number of characters input.
;   NZ = Terminator character found.

0001 = RCS%ECHO    EQU    0000%0001B ;Input characters to be echoed
0002 = RCS%ABORT  EQU    0000%0010B ;Abort on Control-C
0004 = RCS%FOLD   EQU    0000%0100B ;Fold lowercase to uppercase
0008 = RCS%TERM   EQU    0000%1000B ;DE -> term. char. set

0006 = B$DIRCONID EQU    6          ;Direct console I/O
0005 = B$DOS      EQU    5          ;BDOS entry point

0003 = CTL%C      EQU    03H        ;Control-C
000D = CR         EQU    0DH        ;Carriage return

```

Figure 5-8. Read/write string from/to console using raw I/O

000A =	LF	EQU	0AH	;Line feed
0008 =	BS	EQU	08H	;Backspace
	RCS\$ST:			;Internal standard terminator table
0124 0D	DB	0DH		;Carriage return
0125 0A	DB	0AH		;Line feed
0126 00	DB	0		;End of table
	RCS\$BSS:			;Destructive backspace sequence
0127 08200800	DB	BS, ' ', BS, 0		
	RCS:			;<<<< Main entry
012B 23	INX	H		;HL -> actual count
012C 3600	MVI	M,0		;Reset to initial state
012E 2B	DCX	H		;HL -> max. count
	RCS\$L:			
012F E5	PUSH	H		;Save buffer pointer
0130 CD9201	CALL	RCS\$GC		;Get character and execute;
				; ECHO, ABORT, and FOLD options
				;C = character input
0133 E1	POP	H		;Recover buffer pointer
0134 3E08	MVI	A,RCS\$TERM		;Check if user-specified terminator
0136 A0	ANA	B		;B = options
0137 C23D01	JNZ	RCS\$UST		;User specified terminators
013A 112401	LXI	D,RCS\$ST		;Standard terminators
	RCS\$UST:			
013D CDD401	CALL	RCS\$CT		;Check for terminator
0140 CA4C01	JZ	RCS\$NOTT		;Not terminator
0143 47	MOV	B,A		;Preserve terminating char.
	RCS\$MCI:			; (Max. char. input shares this code)
0144 0E00	MVI	C,0		;Terminate buffer
0146 CD7F01	CALL	RCS\$SC		;Save character
0149 78	MOV	A,B		;Recover terminating char.
014A E7	'ORA	A		;Set flags
014B C9	RET			
	RCS\$NOTT:			;Not a terminator
014C 3E08	MVI	A,BS		;Check for backspace
014E B9	CMP	C		
014F CA6001	JZ	RCS\$BS		;Backspace entered
0152 CD7F01	CALL	RCS\$SC		;Save character in buffer
0155 CD8B01	CALL	RCS\$UC		;Update count
0158 C22F01	JNZ	RCS\$L		;Not max. so get another char.
015B 0600	MVI	B,0		;Fake terminating char.
015D C34401	JMP	RCS\$MCI		;A = 0 for max. chars. input
	RCS\$BS:			;Backspace entered
0160 E5	PUSH	H		;Save buffer pointer
0161 23	INX	H		;HL -> actual count
0162 35	DCR	M		;Back up one
0163 FA7A01	JM	RCS\$NBS		;Check if count negative
0166 212701	LXI	H,RCS\$BSS		;HL -> backspacing sequence
0169 3E01	MVI	A,RCS\$ECHO		;No, check if echoing
016B A0	ANA	B		;BS will have been echoed if so
016C CA7001	JZ	RCS\$BSNE		;No, input BS not echoed
016F 23	INX	H		;Bypass initial backspace
	RCS\$BSNE:			
0170 C5	PUSH	B		;Save options and character
0171 D5	PUSH	D		;Save terminator table pointer
0172 CDF601	CALL	WCS		;Write console string
0175 D1	POP	D		;Recover terminator table pointer
0176 C1	POP	B		;Recover options and character
0177 C37B01	JMP	RCS\$BSX		;Exit from backspace logic
	RCS\$NBS:			
017A 34	INR	M		;Reset count to 0
	RCS\$BSX:			
017B E1	POP	H		;Recover buffer pointer
017C C32F01	JMP	RCS\$L		;Get next character

Figure 5-8. (Continued)

```

RCS#SC:                                ;Save character in C in buffer
017F D5      PUSH      D                ;HL -> buffer pointer
0180 E5      PUSH      H                ;Save terminator table pointer
0181 23      INX       H                ;Save buffer pointer
0182 5E      MOV       E,M              ;HL -> actual count in buffer
0183 1C      INR       E                ;Get actual count
0184 1600    MVI       D,0              ;Count of 0 points to first data byte
0186 19      DAD       D                ;Make word value of actual count
0187 71      MOV       M,C              ;HL -> next free data byte
0188 E1      POP       H                ;Save data byte away
0189 D1      POP       D                ;Recover buffer pointer
                                           ;Recover terminator table
                                           ; pointer

018A C9      RET

RCS#UC:                                ;Update buffer count and check for max.
                                           ;Return Z set if = to max., NZ
                                           ; if not HL -> buffer on entry
018B E5      PUSH      H                ;Save buffer pointer
018C 7E      MOV       A,M              ;Get max. count
018D 23      INX       H                ;HL -> actual count
018E 34      INR       M                ;Increase actual count
018F BE      CMP       M                ;Compare max. to actual
0190 E1      POP       H                ;Recover buffer pointer
0191 C9      RET                        ;Z-flag set

RCS#GC:                                ;Get character and execute
                                           ; ECHO, ABORT and FOLD options
0192 D5      PUSH      D                ;Save terminator table pointer
0193 E5      PUSH      H                ;Save buffer pointer
0194 C5      PUSH      B                ;Save option flags

RCS#WT:                                ;Function code
0195 0E06    MVI       C,B*DIRCONIO    ;Specify input
0197 1EFF    MVI       E,OFFH
0199 CD0500  CALL      BDOS
019C B7      ORA       A                ;Check if data waiting
019D CA9501  JZ       RCS#WT            ;Go back and wait
01A0 C1      POP       B                ;Recover option flags
01A1 4F      MOV       C,A              ;Save data byte
01A2 3E02    MVI       A,RCS#ABORT      ;Check if abort option enabled
01A4 A0      ANA       B
01A5 CAE01  JZ       RCS#NA              ;No abort
01A8 3E03    MVI       A,CTL*C          ;Check for control-C
01AA B9      CMP       C
01AB CA0000  JZ       0                ;Warm boot

RCS#NA:                                ;Check if folding enabled
01AE 3E04    MVI       A,RCS#FOLD
01B0 A0      ANA       B
01B1 C4E501  CNZ      TOUPPER            ;Convert to uppercase
01B4 3E01    MVI       A,RCS#ECHO
01B6 A0      ANA       B                ;Check if echo required
01B7 CAD101  JZ       RCS#NE            ;No echo required
01BA C5      PUSH      B                ;Save options and character
01BB 59      MOV       E,C              ;Move character for output
01BC 0E06    MVI       C,B*DIRCONIO    ;Function code
01BE CD0500  CALL      BDOS              ;Echo character
01C1 C1      POP       B                ;Recover options and character
01C2 3E0D    MVI       A,CR            ;Check if carriage return
01C4 B9      CMP       C
01C5 C2D101  JNZ      RCS#NE            ;No
01C8 C5      PUSH      B                ;Save options and character
01C9 0E06    MVI       C,B*DIRCONIO    ;Function code
01CB 1E0A    MVI       E,LF            ;Output line feed
01CD CD0500  CALL      BDOS
01D0 C1      POP       B                ;Recover options and character

RCS#NE:                                ;Recover buffer pointer
01D1 E1      POP       H
01D2 D1      POP       D                ;Recover terminator table
01D3 C9      RET                        ;Character in C

```

Figure 5-8. (Continued)

```

RCS*CT:                                ;Check for terminator
;C = character just input
;DE -> 00-byte character
; string of term. chars.
;Returns Z status if no
; match found, NZ if found
; (with A = C = terminating
; character)
01D4 D5          PUSH    D                ;Save table pointer

RCS*CTL:
01D5 1A          LDAX   D                ;Get next terminator character
01D6 B7          ORA    A                ;Check for end of table
01D7 CAE201     JZ     RCS*CTX          ;No terminator matched
01DA B9          CMP    C                ;Compare to input character
01DB CAE201     JZ     RCS*CTX          ;Terminator matched
01DE 13          INX   D                ;Move to next terminator
01DF C3D501     JMP    RCS*CTL          ; loop to try next character in table

RCS*CTX:                                ;Check terminator exit
01E2 B7          ORA    A                ;At this point, A will either
; be 0 if the end of the
; table has been reached, or
; NZ if a match has been
; found. The Z-flag will be
; set.
01E3 D1          POP    D                ;Recover table pointer
01E4 C9          RET

;TOUPPER - Fold lowercase letters to upper
; C = Character on entry and exit

TOUPPER:
01E5 3E60       MVI    A,'a'-1          ;Check if folding needed
01E7 B9         CMP    C                ;Compare to input char.
01E8 D2F501     JNC    TOUPX          ;No, char. is < or = "a"-1
01EB 3E7A       MVI    A,'z'          ;Maybe, char. is = or > "a"
01ED B9         CMP    C                ;
01EE DAF501     JC     TOUPX          ;No, char. is > "z"
01F1 3EDF       MVI    A,ODFH          ;Fold character
01F3 A1         ANA    C                ;
01F4 4F         MOV    C,A            ;Return folded character

TOUPX:
01F5 C9         RET

;WCS - Write console string (using raw I/O)
;Output terminates when a 00H byte is encountered.
;A carriage return is output when a line feed is
;encountered.

;Calling sequence
;   LXI   H,BUFFER
;   CALL WCS

;Exit parameters
;   HL -> 00H byte terminator

WCS:
01F6 E5         PUSH   H                ;Save buffer pointer
01F7 7E         MOV    A,M            ;Get next character
01F8 B7         ORA    A                ;Check if 00H
01F9 CA1602     JZ     WCSX          ;Yes, exit
01FC FE0A       CPI    LF            ;Check if line feed
01FE CC0C02     CZ     WCSLF         ;Yes, output a carriage return
0201 5F         MOV    E,A            ;Character to be output
0202 0E06       MVI    C,B*DIRCONIO ;Function code
0204 CD0500     CALL   BDOS            ;Output character
0207 E1         POP    H                ;Recover buffer pointer
0208 23         INX   H                ;Update to next char.
0209 C3F601     JMP    WCS            ;Output next char.

WCSLF:
020C 0E06       MVI    C,B*DIRCONIO ;Line feed encountered
;Function code

```

Figure 5-8. (Continued)

```

020E 1E0D      MVI   E,CR      ;Output a CR
0210 CD0500    CALL  BDOS      ;
0213 3E0A      MVI   A,LF      ;Recreate line feed
0215 C9        RET                ;Output LF

                WCSX:
0216 E1        POP   H                ;Exit
0217 C9        RET                ;Balance the stack

```

Figure 5-8. (Continued)

Example

```

0007 =      B%GETIO    EQU   7      ;Get IOBYTE
0005 =      BDOS      EQU   5      ;BDOS entry point

0000 0E07      MVI   C,B%GETIO    ;Function code
0002 CD0500    CALL  BDOS      ;A = IOBYTE

```

Purpose This function places the current value of the IOBYTE in register A.

Notes

As we saw in Chapter 4, the IOBYTE is a means of associating CP/M's logical devices (console, reader, punch, and list) with the physical devices supported by a particular BIOS. Use of the IOBYTE is completely optional. CP/M, to quote from the Digital Research *CP/M 2.0 Alteration Guide*, "...tolerate[s] the existence of the IOBYTE at location 0003H."

In practice, the STAT utility provided by Digital Research does have some features that set the IOBYTE to different values from the system console.

Figure 5-9 summarizes the IOBYTE structure. A more detailed description was given in Chapter 4.

Each two-bit field can take on one of four values: 00, 01, 10, and 11. The value can be interpreted by the BIOS to mean a specific physical device, as shown in Table 4-1.

Figure 5-10 has equates that are used to refer to the IOBYTE. You can see that the values shown are declared using the SHL (shift left) operator in the Digital Research Assembler. This is just a reminder that the values are structured this way in the IOBYTE itself.

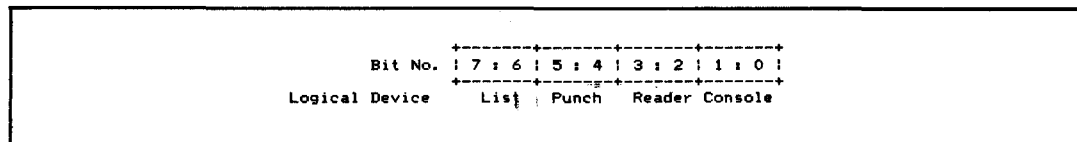

Figure 5-9. The IOBYTE structure

```

;IOBYTE equates
;These are for accessing the IOBYTE.

;Mask values to isolate specific devices.
;(These can also be inverted to preserve all BUT the
; specific device)

0003 =      IO*CONM EQU      0000*0011B      ;Console mask
000C =      IO*DRM EQU      0000*1100B      ;Reader mask
0030 =      IO*PUNM EQU      0011*0000B      ;Punch mask
00C0 =      IO*LSTM EQU      1100*0000B      ;List mask

;Console values
0000 =      IO*CTTY EQU      0              ;Console -> TTY:
0001 =      IO*CCRT EQU      1              ;Console -> CRT:
0002 =      IO*CBAT EQU      2              ;Console input <- RDR:
0003 =      IO*CUC1 EQU      3              ;Console output -> LST:
                                           ;Console -> UC1: (user console 1)

;Reader values
0000 =      IO*RTTY EQU      0 SHL 2        ;Reader <- TTY:
0004 =      IO*RRDR EQU      1 SHL 2        ;Reader <- RDR:
0008 =      IO*RUR1 EQU      2 SHL 2        ;Reader <- UR1: (user reader 1)
000C =      IO*RUR2 EQU      3 SHL 2        ;Reader <- UR2: (user reader 2)

;Punch values
0000 =      IO*PTTY EQU      0 SHL 4        ;Punch -> TTY:
0010 =      IO*PPUN EQU      1 SHL 4        ;Punch -> PUN:
0020 =      IO*PUP1 EQU      2 SHL 4        ;Punch -> UP1: (user punch 1)
0030 =      IO*PUP2 EQU      3 SHL 4        ;Punch -> UP2: (user punch 2)

;List values
0000 =      IO*LTTY EQU      0 SHL 6        ;List -> TTY:
0040 =      IO*LCRT EQU      1 SHL 6        ;List -> CRT:
0080 =      IO*LLPT EQU      2 SHL 6        ;List -> LPT: (physical line printer)
00C0 =      IO*LUL1 EQU      3 SHL 6        ;List -> UL1: (user list 1)

```

Figure 5-10. IOBYTE equates

Function 8: Set IOBYTE

Function Code: C = 08H

Entry Parameters: E = New IOBYTE value

Exit Parameters: None

Example This listing shows you how to assign the logical reader device to the BIOS's console driver. It makes use of some equates from Figure 5-10.

```

0007 =      B*GETIO      EQU      7          ;Get IOBYTE
0008 =      B*SETIO      EQU      8          ;Set IOBYTE
0005 =      BDOS         EQU      5          ;BDOS entry point

000C =      IO*DRM       EQU      0000*1100B ;Reader bit mask
0008 =      IO*RUR1     EQU      2 SHL 2     ;User reader select

;This example shows how to assign the logical
;reader to the user-defined reader #1 (UR1:)

0100                ORG      100H
0100 0E07            MVI      C,B*GETIO      ;First, get current IOBYTE

```

```

0102 CD0500      CALL    BDOS
0105 E6F3        ANI     (NOT IO$RDRM) AND OFFH ;Preserve all but
                                ; reader bits
0107 F608        ORI     IO$RUR1      ;OR in new setting
0109 5F          MOV     E,A          ;Ready for set IOBYTE
010A 0E08        MVI     C,B$SETIO  ;Set new value
010C CD0500      CALL    BDOS

```

Purpose This function sets the IOBYTE to a new value which is given in register E. Because of the individual bit fields in the IOBYTE, you will normally use the Get IOBYTE function, change some bits in the current value, and then call the Set IOBYTE function.

Notes You can use the Set IOBYTE, Get IOBYTE, and Direct Console I/O functions together to create a small program that transforms your computer system into a “smart” terminal. Any data that you type on your keyboard can be sent out of a serial communications line to another computer, and any data received on the line can be sent to the screen.

Figure 5-11 shows this program and illustrates the use of all of these functions.

For this program to function correctly, your BIOS must check the IOBYTE and detect whether the logical console is connected to the physical console (with the IOBYTE set to TTY:) or to the input side of the serial communications line (with the IOBYTE set to RDR:).

Figure 5-11 shows how to use the Get and Set IOBYTE functions to make a simple terminal emulator. For this example to work, the BIOS must detect the Console Value as 3 (IO\$CUC1) and connect Console Status, Input, and Output functions to the communications line.

```

0006 =      B$DIRCONIO EQU 6      ;Direct console input/output
0007 =      B$GETIO   EQU 7      ;Get IOBYTE
0008 =      B$SETIO   EQU 8      ;Set IOBYTE
000B =      B$CONST   EQU 11     ;Get console status (sneak preview)
0005 =      BDOS      EQU 5      ;BDOS entry point

0003 =      IO$CONM EQU 0000*0011B ;Console mask for IOBYTE
0001 =      IO$CCRT EQU 1        ;Console -> CRT:
0003 =      IO$CUC1 EQU 3        ;Console -> user console #1

      TERM:
0000 CD2A00      CALL    SETCRT      ;Connect console -> CRT:

      TERM$CKS:
0003 CD5200      CALL    CONST      ;Get CRT status
0006 CA2400      JZ     TERM$NOKI   ;No console input
0009 CD4B00      CALL    CONIN      ;Get keyboard character
000C CD3000      CALL    SETCOMM     ;Connect console -> comm. line
000F CD4500      CALL    CONOUT     ;Output to comm. line

      TERM$CCS:
0012 CD5200      CALL    CONST      ;Check comm. status
0015 CA0000      JZ     TERM        ;Get "console" status
0018 CD4B00      CALL    CONIN      ;No incoming comm. character
                                ;Get incoming comm. character

```

Figure 5-11. Simple terminal emulator

001B CD2A00	CALL	SETCRT	;Connect console -> CRT:
001E CD4500	CALL	CONOUT	;Output to CRT
0021 C30300	JMP	TERM#CKS	;Loop back to check keyboard status
TERM#NOKI:			
0024 CD3000	CALL	SETCOMM	;Connect console -> comm. line
0027 C31200	JMP	TERM#CCS	;Loop back to check comm. status
SETCRT:			
002A F5	PUSH	PSW	;Connect console -> CRT:
002B 0601	MVI	B,IO#CCRT	;Save possible data character
002D C33300	JMP	SETCON	;Connect console -> CRT;
;Common code			
SETCOMM:			
0030 F5	PUSH	PSW	;Connect console -> comm. line
0031 0603	MVI	B,IO#CUC1	;Save possible data character
;Connect console -> comm. line			
;Drop into SETCON			
SETCON:			
;Set console device			
;New code in B (in bits 1,0)			
0033 C5	PUSH	B	;Save code
0034 0E07	MVI	C,B#GETIO	;Get current IOBYTE
0036 CD0500	CALL	BDOS	
0039 E6FC	ANI	(NOT IO#CONM) AND OFFH	;Preserve all but console
003B C1	POP	B	;Recover required code
003C B0	ORA	B	;OR in new bits
003D 5F	MOV	E,A	;Ready for setting
003E 0E08	MVI	C,B#SETIO	;Function code
0040 CD0500	CALL	BDOS	
0043 F1	POP	PSW	;Recover possible data character
0044 C9	RET		
CONOUT:			
0045 5F	MOV	E,A	;Get data byte for output
0046 0E06	MVI	C,B#DIRCONIO	;Function code
0048 C30500	JMP	BDOS	;BDOS returns to CONOUT's caller
CONIN:			
004B 0E06	MVI	C,B#DIRCONIO	;Function code
004D 1EFF	MVI	E,OFFH	;Indicate console input
004F C30500	JMP	BDOS	;BDOS returns to CONIN's caller
CONST:			
0052 0E0B	MVI	C,B#CONST	;Function code
0054 CD0500	CALL	BDOS	
0057 B7	ORA	A	;Set Z-flag to result
0058 C9	RET		

Figure 5-11. (Continued)

Function 9: Display "\$"-Terminated String

Function Code: C = 09H

Entry Parameters: DE = Address of first byte of string

Exit Parameters: None

Example

```

0009 = B*PRINTS EQU 9 ;Print $-Terminated String
0005 = BDOS EQU 5 ;BDOS entry point

000D = CR EQU 0DH ;Carriage return
000A = LF EQU 0AH ;Line feed
0009 = TAB EQU 09H ;Horizontal tab

```

```

0000 0D0A095468MESSAGE:      DB      CR,LF,TAB,'This is a message',CR,LF,'$'
0017 0E09                    MVI     C,B$PRINTS      ;Function code
0019 110000                   LXI     D,MESSAGE      ;Pointer to message
001C CD0500                   CALL    BDOS

```

Purpose This function outputs a string of characters to the console device. The address of this string is in registers DE. You must make sure that the last character of the string is "\$"; the BDOS uses this character as a marker for the end of the string. The "\$" itself does not get output to the console.

While the BDOS is outputting the string, it expands tabs as previously described, checks to see if there is an incoming character, and checks for CONTROL-S (XOFF, which stops the output until another character is entered) or CONTROL-P (which turns on or off echoing of console characters to the printer).

Notes One of the biggest drawbacks of this function is its use of "\$" as a terminating character. As a result, you cannot output a string with a "\$" in it. To be truly general-purpose, it would be better to use a subroutine that used an ASCII NUL (00H) character as a terminator, and simply make repetitive calls to the BDOS CONOUT function (code 2). Figure 5-3 is an example of such a subroutine.

Figure 5-12 shows an example of a subroutine that outputs one of several messages. It selects the message based on a message code that you give it as a parameter. Therefore, it is useful for handling error messages; the calling code can pass it an 8-bit error code. You may find it more flexible to convert this subroutine to using 00H-byte-terminated messages using the techniques shown in Figure 5-3.

```

;OM (Output message)
;This subroutine selects one of several messages based on
; the contents of the A register on entry. It then displays
; this message on the console.

;Each message is declared with a "$" as its last character.
; If the A register contains a value larger than the number
; of messages declared, OM will output "Unknown Message".

;As an option, OM can output carriage return / line feed
; prior to outputting the message text.

;Entry parameters
; HL -> message table
; This has the form :
;           DB      3           ;Number of messages in table
;           DW      MSG0      ;Address of text (A = 0)
;           DW      MSG1      ; (A = 1)
;           DW      MSG2      ; (A = 2)
;
;           MSG0:  DB      'Message text$'
;                   ...etc.
;           A = Message code (from 0 on up)
;           B = Output CR/LF if non-zero

```

Figure 5-12. Display \$-terminated message on console

```

;          Calling sequence
;          LXI   H,MSG$TABLE
;          LDA   MSGCODE
;          MVI   B,0      ;Suppress CR/LF
;          CALL  OM

0009 =      B$PRINTS    EQU   9      ;Print $-terminated string
0005 =      BDOS        EQU   5      ;BDOS entry point

000D =      CR          EQU   0DH     ;Carriage return
000A =      LF          EQU   0AH     ;Line feed

0000 0D0A24  OM$CRLF:   DB    CR,LF,'$'
0003 556E6B6E6FOM$UM: DB    'Unknown Message$'

OM:
0013 F5      PUSH      PSW          ;Save message code
0014 E5      PUSH      H            ;Save message table pointer
0015 78      MOV       A,B          ;Check if CR/LF required
0016 B7      ORA       A            ;
0017 CA2200  JZ        OM$NOCR      ;No
001A 110000  LXI       D,OM$CRLF    ;Output CR/LF
001D 0E09   MVI       C,B$PRINTS
001F CD0500  CALL      BDOS

OM$NOCR:
0022 E1      POP       H            ;Recover message table pointer
0023 F1      POP       PSW         ;Recover message code
0024 BE      CMP       M            ;Compare message to max. value
0025 D23700  JNC      OM$ERR      ;Error-code not <= max.
0028 23      INX       H            ;Bypass max. value in table
0029 87      ADD       A            ;Message code * 2
002A 5F      MOV       E,A          ;Make (code * 2) a word value
002B 1600   MVI       D,0
002D 19      DAD       D            ;HL -> address of message text
002E 5E      MOV       E,M          ;Get LS byte
002F 23      INX       H            ;HL -> MS byte
0030 56      MOV       D,M          ;Get MS byte
;DE -> message text itself

OM$PS:
0031 0E09   MVI       C,B$PRINTS
0033 CD0500  CALL      BDOS
0036 C9      RET                    ;Return to caller

OM$ERR:
0037 110300  LXI       D,OM$UM
003A C33100  JMP      OM$PS
;Error
;Point to "Unknown Message"
;Print string

```

Figure 5-12. (Continued)

Function 10: Read Console String

Function Code: C = 0AH

Entry Parameters: DE = Address of string buffer

Exit Parameters: String buffer with console bytes in it

Example

```

000A =      B$READCONS  EQU   10     ;Read Console String
0005 =      BDOS        EQU   5      ;BDOS entry point

```

```

0050 =      BUFLen      EQU      80      ;Buffer length
          BUFFER:      ;Console input buffer
0000 50      BUFMACH:   DB      BUFLen   ;Max. no. of characters in
          ; buffer
0001 00      BUFACTCH:  DB      0       ;Actual no. of characters input
0002          BUFBCH:   DS      BUFLen   ;Buffer characters

0052 0E0A          MVI      C,B*READCONS ;Function code
0054 110000        LXI      D,BUFFER     ;Pointer to buffer
0057 CD0500        CALL     BDOS

```

Purpose This function reads a string of characters from the console device and stores them in a buffer (address in DE) that you define. Full line editing is possible: the operator can backspace, cancel the line and start over, and use all the normal control functions. What you will ultimately see in the buffer is the final version of the character string entered, without any of the errors or control characters used to do the line editing.

The buffer that you define has a special format. The first byte in the buffer tells the BDOS the maximum number of characters to be accepted. The second byte is reserved for the BDOS to tell you how many characters were actually placed in the buffer. The following bytes contain the characters of the string.

Character input will cease either when a CARRIAGE RETURN is entered or when the maximum number of characters, as specified in the buffer, has been received. The CARRIAGE RETURN is not stored in the buffer as a character—it just serves as a terminator.

If the first character entered is a CARRIAGE RETURN, then the BDOS sets the “characters input” byte to 0. If you attempt to input more than the maximum number of characters, the “characters input” count will be the same as the maximum value allowed.

Notes This function is useful for accepting console input, especially because of the line editing that it allows. It should be used even for single-character responses, such as “Y/N” (yes or no), because the operator can type “Y”, backspace, and overtype with “N”. This makes for more “forgiving” programs, tolerant of humans who change their minds.

Figure 5-13 shows an example subroutine that uses this function. It accepts console input, matches the input against a table, and transfers control to the appropriate subroutine. Many interactive programs need to do this; they accept an operator command and then transfer control to the appropriate command processor to deal with that command.

This example also includes two other subroutines that are useful in their own right. One compares null-byte-terminated strings (FSCMP), and the other converts, or “folds,” lowercase letters to uppercase (FOLD).

```

;RSA
;Return subprocessor address
;This subroutine returns one of several addresses selected
; from a table by matching keyboard input against specified
; strings. It is normally used to switch control to a
; particular subprocessor according to an option entered
; by the operator from the keyboard.
;
;Character string comparisons are performed with case-folding;
; that is, lowercase letters are converted to uppercase.
;
;If the operator input fails to match any of the specified
; strings, then the carry flag is set. Otherwise, it is
; cleared.

;Entry parameters
; HL -> Subprocessor select table
;       This has the form:
;       DW      TEXT0,SUBPROCO
;       DW      TEXT1,SUBPROCI
;       DW      0      ;Terminator
; TEXT0: DB      'add',0 ;OOH-byte terminated
; TEXT1: DB      'subtract',0
; SUBPROCO:
;       Code for processing ADD function.
; SUBPROCI:
;       Code for processing SUBTRACT function.

;Exit parameters
; DE -> operator input string (OOH-terminated
;       input string).
; Carry Clear, HL -> subprocessor.
; Carry Set, HL = 0000H.

;Calling sequence
; LXI  H,SUBPROCTAB ;Subprocessor table
; CALL  RSA
; JC   ERROR ;Carry set only on error
; LXI  D,RETURN ;Fake CALL instruction
; PUSH D ;Push return address on stack
; PCHL ;"CALL" to subprocessor
; RETURN;

000A = B*READCONS EQU 10 ;Read console string into buffer
0005 = BDOS EQU 5 ;BDOS entry point

0050 = RSA#BL EQU 80 ;Buffer length
0000 50 RSA#BUF: DB RSA#BL ;Max. no. of characters
0001 00 RSA#ACTC: DB 0 ;Actual no. of characters
0002 RSA#BUFC: DS RSA#BL ;Buffer characters
0052 00 DB 0 ;Safety terminator

RSA:
0053 2B DCX H ;Adjust Subprocessor pointer
0054 2B DCX H ; for code below
0055 E5 PUSH H ;Top of stack (TOS) -> subproc. table - 2
0056 0E0A MVI C,B*READCONS ;Function code
0058 110000 LXI D,RSA#BUF ;DE -> buffer
005B CD0500 CALL BDOS ;Read operator input and
; Convert to OOH-terminated
005E 210100 LXI H,RSA#ACTC ;HL -> actual no. of chars. input
0061 5E MOV E,M ;Get actual no. of chars. input
0062 1600 MVI D,0 ;Make into word value
0064 23 INX H ;HL -> first data character
0065 19 DAD D ;HL -> first UNUSED character in buffer
0066 3600 MVI M,0 ;Make input buffer OOH terminated

RSA#ML:
;Compare input to specified values
; Main loop
0068 E1 POP H ;Recover subprocessor table pointer
0069 23 INX H ;Move to top of next entry
006A 23 INX H ;HL -> text address
006B 5E MOV E,M ;Get text address

```

Figure 5-13. Read console string for keyboard options

006C 23	INX	H	
006D 56	MOV	D,M	;DE -> text
006E 7A	MOV	A,D	;Check if at end of subprocessor table
006F B3	ORA	E	
0070 C8500	JZ	RSA#NFND	;Match not found
0073 23	INX	H	;HL -> subprocessor address
0074 E5	PUSH	H	;Save ptr. to subprocessor table
0075 210200	LXI	H,RSA#BUFC	;HL -> input characters
0078 CDBA00	CALL	FSCMP	;Folded string compare
007B C26800	JNZ	RSA#HL	;No match, move to next entry
007E E1	POP	H	;Match found, recover subprocessor ptr.
007F 5E	MOV	E,M	;Get actual subprocessor address
0080 23	INX	H	
0081 56	MOV	D,M	;DE -> Subprocessor code
0082 EB	XCHG		;HL -> Subprocessor code
0083 B7	ORA	A	;Clear carry (match found)
0084 C9	RET		
0085 210000	LXI	H,0	;Indicate no match found
0088 37	STC		;Set carry
0089 C9	RET		
			;FSCMP
			;Compare folded (lowercase to upper) string.
			;This subroutine compares two 00H-byte terminated
			;strings and returns with the condition flags set
			;to indicate their relationship.
			;Entry parameters
			; DE -> string 1
			; HL -> string 2
			;Exit parameters
			; Flags set (based on string 1 - string 2, on a
			; character-by-character basis)
			FSCMP:
008A 1A	LDAX	D	;Get string 1 character
008B CD9E00	CALL	FOLD	;Fold to uppercase
008E F5	PUSH	PSW	;Save string 1 character
008F 7E	MOV	A,M	;Get string 2 character
0090 CD9E00	CALL	FOLD	;Fold to uppercase
0093 47	MOV	B,A	;Save string 2 character
0094 F1	POP	PSW	;Recover string 1 character
0095 B8	CMP	B	;String 1 - string 2
0096 C0	RNZ		;Return if not equal
0097 B7	ORA	A	;Equal, so check if end of strings
0098 C8	RZ		;Yes
0099 13	INX	D	;No, update string 1 pointer
009A 23	INX	H	; and string 2 pointer
009B C3BA00	JMP	FSCMP	;Check next character
			;FOLD
			;Folds a lowercase letter (a-z) to uppercase (A-Z)
			;The character to be folded is in A on entry and on exit.
			FOLD:
009E 4F	MOV	C,A	;Preserve input character
009F 3E60	MVI	A,'a'-1	;Check if folding needed
00A1 B9	CMP	C	;Compare to input character
00A2 D2AF00	JNC	FOLDX	;No, char. is <= "a"
00A5 3E7A	MVI	A,'z'	;Check if < "z"
00A7 B9	CMP	C	
00A8 DAAF00	JC	FOLDX	;No, char. is > "z"
00AB 3EDF	MVI	A,ODFH	;Fold character
00AD A1	ANA	C	
00AE C9	RET		
			FOLDX:
00AF 79	MOV	A,C	;Recover original input char.
00B0 C9	RET		

Figure 5-13. (Continued)

Function 11: Read Console Status

Function Code: C = 0BH
 Entry Parameters: None
 Exit Parameters: A = 00H if no incoming data byte
 A = 0FFH if incoming data byte

Example

```

000B =      B*CONST      EQU    11      ;Get Console Status
0005 =      BDOS        EQU    5        ;BDOS entry point

0000 0E0B          MVI    C,B*CONST      ;Function code
0002 CD0500       CALL   BDOS          ;A = 00 if no character waiting
                                           ;A = 0FFH if character waiting
  
```

Purpose This function tells you whether a console input character is waiting to be processed. Unlike the Console Input functions, which will wait until there is input, this function simply checks and returns immediately.

Notes Use this function wherever you want to interrupt an executing program if a console keyboard character is entered. Just put a Console Status call in the main loop of the program. Then, if the program detects that keyboard data is waiting, it can take the appropriate action. Normally this would be to jump to location 0000H, thereby aborting the current program and initiating a warm boot.

Figure 5-11 is an example subroutine that shows how to use this function.

Function 12: Get CP/M Number

Function Code: C = 0CH
 Entry Parameters: None
 Exit Parameters: HL = Version number code

Example

```

000C =      B*GETVER     EQU    12      ;Get CP/M Version Number
0005 =      BDOS        EQU    5        ;BDOS entry point

0000 0E0C          MVI    C,B*GETVER     ;Function code
0002 CD0500       CALL   BDOS          ;H = 00 for CP/M
                                           ;L = version (e.g. 22H for 2.2)
  
```

Purpose This function tells you which version of CP/M you are currently running. A two-byte value is returned:

H = 00H for CP/M, H = 01H for MP/M

L = 00H for all releases before CP/M 2.0

L = 20H for CP/M 2.0, 21H for 2.1, 22H for 2.2, and so on for any subsequent releases.

This information is of interest only if your program has some version-specific logic built into it. For example, CP/M version 1.4 does not support the same Random File Input/Output operations that CP/M 2.2 does. Therefore, if your program uses Random I/O, put this check at the beginning to ensure that it is indeed running under the appropriate version of CP/M.

Notes Figure 5-14 is a subroutine that checks the current CP/M version number, and, if it is not CP/M 2.2, displays an explanatory message on the console and does a warm boot by jumping to location 0000H.

Function 13: Reset Disk System

Function Code: C = 0DH

Entry Parameters: None

Exit Parameters: None

```

;CCPM
;Check if CP/M
;This subroutine determines the version number of the
;operating system and, if not CP/M version 2, displays
;an error message and executes a warm boot.

;Entry and exit parameters
;
;
;Calling sequence
; CALL CCPM ;Warm boots if not CP/M 2

0009 = B%PRINTS EQU 9 ;Display $-terminated string
000C = B%GETVER EQU 12 ;Get version number
0005 = BDOS EQU 5 ;BDOS entry point

000D = CR EQU 0DH ;Carriage return
000A = LF EQU 0AH ;Line feed

0000 0D0A CCPM: DB CR,LF
0002 5468697320 DB 'This program can only run under CP/M version 2.'
0031 0D0A24 DB CR,LF,'$'

CCPM:
0034 0E0C MVI C,B%GETVER ;Get version number
0036 CD0500 CALL BDOS
0039 7C MOV A,H ;H must be 0 for CP/M
003A B7 ORA A
003B C24700 JNZ CCPME ;Must be MP/M
003E 7D MOV A,L ;L = version number of CP/M
003F E6F0 ANI OF0H ;Version number in MS nibble
0041 FE20 CPI 20H ;Check if version 2
0043 C24700 JNZ CCPME ;Must be an earlier version
0046 C9 RET ;Yes, CP/M version 2

CCPME:
0047 0E09 MVI C,B%PRINTS ;Error
0049 110000 LXI D,CCPMM ;Display error message
004C CD0500 CALL BDOS
004F C30000 JMP 0 ;Warm boot

```

Figure 5-14. Determine the CP/M version number

Example

```

000D =      B*DSKRESET      EQU    13      ;Reset Disk System
0005 =      BDOS            EQU    5        ;BDOS entry point

0000 OE0D          MVI      C,B*DSKRESET  ;Function code
0002 CD0500        CALL     BDOS

```

Purpose

This function requests CP/M to completely reset the disk file system. CP/M then resets its internal tables, selects logical disk A as the default disk, resets the DMA address back to 0080H (the address of the buffer used by the BDOS to read and write to the disk), and marks all logical disks as having Read/Write status.

The BDOS will then have to log in each logical disk as each disk is accessed. This involves reading the entire file directory for the disk and rebuilding the allocation vectors (which keep track of which allocation blocks are free and which are used for file storage).

Notes

This function lets you change the diskettes under program control. If the operator were to simply change diskettes, without CP/M knowing about it, the next access to the (now different) diskette would force CP/M to declare the disk Read-Only, thwarting any further attempts to write on the diskette. If you need to reset one or two disks, rather than the entire disk system, look ahead to the Reset Disk function (code 37) described at the end of this chapter.

Figure 5-15 shows a simple subroutine that outputs a message on the console, requesting that the diskette in a specified drive be changed. It then issues a Reset Disk function call to make sure that CP/M will log in the diskette on the next access to the drive.

```

;CDISK
;Change disk
;This subroutine displays a message requesting the
;user to change the specified logical disk, then waits
;for a carriage return to be pressed. It then issues
;a Disk Reset and returns to the caller.

;Entry parameters
;   A = Logical disk to be changed (A = 0, B = 1)

;Exit parameters
;   None

;Calling sequence
;   MVI   A,0           ;Change drive A:
;   CALL  CDISK

000D =      B*DSKRESET      EQU    13      ;Disk Reset function code
0009 =      B*PRINTS       EQU    9        ;Print $-terminated string
0001 =      B*CONIN        EQU    1        ;Get console input
0005 =      BDOS           EQU    5        ;BDOS entry point

```

Figure 5-15. Reset requested disk drive

```

000D =      CR      EQU 0DH
000A =      LF      EQU 0AH

0000 0D0A436861CDISKH:  DB  CR,LF,'Change logical disk '
0016 00          CDISKD:  DB  0
0017 3A20616E64      DB  ': and press Carriage Return to continue#'

      CDISK:
003F C640`      ADI  'A'-1      ;Convert to letter
0041 321600      STA  CDISKD      ;Store in message
0044 0E09      MVI  C,B#PRINTS  ;Display message
0046 110000      LXI  D,CDISKM
0049 CD0500      CALL BDOS

      CDISKW:
004C 0E01      MVI  C,B#CONIN      ;Get keyboard character
004E CD0500      CALL BDOS
0051 FE0D      CPI  CR
0053 C24C00      JNZ  CDISKW
0056 0E0D      MVI  C,B#DSKRESET  ;Now reset disk system
0058 CD0500      CALL BDOS
005B C9      RET

```

Figure 5-15. Reset requested disk drive (continued)

Function 14: Select Logical Disk

Function Code: C = 0EH
 Entry Parameters: E = Logical Disk Code
 00H = Drive A
 01H = Drive B and so on
 Exit Parameters: None

Example

```

000E =      B#SELDSK  EQU 14      ;Select Logical Disk
0005 =      BDOS      EQU 5        ;BDOS entry point

0000 0E0E      MVI  C,B#SELDSK  ;Function code
0002 1E00      MVI  E,0          ;E = 0 for A:, 1 for B: etc.
0004 CD0500      CALL  BDOS

```

Purpose This function makes the logical disk named in register E the default disk. All subsequent references to disk files that do not specify the disk will use this default.

When you reference a disk file that *does* have an explicit logical disk in its name you do not have to issue another Select Disk function; the BDOS will take care of that for you.

Notes Notice the way in which the logical disk is specified in register E. It is not the same as the disk drive specification in the first byte of the file control block. In the FCB, a value of 00H is used to mean "use the current default disk" (as specified in the last Select Disk call or by the operator on the console). With this function, a

value of 00H in register A means that A is the selected drive, a value of 01H means drive B, and so on to 0FH for drive P, allowing 16 drives in the system.

If you select a logical disk that does not exist in your computer system, the BDOS will display the following message:

```
BDOS Err on J: Select
```

If you type a CARRIAGE RETURN in order to proceed, the BDOS will do a warm boot and transfer control back to the CCP. To avoid this, you must rely on the computer operator not to specify nonexistent disks or build into your program the knowledge of how many logical disk drives are on the system.

Another problem with this function is that you cannot distinguish a logical disk for which the appropriate tables have been built into the BIOS, but for which there is no physical disk drive. The BDOS does not check to see if the drive is physically present when you make the Select Disk call. It merely sets up some internal values ready to access the logical disk. If you then attempt to access this nonexistent drive, the BIOS will detect the error. What happens next is completely up to the BIOS. The standard BIOS will return control to the BDOS, indicating an error condition. The BDOS will output the message

```
BDOS Err on C: Bad Sector
```

You then have a choice. You can press CARRIAGE RETURN, in which case the BDOS will ignore the error and attempt to continue with whatever appears to have been read in. Or you can enter a CONTROL-C, causing the program to abort and CP/M to perform a warm boot.

Note that the Select Disk function does not return any values. If your program gets control back, you can assume that the logical disk you asked for at least has tables declared for it.

Function 15: Open File

Function Code: C = 0FH
 Entry Parameters: DE = Address of file control block
 Exit Parameters: A = Directory code

Example

```
000F =      B*OPEN      EQU    15      ;Open File
0005 =      BDOS       EQU    5        ;BDOS entry point

      FCB:             ;File control block
0000 00      FCB*DISK:  DB    0        ;Search on default disk drive
0001 46494C454EFCB*NAME: DB    'FILENAME' ;File name
0009 545950    FCB*TYP:  DB    'TYP'   ;File type
000C 00      FCB*EXTENT: DB    0        ;Extent
000D 0000    FCB*RESV:  DB    0,0      ;Reserved for CP/M
000F 00      FCB*RECUSED: DB    0        ;Records used in this extent
0010 0000000000FCB*ABUSED: DB    0,0,0,0,0,0,0,0 ;Allocation blocks used
0018 0000000000    DB    0,0,0,0,0,0,0,0
0020 00      FCB*SEQREC: DB    0        ;Sequential rec. to read/write
```

```

0021 0000      FCB#RANREC:   DW      0      ;Random rec. to read/write
0023 00       FCB#RANRECO:  DB      0      ;Random rec. overflow byte (MS)

0024 0E0F              MVI      C,B#OPEN   ;Function code
0026 110000          LXI      D,FCB     ;DE -> File control block
0029 CD0500          CALL     BDOS      ;A = 0FFH if file not found

```

Purpose This function opens a specified file for reading or writing. The FCB, whose address must be in register DE, tells CP/M the user number, the logical disk, the file name, and the file type. All other bytes of the FCB will normally be set to 0.

The code returned by the BDOS in register A indicates whether the file has been opened successfully. If A contains 0FFH, then the BDOS was unable to find the correct entry in the directory. If A = 0, 1, 2, or 3, then the file has been opened.

Notes The Open File function searches the entire file directory on the specified logical disk looking for the file name, type, and extent specified in the FCB; that is, it is looking for an exact match for bytes 1 through 14 of the FCB. The file name and type may be ambiguous; that is, they may contain “?” characters. In this case, the BDOS will open the first file in the directory that matches the ambiguous name in the FCB. If the file name or type is shorter than eight or three characters respectively, then the remaining characters must be filled with blanks.

When the BDOS searches the file directory, it expects to find an *exact* match with each character of the file name and type, including lowercase letters or nongraphic characters. However, the BDOS uses only the least significant seven bits of each character—the most significant bit is used to indicate special file status characteristics, or *attributes*.

By matching the file extent as well as the name and type, you can, if you wish, open the file at some point other than its beginning. For normal sequential access, you would not usually want to do this, but if your program can predict which file extent is required, this is a method of moving directly to it.

It is also possible to open the same file more than once. Each instance requires a separate FCB. The BDOS is not aware that this is happening. It is really only safe to do this when you are reading the file. Each FCB can be used to read the file independently.

Once the file has been found in the directory, the number of records and the allocation blocks used are copied from the directory entry into the FCB (bytes 16 through 31). If the file is to be accessed sequentially from the beginning of the file, the current record (byte 32) must be set to zero by your program.

The value returned in register A is the relative directory entry number of the entry that matched the FCB. As previously explained, the buffer that CP/M uses holds a 128-byte record from the directory with four directory entries numbered 0, 1, 2, and 3. This *directory code* is returned by almost all of the file-related BDOS functions, but under normal circumstances you will be concerned only with whether the value returned in A is 0FFH or not.

Figure 5-16 shows a subroutine that takes a 00H-byte terminated character

string, creates a valid FCB, and then opens the specified file. Shown as part of this example is the subroutine BF (Build FCB). It performs the brunt of the work of converting a string of ASCII characters into an FCB-style disk, file name, and type.

```

;OPENF
;Open File

;Given a pointer to a 00H-byte-terminated file name,
;and an area that can be used for a file control
;block, this subroutine builds a valid file control
;block and attempts to open the file.

;If the file is opened, it returns with the carry flag clear.
;If the file cannot be opened, this subroutine returns
;with the carry flag set.

;Entry parameters
;   DE -> 36-byte area for file control block
;   HL -> 00H-byte terminated file name of the
;         form {disk:} Name {.typ}
;         (disk and typ are optional)

;Exit parameters
;   Carry clear : File opened correctly.
;   Carry set   : File not opened.

;Calling Sequence
;   LXI   D,FCB
;   LXI   H,FNAME
;   CALL  OPENF
;   JC    ERROR

;where
;FCB: DS   36           ;Space for file control block
;FNAME: DB  'A:TESTFILE.DAT',0

000F = B*OPEN      EQU  15   ;File Open function code
0005 = BDOS       EQU   5    ;BDOS entry point

OPENF:
0000 D5          PUSH   D           ;Preserve pointer to FCB
0001 C0C00      CALL   BF           ;Build file control block
0004 0E0F      MVI    C,B*OPEN
0006 D1          POP    D           ;Recover pointer to FCB
0007 CD0500    CALL   BDOS
000A 17        RAL                ;If A=OFFH, carry set
                                ;otherwise carry clear
000B C9        RET

;BF
;Build file control block
;This subroutine formats a 00H-byte-terminated string
;(presumed to be a file name) into an FCB, setting
;the disk and file name and type and clearing the
;remainder of the FCB to 0's.

;Entry parameters
;   DE -> file control block (36 Bytes)
;   HL -> file name string (00H-byte-terminated)

;Exit parameters
;   The built file control block

;Calling sequence
;   LXI   D,FCB
;   LXI   H,FILENAME
;   CALL  BF

BF:

```

Figure 5-16. Open file request

```

000C 23      INX  H           ;Check if 2nd char. is ":"
000D 7E      MOV  A,M          ;Get character from file name
000E 2B      DCX  H           ;HL -> now back at 1st char.
000F FE3A    CPI  '/'         ;If ":", then disk specified
0011 C21C00  JNZ  BF#ND        ;No disk
0014 7E      MOV  A,M          ;Get disk letter
0015 E61F    ANI  0001#1111B    ;A (41H) -> 1, B (42H) -> 2 ...
0017 23      INX  H           ;Bypass disk letter
0018 23      INX  H           ;Bypass ":"
0019 C31D00  JMP  BF#SD        ;Store disk in FCB

BF#ND:
001C AF      XRA  A           ;No disk present
                                ;Indicate default disk

BF#SD:
001D 12      STAX D          ;Store disk in FCB
001E 13      INX  D           ;DE -> 1st char. of name in FCB
001F 0E08    MVI  C,8          ;File name length
0021 CD3700  CALL BF#GT        ;Get token
                                ;Note -- at this point, BF#GT
                                ;will have advanced the string
                                ;pointer to either a "." or
                                ;OOH byte
0024 FE2E    CPI  '/'         ;Check terminating character
0026 C22A00  JNZ  BF#NT        ;No file type specified
0029 23      INX  H           ;Bypass "." in file name

BF#NT:
002A 0E03    MVI  C,3          ;File type length
002C CD3700  CALL BF#GT        ;Get token
                                ;Note -- if no file type is
                                ;present BF#GT will merely
                                ;spacefill the FCB
                                ;0-fill the remainder of the FCB
                                ;36 - 12 (disk, name, type = 12 chars.)
                                ;Re-use fill token S/R

002F 0600    MVI  B,0
0031 0E18    MVI  C,24
0033 CD6400  CALL BF#FT
0036 C9      RET

;BF#GT
;Build FCB -- get token

;This subroutine scans a file name string,
;placing characters into a file control block.
;On encountering a terminator character ("," or OOH),
;the remainder of the token is space filled.
;If an "*" is encountered, the remainder of the token
;is filled with "?".

;Entry parameters
; DE -> Into file control block
; HL -> Into file name string
; C = Maximum no. of characters in token

;Exit parameters
; File control block contains next token
; A = Terminating character

BF#GT:
0037 7E      MOV  A,M          ;Get next string character
0038 B7      ORA  A           ;Check if end of string
0039 CA5700  JZ   BF#SFT      ;Yes, space fill token
003C FE2A    CPI  '*'         ;Check if ?-fill required
003E CA5C00  JZ   BF#QFT      ;Yes, fill with ?
0041 FE2E    CPI  '/'         ;Assume current token is file
                                ;name
                                ;Check if file type coming up
                                ;(If current token is file
                                ;type this check is
                                ;benignly redundant)
                                ;Yes, space fill token
                                ;None of the above, so store
                                ;in FCB
0043 CA5700  JZ   BF#SFT      ;Yes, space fill token
0046 12      STAX D          ;None of the above, so store
                                ;in FCB
0047 13      INX  D           ;Update FCB pointer
0048 23      INX  H           ;Update string pointer

```

Figure 5-16. (Continued)

0049 0D	DCR	C		;Countdown on token length
004A C23700	JNZ	BF#GT		;Still more characters to go
	BF#SKIP:			
004D 7E	MOV	A,M		;Skip chars. until "." or 00H
004E B7	ORA	A		;Get next string character
004F C8	RZ			;Check if 00H
0050 FE2E	CPI	','		;Yes
0052 C8	RZ			;Check if "."
0053 23	INX	H		;Yes
0054 C34D00	JMP	BF#SKIP		;Update string pointer (only)
				;Try next character
	BF#SFT:			
0057 0620	MVI	B,' '		;Space fill token
0059 C36400	JMP	BF#FT		;Common fill token code
				;BF#FT returns to caller
	BF#QFT:			
005C 063F	MVI	B,'?'		;Question mark fill token
005E CD6400	CALL	BF#FT		;Common fill token code
0061 C34D00	JMP	BF#SKIP		;Bypass multiple "*" etc.
	BF#FT:			
0064 F5	PUSH	PSW		;Fill token
0065 78	MOV	A,B		;Save terminating character
				;Get fill character
	BF#FTL:			
0066 12	STAX	D		;Inner loop
0067 13	INX	D		;Store in FCB
0068 0D	DCR	C		;Update FCB Pointer
0069 C26600	JNZ	BF#FTL		;Downdate residual count
006C F1	POP	PSW		;Keep going
006D C9	RET			;Recover terminating character

Figure 5-16. (Continued)

Function 16: Close File

Function Code: C = 10H
 Entry Parameters: DE = Address of file control block
 Exit Parameters: A = Directory code

Example

```

0010 =      B#CLOSE      EQU    16      ;Close File
0005 =      BDOS        EQU    5        ;BDOS entry point

0000      FCB:         DS      36      ;File control block

0024 0E10      MVI      C,B#CLOSE      ;Function code
0026 110000    LXI      D,FCB          ;DE -> File control block
0029 CD0500    CALL     BDOS                    ;A = 0,1,2,3 if successful
                                           ;A = 0FFH if file name not
                                           ; in directory
    
```

Purpose This function terminates the processing of a file to which you have written information. Under CP/M you do not need to close a file that you have been reading. However, if you ever intend for your program to function correctly under MP/M (the multi-user version of CP/M) you should close all files regardless of their use.

The Close File function, like Open File, returns a directory code in the A register. Register A will contain 0FFH if the BDOS could not close the file successfully. If A is 0, 1, 2, or 3, then the file has been closed.

Notes

When the BDOS closes a file to which data has been written, it writes the current contents of the FCB out to the disk directory, updating an existing directory entry by matching the disk, name, type, and extent number in the same manner that the Open File function does.

Note that the BDOS does not transfer the last record of the file to the disk during the close operation. It merely updates the file directory. You must arrange to flush any partly filled record to the disk. If the file that you have created is a standard CP/M ASCII text file, you must arrange to fill the unused portion of the record with the standard IAH end-of-file characters as CP/M expects, as explained in the section on the Write Sequential function (code 21).

Function 17: Search for First Name Match

Function Code: C = 11H

Entry Parameters: DE = Address of file control block

Exit Parameters: A = Directory code

Example

```

0011 =      B*SEARCHF      EQU    17      ;Search First
0005 =      BDOS          EQU    5        ;BDOS entry point

          FCB:           ;File control block
0000 00      FCB$DISK:     DB    0        ;Search on default disk drive
0001 46494C453F FCB$NAME:  DB    'FILE????' ;Ambiguous file name
0009 543F50      FCB$TYP:  DB    'T?P'   ;Ambiguous file type
000C 00      FCB$EXTENT:  DB    0        ;Extent
000D 0000      FCB$RESV:   DB    0,0     ;Reserved for CP/M
000F 00      FCB$RECUSED: DB    0        ;Records used in this extent
0010 0000000000 FCB$ABUSED: DB    0,0,0,0,0,0,0,0 ;Allocation blocks used
0018 0000000000      DB    0,0,0,0,0,0,0,0
0020 00      FCB$SEQREC:  DB    0        ;Sequential rec. to read/write
0021 0000      FCB$RANREC: DW    0        ;Random rec. to read/write
0023 00      FCB$RANRECO: DB    0        ;Random rec. overflow byte (MS)

0024 0E11      MVI    C,B*SEARCHF      ;Function code
0026 110000     LXI    D,FCB          ;DE -> File control block
0029 CD0500     CALL   BDOS          ;A = 0,1,2,3.
                                ;(A * 32) + DMA -> directory
                                ; entry
                                ;A = 0FFH if file name not
                                ; found

```

Purpose

This function scans down the file directory for the first entry that matches the file name, type, and extent in the FCB addressed by DE. The file name, type, and extent may contain a "?" (ASCII 3FH) in one or more character positions. Where a "?" occurs, the BDOS will match *any* character in the corresponding position in the file directory. This is known as ambiguous file name matching.

The first byte of an FCB normally contains the logical disk number code. A value of 0 indicates the default disk, while 1 means disk A, 2 is B, and so on up to a

possible maximum of 16 for disk P. However, if this byte contains a "?", the BDOS will search the default logical disk and will match the file name and type regardless of the user number. This function is normally used in conjunction with the Search Next function (which is described immediately after this function). Search First, in the process of matching a file, leaves certain variables in the BDOS set, ready for a subsequent Search Next.

Both Search First and Search Next return a directory code in the A register. With Search First, A = 0FFH when no files match the FCB; if a file match is found, A will have a value of 0, 1, 2, or 3.

Notes

To locate the particular directory entry that either the Search First or Search Next function matched, multiply the directory code returned in A by the length of a directory entry (32 bytes). This is easily done by adding the A register to itself five times (see the code in Figure 5-17 near the label GNFC). Then add the DMA address to get the actual address where the matched directory entry is stored.

There are many occasions when you may need to write a program that will accept an ambiguous file name and operate on all of the file names that match it. (The DIR and ERA commands built into the CCP are examples that use ambiguous file names.) To do this, you must use several BDOS functions: the Set DMA Address function (code 26, described later in this chapter), this function (Search First), and Search Next (code 18). All of this is shown in the subroutine given in Figure 5-17.

```

;GNF
;This subroutine returns an FCB setup with either the
;first file matched by an ambiguous file name, or (if
;specified by entry parameter) the next file name.

;Note : this subroutine is context sensitive. You must
;       not have more than one ambiguous file name
;       sequence in process at any given time.

;>>> Warning : This subroutine changes the DMA address
;>>>         inside the BDOS.

;Entry parameters
; DE -> Possibly ambiguous file name
;       (OO-byte terminated)
;       (Only needed for FIRST request)
; HL -> File control block
; A = 0 : Return FIRST file name that matches
;   = NZ : Return NEXT file name that matches

;Exit parameters
; Carry set : A = FF, no file name matches
;            A not = 0FFH, error in input file name
; Carry clear : FCB setup with next name
;             HL -> Directory entry returned
;                by Search First/Next

;Calling sequence
;   LXI   D,FILENAME
;   LXI   H,FCB

```

Figure 5-17. Search first/next calls for ambiguous file name

				for MVI A,1 for NEXT
		MVI	A,0	
		CALL	GNF	
0011 =	B\$SEARCHF	EQU	17	;Search for first file name
0012 =	B\$SEARCHN	EQU	18	;Search for next file name
001A =	B\$SETDMA	EQU	26	;Set up DMA address
0005 =	BDOS	EQU	5	;BDOS entry point
0080 =	GNFDMA	EQU	80H	;Default DMA address
000D =	GNFSVL	EQU	13	;Save length (no. of chars to move)
0024 =	GNFFCL	EQU	36	;File control block length
0000	GNFSV:	DS	GNFSVL	;Save area for file name/type
	GNF:			
000D E5	PUSH	H		;Save FCB pointer
000E D5	PUSH	D		;Save file name pointer
000F F5	PUSH	PSW		;Save first/next flag
0010 118000	LXI	D,GNFDMA		;Set DMA to known address
0013 0E1A	MVI	C,B\$SETDMA		;Function code
0015 CD0500	CALL	BDOS		
0018 F1	POP	PSW		;Recover first/next flag
0019 E1	POP	H		;Recover file name pointer
001A D1	POP	D		;Recover FCB pointer
001B D5	PUSH	D		;Resave FCB pointer
001C B7	ORA	A		;Check if FIRST or NEXT
001D C23E00	JNZ	GNFN		;NEXT
0020 CD9300	CALL	BF		;Build file control block
0023 E1	POP	H		;Recover FCB pointer (to balance stack)
0024 D8	RC			;Return if error in file name
0025 E5	PUSH	H		;Resave FCB pointer
				;Move ambiguous file name to
				;save area
				;HL -> FCB
				;DE -> save area
				;Get save length
0026 110000	LXI	D,GNFSV		
0029 0E0D	MVI	C,GNFSVL		
002B CDBA00	CALL	MOVE		
002E D1	POP	D		;Recover FCB pointer
002F D5	PUSH	D		;and resave
0030 0E11	MVI	C,B\$SEARCHF		;Search FIRST
0032 CD0500	CALL	BDOS		
0035 E1	POP	H		;Recover FCB pointer
0036 FEFF	CPI	OFFH		;Check for error
0038 CA7D00	JZ	GNFEX		;Error exit
003B C35D00	JMP	GNFC		;Common code
	GNFN:			
				;Execute search FIRST to re-
				;establish contact with
				;previous file
				;User's FCB still has
				;name/type in it
				;Zero-fill all but file name/type
003E CD7F00	CALL	GNFZF		
0041 D1	POP	D		;Recover FCB address
0042 D5	PUSH	D		;and resave
0043 0E11	MVI	C,B\$SEARCHF		;Re-find the file
0045 CD0500	CALL	BDOS		
0048 D1	POP	D		;Recover FCB pointer
0049 D5	PUSH	D		;and resave
004A 210000	LXI	H,GNFSV		;Move file name from save area
				;into FCB
004D 0E0D	MVI	C,GNFSVL		;Save area length
004F CDBA00	CALL	MOVE		
0052 0E12	MVI	C,B\$SEARCHN		;Search NEXT
0054 CD0500	CALL	BDOS		
0057 E1	POP	H		;Recover FCB address
0058 FEFF	CPI	OFFH		;Check for error
005A CA7D00	JZ	GNFEX		;Error exit
	GNFC:			
005D E5	PUSH	H		;Save FCB address
005E 87	ADD	A		;Multiply BDOS return code * 32

Figure 5-17. (Continued)

```

005F 87          ADD    A          ;* 4
0060 87          ADD    A          ;* 8
0061 87          ADD    A          ;* 16
0062 87          ADD    A          ;* 32
0063 218000     LXI    H,GNFDMA    ;HL -> DMA address
0066 5F          MOV    E,A          ;Make (code * 32) a word value
                                ;in DE

0067 1600       MVI    D,0
0069 19          DAD    D          ;HL -> file's directory entry

                                ;Move file name into FCB
006A D1          POP    D          ;Recover FCB address
006B E5          PUSH   H          ;Save directory entry pointer
006C D5          PUSH   D          ;and resave
006D 0E0D       MVI    C,GNFSVL        ;Length of save area
006F C8A000     CALL   MOVE         ;
0072 3A0000     LDA    GNFSV        ;Get disk from save area
0075 D1          POP    D          ;Recover FCB address
0076 12          STAX   D          ;Overwrite user number in FCB

                                ;Set up to zero-fill tail end
                                ;of FCB
0077 CD7F00     CALL   GNZF         ;Zero-fill
007A E1          POP    H          ;Recover directory entry
                                ;pointer
007B AF          XRA    A          ;Clear carry
007C C9          RET

GNFEX:
007D 37          STC
007E C9          RET          ;Set carry to indicate error

;GNZF
;Get next file -- zero fill
;This subroutine zero-fills the bytes that follow the
;file name and type in an FCB.

;Entry parameters
; DE -> file control block

GNZF:
007F 210D00     LXI    H,GNFSVL        ;Bypass area that holds file name
0082 19          DAD    D          ;HL -> FCB + GNFSVL
0083 54          MOV    D,H          ;DE -> FCB + GNFSVL
0084 5D          MOV    E,L          ;
0085 13          INX    D          ;DE -> FCB + GNFSVL + 1
0086 3600       MVI    M,0          ;FCB + GNFSVL = 0
0088 0E17       MVI    C,GNFFCL-GNFSVL ;Remainder of file control block

;Drop into MOVE
;Spread 0's through remainder
;of FCB

;MOVE
;This subroutine moves C bytes from HL to DE.

MOVE:
008A 7E          MOV    A,M          ;Get source byte
008B 12          STAX   D          ;Save destination byte
008C 13          INX    D          ;Increment destination pointer
008D 23          INX    H          ;Increment source pointer
008E 0B          DCR    C          ;Decrement count
008F C28A00     JNZ   MOVE         ;Go back for more
0092 C9          RET

;BF
;Build file control block

;This subroutine formats a 00H-byte terminated string
;(presumed to be a file name) into an FCB, setting the
;disk and file name and type, and clearing the
;remainder of the FCB to 0's.

```

Figure 5-17. (Continued)

```

;Entry parameters
;   DE -> File control block (36 bytes)
;   HL -> File name string (00H-byte-terminated)

;Exit parameters
;   The built file control block

;This subroutine is shown in full in Figure 5-16

0093 C9      BF:      RET                ;Dummy subroutine for this example

```

Figure 5-17. (Continued)

Function 18: Search for Next Name Match

Function Code: C = 12H

Entry Parameters: None (assumes previous Search First call)

Exit Parameters: A = Directory code

Example

```

0012 =      B$SEARCHN      EQU      18      ;Search Next
0005 =      BDOS           EQU      5        ;BDOS entry point

0000 0E12           MVI      C,B$SEARCHN    ;Function code
;Note: No FCB pointer
;You must precede this call
;with a call to Search First
0002 CD0500        CALL     BDOS           ;A = 0,1,2,3
; (A * 32) + DMA -> directory
; entry
; A = 0FFH if file name not
; found

```

Purpose This function searches down the file directory for the *next* file name, type, and extent that match the FCB specified in a previous Search First function call.

Search First and Search Next are the only BDOS functions that must be used together. As you can see, the Search Next function does not require an FCB address as an input parameter—all the necessary information will have been left in the BDOS on the Search First call.

Like Search First, Search Next returns a directory code in the A register; in this case, if A = 0FFH, it means that there are no *more* files that match the file control block. If A is not 0FFH, it will be a value of 0, 1, 2, or 3, indicating the relative directory entry number.

Notes There are two ways of using the Search First/Next calls. Consider a simple file copying program that takes as input an ambiguous file name. You could scan the file directory, matching all of the possible file names, possibly displaying them on the console, and storing the names of the files to be copied in a table inside your program. This would have the advantage of enabling you to present the file names

to the operator before any copying occurred. You could even arrange for the operator to select which files to copy on a file-by-file basis. One disadvantage would be that you could not accurately predict how many files might be selected. On some hard disk systems you might have to accommodate several thousand file names.

The alternative way of handling the problem would be to match one file name, copy it, then match the next file name, copy it, and so on. If you gave the operator the choice of selecting which files to copy, this person would have to wait at the terminal as each file was being copied, but the program would not need to have large table areas set aside to hold file names. This solution to the problem is slightly more complicated, as you can see from the logic in Figure 5-17.

The subroutine in Figure 5-17, Get Next File (GNF), contains all of the necessary logic to search down a directory for both alternatives described. It does require that you indicate *on entry* whether it should search for the first or next file match, by setting A to zero or some nonzero value respectively.

You can see from Figure 5-17 that whenever the subroutine is called to get the *next* file, you must execute a Search First function to re-find the previous file. Only then can a Search Next be issued.

As with all functions that return a directory code in A, if this value is not 0FFH, it will be the relative directory entry number in the directory record currently in memory. This directory record will have been read into memory at whatever address was specified at the last Set DMA Address function call (code 26, 1AH). Notwithstanding its odd name, the DMA Address is simply the address into which any record input from disk will be placed. If the Set DMA Address function has not been used to change the value, then the CP/M default DMA address, location 0080H, will be used to hold the directory record.

The actual code for locating the address of the particular directory entry matched by the Search First/Next functions is shown in Figure 5-17 near the label GNFC. The method involves multiplying the directory code by 32 and then adding this product to the current DMA address.

Function 19: Erase (Delete) File

Function Code: C = 13H
 Entry Parameters: DE = Address of file control block
 Exit Parameters: A = Directory code

Example

```

0013 =      B*ERASE      EQU    19      ;Erase File
0005 =      BDOS        EQU    5        ;BDOS entry point

          FCB:
0000 00      FCB*DISK:   DB        0        ;File control block
0001 3F3F4C454EFCB*NAME: DB        '??LENAME' ;Search on default disk drive
0009 3F5950      FCB*TYP: DB        '?YP'   ;Ambiguous file name
000C 00      FCB*EXTENT: DB        0        ;Ambiguous file type
          ;Extent

```

```

000D 0000      FCB$RESV:      DB      0,0      ;Reserved for CP/M
000F 00        FCB$RECUSED:     DB      0          ;Records used in this extent
0010 00000000 FCB$ABUSED:     DB      0,0,0,0,0,0,0,0 ;Allocation blocks used
0018 0000000000 DB      0,0,0,0,0,0,0,0
0020 00        FCB$SEQREC:      DB      0          ;Sequential rec. to read/write
0021 0000      FCB$RANREC:     DW      0          ;Random rec. to read/write
0023 00        FCB$RANRECO:     DB      0          ;Random rec. overflow byte (MS)

0024 0E13          MVI      C,B$ERASE      ;Function code
0026 110000       LXI      D,FCB        ;DE -> file control block
0029 CD0500       CALL     BDOS          ;A = OFFH if file not found

```

Purpose This function logically deletes from the file directory files that match the FCB addressed by DE. It does so by replacing the first byte of each relevant directory entry (remember, a single file can have several entries, one for each extent) by the value 0E5H. This flags the directory entry as being available for use.

Notes Like the previous two functions, Search First and Search Next, this function can take an ambiguous file name and type as part of the file control block, but unlike those functions, the logical disk select code cannot be a "?".

This function returns a directory code in A in the same way as the previous file operations.

Function 20: Read Sequential

Function Code: C = 14H
 Entry Parameters: DE = Address of file control block
 Exit Parameters: A = Directory code

Example

```

0014 =          B$READSEQ      EQU      20          ;Read Sequential
0005 =          BDOS          EQU      5           ;BDOS entry point

          FCB:                ;File control block
0000 00        FCB$DISK:      DB      0          ;Search on default disk drive.
0001 46494C454EFCB$NAME:     DB      'FILENAME' ;file name
0009 545950     FCB$TYP:      DB      'TYP'    ;File type
000C          DS              DS      24          ;Set by file open

          ;Record will be read into
          ; address set by prior SETDMA
          ; call
0024 0E14          MVI      C,B$READSEQ      ;Function code
0026 110000       LXI      D,FCB        ;DE -> File control block
0029 CD0500       CALL     BDOS          ;A = 00 if operation successful
          ; A = nonzero if no data in
          ; file

```

Purpose This function reads the next record (128-byte sector) from the designated file into memory at the address set by the last Set DMA function call (code 26, 1AH). The record read is specified by the FCB's sequential record field (FCB\$SEQREC in the example listing for the Open File function, code 15). This field is incremented by 1 so that a subsequent call to Read Sequential will get the next record from the file. If the end of the current extent is reached, then the BDOS will

```

;GETC
;This subroutine gets the next character from a
;sequential disk file. It assumes that the file has
;already been opened.

;>>> Note : this subroutine changes CP/M's DMA address.

;Entry parameters
; DE -> file control block

;Exit parameters
; A = next character from file
; (= OFFH on physical end of file)
; Note : 1AH is normal EOF character for
; ASCII Files.

;Calling sequence
; LXI DE,FCB
; CALL GETC
; CPI 1AH
; JZ EOFCHAR
; CPI OFFH
; JZ ACTUALEOF

0014 = B#READSEQ EQU 20 ;Read sequential
001A = B#SETDMA EQU 26 ;Set DMA address
0005 = BDOS EQU 5 ;BDOS entry point

0080 = GETCBS EQU 128 ;Buffer size
0000 GETCBF: DS GETCBS ;Declare buffer
0080 00 GETCCC: DB 0 ;Char. count (initially
;"empty")

GETC:
0081 3A8000 LDA GETCCC ;Check if buffer is empty
0084 B7 ORA A
0085 CA9900 JZ GETCFB ;Yes, fill buffer

GETCRE:
0088 3D DCR A ;Re-entry point after buffer filled
0089 328000 STA GETCCC ;No. downdate count
;Save downdated count

008C 47 MOV B,A ;Compute offset of next
;character
008D 3E7F MVI A,GETCBS-1 ;By subtracting
008F 90 SUB B ;(buffer size -- downdated count)
0090 5F MOV E,A ;Make result into word value
0091 1600 MVI D,0
0093 210000 LXI H,GETCBF ;HL -> base of buffer
0096 19 DAD D ;HL -> next character in buffer
0097 7E MOV A,M ;Get next character
0098 C9 RET

GETCFB:
0099 D5 PUSH D ;Fill buffer
009A 110000 LXI D,GETCBF ;Save FCB pointer
009D 0E1A MVI C,B#SETDMA ;Set DMA address to buffer
009F CD0500 CALL BDOS ;function code

00A2 D1 POP D ;Recover FCB pointer
00A3 0E14 MVI C,B#READSEQ ;Read sequential "record" (sector)
00A5 CD0500 CALL BDOS
00A8 B7 ORA A ;Check if read unsuccessful (A = NZ)
00A9 C2B400 JNZ GETCX ;Yes
00AC 3E80 MVI A,GETCBS ;Reset count
00AE 328000 STA GETCCC
00B1 C38800 JMP GETCRE ;Re-enter subroutine

GETCX:
00B4 3EFF MVI A,OFFH ;Physical end of file
00B6 C9 RET ;Indicate such

```

Figure 5-18. Read next character from sequential disk file

automatically open the next extent and reset the sequential record field to 0, ready for the next Read function call.

The file specified in the FCB must have been readied for input by issuing an Open File (code 15, 0FH) or a Create File (code 22, 16H) BDOS call.

The value 00H is returned in A to indicate a successful Read Sequential operation, while a nonzero value shows that the Read could not be completed because there was no data in the next record, as at the end of file.

Notes

Although it is not immediately obvious, you can change the sequential record number, FCB\$SEQREC, and within a given extent, read a record at random. If you want to access any given record within a file, you must compute which extent that record would be in and set the extent field in the file control block (FCB\$EXTENT) before you open the file. Thus, although the function name implies sequential access, in practice you can use it to perform a simple type of random access. If you need to do true random access, look ahead to the Random Read function (code 33), which takes care of opening the correct extent automatically.

Figure 5-18 shows an example of a subroutine that returns the data from a sequential file byte-by-byte, reading in records from the file as necessary. This subroutine, GETC, is useful as a low-level “primitive” on which you can build more sophisticated functions, such as those that read a fixed number of characters or read characters up to a CARRIAGE RETURN/LINE FEED combination.

When you read data from a CP/M text file, the normal convention is to fill the last record of the file with 1AH characters (CONTROL-Z). Therefore, two possible conditions can indicate end-of-file: either encountering a 1AH, or receiving a return code from the BDOS function (in the A register) of 0FFH. However, if the file that you are reading is not an ASCII text file, then a 1AH character has no special meaning—it is just a normal data byte in the body of the file.

Function 21: Write Sequential

Function Code: C = 15H

Entry Parameters: DE = Address of file control block

Exit Parameters: A = Directory code

Example

```

0015 =      B$WRITESEQ      EQU    21      ;Write Sequential
0005 =      BDOS           EQU    5       ;BDOS entry point

          FCB:
0000 00      FCB$DISK:      DB    0       ;File control block
          ;Search on default disk drive
0001 46494C454E FCB$NAME:  DB    'FILENAME' ;file name
0009 545950      FCB$TYP:  DB    'TYP'   ;File type
000C                                DS    24   ;Set by Open or Create File

          ;Record must be in address
          ; set by prior SETDMA call
          ;Function code
0024 0E15      MVI    C,B$WRITESEQ
0026 110000     LXI    D,FCB
0029 CD0500     CALL   BDOS
          ;DE -> File control block
          ;A = 00H if operation
          ; successful
          ;A = nonzero if disk full

```

Purpose This function writes a record from the address specified in the last Set DMA (code 26, 1AH) function call to the file defined in the FCB. The sequential record number in the FCB (FCB\$SEQREC) is updated by 1 so that the next call to Write Sequential will write to the next record position in the file. If necessary, a new extent will be opened to receive the new record.

This function is directly analogous to the Read Sequential function, writing instead of reading. The file specified in the FCB must first be activated by an Open File (code 15, 0FH) or create File call (code 22, 16H).

A directory code of 00H is returned in A to indicate that the Write was successful; a nonzero value is returned if the Write could not be completed because the disk was full.

Notes As with the Read Sequential function (code 20, 14H), you can achieve a simple form of random writing to the file by manipulating the sequential record number (FCB\$SEQREC). However, you can only overwrite *existing* records in the file, and if you want to move to another extent, you must close the file and reopen it with the FCB\$EXTENT field set to the correct value. For true random writing to the file, look ahead to the Write Random function (code 34, 22H). This takes care of opening or creating the correct extent of the file automatically.

The only logical error condition that can occur when writing to a file is insufficient room on the disk to accommodate the next extent of the file. Any hardware errors detected will be handled by the disk driver built into the BIOS or BDOS.

Figure 5-19 shows a subroutine, PUTC, to which you can pass data a byte at a time. It assembles this data into a buffer, making a call to Write Sequential whenever the buffer becomes full. You can see that provision is made in the entry parameters (by setting register B to a nonzero value) for the subroutine to fill the remaining unused characters of the buffer with 1AH characters. You must do this to denote the end of an ASCII text file.

Function 22: Create (Make) File

Function Code: C = 16H

Entry Parameters: DE = Address of file control block

Exit Parameters: A = Directory code

Example

```

0016 =      B*CREATE      EQU      22      ;File Create
0005 =      BDOS         EQU      5       ;BDOS entry point

          FCB:
0000 00      FCB*DISK:    DB          0       ;File control block
          FCB*NAME:      DB          'FILENAME' ;file name
0001 46494C454E FCB*NAME: DB          'FILETYPE' ;file type
0009 545950      FCB*TYP: DB          0       ;File type
000C 00      FCB*EXTENT: DB          0       ;Extent

```

```

000D 0000      FCB$RESV:      DB      0,0      ;Reserved for CP/M
000F 00        FCB$RECUSED:    DB      0          ;Records used in this extent
0010 0000000000FCB$ABUSED:  DB      0,0,0,0,0,0,0,0 ;Allocation blocks used
0018 0000000000      DB      0,0,0,0,0,0,0,0
0020 00        FCB$SEQREC:      DB      0          ;Sequential rec. to read/write
0021 0000      FCB$RANREC:    DW      0          ;Random rec. to read/write
0023 00        FCB$RANRECO:   DB      0          ;Random rec. overflow byte (MS)

;Note : file to be created
;must not already exist....
;Function code
0024 0E16      MVI      C,B$CREATE
0026 110000     LXI      D,FCB      ;DE -> file control block
0029 CD0500     CALL     BDOS      ;A = 0,1,2,3 if operation
; successful
; A = OFFH if directory full

```

```

;PUTC
;This subroutine either puts the next character out
;to a sequential file, writing out completed "records"
;(128-byte sectors) or, if requested to, will fill the
;remainder of the current "record" with 1AH's to
;indicate end of file to CP/M.

;Entry parameters
; DE -> File control block
; B = 0, A = next data character to be output
; B /= 0, fill the current "record" with 1AH's

;Exit parameters
; none.

;Calling sequence
; LXI D,FCB
; MVI B,0 ;Not end of file
; LDA CHAR
; CALL PUTC
; or
; LXI D,FCB
; MVI B,1 ;Indicate end of file
; CALL PUTC

0015 = B$WRITESEQ EQU 21 ;Write sequential
001A = B$SETDMA EQU 26 ;Set DMA address
0005 = BDOS EQU 5 ;BDOS entry point

0080 = PUTCBS EQU 128 ;Buffer size
0000 PUTCBF: DS PUTCBS ;Declare buffer
0080 00 PUTCBC: DB 0 ;Char. count (initially "empty")

PUTC:
0081 D5 PUSH D ;Save FCB address
0082 F5 PUSH PSW ;Save data character
0083 78 MOV A,B ;Check if end of file requested
0084 B7 ORA A
0085 C29900 JNZ PUTCEF ;Yes
0088 CDC300 CALL PUTCGA ;No, get address of next free byte
;HL -> next free byte
;E = Current char. count (as
;well as A)
;Recover data character
008B F1 POP PSW
008C 77 MOV M,A ;Save in buffer
008D 7E MOV A,E ;Get current character count
008E 3C INR A ;Update character count
008F FE80 CPI PUTCBS ;Check if buffer full
0091 CAA900 JZ PUTCWB ;Yes, write buffer
0094 328000 STA PUTCBC ;No, save updated count
0097 D1 POP D ;Dump FCB address for return
0098 C9 RET

```

Figure 5-19. Write next character to sequential disk file

0099 F1	PUTCEF:	POP	PSW	;End of file
009A CDC300	CALL	PUTCGA		;Dump data character
				;HL -> next free byte
				;A = current character count
009D FE80	PUTCCE:	CPI	PUTCBS	;Copy EOF character
009F CAA900	JZ	PUTCWB		;Check for end of buffer
00A2 361A	MVI	M,IAH		;Yes, write out the buffer
00A4 3C	INR	A		;No, store EOF in buffer
00A5 23	INX	H		;Update count
00A6 C39D00	JMP	PUTCCE		;Update buffer pointer
				;Continue until end of buffer
00A9 AF	PUTCWB:	XRA	A	;Write buffer
00AA 328000	STA	PUTCCC		;Reset character count to 0
00AD 110000	LXI	D,PUTCBF		;DE -> buffer
00B0 0E1A	MVI	C,B*SETDMA		;Set DMA address -> buffer
00B2 CD0500	CALL	BDOS		
00B5 D1	POP	D		;Recover FCB address
00B6 0E15	MVI	C,B*WRITESEQ		;Write sequential record
00B8 CD0500	CALL	BDOS		
00BB B7	ORA	A		;Check if error
00BC C2C000	JNZ	PUTCX		;Yes if A = NZ
00BF C9	RET			;No, return to caller
00C0 3EFF	PUTCX:	MVI	A,OFFH	;Error exit
00C2 C9	RET			;Indicate such
00C3 3A8000	PUTCGA:	LDA	PUTCCC	;Return with HL -> next free char.
00C6 5F	MOV	E,A		;and A = current char. count
00C7 1600	MVI	D,0		;Get current character count
00C9 210000	LXI	H,PUTCBF		;Make word value in DE
00CC 19	DAD	D		
00CD C9	RET			;HL -> Base of buffer
				;HL -> next free character

Figure 5-19. Write next character to sequential disk file (continued)

Purpose This function creates a new file of the specified name and type. You must first ensure that no file of the same name and type already exists on the same logical disk, either by trying to open the file (if this succeeds, the file already exists) or by unconditionally erasing the file.

In addition to creating the file and its associated file directory entry, this function also effectively opens the file so that it is ready for records to be written to it.

This function returns a normal directory code if the file creation has completed successfully or a value of 0FFH if there is insufficient disk or directory space.

Notes Under some circumstances, you may want to create a file that is slightly more "secure" than normal CP/M files. You can do this by using either lowercase letters or nongraphic ASCII characters such as ASCII NUL (00H) in the file name or type. Neither of these classes of characters can be generated from the keyboard; in the first case, the CCP changes all lowercase characters to uppercase, and in the second, it rejects names with odd characters in them. Thus, computer operators

cannot erase such a file because there is no way that they can create the same file name from the CCP.

The converse is also true; the only way that you can erase these files is by using a program that *can* set the exact file name into an FCB and then issue an Erase File function call.

Note that this function cannot accept an ambiguous file name in the FCB.

Figure 5-20 shows a subroutine that creates a file only after it has erased any existing files of the same name.

Function 23: Rename File

Function Code: C = 17H
 Entry Parameters: DE = Address of file control block
 Exit Parameters: A = Directory code

Example

```

0017 =      B$RENAME      EQU    23      ;Rename file
0005 =      BDOS          EQU    5        ;BDOS entry point

          FCB:
0000 00          DB        0            ;File control block
0001 4F4C444E41  DB        'OLDNAME '    ;Search on default disk drive
0009 545950      DB        'TYP'        ;File name
000C 00000000    DB        0,0,0,0          ;File type

```

```

;CF
;Create file
;This subroutine creates a file. It erases any
;previous file before creating the new one.

;Entry parameters
; DE -> File control block for new file

;Exit parameters
; Carry clear if operation successful
; (A = 0,1,2,3)
; Carry set if error (A = 0FFH)

;Calling sequence
; LXI D,FCB
; CALL CF
; JC ERROR

0013 =      B$ERASE      EQU    19      ;Erase file
0016 =      B$CREATE    EQU    22      ;Create file
0005 =      BDOS          EQU    5        ;BDOS entry point

          CF:
0000 D5          PUSH     D            ;Preserve FCB pointer
0001 0E13        MVI     C,B$ERASE    ;Erase any existing file
0003 CD0500      CALL    BDOS
0006 D1          POP      D            ;Recover FCB pointer
0007 0E16        MVI     C,B$CREATE    ;Create (and open new file)
0009 CD0500      CALL    BDOS
000C FEFF        CPI     0FFH        ;Carry set if OK, clear if error
000E 3F          CMC
000F C9          RET

```

Figure 5-20. Create file request

```

0010 00          DB      0          ;FCB + 16
0011 4E45574E41 DB      'NEWNAME'      ;File name
0019 545950          DB      'TYP'      ;File type
001C 00000000       DB      0,0,0,0

0020 0E17          MVI      C,B*RENAME    ;Function code
0022 110000       LXI      D,FCB          ;DE -> file control block
0025 CD0500       CALL     BDOS          ;A = 00H if operation successful
                                ;A = 0FFH if file not found

```

Purpose This function renames an existing file name and type to a new name and type. It is unusual in that it uses a single FCB to store both the old file name and type (in the first 16 bytes) and the new file name and type (in the second 16 bytes).

This function returns a normal directory code if the file rename was completed successfully or a value of 0FFH if the old file name could not be found.

Notes The Rename File function only checks that the old file name and type exist; it makes no check to ensure that the new name and type combination does not already exist. Therefore, you should try to open the new file name and type. If you succeed, do not attempt the rename operation. CP/M will create more than one file of the same name and type, and you stand to lose the information in both files as you attempt to sort out the problem.

For security, you can also use lowercase letters and nongraphic characters in the file name and type, as described under the File Create function (code 22, 16H) above.

Never use ambiguous file names in a rename operation; it produces strange effects and may result in files being irreparably damaged. This function will change *all* occurrences of the old file name to the new name.

Figure 5-21 shows a subroutine that will accept an existing file name and type and a new name and type and rename the old to the new. It checks to make sure that the new file name does not already exist, returning an error code if it does.

Function 24: Get Active Disks (Login Vector)

Function Code: C = 18H

Entry Parameters: None

Exit Parameters: HL = Active disk map (login vector)

Example

```

0018 =      B*GETACTDSK EQU      24      ;Get Active Disks
0005 =      BDOS      EQU      5        ;BDOS entry point

0000 0E18          MVI      C,B*GETACTDSK ;Example of getting active
0002 CD0500       CALL     BDOS      ; disk function code
                                ;HL = active disk bit map
                                ;Bits are = 1 if disk active
                                ;Bits 15 14 13 ... 2 1 0
                                ;Disk P 0 N ... C B A

```

Purpose This function returns a bit map, called the *login vector*, in register pair HL, indicating which logical disk drives have been selected since the last warm boot or

```

;RF
;Rename file
;This subroutine renames a file.
;it uses the BF (build FCB) subroutine shown in Figure 5.16

;Entry parameters
;   *** No case-folding of file names occurs ***
;   HL -> old file name (00-byte terminated)
;   DE -> new file name (00-byte terminated)

;Exit parameters
;   Carry clear if operation successful
;       (A = 0,1,2,3)
;   Carry set if error
;       A = OFEH if new file name already exists
;       A = OFFH if old file name does not exist

;Calling sequence
;   LXI   M,OLDNAME   ;HL -> old name
;   LXI   D,NEWNAME   ;DE -> new name
;   CALL  RF
;   JC    ERROR

000F =   B$OPEN      EQU   15   ;Open file
0017 =   B$RENAME    EQU   23   ;Rename file
0005 =   BDOS        EQU   5    ;BDOS entry point

0000 0000000000RFFCB: DW   0,0,0,0,0,0,0,0 ;1 1/2 FCB's long
0010 0000000000      DW   0,0,0,0,0,0,0,0
0020 0000000000      DW   0,0,0,0,0,0,0,0
0030 0000000000      DW   0,0,0

RF:
0036 D5      PUSH    D          ;Save new name pointer
0037 110000   LXI     D,RFFCB    ;Build old name FCB
                                ;HL already -> old name
003A CD5D00   CALL    BF

003D E1      POP     H          ;Recover new name pointer
003E 111000   LXI     D,RFFCB+16      ;Build new name in second part of file
0041 CD5D00   CALL    BF          ;control block

0044 111000   LXI     D,RFFCB+16 ;Experimentally try
0047 0E0F    MVI     C,B$OPEN        ;to open the new file
0049 CD0500   CALL    BDOS              ;to ensure it does
004C FEFF    CPI     OFFH        ;not already exist
004E 3EFE    MVI     A,OFEH      ;Assume error (flags unchanged)
0050 D8      RC              ;Carry set if A was 0,1,2,3

0051 110000   LXI     D,RFFCB    ;Rename the file
0054 0E17    MVI     C,B$RENAME
0056 CD0500   CALL    BDOS
0059 FEFF    CPI     OFFH        ;Carry set if OK, clear if error
005B 3F      CMC              ;Invert to use carry, set if error
005C C9      RET

;BF
;Build file control block
;This subroutine formats a 00H-byte terminated string
;(presumed to be a file name) into an FCB, setting the
;disk and the file name and type, and clearing the
;remainder of the FCB to 0's.

;Entry parameters
;   DE -> file control block (36 bytes)
;   HL -> file name string (00H-byte terminated)

;Exit parameters
;   The built file control block.

;Calling sequence
;   LXI   D,FCB
;   LXI   H,FILENAME
;   CALL  BF

BF:
005D C9      RET          ;Dummy subroutine ; see Figure 5.16.

```

Figure 5-21. Rename file request

Reset Disk function (code 13, 0DH). The least significant bit of L corresponds to disk A, while the highest order bit in H maps disk P. The bit corresponding to the specific logical disk is set to 1 if the disk has been selected or to 0 if the disk is not currently on-line.

Logical disks can be selected programmatically through any file operation that sets the drive field to a nonzero value, through the Select Disk function (code 14, 0EH), or by the operator entering an "X:" command where "X" is equal to A, B, ..., P.

Notes This function is intended for programs that need to know which logical disks are currently active in the system—that is, those logical disks which have been selected.

Function 25: Get Current Default Disk

Function Code: C = 19H
 Entry Parameters: None
 Exit Parameters: A = Current disk
 (0 = A, 1 = B, ..., F = P)

Example

```
0019 =      B*GETCURDSK   EQU    25      ;Get Current Disk
0005 =      BDOS        EQU     5       ;BDOS entry point

0000 0E19          MVI    C,B*GETCURDSK ;Function code
0002 CD0500       CALL   BDOS        ;A = 0 if A:, 1 if B: ...
```

Purpose This function returns the current default disk set by the last Select Disk function call (code 14, 0EH) or by the operator entering the "X:" command (where "X" is A, B, ..., P) to the CCP.

Notes This function returns the current default disk in coded form. Register A = 0 if drive A is the current drive, 1 if drive B, and so on. If you need to convert this to the corresponding ASCII character, simply add 41H to register A.

Use this function when you convert a file name and type in an FCB to an ASCII string in order to display it. If the first byte of the FCB is 00H, the current default drive is to be used. You must therefore use this function to determine the logical disk letter for the default drive.

Function 26: Set DMA (Read/Write) Address

Function Code: C = 1AH
 Entry Parameters: DE = DMA (read/write) address _
 Exit Parameters: None

Example

```
001A =      B*SETDMA     EQU    26      ;Set DMA Address
0005 =      BDOS        EQU     5       ;BDOS entry point
```

```

0000          SECBUFF:      DS      128      ;Sector buffer
0080 0E1A          MVI      C,B$SETDMA    ;Function code
0082 110000        LXI      D,SECBUFF    ;Pointer to buffer
0085 CD0500        CALL     BDOS

```

Purpose This function sets the BDOS's direct memory access (DMA) address to a new value. The name is an historic relic dating back to the Intel Development System on which CP/M was originally developed. This machine, by virtue of its hardware, could read data from a diskette directly into memory or write data to a diskette directly from memory. The name *DMA address* now applies to the address of the buffer to and from which data is transferred whenever a diskette Read, Write, or directory operation is performed.

Whenever CP/M first starts up (cold boot) or a warm boot or Reset Disk operation occurs, the DMA address is reset to its default value of 0080H.

Notes No function call can tell you the current value of the DMA address. All you can do is make a Set DMA function call to ensure that it is where you want it.

Once you have set the DMA address to the correct place for your program, it will remain set there until another Set DMA call, Reset Disk, or warm boot occurs.

The Read and Write Sequential and Random operations use the current setting of the DMA address, as do the directory operations Search First and Search Next.

Function 27: Get Allocation Vector

Function Code: C = 1BH
 Entry Parameters: None
 Exit Parameters: HL = Address of allocation vector

Example

```

001B =      B$GETALVEC    EQU      27      ;Get Allocation Vector Address
0005 =      BDOS          EQU      5        ;BDOS entry point

0000 0E1B          MVI      C,B$GETALVEC    ;Function code
0002 CD0500        CALL     BDOS          ;HL -> Base address of
;                    allocation vector

```

Purpose This function returns the base, or starting, address of the allocation vector for the currently selected logical disk. This information, indicating which parts of the disk are assigned, is used by utility programs and the BDOS itself to determine how much unused space is on the logical disk, to locate an unused allocation block in order to extend a file, or to relinquish an allocation block when a file is deleted.

Notes Digital Research considers the actual layout of the allocation vector to be proprietary information.

Function 28: Set Logical Disk to Read-Only Status

Function Code: C = 1CH
 Entry Parameters: None
 Exit Parameters: None

Example

```

001C =      B*SETDSKRO      EQU    28      ;Set disk to Read Only
                                ; function code
0005 =      BDOS           EQU    5        ;BDOS entry point

                                ;Sets disk selected by prior
                                ;Select disk function call
0000 0E1C          MVI     C,B*SETDSKRO   ;Function code
0002 CD0500        CALL    BDOS

```

Purpose This function logically sets the currently selected disk to a Read-Only state. Any attempts to execute a Write Sequential or Write Random function to the selected disk will be intercepted by the BDOS, and the following message will appear on the console:

```
BDOS Err on X: R/O
```

where X: is the selected disk.

Notes Once you have requested Read-Only status for the currently selected logical disk, this status will persist even if you proceed to select other logical disks. In fact, it will remain in force until the next warm boot or Reset Disk System function call.

Digital Research documentation refers to this function code as Disk Write Protect. The Read-Only description is used here because it corresponds to the error message produced if your program attempts to write on the disk.

Function 29: Get Read-Only Disks

Function Code: C = 1DH
 Entry Parameters: None
 Exit Parameters: HL = Read-Only disk map

Example

```

001D =      B*GETRODSKS    EQU    29      ;Get Read Only disks
0005 =      BDOS           EQU    5        ;BDOS entry point

                                ;Function code
0000 0E19          MVI     C,B*GETRODSKS ;HL = Read Only disk bit map
0002 CD0500        CALL    BDOS          ;Bits are = 1 if disk Read Only
                                ;Bits 15 14 13 ... 2 1 0
                                ;Disk P O N ... C B A

```

Purpose This function returns a bit map in registers H and L showing which logical disks in the system have been set to Read-Only status, either by the Set Logical

Disk to Read-Only function call (code 28, 1CH), or by the BDOS itself, because it detected that a diskette had been changed.

The least significant bit of L corresponds to logical disk A, while the most significant bit of H corresponds to disk P. The bit corresponding to the specific logical disk is set to 1 if the disk has been set to Read-Only status.

Function 30: Set File Attributes

Function Code: C = 1EH
 Entry Parameters: DE = Address of FCB
 Exit Parameters: A = Directory code

Example

```

001E =      B*SETFAT      EQU    30      ;Set File Attribute
0005 =      BDOS         EQU    5        ;BDOS entry point

          FCB:           ;File control block
0000 00      FCB*DISK:    DB    0        ;Search on default disk drive
0001 46494C454EFCB*NAME: DB    'FILENAME' ;File name
0009 D4      FCB*TYP:    DB    'T'+80H   ;Type with R/O
          ; attribute

000A 5950          DB    'YP'
000C 0000000000    DW    0,0,0,0,0,0,0,0,0,0

0022 0E1E          MVI    C,B*SETFAT    ;Function code
0024 110000        LXI    D,FCB        ;DE -> file control block
          ;MS bits set in file name/type
0027 CD0500        CALL   BDOS         ;A = 0FFH if file not found
  
```

Purpose

This function sets the bits that describe attributes of a file in the relevant directory entries for the specified file. Each file can be assigned up to 11 file attributes. Of these 11, two have predefined meanings, four others are available for you to use, and the remaining five are reserved for future use by CP/M.

Each attribute consists of a single bit. The most significant bit of each byte of the file name and type is used to store the attributes. The file attributes are known by a code consisting of the letter "f" (for file name) or "t" (for file type), followed by the number of the character position and a single quotation mark. For example, the Read-Only attribute is t1'.

The significance of the attributes is as follows:

- f1' to f4' Available for you to use
- f5' to f8' Reserved for future CP/M use
- t1' Read-Only File attribute
- t2' System File attribute
- t3' Reserved for future CP/M use

Attributes are set by presenting this function with an FCB in which the unambiguous file name has been preset with the most significant bits set appropriately. This function then searches the directory for a match and changes the matched entries to contain the attributes which have been set in the FCB.

The BDOS will intercept any attempt to write on a file that has the Read-Only attribute set. The DIR command in the CCP does not display any file with System status.

Notes

You can use the four attributes available to you to set up a file security system, or perhaps to flag certain files that must be backed up to other disks. The Search First and Search Next functions allow you to view the complete file directory entry, so your programs can test the attributes easily.

The example subroutines in Figures 5-22 and 5-23 show how to set file attributes (SFA) and get file attributes (GFA), respectively. They both use a bit map in which the most significant 11 bits of the HL register pair are used to indicate the corresponding high bits of the 11 characters of the file name/type combination. You will also see some equates that have been declared to make it easier to manipulate the attributes in this bit map.

```

:SFA
;Set file attributes
;This subroutine takes a compressed bit map of all the
;file attribute bits, expands them into an existing
;file control block and then requests CP/M to set
;the attributes in the file directory.

;Entry parameters
; DE -> file control block
; HL = bit map. Only the most significant 11
; bits are used. These correspond directly
; with the possible attribute bytes.

;Exit parameters
; Carry clear if operation successful (A = 0,1,2,3)
; Carry set if error (A = 0FFH)

;Calling sequence
; LXI D,FCB
; LXI H,0000*0000*1100*0000B ;Bit Map
; CALL SFA
; JC ERROR

;File Attribute Equates

8000 = FA#F1 EQU 1000*0000*0000*0000B ;F1' - F4'
4000 = FA#F2 EQU 0100*0000*0000*0000B ;Available for use by
2000 = FA#F3 EQU 0010*0000*0000*0000B ; application programs
1000 = FA#F4 EQU 0001*0000*0000*0000B

0800 = FA#F5 EQU 0000*1000*0000*0000B ;F5' - F8'
0400 = FA#F6 EQU 0000*0100*0000*0000B ;Reserved for CP/M
0200 = FA#F7 EQU 0000*0010*0000*0000B
0100 = FA#F8 EQU 0000*0001*0000*0000B

0080 = FA#T1 EQU 0000*0000*1000*0000B ;T1' -- read/only file
0080 = FA#R0 EQU FA#T1
0040 = FA#T2 EQU 0000*0000*0100*0000B ;T2' -- system files
0040 = FA#SYS EQU FA#T2
0020 = FA#T3 EQU 0000*0000*0010*0000B ;T3' -- reserved for CP/M

001E = B#SETFAT EQU 30 ;Set file attributes
0005 = BDOS EQU 5 ;BDOS entry point

```

Figure 5-22. Set file attributes

```

SFA:
0000 D5      PUSH    D           ;Save FCB pointer
0001 13      INX     D           ;HL -> 1st character of file name
0002 0E0B    MVI     C,B+3         ;Loop count for file name and type

SFAL:
0004 AF      XRA     A           ;Main processing loop
0005 29      DAD     H           ;Clear carry and A
0006 CE00    ACI     0           ;Shift next MS bit into carry
0008 0F      RRC     C           ;A = 0 or 1 depending on carry
0009 47      MOV     B,A         ;Rotate LS bit of A into MS bit
000A EB      XCHG    B,A         ;Save result (00H or 80H)
000B 7E      MOV     A,M         ;HL -> FCB character
000C E67F    ANI     7FH          ;Get FCB character
000E B0      ORA     B           ;Isolate all but attribute bit
000F 77      MOV     M,A         ;Set attribute with result
0010 EB      XCHG    B,A         ;and store back into FCB
0011 13      INX     D           ;DE -> FCB, HL = remaining bit map
0012 0D      DCR     C           ;DE -> next character in FCB
0013 C20400  JNZ     SFAL        ;Downdate character count
0014 0E1E    MVI     C,B$SETFAT  ;Loop back for next character
0018 D1      POP     D           ;Set file attribute function code
0019 CD0500  CALL    BDOS        ;Recover FCB pointer
001C FEFF    CPI     OFFH       ;Carry set if OK, clear if error
001E 3F      CMC     C           ;Invert to use carry set if error
001F C9      RET

```

Figure 5-22. Set file attributes (continued)

```

;GFA
;Get file attributes
;This subroutine finds the appropriate file using a
;search for First Name Match function rather than opening
;the file. It then builds a bit map of the file attribute
;bits in the file name and type. This bit map is then ANDed
;with the input bit map, and the result is returned in the
;zero flag. The actual bit map built is also returned in case
;more complex check is required.

;>>> Note: This subroutine changes the CP/M DMA address.

;Entry parameters
; DE -> File control block
; HL = Bit map mask to be ANDed with attribute
; results

;Exit parameters
; Carry clear, operation successful
; Nonzero status set to result of AND between
; input mask and attribute bits set.
; HL = Unmasked attribute bytes set.
; Carry set, file could not be found

001A = B$SETDMA EQU 26 ;Set DMA address
0011 = B$SEARCHF EQU 17 ;Search for first entry to match
0005 = BDOS EQU 5 ;BDOS entry point
0080 = GFADMA EQU 80H ;Default DMA address

;Calling sequence
; LXI D,FCB
; LXI H,0000$0000$1100$0000B ;Bit map
; CALL GFA
; JC ERROR

;File attribute equates

8000 = FA$F1 EQU 1000$0000$0000$0000B ;F1' - F5'
4000 = FA$F2 EQU 0100$0000$0000$0000B ;Available for use by

```

Figure 5-23. Get file attributes

2000 =	FA#F3	EQU	0010#0000#0000#0000B	;Application programs
1000 =	FA#F4	EQU	0001#0000#0000#0000B	
0800 =	FA#F5	EQU	0000#1000#0000#0000B	;F6' - F8'
0400 =	FA#F6	EQU	0000#0100#0000#0000B	;Reserved for CP/M
0200 =	FA#F7	EQU	0000#0010#0000#0000B	
0100 =	FA#F8	EQU	0000#0001#0000#0000B	
0080 =	FA#T1	EQU	0000#0000#1000#0000B	;T1' -- read/only file
0080 =	FA#R0	EQU	FA#T1	
0040 =	FA#T2	EQU	0000#0000#0100#0000B	;T2' -- system files
0040 =	FA#SYS	EQU	FA#T2	
0020 =	FA#T3	EQU	0000#0000#0010#0000B	;T3' -- reserved for CP/M
GFA:				
0000 E5	PUSH	H		;Save AND-mask
0001 D5	PUSH	D		;Save FCB pointer
0002 0E1A	MVI	C,B#SETDMA		;Set DMA to default address
0004 118000	LXI	D,GFADMA		;DE -> DMA address
0007 CD0500	CALL	BDOS		
000A D1	POP	D		;Recover FCB pointer
000B 0E11	MVI	C,B#SEARCHF		;Search for match with name
000D CD0500	CALL	BDOS		
0010 FEFF	CPI	OFFH		;Carry set if OK, clear if error
0012 3F	CMC			;Invert to use set carry if error
0013 DA4100	JC	GFAX		;Return if error
0016 87	ADD	A		;Multiply by 32 to get offset into DMA buffer
0017 87	ADD	A		; * 2
0018 87	ADD	A		; * 4
0019 87	ADD	A		; * 8
001A 87	ADD	A		; * 16
001B 5F	MOV	E,A		; * 32
001C 1600	MVI	D,0		;Make into a word value
001E 218000	LXI	H,GFADMA		;HL -> DMA address
0021 19	DAD	D		;HL -> Directory entry in DMA buffer
0022 23	INX	H		;HL -> 1st character of file name
0023 EB	XCHG			;DE -> 1st character of file name
0024 0E0B	MVI	C,B+3		;Count of characters in file name and type
0026 210000	LXI	H,0		;Clear bit map
GFAL:				
0029 1A	LDAX	D		;Main loop
002A E680	ANI	80H		;Get next character of file name
002C 07	RLC			;Isolate attribute bit
002D B5	ORA	L		;Move MS bit into LS bit
002E 6F	MOV	L,A		;OR in any previously set bits
002F 29	DAD	H		;Save result
0030 13	INX	D		;Shift HL left one bit for next time
0031 0D	DCR	C		;DE -> next character in file name, type
0032 C22900	JNZ	GFAL		;Downdate count
0035 29	DAD	H		;Go back for next character
0036 29	DAD	H		;Left justify attribute bits in HL
0037 29	DAD	H		;MS attribute bit will already be in
0038 29	DAD	H		;bit 11 of HL, so only 4 shifts are
				;necessary
0039 D1	POP	D		;Recover AND-mask
003A 7A	MOV	A,D		;Get MS byte of mask
003B A4	ANA	H		;AND with MS byte of result
003C 47	MOV	B,A		;Save interim result
003D 7B	MOV	A,E		;Get LS byte of mask
003E A5	ANA	L		;AND with LS byte of result
003F B0	ORA	B		;Combine two results to set Z flag
0040 C9	RET			
GFAX:				
0041 E1	POP	H		;Error exit
0042 C9	RET			;Balance stack

Figure 5-23. Get file attributes (continued)

Function 31: Get Disk Parameter Block Address

Function Code: C = 1FH
 Entry Parameters: None
 Exit Parameters: HL = Address of DPB

Example

```

001F =      B#GETDPB      EQU      31      ;Get Disk Parameter Block
                                ; Address
0005 =      BDOS         EQU      5        ;BDOS entry point

                                ;Returns DPB address of
                                ; logical disk previously
                                ; selected with a Select
                                ; Disk function.
                                ;Function code
0000 0E1F          MVI      C,B#GETDPB    ;HL -> Base address of current
0002 CD0500       CALL     BDOS          ; disk's parameter block

```

Purpose

This function returns the address of the disk parameter block (DPB) for the last selected logical disk. The DPB, explained in Chapter 3, describes the physical characteristics of a specific logical disk—information mainly of interest for system utility programs.

Notes

The subroutines shown in Figure 5-24 deal with two major problems. First, given a track and sector number, what allocation block will they fall into? Conversely, given an allocation block, what is its starting track and sector?

These subroutines are normally used by system utilities. They first get the DPB address using this BDOS function. Then they switch to using direct BIOS calls to perform their other functions, such as selecting disks, tracks, and sectors and reading and writing the disk.

The first subroutine, GTAS (Get Track and Sector), in Figure 5-24, takes an allocation block number and converts it to give you the starting track and sector number. GMTAS (Get Maximum Track and Sector) returns the maximum track and sector number for the specified disk. GDTAS (Get Directory Track and Sector) tells you not only the starting track and sector for the file directory, but also the number of 128-byte sectors in the directory.

Note that whenever a track number is used as an entry or an exit parameter, it is an absolute track number. That is, the number of reserved tracks on the disk before the directory has already been added to it.

GNTAS (Get Next Track and Sector) helps you read sectors sequentially. It adds 1 to the sector number, and when you reach the end of a track, updates the track number by 1 and resets the sector number to 1.

GAB (Get Allocation Block) is the converse of GTAS (Get Track and Sector). It returns the allocation block number, given a track and sector.

Finally, Figure 5-24 includes several useful 16-bit subroutines to divide the HL register pair by DE (DIVHL), to multiply HL by DE (MULHL), to subtract DE from HL (SUBHL —this can also be used as a 16-bit compare), and to shift HL right one bit (SHLR). The divide and multiply subroutines are somewhat primitive, using iterative subtraction and addition, respectively. Nevertheless, they do perform their role as supporting subroutines.

```

;Useful subroutines for accessing the data in the
;disk parameter block

000E = B*SELDSK EQU 14 ;Select Disk function code
001F = B*GETDPB EQU 31 ;Get DPB address
0005 = BDOS EQU 5 ;BDOS entry point

;It makes for easier, more compact code to copy the
;specific disk parameter block into local variables
;while manipulating the information.
;Here are those variables --

DPB:
0000 0000 DPBSPT: DW 0 ;Disk parameter block
;128-byte sectors per track
0002 00 DPBBS: DB 0 ;Block shift
0003 00 DPBEM: DB 0 ;Block mask
0004 00 DPBEM: DB 0 ;Extent mask
0005 0000 DPBMAB: DW 0 ;Maximum allocation block number
0007 0000 DPBNOD: DW 0 ;Number of directory entries - 1
0009 0000 DPBDAB: DW 0 ;Directory allocation blocks
000B 0000 DPBCBS: DW 0 ;Check buffer size
000D 0000 DPBTBD: DW 0 ;Tracks before directory (reserved tracks)

000F = DPBSZ EQU $-DPB ;Disk parameter block size

;GETDPB
;Gets disk parameter block
;This subroutine copies the DPB for the specified
;logical disk into the local DPB variables above.

;Entry parameters
; A = Logical disk number (A: = 0, B: = 1...)

;Exit parameters
; Local variables contain DPB

GETDPB:
000F 5F MOV E,A ;Get disk code for select disk
0010 0E0E MVI C,B*SELDSK ;Select the disk
0012 CD0500 CALL BDOS
0015 0E1F MVI C,B*GETDPB ;Get the disk parameter base address
0017 CD0500 CALL BDOS ;HL -> DPB
001A 0E0F MVI C,DPBSZ ;Set count
001C 110000 LXI D,DPB ;Get base address of local variables

GDPBL:
001F 7E MOV A,M ;Copy DPB into local variables
0020 12 STAX D ;Get byte from DPB
0021 13 INX D ;Store into local variable
0022 23 INX H ;Update local variable pointer
0023 0D DCR C ;Update DPB pointer
0024 C21F00 JNZ GDPBL ;Downdate count
0027 C9 RET ;Loop back for next byte

;GTAS
;Get track and sector (given allocation block number)

;This subroutine converts an allocation block into a
;track and sector number -- note that this is based on
;128-byte sectors.

;>>>> Note: You must call GETDPB before
;>>>> you call this subroutine

;Entry parameters
; HL = allocation block number

;Exit parameters
; HL = track number
; DE = sector number

;Method :
;In mathematical terms, the track can be derived from:
;Trk = ((allocation block * sec. per all. block) / sec. per trk)
; + tracks before directory

```

Figure 5-24. Accessing disk parameter block data

```

;The sector is derived from:
;Sec = ((allocation block * sec. per all. block) modulo/
;      sec. per trk) + 1

0028 3A0200      GTAS:      LDA      DPBBS      ;Get block shift -- this will be 3 to
;7 depending on allocation block size
;It will be used as a count for shifting

002B 29          GTASS:      DAD      H          ;Shift allocation block left one place
002C 3D          DCR      A          ;Decrement block shift count
002D C22B00      UNZ      GTASS      ;More shifts required
0030 EB          XCHG      ;DE = all. block * sec. per block
;i.e. DE = total number of sectors
0031 2A0000      LHL      DPBSPT      ;Get sectors per track
0034 EB          XCHG      ;HL = sec. per trk, DE = tot. no. of sec.
0035 CDBF00      CALL     DIVHL      ;BC = HL/DE, HL = remainder
;BC = track, HL = sector
0038 23          INX      H          ;Sector numbering starts from 1
0039 EB          XCHG      ;DE = sector, HL = track
003A 2A0D00      LHL      DPBTBD      ;Tracks before directory
003D 09          DAD      B          ;DE = sector, HL = absolute track
003E C9          RET

;GMTAS
;Get maximum track and sector

;This is just a call to GTAS with the maximum
;allocation block as the input parameter

;>>>> Note: You must call GETDPB before
;>>>> you call this subroutine

;Entry parameters: none

;Exit parameters:
; HL = maximum track number
; DE = maximum sector

003F 2A0500      GMTAS:      LHL      DPBMAB      ;Get maximum allocation block
0042 C32800      JMP      GTAS      ;Return from GTAS with parameters in HL and DE

;GDTAS
;Get directory track and sector

;This returns the START track and sector for the
;file directory, along with the number of sectors
;in the directory.

;>>>> Note: You must call GETDPB before
;>>>> you call this subroutine

;Entry parameters: none

;Exit parameters:
; BC = number of sectors in directory
; DE = directory start sector
; HL = directory start track

0045 2A0700      GDTAS:      LHL      DPBNOD      ;Get number of directory entries - 1
0048 23          INX      H          ;Make true number of entries
;Each entry is 32 bytes long, so to
;convert to 128 byte sectors, divide by 4
; / 2 (by shifting HL right one bit)
; / 4
0049 CDD000      CALL     SHLR      ;Save number of sectors
004C CDD000      CALL     SHLR      ;Directory starts in allocation block 0
004F E5          PUSH     H          ;HL = track, DE = sector
0050 210000      LXI     H,0
0053 CD2800      CALL     GTAS      ;Recover number of sectors
0056 C1          POP      B
0057 C9          RET

```

Figure 5-24. (Continued)

```

;GNTAS
;Get NEXT track and sector

;This subroutine updates the input track and sector
;by one, incrementing the track and resetting the
;sector number as required.

;>>>> Note: You must call GETDPB before
;>>>>         you call this subroutine

; Note: you must check for end of disk by comparing
; the track number returned by this subroutine
; to that returned by by GMTAS + 1. When
; equality occurs, the end of disk has been reached.

;Entry parameters
; HL = current track number
; DE = current sector number

;Exit parameters
; HL = updated track number
; DE = updated sector number

GNTAS:
0058 E5      PUSH    H           ;Save track
0059 13      INX     D           ;Update sector
005A 2A0000  LHL    DPBSPT          ;Get sectors per track
005D CDC900  CALL   SUBHL            ;HL = HL - DE
0060 E1      POP     H           ;Recover current track
0061 D0      RNC     ;Return if updated sector <= sec. per trk.
0062 23      INX     H           ;Update track if upd. sec > sec. per trk.
0063 110100  LXI    D,1          ;Reset sector to 1
0066 C9      RET

;GAB
;Get allocation block

;This subroutine returns an allocation block number
;given a specific track and sector. It also returns
;the offset down the allocation block at which the
;sector will be found. This offset is in units of
;128-byte sectors.

;>>>> Note: You must call GETDPB before
;>>>>         you call this subroutine

;Entry parameters
; HL = track number
; DE = sector number

;Exit parameters
; HL = allocation block number

;Method
;The allocation block is formed from:
;AB = (sector + ((track - tracks before directory)
; * sectors per track)) / log2 (sectors per all. block)

;The sector offset within allocation block is formed from:
;Offset = (sector + ((track - tracks before directory)
; * sectors per track)) / AND (sectors per all. block - 1)

GAB:
0067 D5      PUSH    D           ;Save sector
0068 EB      XCHG   ;DE = track
0069 2A0D00  LHL    DPBTBD          ;Get no. of tracks before directory
006C EB      XCHG   ;DE = no. of tracks before dir. HL = track
006D CDC900  CALL   SUBHL            ;HL = HL - DE
;HL = relative track within logical disk
;DE = relative track
0070 EB      XCHG   ;DE = relative track
0071 2A0000  LHL    DPBSPT          ;Get sectors per track
0074 CDA400  CALL   MULHL            ;HL = HL * DE
;HL = number of sectors
;DE = number of sectors
0077 EB      XCHG

```

Figure 5-24. (Continued)

```

0078 E1      POP      H          ;Recover sector
0079 2B      DCX      H          ;Make relative to 0
007A 19      DAD      D          ;HL = relative sector
007B 3A0300  LDA      DPBBM        ;Get block mask
007E 47      MOV      B,A          ;Ready for AND operation
007F 7D      MOV      A,L          ;Get LS byte of relative sector
0080 A0      ANA      B          ;AND with block mask
0081 F5      PUSH     PSW          ;A = sector displacement
0082 3A0200  LDA      DPBBS          ;Get block shift
0085 4F      MOV      C,A          ;Make into counter

GABS:
0086 CDD000  CALL     SHLR           ;Shift loop
0089 0D      DCR      C          ;HL shifted right (divided by 2)
008A C28600  JNZ     GABS          ;Count down
008D F1      POP      PSW          ;Shift again if necessary
008E C9      RET

;Utility subroutines
;These perform 16-bit arithmetic on the HL register pair.

;DIVHL
;Divides HL by DE using an iterative subtract.
;In practice, it uses an iterative ADD of the complemented divisor.

;Entry parameters
;   HL = dividend
;   DE = divisor

;Exit parameters
;   BC = quotient
;   HL = remainder

DIVHL:
008F D5      PUSH     D          ;Save divisor
                                ;Note : 2's complement is formed by
                                ;inverting all bits and adding 1.
0090 7B      MOV      A,E          ;Complement divisor (for iterative
0091 2F      CMA                      ;ADD later on)
0092 5F      MOV      E,A
0093 7A      MOV      A,D          ;Get MS byte
0094 2F      CMA                      ;Complement it
0095 57      MOV      D,A
0096 13      INX      D          ;Make 2's complement
                                ;Now, subtract negative divisor until
                                ;dividend goes negative, counting the number
                                ;of times the subtract occurs
0097 010000  LXI     B,0          ;Initialize quotient
DIVHLS:
009A 03      INX      B          ;Subtract loop
009B 19      DAD      D          ;Add 1 to quotient
009C DA9A00  JC      DIVHLS        ;"Subtract" divisor
                                ;Dividend not yet negative
                                ;Dividend now negative, quotient 1 too large
009F 0B      DCX      B          ;Correct quotient
                                ;Compute correct remainder
00A0 EB      XCHG                      ;DE = remainder - divisor
00A1 E1      POP      H          ;Recover positive divisor
00A2 19      DAD      D          ;HL = remainder
00A3 C9      RET                      ;BC = quotient, HL = remainder

;MULHL
;Multiply HL * DE using iterative ADD.

;Entry parameters
;   HL = multiplicand
;   DE = multiplier

;Exit parameters
;   HL = product
;   DE = multiplier

MULHL:
00A4 C5      PUSH     B          ;Save user register
                                ;Check if either multiplicand
                                ;or multiplier is 0

```

Figure 5-24. (Continued)

```

00A5 7C          MOV    A,H
00A6 B5          ORA    L
00A7 CAC400     JZ     MULHLZ      ;Yes, fake product
00AA 7A          MOV    A,D
00AB B3          ORA    E
00AC CAC400     JZ     MULHLZ      ;Yes, fake product

                                ;This routine will be faster if
                                ; the smaller value is in DE
00AF 7A          MOV    A,D      ;Get MS byte of current DE value
00B0 BC          CMP    H          ;Check which is smaller
00B1 DAB500     JC     MULHLN     ;C set if D < H, so no exchange
00B4 EB

MULHLN:
00B5 42          MOV    B,D      ;BC = multiplier
00B6 4B          MOV    C,E
00B7 54          MOV    D,H      ;DE = HL = multiplicand
00B8 5D          MOV    E,L
00B9 0B          DCX    B          ;Adjust count as
                                ; 1 * multiplicand = multiplicand

MULHLA:
                                ;ADD loop
00BA 78          MOV    A,B      ;Check if all iterations completed
00BB B1          ORA    C
00BC CAC700     JZ     MULHLX     ;Yes, exit
00BF 19          DAD    D          ;HL = multiplicand + multiplicand
00C0 0B          DCX    B          ;Countdown on multiplier - 1
00C1 C3BA00     JMP    MULHLA     ;Loop back until all ADDs done

00C4 210000     LXI    H,0      ;Fake product as either multiplicand
                                ; or multiplier is 0

MULHLX:
00C7 C1          POP    B          ;Recover user register
00C8 C9          RET

;SUBHL
;Subtract HL - DE

;Entry parameters
;   HL = subtrahend
;   DE = subtractor

;Exit parameters
;   HL = difference

SUBHL:
00C9 7D          MOV    A,L      ;Get LS byte
00CA 93          SUB    E          ;Subtract without regard to carry
00CB 6F          MOV    L,A      ;Put back into difference
00CC 7C          MOV    A,H      ;Get MS byte
00CD 9A          SBB    D          ;Subtract including carry
00CE 67          MOV    H,A      ;Move back into difference
00CF C9          RET

;SHLR
;Shift HL right one place (dividing HL by 2)

;Entry parameters
;   HL = value to be shifted

;Exit parameters
;   HL = value/2

SHLR:
00D0 B7          ORA    A          ;Clear carry
00D1 7C          MOV    A,H      ;Get MS byte
00D2 1F          RAR          ;Bit 7 set from previous carry,
                                ; bit 0 goes into carry
00D3 67          MOV    H,A      ;Put shift MS byte back
00D4 7D          MOV    A,L      ;Get LS byte
00D5 1F          RAR          ;Bit 7 = bit 0 of MS byte
00D6 6F          MOV    L,A      ;Put back into result
00D7 C9          RET

```

Figure 5-24. (Continued)

Function 32: Set/Get User Number

Function Code: C = 20H
 Entry Parameters: E = 0FFH to get user number, or
 E = 0 to 15 to set user number
 Exit Parameters: A = Current user number if E was 0FFH

Example

```

0020 =      B$SETGETUN    EQU    32    ;Set/Get User Number
0005 =      BDOS        EQU    5      ;BDOS entry point

                                ;To set user number
0000 0E20          MVI    C,B$SETGETUN ;Function code
0002 1E0F          MVI    E,15       ;Required user number
0004 CD0500        CALL   BDOS        ;To get user number
0007 0E20          MVI    C,B$SETGETUN ;Function code
0009 1E0F          MVI    E,0FFH     ;Indicate request to GET
000B CD0500        CALL   BDOS        ;A = Current user no. (0 -- 15)

```

Purpose This subroutine either sets or gets the current user number. The current user number determines which file directory entries are matched during all disk file operations.

When you call this function, the contents of the E register specify what action is to be taken. If E = 0FFH, then the function will return the current user number in the A register. If you set E to a number in the range 0 to 15 (that is, a valid user number), the function will set the current user number to this value.

Notes You can use this function to share files with other users. You can locate a file by attempting to open a file and switching through all of the user numbers. Or you can share a file in another user number by setting to that number, operating on the file, and then reverting back to the original user number.

If you do change the current user number, make provisions in your program to return to the original number before your program terminates. It is disconcerting for computer operators to find that they are in a different user number after a program. Files can easily be damaged or accidentally erased this way.

Function 33: Read Random

Function Code: C = 21H
 Entry Parameters: DE = Address of FCB
 Exit Parameters: A = Return code

Example

```

0021 =      B$READRAN   EQU    33    ;Read Random
0005 =      BDOS        EQU    5      ;BDOS entry point

                                ;File control block
0000 00          FCB$*DISK:  DB    0      ;Search on default disk drive
0001 46494C454EFCB$*NAME:  DB    'FILENAME' ;File name
0009 545950      FCB$*TYP:   DB    'TYP'  ;File type

```

```

000C 00          FCB$EXTENT:   DB      0          ;Extent
000D 0000       FCB$RESV:     DB      0,0         ;Reserved for CP/M
000F 00          FCB$RECUSED:  DB      0          ;Records used in this extent
0010 0000000000 FCB$ABUSED:  DB      0,0,0,0,0,0,0,0 ;Allocation blocks used
0018 0000000000          DB      0,0,0,0,0,0,0,0
0020 00          FCB$SEQREC:   DB      0          ;Sequential rec. to read/write
0021 0000       FCB$RANREC:   DW      0          ;Random rec. to read/write
0023 00          FCB$RANRECO:  DB      0          ;Random rec. overflow byte (MS)

0024 D204       RANRECNO:     DW      1234         ;Example random record number

;Record will be read into
; address set by prior
; SETDMA call
;Get random record number
0026 2A2400          LHL D, RANRECNO
0029 222100          SHL D, FCB$RANREC
;Set up file control block
002C 0E21          MVI C, B$READRAN ;Function code
002E 110000        LXI D, FCB ;DE -> .file control block
0031 CD0500        CALL BDOS ;A = 00 if operation successful
;A = nonzero if no data in
; file specifically:
;A = 01 -- attempt to read
;          unwritten record
;          03 -- CP/M could not
;          close current extent
;          04 -- attempt to read
;          unwritten extent
;          06 -- attempt to read
;          beyond end of disk

```

Purpose

This function reads a specific CP/M record (128 bytes) from a random file—that is, a file in which records can be accessed directly. It assumes that you have already opened the file, set the DMA address using the BDOS Set DMA function, and set the specific record to be read into the random record number in the FCB. This function computes the extent of the specified record number and attempts to open it and read the correct CP/M record into the DMA address.

The random record number in the FCB is three bytes long (at relative bytes 33, 34, and 35). Byte 33 is the least significant byte, 34 is the middle byte, and 35 the most significant. CP/M uses only the most significant byte (35) for computing the overall file size (function 35). You must set this byte to 0 when setting up the FCB. Bytes 33 and 34 are used together for the Read Random, so you can access from record 0 to 65535 (a maximum file size of 8,388,480 bytes).

This function returns with A set to 0 to indicate that the operation has been completed successfully, or A set to a nonzero value if an error has occurred. The error codes are as follows:

- A = 01 (attempt to read unwritten record)
- A = 03 (CP/M could not close current extent)
- A = 04 (attempt to read unwritten extent)
- A = 06 (attempt to read beyond end of disk)

Unlike the Read Sequential BDOS function (code 20, 14H), which updates the current (sequential) record number in the FCB, the Read Random function leaves the record number unchanged, so that a subsequent Write Random will replace the record just read.

You can follow a Read Random with a Write Sequential (code 21, 15H). This

will rewrite the record just read, but will then update the sequential record number. Or you may choose to use a Read Sequential after the Read Random. In this case, the same record will be reread and the sequential record number will be incremented. In short, the file can be sequentially read or written once the Read Random has been used to position to the required place in the file.

Notes

To use the Read Random function, you must first open the *base extent* of the file, that is, extent 0. Even though there may be no actual data records in this extent, opening permits the file to be processed correctly.

One problem that is not immediately obvious with random files is that they can easily be created with gaps in the file. If you were to create the file with record number 0 and record number 5000, there would be no intervening file extents. Should you attempt to read or copy the file sequentially, even using CP/M's file copy utility, only the first extent (and in this case, record 0) would get copied. A Read Sequential function would return an "end of file" error after reading record 0. You must therefore be conscious of the type of the file that you try and read.

See Figure 5-26 for an example subroutine that performs Random File Reads and Writes. It reads or writes records of sizes other than 128 bytes, where necessary reading or writing several CP/M records, prereading them into its own buffer when the record being written occupies only part of a CP/M record. It also contains subroutines to produce a 32-bit product from multiplying HL by DE (MLDL—Multiply double length) and a right bit shift for DE, HL (SDLR—Shift double length right).

Function 34: Write Random

Function Code: C = 22H
 Entry Parameters: DE = Address of file control block
 Exit Parameters: A = Return code

Example

```

0022 =      B$WRITERAN      EQU      34      ;Write Random
0005 =      BDOS           EQU      5        ;BDOS entry point

          FCB:             ;File control block
0000 00      FCB$DISK:      DB      0        ;Search on default disk drive
0001 46494C454EFCB$NAME:  DB      'FILENAME' ;File name
0009 545950      FCB$TYP:   DB      'TYP'   ;File type
000C 00      FCB$EXTENT:   DB      0        ;Extent
000D 0000      FCB$RESV:   DB      0,0      ;Reserved for CP/M
000F 00      FCB$RECUSED:  DB      0        ;Records used in this extent
0010 0000000000FCB$ABUSED:DB      0,0,0,0,0,0,0,0 ;Allocation blocks used
0018 0000000000      DB      0,0,0,0,0,0,0,0
0020 00      FCB$SEQREC:   DB      0        ;Sequential rec. to read/write
0021 0000      FCB$RANREC: DW      0        ;Random rec. to read/write
0023 00      FCB$RANRECO:  DB      0        ;Random rec. overflow byte (MS)

0024 D204      RANRECNO:   DW      1234     ;Example random record number

          ;Record will be written from
          ; address set by prior
          ; SETDMA call

```

```

0026 2A2400      LHL  RANRECNO      ;Get random record number
0029 222100      SHLD FCB$RANREC    ;Set up file control block
002C 0E22        MVI  C,B$WRITERAN ;Function code
002E 110000      LXI  D,FCB         ;DE -> file control block
0031 CD0500      CALL BDOS          ;A = 00 if operation successful
                                ;A = nonzero if no data in file
                                ; specifically:
                                ; A = 03 -- CP/M could not
                                ;       close current extent
                                ;       05 -- directory full
                                ;       06 -- attempt to write
                                ;       beyond end of disk

```

Purpose This function writes a specific CP/M record (128 bytes) into a random file. It is initiated in much the same way as the companion function, Read Random (code 33, 21H). It assumes that you have already opened the file, set the DMA address to the address in memory containing the record to be written to disk, and set the random record number in the FCB to the specified record being written. This function also computes the extent in which the specified record number lies and opens the extent (creating it if it does not already exist). The error codes returned in A by this call are the same as those for Read Random, with the addition of error code 05, which indicates a full directory.

Like the Read Random (but unlike the Write Sequential), this function does not update the logical extent and sequential (current) record number in the FCB. Therefore, any subsequent sequential operation will access the record just written by the Read Random call, but these functions will update the sequential record number. The Write Random can therefore be used to position to the required place in the file, which can then be accessed sequentially.

Notes In order to use the Write Random, you must first open the base extent (extent 0) of the file. Even though there may be no data records in this extent, opening permits the file to be processed correctly.

As explained in the notes for the Read Random function, you can easily create a random file with gaps in it. If you were to create a file with record number 0 and record number 5000, there would be no intervening file extents.

Figure 5-25 shows an example subroutine that creates a random file (CRF) but avoids this problem. You specify the number of 128-byte CP/M records in the file. The subroutine creates the file and then writes zero-filled records throughout. This makes it easier to process the file and permits standard CP/M utility programs to copy the file because there is a data record in every logical record position in the file. It is no longer a "sparse" file.

Figure 5-26 shows a subroutine that ties the Read and Write Random functions together. It performs Random Operations (RO). Unlike the standard BDOS functions that operate on 128-byte CP/M records, RO can handle arbitrary record size from one to several thousand bytes. You specify the relative record number of your record, not the CP/M record number (RO computes this). RO also prereads a CP/M record when your logical record occupies part of a 128-byte record, either because your record is less than 128 bytes or because it spans more than one

128-byte sector. The subroutine suppresses this pre-read if you happen to use a record size that is some multiple of 128 bytes. In this case, your records will fit exactly onto a 128-byte record, so there will never be some partially occupied 128-byte sector.

This example also contains subroutines to produce a 32-bit product from multiplying HL by DE (MLDL—Multiply double length) and a right bit shift for DE, HL (SDLR—Shift double length right).

```

;RO
;Random operation (read or write)

;This subroutine reads or writes a random record from a file.
;The record length can be other than 128-bytes. This
;subroutine computes the start CP/M record (which
;is 128 bytes), and, if reading, performs a random read
;and moves the user-specified record into a user buffer.
;If necessary, more CP/M records will be read until the complete
;user-specified record has been input.
;For writing, if the size of the user-specified record is not an exact
;multiple of CP/M records, the appropriate sectors will be pre-read.
;It is not necessary to pre-read when the user-specified record
;is an exact CP/M record, nor when subroutine is processing
;CP/M records entirely spanned by a user-specified record.

;Entry parameters
;   HL -> parameter block of the form:
;       DB 0           ;OFFH when reading, 00H for write
;       DW FCB        ;Pointer to FCB
;       DW RECNO      ;User record number
;       DW RECSZ      ;User record size
;       DW BUFFER     ;Pointer to buffer of
;                       ; RECSZ bytes in length

;Exit parameters
;   A = 0 if operation completed (and user record
;       copied into user buffer)
;       1 if attempt to read unwritten CP/M record
;       3 if CP/M could not close an extent
;       4 if attempt to read unwritten extent
;       5 if CP/M could not create a new extent
;       6 if attempt to read beyond end of disk

;Calling sequence
;   LXI  H,PARAMS      ;HL -> parameter block
;   CALL RO            ;
;   ORA  A             ;Check if error
;   JNZ  ERROR        ;

0021 = FCBE$RANREC EQU 33 ;Offset of random record no. in FCB
001A = B$SETDMA EQU 26 ;Set the DMA address
0021 = B$READRAN EQU 33 ;Read random record
0028 = B$WRITERANZ EQU 40 ;Write random record with zero-fill
; previously unallocated allocation
; blocks
0005 = BDOS EQU 5 ;BDOS entry point

ROPB:
ROREAD: DB 0 ;Parameter block image
;NZ when reading, Z when writing
ROFCB: DW 0 ;Pointer to FCB
ROURN: DW 0 ;User record number
ROURL: DW 0 ;User record length
ROUB: DW 0 ;Pointer to user buffer
ROPB: EQU $-ROPB ;Parameter block length

0009 0000 RDRFP: DW 0 ;Pointer to start of user record fragment
; in first CP/M-record read in

```

Figure 5-26. Read/Write variable length records randomly

```

000B 00      ROFRL: DB      0          ;Fragment length
000C 0000    RORNP: DW      0          ;Record number pointer (in user FCB)
000E 00      ROWECR: DB      0          ;NZ when writing user records that are an
                                        ; exact super-multiple of CP/M-record (and
                                        ; therefore no pre-read is required)

000F          ROBUF: DS      128        ;Buffer for CP/M record

RO:
008F 110000  LXI      D,ROPB          ;DE -> local parameter block
0092 0E09    MVI      C,ROPBL          ;Parameter block length
0094 CDFE01  CALL     MOVE          ;Move C bytes from HL to DE

                                        ;To compute offset of user record in CP/M record,
                                        ; compute the relative BYTE offset of the start
                                        ; of the user record within the file (i.e.,
                                        ; user record number * record size). The least
                                        ; significant 7 bits of this product give the
                                        ; byte offset of the start of the user record.
                                        ;The product / 128 (shifted left 7 bits) gives the
                                        ;CP/M record number of the start of the user record.

0097 2A0500  LHL      ROURL          ;Get user record length
009A 7D      MOV      A,L          ;Get LS bytes of user rec. length
009B E67F    ANI      7FH          ;Check if exact multiple of 128
009D B7      ORA      A          ;(i.e., exact CP/M records)
009E 3E00    MVI      A,0          ;A = 0, flags unchanged
00A0 C2A400  JNZ      RONE          ;Not exact CP/M records
00A3 3D      DCR      A          ;A = FF

RONE:
00A4 320E00  STA      ROWECR          ;Set write-exact-CP/M-records flag
00A7 EB      XCHG          ;DE = user record length
00A8 2A0300  LHL      ROURL          ;Get user record number
00AB CDB801  CALL     MLDL          ;DE,HL = HL * DE
                                        ;DE,HL = user-record byte offset in file
                                        ;Save user-record byte offset

00AE D5      PUSH     D          ;Save user-record byte offset
00AF E5      PUSH     H
00B0 7D      MOV      A,L          ;Get LS byte of product
00B1 E67F    ANI      7FH          ;Isolate byte offset within

00B3 4F      MOV      C,A          ;CP/M record
00B4 0600    MVI      B,0          ;Make into word value
00B6 210F00  LXI      H,ROBUF       ;Get base address of local buffer
00B9 09      DAD      B          ;HL -> Start of fragment in buffer
00BA 220900  SHLD    ROFRP          ;Save fragment pointer

                                        ;Compute maximum fragment length that could reside in
                                        ;remainder of CP/M record, based on the offset in the
                                        ;CP/M record where the fragment starts.

00BD 47      MOV      B,A          ;Take copy of offset in CP/M record
00BE 3E80    MVI      A,128        ;CP/M record size
00C0 90      SUB      B          ;Compute 128 - offset
00C1 320B00  STA      ROFRL          ;Assume this is the fragment length

                                        ;If the user record length is less than the assumed
                                        ; fragment length, use it in place of the result above

00C4 47      MOV      B,A          ;Get copy of assume frag. length
00C5 3A0600  LDA      ROURL+1       ;Get MS byte of user record length
00C8 B7      ORA      A          ;If NZ, rec. len. must be > 128
00C9 C2D600  JNZ      ROFLOK        ;So fragment length is OK
00CC 3A0500  LDA      ROURL          ;Still a chance that rec. len.
00CF B8      CNP      B          ; less than fragment len.
00D0 D2D600  JNC      ROFLOK        ;NC if user rec. len. => frag. len.
00D3 320B00  STA      ROFRL          ;User rec. len. < frag. len. so
                                        ; reset fragment length to smaller

ROFLOK:
00D6 3A0E00  LDA      ROWECR          ;Get exact CP/M record flag
00D9 47      MOV      B,A          ;for ANDING with READ flag
00DA 3A0000  LDA      ROREAD        ;Get read operation flag
00DD 2F      CMA          ;Invert so NZ when writing

```

Figure 5-26. (Continued)

00DE A0	ANA	B		;Form logical AND
00DF 320E00	STA	ROWECR		;Save back in flag
				;Recover the double length byte offset within the file
				;of the start of the user record. Shift 7 places right
				;to divide by 128 and get the CP/M record number for
				;the start of the user record.
00E2 E1	POP	H		;Recover user rec. byte offset
00E3 D1	POP	D		
00E4 0E07	MVI	C,7		;Count for shift right
	ROS:			
00E6 CDF101	CALL	SDLR		;DE,HL = DE,HL / 2
00E9 0D	DCR	C		
00EA C2E600	JNZ	ROS		
00ED 7A	MOV	A,D		;Error if DE still NZ after
00EE B3	ORA	E		; division by 128.
00EF C2AC01	JNZ	ROERO		
				;Set CP/M record number in FCB
00F2 EB	XCHG			;DE = CP/M record number
00F3 2A0100	LHLD	ROFCB		;Get pointer to FCB
00F6 012100	LXI	B,FCBE#RANREC		;Offset of random record no. in FCB
00F9 09	DAD	B		;HL -> ran. rec. no. in FCB
00FA 220C00	SHLD	RORNPN		;Save record number pointer
00FD 73	MOV	M,E		;Store LS byte
00FE 23	INX	H		
00FF 72	MOV	M,D		;Store MS byte
0100 0E1A	MVI	C,B#SETDMA		;Set DMA address to local buffer
0102 110F00	LXI	D,ROBUF		
0105 CD0500	CALL	BDOS		
0108 3A0E00	LDA	'ROWECR		;Bypass preread if exact sector write
010B B7	ORA	A		
010C C21F01	JNZ	ROMNF		
010F 2A0100	LHLD	ROFCB		;Get pointer to FCB
0112 EB	XCHG			;DE -> FCB
0113 0E21	MVI	C,B#READRAN		;Read random function
0115 CD0500	CALL	BDOS		
0118 FE05	CPI	5		;Check if error code < 5
011A DCAF01	CC	ROEIE		;Yes, check if ignorable error
				; (i.e. error reading unwritten part
				; of file for write operation preread)
011D B7	ORA	A		;Check if error
011E C0	RNZ			;Yes
	ROMNF:			
011F 2A0700	LHLD	ROUB		;Move next fragment
0122 EB	XCHG			;Get pointer to user buffer
0123 2A0900	LHLD	ROFRP		;DE -> user buffer
0126 3A0B00	LDA	ROFRL		;HL -> start of user rec. in local buffer
0129 4F	MOV	C,A		;Get fragment length
				;Ready for MOVE
012A 3A0000	LDA	ROREAD		;Check if reading
012D B7	ORA	A		
012E C23201	JNZ	RORD1		;Yes, so leave DE, HL unchanged
0131 EB	XCHG			;Writing, so swap source and destination
				;DE -> start of user rec. in local buffer
				;HL -> user buffer
	RORD1:			
0132 CDFE01	CALL	MOVE		;Reading - fragment local -> user buffer
				;Writing - fragment user -> local buffer
0135 3A0000	LDA	ROREAD		;Check if writing
0138 B7	ORA	A		
0139 CA3D01	JZ	ROWR1		;Writing, so leave HL -> user buffer
013C EB	XCHG			;HL -> next byte in user buffer
	ROWR1:			
013D 220700	SHLD	ROUB		;Save updated user buffer pointer
0140 3A0000	LDA	ROREAD		;Check if reading

Figure 5-26. (Continued)

```

0143 B7          ORA      A
0144 C25001     JNZ      RORD3      ;Yes, bypass write code

0147 0E28       MVI      C,B*WRITERANZ ;Write random
0149 2A0100     LHLD     ROFCB      ;Get address of FCB
014C EB         XCHG     ;DE -> FCB
014D CD0500     CALL     BDOS

RORD3: ;Compute residual length of user record as yet unmoved.
;If necessary (because more data needs to be transferred)
;more CP/M records will be read. In this case
;the start of the fragment will be offset 0. The fragment
;length depends on whether the user record finishes within
;the next sector or spans it. If the residual length of the
;user record is > 128, the fragment length will be set to
;128.

0150 2A0500     LHLD     ROURL      ;Get residual user rec. length
0153 3A0B00     LDA      ROFRL      ;Get fragment length just moved
0156 5F         MOV      E,A        ;Make into a word value
0157 1600       MVI      D,0
0159 CDEA01     CALL     SUBHL      ;Compute ROURL - ROFRL
015C 7C         MOV      A,H        ;Check if result 0
015D B5         ORA      L
015E C8         RZ              ;Return when complete USER
; record has been transferred
;Save downdated residual rec. length
;Assume residual length < 128
;Check if residual length is < 128
;HL = HL - DE
;negative if < 128
;=> 128, so set frag.length to 128

015F 220500     SHLD     ROURL
0162 4D         MOV      C,L
0163 118000     LXI     D,128
0166 CDEA01     CALL     SUBHL      ;HL = HL - DE
0169 FA6E01     JM      ROLT128
016C 0E80       MVI      C,128

ROLT128:
016E 79         MOV      A,C
016F 320B00     STA     ROFRL      ;Fragment length now is either 128
; if more than 128 bytes left to input
; in user record, or just the right
; number of bytes (< 128) to complete
; the user record.
;All subsequent CP/M records will start
; at beginning of buffer

0172 210F00     LXI     H,ROBUF
0175 220900     SHLD     ROFRP

;Update random record number in FCB
;HL -> random record number in user FCB
;Increment the random record number
;HL -> MS byte of record number
;Get MS byte
;Update record number itself
;Check if record now 0

0178 2A0C00     LHLD     RORNP
017B 5E         MOV      E,M
017C 23         INX     H
017D 56         MOV      D,M
017E 13         INX     D
017F 7A         MOV      A,D
0180 B3         ORA      E
0181 C28701     JNZ     ROSRN      ;No, so save record number
0184 3E06       MVI      A,6        ;Indicate "seek past end of disk"
0186 C9         RET              ;Return to user

RORSRN:
0187 72         MOV      M,D        ;Save record number
0188 2B         DCX     H
0189 73         MOV      M,E        ;HL -> LS byte

;If writing, check if preread required
;Check if exact CP/M record write

018A 3A0E00     LDA      ROWECR
018D B7         ORA      A
018E C21F01     JNZ     ROMNF      ;Yes, go move next fragment

;If reading, perform read unconditionally

0191 3A0000     LDA      ROREAD
0194 B7         ORA      A
0195 C2A001     JNZ     RORD2

;For writes, bypass preread if
; whole CP/M-record is to be overwritten
; (fragment length = 128)

0198 3A0B00     LDA      ROFRL
019B FE80     CPI      128
019D CA1F01     JZ      ROMNF

RORD2:
01A0 0E21       MVI      C,B*READRAN ;Read the next CP/M record
01A2 2A0100     LHLD     ROFCB      ; in sequence

```

Figure 5-26. (Continued)

```

01A5 EB          XCHG          ;DE -> FCB
01A6 CD0500     CALL          BDOS
01A9 C31F01     JMP           ROMNF      ;Go back to move next fragment

;ROERO:
;Error because user record number
; * User record length / 128 gives
; a CP/M record number > 65535.
01AC 3E04       MVI          A,4
01AE C9         RET

;ROEIE:
;Check ignorable error (preread
; for write operation)
;Save original error code
;Check if read operation
01AF 47         MOV          B,A
01B0 3A0000     LDA          ROREAD
01B3 B7         ORA          A
01B4 7B         MOV          A,B      ;Restore original error code but
; leave flags unchanged
01B5 C0         RNZ
01B6 AF         XRA          A      ;Return if reading
01B7 C9         RET          ;Fake "no error" indicator

;MLDL
;Multiply HL * DE using iterative ADD with product
;returned in DE,HL.

;Entry parameters
; HL = multiplicand
; DE = multiplier

;Exit parameters
; DE,HL = product
; DE = multiplier

MLDL:
01BB 010000     LXI          B,0
01BB C5         PUSH         B      ;Put 0 on top of stack
; to act as MS byte of product
;Check if either multiplicand
; or multiplier is 0
01BC 7C         MOV          A,H
01BD B5         ORA          L
01BE CAE501     JZ          MLDLZ     ;Yes, fake product
01C1 7A         MOV          A,D
01C2 B3         ORA          E
01C3 CAE501     JZ          MLDLZ     ;Yes, fake product

;This routine will be faster if
; the smaller value is in DE
;Get MS byte of current DE value
;Check which is smaller
;C set if D < H, so no exchange
01C6 7A         MOV          A,D
01C7 BC         CMP          H
01C8 DACC01     JC          MLDLNX
01CB EB         XCHG

MLDLNX:
01CC 42         MOV          B,D
01CD 4B         MOV          C,E      ;BC = multiplier

01CE 54         MOV          D,H
01CF 5D         MOV          E,L      ;DE = HL = multiplicand

01D0 0B         DCX          B      ;Adjust count as
; 1 * multiplicand = multiplicand
;ADD loop
;Check if all iterations completed
MLDLA:
01D1 7B         MOV          A,B
01D2 B1         ORA          C
01D3 CAE801     JZ          MLDLX     ;Yes, exit
01D4 19         DAD          D      ;HL = multiplicand + multiplicand
;HL = MS bytes of result, TOS = part prod.
01D7 E3         XTHL
01D8 7D         MOV          A,L
01D9 CE00       ACI          0
01DB 6F         MOV          L,A
01DC 7C         MOV          A,H
01DD CE00       ACI          0
01DF 67         MOV          H,A
01E0 E3         XTHL
01E1 0B         DCX          B
01E2 C3D101     JMP          MLDLA     ;Countdown on multiplier - 1
;Loop back until all ADDs done

```

Figure 5-26. (Continued)

```

01E5 210000    MLDLZ:  LXI    H,0          ;Fake product as either multiplicand
                                     ; or multiplier is 0

01E8 D1       MLDLX:  POP    D          ;Recover MS part of product
01E9 C9       RET

;SUBHL
;Subtract HL - DE.

;Entry parameters
;   HL = subtrahend
;   DE = subtractor

;Exit parameters
;   HL = difference

SUBHL:
01EA 7D       MOV    A,L          ;Get LS byte
01EB 93       SUB    E          ;Subtract without regard to carry
01EC 6F       MOV    L,A         ;Put back into difference
01ED 7C       MOV    A,H         ;Get MS byte
01EE 9A       SBB    D          ;Subtract including carry
01EF 67       MOV    H,A         ;Move back into difference
01F0 C9       RET

;SDLR
;Shift DE,HL right one place (dividing DE,HL by 2)

;Entry parameters
;   DE,HL = value to be shifted

;Exit parameters
;   DE,HL = value / 2

SDLR:
01F1 B7       ORA    A          ;Clear carry
01F2 EB       XCHG          ;Shift DE first
01F3 CDF701   CALL   SDLR2        ;Now shift HL
01F6 EB       XCHG

;Drop into SDLR2 with carry
; set correctly from LS bit
; of DE
;Shift HL right one place

SDLR2:
01F7 7C       MOV    A,H         ;Get MS byte
01F8 1F       RAR          ;Bit 7 set from previous carry,
                                     ;Bit 0 goes into carry
01F9 67       MOV    H,A         ;Put shift MS byte back
01FA 7D       MOV    A,L         ;Get LS byte
01FB 1F       RAR          ;Bit 7 = bit 0 of MS byte
01FC 6F       MOV    L,A         ;Put back into result
01FD C9       RET

;MOVE
;Moves C bytes from HL to DE

MOVE:
01FE 7E       MOV    A,M         ;Get source byte
01FF 12       STAX   D          ;Store in destination
0200 13       INX    D          ;Update destination pointer
0201 23       INX    H          ;Update source pointer
0202 0D       DCR    C          ;Downdate count
0203 C2FE01   JNZ   MOVE         ;Get next byte
0206 C9       RET

```

Figure 5-26. (Continued)

Function 35: Get File Size

Function Code: C = 23H
 Entry Parameters: DE = Address of FCB
 Exit Parameters: Random record field set in FCB

Example

```

0023 =      B*GETFSIZ      EQU    35      ;Get Random File LOGICAL size
0005 =      BDOS          EQU    5        ;BDOS entry point

                                FCB:          ;File control block
0000 00      FCB*DISK:     DB          0        ;Search on default disk drive
0001 46494C454E FCB*NAME:  DB          'FILENAME' ;File name
0009 545950      FCB*TYP:  DB          'TYP'   ;File type
000C 00      FCB*EXTENT:  DB          0        ;Extent
000D 0000      FCB*RESV:   DB          0,0      ;Reserved for CP/M
000F 00      FCB*RECUSED: DB          0        ;Records used in this extent
0010 0000000000 FCB*ABUSED: DB          0,0,0,0,0,0,0,0 ;Allocation blocks used
0018 0000000000      DB          0,0,0,0,0,0,0,0
0020 00      FCB*SEQREC:  DB          0        ;Sequential rec. to read/write
0021 0000      FCB*RANREC: DW          0        ;Random rec. to read/write
0023 00      FCB*RANRECO: DB          0        ;Random rec. overflow byte (MS)

0024 0E23      MVI        C,B*GETFSIZ      ;Function code
0026 110000     LXI        D,FCB          ;DE -> file control block
0029 C00500     CALL        BDOS
002C 2A2100     LHL        FCB*RANREC                ;Get random record number
                                           ;HL = LOGICAL file size
                                           ; i.e. the record number of the
                                           ; last record

```

Purpose This function returns the virtual size of the specified file. It does so by setting the random record number (bytes 33-35) in the specified FCB to the maximum 128-byte record number in the file. The virtual file size is calculated from the record address of the record following the end of the file. Bytes 33 and 34 form a 16-bit value that contains the record number, with overflow indicated in byte 35. If byte 35 is 01, this means that the file has the maximum record count of 65,536.

If the function cannot find the file specified by the FCB, it returns with the random record field set to 0.

You can use this function when you want to add data to the end of an existing file. By calling this function first, the random record bytes will be set to the end of file. Subsequent Write Random calls will write out records to this preset address.

Notes Do not confuse the virtual file size with the actual file size. In a random file, if you write just a single CP/M record to record number 1000 and then call this function, it will return with the random record number field set in the FCB to 1000—even though only a single record exists in the file.

For sequential files, this function returns the number of records in the file. In this case, the virtual and actual file sizes coincide.

Function 36: Set Random Record Number

Function Code: C = 24H
 Entry Parameters: DE = Address of FCB
 Exit Parameters: Random record field set in FCB

Example

```

0024 =      B*SETRANREC  EQU   36      ;Set Random Record Number
0005 =      BDOS        EQU   5        ;BDOS entry point

          FCB:          ;File control block
0000 00      FCB*DISK:   DB       0      ;Search on default disk drive
0001 46494C454EFCB*NAME: DB      'FILENAME' ;File name
0009 545950    FCB*TYP:  DB      'TYP'  ;File type
000C 00      FCB*EXTENT: DB       0      ;Extent
000D 0000    FCB*RESV:  DB      0,0    ;Reserved for CP/M
000F 00      FCB*RECUSED: DB       0    ;Records used in this extent
0010 0000000000FCB*ABUSED: DB      0,0,0,0,0,0,0,0 ;Allocation blocks used
0018 0000000000    DB      0,0,0,0,0,0,0,0
0020 00      FCB*SEQREC: DB       0    ;Sequential rec. to read/write
0021 0000    FCB*РАНREC: DW       0    ;Random rec. to read/write
0023 00      FCB*РАНRECO: DB       0    ;Random rec. overflow byte (MS)

          ;... file opened and read
          ; or written sequentially...

0024 0E24      MVI      C,B*SETRANREC  ;Function code
0026 110000    LXI      D,FCB          ;DE -> file control block
0029 CD0500    CALL     BDOS              ;
002C 2A2100    LHLD     FCB*РАНREC      ;Get random record number
          ;HL = random record number
          ; that corresponds to the
          ; sequential progress down
          ; the file.

```

Purpose This function sets the random record number in the FCB to the correct value for the last record read or written sequentially to the file.

Notes This function provides you with a convenient way to build an index file so that you can randomly access a sequential file. Open the sequential file, and as you read each record, extract the appropriate key field from the data record. Make the BDOS Set Random Record request and create a new data record with just the key field and the random record number. Write the new data record out to the index file.

Once you have done this for each record in the file, your index file provides a convenient method, given a search key value, of finding the appropriate CP/M record in which the data lies.

You can also use this function as a means of finding out where you are currently positioned in a sequential file—either to relate a CP/M record number to the position, or simply as a place-marker to allow a repositioning to the same place later.

Function 37: Reset Logical Disk Drive

Function Code: C = 25H
 Entry Parameters: DE = Logical drive bit map
 Exit Parameters: A = 00H

Example

```

0025 =      B*RESETD    EQU   37      ;Reset Logical Disks
0005 =      BDOS        EQU   5        ;BDOS entry point

```

```

;DE = Bit map of disks to be
; reset
;Bits are = 1 if disk to be
; reset
;Bits 15 14 13 ... 2 1 0
;Disk P 0 N ... C B A

0000 110200      LXI      D,0000*0000*0000*0010B ;Reset drive B:
0003 0E25        MVI      C,B*RESETD      ;Function code
0005 CD0500      CALL     BDOS

```

Purpose This function resets individual disk drives. It is a more precise version of the Reset Disk System function (code 13,ODH), in that you can set specific logical disks rather than all of them.

The bit map in DE shows which disks are to be reset. The least significant bit of E represents disk A, and the most significant bit of D, disk P. The bits set to 1 indicate the disks to be reset.

Note that this function returns a zero value in A in order to maintain compatibility with MP/M.

Notes Use this function when only specific diskettes need to be changed. Changing a diskette without requesting CP/M to log it in will cause the BDOS to assume that an error has occurred and to set the new diskette to Read-Only status as a protective measure.

Function 40: Write Random with Zero-fill

Function Code: C = 28H
 Entry Parameters: DE = Address of FCB
 Exit Parameters: A = Return Code

Example

```

0028 =      B*WRITERANZ      EQU      40      ;Write Random with Zero-Fill
0005 =      BDOS            EQU      5        ;BDOS entry point

;File control block
0000 00      FCB*DISK:      DB      0        ;Search on default disk drive
0001 46494C454EFCB*NAME:  DB      'FILENAME' ;File name
0009 545950      FCB*TYP:   DB      'TYP'    ;File type
000C 00      FCB*EXTENT:   DB      0        ;Extent
000D 0000      FCB*RESV:   DB      0,0      ;Reserved for CP/M
000F 00      FCB*RECUSED:  DB      0        ;Records used in this extent
0010 0000000000FCB*ABUSED:DB      0,0,0,0,0,0,0,0 ;Allocation blocks used
0018 0000000000      DB      0,0,0,0,0,0,0,0
0020 00      FCB*SEQREC:   DB      0        ;Sequential rec. to read/write
0021 0000      FCB*RANREC:  DW      0        ;Random rec. to read/write
0023 00      FCB*RANRECO:  DB      0        ;Random rec. overflow byte (MS)

0024 D204      RANRECNO:   DW      1234     ;Example random record number

;Record will be written from
; address set by prior
; SETDMA call

0026 2A2400      LHL      RANRECNO      ;Get random record number
0029 222100      SHLD     FCB*RANREC      ;Set up file control block
002C 0E28        MVI      C,B*WRITERANZ    ;Function code
002E 110000      LXI      D,FCB          ;DE -> file control block
0031 CD0500      CALL     BDOS          ;A = 00 if operation successful

```

```
;A = nonzero if no data in file  
; specifically :  
;A = 03 -- CP/M could not  
;      close current extent  
;      05 -- directory full  
;      06 -- attempt to write  
;           beyond end of disk
```

Purpose This function is an extension to the Write Random function described previously. In addition to performing the Write Random, it will also fill each new allocation block with 00H's. Digital Research added this function to assist Microsoft with the production of its COBOL compiler—it makes the logic of the file handling code easier. It also is an economical way to completely fill a random file with 00H's. You need only write one record per allocation block; the BDOS will clear the rest of the block for you.

Notes Refer to the description of the Write Random function (code 34).

The BIOS Components
The BIOS Entry Points
Bootstrap Functions
Character Input/Output Functions
Disk Functions
Calling the BIOS Functions Directly
Example BIOS



The Basic Input/Output System

This chapter takes a closer look at the Basic Input/Output System (BIOS). The BIOS provides the software link between the Console Command Processor (CCP), the Basic Disk Operating System (BDOS), and the physical hardware of your computer system. The CCP and BDOS interact with the parts of your computer system only as logical devices. They can therefore remain unchanged from one computer system to the next. The BIOS, however, is customized for your particular type of computer and disk drives. The only predictable part of the BIOS is the way in which it interfaces to the CCP and BDOS. This must remain the same no matter what special features are built into the BIOS.

The BIOS Components

A standard BIOS consists of low-level subroutines that drive four types of physical devices:

- Console: CP/M communicates with the outside world via the console. Normally this will be a video terminal or a hard-copy terminal.
- “Reader” and “punch”: These devices are normally used to communicate between computer systems—the names “reader” and “punch” are just historical relics from the early days of CP/M.
- List: This is a hard-copy printer, either letter-quality or dot-matrix.
- Disk drives: These can be anything from the industry standard single-sided, single-density, 8-inch floppy diskette drives to hard disk drives with capacities of several hundred megabytes.

The BIOS Entry Points

The first few instructions of the BIOS are all jump (JMP) instructions. They transfer control to the 17 different subroutines in the BIOS. The CCP and the BDOS, when making a specific request of the BIOS, do so by transferring control to the appropriate JMP instruction in this BIOS *jump table* or *jump vector*. The BIOS jump vector always starts at the beginning of a 256-byte page, so the address of the first jump instruction is always of the form xx00H, where “xx” is the page address. Location 0000H to 0002H has a jump instruction to the second entry of the BIOS jump vector—so you can always find the page address of the jump vector by looking in location 0002H.

Figure 6-1 shows the contents of the BIOS jump vector along with the page-relative address of each jump. The labels used in the jump instructions have been adopted by convention.

The following sections describe the functions of each of the BIOS's main subroutines. You should also refer to Digital Research's manual *CP/M 2.0 Alteration Guide* for their description of the BIOS routines.

Bootstrap Functions

There are two bootstrap functions. The cold bootstrap loads the entire CP/M operating system when the system is either first turned on or reset. The warm bootstrap reloads the CCP whenever a program branches to location 0000H.

xx00H	JMP	BOOT	;"Cold" (first time) bootstrap
xx03H	JMP	WBOOT	;"Warm" bootstrap
xx06H	JMP	CONST	;"Console input status
xx09H	JMP	CONIN	;"Console input
xx0CH	JMP	CONOUT	;"Console output
xx0FH	JMP	LIST	;"List output
xx12H	JMP	PUNCH	;"Punch" output
xx15H	JMP	READER	;"Reader" input
xx18H	JMP	HOME	;"Home disk heads (to track 0)
xx1BH	JMP	SELDSK	;"Select logical disk
xx1EH	JMP	SETTRK	;"Set track number
xx21H	JMP	SETSEC	;"Set sector number
xx24H	JMP	SETDMA	;"Set DMA address
xx27H	JMP	READ	;"Read (128-byte) sector
xx2AH	JMP	WRITE	;"Write (128-byte) sector
xx2DH	JMP	LISTST	;"List device output status
xx30H	JMP	SECTTRAN	;"Sector translate

Figure 6-1. Layout of the standard BIOS jump vector

BOOT: "Cold" Bootstrap

The BOOT jump instruction is the first instruction executed in CP/M. The bootstrap sequence must transfer control to the BOOT entry point in order to bring up CP/M. In general, a PROM receives control either when power is first applied or after you press the RESET button on the computer. This reads in the CP/M loader on the first sector of the physical disk drive chosen to be logical disk A. This CP/M loader program reads the binary image of the CCP, BDOS, and BIOS into memory at some predetermined address. Then it transfers control to the BOOT entry point in the BIOS jump vector.

This BOOT routine must initialize all of the required computer hardware. It sets up the baud rates for the physical console (if this has not already been done during the bootstrap sequence), the "reader," "punch," and list devices, and the disk controller. It must also set up the base page of memory so that there is a jump at location 0000H to the warm boot entry point in the BIOS jump vector (at xx03H) and a jump at location 0005H to the BDOS entry point.

Most BOOT routines sign on by displaying a short message on the console, indicating the current version of CP/M and the computer hardware that this BIOS can support.

The BOOT routine terminates by transferring control to the start of the CCP + 6 bytes (the CCP has its own small jump vector at the beginning). Just before the BOOT routine jumps into the CCP, it sets the C register to 0 to indicate that logical disk A is to be the default disk drive. This is what causes "A>" to be the CCP's initial prompt.

The actual CCP entry point is derived from the base address of the BIOS. The CCP and BDOS together require 1E00H bytes of code, so the first instruction of the CCP starts at BIOS - 1E00H.

WBOOT: "Warm" Bootstrap

Unlike the "cold" bootstrap entry point, which executes only once, the WBOOT or warm boot routine will be executed every time a program terminates by jumping to location 0000H, or whenever you type a CONTROL-C on the console as the first character of an input line.

The WBOOT routine is responsible for reloading the CCP into memory. Programs often use all of memory up to the starting point of the BDOS, overwriting the CCP in the process. The underlying philosophy is that while a program is executing, the CCP is not needed, so the program can use the memory previously occupied by the CCP. The CCP occupies 800H (2048) bytes of memory — and this is frequently just enough to make the difference between a program that cannot run and one that can.

A few programs that are self-contained and do not require the BDOS's facilities will also overwrite the BDOS to get another 1600H (5632) bytes of memory. Therefore, to be really safe, the WBOOT routine should read in both the CCP and the BDOS. It also needs to set up the two JMPs at location 0000H (to WBOOT itself) and at location 0005H (to the BDOS). Location 0003H should be set to the initial value of the IOBYTE if this is implemented in the BIOS.

As its last act, the WBOOT routine sets register C to indicate which logical disk is to be selected (C = 0 for A, 1 for B, and so on). It then transfers control into the CCP at the first instruction in order to restart the CCP. Again, the actual address is computed based on the knowledge that the CCP starts 1E00H bytes lower in memory than the base address of the BIOS.

Character Input/Output Functions

Character input/output functions deal with logical devices: the console, "reader," "punch," and list devices. Because these logical devices can in practice be connected by software to one of several physical character I/O devices, many BIOS's use CP/M's IOBYTE features to assign logical devices to physical ones.

In this case, each of the BIOS functions must check the appropriate bit fields of the IOBYTE (see Figure 4-2 and Table 4-1) to transfer control to the correct physical device *driver* (program that controls a physical device).

CONST: Console Input Status

CONST simply returns an indicator showing whether there is an incoming character from the console device. The convention is that A = 0FFH if a character is waiting to be processed, A = 0 if one is not. Note that the zero flag need not be set to reflect the contents of the A register — it is the contents that are important.

CONST is called by the CCP whenever the CCP is in the middle of an operation that can be interrupted by pressing a keyboard character.

The BDOS will call CONST if a program makes a Read Console Status function call (B\$CONST, code 11, 0BH). It is also called by the console input BIOS routine, CONIN (described next).

CONIN: Console Input

CONIN reads the next character from the console to the A register and sets the most significant (parity) bit to 0.

Normally, CONIN will call the CONST routine until it detects A = 0FFH. Only then will it input the data character and mask off the parity bit.

CONIN is called by the CCP and by the BDOS when a program executes a Read Console Byte function (B\$CONIN, code 1).

CONOUT: Console Output

CONOUT outputs the character (in ASCII) in register C to the console. The most significant (parity) bit of the character will always be 0.

CONOUT must first check that the console device is ready to receive more data, delaying if necessary until it is, and only then sending the character to the device.

CONOUT is called by the CCP and by the BDOS when a program executes a Write Console Byte function (B\$CONOUT, code 2).

LIST: List Output

LIST is similar to CONOUT except that it sends the character in register C to the list device. It too checks first that the list device is ready to receive the character.

LIST is called by the CCP in response to the CONTROL-P toggle for printer echo of console output, and by the BDOS when a program makes a Write Printer Byte or Display String call (B\$LISTOUT and B\$PRINTS, codes 5 and 9).

PUNCH: "Punch" Output

PUNCH sends the character in register C to the "punch" device. As mentioned earlier, the "punch" is rarely a real paper tape punch. In most BIOS's, the PUNCH entry point either returns immediately and is effectively a null routine, or it outputs the character to a communications device, such as a modem, on your computer.

PUNCH must check that the "punch" device is indeed ready to accept another character for output, and must wait if it is not.

Digital Research's documentation states that the character to be output will always have its most significant bit set to 0. This is not true. The BDOS simply transfers control over to the PUNCH entry point in the BIOS; the setting of the most significant bit will be determined by the program making the BDOS function request (B\$PUNOUT, code 4). This is important because the requirement of a zero

would preclude being able to send pure binary data via the BIOS PUNCH function.

READER: "Reader" Input

As with the PUNCH entry point, the READER entry point rarely connects to a real paper tape reader.

The READER function must return the next character from the reader device in the A register, waiting, if need be, until there is a character.

Digital Research's documentation again says that the most significant bit of the A register must be 0, but this is not the case if you wish to receive pure binary information via this function.

READER is called whenever a program makes a Read "Reader" Byte function request (B\$READIN, code 3).

Disk Functions

All of the disk functions that follow were originally designed to operate on the 128-byte sectors used on single-sided, single-density, 8-inch floppy diskettes that were standard in the industry at the time. Now that CP/M runs on many different types of disks, some of the BIOS disk functions seem strange because most of the new disk drives use sector sizes other than 128 bytes.

To handle larger sector sizes, the BIOS has some additional code that makes the BDOS respond as if it were still handling 128-byte sectors. This code is referred to as the *blocking/deblocking* code. As its name implies, it blocks together several 128-byte "sectors" and only writes to the disk when a complete *physical* sector has been assembled. When reading, it reads in a physical sector and then deblocks it, handing back several 128-byte "sectors" to the BDOS.

To do all of this, the blocking/deblocking code uses a special buffer area of the same size as the physical sectors on the disk. This is known as the host disk buffer or HSTBUF. Physical sectors are read into this buffer and written to the disk from it.

In order to optimize this blocking/deblocking routine, the BIOS has code in it to reduce the number of times that an actual disk read or write occurs. A side effect is that at any given moment, several 128-byte "sectors" may be stored in the HSTBUF, waiting to be written out to the disk when HSTBUF becomes full. This sometimes complicates the logic of the BIOS disk functions. You cannot simply select a new disk drive, for example, when the HSTBUF contains data destined for another disk drive. You will see this complication in the BIOS only in the form of added logical operations; the BIOS disk functions rarely trigger immediate physical operations. It is easier to understand these BIOS functions if you consider that

they make *requests*—and that these requests are satisfied only when it makes sense to do so, taking into account the blocking/deblocking logic.

HOME: Home Disk

HOME sets the requested track and sector to 0.

SELDSK: Select Disk

SELDSK does not do what its name implies. It does not (and must not) physically select a logical disk. Instead, it returns a pointer in the HL register pair to the disk parameter header for the logical disk specified in register C on entry. C = 0 for drive A, 1 for drive B, and so on. SELDSK also stores this code for the requested disk to be used later in the READ and WRITE functions.

If the logical disk code in register C refers to a nonexistent disk or to one for which no disk parameter header exists, then SELDSK must return with HL set to 0000H. Then the BDOS will output a message of the form

```
"BDOS Err on X: Select"
```

Note that SELDSK not only does not select the disk, but also does not indicate whether or not the requested disk is physically present—merely whether or not there are disk tables present for the disk.

SELDSK is called by the BDOS either during disk file operations or by a program issuing a Select Disk request (B\$SELDSK, code 14).

SETTRK: Set Track

SETTRK saves the requested disk track that is in the BC register pair when SETTRK gets control. Note that this is an absolute track number; that is, the number of reserved tracks before the file directory will have been added to the track number relative to the start of the logical disk.

The number of the requested track will be used in the next BIOS READ or WRITE function (described later in this chapter).

SETTRK is called by the BDOS when it needs to read or write a 128-byte sector. Legitimate track numbers are from 0 to 0FFFFH (65,535).

SETSEC: Set Sector

SETSEC is similar to SETTRK in that it stores the requested sector number for later use in BIOS READ or WRITE functions. The requested sector number is handed to SETSEC in the A register; legitimate values are from 0 to 0FFH (255).

The sector number is a logical sector number. It does not take into account any sector skewing that might be used to improve disk performance.

SETSEC is called by the BDOS when it needs to read or write a 128-byte sector.

SETDMA: Set DMA Address

SETDMA saves the address in the BC register pair in the requested DMA address. The next BIOS READ or WRITE function will use the DMA address as a pointer to the 128-byte sector buffer into which data will be read or from which data will be written.

The default DMA address is 0080H. SETDMA is called by the BDOS when it needs to READ or WRITE a 128-byte sector.

READ: Read Sector

READ reads in a 128-byte sector provided that there have been previous BIOS function calls to

- SELDSK — “select” the disk
- SETDMA — set the DMA address
- SETTRK — set the track number
- SETSEC — set the sector number.

Because of the blocking/deblocking code in the BIOS, there are frequent occasions when the requested sector will already be in the host buffer (HSTBUF), so that a physical disk read is not required. All that is then required is for the BIOS to move the appropriate 128 bytes from the HSTBUF into the buffer pointed at by the DMA address.

Only during the READ function will the BIOS normally communicate with the physical disk drive, selecting it and seeking to read the requested track and sector. During this process, the READ function must also handle any hardware errors that occur, trying an operation again if a “soft,” or recoverable, error occurs.

The READ function must return with the A register set to 00H if the read operation is completed successfully. If the READ function returns with the A register set to 01H, the BDOS will display an error message of the form

BDOS Err on X: Bad Sector

Under these circumstances, you have only two choices. You can enter a CARRIAGE RETURN, ignore the fact that there was an error, and attempt to make sense of the data in the DMA buffer. Or you can type a CONTROL-C to abort the operation, perform a warm boot, and return control to the CCP.

As you can see, CP/M's error handling is not particularly helpful, so most BIOS writers add more sophisticated error recovery right in the disk driver. This can include some interaction with the console so that a more determined effort can be made to correct errors or, if nothing else, give you more information as to what has gone wrong. Such error handling is discussed in Chapter 9.

If you are working with a hard disk system, the BIOS driver must also handle the management of bad sectors. You cannot simply replace a hard disk drive if one or two sectors become unreadable. This bad sector management normally requires

that a directory of “spare” sectors be put on the hard disk before it is used to store data. Then, when a sector is found to be bad, one of the spare sectors is substituted in its place. This is also discussed in Chapter 9.

WRITE: Write Sector

WRITE is similar to READ but with the obvious difference that data is transferred from the DMA buffer to the specified 128-byte sector. Like READ, this function requires that the following function calls have already been made:

- SELDSK — “select” the disk
- SETDMA — set the DMA address
- SETTRK — set the track number
- SETSEC — set the sector number.

Again, it is only in the WRITE routine that the driver will start to talk directly to the physical hardware, selecting the disk unit, track, and sector, and transferring the data to the disk.

With the blocking/deblocking code, the BDOS optimizes the number of disk writes that are needed by indicating in register C the type of disk write that is to be performed:

- 0 = normal sector write
- 1 = write to file directory sector
- 2 = write to sector of previously unused allocation block.

Type 0 occurs whenever the BDOS is writing to a data sector in an already used allocation block. Under these circumstances, the disk driver must pre-read the appropriate host sector because there may be previously stored information on it.

Type 1 occurs whenever the BDOS is writing to a file directory sector — in this case, the BIOS must not defer writing the sector to the disk, as the information is too valuable to hold in memory until the HSTBUF is full. The longer the information resides in the HSTBUF, the greater the chance of a power failure or glitch, making file data already physically written to the disk inaccessible because the file directory is out of date.

Type 2 occurs whenever the BDOS needs to write to the first sector of a previously unused allocation block. Unused, in this context, includes an allocation block that has become available as a result of a file being erased. In this case, there is no need for the disk driver to pre-read an entire host-sized sector into the HSTBUF, as there is no data of value in the physical sector.

As with the READ routine, the WRITE function returns with A set to 00H if the operation has been completed successfully. If the WRITE function returns with A set to 01H, then the BDOS will display the *same* message as for READ:

BDOS Err on X: Bad Sector

You can see now why most BIOS writers add extensive error-recovery and user-interaction routines to their disk drivers.

For hard disk systems, some disk drivers are written so that they automatically “spare out” a failing sector, writing the data to one of the spare sectors on the disk.

LISTST: List Status

As you can tell from its position in the list of BIOS functions, the LISTST function was a latecomer. It was added when CP/M was upgraded from version 1.4 to version 2.0.

This function returns the current status of the list device, using the IOBYTE if necessary to select the correct physical device. It sets the A register to 0FFH if the list device can accept another character for output or to 00H if it is not ready.

Digital Research's documentation states that this function is used by the DESPOOL utility program (which allows you to print a file “simultaneously” with other operations) to improve console response during its operation, and that it is acceptable for the routine always to return 00H if you choose not to implement it fully.

Unfortunately, this statement is wrong. Many other programs use the LISTST function to “poll” the list device to make sure it is ready, and if it fails to come ready after a predetermined time, to output a message to the console indicating that the printer is not ready. If you ever make a call to the BDOS list output functions, Write Printer Byte and Print String (codes 5 and 9), and the printer is not ready, then CP/M will wait forever — and your program will have lost control so it cannot even detect that the problem has occurred. If LISTST always returns a 00H, then the printer will always appear not to be ready. Not only does this make nonsense out of the LISTST function, but it also causes a stream of false “Printer not Ready” error messages to appear on the console.

SECTRAN: Sector Translate

SECTRAN, given a logical sector number, locates the correct physical sector number in the sector translate table for the previously selected (via SELDSK) logical disk drive.

Note that both logical and physical sector numbers are 128-byte sectors, so if you are working with a hard disk system, it is not too efficient to impose a sector interlace at the 128-byte sector level. It is better to impose the sector interlace right inside the hard disk driver, if at all; in general, hard disks spin so rapidly that CP/M simply cannot take advantage of sector interlace.

The BDOS hands over the logical sector number in the BC register pair, with the address of the sector translate table in the DE register pair. SECTRAN must return the physical sector number in HL.

If SECTRAN is to be a null routine, it must move the contents of BC to HL and return.

Calling the BIOS Functions Directly

As a general rule, you should not make direct calls to the BIOS. To do so makes your programs less transportable from one CP/M system to the next. It precludes being able to run these programs under MP/M, which has a different form of BIOS called an extended I/O system, or XIOS.

There are one or two problems, however, that can only be solved by making direct BIOS calls. These occur in utility programs that, for example, need to make direct access to the CP/M file directory, or need to access some "private" jump instructions which have been added to the standard BIOS jump vector.

If you really do need direct access to the BIOS, Figure 6-2 shows an example subroutine that does this. It requires that the A register contain a BIOS function code indicating the offset in the jump vector of the jump instruction to which control is to be passed.

```

;      Equates for use with BIOS subroutine
;
0003 = WBOOT EQU 03H ;Warm boot
0006 = CONST EQU 06H ;Console status
0009 = CONIN EQU 09H ;Console input
000C = CONOUT EQU 0CH ;Console output
000F = LIST EQU 0FH ;Output to list device
0012 = PUNCH EQU 12H ;Output to punch device
0015 = READER EQU 15H ;Input from reader
0018 = HOME EQU 18H ;Home selected disk to track 0
001B = SELDSK EQU 1BH ;Select disk
001E = SETTRK EQU 1EH ;Set track
0021 = SETSEC EQU 21H ;Set sector
0024 = SETDMA EQU 24H ;Set DMA address
0027 = READ EQU 27H ;Read 128-byte sector
002A = WRITE EQU 2AH ;Write 128-byte sector
002D = LISTST EQU 2DH ;Return list status
0030 = SECTRAN EQU 30H ;Sector translate
;
;      ;Add further "private" BIOS codes here
;
;      BIOS
;      This subroutine transfers control to the appropriate
;      entry in the BIOS Jump Vector, based on a code number
;      handed to it in the L register.
;
;      Entry parameters
;
;      L = Code number (which is in fact the page-relative
;      address of the correct JMP instruction within
;      the jump vector)
;      All other registers are preserved and handed over to
;      the BIOS routine intact.
;
;      Exit parameters
;

```

Figure 6-2. BIOS equates

```

;          ;          This routine does not CALL the BIOS routine, therefore
;          ;          when the BIOS routine RETURNS, it will do so directly
;          ;          to this routine's caller.
;          ;
;          ;          Calling sequence
;          ;
;          ;          MVI     L,Code#Number
;          ;          CALL    BIOS
;
BIOS:
0000 F5      PUSH    PSW      ;Save user's A register
0001 3A0200  LDA     0002H    ;Get BIOS JMP vector page from
;          ;          warm boot JMP
0004 67      MOV     H,A      ;HL -> BIOS JMP vector entry
0005 F1      POP     PSW     ;Recover user's A register
0006 E9      PCHL    ;Transfer control into the BIOS routine

```

Figure 6-2. BIOS equates (continued)

Line Numbers	Functional Component or Routine
0072-0116	BIOS Jump Vector
0120-0270	Initialization Code
0275-0286	Display Message
0289-0310	Enter CP/M
0333-0364	CONST - Console Status
0369-0393	CONIN - Console Input
0397-0410	CONOUT - Console Output
0414-0451	LISTST - List Status
0456-0471	LIST - List Output
0476-0492	PUNCH - Punch Output
0496-0511	READER - Reader Input
0516-0536	IOBYTE Driver Select
0540-0584	Device Control Tables
0589-0744	Low-level Drivers for Console, List, etc.
0769-0824	Disk Parameter Header Tables
0831-0878	Disk Parameter Blocks
0881-0907	Other Disk data areas
0910-0955	SELDSK - Select Disk
0958-0964	SETTRK - Set Track
0967-0973	SETSEC - Set Sector
0978-0984	SETDMA - Set DMA Address
0987-1025	Sector Skew Tables
1028-1037	SECTRAN - Logical to Physical Sector translation
1041-1056	HOME - Home to Track 0
1059-1154	Deblocking Algorithm data areas
1157-1183	READ - Read 128-byte sector
1185-1204	WRITE - Write 128-byte sector
1206-1378	Deblocking Algorithm
1381-1432	Buffer Move
1435-1478	Deblocking subroutines
1481-1590	8" Floppy Physical Read/Write
1595-1681	5 1/4" Floppy Physical Read/Write
1685-1764	WBOOT - Warm Boot

Figure 6-3. Functional Index to Figure 6-4

Example BIOS

The remainder of this chapter is devoted to an example BIOS listing. This actual working BIOS shows the overall structure and interface to the individual BIOS subroutines.

Unlike most BIOS's, this one has been written specifically to be understood easily. The variable names are uncharacteristically long and descriptive, and each block of code has commentary to put it into context.

Each source line has been sequentially numbered (an infrequently used option that Digital Research's Assembler, ASM, permits). Figure 6-3 contains a functional index to the BIOS as a whole so that you can find particular functions in the listing in Figure 6-4 by line number.

```

0001 <-- Line Number ; Figure 6-4.
0002 ;
0003 ;*****
0004 ;*
0005 ;*          Simple BIOS Listing
0006 ;*
0007 ;*****
0008 ;
0009 ;
0010 3030 = VERSION EQU '00' ;Equates used in the sign on message
0011 3730 = MONTH EQU '07'
0012 3531 = DAY EQU '15'
0013 3238 = YEAR EQU '82'
0014 ;
0015 ;*****
0016 ;*
0017 ;* This BIOS is for a computer system with the following
0018 ;* hardware configuration :
0019 ;*
0020 ;* - 8080 CPU
0021 ;* - 64KBytes of RAM
0022 ;* - CRT/keyboard controller that transfers data
0023 ;* as though it were a serial port (but requires
0024 ;* no baud rate generator or USART programming)
0025 ;* - A serial port, used for both list and "reader"/
0026 ;* "punch" devices. The serial port chip is an
0027 ;* Intel 8251A with an 8253 baud rate generator.
0028 ;* - Two 5 1/4" mini-floppy, double-sided, double-
0029 ;* density drives. These drives use 512-byte sectors.
0030 ;* These are used as logical disks A: and B:.
0031 ;* - Two 8" standard diskette drives (128-byte sectors).
0032 ;* These are used as logical disks C: and D:.
0033 ;*
0034 ;* Two intelligent disk controllers are used, one for
0035 ;* each diskette type. These controllers access memory
0036 ;* directly, both to read the details of the
0037 ;* operations they are to perform and also to read
0038 ;* and write data from and to the diskettes.
0039 ;*
0040 ;*
0041 ;*****
0042 ;
0043 ;
0044 ; Equates for defining memory size and the base address and
0045 ; length of the system components.

```

Figure 6-4. Simple BIOS listing

```

0046      ;
0047 0040 =      Memory$Size      EQU      64      ;Number of Kbytes of RAM
0048      ;
0049      ; The BIOS Length must be determined by inspection.
0050      ; Comment out the ORG BIOS$Entry line below by changing the first
0051      ; character to a semicolon. (This will make the Assembler start
0052      ; the BIOS at location 0.) Then assemble the BIOS and round up to
0053      ; the nearest 100H the address displayed on the console at the end
0054      ; of the assembly.
0055      ;
0056 0900 =      BIOS$Length      EQU      0900H
0057      ;
0058 0800 =      CCP$Length EQU      0800H ;Constant
0059 0E00 =      BDOS$Length EQU      0E00H ;Constant
0060      ;
0061 0008 =      Overall$Length EQU      ((CCP$Length + BDOS$Length + BIOS$Length) / 1024) + 1
0062      ;
0063 E000 =      CCP$Entry EQU      (Memory$Size - Overall$Length) * 1024
0064 E806 =      BDOS$Entry EQU      CCP$Entry + CCP$Length + 6
0065 F600 =      BIOS$Entry EQU      CCP$Entry + CCP$Length + BDOS$Length
0066      ;
0067      ;
0068      ;
0069      ;
0070 F600      ORG      BIOS$Entry      ;Assemble code at BIOS address
0071      ;
0072      ; BIOS jump vector
0073      ; Control will be transferred to the appropriate entry point
0074      ; from the CCP or the BDOS, both of which compute the relative
0075      ; address of the BIOS jump vector in order to locate it.
0076      ; Transient programs can also make direct BIOS calls transferring
0077      ; control to location xx00H, where xx is the value in location
0078      ; 0002H.
0079      ;
0080 F600 C3F9F6      JMP      BOOT      ;Cold boot -- entered from CP/M bootstrap loader
0081 Warm$Boot$Entry: ; Labeled so that the initialization code can
0082      ; put the warm boot entry address down in location
0083      ; 0001H and 0002H of the base page
0084 F603 C329FE      JMP      WBOOT      ;Warm boot -- entered by jumping to location 0000H.
0085      ; Reloads the CCP which could have been
0086      ; overwritten by previous program in transient
0087      ; program area
0088 F606 C362F8      JMP      CONST      ;Console status -- returns A = OFFH if there is a
0089      ; console keyboard character waiting
0090 F609 C378F8      JMP      CONIN      ;Console input -- returns the next console keyboard
0091      ; character in A
0092 F60C C386F8      JMP      CONOUT     ;Console output -- outputs the character in C to
0093      ; the console device
0094 F60F C3ACF8      JMP      LIST      ;List output -- outputs the character in C to the
0095      ; list device
0096 F612 C3BCF8      JMP      PUNCH     ;Punch output -- outputs the character in C to the
0097      ; logical punch device
0098 F615 C3CDF8      JMP      READER    ;Reader input -- returns the next input character from
0099      ; the logical reader device in A
0100 F618 C3D3FB      JMP      HOME      ;Homes the currently selected disk to track 0
0101 F61B C32BFB      JMP      SELDSK    ;Selects the disk drive specified in register C and
0102      ; returns the address of the disk parameter header
0103 F61E C358FB      JMP      SETTRK    ;Sets the track for the next read or write operation
0104      ; from the BC register pair
0105 F621 C35EFB      JMP      SETSEC    ;Sets the sector for the next read or write operation
0106      ; from the A register
0107 F624 C365FB      JMP      SETDMA    ;Sets the direct memory address (disk read/write)
0108      ; address for the next read or write operation
0109      ; from the DE register pair
0110 F627 C3FBFB      JMP      READ      ;Reads the previously specified track and sector from
0111      ; the selected disk into the DMA address
0112 F62A C315FC      JMP      WRITE     ;Writes the previously specified track and sector onto
0113      ; the selected disk from the DMA address
0114 F62D C394F8      JMP      LISTST    ;Returns A = OFFH if the list device can accept
0115      ; another output character
0116 F630 C3CDFB      JMP      SECTRAN   ;Translates a logical sector into a physical one
0117      ;
0118      ;
0119      ;
0120      ; The cold boot initialization code is only needed once.

```

Figure 6-4. (Continued)

```

0121 ; It can be overwritten once it has been executed.
0122 ; Therefore, it is "hidden" inside the main disk buffer.
0123 ; When control is transferred to the BOOT entry point, this
0124 ; code will be executed, only being overwritten by data from
0125 ; the disk once the initialization procedure is complete.
0126 ;
0127 ; To hide code in the buffer, the buffer is first declared
0128 ; normally. Then the value of the location counter following
0129 ; the buffer is noted. Then, using an ORG (ORiGin) statement, the
0130 ; location counter is "wound back" to the start of the buffer
0131 ; again and the initialization code written normally.
0132 ; At the end of this code, another ORG statement is used to
0133 ; set the location counter back as it was after the buffer had
0134 ; been declared.
0135 ;
0136 ;
0137 0200 = Physical$Sector$Size EQU 512 ;This is the actual sector size
0138 ;for the 5 1/4" mini-floppy diskettes.
0139 ;The 8" diskettes use 128-byte sectors.
0140 ;Declare the physical disk buffer for the
0141 ;5 1/4" diskettes
0142 F633 Disk$buffer: DS Physical$Sector$Size
0143 ;
0144 ;Save the location counter
0145 F833 = After$Disk$Buffer EQU $ ;$ = Current value of location counter
0146 ;
0147 F633 ORG Disk$Buffer ;Wind the location counter back
0148 ;
0149 Initialize$Stream: ;This stream of data is used by the
0150 ;initialize subroutine. It has the following
0151 ;format:
0152 ;
0153 ; DB Port number to be initialized
0154 ; DB Number of bytes to be output
0155 ; DB xx,xx,xx,xx data to be output
0156 ; ;
0157 ; ;
0158 ; DB Port number of 00H terminator
0159 ;
0160 ;Note: On this machine, the console port does
0161 ;not need to be initialized. This has
0162 ;already been done by the PROM bootstrap code.
0163 ;
0164 ;Initialize the 8251A USART used for
0165 ;the list and communications devices.
0166 F633 ED DB Communication$Status$Port ;Port number
0167 F634 06 DB 6 ;Number of bytes
0168 F635 00 DB 0 ;Get chip ready to be programmed by
0169 F636 00 DB 0 ; sending dummy data out to it
0170 F637 00 DB 0
0171 F638 42 DB 0100*0010B ;Reset and raise data terminal ready
0172 F639 6E DB 01*10*11*10B ;1 stop bit, no parity, 8 bits per character
0173 ; baud rate divide factor of 16.
0174 F63A 25 DB 0010*0101B ;Raise request to send, and enable
0175 ; transmit and receive.
0176 ;
0177 ;Initialize the 8253 programmable interval
0178 ; timer used to generate the baud rate for
0179 ; the 8251A USART
0180 F63B DF DB Communication$Baud$Mode ;Port number
0181 F63C 01 DB 1 ;Number of bytes
0182 F63D B6 DB 10*11*011*0B ;Select counter 2, load LS byte first,
0183 ; Mode 3 (for baud rates), binary count.
0184 ;
0185 F63E DE DB Communication$Baud$Rate ;Port number
0186 F63F 02 DB 2 ;Number of bytes
0187 F640 3800 DW 0038H ;1200 baud (based on 16X divide-down selected
0188 ; in the 8251A USART)
0189 ;
0190 F642 00 DB 0 ;Port number of 0 terminates
0191 ;
0192 ;
0193 ; Equates for the sign-on message
0194 ;
0195 000D = CR EQU 0DH ;Carriage return

```

Figure 6-4. (Continued)

```

0196 000A =      LF EQU      0AH      ;Line feed
0197          ;
0198          ; Signon$Message:      ;Main sign-on message
0199 F643 43502F4D20 DB      'CP/M 2.2.'
0200 F64C 3030      DW      VERSION   ;Current version number
0201 F64E 20       DB      '/'
0202 F64F 3037      DW      MONTH     ;Current date
0203 F651 2F       DB      '/'
0204 F652 3135      DW      DAY
0205 F654 2F       DB      '/'
0206 F655 3832      DW      YEAR
0207 F657 0D0A0A    DB      CR,LF,LF
0208 F65A 53696D706C DB      'Simple BIOS',CR,LF,LF
0209 F668 4469736B20 DB      'Disk configuration:',CR,LF,LF
0210 F67F 2020202020 DB      ' A: 0.35 Mbyte 5" Floppy',CR,LF
0211 F69D 2020202020 DB      ' B: 0.35 Mbyte 5" Floppy',CR,LF,LF
0212 F6BC 2020202020 DB      ' C: 0.24 Mbyte 8" Floppy',CR,LF
0213 F6DA 2020202020 DB      ' D: 0.24 Mbyte 8" Floppy',CR,LF
0214          ;
0215 F6F8 00        DB      0
0216          ;
0217 0004 =      ; Default$Disk      EQU      0004H ;Default disk in base page
0218          ;
0219          ; BOOT:      ;Entered directly from the BIOS JMP vector.
0220          ;Control will be transferred here by the CP/M
0221          ; bootstrap loader.
0222          ;The initialization state of the computer system
0223          ; will be determined by the
0224          ; PROM bootstrap and the CP/M loader setup.
0225          ;
0226          ;
0227          ; Initialize system.
0228          ; This routine uses the Initialize$Stream
0229          ; declared above.
0229 F6F9 F3        DI          ;Disable interrupts to prevent any
0230          ; side effects during initialization.
0231 F6FA 2133F6     LXI      H,Initialize$Stream ;HL -> Data stream
0232          ;
0233          ; Initialize$Loop:
0234 F6FD 7E        MOV      A,M      ;Get port number
0235 F6FE B7        ORA      A      ;If 00H, then initialization complete
0236 F6FF CA13F7     JZ      Initialize$Complete
0237 F702 320AF7     STA      Initialize$Port ;Set up OUT instruction
0238 F705 23        INX      H      ;HL -> Count of number of bytes to output
0239 F706 4E        MOV      C,M      ;Get byte count
0240          ;
0241          ; Initialize$Next$Byte:
0242 F707 23        INX      H      ;HL -> Next data byte
0243 F708 7E        MOV      A,M      ;Get next data byte
0244 F709 D3        DB      OUT      ;Output to correct port
0245          ;
0246          ; Initialize$Port:
0246 F70A 00        DB      0      ;<- Set above
0247 F70B 0D        DCR      C      ;Count down
0248 F70C C207F7     JNZ     Initialize$Next$Byte ;Go back if more bytes
0249 F70F 23        INX      H      ;HL -> Next port number
0250 F710 C3FDF6     JMP     Initialize$Loop ;Go back for next port initialization
0251          ;
0252          ; Initialize$Complete:
0253          ;
0254          ;
0255 F713 3E01        MVI      A,00$00$00$01B ;Set IOBYTE to indicate terminal
0256 F715 320300     STA      IOBYTE      ; is to act as console
0257          ;
0258 F718 2143F6     LXI      H,Signon$Message ;Display sign-on message on console
0259 F71B CD33F8     CALL     Display$Message
0260          ;
0261          ;
0262 F71E AF        XRA      A      ;Set default disk drive to A:
0263 F71F 320400     STA      Default$Disk
0264 F722 FB        EI          ;Interrupts can now be enabled
0265          ;
0266 F723 C340F8     JMP     Enter$CPM    ;Complete initialization and enter
0267          ; CP/M by going to the Console Command
0268          ; Processor.
0269          ;
0270          ; End of cold boot initialization code
0271          ;

```

Figure 6-4. (Continued)

```

0272 F833          ORG    After$Disk$Buffer    ;Reset location counter
0273          ;
0274          ;
0275          Display$Message: ;Displays the specified message on the console.
0276          ;On entry, HL points to a stream of bytes to be
0277          ; output. A 00H-byte terminates the message.
0278 F833 7E      MOV    A,M                ;Get next message byte
0279 F834 B7      ORA    A                ;Check if terminator
0280 F835 C8      RZ                    ;Yes, return to caller
0281 F836 4F      MOV    C,A                ;Prepare for output
0282 F837 E5      PUSH   H                ;Save message pointer
0283 F838 CD86F8 CALL   CONOUT                ;Go to main console output routine
0284 F83B E1      POP    H                ;Recover message pointer
0285 F83C 23      INX    H                ;Move to next byte of message
0286 F83D C333F8 JMP    Display$Message ;Loop until complete message output
0287          ;
0288          ;
0289          Enter$CPM: ;This routine is entered either from the cold or warm
0290          ; boot code. It sets up the JMP instructions in the
0291          ; base page, and also sets the high-level disk driver's
0292          ; input/output address (also known as the DMA address).
0293          ;
0294 F840 3EC3     MVI    A,JMP                ;Get machine code for JMP
0295 F842 320000   STA    0000H                ;Set up JMP at location 0000H
0296 F845 320500   STA    0005H                ; and at location 0005H
0297          ;
0298 F848 2103F6   LXI    H,Warm$Boot$Entry    ;Get BIOS vector address
0299 F84B 220100   SHLD   0001H                ;Put address at location 0001H
0300          ;
0301 F84E 2106E8   LXI    H,BDOS$Entry        ;Get BDOS entry point address
0302 F851 220600   SHLD   6                    ;Put address at location 0005H
0303          ;
0304 F854 018000   LXI    B,80H               ;Set disk I/O address to default
0305 F857 CD65FB   CALL   SETDMA              ;Use normal BIOS routine
0306          ;
0307 F85A FB      EI                    ;Ensure interrupts are enabled
0308 F85B 3A0400   LDA    Default$Disk        ;Transfer current default disk to
0309 F85E 4F      MOV    C,A                ; Console Command Processor
0310 F85F C300E0   JMP    CCP$Entry           ;Transfer to CCP
0311          ;
0312          ;
0313          ; Serial input/output drivers
0314          ;
0315          ; These drivers all look at the IOBYTE at location
0316          ; 0003H, which will have been set by the cold boot routine.
0317          ; The IOBYTE can be modified by the STAT utility, by
0318          ; BDOS calls, or by a program that puts a value directly
0319          ; into location 0003H.
0320          ;
0321          ; All of the routines make use of a subroutine, Select$Routine,
0322          ; that takes the least significant two bits of the A register
0323          ; and uses them to transfer control to one of the routines whose
0324          ; address immediately follows the call to Select$Routine.
0325          ; A second entry point, Select$Routine$21, uses bits
0326          ; 2 and 1 to do the same job -- this saves some space
0327          ; by avoiding an unnecessary instruction.
0328          ;
0329 0003 = IOBYTE EQU 0003H ;I/O redirection byte
0330          ;
0331          ;
0332          ;
0333          CONST: ;Get console status
0334          ;Entered directly from the BIOS JMP vector
0335          ; and returns a parameter that reflects whether
0336          ; there is incoming data from the console.
0337          ;
0338          ;A = 00H (zero flag set) if no data
0339          ;A = 0FFH (zero flag clear) if data
0340          ;
0341          ;CONST will be called by programs that
0342          ; make periodic checks to see if the computer
0343          ; operator has pressed any keys -- for example,
0344          ; to interrupt an executing program.
0345          ;
0346 F862 CD6AF8   CALL   Get$Console$Status ;Return A = zero or nonzero
0347          ;According to status, then convert

```

Figure 6-4. (Continued)

```

0348                                     ; to return parameter convention.
0349 F865 B7          ORA    A                ;Set flags to reflect status
0350 F866 C8          RZ     A                ;If 0, no incoming data
0351 F867 3EFF       MVI    A,OFFH          ;Otherwise return A = OFFH to
0352 F869 C9          RET                     ; indicate incoming data
0353                                     ;
0354                                     ;Get#Console#Status:
0355 F86A 3A0300     LDA    IOBYTE           ;Get I/O redirection byte
0356                                     ;Console is selected according to
0357                                     ; bits 1,0 of IOBYTE
0358 F86D CDDCF8     CALL    Select#Routine ;Select appropriate routine
0359                                     ;These routines return to the caller
0360                                     ; of Get#Console#Status.
0361 F870 F6F8       DW     Teletype#In#Status ;00 ← IOBYTE bits 1,0
0362 F872 FCF8       DW     Terminal#In#Status ;01
0363 F874 02F9       DW     Communication#In#Status ;10
0364 F876 08F9       DW     Dummy#In#Status   ;11
0365                                     ;
0366                                     ;
0367                                     ;
0368                                     ;
0369 CONIN:          ;Get console input character
0370                                     ;Entered directly from the BIOS JMP vector;
0371                                     ; returns the next data character from the
0372                                     ; Console in the A register. The most significant
0373                                     ; bit of the data character will be 0, except
0374                                     ; when "reader" (communication port) input has
0375                                     ; been selected. In this case, the full eight bits
0376                                     ; of data are returned to permit binary data to be
0377                                     ; received.
0378                                     ;
0379                                     ;Normally, this routine will be called after
0380                                     ; a call to CONST has indicated that a data character
0381                                     ; is ready, but whenever the CCP or the BDOS can
0382                                     ; proceed no further until console input occurs,
0383                                     ; then CONIN will be called without a preceding
0384                                     ; CONST call.
0385                                     ;
0386 F878 3A0300     LDA    IOBYTE           ;Get I/O redirection byte
0387 F87B CDDCF8     CALL    Select#Routine ;Select correct CONIN routine
0388                                     ;These routines return directly
0389                                     ; to CONIN's caller.
0390 F87E 20F9       DW     Teletype#Input    ;00 ← IOBYTE bits 1,0
0391 F880 26F9       DW     Terminal#Input    ;01
0392 F882 2FF9       DW     Communication#Input ;10
0393 F884 35F9       DW     Dummy#Input      ;11
0394                                     ;
0395                                     ;
0396                                     ;
0397 CONOUT:         ;Console output
0398                                     ;Entered directly from BIOS JMP vector;
0399                                     ; outputs the data character in the C register
0400                                     ; to the appropriate device according to bits
0401                                     ; 1,0 of IOBYTE
0402                                     ;
0403 F886 3A0300     LDA    IOBYTE           ;Get I/O redirection byte
0404 F889 CDDCF8     CALL    Select#Routine ;Select correct CONOUT routine
0405                                     ;These routines return directly
0406                                     ; to CONOUT's caller.
0407 F88C 38F9       DW     Teletype#Output   ;00 ← IOBYTE bits 1,0
0408 F88E 3EF9       DW     Terminal#Output   ;01
0409 F890 44F9       DW     Communication#Output ;10
0410 F892 4AF9       DW     Dummy#Output     ;11
0411                                     ;
0412                                     ;
0413                                     ;
0414 LISTST:        ;List device (output) status
0415                                     ;Entered directly from the BIOS JMP vector;
0416                                     ; returns in A list device status that
0417                                     ; indicates whether the list device can accept
0418                                     ; another output character. The IOBYTE's bits
0419                                     ; 7,6 determine the physical device used.
0420                                     ;
0421                                     ; A = 00H (zero flag set): cannot accept data
0422                                     ; A = OFFH (zero flag clear): can accept data
0423                                     ;

```

Figure 6-4. (Continued)

```

0424                                     ;Digital Research's documentation indicates
0425                                     ; that you can always return with A = 00H
0426                                     ; ("Cannot accept data") if you do not wish to
0427                                     ; implement the LISTST routine. This is NOT TRUE.
0428                                     ;If you do not wish to implement the LISTST routine
0429                                     ; always return with A = OFFH ("Can accept data").
0430                                     ;The LIST driver will then take care of things rather
0431                                     ; than potentially hanging the system.
0432                                     ;
0433 F894 CD9CF8      CALL      Get#List#Status ;Return A = zero or nonzero
0434                                     ; according to status, then convert
0435                                     ; to return parameter convention
0436 F897 B7          ORA      A              ;Set flags to reflect status
0437 F898 C8          RZ          ;If 0, cannot accept data for output
0438 F899 3EFF        MVI      A,OFFH        ;Otherwise return A = OFFH to
0439 F89B C9          RET          ; indicate can accept data for output
0440
0441                                     ;
0441 Get#List#Status:
0442 F89C 3A0300      LDA      IOBYTE        ;Get I/O redirection byte
0443 F89F 07          RLC          ;Move bits 7,6 to 1,0
0444 F8A0 07          RLC          ;
0445 F8A1 CDDCF8      CALL      Select#Routine ;Select appropriate routine
0446                                     ;These routines return directly
0447                                     ; to Get#List#Status's caller.
0448 F8A4 0BF9        DW      Teletype#Out#Status ;00 <- IOBYTE bits 1,0
0449 F8A6 11F9        DW      Terminal#Out#Status ;01
0450 F8A8 17F9        DW      Communication#Out#Status ;10
0451 F8AA 1DF9        DW      Dummy#Out#Status ;11
0452
0453                                     ;
0454                                     ;
0455 LIST:
0456                                     ;List output
0457                                     ;Entered directly from BIOS JMP vector;
0458                                     ; outputs the data character in the C register
0459                                     ; to the appropriate device according to bits
0460                                     ; 7,6 of IOBYTE
0461                                     ;
0462 F8AC 3A0300      LDA      IOBYTE        ;Get I/O redirection byte
0463 F8AF 07          RLC          ;Move bits 7,6 to 1,0
0464 F8B0 07          RLC          ;
0465 F8B1 CDDCF8      CALL      Select#Routine ;Select correct LIST routine
0466                                     ;These routines return directly
0467                                     ; to LIST's caller.
0468 F8B4 38F9        DW      Teletype#Output ;00 <- IOBYTE bits 1,0
0469 F8B6 3EF9        DW      Terminal#Output ;01
0470 F8B8 44F9        DW      Communication#Output ;10
0471 F8BA 4AF9        DW      Dummy#Output ;11
0472
0473                                     ;
0474                                     ;
0475 PUNCH:
0476                                     ;Punch output
0477                                     ;Entered directly from BIOS JMP vector;
0478                                     ; outputs the data character in the C register
0479                                     ; to the appropriate device according to bits
0480                                     ; 5,4 of IOBYTE
0481                                     ;
0482 F8BC 3A0300      LDA      IOBYTE        ;Get I/O redirection byte
0483 F8BF 0F          RRC          ;Move bits 5,4 to 2,1
0484 F8C0 0F          RRC          ;
0485 F8C1 0F          RRC          ;
0486 F8C2 CDDDF8      CALL      Select#Routine#21 ;Select correct PUNCH routine
0487                                     ;These routines return directly
0488                                     ; to PUNCH's caller.
0489 F8C5 38F9        DW      Teletype#Output ;00 <- IOBYTE bits 1,0
0490 F8C7 4AF9        DW      Dummy#Output ;01
0491 F8C9 44F9        DW      Communication#Output ;10
0492 F8CB 3EF9        DW      Terminal#Output ;11
0493
0494                                     ;
0495 READER:
0496                                     ;Reader input
0497                                     ;Entered directly from BIOS JMP vector;
0498                                     ; inputs the next data character from the
0499                                     ; reader device into the A register

```

Figure 6-4. (Continued)

```

0500                                     ;The appropriate device is selected according
0501                                     ; to bits 3,2 of IOBYTE.
0502                                     ;
0503 F8CD 3A0300 LDA IOBYTE ;Get I/O redirection byte
0504 F8D0 0F RRC ;Move bits 3,2 to 2,1
0505 F8D1 CDDDF8 CALL Select$Routine$21' ;Select correct READER routine
0506 ;These routines return directly
0507 ; to READER's caller.
0508 F8D4 38F9 DW Teletype$Output ;00 <- IOBYTE bits 1,0
0509 F8D6 4AF9 DW Dummy$Output ;01
0510 F8D8 44F9 DW Communication$Output ;10
0511 F8DA 3EF9 DW Terminal$Output ;11
0512 ;
0513 ;
0514 ;
0515 ;
0516 Select$Routine: ;Transfers control to a specified address
0517 ; following its calling address according to
0518 ; the value of bits 1,0 in A.
0519 F8DC 07 RLC ;Shift select values into bits 2,1
0520 ; in order to do word arithmetic
0521 ;
0522 Select$Routine$21: ;Entry point to select routine selection bits
0523 ; are already in bits 2,1
0524 F8DD E606 ANI 0000$0110B ;Isolate just bits 2,1
0525 F8DF E3 XTHL ;HL -> first word of addresses after
0526 ; CALL instruction
0527 F8E0 5F MOV E,A ;Add on selection value to address table
0528 F8E1 1600 MVI D,0 ; base
0529 F8E3 19 DAD D ;HL -> selected routine address
0530 ;Get routine address into HL
0531 F8E4 7E MOV A,M ;LS byte
0532 F8E5 23 INX H ;HL -> MS byte
0533 F8E6 66 MOV H,M ;MS byte
0534 F8E7 6F MOV L,A ;HL -> routine
0535 F8E8 E3 XTHL ;Top of stack -> routine
0536 F8E9 C9 RET ;transfer to selected routine
0537 ;
0538 ;
0539 ;
0540 ; Input/Output Equates
0541 ;
0542 00ED = Teletype$Status$Port EQU 0EDH
0543 00EC = Teletype$Data$Port EQU 0ECH
0544 0001 = Teletype$Output$Ready EQU 0000$0001B ;Status mask
0545 0002 = Teletype$Input$Ready EQU 0000$0010B ;Status mask
0546 ;
0547 0001 = Terminal$Status$Port EQU 01H
0548 0002 = Terminal$Data$Port EQU 02H
0549 0001 = Terminal$Output$Ready EQU 0000$0001B ;Status mask
0550 0002 = Terminal$Input$Ready EQU 0000$0010B ;Status mask
0551 ;
0552 00ED = Communication$Status$Port EQU 0EDH
0553 00EC = Communication$Data$Port EQU 0ECH
0554 0001 = Communication$Output$Ready EQU 0000$0001B ;Status mask
0555 0002 = Communication$Input$Ready EQU 0000$0010B ;Status mask
0556 ;
0557 00DF = Communication$Baud$Mode EQU 0DFH ;Mode Select
0558 00DE = Communication$Baud$Rate EQU 0DEH ;Rate Select
0559 ;
0560 ;
0561 ; Serial device control tables
0562 ;
0563 ; In order to reduce the amount of executable code,
0564 ; the same low-level driver code is used for all serial ports.
0565 ; On entry to the low-level driver, HL points to the
0566 ; appropriate control table.
0567 ;
0568 Teletype$Table:
0569 F8EA ED DB Teletype$Status$Port
0570 F8EB EC DB Teletype$Data$Port
0571 F8EC 01 DB Teletype$Output$Ready
0572 F8ED 02 DB Teletype$Input$Ready
0573 ;
0574 Terminal$Table:
0575 F8EE 01 DB Terminal$Status$Port

```

Figure 6-4. (Continued)

```

0576 F8EF 02      DB      Terminal$Data$Port
0577 F8F0 01      DB      Terminal$Output$Ready
0578 F8F1 02      DB      Terminal$Input$Ready
0579
0580
0581 F8F2 ED      DB      Communication$Table:
0582 F8F3 EC      DB      Communication$Status$Port
0583 F8F4 01      DB      Communication$Data$Port
0584 F8F5 02      DB      Communication$Output$Ready
0585
0586
0587
0588
0589
0590
0591
0592
0593 F8F6 21EAF8   LXI    H,Teletype$Table      ;HL -> control table
0594 F8F9 C34BF9   JMP    Input$Status         ;Note use of JMP. Input$Status
0595                                     ; will execute the RETURN.
0596
0597
0598 F8FC 21EEF8   LXI    H,Terminal$Table     ;HL -> control table
0599 F8FF C34BF9   JMP    Input$Status         ;Note use of JMP. Input$Status
0600                                     ; will execute the RETURN.
0601
0602
0603 F902 21F2F8   LXI    H,Communication$Table ;HL -> control table
0604 F905 C34BF9   JMP    Input$Status         ;Note use of JMP. Input$Status
0605                                     ; will execute the RETURN.
0606
0607
0608 F908 3EFF     MVI    A,OFFH              ;Dummy status, always returns
0609 F90A C9      RET                        ; indicating incoming data is ready
0610
0611
0612
0613 F90B 21EAF8   LXI    H,Teletype$Table     ;HL -> control table
0614 F90E C356F9   JMP    Output$Status        ;Note use of JMP. Output$Status
0615                                     ; will execute the RETURN.
0616
0617
0618 F911 21EEF8   LXI    H,Terminal$Table     ;HL -> control table
0619 F914 C356F9   JMP    Output$Status        ;Note use of JMP. Output$Status
0620                                     ; will execute the RETURN.
0621
0622
0623 F917 21F2F8   LXI    H,Communication$Table ;HL -> control table
0624 F91A C356F9   JMP    Output$Status        ;Note use of JMP. Output$Status
0625                                     ; will execute the RETURN.
0626
0627
0628 F91D 3EFF     MVI    A,OFFH              ;Dummy status, always returns
0629 F91F C9      RET                        ; indicating ready for output
0630
0631
0632
0633 F920 21EAF8   LXI    H,Teletype$Table     ;HL -> control table
0634 F923 C360F9   JMP    Input$Data           ;Note use of JMP. Input$Data
0635                                     ; will execute the RETURN.
0636
0637
0638 F926 21EEF8   LXI    H,Terminal$Table     ;HL -> control table
0639                                     ; will execute the RETURN.
0640 F929 CD60F9   CALL   Input$Data           ;** Special case **
0641                                     ; Input$Data will return here
0642 F92C E67F     ANI    7FH                  ; so that parity bit can be set 0
0643 F92E C9      RET
0644
0645
0646 F92F 21F2F8   LXI    H,Communication$Table ;HL -> control table
0647 F932 C360F9   JMP    Input$Data           ;Note use of JMP. Input$Data
0648                                     ; will execute the RETURN.
0649
0650
0651 F935 3E1A     MVI    A,1AH                ;Dummy input, always returns
                                     ; indicating CP/M end of file

```

Figure 6-4. (Continued)

```

0652 F937 C9          RET
0653                ;
0654                ;
0655                ;
0656                ;
0657                ;
0658                Teletype#Output:
0658 F938 21EAF8      LXI    H,Teletype#Table    ;HL -> control table
0659 F93B C370F9      JMP    Output#Data      ;Note use of JMP. Output#Data
0660                ; will execute the RETURN.
0661                ;
0662                ;
0662                Terminal#Output:
0663 F93E 21EEF8      LXI    H,Terminal#Table    ;HL -> control table
0664                ; will execute the RETURN.
0665 F941 C370F9      JMP    Output#Data      ;Note use of JMP. Output#Data
0666                ; will execute the RETURN.
0667                ;
0668                ;
0668                Communication#Output:
0669 F944 21F2F8      LXI    H,Communication#Table ;HL -> control table
0670 F947 C370F9      JMP    Output#Data      ;Note use of JMP. Output#Data
0671                ; will execute the RETURN.
0672                ;
0673                ;
0673                Dummy#Output:
0674 F94A C9          RET                ;Dummy output, always discards
0675                ; the output character
0676                ;
0677                ;
0678                ;
0679                ; These are the general purpose low-level drivers.
0680                ; On entry, HL points to the appropriate control table.
0681                ; For output, the C register contains the data to be output.
0682                ;
0683                ;
0683                Input#Status:
0684                ;Return with A = 00H if no incoming data,
0685                ; otherwise A = nonzero.
0685 F94B 7E          MOV    A,M                ;Get status port
0686 F94C 3250F9      STA    Input#Status#Port ;*** Self-modifying code ***
0687 F94F DB          DB    IN                ;Input to A from correct status port
0688                ;
0689                ;
0689                Input#Status#Port:
0690 F950 00          DB    00                ;<- Set above
0691 F951 23          INX    H                ;Move HL to point to input data mask
0692 F952 23          INX    H
0693 F953 23          INX    H
0694 F954 A6          ANA    M                ;Mask with input status
0695 F955 C9          RET
0696                ;
0697                ;
0698                ;
0698                Output#Status:
0699                ;Return with A = 00H if not ready for output
0700                ; otherwise A = nonzero.
0700 F956 7E          MOV    A,M                ;Get status port
0701 F957 325BF9      STA    Output#Status#Port ;*** Self-modifying code ***
0702 F95A DB          DB    IN                ;Input to A from correct status port
0703                ;
0704                ;
0704                Output#Status#Port:
0705 F95B 00          DB    00                ;<- Set above
0706 F95C 23          INX    H                ;Move HL to point to output data mask
0707 F95D 23          INX    H
0708 F95E A6          ANA    M                ;Mask with output status
0709 F95F C9          RET
0710                ;
0711                ;
0712                ;
0712                Input#Data:
0713                ;Return with next data character in A.
0714                ;Wait for status routine to indicate
0715                ; incoming data.
0715 F960 E5          PUSH   H                ;Save control table pointer
0716 F961 CD4BF9      CALL  Input#Status      ;Get input status in zero flag
0717 F964 E1          POP    H                ;Recover control table pointer
0718 F965 CA60F9      JZ    Input#Data        ;Wait until incoming data
0719 F968 23          INX    H                ;HL -> data port
0720 F969 7E          MOV    A,M                ;Get data port
0721 F96A 326EF9      STA    Input#Data#Port ;*** Self-modifying code ***
0722 F96D DB          DB    IN                ;Input to A from correct data port
0723                ;
0724                ;
0724                Input#Data#Port:
0725 F96E 00          DB    0                ;<- Set above
0726 F96F C9          RET
0727                ;

```

Figure 6-4. (Continued)

```

0728 ;
0729 Output$Data: ;Output the data character in the C register.
0730 ;Wait for status routine to indicate device
0731 ; ready to accept another character
0732 F970 E5 PUSH H ;Save control table pointer
0733 F971 CD56F9 CALL Output$Status ;Get output status in zero flag
0734 F974 E1 POP H ;Recover control table pointer
0735 F975 CA70F9 JZ Output$Data ;Wait until ready for output
0736 F978 23 INX H ;HL -> output port
0737 F979 7E MOV A,M ;Get output port
0738 F97A 327FF9 STA Output$Data$Port ;*** Self-modifying code ***
0739 F97D 79 MOV A,C ;Get data character to be output
0740 F97E D3 DB OUT ;Output data to correct port
0741 ;
0742 Output$Data$Port:
0743 F97F 00 DB 0 ;<- Set above
0744 F980 C9 RET
0745 ;
0746 ;
0747 ; High level diskette drivers
0748 ;
0749 ; These drivers perform the following functions:
0750 ;
0751 ; SELDSK Select a specified disk and return the address of
0752 ; the appropriate disk parameter header
0753 ; SETTRK Set the track number for the next read or write
0754 ; SETSEC Set the sector number for the next read or write
0755 ; SETDMA Set the DMA (read/write) address for the next read or write.
0756 ; SECTRAN Translate a logical sector number into a physical
0757 ; HOME Set the track to 0 so that the next read or write will
0758 ; be on Track 0
0759 ;
0760 ; In addition, the high-level drivers are responsible for making
0761 ; the 5 1/4" floppy diskettes that use a 512-byte sector appear
0762 ; to CP/M as though they used a 128-byte sector. They do this
0763 ; by using what is called blocking/deblocking code,
0764 ; described in more detail later in this listing,
0765 ; just prior to the code itself.
0766 ;
0767 ;
0768 ;
0769 ; Disk parameter tables
0770 ;
0771 ; As discussed in Chapter 3, these describe the physical
0772 ; characteristics of the disk drives? In this example BIOS,
0773 ; there are two types of disk drives: standard single-sided,
0774 ; single-density 8", and double-sided, double-density 5 1/4"
0775 ; diskettes.
0776 ;
0777 ; The standard 8" diskettes do not need to use the blocking/
0778 ; deblocking code, but the 5 1/4" drives do. Therefore an additional
0779 ; byte has been prefixed to the disk parameter block to
0780 ; tell the disk drivers each logical disk's physical
0781 ; diskette type, and whether or not it needs deblocking.
0782 ;
0783 ;
0784 ; Disk definition tables
0785 ;
0786 ; These consist of disk parameter headers, with one entry
0787 ; per logical disk driver, and disk parameter blocks, with
0788 ; either one parameter block per logical disk or the same
0789 ; parameter block for several logical disks.
0790 ;
0791 ;
0792 Disk$Parameter$Headers: ;Described in Chapter 3
0793 ;
0794 ; ;Logical Disk A: (5 1/4" Diskette)
0795 F981 68FB DW Floppy$5$Skewtable ;5 1/4" skew table
0796 F983 00000000 DW 0,0,0 ;Reserved for CP/M
0797 F989 C1F9 DW Directory$Buffer
0798 F98B 42FA DW Floppy$5$Parameter$Block
0799 F98D 61FA DW Disk$A$Workarea
0800 F98F C1FA DW Disk$A$Allocation$Vector
0801 ;
0802 ; ;Logical Disk B: (5 1/4" Diskette)
0803 F991 68FB DW Floppy$5$Skewtable ;Shares same skew table as A:

```

Figure 6-4. (Continued)

```

0804 F993 000000000 DW 0,0,0 ;Reserved for CP/M
0805 F999 C1F9 DW Directory$Buffer ;Share same buffer as A:
0806 F99B 42FA DW Floppy$5$Parameter$Block ;Same DPB as A:
0807 F99D B1FA DW Disk$B$Workarea ;Private work area
0808 F99F D7FA DW Disk$B$Allocation$Vector ;Private allocation vector
0809 ;
0810 ;Logical Disk C: (8" Floppy)
0811 F9A1 B3FB DW Floppy$8$Skewtable ;8" skew table
0812 F9A3 000000000 DW 0,0,0 ;Reserved for CP/M
0813 F9A9 C1F9 DW Directory$Buffer ;Share same buffer as A:
0814 F9AB 52FA DW Floppy$8$Parameter$Block
0815 F9AD A1FA DW Disk$C$Workarea ;Private work area
0816 F9AF EDFA DW Disk$C$Allocation$Vector ;Private allocation vector
0817 ;
0818 ;Logical Disk D: (8" Floppy)
0819 F9B1 68FB DW Floppy$5$Skewtable ;Shares same skew table as A:
0820 F9B3 000000000 DW 0,0,0 ;Reserved for CP/M
0821 F9B9 C1F9 DW Directory$Buffer ;Share same buffer as A:
0822 F9BB 52FA DW Floppy$8$Parameter$Block ;Same DPB as C:
0823 F9BD B1FA DW Disk$D$Workarea ;Private work area
0824 F9BF 0CFB DW Disk$D$Allocation$Vector ;Private allocation vector
0825 ;
0826 ;
0827 ;
0828 F9C1 Directory$Buffer: DS 128
0829 ;
0830 ;
0832 ;
0833 ; Disk Types
0834 ;
0835 0001 = Floppy$5 EQU 1 ;5 1/4" mini floppy
0836 0002 = Floppy$8 EQU 2 ;8" floppy (SS SD)
0837 ;
0838 ; Blocking/deblocking indicator
0839 ;
0840 0080 = Need$Deblocking EQU 1000$0000B ;Sector size > 128 bytes
0841 ;
0842 ;
0843 ; Disk parameter blocks
0844 ;
0845 ; 5 1/4" mini floppy
0846 ;
0847 ;
0848 ;Extra byte prefixed to indicate
0849 FA41 B1 DB Floppy$5 + Need$Deblocking ; disk type and blocking required
0850 Floppy$5$Parameter$Block:
0851 FA42 4800 DW 72 ;128-byte sectors per track
0852 FA44 04 DB 4 ;Block shift
0853 FA45 0F DB 15 ;Block mask
0854 FA46 01 DB 1 ;Extent mask
0855 FA47 AE00 DW 174 ;Maximum allocation block number
0856 FA49 7F00 DW 127 ;Number of directory entries - 1
0857 FA4B C0 DB 1100$0000B ;Bit map for reserving 1 alloc. block
0858 FA4C 00 DB 0000$0000B ; for file directory
0859 FA4D 2000 DW 32 ;Disk changed work area size
0860 FA4F 0100 DW 1 ;Number of tracks before directory
0861 ;
0862 ;
0863 ; Standard 8" Floppy
0864 ;
0865 ;Extra byte prefixed to DPB for
0866 FA51 02 DB Floppy$8 ; this version of the BIOS
0867 ; Indicates disk type and the fact
0868 ; that no deblocking is required
0869 Floppy$8$Parameter$Block:
0869 FA52 1A00 DW 26 ;Sectors per track
0870 FA54 03 DB 3 ;Block shift
0871 FA55 07 DB 7 ;Block mask
0872 FA56 00 DB 0 ;Extent mask
0873 FA57 F200 DW 242 ;Maximum allocation block number
0874 FA59 3F00 DW 63 ;Number of directory entries - 1
0875 FA5B C0 DB 1100$0000B ;Bit map for reserving 2 alloc. blocks
0876 FA5C 00 DB 0000$0000B ; for file directory
0877 FA5D 1000 DW 16 ;Disk changed work area size
0878 FA5F 0200 DW 2 ;Number of tracks before directory
0879 ;
0880 ;

```

Figure 6-4. (Continued)

```

0881      ; Disk work areas
0882      ;
0883      ; These are used by the BDOS to detect any unexpected
0884      ; change of diskettes. The BDOS will automatically set
0885      ; such a changed diskette to read-only status.
0886      ;
0887      FA61      Disk#A#Workarea: DS      32      ; A:
0888      FA61      Disk#B#Workarea: DS      32      ; B:
0889      FAA1      Disk#C#Workarea: DS      16      ; C:
0890      FAB1      Disk#D#Workarea: DS      16      ; D:
0891      ;
0892      ;
0893      ; Disk allocation vectors
0894      ;
0895      ; These are used by the BDOS to maintain a bit map of
0896      ; which allocation blocks are used and which are free.
0897      ; One byte is used for eight allocation blocks, hence the
0898      ; expression of the form (allocation blocks/8)+1.
0899      ;
0900      FAC1      Disk#A#Allocation#Vector DS      (174/8)+1      ; A:
0901      FAB7      Disk#B#Allocation#Vector DS      (174/8)+1      ; B:
0902      ;
0903      FAED      Disk#C#Allocation#Vector DS      (242/8)+1      ; C:
0904      FB0C      Disk#D#Allocation#Vector DS      (242/8)+1      ; D:
0905      ;
0906      ;
0907      0004 =    Number#of#Logical#Disks      EQU      4
0908      ;
0909      ;
0910      SELDSK:      ;Select disk in C
0911                  ;C = 0 for drive A, 1 for B, etc.
0912                  ;Return the address of the appropriate
0913                  ; disk parameter header in HL, or 0000H
0914                  ; if the selected disk does not exist.
0915                  ;
0916      FB2B 210000      LXI      H,0      ;Assume an error
0917      FB2E 79          MOV      A,C      ;Check if requested disk valid
0918      FB2F FE04        CPI      Number#of#Logical#Disks
0919      FB31 D0          RNC          ;Return if > maximum number of disks
0920      ;
0921      FB32 32EAFB      STA      Selected#Disk      ;Save selected disk number
0922                  ;Set up to return DPH address
0923      FB35 6F          MOV      L,A      ;Make disk into word value
0924      FB36 2600        MVI      H,0
0925                  ;Compute offset down disk parameter
0926                  ; header table by multiplying by
0927                  ; parameter header length (16 bytes)
0928      FB38 29          DAD      H      ; *2
0929      FB39 29          DAD      H      ; *4
0930      FB3A 29          DAD      H      ; *8
0931      FB3B 29          DAD      H      ; *16
0932      FB3C 1181F9      LXI      D, Disk#Parameter#Headers      ;Get base address
0933      FB3F 19          DAD      D      ;DE -> Appropriate DPH
0934      FB40 E5          PUSH     H      ;Save DPH address
0935      ;
0936                  ;Access disk parameter block
0937                  ; to extract special prefix byte that
0938                  ; identifies disk type and whether
0939                  ; deblocking is required
0940                  ;
0941      FB41 110A00      LXI      D,10      ;Get DPB pointer offset in DPH
0942      FB44 19          DAD      D      ;DE -> DPB address in DPH
0943      FB45 5E          MOV      E,M      ;Get DPB address in DE
0944      FB46 23          INX      H
0945      FB47 56          MOV      D,M
0946      FB48 EB          XCHG      ;DE -> DPB
0947      FB49 2B          DCX      H      ;DE -> prefix byte
0948      FB4A 7E          MOV      A,M      ;Get prefix byte
0949      FB4B E60F        ANI      0FH      ;Isolate disk type
0950      FB4D 32FAFB      STA      Disk#Type      ;Save for use in low-level driver
0951      FB50 7E          MOV      A,M      ;Get another copy of prefix byte
0952      FB51 E680        ANI      Need#Deblocking      ;Isolate deblocking flag
0953      FB53 32F9FB      STA      Deblocking#Required      ;Save for use in low-level driver
0954      FB56 E1          POP      H
0955      FB57 C9          RET
0956      ;

```

Figure 6-4. (Continued)

```

0957 ;
0958 ; Set logical track for next read or write
0959 ;
0960 ; SETTRK:
0961 FB58 60 MOV H,B ;Selected track in BC on entry
0962 FB59 69 MOV L,C
0963 FB5A 22EBFB SHLD Selected$Track ;Save for low-level driver
0964 FB5D C9 RET
0965 ;
0966 ;
0967 ; Set logical sector for next read or write
0968 ;
0969 ;
0970 ; SETSEC:
0971 FB5E 79 MOV A,C ;Logical sector in C on entry
0972 FB5F 32EDFB STA Selected$Sector ;Save for low-level driver
0973 FB62 C9 RET
0974 ;
0975 ;
0976 ; Set disk DMA (input/output) address for next read or write
0977 ;
0978 FB63 0000 DMA$Address: DW 0 ;DMA address
0979 ;
0980 ; SETDMA:
0981 FB65 69 MOV L,C ;Address in BC on entry
0982 FB66 60 MOV H,B ;Move to HL to save
0983 FB67 2263FB SHLD DMA$Address ;Save for low-level driver
0984 FB6A C9 RET
0985 ;
0986 ;
0987 ; Translate logical sector number to physical
0988 ;
0989 ; Sector translation tables
0990 ; These tables are indexed using the logical sector number,
0991 ; and contain the corresponding physical sector number.
0992 ;
0993 ; Floppy$5$Skewtable: ;Each physical sector contains four
0994 ; ; 128-byte sectors.
0995 ; ; Physical 128b Logical 128b Physical 512-byte
0996 FB6B 00010203 DB 00,01,02,03 ;00,01,02,03 0 )
0997 FB6F 10111213 DB 16,17,18,19 ;04,05,06,07 4 )
0998 FB73 20212223 DB 32,33,34,35 ;08,09,10,11 8 )
0999 FB77 0C0D0E0F DB 12,13,14,15 ;12,13,14,15 3 ) Head
1000 FB7B 1C1D1E1F DB 28,29,30,31 ;16,17,18,19 7 ) 0
1001 FB7F 08090A0B DB 08,09,10,11 ;20,21,22,23 2 )
1002 FB83 18191A1B DB 24,25,26,27 ;24,25,26,27 6 )
1003 FB87 04050607 DB 04,05,06,07 ;28,29,30,31 1 )
1004 FB8B 14151617 DB 20,21,22,23 ;32,33,34,35 5 )
1005 ;
1006 FB8F 24252627 DB 36,37,38,39 ;36,37,38,39 0 J
1007 FB93 34353637 DB 52,53,54,55 ;40,41,42,43 4 J
1008 FB97 44454647 DB 68,69,70,71 ;44,45,46,47 8 J
1009 FB9B 30313233 DB 48,49,50,51 ;48,49,50,51 3 J Head
1010 FB9F 40414243 DB 64,65,66,67 ;52,53,54,55 7 J 1
1011 FBA3 2C2D2E2F DB 44,45,46,47 ;56,57,58,59 2 J
1012 FBA7 3C3D3E3F DB 60,61,62,63 ;60,61,62,63 6 J
1013 FBAB 28292A2B DB 40,41,42,43 ;64,65,66,67 1 J
1014 FBAF 38393A3B DB 56,57,58,59 ;68,69,70,71 5 J
1015 ;
1016 ;
1017 ; Floppy$8$Skewtable: ;Standard 8" Driver
1018 ; ; 01,02,03,04,05,06,07,08,09,10 Logical sectors
1019 FBB3 01070D1319 DB 01,07,13,19,25,05,11,17,23,03 ;Physical sectors
1020 ; ;
1021 ; ; 11,12,13,14,15,16,17,18,19,20 Logical sectors
1022 FBD0 090F150208 DB 09,15,21,02,08,14,20,26,06,12 ;Physical sectors
1023 ; ;
1024 ; ; 21,22,23,24,25,26 Logical sectors
1025 FBC7 1218040A10 DB 18,24,04,10,16,22 ;Physical sectors
1026 ; ;
1027 ;
1028 ; SECTRAN: ;Translate logical sector into physical
1029 ; ; On entry, BC = logical sector number
1030 ; ; DE -> appropriate skew table
1031 ; ;
1032 ; ; on exit, HL = physical sector number

```

Figure 6-4. (Continued)

```

1033 FBCD EB      XCHG          ;HL -> skew table base
1034 FBCE 09     DAD           B          ;Add on logical sector number
1035 FBCF 6E     MOV           L,M         ;Get physical sector number
1036 FBDD 2600   MVI           H,0         ;Make into a 16-bit value
1037 FBD2 C9     RET
1038
1039
1040
1041 HOME:
1042
1043 ;Home the selected logical disk to track 0.
1044 ;Before doing this, a check must be made to see
1045 ; if the physical disk buffer has information
1046 ; that must be written out. This is indicated by
1047 ; a flag, Must$Write$Buffer, set in the
1048 ; deblocking code.
1049
1050 FBD3 3AE9FB   LDA           Must$Write$Buffer ;Check if physical buffer must
1051 FBD6 B7       ORA           A           ; be written out to disk
1052 FBD7 C2DDFB   JNZ          HOME$No$Write
1053 FBDA 32E8FB   STA          Data$In$Disk$Buffer ;No, so indicate that buffer
1054
1055 HOME$No$Write:
1056 MVI          C,0           ;Set to track 0 (logically --
1057 CALL         SETTRK        ; no actual disk operation occurs)
1058 RET
1059
1060 ;
1061 ; Data written to or read from the mini-floppy drive is transferred
1062 ; via a physical buffer that is actually 512 bytes long (it was
1063 ; declared at the front of the BIOS and holds the "one-time"
1064 ; initialization code used for the cold boot procedure).
1065 ;
1066 ; The blocking/deblocking code attempts to minimize the amount
1067 ; of actual disk I/O by storing the disk, track, and physical sector
1068 ; currently residing in the Physical Buffer. If a read request is for
1069 ; a 128-byte CP/M "sector" that already is in the physical buffer,
1070 ; then no disk access occurs.
1071 ;
1072 ;
1073 Allocation$Block$Size EQU 2048
1074 Physical$Sec$Per$Track EQU 18
1075 CPM$Sec$Per$Physical EQU Physical$Sector$Size/128
1076 CPM$Sec$Per$Track EQU CPM$Sec$Per$Physical*Physical$Sec$Per$Track
1077 Sector$Mask EQU CPM$Sec$Per$Physical-1
1078 Sector$Bit$Shift EQU 2 ;LOG2(CPM$Sec$Per$Physical)
1079 ;
1080 ;These are the values handed over by the BDOS
1081 ; when it calls the WRITE operation.
1082 ;The allocated/unallocated indicates whether the
1083 ; BDOS is set to write to an unallocated allocation
1084 ; block (it only indicates this for the first
1085 ; 128-byte sector write) or to an allocation block
1086 ; that has already been allocated to a file.
1087 ;The BDOS also indicates if it is set to write to
1088 ; the file directory.
1089 ;
1090 0000 = Write$Allocated EQU 0
1091 0001 = Write$Directory EQU 1
1092 0002 = Write$Unallocated EQU 2
1093 ;
1094 FBE3 00 Write$Type: DB 0 ;Contains the type of write
1095 ; indicated by the BDOS.
1096 ;
1097 ;
1098 In$Buffer$Dk$Trk$Sec: ;Variables for physical sector
1099 ; currently in Disk$Buffer in memory
1100 FBE4 00 In$Buffer$Disk: DB 0 ; These are moved and compared
1101 FBE5 0000 In$Buffer$Track: DW 0 ; as a group, so do not alter
1102 FBE7 00 In$Buffer$Sector: DB 0 ; these lines.
1103 ;
1104 FBE8 00 Data$In$Disk$Buffer: DB 0 ;When nonzero, the disk buffer has
1105 FBE9 00 Must$Write$Buffer: DB 0 ; data from the disk in it.
1106 ;Nonzero when data has been
1107 ; written into Disk$Buffer but
1108 ; not yet written out to disk
1109 ;
1110 Selected$Dk$Trk$Sec: ;Variables for selected disk, track, and sector

```

Figure 6-4. (Continued)

```

1109                                     ; (Selected by SELDSK, SETTRK, and SETSEC)
1110 FBEA 00      Selected$Disk:          DB      0      ; These are moved and
1111 FBEB 0000    Selected$Track:         DW      0      ; compared as a group so
1112 FBED 00      Selected$Sector:        DB      0      ; do not alter order.
1113
1114 FBEE 00      Selected$Physical$Sector: DB      0      ; Selected physical sector derived
1115                                     ; from selected (CP/M) sector by
1116                                     ; shifting it right the number of
1117                                     ; of bits specified by
1118                                     ; Sector$Bit$Shift
1119
1120 FBEB 00      Selected$Disk$Type:      DB      0      ; Set by SELDSK to indicate either
1121                                     ; "8" or 5 1/4" floppy
1122 FBFO 00      Selected$Disk$Deblock:   DB      0      ; Set by SELDSK to indicate whether
1123                                     ; deblocking is required.
1124
1125
1126                                     Unallocated$Dk$Trk$Sec: ; Parameters for writing to a previously
1127                                     ; unallocated allocation block.
1128 FBF1 00      Unallocated$Disk:        DB      0      ; These are moved and compared
1129 FBF2 0000    Unallocated$Track:       DW      0      ; as a group so do not alter
1130 FBF4 00      Unallocated$Sector:      DB      0      ; these lines.
1131
1132 FBF5 00      Unallocated$Record$Count: DB      0      ; Number of unallocated "records"
1133                                     ; in current previously unallocated
1134                                     ; allocation block.
1135
1136 FBF6 00      Disk$Error$Flag:         DB      0      ; Nonzero to indicate an error
1137                                     ; that could not be recovered
1138                                     ; by the disk drivers. BDOOS will
1139                                     ; output a "bad sector" message.
1140
1141                                     ;
1142                                     ; Flags used inside the deblocking code
1143
1144 FBF7 00      Must$Preread$Sector:      DB      0      ; Nonzero if a physical sector must
1145                                     ; be read into the disk buffer
1146                                     ; either before a write to an
1147                                     ; allocated block can occur, or
1148                                     ; for a normal CP/M 128-byte
1149                                     ; sector read
1150 FBF8 00      Read$Operation:           DB      0      ; Nonzero when a CP/M 128-byte
1151 FBF9 00      Deblocking$Required:      DB      0      ; sector is to be read
1152                                     ; Nonzero when the selected disk
1153 FBFA 00      Disk$Type:                DB      0      ; needs deblocking (set in SELDSK)
1154                                     ; Indicates 8" or 5 1/4" floppy
1155                                     ; selected (set in SELDSK).
1156
1157                                     ;
1158                                     ; Read in the 128-byte CP/M sector specified by previous calls
1159                                     ; to select disk and to set track and sector. The sector will be read
1160                                     ; into the address specified in the previous call to set DMA address.
1161                                     ;
1162                                     ; If reading from a disk drive using sectors larger than 128 bytes,
1163                                     ; deblocking code will be used to "unpack" a 128-byte sector from
1164                                     ; the physical sector.
1165 READ:
1166 FBF8 3AF9FB   LDA      Deblocking$Required      ; Check if deblocking needed
1167 FBF9 B7       ORA      A                          ; (flag was set in SELDSK call)
1168 FBFF CA52FD   JZ       Read$No$Deblock           ; No, use normal nondeblocked
1169
1170                                     ; The deblocking algorithm used is such
1171                                     ; that a read operation can be viewed
1172                                     ; up until the actual data transfer as
1173                                     ; though it was the first write to an
1174                                     ; unallocated allocation block.
1175 FC02 AF       XRA      A                          ; Set the record count to 0
1176 FC03 32F5FB   STA      Unallocated$Record$Count ; for first "write"
1177 FC06 3C       INR      A                          ; Indicate that it is really a read
1178 FC07 32F8FB   STA      Read$Operation           ; that is to be performed
1179 FC0A 32F7FB   STA      Must$Preread$Sector       ; and force a pre-read of the sector
1180 FC0D 3E02     MVI      A, Write$Unallocated     ; to get it into the disk buffer
1181 FC0F 32E3FB   STA      Write$Type               ; Fake deblocking code into responding
1182                                     ; as if this is the first write to an
1183 FC12 C36EFC   JMP      Perform$Read$Write             ; unallocated allocation block.
1184                                     ; Use common code to execute read

```

Figure 6-4. (Continued)

```

1184 ;
1185 ; Write a 128-byte sector from the current DMA address to
1186 ; the previously selected disk, track, and sector.
1187 ;
1188 ; On arrival here, the BDOS will have set register C to indicate
1189 ; whether this write operation is to an already allocated allocation
1190 ; block (which means a prered of the sector may be needed),
1191 ; to the directory (in which case the data will be written to the
1192 ; disk immediately), or to the first 128-byte sector of a previously
1193 ; unallocated allocation block (in which case no prered is required).
1194 ;
1195 ; Only writes to the directory take place immediately. In all other
1196 ; cases, the data will be moved from the DMA address into the disk
1197 ; buffer, and only written out when circumstances force the
1198 ; transfer. The number of physical disk operations can therefore
1199 ; be reduced considerably.
1200 ;
1201 ;
1202 WRITE:
1202 FC15 3AF9FB LDA Deblocking$Required ;Check if deblocking is required
1203 FC18 B7 ORA A ;(flag set in SELDSK call)
1204 FC19 CA4DFD JZ Write$No$Deblock
1205 ;
1206 FC1C AF XRA A ;Indicate that a write operation
1207 FC1D 32F8FB STA Read$Operation ; is required (i.e. NOT a read)
1208 FC20 79 MOV A,C ;Save the BDOS write type
1209 FC21 32E3FB STA Write$Type
1210 FC24 FE02 CPI Write$Unallocated ;Check if the first write to an
1211 ; unallocated allocation block
1212 FC26 C237FC JNZ Check$Unallocated$Block ;No, check if in the middle of
1213 ; writing to an unallocated block
1214 ;Yes, first write to unallocated
1215 ; allocation block -- initialize
1216 ; variables associated with
1217 ; unallocated writes.
1218 FC29 3E10 MVI A,Allocation$Block$Size/128 ;Get number of 128-byte
1219 ; sectors and
1220 FC2B 32F5FB STA Unallocated$Record$Count ; set up a count.
1221 ;
1222 FC2E 21EAFB LXI H,Selected$Dk$Trk$Sec ;Copy disk, track, and sector
1223 FC31 11F1FB LXI D,Unallocated$Dk$Trk$Sec ; into unallocated variables
1224 FC34 CD35FD CALL Move$Dk$Trk$Sec
1225 ;
1226 ; Check if this is not the first write to an unallocated
1227 ; allocation block -- if it is, the unallocated record count
1228 ; has just been set to the number of 128-byte sectors in the
1229 ; allocation block.
1230 ;
1231 ;
1231 Check$Unallocated$Block:
1232 FC37 3AF5FB LDA Unallocated$Record$Count
1233 FC3A B7 ORA A
1234 FC3B CA66FC JZ Request$Prered ;No, this is a write to an
1235 ; allocated block
1236 ;Yes, this is a write to an
1237 ; unallocated block
1238 FC3E 3D DCR A ;Count down on number of 128-byte sectors
1239 ; left unwritten to in allocation block
1240 FC3F 32F5FB STA Unallocated$Record$Count ; and store back new value.
1241 ;
1242 FC42 21EAFB LXI H,Selected$Dk$Trk$Sec ;Check if the selected disk, track,
1243 FC45 11F1FB LXI D,Unallocated$Dk$Trk$Sec; and sector are the same as for
1244 FC48 CD29FD CALL Compare$Dk$Trk$Sec ; those in the unallocated block.
1245 FC4B C266FC JNZ Request$Prered ;No, a prered is required
1246 ;Yes, no prered is needed.
1247 ;Now is a convenient time to
1248 ; update the current sector and see
1249 ; if the track also needs updating.
1250 ;
1251 ;
1251 ;By design, Compare$Dk$Trk$Sec
1252 ; returns with
1253 ; DE -> Unallocated$Sector
1254 ; HL -> Unallocated$Sector
1254 FC4E EB XCHG
1255 FC4F 34 INR M
1256 FC50 7E MOV A,M ;Update Unallocated$Sector
1257 FC51 FE48 CPI CPM$Sec$Per$Track ;Check if sector now > maximum
1258 FC53 DA5FFC JC No$Track$Change ; on a track
1259 ;No (A < M)
1259 ;Yes,

```

Figure 6-4. (Continued)

1260	FC56 3600	MVI	M,0	;Reset sector to 0
1261	FC58 2AF2FB	LHLD	Unallocated\$Track	;Increase track by 1
1262	FC5B 23	INX	H	
1263	FC5C 22F2FB	SHLD	Unallocated\$Track	
1264				
1265			No\$Track\$Change:	
1266				;Indicate to later code that
1267				; no preread is needed.
1268	FC5F AF	XRA	A	
1269	FC60 32F7FB	STA	Must\$Preread\$Sector	;Must\$Preread\$Sector=0
1270	FC63 C36EFC	JMP	Perform\$Read\$Write	
1271				
1272			Request\$Preread:	
1273	FC66 AF	XRA	A	;Indicate that this is not a write
1274	FC67 32F5FB	STA	Unallocated\$Record\$Count	; into an unallocated block.
1275	FC6A 3C	INR	A	
1276	FC6B 32F7FB	STA	Must\$Preread\$Sector	;Indicate that a preread of the
1277				; physical sector is required.
1278				
1279				
1280			Perform\$Read\$Write:	;Common code to execute both reads and
1281				; writes of 128-byte sectors.
1282	FC6E AF	XRA	A	;Assume that no disk errors will
1283	FC6F 32F6FB	STA	Disk\$Error\$Flag	; occur
1284				
1285	FC72 3AEDFB	LDA	Selected\$Sector	;Convert selected 128-byte sector
1286	FC75 1F	RAR		; into physical sector by dividing by 4
1287	FC76 1F	RAR		
1288	FC77 E63F	ANI	3FH	;Remove any unwanted bits
1289	FC79 32EEFB	STA	Selected\$Physical\$Sector	
1290				
1291	FC7C 21E8FB	LXI	H,Data\$In\$Disk\$Buffer	;Check if disk buffer already has
1292	FC7F 7E	MOV	A,M	; data in it.
1293	FC80 3601	MVI	M,1	; (Unconditionally indicate that
1294				; the buffer now has data in it)
1295	FC82 B7	ORA	A	;Did it indeed have data in it?
1296	FC83 CAA3FC	JZ	Read\$Sector\$into\$Buffer	;No, proceed to read a physical
1297				; sector into the buffer.
1298				
1299				;The buffer does have a physical sector
1300				; in it.
1301				; Note: The disk, track, and PHYSICAL
1302				; sector in the buffer need to be
1303				; checked, hence the use of the
1304				; Compare\$Dk\$Trk subroutine.
1305				
1306	FC86 11E4FB	LXI	D,In\$Buffer\$Dk\$Trk\$Sec	;Check if sector in buffer is the
1307	FC89 21EAFB	LXI	H,Selected\$Dk\$Trk\$Sec	; same as that selected earlier
1308	FC8C CD24FD	CALL	Compare\$Dk\$Trk	;Compare ONLY disk and track
1309	FC8F C29CFC	JNZ	Sector\$Not\$In\$Buffer	;No, it must be read in
1310				
1311	FC92 3AE7FB	LDA	In\$Buffer\$Sector	;Get physical sector in buffer
1312	FC95 21EEFB	LXI	H,Selected\$Physical\$Sector	
1313	FC98 BE	CMP	M	;Check if correct physical sector
1314	FC99 CAB1FC	JZ	Sector\$In\$Buffer	;Yes, it is already in memory
1315				
1316			Sector\$Not\$In\$Buffer:	
1317				;No, it will have to be read in
1318				; over current contents of buffer
1319	FC9C 3AE9FB	LDA	Must\$Write\$Buffer	;Check if buffer has data in that
1320	FC9F B7	ORA	A	; must be written out first
1321	FOA0 C495FD	CNZ	Write\$Physical	;Yes, write it out
1322				
1323			Read\$Sector\$into\$Buffer:	
1324	FOA3 CD11FD	CALL	Set\$In\$Buffer\$Dk\$Trk\$Sec	;Set in buffer variables from
1325				; selected disk, track, and sector
1326				; to reflect which sector is in the
1327				; buffer now
1328	FOA6 3AF7FB	LDA	Must\$Preread\$Sector	;In practice, the sector need only
1329	FOA9 B7	ORA	A	; be physically read in if a preread
1330				; is required
1331	FOAA C49AFD	CNZ	Read\$Physical	;Yes, preread the sector
1332	FOAD AF	XRA	A	;Reset the flag to reflect buffer
1333	FOAE 32E9FB	STA	Must\$Write\$Buffer	; contents.
1334				
1335			Sector\$In\$Buffer:	;Selected sector on correct track and

Figure 6-4. (Continued)

```

1336                                     ; disk is already in the buffer.
1337                                     ;Convert the selected CP/M (128-byte)
1338                                     ; sector into a relative address down
1339                                     ; the buffer.
1340 FCB1 3AEDFB      LDA      Selected$Sector ;Get selected sector number
1341 FCB4 E603        ANI      Sector$Mask   ;Mask off only the least significant bits
1342 FCB6 6F          MOV      L,A           ;Multiply by 128 by shifting 16-bit value
1343 FCB7 2600        MVI      H,0          ; left 7 bits
1344 FCB9 29          DAD      H            ; * 2
1345 FCBA 29          DAD      H            ; * 4
1346 FCBB 29          DAD      H            ; * 8
1347 FCBC 29          DAD      H            ; * 16
1348 FCBD 29          DAD      H            ; * 32
1349 FCBE 29          DAD      H            ; * 64
1350 FCBF 29          DAD      H            ; * 128
1351
1352 FCC0 1133F6      LXI      D, Disk$Buffer ;Get base address of disk buffer
1353 FCC3 19          DAD      D            ;Add on sector number * 128
1354                                     ;HL -> 128-byte sector number start
1355                                     ; address in disk buffer
1356 FCC4 EB          XCHG      DMA$Address ;DE -> sector in disk buffer
1357 FCC5 2A63FB      LHL      DMA$Address ;Get DMA address set in SETDMA call
1358 FCC8 EB          XCHG      DMA$Address ;Assume a read operation, so
1359                                     ; DE -> DMA address
1360                                     ; HL -> sector in disk buffer
1361 FCC9 0E10        MVI      C, 128/8     ;Because of the faster method used
1362                                     ; to move data in and out of the
1363                                     ; disk buffer, (eight bytes moved per
1364                                     ; loop iteration) the count need only
1365                                     ; be 1/8th of normal.
1366                                     ;At this point -
1367                                     ; C = loop count
1368                                     ; DE -> DMA address
1369                                     ; HL -> sector in disk buffer
1370 FCCB 3AF8FB      LDA      Read$Operation ;Determine whether data is to be moved
1371 FCCD B7          ORA      A            ; out of the buffer (read) or into the
1372 FCCF C2D7FC      JNZ      Buffer$Move    ; buffer (write)
1373                                     ;Writing into buffer
1374                                     ;(A must be 0 get here)
1375 FCD2 3C          INR      A            ;Set flag to force a write
1376 FCD3 32E9FB      STA      Must$Write$Buffer ; of the disk buffer later on.
1377 FCD6 EB          XCHG      DMA$Address ;Make DE -> sector in disk buffer
1378                                     ; HL -> DMA address
1379                                     ;
1380                                     ;
1381 Buffer$Move:
1382                                     ;The following move loop moves eight bytes
1383                                     ; at a time from (HL) to (DE), C contains
1384                                     ; the loop count.
1384 FCD7 7E          MOV      A,M          ;Get byte from source
1385 FCD8 12          STAX     D            ;Put into destination
1386 FCD9 13          INX      D            ;Update pointers
1387 FCDA 23          INX      H            ;
1388 FCDB 7E          MOV      A,M          ;Get byte from source
1389 FCDC 12          STAX     D            ;Put into destination
1390 FCDD 13          INX      D            ;Update pointers
1391 FCDE 23          INX      H            ;
1392 FCD7 7E          MOV      A,M          ;Get byte from source
1393 FCE0 12          STAX     D            ;Put into destination
1394 FCE1 13          INX      D            ;Update pointers
1395 FCE2 23          INX      H            ;
1396 FCE3 7E          MOV      A,M          ;Get byte from source
1397 FCE4 12          STAX     D            ;Put into destination
1398 FCE5 13          INX      D            ;Update pointers
1399 FCE6 23          INX      H            ;
1400 FCE7 7E          MOV      A,M          ;Get byte from source
1401 FCE8 12          STAX     D            ;Put into destination
1402 FCE9 13          INX      D            ;Update pointers
1403 FCEA 23          INX      H            ;
1404 FCEB 7E          MOV      A,M          ;Get byte from source
1405 FCEC 12          STAX     D            ;Put into destination
1406 FCED 13          INX      D            ;Update pointers
1407 FCEE 23          INX      H            ;
1408 FCEF 7E          MOV      A,M          ;Get byte from source
1409 FCF0 12          STAX     D            ;Put into destination
1410 FCF1 13          INX      D            ;Update pointers

```

Figure 6-4. (Continued)

```

1411 FCF2 23      INX      H
1412 FCF3 7E      MOV      A,M          ;Get byte from source
1413 FCF4 12      STAX     D            ;Put into destination
1414 FCF5 13      INX      D            ;Update pointers
1415 FCF6 23      INX      H
1416
1417 FCF7 0D      DCR      C            ;Count down on loop counter
1418 FCF8 C2D7FC  JUNZ     Buffer$Move  ;Repeat until CP/M sector moved
1419
1420 FCFB 3AE3FB   LDA      Write$Type   ;If write to directory, write out
1421 FCFE FE01     CPI      Write$Directory ; buffer immediately
1422 FD00 3AF6FB   LDA      Disk$error$Flag ;Get error flag in case delayed write or read
1423 FD03 C0      RNZ
1424
1425 FD04 B7      ORA      A            ;Check if any disk errors have occurred
1426 FD05 C0      RNZ
1427
1428 FD06 AF      XRA      A            ;Clear flag that indicates buffer must be
1429 FD07 32E9FB   STA     Must$Write$Buffer ; written out
1430 FD0A CD95FD   CALL    Write$Physical ;Write buffer out to physical sector
1431 FD0D 3AF6FB   LDA      Disk$error$Flag ;Return error flag to caller
1432 FD10 C9      RET
1433
1434 ;
1435 ;
1436 ;
1437 FD11 3AEAFB   LDA      Selected$Disk
1438 FD14 32E4FB   STA     In$Buffer$Disk
1439
1440 FD17 2AEBFB   LHL     Selected$Track
1441 FD1A 22E5FB   SHLD    In$Buffer$Track
1442
1443 FD1D 3AEAFB   LDA      Selected$Physical$Sector
1444 FD20 32E7FB   STA     In$Buffer$Sector
1445
1446 FD23 C9      RET
1447
1448 ;
1449 ;
1450 FD24 0E03     MVI     C,3           ;Compares just the disk and track
1451 FD26 C32BFD   JMP     Compare$Dk$Trk$Sec$Loop ; pointed to by DE and HL
1452 ;                                     ;Disk (1), track (2)
1453 ;                                     ;Use common code
1454 ;
1455 FD29 0E04     MVI     C,4           ;Compares the disk, track, and sector
1456 ;                                     ; variables pointed to by DE and HL
1457 ;                                     ;Disk (1), track (2), and sector (1)
1458 ;
1459 ;
1460 ;
1461 ;
1462 ;
1463 ;
1464 ;
1465 ;
1466 ;
1467 ;
1468 ;
1469 ;
1470 FD35 0E04     MVI     C,4           ;Compares the disk, track, and sector
1471 ;                                     ; variables pointed at by HL to
1472 ;                                     ; those pointed at by DE
1473 ;                                     ;Disk (1), track (2), and sector (1)
1474 ;
1475 ;
1476 ;
1477 ;
1478 ;
1479 ;
1480 ;
1481 ;
1482 ;
1483 ;
1484 ;
1485 ;
1486 ;
1487 ;

```

Figure 6-4. (Continued)

```

1488 ; in memory to detect when they are to perform some disk
1489 ; operation. The 8" controller monitors location 0040H, and
1490 ; the 5 1/4" controller monitors location 0045H. These are
1491 ; called their disk control bytes. If the most significant
1492 ; bit of a disk control byte is set, the controller will
1493 ; look at the word following the respective control bytes.
1494 ; This word must contain the address of a valid disk control
1495 ; table that specifies the exact disk operation to be performed.
1496 ;
1497 ; Once the operation has been completed, the controller resets
1498 ; its disk control byte to 00H. This indicates completion
1499 ; to the disk driver code.
1500 ;
1501 ; The controller also sets a return code in a disk status block --
1502 ; both controllers use the SAME location for this; 0043H.
1503 ; If the first byte of this status block is less than 80H, then
1504 ; a disk error has occurred. For this simple BIOS, no further details
1505 ; of the status settings are relevant. Note that the disk controller
1506 ; has built-in retry logic -- reads and writes are attempted ten
1507 ; times before the controller returns an error.
1508 ;
1509 ; The disk control table layout is shown below. Note that the
1510 ; controllers have the capability for control tables to be
1511 ; chained together so that a sequence of disk operations can
1512 ; be initiated. In this BIOS this feature is not used. However,
1513 ; the controller requires that the chain pointers in the
1514 ; disk control tables be pointed back to the main control bytes
1515 ; in order to indicate the end of the chain.
1516 ;
1517 0040 = Disk%Control%8 EQU 40H ;8" control byte
1518 0041 = Command%Block%8 EQU 41H ;Control table pointer
1519 ;
1520 0043 = Disk%Status%Block EQU 43H ;8" AND 5 1/4" status block
1521 ;
1522 0045 = Disk%Control%5 EQU 45H ;5 1/4" control byte
1523 0046 = Command%Block%5 EQU 46H ;Control table pointer
1524 ;
1525 ;
1526 ; Floppy Disk Control Tables
1527 ;
1528 FD40 00 Floppy%Command: DB 0 ;Command
1529 0001 = Floppy%Read%Code EQU 01H
1530 0002 = Floppy%Write%Code EQU 02H
1531 FD41 00 Floppy%Unit: DB 0 ;Unit (drive) number = 0 or 1
1532 FD42 00 Floppy%Head: DB 0 ;Head number = 0 or 1
1533 FD43 00 Floppy%Track: DB 0 ;Track number
1534 FD44 00 Floppy%Sector: DB 0 ;Sector number
1535 FD45 0000 Floppy%Byte%Count: DW 0 ;Number of bytes to read/write
1536 FD47 0000 Floppy%DMA%Address: DW 0 ;Transfer address
1537 FD49 0000 Floppy%Next%Status%Block: DW 0 ;Pointer to next status block
1538 ; if commands are chained.
1539 FD4B 0000 Floppy%Next%Control%Location: DW 0 ;Pointer to next control byte
1540 ; if commands are chained.
1541 ;
1542 ;
1543 ;
1544 Write%No%Deblock: ;Write contents of disk buffer to
1545 ; correct sector.
1546 FD4D 3E02 MVI A,Floppy%Write%Code ;Get write function code
1547 FD4F C354FD JMP Common%No%Deblock ;Go to common code
1548 Read%No%Deblock: ;Read previously selected sector
1549 ; into disk buffer.
1550 FD52 3E01 MVI A,Floppy%Read%Code ;Get read function code
1551 Common%No%Deblock: ;Get read function code
1552 FD54 3240FD STA Floppy%Command ;Set command function code
1553 ;Set up nondeblocked command table
1554 FD57 218000 LXI H,128 ;Bytes per sector
1555 FD5A 2245FD SHLD Floppy%Byte%Count
1556 FD5D AF XRA A ;8" floppy only has head 0
1557 FD5E 3242FD STA Floppy%Head
1558 ;
1559 FD61 3AEAFB LDA Selected%Disk ;8" Floppy controller only has information
1560 ; on units 0 and 1 so Selected%Disk must
1561 ; be converted
1562 ;
1562 FD64 E601 ANI 01H ;Turn into 0 or 1
1563 FD66 3241FD STA Floppy%Unit ;Set unit number

```

Figure 6-4. (Continued)

```

1564                                     ;
1565 FD69 3AEBFB LDA Selected$Track ;
1566 FD6C 3243FD STA Floppy$Track ;Set track number
1567                                     ;
1568 FD6F 3AEDFB LDA Selected$Sector ;
1569 FD72 3244FD STA Floppy$Sector ;Set sector number
1570                                     ;
1571 FD75 2A63FB LHL DMA$Address ;Transfer directly between DMA address
1572 FD78 2247FD SHLD Floppy$DMA$Address ;and 8" controller.
1573                                     ;
1574                                     ;The disk controller can accept chained
1575                                     ; disk control tables, but in this case,
1576                                     ; they are not used, so the "Next" pointers
1577                                     ; must be pointed back at the initial
1578                                     ; control bytes in the base page.
1579 FD7B 214300 LXI H,Disk$Status$Block ;Point next status back at
1580 FD7E 2249FD SHLD Floppy$Next$Status$Block ; main status block
1581                                     ;
1582 FD81 214000 LXI H,Disk$Control$B ;Point next control byte
1583 FD84 2248FD SHLD Floppy$Next$Control$Location ; back at main control byte
1584                                     ;
1585 FD87 2140FD LXI H,Floppy$Command ;Point controller at control table
1586 FD8A 224100 SHLD Command$Block$B
1587                                     ;
1588 FD8D 214000 LXI H,Disk$Control$B ;Activate controller to perform
1589 FD90 3680 MVI M,80H ; operation.
1590 FD92 C3F7FD JMP Wait$For$Disk$Complete
1591
1592 ;
1593 ;
1594
1595 Write$Physical: ;Write contents of disk buffer to
1596                                     ; correct sector.
1597 FD95 3E02 MVI A,Floppy$Write$Code ;Get write function code
1598 FD97 C39CFD JMP Common$Physical ;Go to common code
1599 Read$Physical: ;Read previously selected sector
1600                                     ; into disk buffer.
1601 FD9A 3E01 MVI A,Floppy$Read$Code ;Get read function code
1602 ;
1603 Common$Physical:
1604 FD9C 3240FD STA Floppy$Command ;Set command table
1605
1606 ;
1607 FD9F 3AF8FB LDA Disk$Type ;Get disk type (set in SELDSK)
1608 FDA2 FE01 CPI Floppy$B ;Confirm it is a 5 1/4" Floppy
1609 FDA4 CAADF0 JZ Correct$Disk$Type ;Yes
1610 FDA7 3E01 MVI A,1 ;No, indicate disk error
1611 FDA9 32F6FB STA Disk$Error$Flag
1612 FDAC C9 RET
1613 Correct$Disk$Type: ;Set up disk control table
1614 ;
1615 FDAD 3AE4FB LDA In$Buffer$Disk ;Convert disk number to 0 or 1
1616 FDB0 E601 ANI 1 ; for disk controller
1617 FDB2 3241FD STA Floppy$Unit
1618
1619 FDB5 2AE5FB LHL In$Buffer$Track ;Set up track number
1620 FDB8 7D MOV A,L ;Note: This is single byte value
1621 FDB9 3243FD STA Floppy$Track ; for the controller.
1622 ;
1623 ;The sector must be converted into a
1624 ; head number and sector number.
1625 ; Sectors 0 - 8 are head 0, 9 - 17
1626 ; are head 1
1627 FDBC 0600 MVI B,0 ;Assume head 0
1628 FDBE 3AE7FB LDA In$Buffer$Sector ;Get physical sector number
1629 FDC1 4F MOV C,A ;Save copy in case it is head 0
1630 FDC2 FE09 CPI 9 ;Check if < 9
1631 FDC4 DACBFD JC Head$0 ;Yes it is < 9
1632 FDC7 D609 SUI 9 ;No, modify sector number back
1633 ; in the 0 - 8 range.
1634 FDC9 4F MOV C,A ;Put sector in B
1635 FDCA 04 INR B ;Set to head 1
1636 Head$0:
1637 FDCB 78 MOV A,B ;Set head number
1638 FDCC 3242FD STA Floppy$Head
1639 FDC9 79 MOV A,C ;Set sector number

```

Figure 6-4. (Continued)

```

1640 FDD0 3C      INR   A                ; (physical sectors start at 1)
1641 FDD1 3244FD  STA   Floppy$Sector
1642                ;
1643 FDD4 210002  LXI   H,Physical$Sector$Size ;Set byte count
1644 FDD7 2245FD  SHLD  Floppy$Byte$Count
1645                ;
1646 FDDA 2133F6  LXI   H,Disk$Buffer          ;Set transfer address to be
1647 FDDD 2247FD  SHLD  Floppy$DMA$Address     ; disk buffer
1648                ;
1649                ;As only one control table is in
1650                ; use, close the status and busy
1651                ; chain pointers back to the
1652                ; main control bytes.
1653 FDE0 214300  LXI   H,Disk$Status$Block
1654 FDE3 2249FD  SHLD  Floppy$Next$Status$Block
1655 FDE6 214500  LXI   H,Disk$Control$5
1656 FDE9 224BFD  SHLD  Floppy$Next$Control$Location
1657                ;
1658 FDEC 2140FD  LXI   H,Floppy$Command
1659 FDEF 224600  SHLD  Command$Block$5
1660                ;
1661 FDF2 214500  LXI   H,Disk$Control$5
1662 FDF5 3680    MVI   M,80H                  ;Activate 5 1/4" disk controller
1663                ;
1664                ;Wait$For$Disk$Complete:
1665                ;Wait until Disk Status Block indicates
1666                ; operation complete, then check
1667                ; if any errors occurred.
1668 FDF7 7E      MOV   A,M
1669 FDF8 B7      ORA   A
1670 FDF9 C2F7FD  JNZ   Wait$For$Disk$Complete ;Operation still not yet done
1671                ;
1672 FDFC 3A4300  LDA   Disk$Status$Block
1673 FDFE FE80    CPI   80H
1674 FE01 DA09FE  JC   Disk$error
1675 FE04 AF     XRA   A
1676 FE05 32F6FB STA  Disk$error$Flag
1677 FE08 C9     RET
1678                ;
1679 FE09 3E01    MVI   A,1
1680 FE0B 32F6FB STA  Disk$error$Flag
1681 FE0E C9     RET
1682                ;
1683                ;
1684                ;
1685                ; Disk control table images for warm boot
1686                ;
1687                ;
1688 FE0F 01     DB   1
1689 FE10 00     DB   0
1690 FE11 00     DB   0
1691 FE12 00     DB   0
1692 FE13 02     DB   2
1693 FE14 0010   DW   8*512
1694 FE16 00E0  DW   CCP$Entry
1695 FE18 4300   DW   Disk$Status$Block
1696 FE1A 4500   DW   Disk$Control$5
1697                ;
1698                ;
1699                ;
1700                ;
1701                ;
1702                ;
1703 FE20 01     DB   1
1704 FE21 0006   DW   3*512
1705 FE23 00F0  DW   CCP$Entry + (8*512)
1706 FE25 4300   DW   Disk$Status$Block
1707 FE27 4500   DW   Disk$Control$5
1708                ;
1709                ;
1710                ;
1711 WBOOT:      ;Warm boot entry
1712                ;On warm boot, the CCP and BDOS must be reloaded
1713                ; into memory. In this BIOS, only the 5 1/4"
1714                ; diskettes will be used. Therefore this code

```

Figure 6-4. (Continued)

```

1715                                     ; is hardware specific to the controller. Two
1716                                     ; prefabricated control tables are used.
1717 FE29 318000     LXI    SP,80H
1718 FE2C 110FFE     LXI    D,Boot$Control$Part1      ;Execute first read of warm boot
1719 FE2F CD3BFE     CALL   Warm$Boot$Read           ;Load drive 0, track 0,
1720                                     ; head 0, sectors 2 to 8
1721 FE32 111CFE     LXI    D,Boot$Control$Part2      ;Execute second read
1722 FE35 CD3BFE     CALL   Warm$Boot$Read           ;Load drive 0, track 0,
1723                                     ; head 1, sectors 1 - 3
1724 FE38 C340F8     JMP    Enter$CPM                   ;Set up base page and enter CCP
1725
1726                                     ;
1727 Warm$Boot$Read:                                     ;On entry, DE -> control table image
1728                                     ;This control table is moved into
1729                                     ; the main disk control table and
1730                                     ; then the controller activated.
1731 FE3B 2140FD     LXI    H,Floppy$Command          ;HL -> actual control table
1732 FE3E 224600     SHLD   Command$Block$5           ;Tell the controller its address
1733                                     ;Move the control table image
1734 FE41 0E0D       MVI    C,13                          ; into the control table itself
1735 Warm$Boot$Move:                                     ;Set byte count
1736 FE43 1A         LDAX   D                          ;Get image byte
1737 FE44 77         MOV    M,A                          ;Store into actual control table
1738 FE45 23         INX    H                          ;Update pointers
1739 FE46 13         INX    D
1740 FE47 0D         DCR    C                          ;Count down on byte count
1741 FE48 C243FE     JNZ    Warm$Boot$Move                       ;Continue until all bytes moved
1742
1743 FE4B 214500     LXI    H,Disk$Control$5                       ;Activate controller
1744 FE4E 3680     MVI    M,80H
1745 Wait$For$Boot$Complete:
1746 FE50 7E         MOV    A,M                          ;Get status byte
1747 FE51 B7         ORA   A                          ;Check if complete
1748 FE52 C250FE     JNZ    Wait$For$Boot$Complete           ;No
1749                                     ;Yes, check for errors
1750 FE55 3A4300     LDA    Disk$Status$Block
1751 FE58 FE80     CPI    80H
1752 FE5A DA5EFE     JC    Warm$Boot$error                   ;Yes, an error occurred
1753 FE5D C9         RET
1754
1755 Warm$Boot$error:
1756 FE5E 2167FE     LXI    H,Warm$Boot$error$Message
1757 FE61 CD33F8     CALL   Display$Message
1758 FE64 C329FE     JMP    WBOOT                           ;Restart warm boot
1759
1760 Warm$Boot$error$Message:
1761 FE67 0D0A576172 DB    CR,LF,"Warm Boot Error - retrying...",CR,LF,0
1762
1763
1764 FE89           END    ;Of simple BIOS listing

```

Figure 6-4. (Continued)

The Major Steps
Building Your First System
Using SYSGEN to Write
CP/M to Disk
Using DDT to Build the
CP/M Memory Image
The CP/M Bootstrap Loader
Using MOVCPM to Relocate the
CCP and BDOS
Putting It All Together

7

Building a New CP/M System

This chapter describes how to build a version of CP/M with your own BIOS built into it. It also shows you how to put CP/M onto a floppy disk and how to write a bootstrap loader to bring CP/M into memory.

The manufacturer of your computer system plays a significant role in building a new CP/M system. Several of CP/M's utility programs may be modified by manufacturers to adapt them to individual computer systems. Unfortunately, not all manufacturers customize these programs. You should therefore invest some time in studying the documentation provided with your system to see what and how much customizing may have already been done. You should also assemble and print out listings of all assembly language source files from your CP/M release diskette.

It is impossible to predict the details of customization and special procedures that the manufacturer may have installed on your particular system. Therefore, this chapter describes first the overall mechanism of building a CP/M system, and

second the details of building a CP/M system around the example BIOS shown in the previous chapter as Figure 6-4.

The Major Steps

Building a new CP/M system consists of the following major steps:

- Create a new or modified BIOS with the appropriate device drivers in it. Assemble this so that it will execute at the top end of memory (by using an *origin* statement (ORG) to set the location counter).
- Create new versions of the CCP and BDOS with all addresses in the instructions changed so that they will be correctly located in memory just below the new BIOS. Digital Research provides a special utility called MOVCPM to do this.
- Create or modify a CP/M bootstrap loader that will be loaded by the firmware that executes when you first switch on your computer (or press the RESET button). Normally, the CP/M bootstrap loader executes in the low-address end of memory. The exact address and the details of any hardware initialization that it must perform will depend entirely on your particular computer system.
- Using Digital Research standard utility programs, bring the bootstrap loader, the CCP and BDOS, and the BIOS together in the low part of memory. Then write this new version of CP/M onto a disk in the appropriate places. Again, depending on the design of your computer system, you may be able to use the standard utility program, SYSGEN, to write the entire CP/M *image* onto disk. Otherwise you may have to write a special program to do this.

When CP/M is already running on your computer system and you want to add new features to the BIOS, all you need to do is change the BIOS and rebuild the system. The CCP and BDOS will need to be moved down in memory if the changes expand the BIOS significantly. If this happens, you will have to make minor changes in the bootstrap loader so that it reads the new CP/M image into memory at a lower address and transfers control to the correct location (the first instruction of the BIOS jump vector).

Building Your First System

The first time that you build CP/M, it is a good idea to make no changes to the BIOS at all. Simply reassemble the BIOS source code and proceed with the system build. Then, if the new system does not run, you know that it must be something in the procedure you used rather than any new features or modification to the BIOS

source code. Changes in the BIOS could easily obscure any problems you have with the build procedure itself.

The Ingredients

To build CP/M, you will need the following files and utility programs:

- The assembly language source code for your BIOS. Check your CP/M release diskette for a file with a name like CBIOS.ASM (Customized Basic Input/Output System). Some manufacturers do not supply you with the source code for their BIOS; it may be sold separately or not released at all. If you cannot get hold of the source code, the only way that you can add new features to the BIOS is by writing the entire BIOS from scratch.
- The source code for the CP/M bootstrap loader. This too may be on the release diskette or available separately from your computer's manufacturer.
- The Digital Research assembler, which converts source code into machine language in hexadecimal form. This program, called ASM.COM, will be on your CP/M release diskette. Equivalent assemblers, such as Digital Research's macro-assemblers MAC and RMAC or Microsoft's M80, can also be used.
- The Digital Research utility called MOVCPM, which prepares a memory image of the CCP and BDOS with all addresses adjusted to the right values.
- The Digital Research debugging utility, called DDT (Dynamic Debugging Tool), or the more enhanced version for the Z80 CPU chip, ZSID (Z80 Symbolic Interactive Debugger). DDT is used to read in the various program files and piece together a memory image of the CP/M system.
- The Digital Research utility program SYSGEN. This writes the composite memory image of the bootstrap, CCP, BDOS, and BIOS onto the disk. SYSGEN was designed to work on floppy disk systems. If your computer uses a hard disk, you may have a program with a name like PUTCPM or WRITECPM that performs the same function.

The Ultimate Goal

In Figure 6-4, lines 0044 to 0065, you can see the equates that define the base addresses for the CCP, the BDOS, and the BIOS. Figure 7-1 shows how the top of memory will look when this version of CP/M has been loaded into memory.

Life would be simple if you could build this image in memory at the addresses shown and write the image out to disk. Building this image, however, would probably overwrite the version of CP/M that you were operating since it too lives at the top of memory. Therefore, the goal is to create a replica of this image lower down in memory, but with all the instruction addresses set to *execute* at the addresses shown in Figure 7-1.

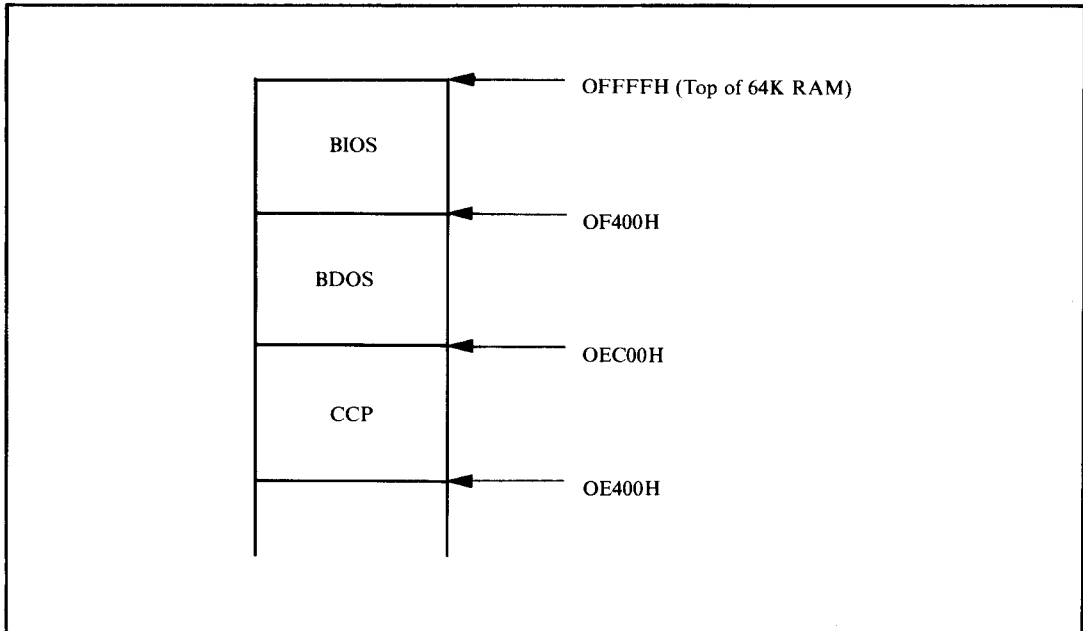

Figure 7-1. Memory layout of CP/M

Using SYSGEN to Write CP/M to Disk

The SYSGEN utility writes a memory image onto a specified logical disk. It can use a memory image that you arrange to be in memory before you invoke SYSGEN, or you can direct SYSGEN to read in a disk file that contains the image. You can also use SYSGEN to transport an existing CP/M system from one diskette to another by directing it to load the CP/M image from one diskette into memory and then to write that image out to another diskette.

Check the documentation supplied by your computer's manufacturer to make sure that you can use SYSGEN on your system. SYSGEN, as released by Digital Research, is constructed to run on 8-inch, single-sided, single-density diskettes. If your system does not use these standard diskettes, SYSGEN must be customized to your disk system.

When SYSGEN loads a CP/M image into memory, it will place the bootstrap, CCP, BDOS, and BIOS at the predetermined addresses shown in Figure 7-2, regardless of where this CP/M originated.

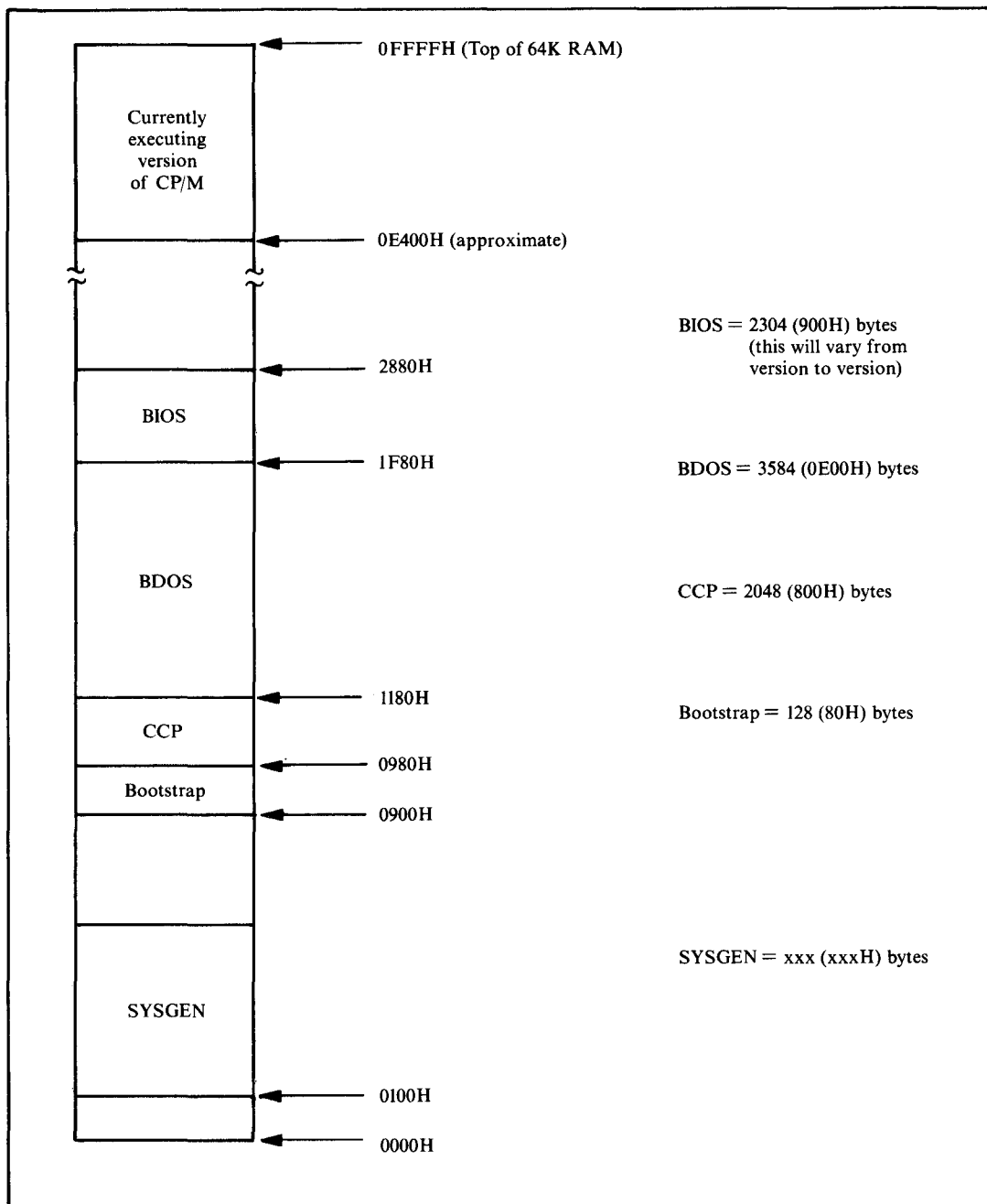

Figure 7-2. SYSGEN's memory layout

You can see that the *relative* arrangement between the components has not changed; the whole image has simply been moved down in memory well below the currently executing version of CP/M. The bootstrap has been added to the picture just beneath the CCP.

The SYSGEN utility writes this image onto a floppy diskette starting at sector 1 of track 0 and continuing to sector 26 on track 1. Refer back to Figure 2-2 to see the layout of CP/M on a standard 8-inch, single-sided, single-density diskette.

If you request SYSGEN to read the memory image from a file (which you do by calling SYSGEN with the file name on the same line as the SYSGEN call), then SYSGEN presumes that you have previously created the correct memory image and saved it (with the SAVE command). SYSGEN then skips over the first 16 sectors of the file so as to avoid overwriting itself.

Here is an example of how to use SYSGEN to move the CP/M image from one diskette to another:

```
A>SYSGEN<CR>
SYSGEN VER 2.0
SOURCE DRIVE NAME (OR RETURN TO SKIP) A
SOURCE ON A:; THEN TYPE RETURN <cr>
FUNCTION COMPLETE
DESTINATION DRIVE NAME (OR RETURN TO REBOOT) B
DESTINATION ON B; THEN TYPE RETURN <cr>
FUNCTION COMPLETE
DESTINATION DRIVE NAME (OR RETURN TO REBOOT) <cr>
A>_
```

As you can see, SYSGEN gives you the choice of specifying the source drive name or typing CARRIAGE RETURN. If you enter a CARRIAGE RETURN, SYSGEN assumes that the CP/M image is already in memory. Note that you need to call up SYSGEN only once to write out the same CP/M image to more than one disk.

A larger than standard BIOS can cause difficulties in using SYSGEN. The standard SYSGEN format only allows for six 128-byte sectors to contain the BIOS, so if your BIOS is larger than 768 (300H) bytes, it will be a problem. The CP/M image will not fit on the first two tracks of a standard 8-inch diskette.

Nowadays it is rare to find an 8-inch floppy diskette system where you must load CP/M from a single-sided, single-density diskette. Most systems now use double-sided or double-density diskettes as the normal format, but can switch to single-sided, single-density diskettes to interchange information with other computer systems.

Because there is no "standard" format for 8-inch, double-sided and double-density diskettes, you probably won't be able to read diskettes written on systems of a different make or model. Therefore, you need only be concerned about using a disk layout that will keep your disks compatible with other machines that are exactly the same as yours.

This is also true if you have 5 1/4-inch diskettes. There is no industry standard for these either, so your main consideration is to place the file directory in the same

place as it will be on diskettes written by other users of your model of computer. You must also be sure to use the same sector skewing. Otherwise, you will get a garbled version whenever you try to read files originating on other systems.

With the higher capacity diskettes, you can reserve more space to hold the CP/M image on the diskette. For example, in the case of the BIOS shown in Figure 6-4, the CP/M image is written to a 5 1/4-inch, double-sided, double-density diskette using 512-byte sectors. Figure 7-3 shows the layout of this diskette. Note that the bootstrap loader is placed in a 512-byte sector all by itself. Doing so makes the bootstrap code and warm boot code in the BIOS much simpler.

The memory image must be altered to reflect the fact that the bootstrap now occupies an entire 512-byte sector. Rather than change all of the addresses, the bootstrap is loaded into memory 384 (180H) bytes lower, so that it ends at the same address as before. Figure 7-4 shows the revised memory image.

Writing a PUTCPM Utility

Because the example system uses 5 1/4-inch floppy diskettes with 512-byte sectors, the standard version of SYSGEN cannot be used to write the CP/M image onto a diskette. You will have to use a functional replacement provided by your computer's manufacturer or develop a small utility program to do the job.

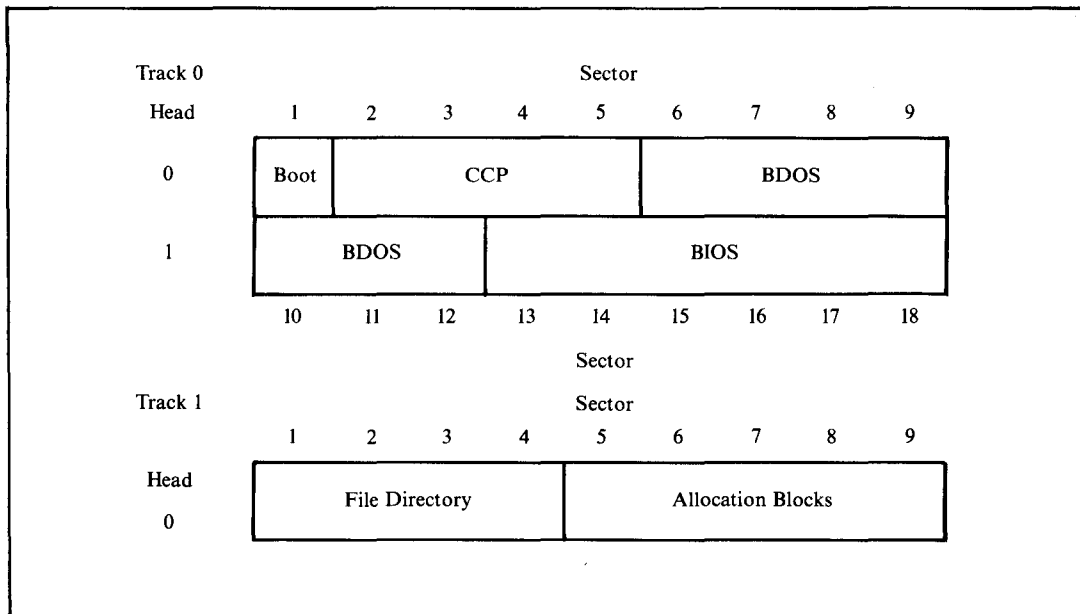

Figure 7-3. Disk layout for example BIOS on 5 1/4-inch diskettes

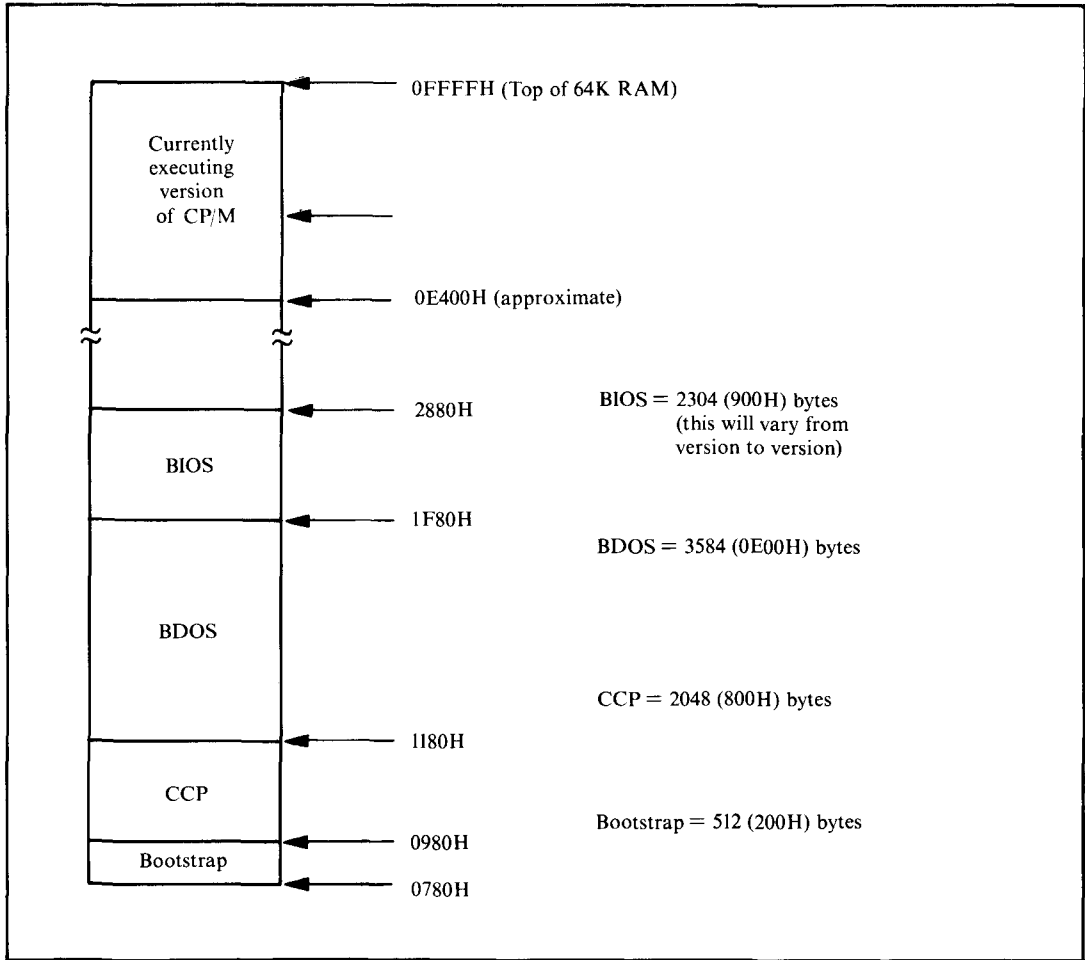

Figure 7-4. Addresses for example BIOS image

Figure 7-5 shows an example of such a program. It is written in a general-purpose way, so that you may be able to use it for your system by changing the equates at the front of the program to reflect the specifics of your disk drives.

Note that there are two problems to be solved. First, the area of the disk on which the CP/M image resides cannot be accessed by the BDOS, as it is outside the file system area on the disk. Second, it is rare to write the CP/M image onto the disk with any kind of sector skewing; to do so would slow down the loading process. In any case, skewing would be redundant, since the loader is doing no processing other than reading the disk and can therefore read the disk without skewing.

```

; This program writes out the CP/M cold boot loader,
; CCP, BDOS, and BIOS to a floppy diskette. It runs
; under CP/M as a normal transient program.
;
3130 = Version EQU '01' ;Equates used in the sign-on
; message
3730 = Month EQU '07'
3432 = Day EQU '24'
3238 = Year EQU '82'
;
;
; The actual PUTCPMFS.COM program consists of this code,
; plus the BOOTFS.HEX, CCP, BDOS, and BIOS.
;
; When this program executes, the memory image should
; look like this:
;
; Component Base Address
; BIOS 1F80H
; BDOS 1180H
; CCP 0980H
; BOOTFS 0780H
;
; The components are produced as follows:
;
; BIOS.HEX By assembling source code
; BDOS ) From a CPMnn.COM file output
; CCP ) by MOVCPM and SAVED on disk
; BOOTFS.HEX By assembling source code
;
; The components are pieced together using DDT with the
; following commands:
;
; DDT CPMnn.COM
; IPUTCPMFS.HEX
; R (Reads in this program)
; IBOOTFS.HEX
; R680 (Reads in BOOT at 0780H)
; IBIOS.HEX
; R2980 (Reads in BIOS at 1F80H)
; GO (Exit from DDT)
; SAVE 40 PUTCPMFS.COM (Create final .COM file)
;
; The actual layout of the diskette is as follows:
;
; Track 0 Sector
; Head 0 |Boot |<===== CCP =====>|<===== BDOS =====>|
; |-----|-----|-----|-----|-----|-----|-----|-----|
; 1 |===== BDOS =====>|<===== BIOS =====>|
; |-----|-----|-----|-----|-----|-----|-----|-----|
; 10 11 12 13 14 15 16 17 18
; Sector
;
; Equates for defining memory size and the base address and
; length of the system components
;
0040 = Memory$Size EQU 64 ;Number of Kbytes of RAM
;
; The BIOS Length must match that declared in the BIOS.
;
0900 = BIOS$Length EQU 0900H
;
0200 = Boot$Length EQU 512
0800 = CCP$Length EQU 0800H ;Constant
0E00 = BDOS$Length EQU 0E00H ;Constant
;
1F00 = Length$In$Bytes EQU CCP$Length + BDOS$Length + BIOS$Length
;
0780 = Start$Image EQU 980H - Boot$Length ;Address of CP/M image
2100 = Length$Image EQU Length$In$Bytes + Boot$Length
;
;

```

Figure 7-5. Example PUTCPM

```

;      Disk characteristics
;
;      These equates describe the physical characteristics of
;      the floppy diskette so that the program can move from
;      one sector to the next, updating the track and resetting
;      the sector when necessary.
;
0001 = First$Sector$on$Track EQU 1
0012 = Last$Sector$on$Track EQU 18
0009 = Last$Sector$on$Head$0 EQU 9
0200 = Sector$Size EQU 512
;
;      Controller characteristics
;
;      On this computer system, the floppy disk controller can write
;      multiple sectors in a single command. However, in order
;      to produce a more general example it is shown only reading one
;      sector at a time.
;
0001 = Sectors$Per$Write EQU 1
;
;      Cold boot characteristics
;
0000 = Start$Track EQU 0 ;Initial values for CP/M image
0001 = Start$Sector EQU 1 ;" " =
0011 = Sectors$To$Write EQU (Length$Image + Sector$Size - 1) / Sector$Size
;
;
0009 = B$PRINTS EQU 9 ;Print string terminated by $
0005 = BDOS EQU 5 ;BDOS entry point
;
;
0100 ORG 100H
Put$CPM:
0100 C33F01 JMP Main$Code ;Enter main code body
;For reasons of clarity, the main
; data structures are shown before the
; executable code.
;Carriage return
;Line feed
;
000D = CR EQU 0DH
000A = LF EQU 0AH
;
Signon$Message:
0103 0D0A507574 DB CR,LF,"Put CP/M on Diskette"
0119 0D0A DB CR,LF
011B 5665727369 DB "Version "
0123 3031 DW Version
0125 20 DB " "
0126 3037 DW Month
0128 2F DB " "
0129 3234 DW Day
012B 2F DB " "
012C 3832 DW Year
012E 0D0A24 DB CR,LF,"$"
;
;      Disk control tables
;
0045 = Disk$Control$5 EQU 45H ;5 1/4" control byte
0046 = Command$Block$5 EQU 46H ;Control table pointer
0043 = Disk$Status EQU 43H ;Completion status
;
;
;      The command table track and DMA$Address can also be used
;      as working storage and updated as the load process
;      continues. The sector in the command table cannot be
;      used directly as the disk controller requires it to be
;      the sector number on the specified head (1 -- 9) rather
;      than the sector number on track. Hence a separate variable
;      must be used.
;

```

Figure 7-5. (Continued)

```

0131 01      Sector:      DB      Start$Sector
;
0132 02      Command$Table: DB      02H      ;Command -- Write
0133 00      Unit:       DB      0          ;Unit (drive) number = 0 or 1
0134 00      Head:      DB      0          ;Head number = 0 or 1
0135 00      Track:     DB      Start$Track ;Used as working variable
0136 00      Sector$on$head: DB      0          ;Converted by low-level driver
0137 0002    Byte$Count: DW      Sector$Size * Sectors$Per$Write
0139 8007    DMA$Address: DW      Start$Image
013B 4300    Next$Status: DW      Disk$Status ;Pointer to next status block
; if commands are chained
013D 4500    Next$Control: DW      Disk$Control$5 ;Pointer to next control byte
; if commands are chained

Main$Code:
013F 310001  LXI      SP,Put$CPM      ;Stack grows down below code

0142 110301  LXI      D,Signon$Message ;Sign on
0145 0E09    MVI      C,B$PRINTS      ;Print string until $
0147 CD0500  CALL     BDOS

014A 213201  LXI      H,Command$Table ;Point the disk controller at
014D 224600  SHLD     Command$Block$5 ; the command block

0150 0E11    MVI      C,Sectors$To$Write ;Set sector count

Write$Loop:
0152 CD7C01  CALL     Put$CPM$Write ;Write data onto diskette
0155 0D      DCR      C          ;Downdate sector count
0156 CA0000  JZ      0          ;Warm boot

0159 213101  LXI      H,Sector ;Update sector number
015C 3E01    MVI      A,Sectors$Per$Write ; by adding on number of sectors
015E 86      ADD     M          ; by controller
015F 77      MOV     M,A       ;Save result
0160 3E13    MVI      A,Last$Sector$On$Track + 1 ;Check if at end of track
0162 BE      CMP     M
0163 C26F01  JNZ     Not$End$Track

0166 3601    MVI      M,First$Sector$On$Track ;Yes, reset to beginning
0168 LHL     LHL     Track ;Update track number
016B 23      INX     H
016C 223501  SHLD     Track

Not$End$Track:
016F 2A3901  LHL     DMA$Address ;Update DMA address
0172 110002  LXI      D,Sector$Size * Sectors$Per$Write
0175 19      DAD     D
0176 223901  SHLD     DMA$Address
0179 C35201  JMP     Write$Loop ;Write next block
;
Put$CPM$Write: ;At this point, the description of the
; operation required is in the variables
; contained in the command table, along
; with the sector variable.

017C C5      PUSH     B          ;Save sector count in C

;----- Change this routine to match the disk controller in use -----

017D 0600    MVI      B,0 ;Assume head 0
017F 3A3101  LDA     Sector ;Get requested sector
0182 4F      MOV     C,A ;Take a copy of it
0183 FE0A    CPI     Last$Sector$on$Head$0+1 ;Check if on head 1
0185 D8BC01  JC      Head$0 ;No
0188 D609    SUI     Last$Sector$on$Head$0 ;Bias down for head 1
018A 4F      MOV     C,A ;Save copy
018B 04      INR     B ;Set head 1

Head$0:
018C 78      MOV     A,B ;Get head
018D 323401  STA     Head
0190 79      MOV     A,C ;Get sector
0191 323601  STA     Sector$On$Head

```

Figure 7-5. (Continued)

```

0194 214500      LXI    H,Disk#Control#5      ;Activate controller
0197 3680       MVI    M,80H

Wait#For#Boot#Complete:
0199 7E        MOV    A,M                                ;Get status byte
019A B7        ORA    A                                ;Check if complete
019B C29901    JNZ    Wait#For#Boot#Complete          ;No
                                                ;Yes, check for errors
019E 3A4300    LDA    Disk#Status
01A1 FE80      CPI    80H
01A3 DA801    JC     Put#CPM#Error                    ;Yes, an error occurred

;----- End of physical write routine -----

01A6 C1       POP    B                                ;Recover sector count in C
01A7 C9       RET

;
Put#CPM#Error:
01AB 11B301    LXI    D,Put#CPM#Error#Message
01AB 0E09      MVI    C,B#PRINTS                          ;Print string until $
01AD C00500    CALL  BDOS                                ;Output error message
01B0 C33F01    JMP    Main#Code                          ;Restart the loader
;

Put#CPM#Error#Message:
01B3 0D0A457272 DB    CR,LF,'Error in writing CP/M - retrying...',CR,LF,'$'
01DB                                END    Put#CPM

```

Figure 7-5. (Continued)

Using DDT to Build the CP/M Memory Image

DDT, the Digital Research debug program, is used to read files of type “.COM” and “.HEX” into memory. Understanding the internal structure of these file types is important, both to understand what DDT can do and to understand how the MOVCPM utility can effectively change a machine code file so that it can be executed at a new address in memory.

“.COM” File Structure

A COM file is a memory image. It is a replica of the bit patterns that are to be created when the file is loaded into memory. COM files are normally designed to load at location 100H upwards. No internal structure to the file requires this, however, so if you know what the contents of a COM file are, there is nothing to preclude you from loading it into memory starting at some address other than 100H.

As you may recall from the description of the CCP in Chapter 4, the SAVE command built into the CCP allows you to create a COM file by specifying the number of 256-byte “pages” of memory and the name of the file. The CCP will write out an exact image of memory from location 100H up.

“.HEX” File Structure

HEX files are output by the assembler. They contain an ASCII character representation of hexadecimal values. For example, the contents of a single byte of memory with the binary value 10101111 would be represented by two ASCII characters, A F, in a HEX file.

The HEX file has a higher level structure than just a series of ASCII characters however. Each line of ASCII characters is terminated by CARRIAGE RETURN/LINE FEED. The overall structure is shown in Figure 7-6.

The most important aspect of a HEX file is that each line contains the address at which the data bytes are loaded. Each line is processed independently, so the load addresses of succeeding lines need not be in order.

DDT can read in a HEX file at an address different from the address where the code must be in order to execute. For example, you can read in the HEX file of the BIOS at the correct place for the memory image (shown in Figure 7-4). There are two ways of using DDT to read in a COM or HEX file. You can specify the name of the file on the same command line with DDT. For example:

```
A>DDT B:XYZ.HEX<cr>      <- Call up DDT with file name
DDT VERS 2.0             <- DDT signs on
NEXT PC                  <- ... and displays next free byte
0180 0100                <- ... and entry point address
                          <- ... and prompts for a command
```

The advantage of this method of loading a file is that you can specify which logical disk is to be searched for the file. The second way of using DDT is to load DDT first, and then, when it has given its prompt, specify the file name and request that DDT load it like this:

```
-Ifilename.typ<cr>      <- Enter the file name and type
-R<cr>                  <- Read in the file
```

The “I” command initializes the default file control block in the base page (at location 005CH) with the file name and type; it does *not* set up the logical disk. If you need to do this, you must set the first byte of the default FCB manually like this:

```
-Ifilename.typ<cr>      <- Specify file name
-S5C<cr>                <- "S"et location 5C
005C 00 02<cr>          <- Was 00, you enter 02<cr>
005D 41 .<cr>           <- Enter "." to terminate
-R<cr>                  <- Read in the file
```

Location 005CH should be set to 01H for Drive A, 02H for B, and so on.

The “R” command will read in HEX files to the *execution* addresses specified in each line of the HEX file, so be careful—if you forget to put an ORG (origin)

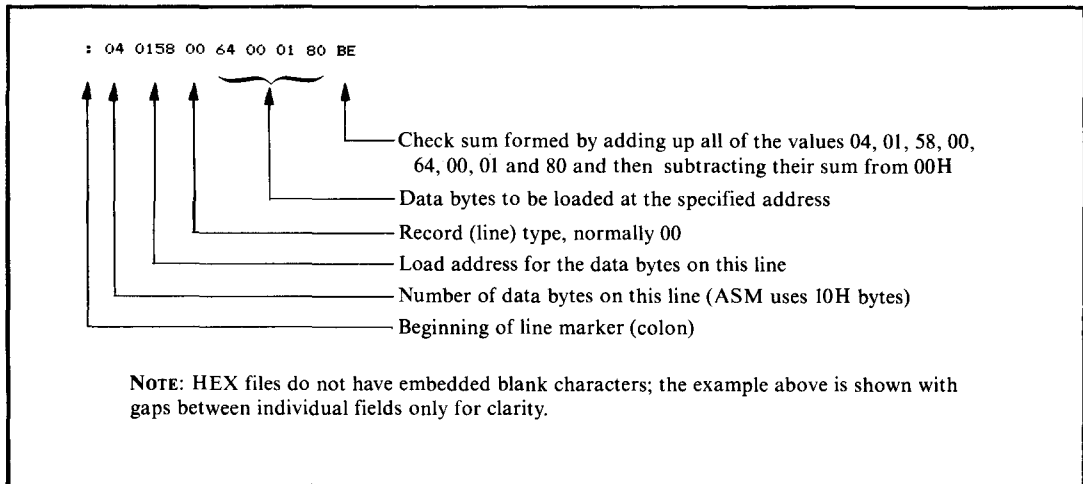

Figure 7-6. Example line from HEX file

statement at the front of the assembly language source code, reading in the resultant HEX file will overwrite location 0000H on up, destroying the contents of the base page. Similarly, if you were trying to read in the HEX file for a BIOS, there is an excellent chance that you will overwrite the currently executing CP/M system.

DDT reacts to the file type you enter as part of the file name. For file types other than .HEX, DDT loads the file starting at location 0100H on up.

The "R" command can also be used to read files into memory at different addresses. You do this by typing a hexadecimal number immediately after the R, with no intervening punctuation. For HEX files, the number that you enter is added to the address in each line of the HEX file and the sum is used as the address into which the data bytes are loaded. The data bytes themselves are not changed, just the load address.

For COM files, the number that you enter is added to 0100H and the sum is used as the starting address for loading the file.

The sum is performed as 16-bit, unsigned arithmetic with any carry ignored, so you can load a BIOS HEX file into low memory by using the "R" command with what is called an "offset value."

If a HEX file has been assembled to execute at address "exec," and you need to use DDT to read in this file to address "load," you need to solve the following equation:

$$\text{offset} = \text{load} - \text{exec}.$$

DDT's "H" command performs hexadecimal arithmetic. It calculates and displays the sum of and difference between two hexadecimal values. For example,

the BIOS in Figure 6-4 has been assembled to *execute* at location 0F600H, but needs to be *loaded* into memory at location 1F80H. Here is how to compute the correct offset for the “R” command:

```
-H1F80,F600<cr>      <- Use the H command
1580,2980            <- Sum, difference
```

Thus, to read in the BIOS HEX file called FIG6-4.HEX at location 1F80H, you would enter the following commands to DDT:

```
-IFIG6-4.HEX<cr>    <- Specify file name and type
-R2980<cr>          <- Load at 0F600H + 2980H (= 1F80H)
```

In this way, using DDT, you can read in the HEX files for both the BIOS and the bootstrap loader.

The CP/M Bootstrap Loader

The bootstrap loader is brought into memory by PROM-based firmware in the computer system. It loads in the CCP, BDOS, and BIOS and then transfers control to the cold boot entry point in the BIOS—the first jump instruction in the BIOS jump vector.

The bootstrap loader is a stand-alone program; it cannot make use of any CP/M functions because no part of CP/M is in memory when the bootstrap loader is needed. The firmware in the PROM that loaded the bootstrap may contain some subroutines that can be used by the bootstrap, but this will vary from system to system.

Figure 7-7 shows the bootstrap code for the example BIOS (from Figure 6-4). This code has been written in a general way, so that you can adapt it to your system. The disk controller on the example system can in fact read in multiple sectors from the disk, but for generality the code shown reads in only one sector at a time. This considerably increases the time it takes to load CP/M, but does make the bootstrap loader more general.

Note that almost the first thing that the bootstrap does is to output to the console a sign-on message. Not only does this confirm the version number, but it shows that the bootstrap has been successfully loaded.

The PROM-based code has been designed to load the CP/M bootstrap into location 100H, allowing the code to be debugged as though it were a normal transient program, albeit with minor changes to the address at which it loads the CP/M image from disk. Clearly, this feature is not very helpful if CP/M is being brought up for the first time on a computer system. It helps a great deal, however, if you need to modify the bootstrap or add the capability to boot your system from a new type of disk drive.

```

;      Example CP/M cold bootstrap loader
;
;      This program is written out to track 0, head 0, sector 1
;      by the PUTCPMF5 program.
;      It is loaded into memory at location 100H on up by the
;      PROM-based bootstrap mechanism that gets control of the
;      CPU on power up or system reset.
;
3130 = Version      EQU    '01'      ;Equates used in the sign-on message
3730 = Month       EQU    '07'
3432 = Day        EQU    '24'
3238 = Year       EQU    '82'
;
0000 = Debug      EQU    0          ;Set nonzero to debug as normal
;                               ; transient program
;
;      The actual layout of the diskette is as follows :
;
;      Track 0
;      Sector
;      Head 0 1 2 3 4 5 6 7 8 9
;      0 |Boot |<===== CCP =====>|<===== BDOS =====>|
;      1 |===== BDOS =====>|<===== BIOS =====>|
;      10 11 12 13 14 15 16 17 18
;      Sector
;
;      Equates for defining memory size and the base address and
;      length of the system components.
;
0040 = Memory$Size EQU    64        ;Number of Kbytes of RAM
;
;      The BIOS Length must match that declared in the BIOS.
0900 = BIOS$Length EQU    0900H
;
0800 = CCP$Length EQU    0800H      ;Constant
0E00 = BDOS$Length EQU    0E00H      ;Constant
;
0008 = Length$In$K EQU    ((CCP$Length + BDOS$Length + BIOS$Length) / 1024) + 1
1F00 = Length$In$Bytes EQU    CCP$Length + BDOS$Length + BIOS$Length
;
E000 = IF NOT Debug
      CCP$Entry EQU    (Memory$Size - Length$In$K) * 1024
      ENDIF
      IF Debug
      CCP$Entry EQU    3980H          ;Read into a lower address.
;                               ;This address is chosen to be above
;                               ; the area into which DDT initially loads
;                               ; and the 980H makes the addresses similar
;                               ; to the SYSGEN values so that the memory
;                               ; image can be checked with DDT.
      ENDIF
;
E806 = BDOS$Entry EQU    CCP$Entry + CCP$Length + 6
F600 = BIOS$Entry EQU    CCP$Entry + CCP$Length + BDOS$Length
;
;      Disk characteristics
;
;      These equates describe the physical characteristics of
;      the floppy diskette so that the program can move from
;      one sector to the next, updating the track and resetting
;      the sector when necessary.
;
0001 = First$Sector$on$Track EQU    1
0012 = Last$Sector$on$Track EQU    18
0009 = Last$Sector$on$Head$0 EQU    9
0200 = Sector$Size EQU    512
;
;      Controller characteristics
;

```

Figure 7-7. Example CP/M cold bootstrap loader

```

;      On this computer system, the floppy disk controller can read
;      multiple sectors in a single command. However, in order to
;      produce a more general example it is shown only reading one
;      sector at a time.
;
0001 =   Sectors%Per%Read      EQU    1
;
;      Cold boot characteristics
;
0000 =   Start%Track          EQU    0      ;Initial values for CP/M image
0002 =   Start%Sector         EQU    2      ;" =
0010 =   Sectors%To%Read      EQU    (Length%In%Bytes + Sector%Size - 1) / Sector%Size
;
;
0100          ORG            100H
Cold%Boot%Loader:
0100 C34001   JMP            Main%Code      ;Enter main code body
;For reasons of clarity, the main
; data structures are shown before the
; executable code.
000D =   CR                    EQU    0DH      ;Carriage return
000A =   LF                    EQU    0AH      ;Line feed
;
; Signon%Message:
0103 0D0A43502F DB      CR,LF,'CP/M Bootstrap Loader'
;
;
011A 0D0A          DB      CR,LF
011C 5665727369   DB      'Version '
0124 3031          DW      Version
0126 20           DB      '/'
0127 3037          DW      Month
0129 2F           DB      '/'
012A 3234          DW      Day
012C 2F           DB      '/'
012D 3832          DW      Year
012F 0D0A00       DB      CR,LF,0
;
;      Disk Control Tables
;
0045 =   Disk%Control%5      EQU    45H      ;5 1/4" control byte
0046 =   Command%Block%5    EQU    46H      ;Control table pointer
0043 =   Disk%Status        EQU    43H      ;Completion status
;
;
;      The command table track and DMA%Address can also be used
;      as working storage and updated as the load process
;      continues. The sector in the command table cannot be
;      used directly as the disk controller requires it to be
;      the sector number on the specified head (1 -- 9) rather
;      than the sector number on track. Hence a separate variable
;      must be used.
;
0132 02          Sector:      DB      Start%Sector
;
0133 01          Command%Table: DB    01H      ;Command -- read
0134 00          Unit:        DB    0          ;Unit (drive) number = 0 or 1
0135 00          Head:        DB    0          ;Head number = 0 or 1
0136 00          Track:       DB    Start%Track ;Used as working variable
0137 00          Sector%on%head: DB    0      ;Converted by low-level driver
0138 0002        Byte%Count:  DW    Sector%Size * Sectors%Per%Read
013A 00E0        DMA%Address:  DW    CCP%Entry
013C 4300        Next%Status:  DW    Disk%Status ;Pointer to next status block
; if commands are chained.
013E 4500        Next%Control: DW    Disk%Control%5 ;Pointer to next control byte
; if commands are chained.
;
Main%Code:
0140 310001      LXI          SP,Cold%Boot%Loader ;Stack grows down below code

```

Figure 7-7. (Continued)

```

0143 210301      LXI    H,Signon$Message      ;Sign on
0146 CDD901      CALL   Display$Message

0149 213301      LXI    H,Command$Table      ;Point the disk controller at
014C 224600      SHLD   Command$Block$5          ; the command block

014F 0E10        MVI    C,Sectors$To$Read          ;Set sector count
Load$Loop:
0151 CD7B01      CALL   Cold$Boot$Read              ;Read data into memory
0154 0D          DCR    C                          ;Downdate sector count

0155 CA00F6      IF     NOT Debug                    ;Enter BIOS when load done
JZ     BIOS$Entry
ENDIF
IF     Debug
JZ     0                          ;Warm boot
ENDIF

0158 213201      LXI    H,Sector                      ;Update sector number
015B 3E01        MVI    A,Sectors$Per$Read          ; by adding on number of sectors
015D 86          ADD    M                          ; by controller
015E 77          MOV    M,A                          ;Save result
015F 3E13        MVI    A,Last$Sector$On$Track + 1 ;Check if at end of track
0161 BE          CMP    M
0162 C26E01      JNZ    Not$End$Track

0165 3601        MVI    M,First$Sector$On$Track ;Yes, reset to beginning
0167 2A3601      LHLD   Track                      ;Update track number
016A 23          INX    H
016B 223601      SHLD   Track

Not$End$Track:
016E 2A3A01      LHLD   DMA$Address                ;Update DMA Address
0171 110002      LXI    D,Sector$Size * Sectors$Per$Read
0174 19          DAD    D
0175 223A01      SHLD   DMA$Address
0178 C35101      JMP    Load$Loop                  ;Read next block

;
Cold$Boot$Read:
;At this point, the description of the
; operation required is in the variables
; contained in the command table, along
; with the sector variable.

017B C5          PUSH   B                          ;Save sector count in C

;----- Change this routine to match the disk controller in use -----

017C 0600        MVI    B,0                          ;Assume head 0
017E 3A3201      LDA    Sector                      ;Get requested sector
0181 4F          MOV    C,A                          ;Take a copy of it
0182 FE0A        CPI    Last$Sector$on$Head$0+1 ;Check if on head 1
0184 DAB801      JC     Head$0                      ;No
0187 D609        SUI    Last$Sector$on$Head$0      ;Bias down for head 1
0189 4F          MOV    C,A                          ;Save copy
018A 04          INR    B                          ;Set head 1

Head$0:
018B 78          MOV    A,B                          ;Get head
018C 323501      STA    Head                        ;
018F 79          MOV    A,C                          ;Get sector
0190 323701      STA    Sector$On$Head

0193 214500      LXI    H,Disk$Control$5          ;Activate controller
0196 3680        MVI    M,80H

Wait$For$Boot$Complete:
0198 7E          MOV    A,M                          ;Get status byte
0199 87          ORA    A                          ;Check if complete
019A C29801      JNZ    Wait$For$Boot$Complete ;No
;Yes, check for errors

019D 3A4300      LDA    Disk$Status
01A0 FE80        CPI    80H
01A2 DAA701      JC     Cold$Boot$Error          ;Yes, an error occurred

;----- End of physical read routine -----

```

Figure 7-7. (Continued)

```

01A5 C1          POP      B                ;Recover sector count in C
01A6 C9          RET

;
Cold#Boot#Error:
01A7 21B001     LXI      H,Cold#Boot#Error#Message
01AA CDD901     CALL     Display#Message ;Output error message
01AD C34001     JMP      Main#Code       ;Restart the loader
;
Cold#Boot#Error#Message:
01B0 0D0A426F6F DB      CR,LF,'Bootstrap Loader Error - retrying... ',CR,LF,0
;
; Equates for Terminal Output
;
0001 =         Terminal#Status#Port EQU   01H
0002 =         Terminal#Data#Port  EQU   02H
;
0001 =         Terminal#Output#Ready EQU  0000#0001B
;
;
Display#Message: ;Displays the specified message on the console.
;On entry, HL points to a stream of bytes to be
;output. A 00H-byte terminates the message.

01D9 7E          MOV      A,M ;Get next message byte
01DA B7          ORA      A ;Check if terminator
01DB C8          RZ ;Yes, return to caller
01DC 4F          MOV      C,A ;Prepare for output

Output#Not#Ready:
01DD DB01         IN      Terminal#Status#Port ;Check if ready for output
01DF E601         ANI     Terminal#Output#Ready
01E1 CAD001         JZ      Output#Not#Ready ;No, wait
01E4 79          MOV      A,C ;Get data character
01E5 D302         OUT     Terminal#Data#Port ;Output to screen

01E7 23          INX      H ;Move to next byte of message
01E8 C3D901     JMP     Display#Message ;Loop until complete message output

;The PROM-based bootstrap loader checks
; to see that the characters "CP/M"
; are on the diskette bootstrap sector
; before it transfers control to it.

02E0           ORG      2E0H
02E0 43502F4D     DB      'CP/M'
02E4           END      Cold#Boot#Loader

```

Figure 7-7. (Continued)

In this case, the bootstrap code must be loaded at location 0780H, not the normal 0980H, because the bootstrap takes a complete 512-byte sector (200H). The same principle applies in determining the offset value to be used with DDT's "R" command to read the bootstrap HEX file, namely:

offset = load address - execution address.

In this case, the values are the following:

0680H = 0780H - 0100H

Using MOVCPM to Relocate the CCP and BDOS

MOVCPM builds a CP/M memory image at the correct locations for SYSGEN, but with the instructions modified to execute at a specific address. Inside MOVCPM is not only a complete replica of CP/M, but also enough

information to tell MOVCPM which bytes of which instructions need be changed whenever the execution address of the image needs to be moved.

MOVCPM, as released from Digital Research, contains the bootstrap and BIOS for an Intel MDS-800 computer along with the generic CCP and BDOS. Unless you have an MDS-800, all you use is the CCP and BDOS. Some manufacturers have customized MOVCPM to include the correct bootstrap and BIOS for their own computers; consult their documentation to see if this applies to your computer system.

When you invoke MOVCPM, you have the following options:

- MOVCPM<cr>
MOVCPM will relocate its built-in copy of CP/M to the top of available memory and will then transfer control to this new image of CP/M. Unless your manufacturer has included the correct BIOS into MOVCPM, using this option will cause an immediate system crash.
- MOVCPM *nn*<cr>
This is similar to the option above, except that MOVCPM assumes that *nnK* bytes of memory are available and will relocate the CP/M image to the top of that before transferring control. Again, this will crash the system unless the correct BIOS has been installed into MOVCPM.
- MOVCPM * * <cr>
MOVCPM will adjust all of the internal addresses inside the CP/M image so that the image could execute at the top of available memory, but instead of actually putting this image at the top of memory, MOVCPM will leave it in low memory at the correct place for SYSGEN to write it onto a disk. The SAVE command could also preserve the image on a disk.
- MOVCPM *nn* * <cr>
MOVCPM proceeds as above for the “* *” option except that the CP/M image is modified to execute at the top of *nnK*.

MOVCPM has a fundamental problem. The *nn* value indicates that the top of available memory is computed, assuming that your BIOS is small—less than 890 (380H) bytes. If your BIOS is larger (as is the case with the example in Figure 6-4), then you will have to reduce the value of “*nn*” artificially.

Figure 7-8 shows the relationship between the size of the BIOS and the “*nn*” value to use with MOVCPM. It also shows, for different lengths of BIOS, the BIOS base address, the offset value to be used in DDT to read in the BIOS to location 1F80H (preparatory to using SYSGEN or PUTCPM to write it out), and also the base addresses for the CCP and the BDOS. The base address of the BDOS indicates how much memory is available for loading transient programs, as the CCP can be overwritten if necessary.

The numbers in Figure 7-8 are based on the assumption that you have 64K of memory in your computer system. If this is not the case, then proceed as follows:

1. Convert the amount of memory in your system to hex. Remember that 1K is 1024 bytes.
2. Determine the length of your BIOS in hex.
3. Locate the line in Figure 7-8 that shows a BIOS length equal to or greater than the length of your BIOS.
4. Using the "H" command in DDT, compute the BIOS Base Address using the formula:

Memory in system – BIOS length from Figure 7-8

5. Find the line in Figure 7-8 that shows the same BIOS Base Address as the result of the computation above. Use this line to derive the other relevant numbers.

It is helpful to use DDT to examine a CP/M image in memory to check that all of the components are correctly placed, and, in the case of the CCP and BDOS, correctly relocated.

Figure 7-9 shows an example console dialog in which DDT is used first to examine the memory image produced by MOVCPM and second to examine the image built into the PUTCPMF utility shown in Figure 7-5.

BIOS Length	BIOS Base	DDT Offset	MOVCPM 'nn'	CCP Base	BDOS Base
600	FA00	2580	64	E400	EC00
A00	F600	2980	63	E000	E800
E00	F200	2D80	62	DC00	E400
1200	EE00	3180	61	D800	E000
1600	E800	3580	60	D400	DC00
1A00	E600	3980	59	D000	D800
1E00	E200	3D80	58	CC00	D400
2200	DE00	4180	57	C800	D000
2600	DA00	4580	56	C400	CC00
2A00	D600	4980	55	C000	C800
2E00	D200	4D80	54	BC00	C400
3200	CE00	5180	53	B800	C000
3600	CA00	5580	52	B400	BC00
3A00	C600	5980	51	B000	B800
3E00	C200	5D80	50	AC00	B400
4200	BE00	6180	49	A800	B000
4600	BA00	6580	48	A400	AC00
4A00	B600	6980	47	A000	A800
4E00	B200	6D80	46	9C00	A400
5200	AE00	7180	45	9800	A000
5600	AA00	7580	44	9400	9C00
5A00	A600	7980	43	9000	9800
5E00	A200	7D80	42	8C00	9400
6200	9E00	8180	41	8800	9000
6600	9A00	8580	40	8400	8C00
6A00	9600	8980	39	8000	8800

Apart from the MOVCPM 'nn' value all other values are in hexadecimal

Figure 7-8. CP/M addresses for different BIOS lengths

```

                                In contrast, load DDT and request that it
                                load the PUTCPMF5.COM program.
A>ddt putcpmf5.com<cr>
DDT VERS 2.2
NEXT PC
2900 0100

                                Display the special bootstrap loader that
                                starts at location 0780H (compared to the
                                MDS-800 bootstrap which is at 0980H). Note
                                the sign-on message.
-d780,7af<cr>
0780 C3 40 01 0D 0A 43 50 2F 4D 20 42 6F 6F 74 73 74 .@...CP/M Bootst
0790 72 61 70 20 4C 6F 61 64 65 72 0D 0A 56 65 72 73 rap Loader..Vers
07A0 69 6F 6E 20 30 31 20 30 37 2F 32 34 2F 38 32 0D ion 01 07/24/82.

                                Confirm that the CCP is loaded in the correct
                                place. Check the address of the first JMP
                                instruction (0E35CH).
-d980,9bf<cr>
0980 C3 5C E3 C3 58 E3 7F 00 20 20 20 20 20 20 20 20 .\..X...
0990 20 20 20 20 20 20 20 20 43 4F 50 59 52 49 47 48          COPYRIGH
09A0 54 20 28 43 29 20 31 39 37 39 2C 20 44 49 47 49 T (C) 1979, DIGI
09B0 54 41 4C 20 52 45 53 45 41 52 43 48 20 20 00 00 TAL RESEARCH ..

                                Confirm that the BDOS is also in place.
-d1180,118f<cr>
1180 00 16 00 00 09 85 C3 11 E8 99 E8 A5 E8 AB E8 B1 .....

                                Confirm that the BIOS has been loaded in the
                                correct place. Check the first JMP to get
                                some idea of the BIOS base address. Note the
                                sign-on message.
-d1f80<cr>
1F80 C3 F9 F6 C3 0C FE C3 62 F8 C3 78 F8 C3 86 F8 C3 .....b..x.....
1F90 A4 F8 C3 B4 F8 C3 C5 F8 C3 B6 F8 C3 0E FB C3 3B .....f
1FA0 F8 C3 41 FB C3 48 FB C3 DE FB C3 F8 FB C3 94 F8 ..A..H.....
1FB0 C3 B0 FB ED 06 00 00 00 42 6E 25 DF 01 B6 DE 02 .....Bn%.....
1FC0 38 00 00 43 50 2F 4D 20 32 2E 32 2E 30 30 20 30 S..CP/M 2.2.00 0
1FD0 37 2F 31 35 2F 38 32 0D 0A 0A 53 69 6D 70 6C 65 7/15/82...Simple
1FE0 20 42 49 4F 53 0D 0A 0A 44 69 73 6B 20 43 6F 6E BIOS...Disk Con
1FF0 66 69 67 75 72 61 74 69 6F 6E 20 3A 0D 0A 0A 20 figation !...
2000 20 20 20 20 20 41 3A 20 30 2E 33 35 20 4D 62 79 74 A: 0.35 Mbyt
2010 65 20 35 22 20 46 6C 6F 70 70 79 0D 0A 20 20 20 e 5" Floppy...
2020 20 20 42 3A 20 30 2E 33 35 20 4D 62 79 74 65 20 B: 0.35 Mbyte
2030 35 22 20 46 6C 6F 70 70 79 0D 0A 0A 20 20 20 20 5" Floppy...
-^C
A>_

```

Figure 7-9. Using DDT to check CP/M images (continued)

Putting it all Together

Figure 7-10 shows an annotated console dialog for the complete generation of a new CP/M system. Note that the following file names appear in the dialog:

BIOS1.ASM Figure 6-4.
 PUTCPMF5.ASM Figure 7-5.
 BOOTF5.ASM Figure 7-7.

<pre> C>asm bootf5.ccz<cr> CP/M ASSEMBLER - VER 2.0 02E4 004H USE FACTOR END OF ASSEMBLY </pre>	<p>Assemble the CP/M Bootstrap Loader, with the source code and HEX file on drive C:, no listing output.</p>
<pre> C>asm putcpmf5.ccz<cr> CP/M ASSEMBLER - VER 2.0 01DB 003H USE FACTOR END OF ASSEMBLY </pre>	<p>Assemble the PUTCPMF5 program (that writes CP/M onto the disk), with the source code and HEX file on drive C:, no listing output.</p>
<pre> C>asm bios1.ccz<cr> CP/M ASSEMBLER - VER 2.0 FE6C 011H USE FACTOR END OF ASSEMBLY </pre>	<p>Assemble the BIOS with the source code and HEX file on drive C:, no listing output.</p>
<pre> C>ddt cpm63.com<cr> DDT VERS 2.2 NEXT PC 2300 0100 </pre>	<p>Start piecing the CP/M image together. Load DDT and ask it to read in the file previously SAVED after a MOVCPM 63 %.</p>
<pre> -r<cr> NEXT PC 2300 0100 </pre>	<p>Indicate the file name of PUTCPMF5.HEX, and read in without any offset (i.e. it will load at 100H because of the ORG 100H it contains). -iputcpmf5.hex<cr></p>
<pre> -ibootf5.hex<cr> -r680<cr> NEXT PC 2300 0100 </pre>	<p>Indicate the file name of BOOTF5.HEX and read in with an offset of 680H to make it load at 780H on up (it contains ORG 100H too).</p>
<pre> -ibios1.hex<cr> -r2980<cr> NEXT PC 27EC 0000 </pre>	<p>Indicate the file name of the BIOS HEX file, and read it in with an offset of 2980 such that it will load at 1F80H (it contains an ORG 0F600H).</p>
<pre> -g0<cr> </pre>	<p>Exit from DDT by going to location 0000H and executing a warm boot.</p>
<pre> C>save 40 putcpmf5.com<cr> </pre>	<p>Save the complete CP/M image on disk. Saving 40 256-byte pages from location 100H to 2900H.</p>

Figure 7-10. Console dialog for system build

<pre>C>putcpmf5<cr></pre>	<pre>Load and execute the PUTCPMF5 Program.</pre>
<pre>Put CP/M on Diskette Version 01 07/24/82</pre>	<pre>PUTCPMF5 signs on</pre>
<pre>C></pre>	<pre>and writes the CP/M image to disk.</pre>

Figure 7-10. Console dialog for system build (continued)

BIOS Enhancements
Character Input/Output
Data Structures
Disk Input/Output
Custom Patches to CP/M
An Enhanced BIOS

8

Writing An Enhanced BIOS

This chapter describes ways in which you can enhance your BIOS to make CP/M easier to use, faster, and more versatile.

Get a standard BIOS working on your computer system, and then install the additional features. Although you can write an enhanced BIOS from the outset, it will take considerably longer to get it functioning correctly.

A complete listing of an enhanced BIOS is included at the end of this chapter. It is quite large: approximately 4500 lines of source code, with extensive comments and long variable names to make it more understandable.

The sections that follow describe the main concepts embodied in the enhanced BIOS listing.

BIOS Enhancements

BIOS enhancements fall into two classes: those that add new capabilities and those that extend existing features.

Some enhancements are normally accompanied by utility programs that allow you to select the enhancement option from the console. For example, when the BIOS is enhanced to include a *real time clock*, you need a utility program to set the clock to the correct time. Other enhancements will not require supporting utilities. For example, if the disk drivers are improved to read and write data faster, the enhancement is “transparent.” As a user, you are aware of the results of the enhancement but not of the enhancement itself.

Viewed at its simplest, the BIOS deals with two broad classes of input/output:

Character input/output

This includes the console, auxiliary, and list devices.

Disk input/output

This can accommodate several types of floppy and hard disks.

Enhancements in these areas do not fundamentally change the way that the BDOS and CCP interact with these devices. Instead, enhancements improve the way in which the *device drivers* deal with the devices. They can improve the speed of manipulating data, the way of handling external devices, or the user's control over the behavior of the system.

The example enhanced BIOS has capabilities not found in standard CP/M systems. These can be grouped in several main categories:

Character input/output

This area probably benefits most from enhancement. This is partly because such a wide range of peripheral devices needs to be supported and partly because this is the most visible area of interaction between you and your computer. Any improvements here will therefore be immediate and obvious to you as a user.

Error handling

CP/M's error handling is, at best, startling in its simplicity. Enhanced error handling gives you more information about the nature of the failure, and then gives you the options of retrying the operation, ignoring the error, or aborting the program. This topic is covered in detail in Chapter 9.

System date and time

This is the ability to maintain a time-of-day clock and the current date. It allows your programs to set and access the date and time. In addition, your system can react to the passing of time, and you can move certain operations into the time domain. For example, you can set upper limits on the

number of seconds, or milliseconds, that each operation should take, and arrange for emergency action if the operation takes too long.

Logical-to-physical device assignment

CP/M's logical-to-physical device assignment is primitive. With enhancements, you can use any character input/output device as the system console, and output data to several devices at the same time.

Disk input/output

CP/M only knows about the 128-byte sector. Even with the deblocking routines shown in Figure 6-4, overall disk performance can be slow. Performance can be improved dramatically by "track buffering" (in which entire tracks are read and written at one time) or by using a *memory disk* (that is, using large areas of RAM as though they were a disk). These have a cost, though, in increased memory requirements.

Public files

CP/M's user number system needs improvements to function well in conjunction with large hard disks.

Preserving User-Settable Options

A by-product of adding features to the BIOS is that many of these features have options that you can alter, either from the console using a utility program or from within one of your programs.

Each of these options, once set according to your preferences, or to the requirements of your hardware, do not normally change from day to day. Therefore, the BIOS should be designed so that options set by the user can be "frozen" or preserved on the disk by using a utility program, FREEZE. All of the variables recording these options are gathered into a single area and then this area is written out to the disk.

This area is called the *configuration block*. In practice, there are two configuration blocks: one short term and the other long term. The short term block is not preservable—you can set options within it, but they cannot be preserved after you switch your computer off. The system date, for example, is normally set each time you turn your computer on, and therefore is kept in the short term block. The baud rate for your printer, on the other hand, is kept in the long term block so that it can be saved permanently.

An extra BIOS entry point, `CBGetAddress`, has been built into the enhanced BIOS so that utility programs can locate variables in both configuration blocks. For example, when a utility needs to know where the date is kept in memory, it calls `CBGetAddress` using a code number (specific for date) in a register. `CBGetAddress` returns the address of the date in memory. If a new version of the BIOS is produced with the date in a different location, `CBGetAddress` will still hand the correct, although different, address back to the utility program.

Two other variables that `CBGetAddress` can access pertain to the configuration block itself. One is the relative address of the start of the long term configuration block. The other is the length of the long term block. These are used by the `FREEZE` utility when it needs to preserve the long term block on a disk. `FREEZE` must (1) read in the sectors containing the long term block from the CP/M BIOS image on the reserved area of the disk, (2) copy the current RAM-resident version of the long term block over the disk image version, and then (3) write the sectors back onto the disk.

Figure 8-1 shows how the long term block appears on disk and in memory. The

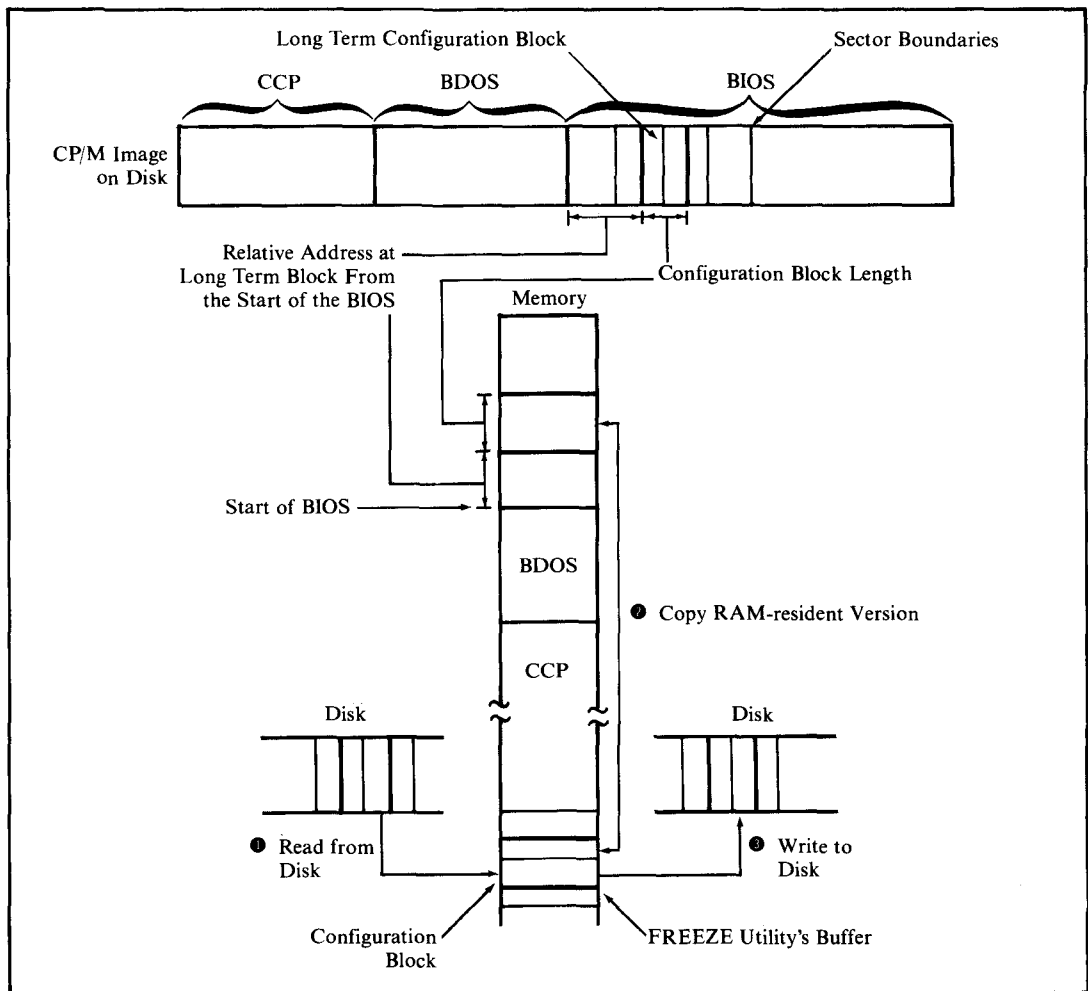

Figure 8-1. Saving the long term configuration block

size of the CCP and BDOS do not change, even if the BIOS does. Therefore, the sector containing the start of the BIOS will not change. The formula (using decimal numbers)

$$\text{BIOS Start Sector} + \text{INT}(\text{Relative LTB Address} / 128)$$

then gives the start sector number to be read in. The number of sectors to read is calculated as follows:

$$(\text{Long Term Block Length} + 127) / 128$$

The relative address and length can be used to locate the long term block in the BIOS executing in RAM.

Character Input/Output

The character I/O drivers shown in the example BIOS, Figure 8-10, have been enhanced to have the following features:

- A single set of driver subroutines controlling all character devices
- Preservation of option settings
- Flexible redirection of input/output between logical and physical devices
- Interrupt-driven input drivers, to get user “type-ahead” capability
- Support of several different protocols to avoid loss of data during high-speed output to printers or other operations
- Forced input of characters into the console input stream, allowing automatic commands at system start-up
- Conversion of terminal function keys into useful character strings
- Ability to recognize “escape sequences” output to the console and to take special action as a result
- Ability to read the current time and date as though they were typed on the console
- “Timeout” signaling when the printer is busy for too long.

Each of these features is discussed in the following sections, as an introduction to the actual code example.

Single Set of Driver Subroutines

In the following examples, only a single set of subroutines is used to process the input and output for all of the physical devices in the system.

This is made possible by grouping all of the individual device’s characteristics

into a table called the *device table*. For example, in order to get a character from the current console device, the address of its device table will be handed over to the subroutines. These in turn will use the appropriate values from the device table when they need to access a port number or any unique attribute of that device.

In our example, the drivers assume that all of the physical devices use serial input/output. To support a device with parallel input/output, you would need to extend the device table to include a field that would enable the drivers to detect whether they were operating on a serial or parallel device. You would probably also have to add different device initialization and input/output routines more suited to the problems of dealing with a parallel port.

The device table structure consists of a series of equate (EQU) instructions. These define the relative offset of each field in the table. Each definition is expressed by referencing the *preceding* field so that you can insert additional fields without revising the definitions for all the other fields.

Individual instances of device tables are then defined as a series of define byte (DB) and define word (DW) lines. The drivers are given the base address of the device table whenever they need to do something with a device. By adding the base address to the relative address (defined by the equate), the drivers can determine the actual address in memory that contains the required value. The detailed contents of the device table are described later in this chapter.

Permanent Setting of Options

About the only options that need preserving in the long term configuration block are the values used to initialize the hardware chips. Other options can be set during automatic execution of the command file when CP/M is first loaded.

Redirection of Input/Output Between Devices

As you recall, the BDOS only “knows about” the *logical* devices console, reader, punch, and list. Using the IOBYTE at location 0003H in conjunction with the STAT utility, you can redirect the BDOS to assign the logical devices to specific physical devices. However, the redirection provided by CP/M is rather primitive. It permits only four physical devices per logical device. Input and output of a logical device must always come from the same physical device. Output data can only be sent to a single destination, or (using the CONTROL-P toggle) to the console and the list device.

The system in Figure 8-10 supports up to 16 physical devices. Any one of these devices can act as the console, reader, punch, or list device. Input can come from any single device. Output can be sent to any or all of the devices. Each logical device's input and output are separate—that is, console input can come from physical device X while the output can be sent to physical devices Y and Z.

Device redirection can be done dynamically, either from within a program or by using a system utility program. For example, if you have some special input

device, your program can momentarily switch over to reading input from this device as though it were the console, and then revert back to reading data from the “real” console.

This redirection scheme is achieved by defining a 16-bit word, called the *redirection word*, in the long term configuration block for each of the following logical devices:

- Console input
- Console output
- Auxiliary (reader/punch) input
- Auxiliary (reader/punch) output
- List input (printers need to send data, too)
- List output.

Each bit in a given redirection word is assigned to a physical device. For input, the drivers use the device corresponding to the first 1 bit that they find in the redirection word. For output, the drivers send the character to be output to all of the devices for which the corresponding bit is set.

The example code does not select a different driver for each bit set — it selects a specific device table and then hands over the base address of this table to the common driver used for all character operations.

Interrupt-Driven Input Drivers

With a standard CP/M BIOS, character data is read from the hardware chips only when control is transferred to the CONIN or READER subroutines. If this character data arrives faster than the BIOS can handle, data overrun occurs and incoming characters are lost.

By using interrupts, the hardware can transfer control to the appropriate interrupt service routine whenever an incoming character arrives. This routine reads the data character and places it into a buffer area to wait for the next CONIN or READER call, which will get the character from the buffer and feed it into the incoming data stream.

User programs and the CCP are “unaware” of this process, perceiving only that data characters are available. However, users will become aware of the process; they will be able to enter data characters from the keyboard before the program is ready for them. This gives the technique its other name—“type-ahead.” Although this technique does not alter the speed of execution of any programs running under CP/M, it does create the illusion of greater speed, since pauses while a program accepts data vanish completely. The user can enter data at a rate convenient to the tasks or thoughts at hand, without regard to the rate at which the program can accept that data.

The example contains the code necessary to handle arriving characters under interrupt control. In order to be of general applicability, the code assumes a “flat” interrupt structure: that is, all character input interrupts cause control to be transferred to the same address in memory. The address is determined by the actual hardware interrupt architecture.

The simplest interrupt schemes use the restart (RST) instructions built into the 8080 CPU chip. In the RST scheme, the external hardware interrupts what the CPU chip is doing and forces one of the eight RST instructions into the processor. Each RST instruction causes the processor to execute what is, in effect, a CALL instruction to a predetermined address in memory.

In more complicated systems, a specific interrupt controller chip (such as the Intel 8259A) will be used. In addition to providing very sophisticated (and complicated) prioritization of interrupts, the interrupt controller can transfer control to a *different* address depending on which physical device causes the interrupt. It does this by forcing the CPU to execute a CALL instruction to a different address for each device.

In both architectures, it is the responsibility of the BIOS writer to initialize all the hardware chips so that an interrupt occurs under the correct circumstances. The BIOS writer also must plant instructions at the correct places in memory to receive control from an RST instruction or from the fake CALL instruction emitted by the interrupt controller.

Some hardware requires that the interrupt service subroutine inform it as soon as the interrupt has been serviced and the character has been input. The example drivers provide for this.

This section deals with using interrupts for the *input* drivers, not the output drivers. All of today's microcomputers can output data much faster than external peripherals can handle. After the first few minutes of output, the computer will fill any reasonably sized buffer — and from this point there is no advantage in having a buffered output system. The computer still must slow down to the peripheral's data rate for each character, although now it is waiting to put the character in the output buffer rather than out to the peripheral.

One exception to this is where you have a large amount of “spare” memory and a “slow” printer (which most of them are). Increasing numbers of systems have more than 64K of RAM. The 8080 or Z80 can't address more than this, but a “bank switched” memory system can switch blocks of memory in and out of that 64K address space.

Using this trick, you can access memory “unknown” to CP/M, store some characters in it, switch back to the normal 64K memory, and return control to the caller of the BIOS output routine. When the physical device is ready to accept another output data character from the CPU, it will generate an interrupt. The interrupt service routine then will access the “secret” buffer, output the characters to the device, and switch back to the normal memory.

For example, if you have a printer that prints at 80 characters per second and

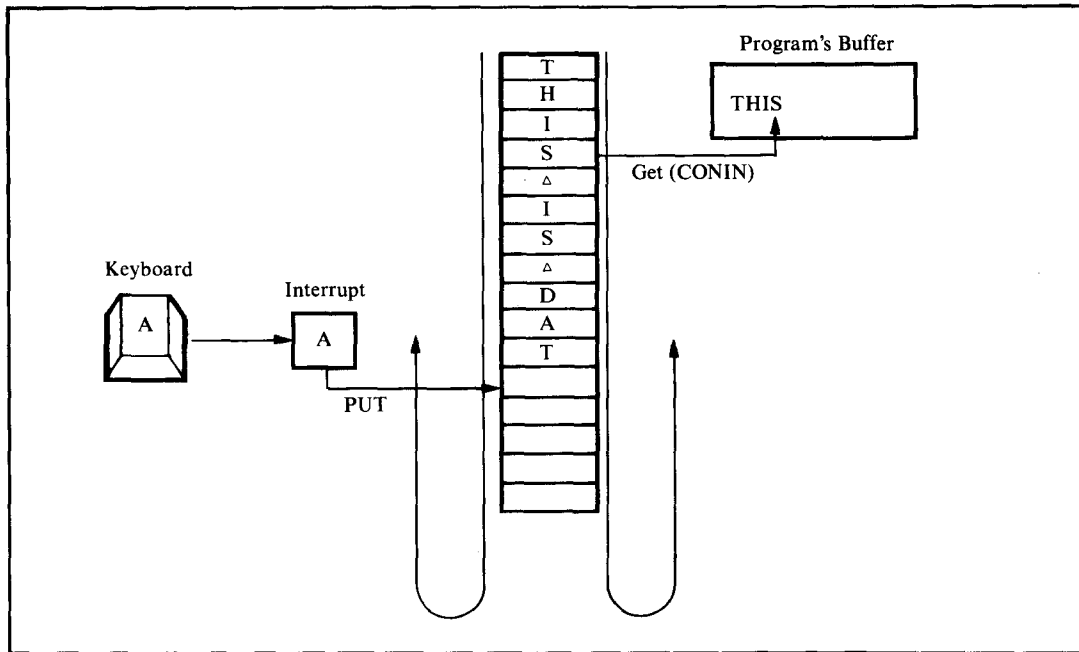

Figure 8-2. Circular buffer type-ahead

you can afford to use 64K of bank switched memory, you can squirrel away 13 minutes of printing—or even more if you design a scheme to compress blanks, storing them in the hidden buffer as a special control sequence.

From the point of view of software, interrupt-driven input drivers are divided into two major groups: the interrupt service routine that reads the characters and stacks them in a buffer, and the non-interrupt routines that get the characters from the buffer and handle the other BIOS functions such as returning console status.

The input character buffer serves as a transfer mechanism between the two groups of subroutines, although the device table also plays an important role.

The example code uses a circular buffer, as shown in Figure 8-2.

The drivers start putting data into the beginning of the buffer. When the last character in the buffer has been reached, the drivers reset to the beginning of the buffer and start over. This, of course, assumes that the non-interrupt drivers have been getting data from the front of the buffer, thus creating space for additional incoming data.

Each device table contains the address of the input buffer, a “put” pointer (for the interrupt service routine), and a “get” pointer (for the non-interrupt service routine). It also contains two character counts: the total number of characters and the number of control characters in the input buffer. You can see how the put and

get pointers operate asynchronously. The put pointer is used every time an incoming character generates an interrupt. The get pointer is used for each CONIN call.

The get and put pointers are only single-byte values and are more accurately described as “relative offsets.” That is, they contain a value which, when converted to a word and added to the base address of the buffer, will point directly to the appropriate position inside the buffer.

By making the buffer a binary number of characters long—32 characters, for example—a programming trick can be used to make the buffer appear circular. The device tables contain a mask value formed from the buffer's length minus one ($\text{length} - 1$). Whenever the get or put pointers are incremented by one (to “point” to the next character position), the updated value is ANDed with this ($\text{length} - 1$) mask. In this example, if the get value goes from 31 (the relative address of the last character in the buffer) to 32 (which would be “off the end”), the masking operation will reset it to zero (the relative address of the first character of the buffer). This avoids having to compare pointers to know when to reset them.

It is also simpler to use a count of the number of characters in the buffer, rather than comparing the get and put pointers, to distinguish between an empty and a full buffer. To support different serial protocols, the driver must be able to react when the buffer is within five characters of being full and when it drops below half empty. Both of these conditions are much easier to detect using a simple count that is incremented as a character is put into the buffer and decremented as a character is retrieved from the buffer.

The count of control characters is used to deal with a class of programs that incessantly “gobble” characters, thereby rendering any type-ahead useless. An example is Microsoft's BASIC interpreter. When it is interpreting a program, you can enter a CONTROL-C from the keyboard and the interpreter will come to an orderly stop. It does this by constantly making calls to CONST (console status). If it ever detects an incoming character, it makes a call to CONIN to input the character. A character that is not CONTROL-C is discarded without further ado. Thus, any characters that are input are consumed, destroying the effect of type-ahead.

To deal with this problem, the CONST routine shown in the example can be told to “lie” about the console's status. In this mode, CONST will only indicate that characters are waiting in the input buffer if a control character is received. It uses the control character count to determine whether there are control characters in the buffer; this count is incremented by the interrupt service routine when it detects one, and decremented by the CONIN routine when it gets a control character from the buffer.

Protocol Support

In this context, a protocol is a scheme to avoid loss of data that would otherwise occur if a device sent data faster than the receiving device could handle

it. For example, protocols are used to prevent the CPU sending data out to a printer faster than the printer can print the characters and move the paper. The drivers also support input protocols, indicating to a transmitting device when the input buffer gets close to being full.

Two basic methods are used to implement protocols. The first uses the control lines found in the normal RS-232C serial interface cables. For data being output by the computer, the data terminal ready (DTR) signal is used, and for incoming data, the request to send (RTS) signal. These signals conform to the electrical standards for the RS-232C interface; they are considered true when they are at some positive voltage between +3 and +12 volts, and false when they are between -3 and -12 volts.

The second method uses ASCII control characters instead of control signals. Two separate protocols are supported by this method. One uses the ASCII characters XON and XOFF. Before the sending device (the computer or some peripheral device) sends a data character, it checks to see if an XOFF character has been received. If so, the sender will wait for an XON character. The receiving device will only send an XON when it is ready to receive more data.

The second protocol uses the characters ETX (end of transmission) and ACK (acknowledge). This method is normally used only when transmitting data from the computer to a buffered printer. A message length (usually half the printer's buffer size) is defined. When this number of characters has been output, the computer will send an ETX character. No further output will occur until the computer receives an ACK character from the printer.

The example drivers support the DTR high-to-send, the XON/XOFF, and the ETX/ACK protocols for output data. For input, they support RTS high-to-receive and XON/XOFF.

The input protocols are invoked when the input buffer gets within five characters of being full. Then the drivers output an XOFF character or lower the RTS signal voltage, or do both. Only when the input buffer has been emptied to 50% capacity will the drivers send XON or raise the RTS line, or both.

As an emergency measure, if the input buffer becomes completely full, notwithstanding protocols, the drivers will output a predetermined character (defined in the device table) each time they discard an incoming character. This is normally the ASCII BEL (bell) character. When you type too far ahead, the terminal will start beeping to tell you that data is being dropped.

Forced Input into the Console Stream

All application languages provide a means of reading data from the console keyboard. This makes the console input stream a useful gateway to the system. A simple enhancement to the CONIN/CONST routines makes it easy to "fool" the system into acting as if data had been input from the keyboard when in fact the data is coming in from a character string in memory.

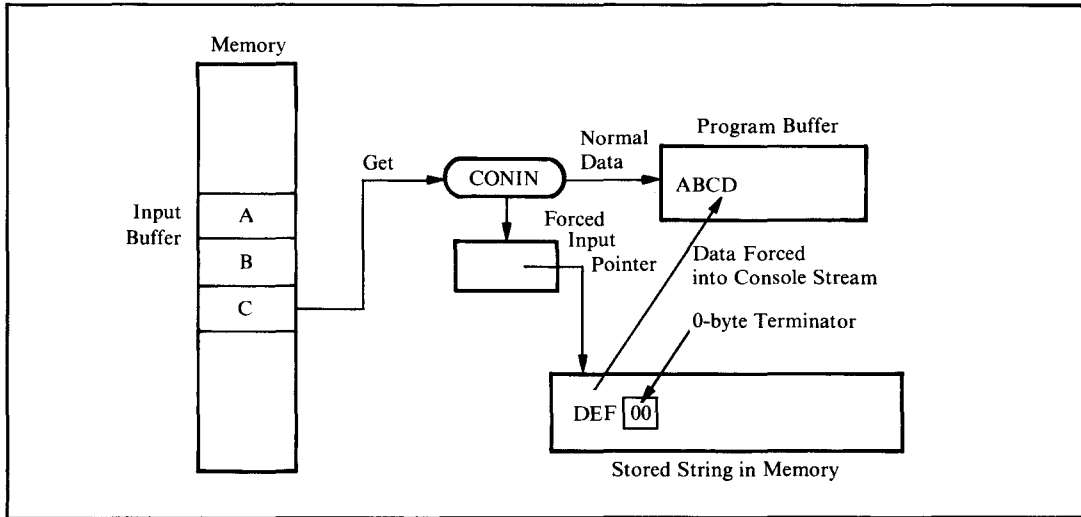

Figure 8-3. CONIN uses forced input data if pointer points to nonzero byte

In the enhanced BIOS, both CONIN and CONST are extended to check a pointer in the long term configuration block, as shown in Figure 8-3.

If this pointer is pointing at a nonzero byte, then that byte is returned as though it had come from the console keyboard. The forced input pointer is then moved up one byte in memory. The process of forcing input continues until a zero byte is encountered.

Forced input serves several purposes. It can be used to force a command or commands into the system when the system first starts up. In conjunction with a utility program, it can allow the user to enter several CP/M commands on a single command line, injecting the characters as each of the commands is executed. It also makes possible the features described in the next two sections.

Support of Terminal Function Keys

Many terminals on the market today have special function keys on their keyboards. When you press one of these keys, the terminal will emit several characters, the first of which is normally the ASCII ESC (escape) character. The remaining one or two characters identify the specific function key that was pressed.

For these function keys to be of any practical use, an applications program must detect the incoming escape sequence and take appropriate action. The problem is that not all terminal manufacturers support the ANSI standard escape sequences.

The example drivers avoid this problem by providing a general-purpose method, shown in Figure 8-4, of detecting escape sequences and of substituting a user-defined character string that is injected into the console input stream as though it had been entered from the keyboard.

This scheme permits function keys to be used very flexibly, even for off-the-shelf programs that have not been designed specifically to accept function key input.

There is, however, one stumbling block. When an ESCAPE character is received, the program must detect whether this is the start of a function key sequence or the user pressing the ESCAPE key on the terminal's keyboard. In the former case, the

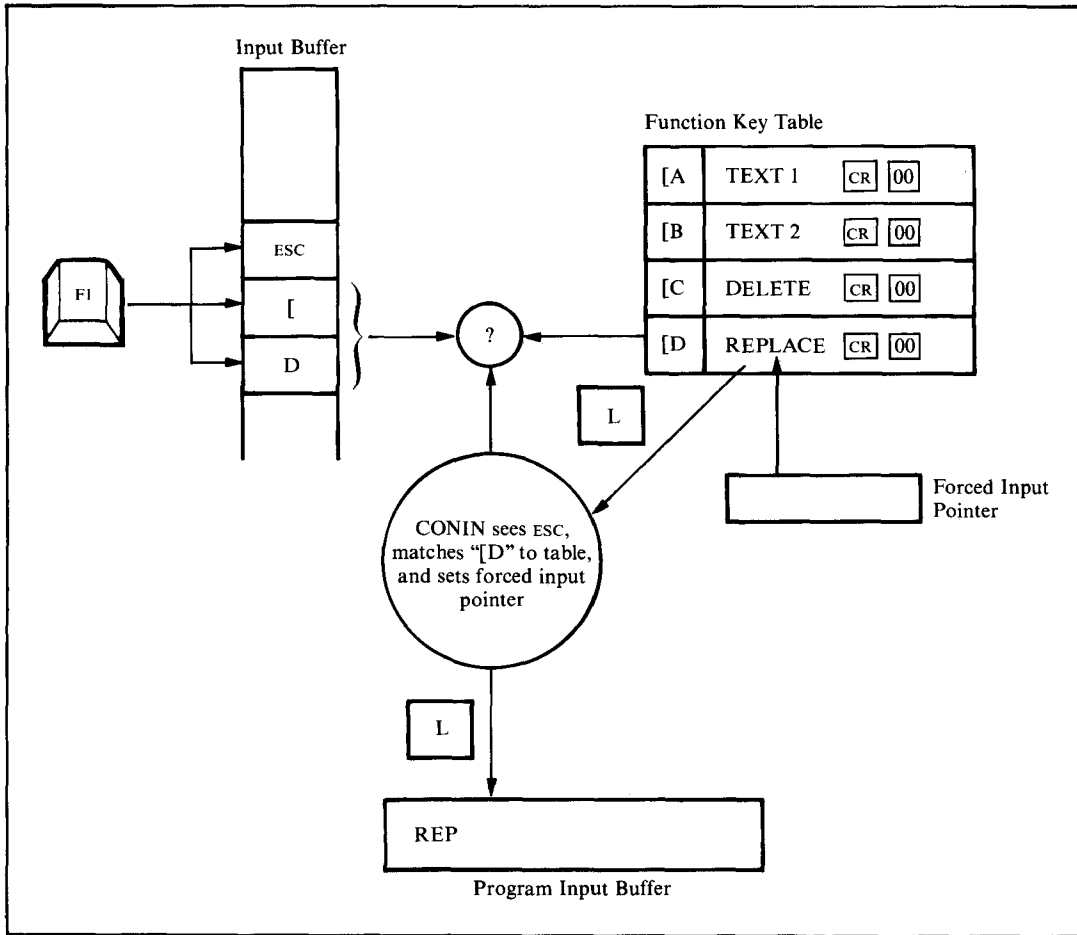

Figure 8-4. CONIN decodes terminal function keys

driver must wait to determine whether a function key string must be substituted for the escape sequence. In the latter case, the driver must input the ESCAPE character as it would other incoming data characters.

This recognition can only be done by moving into the time domain. When the CONIN routine (the non-interrupt routine) gets an ESCAPE character from the input buffer, it delays for approximately 90 milliseconds, enough time for a terminal-generated character sequence to arrive. CONIN then checks the input buffer to see if it contains at least two characters. If it does, the driver checks for a match in a function key table in the long term configuration block. If the characters match a defined function key, then the string associated with the function key will be injected into the console stream by pointing the forced input pointer at it. If the characters do not match anything in the function key table, then the ESCAPE and subsequent characters are handed over as normal data characters.

If after the 90-millisecond delay no further characters have arrived, the ESCAPE character is handed over as a normal character, on the basis that it must have been a manually entered ESCAPE character rather than part of a terminal-generated sequence.

The example drivers show the necessary code and tables for function keys that emit three characters. You could modify them easily for two-character sequences, or, if you are fortunate enough to have a keyboard that uses all eight bits of a byte, to recognize single incoming characters.

Processing Output Escape Sequences

The output side of the console driver, the CONOUT routine, can also be enhanced to recognize escape sequences. It uses a vectored JMP instruction to keep track of the current state of affairs. The CONOUT driver gets an address from the vector and transfers control to it. Normally this vector is set to direct control to the output byte routine. However, if an ESCAPE character is detected in the output stream, the vector is changed to transfer control to a routine that will recognize the character following the ESCAPE. If recognition does not occur, the driver will output an ESCAPE followed by the character that arrived after it.

If the second character is recognized, then the driver can transfer control to the correct escape-sequence processor. This processor can then take whatever action is appropriate. It must also make sure that when all processing is finished, the console output vector is set to process normal output characters again.

This technique is described in more practical detail in the next section, where it is used to preset and read the date and time. You can easily extend the recognition tables in the long term configuration block to perform any special processing that you need, ranging from altering the I/O redirection words to changing any other variable in the system or programming special hardware in your computer.

Be careful not to embed any pure binary values in the sequence of characters going out to the CONOUT routine. If you attempt to send a value of 09H (the TAB

character) out via the BDOS, it will gratuitously expand the tab out to some number of blanks. If you need to send out a bit pattern, such as the I/O redirection word, split it up into a series of 7-bit long values. Then send it out with each byte having the most significant bit set to 1. A value of 09H will then become 89H, preventing the BDOS from expanding it to blanks.

Reading Date and Time From Console

For the moment, set aside the question of how the date and time get into the system. Since the date and time are stored in the short term configuration block (there being no need to save them from one work session to the next), all that the BIOS needs to be able to do is recognize a request from an applications program to read either the date or the time and then set the forced input pointer to the appropriate string in memory. Both the date and time strings are terminated by a LINE FEED followed by a 00 byte.

This sequence of events is shown in Figure 8-5.

You can see that the characters "ESC d" output to CONOUT cause it to point the forced input pointer at the date in memory. Subsequent calls to CONIN bring the characters in the date into the program as though they were being entered on the keyboard.

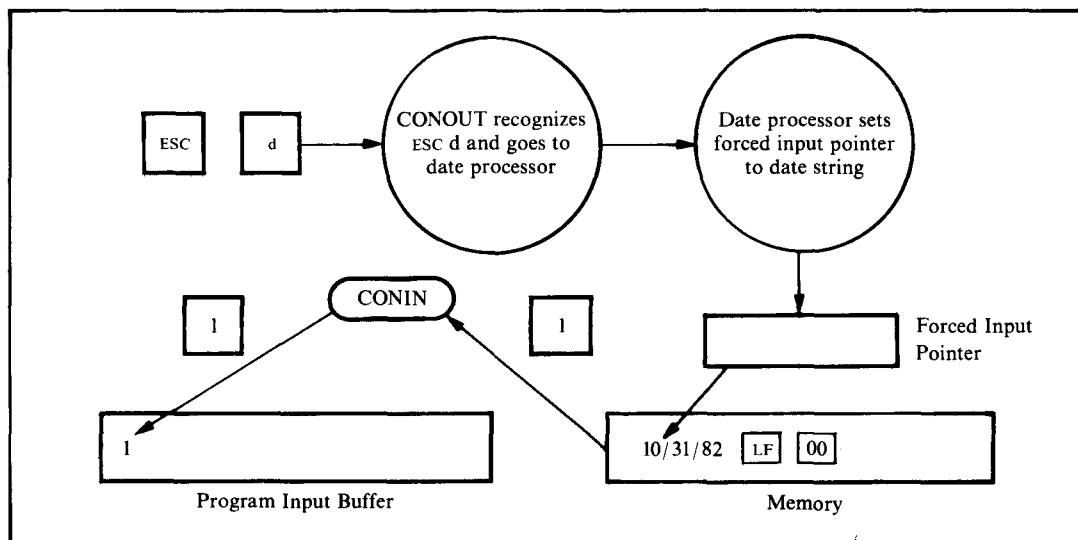

Figure 8-5. Escape sequences sent to CONOUT allow the date to be read by CONIN

“Watchdog” Timeout on Printer

There is no provision in CP/M to deal with a hardware device that for one reason or another is permanently unavailable. Unless special steps are taken in the drivers, the system will screech to a halt in a loop, reading status and testing for the peripheral to be ready.

The example enhancement code shows a scheme, using a real time clock, that can detect when a device such as a printer fails to come ready for more than 30 seconds. On detecting this situation, the code outputs a message to all of the console devices that are not also being used as printers. This type of output is needed to avoid “deadly embraces” where a printer not being ready generates a message that cannot be output because the printer is not ready.

The code that performs the timing function is known as a *watchdog timer*. Each time the real time clock “ticks,” the interrupt service routine checks the watchdog count. If the count is nonzero, it is decremented. If the watchdog timer reaches zero, exceeding the time allowed, the drivers will display a message on the console indicating that the printer has been busy for too long. The user then has the option of making the printer ready and trying again to output data, ignoring the error and carrying on, or aborting the program by doing a BDOS System Reset (function 0).

Although sending an error message to the console sounds simple, it is complicated if console output is directed to the offending printer itself. The drivers attempt to solve this problem by sending the message only to those devices being used as consoles and *not* as printers. If all consoles are being used as printer devices as well, the driver will send the message to device 0 — normally the main console.

Keeping Time and Date

CP/M does not have provision for keeping the current time and date in the system. The example enhancement shows how to keep the time of day and the current date in the short term configuration block by using escape sequences output to the console (1) to set them to the correct values and (2) to “read” them from the console input stream.

The example presupposes that the system has a hardware chip that can be programmed to generate an interrupt every 1/60th of a second (16.666 milliseconds). This provides a divide-down counter to measure seconds elapsed. Of course, if your computer has a *true* real time clock that you can read and get the current time in hours, minutes, and seconds, your code will be very simple. You still will need to have the clock generate a periodic interrupt, however, in order to use the watchdog feature for timing printer and disk operations.

Actual time is kept as ASCII characters, using another ASCII control table to determine when “carry and reset to zero” should occur. By changing two bytes in this table, the time can be kept in 12- or 24-hour format.

The date is simply stored as a string. The example code does not attempt to make sure that the date is valid, nor to update when midnight rolls around. This could be done easily by the BIOS — but it would take a fairly large amount of code.

Watchdog Timer

Having a periodic source of interrupts also opens the door to building in an emergency or watchdog timer. This is nothing more than a 16-bit counter. Each time the real time clock interrupts, or ticks, the interrupt service routine checks the watchdog count. If it is already at zero, nothing more happens — the watchdog is not in use. If it is nonzero, the routine decrements the count by one. If this results in a zero value, the interrupt service routine CALLs a predetermined address. This will be the address of some emergency interrupt service routine that can then take special action, such as investigating the cause of the timeout.

The watchdog routine has a non-interrupt-level subroutine associated with it. Calling this set watchdog subroutine provides a means of setting the count to a predetermined number of real time clock “ticks” and setting the address to which control should be transferred if the count reaches zero.

Having called the set watchdog subroutine, the driver can then sit in a status loop, with interrupts enabled, waiting for some event to occur. If the event happens before the watchdog count hits zero, the driver must call the set watchdog routine again to set the count back to zero, thereby disabling the watchdog mechanism.

The watchdog timer can be used to detect printers that are busy for too long or disk drives that take too long to complete an action either because of a hardware failure or because the user has not loaded the disk into the drive.

Data Structures

As already stated, each character I/O device has its own device table that describes all of its unique characteristics.

The other major data structure is the configuration blocks — both short and long term.

This section describes each field in these data structures.

Device Table

Figure 8-6 shows the contents of a device table. More correctly, it shows a series of equates that define the offsets of each field in the device table. The drivers are given the base address of a specific device table. They then access each field by adding the required offset to this base address.

The first part of the device table is devoted to the physical aspect of the device, defining which port numbers are to be used to communicate with it. The drivers need to know several different port numbers since each one is used for a particular

```

; The drivers use a device table for each
; physical device they service. The equates that follow
; are used to access the various fields within the
; device table.
;
;
; Port numbers and status bits
0000 = DT$Status$Port EQU 0 ;Device status port number
0001 = DT$Data$Port EQU DT$Status$Port+1 ;Device data port number
0002 = DT$Output$Ready EQU DT$Data$Port+1 ;Output ready status mask
0003 = DT$Input$Ready EQU DT$Output$Ready+1 ;Input ready status mask
0004 = DT$DTR$Ready EQU DT$Input$Ready+1 ;DTR ready to send mask
0005 = DT$Reset$Int$Port EQU DT$DTR$Ready+1 ;Port number used to reset an
; interrupt
0006 = DT$Reset$Int$Value EQU DT$Reset$Int$Port+1 ;Value output to reset interrupt
0007 = DT$Detect$Error$Port EQU DT$Reset$Int$Value+1 ;Port number for error detect
0008 = DT$Detect$Error$Value EQU DT$Detect$Error$Port+1 ;Mask for detecting error (parity etc.)
0009 = DT$Reset$Error$Port EQU DT$Detect$Error$Value+1 ;Output to port to reset error
000A = DT$Reset$Error$Value EQU DT$Reset$Error$Port+1 ;Value to output to reset error
000B = DT$RTS$Control$Port EQU DT$Reset$Error$Value+1 ;Control port for lowering RTS
000C = DT$Drop$RTS$Value EQU DT$RTS$Control$Port+1 ;Value, when output, to drop RTS
000D = DT$Raise$RTS$Value EQU DT$Drop$RTS$Value+1 ;Value, when output, to raise RTS
;
; Device logical status (incl. protocols)
000E = DT$Status EQU DT$Raise$RTS$Value+1 ;Status bits
0001 = DT$Output$Suspend EQU 0000$0001B ;Output suspended pending
; protocol action
0002 = DT$Input$Suspend EQU 0000$0010B ;Input suspended until
; buffer empties
0004 = DT$Output$DTR EQU 0000$0100B ;Output uses DTR-high-to-send
0008 = DT$Output$Xon EQU 0000$1000B ;Output uses Xon/Xoff
0010 = DT$Output$Etx EQU 0001$0000B ;Output uses Etx/Ack
0020 = DT$Output$Timeout EQU 0010$0000B ;Output uses Timeout
0040 = DT$Input$RTS EQU 0100$0000B ;Input uses RTS-high-to-receive
0080 = DT$Input$Xon EQU 1000$0000B ;Input uses Xon/Xoff
;
000F = DT$Status$2 EQU DT$Status+1 ;Secondary status byte
0001 = DT$Fake$Typeahead EQU 0000$0001B ;Requests Input$Status to
; return "Data Ready" when
; control characters are in
; input buffer
;
0010 = DT$Etx$Count EQU DT$Status$2+1 ;No. of chars. sent in Etx protocol
0012 = DT$Etx$Message$Length EQU DT$Etx$Count+2 ;Specified message length
;
; Input buffer values
0014 = DT$Buffer$Base EQU DT$Etx$Message$Length+2 ;Address of input buffer
0016 = DT$Put$Offset EQU DT$Buffer$Base+2 ;Offset for putting chars. into buffer
0017 = DT$Get$Offset EQU DT$Put$Offset+1 ;Offset for getting chars. from buffer
0018 = DT$Buffer$Length$Mask EQU DT$Get$Offset+1 ;Length of buffer - 1
;Note: Buffer length must always be
; a binary number; e.g. 32, 64, or 128.
;This mask then becomes:
; 32 -> 31 (0001$1111B)
; 64 -> 63 (0011$1111B)
; 128 -> 127 (0111$1111B)

```

Figure 8-6. Device table equates

				<pre> ;After the get/put offset has been ; incremented it is ANDed with the mask ; to reset it to zero when the end of ; the buffer has been reached. </pre>
0019 =	DT\$Character\$Count	EQU	DT\$Buffer\$Length\$Mask+1	<pre> ;Count of the number of characters ; currently in the buffer </pre>
001A =	DT\$Stop\$Input\$Count	EQU	DT\$Character\$Count+1	<pre> ;Stop input when the count reaches ; this value </pre>
001B =	DT\$Resume\$Input\$Count	EQU	DT\$Stop\$Input\$Count+1	<pre> ;Resume input when the count reaches ; this value </pre>
001C =	DT\$Control\$Count	EQU	DT\$Resume\$Input\$Count+1	<pre> ;Count of the number of control ; characters in the buffer </pre>
001D =	DT\$Function\$Delay	EQU	DT\$Control\$Count+1	<pre> ;Number of clock ticks to delay to ; allow all characters after function ; key lead-in to arrive </pre>
001E =	DT\$Initialize\$Stream	EQU	DT\$Function\$Delay+1	<pre> ;Address of byte stream necessary to ; initialize this device </pre>

Figure 8-6. Device table equates (continued)

function. Depending upon your hardware, each port number could be different; however, with standard Intel or Zilog chips, you will often find that the same port number is used for several functions. The drivers also need to know what bit patterns to expect when they read some ports and what values to output to ports in order to obtain particular results.

The layout of the device table and the manner in which the equates are declared are designed to make it easy for you to change the contents of the table to meet your own special requirements. The fields in this first section of the device table are discussed in the sections that follow.

DT\$Status\$Port The driver reads this port to determine whether the hardware chip has incoming data ready to be input to the computer or whether the chip is capable of accepting another data character for output to the physical device.

DT\$Data\$Port The driver reads from this port to access the next data character from the physical device. The driver also writes to this port to output the next data character to the device.

If your computer hardware requires that the input data port be a different number from the output data port, you will have to alter the coding in the device table equates as well as make the necessary changes in the input and output subroutines in the body of the code.

DT\$Output\$Ready This is the bit mask that the driver will AND with the current device status (obtained by reading the DT\$Status\$Port) to see whether the device is ready to accept another output character. It assumes that the device is ready if the result of the AND instruction is nonzero. You may have to change some JNZ (jump

nonzero) instructions to JZ (jump zero) instructions if your hardware device uses inverted logic, with bits in the status byte set to 0 to indicate that the device can accept another character for output.

Note that this status check relates only to the output chip—it is completely separate from the question of whether the peripheral itself is ready to accept data.

DT\$Input\$Ready This is the bit mask that the driver will AND with the current device status to see if there is an incoming data character. The drivers again presume that if the result of the AND is nonzero, then an incoming data character is waiting to be read from the data port. You will need to make changes similar to those for the output subroutines described in the previous section if your hardware uses inverted logic (0 bit means incoming data).

DT\$DTR\$Ready DTR stands for *data terminal ready*. It refers to one of the control lines connected from the actual peripheral device to the I/O chip (via several other integrated circuits). The drivers, as an option, will only output data to the device when the DTR signal is at a positive voltage. If the peripheral, in order to stop the flow of data characters being output to it, lowers the DTR signal to a negative voltage, the drivers will wait. Once DTR goes positive again, the drivers will resume sending data. Many hard-copy devices use this scheme to give themselves a chance to print out data received from the computer. They may have to lower DTR for several seconds, while they perform paper movement, for example.

The value in this field is a bit mask that the drivers use on the device status to determine the state of the data-terminal-ready control signal.

DT\$Reset\$Int\$Port Since the input side of the drivers uses interrupts, when an incoming character is ready to be input by the CPU, the hardware generates an interrupt signal, and control is transferred to the interrupt service routine. This routine “services” the interrupt by reading the incoming data character, saving it in memory, and then transferring control back to whatever was being executed when the interrupt occurred.

The more complicated interrupt controller chips (such as the Intel 8259A) must be told as soon as a given interrupt has been serviced so that they can permit servicing of any lower priority interrupts that may be waiting.

This field contains the port number that will be used to “reset” the interrupt, or more correctly, to indicate the end of the previous interrupt’s servicing.

DT\$Reset\$Int\$Value This is the value that will be output to the DT\$Reset\$Int\$Port to tell the hardware that the previous interrupt service has been completed.

DT\$Detect\$Error\$Port Before the driver attempts to read any incoming data from the DT\$Data\$Port, it checks to see if any hardware errors have occurred. It does so by reading status from this port.

DT\$Detect\$Error\$Value The status byte that is input from the DT\$Detect\$Error\$Port is ANDed with this value. If the result is nonzero, the driver assumes that an error has occurred.

DT\$Reset\$Error\$Port If an error has occurred, the driver outputs an error reset value to this port number.

DT\$Reset\$Error\$Value This is the value that will be output to the DT\$Reset\$Error\$Port to reset an error.

DT\$RTS\$Control\$Port The drivers use this port number to control the request-to-send line if the RTS protocol option is selected.

DT\$Drop\$RTS\$Value This value is output to the RTS control port to lower the RTS line so that some external device will stop sending data to the computer.

DT\$Raise\$RTS\$Value This value is output to raise the RTS line so that the external device will resume sending data to the computer.

DT\$Status This is the first of two status bytes. It contains bit flags that are set to a 1 bit to indicate the following conditions:

DT\$Output\$Suspend

Because of protocol, the device is currently suspended from receiving any further output characters.

DT\$Input\$Suspend

Because of protocol, the device has been requested not to send any more input characters.

DT\$Output\$DTR

The driver will maintain DTR-high-to-send protocol for output data.

DT\$Output\$Xon

The driver will maintain XON/XOFF protocol for output data.

DT\$Output\$Etx

The driver will maintain ETX/ACK protocol for output data.

DT\$Input\$RTS

The driver will maintain RTS-high-to-receive protocol for input data.

DT\$Input\$Xon

The driver will maintain XON/XOFF protocol for input data.

DT\$Status\$2 This is another status byte, also with the following bit flag:

DT\$Fake\$Typeahead

CONST will “lie” about the availability of incoming console characters. It

will only indicate that data is waiting if there are control characters other than CARRIAGE RETURN, LINE FEED, or TAB in the input buffer.

DT\$Etx\$Count This value is only used for ETX/ACK protocol. It is a count of the number of characters sent in the current message. When this count reaches the defined message length, then the driver will send an ETX character and suspend any further output.

DT\$Etx\$Message\$Length This value is the defined message length for the ETX/ACK protocol. It is used to reset the DT\$Etx\$Count.

DT\$Buffer\$Base This is the address of the first byte of the device's input buffer.

DT\$Put\$Offset This *byte* contains the relative offset indicating where the next incoming character is to be "put" in the input buffer. This byte must then be converted into a word value and added to the DT\$Buffer\$Base address to get the absolute memory location.

DT\$Get\$Offset This byte contains the relative offset indicating where the next character is to be "got" in the input buffer.

DT\$Buffer\$Length\$Mask This byte contains the length of the buffer minus one. The length of the buffer must always be a binary number (8, 16, 32, 64...). Therefore, one less than the length forms a mask value. Both the get and put offsets, after being incremented, are masked with this value. When the offset reaches the end of the buffer, this masking operation will "automatically" reset the offset to zero.

DT\$Character\$Count This is a count of the total number of characters in the buffer. It is incremented by the interrupt service routine each time a character is placed in the buffer, and decremented by the CONIN routine each time it gets a character from the buffer.

CONST uses this value to determine whether any characters are available for input.

DT\$Stop\$Input\$Count When the interrupt service routines detect that the DT\$Character\$Count is equal to this value (normally buffer length minus five), the drivers will invoke the selected input protocol, lowering RTS or sending XOFF, to shut off the incoming data stream.

DT\$Resume\$Input\$Count When the CONIN routine detects that the DT\$Character\$Count has become equal to this value, the drivers will again invoke the selected input protocol, either raising RTS or sending XON to resume receiving input data.

DT\$Control\$Count This is a count of the number of control characters in the input buffer. CARRIAGE RETURN, LINE FEED, and TAB characters are not included in this count.

It is incremented by the interrupt service routine and decremented by CONIN. CONST uses the count when the DT\$Fake\$Typeahead mode is active; it will only indicate that characters are waiting in the input buffer if the control count is nonzero.

DT\$Function\$Delay This is the number of clock ticks that should be allowed to elapse after the first character of an incoming escape sequence has been detected. It allows time for the remaining characters in the escape sequence to arrive, assuming that these are being emitted by a terminal at maximum baud rate. Normally, this will correspond to a delay of approximately 90 milliseconds.

DT\$Initialize\$Stream This is the address of the first byte of a string. This string has the following format:

DB ppH	Port number
DB nnH	Number of bytes to be output
DB vvH,vvH...	Initialization bytes to be output to the specified port number

This sequence can be repeated as many times as is necessary, with a “port” number of 00H acting as a terminator.

Disk Input/Output

The example drivers show three main disk I/O enhancements:

- Full track buffering
- Using memory as an ultra-fast disk
- Improved error handling.

Full Track Buffering

The 5 1/4" diskettes used in the example system are double-sided. Each side has a separate read/write head in the disk drive. The disk controller is fast enough that, if so commanded, it can read in a complete track's worth of data from one side of the diskette in a single revolution of the diskette.

The drivers have been modified to do just this. The main disk buffer has been dramatically enlarged to accommodate nine 512-byte sectors.

In the earlier standard BIOS, CP/M was configured for tracks of 18 512-byte sectors. The data from each head on a given track was laid “end-to-end” to create the illusion of a single surface with twice as much data on it. For track buffering, performance would be reduced if each read required two revolutions of the diskette, and so in this BIOS the tables and the low-level driver logic have been changed. Each surface is separated, with even numbered tracks on head 0, odd on head 1.

1 track!

The track number given to the low-level drivers serves two purposes. The least significant bit identifies the head number. When the track number is shifted one bit right, the result is the *physical* track number to which the head assembly must be positioned.

The deblocking algorithm has also been modified by deleting references to sectors. The code is now concerned only with whether the correct disk and track are in the buffer. If this is true, the correct sector must, by definition, be in the buffer.

The deblocking code no longer takes any note when the BDOS indicates that it is writing to an unallocated allocation block—knowledge it used to bypass a sector pre-read in the standard BIOS. The track size in this enhanced BIOS is much larger than an allocation block, and so the question is meaningless; the whole track must be pre-read to write just a single sector.

This enhancement really excels when the BDOS is doing directory operations, which always involve a series of sequential reads. The entire directory can be brought into memory, updated, and written back in just two disk revolutions.

One point to watch out for is what is known as “deferred writes.” Imagine a program instructed to write on a sector on track 20. The drivers will read in track 20, copy the contents of the designated sector into the track buffer, and return to the program *without* actually writing the data to the disk. The program could “write” to all of the sectors on this track without any actual disk writes. During all this time, this data would exist only in memory and not on the disk drive, so if a power failure occurred, several thousand bytes of data would be lost. Writing to the directory is an exception. The drivers always physically write to the disk when the BDOS indicates that it is writing to a directory sector.

In reality, the increased risk is small. Most programs are constantly reading and writing files, so that the track buffer will be written out frequently in order to read in another track. When programs end, they close output files. This in turn triggers directory writes that force data tracks onto the disk.

If high security is a requirement for your computer, you could extend the watchdog routine to include another separate timer. You could preset this timer for, say, a ten-second delay each time you write into the track buffer but do not write the buffer to the disk. When the count expires, it would set a flag that could be tested by all of the BIOS entry points. If set, they would initiate a write of the track buffer to the disk.

Using Memory as an Ultra-Fast Disk

As you can see from the preceding section, increased performance tends to go hand in hand with increased memory requirements. This is certainly true with a “memory disk,” commonly called a RAM-disk or M-disk. In fact, to have an M-disk with reasonable storage capacity, your computer must have at least 128K bytes of additional memory.

Since the 8080 or Z80 can only address 64K of memory at one time, to get access to any of this additional memory, some part of your computer's "normal" memory must be removed from the 64K address space and the additional memory must be switched in. This is known as bank-switched memory.

Figure 8-7 shows the memory organization that is supported by the example M-disk drivers.

You can see that the system has a total of 256K bytes of RAM, organized with the top 16K, from 64K down to 48K, being "common"—that is, switched into the address space all the time. The lower 48K can be selected from five banks, numbered 0 to 4. Bank 0 is switched in for normal CP/M operations.

The M-disk parameter blocks describe a disk with eight "tracks," numbered 0 to 7. The least significant bit of the track number determines whether the base address of the track will be 0000H or 6000H. Shifting the track number right one bit gives the bank number. Each track consists of 192 sectors. To get the relative address of a sector within its "track," shift the sector number eight bits left, thus multiplying it by 128.

The M-disk is referenced by logical disk M:. A few special-case instructions are required to return the special M-disk parameter header in SELDSK.

One problem, fortunately easily solved, is that the user's DMA address coexists in the address space with the M-disk image itself. There is no direct way to move data between bank 0 and any other bank. The M-disk uses an intermediary buffer in common memory (above 48K), moving data into this, switching banks, and then moving the data down again. Figure 8-8 shows an example of this sequence, as used when reading from the M-disk.

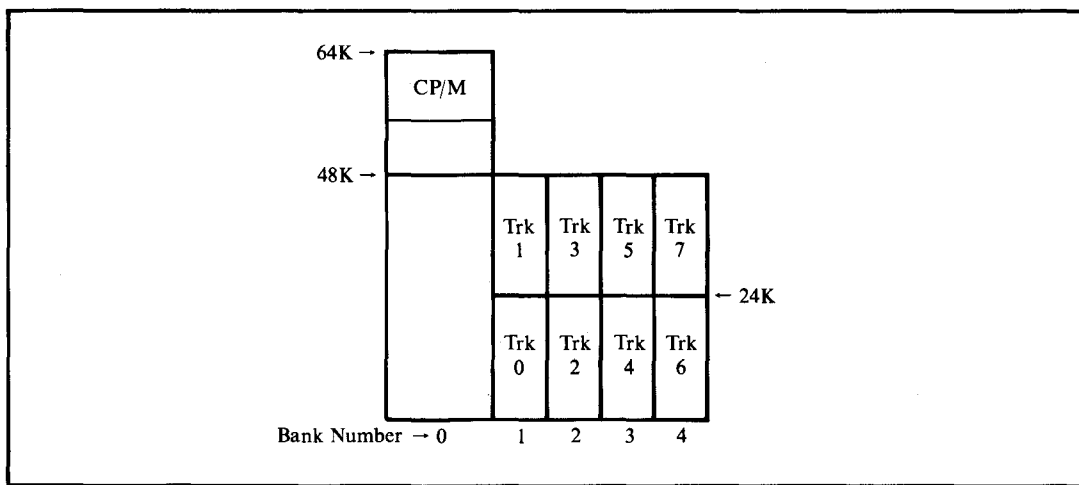

Figure 8-7. Memory organization for M-disk

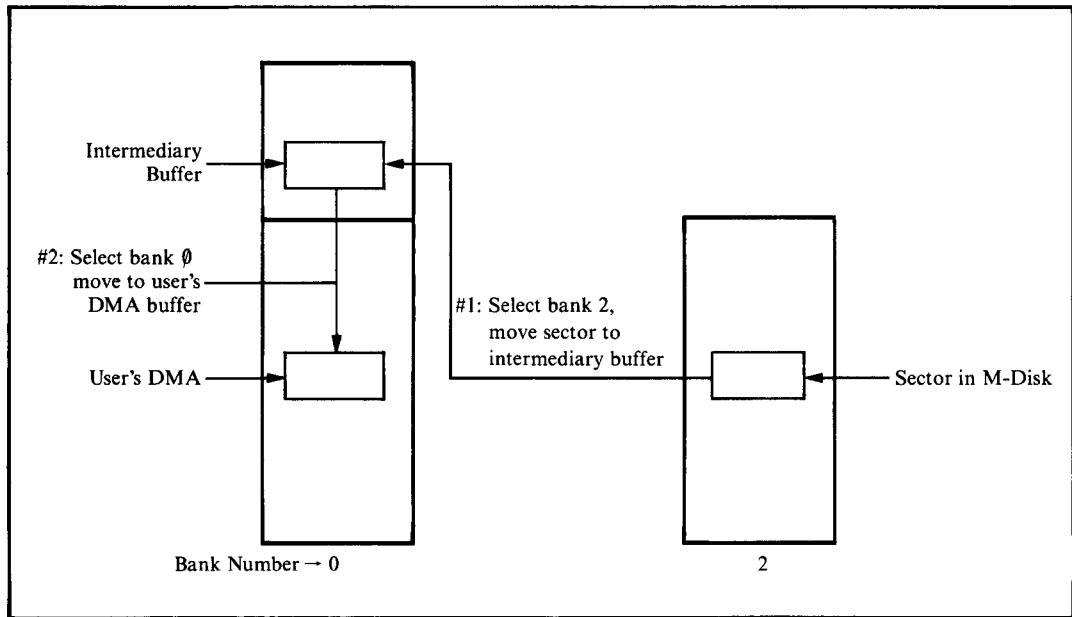

Figure 8-8. Reading a sector from the M-disk image

During cold boot initialization, the M-disk driver checks the very first directory entry (in bank 1) to see if it matches a dummy entry for a file called “M\$Disk.” If this entry is present, the M-disk is assumed to contain valid information. If the entry is absent, the initialization code makes this special directory entry and fills the remainder of the directory with 0E5H, making it appear empty. The dummy entry makes it appear that the “M\$Disk” file is in user 15, marked System status and Read-Only—all of which are designed to prevent its accidental erasure.

Custom Patches to CP/M

Two features shown in the enhanced BIOS, one in the CCP and one in the BDOS, require changes to CP/M itself. These features are implemented by modifying the CCP and BDOS to transfer control to the BIOS at specific points, execute a few instructions in the BIOS, and then return to CP/M. The patches could be made by modifying the MOVCPM program to install the changes permanently. The changed version of MOVCPM, however, *must* be used with a specific version of the BIOS. Therefore, patching CP/M “on the fly” ensures that there will be no mismatch between the BIOS and the rest of CP/M.

Both of these patches were produced with the assistance of Digital Research.

User 0 Files Made Public

The first change permits files created in user area 0 to be accessible from all other user numbers. This feature comes into its own only with hard disk systems. On a hard disk, user numbers can partition the disk, but the frequently used utilities must then be duplicated in each user area. Allowing files in user area 0 to be public means that these files will be accessible from all the other user numbers. Hence the files need not be copied into each user area.

The public files feature alters the way that the BDOS performs the Search Next function, allowing access to files declared in user area 0 even when the current user number is not 0. However, the feature is a double-edged sword—user 0 files can be accidentally erased or damaged as well as accessed. Therefore, user 0 files should be declared as System status and Read-Only to protect them. As an additional precaution, public files can be turned off by a control flag in the long term configuration block. This flag is set to an initial state that disables public files.

Modified User Prompt

This modification makes the CCP display the current user number as well as the default disk. For example,

```
3B>
```

indicates that you are currently in user number 3, with disk B: as the default. In addition, if you have enabled public files, the prompt is preceded by the letter “P” to serve as a reminder:

```
P3B>
```

An Enhanced BIOS

The remainder of this chapter consists of the assembly language source code for the enhanced BIOS described here. It is rather a daunting listing, but will be well worth your study. The copious commentary has been written to make this study easier, and emphasis has been placed on explaining *why* as well as *what* things are done.

As with the standard BIOS, each line is numbered so that you can use the functional index in Figure 8-9 to find areas of interest in the listing. Note that the line numbers are not contiguous. They jump several hundred at the start of each major section or subroutine. This facilitates minor changes in the listing without revision of the functional index. The full listing is given in Figure 8-10.

Start Line	Functional Component or Routine
00001	Introductory Comments and Equates
00200	BIOS Jump Table with Additional Private Entries
00400	Long Term Configuration Block
00800	Interrupt Vector
00900	Device Port Numbers and Other Equates
01100	Display\$Message Subroutine
01200	Enter\$CPM Setup
01300	Device Table Equates
01500	Device Table Declarations
01700	General Device Initialization
01800	Specific Device Initialization
02000	Output Byte Stream
02100	CONST Routine
02200	CONIN Routine with Function Key Processing
02500	Console Output
02700	CONOUT Routine with Escape Sequence Processing
02900	AUXIST—Auxiliary Input Status Routine
03000	AUXOST—Auxiliary Output Status Routine
03100	AUXIN—Auxiliary Input Routine
03200	AUXOUT—Auxiliary Output Routine
03300	LISTST—List Status Routine
03400	LIST—List Output Routine
03500	Request User Choice—Request Action After Error
03600	Output Error Message
03656	Get Composite Status from Selected Output Devices
03800	Multiple Output of Byte to All Output Devices
04000	Check Output Device Logically (Protocol) Ready
04200	Process ETX/ACK Protocol
04400	Select Device Table from I/O Redirection Bit Map
04600	Get Input Character from Input Buffer
04800	Introductory Comments for Interrupt-Driven Drivers
04900	Character Interrupt Service Routine
05000	Service Device—Puts Character into Input Buffer
05300	Get Address of Character in Input Buffer
05400	Check if Control Character (not CR, LF, TAB)
05500	Output Data Byte
05700	Input Status Routine
05900	Set Watchdog Timer Routine
06000	Real Time Clock Interrupt Service Routine
06200	Shift HL Right One Bit Routine
06300	Introductory Comments for High-Level Disk Drivers
06400	Disk Parameter Headers
06600	Disk Parameter Blocks
06800	SELDSK—Select Disk Routine
07000	SETTRK—Set Track Routine
07100	SETSEC—Set Sector Routine

Figure 8-9. Functional index for listing in Figure 8-10

07200	SETDMA—Set DMA Routine
07300	Skew Tables for Sector Translation
07400	SECTTRAN—Sector Translation Routine
07500	HOME—Home Disk to Track and Sector 0
07600	Equates for Physical Disk and Deblocking Variables
07800	READ—Sector Read Routine
07900	WRITE—Sector Write Routine
08000	Common Read/Write Code with Deblocking Algorithm
08300	Move\$8 Routine—Moves Memory in 8-Byte Blocks
08500	Introductory Comments for Disk Controllers
08700	Nondeblocked Read and Write
08900	M-Disk Driver
09100	Select Memory Bank Routine
09200	Physical Read/Write to Deblocked Disks
09400	Disk Error Handling Routines
09700	Disk Control Tables for Warm Boot
09800	WBOOT—Warm Boot Routine
10000	Ghost Interrupt Service
10100	Patch CP/M for Public Files and Prompt Changes
10300	Get Configuration Block Addresses
10400	Addresses of Objects in Configuration Blocks
10500	Short Term Configuration Block
10700	Note on Why Uninitialized Buffers are at End of BIOS
10800	Cold Boot Initialization Hidden in Disk Buffer Followed by All Uninitialized Buffers

FIGURE 8-9. Functional index for listing in Figure 8-10 (continued)

```

00001 ;      This is a skeletal example of an enhanced BIOS.
00010 ;      It includes fragments of the standard BIOS
00011 ;      shown as Figure 6-4 in outline, so as to
00012 ;      avoid cluttering up the enhancements with the
00013 ;      supporting substructure. Many of the original
00014 ;      comment blocks have been abbreviated or deleted
00015 ;      entirely.
00016 ;
00017 ;< -- NOTE:      The line numbers at the left are included
00018 ;              to allow reference to the code from the text.
00019 ;              There are deliberate discontinuities in the
00020 ;              numbers to allow space for expansion.
00021 ;
3030 = 00022 VERSION      EQU      '00'      ;Equates used in the sign-on message
3230 = 00023 MONTH      EQU      '02'
3632 = 00024 DAY        EQU      '26'
3338 = 00025 YEAR       EQU      '83'
00026 ;
00027 ;*****
00028 ;*
00029 ;*      This BIOS is for a computer system with the following
00030 ;*      hardware configuration :
00031 ;*
00032 ;*      -- 8080 CPU
00033 ;*      -- 64K bytes of RAM
00034 ;*      -- 3 serial I/O ports (using signetics 2651) for:
00035 ;*      console, communications and list
00036 ;*      -- Two 5 1/4" mini floppy, double-sided, double-
00037 ;*      density drives. These drives use 512-byte sectors.
00038 ;*      These are used as logical disks A: and B:.
00039 ;*      Full track buffering is supported.

```

Figure 8-10. Enhanced BIOS listing

```

00040 ;*          -- Two 8" standard diskette drives (128-byte sectors) *
00041 ;*          These are used as logical disks C: and D:. *
00042 ;*          -- A memory-based disk (M-disk) is supported. *
00043 ;* *
00044 ;*          Two intelligent disk controllers are used, one for *
00045 ;*          each diskette type. These controllers access memory *
00046 ;*          directly, both to read the details of the *
00047 ;*          operations they are to perform and also to read *
00048 ;*          and write data from and to the diskettes. *
00049 ;* *
00050 ;* *
00051 ;*****
00052
00053
00054 ;          Equates for characters in the ASCII character set
00055 ;
0011 = 00056 XON EQU 11H ;Reenables transmission of data
0013 = 00057 XOFF EQU 13H ;Disables transmission of data
0003 = 00058 ETX EQU 03H ;End of transmission
0006 = 00059 ACK EQU 06H ;Acknowledge
000D = 00060 CR EQU 0DH ;Carriage return
000A = 00061 LF EQU 0AH ;Line feed
0009 = 00062 TAB EQU 09H ;Horizontal tab
0007 = 00063 BELL EQU 07H ;Sound terminal's bell
00064 ;
00065 ;
00066 ;          Equates for defining memory size and the base address and
00067 ;          length of the system components
00068 ;
0040 = 00069 Memory$Size EQU 64 ;Number of Kbytes of RAM
00070 ;
00071 ;          The BIOS length must be determined by inspection.
00072 ;          Comment out the ORG BIOS$Entry line below by changing the first
00073 ;          character to a semicolon (this will make the assembler start
00074 ;          the BIOS at location 0). Then assemble the BIOS and round up to
00075 ;          the nearest 100H the address displayed on the console at the end
00076 ;          of the assembly.
00077 ;
2500 = 00078 BIOS$Length EQU 2500H ;<-- Revised to an approximate value
00079 ;          ; to reflect enhancements
00080 ;
0800 = 00081 CCP$Length EQU 0800H ;Constant
0E00 = 00082 BDOS$Length EQU 0E00H ;Constant
00083 ;
000F = 00084 Overall$Length EQU (CCP$Length + BDOS$Length + BIOS$Length + 1023) / 1024
00085 ;
C400 = 00086 CCP$Entry EQU (Memory$Size - Overall$Length) * 1024
CC06 = 00087 BDOS$Entry EQU CCP$Entry + CCP$Length + 6
DA00 = 00088 BIOS$Entry EQU CCP$Entry + CCP$Length + BDOS$Length
00089 ;
0005 = 00090 BDOS EQU 0005H ;BDOS entry point (used for making
00091 ;          ; system reset requests)
00092 ;
00200 ;#
00201 ;          ORG BIOS$Entry ;Assemble code at BIOS address
00202 ;
00203 ;          BIOS jump vector
00204 ;
0000 C31311 00205 JMP BOOT ;Cold boot -- entered from CP/M bootstrap loader
00206 Warm$Boot$Entry: ; Labelled so that the initialization code can
00207 ; put the warm boot entry address in location
00208 ; 0001H and 0002H of the base page
0003 C3750E 00209 JMP WBOOT ;Warm boot -- entered by jumping to location 0000H
00210 ; Reloads the CCP, which could have been
00211 ; overwritten by previous program in transient
00212 ; program area
0006 C32D03 00213 JMP CONST ;Console status -- returns A = 0FFH if there is a
00214 ; console keyboard character waiting
0009 C33A03 00215 JMP CONIN ;Console input -- returns the next console keyboard
00216 ; character in A
000C C3D703 00217 JMP CONOUT ;Console output -- outputs the character in C to
00218 ; the console device
000F C3F504 00219 JMP LIST ;List output -- outputs the character in C to the
00220 ; list device
0012 C3CE04 00221 JMP AUXOUT ;Auxiliary output -- outputs the character in C to the
00222 ; logical auxiliary device

```

Figure 8-10. (Continued)

```

0015 C3A104 00223 JMP AUXIN ;Auxiliary input -- returns the next input character from
00224 ; the logical auxiliary device in A
0018 C3160A 00225 JMP HOME ;Homes the currently selected disk to track 0
001B C36309 00226 JMP SELDSK ;Selects the disk drive specified in register C and
00227 ; returns the address of the disk parameter header
001E C39B09 00228 JMP SETTRK ;Sets the track for the next read or write operation
00229 ; from the BC register pair
0021 C3A109 00230 JMP SETSEC ;Sets the sector for the next read or write operation
00231 ; from the A register
0024 C3A809 00232 JMP SETDMA ;Sets the direct memory address (disk read/write)
00233 ; address for the next read or write operation
00234 ; from the DE register pair
0027 C3370A 00235 JMP READ ;Reads the previously specified track and sector from
00236 ; the selected disk into the DMA address
002A C34B0A 00237 JMP WRITE ;Writes the previously specified track and sector onto
00238 ; the selected disk from the DMA address
002D C3D704 00239 JMP LISTST ;Returns A = OFFH if the list device(s) are
00240 ; logically ready to accept another output byte
0030 C3100A 00241 JMP SECTRAN ;Translates a logical sector into a physical one
00242 ;
00243 ; Additional "private" BIOS entry points
00244 ;
0033 C38F04 00245 JMP AUXIST ;Returns A = OFFH if there is input data for
00246 ; the logical auxiliary device
0036 C39B04 00247 JMP AUXOST ;Returns A = OFFH if the auxiliary device(s) are
00248 ; logically ready to accept another output byte
0039 C3FA02 00249 JMP Specific;CIO$Initialization
00250 ;Initializes character device whose device
00251 ; number is in register A on entry
003C C36D08 00252 JMP Set$Watchdog
00253 ;Sets up watchdog timer to CALL address specified
00254 ; in HL, after BC clock ticks have elapsed
003F C33C0F 00255 JMP CB$Get$Address
00256 ;Configuration block get address
00257 ; Returns address in HL of data element whose
00258 ; code number is specified in C
00259 ;
00400 ;#
00401 ; Long term configuration block
00402 ;
00403 Long$Term$CB:
00404 ;
00405 ;
00406 ; Public files (files in user 0 accessible from all
00407 ; other user numbers) enabled when this flag is set
00408 ; nonzero.
00409 ;
0042 00 00410 CB$Public$Files: DB 0 ;Default is OFF
00411 ;
00412 ;
00413 ; The forced input pointer is initialized to point to the
00414 ; following string of characters. These are injected into
00415 ; the console input stream on system start-up.
00416 ;
0043 5355424D4900417 CB$Startup: DB 'SUBMIT STARTUP',LF,0,0,0,0,0
00418 ;
00419 ; Logical to physical device redirection
00420 ;
00421 ; Each logical device has a 16-bit word associated
00422 ; with it. Each bit in the word is assigned to a
00423 ; specific physical device. For input, only one bit
00424 ; can be set -- input will be read from the
00425 ; corresponding physical device. Output can be
00426 ; directed to several devices, so more than one
00427 ; bit can be set.
00428 ;
00429 ; The following equates are used to indicate
00430 ; specific physical devices.
00431 ;
00432 ; 1111 11 )
00433 ; 5432 1098 7654 3210 )<- Device number
0001 = 00434 Device#0 EQU 0000$0000$0000$0001B
0002 = 00435 Device#1 EQU 0000$0000$0000$0010B
0004 = 00436 Device#2 EQU 0000$0000$0000$0100B
00437 ;
00438 ; The following words are tested by the logical
00439 ; device drivers to transfer control to

```

Figure 8-10. (Continued)

```

00440 ; the appropriate physical device drivers
00441 ;
0058 0100 00442 CB#Console#Input: DW Device#0
005A 0100 00443 CB#Console#Output: DW Device#0
00444 ;
005C 0200 00445 CB#Auxiliary#Input: DW Device#1
005E 0200 00446 CB#Auxiliary#Output: DW Device#1
00447 ;
0060 0400 00448 CB#List#Input: DW Device#2
0062 0400 00449 CB#List#Output: DW Device#2
00450 ;
00451 ; The table below relates specific bits in the
00452 ; redirection words above to specific device
00453 ; tables used by the physical drivers
00454 ;
00455 CB#Device#Table#Addresses:
0064 8E02 00456 DW DT#0
0066 AE02 00457 DW DT#1
0068 CE02 00458 DW DT#2
006A 00000000000000459 - DW 0,0,0,0,0,0,0,0,0,0,0,0,0,0 ;Unassigned
00460 ;
00461 ;
00462 ; Device initialization byte streams
00463 ;
00464 ; These initialization streams are output during the device
00465 ; initialization phase, or on request whenever the baud rate
00466 ; needs to be changed. They are defined in the long term
00467 ; configuration block so as to "freeze" their contents from one
00468 ; system startup until the next.
00469 ;
00470 ; The address of each stream is contained in each device table.
00471 ;
00472 ; The stream format is:
00473 ;
00474 ; DB xx ;Port number (00H terminates)
00475 ; DB nn ;Number of bytes to output to port
00476 ; DB vv,vv,vv.. ;Values to be output
00477 ;
00478 DO#Initialize#Stream: ;Example data for an 8251A chip
0084 ED 00479 DB OEDH ;Port number for 8251A
0085 06 00480 DB 6 ;Number of bytes
0086 000000 00481 DB 0,0,0 ;Dummy bytes to get chip ready
0089 42 00482 DB 0100#0010B ;Reset and raise DTR
008A 6E 00483 DB 01#10#11#10B ;1 stop, no parity, 8 bits/char,
00484 ; divide down of 16
008B 25 00485 DB 0010#0101B ;RTS high, enable Tx/Rx
008C DF 00486 ;Example data for an 8253 chip
008D 01 00487 DB ODFH ;Port number for 8253 mode
008E 76 00488 DB 1 ;Number of bytes to output
00489 ;Select:
00490 ; Counter 1
00491 ; Load LS byte first
00492 ; Mode 3, binary count
008F DE 00493 DB ODEH ;Port number for counter
0090 02 00494 DB 2 ;Number of bytes to output
00495 DO#Baud#Rate#Constant: ;Label used by utilities
0091 0700 00496 DW 0007H ;9600 Baud (based on 16x divider)
0093 00 00497 DB 0 ;Port number of 00 terminates stream
00498 ;
00499 D1#Initialize#Stream: ;Example data for an 8251A chip
0094 DD 00500 DB ODDH ;Port number for 8251A
0095 06 00501 DB 6 ;Number of bytes
0096 000000 00502 DB 0,0,0 ;Dummy bytes to get chip ready
0099 42 00503 DB 0100#0010B ;Reset and raise DTR
009A 6E 00504 DB 01#10#11#10B ;1 stop, no parity, 8 bits/char,
00505 ; divide down of 16
009B 25 00506 DB 0010#0101B ;RTS high, enable Tx/Rx
00507 ;
00508 ;Example data for an 8253 chip
009C DF 00509 DB ODFH ;Port number for 8253 mode
009D 01 00510 DB 1 ;Number of bytes to output
009E B6 00511 DB 10#11#011#0B ;Select:
00512 ; Counter 2
00513 ; Load LS byte first
00514 ; Mode 3, binary count
009F DE 00515 DB ODEH ;Port number for counter
00A0 02 00516 DB 2 ;Number of bytes to output

```

Figure 8-10. (Continued)

```

00A1 3800 00517 D1#Baud#Rate#Constant:
00A3 00 00518 DW 0038H ;1200 baud (based on 16x divider)
00519 DB 0 ;Port number of 00 terminates stream
00520
00521 D2#Initialize#Stream: ;Example data for an 8251A chip
00A4 DD 00522 DB 0DDH ;Port number for 8251A
00A5 06 00523 DB 6 ;Number of bytes
00A6 000000 00524 DB 0,0,0 ;Dummy bytes to get chip ready
00A9 42 00525 DB 0100#0010B ;Reset and raise DTR
00AA 6E 00526 DB 01#10#11#10B ;1 stop, no parity, 8 bits/char,
; divide down of 16
00AB 25 00528 DB 0010#0101B ;RTS high, enable Tx/Rx
00529
00530 ;Example data for an 8253 chip
00AC DF 00531 DB 0DFH ;Port number for 8253 mode
00AD 01 00532 DB 1 ;Number of bytes to output
00AE F6 00533 DB 11#11#011#0B ;Select:
; Counter 3
; Load LS byte first
; Mode 3, binary count
;Port number for counter
;Number of bytes to output
00AF DE 00537 DB 0DEH
00B0 02 00538 DB 2
00539
00B1 3800 00540 D2#Baud#Rate#Constant:
00B3 00 00541 DW 0038H ;1200 baud (based on 16x divider)
00542 DB 0 ;Port number of 00 terminates stream
00543 ;
00544 ; This following table is used to determine the maximum
00545 ; value for each character position in the ASCII time
00546 ; value above (except the ":"). Note -- this table is
00547 ; in the long term configuration block so that the clock
00548 ; can be set "permanently" to either 12 or 24 hour format.
00549 ;
00550 ; NOTE: The table is processed backwards -- to correspond
00551 ; with the ASCII time.
00552 ; Each character represents the value for the corresponding
00553 ; character in the ASCII time at which a carry-and-reset-to-zero
00554 ; should occur.
00555 ;
00B4 00 00556 DB 0 ;"Terminator"
00557
00B5 3334 00558 CB#12#24#Clock: DB '34' ;Change to '23' for a 12-hour clock
00B7 FF 00559 DB 0FFH ;"Skip" character
00B8 363A 00560 DB '6:' ;Maximum minutes are 59
00BA FF 00561 DB 0FFH ;"Skip" character
00BB 363A 00562 DB '6:' ;Maximum seconds are 59
00563 Update#Time#End: ;Used when updating the time
00564 ;
00565 ;
00566 ; Variables for the real time clock and watchdog
00567 ; timer
00568 ;
00BD 3C 00569 RTC#Ticks#per#Second DB 60 ;Number of real time clock
00570 ; ticks per elapsed second
00BE 3C 00571 RTC#Tick#Count DB 60 ;Residual count before next
00572 ; second will elapse
00BF 0000 00573 RTC#Watchdog#Count DW 0 ;Watchdog timer tick count
00574 ;(0 = no watchdog timer set)
00C1 0000 00575 RTC#Watchdog#Address DW 0 ;Address to which control
00576 ; will be transferred if the
00577 ; watchdog count hits 0
00578
00579 ;
00580 ; Function key table
00581 ;
00582 ; This table consists of a series of entries, each one having the
00583 ; following structure:
00584 ;
00585 ; DB Second character of sequence emitted by
00586 ; terminal's function key
00587 ; ( DB Third character of sequence -- NOTE: this )
00588 ; ( field will not be present if the source code )
00589 ; ( has been configured to accept only two characters )
00590 ; ( in function key sequences. )
00591 ; ( NOTE: Adjust the equates for; )
00592 ; ( Function#Key#Length )
00593 ; ( Three#Character#Function )

```

Figure 8-10. (Continued)

```

00594 ;
00595 ; DB A character string to be forced into the console
00596 ; input stream when the corresponding function key
00597 ; is pressed. The last byte of this string must be
00598 ; 00H to terminate the forced input.
00599 ;
001B = 00600 Function$Key$Lead EQU 1BH ;Signals function key sequence
0003 = 00601 Function$Key$Length EQU 3 ;Number of characters in function
; key input sequence (NOTE: this
; can only be 3 or 2 characters).
00602 ;
00603 ;
00604 ;
00605 ;
00606 ;
00607 ; ;The logic associated with function
00608 ; key recognition is made easier with
0001 = 00609 Three$Character$Function EQU Function$Key$Length - 2
00610 ;Three$Character$Function will be TRUE if the
00611 ; function keys emit a three character
00612 ; sequence, FALSE if they emit a two character
00613 ; sequence.
00614 ;
00615 ; Each entry in the table must be the same length, as defined by:
00616 ;
0013 = 00617 CB$Function$Key$Entry$Size EQU 16 + 1 + Function$Key$Length - 1
00618 ;
00619 ; ;
00620 ; Maximum length of substitute ; Lead character is not
00621 ; string ; in table entry
00622 ; ; For the terminating 00H
00623 ;
00624 ; The last entry in the table is marked by a 00-byte.
00625 ;
00626 ; The example values shown below are for a VT-100 terminal.
00627 ;
00628 ; CB$Function$Key$Table:
00629 ; 123456789.1234 5 6 7 <- Use to check length
0003 4F5046756E00630 ; DB '0','P','Function Key 1',LF,0,0
0006 4F5146756E00631 ; DB '0','Q','Function Key 2',LF,0,0
00E9 4F5246756E00632 ; DB '0','R','Function Key 3',LF,0,0
00FC 4F5346756E00633 ; DB '0','S','Function Key 4',LF,0,0
00634 ;
00635 ; ;
; 123456789.1
010F 5B4155702000636 ; DB '[','A','Up Arrow',LF,0,0,0,0,0,0,0,0,0,0,0,0,0,0
0122 5B42446F7700637 ; DB '[','B','Down Arrow',LF,0,0,0,0,0,0,0,0,0,0,0,0,0,0,0,0
0135 5B4352696700638 ; DB '[','C','Right Arrow',LF,0,0,0,0,0,0,0,0,0,0,0,0,0,0,0,0
0148 5B444C656600639 ; DB '[','D','Left Arrow',LF,0,0,0,0,0,0,0,0,0,0,0,0,0,0,0,0
00640 ;
015B 000000000000641 ; DB 0,0,0,0,0,0,0,0,0,0,0,0,0,0,0,0,0,0,0,0,0,0,0,0,0,0,0,0 ;Spare entries
016E 000000000000642 ; DB 0,0,0,0,0,0,0,0,0,0,0,0,0,0,0,0,0,0,0,0,0,0,0,0,0,0,0,0
0181 000000000000643 ; DB 0,0,0,0,0,0,0,0,0,0,0,0,0,0,0,0,0,0,0,0,0,0,0,0,0,0,0,0
0194 000000000000644 ; DB 0,0,0,0,0,0,0,0,0,0,0,0,0,0,0,0,0,0,0,0,0,0,0,0,0,0,0,0
01A7 000000000000645 ; DB 0,0,0,0,0,0,0,0,0,0,0,0,0,0,0,0,0,0,0,0,0,0,0,0,0,0,0,0
01BA 000000000000646 ; DB 0,0,0,0,0,0,0,0,0,0,0,0,0,0,0,0,0,0,0,0,0,0,0,0,0,0,0,0
01CD 000000000000647 ; DB 0,0,0,0,0,0,0,0,0,0,0,0,0,0,0,0,0,0,0,0,0,0,0,0,0,0,0,0
01E0 000000000000648 ; DB 0,0,0,0,0,0,0,0,0,0,0,0,0,0,0,0,0,0,0,0,0,0,0,0,0,0,0,0
01F3 000000000000649 ; DB 0,0,0,0,0,0,0,0,0,0,0,0,0,0,0,0,0,0,0,0,0,0,0,0,0,0,0,0
0206 000000000000650 ; DB 0,0,0,0,0,0,0,0,0,0,0,0,0,0,0,0,0,0,0,0,0,0,0,0,0,0,0,0
00651 ;
0219 FFFF 00652 ; DB OFFH,OFFH ;Terminator for utility that preprograms
; function key sequence
00653 ;
00654 ;
00655 ;
00656 ; Console output escape sequence control table
00657 ;
00658 ; This table is referenced after a Function$Key$Lead character
00659 ; has been detected in the CONOUT routine. The next character
00660 ; to be output to the console is compared to the first byte
00661 ; in each 3-byte table entry. If a match is found, then control
00662 ; is transferred to the address following the byte that matched.
00663 ;
; CONOUT$Escape$Table:
021B 74 00665 ; DB 't' ;Read current time
021C 4804 00666 ; DW CONOUT$Time
021E 64 00667 ; DB 'd' ;Read current date
021F 4104 00668 ; DW CONOUT$Date
0221 75 00669 ; DB 'u' ;Set current time
0222 5D04 00670 ; DW CONOUT$Set$Time

```

Figure 8-10. (Continued)

```

00941                                     ; data-set-ready pin
00942                                     ; on the chip. It is connected
00943                                     ; to the DTR pin on the cable
0027 = 00944 D$Raise$RTS EQU 00$1$00111B ;Raise RTS, Tx/Rx enable
0007 = 00945 D$Drop$RTS EQU 00$0$00111B ;Drop RTS, Tx/Rx enable
00946 ;
00947 ;
00948 ; Interrupt controller ports (Intel 8259A)
00949 ;
00950 ; Note : these equates are placed here so that they
00951 ; follow the definition of the interrupt vector
00952 ; and thus avoid 'P' (phase) errors in ASM.
00953 ;
00D9 = 00954 IC$OCW1$Port EQU 0D9H ;Operational control word 1
00D8 = 00955 IC$OCW2$Port EQU 0D8H ;Operational control word 2
00D8 = 00956 IC$OCW3$Port EQU 0D8H ;Operational control word 3
00D8 = 00957 IC$ICW1$Port EQU 0D8H ;Initialization control word 1
00D9 = 00958 IC$ICW2$Port EQU 0D9H ;Initialization control word 2
00959 ;
0020 = 00960 IC$EOI EQU 20H ;Nonspecific end of interrupt
00961 ;
0056 = 00962 IC$ICW1 EQU (Interrupt$Vector AND 1110$0000B) + 000$10110B
00963 ;Sets the A7 - A5 bits of the interrupt
00964 ; vector address plus:
00965 ; Edge triggered
00966 ; 4-byte interval
00967 ; Single 8259 in system
00968 ; No ICW4 needed
0002 = 00969 IC$ICW2 EQU Interrupt$Vector SHR 8
00970 ;Address bits A15 - A8 of the interrupt
00971 ; vector address. Note the interrupt
00972 ; vector is the first structure in
00973 ; the long term configuration block
00974 ;
00FC = 00975 IC$OCW1 EQU 1111$1100B ;Interrupt mask
00976 ;Interrupt 0 (clock) enabled
00977 ;Interrupt 1 (character input) enabled
00978 ;
;#
01100 ;
01101 ;
01102 ;
01103 Display$Message: ;Displays the specified message on the console.
01104 ;On entry, HL points to a stream of bytes to be
01105 ;output. A 00H-byte terminates the message.
025F 7E 01106 MOV A,M ;Get next message byte
0260 B7 01107 ORA A ;Check if terminator
0261 C8 01108 RZ ;Yes, return to caller
0262 4F 01109 MOV C,A ;Prepare for output
0263 E5 01110 PUSH H ;Save message pointer
0264 CDD703 01111 CALL CONOUT ;Go to main console output routine
0267 E1 01112 POP H ;Recover message pointer
0268 23 01113 INX H ;Move to next byte of message
0269 C35F02 01114 JMP Display$Message ;Loop until complete message output
01115 ;
;#
01200 ;
01201 ;
01202 Enter$CPM: ;This routine is entered either from the cold or warm
01203 ; boot code. It sets up the JMP instructions in the
01204 ; base page, and also sets the high-level disk driver's
01205 ; input/output address (the DMA address).
01206 ;
026C 3EC3 01207 MVI A,JMP ;Get machine code for JMP
026E 320000 01208 STA 0000H ;Set up JMP at location 0000H
0271 320500 01209 STA 0005H ; and at location 0005H
01210 ;
0274 210300 01211 LXI H,Warm$Boot$Entry ;Get BIOS vector address
0277 220100 01212 SHLD 0001H ;Put address at location 0001H
01213 ;
027A 2106CC 01214 LXI H,BDOS$Entry ;Get BDOS entry point address
027D 220600 01215 SHLD 6 ;Put address at location 0005H
01216 ;
0280 018000 01217 LXI B,80H ;Set disk I/O address to default
0283 CDA809 01218 CALL SETDMA ;Use normal BIOS routine
01219 ;
0286 FB 01220 EI ;Ensure interrupts are enabled
0287 3A0400 01221 LDA Default$Disk ;Handover current default disk to
028A 4F 01222 MOV C,A ; console command processor

```

Figure 8-10. (Continued)

028B C300C4	01223	JMP	CCP%Entry	;Transfer to CCP
	01224	;		
	01300	;		
	01301	;		
	01302	;	Device table equates	
	01303	;	The drivers use a device table for each	
	01304	;	physical device they service. The equates that follow	
	01305	;	are used to access the various fields within the	
	01306	;	device table.	
	01307	;		
	01308	;	Port numbers and status bits	
0000 =	01309	DT%Status%Port	EQU	0 ;Device status port number
0001 =	01310	DT%Data%Port	EQU	DT%Status%Port+1
	01311			;Device data port number
0002 =	01312	DT%Output%Ready	EQU	DT%Data%Port+1
	01313			;Output ready status mask
0003 =	01314	DT%Input%Ready	EQU	DT%Output%Ready+1
	01315			;Input ready status mask
0004 =	01316	DT%DTR%Ready	EQU	DT%Input%Ready+1
	01317			;DTR ready to send mask
0005 =	01318	DT%Reset%Int%Port	EQU	DT%DTR%Ready+1
	01319			;Port number used to reset an
	01320			; interrupt
0006 =	01321	DT%Reset%Int%Value	EQU	DT%Reset%Int%Port+1
	01322			;Value output to reset interrupt
0007 =	01323	DT%Detect%Error%Port	EQU	DT%Reset%Int%Value+1
	01324			;Port number for detecting error
0008 =	01325	DT%Detect%Error%Value	EQU	DT%Detect%Error%Port+1
	01326			;Mask for detecting error (parity etc.)
0009 =	01327	DT%Reset%Error%Port	EQU	DT%Detect%Error%Value+1
	01328			;Output to port to reset error
000A =	01329	DT%Reset%Error%Value	EQU	DT%Reset%Error%Port+1
	01330			;Value to output to reset error
000B =	01331	DT%RTS%Control%Port	EQU	DT%Reset%Error%Value+1
	01332			;Control port for lowering RTS
000C =	01333	DT%Drop%RTS%Value	EQU	DT%RTS%Control%Port+1
	01334			;Value, when output, to drop RTS
000D =	01335	DT%Raise%RTS%Value	EQU	DT%Drop%RTS%Value+1
	01336			;Value, when output, to raise RTS
	01337	;		
	01338			Device logical status (incl. protocols)
000E =	01339	DT%Status	EQU	DT%Raise%RTS%Value+1
	01340			;Status bits
0001 =	01341	DT%Output%Suspend	EQU	0000%0001B
	01342			;Output suspended pending
	01343			; protocol action
0002 =	01343	DT%Input%Suspend	EQU	0000%0010B
	01344			;Input suspended until
	01345			; buffer empties
0004 =	01345	DT%Output%DTR	EQU	0000%0100B
	01346	DT%Output%Xon	EQU	0000%1000B
	01347	DT%Output%EtX	EQU	0001%0000B
	01348	DT%Output%Timeout	EQU	0010%0000B
0040 =	01349	DT%Input%RTS	EQU	0100%0000B
	01350	DT%Input%Xon	EQU	1000%0000B
	01351	;		;Output uses DTR-high-to-send
	01352			;Output uses XON/XOFF
000F =	01352	DT%Status%2	EQU	DT%Status+1
	01353			;Secondary status byte
0001 =	01353	DT%Fake%Typeahead	EQU	0000%0001B
	01354			;Requests Input%Status to
	01355			; return "Data Ready" when
	01356			; control characters are in
	01357			; input buffer
0010 =	01358	DT%EtX%Count	EQU	DT%Status%2+1
	01359			;No. of chars. sent in EtX protocol
0012 =	01360	DT%EtX%Message%Length	EQU	DT%EtX%Count+2
	01361			;Specified message length
	01362	;		
	01363			Input buffer values
0014 =	01364	DT%Buffer%Base	EQU	DT%EtX%Message%Length+2
	01365			;Address of input buffer
0016 =	01366	DT%Put%Offset	EQU	DT%Buffer%Base+2
	01367			;Offset for putting chars. into buffer
0017 =	01368	DT%Get%Offset	EQU	DT%Put%Offset+1
	01369			;Offset for getting chars. from buffer
0018 =	01370	DT%Buffer%Length%Mask	EQU	DT%Get%Offset+1
	01371			;Length of buffer - 1
	01372			;Note: Buffer length must always be
	01373			; a binary number; e.g. 32, 64 or 128

Figure 8-10. (Continued)

```

01374                                     ;This mask then becomes:
01375                                     ; 32 -> 31 (0001#1111B)
01376                                     ; 64 -> 63 (0011#1111B)
01377                                     ; 128 -> 127 (0111#1111B)
01378                                     ;After the get/put offset has been
01379                                     ; incremented, it is ANDed with the mask
01380                                     ; to reset it to zero when the end of
01381                                     ; the buffer has been reached
0019 = 01382 DT$Character$Count EQU DT$Buffer$Length$Mask+1
01383                                     ;Count of the number of characters
01384                                     ; currently in the buffer
001A = 01385 DT$Stop$Input$Count EQU DT$Character$Count+1
01386                                     ;Stop input when the count reaches
01387                                     ; this value
001B = 01388 DT$Resume$Input$Count EQU DT$Stop$Input$Count+1
01389                                     ;Resume input when the count reaches
01390                                     ; this value
001C = 01391 DT$Control$Count EQU DT$Resume$Input$Count+1
01392                                     ;Count of the number of control
01393                                     ; characters in the buffer
001D = 01394 DT$Function$Delay EQU DT$Control$Count+1
01395                                     ;Number of clock ticks to delay to
01396                                     ; allow all characters after function
01397                                     ; key lead-in to arrive
001E = 01398 DT$Initialize$Stream EQU DT$Function$Delay+1
01399                                     ;Address of byte stream necessary to
01400                                     ; initialize this device
01401
01500 ;#
01501 ;
01502 ; Device tables
01503 ;
01504 DT$0:
028E 81 01505 DB D0$Status$Port ;Status port (8251A chip)
028F 80 01506 DB D0$Data$Port ;Data port
0290 01 01507 DB D$Output$Ready ;Output data ready
0291 02 01508 DB D$Input$Ready ;Input data ready
0292 80 01509 DB D$DTR$High ;DTR ready to send
0293 D8 01510 DB IC$OCW2$Port ;Reset interrupt port (00H is an unused port)
0294 20 01511 DB IC$EOI ;Reset interrupt value (nonspecific EOI)
0295 81 01512 DB D0$Status$Port ;Detect error port
0296 38 01513 DB D$error ;Mask: framing, overrun, parity errors
0297 83 01514 DB D0$Command$Port ;Reset error port
0298 37 01515 DB D$error$Reset ;Reset errors: RTS high, reset, Tx/Rx enable
0299 83 01516 DB D0$Command$Port ;Drop/raise RTS port
029A 07 01517 DB D$Drop$RTS ;Drop RTS Value (keep Tx & Rx enabled)
029B 27 01518 DB D$Raise$RTS ;Raise RTS value (keep Tx & Rx enabled)
029C C0 01519 DB DT$Input$Xon + DT$Input$RTS ;Protocol and status
029D 00 01520 DB 0 ;Status #2
029E 0004 01521 DW 1024 ;Etx/Ack message count
02A0 0004 01522 DW 1024 ;Etx/Ack message length
02A2 2422 01523 DW D0$Buffer ;Input buffer
02A4 00 01524 DB 0 ;Put offset into buffer
02A5 00 01525 DB 0 ;Get offset into buffer
02A6 1F 01526 DB D0$Buffer$Length - 1 ;Buffer length mask
02A7 00 01527 DB 0 ;Count of characters in buffer
02A8 1B 01528 DB D0$Buffer$Length - 5 ;Stop input when count hits this value
02A9 10 01529 DB D0$Buffer$Length / 2 ;Resume input when count hits this value
02AA 00 01530 DB 0 ;Count of control characters in buffer
02AB 06 01531 DB 6 ;Number of 16.66ms ticks to allow function
01532 ; key sequence to arrive (approx. 90ms)
02AC 8400 01533 DW D0$Initialize$Stream ;Address of initialization stream
01534 ;
01535 DT$1:
02AE 85 01536 DB D1$Status$Port ;Status port (8251A chip)
02AF 84 01537 DB D1$Data$Port ;Data port
02B0 01 01538 DB D$Output$Ready ;Output data ready
02B1 02 01539 DB D$Input$Ready ;Input data ready
02B2 80 01540 DB D$DTR$High ;DTR ready to send
02B3 D8 01541 DB IC$OCW2$Port ;Reset interrupt port (00H is an unused port)
02B4 20 01542 DB IC$EOI ;Reset interrupt value (nonspecific EOI)
02B5 85 01543 DB D1$Status$Port ;Detect error port
02B6 38 01544 DB D$error ;Mask: framing, overrun, parity errors
02B7 87 01545 DB D1$Command$Port ;Reset error port
02B8 37 01546 DB D$error$Reset ;Reset errors: RTS high, reset, Tx/Rx enable
02B9 87 01547 DB D1$Command$Port ;Drop/raise RTS port
02BA 07 01548 DB D$Drop$RTS ;Drop RTS value (keep Tx & Rx enabled)

```

Figure 8-10. (Continued)

```

02BB 27      01549      DB      D#Raise#RTS      ;Raise RTS value (keep Tx & Rx enabled)
02BC C0      01550      DB      DT#Input#Xon + DT#Input#RTS ;Protocol and status
02BD 00      01551      DB      0                ;Status #2
02BE 0004    01552      DW      1024            ;Etx/Ack message count
02C0 0004    01553      DW      1024            ;Etx/Ack message length
02C2 4422    01554      DW      D1#Buffer      ;Input buffer
02C4 00      01555      DB      0                ;Put offset into buffer
02C5 00      01556      DB      0                ;Get offset into buffer
02C6 1F      01557      DB      D1#Buffer#Length - 1 ;Buffer length mask
02C7 00      01558      DB      0                ;Count of characters in buffer
02C8 1B      01559      DB      D1#Buffer#Length - 5 ;Stop input when count hits this value
02C9 10      01560      DB      D1#Buffer#Length / 2 ;Resume input when count hits this value
02CA 00      01561      DB      0                ;Count of control characters in buffer
02CB 06      01562      DB      6                ;Number of 16.66ms ticks to allow function
                                ; key sequence to arrive (approx. 90ms)
02CC 9400    01564      DW      D1#Initialize#Stream ;Address of initialization stream
                                01565      ;
                                01566      ;
                                DT#2:
02CE 89      01568      DB      D2#Status#Port ;Status port (8251A chip)
02CF 88      01569      DB      D2#Data#Port   ;Data port
02D0 01      01570      DB      D#Output#Ready ;Output data ready
02D1 02      01571      DB      D#Input#Ready  ;Input data ready
02D2 80      01572      DB      D#DTR#High     ;DTR ready to send
02D3 D8      01573      DB      IC#OCW2#Port   ;Reset interrupt port (00H is an unused port)
02D4 20      01574      DB      IC#EOI         ;Reset interrupt value (nonspecific EOI)
02D5 89      01575      DB      D2#Status#Port ;Detect error port
02D6 38      01576      DB      D#Error        ;Mask: framing, overrun, parity errors
02D7 8B      01577      DB      D2#Command#Port ;Reset error port
02D8 37      01578      DB      D#Error#Reset  ;Reset error: RTS high, reset, Tx/Rx enable
02D9 8B      01579      DB      D2#Command#Port ;Drop/raise RTS port
02DA 07      01580      DB      D#Drop#RTS     ;Drop RTS value (keep Tx & Rx enabled)
02DB 27      01581      DB      D#Raise#RTS    ;Raise RTS value (keep Tx & Rx enabled)
02DC C0      01582      DB      DT#Input#Xon + DT#Input#RTS ;Protocol and status
02DD 00      01583      DB      0                ;Status #2
02DE 0004    01584      DW      1024            ;Etx/Ack message count
02E0 0004    01585      DW      1024            ;Etx/Ack message length
02E2 6422    01586      DW      D2#Buffer      ;Input buffer
02E4 00      01587      DB      0                ;Put offset into buffer
02E5 00      01588      DB      0                ;Get offset into buffer
02E6 1F      01589      DB      D2#Buffer#Length - 1 ;Buffer length mask
02E7 00      01590      DB      0                ;Count of characters in buffer
02E8 1B      01591      DB      D2#Buffer#Length - 5 ;Stop input when count hits this value
02E9 10      01592      DB      D2#Buffer#Length / 2 ;Resume input when count hits this value
02EA 00      01593      DB      0                ;Count of control characters in buffer
02EB 06      01594      DB      6                ;Number of 16.66ms ticks to allow function
                                ; Key sequence to arrive (approx. 90ms)
02EC A400    01596      DW      D2#Initialize#Stream ;Address of initialization stream
                                01597      ;
                                ;#
02EE AF      01700      ;
                                01701      ;      General character I/O device initialization
                                01702      ;
                                01703      ;      This routine will be called from the main CP/M
                                01704      ;      initialization code.
                                01705      ;
                                01706      ;      It makes repeated calls to the specific character I/O
                                01707      ;      device initialization routine.
                                01708      ;
                                01709      ;      General#CIO#Initializations:
02EE AF      01710      XRA      A                ;Set device number (used to access the
                                01711      ;      table of device table addresses in the
                                01712      ;      configuration block)
02EF 4F      01713      MOV      C,A              ;Match to externally CALLable interface
                                01714      ;
                                GCI#Next#Device:
02F0 CDFA02  01715      CALL    Specific#CIO#Initialization ;Initialize the device
02F3 3C      01716      INR     A                ;Move to next device
02F4 FE10    01717      CPI     16               ;Check if all possible devices (0 - 15)
02F6 C8      01718      RZ                      ; have been initialized
02F7 C3F002  01719      JMP     GCI#Next#Device
                                01720      ;
                                ;#
                                01800      ;
                                01801      ;
                                01802      ;      Specific character I/O initialization
                                01803      ;
                                01804      ;      This routine outputs the specified byte values to the specified
                                01805      ;      ports as controlled by the initialization streams in the
                                01806      ;      configuration block. Each device table contains a pointer to

```

Figure 8-10. (Continued)

```

01807 ;      these streams. The device table itself is selected according
01808 ;      to the device NUMBER -- this is an entry parameter for this
01809 ;      routine.
01810 ;      This routine will be called either from the general device
01811 ;      initialization routine above, or directly by a BIOS call from
01812 ;      a system utility executing in the TPA.
01813 ;
01814 ;      Entry parameters
01815 ;
01816 ;          C = device number
01817 ;
01818 ;      Exit parameters
01819 ;
01820 ;          A = Device number (preserved)
01821 ;
01822 ;=====
01823 Specific$CIO$Initialization:          ;<=== BIOS entry point (private)
01824 ;=====
02FA 79 01825      MOV     A,C          ;Get device number
02FB F5 01826      PUSH  PSW          ;Preserve device number
02FC 87 01827      ADD     A          ;Make device number into word pointer
02FD 4F 01828      MOV     C,A          ;
02FE 0400 01829     MVI     B,0          ;Make into a word
0300 216400 01830     LXI     H,CB$Device$Table$Addresses ;Get table base
0303 09 01831      DAD     B          ;HL -> device table address
0304 5E 01832      MOV     E,M          ;Get LS byte
0305 23 01833      INX     H          ;
0306 56 01834      MOV     D,M          ;Get MS byte: DE -> device table
01835 ;
0307 7A 01836      MOV     A,D          ;Check if device table address = 0
0308 B3 01837      ORA     E          ;
0309 CA1703 01838     JZ     SCI$Exit      ;Yes, device table nonexistent
01839 ;
030C 211E00 01840     LXI     H,DT$Initialize$Stream
030F 19 01841      DAD     D          ;HL -> initialization stream address
0310 5E 01842      MOV     E,M          ;Get LS byte
0311 23 01843      INX     H          ;
0312 56 01844      MOV     D,M          ;Get MS byte
0313 EB 01845      XCHG          ;HL -> initialization stream itself
0314 CD1903 01846     CALL    Output$Byte$Stream ;Output byte stream to various
01847 ;          ; ports
01848 ;
01849 SCI$Exit:
0317 F1 01850      POP     PSW          ;Recover user's device number in C
0318 C9 01851      RET
01852 ;
02000 ;#
02001 ;      Output byte stream
02002 ;
02003 ;      This routine outputs initialization bytes to port
02004 ;      numbers. The byte stream has the following format:
02005 ;
02006 ;          DB     ppH      Port number
02007 ;          DB     nn      Number of bytes to output
02008 ;          DB     vvH,vvH... Bytes to be output
02009 ;          :
02010 ;          :      Repeated
02011 ;          :
02012 ;          DB     00H      Port number of 0 terminates
02013 ;
02014 ;      Entry parameters
02015 ;
02016 ;          HL -> Byte stream
02017 ;
02018 Output$Byte$Stream:
02019 OBS$Loop:
0319 7E 02020      MOV     A,M          ;Get port number
031A B7 02021      ORA     A          ;Check if 00H (terminator)
031B C8 02022      RZ          ;Exit if at end of stream
031C 322503 02023     STA     OBS$Port      ;Store in port number below
031F 23 02024      INX     H          ;HL -> count of bytes
0320 4E 02025      MOV     C,M          ;Get count
0321 23 02026      INX     H          ;HL -> first initialization byte
02027 ;
02028 OBS$Next$Byte:
0322 7E 02029      MOV     A,M          ;Get next byte
0323 23 02030      INX     H          ;HL -> next data byte (or port number)

```

Figure 8-10. (Continued)

```

0324 D3      02031
             02032          DB      OUT
             02033 OBS#Port:
0325 00      02034          DB      0          ;<- Set up in instruction above
0326 0D      02035          DCR      C          ;Count down on byte counter
0327 C22203  02036          JNZ     OBS#Next$Byte ;Output next data byte
032A C31903  02037          JMP     OBS#Loop    ;Go back for next port number
             02038
             ;
             02100          ;#
             02101          ;
             02102          ;          CONST - Console status
             02103          ;
             02104          ;          This routine checks both the forced input pointer and
             02105          ;          the character count for the appropriate input buffer.
             02106          ;          The A register is set to indicate whether or not there
             02107          ;          is data waiting.
             02108          ;
             02109          ;          Entry parameters: none.
             02110          ;
             02111          ;          Exit parameters
             02112          ;
             02113          ;          A = 000H if there is no data waiting
             02114          ;          A = 0FFH if there is data waiting
             02115          ;
             02116          ;          =====
             02117          ;          CONST:                                     ;<== BIOS entry point (standard)
             02118          ;          =====
032D 2A5800  02118          LHL     CB#Console$Input ;Get redirection word
0330 116400  02119          LXI     D,CB#Device$Table$Addresses
0333 CD6F06  02120          CALL    Select$Device$Table ;Get device table address
0336 C34708  02121          JMP     Get$Input$Status ;Get status from input device
             02122          ;          ; and return to caller
             02200          ;#
             02201          ;
             02202          ;          CONIN -- console input
             02203          ;
             02204          ;          This routine returns the next character for the console input
             02205          ;          stream. Depending on the circumstances, this can be a character
             02206          ;          from the console input buffer, or from a previously stored
             02207          ;          string of characters to be "forced" into the input stream,for
             02208          ;          the automatic execution of system initialization routines.
             02209          ;          The "forced input" can come from any previously stored character
             02210          ;          string in memory. It is used to inject the current time and date
             02211          ;          or a string associated with a function key into the console
             02212          ;          stream. On system startup, a string of "SUBMIT STARTUP" is
             02213          ;          forced into the console input stream to provide a mechanism.
             02214          ;
             02215          ;          Normal ("unforced") input comes from whichever physical device
             02216          ;          is specified in the console input redirection word (see the
             02217          ;          configuration block).
             02218          ;
0339 00      02219          CONIN$Delay$Elapsed: DB      0          ;Flag used during function key
             02220          ;          ; processing to indicate that
             02221          ;          ; a predetermined delay has
             02222          ;          ; elapsed
             02223          ;
             02224          ;          =====
             02225          ;          CONIN:                                     ;<== BIOS entry point (standard)
             02226          ;          =====
033A 2ABD0F  02227          LHL     CB#Forced$Input ;Get the forced input pointer
033D 7E      02228          MOV     A,M          ;Get the next character of input
033E B7      02229          ORA     A          ;Check if a null
033F CA4703  02230          JZ     CONIN$No$FI ;Yes, no forced input
0342 23      02231          INX     H          ;Yes, update the pointer
0343 22BD0F  02232          SHLD   CB#Forced$Input ; and store it back
0346 C9      02233          RET
             02234          ;
             02235          ;          CONIN$No$FI ;No forced input
0347 2A5800  02236          LHL     CB#Console$Input ;Get redirection word
034A 116400  02237          LXI     D,CB#Device$Table$Addresses
034D CD6F06  02238          CALL    Select$Device$Table ;Get device table address
0350 CD9106  02239          CALL    Get$Input$Character ;Get next character from input device
             02240          ;
             02241          ;          ;Function key processing
0353 FE1B   02242          CPI     Function$Key$Lead ;Check if first character of function
             02243          ;          ; key sequence (normally escape)
0355 C0      02244          RNZ     ;Return to BIOS caller if not
0356 F5      02245          PUSH   PSW          ;Save lead in character

```

Figure 8-10. (Continued)

0357	211D00	02246	LXI	H,DT#Function\$Delay	;Get delay time constant for
		02247			; delay while waiting for subsequent
		02248			; characters of function key sequence
		02249			; to arrive
035A	19	02250	DAD	D	
035B	4E	02251	MOV	C,M	
035C	0600	02252	MVI	B,0	;Get delay value
035E	AF	02253	XRA	A	;Make into word value
035F	323903	02254	STA	CONIN\$Delay\$Elapsed	;Indicate timer not yet out of time
0362	217B03	02255	LXI	H,CONIN\$Set\$Delay\$Elapsed	;Address to resume at after delay
0365	CD6D08	02256	CALL	Set\$Watchdog	;Sets up delay based on real time
		02257			; clock such that control will be
		02258			; transferred to specified address
		02259			; after time interval has elapsed
		02260			;Wait here until delay has elapsed
0368	3A3903	02261	LDA	CONIN\$Delay\$Elapsed	;Check flag set by watchdog routine
036B	B7	02262	ORA	A	
036C	CA6803	02263	JZ	CONIN\$Wait\$for\$Delay	
		02264			
		02265			CONIN\$Check\$for\$Function:
036F	211900	02266	LXI	H,DT\$Character\$Count	;Now check if the remaining characters
		02267			; of the sequence have been input
0372	19	02268	DAD	D	
0373	7E	02269	MOV	A,M	;Get count of characters in buffer
0374	FE02	02270	CPI	Function\$Key\$Length - 1	
0376	D28103	02271	JNC	CONIN\$Check\$Function	;Enough characters in buffer for
		02272			; possible function key sequence
0379	F1	02273	POP	PSW	;Insufficient characters in buffer
		02274			; to be a function key, so return
		02275			; to caller with lead character
037A	C9	02276	RET		
		02277			
		02278			
		02279			; The following routine is called by the watchdog routine
		02280			; when the specified delay has elapsed.
		02281			
		02282			CONIN\$Set\$Delay\$Elapsed:
037B	3EFF	02283	MVI	A,OFFH	;Indicate watchdog timer out of time
037D	323903	02284	STA	CONIN\$Delay\$Elapsed	
0380	C9	02285	RET		;Return to watchdog routine
		02286			
		02287			
		02288			CONIN\$Check\$Function:
0381	211700	02289	LXI	H,DT\$Get\$Offset	;Save the current "get pointer"
0384	19	02290	DAD	D	; in the buffer
0385	7E	02291	MOV	A,M	;Get the pointer
0386	F5	02292	PUSH	PSW	;Save pointer on the stack
		02293			
0387	211700	02294	LXI	H,DT\$Get\$Offset	;Check the second (and possibly third)
038A	CDF007	02295	CALL	Get\$Address\$in\$Buffer	; character in the sequence
038D	46	02296	MOV	B,M	;Get the second character
		02297			
		02298			IF Three\$Character\$Function
038E	C5	02299	PUSH	B	;Save for later use
038F	211700	02300	LXI	H,DT\$Get\$Offset	;Retrieve the third character
0392	CDF007	02301	CALL	Get\$Address\$in\$Buffer	
0395	C1	02302	POP	B	;Recover second character
0396	4E	02303	MOV	C,M	;Now BC = Char 2, Char 3
		02304	ENDIF		
		02305			
0397	D5	02306	PUSH	D	;Save device table pointer
0398	21B000	02307	LXI	H,CB\$Function\$Key\$Table - CB\$Function\$Key\$Entry\$Size	
		02308			;Get pointer to function key table
		02309			; in configuration block
039B	111300	02310	LXI	D,CB\$Function\$Key\$Entry\$Size	;Get entry size ready for loop
		02311			CONIN\$Next\$Function:
039E	19	02312	DAD	D	;Move to next (or first) entry
039F	7E	02313	MOV	A,M	;Get second character of sequence
03A0	B7	02314	ORA	A	;Check if end of function key table
03A1	CAC203	02315	JZ	CONIN\$Not\$Function	;Yes -- it is not a function key
03A4	B8	02316	CMF	B	;Compare second characters
03A5	C29E03	02317	JNZ	CONIN\$Next\$Function	;No match, so try next entry in table
		02318			
		02319			IF Three\$Character\$Function
03A8	23	02320	INX	H	;HL -> third character
03A9	7E	02321	MOV	A,M	;Get third character of sequence
03AA	2B	02322	DCX	H	;Simplify logic for 2 & 3 char. seq.

Figure 8-10. (Continued)

```

03AB B9      02323      CMP      C      ;Compare third characters
03AC C29E03  02324      JNZ      CONIN#Next#Function ;No match, so try next entry in table
03AF 23      02325      INX      H      ;When match found, compensate for
                                ; extra decrement
                                02326
                                02327      ENDIF
                                02328
03B0 23      02329      INX      H      ;HL -> first character of substitute
                                ; string of characters (00-byte term.)
03B1 228D0F  02330      SHLD    CB#Forced#Input ;Make the CONIN routine inject the
                                ; substitute string into the input
                                ; stream
                                02331
                                02332
                                02333
                                02334
                                02335      ;Now that a function sequence has been
                                ; identified, the stack must be
                                ; balanced prior to return
03B4 D1      02336      POP      D      ;Get the device table pointer
03B5 F1      02337      POP      PSW     ;Dump the "get" offset value
03B6 F1      02340      POP      PSW     ;Dump the function sequence lead char.
                                02341
03B7 211900  02342      LXI     H,DT#Character#Count ;Downdate the character count
03BA 19      02343      DAD     D      ; to reflect the characters removed
                                ; from the buffer
03BB 7E      02345      MOV     A,M     ;Get the count
03BC D602    02346      SUI     Function#Key#Length -1 ; (the lead character has already
03BE 77      02347      MOV     M,A     ; been deducted)
03BF C33A03  02348      JMP     CONIN   ;Return to CONIN processing to get
                                ; the forced input characters
                                02349
                                02350      CONIN#Not#Function:
                                02351      ;Attempts to recognize a function key sequence
                                02352      ; have failed. The "get" offset pointer must be
                                02353      ; restored to its previous value so that
                                02354      ; the character(s) presumed to be part of
                                02355      ; the function sequence are not lost.
                                02356
03C2 D1      02357      POP      D      ;Recover device table pointer
03C3 F1      02358      POP      PSW     ;Recover previous "get" offset
03C4 211700  02359      LXI     H,DT#Get#Offset
03C7 19      02360      DAD     D      ;HL -> "get" offset in table
03C8 77      02361      MOV     M,A     ;Reset "get" offset as it was after
                                ; the lead character was detected
03C9 F1      02362      POP      PSW     ;Recover lead character
03CA C9      02364      RET      ;Return the lead character to the user
                                02365
                                ;
                                02500      ;#
                                02501      ;
                                02502      ; Console output
                                02503      ;
                                02504      ; This routine outputs data characters to the console device(s).
                                02505      ; It also "traps" escape sequences being output to the console,
                                02506      ; triggering specific actions according to the sequences.
                                02507      ; A primitive "state-machine" is used to step through escape
                                02508      ; sequence recognition.
                                02509      ; In addition to outputting the next character to all of the
                                02510      ; devices currently selected in the console output redirection word,
                                02511      ; it checks to see that output to the selected device has not been
                                02512      ; suspended by XON/XOFF protocol, and that DTR is high if
                                02513      ; it should be.
                                02514      ; Once the character has been output, if ETX/ACK protocol is in use,
                                02515      ; and the specified length of message has been output, an Etx
                                02516      ; character is output and the device is flagged as being suspended.
                                02517      ;
                                02518      ; Entry parameters
                                02519      ;
                                02520      ; C = character to be output
                                02521      ;
                                02522      ; CONOUT storage variables
                                02523
03CB 00      02523      CONOUT#Character: DB 0 ;Save area for character to be output
                                02524
03CC DB03    02525      CONOUT#Processor: DW CONOUT#Normal
                                02526      ;This is the address of the piece of
                                02527      ; code that will process the next
                                02528      ; character. The default case is
                                02529      ; CONOUT#Normal
03CE 0000   02530      CONOUT#String#Pointer: DW 0 ;This points to a string (normally
                                02531      ; in the configuration block) that
                                02532      ; is being preset by characters from
                                02533      ; the console output stream

```

Figure 8-10. (Continued)

03D0 00	02534	CONOUT\$String\$Length:	DB	0	;This contains the maximum number of
	02535				; characters to be preset into a
	02536				; from the console output stream
	02537				
	02538				
	02539				*** WARNING ***
	02540				The output error message routine shares the code in this
	02541				subroutine. On entry here, the data byte to be output
	02542				will be on the stack, and the DE registers set up correctly.
	02543				
	02544				
	02545	CONOUT\$OEM\$Entry:			
03D1 32CB03	02546	STA	CONOUT\$Character		;Save data byte
03D4 C3E803	02547	JMP	CONOUT\$Entry2		;HL already has special bit map
	02548				
	02549				=====
	02550	CONOUT:			<=== BIOS entry point (standard)
	02551				=====
03D7 2ACC03	02552	LHLD	CONOUT\$Processor		;Get address of processor to handle
	02553				; the next character to be output
	02554				; (Default is CONOUT\$Normal)
03DA E9	02555	PCHL			;Transfer control to the processor
	02556				
	02557				
	02558	CONOUT\$Normal:			;Normal processor for console output
03DB 79	02559	MOV	A,C		;Check if possible start of escape
03DC FE1B	02560	CPI	Function\$Key\$Lead		; sequence
03DE CA1204	02561	JZ	CONOUT\$Escape\$Found		;Perhaps
	02562	CONOUT\$Forced:			
03E1 79	02563	MOV	A,C		;Forced output entry point
03E2 32CB03	02564	STA	CONOUT\$Character		;Not escape sequence -- Save data byte
	02565				
03E5 2A5A00	02566	LHLD	CB\$Console\$Output		;Get console redirection word
	02567				
	02568	CONOUT\$Entry2:			<=== output error message entry point
	02569				
03E8 116400	02570	LXI	D,CB\$Device\$Table\$Addresses		;Addresses of dev. tables
03EB D5	02571	PUSH	D		;Put onto stack ready for loop
03EC E5	02572	PUSH	H		
	02573				
	02574	CONOUT\$Next\$Device:			
03ED E1	02575	POP	H		;Recover redirection bit map
03EE D1	02576	POP	D		;Recover device table addresses pointer
03EF CD6F06	02577	CALL	Select\$Device\$Table		;Get device table in DE
03F2 B7	02578	ORA	A		;Check if a device has been
	02579				; selected (i.e. bit map not all zero)
03F3 CA0D04	02580	JZ	CONOUT\$Exit		;No, exit
03F6 C5	02581	PUSH	B		;Yes - B..
03F7 E5	02582	PUSH	H		;Save redirection bit map
	02583	CONOUT\$Wait:			;Save device table addresses pointer
03F8 CD0F06	02584	CALL	Check\$Output\$Ready		;Check if device not suspended and
	02585				; (if appropriate) DTR is high
03FB CAF803	02586	JZ	CONOUT\$Wait		;No, wait
	02587				
03FE F3	02588	DI			;Interrupts off to avoid
	02589				; involuntary re-entrance
03FF 3ACB03	02590	LDA	CONOUT\$Character		;Recover the data byte
0402 4F	02591	MOV	C,A		;Ready for output
0403 CD2608	02592	CALL	Output\$Data\$Byte		;Output the data byte
0406 FB	02593	EI			
	02594				
0407 CD3A06	02595	CALL	Process\$Etx\$Protocol		;Deal with Etx/Ack protocol
040A C3ED03	02596	JMP	CONOUT\$Next\$Device		;Loop back for next device
	02597				
	02598	CONOUT\$Exit:			
040D 3ACB03	02599	LDA	CONOUT\$Character		;Recover data character
0410 79	02600	MOV	A,C		;CP/M "convention"
0411 C9	02601	RET			
	02602				
	02603	CONOUT\$Escape\$Found:			;Possible escape sequence
0412 211904	02604	LXI	H,CONOUT\$Process\$Escape		;Vector processing of next character
	02605	CONOUT\$Set\$Processor:			
0415 22CC03	02606	SHLD	CONOUT\$Processor		;Set vector address
0418 C9	02607	RET			;Return to BIOS caller
	02700	;			
	02701	;			
	02702	;	Console output: escape sequence processing		

Figure 8-10. (Continued)

```

02703 ;
02704 CONOUT$Process$Escape: ;Control arrives here with character
02705 ; after escape in C
0419 211B02 02706 LXI H,CONOUT$Escape$Table ;Get base of recognition table
02707 CONOUT$Next$Entry:
041C 7E 02708 MOV A,M ;Check if at end of table
041D B7 02709 ORA A
041E CA2B04 02710 JZ CONOUT$No$Match ;Yes, no match found
0421 B9 02711 CMP C ;Compare to data character
0422 CA3B04 02712 JZ CONOUT$Match ;They match
0425 23 02713 INX H ;Move to next entry in table
0426 23 02714 INX H
0427 23 02715 INX H
0428 C31C04 02716 JMP CONOUT$Next$Entry ;Go back and check again
02717 ;
02718 CONOUT$No$Match: ;No match found, so original
02719 ; escape and following character
02720 ; must be output
042B C5 02721 PUSH B ;Save character after escape
042C 0E1B 02722 MVI C,Function$Key$Lead ;Get escape character
042E CDE103 02723 CALL CONOUT$Forced ;Output to console devices
0431 C1 02724 POP B ;Get character after escape
0432 CDE103 02725 CALL CONOUT$Forced ;Output it, too
02726 ;
02727 CONOUT$Set$Normal:
0435 21DB03 02728 LXI H,CONOUT$Normal ;Set vector back to normal
0438 C31504 02729 JMP CONOUT$Set$Processor ; for subsequent characters
02730 ;
02731 ;
02732 CONOUT$Match:
043B 23 02733 INX H ;HL -> LS byte of subprocessor
043C 5E 02734 MOV E,M ;Get LS byte
043D 23 02735 INX H
043E 56 02736 MOV D,M ;Get MS byte
043F EB 02737 XCHG ;HL -> subprocessor
0440 E9 02738 PCHL ;Goto subprocessor
02739 ;
02740 CONOUT$Date: ;Subprocessor to inject current date
02741 ; into console input stream (using
02742 ; forced input)
0441 218F0F 02743 LXI H,Date
02744 CONOUT$Set$Forced$Input:
0444 228D0F 02745 SHLD CB$Forced$Input
0447 C9 02746 RET ;Return to BIOS' caller
02747 ;
02748 CONOUT$Time: ;Subprocessor to inject time into
02749 ; console input stream
0448 21990F 02750 LXI H,Time$In$ASCII
044B C34404 02751 JMP CONOUT$Set$Forced$Input
02752 ;
02753 CONOUT$Set$Date: ;Subprocessor to set the date by taking
02754 ; the next 8 characters of console output
02755 ; and storing them in the date string
044E 21A30F 02756 LXI H,Time$Date$Flags ;Set flag to indicate that the
0451 3E02 02757 MVI A,Date$Set ; date has been set by program
0453 B6 02758 ORA M
0454 77 02759 MOV M,A
0455 3E08 02760 MVI A,8 ;Set character count
0457 218F0F 02761 LXI H,Date ;Set address
045A C36C04 02762 JMP CONOUT$Set$String$Pointer
02763 ;
02764 ;
02765 CONOUT$Set$Time: ;Subprocessor to set the time by taking
02766 ; the next 8 characters of console output
02767 ; and storing them in the time string
045D 21A30F 02768 LXI H,Time$Date$Flags ;Set flag to indicate that the
0460 3E01 02769 MVI A,Time$Set ; time has been set by program
0462 B6 02770 ORA M
0463 77 02771 MOV M,A
0464 3E08 02772 MVI A,8 ;Set character count
0466 21990F 02773 LXI H,Time$in$ASCII ;Set address
0469 C36C04 02774 JMP CONOUT$Set$String$Pointer
02775 ;
02776 CONOUT$Set$String$Pointer: ;HL -> string, A = count
046C 32D003 02777 STA CONOUT$String$Length ;Save count
046F 22CE03 02778 SHLD CONOUT$String$Pointer ;Save address
0472 217804 02779 LXI H,CONOUT$Process$String ;Vector further output

```

Figure 8-10. (Continued)

```

0475 C31504 02780      JMP      CONOUT$Set$Processor
02781      ;
02782      CONOUT$Process$String:      ;Control arrives here for each character
02783      ; in the string in register C. The
02784      ; characters are stacked into the
02785      ; receiving string until either a 00-byte
02786      ; is encountered or the specified number
02787      ; of characters is stacked.
0478 2ACE03 02788      LHLD    CONOUT$String$Pointer      ;Get current address for stacking chars
047B 79      02789      MOV     A,C                          ;Check if current character is 00H
047C B7      02790      ORA     A
047D CA3504 02791      JZ      CONOUT$Set$Normal          ;Revert to normal processing
0480 77      02792      MOV     M,A                          ;Otherwise, stack character
0481 23      02793      INX     H                            ;Update pointer
0482 3600    02794      MVI     M,00H                       ;Stack fail-safe terminator
0484 22CE03 02795      SHLD   CONOUT$String$Pointer      ;Save updated pointer
0487 21D003 02796      LXI    H,CONOUT$String$Length      ;Downdate count
048A 35      02797      DCR     M
048B CA3504 02798      JZ      CONOUT$Set$Normal          ;Revert to normal processing
048E C9      02799      ; if count hits 0
02800      RET                                ;Return with output vectored back
02801      ; to CONOUT$Process$String
02802      ;
02900      ;#
02901      ;
02902      ; Auxiliary input status
02903      ;
02904      ; This routine checks the character count in the
02905      ; appropriate input buffer.
02906      ; The A register is set to indicate whether or not
02907      ; data is waiting.
02908      ;
02909      ; Entry parameters: none.
02910      ;
02911      ; Exit parameters
02912      ;
02913      ; A = 000H if there is no data waiting
02914      ; A = 0FFH if there is data waiting
02915      ;
02916      ;=====
02917      AUXIST:                          ;<=== BIOS entry point (Private)
02918      ;=====
048F 2A5C00 02919      LHLD   CB$Auxiliary$Input          ;Get redirection word
0492 116400 02920      LXI    D,CB$Device$Table$Addresses ; and table pointer
0495 CD6F06 02921      CALL   Select$Device$Table        ;Get device table address
0498 C34708 02922      JMP     Get$Input$Status           ;Get status from input device
02923      ; and return to caller
02924      ;
03000      ;#
03001      ;
03002      ; Auxiliary output status
03003      ;
03004      ; This routine sets the A register to indicate whether the
03005      ; Auxiliary device(s) is/are ready to accept output data.
03006      ; As more than one device can be used for auxiliary output, this
03007      ; routine returns a Boolean AND of all of their statuses.
03008      ;
03009      ; Entry parameters: none
03010      ;
03011      ; Exit parameters
03012      ;
03013      ; A = 000H if one or more list devices are not ready
03014      ; A = 0FFH if all list devices are ready
03015      ;
03016      ;
03017      ;=====
03018      AUXOST:                          ;<=== BIOS entry point (Private)
03019      ;=====
049B 2A5E00 03020      LHLD   CB$Auxiliary$Output        ;Get list redirection word
049E C37905 03021      JMP     Get$Composite$Status
03022      ;
03100      ;#
03101      ;
03102      ; Auxiliary input (replacement for READER)
03103      ;
03104      ; This routine returns the next input character from the

```

Figure 8-10. (Continued)

```

03105 ; appropriate logical auxiliary device.
03106 ;
03107 ; Entry parameters: none.
03108 ;
03109 ; Exit parameters
03110 ;
03111 ; A = data character
03112 ;
03113 ;=====
03114 AUXIN: ;<=== BIOS entry point (standard)
03115 ;=====
04A1 2A5C00 03116 LHL D, CB#Auxiliary$Input ;Get redirection word
04A4 116400 03117 LXI D, CB#Device$Table$Addresses ; and table pointer
04A7 CD6F06 03118 CALL Select$Device$Table ;Get device table address
04AA C39106 03119 JMP Get$Input$Character ;Get next input character
03120 ; and return to caller
03121 ;
03200 ;#
03201 ; Auxiliary output (replaces PUNCH)
03202 ;
03203 ; This routine outputs a data byte to the auxiliary device(s).
03204 ; It is similar to CONOUT except that it uses the watchdog
03205 ; timer to detect if a device stays busy for more than
03206 ; 30 seconds at a time. It outputs a message to the console
03207 ; if this happens.
03208 ;
03209 ; Entry parameters
03210 ;
03211 ; C = data byte
03212 ;
04AD 0D0A07417503213 AUXOUT$Busy$Message: DB CR,LF,7,'Auxiliary device not Ready?',CR,LF,0
03214 ;
03215 ;=====
03216 AUXOUT: ;<=== BIOS entry point (standard)
03217 ;=====
04CE 2A5E00 03218 LHL D, CB#Auxiliary$Output ;Get aux. redirection word
04D1 11AD04 03219 LXI D, AUXOUT$Busy$Message ;Message to be output if time
03220 ; runs out
04D4 C3A205 03221 JMP Multiple$Output$Byte
03222 ;
03300 ;#
03301 ;
03302 ; List status
03303 ;
03304 ; This routine sets the A register to indicate whether the
03305 ; List Device(s) is/are ready to accept output data.
03306 ; As more than one device can be used for list output, this
03307 ; routine returns a Boolean AND of all of their statuses.
03308 ;
03309 ; Entry parameters: none
03310 ;
03311 ; Exit parameters
03312 ;
03313 ; A = 000H if one or more list devices are not ready
03314 ; A = 0FFH if all list devices are ready
03315 ;
03316 ;=====
03317 ;
03318 LISTST: ;<=== BIOS entry point (standard)
03319 ;=====
04D7 2A6200 03320 LHL D, CB#List$Output ;Get list redirection word
04DA C37905 03321 JMP Get$Composite$Status
03322 ;
03400 ;#
03401 ; List output
03402 ;
03403 ; This routine outputs a data byte to the list device.
03404 ; It is similar to CONOUT except that it uses the watchdog
03405 ; timer to detect if the printer stays busy for more
03406 ; than 30 seconds at a time. It outputs a message to the console
03407 ; if this happens.
03408 ;
03409 ; Entry parameters
03410 ;
03411 ; C = data byte
03412 ;

```

Figure 8-10. (Continued)

```

04DD 0D0A07507203413 LIST$Busy$Message: DB CR,LF,7,'Printer not Ready?',CR,LF,0
03414 ;
03415 ;=====
03416 LIST: ;<== BIOS entry point (standard)
03417 ;=====
04F5 2A6200 03418 LHL D,CB$List$Output ;Get list redirection word
04F8 11DD04 03419 LXI D,LIST$Busy$Message ;Message to be output if time
03420 ; runs out
04FB C3A205 03421 JMP Multiple$Output$Byte
03422 ;
03500 ;#
03501 ; Request user choice
03502 ;
03503 ; This routine displays an error message, requesting
03504 ; a choice of:
03505 ;
03506 ; R -- Retry the operation that caused the error
03507 ; I -- Ignore the error and attempt to continue
03508 ; A -- Abort the program and return to CP/M
03509 ;
03510 ; This routine accepts a character from the console,
03511 ; converts it to uppercase and returns to the caller
03512 ; with the response in the A register.
03513 ;
03514 RUC$Message:
04FE 0D0A 03515 DB CR,LF
0500 202020202003516 DB ' Enter R - Retry, I - Ignore, A - Abort : ',0
03517 ;
03518 ;
03519 Request$User$Choice:
052F CD2D03 03520 CALL CONST ;Gobble up any type-ahead
0532 CA3B05 03521 JZ RUC$Buffer$Empty
0535 CD3A03 03522 CALL CONIN
0538 C32F05 03523 JMP Request$User$Choice
03524 ;
03525 RUC$Buffer$Empty:
053B 21FE04 03526 LXI H,RUC$Message ;Display prompt
053E CD5305 03527 CALL Output$error$Message
03528 ;
0541 CD3A03 03529 CALL CONIN ;Get console character
0544 CD3B0E 03530 CALL A$To$Upper ;Make uppercase for comparisons
0547 32B00D 03531 STA Disk$action$Confirm ;Save in confirmatory message
054A F5 03532 PUSH PSW ;Save for later
03533 ;
054B 21B00D 03534 LXI H,Disk$action$Confirm
054E CD5305 03535 CALL Output$error$Message
03536 ;
0551 F1 03537 POP PSW ;Recover action code
0552 C9 03538 RET
03539 ;
03600 ;#
03601 ;
03602 ; Output error message
03603 ;
03604 ; This routine outputs an error message to all the currently
03605 ; selected console devices except those being used to receive
03606 ; LIST output as well. This is to avoid "deadly embrace" situations
03607 ; where the printer's being busy for too long causes an error message
03608 ; to be output -- and console output is being directed to the
03609 ; printer as well.
03610 ;
03611 ; This subroutine makes use of most of the CONOUT subroutine.
03612 ; For memory economy it enters CONOUT using a private
03613 ; entry point.
03614 ;
03615 ; Entry parameters
03616 ;
03617 ; HL -> 00-byte terminated error message
03618 ;
03619 Output$error$Message:
0553 E5 03620 PUSH H ;Save message address
0554 2A5A00 03621 LHL D,CB$Console$Output ;Get console redirection bit map
0557 EB 03622 XCHG
0558 2A6200 03623 LHL D,CB$List$Output ;Get list redirection bit map
03624 ;HL = list, DE = console
03625 ;Now set to 0 all bits in the console

```

Figure 8-10. (Continued)

```

03626 ; bit map that are set to 1 in the
03627 ; list bit map
055B 7C 03628 MOV A,H ;Get MS byte of list
055C 2F 03629 CMA ;Invert
055D A2 03630 ANA D ;Preserve only bits with 0's
055E 67 03631 MOV H,A ;Save result
055F 7D 03632 MOV A,L ;Repeat for LS byte of list
0560 2F 03633 CMA
0561 A3 03634 ANA E
0562 6F 03635 MOV L,A ;HL now has only pure console
03636 ; devices
0563 B4 03637 ORA H ;Ensure that at least one device
0564 CA6A05 03638 JZ OEM#Device#Present ; is selected
0567 210100 03639 LXI H,0001H ;Otherwise use default of device 0
03640 OEM#Device#Present:
03641 OEM#Next#Character:
056A D1 03642 POP D ;Recover message address into DE
056B 1A 03643 LDAX D ;Get next byte of message
056C 13 03644 INX D ;Update message pointer
056D B7 03645 ORA A ;Check if end of message
056E C8 03646 RZ ;Yes, exit
056F D5 03647 PUSH D ;Save message address for later
0570 E5 03648 PUSH H ;Save special bit map
03649 ;Data character is in A
0571 CDD103 03650 CALL CONOUT#OEM#Entry ;Enter shared code
0574 E1 03651 POP H ;Recover special bit map
0575 C36A05 03652 JMP OEM#Next#Character
03653 ;
03654 ;
03655 ;
03656 ; Get composite status
03657 ;
03658 ; This routine sets the A register to indicate whether the
03659 ; output device(s) is/are ready to accept output data.
03660 ; As more than one device can be used for output, this
03661 ; routine returns a Boolean AND of all of their statuses.
03662 ;
03663 ; Entry parameters
03664 ;
03665 ; HL = I/O redirection bit map for output device(s)
03666 ;
03667 ; Exit parameters
03668 ;
03669 ; A = 000H if one or more list devices are not ready
03670 ; A = 0FFH if all list devices are ready
03671 ;
0578 00 03672 GCS#Status: DB 0 ;Composite status of all devices
03673 ;
03674 ;
03675 ; Get#Composite#Status:
0579 3EFF 03676 MVI A,0FFH ;Assume all devices are ready
057B 327805 03677 STA GCS#Status ;Preset composite status byte
03678 ;
057E 116400 03679 LXI D,CB#Device#Table#Addresses ;Addresses of dev. tables
0581 D5 03680 PUSH D ;Put onto stack ready for loop
0582 E5 03681 PUSH H ;Save bit map
03682 GCS#Next#Device:
0583 E1 03683 POP H ;Recover redirection bit map
0584 D1 03684 POP D ;Recover device table addresses pointer
0585 CD6F06 03685 CALL Select#Device#Table ;Get device table in DE
0588 B7 03686 ORA A ;Check if a device has been
; selected (i.e. bit map not all zero)
0589 CA9905 03688 JZ GCS#Exit ;No, exit
058C C5 03689 PUSH B ;Yes - B.. ;Save redirection bit map
058D E5 03690 PUSH H ;Save device table addresses pointer
058E CD0F06 03691 CALL Check#Output#Ready ;Check if device ready
0591 217805 03692 LXI H,GCS#Status ;AND together with previous devices
0594 A6 03693 ANA H ; status
0595 77 03694 MOV M,A ;Save composite status
03695 ;
0596 C38305 03696 JMP GCS#Next#Device ;Loop back for next device
03697 ;
;
03698 GCS#Exit:
0599 3A7805 03699 LDA GCS#Status ;Return with composite status
059C B7 03700 ORA A
059D C9 03701 RET

```

Figure 8-10. (Continued)

```

03702 ;
03800 ;#
03801 ;
03802 ; Multiple output byte
03803 ;
03804 ; This routine outputs a data byte to the all of the
03805 ; devices specified in the I/O redirection word.
03806 ; It is similar to CONOUT except that it uses the watchdog
03807 ; timer to detect if any of the devices stays busy for more
03808 ; than 30 seconds at a time. It outputs a message to the console
03809 ; if this happens.
03810 ;
03811 ; Entry parameters
03812 ;
03813 ; HL = I/O redirection bit map
03814 ; DE -> Message to be output if time runs out
03815 ; C = data byte
03816 ;
0708 = 03817 MOB#Maximum#Busy EQU 1800 ;Number of clock ticks (each at
03818 ; 16.666 milliseconds) for which the
03819 ; device might be busy
059E 00 03820 MOB#Character: DB 0 ;Character to be output
059F 0000 03821 MOB#Busy#Message: DW 0 ;Address of message to be
03822 ; output if time runs out
05A1 00 03823 MOB#Need#Message: DB 0 ;Flag used to detect that the
03824 ; watchdog timer timed out
03825 ;
03826 ; Multiple#Output#Bytes:
05A2 79 03827 MOV A,C ;Get data byte
05A3 320807 03828 STA MOB#Maximum#Busy ;Save copy
05A6 EB 03829 XCHG ;HL -> timeout message
05A7 229F05 03830 SHLD MOB#Busy#Message ;Save for later use
05AA EB 03831 XCHG ;HL = bit map again
03832 ;
05AB 116400 03833 LXI D,CB#Device#Table#Addresses ;Addresses of dev. tables
05AE D5 03834 PUSH D ;Save on stack ready for loop
05AF E5 03835 PUSH H ;Save I/O redirection bit map
03836 ;
03837 MOB#Next#Device:
05B0 E1 03837 POP H ;Recover redirection bit map
05B1 D1 03838 POP D ;Recover device table addresses pointer
05B2 CD6F06 03839 CALL Select#Device#Table ;Get device table in DE
05B5 B7 03840 ORA A ;Check if any device selected
05B6 CAEC05 03841 JZ MOB#Exit
03842 ;
05B9 C5 03843 PUSH B ;<- Yes : B ;Save device table addresses pointer
05BA E5 03844 PUSH H ;Save redirection bit map
03845 ;
03846 MOB#Start#Watchdog:
05BB AF 03847 XRA A ;Reset message needed flag
05BC 32A105 03848 STA MOB#Need#Message
05BF 010807 03849 LXI B,MOB#Maximum#Busy ;Time delay
05C2 210906 03850 LXI H,MOB#Not#Ready ;Address to go to
05C5 CD6D08 03851 CALL Set#Watchdog ;Start timer
03852 ;
03853 MOB#Wait:
05C8 3AA105 03854 LDA MOB#Need#Message ;Check if watchdog timed out
05CB B7 03855 ORA A
05CC C2EE05 03856 JNZ MOB#Output#Message ;Yes, output warning message
05CF CD0F06 03857 CALL Check#Output#Ready ;Check if device ready
05D2 CAC805 03858 JZ MOB#Wait ;No, wait
03859 ;
05D5 F3 03860 DI ;Interrupts off to avoid
03861 ; involuntary reentrance
05D6 010000 03862 LXI B,0 ;Turn off watchdog
05D9 CD6D08 03863 CALL Set#Watchdog ;(HL setting is irrelevant)
03864 ;
05DC 3A9E05 03865 LDA MOB#Character ;Get data byte
05DF 4F 03866 MOV C,A
05E0 CD2608 03867 CALL Output#Data#Byte ;Output the data byte
05E3 FB 03868 EI
05E4 CD3A06 03869 CALL Process#ETX#Protocol ;Deal with ETX/ACK protocol
05E7 C3B005 03870 JMP MOB#Next#Device
03871 ;
03872 MOB#Ignore#Exit:
05EA E1 03873 POP H ;Ignore timeout error
05EB D1 03874 POP D ;Balance the stack

```

Figure 8-10. (Continued)

```

03875 ;
03876 MOB$Exit:
05EC 79      03877      MOV     A,C                ;CP/M "convention"
05ED C9      03878      RET
03879 ;
05EE 2A9F05 03880 MOB$Output$Message:
05F1 CD5305 03881      LHL    MOB$Busy$Message    ;Display warning message
03882      CALL  Output$error$Message ; on selected console devices
03883 MOB$Request$Choice:
05F4 CD2F05 03884      CALL  Request$user$Choice ;Display message and get
03885 ; action character
05F7 FE52    03886      CPI   'R'                ;Retry
05F9 CABB05 03887      JZ    MOB$Start$Watchdog    ;Restart watchdog and try again
05FC FE49    03888      CPI   'I'                ;Ignore
05FE CAEA05 03889      JZ    MOB$Ignore$Exit      ;
0601 FE41    03890      CPI   'A'                ;Abort
0603 CA360E 03891      JZ    System$Reset         ; Give BDOS function 0
0606 C3F405 03892      JMP   MOB$Request$Choice
03893 ;
03894 MOB$Not$Ready:
03895 ; Watchdog timer routine will call this
03896 ; routine if the device is busy
03897 ; for more than approximately 30 seconds
03898 ; Note: This is an interrupt service routine
0609 3EFF    03898      MVI   A,OFFH              ;Set request to output message
060B 32A105 03899      STA  MOB$Need$Message
060E C9      03900      RET                        ;Return to the watchdog routine
03901 ;
04000 ;#
04001 ;
04002 ;
04003 ; Check output ready
04004 ;
04005 ; This routine checks to see if the specified device is ready
04006 ; to receive output data.
04007 ; It does so by checking to see if the device has been suspended
04008 ; for protocol reasons and if DTR is low.
04009 ;
04010 ; NOTE: This routine does NOT check if the USART itself is ready.
04011 ; This test is done in the output data byte routine itself.
04012 ;
04013 ; Entry parameters
04014 ;
04015 ; DE -> device table
04016 ;
04017 ; Exit parameters
04018 ;
04019 ; A = 000H (Zero-flag set) : Device not ready
04020 ; A = 0FFH (Zero-flag clear): Device ready
04021 Check$Output$Ready:
060F 210E00 04021      LXI   H,DT$Status         ;Get device status
0612 19      04022      DAD   D                  ;HL -> status byte
0613 7E      04023      MOV   A,M                ;Get status byte
0614 47      04024      MOV   B,A                ;Take a copy of the status byte
0615 E601    04025      ANI   DT$Output$Suspend    ;Check if output is suspended
0617 C23806 04026      JNZ   COR$Not$Ready       ;Yes, indicate not ready
04027 ;
061A 3E04    04028      MVI   A,DT$Output$DTR     ;Check if DTR must be high to send
061C A0      04029      ANA   B                  ;Mask with device status from table
061D CA3406 04030      JZ    COR$Ready          ;No, device is logically ready
04031 ;
0620 210000 04032      LXI   H,DT$Status$Port    ;Set up to read device status
0623 19      04033      DAD   D                  ;
0624 7E      04034      MOV   A,M                ;Get status port number
0625 322906 04035      STA  COR$Status$Port     ;Set up instruction below
04036 ;
0628 DB      04037      DB    IN                  ;
04038 COR$Status$Port:
0629 00      04039      DB    0                  ;<-- Set up by instruction above
062A 4F      04040      MOV   C,A                ;Save hardware status
04041 ;
062B 210400 04042      LXI   H,DT$DTR$Ready     ;Yes, set up to check chip status
062E 19      04043      DAD   D                  ; to see if DTR is high
062F 7E      04044      MOV   A,M                ;Get DTR high status mask
0630 A1      04045      ANA   C                  ;Test chip status
0631 CA3806 04046      JZ    COR$Not$Ready       ;DTR low, indicate not ready
04047 ;
04048 COR$Ready:

```

Figure 8-10. (Continued)

```

04407 ;      Entry parameters
04408 ;
04409 ;      HL = Bit map
04410 ;      DE -> Table of device table addresses
04411 ;      The first address in the list is called
04412 ;      if the least significant bit of the bit map is
04413 ;      nonzero, and so on.
04414 ;
04415 ;      Exit parameters
04416 ;
04417 ;      BC -> Current entry in device table addresses
04418 ;      DE = Selected device table address
04419 ;      HL = Shifted bit map
04420 ;      Nonzero if a 1-bit was found
04421 ;      Zero if bit map now entirely 0000
04422 ;
04423 ;      Note: If HL is 0000H on input, then the first entry in the
04424 ;      device table addresses will be returned in DE.
04425 ;
04426 ;      Select$Device$Table:
066F 7C 04427 MOV    A,H           ;Get most significant byte of bit map
0670 B5 04428 ORA    L             ;Check if HL completely 0
0671 C8 04429 RZ              ;Return indicating no more bits set
0672 7D 04430 MOV    A,L           ;Check if the LS bit is nonzero
0673 E601 04431 ANI    1             ;
0675 C29006 04432 JNZ    SDT$Bit$Set      ;Yes, return corresponding address
0676 13 04433 INX    D             ;No, update table pointer
0679 13 04434 INX    D             ;
067A CDB08 04435 CALL   SHLR           ;Shift HL right one bit
067D C36F06 04436 JMP    Select$Device$Table ;Check next bit
04437 ;      SDT$Bit$Set:
0680 E5 04438 PUSH   H             ;Save shifted bit map
0681 42 04439 MOV    B,D           ;Take copy of table pointer
0682 4B 04440 MOV    C,E           ;
0683 EB 04441 XCHG          ;HL -> address in table
0684 5E 04442 MOV    E,M           ;
0685 23 04443 INX    H             ;
0686 56 04444 MOV    D,M           ;DE -> selected device table
04445 ;      ;Set up registers for another
04446 ;      ; entry
0687 E1 04447 POP    H             ;Recover shifted bit map
0688 CDB08 04448 CALL   SHLR           ;Shift bit map right one bit
068B 03 04449 INX    B             ;Update DT address table pointer to
068C 03 04450 INX    B             ; entry
068D 3E01 04451 MVI    A,1         ;Indicate that a one bit was found
068F B7 04452 ORA    A             ; and registers are set up correctly
0690 C9 04453 RET
04454 ;
04600 ;#
04601 ;
04602 ;      Get input character
04603 ;
04604 ;      This routine gets the next input character from the device
04605 ;      specified in the device table handed over as an input
04606 ;      parameter.
04607 ;
04608 ;      Get$Input$Character:
0691 211900 04609 LXI    H,DT$Character$Count ;Check if any characters have
0694 19 04610 DAD    D             ; been stored in the buffer
04611 ;      GIC$Wait:
0695 FB 04612 EI              ;Ensure that incoming chars. will
04613 ;      ; be detected
0696 7E 04614 MOV    A,M           ;Get character count
0697 B7 04615 ORA    A             ;
0698 CA9506 04616 JZ    GIC$Wait         ;No characters, so wait
069B 35 04617 DCR    M             ;Down date character count for
04618 ;      ; the character about to be
04619 ;      ; removed from the buffer
069C 211700 04620 LXI    H,DT$Get$Offset ;Use the get offset to access
069F CDF007 04621 CALL   Get$Address$in$Buffer ;Returns HL -> character
04622 ;      ; and with get offset updated
06A2 7E 04623 MOV    A,M           ;Get the actual data character
06A3 F5 04624 PUSH   PSW          ;Save until later
04625 ;
06A4 211900 04626 LXI    H,DT$Character$Count ;Check downdated count of chars. in
06A7 19 04627 DAD    D             ; buffer, checking if input should be

```

Figure 8-10. (Continued)

```

0702 11CE02 04920
0705 CD1607 04921      LXI    D,DT#2      ;Device 2
                        04922      CALL   Service$Device
                        04923
0708 3E20   04924      MVI    A,IC#EOI    ;Tell the interrupt controller chip
070A D3D8   04925      OUT   IC#OCW2$Port ; that the interrupt has been serviced
070C D1     04926      POP   D            ;Restore registers
070D C1     04927      POP   B
070E F1     04928      POP   PSW
070F 2A8422 04929      LHLD  PI#User$Stack ;Switch back to user's stack
0712 F9     04930      SPHL
0713 E1     04931      POP   H
0714 FB     04932      EI            ;Renable interrupts in the CPU
0715 C9     04933      RET          ;Resume pre-interrupt processing
                        04934      ;
                        05000      ;#
                        05001      ;
                        05002      ;      Service device
                        05003      ;
                        05004      ;      This routine performs the device interrupt servicing,
                        05005      ;      checking to see if the device described in the specified
                        05006      ;      device table (address in DE) is actually interrupting,
                        05007      ;      and if so, inputs the character. Depending on which data character
                        05008      ;      is input, this routine will either stack it in the input buffer
                        05009      ;      (shutting off the input stream if the buffer is nearly full),
                        05010      ;      or will suspend or resume the output to the device.
                        05011      ;
                        05012      ;      Entry parameters
                        05013      ;
                        05014      ;      DE -> device table
                        05015      ;
                        05016      ;      Service$Device:
0716 210000 05017      LXI    H,DT#Status$Port ;Check if this device is really
0719 19     05018      DAD   D            ; interrupting
071A 7E     05019      MOV   A,M          ;Get status port number
071B 321F07 05020      STA  SD#Status$Port ;Store in instruction below
                        05021
071E DB     05022      DB    IN           ;Input status
                        05023      SD#Status$Port:
071F 00     05024      DB    0            ;<-- Set up by instruction above
                        05025      ;
0720 210300 05026      LXI    H,DT#Input$Ready ;Check if status indicates data ready
0723 19     05027      DAD   D
0724 A6     05028      ANA   M            ;Mask with input ready value
0725 C8     05029      RZ            ;No, return to interrupt service
                        05030      ;Check if any errors have occurred
0726 210700 05031      LXI    H,DT#Detect$Error$Port ;Set up to read error status
0729 19     05032      DAD   D            ; interrupting
072A 7E     05033      MOV   A,M          ;Get status port number
072B 322F07 05034      STA  SD$Error$Port ;Store in instruction below
                        05035
072E DB     05036      DB    IN           ;Input error status
                        05037      SD$Error$Port:
072F 00     05038      DB    0            ;<-- Set up by instruction above
                        05039      ;
0730 210800 05040      LXI    H,DT#Detect$Error$Value ;Mask with error bit(s)
0733 19     05041      DAD   D
0734 A6     05042      ANA   M
0735 CA4707 05043      JZ    SD$No$Error ;No bit(s) set
0738 210900 05044      LXI    H,DT#Reset$Error$Port ;Set up to reset error
073E 19     05045      DAD   D
073C 7E     05046      MOV   A,M          ;Get reset port number
073D 324607 05047      STA  SD$Reset$Error$Port ;Store in instruction below
0740 210A00 05048      LXI    H,DT#Reset$Error$Value
0743 19     05049      DAD   D
0744 7E     05050      MOV   A,M          ;Get reset interrupt value
                        05051
0745 D3     05052      DB    OUT
                        05053      SD$Reset$Error$Port:
0746 00     05054      DB    0            ;<-- Set up in instruction above
                        05055
                        05056      SD$No$Error:
0747 210100 05057      LXI    H,DT#Data$Port ;Input the data character (this may
074A 19     05058      DAD   D            ; be garbled if an error occurred)
074B 7E     05059      MOV   A,M          ;Get data port number
074C 325007 05060      STA  SD$Data$Port ;Store in instruction below

```

Figure 8-10. (Continued)

074F	DB	05061			
		05062	DB	IN	;Input data character
		05063	SD#Data#Port:		
0750	00	05064	DB	0	;-- Set up by instruction above
		05065			
0751	47	05066	MOV	B,A	;Take copy of data character above
0752	210E00	05067	LXI	H,DT#Status	;Check if either XON or ETX protocols
0755	19	05068	DAD	D	; is currently active
0756	7E	05069	MOV	A,M	;Get protocol byte
0757	E618	05070	ANI	DT#Output#Xon + DT#Output#EtX	
0759	CAB107	05071	JZ	SD#No#Protocol	;Neither is active
075C	E608	05072	ANI	DT#Output#Xon	;Check if XON/XOFF is active
075E	C26E07	05073	JNZ	SD#Check#if#Xon	;Yes, check if XON char. input
		05074			;No, assume ETX/ACK active
0761	3E06	05075	MVI	A,ACK	;Check if input character is ACK
0763	B8	05076	CMP	B	
0764	C28107	05077	JNZ	SD#No#Protocol	;No, process character as data
		05078	SD#Output#Desuspend:		;Yes, device now ready
		05079			; to accept more data, so indicate
		05080			; output to device can resume
		05081			;The noninterrupt driven output
		05082			; routine checks the suspend bit
0767	7E	05083	MOV	A,M	;Get status/protocol byte again
0768	E6FE	05084	ANI	OFFH AND NOT DT#Output#Suspend	;Preserve all bits BUT suspend
076A	77	05085	MOV	M,A	;Save back with suspend = 0
076B	C3D907	05086	JMP	SD#Exit	;Exit to interrupt service without
		05087			; saving data character
		05088			
		05089	SD#Check#if#Xon:		;XON/XOFF protocol active, so
		05090			; if XOFF received, suspend output
		05091			; if XON received, resume output
		05092			;The noninterrupt driven output
		05093			; routine checks the suspend bit
076E	3E11	05094	MVI	A,XON	;Check if XON character input
0770	B8	05095	CMP	B	
0771	CA6707	05096	JZ	SD#Output#Desuspend	;Yes, enable output to device
0774	3E13	05097	MVI	A,XOFF	;Check if XOFF character input
0776	B8	05098	CMP	B	
0777	C28107	05099	JNZ	SD#No#Protocol	;No, process character as data
		05100	SD#Output#Suspend:		;Device needs pause in output of
		05101			; data, so indicate output suspended
077A	7E	05102	MOV	A,M	;Get status/protocol byte again
077B	F601	05103	ORI	DT#Output#Suspend	;Set suspend bit to 1
077D	77	05104	MOV	M,A	;Save back in device table
077E	C3D907	05105	JMP	SD#Exit	;Exit to interrupt service without
		05106			; saving the input character
		05107			
		05108	SD#No#Protocol:		
0781	211800	05109	LXI	H,DT#Buffer#Length#Mask	;Check if there is still space
0784	19	05110	DAD	D	; in the input buffer
0785	7E	05111	MOV	A,M	;Get length - 1
0786	3C	05112	INR	A	;Update to actual length
0787	211900	05113	LXI	H,DT#Character#Count	;Get current count of characters
078A	19	05114	DAD	D	; in buffer
078B	BE	05115	CMP	M	;Check if count = length
078C	CAEB07	05116	JZ	SD#Buffer#Full	;Yes, output bell character
078F	C5	05117	PUSH	B	;Save data character
0790	211600	05118	LXI	H,DT#Put#Offset	;Compute address of character in
		05119			; input buffer
0793	CDF007	05120	CALL	Get#Address#In#Buffer	;HL -> character position
0796	C1	05121	POP	B	;Recover input character
0797	70	05122	MOV	M,B	;Save character in input buffer
		05123			;Update number of characters in input
		05124			; buffer, checking if input should
		05125			; be temporarily halted
0798	211900	05126	LXI	H,DT#Character#Count	
079B	19	05127	DAD	D	
079C	34	05128	INR	M	;Update character count
079D	7E	05129	MOV	A,M	;Get updated count
079E	211A00	05130	LXI	H,DT#Stop#Input#Count	;Check if current count matches
07A1	19	05131	DAD	D	; buffer-full threshold
07A2	BE	05132	CMP	M	
07A3	C2CE07	05133	JNZ	SD#Check#Control	;Not at threshold, check if control
		05134			; character input
07A6	210E00	05135	LXI	H,DT#Status	;At threshold, check which means
07A9	19	05136	DAD	D	; for pausing input are to be used

Figure 8-10. (Continued)

```

07AA 7E      05137      MOV     A,M                ;Get status/protocol byte
07AB F602   05138      ORI     DT#Input$Suspend  ;Indicate input is suspended
07AD 77      05139      MOV     M,A                ;Save updated status in table
07AE F5      05140      PUSH   PSW                ;Save for later use
07AF E640   05141      ANI     DT#Input$RTS      ;Check if clear to send to be dropped
07B1 CAC307 05142      JZ      SD$Check$Input$Xon ;No
07B4 210B00 05143      LXI     H,DT#RTS$Control$Port ;Yes, get control port number
07B7 19      05144      DAD     D
07B8 7E      05145      MOV     A,M
07B9 32C207 05146      STA     SD$Drop$RTS$Port  ;Store in instruction below
07BC 210C00 05147      LXI     H,DT$Drop$RTS$Value
07BF 19      05148      DAD     D
07C0 7E      05149      MOV     A,M                ;Get value needed to drop RTS
07C1 D3      05150      ;
07C1 D3      05151      DB      OUT
07C1 D3      05152      SD$Drop$RTS$Port:
07C2 00      05153      DB      0                    ;<-- Set up in instruction above
07C2 00      05154      ;Drop into input XON test
07C2 00      05155      SD$Check$Input$Xon:      ;Check if XON/XOFF protocol being used
07C2 00      05156      ; to temporarily suspend input
07C3 F1      05157      POP     PSW                ;Recover status/protocol byte
07C4 E680   05158      ANI     DT#Input$Xon      ;Check if XON bit set
07C6 CACE07 05159      JZ      SD$Check$Control  ;No, see if control char. input
07C9 0E13   05160      MVI     C,XOFF            ;Yes, output XOFF character
07CB CD2608 05161      CALL    Output$Data$Byte  ;Output data byte
07CB CD2608 05162      ;
07CB CD2608 05163      SD$Check$Control:      ;Check if control character (other than
07CB CD2608 05164      ; CR, LF, or TAB) input, and update
07CB CD2608 05165      ; count of control characters in buffer
07CE CD0808 05166      CALL    Check$Control$Char ;Check if control character
07D1 CAD907 05167      JZ      SD$Exit            ;No, it is not a control character
07D4 211C00 05168      LXI     H,DT#Control$Count
07D7 19      05169      DAD     D
07D8 34      05170      INR     M                    ;Update count of control chars.
07D8 34      05171      ;
07D8 34      05172      SD$Exit:                ;Reset hardware interrupt system
07D9 210500 05173      LXI     H,DT#Reset$Int$Port
07DB 19      05174      DAD     D
07DD 7E      05175      MOV     A,M                ;Get reset port number
07DE B7      05176      ORA     A                    ;Check if port specified
07DE B7      05177      ; (assumes it will always be NZ)
07DF C8      05178      RZ                          ;Bypass reset if no port specified
07E0 32E907 05179      STA     SD$Reset$Int$Port ;Store in instruction below
07E3 210600 05180      LXI     H,DT#Reset$Int$Value
07E6 19      05181      DAD     D
07E7 7E      05182      MOV     A,M                ;Get reset interrupt value
07E7 7E      05183      ;
07E8 D3      05184      DB      OUT
07E8 D3      05185      SD$Reset$Int$Port:
07E9 00      05186      DB      0                    ;<-- Set up in instruction above
07EA C9      05187      RET                          ;Return to interrupt service routine
07EA C9      05188      ;
07EB 0E07   05189      SD$Buffer$Full:          ;Input buffer completely full
07ED C32608 05190      MVI     C,BELL            ;Send bell character as desperate
07ED C32608 05191      JMP     Output$Data$Byte  ; measure. Note JMP return to
07ED C32608 05192      ; caller will be done by subroutine
07ED C32608 05193      ;
07ED C32608 05300      ;*
07ED C32608 05301      ;
07ED C32608 05302      ; Get address in buffer
07ED C32608 05303      ;
07ED C32608 05304      ; This routine computes the address of the next character to
07ED C32608 05305      ; access in a device buffer.
07ED C32608 05306      ;
07ED C32608 05307      ; Entry parameters
07ED C32608 05308      ;
07ED C32608 05309      ; DE -> appropriate device table
07ED C32608 05310      ; HL = offset in the device table of either the
07ED C32608 05311      ; Get$Offset or the Put$Offset
07ED C32608 05312      ;
07ED C32608 05313      ; Exit parameters
07ED C32608 05314      ;
07ED C32608 05315      ; DE unchanged
07ED C32608 05316      ; HL -> address in character buffer
07ED C32608 05317      ;
07ED C32608 05318      Get$Address$In$Buffer:

```

Figure 8-10. (Continued)

```

07F0 19      05319      DAD      D                ;HL -> get/put offset in dev. table
07F1 E5      05320      PUSH    H                ;Preserve pointer to table
07F2 4E      05321      MOV     C,M              ;Get offset value
07F3 0600    05322      MVI     B,0              ;Make into word value
                                ;Update offset value, resetting to
                                ; 0 at
                                ; end of buffer
07F5 79      05325      MOV     A,C              ;Get copy of offset
07F6 3C      05326      INR     A                ;Update to next position
07F7 211800  05327      LXI     H,DT#Buffer$Length$Mask
07FA 19      05328      DAD     D
07FB A6      05329      ANA     M                ;Mask LS bits with length - 1
07FC E1      05330      POP     H                ;Recover pointer to offset in table
07FD 77      05331      MOV     M,A              ;Save new value (set to 0 if nec.)
07FE 211400  05332      LXI     H,DT#Buffer$Base ;Get base address of input buffer
0801 19      05333      DAD     D                ;HL -> address of buffer in table
0802 7E      05334      MOV     A,M              ;Get LS byte of address
0803 23      05335      INX     H                ;HL -> MS byte of address
0804 46      05336      MOV     H,M              ;H = MS byte
0805 4F      05337      MOV     L,A              ;L = LS byte
0806 09      05338      DAD     B                ;Add on offset to base
0807 C9      05339      RET
                                ;
                                ;#
05400      ;
05401      ;
05402      ;      Check control character
05403      ;
05404      ;      This routine checks the character in A to see if it is a
05405      ;      control character other than CR, LF, or TAB. The result is
05406      ;      returned in the Z-flag.
05407      ;
05408      ;      Entry parameters
05409      ;
05410      ;          A = character to be checked
05411      ;
05412      ;      Exit parameters
05413      ;
05414      ;          Zero status if A does not contain a control character
05415      ;          or if it is CR, LF, or TAB
05416      ;
05417      ;          Nonzero if A contains a control character other than
05418      ;          CR, LF, or TAB.
05419      ;      Check$Control$Char:
0808 3E1F    05420      MVI     A,' ' - 1        ;Space is first noncontrol char.
080A B8      05421      CMP     B
080B DA2408  05422      JC      CCC$No           ;Not a control character
080E 3E0D    05423      MVI     A,CR            ;Check if carriage return
0810 B8      05424      CMP     B
0811 CA2408  05425      JZ      CCC$No           ;Not really a control character
0814 3E0A    05426      MVI     A,LF            ;Check if LF
0816 B8      05427      CMP     B
0817 CA2408  05428      JZ      CCC$No           ;Not really a control character
081A 3E09    05429      MVI     A,TAB           ;Check if horizontal tab
081C B8      05430      CMP     B
081D CA2408  05431      JZ      CCC$No           ;Not really a control character
0820 3E01    05432      MVI     A,1              ;Indicate a control character
0822 B7      05433      ORA     A
0823 C9      05434      RET
                                ;
0824 AF      05435      CCC$No: XRA     A                ;Indicate A does not contain
0825 C9      05436      RET                    ; a control character
                                ;
                                ;#
05500      ;
05501      ;      Output data byte
05502      ;
05503      ;
05504      ;      This is a simple polled output routine that outputs a single
05505      ;      character (in register C on entry) to the device specified in
05506      ;      the device table.
05507      ;      Preferably, this routine would have been re-entrant; however
05508      ;      it does have to store the port numbers. Therefore, to use it
05509      ;      from code executed with interrupts enabled, the instruction
05510      ;      sequence must be:
05511      ;
05512      ;          DI                ;Interrupts off
05513      ;          CALL    Output$Data$Byte

```

Figure 8-10. (Continued)

```

05514 ;           EI           ;Interrupts on
05515 ;
05516 ;           Failure to do this may cause involuntary re-entrance.
05517 ;
05518 ;           Entry parameters
05519 ;
05520 ;           C = character to be output
05521 ;           DE -> device table
05522 ;
05523 ;           Output#Data#Byte:
0826 C5 05524 PUSH B ;Save registers
0827 210200 05525 LXI H,DT#Output#Ready ;Get output ready status mask
082A 19 05526 DAD D
082B 46 05527 MOV B,M
082C 210000 05528 LXI H,DT#Status#Port ;Get status port number
082F 19 05529 DAD D
0830 7E 05530 MOV A,M
0831 323508 05531 STA ODB#Status#Port ;Store in instruction below
05532 ;
05533 ;           ODB#Wait#until#Ready:
0834 DB 05534 DB IN ;Read status
05535 ;           ODB#Status#Port:
0835 00 05536 DB 0 ;<-- Set up in instruction above
05537 ;
0836 A0 05538 ANA B ;Check if ready for output
0837 CA3408 05539 JZ ODB#Wait#until#Ready ;No
083A 210100 05540 LXI H,DT#Data#Port ;Get data port
083D 19 05541 DAD D
083E 7E 05542 MOV A,M
083F 324408 05543 STA ODB#Data#Port ;Store in instruction below
0842 79 05544 MOV A,C ;Get character to output
05545 ;
0843 D3 05546 DB OUT
05547 ;           ODB#Data#Port:
0844 00 05548 DB 0 ;<-- Set up in instruction above
05549 ;
0845 C1 05550 POP B ;Restore registers
0846 C9 05551 RET
05552 ;
05700 ;*
05701 ;
05702 ;
05703 ;           Input status routine
05704 ;
05705 ;           This routine returns a value in the A register indicating whether
05706 ;           one or more data characters is/are waiting in the input buffer.
05707 ;           Some products, such as Microsoft BASIC, defeat normal type-ahead
05708 ;           by constantly "gobbling" characters in order to see if an incoming
05709 ;           Control-S, -Q or -C has been received. In order to preserve
05710 ;           type-ahead under these circumstances, the input status return
05711 ;           can, as an option selected by the user, return "data waiting" only
05712 ;           if the input buffer contains a Control-S, -Q or -C. This fools
05713 ;           Microsoft BASIC into allowing type-ahead.
05714 ;
05715 ;           Entry parameters
05716 ;
05717 ;           DE -> device table
05718 ;
05719 ;           Exit parameters
05720 ;
05721 ;           A = 000H if no characters are waiting in the input
05722 ;           buffer
05723 ;
05724 ;
05725 ;           Get#Input#Status:
0847 210F00 05726 LXI H,DT#Status#2 ;Check if fake mode enabled
084A 19 05727 DAD D ;HL -> status byte in table
084B 7E 05728 MOV A,M ;Get status byte
084C E601 05729 ANI DT#Fake#Typeahead ;Isolate status bit
084E CA5B08 05730 JZ GIS#True#Status ;Fake mode disabled
05731 ;
05732 ;           ;Fake mode -- only indicates data
05733 ;           ;ready if control chars. in buffer
0851 211C00 05734 LXI H,DT#Control#Count ;Check if any control characters
0854 19 05735 DAD D ; in the input buffer
0855 AF 05736 XRA A ;Cheap 0

```

Figure 8-10. (Continued)

0856 B6	05737	ORA	M		;Set flags according to count
0857 C8	05738	RZ			;Return indicating zero
	05739	GIS>Data\$Ready:			
0858 AF	05740	XRA	A		;Cheap 0
0859 3D	05741	DCR	A		;Set A = OFFH and flags NZ
085A C9	05742	RET			;Return to caller
	05743				
	05744	GIS\$True\$Status:			
	05745				;True status, based on any characters
	05746				;ready in input buffer
085B 2ABD0F	05747	LHLD	CB\$Forced\$Input		;Check if any forced input waiting
085E 7E	05748	MOV	A,M		;Get next character of forced input
085F B7	05749	ORA	A		;Check if nonzero
0860 C25808	05750	JNZ	GIS\$Data\$Ready		;Yes, indicate data waiting
	05751				
0863 211900	05752	LXI	H,DT\$Character\$Count		;Check if any characters
0866 19	05753	DAD	D		; in buffer
0867 7E	05754	MOV	A,M		;Get character count
0868 B7	05755	ORA	A		
0869 C8	05756	RZ			;Empty buffer, A = 0, Z-set
086A C35808	05757	JMP	GIS\$Data\$Ready		
	05758				
	05759				
	05900				;#
	05901				
	05902				Real time clock processing
	05903				
	05904				Control is transferred to the RTC\$Interrupt routine each time
	05905				the real time clock ticks. The tick count is downdated to see
	05906				if a complete second has elapsed. If so, the ASCII time in
	05907				the configuration block is updated.
	05908				
	05909				With each tick, the watchdog count is downdated to see if control
	05910				must be "forced" to a previously specified address on return
	05911				from the RTC interrupt. The watchdog timer can be used to pull
	05912				control out of what would otherwise be an infinite loop, such
	05913				as waiting for the printer to come ready.
	05914				
	05915				
	05916				Set watchdog
	05917				
	05918				This is a noninterrupt level subroutine that simply sets the
	05919				watchdog count and address
	05920				
	05921				Entry parameters
	05922				
	05923				BC = number of clock ticks before watchdog should
	05924				"time out"
	05925				HL = address to which control will be transferred when
	05926				watchdog times out
	05927				
	05928	Set\$Watchdog:			
086D F3	05929	DI			;Avoid interference from interrupts
086E 22C100	05930	SHLD	RTC\$Watchdog\$Address		;Set address
0871 40	05931	MOV	H,B		
0872 69	05932	MOV	L,C		
0873 22BF00	05933	SHLD	RTC\$Watchdog\$Count		;Set count
0876 FB	05934	EI			
0877 C9	05935	RET			
	05936				
	05937				
	06000				;#
	06001				
	06002				
	06003				;Control is received here each time the
	06004				; real time clock ticks
	06005	RTC\$Interrupt:			
0878 F5	06005	PUSH	PSW		;Save other registers
0879 228622	06006	SHLD	PI\$User\$HL		;Switch to local stack
087C 210000	06007	LXI	H,0		
087F 39	06008	DAD	SP		;Get user's stack
0880 228422	06009	SHLD	PI\$User\$Stack		;Save it
0883 31B022	06010	LXI	SP,PI\$Stack		;Switch to local stack
0886 C5	06011	PUSH	B		
0887 D5	06012	PUSH	D		
	06013				
0888 21BE00	06014	LXI	H,RTC\$Tick\$Count		;Downdate tick count

Figure 8-10. (Continued)

088B 35	06015	DCR	M	
088C C2B008	06016	JNZ	RTC#Check#Watchdog	;Is not at 0 yet
	06017			;One second has elapsed so
088F 3ABD00	06018	LDA	RTC#Ticks#per#Second	; reset to original value
0892 77	06019	MOV	M,A	
	06020			
0893 11A10F	06021	LXI	D,Time#in#ASCII#End	;Update ASCII real time clock
0896 21BD00	06022	LXI	H,Update#Time#End	;DE -> 1 character after ASCII time
	06023			;HL -> 1 character after control table
			RTC#Update#Digit:	
0899 1B	06024	DCX	D	;Downdate pointer to time in ASCII
089A 2B	06025	DCX	H	;Downdate pointer to control table
089E 7E	06026	MOV	A,M	;Get next control character
089C B7	06027	ORA	A	;Check if end of table and therefore
089D CAB008	06028	JZ	RTC#Clock#Updated	; all digits of clock updated
08A0 FA9908	06029	JM	RTC#Update#Digit	;Skip over ":" in ASCII time
08A3 1A	06030	LDAX	D	;Get next ASCII time digit
08A4 3C	06031	INR	A	;Update it
08A5 12	06032	STAX	D	; and store it back
08A6 BE	06033	CMP	M	;Compare to maximum value
08A7 C2B008	06034	JNZ	RTC#Clock#Updated	;No carry needed so update complete
08AA 3E30	06035	MVI	A,'0'	;Reset digit to ASCII 0
08AC 12	06036	STAX	D	; and store back in ASCII time
08AD C39908	06037	JMP	RTC#Update#Digit	;Go back for next digit
	06038			
	06039			
	06040			
			RTC#Clock#Updated:	
			RTC#Check#Watchdog:	
08B0 2ABF00	06041	LHLD	RTC#Watchdog#Count	;Get current watchdog count
08B3 2B	06042	DCX	H	;Downdate it
08B4 7C	06043	MOV	A,H	;Check if it is now OFFFFH
08B5 B7	06044	ORA	A	
08B6 FACB08	06045	JM	RTC#Dog#Not#Set	;It must have been 0 beforehand
08B9 B5	06046	ORA	L	;Check if it is now 0
08BA C2C808	06047	JNZ	RTC#Dog#NZ	;No, it is not out of time
	06048			
	06049			
	06050			
08BD 21C508	06051	LXI	H,RTC#Watchdog#Return	; appropriate routine
08C0 E5	06052	PUSH	H	;Set up return address
08C1 2AC100	06053	LHLD	RTC#Watchdog#Address	; ready for return
08C4 E9	06054	PCHL		;Transfer control as though by CALL
	06055			
	06056			
			RTC#Watchdog#Return:	
08C5 C3CB08	06057	JMP	RTC#Dog#Not#Set	;Control will come back here from
	06058			; the user's watchdog routine
	06059			;Behave as though watchdog not active
			RTC#Dog#NZ:	
08C8 22BF00	06060	SHLD	RTC#Watchdog#Count	;Save downdated count
	06061			; (Leaves count unchanged)
			RTC#Dog#Not#Set:	
08CB 3E20	06062	MVI	A,IC#EOI	;Reset the interrupt controller chip
08CD D3D8	06063	OUT	IC#OCW2#Port	
	06064			
08CF D1	06065	POP	D	;Restore registers from local stack
08D0 C1	06066	POP	B	
08D1 2AB422	06067	LHLD	PI#User#Stack	;Switch back to user's stack
08D4 F9	06068	SPHL		
08D5 2AB622	06069	LHLD	PI#User#HL	;Recover user's registers
08D8 F1	06070	POP	PSW	
08D9 FB	06071	EI		;Re-enable interrupts
08DA C9	06072	RET		
	06073			
	06200			
	06201			
	06202			
	06203			
	06204			
			SHLR:	
08DB B7	06205	ORA	A	;Clear carry
08DC 7C	06206	MOV	A,H	;Get MS byte
08DD 1F	06207	RAR		;Bit 7 set from previous carry
	06208			
08DE 67	06209	MOV	H,A	;Bit 0 goes into carry
08DF 7D	06210	MOV	A,L	;Put shifted MS byte back
08E0 1F	06211	RAR		;Get LS byte
08E1 6F	06212	MOV	L,A	;Bit 7 = bit 0 of MS byte
08E2 C9	06213	RET		;Put back into result
	06214			
	06215			
	06300			

Figure 8-10. (Continued)

```

06301 ; High level diskette drivers
06302 ;
06303 ; These drivers perform the following functions:
06304 ;
06305 ; SELDSK Select a specified disk and return the address of
06306 ; the appropriate disk parameter header
06307 ; SETTRK Set the track number for the next read or write
06308 ; SETSEC Set the sector number for the next read or write
06309 ; SETDMA Set the DMA (read/write) address for the next read or write
06310 ; SECTRAN Translate a logical sector number into a physical
06311 ; HOME Set the track to 0 so that the next read or write will
06312 ; be on Track 0
06313 ;
06314 ; In addition, the high level drivers are responsible for making
06315 ; the 5 1/4" floppy diskettes that use a 512-byte sector appear
06316 ; to CP/M as though they used a 128-byte sector. They do this
06317 ; by using blocking/deblocking code. This blocking/deblocking
06318 ; code is described in more detail later in this listing,
06319 ; just prior to the code itself.
06320 ;
06321 ;
06322 ;
06323 ; Disk parameter tables
06324 ;
06325 ; As discussed in Chapter 3, these describe the physical
06326 ; characteristics of the disk drives. In this example BIOS,
06327 ; there are two types of disk drives; standard single-sided,
06328 ; single-density 8", and double-sided, double-density 5 1/4"
06329 ; mini-diskettes.
06330 ;
06331 ; The standard 8" diskettes do not need to use the blocking/
06332 ; deblocking code, but the 5 1/4" drives do. Therefore an additional
06333 ; byte has been prefixed onto the disk parameter block to
06334 ; tell the disk drivers what each logical disk's physical
06335 ; diskette type is, and whether or not it needs deblocking.
06336 ;
06337 ;
06338 ; Disk definition tables
06339 ;
06340 ; These consist of disk parameter headers, with one entry
06341 ; per logical disk driver, and disk parameter blocks with
06342 ; either one parameter block per logical disk, or the same
06343 ; parameter block for several logical disks.
06344 ;
06400 ;#
06401 ;
06402 ;Disk#Parameter#Headers: ;Described in Chapter 3
06403 ;
06404 ; ;Logical disk A: (5 1/4" diskette)
08E3 AE09 06405 DW Floppy#5#Skewtable ;5 1/4" skew table
08E5 000000000006406 DW 0,0,0 ;Reserved for CP/M
08E8 B022 06407 DW Directory#Buffer
08ED 3409 06408 DW Floppy#5#Parameter#Block
08EF B023 06409 DW Disk#A#Workarea
08F1 1024 06410 DW Disk#A#Allocation#Vector
06411 ;
06412 ; ;Logical disk B: (5 1/4" diskette)
08F3 AE09 06413 DW Floppy#5#Skewtable ;Shares same skew table as A:
08F5 000000000006414 DW 0,0,0 ;Reserved for CP/M
08FB B022 06415 DW Directory#Buffer ;Shares same buffer as A:
08FD 3409 06416 DW Floppy#5#Parameter#Block ;Same DPB as A:
08FF D023 06417 DW Disk#B#Workarea ;Private work area
0901 2624 06418 DW Disk#B#Allocation#Vector ;Private allocation vector
06419 ;
06420 ; ;Logical disk C: (8" floppy)
0903 F609 06421 DW Floppy#8#Skewtable ;8" skew table
0905 000000000006422 DW 0,0,0 ;Reserved for CP/M
090B B022 06423 DW Directory#Buffer ;Shares same buffer as A:
090D 4409 06424 DW Floppy#8#Parameter#Block
090F F023 06425 DW Disk#C#Workarea ;Private work area
0911 3C24 06426 DW Disk#C#Allocation#Vector ;Private allocation vector
06427 ;
06428 ; ;Logical disk D: (8" floppy)
0913 AE09 06429 DW Floppy#5#Skewtable ;Shares same skew table as A:
0915 000000000006430 DW 0,0,0 ;Reserved for CP/M
091B B022 06431 DW Directory#Buffer ;Shares same buffer as A:

```

Figure 8-10. (Continued)

091D	4409	06432	DW	Floppy%8#Parameter#Block	;Same DPB as C:
091F	0024	06433	DW	Disk%D#Workarea	;Private work area
0921	5B24	06434	DW	Disk%D#Allocation#Vector	;Private allocation vector
		06435			
		06436			
		06437			
			M#Disk#DPH:		;Logical disk M: (memory disk)
0923	0000	06438	DW	0	;No skew required
0925	0000000000	06439	DW	0,0,0	;Reserved for CP/M
092B	B022	06440	DW	Directory#Buffer	
092D	5409	06441	DW	M#Disk#Parameter#Block	
092F	0000	06442	DW	0	;Disk cannot be changed, therefore
		06443			; no work area is required
0931	7A24	06444	DW	M#Disk#Allocation#Vector	
		06445			
		06446			
		06447			
		06448			
		06449			
		06450			
		06451	Floppy%5	EQU 1	;5 1/4" mini floppy
0001 =		06452	Floppy%8	EQU 2	;8" floppy (SS SD)
0002 =		06453	M#Disk	EQU 3	;Memory disk
0003 =		06454			
		06455			
		06456			
		06457	Need#Deblocking	EQU 1000#0000B	;Sector size > 128 bytes
0080 =		06458			
		06600			
		06601			
		06602			
		06603			
		06604			
		06605			
		06606			
		06607			
0933	81	06608	DB	Floppy%5 + Need#Deblocking	;Extra byte prefixed to indicate
		06609			; disk type and blocking required
		06610			;The parameter block has been amended
		06611			; to reflect the new layout of one
		06612			; track per diskette side, rather
		06613			; than viewing one track as both
		06614			; sides on a given head position.
		06615			;It has also been adjusted to reflect
		06616			; one "new" track more being used for
		06617			; the CP/M image, with the resulting
		06618			; change in the number of allocation
		06619			; blocks and the number of reserved
		06620			; tracks.
			Floppy%5#Parameter#Block:		
0934	2400	06621	DW	36	;128-byte sectors per track
0936	04	06622	DB	4	;Block shift
0937	0F	06623	DB	15	;Block mask
0938	01	06624	DB	1	;Extent mask
0939	AB00	06625	DW	171	;Maximum allocation block number
093B	7F00	06626	DW	127	;Number of directory entries - 1
093D	C0	06627	DB	1100#0000B	;Bit map for reserving 1 alloc. block
093E	00	06628	DB	0000#0000B	; for file directory
093F	2000	06629	DW	32	;Disk-changed work area size
0941	0300	06630	DW	3	;Number of tracks before directory
		06631			
		06632			
		06633			
		06634			
		06635			
0943	02	06636	DB	Floppy%8	;Extra byte prefixed to DPB for
		06637			; this version of the BIOS
		06638			; Indicates disk type and the fact
			Floppy%8#Parameter#Block:		; that no deblocking is required
0944	1A00	06639	DW	26	;Sectors per track
0946	03	06640	DB	3	;Block shift
0947	07	06641	DB	7	;Block mask
0948	00	06642	DB	0	;Extent mask
0949	F200	06643	DW	242	;Maximum allocation block number
094B	3F00	06644	DW	63	;Number of directory entries - 1
094D	C0	06645	DB	1100#0000B	;Bit map for reserving 2 alloc. blocks
094E	00	06646	DB	0000#0000B	; for file directory
094F	1000	06647	DW	16	;Disk-changed work area size
0951	0200	06648	DW	2	;Number of tracks before directory

Figure 8-10. (Continued)

```

06649 ;
06650 ; M$Disk
06651 ;
06652 ;The M$Disk presumes that 4 x 48K memory
06653 ; banks are available. The following
06654 ; table describes the disk as having
06655 ; 8 tracks; two tracks per memory bank
06656 ; with each track having 192 128-byte
06657 ; sectors.
06658 ; The track number divided by 2 will be
06659 ; used to select the bank
06660 ;Type is M$Disk, no deblocking
0953 03 06660 DB M$Disk
06661 M$Disk$Parameter$Block:
0954 C000 06662 DW 192 ;Sectors per "track". Each track is
06663 ; 24K of memory
0956 03 06664 DB 3 ;Block shift (1024 byte allocation)
0957 07 06665 DB 7 ;Block mask
0958 00 06666 DB 0 ;Extent mask
0959 C000 06667 DW 192 ;Maximum allocation block number
095B 3F00 06668 DW 63 ;Number of directory entries -1
095D C0 06669 DB 1100$0000B ;Bit map for reserving 2 allocation blocks
095E 00 06670 DB 0000$0000B ; for file directory
095F 0000 06671 DW 0 ;Disk cannot be changed, therefore no
06672 ; work area
0961 0000 06673 DW 0 ;No reserved tracks
06674 ;
0004 = 06675 Number$of$Logical$Disks EQU 4
06676 ;#
06800 ;
06801 ;
06802 SELDSK: ;Select disk in register C
06803 ;C = 0 for drive A, 1 for B, etc.
06804 ;Return the address of the appropriate
06805 ; disk parameter header in HL, or 0000H
06806 ; if the selected disk does not exist.
06807 ;
0963 210000 06808 LXI H,0 ;Assume an error
0966 79 06809 MOV A,C ;Check if requested disk valid
06810 ;
0967 FE0C 06811 CPI 'M' - 'A' ;Check if memory disk
0969 CA9509 06812 JZ SELDSK$M$Disk ;Yes
06813 ;
096C FE04 06814 CPI Number$of$Logical$Disks
096E D0 06815 RNC ;Return if > maximum number of disks
06816 ;
096F 322D0A 06817 STA Selected$Disk ;Save selected disk number
06818 ;Set up to return DPH address
0972 6F 06819 MOV L,A ;Make disk into word value
0973 2600 06820 MVI H,0
06821 ;
06822 ;Compute offset down disk parameter
06823 ; header table by multiplying by
06824 ; parameter header length (16 bytes)
0975 29 06824 DAD H ;#2
0976 29 06825 DAD H ;#4
0977 29 06826 DAD H ;#8
0978 29 06827 DAD H ;#16
0979 11E308 06828 LXI D,Disk$Parameter$Headers ;Get base address
097C 19 06829 DAD D ;DE -> appropriate DPH
097D E5 06830 PUSH H ;Save DPH address
06831 ;
06832 ;Access disk parameter block to
06833 ; extract special prefix byte that
06834 ; identifies disk type and whether
06835 ; deblocking is required
06836 ;
097E 110A00 06837 LXI D,10 ;Get DPB pointer offset in DPH
0981 19 06838 DAD D ;DE -> DPB address in DPH
0982 5E 06839 MOV E,M ;Get DPB address in DE
0983 23 06840 INX H
0984 56 06841 MOV D,M
0985 EB 06842 XCHG ;DE -> DPB
06843 ;
06844 SELDSK$Set$Disk$Type:
0986 2B 06845 DCX H ;DE -> prefix byte
0987 7E 06846 MOV A,M ;Get prefix byte
0988 E60F 06847 ANI 0FH ;Isolate disk type

```

Figure 8-10. (Continued)

```

098A 32360A 06848 STA Selected$Disk$Type ;Save for use in low level driver
098D 7E 06849 MOV A,M ;Get another copy of prefix byte
098E E680 06850 ANI Need$Deblocking ;Isolate deblocking flag
0990 32350A 06851 STA Selected$Disk$Deblock ;Save for use in low level driver
0993 E1 06852 POP H ;Recover DPH pointer
0994 C9 06853 RET
06854 ;
0995 212309 06855 SELDSK*M$Disk: ;M$Disk selected
0998 C38609 06856 LXI H,M$Disk$DPH ;Return correct parameter header
06857 JMP SELDSK$Set$Disk$Type ;Resume normal processing
06858 ;
07000 ;#
07001 ;
07002 ; Set logical track for next read or write
07003 ;
07004 ;
099B 60 07005 MOV H,B ;Selected track in BC on entry
099C 69 07006 MOV L,C
099D 222EOA 07007 SHLD Selected$Track ;Save for low level driver
09A0 C9 07008 RET
07009 ;
07100 ;#
07101 ;
07102 ; Set logical sector for next read or write
07103 ;
07104 ;
07105 ;
09A1 79 07106 MOV A,C ;Logical sector in C on entry
09A2 32300A 07107 STA Selected$Sector ;Save for low level driver
09A5 C9 07108 RET
07109 ;
07200 ;#
07201 ;
07202 ; Set disk DMA (Input/Output) address for next read or write
07203 ;
09A6 0000 07204 DMA$Address: DW 0 ;DMA address
07205 ;
07206 ;
09AB 69 07207 SETDMA: ;Address in BC on entry
09A9 60 07208 MOV L,C ;Move to HL to save
09AA 22A609 07209 SHLD DMA$Address ;Save for low level driver
09AD C9 07210 RET
07211 ;
07300 ;#
07301 ;
07302 ; Translate logical sector number to physical
07303 ;
07304 ;
07305 ; Sector translation tables
07306 ; These tables are indexed using the logical sector number,
07307 ; and contain the corresponding physical sector number.
07308 ;
07309 ; Floppy$5$Skewtable: ;Each physical sector contains four
07310 ; ; 128-byte sectors.
09AE 00010203 07311 DB 00,01,02,03 ;00,01,02,03 0 )
09B2 10111213 07312 DB 16,17,18,19 ;04,05,06,07 4 )
09B6 20212223 07313 DB 32,33,34,35 ;08,09,10,11 8 )
09BA 0C0D0E0F 07314 DB 12,13,14,15 ;12,13,14,15 3 ) Head
09BE 1C1D1E1F 07315 DB 28,29,30,31 ;16,17,18,19 7 ) 0
09C2 08090A0B 07316 DB 08,09,10,11 ;20,21,22,23 2 )
09C6 18191A1B 07317 DB 24,25,26,27 ;24,25,26,27 6 )
09CA 04050607 07318 DB 04,05,06,07 ;28,29,30,31 1 )
09CE 14151617 07319 DB 20,21,22,23 ;32,33,34,35 5 )
07320 ;
09D2 24252627 07321 DB 36,37,38,39 ;36,37,38,39 0 ]
09D6 34353637 07322 DB 52,53,54,55 ;40,41,42,43 4 ]
09DA 44454647 07323 DB 68,69,70,71 ;44,45,46,47 8 ]
09DE 30313233 07324 DB 48,49,50,51 ;48,49,50,51 3 ] Head
09E2 40414243 07325 DB 64,65,66,67 ;52,53,54,55 7 ] 1
09E6 2C2D2E2F 07326 DB 44,45,46,47 ;56,57,58,59 2 ]
09EA 3C3D3E3F 07327 DB 60,61,62,63 ;60,61,62,63 6 ]
09EE 28292A2B 07328 DB 40,41,42,43 ;64,65,66,67 1 ]
09F2 38393A3B 07329 DB 56,57,58,59 ;68,69,70,71 5 ]
07330 ;
07331 ;
07332 ; Floppy$8$Skewtable: ;Standard 8" Driver

```

Figure 8-10. (Continued)

```

09F6 01070D131907334      07333      ;          01,02,03,04,05,06,07,08,09,10      Logical sectors
                                DB          01,07,13,19,25,05,11,17,23,03      ;Physical sectors
                                07335      ;
                                07336      ;
0A00 090F15020807337      07336      ;          11,12,13,14,15,16,17,18,19,20      Logical sectors
                                DB          09,15,21,02,08,14,20,26,06,12      ;Physical sectors
                                07338      ;
                                07339      ;          21,22,23,24,25,26      Logical sectors
0A0A 1218040A1007340      07338      DB          18,24,04,10,16,22      ;Physical sectors
                                07341      ;
                                07400      ;#
                                07401      ;
                                07402      ;SECTRAN:      ;Translate logical sector into physical
                                07403      ;On entry, BC = logical sector number
                                07404      ;          DE -> appropriate skew table
                                07405      ;
                                07406      ;on exit, HL = physical sector number
0A10 EB 07407      XCHG      ;HL -> skew table base
0A11 09 07408      DAD      B      ;Add on logical sector number
0A12 6E 07409      MOV      L,M      ;Get physical sector number
0A13 2600 07410      MVI      H,0      ;Make into a 16-bit value
0A15 C9 07411      RET
                                07412      ;
                                07500      ;#
                                07501      ;
                                07502      ;
                                07503      ;HOME:      ;Home the selected logical disk to track 0
                                07504      ;Before doing this, a check must be made to see
                                07505      ; if the physical disk buffer has information in
                                07506      ; it that must be written out. This is indicated by
                                07507      ; a flag, Must$Write$Buffer, that is set in the
                                07508      ; deblocking code.
                                07509      ;
0A16 3A2C0A 07510      LDA      Must$Write$Buffer      ;Check if physical buffer must
0A19 B7 07511      ORA      A      ; be written to a disk
0A1A C2200A 07512      JNZ      HOME$No$Write
0A1D 322B0A 07513      STA      Data$In$Disk$Buffer      ;No, so indicate that buffer
                                07514      ; is now unoccupied
                                07515      HOME$No$Write:
0A20 0E00 07516      MVI      C,0      ;Set to track 0 (logically,
0A22 CD9B09 07517      CALL    SETTRK      ; no actual disk operation occurs)
0A25 C9 07518      RET
                                07519      ;
                                07520      ;
                                07600      ;#
                                07601      ;
                                07602      ; Data written to or read from the mini-floppy drive is transferred
                                07603      ; via a physical buffer that is one complete track in length,
                                07604      ; 9 * 512 bytes. It is declared at the end of the BIOS, and has
                                07605      ; some small amount of initialization code "hidden" in it.
                                07606      ;
                                07607      ; The blocking/deblocking code attempts to minimize the amount
                                07608      ; of actual disk I/O by storing the disk and track
                                07609      ; currently residing in the physical buffer.
                                07610      ; If a read request occurs of a 128-byte CP/M "sector"
                                07611      ; that already is in the physical buffer, no disk access occurs
                                07612      ; If a write request occurs if and the 128-byte CP/M "sector"
                                07613      ; is already in the physical buffer, no disk access will occur,
                                07614      ; UNLESS the BDOS indicates that it is writing to the directory.
                                07615      ; Directory writes cause an immediate write to disk of the entire
                                07616      ; track in the physical buffer.
                                07617      ;
0800 = 07618      Allocation$Block$Size      EQU      2048
0009 = 07619      Physical$Sec$Per$Track      EQU      9      ;Adjusted to reflect a "new"
                                07620      ; track is only one side of the
                                07621      ; disk
0200 = 07622      Physical$Sector$Size      EQU      512      ;This is the actual sector size
                                07623      ; for the 5 1/4" mini-floppy diskettes
                                07624      ; The 8" diskettes and memory disk
                                07625      ; use 128-byte sectors
                                07626      ; Declare the physical disk buffer for the
                                07627      ; 5 1/4" diskettes
0004 = 07628      CPM$Sec$Per$Physical      EQU      Physical$Sector$Size/128
0024 = 07629      CPM$Sec$Per$Track      EQU      CPM$Sec$Per$Physical*Physical$Sec$Per$Track
1200 = 07630      Bytes$Per$Track      EQU      Physical$Sec$Per$Track*Physical$Sector$Size
0003 = 07631      Sector$Mask      EQU      CPM$Sec$Per$Physical-1
0002 = 07632      Sector$Bit$Shift      EQU      2      ;LOG2(CPM$Sec$Per$Physical)

```

Figure 8-10. (Continued)

```

07633 ;
07634 ;These are the values handed over by the BDOS
07635 ; when it calls the write operation.
07636 ;The allocated/unallocated indicates whether the
07637 ; BDOS wishes to write to an unallocated allocation
07638 ; block (it only indicates this for the first
07639 ; 128-byte sector write), or to an allocation block
07640 ; that has already been allocated to a file.
07641 ;The BDOS also indicates if it wishes to write to
07642 ; the file directory.
07643 ;
0000 = 07644 Write$Allocated EQU 0
0001 = 07645 Write$Directory EQU 1
0002 = 07646 Write$Unallocated EQU 2 ;<= ignored for track buffering
07647 ;
0A26 00 07648 Write$Type: DB 0 ;Contains the type of write
07649 ; indicated by the BDOS
07650 ;
07651 ;
07652 In$Buffer$Dk$Trk: ;Variables for physical sector currently
07653 ; in Disk$Buffer in memory
0A27 00 07654 In$Buffer$Disk: DB 0 ;) These are moved and compared
0A28 0000 07655 In$Buffer$Track: DW 0 ;) as a group, so do not alter
07656 ; these lines
0A2A 00 07657 In$Buffer$Disk$Type: DB 0 ;Disk type for sector in buffer
07658 ;
0A2B 00 07659 Data$In$Disk$Buffer: DB 0 ;When nonzero, the disk buffer has
07660 ; data from the disk in it
0A2C 00 07661 Must$Write$Buffers: DB 0 ;Nonzero when data has been written
07662 ; into Disk$Buffer but not yet
07663 ; written out to disk
07664 ;
07665 Selected$Dk$Trk: ;Variables for selected disk, track and sector
07666 ; (Selected by SELDSK, SETTRK and SETSEC)
0A2D 00 07667 Selected$Disk: DB 0 ;) These are moved and compared
0A2E 0000 07668 Selected$Track: DW 0 ;) as a group so do not alter order
07669 ;
0A30 00 07670 Selected$Sector: DB 0 ;Not part of group but needed here
07671 ;
0A31 00 07672 Selected$Physical$Sector: DB 0 ;Selected physical sector derived
07673 ; from selected (CP/M) sector by
07674 ; shifting it right the number of
07675 ; bits specified by Sector$Bit$Shift
07676 ;
07677 ;
07678 ;
0A32 00 07679 Disk$Error$Flag: DB 0 ;Nonzero to indicate an error
07680 ; that could not be recovered
07681 ; by the disk drivers. The BDOS
07682 ; will output a "Bad Sector" message
0A33 00 07683 Disk$Hung$Flag: DB 0 ;Nonzero if a watchdog timeout
07684 ; occurs
0258 = 07685 Disk$Timer EQU 600 ;Number of 16.66 ms clock ticks
07686 ; for a 10 second timeout
07687 ;
07688 ;Flags used inside the deblocking code
07689 ;
0A34 00 07690 Read$Operation: DB 0 ;Nonzero when a CP/M 128-byte
07691 ; sector is to be read
0A35 00 07692 Selected$Disk$Deblock: DB 0 ;Nonzero when the selected disk
07693 ; needs deblocking (set in SELDSK)
0A36 00 07694 Selected$Disk$Type: DB 0 ;Indicates 8" or 5 1/4" floppy or
07695 ; M$Disk selected. (set in SELDSK)
07696 ;
07800 ;#
07801 ;
07802 ; Read in the 128-byte CP/M sector specified by previous calls
07803 ; to Select Disk, Set Track and Sector. The sector will be read
07804 ; into the address specified in the previous Set DMA Address call.
07805 ;
07806 ; If reading from a disk drive using sectors larger than 128 bytes,
07807 ; deblocking code will be used to "unpack" a 128-byte sector from
07808 ; the physical sector.
07809 ;
07809 READ:
0A37 3A350A 07810 LDA Selected$Disk$Deblock ;Check if deblocking needed
0A3A B7 07811 ORA A ; (flag was set in SELDSK call)

```

Figure 8-10. (Continued)

0A3B CA2F0B	07812	JZ	Read#No#Deblock	;No, use normal nondeblocked
	07813			
	07814			;The deblocking algorithm used is such
	07815			; that a read operation can be viewed
	07816			; until the actual data transfer as though
	07817			; it was the first write to an unallocated
	07818			; allocation block
0A3E 3E01	07819	MVI	A,1	;Indicate that a read actually
0A40 32340A	07820	STA	Read#Operation	; is to be performed
	07821			
0A43 3E00	07822	MVI	A,Write#Allocated	;Fake deblocking code into believing
0A45 32260A	07823	STA	Write#Type	; that this is a write to an
	07824			; allocated allocation block
0A48 C35C0A	07825	JMP	Perform#Read#Write	;Use common code to execute read
	07826			
	07900			;#
	07901			Write a 128-byte sector from the current DMA address to
	07902			the previously selected disk, track and sector.
	07903			
	07904			On arrival here, the BDOS will have set register C to indicate
	07905			whether this write operation is to an already allocated allocation
	07906			block (which means a pre-read of the sector may be needed), or
	07907			to the directory (in which case the data will be written to the
	07908			disk immediately).
	07909			
	07910			Only writes to the directory take place immediately. In all other
	07911			cases, the data will be moved from the DMA address into the disk
	07912			buffer, and only be written out when circumstances force the
	07913			transfer. The number of physical disk operations can therefore
	07914			be reduced considerably.
	07915			
	07916		WRITE:	
0A4B 3A350A	07917	LDA	Selected#Disk#Deblock	;Check if deblocking is required
0A4E B7	07918	ORA	A	; (flag set in SELDSK call)
0A4F CA2A0B	07919	JZ	Write#No#Deblock	
	07920			
0A52 AF	07921	XRA	A	;Indicate that a write operation
0A53 32340A	07922	STA	Read#Operation	; is required (i.e NOT a read)
0A56 79	07923	MOV	A,C	;Save the BDOS write type
0A57 E601	07924	ANI	1	; but only distinguish between
	07925			; write to allocated block or
0A59 32260A	07926	STA	Write#Type	; directory write
	07927			
	07928			
	08000			;#
	08001			
	08002		Perform#Read#Write:	;Common code to execute both reads and
	08003			; writes of 128-byte sectors.
0A5C AF	08004	XRA	A	;Assume that no disk errors will
0A5D 32320A	08005	STA	Disk#Error#Flag	; occur
	08006			
0A60 3A300A	08007	LDA	Selected#Sector	;Convert selected 128-byte sector
0A63 1F	08008	RAR		; into physical sector by dividing by 4
0A64 1F	08009	RAR		
0A65 E63F	08010	ANI	3FH	;Remove any unwanted bits
0A67 32310A	08011	STA	Selected#Physical#Sector	
	08012			
0A6A 212B0A	08013	LXI	H,Data#In#Disk#Buffer	;Check if disk buffer already has
0A6D 7E	08014	MOV	A,M	; data in it
0A6E 3601	08015	MVI	M,1	; (Unconditionally indicate that
	08016			; the buffer now has data in it)
0A70 B7	08017	ORA	A	; Did it indeed have data in it?
0A71 CA870A	08018	JZ	Read#Track#into#Buffer	;No, proceed to read a physical
	08019			; track into the buffer
	08020			
	08021			;The buffer does have a physical track
	08022			; in it. Check if it is the right one
	08023			
0A74 11270A	08024	LXI	D,In#Buffer#Dk#Trk	;Check if track in buffer is the
0A77 212D0A	08025	LXI	H,Selected#Dk#Trk	; same as that selected earlier
0A7A CDE10A	08026	CALL	Compare#Dk#Trk	;Compare ONLY disk and track
0A7D CA910A	08027	JZ	Track#In#Buffer	;Yes, it is already in buffer
	08028			
	08029			;No, it will have to be read in
	08030			; over current contents of buffer
0A80 3A2C0A	08031	LDA	Must#Write#Buffer	;Check if buffer has data in that

Figure 8-10. (Continued)

0A83 B7	08032	ORA	A		; must be written out first
0A84 C4E50B	08033	CNZ	Write#Physical		;Yes, write it out
	08034				
	08035				
0A87 CDCE0A	08036	CALL	Read#Track#into#Buffers		
	08037	CALL	Set#In#Buffer#Dk#Trk		;Set in buffer variables from
	08038				; selected disk, track
	08039				; to reflect which track is in the
0A8A CDEA0B	08040	CALL	Read#Physical		; buffer now
0A8D AF	08041	XRA	A		;Read the track into the buffer
0A8E 322C0A	08042	STA	Must#Write#Buffer		;Reset the flag to reflect buffer
	08043				; contents
	08044				
	08045				
	08046				
	08047				
	08048				
0A91 3A300A	08049	LDA	Selected#Sector		;Selected track and
0A94 6F	08050	MOV	L,A		; disk is already in the buffer
0A95 2600	08051	MVI	H,0		;Convert the selected CP/M (128-byte)
0A97 29	08052	DAD	H		; sector into a relative address down
0A98 29	08053	DAD	H		; the buffer
0A99 29	08054	DAD	H		
0A9A 29	08055	DAD	H		
0A9B 29	08056	DAD	H		
0A9C 29	08057	DAD	H		
0A9D 29	08058	DAD	H		
	08059				
0A9E 11A40F	08060	LXI	D,Disk#Buffer		;Get base address of disk buffer
0AA1 19	08061	DAD	D		;Add on sector number * 128
	08062				;HL -> 128-byte sector number start
	08063				; address in disk buffer
0AA2 EB	08064	XCHG			;DE -> sector in disk buffer
0AA3 2AA609	08065	LHLD	DMA#Address		;Get DMA address set in SETDMA call
0AA6 EB	08066	XCHG			;Assume a read operation, so
	08067				; DE -> DMA address
	08068				; HL -> sector in disk buffer
0AA7 0E10	08069	MVI	C,128/8		;Because of the faster method used
	08070				; to move data in and out of the
	08071				; disk buffer, (eight bytes moved per
	08072				; loop iteration) the count need only
	08073				; be 1/8 of normal
	08074				;At this point,
	08075				; C = loop count
	08076				; DE -> DMA address
	08077				; HL -> sector in disk buffer
0AA9 3A340A	08078	LDA	Read#Operation		;Determine whether data is to be moved
0AAC B7	08079	ORA	A		; out of the buffer (read) or into the
0AAD C2B50A	08080	JNZ	Buffer#Move		; buffer (write)
	08081				;Writing into buffer
	08082				; (A must be 0 get here)
0AB0 3C	08083	INR	A		;Set flag to force a write
0AB1 322C0A	08084	STA	Must#Write#Buffer		; of the disk buffer later on.
0AB4 EB	08085	XCHG			;Make DE -> sector in disk buffer
	08086				; HL -> DMA address
	08087				
	08088				
	08089				
0AB5 CDF80A	08090	CALL	Buffer#Move		;Moves 8 bytes * C times from (HL)
	08091				; to (DE)
	08092				
	08093				
0AB8 3A260A	08094	LDA	Write#Type		;If write to directory, write out
0ABB FE01	08095	CPI	Write#Directory		; buffer immediately
0ABD 3A320A	08096	LDA	Disk#Error#Flag		;Get error flag in case delayed write or read
0AC0 C0	08097	RNZ			;Return if delayed write or read
	08098				
0AC1 B7	08099	ORA	A		;Check if any disk errors have occurred
0AC2 C0	08100	RNZ			;Yes, abandon attempt to write to directory
	08101				
0AC3 AF	08102	XRA	A		;Clear flag that indicates buffer must be
0AC4 322C0A	08103	STA	Must#Write#Buffer		; written out
0AC7 CDE50B	08104	CALL	Write#Physical		;Write buffer out to physical track
0ACA 3A320A	08105	LDA	Disk#Error#Flag		;Return error flag to caller
0ACD C9	08106	RET			
	08107				

Figure 8-10. (Continued)

	08108	;		
	08109	;		
	08110	Set\$In\$Buffer\$Dk\$Trk:		;Indicate selected disk, track
	08111			; now residing in buffer
OACE 3A2D0A	08112	LDA	Selected\$Disk	
OAD1 32270A	08113	STA	In\$Buffer\$Disk	
	08114			
OAD4 2A2E0A	08115	LHLD	Selected\$Track	
OAD7 22280A	08116	SHLD	In\$Buffer\$Track	
	08117			
OADA 3A360A	08118	LDA	Selected\$Disk\$Type	;Also reflect disk type
OADD 322A0A	08119	STA	In\$Buffer\$Disk\$Type	
	08120			
OAE0 C9	08121	RET		
	08122	;		
	08123	;		
	08124	Compare\$Dk\$Trk:		;Compares just the disk and track
	08125			; pointed to by DE and HL
OAE1 OE03	08126	MVI	C,3	;Disk (1), track (2)
	08127	Compare\$Dk\$Trk\$Loop:		
OAE3 1A	08128	LDAX	D	;Get comparator
OAE4 BE	08129	CMP	M	;Compare with comparand
OAE5 C0	08130	RNZ		;Abandon comparison if inequality found
OAE6 13	08131	INX	D	;Update comparator pointer
OAE7 23	08132	INX	H	;Update comparand pointer
OAE8 0D	08133	DCR	C	;Count down on loop count
OAE9 C8	08134	RZ		;Return (with zero flag set)
OAEA C3E30A	08135	JMP	Compare\$Dk\$Trk\$Loop	
	08136	;		
	08137	;		
	08138	Move\$Dk\$Trk:		;Moves the disk, track
	08139			; variables pointed at by HL to
	08140			; those pointed at by DE
OAE1 OE03	08141	MVI	C,3	;Disk (1), Track (2)
	08142	Move\$Dk\$Trk\$Loop:		
OAEF 7E	08143	MOV	A,M	;Get source byte
OAF0 12	08144	STAX	D	;Store in destination
OAF1 13	08145	INX	D	;Update pointers
OAF2 23	08146	INX	H	
OAF3 0D	08147	DCR	C	;Count down on byte count
OAF4 C8	08148	RZ		;Return if all bytes moved
OAF5 C3EFOA	08149	JMP	Move\$Dk\$Trk\$Loop	
	08150	;		
	08300	;		
	08301	;		
	08302	;		
	08303	;		
	08304	;		
	08305	;		
	08306	;		
	08307	;		
	08308	;		
	08309	;		
	08310	;		
	08311	;		
	08312	;		
	08313	;		
	08314	Move\$8:		
OAFB 7E	08315	MOV	A,M	;Get byte from source
OAF9 12	08316	STAX	D	;Put into destination
OAF1 13	08317	INX	D	;Update pointers
OAFB 23	08318	INX	H	
OAF1 7E	08319	MOV	A,M	;Get byte from source
OAFD 12	08320	STAX	D	;Put into destination
OAFE 13	08321	INX	D	;Update pointers
OAFF 23	08322	INX	H	
OB00 7E	08323	MOV	A,M	;Get byte from source
OB01 12	08324	STAX	D	;Put into destination
OB02 13	08325	INX	D	;Update pointers
OB03 23	08326	INX	H	
OB04 7E	08327	MOV	A,M	;Get byte from source
OB05 12	08328	STAX	D	;Put into destination
OB06 13	08329	INX	D	;Update pointers
OB07 23	08330	INX	H	
OB08 7E	08331	MOV	A,M	;Get byte from source
OB09 12	08332	STAX	D	;Put into destination

Figure 8-10. (Continued)

OB0A 13	08333	INX	D	;Update pointers
OB0B 23	08334	INX	H	
OB0C 7E	08335	MOV	A,M	;Get byte from source
OB0D 12	08336	STAX	D	;Put into destination
OB0E 13	08337	INX	D	;Update pointers
OB0F 23	08338	INX	H	
OB10 7E	08339	MOV	A,M	;Get byte from source
OB11 12	08340	STAX	D	;Put into destination
OB12 13	08341	INX	D	;Update pointers
OB13 23	08342	INX	H	
OB14 7E	08343	MOV	A,M	;Get byte from source
OB15 12	08344	STAX	D	;Put into destination
OB16 13	08345	INX	D	;Update pointers
OB17 23	08346	INX	H	
	08347			
OB18 0D	08348	DCR	C	;Count down on loop counter
OB19 C2F80A	08349	JNZ	Move%B	;Repeat until done
OB1C C9	08350	RET		
	08351			
	08352			
	08500			
	08501			
	08502			
	08503			
	08504			
	08505			
	08506			
	08507			
	08508			
	08509			
	08510			
	08511			
	08512			
	08513			
	08514			
	08515			
	08516			
	08517			
	08518			
	08519			
	08520			
	08521			
	08522			
	08523			
	08524			
	08525			
	08526			
	08527			
	08528			
	08529			
	08530			
	08531			
	08532			
	08533			
	08534			
	08535			
	08536			
	08537			
0040 =	08538	Disk\$Control\$8	EQU	40H ;8" control byte
0041 =	08539	Command\$Block\$8	EQU	41H ;Control table pointer
	08540			
0043 =	08541	Disk\$Status\$Block	EQU	43H ;8" AND 5 1/4" status block
	08542			
0045 =	08543	Disk\$Control\$5	EQU	45H ;5 1/4" control byte
0046 =	08544	Command\$Block\$5	EQU	46H ;Control table pointer
	08545			
	08546			
	08547			
	08548			
	08549			
OB1D 00	08549	Floppy\$Command:	DB	0 ;Command
0001 =	08550	Floppy\$Read\$Code	EQU	01H
0002 =	08551	Floppy\$Write\$Code	EQU	02H
OB1E 00	08552	Floppy\$Unit:	DB	0 ;Unit (drive) number = 0 or 1
OB1F 00	08553	Floppy\$Head:	DB	0 ;Head number = 0 or 1
OB20 00	08554	Floppy\$Track:	DB	0 ;Track number
OB21 00	08555	Floppy\$Sector:	DB	0 ;Sector number

Figure 8-10. (Continued)

0B22	0000	0B556	Floppy%Byte#Count:	DW	0	;Number of bytes to read/write
0B24	0000	0B557	Floppy%DMA#Address:	DW	0	;Transfer address
0B26	0000	0B558	Floppy%Next#Status#Block:	DW	0	;Pointer to next status block
		0B559				; if commands are chained.
0B28	0000	0B560	Floppy%Next#Control#Location:	DW	0	;Pointer to next control byte
		0B561				; if commands are chained
		0B562	;			
		0B700	;			
		0B701	;			
		0B702	;			
		0B703	Write#No#Deblock:			;Write contents of disk buffer to
		0B704				; correct sector
0B2A	3E02	0B705	MVI	A,Floppy#Write#Code		;Get write function code
0B2C	C3310B	0B706	JMP	Common#No#Deblock		;Go to common code
		0B707	Read#No#Deblock:			;Read previously selected sector
		0B708				; into disk buffer.
0B2F	3E01	0B709	MVI	A,Floppy#Read#Code		;Get read function code
		0B710	Common#No#Deblock:			
0B31	321D0B	0B711	STA	Floppy#Command		;Set command function code
		0B712				;Set up nondeblocked command table
		0B713				
0B34	3A360A	0B714	LDA	Selected#Disk#Type		;Check if memory disk operation
0B37	FE03	0B715	CPI	M#Disk		
0B39	CA7A0B	0B716	JZ	M#Disk#Transfer		;Yes, it is M#Disk
		0B717				
		0B718	No#Deblock#Retry:			;Re-entry point to retry after error
0B3C	218000	0B719	LXI	H,128		;Bytes per sector
0B3F	22220B	0B720	SHLD	Floppy#Byte#Count		
0B42	AF	0B721	XRA	A		;8" floppy only has head 0
0B43	321F0B	0B722	STA	Floppy#Head		
		0B723				
0B46	3A2D0A	0B724	LDA	Selected#Disk		;8" floppy controller only knows about
		0B725				; units 0 and 1 so Selected#Disk must
		0B726				; be converted
0B49	E601	0B727	ANI	01H		;Turn into 0 or 1
0B4B	321E0B	0B728	STA	Floppy#Unit		;Set unit number
		0B729				
0B4E	3A2E0A	0B730	LDA	Selected#Track		
0B51	32200B	0B731	STA	Floppy#Track		;Set track number
		0B732				
0B54	3A300A	0B733	LDA	Selected#Sector		
0B57	32210B	0B734	STA	Floppy#Sector		;Set sector number
		0B735				
0B5A	2AA609	0B736	LHLD	DMA#Address		;Transfer directly between DMA Address
0B5D	22240B	0B737	SHLD	Floppy#DMA#Address		; and 8" controller.
		0B738				
		0B739				;The disk controller can accept chained
		0B740				; disk control tables, but in this case,
		0B741				; they are not used, so the "Next" pointers
		0B742				; must be pointed back at the initial
		0B743				; control bytes in the base page.
0B60	214300	0B744	LXI	H,Disk#Status#Block		;Point next status back at
0B63	22260B	0B745	SHLD	Floppy%Next#Status#Block		; main status block
		0B746				
0B66	214000	0B747	LXI	H,Disk#Control#8		;Point next control byte
0B69	22280B	0B748	SHLD	Floppy%Next#Control#Location		; back at main control byte
		0B749				
0B6C	211D0B	0B750	LXI	H,Floppy#Command		;Point controller at control table
0B6F	224100	0B751	SHLD	Command#Block#8		
		0B752				
0B72	214000	0B753	LXI	H,Disk#Control#8		;Activate controller to perform
0B75	3680	0B754	MVI	M,80H		; operation
0B77	C33B0C	0B755	JMP	Wait#For#Disk#Complete		
		0B756				
		0B757	;			
		0B900	;			
		0B901	;			
		0B902	;			
		0B903	;			
		0B904	;			
		0B905	;			
		0B906	;			
		0B907	;			
		0B908	;			
		0B909	;			
		0B910	;			

Figure 8-10. (Continued)

	08911	;		For writing, the 128-byte sector must be processed:
	08912	;		
	08913	;		1. Move sector DMA\$Address -> M\$Disk\$Buffer
	08914	;		2. Select correct track (+1 to get bank number)
	08915	;		3. Move sector M\$Disk\$Buffer -> M\$Disk image
	08916	;		4. Select bank 0
	08917	;		
	08918	;		For reading, the processing is:
	08919	;		
	08920	;		1. Select correct track/bank
	08921	;		2. Move sector M\$Disk image -> M\$Disk\$Buffer
	08922	;		3. Select Bank 0
	08923	;		4. Move sector M\$Disk\$Buffer -> DMA\$Address
	08924	;		
	08925	;		If there is any risk of any interrupt causing control
	08926	;		to be transferred to an address below 48K, interrupts must
	08927	;		be disabled when any bank other than 0 is selected.
	08928	;		
	08929	;		M\$Disk\$Transfer:
	08930	LDA	Selected\$Sector	;Compute address in memory
OB7A 3A300A	08931	MOV	L,A	; by multiplying sector * 128
OB7D 6F	08932	MVI	H,0	
OB7E 2600	08933	DAD	H	;* 2
OB80 29	08934	DAD	H	;* 4
OB81 29	08935	DAD	H	;* 8
OB82 29	08936	DAD	H	;* 16
OB83 29	08937	DAD	H	;* 32
OB84 29	08938	DAD	H	;* 64
OB85 29	08939	DAD	H	;* 128
OB86 29	08940			
	08941	LDA	Selected\$Track	;Compute which half of bank sector
OB87 3A2EOA	08942			; is in by using LS bit of track
	08943	MOV	B,A	;Save copy for later
OB8A 47	08944	ANI	1	;Isolate lower/upper indicator
OB8B E601	08945	JZ	M\$Disk\$Lower\$Half	
OB8D CA940B	08946			
	08947	LXI	D,(48 * 1024) / 2	;Upper half, so bias address
OB90 110060	08948	DAD	D	
OB93 19	08949			
	08950			M\$Disk\$Lower\$Half:
	08951	MOV	A,B	;HL -> sector in memory
OB94 78	08952	RAR		;Recover selected track
OB95 1F	08953	INR	A	;Divide by 2 to get bank number
OB96 3C	08954	MOV	B,A	;Bank 1 is first track
OB97 47	08955			;Preserve for later use
	08956	LDA	Floppy\$Command	;Check if reading or writing
OB98 3A1DOB	08957	CPI	Floppy\$Write\$Code	
OB9B FE02	08958	JZ	M\$Disk\$Write	;Writing
OB9D CABEOB	08959			;Reading
	08960			
	08961	CALL	Select\$Bank	;Select correct memory bank
OBAA CDDDOB	08962	LXI	D,M\$Disk\$Buffer	;DE -> M\$Disk\$Buffer, HL -> M\$Disk image
OBAB 0600	08963	MVI	C,128/8	;Number of 8-byte blocks to move
OBAD CDDDOB	08964	CALL	Move\$8	
OBAB 0600	08965			
OBAD CDDDOB	08966	MVI	B,0	;Revert to normal memory bank
OBAB 0600	08967	CALL	Select\$Bank	
OBAB 0600	08968			
OB80 2AA609	08969	LHLD	DMA\$Address	;Get user's DMA address
OB83 113023	08970	LXI	D,M\$Disk\$Buffer	
OB86 EB	08971	XCHG		;DE -> User's DMA, HL -> M\$Disk buffer
OB87 0E10	08972	MVI	C,128/8	;Number of 8-byte blocks to move
OB89 CDF80A	08973	CALL	Move\$8	
OB89 CDF80A	08974			
OBBC AF	08975	XRA	A	
OBBD C9	08976	RET		;Indicate no error
	08977			
	08978			M\$Disk\$Write:
	08979	PUSH	H	;Writing
OBBE E5	08980	LHLD	DMA\$Address	;Save sector's address in M\$Disk image
OBBF 2AA609	08981	LXI	D,M\$Disk\$Buffer	;Move sector into M\$Disk\$Buffer
OBC2 113023	08982	MVI	C,128/8	
OBC5 0E10	08983	CALL	Move\$8	;Number of 8-byte blocks to move
OBC7 CDF80A	08984			;(Does not use B register)
ORCA CDDDOB	08985	CALL	Select\$Bank	;B = memory bank to select
	08986			

Figure 8-10. (Continued)

OBCE	D1	08987	POP	D		;Recover sector's M\$Disk image address
OBCE	213023	08988	LXI	H,M\$Disk\$Buffer		
OBDD	0E10	08989	MVI	C,128/B		
OBDD	CDFA0A	08990	CALL	Move\$B		;Move into M\$Disk image
		08991				
OBDD	0600	08992	MVI	B,0		;Select bank 0
OBDD	CDDDOB	08993	CALL	Select\$Bank		
		08994				
OBDD	AF	08995	XRA	A		;Indicate no error
OBDD	C9	08996	RET			
		08997				
		09100				;#
		09101		Select bank		
		09102				
		09103				This routine switches in the required memory bank.
		09104				Note that the hardware port that controls bank selection
		09105				also has other bits in it. These are preserved across
		09106				bank selections.
		09107				
		09108		Entry parameter		
		09109				
		09110		B = bank number		
		09111				
0040 =		09112	Bank\$Control\$Port	EQU	40H	
00F8 =		09113	Bank\$Mask	EQU	1111\$1000B	;To preserve other bits
		09114				
		09115	Select\$Bank:			
OBDD	DB40	09116	IN	Bank\$Control\$Port		;Get current setting in port
OBDD	E6F8	09117	ANI	Bank\$Mask		;Preserve all other bits
OBE1	B0	09118	ORA	B		;Set bank code
OBE2	D340	09119	OUT	Bank\$Control\$Port		;Select the bank
OBE4	C9	09120	RET			
		09121				
		09200				;#
		09201				
		09202				
		09203	Write\$Physical:			;Write contents of disk buffer to
		09204				; correct sector
OBE5	3E02	09205	MVI	A,Floppy\$Write\$Code		;Get write function code
OBE7	C3EC0B	09206	JMP	Common\$Physical		;Go to common code
		09207	Read\$Physical:			;Read previously selected sector
		09208				; into disk buffer
OBEA	3E01	09209	MVI	A,Floppy\$Read\$Code		;Get read function code
		09210				
		09211	Common\$Physical:			
OBEA	321DOB	09212	STA	Floppy\$Command		;Set command table
		09213				
		09214				
		09215	Deblock\$Retry:			;Re-entry point to retry after error
OBEF	3A2A0A	09216	LDA	In\$Buffer\$Disk\$Type		;Get disk type currently in buffer
OBF2	FE01	09217	CPI	Floppy\$5		;Confirm it is a 5 1/4" floppy
OBF4	CAFDOB	09218	JZ	Correct\$Disk\$Type		;Yes
OBF7	3E01	09219	MVI	A,1		;No, indicate disk error
OBF9	32320A	09220	STA	Disk\$Error\$Flag		
OBF8	C9	09221	RET			
		09222	Correct\$Disk\$Type:			;Set up disk control table
		09223				
OBF8	3A270A	09224	LDA	In\$Buffer\$Disk		;Convert disk number to 0 or 1
OC00	E601	09225	ANI	1		; for disk controller
OC02	321E0B	09226	STA	Floppy\$Unit		
		09227				
OC05	2A280A	09228	LHLD	In\$Buffer\$Track		;Set up head and track number
OC08	7D	09229	MOV	A,L		;Even numbered tracks will be on
OC09	E601	09230	ANI	1		; head 0, odd numbered on head 1
OC0B	321F0B	09231	STA	Floppy\$Head		;Set head number
		09232				
OC0E	7D	09233	MOV	A,L		;Note: this is single byte value
OC0F	1F	09234	RAR			; /2 for track (carry off from ANI above)
OC10	32200B	09235	STA	Floppy\$Track		
		09236				
OC13	3E01	09237	MVI	A,1		;Start with sector 1 as a whole
OC15	32210B	09238	STA	Floppy\$Sector		; track will be transferred
		09239				
OC18	210012	09240	LXI	H,Bytes\$Per\$Track		;Set byte count for complete
OC1B	22220B	09241	SHLD	Floppy\$Byte\$Count		; track to be transferred
		09242				

Figure 8-10. (Continued)

0C1E	21A40F	09243	LXI	H,Disk\$Buffer	;Set transfer address to be
0C21	22240B	09244	SHLD	Floppy\$DMA\$Address	; disk buffer
		09245			;
		09246			;
		09247			As only one control table is in
		09248			use, close the status and busy
		09249			chain pointers back to the
					main control bytes
0C24	214300	09250	LXI	H,Disk\$Status\$Block	
0C27	22260B	09251	SHLD	Floppy\$Next\$Status\$Block	
0C2A	214500	09252	LXI	H,Disk\$Control\$5	
0C2D	22280B	09253	SHLD	Floppy\$Next\$Control\$Location	
		09254			
0C30	211D0B	09255	LXI	H,Floppy\$Command	;Set up command block pointer
0C33	224600	09256	SHLD	Command\$Block\$5	
		09257			
0C36	214500	09258	LXI	H,Disk\$Control\$5	;Activate 5 1/4" disk controller
0C39	3680	09259	MVI	M,80H	
		09260			;
		09261			Wait\$For\$Disk\$Complete:
		09262			;Wait until disk status block indicates
		09263			operation has completed, then check
		09264			if any errors occurred.
					On entry HL -> disk control byte
					Ensure hung flag clear
0C3B	AF	09265	XRA	A	
0C3C	32330A	09266	STA	Disk\$Hung\$Flag	
		09267			
0C3F	21570C	09268	LXI	H,Disk\$Timed\$Out	;Set up watchdog timer
0C42	015802	09269	LXI	B,Disk\$Timer	;Time delay
0C45	CD6D08	09270	CALL	Set\$Watchdog	
		09271			
					Disk\$Wait\$Loop:
0C48	7E	09272	MOV	A,M	;Get control byte
0C49	B7	09273	ORA	A	
0C4A	CA5D0C	09274	JZ	Disk\$Complete	;Operation done
		09275			
0C4D	3A330A	09276	LDA	Disk\$Hung\$Flag	;Also check if time expired
0C50	B7	09277	ORA	A	
0C51	C2B40D	09278	JNZ	Disk\$Error	;Will be set to 40H
		09279			
0C54	C3480C	09280	JMP	Disk\$Wait\$Loop	
		09281			
		09282			Disk\$Timed\$Out:
		09283			;Control arrives here from watchdog
		09284			routine itself -- so this is effectively
					part of the interrupt service routine.
0C57	3E40	09285	MVI	A,40H	;Set disk hung error code
0C59	32330A	09286	STA	Disk\$Hung\$Flag	; into error flag to pull
		09287			control out of loop
0C5C	C9	09288	RET		;Return to watchdog routine
		09289			
		09290			Disk\$Complete:
0C5D	010000	09291	LXI	B,0	;Reset watchdog timer
		09292			;HL is irrelevant here
0C60	CD6D08	09293	CALL	Set\$Watchdog	
		09294			
0C63	3A4300	09295	LDA	Disk\$Status\$Block	;Complete, now check status
0C66	FE80	09296	CPI	80H	;Check if any errors occurred
0C68	DAB40D	09297	JC	Disk\$Error	;Yes
		09298			
		09299			Disk\$Error\$Ignore:
0C6B	AF	09300	XRA	A	;No
0C6C	32320A	09301	STA	Disk\$Error\$Flag	;Clear error flag
0C6F	C9	09302	RET		
		09303			
		09304			;
		09400			;
		09401			Disk error message handling
		09402			;
		09403			;
		09404			Disk\$Error\$Messages:
		09405			;This table is scanned, comparing the
		09406			disk error status with those in the
		09407			table. Given a match, or even when
		09408			then end of the table is reached, the
		09409			address following the status value
					points to the correct message text.
0C70	40	09410	DB	40H	
0C71	9D0C	09411	DW	Disk\$Msg\$40	
0C73	41	09412	DB	41H	
0C74	A20C	09413	DW	Disk\$Msg\$41	

Figure 8-10. (Continued)

0C76	42	09414	DB	42H	
0C77	AC0C	09415	DW	Disk*Msg#42	
0C79	21	09416	DB	21H	
0C7A	BC0C	09417	DW	Disk*Msg#21	
0C7C	22	09418	DB	22H	
0C7D	C10C	09419	DW	Disk*Msg#22	
0C7F	23	09420	DB	23H	
0C80	C80C	09421	DW	Disk*Msg#23	
0C82	24	09422	DB	24H	
0C83	DA0C	09423	DW	Disk*Msg#24	
0C85	25	09424	DB	25H	
0C86	E60C	09425	DW	Disk*Msg#25	
0C88	11	09426	DB	11H	
0C89	F90C	09427	DW	Disk*Msg#11	
0C8B	12	09428	DB	12H	
0C8C	070D	09429	DW	Disk*Msg#12	
0C8E	13	09430	DB	13H	
0C8F	140D	09431	DW	Disk*Msg#13	
0C91	14	09432	DB	14H	
0C92	220D	09433	DW	Disk*Msg#14	
0C94	15	09434	DB	15H	
0C95	310D	09435	DW	Disk*Msg#15	
0C97	16	09436	DB	16H	
0C98	3D0D	09437	DW	Disk*Msg#16	
0C9A	00	09438	DB	0	; <= Terminator
0C9E	4D0D	09439	DW	Disk*Msg#Unknown	; Unmatched code
		09440			
0003	=	09441	DEM*Entry*Size	EQU	3 ;Disk error message table entry size
		09442			
		09443	Message texts		
		09444			
0C9D	48756E670009445		Disk*Msg#40:	DB	'Hung',0 ;Timeout message
0CA2	4E6F74205209446		Disk*Msg#41:	DB	'Not Ready',0
0CAC	577269746509447		Disk*Msg#42:	DB	'Write Protected',0
0CBC	446174610009448		Disk*Msg#21:	DB	'Data',0
0CC1	466F726D6109449		Disk*Msg#22:	DB	'Format',0
0CC8	4D6973736909450		Disk*Msg#23:	DB	'Missing Data Mark',0
0CDA	427573205409451		Disk*Msg#24:	DB	'Bus Timeout',0
0CE6	436F6E747209452		Disk*Msg#25:	DB	'Controller Timeout',0
0CF9	447269766509453		Disk*Msg#11:	DB	'Drive Address',0
0D07	486561642009454		Disk*Msg#12:	DB	'Head Address',0
0D14	547261636B09455		Disk*Msg#13:	DB	'Track Address',0
0D22	536563746F09456		Disk*Msg#14:	DB	'Sector Address',0
0D31	427573204109457		Disk*Msg#15:	DB	'Bus Address',0
0D3D	496C6C656709458		Disk*Msg#16:	DB	'Illegal Command',0
0D4D	556E6B6E6F09459		Disk*Msg#Unknown:	DB	'Unknown',0
		09460			
		09461	Disk*EM#1:		;Main disk error message -- part 1
0D55	070D0A	09462		DB	BELL,CR,LF
0D58	4469736B2009463			DB	'Disk ',0
		09464			
		09465			;Error text output next
		09466			
		09467	Disk*EM#2:		;Main disk error message -- part 2
0D5E	204572726F09468			DB	' Error ('
0D66	0000	09469	Disk*EM*Status:	DB	0,0 ;Status code in Hex.
0D68	290D0A202009470			DB	'),' ,CR,LF,' Drive '
0D76	00	09471	Disk*EM*Drive:	DB	0 ;Disk drive code, A,B...
0D77	2C2048656109472			DB	',' Head '
0D7E	00	09473	Disk*EM*Head:	DB	0 ;Head number
0D7F	2C2054726109474			DB	',' Track '
0D87	0000	09475	Disk*EM*Track:	DB	0,0 ;Track number
0D89	2C2053656309476			DB	',' Sector '
0D92	0000	09477	Disk*EM*Sector:	DB	0,0 ;Sector number
0D94	2C204F706509478			DB	',' Operation - '
0DA2	00	09479		DB	0 ;Terminator
		09480			
0DA3	526561642E09481		Disk*EM*Read:	DB	'Read.',0 ;Operation names
0DA9	577269746509482		Disk*EM*Write:	DB	'Write.',0
		09483			
		09484			
		09485	Disk*Action*Confirms:		
0DB0	00	09486		DB	0 ;Set to character entered by user
0DB1	0D0A00	09487		DB	CR,LF,0
		09488			
		09489			
					Disk error processor

Figure 8-10. (Continued)

```

09490 ;
09491 ;       This routine builds and outputs an error message.
09492 ;       The user is then given the opportunity to:
09493 ;
09494 ;       R -- retry the operation that caused the error
09495 ;       I -- ignore the error and attempt to continue
09496 ;       A -- abort the program and return to CP/M.
09497 ;
09498 ; Disk$Error:
09499 ;
0DB4 F5      09499      PUSH   PSW           ;Preserve error code from controller
0DB5 21660D  09500      LXI   H,Disk$EM$Status ;Convert code for message
0DB8 CD440E  09501      CALL  CAH           ;Converts A to hex.
09502 ;
0DB8 3A270A  09503      LDA   In$Buffer$Disk  ;Convert disk id. for message
0DBE C641    09504      ADI   'A'           ;Make into letter
0DC0 32760D  09505      STA   Disk$EM$Drive
09506 ;
0DC3 3A1F0B  09507      LDA   Floppy$Head     ;Convert head number
0DC6 C630    09508      ADI   '0'           ;
0DC8 327E0D  09509      STA   Disk$EM$Head
09510 ;
0DCB 3A200B  09511      LDA   Floppy$Track    ;Convert track number
0DCE 21870D  09512      LXI   H,Disk$EM$Track
0DD1 CD440E  09513      CALL  CAH
09514 ;
0DD4 3A210B  09515      LDA   Floppy$Sector   ;Convert sector number
0DD7 21920D  09516      LXI   H,Disk$EM$Sector
0DDA CD440E  09517      CALL  CAH
09518 ;
0DDD 21550D  09519      LXI   H,Disk$EM$1     ;Output first part of message
0DE0 CD5305  09520      CALL  Output$error$Message
09521 ;
0DE3 F1      09522      POP   PSW           ;Recover error status code
0DE4 47      09523      MOV   B,A           ;For comparisons
0DE5 216D0C  09524      LXI   H,Disk$error$Messages - DEM$Entry$Size
09525 ;HL -> table - one entry
0DE8 110300  09526      LXI   D,DEM$Entry$Size ;Get entry size for loop below
09527 ;
0DEB 19      09528      Disk$error$Next$Code:
09529 ;
09529      DAD   D           ;Move to next (or first) entry
09530 ;
0DEC 7E      09530      MOV   A,M           ;Get code number from table
0DED B7      09531      ORA   A           ;Check if end of table
0DEE CAF80D  09532      JZ    Disk$error$Matched ;Yes, pretend a match occurred
0DF1 B8      09533      CMP   B           ;Compare to actual code
0DF2 CAF80D  09534      JZ    Disk$error$Matched ;Yes, exit from loop
0DF5 C3EB0D  09535      JMP   Disk$error$Next$Code ;Check next code
09536 ;
09537 ; Disk$error$Matched:
09538 ;
0DF8 23      09538      INX   H           ;HL -> address of text
0DF9 5E      09539      MOV   E,M         ;Get address into DE
0DFA 23      09540      INX   H           ;
0DFB 56      09541      MOV   D,M         ;
0DFC EB      09542      XCHG ;HL -> text
0DFD CD5305  09543      CALL  Output$error$Message ;Display explanatory text
09544 ;
0E00 215E0D  09545      LXI   H,Disk$EM$2   ;Display second part of message
0E03 CD5305  09546      CALL  Output$error$Message
09547 ;
0E06 21A30D  09548      LXI   H,Disk$EM$Read ;Choose operation text
09549 ; (assume a read)
0E09 3A1D0B  09550      LDA   Floppy$Command ;Get controller command
0E0C FE01    09551      CPI   Floppy$Read$Code
0E0E CA140E  09552      JZ    Disk$error$Read ;Yes
0E11 21A90D  09553      LXI   H,Disk$EM$Write ;No, change address in HL
09554 ;
0E14 CD5305  09555      Disk$error$Read:
09556 ;
09556      CALL  Output$error$Message ;Display operation type
09557 ;
09557 ; Disk$error$Request$Actions:
09558 ;
0E17 CD2F05  09558      CALL  Request$user$Choice ;Ask the user what to do next
09559 ;
09559 ;
09559 ;
0E1A FE52    09560      CPI   'R'         ;Display prompt and wait for input
0E1C CA2C0E  09561      JZ    Disk$error$Retry ; Returns with A = uppercase char.
0E1F FE41    09562      CPI   'A'         ;Retry?
0E21 CA360E  09563      JZ    System$Reset ;Abort
0E24 FE49    09564      CPI   'I'         ;Ignore
0E26 CA6B0C  09565      JZ    Disk$error$Ignore

```

Figure 8-10. (Continued)

0E29	C3170E	09566	JMP	Disk\$Error\$Request\$Action	
		09567	;		
		09568	Disk\$Error\$Retry:		;The decision on where to return
		09569			; depends on whether the operation
		09570			; failed on a deblocked or
		09571			; nondeblocked drive.
0E2C	3A350A	09572	LDA	Selected\$Disk\$Deblock	
0E2F	B7	09573	ORA	A	
0E30	C2EFOB	09574	JNZ	Deblock\$Retry	
0E33	C33C0B	09575	JMP	No\$Deblock\$Retry	
		09576	;		
		09577	System\$Reset:		;This is a radical approach, but
		09578			; it does cause CP/M to restart.
0E36	0E00	09579	MVI	C,0	;System reset
0E38	CD0500	09580	CALL	BDOS	
		09581	;		
		09582	;		
		09583	;		
		09584	;	A to upper	
		09585	;		
		09586	;	Converts the contents of the A register to an upper-	
		09587	;	case letter if it is currently a lowercase letter.	
		09588	;		
		09589	;	Entry parameters	
		09590	;		
		09591	;	A = character to be converted	
		09592	;		
		09593	;	Exit parameters	
		09594	;		
		09595	;	A = converted character	
		09596	;		
		09597	A\$To\$Upper:		
0E3B	FE61	09598	CPI	'a'	;Compare to lower limit
0E3D	D8	09599	RC		;No need to convert
0E3E	FE7B	09600	CPI	'z' + 1	;Compare to upper limit
0E40	D0	09601	RNC		;No need to convert
0E41	E65F	09602	ANI	5FH	;Convert to uppercase
0E43	C9	09603	RET		
		09604	;		
		09605	;	Convert A register to hexadecimal	
		09606	;		
		09607	;	This subroutine converts the A register to hexadecimal.	
		09608	;		
		09609	;	Entry parameters	
		09610	;		
		09611	;	A = value to be converted and output	
		09612	;	HL -> buffer area to receive two characters of output	
		09613	;		
		09614	;	Exit parameters	
		09615	;		
		09616	;	HL -> byte following last hex byte output	
		09617	;		
		09618	CAH:		
0E44	F5	09619	PUSH	PSW	;Take a copy of the value to be converted
0E45	0F	09620	RRC		;Shift A right four places
0E46	0F	09621	RRC		
0E47	0F	09622	RRC		
0E48	0F	09623	RRC		
0E49	CD4D0E	09624	CALL	CAH\$Convert	;Convert to ASCII
0E4C	F1	09625	POP	PSW	;Get original value again
		09626			;Drop into subroutine, which converts
		09627			; and returns to caller
		09628	CAH\$Converts:		
0E4D	E60F	09629	ANI	0000\$1111B	;Isolate LS four bits
0E4F	C630	09630	ADI	'0'	;Convert to ASCII
0E51	FE3A	09631	CPI	'9' + 1	;Compare to maximum
0E53	BA580E	09632	JC	CAH\$Numeric	;No need to convert to A -> F
0E56	C607	09633	ADI	7	;Convert to a letter
		09634	CAH\$Numeric:		
0E58	77	09635	MOV	M,A	;Save character
0E59	23	09636	INX	H	;Update character pointer
0E5A	C9	09637	RET		
		09638	;		
		09639	;		
		09640	;		
		09700	;	#	

Figure 8-10. (Continued)

```

09701 ;
09702 ;       Disk control table images for warm boot
09703 ;
09704 Boot#Control#Part1:
0E5B 01 09705      DB      1           ;Read function
0E5C 00 09706      DB      0           ;Unit (drive) number
0E5D 00 09707      DB      0           ;Head number
0E5E 00 09708      DB      0           ;Track number
0E5F 02 09709      DB      2           ;Starting sector number
0E60 0010 09710     DW      8*512        ;Number of bytes to read
0E62 00C4 09711     DW      CCP#Entry    ;Read into this address
0E64 4300 09712     DW      Disk#Status#Block ;Pointer to next status block
0E66 4500 09713     DW      Disk#Control#5 ;Pointer to next control table
09714 Boot#Control#Part2:
0E68 01 09715      DB      1           ;Read function
0E69 00 09716      DB      0           ;Unit (drive) number
0E6A 01 09717      DB      1           ;Head number
0E6B 00 09718      DB      0           ;Track number
0E6C 01 09719      DB      1           ;Starting sector number
0E6D 0006 09720     DW      3*512        ;Number of bytes to read
0E6F 00D4 09721     DW      CCP#Entry + (8*512) ;Read into this address
0E71 4300 09722     DW      Disk#Status#Block ;Pointer to next status block
0E73 4500 09723     DW      Disk#Control#5 ;Pointer to next control table
09724 ;
09725 ;
09726 ;
09800 ;#
09801 ;
09802 WBOOT:       ;Warm boot entry
09803             ;On warm boot, the CCP and BDOS must be reloaded
09804             ; into memory. In this BIOS, only the 5 1/4"
09805             ; diskettes will be used, therefore this code
09806             ; is hardware specific to the controller. Two
09807             ; prefabricated control tables are used.
0E75 318000 09808     LXI      SP,80H
0E78 115B0E 09809     LXI      D,Boot#Control#Part1 ;Execute first read of warm boot
0E7B CDBA0E 09810     CALL     Warm#Boot#Read ;Load drive 0, track 0,
09811             ; head 0, sectors 2 - 8
0E7E 11680E 09812     LXI      D,Boot#Control#Part2 ;Execute second read
0E81 CDBA0E 09813     CALL     Warm#Boot#Read ;Load drive 0, track 0,
09814             ; head 1, sectors 1 - 3
0E84 CDDF0E 09815     CALL     Patch#CPM ;Make custom enhancements patches
0E87 C36C02 09816     JMP      Enter#CPM ;Set up base page and enter CCP
09817 ;
09818 Warm#Boot#Read: ;On entry, DE -> control table image
09819             ;This control table is moved into
09820             ; the main disk control table and
09821             ; then the controller activated.
0E8A 211D0B 09822     LXI      H,Floppy#Command ;HL -> actual control table
0E8D 224600 09823     SHLD     Command#Block#5 ;Tell the controller its address
09824             ;Move the control table image
09825             ; into the control table itself.
0E90 0E0D 09826     MVI      C,13 ;Set byte count
09827 Warm#Boot#Move: ;
0E92 1A 09828     LDAX     D ;Get image byte
0E93 77 09829     MOV      M,A ;Store into actual control table
0E94 23 09830     INX      H ;Update pointers
0E95 13 09831     INX      D
0E96 0D 09832     DCR      C ;Count down on byte count
0E97 C2920E 09833     JNZ      Warm#Boot#Move ;Continue until all bytes moved
09834 ;
0E9A 214500 09835     LXI      H,Disk#Control#5 ;Activate controller
0E9D 3680 09836     MVI      H,80H
09837 Wait#For#Boot#Complete:
0E9F 7E 09838     MOV      A,M ;Get status byte
0EA0 B7 09839     ORA      A ;Check if complete
0EA1 C29F0E 09840     JNZ      Wait#For#Boot#Complete ;No
09841             ;Yes, check for errors
0EA4 3A4300 09842     LDA      Disk#Status#Block
0EA7 FE80 09843     CPI      80H
0EA9 DAAD0E 09844     JC      Warm#Boot#Error ;Yes, an error occurred
0EAC C9 09845     RET
09846 ;
09847 Warm#Boot#Error: ;
0EAD 21B60E 09848     LXI      H,Warm#Boot#Error#Message
0EB0 CD5F02 09849     CALL     Display#Message

```

Figure 8-10. (Continued)

```

0EB3 C3750E 09850          JMP      WBOOT          ;Restart warm boot
09851          ;
09852          Warm$Boot$Error$Message:
0EB6 0D0A57617209853      DB      CR,LF,"Warm Boot Error - retrying...",CR,LF,0
09854          ;
09855          ;
10000         ;#
10001         ;
10002         Ghost$Interrupt:      ;Control will only arrive here under the most
10003         ; unusual circumstances, as the interrupt
10004         ; controller will have been programmed to
10005         ; suppress unused interrupts.
10006         ;
0ED8 F5      10007         PUSH     PSW          ;Save pre-interrupt registers
0ED9 3E20    10008         MVI     A,IC$EOI     ;Indicate end of interrupt
0EDB D3D8    10009         OUT     IC$OCW2$Port
0EDD F1      10010         POP      PSW
0EDE C9      10011         RET
10012         ;
10013         ;
10100         ;#
10101         ;
10102         Patch CP/M
10103         ;
10104         ; This routine makes some very special patches to the
10105         ; CCP and BDOS in order to make some custom enhancements
10106         ;
10107         ; Public files:
10108         ; On large hard disk systems it is extremely useful
10109         ; to partition the disk using the user number features.
10110         ; However, it becomes wasteful of disk space because
10111         ; multiple copies of common programs must be stored in
10112         ; each user area. This patch makes User 0 public --
10113         ; accessible from any other user area.
10114         ; *** WARNING ***
10115         ; Files in User 0 MUST be set to system and read/only
10116         ; status to avoid their being accidentally damaged.
10117         ; Because of the side effects associated with public
10118         ; files, the patch can be turned on or off using
10119         ; a flag in the long term configuration block.
10120         ;
10121         ; User prompts:
10122         ; When using CP/M's USER command and user numbers
10123         ; in general, it is all too easy to become confused
10124         ; and forget which user number you are "in." This
10125         ; patch modifies the CCP to display a prompt which
10126         ; shows not only the default disk id., but also the
10127         ; current user number, and an indication of whether
10128         ; public files are enabled:
10129         ;
10130         ; P3B> or 3B>
10131         ; ^
10132         ; When public files are enabled.
10133         ;
10134         ; Equates for public files
10135         ;
D35E = 10136 PF$BDOS$Exit$Point EQU BDOS$Entry + 75BH
D37C = 10137 PF$BDOS$Char$Matches EQU BDOS$Entry + 776H
D361 = 10138 PF$BDOS$Resume$Point EQU BDOS$Entry + 75BH
000D = 10139 PF$BDOS$Unused$Bytes EQU 13
10140         ;
10141         ;
10142         ; Equates for user prompt
10143         ;
C788 = 10144 UP$CCP$Exit$Point EQU CCP$Entry + 388H
C78B = 10145 UP$CCP$Resume$Point EQU CCP$Entry + 38BH
C513 = 10146 UP$CCP$Get$User EQU CCP$Entry + 113H
C5D0 = 10147 UP$CCP$Get$Disk$Id EQU CCP$Entry + 1D0H
C4BC = 10148 UP$CCP$CONOUT EQU CCP$Entry + 8CH
10149         ;
10150         ;
10151         ; Set up the intervention points
10152         ;
10153         Patch$CPM:
0EDF 3EC3    10154         MVI     A,JMP          ;Set up opcode
0EE1 325ED3 10155         STA     PF$BDOS$Exit$Point

```

Figure 8-10. (Continued)

0EE4	3288C7	10156	STA	UP*CCP*Exit*Point	
0EE7	21F40E	10157	LXI	H,Public*Patch	
0EEA	225FD3	10158	SHLD	PF*BDOS*Exit*Point + 1	
0EED	21110F	10159	LXI	H,Prompt*Patch ;Get address of intervening code	
0EF0	2289C7	10160	SHLD	UP*CCP*Exit*Point + 1	
		10161			
0EF3	C9	10162	RET		;Return to enter CP/M
		10163			
		10164			
		10165			
		10166	Public*Patch:		;Control arrives here from the BDOS
		10167			;The BDOS is in the process of scanning
		10168			; down the target file name in the
		10169			; search next function
		10170			; HL -> the name of the file searched for
		10171			; DE -> directory entry
		10172			; B = character count
		10173			
0EF4	3A4200	10174	LDA	CB*Public*Files ;Check if public files are to be enabled	
0EF7	B7	10175	ORA	A	
0EF8	CA0B0F	10176	JZ	No*Public*Files ;No	
		10177			
0EFB	78	10178	MOV	A,B ;Get character count	
0EFC	B7	10179	ORA	A ;Check if looking at first byte	
		10180			; (that contains the user number)
0EFD	C20B0F	10181	JNZ	No*Public*Files ;No, ignore this patch	
		10182			
0F00	1A	10183	LDAX	D ;Get user number from directory entry	
0F01	FEE5	10184	CPI	OE5H ;Check if active directory entry	
0F03	CA0B0F	10185	JZ	No*Public*Files ;Yes, ignore this patch	
		10186			
0F06	7E	10187	MOV	A,M ;Get user number	
0F07	B7	10188	ORA	A ;Check if User 0	
0F08	CA7CD3	10189	JZ	PF*BDOS*Char*Matches ;Force character match	
		10190			
		10191	No*Public*Files:		;Replaced patched out code
0F0B	78	10192	MOV	A,B ;Check if count indicates that	
0F0C	FE0D	10193	CPI	PF*BDOS*Unused*Bytes ; registers are pointing at	
		10194			; unused bytes field of FCB
0F0E	C361D3	10195	JMP	PF*BDOS*Resume*Point ;Return to BDOS	
		10196			
		10197	Prompt*Patch:		;Control arrives here from the CCP
		10198			;The CCP is just about to get the
		10199			; drive id. when control gets here.
		10200			;The CCP's version of CONOUT is used
		10201			; so that the CCP can keep track of
		10202			; the cursor position.
		10203			
0F11	3A4200	10204	LDA	CB*Public*Files ;Check if public files are enabled	
0F14	B7	10205	ORA	A	
0F15	CA1D0F	10206	JZ	UP*Private*Files ;No	
		10207			
0F18	3E50	10208	MVI	A,'P'	
0F1A	CD8CC4	10209	CALL	UP*CCP*CONOUT ;Use CCP's CONOUT routine	
		10210			
		10211	UP*Private*Files:		
0F1D	CD13C5	10212	CALL	UP*CCP*Get*User ;Get current user number	
0F20	FE0A	10213	CPI	9 + 1 ;Check if one or two digits	
0F22	D2300F	10214	JNC	UP*2*Digits	
0F25	C630	10215	ADI	'0'	;Convert to ASCII
		10216			
		10217	UP*1*Digit:		
0F27	CD8CC4	10217	CALL	UP*CCP*CONOUT ;Output the character	
0F2A	CD0CC5	10218	CALL	UP*CCP*Get*Disk*Id ;Get disk identifier	
0F2D	C38BC7	10219	JMP	UP*CCP*Resume*Point ;Return to CCP	
		10220			
		10221	UP*2*Digits:		
0F30	C626	10222	ADI	'0' - 10 ;Subtract 10 and convert to ASCII	
0F32	F5	10223	PUSH	PSW ;Save converted second digit	
0F33	3E31	10224	MVI	A,'1'	;Output leading '1'
0F35	CD8CC4	10225	CALL	UP*CCP*CONOUT	
0F38	F1	10226	POP	PSW ;Recover second digit	
0F39	C3270F	10227	JMP	UP*1*Digit ;Output remainder of prompt and return to	
		10228			; the CCP
		10229			
		10230			
		10231			
		10300			

Figure 8-10. (Continued)

```

10301 ;
10302 ; Configuration block get address
10303 ;
10304 ; This routine is called by utility programs running in the TPA.
10305 ; Given a specific code number, it returns the address of a specific
10306 ; object in the configuration block.
10307 ;
10308 ; By using this routine, utility programs need not know the exact
10309 ; layout of the configuration block.
10310 ;
10311 ; Entry parameters
10312 ;
10313 ; C = Object identity code (in effect, this is the
10314 ; subscript of the object's address in the
10315 ; table below)
10316 ;
10317 ;=====
10318 CB#Get#Address: ;<== BIOS entry point (private)
10319 ;=====
0F3C F5 10320 PUSH PSW ;Save user's registers
0F3D C5 10321 PUSH B
0F3E D5 10322 PUSH D
10323
0F3F 69 10324 MOV L,C ;Make code into a word
0F40 2600 10325 MVI H,0
0F42 29 10326 DAD H ;Convert code into word offset
0F43 114F0F 10327 LXI D,CB#Object#Table ;Get base address of table
0F46 19 10328 DAD D ;HL -> object's address in table
0F47 5E 10329 MOV E,M ;Get LS byte
0F48 23 10330 INX H
0F49 56 10331 MOV D,M ;Get MS byte
0F4A EB 10332 XCHG ;HL = address of object
10333
0F4B D1 10334 POP D ;Recover user's registers
0F4C C1 10335 POP B
0F4D F1 10336 POP PSW
10337
0F4E C9 10338 RET
10339 ;
;#
10401 ;
10402 CB#Object#Table:
10403 ; Code
10404 ; vv
0F4F 8F0F 10405 DW Date ;01 date in ASCII
0F51 990F 10406 DW Time#In#ASCII ;02 time in ASCII
0F53 A30F 10407 DW Time#Dates#Flags ;03 flags indicated if time/date set
0F55 8D0F 10408 DW CB#Forced#Input ;04 forced input pointer
0F57 4300 10409 DW CB#Startup ;05 system startup message
10410 ; Redirection words
0F59 5800 10411 DW CB#Console#Input ;06
0F5B 5A00 10412 DW CB#Console#Output ;07
0F5D 5C00 10413 DW CB#Auxiliary#Input ;08
0F5F 5E00 10414 DW CB#Auxiliary#Output ;09
0F61 6000 10415 DW CB#List#Input ;10
0F63 6200 10416 DW CB#List#Output ;11
10417
0F65 6400 10418 DW CB#Device#Table#Addresses ;12
0F67 B500 10419 DW CB#12#24#Clock ;13 Selects 12/24 hr. format clock
0F69 BD00 10420 DW RTC#Ticks#per#Second ;14
0F6B BF00 10421 DW RTC#Watchdog#Count ;15
0F6D C100 10422 DW RTC#Watchdog#Address ;16
0F6F C300 10423 DW CB#Function#Key#Table ;17
0F71 1B02 10424 DW CONOUT#Escape#Table ;18
10425
0F73 8400 10426 DW D0#Initialize#Stream ;19
0F75 9100 10427 DW D0#Baud#Rate#Constant ;20
0F77 9400 10428 DW D1#Initialize#Stream ;21
0F79 A100 10429 DW D1#Baud#Rate#Constant ;22
0F7B A400 10430 DW D2#Initialize#Stream ;23
0F7D B100 10431 DW D2#Baud#Rate#Constant ;24
0F7F 4002 10432 DW Interrupt#Vector ;25
0F81 890F 10433 DW LTCB#Offset ;26
0F83 8B0F 10434 DW LTCB#Length ;27
0F85 4200 10435 DW CB#Public#Files ;30

```

Figure 8-10. (Continued)

0F87	A421	10436	DW	Multi\$Command\$Buffer	;31
		10437			;
		10500			;*
		10501		The short term configuration block.	
		10502			;
		10503		This contains variables that can be set once CP/M	
		10504		has been initiated, but that are never preserved	
		10505		from one loading of CP/M to the next. This part of	
		10506		the configuration block form the last initialized bytes	
		10507		in the BIOS.	
		10508			;
		10509		The two values below are used by utility programs that	
		10510		need to read in the long term configuration block from disk.	
		10511		The BIOS starts on a 256-byte page boundary, and therefore	
		10512		will always be on a 128-byte sector boundary in the reserved	
		10513		area on the disk. A utility program can then, using the	
		10514		CB\$Get\$Address Private BIOS call, determine how many 128-byte	
		10515		sectors need to be read in by the formula:	
		10516			;
		10517		(LCTB\$Offset + LTCB\$Length) / 128	
		10518			;
		10519		The LTCB\$Offset is the offset from the start of the BIOS to	
		10520		where the first byte of the long term configuration block	
		10521		starts. Using the offset and the length, the utility can	
		10522		copy the RAM version of the LTCB over the disk image	
		10523		that it has read from the disk, and then write the	
		10524		updated LTCB back onto the disk.	
		10525			;
0F89	BED9	10526	LTCB\$Offset:	DW	BIOS\$Entry - Long\$Term\$CB
0F8B	E601	10527	LTCB\$Length:	DW	Long\$Term\$CB\$End - Long\$Term\$CB
		10528			;
		10529		Forced input pointer	
		10530			;
		10531		If CONIN ever finds that this pointer is pointing to a nonzero	
		10532		byte, then this byte will be injected into the console input	
		10533		stream as though it had been typed on the console. The	
		10534		pointer is then updated to the next byte in memory.	
		10535			;
0F8D	4300	10536	CB\$Forced\$Input:	DW	CB\$Startup
		10537			;
		10538			;
		10539	Date:		;Current system date
0F8F	31302F3137	10540	DB	'10/17/82',LF	;Unless otherwise set to the contrary
		10541			; this is the release date of the system
		10542			;Normally, it will be set by the DATE utility
0F98	00	10543	DB	0	;00-byte terminator
		10544			;
		10545	Time\$in\$ASCII:		;Current system time
0F99	3030	10546	HH:	DB	'00'
0F9B	3A	10547		DB	','
0F9C	3030	10548	MM:	DB	'00'
0F9E	3A	10549		DB	','
0F9F	3030	10550	SS:	DB	'00'
		10551	Time\$in\$ASCII\$End:		;Used when updating the time
0FA1	0A	10552	DB	LF	
0FA2	00	10553	DB	0	;00-byte terminator
		10554			;
		10555			;
		10556	Time\$Date\$Flags:		;This byte contains two flags that are used
		10557			; to indicate whether the time and/or date
		10558			; have been set either programmatically or
		10559			; by using the TIME and DATE utilities. These
		10560			; flags can be tested by utility programs that
		10561			; need to have the correct time and date set.
0FA3	00	10562	DB	0	
0001 =		10563	Time\$Set	EQU	0000\$0001B
0002 =		10564	Date\$Set	EQU	0000\$0010B
		10565			;
		10566			;
		10700			;*
		10701			;
		10702		Uninitialized buffer areas	
		10703			;
		10704		With the exception of the main Disk\$Buffer, which contains a few	
		10705		bytes of code, all of the other uninitialized variables	
		10706		occur here. This has the effect of reducing the number of	
		10706		bytes that need be stored in the CP/M image on the disk,	

Figure 8-10. (Continued)

```

10707 ;       since uninitialized areas do not need to be kept on the disk.
10708 ;
10709 ;
10800 ;*
10801 ;
10802 ;       The cold boot initialization code is only needed once.
10803 ;       It can be overwritten once it has been executed.
10804 ;       Therefore, it is "hidden" inside the main disk buffer.
10805 ;
10806 ;
OFA4 10807 Disk#buffer: DS      Physical#Sector#Size * Physical#Sec#Per#Track
10808 ;
10809 ;                               ;Save the location counter
21A4 = 10810 After#Disk#Buffer EQU    $      ;$ = current value of location counter
10811 ;
OFA4 10812 ORG      Disk#Buffer      ;Wind the location counter back
10813 ;
10814 ; Initialize#Stream:      ;This stream of data is used by the
10815 ;       Initialize subroutine. It has the following
10816 ;       format:
10817 ;
10818 ;                               ; DB      Port number to be initialized
10819 ;                               ; DB      Number of byte to be output
10820 ;                               ; DB      xx,xx,xx,xx data to be output
10821 ;                               ;
10822 ;                               ;
10823 ;                               ; DB      Port number of 00H terminates
10824 ;
10825 ;
10826 ;
10827 ;       Initialization stream declared here
OFA4 DB 10828 IC#ICW1#Port ;Program the 8259 interrupt controller
OFA5 DB 10829 1
OFA6 DB 10830 IC#ICW1
10831 ;
OFA7 DB 10832 IC#ICW2#Port
OFA8 DB 10833 1
OFA9 DB 10834 IC#ICW2
10835 ;
OFAA DB 10836 IC#OCW1#Port
OFAB DB 10837 1
OFAC DB 10838 IC#OCW1
10839 ;
OFAD DB 10840 83H ;Program the 8253 clock generator
OFAE DB 10841 1
OFAF DB 10842 00#11#010#0B ;Counter 0, periodic interrupt, mode 2
10843 ;
OFB0 DB 10844 80H ;RTC uses channel 0
OFB1 DB 10845 2
OFB2 DW 10846 17921 ;17921 * 930 nanoseconds =
10847 ; ; 16.666 milliseconds). 60 ticks/sec.
OFB4 DB 10848 0 ;Port number of 0 terminates
10849 ;
10850 ;
10851 ; Signon#Message:
OFB5 DB 10852 'CP/M 2.2.'
OFBE DW 10853 VERSION ;Current version number
OFC0 DB 10854 '/'
OFC1 DW 10855 MONTH ;Current date
OFC3 DB 10856 '/'
OFC4 DW 10857 DAY
OFC6 DB 10858 '/'
OFC7 DW 10859 YEAR
OFC9 DB 10860 CR,LF,LF
OFCC DB 10861 'Enhanced BIOS',CR,LF,LF
OFDC DB 10862 'Disk Configuration :',CR,LF,LF
OFF3 DB 10863 ' A: 0.35 Mbyte 5" Floppy',CR,LF
1011 DB 10864 ' B: 0.35 Mbyte 5" Floppy',CR,LF,LF
1030 DB 10865 ' C: 0.24 Mbyte 8" Floppy',CR,LF
104E DB 10866 ' D: 0.24 Mbyte 8" Floppy',CR,LF
106C DB 10867 ' M: 0.19 Mbyte Memory Disk',CR,LF,LF
10868 ;
108D DB 10869 0
10870 ;
10871 ; Messages for M#Disk
10872 ;

```

Figure 8-10. (Continued)

```

10873 M$Disk$Setup$Message:
108E 202020202010874 DB / M$Disk already contains valid information.,CR,LF,0
10875 M$Disk$Not$Setup$Message:
10C0 202020202010876 DB / M$Disk has been initialized to empty state.,CR,LF,0
10877 ;
10878 M$Disk$Dir$Entry: ;Dummy directory entry used to determine
10879 ; if the M$Disk contains valid information
10F3 0F 10880 DB 15 ;User 15
10F4 4D2444697310881 DB /M$Disk /
10FC A0A020 10882 DB /'+80H,/' '+80H,/' ;System and read/only
10FF 00000000 10883 DB 0,0,0,0
1103 00000000010884 DB 0,0,0,0,0,0,0,0,0,0,0,0,0,0,0,0
10885 ;
0004 = 10886 EQU 0004H ;Default disk in base page
10887 ;
10888 ;BOOT: ;Entered directly from the BIOS JMP Vector
10889 ;Control will be transferred here by the CP/M
10890 ; bootstrap loader
10891 ;
10892 ;Initialize system
10893 ;This routine uses the Initialize$Stream
10894 ; declared above
10895 ;
1113 F3 10896 DI ;Disable interrupts to prevent any
10897 ; side effects during initialization
1114 21A40F 10898 LXI H,Initialize$Stream ;HL -> data stream
1117 CD1903 10899 CALL Output$Byte$Stream ;Output it to the specified
10900 ; ports
10901 ;
111A CDEE02 10902 CALL General$CIC$Initialization ;Initialize character devices
10903 ;
111D 21B50F 10904 LXI H,Signon$Message ;Display sign-on message on console
1120 CD5F02 10905 CALL Display$Message
10906 ;
1123 CDDFOE 10907 CALL Patch$CPM ;Make necessary patches to CCP and BDOS
10908 ; for custom enhancements
10909 ;
10910 ;Initialize M$Disk
10911 ;If the M$Disk directory has the
10912 ; special reserved file name "M$disk"
10913 ; (with lowercase letters and marked
10914 ; SYS and R/O), then the M$Disk is
10915 ; assumed to contain valid data.
10916 ;If the "M$Disk" file is absent, the
10917 ; M$Disk Directory entry is moved into
10918 ; the M$Disk image, and the remainder of
10919 ; the directory set to 0E5H.
1126 0601 10920 MVI B,1 ;Select bank 1
1128 CDD0B 10921 CALL Select$Bank ; which contains the M$Disk directory
10922 ;
10923 ;Check if M$Disk directory entry present
112B 210000 10924 LXI H,0 ;Start address for first directory
112E 11F310 10925 LXI D,M$Disk$Dir$Entry
1131 0E20 10926 MVI C,32 ;Length to compare
10927 M$Disk$Test:
1133 1A 10928 LDAX D ;Get byte from initialized variable
1134 BE 10929 CMP M ;Compare with M$Disk image
1135 C24F11 10930 JNZ M$Disk$Not$Setup ;Match fails
1138 13 10931 INX D
1139 23 10932 INX H
113A 0D 10933 DCR C
113B CA4111 10934 JZ M$Disk$Setup ;All bytes match
113E C33311 10935 JMP M$Disk$Test
10936 ;
10937 M$Disk$Setup:
1141 218E10 10938 LXI H,M$Disk$Setup$Message ;Inform user
10939 ;
10940 M$Disk$Setup$Done:
1144 CD5F02 10941 CALL Display$Message
10942 ;
1147 AF 10943 XRA A ;Set default disk drive to A:
1148 320400 10944 STA Default$Disk
114B FB 10945 EI ;Interrupts can now be enabled
10946 ;
114C C36C02 10947 JMP Enter$CPM ;Go into CP/M
10948 ;

```

Figure 8-10. (Continued)

	10949	M#Disk#Not#Setup:		
114F 110000	10950	LXI	D,0	;Move M#Disk directory entry into
1152 21F310	10951	LXI	H,M#Disk#Dir#Entry	; M#Disk image
1155 0E04	10952	MVI	C,32/8	;Number of 8-byte blocks to move
1157 CDF80A	10953	CALL	Move#8	
	10954			
	10955			;DE -> next byte after M#Disk directory
	10956			; entry in image
115A 3EE5	10957	MVI	A,0E5H	;Set up to do memory fill
115C 12	10958	STAX	D	;Store first byte in "source" area
115D 62	10959	MOV	H,D	;Set HL to DE +1
115E 68	10960	MOV	L,E	
115F 23	10961	INX	H	
1160 0EFC	10962	MVI	C,((2 * 1024) - 32) / 8	;Two allocation blocks
	10963			; less 32 bytes for M#Disk entry
1162 CDF80A	10964	CALL	Move#8	;Use Move#8 to do fill operation
	10965			
1165 21C010	10966	LXI	H,M#Disk#Not#Setup#Message	
1168 C34411	10967	JMP	M#Disk#Setup#Done	;Output message and enter CP/M
	10968			
	10969			
116B 00	10970			;Dummy
	10971	DB	0	;Last#Initialized#Bytes
	10972			; <= address of last initialized byte
	10973			; End of cold boot initialization code
	10974			
21A4	10975	ORG	After#Disk#Buffer	;Reset location counter
	10976			
21A4	10977	Multi#Command#Buffer:	DS 128	;This can be used to insert long
	10978			; command sequences into the
	10979			; console input stream by setting
	10980			; the forced input pointer here
	10981			
0020 =	10982	D0#Buffer#Length	EQU 32	;Must be binary number
2224	10983	D0#Buffer:	DS D0#Buffer#Length	
	10984			
0020 =	10985	D1#Buffer#Length	EQU 32	;Must be binary number
2244	10986	D1#Buffer:	DS D1#Buffer#Length	
	10987			
0020 =	10988	D2#Buffer#Length	EQU 32	;Must be binary number
2264	10989	D2#Buffer:	DS D2#Buffer#Length	
	10990			
	10991			; Data areas for the character drivers
	10992			
2284	10993	PI#User#Stack:	DS 2	;Storage area for user's stack pointer
	10994			; when an interrupt occurs
2286	10995	PI#User#HL:	DS 2	;Save area for user's HL
2288	10996	PI#Stack:	DS 40	;Stack area for use by interrupt service
	10997			; routines to avoid overflowing the
	10998			; user's stack area
	10999			
22B0	11000	Directory#Buffer:	DS 128	;Disk directory buffer
	11001			
2330	11002	M#Disk#Buffer:	DS 128	;Intermediary buffer for
	11003			; M#Disk
	11004			
	11005			; Disk work areas
	11006			
	11007			; These are used by the BDOS to detect any unexpected
	11008			; change of diskettes. The BDOS will automatically set
	11009			; such a changed diskette to read-only status.
	11010			
23B0	11011	Disk#A#Workarea:	DS 32	; A:
23D0	11012	Disk#B#Workarea:	DS 32	; B:
23F0	11013	Disk#C#Workarea:	DS 16	; C:
2400	11014	Disk#D#Workarea:	DS 16	; D:
	11015			
	11016			
	11017			; Disk allocation vectors
	11018			
	11019			; These are used by the BDOS to maintain a bit map of
	11020			; which allocation blocks are used and which are free.
	11021			; One byte is used for eight allocation blocks, hence the
	11022			; expression of the form (allocation blocks/8)+1.
	11023			
2410	11024	Disk#A#Allocation#Vector	DS (174/8)+1	; A:

Figure 8-10. (Continued)

```
2426      11025  Disk#B$Allocation$Vector      DS      (174/8)+1      ; B:
          11026  ;
243C     11027  Disk#C$Allocation$Vector      DS      (242/8)+1      ; C:
245B     11028  Disk#D$Allocation$Vector      DS      (242/8)+1      ; D:
          11029  ;
247A     11030  M$Disk$Allocation$Vector      DS      (192/8)+1      ; M$Disk
          11031  ;
2493     11032  END      ;of enhanced BIOS listing
```

Figure 8-10. (Continued)

Classes of Errors
BIOS Error-Handling Functions
Practical Error Handling
Character I/O Errors
Disk Errors
Improving Error Messages



Dealing with Hardware Errors

This chapter describes the enhancements you can make to improve CP/M's somewhat primitive error handling. It covers the general classes of errors that the BIOS may have to handle. It describes some of the underlying philosophical aspects of errors, how to detect them, and how to correct them or otherwise make the best of the situation.

At the end of the chapter are some example error-handling subroutines. Some of these have already been shown in the previous chapter as part of the enhanced BIOS (Figure 8-10); they are repeated here so that you can see them in isolation.

Classes of Errors

Basically, the user perceives only two classes of errors—those that are user-correctable and those that are not. There is a third, almost invisible class of errors—those that are recoverable by the hardware or software without the user's intervention.

The possible sources for hardware errors vary wildly from one computer system to another, since error detection is heavily dependent on the particular logic in the hardware. The BIOS can detect some hardware-related errors — mainly errors caused when something takes too long to happen, such as when a recalcitrant printer does not react in a specified length of time.

The BDOS has no built-in hardware detection code. It can detect *system* errors, such as an attempt to write to a disk file that is marked “Read-Only” in the file directory or attempts to access files that are not on the disk. These BDOS-detected errors, however, generally are unrelated to the well-being of the hardware. For example, a disk controller with a hardware problem could easily overwrite a sector of the directory, thereby deleting several files. This error would not show up until the user tried to use one of the now-departed files.

BIOS Error-Handling Functions

The error-handling code in the BIOS has to serve the following functions:

- Detection
- Analysis
- Indication
- Correction.

Error Detection

Clearly, before any later steps can be taken, an error must be detected. This can be done by the software alone or by the BIOS interacting with error-detecting logic in the hardware. In general, the only errors that the BIOS can detect unassisted are caused when certain operations take longer to complete than expected. Because the writer of the BIOS knows the operating environment of the specific peripherals in the system, the code can predict how long a particular operation should take and can signal an error when this time is exceeded. This would include such problems as printers that fail to react within a specified time period.

The BIOS can work in cooperation with the hardware to determine whether the hardware itself has detected an error. Armed with the hardware's specifications, the BIOS can input information on controller or device status to trigger error-detecting logic. How this should be done depends heavily on the peripheral devices in your computer system and the degree to which these devices have “smart” controllers capable of processing independently of the computer. Unfortunately, many manufacturers document the significance of individual status bits that indicate errors, but not combinations of errors, or what to do when a particular error occurs.

Error Analysis

Given that your BIOS has detected an error, it must first determine the class of error; that is, whether or not the error can be corrected by simply trying the operation again. Some errors appear at first to be correctable, but retrying the operation several times still fails to complete it. An example would be a check-sum error while reading a disk sector. If several attempts to read the sector all yield an error, then it becomes a “fatal” error. The code in your BIOS must be capable of initial classification and then subsequent reclassification if remedial action fails.

Other types of errors can be classified immediately as fatal errors—nothing can be done to save the situation. For example, if the floppy disk controller indicates that it cannot find a particular sector number on a diskette (due to an error in formatting), there is nothing that the BIOS can do other than inform the user of the problem and supply other helpful information.

Analysis of errors may require some basic research, such as inducing failures in the hardware and observing combinations of error indicators. For example, some printers (interfaced via a parallel port) indicate that they are “Out of Paper” or “Busy” when, in fact, they are switched off. The BIOS should detect this condition and tell the user to switch the printer on, not load more paper.

Error Indication

An incomplete or cryptic error message is infuriating. It is the functional equivalent of saying, “There has been an error. See if you can guess what went wrong!”

An error message, to be complete, should inform the recipient of the following:

- The fact that an error has occurred.
- Whether or not automatic recovery has been attempted and failed.
- The details of the error, if need be in technical terms to assist a hardware engineer.
- What possible choices the user has now.

To put these points into focus, consider the error message that can be output by CP/M after you have attempted to load a program by entering its name into the CCP. What you see on the console is the following dialog:

```
A>myprog<cr>
BAD LOAD
A>
```

All you know is that there has been an error, and you must guess what it is, even though the specific cause of the error was known to CP/M when it output the message. This error message is output by the CCP when it attempts to load a

“.COM” file larger than the current transient program area. The message “BAD LOAD” is only understandable *after* you know what the error is. Even then, it does not tell you what went wrong, whether there is anything you can do about it, and how to go about doing it.

To be complete, this error message could say something like this:

```
A>myprog<cr>
"MYPROG.COM" exceeds the available memory space by
1,024 bytes, and therefore cannot be loaded under the
current version of CP/M.
```

Notice how the message tells you what the problem is, and even quantifies it so that you can determine its severity (you need to get 1K more memory or reduce the program's size). It also tells you how you stand—you cannot load this program under the current version of CP/M, so retrying the operation is futile.

Not many systems programmers like to output messages like the example above. They argue that such a message is too long and too much work for something that does not happen often. Admittedly, the message *is* too long. It could be shortened to read

```
(131) Program 1,024 bytes too large to load.
```

This conveys the same information; the number in parentheses can serve as a reference to a manual where the full impact of the message should be described.

The major problem with the way error messages are designed is that they usually are written by programmers to be read by nontechnical lay users, and programmers are notoriously bad at guessing what nonexperts need to know.

Error indications you design should address the following issues, from the point of view of the user:

- The cause of the error
- The severity of the error
- The corrective action that has and can be taken.

Examine the error messages in the error processor for the example BIOS in Figure 8-10, from line 03600 onward. Although these are an improvement on the BDOS all-purpose

```
BDOS Error on A: Bad Sector
```

even these messages do not really meet all of the requirements of a good error message system.

Another often overlooked aspect of errors is that most hardware errors form a pattern. This pattern is normally only discernible to the trained eye of a hardware maintenance engineer. When these engineers are called to investigate a problem,

they will quiz the user to determine whether a given failure is an isolated incident or part of an ongoing pattern. This is why an error message should contain additional technical details. For example, a disk error message should include the track and sector used in the operation that resulted in an error. Only with these details can the engineer piece together the context of a failure or group of failures.

Error Correction

Given that a lucid error message has been displayed on the console, the user is still confronted with the question: “Now what do I do?” Not only can this be difficult for the user to answer, but also the particular solution decided upon can be hard for the BIOS to execute.

Normally, there are three possible options in response to errors:

- Try the operation again
- Ignore the error and attempt to continue
- Abort the program causing the error and return to CP/M.

For some errors, retrying can be effective. For example, if you forget to put the printer on-line and get a “Printer Timeout” error message, it is easy to put the printer back on-line and ask the BIOS to try again to send data to the printer.

Seldom can you ignore an error and hope to get sensible results from the machine; many disk controllers do not even transfer data between themselves and the disk drive if an error has been detected. Only ignorant users, or brave ones in desperation, ignore errors.

Aborting the program causing the error is a drastic measure, although it does escape from what could otherwise be a “deadly embrace” situation. For example, if you misassign the printer to an inactive serial port and turn on printer echoing (with the CONTROL-P toggle), you will send the system into an endless series of “Printer Timeout” messages. If you abort the program, the error handler in the BIOS executes a System Reset function (function 0) in the BDOS, CP/M warm boots, and control is returned to the CCP. In the process, the printer toggle is reset and the circle is broken.

Practical Error Handling

This section discusses several errors, describing their causes and the way in which the BIOS and the user can handle them when they occur.

Character I/O Errors

At the BIOS level, most detectable errors related to character input or output will be found by the hardware chips.

Parity Error

Parity, in this context, refers to the number of bits set to 1 in an 8-bit character. The otherwise unused eighth bit in ASCII characters can be set to make this number always odd, or alternatively, always even. Your computer hardware can be programmed to count the number of 1 bits in each character and to generate an error if the number is odd (odd parity) or, alternatively, if it is even (even parity). If the hardware on the other end of the line is programmed to operate in the same mode, parity checking provides a primitive error-detection mechanism—you can tell that a character is bad, but not what it should have been.

CP/M does not provide a standard mechanism for reporting a parity error, so your only option is to reset the hardware and substitute an ASCII DEL (7FH; delete) character in the place of the erroneous character.

If your BIOS is operating in a highly specialized environment, you may need to count the number of such parity errors so that a utility program can report on the overall performance of the system.

Framing Error

When an 8-bit ASCII character is transmitted over a serial line, the eight bits are transmitted serially, one after the other. A *start* bit is transmitted first, followed by the data character and then a *stop* bit. If the hardware fails to find the stop and start bits in the correct positions, a *framing error* will occur. Again, the only option available to the BIOS is to reset the hardware chip and substitute an ASCII DEL.

Overrun Error

This error occurs when incoming data characters arrive faster than the program can handle them, so that the last characters overrun those being processed by the hardware chip. This error can normally be avoided by the use of serial line protocols, such as those in the example BIOS in Figure 8-10.

An *overrun error* implies that the protocol has broken down. As with the parity and framing errors, almost the only option is to reset the hardware and substitute a DEL character.

Printer Timeout Error

This is one of the few errors where the BIOS can sensibly attempt an error recovery. The error occurs when the BIOS tries to output a character to a serial printer and finds that the printer is not ready for more than, say, 30 seconds. The most common cause of this error is that the user forgets to put the printer on-line. Many printers require that they be off-line during a manual form feed, and users will often forget to push the on-line button afterward.

After a 30-second delay, the BIOS can send a message to the console device(s) informing the user of the error and asking the user to choose the appropriate course of action. Note that console output can be directed to more than one device.

Parallel Printers

Printers connected to your system by means of a parallel port can indicate their status to the computer much more easily than can serial printers. They can communicate such error states as “Out of Paper,” “End of Ribbon,” and “Off-line.”

These single-error indicators can also be used in combination to indicate whether the printer cable is connected, or even whether the printer is receiving power. You need to experiment, deliberately putting the printer into these states and reading status in order to identify them. It is misleading to indicate to the inexperienced user that the printer is “Out of Paper” when the problem is that the data cable has inadvertently become disconnected.

However, each of these errors can be dealt with in the same way as the serial printer’s timeout problem: display an error message and request the user’s choice of action.

Example Printer Error Routine

Figure 9-1 shows an example of a program that handles printer errors. It consists of several subroutines, including

- The error detection classification and indication routine
- The error correction routine.

It uses other subroutines that are omitted from the figure to avoid obscuring the logic. These subroutines are listed in full in the example BIOS in Figure 8-10.

```

;      This example shows, in outline form, how to handle the
;      situation when a serial printer remains busy for too long.
;      It is intended that this generic example show how to
;      deal with this class of errors.
;
;      The example presupposes the existence of a clock interrupt
;      every 16.666 milliseconds (1/60th of a second), and that
;      control will be transferred to the Real Time Clock service
;      routine each time the clock "ticks".
;
;      Figure 8-10 shows a more complete example, installed in a real
;      BIOS.
;
;
0000 = B*System*Reset      EQU    0      ;BDOS system reset function
0005 = BDOS                EQU    5      ;BDOS entry point
;
0000 00 Printer*Timeout*Flag: DB      0      ;This flag is set by the interrupt
;      ; service subroutine that is called
;      ; when the watchdog timer subroutine
;      ; count hits zero (after having
;      ; counted down a 30-second delay)

0708 = Printer*Delay*Count EQU    1800   ;Given a clock period of 16.666 ms
;      ; this represents a delay of 30 secs

```

Figure 9-1. Serial printer error handling

```

000D =      ;
000A =      CR          EQU   ODH   ;Carriage return
        LF          EQU   OAH   ;Line feed
        ;
        Printer$Busy$Message:
0001 0D0A      DB   CR,LF
0003 5072696E74 DB   'Printer has been busy for too long,\'CR,LF
0028 436865636B DB   'Check that it is on-line and ready,\'CR,LF,0
        ;
004E 00      Printer$Character:  DB   0      ;Save area for the data character
        ;                                     ; to be output
        ;
        LIST:                                     ;<=== Main BIOS entry point
        ;.....                                   ;<=== I/O redirection code occurs here
004F 79      MOV   A,C
0050 324E00   STA   Printer$Character      ;Save the data character
        ;
        Printer$Retry:
0053 010807   LXI   B,Printer$Delay$Count ;This is the count of the number
        ;                                     ; of clock ticks before the watchdog
        ;                                     ; subroutine call
0056 217E00   LXI   H,Printer$Timed$Out      ; <== this address
0059 CDA300   CALL  Set$Watchdog                ;Sets the watchdog running
        ;
        Printer$Wait:
005C CDA300   CALL  Get$Printer$Status        ;See if the printer is ready to
        ;                                     ; accept a character for output
        ;                                     ; This includes checking if the printer
        ;                                     ; is "Busy" because the driver is
        ;                                     ; waiting for XON, ACK, or DTR to
        ;                                     ; come high
005F C26C00   JNZ   Printer$Ready              ;The printer is now ready
0062 3A0000   LDA   Printer$Timeout$Flag        ;Check if the watchdog timer has
        ;                                     ; hit zero (if it does, the
        ;                                     ; watchdog routine will call
        ;                                     ; the Printer$Timed$Out code
        ;                                     ; that sets this flag)
0065 B7      DRA   A
0066 C28400   JNZ   Display$Busy$Message        ;Yes, so display message to
        ;                                     ; indicate an error has occurred
0069 C35C00   JMP   Printer$Wait                ;Otherwise, check if printer is
        ;                                     ; now not busy
        ;
        Printer$Ready:
        ;                                     ;The printer is now ready to output
        ;                                     ; a character, but before doing so,
        ;                                     ; the watchdog timer must be reset
        ;                                     ;Ensure no false timeout occurs
006C F3      DI
006D 010000   LXI   B,0
0070 CDA300   CALL  Set$Watchdog                ;This is done by setting the count
0073 FB      EI                                     ; to zero
0074 3A4E00   LDA   Printer$Character          ;Get character to output
0077 11A300   LXI   D,Printer$Device$Table      ;DE -> device table for printer
007A CDA300   CALL  Output$Data$Byte            ;Output the character to the printer
007D C9      RET
        ;                                     ;Return to the BIOS's caller
        ;
        Printer$Timed$Out:
        ;                                     ;Control arrives here from the
        ;                                     ; watchdog routine if the
        ;                                     ; watchdog count ever hits zero
        ;                                     ; This is an interrupt service
        ;                                     ; routine
        ;                                     ; All registers have been saved
        ;                                     ; before control arrives here
007E 3EFF   MVI   A,OFFH
0080 320000   STA   Printer$Timeout$Flag        ;Set printer timeout flag
0083 C9      RET
        ;                                     ;Return back to the watchdog
        ;                                     ;Interrupt service routine

```

Figure 9-1. (Continued)

```

;
; Display#Busy#Message:
;Printer has been busy for
; 30 seconds or more
;Reset timeout flag
0084 AF XRA A
0085 320000 STA Printer#Timeout#Flag

0088 210100 LXI H,Printer#Busy#Message ;Output error message
008B CDA300 CALL Output#Error#Message

008E CDA300 CALL Request#User#Choice ;Displays a Retry, Abort, Ignore?
; prompt, accepts a character from
; the keyboard, and returns with the
; character, converted to upper
; case in the A register
;Check if Retry

0091 FE52 CPI 'R'

0093 CA5300 JZ Printer#Retry
0096 FE41 CPI 'A' ;Check if Abort
0098 CA9E00 JZ Printer#Abort
009B FE49 CPI 'I' ;Check if Ignore
009D C8 RZ

;
; Printer#Abort:
;Issue system reset
;No need to give call as
; control will not be returned
009E 0E00 MVI C,B#System#Reset
00A0 C30500 JMP BDOS

;
;
; Dummy subroutines
; These are shown in full in Figure 8-10. The line numbers in
; Figure 8-10 are shown in the comment field below
;
Printer#Device#Table: ;Line 01300 (example layout)
Request#User#Choice: ;Line 03400
Output#Error#Message: ;Line 03500
Get#Printer#Status: ;Line 03900 (similar code)
Output#Data#Byte: ;Line 05400 (similar code)
Set#Watchdog: ;Line 05800

```

Figure 9-1. Serial printer error handling (continued)

Disk Errors

Disks are much more complicated than character I/O devices. Errors are possible in the electronics and in the disk medium itself. Most of the errors concerned with electronics need only be reported in enough detail to give a maintenance engineer information about the problem. This kind of error is rarely correctable by retrying the operation. In contrast, media errors often can be remedied by retrying the operation or by special error processing software built into the BIOS. This chapter discusses this class of errors.

Media errors occur when the BIOS tries to read a sector from the disk and the hardware detects a check-sum failure in the data. This is known as a *cyclical redundancy check (CRC)* error. Some disk controllers execute a read-after-write check, so a CRC error can also occur during an attempt to write a sector to the disk.

With floppy diskettes, the disk driver should retry the operation at least ten times before reporting the error to the user. Then, because diskettes are inexpensive and replaceable, the user can choose to discard the diskette and continue with a new one.

With hard disks, the media cannot be exchanged. The only way of dealing with bad sectors is to replace them logically, substituting other sectors in their place.

There are two fundamentally different ways of doing this. Figure 9-2 shows the scheme known as sector sparing—substituting sectors on an outer track for a sector that is bad.

The advantage of this scheme is that it is dynamic. If a sector is found to be bad in a read-after-write check, even after several retries, then the data intended for the failing sector can be written to a spare sector. The failing sector's number is placed into a spare-sector directory on the disk. Thereafter, the disk drivers will be redirected to the spare sector every time an attempt is made to read or write the bad sector.

The disadvantage of this system is that the read/write heads on the disk must move out to the spare sector and then back to access the next sector. This can be a problem if you attempt to make a high-speed backup on a streaming tape drive (one that writes data to a tape in a single stream rather than in discrete blocks). The delay caused by reading the spare sector interrupts the data flow to the streaming tape drive.

You need a special utility program to manipulate the spare-sector directory, both to substitute for a failing sector manually and to attempt to rewrite a spare sector back onto the bad sector.

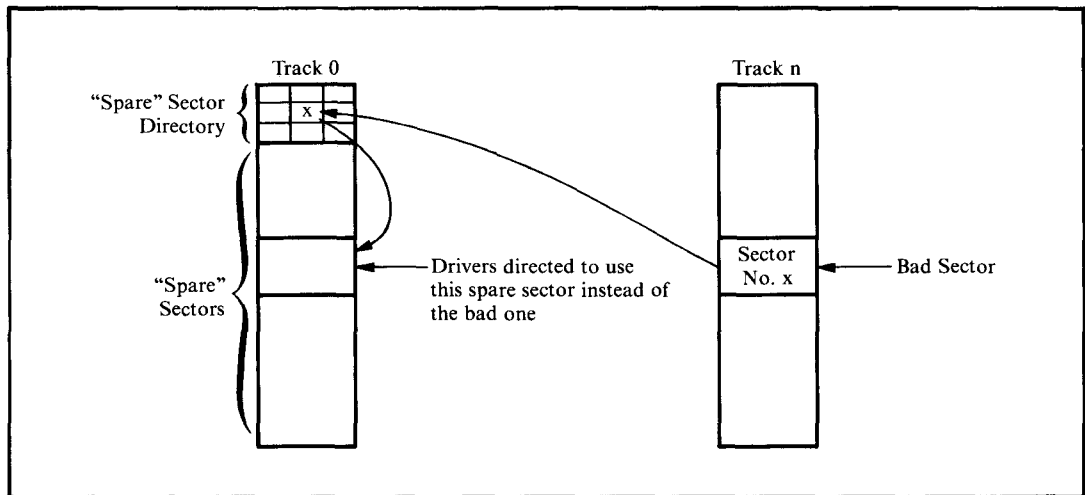

Figure 9-2. Sector sparing

Figure 9-3 shows another scheme for dealing with bad sectors. In this method, bad sectors are skipped rather than having sectors substituted for them.

The advantage of sector skipping is that the heads do not have to perform any long seeks. The failing sector is skipped, and the next sector is used in its place. Because of this, sector skipping can give much better performance. Data can be read off the disk fast enough to keep a streaming tape drive “fed” with data.

The disadvantage of sector skipping is that it does not lend itself to dynamic operation. The bad sector table is best built during formatting. Once data has been written to the disk, if a sector goes bad, all subsequent sectors on the disk must be “moved down one” to make space to skip the bad sector. On a large hard disk, this could take several minutes.

Example Bad Sector Management

Sector sparing and sector skipping use similar logic. Both require a spare-sector directory on each physical disk, containing the sector numbers of the bad sectors. This directory is read into memory during cold start initialization. Thereafter, all disk read and write operations refer to the memory-resident table to see if they are about to access a bad sector.

For sector sparing, if the sector about to be read or written is found in the spare directory, its position in the directory determines which spare sector should be read.

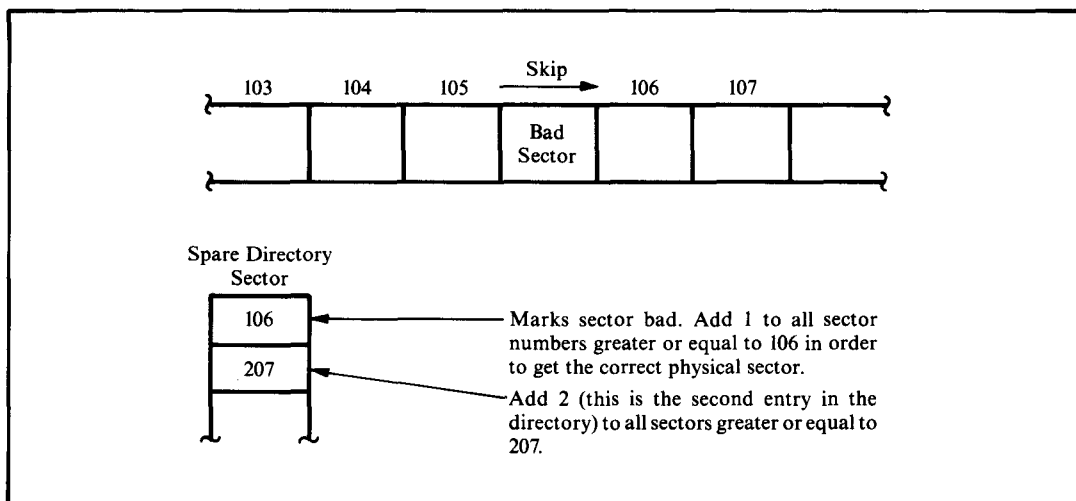

Figure 9-3. Sector skipping

In the case of sector skipping, every access to the disk makes the driver check the bad sector directory. The directory is used to tell how many bad sectors exist between the start of the disk and the failing bad sector. This number must be added to the requested track and sector to compensate for all the bad sectors.

The physical low-level drivers need four entry points:

- Read the specified sector without using bad sector management. This is used to read in the spare directory itself.
- Write the specified sector without using bad sector management. This is used to write the spare directory onto the disk, both to initialize it and to update it.
- Read and write the sector using bad sector management. These entry points are used for normal disk input/output.

Figure 9-4 shows the code necessary for both sector sparing and (using conditional code) sector skipping.

```

;      This example shows the modifications to be made in order
;      to implement bad sector management using sector sparing
;      and sector skipping.
;
0000 =      False      EQU      0
FFFF =      True       EQU      Not False
;
0000 =      Sector$Sparing EQU      False
FFFF =      Sector$Skipping EQU      Not Sector$Sparing
;
;      Additional equates and definitions
;
Spare$Directories:      ;Table of spare directory addresses
                        ;Note: The directories themselves
                        ; are declared at the end of the
                        ; BIOS
0000 D500      DW      Spare$Directory%0      ;Physical disk 0
0002 9701      DW      Spare$Directory%1      ;Physical disk 1
;
Spare$Dir$In$Memory:    ;Flags used to indicate whether spare
                        ; directory for a given physical disk
0004 00      DB      0                        ; has been loaded into memory. Set by SELDSK
0005 00      DB      0
;
;
0000 =      Spare$Track      EQU      0      ;Track containing spare directory
                        ; sectors
0004 =      Spare$Sector     EQU      4      ;Sector containing directory
0005 =      First$Spare$Sector EQU      Spare$Sector + 1
;
;      Variables set by SELDSK
;
Selected$Spare$Directory:
0006 0000      DW      0      ;Pointer to directory
0008 00      Selected$Disk:   DB      0      ;Logical disk number
0009 00      Disk$Type:      DB      0      ;Floppy/hard disks
000A 00      Deblocking$Required: DB      0      ;Deblocking flag
000B 00      Selected$Physical$Disk: DB      0      ;Physical disk number
;
000C 0000      Disk$Track:    DW      0      ;) These variables are part of the command
000E 00      Disk$Sector:    DB      0      ;) block handed over to the disk controller

```

Figure 9-4. Bad sector management

```

8000 =      ;
          ; Maximum$Track      EQU    32768  ;Used as a terminator
0012 =      ; Sectors$Per$Track EQU    18
0000 =      ; First$Sector$On$Track EQU    0
          ;
          ; Disk$Parameter$Headers:
          ; -----
          ; Standard DPH Declarations
          ; -----
          ;
          ; Equates for disk parameter block
          ;
          ; The special disk parameter byte that precedes each disk
          ; parameter block, needs to be rearranged so that a
          ; physical disk drive number can be added.
          ;
          ; Disk types
          ;
          ; vvvv--- Physical disk number
0010 =      ; Floppy$5      EQU    0$001$0000B  ;5 1/4" mini floppy
0020 =      ; Floppy$8      EQU    0$010$0000B  ;8" floppy (SS SD)
0030 =      ; M$Disk      EQU    0$011$0000B  ;Memory disk
0040 =      ; H$Disk$10    EQU    0$100$0000B  ;Hard disk - 10 megabyte
          ;
0070 =      ; Disk$Type$$Mask EQU    0$111$0000B  ;Masks to isolate values
000F =      ; Physical$Disk$Mask EQU    0$000$1111B
          ;
          ; Blocking/deblocking indicator
0080 =      ; Need$Deblocking EQU    1$000$0000B  ;Sector size > 128 bytes
          ;
          ; Disk parameter blocks
          ;
          ; -----
          ; Standard DPB's for A: and B:
          ; -----
          ;
          ; Logical disk C:
          ; Extra byte indicates disk type
          ; deblocking requirements and physical
          ; disk drive.
000F C0     ; DB      H$Disk$10 + Need$Deblocking + 0 ; Physical drive 0
          ; Hard$5$Parameter$Block$C:
          ; -----
          ; Standard format parameter block
          ; -----
          ;
0010 C0     ; DB      H$Disk$10 + Need$Deblocking + 0 ; Physical drive 0
          ; Hard$5$Parameter$Block$D:
          ; -----
          ; Standard format parameter block
          ; -----
          ;
0004 =      ; Number$of$Logical$Disks EQU    4
          ;
          ; SELDSK:
          ; Select disk in register C
          ; C = 0 for drive A, 1 for B, etc.
          ; Return the address of the appropriate
          ; disk parameter header in HL, or 0000H
          ; if the selected disk does not exist.
          ;
0011 210000 ; LXI    H,0      ;Assume an error
0014 79     ; MOV    A,C      ;Check if requested disk valid

0015 FE04   ; CPI    Number$of$Logical$Disks
0017 D0     ; RNC    ;Return if > maximum number of disks

```

Figure 9-4. (Continued)

```

0018 320800      STA      Selected$Disk      ;Save selected disk number
;Set up to return DPH address
001B 6F          MOV      L,A                ;Make disk into word value
001C 2600        MVI      H,0

;Compute offset down disk parameter
; header table by multiplying by
; parameter header length (16 bytes)
001E 29          DAD      H                ;*2
001F 29          DAD      H                ;*4
0020 29          DAD      H                ;*8
0021 29          DAD      H                ;*16
0022 110F00     LXI      D,Disk$Parameter$Headers ;Get base address
0025 19          DAD      D                ;DE -> appropriate DPH
0026 E5          PUSH     H                ;Save DPH address

;Access disk parameter block in order
; to extract special prefix byte that
; identifies disk type and whether
; deblocking is required
;
0027 110A00     LXI      D,10                ;Get DPB pointer offset in DPH
002A 19          DAD      D                ;DE -> DPB address in DPH
002B 5E          MOV      E,M                ;Get DPB address in DE
002C 23          INX      H
002D 56          MOV      D,M
002E EB          XCHG                    ;DE -> DPB

SELDSK$Set$Disk$Type:
002F 2B          DCX      H                ;DE -> prefix byte
0030 7E          MOV      A,M                ;Get prefix byte
0031 E670        ANI      Disk$Type$Mask      ;Isolate disk type
0033 320900     STA      Disk$Type          ;Save for use in low-level driver
0036 7E          MOV      A,M                ;Get another copy of prefix byte
0037 E680        ANI      Need$Deblocking    ;Isolate deblocking flag
0039 320A00     STA      Deblocking$Required ;Save for use in low-level driver

;Additional code to check if spare
; directory for given disk has already
; been read in.
003C 7E          MOV      A,M                ;Get physical disk number
003D E60F        ANI      Physical$Disk$Mask
003F 320B00     STA      Selected$Physical$Disk ;Save for low-level drivers

0042 5F          MOV      E,A                ;Make into word
0043 1600        MVI      D,0
0045 210400     LXI      H,Spare$Dir$In$Memory ;Make pointer into table
0048 19          DAD      D

0049 7E          MOV      A,M                ;Get flag
004A B7          ORA      A
004B C27700     JNZ     Dir$In$Memory      ;Spare directory already in memory
004E 34          INR      M                ;Set flag

004F 210000     LXI      H,Spare$Directories ;Create pointer to spare
0052 19          DAD      D                ; spare directory (added twice
0053 19          DAD      D                ; as table has word entries)
;HL -> word containing directory addr.

0054 5E          MOV      E,M
0055 23          INX      H
0056 56          MOV      D,M                ;Spare directory address in DE
0057 EB          XCHG                    ;HL -> spare directory

0058 220600     SHLD    Selected$Spare$Directory ;Save for use in physical
; drivers later on

005B 110000     LXI      D,Spare$Track      ;Track containing spare directory
005E 3A0B00     LDA      Selected$Physical$Disk
0061 47          MOV      B,A
0062 3E04        MVI      A,Spare$Sector     ;Sector containing spare directory
0064 0E18        MVI      C,Spare$Length/8  ;Number of bytes in spare directory / 8
0066 CD0500     CALL    Absolute$Read      ;Read in spare directory - without
; using bad sector management

```

Figure 9-4. (Continued)

```

                                LXI    H,Spare$Track      ;Get track number used for spare
                                SHLD   Disk$Track        ; sectors
                                ;Substitute track

                                MVI    A,First$Spare$Sector ;Get first sector number
                                ADD    B                ;Add on matched directory
                                ; entry number
                                STA    Disk$Sector      ;Substitute sector
                                ENDIF

                                IF      Sector$Skipping  ;Use the following code for
                                ; sector skipping
                                ;The object is to find the
                                ; entry in the table which
                                ; is greater or equal to the
                                ; requested sector/track

0095 CA9E00      JZ      Tracks$Match      ;Possible match of track and sector
0096 D2AC00      JNC     Compute$Increment ;Requested track < table entry
009B C38900      JMP     Check$Next$Entry  ;Requested track > table entry

                                Tracks$Match:
009E 23          INX    H                    ;HL -> MS byte of track
009F 23          INX    H                    ;HL -> sector
00A0 77          MOV    M,A                  ;Get sector from table

00A1 B9          CMP    C                    ;Compare with requested sector
00A2 CAAB00      JZ      Sectors$Match      ;Track/sector matches
00A5 D2AC00      JNC     Compute$Increment ;Req. trk/sec < spare trk/sec
00A8 C38B00      JMP     Check$Next$Entry2 ;Move to next table entry

                                Sectors$Match:
00AB 04          INR    B                    ;If track and sectors match with
                                ; a table entry, then an additional
                                ; sector must be skipped

                                Compute$Increment:
                                ;B contains number of cumulative
                                ; number of sectors to skip
00AC 79          MOV    A,C                  ;Get requested sector
00AD 80          ADD    B                    ;Skip required number
00AE 0612        MVI    B,Sectors$Per$Track ;Determine final sector number
                                ; and track increment
00B0 CDC300      CALL   DIV$A$BY$B          ;Returns C = quotient, A = remainder
00B3 320E00      STA    Disk$Sector        ;A = new sector number

00B6 59          MOV    E,C                  ;Make track increment a word
00B7 1600        MVI    D,0
00B9 2A0C00      LHLD   Disk$Track        ;Get requested track
00BC 19          DAD    D                    ;Add on increment
00BD 220C00      SHLD   Disk$Track        ;Save updated track
                                ENDIF

                                Not$Bad$Sector:
                                ;Either track/sector were not bad,
                                ; or requested track and sector have
                                ; been updated.
                                ; Go to physical disk read/write

00C0 C3D500      JMP     Read$Write$Disk      ;Subroutine required for skipping
                                ; routine
                                ;
                                ;
                                ;      DIV$A$BY$B
                                ;      Divide A by B
                                ;
                                ;      This routine divides A by B, returning the quotient in C
                                ;      and the remainder in A.
                                ;
                                ;      Entry parameters
                                ;
                                ;          A = dividend
                                ;          B = divisor
                                ;
                                ;      Exit parameters

```

Figure 9-4. (Continued)

```

;
;           A = remainder
;           C = quotient
;
DIV%A$B$B:
00C3 0E00      MVI   'C,0           ;Initialize quotient
DIV%A$B$B$Loop:
00C5 0C       INR   C           ;Increment quotient
00C6 90       SUB   B           ;Subtract divisor
00C7 F2C500   JP    DIV%A$B$B$Loop ;Repeat if result still +ve
00CA 0D       DCR   C           ;Correct quotient
00CB 80       ADD   B           ;Correct remainder
00CC C9       RET
ENDIF

;
; CPM
; Compare memory
;
; This subroutine compares the contents of DE to (HL) and (HL+1)
; returning with the flags as though the subtraction (HL) - DE
; were performed.
;
; Entry parameters
;
; HL -> word in memory
; DE = value to be compared
;
; Exit parameters
;
; Flags set for (HL) - DE
;
CPM:
00CD 7E       MOV   A,M           ;Get MS byte
00CE BA       CMP   D
00CF C0       RNZ           ;Return now if MS bytes unequal
00D0 23       INX   H           ;HL -> LS byte
00D1 7E       MOV   A,M           ;Get LS byte
00D2 BB       CMP   E
00D3 2B       DCX   H           ;Return with HL unchanged
00D4 C9       RET

;
; Absolute$Read:
;           ;The absolute read (and write) routines
;           ; access the specified sector and track
;           ; without using bad sector management.
;
; Entry parameters
;
; HL -> Buffer
; DE = Track
; A = Sector
; B = Physical disk drive number
; C = Number of bytes to read / 8
;
; Set up disk controller command block with parameters in
; registers, then initiate read operation by falling through
; into Read$Write$Disk code below.
;
;
; Read$Write$Disk:
;
;-----
;The remainder of the low level disk drivers follow,
; reading the required sector and track.
;-----

;
; Spare directory declarations
;
; Note: The disk format utility creates an initial spare
; directory with track/sector entries for those track/sectors
; that it finds are bad. It fills the remainder of the
; directory with OFFH's (these serve to terminate the
; searching of the directory).

```

Figure 9-4. (Continued)

```

;
;
00C0 = Spare$Length EQU 64 * 3 ;64 Entries, 3 bytes each
; Byte 0,1 = track
; Byte 2 = sector

Spare$Directory$0:
00D5 DS Spare$Length ;Spare directory itself
0195 DS 2 ;Set to maximum track number by SELDSK as
; a safety precaution. The FORMAT utility
; puts the maximum track number into all
; unused entries in the spare directory.

Spare$Directory$1:
0197 DS Spare$Length ;Spare directory itself
0257 DS 2 ;End marker

```

Figure 9-4. Bad sector management (continued)

Improving Error Messages

The final extension to BIOS error handling discussed here is in disk-driver error-message handling. The subroutine shown in the example BIOS in Figure 8-10, although a significant improvement on the messages normally output by the BDOS, did not advise the user of the most suitable course of action for each error. Figure 9-5 shows an improved version of the error message processor.

```

; This shows slightly more user-friendly error processor
; for disk errors than that shown in the enhanced BIOS
; in Figure 8-10.
; This version outputs a recommended course of action
; depending on the nature of the error detected.
; Code that remains unchanged from Figure 8-10 has been
; abbreviated.
;
; Dummy equates and data declarations needed to get
; an error free assembly of this example.
;
0001 = Floppy$Read$Code EQU 01H ;Read command for controller
0002 = Floppy$Write$Code EQU 02H ;Write command for controller
;
0000 00 Disk$Hung$Flag: DB 0 ;Set NZ when watchdog timer times
; out
0258 = Disk$Timer EQU 600 ;10-second delay (16.66ms tick)
;
0043 = Disk$Status$Block EQU 43H ;Address in memory where controller
; returns status
;Values from controller command table

0001 00 Floppy$Command: DB 0
0002 00 Floppy$Head: DB 0
0003 00 Floppy$Track: DB 0
0004 00 Floppy$Sector: DB 0

```

Figure 9-5. User-friendly disk-error processor

```

0005 00.    Deblocking$Required:  DB    0    ;Flag set by SELDSK according
; to selected disk type

0006 00     Disk$Error$Flag:    DB    0    ;Error flag returned to BDOS
;
0007 00     In$Buffer$Disk:     DB    0    ;Logical disk Id. relating to current
; disk sector in deblocking buffer
;
; Equates for Messages
;
0007 =     BELL    EQU    07H    ;Sound terminal bell
000D =     CR     EQU    0DH    ;Carriage return
000A =     LF     EQU    0AH    ;Line feed
;
0005 =     BDOS   EQU    5      ;BDOS entry point (for system reset)
;
;
;
No$Deblock$Retry:
;-----
; Omitted code to set up disk controller command table
; and initiate the disk operation
;-----
0008 C31500    JMP     Wait$For$Disk$Complete
;
;
Write$Physical:
; Write contents of disk buffer to
; correct sector
000B 3E02     MVI    A,Floppy$Write$Code ;Get write function code
000D C31200    JMP     Common$Physical ;Go to common code
Read$Physical:
; Read previously selected sector
; into disk buffer
0010 3E01     MVI    A,Floppy$Read$Code ;Get read function code
Common$Physical:
0012 320100    STA    Floppy$Command ;Set command table
;
;
Deblock$Retry:
; Re-entry point to retry after error
; Omitted code sets up disk controller command block
; and initiates the disk operation
;-----
;
Wait$For$Disk$Complete:
; Wait until disk status block indicates
; operation has completed, then check
; if any errors occurred
; On entry HL -> disk control byte
; Ensure hung flag clear
0015 AF       XRA    A
0016 320000    STA    Disk$Hung$Flag
;
0019 213100    LXI    H,Disk$Timed$Out ;Set up watchdog timer
001C 015802    LXI    B,Disk$Timer ;Time delay
001F CD3803    CALL   Set$Watchdog
;
Disk$Wait$Loop:
0022 7E       MOV    A,M ;Get control byte
0023 B7       ORA    A
0024 CA3700    JZ     Disk$Complete ;Operation done
;
0027 3A0000    LDA    Disk$Hung$Flag ;Also check if timed out
002A B7       ORA    A
002B C29F02    JNZ    Disk$Error ;Will be set to 40H
;
002E C32200    JMP     Disk$Wait$Loop
;
Disk$Timed$Out:
; Control arrives here from watchdog
; routine itself -- so this is effectively
; part of the interrupt service routine.
0031 3E40     MVI    A,40H ;Set disk hung error code
0033 320000    STA    Disk$Hung$Flag ; into error flag to pull
; control out of loop
0036 C9       RET     ;Return to watchdog routine

```

Figure 9-5. (Continued)

```

Disk#Complete:
0037 010000      LXI    B,0           ;Reset watchdog timer
                                ;HL is irrelevant here
003A CD3B03      CALL   Set#Watchdog

003D 3A4300      LDA    Disk#Status#Block      ;Complete -- now check status
0040 FE80        CPI    80H                ;Check if any errors occurred
0042 DA9F02      JC     Disk#Error           ;Yes
;
Disk#Error#Ignore:
0045 AF          XRA    A                   ;No
0046 320600      STA   Disk#Error#Flag       ;Clear error flag
0049 C9          RET

;
;       Disk error message handling
;
;
Disk#Error#Messages:           ;This table is scanned, comparing the
                                ; disk error status with those in the
                                ; table. Given a match, or even when
                                ; the end of the table is reached, the
                                ; address following the status value
                                ; points to the correct advisory message text.
                                ; Following this is the address of an
                                ; error description message.

004A 40          DB     40H
004B B0019500    DW    Disk#Advice1,Disk#Msg#40
004F 41          DB     41H
0050 C9019A00    DW    Disk#Advice2,Disk#Msg#41
0054 42          DB     42H
0055 E301A400    DW    Disk#Advice3,Disk#Msg#42
0059 21          DB     21H
005A 0702B400    DW    Disk#Advice4,Disk#Msg#21
005E 22          DB     22H
005F 1802B900    DW    Disk#Advice5,Disk#Msg#22
0063 23          DB     23H
0064 1802C000    DW    Disk#Advice5,Disk#Msg#23
0068 24          DB     24H
0069 3D02D200    DW    Disk#Advice6,Disk#Msg#24
006D 25          DB     25H
006E 3D02DE00    DW    Disk#Advice6,Disk#Msg#25
0072 11          DB     11H
0073 5302F100    DW    Disk#Advice7,Disk#Msg#11
0077 12          DB     12H
0078 5302FF00    DW    Disk#Advice7,Disk#Msg#12
007C 13          DB     13H
007D 53020C01    DW    Disk#Advice7,Disk#Msg#13
0081 14          DB     14H
0082 53021A01    DW    Disk#Advice7,Disk#Msg#14
0086 15          DB     15H
0087 53022901    DW    Disk#Advice7,Disk#Msg#15
008B 16          DB     16H
008C 53023501    DW    Disk#Advice7,Disk#Msg#16
0090 00          DB     0
0091 53024501    DW    Disk#Advice7,Disk#Msg#Unknown ;Unmatched code

;
0005 =           DEM#Entry#Size EQU    5           ;Entry size in error message table
;
;
;       Message texts
;
0095 48756E6700Disk#Msg#40:  DB    'Hung',0           ;Timeout message
009A 4E6F742052Disk#Msg#41:  DB    'Not Ready',0
00A4 5772697465Disk#Msg#42:  DB    'Write Protected',0
00B4 4461746100Disk#Msg#21:  DB    'Data',0
00B9 466F726D61Disk#Msg#22:  DB    'Format',0
00C0 4D69737369Disk#Msg#23:  DB    'Missing Data Mark',0
00D2 4275732054Disk#Msg#24:  DB    'Bus Timeout',0
00DE 436F6E7472Disk#Msg#25:  DB    'Controller Timeout',0
00F1 4472697665Disk#Msg#11:  DB    'Drive Address',0
00FF 4865616420Disk#Msg#12:  DB    'Head Address',0
010C 547261636BDisk#Msg#13:  DB    'Track Address',0

```

Figure 9-5. (Continued)

```

011A 536563746FDisk#Msg#14: DB 'Sector Address',0
0129 4275732041Disk#Msg#15: DB 'Bus Address',0
0135 496C6C6567Disk#Msg#16: DB 'Illegal Command',0
0145 556E6B6E6FDisk#Msg#Unknown: DB 'Unknown',0
;
; Disk#EM#1: ;Main disk error message -- part 1
014D 070D0A DB BELL,CR,LF
0150 446973d520 DB 'Disk ',0
;
; Error text output next
;
; Disk#EM#2: ;Main disk error message -- part 2
0156 204572726F DB ' Error ('
015E 0000 Disk#EM#Status: DB 0,0 ;Status code in hex
0160 290D0A2020 DB ')',CR,LF,' Drive '
016E 00 Disk#EM#Drive: DB 0 ;Disk drive code, A,B...
016F 2C20486561 DB ', Head '
0176 00 Disk#EM#Head: DB 0 ;Head number
0177 2C20547261 DB ', Track '
017F 0000 Disk#EM#Track: DB 0,0 ;Track number
0181 2C20536563 DB ', Sector '
018A 0000 Disk#EM#Sector: DB 0,0 ;Sector number
018C 2C204F7065 DB ', Operation - '
019A 00 DB 0 ;Terminator
;
019B 526561642EDisk#EM#Read: DB 'Read.',0 ;Operation names
01A1 5772697465DDisk#EM#Write: DB 'Write.',0
;
01A8 0D0A202020Disk#Advice0: DB CR,LF,' ',0
01B0 4368656368DDisk#Advice1: DB 'Check disk loaded, Retry',0
01C9 506F737369DDisk#Advice2: DB 'Possible hardware problem',0
01E3 5772697465DDisk#Advice3: DB 'Write enable if correct disk, Retry',0
0207 5265747279DDisk#Advice4: DB 'Retry several times',0
021B 5265666FF72DDisk#Advice5: DB 'Reformat disk or use another disk',0
023D 4861726477DDisk#Advice6: DB 'Hardware error, Retry',0
0253 4861726477DDisk#Advice7: DB 'Hardware or Software error, Retry',0
;
0275 2C206F722DDisk#Advice9: DB ', or call for help if error persists',CR,LF
;
; Disk#Action#Confirm:
029B 00 DB 0 ;Set to character entered by user
029C 0D0A00 DB CR,LF,0
;
; Disk error processor
;
; This routine builds and outputs an error message.
; The user is then given the opportunity to:
;
; R -- retry the operation that caused the error
; I -- ignore the error and attempt to continue
; A -- abort the program and return to CP/M
;
; Disk#Error:
029F F5 PUSH PSW ;Preserve error code from controller
02A0 215E01 LXI H,Disk#EM#Status ;Convert code for message
02A3 CD3B03 CALL CAH ;Converts A to hex
;
02A6 3A0700 LDA In#Buffer#Disk ;Convert disk id. for message
02A9 C641 ADI 'A' ;Make into letter
02AB 326E01 STA Disk#EM#Drive
;
02AE 3A0200 LDA Floppy#Head ;Convert head number
02B1 C630 ADI '0'
02B3 327601 STA Disk#EM#Head
;
02B6 3A0300 LDA Floppy#Track ;Convert track number
02B9 217F01 LXI H,Disk#EM#Track
02BC CD3B03 CALL CAH
;
02BF 3A0400 LDA Floppy#Sector ;Convert sector number
02C2 218A01 LXI H,Disk#EM#Sector
02C5 CD3B03 CALL CAH
;
02CB 214D01 LXI H,Disk#EM#1 ;Output first part of message
02CB CD3B03 CALL Output#Error#Message

```

Figure 9-5. (Continued)

```

02CE F1          POP     PSW          ;Recover error status code
02CF 47          MOV     B,A           ;For comparisons
02D0 214500      LXI     H,Disk$Error$Messages - DEM$Entry$Size
                                ;HL -> table -- one entry
                                ;For loop below
02D3 110500      LXI     D,DEM$Entry$Size
Disk$Error$Next$Code:
02D6 19          DAD     D           ;Move to next (or first) entry
02D7 7E          MOV     A,M           ;Get code number from table
02D8 B7          ORA     A           ;Check if end of table
02D9 CAE302      JZ     Disk$Error$Matched ;Yes, pretend a match occurred
02DC BB          CMP     B           ;Compare to actual code
02DD CAE302      JZ     Disk$Error$Matched ;Yes, exit from loop
02E0 C3D602      JMP     Disk$Error$Next$Code ;Check next code
;
02E3 23          INX     H           ;HL -> advisory text address
02E4 5E          MOV     E,M
02E5 23          INX     H
02E6 56          MOV     D,M           ;DE -> advisory test
02E7 D5          PUSH   D           ;Save for later
02E8 23          INX     H           ;HL -> message text address
02E9 5E          MOV     E,M           ;Get address into DE
02EA 23          INX     H
02EB 56          MOV     D,M
02EC EB          XCHG
02ED CD3B03      CALL   Output$Error$Message ;Display explanatory text
02F0 215601      LXI     H,Disk$EM#2
02F3 CD3B03      CALL   Output$Error$Message ;Display second part of message
02F6 219B01      LXI     H,Disk$EM$Read
                                ;Choose operation text
                                ; (assume a read)
02F9 3A0100      LDA     Floppy$Command ;Get controller command
02FC FE01      CPI     Floppy$Read$Code
02FE CA0403      JZ     Disk$Error$Read ;Yes
0301 21A101      LXI     H,Disk$EM$Write ;No, change address in HL
Disk$Error$Read:
0304 CD3B03      CALL   Output$Error$Message ;Display operation type
0307 21A801      LXI     H,Disk$Advice0
030A CD3B03      CALL   Output$Error$Message ;Display leading blanks
030D E1          POP     H           ;Recover advisory text pointer
030E CD3B03      CALL   Output$Error$Message
0311 217502      LXI     H,Disk$Advice9
0314 CD3B03      CALL   Output$Error$Message ;Display trailing component
;
0317 CD3B03      CALL   Request$User$Choice ;Ask the user what to do next
                                ;Display prompt and get single
                                ; character response (folded to
                                ; uppercase)
031A FE52      CPI     'R'         ;Retry
031C CA2C03      JZ     Disk$Error$Retry
031F FE41      CPI     'A'         ;Abort?
0321 CA3603      JZ     System$Reset
0324 FE49      CPI     'I'         ;Ignore?
0326 CA4500      JZ     Disk$Error$Ignore
0329 C31703      JMP     Disk$Error$Request$Action
;
Disk$Error$Retry:
                                ;The decision on where to return to
                                ; depends on whether the operation
                                ; failed on a deblocked or
                                ; nondeblocked drive
032C 3A0500      LDA     Deblocking$Required
032F B7          ORA     A
0330 C21500      JNZ     Deblock$Retry
0333 C30800      JMP     No$Deblock$Retry

```

Figure 9-5. (Continued)

```

;
System$Reset:
;This is a radical approach, but
; it does cause CP/M to restart
;System reset
0336 0E00      MVI    C,0
0338 CD0500    CALL   BDOS

;
;      Omitted subroutines (listed in full in Figure 8-10)
;
Set$Watchdog: ;Set watchdog timer (to number of "ticks" in BC, and
; to transfer control to (HL) if timer hits zero).
CAH:          ;Convert A to two ASCII hex characters, storing
; the output in (HL) and (HL+1)
Output$Error$Message: ;Display the 00-byte terminated error message
; pointed to by HL. Output is directed only to
; those console devices not being used for list
; output as well.
Request$User$Choice: ;Display prompt "Enter R, A, I..." and return
; single keyboard character (uppercase) in A
;Dummy
033B C9      RET

```

Figure 9-5. User-friendly disk-error processor (continued)

build a machine, take it to the top of a hill, throw it off, and, when it crashes, examine the debris to discover what went wrong.

Each time you do an assembly and test, you are building the aircraft and lobbing it off the edge of a cliff. Each time it crashes, you examine the wreckage and try to determine the possible cause.

This is a highly inferential process. With the wreckage as a starting point, you use inference and intuition to extrapolate the real problem and the correction for it.

Built-In Debug Code

The single most important concept that you will need in testing CP/M systems is the same as that used in the modern day “black box” flight recorder. This device is essentially a multi-channel tape recorder that records all of the relevant conditions of the aircraft, its height, altitude, throttle settings, flap settings, and even the voice communications among crew members. If the airplane crashes, investigators can replay the information and understand what happened during the flight.

Applying this concept to debugging CP/M means that you must build into your code some method for recording what it is doing, so that if the system crashes, you can see what it was doing. Make the code tell you what went wrong.

The debug code should be designed at the same time as the rest of the program. Plan the debugging code while the design is still on the drawing board. The source code for debugging should be a permanent part of the BIOS. Use conditional assembly to “IF” out most of the debug code from the final version, or make the code sensitive to a flag in the configuration block so that you can re-enable the debug code at a moment’s notice if the system begins to behave strangely.

The more meaningful the debug output data, the less you will have to guess at what is wrong, and therefore the less painful and time-consuming the debugging process will be. Make the output intelligible to others who may use it or yourself several months hence. Data that tells you what is happening is more useful than internal hexadecimal values, particularly if someone else must interpret it or relay it to you over the telephone.

Debug Subroutines

Many programmers do their debugging on a casual “catch as catch can” basis because they are overwhelmed by the task of building the necessary tools. Others are too eager to start on a new program to take a few extra hours or days to build debug subroutines.

To help solve this problem, the following section provides some ready-made debugging tools that can be used “as is.” Each of these routines has been thor-

oughly debugged (there's nothing worse than debug code with bugs in it!) and has been used in actual program testing.

Overall Design Philosophy

Some common methods run through the examples that follow. These include displaying meaningful "captions" (including the specific address that called the debug routine), grouping all debugging code together, preserving the contents of all registers, and setting up the stack area in a standard way.

Debug Code Captions When the contents of registers or memory are output as part of a debugging process, a caption of explanatory text describing the values should be displayed. For example, rather than displaying the contents of the A register like this,

```
A = 1F
```

you can use a meaningful caption such as:

```
Transaction Code A = 1F.
```

When you write additional debugging code, especially if you need to add it to an existing routine, it is cumbersome to have to write the call to the debug routine and then search through the source code to find a convenient place to put an ASCII caption string. A caption string several pages removed from the point where it is referenced makes for problems when you want to relate the debug output on the screen or listing to the source code itself. Therefore, all of the routines that follow allow you to declare the caption strings "in-line" like this:

```
IF          DEBUG
CALL       Debug$Routine
DB         'Caption string here',CR,LF,0
ENDIF

MVI        .....          ;Next instruction
```

All of the following routines that output a caption recognize one specific 8-bit value in the caption string. If they encounter a value of 0ADH (mnemonic for ADDRESS), they will output the address of the byte following the call to the debug routine. For example,

```
0210      CALL       Debug$Routine
0213      DB         0ADH,'Caption string',0
```

will cause the routine to display the following:

```
0213 Caption string
```

This identifies the point in your program from which the debug routine was called, and thus avoids any possible ambiguity between different calls to the same debug routine with similar captions.

Grouping Debug Code Grouping all the debug code together lends itself to using conditional assembly with IF/ENDIF statements.

Setting Up the Stack Area All of the following routines preserve the CPU registers so that there are no side effects from using them. All of them assume that they can use the stack pointer and that there is sufficient room in the stack area. Hence you will need to declare adequate stack space for your main code and for the debug routines. Fill the stack area with a known pattern like this:

```
DW  9999H, 9999H, 9999H, 9999H, 9999H, 9999H, 9999H, 9999H
DW  9999H, 9999H, 9999H, 9999H, 9999H, 9999H, 9999H, 9999H
DW  9999H, 9999H, 9999H, 9999H, 9999H, 9999H, 9999H, 9999H
Stack$Area:                ;Label the upper end of the area
```

Then, during debugging, you can examine the stack area and determine how much of it is unused. For example, if you looked at the stack area you might see something like this:

```
                                "Low-water mark"
                                v
99 99 99 99 99 99 99 99 99 99 99 99 09 15 43 42
01 29 00 00 1A 2B 10 FF FF 39 02 ED 11 01 37 44
DD 00 00 11 1A 23 31 00 41 AE FE 00 01 10 70 C9
```

Stack area overflow can give arcane bugs; the program seems to leap off into space in a nondeterministic way. By setting up the stack area in this way, you can recognize an overflow condition easily.

Debug Initialization Before you can execute any of the debug subroutines in this chapter, you must make a call to the initialization subroutine, DB\$Init. The DB\$Init routine sets up some of the internal variables needed by the debug package. You may need to add some of your own initialization code here.

Console Output

Normally, you can use the CONOUT functions either via the BDOS (Function 2), or via the BIOS by calling the jump vector directly. You cannot do this when you need to debug console routines themselves, nor when you need to debug interrupt service routines. In the latter case, if an interrupt pulled control out of the CONOUT routine in the BIOS, you would get unwanted re-entrancy if the debug code again entered the CONOUT driver to display a caption. Therefore, the debug routines have been written to call their own local CONOUT routine, which is called DB\$CONOUT. DB\$CONOUT can be changed to call the BDOS, the BIOS, or a "private" polled output routine.

A counterpart DB\$CONIN routine for console input is provided for essentially the same reasons.

Controlling Debug Output

All output of debug routines in this chapter is controlled by a single master flag, `DB$Flag`. If this flag is nonzero, debug output will occur; if zero, all output is suppressed.

This flag can be set and cleared from any part of the program you are testing. It is especially useful when you need to debug a subroutine that is called many times from many different places. You can write additional code to enable debug output when certain conditions prevail; for example, when a particular track or sector is about to be written or when a character input buffer is almost full.

Two subroutines, `DB$On` and `DB$Off`, are shown that access the debug control flag. These, as their names suggest, turn debug output on and off.

Turning the debug output on and off from within the program can create a confusing display of debug output, lacking any apparent continuity. `DB$Off` gives you the option of outputting a character string indicating that debug output has been turned off.

Pass Counters

Another method of controlling debug output is to use a *pass counter*, enabling debug output only after control has passed through a particular point in the code a specific number of times.

Two subroutines are provided for this purpose. `DBSetPass` sets the pass counter to a specific value. `DB$Pass` decrements this pass count each time control is transferred to it. When the pass count hits zero, the debug control flag `DB$Flag` is nonzero and debug output begins.

Using pass counter techniques can save you time and effort in tracking down a problem that occurs only after the code has been running for several minutes.

Displaying Contents of Registers and Memory

Figure 10-2 shows a series of display subroutines, the primary one of which is `DB$Display`. It takes several parameters, depending on the information you want displayed. The generic call to `DB$Display` is as follows:

```
CALL    DB$Display
DB      Code      <- Indicates the data to be
                    displayed
{DW     Optional additional parameters}
DB      'Caption string',0
```

The codes that can be used in this call are shown in Table 10-1.

The only function that uses additional parameters is `DB$Memory`. This displays bytes from memory in hexadecimal and ASCII, using the start and finish

addresses following the call. Here is an example:

```
CALL    DB$Display
DB      DB$Memory
DW      Start$Address,End$Address
DB      ^Caption string^,0
```

Table 10-1. Codes for DB\$Display

Code	Value displayed
8-bit registers	
DB\$F	Condition Flags
DB\$A	Register A
DB\$B	Register B
DB\$C	Register C
DB\$D	Register D
DB\$E	Register E
DB\$H	Register H
DB\$L	Register L
Memory	
DB\$Memory	Bytes starting and ending at the addresses specified by the two word values following the code value.
16-bit registers	
DB\$BC	Register pair BC
DB\$DE	Register pair DE
DB\$HL	Register pair HL
DB\$SP	Stack Pointer
Byte values	
DB\$B\$BC	Byte addressed by BC
DB\$B\$DE	Byte addressed by DE
DB\$B\$HL	Byte addressed by HL
Word values	
DB\$W\$BC	Word addressed by BC
DB\$W\$DE	Word addressed by DE
DB\$W\$HL	Word addressed by HL

Debugging Program Logic

In addition to displaying the contents of registers and memory, you need to display the program's execution path, not in terms of addresses, but in terms of the *problem*. You can do this by displaying debug messages that indicate what decisions have been made by the program as it executes. For example, if your BIOS checks a particular value to see whether the system should read or write on a particular device, the debug routine should display a message like this:

Entering Disk Read Routine

This is more meaningful than just displaying the function code for the drivers — although you may want to display this as well, in case it has been set to some strange value.

Two subroutines are provided to display debug messages. They are DB\$MSG and DB\$MSGI. Both of these display text strings are terminated with a byte of 00H. You can see the difference between the two subroutines if you examine the way they are called.

DB\$MSG is called like this:

```
LXI H,Message$Text      ;HL -> text string
CALL DB$MSG
```

DB\$MSGI is called like this:

```
CALL DB$MSG
DB 0DH,0AH,'Message Text',0 ;In-line
```

DB\$MSGI is more convenient to use. If you decide that you need to add a message, you can declare the message immediately following the call. This also helps when you look at the listing, since you can see the complete text at a glance.

Use DB\$MSG when the text of the message needs to be selected from a table. Get the address of the text into HL and then call DB\$MSG to display it.

Creating Your Own Debug Displays

If you need to build your own special debug display routines, you may find it helpful to incorporate some of the small subroutines in the debug package. The following are the subroutines you may want to use:

DB\$CONOUT

Displays the character in the C register.

DB\$CONIN

Returns the next keyboard character in A.

DB\$CONINU

Returns the next keyboard character in A, converting lowercase letters to uppercase.

DB\$DHLH

Displays contents of HL in hexadecimal.

DB\$DAH

Displays contents of A in hexadecimal.

DB\$CAH

Converts contents of A to hexadecimal and stores in memory pointed at by HL.

DB\$Nibble\$To\$Hex

Converts the least significant four bits of A into an ASCII hexadecimal character in A.

DB\$CRLF

Displays a CARRIAGE RETURN/LINE FEED.

DB\$Colon

Displays the string " : ".

DB\$Blank

Displays a single space character.

DB\$Flag\$Save\$On

Saves the current state of the debug output control flag and then sets the flag "on" to enable debug output.

DB\$Flag\$Restore

Restores the debug output control flag to the state it was in when the *DB\$Flag\$Save\$On* routine was last called.

DB\$GHV

Gets a hexadecimal value from the keyboard, displaying a prompt message first. From one to four characters can be specified as the maximum number of characters to be input.

DB\$A\$To\$Upper

If the A register contains a lowercase letter, this converts it to an uppercase letter.

Debugging I/O Drivers

Debugging low-level device drivers creates special problems. The major one is that you do not normally want to read and write via actual hardware ports while you are debugging the code—either because doing so would cause strange things to happen to the hardware during the debugging, or because you are developing and debugging the drivers on a system different from the target hardware on which the drivers are to execute.

Before considering the solution, remember that the input and output instructions (IN and OUT) are each two bytes long. The first byte is the operation code

(0DBH for input, 0D3H for output), and the second byte is the port number to “input from” or “output to.”

Debug subroutines are provided here to intercept all IN and OUT instructions, displaying the port number and either accepting a hexadecimal value from the console and putting it into the A register (in the case of IN), or displaying the contents of the A register (for the OUT instruction).

IN and OUT instructions can be “trapped” by changing the operation code to one of two RST (restart) instructions. An RST is effectively a single-byte CALL instruction, calling down to a predetermined address in low memory. The debug routines arrange for JMP instructions in low memory to receive control when the correct RST is executed. The code that receives control can pick up the port number, display it, and then accept a hex value for the A register (for IN) or display the current contents of the A register (for OUT). The example subroutines shown later in this chapter use RST 4 in place of IN instructions, RST 5 for OUT.

Wherever you plan to use IN, use the following code:

```
IF          Debug
RST        4
ENDIF
IF          NOT Debug
DB         IN
ENDIF
DB         Port$Number
```

Note that you can use the IN operation code as the operand of a DB statement. The assembler substitutes the correct operation code.

Use the following code wherever you need to use an OUT instruction:

```
IF          Debug
RST        5
ENDIF
IF          NOT Debug
DB         OUT
ENDIF
DB         Port$Number
```

When the RST 4 (IN) instruction is executed, the debug subroutine displays

```
1AB3 : Input from Port 01 : _
```

The “1AB3” is the address in memory of the byte containing the port number. It serves to pinpoint the IN instruction in memory. You can then enter one or two hexadecimal digits. These will be converted and put into the A register before control returns to the main program at the instruction following the byte containing the port number.

When the RST 5 (OUT) instruction is encountered, the debug subroutine displays

```
1AB5 : Output to Port 01 : FF
```

This identifies where the OUT instruction would normally be as well as the port number and the contents of the A register when the RST 5 (OUT) is executed.

Debugging Interrupt Service Routines

You can use a technique similar to that of the RST instruction just described to “fake” an interrupt. You preset the low-memory address for the RST instruction you have chosen for the jump into the interrupt service routine under test.

When the RST instruction is executed, control will be transferred into the interrupt service routine just as though an interrupt had occurred. You will need to intercept any IN or OUT instructions as described above—otherwise the code probably will go into an endless loop.

Before executing the RST instruction to fake the interrupt, load all the registers with known values. For example:

```
MVI    A,0AAH
LXI    B,0BBCCH
LXI    D,0DDEEH
LXI    H,01122H
RST    6      ;Fake interrupt
NOP
```

When control returns from the service routine, you can check to see that it restored all of the registers to their correct values. An interrupt service routine that does not restore all the registers can produce bugs that are very hard to find.

Check, too, that the stack pointer register has been restored and that the service routine did not require too many bytes on the stack.

You also can use the CALL instruction to transfer control to the interrupt service routine in order to fake an interrupt. RST and CALL achieve the same effect, but RST is closer to what happens when a real interrupt occurs. As it is a single-byte instruction, it also is easier to patch in.

Subroutine Listings

Figure 10-1 is a functional index to the source code listing for the debug subroutines shown in Figure 10-2. The listing’s commentary defines precisely how each debug subroutine is called.

Figure 10-3 shows the output from the debug testbed.

Software Tools for Debugging

In addition to building in debugging subroutines, you will need one of the following proprietary debug programs:

DDT (Dynamic Debugging Tool)

This program, included with the standard CP/M release, allows you to load programs, set and display memory and registers, trace through your program instruction by instruction, or execute it at full speed, but stopping

Start Line	Functional Component or Routines
00001	Debug subroutine's Testbed
00100	Test register display
00200	Test memory dump display
00300	Test register pair display
00400	Test byte indirect display
00500	Test DB\$On/Off
00600	Test DB\$Set\$Pass and DB\$Pass
00700	Test debug input/output
00800	Debug subroutines themselves
01100	DB\$Init - initialization
01200	DB\$CONINU - get uppercase keyboard character
01300	DB\$CONIN - get keyboard character
01400	DB\$CONOUT - display character in C
01500	DB\$On - enable debug output
01600	DB\$Off - disable debug output
01700	DB\$Set\$Pass - set pass counter
01800	DB\$Pass - execute pass point
01900	DB\$Display - main debug display routine
02200	Main display processing subroutines
02500	DB\$Display\$CALLA - display CALL's address
02600	DB\$DHLH - display HL in hexadecimal
02700	DB\$DAH - display A in hexadecimal
02800	DB\$CAH - convert A to hexadecimal in memory
02900	DB\$Nibble\$To\$Hex - convert LS 4 bits of A to hex.
02930	DB\$CRLF - display Carriage Return, Line Feed
02938	DB\$Colon - display ":"
02946	DB\$Blank - display " "
03100	DB\$MSGI - display in-line message
03147	DB\$MSG - display message addressed by HL
03300	DB\$Input - debug INput routine
03500	DB\$Output - debug OUTput routine
03700	DB\$Flag\$Save\$On - save debug flag and enable
03800	DB\$Flag\$Restore - restore debug control flag
03900	DB\$GHV - get hexadecimal value from keyboard
04100	DB\$A\$To\$Upper - convert A to upper case

Figure 10-1. Functional index for Figure 10-2

at certain addresses (called breakpoints). It also has a built-in mini-assembler and disassembler so you do not have to hand assemble any temporary code "patches" you add.

SID (Symbolic Interactive Debug)

Similar to DDT in many ways, SID has enhancements that are helpful if you use Digital Research's MAC (Macro Assembler) or RMAC (Relocating Macro Assembler). Both of these assemblers can be told to output a file

```

00001
00002
00003
00004 ;
00005 ; Debug Subroutines
00006 ;
00007 ;<---- NOTE:
00008 ; The line numbers at the extreme left are included purely
00009 ; to reference the code from the text.
00010 ; There are deliberately induced discontinuities
00011 ; in the numbers in order to allow space for expansion.
00012 ;
00013 ; Because of the need to test these routines thoroughly,
00014 ; and in case you wish to make any changes, the testbed
00015 ; routine for the debug package itself has been left in
00016 ; in this figure.
00017 ;
00018 ; Debug testbed
00019 ;
00020 ;
00021 0100 START: ORG 100H
00022 0100 316B03 LXI SP,Test$Stack ;Set up local stack
00023 0103 CDEA04 CALL DB$Init ;Initialize the debug package
00024 0106 CD1505 CALL DB$On ;Enable debug output
00025 0109 3EAA MVI A,OAAH ;Simple test of A register display
00026 010B 01CCBB LXI B,OBBCBH ;Preset a value in the A register
00027 010E 11EEDD LXI D,ODDEEH ;Prefill all other registers, partly
00028 0111 2111FF LXI H,OFF11H ; to check the debug display, but
00100 ; also to check register save/restore
00101 ;#
00102 ;
00103 ; Test register display
00104 0114 B7 ORA A ;Set M-flag, clear Z-flag, set E-flag
00105 0115 37 STC ;Set carry
00106 0116 CD5205 CALL DB$Display ;Call the debug routine
00107 0119 00 DB DB$F
00108 011A 466C616773 DB 'Flags',0
00109 ;
00110 0120 CD5205 CALL DB$Display ;Call the debug routine
00111 0123 02 DB DB$A
00112 0124 4120526567 DB 'A Register',0
00113 ;
00114 012F CD5205 CALL DB$Display ;Call the debug routine
00115 0132 04 DB DB$B
00116 0133 4220526567 DB 'B Register',0
00117 ;
00118 013E CD5205 CALL DB$Display ;Call the debug routine
00119 0141 06 DB DB$C
00120 0142 4320526567 DB 'C Register',0
00121 ;
00122 014D CD5205 CALL DB$Display ;Call the debug routine
00123 0150 08 DB DB$D
00124 0151 4420526567 DB 'D Register',0
00125 ;
00126 015C CD5205 CALL DB$Display ;Call the debug routine
00127 015F 0A DB DB$E
00128 0160 4520526567 DB 'E Register',0
00129 ;
00130 016B CD5205 CALL DB$Display ;Call the debug routine
00131 016E 0C DB DB$H
00132 016F 4820526567 DB 'H Register',0
00133 ;
00134 017A CD5205 CALL DB$Display ;Call the debug routine
00135 017D 0E DB DB$L
00136 017E 4C20526567 DB 'L Register',0
00200 ;#
00201 ;
00202 ; Test Memory Dump Display
00203 ;
00204 0189 CD5205 CALL DB$Display
00205 018C 18 DB DB$M ;Dump memory
00206 018D 08012801 DW 108H,128H ;Check start/end at nonmultiples
00207 0191 4D656D6F72 DB 'Memory Dump #1',0 ; of 10H
00208 ;
00209 01A0 CD5205 CALL DB$Display
00210 01A3 18 DB DB$M ;Dump memory
00211 01A4 00011F01 DW 100H,11FH ;Check start and end on displayed
00212 01A8 4D656D6F72 DB 'Memory Dump #2',0 ; line boundaries

```

Figure 10-2. Debug subroutines

```

00603 02EE CD1D05      CALL    DB#Off      ;Disable debug output
00604 02F1 CD2405      CALL    DB#Set#Pass ;Set pass count
00605 02F4 1E00        DW      30
00606
00607 02F6 3E22        MVI     A,34        ;Set loop counter greater than pass
00608                                ; counter
00609                                Test#Pass#Loop:
00610 02F8 CD3505      CALL    DB#Pass     ;Decrement pass count
00611 02FB CDD407      CALL    DB#MSGI     ;Display in-line message
00612 02FE 0D0A546869  DB      0DH,0AH,'This message should display 5 times',0
00613 0324 3D          DCR     A
00614 0325 C2F802      JNZ     Test#Pass#Loop
00700                                ;#
00701                                ; Test debug input/output
00702                                ;
00703 0328 CD1D05      CALL    DB#Off      ;Check that debug IN/OUT
00704                                ; must still occur when debug
00705                                ; output is disabled.
00706 032B E7          RST     4           ;Debug input
00707 032C 11          DB      11H        ;Port number
00708 032D EF          RST     5           ;Debug output (value return from input)
00709 032E 22          DB      22H        ;Port number
00710
00711 032F C30000      JMP     0           ;Warm boot at end of testbed
00712                                ;
00713                                ;
00714                                ; Dummy values for byte and word displays
00715 0332 BC          Byte#BC: DB      0BCH
00716 0333 DE          Byte#DE: DB      0DEH
00717 0334 F1          Byte#HL: DB      0F1H
00718                                ;
00719 0335 0C0B       Word#BC: DW      0B0CH
00720 0337 0E0D       Word#DE: DW      0D0EH
00721 0339 010F       Word#HL: DW      0F01H
00722                                ;
00723 033B 9999999999  DW      9999H,9999H,9999H,9999H,9999H,9999H,9999H,9999H
00724 034B 9999999999  DW      9999H,9999H,9999H,9999H,9999H,9999H,9999H,9999H
00725 035B 9999999999  DW      9999H,9999H,9999H,9999H,9999H,9999H,9999H,9999H
00726                                Test#Stack:
00727                                ;
00728                                ;
00729                                ;
00730 0400            ORG     400H      ;To avoid unnecessary listings
00731                                ; when only the testbed changes
00732                                ;-----
00800                                ;#
00801                                ;
00802                                ; Debug subroutines
00803                                ;
00804                                ;
00805                                ; Equates for DB#Display codes
00806                                ; These equates are the offsets down the table of addresses
00807                                ; for various subroutines to be used.
00808                                ;
00809 0000 =          DB#F EQU     00      ;Flags
00810 0002 =          DB#A EQU     02      ;A register
00811 0004 =          DB#B EQU     04      ;B
00812 0006 =          DB#C EQU     06      ;C
00813 0008 =          DB#D EQU     08      ;D
00814 000A =          DB#E EQU     10      ;E
00815 000C =          DB#H EQU     12      ;H
00816 000E =          DB#L EQU     14      ;L
00817 0010 =          DB#BC EQU    16      ;BC
00818 0012 =          DB#DE EQU    18      ;DE
00819 0014 =          DB#HL EQU    20      ;HL
00820 0016 =          DB#SP EQU    22      ;Stack pointer
00821 0018 =          DB#M EQU     24      ;Memory
00822 001A =          DB#B#BC EQU    26      ;(BC)
00823 001C =          DB#B#DE EQU    28      ;(DE)
00824 001E =          DB#B#HL EQU    30      ;(HL)
00825 0020 =          DB#W#BC EQU    32      ;(BC+1),(BC)
00826 0022 =          DB#W#DE EQU    34      ;(DE+1),(DE)
00827 0024 =          DB#W#HL EQU    36      ;(HL+1),(HL)
00828                                ;
00829                                ;
00830                                ; Equates
00831 0020 =          RST4 EQU     20H      ;Address for RST 4 - IN instruction

```

Figure 10-2. (Continued)

```

00832 0028 = RST5 EQU 28H ;Address for RST 5 - OUT instruction
00833 ;
00834 0001 = B%CONIN EQU 1 ;BDOS CONIN function code
00835 0002 = B%CONOUT EQU 2 ;BDOS CONOUT function code
00836 000A = B%READCONS EQU 10 ;BDOS read console function code
00837 0005 = BDOS EQU 5 ;BDOS entry point
00838 ;
00839 0000 = False EQU 0
00840 FFFF = True EQU NOT False
00841 ;
00842 ;Equates to specify how DB%CONOUT
00843 ; and DB%CONIN should perform
00844 ; their input/output
00845 0000 = DB%Polled%IO EQU False ;)
00846 0000 = DB%BIOS%IO EQU False ;) Only one must be true
00847 FFFF = DB%BDOS%IO EQU True ;)
00848 ;
00849 ;Equates for polled I/O
00850 0001 = DB%Status%Port EQU 01H ;Console status port
00851 0002 = DB%Data%Port EQU 02H ;Console data port
00852 ;
00853 0002 = DB%Input%Ready EQU 0000%0010B ;Incoming data ready
00854 0001 = DB%Output%Ready EQU 0000%0001B ;Ready for output
00855 ;
00856 ;Data for BIOS I/O
00857 0400 C3 BIOS%CONIN: DB JMP ;The initialization routine sets these
00858 0401 0000 DW 0 ; two JMP addresses into the BIOS
00859 0403 C3 BIOS%CONOUT: DB JMP
00860 0404 0000 DW 0
00861 ;
00862 ; Main debug variables and constants
00863 ;
00864 0406 00 DB%Flag: DB 0 ;Main debug control flag
00865 ; When this flag is nonzero, all debug
00866 ; output will be made. When zero, all
00867 ; debug output will be suppressed.
00868 ; It is altered either directly by the user
00869 ; or using the routines DB%On, DB%Off and
00870 ; DB%Pass.
00871 ;
00872 0407 0000 DB%Pass%Count: DW 0 ;Pass counter
00873 ; When this is nonzero, calls to DB%Pass
00874 ; decrement it by one. When it reaches
00875 ; zero, the debug control flag, DB%Flag,
00876 ; is set nonzero, thereby enabling
00877 ; debug output.
00878 ;
00879 DB%Save%HL: ;Save area for HL
00880 0409 00 DB%Save%L: DB 0
00881 040A 00 DB%Save%H: DB 0
00882 ;
00883 040B 0000 DB%Save%SP: DW 0 ;Save area for stack pointer
00884 040D 0000 DB%Save%RA: DW 0 ;Save area for return address
00885 040F 0000 DB%Call%Address: DW 0 ;Starts out the same as DB%Save%RA
00886 ; but DB%Save%RA gets updated during
00887 ; debug processing. This value is
00888 ; output ahead of the caption
00889 DB%Start%Address: ;Start address for memory display
00890 0411 0000 DW 0
00891 DB%End%Address: ;End address for memory display
00892 0413 0000 DW 0
00893 DB%Display%Code: ;Display code requested
00894 0415 00 DB 0
00895 ;
00896 ;
00897 ;Stack area
00898 0416 99999999 DW 9999H,9999H,9999H,9999H,9999H,9999H,9999H,9999H
00899 0426 99999999 DW 9999H,9999H,9999H,9999H,9999H,9999H,9999H,9999H
00900 0436 99999999 DW 9999H,9999H,9999H,9999H,9999H,9999H,9999H,9999H
00901 0446 00 DB%Save%E: DB 0 ;E register
00902 0447 00 DB%Save%D: DB 0 ;D register
00903 0448 00 DB%Save%C: DB 0 ;C register
00904 0449 00 DB%Save%B: DB 0 ;B register
00905 044A 00 DB%Save%F: DB 0 ;Flags
00906 044B 00 DB%Save%A: DB 0 ;A register
00907 DB%Stack: ;Debug stack area
00908 ; The registers in the stack area are PUSHed
00909 ; onto the stack and accessed directly.

```

Figure 10-2. (Continued)

```

00910 ;
00911 ; Register caption messages
00912 ;
00913 ; The table below, indexed by the Display%Code is used to access
00914 ; the register caption string.
00915 ;
00916 DB*Register%Captions:
00917 044C 7204 DW DB*F*RC ;Flags
00918 044E 7804 DW DB*A*RC ;A register
00919 0450 7A04 DW DB*B*RC ;B
00920 0452 7C04 DW DB*C*RC ;C
00921 0454 7E04 DW DB*D*RC ;D
00922 0456 8004 DW DB*E*RC ;E
00923 0458 8204 DW DB*H*RC ;H
00924 045A 8404 DW DB*L*RC ;L
00925 045C 8604 DW DB*BC*RC ;BC
00926 045E 8704 DW DB*DE*RC ;DE
00927 0460 8C04 DW DB*HL*RC ;HL
00928 0462 8F04 DW DB*SP*RC ;Stack pointer
00929 0464 9204 DW DB*M*RC ;Memory
00930 0466 A604 DW DB*BC*RC ;(BC)
00931 0468 AB04 DW DB*DE*RC ;(DE)
00932 046A B004 DW DB*HL*RC ;(HL)
00933 046C B504 DW DB*BC*RC ;(BC+1),(BC)
00934 046E C104 DW DB*DE*RC ;(DE+1),(DE)
00935 0470 C004 DW DB*HL*RC ;(HL+1),(HL)
00936 ;
00937 0472 466C616773DB*F*RC: DB 'Flags',0 ;Flags
00938 0478 4100 DB*A*RC: DB 'A',0 ;A register
00939 047A 4200 DB*B*RC: DB 'B',0 ;B
00940 047C 4300 DB*C*RC: DB 'C',0 ;C
00941 047E 4400 DB*D*RC: DB 'D',0 ;D
00942 0480 4500 DB*E*RC: DB 'E',0 ;E
00943 0482 4800 DB*H*RC: DB 'H',0 ;H
00944 0484 4C00 DB*L*RC: DB 'L',0 ;L
00945 0486 424300 DB*BC*RC: DB 'BC',0 ;BC
00946 0489 444500 DB*DE*RC: DB 'DE',0 ;DE
00947 048C 484C00 DB*HL*RC: DB 'HL',0 ;HL
00948 048F 535000 DB*SP*RC: DB 'SP',0 ;Stack pointer
00949 0492 5374617274DB*M*RC: DB 'Start, End Address',0 ;Memory
00950 04A6 2842432900DB*BC*RC: DB '(BC)',0 ;(BC)
00951 04AB 2844452900DB*DE*RC: DB '(DE)',0 ;(DE)
00952 04B0 28484C2900DB*HL*RC: DB '(HL)',0 ;(HL)
00953 04B5 2842432B31DB*BC*RC: DB '(BC+1),(BC)',0 ;(BC+1),(BC)
00954 04C1 2844452B31DB*DE*RC: DB '(DE+1),(DE)',0 ;(DE+1),(DE)
00955 04CD 28484C2B31DB*HL*RC: DB '(HL+1),(HL)',0 ;(HL+1),(HL)
00956 ;
00957 ; Flags message
00958 ;
00959 04D9 43785A784DDB*Flags*Msg: DB 'CxZxMxExIx',0 ;Compatible with DDT's display
00960 ;
00961 ; Flags masks used to test user's flag byte
00962 ;
00963 DB*Flag*Masks:
00964 04E4 01 DB 0000*0001B ;Carry
00965 04E5 40 DB 0100*0000B ;Zero
00966 04E6 80 DB 1000*0000B ;Minus
00967 04E7 04 DB 0000*0100B ;Even parity
00968 04E8 10 DB 0001*0000B ;Interdigit carry (aux carry)
00969 04E9 00 DB 0 ;Terminator
01100 ;#
01101 ; DB*Init
01102 ; This routine initializes the debug package.
01103 ;
01104 DB*Init:
01105 IF DB*BIOS*IO ;Use BIOS for CONIN/CONOUT
01106 LHL 1 ;Get warm boot address from base
01107 ; page. H = BIOS jump vector page
01108 MVI L,09H ;Get CONIN offset in jump vector
01109 SHLD BIOS*CONIN + 1 ;Set up address
01110 MVI L,0CH ;Get CONOUT offset in jump vector
01111 SHLD BIOS*CONOUT + 1
01112 ENDIF
01113 ;
01114 ;Set up JMP instructions to receive control
01115 ; when an RST instruction is executed
01116 04EA 3EC3 MVI A,JMP ;Set JMP instructions at RST points

```

Figure 10-2. (Continued)

```

01117 04EC 322000 STA RST4
01118 04EF 322800 STA RST5
01119 04F2 211A08 LXI H,DB*Input ;Address of fake input routine
01120 04F5 222100 SHLD RST4 + 1
01121 04F8 216C08 LXI H,DB*Output ;Address of fake output routine
01122 04FB 222900 SHLD RST5 + 1
01123
01124 04FE C9 RET
01200 ;#
01201 ; DB*CONINU
01202 ; This routine returns the next character from the console,
01203 ; but converting "a" to "z" to uppercase letters.
01204 ;
01205 DB*CONINU:
01206 04FF CD0505 CALL DB*CONIN ;Get character from keyboard
01207 0502 C31B09 JMP DB*A*To$Upper ;Fold to upper and return
01300 ;#
01301 ; DB*CONIN
01302 ; This routine returns the next character from the console.
01303 ; According to the setting of equates, it uses simple
01304 ; polled I/O, the BDOS (function 2) or the BIOS.
01305 ;
01306 ; Exit parameters
01307 ;
01308 ; A = character from console
01309 ;
01310 DB*CONIN:
01311 IF DB*Polled$IO ;Simple polled input
01312 IN DB*Status$Port ;Check if incoming data
01313 ANI DB*Input$Ready
01314 JZ DB*CONIN ;No
01315 IN DB*Data$Port ;Input data character
01316 PUSH PSW ;Save data character
01317 MOV C,A ;Ready for output
01318 CALL DB*CONOUT ;Echo it back
01319 POP PSW ;Recover data character
01320 RET
01321 ENDIF
01322
01323 IF DB*BDOS$IO ;Use BDOS for input
01324 0505 0E01 MVI C,B*CONIN ;Read console
01325 0507 C30500 JMP BDOS ;BDOS returns to our caller
01326 ENDIF
01327
01328 IF DB*BIOS$IO ;Use BIOS for input
01329 JMP BIOS*CONIN ;This was set up during BIOS
01330 ; initialization
01331 ENDIF
01332
01400 ;#
01401 ; DB*CONOUT
01402 ; This routine outputs the character in the C register to the
01403 ; console, using simple polled I/O, the BDOS or the BIOS.
01404 ;
01405 ; Entry parameters
01406 ; A = byte to be output
01407 ;
01408 DB*CONOUT:
01409 050A 3A0604 LDA DB*Flag ;Check if debug output enabled
01410 050D B7 ORA A
01411 050E C8 RZ ;Ignore output if disabled
01412
01413 IF DB*Polled$IO ;Use simple polled output
01414 IN DB*Status$Port ;Check if ready for output
01415 ANI DB*Output$Ready
01416 JZ DB*CONOUT ;No
01417 MOV A,C ;Get data byte
01418 OUT DB*Data$Port
01419 RET
01420 ENDIF
01421
01422 IF DB*BDOS$IO ;Use BDOS for output
01423 050F 59 MOV E,C ;Move into correct register
01424 0510 0E02 MVI C,B*CONOUT
01425 0512 C30500 JMP BDOS ;BDOS returns to our caller
01426 ENDIF
01427
01428 IF DB*BIOS$IO ;Use BIOS for output

```

Figure 10-2. (Continued)

```

01429          MOV     A,C           ;Move into correct register
01430          JMP     BIOS%CONOUT    ;Set up during debug initialization
01431          ENDIF
01500          ;#
01501          ;
01502          ;         DB%On
01503          ;         This routine enables all debug output by setting the
01504          ;         DB%Flag nonzero.
01505          ;
01506          ;#
01507          ;         DB%On:
01507          0515 F5          PUSH    PSW           ;Preserve registers
01508          0516 3EFF        MVI     A,OFFH
01509          0518 320604      STA     DB%Flag      ;Set control flag on
01510          051B F1          POP     PSW
01511          051C C9          RET
01600          ;#
01601          ;
01602          ;         DB%Off
01603          ;         This routine disables all debug output by setting the
01604          ;         DB%Flag to zero.
01605          ;
01606          ;#
01607          ;         DB%Off:
01607          051D F5          PUSH    PSW           ;Preserve registers
01608          051E AF          XRA     A
01609          051F 320604      STA     DB%Flag      ;Clear control flag
01610          0522 F1          POP     PSW
01611          0523 C9          RET
01700          ;#
01701          ;
01702          ;         DB%Set%Pass
01703          ;         This routine sets the pass counter. Subsequent calls to DB%Pass
01704          ;         decrement the count, and when it reaches 0, debug output
01705          ;         is enabled.
01706          ;
01707          ;         Calling sequence
01708          ;
01709          ;         CALL    DB%Set%Pass
01710          ;         DW     Pass%Count%Value
01711          ;
01712          ;#
01712          ;         DB%Set%Pass:
01713          0524 220904      SHLD   DB%Save%HL    ;Preserve user's HL
01714          0527 E1          POP     H             ;Recover return address
01715          0528 D5          PUSH   D             ;Preserve user's DE
01716          0529 5E          MOV     E,M          ;Get LS byte of count
01717          052A 23          INX    H             ;Update pointer
01718          052B 56          MOV     D,M          ;Get MS byte
01719          052C 23          INX    H             ;HL points to return address
01720          052D EB          XCHG                    ;HL = pass counter
01721          052E 220704      SHLD   DB%Pass%Count ;Set debug pass counter
01722          0531 EB          XCHG                    ;HL points to return address
01723          0532 D1          POP     D             ;Recover user's DE
01724          0533 E3          XTHL                    ;Recover user's HL and set
01725          ;         ; return address on top of stack
01726          0534 C9          RET
01800          ;#
01801          ;
01802          ;         DB%Pass
01803          ;         This routine decrements the debug pass counter -
01804          ;         if the result is negative, it takes no further action.
01805          ;         If the result is zero, it sets the debug control flag nonzero
01806          ;         to enable debug output.
01807          ;
01808          ;#
01808          ;         DB%Pass:
01809          0535 F5          PUSH    PSW           ;Save user's registers
01810          0536 E3          PUSH   H
01811          0537 2A0704      LHLD   DB%Pass%Count ;Get pass count
01812          053A 2B          DCX    H
01813          053B 7C          MOV     A,H          ;Check if count now negative
01814          053C B7          ORA    A
01815          053D FA4705      JM     DB%Pass%x     ;Yes, take no further action
01816          0540 220704      SHLD   DB%Pass%Count ;Save downdated count
01817          0543 B5          ORA    L
01818          0544 CA4A05      JZ     DB%Pass%ED    ;Yes, enable debug
01819          ;#
01819          ;         DB%Pass%x:
01820          0547 E1          POP     H             ;Recover user's registers
01821          0548 F1          POP     PSW
01822          0549 C9          RET

```

Figure 10-2. (Continued)

```

01823                ;
01824                DB*Pass*Ed:                                ;Enable debug
01825                MVI    A,OFFH                               ;
01826                STA    DB*Flag                             ;Set debug control flag
01827                JMP    DB*Pass*x
01900                ;#
01901                ;
01902                ;      DB*Display
01903                ;      This is the primary debug display routine.
01904                ;
01905                ;      Calling sequence
01906                ;
01907                ;      CALL    DB*Display
01908                ;      DB      Display*Code
01909                ;      DB      'Caption String',0
01910                ;
01911                ;      Display code identifies which register(s) are to be
01912                ;      displayed.
01913                ;
01914                ;      When the display code specifies a block of memory
01915                ;      the sequence is:
01916                ;
01917                ;      CALL    DB*Display
01918                ;      DB      Display*Code
01919                ;      DW      Start*Address,End*Address
01920                ;      DB      'Caption String',0
01921                ;
01922                DB*Display:
01923                ;
01924                ;      DB*Display*Enabled:
01925                ;      SHLD   DB*Save*HL                      ;Save user's HL
01926                ;
01927                ;      0555 E3                                XTHL                      ;Get return address from stack
01928                ;      0556 220D04                          SHLD   DB*Save*RA        ;This gets updated by debug code
01929                ;      0559 E5                                PUSH   H                 ;Save return address temporarily
01930                ;      055A 2B                                DCX    H                 ;Subtract 3 to address call instruction
01931                ;      055B 2B                                DCX    H                 ; itself
01932                ;      055C 2B                                DCX    H
01933                ;      055D 220F04                          SHLD   DB*Call*Address   ;Save actual address of CALL
01934                ;      0560 E1                                POP    H                 ;Recover return address
01935                ;
01936                ;      0561 F5                                PUSH   PSW               ;Temporarily save flags to avoid
01937                ;      ; them being changed by DAD SP
01938                ;      0562 210000                          LXI    H,0               ;Preserve stack pointer
01939                ;      0565 39                                DAD   SP
01940                ;      0566 23                                INX   H                 ;Correct for extra PUSH PSW needed
01941                ;      0567 23                                INX   H                 ; to save the flags
01942                ;      0568 220B04                          SHLD   DB*Save*SP       ;
01943                ;      056B F1                                POP    PSW              ;Recover flags
01944                ;
01945                ;      056C 314C04                          LXI    SP,DB*Stack      ;Switch to local stack
01946                ;
01947                ;      056F F5                                PUSH   PSW               ;Save other user's registers
01948                ;      0570 C5                                PUSH   B                 ;The stack area is specially laid
01949                ;      0571 D5                                PUSH   D                 ; out to access these registers
01950                ;
01951                ;      0572 2A0D04                          LHL   DB*Save*RA        ;Get return address
01952                ;      0575 7E                                MOV   A,M               ;Get display code
01953                ;      0576 321504                          STA   DB*Display*Code   ;
01954                ;      0579 23                                INX   H                 ;Update return address
01955                ;
01956                ;      057A FE18                                CPI   DB*M              ;Check if memory to be displayed
01957                ;      057C C29105                          JNZ   DB*Not*Memory     ;
01958                ;      057F 5E                                MOV   E,M               ;Get DE = start address
01959                ;      0580 23                                INX   H
01960                ;      0581 56                                MOV   D,M
01961                ;      0582 23                                INX   H
01962                ;      0583 EB                                XCHG                      ;HL = start address
01963                ;      0584 221104                          SHLD   DB*Start*Address ;
01964                ;      0587 EB                                XCHG                      ;HL -> end address
01965                ;      0588 5E                                MOV   E,M               ;Get DE = end address
01966                ;      0589 23                                INX   H
01967                ;      058A 56                                MOV   D,M
01968                ;      058B 23                                INX   H
01969                ;      058C EB                                XCHG                      ;HL = end address, DE -> caption
01970                ;      058D 221304                          SHLD   DB*End*Address   ;
01971                ;      0590 EB                                XCHG                      ;HL -> caption string

```

Figure 10-2. (Continued)

```

01972      DB$Not$Memory:
01973      ;
01974      ;      Output preamble and caption string
01975      ;      The format for everything except memory display is:
01976      ;
01977      ;      nnnn : Caption String : RC = vvvv
01978      ;      ^           ^           ^
01979      ;      Call Address      | Value
01980      ;      f                 Register Caption (A, B, C...)
01981      ;
01982      ;      A carriage return, line feed is output at the start of the
01983      ;      message - but NOT at the end.
01984      ;
01985      ;      Memory displays look like :
01986      ;
01987      ;      nnnn : Caption String : Start, End ssss, eeee
01988      ;      ssss : hh hh hh hh hh hh hh hh hh hh hh hh hh hh hh ; cccc cccc cccc cccc
01989      ;
01990
01991      0591 E5          PUSH   H           ;Save pointer to caption string
01992      0592 CDC107     CALL    DB$CRLF          ;Display carriage return, line feed
01993      0593 CD7C07     CALL    DB$Display$CALLA      ;Display DB$Call$Address in hex.
01994
01995      0598 E1          POP     H           ;Recover pointer to caption string
01996      DB$Display$Caption:
01997      0599 7E          MOV    A,M           ;HL -> caption string
01998      059A 23          INX    H           ;Get character
01999      059B B7          ORA    A           ;Check if end of string
02000      059C CAA805     JZ     DB$End$Caption      ;Yes
02001
02002      059F E5          PUSH   H           ;Save string pointer
02003      05A0 4F          MOV    C,A           ;Ready for output
02004      05A1 CDOA05     CALL   DB$CONOUT        ;Display character
02005      05A4 E1          POP    H           ;Recover string pointer
02006      05A5 C39905     JMP    DB$Display$Caption ;Go back for next character
02007
02008      ;
02009      05A8 220D04     SHLD  DB$Save$RA       ;Save updated return address
02010
02011      05AB CDC807     CALL   DB$Colon        ;Display ':'
02012
02013      ;
02014      05AE 3A1504     LDA    DB$Display$Code ;Display register caption
02015      05B1 5F          MOV    E,A           ;Get user's display code
02016      05B2 1600     MVI    D,0           ;Make display code into word
02017      05B4 D5          PUSH   D           ;Save word value for later
02018
02019      05B5 FE18     CPI    DB$M           ;Memory display is a special case
02020      05B7 CACF05     JZ     DB$Display$Mem$Caption ;Yes
02021
02022      05BA 214C04     LXI    H,DB$Register$Captions ;Make pointer to address in table
02023      05BD 19          DAD    D           ;HL -> word containing address of
02024      ;
02025      05BE 5E          MOV    E,M           ; register caption
02026      05BF 23          INX    H           ;Get LS byte of address
02027      05C0 56          MOV    D,M           ;DE -> register caption string
02028      05C1 EB          XCHG          ;HL -> register caption string.
02029      05C2 CDEE07     CALL   DB$MSG          ;Display message addressed by HL
02030
02031      05C5 CDD607     CALL   DB$MSGI         ;Display in-line message
02032      05C8 203D2000   DB      ', ',0
02033      05CC C3E005     JMP    DB$Select$Routine ;Go to correct processor
02034
02035      ;
02036      DB$Display$Mem$Caption:
02037      ;
02038      ;      The memory display requires a special
02039      ;      caption with the start and end
02040      ;      addresses
02041      ;
02042      05CF 219204     LXI    H,DB$M$RC      ;Display specific caption
02043      05D2 CDEE07     CALL   DB$MSG          ;
02044      05D5 CDC807     CALL   DB$Colon        ;Display ':'
02045
02046      05D8 2A1104     LHLD  DB$Start$Address ;Display start address
02047      05DB C88707     CALL   DB$DHLH         ;Display HL in hex.
02048
02049      05DE CDD607     CALL   DB$MSGI         ;Display in-line message
02050      05E1 2C2000   DB      ', ',0
02051
02052      05E4 2A1304     LHLD  DB$End$Address  ;Get end address

```

Figure 10-2. (Continued)

```

02049 05E7 CD8707 CALL DB%DHLH ;Display HL in hex.
02050 05EA CDC107 CALL DB%CRLF ;Display carriage return, line feed
02051 ;Drop into select routine
02052 DB>Select$Routine:
02053 POP D ;Recover word value Display$Code
02054 05ED D1 LXI H,DB$Display$Table
02055 05F1 19 DAD D ;HL -> address of code to process
02056 ; display requirements
02057 05F2 5E MOV E,M ;Get LS byte of address
02058 05F3 23 INX H ;Update pointer
02059 05F4 56 MOV D,M ;Get MS byte of address
02060 05F5 EB XCHG ;HL -> code
02061
02062 05F6 11FB05 LXI D,DB$Exit ;Fake link on stack
02063 05F9 D5 PUSH D
02064 05FA E9 PCHL ;"CALL" display processor
02065
02066 DB$Exit: ;Return to the user
02067 05FB D1 POP D ;Recover user's registers saved
02068 05FC C1 POP B ; on local debug stack
02069 05FD F1 POP PSW
02070 05FE 2A0B04 LHL DB$Save$SP ;Revert to user's stack
02071 0601 F9 SPHL
02072 0602 2A0D04 LHL DB$Save$RA ;Get updated return address (bypasses
; in-line parameters)
02073 ;Replace on top of user's stack
02074 0605 E3 XTHL DB$Save$HL ;Get user's HL
02075 0606 2A0904 LHL DB$Save$HL ;Transfer to correct return address
02076 0609 C9 RET
02077
02078 DB$Display$Table:
02079
02080 060A 3006 DW DP$F ;Flags
02081 060C 5406 DW DP$A ;A register
02082 060E 5A06 DW DP$B ;B
02083 0610 6006 DW DP$C ;C
02084 0612 6606 DW DP$D ;D
02085 0614 6C06 DW DP$E ;E
02086 0616 7206 DW DP$H ;H
02087 0618 7806 DW DP$L ;L
02088 061A 7E06 DW DP$BC ;BC
02089 061C 8406 DW DP$DE ;DE
02090 061E 8A06 DW DP$HL ;HL
02091 0620 9006 DW DP$SP ;Stack pointer
02092 0622 9606 DW DP$M ;Memory
02093 0624 9907 DW DP$B$BC ;(BC)
02094 0626 5007 DW DP$B$DE ;(DE)
02095 0628 5707 DW DP$B$HL ;(HL)
02096 062A 5E07 DW DP$W$BC ;(BC+1),(BC)
02097 062C 6807 DW DP$W$DE ;(DE+1),(DE)
02098 062E 7207 DW DP$W$HL ;(HL+1),(HL)
02200 ;#
02201 ; Debug display processing routines
02202 ;
02203 DP$F: ;Flags
02204 ;The flags are displayed in the same way that
02205 ; DDT uses: CIZOMOEIO
02206 0630 3A4A04 LDA DB$Save$F ;Get flags
02207 0633 47 MOV B,A ;Preserve copy
02208 0634 21DA04 LXI H,DB$Flags$Msg + 1 ;HL -> first 0/1 in message
02209 0637 11E404 LXI D,DB$Flag$Masks ;DE -> table of flag mask values
02210 DB$F$Next:
02211 063A 1A LDAX D ;Get next flag mask
02212 063B B7 ORA A ;Check if end of table
02213 063C CA4E06 JZ DB$F$Display ;Yes, display the results
02214
02215 063F A0 ANA B ;Check if this flag is set
02216 0640 3E31 MVI A,'1' ;Assume yes
02217 0642 C24706 JNZ DB$F$NZ ;Yes, it is set
02218 0645 3E30 MVI A,'0' ;No, it is clear
02219 DB$F$NZ:
02220 0647 77 MOV M,A ;Store '0' or '1' in message text
02221 0648 23 INX H ;Update pointer to next 0/1
02222 0649 23 INX H
02223 064A 13 INX D ;Update flag mask pointer
02224 064B C33A06 JMP DB$F$Next
02225 DB$F$Display: ;Display results
02226 064E 21D904 LXI H,DB$Flags$Msg

```

Figure 10-2. (Continued)

02227	0651	C3E07	JMP	DB#MS0	;Display message and return
02228					
02229			DP#A:	;A register	
02230	0654	3A4B04	LDA	DB#Save#A	;Get saved value
02231	0657	C39107	JMP	DB#DAH	;Display it and return
02232					
02233			DP#B:	;B	
02234	065A	3A4904	LDA	DB#Save#B	;Get saved value
02235	065D	C39107	JMP	DB#DAH	;Display it and return
02236					
02237			DP#C:	;C	
02238	0660	3A4804	LDA	DB#Save#C	;Get saved value
02239	0663	C39107	JMP	DB#DAH	;Display it and return
02240					
02241			DP#D:	;D	
02242	0666	3A4704	LDA	DB#Save#D	;Get saved value
02243	0669	C39107	JMP	DB#DAH	;Display it and return
02244					
02245			DP#E:	;E	
02246	066C	3A4604	LDA	DB#Save#E	;Get saved value
02247	066F	C39107	JMP	DB#DAH	;Display it and return
02248					
02249			DP#H:	;H	
02250	0672	3A0A04	LDA	DB#Save#H	;Get saved value
02251	0675	C39107	JMP	DB#DAH	;Display it and return
02252					
02253			DP#L:	;L	
02254	0678	3A0904	LDA	DB#Save#L	;Get saved value
02255	067B	C39107	JMP	DB#DAH	;Display it and return
02256					
02257			DP#BC:	;BC	
02258	067E	2A4804	LHLD	DB#Save#C	;Get saved word value
02259	0681	C38707	JMP	DB#DHLH	;Display it and return
02260					
02261			DP#DE:	;DE	
02262	0684	2A4604	LHLD	DB#Save#E	;Get saved word value
02263	0687	C38707	JMP	DB#DHLH	;Display it and return
02264					
02265			DP#HL:	;HL	
02266	068A	2A0904	LHLD	DB#Save#HL	;Get saved word value
02267	068D	C38707	JMP	DB#DHLH	;Display it and return
02268					
02269			DP#SP:	;Stack Pointer	
02270	0690	2A0B04	LHLD	DB#Save#SP	;Get saved word value
02271	0693	C38707	JMP	DB#DHLH	;Display it and return
02272					
02273			DP#M:	;Memory	
02274	0696	2A1304	LHLD	DB#End#Address	;Increment end address to make
02275	0699	23	INX	H	; arithmetic easier
02276	069A	221304	SHLD	DB#End#Address	
02277					
02278	069D	2A1104	LHLD	DB#Start#Address	
02279	06A0	CD3A07	CALL	DB#M#Check#End	;Compare HL to End#Address
02280	06A3	DAD106	JC	DB#M#Address#OK	;End > start
02281	06A6	DD6607	CALL	DB#MSGI	;EPPOR start > end
02282	06A9	DD6A2A2A20	DB	0DH,0AH,'** ERROR - Start Address > End **',0	
02283	06CD	C9	RET		
02284					
02285			DB#M#Next#Line:		
02286	06CE	CDC107	CALL	DB#CRLF	;Output carriage return, line feed
02287			DB#M#Address#OK:		
02288	06D1	CDD607	CALL	DB#MSGI	;Bypass CR,LF for first line
02289	06D4	202000	DB	' ',0	;Indent line
02290	06D7	2A1104	LHLD	DB#Start#Address	;Get start of line address
02291	06DA	CD8707	CALL	DB#DHLH	;Display in hex
02292					
02293	06DD	CDC807	CALL	DB#Colon	;Display ':'
02294					
02295	06E0	2A1104	LHLD	DB#Start#Address	
02296			DB#M#Next#Hex#Byte:		
02297	06E3	E5	PUSH	H	;Save memory address
02298	06E4	CDD007	CALL	DB#Blank	;Output a blank
02299	06E7	E1	POP	H	;Recover current byte address
02300	06E8	7E	MOV	A,M	;Get byte from memory
02301	06E9	23	INX	H	;Update memory pointer
02302	06EA	E5	PUSH	H	;Save for later
02303	06EB	CD9107	CALL	DB#DAH	;Display in hex.
02304	06EE	E1	POP	H	;Recover memory updated address

Figure 10-2. (Continued)

02305	06EF	CD3A07	CALL	DB##Check#End	;Compare HL vs.end address
02306	06F2	CAFE06	JZ	DB##Display#ASCII	;Yes, end of area
02307	06F5	7D	MOV	A,L	;Check if at start of new line,
02308	06F6	E60F	ANI	00001111B	; (is address XXX0H?)
02309	06F8	CAFE06	JZ	DB##Display#ASCII	;Yes
02310	06FB	C3E306	JMP	DB##Next#Hex#Byte	;No, loop back for another
02311					
02312				DB##Display#ASCII:	;Display bytes in ASCII
02313	06FE	CDC807	CALL	DB#Colon	;Display ':'
02314	0701	2A1104	LHLD	DB#Start#Address	;Start ASCII as beginning of line
02315				DB##Next#ASCII#Byte:	
02316	0704	7E	MOV	A,M	;Get byte from memory
02317	0705	E5	PUSH	H	;Save memory address
02318	0706	E67F	ANI	01111111B	;Remove parity
02319	0708	4F	MOV	C,A	;Prepare for output
02320	0709	FE20	CPI	''	;Check if non-graphic
02321	070B	D21007	JNC	DB##Display#Char	;Char >= space
02322	070E	0E2E	MVI	C,'.'	;Display non-graphic as '.'
02323				DB##Display#Char:	
02324	0710	FE7F	CPI	7FH	;Check if DEL (may be non-graphic)
02325	0712	C21707	JNZ	DB##Not#DEL	;No, it is graphic
02326	0715	0E2E	MVI	C,'.'	;Force to '.'
02327					
02328				DB##Not#DEL:	
02329	0717	CD0A05	CALL	DB#CONOUT	;Display character
02330	071A	E1	POP	H	;Recover memory address
02331	071B	23	INX	H	;Update memory pointer
02332	071C	221104	SHLD	DB#Start#Address	;Update memory copy
02333	071F	CD3A07	CALL	DB##Check#End	;Check if end of memory dump
02334	0722	CA3707	JZ	DB##Exit	;Yes, done
02335	0725	7D	MOV	A,L	;Check if end of line
02336	0726	E60F	ANI	00001111B	; by checking address = XXX0H
02337	0728	CACE06	JZ	DB##Next#Line	;Yes, start next line
02338	072B	7D	MOV	A,L	;Check if extra blank needed
02339	072C	E603	ANI	00000011B	; if address is multiple of 4
02340	072E	C20407	JNZ	DB##Next#ASCII#Byte	;No -- go back for next character
02341	0731	CDD007	CALL	DB#Blank	;Yes, output blank
02342	0734	C30407	JMP	DB##Next#ASCII#Byte	;Go back for next character
02343					
02344					
02345				DB##Exit:	
02346	0737	C3C107	JMP	DB#CRLF	;Output carriage return, line feed
02347					; and return
02348					
02349				DB##Check#End:	;Compares HL vs End#Address
02350	073A	D5	PUSH	D	;Save DE (defensive programming)
02351	073B	EB	XCHG		;DE = current address
02352	073C	2A1304	LHLD	DB#End#Address	;Get end address
02353	073F	7A	MOV	A,D	;Compare MS bytes
02354	0740	BC	CMP	H	
02355	0741	C24607	JNZ	DB##Check#End#X	;Exit now as they are unequal
02356	0744	7B	MOV	A,E	;Compare LS bytes
02357	0745	BD	CMP	L	
02358				DB##Check#End#X:	
02359	0746	EB	XCHG		;HL = current address
02360	0747	D1	POP	D	;Recover DE
02361	0748	C9	RET		;Return with condition flags set
02362					
02363				DP#B#BC:	; (BC)
02364	0749	2A4804	LHLD	DB#Save#C	;Get saved word value
02365	074C	7E	MOV	A,M	;Get byte addressed by it
02366	074D	C39107	JMP	DB#DAH	;Display it and return
02367					
02368				DP#B#DE:	; (DE)
02369	0750	2A4604	LHLD	DB#Save#E	;Get saved word value
02370	0753	7E	MOV	A,M	;Get byte addressed by it
02371	0754	C39107	JMP	DB#DAH	;Display it and return
02372					
02373				DP#B#HL:	; (HL)
02374	0757	2A0904	LHLD	DB#Save#HL	;Get saved word value
02375	075A	7E	MOV	A,M	;Get byte addressed by it
02376	075B	C39107	JMP	DB#DAH	;Display it and return
02377					
02378				DP#W#BC:	; (BC+1), (BC)
02379	075E	2A4804	LHLD	DB#Save#C	;Get saved word value
02380	0761	5E	MOV	E,M	;Get word addressed by it
02381	0762	23	INX	H	

Figure 10-2. (Continued)

```

02382 0763 56      MOV    D,M
02383 0764 EB      XCHG
02384 0765 C38707  JMP    DB%DHLH ;HL = word to be displayed
                                ;Display it and return
02385
02386 ;
DP$W$DE: ;(DE+1),(DE)
02387 0768 2A4604  LHLD  DB$Save$E ;Get saved word value
02388 0768 5E      MOV    E,M ;Get word addressed by it
02389 076C 23      INX   H
02390 076D 56      MOV    D,M
02391 076E EB      XCHG
02392 076F C38707  JMP    DB%DHLH ;HL = word to be displayed
                                ;Display it and return
02393
02394 ;
DP$W$HL: ;(HL+1),(HL)
02395 0772 2A0904  LHLD  DB$Save$HL ;Get saved word value
02396 0775 5E      MOV    E,M ;Get word addressed by it
02397 0776 23      INX   H
02398 0777 56      MOV    D,M
02399 0778 EB      XCHG
02400 0779 C38707  JMP    DB%DHLH ;HL = word to be displayed
                                ;Display it and return
02401
02500 ;
;#
02501 ;
; DB$Display$CALLA
02502 ; This routine displays the DB$Call$Address in hexadecimal,
02503 ; followed by " : ".
02504 ;
;
02505 DB$Display$CALLA:
02506 077C E5      PUSH  H ;Save caller's HL
02507 077D 2A0F04  LHLD  DB$Call$Address ;Get the call address
02508 0780 CD8707  CALL  DB%DHLH ;Display HL in hex.
02509 0783 E1      POP   H ;Recover caller's HL
02510 0784 C3C807  JMP   DB$Colon ;Display " : " and return
02511
02600 ;
;#
02601 ;
; DB%DHLH
02602 ; Display HL in hex.
02603 ;
; Entry parameters
02604 ;
; HL = value to be displayed
02605 ;
;
02606 DB%DHLH:
02610 0787 E5      PUSH  H ;Save input value
02611 0788 7C      MOV   A,H ;Get MS byte first
02612 0789 CD9107  CALL  DB$DAH ;Display A in hex.
02613 078C E1      POP   H ;Recover input value
02614 078D 7D      MOV   A,L ;Get LS byte
02615 078E C39107  JMP   DB$DAH ;Display it and return
02616
02700 ;
;#
02701 ;
; DB$DAH
02702 ; Display A register in hexadecimal
02703 ;
; Entry parameters
02704 ;
; A = value to be converted and output
02705 ;
;
02706 DB$DAH:
02710 0791 F5      PUSH  PSW ;Take a copy of the value to be converted
02711 0792 0F      RRC   ;Shift A right four places
02712 0793 0F      RRC
02713 0794 0F      RRC
02714 0795 0F      RRC
02715 0796 CDB407  CALL  DB$Nibble$To$Hex ;Convert LS 4 bits to ASCII
02716 0799 CDA005  CALL  DB$CONOUT ;Display the character
02717 079C F1      POP   PSW ;Get original value again
02718 079D CDB407  CALL  DB$Nibble$To$Hex ;Convert LS 4 bits to ASCII
02719 07A0 C30A05  JMP   DB$CONOUT ;Display and return to caller
02800
02801 ;
;#
02802 ;
; DB$CAH
02803 ; Convert A register to hexadecimal ASCII and store in
02804 ; specified address.
02805 ;
; Entry parameters
02806 ;
02807 ;

```

Figure 10-2. (Continued)

```

02808 ; A = value to be converted and output
02809 ; HL -> buffer area to receive two characters of output
02810 ;
02811 ; Exit parameters
02812 ;
02813 ; HL -> byte following last hex.byte output
02814 ;
02815 ;
02816 07A3 F3 DB#CAH: PUSH PSW ;Take a copy of the value to be converted
02817 07A4 0F RRC ;Shift A right four places
02818 07A5 0F RRC
02819 07A6 0F RRC
02820 07A7 0F RRC
02821 07A8 CDB407 CALL DB#Nibble*To*Hex ;Convert to ASCII hex.
02822 07AB 77 MOV M,A ;Save in memory
02823 07AC 23 INX H ;Update pointer
02824 07AD F1 POP PSW ;Get original value again
02825 07AE CDB407 CALL DB#Nibble*To*Hex ;Convert to ASCII hex.
02826 07B1 77 MOV M,A ;Save in memory
02827 07B2 23 INX H ;Update pointer
02828 07B3 C9 RET
02900 ;#
02901 ;
02902 ; Minor subroutines
02903 ;
02904 ;
02905 ; DB#Nibble*To*Hex
02906 ; This is a minor subroutine that converts the least
02907 ; significant four bits of the A register into an ASCII
02908 ; hex. character in A and C
02909 ;
02910 ; Entry parameters
02911 ;
02912 ; A = nibble to be converted in LS 4 bits
02913 ;
02914 ; Exit parameters
02915 ;
02916 ; A,C = ASCII hex. character
02917 ;
02918 ; DB#Nibble*To*Hex:
02919 07B4 E60F ANI 00001111B ;Isolate LS four bits
02920 07B6 C630 ADI '0' ;Convert to ASCII
02921 07B8 FE3A CPI '9' + 1 ;Compare to maximum
02922 07BA DABF07 JC DB#NTH#Numeric ;No need to convert to A -> F
02923 07BD C607 ANI 7 ;Convert to a letter
02924 ; DB#NTH#Numeric:
02925 07BF 4F MOV C,A ;For convenience of other routines
02926 07C0 C9 RET
02927 ;
02928 ;
02929 ; DB#CRLF
02930 ; Simple routine to display carriage return, line feed.
02931 ;
02932 ;
02933 ; DB#CRLF:
02934 07C1 CDD607 CALL DB#MSGI ;Display in-line message
02935 07C4 0D0A00 DB ODH,0AH,0
02936 07C7 C9 RET
02937 ;
02938 ; DB#Colon
02939 ; Simple routine to display ':'.
02940 ;
02941 ; DB#Colon:
02942 07C8 CDD607 CALL DB#MSGI ;Display in-line message
02943 07CB 203A2000 DB ':',0
02944 07CF C9 RET
02945 ;
02946 ; DB#Blank
02947 ; Simple routine to display ' '.
02948 ;
02949 ; DB#Blank:
02950 07D0 CDD607 CALL DB#MSGI ;Display in-line message
02951 07D3 2000 DB ' ',0
02952 07D5 C9 RET
03100 ;#
03101 ;
03102 ; Message processing subroutines

```

Figure 10-2. (Continued)

```

03103      ;
03104      ;      DB*MSGI (message in-line)
03105      ;      Output null-byte terminated message that follows the
03106      ;      CALL to MSGOUTI
03107      ;
03108      ;      Calling sequence
03109      ;
03110      ;      CALL    DB*MSGI
03111      ;      DB      'Message',0
03112      ;      ... next instruction
03113      ;
03114      ;      Exit parameters
03115      ;      HL -> instruction following message
03116      ;
03117      ;
03118      ;      DB*MSGI:
03119      ;      ;Get return address of stack, save
03120      ;      ; user's HL on top of stack
03121      ;      ;HL -> message
03122      ;
03123      ;      07D6 E3          XTHL
03124      ;
03125      ;      07D7 F5          PUSH    PSW
03126      ;      07D8 C5          PUSH    B
03127      ;      07D9 D5          PUSH    D
03128      ;      ;Save all user's registers
03129      ;
03130      ;      DB*MSGI*Next:
03131      ;      07DA 7E          MOV     A,M
03132      ;      07DB 23          INX     H
03133      ;      07DC B7          ORA     A
03134      ;      07DD C2E507     JNZ     DB*MSGIC
03135      ;      ;Get next data byte
03136      ;      ;Update message pointer
03137      ;      ;Check if null byte
03138      ;      ;No, continue
03139      ;
03140      ;      07E0 D1          POP     D
03141      ;      07E1 C1          POP     B
03142      ;      07E2 F1          POP     PSW
03143      ;      07E3 E3          XTHL
03144      ;      ;Recover user's registers
03145      ;
03146      ;      07E4 C9          RET
03147      ;      ;Recover user's HL from stack, replacing
03148      ;      ; it with updated return address
03149      ;      ;Return to address after 00-byte
03150      ;      ; after in-line message
03151      ;
03152      ;      DB*MSGIC:
03153      ;      07E5 E5          PUSH    H
03154      ;      07E6 4F          MOV     C,A
03155      ;      07E7 CD0A05     CALL   DB*CONOUT
03156      ;      07EA E1          POP     H
03157      ;      07EB C3DA07     JMP    DB*MSGI*Next
03158      ;      ;Save message pointer
03159      ;      ;Ready for output
03160      ;      ;Recover message pointer
03161      ;      ;Go back for next char.
03162      ;
03163      ;      ;
03164      ;      ;      DB*MSG
03165      ;      ;      Output null-byte terminated message
03166      ;      ;
03167      ;      ;      Calling sequence
03168      ;      ;
03169      ;      ;      MESSAGE:      DB      'Message',0
03170      ;      ;
03171      ;      ;      LXI     H,MESSAGE
03172      ;      ;      CALL    DB*MSG
03173      ;      ;
03174      ;      ;      Exit parameters
03175      ;      ;      HL -> null byte terminator
03176      ;
03177      ;      ;
03178      ;      ;      DB*MSG:
03179      ;      ;      ;Save user's registers
03180      ;      ;
03181      ;      ;      07EE F5          PUSH    PSW
03182      ;      ;      07EF C5          PUSH    B
03183      ;      ;      07F0 D5          PUSH    D
03184      ;      ;      ;Save user's registers
03185      ;
03186      ;      ;      DB*MSG*Next:
03187      ;      ;      07F1 7E          MOV     A,M
03188      ;      ;      07F2 B7          ORA     A
03189      ;      ;      07F3 CA0008     JZ     DB*MSG*X
03190      ;      ;      07F4 23          INX     H
03191      ;      ;      07F5 E5          PUSH    H
03192      ;      ;      07F6 4F          MOV     C,A
03193      ;      ;      07F7 CD0A05     CALL   DB*CONOUT
03194      ;      ;      07F8 E1          POP     H
03195      ;      ;      07F9 C3F107     JMP    DB*MSG*Next
03196      ;      ;Update message pointer
03197      ;      ;Save updated pointer
03198      ;      ;Ready for output
03199      ;
03200      ;      ;
03201      ;      ;      DB*MSG*X:
03202      ;      ;      0800 D1          POP     D
03203      ;      ;      0801 C1          POP     B
03204      ;      ;      0802 F1          POP     PSW
03205      ;      ;Recover user's registers

```

Figure 10-2. (Continued)

```

03180 0803 C9          RET
03300                ;#
03301                ;
03302                ;       Debug input routine
03303                ;
03304                ;       This routine helps debug code in which input instructions
03305                ;       would normally occur. The opcode of the IN instruction
03306                ;       must be replaced by a value of 0E7H (RST 4).
03307                ;
03308                ;       This routine picks up the port number contained in the byte
03309                ;       following the RST 4, converts it to hexadecimal, and
03310                ;       displays the message:
03311                ;
03312                ;               Input from port XX :
03313                ;
03314                ;       It then accepts two characters (in hex.) from the keyboard,
03315                ;       converts these to binary in A, and then returns control
03316                ;       to the byte following the port number
03317                ;
03318                ;       *****
03319                ;       WARNING - This routine uses both DB*CONOUT and BDOS calls
03320                ;       *****
03321                ;
03322 0804 496E707574DBIN$Message: DB      'Input from Port '
03323 0814 5858203A20DBIN$Port:   DB      'XX : ',0
03324                ;
03325                ;
03326                ;       DB$Input:
03327 081A 220904        SHLD  DB$Save$HL      ;Save user's HL
03328 081D E1           POP   H                ;Recover address of port number
03329 081E 2B          DCX   H                ;Backup to point to RST
03330 081F 220F04      SHLD  DB$Call$Address ;Save for later display
03331 0822 23          INX   H                ;Restore to point to port number
03332                ;       ;Note: A need not be preserved
03333 0823 7E          MOV   A,M              ;Get port number
03334 0824 23          INX   H                ;Update return address to bypass port number
03335 0825 220D04      SHLD  DB$Save$RA      ;Save return address
03336 0828 C5          PUSH  B                ;Save remaining registers
03337 0829 D5          PUSH  D                ;
03338 082A F5          PUSH  PSW              ;Save port number for later
03339                ;
03340                ;
03341 082B CDB108       CALL  DB$Flag$Save$On ;Save current state of debug flag
03342                ;       ; and enable debug output
03343                ;
03344 082E CDC107       CALL  DB$CRLF          ;Display carriage return, line feed
03345 0831 CD7C07       CALL  DB$Display$CALLA;Display call address
03346 0834 F1          POP   PSW              ;Recover port number
03347 0835 211408      LXI   H,DBIN$Port
03348 0838 CDA307       CALL  DB$CAH          ;Convert to hex. and store in message
03349 083B 210408      LXI   H,DBIN$Message ;Output prompting message
03350 083E CDEE07       CALL  DB$MSG
03351 0841 0E02        MVI   C,2              ;Get 2 digit hex. value
03352 0843 CDCF08       CALL  DB$GHV          ;Returns value in HL
03353 0846 7D          MOV   A,L              ;Get just single byte
03354                ;
03355 0847 CDBF08       CALL  DB$Flag$Restore ;Restore debug output to previous state
03356                ;
03357 084A D1          POP   D                ;Recover registers
03358 084B C1          POP   B                ;
03359 084C 2A0904      LHLD  DB$Save$HL      ;Get previous HL
03360 084F E5          PUSH  H                ;Put on top of stack
03361 0850 2A0D04      LHLD  DB$Save$RA      ;Get return address
03362 0853 E3          XTHL                ;TOS = return address, HL = previous value
03363 0854 C9          RET
03500                ;#
03501                ;
03502                ;       Debug output routine
03503                ;
03504                ;       This routine helps debug code in which output instructions
03505                ;       would normally occur. The opcode of the OUT instruction
03506                ;       must be replaced by a value of 0EFH (RST 5).
03507                ;
03508                ;       This routine picks up the port number contained in the byte
03509                ;       following the RST 5, converts it to hexadecimal, and
03510                ;       displays the message:
03511

```

Figure 10-2. (Continued)

```

03512      ;           Output to port XX : AA
03513      ;
03514      ;           where AA is the contents of the A register prior to the
03515      ;           RST 5 being executed.
03516      ;           Control is then returned to the byte following the port number.
03517      ;
03518      ;           *****
03519      ;           WARNING - This routine uses both DB$CONOUT and BDOS calls
03520      ;           *****
03521      ;
03522      ;
03523      0855 4F75747078DB0$Message:  DB    'Output to Port '
03524      0864 5858203A20DB0$Port:   DB    'XX : '
03525      0869 414100    DB0$Value:   DB    'AA',0
03526      ;
03527      ;
03528      ;           DB$Output:
03529      086C 220904    SHLD   DB$Save$HL    ;Save user's HL
03530      086F E1       POP    H           ;Recover address of port number
03531      0870 2B       DCX    H           ;Backup to point to RST
03532      0871 220F04    SHLD   DB$Call$Address ;Save for later display
03533      0874 23       INX    H           ;Restore to point at port number
03534      0875 324B04    STA   DB$Save$A      ;Preserve value to be output
03535      0878 7E       MOV    A,M          ;Get port number
03536      0879 23       INX    H           ;Update return address to bypass port number
03537      087A 220D04    SHLD   DB$Save$RA    ;Save return address
03538      087D C5       PUSH  B           ;Save remaining registers
03539      087E D5       PUSH  D           ;
03540      087F F5       PUSH  PSW          ;Save port number for later
03541      ;
03542      0880 CDB108    CALL  DB$Flag$Save$On ;Save current state of debug flag
03543      ;           ; and enable debug output
03544      ;
03545      0883 CDC107    CALL  DB$CRLF        ;Display carriage return, line feed
03546      0886 CD7C07    CALL  DB$Display$CALLA ;Display call address
03547      0889 F1       POP    PSW          ;Recover port number
03548      088A 216408    LXI   H,DB0$Port    ;
03549      088D CDA307    CALL  DB$CAH         ;Convert to hex, and store in message
03550      ;
03551      0890 3A4B04    LDA   DB$Save$A      ;
03552      0893 216908    LXI   H,DB0$Value    ;Convert value to be output
03553      0896 CDA307    CALL  DB$CAH         ;Convert to hex, and store in message
03554      ;
03555      0899 215508    LXI   H,DB0$Message  ;Output prompting message
03556      089C CDEE07    CALL  DB$MSG        ;
03557      ;
03558      089F CDBF08    CALL  DB$Flag$Restore ;Restore debug flag to previous state
03559      ;
03560      08A2 D1       POP    D           ;Recover registers
03561      08A3 C1       POP    B           ;
03562      08A4 2A0904    LHLD  DB$Save$HL    ;Get previous HL
03563      08A7 E5       PUSH  H           ;Put on top of stack
03564      08A8 2A0D04    LHLD  DB$Save$RA    ;Get return address
03565      08AB E3       XTHL  ;TOS = return address, HL = previous value
03566      08AC 3A4B04    LDA   DB$Save$A      ;Recover A (NOTE: FLAG NOT RESTORED)
03567      08AF C9       RET
03700      ;#
03701      ;
03702      ;           DB$Flag$Save$On
03703      ;           This routine is only used for DB$IN/OUT.
03704      ;           It saves the current state of the debug control flag,
03705      ;           DB$Flag, and then enables it to make sure that
03706      ;           DB$IN/OUT output always goes out.
03707      ;
03708      08B0 00      DB$Flag$Previous:  DB    0           ;Previous flag value
03709      ;
03710      ;           DB$Flag$Save$On:
03711      08B1 F5       PUSH  PSW          ;Save caller's registers
03712      08B2 3A0604    LDA   DB$Flag       ;Get current value
03713      08B5 32B008    STA   DB$Flag$Previous ;Save it
03714      08B8 3EFF     MVI   A,OFFH        ;Set flag
03715      08BA 320604    STA   DB$Flag       ;
03716      08BD F1       POP    PSW          ;
03717      08BE C9       RET
03800      ;#
03801      ;

```

Figure 10-2. (Continued)

```

03802                ;      DB$Flag$Restore
03803                ;      This routine is only used for DB$IN/OUT.
03804                ;      It restores the debug control flag, DB$Flag, to
03805                ;      its former state.
03806                ;
03807                ;      DB$Flag$Restore:
03808                ;      PUSH      PSW
03809                ;      LDA       DB$Flag$Previous      ;Get previous setting
03810                ;      STA       DB$Flag           ;Set debug control flag
03811                ;      POP      PSW
03812                ;      OBC7 C9      RET
03813
03814                ;
03900                ;#
03901                ;
03902                ;      Get hex. value
03903                ;
03904                ;      This subroutine outputs a prompting message, and then reads
03905                ;      the keyboard in order to get a hexadecimal value.
03906                ;      It is somewhat simplistic in that the first non-hex value
03907                ;      terminates the input. The maximum number of digits to be
03908                ;      converted is specified as an input parameter. If more than the
03909                ;      maximum number is entered, only the last four are significant.
03910                ;
03911                ;      *****
03912                ;      W A R N I N G
03913                ;      DB$GHV will always use the BDOS to perform a read console
03914                ;      function (#10). Be careful if you use this routine from
03915                ;      within an executing BIOS.
03916                ;      *****
03917                ;
03918                ;      Entry parameters
03919                ;
03920                ;      HL -> 00-byte terminated message to be output
03921                ;      C = number of hexadecimal digits to be input
03922                ;
03923                ;
03924                ;      DB$GHV$Buffer:          ;Input buffer for console characters
03925                ;      DB$GHV$Max$Count:      ;Set to the maximum number of chars.
03926                ;      DB 0                   ; to be input
03927                ;
03928                ;      DB$GHV$Input$Count:    ;Set by the BDOS to the actual number
03929                ;      DB 0                   ; of chars. entered
03930                ;
03931                ;      DB$GHV$Data$Bytes      ;Buffer space for the characters
03932                ;      DB CA                   ;
03933                ;
03934                ;
03935                ;      DB$GHV:
03936                ;      MOV      A,C           ;Get maximum characters to be input
03937                ;      CPI      5           ;Check against maximum count
03938                ;      JC       DB$GHV$Count$OK ;Carry set if A < 5
03939                ;      MVI      A,4         ;Force to only four characters
03940                ;      DB$GHV$Count$OK:
03941                ;      STA      DB$GHV$Max$Count ;Set up maximum count in input buffer
03942                ;      CALL   DB$MSG        ;Output prompting message
03943                ;      LXI    D,DB$GHV$Buffer ;Accept characters from console
03944                ;      MVI    C,B$READCONS ;Function code
03945                ;      CALL   BDOS
03946                ;
03947                ;      MVI    C,B$CONOUT    ;Output a line feed
03948                ;      MVI    E,0AH
03949                ;      CALL   BDOS
03950                ;
03951                ;      LXI    H,0           ;Initial value
03952                ;      LXI    D,DB$GHV$Data$Bytes ;DE -> data characters
03953                ;      LDA    DB$GHV$Input$Count ;Get count of characters input
03954                ;      MOV    C,A           ;Keep count in C
03955                ;      DB$GHV$Loop:
03956                ;      DCR    C           ;Downdate count
03957                ;      RM                    ;Return when all done (HL has value)
03958                ;      LDAX  D           ;Get next character from buffer
03959                ;      INX    D           ;Update buffer pointer
03960                ;      CALL   DB$A$To$Upper ;Convert A to uppercase if need be
03961                ;      CPI    '0'         ;Check if less than 0
03962                ;      RC                    ;Yes, terminate
03963                ;      CPI    '9' + 1     ;Check if > 9
03964                ;      JC     DB$GHV$Hex$Digit ;No, it must be numeric

```

Figure 10-2. (Continued)

```

03965 0905 FE41      CPI      'A'          ;Check if < 'A'
03966 0907 D8       RC          ;Yes, terminate
03967 0908 FE47      CPI      'F' + 1      ;Check if > 'F'
03968 090A D0       RNC          ;Yes, terminate
03969 090B D637      SUI      'A' - 10     ;Convert A through F to numeric
03970 090D C31209    JMP      DB$GHV$Shift$Left$4 ;Combine with current result
03971
03972                ;
03973                DB$GHV$Hex$Digit:
03974 0910 D630      SUI      '0'          ;Convert to binary
03975                DB$GHV$Shift$Left$4:
03976 0912 29       DAD      H          ;Shift HL left four bits
03977 0913 29       DAD      H
03978 0914 29       DAD      H
03979 0915 29       DAD      H
03980 0916 85       ADD      L          ;Add binary value in LS 4 bits of A
03981 0917 6F       MOV      L,A        ;Put back into HL total
03982 0918 C3F608    JMP      DB$GHV$Loop  ;Loop back for next character
04100                ;#
04101                ;
04102                ; A to upper
04103                ; Converts the contents of the A register to an uppercase
04104                ; letter if it is currently a lowercase letter
04105                ;
04106                ; Entry parameters
04107                ;
04108                ; A = character to be converted
04109                ;
04110                ; Exit parameters
04111                ;
04112                ; A = converted character
04113                ;
04114                DB$A$To$Upper:
04115 091B FE61      CPI      'a'          ;Compare to lower limit
04116 091D D8       RC          ;No need to convert
04117 091E FE7B      CPI      'z' + 1      ;Compare to upper limit
04118 0920 D0       RNC          ;No need to convert
04119 0921 E65F      ANI      5FH         ;Convert to uppercase
04120 0923 C9       RET

```

Figure 10-2. Debug subroutines (continued)

```

B>ddt fig10-2.hex<cr>
DDT VERS 2.0
NEXT PC
0924 0000
-a100<cr>

0116 : Flags : Flags = C1Z0M1E110
0120 : A Register : A = AA
012F : B Register : B = BB
013E : C Register : C = CC
014D : D Register : D = DD
015C : E Register : E = EE
016B : H Register : H = FF
017A : L Register : L = 11
0189 : Memory Dump #1 : Start, End Address : 0108, 0128
0108 : 05 3E AA 01 CC BB 11 EE : .>*. L.i.n
0110 : DD 21 11 FF B7 37 CD 52 05 00 46 6C 61 67 73 00 : 11.. 77MR ..F1 ags.
0120 : CD 52 05 02 41 20 52 65 67 : MR.. A Re g

01A0 : Memory Dump #2 : Start, End Address : 0100, 011F
0100 : 31 6B 03 CD EA 04 CD 15 05 3E AA 01 CC BB 11 EE : 1k.M j.M. .>*. L.i.n
0110 : DD 21 11 FF B7 37 CD 52 05 00 46 6C 61 67 73 00 : 11.. 77MR ..F1 ags.

01B7 : Memory Dump #3 : Start, End Address : 0101, 0100

** ERROR - Start Address > End **
01CE : Memory Dump #4 : Start, End Address : 0100, 0100
0100 : 31 : 1

```

Figure 10-3. Console output from debug testbed run

```

01E5 : BC Register : BC = BBCC
01F5 : DE Register : DE = DDEE
0205 : HL Register : HL = FF11
0215 : SP Register : SP = 0369
022E : Byte at (BC) : (BC) = BC
023F : Byte at (DE) : (DE) = DE
0250 : Byte at (HL) : (HL) = F1
026A : Word at (BC) : (BC+1), (BC) = 0B0C
027B : Word at (DE) : (DE+1), (DE) = 0D0E
028C : Word at (HL) : (HL+1), (HL) = 0F01
Debug output has been re-enabled.
This message should display 5 times
This message should display 5 times
This message should display 5 times
This message should display 5 times
This message should display 5 times
032B : Input from Port 11 : aa

032D : Output to Port 22 : AA

```

Figure 10-3. Console output from debug tested run (continued)

containing all of the symbols in your program, along with their respective addresses. Once the program has been loaded by SID, you can refer to the memory image of your program not by address, but by the actual symbol name from your source code. SID also supports the “pass count” concept when using breakpoints.

ZSID (Z80 Symbolic Debug)

This is the Z80 CPU's version of SID. The mini-assembler/disassembler uses Zilog instruction mnemonics rather than those used by Intel.

Bringing Up CP/M for the First Time

It is much harder to bring up CP/M on a new computer system than to debug an enhanced version on a system already running CP/M. You will often find yourself staring at a programmatic “brick wall” with no adequate debugging tools to assist you.

For example, you install the CP/M system on a diskette (using another CP/M-based computer system), put the diskette into the new computer, and press the RESET button. The disk head loads on the disk, and then — nothing! You cannot use any programs such as DDT or SID because you do not yet have CP/M up and running on the new computer. Or can you?

The answer is, wherever possible, debug the code for the new machine on an existing CP/M system. You may have to “fake” some aspects of the new bootstrap or BIOS so that the act of testing it on the host machine does not interact with the CP/M already running on it.

This scheme permits you to be fairly sure of your program logic before loading the diskette into the new machine. It will help pin down problems caused by hardware problems on the new computer.

The hardest situation of all is if you have only the new computer and the release diskettes from Digital Research. Your only option is to find a way of reading the CP/M image on the release diskette into memory, hand patch in new console and disk drivers (not a trivial task), write the patched image back onto a diskette, and resort to Orville Wright testing.

If you value your time, it is always more cost-effective to use another system with CP/M already installed. This is true even if the two systems do not have the same diskette format. You can still do the bootstrap and build the CP/M image on the host machine. Then download the image directly into the memory of the new machine and write it out to a diskette.

This *downloading* process does require, however, that the new computer have a read-only memory (ROM) monitor program. Depending on the capability of this ROM monitor program, you may have to hand patch into the new machine's memory a primitive "download" program that reads 8-bit characters from a serial port, stacking them up in memory and returning control to the monitor program when you press a keyboard character on the new machine's console. In fact, some ROM monitor programs have a downloading program built in.

Debugging the CP/M Bootstrap Loader

The CP/M bootstrap loader, as you may recall, is written on one of the outermost tracks on a diskette or hard disk. On a standard 8-inch single-sided, single-density diskette, CP/M's bootstrap loader is stored on the first sector of the first track. The loader is brought into memory by firmware that gets control of the CPU when you turn your machine on or press the RESET button.

The bootstrap has to be compact, as the diskette space on which it is stored is limited: no more than 128 bytes for standard 8-inch diskettes. This tends to rule out the use of the debug subroutines already described, so you have to fall back to more primitive techniques.

Testing the Bootstrap Under CP/M

A bootstrap is best developed on a CP/M-based system. The task is easiest of all if you already have CP/M running on your new machine and are simply preparing an enhanced version of the bootstrap loader. In this case, you can test most of the code as though it were a user program running in the transient program area (TPA).

Most bootstraps get loaded into memory at location 0000H, so at the front of the code to be debugged you must put a temporary origin line that reads

```
ORG      100H
```

If you omit this and ask DDT to load the HEX file output by the assembler, it will load at the true origin, 0000H, and wipe out the contents of the base page for the version of CP/M that you are running. This will cause a system crash; you will have to press the RESET button and reload CP/M. When this happens, DDT does not tell you directly that anything is amiss; it just displays a “?” after your request to load the HEX file. You will discover that the system has “gone away” only when you try to do something else.

You also will need to adjust the addresses into which the bootstrap tries to load the CP/M image. If you do not, you will overwrite the version of CP/M presently running.

With these adjustments made, you can load the bootstrap under DDT and watch it execute, confirming that it does load the correct image into the correct addresses for debugging and transfer control to the BIOS jump vector. When everything appears to be functioning correctly, use the IF instruction to disable the debug code, reassemble the bootstrap, and write it onto a diskette. Then put the diskette into drive A and press RESET.

Was the Bootstrap Loaded?

At this point you must establish whether the bootstrap is being loaded into memory when the machine is turned on or RESET is pressed. The best way of doing this, and one that you can leave in place permanently, is to output a sign-on message as soon as the loader gets control. This requires hardware set up to prepare the USART (Universal Synchronous/Asynchronous Receive/Transmit) chip to output data, although some manufacturers write this initialization code into the firmware that loads the bootstrap. A suitable sign-on message would be the following:

```
CP/M Bootstrap Loader : Vn 1.0 11/18/82
```

If you do not see this message, assume that control is *not* being transferred to the bootstrap loader. This will be useful in the future if someone should call you with a complaint that CP/M cannot be loaded. If this message does not appear, they probably do not have CP/M on the disk.

Did the Bootstrap Load CP/M?

This is a harder question to answer than whether the bootstrap itself has been loaded, especially if the bootstrap loader sign-on is displayed and then the system crashes. A sign-on message early in the BIOS cold boot processing can confirm the correct transfer of control into the BIOS.

If the problems with the bootstrap program are severe, you may have to adapt the memory-dump debugging subroutine, dumping the contents of memory to the console in order to see what information the bootstrap loader is placing in memory. Display 100H bytes starting from the front of the BIOS jump vector. This

table has an immediately recognizable pattern of 0C3H values every three bytes.

You should also check to see that the bootstrap is loading the correct number of sectors from the disk into memory. If it loads too few, CP/M may sign on only to crash a few moments later because it attempts either to execute code or access a constant at the end of the BIOS. If the bootstrap loads too many sectors from the disk, the excess may “wrap around” the top of memory and overwrite the bootstrap itself, down at location 0000H, before it has completed its task. In this case, you would see only the sign-on for the bootstrap, not for the BIOS.

Debugging the BIOS

Rather than try to debug the BIOS as a single piece of code, debug it as a series of separate functional modules.

Notwithstanding current “top-down” philosophies of dealing with overall structure first, it can be quicker to debug the low-level subroutines in a device driver first. This gives you a solid base on which to build.

The BIOS can be divided up into its constituent modules as follows:

Character input

- Interrupt service
- Non-interrupt service

Character output

Interrupt routines

- Real time clock
- Watchdog timers

Disk drivers

- High-level (deblocking)
- Low-level (physical I/O)

Plan to write a *testbed* program for each of these modules. This testbed code serves two purposes; first, it provides a means of transferring control into the module under test in a controlled way. Second, it includes the necessary modules or dummy modules to “fool” the module under test into responding as if it were running in a complete BIOS under CP/M.

Using the testbed, you can check every part of the module’s logic except the part that may be time-critical. Problems caused by timing, such as interrupts disabled for too long or code that is too slow or too fast for a particular peripheral controller chip, tend to show up only when you are testing on the final hardware and when you are running your new BIOS under CP/M.

What You Should Test for in the BIOS

Describing fully how to debug each module in the BIOS could fill several books. Remember that you are trying to establish the *absence* of errors using a technique that, by its very nature, tends to show only their *presence*.

There are two basic approaches to debugging. One is the plodding method, checking every aspect of the code to ensure that every feature really does work. The second is to try to do something useful with the code.

Plan to use both. Start with the plodding method, testing each feature under control of the testbed until you are sure that it is working *in vitro*. When all of the BIOS modules have been tested individually, build a CP/M system and try to do some useful work with it. Trying to use the system for actual work testing *in vitro* can be a good test.

Feature Checklist

Make a list of the specific features included in the various BIOS modules. Then devise specific test sequences that will show that each of the features is working correctly.

The same testbed code can often test all of the features of a driver module. If it cannot, create a new testbed for the more exotic features.

Keep the testbed routines. Experience shows that they are most often needed shortly after you have erased them. Even after you have tested the BIOS, the testbed routines will come in handy if you decide to enhance a particular driver later on. You can extract the driver code from the BIOS, glue it together with the testbed, and test the new feature code in isolation from the BIOS.

The following sections show example testbeds for the various drivers, along with example checklists. These checklists were used to test the example BIOS routines shown in earlier chapters.

Character Drivers

Figure 10-4 shows the code for an example testbed routine for character I/O drivers in the BIOS. This code would be followed by the actual character I/O drivers, exactly as they would appear in the BIOS except that all IN and OUT instructions would be replaced with RST 4's and 5's respectively (see Figure 10-2) so that you could enter input values and inspect output values on the console.

This example contains the initialization code for the debug package shown in Figure 10-2 and the code setting up an RST 6 used to "fake" incoming character interrupts.

The main testbed loop consists of a faked incoming character interrupt followed by optional calls to CONIN or CONOUT, the return of control to DDT, or a loop back to fake another character interrupt. You can only return control to DDT if you used DDT to load the testbed and driver programs in the first place.

```

;      Testbed for character I/O drivers in the BIOS
;
;      The complete source file consists of three components:
;
;      1. The testbed code shown here
;      2. The character I/O drivers destined for the BIOS
;      3. The debug package shown in Figure 10-2.
;
FFFF = TRUE EQU OFFFFH
0000 = FALSE EQU NOT TRUE

FFFF = DEBUG EQU TRUE ;For conditional assembly of RST
; instructions in place of IN and
; OUT instructions in the drivers
0030 = RST6 EQU 30H ;Use RST 6 for fake incoming character
; interrupt

0100 ORG 100H

START:
0100 31D101 LXI SP,Test$Stack ;Use a local stack
0103 CDD101 CALL DB$Init ;Initialize the debug package
0106 3EC3 MVI A,JMP ;Set up RST 6 with JMP opcode
0108 323000 STA RST6
010B 21D101 LXI H,Character$Interrupt ;Set up RST 6 JMP address
010E 223100 SHLD RST6 + 1

;
; Make repeated entry to character interrupt routine
; to ensure that characters can be captured and stored in
; an input buffer
;
Testbed$Loop:
0111 3EAA MVI A,0AAH ;Set registers to known pattern
0113 01CCBB LXI B,0BBCCH
0116 11EEDD LXI D,0DDEEH
0119 2111FF LXI H,OFF11H
011C F7 RST 6 ;Fake interrupt for incoming character

011D CDD101 CALL DB$MSGI ;Display in-line message
0120 0D0A456E74 DB 0DH,0AH,'Enter I to Input Char., 0 to Output, D to enter
0132 444454203A DB 'DDT : ',0

0139 CDD101 CALL DB$CONINU ;Get uppercase character
015C FE49 CPI 'I' ;CONIN?
015E CA7201 JZ Go$CONIN
0161 FE44 CPI 'D' ;DDT?
0163 CA6E01 JZ Go$DDT
0166 FE4F CPI 'O' ;CONOUT?
0168 CA9101 JZ Go$CONOUT
016B C31101 JMP Testbed$Loop ;Loop back to interrupt again

016E FF RST 7 ;Enter DDT (RST 7 set up by DDT)
016F C31101 JMP Testbed$Loop

Go$CONIN:
0172 CDD101 CALL CONST ;Get console status
0175 CA1101 JZ Testbed$Loop ;No data waiting
0178 CDD101 CALL CONIN ;Get data from buffer

017B CDD101 CALL DB$Display ;Display character returned
017E 02 DB DB$A ; in A register
017F 434F4E494E DB 'CONIN returned',0

018E C37201 JMP Go$CONIN ;Repeat CONIN loop until no chars.
; waiting

Go$CONOUT:
0191 CDD101 CALL CONST ;Get console status
0194 CA1101 JZ Testbed$Loop ;No data waiting
0197 CDD101 CALL CONIN
019A 4F MOV C,A ;Ready for output
019B CDD101 CALL CONOUT ;Output to console
019E C39101 JMP Go$CONOUT ;Repeat while there is still data

;
01A1 9999999999 DW 9999H,9999H,9999H,9999H,9999H,9999H,9999H,9999H
01B1 9999999999 DW 9999H,9999H,9999H,9999H,9999H,9999H,9999H,9999H
01C1 9999999999 DW 9999H,9999H,9999H,9999H,9999H,9999H,9999H,9999H

```

Figure 10-4. Testbed for character I/O drivers in the BIOS

```

Test$Stack:
;
;   Dummy routines for those shown in other figures
;
;   BIOS routines (Figure 8-10)
;
CONST:           ;BIOS console status
CONIN:           ;BIOS console input
CONOUT:          ;BIOS console output;
Character$Interrupt: ;Interrupt service routine for incoming chars.
;
;   Debug routines (Figure 10-2)
;
DB$Init:         ;Debug initialization
DB$MSGI:         ;Display message in-line
DB$CONINU:       ;Get uppercase character from keyboard
DB$Display:      ;Main debug display routine
DB%A EQU 02      ;Display code for DB$Display
0002 =

```

Figure 10-4. Testbed for character I/O drivers in the BIOS (continued)

Executing an RST 7 without using DDT will cause a system crash, as DDT sets up the necessary JMP instruction at location 0038H in the base page.

The faked incoming character interrupt transfers control directly to the interrupt service routine in the BIOS (see the example in Figure 8-10, line 04902, label Character\$Interrupt). This reads the status ports of each of the character devices; you can enter the specific status byte values that you want. If you enter a value that indicates that a data character is "incoming," you will be prompted for the actual 8-bit data value to be "input." You can make the interrupt service routine appear to be inputting characters and stacking characters up in the input buffer. For debugging purposes, reduce the size of the input buffer to eight bytes. Making it larger means you will have to input more characters to test the buffer threshold logic. To check the interrupt service routine, you will pass through the main testbed loop doing nothing but faking incoming character interrupts and entering status and data values. The data characters will then be stacked up in the input buffer.

To check the correct functioning of the interrupt service routines, you can stay in control with DDT from the outset. Alternatively, you can just use DDT to load the testbed/driver HEX file, loop around inputting several characters, and then request that the testbed return control to DDT. Then you can use DDT to inspect the contents of the device table(s) and input buffers.

Another possibility is to create debugging routines that display the contents of the device table in a meaningful way, with each field captioned like this:

```

DEVICE TABLE 0
  Status Port      81   Data Port          80
  Output Ready    01   Input Ready       02
  DTR high        40
  Reset Int. Prt  D8   Reset Int. Val.  20
  :
  :
  Status Byte 1
    Output Suspended
    Output Xon Enabled
  :

```

```

:
Buffer Base  OE8C
Put Offset   05      Get Offset       01
Char. Count  04      Control Count  00
Data Buffer
41 42 43 44 45 00 00 00

```

This display device table routine will require a fair amount of effort to code and debug—but it will pay dividends. You can obtain a complete “snapshot” of the device table without having to decode hexadecimal memory dumps and individual bits. Constant values in the device tables are also displayed, so that if a bug in your code corrupts the table, you will know about it immediately.

The next section shows examples of the specific tests you need to make, along with a description of the strategy you can use.

Interrupt Service Routine Checklist In a functioning BIOS, control is transferred to the interrupt service module whenever an incoming character causes an interrupt. In the example BIOS in Figure 8-10 (line 4900), the code scans each character device in turn to determine which one is causing the interrupt.

When you are debugging the interrupt service routines using the “fake” input/output instructions, you will have to enter specific status byte values. Refer to the device table declarations in Figure 8-10, line 1500, to determine what values you must enter to make the service routine think that an incoming character is arriving or that data terminal ready (DTR) is high or low.

Start the debugging process using the first device table. Then repeat the tests on the other device tables.

The following is a checklist of features that should be checked in debugging the interrupt service routine:

Are all registers restored correctly on exit from the interrupt servicing?

Using DDT, start execution from the beginning of the testbed. Set a breakpoint (with the G100,nnnn command) to get control back immediately before the CALL Character\$Interrupt. Use the X command to display all of the registers, and then, by using the G,nnnn command, you set a breakpoint at the instruction that immediately follows the CALL Character\$Interrupt. The character drivers will prompt you for the status values. Enter 00 (which indicates that no character is incoming). Display the registers again—their values should be the same. Remember to check the value of the stack pointer and the amount of the stack area that has been used.

NOTE: Do not be too surprised if you lose control of the machine when you first try this test. You may have some fundamental logic errors initially. If the system crashes, reset it, reload CP/M, and then start the test again. This time, rather than setting the second breakpoint at the instruction following the CALL Character\$Interrupt, venture down into the Character\$Interrupt code and go through the code a few instructions

at a time, setting breakpoints before any instructions that could cause a transfer of control. Find out how far you are getting into the driver before it either jumps off into space or settles into a loop.

Does the service routine push a significant number of bytes onto the stack after an interrupt has occurred?

When you get control back after the CALL Character\$Interrupt, use the D (dump) command to dump the stack area's memory on the console. Check how far down the stack came by looking for the point where the constants that used to fill the stack area are overwritten by other data.

The example BIOS in Figure 8-10 saves only the contents of the HL register pair on the pre-interrupt stack. It then switches over to a private BIOS stack to save the contents of the rest of the registers and service the interrupt.

Are data characters added to the input buffer correctly?

"Input" a noncontrol character via the Character\$Interrupt routine. Then check the contents of the appropriate device table. The character count and the put offset should both be set to one. Then check the contents of the input buffer itself; does it contain the character that you "input?"

Are control characters added to the input buffer correctly?

"Input" a control character such as 01H. Do not use ETX, ACK, XON, or XOFF (03H, 06H, 11H, and 13H, respectively); these may cause side effects if you have errors in the protocol handling logic. Check that the character is stored in the next byte of the input buffer and that the character and control counts are set to two and one, respectively. The put offset should also be set to two.

When the input buffer full threshold is reached, does the driver output the correct protocol character?

Set the first status byte in the first device table to enable input XON or RTS protocol, or both. Then go round the main testbed loop putting characters into the input buffer. Check the console display to see if the drivers output the correct values when the buffer is almost full (the default threshold is when five bytes remain). The driver should then drop the RTS line or output an XOFF character or both, according to the input protocol that you enabled.

When the input buffer is completely full, does the driver respond correctly?

This is an extension of the test above. Input one more character than can fit into the buffer. Check to see that the drivers do not stack the character into the input buffer and that a BELL character (07H) is output to the data port.

Are protocol characters XON/XOFF recognized and the necessary control flags set or reset?

Reload the testbed and drivers. Set the status byte to enable the output XON/XOFF protocol. Then use the Character\$Interrupt routine to input an XOFF character (13H). Check to see that the XOFF character has not been put into the input buffer. Instead, the status byte should be set to indicate that output has indeed been suspended.

Input an XON and check to see that the output suspended flag has been reset.

Does the driver detect and reset hardware errors correctly?

Proceed as though you were going to input a character into the input buffer, but instead enter a status byte value that indicates that a hardware error has occurred (enter the value given in the device table for DT\$Detect\$Error\$Value).

Check that the driver detects the error status and outputs the correct error-reset value to the appropriate control port.

Non-interrupt Service Routine Checklist In a “live” BIOS, non-interrupt service routines are accessed via the CONIN and CONST entry points in the BIOS jump vector. During debugging, the testbed can call the CONIN and CONST code directly.

Is input redirection functioning? Does control arrive in the driver with the correct device table selected?

This is best tested directly with DDT. Use the Gnnnn,bbbb command to transfer control into the CONIN code with a breakpoint at the RET instruction at the end of the Select\$Device\$Table routine (see Figure 8-10, line 04400). Check that the DE register pair is pointing at device table 0. If it is not, you will have to restart the test. Use the Tn command to make DDT trace through the Select\$Device\$Table subroutine to find the bug.

Are characters returned correctly from the buffer?

Use the testbed to “input” a character or two. Then use the testbed to make several entries into CONIN. Check the characters returned from the buffer.

Are the data character and control character counts correctly decremented?

After each character has been removed from the buffer by CONIN, use DDT to examine the device table and check that the data character and control character counts have been decremented correctly. Also check that the get pointer has moved up the input buffer.

When the buffer “almost empty” threshold is reached, does the driver emit the correct protocol character or manipulate the request to send (RTS) line correctly?

Use DDT to enable the input RTS or XON protocol or both. Then input characters into the input buffer until it reaches the buffer full threshold (the

default is when only five spare bytes remain in the buffer). Confirm that “buffer almost full” processing occurs. Then make repetitive calls to CONIN to flush data out of the buffer. Check that the “buffer emptying” processing occurs when the correct threshold is reached. For RTS protocol, the driver should output a raise RTS value to the specified RTS control port. For XON, the driver should output an XON character to the data port (after first having read the status port to ensure that the hardware can output the character).

Does the driver handle buffer “wraparound” correctly?

Input characters to the input buffer until it becomes completely full. Then make a single CONIN call to remove the first character from the buffer. Follow this by inputting one more character to the buffer. Check that the get pointer is set to one and the put pointer set to zero.

Next, make successive CONIN calls to empty the buffer. Then input one more character to the buffer. Check that this last character is put into the first byte of the input buffer.

Can the driver handle “forced input” correctly?

Using DDT, set the forced input pointer to point to a 00-byte-terminated string; for example, use one of the function key decode default strings. (In Figure 8-10, the forced input pointer is initialized to point to a “startup string”—this is declared at the beginning of the configuration block at line 00400.)

Using DDT, call the CONST routine and check that it returns with A = 0FFH (indicating that there appears to be input data waiting).

Make successive calls to CONIN and confirm that the data bytes in the forced input string are returned. Check that the forcing of input ends when the 00H-byte is detected.

Does the console status routine operate correctly when it checks for data characters in the buffer, control characters in the buffer, and forced input?

Input a single noncontrol character, such as 41H, into the input buffer. Using DDT, check that the second status byte in the device table has the fake type-ahead flag set to zero. Call the CONST routine—it should return with A = 0FFH (meaning that there is data in the buffer). Then set the fake type-ahead bit in the second status byte and call CONST again. It should return with A = 00H (meaning that there is now “no data” in the buffer). Input a single control character into the buffer. Now CONST should return with A = 0FFH because there is a control character in the buffer.

Does the driver recognize escape sequences incoming from keyboard function keys?

This is a difficult feature to test when the real time clock routine is not running. The driver uses the watchdog timer to wait until all characters in

the escape sequence have arrived. You will therefore have to modify the code in CONIN so that the watchdog timer appears to time out immediately, rather than waiting for the real time clock to tick. To make this change, refer to Figure 8-10, line 2200; this is the start of the CONIN routine. Look for the label CONIN\$Wait\$For\$Delay. A few instructions later there is a JNZ CONIN\$Wait\$For\$Delay. Using DDT, set all three bytes of this JNZ to 00H.

Then, using the testbed, input the complete escape sequence into the input buffer. For example, input hexadecimal values 1B, 4F, 51 (ESCAPE, O, P), which correspond to the characters emitted on a VT-100 terminal when FUNCTION KEY 1 (PF1) is pressed.

Next, use the testbed to make successive calls to CONIN. You should see the text associated with the function key (FUNCTION KEY 1, LINE FEED) being returned by CONIN.

Repeat this test using different function key sequences, including a sequence that does not correspond to any of the preset function keys. Check that the escape sequence itself is returned by CONIN without being changed into another string.

Can the driver differentiate between a function key and the same escape sequence generated by discrete key strokes?

This is almost the same test as above. Make the same patch to the CONIN code, only this time do not enter the complete escape sequence into the buffer. Enter only the hex characters 1B and 4F. Make sure that the CONIN routine does not substitute another string in place of this quasi-escape sequence.

This test only mimics the results of manually entering an escape sequence. You could not press the keys on a terminal fast enough to get all three characters into the input buffer within the time allowed by the watchdog timer.

Character Output Checklist *Can the driver output a character?*

The CONOUT option in the testbed calls CONIN first to get a character. To start with, you may want to use DDT to set the C register to some graphic ASCII character such as 41H (A), and transfer control into CONOUT directly. Check that CONOUT reads the USART's status, waits for the output ready value, and then outputs the data to the data port. Note that the testbed will output all characters waiting in the input buffer (or forced input) when you select its CONOUT option. This is a convenience for advanced testing of the drivers—for initial testing you may want to modify the testbed to make only one call to CONIN and CONOUT and then return to the top of the testbed loop.

Does the driver suspend output when a protocol control flag indicates that output is to be suspended?

Using DDT, set the status byte in the device table to enable output XON/XOFF protocol. Then input an XOFF character and confirm that the output suspended bit in the status byte is set. Output a single character, and using DDT, confirm that the driver will remain in a status loop waiting for the output suspended bit to be cleared. Clear the bit using DDT and check that the character is output correctly.

When using ETX/ACK protocol, does the driver output an ETX after the specified number of characters have been output, then indicate that output is suspended?

For debugging purposes, alter the ETX message count value in the device table to three bytes. Then output three bytes of data via CONOUT. Check that the driver sends an ETX character (03H) after the three bytes have been output and that the output suspended flag in the status byte has been set.

Then input an ACK character (06H). Check that this character is not stored in the input buffer and that the output suspended flag is cleared.

Does the driver recognize and output escape sequences?

Input an ESCAPE, "t" (1BH, 74H) into the input buffer. Then output them via CONOUT. Using DDT, check that the CONOUT routine recognizes that an escape sequence is being output and selects the correct processing routine. In this case, the forced input pointer should be set to point at the ASCII time of day in the configuration block.

Does each of the escape sequence processors function correctly? Can the time and date be set to specified values using escape sequences?

Repeat the test above using all of the other escape sequences to make sure that they can be recognized and that they function correctly.

Real Time Clock Routines

A separate testbed program, shown in Figure 10-5, is used to check these routines. It calls the interrupt service routine directly to simulate a real time clock "tick," and then displays the time of day in ASCII on the console.

As you can see, the testbed makes a call into the debug package's initialization routine, DB\$Init, and then uses an RST 6 to generate fake clock "ticks."

There is a JMP instruction in the testbed that bypasses a call to Set\$Watchdog. Remove this JMP, either by editing it out or by using DDT to change it to NO OPERATIONS (NOP, 00H) when you are ready to test the watchdog routines.

Real Time Clock Test Checklist *Is the clock running at all?*

Using DDT, trace through the interrupt service routine logic. Check that the seconds are being updated.

```

;
; Testbed for real time clock driver in the BIOS.
;
; The complete source file consists of three components:
;
; 1. The testbed code shown here
; 2. The real time clock driver destined for the BIOS.
; 3. The debug package shown in Figure 10-2.
;
FFFF = TRUE EQU OFFFH
0000 = FALSE EQU NOT TRUE
;
FFFF = DEBUG EQU TRUE ;For conditional assembly of RST
; instructions in place of IN and
; OUT instructions in the drivers.
0030 = RST6 EQU 30H ;Use RST 6 for fake clock tick.
;
0100 ORG 100H
;
0100 318B01 LXI SP,Test$Stack ;Use local stack
0103 CDBB01 CALL DB$Init ;Initialize the debug package
0106 3EC3 MVI A,JMP ;Set up RST 6 with JMP opcode
0108 323000 STA RST6
010B 218B01 LXI H,RTC$Interrupt ;Set up RST 6 JMP address
010E 223100 SHLD RST6 + 1
;
0111 C31D01 JMP Testbed$Loop ;<=== REMOVE THIS JMP WHEN READY TO
; TEST WATCHDOG ROUTINES
;
0114 013200 LXI B,50 ;50 ticks before timeout
0117 214201 LXI H,WD$Timeout ;Address to transfer to
011A CDBB01 CALL Set$Watchdog ;Set the watchdog timer
;
;
; Make repeated entry to RTC interrupt routine
; to ensure that clock is correctly updated
;
Testbed$Loop:
011D 3EAA MVI A,0AAH ;Set registers to known pattern
011F 01CCBB LXI B,0BBCCB
0122 11EEDD LXI D,0DDEEH
0125 2111FF LXI H,0FF11H
0128 F7 RST 6 ;Fake interrupt clock
;
0129 CDBB01 CALL DB$MSGI ;Display in-line message
012C 436C4F636B DB 'Clock=',0
;
0134 218B01 LXI H,Time$In$ASCII ;Get address of clock in driver
0137 CDBB01 CALL DB$MSG ;Display current clock value
; (Note: Time$In$ASCII already has
; a line feed character in it)
013A CDBB01 CALL DB$MSGI ;Display in-line message
013D OD00 DB ODH,0 ;Carriage return
;
013F C31D01 JMP Testbed$Loop
;
; Control arrives here when the watchdog timer times
; out
WD$Timeout:
0142 CDBB01 CALL DB$MSGI
0145 OD0A576174 DB ODH,0AH,'Watchdog timed out',0
015A C9 RET ;Return to watchdog routine
;
015B 9999999999 DW 9999H,9999H,9999H,9999H,9999H,9999H,9999H,9999H
016B 9999999999 DW 9999H,9999H,9999H,9999H,9999H,9999H,9999H,9999H
017B 9999999999 DW 9999H,9999H,9999H,9999H,9999H,9999H,9999H,9999H
;
Test$Stack:
;
; Dummy routines for those shown in other figures
;
; BIOS routines (Figure 8-10)
;
RTC$Interrupts: ;Interrupt service routine for clock tick
Set$Watchdog: ;Set watchdog timer
Time$In$ASCII: ;ASCII string of HH:MM:SS, LF, 0
;
; Debug routines (Figure 10-2)
;
DB$Init: ;Debug initialization
DB$MSGI: ;Display message in-line
DB$MSG: ;Display message

```

Figure 10-5. Testbed for real-time-clock driver in the BIOS

Are the hours, minutes, and seconds carrying over correctly?

Let the testbed code run at full speed. You should see the time being updated on the console display—although it will be updated much more rapidly than real time.

Use DDT to set the minutes to 58 and then let the clock run again. Does it correctly show the hour and reset the minutes to 00? Then set the hours to 11 and the minutes to 58 and let the clock run. Do minutes carry over into hours and are hours reset to 0?

Repeat these tests with the clock update constants set for 24-hour format.

Is the clock interrupt service routine restoring the registers correctly?

Using DDT, check that the registers are still set correctly on return from the clock interrupt service routine.

How much of a load on the pre-interrupt stack is the service routine imposing?

Check the “low water mark” of the preset values remaining in the testbed stack area to see how much of a load the interrupt service routine is imposing on the stack.

Can the watchdog timer be set to a nonzero value? Can it be set back to zero?

Using the second part of the testbed, call the Set\$Watchdog routine, and then monitor the testbed's execution as the watchdog timer times out. Check that the registers and stack pointer are set correctly when control is transferred to the timeout routine. Also check that control is returned properly from this routine, and thence from the interrupt service routine.

Disk Drivers

It is only feasible to check the low-level disk drivers in isolation from a real BIOS, as the BDOS interface to the deblocking code is very difficult to simulate. The testbed shown in Figure 10-6 serves only as a time-saver. It does not test the interface to the subroutines. Use DDT to set up the disk, track, and sector numbers, and then monitor the calls into SELDSK, SETTRK, SETSEC, SETDMA, and the read/write routines.

Unless you have the same disk controller on the host system as you do on the target machine, you will have to use the fake input/output system described earlier in this chapter, rather than attempt to read and write on real disks.

You can see that the testbed, after initializing the debugging package, makes calls to SELDSK, SETTRK, SETSEC, and SETDMA. It then calls a low-level read or write routine. The low-level routine called depends on which driver you wish to debug. For the standard floppy diskette driver shown in Figure 8-10, use Read\$No\$Deblock and Write\$No\$Deblock. For the 5 1/4-inch diskettes, use Read\$Physical and Write\$Physical. You will have to use DDT to set up some of the variables required by the low-level drivers that would normally be set up by the deblocking code.

```

;       Testbed for disk I/O drivers in the BIOS
;
;       The complete source file consists of three components:
;
;       1. The testbed code shown here
;       2. The Disk I/O drivers destined for the BIOS
;       3. The debug package shown in Figure 10-2.
;
FFFF = TRUE EQU OFFFFH
0000 = FALSE EQU NOT TRUE

FFFF = DEBUG EQU TRUE ;For conditional assembly of RST
; instructions in place of IN and
; OUT instructions in the drivers.

0100 START: ORG 100H
0100 314704 LXI SP,Test$Stack ;Use a local stack
0103 CD4704 CALL DB$Init ;Initialize the debug package
;
; Make calls to SELDSK, SETTRK, SETSEC and SETDMA,
; then either a read or write routine.
;
Testbed$Loop:
0106 314704 LXI SP,Test$Stack ;Use local stack
0109 3A1202 LDA Logical$Disk ;Set up for SELDSK call
010C 4F MOV C,A
010D CD4704 CALL SELDSK
0110 CD4704 .CALL DB$Display ;Display return value in HL
0113 14 DB DB$HL
0114 53454C4453 DB 'SELDISK returned',0

0124 223201 SHLD DPH$Start ;Set up to display disk parameter header
0127 111000 LXI D,16 ;Compute end address
012A 19 DAD D
012B 223401 SHLD DPH$End ;Store into debug call

012E CD4704 CALL DB$Display ;Display DPH
0131 18 DB DB$M ;Memory
DPH$Start:
0132 0000 DW 0
DPH$End:
0134 0000 DW 0
0136 53656C6563 DB 'Selected DPH',0

0143 2A1302 LHLD Track ;Call SETTRK
0144 E5 PUSH H
0147 C1 POP B ;SETTRK needs track in BC
0148 CD4704 CALL SETTRK

014B 3A1502 LDA Sector ;Call SETSEC
014E 4F MOV C,A ;SETSEC need sector in C
014F CD4704 CALL SETSEC

0152 011702 LXI B,Test$Buffer ;Set DMA address
0155 CD4704 CALL SETDMA
0158 3A1602 LDA Write$Disk ;Check if reading or writing
015B B7 ORA A
015C C2D101 JNZ Test$Write

015F CD4704 CALL Read$No$Deblock ;*** or Read$Physical depending on which
;*** drivers you are testing
0162 CD4704 CALL DB$Display ;Display return code
0165 02 DB DB$A
0166 5465737420 DB 'Test Read returned',0

0179 CD0102 CALL Check$Ripple ;Check if ripple pattern in buffer
017C CA0601 JZ Testbed$Loop ;Yes, it is correct

017F CD4704 CALL DB$MSGI ;Indicate problem
0182 14 DB DB$HL ;Display HL (points to offending byte)
0183 526970706C DB 'Ripple pattern incorrect. HL -> failure.',0

01AC CD4704 CALL DB$Display ;Display test buffer
01AF CD1800 CALL DB$M ;Memory
01B2 1702 DW Test$Buffer

```

Figure 10-6. Testbed for disk I/O drivers in the BIOS

```

01B4 0002      DW      Test$Buffer$Size
01B6 436F6E7465  DB      'Contents of Test$Buffer',0

01CE C30601      JMP      Testbed$Loop

Test$Writes:
01D1 CDF201      CALL     Fill$Ripple      ;Fill the test buffer with ripple pattern
01D4 CD4704      CALL     Write$No$Deblock;*** or Write$Physical depending on which
                                ;*** drivers you are testing

01D7 CD4704      CALL     DB$Display      ;Display return code
01DA 02          DB      DB$A
01DB 5465737420  DB      'Test Write returned',0

01EF C30601      JMP      Testbed$Loop

Fill$Ripple:
                                ;Fills the Test$Buffer with a pattern
                                ; formed by putting into each byte, the
                                ; least significant 8-bits of the byte's
                                ; address.

01F2 010002     LXI     B,Test$Buffer$Size
01F5 211702     LXI     H,Test$Buffer

FR$Loop:
01F8 75         MOV     M,L      ;Set pattern value into buffer
01F9 23         INX     H      ;Update buffer pointer
01FA 0B         DCX     B      ;Down date count
01FB 79         MOV     A,C      ;Check if count zero
01FC B0         ORA     B      ;
01FD C2F801     JNZ     FR$Loop   ;Repeat until zero
0200 C9         RET

;
Check$Ripple:
                                ;Check that the buffer is filled with the
                                ; correct ripple pattern.
                                ; Returns with zero status if this is true,
                                ; nonzero status if the ripple is not
                                ; correct. HL point to the offending byte
                                ; (which should = L)

0201 010002     LXI     B,Test$Buffer$Size
0204 211702     LXI     H,Test$Buffer

CR$Loop:
0207 7D         MOV     A,L      ;Get correct value
0208 BE         CMP     M      ;Compare to that in the buffer
0209 C0         RNZ     ;Mismatch, nonzero already indicated
020A 23         INX     H      ;Update buffer pointer
020B 0B         DCX     B      ;Downdate count
020C 79         MOV     A,C      ;Check count zero
020D B0         ORA     B      ;
020E C2702     JNZ     CR$Loop   ;Repeat until zero
0211 C9         RET      ;Zero flag will already be set

;
; Testbed variables
;

0212 00         Logical$Disk: DB      0      ;A = 0, B = 1,...
0213 0000      Track:   DW      0      ;Disk track number
0215 00         Sectors:  DB      0      ;Disk sector number
0216 00         Write$Disk: DB      0      ;NZ to write to disk

;
0200 =         Test$Buffer$Size EQU     512      ;<== Alter as required
0217          Test$Buffer:  DS      Test$Buffer$Size

;
0417 9999999999  DW      9999H,9999H,9999H,9999H,9999H,9999H,9999H,9999H
0427 9999999999  DW      9999H,9999H,9999H,9999H,9999H,9999H,9999H,9999H
0437 9999999999  DW      9999H,9999H,9999H,9999H,9999H,9999H,9999H,9999H

Test$Stack:
;
; Dummy routines for those shown in other figures
;
; BIOS routines (Figure 8-10)
;
SELDISK:      ;Select logical disk
SETTRK:      ;Set track number
SETSEC:      ;Set sector number
SETDMA:      ;Set DMA address
Read$No$Deblock: ;Driver read routines
Read$Physical:
Write$No$Deblock: ;Driver write routines
Write$Physical:

```

Figure 10-6. (Continued)

```

;
;      Debug routines (Figure 10-2)
;
DB*Init:          ;Debug initialization
DB*MSGI:         ;Display message in-line
DB*Display:      ;Main debug display routine
0002 = DB*A      EQU      02      ;Display codes for DB*Display
0014 = DB*HL     EQU      20
0018 = DB*M      EQU      24

```

Figure 10-6. Testbed for disk I/O drivers in the BIOS (continued)

Before issuing the write call, the testbed fills the disk buffer with a known pattern. This pattern is checked on return from a read operation.

For both reading and writing, the testbed shows the contents of the A register. If you have added the enhanced disk error handling described in the previous chapter, the return value in A must *always* be zero.

Disk Driver Checklist *Does SELDSK return the correct address and set up the required system variables?*

Check that the correct disk parameter header address is returned for legitimate logical disks. Check, too, that it returns an address of 0000H for illegal disks.

Check that any custom processing, such as setting the disk type and deblocking requirements from extra bytes on the disk parameter blocks, is performed correctly.

Does the SETTRK and SETSEC processing function correctly?

Using DDT, check that the correct variables are set to the specified values.

Does the driver read in the spare-sector directory correctly?

Set up to execute a physical read and, using DDT, trace the logic of the READ entry point. Check that the spare-sector directory would be loaded into the correct buffer. If you are using fake input/output, use DDT to patch in a typical spare-sector directory with two or three “spared-out” sectors.

Does the driver produce the correct spare sector in place of a bad one?

Continuing with the physical read operation, check that, for “good” track/sectors, the sector-sparing logic returns the original track and sector number, and for “bad” track/sectors, it substitutes the correct spare track and sector. If you are using sector skipping, check that the correct number of sectors is skipped.

Can a sector be read in from the disk?

Continuing further with the physical read, check that the correct sector is read from the specified disk and track. If you are using real I/O (as

opposed to faking it), the “ripple pattern” set by the testbed can be used, or you can fill the disk buffer area with some known pattern (using DDT's F command) so you can tell if any data gets read in.

Make sure you do not have any disks or diskettes in the computer system that are not write-protected—you may inadvertently write on a disk rather than read it during the early stages of testing.

Can a sector be written to the disk?

Using DDT, set up to write to a particular disk, track, and sector. Remove any write protection that you put on the target disk during earlier testing. You can either use the testbed's ripple pattern or fill the disk buffer area with a distinctive pattern. Write this data onto the disk, fill the buffer area with a *different* pattern, and read in the sector that you wrote. Check that the disk buffer gets changed back to the pattern written to the disk.

Does the driver display error messages correctly?

Rather than deliberately damaging a diskette to create errors, use DDT to temporarily sabotage the disk driver's logic. Make it return each of the possible error codes in turn, checking each time that the correct error message is displayed.

For each error condition in turn, check that the disk driver performs the correct recovery action, including interacting with the user and offering the choice of retrying, ignoring the error, or aborting the program.

Live Testing a New BIOS

Given that the drivers have passed all of the testing outlined above, you are ready to pull all of the BIOS pieces together and build a CP/M image.

For your initial testing, disable the real time clock, and use simple, polled I/O for the console driver if you can. It is important to get *something* up and running as soon as possible, and it is easier to do this without possible side effects from interrupts.

Prepare a complete listing of the BIOS and plan to spend at least an hour checking through it. Take a dry run through the console and disk driver—if there are any serious bugs left in these two drivers, CP/M may not start up. Remember that once the BIOS cold boot code has been executed and control is handed over to the CCP, the BDOS will be requested to log in the system disk, and this involves reading in the disk's directory.

Pay special attention to checking some of the major data structures. Make certain that everything is at a reasonable place in memory; for example, if the last address used by the BIOS is greater than 0FFFFH, you will need to move the entire CP/M image down in memory.

Then build a system disk, load it into the machine, and press the RESET button. You should see the bootstrap sign on, then the BIOS, and after a pause of about one second, the A> prompt (or 0A> if you have included the special feature that patches the CCP).

If you see both sign-on messages but do not get an A> prompt, a likely cause of the problem is in the disk drivers. Alternatively, the directory area on the disk may be full of random data rather than 0E5H's.

If you cannot see what is wrong with the system, you might try faking the disk drivers to return a 128-byte block of 0E5H's for each read operation. The CCP should then sign on.

Once you do have the A> prompt, you can proceed with the system checkout. Start by checking that the warm boot logic works. Type a CONTROL-C. There should be a slight pause, and the A> prompt should be output again.

Next, check that you can read the disk directory by using the DIR command. If you have an empty directory, you should get a NO FILE response. If you get strange characters instead, you either forgot to initialize the directory area or the disk parameter block is directing CP/M to the wrong part of the disk for the file directory. If the system crashes, there is a problem with the disk driver.

Check that you can write on the disk by entering the command SAVE I TEST. Then use the DIR command to confirm that file TEST shows up in the file directory. If it does, use the ERA command ERA TEST and do another DIR command to confirm that TEST has indeed been erased.

If TEST either does not show up on the disk or cannot be erased, then you have a problem with the disk driver WRITE routine.

Put a standard CP/M release diskette into drive B and use the DIR command to check that you can access the drive and display a disk directory. If you do, then load the DDT utility and exit from it by using a G0 (G, zero) command. This further tests if the disk drivers are functioning correctly.

To test the deblocking logic (if you are using disks that require deblocking), use the command:

```
PIP A:=B:*. * [V]
```

This copies all files from drive B to drive A using the verify option. It is a particularly good test of the system, and if you have any problems with the high-level disk drivers and deblocking code, you will get a Verify Error message from PIP. You can also get this message if you have hardware problems with the computer's memory, so run a memory test if you cannot find anything obviously wrong with the deblocking algorithm.

To completely test the deblocking code, you need to use PIP to copy a file of text larger than the amount of memory available. Thus, you may have to create a large text file using a text editor just to provide PIP with test data.

With the disk driver functioning correctly, rebuild the system with the real time clock enabled. Bring up the new system and check that the ASCII time of day is

being updated in the configuration block; use DDT to inspect this in memory. Set the clock to the current time, let it run for five minutes, and see if it is still accurate. You may have to adjust one of the initialization time constants for the device that is providing the periodic interrupts for the clock.

Rebuild the system yet again, this time with the real interrupt-driven console input and the real console output routines. Check that the system comes up properly and that the initial forced-input startup string appears on the console.

Check that when you type characters on the keyboard they are displayed as you type them. If not, there could be a problem with either the CONIN or CONOUT routines. Experimentally type in enough characters to fill the input buffer. If the terminal's bell starts to sound, the interrupt service routine is probably not the culprit. Check the CONOUT routine again.

Check that the function key decode logic is working correctly. With the A> prompt displayed, press a function key. The CONIN driver should inject the correct function key string and it should appear on the terminal. For example, with the BIOS in Figure 8-10, pressing PF1 on the VT-100 terminal should produce this on the display:

```
A>Function Key1
Function?
A>
```

The CCP does not recognize "Function" as a legitimate command name, nor is there such a COM file—hence the question mark.

Using DDT, write a small program that outputs ESCAPE, "t" to the console, and check that the ASCII time of day string appears on the console. This checks that the escape sequence has been recognized.

Library Functions
Reading or Writing Using the BIOS
 Accessing the File Directory
Utility Programs Enhancing
 Standard CP/M
Utility Programs for the Enhanced BIOS

11

Additional Utility Programs

This chapter contains the narrated source code for several useful utility programs. Two groups of such programs are included—those that supplement Digital Research’s standard utility programs, and those that work in conjunction with features shown in the enhanced BIOS (Figure 8-10).

To avoid unnecessary detail, the programs shown in this chapter are all written in the C language. C is a good language to use for such purposes since it can show the overall logic of a program without the clutter of details common in assembly language.

In order to reuse as much source code as possible, this chapter includes a “library” of all the general-purpose C functions that can be called from within any of the utility programs. This file, called “LIBRARY.C”, is shown in Figure 11-1. Once a utility program has been compiled, the necessary functions from the library can be linked with the utility’s binary output to form the “.COM” file.

```

/* Library of commonly-used functions */
#include <LIBRARY.H> /* Standard defines and structures */

/* Configuration block access */

/*=====*/
char
*get_cba(code) /* Get configuration block address */
/*=====*/
/* This function makes a call to a "private" entry in the BIOS
jump vector to return the address of a specific data object in
the BIOS. The code indicates which object is required.
Each program using this function could make a direct call to
the BIOS using the biosh() function provided by BDS C. This
function provides a common point to which debugging code can
be added to display the addresses returned. */

/* Entry parameters */
int code; /* Code that specifies the object
whose address is required */

/* Exit Parameters
Address returned by the BIOS routine */

{
char *retval; /* Value returned by the BIOS */

retval = biosh(CBGADDR,code);
/* printf("\nget_cba : code %d address %4x",code,retval); */
return retval;
} /* End of get_cba(code) */

/* Character manipulation functions */

/*=====*/
strscn(string,key) /* String scan */
/*=====*/
/* This function scans a 00-terminated character string looking
for a key string in it. If the key string is found within the
string, the function returns a pointer to it. Otherwise it
returns a value of zero. */

/* Entry parameters */
char *string; /* String to be searched */
char *key; /* Key string to be searched for */

/* Exit parameters
Pointer to key string within searched string, or
zero if key not found
*/

{
while (*string) /* For all non-null chars. in string */
{
if ((*string == *key) && /* First char. matches */
(sstrcmp(string,key) == 0) /* Perform substring
compare on rest */
)
return string; /* Substring matches,
return pointer */
string++; /* Move to next char. in string */
}
return 0; /* Indicate no match found */
} /* End of strscn */

/*=====*/
ustrcmp(string1,string2) /* Uppercase string compare */
/*=====*/
/* This function is similar to the normal strcmp function;
it differs only in that the characters are compared as if they
were all uppercase characters -- the strings are left
unaltered. */

```

Figure 11-1. LIBRARY.C, commonly used functions, in C language

```

/* Entry Parameters */
char *string1; /* Pointer to first string */
char *string2; /* Pointer to second string */

/* Exit parameters
0 - if string 1 = string 2
-ve integer if string 1 > string 2
+ve integer if string 1 < string 2
*/

{
int count; /* Used to access chars. in both strings */
count = 0; /* Start with the first character of both */

/* While string 1 characters are non-null, and
match their counterparts in string 2. */
while (string1[count] == string2[count])
{
if (string1[+count] == '\0') /* Last char. in string 1 */
return 0; /* Indicate equality */
}
return string2[count] - string1[count]; /* "Compare" chars. */
} /* End of strcmp */

/*=====*/
strcmp(string,substring) /* Substring compare */
/*=====*/
/* This function compares two strings. The first, string, need not
be 00-terminated. The second, substring, must be 00-terminated.
It is similar to the standard function strcmp, except that the
length of the substring controls how many characters are compared. */

/* Entry parameters */
char *string; /* Pointer to main string */
char *substring; /* Pointer to substring */

/* Exit parameters
0 - substring matches corresponding characters in string
-ve integer if char. in string is > char. in substring
+ve integer if char. in string is < char. in substring
*/

{
int count; /* Used to access chars. in string and substring */
count = 0; /* Start with the first character of each */

/* While substring characters are non-null, and
match their counterparts in string. */
while (string[count] == substring[count])
{
if (substring[+count] == '\0') /* Last char in substring */
return 0; /* Indicate equality */
}
return substring[count] - string[count]; /* "Compare" chars. */
} /* End of strcmp */

/*=====*/
usstrcmp(string,substring) /* Uppercase substring compare */
/*=====*/
/* This function compares two strings. The first, string, need not
be 00-terminated. The second, substring, must be 00-terminated.
It is similar to the substring compare above except all
characters are made uppercase. */

/* Entry parameters */
char *string; /* Pointer to main string */
char *substring; /* Pointer to substring */

/* Exit parameters
0 -- substring matches corresponding characters in string

```

Figure 11-1. (Continued)

```

-ve integer if char. in string is > char. in substring
+ve integer if char. in string is < char. in substring
*/
{
int count;      /* Used to access chars in string and substring */
count = 0;      /* Start with the first character of each */

/* While substring characters are non-null, and
match their counterparts in string. */
while (toupper(string[count]) == toupper(substring[count]))
{
if (substring[count] == '\0') /* Last char. in substring */
return 0; /* Indicate equality */
}
return substring[count] - string[count]; /* "Compare" chars. */
} /* End of usstrcmp */

/*****
comp_fname(scb,name) /* Compare file names */
*****/
/* This function compares a possibly ambiguous file name
to the name in the specified character string. The number of
bytes compared is determined by the number of characters in
the mask.
This function can be used to compare file names and types,
or, by appending an extra byte to the mask, the file names,
types, and extent numbers.
For file directory entries, an extra byte can be prefixed to
the mask and the function used to compare user number, file
name, type, and extent.
Note that a "?" in the first character of the mask will NOT
match with a value of 0xE5 (this value is used to indicate
an inactive directory entry). */

/* Entry parameters */
struct _scb *scb; /* Pointer to search control block */
char *name; /* Pointer to file name */

/* Exit parameter
NAME_EQ if the names match the mask
NAME_LT if the name is less than the mask
NAME_GT if the name is greater than the mask
NAME_NE if the name is not equal to the mask (but the outcome
is ambiguous because of the wildcards in the mask)
*/

{
int count; /* Count of the number of chars. processed */
short ambiguous; /* NZ when the mask is ambiguous */
char *mask; /* Pointer to bytes at front of SCB */

/* Set pointer to characters at beginning of search control block */
mask = scb;

/* Ambiguous match on user number, matches
only users 0 - 15, and not inactive entries */
if (mask[0] == '?')
{
if (name[0] == 0xE5)
return NAME_NE; /* Indicate inequality */
}
else /* First char. of mask is not "?" */
{
if (mask[0] != name[0]) /* User numbers do not match */
return NAME_NE; /* Indicate inequality */
}

/* No, check the name (and, if the length is such, the extent) */
for (count = 1; /* Start with first name character */
count <= scb -> scb_length; /* For all required characters */
count++) /* Move to next character */
{
if (mask[count] == '?') /* Wildcard character in mask */

```

Figure 11-1. (Continued)

```

        {
            ambiguous = 1; /* Indicate ambiguous name in mask */
            continue; /* Do not make any comparisons */
        }
        if (mask[count] != (name[count] & 0x7F))
        {
            /* Mask char. not equal to FCB char. */
            if (ambiguous) /* If previous wildcard, indicate NE */
                return NAME_NE;
            else
                /* Compare chars. to determine relationship */
                return (mask[count] > name[count]) ?
                    NAME_LT : NAME_GT;
        }
    }
    /* If control reaches here, then all characters of the
       mask and name have been processed, and either there
       were wildcards in the mask, or they all matched. */
    return NAME_EQ; /* Indicate mask and name are "equal" */
} /* End of comp_fname */

/*=====*/
conv_fname(fcb,fn) /* Convert file name for output */
/*=====*/
/* This function converts the contents of a file control
   block into a printable string "D:FILENAME.TYP." */

/* Entry parameters */
struct_fcb *fcb; /* Pointer to file control block */
char *fn; /* Pointer to area to receive name */

{
    /* If the disk specification in the
       FCB is 0, use the current disk */
    *fn++ = (fcb->fcb_disk) ? (fcb->fcb_disk + ('A'-1)) :
        (bdos(GETDISK) + 'A');

    *fn++ = ':'; /* Insert disk id. delimiter */

    movmem(&fcb->fcb_fname,fn,8); /* Move file name */
    fn += 8; /* Update pointer */
    *fn++ = '.'; /* Insert file name/type delimiter */
    movmem(&fcb->fcb_fname+8,fn,3); /* Move file type */
    *fn++ &= 0x7F; /* Remove any attribute bits */
    *fn++ &= 0x7F; /* Remove any attribute bits */
    *fn++ &= 0x7F; /* Remove any attribute bits */
    *fn = '\0'; /* Terminator */
} /* End of conv_fname */

/*=====*/
conv_dfname(disk,dir,fn) /* Convert directory file name for output */
/*=====*/
/* This function converts the contents of a file directory entry
   block into a printable string "D:FILENAME.TYP." */

/* Entry parameters */
short disk; /* Disk id. (A = 0, B = 1) */
struct_dir *dir; /* Pointer to file control block */
char *fn; /* Pointer to area to receive name */

{
    /* Convert user number and disk id. */
    sprintf(fn,"%2d/%c:",dir->de_userno,disk + 'A');
    fn += 5; /* Update pointer to file name */

    movmem(&dir->de_fname,fn,8); /* Move file name */
    fn += 8; /* Update pointer */
    *fn++ = '.'; /* Insert file name/type delimiter */

    movmem(&dir->de_fname+8,fn,3); /* Move file type */
    *fn++ &= 0x7F; /* Remove any attribute bits */
    *fn++ &= 0x7F; /* Remove any attribute bits */
    *fn++ &= 0x7F; /* Remove any attribute bits */
    *fn = '\0'; /* Terminator */
}

```

Figure 11-1. (Continued)

```

} /* End of conv_dfname */

/*=====*/
get_nfn(amb_fname,next_fname) /* Get next file name */
/*=====*/
/* This function sets the FCB at "next_fname" to contain the
   directory entry found that matches the ambiguous file name
   in "amb_fname."
   On the first entry for a given file name, the most significant
   bit in the FCB's disk field must be set to one (this causes a
   search first BDOS call to be made). */

/* Entry parameters */
struct _fcb *amb_fname; /* Ambiguous file name */
struct _fcb *next_fname; /* First byte must have ms bit set for
                           first time entry*/

/* Exit parameters
   0 = No further name found
   1 = Further name found (and set up in next_fname)
*/
{
char bdos_func; /* Set to either search first or next */
char *pfname; /* Pointer to file name in directory entry */

/* Initialize tail-end of next file FCB to zero */
setmem(&next_fname -> fcb_extnt,FCBSIZE-12,0);

bdos_func = SEARCHF; /* Assume a search first must be given */

if (!(next_fname -> fcb_disk & 0x80)) /* If not first time */
{
/* search first on previous name */
srch_file(next_fname,SEARCHF);
bdos_func = SEARCHN; /* Then do a search next */
}
else /* First time */
next_fname -> fcb_disk &= 0x7F; /* Reset first-time flag */

/* Refresh next_fname from ambiguous file name
   (move disk, name, type) */
movmem(amb_fname,next_fname,12);

/* If first time, issue search first, otherwise
   issue a search next call. "srch_file" returns
   a pointer to the directory entry that matches
   the ambiguous file name, or 0 if no match */
if (!(pfname = srch_file(next_fname,bdos_func)) )
{
return 0; /* Indicate no match */
}
/* Move file name and type */
movmem(pfname,&next_fname -> fcb_fname,11);
return 1; /* Indicate match found */
} /* End of get_nfn */

/*=====*/
char *srch_file(fcb,bdos_code) /* Search for file */
/*=====*/
/* This function issues either a search first or search next
   BDOS call. */

/* Entry Parameters */
struct _fcb *fcb; /* pointer to file control block */
short bdos_code; /* either SEARCHF or SEARCHN */

/* Exit parameters
   0 = no match found
   NZ = pointer to entry matched (currently in buffer)
*/

```

Figure 11-1. (Continued)

```

{
  unsigned r_code;      /* Return code from search function
                        This is either 255 for no match, or 0, 1, 2, or 3
                        being the ordinal of the 32-byte entry in the
                        buffer that matched the name */
  char *dir_entry;     /* Pointer to directory entry */

  /* The BDS C compiler always sets the BDOS DMA
  to location 0x80 */

  r_code = bdos(bdos_code, fcb); /* Issue the BDOS call */
  if (r_code == 255)             /* No match found */
    return 0;

  /* Set a pointer to the matching
  entry by multiplying return code by 128
  and adding onto the buffer address (0x80),
  also add 1 to point to first character of name */

  return (r_code << 5) + 0x81;
} /* End of srch_file */

/*=====*/
rd_disk(drb) /* Read disk (via BIOS) */
/*=====*/
/* This function uses the parameters previously set up in the
incoming request block, and, using the BIOS directly,
executes the disk read. */

/* Entry parameters */
struct _drb *drb; /* Disk request block (disk, track, sector, buffer) */

/* Exit parameters
0 = No data available
1 = Data available
*/
{
  if (iset_disk(drb)) /* Call SELDSK, SETTRK, SETSEC */
    return 0; /* If SELDSK fails, indicate
              no data available */
  if (bios(DREAD)) /* Execute BIOS read */
    return 0; /* Indicate no data available if error returned */

  return 1; /* Indicate data available */
} /* End of rd_disk */

/*=====*/
wrt_disk(drb) /* Write disk (via BIOS) */
/*=====*/
/* This function uses the parameters previously set up in the
incoming request block, and, using the BIOS directly,
executes the disk write. */

/* Entry parameters */
struct _drb *drb; /* Disk request block (disk, track, sector, buffer) */

/* Exit parameters
0 = Error during write
1 = Data written OK
*/
{
  if (iset_disk(drb)) /* Call SELDSK, SETTRK, SETSEC, SETDMA */
    return 0; /* If SELDSK fails, indicate no data written */
  if (bios(DWRITE)) /* Execute BIOS write */
    return 0; /* Indicate error returned */

  return 1; /* Indicate data written */
} /* End of wrt_disk */

```

Figure 11-1. (Continued)

```

/*****
short set_disk(drb)      /* Set disk parameters */
/*****
/* This function sets up the BIOS variables in anticipation of
   a subsequent disk read or write. */

/* Entry parameters */
struct _drb *drb;      /* Disk request block (disk, track, sector, buffer) */

/* Exit parameters
   0 = Invalid disk (do not perform read/write)
   1 = BIOS now set up for read/write
*/

{
    /* The sector in the disk request block contains a
       LOGICAL sector. If necessary (as determined by the
       value in the disk parameter header), this must be
       converted into the PHYSICAL sector.
       NOTE: skewtab is declared as a pointer to a pointer to
       a short integer (single byte). */
    short **skewtab;    /* Skewtab -> disk parameter header -> skew table */
    short phy_sec;      /* Physical sector */

    /* Call the SELDSK BIOS entry point. If this returns
       a 0, then the disk is invalid. Otherwise, it returns
       a pointer to the pointer to the skew table */
    if ( !(skewtab = biosh(SELDSK,drb -> dr_disk)) )
        return 0;      /* Invalid disk */

    bios(SETTRK,drb -> dr_track); /* Set track */

    /* Note that the biosh function puts the sector into
       registers BC, and a pointer to the skew table in
       registers HL. It returns the value in HL on exit
       from the BIOS */
    phy_sec = biosh(SECTRN,drb -> dr_sector,*skewtab); /* Get physical sector */
    bios(SETSEC,phy_sec); /* Set sector */
    bios(SETDMA,drb -> dr_buffer); /* Set buffer address */

    return 1;          /* Indicate no problems */
} /* End of setp_disk */

/*      Directory Management Functions      */

/*****
get_nde(dir_pb)      /* Get next directory entry */
/*****
/* This function returns a pointer to the next directory entry.
   If the directory has not been opened, it opens it.
   When necessary, the next directory sector is read in.
   If the current sector has been modified and needs to be written back
   onto the disk, this will be done before reading in the next sector. */

/* Entry parameters */
struct _dirpb *dir_pb; /* Pointer to the disk parameter block */

/* Exit Parameters
   Returns a pointer to the next directory entry in the buffer.
   The directory open and write sector flags in the parameter
   block are reset as necessary.
*/

{
    if(!dir_pb -> dp_open) /* Directory not yet opened */
    {
        if (!open_dir(dir_pb)) /* Initialize and open directory */
        {
            err_dir(O_DIR,dir_pb); /* Report error on open */
            exit();
        }
        /* Deliberately set the directory entry pointer to the end
           of the buffer to force a read of a directory sector */
    }
}

```

Figure 11-1. (Continued)

```

dir_pb -> dp_entry = dir_pb -> dp_buffer + DIR_BSZ;
dir_pb -> dp_write = 0; /* Reset write-sector flag */
}

/* Update the directory entry pointer to the next entry in
the buffer. Check if the pointer is now "off the end"
of the buffer and another sector needs to be read. */
if (++dir_pb -> dp_entry < dir_pb -> dp_buffer + DIR_BSZ)
{
return dir_pb -> dp_entry; /* Return pointer to next entry */
}

/* Need to move to next sector and read it in */

/* Do not check if at end of directory or move to
the next sector if the directory has just been
opened (but the opened flag has not yet been set) */
if (!dir_pb -> dp_open)
dir_pb -> dp_open = 1; /* Indicate that the directory is now open */
else
{
/* Check if the sector currently in the buffer needs to be
written back out to the disk (having been changed) */
if (dir_pb -> dp_write)
{
dir_pb -> dp_write = 0; /* Reset the flag */
if(!rw_dir(W_DIR,dir_pb)) /* Write the directory sector */
{
err_dir(W_DIR,dir_pb); /* Report error on writing */
exit();
}
}

/* Count down on number of directory entries left to process,
always four 32-byte entries per 128-byte sector */
dir_pb -> dp_entrem -= 4;

/* Set directory-end flag true if number of entries now < 0 */
if (dir_pb -> dp_entrem == 0) /* now at end of directory */
{
dir_pb -> dp_end = 1; /* Indicate end */
dir_pb -> dp_open = 0; /* Indicate directory now closed */
return 0; /* Indicate no more entries */
}

/* Update sector (and if need be track and sector) */
if (++dir_pb -> dp_sector == dir_pb -> dp_sptrk)
{
++dir_pb -> dp_track; /* Update track */
dir_pb -> dp_sector = 0; /* Reset sector */
}
}

if(!rw_dir(R_DIR,dir_pb)) /* Read next directory sector */
{
err_dir(R_DIR,dir_pb); /* Report error on reading */
exit();
}

/* Reset directory-entry pointer to first entry in buffer */
return dir_pb -> dp_entry = dir_pb -> dp_buffer;
} /* End of get_nde */

/*=====*/
open_dir(dir_pb) /* Open directory */
/*=====*/
/* This function "opens" up the file directory
on a specified disk for subsequent processing
by rw_dir, next_dir functions. */

/* Entry parameters */
struct_dirpb *dir_pb; /* Pointer to directory parameter block */

```

Figure 11-1. (Continued)

```

/* Exit parameters
0 = Error, directory not opened
1 = Directory open for processing
*/
{
struct _dpcb *dpcb;          /* CP/M disk parameter block */

/* Get disk parameter block address for the disk specified in
the directory parameter block */
if ((dpcb = get_dpcb(dir_pb -> dp_disk)) == 0)
return 0; /* Return indicating no DPB for this disk */

/* Set the remaining fields in the parameter block */
dir_pb -> dp_sptrk = dpcb -> dpb_sptrk; /* Sectors per track */
dir_pb -> dp_track = dpcb -> dpb_trkoff; /* Track offset of the directory */
dir_pb -> dp_sector = 0; /* Beginning of directory */
dir_pb -> dp_nument = dpcb -> dpb_maxdent+1; /* No. of directory entries */
dir_pb -> dp_entrem = dir_pb -> dp_nument; /* Entries remaining to process */
dir_pb -> dp_end = 0; /* Indicate not at end */

/* Set number of allocation blocks per directory entry to
8 or 16 depending on the number of allocation blocks */
dir_pb -> dp_nabpde = (dpcb -> dpb_maxabn > 255 ? 8 : 16);
/* Set number of allocation blocks (one more than number of
highest block) */
dir_pb -> dp_nab = dpcb -> dpb_maxabn;

/* Set the allocation block size based on the block shift.
The possible values are: 3 = 1k, 4 = 2K, 5 = 4K, 6 = 8K, 7 = 16K.
So a value of 16 is shifted right by (7 - bshift) bits. */
dir_pb -> dp_absize = 16 >> (7 - dpcb -> dpb_bshift);

return 1; /* Indicate that directory now opened */
} /* End of open_dir */

/*=====*/
rw_dir(read_op,dir_pb) /* Read/write directory */
/*=====*/
/* This function reads/writes the next 128-byte
sector from/to the currently open directory. */

/* Entry parameters */
short read_op; /* True to read, false (0) to write */
struct _dirpb *dir_pb; /* Directory parameter block */

/* Exit parameters
0 = error -- operation not performed
1 = operation completed
*/
{
struct _drb drb; /* Disk request (for BIOS read/write) */

drb.dr_disk = dir_pb -> dp_disk; /* Set up disk request */
drb.dr_track = dir_pb -> dp_track;
drb.dr_sector = dir_pb -> dp_sector;
drb.dr_buffer = dir_pb -> dp_buffers;

if (read_op)
{
if (!rd_disk(&drb)) /* Issue read command */
return 0; /* Indicate error -- no data available */
}
else
{
if (!wrt_disk(&drb)) /* Issue write command */
return 0; /* Indicate error -- no data written */
}
return 1; /* Indicate operation complete */
} /* End of rd_dir */

```

Figure 11-1. (Continued)

```

/*=====*/
err_dir(opcode,dir_pb) /* Display directory error
/*=====*/
/* This function displays an error message to report an error
detected in the directory management functions open_dir and rw_dir. */
/* Entry parameters */
short opcode; /* Operation being attempted */
struct_dirpb *dir_pb; /* Pointer to directory parameter block */

{
printf("\n\007Error during ");
switch(opcode)
{
case R_DIR:
printf("Reading");
break;
case W_DIR:
printf("Writing");
break;
case O_DIR:
printf("Opening");
break;
default:
printf("Unknown Operation (%d) on",opcode);
}

printf(" Directory on disk %c: ",dir_pb -> dp_disk + 'A');
} /* End of err_dir */

/*=====*/
setscb(scb,filename,user,extent,length) /* Set search control block */
/*=====*/
/* This function sets up a search control block according
to the file name specified. The file name can take the
following forms:

filename
filename.typ
d:filename.typ
*filename.typ (meaning "all disks")
ABCD...NOP:filename.typ (meaning "just the specified disks")

The function sets the bit map according to which disks should be
searched. For each selected disk, it checks to see if an error is
generated when selecting the disk (i.e. if there are disk tables
in the BIOS for the disk). */

/* Entry parameters */
struct_scb *scb; /* Pointer to search control block */
char *filename; /* Pointer to the file name */
short user; /* User number to search for */
short extent; /* Extent number to search for */
int length; /* Number of bytes to compare */

/* Exit parameters
None.
*/

{
int disk; /* Disk number currently being checked */
unsigned adisks; /* Bit map for active disks */

adisks = 0; /* Assume no disks to search */

if (strscn(filename,":")) /* Check if ":" in file name */
{
if (*filename == '*') /* Check if "all disks" */
{
adisks = 0xFFFF; /* Set all bits */
}
else /* Set specific disks */
{
while(*filename != ':') /* Until ":" reached */

```

Figure 11-1. (Continued)

```

        {
            /* Build the bit map by getting the next disk
               id. (A - P), converting it to a number in
               the range 0 - 15, shifting a 1-bit left
               that many places, and OR-ing it into the
               current active disks. */
            adisks |= 1 << (toupper(*fname) - 'A');
            ++fname; /* Move to next character */
        }
        ++fname; /* Bypass colon */
    }
else /* Use only current default disk */
    {
        /* Set just the bit corresponding to the current disk */
        adisks = 1 << bdos(GETDISK);
    }

setfcb(scb,fname); /* Set search control block as though it
                   were a file control block. */

/* Make calls to the BIOS SELDSK routine to make sure that
   all of the active disk drives have disk tables for them
   in the BIOS. If they don't, turn off the corresponding
   bits in the bit map. */

for (disk = 0; /* Start with disk A: */
     disk < 16; /* Until disk P: */
     disk++) /* Use next disk */
    {
        if ( !((1 << disk) & adisks) )
            continue; /* Avoid selecting unspecified disks */
        if (biosh(SELDSK,disk) == 0) /* Make BIOS SELDSK call */
            { /* Returns 0 if invalid disk */
                /* Turn OFF corresponding bit in mask
                   by AND-ing it with bit mask having
                   all the other bits set = 1 */
                adisks &= ((1 << disk) ^ 0xFFFF);
            }
    }

scb -> scb_adisks = adisks; /* Set bit map in SCB */
scb -> scb_userno = user; /* Set user number */
scb -> scb_extent = extent; /* Set extent number */
scb -> scb_length = length; /* Set number of bytes to compare */
} /* End setscb */

/*=====*/
dm_clr(disk_map) /* Disk map clear (to zeros) */
/*=====*/
/* This function clears all elements of the disk map to zero. */

/* Entry Parameters */
unsigned disk_map[16][18]; /* Address of array of unsigned integers */

/* Exit parameters
   None.
*/

{
    /* WARNING -- The 576 in the setmem call below is based on
       the disk map array being [16][18] -- i.e. 288 unsigned
       integers, hence 576 bytes. */
    setmem(disk_map,576,'\0'); /* Fill array with zeros */
} /* End of dm_clr */

/*=====*/
dm_disp(disk_map,adisks) /* Disk map display */
/*=====*/
/* This function displays the elements of the disk map, showing
   the count in each element. A zero value-element is shown as
   blanks. For example:

```

Figure 14-1. (Continued)

```

    0  1  2  3  4  5  6  7  8  9 10 11 12 13 14 15 Used Free
A: 123  20 98      202  199 101 211                954  70

    Lines will only be printed for active disks (as indicated by
    the bit map). */

/* Entry Parameters */
unsigned disk_map[16][18]; /* Pointer to disk map array */
unsigned adisks;          /* Bit map of active disks */

{
#define USED_COUNT 16      /* "User" number for used entities */
#define FREE_COUNT 17     /* "User" number for free entities */

int disk;                 /* Current disk number */
int usern;                /* Current user number */
unsigned dsum;            /* Sum of entries for given disk */

printf("\n    0  1  2  3  4  5  6  7  8  9 10 11 12 13 14 15 Used Free");

for (disk = 0;            /* Start with disk A */
     disk < 16;          /* Until disk P */
     disk++)             /* Next disk */
    {
        if (!(adisks & (1 << disk))) /* Check if disk is active */
            continue; /* No -- so bypass this one */

        printf("\nXc: ",disk + 'A'); /* Display disk number */

        dsum = 0; /* Reset sum for this disk */
        for (usern = 0; /* Start with user 0 */
             usern < 16; /* Until user 15 */
             usern++) /* Next user number */
            {
                dsum += disk_map[disk][usern]; /* Build sum */
            }

        if (dsum) /* Check if any output for this disk,
                   and if not, display d: None */
            {
                /* Print either number or blanks */
                for (usern = 0; /* Start with user 0 */
                     usern < 16; /* Until user 15 */
                     usern++) /* Next user number */
                    {
                        if (disk_map[disk][usern])
                            printf("%4d",disk_map[disk][usern]);
                        else
                            printf(" ");
                    }
            }
        else /* No output for this disk */
            {
                printf(" -- None --");
            }
        printf(" %4d %4d",disk_map[disk][USED_COUNT],disk_map[disk][FREE_COUNT]);
    }

} /* End dm_disp */

/*=====*/
get_dpb(disk) /* Get disk parameter block address */
/*=====*/
/* This function returns the address of the disk parameter
   block (located in the BIOS). */

/* Entry parameters */
char disk; /* Logical disk for which DPB address is needed */

/* Exit parameters
   0 = Invalid logical disk
   NZ = Pointer to disk parameter block
*/

{
if (biosh(SELDSK,disk) == 0) /* Make BIOS SELDSK call */
    return 0; /* Invalid disk */
}

```

Figure 11-1. (Continued)

```

bdos(SETDISK,disk);          /* Use BDOS SETDISK function */
return bdos(GETDPARM);      /* Get the disk parameter block */
} /* End of get_dpb */

/*      Code table functions      */

/* Most programs that interact with a user must
accept parameters from the user by name and translate
the name into some internal code value.
They also must be able to work in reverse, examining
the setting of a variable, and determining what (ASCII
name) it has been set to.

An example is setting baud rates. The user may want to
enter "19200," and have this translated into a number
to be output to a chip. Alternatively, a previously
set baud rate variable may have to be examined and the
string "19200" generated to display its current
setting to the user.

A code table is used to make this task easier.
Each element in the table logically consists of:
  A code value (unsigned integer)
  An ASCII character string (actually a pointer to it) */

/*=====*/
ct_init(entry,code,string) /* Initialize code table */
/*=====*/
/* This function initializes a specific entry in a code table
with a code value and string pointer.

"); NOTE: By convention, the last entry in a given
code table will have a code value of CT_SNF (string not found). */

/* Entry parameters */
struct _ct *entry; /* Pointer to code table entry */
int code; /* Code value to store in entry */
char *string; /* Pointer to string for entry */

/* Exit parameters
None.
*/

{
entry -> _ct_code = code; /* Set _ct_code */
entry -> _ct_sp = string; /* Set string pointer */
} /* end of ct_inti */

/*=====*/
unsigned
ct_parc(table,string) /* Parameter - return code */
/*=====*/
/* This function searches the specified table for a
matching string, and returns the code value that corresponds to it.
If only one match is found in the table, then this function returns
that code value. If no match or more than one match is found,
it returns the error value, CT_SNF (string not found).
This function is specifically designed for processing
parameters on a command tail.
Note that the comparison is done after conversion to uppercase
(i.e. "STRING" matches "string"). A substrng compare is used so
that only the minimum number of characters for an unambiguous
response need be entered. For example, if the table contained:

Code Value
1 "APPLES"
2 "ORANGES"
3 "APRICOTS"

A response of "O" would return code = 2, but "A" or "AP" would
be ambiguous. "APR" or "APP" would be required. */

struct _ct *table; /* Pointer to table */
char *string; /* Pointer to key string */

```

Figure 11-1. (Continued)

```

{
int mcode;           /* Matched code to return */
int mcount;         /* Count of number of matches found */
mcode = CT_SNF;    /* Assume error */
mcount = 0;        /* Reset match count */

while(table -> _ct_code != CT_SNF) /* Not at end of table */
{
/* Compare keyboard response to table entry using
uppercase substring compare. */
if (ustrcmp(table -> _ct_sp, string) == 0)
{
mcount++; /* Update match count */
mcode = table -> _ct_code; /* Save code */
}
table++; /* Move to next entry */
}

if (mcount == 1) /* Only one match found */
return mcode; /* Return matched code */
else
return CT_SNF; /* Illegal or ambiguous */
} /* End ct_parc */

/*=====*/
unsigned
ct_code(table, string) /* Return code for string */
/*=====*/
/* This function searches the specified table for the
specified string. If a match occurs, it returns the
corresponding code value. Otherwise it returns CT_SNF
(string not found).
Unlike ct_parc, this function compares every character in the
key string, and will return the code on the first match found. */

/* Entry parameters */
struct _ct *table; /* Pointer to table */
char *string; /* Pointer to string */

/* Exit parameters
Code value -- if string found
CT_SNF -- if string not found
*/

{
while(table -> _ct_code != CT_SNF) /* For all entries in table */
{
if (ustrcmp(table -> _ct_sp, string) == 0) /* Compare strings */
return table -> _ct_code; /* Return code */
table++; /* Move to next entry */
}
return CT_SNF; /* String not found */
} /* End ct_code */

/*=====*/
ct_disps(table) /* Displays all strings in specified table */
/*=====*/
/* This function displays all of the strings in a given table.
It is used to indicate valid responses for operator input. */

/* Entry parameters */
struct _ct *table; /* Pointer to table */

/* Exit Parameters
None.
*/

{
while(table -> _ct_code != CT_SNF) /* Not end of table */
{
printf("\n\t\t%s", table -> _ct_sp); /* Print string */
table++; /* Move to next entry */
}
}

```

Figure 11-1. (Continued)

```

putchar('\n'); /* Add final return */
} /* End of ct_disps */

/*=====*/
ct_index(table,string) /* Returns index for a given string */
/*=====*/
/* This function searches the specified table, and returns
the INDEX of the entry containing a matching string.
All characters of the string are used for the comparison,
after they have been made uppercase. */

/* Entry parameters */
struct _ct *table; /* Pointer to table */
char *string; /* Pointer to string */

/* Exit parameters
Index of entry matching string, or
CT_SNF if string not found.
*/
{
int index; /* Current value of index */

index = 0; /* Initialize index */

while(table -> _ct_code != CT_SNF) /* Not at end of table */
{
if (ustrcmp(table -> _ct_sp,string) == 0)
return index; /* Return index */
table++; /* Move to next table entry */
index++; /* Update index */
}
return CT_SNF; /* String not found */
}

/*=====*/
char *ct_stri(table,index) /* Get string according to index */
/*=====*/
/* This function returns a pointer to the string in the
table entry specified by the index. */

/* Entry parameters */
struct _ct *table; /* Pointer to table */
int index; /* Index into table */

{
struct _ct *entry; /* Entry pointer */
entry = table[index]; /* Point to entry */
return entry -> _ct_sp; /* Return pointer to string */
} /* End of ct_stri */

/*=====*/
char *ct_strc(table,code) /* Get string according to code value */
/*=====*/
/* This function searches the specified table and returns a
pointer to the character string in the entry with the
matching code value or a pointer to a string of "unknown"
if the code value is not found. */

/* Entry parameters */
struct _ct *table; /* Pointer to table */
unsigned code; /* Code value */

{
while(table -> _ct_code != CT_SNF) /* Until end of table */
{
if (table -> _ct_code == code) /* Check code matches */
return table -> _ct_sp; /* Yes, return ptr. to str. */
table++; /* No, move to next entry */
}
}

```

Figure 11-4. (Continued)

```

    }
    return "Unknown";
}

/*      Bit vector functions      */

/* These functions manipulate bit vectors. A bit vector is a group
of adjacent bits, packed eight per byte. Each bit vector has the
structure defined in the LIBRARY.H file.

Bit vectors are used primarily to manipulate the operating
system's allocation vectors and other values that can best
be represented as a series of bits. */

/*=====*/
bv_make(bv,bytes)      /* Make a bit vector and clear to zeros */
/*=====*/
/* This function uses C's built-in memory allocation, alloc,
to allocate the necessary amount of memory, and then
sets the vector to zero-bits. */

/* Entry parameters */
struct _bv #bv;      /* Pointer to a bit vector */
unsigned bytes;      /* Number of bytes in bit vector */

/* Exit parameter
NZ = vector created
0 = insufficient memory to create vector
*/

{
if(!(bv -> bv_bits = alloc(bytes))) /* Request memory */
return 0; /* Request failed */

bv -> bv_bytes = bytes; /* Set length */
bv -> bv_end = bv -> bv_bits + bytes; /* Set pointer to end */

bv_fill(bv,0); /* Fill with 0's */
return 1;
} /* End bv_make */

/*=====*/
bv_fill(bv,value) /* Fill bit vector with value */
/*=====*/
/* This function fills the specified bit vector with the
specified value.
This function exist only for consistency's sake and
to isolate the main body of code from standard
functions like setmem. */

/* Entry parameters */
struct _bv #bv; /* Pointer to bit vector */
char value; /* Value to fill vector with */

/* Exit parameters
None.
*/

{
/* address length value */
setmem(bv -> bv_bits,bv -> bv_bytes,value);
}

/*=====*/
bv_set(bv,bitnum) /* Set the specified bit number */
/*=====*/
/* This function sets the specified bit number in the bit vector
to one-bit. */

/* Entry parameters */
struct _bv #bv; /* Pointer to bit vector */
unsigned bitnum; /* Bit number to be set */

```

bb

cc

dd

ee

Figure 11-4. (Continued)

```

/* Exit parameters
   None.
*/
{
  unsigned byte_offset;      /* Byte offset into the bit vector */
  if ((byte_offset = bitnum >> 3) > bv -> bv_bytes)
    return 0;                /* Bitnum is "off the end" of the vector */

  /* Set the appropriate bit in the vector. The byte offset
     has already been calculated. The bit number in the byte
     is calculated by AND ing the bit number with 0x07.
     The specified bit is then OR ed into the vector */
  bv -> bv_bits[byte_offset] |= (1 << (bitnum & 0x7));
  return 1;                  /* Indicate completion */

  /* End of bv_set */
}

/*=====*/
bv_test(bv,bitnum)          /* Test the specified bit number */
/*=====*/
/* This function returns a value that reflects the current
   setting of the specified bit. */

/* Entry parameters */
struct _bv *bv;            /* Pointer to bit vector */
unsigned bitnum;           /* Bit number to be set */

/* Exit parameters
   None.
*/
{
  unsigned byte_offset;    /* Byte offset into the bit vector */
  if ((byte_offset = bitnum >> 3) > bv -> bv_bytes)
    return 0;              /* Bitnum is "off the end" of the vector */

  /* Set the appropriate bit in the vector. The byte offset
     has already been calculated. The bit number in the byte
     is calculated by AND ing the bit number with 0x07.
     The specified bit is then OR ed into the vector */
  return bv -> bv_bits[byte_offset] & (1 << (bitnum & 0x7));
} /* End of bv_tests */

/*=====*/
bv_nz(bv)                  /* Test bit vector nonzero */
/*=====*/
/* This function tests each byte in the specified vector,
   and returns indicating whether any bits are set in
   the vector. */

/* Entry parameters */
struct _bv *bv;           /* Pointer to bit vector */

/* Exit Parameters
   NZ = one or more bits are set in the vector
   0 = all bits are off
*/
{
  char *bits;             /* Pointer to bits in bit vector */
  bits = bv -> bv_bits;   /* Set working pointer */
  while (bits != bv -> bv_end) /* For entire bit vector */
  {
    if (*bits++)          /* If nonzero */
      return bits--;     /* Return pointer to NZ byte */
  }
}

```

Figure 11-1. (Continued)

```

    }
    return 0; /* Indicate vector is zero */
} /* End of bv_nz */

/*=====*/
bv_and(bv3,bv1,bv2) /* bv3 = bv1 & bv2 */
/*=====*/
/* This function performs a boolean AND between the bytes
of bit vector 1 and 2, storing the result in bit vector 3. */

/* Entry parameters */
struct _bv #bv1; /* Pointer to input bit vector */
struct _bv #bv2; /* Pointer to input bit vector */

/* Exit parameters */
struct _bv #bv3; /* Pointer to output bit vector */

{
char #bits1, #bits2, #bits3; /* Working pointers to bit vectors */
bits1 = bv1 -> bv_bits; /* Initialize working pointers */
bits2 = bv2 -> bv_bits;
bits3 = bv3 -> bv_bits;

/* AND ing will proceed until the end of any one of the bit
vectors is reached. */
while (bits1 != bv1 -> bv_end &&
bits2 != bv2 -> bv_end &&
bits3 != bv3 -> bv_end)
{
bits3++ = #bits1++ & #bits2++; /* bv3 = bv1 & bv2 */
}
} /* End of bv_and */

/*=====*/
bv_or(bv3,bv1,bv2) /* bv3 = bv1 or bv2 */
/*=====*/
/* This function performs a boolean inclusive OR between the bytes
of bit vectors 1 and 2, storing the result in bit vector 3. */

/* Entry parameters */
struct _bv #bv1; /* Pointer to input bit vector */
struct _bv #bv2; /* Pointer to input bit vector */

/* Exit parameters */
struct _bv #bv3; /* Pointer to output bit vector */

{
char #bits1, #bits2, #bits3; /* Working pointers to bit vectors */
bits1 = bv1 -> bv_bits; /* Initialize working pointers */
bits2 = bv2 -> bv_bits;
bits3 = bv3 -> bv_bits;

/* The OR ing will proceed until the end of any one of the bit
vectors is reached. */
while (bits1 != bv1 -> bv_end &&
bits2 != bv2 -> bv_end &&
bits3 != bv3 -> bv_end)
{
bits3++ = #bits1++ | #bits2++; /* bv3 = bv1 or bv2 */
}
} /* End of bv_or */

/*=====*/
bv_disp(title,bv) /* Bit vector display */
/*=====*/
/* This function displays the contents of the specified bit vector
in hexadecimal. It is normally only used for debugging. */

/* Entry parameters */
char #title; /* Title for the display */
struct _bv #bv; /* Pointer to the bit vector */

```

Figure 11-1. (Continued)

```

/* Exit parameters
   None.
*/

{
char *bits;           /* Working pointer */
unsigned byte_count; /* Count used for formatting display */
unsigned bit_count;  /* Count for processing bits in a byte */
char byte_value;     /* Value to be displayed */

printf("\nBit Vector : %s",title); /* Display title */

bits = bv -> bv_bits; /* Set working pointer */
byte_count = 0;       /* Initialize count */

while (bits != bv -> bv_end) /* For the entire vector */
{
    if (byte_count % 5 == 0) /* Check if new line */
        printf("\n%4d : ",byte_count << 3); /* Display bit number */

    byte_value = *bits++; /* Get the next byte from the vector */

    for (bit_count = 0; bit_count < 8; bit_count++)
    {
        /* Display the leftmost bit, then shift the value
           left one bit */
        if (bit_count == 4) putchar(' '); /* Separator */
        putchar((byte_value & 0x80) ? '1' : '0');
        byte_value <<= 1; /* Shift value left */
    }

    printf(" "); /* Separator */

    byte_count++; /* Update byte count */
}
} /* End of bv_disp */

/* End of LIBRARY.C */

```

Figure 11-1. (Continued)

Associated with the library of functions is another section of source code called "LIBRARY.H", shown in Figure 11-2. This "header" file must be included at the beginning of each program that calls any of the library functions.

For reasons of clarity, this chapter describes the simplest functions first, followed by the more complex, and finally by the utility programs that use the functions.

Several functions in the library and some definitions in the library header are not used by the utilities shown in this chapter. They have been included to illustrate techniques and because they might be useful in other utilities you could write.

```

#define LIBVN "1.0" /* Library version number */

/* This file contains groups of useful definitions.
   It should be included at the beginning of any program
   that uses the functions in LIBRARY.C */

/* Definition to make minor language modification to C. */
#define short char /* Short is not supported directly */

```

Figure 11-2. LIBRARY.H, code to be included at the beginning of any program that calls LIBRARY functions in Figure 11-1

```

/* One of the functions (bv_make) in the library uses the BDS C
function, alloc, to allocate memory. The following definitions
are provided for alloc. */

struct _header                                /* Header for block of memory allocated */
{
    struct _header *_ptr; /* Pointer to the next header in the chain */
    unsigned _size;      /* Number of bytes in the allocated block */
}
struct _header _base; /* Declare the first header of the chain */
struct _header *_alloc; /* Used by alloc() and free() functions */

/* BDOS function call numbers */

#define SETDISK 14 /* Set (select) disk */
#define SEARCHF 17 /* Search first */
#define SEARCHN 18 /* Search next */
#define DELETF 19 /* Delete file */
#define GETDISK 25 /* Get default disk (currently logged in) */
#define SETDMA 26 /* Set DMA (Read/Write) Address */
#define GETPDM 31 /* Get disk parameter block address */
#define GETUSER 32 /* Get current user number */
#define SETUSER 32 /* Set current user number */

/* Direct BIOS calls
These definitions are for direct calls to the BIOS.
WARNING: Using these makes program less transportable.
Each symbol is related to its corresponding jump in the
BIOS jump vector.
Only the more useful entries are defined. */

#define CONST 2 /* Console status */
#define CONIN 3 /* Console input */
#define CONOUT 4 /* Console output */
#define LIST 5 /* List output */
#define AUXOUT 6 /* Auxiliary output */
#define AUXIN 7 /* Auxiliary input */

#define HOME 8 /* Home disk */
#define SELDSK 9 /* Select logical disk */
#define SETTRK 10 /* Set track */
#define SETSEC 11 /* Set sector */
#define SETDMA 12 /* Set DMA address */
#define DREAD 13 /* Disk read */
#define DWRITE 14 /* Disk write */
#define LISTST 15 /* List status */
#define SECTRN 16 /* Sector translate */
#define AUXIST 17 /* Auxiliary input status */
#define AUXOST 18 /* Auxiliary output status */

/* "Private" entries in jump vector */
#define CIOINIT 19 /* Specific character I/O initialization */
#define SETDOG 20 /* Set watchdog timer */
#define CBGADDR 21 /* Configuration block, get address */

/* Definitions for accessing the configuration block */

#define CB_GET 21 /* BIOS jump number to access routine */
#define DEV_INIT 19 /* BIOS jump to initialize device */

#define CB_DATE 0 /* Date in ASCII */
#define CB_TIMEA 1 /* Time in ASCII */
#define CB_DTFLAGS 2 /* Date, time flags */
#define TIME_SET 0x01 /* This bit NZ means date has been set */
#define DATE_SET 0x02 /* This bit NZ means time has been set */

#define CB_FIP 3 /* Forced input pointer */
#define CB_SUM 4 /* System start-up message */

#define CB_CI 5 /* Console input */
#define CB_CO 6 /* Console output */
#define CB_AI 7 /* Auxiliary input */
#define CB_AO 8 /* Auxiliary output */

```

Figure 11-2. (Continued)

```

#define CB_LI 9          /* List input */
#define CB_LO 10         /* List output */

#define CB_DTA 11        /* Device table addresses */
#define CB_C1224 12     /* Clock 12/24 format flag */
#define CB_RTCTR 13     /* Real time clock tick rate (per second) */

#define CB_WDC 14        /* Watchdog count */
#define CB_WDA 15        /* Watchdog address */

#define CB_FKT 16        /* Function key table */
#define CB_COET 17       /* Console output escape table */

#define CB_DO_IS 18      /* Device 0 initialization stream */
#define CB_DO_BRC 19    /* Device 0 baud rate constant */

#define CB_D1_IS 20      /* Device 1 initialization stream */
#define CB_D1_BRC 21    /* Device 1 baud rate constant */

#define CB_D2_IS 22      /* Device 2 initialization stream */
#define CB_D2_BRC 23    /* Device 2 baud rate constant */

#define CB_IV 24         /* Interrupt vector */
#define CB_LTCBO 25     /* Long term config. block offset */
#define CB_LTCBL 26     /* Long term config. block length */

#define CB_PUBF 27       /* Public files flag */
#define CB_MCBUF 28     /* Multi-command buffer */
#define CB_POLLC 29     /* Polled console flag */

/* Device numbers and names for physical devices */
/* NOTE! Change these definitions for your computer system */

#define T_DEVN 0         /* Terminal */
#define M_DEVN 1         /* Modem */
#define P_DEVN 2         /* Printer */

#define MAXPDEV 2       /* Maximum physical device number */

/* Names for the physical devices */

#define PN_T "TERMINAL"
#define PN_M "MODEM"
#define PN_P "PRINTER"

/* Structure and definitions for function keys */

#define FK_ILENGTH 2    /* No. of chars. input when func. key pressed
NOTE: This does NOT include the ESCAPE. */
#define FK_LENGTH 16   /* Length of string (not including fk_term) */
#define FK_ENTRIES 18  /* Number of function key entries in table */

struct _fkt             /* Function key table */
{
    char fk_input[FK_ILENGTH]; /* Lead-in character is not in table */
    char fk_output[FK_LENGTH]; /* Output character string */
    char fk_term;             /* Safety terminating character */
};

/* Definitions and structure for device tables */

/* Protocol bits */
/* Note: if the most significant bit is
set = 1, then the set_proto function
will logically OR in the value. This
permits input DTR to co-exist with
XON or ETX protocol. */

#define DT_ODTR 0x8004  /* Output DTR high to send (OR ed in) */
#define DT_OXON 0x0008 /* Output XON */
#define DT_OETX 0x0010 /* Output ETX/ACK */

#define DT_IRTS 0x8040  /* Input RTS (OR-ed in) */
#define DT_IXON 0x0080 /* Input XON */

```

Figure 11-2. (Continued)

```

#define ALLPROTO 0xDC          /* All protocols combined */

struct _dt                    /* Device table */
{
    char dt_f1[14];           /* Filler */
    char dt_st1;              /* Status byte 1 -- has protocol flags */
    char dt_st2;              /* Status byte 2 */
    unsigned dt_f2;           /* Filler */
    unsigned dt_etxml;        /* ETX/ACK message length */
    char dt_f3[12];           /* Filler */
};

/* Values returned by the comp_fname (compare file name) */

#define NAME_EQ 0             /* Names equal */
#define NAME_LT 1            /* Name less than mask */
#define NAME_GT 2            /* Name greater than mask */
#define NAME_NE 3            /* Name not equal (and comparison ambiguous) */

/* Structure for standard CP/M file control block */

#define FCBSIZE 36           /* Define the overall length of an FCB */

struct _fcb
{
    short fcb_disk;           /* Logical disk (0 = default) */
    char fcb_fname[11];       /* File name, type (with attributes) */
    short fcb_extent;         /* Current extent */
    unsigned fcb_s12;         /* Reserved for CP/M */
    short fcb_reccnt;         /* Record count used in current extent */
    union
    {
        short fcbab_short[16]; /* Allocation blocks can be either */
        unsigned fcbab_long[8]; /* Single or double bytes */
    } _fcbab;
    short fcb_currec;         /* Current record within extent */
    char fcb_ranrec[3];       /* Record for random read/write */
};

/* Parameter block used for calls to the directory management routines */

#define DIR_BSZ 128          /* Directory buffer size */

struct _dirpb
{
    short dp_open;           /* 0 to request directory to be opened */
    short dp_end;            /* NZ when at end of directory */
    short dp_writes;         /* NZ to write current sector to disk */
    struct _dir *dp_entry;    /* Pointer to directory entry in buffer */
    char dp_buffer [DIR_BSZ]; /* Directory sector buffer */
    char dp_disk;            /* Current logical disk */
    int dp_track;            /* Start track */
    int dp_sector;           /* Start sector */
    int dp_nument;           /* Number of directory entries */
    int dp_entrem;           /* Entries remaining to process */
    int dp_sptrk;            /* Number of sectors per track */
    int dp_nabpde;           /* Number of allocation blocks per dir. entry */
    unsigned dp_nab;         /* Number of allocation blocks */
    int dp_ahsize;           /* Allocation block size (in Kbytes) */
};

/* The err_dir function is used to report errors found by the
   directory management routines. open_dir and rw_dir.
   Err_dir needs a parameter to define the operation being
   performed when the error occurred. The following definitions
   represent the operations possible. */

#define W_DIR 0              /* Writing directory */
#define R_DIR 1              /* Reading directory */
#define O_DIR 2              /* Opening directory */

```

Figure 11-2. (Continued)

```

/* Disk parameter block maintained by CPM */
struct _dpb
{
    unsigned dpb_sptrk;    /* Sectors per track */
    short dpb_bshift;     /* Block shift */
    short dpb_bmask;      /* Block mask */
    short dpb_emask;      /* Extent mask */
    unsigned dpb_maxabn;  /* Maximum allocation block number */
    unsigned dpb_maxden;  /* Maximum directory entry number */
    short dpb_rab0;       /* Allocation blocks reserved for */
    short dpb_rabl;       /* directory blocks */
    unsigned dpb_diskca;  /* Disk changed workarea */
    unsigned dpb_trkoff;  /* Track offset */
};

/* Disk directory entry format */
struct _dir {
    char de_userno;       /* User number or 0xE5 if free entry */
    char de_fname[11];    /* File name [8] and type [3] */
    int de_extnt;        /* Extent number of this entry */
    int de_reccnt;       /* Number of 128-byte records used in last
                        allocation block */
    union                /* Allocation blocks can be either
                        single or double bytes */
    {
        short de_short[16];
        unsigned de_long[8];
    } _dirab;
};

/* Disk request parameters for BIOS-level read/writes */
struct _drb
{
    short dr_disk;        /* Logical disk A = 0, B = 1... */
    unsigned dr_track;    /* Track (for SETTRK) */
    unsigned dr_sector;   /* Sector (for SETSEC) */
    char *dr_buffer;      /* Buffer address (for SETDMA) */
};

/* Search control block used by directory scanning functions */
struct _scb
{
    short scb_userno;     /* User number(s) to match */
    char scb_fname[11];   /* File name and type */
    short scb_extnt;      /* Extent number */
    char unused[19];      /* Dummy bytes to make this look like
                        a file control block */
    short scb_length;     /* Number of bytes to compare */
    short scb_disk;       /* Current disk to be searched */
    unsigned scb_adisks;  /* Bit map of disks to be searched.
                        the rightmost bit is for disk A1. */
};

/* Code table related definitions */
#define CT_SNF 0xFFFF    /* String not found */

struct _ct                /* Define structure of code table */
{
    unsigned _ct_code;     /* Code value */
    char *_ct_sp;          /* String pointer */
};

```

Figure 11-2. (Continued)

```

/* Structure for bitvectors */
struct _bv
{
    unsigned bv_bytes; /* Number of bytes in the vector */
    char *bv_bits; /* Pointer to the first byte in the vector */
    char *bv_end; /* Pointer to byte following bit vector */
};

/* End of LIBRARY.H */

```

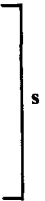

Figure 11-2. (Continued)

Library Functions

This section describes the library functions and the sections from the header file that must be included at the beginning of each utility program.

A Minor Change to C Language

One minor problem with the BDS C Compiler is that it does not support “short” integers, or integers that are only a single byte long. It is convenient to declare certain values as short to serve as a reminder of the standard type definition. Therefore, the BDS C compiler must be “fooled” by declaring these values to be single characters. To do this, the library header file contains the declaration

```
#define short char.
```

shown in Figure 11-2, section a.

The “#define” tells the first part of the C compiler, the preprocessor, to substitute the string “char” (which declares a character variable) whenever it encounters the string “short” (which would ordinarily declare a short integer in standard C).

Note that character strings enclosed in “/*” and “*/” are regarded as comments and are ignored by the compiler.

BDOS Calls

The standard library of functions that comes with the BDS C compiler includes a function to make BDOS calls, called “bdos.” It takes two parameters, and a typical call is of the following form:

```
bdos(c, de);
```

The “c” parameter represents the value that will be placed into the C register. This is the BDOS function code number. The “de” is the value that will be placed in the DE register pair.

The library header contains definitions (#define declarations) for BDOS functions 14 through 32, making these functions easier to use (Figure 11-2, c). Function 32 (Get/Set Current User Number) has two definitions; the “de” parameter is used to differentiate whether a get or a set function is to be performed.

BIOS Calls

The BDS C standard library also contains two functions that make direct BIOS calls. These are “bios” and “biosh.” They differ only in that the bios function returns the value in the A register on return from the BIOS routine, whereas biosh, as its name implies, returns the value in the HL register pair. Examples of their use are

```
bios(jump_number, bc);
and
biosh(jump_number, bc, de);
```

Both functions take as their first parameter the number of the jump instruction in the BIOS jump vector to which control is to be transferred. For example, the console-status entry point is the third JMP in the vector. Numbering from 0, this would be jump number 2.

The library header file contains #defines for BIOS jumps 2 through 21 (Figure 11-2, d). The last group of these #defines (19 through 21) is for the “private” additions to the standard BIOS jump vectors described in Chapter 8.

Remember, though, that using direct BIOS calls makes programs more difficult to move from one system to another.

BIOS Configuration Block Access

As you may recall, the configuration block is a collection of data structures in the BIOS. These structures are used either to store the current settings of certain user-selectable options, or to point to other important data structures in the BIOS.

One of the “private” jumps appended to the standard BIOS jump vector transfers control to a routine that returns the address in memory of a specified data structure. For example, if a utility program needs to locate the word in the BIOS that determines from which physical device the console input is to read, it can transfer control to jump 21 in the BIOS jump vector (actually the 22nd jump) with a code value of 5 in the C register. This jump transfers control to the CB\$Get\$-Address code, which on its return will set HL to the address of the console input redirection vector. The utility program can then read from or write into this variable. The library header file contains #define declarations relating the code values to mnemonic names (Figure 11-2, e).

You will need to refer to the source code in Figure 8-10 to determine whether the address returned by the BIOS function is the address of the data element or the

address of a higher-level table that in turn points to the data element.

In order to access the current system date, for example, you would include the following code:

```
char *ptr_to_date;          /* declare date pointer*/
ptr_to_date = biosh(CB_DATE); /* get address */
```

The `ptr_to_date` can then be used to access the date directly.

During initial debugging of a utility, it is useful to be able to intercept all such accesses to the configuration block, partly to reassure yourself that the utility program is working as it should, and partly to ensure that the BIOS routine is returning the correct addresses to the data structures. Therefore, the utility library contains a function, “`get_cba`,” that gets a configuration block address (Figure 11-1, a).

At first, it appears that `get_cba` is declared as a function that returns a pointer to characters. This is not strictly true. Sometimes the address it returns will point to characters, sometimes to integers, and sometimes to structures (such as the function key table).

The “`printf`” instruction has been left in the function in anticipation of debugging a utility. If you need to see some debug output whenever the `get_cba` function is used, delete the “`/*`” and “`*/`” surrounding the “`printf`” and recompile the library.

BIOS Function Key Table Access

The BIOS shown in Figure 8-10 contains code to recognize when an incoming escape sequence indicates that one of the terminal’s function keys has been pressed. Instead of returning just the escape sequence, the console driver injects a previously programmed string of characters into the console input stream. For example, on a DEC VT-100 terminal, when the PF1 function key is pressed, the terminal emits the following character sequence: ESCAPE, “O”, “P”. The function key table contains the “OP” and a 00H-byte-terminated string of characters to be injected into the console input stream. In Figure 8-10, the example string is “FUNCTION KEY 1”, LINE FEED. The library header file contains a declaration for the structure of the function key table (Figure 11-2, h).

Note the use of “`#define`” to declare the length of the incoming characters emitted by the terminal as well as the length of the output string.

In order to access a function key table entry, you must declare a pointer to a “`_fkt`” structure like this:

```
struct _fkt *ptr_to_fkt;    /* Declare pointer */
ptr_to_fkt = get_cba(CB_FKT); /* Set pointer */
printf("Display the first string: %s",
      ptr_to_fkt->fk_output);
++ptr_to_fkt;              /* Move to next entry */
```

The `get_cba` function is used to return the address of the first entry in the function key table and set a pointer to it. Then the `printf` function (part of the

standard BDS C library) is used to print out the first string, which gets substituted for the "%s" in the quoted string. Note that the statement

```
++ptr_to_fkt
```

does not just add one to the pointer to the function key table—it adds whatever it takes to move the pointer to the next *entry* in the table.

BIOS Device Table Access

The device tables are important structures for the serial devices served by the console, auxiliary, and list device drivers in the BIOS. They are declared at line 1500 in Figure 8-10.

The `get_cba` function does not return a pointer to a specific device table, but a pointer to a table of device table addresses. Each entry in the address table corresponds to a specific device number. If there is no device table for a specific device number, then the corresponding entry in the table will be set to zero. The library header file contains definitions for the device table (Figure 11-2, i).

The device tables contain, among other things, the current serial line protocols used to synchronize the transmission and reception of data by the device drivers and the physical devices. An example utility, `PROTOCOL`, is shown later in the chapter. The example `#define` declarations and structure definition shown here are modeled on the requirements of this utility. The only relevant bytes are the two status bytes `dt_st1` and `dt_st2` and the message length used with the ETX/ACK protocol, `dt_etxml`. The `#defines` shown are for the specific bits in the device table's status bytes. The `PROTOCOL` utility uses the most significant bit to indicate whether a given protocol setting can coexist with others.

To access these fields, use the following code:

```
struct _ppdt
{
    char *pdt[16];      /* Array of 16 pointers to device tables */
} *ppdt;              /* Pointer to array of 16 pointers */
struct _dt *dt;       /* Pointer to device table */

ppdt = get_cba(CB_DTA); /* Set pointer to array of pointers */
dt = ppdt -> pdt[device_no]; /* Set pointer to specified device
                             table */

if (!dt)
    printf("\nError - no device table for this device.");

dt -> dt_etxml = 0;    /* Clear ETX message length */
```

BIOS Disk Parameter Block Access

Several of the utility programs shown in this chapter must access the file directory on a given logical disk. The disk parameter block (DPB) indicates the size and location of the file directory. The library header contains a structure definition that describes the DPB (Figure 11-2, n).

To locate the DPB, you can make a direct BIOS call to the SELDSK routine, which returns the address of the disk parameter header (DPH). You then can access the DPB pointer in the DPH. Alternatively, using the BDOS, you can make the required disk the default disk and then request the address of its DPB. The code for the latter method is shown in the `get_dpb` function included in the utility library (Figure 11-1, u).

The `get_dpb` function uses a BIOS SELDSK function first to see if the specified disk is legitimate. Only then does it use the BDOS.

Reading or Writing a Disk Using the BIOS

When you write a program that uses direct BIOS calls, you increase the possibility of problems in moving the program from one system to another. However, in certain circumstances it is necessary to use the BIOS. Reading and writing the file directory is one of these; the BDOS cannot be used to access the directory directly. The library header contains a structure declaration for a parameter block that contains the details of an “absolute” disk read or write (Figure 11-2, p).

Note the pointer to the 128-byte data buffer used to hold one of CP/M’s “records.”

The disk read and write functions are `rd_disk` (Figure 11-1, k) and `wrt_disk` (Figure 11-1, l). Both of them take a `_drb` as an input parameter, and both call the `set_disk` function to make the individual BIOS calls to SELDSK, SETTRK, and SETSEC.

Of special note is the code in `set_disk` (Figure 11-1, m) that converts a logical sector into a physical sector using the sector translation table and the SECTTRAN entry point in the BIOS.

File Directory Entry Access

All of the utility programs that access a disk directory share the same basic logic regardless of their specific task. This logic can be described best in pseudo-code:

```

while (not at the end of the directory)
{
    access the next directory entry
    if (this entry matches the current search criteria)
    {
        process the entry
    }
}

```

There are two ways of implementing this logic. The first uses the BIOS to read the directory. Entries are presented to the utility exactly as they occur in the file

directory. The second uses the BDOS functions Search First and Search Next and accesses the directory file-by-file rather than by entry. This latter method is more suited to utilities that process files rather than entries. The ERASE utility, described later in this chapter, illustrates this second method.

Three groups of functions are provided in the library: to access the next entry in the directory, to match the name in the current entry against a search key, and to assist with processing the directory.

Directory Accessing Functions

A number of functions involve access to the file directory. The first group of such functions performs the following:

`get_nde` (get next directory entry; Figure 11-1, n)

This function returns a pointer to the next directory entry, or returns zero if the end of the directory has been reached.

`open_dir` (open directory; Figure 11-1, o)

This function is called by `get_nde` to open up a directory for processing.

`rw_dir` (read/write directory; Figure 11-1, p)

This function reads or writes the current directory sector.

`err_dir` (error on directory; Figure 11-1, q)

This general-purpose routine displays an error message if the BIOS indicates that it had problems either reading or writing the directory.

All of these functions use a directory parameter block to coordinate their activity. The library header contains the definitions for this structure (Figure 11-2, l), as well as `#define` declarations for operation codes used by the directory-accessing functions (Figure 11-2, m).

Before calling `get_nde`, the calling program needs to set `dp_open` to zero (forcing a call to `open_dir`) and the `dp_disk` field to the correct logical disk. The `open_dir` function sets up all of the remaining fields, using `get_dpb` to access the disk parameter block for the disk specified in `dp_disk`.

Of the remaining flags, `dp_end` will be set to true, when the end of the directory is reached, and `dp_write` must be nonzero for `rw_dir` to write the current sector back onto the disk.

The `get_nde` function includes all of the necessary logic to move from one directory entry to the next, reading in the next sector when necessary, and writing out the previous sector if the `dp_write` flag has been set to a nonzero value by the calling program. It also counts down on the number of directory entries processed, detecting and indicating the end of the directory.

The code at the beginning of the function calls `open_dir` if the `dp_open` flag is false. Note the code at the end of `open_dir` that sets the number of allocation blocks per directory entry (`dp_nabpde`). This number is computed from the maximum

allocation block number in the disk parameter block. If it is larger than 255, each allocation block must occupy a word, and there will be eight blocks per directory entry. If there are 255 or fewer allocation blocks, each will be one byte long and there will be 16 per entry. The allocation block size, in Kbytes, is computed from a simple formula.

In the early stages of debugging utilities, comment out the line that makes the call to `wrt_disk`. This will prevent the directory from being overwritten. You then can test even those utilities that attempt to erase entries from the directory without any risk of damaging any data on the disk.

The last function in this group, `err_dir`, is a common error handling function for taking care of errors while reading or writing the directory.

Directory Matching Functions

The second group of functions that access the file directory matches each directory entry against specific search criteria. These include the following functions:

`setscb` (set search control block; Figure 11-1, r)

A search control block (SCB) is a structure that defines the entries in the directory that are to be selected for processing.

`comp_fname` (compare file name; Figure 11-1, f)

This function compares the file name in the current directory entry with the one specified in the search control block.

The library header contains the structure definition for the search control block (Figure 11-2, q). This SCB is a hybrid structure. The first part of it is a cross between a file control block (FCB) and a directory entry. The last three fields, `scb_length`, `scb_disk`, and `scb_adisks`, are peculiar to the search control block. Note that its overall length is the same as an FCB's so that the standard BDS C function `set_fcb` can be used. This function sets the file name and type into an FCB, replacing "*" with as many "?" characters as are required, and clears all unused bytes to zero.

The `scb_length` field indicates to the `comp_fname` (compare file name) function how many bytes of the structure are to be compared. This field will be set to 12 to compare the user number, file name, and type, or to 13 to include the extent number.

Note that `scb_disk` is the *current* disk to be searched, whereas `scb_adisks` is a bit map with a 1 bit corresponding to each of the 16 possible logical disks that must be searched.

The search control block is initialized by the `setscb` function.

Note the form of the file name that `setscb` expects to receive. This is described in the comments at the beginning of the function.

Several of the utility programs use their own special versions of `setscb`,

renaming it `ssetscb` (special `setscb`) to avoid the library version being linked into the programs.

The complementary function `comp_fname` is used to compare the first few bytes of the current directory entry to the corresponding bytes of the SCB.

The `comp_fname` function performs a specialized string match of the user number, the file name, the file type, and, optionally, the extent number. A “?” character in the search control block file name, type, and extent will match with any character in the file directory entry. However, in the SCB user number, a “?” will only match a number in the range 0 to 15; it will not match a directory entry that has the user number byte set to `E5H` (or `0xE5`, as hexadecimal notation in C).

This function also returns one of several values to indicate the result of the comparison. These values are defined in the library header file (Figure 11-2, j).

Directory Processing Functions

The final group of functions that access the directory are those that help process the directory entries themselves. These functions use a structure definition to access each directory entry (Figure 11-2, o).

A union statement is used for the allocation block numbers. These can be single- or two-byte entries, depending on the maximum number of allocation blocks that must be represented. The union statement tells the BDS C compiler whether there will be a 16-byte array of short integers (characters) or an array of eight unsigned two-byte integers.

The functions contained in this group can be divided into three subgroups:

- Those that deal with converting directory entries for display on the console.
- Those that deal with a “disk map”—a convenient array for representing logical disks and the user numbers they contain.
- Those that deal with “bit vectors”—a convenient representation of which allocation blocks on a logical disk are in use or available.

The library contains only one function to convert a directory-entry file name into a suitable form for display on the console. This is the `conv_dfname` function (Figure 11-1, h). It takes the information from the specified directory entry (or, as a convenience, a search control block) and formats it into a string of the form

```
uu/d:filename.typ
```

The “uu” specifies the user number and the “d” specifies the disk identification.

The repetitive code at the end of the function is necessary to make sure that the characters in the file type do not have their high-order bits set. These bits are the file attributes. If they are set, they can render the characters nondisplayable on some terminals.

The second subgroup of functions, those that manipulate a “disk map,” produce an array that looks like this:

```

Disks
|
| v User Numbers -->                                     -Totals-
A 0 1 2 3 4 5 6 7 8 9 10 11 12 13 14 15 Used Free
B
:
:
P

```

This disk map is used by several utility programs. For example, the SPACE utility displays a disk map that shows, for each logical disk in the system, and for each user on each logical disk, how many Kbytes of disk space are in use. The totals at the right show the total of used and free space. In another example, the FIND utility shows how many files on each disk and in each user number match the search name.

Each utility program that uses a disk map is coded:

```
unsigned disk_map[16][18];
```

Two functions are provided in the library to deal with the disk map:

`dm_clr` (disk map clear; Figure 11-1, s)

This function fills the entire disk map with zeros.

`dm_disp` (disk map display; Figure 11-1, t)

This function displays the horizontal and vertical caption lines for the disk map and then converts each element of the disk map to a decimal number.

The first function, `dm_clr`, uses one of the standard BDS C functions to set a block of memory to a specific value. It presumes that the disk map is 16×18 elements, each two bytes long.

The second function, `dm_disp`, prints horizontal lines only for those disks specified in the bit map parameter. Here is an example of its output:

```

      0  1  2  3  4  ...  10  11  12  13  14  15  Used Free
A:    1  1
B:   66 20 74 50  3
C:   -- None --
(NOTE: All user groups would be shown on the terminal.)

```

The final subgroup deals with processing “bit vectors.” A bit vector is a string of bits packed eight bits per byte. Each bit is addressed by its relative number along the vector; the first bit is number 0.

An example of why bit vectors are used is a utility program that needs to scan the directory of a disk and build a structure showing which allocation blocks are in use. It can do this by accessing each active directory element and, for each nonzero allocation block number, setting the corresponding bit number in a bit vector.

The library header has a structure definition for a bit vector (Figure 11-2, s).

This vector contains the overall length of the bit vector in bytes, and two pointers. The first points to the start of the vector, the second to the end. The bytes that contain the vector bits themselves are allocated by the `alloc` function — one of the standard BDS C functions.

The following bit vector functions are provided in the library:

`bv_make` (bit vector make; Figure 11-1, cc)

This function allocates memory for the bit vector (using the standard mechanism provided by BDS C) and sets all of the bits to zero.

`bv_fill` (bit vector fill; Figure 11-1, dd)

This fills a specified vector, setting each byte to a specified value.

`bv_set` (bit vector set; Figure 11-1, ee)

This sets the specified bit of a vector to one.

`bv_test` (bit vector test; Figure 11-1, ff)

This function returns a value of zero or one, reflecting the setting of the specified bit in a bit vector.

`bv_nz` (bit vector nonzero; Figure 11-1, gg)

This returns zero or a nonzero value to reflect whether *any* bits are set in the specified bit vector.

`bv_and` (bit vector AND; Figure 11-1, hh)

This function performs a Boolean AND between two bit vectors and places the result into a third vector.

`bv_or` (bit vector OR; Figure 11-1, ii)

This is similar to `bv_and`, except that it performs an inclusive OR on the two input vectors.

`bv_disp` (bit vector display; Figure 11-1, jj)

This function displays a caption line and then prints out the contents of the specified bit vector as a series of zeros and ones. Each byte is formatted to make the output easier to read.

The `bv_make` function uses the `alloc` function to allocate a block from the unused part of memory between the end of a program and the base of the BDOS. It requires that two data structures be declared at the beginning of the program. These structures are declared in the library header file (Figure 11-2, b).

The `bv_fill` function uses the standard BDS C `setmem` function.

The `bv_set` function converts the bit number into a byte offset by shifting the bit number right three places. The least significant three bits of the original bit number specify which bit in the appropriate byte needs to be ORed in.

The `bv_test` function is effectively the reverse of `bv_set`. It accesses the specified bit and returns its value to the calling program.

The `bv_nz` function scans the entire bit vector looking for the first nonzero

byte. If the entire vector is zero, it returns a value of zero. Otherwise, it returns a pointer to the first nonzero byte.

Both `bv_and` and `bv_or` functions take three bit vectors as parameters. The first vector is used to hold the result of either ANDing or ORing the second and third vectors together. Both of these functions assume that the output vector has already been created using `bv_make`. The shortest of the three vectors will terminate the `bv_and` or `bv_or` function; that is, these functions will terminate when they reach the end of the first (shortest) vector.

The final function, `bv_disp`, displays the title line specified by the calling program, and then displays all of the bits in the vector, with the bit number of the first bit on each line shown on the left.

None of the utility programs uses `bv_disp`—it has been left in the library purely as an aid to debugging.

Here is an example of `bv_disp`'s output:

```
Bit Vector : Allocation Blocks in Use
 0 : 0000 0000 0001 1000 1000 0001 1111 1111 1111 1111
40 : 1111 1111 1111 1111 1111 1111 1110 1011 0000 0000
80 : 1100 0000 1111 1100 1111 1001 1100 0000 1001 1111
120 : 1110 1100 0001 1111 0000 0000 1101 1000 0001 1110
160 : 1111 1111 1110 1111 1110 1111 0000 0111 0000 0111
200 : 1111 0010
```

Checking User-Specified Parameters

The C language provides a mechanism for accessing the parameters specified in the “command tail.” It provides a count of the number of parameters entered, “`argc`” (argument count), and an array of pointers to each of the character strings, “`argv`” (argument vector). At the beginning of the main function of each program you must define these two variables like this:

```
main(argc, argv)
{
int argc;      /* Argument count */
char *argv[]; /* Array of pointers to char. strings */
:
: /* Remainder of main function */
:
}
```

Consider the minimum case—a command line with just the program name on it:

```
A>command
```

The convention is that the first argument on the line is the name of the program itself. Hence `argc` would be set to one, and `argv[0]` would be a pointer to the program name, “`command`.”

Next consider a more complex case — a command line with parameters like the following:

```
A>command param1 123
```

In this case, `argc` will be three; `argv[1]` will be a pointer to `param1`; and `argv[1][0]` will access the 0 (the first) character of `argv[1]`—in this case the character “p.”

To detect whether the second parameter is present and numeric, the code will be

```
if (isdigit(argv[1][0]))
    {
        /* Process digit */
    }
else
    {
        /* Parameter either not present or has
           alpha character at the front */
    }
```

In most of the utilities, you will get a much “friendlier” program if the user need only specify enough characters of a parameter to distinguish the value entered from the other possible values. For example, consider a program that can have as a parameter one of the following values: 300, 600, 1200, 2400, 4800, 9600, or 19200. It would be convenient if the user needed to type only the first digit, rather than having to enter redundant keystrokes. However, the values 1200 and 19200 would then be ambiguous. The user would have to enter 12 or 19. Novice users often prefer to specify the entire parameter for clarity and security.

The standard C library provides a character string comparison function, `strcmp`. Unfortunately, this function does not provide for the partial matching just described. Therefore, the library includes two special functions that do make this possible: `sstrcmp` (substring compare, Figure 11-1, d) and `usstrcmp` (uppercase substring compare, Figure 11-1, e). The latter function is necessary when you need to compare a substring that could contain lowercase characters; it converts characters to uppercase before the comparison.

To assist with character string manipulation, two additional functions have been included in the library. These are `strscn` (string scan, Figure 11-1, b) and `ustrcmp` (uppercase string compare, Figure 11-1, c).

Using Code Tables

A code table is a simple structure used by all of the utility programs that accept parameters that can have any of several values. The library header contains a structure definition for a code table (Figure 11-2, r).

A code table entry contains an unsigned code value and a pointer to a character string. It is used in the utility programs wherever there is a need to relate some arbitrary code number or bit pattern to an ASCII character string. For example,

to program a serial port baud-rate-generator chip to various baud rates requires different time constants for each rate. Users do not need to know what these numbers are; they only need to be able to specify the baud rate as an ASCII string.

Thus, a code table is set up as follows:

Baud Rate Constant	User's Name
0x35	"300"
0x36	"600"
0x37	"1200"
0x3A	"2400"
0x3C	"4800"
0x3E	"9600"
0x3F	"19200"

A utility program now needs to be able to perform various operations using the code table:

- Given the input parameter on the command tail, the utility must check whether the ASCII string is in the code table, display all of the legal options on the console if it is not, and return the code value for subsequent processing if it is.
- Given the current baud rate constant (held in the BIOS), the utility must scan the code table and display the corresponding ASCII string to tell the user the current baud rate setting.

The library includes specialized functions to do this, plus some additional functions to make code tables more generally usable. These functions are

`ct_init` (code table initialize; Figure 11-1, v)

This function initializes a specific entry in a code table, setting the code value and the pointer to the character string.

`ct_parc` (code table parameter return code; Figure 11-1, w)

This performs an uppercase substring match on the specified key string, returning either an error (the value `CT_SNF`—string not found) or a code value.

`ct_code` (code table return code; Figure 11-1, x)

This function is similar to `ct_parc` in that it scans a code table and returns the corresponding code. It differs in the way that the comparison is done. The entire search string is compared with the string in the code table entry. A match only occurs when all characters are the same.

`ct_disps` (code table display strings; Figure 11-1, y)

This function displays all strings in a given code table. It is used either when the user has entered an invalid string, or when the utility program is requested to show what options are available for a parameter.

`ct_index` (code table return index; Figure 11-1, z)

This function, given a string, searches the code table and returns the *index*

of the entry that has a string matching the search string. The index is not the code value; it is the number of the entry in the table.

`ct_stri` (code table string index; Figure 11-1, aa)

This function, given an entry index number, returns a pointer to the string in that entry.

`ct_strc` (code table string code; Figure 11-1, bb)

This function, given a code number, returns a pointer to the string in the entry that has a matching code number.

Accessing a Directory via the BDOS

One problem associated with accessing the file directory directly, as illustrated by earlier functions, is that the program is presented with directory entries in exactly the order that they occur in the directory. For some programs, such as those that process groups of files, it is better to use the BDOS Search First and Search Next functions to access the directory.

Using the BDOS, the program can process the first file name to match an ambiguous search key, then go back to the BDOS to get the name of the next file, and so on. The library header contains a structure definition for a standard CP/M file control block (Figure 11-2, k).

Notice that the first byte of the FCB is a disk number rather than the user number of the directory entry. Note also the use of a union statement to describe the allocation block numbers.

The standard BDS C library contains a function, `setfcb`, that is given the address of an FCB and a pointer to a string containing a file name. It converts any "*" in the name to the appropriate number of "?", and fills the remainder of the FCB with zeros.

The example library contains the following functions designed for BDOS file directory access:

`get_nfn` (get next file name; Figure 11-1, i)

This function is given a pointer to an ambiguous file name and a pointer to an FCB. It returns with the FCB set up to access the next file that matches the ambiguous file name.

`srch_file` (search for file; Figure 11-1, j)

This function, used by `get_nfn`, issues either a Search First or a Search Next BDOS call.

`conv_fname` (convert file name; Figure 11-1, g)

This function converts a file name from an FCB into a form suitable for display on the console. It is similar to the `conv_dfname` function described earlier except that it outputs only the disk, file name, and type (not the user number) in the form

```
d:filename.typ
```

To signal the `get_nfn` function that you want the first file name, you must set the most significant bit of the first byte, the disk number.

Here is an example showing how to use the `get_nfn` function:

```

struct _fcb fcb;          /* Declare a file control block */
setmem(fcb,FCB_SIZE,0);  /* Clear FCB to zeros */
fcb.fcb_disk = 0x80;     /* Mark FCB for "first time" */

while (get_nfn(fcb,"B:XYZ*.*"))
    /* Until get_nfn returns a zero */
    {
        /* Open the file using FCB */
        while (/* Not at end of file */)
            {
                /* Process next record or
                 Character in file*/
            }
        /* Close the file */
    }

```

The quoted string "B:XYZ*.*" could also be just a pointer to a string, or a parameter on the command line, `argv[n]`.

The last function for BDOS processing of the file directory, `conv_fname`, is used to convert a file name for output to a terminal. Again, the repetitive code at the end clears the file attribute bits to avoid any side effects from the terminal.

Utility Programs Enhancing Standard CP/M

This group of utilities is designed to enhance those supplied by Digital Research. They do not take advantage of any special features of the enhanced BIOS in Figure 8-10 and can be used on *any* CP/M Version 2.2 installation.

With the exception of the ERASE utility, all of the utilities scan down the file directory using BIOS calls, as described earlier in this chapter.

ERASE — A Safer Way to Erase Files

There are two disadvantages to the Console Command Processor's built-in ERA command. First, it will unquestioningly erase groups of files. Second, if you have a file name with nongraphic or lowercase characters, you cannot use the ERA command, as the CCP converts the command tail characters to uppercase and terminates a file name on encountering any strange character in the string.

The ERASE utility shown in Figure 11-3 erases groups of files, but it asks the user for confirmation before it erases each file.

Rather than use the BIOS to access each directory entry, it uses the `get_nfn` function, which then calls the BDOS. Thus ERASE functions equally well for files

that have multiple entries in the directory. It can use the BDOS Delete File function to erase all extents of a given file.

Here is an example console dialog showing ERASE in operation:

```
P3A>erase<CR>
ERASE Version 1.0 02/23/83 (Library 1.0)
Usage :
      ERASE {d;}file_name.typ

P3A>erase *.com<CR>
ERASE Version 1.0 02/23/83 (Library 1.0)

Searching for file(s) matching A:???????.COM.
Erase A:UNERASE .COM y/n? n
Erase A:TEMP1 .COM y/n? y <== Will be Erased!
Erase A:TEMP2 .COM y/n? n
Erase A:TEMP3 .COM y/n? n
Erase A:TEMP4 .COM y/n? y <== Will be Erased!
Erase A:ERASE .COM y/n? n

Erasing files now...
File A:TEMP1 .COM erased.
File A:TEMP4 .COM erased.
```

```
#define VN "1.0 02/24/83"

/* ERASE
   This utility erases the specified file(s) logically
   by using a BDOS delete function. */

#include <LIBRARY.H>

struct _fcb amb_fcb;          /* Ambiguous name file control block */
struct _fcb fcb;             /* Used for BDOS search functions */

char file_name[20];          /* Formatted for display: d:FILENAME.TYP */
short cur_disk;              /* Current logical disk at start of program */
/* ERASE saves the FCB's of the all the
   files that need to be erased in the
   following array */

#define MAXERA 1024
struct _fcb era_fcb[MAXERA];
int ecount;                  /* Count of number of files to be erased */
int count;                   /* Used to access era_fcb during erasing */

main(argc,argv)
short argc;                  /* Argument count */
char *argv[];                /* Argument vector (pointer to an array of char. */
{
    printf("\nERASE Version %s (Library %s)",VN,LIBVN);
    chk_use(argc);           /* Check usage */
    cur_disk = bdos(GETDISK); /* Get current default disk */

    ecount = 0;              /* Initialize count of files to erase */

    setfcb(amb_fcb,argv[1]); /* Set ambiguous file name */
    if (amb_fcb.fcb_disk)    /* Check if default disk to be used */
    {
        bdos(SETDISK,amb_fcb.fcb_disk + 1); /* Set to specified disk */
    }
}
```

Figure 11-3. ERASE.C, a utility that requests confirmation before erasing

```

    /* Convert ambiguous file name for output */
    conv_fname(amb_fcb,file_name);
    printf("\n\nSearching for file(s) matching %s.",file_name);

    /* Set the file control block to indicate a "first" search */
    fcb.fcb_disk |= 0x80; /* OR in the ms bit */

    /* While not at the end of the directory, set the FCB
    to the next name that matches */
    while(get_nfn(amb_fcb,fcb))
    {
        conv_fname(fcb,file_name);
        /* Ask whether to erase file or not */
        printf("\n\terase %s y/n? ",file_name);
        if (toupper(getchar()) == 'Y')
            {
                printf(" <= Will be erased!");
                /* add current fcb to array of FCB's */
                movmem(fcb,&era_fcb[ecount++],FCBSIZE);
                /* Check that the table is not full */
                if (ecount == MAXERA)
                    {
                        printf("\nWarning : Internal table now full. No more files can be erased");
                        printf("\n until those already specified have been erased.");
                        break; /* Break out of while loop */
                    }
            }
        /* All directory entries processed */
    }

    if (ecount)
        printf("\n\nErasing files now...");

    /* now process each FCB in the array, erasing the files */
    for (count = 0; /* Starting with the first file in the array */
        count < ecount; /* Until all active entries processed */
        count++) /* Move to next FCB */
    {
        conv_fname(&era_fcb[count],file_name);
        if (bdos(DELETF,&era_fcb[count]) == -1) /* error? */
            printf("\n\007Error trying to erase %s",file_name);
        else /* File erased */
            printf("\n\terase %s",file_name);
    }
    bdos(SETDISK,cur_disk); /* reset to current disk */
}

chk_use(argc) /* Check usage */
/* This function checks that the correct number of
parameters has been specified, outputting instructions if not. */

/* Entry parameter */
int argc; /* Count of the number of arguments on the command line */

{
    /* The minimum value of argc is 1 (for the program name itself),
    so argc is always one greater than the number of parameters
    on the command line */

    if (argc != 2)
        {
            printf("\nUsage :");
            printf("\n\terase {d;}file_name.typ");
            exit();
        }
}

```

Figure 11-3. (Continued)

UNERASE — Restore Erased Files

UNERASE, as its name implies, can be used to “revive” an accidentally erased file. Only files whose allocation blocks have not been reallocated to other files can be revived. The UNERASE utility shown in Figure 11-4 builds a bit vector of all the allocation blocks used by active directory entries. Then it builds a bit vector for all the allocation blocks required by the file to be UNERASEd. If a Boolean AND between the two vectors yields a nonzero vector, then one or more blocks that originally belonged to the erased file are now allocated to other files on the disk.

```
#define VN "1.0 02/12/83"

/* UNERASE --
   This utility does the inverse of ERASE: it restores
   specified files to the directory by changing the first byte of
   their directory entries from 0xE5 back to the specified user
   number. */

#include <LIBRARY.H>

struct _dirpb dir_pb;          /* Directory management parameter block */
struct _dir *dir_entry;       /* Pointer to directory entry */
struct _scb scb;              /* Search control block */
struct _scb scba;             /* SCB set up to match all files */
struct _dpb dpb;              /* CP/M's disk parameter block */
struct _bv inuse_bv;          /* Bit vector for blocks in use */
struct _bv file_bv;           /* Bit vector for file to be unerased */
struct _bv extents;           /* Bit vector for those extents unerased */

char file_name[20];           /* Formatted for display : un/d:FILENAME.TYP */

short cur_disk;               /* Current logical disk at start of program
                               NZ = show map of number of files */
int count;                    /* Used to access the allocation block numbers
                               in each directory entry */
int user;                      /* User in which the file is to be revived */

main(argc,argv)
short argc;                    /* Argument count */
char *argv[];                  /* Argument vector (pointer to an array of chars.) */
{
    printf("\nUNERASE Version %s (Library %s)",VN,LIBVN);
    chk_use(argc);              /* Check usage */
    cur_disk = bdos(GETDISK);   /* Get current default disk */

    /* Using a special version of the set search-control-block utility,
       set the disk, name, type (no ambiguous names), the user number
       to match only erased entries, and the length to compare
       the user, name, and type.
       This special version also returns the disk_id taken from
       the file name on the command line. */
    if ((dir_pb.dp_disk = ssetscb(scb,argv[1],0xE5,12)) == 0)
    {
        /* Use default disk */
        dir_pb.dp_disk = cur_disk;
    }
    else
    {
        /* make disk A = 0, B = 1 (for SELDSK) */
        dir_pb.dp_disk--;
    }
    printf("\nSearching disk %d.",dir_pb.dp_disk);

    if(strscn(scb,"?"))          /* Check if ambiguous name */
    {
        printf("\nError -- UNERASE can only revive a single file at a time.");
        exit();
    }
}
```

Figure 11-4. UNERASE.C, a utility program that “revives” erased files

```

}

/* Set up a special search control block that will match with
all existing files. */

ssetscb(scba,"*.*",'? ',12); /* Set file name and initialize SCB */
if (argc == 2) /* No user number specified */
    user = bdos(GETUSER,0xFF); /* Get current user number */
else
{
    user = atoi(argv[2]); /* Get specified number */
    if (user > 15)
    {
        printf("\nUser number can only be 0 - 15.");
        exit();
    }
}

/* Build a bit vector that shows the allocation blocks
currently in use. SCBA has been set up to match all
active directory entries on the disk. */
build_bv(inuse_bv,scba);

/* Build a bit vector for the file to be restored showing
which allocation blocks will be needed for the file. */
if (!build_bv(file_bv,scb))
{
    printf("\nNo directory entries found for file %s.",
        argv[1]);
    exit();
}

/* Perform a boolean AND of the two bit vectors. */
bv_and(file_bv,inuse_bv,file_bv);

/* Check if the result is nonzero -- if so, then one or more
of the allocation blocks required by the erased file is
already in use for an existing file and the file cannot
be restored. */
if (bv_nz(file_bv))
{
    printf("\n--- This file cannot be restored as some parts of it");
    printf("\n have been re-used for other files! ---");
    exit();
}

/* Continue on to restore the file by changing all the entries
in the directory to have the specified user number.
Notes: There may be several entries in the directory for
the same file name and type, and even with the same extent
number. For this reason, a bit map is kept of the extent
numbers unerased -- duplicate extent numbers will not be
unerased. */

/* Set up the bit vector for up to 127 unerased extents */
bv_make(extents,16); /* 16 * 8 bits */

/* Set the directory to "closed", and force the get_nde
function to open it. */
dir_pb.dp_open = 0;

/* While not at the end of the directory, return a pointer to
the next entry in the directory. */
while(dir_entry = get_nde(dir_pb))
{
    /* Check if user = 0xE5 and name, type match */
    if (comp_fname(scb,dir_entry) == NAME_EQ)
    {
        /* Test if this extent has already been
unerased */
        if (bv_test(extents,dir_entry -> de_extent))
        {
            /* Yes it has */
            printf("\n\t\tExtent %d of %s ignored.",
                dir_entry -> de_extent,argv[1]);
            continue; /* Do not unerase this one */
        }
    }
}

```

Figure 11-4. (Continued)

```

else
    /* Indicate this extent unerased */
    {
        bv_set(extents,dir_entry -> de_extent);
        dir_entry -> de_userno = user; /* Unerase entry */
        dir_pb.dp_write = 1; /* Need to write sector back */
        printf("\n\tExtent %d of %s unerased.",
            dir_entry -> de_extent,argv[1]);
    }
}

printf("\n\nFile %s unerased in User Number %d.",
    argv[1],user);

bdos(SETDISK,cur_disk); /* Reset to current disk */
}

build_bv(bv,scb) /* Build bit vector (from directory) */
/* This function scans the directory of the disk specified in
the directory parameter block (declared as a global variable),
and builds the specified bit vector, showing all the allocation
blocks used by files matching the name in the search control
block. */

/* Entry parameters */
struct _bv *bv; /* Pointer to the bit vector */
struct _scb *scb; /* Pointer to search control block */
/* Also uses : directory parameter block (dir_pb) */

/* Exit parameters
The specified bit vector will be created, and will have 1-bits
set wherever an allocation block is found in a directory
entry that matches the search control block.
It also returns the number of directory entries matched. */
{
    unsigned abno; /* Allocation block number */
    struct _dpb *dpb; /* Pointer to the disk parameter block in the BIOS */
    int mcount; /* Match count of dir. entries matched */

    mcount = 0; /* Initialize match count */
    dpb = get_dpb(dir_pb.dp_disk); /* Get disk parameter block address */

    /* make the bit vector with one byte for each eight allocation
    blocks + 1 */
    if (!(bv_make(bv,(dpb -> dpb_maxabn >>3)+1)))
    {
        printf("\nError -- Insufficient memory to make a bit vector.");
        exit();
    }

    /* Set directory to "closed" to force the get_nde
    function to open it. */
    dir_pb.dp_open = 0;

    /* Now scan the directory building the bit vector */
    while(dir_entry = get_nde(dir_pb))
    {
        /* Compare user number (which can legitimately be
        0xE5), the file name and the type. */
        if (comp_fname(scb,dir_entry) == NAME_EQ)
        {
            ++mcount; /* Update match count */
            for (count = 0; /* Start with the first alloc. block */
                count < dir_pb.dp_nabpde; /* For number of alloc. blks. per dir. entry */
                count++)
            {
                /* Set the appropriate bit number for
                each nonzero allocation block number */
                if (dir_pb.dp_nabpde == 8) /* assume 8 2-byte numbers */
                {
                    abno = dir_entry -> _dirab.de_long[count];
                }
                else /* Assume 16 1-byte numbers */
                {

```

Figure 11-4. (Continued)

```

        abno = dir_entry -> _dirab.de_short[count];
        }
        if (abno) bv_set(bv,abno); /* Set the bit */
    }
}
return mcount; /* Return number of dir. entries matched */
}

chk_use(argc) /* Check usage */
/* This function checks that the correct number of
parameters has been specified, outputting instructions
if not. */

/* Entry parameter */
int argc; /* Count of the number of arguments on the command line */
{

/* The minimum value of argc is 1 (for the program name itself),
so argc is always one greater than the number of parameters
on the command line */

if (argc == 1 || argc > 3)
{
printf("\nUsage :");
printf("\n\tTUNERASE {d:}filename.typ {user}");
printf("\n\t\tOnly a single unambiguous file name can be used.");
exit();
}
} /* end chk_use */

ssetscb(scb,filename,user,length) /* Special version of set search control block */
/* This function sets up a search control block according
to the file name, type, user number, and number of bytes
to compare.
The file name can take the following forms :
filename
filename.typ
d:filename.typ

It sets the bit map according to which disks should be searched.
For each selected disk, it checks to see if an error is generated
when selecting the disk (i.e. if there are disk tables in the BIOS
for the disk). */

/* Entry parameters */
struct _scb *scb; /* Pointer to search control block */
char *filename; /* Pointer to the file name */
short user; /* User number to be matched */
int length; /* Number of bytes to compare */

/* Exit parameters
Disk number to be searched. (A = 1, B = 2...)
*/
{
short disk_id; /* Disk number to search */

setfcb(scb,filename); /* Set search control block as though it
were a file control block. */
disk_id = scb -> scb_userno; /* Set disk_id before it gets overwritten
by the user number */
scb -> scb_userno = user; /* Set user number */
scb -> scb_length = length; /* Set number of bytes to compare */
return disk_id;
} /* end ssetscb */

```

Figure 11-4. (Continued)

A further complication occurs if two or more directory entries of the erased file have the same extent number. This can happen if the file has been created and erased several times. Under these circumstances, UNERASE revives the first entry with a given extent number that it encounters, and displays a message on the console both when an extent is revived and when one is ignored.

Because of the complicated nature of the UNERASE process, the utility can process only a single, unambiguous file name.

The following console dialog shows UNERASE in operation:

```
P3A>dir *.com<CR>
A: UNERASE COM : TEMP2 COM : TEMP3 COM : ERASE COM

P3A>unerase<CR>
UNERASE Version 1.0 02/12/83 (Library 1.0)
Usage :
    UNERASE {d:}filename.typ {user}
    Only a single unambiguous file name can be used.

P3A>unerase temp1.com<CR>
UNERASE Version 1.0 02/12/83 (Library 1.0)
Searching disk A.
    Extent #0 of TEMP1.COM unerased.
    Extent #0 of TEMP1.COM ignored.

File TEMP1.COM unerased in User Number 3.

P3A>dir *.com<CR>
A: UNERASE COM : TEMP1 COM : TEMP2 COM : TEMP3 COM
A: ERASE COM

P3A>unerase temp5.com<CR>
UNERASE Version 1.0 02/12/83 (Library 1.0)
Searching disk A.
No directory entries found for file TEMP5.COM.
```

FIND — Find “Lost” Files

The FIND utility shown in Figure 11-5 searches all user numbers on specified logical disks, matching each entry against an ambiguous file name. It can then display either a disk map showing how many matching files were found in each user number for each disk, or the user number, file name, and type for each matched directory entry.

You can use FIND to locate a specific file or group of files, as shown in the following console dialog:

```
P3B>find<CR>
FIND Version 1.0 02/11/83 (Library 1.0)
Usage :
    FIND d:filename.typ {NAMES}
    *:filename.typ (All disks)
    ABCD..OP:filename.typ (Selected Disks)
    NAMES option shows actual names rather than map.

P3B>find ab:*. *<CR>
FIND Version 1.0 02/11/83 (Library 1.0)
```

```

Searching disk : A
Searching disk : B
      Numbers show files in each User Number.
      --- User Numbers ---
      0  1  2  3  4  5  ...  11 12 13 14 15  Used Free
A:    1  1  8
B:   66 20 74 55  3
                                     23 233
                                     252 772

P3B>find *:*.*com<CR>
FIND Version 1.0 02/11/83 (Library 1.0)
Searching disk : A
Searching disk : B
Searching disk : C
      --- User Numbers ---
      0  1  2  3  4  5  ...  11 12 13 14 15  Used Free
A:
B:   61  5  4 13
C:  -- None --
                                     23 233
                                     252 772
                                     16 112

P3B>find *.com names<CR>
FIND Version 1.0 02/11/83 (Library 1.0)
Searching disk : B
O/B:CC .COM O/B:CC2 .COM O/B:CLINK .COM 2/B:CLIB .COM
1/B:CPM61 .COM 1/B:MOVCPM .COM 1/B:PSWX .COM O/B:SUBMIT .COM
2/B:CDB .COM 1/B:CPM60 .COM O/B:DDT .COM O/B:EREMOTE .COM
O/B:SPEEDSP .COM O/B:PIP .COM O/B:PROTOSP .COM O/B:RX .COM
O/B:TXA .COM O/B:EPUB .COM O/B:EPRIV .COM O/B:WSC .COM
O/B:X .COM O/B:CRCK .COM O/B:XSUB .COM O/B:DU .COM
O/B:GERA .COM O/B:FINDALL .COM O/B:MOVEF .COM O/B:REMOTE .COM
O/B:LOCAL .COM O/B:DUMP .COM O/B:MRESET .COM O/B:ELOCAL .COM
O/B:PUTCPMF5.COM O/B:TEST .COM O/B:FDUMP .COM O/B:INVIS .COM
O/B:L80 .COM O/B:LIST .COM O/B:PUB .COM O/B:LOAD .COM
O/B:MAC .COM O/B:SCRUB .COM O/B:RXA .COM O/B:STAT .COM
O/B:TX .COM O/B:ERASEALL.COM O/B:WM .COM O/B:MSFORMAT.COM
O/B:STATUS .COM O/B:UNERA .COM O/B:MSINIT .COM O/B:VIS .COM
O/B:WSVTIP .COM O/B:XD .COM O/B:NEWVE .COM O/B:DDUMP .COM
O/B:FORMATMA.COM O/B:PRIV .COM O/B:FCOMP .COM O/B:DDUMPA .COM
O/B:PUTSYS1C.COM O/B:DDUMPNI .COM O/B:DSTAT .COM O/B:ASM .COM
2/B:CDBTEST .COM O/B:OLDSYS .COM O/B:E .COM 2/B:F/C .COM
3/B:ERASE .COM 3/B:FUNKEY .COM 3/B:DATE .COM 3/B:FIND .COM

Press Space Bar to continue....
3/B:SPACE .COM 3/B:UNERASE .COM 3/B:MAKE .COM 3/B:MOVE .COM
1/B:PUTSYSWX.COM 3/B:TIME .COM 3/B:ASSIGN .COM 3/B:SPEED .COM
3/B:PROTOCOL.COM O/B:PRINTC .COM 3/B:T .COM

```

```

#define VN "1.0 02/11/83"

/* FIND - This utility can display either a map showing on which disks
and in which user numbers files matching the specified ambiguous
file name are found, or the actual names matched. */

#include <LIBRARY.H>

struct _dirpb dir_pb; /* Directory management parameter block */
struct _dir #dir_entry; /* Pointer to directory entry (somewhere in
dir_pb) */
struct _scb scb; /* Search control block */
char file_name[20]; /* Formatted for display : un/d:FILENAME.TYP */

```

Figure 11-5. FIND.C, a utility program that locates specific files or groups of files

```

short cur_disk;          /* Current logical disk at start of program */
int mcount;             /* Match count (no. of file names matched) */
int dmcoun;            /* Per disk match count */
int lcount;            /* Line count (for lines displayed) */

int map_flag;          /* 0 = show file names of matched files,
                       NZ = show map of number of files */

/* The array below is used to tabulate the results for each
   disk drive, and for each user number on the drive.
   In addition, two extra "users" have been added for "free"
   and "used" values. */

unsigned disk_map[16][18]; /* Disk A -> P, users 0 -> 15, free, used */
#define USED_COUNT 16    /* "User" number for used entities */
#define FREE_COUNT 17   /* "User" number for free entities */

main(argc,argv)
short argc;           /* Argument count */
char *argv[];        /* Argument vector (pointer to an array of chars.) */
{
    printf("\nFIND Version %s (Library %s)",VN,LIBVN);
    chk_use(argc);    /* Check usage */
    cur_disk = bdos(GETDISK); /* Get current default disk */
    dm_clr(disk_map); /* Reset disk map */

    /* Set search control block
       disks, name, type, user number, extent number,
       and number of bytes to compare -- in this case, match all users,
       but only extent 0 */
    setscb(scb,argv[1], '?', 0, 13); /* Set disks, name, type */

    map_flag = usstrcmp("NAMES",argv[2]); /* Set flag for map option */

    lcount = dmcoun = mcount = 0; /* Initialize counts */

    for (scb.scb_disk = 0; /* Starting with logical disk A; */
         scb.scb_disk < 16; /* Until logical disk P; */
         scb.scb_disk++) /* Move to next logical disk */
    {
        /* Check if current disk has been selected for search */
        if (!(scb.scb_adisks & (1 << scb.scb_disk)))
            continue; /* No, so bypass this disk */

        printf("\nSearching disk : %c", (scb.scb_disk + 'A'));
        lcount++; /* Update line count */

        dir_pb.dp_disk = scb.scb_disk; /* Set to disk to be searched */
        dmcoun = 0; /* Reset disk matched count */

        if (!map_flag) /* If file names are to be displayed */
            putchar('\n'); /* Move to column 1 */

        /* Set the directory to "closed", and force the get_nde
           function to open it */
        dir_pb.dp_open = 0;

        /* While not at the end of the directory, set a pointer to the
           next directory entry */
        while(dir_entry = get_nde(dir_pb))
        {
            /* Check if entry in use, to update
               the free/used counts */

            if (dir_entry -> de_userno == 0xE5) /* Unused */
                disk_map[scb.scb_disk][FREE_COUNT]++;
            else /* In use */
                disk_map[scb.scb_disk][USED_COUNT]++;

            /* Select only those active entries that are the
               first extent (numbered 0) of a file that matches
               the name supplied by the user */

```

Figure 11-5. (Continued)

```

    if (
        (dir_entry -> de_userno != 0xES) &&
        (dir_entry -> de_extent == 0) &&
        (comp_fname(scb,dir_entry) == NAME_EQ)
    )
    {
        mcount++; /* Update matched counts */
        dmcount++; /* Per disk count */

        if (map_flag) /* Check map option */
        {
            /* Update disk map */
            disk_map[scb.scb_disk][dir_entry -> de_userno]++;
        }
        else /* Display names */
        {
            conv_dfname(scb.scb_disk,dir_entry,file_name);
            printf("%s ",file_name);

            /* Check if need to start new line */
            if (!(dmcount % 4))
            {
                putchar('\n');
                if (++lcount > 18)
                {
                    lcount = 0;
                    printf("\nPress Space Bar to continue....");
                    getchar();
                    putchar('\n');
                }
            }
        }
    }
} /* End of directory */
} /* All disks searched */

if (map_flag)
{
    printf("\n          Numbers show files in each user number.");
    printf("\n          --- User Numbers ---                               Dir. Entries");

    dm_disp(disk_map,scb.scb_adisks); /* Display disk map */
}

if (mcount == 0)
    printf("\n --- File Not Found --- ");

bdos(SETDISK,cur_disk); /* Reset to current disk */
}

chk_use(argc) /* check usage */
/* This function checks that the correct number of
   parameters has been specified, outputting instructions
   if not.
*/

/* Entry parameter */
int argc; /* Count of the number of arguments on the command line */
{
    /* The minimum value of argc is 1 (for the program name itself),
       so argc is always one greater than the number of parameters
       on the command line */

    if (argc == 1 || argc > 3)
    {
        printf("\nUsage :");
        printf("\n\tFIND d:filename.typ (NAMES)");
        printf("\n\t *filename.typ (All disks)");
        printf("\n\t ABCD.OP:filename.typ (Selected Disks)");
        printf("\n\tNAMES option shows actual names rather than map.");
        exit();
    }
}
}

```

Figure 11-5. (Continued)

SPACE — Show Used Disk Space

The SPACE utility shown in Figure 11-6 scans the specified logical disks and displays a disk map that shows, for each user number on each logical disk, how many Kbytes of storage have been used. It also displays the total number of Kbytes used and free on each logical disk.

Here is an example console dialog showing SPACE in operation:

```
P3B>space<CR>
SPACE Version 1.0 02/11/83 (Library 1.0)
Usage :
        SPACE *           (All disks)
        SPACE ABCD..OP (Selected Disks)

P3B>space * <CR>
SPACE Version 1.0 02/11/83 (Library 1.0)
Searching disk : A
Searching disk : B
Searching disk : C

                        Numbers show space used in kilobytes.
                        --- User Numbers ---
A:  0  1  2  3  4  5  ...  10 11 12 13 14 15  Used Free
B: 18 202      38      258 1196
C: 692 432 656 548 36    2364 996
   140                      140 204
```

```
#define VN "1.0 02/11/83"

/* SPACE -- This utility displays a map showing on the amount of space
(expressed as relative percentages) occupied in each user number
for each logical disk. It also shows the relative amount of space
free. */

#include <LIBRARY.H>

struct _dirpb dir_pb;      /* Directory management parameter block */
struct _dir *dir_entry;   /* Pointer to directory entry */
struct _scb scb;          /* Search control block */
struct _dpb dpb;          /* CP/M's disk parameter block */

char file_name[20];        /* Formatted for display : un/d:FILENAME.TYP */

short cur_disk;           /* Current logical disk at start of program
                           NZ = show map of number of files */
int count;                /* Used to access the allocation block numbers
                           in each directory entry */
int user;                 /* Used to access the disk map when calculating */

/* The array below is used to tabulate the results for each
disk drive, and for each user number on the drive.
In addition, two extra "users" have been added for "free"
and "used" values.
*/
unsigned disk_map[16][18]; /* Disk A -> P, users 0 -> 15, free, used */
#define USED_COUNT 16      /* "User" number for used entities */
#define FREE_COUNT 17     /* "User" number for free entities */

main(argc,argv)
short argc;               /* Argument count */
char *argv[];             /* Argument vector (pointer to an array of chars.) */
{
```

Figure 11-6. SPACE.C, a utility that displays how much disk storage is used or available

```

printf("\nSPACE Version %s (Library %s)",VN,LIBVN);
chk_use(argc); /* Check usage */
cur_disk = bdos(OETDISK); /* Get current default disk */

dm_clr(disk_map); /* Reset disk map */

ssetscb(scb,argv[1]); /* Special version : set disks,
name, type */

for (scb.scb_disk = 0; /* Starting with logical disk A: */
scb.scb_disk < 16; /* Until logical disk P: */
scb.scb_disk++) /* Move to next logical disk */
{
/* Check if current disk has been selected for search */
if (!(scb.scb_adisks & (1 << scb.scb_disk)))
continue; /* No, so bypass this disk */

printf("\nSearching disk : %c", (scb.scb_disk + 'A'));
dir_pb.dp_disk = scb.scb_disk; /* Set to disk to be searched */

/* Set the directory to "closed", and force the get_nde
function to open it */
dir_pb.dp_open = 0;

/* While not at the end of the directory, set a pointer
to the next entry in the directory */
while (dir_entry = get_nde(dir_pb))
{
if (dir_entry -> de_userno == 0xE5)
continue; /* Bypass inactive entries */

for (count = 0; /* Start with the first alloc. block */
count < dir_pb.dp_nabpde; /* For number of alloc. blks. per dir. entry */
count++)
{
if (dir_pb.dp_nabpde == 8) /* Assume 8 2-byte numbers */
{
disk_map[scb.scb_disk][dir_entry -> de_userno]
+= (dir_entry -> _dirab.de_long[count] > 0 ? 1 : 0);
}
else /* Assume 16 1-byte numbers */
{
disk_map[scb.scb_disk][dir_entry -> de_userno]
+= (dir_entry -> _dirab.de_short[count] > 0 ? 1 : 0);
}
} /* All allocation blocks processed */
} /* End of directory for this disk */

/* Compute the storage used by multiplying the number of
allocation blocks counted by the number of Kbytes in
each allocation block. */

for (user = 0; /* Start with user 0 */
user < 16; /* End with user 15 */
user++) /* Move to next user number */
{
/* Compute size occupied in Kbytes */
disk_map[scb.scb_disk][user] *= dir_pb.dp_abszize;
/* Build up sum for this disk */
disk_map[scb.scb_disk][USED_COUNT] += disk_map[scb.scb_disk][user];
}

/* Free space = (# of alloc. blks * # of kbyte per blk)
- used Kbytes
- (directory entries * 32) / 1024 ... or divide by 32 */
disk_map[scb.scb_disk][FREE_COUNT] = (dir_pb.dp_nab * dir_pb.dp_abszize)
- disk_map[scb.scb_disk][USED_COUNT]
- (dir_pb.dp_nument >> 5); /* Same as / 32 */
} /* All disks processed */

printf("\n
Numbers show space used in kilobytes.");
printf("\n
--- User Numbers ---
Space (Kb)");

dm_disp(disk_map,scb.scb_adisks); /* Display disk map */

```

Figure 11-6. (Continued)

```

bdos(SETDISK,cur_disk); /* Reset to current disk */
}

ssetsb(scb,ldisks) /* Special version of set search control block */

/* This function sets up a search control block according
to just the logical disks specified. The disk are specified as
a single string of characters without any separators. An
asterisk means "all disks." For example --

    ABGH (disks A:, B:, G: and H:)
    * (all disks for which SELDSK has tables)

It sets the bit map according to which disks should be searched.
For each selected disk, it checks to see if an error is generated
when selecting the disk (i.e. if there are disk tables in the BIOS
for the disk).
The file name, type, and extent number are all set to "?" to match
all possible entries in the directory. */

/* Entry parameters */
struct _scb *scb; /* Pointer to search control block */
char *ldisks; /* Pointer to the logical disks */

/* Exit parameters
None.
*/
{
int disk; /* Disk number currently being checked */
unsigned adisks; /* Bit map for active disks */

adisks = 0; /* Assume no disks to search */

if (*ldisks) /* Some values specified */
    {
    if (*ldisks == '*') /* Check if "all disks" */
        {
        adisks = 0xFFFF; /* Set all bits */
        }
    else /* Set specific disks */
        {
        while(*ldisks) /* Until end of disks reached */
            {
            /* Build the bit map by getting the next disk
            id. (A - P), converting it to a number
            in the range 0 - 15, and shifting a 1-bit
            left that many places and OR ing it into
            the current active disks.
            */
            adisks := 1 << (toupper(*ldisks) - 'A');
            ++ldisks; /* Move to next character */
            }
        }
    }
else /* Use only current default disk */
    {
    /* Set just the bit corresponding to the current disk */
    adisks = 1 << bdos(GETDISK);
    }

    /* Set the user number, file name, type, and extent to "?"
    so that all active directory entries will match */
    /* 0123456789012 */
    strcpy(&scb -> scb_userno, "????????????");

    /* Make calls to the BIOS SELDSK routine to make sure that
    all of the active disk drives have disk tables for them
    in the BIOS. If they don't, turn off the corresponding
    bits in the bit map. */

for (disk = 0; /* Start with disk A: */
disk < 16; /* Until disk P: */
disk++) /* Use next disk */
    {
    if ( !((1 << disk) & adisks))
        continue; /* Avoid selecting unspecified disks */

```

Figure 11-6. (Continued)

```

        if (biosh(SELDSK,disk) == 0)    /* Make BIOS SELDSK call */
        {                               /* Returns 0 if invalid disk */
            /* Turn OFF corresponding bit in mask
            by AND-ing it with bit mask having
            all the other bits set = 1. */
            adisks &= ((1 << disk) ^ 0xFFFF);
        }
    }

    scb -> scb_adisks = adisks;    /* Set bit map in scb */
} /* End ssetscb */

chk_use(argc)                    /* Check usage */
/* This function checks that the correct number of
parameters has been specified, outputting instructions
if not. */

/* Entry parameter */
int argc;                        /* Count of the number of arguments on the command line */
{
    /* The minimum value of argc is 1 (for the program name itself),
    so argc is always one greater than the number of parameters
    on the command line */

    if (argc != 2)
    {
        printf("\nUsage :");
        printf("\n\tSPACE *      (All disks)");
        printf("\n\tSPACE ABCD..OP (Selected Disks)");
        exit();
    }
} /* End chk_use */

```

Figure 11-6. (Continued)

MOVE — Move Files Between User Numbers

The MOVE utility shown in Figure 11-7 moves files from one user number to another on the same logical disk. The movement is achieved by changing the user number in all the relevant directory entries. This is much faster than copying the files. It also avoids having multiple copies of the same file on the disk.

Here is a console dialog showing MOVE in operation:

```

P3B>move<CR>
MOVE Version 1.0 02/10/83 (Library 1.0)
Usage :
    MOVE d:filename.typ to_user {from_user} {NAMES}
        *:filename.typ (All disks)
        ABCD..OP:filename.typ (Selected Disks)
    NAMES option shows names of files moved.

P3B>dir *.com<CR>
B: ERASE      COM : FUNKEY  COM : DATE      COM : FIND      COM
B: SPACE     COM : UNERASE COM : MAKE     COM : MOVE      COM
B: TIME      COM : ASSIGN  COM : SPEED   COM : PROTOCOL COM

P3B>move *.com 0 names<CR>
MOVE Version 1.0 02/10/83 (Library 1.0)

Moving file(s) 3/B:?????????.COM -> User 0.

```

```

O/B:ERASE .COM O/B:FUNKEY .COM O/B:DATE .COM O/B:FIND .COM
O/B:SPACE .COM O/B:UNERASE .COM O/B:MAKE .COM O/B:MOVE .COM
O/B:TIME .COM O/B:ASSIGN .COM O/B:SPEED .COM O/B:PROTOCOL.COM

```

```
P3B>user O<CR>
```

```
POB>dir
```

```

B: ERASE COM : FUNKEY COM : DATE COM : FIND COM
B: SPACE COM : UNERASE COM : MAKE COM : MOVE COM
B: TIME COM : ASSIGN COM : SPEED COM : PROTOCOL COM

```

```

#define VN "1.0 02/10/83"

/* MOVE -- This utility transfers file(s) from one user number to
another, but on the SAME logical disk. Files are not actually
copied -- rather, their directory entries are changed. */

#include <LIBRARY.H>

struct _dirpb dir_pb; /* Directory management parameter block */
struct _dir *dir_entry; /* Pointer to directory entry */
struct _scb scb; /* Search control block */

#define DIR_BSZ 128 /* Directory buffer size */
char dir_buffer[DIR_BSZ]; /* Directory buffer */

char file_name[20]; /* Formatted for display : un/dr:FILENAME.TYP */
short name_flag; /* NZ to display names of files moved */

short cur_disk; /* Current logical disk at start of program */
int from_user; /* User number from which to move files */
int to_user; /* User number to which files will be moved */

int mcount; /* Match count (no. of file names matched) */
int dcount; /* Per-disk match count */
int lcount; /* Line count (for lines displayed) */

main(argc,argv)
short argc; /* Argument count */
char *argv[]; /* Argument vector (pointer to an array of chars.) */
{
printf("\nMOVE Version %s (Library %s)",VN,LIBVN);

chk_use(argc); /* Check usage */

to_user = atoi(argv[2]); /* Convert user no. to integer */
/* Set and check destination user number */
if((to_user > 15)
{
printf("\nError -- the destination user number cannot be greater than 15.");
}

/* Set the current user number */
from_user = bdos(GETUSER,0xFF);

/* Check if source user number specified */
if (isdigit(argv[3][0])
{
/* Set and check source user number */
if((from_user = atoi(argv[3])) > 15)
{
printf("\nError -- the source user number cannot be greater than 15.");
exit();
}
/* Set name suppress flag from parameter #4 */
name_flag = usstrcmp("NAMES",argv[4]);
}
else
/* No source user specified */
{

```

Figure 11-7. MOVE.C, a utility program that changes files' user numbers

```

    /* Set name suppress flag from parameter #3 */
    name_flag = usstrcmp("NAMES",argv[3]);
}

/* To simplify the logic below, name_flag must be made
   NZ if it is equal to NAME_EQ, 0 if it is any other value */
name_flag = (name_flag == NAME_EQ ? 1 : 0);

if (to_user == from_user) /* To = from */
{
    printf("\nError - 'to' user number is the same as 'from' user number.");
    exit();
}

/* Set the search control block file name, type, user number,
   extent number, and length -- length matches user number, file
   name, and type. As the extent number does not enter into the
   comparison, all extents of a given file will be found. */
setscb(scb,argv[1],from_user,'?',13);

cur_disk = bdos(GETDISK); /* Get current default disk */
lcount = dmcount = mcount = 0; /* Initialize counts */

for (scb.scb_disk = 0; /* Starting with logical disk A: */
     scb.scb_disk < 16; /* Until logical disk P: */
     scb.scb_disk++) /* Move to next logical disk */
{
    /* Check if current disk has been selected for search */
    if (!(scb.scb_adisks & (1 << scb.scb_disk)))
        continue; /* No, so bypass this disk */
    /* convert search user number and name for output */
    conv_dfname(scb.scb_disk,scb.file_name);
    printf("\n\nMoving file(s) %s -> User %d.",file_name,to_user);

    lcount++; /* Update line count */

    dir_pb.dp_disk = scb.scb_disk; /* Set to disk to be searched*/
    dmcount = 0; /* Reset disk matched count */

    if (name_flag) /* If file names are to be displayed */
        putchar('\n'); /* Move to column 1 */

    /* Set the directory to "closed" to force the get_nde
       function to open it. */
    dir_pb.dp_open = 0;

    /* While not at the end of the directory, set a pointer
       to the next directory entry */
    while(dir_entry = get_nde(dir_pb))
    {
        /* Match those entries that have the correct
           user number, file name, type, and any
           extent number. */

        if (
            (dir_entry->de_userno != 0xE5) &&
            (comp_fname(scb,dir_entry) == NAME_EQ)
        )
        {
            dir_entry->de_userno = to_user; /* Move to new user */
            /* Request sector to be written back */
            dir_pb.dp_write = 1;

            mcount++; /* Update matched counts */
            dmcount++; /* Per-disk count */

            if (name_flag) /* Check map option */
            {
                conv_dfname(scb.scb_disk,dir_entry,file_name);
                printf("%s ",file_name);

                /* Check if need to start new line */
                if (!(dmcount % 4))
                {
                    putchar('\n');
                    if (++lcount > 18)

```

Figure 11-7. (Continued)

```

        {
        lcount = 0;
        printf("\nPress Space Bar to continue....");
        getchar();
        putchar('\n');
        }
    }
}

if (mcount == 0)
    printf("\n --- No Files Moved --- ");

bdos(SETDISK,cur_disk); /* Reset to current disk */
}

chk_use(argc) /* Check usage */
/* This function checks that the correct number of
parameters has been specified, outputting instructions
if not */
/* Entry parameter */
int argc; /* Count of the number of arguments on the command line */
{
/* The minimum value of argc is 1 (for the program name itself),
so argc is always one greater than the number of parameters
on the command line */

if (argc == 1 || argc > 5)
{
printf("\nUsage :");
printf("\n\tMOVE d:filename.typ to_user {from_user} {NAMES}");
printf("\n\t\t*:filename.typ (All disks)");
printf("\n\t\tABCD..OP:filename.typ (Selected Disks)");
printf("\n\tNAMES option shows names of files moved.");
exit();
}
}
}

```

Figure 11-7. (Continued)

Other Utilities

The utility programs described in this section are by no means a complete set. You may want to develop many other specialized utility programs. Some possibilities are:

FILECOPY

A more specialized version of PIP could copy ambiguously specified groups of files. Of special importance would be the ability to read a file containing the names of the files to be copied. A useful option would be the ability to detect the setting of the unused file attribute bit and copy only files that have been changed.

PROTECT/UNPROTECT

This pair of utilities would allow you to "hide" files in user numbers greater than 15. Files so hidden could not be accessed other than by UNPROTECTing them, thereby moving them back into the normal user number range.

RECLAIM

This utility would read all sectors on a disk (using the BIOS). Any bad sectors encountered could then be logically removed by creating an entry in the file directory, with allocation block numbers that would effectively “reserve” the blocks containing the bad sectors.

OWNER

This utility, given a track or sector number, would access the directory and determine which file or files were using that part of the disk. This is useful if you have a bad sector or track on a disk. You then can determine which files have been damaged.

Utility Programs for the Enhanced BIOS

This section describes several utility programs that work with the enhanced BIOS shown in Figure 8-10. Several of these utilities work directly with the physical devices on the computer system, which can vary from computer to computer. The library header contains #define declarations for device numbers and names for physical devices (Figure 11-2, f and Figure 11-2, g).

These #define statements are used to build a physical-device code table. If you have more physical devices or want to change the names by which you refer to the devices, you will need to change these definitions.

All of these utilities share some common features in the way that they are invoked. If they are called without any parameters, they display instructions on the console regarding what parameters are available. If they are called with the word “SHOW” (or “S”, “SH”, and so forth) as a parameter, they display the current settings of whatever attribute the utility controls.

MAKE — Make Files “Invisible” or “Visible”

The MAKE utility shown in Figure 11-8 is designed to operate in conjunction with the public files option implemented in the enhanced BIOS of Figure 8-10. It has two modes of operation — making files “invisible” or “visible.”

An invisible file is one in user 0 which has been set to Read-Only and System status. When the public files option is enabled, these files cannot be seen when you use the DIR command, nor can they be erased accidentally.

A visible file is one that has been set to Read/Write and Directory status.

When files are made invisible, they are transferred from the current user number to user 0. When files are made visible, they are transferred from user 0 to the current user number.

Here is an example console dialog showing MAKE in operation:

```
P3B>make<CR>
MAKE Version 1.0 02/12/83 (Library 1.0)
```

SPEED — Set Baud Rates

The SPEED utility shown in Figure 11-9 sets the baud rate for a specific serial device. Here is an example console dialog that shows several of the options:

```
P3B>speed<CR>
SPEED 1.0 02/17/83
The SPEED utility sets the baud rate speed for each physical device.
Usage is : SPEED physical-device baud-rate, or
          SPEED SHOW      (to show current settings)
```

```
Valid physical devices are:
    TERMINAL
    PRINTER
    MODEM
```

```
Valid baud rates are:
    300
    600
    1200
    2400
    4800
    9600
    19200
```

```
P3B>speed show<CR>
SPEED 1.0 02/17/83
Current Baud Rate settings are :
    TERMINAL set to 9600 baud.
    PRINTER set to 9600 baud.
    MODEM set to 9600 baud.
```

```
P3B>speed m 19<CR>
SPEED 1.0 02/17/83
Current Baud Rate settings are :
    TERMINAL set to 9600 baud.
    PRINTER set to 9600 baud.
    MODEM set to 19200 baud.
```

```
P3B>speed xyz 12<CR>
SPEED 1.0 02/17/83
Physical Device 'XYZ' is invalid or ambiguous.
Legal Physical Devices are :
    TERMINAL
    PRINTER
    MODEM
```

```
#define VN "\nSPEED 1.0 02/17/83"
/* This utility sets the baud rate speed for each of the physical
   devices. */
#include <LIBRARY.H>
struct _ct ct_pdev[IMAXPDEV + 2];      /* Physical device table */
/* Hardware specific items */
```

Figure 11-9. SPEED.C, a utility that sets the baud rate for a specific device

```

/* Baud rates for serial ports */
#define B300    0x35    /* 300 baud */
#define B600    0x36    /* 600 baud */
#define B1200   0x37    /* 1200 baud */
#define B2400   0x3A    /* 2400 baud */
#define B4800   0x3C    /* 4800 baud */
#define B9600   0x3E    /* 9600 baud */
#define B19200  0x3F    /* 19200 baud */
struct _ct ct_br[10]; /* Code table for baud rates (+ spare entries) */

/* Parameters on the command line */
#define PDEV argv[1] /* Physical device */
#define BAUD argv[2] /* Baud rate */

main(argc,argv)
int argc;
char *argv[];
{
printf(VN); /* Display sign-on message */
setup(); /* Set up code tables */
chk_use(argc); /* Check correct usage */

/* Check if request to show current settings */
if (usstrcmp("SHOW",argv[1]))
{ /* No -- assume setting is required */
set_baud(get_pdev(PDEV),get_baud(BAUD)); /* Set baud rate */
}

show_baud(); /* Display current settings */
} /* end of program */

setup() /* set up the code tables for this program */
{
/* Initialize the physical device table */
ct_init(ct_pdev[0],T_DEVN,PN_T); /* Terminal */
ct_init(ct_pdev[1],P_DEVN,PN_P); /* Printer */
ct_init(ct_pdev[2],M_DEVN,PN_M); /* Modem */
ct_init(ct_pdev[3],CT_SNF,""); /* Terminator */

/* Initialize the baud rate table */
ct_init(ct_br[0],B300,"300");
ct_init(ct_br[1],B600,"600");
ct_init(ct_br[2],B1200,"1200");
ct_init(ct_br[3],B2400,"2400");
ct_init(ct_br[4],B4800,"4800");
ct_init(ct_br[5],B9600,"9600");
ct_init(ct_br[6],B19200,"19200");
ct_init(ct_br[7],CT_SNF,""); /* Terminator */
}

unsigned
get_pdev(ppdev) /* Get physical device */
/* This function returns the physical device code
specified by the user in the command line. */
char *ppdev; /* Pointer to character string */
{
unsigned retval; /* Return value */

retval = ct_parc(ct_pdev,ppdev); /* Get code for ASCII string */
if (retval == CT_SNF) /* If string not found */
{
printf("\n\007Physical Device '%s' is invalid or ambiguous.",
ppdev);
printf("\nLegal Physical Devices are : ");
ct_disps(ct_pdev); /* Display all values */
exit();
}
return retval; /* Return code */
}

unsigned
get_baud(pbaud)
/* This function returns the baud rate time constant for
the baud rate specified by the user in the command line */

```

Figure 11-9. (Continued)

```

char #pbaud;          /* Pointer to character string */
{
  unsigned retval;   /* Return value */
  retval = ct_parc(ct_br,pbaud); /* Get code for ASCII string */
  if (retval == CT_SNF) /* If string not found */
  {
    printf("\n\007Baud Rate '%s' is invalid or ambiguous.",
           pbaud);
    printf("\nLegal Baud Rates are : ");
    ct_disps(ct_br); /* Display all values */
    exit();
  }
  return retval;    /* Return code */
}

set_baud(pdevc,baudc) /* Set the baud rate of the specified device */
int pdevc;           /* Physical device code */
short baudc;        /* Baud rate code */
/* On some systems this may have to be a
two-byte (unsigned) value */
{
  short #baud_rc;   /* Pointer to the baud rate constant */
/* On some systems this may have to be a
two-byte (unsigned) value */
/* Note: the respective codes for accessing the baud rate constants
via the get_cba (get configuration block address) function are:
Device #0 = 19, #1 = 21, #2 = 23. This function uses this
mathematical relationship */

/* Set up pointer to the baud rate constant */
baud_rc = get_cba(CB_DO_BRC + (pdevc << 1));

/* Then set the baud rate constant */
#baud_rc = baudc;

/* Then call the BIOS initialization routine */
bios(CIOINIT,pdevc);
}

show_baud()         /* Show current baud rate */
{
  int pdevn;        /* Physical device number */
  short baudc;     /* Baud rate code */
/* On some systems this may have to be a
two-byte (unsigned) value */
  short #baud_rc; /* Pointer to the baud rate constant */
/* On some systems this may have to be a
two-byte (unsigned) value */
/* Note: the respective codes for accessing the baud rate constants
via the get_cba (get configuration block address) function are:
Device #0 = 19, #1 = 21, #2 = 23. This function uses this
mathematical relationship */

printf("\nCurrent baud rate settings are :");

for (pdevn = 0; pdevn <= MAXPDEV; pdevn++) /* All physical devices */
{
  /* Set up pointer to the baud rate constant --
the code for the get_cba function is computed
by adding the physical device number *2 to
the Baud Rate code for device #0 */

  baud_rc = get_cba(CB_DO_BRC + (pdevn << 1));

  /* Then set the baud rate constant */
  baudc = #baud_rc;

  printf("\n\t%s set to %s baud.",
         ct_strc(ct_pdev,pdevn), /* Get ptr. to device name */
         ct_strc(ct_br,baudc)); /* Get ptr. to baud rate */
}
}

chk_use(argc)      /* Check correct usage */
int argc;          /* Argument count */
{

```

Figure 11-9. (Continued)

```

if (argc == 1)
{
printf("\nThe SPEED utility sets the baud rate speed for each physical device.");
printf("\nUsage is :  SPEED physical-device baud rate, or");
printf("\n          SPEED SHOW    (to show current settings)");
printf("\n\nValid physical devices are: ");
ct_disps(ct_pdev);
printf("\nValid baud rates are: ");
ct_disps(ct_br);
exit();
}
}

```

Figure 11-9. (Continued)

PROTOCOL — Set Serial Line Protocols

The PROTOCOL utility shown in Figure 11-10 is used to set the protocol for a specific serial device.

The drivers for each physical device can support several serial line protocols. The protocols are divided into two groups, depending on whether they apply to data output by or input to the computer.

Note that the output DTR and input RTS protocols can coexist with other protocols. The strategy is first to set the required character-based protocol and then to set the DTR/RTS protocol. There is an example of this in the following console dialog:

```

P3B>protocol<CR>
PROTOCOL Vn 1.0 02/17/83
PROTOCOL sets the physical device's serial protocols.
          PROTOCOL physical-device direction protocol {message-length}

```

```

Legal physical devices are :
          TERMINAL
          PRINTER
          MODEM

```

```

Legal direction/protocols are :
          Output DTR
          Output XON
          Output ETX
          Input RTS
          Input XON

```

Message length can be specified with Output ETX.

```

P3B>protocol show<CR>
PROTOCOL Vn 1.0 02/17/83
          Protocol for TERMINAL - None.
          Protocol for PRINTER - Output XON
          Protocol for MODEM - Input RTS

```

```

P3B>protocol m o e 128<CR>
PROTOCOL Vn 1.0 02/17/83
          Protocol for TERMINAL - None.
          Protocol for PRINTER - Output XON

```

Protocol for MODEM - Output ETX Message Length 128 bytes.

```
P3B>protocol m q d<CR>
PROTOCOL Vn 1.0 02/17/83
Protocol for TERMINAL - None.
Protocol for PRINTER - Output XON
Protocol for MODEM - Output DTR Output ETX Message Length
128 bytes.
```

```
#define VN "\nPROTOCOL Vn 1.0 02/17/83"
/* PROTOCOL -- This utility sets the serial port protocol for the
specified physical device. Alternatively, it displays the
current protocols for all of the serial devices. */

#include <LIBRARY.H>

/* Code tables used to relate ASCII strings to code values */
struct _ct ct_iproto[3]; /* Code table for input protocols */
struct _ct ct_oproto[4]; /* Code table for output protocols */
struct _ct ct_dproto[7]; /* Code table for displaying protocols */
struct _ct ct_pdev[MAXPDEV + 2]; /* Physical device table */
struct _ct ct_io[3]; /* Input, output */

/* Parameters on the command line */
#define PDEV argv[1] /* Physical device */
#define IO argv[2] /* Input/output */
#define PROTO argv[3] /* Protocol */
#define PROTOL argv[4] /* Protocol message length */

main(argc,argv)
int argc;
char *argv[];
{
printf(VN); /* Display sign-on message */
setup(); /* Set up code tables */
chk_use(argc); /* Check correct usage */

/* Check if request to show current settings */
if (usstrcmp("SHOW",argv[1]))
{ /* No -- assume a set is required */
set_pdev(get_pdev(PDEV), /* Physical device */
/* Input/output and protocol */
get_proto(get_io(IO),PROTO),
PROTOL); /* Protocol message length */
}
show_proto();
} /* end of program */

setup() /* Set up the code tables for this program */
{
/* Initialize the physical device table */
ct_init(ct_pdev[0],0,PN_T); /* Terminal */
ct_init(ct_pdev[1],1,PN_P); /* Printer */
ct_init(ct_pdev[2],2,PN_M); /* Modem */
ct_init(ct_pdev[3],CT_SNF,"#"); /* Terminator */

/* Initialize the input/output table */
ct_init(ct_io[0],0,"INPUT");
ct_init(ct_io[1],1,"OUTPUT");
ct_init(ct_io[2],CT_SNF,"#"); /* Terminator */

/* Initialize the output protocol table */
ct_init(ct_oproto[0],DT_ODTR,"DTR");
ct_init(ct_oproto[1],DT_OXON,"XON");
ct_init(ct_oproto[2],DT_DETX,"ETX");
```

Figure 11-10. PROTOCOL.C, a utility that sets the protocol governing input and output of a specified serial device

```

ct_init(ct_oproto[3],CT_SNF,"*");      /* Terminator */

/* Initialize the input protocol table */
ct_init(ct_iproto[0],DT_IRTS,"RTS");
ct_init(ct_iproto[1],DT_IXON,"XON");
ct_init(ct_iproto[2],CT_SNF,"*");      /* Terminator */

/* Initialize the display protocol */
ct_init(ct_dproto[0],DT_ODTR,"Output DTR");
ct_init(ct_dproto[1],DT_OXON,"Output XON");
ct_init(ct_dproto[2],DT_OETX,"Output ETX");
ct_init(ct_dproto[3],DT_IRTS,"Input RTS");
ct_init(ct_dproto[4],DT_IXON,"Input XON");
ct_init(ct_dproto[5],CT_SNF,"*");
}

unsigned
get_pdev(ppdev)      /* Get physical device */
/* This function returns the physical device code
   specified by the user in the command line. */
char *ppdev;        /* Pointer to character string */
{
unsigned retval;    /* Return value */

retval = ct_pars(ct_pdev,ppdev); /* Get code for ASCII string */
if (retval == CT_SNF) /* If string not found */
{
printf("\n007Physical Device '%s' is invalid or ambiguous.",
      ppdev);
printf("\nLegal Physical Devices are : ");
ct_disps(ct_pdev); /* Display all values */
exit();
}
return retval;     /* Return code */
}

unsigned
get_io(pio)         /* Get input/output parameter */
char *pio;         /* Pointer to character string */
{
unsigned retval;   /* Return value */

retval = ct_pars(ct_io,pio); /* Get code for ASCII string */
if (retval == CT_SNF) /* If string not found */
{
printf("\n007Input/Output direction '%s' is invalid or ambiguous.",
      pio);
printf("\nLegal values are : ");
ct_disps(ct_io); /* Display all values */
exit();
}
return retval;    /* Return code */
}

unsigned
get_proto(output,pproto)
/* This function returns the protocol code for the
   protocol specified by the user in the command line. */
int output; /* =1 for output, =0 for input */
char *pproto; /* Pointer to character string */
{
unsigned retval; /* Return value */

if (output) /* OUTPUT specified */
{
/* Get code for ASCII string */
retval = ct_pars(ct_oproto,pproto);
if (retval == CT_SNF) /* If string not found */
{
printf("\n007Output Protocol '%s' is invalid or ambiguous.",
      pproto);
printf("\nLegal Output Protocols are : ");
ct_disps(ct_oproto); /* Display valid protocols */
exit();
}
}
}

```

Figure 11-10. (Continued)

```

    }
else
    {
        /* INPUT specified */
        /* Get code for ASCII string */
        retval = ct_parc(ct_iproto,pproto);
        if (retval == CT_SNF) /* If string not found */
        {
            printf("\n\007Input Protocol '%s' is invalid or ambiguous.",
                pproto);
            printf("\nLegal Input Protocols are : ");
            ct_disps(ct_iproto); /* Display valid protocols */
            exit();
        }
    }
return retval; /* Return code */
}

set_proto(pdevc,protoc,pplength)/* Set the protocol for physical device */
int pdevc; /* Physical device code */
unsigned protoc; /* Protocol byte */
char *pplength; /* Pointer to protocol length */
{
    struct _ppdt
    {
        char *pdt[16]; /* Array of 16 pointers to the device tables */
    };
    struct _ppdt *ppdt; /* Pointer to the device table array */
    struct _dt *dt; /* Pointer to a device table */

    ppdt = get_cba(CB_DTA); /* Set pointer to array of pointers */
    dt = ppdt -> pdt[pdevc];

    if (!dt) /* Check if pointer in array is valid */
    {
        printf("\nError -- Array of Device Table Addresses is not set for device %d.",
            pdevc);
        exit();
    }

    if (protoc & 0x8000) /* Check if protocol byte to be set
                        directly or to be OR ed in */
    {
        /* OR ed */
        dt -> dt_st1 := (protoc & 0x7F);
    }
else
    {
        /* Set directly */
        dt -> dt_st1 = (protoc & 0x7F);
    }

    if ((protoc & 0x7F) == DT_DET) /* If ETX/ACK, check for message
                                length */
    {
        if (isdigit(*pplength)) /* Check if length present */
        {
            /* Convert length to binary and set device
            table field. */
            dt -> dt_etx1 = atoi(pplength);
        }
    }
}

show_proto() /* Show the current protocol settings */
{
    struct _ppdt
    {
        char *pdt[16]; /* Array of 16 pointers to the device tables */
    };
    struct _ppdt *ppdt; /* Pointer to the device table array */
    struct _dt *dt; /* Pointer to a device table */
    int pdevc; /* Physical device code */
    struct _ct *dproto; /* Pointer to display protocols */

    ppdt = get_cba(CB_DTA); /* Set pointer to array of pointers */

    /* For all physical devices */

```

Figure 11-10. (Continued)

```

for (pdevc = 0; pdevc <= MAXPDEV; pdevc++)
{
    /* Set pointer to device table */
    dt = ppdt -> pdt[pdevc];

    if (dt) /* Check if pointer in array is valid */
    {
        printf("\n\tProtocol for %s - ",ct_strc(ct_pdev,pdevc));
        /* Check if any protocols set */
        if (!(dt -> dt_st1 & ALLPROTO))
        {
            printf("None.");
            continue;
        }

        /* Set pointer to display protocol table */
        dproto = ct_dproto;
        while (dproto -> _ct_code != CT_SNF)
        {
            /* Check if protocol bit set */
            if (dproto -> _ct_code & dt -> dt_st1)
            {
                /* Display protocol */
                printf("%s ",dproto -> _ct_sp);
            }
            ++dproto; /* Move to next entry */
        }
        /* Check if ETX/ACK protocol and
        message length to be displayed */
        if (dt -> dt_st1 & DT_OETX)
            printf(" Message length %d bytes.",
                dt -> dt_etxml);
    }
}

}

chk_use(argc) /* Check for correct usage */
int argc; /* Argument count on command line */
{
    if (argc == 1)
    {
        printf("\nPROTOCOL sets the physical device's serial protocols.");
        printf("\n\tPROTOCOL physical-device direction protocol {message-length}");
        printf("\n\nLegal physical devices are :");
        ct_disps(ct_pdev);
        printf("\nLegal direction/protocols are :");
        ct_disps(ct_dproto);
        printf("\n\tMessage length can be specified with Output ETX.\n");
        exit();
    }
}

```

Figure 11-10. (Continued)

ASSIGN — Assign Physical to Logical Devices

The ASSIGN utility shown in Figure 11-11 sets the necessary bits in the physical input/output redirection bits in the BIOS. It assigns a logical device's input and output to physical devices. Input can only be derived from a single physical device, while output can be directed to multiple devices.

Here is an example console dialog showing ASSIGN in action:

```

P3B>assign<CR>
ASSIGN Vn 1.0 02/17/83
ASSIGN sets the Input/Output redirection.
        ASSIGN logical-device INPUT physical-device
        ASSIGN logical-device OUTPUT physical-dev1 {phy_dev2..}
        ASSIGN SHOW      (to show current assignments)

```

```
Legal logical devices are :
    CONSOLE
    AUXILIARY
    LIST
```

```
Legal physical devices are :
    TERMINAL
    PRINTER
    MODEM
```

```
P3B>assign show<CR>
ASSIGN Vn 1.0 02/17/83
Current Device Assignments are :
    CONSOLE INPUT is assigned to - TERMINAL
    CONSOLE OUTPUT is assigned to - TERMINAL
    AUXILIARY INPUT is assigned to - MODEM
    AUXILIARY OUTPUT is assigned to - MODEM
    LIST INPUT is assigned to - PRINTER
    LIST OUTPUT is assigned to - PRINTER
```

```
P3B>assign a o t m p<CR>
ASSIGN Vn 1.0 02/17/83
Current Device Assignments are :
    CONSOLE INPUT is assigned to - TERMINAL
    CONSOLE OUTPUT is assigned to - TERMINAL
    AUXILIARY INPUT is assigned to - MODEM
    AUXILIARY OUTPUT is assigned to - TERMINAL PRINTER MODEM
    LIST INPUT is assigned to - PRINTER
    LIST OUTPUT is assigned to - PRINTER
```

```
#define VN "\nASSIGN Vn 1.0 02/17/83"
#include <LIBRARY.H>

struct _ct ct_pdev[MAXPDEV + 2];    /* Physical device table */

/* Names of logical devices */
#define LN_C "CONSOLE"
#define LN_A "AUXILIARY"
#define LN_L "LIST"
struct _ct ct_ldev[4];    /* Logical device table */

struct _ct ct_io[3];    /* Input, output */

/* Parameters on the command line */
#define LDEV argv[1]    /* Logical device */
#define IO argv[2]    /* Input/output */

main(argc,argv)
int argc;
char *argv[];
{
    printf(VN);    /* Display sign-on message */
    setup();    /* Set up code tables */
    chk_use(argc);    /* Check correct usage */

    /* Check if request to show current settings */
    if (usstrcmp("SHOW",argv[1]))
        /* No, assume a set is required */
}
```

Figure 11-11. ASSIGN.C, a utility that assigns a logical device's input and output to two physical devices

```

        /* NOTE : the number of physical devices to
        Process is given by argc - 3 */
        set_assign(get_ldev(LDEV),get_io(IO),argc - 3,argv);
    }
    show_assign();
}

setup() /* Set up the code tables for this program */
{
    /* Initialize the physical device table */
    ct_init(ct_pdev[0],0,PN_T); /* Terminal */
    ct_init(ct_pdev[1],1,PN_P); /* Printer */
    ct_init(ct_pdev[2],2,PN_M); /* Modem */
    ct_init(ct_pdev[3],CT_SNF,"*"); /* Terminator */

    /* Initialize the logical device table */
    ct_init(ct_ldev[0],0,LN_C); /* Terminal */
    ct_init(ct_ldev[1],1,LN_A); /* Auxiliary */
    ct_init(ct_ldev[2],2,LN_L); /* List */
    ct_init(ct_ldev[3],CT_SNF,"*"); /* Terminator */

    /* Initialize the input/output table */
    ct_init(ct_io[0],0,"INPUT");
    ct_init(ct_io[1],1,"OUTPUT");
    ct_init(ct_io[2],CT_SNF,"*"); /* Terminator */
}

unsigned
get_ldev(pldev) /* Get logical device */
/* This function returns the logical device code
specified by the user in the command line. */
char *pldev; /* Pointer to character string */
{
    unsigned retval; /* Return value */
    retval = ct_parc(ct_ldev,pldev); /* Get code for ASCII string */
    if (retval == CT_SNF) /* If string not found */
    {
        printf("\n\007Logical device '%s' is invalid or ambiguous.",
            pldev);
        printf("\nLegal logical devices are : ");
        ct_disps(ct_ldev); /* Display all values */
        exit();
    }
    return retval; /* Return code */
}

unsigned
get_io(pio) /* Get input/output parameter */
char *pio; /* Pointer to character string */
{
    unsigned retval; /* Return value */

    retval = ct_parc(ct_io,pio); /* Get code for ASCII string */
    if (retval == CT_SNF) /* If string not found */
    {
        printf("\n\007Input/output direction '%s' is invalid or ambiguous.",
            pio);
        printf("\nLegal values are : ");
        ct_disps(ct_io); /* Display all values */
        exit();
    }
    return retval; /* Return code */
}

set_assign(ldevc,output,argc,argv) /* Set assignment (I/O redirection) */
int ldevc; /* Logical device code */
int output; /* I/O redirection code */
int argc; /* count of arguments to process */
char *argv[]; /* Replica of parameter to main function */
{
    unsigned *redir; /* Pointer to redirection word */
    int pdevc; /* Physical device code */
    unsigned rd_val; /* Redirection value */

    /* Get the address of the I/O redirection word.

```

Figure 11-11. (Continued)

```

This code assumes that get_cba code values
are ordered:
    Device #0, input & output
    Device #1, input & output
    Device #2, input & output

The get_cba code is computed by multiplying the
logical device code by 2 (that is, shift left 1)
and added onto the code for Device #0, input
Then the output variable (0 = input, 1 = output)
is added on */
redir = get_cba(CB_CI + (ldevc << 1) + output);
rd_val = 0; /* Initialize redirection value */

/* For output, assignment can be made to several physical
devices, so this code may be executed several times */
do
{
    /* Get code for ASCII string */
    /* NOTE: the physical device parameters start
with parameter #3 (argv[3]). However argc
is a decreasing count of the number of physical
devices to be processed, Therefore, argc + 2
causes them to be processed in reverse order
(i.e. from right to left on the command line) */

    pdevc = ct_parc(ct_pdev, argv[argc + 2]);

    if (pdevc == CT_SNF) /* If string not found */
    {
        printf("\n\007Physical device '%s' is invalid or ambiguous.",
argv[argc + 2]);
        printf("\nLegal physical devices are : ");
        ct_disps(ct_pdev); /* Display all values */
        exit();
    }
    /* Repeat this loop for as long as there are
more parameters (for output only) */

    else
    {
        /* Build new redirection value by OR ing in
a one-bit shifted left pdevc places. */
        rd_val |= (1 << pdevc);
    }
} while (--argc && output);

*redir = rd_val; /* Set the value into the config. block */
}

show_assign() /* Show current baud rate */
{
    int rd_code; /* Redirection code for get_cba */
    int ldevn; /* Logical device number */
    int pdevn; /* Physical device number */
    unsigned rd_val; /* Redirection value */
    unsigned *prd_val; /* Pointer to the redirection value */

/* Note: the respective codes for accessing the redirection values
via the get_cba (get configuration block address) function are:
Device #0 console input -- 5
Device #0 console putput -- 6
Device #1 auxiliary input -- 7
Device #1 auxiliary output -- 8
Device #2 list input -- 9
Device #2 list output -- 10

This function uses this mathematical relationship */
printf("\nCurrent device assignments are :");

/* For all get_cba codes */
for (rd_code = CB_CI; rd_code <= CB_LO; rd_code++)
{
    /* Set pointer to redirection value */
    prd_val = get_cba(rd_code);
    /* Get the input redirection value */

```

Figure 11-11. (Continued)

```

rd_val = *prd_val;      /* This also performs byte reversal */

/* Display device name. The rd_code is converted to a
device number by subtracting the first code number
from it and dividing by 2 (shift right one place).
The input/output direction is derived from the
least significant bit of the rd_code. */

printf("\n\t%s %s is assigned to - ",
       ct_strc(ct_ldev,(rd_code - CB_CI) >> 1),
       ct_strc(ct_io,((rd_code & 0x01) ^ 1));

/* For all physical devices */
for (pdevn = 0; pdevn < 16; pdevn++)
{
    /* Check if current physical device is assigned
    by AND ing with a 1-bit shifted left pdevn times */
    if (rd_val & (1 << pdevn)) /* Is device active? */
    {
        /* Display physical device name */
        printf(" %s",ct_strc(ct_pdev,pdevn) );
    }
}
}

}

chk_use(argc)          /* Check for correct usage */
int argc;              /* Argument count on command line */
{
    if (argc == 1)
    {
        printf("\nASSIGN sets the Input/Output redirection.");
        printf("\n\tASSIGN logical-device INPUT physical-device");
        printf("\n\tASSIGN logical-device OUTPUT physical-dev1 {phy_dev2..}");
        printf("\n\tASSIGN SHOW (to show current assignments)");
        printf("\n\nLegal logical devices are :");
        ct_disps(ct_ldev);
        printf("\nLegal physical devices are :");
        ct_disps(ct_pdev);
        exit();
    }
}
}

```

Figure 11-11. (Continued)

DATE — Set the System Date

The DATE utility shown in Figure 11-12 sets the system date in the configuration block, along with a flag that indicates that the DATE utility has been used. Other utility programs can use this flag as a primitive test of whether the system date is current.

Here is an example console dialog:

```

P3B>date<CR>
DATE Vn 1.0 02/18/83
DATE sets the system date. Usage is :
    DATE mm/dd/yy
    DATE SHOW (to display current date)

P3B>date show<CR>
DATE Vn 1.0 02/18/83
    Current Date is 12/18/82

P3B>date 2/23/83<CR>
DATE Vn 1.0 02/18/83
    Current Date is 02/23/83

```

```

#define VN "\nDATE Vn 1.0 02/18/83"

/* This utility accepts the current date from the command tail,
   validates it, and set the internal system date in the BIOS.
   Alternatively, it can be requested just to display the current
   system date. */

#include <LIBRARY.H>

char *date;          /* Pointer to the date in the config. block */
char *date_flag;    /* Pointer to date-set flag */
int mm,dd,yy;       /* Variables to hold month, day, year */
int mcount;         /* Match count of numeric values entered */
int count;          /* Count used to add leading 0's to date */

main(argc,argv)
int argc;
char *argv[];
{
    printf(VN);      /* Display sign-on message */
    date = get_cba(CB_DATE); /* Set pointer to date */
    date_flag = get_cba(CB_DTFLAGS); /* Set pointer to date-set flag */

    if (argc != 2) /* Check if help requested (or needed) */
        show_use(); /* Display correct usage and exit */

    if (usstrcmp("SHOW",argv[1])) /* Check if not SHOW option */
    {
        /* Convert specified time into month, day, year */
        mcount = sscanf(argv[1],"%d/%d/%d",&mm,&dd,&yy);
        if (mcount != 3) /* Input not numeric */
            show_use(); /* Display correct usage and exit */

        /* NOTE: The following validity checking is
           simplistic, but could be expanded to accommodate
           more context-sensitive checking: days in the month,
           leap years, etc. */
        if (mm > 12 || mm < 1) /* Check valid month, day, year */
        {
            printf("\nMonth = %d is illegal.",mm);
            show_use(); /* Display correct usage and exit */
        }
        if (dd > 31 || dd < 1)
        {
            printf("\nDay = %d is illegal.",dd);
            show_use(); /* Display correct usage and exit */
        }
        if (yy > 90 || yy < 83) /* <== NOTE ! */
        {
            printf("\nYear = %d is illegal.",yy);
            show_use(); /* Display correct usage and exit */
        }

        /* Convert integers back into a formatted string */
        sprintf(date,"%2d/%2d/%2d",mm,dd,yy);
        date[8] = 0x0A; /* Terminate with line feed */
        date[9] = '\0'; /* New string terminator */

        /* Change " 1/ 2/ 3" into "01/02/03" */
        for (count = 0; count < 7; count+=3)
        {
            if (date[count] == ' ')
                date[count] = '0';
        }

        /* Turn flag on to indicate that user has set date */
        *date_flag |= DATE_SET;
    }
    printf("\n\tCurrent Date is %s",date);
}

show_use() /* Display correct usage and exit */
{
    printf("\nDATE sets the system date. Usage is :");
    printf("\n\tDATE mm/dd/yy");
    printf("\n\tDATE SHOW (to display current date)\n");
    exit();
}

```

Figure 11-12. DATE.C, a utility that makes the current date part of the system

TIME — Set the System Time

The TIME utility shown in Figure 11-13 sets the current system time. Like DATE, TIME sets a flag so that other utilities can test that the system time is likely to be current.

Here is an example console dialog:

```
P3B>time<CR>
TIME Vn 1.0 02/18/83
TIME sets the system time. Usage is :
      TIME hh:mm:ss}
      TIME SHOW (to display current time)

P3B>time show<CR>
TIME Vn 1.0 02/18/83
      Current Time is 13:08:44

P3B>time 5:47<CR>
TIME Vn 1.0 02/18/83
      Current Time is 05:47:00
```

```
#define VN "\nTIME Vn 1.0 02/18/83"

/* This utility accepts the current time from the command tail,
   validates it, and sets the internal system time in the BIOS.
   Alternatively, it can just display the current system time. */

#include <LIBRARY.H>

char *time;          /* Pointer to the time in the config. block */
char *time_set;     /* Pointer to the time set flag */
int hh,mm,ss;       /* Variables to hold hours, minutes, seconds */
int mcount;         /* Match count of numeric values entered */
int count;          /* Count used to add leading zeros to time */

main(argc,argv)
int argc;
char *argv[];
{
  printf(VN);        /* Display sign-on message */
  time = get_cba(CB_TIMEA); /* Set pointer to time */
  time_flag = get_cba(CB_DTFLAGS); /* Set pointer to the
                                     time-set flag */
  hh = mm = ss = 0; /* Initialize the time if seconds or
                    minutes are not specified */

  if (argc != 2)    /* Check if help requested (or needed) */
    show_use();    /* Display correct usage and exit */

  if (usstrcmp("SHOW",argv[1])) /* Check if not SHOW option */
  {
    /* Convert time into hours, minutes, seconds */
    mcount = sscanf(argv[1],"%d:%d:%d",&hh,&mm,&ss);
    if (!mcount) /* Input not numeric */
      show_use(); /* Display correct usage and exit */

    if (hh > 12) /* Check valid hours, minutes, seconds */
    {
      printf("\n\007Hours = %d is illegal.",hh);
      show_use(); /* Display correct usage and exit */
    }
  }
}
```

Figure 11-13. TIME.C, a utility that makes the current time part of the system

```

if (mm > 59)
{
printf("\n\007Minutes = %d is illegal.",mm);
show_use(); /* Display correct usage and exit */
}
if (ss > 59)
{
show_use(); /* Display correct usage and exit */
printf("\n\007Seconds = %d is illegal.",ss);
}

/* Convert integers back into formatted string */
sprintf(time,"%2d:%2d:%2d",hh,mm,ss);
time[8] = 0x0A; /* Terminate with line feed */
time[9] = '\0'; /* New string terminator */

/* Convert " 1: 2: 3" into "01:02:03" */
for (count = 0; count < 7; count+=3)
{
if (time[count] == ' ')
time[count] = '0';
}
/* Turn bit on to indicate that the time has been set */
*time_flag |= TIME_SET;
}

printf("\n\tCurrent Time is %s",time);
}

show_use() /* Display correct usage and exit */
{
printf("\n\tTIME sets the system time. Usage is :");
printf("\n\tTIME hh:mm:ss");
printf("\n\tTIME SHOW (to display current time)\n");
exit();
}

```

Figure 11-13. TIME.C, a utility that makes the current time part of the system (continued)

FUNKEY — Set the Function Keys

The FUNKEY utility shown in Figure 11-14 sets the character strings associated with specific function keys. In the specified character string, the character "<" is converted into a LINE FEED character. Here is an example console dialog:

```

P3B>funkey<CR>
FUNKEY sets a specific function key string.
      FUNKEY key-number "string to be programmed"
              (Note : '<' is changed to line feed.)
              ( key-number is from 0 to 17.)
              ( string can be up to 16 chars.)
FUNKEY SHOW (displays settings for all keys)

P3B>funkey show<CR>
FUNKEY Vn 1.0 02/18/83
      Key #0 = 'Function Key 1<'
      Key #1 = 'Function Key 2<'

P3B>funkey 0 "PIP B:=A:*.#[V]<"<CR>

P3B>funkey show<CR>
FUNKEY Vn 1.0 02/18/83
      Key #0 = 'PIP B:=A:*.#[V]<'
      Key #1 = 'Function Key 2<'

```

```

#define VN "\nFUNKEY Vn 1.0 02/18/83"

#include <LIBRARY.H>

int fnum; /* Function key number to be programmed */
char fstring[20]; /* String for function key */
struct _fkt *pfk; /* Pointer to function key table */

main(argc,argv)
int argc;
char *argv[];
{
    if (argc == 1 || argc > 3)
        show_use();

    pfk = get_cba(CB_FKT); /* Set pointer to function key table */

    if (usstrcmp("SHOW",argv[1]))
    {
        if (!isdigit(argv[1][0]))
        {
            printf("\n\007'%s' is an illegal function key.",
                argv[1]);
            show_use();
        }

        fnum = atoi(argv[1]); /* Convert function key number */

        if (fnum > FK_ENTRIES)
        {
            printf("\n\007Function key number %d too large.",fnum);
            show_use();
        }

        if (get_fs(fstring) > FK_LENGTH)
        {
            printf("\n\007Function key string is too long.");
            show_use();
        }

        pfk += fnum; /* Update pointer to string */
        /* Copy string into function key table */

        /* Check if function key input present */
        if (!(pfk -> fk_input[0]))
        {
            printf("\n\007Error : Function Key %d is not set up to be programmed.",fnum);
            show_use();
        }

        strcpy(pfk -> fk_output,fstring);
    }
    else /* SHOW function specified */
    {
        printf(VN); /* Display sign-on message */
        show_fun();
    }
}

get_fs(string) /* Get function string from command tail */
char string[]; /* Pointer to character string */
{
    char *tail; /* Pointer to command tail */
    short tcount; /* Count of TOTAL characters in command tail */
    int slen; /* String length */

    tail = 0x80; /* Command line is in memory at 0080H */
    tcount = *tail++; /* Set TOTAL count of characters in command tail */
    slen = 0; /* Initialize string length */

    while(tcount-- /* For all characters in the command tail */
    {
        if (*tail++ == '"' /* Scan for first quotes */
            break;
    }
}

```

Figure 11-14. FUNKEY.C, a utility that sets the character strings associated with specific function keys

Other Utilities

Because of space limitations, not all of the possible utility programs for the BIOS features can be shown in this chapter. Others that would need to be developed in order to have a complete set are

PUBLIC/PRIVATE

This pair of utilities would turn the public files flag on or off, making the files in user 0 available from other user numbers or not, respectively.

SETTERM

This program would program the CONOUT escape table, setting the various escape sequences as required. It could also program the characters in the function key table that match with those emitted by the terminal currently in use.

SAVESYS

This utility would save the current settings in the long term configuration block.

LOADSYS

This would load the long term configuration block from a previously saved image.

DO

This utility would copy the command tail into the multi-command buffer, changing “\” into LINE FEED, and then set the forced input pointer to the multi-command buffer. As a result, characters from the multi-command buffer would be fed into the console input stream as though they had been typed one command at a time.

SPARE

This utility would work in conjunction with the hard-disk bad-sector management in your disk drivers. It would spare out bad sectors or tracks on the hard disk. This done, all subsequent references to the sectors or tracks would be redirected to a different part of the disk.

Error Messages Displayed
Miscellaneous Errors

12

Error Messages

This chapter lists the error messages that emanate from standard CP/M and its utility programs. It does not include any error messages from the BIOS; these messages, if any, are the individualized product of the programmers who wrote the various versions of the BIOS.

The error messages are shown in alphabetical order, followed (in parentheses) by the name of the program or CP/M component outputting the message. Messages are shown in uppercase even if the actual message you will see contains lowercase letters. Additional characters that are displayed to “pretty up” the message have been omitted. For example, the message “** ABORTED **” will be listed as “ABORTED”.

Following each message is an explanation and, where possible, some information to help you deal with the error.

The last section of the chapter deals with known errors or peculiarities in CP/M and its utilities. Read this section so that you will recognize these problems when they occur.

Error Messages Displayed

? (CCP)

The CCP displays a question mark if you enter a command name and there is no corresponding "command.COM" file on the disk.

It is also displayed if you omit the number of pages required as a parameter in the SAVE command.

? (DDT)

DDT outputs a question mark under several circumstances. You must use context (and some guesswork) to determine what has gone wrong. Here are some specific causes of problems:

- DDT cannot find the file that you have asked it to load into memory. Exit from DDT and investigate using DIR or STAT (the file may be set to System status and therefore invisible with DIR).
- There is a problem with the data in the HEX file that you have asked DDT to load. The problem could be a bad check-sum on a given line or an invalid field somewhere in the record. Try typing the HEX file out on a console, or use an editor to examine it. It is rare to have only one or two bad bits or bytes in a HEX file; large amounts of the file are more likely to have been corrupted. Therefore, you may be able to spot the trouble fairly readily. If you have the source code for the program, reassemble it to produce another copy of the HEX file. If you do not have the source code, there is no reliable way around this problem unless you are prepared to hand-create the HEX file—a difficult and tedious task.
- DDT does not recognize the instruction you have entered when using the "A" (assemble) command to convert a source code instruction into hexadecimal. Check the line that you entered. DDT does not like tabs in the line (although it appears to accept them) or hexadecimal numbers followed by "H". Check that the mnemonic and operands are valid, too.

?? = (DDT)

This cryptic notation is used by DDT when you are using the "L" (list disassembled) command to display some part of memory in DDT's primitive assembly language form. DDT cannot translate all of the 256 possible values of a byte. Some of them are not used in the 8080 instruction set. When DDT encounters an untranslatable value, it displays this message as the instruction code, followed by the actual value of the byte in hexadecimal.

You will see this if you try to disassemble code written for the Z80 CPU, which

uses unassigned 8080 instructions. You will also see it if you try to disassemble bytes that contain ASCII text strings rather than 8080 instructions.

ABORTED (STAT)

If you enter any keyboard character while STAT is working its way down the file directory setting files to \$DIR (Directory), \$SYS (System), \$R/W (Read/Write), or \$R/O (Read-Only) status, then it will display this message, stop what it is doing, and execute a warm boot.

By contrast, if you enter the command

```
A>stat *.*<cr>
```

to display all of the files on a disk, there is no way that the process can be aborted.

ABORTED (PIP)

This message is displayed if you press any keyboard character while PIP is copying a file to the list device.

BAD DELIMITER (STAT)

If your BIOS uses the normal IOBYTE method of assigning physical devices to logical devices, you use STAT to perform the assignment. The command has this format:

```
STAT RDR:=PTR:
```

STAT displays this message if it cannot find the “=” in the correct place.

BAD LOAD (CCP)

This is probably the most obscure error message that emanates from CP/M. You will get this message if you attempt to load a COM file that is larger than the transient program area. Your only recourse is to build a CP/M system that has a larger TPA.

BAD PARAMETER (PIP)

PIP accepts certain parameters in square brackets at the end of the command line. This message is displayed if you enter an invalid parameter or an illegal numeric value following a parameter letter.

BDOS ERROR ON d: BAD SECTOR (BDOS)

The BDOS displays this message if the READ and WRITE functions in your BIOS ever return indicating an error. The only safe response to this message is to type CONTROL-C. CP/M will then execute a warm boot. If you type CARRIAGE RETURN, the error will be ignored—with unpredictable results.

A well-implemented BIOS should include disk error recovery and control so that the error will never be communicated to the BDOS. If the BIOS gives you the option of ignoring an error, do so only when you are reasonably sure of the outcome or have adequate backup copies so that you can recreate your files.

BDOS ERROR ON d: FILE R/O (BDOS)

You will see this message if you attempt to erase (ERA) a file that has been set to Read-Only status. Typing any character on the keyboard causes the BDOS to perform a warm boot operation. Note that the BDOS does not tell you *which* file is creating the problem. This can be a problem when you use ambiguous file names in the ERA command. Use the STAT command to display all the files on the disk; it will tell you which files are Read-Only.

This message is also displayed if a program tries to delete a Read-Only file. Again, it can be difficult to determine which file is causing the problem. Your only recourse is to use STAT to try to infer which of the Read-Only files might be causing the problems.

BDOS ERROR ON d: R/O (BDOS)

This looks similar to the previous message, but it refers to an entire logical disk instead of a Read-Only file. However, it is rarely output because you have declared a disk to be Read-Only. Usually, it occurs because you changed diskettes without typing a CONTROL-C; CP/M will detect the new diskette and, without any external indication, will set the disk to Read-Only status.

If you or a program attempts to write any data to the disk, the attempt will be trapped by the BDOS and this message displayed. Typing any character on the keyboard causes a warm boot—then you can proceed.

BDOS ERROR ON d: SELECT (BDOS)

The BDOS displays this message if you or a program attempts to select a logical disk for which the BIOS lacks the necessary tables. The BDOS uses the value returned by SELDSK to determine whether a logical disk “exists” or not.

If you were trying to change the default disk to a nonexistent one, you will have to press the RESET button on your computer. There is no way out of this error.

However, if you were trying to execute a command that accessed the nonexistent disk, then you can type a CONTROL-C and CP/M will perform a warm boot.

BREAK x AT y (ED)

This is another cryptic message whose meaning you cannot guess. The list that follows explains the possible values of “x.” The value “y” refers to the command ED was executing when the error occurred.

x	Meaning
#	Search failure. ED did not find the string you asked it to search for.
?	Unrecognized command.
0	File not found.
>	ED's internal buffer is full.
E	Command aborted.
F	Disk or directory full. You will have to determine which is causing the problem.

CANNOT CLOSE, READ/ONLY? (SUBMIT)

SUBMIT displays this message if the disk on which it is trying to write its output file, "\$\$\$SUB", is physically write protected. Do not confuse this with the disk being *logically* write protected.

The standard version of SUBMIT writes the output file onto the current default disk, so if your current default disk is other than drive A:, you may be able to avoid this problem if you switch the default to A: and then enter a command of the form

```
A><u>submit b:subfile</u><cr>
```

CANNOT CLOSE DESTINATION FILE (PIP)

PIP displays this message if the destination disk is physically write protected. Check the destination disk. If it is write protected, remove the protection and repeat the operation.

If the disk is not protected, you have a hardware problem. The directory data written to the disk is being written to the wrong place, even the wrong disk, or is not being recorded on the medium.

CANNOT CLOSE FILES (ASM)

ASM displays this message if it cannot close its output files because the disk is physically write protected, or if there is a hardware problem that prevents data being written to the disk. See the paragraph above.

CANNOT READ (PIP)

PIP displays this message if you attempt to read information from a logical device that can only output. For example:

```
A><u>pip diskfile=LST:</u><cr>
```

PIP also will display this message if you confuse it sufficiently, as with the following instruction:

```
A><u>pip file1=file2;file3</u><cr>
```

CANNOT WRITE (PIP)

PIP displays this message if you attempt to output (write) information to a logical device that can only be used for input, such as the RDR: (reader, the anachronistic name for the auxiliary input device).

CHECKSUM ERROR (LOAD)

LOAD displays this message if it encounters a line in the input HEX file that does not have the correct check sum for the data on the line.

LOAD also displays information helpful in pinpointing the problem:

```
CHECKSUM ERROR
LOAD ADDRESS 0110  <- First address on line in file
ERROR ADDRESS 0112  <- Address of next byte to be loaded
BYTES READ:
0110:
0110: 00 33 22 2B 02 21 27 02    <- Bytes preceding error
```

Note that LOAD does not display the check-sum value itself. Use TYPE or an editor to inspect the HEX file in order to see exactly what has gone wrong.

CHECKSUM ERROR (PIP)

If you ask PIP to copy a file of type HEX, it will check each line in the file, making sure that the line's check sum is valid. If it is not, PIP will display this message. Unfortunately, PIP does not tell you which line is in error—you must determine this by inspection or recreate the HEX file and try again.

COMMAND BUFFER OVERFLOW (SUBMIT)

SUBMIT displays this message if the SUB file you specified is too large to be processed. SUBMIT's internal buffer is only 2048 bytes. You must reduce the size of the SUB file; remove any comment lines, or split it into two files with the last line of the first file submitting the second to give a nested SUBMIT file.

COMMAND TOO LONG (SUBMIT)

The longest command line that SUBMIT can process is 125 characters. There is no way around this error other than reducing the length of the offending line. You will have to find this line by inspection—SUBMIT does not identify the line.

One way that you can remove a few characters from a command line is to rename the COM file you are invoking to a shorter name, or use abbreviated names for parameters if the program will accept these.

CORRECT ERROR, TYPE RETURN OR CTL-Z (PIP)

This message is a carryover from the days when PIP used to read hexadecimal data from a high-speed paper tape reader. If PIP detected the end of a physical roll

of paper tape, it would display this message. The user could then check to see if the paper tape had torn or had really reached its end. If there was more tape to be read, the user could enter a CARRIAGE RETURN to resume reading tape or enter a CONTROL-Z to serve as the end-of-file character.

Needless to say, it is unlikely that you will see this message if you do not have a paper tape reader.

DESTINATION IS R/O, DELETE (Y/N)? (PIP)

PIP displays this message if you try to overwrite a disk file that has been set to Read-Only status. If you type “Y” or “y”, PIP will overwrite the destination file. It leaves the destination file in Read/Write status with its Directory/System status unchanged. Typing any character other than “Y” or “y” makes PIP abandon the copy and display the message

**** NOT DELETED****

You can avoid this message altogether if you specify the “w” option on PIP’s command line. For example:

```
A>pip destfile=srcfile[wl]<cr>
```

PIP will then overwrite Read-Only files without question.

DIRECTORY FULL (SUBMIT)

This message is displayed if the BDOS returns an error when SUBMIT tries to create its output file, “\$\$\$SUB”. As a rough and ready approximation, use “STAT *.*” to see how many files and extents you have on the disk. Erase any unwanted ones. Then use “STAT DSK:” to find out the maximum number of directory entries possible for the disk.

You may also see this message if the file directory has become corrupted or if the disk formatting routine leaves the disk with the file directory full of some pattern other than E5H.

You can assess whether the directory has been corrupted by using “STAT USR:”. STAT then displays which user numbers contain files. If the directory is corrupt, you will normally see user numbers greater than 15.

It is not easy to repair a corrupted directory. “ERA *.*” erases only the files for the current user number, so you will have to enter the command 16 times, once for each user number from 0 to 15. Alternatively, you can reformat the disk.

DISK OR DIRECTORY FULL (ED)

Self-explanatory.

**DISK READ ERROR (PIP)
DISK WRITE ERROR (SUBMIT)
DISK WRITE ERROR (PIP)**

These messages will normally be preceded by a BIOS error message. They will only be displayed if the BIOS returns indicating an error. As was described earlier, this is unlikely if the BIOS has any kind of error recovery logic.

END OF FILE, CTL-Z? (PIP)

PIP displays this message if, while copying a HEX file, it encounters a CONTROL-Z (end of file). Again, the underlying idea is based on the concept of physical paper tape. When you saw this message, you could look at the tape in the reader, and if it really was at the end of the roll, enter a CONTROL-Z on the keyboard to terminate the file. Given any other character, PIP would read the next piece of tape.

ERROR : CANNOT CLOSE FILES (LOAD)

LOAD displays this message if you have physically write protected the disk on which it is trying to write the output COM file.

ERROR : CANNOT OPEN SOURCE (LOAD)

LOAD displays this message if it cannot open the HEX file that you specified in the command tail.

**ERROR : DISK READ (LOAD)
ERROR : DISK WRITE (LOAD)**

These two messages would normally be preceded by a BIOS error message. If your BIOS includes disk error recovery, you would not normally see these messages; the error would have been handled by the BIOS.

ERROR : INVERTED LOAD ADDRESS (LOAD)

LOAD displays this message if it detects a load address less than 0100H in the input HEX file. It also displays the actual address input from the file, so you can examine the HEX file looking for this address to determine the likely cause of the problem.

Note that DDT, when asked to load the same HEX file, will do so without any error—and will probably damage the contents of the base page in so doing.

ERROR : NO MORE DIRECTORY SPACE (LOAD)

Self-explanatory.

ERROR ON LINE N (SUBMIT)

SUBMIT displays this message if it encounters a line in the SUB file that it does not know how to process. Most likely you have a file that has type .SUB but does not contain ASCII text.

The first line of the SUB file is number 001.

FILE EXISTS (CCP)

The CCP displays this message if you attempt to use the REN command to rename an existing file to a name already given to another file.

Use "STAT *.*" to display all of the files on the disk. DIR will show only those files that have Directory status, and you may not be able to see the file causing the problem.

FILE IS READ/ONLY (ED)

ED displays this message if you attempt to edit a file that has been set to Read-Only status.

**FILE NOT FOUND (STAT)
FILENAME NOT FOUND (PIP)**

STAT and PIP display their respective messages if you specify a nonexistent file. This applies to both specific and ambiguous file names.

INVALID ASSIGNMENT (STAT)

STAT can be used to assign physical devices to logical devices using the IOBYTE system described earlier. It will display this message if you enter an illogical assignment. Use the "STAT VAL:" command to display the valid assignments.

INVALID CONTROL CHARACTER (SUBMIT)

SUBMIT is supposed to be able to handle a control character in the SUB file—the notation being "^x", where "x" is the control letter. In fact, the standard release version of SUBMIT cannot handle this notation. A patch is available from Digital Research to correct this problem.

Given that this patch has been installed, SUBMIT will display this message if a character other than "A" to "Z" is specified after the circumflex character.

INVALID DIGIT (PIP)

PIP displays this message if it encounters non-numeric data where it expects a numeric value.

INVALID DISK ASSIGNMENT (STAT)

STAT displays this message if you try to set a logical disk to Read-Only status and you specify a parameter other than "R/O." Note that there is no leading "\$" in this case (as there is when you want to set a file to Read-Only).

INVALID DRIVE NAME (USE A, B, C, OR D) (SYSGEN)

SYSGEN displays this message if you attempt to load the CP/M system from, or write the system to, a disk drive other than A, B, C, or D.

INVALID FILE INDICATOR (STAT)

STAT outputs this message if you specify an erroneous file attribute. File attributes can only be one of the following:

\$DIR	Directory
\$SYS	System
\$R/O	Read-Only
\$R/W	Read/Write

INVALID FORMAT (PIP)

PIP displays this message if you enter a badly formatted command; for example, a "+" character instead of an "=" (on some terminals these are on the same key).

INVALID HEX DIGIT (LOAD)

LOAD displays this message if it encounters a nonhexadecimal digit in the input HEX file, where only a hex digit can appear. LOAD then displays additional information to tell you where in the file the problem occurred:

```
INVALID HEX DIGIT
LOAD ADDRESS 0110  <- First address on line in file
ERROR ADDRESS 0112  <- Address of byte containing non-hex
BYTES READ:
0110:
0110: 00 33      <- Bytes preceding error
```

INVALID MEMORY SIZE (MOVCPM)

MOVCPM displays this message if you enter an invalid memory size for the CP/M system size you want to construct.

INVALID SEPARATOR (PIP)

PIP displays this message if you try to concatenate files using something other than a comma between file names.

INVALID USER NUMBER (PIP)

PIP displays this message if you enter a user number outside the range 0 to 15 with the “[gn]” option (where “n” is the user number).

NO 'SUB' FILE PRESENT (SUBMIT)

SUBMIT displays this message if it cannot find a file with the file name that you specified and with a type of .SUB.

**NO DIRECTORY SPACE (ASM)
NO DIRECTORY SPACE (PIP)**

Self-explanatory.

NO FILE (CCP)

The CCP displays this message if you use the REN (rename) command and it cannot find the file you wish to rename.

NO FILE (PIP)

PIP displays this message if it cannot find the file that you specified.

NO MEMORY (ED)

ED displays this message if it runs out of memory to use for storing the text that you are editing.

NO SOURCE FILE ON DISK (SYSGEN)

This error message is misleading. SYSGEN does not read source code files. The message should read “INPUT FILE NOT FOUND”.

NO SOURCE FILE PRESENT (ASM)

In this case, ASM really does mean that the source code file cannot be found. Remember that ASM uses a strange form of specifying its parameters. ASM uses the file name that you enter and then searches for a file of that name, but with file type .ASM. The three characters of the file type that you specify are used to represent the logical disks on which the source, hex, and list files, respectively, are to be placed.

NO SPACE (CCP)

The CCP displays this message if you use the SAVE command and there is insufficient room on the disk to accommodate the file.

NOT A CHARACTER SOURCE (PIP)

PIP displays this message if you attempt to copy characters from a character output device, such as the auxiliary output device (known to PIP as PUN:).

OUTPUT FILE WRITE ERROR (ASM)

ASM will display this message if the BDOS returns an error from a disk write operation. If your BIOS has disk error recovery logic, you should never see this message.

PARAMETER ERROR (SUBMIT)

SUBMIT uses the "\$" to mark points where parameter values are to be substituted. If you have a single "\$" followed by an alphabetic character, SUBMIT will display this message. Use "\$\$" to represent a real "\$".

PERMANENT ERROR, TYPE RETURN TO IGNORE (SYSGEN)

SYSGEN displays this message if the BIOS returns an error from a disk read or write operation. If your BIOS has disk error recovery logic, you should never see this message.

QUIT NOT FOUND (PIP)

PIP displays this message when it cannot find the string specified in the "[Qcharacter string^Z]" option, meaning "Quit copying when you encounter this string."

READ ERROR (CCP)

The CCP displays this message if the BIOS returns an error from a disk read or write operation. If your BIOS includes disk error recovery logic, you should not see this error message.

RECORD TOO LONG (PIP)

PIP displays this message if it encounters a line longer than 80 characters while copying a HEX file. Inspect the HEX file using the TYPE command or an editor.

REQUIRES CP/M 2.0 OR NEWER FOR OPERATION (PIP) REQUIRES CP/M VERSION 2.0 OR LATER (XSUB)

Self-explanatory.

SOURCE FILE INCOMPLETE (SYSGEN)

SYSGEN displays this message if the file that you have asked it to read is too short. Use STAT to check the length of the file.

SOURCE FILE NAME ERROR (ASM)

ASM displays this message if you specify an ambiguous file name: that is, one that contains either "*" or "?".

SOURCE FILE READ ERROR (ASM)

ASM displays this message if it encounters problems reading the input source code file. Check the input file using the TYPE command or an editor.

START NOT FOUND (PIP)

PIP displays this message when it cannot find the string specified in the "[Scharacter string^Z]" option, meaning "Start copying when you encounter this string."

SYMBOL TABLE OVERFLOW (ASM)

ASM displays this message when you have too many symbols in the source code file. Your only recourse is to split the source file into several pieces and arrange for ORG (origin) statements to position the generated object code so that the pieces fit together.

SYNCHRONIZATION ERROR (MOVCPM)

Apart from the spelling error, this message is designed to be cryptic. MOVCPM displays it when the Digital Research serial number embedded in MOVCPM does not match the serial number in the version of CP/M that you are currently running.

SYSTEM FILE NOT ACCESSIBLE (ED)

ED displays this message if you attempt to edit a file that has been set to System status. Use STAT to set the file to Directory status.

TOO MANY FILES (STAT)

STAT displays this message if there is insufficient memory available to sort and display all of the files on the specified disk. Try limiting the number of files it has to sort by judicious use of ambiguous file names.

UNRECOGNIZED DESTINATION (PIP)

PIP displays this message if you specify an "illegal" destination device.

VERIFY ERROR (PIP)

If you use the “[v]” (verify) option of PIP when copying to a disk file, PIP will write a sector to the disk, read it back, and compare the data. PIP displays this message if the data does not match.

If there is a problem with your disk system, you should have seen some form of disk error message preceding this one. If there is no preceding message, then you have a problem with the main memory on your system.

Wrong CP/M Version (Requires 2.0) (STAT)

Self-explanatory.

(XSUB ACTIVE) (XSUB)

This is not really an error message, but you may mistake it for one. XSUB is the eXtended SUBMIT program. Without it, SUBMIT can only feed command lines to the Console Command Processor. XSUB allows character-by-character input into any program that uses the BDOS to read console input.

XSUB is initiated by being the first command in a SUB file. Once initiated it stays in memory until the end of the SUB file has been reached. Until that happens, XSUB will output this message every time a warm boot occurs as a reminder that it is still in memory.

XSUB Already Present (XSUB)

XSUB will display this message if it is already active and you attempt to load it again.

Miscellaneous Errors

This section deals with errors that are not accompanied by any error message. It is included here to help you recognize a problem after it has already occurred. The errors are shown grouped by product.

ASM: Fails to Detect Unterminated IF Clause

If you use the IF pseudo-operation, it must be followed by a matching ENDIF. ASM fails to detect the case that the end of the source file is encountered *before* the ENDIF.

If the condition specified on the IF line is false, you could have a situation in which ASM would ignore the majority of the source file without comment.

ASM: Creates HEX File That Cannot Be Loaded

If you omit the `ORG` statement at the front of a source file, ASM will assemble the code originated at location 0000H. This file will crash the system if you try to load it with DDT. The message “ERROR: INVERTED ADDRESS” will be shown from LOAD.

CP/M: Signs On and Then Dies Without A> Prompt

After the BIOS has signed on, it transfers control to the Console Command Processor. The CCP then attempts to log in the system disk, reading the file directory and building the allocation vector. If your file directory has been badly corrupted, it can cause the system to crash. Use another system disk and try to display the directory on the bad disk.

DDT: Loads HEX File and Then Crashes the System

DDT does not check the addresses specified in a HEX file. If you have forgotten to put an `ORG` statement at the front of the source file, or more subtly, if your source program has “wrapped around” by having addresses up at 0FFFFH and “above,” the assembler will start assembling at 0000H again.

DIR: Shows Odd-Looking File Names

If you have odd-looking file names, or the vertical lines of “:” that DIR uses to separate the file names are misaligned, then the file directory has been corrupted. One strategy is to format a new disk, copy all of the valid files to it, and discard the corrupted disk.

DIR: Shows More than One Entry with the Same Name

This can happen if you use a program that creates a new file without asking the BDOS to delete any existing files of the same name. It can also happen if you use the custom MOVE utility carelessly.

To remedy the situation proceed as follows:

- Use PIP to copy the specific file to another disk. Do not use an ambiguous file name; specify the duplicated file name exactly. PIP will copy the first instance of the file it encounters in the directory.
- Use the ERA command to erase the duplicated file. *This will erase both copies of the file.*
- Use PIP to copy back the first instance of the file.

STAT: User Numbers > 15

If you use the "STAT USR:" command to display which user numbers contain active files, and user numbers greater than 15 are displayed, then the file directory on the disk has been corrupted.

Use PIP to copy the valid files from legitimate user numbers, and then discard the corrupted disk.

SUBMIT: Fails to Start Submit Procedure

There are several reasons why SUBMIT will not initiate a SUB file:

- You are using the standard release version of SUBMIT and your current default disk is other than drive A:. SUBMIT builds its "\$\$.SUB" file on the default disk, but the CCP only looks on drive A: for "\$\$.SUB". Use the following procedure to modify SUBMIT to build its "\$\$.SUB" file on drive A:

```
A>DDT SUBMIT.COM<cr>
DDT VERS 2.2
NEXT PC
0600 0100
-s5bb                <- Change 5bb
05BB 01 00<cr>      <- from 00 (default drive)
05BC 24 .<cr>        to 01 (drive A:)
-^C
A>SAVE 5 SUBMIT.COM<cr>
A>_
```

- If you forgot to terminate the last line of the SUB file with a CARRIAGE RETURN.
- If your SUB file contains a line with nothing but a CARRIAGE RETURN on it (that is, a blank line).

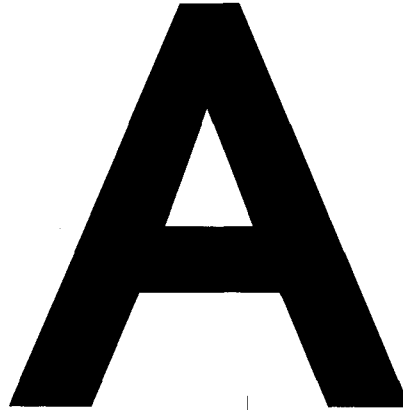

ASCII Character Set

The American Standard Code for Information Interchange (ASCII) consists of a set of 96 displayable characters and 32 nondisplayed characters. Most CP/M systems use at least a subset of the ASCII character set. When CP/M stores characters on a diskette as text, the ASCII definitions are used.

Several of the CP/M utility programs use the ASCII Character Code. Text created using ED is stored as ASCII characters on diskette. DDT, when displaying a “dump” of the contents of memory, displays both the hexadecimal and ASCII representations of memory’s contents.

ASCII does not use an entire byte of information to represent a character. ASCII is a seven-bit code, and the eighth bit is often used for *parity*. Parity is an error-checking method which assures that the character received is the one transmitted. Many microcomputers and microcomputer devices ignore the *parity bit*, while others require one of the following two forms of parity:

Even Parity

The number of binary 1’s in a byte is always an even number. If there is an odd number of 1’s in the character, the parity bit will be a 1; if there is an even number of 1’s in the character, the parity bit is made a 0.

Odd Parity

The number of binary 1’s in a byte is always an odd number. If there is an

even number of 1's in the character, the parity bit will be a 1; if there is an odd number of 1's in the character, the parity bit is made a 0.

Alternative ways of *coding* the information stored by the computer include the 8-bit EBCDIC (Extended Binary Coded Decimal Interchange Code), used by IBM, and a number of *packed binary* schemes, primarily used to represent numerical information.

Table A-1. ASCII Character Codes

				b7 →	0	0	0	0	1	1	1	1
				b6 →	0	0	1	1	0	0	1	1
				b5 →	0	1	0	1	0	1	0	1
b4	b3	b2	b1	Col. / Row	0	1	2	3	4	5	6	7
0	0	0	0	0	NUL	DLE	SP	0	@	P	`	p
0	0	0	1	1	SOH	DC1	!	1	A	Q	a	q
0	0	1	0	2	STX	DC2	"	2	B	R	b	r
0	0	1	1	3	ETX	DC3	#	3	C	S	c	s
0	1	0	0	4	EOT	DC4	\$	4	D	T	d	t
0	1	0	1	5	ENQ	NAK	%	5	E	U	e	u
0	1	1	0	6	ACK	SYN	&	6	F	V	f	v
0	1	1	1	7	BEL	ETB	'	7	G	W	g	w
1	0	0	0	8	BS	CAN	(8	H	X	h	x
1	0	0	1	9	HT	EM)	9	I	Y	i	y
1	0	1	0	10	LF	SUB	*	:	J	Z	j	z
1	0	1	1	11	VT	ESC	+	;	K	[k	{
1	1	0	0	12	FF	FS	'	<	L	\	l	
1	1	0	1	13	CR	GS	-	=	M]	m	}
1	1	1	0	14	SO	RS	.	>	N	^	n	~
1	1	1	1	15	SI	US	/	?	O	_	o	DEL

NUL	Null	DC1	Device control 1
SOH	Start of heading	DC2	Device control 2
STX	Start of text	DC3	Device control 3
ETX	End of text	DC4	Device control 4
EOT	End of transmission	NAK	Negative acknowledge
ENQ	Enquiry	SYN	Synchronous idle
ACK	Acknowledge	ETB	End of transmission block
BEL	Bell or alarm	CAN	Cancel
BS	Backspace	EM	End of medium
HT	Horizontal tabulation	SUB	Substitute
LF	Line feed	ESC	Escape
VT	Vertical tabulation	FS	File separator
FF	Form feed	GS	Group separator
CR	Carriage return	RS	Record separator
SO	Shift out	US	Unit separator
SI	Shift in	SP	Space
DLE	Data link escape	DEL	Delete

Table A-2. ASCII Character Codes in Ascending Order

Hexadecimal	Binary	ASCII	Hexadecimal	Binary	ASCII
00	000 0000	NUL	30	011 0000	0
01	000 0001	SOH	31	011 0001	1
02	000 0010	STX	32	011 0010	2
03	000 0011	ETX	33	011 0011	3
04	000 0100	EOT	34	011 0100	4
05	000 0101	ENQ	35	011 0101	5
06	000 0110	ACK	36	011 0110	6
07	000 0111	BEL	37	011 0111	7
08	000 1000	BS	38	011 1000	8
09	000 1001	HT	39	011 1001	9
0A	000 1010	LF	3A	011 1010	:
0B	000 1011	VT	3B	011 1011	;
0C	000 1100	FF	3C	011 1100	<
0D	000 1101	CR	3D	011 1101	=
0E	000 1110	SO	3E	011 1110	>
0F	000 1111	SI	3F	011 1111	?
10	001 0000	DLE	40	100 0000	
11	001 0001	DC1	41	100 0001	A
12	001 0010	DC2	42	100 0010	B
13	001 0011	DC3	43	100 0011	C
14	001 0100	DC4	44	100 0100	D
15	001 0101	NAK	45	100 0101	E
16	001 0110	SYN	46	100 0110	F
17	001 0111	ETB	47	100 0111	G
18	001 1000	CAN	48	100 1000	H
19	001 1001	EM	49	100 1001	I
1A	001 1010	SUB	4A	100 1010	J
1B	001 1011	ESC	4B	100 1011	K
1C	001 1100	FS	4C	100 1100	L
1D	001 1101	GS	4D	100 1101	M
1E	001 1110	RS	4E	100 1110	N
1F	001 1111	US	4F	100 1111	O
20	010 0000	SP	50	101 0000	P
21	010 0001	!	51	101 0001	Q
22	010 0010	"	52	101 0010	R
23	010 0011	#	53	101 0011	S
24	010 0100	\$	54	101 0100	T
25	010 0101	%	55	101 0101	U
26	010 0110	&	56	101 0110	V
27	010 0111	'	57	101 0111	W
28	010 1000	(58	101 1000	X
29	010 1001)	59	101 1001	Y
2A	010 1010	*	5A	101 1010	Z
2B	010 1011	+	5B	101 1011	[
2C	010 1100	,	5C	101 1100	\
2D	010 1101	-	5D	101 1101]
2E	010 1110	.	5E	101 1110	^
2F	010 1111	/	5F	101 1111	-

Table A-2. ASCII Character Codes in Ascending Order (Continued)

Hexadecimal	Binary	ASCII	Hexadecimal	Binary	ASCII
60	110 0000		70	111 0000	p
61	110 0001	a	71	111 0001	q
62	110 0010	b	72	111 0010	r
63	110 0011	c	73	111 0011	s
64	110 0100	d	74	111 0100	t
65	110 0101	e	75	111 0101	u
66	110 0110	f	76	111 0110	v
67	110 0111	g	77	111 0111	w
68	110 1000	h	78	111 1000	x
69	110 1001	i	79	111 1001	y
6A	110 1010	j	7A	111 1010	z
6B	110 1011	k	7B	111 1011	{
6C	110 1100	l	7C	111 1100	
6D	110 1101	m	7D	111 1101	}
6E	110 1110	n	7E	111 1110	~
6F	110 1111	o	7F	111 1111	DEL

B

CP/M Command Summary

This appendix summarizes the command line format and the function of each CP/M built-in and transient command. The commands are listed in alphabetical order.

ASM Command Lines

ASM filename<cr> Assembles the file filename.ASM; uses the currently logged disk for all files.

ASM filename.opt<cr> Assembles the file filename.ASM on drive o: (A:,B:,...,P:). Writes HEX file on drive p: (A:,B:,...,P:), or skips if p: is Z:.

Writes PRN file on drive t: (A:,B:,...,P:), sends to console if p: is X:, or skips if p: is Z:.

DDT Command Lines

DDT<cr> Loads DDT and waits for DDT commands.

DDT x:filename.typ<cr> Loads DDT into memory and also loads filename.typ from drive x: into memory for examination, modification, or execution.

DDT Command Summary

- Asss** Enters assembly language statements beginning at hexadecimal address ssss.
- D** Displays the contents of the next 192 bytes of memory.
- Dssss,ffff** Displays the contents of memory starting at hexadecimal address ssss and finishing at hexadecimal address ffff.
- Fssss,ffff,cc** Fills memory with the 8-bit hexadecimal constant cc starting at hexadecimal address ssss and finishing with hexadecimal address ffff.
- G** Begins execution at the address contained in the program counter.
- G,bbbb** Sets a breakpoint at hexadecimal address bbbb, then begins execution at the address contained in the program counter.
- G,bbbb,cccc** Sets breakpoints at hexadecimal addresses bbbb and cccc, then begins execution at the address contained in the program counter.
- Gssss** Begins execution at hexadecimal address ssss.
- Gssss,bbbb** Sets a breakpoint at hexadecimal address bbbb, then begins execution at hexadecimal address ssss.
- Hx,y** Hexadecimal sum and difference of x and y.
- ifilename.typ** Sets up the default file control block using the name filename.typ.
- L** Lists the next eleven lines of assembly language program disassembled from memory.
- Lssss** Lists eleven lines of assembly language program disassembled from memory starting at hexadecimal address ssss.
- Lssss,ffff** Lists the assembly language program disassembled from memory starting at hexadecimal address ssss and finishing at hexadecimal address ffff.

- Mssss,ffff,dddd** Moves the contents of the memory block starting at hexadecimal address ssss and ending at hexadecimal address ffff to the block of memory starting at hexadecimal address dddd.
- R** Reads a file from disk into memory (use “I” command first).
- Rnnnn** Reads a file from disk into memory beginning at the hexadecimal address nnnn higher than normal (use “I” command first).
- Sssss** Displays the contents of memory at hexadecimal address ssss and optionally changes the contents.
- Tnnnn** Traces the execution of (hexadecimal) nnnn program instructions.
- Unnnn** Executes (hexadecimal) nnnn program instructions, then stops and displays the CPU register’s contents.
- X** Displays the CPU register’s contents.
- Xr** Displays the contents of CPU or Flag r and optionally changes them.

DIR Command Lines

- DIR x:<cr>** Displays directory of all files on drive x:. Drive x: is optional; if omitted, the currently logged drive is used.
- DIR x:filename.typ<cr>** Displays directory of all files on drive x: whose names match the ambiguous or unambiguous filename.typ. Drive x: is optional; if omitted, the currently logged drive is used.

DUMP Command Line

- DUMP x:filename.typ <cr>** Displays the hexadecimal representations of each byte stored in the file filename.typ on drive x:. If filename.typ is ambiguous, displays the first file which matches the ambiguous file name.

ED Command Line

- ED x:filename.typ <cr>** Invokes the editor, which then searches for filename.typ on drive x: and creates a temporary file x:filename.\$\$\$ to store the edited text. The filename.typ is unambiguous. Drive x: is optional; if omitted, the currently logged drive is assumed.

ED Command Summary

NOTE: Non-alphabetic commands follow the “Z” command.

- nA** Append lines. Moves "n" lines from original file to edit buffer. 0A moves lines until edit buffer is at least half full.
- +/-B** Begin/Bottom. Moves CP.
 +B moves CP to beginning of edit buffer
 -B moves CP to end of edit buffer.
- +/-nC** Move by characters. Moves CP by "n" character positions.
 + moves forward
 - moves backward.
- +/-nD** Delete characters. Deletes "n" characters before or after the CP in the edit buffer.
 + deletes before the CP
 - deletes after the CP.
- E** End. Ends edit, closes files, and returns to CP/M; normal end.
- nFstring^Z** Find string. Finds the "n"th occurrence of string, beginning the search after the CP.
- H** Move to head of edited file. Ends edit, renames files, and then edits former temporary file.
- I<cr>** Enter insert mode. Text from keyboard goes into edit buffer after the CP; exit with CONTROL-Z.
- Istring^Z** Insert string. Inserts string in edit buffer after the CP.
- Istring<cr>** Insert line. Inserts string and CRLF in the edit buffer after the CP.
- nJfindstring^Zinsertstring^Zendstring^Z** Juxtaposition. Beginning after the CP, finds findstring, inserts insertstring after it, then deletes all following characters up to but not including endstring; repeats until performed "n" times.
- +/-nK** Kill lines. Deletes "n" lines.
 + deletes after the CP
 - deletes before the CP.
- +/-nL** Move by lines. Moves the CP to the beginning of the line it is in, then moves the CP "n" lines forward or backward.
 + moves forward
 - moves backward.
- nMcommandstring^Z** Macro command. Repeats execution of the ED commands in

commandstring “n” times. “n” = 0, “n” = 1, or “n” absent repeats execution until error occurs.

- nNstring^Z** Find string with autoscans. Finds the “n”th occurrence of string, automatically appending from original file and writing to temporary file as necessary.
- O** Return to original file. Empties edit buffer, empties temporary file, returns to beginning of original file, ignores previous ED commands.
- +/-nP** Move CP and print pages. Moves the CP forward or backward one page, then displays the page following the CP. “nP” displays “n” pages, pausing after each.
- Q** Quit edit. Erases temporary file and block move file, if any, and returns to CP/M; original file is not changed.
- R<cr>** Read block move file. Copies the entire block move file X\$\$\$\$\$\$\$.LIB from disk and inserts it in the edit buffer after the CP.
- Rfilename<cr>** Read library file. Copies the entire file filename with extension LIB from the disk and inserts it in the edit buffer after the CP.
- nSfindstring^Zreplacestring^Z** Substitute string. Starting at the CP, repeats “n” times: finds findstring and replaces it with replacestring.
- +/-nT** Type lines. Displays “n” lines.
 + displays the “n” lines after the CP
 - displays the “n” lines before the CP.
- If the CP is not at the beginning of a line
 0T displays from the beginning of the line to the CP
 T displays from the CP to the end of the line
 0TT displays the entire line without moving the CP.
- +/-U** Uppercase translation. After +U command, alphabetic input to the edit buffer is translated from lowercase to uppercase; after -U, no translation occurs.
- OV** Edit buffer free space/size. Displays the decimal number of free (empty) bytes in the edit buffer and the total size of the edit buffer.
- +/-V** Verify line numbers. After +V, a line number is displayed with each line displayed; ED’s prompt is then preceded by the number of the line containing the CP. After -V, line numbers are not displayed, and ED’s prompt is “*”.

- nW** Write lines. Writes first "n" lines from the edit buffer to the temporary file; deletes these lines from the edit buffer.
- nX** Block transfer (Xfer). Copies the "n" lines following the CP from the edit buffer to the temporary block move file X\$\$\$\$\$.LIB; adds to previous contents of that file.
- nZ** Sleep. Delays execution of the command which follows it. Larger "n" gives longer delay, smaller "n" gives shorter delay.
- n:** Move CP to line number "n." Moves the CP to the beginning of the line number "n" (see "+/-V").
- :m** Continue through line number "m." A command prefix which gives the ending point for the command which follows it. The beginning point is the location of the CP (see "+/-V").
- +/-n** Move and display one line. Abbreviated form of +/-nLT.

ERA Command Lines

ERA x:filename.typ<cr> Erases the file filename.typ on the disk in drive x:. The filename and/or typ can be ambiguous. Drive x: is optional; if omitted, the currently logged drive is used.

ERA x:.*<cr> Erases all files on the disk in drive x:. Drive x: is optional; if omitted, the currently logged drive is used.

Line Editing Commands

CONTROL-C Restarts CP/M if it is the first character in command line. Called *warm start*.

CONTROL-E Moves to the beginning of next line. Used for typing long commands.

CONTROL-H or BACKSPACE Deletes one character and erases it from the screen (CP/M version 2.0 and newer).

CONTROL-J or LINE FEED Same as CARRIAGE RETURN (CP/M version 2.0 and newer).

CONTROL-M Same as CARRIAGE RETURN (<cr>).

CONTROL-P Turns on the list device (usually your printer). Type it again to turn off the list device.

CONTROL-R Repeats current command line (useful with version 1.4); it verifies the line is corrected after you delete several characters (CP/M version 1.4 and newer).

CONTROL-S Temporarily stops display of data on the console. Press any key to continue.

CONTROL-U or CONTROL-X Cancels current command line (CP/M version 1.4 and newer).

RUBOUT (RUB) or DELETE (DEL) Deletes one character and echoes (repeats) it.

Load Command Line

LOAD x:filename<cr> Reads the file filename.HEX on drive x: and creates the executable program file filename.COM on drive x:.

MOVCPM Command Lines

MOVCPM<cr> Prepares a new copy of CP/M which uses all of memory; gives control to the new CP/M, but does not save it on disk.

MOVCPM nn<cr> Prepares a new copy of CP/M which uses “nn” K bytes of memory; gives control to the new CP/M, but does not save it on disk.

MOVCPM * * <cr> Prepares a new copy of CP/M that uses all of memory, to be saved with SYSGEN or SAVE.

MOVCPM nn * <cr> Prepares a new copy of CP/M that uses “nn” K bytes of memory, to be saved with SYSGEN or SAVE.

The “nn” is an integer decimal number. It can be 16 through 64 for CP/M 1.3 or 1.4. For CP/M 2.0 and newer “nn” can be 20 through 64.

PIP Command Lines

PIP<cr> Loads PIP into memory. PIP prompts for commands, executes them, then prompts again.

PIP pipcommandline<cr> Loads PIP into memory. PIP executes the command pipcommandline, then exits to CP/M.

PIP Command Summary

x:new.typ=y:old.typ[p]<cr> Copies the file old.typ on drive y: to the file new.typ on drive x:, using parameters p.

x:new.typ=y:old1.typ[p],z:old2.typ[q]<cr> Creates a file new.typ on drive x: that

consists of the contents of file old1.typ on drive y: using parameters p followed by the contents of file old2.typ on drive z: using parameters q.

x:filename.typ=dev:[p]<cr> Copies data from device dev: to the file filename.typ on drive x:.

dev:=x:filename.typ[p]<cr> Copies data from filename.typ on drive x: to device dev:.

dst:=src:[p]<cr> Copies data to device dst: from device src:.

PIP Parameter Summary

B	Specifies block mode transfer.
Dn	Deletes all characters after the "n"th column.
E	Echoes the copying to the console as it is being performed.
F	Removes form feed characters during transfer.
Gn	Directs PIP to copy a file from user area "n."
H	Checks for proper Intel Hex File format.
I	Ignores any :00 records in Intel Hex File transfers.
L	Translates uppercase letters to lowercase.
N	Adds a line number to each line transferred.
O	Object file transfer (ignores end-of-file markers).
Pn	Issues page feed after every "n"th line.
Qs^Z	Specifies quit of copying after the string "s" is encountered.
R	Directs PIP to copy from a system file.
Ss^Z	Specifies start of copying after the string "s" is encountered.
Tn	Sets tab stops to every "n"th column.
U	Translates lowercase letters to uppercase.
V	Verifies copy by comparison after copy finished.
W	Directs PIP to copy onto an R/O file.
Z	Zeroes the "parity" bit on ASCII characters.

PIP Destination Devices

CON:	PUN:	LST:	Logical devices
TTY:	PTP:	LPT:	
CRT:	UP1:	UL1:	
UC1:	UP2:		Physical devices
OUT:	PRN:		Special PIP devices

PIP Source Devices

CON:	RDR:	Logical devices	
TTY:	PTR:		
CRT:	UR1:		
UC1:	UR2:	Physical devices	
NUL:	EOF:	INP:	Special PIP devices

REN Command Line

REN newname.typ=oldname.typ<cr> Finds the file oldname.typ and renames it newname.typ.

SAVE Command Line

SAVE nnn x:filename.typ<cr> Saves a portion of the Transient Program Area of memory in the file filename.typ on drive x: where nnn is a decimal number representing the number of pages of memory. Drive x: is the option drive specifier.

STAT Command Lines

STAT<cr> Displays attributes and amount of free space for all diskette drives accessed since last warm or cold start.

STAT x:<cr> Displays amount of free space on the diskette in drive x:.

STAT x:filename.typ<cr> (CP/M 2.0 and newer) Displays size and attributes of file(s) filename.typ on drive x:. filename.typ may be ambiguous. x: is optional; if omitted, currently logged drive is assumed.

STAT x:filename.typ \$atr<cr> Assigns the attribute atr to the file(s) filename.typ on drive x:. File filename.typ may be ambiguous. Drive x: is optional; if omitted, currently logged drive is assumed.

STAT DEV:<cr> Reports which physical devices are currently assigned to the four logical devices.

STAT VAL:<cr> Reports the possible device assignments and partial STAT command line summary.

STAT log:=phy:<cr> Assigns the physical device phy: to the logical device log: (may be more than one assignment on the line; each should be set off by a comma).

STAT USR:<cr> (CP/M 2.0 and newer) Reports the current user number as well as all user numbers for which there are files on currently logged disks.

STAT x:DSK<cr> (CP/M 1.4 and newer) Assigns a temporary write-protect status to drive x:.

SUBMIT Command Lines

SUBMIT filename<cr> Creates a file \$\$\$SUB which contains the commands listed in filename.SUB; CP/M then executes commands from this file rather than the keyboard.

SUBMIT filename parameters<cr> Creates a file \$\$\$SUB which contains commands from the file filename.SUB; certain parts of the command lines in filename.SUB are replaced by parameters during creation of \$\$\$SUB. CP/M then gets commands from this file rather than the keyboard.

SYSGEN Command Line

SYSGEN<cr> Loads the SYSGEN program to transfer CP/M from one diskette to another.

TYPE Command Line

TYPE x:filename.typ<cr> Displays the contents of file filename.typ from drive x: on the console.

USER Command Line

USER n<cr> Sets the User Number to "n," where "n" is an integer decimal number from 0 to 15, inclusive.

x: Command Line

x:<cr> Changes the currently logged disk drive to drive x:. Drive x: can be "A" through "P."

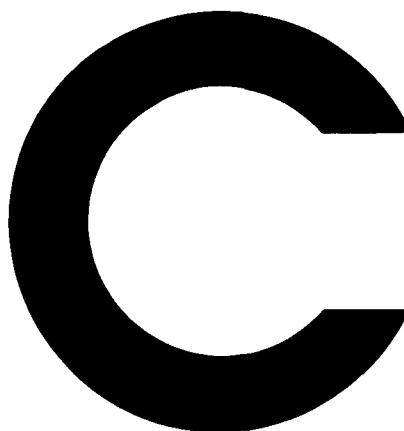

Summary of BDOS Calls

Table C-1. BDOS Function Definitions for CP/M-80 Version 2.2

Function		Entry Parameter(s)	Exit Parameter(s)	Explanation
No.	Name			
00	SYSTEM RESET	None	None	Restarts CP/M-80 by returning control to the the CCP after reinitializing the disk subsystem.
01	CONSOLE INPUT	None	A = ASCII character	Returns the next character typed to the character calling program. Any non-printable character is echoed to the screen (like BACKSPACE, TAB, or CARRIAGE RETURN). Execution does not return to the calling program until a character has been typed. Standard CCP control characters are recognized and their actions performed (CONTROL-P begins or ends printer echoing and so on).

Table C-1. (Continued)

Function		Entry Parameter(s)	Exit Parameter(s)	Explanation
No.	Name			
02	CONSOLE OUTPUT	E = ASCII character	None	Displays the character in the E register on the console device. Standard CCP control characters are recognized and their actions performed (CONTROL-P begins or ends printer echoing and so on.).
03	READER INPUT	None	A = ASCII character	Returns the next character received from the reader device to the calling program. Execution does not return to the calling program until a character is received.
04	PUNCH OUTPUT	E = ASCII character	None	Transmits the character in the E register to the punch device.
05	LIST OUTPUT	E = ASCII character	None	Transmits the character in the E register to the list device.
06	DIRECT CONSOLE IN	E = FF hex	A = ASCII	If register E contains an FF hex, the console device is interrogated to see if a character is ready. If no character is ready, a 00 is returned to the calling program in register A; otherwise the character detected is returned in register A. If register E contains any character other than an FF hex, that character is passed to the console display. All CCP control characters are ignored. The user must protect the program against nonsensical characters being sent from or received by the console device.
	DIRECT CONSOLE OUT	E = ASCII character	None	
07	GET IOBYTE	None	A = IOBYTE	Places a copy of the byte stored at location 0003 hex in the A register before returning control to the calling program.
08	SET IOBYTE	E = IOBYTE	None	Places a copy of the value in register E into the memory location of 0003 hex before returning control to the calling program.
09	PRINT STRING	DE = String address	None	Sends the string of characters stored beginning at the address stored in the DE register pair to the console device. All characters in subsequent addresses are sent until BDOS encounters a memory location which contains a 24 hex (an ASCII "\$"). The CCP control characters are checked for and performed if encountered.

NOTE: CP/M-80 always copies the contents of the H register in the A register if nothing is to be specifically returned in the A register. Some manufacturers, specifically Microsoft, make use of such information to reduce movement of information between the H and A registers.

Table C-1. (Continued)

Function		Entry Parameter(s)	Exit Parameter(s)	Explanation
No.	Name			
0A	READ CONSOLE BUFFER	DE = Buffer address	Data in buffer	This function performs essentially the same as the CCP would in that it takes the characters the user types and stores them into the buffer that begins at the address stored in the DE register pair. The first byte in the buffer pointed to by the DE pair must be the maximum length of the command; BDOS will place the number of characters encountered in the second byte, with the typed command beginning with the third byte pointed to by the DE pair. All standard CCP editing characters are recognized during the command entry.
0B	GET CONSOLE STATUS	None	A = Status	BDOS checks the status of the console device and returns a 00 hex if no character is ready, FF hex if a character has been typed.
0C	GET VERSION NUMBER	None	HL = Version	If the byte returned in the H register is 00 hex then CP/M is present, if 01, then MP/M is present. The byte returned in the L register is 00 if the version is previous to CP/M 2.0, 20 hex if the version is 2.0, 21 hex if 2.1 and so on.
0D	RESET DISK SYSTEM	None		Used to tell CP/M to reset the disk subsystem. Should be used any time diskettes are changed.
0E	SELECT DISK	E = Disk number	None	Selects the disk to be used for subsequent disk operations. A 00 hex in the E register indicates disk A, a 01 hex indicates disk B, etc.
0F	OPEN FILE	DE = FCB address	A = 'Found'/ not found code	Used to activate a file on the current disk drive and current user area. BDOS scans the first 14 bytes of the designated FCB block and attempts to find a match to the filename in the block. A 3F hex (ASCII "?") can be used in any of the filename positions to indicate a "don't care" character. If a match is found, the relevant information about that file is filled into the rest of the FCB by CP/M-80. A value of 00 hex to 03 in register A upon return indicates the open operation was successful, while an FF hex indicates that the file could not be found. If question marks are used to identify a file, the first matching entry is used.

NOTE: CP/M-80 always copies the contents of the H register in the A register if nothing is to be specifically returned in the A register. Some manufacturers, specifically Microsoft, make use of such information to reduce movement of information between the H and A registers.

488 The CP/M Programmer's Handbook

BDOS Function codes *(continued)*

490 The CP/M Programmer's Handbook

CONIN *(continued)*

Console input, in the BIOS, 151
Recognizing incoming function key characters, 221
Use with forced input, 219

CONOUT:

Console output, in the BIOS, 151
Escape sequences to input date and time, 223
Processing output escape sequences, 222

CONST:

Console input status, in the BIOS, 50
Problems with programs that "gobble" characters, 218
Use with forced input, 219

CP/M:

Bringing up a new system, 350

CP/M 128-byte "records": 41

CP/M file system:

Concepts, 17

CP/M records as 128-byte sectors: 71

CRC:

See Cyclic Redundancy Check

CRF:

Example of Random Write, 135

Cancel command line:

CONTROL-U, 49

Captions:

For debug subroutines, 322

CARRIAGE RETURN:

CONTROL-M, 48

Changed diskette:

Size of buffer for detection, in disk parameter block, 36
Work area in disk parameter header, 32

Changing disks:

Need to force disk log-in, 96

Changing user number:

USER, 53

BIOS *(continued)*

Code table:

Definition of structure in LIBRARY.H, 394
Display all strings, ct__disps, Code, 385, Narrative, 407
Get string for code, ct__strc, Code, 386, Narrative, 407
Get string for index, ct__stri, Code, 386, Narrative, 407
Initialize, ct__init, Code, 384, Narrative, 407
Prompt and return code, ct__parc, Code, 384, Narrative, 407
Return code, ct__code, Code, 385, Narrative, 407
Return index, ct__index, Code, 386, Narrative, 407
Used for command tail parameters, 406

Cold Boot:

BIOS functions, 149
Concepts, 12

Command line:

Canceling, CONTROL-U, 49
Deleting last character typed, 49
Repeating, CONTROL-R, 49

Command Line Editing:

By the CCP, 46

Command tail:

Code tables, C functions, 405
Example program to process parameters, 63
In base page, 60
Input to the CCP, 46
Processing, C functions, 405

Communications:

Using Reader/Punch (Auxiliary), 151

Comp__fname:

Compare file name, Code, 374, Narrative, 401

Compare file name:

Comp__fname, Code, 374, Narrative, 401

Configuration Block:

Accessing from C, 396
Concepts, 211
Suggestion for utility program, 448

Default disk:

Changing, 50
 In base page, 59
 In CCP prompt, 46

Default File Control Blocks:

In base page, 60

Deferred writes:

In conjunction with track buffering, 231

Delete character:

Rubout/Del, 49

Deleting files:

ERA, 51

Device table:

Accessing from C, 398
 Displaying for debugging, 356
 Structure, 225

Digital Research:

Manuals, 6

Direct BIOS calls:

Example code, 156
 Examples, 65
 When to avoid, 15

Directory code:

As returned by BDOS calls, 71
 As returned from Create (Make) File, 114
 As returned from Rename File, 116
 Returned by BDOS Close File, 103
 Returned by BDOS Open File, 99
 Returned by Search for First Name Match, 103
 Returned by Search for Next Name Match, 107

Directory entry: 99

Definition in LIBRARY.H, 394

Directory Parameter Block:

Definition in LIBRARY.H, 393

Disk Drivers:

Debugging, 364

Disk I/O:

Enhancements, 231
 In the BIOS, 152

Disk Map:

In file directory entry, 26

Disk Parameter Block:

Accessing from C, 398
 Adding extra information, 41
 Block shift, mask, and extent mask, 33
 Definition in LIBRARY.H, 394
 Details, 33
 Finding the address of, 125
 Maximum allocation block number, 34

Disk Parameter Block (continued)

Number of directory entries — 1, 35
 Number of tracks before directory, 36
 Pointer in disk parameter header, 31
 Reserving allocation blocks for file directory, 35
 Sectors per track, 33
 Size of buffer for detecting changed diskettes, 36
 Worked example for hard disk, 39

Disk Parameter Header:

Details, 28
 Disk buffer, 31
 Disk parameter block, 31
 Pointer to allocation vector, 32
 Sector skewing, 28
 Work area for changed diskette detection, 32

Disk buffer:

In disk parameter header, 31

Disk definition tables:

Concept, 18
 Details, 27

Disk drivers:

Example testbed code, 365

Disk errors:

Strategy, 303

Disk full:

Error returned from Sequential Write, 112

Disk layout:

CP/M on diskettes, 189

Disk map:

As used in C functions, 402

Disk map clear:

Dm_clr, Code, 382, Narrative, 403

Disk map display:

Dm_disp, Code, 382, Narrative, 403

Diskette:

Layout of standard CP/M diskette, 37

Diskette format:

Concepts, 9

Display S-Terminated String:

BDOS Function 9, 88

Display directory error:

Err_dir, Code, 381, Narrative, 400

Displaying an ASCII file:

TYPE, 52

Displaying current user number: 54**Dm_clr:**

Disk map clear, Code, 382, Narrative, 403

Dm_disp:

Disk map display, Code, 382, Narrative, 403

Control characters (*continued*)

CONTROL-C:

Used to abort after BDOS error, 98

CONTROL-P:

Errors generated, 299

CONTROL-Z:

If no Reader driver in BIOS, 75

Used to indicate end of file, 110

Used to terminate prior to BDOS Close File, 103

Conv__dfname:

Convert directory file name, Code, 375, Narrative, 402

Conv__fname:

Convert file name, Code, 375, Narrative, 408

Convert directory file name:

Conv__dfname, Code, 375, Narrative, 402

Convert file name:

Conv__fname, Code, 375, Narrative, 408

Create (Make) file:

BDOS Function 22, 112

Ct__code:

Code table, return code, Code, 385, Narrative, 407

Ct__disps:

Code table, display all strings, Code, 385, Narrative, 407

Ct__index:

Code table, return index, Code, 386, Narrative, 407

Ct__init:

Code table, initialize, Code, 384, Narrative, 407

Ct__parc:

Code table, prompt and return code, Code, 384, Narrative, 407

Ct__strc:

Code table, get string for code, Code, 386, Narrative, 407

Ct__stri:

Code table, get string for index, Code, 386, Narrative, 407

Current default drive: 97

Current logical disk:

In base page, 59

Current record number:

In FCB, unchanged for Random Read, 132

In FCB, unchanged for Random Write, 132

Current user number:

Displaying, 54

In base page, 59

Customization:

Of CP/M, an overview, 8

Cyclic Redundancy Check:

As used in disk errors, 303

D

DDT:

Dynamic Debug Tool, 185, 329

Manual, 6

I Command used for building new CP/M system, 195

R Command used for building new CP/M system, 195

Used for checking CP/M images, 204

Used for debugging character drivers, 354

Used to create CP/M memory image, 194

Used to debug disk drivers, 364

DESPOOL:

Use of LISTST BIOS entry, 156

DIR:

Display directory of files, 50

DMA buffer:

Default in base page, 60

DPB:

See Disk Parameter Block

DPH:

See Disk Parameter Header

DTR:

PROTOCOL, C program to set protocols, 434

See Data Terminal Ready

Data storage area:

Concept, 17

Data Terminal Ready:

Explanation of DTR protocol, 219

DATE:

C program, sets the date, 442

Date:

Keeping the current date in the BIOS, 224

Reading the date from the console driver, 223

Debug output:

Controlling when it occurs, 324

Debug subroutines: 322

Overall design philosophy, 322

Debugging a new CP/M system, 319

Debugging checklist:

Character output, 361

Disk drivers, 367

Interrupt service routines, 359

Non-interrupt service routine, 359

Real Time Clock, 362

Default DMA Address: 118

Default DMA buffer:

In base page, 60

DO:

Suggestion for utility program, 448

DPB:

See Disk Parameter Block

DPH:

See Disk Parameter Header

E**ED:**

Editor, manual, 6

ERA:

Erase (delete) files, 51

Echoing of keyboard characters:

Read Console Byte, 72

End of File:

Detection using Read Sequential, 110

Erase (Delete) File:

BDOS Function 19, 108

ERASE:

C program, a safer way to erase files, 409

Erased files:

Unerasing them, 26

Erasing a file:

ERA, 51

Logical deletion only, 23

Err_dir:

Display directory error, Code, 381, Narrative, 400

Error messages:

Debugging disk drivers, 368, Chapter 12

Errors:

Dealing with hardware errors, 295

Example printer error routine, 301

Handling disk errors, 303

Hardware, analysis, 297

Hardware, correction, 299

Hardware, detection strategy, 296

Hardware, indication, 297

Improved disk error messages, 312

Practical handling, character I/O, 299

Escape sequences:

Function keys, debugging character driver, 360

Incoming, debugging character driver, 360

Processing output sequences, 222

Recognizing function key sequences, 222

Suggestion for utility program, 448

Support via device table, 226

Etx/Ack:

Debugging character drivers, 358, 362

Explanation of protocol, 219

Etx/Ack (continued)

Protocol, C program to set protocols, 434

Example programs:

Ordering diskette, 4

Extent:

In file directory entry, 26

Of files, concepts, 18

Extent mask:

In disk parameter block, 33

F**FCB:**

Default FCB's in base page, 60

See File Control Block

FDOS:

Rarely used term for BDOS/CCP combined

File Attributes: 99

Setting, 121

See File status

File Control Block:

Creating one from an ASCII file name, 100

Concepts, 18

Definition in LIBRARY.H, 393

Structure, 41

Used for random file operations, 43

Used for sequential file operations, 43

Used in BDOS Open File, 99

Used in BDOS Requests, 71

File Directory:

Accessing entries directly, 399

Processing, C functions, 402

File Organizations:

Concepts, 41

File Protection:

Special characters in file name, 114

File changed:

File status bit in file directory entry, 26

File directory:

Accessing, C functions, 400

Accessing, via BDOS & C functions, 408

Concept, 17

Details, 18

Disk map, 26

Displaying contents, DIR, 50

Entry structure, 22

Erasing files, ERA, 51

File extent, 26

File name and type in entry, 27

Matching names, C functions, 401

Number of entries — I, in disk parameter block, 35

File directory (*continued*)

Number of tracks before, 36

Record number, 27

Status (attribute) bits, 26

User number in entry, 22

File extent:

Concepts, 18

In file directory entry, 26

Manipulation to achieve Random I/O, 110-12

Opening extent 0 for Random I/O, 133-34

File name/type:

In file directory entry, 23

File protection:

Suggestion for utility program, 426

File status:

In file directory entry, 26

File system:

Concepts, 17

File type:

Conventions for actual types, 24

Filecopy:

Suggestion for utility program, 426

Files:

Creating, sequence of operations, 20

Displaying a directory, DIR, 50

Find:

C program, finds lost files, 416

Flushing buffers:

Prior to BDOS Close File, 103

Forced input:

Concepts, 219

Debugging character driver, 360

Suggestion for utility program, 448

Framing error:

Character I/O, handling, 300

Function Key table:

Accessing from C, 397

Function keys:

Structure in LIBRARY.H, 392

Support with enhanced BIOS, 220

Testing in a live BIOS, 370

FUNKEY:

C program, sets the function keys, 445

G

GETC:

Example of Read Sequential, 111

GETDPB:

Example of Get Disk Parameter Block Address, 126

GFA:

Example of Get File Attributes, 122

GNF:

Example of Search First/Next File Name Match, 104

Get CP/M Version Number:

BDOS Function 12, 94

Get Current Default Disk:

BDOS Function 25, 118

Get Disk Parameter Block Address:

BDOS Function 31, 125

Get Disk Parameter Block Address:

Get_dpb, Code, 383

Get File Size:

BDOS Function 35, 142

Get IOBYTE Setting:

BDOS Function 7, 80

Get Read-Only Disks:

BDOS Function 29, 120

Get allocation vector:

BDOS Function 27, 119

Get configuration block address:

Get_cba, 372

Get next directory entry:

Get_nde, Code, 378, Narrative, 400

Get next file name:

Get_nfn, Code, 376, Narrative, 408

Get_cba:

Get configuration block address, 372

Get_dpb:

Get Disk Parameter Block Address, Code, 383

Get_nde:

Get next directory entry, Code, 378, Narrative, 400

Get_nfn:

Get next file name, Code, 376, Narrative, 408

H

HEX file structure: 195

HOME:

Home disk heads, in the BIOS, 153

HSTBUF:

In the BIOS, 152

Hard disk:

Division into several logical disks, 39

Special considerations, 36

Hardware errors:

Dealing with, 295, Chapter 9

Hardware reset:

Debugging character driver, 359

Heath/Zenith:

Special version of CP/M, 55

Host Buffer:

In the BIOS, 152

Host sector size:

In the BIOS, 152

I**I/O Redirection:**

Assign, C program to assign physical devices, 439

Concepts, 214

IOBYTE Structure, 57

IF/ENDIF directives:

Used for debug subroutines, 323

IOBYTE:

Equates for bit fields, 86

Structure, 57

Use for polling communications line, 75

Use with Direct Console I/O for communications, 80

Initialization of debug subroutines: 323

Input redirection:

Debugging character driver, 359

Input/Output:

Fake I/O for debugging purposes, 327

Interactions:

Between CCP, BDOS, and BIOS, 15

Interlace:

See Sector skewing

Interrupt service routines:

Debugging checklist, 357

Interrupts:

Architecture, 216

Circular buffers, 217

Dealing with buffer overflow, 219

Debugging service routines, 329

Use for character input drivers, 215

J**Johnson-Laird Inc.:**

Ordering diskette, 4

Jump vector:

Use for entering the BIOS, 15

L**LIBRARY.C:**

Utility function library, 372

LIBRARY.H:

Header for LIBRARY.C functions, 390

LIST:

List output, in the BIOS, 151

LISTST:

List device output status, in the BIOS, 156

LST:

Logical list device, 56

Line editing:

Using Read Console String, 91

Line feed:

CONTROL-J, 48

List Device Errors:

Problems with BDOS Function 5, 78

Loading CP/M:

Overview, 11

Loading programs:

Via the CCP, 54

Loadsys:

Suggestion for utility program, 448

Location 0000H:

Use for warm boot, 13

Location 0005H:

Simple examples of use, 20

Use for BDOS function calls, 14

Logging in a disk:

Using BDOS Reset Disk System, 96

Logical deletion of files, 23

ERA, 51

Logical devices:

CON:, LST:, AUX:, RDR:, PUN:, 56

Logical disk:

As represented in File Control Block, 42

Division of hard disk into several logical disks, 39

Selecting, 97

Logical Input/Output:

As afforded by the BIOS, 15

Logical records:

Concepts, 41

Logical sectors to physical: 28

SECTTRAN, in the BIOS, 156

Login Vector:

See BDOS Function 24, 116

Lowercase letters in file name: 114**M-disk:**

Using memory as an ultra-fast disk, 232

M80:

Macro Assembler, 185

MAC:

Macro Assembler, 185

MAKE:

C program, makes files visible/invisible, 427

MOVE:

C program, moves files between user numbers, 423

MOVCPM:

In conjunction with patches to CP/M, 234

Relocating the CCP and BDOS, 201

Use in building a new CP/M system, 182

MSGOUT:

Example of Write Console Byte, 74

MSGOUTI:

Example of Write Console Byte, 74

Manuals:

From Digital Research, 6

Maximum allocation block number:

In disk parameter block, 34

Memory:

Displaying in debug subroutines, 324

Finding size of area available for programs, 65

Use of hidden memory for buffers, 216

Used as an ultra-fast disk, 232

Memory dumps:

Base page, 61

Memory image:

Checking a new system, 204

Of new CP/M system, 185

Memory layout:

For example BIOS, 190

For input to SYSGEN, 187

With CP/M loaded, 13

Messages:

As an aid to debugging, 326

N

Notation:

For example console dialog, 3

Number of file directory entries:

In disk parameter block, 35

O

OM:

Example of Display \$-Terminated String, 89

OPENF:

Example of Open File, 100

Open File:

BDOS Function 15, 98

Open directory:

Open_dir, Code, 378, Narrative, 400

Open_dir:

Open directory, Code, 378, Narrative, 400

Orville Wright approach to debugging: 320

Output Escape sequence:

Debugging character output driver, 362

Overrun error:

Character I/O, handling, 300

Overwriting the CCP:

To gain memory, 45

Owner:

Suggestion for utility program, 426

P

PIP:

Used to test a new BIOS, 369

PROM Bootstrap:

Used to load CP/M, 11

PUN:

Logical Punch, 56

PUNCH:

Punch (Auxiliary) output, in the BIOS, 151

PUTC:

Example of Write Sequential, 113

PUTCPM:

Example program, 191

Writing a utility, 189

Parallel printers:

Error handling, 301

Parameters:

Example program to process command tail, 63

Parity error:

Character I/O, handling, 300

Pass counters:

Use in debug subroutines, 324

Patching CP/M:

General techniques, 234

Performance:

Effect of sector skewing, 29

Physical end of line:

CONTROL-E, 47

Physical sectors:

Relative, on a hard disk, 38

Polled Reader Input:

Problems and solutions, 75

Polled communications:

Using Direct Console I/O, 80

Printer echo:

CONTROL-P, 48

Printer errors:

Example routine, 301

Use of watchdog timer, 224

Printer timeout error:

Handling, 300

Program loading:

Via the CCP, 54

Program termination:

Returning to CP/M, 66

Prompt:

From the CCP, 46

Protect/Unprotect:

Suggestion for utility program, 426

PROTOCOL:

C program, sets serial line protocols, 434

Protocol:

See also Data Terminal Ready, Request to Send,

Xon/Xoff, Etx/Ack

Definitions in LIBRARY.H, 392

Support in enhanced BIOS, 218

Support via device table, 226

Xon/Xoff, used by TYPE, 52

Public files:

Patches to create this feature, 235

Suggestion for utility program, 448

Public/Private:

Suggestion for utility program, 448

R**RAM-disk:**

Using memory as an ultra-fast disk, 232

RCS:

Example of Direct Console I/O, 81

RDR:

Logical Reader, 56

READ:

Read Sector, in the BIOS, 154

READER:

Reader input, in the BIOS, 152

REN:

Rename file, 52

RF:

Example of Rename File, 117

RLSRDR:

Example of Read Reader Byte, 76

RMAC:

Relocatable Macro Assembler, 185

RO:

Example of Random File I/O, 136

RSA:

Example of Read Console String, 92

RST7:

Use for debugging drivers, 356

RTS:

See also Buffer thresholds, Request to Send

Protocol, C program to set protocols, 434

Random Read:

Using Read Sequential, 110

Random Write:

Using Write Sequential, 112

Random files:

Concepts, 43

Creating an empty file, 144

Problem of sparse files, 44

Virtual size, 142

Random record number:

In FCB, set for Random Read, 132

In FCB, set for Random Write, 132

Rd_disk:

Read disk (via BIOS), Code, 377, Narrative, 400

Read Console Byte:

BDOS Function 1, 72

Read Console Status:

BDOS Function 11, 94

Read Console String:

BDOS Function 10, 90

Read Random:

BDOS Function 33, 131

Read Reader Byte:

BDOS Function 3, 75

Read Sequential:

BDOS Function 20, 109

Read disk (via BIOS):

Rd_disk, Code, 377, Narrative, 400

Read-Only:

Automatic setting after changing diskettes, 32

File status bit in file directory entry, 26

Read-Only Disks: 120**Read-Only File:**

Attribute bit, 121

Read/write directory:

Rw_dir, Code, 380, Narrative, 400

Reading/Writing disk:

Direct BIOS calls from C, 399

Real Time Clock:

Debugging, 362

Example testbed code, 363

TIME, C program to set the time, 444

Reclaim:

Suggestion for utility program, 426

Record number:

In file directory entry, 26

Manipulation to achieve Random I/O, 110, 112

Registers:

Displaying in debug subroutines, 324

Relative page offset:

Use for making direct BIOS calls, 65

Relative physical sectors:

On a hard disk, 38

Release diskettes:

Files from Digital Research, 6

Rename File:

BDOS Function 23, 115

Renaming a file:

REN, 52

Repeat command line:

CONTROL-R, 48

Request to Send:

Explanation of RTS protocol, 219

Reserved area:

Concept, 17

Reset:

Signal used to start loading of CP/M, 11

Reset Disk System:

BDOS Function 13, 95

Reset Logical Disk Drive:

BDOS Function 37, 143

Resident CCP commands: 14

Restoring registers:

In interrupt service routine, 356

Rw_dir:

Read/write directory, Code, 380, Narrative, 400

S

SAVE:

Save memory image in disk file, 53

Use in building new CP/M system, 194

SECTRA:

Logical sector to physical, in the BIOS, 156

SELDSK:

Debugging disk drivers, 367

Select disk, in the BIOS, 153

SETDMA:

Set DMA Address, in the BIOS, 154

SETSEC:

Set Sector, in the BIOS, 153

SETTRK:

Set Track, in the BIOS, 153

SETTRK/SEC:

Debugging disk drivers, 367

SFA:

Example of Set File Attributes, 122

SID:

Debugging tool, 330

STAT:

Use for displaying current user number, 54

SYSGEN:

System Generator, 185

Writing a new system to disk, 186

Savesys:

Suggestion for utility program, 448

Saving memory on disk:

SAVE, 53

Search First/Next:

Example use together, 107

Search for file:

Srch_file, Code, 376, Narrative, 408

Search for Next File Name Match:

BDOS Function 18, 107

Require for Search for First, 104

Sector interlace:

See Sector skewing

Sector size:

Host, in the BIOS, 152

Sector skewing:

Effect on performance, 29

For CP/M image on disk, 190

In disk parameter header, 28

Sector skipping:

Concepts, 304

Sector sparing:

Concepts, 304

Sectors:

Use in allocation blocks, 18

Sectors per track:

In disk parameter block, 33

Select Logical Disk:

BDOS Function 14, 97

Sequential Files:

Concepts, 43

Set DMA (Read/Write) Address:

BDOS Function 26, 118

Required by Search for First Name Match, 104

Set File Attributes:

BDOS Function 30, 121

Set IOBYTE:

BDOS Function 8, 86

Set Logical Disk Read-Only:

BDOS Function 28, 120

Set Random Record Number:

BDOS Function 36, 142

Set disk parameters for rd/wrt__disk:

Set__disk, Code, 378, Narrative, 400

Set search control block:

Setscb, Code, 381, Narrative, 401

Set/Get User Number:

BDOS Function 32, 131

Set__disk:

Set disk parameters for rd/wrt__disk, Code, 378, Narrative, 401

Setscb:

Set search control block, Code, 381, Narrative, 401

Setterm:

Suggestion for utility program, 448

Shadow PROM:

Used to load CP/M, 11

Short:

Minor change to C Language, 395

Single-density, single-sided:

Diskette format, 10

Single disk reset, 143**Skewing:**

See Sector skewing

Skipping:

Skipping bad sectors on disk, 304

SPACE:

C program, shows used/free disk space, 420

Spare:

Suggestion for utility program, 448

Spare directory:

Debugging disk drivers, 367

Sparing:

Use of spare sectors on disk, 304

Sparse Random Files:

Problem, 44

Special version of CP/M:

Heath/Zenith, 55

SPEED:

C program, sets baud rates, 431

Srch__file:

Search for file, Code, 376, Narrative, 408

Sstrcmp:

Substring compare, 373

Stack:

Filling with known pattern, 323

Stack overflow:

In interrupt service routine, 358

Standard BIOS:

Example code, 158

String scan:

Strscn, 372

String scan, uppercase:

Ustrscn, 372

Strscn:

String scan, 372

Structure:

Of CP/M, 5

Subroutine:

CCPM, Check if CP/M Version 2, 95

CDISK, Change Disk, 96

CRF, Create Random File, 135

DB\$Blank, Display a blank, 344

DB\$CAH, Convert A to ASCII Hex., 343

DB\$CRLF, Display Carriage Return, Line Feed, 344

DB\$Colon, Display a colon, 344

DB\$Conin, Debug console input, 336

DB\$Conout, Debug console output, 336

DB\$DAH, Display A in Hex., 343

DB\$DHLH, Display HL in Hex., 343

DB\$Display\$CALLA, Display call address, 343

DB\$Display, Main debug display, 338

DB\$GHV, Get Hex. Value, 348

DB\$Init, Debug initialize, 335

DB\$Input, Debug Port Input, 346

DB\$MEMORY, Debug display of memory/registers, 325

DB\$MESSG, Display Message, 345

DB\$MSGI, Display Message (In-line), 345

DB\$Off, Turn debug output off, 337

DB\$On, Turn debug output on, 337

DB\$Output, Debug Port Output, 347

DB\$Pass, Decrement the pass counter, 337

DB\$Set\$Pass, Set pass counter, 337

DIVHL, Divide HL by DE, 129

FOLD, Fold lowercase to upper, 93

FSCMP, Folded String Compare, 93

GAB, Get Allocation Block given Track/Sector, 128

GDTAS, Get Directory Track/Sector, 127

GETC, Get Character from Sequential File, 111

GETDPB, Get Disk Parameter Block Address, 126

GFA, Get File Attributes, 122

GMTAS, Get Maximum Track/Sector, 127

Subroutine (*continued*)

GNF, Get Next File matching ambiguous name, 104
GNTAS, Get Next Track/Sector, 128
GTAS, Get Track/Sector from Allocation block No., 126
MSGOUT, Message Output, 74
MSGOUTI, Message Output In-Line, 74
MULHL, Multiply HL by DE, 129
OM, Output Message selected by A register, 89
OPENF, Open File given ASCII file name, 100
PUTC, Put Character to Sequential File, 113
RCS, Read Console String, 81
RF, Rename File, 117
RLSRDR, Read Line from Reader, 76
RO, Random File I/O (non-128-byte records), 136
RSA, Return Subprocessor Address, 93
SDLR, Shift DE,HL one bit right, 141
SFA, Set File Attributes, 122
SHLR, Shift HL right one bit, 130
SUBHL, Subtract DE from HL, 130
TERM, Terminal Emulator, 87
TOUPPER, Fold lowercase to upper, 84
WL\$LST, Write Line to List Device, 79
WL\$PUN, Write Line to Punch, 78

Substring compare:

Sstrcmp, 373
Uppercase: Usstrcmp, 373

System file:

Attribute bit, 121
File status bit in file directory entry, 26
Not displayed by DIR, 51

System Reset:

BDOS Function 0, 71

T

TERM:

Example of Set/Get IOBYTE, 87

TIME:

C program, sets the time, 442

TYPE:

Type an ASCII file, 52

Tab:

Interaction of tab characters and escape sequences, 222

Tab expansion:

Supported by Write Console Byte, 73
Using Display \$-Terminated String, 89

Termination of programs, returning to CCP: 45

Testbed:

Use for new drivers, 353

Time:

Correct display during debugging, 364
Keeping the current time in the BIOS, 224
Reading the time from the console driver, 223

Top of RAM:

Finding, via base page, 60

Track buffering:

Enhancement to disk I/O, 231

Track offset:

See Tracks before directory

Tracks before directory:

In disk parameter block, 36

Transient Program Area:

Finding available size, 65

Typeahead:

Concepts, 217
Dealing with buffer overflow, 219

U

Undo command line:

CONTROL-U, 49

UNERASE:

C program, restores erased files, 412

User Number:

Changing under program control, 131
Changing using USER, 53
Displaying, 54
In base page, 59
In file directory entry, 22
Patches to make this appear in CCP prompt, 235
Suggestion for utility program, 426

Usstrcmp:

Uppercase substring compare, 373

Ustrcmp:

Uppercase string scan, 372

Utility programs: 371

V

Variable record lengths:

Processing in Random Files, 133, 134

W

WL\$LST:

Example of Write List Byte, 79

WL\$PUN:

Example of Write Punch Byte, 78

WRITE:

Write sector, in the BIOS, 155

Warm Boot:

After BDOS Error, 98

Warm Boot (*continued*)

BIOS functions, 150
 Initiated by CONTROL-C, 47
 Initiated by pressing a key, 94
 Initiated by System Reset BDOS Function, 72
 JMP at location 0000H, 55
 Reloading the CCP, 45
 Resetting Read-Only disks, 120
 Setting default DMA Address, 118
 Technique for avoiding, 66
 Use of location 0000H, 13
Watchdog timer:
 Concepts, 225
 Debugging Real Time Clock, 364
 Use for detecting printer errors, 224
Write Console Byte:
 BDOS Function 2, 73
Write List Byte:
 BDOS Function 5, 77
Write Punch Byte:
 BDOS Function 4, 77
Write Random:
 BDOS Function 34, 133
Write Random with Zero-fill:
 BDOS Function 40, 144

Write Sequential:

BDOS Function 21, 110
Write disk (via BIOS):
 Wrt_disk, Code, 377, Narrative, 400
Wrt_disk:
 Write disk (via BIOS), Code, 377, Narrative, 400

X

Xoff:
 CONTROL-S, 48
Xon:
 CONTROL-Q, 49
Xon/Xoff:
 Debugging character driver, 358, 362
 Explanation of protocol, 240
 PROTOCOL, C program to set protocols, 434
 Supported by Read Console Byte, 72
 Use by TYPE, 53

Z

ZSID:
 Z80 Symbolic Interactive Debugger, 185, 350