

4th Edition

The Collector's Guide To
Vintage Intel Microchips

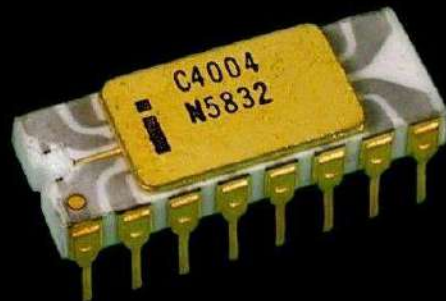

THE INTEL 4004 THRU 8088 PROCESSORS
WITH RAM, ROM, PROM, EPROM, SUPPORT CIRCUITS
AND MICROCONTROLLERS

GEORGE M. PHILLIPS JR.

The Collector's guide to
Vintage Intel Microchips
4th Edition, 2007

George M. Phillips Jr.

This work dedicated to the public domain

This work, originally copyrighted in 2007, is now dedicated to the public domain effective May 1, 2018.

Acknowledgements

The following collectors, individuals, and organizations have provided information, photographs, and/or given selflessly of their time for which I am gratefully indebted:

Christian Bassow

Franz Bruck

Pierre Buckenmeier

Mats Byström

John Culver

Anthony Conrad

Steve Emery

Hal Feeney

The Intel Museum

Lee Gallagher

Gennadiy Shvets

Will Smith

Rachel Stewart

Andrew Volk

Contents

Introduction

Numeric Index

- 1 Microprocessors
- 2 RAMs
- 3 ROMs
- 4 PROMs
- 5 EPROMs
- 6 Shift Registers/Serial Memories
- 7 Telecommunications
- 8 Intel Magnetics
- 9 CMOS Timekeeping Circuits
- 10 Series 3000
- 11 MCS-4/40
- 12 MCS-48
- 13 MCS-80/85
- 14 iAPX 86/88

- 15 [Chip Collecting](#)
- 16 [Value](#)
- 17 [Deciphering Intel Part Numbers](#)
- 18 [Intel Microchips](#)
- 19 [Links](#)

Introduction

The Collector's Guide to Vintage Intel Microchips is intended for those interested in vintage Intel microchips. This guide is not a book about the history of the Intel Corporation. For those interested in the history of Intel, there are a number of good books that have been written on this subject.

This guide contains historical information, photos, part numbers, and collector values of vintage Intel microchips. While this guide does include general specifications of vintage Intel microchips, it does not contain the level of detail found in a data catalog, and is not intended to be used as such.

What possessed me to write this book? Maybe the best answer is because it matters. I've been a programmer for 20 years. I've seen computers change the world. People who live thru historic events typically don't realize the significance of those events as they are happening. Likewise, I don't think most people today really comprehend the significance of the computer revolution that has been occurring around us the last few decades. It's all still too new. But I think that future generations will look back on this time as a monumental turning point in history on par with the discovery of fire and the invention of writing.

This guide is an attempt to document a previously undocumented chapter in the history of the computer revolution – the chips that made it possible.

Numeric Index

Part	Description	Year
1101	256-bit (256 x 1) Static RAM	1969
1101A	256-bit (256 x 1) Static RAM	1970-71
1103	1024-bit (1024 x 1) Dynamic RAM	Oct. 1970
1103A	1024-bit (1024 x 1) Dynamic RAM	3 rd Qtr 1973
1301	2048-bit (256 x 8) Static / Dynamic ROM	1969-71
1302	2048-bit (256 x 8) Static ROM	4 th Qtr 1972
1311	2240-bit (64 x 7 x 5) Static / Dynamic ROM (Character Generator)	1969-72
1312	2240-bit (64 x 7 x 5) Static ROM (Character Generator) w/Chip Select	1969-72
1313	2240-bit (64 x 7 x 5) Static ROM (Character Generator)	1969-72
1401	1024-bit Shift Register	1970
1402	1024-bit (256 x 4) Dynamic Shift Register	1970
1402A	1024-bit (256 x 4) Dynamic Shift Register	1970-71
1403	1024-bit (512 x 2) Dynamic Shift Register	1970
1403A	1024-bit (512 x 2) Dynamic Shift Register	1970-71
1404	1024-bit (1024 x 1) Dynamic Shift Register	1970
1404A	1024-bit (1024 x 1) Dynamic Shift Register	1970-71
1405	512-bit (512 x 1) Dynamic Recirculating Shift Register	1970
1405A	512-bit (512 x 1) Dynamic Recirculating Shift Register	1971-72
1406	200-bit (100 x 2) Dynamic Shift Register	1970-71
1407	200-bit (100 x 2) Dynamic Shift Register (20 kΩ output)	1970
1506	200-bit (100 x 2) Dynamic Shift Register	1970-71
1507	200-bit (100 x 2) Dynamic Shift Register (20 kΩ output)	1970-71
1601	2048-bit (256 x 8) Static / Dynamic PROM	1969-71
1602	2048-bit (256 x 8) Static PROM	1971-72
1602A	2048-bit (256 x 8) Static PROM	4 th Qtr 1972
1602AL	2048-bit (256 x 8) Static PROM	1975
1701	2048-bit (256 x 8) Static / Dynamic EPROM	Jan. 1971
1702	2048-bit (256 x 8) Static EPROM	1971
1702A	2048-bit (256 x 8) Static EPROM	4 th Qtr 1972
1702AL	2048-bit (256 x 8) Static EPROM	1975
2101	1024-bit (256 x 4) Static RAM w/Separate I/O	4 th Qtr 1974
2101A	1024-bit (256 x 4) Static RAM w/Separate I/O	1976
2102	1024-bit (1024 x 1) Static RAM w/Separate I/O	1972
2102A	1024-bit (1024 x 1) Static RAM w/Separate I/O	1974
2102AL	1024-bit (1024 x 1) Static RAM w/Separate I/O	1974-75
2104	4096-bit (4096 x 1) Dynamic RAM	1975

Numeric Index

2104A	4096-bit (4096 x 1) Dynamic RAM	1976-77
2105	1024-bit (1024 x 1) Dynamic RAM	3 rd Qtr 1973
2106A	4096-bit (4096 x 1) Dynamic RAM	1974
2107	4096-bit (4096 x 1) Dynamic RAM	July 1973
2107A	4096-bit (4096 x 1) Dynamic RAM	1973-74
2107B	4096-bit (4096 x 1) Dynamic RAM	1974-75
2107C	4096-bit (4096 x 1) Dynamic RAM	1977-78
2108	8192-bit (8192 x 1) Dynamic RAM	1976-77
2109	8192-bit (8192 x 1) Dynamic RAM	1977-78
2111	1024-bit (256 x 4) Static RAM w/Common I/O	1974
2111A	1024-bit (256 x 4) Static RAM w/Common I/O	1976
2112	1024-bit (256 x 4) Static RAM w/Common I/O	1974
2112A	1024-bit (256 x 4) Static RAM w/Common I/O	1976
2113	2048-bit (512 x 4) Static RAM	1976
2114	4096-bit (1024 x 4) Static RAM w/Common I/O	1976
2114L	4096-bit (1024 x 4) Static RAM w/Common I/O	1976-77
2114A	4096-bit (1024 x 4) Static RAM w/Common I/O	1979-80
2114AL	4096-bit (1024 x 4) Static RAM w/Common I/O	1979-80
2115	1024-bit (1024 x 1) Static RAM	1976
2115L	1024-bit (1024 x 1) Static RAM	1976
2115A	1024-bit (1024 x 1) Static RAM	1977
2115AL	1024-bit (1024 x 1) Static RAM	1977
2115H	1024-bit (1024 x 1) Static RAM	1979-80
2116	16,384-bit (16,384 x 1) Dynamic RAM	1975-76
2117	16,384-bit (16,384 x 1) Dynamic RAM	1977
2118	16,384-bit (16,384 x 1) Dynamic RAM	1979
2125	1024-bit (1024 x 1) Static RAM	1976
2125L	1024-bit (1024 x 1) Static RAM	1976
2125A	1024-bit (1024 x 1) Static RAM	1977
2125AL	1024-bit (1024 x 1) Static RAM	1977
2125H	1024-bit (1024 x 1) Static RAM	1979-80
2141	4096-bit (4096 x 1) Static RAM w/Separate I/O	1978
2141L	4096-bit (4096 x 1) Static RAM w/Separate I/O	1979
2142	4096-bit (1024 x 4) Static RAM w/Common I/O	1978
2142L	4096-bit (1024 x 4) Static RAM w/Common I/O	1978
2147	4096-bit (4096 x 1) Static RAM w/Separate I/O	1977
2147L	4096-bit (4096 x 1) Static RAM w/Separate I/O	1977
2147A	4096-bit (4096 x 1) Static RAM w/Separate I/O	1981
2147AL	4096-bit (4096 x 1) Static RAM w/Separate I/O	1981
2147H	4096-bit (4096 x 1) Static RAM w/Separate I/O	1979

Numeric Index

2147HL	4096-bit (4096 x 1) Static RAM w/Separate I/O	1980-81
2148	4096-bit (1024 x 4) Static RAM w/Common I/O	1980
2148H	4096-bit (1024 x 4) Static RAM w/Common I/O	1981-82
2148HL	4096-bit (1024 x 4) Static RAM w/Common I/O	1981-82
2149H	4096-bit (1024 x 4) Static RAM w/Common I/O	1981-82
2149HL	4096-bit (1024 x 4) Static RAM w/Common I/O	1981-82
2308	8192-bit (1024 x 8) Static ROM	1973-74
2316A	16,384-bit (2048 x 8) Static ROM	1974-75
2316E	16,384-bit (2048 x 8) Static ROM	1977
2401	2048-bit (1024 x 2) Dynamic Recirculating Shift Register	1972
2402	2048-bit Dynamic Recirculating Shift Register	1972
2403	2000-bit Dynamic Recirculating Shift Register	1972
2404	2000-bit Dynamic Recirculating Shift Register	1972
2405	1024-bit (1024 x 1) Dynamic Recirculating Shift Register	1972
2416	16384-bit (16384 x 1) CCD Memory	1974-75
2608	8192-bit (1024 x 8) PROM	1977-78
2616	16,384-bit (2048 x 8) Static PROM	1977-78
2704	4096-bit (512 x 8) EPROM	1975
2708	8192-bit (1024 x 8) EPROM	1975
2708L	8192-bit (1024 x 8) EPROM	1975
2716	16384-bit (2048 x 8) Static EPROM	1977
2732	32,768-bit (4096 x 8) EPROM	1978
2732A	32,768-bit (4096 x 8) EPROM	1980-81
2758	8192-bit (1024 x 8) Static EPROM w/Single 5V Supply	1977-78
2910	PCM CODEC – μ LAW	1977
2910A	PCM CODEC – μ LAW	1979-80
2911	PCM CODEC – A LAW	1978
2911A	PCM CODEC – A LAW	1979-80
2912	PCM Line Filters	1979
2912A	PCM Line Filters	1980-81
2920	Signal Processor	1979
3001	Microprogram Control Unit for 3002 Processor	Sept. 1974
3002	2-bit Bipolar Bit-Slice Central Processing Element	Sept. 1974
3003	Look-Ahead Carry Generator for 3002 Processor	Sept. 1974
3101	64-bit (16 x 4) Static RAM	1969
3101A	64-bit (16 x 4) Static RAM	1971-72
3102	256-bit (256 x 1) Partially Decoded Static RAM	1970
3102A	256-bit (256 x 1) Partially Decoded Static RAM	1971-72
3104	16-bit (4 x 4) Content Addressable Static RAM	1969-72
3106	256-bit (256 x 1) Static RAM	1971-72

Numeric Index

3106A	256-bit (256 x 1) Static RAM	1971-72
3107	256-bit (256 x 1) Static RAM	1971-72
3107A	256-bit (256 x 1) Static RAM	1971-72
3202	Binary to 3-of-6 Decoder-Driver for 3102 Static RAM	1969-71
3205	High Speed 1-of-8 Decoder	1970
3207	Quad Bipolar-to-MOS Level Shifter and Driver	1971
3207A	Quad Bipolar-to-MOS Level Shifter and Driver	4 th Qtr 1972
3208	Hex Sense Amp for MOS Memories	1971-72
3208A	Hex Sense Amp for MOS Memories	1972
3210	TTL-to-MOS Level Shifter and High Voltage Clock Driver	1973
3211	ECL-to-MOS Level Shifter and High Voltage Clock Driver	1974-75
3212	Multi-Mode Latch Buffer	1974
3214	Interrupt Control Unit	1974
3216	4-bit Non-Inverting Parallel Bi-Directional Bus Driver	1974
3222	Refresh Controller for 4K NMOS DRAMs	1975
3224	Single Chip Clock Generator/Driver	1974-75
3226	4-bit Inverting Bi-Directional BUS Driver	1974
3228	System Controller and Bus Driver	1979-80
3232	Address Multiplexer and Refresh Counter for 4K DRAMs	1976
3235	Quad Bipolar-to-MOS Driver	1973-75
3238	System Controller and Bus Driver w/Advanced IOW/MEMW	1979-80
3242	Address Multiplexer and Refresh Counter for 16K DRAMs	1976
3245	Quad Bipolar TTL-to-MOS Level Shifter and Driver for 4K NMOS RAMs	1973-75
3246	Quad Bipolar ECL-to-MOS Level Shifter and Driver for 4K NMOS RAMs	1975-76
3301	1024-bit (256 x 4) Static ROM	1969
3301A	1024-bit (256 x 4) Static ROM	1971-72
3302	2048-bit (512 x 4) Static ROM	1973-75
3302A	2048-bit (512 x 4) Static ROM	1975
3302AL	2048-bit (512 x 4) Static ROM	1975
3304	4096-bit (1024 x 4 or 512 x 8) Static ROM	1969-72
3304A	4096-bit (512 x 8) Static ROM	1974-75
3304AL	4096-bit (512 x 8) Static ROM	1975
3322	2048-bit (512 x 4) Static ROM	1973-75
3322A	2048-bit (512 x 4) Static ROM	1975
3322AL	2048-bit (512 x 4) Static ROM	1975
3324	4096-bit (512 x 8) Static ROM	1973-75
3324A	4096-bit (512 x 8) Static ROM	1975
3404	High-Speed 6-bit Latch	1970
3405	3-bit CTL Register	1971

Numeric Index

3406	3-bit CTL Arithmetic Unit	1971
3408	Hex Sense Amp and Latch for MOS Memories	1970-72
3408A	Hex Sense Amp and Latch for MOS Memories	1970-72
3496	4-bit CTL Register	1971
3601	1024-bit (256 x 4) PROM	1972
3602	2048-bit (512 x 4) PROM	1974-75
3602L	2048-bit (512 x 4) PROM	1975-76
3602A	2048-bit (512 x 4) PROM	1976-77
3604	4096-bit (512 x 8) PROM	1974
3604L	4096-bit (512 x 8) PROM	1975
3604A	4096-bit (512 x 8) PROM	1976-77
3604AL	4096-bit (512 x 8) PROM	1976-77
3605	4096-bit (1024 x 4) PROM	1976
3605A	4096-bit (1024 x 4) PROM	1978-79
3608	8192-bit (1024 x 8) PROM	1976
3621	1024-bit (256 x 4) PROM	1975
3622	2048-bit (512 x 4) PROM	1974-75
3622L	2048-bit (512 x 4) PROM	1975-76
3622A	2048-bit (512 x 4) PROM	1976-77
3624	4096-bit (512 x 8) PROM	1974
3624A	4096-bit (512 x 8) PROM	1976-77
3625	4096-bit (1024 x 4) PROM	1976
3625A	4096-bit (1024 x 4) PROM	1979
3628	8192-bit (1024 x 8) PROM	1976
3628A	8192-bit (1024 x 8) PROM	1980
3628B	8192-bit (1024 x 8) PROM	1981
3636	16,384-bit (2048 x 8) PROM	1979
3636B	16,384-bit (2048 x 8) PROM	1981
4001	2048-bit (256 x 8) ROM w/4-bit I/O Port	1971
4002	320-bit (4 x 80) RAM w/4-bit Output Port	1971
4003	10-bit Shift Register/Output Expander	1971
4004	4-bit Microprocessor	Nov 15 1971
4008	Standard Memory and I/O Interface for 4004	4 th Qtr 1972
4009	Standard Memory and I/O Interface for 4004	4 th Qtr 1972
4040	4-bit Microprocessor	4 th Qtr 1974
4101	1024-bit (256 x 4) Static RAM w/Separate I/O	1974
4201	4 MHz Clock Generator	1 st Qtr 1975
4201A	4 MHz Clock Generator	1976-77
4207	General Purpose Byte Output Port	1974
4209	General Purpose Byte Input Port	1974

Numeric Index

4211	General Purpose Byte I/O Port	1974
4265	Programmable General Purpose I/O Device	1976
4269	Programmable Keyboard Display Device	1976
4289	Standard Memory Interface for MCS-4/40	1974
4308	8192-bit (1024 x 8) ROM w/4-bit I/O Ports	1974
4316	16384-bit (2048 x 8) Static ROM	1973-74
4316A	16384-bit (2048 x 8) Static ROM	1975-76
4702A	2048-bit (256 x 8) EPROM	1974
4801	5.185 MHz Clock Generator Crystal for 4004/4201A or 4040/4201A	1976-77
5101	1024-bit (256 x 4) Static RAM	1974
5101L	1024-bit (256 x 4) Static RAM	1974
5201	LCD Decoder-Driver	1973
5202	LCD Decoder-Driver	1973-75
5204	Time/Seconds/Date LCD Decoder-Driver	1973-75
5234	Quad CMOS-to-MOS Level Shifter and Driver for 4K NMOS RAMs	1975
5235	Quad CMOS TTL-to-MOS Level Shifter and Driver for 4K NMOS RAMs	1975
5244	Quad CCD Clock Driver	1975
5801	Low Power Oscillator-Divider	1973
5810A	Single Chip LCD Time/Seconds/Date Watch Circuit	1975-76
7110	1,048,576-bit Bubble Memory	1979
7110A	1,048,576-bit Bubble Memory	1983-84
7220	Bubble Memory Controller for Intel 7110 Bubble Memory	1979
7230	Current Pulse Generator for Intel 7110 Bubble Memory	1979
7242	Dual Formatter/Sense Amplifier for Intel 7110 Bubble Memory	1979
7250	Coil Predriver (CPD) for Intel 7110 Bubble Memory	1979
7254	Driver Transistor for Intel 7110 Bubble Memory	1979
8008	8-bit Microprocessor	April 1972
8021	Single Component 8-Bit Microcomputer	1978-79
8021H	Single Component 8-Bit Microcomputer	1982-83
8022	Single Component 8-Bit Microcomputer with On-Chip A/D Converter	1978-79
8022H	Single Component 8-Bit Microcomputer with On-Chip A/D Converter	1982-83
8035	Single Component 8-bit Microcomputer w/512-bit (64 x 8) RAM, and I/O	1977
8035L	Single Component 8-bit Microcomputer w/512-bit (64 x 8) RAM, and I/O	1977-78
8035H	Single Component 8-Bit Microcomputer w/512-bit (64 x 8) RAM, and I/O	1982-83
8035HL	Single Component 8-Bit Microcomputer w/512-bit (64 x 8) RAM, and I/O	1981

Numeric Index

8035AHL	Single Component 8-Bit Microcomputer w/512-bit (64 x 8) RAM, and I/O	1983-84
8039	Single Component 8-bit Microcomputer w/1024-bit (128 x 8) RAM and I/O	1978
8039H	Single Component 8-bit Microcomputer w/1024-bit (128 x 8) RAM and I/O	1982-83
8039HL	Single Component 8-bit Microcomputer w/1024-bit (128 x 8) RAM and I/O	1982-83
8039AHL	Single Component 8-bit Microcomputer w/1024-bit (128 x 8) RAM and I/O	1983-84
8041	Universal Peripheral Interface 8-Bit Microcomputer w/8,192-bit (1024 x 8) ROM, 512-bit (64 x 8) RAM and I/O	1978
8041A	Universal Peripheral Interface 8-Bit Microcomputer w/8,192-bit (1024 x 8) ROM, 512-bit (64 x 8) RAM and I/O	1979-80
8041AH	Universal Peripheral Interface 8-Bit Microcomputer w/8,192-bit (1024 x 8) ROM, 512-bit (64 x 8) RAM and I/O	1981-82
8048	Single Component 8-bit Microcomputer w/8,192-bit (1024 x 8) ROM, 512-bit (64 x 8) RAM, and I/O	1976
8048L	Single Component 8-bit Microcomputer w/8,192-bit (1024 x 8) ROM, 512-bit (64 x 8) RAM, and I/O	1976-81
8048H	Single Component 8-bit Microcomputer w/8,192-bit (1024 x 8) ROM, 512-bit (64 x 8) RAM, and I/O	1981
8048AH	Single Component 8-bit Microcomputer w/8,192-bit (1024 x 8) ROM, 512-bit (64 x 8) RAM, and I/O	1983-84
8049	Single Component 8-bit Microcomputer w/16,384-bit (2048 x 8) ROM, 1024-bit (128 x 8) RAM and I/O	1978
8049H	Single Component 8-bit Microcomputer w/16,384-bit (2048 x 8) ROM, 1024-bit (128 x 8) RAM, and I/O	1982-83
8049AH	Single Component 8-bit Microcomputer w/16,384-bit (2048 x 8) ROM, 1024-bit (128 x 8) RAM and I/O	1983-84
8080	8-bit Microprocessor	April 1974
8080A	8-bit Microprocessor	Early 1975
8080B	8-bit Microprocessor	2 nd Qtr 1978
8085	8-bit Microprocessor	March 1976
8085A	8-bit Microprocessor	1978
8085AH	8-bit Microprocessor	1980-81
8086	16-bit Microprocessor	June 8 1978
8087	Math Coprocessor	1980
8088	8/16-bit Microprocessor	June 1979
8089	8/16-bit I/O Processor	1979
8089A	8/16-bit I/O Processor	1984-85
8101	1024-bit (256 x 4) Static RAM w/Separate I/O	3 rd Qtr 1974
8101A	1024-bit (256 x 4) Static RAM w/Separate I/O	1976

Numeric Index

8102	1024-bit (1024 x 1) Static RAM w/Separate I/O	1974
8102A	1024-bit (1024 x 1) Static RAM w/Separate I/O	1974
8107A	4096-bit (4096 x 1) Dynamic RAM	1973-74
8107B	4096-bit (4096 x 1) Dynamic RAM	1974-75
8111	1024-bit (256 x 4) Static RAM w/Common I/O	3 rd Qtr 1974
8111A	1024-bit (256 x 4) Static RAM w/Common I/O	1976
8155	2048-bit (256 x 8) Static RAM w/I/O Ports and Timer, CE Active Low	1977
8155H	2048-bit (256 x 8) Static RAM w/I/O Ports and Timer, CE Active Low	1982
8156	2048-bit (256 x 8) Static RAM w/I/O Ports and Timer, CE Active High	1977
8156H	2048-bit (256 x 8) Static RAM w/I/O Ports and Timer, CE Active High	1982
8185	8192-bit (1024 x 8) Static RAM for MCS-85™	1978-79
8202	Dynamic RAM Controller	1978
8202A	Dynamic RAM Controller	1981-82
8205	High Speed 1 out of 8 Binary Decoder	1973-74
8210	Quad MOS Driver and Clock driver for 8107 DRAM	1974
8212	8-bit Input/Output Port	1974
8214	Priority Interrupt Control Unit (PICU)	1974
8216	4-bit Non-Inverting Parallel Bi-Directional BUS Driver	3 rd Qtr 1974
8218	Bipolar Microcomputer Bus Controller for MCS-80™	1979
8219	Bipolar Microcomputer Bus Controller for MCS-85™	1979
8222	Refresh Controller for 4K DRAMs	1974-75
8224	Single Chip Clock Generator/Driver for 8080A CPU	1974
8226	4-bit Inverting Parallel Bi-Directional BUS Driver	3 rd Qtr 1974
8228	System Controller and Bus Driver for 8080A CPU	1975
8231	Arithmetic Processing Unit	1980
8231A	Arithmetic Processing Unit	1981-82
8232	Floating Point Processor	1980
8237	High Performance Programmable DMA Controller	1979-80
8237A	High Performance Programmable DMA Controller	1981-82
8238	System Controller and Bus Driver w/Advanced IOW/MEMW for 8080A CPU	1976
8243	MCS-48™ Input/Output Expander	1977-78
8251	Programmable Communication Interface	1975
8251A	Programmable Communication Interface	1977
8253	Programmable Interval Timer	1976
8255	Programmable Peripheral Interface	1975
8255A	Programmable Peripheral Interface	1976-77
8257	Programmable DMA Controller	1976

Numeric Index

8259	Programmable Interrupt Controller	1976
8259A	Programmable Interrupt Controller	1979
8271	Programmable Floppy Disk Controller	1977
8272	Single/Double Density Floppy Disk Controller	1980
8272A	Single/Double Density Floppy Disk Controller	1982-83
8273	Programmable HDLC/SDLC Protocol Controller	1977
8275	Programmable CRT (Video) Controller	1977
8278	Programmable Keyboard Interface	1978
8279	Programmable Keyboard / Display Controller	1977
8282	8-bit Non-Inverting Latch with Output Buffer	1978
8283	8-bit Inverting Latch with Output Buffer	1978
8284	Clock Generator and Driver for iAPX86/88 Processors	1978
8284A	Clock Generator and Driver for iAPX86/88 Processors	1980-81
8286	8-bit Non-Inverting Bus Transceiver	1978
8287	8-bit Inverting Bus Transceiver	1978
8288	Bipolar Bus Controller for iAPX 86/88 Processors	1978
8289	Bus Arbiter iAPX 86/88 Processors	1979
8291	GPIB Talker/ Listener	1979
8291A	GPIB Talker/ Listener	1981-82
8292	GPIB Controller	1979
8293	GPIB Transceiver	1979-80
8294	Data Encryption Unit	1978
8294A	Data Encryption Unit	1982
8295	Dot Matrix Printer Controller	1979
8302	2048-bit (256 x 8) Static ROM	1974
8308	8096-bit (1024 x 8) Static ROM	3 rd Qtr 1974
8316	16384-bit (2048 x 8) Static ROM	1973-74
8316A	16384-bit (2048 x 8) Static ROM	1974-75
8355	16,384-bit (2048 x 8) ROM with I/O	1977-78
8604	4096-bit (512 x 8) PROM	4 th Qtr 1974
8641A	Universal Peripheral Interface 8-Bit Microcomputer w/8,192-bit (1024 x 8) PROM, 512-bit (64 x 8) RAM and I/O	1979
8702A	2048-bit (256 x 8) EPROM	1973-74
8704	4096-bit (512 x 8) EPROM	4 th Qtr 1974
8708	8192-bit (1024 x 8) EPROM	1975
8741	Universal Peripheral Interface 8-Bit Microcomputer w/8,192-bit (1024 x 8) EPROM, 512-bit (64 x 8) RAM and I/O	1978
8741A	Universal Peripheral Interface 8-Bit Microcomputer w/8,192-bit (1024 x 8) EPROM, 512-bit (64 x 8) RAM and I/O	1979-80
8748	Single Component 8-bit Microcomputer w/8,192-bit (1024 x 8) EPROM, 512-bit (64 x 8) RAM, and I/O	1976

Numeric Index

8748H	Single Component 8-bit Microcomputer w/8,192-bit (1024 x 8) EPROM, 512-bit (64 x 8) RAM, and I/O	1982-83
8755	16,384-bit (2048 x 8) EPROM with I/O	1976-77
8755A	16,384-bit (2048 x 8) EPROM with I/O	1978-79
8801	Clock Generator Crystal for 8224/8080A	1975-77

1. Microprocessors

History

A microprocessor (abbreviated as μP or uP) is an electronic computer central processing unit (CPU) made from miniaturized transistors and other circuit elements on a single semiconductor integrated circuit (IC) (aka *microchip* or just *chip*) [1].

Before the advent of microprocessors, electronic CPUs were made from discrete (separate) TTL integrated circuits; before that, individual transistors; and before that, from vacuum tubes. There have even been designs for simple computing machines based on mechanical parts such as gears, shafts, levers, Tinkertoys, etc. Leonardo DaVinci made one such design, although none were possible to construct using the manufacturing techniques of the time [1].

Measuring one-eighth of an inch wide by one-sixth of an inch long and made up of 2300 MOS transistors, Intel's first microprocessor was equal in computing power to the first electronic computer, ENIAC, which filled 3000 cubic feet with 18,000 vacuum tubes. The 4004 as it was to be called could execute 60,000 operations a second, which by today's standards is primitive [2].

Intel Microprocessors

Part	Description	Year
3002	2-bit Bipolar Bit-Slice Central Processing Element	Sept. 1974
4004	4-bit Microprocessor	Nov 15 1971
4040	4-bit Microprocessor	4 th Qtr 1974
8008	8-bit Microprocessor	April 1972
8080	8-bit Microprocessor	April 1974
8080A	8-bit Microprocessor	Early 1975
8080B	8-bit Microprocessor	2 nd Qtr 1978
8085	8-bit Microprocessor	March 1976
8085A	8-bit Microprocessor	1978
8085AH	8-bit Microprocessor	1980-81
8086	16-bit Microprocessor	June 8 1978
8088	8/16-bit Microprocessor	June 1979

References

- [1] Wikipedia (2005). Microprocessor, <http://en.wikipedia.org/wiki/Microprocessor>
- [2] Intel (1984). A Revolution in Progress... A History of Intel to Date, p. 12

2. RAMs

History

Random Access Memory or RAM is a type of computer storage whose contents can be accessed in any order. This is in contrast to *sequential memory devices* such as magnetic tapes, discs and drums, in which the mechanical movement of the storage medium forces the computer to access data in a fixed order. It is usually implied that RAM can be both written to and read from, in contrast to Read-Only Memory or ROM. RAM is usually used for primary storage in computers to hold actively-used and actively-changing information, although some devices use certain types of RAM to provide long term secondary storage [1].

Before integrated-circuit memory came along in the early 1970s, if you needed random-access memory, you used ferrite-core memory. Ferrite-core memory (developed by IBM in the 1950s) was the dominant random access memory technology during the mid 1960s thru the early 1970s. As core memory technology advanced, cores got smaller and storage density increased. Core memory can actually be dated to some extent by the size of the cores, the larger the cores, the older the memory.

By the time core memory became obsolete in the early 1970s, the cores had become so small that they were difficult to see with the naked eye.

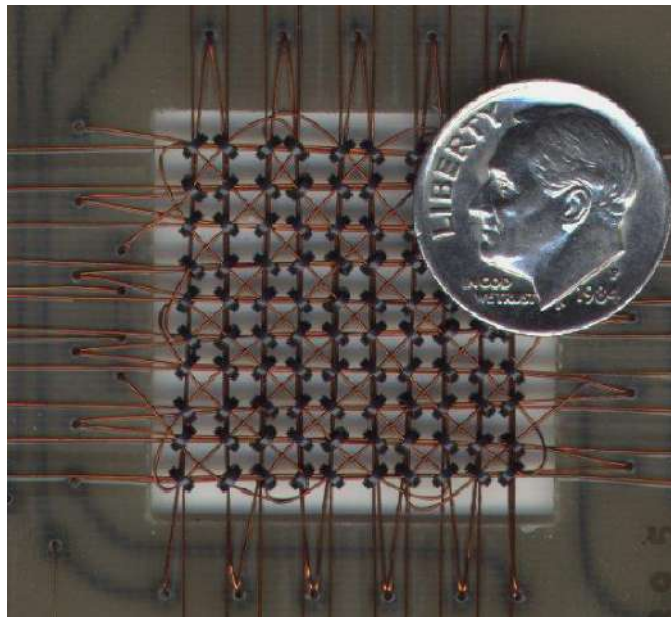

Early Core Memory

RAMs

Intel Static MOS RAM

Part	Description	Year
1101	256-bit (256 x 1) Static RAM	1969
1101A	256-bit (256 x 1) Static RAM	1970-71
2101	1024-bit (256 x 4) Static RAM w/Separate I/O	4 th Qtr 1974
2101A	1024-bit (256 x 4) Static RAM w/Separate I/O	1976
2102	1024-bit (1024 x 1) Static RAM w/Separate I/O	1972
2102A	1024-bit (1024 x 1) Static RAM w/Separate I/O	1974
2102AL	1024-bit (1024 x 1) Static RAM w/Separate I/O	1974-75
2111	1024-bit (256 x 4) Static RAM w/Common I/O	1974
2111A	1024-bit (256 x 4) Static RAM w/Common I/O	1976
2112	1024-bit (256 x 4) Static RAM w/Common I/O	1974
2112A	1024-bit (256 x 4) Static RAM w/Common I/O	1976
2113	2048-bit (512 x 4) Static RAM	1976
2114	4096-bit (1024 x 4) Static RAM w/Common I/O	1976
2114L	4096-bit (1024 x 4) Static RAM w/Common I/O	1976-77
2114A	4096-bit (1024 x 4) Static RAM w/Common I/O	1979-80
2114AL	4096-bit (1024 x 4) Static RAM w/Common I/O	1979-80
2115	1024-bit (1024 x 1) Static RAM	1976
2115L	1024-bit (1024 x 1) Static RAM	1976
2115A	1024-bit (1024 x 1) Static RAM	1977
2115AL	1024-bit (1024 x 1) Static RAM	1977
2115H	1024-bit (1024 x 1) Static RAM	1979-80
2125	1024-bit (1024 x 1) Static RAM	1976
2125L	1024-bit (1024 x 1) Static RAM	1976
2125A	1024-bit (1024 x 1) Static RAM	1977
2125AL	1024-bit (1024 x 1) Static RAM	1977
2125H	1024-bit (1024 x 1) Static RAM	1979-80
2141	4096-bit (4096 x 1) Static RAM w/Separate I/O	1978
2141L	4096-bit (4096 x 1) Static RAM w/Separate I/O	1979
2142	4096-bit (1024 x 4) Static RAM w/Common I/O	1978
2142L	4096-bit (1024 x 4) Static RAM w/Common I/O	1978
2147	4096-bit (4096 x 1) Static RAM w/Separate I/O	1977
2147L	4096-bit (4096 x 1) Static RAM w/Separate I/O	1977

RAMs

2147A	4096-bit (4096 x 1) Static RAM w/Separate I/O	1981
2147AL	4096-bit (4096 x 1) Static RAM w/Separate I/O	1981
2147H	4096-bit (4096 x 1) Static RAM w/Separate I/O	1979
2147HL	4096-bit (4096 x 1) Static RAM w/Separate I/O	1980-81
2148	4096-bit (1024 x 4) Static RAM w/Common I/O	1980
2148H	4096-bit (1024 x 4) Static RAM w/Common I/O	1981-82
2148HL	4096-bit (1024 x 4) Static RAM w/Common I/O	1981-82
2149H	4096-bit (1024 x 4) Static RAM w/Common I/O	1981-82
2149HL	4096-bit (1024 x 4) Static RAM w/Common I/O	1981-82
4101	1024-bit (256 x 4) Static RAM w/Separate I/O	1974
8101	1024-bit (256 x 4) Static RAM w/Separate I/O	3 rd Qtr 1974
8101A	1024-bit (256 x 4) Static RAM w/Separate I/O	1976
8102	1024-bit (1024 x 1) Static RAM w/Separate I/O	1974
8102A	1024-bit (1024 x 1) Static RAM w/Separate I/O	1974
8111	1024-bit (256 x 4) Static RAM w/Common I/O	3 rd Qtr 1974
8111A	1024-bit (256 x 4) Static RAM w/Common I/O	1976

Intel Dynamic MOS RAM

Part	Description	Year
1103	1024-bit (1024 x 1) Dynamic RAM	Oct. 1970
1103A	1024-bit (1024 x 1) Dynamic RAM	3 rd Qtr 1973
2104	4096-bit (4096 x 1) Dynamic RAM	1975
2104A	4096-bit (4096 x 1) Dynamic RAM	1976-77
2105	1024-bit (1024 x 1) Dynamic RAM	3 rd Qtr 1973
2106A	4096-bit (4096 x 1) Dynamic RAM	1974
2107	4096-bit (4096 x 1) Dynamic RAM	July 1973
2107A	4096-bit (4096 x 1) Dynamic RAM	1973-74
2107B	4096-bit (4096 x 1) Dynamic RAM	1974-75
2107C	4096-bit (4096 x 1) Dynamic RAM	1977-78
2108	8192-bit (8192 x 1) Dynamic RAM	1976-77
2109	8192-bit (8192 x 1) Dynamic RAM	1977-78
2116	16,384-bit (16,384 x 1) Dynamic RAM	1975-76
2117	16,384-bit (16,384 x 1) Dynamic RAM	1977
2118	16,384-bit (16,384 x 1) Dynamic RAM	1979

RAMs

8107A	4096-bit (4096 x 1) Dynamic RAM	1973-74
8107B	4096-bit (4096 x 1) Dynamic RAM	1974-75

Intel Bipolar RAM

Part	Description	Year
3101	64-bit (16 x 4) Static RAM	1969
3101A	64-bit (16 x 4) Static RAM	1971-72
3102	256-bit (256 x 1) Partially Decoded Static RAM	1970
3102A	256-bit (256 x 1) Partially Decoded Static RAM	1971-72
3104	16-bit (4 x 4) Content Addressable Static RAM	1969-72
3106	256-bit (256 x 1) Static RAM	1971-72
3106A	256-bit (256 x 1) Static RAM	1971-72
3107	256-bit (256 x 1) Static RAM	1971-72
3107A	256-bit (256 x 1) Static RAM	1971-72

Intel CMOS RAM

Part	Description	Year
5101	1024-bit (256 x 4) Static RAM	1974
5101L	1024-bit (256 x 4) Static RAM	1974

References

- [1] Wikipedia (2005). Random Access Memory, http://en.wikipedia.org/wiki/Random_access_memory

3. ROMs

History

As the name implies, Read Only Memory (ROM) can only be read. The memory elements are hard coded during the wafer manufacturing process and cannot be altered or changed. This type of memory is commonly used for program code storage on a microcontroller or permanent lookup tables and parameters.

Fairchild came out with the first masked ROM in 1967. It was done in MOS, which was new for Fairchild, had 256 bits (64 x 4), and had an access time of 1 us. It was not a big hit because it was too small to store a sine/cosine lookup table and too slow to replace random logic. It also had a mask charge of \$4,000.

Remember, in 1967 there were no microprocessors. A computer consisted of one or more processor boards, with one or more stacks of magnetic core memory.

In the case of Digital Equipment Corporation's PDP8, once the boot program was loaded in by the front panel switches, everything else came in on paper tape or magnetic tape.

The only real use for masked ROM would be to free-up core that was used to store fixed tables, assuming masked ROM was cheap enough.

Fairchild and others kept working on masked ROM until they got it up to respectable size and speed [1].

Before integrated-circuit memory came along in the late 1960s, if you needed read only memory, you used wire rope ROMs.

In a wire rope ROM the ferrite rings act as transformer cores. Address line wires are either threaded through a core, or not, making a pulse in the secondary of each core that the address wire passes through, and no pulse if the wire doesn't pass through it, encoding a '1' or a '0'. The number of wires determines the number of 'words' of ROM, and the number of cores determines the number of bits in each 'word'.

The content of a wire rope ROM is determined solely by the way it is wired. Devices such as this were frequently used to contain microcode for microcoded-architecture computer systems.

ROMs



Wire Rope ROM

Collecting ROMs

Early ROMs were not salvaged for resale like early CPUs, RAM, EPROMs, and support chips. As a result, early ROMs are extremely rare. For the sophisticated collector, vintage ROMs are the Crown Jewels of chip collecting.

ROMs

Intel MOS ROM

Part	Description	Year
1301	2048-bit (256 x 8) Static / Dynamic ROM	1969-71
1302	2048-bit (256 x 8) Static ROM	4 th Qtr 1972
1311	2240-bit (64 x 7 x 5) Static / Dynamic ROM (Character Generator)	1969-72
1312	2240-bit (64 x 7 x 5) Static ROM (Character Generator) w/Chip Select	1969-72
1313	2240-bit (64 x 7 x 5) Static ROM (Character Generator)	1969-72
2308	8192-bit (1024 x 8) Static ROM	1973-74
2316A	16,384-bit (2048 x 8) Static ROM	1974-75
2316E	16,384-bit (2048 x 8) Static ROM	1977
4316	16384-bit (2048 x 8) Static ROM	1973-74
4316A	16384-bit (2048 x 8) Static ROM	1975-77
8302	2048-bit (256 x 8) Static ROM	1974
8308	8096-bit (1024 x 8) Static ROM	3 rd Qtr 1974
8316	16384-bit (2048 x 8) Static ROM	1973-74
8316A	16384-bit (2048 x 8) Static ROM	1974-75

Intel Bipolar ROM

Part	Description	Year
3301	1024-bit (256 x 4) Static ROM	1969
3301A	1024-bit (256 x 4) Static ROM	1971-72
3302	2048-bit (512 x 4) Static ROM	1973-75
3302A	2048-bit (512 x 4) Static ROM	1975
3302AL	2048-bit (512 x 4) Static ROM	1975
3304	4096-bit (1024 x 4 or 512 x 8) Static ROM	1969-72
3304A	4096-bit (512 x 8) Static ROM	1974-75
3304AL	4096-bit (512 x 8) Static ROM	1975
3322	2048-bit (512 x 4) Static ROM	1973-75
3322A	2048-bit (512 x 4) Static ROM	1975
3322AL	2048-bit (512 x 4) Static ROM	1975
3324	4096-bit (512 x 8) Static ROM	1973-75
3324A	4096-bit (512 x 8) Static ROM	1975

References

- [1] Jed Margolin (2002). *Eproms*. Available from: <http://www.jmargolin.com/patents/eprom.htm>
[Accessed 10 July 2002]

4. PROMs

History

PROMs (Programmable Read-Only Memory) can be written to (*programmed*) via a special device, a PROM programmer. The writing often takes the form of destroying internal links with the result that a PROM can only be programmed once [2].

Programmable ROMs (PROMs) were key products for Intel. Again, both bipolar and PMOS versions were developed in the early days. The bipolar parts used polysilicon fuses that were blown by pulses of high current. The PMOS memories stored charge on a floating gate. PROMs that could only be programmed once were given "6" as the second digit. The PMOS PROMs could also be erased using ultraviolet light. These erasable PROMs (EPROMs) were assigned "7" as the second digit.

The first P-MOS PROMs were in packages with metal lids and could not be erased with ultraviolet (UV) light. It was suggested that perhaps X-rays could be used and this was tried. It was unsuccessful for two reasons. It took a lot of X-rays to erase the memory properly and when the process was complete, the X-rays had damaged the transistors, permanently changing their electrical characteristics.

Customers were skeptical of the reliability of the early EPROMs and were afraid that sunlight would erase them. To test the technology, 1702s were left on the roof of an Intel® building in full sunlight for many days with no data loss. (Later N-MOS EPROMs were, in fact, more sensitive to ambient UV, so a yellow tape was applied to the quartz lid to block the UV. The tape was removed for erasure and reapplied for use.)

The first P-MOS PROMs were in packages with metal lids and could not be erased with ultraviolet (UV) light [1].

Collecting PROMs

By definition, PROMs cannot be erased and reused. Because of this, early PROMs were not salvaged for resale like early CPUs, RAM, EPROMs, and support chips. While not as rare as ROMs, PROMs are still much more rare than equivalent EPROMs.

PROMs

Intel MOS PROM

Part	Description	Year
1601	2048-bit (256 x 8) Static / Dynamic PROM	1969-71
1602	2048-bit (256 x 8) Static PROM	1971-72
1602A	2048-bit (256 x 8) Static PROM	4 th Qtr 1972
1602AL	2048-bit (256 x 8) Static PROM	1975
2608	8192-bit (1024 x 8) PROM	1977-78
2616	16,384-bit (2048 x 8) Static PROM	1977-78
8604	4096-bit (512 x 8) PROM	4 th Qtr 1974

Intel Bipolar PROM

Part	Description	Year
3601	1024-bit (256 x 4) PROM	1972
3602	2048-bit (512 x 4) PROM	1974-75
3602L	2048-bit (512 x 4) PROM	1975-76
3602A	2048-bit (512 x 4) PROM	1976-77
3604	4096-bit (512 x 8) PROM	1974
3604L	4096-bit (512 x 8) PROM	1975
3604A	4096-bit (512 x 8) PROM	1976-77
3604AL	4096-bit (512 x 8) PROM	1976-77
3605	4096-bit (1024 x 4) PROM	1976
3605A	4096-bit (1024 x 4) PROM	1978-79
3608	8192-bit (1024 x 8) PROM	1976
3621	1024-bit (256 x 4) PROM	1975
3622	2048-bit (512 x 4) PROM	1974-75
3622L	2048-bit (512 x 4) PROM	1975-76
3622A	2048-bit (512 x 4) PROM	1976-77
3624	4096-bit (512 x 8) PROM	1974
3624A	4096-bit (512 x 8) PROM	1976-77
3625	4096-bit (1024 x 4) PROM	1976
3625A	4096-bit (1024 x 4) PROM	1979
3628	8192-bit (1024 x 8) PROM	1976

PROMs

3628A	8192-bit (1024 x 8) PROM	1980
3628B	8192-bit (1024 x 8) PROM	1981
3636	16,384-bit (2048 x 8) PROM	1979
3636B	16,384-bit (2048 x 8) PROM	1981

References

- [1] Intel (2002). *Recollections of Early Chip Development at Intel*. Available from: http://intel.com/technology/itj/q12001/articles/art_1.htm [Accessed 10 July 2002]
- [2] Wikipedia (2005). Read Only Memory, http://en.wikipedia.org/wiki/Read-only_memory

5. EPROMs

History

An EPROM, or *erasable programmable read-only memory*, is a type of computer memory chip that retains its data when its power supply is switched off. In other words, it is non-volatile. It is programmed by an electronic device that supplies higher voltages than those normally used in electronic circuits. Once programmed, an EPROM can be erased only by exposing it to strong ultraviolet light. EPROMs are easily recognisable by the transparent window in the top of the package, through which the silicon chip can be seen, and which admits UV light during erasing [1].

The first P-MOS PROMs were in packages with metal lids and could not be erased with ultraviolet (UV) light. It was suggested that perhaps X-rays could be used and this was tried. It was unsuccessful for two reasons. It took a lot of X-rays to erase the memory properly and when the process was complete, the X-rays had damaged the transistors, permanently changing their electrical characteristics.

Customers were skeptical of the reliability of the early EPROMs and were afraid that sunlight would erase them. To test the technology, 1702s were left on the roof of an Intel® building in full sunlight for many days with no data loss. (Later N-MOS EPROMs were, in fact, more sensitive to ambient UV, so a yellow tape was applied to the quartz lid to block the UV. The tape was removed for erasure and reapplied for use.) [2].

Intel EPROMs

Part	Description	Year
1701	2048-bit (256 x 8) Static / Dynamic EPROM	1971
1702	2048-bit (256 x 8) Static EPROM	1971
1702A	2048-bit (256 x 8) Static EPROM	4 th Qtr 1972
1702AL	2048-bit (256 x 8) Static EPROM	1975
2704	4096-bit (512 x 8) EPROM	1975
2708	8192-bit (1024 x 8) EPROM	1975
2708L	8192-bit (1024 x 8) EPROM	1975
2716	16384-bit (2048 x 8) Static EPROM	1977
2732	32,768-bit (4096 x 8) EPROM	1978
2732A	32,768-bit (4096 x 8) EPROM	1980-81
2758	8192-bit (1024 x 8) Static EPROM w/Single 5V Supply	1977-78
4702A	2048-bit (256 x 8) EPROM	1974
8702A	2048-bit (256 x 8) EPROM	1973-74
8704	4096-bit (512 x 8) EPROM	4 th Qtr 1974
8708	8192-bit (1024 x 8) EPROM	1975

References

[1] Wikipedia (2005). EPROM, <http://en.wikipedia.org/wiki/EPROM>

[2] Intel (2002). *Recollections of Early Chip Development at Intel*. Available from: http://intel.com/technology/itj/q12001/articles/art_1.htm [Accessed 10 July 2002]

6. Shift Registers/Serial Memories

History

In digital circuits a shift register is a group of registers set up in a linear fashion which have their inputs and outputs connected together in such a way that the data is shifted down the line when the circuit is activated.

Shift registers can have a combination of serial and parallel inputs and outputs, including serial-in, parallel-out and parallel-in, serial-out types. There are also types that have both serial and parallel input and types with serial and parallel output. There are also bi-directional shift registers which allow you to vary the direction of the shift register. The serial input and outputs of a register can also be connected together to create a circular shift register. One could also create multi-dimensional shift registers.

One of the most common uses of a shift register is to convert between serial and parallel interfaces. This is useful as many circuits work on groups of bits in parallel, but serial interfaces are simpler to construct. Shift registers can be used as simple delay circuits. Several bi-directional shift registers could also be connected in parallel for a hardware implementation of a stack [1].

Before core memory arrived in the mid 1960s, the dominant memory technology was magnetic drums. Magnetic drums were used during the late 1950s thru the early 1960s. These were serial, rather than random-access, memories. The Intel 2416 CCD would render drum memory obsolete in the same way the Intel 1103 rendered core memory obsolete.

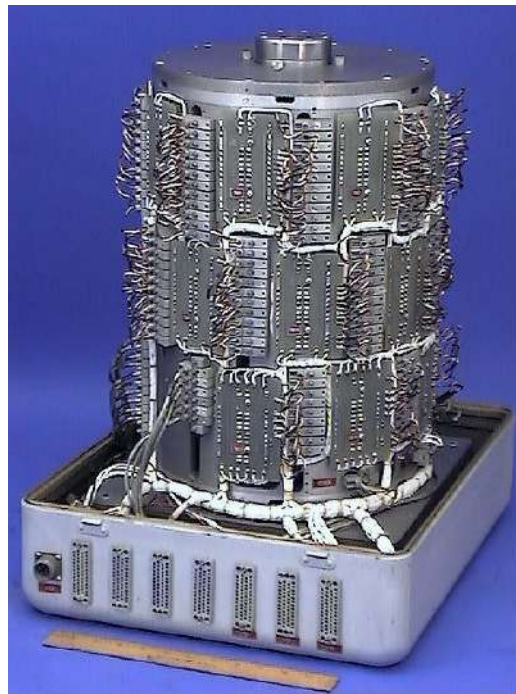

Magnetic Drum Memory

Intel Shift Registers/Serial Memories

Part	Description	Year
1401	1024-bit Shift Register	1970
1402	1024-bit (256 x 4) Dynamic Shift Register	1970
1402A	1024-bit (256 x 4) Dynamic Shift Register	1970-71
1403	1024-bit (512 x 2) Dynamic Shift Register	1970
1403A	1024-bit (512 x 2) Dynamic Shift Register	1970-71
1404	1024-bit (1024 x 1) Dynamic Shift Register	1970
1404A	1024-bit (1024 x 1) Dynamic Shift Register	1970-71
1405	512-bit (512 x 1) Dynamic Recirculating Shift Register	1970
1405A	512-bit (512 x 1) Dynamic Recirculating Shift Register	1971-72
1406	200-bit (100 x 2) Dynamic Shift Register	1970-71
1407	200-bit (100 x 2) Dynamic Shift Register (20 kΩ output)	1970
1506	200-bit (100 x 2) Dynamic Shift Register	1970-71
1507	200-bit (100 x 2) Dynamic Shift Register (20 kΩ output)	1970-71
2401	2048-bit (1024 x 2) Dynamic Recirculating Shift Register	1972
2402	2048-bit (1024 x 2) Dynamic Recirculating Shift Register	1972
2403	2000-bit Dynamic Recirculating Shift Register	1972
2404	2000-bit Dynamic Recirculating Shift Register	1972
2405	1024-bit (1024 x 1) Dynamic Recirculating Shift Register	1972
2416	16384-bit (16384 x 1) CCD Memory	1974-75

References

- [1] Wikipedia (2005). Shift Register, http://en.wikipedia.org/wiki/Shift_register

7. Telecommunications

History

Intel Telecommunications Product Family

The '29xx' product family was reserved for telecommunications products. In 1977, Intel introduced the first single-chip CODEC, the 2910. It was designed by Ted Hoff, one of the inventors of the microprocessor, and fellow Intel engineers John Huggins and Ben Warren.

CODECs (Coder-Decoders)

PCM (Pulse-Code Modulation) is a technique where the amplitude of a wave is sampled many times per second and converted, or coded, into digital pulses. By sampling many conversations in rapid succession, a PCM system can transmit dozens of phone calls simultaneously over the same wire.

A CODEC is a single chip that contains the PCM circuitry required to convert analogue signals into digital data that can be interwoven, many conversations at a time, onto a single line.

Intel Telecommunication Products

Part	Description	Year
2910	PCM CODEC – μ LAW	1977
2910A	PCM CODEC – μ LAW	1979-80
2911	PCM CODEC – A LAW	1978
2911A	PCM CODEC – A LAW	1979-80
2912	PCM Line Filters	1979
2912A	PCM Line Filters	1980-81
2920	Signal Processor	1979

8. Intel Magnetics

History

A bubble memory stores information in small 'bubbles' on a magnetic surface. Bubble memories are not sensitive to shock and vibration, unlike other memory devices such as disc drives. Bubble memories are also nonvolatile and do not lose their information when the computer is switched off.

Intel entered the bubble memory business in 1977. The '7xxx' product family was reserved for bubble memory products, and the 7110 1-megabit bubble memory chip was introduced in 1979.



Intel Bubble Memory

Intel Magnetics Products

Part	Description	Year
7110	1,048,576-bit Bubble Memory	1979
7110A	1,048,576-bit Bubble Memory	1983-84
7220	Bubble Memory Controller for Intel 7110 Bubble Memory	1979
7230	Current Pulse Generator for Intel 7110 Bubble Memory	1979
7242	Dual Formatter/Sense Amplifier for Intel 7110 Bubble Memory	1979
7250	Coil Predriver (CPD) for Intel 7110 Bubble Memory	1979
7254	Driver Transistor for Intel 7110 Bubble Memory	1979

9. CMOS Timekeeping Circuits

History

In 1972, Intel acquired Microma Universal, Inc., a small firm that had a prototype liquid-crystal watch. The unique combination of Microma's LCD display and Intel's low power CMOS circuits and assembly facilities quickly made the Microma the leading LCD watch on the market.



Microma Watch with Intel Circuit

Intel CMOS Timekeeping Circuits

Part	Description	Year
5201	LCD Decoder-Driver	1973
5202	LCD Decoder-Driver	1973-75
5204	Time/Seconds/Date LCD Decoder-Driver	1973-75
5801	Low Power Oscillator-Divider	1973
5810A	Single Chip LCD Time/Seconds/Date Watch Circuit	1975-76

10. Series 3000

History

The Intel 3002 was Intel's first entry into the Bit-slice marketplace and the first bipolar Bit-slice device. Introduced in the 3rd quarter of 1974, it is an unusual device in that it was a 2-bit device at a time when most others devices were 4-bit devices.

The 3002 was a peer of the Intel 8080, but the 8080 could only handle 8-bits of data at time. The 3002 was a 2-bit ALU, but 8 3002's could be linked together to create a computer that could handle 16-bits at a time. Whereas the 8080 would have to use multiple cycles to process 16 or 32 bits, the appropriate 3002 configuration could handle it in a single cycle giving such a computer significantly more power than the 8080 [1].

Intel Series 3000 Products

Part	Description	Year
3001	Microprogram Control Unit for 3002 Processor	Sept 1974
3002	2-bit Bipolar Bit-Slice Central Processing Element	Sept 1974
3003	Look-Ahead Carry Generator for 3002 Processor	Sept 1974
3212	Multi-Mode Latch Buffer	1974
3214	Interrupt Control Unit	1974
3216	4-bit Non-Inverting Parallel Bi-Directional Bus Driver	1974
3226	4-bit Inverting Bi-Directional BUS Driver	1974

References

- [1] www.cpu-Museum.com (2005), 2- / 4-bit Microprocessors, 3002,
http://www.cpu-museum.com/3002_e.htm

11. MCS-4/40

History

The MCS-4 product family was introduced November 15, 1971 and included the world's first microprocessor, the Intel 4004.

The MCS-4 (Microcomputer set 4-bit) family initially consisted of four 16-pin devices: The 4001 was a 2-Kb ROM with a 4-bit mask-programmable I/O port; the 4002 was a 320-bit RAM with a 4-bit output port; the 4003 was a 10-bit serial-in, parallel-out shift register to be used as an I/O expander; and the 4004 was a 4-bit CPU

The MCS-4 family was later expanded to include the 4008 and 4009 standard memory and I/O interface set. The 4008 and 4009 were designed, as a pair, to simplify interfacing the 4004 with standard RAM and ROM devices, like the C2102A (RAM) and C1702A (EPROM). Prior to the 4008/4009, interfacing the 4004 to standard RAMs and ROMs (those other than the 4001 and 4002) was a difficult task that required significant wiring and multiple IC's.

The smallest [MCS-4] system would contain two chips - a CPU and a ROM. A typical calculator had 4 ROM's and a RAM chip with five I/O ports, (20) wires for connecting peripheral devices. A fully loaded system could have 16 ROM and 16 RAM chips, and obviously a plethora of I/O ports.

The MCS-40 product family was introduced in the 4th Qtr. Of 1974 and included the Intel 4040 microprocessor.

The 4040 was an enhanced version of the 4004 and as such retains all the functional capability of that device. It will execute all the 4004 instructions, and is also electrically compatible with all components used with a 4004 CPU.

Intel MCS-4/40 Family Products

Part	Description	Year
4001	2048-bit (256 x 8) ROM w/4-bit I/O Port	1971
4002	320-bit (4 x 80) RAM w/4-bit Output Port	1971
4003	10-bit Shift Register/Output Expander	1971
4004	4-bit Microprocessor	Nov 15 1971
4008	Standard Memory and I/O Interface for 4004	4 th Qtr 1972
4009	Standard Memory and I/O Interface for 4004	4 th Qtr 1972
4040	4-bit Microprocessor	4 th Qtr 1974
4101	1024-bit (256 x 4) Static RAM w/Separate I/O	1974
4201	4 MHz Clock Generator	1 st Qtr 1975
4201A	4 MHz Clock Generator	1976-77
4207	General Purpose Byte Output Port	1974
4209	General Purpose Byte Input Port	1974
4211	General Purpose Byte I/O Port	1974
4265	Programmable General Purpose I/O Device	1976
4269	Programmable Keyboard Display Device	1976
4289	Standard Memory Interface for MCS-4/40	1974
4308	8192-bit (1024 x 8) ROM w/4-bit I/O Ports	1974
4316	16384-bit (2048 x 8) Static ROM	1973-74
4316A	16384-bit (2048 x 8) Static ROM	1975-76
4702A	2048-bit (256 x 8) EPROM	1974
4801	5.185 MHz Clock Generator Crystal for 4004/4201A or 4040/4201A	1976-77

12. MCS-48

History

In 1976, Intel introduced the 8748, an 8-bit, single chip computer or “microcontroller”. It contained its own central processor, EPROM, data memory, on-chip peripherals and I/O to provide a highly integrated controller for systems.

The 8748 enabled users to prototype their products quickly and modify EPROM storage as required, thus avoiding the long mask generation process. This proved to be a major innovation, and the MCS®-48 family, of which the 8748 was the first, soon became the most widely applied 8-bit microcontroller architecture in the world. Technically, it was innovative as well, tying EPROM technology with microprocessors. As a result, the 8748 and the 8048, its smaller ROM version, were among Intel’s hottest products in the late 1970’s.

Intel MCS-48 Family Products

Part	Description	Year
8021	Single Component 8-Bit Microcomputer	1978-79
8021H	Single Component 8-Bit Microcomputer	1982-83
8022	Single Component 8-Bit Microcomputer with On-Chip A/D Converter	1978-79
8022H	Single Component 8-Bit Microcomputer with On-Chip A/D Converter	1982-83
8035	Single Component 8-bit Microcomputer w/512-bit (64 x 8) RAM, and I/O	1977
8035L	Single Component 8-bit Microcomputer w/512-bit (64 x 8) RAM, and I/O	1977-78
8035H	Single Component 8-Bit Microcomputer w/512-bit (64 x 8) RAM, and I/O	1982-83
8035HL	Single Component 8-Bit Microcomputer w/512-bit (64 x 8) RAM, and I/O	1981
8035AHL	Single Component 8-Bit Microcomputer w/512-bit (64 x 8) RAM, and I/O	1983-84
8039	Single Component 8-bit Microcomputer w/1024-bit (128 x 8) RAM and I/O	1978
8039H	Single Component 8-bit Microcomputer w/1024-bit (128 x 8) RAM and I/O	1982-83

MCS-48

8039HL	Single Component 8-bit Microcomputer w/1024-bit (128 x 8) RAM and I/O	1982-83
8039AHL	Single Component 8-bit Microcomputer w/1024-bit (128 x 8) RAM and I/O	1983-84
8048	Single Component 8-bit Microcomputer w/8,192-bit (1024 x 8) ROM, 512-bit (64 x 8) RAM, and I/O	1976
8048L	Single Component 8-bit Microcomputer w/8,192-bit (1024 x 8) ROM, 512-bit (64 x 8) RAM, and I/O	1976-81
8048H	Single Component 8-bit Microcomputer w/8,192-bit (1024 x 8) ROM, 512-bit (64 x 8) RAM, and I/O	1981
8048AH	Single Component 8-bit Microcomputer w/8,192-bit (1024 x 8) ROM, 512-bit (64 x 8) RAM, and I/O	1983-84
8049	Single Component 8-bit Microcomputer w/16,384-bit (2048 x 8) ROM, 1024-bit (128 x 8) RAM and I/O	1978
8049H	Single Component 8-bit Microcomputer w/16,384-bit (2048 x 8) ROM, 1024-bit (128 x 8) RAM, and I/O	1982-83
8049AH	Single Component 8-bit Microcomputer w/16,384-bit (2048 x 8) ROM, 1024-bit (128 x 8) RAM and I/O	1983-84
8243	MCS-48™ Input/Output Expander	1977-78
8748	Single Component 8-bit Microcomputer w/8,192-bit (1024 x 8) EPROM, 512-bit (64 x 8) RAM, and I/O	1976
8748H	Single Component 8-bit Microcomputer w/8,192-bit (1024 x 8) EPROM, 512-bit (64 x 8) RAM, and I/O	1982-83

13. MCS-80/85

History

The MCS-80 product family was introduced in March of 1974 and included the world's first true general-purpose microprocessor, the Intel 8080. The 8080 was used in the Altair 8800, the first affordable personal computer.

The MCS-85 product family was introduced in March 1976 and included the Intel 8085 microprocessor.

The 8085 was designed to use a single five-volt power supply as opposed to the 8080, which required three (+5V, +12V, and -5V). The 8085 was 100% software compatible with the 8080A. The 8085 incorporated all the features of the 8224 clock generator and 8228 system controller. The 8085 along with the 8156 RAM and 8255/8755 ROM/EPROM constituted a complete system. The on-chip address latch of 8155/8355/8755 memory chips allowed a direct interface with the 8085.

Intel MCS-80/85 Family Products

Part	Description	Year
8008	8-bit Microprocessor	April 1972
8080	8-bit Microprocessor	April 1974
8080A	8-bit Microprocessor	Early 1975
8080B	8-bit Microprocessor	2 nd Qtr 1978
8085	8-bit Microprocessor	March 1976
8085A	8-bit Microprocessor	1978
8085AH	8-bit Microprocessor	1981-83
8155	2048-bit (256 x 8) Static RAM w/I/O Ports and Timer, CE Active Low	1977
8155H	2048-bit (256 x 8) Static RAM w/I/O Ports and Timer, CE Active Low	1982
8156	2048-bit (256 x 8) Static RAM w/I/O Ports and Timer, CE Active High	1977
8156H	2048-bit (256 x 8) Static RAM w/I/O Ports and Timer, CE Active High	1982
8185	8192-bit (1024 x 8) Static RAM for MCS-85™	1978-79
8218	Bipolar Microcomputer Bus Controller for MCS-80™	1979-80
8219	Bipolar Microcomputer Bus Controller for MCS-85™	1979-80
8224	Single Chip Clock Generator/Driver for 8080A CPU	1974
8228/ 3228	System Controller and Bus Driver for 8080A CPU	1975

MCS-80/85

8231	Arithmetic Processing Unit	1980
8231A	Arithmetic Processing Unit	1981-83
8232	Floating Point Processor	1980
8238/ 3238	System Controller and Bus Driver w/Advanced IOW/MEMW for 8080A CPU	1976
8355	16,384-bit (2048 x 8) ROM with I/O	1977-78
8755	16,384-bit (2048 x 8) EPROM with I/O	1976-77
8755A	16,384-bit (2048 x 8) EPROM with I/O	1978-79
8801	Clock Generator Crystal for 8224/8080A	1975-77

14. iAPX 86/88

History

The iAPX 86 family of products was introduced June 8, 1978 and included the Intel 8086 microprocessor.

Intel's 8086 was a major advancement in 1978. The chip brought the x86 instruction set that's still present on x86-compatible chips today. The chip was 16-bit throughout with 29,000 transistors and 16-bit registers, and a 16-bit data bus. The processor had a clock speed of 4 MHz. The 8086 included segmented memory addressing. The chip also contained a 20-bit address bus providing it with 1 MB of memory space. The largest benefit was the 8086 kept assembly language compatible to a certain extent with the previous 8080.

The 8086 was not chosen for the original PC because IBM wanted to keep costs down by going with an 8-bit bus design. The 8086 was used in some PC clones and later on in early IBM PS/2 models, but was never a popular choice for PCs. This is probably because by the time it started to be used, the 80286 was introduced, offering much improved performance over the 8086. The 8086 is architecturally identical to the 8088 aside from the wider data bus.

The iAPX 88 family of products was introduced June 1979 and included the Intel 8088 microprocessor.

The 8088 operating at 4.77 MHz was IBM's choice for the microprocessor in its first Personal Computer, the IBM PC model 5150 (August 1981). Compared to its predecessor, the 8086, the 8088 microprocessor comes across as a backward step in chip design. The 8088 was identical to the 8086 in every way-16-bit registers, 20 address lines, the same command set-except one. Its data bus was reduced to 8 bits, enabling the 8088 to exploit readily available 8-bit support hardware but effectively halving the speed of memory access.

MCS-86

The Intel 8086 family of products was originally known as the MCS-86 product family. It was later renamed to the iAPX 86 family of products.

Intel iAPX 86/88 Family Products

Part	Description	Year
8086	16-bit Microprocessor	June 8 1978
8087	Math Coprocessor	1980
8088	8/16-bit Microprocessor	June 1979
8089	8/16-bit I/O Processor	1979
8089A	8/16-bit I/O Processor	1984-85
8259A	Programmable Interrupt Controller	1979
8282	8-bit Non-Inverting Latch with Output Buffer	1978
8283	8-bit Inverting Latch with Output Buffer	1978
8284	Clock Generator and Driver for iAPX 86/88 Processors	1978
8284A	Clock Generator and Driver for iAPX 86/88 Processors	1980-81
8286	8-bit Non-Inverting Bus Transceiver	1978
8287	8-bit Inverting Bus Transceiver	1978
8288	Bipolar Bus Controller for iAPX 86/88 Processors	1978
8289	Bus Arbiter iAPX 86/88 Processors	1979

15. Chip Collecting

Why Collect Vintage Microchips?

I got into collecting vintage microchips for a number of reasons. For one, I am one of those people who enjoy collecting things. Some people collect stamps, others collect coins, I collect vintage microchips.

Another reason I collect vintage microchips and that is I am worried that unless someone preserves them, they are going to be lost forever. I like to think that one day, a hundred years from now, someone in a museum will look in awe at a glass case containing an Intel C4004, the worlds first microprocessor, because I and a few other collectors like me, cared enough to preserve these things for future generations.

Some might assume that only a chip engineer could enjoy collecting something like vintage microchips. This is not true. Does a coin collector need to know how to engrave a die and mint a coin in order to enjoy collecting coins? The answer is no. Likewise, you don't have to be a semiconductor engineer to enjoy collecting chips and appreciate their historic value.

What's a Vintage Microchip?

For the purposes of this guide, a "vintage" Intel microprocessor is defined to the Intel i4004 thru i8088 family of microprocessors.

"Vintage" RAM, ROM, PROM, EPROM, and other support chips are defined as the family of chips that were manufactured during the same period of time that the Intel i4004 thru i8088 family of microprocessors were manufactured.

The exclusion of microprocessors after the Intel i8088 was done for a number of reasons. With few exceptions, most of the Intel microchips manufactured after the introduction of the 8088 were mass-produced and are not particularly rare compared to the chips produced before the introduction of the 8088. In fact, some of the microcontrollers introduced shortly after the introduction of the 8088 were so popular that they were still being manufactured until just a few years ago.

What Kind of Chips do Collectors Collect?

The most commonly collected vintage microchips are microprocessors (CPUs). Most new vintage microchip collectors get started collecting vintage microchips collecting microprocessors.

Chip Collecting

Some collectors collect processors exclusively but most serious collectors eventually get into collecting other types of microchips as well, like RAM, ROM, PROM, EPROM, support circuits, and microcontrollers.

Serious vintage Intel microchip collectors may also collect corresponding vintage Intel Data Catalogs, User's Manuals, Datasheets, Price Lists, and other miscellaneous Intel memorabilia.

Intel was not the only game in town during the early days of microprocessors. Companies like Zilog, Motorola, Texas Instruments, and a host of others also produced competing products. Some of these non-Intel chips are highly collectible.

2nd source vintage microchips are another area of interest got serious collectors. Companies like AMD, National Semiconductor, Microsystems International Ltd., and a host of others produced their own versions of Intel microchips. Many of these 2nd source chips are actually more rare than the equivalent Intel chips, but usually don't command the same prices due to lower demand.

Protecting Vintage Microchips from ESD

- Always observe ESD (Electro-Static Discharge) precautions when handling vintage microchips - i.e., wear a ground strap and always keep the chip on a conductive surface (metal plate, conductive foam, etc.) when not in use. This holds true for bipolar as well as MOS ICs.
- Wash you hands before handling chips and try and not touch the pins or lid. Fingertips contain oil, dirt, and corrosives that can attack and ruin the metal. Gold lids and pins are no exception, as contaminants can seep through scratches or hairline cracks in the gold plating.
- Be careful forcing chips into conductive foam, especially if the pins are the more delicate "fiddle" design (as was the case with the 1601 PROM). There are various grades of foam, some with much higher insertion pressures than others. Be sure to use a type appropriate for the IC in question.

Chip Collecting

Storing your collection

I store my collection in wood shadowbox style display cases with hinged doors lined with conductive foam. The display cases are easy to find and can be obtained for 20.00 or less. The nice thing about these types of cases is that the backs are usually lined in felt so they can be stacked flat on top of each other for storage.

Sheets of conductive foam large enough to line a case like can be harder to find. I found 24"x12"x1/4" sheets of conductive foam at www.jameco.com. Jameco P/N: 13864

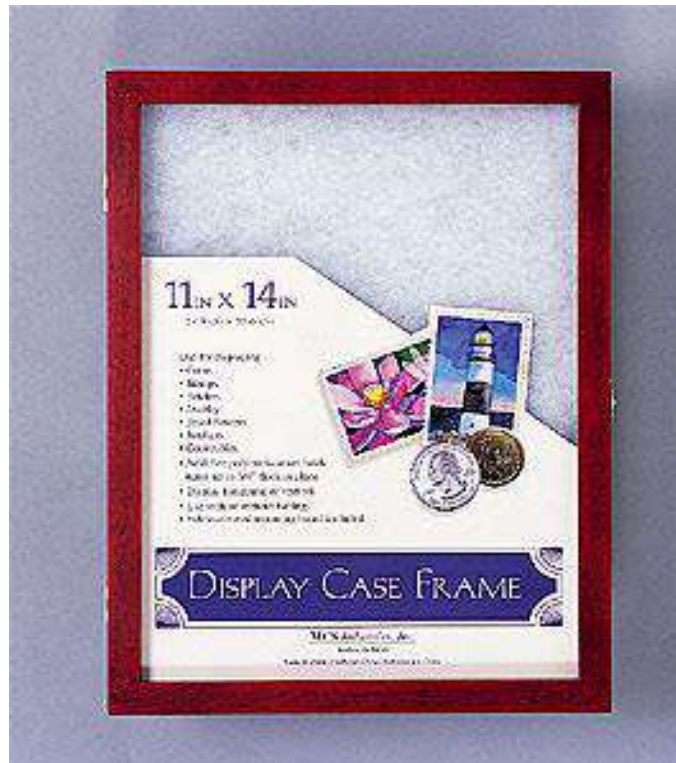

Stuart Products <http://www.pfile.com/>

Vintage Microchip Collectors vs. Vintage Computer Enthusiasts

Some vintage computer enthusiasts have this notion that chip collectors are going around busting up vintage computers with a sledgehammers to get the chips out of them.

This is simply not true. Chip collectors hang out in the same vintage computer section on EBAY that vintage computer enthusiasts do and know full well what rare machines are worth, we see them all the time.

The real truth is that chip collectors have saved more than a few vintage machines from the smelter simply because they recognized them and knew what they were.

Here are a few things vintage computers enthusiasts should think about before flaming chip collectors for driving up the prices of vintage microchips:

Many chips that chip collectors collect are rare but electronically equivalent versions of “common” chips.

A good example would be an Intel C8080 vs. an Intel P8080A. Only a handful of Intel C8080's are known to exist but you could find 5000 Intel P8080A's in 10 minutes if you want them.

The point is, even if every Intel C8080 ended up in some chip collectors collection, it would have no effect on any vintage computer enthusiasts ability to restore an Altair 8800 back to working order.

The fact is there are FAR more chips than there are, or will ever be, vintage computers to put them in.

Just because a chip ends up in the hands of a chip collector does not mean it has vanished off the face of the earth.

Most chip collectors have spare chips that they keep on hand for trading with other collectors.

These same chip collectors are more than willing to sell spare chips to vintage computer enthusiasts or trade them a spare chip for another chip.

Vintage computer enthusiasts can often purchase a required chip from a chip collector for less than they could get the same chip from a parts distributor.

Every chip collector is potential vintage computer enthusiast.

What many of the old timers who are into vintage computers don't seem to realize, is that the “youngsters”, who came along after the 8088 based machines, do not view computers the same way as they do.

Today's computer enthusiasts don't buy “brand name” computers. They build their own machines and then constantly upgrade them. The very concept of owning a computer a brand name computer (MITS Altair 8800, etc) is foreign to them.

Chip Collecting

However, today's computer enthusiasts do share one thing in common. Many of them have every CPU they have ever owned sitting in a drawer somewhere. Chip collecting makes "sense" to these people. In fact, the typical response you get from these same people when you mention chip collecting is "that's the coolest thing I've ever heard" after which they start rattling off every chip they have saved over the years.

The sad thing is that many of today's computer enthusiasts who get into chip collecting will never take the next step of obtaining a vintage machine because of the attitudes of vintage computer enthusiasts towards chip collectors.

16. Value

A Word to the Wise

Before getting into the topics of demand, rarity, condition, etc., *a word to the wise*, the values in this guide should be taken with a healthy grain of salt. This guide represents the first attempt to establish values for vintage microchips. In many cases, the values listed are nothing more than a best guess at what a given chip might be worth, based loosely based on what collectors have been recently paying for what I think is an equivalently rare chip of the same type. That said, the value of any collectible, including microchips, depends on a number of factors, the most important being: demand, rarity, and condition.

Demand

Demand has a lot to do with the value of old chips. Collectors like to display their chips and many collectors find the “C” prefix chips in the white ceramic package with gold cap and pins to be more attractive than equally rare “D” prefix chips in grey ceramic with tin pins or the “P” prefix chips in black plastic resin package with tin pins package.

More collectors collect Intel chips than Intel second source chips. In turn, prices on vintage Intel chips are somewhat higher than prices for equally rare second source chips.

Ceramic and plastic DIP, and PGA package types tend to be collected more than other package types (LCC, QFP, etc) because ceramic and plastic DIP, and PGA packages have pins that allow the chips to be displayed vertically on antistatic foam in a shadowbox type display case.

Rarity

Rarity is another factor that affects the value of an old chip. Many of the old “white gold” chips have been melted down for their gold content. How many still survive? No one knows for sure.

One indication of rarity is how often you see a given chip for sale. If you see a given chip for sale everyday on EBAY then it is probably not as rare as a chip that only shows up for sale once every few months.

Another technique to determine rarity is to query the large databases that list worldwide electronic component distributors’ inventories. Some of these databases contain over 50 billion electronic components and include remaining inventories of vintage computer chips.

If these databases show 5000 pieces of a given chip gathering dust in the inventories of distributors around the world, then that chip is not rare. If on the other hand, these databases do not list a single example of a given chip in stock anywhere in the world, then that chip is probably not common.

You may notice that the difference in value between chips in good condition and choice like new condition is more pronounced on the more common chips. The value of a common chip in choice like new condition may be 4x the value of the same chip in good condition. On the other hand, the difference in the value of an extremely rare chip in choice like new condition may be only 2x the value of the same chip in good condition.

Value

The reason for this is that collectors can be choosy when looking for an example of common chips. With common chips, collectors tend to look for “perfect” examples. With extremely rare chips, collectors can’t that choosy. When there are only 2 known examples of a chip and a 3rd shows up for sale, condition takes a back seat to rarity.

Visual Condition

Chips in the best visual condition are invariably the hardest to find and command the highest prices.

Beware of the term NOS (New Old Stock). It says nothing about the visual condition of the chip other than it is old stock that has never been used.

The following system of grading chips has been developed to allow collectors to communicate the visual state of preservation of a particular chip.

This grading scale is loosely based on the grading scales used for some other mainstream collectibles. Be aware that the grading scales used for other collectibles tend to be a little optimistic in the use of “good” and “fair” as applied to condition.

In coin collecting for example, a coin that is graded “good” is described as “Heavily worn. Design and legend visible but faint in spots”.

In paper currency collecting, a note in “good” condition is described as “a well worn and heavily used note. Normal damage from prolonged circulation will include strong multiple folds and creases, stains, pinholes and/or staple holes, dirt, discoloration, edge tears, center hole, rounded corners and an overall unattractive appearance. No large pieces of the note may be missing”.

Grading System

ChLN (Choice Like New): Like new condition with well-centered and boldly printed part number and logo. No scratches or scuffs on cap or package. Pins are bright and shiny with no scratches. This is the higher of the two values listed for each chip in the guide.

LN (Like New): A part that would have graded ChLN except for some *minor* detractor such as the part number or logo might not be as boldly printed, or the part number and logo might not be as well centered. No scratches or scuffs on cap or package. Pins should be bright and shiny without any scratches.

ALN (Almost Like New): Part is in nearly new condition except for a few faint scratches or scuffs that in *no way* detract from part number or logo on the cap or package. Small “Fleabites” on corners of ceramic packages. Pins are shiny other than faint socketing scratches.

EF (Extremely fine): Part may have some minor scratches or scuffs but nothing that *significantly* detracts from part number or logo. Pins may have light-socketing scratches but will still be shiny.

F (Fine): Part may have significant scratches or scuffs as long as they do not *significantly* detract from part number or logo. Tin pins may be starting to show light oxidization but gold pins should still be shiny other than socketing scratches.

Value

VG (Very Good). Part is clearly used and may have many scratches and scuffs. Part number and other printing on package may be scratched but should still be *clearly* legible. Tin pins may be lightly oxidized. Gold pins may be discolored but not pitted. This is the lower of the two values listed for each chip in the guide.

G (Good). Part that shows considerable wear and tear. Part number should be legible but lot number and other markings may be difficult to read. Light pitting on gold caps may be visible. Tin pins may have significant oxidation. Gold pins may be discolored and have light pitting.

FR (Fair). Part that shows heavy wear and tear. Part number may be barely legible. Tin pins may be heavily oxidized. Gold pins may have significant pitting.

PR (Poor). Parts with seriously corroded, broken or missing pins, cracked package, illegible part number, or other major defects. A filler only for the most rare parts.

Functional Condition

Values listed in this guide are for chips that are assumed to be functional.

If a chip is known to be non-functional then this should be indicated in the chips condition. For example, “Non-functional Intel C8080A in ChLN visual condition”.

That said, the general rule in the chip collector community is that a chip is assumed functional unless it is known to be non-functional.

The fact is, most chip collectors would be hesitant to try and test a rare vintage chip because that would require putting it into a vintage machine or vintage testing equipment with a vintage power supply and other vintage components that could damage the chip being tested if they were to malfunction during the test.

Likewise, finding someone with a vintage machine that is willing to test your chip would likely be difficult because the owner of the vintage machine does not want to risk damaging it by putting a potentially bad chip in it.

So what are the odds that the vintage chips in our collections are functional? Pretty good actually. The size of the circuits in vintage chips was huge in comparison to the size of circuits in modern chips. This means vintage chips are much more tolerant of ESD (electro static discharge) than modern chips.

Treat your vintage chips with the same ESD protection you would use when handling modern chips and they should be just fine.

Date codes

Usually found on the bottom of vintage Intel chips, date codes can have a considerable effect on a chips value.

Intel Date Code Format = YYWW

Value

Where:

YY = Year of manufacture (73 thru 99).

WW = Week of manufacture (01 thru 52).

Many early Intel chips were manufactured years after they were originally introduced. For example, the Intel i4004 was introduced in late 1971, but you can find Intel 4004 microprocessors with 1981 date codes.

These “late date” chips do not command the prices as those chips manufactured closer to the date they were introduced.

You also have chips with no date codes. Intel did not start putting date codes on their chips until around 1973 and did not always put date codes on chips after that. The difference in value between a late date and no date code Intel chip introduced prior to 1973 can be spectacular.

A few years ago, a late date Intel P4004 in good condition sold on EBAY for \$20. The next week, an Intel P4004 in about the same condition with no date code brought over \$200.

The values listed in this guide for microprocessors are the values for chips with date codes prior to the introduction of their successors. Late date chips may be worth considerably less. Chips with early dates or no date code may be worth considerably more.

One exception to this rule is rare package and part number variants. Some of these chips only exist with late dates but can still be very valuable.

Copyrights

The copyright date(s) on most common chips will have little or no effect on the chips value.

However, there are cases where the absence or presence of a copyright can affect a chips value.

For example, an Intel C8080A with copyright Intel '74 is more rare than the earlier Intel C8080A without a copyright.

On the other hand, the Intel C8085 without a copyright is more rare than the later Intel C8085 with copyright Intel '76.

Missing Package Type Prefix

If you have collecting vintage Intel chips for any amount of time, you have probably seen examples of Intel chips that are missing the ‘C’ prefix normally found on Intel ceramic DIPs with side-brazed pins.

The first time I saw one of these chips, I assumed that the prefix had been inadvertently left off when the part number was stamped. However, it soon became obvious that the missing ‘C’ prefix occurs far to often to be an accident. The missing ‘C’ prefix meant something, but what?

Then one day while looking thru some old data sheets, I came across an Intel price list dated March 1971.

Value

The Intel price list stated that “Products which are offered in both plastic and ceramic packages are differentiated by a ‘C’ for ceramic and ‘P’ for plastic.”

The price list gave separate prices for the ‘C’ and ‘P’ prefix 1101A Static RAM, whereas prices for chips like the 1601 PROM were listed without any prefix.

While there is some debate about just how closely Intel followed this scheme with regards to missing prefixes, it is clear that Intel’s early part numbering scheme called for prefixes to be used only on chips that were available in more than one type of package at the time the chips were manufactured.

This is important because it means that an example of a given chip without the package type prefix is generally older than an example of the same chip with the package type prefix.

Customer/Engineering Samples

Customer samples were often provided to large customers. These chips were typically marked ‘CS’. A ‘CS’ designation does not always indicate an early date. Customer samples were produced throughout many chips production life cycle.

Engineering samples on the other hand were typically marked ‘ES’. An ‘ES’ designation usually indicates an early production or pre-production chip.

Customer and Engineering samples of early Intel chips are highly sought after by collectors.

The value adjustment for chips marked ‘CS’ or ‘ES’ depends on the type of chip. An ‘ES’ or ‘CS’ marked processor can be worth substantially more than a non-Engineering or Customer Sample. On the other hand, a ‘CS’ or even an ‘ES’ designation may not have much effect on an obscure support chip.

A ‘CS’ designation can increase a chips value by 1.5x or more.

An ‘ES’ designation can increase a chips value by 2x or more.

Vendor Inspection Marks

Some vendors would retest chips before selling them and would mark those chips that passed inspection with some sort of a mark.

Inspection marks sometimes seen include a dot of fingernail polish or paint on the body of the chip or a dot of solder on the cap.

As long as these inspection marks do not obscure the part number or any other writing on the chip these marks generally do not have much affect on a chips value.

Other Marks

Writing on the top of a chip can reduce a chips value by ½ and it’s not uncommon to find old chips with writing on them, especially EPROMS.

Value

Be aware that removing ink from a ceramic package can be extremely difficult if not impossible.

Pencil marks on the other hand, can usually be removed from a ceramic package.

Plastic DIP Packages with Yellow Logos

Very Early Intel chips in Type P packages are occasionally found with yellow Intel logo and part number as opposed to the much more common white ink.



Intel P4001 with Yellow Logo and Part Number on Busicom 141-PF Main Board

Soldered Pulls

Soldered pulls typically reduce the collector value of a chip by approx. ½, especially soldered pulls of type C package chips with gold pins.

17. Deciphering Intel Part Numbers

The Intel Part Number Format

Intel part numbers consist of different components. Each component of the Intel part number identifies different information about the part.

Intel part number format: Temp Modifier + Package Type + Product Number + Version + Power Modifier + ('-' + Speed/Processing Modifier) + ('/' + Military Test Procedure Identifier)

Note: All components may not exist in a given part number and some part numbers may include additional letters to indicate HMOS or CMOS parts.

Example:

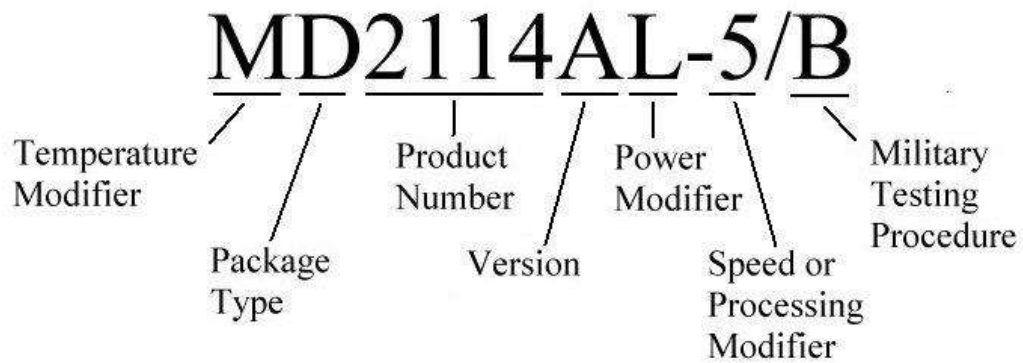

Deciphering Intel Part Numbers

Temperature Modifier

Modifier	Description
I	Industrial Temperature Range (-40°C to 85°C) with 44 hour Burn-In at 125°C
L	Extended Temperature Range (-40°C to 85°C) with 160 ± 8 hrs. Dynamic Burn-In
M	Military Temperature Range (-55°C to 125°C)
Q	Commercial Temperature Range (0°C to 70°C) with 160 ± 8 hrs. Dynamic Burn-In
T	Extended Temperature Range (-40°C to 85°C) without Burn-In.

Package Type

A package type identifier is usually found in front of the product number. The package type identifier identifies the package type (CerDIP, Plastic DIP, etc).

Package Type Identifiers, Descriptions, and Examples typically found on vintage chips:

Package Type Identifier	Description	Examples
B	Type D w/epoxied Ceramic Lid	B1702A
C	Ceramic DIP w/Side or Top-Brazed Pins and Soldered Metal Lid	C4004, C4040, C8085
D	Ceramic DIP (Glass Frit Sealed)	D4004, D4040, D8085
H	Type C with Transparent Window for EPROMS	H1702A
N	Plastic Leadless Chip Carrier (PLCC)	N80186, N80286
P	Plastic DIP	P4004, P4040, P8085
R	Ceramic Leadless Chip Carrier (CLCC)	R80186, R80286

Note: Package type identifier was not printed on some early Intel chips. See section on missing 'C' prefixes.

Deciphering Intel Part Numbers

Product Number

Early Intel part numbers contain a 4-digit product number in the format ABCC

Where:

- A = Product Family Number
- B = Product Type Number
- CC = Product Sequence number

Product Family			Product Type		
A	Used For:	Examples	B	Used For	Examples
0	Test Chips	N.A.	0	Processors	4004*, 4040
1	PMOS Products	1101*, 1103	1	RAMS (static, dynamic)	3101*, 2102, 2104
2	NMOS Products	2101, 2401, 2107B	2	Controllers	2201, 8251, 8253
3	Bipolar Products	3101*	3	ROM	3301*
4	4-bit Microprocessors	4004*, 4008, 4009	4	Shift Registers	1406*, 2401
5	CMOS Products	5101, 5201*	5	EPLD	
6	(Not used)		6	PROM	1601*
7	Bubble Memory Products	7110*	7	EPROM	1701*, 1702, 2708
8	8-bit and beyond microprocessors and microcontrollers	8008*, 8080, 8085, 8086, 8088, 8048, 8051, 8096	8	Watch chips and timing circuits with oscillators	5801*, 5810
9	(Not used)		9	Telecommunications	2910*, 2920

* First Product In This Category

Version ID

A version ID sometimes follows product numbers.

The version identifier was used to identify different versions of a given part. The letter 'A' was used to indicate 1st version, B = 2nd version, etc. For example: C8085 vs. C8085A

Power Modifier

An 'L' after the part number or version was used to indicate a low power dissipation part.

Speed or Processing Modifier

The Product Numbers, Version, or Power Modifier is sometimes followed by a hyphen ('-') followed by a Speed or Processing Modifier.

Beware! On early Intel parts, the speed modifier will not necessarily correspond to the actual KHz/MHz rating of the chip.

Military Testing Procedure Identifier

Intel parts with a 'M' modifier (Military) will sometimes have a slash ('/') on the end of the part number followed by a Military Testing Procedure Identifier of 'B', or 'C'. These are commonly known as Level B and Level C products [1].

Example: MD8080A/B, MD8085A/C

Intel parts with a 'M' modifier that do not have a Military Testing Procedure are military temperature only parts [1].

Example: MC8087

HMOS/CMOS Parts

Intel introduced high-density NMOS parts in 1977. Intel's terminology for parts made using the new high-density NMOS process was HMOS.

Intel Process Evolution [2]

	HMOS I	HMOS II	HMOS III	CHMOS III
Introduction	1977	1978	1983	1984

Intel's HMOS parts were sometimes, but not always, identified by an 'H' after the part number or version ID (NMOS C8085A vs. HMOS C8085AH).

Intel's CHMOS parts were normally identified by a 'C' between the product type number and the product sequence number (NMOS 8086 vs. CHMOS 80C86).

References

- [1] Intel (October 1977). MCS-80 Users Manual, pg. 8-9
- [2] Intel (1987). Military Handbook, Radiation Tolerance, pg. 10-4
- [3] Intel (July 1977). MCS-48 Microcomputer User's Manual, pg. A2-1

18. Intel Microchips

Part Number Listings

Part number listings in this guide consist of the Intel Part Number, a package description, value in very good (VG) condition and value in Choice Like New (ChLN) condition.

Values listed in this guide DO NOT take into account 'ES' and 'CS' designations sometimes found on chips the photos used to identify package and/or copyright variations!

Example:

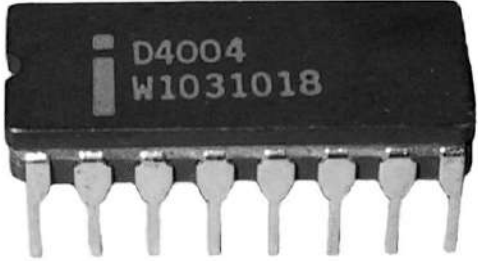
Part Number	Package	Value
		
D4004	Type D grey ceramic package w/tin pins	\$15-\$60

While I have made every attempt to verify the part number in this guide from multiple sources or photos, there are some part numbers that I suspect could be legitimate that I have not been able to sufficiently verify. These part numbers are designated as suspect.

Package Descriptions

Ceramic and plastic DIPS come in a number of colors like black, white, grey, purple, blue, and various shades between.

Most CerDIPs are a charcoal grey color that some collectors call "black". For the purposes of this guide, the color black will be reserved for black plastic DIPS. Grey is used to describe charcoal grey colored CerDIPs and battleship grey colored Type P plastic DIPS.

Intel i1101

256-bit (256 x 1) Static RAM

1969

Specifications

- 256-bit (256 x 1) Static RAM
- PMOS
- Low Power Dissipation – 2mW/bit During Access
- Access Time – Typically Below 900 nsec
- Directly DTL and TTL Compatible
- OR-Tie Capability
- Simple Memory Expansion – Chip Select Input Lead
- Fully Decoded – on Chip Address Decode and Sense
- Inputs Protected – All Inputs Have protection Against Static Charge
- Three State Output
- 16-pin Dual In-line Package

Type	Access Time Max.	Cycle Time Max.	Power Dissipation Max. Operating/Standby	Supplies [V]
1101	1.5 μ s	1.5 μ s	700mW/350mW	+5, -7, -10
1101-1	1 μ s	1 μ s	700mW/350mW	+5, -7, -10

The Intel 1101 is a 256 word by 1-bit random access memory element using normally off P-channel MOS devices integrated on a monolithic array. It uses fully DC stable (static) circuitry and therefore requires no clocks to operate.

The 1101 will directly interface with standard bipolar logic circuits (TTL, DTL, etc.) There is no need for either special driver circuits or special level converters for inputs or outputs. The data output buffers are capable of driving TTL loads directly.

A separate Chip Select lead allows easy selection of an individual package when outputs are OR-tied.

The Intel 1101 is fabricated with silicon gate technology. This low threshold technology allows the design and production of higher performance MOS circuits and provides a higher functional density on a monolithic chip than conventional MOS technologies.

The 1101 is designed primarily for small buffer store applications high performance, low cost, and ease of interfacing with other standard logic circuits are important design objectives.

For applications requiring a faster access time we recommend the 11011, which is a selection from the 1101 and has a guaranteed maximum access time of 1 μ sec [1].

History

1st PMOS Memory Device

Intel 1101 Die

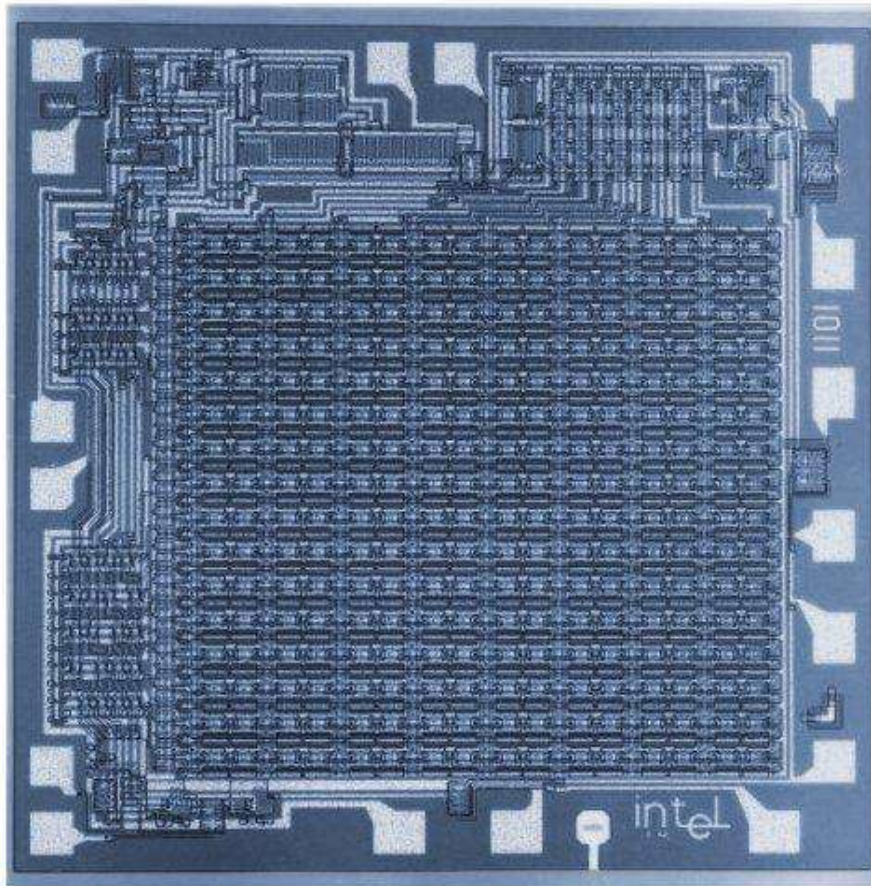

Copyright Intel Corporation

Packaging

The Intel 1101 was not produced in a type D package.

No examples are known to exist in the type P package.

Part Numbers

Type C Packages

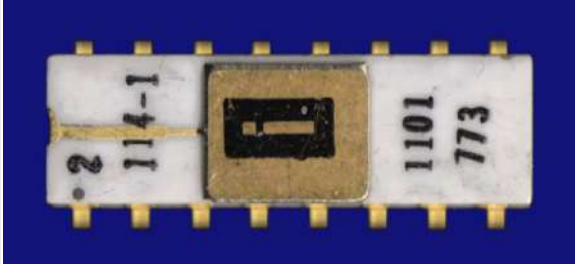
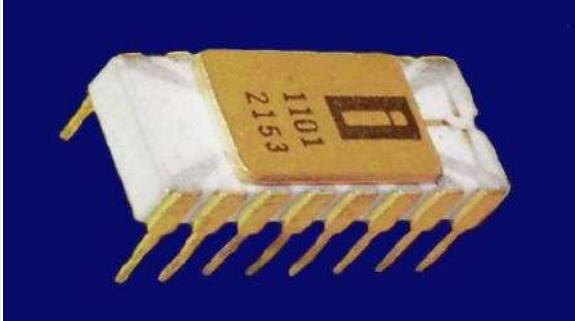
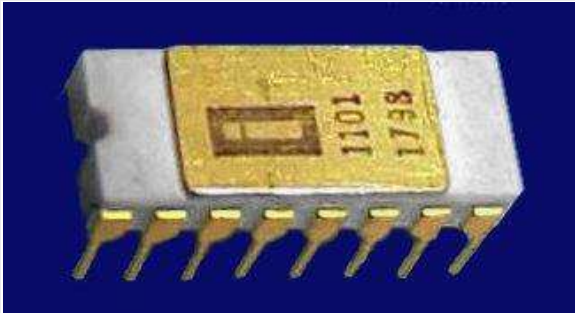
Part Number	Package Description	Values
		
1101	<p>1. Type C white ceramic package w/gold cap, gold cap ground strap, and gold pins. Black dot denotes pin #1. Vertical blocked 'i' Intel logo on cap. Part number on ceramic package. This package featured in a photo in the article 'Solid-State Memory Offers New Organizations' by Dr. Marcian E. Hoff, Intel Corp. printed in the October 15, 1969 issue of EDN magazine.</p>	Ex. Rare (1 Known) \$75-\$300
		
1101	<p>2. Type C white ceramic package w/grey traces, gold cap, gold cap ground strap, and gold pins. Vertical blocked 'i' Intel logo and part number on cap. The grey traces on this package are practically straight where the grey traces on early Intel chips are usually curved. This package is also missing the gold dot usually found on packages with grey traces to denote pin #1.</p>	Ex. Rare (6 Known) \$50-\$200
		
1101	<p>3. Type C white ceramic package w/gold cap and gold pins. Vertical blocked 'i' Intel logo and part number on cap.</p>	\$25-\$100

Intel i1101

		
1101	4. Type C white ceramic package w/gold cap and gold pins. Dropped 'e' Intel logo and part number on cap.	Ex. Rare \$50-\$200
		
C1101	Type C white ceramic package w/grey traces, gold cap, and gold pins. Gold dot indicates pin #1. Dropped 'e' Intel logo and part number on cap.	Ex. Rare \$50-\$200
		
1101-1	Type C white ceramic package w/gold cap and gold pins. Vertical blocked 'i' Intel logo and part number on cap.	\$25-\$100

References

[1] Intel (September 1970). Intel 1101, 11011 Data Sheet.

[2] Intel (1984). A Revolution in Progress... A History of Intel to Date, 1101 introduced 1969, p. 26.

Intel i1101A

256-bit (256 x 1) Static RAM

1970-71

Specifications

- 256-bit (256 x 1) Static RAM
- PMOS
- Access Time – Typically Below 650 nsec – 1101A1, 850 nsec – 1101A
- Low Power Standby Mode
- Low Power Dissipation – Typically less than 1.5 mW/bit during access
- Directly DTL and TTL Compatible
- Three State Output – OR-tie Capability
- Simple Memory Expansion – Chip Select Input Lead
- Fully Decoded – On Chip Address Decode and Sense
- Inputs Protected – All Inputs Have Protection Against Static Charge
- Ceramic and Plastic Package -- 16-pin Dual In-line Configuration

Type	Access Time Max.	Cycle Time Max.	Power Dissipation Max. Operating/Standby	Supplies [V]
1101A	1.5 μ s	1.5 μ s	685mW/340mW	+5, -9
1101A-1	1 μ s	1 μ s	685mW/340mW	+5, -9

The 1101A is an improved version of the 1101 which only requires two power supplies (+5V and -9V). The 1101A is a direct pin replacement for the 1101.

The Intel® 1101A is a 256 word by 1-bit random access memory element using normally off P-channel MOS devices integrated on a monolithic array. It uses fully DC stable (static) circuitry and therefore requires no clocks to operate.

The 1101A is designed primarily for small buffer storage applications where high performance, low cost, and ease of interfacing with other standard logic circuits are important design objectives. The unit will directly interface with standard bipolar logic circuits (TTL, DTL, etc.) The data output buffers are capable of driving TTL loads directly. A separate chip select lead allows easy selection of an individual package when outputs are OR-tied.

For applications requiring a faster access time we recommend the 1101A1, which is a selection from the 1101A and has a guaranteed maximum access time of 1.0 μ sec.

The Intel 1101A is fabricated with silicon gate technology. This low threshold technology allows the design and production of higher performance MOS circuits and provides a higher functional density on a monolithic chip than conventional MOS technologies.

Intel's silicon gate technology also provides excellent protection against contamination. This permits the use of low cost silicone packaging [4].

Intel i1101A

Packaging

The Intel 1101A was not produced in a type D package.

An Intel pricelist dated March 1971 lists prices: P1101A – \$20.00 ea., C1101A - \$24.00 ea., P1101A1 - \$24.00 ea., C1101A1 - \$28.20 ea., in quantity 1-24.

Part Numbers

Type C Packages



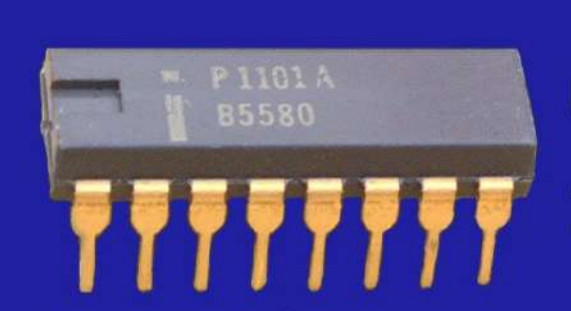
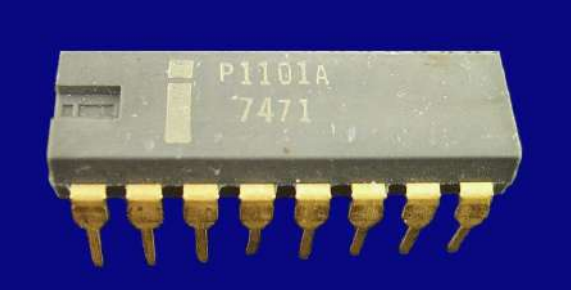
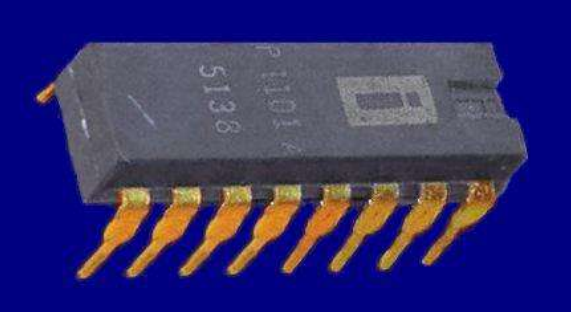

Part Number	Package Description	Values
		
C1101A	1. Type C white ceramic package w/grey traces, gold cap, gold cap ground strap, and gold pins. Gold dot denotes pin #1	\$25-\$100
		
C1101A	2. Type C white ceramic package w/gold cap and gold pins. Unidentified symbol denotes pin #1.	\$20-\$80
		
C1101A1	Type C white ceramic package w/grey traces, gold cap, gold cap ground strap, and gold pins. Gold dot denotes pin #1.	\$25-\$100

Intel i1101A

Type P Packages

Part Number	Package Description	Values
		
P1101A	1. Type P grey plastic package w/gold pins. Plain key.	Rare \$20-\$80
		
P1101A	2. Type P grey plastic package w/gold pins. Embossed Intel 'i' in key.	Rare \$20-\$80
		
P1101A	3. Type P grey plastic package w/gold pins. Vertical blocked 'i' Intel logo and part number. Embossed Intel 'i' in key.	Ex. Rare \$25-\$100

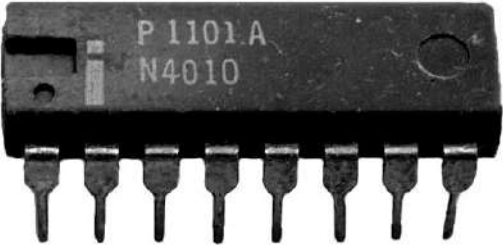
Intel i1101A

		
P1101A	4. Type P grey plastic package w/tin pins. Plain rectangular key.	Rare \$15-\$60
		
P1101A	5. Type P grey plastic package w/tin pins. Small square key.	Rare \$15-\$60
		
P1101A	6. Type P black plastic package w/tin pins. Plain rectangular key.	\$5-\$20
		
P1101A-1	Type P grey plastic package w/gold pins. Embossed Intel 'i' in key.	Ex. Rare \$50-\$200

References

- [1] Intel (September 1970). Intel 1101, 11011 Data Sheet. No reference to 1101A dates chip after September 1970.
- [2] Intel (March 1971). Intel Price List, C1101A, P1101A, C1101A1, and P1101A1 prices. No Reference to 1101 family.
- [3] Intel (September 1972). Intel Data Catalog, 1101A and 1101A1 Data Sheet, p. 2-3
- [4] Intel (1976). Intel Data Catalog, 1101A and 1101A1 Data Sheet, p. 2-4.

Intel i1103

1024-bit (1024 x 1) Dynamic RAM

October 1970

Specifications

- 1024-bit (1024 x 1) Dynamic RAM
- PMOS
- Low Power Dissipation – Dissipates Power Primarily on Selected Chips
- OR-Tie Capability
- Simple Memory Expansion – Chip Enable Input Lead
- Fully Decoded – on Chip Address Decode
- Inputs Protected – All Inputs Have Protection Against Static Charge
- 18-pin Dual In-line Package

Type	Access Time Max.	Cycle Time Max.	Power Dissipation Max. Operating/Standby	Supplies [V]
1103	300ns	580ns	400mW/67mW	+16, +19.5
1103-1	150ns	340ns	437mW/76mW	+19, +22.5

The Intel 1103 is designed primarily for main memory applications where high performance, low cost, and large bit storage are important design objectives.

The 1103 is a 1024 word by 1-bit random access memory element using normally off P-channel MOS devices integrated on a monolithic array. It is fully decoded, permitting the use of an 18-pin dual in-line package. It uses dynamic circuitry and primarily dissipates power only during Precharge.

Information stored in the memory is non-destructively read. Refreshing of all 1024 bits is accomplished in 32 read cycles and is required every two milliseconds.

A Separate enable (chip enable) lead allows easy selection of an individual package when outputs are OR-tied.

The Intel 1103 is fabricated with silicon gate technology. This low threshold technology allows the design and production of higher performance MOS circuits and provides a higher functional density on a monolithic chip than conventional MOS technologies.

Intel's silicon gate technology also provides excellent protection against contamination. This permits the use of low cost plastic packaging [3].

Intel 1103 Die

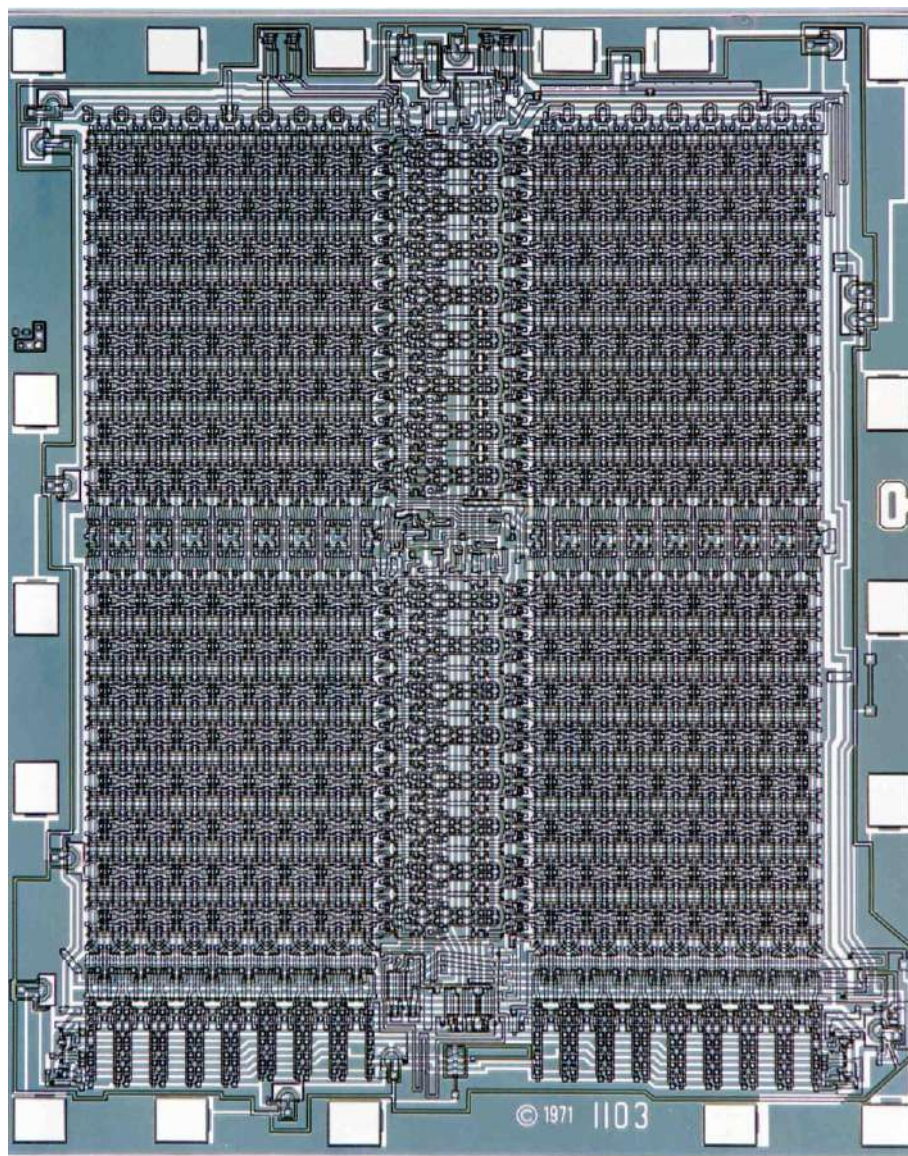

Copyright Intel Corporation

History

The Intel 1103, introduced in late 1970, was the chip that broke the back of ferrite cores. It was a fully decoded, 1,024-bit dynamic RAM using silicon-gate PMOS technology. In an 18-pin ceramic or plastic DIP, the 1103 sold at first for about a penny a bit, matching core's price. But then core prices cratered to 0.3 cent a bit. Intel's prices declined further. Intel boasted that this chip, whose core equivalent occupied about a square foot and weighed almost a pound, was the core killer, and Intel was right [5].

The first commercially available computer using the 1103 was the HP 9800 series [6].

RAM stands for random access memory, memory that can be accessed or written to randomly -- any byte or piece of memory can be used without accessing the other bytes or pieces of memory. There were two basic types of RAM, dynamic RAM (DRAM) and static RAM (SRAM).

DRAM needs to be refreshed thousands of times per second. SRAM does not need to be refreshed, which makes it faster. Both types of RAM are volatile -- they lose their contents when the power is turned off [6].

By 1972, the 1103, Intel's original DRAM, was the world's largest selling semiconductor and accounted for over 90% of Intel's \$23.4 million in revenue.

An Intel price list dated March 1971 lists P1103 - \$60.00 ea. in quantity 1-24. No reference in same price list for C1103.

D1103/D1103-1

Only a few sources show these chips in stock but these sources lists several thousand in stock.

Part Numbers

Type C Packages

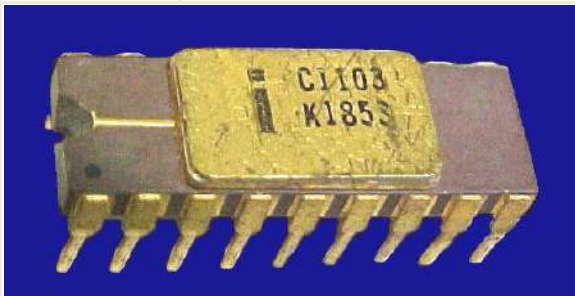
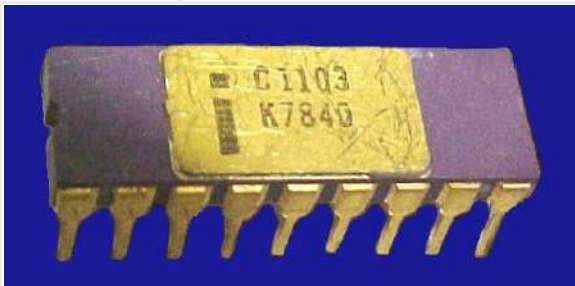
Part Number	Package Description	Values
		
C1103	1. Type C brown ceramic package w/gold cap, gold cap ground strap, and gold pins. Gold dot denotes pin #1.	Ex. Rare (2 Known) \$75-\$300
		
C1103	2. Type C brown ceramic package w/gold cap, gold cap ground strap, and gold pins. Black dot denotes pin #1.	Ex. Rare (2 Known) \$75-\$300
		
C1103	3. Type C purple ceramic package w/gold cap and gold pins. Black triangle denotes pin #1.	Rare \$50-\$200

Type D Packages

Part Number	Package Description	Values
D1103	Type D grey ceramic package w/tin pins.	\$3-\$12
D1103-1	Type D package	\$2-\$8

Intel i1103

Type P Packages

Part Number	Package Description	Values
		
P1103	1. Type P grey plastic package w/gold pins. Sunken Intel 'i' in key.	\$15-\$60
		
P1103	2. Type P grey plastic package w/gold pins. Raised Intel 'i' in key.	\$15-\$60
		
P1103	3. Type P black plastic package w/gold pins. Sunken Intel 'i' in key.	\$15-\$60
P1103	4. Type P black plastic package w/gold pins. Raised Intel 'i' in key.	\$15-\$60
		
P1103	5. Type P grey plastic package w/tin pins	\$15-\$60
P1103-1	Type P grey plastic package w/tin pins.	\$15-\$60

References

- [1] Intel (March 1971). Intel Price List. Reference to P1103 dates chip to March 1971. No reference to 1103-1 or 1103A Family.
- [2] Intel (September 1972). Intel Data Catalog, 1103 Data Sheet. Data sheet indicates 1103 is available in "Ceramic and Plastic Package – 18 Pin Dual In-Line Configuration". No reference to 1103-1 or 1103A family.
- [3] Intel (1978). Intel Component Data Catalog, 1103 Data Sheet, p. 3-4.
- [4] Intel (1978). The Semiconductor Memory Book, 1103 Data Sheet, p. 182.
- [5] George Rostky (2002). Ferrite cores: to remember forever. Available from: http://www.eetimes.com/special/special_issues/millennium/milestones/whittier.html [Accessed 10 July 2002]
- [6] Mary Bellis (2002). Inventors of the Modern Computer, The Invention of the Intel 1103 - The World's First Available DRAM Chip, "The Intel i1103 "came to market" in October of 1970". Available from: <http://inventors.about.com/library/weekly/aa100898.htm> [Accessed 10 July 2002]

Intel i1103A

1024-bit (1024 x 1) Dynamic RAM

3rd Qtr 1973

Specifications

- 1024-bit (1024 x 1) Dynamic RAM
- PMOS
- No Precharge Required – Critical Precharge Timing is Eliminated
- Electrically Equivalent to 1103 – Pin-for-Pin/Functionally Compatible
- Fast Access Time – 205 ns max.
- Low Standby Power Dissipation -- 2 μ W/Bit Typical
- Address Registers Incorporated on the Chip
- Simple Memory Expansion – Chip Enable Input Lead
- Inputs Protected – All Inputs Have Protection Against Static Charge
- 18-pin Dual In-line Package

Type	Access Time Max.	Cycle Time Max.	Power Dissipation Max. Operating/Standby	Supplies [V]
1103A	205ns	580ns	400mW/64mW	+16, +19.5
1103A-1	145ns	340ns	627mW/10mW	+19, +22.5
1103A-2	145ns	400ns	570mW/10mW	+19, +22.5

The 1103A is a 1024 word by 1 bit dynamic RAM. It is designed primarily for main memory applications where high performance, low cost, and large bit storage are important design objectives. The 1103A is electrically equivalent to the 1103.

1103A systems may be simplified due to the elimination of the Precharge clock, its associated circuitry, and critical overlap timing. Only one external clock is required.

Information stored in the memory is non-destructively read. Refreshing of all 1024 bits is accomplished in 32 read cycles and is required every two milliseconds.

The 1103A is fabricated with silicon gate technology. The low threshold technology allows the design and production of higher performance MOS circuits and provides a higher functional density on a monolithic chip than conventional MOS technologies [5].



History

When production of the 1103 was phased out in 1979, more than 35 million 1103's had been shipped [6].

Intel i1103A

Part Numbers

Type C Packages

Part Number	Package Description	Values
	 A photograph of a purple ceramic package with a gold cap and gold pins. The cap is marked with 'C1103A' and 'H2492'.	
C1103A	Type C package purple ceramic package w/gold cap and gold pins.	Ex. Rare \$50-\$200
	 A photograph of a brown ceramic package with a gold cap, a gold ground strap, and gold pins. The cap is marked with 'C1103A-2' and 'K0491S500'.	
C1103A-2	1. Type C brown ceramic package w/gold cap, gold cap ground strap and gold pins. Small black dot denotes pin #1.	Ex. Rare \$50-\$200
	 A photograph of a purple ceramic package with a gold cap and gold pins. The cap is marked with 'C1103A-2' and 'H9971S500'.	
C1103A-2	2. Type C purple ceramic package w/gold cap and gold pins.	\$20-\$80

Type D Packages

Part Number	Package Description	Values
D1103A	Type D package	\$.75-\$3
D1103A-1	Type D package	\$5-\$20
D1103A-2	Type D package	\$5-\$20

Intel i1103A

Type P Packages

Part Number	Package Description	Values
P1103A	Type P package	\$1.50-\$6
P1103A-1	Type P package	\$4-\$16

References

- [1] Intel (March 1971). Intel Price List, P1103 prices date P1103 to March 1971. No reference to 1103A dates 1103A after March 1971.
- [2] Intel (September 1972). Intel Data Catalog, 1103 Data Sheet. Data sheet indicates 1103 is available in “Ceramic and Plastic Package – 18 Pin Dual In-Line Configuration”. No reference to 1103-1 or 1103A series.
- [3] Intel (August 1973). The Intel Memory Design Handbook, 1103A and 2105 announced 3rd Qtr 1973, Order Form for Supplement in Back of Handbook.
- [4] Intel (1975). Intel Memory Design Handbook, 1103A Specifications, p. PSG-1
- [5] Intel (1977). Intel Data Catalog, 1103A Data Sheet, p. 2-16
- [6] Intel (1984). A Revolution in Progress... A History of Intel to Date, p. 10

Intel i1301

2048-bit (256 x 8) Static / Dynamic ROM

1969-71

Specifications

- 2048-bit (256 x 8) Static / Dynamic ROM
- PMOS
- Erasable and Field Programmable (1701, 1702)
- Field Programmable (1601, 1602)
- All 2048 Bits Guaranteed Programmable – 100% Factory tested (1601/1701, 1602/1702)
- Inputs and Outputs DTL and TTL Compatible
- Static and Dynamic Operation (1601, 1701, 1301)
- Static Only Operation (1602, 1702)
- OR-tie Capability
- Simple Memory Expansion – Chip Select Input Lead
- ROM equivalent of Intel 1601 PROM and Intel 1701 EPROM
- 24-pin Dual In-Line Package

Type	Access Time Max.	Power Dissipation Max. Operating/Standby	Supplies [V]
1301	1 μ s	700mW	+5, -9

The Intel 1601, 1602, 1701, and 1702 is a 256 word by 8-bit electrically programmable ROM ideally suited for uses where fast turnaround and pattern experimentation are important such as in prototype or in one of a kind systems. The 1601, 1602, 1701, and 1702 is factory reprogrammable which allows Intel to perform a complete programming and functional test on each bit position before delivery.

The four devices 1601, 1602, 1701, and 1702 use identical chips. The 1601 and 1701 is operable in both the static and dynamic mode while the 1602 and 1702 is operable in the static mode only. Also, the 1701 and 1702 has the unique feature of being completely erasable and field reprogrammable. This is accomplished by a quartz lid that allows high intensity ultraviolet light to erase the 1701 and 1702. A new pattern can then be written into the device. This procedure can be repeated as many times as required.

The 1301 is a pin-for-pin replacement part which is programmed by a metal mask and is ideal for large volumes and lower cost production runs of systems initially using the 1601/1701 or the static only 1602/1702.

The Dynamic mode of the 1601/1701 and 1301 refers to the decoding circuitry and not the memory cell. Dynamic operation offers higher speed and lower power dissipation than static operation.

The 1601, 1602, 1701, and 1702 is fabricated with silicon gate technology. This low threshold technology allows the design and production of higher performance MOS circuits and provides a higher functional density on a monolithic chip than conventional MOS technologies [2].

History

The 1601 and 1301 are both listed on an Intel Price list dated March 1971. No reference on same pricelist to 1701 and 1702.

Part Numbers

Type C Packages

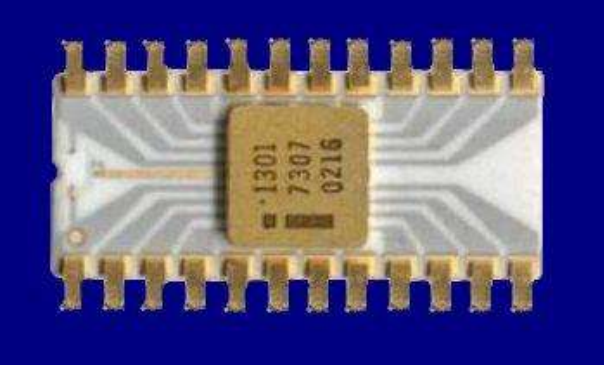
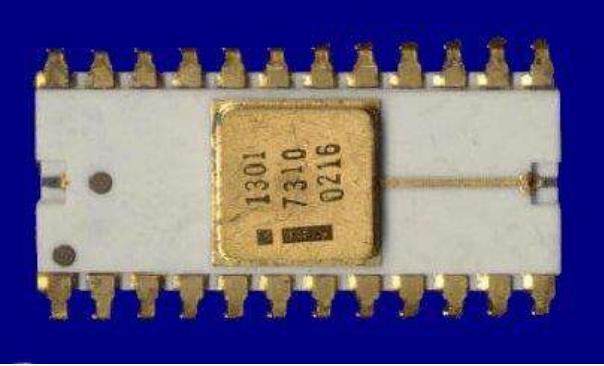
Part Number	Package Description	Values
1301	 <p data-bbox="418 793 1218 856">1. Type C white ceramic package w/grey traces, gold cap, gold cap ground strap, and gold pins. Gold dot denotes pin #1. No copyright.</p>	Ex. Rare \$75-\$300
1301	 <p data-bbox="418 1234 1218 1297">2. Type C white ceramic package w/gold cap, gold cap ground strap, and gold pins. Cap ground strap connection points on both ends (only one used). Black dot or gold dot denotes pin #1. No copyright.</p>	Ex. Rare \$75-\$300

References

[1] Intel (March 1971). Intel Price List, 1301 prices date chip to 1971.

[2] Intel (September 1972). Intel Data Catalog, 1601/1701, 1602/ 1702, 1301 Data Sheet, p. 3-11.

Intel i1302

2048-bit (256 x 8) Static ROM

4th Qtr 1972

Specifications

- 2048-bit (256 X 8) Static ROM
- PMOS
- Access Time – 1µsec Max.
- Fully Decoded, 256 x 8 Organization
- Inputs and Outputs TTL Compatible
- Three-State Output – OR-tie Capability
- Static MOS – No Clocks Required
- Simple Memory Expansion – Chip Select Input Lead
- ROM equivalent of the Intel 1602 PROM and Intel 1702 EPROM
- 24-pin Dual In-Line Package

Type	Access Time Max.	Power Dissipation Max. Operating/Standby	Supplies [V]
1302	1µs	700mW	+5, -9

The Intel ® 1302 is a fully decoded 256 word by 8 bit metal mask ROM. It is ideal for large volume production runs of microcomputer systems initially using the 1702A erasable and electrically programmable ROM. The 1302 is pin compatible with the 1702A.

The 1302 is entirely static – no clocks are required. Inputs and outputs of the 1302 are TTL compatible. The output is three-state for OR-tie capability. A separate chip select input allows easy memory expansion. The 1302 is packaged in a 24-pin dual-in-line hermetically sealed ceramic package.

The 1302 is fabricated with p-channel silicon gate technology. This low threshold allows the design and production of higher performance MOS circuits and provides a higher functional density on a monolithic chip than conventional MOS technologies [3].

History

Intel price list dated March 1971 lists the Intel 1301 and 1601 but has no reference to 1302, 1602, or 1702.

Intel's September 1972 Data Catalog contains the 1301, 1601, 1602, 1701, and 1702 data sheets but there's no reference to the 1302.

Intel's February 1973 Data Catalog contains a data sheet for the 1302.

1302 w/Grey Traces

1302 with grey traces is unknown but may exist.

1302A?

Did Intel produce a 1302A ROM equivalent of the Intel 1602A PROM and Intel 1702A EPROM? There are no known references in Intel literature to a 1302A.

Part Numbers

Type C Packages

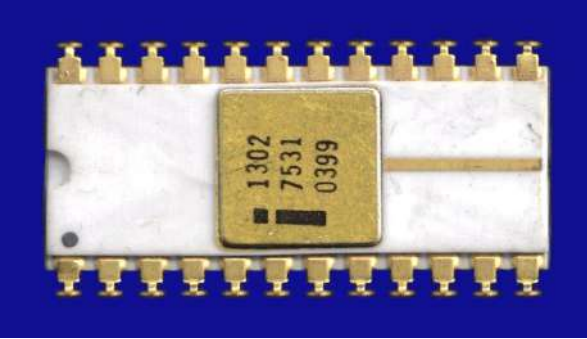
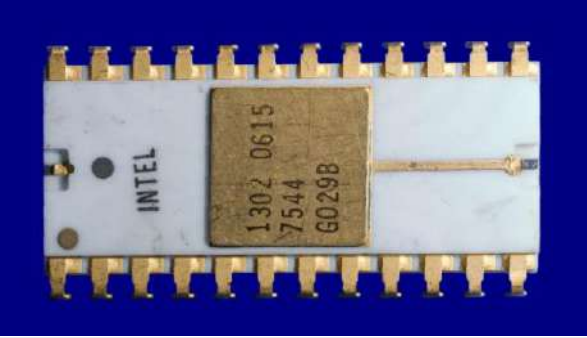
Part Number	Package Description	Values
		
1302	1. Type C white ceramic package w/gold cap, gold cap ground strap, and gold pins. Vertical logo/part number with no prefix. Black dot denotes pin #1. No copyright. Example shown made in Malaysia and dated 7531.	Ex. Rare (5 Known) \$75-\$300
		
1302	2. Type C white ceramic package w/gold cap, gold cap ground strap, and gold pins. Cap ground strap connection points on both ends of package (only one used). Gold dot denotes pin #1. 'Intel' printed on ceramic package.	Ex. Rare (3 Known) \$75-\$300
1302	3. Type C white ceramic package w/gold cap, gold cap ground strap, and gold pins. Cap ground strap connection points on both ends of package (only one used). Black dot denotes pin #1.	Ex. Rare (1 Known) \$75-\$300
1302	4. Type C white ceramic package w/gold cap and integrated gold pins. Raised bump denotes pin #1.	Ex. Rare (1 Known) \$75-\$300
1302	5. Type C white ceramic package w/gold cap and gold pins. Large number 1 denotes pin #1. 'Intel' printed on ceramic package.	Ex. Rare \$75-\$300

References

- [1] Intel (September 1972). Intel Data Catalog. No reference to 1302 dates chip after September 1972.
- [2] Intel (November 1974). Intel MCS-40 User's Manual For Logic Designers, 1302 Reference in 4702A Data Sheet, p. 4-28.
- [3] Intel (September 1975). Intel MCS-80 User's Manual, 8302 (8xxx equivalent of 1302) Data Sheet, p. 5-51.
- [4] Hearst (1977). Intel 8302 listed as 8xxx equivalent of Intel 1302 in 8080 section of Microprocessor System Components, p. 871
- [5] Intel (1984). A Revolution in Progress... A History of Intel to Date, 1302 introduced 1970, p. 26.

Intel i1311

2240-bit (64 x 7 x 5) Static / Dynamic ROM (Character Generator)

1969-72

Specifications

- 2240-bit (64 x 7 x 5) Static/Dynamic ROM (Character Generator)
- PMOS
- Inputs and Outputs DTL/TTL Compatible
- 5 bit Parallel Output
- High Speed Dynamic – 400ns Character Access Time
- Row Selection by 3 Bit Binary Code
- Chip Select Lead to Disable Output
- 24-pin Dual In-Line Package

Type	Access Time Max.	Power Dissipation Max. Operating/Standby	Supplies [V]
1311	400ns	590mW	+5, -9

The Intel 1311/1312/1313 is 2240 bit MOS ROM which can be used as a dot-matrix, character generator. A 6-bit ASCII address input will select any one of the 64 characters stored in the ROM. Each character is composed of 35-bits stored as 7 rows of 5 bits each. The 5 bits will appear in parallel at the output after each row is selected by either applying a 3 bit binary code or clocking an internal counter.

The 2240 bit memory matrix in the 1311/1312/1313 is completely static. The 2-phase clock in the 1311 is used only to activate the peripheral logic circuitry in the device. This dynamic operation of the 1311 offers a distinct speed advantage over the static operation of the 1312 and 1313. The clock input of the 1313 (and the 1312 in the counter clock mode) is used only to advance the row select counter state and may remain in one state indefinitely.

The 1311/1312/1313 is fabricated with p-channel MOS silicon gate technology [1].

Intel i1311

Part Numbers

Type C Packages

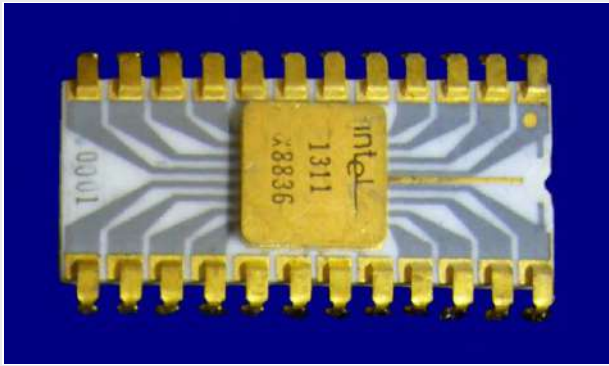
Part Number	Package Description	Values
		
1311	1. Type C white ceramic package w/grey traces, gold cap, gold cap ground strap, and gold pins. Gold dot denotes pin #1.	Ex. Rare (1 known) \$100-\$400

References

- [1] Intel (September 1972). Intel Data Catalog, 1311/1312/1313 Data Sheet, p. 3-3.

Intel i1312

2240-bit (64 x 7 x 5) Static ROM (Character Generator) w/Chip Select

1969-72

Specifications

- 2240-bit (64 x 7 x 5) Static ROM (Character Generator) w/Chip Select
- PMOS
- Inputs and Outputs DTL/TTL Compatible
- 5 bit Parallel Output
- Guaranteed Character Access Time Over Temperature – 900ns
- Static Operation only
- Row Selection by Internal Counter or by 3 Bit Binary Code
- Chip Select Lead to Disable Output
- 24-pin Dual In-Line Package

Type	Access Time Max.	Power Dissipation Max. Operating/Standby	Supplies [V]
1312	900ns	700mW	+5, -9

The Intel 1311/1312/1313 is 2240 bit MOS ROM which can be used as a dot-matrix, character generator. A 6-bit ASCII address input will select any one of the 64 characters stored in the ROM. Each character is composed of 35-bits stored as 7 rows of 5 bits each. The 5 bits will appear in parallel at the output after each row is selected by either applying a 3 bit binary code or clocking an internal counter.

The 2240 bit memory matrix in the 1311/1312/1313 is completely static. The 2-phase clock in the 1311 is used only to activate the peripheral logic circuitry in the device. This dynamic operation of the 1311 offers a distinct speed advantage over the static operation of the 1312 and 1313. The clock input of the 1313 (and the 1312 in the counter clock mode) is used only to advance the row select counter state and may remain in one state indefinitely.

The 1311/1312/1313 is fabricated with p-channel MOS silicon gate technology [1].

Part Numbers

No Examples Known

References

- [1] Intel (September 1972). Intel Data Catalog, 1311/1312/1313 Data Sheet, p. 3-3.

Intel i1313

2240-bit (64 x 7 x 5) Static ROM (Character Generator)

1969-72

Specifications

- 2240-bit (64 x 7 x 5) Static ROM (Character Generator)
- PMOS
- Inputs and Outputs DTL/TTL Compatible
- 5 bit Parallel Output
- Guaranteed Character Access Time Over Temperature – 900ns
- Static Operation only
- Row Selection by Internal Counter or by 3 Bit Binary Code
- 16-pin Dual In-Line Package

Type	Access Time Max.	Power Dissipation Max. Operating/Standby	Supplies [V]
1313	900ns	630mW	+5, -9

The Intel 1311/1312/1313 is 2240 bit MOS ROM which can be used as a dot-matrix, character generator. A 6-bit ASCII address input will select any one of the 64 characters stored in the ROM. Each character is composed of 35-bits stored as 7 rows of 5 bits each. The 5 bits will appear in parallel at the output after each row is selected by either applying a 3 bit binary code or clocking an internal counter.

The 2240 bit memory matrix in the 1311/1312/1313 is completely static. The 2-phase clock in the 1311 is used only to activate the peripheral logic circuitry in the device. This dynamic operation of the 1311 offers a distinct speed advantage over the static operation of the 1312 and 1313. The clock input of the 1313 (and the 1312 in the counter clock mode) is used only to advance the row select counter state and may remain in one state indefinitely.

The 1311/1312/1313 is fabricated with p-channel MOS silicon gate technology [1].

Part Numbers

No Examples Known

References

- [1] Intel (September 1972). Intel Data Catalog, 1311/1312/1313 Data Sheet, p. 3-3.

Intel i1401

1024-bit Shift Register

1970

Specifications

- 1024-bit Shift Register
- PMOS

Type	Clock Min.	Clock Max.	Power Dissipation Max. Operating/Standby	Supplies [V]
1401	-	-	-	-

No data sheet known to exist for this part.

Part Numbers

No Examples Known

References

[1] Intel (March 1971). Intel Price List. Prices listed for 1402A, 1403A, 1404A, 1405, 1406, 1407, 1506, 1507. No reference to 1401.

[2] Intel (September 1972). Intel Data Catalog. No reference to 1401. Suspect that the 1401 may have been discontinued by September 1972.

[3] Intel (1984). A Revolution in Progress... A History of Intel to Date, 1401 introduced 1970, p. 26.

Intel i1402

1024-bit (256 x 4) Dynamic Shift Register

1970

Specifications

- 1024-bit (256 x 4) Dynamic Shift Register
- PMOS
- Low Power Dissipation - .1mW/bit at 1 MHz
- High Frequency Operation – 5 MHz Guaranteed
- DTL, TTL Compatible
- Low Clock Capacitance – 140 pF
- Low Clock Leakage - $\leq 1\mu\text{A}$ at -15 V
- Inputs Protected Against Static Charge
- Three Standard Configurations – Quad 256 Bit (1402), Dual 512 Bit (1403), Single 1024 Bit (1404)
- Standard Packaging – 8 Lead Low Profile TO-5, 16-pin Dual In-Line

Type	Clock Min.	Clock Max.	Power Dissipation Max. Operating/Standby	Supplies [V]
1402	10 kHz	5 MHz		+5, -5 or +5, -9

The Intel 1024 Bit Dynamic shift register consists of normally off P-channel MOS devices integrated on a monolithic chip. The use of low voltage circuitry minimizes power dissipation and facilitates interfacing with bipolar integrated circuits.

These registers can be driven directly by standard bipolar integrated circuits (TTL, DTL, etc.) or by MOS circuits. The design of the output stage provides driving capability for both MOS and bipolar IC's.

Use of low threshold silicon gate technology allows high speed (5 MHz guaranteed) while reducing power dissipation by a factor of two and clock input capacitance by a factor of three compared to equivalent products manufactured by conventional technologies.

The 1402/3/4 family is designed for low cost memory and delay line applications. Due to "on chip" multiplexing the data rate is twice the clock rate. Data is shifted one bit on each clock pulse [1].

Intel 1402 Die

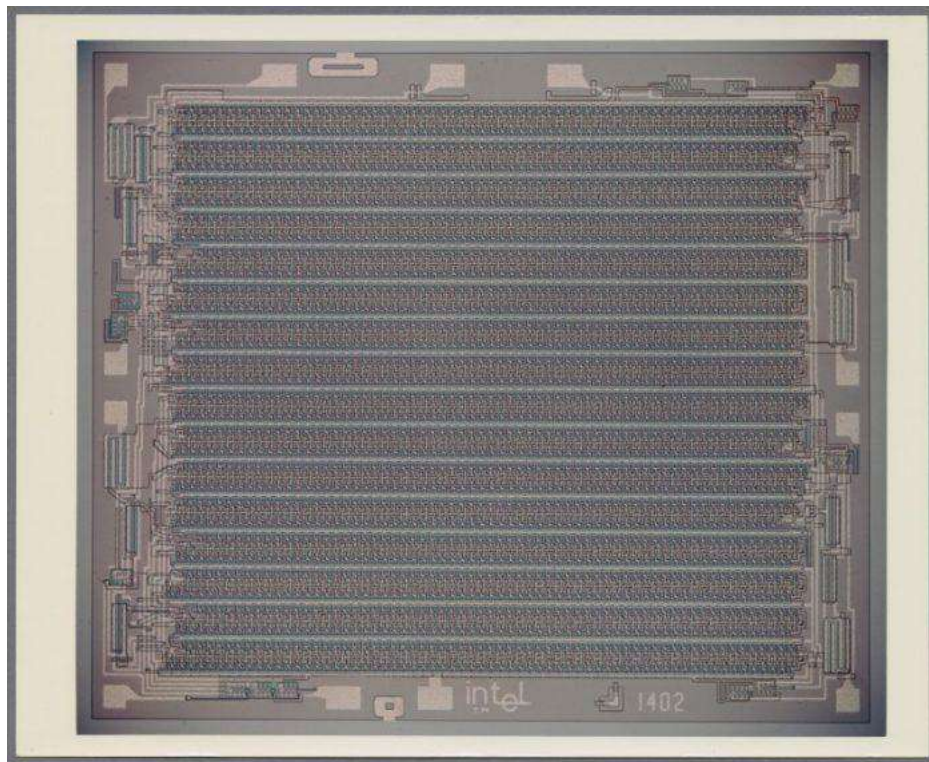

Copyright Intel Corporation

Part Numbers

Type C Packages

Part Number	Package Description	Values
		
1402	1. Type C white ceramic package w/black cap and gold pins. Vertical blocked 'i' Intel logo and part number on cap.	Ex. Rare (2 Known) \$50-\$200
		
1402	2. Type C white ceramic package w/gold cap and gold pins. Vertical blocked 'i' Intel logo and part number on cap.	Ex. Rare (2 Known) \$50-\$200

References

[1] Intel (May 1970). Intel 1402, 1403, 1404 Data Sheet, p. 1.

[2] Intel (March 1971). Intel Price List, 1402A prices listed. No reference to 1402 dates chip before March 1971.

[3] Intel (September 1972). Intel Data Catalog, 1402A, 1403A, 1404A Data Sheet, p. 4-3.

[4] Intel (1984). A Revolution in Progress... A History of Intel to Date, 1402/3/4 introduced 1970, p. 26.

Intel i1402A

1024-Bit (256 x 4) PMOS Shift Register

1970-71

Specifications

- 1024 Byte (256 x 4) Dynamic Shift Register
- PMOS
- Guaranteed 5 MHz Operation over Temperature Range
- Low Power Dissipation -- .1mW/bit at 1 MHz
- DTL, TTL Compatible
- Low Clock Capacitance – 140 pF
- Low Clock Leakage -- $\leq 1 \mu\text{A}$
- Inputs Protected Against Static Charge
- 16-Pin Dual In-Line Package

Type	Clock Min.	Clock Max.	Power Dissipation Max. Operating/Standby	Supplies [V]
1402A	10kHz	5MHz	500mW	+5, -5 or +5, -9

The 1402A/1403A/1404A are direct pin for pin replacements for the 1402/1403/1404. Due to “on chip” multiplexing the data rate is twice the clock rate. Data is shifted one bit on each clock pulse.

The 1402A/1403A/1404A family is ideally suited for usage in low cost serial memories or delay line applications. A high-speed data rate of 5 MHz is easily obtained at the power supplies of +5V and -5V. The 1402A/3A/4A are capable of operating at the power supply voltages of +5V, -9V as well as +5V, -5V.

The input to the shift register can be driven directly by standard bipolar integrated circuits (TTL, DTL, etc.). The design of the output stage provides driving capability for both MOS and bipolar IC's.

Use of low threshold silicon gate technology allows high speed (5MHz guaranteed) while reducing power dissipation by a factor of two and clock input capacitance by a factor of three compared to equivalent products manufactured by conventional technologies [2].



Intel i1402A

Part Numbers

Type C Packages

Part Number	Package Description	Values
1402A	1. Type C white ceramic package w/grey traces, gold cap, gold cap ground strap, and gold pins. Gold dot denotes pin #1. Dropped 'e' Intel logo.	Rare \$25-\$100
		
1402A	2. Type C white ceramic package w/grey traces, gold cap, gold cap ground strap, and gold pins. Gold dot denotes pin #1. Dropped 'e' Intel logo. Part number typo 'i402A' instead of '1402A'.	Ex. Rare \$50-\$200
1402A	3. Type C white ceramic package w/gold cap and gold pins. Unidentified symbol denotes pin #1. Dropped 'e' Intel logo.	Ex. Rare \$50-\$200
		
C1402A	1. Type C white ceramic package w/grey traces, gold cap, gold cap ground strap, and gold pins. Gold dot denotes pin #1.	Rare \$20-\$80
		
C1402A	2. Type C white ceramic package w/gold cap, gold cap ground strap, and gold pins. Black dot denotes pin #1.	\$15-\$60

Intel i1402A

		
C1402A	3. Type C white ceramic package w/gold cap and gold pins. Black dot denotes pin #1. Example shown made in Malaysia and dated 7723.	\$15-\$60
		
C1402A	4. Type C white ceramic package w/gold cap and gold pins. Unidentified symbol denotes pin #1. Example shown made in Malaysia. No date code.	\$15-\$60

Type P Packages

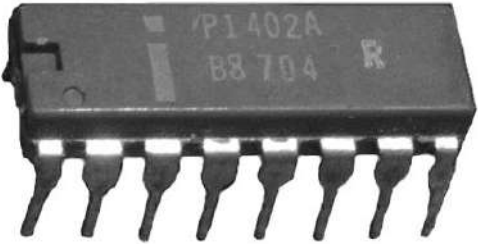
Part Number	Package Description	Values
P1402A	1. Type P grey plastic package w/gold pins. Embossed Intel 'i' in rectangular key.	Ex. Rare (1 Known) \$25-\$100
		
P1402A	2. Type P grey plastic package w/tin pins. Square key.	Ex. Rare (1 Known) \$25-\$100

References

- [1] Intel (March 1971). Intel Price List, 1402A prices date chip to March 1971.
- [2] Intel (September 1972). Intel Data Catalog, 1402A, 1403A, 1404A Data Sheet, p. 4-3. C1402A listed in ordering information, p. 8-4.
- [3] Intel (1984). A Revolution in Progress... A History of Intel to Date, 1402/3/4 introduced 1970, p. 26.

Intel i1403

1024-bit (512 x 2) Dynamic Shift Register

1970

Specifications

- 1024-bit (512 x 2) Dynamic Shift Register
- PMOS
- Low Power Dissipation - .1mW/bit at 1 MHz
- High Frequency Operation – 5 MHz Guaranteed
- DTL, TTL Compatible
- Low Clock Capacitance – 140 pF
- Low Clock Leakage - $\leq 1\mu\text{A}$ at -15 V
- Inputs Protected Against Static Charge
- Three Standard Configurations – Quad 256 Bit (1402), Dual 512 Bit (1403), Single 1024 Bit (1404)
- Standard Packaging – 8 Lead Low Profile TO-5, 16-pin Dual In-Line

Type	Clock Min.	Clock Max.	Power Dissipation Max. Operating/Standby	Supplies [V]
1403	10 kHz	5 MHz		+5, -5 or +5, -9

The Intel 1024 Bit Dynamic shift register consists of normally off P-channel MOS devices integrated on a monolithic chip. The use of low voltage circuitry minimizes power dissipation and facilitates interfacing with bipolar integrated circuits.

These registers can be driven directly by standard bipolar integrated circuits (TTL, DTL, etc.) or by MOS circuits. The design of the output stage provides driving capability for both MOS and bipolar IC's.

Use of low threshold silicon gate technology allows high speed (5 MHz guaranteed) while reducing power dissipation by a factor of two and clock input capacitance by a factor of three compared to equivalent products manufactured by conventional technologies.

The 1402/3/4 family is designed for low cost memory and delay line applications. Due to "on chip" multiplexing the data rate is twice the clock rate. Data is shifted one bit on each clock pulse [1].

Metal Can Packages

Intel didn't make logic chips or transistors, which were commonly placed in metal can packages. However, Intel did put a couple memory chips in metal can packages, they were the 1403, 1404, 1405, 1406, 1506, 1407, 1507 serial memories (shift registers).

Part Numbers

Type C Packages

Part Number	Package Description	Values
		
1403	Type C white ceramic package w/gold cap and gold pins.	Ex. Rare (4 known) \$50-\$200

References

[1] Intel (May 1970). Intel 1402, 1403, 1404 Data Sheet, p. 1.

[2] Intel (March 1971). Intel Price List, 1403A prices listed. No reference to 1403 dates chip before March 1971.

[3] Intel (September 1972). Intel Data Catalog, 1402A, 1403A, 1404A Data Sheet, p. 4-3.

[4] Intel (1984). A Revolution in Progress... A History of Intel to Date, 1402/3/4 introduced 1970, p. 26.

Intel i1403A

1024-bit (512 x 2) Shift Register

1970-71

Specifications

- 1024-bit (512 x 2) Dynamic Shift Register
- PMOS
- Guaranteed 5 MHz Operation over Temperature Range
- Low Power Dissipation -- .1mW/bit at 1 MHz
- DTL, TTL Compatible
- Low Clock Capacitance – 140 pF
- Low Clock Leakage -- $\leq 1 \mu\text{A}$
- Inputs Protected Against Static Charge
- 8-lead Metal Can Package or 8-pin Dual-Inline Package

Type	Clock Min.	Clock Max.	Power Dissipation Max. Operating/Standby	Supplies [V]
1403A	10kHz	5MHz	500mW	+5, -5 or +5, -9

The 1402A/1403A/1404A are direct pin for pin replacements for the 1402/1403/1404. Due to “on chip” multiplexing the data rate is twice the clock rate. Data is shifted one bit on each clock pulse.

The 1402A/1403A/1404A family is ideally suited for usage in low cost serial memories or delay line applications. A high-speed data rate of 5 MHz is easily obtained at the power supplies of +5V and -5V. The 1402A/3A/4A are capable of operating at the power supply voltages of +5V, -9V as well as +5V, -5V.

The input to the shift register can be driven directly by standard bipolar integrated circuits (TTL, DTL, etc.). The design of the output stage provides driving capability for both MOS and bipolar IC's.

Use of low threshold silicon gate technology allows high speed (5MHz guaranteed) while reducing power dissipation by a factor of two and clock input capacitance by a factor of three compared to equivalent products manufactured by conventional technologies [2].

Intel i1403A

Part Numbers

Type M Packages

Part Number	Package Description	Values
1403A	Type M metal package w/8 gold leads.	Ex. Rare \$25-\$100

Type P Packages

Part Number	Package Description	Values
P1403A	Type P package	Ex. Rare (0 Known) \$\$\$

References

- [1] Intel (March 1971). Intel Price List, 1403A prices date chip to March 1971.
- [2] Intel (September 1972). Intel Data Catalog, 1402A, 1403A, 1404A Data Sheet, p. 4-3. M1403A listed in ordering information, p. 8-4.
- [3] Intel (1984). A Revolution in Progress... A History of Intel to Date, 1402/3/4 introduced 1970, p. 26.

Intel i1404

1024-bit (1024 x 1) Dynamic Shift Register

1970

Specifications

- 1024-bit (1024 x 1) Dynamic Shift Register
- PMOS
- Low Power Dissipation - .1mW/bit at 1 MHz
- High Frequency Operation – 5 MHz Guaranteed
- DTL, TTL Compatible
- Low Clock Capacitance – 140 pF
- Low Clock Leakage - $\leq 1\mu\text{A}$ at -15 V
- Inputs Protected Against Static Charge
- Three Standard Configurations – Quad 256 Bit (1402), Dual 512 Bit (1403), Single 1024 Bit (1404)
- Standard Packaging – 8 Lead Low Profile TO-5, 16-pin Dual In-Line

Type	Clock Min.	Clock Max.	Power Dissipation Max. Operating/Standby	Supplies [V]
1404	10 kHz	5 MHz		+5, -5 or +5, -9

The Intel 1024 Bit Dynamic shift register consists of normally off P-channel MOS devices integrated on a monolithic chip. The use of low voltage circuitry minimizes power dissipation and facilitates interfacing with bipolar integrated circuits.

These registers can be driven directly by standard bipolar integrated circuits (TTL, DTL, etc.) or by MOS circuits. The design of the output stage provides driving capability for both MOS and bipolar IC's.

Use of low threshold silicon gate technology allows high speed (5 MHz guaranteed) while reducing power dissipation by a factor of two and clock input capacitance by a factor of three compared to equivalent products manufactured by conventional technologies.

The 1402/3/4 family is designed for low cost memory and delay line applications. Due to "on chip" multiplexing the data rate is twice the clock rate. Data is shifted one bit on each clock pulse [1].

Part Numbers

Type M Packages

Part Number	Package Description	Values
		
1404	Type M metal package w/8 gold leads.	Ex. Rare \$25-\$100

References

[1] Intel (May 1970). Intel 1402, 1403, 1404 Data Sheet, p. 1.

[2] Intel (March 1971). Intel Price List, 1404A prices listed. No reference to 1404 dates chip before March 1971.

[3] Intel (September 1972). Intel Data Catalog, 1402A, 1403A, 1404A Data Sheet, p. 4-3.

[4] Intel (1984). A Revolution in Progress... A History of Intel to Date, 1402/3/4 introduced 1970, p. 26.

Intel i1404A

1024-bit (1024 x 1) Dynamic Shift Register

1970-71

Specifications

- 1024-bit (1024 x 1) Dynamic Shift Register
- PMOS
- Guaranteed 5 MHz Operation over Temperature Range
- Low Power Dissipation -- .1mW/bit at 1 MHz
- DTL, TTL Compatible
- Low Clock Capacitance – 140 pF
- Low Clock Leakage -- $\leq 1 \mu\text{A}$
- Inputs Protected Against Static Charge
- 8-lead Metal Can Package or 8-pin Dual-Inline Package

Type	Clock Min.	Clock Max.	Power Dissipation Max. Operating/Standby	Supplies [V]
1404A	10kHz	5MHz	500mW	+5, -5 or +5, -9

The 1402A/1403A/1404A are direct pin for pin replacements for the 1402/1403/1404. Due to “on chip” multiplexing the data rate is twice the clock rate. Data is shifted one bit on each clock pulse.

The 1402A/1403A/1404A family is ideally suited for usage in low cost serial memories or delay line applications. A high-speed data rate of 5 MHz is easily obtained at the power supplies of +5V and -5V. The 1402A/3A/4A are capable of operating at the power supply voltages of +5V, -9V as well as +5V, -5V.

The input to the shift register can be driven directly by standard bipolar integrated circuits (TTL, DTL, etc.). The design of the output stage provides driving capability for both MOS and bipolar IC's.

Use of low threshold silicon gate technology allows high speed (5MHz guaranteed) while reducing power dissipation by a factor of two and clock input capacitance by a factor of three compared to equivalent products manufactured by conventional technologies [2].

Part Numbers

Type C Packages

Part Number	Package Description	Values
		
C1404A	Type C white ceramic package w/grey traces. Gold cap, and gold pins. Gold dot denotes pin #1.	Ex. Rare \$50-\$200

Type P Packages

Part Number	Package Description	Values
P1404A	Type P package	Ex. Rare (0 Known) \$\$\$

Type M Packages

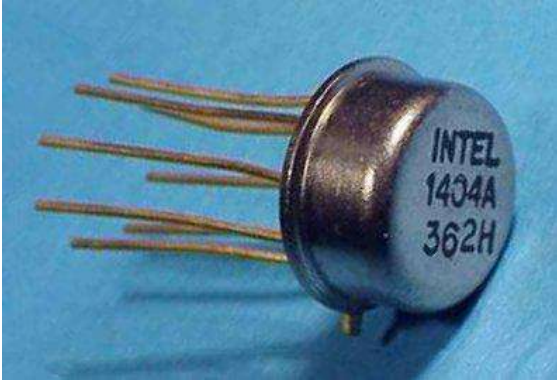
Part Number	Package Description	Values
		
1404A	Type M metal package w/8 gold leads.	Rare \$10-\$40

References

- [1] Intel (March 1971). Intel Price List, 1404A prices date chip to March 1971.
- [2] Intel (September 1972). Intel Data Catalog, 1402A, 1403A, 1404A Data Sheet, p. 4-3.
- [3] Intel (1984). A Revolution in Progress... A History of Intel to Date, 1402/3/4 introduced 1970, p. 26.

Intel i1405

512-bit (512 x 1) Dynamic Recirculating Shift Register

1970

Specifications

- 512-bit (512 x 1) Dynamic Recirculating Shift Register
- PMOS
- Low Power Dissipation – .3 mW/bit at 1 MHz
- High Frequency Operation – 2 MHz Guaranteed
- DTL, TTL Compatible
- Low Clock Capacitance – 80 pF
- Low Clock Leakage – $\leq 1\mu\text{A}$ at -15V
- Inputs Protected Against Static Charge
- Standard Packaging – 10 Lead Low Profile TO-5
- Simple Two Dimensional Memory Matrix Organization – 2 Chip Select Controls
- Write/Recirculate and Read Controls Incorporated on the Chip
- Standard Packaging – 10 Lead Low Profile TO-5

Type	Clock Min.	Clock Max.	Power Dissipation Max. Operating/Standby	Supplies [V]
1405	10 kHz	2 MHz	-	+5, -5 or +5, -9

The Intel 512 bit dynamic recirculating shift register consists of normally off P-channel MOS devices integrated on a monolithic chip. The use of low voltage circuitry minimizes power dissipation and facilitates interfacing with bipolar integrated circuits.

These registers can be driven directly by standard bipolar integrated circuits (TTL, DTL, etc.) or by MOS circuits. The design of the output stage provides driving capability for both MOS and bipolar IC's as well as OR-tying of soft registers.

Use of low threshold silicon gate technology allows high speed (2 MHz guaranteed) while reducing power dissipation by a factor of two and clock input capacitance by a factor of three compared to equivalent products manufactured by conventional technologies.

The 1405 is designed for low cost memory and delay line applications.

Write/Recirculate and read controls eliminate the need for external logic elements when recirculating data. In addition, any number of devices can be combined to form a multi-dimensional memory array. For this purpose two chip select controls have been provided [1].

Intel i1405

Part Numbers

Type M Packages

Part Number	Package Description	Values
		
1405	Type M metal package w/10 gold leads.	Ex. Rare \$25-\$100

References

- [1] Intel (July 1970). Intel 1405 Data Sheet, p. 1.
- [2] Intel (March 1971). Intel Price List, 1405 prices date chip to March 1971.
- [3] Intel (September 1972). Intel Data Catalog, 1405A Data Sheet, p. 4-7.

Intel i1405A

512-bit (512 x 1) Dynamic Recirculating Shift Register

1971-72

Specifications

- 512-bit (512 x 1) Dynamic Recirculating Shift Register
- PMOS
- High Frequency Operation – 2 MHz Guaranteed over Temperature
- DTL, TTL Compatible
- Write/Recirculate and Read Controls Incorporated on the Chip
- Low Power Dissipation -- .3 mW/bit at 1 MHz
- Low Clock Capacitance – 85 pF
- Low Clock Leakage -- $\leq 1\mu\text{A}$ at -17V
- Simple Two Dimensional Memory Matrix Organization – 2 Chip Select Controls
- Inputs Protected Against Static Charge
- 10-lead Low Profile TO-99 Metal Can Package

Type	Clock Min.	Clock Max.	Power Dissipation Max. Operating/Standby	Supplies [V]
1405A	10kHz	2MHz	400mW	+5, -5 or +5, -9

The 1405A is a 512-bit dynamic recirculating shift register and is a direct pin replacement for the 1405. The 1405A is capable of operating at power supply voltages of +5V, -9V as well as +5V, -5V. A high speed recirculating data rate of 2 MHz over temperature is easily obtained at the +5, -5 power supplies.

Write/Recirculate and read controls eliminate the need for external logic elements when recirculating data. In addition, any number of devices can be combined to form a multi-dimensional memory array. For this purpose two chip select controls have been provided.

These registers can be driven directly by standard bipolar integrated circuits (TTL, DTL, etc.) or by MOS circuits. The design of the output stage provides driving capability for both MOS and bipolar IC's as well as OR-tieing of shift registers. The 1405A is ideally suited for usage in low cost memories or delay line applications.

Use of low threshold silicon gate technology allows high speed (2 MHz guaranteed) while reducing power dissipation by a factor of two and clock input capacitance by a factor of three over equivalent products manufactured by conventional technologies [2].

Intel i1405A

Part Numbers

Type M Packages

Part Number	Package Description	Values
		
1405A	Type M metal package w/10 gold leads.	Ex. Rare \$25-\$100

References

[1] Intel (March 1971). Intel Price List, 1405 prices listed. No reference to 1405A dates chip after March 1971.

[2] Intel (September 1972). Intel Data Catalog, 1405A Data Sheet, p. 4-7. M1405A listed in ordering information, p. 8-4.

Intel i1406

200-bit (100 x 2) Dynamic Shift Register 1970-71

Specifications

- 200-bit (100 x 2) Dynamic Shift Register
- PMOS
- Low Power Dissipation -- .4 mW/bit at 1 MHz
- High frequency Operation – 2MHz Guaranteed over Temperature Range
- DTL, TTL Compatible
- Low Clock Capacitance – 40 pF
- Low Clock Leakage -- $\leq .5\mu\text{A}$ at -18V
- Inputs Protected Against Static Charge
- 8-lead Low Profile TO-5 Metal Can
- Military Equivalent of the Intel 1506
- Low Output Impedance – 300Ω Typical

Type	Clock Min.	Clock Max.	Power Dissipation Max. Operating/Standby	Supplies [V]
1406	6 kHz	2 MHz	110mW	+5, -5

The Intel dual 100-bit dynamic shift register element consists of normally off P-channel MOS devices integrated on a monolithic array. It uses low voltage circuitry to minimize power dissipation and to facilitate interfacing with bipolar integrated circuits. It uses two clock phases only.

The dual 100-bit device can be driven directly by standard bipolar integrated circuits (TTL, DTL, etc.) or by MOS circuits. The design of the output stage provides driving capability for MOS or bipolar IC's.

Use of the low threshold silicon gate technology allows high speed (2 MHz guaranteed), while reducing power dissipation by a factor of 2 and reducing clock input capacitance by a factor of 3 compared to equivalent products manufactured by conventional MOS technologies.

This family is designed for low cost buffer applications. It is available in both military (-55°C to $+125^{\circ}\text{C}$) and industrial (0°C to $+70^{\circ}\text{C}$) grade. It is also available with or without an internal 20K pull-up resistor, which may provide easier interfacing to other circuitry [2].

Part Numbers

No Examples Known

References

[1] Intel (March 1971). Intel Price List, 1406 prices date chip to March 1971.

[2] Intel (September 1972). Intel Data Catalog, 1406, 1506, 1407, 1507 Data Sheet, p. 4-11. M1406 (Open Drain Output) listed in ordering information, p. 8-4.

Intel i1407

200-bit (100 x 2) Dynamic Shift Register (20 kΩ output) 1970

Specifications

- 200-bit (100 x 2) Dynamic Shift Register (20 kΩ output)
- PMOS
- Low Power Dissipation -- .4 mW/bit at 1 MHz
- High frequency Operation – 2MHz Guaranteed over Temperature Range
- DTL, TTL Compatible
- Low Clock Capacitance – 40 pF
- Low Clock Leakage -- ≤ .5uA at –18V
- Inputs Protected Against Static Charge
- 8-lead Low Profile TO-5 Metal Can
- Military Equivalent of the Intel 1507
- Low Output Impedance – 300Ω Typical

Type	Clock Min.	Clock Max.	Power Dissipation Max. Operating/Standby	Supplies [V]
1407	6kHz	2Mhz	110mW	+5, -5

The Intel dual 100-bit dynamic shift register element consists of normally off P-channel MOS devices integrated on a monolithic array. It uses low voltage circuitry to minimize power dissipation and to facilitate interfacing with bipolar integrated circuits. It uses two clock phases only.

The dual 100-bit device can be driven directly by standard bipolar integrated circuits (TTL, DTL, etc.) or by MOS circuits. The design of the output stage provides driving capability for MOS or bipolar IC's.

Use of the low threshold silicon gate technology allows high speed (2 MHz guaranteed), while reducing power dissipation by a factor of 2 and reducing clock input capacitance by a factor of 3 compared to equivalent products manufactured by conventional MOS technologies.

This family is designed for low cost buffer applications. It is available in both military (-55°C to +125°C) and industrial (0°C to +70°C) grade. It is also available with or without an internal 20K pull-up resistor, which may provide easier interfacing to other circuitry [2].

Part Numbers

No Examples Known

References

- [1] Intel (March 1971). Intel Price List, 1407 prices date chip to March 1971.
- [2] Intel (September 1972). Intel Data Catalog, 1406, 1506, 1407, 1507 Data Sheet, p. 4-11. M1407 listed in ordering information, p. 8-4.
- [3] Intel (1984). A Revolution in Progress... A History of Intel to Date, 1407 introduced 1970, p. 26.

Intel i1506

200-bit (100 x 2) Dynamic Shift Register

1970-71

Specifications

- 200-bit (100 x 2) Dynamic Shift Register
- PMOS
- Low Power Dissipation -- .4 mW/bit at 1 MHz
- High frequency Operation – 2MHz Guaranteed over Temperature Range
- DTL, TTL Compatible
- Low Clock Capacitance – 40 pF
- Low Clock Leakage -- $\leq .5\mu\text{A}$ at -18V
- Inputs Protected Against Static Charge
- 8-lead Low Profile TO-5 Metal Can
- Low Output Impedance – 300Ω Typical

Type	Clock Min.	Clock Max.	Power Dissipation Max. Operating/Standby	Supplies [V]
1506	6kHz	2Mhz	110mW	+5, -5

The Intel dual 100-bit dynamic shift register element consists of normally off P-channel MOS devices integrated on a monolithic array. It uses low voltage circuitry to minimize power dissipation and to facilitate interfacing with bipolar integrated circuits. It uses two clock phases only.

The dual 100-bit device can be driven directly by standard bipolar integrated circuits (TTL, DTL, etc.) or by MOS circuits. The design of the output stage provides driving capability for MOS or bipolar IC's.

Use of the low threshold silicon gate technology allows high speed (2 MHz guaranteed), while reducing power dissipation by a factor of 2 and reducing clock input capacitance by a factor of 3 compared to equivalent products manufactured by conventional MOS technologies.

This family is designed for low cost buffer applications. It is available in both military (-55°C to $+125^{\circ}\text{C}$) and industrial (0°C to $+70^{\circ}\text{C}$) grade. It is also available with or without an internal 20K pull-up resistor, which may provide easier interfacing to other circuitry [2].

Part Numbers

No Examples Known

References

[1] Intel (March 1971). Intel Price List, 1506 prices date chip to March 1971.

[2] Intel (September 1972). Intel Data Catalog, 1406, 1506, 1407, 1507 Data Sheet, p. 4-11. M1506 (Open Drain Output) listed in ordering information, p. 8-4.

Intel i1507

200-bit (100 x 2) Dynamic Shift Register (20 kΩ output)

1970-71

Specifications

- 200-bit (100 x 2) Dynamic Shift Register (20 kΩ output)
- PMOS
- Low Power Dissipation -- .4 mW/bit at 1 MHz
- High frequency Operation – 2MHz Guaranteed over Temperature Range
- DTL, TTL Compatible
- Low Clock Capacitance – 40 pF
- Low Clock Leakage -- ≤ .5uA at –18V
- Inputs Protected Against Static Charge
- 8-lead Low Profile TO-5 Metal Can
- Low Output Impedance – 300Ω Typical

Type	Clock Min.	Clock Max.	Power Dissipation Max. Operating/Standby	Supplies [V]
1507	6kHz	2Mhz	110mW	+5, -5

The Intel dual 100-bit dynamic shift register element consists of normally off P-channel MOS devices integrated on a monolithic array. It uses low voltage circuitry to minimize power dissipation and to facilitate interfacing with bipolar integrated circuits. It uses two clock phases only.

The dual 100-bit device can be driven directly by standard bipolar integrated circuits (TTL, DTL, etc.) or by MOS circuits. The design of the output stage provides driving capability for MOS or bipolar IC's.

Use of the low threshold silicon gate technology allows high speed (2 MHz guaranteed), while reducing power dissipation by a factor of 2 and reducing clock input capacitance by a factor of 3 compared to equivalent products manufactured by conventional MOS technologies.

This family is designed for low cost buffer applications. It is available in both military (-55°C to +125°C) and industrial (0°C to +70°C) grade. It is also available with or without an internal 20K pull-up resistor, which may provide easier interfacing to other circuitry [2].

Part Numbers

No Examples Known

References

[1] Intel (March 1971). Intel Price List, 1507 prices date chip to March 1971.

[2] Intel (September 1972) Intel Data Catalog, 1406, 1506, 1407, 1507 Data Sheet, p. 4-11. M1507 listed in ordering information, p. 8-4.

Intel i1601

2048-bit (256 x 8) Static / Dynamic PROM

1969-71

Specifications

- 2048-bit (256 x 8) Static / Dynamic PROM
- PMOS
- Erasable and Field Programmable (1701, 1702)
- Field Programmable (1601, 1602)
- All 2048 Bits Guaranteed Programmable – 100% Factory tested (1601/1701, 1602/1702)
- Inputs and Outputs DTL and TTL Compatible
- Static and Dynamic Operation (1601, 1701, 1301)
- Static Only Operation (1602, 1702)
- OR-tie Capability
- Simple Memory Expansion – Chip Select Input Lead
- PROM equivalent of Intel 1301 ROM and Intel 1701 EPROM
- 24-pin Dual In-Line Package

Type	Access Time Max.	Power Dissipation Max. Operating/Standby	Supplies [V]
1601	1 μ s	700mW	+5, -9

The Intel 1601, 1602, 1701, and 1702 is a 256 word by 8-bit electrically programmable ROM ideally suited for uses where fast turnaround and pattern experimentation are important such as in prototype or in one of a kind systems. The 1601, 1602, 1701, and 1702 is factory reprogrammable which allows Intel to perform a complete programming and functional test on each bit position before delivery.

The four devices 1601, 1602, 1701, and 1702 use identical chips. The 1601 and 1701 is operable in both the static and dynamic mode while the 1602 and 1702 is operable in the static mode only. Also, the 1701 and 1702 has the unique feature of being completely erasable and field reprogrammable. This is accomplished by a quartz lid that allows high intensity ultraviolet light to erase the 1701 and 1702. A new pattern can then be written into the device. This procedure can be repeated as many times as required.

The 1301 is a pin-for-pin replacement part which is programmed by a metal mask and is ideal for large volumes and lower cost production runs of systems initially using the 1601/1701 or the static only 1602/1702.

The Dynamic mode of the 1601/1701 and 1301 refers to the decoding circuitry and not the memory cell. Dynamic operation offers higher speed and lower power dissipation than static operation.

The 1601, 1602, 1701, and 1702 is fabricated with silicon gate technology. This low threshold technology allows the design and production of higher performance MOS circuits and provides a higher functional density on a monolithic chip than conventional MOS technologies [2].

History

1st Intel Prom

1601/1301 Introduced Before 1701/1702

The 1601 and 1301 are both listed on an Intel Price list dated March 1971. No reference on same pricelist to 1701 and 1702 supports the fact that the 1601 and 1301 were introduced before the 1701 and 1702.

“A glass window was added to the 1601 to allow the erasure, and another new product resulted – the 1701 EPROM” [3]

Part Numbers

Type C Packages

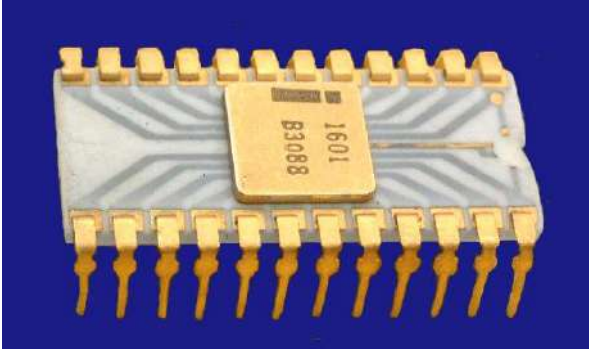
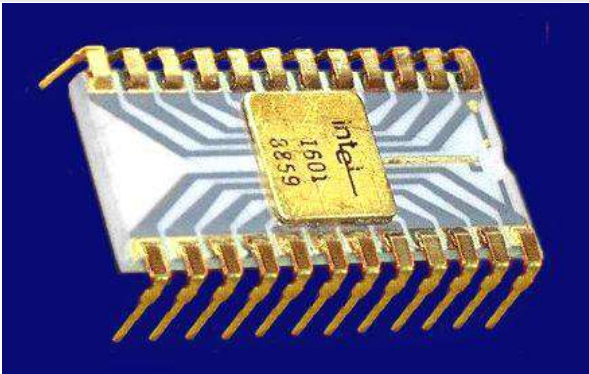
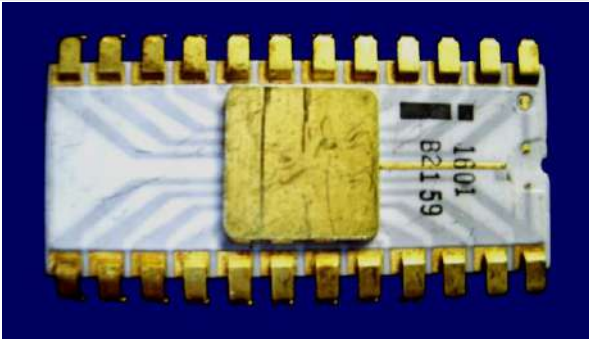
Part Number	Package Description	Values
		
1601	1. Type C white ceramic package w/grey traces, gold cap, gold cap ground strap, and gold pins. Gold dot denotes pin #1. Intel 'i' logo and part number stamped on cap.	Rare \$50-\$200
		
1601	2. Type C white ceramic package w/grey traces, gold cap, gold cap ground strap, and gold pins. Gold dot denotes pin #1. Dropped 'e' Intel logo and part number stamped on cap.	Ex. Rare (1 Known) \$75-\$300
		
1601	3. Type C white ceramic package w/grey traces, gold cap, gold cap ground strap, and gold pins. Gold dot denotes pin #1. Intel 'i' logo and part number stamped on ceramic package.	Ex. Rare (2 Known) \$75-\$300

References

[1] Intel (March 1971). Intel Price List. Reference to 1601 dates chip to March 1971.

[2] Intel (September 1972). Intel Data Catalog, 1601/1701, 1602/1702, 1301 Data Sheet, p. 3-11.

[3] Intel (1984). A Revolution in Progress... A History of Intel to Date, p. 21

Intel i1602

2048-bit (256 x 8) Static PROM

1971-72

Specifications

- 2048-bit (256 x 8) Static PROM
- PMOS
- Erasable and Field Programmable (1701, 1702)
- Field Programmable (1601, 1602)
- All 2048 Bits Guaranteed Programmable – 100% Factory tested (1601/1701, 1602/1702)
- Inputs and Outputs DTL and TTL Compatible
- Static and Dynamic Operation (1601, 1701, 1301)
- Static Only Operation (1602, 1702)
- OR-tie Capability
- Simple Memory Expansion – Chip Select Input Lead
- PROM equivalent of Intel 1302 ROM and Intel 1702 EPROM
- 24-pin Dual In-Line Package

Type	Access Time Max.	Power Dissipation Max. Operating/Standby	Supplies [V]
1602	1 μ s	700mW	+5, -9

The Intel 1601, 1602, 1701, and 1702 is a 256 word by 8-bit electrically programmable ROM ideally suited for uses where fast turnaround and pattern experimentation are important such as in prototype or in one of a kind systems. The 1601, 1602, 1701, and 1702 is factory reprogrammable which allows Intel to perform a complete programming and functional test on each bit position before delivery.

The four devices 1601, 1602, 1701, and 1702 use identical chips. The 1601 and 1701 is operable in both the static and dynamic mode while the 1602 and 1702 is operable in the static mode only. Also, the 1701 and 1702 has the unique feature of being completely erasable and field reprogrammable. This is accomplished by a quartz lid that allows high intensity ultraviolet light to erase the 1701 and 1702. A new pattern can then be written into the device. This procedure can be repeated as many times as required.

The 1301 is a pin-for-pin replacement part which is programmed by a metal mask and is ideal for large volumes and lower cost production runs of systems initially using the 1601/1701 or the static only 1602/1702.

The Dynamic mode of the 1601/1701 and 1301 refers to the decoding circuitry and not the memory cell. Dynamic operation offers higher speed and lower power dissipation than static operation.

The 1601, 1602, 1701, and 1702 is fabricated with silicon gate technology. This low threshold technology allows the design and production of higher performance MOS circuits and provides a higher functional density on a monolithic chip than conventional MOS technologies [2].

1602/1702 and 1602A/1702A Compatibility

Take note when using PROMS that the programming operation on devices from the same family are not necessarily compatible. Examples are the 1602 and 1702 devices In which the programming operation forces “ones” to “zeros” and the 1602A and 1702A Which force “zeros” to “ones” [3].

Part Numbers

No Examples Known

References

- [1] Intel (March 1971). Intel Price List. No reference to 1602 dates chip after March 1971.
- [2] Intel (September 1972). Intel Data Catalog, 1601/1701, 1602/1702, 1301 Data Sheet, p. 3-11.
- [3] NASA (2002). Untitled Document. Available from:
<http://www.hq.nasa.gov/office/codeq/relpract/2203.pdf> [Accessed 10 July 2002]

Intel i1602A

2048-bit (256 x 8) Static PROM

4th Qtr 1972

Specifications

- 2048-Bit (256 x 8) Static PROM
- PMOS
- Electrically Programmable (1602A)
- Erasable and Electrically Programmable (1702A)
- Fast Programming: 2 Minutes for all 2048 Bits
- All 2048 Bits Guaranteed Programmable: 100% Factory Tested
- Fully Decoded
- Static MOS: No Clocks Required
- Inputs and Outputs DTL and TTL Compatible
- Three-State Output: OR-Tie Capability
- Simple Memory Expansion: Chip Select Input Lead
- PROM equivalent of the Intel 1302 ROM and Intel 1702A EPROM
- 24-pin Dual In-Line Package

Type	Access Time Max.	Power Dissipation Max. Operating/Standby	Supplies [V]
1602A	1 μ s	700mW	+5, -9
1602A-6	1.5 μ s	700nW	+5, -9

The 1602A and 1702A are 256 word by 8-bit electrically programmable ROMs ideally suited for uses where fast turn-around and pattern experimentation are important. The 1602A and 1702A undergo complete programming and function testing on each bit position prior to shipment, thus insuring 100% programmability.

The 1602A and 1702A use identical chips. The 1702A is packaged in a 24-pin dual in-line package with a transparent lid. The transparent lid allows the user to expose the chip to ultraviolet light to erase the bit pattern. A new pattern can then be written into the device. The 1602A is packaged in a 24-pin dual in-line package with a metal lid and is not erasable.

The circuitry of the 1602A/1702A is entirely static; no clocks are required.

A pin-for-pin metal mask programmed ROM, the 1302, is ideal for large volume production runs of systems initially using the 1602A or 1702A.

The 1602A/1702A is fabricated with silicon gate technology. This low threshold technology allows for the design and production of higher performance MOS circuits and provides a higher function density on a monolithic chip than conventional MOS technologies [1].

1602A/1702A - S314 and S714

The Intel 1602A/1702A datasheet dated April 1973 in the 1974 Intel Intellec 8 Reference manual states that “The 1602A/1702A—S714 is ideally suited for use with Intel’s MCS-8 Micro Computer Set. It may also be used with systems requiring 2μsec access time.”

The Intel Microcomputers guide, March 1974 contains separate data sheets for the S314 and S714 versions of the 1602A/1702A.

The S314 data sheet says “Compatible with Intel’s MCS™-4 Micro Computer Set” and “Uses +5, -10 V Supplies”.

The S714 data sheet says “Compatible with Intel’s MCS™-8 Micro Computer Set”. No mention of supply voltage but I assume it was the same +5, -9 V supplies as 1702A.

The S314/S714 designation must have caused some confusion because Intel quickly discontinued the S314/S714 and introduced the 4702A (+5, -10 V Supplies) for The MCS™-4.

4602A?

Intel replaced the MCS™-4 1702A-S314 with the 4702A. What replaced the 1602A-S314? No references to an Intel 4xxx equivalent of the 1602A-S314 are known to exist. The 4xxx equivalent of the 1602A-S314 would have been the 4602A.

1602A w/grey traces

Since 1702A’s with grey traces are known, it’s possible that 1602A’s with gray traces may also exist. Possibly also marked S314 or S714.

Part Numbers

Type C Packages

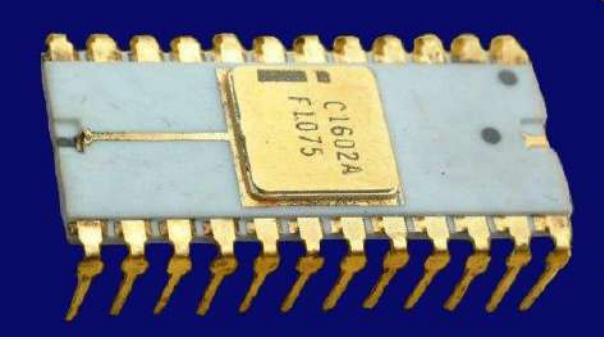
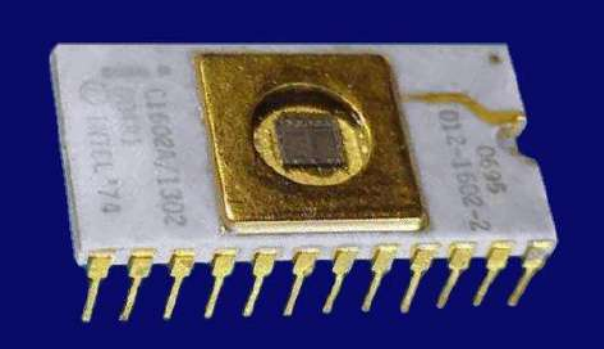
Part Number	Package Description	Values
C1602A	 <p>1. Type C white ceramic package w/gold cap, gold cap ground strap, and gold pins. Cap ground strap connection points on both ends of package (only one used). Large black dot denotes pin #1. No copyright.</p>	Ex. Rare \$75-\$300
C1602A/ 1302	 <p>2. Type C white ceramic package w/gold cap with quartz porthole, offset gold cap ground strap, and gold pins. Small black dot denotes pin #1. © Intel '74.</p>	Ex. Rare \$75-\$300

Intel i1602A

Type B Packages

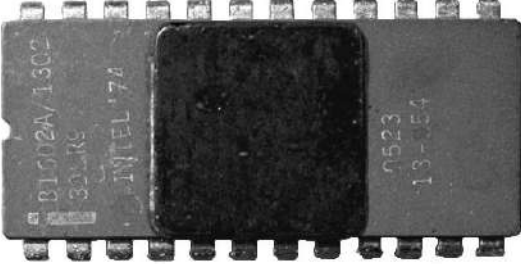
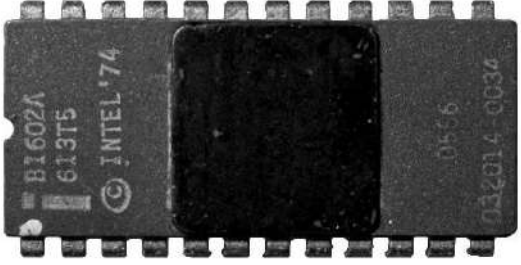
Part Number	Package Description	Values
		
B1602A/ 1302	1. Type B grey ceramic package quartz cap (painted over) and tin pins. © Intel '74	Ex. Rare \$20-\$80
		
B1602A	1. Type B grey ceramic package quartz cap (painted over) and tin pins. © Intel '74	Ex. Rare \$20-\$80

References

- [1] Intel (September 1972). Intel Data Catalog. No reference to 1602A dates chip after September 1972.
- [2] Intel (November 1972). Intel MCS-8 User's Manual, 1602A Reference, p. 31.
- [3] Intel (1975). Intel Data Catalog, 1602A/1702A Data Sheet, p. 3-7

Intel i1602AL

2048-bit (256 x 8) Static PROM

1975

Specifications

- 2048-bit (256 x 8) Static EPROM
- PMOS
- Clocked V_{gg} Mode for Low Power Dissipation
- Fast Programming: 2 Minutes for all 2048 Bits
- All 2048 Bits Guaranteed Programmable: 100% Factory tested
- Inputs and Outputs DTL and TTL Compatible
- Three-State Output: OR-Tie Capability
- Low Power Version of the Intel 1602A PROM
- PROM equivalent of the Intel 1702AL EPROM
- 24-pin Dual In-Line Package

Type	Access Time Max.	Power Dissipation Max. Operating/Standby	Supplies [V]
1602AL-6	1.5 μ s	700mW	+5, -9

The 1602AL is a 256 word by 8-bit electrically programmable ROM (EPROM) and is the same chip as the industry standard 1602A. The programming and erasing specifications are identical to the 1602A. The 1602AL operates with the V_{gg} clocked to reduce the power dissipation [2].

Was the Intel 1602AL Actually Produced?

The only reference to the 1602AL that I have been able to find is in the 1975 Intel Memory Design Handbook. This reference says that the 1602AL has the same specifications as the 1702AL, i.e. it supports clocked V_{gg} mode for low power dissipation. Neither the 1602AL nor the 1702AL is listed in the 1975 Intel Data Catalog.

The 1977 Intel Data Catalog contains the Data Sheet for the 1702AL but there's no reference to the 1602AL.

Was the 1602AL actually produced? There are references to several other chips in the 1975 Intel Memory Design Handbook that seem to never had made it into production.

If the 1602AL was actually produced it would have been in production in 1975 (Probably Late 1975) and would have been discontinued before 1977.

Part Numbers

No Examples Known

References

[1] Intel (1975). Intel Data Catalog. No reference to 1702AL/1602AL.

[2] Intel (1975). Intel Memory Design Handbook, 1702AL-6/1602AL-6 Specifications, p. PSG-2

Intel i1701

2048-bit (256 x 8) Static / Dynamic EPROM

January 1971

Specifications

- 2048-bit (256 x 8) Static / Dynamic EPROM
- PMOS
- Erasable and Field Programmable (1701, 1702)
- Field Programmable (1601, 1602)
- All 2048 Bits Guaranteed Programmable – 100% Factory tested (1601/1701, 1602/1702)
- Inputs and Outputs DTL and TTL Compatible
- Static and Dynamic Operation (1601, 1701, 1301)
- Static Only Operation (1602, 1702)
- OR-tie Capability
- Simple Memory Expansion – Chip Select Input Lead
- EPROM equivalent of Intel 1301 ROM and Intel 1601 PROM
- 24-pin Dual In-Line Package

Type	Access Time Max.	Power Dissipation Max. Operating/Standby	Supplies [V]
1701	1 μ s	700mW	+5, -9

The Intel 1601, 1602, 1701, and 1702 is a 256 word by 8-bit electrically programmable ROM ideally suited for uses where fast turnaround and pattern experimentation are important such as in prototype or in one of a kind systems. The 1601, 1602, 1701, and 1702 is factory reprogrammable which allows Intel to perform a complete programming and functional test on each bit position before delivery.

The four devices 1601, 1602, 1701, and 1702 use identical chips. The 1601 and 1701 is operable in both the static and dynamic mode while the 1602 and 1702 is operable in the static mode only. Also, the 1701 and 1702 has the unique feature of being completely erasable and field reprogrammable. This is accomplished by a quartz lid that allows high intensity ultraviolet light to erase the 1701 and 1702. A new pattern can then be written into the device. This procedure can be repeated as many times as required.

The 1301 is a pin-for-pin replacement part which is programmed by a metal mask and is ideal for large volumes and lower cost production runs of systems initially using the 1601/1701 or the static only 1602/1702.

The Dynamic mode of the 1601/1701 and 1301 refers to the decoding circuitry and not the memory cell. Dynamic operation offers higher speed and lower power dissipation than static operation.

The 1601, 1602, 1701, and 1702 is fabricated with silicon gate technology. This low threshold technology allows the design and production of higher performance MOS circuits and provides a higher functional density on a monolithic chip than conventional MOS technologies [2].

History

As the 4004 project was being completed in early 1971; Intel introduced the 1701 EPROM (erasable programmable read-only memory) [3].

The Dynamic mode of the 1601/1701 and 1301 refers to the decoding circuitry and not the memory cell. Dynamic operation offers higher speed and lower power dissipation than static operation [2].

To use a microprocessor, you first had to visualize a problem as a computer program and then write and debug it in some kind of hardware-simulation environment before committing the program to ROM. Fortunately, Intel had just developed the 1701, the first EPROM to use a floating polysilicon gate as the storage element [4].

The 1701 was a 2-Kb device programmable with special hardware and erasable with ultraviolet light. Introduced six months earlier than the 1201 [Later renamed the 8008], the 1701 was a solution looking for a problem. However, it made possible the development of a board that you could use to develop, run, and debug software for the MCS-4 [4].

Part Numbers

Type C Packages

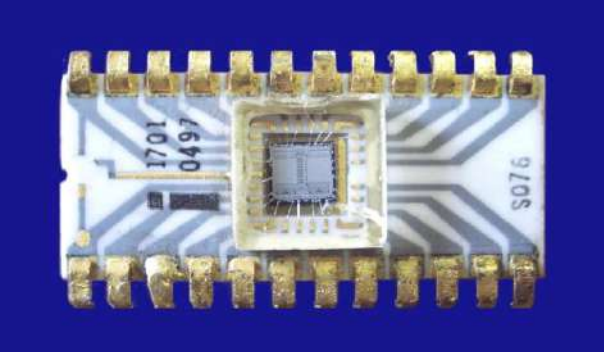
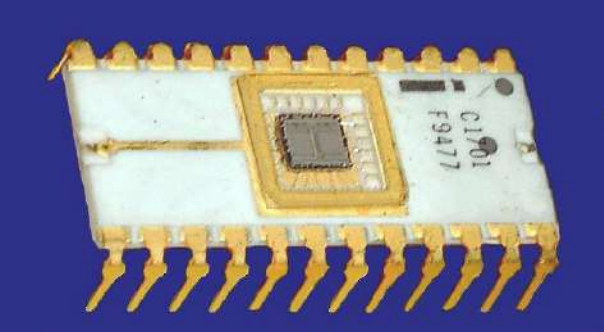
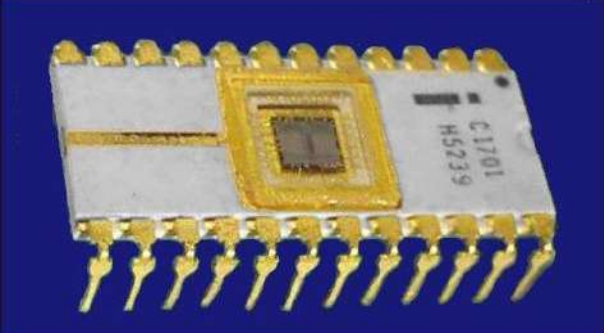
Part Number	Package Description	Values
		
1701	1. Type C white ceramic package w/grey traces, quartz cap, gold cap ground strap, and gold pins. Gold dot denotes pin #1.	Ex. Rare (2 Known) \$200-\$800
		
C1701	1. Type C white ceramic package w/quartz cap, gold cap ground strap, and gold pins. Cap ground strap connection points on both ends of package (only one used). Large black dot denotes pin #1.	Ex. Rare (3 Known) \$150-\$600
		
C1701	2. Type C white ceramic package w/quartz cap, gold cap ground strap, and gold pins. Small black dot denotes pin #1.	Ex. Rare (1 Known) \$150-\$600

References

- [1] Intel (March 1971). Intel Price List. No reference to 1701 dates chip after March 1971.
- [2] Intel (September 1972). Intel Data Catalog, 1601/1701, 1602/1702, 1301 Data Sheet, p. 3-11.
- [3] Edward Harding (2002). The History of Microprocessors, Recession. Available from: <http://oz.plymouth.edu/~harding/historymicro.html> [Accessed 10 July 2002]
- [4] Frederico Faggin (n/d). The Birth Of The Microprocessor, Available from: <http://www.uib.es/c-calculo/scings/fc/tc1/html/MicroProcBirth.html> [Accessed 8 August 2002] - Verification that the 1701 was the 1st Intel PMOS EPROM.
- [5] Intel (1984). A Revolution in Progress... A History of Intel to Date, "Intel introduced the worlds first EPROM in January 1971", p. 21

Intel i1702

2048-bit (256 x 8) Static EPROM

1971

Specifications

- 2048-bit (256 x 8) Static EPROM
- PMOS
- Erasable and Field Programmable (1701, 1702)
- Field Programmable (1601, 1602)
- All 2048 Bits Guaranteed Programmable – 100% Factory tested (1601/1701, 1602/1702)
- Inputs and Outputs DTL and TTL Compatible
- Static and Dynamic Operation (1601, 1701, 1301)
- Static Only Operation (1602, 1702)
- OR-tie Capability
- Simple Memory Expansion – Chip Select Input Lead
- EPROM equivalent of Intel 1602 PROM
- 24-pin Dual In-Line Package

Type	Access Time Max.	Power Dissipation Max. Operating/Standby	Supplies [V]
1702	1 μ s	700mW	+5, -9

The Intel 1601, 1602, 1701, and 1702 is a 256 word by 8-bit electrically programmable ROM ideally suited for uses where fast turnaround and pattern experimentation are important such as in prototype or in one of a kind systems. The 1601, 1602, 1701, and 1702 is factory reprogrammable which allows Intel to perform a complete programming and functional test on each bit position before delivery.

The four devices 1601, 1602, 1701, and 1702 use identical chips. The 1601 and 1701 is operable in both the static and dynamic mode while the 1602 and 1702 is operable in the static mode only. Also, the 1701 and 1702 has the unique feature of being completely erasable and field reprogrammable. This is accomplished by a quartz lid that allows high intensity ultraviolet light to erase the 1701 and 1702. A new pattern can then be written into the device. This procedure can be repeated as many times as required.

The 1301 is a pin-for-pin replacement part which is programmed by a metal mask and is ideal for large volumes and lower cost production runs of systems initially using the 1601/1701 or the static only 1602/1702.

The Dynamic mode of the 1601/1701 and 1301 refers to the decoding circuitry and not the memory cell. Dynamic operation offers higher speed and lower power dissipation than static operation.

The 1601, 1602, 1701, and 1702 is fabricated with silicon gate technology. This low threshold technology allows the design and production of higher performance MOS circuits and provides a higher functional density on a monolithic chip than conventional MOS technologies [2].

1602/1702 and 1602A/1702A Compatibility

Take note when using PROMS that the programming operation on devices from the same family are not necessarily compatible. Examples are the 1602 and 1702 devices In which the programming operation forces “ones” to “zeros” and the 1602A and 1702A which force “zeros” to “ones” [4].

Part Numbers

Type C Packages

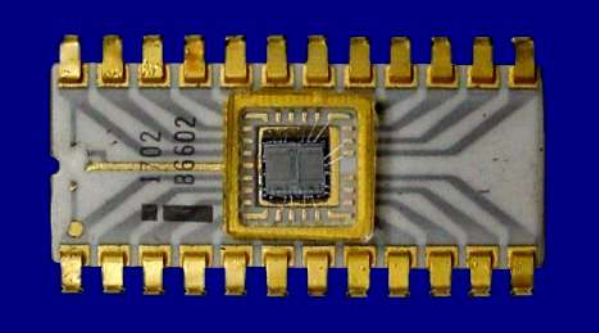
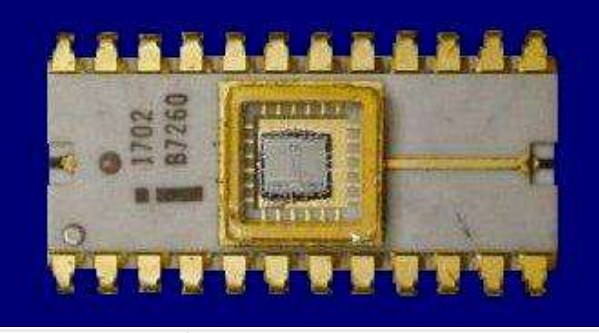
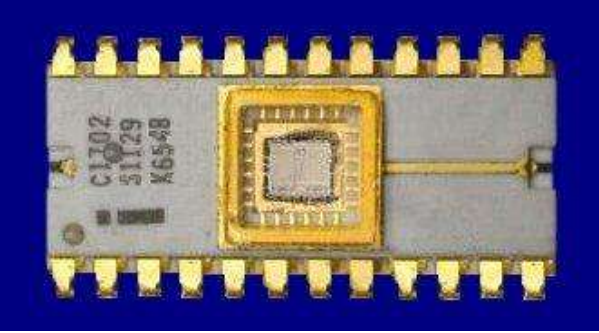
Part Number	Package Description	Values
		
1702	1. Type C white ceramic package w/grey traces, quartz cap, gold cap ground strap, and gold pins. Gold dot denotes pin #1. No copyright. Example shown has no date or any other markings on the back.	Ex. Rare (12 Known) \$75-\$300
		
1702	2. Type C white ceramic package w/quartz cap, gold cap ground strap, and gold pins. Cap ground strap connection points on both ends of package (only one used). Black dot denotes pin #1.	Ex. Rare (2 Known) \$75-\$300
		
C1702	1. Type C white ceramic package w/quartz cap, gold cap ground strap, and gold pins. Cap ground strap connection points on both ends of package (only one used). Black dot denotes pin #1.	Ex. Rare \$75-\$300

Intel i1702

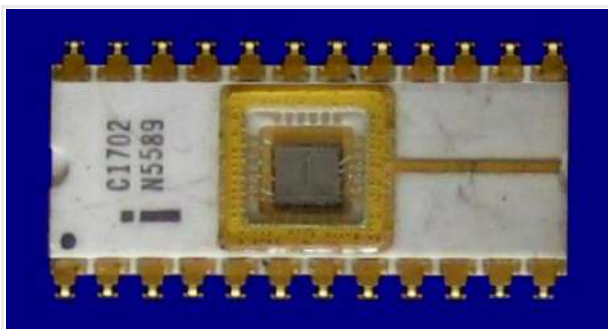

C1702	2. Type C white ceramic package w/quartz cap, gold cap ground strap, and gold pins. Black dot denotes pin #1.	Ex. Rare \$75-\$300
-------	---	------------------------

References

- [1] Intel (March 1971). Intel Price List. No reference to 1702 (or 1701) dates chips after March 1971.
- [2] Intel (September 1972). Intel Data Catalog, 1601/1701, 1602/1702, 1301 Data Sheet, p. 3-11.
- [3] Intel (1984). A Revolution in Progress... A History of Intel to Date, 1702 introduced 1971, p. 26.
- [4] NASA (2002). Guideline No. GD-ED-2203, Design Checklists for Microcircuits, p. 6. Available from: <http://www.hq.nasa.gov/office/codeq/relpract/2203.pdf> [Accessed 10 July 2002]

Intel i1702A

2048-bit (256 x 8) Static EPROM

4th Qtr 1972

Specifications

- 2048-bit (256 x 8) Static EPROM
- PMOS
- Electrically Programmable (1602A)
- Erasable and Electrically Programmable (1702A)
- Fast Programming: 2 Minutes for all 2048 Bits
- All 2048 Bits Guaranteed Programmable: 100% Factory Tested
- Fully Decoded
- Static MOS: No Clocks Required
- Inputs and Outputs DTL and TTL Compatible
- Three-State Output: OR-Tie Capability
- Simple Memory Expansion: Chip Select Input Lead
- EPROM equivalent of the Intel 1602A PROM
- 24-pin Dual In-Line Package

Type	Access Time Max.	Power Dissipation Max. Operating/Standby	Supplies [V]
1702A	1 μ s	700mW	+5, -9
1702A-2	650ns	959mW	+5, -9
1702A-6	1.5 μ s	700mW	+5, -9
M1702A	850ns	960mW	+5, -9

The 1602A and 1702A are 256 word by 8-bit electrically programmable ROMs ideally suited for uses where fast turn-around and pattern experimentation are important. The 1602A and 1702A undergo complete programming and function testing on each bit position prior to shipment, thus insuring 100% programmability.

The 1602A and 1702A use identical chips. The 1702A is packaged in a 24-pin dual in-line package with a transparent lid. The transparent lid allows the user to expose the chip to ultraviolet light to erase the bit pattern. A new pattern can then be written into the device. The 1602A is packaged in a 24-pin dual in-line package with a metal lid and is not erasable.

The circuitry of the 1602A/1702A is entirely static; no clocks are required.

A pin-for-pin metal mask programmed ROM, the 1302, is ideal for large volume production runs of systems initially using the 1602A or 1702A.

The 1602A/1702A is fabricated with silicon gate technology. This low threshold technology allows for the design and production of higher performance MOS circuits and provides a higher function density on a monolithic chip than conventional MOS technologies [3].

Intel 1702A Die

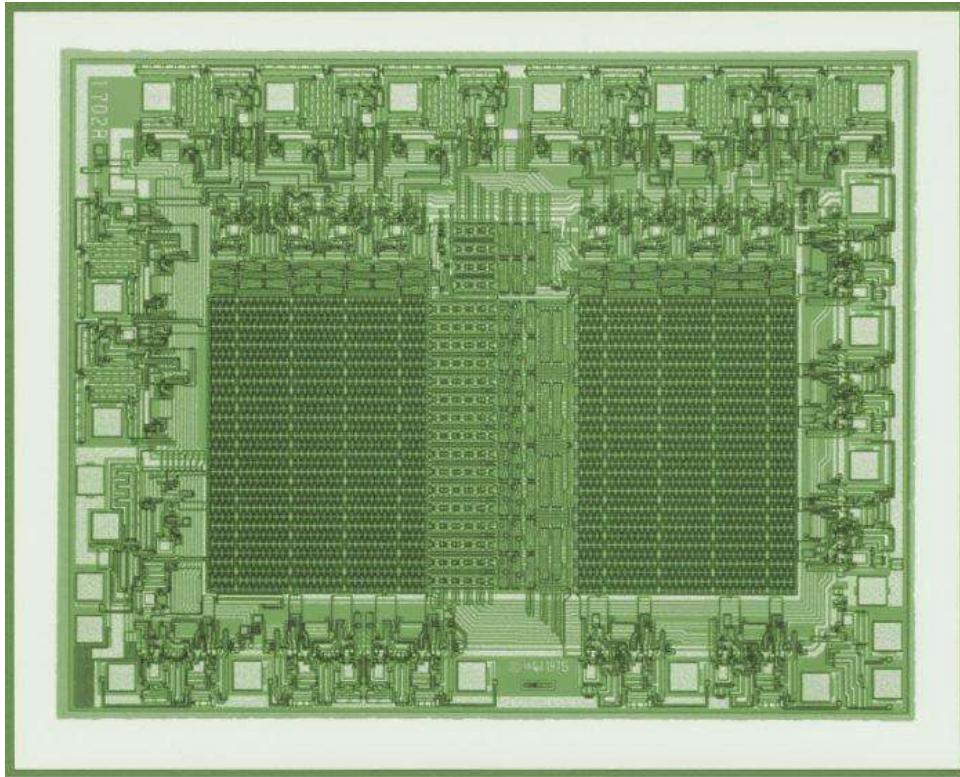

Copyright Intel Corporation

History

In the beginning of 1970 the market needs for this chip was enormous but the yield of the first 1702 production was very poor. On each functional chip there were hundreds of unusable chips. After modification of chip architecture from parallel in serial design and including the Walkout (put the chips under high negative voltage) into the manufacturing process the production yield suddenly increased to 60 chips per wafer. After modification of this production process the chip was marked 1702A [4].

EPROMs were actually Intel's most profitable product line through 1985 [5].

1702A's made in Mexico

Undated 1702A's made in Mexico are much more rare than the common undated 1702A's with no country code.

1602A/1702A - S314 and S714

The Intel 1602A/1702A datasheet dated April 1973 in the 1974 Intel Intellec 8 Reference manual states that “The 1602A/1702A—S714 is ideally suited for use with Intel’s MCS-8 Micro Computer Set. It may also be used with systems requiring 2μsec access time.”

The Intel Microcomputers guide, March 1974 contains separate data sheets for the S314 and S714 versions of the 1602A/1702A.

The S314 data sheet says “Compatible with Intel’s MCS™-4 Micro Computer Set” and “Uses +5, -10 V Supplies”.

The S714 data sheet says “Compatible with Intel’s MCS™-8 Micro Computer Set”. No mention of supply voltage but I assume it was the same +5, -9 V supplies as 1702A.

The S314/S714 designation must have caused some confusion because Intel quickly discontinued the S314/S714 and introduced the 4702A (+5, -10 V Supplies) for The MCS™-4.

Part Numbers

Type C Packages

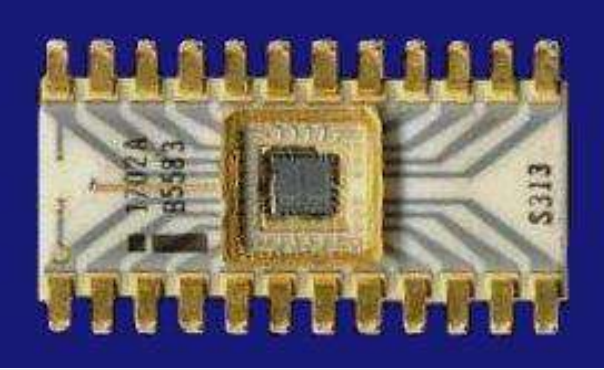
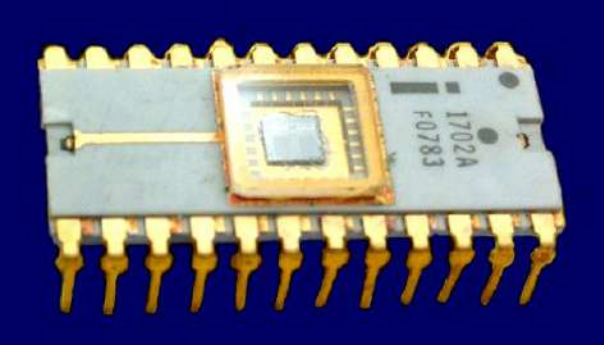
Part Number	Package Description	Values
		
1702A-S313	Type C white ceramic package w/grey traces, quartz cap, gold cap ground strap, and gold pins. Gold dot denotes pin #1. No copyright. Example shown marked S313. See notes on 1602A/1702A-S314 and S714.	Ex. Rare (1 Known) \$75-\$300
1702A-S314	Type C white ceramic package w/grey traces, quartz cap, gold cap ground strap, and gold pins. Gold dot denotes pin #1. No copyright. See notes on 1602A/1702A-S314 and S714	Ex. Rare (1 Known) \$75-\$300
1702A-S714	Type C package. See notes on 1602A/1702A-S314 and S714	Ex. Rare (0 Known) \$\$\$
		
1702A	1. Type C white ceramic package w/quartz cap, gold cap ground strap, and gold pins. Cap ground strap connection points on both ends of package (only one used). Black dot denotes pin #1. No copyright.	Ex. Rare \$40-\$160

Intel i1702A

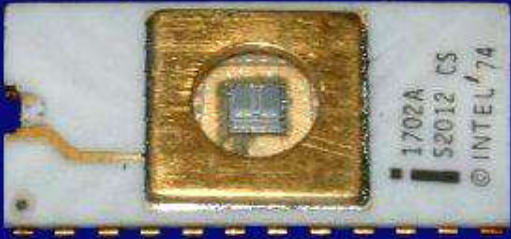
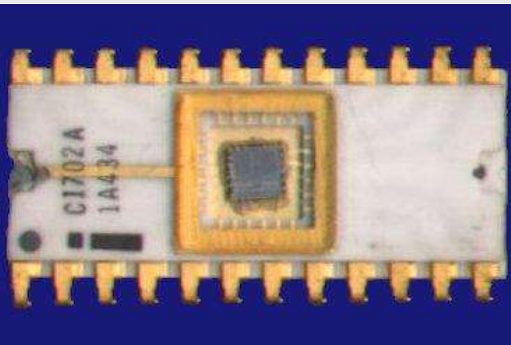
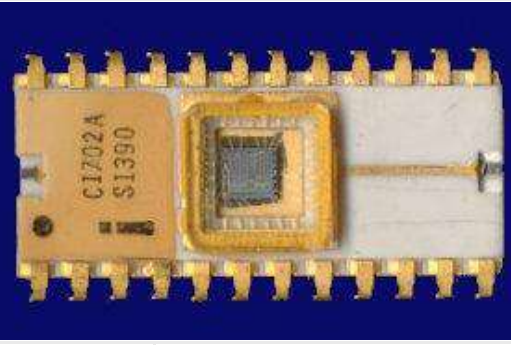
		
1702A	2. Type C white ceramic package w/gold cap with quartz porthole, offset gold cap ground strap, and gold pins. Small black dot denotes pin #1. © Intel '74	Ex. Rare \$40-\$160
		
C1702A	1a. Type C white ceramic package w/quartz cap, gold cap ground strap, and gold pins. Cap ground strap connection points on both ends of package (only one used). Black dot denotes pin #1. No copyright.	\$5-\$20
		
C1702A	1b. Type C white ceramic package w/quartz cap, gold cap ground strap, and gold pins. Cap ground strap connection points on both ends of package (only one used). Black dot denotes pin #1. Remarkd. No copyright.	\$40-\$160

Intel i1702A

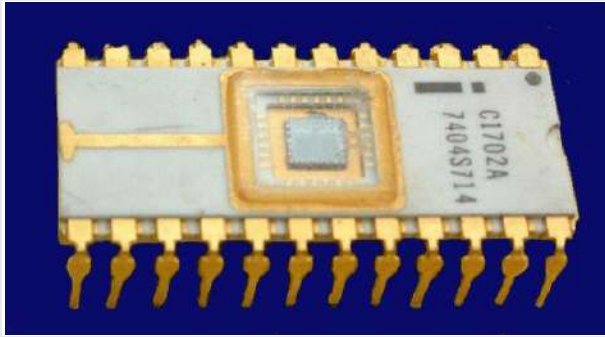

C1702A	2a. Type C white ceramic package w/quartz cap, gold cap ground strap, and gold pins. Black dot denotes pin #1. No copyright.	\$5-\$20
--------	--	----------

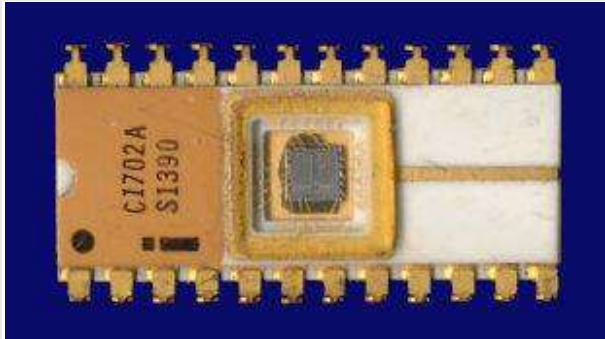

C1702A	2b. Type C white ceramic package w/quartz cap, gold cap ground strap, and gold pins. Black dot denotes pin #1. Remarkd. No copyright. One of these chips in like new condition sold for \$180 on EBAY on 01/19/03.	Ex. Rare \$40-\$160
--------	--	------------------------

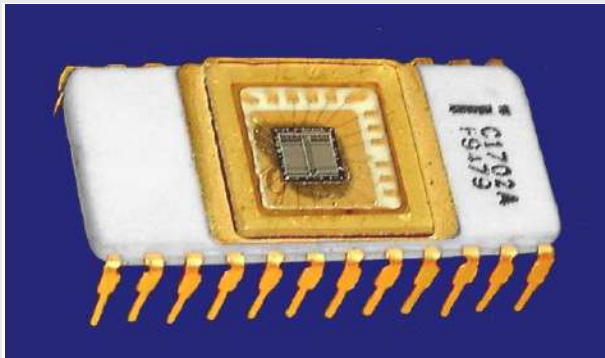

C1702A	3. Type C white ceramic package w/quartz cap and integrated gold pins. No copyright. Die marked NS for National Semiconductor.	Ex. Rare (2 Known) \$50-\$200
--------	--	-------------------------------------

Intel i1702A

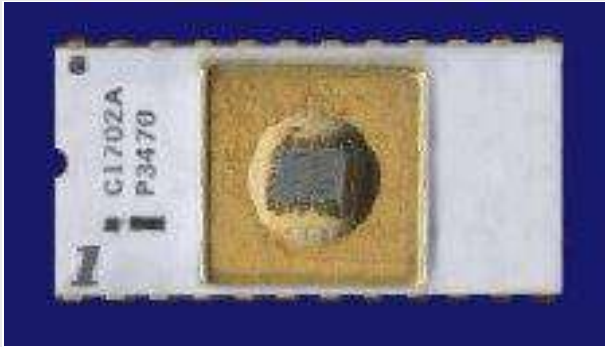

C1702A	4. Type C white ceramic package w/gold cap with quartz porthole and gold pins. Large '1' denotes pin #1. No copyright.	Rare \$20-\$80
--------	--	-------------------



C1702A	5. Type C white ceramic package w/gold cap with quartz porthole, offset gold cap ground strap, and gold pins. Small '1' in a circle denotes pin #1. © Intel '74	\$15-\$60
--------	---	-----------

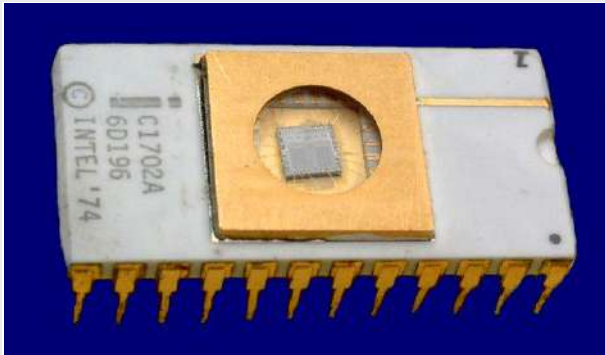

C1702A	6. Type C white ceramic package w/gold cap with quartz porthole, offset gold cap ground strap, and gold pins. Small '1' denotes pin #1. © Intel '74	\$15-\$60
--------	---	-----------

Intel i1702A

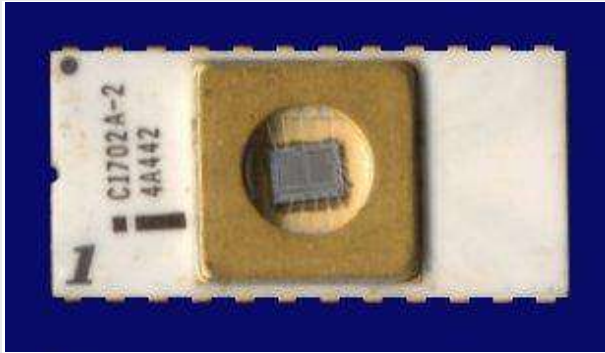

C1702A-2	1. Type C white ceramic package w/gold cap with quartz porthole and gold pins. Large '1' denotes pin #1. No copyright.	\$10-\$40
----------	--	-----------

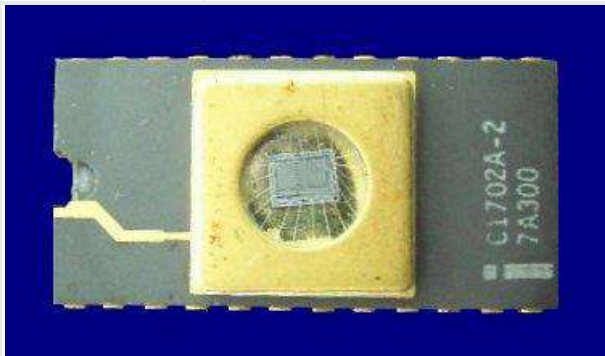

C1702A-2	2. Type C grey ceramic package w/gold cap with quartz porthole, offset gold cap ground strap, and gold pins. No copyright.	Rare \$20-\$60
----------	--	-------------------

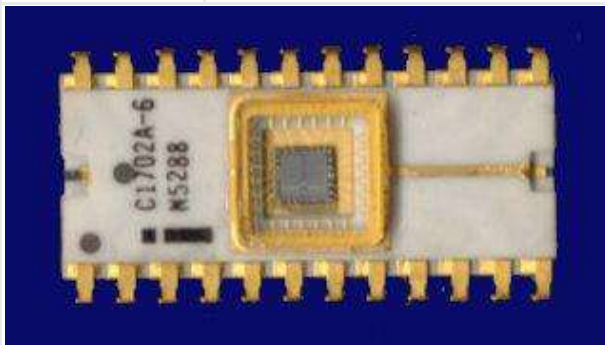

C1702A-6	1. Type C white ceramic package w/quartz cap, gold cap ground strap, and gold pins. Cap ground strap connection points on both ends of package (only one used). Black dot denotes pin #1. No copyright.	Rare \$15-\$60
----------	---	-------------------

Intel i1702A

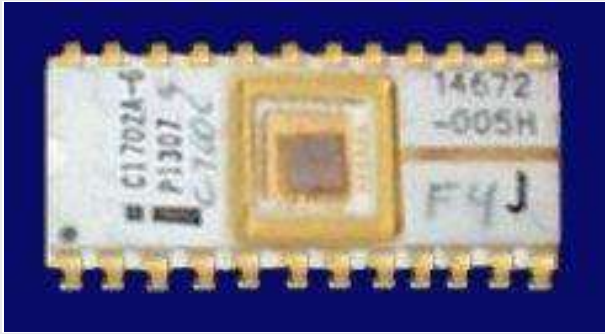

C1702A-6	2. Type C white ceramic package w/quartz cap, gold cap ground strap, and gold pins. Black dot denotes pin #1. No copyright.	Rare \$15-\$60
----------	---	-------------------

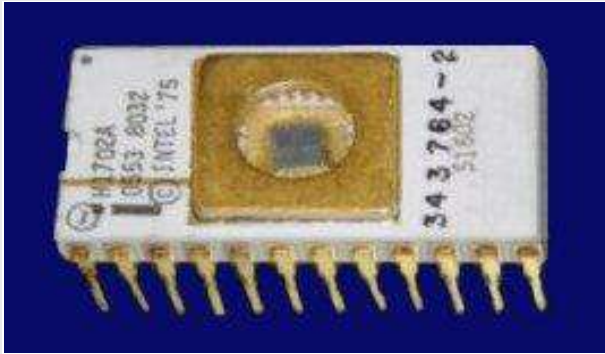

H1702A	Type C white ceramic package w/gold cap with quartz porthole, offset gold cap ground strap, and gold pins. Small '1' in a circle denotes pin #1. © Intel '75	Rare \$15-\$60
--------	--	-------------------

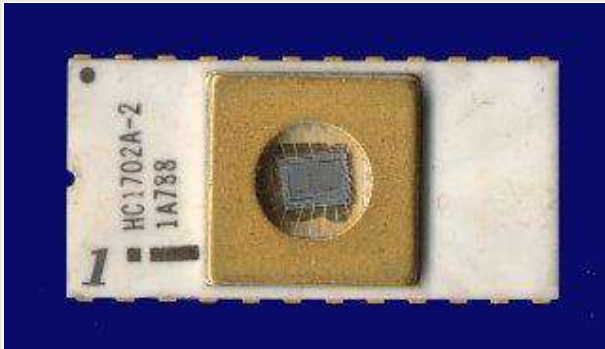

HC1702A-2	Type C white ceramic package w/gold cap with quartz porthole and gold pins. Large '1' denotes pin #1. No copyright.	Ex. Rare \$25-\$100
-----------	---	------------------------

Intel i1702A



MC1702A	Type C white ceramic package w/gold cap with quartz porthole, offset gold cap ground strap, and gold pins. Black dot denotes pin #1. © Intel '75	Ex. Rare \$30-\$120
---------	---	------------------------

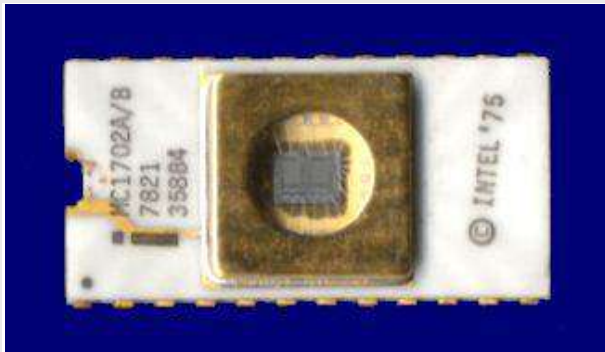

MC1702A/B	Type C white ceramic package w/gold cap with quartz porthole, offset gold cap ground strap, and gold pins. Black dot denotes pin #1. © Intel '75	Rare \$20-\$80
-----------	---	-------------------

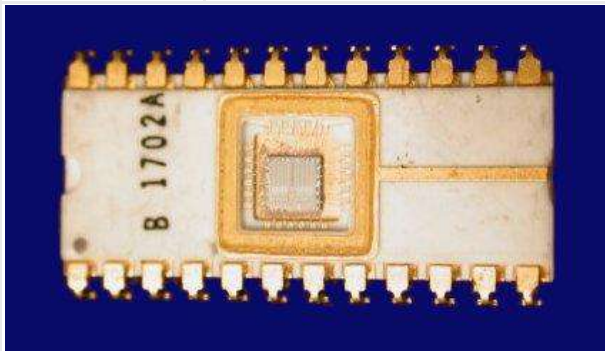

B 1702A	1. Type C white ceramic package w/quartz cap, gold cap ground strap, and gold pins. Black dot denotes pin #1. No copyright. No Intel Logo. Die is marked Intel 1602A.	Ex. Rare \$25-\$100
---------	---	------------------------

Intel i1702A

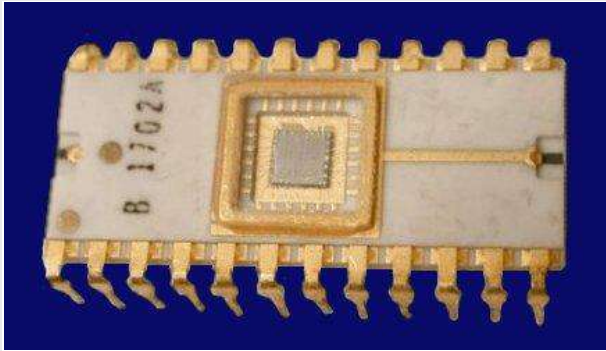

B 1702A	2. Type C white ceramic package w/quartz cap, gold cap ground strap, and gold pins. Cap ground strap connection points on both ends of package (only one used). Black dot denotes pin #1. No copyright. No Intel logo. Die is marked Intel 1602A.	Ex. Rare (1 Known) \$25-\$100
---------	---	-------------------------------------

Type B Packages

Part Number	Package Description	Values
1702A	1. Type B grey ceramic package w/quartz cap and tin pins. No copyright. Example shown marked 'CS' for Customer Sample, made in Malaysia and dated 7723.	Ex. Rare \$25-\$100
1702A	2. Type B grey ceramic package w/quartz cap and tin pins. © Intel '74. Example shown marked 'CS' for Customer Sample.	Ex. Rare \$25-\$100

Intel i1702A

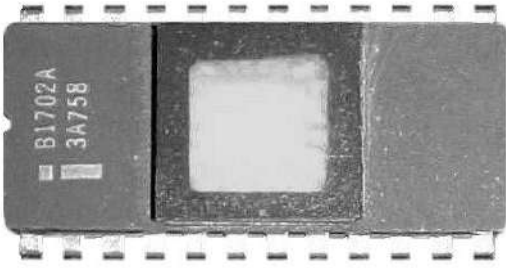
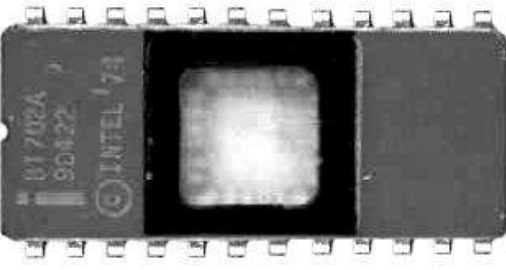
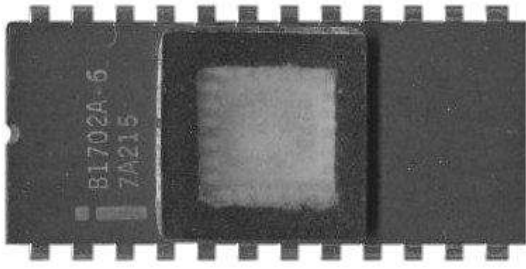
		
B1702A	1. Type B grey ceramic package w/quartz cap and tin pins. No copyright	\$5-\$20
		
B1702A	2. Type B grey ceramic package w/quartz cap and tin pins. © Intel '74	\$5-\$20
B1702A-2	Type B package	\$8-\$32
		
B1702A-6	1. Type B grey ceramic package w/quartz cap and tin pins. No copyright.	\$10-\$40

Intel i1702A



B1702A-6	2. Type B grey ceramic package w/quartz cap and tin pins. © Intel '74.	\$10-\$40
H1702A	Type B grey ceramic package w/quartz cap and tin pins. © Intel '75.	Rare \$15-\$60

Type D Packages

Part Number	Package Description	Values
D1702A	Type D package. <i>Suspect that the few listings for this part number on part number databases may be typos. Will need to see this chip to verify it exists.</i>	Rare <i>(Suspect)</i> \$20-\$60

References

- [1] Intel (September 1972). Intel Data Catalog. No reference to 1702A dates chip after September 1972.
- [2] Intel (November 1972). Intel MCS-8 User's Manual, p. 25. Reference to Intel's "new" 1702A dates chip to November 1972
- [3] Intel (1975). Intel Data Catalog, 1602A/1702A Data Sheet, p. 3-7.
- [4] CPU-Museum.com (2003). Memories. Available from: <http://www.cpu-museum.com/> [Accessed 22 December 2003]
- [5] Intel (2002). *Recollections of Early Chip Development at Intel*. Available from: http://intel.com/technology/itj/q12001/articles/art_1.htm [Accessed 10 July 2002]

Intel i1702AL

2048-bit (256 x 8) Static EPROM

1975

Specifications

- 2048-bit (256 x 8) Static EPROM
- PMOS
- Clocked V_{gg} Mode for Low Power Dissipation
- Fast Programming: 2 Minutes for all 2048 Bits
- All 2048 Bits Guaranteed Programmable: 100% Factory tested
- Inputs and Outputs DTL and TTL Compatible
- Three-State Output: OR-Tie Capability
- Low Power Version of the Intel 1702A EPROM
- EPROM equivalent of the Intel 1602AL PROM
- 24-pin Dual In-Line Package

Type	Access Time Max.	Power Dissipation Max. Operating/Standby	Supplies [V]
1702AL	1 μ s	221mW	+5, -9
1702AL-2	650ns	221mW	+5, -9
1702AL-6	1.5 μ s	700mW	+5, -9



The 1702AL is a 256 word by 8-bit electrically programmable ROM (EPROM) and is the same chip as the industry standard 1702A. The programming and erasing specifications are identical to the 1702A. The 1702AL operates with the V_{gg} clocked to reduce the power dissipation.

Initially all 2048 bits of the 1702AL are in the “0” state (output low). Information is introduced by selectively programming “1”s (output high) in the proper bit location. The 1702AL is packaged in a 24-pin dual in-line package with transparent lid. The transparent lid allows the user to expose the 1702AL to ultraviolet light to erase the bit pattern. A new pattern can then be written into the device.

The 1702AL is fabricated with silicon gate technology. This low threshold technology allows the design and production of higher performance MOS circuits and provides a higher functional density on a monolithic chip than conventional MOS technologies [3].

Part Numbers

Type C Packages

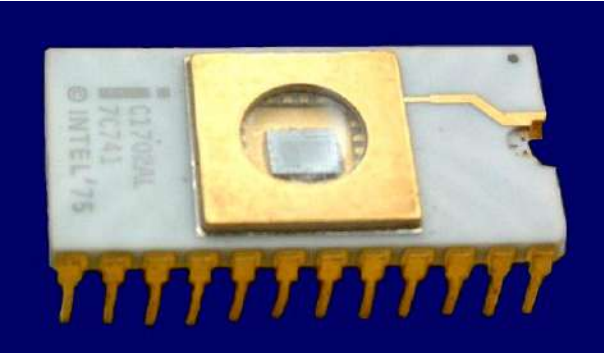
Part Number	Package Description	Values
		
C1702AL	1. Type C grey ceramic package w/gold cap with quartz porthole, offset gold cap ground strap, and gold pins. No Copyright.	Ex. Rare \$25-\$100
		
C1702AL	2. Type C white ceramic package w/gold cap with quartz porthole and gold pins. Large '1' denotes pin #1. No Copyright.	Rare \$20-\$80
		
C1702AL	3. Type C white ceramic package w/gold cap with quartz porthole, offset gold cap ground strap, and gold pins. Small black dot denotes pin #1. © Intel '75.	Rare \$20-\$80

Intel i1702AL

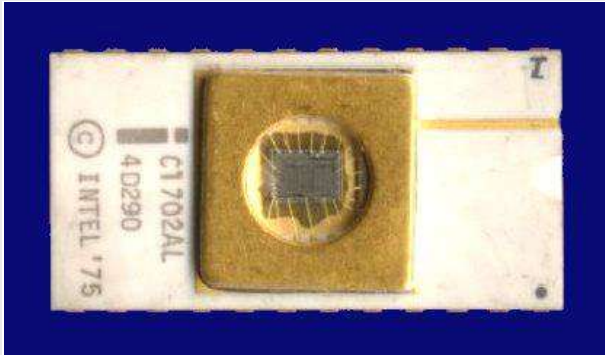

C1702AL	4. Type C white ceramic package w/gold cap with quartz porthole, offset gold cap ground strap, and gold pins. Small '1' denotes pin #1. © Intel '75.	Rare \$20-\$80
---------	--	-------------------

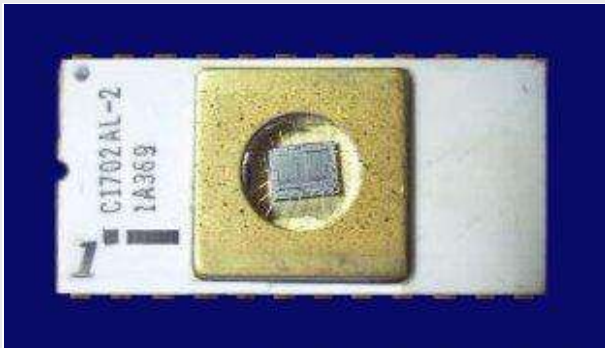

C1702AL-2	1. Type C white ceramic package w/gold cap with quartz porthole and gold pins. Large '1' denotes pin #1. No Copyright.	Rare \$20-\$80
-----------	--	-------------------

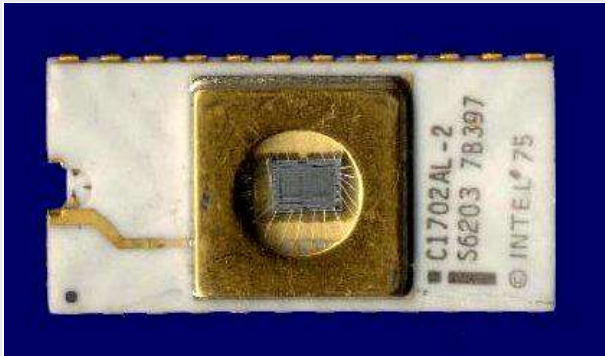

C1702AL-2	2. Type C white ceramic package w/gold cap with quartz porthole, offset gold cap ground strap, and gold pins. Small black dot denotes pin #1. © Intel '75.	Rare \$20-\$80
-----------	--	-------------------

Intel i1702AL

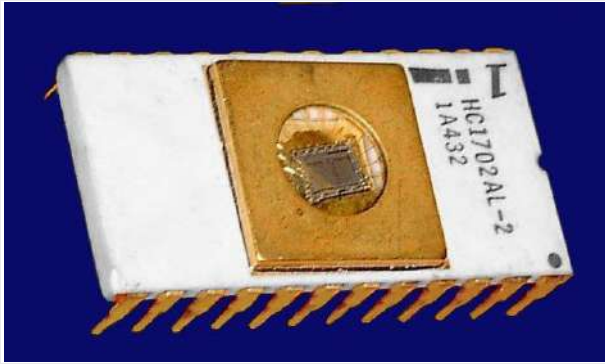

HC1702AL-2	Type C white ceramic package w/gold cap with quartz porthole and gold pins. Large '1' denotes pin #1. No copyright.	Ex. Rare \$25-\$100
------------	--	------------------------

Type B Packages

Part Number	Package Description	Values
B1702AL	Type B grey ceramic package w/quartz cap and tin pins. © Intel '75	\$8-\$32
B1702AL-2	Type B grey ceramic package w/quartz cap and tin pins. © Intel '75	\$10-\$40

References

- [1] Intel (1975). Intel Data Catalog. No reference to 1702AL/1602AL.
- [2] Intel (1975). Intel Memory Design Handbook, 1702AL-6/1602AL-6 Specifications, p. PSG-2
- [3] Intel (1978). Intel Component Data Catalog, 1702AL Data Sheet, p. 4-11.

Intel i2101

1024-bit (256 x 4) Static RAM w/Separate I/O

4th Qtr 1974

Specifications

- 1024-bit (256 x 4) Static RAM w/Separate I/O
- NMOS
- 256 x 4 Organization to Meet Needs for Small System Memories
- Access Time: 0.5 to 1µsec Max.
- Single +5V Supply Voltage
- Directly TTL Compatible: All Inputs and Output
- Static MOS: No Clocks or Refreshing Required
- Simple Memory Expansion: Chip Enable Input
- Inputs Protected: All Inputs Have Protection Against Static Charge
- Low Power: Typically 150mW
- Three-State Output: OR-Tie Capability
- Output Disable Provided for Ease of Use in Common Data Bus Systems
- 22-pin Dual In-Line Package

Type	Access Time Max.	Cycle Time Max.	Power Dissipation Max. Operating/Standby	Supplies [V]
2101	1µs	1µs	350mW	+5
2101-1	500ns	500ns	350mW	+5
2101-2	650ns	650ns	350mW	+5
2101-4	450ns	450ns	-	+5

The Intel® 2101 is a 256 word by 4-bit static random access memory element using N-channel MOS devices integrated on a monolithic array. It uses fully DC stable (static) circuitry and therefore requires no clocks or refreshing to operate. The data is read out nondestructively and has the same polarity as the input data.

The 2101 is designed for memory applications where high performance, low cost, large bit storage, and simple interfacing are important design objectives.



It is directly TTL compatible in all respects: inputs, outputs, and a single +5V supply. Two chip-enables allow easy selection of an individual package when outputs are OR-tied. An output disable is provided so that data inputs and outputs can be tied for common I/O systems. The output disable function eliminates the need for bi-directional logic in a common I/O system.

The Intel 2101 is fabricated with N-channel silicon gate technology. This technology allows the design and production of high performance, easy-to-use MOS circuits and provides a higher functional density on a monolithic chip than either conventional MOS technology or P-channel silicon gate technology.

Intel's silicon gate technology also provides excellent protection against contamination. This permits the use of low cost plastic packaging [4].



Part Numbers

Type C Packages

Part Number	Package Description	Values
		
C2101	1. Type C white ceramic package w/grey traces, gold cap, gold cap ground strap and gold pins. Gold dot denotes pin #1. Example shown made in the Philippines and dated 7622.	Ex. Rare (1 Known) \$50-\$200
C2101	2. Type C purple ceramic package w/gold cap and gold pins.	Ex. Rare (1 Known) \$30-\$120
		
C2101-1	Type C purple ceramic package w/gold cap and gold pins	Ex. Rare (2 Known) \$30-\$120
		
C2101-2	Type C white ceramic package w/grey traces, gold cap, gold cap ground strap and gold pins. Gold dot denotes pin #1.	Ex. Rare (2 Known) \$50-\$200

Intel i2101

Type P Packages

Part Number	Package Description	Values
P2101	Type P package	\$10-\$40
		
P2101-1	1. Type P grey plastic package w/tin pins. Embossed Intel 'i' in key. Small round indentation denotes pin #1.	Rare \$10-\$40
		
P2101-1	2. Type P grey plastic package w/tin pins. Plain key. Small round indentation denotes pin #1.	\$5-\$20
		
P2101-2	Type P grey plastic package w/tin pins. Embossed Intel 'i' in key. Small round indentation denotes pin #1.	Rare \$10-\$40

References

- [1] Intel (September 1972). Intel Data Catalog. No reference to 2101 dates chip after September 1972.
- [2] Intel (November 1974). Intel Static RAMs, 2101, 2101-1, 2101-2 Preliminary Data Sheet, p. 21
- [3] Intel (November 1974). Intel MCS-40 User's Manual For Logic Designers, Figure 4-27. RAM and PROM Program Memory Organization, p. 4-26.
- [4] Intel (1975). Intel Data Catalog, 2101, 2101-1, 2101-2 Data Sheet, p. 2-29.
- [5] Classic Coin-Ops (2002). Parts for Sale. *The 2101-1 was used in Centipede, Galaxian, and Millipede arcade games.* Available from: <http://users.sisna.com/woodcock/partsale.htm> [Accessed 10 July 2002]

Intel i2101A

1024-bit (256 x 4) Static RAM w/Separate I/O

1976

Specifications

- 1024-bit (256 x 4) Static RAM w/Separate I/O
- NMOS
- 256 x 4 Organization to Meet Needs for Small System Memories
- Single +5V Supply Voltage
- Directly TTL Compatible: All Inputs and Output
- Static MOS: No Clocks or Refreshing Required
- Simple Memory Expansion: Chip Enable Input
- Inputs Protected: All Inputs Have Protection Against Static Charge
- Low Power: Typically 150mW
- Three-State Output: OR-Tie Capability
- Output Disable Provided for Ease of Use in Common Data Bus Systems
- 22-pin Dual In-Line Package

Type	Access Time Max.	Cycle Time Max.	Power Dissipation Max. Operating/Standby	Supplies [V]
2101A	350ns	350ns	300mW	+5
2101A-2	250ns	250ns	350mW	+5
2101A-4	450ns	450ns	300mW	+5

The Intel® 2101A is a 256 word by 4-bit static random access memory element using N-channel MOS devices integrated on a monolithic array. It uses fully DC stable (static) circuitry and therefore requires no clocks or refreshing to operate. The data is read out nondestructively and has the same polarity as the input data.

The 2101A is designed for memory applications where high performance, low cost, large bit storage, and simple interfacing are important design objectives.

It is directly TTL compatible in all respects: inputs, outputs, and a single +5V supply. Two chip-enables allow easy selection of an individual package when outputs are OR-tied. An output disable is provided so that data inputs and outputs can be tied for common I/O systems. The output disable function eliminates the need for bi-directional logic in a common I/O system.

The Intel® 2101A is fabricated with N-channel silicon gate technology. This technology allows the design and production of high performance, easy-to-use MOS circuits and provides a higher functional density on a monolithic chip than either conventional MOS technology or P-channel silicon gate technology.

Intel's silicon gate technology also provides excellent protection against contamination. This permits the use of low cost plastic packaging [4].

Part Numbers

Type B Packages

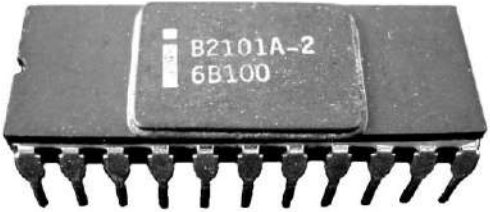
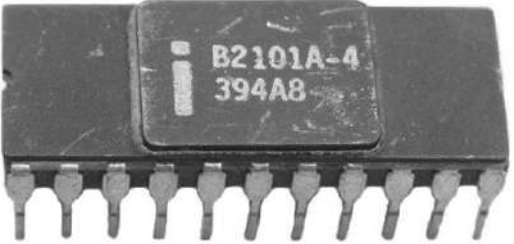
Part Number	Package Description	Values
B2101A	Type B package	\$5-\$20
 <p>A photograph of an Intel B2101A-2 chip. The chip is a grey ceramic package with a black cap on top. The cap has the text 'B2101A-2' and '6B100' printed on it. The chip has 18 tin pins extending from the bottom.</p>		
B2101A-2	Type B grey ceramic package w/black cap and tin pins.	\$5-\$20
 <p>A photograph of an Intel B2101A-4 chip. The chip is a grey ceramic package with a black cap on top. The cap has the text 'B2101A-4' and '394A8' printed on it. The chip has 18 tin pins extending from the bottom.</p>		
B2101A-4	Type B grey ceramic package w/black cap and tin pins	\$5-\$20

Type D Packages

Part Number	Package Description	Values
D2101A	Type D package	\$3-\$12
D2101A-2	Type D package	\$3-\$12
D2101A-4	Type D package	\$3-\$12

Type P Packages

Part Number	Package Description	Values
P2101A	Type P black plastic package w/tin pins.	\$1-\$4
P2101A-2	Type P black plastic package w/tin pins.	\$1.50-\$6

Intel i2101A

 A black plastic integrated circuit chip with ten pins. The top surface is marked with 'P2101A-4' and '342A4'. A small notch is visible on the left side of the chip.		
P2101A-4	Type P black plastic package w/tin pins.	\$.75-\$3

References

- [1] Intel (1975). Intel Memory Design Handbook. No reference to 2101A dates chip after 1975.
- [2] Intel (1976). Intel Data Catalog, 2101A Preliminary Data Sheet, p. 2-30
- [3] Intel (1977). Intel Data Catalog, 2101A Data Sheet, p. 2-30
- [4] Intel (1978). Intel Component Data Catalog, 2101A / 8101A-4 Data Sheet, p. 3-26

Intel i2102

1024-bit (1024 x 1) Static RAM w/Separate I/O 1972

Specifications

- 1024-bit (1024 x 1) Static RAM w/Separate I/O
- NMOS
- Single +5 Volts Supply Voltage
- Directly TTL Compatible – All Inputs and Outputs
- Static MOS – No Clocks or Refreshing Required
- Three-State Output – OR-Tie Capability
- Simple Memory Expansion – Chip Enable Input
- Fully Decoded – On Chip Address Decode
- Inputs Protected – All Inputs Have Protection Against Static Charges
- 16-pin Dual In-Line Package

Type	Access Time Max.	Cycle Time Max.	Power Dissipation Max. Operating/Standby	Supplies [V]
2102	1 μ s	1 μ s	350mW	+5
2102-1	500ns	500ns	350mW	+5
2102-2	650ns	650ns	350mW	+5
2102-4	-	-	-	+5
2102-8	1500ns	1500ns	350mW	+5

The Intel 2102 is a 1024 word by 1-bit static random access memory element using normally off N-channel MOS devices integrated on a monolithic array. It uses fully DC stable (static) circuitry and therefore requires no clocks or refreshing to operate. The data is read out nondestructively and has the same polarity as the input data.

The 2102 is designed for memory applications where high performance, low cost, large bit storage, and simple interfacing are important design objectives.

It is directly TTL compatible in all respects, inputs, output, and a single +5 volt supply. A separate chip enable lead allows easy selection of an individual package when outputs are OR-tied.

The Intel 2102 is fabricated with N-channel silicon gate technology. This technology allows the design and production of high performance easy to use MOS circuits and provides a higher functional density on a monolithic chip than either conventional MOS technology or P-channel silicon gate technology.

Intel's silicon gate technology also provides excellent protection against contamination. This permits the use of low cost silicone packaging [2].

History

The Intel 2102 was used in MITS Altair 8800 and IMSAI 8080 RAM boards.

The “Godbout” G2102

“Ray Stevens (founder of RGS Electronics and creator of the RGS-008, subject of the first hardware review in Byte Vol 1:1) hung out with Bill Godbout and Mike Quinn in the early '70s. They were all chasing Silicon Valley surplus for resale. Ray bought a chip printer and printed the G8008 designation on the original blank 8008 culls that Godbout pulled from Intel's discards.” (Jack Rubin, email dated 8/31/2004).

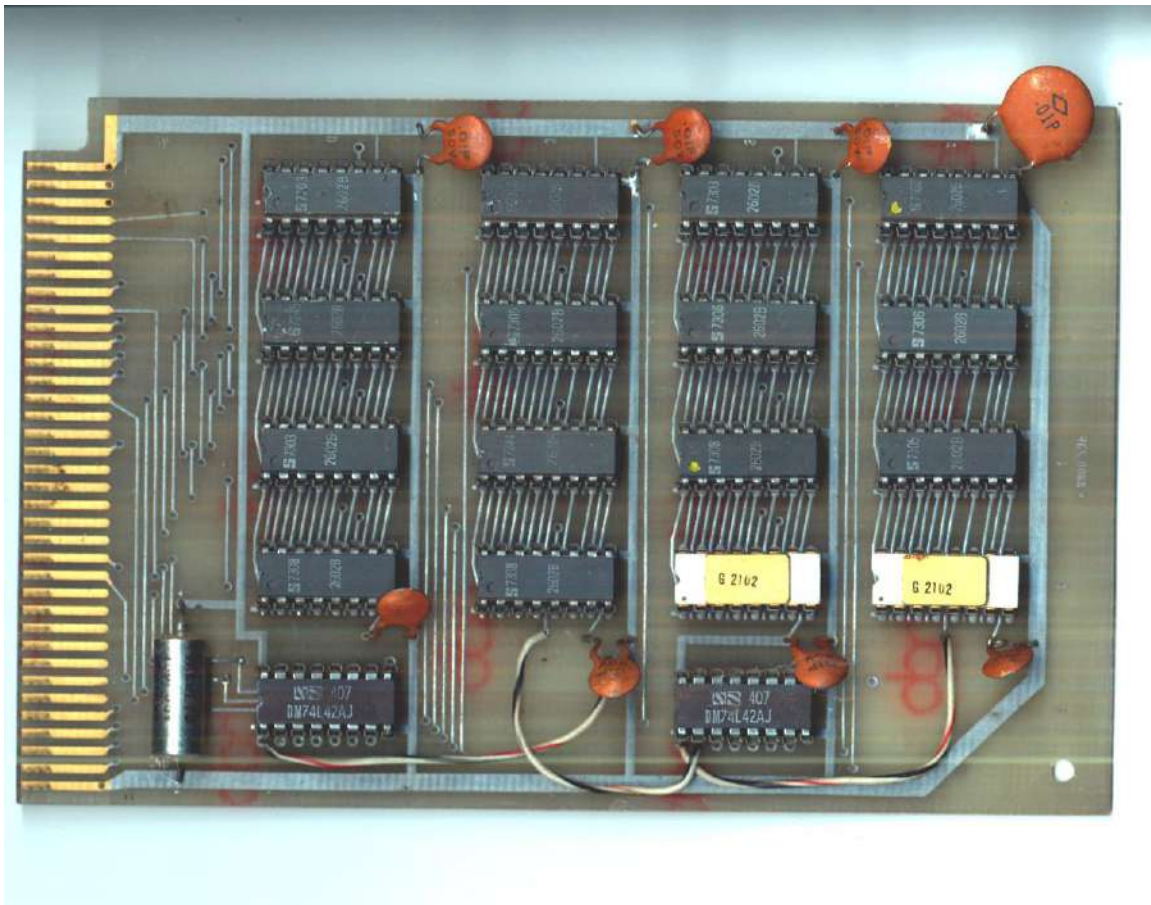

This is a memory card from an RGS-008, an 8008 computer that Ray Stevens was selling in 1974. Obviously CPUs weren't the only thing Bill Godbout was reselling.

Part Numbers

Type C Packages

Part Number	Package Description	Values
		
C2102	1. Type C white ceramic package w/gold cap, gold cap ground strap, and gold pins. Gold dot denotes pin #1.	Ex. Rare (3 Known) \$50-\$200
		
C2102	2. Type C white ceramic package w/gold cap and gold pins. Small black dot denotes pin #1.	Rare \$25-\$100
		
C2102	3. Type C white ceramic package w/gold cap, gold cap ground strap, and gold pins. Black dot denotes pin #1.	Rare \$25-\$100
		
C2102-2	Type C white ceramic package w/gold cap, gold cap ground strap, and gold pins. Gold dot denotes pin #1.	Ex. Rare \$50-\$200

Intel i2102

C2102-4	Type C package	Ex. Rare (0 Known) \$\$\$
		
G2102	Type C white ceramic package w/gold cap and gold pins. Gold dot denotes pin #1. No markings other than G2102 part number.	Ex. Rare (2 Known) \$100-\$400

Type P Packages

Part Number	Package Description	Values
		
P2102	Type P grey plastic package w/tin pins. Embossed Intel 'i' in key.	\$10-\$40
P2102-1	Type P package	\$10-\$40
P2102-2	Type P package	\$10-\$40
P2102-4	Type P package	\$10-\$40

References

- [1] Intel (March 1971). Intel Price List. No reference to 2102 dates chip after March 1971.
- [2] Intel (September 1972). Intel Data Catalog, 2102 Data Sheet, p. 2-13. No reference to 2102-1, 2102-2, 2102-4, or 2102A family.
- [3] Intel (1975). Intel Memory Design Handbook, 2102 and 2102A Family Specifications, p. PSG-1
- [4] Intel (1977). Intel Component Data Catalog, 2102A Family Data Sheet, p. 2-34
- [5] Intel (1984). A Revolution in Progress... A History of Intel to Date, 2102 introduced 1972, p. 26.

Intel i2102A

1024-bit (1024 x 1) Static RAM w/Separate I/O

1974

Specifications

- 1024-bit (1024 x 1) Static RAM w/Separate I/O
- NMOS
- Single +5V Supply Voltage
- Directly TTL Compatible – All Inputs and output
- Standby Power Mode (2102AL)
- Static MOS – No Clocks or Refreshing Required
- Three-State Output – OR-Tie Capability
- Inputs Protected – All Inputs Have Protection Against Static Charge
- 16-pin Dual In-Line Package

Type	Access Time Max.	Cycle Time Max.	Power Dissipation Max. Operating/Standby	Supplies [V]
2102A	350ns	350ns	275mW	+5
2102A-1	-	-	-	+5
2102A-2	250ns	250ns	325mW	+5
2102A-4	450ns	450ns	275mW	+5
2102A-6	650ns	650ns	275mW	+5
M2102A-4	450ns	450ns	350mW	+5
M2102A-6	650ns	650ns	350mW	+5

The Intel® 2102A is a 1024 word by 1-bit static random access memory element using N-channel MOS devices integrated on a monolithic array. It uses full DC stable (static) circuitry and therefore requires no clocks or refreshing to operate. The data is read out nondestructively and has the same polarity as the input data.

The 2102A is designed for microprocessor memory applications where high performance, low cost, large bit storage, and simple interfacing are important design objectives. A low standby power version (2102AL) is also available. It has all the same operating characteristics of the 2102A with the added feature of 35mW maximum power dissipation in standby and 174mW in operation.

It is directly TTL compatible in all respects: inputs, output, and a single +5 volt supply. A separate chip enable lead allows easy selection of an individual package when outputs are OR-tied.



The Intel 2102A is fabricated with N-channel silicon gate technology. This technology allows the design and production of high performance, easy-to-use MOS circuits and provides a higher functional density on a monolithic chip than either conventional MOS technology or P-channel silicon gate technology [7].

History



The Intel 2102A was used in MITS Altair 8800 and IMSAI 8080 RAM boards.

Part Numbers

Type C Packages

Part Number	Package Description	Values
		
C2102A	1. Type C white ceramic package w/gold cap and gold pins. Small black dot denotes pin #1.	Rare \$25-\$100
		
C2102A	2. Type C white ceramic package w/gold cap, gold cap ground strap, and gold pins. Cap ground strap connection points on both ends of package (only one used). Small black dot denotes pin #1.	Rare \$25-\$100
		
C2102A-2	1. Type C white ceramic package w/grey traces, gold cap, gold cap ground strap, and gold pins. Small black dot denotes pin #1. Example shown marked 'CS' for Customer Sample.	Ex. Rare \$50-\$200
C2102A-2	2. Type C white ceramic package w/gold cap and gold pins. Small black dot denotes pin #1.	Rare \$25-\$100

Intel i2102A

		
C2102A-2	3. Type C white ceramic package w/gold cap, gold cap ground strap, and gold pins. Cap ground strap connection points on both ends of package (only one used). Small black dot denotes pin #1.	Rare \$25-\$100
		
C2102A-4	1. Type C white ceramic package w/grey traces, gold cap, gold cap ground strap, and gold pins. Small black dot denotes pin #1. Example shown made in the Philippines and dated 7536.	Ex. Rare \$50-\$200
		
C2102A-4	2. Type C white ceramic package w/gold cap and gold pins. Small black dot denotes pin #1. Example shown made in the Philippines and dated 7609.	Rare \$25-\$100
MC2102A-4	Type C package	Ex. Rare (0 Known) \$\$\$
MC2102A-6	Type C white ceramic package w/gold cap, gold cap ground strap, and gold pins. Small black dot denotes pin #1. Example known made in Phillipines and dated 7616	Ex. Rare \$50-\$200

Intel i2102A

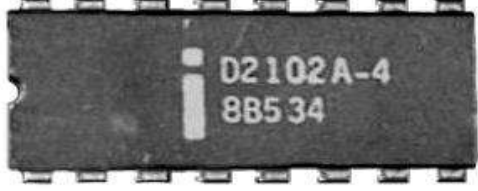

Type D Packages

Part Number	Package Description	Values
		
D2102A	Type D grey ceramic package w/tin pins. Example shown marked 'CS' for Customer Sample.	\$2-\$8
D2102A-1	Type D package	\$3-\$12
D2102A-2	Type D package	\$1.50-\$6
		
D2102A-4	Type D grey ceramic package w/tin pins	\$1.50-\$6
D2102A-6	Type D package	\$4-\$16
MD2102A-4	Type D package	\$6-\$24
MD2102A-4/B	Type D package	\$6-\$24
MD2102A-6	Type D package	\$6-\$24

Type P Packages

Part Number	Package Description	Values
		
P2102A	Type P black plastic package w/tin pins. Example shown marked 'CS' for Customer Sample.	\$1.50-\$6

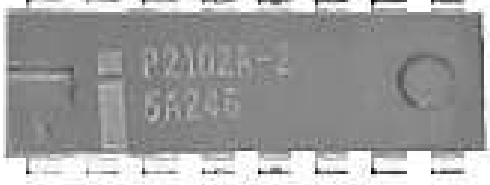
Intel i2102A

P2102A-1	Type P package	Rare \$10-\$40
		
P2102A-2	Type P grey plastic package w/tin pins. Small round indentation denotes pin #1.	\$1.50-\$6
		
P2102A-4	1. Type P grey plastic package w/tin pins. Small round indentation denotes pin #1.	\$1.50-\$6
		
P2102A-4	2. Type P black plastic package w/tin pins. Example shown marked 'CS' for Customer Sample	\$1.50-\$6
P2102A-6	Type P black package w/tin pins.	\$1.50-\$6

References

- [1] Intel (September 1972). Intel Data Catalog. No Reference to 2102A dates chip After September 1972.
- [2] Intel (August 1973). The Intel Memory Design Handbook, 2102 Specifications, Selection Guide in Back of Handbook. No reference to 2102A dates chip after Aug. 1973.
- [3] Intel (November 1974). Intel Static RAMs, 2102A Data Sheet, p. 1
- [4] Intel (November 1974). Intel Static RAMs, MC2102A-4 Data Sheet, p. 9
- [5] Intel (November 1974). Intel Static RAMs, MC2102A-6 Data Sheet, p. 11
- [6] Intel (1975). Intel Memory Design Handbook, 2102 and 2102A Family Specifications, p. PSG-1
- [7] Intel (1978). Intel Component Data Catalog, 2102A, 2102AL / 8102A-4 Data Sheet, p. 3-30
- [8] Intel (1984). A Revolution in Progress... A History of Intel to Date, 2102A introduced 1974, p. 26.

Intel i2102AL

1024-bit (1024 x 1) Static RAM w/Separate I/O 1974-75

Specifications

- 1024-bit (1024 x 1) Static RAM w/Separate I/O
- NMOS
- Single +5V Supply Voltage
- Directly TTL Compatible – All Inputs and output
- Standby Power Mode (2102AL)
- Static MOS – No Clocks or Refreshing Required
- Three-State Output – OR-Tie Capability
- Inputs Protected – All Inputs Have Protection Against Static Charge
- 16-pin Dual In-Line Package

Type	Access Time Max.	Cycle Time Max.	Power Dissipation Max. Operating/Standby	Supplies [V]
2102AL	350ns	350ns	165mW/35mW	+5
2102AL-2	250ns	250ns	325mW/42mW	+5
2102AL-4	450ns	450ns	165mW/35mW	+5

The Intel® 2102A is a 1024 word by 1-bit static random access memory element using N-channel MOS devices integrated on a monolithic array. It uses full DC stable (static) circuitry and therefore requires no clocks or refreshing to operate. The data is read out nondestructively and has the same polarity as the input data.

The 2102A is designed for microprocessor memory applications where high performance, low cost, large bit storage, and simple interfacing are important design objectives. A low standby power version (2102AL) is also available. It has all the same operating characteristics of the 2102A with the added feature of 35mW maximum power dissipation in standby and 174mW in operation.

It is directly TTL compatible in all respects: inputs, output, and a single +5 volt supply. A separate chip enable lead allows easy selection of an individual package when outputs are OR-tied.

The Intel 2102A is fabricated with N-channel silicon gate technology. This technology allows the design and production of high performance, easy-to-use MOS circuits and provides a higher functional density on a monolithic chip than either conventional MOS technology or P-channel silicon gate technology [4].

Part Numbers

Type D Packages

Part Number	Package Description	Values
D2102AL	Type D package	\$1.50-\$6
D2102AL-2	Type D package	\$1-\$4
D2102AL-4	Type D package	\$.75-\$3

Type P Packages

Part Number	Package Description	Values
P2102AL	Type P package	\$1.50-\$6



P2102AL-2	Type P black plastic package w/tin pins. Example shown marked 'CS' for Customer Sample.	\$2-\$8
-----------	---	---------



P2102AL-4	Type P grey plastic package w/tin pins.	\$2.50-\$10
-----------	---	-------------



P2102AL-4	Type P black plastic package w/tin pins.	\$1.50-\$6
-----------	--	------------

References

- [1] Intel (1975). Intel Data Catalog, 2102A, 2102AL Data Sheet, p. 2-43
- [2] Intel (1976). Intel Data Catalog, 2102AL Data Sheet, p. 2-38
- [3] Intel (1977). Intel Data Catalog, 2102AL Data Sheet, p. 2-34
- [4] Intel (1978). Intel Component Data Catalog, 2102A, 2102AL / 8102A-4 Data Sheet, p. 3-30

Intel i2104

4096-bit (4096 x 1) Dynamic RAM

1975

Specifications

- 4096-bit (4096 x 1) Dynamic RAM
- NMOS
- Highest Density 4K RAM Industry Standard 16 Pin Package
- All Inputs Including Clocks TTL Compatible
- Standard +12V, +5V, -5V Power Supply
- Three-State Output; TTL Compatible
- 16-pin Dual In-Line Package

Type	Access Time Max.	Cycle Time Max.	Power Dissipation Max. Operating/Standby	Supplies [V]
2104	350ns	500ns	-	+12, +5, -5
2104-2	250ns	375ns	-	+12, +5, -5
2104-4	300ns	425ns	-	+12, +5, -5
2104-6	-	-	-	+12, +5, -5

The Intel 2104 is based on the proven single-transistor cell design of the Intel 2107B, the highest performance 22-pin 4K MOS RAM. Like the 2107B, the 2104 chip is much smaller than other 4K RAM chips produced today.

The fastest available 16-pin 4K RAMs are also in the 2104 series. Out 2104-2 guarantees an access time of only 250ns and a cycle time of 375ns over the full 0°C to 70°C operating temperature range.

To keep system costs low, the 2104 operates on standard -5, +5, +12V power supplies, and TTL I/O levels. All inputs including clock inputs are fully TTL compatible [2].

Part Numbers

Type C Packages

Part Number	Package Description	Values
		
C2104	Type C white ceramic package w/gold cap and gold pins. Small black dot denotes pin #1.	\$15-\$60
C2104-4	Type C white ceramic package w/gold cap and gold pins. Small black dot denotes pin #1.	Rare \$25-\$100
		
C2104-6	1. Type C white ceramic package w/gold cap and gold pins. Small black dot denotes pin #1.	\$15-\$60
C2104-6	2. Type C white ceramic package w/gold cap, gold cap ground strap and gold pins. Small black dot denotes pin #1.	Rare \$25-\$100

Type D Packages

Part Number	Package Description	Values
D2104	Type D package	\$5-\$20
D2104-6	Type D package	\$5-\$20

References

[1] Intel (1975). Intel Data Catalog. No Reference to 2104.

[2] Intel (1975). Intel Memory Design Handbook, Advertisement “Intel is the way to go for 4K RAMs”, p. 4-23. Ad lists 2104, 2104-2, and 2104-4 Specifications

[3] Intel (1984). A Revolution in Progress... A History of Intel to Date, 2104 introduced 1974, p. 26.

Intel i2104A

4096-bit (4096 x 1) Dynamic RAM

1976-77

Specifications

- 4096-bit (4096 x 1) Dynamic RAM
- NMOS
- Highest Density 4K RAM Industry Standard 16 Pin Package
- Low Power 4K RAM
- All Inputs Including Clocks TTL Compatible
- $\pm 10\%$ Tolerance on All Power Supplies +12V, +5V, -5V
- Refresh Period: 2 ms
- On-Chip Latches for Addresses, Chip Select and Data In
- Simply Memory Expansion: Chip Select
- Output is Three-State, TTL Compatible; Data is Latched and Valid into Next Cycle
- Compatible with Intel® 2116 16K RAM
- 16-pin Dual In-Line Package

Type	Access Time Max.	Cycle Time Max.	Power Dissipation Max. Operating/Standby	Supplies [V]
2104A	350ns	500ns	441mW/25mW	+12, +5, -5
2104A-1	150ns	320ns	420mW/18mW	+12, +5, -5
2104A-2	200ns	320ns	384mW/18mW	+12, +5, -5
2104A-3	250ns	375ns	360mW/18mW	+12, +5, -5
2104A-4	300ns	425ns	360mW/18mW	+12, +5, -5
2104A-5	-	-	-	+12, +5, -5
2104A-9	-	-	-	+12, +5, -5
MD2104A	-	-	-	+12, +5, -5
MD2104A-2	-	-	-	+12, +5, -5
MD2104A-3	-	-	-	+12, +5, -5

The Intel® 2104A is a 4096 word by 1-bit MOS RAM fabricated with N-channel silicon gate technology for high performance and high functional density.

The efficient design of the 2104A allows it to be packaged in the industry standard 16-pin dual in-line package. The 16-pin package provides the highest system bit densities and is compatible with widely available automated handling equipment.

The use of the 16-pin package is made possible by multiplexing the 12 address bits (required to address 1 of 4096 bits) into the 2104A on 6 address input pins. The two 6 bit address words are latched into the 2104A by the two TTL clocks, Row Address Strobe (RAS) and Column Address Strobe (CAS). Non-critical clock timing requirements allow use of the multiplexing technique while maintaining high performance.

Intel i2104A

A new unique dynamic storage cell provides high speed along with low power dissipation and wide voltage margins. The memory cell requires refreshing for data retention. Refreshing is most easily accomplished by performing a read cycle at each of the 64 row addresses every 2 milliseconds.

The 2104A is designed for page mode operation, “RAS-only refreshing”, and “CAS-only deselection.” Thus it is compatible with the Intel® 2116 16K RAM [3].

Part Numbers

Type D Packages

Part Number	Package Description	Values
D2104A	Type D package	\$.50-\$2
		
D2104A-1	Type D grey ceramic package w/tin pins.	\$.75-\$3
D2104A-2	Type D grey ceramic package w/tin pins.	\$.50-\$2
D2104A-3	Type D package	\$.50-\$2
D2104A-4	Type D grey ceramic package w/tin pins.	\$.50-\$2
D2104A-5	Type D package	\$2-\$8
D2104A-9	Type D package	\$.50-\$2
MD2104A	Type D package	\$2-\$8
MD2104A-2/B	Type D package	\$1.50-\$6
MD2104A-3/B	Type D package	\$1.50-\$6

Type P Packages

Part Number	Package Description	Values
P2104A-3	Type P package	\$1-\$4
P2104A-4	Type P package	\$2-\$8

References

- [1] Intel (1975). Intel Memory Design Handbook. No reference to 2104A dates chip after 1975.
- [2] Intel (1976). Intel Data Catalog, 2104 Family Data Sheet, p. 2-44. No reference to 2104A.
- [3] Intel (1977). Intel Data Catalog, 2104A Family Data Sheet, p. 2-40.

Intel i2105

1024-bit (1024 x 1) Dynamic RAM

3rd Qtr 1973

Specifications

- 1024-bit (1024 x 1) Dynamic RAM
- NMOS
- Maximum Access Time: 80ns (2105-1); 95ns (2105); 85ns (2105-2)
- Maximum Cycle Time: 260ns (2105-1); 270ns (2105); 190ns (2105-2)
- Planar Refresh (2105, 2105-1, 2105-2)
- Invisible Refresh (2105-2)
- Standby Power: 100 μ W/Bit
- Fully Decoded: On Chip Address Decode
- Low Level Address, Data, Write Enable Inputs
- Current Sinking Output
- OR-Tie Capability
- All Inputs Have Protection Against Static Charge
- 18-pin Dual In-Line Package

Type	Access Time Max.	Cycle Time Max.	Power Dissipation Max. Operating/Standby	Supplies [V]
2105	95ns	260ns	460mW/97mW	+12, -5.2
2105-1	80ns	270ns	513mW/97mW	+12, -5.2
2105-2	85ns	190ns	540mW/97mW	+12, -5.2

The Intel® 2105 is very high speed 1024 word by 1-bit dynamic random access memories using normally off N-channel MOS devices integrated on a monolithic array.

The 2105 is designed for memory applications where very high speed, low cost, and low power dissipation are important design objectives. The planar refresh mode of operation simplifies system design and allows all 1024 memory cells to be refreshed at once.

The Intel 2105 is fabricated with N-Channel silicon gate technology. This technology allows the design and production of high performance, easy-to-use MOS circuits and provides a higher functional density on a monolithic chip than either conventional MOS technology or P-channel silicon gate technology [4, 5].

Note: The 1975 Intel Data Catalog shows different max. cycle times for 2105/2105-1 (200ns/180ns) in the summary table on pg. 2-2 than are shown in the 2105/2105-1 data sheet on pg. 2-55.

Part Numbers

Type C Packages

Part Number	Package Description	Values
		
C2105	Type C purple ceramic package w/gold cap and gold pins. Yellow triangle denotes pin #1. Example shown made in Philippines and dated 7631.	Ex. Rare \$25-\$100

Type D Packages

Part Number	Package Description	Values
D2105	Type D package	\$.75-\$3

Type P Packages

Part Number	Package Description	Values
P2105	Type P package	\$2-\$8

References

- [1] Intel (September 1972). Intel Data Catalog. No reference to 2105 dates chip after September 1972.
- [2] Intel (August 1973). The Intel Memory Design Handbook, 1103A and 2105 announced 3rd Qtr 1973, Order Form for Supplement in Back of Handbook.
- [3] Computer Design (1974). Computer Design, Intel 2105, 2105-1, and 2105-2 Specifications.
- [4] Intel (1975). Intel Data Catalog, 2105, 2105-1 Data Sheet, p. 2-55
- [5] Intel (1975). Intel Data Catalog, 2105-2 Data Sheet, p. 2-63
- [6] Intel (1975). Intel Memory Design Handbook, 2105 Family Specifications, p. PSG-1
- [7] Intel (1984). A Revolution in Progress... A History of Intel to Date, 2105 introduced 1971, p. 26. Suspect this date is early given that the 2105 does not appear in the 1972 Intel Data Catalog.

Intel i2106A

4096-bit (4096 x 1) Dynamic RAM

1974

Specifications

- 4096-bit (4096 x 1) Dynamic RAM
- NMOS
- 22-pin Dual In-Line Package

Type	Access Time Max.	Cycle Time Max.	Power Dissipation Max. Operating/Standby	Supplies [V]
2106A	-	-	-	-
2106A-6	-	-	-	-

I suspect this chip was too new to be included in Intel's 1975 data catalog and I suspect it was discontinued before Intel's 1977 data catalog went to press, which would explain why there's no reference to it in Intel's 1977 data catalog.

No data sheet known to exist for this part.

Intel i2106A

Part Numbers

Type C Packages

Part Number	Package Description	Values
		
C2106A	Type C purple ceramic package w/black cap and tins. Example shown made in Malaysia and dated 7716.	Rare \$40-\$160

Type P Packages

Part Number	Package Description	Values
P2106A-6	Type P package	Rare \$12-\$48

References

[1] Intel (1975). Intel Data Catalog. No reference to 2106. Suspect that 2106 was discontinued by 1975.

[2] Intel (1975). Intel Memory Design Handbook. No reference to 2106. Suspect that 2106 was discontinued by 1975.

[3] Hearst (1977). IC Master. No reference to 2106. Suspect that 2106 was discontinued by 1977.

[5] Intel (1984). A Revolution in Progress... A History of Intel to Date, 2106 introduced 1974, p. 26.

Intel i2107

4096-bit (4096 x 1) Dynamic RAM

July 1973

Specifications

- 4096-bit (4096 x 1) Fully Decoded Dynamic RAM
- NMOS
- Low Cost Per Bit
- Low Standby Power - Typical 7 μ W/bit
- Easy System Interface
- Only One High Voltage Input Signal – Chip Enable
- All Other Inputs are TTL Compatible
- Address Registers Incorporated on the Chip
- Simple Memory Expansion – Chip Select Input Lead
- Fully Decoded – On Chip Address Decode
- Output is Three State and Compatible with Low Power TTL Gates
- 22-pin Dual In-Line Package

Type	Access Time Max.	Cycle Time Max.	Power Dissipation Max. Operating/Standby	Supplies [V]
2107	600ns	-	-	+12, +5, -5
2107-2	-	-	-	+12, +5, -5
2107-4	-	-	-	+12, +5, -5

The 2107 is a 4096 word by 1 bit dynamic RAM. It was designed for memory applications where very low cost and large bit storage are important design objectives. The 2107 uses dynamic circuitry which reduces the operating and standby power dissipation.

Reading information from the memory is non-destructive. Refreshing is accomplished by performing one read cycle on each of the 64 row addresses. Each row address must be refreshed every one millisecond. The memory is refreshed whether Chip Select is a logic one or a logic zero.

The 2107 is fabricated with n-channel silicon gate technology. This low voltage technology allows the design and manufacture of devices using minimum size transistors that have the same performance as devices using much larger transistors [1].

Part Numbers

Type C Packages

Part Number	Package Description	Values
C2107	Type C package	Ex. Rare (0 Known) \$40-\$160
C2107-2	Type C package	Ex. Rare (0 Known) \$40-\$160
C2107-4	Type C package	Ex. Rare (0 Known) \$40-\$160

References

- [1] Intel (September 1972). Intel Data Catalog. No reference to 2107 dates chip after September 1972.
- [2] Intel (August 1973). The Intel Memory Design Handbook, 2107 announced in July 1973, p. Order Form for Supplement in Back of Handbook.
- [3] Intel (October 1973). Intel Data Catalog, 2107 Data Sheet, p. 2-45.
- [4] Intel (1975). Intel Data Catalog, 2107A Data Sheet, p. 2-67. No reference to 2107.
- [5] Intel (1984). A Revolution in Progress... A History of Intel to Date, 2107 introduced 1972, p. 26.

Intel i2107A

4096-bit (4096 x 1) Dynamic RAM

1973-74

Specifications

- 4096-bit (4096 x 1) Fully Decoded Dynamic RAM
- NMOS
- Low Cost Per Bit
- Low Standby Power
- Easy System Interface
- Only One High Voltage Input Signal – Chip Enable
- Low Level Address, Data, Write Enable, Chip Select Inputs
- Address Registers Incorporated on the Chip
- Simple Memory Expansion: Chip Select Input Lead
- Fully Decoded: On Chip Address Decode
- Output is Three-State and TTL Compatible
- 22-pin Dual In-Line Package

Type	Access Time Max.	Cycle Time Max.	Power Dissipation Max. Operating/Standby	Supplies [V]
2107A	300ns	700ns	458mW/10mW	+12, +5, -5
2107A-1	280ns	550ns	516mW/16mW	+12, +5, -5
2107A-4	350ns	840ns	450mW/10mW	+12, +5, -5
2107A-5	420ns	970ns	376mW/11mW	+12, +5, -5
2107A-8	420ns	970ns	376mW/11mW	+12, +5, -5

The Intel 2107A is a 4096 word by 1-bit dynamic N-channel MOS RAM. It was designed for memory applications where very low cost and large bit storage are important design objectives. The 2107A uses dynamic circuitry, which reduces the operation and standby power dissipation.

Reading information from the memory is non-destructive. Refreshing is accomplished by performing one read cycle on each of the 64 row addresses. Each row address must be refreshed every two milliseconds. The memory is refreshed whether Chip Select is a logic one or a logic zero.

The 2107A is fabricated with N-channel silicon gate technology. This technology allows the design and production of high performance, easy-to-use MOS circuits and provides a higher functional density on a monolithic chip than other MOS technologies [2].

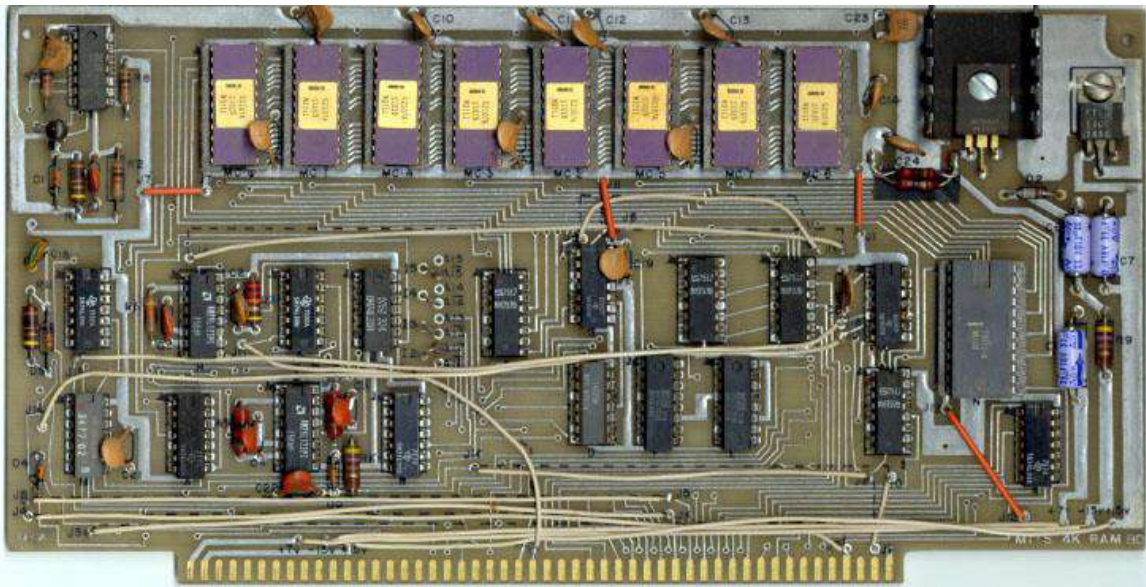

MITS Altair 8800 4K RAM Board



MITS Altair 8800 4K Ram Board, Rev 0 with 8 Intel C2107A DRAMs

Part Numbers

Type C Packages

Part Number	Package Description	Values
		
C2107A	1. Type C grey ceramic package w/gold cap and gold pins.	\$15-\$60
		
C2107A	2. Type C purple ceramic package w/gold cap and gold pins.	\$15-\$60
C2107A-1	Type C package	\$15-\$60
C2107A-4	Type C package	\$15-\$60
C2107A-5	Type C package	\$15-\$60
		
C2107A-8	Type C purple ceramic package w/gold cap and gold pins.	\$15-\$60

References

[1] Intel (1975). Intel Data Catalog, 2107A-8 Data Sheet, p. 2-79

[2] Intel (1977). Intel Component Data Catalog, 2107A Family Data Sheet, p. 2-48

Intel i2107B

4096-bit (4096 x 1) Dynamic RAM

1974-75

Specifications

- 4096-bit (4096 x 1) Fully Decoded Dynamic RAM
- NMOS
- Low Cost Per Bit
- Low Standby Power
- Easy System Interface
- Only One High Voltage Input Signal – Chip Enable
- TTL Compatible – All Address, Data, Write Enable, Chip Select Inputs
- Refresh Period – 2ms for 2107B, 2107B-4, 1ms for 2107B-5 @ 70°C
- Address Registers Incorporated on the Chip
- Simple Memory Expansion: Chip Select Input Lead
- Fully Decoded: On Chip Address Decode
- Output is Three-State and TTL Compatible
- 22-pin Dual In-Line Package

Type	Access Time Max.	Cycle Time Max.	Power Dissipation Max. Operating/Standby	Supplies [V]
2107B (S1109)	200ns	400ns	648mW/12mW	+12, +5, -5
2107B-2	220ns	470ns	-	+12, +5, -5
2107B-4 (S1110)	270ns	470ns	648mW/13mW	+12, +5, -5
2107B-5	300ns	590ns	648mW/5mW	+12, +5, -5
2107B-6 (S1155)	350ns	800ns	840mW/25mW	+12, +5, -5

The Intel 2107B is a 4096 word by 1-bit dynamic N-channel MOS RAM. It was designed for memory applications where very low cost and large bit storage are important design objectives. The 2107B uses dynamic circuitry, which reduces the operation and standby power dissipation.

Reading information from the memory is non-destructive. Refreshing is most easily accomplished by performing one read cycle on each of the 64 row addresses. Each row address must be refreshed every two milliseconds. The memory is refreshed whether Chip Select is a logic one or a logic zero.

The 2107B is fabricated with N-channel silicon gate technology. This technology allows the design and production of high performance, easy-to-use MOS circuits and provides a higher functional density on a monolithic chip than other MOS technologies. The 2107B uses a single transistor cell to achieve high speed and low cost. It is a replacement for the 2107A [3].

Part Numbers

Type C Packages

Part Number	Package Description	Values
C2107B	Type C package	\$15-\$60
		
C2107B-4	1. Type C brown ceramic package w/gold cap, gold pins, and gold cap ground strap. Black dot denotes pin #1.	\$15-\$16
		
C2107B-4	2. Type C purple ceramic package w/gold cap and gold pins	\$15-\$60
		
C2107B-4	3. Type C purple ceramic package w/silver cap and tin pins	\$15-\$60
		
C2107B-5	Type C reddish brown ceramic package w/gold cap, gold cap ground strap, and gold pins. Gold dot denotes pin #1.	Rare \$25-\$100

Intel i2107B

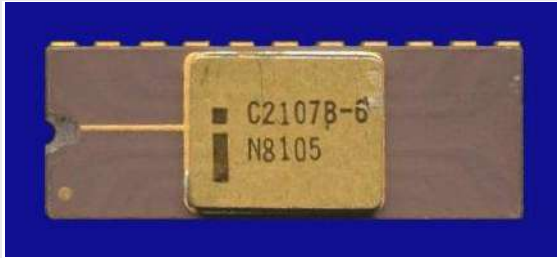

C2106B-6	1. Type C reddish brown ceramic package w/dark brown traces, gold cap, gold cap ground strap, and gold pins. Gold dot denotes pin #1.	Rare \$25-\$100
----------	---	--------------------



C2106B-6	2. Type C purple ceramic package w/gold cap and gold pins.	\$15-\$60
----------	--	-----------

Type B Packages

Part Number	Package Description	Values
B2107B	Type B package	\$8-\$32
B2107B-4	Type B package	\$8-\$32
B2107B-6	Type B package	\$8-\$32

References

[1] Intel (December, 1974). Intel 2107B Data Sheet, p. 3

[2] Intel (1975). Intel Memory Design Handbook, 2107B access times, p. 1-2. “In 1973 Intel introduces the 2107”, p. 1-2. Advertisement, “Intel’s 2107B. The new 4K RAM with the edge on speed, price and delivery”, p. 2-27

[3] Intel (1977). Intel Data Catalog, 2107B Family Data Sheet, p. 2-54

Intel i2107C

4096-bit (4096 x 1) Dynamic RAM

1977-78

Specifications

- 4096-bit (4096 x 1) Fully Decoded Dynamic RAM
- NMOS
- Direct Replacement for Industry Standard 22-Pin 4K RAMs
- Low Operating Power
- Only One High Voltage Input Signal – Chip Enable
- 150 ns Access Time (2107C-1)
- $\pm 10\%$ Tolerance on all Power Supplies
- Output is Three-State and TTL Compatible
- TTL Compatible – All Address, Data, Write Enable, Chip Select Inputs
- Refresh Period 2 ms
- 22-pin Dual In-Line Package

Type	Access Time Max.	Cycle Time Max.	Power Dissipation Max. Operating/Standby	Supplies [V]
2107C	250ns	430ns	396mW/2.6mW	+12, +5, -5
2107C-1	150ns	380ns	462mW/2.6mW	+12, +5, -5
2107C-2	200ns	400ns	436mW/2.6mW	+12, +5, -5
2107C-4	300ns	470ns	396mW/2.6mW	+12, +5, -5

The Intel® 2107C is a 4096-word by 1-bit dynamic N-channel MOS RAM. It was designed for memory applications where very low cost and large bit storage are important design objectives. A new unique dynamic storage cell provides high speed and wide operating margins. The 2107C uses dynamic circuitry, which reduces the standby power dissipation.



Reading information for the memory is non-destructive. Refreshing is most easily accomplished by performing one read cycle on each of 64 row addresses. Each row address must be refreshed every two milliseconds. The memory is refreshed whether Chip Select is a logic one or a logic zero.

The 2107C is fabricated with N-channel silicon gate technology. This technology allows the design and production of high performance, easy-to-use MOS circuits and provides a higher functional density on a monolithic chip than other MOS technologies. The 2107C is a replacement for the 2107A, 2107B and other industry standard 22-pin 4K Rams [2].

Intel i2107C

Part Numbers

Type D Packages

Part Number	Package Description	Values
 A black, rectangular ceramic package with a notch on the left side. The top surface is marked with the Intel logo, 'D2107C', and '74A96'. It has several pins along the bottom edge.		
D2107C	Type D grey ceramic package w/tin pins.	\$1-\$4
D2107C-1	Type D package	Rare \$10-\$40
 A black, rectangular ceramic package with a notch on the left side. The top surface is marked with the Intel logo, 'D2107C-2', and '68324'. It has several pins along the bottom edge.		
D2107C-2	Type D grey ceramic package w/tin pins.	\$1.50-\$6
D2107C-4	Type D package	\$2-\$8

Type P Packages

Part Number	Package Description	Values
 A black, rectangular plastic package with a notch on the left side. The top surface is marked with the Intel logo, 'P2107C', and '2D319'. It has several pins along the bottom edge.		
P2107C	Type P black plastic package w/tin pins. Small round indentation denotes pin #1.	\$.75-\$3

Intel i2107C

P2107C-1	Type P package	Rare (0 Known) \$\$\$
P2107C-2	Type P package	\$1.50-\$6
P2107C-4	Type P package	\$2-\$8

References

- [1] Intel (1977). Intel Data Catalog. No reference to 2107C dates chip after 1977.
- [2] Intel (1978). Intel Component Data Catalog, 2107C Family Data Sheet, p. 3-60

Intel i2108

8192-bit (8192 x 1) Dynamic RAM

1976-77

Specifications

- 8192-bit (8192 x 1) Dynamic RAM
- NMOS
- 8K RAM in Industry Standard 10-Pin Package
- Low Standby Power
- All Inputs Including Clocks TTL Compatible
- Standard Power Supplies +12V, +5V, -5V
- Only 64 Refresh Cycles Required Every 2 ms
- On-Chip Input Latches
- Output is Three-State, TTL Compatible; Data is Latched and Valid into Next Cycle
- Fully Compatible with 4K and 16K Dynamic RAMs
- 16-pin Dual In-Line Package

Type	Access Time Max.	Cycle Time Max.	Power Dissipation Max. Operating/Standby	Supplies [V]
2108	-	-	-	+12, +5, -5
2108-2	200ns	350ns	828mW/24mW	+12, +5, -5
2108-4	300ns	425ns	780mW/24mW	+12, +5, -5





The Intel® 2108 is a 8K Dynamic MOS RAM organized as 8192 words by 1-bit. The 2108 employs the same masks and highly reliable, production-proven two layer polysilicon N-MOS technology as the Intel® 2116 16K RAM. The 2116 is organized as two 8K RAMs on a single silicon die. Each of these 8K RAMs contains its own row decoders, sense amplifiers, and storage cells. The 2108 is fully tested to insure that one 8K RAM meets all AC and DC specifications.

The 2108 is available as either the upper or lower half of the 2116. The 2108 is packaged in the industry standard 16-pin DIP which is compatible with widely available automated handling equipment and facilitates easy upgrading from 2104A-type 4K RAM Systems and up to 2116-type 16K RAM Systems.

As in the 2104A-type 4K RAM and 2116-type 16K RAM, the 2108 has non-critical clock timing requirements which allow use of addressing multiplexing while maintaining high performance [2].

Part Numbers

Type C Packages

Part Number	Package Description	Values
		
C2108	Type C grey ceramic package w/black cap and tin pins. Example shown marked 'ES' for Engineering Sample	Rare \$25-\$100
		
C2108-2	Type C grey ceramic package w/black cap and tin pins.	\$3-\$12
		
C2108-4	1. Type C grey ceramic package w/black cap and tin pins.	\$8-\$32
		
C2108-4	2. Type C purple ceramic package w/black cap and tin pins.	\$8-\$32

References

- [1] Intel (1977). Intel Data Catalog, 2108-2/2108-4 Data Sheet, p. 2-60.
- [2] Intel (1978). Intel Component Data Catalog, 2108-2/2108-4 Data Sheet, p. 3-65.

Intel i2109

8192-bit (8192 x 1) Dynamic RAM

1977-78

Specifications

- 8192-bit (8192 x 1) Dynamic RAM
- NMOS
- Three-State Output
- $\pm 10\%$ Tolerance on All Power Supplies: +12V, +5V, -5V
- Low Power: 462mW Max. Operating, 20mW Max. Standby
- All Inputs, Including Clocks, TTL Compatible
- Non-Latched Output is Three-State, TTL Compatible
- RAS Only Refresh
- 64 Refresh Cycles Required Every 2ms
- Page Mode Capability
- CAS Controlled Output Allows Hidden Refresh
- 16-pin Dual In-Line Package

Type	Access Time Max.	Cycle Time Max.	Power Dissipation Max. Operating/Standby	Supplies [V]
2109-3	200ns	375ns	462mW/20mW	+5, -5, +12
2109-4	250ns	410ns	436mW/20mW	+5, -5, +12

The Intel® 2109 is an 8,192 word by 1-bit Dynamic MOS RAM which is pin compatible with the industry standard 16K dynamic RAMs. The 2109 is manufactured with the same masks as the Intel® 2117 and is fabricated with Intel's standard two layer polysilicon NMOS technology – a production proven process for high reliability, high performance, and high storage density. The 2109 is organized as two 8K arrays separated by sense amplifiers and column decoders. The selected 8K is tested for all of the A.C. and D.C. characteristics necessary to permit the 2109 to be considered a functionally compatible 8K version of the 16K device.

The 2109 uses a single transistor dynamic storage cell and advanced dynamic circuitry to achieve high speed with low power dissipation. The circuit design minimizes the current transients typical of dynamic RAM operation. These low current transients and $\pm 10\%$ tolerance on all power supplies contribute to the high noise immunity of the 2109 in a system environment.

The 2109 is available as either the upper or lower half of the 2117. The 2109 is packaged in the industry standard 16-pin DIP which is compatible with widely available automated handling equipment [2].

Part Numbers

Type C Packages

Part Number	Package Description	Values
		
C2109-3	1. Type C grey ceramic package w/gold cap, offset gold cap ground strap, and gold pins.	\$5-\$20
		
C2109-3	2. Type C purple ceramic package w/gold cap, offset gold cap ground strap, and gold pins.	\$5-\$20
		
C2109-3	3. Type C purple ceramic package w/gold cap and gold pins	\$5-\$20
		
C2109-3	4. Type C purple ceramic package w/gold cap, offset gold cap ground strap and gold pins	\$5-\$20

Intel i2109

		
C2109-4	1. Type C grey ceramic package w/gold cap, offset gold cap ground strap and gold pins	\$5-\$20
		
C2109-4	2. Type C grey ceramic package w/gold cap and gold pins	\$5-\$20
		
C2109-4	3. Type C purple ceramic package w/gold cap, offset gold cap ground strap, and gold pins.	\$5-\$20
		
C2109-4	4. Type C purple ceramic package w/gold cap and gold pins.	\$5-\$20

Intel i2109

Type D Packages

Part Number	Package Description	Values
D2109-3	Type D package	\$1.50-\$6
		
D2109-4	Type D grey ceramic package w/tin pins.	\$1.25-\$5

References

[1] Intel (1978). Intel Component Data Catalog, 2109 Family Data Sheet, p. 3-73. Dates 2109 Family to 1978.

[2] Intel (1980). Intel Component Data Catalog, 2109 Family Data Sheet, p. 1-2

Intel i2111

1024-bit (256 x 4) Static RAM w/Common I/O

1974

Specifications

- 1024-bit (256 x 4) Static RAM w/Common I/O
- NMOS
- Common Data Input and Output
- Single +5V Supply Voltage
- Directly TTL Compatible: All Inputs and Output
- Static MOS: No Clocks or Refreshing Required
- Access Time: 0.5 to 1 μ sec Max.
- Simple Memory Expansion: Chip Enable Input
- Fully Decoded: On Chip Address Decode
- Inputs Protected: All Inputs Have Protection Against Static Charge
- Low Power: Typically 150mW
- Three-State Output: OR-Toe Capability
- 18-pin Dual In-Line Package

Type	Access Time Max.	Cycle Time Max.	Power Dissipation Max. Operating/Standby	Supplies [V]
2111	1 μ s	1 μ s	350mW	+5
2111-1	500ns	500ns	350mW	+5
2111-2	650ns	650ns	350mW	+5

The Intel® 2111 is a 256 word by 4-bit static random access memory element using normally off N-channel MOS devices integrated on a monolithic array. It uses full DC stable (static) circuitry and therefore requires no clocks or refreshing to operate. The data is read out nondestructively and has the same polarity as the input data. Common input/output pins are provided.

The 2111 is designed for memory applications in small systems where high performance, low cost, large bit storage, and simple interfacing are important design objectives.

It is directly TTL compatible in all respects: inputs, outputs, and a single +5V supply. Separate chip enable (CE) leads allow easy selection of an individual package when outputs are OR-tied.

The Intel 2111 is fabricated with N-channel silicon gate technology. This technology allows the design and production of high performance, easy-to-use MOS circuits and provides a higher functional density on a monolithic chip than either conventional MOS technology or P-channel silicon gate technology.

Intel's silicon gate technology also provides excellent protection against contamination. This permits the use of low cost silicone packaging [4].

Part Numbers

Type C Packages

Part Number	Package Description	Values
C2111	Type C package	Ex. Rare (0 Known) \$50-\$200
		
C2111-1	1. Type C brown ceramic package w/gold cap, gold cap ground strap, and gold pins. Small gold or black dot denotes pin #1.	Ex. Rare \$50-\$200
		
C2111-1	2. Type C purple ceramic package w/gold cap and gold pins.	Ex. Rare (1 Known) \$50-\$200

Type P Packages

Part Number	Package Description	Values
P2111	Type P package	Rare \$10-\$40
P2111-1	Type P package	Rare \$10-\$40

References

- [1] Intel (September 1972). Intel Data Catalog. No reference to 2111 dates chip after September 1972.
- [2] Intel (August 1973). The Intel Memory Design Handbook. No reference to 2111 dates chip after August 1973.
- [3] Intel (November 1974). Intel Static RAMs, Preliminary 2111, 2111-1, 2111-2 Data sheet, p. 25
- [4] Intel (1975). Intel Data Catalog, 2111, 2111-1, 2111-2 Data Sheet, p. 2-93

Intel i2111A

1024-bit (256 x 4) Static RAM w/Common I/O

1976

Specifications

- 1024-bit (256 x 4) Static RAM w/Common I/O
- NMOS
- Common Data Input and Output
- Single +5V Supply Voltage
- Directly TTL Compatible: All Inputs and Output
- Static MOS: No Clocks or Refreshing Required
- Simple Memory Expansion: Chip Enable Input
- Fully Decoded: On Chip Address Decode
- Inputs Protected: All Inputs Have Protection Against Static Charge
- Low Power: Typically 150mW
- Three-State Output: OR-Tie Capability
- 18-pin Dual In-Line Package

Type	Access Time Max.	Cycle Time Max.	Power Dissipation Max. Operating/Standby	Supplies [V]
2111A	350ns	350ns	300mW	+5
2111A-2	250ns	250ns	350mW	+5
2111A-4	450ns	450ns	300mW	+5
M2111A	450ns	450ns	-	+5

The Intel® 2111A is a 256 word by 4-bit static random access memory using N-channel MOS devices integrated on a monolithic array. It uses fully DC stable (static) circuitry and therefore requires no clocks or refreshing to operate. The data is read out nondestructively and has the same polarity as the input data. Common input/output pins are provided.

The 2111A is designed for memory applications in small systems where high performance, low cost, large bit storage, and simple interfacing are important design objectives.

It is directly TTL compatible in all respects: inputs, outputs, and a single +5V supply. Separate chip enable leads allow easy selection of an individual package when outputs are OR-tied.

The Intel® 2111A is fabricated with N-channel silicon gate technology. This technology allows the design and production of high performance, easy-to-use MOS circuits and provides a higher functional density on a monolithic chip than either conventional MOS technology or P-channel silicon gate technology.

Intel's silicon gate technology also provides excellent protection against contamination. This permits the use of low cost plastic packaging [4].

Part Numbers

Type C Packages

Part Number	Package Description	Values
C2111A	Type C package	Rare \$25-\$100
C2111A-4	Type C package	\$15-\$60

Type D Packages

Part Number	Package Description	Values
D2111A	Type D package	\$8-\$32
D2111A-2	Type D grey ceramic package w/tin pins.	\$5-\$20



D2111A-4	Type D grey ceramic package w/tin pins.	\$5-\$20
MD2111A/B	Type D package	Rare \$10-\$40

Type P Packages

Part Number	Package Description	Values
P2111A	Type P black plastic package w/tin pins.	\$2-\$8
P2111A-2	Type P package	\$1.50-\$6

Intel i2111A



P2111A-4	Type P black plastic package w/tin pins.	\$1-\$4
----------	--	---------

References

- [1] Intel (1975). Intel Memory Design Handbook, 2111 family access times, p. 7-18 (PSG-1). No reference to 2111A dates 2111A after 1975.
- [2] Intel (1975). Intel Data Catalog, 2111 Data Sheet, p. 2-93. No reference to 2111A.
- [3] Intel (1976). Intel Data Catalog, 2111A Preliminary Data Sheet, p. 2-64.
- [4] Intel (1978). Intel Component Data Catalog, 2111A / 8111A-4 Data Sheet, p. 3-85.

Intel i2112

1024-bit (256 x 4) Static RAM w/Common I/O

1974

Specifications

- 1024-bit (256 x 4) Static RAM w/Common I/O
- NMOS
- Common Data Input and Output
- Single +5V Supply Voltage
- Directly TTL Compatible: All Inputs and Output
- Static MOS: No Clocks or Refreshing Required
- Access Time: 0.65 to 1 μ sec Max.
- Simple Memory Expansion: Chip Enable Input
- Fully Decoded: On Chip Address Decode
- Inputs Protected: All Inputs Have Protection Against Static Charge
- Low Power: Typically 150mW
- Three-State Output: OR-Toe Capability
- 16-pin Dual In-Line Package

Type	Access Time Max.	Cycle Time Max.	Power Dissipation Max. Operating/Standby	Supplies [V]
2112	1 μ s	1 μ s	350mW	+5
2112-1	500ns	500ns	350mW	+5
2112-2	650ns	650ns	350mW	+5

The Intel® 2112 is a 256 word by 4-bit static random access memory element using normally off N-channel MOS devices integrated on a monolithic array. It uses full DC stable (static) circuitry and therefore requires no clocks or refreshing to operate. The data is read out nondestructively and has the same polarity as the input data. Common input/output pins are provided.

The 2112 is designed for memory applications in small systems where high performance, low cost, large bit storage, and simple interfacing are important design objectives.

It is directly TTL compatible in all respects: inputs, outputs, and a single +5V supply. A separate chip enable (CE) lead allows easy selection of an individual package when outputs are OR-tied.

The Intel 2112 is fabricated with N-channel silicon gate technology. This technology allows the design and production of high performance, easy-to-use MOS circuits and provides a higher functional density on a monolithic chip than either conventional MOS technology or P-channel silicon gate technology.

Intel's silicon gate technology also provides excellent protection against contamination. This permits the use of low cost silicone packaging [3].

2112 vs. 2111

The 2112 is very similar to the 2111. The major difference is that that no output disable is available and one (instead of two) chip enables is used.

Part Numbers

Type C Packages

Part Number	Package Description	Values
		
C2112	Type C white ceramic package w/grey traces, gold cap, gold cap ground strap and gold pins. Gold dot denotes pin #1.	Ex. Rare (1 Known) \$50-\$200

Type P Packages

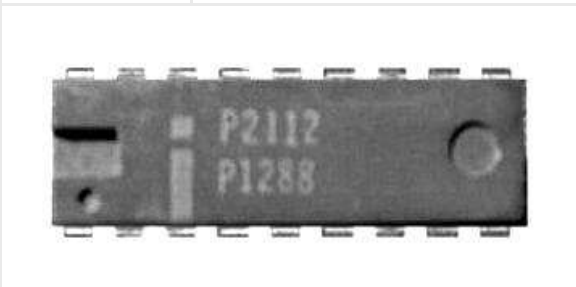
Part Number	Package Description	Values
		
P2112	Type P grey plastic package w/tin pins.	\$8-\$32

References

[1] Intel (August 1973). The Intel Memory Design Handbook. No reference to 2112 dates chip after August 1973.

[2] Intel (November 1974). Intel Static RAMs, Preliminary 2112, 2111-2 Data sheet, p. 29

[3] Intel (1975). Intel Data Catalog, 2112, 2112-2 Data Sheet, p. 2-97

Intel i2112A

1024-bit (256 x 4) Static RAM w/Common I/O

1976

Specifications

- 1024-bit (256 x 4) Static RAM w/Common I/O
- NMOS
- Single +5V Supply Voltage
- Directly TTL Compatible: All Inputs and Outputs
- Static MOS: No Clocks or Refreshing Required
- Simple Memory Expansion: Chip Enable Input
- Fully Decoded: On Chip Address Decode
- Inputs Protected: All Inputs Have Protection Against Static Charge
- Low Power: Typically 150mW
- Three-State Output: OR-Tie Capability
- 16-pin Dual In-Line Package

Type	Access Time Max.	Cycle Time Max.	Power Dissipation Max. Operating/Standby	Supplies [V]
2112A	350ns	350ns	300mW	+5
2112A-2	250ns	250ns	350mW	+5
2112A-4	450ns	450ns	300mW	+5

The Intel® 2112A is a 256 word by 4-bit static random access memory element using N-channel MOS devices integrated on a monolithic array. It uses fully DC stable (static) circuitry and therefore requires no clocks or refreshing to operate. The data is read out nondestructively and has the same polarity as the input data. Common input/output pins are provided.

The 2112A is designed for memory applications in small systems where high performance, low cost, large bit storage, and simple interfacing are important design objectives.

It is directly TTL compatible in all respects: inputs, outputs, and a single +5V supply. A separate chip enable lead allows easy selection of an individual package when outputs are OR-tied.

The Intel® 2112A is fabricated with N-channel silicon gate technology. This technology allows the design and production of high performance, easy-to-use MOS circuits and provides a higher functional density on a monolithic chip than either conventional MOS technology or P-channel silicon gate technology [1].

2112A vs. 2111A

The 2112A is very similar to the Intel 2111A. The major difference is that no output disable is available and one (instead of two) chip enables is used.

Part Numbers

Type C Packages

Part Number	Package Description	Values
C2112A	Type C package	Rare \$20-\$80
C2112A-4	Type C package	Rare \$20-\$80

Type D Packages

Part Number	Package Description	Values
D2112A	Type D package	\$5-\$20
D2112A-4	Type D package	\$5-\$20

Type P Packages

Part Number	Package Description	Values
P2112A	Type P package	Rare (0 Known) \$\$\$
P2112A-4	Type P package	Rare \$5-\$20

References

- [1] Intel (1975). Intel Memory Design Handbook, 2112 family access times, p. 7-18 (PSG-1). No reference to 2112A dates 2112A after 1975.
- [2] Intel (1975). Intel Data Catalog, 2112 Data Sheet, p. 2-97. No reference to 2112A.
- [3] Intel (1976). Intel Data Catalog, 2112A Preliminary Data Sheet, p. 2-72.
- [4] Intel (1978). Intel Component Data Catalog, 2112A Data Sheet, p. 3-89.

Intel i2113

2048-bit (512 x 4) Static RAM

1976

Specifications

- 2048-bit (512 x 4) Static RAM
- NMOS
- Three-State Output
- 18-pin Dual In-Line Package

Type	Access Time Max.	Cycle Time Max.	Power Dissipation Max. Operating/Standby	Supplies [V]
2113	450ns	450ns	-	+5



This is a 2114 with defectives bits. It was used as a 512x4 static memory.

The AOL and AOH suffixes are used to select the pair or impair bit array via Address 0 (Low or High). It was used only in the Intel products like the SBC's and the PROMPT48.

This chip is shown on the Intel SBC 80/20 Single Board Computer on the front over of an Intel SBC 80/20 Single Board Computer brochure dated 1976.

Part Numbers

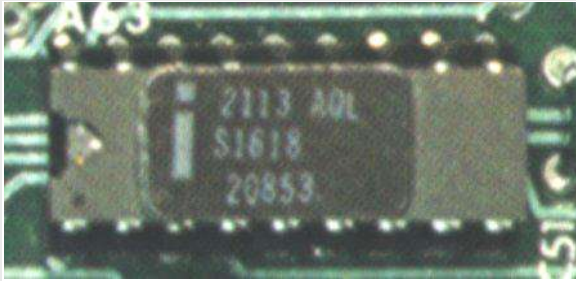
Type C Packages

Part Number	Package Description	Values
		
2113 AOL	Type C grey ceramic package w/black cap and tin pins. Photo from Intel SBC 80/20 Single Board Computer brochure, ca. 1976.	Rare \$20-\$80
		
C2113 AOL	Type C grey ceramic package w/black cap and tin pins	Rare \$20-\$80
C2113 AOH	Type C grey ceramic package w/black cap and tin pins	Rare \$20-\$80

Type P Packages

Part Number	Package Description	Values
		
P2113 AOH	Type P package	Rare \$10-\$40

References

- [1] Intel (1975). Intel Memory Design Handbook. No reference to 2113.
- [2] Intel (1977). Intel Data Catalog. No reference to 2113.
- [3] Intel (1984). A Revolution in Progress... A History of Intel to Date. No reference to 2113.

Intel i2114

4096-bit (1024 x 4) Static RAM w/Common I/O 1976

Specifications

- 4096-bit (1024 x 4) Static RAM w/Common I/O
- NMOS
- Identical Cycle and Access Times
- Single +5V Supply
- No Clock or Timing Strobe Required
- Completely Static Memory
- Directly TTL Compatible: All Inputs and Outputs
- Common Data Input and Output Using Three-State Outputs
- Pin-Out Compatible with 3605 and 3625 Bipolar PROMs
- 18-pin Dual In-Line Package

Type	Access Time Max.	Cycle Time Max.	Power Dissipation Max. Operating/Standby	Supplies [V]
2114	450ns	450ns	525mW	+5
2114-2	200ns	200ns	525mW	+5
2114-3	300ns	300ns	525mW	+5
M2114	450ns	450ns	575mW	+5
M2114-3	300ns	300ns	575mW	+5

The Intel® 2114 is a 4096-bit static Random Access Memory organized as 1024 words by 4-bits using N-channel Silicon-Gate MOS technology. It uses fully DC stable (static) circuitry throughout – in both the array and the decoding – and therefore requires no clocks or refreshing to operate. Data access is particularly simple since address setup times are not required. The data is read out nondestructively and has the same polarity as the input data. Common data input/output pins are provided.

The 2114 is designed for memory applications where high performance, low cost, large bit storage, and simple interfacing are important design objectives. The 2114 is placed in an 18-pin package for the highest possible density.

It is directly TTL compatible in all respects: inputs, outputs, and a single +5V supply. A separate Chip Select (CS) lead allows easy selection of an individual package when output are OR-tied.

The 2114 is fabricated with Intel's N-channel Silicon-Gate technology – a technology providing excellent protection against contamination permitting the use of low cost plastic packaging [1].

History

The 2114 was a microcomputer-compatible (slow) version of the already widely used 2148/49, which was a fast (35-70ns) equivalent to the 2114.

The 2114 was used in a number of popular coin operated video games like Atari's Asteroids, Battle zone, Space dual, Tempest, Dig-Dug, and Bally/Midway's TRON, etc.

Also used in PAC-MAN and Ms. PC-MAN.

The 2114 SRAM was also used in the GCE Vectrex home video game. The GCE Vectrex, introduced in 1982, was the first (and last) home system to use vector-based graphics. The Vectrex, which came with an integrated 9 inch CRT, was the only home game system that could accurately reproduce the vector graphics used popular coin-operated video games like Atari's Asteroids. The Vectrex used two 2114 SRAM chips.

Part Numbers

Type C Packages

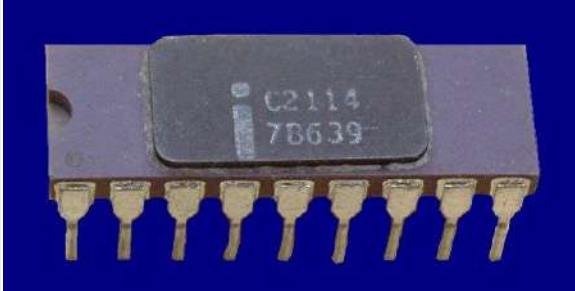
Part Number	Package Description	Values
		
C2114	1. Type C grey ceramic package w/black cap and tin pins.	\$15-\$60
		
C2114	2. Type C purple ceramic package w/black cap and tin pins.	\$15-\$60
C2114-2	Type C package	\$15-\$60
MC2114/B	Type C package	Rare \$25-\$100

Type D Packages

Part Number	Package Description	Values
D2114	Type D package	\$.50-\$2
D2114-2	Type D package	\$2-\$8
D2114-3	Type D package	\$.50-\$2
MD2114	Type D package	\$2-\$8
MD2114/B	Type D grey ceramic package w/tin pins.	\$2-\$8
MD2114-3/B	Type D package	\$3-\$12

Intel i2114

Type P Packages

Part Number	Package Description	Values
P2114	Type P black plastic package w/tin pins. Small round indentation denotes pin #1.	\$1-\$4
 A photograph of an Intel P2114-2 chip. The chip is a black plastic package with tin pins along the bottom edge. It features a small round indentation on the right side, which denotes pin #1. The text 'P2114-2' and '4C504' is printed on the top surface of the chip.		
P2114-2	Type P black plastic package w/tin pins. Small round indentation denotes pin #1.	\$1.50-\$6
 A photograph of an Intel P2114-3 chip. The chip is a black plastic package with tin pins along the bottom edge. It features a small round indentation on the right side, which denotes pin #1. The text 'P2114-3' and '6C003' is printed on the top surface of the chip.		
P2114-3	Type P black plastic package w/tin pins. Small round indentation denotes pin #1.	\$1.50-\$6

References

- [1] Intel (1978). Intel Component Data Catalog, 2114 / 2114L Family Data Sheet, p. 3-94
- [2] Intel (1984). A Revolution in Progress... A History of Intel to Date, 2114 introduced 1976, p. 26.

Intel i2114L

4096-bit (1024 x 4) Static RAM w/Common I/O

1976-77

Specifications

- 4096-bit (1024 x 4) Static RAM w/Common I/O
- NMOS
- Identical Cycle and Access Times
- Single +5V Supply
- No Clock or Timing Strobe Required
- Completely Static Memory
- Directly TTL Compatible: All Inputs and Outputs
- Common Data Input and Output Using Three-State Outputs
- Pin-Out Compatible with 3605 and 3625 Bipolar PROMs
- Low Power Version of the Intel 2114 Static RAM
- 18-pin Dual In-Line Package

Type	Access Time Max.	Cycle Time Max.	Power Dissipation Max. Operating/Standby	Supplies [V]
2114L	450ns	450ns	370mW	+5
2114L-2	200ns	200ns	370mW	+5
2114L-3	300ns	300ns	370mW	+5
M2114L	450ns	450ns	410mW	+5
M2114L-2	200ns	200ns	410mW	+5
M2114L-3	300ns	300ns	410mW	+5

The Intel® 2114 is a 4096-bit static Random Access Memory organized as 1024 words by 4-bits using N-channel Silicon-Gate MOS technology. It uses fully DC stable (static) circuitry throughout – in both the array and the decoding – and therefore requires no clocks or refreshing to operate. Data access is particularly simple since address setup times are not required. The data is read out nondestructively and has the same polarity as the input data. Common data input/output pins are provided.

The 2114 is designed for memory applications where high performance, low cost, large bit storage, and simple interfacing are important design objectives. The 2114 is placed in an 18-pin package for the highest possible density.

It is directly TTL compatible in all respects: inputs, outputs, and a single +5V supply. A separate Chip Select (CS) lead allows easy selection of an individual package when output are OR-tied.

The 2114 is fabricated with Intel's N-channel Silicon-Gate technology – a technology providing excellent protection against contamination permitting the use of low cost plastic packaging [1].

History

The 2114L-3 were used in the Radio Shack TRS-80 Model I microcomputer. 8 of these chips provided the 4K bytes of the original Model I.

Part Numbers

Type C Packages

Part Number	Package Description	Values
C2114L	Type C package	\$15-\$60
		
C2114L-2	Type C grey ceramic package w/black cap and tin pins.	\$15-\$60
C2114L-3	Type C package	\$15-\$60

Type D Packages

Part Number	Package Description	Values
D2114L	Type D package	\$.75-\$3
D2114L-2	Type D package	\$1-\$4
D2114L-3	Type D package	\$1-\$4
MD2114L/B	Type D package	\$4-\$16
MD2114L-2	Type D package	\$3-\$12
MD2114L-2/B	Type D package	\$4-\$16
MD2114L-3	Type D package	\$4-\$16
MD2114L-3/B	Type D package	\$3-\$12

Type P Packages

Part Number	Package Description	Values
		
P2114L	Type P black plastic package w/tin pins.	\$1-\$4

Intel i2114L

P2114L-2	Type P package	\$1.50-\$6
		
P2114L-3	Type P black plastic package w/tin pins.	\$1-\$4

References

- [1] Intel (1978). Intel Component Data Catalog, 2114 / 2114L Family Data Sheet, p. 3-94

Intel i2114A

4096-bit (1024 x 4) Static RAM w/Common I/O

1979-80

Specifications

- 4096-bit (1024 x 4) Static RAM w/Common I/O
- HMOS II
- Low Power, High Speed
- Identical Cycle and Access Times
- Single +5V Supply $\pm 10\%$
- Completely Static Memory – No Clock or Timing Strobe Required
- Directly TTL Compatible: All Inputs and Outputs
- Common Data Input and Output Using Three-State Outputs
- 2114 Upgrade
- 18-pin Dual In-Line Package

Type	Access Time Max.	Cycle Time Max.	Power Dissipation Max. Operating/Standby	Supplies [V]
2114A-4	200ns	200ns	70mA	+5
2114A-5	250ns	250ns	70mA	+5
2114A-6	300ns	300ns	70mA	+5
M2114A-4	200ns	200ns	70mA	+5
M2114A-5	250ns	250ns	70mA	+5

The Intel © 2114A is a 4096-bit static Random Access Memory organized as 1024 words by 4-bits using HMOS, a high performance MOS technology. It uses fully stable (static) circuitry throughout, in both the array and the decoding, therefore it requires no clocks or refreshing to operate. Data access is particularly simple since address setup times are not required. The data is read out nondestructively and has the same polarity as the input data. Common input/output pins are provided.

The 2114A is designed for memory applications where the high performance and high reliability of HMOS, low cost, large bit storage, and simple interfacing are important design objectives. The 2114A is placed in an 18-pin package for the highest possible density.

It is directly TTL compatible in all respects: inputs, outputs, and a single +5V supply. A separate Chip Select lead allows easy selection of an individual package when outputs are or-tied [3].

Pin-Out Compatible with 3605 and 3625 Bipolar PROMs [1].

Part Numbers

Type D Packages

Part Number	Package Description	Values
D2114A-4	Type D package	\$1-\$4
D2114A-5	Type D package	\$.50-\$2
ID2114A-4	Type D package	Rare \$5-\$20
ID2114A-5	Type D package	Rare \$5-\$20
LD2114A-4	Type D package	\$3-\$12
LD2114A-5	Type D package	\$3-\$12
MD2114A-4	Type D package	\$3-\$12
MD2114A-4/B	Type D package	\$3-\$12
MD2114A-4/BC	Type D package	Rare (0 Known) \$\$\$
MD2114A-5	Type D package	\$3-\$12
MD2114A-5/B	Type D package	\$3-\$12
MD2114A-5/BC	Type D package	\$3-\$12

Type P Packages

Part Number	Package Description	Values
P2114A-4	Type P package	\$.25-\$1
		
P2114A-5	Type P black plastic package w/tin pins. Small round indentation denotes pin #1.	\$.25-\$1
P2114A-6	Type P package	\$.50-\$2

References

- [1] Intel (1978). The Semiconductor Memory Book, 2114 / 2114L Family Data Sheet. No reference to 2114A Family or 2114H Family.

- [2] Intel (1979). Intel Component Data Catalog, 2114 / 2114L Family Data Sheet, p. 3-54. No reference to 2114A or 2114AL family.

- [3] Intel (1980). Intel Component Data Catalog, 2114A Family Data Sheet, p. 1-13.

Intel i2114AL

4096-bit (1024 x 4) Static RAM w/Common I/O

1979-80

Specifications

- 4096-bit (1024 x 4) Static RAM w/Common I/O
- HMOS II
- Low Power, High Speed
- Identical Cycle and Access Times
- Single +5V Supply $\pm 10\%$
- Completely Static Memory – No Clock or Timing Strobe Required
- Directly TTL Compatible: All Inputs and Outputs
- Common Data Input and Output Using Three-State Outputs
- 2114 Upgrade
- Low Power Version of the Intel 2114A Static RAM
- 18-pin Dual In-Line Package

Type	Access Time Max.	Cycle Time Max.	Power Dissipation Max. Operating/Standby	Supplies [V]
2114AL-1	100ns	100ns	40mA	+5
2114AL-2	120ns	120ns	40mA	+5
2114AL-3	150ns	150ns	40mA	+5
2114AL-4	200ns	200ns	40mA	+5
M2114AL-3	150ns	150ns	-	+5
M2114AL-4	200ns	200ns	-	+5

The Intel ® 2114A is a 4096-bit static Random Access Memory organized as 1024 words by 4-bits using HMOS, a high performance MOS technology. It uses fully stable (static) circuitry throughout, in both the array and the decoding, therefore it requires no clocks or refreshing to operate. Data access is particularly simple since address setup times are not required. The data is read out nondestructively and has the same polarity as the input data. Common input/output pins are provided.

The 2114A is designed for memory applications where the high performance and high reliability of HMOS, low cost, large bit storage, and simple interfacing are important design objectives. The 2114A is placed in an 18-pin package for the highest possible density.

It is directly TTL compatible in all respects: inputs, outputs, and a single +5V supply. A separate Chip Select lead allows easy selection of an individual package when outputs are or-tied [3].

Pin-Out Compatible with 3605 and 3625 Bipolar PROMs [1].

Part Numbers

Type D Packages

Part Number	Package Description	Values
D2114AL-1	Type D package	\$.75-\$3
D2114AL-2	Type D package	\$.25-\$1
D2114AL-3	Type D package	\$.25-\$1
D2114AL-4	Type D package	\$.50-\$2
ID2114AL-2	Type D package	\$5-\$20
ID2114AL-3	Type D package	\$5-\$20
ID2114AL-4	Type D package	\$5-\$20
LD2114AL-3	Type D package	\$2-\$8
LD2114AL-4	Type D package	\$2-\$8
MD2114AL-3	Type D package	\$2-\$8
MD2114AL-3/B	Type D package	\$2-\$8
MD2114AL-3/BC	Type D package	\$4-\$16
MD2114AL-4	Type D package	\$2-\$8
MD2114AL-4/B	Type D grey ceramic package w/tin pins.	\$1.50-\$6
MD2114AL-4/BC	Type D package	\$2-\$8
QD2114AL-1	Type D package	\$5-\$20
QD2114AL-2	Type D package	\$1.50-\$6
QD2114AL-3	Type D package	\$2-\$8
QD2114AL-4	Type D package	\$2-\$8
TD2114AL-3	Type D package	\$2-\$8
TD2114AL-4	Type D package	\$2-\$8

Type P Packages

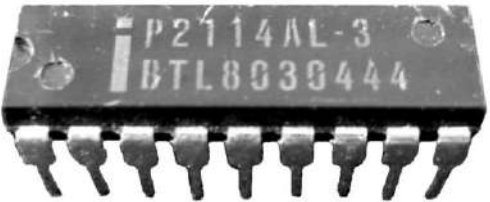
Part Number	Package Description	Values
P2114AL-1	Type P black plastic package w/tin pins.	\$.25-\$1
P2114AL-2	Type P black plastic package w/tin pins.	\$.25-\$1
		
P2114AL-3	Type P black plastic package w/tin pins	\$.25-\$1
P2114AL-4	Type P package	\$.25-\$1

Intel i2114AL

QP2114AL-1	Type P package	\$1.50-\$6
QP2114AL-2	Type P package	\$2-\$8
QP2114AL-3	Type P package	\$1.50-\$6
QP2114AL-4	Type P package	\$1.50-\$6

References

- [1] Intel (1978). The Semiconductor Memory Book, 2114 / 2114L Family Data Sheet. No reference to 2114A Family or 2114H Family.

- [2] Intel (1979). Intel Component Data Catalog, 2114 / 2114L Family Data Sheet, p. 3-54. No reference to 2114A or 2114AL family.

- [3] Intel (1980). Intel Component Data Catalog, 2114AL Family Data Sheet, p. 1-13.

Intel i2115

1024-bit (1024 x 1) Static RAM

1976

Specifications

- 1024-bit (1024 x 1) Static RAM
- NMOS
- Pin Compatible to 93415 (2115) and 93425 (2125)
- Low Operating Power Dissipation:
Typical 0.2mW/bit (2115L, 2125L)
- TTL Inputs and Outputs
- Single +5V Supply
- Uncommitted Collector (2115) And Three State (2125) Output
- Non-Inverting Data Output
- 16-pin Dual In-Line Package

Type	Access Time Max.	Cycle Time Max.	Power Dissipation Max. Operating/Standby	Supplies [V]
2115	95ns	95ns	525mW	+5
2115-2	70ns	70ns	660mW	+5

The Intel® 2115 and 2125 family are fully static read/write random access memories organized as 1024 words by 1 bit. These RAMs are designed for buffer control storage and high performance main memory applications. They are compatible with TTL logic families in all respects: inputs, outputs, and a single +5V supply. Both uncommitted collector and three-state output are available.

The 2115 and 2125 family offers high performance, low power dissipation, and system cost savings. Fast system speed is achieved by using the 2115-2 and 2125-2. The 2115L and 2125L gives low system power dissipation, only 0.2mW/bit typical. The 2115 and 2125 are ideal for slower performance systems where cost is a prime factor.

The 2115 and 2125 family is fabricated with N-channel MOS silicon gate technology. This technology allows the design and production of high speed MOS RAMs which are comparable to the performance of bipolar RAMs, but offering the advantage of lower power dissipation and cost [3].

Part Numbers

Type C Packages

Part Number	Package Description	Values
C2115	Type C package	Ex. Rare (0 Known) \$\$\$

Type D Packages

Part Number	Package Description	Values
D2115	Type D package	Ex. Rare (0 Known) \$\$\$
D2115-2	Type D package	Rare \$15-\$60

Type P Packages

Part Number	Package Description	Values
P2115	Type P package	Ex. Rare (0 Known) \$\$\$
P2115-2	Type P package	Rare \$15-\$60

References

- [1] Intel (1975). Intel Data Catalog. No reference to 2115/2115L.
- [2] Intel (1976). Intel Data Catalog, 2115, 2115L, 2125, 2125L “New Product” Data Sheet, p. 2-81
- [3] Intel (1977). Intel Data Catalog, 2115, 2115L, 2125, 2125L Family Data Sheet, p. 2-81
- [4] Intel (1978). The Semiconductor Memory Book, p. 504. Reference to C2115, D2115, and P2115.
- [5] Intel (1984). A Revolution in Progress... A History of Intel to Date, 2115 introduced 1976, p. 26.

Intel i2115L

1024-bit (1024 x 1) Static RAM

1976

Specifications

- 1024-bit (1024 x 1) Static RAM
- NMOS
- Pin Compatible to 93415 (2115) and 93425 (2125)
- Low Operating Power Dissipation:
Typical 0.2mW/bit (2115L, 2125L)
- TTL Inputs and Outputs
- Single +5V Supply
- Uncommitted Collector (2115) And Three State (2125) Output
- Non-Inverting Data Output
- Low Power Version of the Intel 2115 Static RAM
- 16-pin Dual In-Line Package

Type	Access Time Max.	Cycle Time Max.	Power Dissipation Max. Operating/Standby	Supplies [V]
2115L	95ns	95ns	345mW	+5

The Intel® 2115 and 2125 family are fully static read/write random access memories organized as 1024 words by 1 bit. These RAMs are designed for buffer control storage and high performance main memory applications. They are compatible with TTL logic families in all respects: inputs, outputs, and a single +5V supply. Both uncommitted collector and three-state output are available.

The 2115 and 2125 family offers high performance, low power dissipation, and system cost savings. Fast system speed is achieved by using the 2115-2 and 2125-2. The 2115L and 2125L gives low system power dissipation, only 0.2mW/bit typical. The 2115 and 2125 are ideal for slower performance systems where cost is a prime factor.

The 2115 and 2125 family is fabricated with N-channel MOS silicon gate technology. This technology allows the design and production of high speed MOS RAMs which are comparable to the performance of bipolar RAMs, but offering the advantage of lower power dissipation and cost [3].

Part Numbers

No Examples Known

References

[1] Intel (1975). Intel Data Catalog. No reference to 2115/2115L.

[2] Intel (1976). Intel Data Catalog, 2115, 2115L, 2125, 2125L “New Product” Data Sheet, p. 2-81

[3] Intel (1977). Intel Data Catalog, 2115, 2115L, 2125, 2125L Family Data Sheet, p. 2-81

Intel i2115A

1024-bit (1024 x 1) Static RAM

1977

Specifications

- 1024-bit (1024 x 1) Static RAM
- NMOS
- Pin Compatible to 93415A (2115A) and 93425A (2125A)
- Fan Out of 10 TTL (2115A Family)
 - 16mA Output Sink Current
- Low Operating Power Dissipation
 - Max. 0.39mW/Bit (2115AL, 2125AL)
- TTL Inputs and Outputs
- Single +5V Supply
- Uncommitted Collector (2115A) And Three State (2125A) Output
- 16-pin Dual In-Line Package

Type	Access Time Max.	Cycle Time Max.	Power Dissipation Max. Operating/Standby	Supplies [V]
2115A	45ns	45ns	125mA	+5
2115A-2	70ns	70ns	125mA	+5
M2115A	55ns	55ns	125mA	+5

The Intel ® 2115A and 2125A families are high speed, 1024 words by 1-bit random access memories. Both open collector (2115A) and three-state output (2125A) are available. The 2115A and 2125A use fully DC stable (static) circuitry throughout – in both the array and the decoding and, therefore, require no clocks or refreshing to operate. The data is read out nondestructively and has the same polarity as the input data.

The 2115AL/2125AL at 45ns maximum access time and the 2115AL-2/2125AL-2 at 70ns maximum access time are fully compatible with the industry-produced 1K bipolar RAMs; yet offer a 50% reduction in power over their bipolar equivalents. The power dissipation of the 2115AL/2125AL and 2115AL-2/2125AL-2 is 394mW maximum as compared to 814mW maximum for their bipolar equivalents. For systems already designed for 1K bipolar RAMs, the 2115A/2125A and the 2115A-2/2125A-2 at 45ns and 70ns maximum access times, respectively, offer complete compatibility with a 20% reduction in maximum power dissipation.

The devices are directly TTL compatible in all respects: inputs, outputs, and a single +5V supply. A separate select lead allows easy selection of any individual package when outputs are OR-tied.

The 2115A and 2125A families are fabricated with Intel's N-channel MOS silicon Gate Technology [2].

Part Numbers

Type D Packages

Part Number	Package Description	Values
D2115A	Type D package	\$1-\$4
D2115A-2	Type D package	\$1-\$4
MD2115A/B	Type D package	\$2-\$8
QD2115A	Type D package	Ex. Rare (0 Known)
QD2115A-2	Type D package	Ex. Rare (0 Known)

References

- [1] Intel (1977). Intel Data Catalog, 2115, 2115A Family Data Sheet.
- [2] Intel (1980). Intel Component Data Catalog, 2115A, 2125A Family Data Sheet, p. 1-16.
- [3] Intel (1988). Intel Memory Components Handbook, QD2115A, QD2115A-2 specifications, p. 3-34

Intel i2115AL

1024-bit (1024 x 1) Static RAM

1977

Specifications

- 1024-bit (1024 x 1) Static RAM
- NMOS
- Pin Compatible to 93415A (2115A) and 93425A (2125A)
- Fan Out of 10 TTL (2115A Family)
 - 16mA Output Sink Current
- Low Operating Power Dissipation
 - Max. 0.39mW/Bit (2115AL, 2125AL)
- TTL Inputs and Outputs
- Single +5V Supply
- Uncommitted Collector (2115A) And Three State (2125A) Output
- 16-pin Dual In-Line Package

Type	Access Time Max.	Cycle Time Max.	Power Dissipation Max. Operating/Standby	Supplies [V]
2115AL	45ns	45ns	75mA	+5
2115AL-2	70ns	70ns	75mA	+5
M2115AL	75ns	75ns	75mA	+5

The Intel ® 2115A and 2125A families are high speed, 1024 words by 1-bit random access memories. Both open collector (2115A) and three-state output (2125A) are available. The 2115A and 2125A use fully DC stable (static) circuitry throughout – in both the array and the decoding and, therefore, require no clocks or refreshing to operate. The data is read out nondestructively and has the same polarity as the input data.

The 2115AL/2125AL at 45ns maximum access time and the 2115AL-2/2125AL-2 at 70ns maximum access time are fully compatible with the industry-produced 1K bipolar RAMs; yet offer a 50% reduction in power over their bipolar equivalents. The power dissipation of the 2115AL/2125AL and 2115AL-2/2125AL-2 is 394mW maximum as compared to 814mW maximum for their bipolar equivalents. For systems already designed for 1K bipolar RAMs, the 2115A/2125A and the 2115A-2/2125A-2 at 45ns and 70ns maximum access times, respectively, offer complete compatibility with a 20% reduction in maximum power dissipation.

The devices are directly TTL compatible in all respects: inputs, outputs, and a single +5V supply. A separate select lead allows easy selection of any individual package when outputs are OR-tied.

The 2115A and 2125A families are fabricated with Intel's N-channel MOS silicon Gate Technology [2].

Intel i2115AL

Part Numbers

Type D Packages

Part Number	Package Description	Values
 <p>A black, rectangular Type D package with 14 pins. The top surface is marked with 'D2115AL' and '1E135'.</p>		
D2115AL	Type D grey ceramic package w/tin pins.	\$.75-\$3
 <p>A black, rectangular Type D package with 14 pins. The top surface is marked with 'D2115AL-2' and '2D986'.</p>		
D2115AL-2	Type D grey ceramic package w/tin pins.	\$.50-\$2
MD2115AL/B	Type D package	\$2-\$8
QD2115AL	Type D package	Ex. Rare (0 Known) \$\$\$
QD2115AL-2	Type D package	Ex. Rare (0 Known) \$\$\$

References

- [1] Intel (1977). Intel Data Catalog, 2115, 2115A Family Data Sheet.
- [2] Intel (1980). Intel Component Data Catalog, 2115A, 2125A Family Data Sheet, p. 1-16.
- [3] Intel (1988). Intel Memory Components Handbook, QD2115AL, QD2115AL-2 specifications, p. 3-34

Intel i2115H

1024-bit (1024 x 1) Static RAM

1979-80

Specifications

- 1024-bit (1024 x 1) Static RAM
- HMOS II
- Pin Compatible to 93415A (2115H) and 93425A (2125H)
- 16mA Output Sink Current
- Low Operating Power Dissipation -
Max. 0.53 mW/Bit (2115H-3, 2125H-3)
- TTL Inputs and Outputs
- Single +5V Supply
- Uncommitted Collector (2115H) and Three-State (2125H) Output
- 16-pin Dual In-Line Package

Type	Access Time Max.	Cycle Time Max.	Power Dissipation Max. Operating/Standby	Supplies [V]
2115H-2	25ns	25ns	125mA	+5
2115H-3	30ns	30ns	100mA	+5
2115H-4	35ns	35ns	125mA	+5
M2115H-4	-	-	-	+5

The Intel® 2115H and 2125H families are high speed, 1024 words by 1-bit random access memories fabricated with HMOS II, Intel's advanced N-channel MOS silicon gate technology. Both open collector (2115H) and three-state output (2125H) are available. The 2115H and 2125H use fully stable (static) circuitry throughout – in both the array and the decoding and, therefore, require no clocks or refreshing to operate. The data is read out non-destructively and has the same polarity as the input data.

HMOS II's advanced technology allows the production of the industry's fastest, low power, 1K static RAMs – offering access times as low as 20ns.

HMOS II allows the production of the 2115H/2125H families, fully compatible with the 1K Bipolar RAMs yet offering substantial reductions in power dissipation. The power dissipations of 525mW maximum and 656mW maximum compared to 814mW maximum offer reductions of 19% and 36% respectively.

The devices are directly TTL compatible in all respects: inputs, outputs, and a single +5V supply. A separate select lead allows easy selection of an individual package when outputs are OR-tied [3].

Part Numbers

Type D Packages

Part Number	Package Description	Values
D2115H-2	Type D package	\$1-\$4
D2115H-3	Type D package	\$1-\$4
D2115H-4	Type D package	\$1-\$4
MD2115H-4	Type D package	\$1.50-\$6

References

- [1] Intel (1978). The Semiconductor Memory Book, 2115A Family Data Sheet. No reference to 2115 or 2115H.
- [2] Intel (1979). Intel Component Data Catalog, 2115H / 2125H Family Advance Information, p. 3-63
- [3] Intel (1980). Intel Component Data Catalog, 2115H / 2125H Family Data Sheet, p. 1-21

Intel i2116

16384-bit (16384 x 1) Dynamic RAM

1975-76

Specifications

- 16384-bit (16384 x 1) Dynamic RAM
- NMOS
- Highest Density 16K RAM: Industry Standard 16-Pin Package
- Low Standby Power
- All Inputs Including Clocks TTL Compatible
- ±10% Tolerance on all Power Supplies: +12V, +5V, -5V
- On-Chip Latches for Address and Data In
- Only 64 Refresh Cycles Required Every 2 ms
- Output is Three-State, TTL Compatible; Data is Latched and Valid into Next Cycle
- 16-pin Dual In-Line Package

Type	Access Time Max.	Cycle Time Max.	Power Dissipation Max. Operating/Standby	Supplies [V]
2116	350ns	500ns	-	+12, +5, -5
2116-2	200ns	350ns	828mW/24mW	+12, +5, -5
2116-3	250ns	375ns	816mW/24mW	+12, +5, -5
2116-4	300ns	425ns	780mW/24mW	+12, +5, -5

The Intel® 2116 is a 16,384 word by 1 bit MOS RAM fabricated with two layer polysilicon N-MOS technology – a production proven process for high performance, high reliability, and high functional density. The 2116 uses a single transistor dynamic storage cell and dynamic circuitry to achieve high speed and low power dissipation.

The unique design of the 2116 allows it to be packaged in the industry standard 16-pin dual in-line package. The 16-pin package provides the highest system bit densities and is compatible with widely available automated handling equipment. The 2116 is designed to facilitate upgrading of 2104A-type 4K RAM systems to 16K capabilities.

The use of the 16-pin package is made possible by multiplexing the 14 address bits (required to address 1 of 16384 bits) into the 2116 on 7 address pins. The two 7 bit address words are latched into the 2116 by the two TTL clocks, Row Address Strobe (RAS) and Column Address Strobe (CAS). Non-critical clocking timing requirements allow use of the multiplexing technique while maintaining high performance [3].

Part Numbers

Type C Packages

Part Number	Package Description	Values
		
C2116	Type C purple ceramic package w/black cap and tin pins. Black dot denotes pin #1.	\$10-\$40
		
C2116-2	Type C grey ceramic package w/black cap and tin pins. Black dot denotes pin #1.	\$10-\$40
		
C2116-3	1. Type C grey ceramic package w/black cap and tin pins. Black dot denotes pin #1.	\$10-\$40
C2116-3	2. Type C purple ceramic package w/black cap and tin pins. Black dot denotes pin #1.	\$10-\$40
C2116-4	Type C grey ceramic package w/black cap and tin pins. Black dot denotes pin #1.	\$10-\$40

References

- [1] Intel (1975). Intel Data Catalog. No reference to 2116.
- [2] Intel (1976). Intel Data Catalog, 2116 Advance Information, p. 2-86
- [3] Intel (1978). Intel Component Data Catalog, 2116 Family Data Sheet, p. 3-109
- [4] Intel (1978). Intel Semiconductor Memory Book, p. viii. “In 1977 Intel introduced the 2116”.
- [5] Intel (1984). A Revolution in Progress... A History of Intel to Date, 2116 introduced 1975, p. 26.

Intel i2117

16384-bit (16384 x 1) Dynamic RAM

1977

Specifications

- 16384-bit (16384 x 1) Dynamic RAM
- NMOS
- Three-State Output
- $\pm 10\%$ Tolerance on All Supplies: +12V, +5V, -5V
- Low Power: 462mW Max. Operating, 20mW Max. Standby
- All Inputs, Including Clocks, TTL Compatible
- Non-Latched Output is Three-State, TTL Compatible
- RAS Only Refresh
- 128 Refresh Cycles Required Every 2ms
- Page Mode Capability
- CAS Controlled Output Allows Hidden Refresh
- 16-pin Dual In-Line Package

Type	Access Time Max.	Cycle Time Max.	Power Dissipation Max. Operating/Standby	Supplies [V]
2117	-	-	-	
2117-2	150ns	320ns	462mW/20mW	+12, +5, -5
2117-3	200ns	375ns	462mW/20mW	+12, +5, -5
2117-4	250ns	410ns	436mW/20mW	+12, +5, -5
2117-5	300ns	-	-	+12, +5, -5

The Intel ® 2117 is a 16,384 word by 1-bit Dynamic MOS RAM fabricated with Intel's standard two layer polysilicon NMOS technology – a production proven process for high performance, high reliability, and high storage density.

The 2117 uses a single transistor dynamic storage cell and advanced dynamic circuitry to achieve high speed with low power dissipation. The circuit design minimizes the current transients typical of dynamic RAM operation. These low current transients and $\pm 10\%$ tolerance on all power supplies contribute to the high noise immunity of the 2117 in a system environment.

Multiplexing the 14 address bits into the 7 address input pins allows the 2117 to be packaged in the industry standard 16-pin DIP. The two 7 bit address words are latched into the 2117 by the two TTL clocks, Row Address Strobe (RAS) and Column Address

Strobe (CAS). Non-critical clocking timing requirements allow use of the multiplexing technique while maintaining high performance.

The 2117 three-state output is controlled by CAS, independent of RAS. After a valid read or read-modify-write cycle, data is latched on the output by holding CAS low. The data out pin is returned to the high impedance state by returning CAS to a high state. The 2117 hidden refresh feature allows CAS to be held low to maintain latched data while RAS is used to execute RAS-only refresh cycles.

Intel i2117

The single transistor storage cell requires refreshing for data retention. Refreshing is accomplished by performing RAS only refresh cycles, hidden refresh cycles, or normal read or write cycles on the 128 address combinations of the address input pins during a 2 ms period. A write cycle will refresh stored data on all bits of the selected row except the bit which is addressed [3].

Part Numbers

Type C Packages

Part Number	Package Description	Values
		
C2117	1. Type C purple ceramic package w/gold cap and gold pins	\$5-\$20
		
C2117	2. Type C grey ceramic package w/gold cap, offset gold cap ground strap and gold pins	\$5-\$20
C2117-2	Type C package	\$5-\$20
		
C2117-3	1. Type C purple ceramic package w/gold cap and gold pins	\$5-\$20
		
C2117-3	2. Type C grey ceramic package w/gold cap, offset gold cap ground strap, and gold pins.	\$5-\$20

Intel i2117

 <p>A photograph of an Intel i2117-3 network controller chip. The chip is a small, rectangular, gold-colored component mounted on a purple ceramic package. The markings on the chip are "C2117-3" and "7C142".</p>		
C2117-3	3. Type C purple ceramic package w/gold cap, offset gold cap ground strap, and gold pins	\$5-\$20
 <p>A photograph of an Intel i2117-4 network controller chip. The chip is a small, rectangular, gold-colored component mounted on a purple ceramic package. The markings on the chip are "C2117-4", "S6168", and "1D458".</p>		
C2117-4	1. Type C purple ceramic package w/gold cap, offset gold cap ground strap, and gold pins	\$5-\$20
 <p>A photograph of an Intel i2117-4 network controller chip. The chip is a small, rectangular, gold-colored component mounted on a purple ceramic package. The markings on the chip are "C2117-4", "S6168", and "8B252".</p>		
C2117-4	2. Type C purple ceramic package w/gold cap and gold pins	\$5-\$20
 <p>A photograph of an Intel i2117-5 network controller chip. The chip is a small, rectangular, gold-colored component mounted on a purple ceramic package. The markings on the chip are "C2117-5", "S6070", and "8C736".</p>		
C2117-5	1. Type C purple ceramic package w/gold cap, offset gold cap ground strap, and gold pins.	\$5-\$20

Intel i2117

		
C2117-5	2. Type C grey ceramic package w/gold cap, offset gold cap ground strap, and gold pins	\$5-\$20
		
C2117-5	3. Type C grey ceramic package w/gold cap and gold pins	\$5-\$20

Type D Packages

Part Number	Package Description	Values
D2117	Type D package	\$1.50-\$6
D2117-2	Type D package	\$.75-\$3
D2117-3	Type D package	\$.25-\$1
		
D2117-4	Type D grey ceramic package w/tin pins.	\$.50-\$2
D2117-5	Type D package	\$2-\$8
MD2117/B	Type D package	\$2-\$8

References

- [1] Intel (1977). Intel Data Catalog. No Reference to 2117 Family.
- [2] Intel (1978). Intel Semiconductor Memory Book, 2117-2, 2117-3, 2117-4 Data Sheet.
- [3] Intel (1978). Intel Component Data Catalog, 2117 Family Data Sheet, p. 3-117.

Intel i2118

16384-bit (16384 x 1) Dynamic RAM

1979

Specifications

- 16384-bit (16384 x 1) Dynamic RAM
- HMOS
- Single +5V Supply, $\pm 10\%$ Tolerance
- Low Power:
 - 150mW Max. Operating
 - 11mW Max. Standby
- All Inputs, Including Clocks, TTL Compatible
- CAS Controlled Output is Three-State, TTL Compatible
- RAS Only Refresh
- 128 Refresh Cycles Required Every 2ms
- Page Mode and Hidden Refresh Capability
- 16-pin Dual In-Line Package

Type	Access Time Max.	Cycle Time Max.	Power Dissipation Max. Operating/Standby	Supplies [V]
2118-3	100ns	235ns	150mW/11mW	+5
2118-4	120ns	270ns	150mW/11mW	+5
2118-7	150ns	320ns	150mW/11mW	+5
M2118-4	-	-	-	+5
M2118-7	-	-	-	+5

The Intel ® 2118 is a 16,384 word by 1-bit Dynamic MOS RAM designed to operate from a single +5V power supply. The 2118 is fabricated using HMOS – a production proven process for high performance, high reliability, and high storage density.

The 2118 uses a single transistor dynamic storage cell and advanced dynamic circuitry to achieve high speed with low power dissipation. The circuit design minimizes the current transients typical of dynamic RAM operation. These low current transients contribute to the high noise immunity of the 2118 in a system environment [2].

History

1st 5V HMOS (High-Performance NMOS) DRAM

Part Numbers

Type D Packages

Part Number	Package Description	Values
D2118-3	Type D package	\$.50-\$2
		
D2118-4	Type D grey ceramic package w/tin pins.	\$.50-\$2
		
D2118-7	Type D grey ceramic package w/tin pins.	\$.50-\$2
ID2118-4	Type D package	\$2-\$8
ID2118-7	Type D package	\$2-\$8
MD2118-4	Type D package	\$3-\$12
MD2118-4/B	Type D package	\$3-\$12
MD2118-7	Type D package	\$3-\$12
MD2118-7/B	Type D package	\$3-\$12
QD2118-4	Type D package	\$3-\$12
QD2118-7	Type D package	\$3-\$12

References

- [1] Hearst (1979). IC Master, Intel 2118 Family Data Sheet, p. 1417
- [2] Intel (1980). Intel Component Data Catalog, 2118 Family Data Sheet, p. 1-38
- [3] Intel (1984). A Revolution in Progress... A History of Intel to Date, 2118 introduced 1979, p. 26.

Intel i2125

1024-bit (1024 x 1) Static RAM

1976

Specifications

- 1024-bit (1024 x 1) Static RAM
- NMOS
- Pin Compatible to 93415 (2115) and 93425 (2125)
- Low Operating Power Dissipation:
Typical 0.2mW/bit (2115L, 2125L)
- TTL Inputs and Outputs
- Single +5V Supply
- Uncommitted Collector (2115) And Three State (2125) Output
- Non-Inverting Data Output
- 16-pin Dual In-Line Package

Type	Access Time Max.	Cycle Time Max.	Power Dissipation Max. Operating/Standby	Supplies [V]
2125	95ns	95ns	525mW	+5
2125-2	70ns	70ns	660mW	+5

The Intel® 2115 and 2125 family are fully static read/write random access memories organized as 1024 words by 1 bit. These RAMs are designed for buffer control storage and high performance main memory applications. They are compatible with TTL logic families in all respects: inputs, outputs, and a single +5V supply. Both uncommitted collector and three-state output are available.

The 2115 and 2125 family offers high performance, low power dissipation, and system cost savings. Fast system speed is achieved by using the 2115-2 and 2125-2. The 2115L and 2125L gives low system power dissipation, only 0.2mW/bit typical. The 2115 and 2125 are ideal for slower performance systems where cost is a prime factor.

The 2115 and 2125 family is fabricated with N-channel MOS silicon gate technology. This technology allows the design and production of high speed MOS RAMs which are comparable to the performance of bipolar RAMs, but offering the advantage of lower power dissipation and cost [3].

Part Numbers

Type C Packages

Part Number	Package Description	Values
C2125	Type C package	Rare \$15-\$60
C2125-2	Type C package	Rare \$15-\$60

Type D Packages

Part Number	Package Description	Values
D2125	Type D package	\$3-\$12

References

- [1] Intel (1975). Intel Data Catalog. No reference to 2115.
- [2] Intel (1976). Intel Data Catalog, 2115, 2125 “New Product” Data Sheet, p. 2-81
- [3] Intel (1977). Intel Data Catalog, 2115, 2115L, 2125, 2125L Family Data Sheet, p. 2-81

Intel i2125L

1024-bit (1024 x 1) Static RAM

1976

Specifications

- 1024-bit (1024 x 1) Static RAM
- NMOS
- Pin Compatible to 93415 (2115) and 93425 (2125)
- Low Operating Power Dissipation:
Typical 0.2mW/bit (2115L, 2125L)
- TTL Inputs and Outputs
- Single +5V Supply
- Uncommitted Collector (2115) And Three State (2125) Output
- Non-Inverting Data Output
- Low Power Version of the Intel 2125 Static RAM
- 16-pin Dual In-Line Package

Type	Access Time Max.	Cycle Time Max.	Power Dissipation Max. Operating/Standby	Supplies [V]
2125L	95ns	95ns	345mW	+5

The Intel® 2115 and 2125 family are fully static read/write random access memories organized as 1024 words by 1 bit. These RAMs are designed for buffer control storage and high performance main memory applications. They are compatible with TTL logic families in all respects: inputs, outputs, and a single +5V supply. Both uncommitted collector and three-state output are available.

The 2115 and 2125 family offers high performance, low power dissipation, and system cost savings. Fast system speed is achieved by using the 2115-2 and 2125-2. The 2115L and 2125L gives low system power dissipation, only 0.2mW/bit typical. The 2115 and 2125 are ideal for slower performance systems where cost is a prime factor.

The 2115 and 2125 family is fabricated with N-channel MOS silicon gate technology. This technology allows the design and production of high speed MOS RAMs which are comparable to the performance of bipolar RAMs, but offering the advantage of lower power dissipation and cost [3].

Part Numbers

Type C Packages

Part Number	Package Description	Values
		
C2125L	Type C white ceramic package w/gold cap, gold cap ground strap, and gold pins. Black dot denotes pin #1.	Rare \$15-\$60

Type D Packages

Part Number	Package Description	Values
D2125L	Type D package	Rare \$5-\$20

References

[1] Intel (1975). Intel Data Catalog. No reference to 2125/2125L.

[2] Intel (1976). Intel Data Catalog, 2115, 2115L, 2125, 2125L “New Product” Data Sheet, p. 2-81

[3] Intel (1977). Intel Data Catalog, 2115, 2115L, 2125, 2125L Family Data Sheet, p. 2-81

Intel i2125A

1024-bit (1024 x 1) Static RAM

1977

Specifications

- 1024-bit (1024 x 1) Static RAM
- NMOS
- Pin Compatible to 93415A (2115A) and 93425A (2125A)
- Fan Out of 10 TTL (2115A Family)
 - 16mA Output Sink Current
- Low Operating Power Dissipation
 - Max. 0.39mW/Bit (2115AL, 2125AL)
- TTL Inputs and Outputs
- Single +5V Supply
- Uncommitted Collector (2115A) And Three State (2125A) Output
- 16-pin Dual In-Line Package

Type	Access Time Max.	Cycle Time Max.	Power Dissipation Max. Operating/Standby	Supplies [V]
2125A	45ns	45ns	125mA	+5
2125A-2	70ns	70ns	125mA	+5
M2125A	55ns	55ns	125mA	+5
M2125A-2	-	-	-	+5

The Intel ® 2115A and 2125A families are high speed, 1024 words by 1-bit random access memories. Both open collector (2115A) and three-state output (2125A) are available. The 2115A and 2125A use fully DC stable (static) circuitry throughout – in both the array and the decoding and, therefore, require no clocks or refreshing to operate. The data is read out nondestructively and has the same polarity as the input data.

The 2115AL/2125AL at 45ns maximum access time and the 2115AL-2/2125AL-2 at 70ns maximum access time are fully compatible with the industry-produced 1K bipolar RAMs; yet offer a 50% reduction in power over their bipolar equivalents. The power dissipation of the 2115AL/2125AL and 2115AL-2/2125AL-2 is 394mW maximum as compared to 814mW maximum for their bipolar equivalents. For systems already designed for 1K bipolar RAMs, the 2115A/2125A and the 2115A-2/2125A-2 at 45ns and 70ns maximum access times, respectively, offer complete compatibility with a 20% reduction in maximum power dissipation.

The devices are directly TTL compatible in all respects: inputs, outputs, and a single +5V supply. A separate select lead allows easy selection of any individual package when outputs are OR-tied.

The 2115A and 2125A families are fabricated with Intel's N-channel MOS silicon Gate Technology [2].

Part Numbers

Type D Packages

Part Number	Package Description	Values
D2125A	Type D package	\$.50-\$2
D2125A-2	Type D package	\$.50-\$2
MD2125A/B	Type D package	\$2-\$8
QD2125A	Type D package	\$3-\$12
QD2125A-2	Type D package	\$3-\$12
QM2125A-2D1	Type D package	\$2-\$8

Type P Packages

Part Number	Package Description	Values
P2125A	Type P package	\$2-\$8
P2125A-2	Type P package	\$2-\$8

References

[1] Intel (1977). Intel Data Catalog, 2115A, 2125A Family Data Sheet, p. 2-86

[2] Intel (1980). Intel Component Data Catalog, 2115A, 2125A Family Data Sheet, p. 1-16.

Intel i2125AL

1024-bit (1024 x 1) Static RAM

1977

Specifications

- 1024-bit (1024 x 1) Static RAM
- NMOS
- Pin Compatible to 93415A (2115A) and 93425A (2125A)
- Fan Out of 10 TTL (2115A Family)
 - 16mA Output Sink Current
- Low Operating Power Dissipation
 - Max. 0.39mW/Bit (2115AL, 2125AL)
- TTL Inputs and Outputs
- Single +5V Supply
- Uncommitted Collector (2115A) And Three State (2125A) Output
- 16-pin Dual In-Line Package

Type	Access Time Max.	Cycle Time Max.	Power Dissipation Max. Operating/Standby	Supplies [V]
2125AL	45ns	45ns	125mA	+5
2125AL-2	70ns	70ns	125mA	+5
M2125AL	75ns	75ns	-	+5

The Intel ® 2115A and 2125A families are high speed, 1024 words by 1-bit random access memories. Both open collector (2115A) and three-state output (2125A) are available. The 2115A and 2125A use fully DC stable (static) circuitry throughout – in both the array and the decoding and, therefore, require no clocks or refreshing to operate. The data is read out nondestructively and has the same polarity as the input data.

The 2115AL/2125AL at 45ns maximum access time and the 2115AL-2/2125AL-2 at 70ns maximum access time are fully compatible with the industry-produced 1K bipolar RAMs; yet offer a 50% reduction in power over their bipolar equivalents. The power dissipation of the 2115AL/2125AL and 2115AL-2/2125AL-2 is 394mW maximum as compared to 814mW maximum for their bipolar equivalents. For systems already designed for 1K bipolar RAMs, the 2115A/2125A and the 2115A-2/2125A-2 at 45ns and 70ns maximum access times, respectively, offer complete compatibility with a 20% reduction in maximum power dissipation.

The devices are directly TTL compatible in all respects: inputs, outputs, and a single +5V supply. A separate select lead allows easy selection of any individual package when outputs are OR-tied.

The 2115A and 2125A families are fabricated with Intel's N-channel MOS silicon Gate Technology [2].

Part Numbers

Type D Packages

Part Number	Package Description	Values
		
D2125AL	Type D grey ceramic package w/tin pins	\$.50-\$2
D2125AL-2	Type D package	\$.50-\$2
MD2125AL	Type D package	\$2-\$4
MD2125AL/B	Type D package	\$3-\$12
QD2125AL	Type D package	\$5-\$20
QD2125AL-2	Type D package	\$3-\$12

References

[1] Intel (1977). Intel Data Catalog, 2115A, 2125A Family Data Sheet, p. 2-81

[2] Intel (1980). Intel Component Data Catalog, 2115A, 2125A Family Data Sheet, p. 1-16.

Intel i2125H

1024-bit (1024 x 1) Static RAM

1979-80

Specifications

- 1024-bit (1024 x 1) Static RAM
- HMOS II
- Pin Compatible to 93415A (2115H) and 93425A (2125H)
- 16mA Output Sink Current
- Low Operating Power Dissipation -
Max. 0.53 mW/Bit (2115H-3, 2125H-3)
- TTL Inputs and Outputs
- Single +5V Supply
- Uncommitted Collector (2115H) and Three-State (2125H) Output
- 16-pin Dual In-Line Package

Type	Access Time Max.	Cycle Time Max.	Power Dissipation Max. Operating/Standby	Supplies [V]
2125H-1	20ns	20ns	125mA	+5
2125H-2	25ns	25ns	125mA	+5
2125H-3	30ns	30ns	100mA	+5
2125H-4	35ns	35ns	125mA	+5

The Intel® 2115H and 2125H families are high speed, 1024 words by 1-bit random access memories fabricated with HMOS II, Intel's advanced N-channel MOS silicon gate technology. Both open collector (2115H) and three-state output (2125H) are available. The 2115H and 2125H use fully stable (static) circuitry throughout – in both the array and the decoding and, therefore, require no clocks or refreshing to operate. The data is read out non-destructively and has the same polarity as the input data.

HMOS II's advanced technology allows the production of the industry's fastest, low power, 1K static RAMs – offering access times as low as 20ns.

HMOS II allows the production of the 2115H/2125H families, fully compatible with the 1K Bipolar RAMs yet offering substantial reductions in power dissipation. The power dissipations of 525mW maximum and 656mW maximum compared to 814mW maximum offer reductions of 19% and 36% respectively.

The devices are directly TTL compatible in all respects: inputs, outputs, and a single +5V supply. A separate select lead allows easy selection of an individual package when outputs are OR-tied [3].

Part Numbers

Type D Packages

Part Number	Package Description	Values
D2125H-1	Type D package	\$.75-\$3
D2125H-2	Type D package	\$.50-\$2
D2125H-3	Type D package	\$.75-\$3
D2125H-4	Type D package	\$.75-\$3
QD2125H-1	Type D package	\$3-\$12
QD2125H-2	Type D package	\$3-\$12
QD2125H-3	Type D package	\$3-\$12
QD2125H-4	Type D package	\$4-\$16

References

- [1] Intel (1978). The Semiconductor Memory Book, 2125A Family Data Sheet. No reference to 2125 or 2125H family.
- [2] Intel (1979). Intel Component Data Catalog, 2115H, 2125H Family Advance Information, p. 3-63
- [3] Intel (1980). Intel Component Data Catalog, 2115H, 2125H Family Data Sheet, p. 1-21

Intel i2141

4096-bit (4096 x 1) Static RAM w/Separate I/O

1978

Specifications

- 4096-bit (4096 x 1) Static RAM w/Separate I/O
- HMOS
- Completely Static Memory – No Clock or Timing Strobe Required
- Equal Access and Cycle Times
- Single +5V Supply
- Automatic Power-Down
- Directly TTL Compatible: All Inputs and Outputs
- Separate Data Input and Output
- Three-State Output
- 18-pin Dual In-Line Package

Type	Access Time Max.	Cycle Time Max.	Power Dissipation Max. Operating/Standby	Supplies [V]
2141	150ns	150ns	-	+5
2141-2	120ns	120ns	70mA/20mA	+5
2141-3	150ns	150ns	70mA/20mA	+5
2141-4	200ns	200ns	55mA/12mA	+5
2141-5	250ns	250ns	55mA/12mA	+5
M2141-4	-	-	-	+5

The Intel ® 2141 is a 4096-bit static Random Access Memory organized as 4096 words by 1-bits using HMOS, a high performance MOS technology. It uses a uniquely innovative design approach, which provides the ease-of-use features associated with non-clocked static memories and the reduced standby power dissipation associated with clocked static memories. To the user this means low standby power dissipation without the need for clocks, address setup and hold times, nor reduced data rates due to cycle times that are longer than access times.

Chip Select (CS) controls the power-down feature. In less than a cycle time after CS goes high – deselecting the 2141 – the part automatically reduces its power requirements and remains in this low power standby mode as long as CS remains high. This device feature results in system power savings as great as 85% in larger systems, where the majority of devices are deselected.

The 2141 is placed in an 18-pin package configured with the industry standard pinout, the same as the 2147. It is directly TTL compatible in all respects: inputs, output, and a single +5V supply. The data is read out nondestructively and has the same polarity as the input data. A data input and a separate three-state output are used [3].

Part Numbers

Type D Packages

Part Number	Package Description	Values
D2141	Type D package	\$1-\$4
D2141-2	Type D package	\$.50-\$2
D2141-3	Type D package	\$.50-\$2
D2141-4	Type D package	\$.25-\$1
D2141-5	Type D grey ceramic package w/tin pins.	\$.50-\$2
MD2141-4/B	Type D package	\$2-\$8

Type P Packages

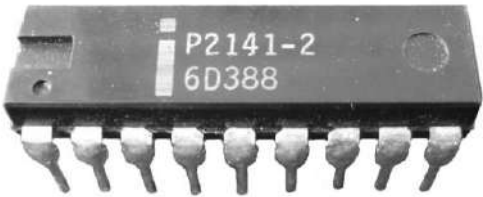
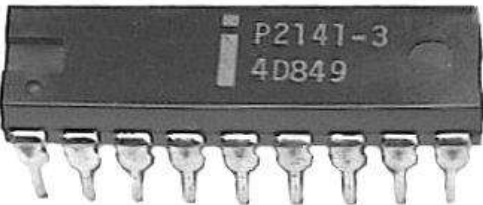
Part Number	Package Description	Values
P2141	Type P package	\$1-\$4
 <p>A black plastic package with 8 pins. The top surface is marked with the Intel logo, 'P2141-2', and '6D388'. There is a small round indentation on the left side of the package.</p>		
P2141-2	Type P black plastic package w/tin pins. Small round indentation denotes pin #1.	\$.50-\$2
 <p>A black plastic package with 8 pins. The top surface is marked with the Intel logo, 'P2141-3', and '4D849'. There is a small round indentation on the left side of the package.</p>		
P2141-3	Type P black plastic package w/tin pins. Small round indentation denotes pin #1. Example shown made in the Philippines and dated 8001.	\$.25-\$1
P2141-4	Type P black plastic package w/tin pins. Small round indentation denotes pin #1.	\$.50-\$2
P2141-5	Type P black plastic package w/tin pins. Small round indentation denotes pin #1.	\$.50-\$2

References

- [1] Intel (1977). Intel Data Catalog. No reference to 2141 family.
- [2] Intel (1978). The Semiconductor Memory Book, 2141 and 2141-2 Data Sheet.
- [3] Intel (1980). Intel Component Data Catalog, 2141/2141L Data Sheet, p. 1-49

Intel i2141L

4096-bit (4096 x 1) Static RAM w/Separate I/O

1979

Specifications

- 4096-bit (4096 x 1) Static RAM w/Separate I/O
- HMOS
- Completely Static Memory – No Clock or Timing Strobe Required
- Equal Access and Cycle Times
- Single +5V Supply
- Automatic Power-Down
- Directly TTL Compatible: All Inputs and Outputs
- Separate Data Input and Output
- Three-State Output
- Low Power Version of the Intel 2141 Static RAM
- 18-pin Dual In-Line Package

Type	Access Time Max.	Cycle Time Max.	Power Dissipation Max. Operating/Standby	Supplies [V]
2141L-3	150ns	150ns	40mA/5mA	+5
2141L-4	200ns	200ns	40mA/5mA	+5
2141L-5	250ns	250ns	40mA/5mA	+5

The Intel ® 2141 is a 4096-bit static Random Access Memory organized as 4096 words by 1-bits using HMOS, a high performance MOS technology. It uses a uniquely innovative design approach, which provides the ease-of-use features associated with non-clocked static memories and the reduced standby power dissipation associated with clocked static memories. To the user this means low standby power dissipation without the need for clocks, address setup and hold times, nor reduced data rates due to cycle times that are longer than access times.

Chip Select (CS) controls the power-down feature. In less than a cycle time after CS goes high – deselection of the 2141 – the part automatically reduces its power requirements and remains in this low power standby mode as long as CS remains high. This device feature results in system power savings as great as 85% in larger systems, where the majority of devices are deselected.

The 2141 is placed in an 18-pin package configured with the industry standard pinout, the same as the 2147. It is directly TTL compatible in all respects: inputs, output, and a single +5V supply. The data is read out nondestructively and has the same polarity as the input data. A data input and a separate three-state output are used [3].

Part Numbers

Type D Packages

Part Number	Package Description	Values
D2141L-3	Type D package	\$.50-\$2
D2141L-4	Type D package	\$.50-\$2
D2141L-5	Type D package	\$.25-\$1

Type P Packages

Part Number	Package Description	Values
P2141L-3	Type P package	\$.50-\$2
P2141L-4	Type P package	\$.50-\$2



P2141L-5	Type P black plastic package w/tin pins.	\$.25-\$1
----------	--	-----------

References

- [1] Intel (1978). The Semiconductor Memory Book, 2141 and 2141-2 Data Sheet. No reference to 2141L.
- [2] Intel (1979). Intel Component Data Catalog, 2141, 2141L Family Data Sheet, p. 3-89
- [3] Intel (1980). Intel Component Data Catalog, 2141, 2141L Family Data Sheet, p. 1-49

Intel i2142

4096-bit (1024 x 4) Static RAM w/Common I/O 1978

Specifications

- 4096-bit (1024 x 4) Static RAM w/Common I/O
- NMOS
- Access Time Selections from 200-450ns
- Identical Cycle and Access Times
- Low Operating Power Dissipation
 - .1mW/Bit Typical
- Single +5V Supply
- No Clocks or Timing Strobe Required
- Completely Static Memory
- Directly TTL Compatible: All Inputs and Outputs
- Common Data Input and Output Using Three-State Outputs
- 20-pin Dual In-Line Package

Type	Access Time Max.	Cycle Time Max.	Power Dissipation Max. Operating/Standby	Supplies [V]
2142	450ns	450ns	100mA	+5
2142-2	200ns	200ns	100mA	+5
2142-3	300ns	300ns	100mA	+5
M2142	450ns	450ns	100mA	+5

The Intel ® 2142 is a 4096-bit static Random Access Memory organized as 1024 words by 4-bits using N-channel Silicon Gate MOS technology. It uses fully DC stable (static) circuitry throughout – in both the array and the decoding – and therefore requires no clocks or refreshing to operate. Data access is particularly simple since address setup times are not required. The data is read out nondestructively and has the same polarity as the input data. Common input/output pins are provided.

The 2142 is designed for memory applications where high performance, low cost, large bit storage, and simple interfacing are important design objectives. It is directly TTL compatible in all respects: inputs, outputs, and a single +5V supply.

The 2142 is placed in a 20-pin package. Two chip selects are provided for easy and flexible selection of individual packages when outputs are OR-tied. An Output Disable is included for direct control of the output buffers.

The 2142 is fabricated with Intel's N-channel Silicon-Gate technology – a technology providing excellent protection against contamination permitting the use of low cost plastic packaging [3].

Part Numbers

Type C Packages

Part Number	Package Description	Values
		
C2142	Type C purple ceramic package w/gold cap and gold pins. Small black dot denotes pin #1.	Rare \$15-\$60

Type D Packages

Part Number	Package Description	Values
D2142	Type D package	\$.75-\$3
D2142-2	Type D package	\$1.50-\$6
D2142-3	Type D package	\$.25-\$1

Type P Packages

Part Number	Package Description	Values
P2142	Type P black plastic package w/tin pins	\$.50-\$2
P2142-2	Type P package	\$1.50-\$6
P2142-3	Type P package	\$1.50-\$6

References

- [1] Intel (October 1977). Intel MCS-80 User's Manual, 2142 Family Advance Information.
- [2] Intel (1978). The Semiconductor Memory Book, 2142 Family Data Sheet.
- [3] Intel (1980). Intel Component Data Catalog, 2142/2142L Family Data Sheet, p. 1-55.

Intel i2142L

4096-bit (1024 x 4) Static RAM w/Common I/O 1978

Specifications

- 4096-bit (1024 x 4) Static RAM w/Common I/O
- NMOS
- Access Time Selections from 200-450ns
- Identical Cycle and Access Times
- Low Operating Power Dissipation
 - .1mW/Bit Typical
- Single +5V Supply
- No Clocks or Timing Strobe Required
- Completely Static Memory
- Directly TTL Compatible: All Inputs and Outputs
- Common Data Input and Output Using Three-State Outputs
- Low Power Version of the Intel 2142 Static RAM
- 20-pin Dual In-Line Package

Type	Access Time Max.	Cycle Time Max.	Power Dissipation Max. Operating/Standby	Supplies [V]
2142L	450ns	450ns	375mW	+5
2142L-3	300ns	300ns	375mW	+5

The Intel ® 2142 is a 4096-bit static Random Access Memory organized as 1024 words by 4-bits using N-channel Silicon Gate MOS technology. It uses fully DC stable (static) circuitry throughout – in both the array and the decoding – and therefore requires no clocks or refreshing to operate. Data access is particularly simple since address setup times are not required. The data is read out nondestructively and has the same polarity as the input data. Common input/output pins are provided.

The 2142 is designed for memory applications where high performance, low cost, large bit storage, and simple interfacing are important design objectives. It is directly TTL compatible in all respects: inputs, outputs, and a single +5V supply.

The 2142 is placed in a 20-pin package. Two chip selects are provided for easy and flexible selection of individual packages when outputs are OR-tied. An Output Disable is included for direct control of the output buffers.

The 2142 is fabricated with Intel's N-channel Silicon-Gate technology – a technology providing excellent protection against contamination permitting the use of low cost plastic packaging [3].

Part Numbers

Type C Packages

Part Number	Package Description	Values
C2142L	Type C package	Rare \$15-\$60
		
C2142L-3	Type C purple ceramic package with unusual black cap and tin pins.	Rare \$15-\$60

Type D Packages

Part Number	Package Description	Values
D2142L	Type D package	\$3-\$12
D2142L-3	Type D grey ceramic package w/tin pins.	\$2.50-\$10

Type P Packages

Part Number	Package Description	Values
P2142L	Type P package	Ex. Rare (0 Known) \$\$\$
P2142L-3	Type P package	\$5-\$20

References

- [1] Intel (October 1977). Intel MCS-80 User's Manual, 2142 Advance Information.
- [2] Intel (1978). The Semiconductor Memory Book, 2142 Family Data Sheet.
- [3] Intel (1980). Intel Component Data Catalog, 2142, 2142L Family Data Sheet, p. 1-55.

Intel i2147

4096-bit (4096 x 1) Static RAM w/Separate I/O 1977

Specifications

- 4096-bit (4096 x 1) Static RAM w/Separate I/O
- HMOS
- Completely Static Memory – No Clock or Timing Strobe Required
- Equal Access and Cycle Times
- Single +5V Supply
- Automatic Power-Down
- Directly TTL Compatible – All Inputs and Output
- Separate Data Input and Output
- Three-State Output
- 18-pin Dual In-Line Package

Type	Access Time Max.	Cycle Time Max.	Power Dissipation Max. Operating/Standby	Supplies [V]
2147	70ns	70ns	840mW/105mW	+5
2147-3	55ns	55ns	945mW/160mW	+5
M2147	85ns	85ns	180mA/30mA	+5



The Intel ® 2147 is a 4096-bit static Random Access Memory organized as 4096 words by 1-bit using HMOS, a high performance MOS technology. It uses a uniquely innovative design approach, which provides the ease-of-use features associated with non-clocked static memories and the reduced standby power dissipation associated with clocked static memories. To the user this means low standby power dissipation without the need for clocks, address setup and hold times, nor reduced data rates due to cycle times that are longer than access times.

Chip Select (CS) controls the power-down feature. In less than a cycle time after CS goes high – deselected the 2147 – the part automatically reduces its power requirements and remains in this low power standby mode as long as CS remains high. This device feature results in system power savings as great as 85% in larger systems, where the majority of devices are deselected.

The 2147 is placed in an 18-pin package configured with the industry standard pinout. It is directly TTL compatible in all respects: inputs, output, and a single +5V supply. The data is read out nondestructively and has the same polarity as the input data. A data input and a separate three-state output are used [3].

Part Numbers

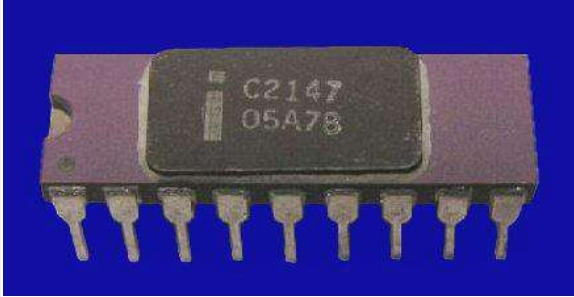
Type C Packages

Part Number	Package Description	Values
		
C2147	Type C purple ceramic package w/black cap and tin pins	\$6-\$24
		
C2147-3	Type C grey ceramic package w/black cap and tin pins	\$6-\$24

Type D Packages

Part Number	Package Description	Values
		
D2147	Type D grey ceramic package w/tin pins	\$.75-\$3
		
D2147-3	Type D grey ceramic package w/tin pins	\$.50-\$2

Intel i2147

MD2147	Type D package	Rare \$10-\$40
		
MD2147/B	Type D grey ceramic package w/tin pins	\$1.50-\$6

References

- [1] Intel (1977). Intel Data Catalog, 2147 Advance Information, p. 2-104
- [2] Intel (1978). The Semiconductor Memory Book, 2147, 2147-3, 2147L Data Sheet.
- [3] Intel (1980). Intel Component Data Catalog, 2147, 2147L Family Data Sheet, p. 159

Intel i2147L

4096-bit (4096 x 1) Static RAM w/Separate I/O 1977

Specifications

- 4096-bit (4096 x 1) Static RAM w/Separate I/O
- HMOS
- Completely Static Memory – No Clock or Timing Strobe Required
- Equal Access and Cycle Times
- Single +5V Supply
- Automatic Power-Down
- Directly TTL Compatible – All Inputs and Output
- Separate Data Input and Output
- Three-State Output
- Low Power Version of the Intel 2147 Static RAM
- 18-pin Dual In-Line Package

Type	Access Time Max.	Cycle Time Max.	Power Dissipation Max. Operating/Standby	Supplies [V]
2147L	70ns	70ns	735mW/53mW	+5

The Intel ® 2147 is a 4096-bit static Random Access Memory organized as 4096 words by 1-bit using HMOS, a high performance MOS technology. It uses a uniquely innovative design approach, which provides the ease-of-use features associated with non-clocked static memories and the reduced standby power dissipation associated with clocked static memories. To the user this means low standby power dissipation without the need for clocks, address setup and hold times, nor reduced data rates due to cycle times that are longer than access times.

Chip Select (CS) controls the power-down feature. In less than a cycle time after CS goes high – deselecting the 2147 – the part automatically reduces its power requirements and remains in this low power standby mode as long as CS remains high. This device feature results in system power savings as great as 85% in larger systems, where the majority of devices are deselected.

The 2147 is placed in an 18-pin package configured with the industry standard pinout. It is directly TTL compatible in all respects: inputs, output, and a single +5V supply. The data is read out nondestructively and has the same polarity as the input data. A data input and a separate three-state output are used [3].

Part Numbers

Type C Packages

Part Number	Package Description	Values
C2147L	Type C package	Rare \$20-\$80

Type D Packages

Part Number	Package Description	Values
D2147L	Type D package	\$1.50-\$6

References

- [1] Intel (1977). Intel Data Catalog, 2147 Advance Information, p. 2-104.
- [2] Intel (1978). The Semiconductor Memory Book, 2147, 2147-3, 2147L Data Sheet, p. 78
- [3] Intel (1980). Intel Component Data Catalog, 2147, 2147L Family Data Sheet, p. 159

Intel i2147A

4096-bit (4096 x 1) Static RAM w/Separate I/O 1981

Specifications

- 4096-bit (4096 x 1) Static RAM w/Separate I/O
- Advanced HMOS-II Technology
- Pinout and Functionally Compatible with the Industry Standard 2147H and the 2147
- Low Power Operation – 275 mW
- Lower Input/Output Leakage Current
- 0.8-2.0V Output Timing Reference Level
- Automatic Power Down Mode
- Directly TTL Compatible – All Inputs and Outputs
- Improved Output Drive
- Three-State Output for Bus Interface
- 18-pin Dual In-Line Package

Type	Access Time Max.	Cycle Time Max.	Power Dissipation Max. Operating/Standby	Supplies [V]
2147A	70ns	70ns	50mA/20mA	+5
2147A-3	55ns	55ns	50mA/20mA	+5

The Intel 2147A is a 4096 words by 1 bit static RAM designed for low power dissipation of 275 mW maximum. The 2147A is fully compatible with the industry standard 2147H and is fabricated on Advanced HMOS-II, an evolution of HMOS-II technology – a production proven process for high reliability, high performance, and high storage density.

The 2147A is fully static which results in reduced overhead costs by elimination of refresh clocking circuitry and by simplification of timing requirements. When deselected, the 2147A automatically changes into a low power standby mode and maintains this state until the chip select signal, CS, is low.

Accordingly, the 2147A is suitable for use in application such as instrumentation, telecommunications, caches, writeable control store, fast buffer memories and large memory systems in which a majority of units are deselected.

The 2147A is placed in an 18-pin plastic or cerdip package and is directly TTL compatible in all respects: inputs, output, and a single +5V supply. The data is read out nondestructively and has the same polarity as the input data. A data input and a separate three state output are used [6].

Was the Intel 2147A/2147AL Actually Produced?

No hits on any 2742A/2742AL part numbers on www.netcomponents.com. This chip may never have actually been produced.

An Intel OEM Price List, dated January 11, 1983, contains part numbers D2147A, D2147A-3, P2147A, P2147A-3, D2147AL, D2147AL-3, P2147AL, and P2147AL-3 with 'Contact Factory' in the price column.

Part Numbers

No Examples Known

References

- [1] Intel (1977). Intel Data Catalog, 2147 Advance Information, p. 2-104
- [2] Intel (1978). The Semiconductor Memory Book, 2147, 2147-3, 2147L Data Sheet, p. 78
- [3] Intel (1980). Intel Component Data Catalog, 2147H Family Data Sheet, p. 1-65. No reference to 2147A dates chip after 1980.
- [4] Hearst (1981). IC Master. No reference to Intel 2147A.
- [5] Intel (January 1982). Intel Component Data Catalog, 2147/2147AL Preliminary Data Sheet, p. 1-40
- [6] Intel (1981). Intel Memory Solutions Data Catalog, 2147A/2147AL Preliminary Data Sheet, p. 1-4.
- [7] Hearst (1983). IC Master. Intel 2147A and 2147AL Family access times, p. 3481

Intel i2147AL

4096-bit (4096 x 1) Static RAM w/Separate I/O 1981

Specifications

- 4096-bit (4096 x 1) Static RAM w/Separate I/O
- Advanced HMOS-II Technology
- Pinout and Functionally Compatible with the Industry Standard 2147H and the 2147
- Low Power Operation – 275 mW
- Lower Input/Output Leakage Current
- 0.8-2.0V Output Timing Reference Level
- Automatic Power Down Mode
- Directly TTL Compatible – All Inputs and Outputs
- Improved Output Drive
- Three-State Output for Bus Interface
- Low Power Version of the Intel 2147A Static RAM
- 18-pin Dual In-Line Package

Type	Access Time Max.	Cycle Time Max.	Power Dissipation Max. Operating/Standby	Supplies [V]
2147AL	70ns	70ns	35mA/10mA	+5
2147AL-3	55ns	55ns	35mA/12mA	+5

The Intel 2147A is a 4096 words by 1 bit static RAM designed for low power dissipation of 275 mW maximum. The 2147A is fully compatible with the industry standard 2147H and is fabricated on Advanced HMOS-II, an evolution of HMOS-II technology – a production proven process for high reliability, high performance, and high storage density.

The 2147A is fully static which results in reduced overhead costs by elimination of refresh clocking circuitry and by simplification of timing requirements. When deselected, the 2147A automatically changes into a low power standby mode and maintains this state until the chip select signal, CS, is low.

Accordingly, the 2147A is suitable for use in application such as instrumentation, telecommunications, caches, writeable control store, fast buffer memories and large memory systems in which a majority of units are deselected.

The 2147A is placed in an 18-pin plastic or cerdip package and is directly TTL compatible in all respects: inputs, output, and a single +5V supply. The data is read out nondestructively and has the same polarity as the input data. A data input and a separate three state output are used [3].

Was the Intel 2147A/2147AL Actually Produced?

No hits on any 2742A/2742AL part numbers on www.netcomponents.com. This chip may never have actually been produced.

An Intel OEM Price List, dated January 11, 1983, contains part numbers D2147A, D2147A-3, P2147A, P2147A-3, D2147AL, D2147AL-3, P2147AL, and P2147AL-3 with 'Contact Factory' in the price column.

Part Numbers

No Examples Known

References

- [1] Intel (1980). Intel Component Data Catalog. No reference to 2147A/2147AL dates chip after 1980.
- [2] Hearst (1981). IC Master. No reference to 2147A dates chip after 1981.
- [3] Intel (1981). Intel Memory Solutions Data Catalog, 2147A/2147AL Preliminary Data Sheet, p. 1-4.
- [4] Intel (January 1982). Intel Component Data Catalog, 2127A/2147AL Preliminary Data Sheet, p. 1-40.
- [5] Hearst (1983). IC Master. Intel 2147A and 2147AL Family access times, p. 3481.

Intel i2147H

4096-bit (4096 x 1) Static RAM w/Separate I/O

1979

Specifications

- 4096-bit (4096 x 1) Static RAM w/Separate I/O
- HMOS II
- Pinout, Function, and Power Compatible to Industry Standard 2147
- Completely Static Memory – No Clock or Timing Strobe Required
- Equal Access and Cycle Times
- Single +5V Supply
- 0.8 – 2.0V Output Timing Reference Levels
- Direct Performance Upgrade for 2147
- Automatic Power-Down
- Directly TTL Compatible – All Inputs and Outputs
- Separate Data Input and Output
- Three-State Output
- 18-pin Dual In-Line Package

Type	Access Time Max.	Cycle Time Max.	Power Dissipation Max. Operating/Standby	Supplies [V]
2147H	70ns	70ns	160mA/20mA	+5
2147H-1	35ns	35ns	180mA/30mA	+5
2147H-2	45ns	45ns	180mA/30mA	+5
2147H-3	55ns	55ns	180mA/30mA	+5
M2147H	70ns	70ns	160mA/20mA	+5
M2147H-1	35ns	35ns	180mA/30mA	+5
M2147H-2	45ns	45ns	180mA/30mA	+5
M2147H-3	55ns	55ns	180mA/30mA	+5

The Intel ® 2147H is a 4096-bit static Random Access Memory organized as 4096 words by 1-bit using HMOS-II, Intel's next generation high-performance MOS technology. It uses a uniquely innovative design approach, which provides the ease-of-use features associated with non-clocked static memories and the reduced standby power dissipation associated with clocked static memories. To the user this means low standby power dissipation without the need for clocks, address setup and hold times, nor reduced data rates due to cycle times that are longer than access times.



Chip Select (CS) controls the power-down feature. In less than a cycle time after CS goes high – deselecting the 2147H – the part automatically reduces its power requirements and remains in this low power standby mode as long as CS remains high. This device feature results in system power savings as great as 85% in larger systems, where the majority of devices are deselected.

Intel i2147H

The 2147H is placed in an 18-pin package configured with the industry standard pinout. It is directly TTL compatible in all respects: inputs, output, and a single +5V supply. The data is read out nondestructively and has the same polarity as the input data. A data input and a separate three-state output are used [4].

Part Numbers

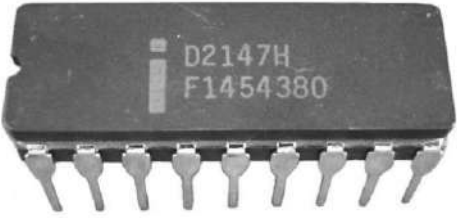
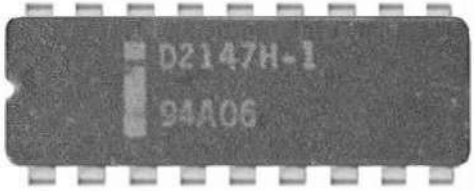
Type D Packages

Part Number	Package Description	Values
		
D2147H	Type D grey ceramic package w/tin pins	\$.15-\$.60
		
D2147H-1	Type D grey ceramic package w/tin pins	\$.15-\$.60
D2147H-2	Type D package	\$.15-\$.60
		
D2147H-3	Type D grey ceramic package w/tin pins. Examples shown made in Barbados and dated 8117.	\$.15-\$.60
LD2147H-2	Type D package	\$1-\$4
LD2147H-3	Type D package	\$.75-\$3
MD2147H	Type D package	\$.75-\$3
MD2147H/B	Type D package	\$.75-\$3
MD2147H/BC	Type D package	\$1-\$4
MD2147H-1	Type D package	\$.75-\$3
MD2147H-1/B	Type D package	\$.75-\$3
MD2147H-2	Type D package	\$.75-\$3
MD2147H-2/B	Type D package	\$.75-\$3

Intel i2147H

MD2147H-3	Type D package	\$.75-\$3
MD2147H-3/B	Type D package	\$.75-\$3
MD2147H-3/BC	Type D package	\$1.50-\$6
QD2147H	Type D package	\$.75-\$3
QD2147H-1	Type D package	\$1-\$4
QD2147H-2	Type D package	\$.75-\$3
QD2147H-3	Type D package	\$.50-\$1

Type P Packages

Part Number	Package Description	Values
P2147H-1	Type P package	\$.50-\$1
P2147H-2	Type P package	\$.75-\$3
P2147H-3	Type P package	Rare \$2-\$8

References

- [1] Intel (1978). Intel Component Data Catalog. No reference to 2147H dates chip after 1978
- [2] Hearst (1979). IC Master. No reference to Intel 2147H dates chip after 1979
- [3] Intel (1979). Intel Component Data Catalog, 2147H Advance Information, p. 3-105
- [4] Intel (1980). Intel Component Data Catalog, 2147H Family Data Sheet, p. 1-65

Intel i2147HL

4096-bit (4096 x 1) Static RAM w/Separate I/O 1980-81

Specifications

- 4096-bit (4096 x 1) Static RAM w/Separate I/O
- HMOS II
- Pinout, Function, and Power Compatible to Industry Standard 2147
- Completely Static Memory – No Clock or Timing Strobe Required
- Equal Access and Cycle Times
- Single +5V Supply
- 0.8 – 2.0V Output Timing Reference Levels
- Direct Performance Upgrade for 2147
- Automatic Power-Down
- Directly TTL Compatible – All Inputs and Outputs
- Separate Data Input and Output
- Three-State Output
- Low Power Version of the Intel 2147H Static RAM
- 18-pin Dual In-Line Package

Type	Access Time Max.	Cycle Time Max.	Power Dissipation Max. Operating/Standby	Supplies [V]
2147HL	70ns	70ns	140mA/10mA	+5
2147HL-3	55ns	55ns	125mA/15mA	+5

The Intel © 2147H is a 4096-bit static Random Access Memory organized as 4096 words by 1-bit using HMOS-II, Intel's next generation high-performance MOS technology. It uses a uniquely innovative design approach, which provides the ease-of-use features associated with non-clocked static memories and the reduced standby power dissipation associated with clocked static memories. To the user this means low standby power dissipation without the need for clocks, address setup and hold times, nor reduced data rates due to cycle times that are longer than access times.

Chip Select (CS) controls the power-down feature. In less than a cycle time after CS goes high – deselection of the 2147H – the part automatically reduces its power requirements and remains in this low power standby mode as long as CS remains high. This device feature results in system power savings as great as 85% in larger systems, where the majority of devices are deselected.

The 2147H is placed in an 18-pin package configured with the industry standard pinout. It is directly TTL compatible in all respects: inputs, output, and a single +5V supply. The data is read out nondestructively and has the same polarity as the input data. A data input and a separate three-state output are used [2].

Part Numbers

Type D Packages

Part Number	Package Description	Values
D2147HL	Type D package	\$.25-\$1
D2147HL-3	Type D package	\$1.50-\$6

References

[1] Intel (1980). Intel Component Data Catalog, 2147H Data Sheet, p. 1-65. No reference to 2147HL dates chip after 1980.

[2] Hearst (1981). IC Master, Intel 2147H and 2147HL Family Data Sheet, p. 3073

Intel i2148

4096-bit (1024 x 4) Static RAM w/Common I/O 1980

Specifications

- 4096-bit (1024 x 4) Static RAM w/Common I/O
- HMOS Technology
- Completely Static Memory – No Clock or Timing Strobe Required
- Equal Access and Cycle Times
- Single +5V Supply
- Automatic Power Down
- Directly TTL Compatible – All Inputs and Outputs
- Common Data Input and Output
- Three-State Output
- 18-pin Dual In-Line Package

Type	Access Time Max.	Cycle Time Max.	Power Dissipation Max. Operating/Standby	Supplies [V]
2148	70ns	70ns	140mA/30mA	+5
2148-3	55ns	55ns	140mA/30mA	+5
2148-6	85ns	85ns	140mA/30mA	+5

The Intel ® 2148 is a 4096-bit static Random Access Memory organized as 1024 words by 4-bits using HMOS, a high performance MOS technology. It uses a uniquely innovative design approach, which provides the ease-of-use features associated with non-clocked static memories and the reduced standby power dissipation associated with clocked static memories. To the user this means low standby power dissipation without the need for clocks, address setup and hold times, nor reduced data rates due to cycle times that are longer than access times.

Chip Select (CS) controls the power-down feature. In less than a cycle time after CS goes high – deselected the 2148 – the part automatically reduces its power requirements and remains in this low power standby mode as long as CS remains high. This device feature results in system power savings as great as 85% in larger systems, where the majority of devices are deselected.

The 2148 is assembled in an 18-pin package configured with the industry standard 1K x 4 pinout. It is directly TTL compatible in all respects: inputs, output, and a single +5V supply. The data is read out nondestructively and has the same polarity as the input data. A data input and a separate three-state output are used [3].

Part Numbers

Type D Packages

Part Number	Package Description	Values
D2148	Type D package	\$.20-\$.80
D2148-3	Type D package	\$.25-\$1
D2148-6	Type D package	Rare \$2-\$8
MD2148/B	Type D package	\$1.50-\$6
MD2148-3/B	Type D package	\$1.50-\$6

Type P Packages

Part Number	Package Description	Values
P2148	Type P package	\$1-\$4
P2148-3	Type P package	\$1-\$4

References

- [1] Hearst (1979). IC Master. No reference to Intel 2148 dates chip after 1979.
- [2] Intel (1979). Intel Component Data Catalog, 2148 Advance Information, p. 3-106
- [3] Intel (1980). Intel Component Data Catalog, 2148 Preliminary Data Sheet, p. 1-69

Intel i2148H

4096-bit (1024 x 4) Static RAM w/Common I/O 1981-82

Specifications

- 4096-bit (1024 x 4) Static RAM w/Common I/O
- HMOS III
- Completely Static Memory – No Clock or Timing Strobe Required
- Equal Access and Cycle Times
- Functionally Compatible to the 2148
- Automatic Power Down
- Three-State Output
- Single +5V Supply
- Fast Chip Select Address 2149H Available
- 18-pin Dual In-Line Package

Type	Access Time Max.	Cycle Time Max.	Power Dissipation Max. Operating/Standby	Supplies [V]
2148H	70ns	70ns	150mA/30mA	+5
2148H-2	45ns	45ns	150mA/30mA	+5
2148H-3	55ns	55ns	150mA/30mA	+5
M2148H	70ns	70ns	150mA/30mA	+5
M2148H-3	55ns	55ns	150mA/30mA	+5

The Intel® 2148H is a 4096-bit static Random Access Memory organized as 1024 words by 4-bits using HMOS III, a high-performance MOS technology. It uses a uniquely innovative design approach, which provides the ease-of-use features associated with non-clocked static memories and the reduced standby power dissipation associated with clocked static memories. To the user this means low standby power dissipation without the need for clocks, address setup and hold times, nor reduced data rates due to cycle times that are longer than access times.

Chip Select (CS) controls the power-down feature. In less than a cycle time after CS goes high – disabling the 2148H – the part automatically reduces its power requirements and remains in this low power standby mode as long as CS remains high. This device feature results in system power savings as great as 85% in larger systems, where the majority of devices are disabled. A non-power-down companion, the 2149H, is available to provide a fast chip select access time for speed critical applications.

The 2148H is assembled in an 18-pin package configured with the industry standard 1K x 4 pinout. It is directly TTL compatible in all respects: inputs, outputs, and a single +5V supply. The data is read out nondestructively and has the same polarity as the input data [1].

Part Numbers

Type D Packages

Part Number	Package Description	Values
		
D2148H	1. Type D grey ceramic package w/tin pins.	\$.25-\$1
D2148H	2. Type D grey ceramic package w/tin pins. Remarkd.	\$1.25-\$5
D2148H-2	Type D package	\$.25-\$1
D2148H-3	Type D package	\$.25-\$1
ID2148H	Type D package	\$2-\$8
ID2148H-2	Type D package	\$2-\$8
LD2148H-3	Type D package	\$2-\$8
MD2148H	Type D package	\$.75-\$3
MD2148H/B	Type D package	\$.75-\$3
MD2148H/BC	Type D package	\$1.50-\$6
MD2148H-3	Type D package	\$.50-\$2
MD2148H-3/B	Type D package	\$.75-\$3
QD2148H	Type D package	\$1-\$4
QD2148H-3	Type D package	\$2-\$8

Type P Packages

Part Number	Package Description	Values
P2148H	Type P package	\$.15-\$60
		
P2148H-2	Type P black plastic package w/tin pins	\$.75-\$3

Intel i2148H

 A photograph of an Intel P2148H-3 network controller chip. The chip is black and rectangular, with eight gold-plated pins along one edge. The top surface of the chip is marked with the text "P2148H-3" and "BCL7130700".		
P2148H-3	Type P package	\$.25-\$1

References

- [1] Intel (1980). Intel Component Data Catalog, 2148H Advance Information, p. 1-73
- [2] Hearst (1981). IC Master, Intel 2148H/2148HL Family Preliminary Data Sheet, p. 3075

Intel i2148HL

4096-bit (1024 x 4) Static RAM w/Common I/O

1981-82

Specifications

- 4096-bit (1024 x 4) Static RAM w/Common I/O
- HMOS III
- Improved Performance Margins
- Single +5V Supply
- Completely Static Memory – No Clock or Timing Strobe Required
- Common Data Input and Output
- Three-State Output
- Low Power version of the Intel 2148H Static RAM
- 18-pin Dual In-Line Package

Type	Access Time Max.	Cycle Time Max.	Power Dissipation Max. Operating/Standby	Supplies [V]
2148HL	70ns	70ns	125mA/20mA	+5
2148HL-3	55ns	55ns	125mA/20mA	+5

The Intel® 2148H is a 4096-bit static Random Access Memory organized as 1024 words by 4-bits using HMOS III, a high-performance MOS technology. It uses a uniquely innovative design approach, which provides the ease-of-use features associated with non-clocked static memories and the reduced standby power dissipation associated with clocked static memories. To the user this means low standby power dissipation without the need for clocks, address setup and hold times, nor reduced data rates due to cycle times that are longer than access times.

Chip Select (CS) controls the power-down feature. In less than a cycle time after CS goes high – disabling the 2148H – the part automatically reduces its power requirements and remains in this low power standby mode as long as CS remains high. This device feature results in system power savings as great as 85% in larger systems, where the majority of devices are disabled. A non-power-down companion, the 2149H, is available to provide a fast chip select access time for speed critical applications.

The 2148H is assembled in an 18-pin package configured with the industry standard 1K x 4 pinout. It is directly TTL compatible in all respects: inputs, outputs, and a single +5V supply. The data is read out nondestructively and has the same polarity as the input data [3].

Part Numbers

Type D Packages

Part Number	Package Description	Values
 A photograph of a grey ceramic Type D package with tin pins. The package is rectangular with a notch on the left side. It has two rows of pins. The top surface is marked with the Intel logo, 'D2148HL', and 'C2351590'.		
D2148HL	Type D grey ceramic package w/tin pins	\$.25-\$1
D2148HL-3	Type D package	\$.25-\$1
QD2148HL	Type D package	\$.50-\$2

Type P Packages

Part Number	Package Description	Values
P2148HL	Type P package	\$.20-\$.80

References

- [1] Intel (1980). Intel Component Data Catalog, 2148H Advance Information, p. 1-73.
- [2] Hearst (1981). IC Master, Intel 2148H/2148HL Family Preliminary Data Sheet, p. 3075
- [3] Intel (1988). Intel Memory Component Handbook, 2148H, 2148HL Family Data Sheet, p. 3-23
- [4] NetComponents (2002). NetComponents. Available from: www.NetComponents.com [Accessed 10 July 2002] - No hits on Intel 2148B series. Found what appear to be legit 1980 date codes on Intel D2148HL.

Intel i2149H

4096-bit (1024 x 4) Static RAM w/Common I/O 1981-82

Specifications

- 4096-bit (1024 x 4) Static RAM w/Common I/O
- Fast Chip Select Access Time – 30ns max.
- HMOS II
- Completely Static Memory – No Clock or Timing Strobe Required
- Equal Access and Cycle Times
- Common Data Input and Output
- Three-State Output
- Single +5V Supply
- Automatic Power-Down 2148H Available
- 18-pin Dual In-Line Package



Type	Access Time Max.	Cycle Time Max.	Power Dissipation Max. Operating/Standby	Supplies [V]
2149H	70ns	70ns	150mA	+5
2149H-1	35ns	35ns	150mA	+5
2149H-2	45ns	45ns	150mA	+5
2149H-3	55ns	55ns	150mA	+5

The Intel® 2149H is a 4096-bit static Random Access Memory organized as 1024 words by 4-bits using HMOS III, a high performance MOS technology. It has a fast chip select access time of less than 30ns instead of an automatic power-down feature. This fast chip select access time could result in doubling of device throughput. An automatic power-down companion, the 2148H, is available for power critical applications.

The 2149H is assembled in an 18-pin package configured with the industry standard 1K x 4 pinout. It is directly TTL compatible in all respects: inputs, outputs, and a single +5V supply. The data is read out nondestructively and has the same polarity as the input data [1].

Part Numbers

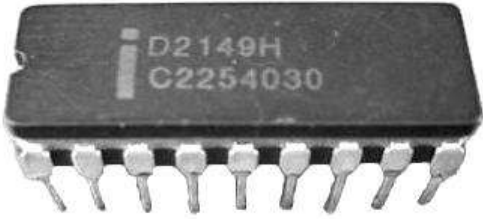
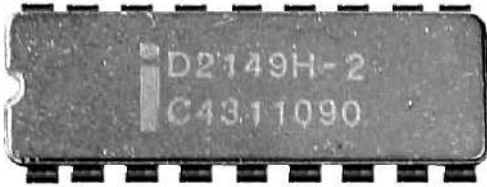
Type D Packages

Part Number	Package Description	Values
 <p>A black ceramic package with 14 pins. The top surface is marked with the Intel logo, 'D2149H', and 'C2254030'.</p>		
D2149H	Type D grey ceramic package w/tin pins	\$.15-\$.60
D2149H-1	Type D package	\$.15-\$.60
 <p>A black ceramic package with 14 pins. The top surface is marked with the Intel logo, 'D2149H-2', and 'C4311090'.</p>		
D2149H-2	Type D grey ceramic package w/tin pins	\$.10-\$.40
 <p>A black ceramic package with 14 pins. The top surface is marked with the Intel logo, 'D2149H-3', and 'BC5360370'.</p>		
D2149H-3	Type D package	\$.15-\$.60
QD2149H-2	Type D package	\$1.50-\$6
QD2149H-3	Type D package	\$1.50-\$6

Type P Packages

Part Number	Package Description	Values
P2149H	Type P package	\$1-\$4
P2149H-1	Type P package	\$1.50-\$6
P2149H-2	Type P package	\$1-\$4
P2149H-3	Type P package	\$.75-\$3

References

- [1] Intel (1980). Intel Component Data Catalog, 2149H Advance Information, p. 1-74
- [2] Hearst (1981). IC Master, Intel 2149H Advance Information, p. 3076

Intel i2149HL

4096-bit (1024 x 4) Static RAM w/Common I/O

1981-82

Specifications

- 4096-bit (1024 x 4) Static RAM w/Common I/O
- HMOS III
- Improved Performance Margins
- Equal Access and Cycle Times
- Common Data Input and Output
- Three-State Output
- Single +5V Supply
- Automatic Power-Down 2148H Available
- Low Power Version of the Intel 2149H Static RAM
- 18-pin Dual In-Line Package

Type	Access Time Max.	Cycle Time Max.	Power Dissipation Max. Operating/Standby	Supplies [V]
2149HL	70ns	70ns	125mA	+5
2149HL-3	55ns	55ns	125mA	+5

The Intel® 2149H is a 4096-bit static Random Access Memory organized as 1024 words by 4-bits using HMOS III, an ultra high-performance MOS technology. It provides a maximum chip select access time as low as 20ns instead of an automatic power-down feature. This fast chip select access time could result in doubling of device throughput. An automatic power-down companion, the 2148H, is available for power critical applications.

The 2149H is assembled in an 18-pin package configured with the industry standard 1K x 4 pinout. It is directly TTL compatible in all respects: inputs, outputs, and a single +5V supply. The data is read out nondestructively and has the same polarity as the input data [2].

Part Numbers

Type D Packages

Part Number	Package Description	Values
D2149HL	Type D grey ceramic package w/tin pins.	\$2-\$8
D2149HL-3	Type D package	\$2-\$8

Type P Packages

Part Number	Package Description	Values
P2149HL	Type P package	\$.75-\$3

References

[1] Intel (1980). Intel Component Data Catalog, 2149H Advance Information, p. 1-74. No reference to 2148HL dates 2149HL after 1980.

[2] Intel (1988). Intel Memory Components Handbook, 2149H, 2149HL Data Sheet, p. 3-28

Intel i2308

8192-bit (1024 x 8) Static ROM

1973-74

Specifications

- 8192-bit (1024 x 8) Static ROM
- NMOS
- Fast Access Time: 450ns
- Standard Power Supplies: +12V, ±5V
- TTL Compatible: All Inputs and Outputs
- Programmable Chip Select Input for Easy Memory Expansion
- Three-State Output: OR-Tie Capability
- Full Decoded: On Chip Address Decode
- Inputs Protected: All Inputs Have Protection Against Static Charge
- Three-State Output
- ROM Equivalent of Intel 2608 PROM and 2708 EPROM
- 24-pin Dual In-Line Package

Type	Access Time Max.	Power Dissipation Max. Operating/Standby	Supplies [V]
2308	450ns	840mW	+12, +5, -5

The Intel® 2308 is a 8192 bit static MOS read only memory organized as 1024 words by 8-bits. This ROM is designed for memory applications where high performance, large bit storage, and simple interfacing are important design objectives.

The inputs and outputs are TTL compatible. The chip select input is programmable. An active high or low-level chip select can be defined by the designer and the desired chip select logic level is fixed at Intel during the masking process. The programmable chip select input, as well as OR-tie compatibility on the outputs, facilitates easy memory expansion. A cost-effective system development program may be implemented by using the 2708 8K UV EPROM for prototyping and the lower cost 2608 PROM and 2308 ROM for production.

The 2308 read only memory is fabricated with N-channel silicon gate technology. This technology provides the designer with high performance, easy-to-use MOS circuits [3].

Part Numbers

No Examples Known

References

[1] Intel (1974). Intel Advertisement. "From CPU to Software The 8080 Microcomputer is here". Lists availability date for 8308 (8xxx equivalent of 2308) as "3rd Q".

[2] Intel (1975). Intel Memory Design Handbook, 2308, p. PSG-2

[3] Intel (1978). Intel Component Data Catalog, 2308/8308 Data Sheet, p. 4-18

Intel i2316A

16384-bit (2048 x 8) Static ROM

1974-75

Specifications

- 16,384-bit (2048 x 8) Static ROM
- NMOS
- Access Time – 850ns Max.
- Single +5V Power Supply
- Directly TTL Compatible – All Inputs and Outputs
- Low Power Dissipation of 31.4 μ W/Bit Maximum
- Three Programmable Chip Select Inputs for Easy memory Expansion
- Three-State Output – OR-Tie Capability
- Fully Decoded – On Chip Address Decode
- Inputs Protected – All Inputs Have Protection Against Static Charge
- 24-pin Dual In-Line Package

Type	Access Time Max.	Power Dissipation Max. Operating/Standby	Supplies [V]
2316A	850ns	515mW	+5

The Intel® 2316A is a 16,384-bit static MOS read only memory organized as 2048 words by 8 bits. This ROM is designed for microcomputer memory applications where high performance, large bit storage, and simple interfacing are important design objectives.

The inputs and outputs are fully TTL compatible. This device operates with a single +5V power supply. This three chip select inputs are programmable. Any combination of active high or low-level chip select inputs can be defined and the desired chip select code is fixed during the masking process. These three programmable chip select inputs, as well as OR-tie compatibility on the inputs, facilitate easy memory expansion.

The 2316A read only memory is fabricated with N-channel silicon gate technology. This technology provides the designer with high performance, easy-to-use MOS circuits. Only a single +5V power supply is needed and all devices are directly TTL compatible [4].

The 2316A is NOT a ROM equivalent of the Intel 2616 PROM and 2716 EPROM

Was the Intel 2316 Actually Produced?

The 2316A is listed as “New Product” in the 1975 Intel Data Catalog. This same catalog still lists the non-‘A’ version of the 4316 and 8316.

The MCS-80 User’s manual dated September 1975 lists the 8316A.

I suspect that 2316A was introduced around the same time that the 4316 and 8316 were replaced by the 4316A and 8316A. In other words, the Intel 2316 may have been introduced as the 2316A.

Part Numbers

No Examples Known

References

- [1] Intel (1974). Intel Advertisement. "From CPU to Software The 8080 Microcomputer is here". Lists availability date for 8316 (8xxx equivalent of 2316) as "NOW".
- [2] Intel (1975). Intel Data Catalog, 2316A "New Product" Data Sheet, p. 3-18
- [3] Intel (1975). Intel Memory Design Handbook, 2316A, p. PSG-2
- [4] Intel (1978). Intel Component Data Catalog, 2316A, 4316A, 8316A Data Sheet, p. 4-22.
- [5] Intel (1984). A Revolution in Progress... A History of Intel to Date, 2316 introduced 1974, p. 26.

Intel i2316E

16384-bit (2048 x 8) Static ROM

1977

Specifications

- 16384-bit (2048 x 8) Static ROM
- NMOS
- Fast Access Time: 450 ns Max.
- Single +5V \pm 10% Power Supply
- Intel MCS-80™ and MCS-85™ Compatible
- Three Programmable Chip Selects for Simple Memory Expansion and System Interface
- EPROM/ROM Pin Compatible for Cost-Effective System Development
- Completely Static Operation
- Inputs and Outputs TTL Compatible
- Three-State Output for Direct Bus Interface
- ROM equivalent of the Intel 2616 PROM and 2716 PROM
- 24-pin Dual In-Line Package

Type	Access Time Max.	Power Dissipation Max. Operating/Standby	Supplies [V]
2316E	450ns	630mW	+5

The Intel® 2316E is a 16,384-bit static, N-channel MOS read only memory (ROM) organized as 2048 words by 8-bits. Its high bit density is ideal for large, non-volatile data storage applications such as program storage. The three-state outputs and TTL input/output levels allow for direct interface with common system bus structures. The 2316E's single +5V power supply and 450ns access time are both ideal for usage with high performance microcomputers such as the Intel MCS-80™ and MCS-85™ devices.

A cost-effective system development program may be implemented by using the pin compatible Intel 2716 16K UV EPROM for prototyping and the lower cost 2616 PROM and 2316E ROM for production. The 2716 is fully compatible to the 2316E in all respects. The three 2316E programmable chip selects may be defined by the user and are fixed during the masking process. To simplify the conversion from 2716 prototyping to 2316E production, it is recommended that the 2316E programmable chip select logic levels be defined the same as the 2716 [2].

Intel i2316E

Part Numbers

Type D Packages

Part Number	Package Description	Values
		
D2316E	Type D grey ceramic package w/pins tins.	\$2.50-\$10

Type P Packages

Part Number	Package Description	Values
P2316E	Type P package	\$2.50-\$10

References

- [1] Intel (1977). Intel Data Catalog, 2316E Preliminary Data Sheet, p. 3-21.
- [2] Intel (1978). Intel Component Data Catalog, 2316E Data Sheet, p. 4-25.

Intel i2401

2048-bit (1024 x 2) Dynamic Recirculating Shift Register

1972

Specifications

- 2048-bit (1024 x 2) Dynamic Recirculating Shift Register
- NMOS
- Single Supply Voltage -- +5 Volts
- Fully TTL Compatible – Inputs, Outputs and Clock
- Single Phase Clock
- Guaranteed 1 MHz Operation with 100 pF Load, over Temperature Range
- Low Power Dissipation – 120 μ W/bit typically at 1 MHz
- Low Clock Capacitance – 7 pF
- Write/Recirculate and Chip Select Logic Incorporated on Chip
- Standard Configurations --
 - Dual 1024 Bit -- 2401
 - Single 1024 Bit -- 2405
- 16-pin Dual In-Line Package

Type	Clock Min.	Clock Max.	Power Dissipation Max. Operating/Standby	Supplies [V]
2401	25 kHz	1 MHz	350mW	+5

The 2401, 2402/2403, 2404 is a family of 2048/2000 bit dynamic recirculating shift registers. They are directly TTL compatible in all respects: inputs, outputs, clock and a single +5 volt power supply.

Write/Recirculate controls have been provided to eliminate the need for external logic elements when recirculating data.

Two “active low” chip select inputs have been provided for combining devices in a matrix array.

The output will drive a 100 pF load at 1MHz to allow for OR-tying of many devices on common input busses. In this mode, only one of the internal load resistors should be connected per output bus.

This Intel shift register family is fabricated with N-channel silicon gate technology. This technology provides the designer with high performance, easy to use MOS circuits. Only a single +5 volt power supply is needed and all devices are directly TTL compatible, including clocks [2].

Part Numbers

Type C Packages

Part Number	Package Description	Values
		
C2401	Type C white ceramic package w/grey traces, gold cap, gold cap ground strap, and gold pins.	Ex. Rare \$50-\$200

Type P Packages

Part Number	Package Description	Values
		
P2401	Type P grey plastic package w/gold pins. Embossed Intel 'i' in key.	\$5-\$20
		
P2401	Type P grey plastic package w/tin pins.	\$3-\$12

References

- [1] Intel (March 1971). Intel Price List. No reference to 2401 dates chip after March 1971.
- [2] Intel (September 1972). Intel Data Catalog, 2401/2406 Data Sheet, p. 4-15
- [3] Intel (1984). A Revolution in Progress... A History of Intel to Date, 2401/2/3/4 introduced 1972, p. 26.

Intel i2402

2048-bit Dynamic Recirculating Shift Register

1972

Specifications

- 2048-bit Dynamic Recirculating Shift Register
- NMOS

Type	Clock Min.	Clock Max.	Power Dissipation Max. Operating/Standby	Supplies [V]
2402	-	-	-	+5

The 2401, 2402/2403, 2404 is a family of 2048/2000 bit dynamic recirculating shift registers. They are directly TTL compatible in all respects: inputs, outputs, clock and a single +5 volt power supply.

Write/Recirculate controls have been provided to eliminate the need for external logic elements when recirculating data.

Two “active low” chip select inputs have been provided for combining devices in a matrix array.

The output will drive a 100 pF load at 1MHz to allow for OR-tieing of many devices on common input busses. In this mode, only one of the internal load resistors should be connected per output bus.

This Intel shift register family is fabricated with N-channel silicon gate technology. This technology provides the designer with high performance, easy to use MOS circuits. Only a single +5 volt power supply is needed and all devices are directly TTL compatible, including clocks [2].

Part Numbers

No Examples Known

References

- [1] Intel (March 1971). Intel Price List. No reference to 2402 dates chip after March 1971.
- [2] Intel (September 1972). Intel Data Catalog, 2401/2405 Data Sheet, p. 4-15.
- [3] Intel (1984). A Revolution in Progress... A History of Intel to Date, 2401/2/3/4 introduced 1972, p. 26.

Intel i2403

2000-bit Dynamic Recirculating Shift Register

1972

Specifications

- 2000-bit Dynamic Recirculating Shift Register
- NMOS

Type	Clock Min.	Clock Max.	Power Dissipation Max. Operating/Standby	Supplies [V]
2403	-	-	-	+5

The 2401, 2402/2403, 2404 is a family of 2048/2000 bit dynamic recirculating shift registers. They are directly TTL compatible in all respects: inputs, outputs, clock and a single +5 volt power supply.

Write/Recirculate controls have been provided to eliminate the need for external logic elements when recirculating data.

Two “active low” chip select inputs have been provided for combining devices in a matrix array.

The output will drive a 100 pF load at 1MHz to allow for OR-tieing of many devices on common input busses. In this mode, only one of the internal load resistors should be connected per output bus.

This Intel shift register family is fabricated with N-channel silicon gate technology. This technology provides the designer with high performance, easy to use MOS circuits. Only a single +5 volt power supply is needed and all devices are directly TTL compatible, including clocks [2].

Part Numbers

No Examples Known

References

- [1] Intel (March 1971). Intel Price List. No reference to 2403 dates chip after March 1971.
- [2] Intel (September 1972). Intel Data Catalog, 2401/2405 Data Sheet, p. 4-15
- [3] Intel (1984). A Revolution in Progress... A History of Intel to Date, 2401/2/3/4 introduced 1972, p. 26.

Intel i2404

2000-bit Dynamic Recirculating Shift Register

1972

Specifications

- 2000-bit Dynamic Recirculating Shift Register
- NMOS

Type	Clock Min.	Clock Max.	Power Dissipation Max. Operating/Standby	Supplies [V]
2404	-	-	-	+5

The 2401, 2402/2403, 2404 is a family of 2048/2000 bit dynamic recirculating shift registers. They are directly TTL compatible in all respects: inputs, outputs, clock and a single +5 volt power supply.

Write/Recirculate controls have been provided to eliminate the need for external logic elements when recirculating data.

Two “active low” chip select inputs have been provided for combining devices in a matrix array.

The output will drive a 100 pF load at 1MHz to allow for OR-tieing of many devices on common input busses. In this mode, only one of the internal load resistors should be connected per output bus.

This Intel shift register family is fabricated with N-channel silicon gate technology. This technology provides the designer with high performance, easy to use MOS circuits. Only a single +5 volt power supply is needed and all devices are directly TTL compatible, including clocks [2].

Part Numbers

No Examples Known

References

- [1] Intel (March 1971). Intel Price List. No reference to 2404 dates chip after March 1971.
- [2] Intel (September 1972). Intel Data Catalog, 2401/2405 Data Sheet, p. 4-15.
- [3] Intel (1984). A Revolution in Progress... A History of Intel to Date, 2401/2/3/4 introduced 1972, p. 26.

Intel i2405

1024-bit (1024 x 1) Dynamic Recirculating Shift Register

1972

Specifications

- 1024-bit (1024 x 1) Dynamic Recirculating Shift Register
- NMOS
- Single Supply Voltage -- +5 Volts
- Fully TTL Compatible – Inputs, Outputs and Clock
- Single Phase Clock
- Guaranteed 1 MHz Operation with 100 pF Load, over Temperature Range
- Low Power Dissipation – 120 μ W/bit typically at 1 MHz
- Low Clock Capacitance – 7 pF
- Write/Recirculate and Chip Select Logic Incorporated on Chip
- Standard Configurations --
 - Dual 1024 Bit -- 2401
 - Single 1024 Bit -- 2405
- 16-pin Dual In-Line Package

Type	Clock Min.	Clock Max.	Power Dissipation Max. Operating/Standby	Supplies [V]
2405	25kHz	1MHz	350mW	+5

The 2401, 2402/2403, 2404 is a family of 2048/2000 bit dynamic recirculating shift registers. They are directly TTL compatible in all respects: inputs, outputs, clock and a single +5 volt power supply.

Write/Recirculate controls have been provided to eliminate the need for external logic elements when recirculating data.

Two “active low” chip select inputs have been provided for combining devices in a matrix array.

The output will drive a 100 pF load at 1MHz to allow for OR-tying of many devices on common input busses. In this mode, only one of the internal load resistors should be connected per output bus.

This Intel shift register family is fabricated with N-channel silicon gate technology. This technology provides the designer with high performance, easy to use MOS circuits. Only a single +5 volt power supply is needed and all devices are directly TTL compatible, including clocks [2].

Part Numbers

Type P Packages

Part Number	Package Description	Values
P2405	Type P package	\$3-\$12

References

- [1] Intel (March 1971). Intel Price List. No reference to 2405 dates chip after March 1971.
- [2] Intel (September 1972). Intel Data Catalog, 2401/2405 Data Sheet, p. 4-15. P2405 listed in ordering information, p. 8-4.
- [3] Intel (2002). Intel Museum Archive. Available from:
http://www.intel.com/intel/intelis/museum/arc_collect/TimelineChron.pdf [Accessed 1 June 2002] – 2401/2/3/4 [introduction] date “01/01/72”.

Intel i2416

16384-bit (16384 x 1) CCD Memory

1974-75

Specifications

- 16384-bit (16384 x 1) CCD Memory
- NMOS
- Organization: 64 Recirculating Shift Registers of 256 Bits Each
- Avg. Latency Time Under 100 μ s
- Max Serial Data Transfer Rate – 2 Mega Bits/sec.
- Address Registers Incorporated On Chip
- Standard Power Supplies +12V, -5V
- Open Drain Output
- Combined Read/Write Cycles Allowed
- Compatible to Intel® 5244 CCD Driver
- 22-Pin Type C Dual In-Line Package
- 18-Pin Type P Dual In-Line Package

Type	Clock Min.	Clock Max.	Power Dissipation Max. Operating/Standby	Supplies [V]
2416	-	2MHz	300mW	+12, -5

The Intel® 2416 is a 16384 word by 1-bit CCD serial memory designed for very low-cost memory applications. The memory is configured as 64 independent recirculating shift registers of 256 bits each. Access to any one of the 64 internal shift registers is done by applying the appropriate code to 6 address inputs. The 2416 is fabricated using Intel's advanced high voltage n-channel silicon gate MOS process [1].

Pins counts are NOT a typo. The 2416 in the type C package actually had a different pin count than the 2416 in the type P package.

Part Numbers

Type C Packages

Part Number	Package Description	Values
		
C2416	Type C grey ceramic package w/gold cap, gold cap ground strap and gold pins.	Ex. Rare \$75-\$300

Type P Packages

Part Number	Package Description	Values
P2416	Type P package	\$.50-\$2

References

- [1] Intel (1975). The Semiconductor Memory Book, Design and Application of 2416 CCD Memory, p. 375.
- [2] Intel (1984). A Revolution in Progress... A History of Intel to Date, 2416 introduced 1975, p. 26.

Intel i2608

8192-bit (1024 x 8) PROM

1977-78

Specifications

- 8192-bit (1024 x 8) PROM
- NMOS
- Fast Access Time: 450ns Max.
- Pin Compatible to 2708 EPROM and 2308 ROM
- Static – No Clocks Required
- Data Inputs and Outputs TTL Compatible
- Three-State Outputs – OR-Tie Capability
- 24-pin Dual In-Line Package

Type	Access Time Max.	Power Dissipation Max. Operating/Standby	Supplies [V]
2608	450ns	800mW	+12, -5, +5

The Intel® 2608 is a 8192-bit, one time factory programmable MOS PROM organized as 1K words by 8-bits. The electrical characteristics are specified over the 0°C to 70°C operating temperature range with 5% power supply variation. The 2608 features are ideally suited for microprocessor systems: 450 ns maximum access time, three-state outputs for common bussing, and TTL inputs/outputs for easy interfacing.

A cost-effective system development program may be implemented by using the Intel® 2708 EPROM for pattern experimentation, the 2608 for first incremental 2308 ROM delivery and the 2308 for volume production. The 2608 is fully compatible to the 2708 in all respects. The fast factory 2608 code pattern turn-around time gives a rapid transition from EPROM to ROM for production [2].

Part Numbers

Type C Packages

Part Number	Package Description	Values
		
C2608	Type C white ceramic package w/gold cap with quartz porthole, offset gold cap ground strap, and gold pins. Small block dot denotes pin #1. © Intel '75	Rare \$20-\$80

Type B Packages

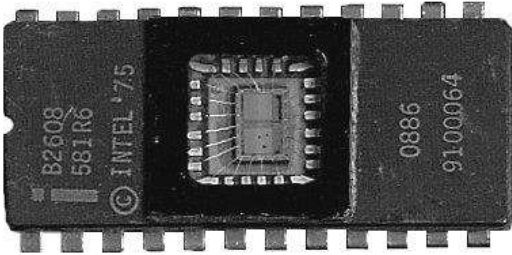
Part Number	Package Description	Values
B2608	1. Type B grey ceramic package w/quartz cap (painted black) and tin pins. No copyright. L. J. Collection	\$3-\$12
		
B2608	2. Type B grey ceramic package w/quartz cap and tin pins. © Intel '75	\$2.50-\$10

Type D Packages

Part Number	Package Description	Values
D2608	Type D grey ceramic package w/tin pins. © Intel '75.	\$1.50-\$6

References

- [1] Intel (1977). Intel Data Catalog. No reference to 2608 dates chip after 1977.
- [2] Intel (1978). Intel Component Data Catalog, 2608 Data Sheet, p. 4-31.

Intel i2616

16384-bit (2048 x 8) Static PROM

1977-78

Specifications

- 16384-bit (2048 x 8) Static PROM
- NMOS
- Single +5V Power Supply
- Low Power Dissipation
 - 525mW Max. Active Power
 - 132mW Max. Standby Power
- Pin Compatible to Intel® 2716 EPROM and 2316E ROM
- Fast Access Time – 450 ns max.
- Inputs and Outputs TTL Compatible
- Completely Static
- Three-State Output
- 24-pin Dual In-Line Package

Type	Access Time Max.	Power Dissipation Max. Operating/Standby	Supplies [V]
2616	450ns	525mW/132mW	+5

The Intel® 2616 is a 16,384-bit, one-time factory programmable MOS PROM organized as 2048 words by 8 bits. The 2616 operates from a single +5V power supply, has a static standby mode, and is TTL input/output compatible. It is specified over the °0C to °70C operating temperature with 5% power supply variation.

A cost-effective system development program may be implemented quickly into production by using the Intel® 2716 EPROM for pattern experimentation, the 2616 for fast first incremental 2316E ROM delivery and the 2316E for volume production. The 2616 is fully compatible to the 2716 in all respects. The fast factory 2616 code pattern turn-around time gives a rapid transition from EPROM to ROM for production.

The 2616 has a static standby mode, which reduces power dissipation without increasing access time. The maximum active power dissipation is 525mW, while the maximum standby power dissipation is only 132mW – a 75% saving [2].

Part Numbers

Type B Packages

Part Number	Package Description	Values
		
B2616	1. Type B grey ceramic package w/black cap and tin pins. © Intel '77. Package marked 'HIGH'.	\$5-\$20
B2616	2. Type B grey ceramic package w/black cap and tin pins. © Intel '77. Package marked 'LOW'.	\$5-\$20

Type D Packages

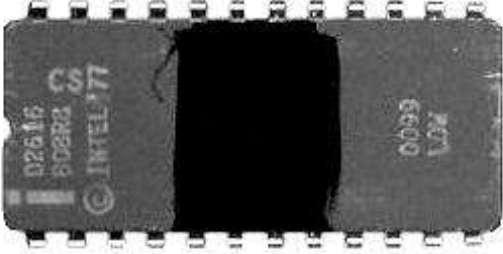
Part Number	Package Description	Values
D2616	1. Type D grey ceramic package w/porthole (filled in with some type of putty and painted over) and tin pins. © Intel '77. Package marked 'HIGH'.	\$4-\$16
		
D2616	2. Type D grey ceramic package w/porthole (filled in with some type of putty and painted over) and tin pins. © Intel '77. Package marked 'LOW'. Example shown also marked 'CS' for Customer Sample	\$4-\$16

References

- [1] Intel (1977). Intel Data Catalog. No reference to 2616 dates chip after 1977.
- [2] Intel (1978). Intel Component Data Catalog, 2616 Data Sheet, p. 4-34.

Intel i2704

4096-bit (512 x 8) EPROM

1975

Specifications

- 4096-bit (512 x 8) EPROM
- NMOS
- Static – No Clocks Required
- Data Inputs and Outputs TTL Compatible During Both Read and Program Modes
- Three-State Output: OR-Tie Capability
- 24-pin Dual In-Line Package

Type	Access Time Max.	Power Dissipation Max. Operating/Standby	Supplies [V]
2704	450ns	800mW	+5, -5, +12
M2704-25	250ns	-	+5, -5, +12

The Intel® 2704 is a 4096-bit ultraviolet light erasable and electrically programmable ROM (EPROM) ideally suited where fast turn-around and pattern experimentation are important requirements. The electrical characteristics of the 2704 are specified over the 0°C to 70°C operating temperature range with 5% power supply variation. All data inputs and outputs are TTL compatible during both the read and program mode. Furthermore, the three-state outputs allow for direct interface common system bus structures. The 2704 is specified at a maximum access time of 450 ns.

The 2704 has all the same operating, programming, and erasing specifications of the Intel® 2708.

The 2704 is fabricated with the time-proven reliable N-channel silicon gate and FAMOS technology [1].

History

The 2704 was used in the Cromemco 8K Bytesaver EPROM Board

Part Numbers

Type C Packages

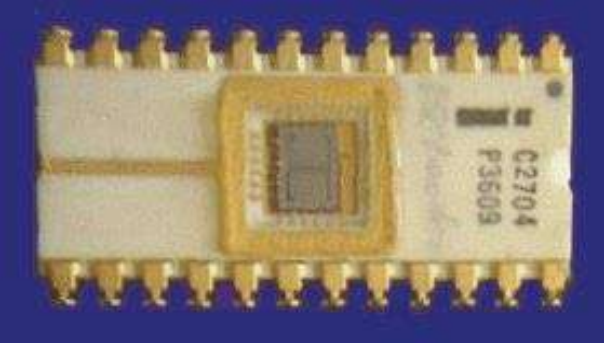
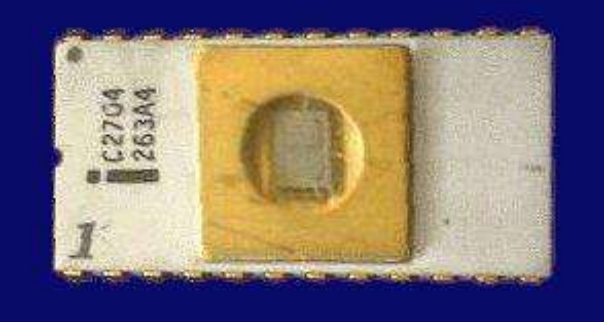
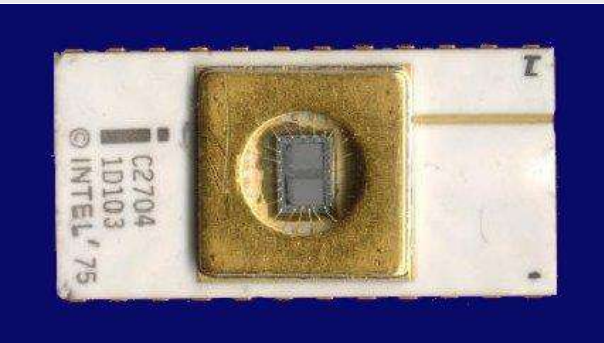
Part Number	Package Description	Values
		
C2704	1. Type C white ceramic package w/quartz cap, gold cap ground strap, and gold pins. Small black dot denotes pin #1. No Copyright.	Rare \$25-\$100
		
C2704	2. Type C white ceramic package w/gold cap with quartz porthole and gold pins. Large '1' denotes pin #1. No copyright.	Rare \$15-\$60
		
C2704	3. Type C white ceramic package w/gold cap with quartz porthole, offset gold cap ground strap, and gold pins. Small '1' denotes pin #1. © Intel '75	Rare \$15-\$60

Intel i2704

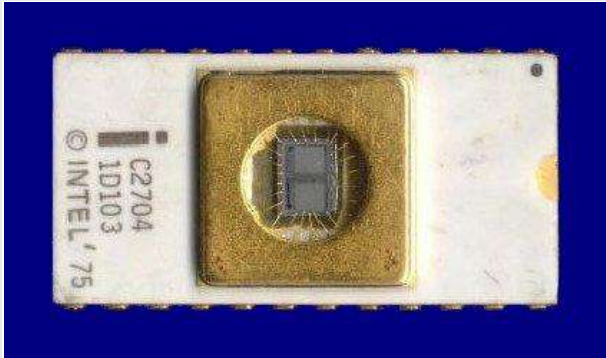

C2704	4. Type C white ceramic package w/gold cap with quartz porthole and gold pins. Small black dot denotes pin #1. © Intel '75	Rare \$15-\$60
-------	--	-------------------

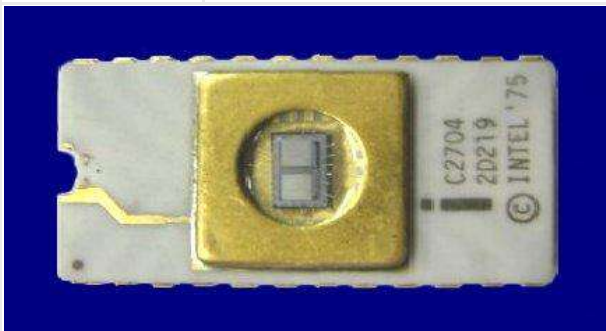

C2704	5. Type C white ceramic package w/gold cap with quartz porthole, offset gold cap ground strap, and gold pins. © Intel '75. Example shown made in Malaysia and dated 7904	Rare \$15-\$60
-------	--	-------------------

Type B Packages

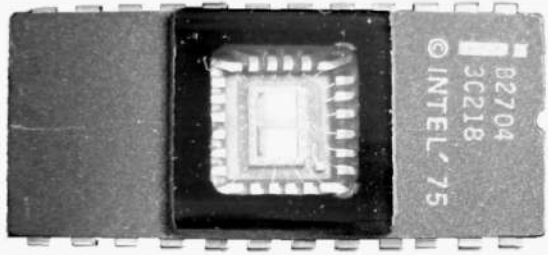
Part Number	Package Description	Values
B2704	 <p style="font-size: small;">A photograph of an Intel i2704 Type B package. It is a grey ceramic package with a square quartz cap in the center. The cap has a square porthole. On the right side of the package, there is a small black dot and the text "B2704 3C218 © INTEL '75".</p>	Rare \$10-\$40

Intel i2704

Type D Packages

Part Number	Package Description	Values
D2704	Type D grey ceramic package w/tin pins. © Intel '75.	Rare \$10-\$40
MD2704-25/B	Type D package	Rare \$15-\$60

References

- [1] Intel (1977). Intel Data Catalog, 2708/2704 Data Sheet, p. 3-24
- [2] Intel (1975). Intel Memory Design Handbook, 2704, p. 1-2.

Intel i2708

8192-bit (1024 x 8) EPROM

1975

Specifications

- 8192-bit (1024 x 8) EPROM
- NMOS
- Low Power Dissipation – 425 mW Max. (2708L)
- Fast Access Time – 350ns Max. (2708-1)
- Static – No Clocks Required
- Data Inputs and Outputs TTL Compatible during both Read and Program Modes
- Three-State Outputs – OR-Tie Capability
- 24-pin Dual In-Line Package

Type	Access Time Max.	Power Dissipation Max. Operating/Standby	Supplies [V]
2708	450ns	800mW	+5, -5, +12
2708-1	350ns	800mW	+5, -5, +12
2708-6	550ns	800mW	+5, -5, +12
M2708	450ns	750mW	+5, -5, +12
M2708-25	250ns	-	+5, -5, +12

The Intel® 2708 is an 8192-bit ultraviolet light erasable electrically programmable EPROM, ideally suited where fast turnaround and pattern experimentation are important requirements. All data inputs are outputs are TTL compatible during both the read and program modes. The outputs are three-state, allowing direct interface with common system bus structures.

The 2708L at 425mW is available for system requiring lower power dissipation than from the 2708. A power dissipation savings of over 50% without any sacrifice in speed is obtained with the 2708L. The 2708L has high input noise immunity and is specified at 10% power supply tolerance. A high speed 2708-1 is also available at 350ns for microprocessors requiring fast access times.

The 2708 family is fabricated with the N-channel silicon gate FAMOS technology and is available in a 24-pin dual in-line package [1].

Part Numbers

Type C Packages

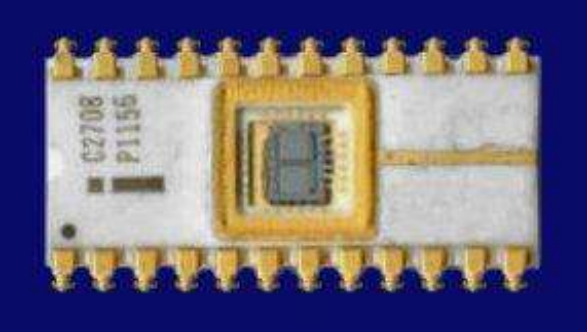
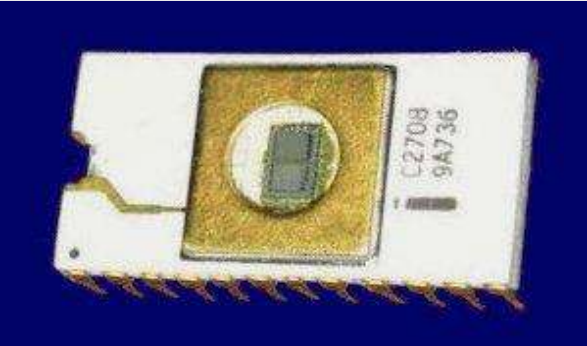
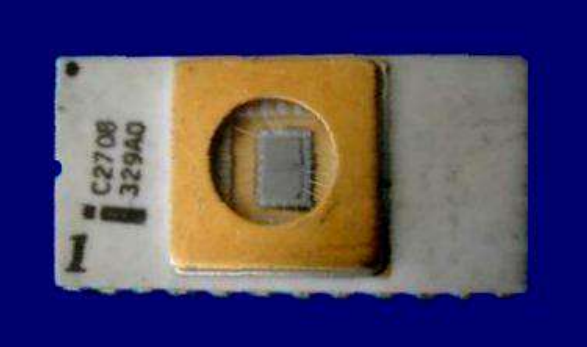
Part Number	Package Description	Values
 <p>C2708</p>	<p>1. Type C white ceramic package w/quartz cap, gold cap ground strap, and gold pins. Small black dot denotes pin #1. No copyright.</p>	<p>Rare \$20-\$80</p>
 <p>C2708</p>	<p>2. Type C white ceramic package w/gold cap with quartz porthole, offset gold cap ground strap, and gold pins. Small black dot denotes pin #1. No copyright.</p>	<p>\$5-\$20</p>
 <p>C2708</p>	<p>3. Type C white ceramic package w/gold cap with quartz porthole and gold pins. Large '1' denotes pin #1. No copyright.</p>	<p>\$5-\$20</p>

Intel i2708

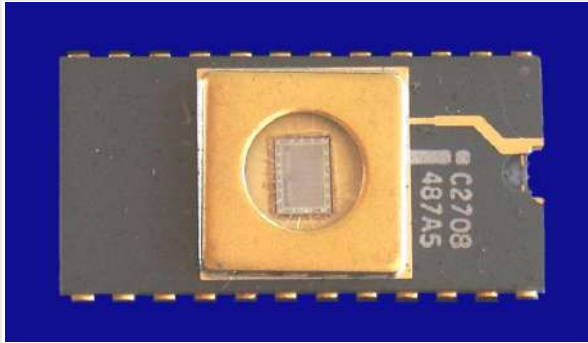

C2708	4. Type C grey ceramic package w/gold cap with quartz porthole, offset gold cap ground strap, and gold pins. No copyright.	Rare \$15-\$60
-------	--	-------------------

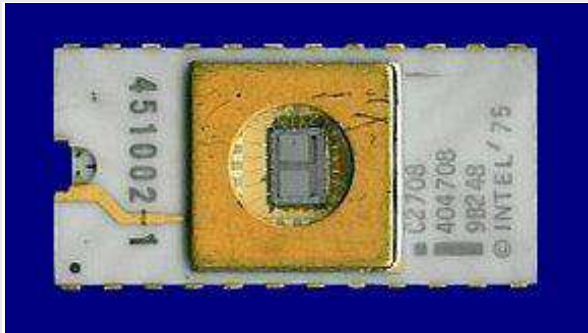

C2708	5. Type C white ceramic package w/gold cap with quartz porthole, offset gold cap ground strap, and gold pins. © Intel '75.	\$5-\$20
-------	--	----------

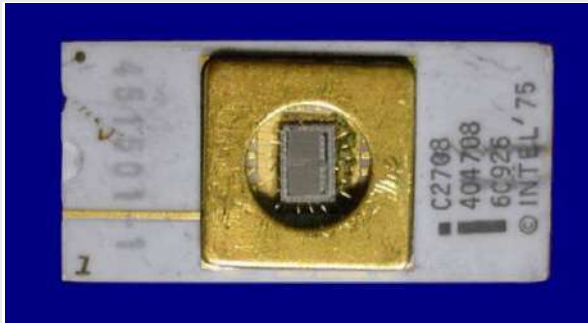

C2708	6. Type C white ceramic package w/gold cap with quartz porthole, offset gold cap ground strap, and gold pins. Small '1' denotes pin #1. © Intel '75.	\$5-\$20
-------	--	----------

Intel i2708

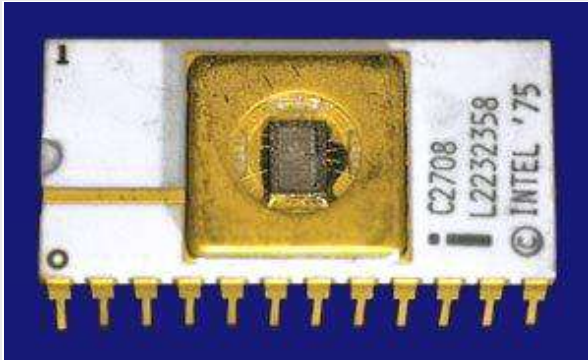

C2708	7. Type C white ceramic package w/gold cap with quartz porthole, offset gold cap ground strap, and gold pins. Small '1' denotes pin #1. © Intel '75.	\$5-\$20
-------	--	----------

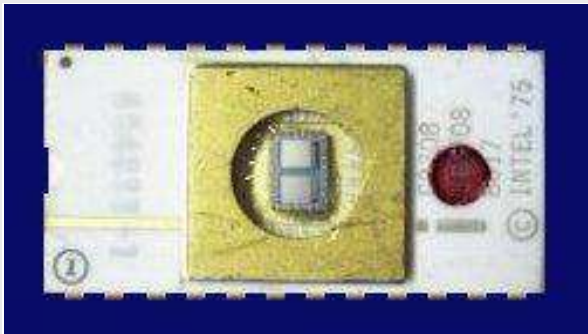

C2708	8. Type C white ceramic package w/gold cap with quartz porthole, offset gold cap ground strap, and gold pins. Small '1' in circle denotes pin #1. © Intel '75.	\$5-\$20
-------	--	----------

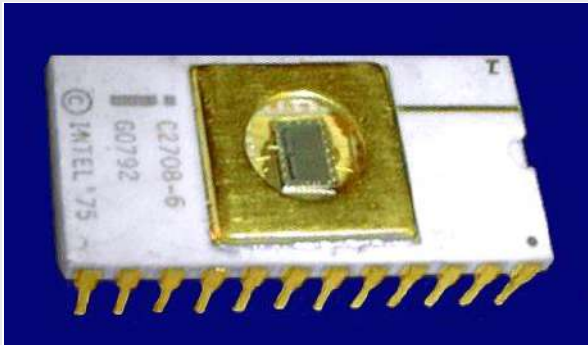

C2708-6	Type C white ceramic package w/gold cap with quartz porthole, offset gold cap ground strap, and gold pins. Small '1' denotes pin #1. © Intel '75	Rare \$15-\$60
---------	--	-------------------

HC2708	Type C package	Rare \$15-\$60
--------	----------------	-------------------

Intel i2708

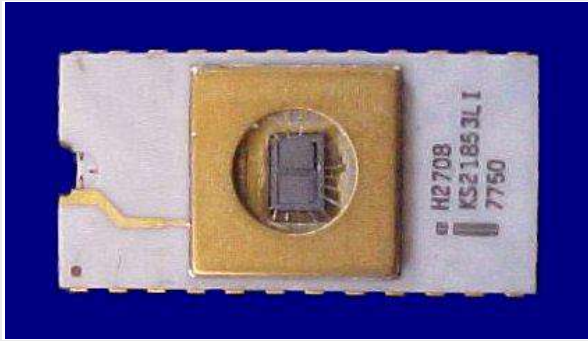

H2708	Type C white ceramic package w/gold cap with quartz porthole, offset gold cap ground strap, and gold pins. Small black dot denotes pin #1.	Rare \$15-\$60
-------	--	-------------------

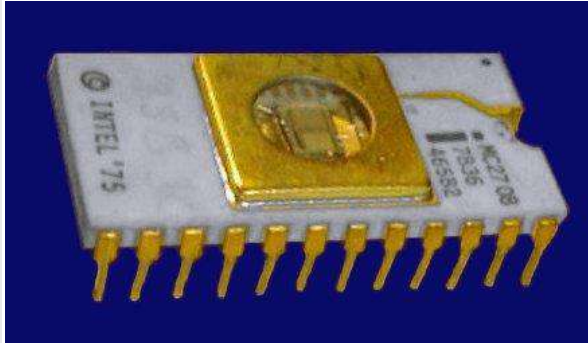

MC2708	Type C white ceramic package w/gold cap with quartz porthole, offset gold cap ground strap, and gold pins. Small black dot denotes pin #1. © Intel '75.	Rare \$15-\$60
MC2708/B	Type C package	Rare \$15-\$60

Type B Packages

Part Number	Package Description	Values
B2708	1. Type B grey ceramic package w/quartz cap and tin pins. No Copyright.	\$2-\$8

Intel i2708

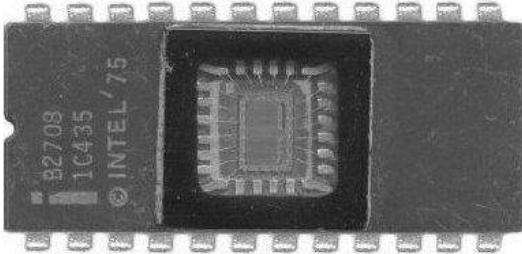
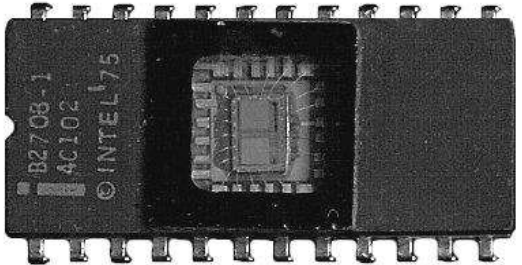
		
B2708	2. Type B grey ceramic package w/quartz cap and tin pins. © Intel '75.	\$2-\$8
		
B2708-1	Type B grey ceramic package w/quartz cap and tine pins. © Intel '75	\$3-\$12

Type D Packages

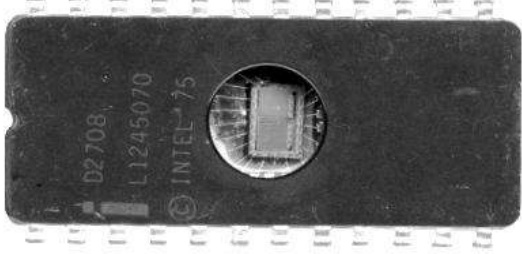
Part Number	Package Description	Values
		
D2708	Type D grey ceramic package w/quartz porthole and tin pins. © Intel '75.	\$1.25-\$5

Intel i2708

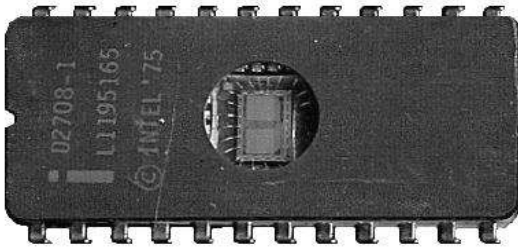

D2708-1	Type D grey ceramic package w/quartz porthole and tine pins. © Intel '75	\$1.50-\$6
D2708-6	Type D package	\$2-\$8
MD2708	Type D package	\$5-\$20
MD2708/B	Type D package	\$5-\$20
MD2708-25/B	Type D package	\$5-\$20

Type DB Packages

Part Number	Package Description	Values
DB2708	Type DB grey ceramic package w/quartz porthole and tine pins. © Intel '75	\$5-\$20
DB2708-6	Type DB package	\$5-\$20

References

[1] Intel (1980). Intel Component Data Catalog, 2708/2708L Data Sheet, p. 2-3

[2] Intel (1984). A Revolution in Progress... A History of Intel to Date, 2708 introduced 1975, p. 26.

Intel i2708L

8192-bit (1024 x 8) EPROM

1975

Specifications

- 8192-bit (1024 x 8) EPROM
- NMOS
- Low Power Dissipation – 425 mW Max. (2708L)
- Fast Access Time – 350ns Max. (2708-1)
- Static – No Clocks Required
- Data Inputs and Outputs TTL Compatible during both Read and Program Modes
- Three-State Outputs – OR-Tie Capability
- 24-pin Dual In-Line Package

Type	Access Time Max.	Power Dissipation Max. Operating/Standby	Supplies [V]
2708L	450ns	425mW	+5, -5, +12
2708L-4	400ns	-	+5, -5, +12

The Intel® 2708 is an 8192-bit ultraviolet light erasable electrically programmable EPROM, ideally suited where fast turnaround and pattern experimentation are important requirements. All data inputs are outputs are TTL compatible during both the read and program modes. The outputs are three-state, allowing direct interface with common system bus structures.

The 2708L at 425mW is available for system requiring lower power dissipation than from the 2708. A power dissipation savings of over 50% without any sacrifice in speed is obtained with the 2708L. The 2708L has high input noise immunity and is specified at 10% power supply tolerance. A high speed 2708-1 is also available at 350ns for microprocessors requiring fast access times.

The 2708 family is fabricated with the N-channel silicon gate FAMOS technology and is available in a 24-pin dual in-line package [1].

Part Numbers

Type B Packages

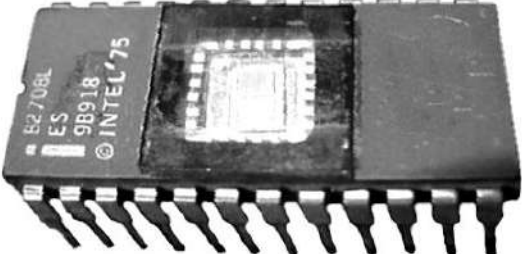
Part Number	Package Description	Values
		
B2708L	Type B grey ceramic package w/quartz cap and tin pins. © Intel '75. Example shown marked 'ES' for Engineering Sample.	\$4-\$16

Type D Packages

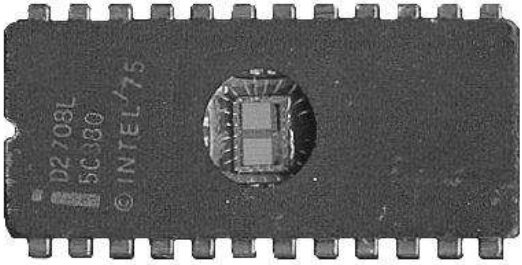
Part Number	Package Description	Values
		
D2708L	Type D package grey ceramic package w/quartz porthole and tin pins. © Intel '75	\$2-\$8
D2708L-4	Type D package	\$3-\$12

Type DB Packages

Part Number	Package Description	Values
DB2708L	Type DB package	Rare \$5-\$20

References

- [1] Intel (1980). Intel Component Data Catalog, 2708/2708L Data Sheet, p. 2-3.

Intel i2716

16384-bit (2048 x 8) Static EPROM

1977

Specifications

- 16384-bit (2048 x 8) Static EPROM
- NMOS
- Single +5V Power Supply
- Pin Compatible to Intel® 2732 EPROM
- Simple Programming Requirements
 - Single Location Programming
 - Programs with One 50ms Pulse
- Inputs and Outputs TTL Compatible during Read and Program
- Completely Static
- Three-State Output
- EPROM equivalent of Intel 2616 PROM and 2316E ROM
- 24-pin Dual In-Line Package

Type	Access Time Max.	Power Dissipation Max. Operating/Standby	Supplies [V]
2716	450ns	525mW/132mW	+5
2716-1	350ns	525mW/132mW	+5
2716-2	390ns	525mW/132mW	+5
2716-5	490ns	525mW/132mW	+5
2716-6	650ns	525mW/132mW	+5
I2716	450ns	525mW/132mW	+5
M2716	450ns	633mW/165mW	+5
M2716M	450ns	-	+5
M2716-20	200ns	-	+5
M2716-25	250ns	-	+5

The Intel® 2716 is a 16,384-bit ultraviolet erasable and electrically programmable read-only memory (EPROM). The 2716 operates from a single 5-volt power supply, has a static standby mode, and features fast single address location programming. It makes designing with EPROMs faster, easier and more economical.

The 2716m with its single 5-volt supply and with an access time up to 350ns, is ideal for use with the newer high performance +5V microprocessors such as Intel's 8085 and 8086. A selected 2716-5 and 2716-6 is available for slower speed applications. The 2716 is also the first EPROM with a static standby mode, which reduces the power dissipation without increasing access time. The maximum active power dissipation is 525mW while the maximum standby power dissipation is only 132mW, a 75% savings.

Intel i2716

The 2716 has the simplest and faster method yet devised for programming EPROMs – single pulse TTL level programming. No need for high voltage pulsing because all programming controls are handled by TTL signals. Program any location at any time – either individually, sequentially or at random, with the 2716's single address location programming. Total programming time for all 16,384 bits is only 100 seconds [2].

M2716 Operating Temperature Range is -55C to +100C [3]

M2716M Operating Temperature Range is -55C to +125C [3]

Part Numbers

Type C Packages

Part Number	Package Description	Values
		
C2716	1. Type C white ceramic package w/gold cap with quartz porthole, offset gold cap ground strap and gold pins. Small '1' denotes pin #1. © Intel '77	\$5-\$20
		
C2716	2. Type C white ceramic package w/gold cap with quartz porthole, offset gold cap ground strap, and gold pins. Small circle denotes pin #1. © Intel '77	\$5-\$20
		
C2716	3. Type C white ceramic package w/gold cap with quartz porthole, offset gold cap ground strap, and gold pins. Small '1' in circle denotes pin #1. © Intel '77	\$5-\$20

Intel i2716

		
C2716-1	1. Type C white ceramic package w/gold cap with quartz porthole, offset gold cap ground strap, and gold pins. Small '1' denotes pin #1. © Intel '77	\$8-\$32
		
C2716-1	2. Type C white ceramic package w/gold cap with quartz porthole, offset gold cap ground strap, and gold pins. Small '1' in circle denotes pin #1. © Intel '77	\$8-\$32
		
C2716-1	3. Type C white ceramic package w/gold cap with quartz porthole, offset gold cap ground strap, and gold pins. Small circle denotes pin #1. © Intel '77	\$8-\$32
C2716-5	Type C package	Rare \$20-\$80
C2716-6	Type C white ceramic package w/gold cap with quartz porthole, offset gold cap ground strap, and gold pins. Small '1' in circle denotes pin #1. © Intel '77.	Rare \$20-\$80

Intel i2716

Type B Packages

Part Number	Package Description	Values
B2716	Type B grey ceramic package w/quartz cap and tin pins. © Intel '77.	\$2.50-\$10
B2716-1	Type B grey ceramic package w/quartz cap and tin pins. © Intel '77.	\$3-\$12
B2716-5	Type B package	Rare \$10-\$40
B2716-6	Type B package	\$5-\$20
MB2716	Type B package	\$4-\$16
MB2716M/B	Type B package	\$4-\$16

Type D Packages

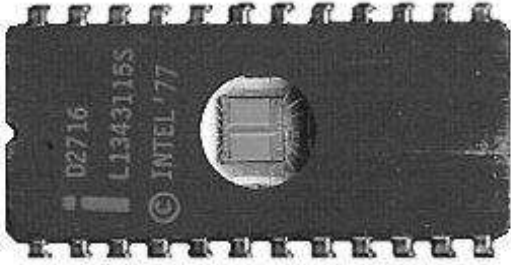
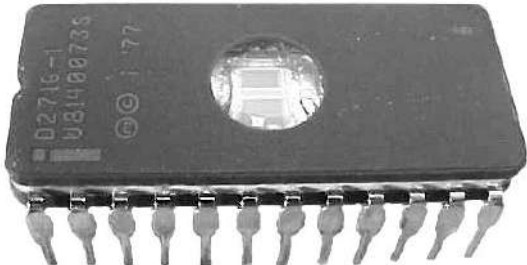
Part Number	Package Description	Values
 <p>A black, rectangular ceramic package with 16 pins on the bottom edge. It features a central circular quartz porthole. The top surface is marked with 'D2716', 'L1343115S', and '© INTEL '77'.</p>		
D2716	Type D grey ceramic package w/quartz porthole and tin pins. © Intel '77.	\$1.25-\$5
 <p>A black, rectangular ceramic package with 16 pins on the bottom edge. It features a central circular quartz porthole. The top surface is marked with 'D2716-1', 'U81400736', and '© INTEL '77'.</p>		
D2716-1	Type D grey ceramic package w/quartz porthole and tin pins. © Intel '77	\$1.50-\$6
D2716-2	Type D grey ceramic package w/quartz porthole and tin pins. © Intel '77.	\$1.25-\$5

Intel i2716

D2716-5	Type D grey ceramic package w/quartz porthole and tin pins. © Intel '77.	\$2.50-\$10
D2716-6	Type D grey ceramic package w/quartz porthole and tin pins. © Intel '77.	\$2-\$8
G2716	Type D grey ceramic package w/quartz porthole and gold pins.	\$2.50-\$10
		
ID2716	Type D grey ceramic package w/ quartz porthole and tin pins. © Intel '77.	\$1.25-\$5
LD2716	Type D package	\$1.50-\$6
MD2716	Type D package	\$1.50-\$6
MD2716/B	Type D package	\$1.50-\$6
MD2716-20/B	Type D package	\$2.50-\$10
MD2716-25/B	Type D package	\$2.50-\$10
MD2716M	Type D package	\$1.50-\$6
MD2716M/B	Type D grey ceramic package w/quartz porthole and tin pins. © Intel '77.	\$1.50-\$6
QD2716	Type D package	\$1.50-\$6
QD2716-1	Type D package	\$2.50-\$10
TD2716	Type D package	\$2.50-\$10

Type P Packages

Part Number	Package Description	Values
P2716	Type P package	\$2.50-\$10

References

- [1] Intel (1977). Intel Data Catalog, 2716 Preliminary Data Sheet, p. 3-30
- [2] Intel (1980). Intel Component Data Catalog, 2716 Family Data Sheet, p. 2-7
- [3] Intel (1987). Intel Military Handbook, M2716/M2716M Data Sheet.
- [4] Intel (1984). A Revolution in Progress... A History of Intel to Date, 2716 introduced 1977, p. 26.

Intel i2732

32768-bit (4096 x 8) EPROM

1978

Specifications

- 32768-bit (4096 x 8) EPROM
- Fast Access Time:
 - 450 ns Max. 2732
 - 550 ns Max 2732-6
- Single +5V \pm 5% Power Supply
- Output Enable for MCS-85™ and MCS-86™ Compatibility
- Low Power Dissipation:
 - 150mA Max. Active Current
 - 30mA Max. Standby Current
- Pin Compatible to Intel® 2716 EPROM
- Completely Static
- Simple Programming Requirements
 - Single Location Programming
 - Programs with One 50ms Pulse
- Three-State Output for Direct Bus Interface
- 24-pin Dual In-Line Package

Type	Access Time Max.	Power Dissipation Max. Operating/Standby	Supplies [V]
2732	450ns	788mW/158mW	+5
2732-4	400ns(?)	-	+5
2732-6	550ns	788mW/158mW	+5
MD2732-10	-	-	+5
MD2732-20	-	-	+5
MD2732-25	-	-	+5

The Intel® 2732 is a 32,768-bit ultraviolet erasable and electronically programmable read-only memory (EPROM). The 2732 operates from a single 5-volt power supply, has a standby mode, and features an output enable control. The total programming time for all bits is three and a half minutes. All these features make designing with the 2732 in microcomputer systems faster, easier, and more economical.

An important 2732 feature is the separate output control. Output Enable (OE) from the Chip Enable (CE). The OE control eliminates bus contention in multiple bus microprocessor systems. Intel's Application Note AP-72 describes the microprocessor system implementation of the OE and CE controls on Intel's 2716 and 2732 EPROMs. AP-72 is available from Intel's Literature Department.

The 2732 has a standby mode, which reduces the power dissipation without increasing access time. The maximum active current is 150mA, while the maximum standby current is only 30mA, an 80% savings. The standby mode is achieved by applying a TTL-high signal to the CE input [2].

Part Numbers

Type B Packages

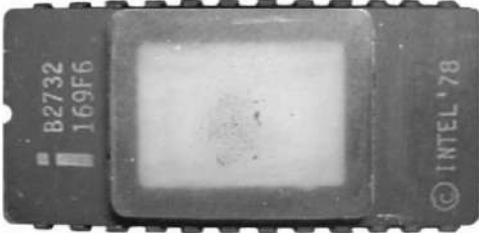
Part Number	Package Description	Values
B2732	1. Type B grey ceramic package w/quartz cap and tin pins. © Intel '77.	\$1.50-\$6
		
B2732	2. Type B grey ceramic package w/quartz cap and tin pins. © Intel '78.	\$1.50-\$6
B2732-6	Type B grey ceramic package w/quartz cap and tin pins. © Intel '78.	\$1.50-\$6

Type D Packages

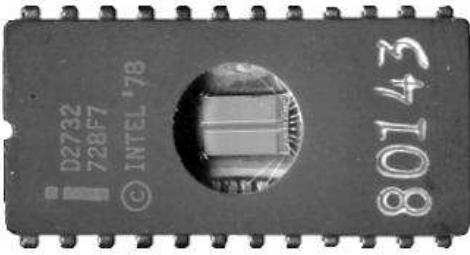
Part Number	Package Description	Values
		
D2732	Type D grey ceramic package w/porthole and tin pins. © Intel '78	\$1.25-\$5
D2732-4	Type D grey ceramic package w/porthole and tin pins. © Intel '78.	\$5-\$20
D2732-6	Type D grey ceramic package w/porthole and tin pins. © Intel '78.	\$1.25-\$5
G2732	Type D package	\$5-\$20
ID2732	Type D package	\$2.50-\$10
ID2732-6	Type D package	Rare \$10-\$40

Intel i2732

LD2732	Type D package	\$1.50-\$6
MD2732	Type D package	\$2.50-\$10
MD2732/B	Type D package	\$2.50-\$10
MD2732-10	Type D package	\$5-\$20
MD2732-20	Type D package	\$2.50-\$10
MD2732-20/B	Type D package	\$2.50-\$10
MD2732-25	Type D package	\$2.50-\$10
MD2732-25/B	Type D package	\$2.50-\$10
QD2732	Type D package	\$1.50-\$6
TD2732	Type D package	\$1.50-\$6

References

- [1] Intel (1978). Intel Component Data Catalog, 2732 Advance Information, p. 4-50.
- [2] Intel (1980). Intel Component Data Catalog, 2732 Preliminary Data Sheet, p. 2-11.

Intel i2732A

32768-bit (4096 x 8) EPROM

1980-81

Specifications

- 32768-bit (4096 x 8) EPROM
- HMOS-E Technology
- 200ns (2732A-2) Maximum Access Time
- Compatible to High Speed 8MHz 8086-2 – Zero Wait State
- Two Line Control
- Pin Compatible to 2764 EPROM
- Industry Standard Pinout – JDEC Approved
- Low Standby Current – 35mA Max.
- 24-pin Dual In-Line Package

Type	Access Time Max.	Power Dissipation Max. Operating/Standby	Supplies [V]
2732A	250ns	150mA/35mA	+5
2732A-2	200ns	-	+5
2732A-3	300ns	-	+5
2732A-4	450ns	-	+5
2732A-20	200ns	-	+5 (± 10% Vcc)
2732A-25	250ns	-	+5 (± 10% Vcc)
2732A-30	300ns	-	+5 (± 10% Vcc)
2732A-45	450ns	-	+5
M2732A	450ns	-	+5

The Intel 2732A is a 5V only, 32,768-bit ultraviolet erasable and electrically programmable read-only memory (EPROM). It is pin compatible to Intel's 450ns 2732. The standard 2732A's access time is 250ns with speed selection (2732A-2) available at 200ns. The access time is compatible to high performance microprocessors, such as the 8MHz 8086-2. In these systems, the 2732A allows the microprocessor to operate without the addition of WAIT states.

An important 2732A feature is the separate output control. Output Enable (OE) from the Chip Enable (CE). The OE control eliminates bus contention in multiple bus microprocessor systems. Intel's Application Note AP-72 describes the microprocessor system implementation of the OE and CE controls on Intel's EPROMs. AP-72 is available from Intel's Literature Department.

The 2732A has a standby mode, which reduces the power dissipation without increasing access time. The maximum active current is 150mA, while the maximum standby current is only 35mA, a 75% savings. The standby mode is achieved by applying a TTL-high signal to the CE input

The 2732A is fabricated with HMOS-E technology, Intel's high speed N-channel MOS Silicon Gate Technology [1].

P2732A

The P2732A is functionally identical to the 2732A except that it is housed in a windowless plastic package and is one-time programmable [3].

Part Numbers

Type C Packages

Part Number	Package Description	Values
C2732A	Type C package. Suspect that single source showing small quantity of this part in stock may be a typo.	Ex. Rare (Suspect) \$\$\$

Type D Packages

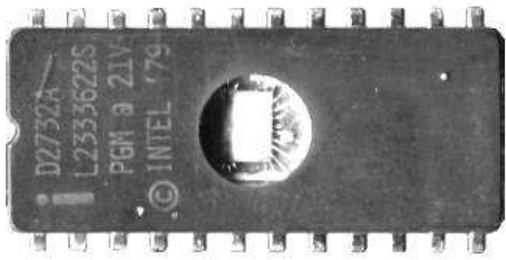
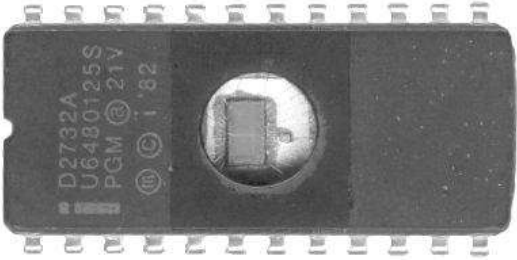
Part Number	Package Description	Values
		
D2732A	1. Type D grey ceramic package w/quartz porthole and tin pins. © Intel '79.	\$.25-\$1
		
D2732A	2. Type D grey ceramic package w/quartz porthole and tin pins. © Intel '82.	\$.25-\$1
D2732A-2	Type D grey ceramic package w/quartz porthole and tin pins. © Intel '82.	\$.25-\$1
D2732A-3	1. Type D grey ceramic package w/quartz porthole and tin pins. © Intel '79.	\$.25-\$1
D2732A-3	2. Type D grey ceramic package w/quartz porthole and tin pins. © Intel '82.	\$.25-\$1

Intel i2732A

D2732A-4	1. Type D grey ceramic package w/quartz porthole and tin pins. © Intel '79.	\$.25-\$1
D2732A-4	2. Type D grey ceramic package w/quartz porthole and tin pins. © Intel '82.	\$.25-\$1
D2732A-20	Type D package	\$.25-\$1
D2732A-25	Type D package	\$.25-\$1
G2732A	Type D package	\$1-\$4
G2732A-2	Type D package	\$1.50-\$6
G2732A-3	Type D package	\$1.50-\$6
G2732A-4	Type D package	\$1.50-\$6
ID2732A	Type D package	\$1-\$4
ID2732A-20	Type D package	\$1-\$4
ID2732A-45	Type D package	\$1-\$4
LD2732A	Type D package	\$.50-\$2
LD2732A-2	Type D package	\$.50-\$2
LD2732A-20	Type D package	\$.50-\$2
LD2732A-25	Type D package	\$.50-\$2
LD2732A-45	Type D grey ceramic package w/quartz porthole and tin pins. © Intel '82.	\$.50-\$2
MD2732A	Type D package	\$.50-\$2
MD2732A/B	Type D package	\$.50-\$2
MD2732A-20	Type D package	\$.50-\$2
MD2732A-20/B	Type D package	\$.50-\$2
MD2732A-25	Type D package	\$.50-\$2
MD2732A-25/B	1. Type D grey ceramic package w/quartz porthole and tin pins. © Intel 1978.	\$.50-\$2
MD2732A-25/B	2. Type D grey ceramic package w/quartz porthole and tin pins. © Intel '81.	\$.50-\$2
MD2732A-45	Type D package	\$.50-\$2
MD2732A-45/B	Type D package	\$.50-\$2
QD2732A	Type D package	\$.50-\$2
QD2732A-2	Type D package	\$.75-\$3
QD2732A-3	Type D package	\$.75-\$3
QD2732A-4	Type D package	\$.75-\$3
QD2732A-20	Type D grey ceramic package w/quartz porthole and tin pins. © Intel '82.	\$.50-\$2
QD2732A-25	Type D package	\$1-\$4
TD2732A	Type D package	\$.75-\$3
TD2732A-2	Type D package	\$.50-\$2
TD2732A-20	Type D package	\$.50-\$2
TD2732A-25	Type D package	\$.50-\$2
TD2732A-45	Type D package	\$.75-\$3

Intel i2732A

Type P Packages

Part Number	Package Description	Values
P2732A	Type P package	\$.50-\$2
P2732A-2	Type P package	\$.50-\$2
P2732A-3	Type P package	\$.50-\$2
P2732A-4	Type P package	\$.50-\$2

References

- [1] Intel (1980). Intel Component Data Catalog, 2732A Advance Information, p. 2-15
- [2] Intel (January 1982). Intel Component Data Catalog, 2732A Data Sheet, p. 2-9
- [3] Intel (1988). Intel Memory Components Handbook, RR-35E EPROM Reliability Data Summary, p. 4-232.

Intel i2758

8192-bit (1024 x 8) Static EPROM w/Single 5V Power Supply 1977-78

Specifications

- 8192-bit (1024 x 8) Static EPROM w/Single 5v Power Supply
- NMOS
- Single +5V Power Supply
- Simple Programming Requirements
 - Single Location Programming
 - Programs with One 50ms Pulse
- Low Power Dissipation
 - 525mW Max. Active Power
 - 132mW Max. Standby Power
- Fast Access Time: 450ns Max. in Active and Standby Power Modes
- Inputs and Outputs TTL Compatible during Read and Program
- Completely Static
- Three-State Outputs for OR-Ties
- 24-pin Dual In-Line Package

Type	Access Time Max.	Power Dissipation Max. Operating/Standby	Supplies [V]
2758	450ns	525mW/132mW	+5

The Intel® 2758 is a 8192-bit ultraviolet erasable and electrically programmable read-only memory (EPROM). The 2758 operates from a single 5-volt power supply, has a static standby mode, and features fast single address location programming. It makes designing with EPROMs faster and more economical. The total programming time for all 8192 bits is 50 seconds.

The 2758 has a static standby mode, which reduces the power dissipation without increasing access time. The maximum active power dissipation is 525mW, while the maximum standby power dissipation is only 132mW, a 75% savings. Power down is achieved by applying a TTL-high signal to the Chip Enable Lead.

A 2758 system may be designed for total upwards compatibility with Intel's 16K 2716 EPROM (see Applications Note AP-72). The 2758 maintains the simplest and fastest method yet devised for programming EPROMs – single pulse TTL-level programming. There is no need for high voltage pulsing because all programming controls are handled by TTL signals. Program any location at any time – either individually, sequentially, or at random, with the single address location programming [3].

Part Numbers

Type C Packages

Part Number	Package Description	Values
		
C2758	Type C white ceramic package w/gold cap with quartz porthole, offset gold cap ground strap, and gold pins. Small '1' denotes pin #1. © Intel '77.	Rare \$20-\$80

Type B Packages

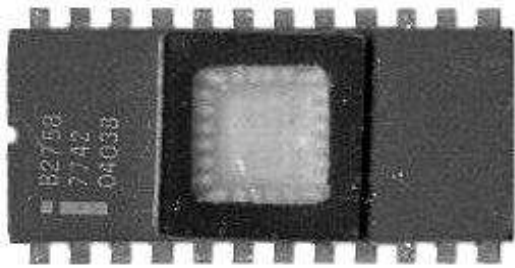
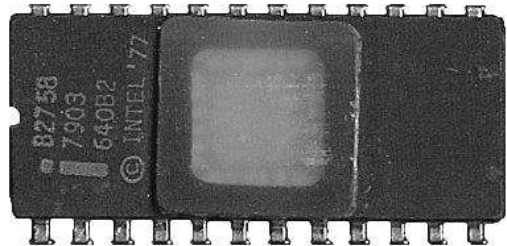
Part Number	Package Description	Values
		
B2758	1. Type B grey ceramic package w/quartz cap and tin pins. No copyright.	\$5-\$20
		
B2758	2. Type B grey ceramic package w/quartz cap and tin pins. © Intel '77.	\$3-\$12

Intel i2758

Type D Packages

Part Number	Package Description	Values
D2758	Type D grey ceramic package w/quartz cap and tin pins. © Intel '77.	\$2-\$8

References

- [1] Intel (1977). Intel Data Catalog. No reference to 2758 dates chip after 1977.
- [2] Intel (1978). The Semiconductor Memory Book, 2758 Data Sheet, p. 345.
- [3] Intel (1980). Intel Component Data Catalog, 2758 Data Sheet, p. 2-16.

Intel i2910

PCM CODEC – μ LAW

1977

Specifications

- PCM CODEC – μ LAW
- Telephony Product
- NMOS
- 8-Bit Companded A/D and D/A Converter
- Per Channel, Single Chip Codec
- CCITT G711 and G733 Compatible, ATT T1 and T1/C Compatible with 8th Bit Signaling
- Microprocessor Interface with On-Chip Timeslot Computation
- 78dB Dynamic Range, with Resolution Equivalent to 12-Bit Linear Conversion Around Zero
- $\pm 5\%$ Power Supplies: +12V, +5V, -5V
- On-Chip Voltage Reference
- Low Power Consumption 399mW
Standby Power 120mW
- All Digital Inputs and Outputs TTL Compatible
- 24-Pin Dual In-Line Package

Type	Timeslot X To Enable Max.	Power Dissipation Max. Operating/Standby	Supplies [V]
2910	120ns	300mW/120mW	+12, +5, -5

The Intel® 2910 is a fully integrated PCM (Pulse Code Modulation) Codec (Coder-Decoder), fabricated with N-channel silicon gate technology. The high density of integration allows the sample and hold circuits, the digital-to-analog converter, the comparator and the successive approximation register to be integrated on the same chip, along with the logic necessary to interface a full duplex PCM link and provide in-band signaling.

The primary applications are in telephone systems:

- Transmission – T1 Carrier (T1C Compatible)
- Switching – Digital PBX's and Central Office Switching Systems
- Concentration – Subscriber Carrier/Concentrators

The Wide dynamic range of the 2910 (78dB) and the minimal conversion time (30 μ sec minimum) make it an ideal product for other applications, like:

- Data Acquisition
- Secure Communications Systems
- Signal Processing Systems
- Telemetry

The 2910 is packaged in a hermetic 24-pin dual in-line package [1].

History

1st Single-Chip CODEC

Part Numbers

Type D Packages

Part Number	Package Description	Values
D2910	Type D package	\$1-\$4

References

- [1] Intel (1978). Intel Component Data Catalog, 2910 Preliminary Data Sheet, p. 7-3.
- [5] Intel (1984). A Revolution in Progress... A History of Intel to Date, 2910 introduced 1977, p. 26.

Intel i2910A

PCM CODEC – μ LAW

1979-80

Specifications

- PCM CODEC – μ LAW
- Telephony Product
- NMOS
- 8-Bit Companded A/D and D/A Converter
- Per Channel, Single Chip Codec
- CCITT G711 and G712 Compatible, ATT T1 Compatible with 8th Bit Signaling
- Microprocessor Interface with On-Chip Timeslot Computation (2910, 2910A-1)
- Simple Direct Mode Interface When Fixed Timeslots are Used
- 78dB Dynamic Range, with Resolution Equivalent to 12-Bit Linear Conversion Around Zero
- $\pm 5\%$ Power Supplies: +12V, +5V, -5V
- Precision On-Chip Voltage Reference
- Low Power Consumption 230mW Typ.
Standby Power 33mW Typ.
- 24-Pin Dual In-Line Package

Type	Timeslot X To Enable Max.	Power Dissipation Max. Operating/Standby	Supplies [V]
2910A	220ns	-	+12, +5, -5
2910A-1	185ns	-	+12, +5, -5
2910A-2	185ns	-	+12, +5, -5
2910A-4	220ns	-	+12, +5, -5

The Intel® 2910A is a fully integrated PCM (Pulse Code Modulation) Codec (Coder-Decoder), fabricated with N-channel silicon gate technology. The high density of integration allows the sample and hold circuits, the digital-to-analog converter, the comparator and the successive approximation register to be integrated on the same chip, along with the logic necessary to interface a full duplex PCM link and provide in-band signaling.

The primary applications are in telephone systems:

- Transmission – T1 Carrier
- Switching – Digital PBX's and Central Office Switching Systems
- Concentration – Subscriber Carrier/Concentrators

The Wide dynamic range of the 2910A (78dB) and the minimal conversion time (80 μ sec minimum) make it an ideal product for other applications, like:

- Data Acquisition
- Secure Communications Systems
- Signal Processing Systems
- Telemetry

Intel i2910A

The 2910A is packaged in a hermetic 24-pin dual in-line package [2].

Part Numbers

Type D Packages

Part Number	Package Description	Values
D2910A	Type D package	\$.50-\$1
D2910A-1	Type D package	\$1.50-\$6
D2910A-4	Type D package	\$3-\$12

References

- [1] Intel (1979). Intel Component Data Catalog, 2910 Data Sheet, p. 6-3. No reference to 2910A.
- [2] Intel (1980). Intel Component Data Catalog, 2910A Preliminary Data Sheet, p. 4-2.

Intel i2911

PCM CODEC – A LAW

1978

Specifications

- PCM CODEC – A LAW
- Telephony Product
- NMOS
- 8-Bit Companded A/D and D/A Converter
- Per Channel, Single Chip Codec
- CCITT G711 and G732 Compatible, Even Order Bits Inversion Included
- Microcomputer Interface with On-Chip Time-Slot Computation
- 66dB Dynamic Range, with Resolution Equivalent to 11-Bit Linear Conversion Around Zero
- $\pm 5\%$ Power Supplies: +12V, +5V, -5V
- On-Chip Voltage Reference
- Low Power Consumption 250mW.
Standby Power 90mW
- All Digital Inputs and Outputs TTL Compatible
- 22-pin Dual In-Line Package

Type	Timeslot X To Enable Max.	Power Dissipation Max. Operating/Standby	Supplies [V]
2911	180ns	250mW/90mW	+12, +5, -5

The Intel® 2911 is a fully integrated PCM (Pulse Code Modulated) Codec (Coder-Decoder), fabricated with N-channel silicon gate technology. The high density of integration allows the sample and hold circuits, the digital-to-analog converter, the comparator and the successive approximation register to be integrated on the same chip, along with the logic necessary to interface a full duplex PCM link.

The primary applications are in telephone systems:

- Transmission – 30/32 Channel Systems at 2.048 Mbps
- Switching – Digital PBX's and Central Office Switching Systems
- Concentration – Subscriber Carrier/Concentrators

The Wide dynamic range of the 2911 (66dB) and the minimal conversion time (40 μ sec minimum) make it an ideal product for other applications, like:

- Data Acquisition
- Secure Communications Systems
- Signal Processing Systems
- Telemetry

The 2911 is packaged in a hermetic 22-pin dual in-line package [1].

Intel i2911

Part Numbers

Type D Packages

Part Number	Package Description	Values
D2911	 A photograph of an Intel i2911 chip. The chip is a grey ceramic package with a row of 14 pins along the bottom edge. The top surface of the chip is marked with the part number 'D2911', the date code '59288', and the Intel logo followed by 'INTEL '77'. Type D grey ceramic package w/tin pins. © Intel '77	\$.75-\$3

References

- [1] Intel (1978). Intel Component Data Catalog, 2911 Preliminary Data Sheet, p. 7-14.
- [2] Intel (1984). A Revolution in Progress... A History of Intel to Date, 2911 introduced 1977, p. 26.

Intel i2911A

PCM CODEC – A LAW

1979-80

Specifications

- PCM CODEC – A LAW
- Telephony Product
- NMOS
- 8-Bit Companded A/D and D/A Converter
- Per Channel, Single Chip Codec
- CCITT G711 and G732 Compatible, Even Order Bits Inversion Included
- Microcomputer Interface with On-Chip Time-Slot Computation (2911A, 2911A-1)
- Simple Direct Mode Interface When Fixed Timeslots Are Used
- 66dB Dynamic Range, with Resolution Equivalent to 11-Bit Linear Conversion Around Zero
- $\pm 5\%$ Power Supplies: +12V, +5V, -5V
- Precision On-Chip Voltage Reference
- Low Power Consumption 230mW Typ.
Standby Power 33mW Typ.
- 22-pin Dual In-Line Package

Type	Timeslot X To Enable Max.	Power Dissipation Max. Operating/Standby	Supplies [V]
2911A	220ns	-	+12, +5, -5
2911A-1	185ns	-	+12, +5, -5
2911A-2	185ns	-	+12, +5, -5
2911A-4	220ns	-	+12, +5, -5

The Intel® 2911A is a fully integrated PCM (Pulse Code Modulated) Codec (Coder-Decoder), fabricated with N-channel silicon gate technology. The high density of integration allows the sample and hold circuits, the digital-to-analog converter, the comparator and the successive approximation register to be integrated on the same chip, along with the logic necessary to interface a full duplex PCM link.

The primary applications are in telephone systems:

- Transmission – 30/32 Channel Systems at 2.048 Mbps
- Switching – Digital PBX's and Central Office Switching Systems
- Concentration – Subscriber Carrier/Concentrators

The Wide dynamic range of the 2911A (66dB) and the minimal conversion time (80 μ sec minimum) make it an ideal product for other applications, like:

- Data Acquisition
- Secure Communications Systems
- Signal Processing Systems
- Telemetry

The 2911A is packaged in a hermetic 22-pin dual in-line package [2].

Intel i2911A

Part Numbers

Type D Packages

Part Number	Package Description	Values
D2911A	Type D package	\$.75-\$3
		
D2911A-1	Type D grey ceramic package w/tin pins.	\$.25-\$1

References

[1] Intel (1979). Intel Component Data Catalog, 2911 Preliminary Data Sheet, p. 6-15. No reference to 2911A.

[2] Intel (1980). Intel Component Data Catalog, 2911A Preliminary Data Sheet, p. 4-17.

Intel i2912

PCM Line Filters

1979

Specifications

- PCM Line Filters
- Telephony Product
- NMOS
- AT&T® D3/D4 Compatible and CCITT G712 Compatible
- Monolithic Device Includes Both Transmit and Receive Filters
- 50Hz/60Hz Rejection Included in the Transmit Filter
- Gain Adjustment in Both Directions
- Direct Interface with Transformer or Electronic Telephone Hybrids
- Direct Interface to the Intel® 2910A/2911A PCM Codecs Including Stand-By, Power Down Mode
- ±5% Power Supplies: +5V, -5V
- Low Power Consumption:
 - 210mW Typical with Power Amplifiers
 - 55mW Typical Stand-By
- 16 pin Dual In-Line Package

The Intel® 2912 is a fully integrated monolithic device containing the two filters of a PCM line or trunk termination. The device is designed to meet the following objectives:

- To meet AT&T D3/D4 frequency response with the 2912 and 2912-6
 - To meet CCITT frequency response with the 2912-3 and 2912-5
- To meet the digital Class 5 central office switching systems stringent specifications
- To simplify interfaces to transformers and hybrids. The primary application for the 2912 is in telephone systems for transmission, switching, or remote concentration.

A switched capacitor filter technique is used to implement the transmit and receive passband filter sections of the 2912. The device is fabricated using Intel's reliable two-layer polysilicon NMOS technology. The combination of the switched capacitor technique and the NMOS technology results in a monolithic 2912 filter, which is packaged in a standard 16-pin DIP [3].

History

1st Single Chip Filter

Part Numbers

Type D Packages

Part Number	Package Description	Values
D2912	Type D package	\$.75-\$3
		
D2912-3	Type D grey ceramic package w/tin pins. © Intel '78.	\$.75-\$3
D2912-5	Type D package	\$.75-\$3
D2912-6	Type D package	\$2.50-\$10

References

- [1] Intel (1978). Intel Component Data Catalog. No reference to 2912 dates chip after 1978.
- [2] Intel (1979). Intel Component Data Catalog, 2912 Preliminary Data Sheet, p. 6-27. No reference to 2912A.
- [3] Intel (1980). Intel Component Data Catalog, 2912 Data Sheet, p. 4-31
- [4] Intel (1984). A Revolution in Progress... A History of Intel to Date, 2912 introduced 1978, p. 26.

Intel i2912A

PCM Line Filters

1980-81

Specifications

- PCM Line Filters
- Telephony Product
- NMOS
- AT&T® D3/D4 Compatible and CCITT G712 Compatible
- Low Power Consumption
- Adjustable Gain in Both Directions
- Direct Interface to the Intel® 2910A/2911A PCM Codecs Including Stand-By, Power Down Mode
- Low Idle Channel Noise
- Excellent Power Supply Rejection
- 16 pin Dual In-Line Package

The Intel® 2912A 2nd generation PCM line filter is a fully integrated monolithic device containing the two filters of a PCM line or trunk termination. It has improved key parameters of power consumption, idle channel noise, and power supply rejection. A single part exceeds both AT&T D3/D4 and CCITT transmission specs, exceeds digital class 5 central office switching system stringent specifications, and is fully compatible with the 2912. The primary application for the 2912A is in telephone systems for transmission, switching, or remote concentration [2].

Intel i2912A

Part Numbers

Type D Packages

Part Number	Package Description	Values
		
D2912A	Type D grey ceramic package w/tin pins. © '82	\$.25-\$1

References

[1] Intel (1980). Intel Component Data Catalog, 2912 Family Data Sheet, p. 4-31. No reference to 2912A dates chip after 1980.

[2] Hearst (1981). IC Master, Intel 2912A Data Sheet, p. 713.

[3] Intel (January 1982). Intel Component Data Catalog, 2912A Data Sheet, p. 4-30.

Intel i2920

Signal Processor

1979

Specifications

- Single Processor
- Telephony Product
- NMOS
- Real Time Digital Processing of Analog Signals
- Nominal Signal Bandwidths from DC to 10KHz
- Digital Processing Accuracy and Stability
- Special Purpose Instruction Set for Signal Processing
- INTELLEC® Compatible Development System Software and Hardware
- Instruction Cycle Period
 - 400nsec – 2920
 - 600nsec – 2920-6
 - 800nsec – 2920-8
- Multiple Analog Inputs and Outputs
- On-Chip Sample and Hold Circuits and D/A Converter
- On-Chip EPROM: User Programmable and UV Erasable
- On-Chip Scratch Pad Memory
- Analog and/or TTL Output Waveforms, User Selectable
- ±5V Power Supplies
- 28-pin Dual In-Line Package

The Intel® 2920 Signal Processor is a programmable, single chip analog and digital signal processor specifically designed to replace analog subsystems in real-time processing applications. Its instruction set plus the high precision (25 bits) digital arithmetic logic unit provides the capability to implement very complex subsystems. Typical functions performed by the 2920 include: Lowpass and Bandpass filters with up to 20 complex pole and/or zero pairs; Threshold Detectors; Limiters; Rectifiers; up to 25-bit multiplication and division; approximations to nonlinear functions such as square law and logarithm; logical operations; Input and Output multiplexing of signals; logical outputs for decision type processing; and analog outputs for multifrequency oscillators, waveform generators, etc. In addition, several 2920's may be cascaded for very complex processing applications with no loss in throughput rate [2].

History

1st Signal Processor

Part Numbers

Type D Packages

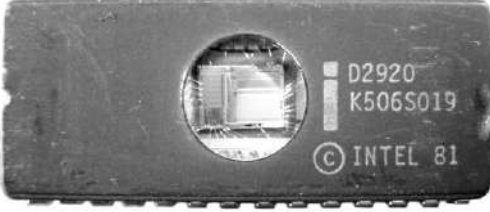
Part Number	Package Description	Values
		
D2920	Type D grey ceramic package w/tin pins. © Intel '81	\$1-\$4

References

- [1] Intel (1979). Intel Component Data Catalog. No reference to 2920.
- [2] Intel (1980). Intel Component Data Catalog, 2920 Preliminary Data Sheet, p. 4-43
- [3] Intel (1984). A Revolution in Progress... A History of Intel to Date, 2920 introduced 1979, p. 26.

Intel i3001

Microprogram Control Unit for 3002 Processor

September 1974

Specifications

- Microprogram Control Unit for 3002 Processor
- Bipolar (3xxx)
- High Performance – 85 ns Cycle Time
- TTL and DTL Compatible
- Fully Buffered Three-State and Open Collector Outputs
- Direct Addressing of Standard Bipolar PROM or ROM
- 512 Microinstruction Addressability
- Advanced Organization:
 - 9-Bit Microprogram Address Register and Bus
 - 4-Bit Program Latch
 - Two Flag Registers
- Eleven Address Control Functions:
 - Three Jump and Test Latch Functions
 - 16-way Jump and Test Instruction Bus Function
- Eight Flag Control Functions:
 - Four Flag Input Functions
 - Four Flag Output Functions
- 40-pin Dual In-Line Package

The Intel® 3001 Microprogram Control Unit (MCU) controls the sequence in which microinstructions are fetched from the microprogram memory. Its functions include the following:

- Maintenance of the microprogram address register.
- Selection of the next microinstruction based on the contents of the microprogram address register.
- Decoding and testing of data supplied via several input busses to determine the microinstruction execution sequence.
- Saving and testing the carry output data from the central processor (CP) array.
- Control of the carry/shift input data to the CP array.
- Control of microprogram interrupts.

The 3001 is packaged in a 40-pin dual in-line package [4].

Intel i3001

Part Numbers

Type C Packages

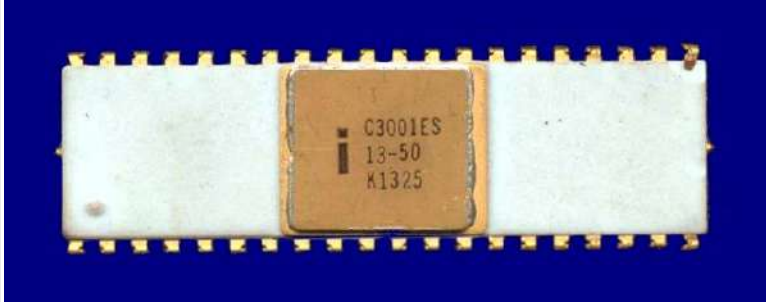
Part Number	Package Description	Values
		
C3001	Type C white ceramic package w/gold cap and embedded gold pins. Example shown marked 'ES' for Engineering Sample.	Ex. Rare (2 Known) \$50-\$200

Type D Packages

Part Number	Package Description	Values
		
D3001	1. Type D grey ceramic package w/tin pins. © Intel '74. Horizontal logo and part no.	\$1.50-\$6
D3001	2. Type D grey ceramic package w/tin pins. © Intel '74. Vertical logo and part no.	\$1.50-\$6
MD3001	Type D grey ceramic package w/tin pins. No copyright.	Rare \$15-\$60
MD3001/B	Type D package	\$5-\$20

References

- [1] Intel (1975). Intel Series 3000 Reference manual, back of front cover, "Since its [Series 3000 family] introduction in September, 1974".
- [2] Intel (1975). Intel Data Catalog, 3001 Data Sheet, p. 6-59
- [3] Intel (1977). Intel Memory Design Handbook, MD3001A listed as member of Intel Military Product Family, p. PSG-5.
- [4] Intel (1978). Intel Component Data Catalog, 3001 Data Sheet, p. 8-3
- [5] Intel (1984). A Revolution in Progress... A History of Intel to Date, 3001 introduced 1973, p. 26.

Intel i3002

2-bit Bipolar Bit-Slice Central Processing Element

September 1974

Specifications

- 2-bit Bipolar Bit-Slice Central Processing Element
- High Performance – 100ns Cycle Time
- TTL and DTL Compatible
- N-Bit Word Expandable Multi-Bus Organization:
 - 3 Input Data Busses
 - 2 Three-State Fully Buffered Output Data Busses
- 11 General Purpose Registers
- Full Function Accumulator
- Independent Memory Address Register
- Cascade Outputs for Full Carry Look-Ahead
- Versatile Functional Capability:
 - 8 Function Groups
 - Over 40 Useful Functions, Zero
 - Detect and Bit test
- Data Width – 2/16-bits
- Single Clock
- 28-pin Dual In-Line Package

Type	Clock	Power Dissipation Max.	Supplies [V]
3002	6 MHz	800mW	+5

The Intel® 3002 Central Processing Element contains all of the circuits that represent a 2-bit wide slice through the data processing section of a digital computer. To construct a complete central processor for a given word length N, it is simply necessary to connect an array of N/2 CPE's together. When wired together in such an array, a set of CPE's provide the following capabilities:

- 2's complement arithmetic
- Logical AND, OR, NOT and exclusive-OR
- Incrementing and decrementing
- Shifting left or right
- Bit testing and zero detection
- Carry look-ahead generation
- Multiple data and address busses

The 3002 is packaged in a 28-pin dual in-line package [4].

History

The Intel 3002 was Intel's first entry into the Bit-slice marketplace and the first bipolar Bit-slice device. Introduced in the 3rd quarter of 1974, it is an unusual device in that it was a 2-bit device while most others devices were 4-bit devices.

The 3002 was a peer of the Intel 8080, but the 8080 could only handle 8-bits of data at a time. The 3002 was a 2-bit ALU, but 8 3002's could be linked together to create a computer that could handle 16-bits at a time. Whereas the 8080 would have to use multiple cycles to process 16 or 32 bits, the appropriate 3002 configuration could handle it in a single cycle giving such a computer significantly more power than the 8080.

The 3002 was a member of a family of devices known as the 3000 Series.

Intel C3002

Intel C3002's are more rare than common varieties of the Intel C4004, C8008, and C8080A.

Because of its rarity, the Intel C3002 is going to be a key chip in any collection of early Intel processors in the type 'C' package.

Copyrights

Intel started putting copyrights on their chips shortly after the 3002 was introduced.

Intel D3002's without a copyright are rare compared to Intel D3002's with a copyright. No copyrighted Intel C3002's are known to exist. This may mean that Intel had discontinued the C3002 by the time they started putting copyrights on their chips.

Package Information

The Intel 3002 was not produced in a type P package.



Part Numbers

Type C Packages

Part Number	Package Description	Values
		
C3002	1. Type C white ceramic package w/gold cap and integrated gold pins. Raised bump denotes pin #1. Example shown marked 'ES' for engineering sample.	\$50-\$200
		
C3002	2. Type C white ceramic package w/gold cap and gold pins. Small black dot denotes pin #1.	\$50-\$200
		
C3002	3. Type C white ceramic package w/gold cap and gold pins. Black square denotes pin #1.	\$50-\$200

Intel i3002

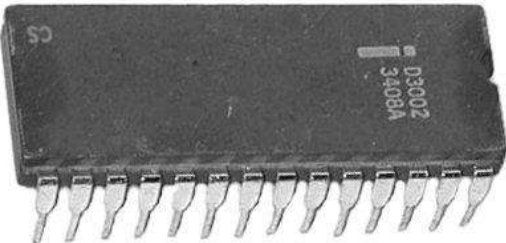
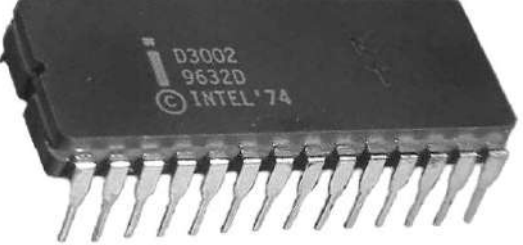
Type D Packages

Part Number	Package Description	Values
3002	 <p>A black rectangular ceramic package with 18 pins. The top surface is marked with '3002', 'S2140', and 'CS'.</p>	
	<p>Type D grey ceramic package w/tin pins. No copyright. Example shown is marked 'CS' for customer sample.</p>	<p>Rare \$10-\$40</p>
D3002	 <p>A black rectangular ceramic package with 18 pins. The top surface is marked with 'D3002', '3400A', and 'CS'.</p>	
	<p>1. Type D grey ceramic package w/tin pins. Vertical part number and logo. No copyright. Example shown is marked 'CS' for Customer Sample.</p>	<p>Rare \$10-\$40</p>
D3002	 <p>A black rectangular ceramic package with 18 pins. The top surface is marked with 'D3002', '9632D', and 'INTEL '74'.</p>	
	<p>2. Type D grey ceramic package w/tin pins. © Intel '74</p>	<p>\$.50-\$2</p>
MD3002/B	 <p>A black rectangular ceramic package with 18 pins. The top surface is marked with 'MD3002/B', '7615', '1477A', and 'CS'.</p>	
	<p>1. Type D grey ceramic package w/tin pins. No copyright. Example shown is marked 'CS' for customer sample.</p>	<p>Rare \$15-\$60</p>

Intel i3002

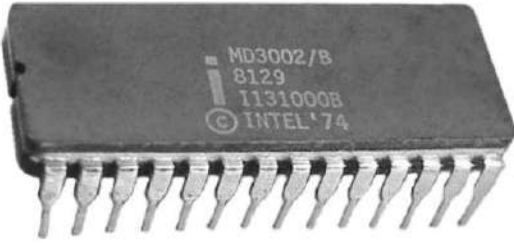
 A photograph of an Intel MD3002/B microprocessor chip. The chip is a grey ceramic package with 18 pins. The top surface is marked with the following text: MD3002/B, 8129, 1131000B, and INTEL '74. A small notch is visible on the left side of the package.		
MD3002/B	2. Type D grey ceramic package w/tin pins. © Intel '74.	\$5-\$20

References

- [1] Intel (1975). Intel Series 3000 Reference manual, back of front cover, “Since its [Series 3000 family] introduction in September, 1974”.
- [2] Intel (1975). Intel Data Catalog, 3002 Data Sheet, p. 6-59
- [3] Intel (1977). Intel Memory Design Handbook, MD3002 listed as member of Intel Military Product Family, p. PSG-5.
- [4] Intel (1978). Intel Component Data Catalog, 3002 Data Sheet, p. 8-4
- [5] Intel (1984). A Revolution in Progress... A History of Intel to Date, 3002 introduced 1973, p. 26

Intel i3003

Look-Ahead Carry Generator for 3002 Processor

September 1974

Specifications

- Look-Ahead Carry Generator for 3002 Processor
- Bipolar (3xxx)
- Compatible with Intel 3001 MCU and 3002 CPE
- High Performance – 10 ns Typical Propagation Delay
- DTL and TTL Compatible
- Full Look-Ahead Across 8 Adders
- Low Voltage Diode Input Clamp
- Expandable
- 28-pin Dual In-Line Package

The Intel 3003 Look-Ahead Carry Generator (LCG) is a high-speed circuit capable of anticipating a carry across a full 16-bit 3002 Central Processing Array. When used with a larger 3002 CP Array, multiple 3003 carry generators provide high speed carry look-ahead capability for any word length.

The LCG accepts eight pairs of active high-speed cascade inputs (X, Y) and an active low carry input and generates active low carries for up to eight groups of binary adders [4].

Intel i3003

Part Numbers

Type C Packages

Part Number	Package Description	Values
		
C3003	Type C white ceramic package w/gold cap and integrated gold pins.	Rare \$25-\$100

Type D Packages

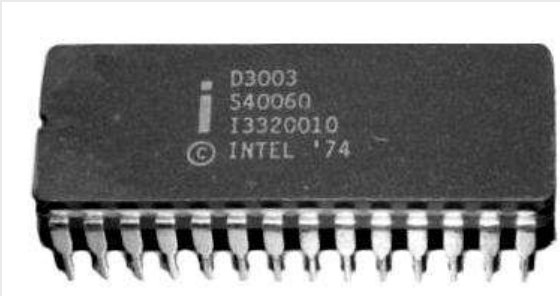
Part Number	Package Description	Values
		
D3003	Type D grey ceramic package w/tin pins. © Intel '74	\$1.25-\$5
MD3003/B	Type D package	\$5-\$20

References

- [1] Intel (1975). Intel Series 3000 Reference manual, back of front cover, “Since its [Series 3000 family] introduction in September, 1974”.
- [2] Intel (1975). Intel Data Catalog, 3003 Data Sheet, p. 6-60
- [3] Intel (1977). Intel Memory Design Handbook, MD3003 listed as member of Intel Military Product Family, p. PSG-5.
- [4] Intel (1978). Intel Component Data Catalog, 3003 Data Sheet, p. 8-5
- [5] Intel (1984). A Revolution in Progress... A History of Intel to Date, 3003 introduced 1973, p. 26

Intel i3101

64-bit (16 x 4) Static RAM

1969

Specifications

- 64-bit (16 x 4) Static RAM
- Bipolar (3xxx)
- DTL and TTL Compatible – Low Input Load Current: 0.25mA. Max.
- OR-Tie Capability -- Open Collector Output
- Fully Decoded – On Chip Address Decode and Buffer
- Minimum Line Reflection – Low Voltage Diode Input Clamp
- 16-pin Dual In-Line Package

Type	Access Time Max.	Cycle Time Max.	Power Dissipation Max. Operating/Standby	Supplies [V]
3101	60ns	60ns	525mW	+5
M3101	75ns	75ns	546mW	+5
31013	75ns	75ns	546mW	+5

The Intel 3101 and 3101A are high-speed fully decoded 64-bit random access memories, organized 16 words by 4-bits. Their high speed makes them ideal in scratch pad applications. An unselected chip will not generate noise at its output during writing of a selected chip. The output is held high on an unselected chip regardless of the state of the read/write signal.

The use of Schottky barrier diode clamped transistors to obtain fast switching speeds results in higher performance than equivalent devices with gold diffusion processes.

The Intel 3101 and 3101A are packaged in either hermetically sealed 16 pin ceramic packages, or in low cost silicone packages, and their performance is specified over a temperature range from 0°C to 75°C.

The storage cells are addressed through an on chip 1 of 16 binary decoder using four input address leads.

A separate Chip Select lead allows easy selection of an individual package when output are OR-tied.

In addition to the address leads and Chip Select lead, there is a write input, which allows data presented at the data leads to be entered at the addressed storage cells [2].

The M3101/31013 had an operating temperature range of -55°C to 125°C [1].

History

1st Intel product

Packaging Information

The Intel 3101 was not produced in a type D package.

Part Numbers

Type C Packages

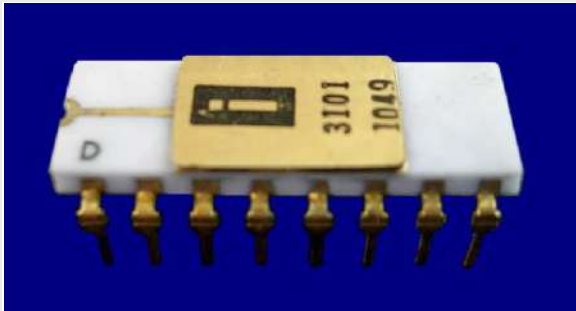
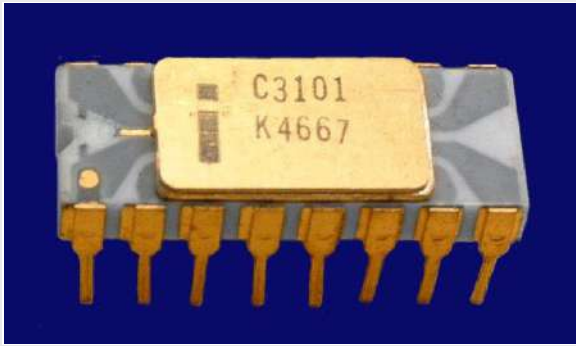
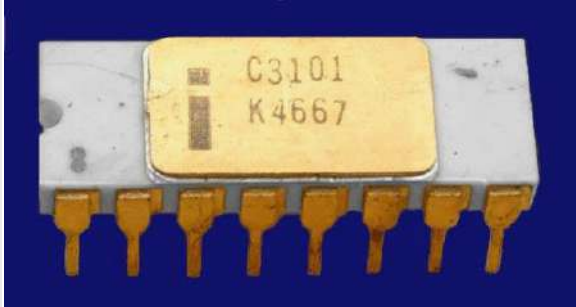
Part Number	Package Description	Values
		
3101	Type C white ceramic package w/gold cap, gold cap ground strap, and gold pins. 'D' denotes pin #1. Vertical blocked 'i' Intel logo and part number on cap.	Ex. Rare (2 Known) \$75-\$300
		
C3101	1. Type C white ceramic package w/grey traces, gold cap, gold cap ground strap, and gold pins. Gold dot denotes pin #1.	\$30-\$120
		
C3101	2. Type C white ceramic package w/gold cap and gold pins. "Double dot" denotes pin #1.	\$30-\$120

Intel i3101

Type P Packages

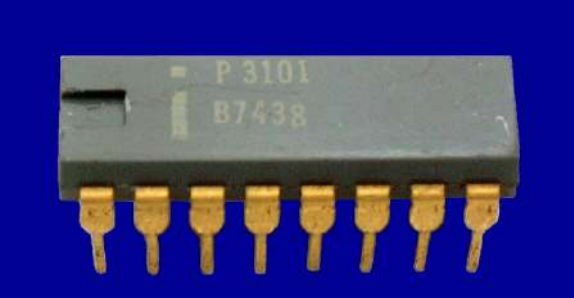
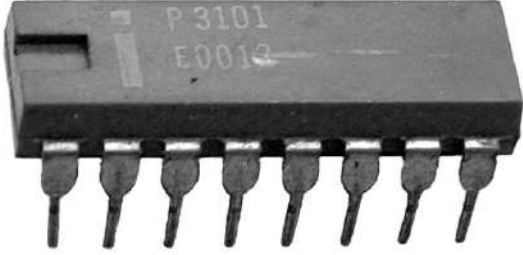
Part Number	Package Description	Values
P3101		
	1. Type P grey plastic package w/gold pins.	Ex. Rare \$50-\$200
P3101	2. Type P grey plastic package w/gold pins. Embossed Intel 'i' in key.	Ex. Rare \$50-\$200
P3101		
	3. Type P grey plastic package w/tin pins	\$5-\$20

References

- [1] Intel (March 1971). Intel Price List, 31013 prices and temperature range.
- [2] Intel (September 1972). Intel Data Catalog, 3101 and 3101A Data Sheet, p. 2-17. No reference to 31013. C3101, P3101, C3101A, and P3101A prices listed in ordering information.
- [3] Intel (1984). A Revolution in Progress... A History of Intel to Date, 3101 introduced 1969, p. 26.

Intel i3101A

64-bit (16 x 4) Static RAM

1971-72

Specifications

- 64-bit (16 x 4) Static RAM
- Bipolar (3xxx)
- OR-Tie Capability -- Open Collector Output
- Fully Decoded – On Chip Address Decode and Buffer
- Minimum Line Reflection – Low Voltage Diode Input Clamp
- 16-pin Dual In-Line Package

Type	Access Time Max.	Cycle Time Max.	Power Dissipation Max. Operating/Standby	Supplies [V]
3101A	35ns	35ns	525mW	+5
M3101A	45ns	45ns	546mW	+5

The Intel 3101 and 3101A are high-speed fully decoded 64-bit random access memories, organized 16 words by 4-bits. Their high speed makes them ideal in scratch pad applications. An unselected chip will not generate noise at its output during writing of a selected chip. The output is held high on an unselected chip regardless of the state of the read/write signal.

The use of Schottky barrier diode clamped transistors to obtain fast switching speeds results in higher performance than equivalent devices with gold diffusion processes.

The Intel 3101 and 3101A are packaged in either hermetically sealed 16 pin ceramic packages, or in low cost silicone packages, and their performance is specified over a temperature range from 0°C to 75°C.

The storage cells are addressed through an on chip 1 of 16 binary decoder using four input address leads.

A separate Chip Select lead allows easy selection of an individual package when output are OR-tied.

In addition to the address leads and Chip Select lead, there is a write input, which allows data presented at the data leads to be entered at the addressed storage cells [2].

Packaging

The Intel 3101A was not produced in a type D package.

Part Numbers

Type C Packages

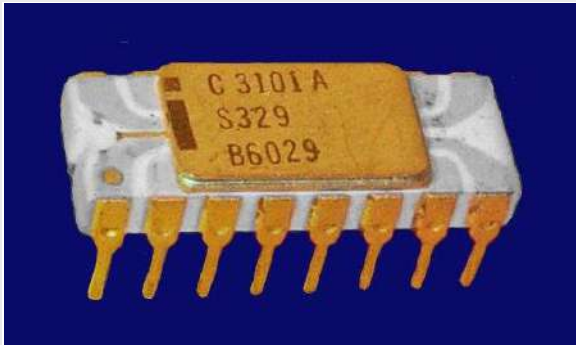
Part Number	Package Description	Values
		
C3101A	Type C white ceramic package w/gold cap, gold cap ground strap, and gold pins. Gold dot denotes pin #1.	\$30-\$120

Type P Packages

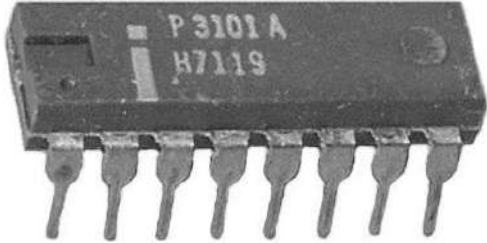
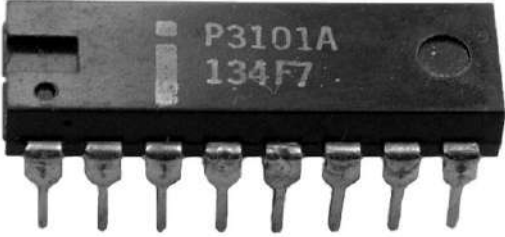
Part Number	Package Description	Values
		
P3101A	1. Type P grey plastic package w/tin pins. Small round indentation denotes pin #1.	\$5-\$20
		
P3101A	2. Type P black plastic package w/tin pins. Small round indentation denotes pin #1.	\$1.50-\$6

References

[1] Intel (March 1971). Intel Price List, 3101 and 31013 prices. No Reference to 3101A.

[2] Intel (September 1972). Intel Data Catalog, 3101 and 3101A Data Sheet, p. 2-17. No reference to 31013. C3101, P3101, C3101A, and P3101A prices listed in ordering information.

Intel i3102

256-bit (256 x 1) Partially Decoded Static RAM

1970

Specifications

- 256-bit (256 x 1) Partially Decoded Static RAM
- Bipolar (3xxx)
- 16-pin Dual In-Line Package

Type	Access Time Max.	Cycle Time Max.	Power Dissipation Max. Operating/Standby	Supplies [V]
3102	80ns	-	-	+5

No data sheet known to exist for this chip.

Part Numbers

Type C Packages

Part Number	Package Description	Values
C3102	Type C package	Ex. Rare (0 Known) \$75-\$300

References

- [1] Intel (March 1971). Intel Price List, 3102 prices date chip to March 1971.
- [2] Intel (September 1972). Intel Data Catalog, 3102A Data Sheet, p. 2-21. Suggested OEM pricing section lists prices and access times for C3102 and C3102A.
- [3] Intel (1975). Intel Memory Design Handbook. No reference to 3102 or 3102A.
- [4] Intel (1984). A Revolution in Progress... A History of Intel to Date, 3102 introduced 1970, p. 26.

Intel i3102A

256-bit (256 x 1) Partially Decoded Static RAM

1971-72

Specifications

- 256-bit (256 x 1) Partially Decoded Static RAM
- Bipolar (3xxx)
- Fast Access Time – 85 ns total – including 3202 Decoder – Driver and Memory over Temperature with Full Fanout of 32
- Low Memory Power Dissipation – 2.0mW/bit
- Directly Compatible with DTL and TTL Logic Circuits
- OR-tie Capability
- Easy Memory Expansion through 4 chip Select Inputs on Decoder-Driver
- Minimum Line Reflection – Low Voltage Diode Input Clamp
- Decoder-Driver (3202) Drives at Least 32 Memory Elements, Memory (3102A) Output Sinks 16 mA
- Low Input Load Current -- .25 mA max., 1/6 Standard TTL Input Load
- 16-pin Dual In-Line Package

Type	Access Time Max.	Cycle Time Max.	Power Dissipation Max. Operating/Standby	Supplies [V]
3102A	50ns	-	500mW	+5

The Intel 3102A is a high-speed 256-bit bipolar random access memory, organized as 256 words by 1-bit. The address of the Memory is coded with a special 3-of-6 code, which offers low power dissipation and high-speed operation for the Memory chip.

Access time listed on 3102A/3202 datasheet in September 1972, Intel Data Catalog, is 85ns total including Decoder-Driver [2].

History

This early chip was quickly discontinued. It can be found in Intel's September 1972 Data Catalog but there is no reference to it in Intel's 1975 Intel Memory Design handbook.

Intel i3102A

Part Numbers

Type C Packages

Part Number	Package Description	Values
C3102A	Type C package	Ex. Rare (0 Known) \$75-\$300

Type P Packages

Part Number	Package Description	Values
P3102A	Type P package	Ex. Rare (0 Known) \$40-\$160

References

[1] Intel (March 1971). Intel Price List. 3102 prices date chip to March 1971. No reference to 3102A dates chip after March 1971.

[2] Intel (September 1972). Intel Data Catalog, 3102A Data Sheet, p. 2-21. Suggested OEM pricing section lists price and access times for C3102 and C3102A.

[3] Intel (1975). Intel Memory Design Handbook. No reference to 3102 or 3102A.

Intel i3104

16-bit (4 x 4) Content Addressable Static RAM

1969-72

Specifications

- 16-bit (4 x 4) Content Addressable Static RAM
- Max. Delay of 30 nsec Over 0° C to 75° C Temperature
- Open Collector Outputs – OR Tie Capability
- High Sinking Current Capability – 15 mA max.
- Low Input Load Current – 0.25 mA max.
- DTL & TTL Compatible
- Bit Enable Input – Bit Masking
- Bipolar (3xxx)
- 24-pin Dual In-Line Package

Type	Access Time Max.	Cycle Time Max.	Power Dissipation Max. Operating/Standby	Supplies [V]
3104	30ns	40ns	625mW	+5

The Intel 3104 is a high speed 16-bit Content Addressable Memory (CAM). It is a linear select 4 word by 4-bit array, which is designed to compare data on its inputs with data already stored in its memory and to indicate a match when these data are identical. This equality search is performed on all bits in parallel. The 3104 can also be used as a read/write RAM with linear selection addressing [1].

Part Numbers

Type C Packages

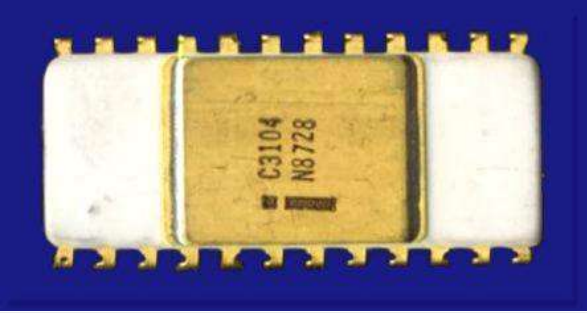
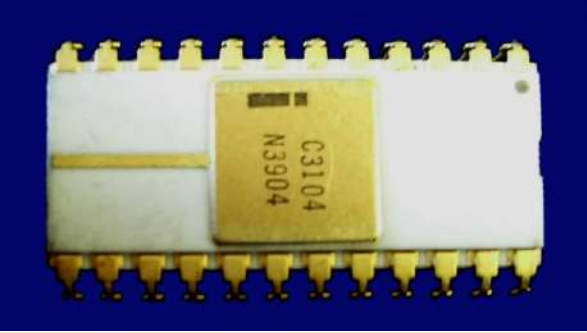
Part Number	Package Description	Values
		
C3104	1. Type C white ceramic package w/gold cap and integrated gold pins. Raised bump denotes pin #1.	Rare \$50-\$200
		
C3104	2. Type C white ceramic package w/gold cap, gold cap ground strap, and gold pins. Black dot denotes pin #1.	Rare \$50-\$200

Type D Packages

Part Number	Package Description	Values
D3104	Type D package	\$.75-\$3

References

- [1] Intel (September 1972). Intel Data Catalog, 3104 Data Sheet, p. 2-29. C3104 listed in ordering information.
- [2] Intel (1984). A Revolution in Progress... A History of Intel to Date, 3104 introduced 1970, p. 26.

Intel i3106

256-bit (256 x 1) Static RAM

1971-72

Specifications

- 256-bit (256 x 1) Static RAM
- Bipolar (3xxx)
- Fully Decoded – On Chip Address Decode and Buffer
- DTL and TTL Compatible – Low Input Load Current: 0.25mA Max.
- Three-State Output
- Simple Memory Expansion through 3 Chip Select Inputs
- Minimum Line Reflection – Low Voltage Diode Input Clamp
- 16-pin Dual In-Line Package

Type	Access Time Max.	Cycle Time Max.	Power Dissipation Max. Operating/Standby	Supplies [V]
3106	80ns	80ns	650mW	+5
3106-8	60ns	70ns	650mW	+5

The Intel 3106, 3106A, 3107, and 3107A are high speed, fully decoded, 256-bit read/write random access memories, in a 256 word by 1 bit organization. These devices are designed for high-speed scratch pad, buffer, and distributed main memory applications. The 3106A and 3107A are higher speed versions of the 3106 and 3107.

All devices feature three chip-select inputs. The 3106 and 3106A have a three-state output and the 3107 and 3107A provide the user with the popular open collector output. On-chip address decoding and the high-speed chip-select facilitate easy memory expansion.

The use of Schottky barrier diode clamped transistors to obtain fast switching speeds results in higher performance than equivalent devices made with a gold diffusion process. The performance of these devices is specified over a temperature range from 0°C to +75°C.

The 3106, 3106A, 3107, and 3107A are compatible with TTL and DTL logic circuits [1].

Intel 3106 vs. 3106-8

The 1975 Intel Memory Design Handbook lists the same access time, cycle time, and power dissipation for the 3106-8 as it does for the 3106. This looks suspect. Why have two different part numbers for what is in effect a single chip?

However, the access time, cycle time, and power dissipation for the 3107 and 3107-8 (open collector equivalents of the three state 3106 and 3106-8) are not the same (80ns/80ns for 3107 vs. 60ns/70ns for 3107-8).

I think that the access and cycle time listed in the 1975 Intel Memory Design handbook for the 3106-8 should be 60ns/70ns (same as 3107-8) instead of 80ns/80ns (same as 3106).

Part Numbers

Type C Packages

Part Number	Package Description	Values
		
C3106	Type C white ceramic package w/gold cap and gold pins. Black double dot denotes pin #1.	Rare \$50-\$200

Type D Packages

Part Number	Package Description	Values
D3106	Type D package	Rare \$25-\$100

Type P Packages

Part Number	Package Description	Values
P3106	Type P package	Ex. Rare (0 Known) \$20-\$80

References

[1] Intel (September 1972). Intel Data Catalog, 3106, 3106A, 3107, and 3107A Data Sheet, p. 2-33. No reference to 3106-8.

[2] Intel (1975). Intel Memory Design Handbook, 3106 and 3106-8 Specifications, p. PSG-1

[3] Intel (1984). A Revolution in Progress... A History of Intel to Date, 3106/7 introduced 1973, p. 26. This Introduction date is probably incorrect given that the September 1972 Intel Data Catalog contains a data sheet for both the 3106 and 3106A.

Intel i3106A

256-bit (256 x 1) Static RAM

1971-72

Specifications

- 256-bit (256 x 1) Static RAM
- Bipolar (3xxx)
- Fully Decoded – On Chip Address Decode and Buffer
- DTL and TTL Compatible – Low Input Load Current: 0.25mA Max.
- Three-State Output
- Simple Memory Expansion through 3 Chip Select Inputs
- Minimum Line Reflection – Low Voltage Diode Input Clamp
- 16-pin Dual In-Line Package

Type	Access Time Max.	Cycle Time Max.	Power Dissipation Max. Operating/Standby	Supplies [V]
3106A	60ns	70ns	650mW	+5

The Intel 3106, 3106A, 3107, and 3107A are high speed, fully decoded, 256-bit read/write random access memories, in a 256 word by 1 bit organization. These devices are designed for high-speed scratch pad, buffer, and distributed main memory applications. The 3106A and 3107A are higher speed versions of the 3106 and 3107.

All devices feature three chip-select inputs. The 3106 and 3106A have a three-state output and the 3107 and 3107A provide the user with the popular open collector output. On-chip address decoding and the high-speed chip-select facilitate easy memory expansion.

The use of Schottky barrier diode clamped transistors to obtain fast switching speeds results in higher performance than equivalent devices made with a gold diffusion process. The performance of these devices is specified over a temperature range from 0°C to +75°C.

The 3106, 3106A, 3107, and 3107A are compatible with TTL and DTL logic circuits [1].

Intel i3106A

Part Numbers

Type C Packages

Part Number	Package Description	Values
C3106A	Type C package	Rare \$50-\$200

Type D Packages

Part Number	Package Description	Values
D3106A	Type D package	Rare \$20-\$80

Type P Packages

Part Number	Package Description	Values
P3106A	Type P package	Rare \$15-\$60

References

- [1] Intel (September 1972). Intel Data Catalog, 3106, 3106A, 3107, and 3107A Data Sheet, p. 2-33.

Intel i3107

256-bit (256 x 1) Static RAM

1971-72

Specifications

- 256-bit (256 x 1) Static RAM
- Bipolar (3xxx)
- Fully Decoded – On Chip Address Decode and Buffer
- DTL and TTL Compatible – Low Input Load Current: 0.25mA Max.
- Open Collector Output
- Simple Memory Expansion through 3 Chip Select Inputs
- Minimum Line Reflection – Low Voltage Diode Input Clamp
- 16-pin Dual In-Line Package

Type	Access Time Max.	Cycle Time Max.	Power Dissipation Max. Operating/Standby	Supplies [V]
3107	80ns	80ns	650mW	+5
3107-8	60ns	70ns	650mW	+5

The Intel 3106, 3106A, 3107, and 3107A are high speed, fully decoded, 256-bit read/write random access memories, in a 256 word by 1 bit organization. These devices are designed for high-speed scratch pad, buffer, and distributed main memory applications. The 3106A and 3107A are higher speed versions of the 3106 and 3107.

All devices feature three chip-select inputs. The 3106 and 3106A have a three-state output and the 3107 and 3107A provide the user with the popular open collector output. On-chip address decoding and the high-speed chip-select facilitate easy memory expansion.

The use of Schottky barrier diode clamped transistors to obtain fast switching speeds results in higher performance than equivalent devices made with a gold diffusion process. The performance of these devices is specified over a temperature range from 0°C to +75°C.

The 3106, 3106A, 3107, and 3107A are compatible with TTL and DTL logic circuits [1].

Intel 3107-8

Intel 3107's with '-8' suffix may exist.

Part Numbers

Type C Packages

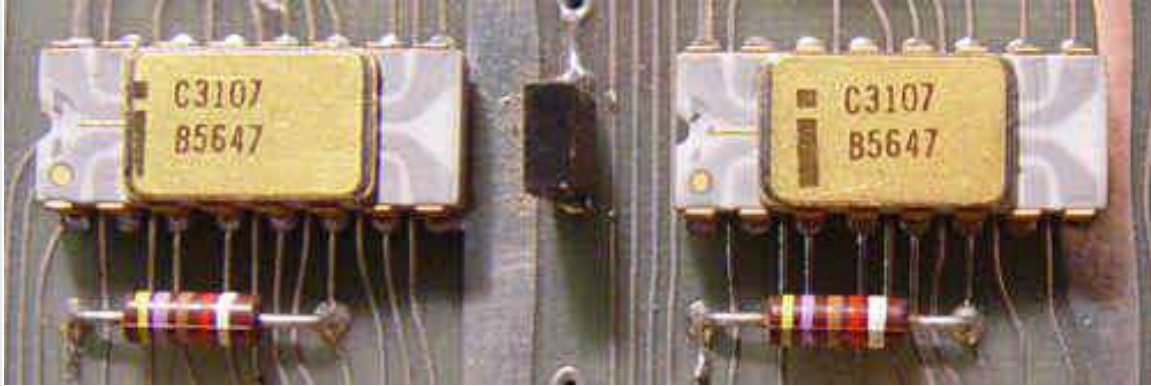
Part Number	Package Description	Values
		
C3107	Type C white ceramic package w/grey traces, gold cap, gold cap ground strap, and gold pins. Gold dot denotes pin #1.	Ex. Rare \$50-\$200

Type D Packages

Part Number	Package Description	Values
D3107	Type D package	Rare \$25-\$100

Type P Packages

Part Number	Package Description	Values
P3107	Type P package	Ex. Rare (0 Known) \$20-\$80

References

- [1] Intel (September 1972). Intel Data Catalog, 3106, 3106A, 3107, and 3107A Data Sheet, p. 2-33.
- [2] Intel (1975). Intel Memory Design Handbook, 3107 and 3107-8 Specifications, p. PSG-1
- [3] Intel (1984). A Revolution in Progress... A History of Intel to Date, 3106/7 introduced 1973, p. 26. This Introduction date is probably incorrect given that the September 1972 Intel Data Catalog contains a data sheet for both the 3107 and 3107A.

Intel i3107A

256-bit (256 x 1) Static RAM

1971-72

Specifications

- 256-bit (256 x 1) Static RAM
- Bipolar (3xxx)
- Fully Decoded – On Chip Address Decode and Buffer
- DTL and TTL Compatible – Low Input Load Current: 0.25mA Max.
- Open Collector Output
- Simple Memory Expansion through 3 Chip Select Inputs
- Minimum Line Reflection – Low Voltage Diode Input Clamp
- 16-pin Dual In-Line Package

Type	Access Time Max.	Cycle Time Max.	Power Dissipation Max. Operating/Standby	Supplies [V]
3107A	60ns	70ns	650mW	+5

The Intel 3106, 3106A, 3107, and 3107A are high speed, fully decoded, 256-bit read/write random access memories, in a 256 word by 1 bit organization. These devices are designed for high-speed scratch pad, buffer, and distributed main memory applications. The 3106A and 3107A are higher speed versions of the 3106 and 3107.

All devices feature three chip-select inputs. The 3106 and 3106A have a three-state output and the 3107 and 3107A provide the user with the popular open collector output. On-chip address decoding and the high-speed chip-select facilitate easy memory expansion.

The use of Schottky barrier diode clamped transistors to obtain fast switching speeds results in higher performance than equivalent devices made with a gold diffusion process. The performance of these devices is specified over a temperature range from 0°C to +75°C.

The 3106, 3106A, 3107, and 3107A are compatible with TTL and DTL logic circuits [1].

Part Numbers

Type C Packages

Part Number	Package Description	Values
C3107A	Type C package	Ex. Rare (0 Known) \$75-\$300

Type D Packages

Part Number	Package Description	Values
D3107A	Type D package	Rare \$25-\$100

Type P Packages

Part Number	Package Description	Values
P3107A	Type P package	Rare \$15-\$60

References

- [1] Intel (September 1972). Intel Data Catalog, 3106, 3106A, 3107, and 3107A Data Sheet, p. 2-33.
- [2] Intel (1975). Intel Memory Design Handbook, 3107 and 3107-8 Specifications, p. PSG-1

Intel i3202

Binary to 3-of-6 Decoder/Driver for 3102A Static RAM

1969-71

Specifications

- Binary to 3-of-6 Decoder-Driver for 3102A Static RAM
- Bipolar (3xxx)
- Fast Access Time – 85 ns total – including 3202 Decoder – Driver and Memory over Temperature with Full Fanout of 32
- Low Memory Power Dissipation – 2.0mW/bit
- Directly Compatible with DTL and TTL Logic Circuits
- OR-tie Capability
- Easy Memory Expansion through 4 chip Select Inputs on Decoder-Driver
- Minimum Line Reflection – Low Voltage Diode Input Clamp
- Decoder-Driver (3202) Drives at Least 32 Memory Elements, Memory (3102A) Output Sinks 16 mA
- Low Input Load Current -- .25 mA max., 1/6 Standard TTL Input Load
- 16-pin Dual In-Line Package

Type	Input to Output Delay Max.	Power Dissipation Max.	Supplies [V]
3202	20ns	525mW	+5

The Intel 3202 is a Binary to 3-of-6 Decoder-Driver, capable of driving thirty-two 3102A Memory chips. The use of 4 chip select inputs provides expansion of up to 4096 words without additional decoding [2].

Part Numbers

Type C Packages

Part Number	Package Description	Values
C3202	Type C package	Ex. Rare (0 Known) \$50-\$200

References

[1] Intel (March 1971). Intel Price List. 3202 prices dates chip to March 1971.

[2] Intel (September 1972). Intel Data Catalog, 3202 Data Sheet, p. 2-21. C3202 listed in ordering information.

Intel i3205

High Speed 1-of-8 Binary Decoder

1970

Specifications



- High Speed 1-of-8 Binary Decoder
- Bipolar (3xxx)
- 18 ns Max. Delay Over 0°C to 75°C Temperature
- Directly Compatible with DTL and TTL Logic Circuits
- Low Input Load Current -- .25 mA Max., 1/6 Standard TTL Input Load
- Minimum Line Reflection – Low Voltage Diode Input Clamp
- Outputs Sink 10 mA Min.
- Simple Expansion – Enable Inputs
- 16-pin Dual In-Line Package

Type	Input to Output Delay Max.	Power Dissipation Max.	Supplies [V]
3205	18ns	350mW	+5

The 3205 decoder can be used for expansion of systems, which utilize memory components with active low chip select input. When the 3205 is enabled, one of its eight outputs goes “low”, thus a single row of a memory system is selected. The 3 chip enable inputs on the 3205 allow easy memory expansion. For very large memory systems, 3205 decoders can be cascaded such that each decoder can drive 8 other decoders for arbitrary memory expansions [1].

Part Numbers

Type C Packages

Part Number	Package Description	Values
		
3205	Type C white ceramic package w/grey traces, gold cap, gold cap ground strap, and gold pins. Gold dot denotes pin #1. Dropped 'e' Intel logo.	Ex. Rare \$50-\$200
		
C3205	1. Type C white ceramic package w/grey traces, gold cap, gold cap ground strap, and gold pins. Gold dot denotes pin #1.	Ex. Rare \$50-\$200
C3205	2. Type C white ceramic package w/gold cap and gold pins. Double dot denotes pin #1.	Ex. Rare \$25-\$100

Type D Packages

Part Number	Package Description	Values
		
D3205	Type D package	\$.30-\$1.20

Intel i3205

Type P Packages

Part Number	Package Description	Values
	 A grey plastic integrated circuit package with 10 pins. The top surface is marked with '3205', 'S2172', and 'CS'. A small round indentation is visible on the left side of the package.	
3205	Type P grey plastic package w/tin pins. Small round indentation denotes pin #1. Example shown marked 'CS' for Customer Sample.	Ex. Rare \$15-\$60
	 A grey plastic integrated circuit package with 10 pins. The top surface is marked with 'P3205', '278A7', and 'CS'. A small round indentation is visible on the left side of the package.	
P3205	Type P grey plastic package w/tin pins. Small round indentation denotes pin #1. Example shown marked 'CS' for Customer Sample	\$1.25-\$5

References

[1] Intel (September 1972). Intel Data Catalog, 3205, 3404 Data Sheet, p. 5-3. C3205 and P3205 listed in ordering information.

[2] Intel (1984). A Revolution in Progress... A History of Intel to Date, 3205 introduced 1970, p. 26

Intel i3207

Quad Bipolar-to-MOS Level Shifter and Driver

1971

Specifications

- Quad Bipolar-to-MOS Level Shifter and Driver
- Bipolar (3xxx)
- High Speed, 45 ns Max. – Delay + Transition Time over Temperature with 200 pF Load
- TTL and DTL Compatible Inputs
- 1103 Memory Compatible at Output
- Simplifies Design – Replaces Discrete Components
- Easy to Use – Operates from Standard Bipolar and MOS Supplies
- Minimum Line Reflection – Low Voltage Diode Input Clamp
- 16-pin Dual In-Line Package

Type	Input to Output Delay Max.	Power Dissipation Max.	Supplies [V]
3207	25ns	925mW	+5

The 3207 is a Quad Bipolar-to-MOS level shifter and driver which accepts TTL and DTL input signals, and provides high output current and voltage suitable for driving MOS circuits. It is particularly suitable for driving the 1103 memory chip.

The device features two common enable inputs per pair of devices, which permits some logic to be done at their inputs, such as cenable and precharge decoding for the 1103 [1].

Part Numbers

Type C Packages

Part Number	Package Description	Values
C3207	Type C package	Ex. Rare (0 Known) \$50-\$200

References

[1] Intel (September 1972). Intel Data Catalog, 3207 Data Sheet, p. 5-7. C3207 listed in ordering information.

[2] Intel (1984). A Revolution in Progress... A History of Intel to Date, 3207 introduced 1971, p. 26

Intel i3207A

Quad Bipolar-to-MOS Level Shifter and Driver

4th Qtr 1972

Specifications

- Quad Bipolar-to-MOS Level Shifter and Driver
- Bipolar (3xxx)
- High Speed, 45 nsec Max. – Delay + Transition Time Over Temperature with 200pF Load
- TTL and DTL Compatible Inputs
- 1103 and 1103A Memory Compatible at Output
- Simplifies Design – Replaces Discrete Components
- Easy to Use – Operates from Standard Bipolar and MOS Supplies
- Minimum Line Reflection – Input and Output Clamp Diodes
- High Input Breakdown Voltage – 19 Volts
- 16-pin Dual In-Line Package

Type	Input to Output Delay Max.	Power Dissipation Max.	Supplies [V]
3207A	25ns	900mW	+5
3207A-1	25ns	1040mW	+5

The 3207A is a Quad Bipolar-to-MOS level shifter and driver which accepts TTL and DTL input signals, and provides high output current and voltage suitable for driving MOS circuits. It is particularly suitable for driving the 1103 and 1103A memory chips. The circuit operates from a 5-volt TTL power supply, and V_{ss} and V_{bb} power supplies from the 1103 and 1103A.

The device features two common enable inputs per pair of devices, which permits some logic to be done at their inputs, such as cenable and precharge decoding for the 1103 and 1103A.

The 3207A is packaged in a hermetically sealed 16-pin ceramic dual in-line package. The device performance is specified over the same temperature range as the 1103 and 1103A, i.e. from 0°C to +70°C [5].

3207A-1 is a high voltage version of the standard 3207A, and is compatible with the 1103-1. The 3207A-1 has all the same features as the standard 3207 [6].

Part Numbers

Type C Packages

Part Number	Package Description	Values
		
C3207A	Type C white ceramic package w/grey traces, gold cap, gold cap ground strap, and gold pins. Gold dot denotes pin #1.	Ex. Rare (1 Known) \$50-\$200

Type D Packages

Part Number	Package Description	Values
		
D3207A	Type D grey ceramic package w/tin pins.	\$.30-\$1.20
D3207A-1	Type D package	\$2.50-\$10

References

[1] Intel (September 1972). Intel Data Catalog, 3207 Data Sheet. No reference to 3207A dates chip after September 1972.

[2] Intel (February 1973). The Intel Memory Design Handbook, 3207A Data Sheet, p. 5-7

[3] Intel (August 1973). The Intel Memory Design Handbook, 3207A Specifications, Selection Guide in Back of Handbook.

[4] Intel (1975). Intel Memory Design Handbook, 3207A, p. PSG-4.

[5] Intel (1977). Intel Data Catalog, 3207A Data Sheet, p. 5-7.

[6] Intel (1977). Intel Data Catalog, 3207A-1 Data Sheet, p. 5-11.

Intel i3208

Hex Sense Amp for MOS Memories

1971-72

Specifications

- Hex Sense Amp for MOS Memories
- Bipolar (3xxx)
- Open Collector Output
- 18-pin Dual In-Line Package

Type	Input to Output Delay Max.	Power Dissipation Max.	Supplies [V]
3208	-	-	+5

3208 is Input Level Compatible with 1103 Output.

Part Numbers

Type P Packages

Part Number	Package Description	Values
P3208	Type P package	Ex. Rare (0 Known) \$25-\$100

References

[1] Intel (September 1972). Intel Data Catalog, 3208A Data Sheet, p. 5-11. Ordering Information lists P3208 and P3208A with notation on P3208 that P3208A is recommended for new designs.

Intel i3208A

Hex Sense Amp for MOS Memories

1972

Specifications

- Hex Sense Amp for MOS Memories
- Bipolar (3xxx)
- High Speed – 20 nsec. Max.
- Wire-OR Capability –
 - Open Collector Output – 3208A
 - Three-State Output – 3408A
- Single 5V Power Supply
- Input Level Compatible with 1103 Output
- Two Enable Inputs
- Minimum Line Reflection – Low Voltage Diode Input Clamp
- Schottky TTL
- 18-pin Dual In-Line Package

Type	Input to Output Delay Max.	Power Dissipation Max.	Supplies [V]
3208A	20ns	600mW	+5

The Intel 3208A is a high-speed hex sense amplifier designed to sense the output signals of the 1103 memory. The device features two separate enable inputs each controlling the output state of three sense amplifiers, and a common voltage reference input. OR-tie capability is available with the 3208A open collector TTL compatible output.

The 3408A is a hex amplifier with a latch circuit connected to each amplifier. The sensed data may be stored in the latches through application of a write pulse. The 3408A has three-state TTL outputs, hence in the non-enabled state the outputs float allowing wire-OR memory expansion. The latches may be bypassed by grounding the write input pin. Under this condition, the 3408A functions as a hex sense amplifier.

The 3208A and 3408A operate from a single +5 volt power supply. Device performance is specified over the complete ambient temperature range from 0°C to 70°C and over a supply voltage range of 5 volts $\pm 5\%$. The 3208A and 3408A are packaged in an 18-pin dual in-line package [2].

Intel i3208A

Part Numbers

Type P Packages

Part Number	Package Description	Values
P3208A	Type P package	\$2-\$8

References

[1] Intel (September 1972). Intel Data Catalog, 3208A, 3408A Data Sheet, p. 5-11. Ordering Information lists P3208 and P3208A with notation on P3208 that P3208A is recommended for new designs.

[2] Intel (1977). Intel Data Catalog, 3208A/3408A Data Sheet, p. 6-13

Intel i3210

TTL-to-MOS Level Shifter and High Voltage Clock Driver

1973

Specifications

- TTL-to-MOS Level Shifter and High Voltage Clock Driver
- Bipolar (3xxx)
- Four Low Voltage Drivers
- One High Voltage Driver
- TTL and DTL Compatible Inputs
- Outputs Compatible with 2105 and 2107 Memories
- Operates from Standard TTL and MOS Power Supplies
- Maximum MOS Device Protection – Output Clamp Diodes
- 18-pin Dual In-Line Package

Type	Input to Output Delay Max.	Power Dissipation Max.	Supplies [V]
3210	40ns	570mW	+5, +12

The Intel 3210 is a Bipolar-to-MOS level shifter and high voltage driver which accepts TTL and DTL inputs. It contains four (4) low voltage drivers and one high voltage driver, each with current driving capabilities suitable for driving N-channel MOS memory devices. The 3210 operates from the 5 volt and 12 volt power supplies used to bias the memory devices.

The four low voltage drivers feature two common enable inputs per pair of drivers which permits address or data decoding. The high voltage driver swings the 12 volts required to drive the chip enable (clock) input for the 2105 and 2107. In addition, the high voltage driver includes AND gate logic which can be used to implement refresh abort for the 2105 MOS memory.

The 3210 high voltage driver requires an externally connected PNP transistor. The PNP base is connected to pin 12, the collector to pin 11, and the emitter to pin 10. The use of fast switching, high voltage, high current gain PNP, like the 2N5057 or 2N3546 is recommended [3].

Intel i3210

Part Numbers

Type C Packages

Part Number	Package Description	Values
		
C3210 C	Type C purple ceramic package w/gold cap and gold pins.	\$10-\$40

Type D Packages

Part Number	Package Description	Values
D3210	Type D grey ceramic package w/tin pins.	\$2-\$8

References

- [1] Intel (September 1972). Intel Data Catalog. No reference to 3210 dates chip after September 1972.
- [2] Intel (October 1973). Intel Data Catalog. Ad Reprint dated July 1973 reference to 3210 being introduced “this fall”.
- [3] Intel (1975). Intel Data Catalog, 3210 Data Sheet, p. 5-19

Intel i3211

ECL-to-MOS Level Shifter and High Voltage Clock Driver

1974-75

Specifications

- ECL-to-MOS Level Shifter and High Voltage Clock Driver
- Bipolar (3xxx)
- Four Low Voltage Drivers
- One High Voltage Driver
- 10K Series ECL Compatible Inputs
- Outputs Compatible with 2105 and 2107 MOS Memories
- Operates from Standard TTL, ECL, and MOS Power Supplies
- Maximum MOS Device Protection – Output Clamp Diodes
- 18-pin Dual In-Line Package

Type	Input to Output Delay Max.	Power Dissipation Max.	Supplies [V]
3211	45ns	705mW	+5, +12, -5.2V

The Intel 3211 is an ECL-to-MOS level shifter and N-channel MOS memory driver. Each package contains four (4) low voltage drivers and one high voltage driver. The 3211 is designed to have high performance when driving many RAM devices. It is compatible with the 2105 and 2107 N-channel MOS memory devices. The operating voltages are +5, +12, and -5.2V which are standard TTL, MOS and ECL power supply voltages.

The four low voltage drivers feature two common enable inputs per pair of drivers which permits address or data decoding. The high voltage driver swings the 12 volts required to drive the chip enable (clock) input for the 2105 and 2107. The chip enable driver has two inputs to simplify logic design.

The 3211 high voltage driver requires an externally connected PNP transistor. The PNP base is connected to pin 12, the collector to pin 11, and the emitter to pin 10. The use of fast switching, high voltage, high current gain PNP, like the 2N5057 or 2N3546 is recommended [3].

Part Numbers

Type C Packages

Part Number	Package Description	Values
C3211	Type C package	Ex. Rare \$50-\$200

Type D Packages

Part Number	Package Description	Values
D3211	Type D package	\$2-\$8

References

- [1] Intel (September 1972). Intel Data Catalog. No reference to 3211 dates chip after September 1972.
- [2] Intel (October 1973). Intel Data Catalog. No reference to 3211 dates chip after October 1973.
- [3] Intel (1975). Intel Data Catalog, 3211 Data Sheet, p. 5-23.

Intel i3212

Multi-Mode Latch Buffer

1974

Specifications

- 8-bit Input/Output Port
- Bipolar (3xxx)
- Fully Parallel 8-Bit Data Register and Buffer
- Service Request Flip-Flop for Interrupt Generation
- Three-State Outputs
- Outputs Sink 15mA
- 3.65V Output High Voltage for Direct Interface to 8080 CPU or 8008 CPU
- Asynchronous Register Clear
- Replaces Buffers, Latches and Multiplexers in Microcomputer Systems
- Reduces System Package Count
- 24-pin Dual In-Line Package

The 8212 input/output port consists of an 8-bit latch with 3-state output buffers along with control and device selection logic. Also included is a service request flip-flop for the generation and control of interrupts to the microprocessor.

The 8212 is multimode in nature. It can be used to implement latches, gated buffers or multiplexers. Thus, all of the principal peripheral and input/output functions of a microcomputer system can be implemented with this device.



The specifications for the 3212 are identical with those for the 8212 [3].

Part Numbers

Type D Packages

Part Number	Package Description	Values
D3212	Type D package	\$2-\$8
MD3212/B	Type D package	\$5-\$20

Type P Packages

Part Number	Package Description	Values
		
3212/8212	1. Type P black plastic package w/tin pins. No Copyright. Example shown marked 'CS' for Customer Sample.	Rare \$15-\$60
		
3212/8212	2. Type P black plastic package w/tin pins. © Intel '74. Example shown marked 'CS' for Customer Sample.	Rare \$15-\$60
P3212	Type P package	\$1.50-\$6

References

[1] Intel (1975). Intel Data Catalog, 3212 Data Sheet, p. 6-63.

[2] Intel (1977). Intel Memory Design Handbook, MD3212 listed as member of Intel Military Product Family, 3000 Series, p. PSG-5.

[3] Intel (1978). Intel Component Data Catalog, 8212/3212 Data Sheet, p. 12-17

[4] Intel (1984). A Revolution in Progress... A History of Intel to Date, 8/3212 introduced 1974, p. 26.

Intel i3214

Interrupt Control Unit

1974

Specifications

- Priority Interrupt Control Unit (PICU)
- Bipolar
- Eight Priority Levels
- Current Status Register
- Priority Comparator
- Fully Expandable
- High Performance (50ns)
- +5V Supply Voltage
- 24-pin Dual In-Line Package

Type	Input to Output Delay Max.	Power Dissipation Max.	Supplies [V]
3214	50ns	-	+5

The 3214 is an eight level priority interrupt control unit designed to simplify interrupt driven microcomputer systems.

The PICU can accept eight registering levels; determine the highest priority, compare this priority to a software controlled current status register and issue an interrupt to the system along with vector information to identify the service routine.

The 3214 is fully expandable by the use of open collector interrupt output and vector information. Control signals are also provided to simplify this function.

The PICU is designed to support a wide variety of vectored interrupt structures and reduce package count in interrupt driven microcomputer systems.

The specifications for the 3214 are identical with those for the 8214 [3].

Part Numbers

Type C Packages

Part Number	Package Description	Values
C3214	Type C package	Ex. Rare \$50-\$200

Type D Packages

Part Number	Package Description	Values
D3214	Type D package	Rare \$15-\$60
MD3214/B	Type D package	Rare \$10-\$40

Type P Packages

Part Number	Package Description	Values
P3214	Type P package	Rare \$8-\$32

References

[1] Intel (1975). Intel Data Catalog, 3214 Data Sheet, p. 6-60.

[2] Intel (1977). Intel Memory Design Handbook, MD3214 listed as member of Intel Military Product Family, 3000 Series, p. PSG-5.

[3] Intel (1978). Intel Component Data Catalog, 8214/3214 Data Sheet, p. 12-31

[4] Intel (1984). A Revolution in Progress... A History of Intel to Date, 8/3214 introduced 1974, p. 26.

Intel i3216

4-bit Non-Inverting Parallel Bi-Directional Bus Driver

1974

Specifications

- 4-bit Non-Inverting Parallel Bi-Directional BUS Driver
- Bipolar (3xxx)
- Data Bus Buffer Driver for MCS-40 I/O
- Low Input Load Current - .25 mA Maximum
- High Output Drive Capability for Driving System Data Bus
- 3.65V Output High Voltage for Direct Interface to MCS-40
- Three-State Outputs
- Reduces System package Count
- 16-pin Dual In-Line Package

The 3216/3226 is a 4-bit bi-directional bus driver/receiver [1]

The specifications for the 3216/3226 are identical with those for the 8216/8226 [3].

Part Numbers

Type C Packages

Part Number	Package Description	Values
C3216	Type C package	Ex. Rare (0 Known) \$50-\$200

Type D Packages

Part Number	Package Description	Values
D3216	Type D package	\$5-\$20
MD3216/B	Type D package	\$5-\$20

Type P Packages

Part Number	Package Description	Values
P3216	Type P package	\$2-\$8

References

- [1] Intel (November 1974). MCS-40 User's Manual For Logic Designers, 3216/3226 Data Sheet, p. 4-31
- [2] Intel (1977). Intel Memory Design Handbook, MD3216 listed as member of Intel Military Product Family, 3000 Series, p. PSG-5.
- [3] Intel (1978). Intel Component Data Catalog, 8216/8226 and 3216/3226 Data Sheet, p. 12-38
- [4] Intel (1984). A Revolution in Progress... A History of Intel to Date, 8/3216 introduced 1974, p. 26.

Intel i3222

Refresh Controller for 4K DRAMs

1975

Specifications

- Refresh Controller for 4K Dynamic RAMs
- Bipolar (3xxx)
- Simplifies System Design
- Reduces Package Count
- Adjustable Refresh Timing Oscillator
- 6-bit Address Multiplexer
- 6-bit Refresh Address Counter
- Refresh Cycle Counter
- The maximum Input to Output Delay of a 3222 is system configuration dependent
- Ideal for use in 2107A, 2107B, 2107C Systems
- Single +5V Supply
- 22-pin Dual In-Line Package

Type	Input to Output Delay Max.	Power Dissipation Max.	Supplies [V]
3222	-	600mW	+5

The Intel 3222 is a refresh controller for dynamic RAMs requiring refresh of up to 6 low order input addresses, (e.g. for a device organized as 64 rows by 64 columns). In normal operation, the device serves as an address multiplexer that outputs addresses from either a refresh counter or a system address bus. Although the part was specifically designed for use with the Intel 2107B, it will work with any dynamic RAM requiring refresh of up to 64 rows [3].

The 3222 operates from a single +5 volt power supply and is specified for operation over a 0°C to 75°C ambient temperature range. It is fabricated by means of Intel's highly reliable Schottky bipolar process [4].

Part Numbers

Type B Packages

Part Number	Package Description	Values
B3222	Type B package	\$5-\$20

Type D Packages

Part Number	Package Description	Values
		
D3222	Type D grey ceramic package w/black cap and tin pins. Example shown marked 'ES' for Engineering Sample.	\$.75-\$3

References

- [1] Intel (September 1972). Intel Data Catalog. No reference to 3222 dates chip after September 1972.
- [2] Intel (1975). Intel Data Catalog. No reference to 3222 dates chip after 1975.
- [3] Intel (1975). Intel Memory Design Handbook, 3222 Data Sheet, p. 16-1.
- [4] Intel (1978). Intel Component Data Catalog, 3222 Data Sheet, p. 6-19.

Intel i3224

Single Chip Clock Generator/Driver

1974-75

Specifications

- Single Chip Clock Generator/Driver
- Bipolar (3xxx)
- Power-up Reset for CPU
- Ready Synchronizing Flip-Flop
- Advanced Status Strobe
- Oscillator Output for External System Timing
- Crystal Controlled for Stable System Operation
- Reduces System Package Count
- 16-pin Dual In-Line Package

The 3224 is a single chip clock generator/driver. It is controlled by a crystal, selected by the designer, to meet a variety of system speed requirements.

Also included are circuits to provide power-up reset, advance status strobe and synchronization of ready.

The specifications for the 3224 are identical with those for the 8224.

Part Numbers

Type D Packages

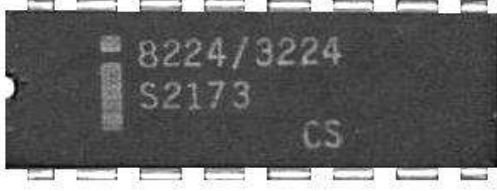
Part Number	Package Description	Values
		
8224/3224	Type D grey ceramic plastic package w/tin pins. Example shown marked 'CS' for Customer Sample	Rare \$15-\$60

Type P Packages

Part Number	Package Description	Values
		
8224/3224	Type P black plastic package w/tin pins. Example shown marked 'CS' for Customer Sample	Rare \$15-60

References

- [1] Intel (September 1975). Intel MCS-80 User's Manual, 8224 Data Sheet, p. 5-1.

Intel i3226

4-bit Inverting Bi-Directional BUS Driver

1974

Specifications

- 4-bit Non-Inverting Parallel Bi-Directional BUS Driver
- Bipolar (3xxx)
- Data Bus Buffer Driver for MCS-40 I/O
- Low Input Load Current - .25 mA Maximum
- High Output Drive Capability for Driving System Data Bus
- 3.65V Output High Voltage for Direct Interface to MCS-40
- Three-State Outputs
- Reduces System package Count
- 16-pin Dual In-Line Package

The 3216/3226 is a 4-bit bi-directional bus driver/receiver [1]

The specifications for the 3216/3226 are identical with those for the 8216/8226 [3].

Part Numbers

Type D Packages

Part Number	Package Description	Values
D3226	Type D grey ceramic package w/tin pins.	\$15-\$30

Type P Packages

Part Number	Package Description	Values
P3226	Type P package	\$15-\$30

References

- [1] Intel (November 1974). Intel MCS-40 User's Manual For Logic Designers, 3216/3226 Data Sheet, p. 4-31
- [2] Intel (1975). Intel Series 3000 Reference Manual, Back of Front Cover, 3216/3226 listed as members of Series 3000 component family.
- [3] Intel (1978). Intel Component Data Catalog, 8216/8226 and 3216/3226 Data Sheet, p. 12-38
- [4] Intel (1984). A Revolution in Progress... A History of Intel to Date, 8/3226 introduced 1974, p. 26.

Intel i3228

System Controller and Bus Driver

1979-80

Specifications

- System Controller and Bus Driver for 8080A CPU
- Bipolar (3xxx)
- Single Chip System Control for MCS-80 Systems
- Built-in Bi-Directional Bus Driver for Data Bus Isolation
- Allows the use of Multiple Byte Instructions (e.g. CALL) for Interrupt Acknowledge
- User Selected Single Level Interrupt Vector (RST 7)
- Reduces System Package Count
- 8238 Has Advanced IOW/MEMW for Large System Timing Control
- 28-pin Dual In-Line Package

The 8228 is a single chip system controller and bus driver for MCS-80. It generates all signals required to directly interface MCS-80 family RAM, ROM, and I/O Components.

A bi-directional bus driver is included to provide high system TTL fan-out. It also provides isolation of the 8080A data bus from memory and I/O. This allows for the optimization of control signals, enabling the systems designer to use slower memory and I/O. The isolation of the bus driver also provides for enhanced system noise immunity.

A user selected single level interrupt vector (RST 7) is provided to simplify real time, interrupt driven, small system requirements. The 8228 also generates the correct control signals to allow the use of multiple byte instructions (e.g. CALL) in response to an INTERRUPT ACKNOWLEDGE by the 8080A. This feature permits large, interrupt driven systems to have an unlimited number of interrupt levels.

The 8228 is designed to support a wide variety of system bus structures and also reduce system package count for cost effective, reliable, design of the MCS-80 systems.

Note: The specifications for the 3228/3238 are identical with those for the 8228/8238 [3].

Part Numbers

Type D Packages

Part Number	Package Description	Values
D3228	Type D Package	Rare \$15-\$60

References

- [1] Intel (1978). Intel Component Data Catalog. No reference to 3228 dates chip after 1978.
- [2] Intel (1979). Intel Component Data Catalog, 8228/8238 Data Sheet, p. 9-25.
- [3] Intel (1980). Intel Component Data Catalog, 8228/8238 Data Sheet, p. 6-81.

Intel i3232

Address Multiplexer and Refresh Counter for 4K DRAMs

1976

Specifications

- Address Multiplexer and Refresh Counter for 4K Dynamic RAMs
- Bipolar (3xxx)
- Ideal for 2104A
- Simplifies System Design
- Reduces Package Count
- Address Input to Output Delay:
 - 9ns Max. Driving 15pF
 - 25ns Max. Driving 250pF.
- Suitable for Either Distributed or Burst Refresh
- Single Power Supply: +5 Volts $\pm 10\%$
- Power Dissipation: 750mW Max.
- 24-pin Dual In-Line Package

The Intel® 3232 contains an address multiplexer and refresh counter for multiplexed address dynamic RAMs requiring refresh of up to 6 input addresses (or 4K bit for 64 x 64 organization). It multiplexes twelve bits of system-supplied address to six output address pins. The device also contains a 6-bit refresh counter which is externally controlled so that either distributed or burst refresh may be used. The high performance of the 3232 makes it especially suitable for use with high speed N-channel RAMs like the 2104A.

The 3232 operates from a single +5 volt power supply and is specified for operation over a 0° to +75°C ambient temperature range [4].

Intel i3232

Part Numbers

Type D Packages

Part Number	Package Description	Values
 A black, rectangular Type D ceramic package with 14 pins protruding from the bottom. The top surface is marked with the Intel logo, the part number 'D3232', the code '530B0', and 'INTEL '76'.		
D3232	Type D grey ceramic package w/tin pins. © Intel '76	\$.75-\$3

References

- [1] Intel (1975). Intel Memory Design Handbook. No reference to 3232 dates chip after 1975.
- [2] Intel (1976). Intel Data Catalog, 3232 Preliminary Data Sheet, p. 5-25
- [3] Intel (October 1977). Intel MCS-80 User's Manual, 3232 Data Sheet.
- [4] Intel (1978). Intel Component Data Catalog, 3232 Data Sheet, p. 6-25

Intel i3235

Quad Bipolar-to-MOS Driver

1973-75

Specifications

- Quad Bipolar-to-MOS Driver
- Bipolar (3xxx)
- High Speed, 32 nsec Max. – Delay + Transition Time Over Temperature with 250pF Load
- High Density – Four Drivers in One Package
- Internal Gating Structure Minimizes Package Count and Eliminates Gating Delays
- TTL and DTL Compatible Inputs
- Minimum Line Reflection – Input and Output Clamp Diodes
- Safety Feature Protects 4K RAMs if +5V System Supply is Lost
- 16-pin Dual In-line Package

Type	Input to Output Delay Max.	Power Dissipation Max.	Supplies [V]
3235	32ns	690mW	+5, +12, +15

The Intel 3235 is a Quad Bipolar-to-MOS driver which accepts TTL and DTL input signals. It provides high output current and voltage suitable for driving the clock inputs of N-channel MOS memories such as the 2107 or 2105. The circuit operates from three power supplies, which are 5, 12, and 15 volts.

The device features two common enable inputs, a refresh select input, and a clock control input for simplified system designs.

A safety feature forces all outputs low if the power supply is lost. This protects 4K RAM's by putting them in the standby mode [2].

Part Numbers

No Examples Known

References

[1] Intel (September 1972). Intel Data Catalog. No reference to 3235 dates chip after September 1972.

[2] Intel (1975). Intel Data Catalog, 3235 Data Sheet, p. 5-27

Intel i3238

System Controller and Bus Driver w/Advanced IOW/MEMW 1979-80

Specifications

- System Controller and Bus Driver for 8080A CPU
- Bipolar (3xxx)
- Single Chip System Control for MCS-80 Systems
- Built-in Bi-Directional Bus Driver for Data Bus Isolation
- Allows the use of Multiple Byte Instructions (e.g. CALL) for Interrupt Acknowledge
- User Selected Single Level Interrupt Vector (RST 7)
- Reduces System Package Count
- 8238 Has Advanced IOW/MEMW for Large System Timing Control
- 28-pin Dual In-Line Package

The 8228 is a single chip system controller and bus driver for MCS-80. It generates all signals required to directly interface MCS-80 family RAM, ROM, and I/O Components.

A bi-directional bus driver is included to provide high system TTL fan-out. It also provides isolation of the 8080A data bus from memory and I/O. This allows for the optimization of control signals, enabling the systems designer to use slower memory and I/O. The isolation of the bus driver also provides for enhanced system noise immunity.

A user selected single level interrupt vector (RST 7) is provided to simplify real time, interrupt driven, small system requirements. The 8228 also generates the correct control signals to allow the use of multiple byte instructions (e.g. CALL) in response to an INTERRUPT ACKNOWLEDGE by the 8080A. This feature permits large, interrupt driven systems to have an unlimited number of interrupt levels.

The 8228 is designed to support a wide variety of system bus structures and also reduce system package count for cost effective, reliable, design of the MCS-80 systems.

The specifications for the 3228/3238 are identical with those for the 8228/8238 [3].

Part Numbers

No Examples Known

References

- [1] Intel (1978). Intel Component Data Catalog. No reference to 3238 dates chip after 1978.
- [2] Intel (1979). Intel Component Data Catalog, 8228/8238 Data Sheet, p. 9-25.
- [3] Intel (1980). Intel Component Data Catalog, 8228/8238 Data Sheet, p. 6-81.

Intel i3242

Address Multiplexer and Refresh Counter for 16K DRAMs

1976

Specifications

- Address Multiplexer and Refresh Counter for 16K Dynamic RAMs
- Bipolar (3xxx)
- Ideal for 2116
- Simplifies System Design
- Reduces Package Count
- Suitable for Either Distributed or Burst Refresh
- Single Power Supply: +5 Volts $\pm 10\%$
- Address Input to Output Delay:
 - 9ns Driving 15pF,
 - 25ns Driving 250pF
- Power Dissipation: 825mW Max.
- 28-pin Dual In-Line Package

The Intel® 3242 is an address multiplexer and refresh counter for multiplexed address dynamic RAMs requiring refresh of 64 or 128 cycles. It multiplexes 14 bits of system-supplied address to 7 output address pins. The device also contains a 7-bit refresh counter which is externally controlled so that either distributed or burst refresh may be used. The high performance of the 3242 makes it especially suitable for use with high-speed N-channel RAMs like the 2116.

The 3242 operates from a single +5 volt power supply and is specified for operation over a 0° to +75°C ambient temperature range. It is fabricated by means of Intel's highly reliable Schottky bipolar process and is packaged in a hermetically sealed 28-pin Type D package [5].

Operation of the Intel® 3242 is identical to the 3232, with one exception. This difference is that a 7-bit, three-way multiplexer is provided on the 3242 (allowing 14 system addresses to be multiplexed by the device). Otherwise, description of operation of the 3232 applies equally to the 3242 [3].

Part Numbers

Type D Packages

Part Number	Package Description	Values
		
D3242	1. Type D grey ceramic package w/tin pins. No copyright.	\$.25-\$1
		
D3242	2. Type D grey ceramic package w/tin pins. © Intel '76	\$.25-\$1

References

- [1] Intel (1975). Intel Memory Design Handbook. No reference to 3242.
- [2] Intel (1976). Intel Data Catalog, 3242 Advance Information, p. 5-29
- [3] Intel (1977). Intel Memory Design Handbook, Support Circuits, p. 11-8.
- [4] Hearst (1977). IC Master, Intel 3242 listed under Memory & Peripheral Drivers, MOS Dynamic Memory, 16K Address Multiplexer and Refresh Counter, p. 394
- [5] Intel (1980). Intel Component Data Catalog, 3242 Data Sheet, p. 2-26.

Intel i3245

Quad Bipolar TTL-to-MOS Level Shifter and Driver for 4K NMOS RAMs

1973-75

Specifications

- Quad Bipolar TTL-to-MOS Level Shifter and Driver for 4K NMOS RAMs
- Bipolar (3xxx)
- Fully Compatible with 4K RAMs Without Requiring Extra Supply or External Devices
- High Speed, 32ns Max. - Delay + Transition Time
- Low Power – 75mW Typical Per Channel
- High Density – Four Drivers in One Package
- TTL and DTL Compatible Inputs
- Only +5 and +12 Volt Supplies Required
- 16-pin Dual In-Line Package

Type	Input to Output Delay Max.	Power Dissipation Max.	Supplies [V]
3245	32ns	388mW	+5, +12

The Intel® 3245 is a Quad Bipolar-to-MOS driver which accepts TTL and DTL input signals. It provides high output current and voltage suitable for driving clock inputs of N-channel MOS memories such as the 2107B. The circuit operates from two power supplies, which are 5 and 12 volts. Input and output clamp diodes minimize line reflections.

The device features two common enable inputs, a refresh select input, and a clock control input for simplified system designs. The internal gating structure of the 3245 eliminates gating delays and minimizes package count.

The 3245 is fabricated by means of Intel's highly reliable Schottky bipolar process and is specified for operation over a 0°C to +75°C ambient temperature range [3].

Part Numbers

Type D Packages

Part Number	Package Description	Values
D3245	Type D grey ceramic package w/tin pins	\$.25-\$1



References

- [1] Intel (September, 1972). Intel Data Catalog. No reference to 3245 dates chip after September 1972.
- [2] Intel (1975). Intel Memory Design Handbook, 3245 Specifications, p. 9-20.
- [3] Intel (1978). Intel Component Data Catalog, 3245 Data Sheet, p. 6-33.

Intel i3246

Quad Bipolar ECL-to-MOS Level Shifter and Driver for 4K NMOS RAMs

1975-76

Specifications

- Quad Bipolar ECL-to-MOS Level Shifter and Driver for 4K NMOS RAMs
- Bipolar (3xxx)
- Fully Compatible with 4K RAMs Without Requiring Extra Supply or External Devices
- High Speed, 30 nsec Max. – Delay + Rise Time
- 10K ECL Compatible Inputs
- High Density – Four Drivers in One Package
- 16-pin Dual In-Line Package

Type	Input to Output Delay Max.	Power Dissipation Max.	Supplies [V]
3246	30ns	725mW	+5, +12, -5.2

The Intel® 3246 is a Quad Bipolar-to-MOS driver which accepts ECL input signals. It provides high output current and voltage suitable for driving the clock inputs of N-channel MOS memories such as the 2107 or 2105. The circuit operates from three power supplies which are 5, -5.2, and 12 volts. Input and output clamp diodes minimize line reflections.

The device features a common enable input, a refresh select input, and a clock control input for simplified system designs. The internal gating structure of the 3246 eliminates gating delays and minimizes package count.

The 3246 is fabricated by means of Intel's Schottky Bipolar technology to assure high performance over the 0°C to +75°C ambient temperature range [3].

Part Numbers

Type D Packages

Part Number	Package Description	Values
D3246	Type D package	Rare \$15-\$60

References

- [1] Intel (1975). Intel Data Catalog. No reference to 3246.
- [2] Intel (1975). Intel Memory Design Handbook, 3246 Specifications, p. 11-6.
- [3] Intel (1976). Intel Data Catalog, 3246 Preliminary Data Sheet, p. 5-34
- [4] Intel (1977). Intel Data Catalog. No reference to 3246. Suspect chip had been discontinued by 1977.

Intel i3301

1024-bit (256 x 4) Static ROM

1969

Specifications

- 1024-bit (256 x 4) Static ROM
- Bipolar (3xxx)
- Open Collector Output
- 16-pin Dual In-Line Package

Type	Access Time Max.	Power Dissipation Max. Operating/Standby	Supplies [V]
3301	-	-	+5

No data sheet known to exist for this part.

History

1st Intel ROM

3301A's with Earlier Date Codes than 3301's?

A 3301 exists with a date code 7317 printed on the cap. So how do we explain this 3301A with date code 7217 printed on the cap?



The 3301 is mask-programmed. In other words it's a custom part. When a customer needed another batch of the same ROM, Intel probably pulled the original mask set on file and basically re-manufactured the old IC. This would explain how 3301's were still being produced a year after the 3301A had been introduced.

Part Numbers

Type C Packages

Part Number	Package Description	Values
		
3301	1. Type C white ceramic package w/grey traces, gold cap, gold cap ground strap, and gold pins. Gold dot denotes pin #1.	Ex. Rare (1 Known) \$100-\$400

References

[1] Intel (March 1971). Intel Price List, 3301 prices dates chip to March 1971.

[2] Intel (September 1972). Intel Data Catalog, 3301A Data Sheet, p. 3-21. 3301A Data Sheet indicates that 3301A is a higher speed version of the 3301 and is a pin for pin replacement of the 3301. C3301A and P3301A listed in ordering information.

[3] Intel (1984). A Revolution in Progress... A History of Intel to Date, 3301 introduced 1969, p. 26.

Intel i3301A

1024-bit (256 x 4) Static ROM

1971-72

Specifications

- 1024-bit (256 x 4) Static ROM
- Bipolar (3xxx)
- Fast Access Time – 45 nsec Maximum over Temperature and Supply Voltage Variation
- Low Power Dissipation – 0.5 mW/bit typical
- DTL and TTL Compatible – Input Loading is .25 mA Max. – Outputs Sink is 15 mA
- OR-Tie Capability – Open Collector Outputs
- Simple Memory Expansion – 2 Chip Select Input Leads
- Fully Decoded – On Chip Address Decode and Buffer
- Minimum Line Reflection – Low Voltage Diode Input Clamp
- 16-pin Dual In-Line Package

Type	Access Time Max.	Power Dissipation Max. Operating/Standby	Supplies [V]
3301A	45ns	625mW	+5
M3301A	60ns	625mW	+5

The 3301A is a fully decoded 1024 bit read only memory (ROM) organized as 256 words by 4 bits. It is a higher speed version of the 3301 and is a direct pin for pin replacement of the 3301. its performance is specified over the complete ambient temperature of 0°C to 75°C and a supply voltage of 5V ± 5%. The 3301A is programmed at the final step of processing, which allows fast turnaround.

The OR-tie capability and the 2 chip select inputs of the 3301A allow easy memory expansion into larger word and bit lengths.

The 3301A is mask programmed to customized patterns. It is also available in standard “off the shelf” configurations. Ideal applications are in microprogramming and table look up.

The 3301A is manufactured using Schottky barrier diode clamped transistors which allows higher switching speeds than those devices made with conventional gold diffusion process [2].

The 3301 is the ROM equivalent of the Intel 3601 PROM.

Intel i3301A

Part Numbers

Type C Packages

Part Number	Package Description	Values
		
3301A	1. Type C white ceramic package w/grey traces, gold cap, gold cap ground strap, and gold pins. Gold dot denotes pin #1.	Rare \$50-\$200
		
3301A	2. Type C white ceramic package w/gold cap and gold pins. Black double dot denotes pin #1.	Rare \$25-\$100

Type P Packages

Part Number	Package Description	Values
		
3301A	Type P grey plastic package w/gold pins. Embossed Intel 'i' in key.	Ex. Rare \$50-\$200

References

- [1] Intel (March 1971). Intel Price List. 3301 prices dates 3301 to March 1971. No reference to 3301A dates 3301A after March 1971.
- [2] Intel (September 1972). Intel Data Catalog, 3301A Data Sheet, p. 3-21. C3301A and P3301A listed in ordering information.
- [3] Intel (1975). Intel Memory Design Handbook, M3301A access times, p. PSG-2

Intel i3302

2048-bit (512 x 4) Static ROM

1973-75

Specifications

- 2048-bit (512 x 4) Static ROM
- Bipolar (3xxx)
- Fast Access Time – 70 ns (3302, 3322) over Temperature and Supply Voltage Variation
- Low Standby Power Dissipation (3302-6, 3322-6) – 100 μ W/bit
- Fully Decoded – On Chip Address Decode and Buffer
- DTL and TTL Compatible –
Input Loading is 0.25 mA Max –
Outputs Sink 15 mA
- Open Collector (3302, 3302-4, 3302-6) and Three-State (3322, 3322-4, 3322-6) Outputs
- The 3302 and 3322 are ROM equivalents of the Intel 3602 and 3622 PROMs
- 16-pin Dual In-Line Package

Type	Access Time Max.	Power Dissipation Max. Operating/Standby	Supplies [V]
3302	70ns	650mW	+5
3302-4	90ns	650mW	+5
3302-6	90ns	575mW/240mW	+5

The 3302 and 3322 device families are high density 2048-bit (512 words by 4-bit) ROMs. Electrical performance is specified over the complete ambient temperature range of 0°C to 75°C and supply voltage range of 5V \pm 5%. The 3302 and 3322 ROM families are pin compatible with the Intel 3602 and 3622 PROM families. Consequently initial circuit prototyping can be performed using the pin compatible PROMs.

The 3302-4 and 3322-4 are ideal for slower performance systems (>90 ns) where low system cost is a prime factor. For those systems requiring low power dissipation, one should consider the 3302-6 and 3322-6. Not only does the 3302-6 and 3322-6 dissipate 20% less active power than the 3302 and 3322 respectively, but it also has an added low standby power dissipation feature. Whenever the 3302-6 and 3322-6 is deselected, power dissipation is reduced 70%.

The 3302 and 3322 devices are manufactured using Schottky barrier diode clamped transistors which results in higher speed performance than equivalent devices made with gold diffusion process [2].

Part Numbers

No Examples Known

References

- [1] Intel (September 1972). Intel Data Catalog. No reference to 3302 dates chip after September 1972.
- [2] Intel (1975). Intel Data Catalog, 3302/3322 Family Data Sheet, p. 3-33

Intel i3302A

2048-bit (512 x 4) Static ROM

1975

Specifications

- 2048-bit (512 x 4) Static ROM
- Bipolar (3xxx)
- Fast Access Time - 70ns (3302A, 3322A) Over Temperature and Supply Voltage Variation
- Low Standby Power Dissipation (3302AL6) – 115 μ W/bit
- Fully Decoded – on Chip Address Decode and Buffer
- DTL and TTL Compatible – Input Loading is 0.25 mA max – Output Sink is 15 mA
- Open Collector (3302A, 3302A-4, 3302AL6) and Three State (3322A, 3322A-4, 3322AL6) Outputs
- Simple Memory Expansion – Single Chip Select Input Lead
- ROM equivalent of the Intel 3602A PROM
- 16-pin Dual In-Line Package

Type	Access Time Max.	Power Dissipation Max. Operating/Standby	Supplies [V]
3302A	70ns	735mW	+5
3302A-4	90ns	735mW	+5

The 3302 and 3322 device families are high density 2048-bit (512 words by 4-bit) ROMs. Electrical performance is specified over the complete ambient temperature range of 0°C to 75°C and supply voltage range of 5V \pm 5%. The 3302A and 3322A ROM families are pin compatible with the Intel 3602 and 3622 PROM families. Consequently initial circuit prototyping can be performed using the pin compatible PROMs.

The 3302A-4 and 3322A-4 are ideal for slower performance systems (>90 ns) where low system cost is a prime factor. For those systems requiring low power dissipation, one should consider the 3302AL6/3322AL6. Not only does the 3302AL6/3322AL6 dissipate 20% less active power than the 3302/3322, but it also has an added low standby power dissipation feature. Whenever the 3302AL6/3322AL6 is deselected, power dissipation is reduced 70%.

The 3302A and 3322A device families are manufactured using Schottky barrier diode clamped transistors which results in higher speed performance than equivalent devices made with gold diffusion process [3].

Part Numbers

No Examples Known

References

- [1] Intel (1975). Intel Data Catalog, 3302/3322 Family Data Sheet, p. 3-33. No reference to 3302A/3302AL.
- [2] Intel (1975). Intel Memory Design Handbook, 3302A/3302AL Specifications, p. PSG-2.
- [3] Intel (1976). Intel Data Catalog, 3302A, 3302A-4, 3302AL6, 3322A, 3322A-4, 3322AL6 Data Sheet, p. 3-31
- [4] Intel (1977). Intel Data Catalog, 3602/3622 family and 3602A/3622A Family Data Sheet, p. 3-40. 3302/3322 listed as pin compatible ROM equivalents of 3602/3622 and 3602A/3622A.

Intel i3302AL

2048-bit (512 x 4) Static ROM

1975

Specifications

- 2048-bit (512 x 4) Static ROM
- Bipolar (3xxx)
- Fast Access Time - 70ns (3302A, 3322A) Over Temperature and Supply Voltage Variation
- Low Standby Power Dissipation (3302AL6) – 115 μ W/bit
- Fully Decoded – on Chip Address Decode and Buffer
- DTL and TTL Compatible – Input Loading is 0.25 mA max – Output Sink is 15 mA
- Open Collector (3302A, 3302A-4, 3302AL6) and Three State (3322A, 3322A-4, 3322AL6) Outputs
- Simple Memory Expansion – Single Chip Select Input Lead
- ROM equivalent of the Intel 3602A PROM
- 16-pin Dual In-Line Package

Type	Access Time Max.	Power Dissipation Max. Operating/Standby	Supplies [V]
3302AL-6	90ns	580mW/240mW	+5

The 3302 and 3322 device families are high density 2048-bit (512 words by 4-bit) ROMs. Electrical performance is specified over the complete ambient temperature range of 0°C to 75°C and supply voltage range of 5V \pm 5%. The 3302A and 3322A ROM families are pin compatible with the Intel 3602 and 3622 PROM families. Consequently initial circuit prototyping can be performed using the pin compatible PROMs.

The 3302A-4 and 3322A-4 are ideal for slower performance systems (>90 ns) where low system cost is a prime factor. For those systems requiring low power dissipation, one should consider the 3302AL6/3322AL6. Not only does the 3302AL6/3322AL6 dissipate 20% less active power than the 3302/3322, but it also has an added low standby power dissipation feature. Whenever the 3302AL6/3322AL6 is deselected, power dissipation is reduced 70%.

The 3302A and 3322A device families are manufactured using Schottky barrier diode clamped transistors which results in higher speed performance than equivalent devices made with gold diffusion process [3].

Part Numbers

No Examples Known

References

[1] Intel (1975). Intel Data Catalog, 3302/3322 Family Data Sheet, p. 3-33. No reference to 3302A/3302AL dates chip after 1975.

[2] Intel (1975). Intel Memory Design Handbook, 3302A/3302AL, p. PSG-2

[3] Intel (1976). Intel Data Catalog, 3302A, 3302A-4, 3302AL6, 3322A, 3322A-4, 3322AL6 Data Sheet, p. 3-31

Intel i3304

4096-bit (1024 x 4 or 512 x 8) Static ROM

1969-72

Specifications

- 4096-bit (1024 x 4 or 512 x 8) Fully Decoded Static ROM
- Bipolar (3xxx)
- Fast Access Time – 65 nsec. Max over Temperature Range and Supply Voltage Variation
- Fully Decoded – On Chip Address Decode and Buffer
- Low Power Dissipation – 160 μ W/bit Typically
- DTL and TTL Compatible – Input Loading is .25mA Max., Outputs Sink 15mA
- Simple Memory Expansion – 3 Chip Selects
- OR-Tie Capability – Open Collector Outputs
- Organized as Either 1024 x 4 or 512 x 8
- 24-pin Dual In-Line Package

Type	Access Time Max.	Power Dissipation Max. Operating/Standby	Supplies [V]
3304	65ns	875mW	+5

The 3304 is a 4096 bit mask programmable read-only memory, which is either organized as 512 words by 8 bits, or 1024 words by 4 bits depending on the voltages applied to the organization select pins.

The high bit density of the 3304 offers usage in applications in look-up tables, microprogramming, code conversion, logic function generation, or character generation.

The 3304 is manufactured using Schottky barrier diode clamped transistors which results in higher speed performance than equivalent devices made with gold diffusion process [1].

Part Numbers

No Examples Known

References

- [1] Intel (September 1972). Intel Data Catalog, 3304 Data Sheet, p. 3-25.

Intel i3304A

4096-bit (512 x 8) Static ROM

1974-75

Specifications

- 4096-bit (512 x 8) Static ROM
- Bipolar (3xxx)
- Fast Access Time – 70ns (3304A, 3324A) Over Temperature and Supply Voltage Variation
- Low Standby Power Dissipation (3304A-6) – 60μW/bit
- Fully Decoded – On Chip Address Decode and Buffer
- DTL and TTL Compatible –
 - Input Loading is 0.25 mA max –
 - Output Sink is 15mA
- Open Collector (3304A, 3304A-4, 3304A-6) and Three-State (3324A, 3324A-4) Outputs
- Simple Memory Expansion – 4 Chip Select Input Leads
- 24-pin Dual In-Line Package

Type	Access Time Max.	Power Dissipation Max. Operating/Standby	Supplies [V]
3304A	70ns	950mW	+5
3304A-4	90ns	950mW	+5
3304A-6	90ns	700mW/225mW	+5

The 3304A and 3324A device families are high density 4096-bit (512 words by 8-bit) ROMs. Electrical performance is specified over the complete ambient temperature range of 0°C to 75°C and supply voltage range of 5V ±5%. The 3304A and 3324A ROM families are pin compatible with the Intel 3604 and 3624 PROM families. Consequently initial circuit prototyping can be performed using the pin compatible PROMs.

The 3304A-4 and 3324A-4 are ideal for slower performance systems (>90 ns) where low system cost is a prime factor. For those systems requiring low power dissipation, one should consider the 3304A-6. Not only does the 3304A-6 dissipate 20% less active power than the 3304A, but it also has an added low standby power dissipation feature. Whenever the 3304A-6 is deselected, power dissipation is reduced 70%.

The 3304A and 3324A devices are manufactured using Schottky barrier diode clamped transistors, which results in higher speed performance than equivalent devices made with gold diffusion process [4].

Part Numbers

No Examples Known

References

- [1] Intel (September 1972). Intel Data Catalog. No reference to 3304A dates chip after September 1972.
- [2] Intel (August 1973). The Intel Memory Design Handbook, 3304 Specifications, Selection Guide in Back of Handbook. No reference to 3304A dates chip after Aug. 1973.
- [3] Intel (October 1973). Intel Data Catalog. No reference to 3304A dates chip after October 1973.
- [4] Intel (1975). Intel Data Catalog, 3304A, 3304A-4, 3304A-6, 3324A, 3324A-4 “New Product” Data Sheet, p. 3-35

Intel i3304AL

4096-bit (512 x 8) Static ROM

1975

Specifications

- 4096-bit (512 x 8) Static ROM
- Bipolar (3xxx)
- Fast Access Time – 70ns (3304A, 3324A) Over Temperature and Supply Voltage Variation
- Low Standby Power Dissipation (3304A-6) – 60 μ W/bit
- Fully Decoded – On Chip Address Decode and Buffer
- DTL and TTL Compatible –
 - Input Loading is 0.25 mA max –
 - Output Sink is 15mA
- Open Collector (3304A, 3304A-4, 3304A-6) and Three-State (3324A, 3324A-4) Outputs
- Simple Memory Expansion – 4 Chip Select Input Leads
- Suspect that 3304AL-6 was renumbered 3304A-6 (See Collectors Notes)
- 24-pin Dual In-Line Package

Type	Access Time Max.	Power Dissipation Max. Operating/Standby	Supplies [V]
3304AL-6	90ns	735mW/240mW	+5

The 3304A and 3324A device families are high density 4096-bit (512 words by 8-bit) ROMs. Electrical performance is specified over the complete ambient temperature range of 0°C to 75°C and supply voltage range of 5V \pm 5%. The 3304A and 3324A ROM families are pin compatible with the Intel 3604 and 3624 PROM families. Consequently initial circuit prototyping can be performed using the pin compatible PROMs.

The 3304A-4 and 3324A-4 are ideal for slower performance systems (>90 ns) where low system cost is a prime factor. For those systems requiring low power dissipation, one should consider the 3304A-6. Not only does the 3304A-6 dissipate 20% less active power than the 3304A, but it also has an added low standby power dissipation feature. Whenever the 3304A-6 is deselected, power dissipation is reduced 70%.

The 3304A and 3324A devices are manufactured using Schottky barrier diode clamped transistors, which results in higher speed performance than equivalent devices made with gold diffusion process [2].

3304AL/3304A-6

It appears that Intel switched to using an 'L' power modifier after the part number or version to indicate a low power dissipation part around the time the 3304A-6 was introduced. Whether or not any 3304A-6's were actually produced before Intel switched over to the new numbering scheme is unknown. Under the new scheme, the 3304A-6 would be renumbered to 3304AL-6.

The 1975 Intel Data Catalog lists the chip as the 3304A-6. The Intel Memory Design Handbook, also published in 1975, lists the chip as the 3304AL-6.

Part Numbers

No Examples Known

References

- [1] Intel (September 1972). Intel Data Catalog. No reference to 3304AL dates chip after September 1972.
- [2] Intel (1975). Intel Data Catalog, 3304A, 3304A-4, 3304A-6, 3324A, 3324A-4 “New Product” Data Sheet, p. 3-35. No reference to 3304AL.
- [3] Intel (1975). Intel Memory Design Handbook, 3304AL-6 Specifications, p. PSG-2.

Intel i3322

2048-bit (512 x 4) Static ROM

1973-75

Specifications

- 2048-bit (512 x 4) Static ROM
- Bipolar (3xxx)
- Fast Access Time – 70 ns (3302, 3322) over Temperature and Supply Voltage Variation
- Low Standby Power Dissipation (3302-6, 3322-6) – 100 μ W/bit
- Fully Decoded – On Chip Address Decode and Buffer
- DTL and TTL Compatible –
 - Input Loading is 0.25 mA Max –
 - Outputs Sink 15 mA
- Open Collector (3302, 3302-4, 3302-6) and Three-State (3322, 3322-4, 3322-6) Outputs
- The 3302 and 3322 are ROM equivalents of the Intel 3602 and 3622 PROMs
- 16-pin Dual In-Line Package

Type	Access Time Max.	Power Dissipation Max. Operating/Standby	Supplies [V]
3322	70ns	650mW	+5
3322-4	90ns	650mW	+5
3322-6	90ns	575mW/240mW	+5

The 3302 and 3322 device families are high density 2048-bit (512 words by 4-bit) ROMs. Electrical performance is specified over the complete ambient temperature range of 0°C to 75°C and supply voltage range of 5V \pm 5%. The 3302 and 3322 ROM families are pin compatible with the Intel 3602 and 3622 PROM families. Consequently initial circuit prototyping can be performed using the pin compatible PROMs.

The 3302-4 and 3322-4 are ideal for slower performance systems (>90 ns) where low system cost is a prime factor. For those systems requiring low power dissipation, one should consider the 3302-6 and 3322-6. Not only does the 3302-6 and 3322-6 dissipate 20% less active power than the 3302 and 3322 respectively, but it also has an added low standby power dissipation feature. Whenever the 3302-6 and 3322-6 is deselected, power dissipation is reduced 70%.

The 3302 and 3322 devices are manufactured using Schottky barrier diode clamped transistors which results in higher speed performance than equivalent devices made with gold diffusion process [2].

Part Numbers

No Examples Known

References

- [1] Intel (September 1972). Intel Data Catalog. No reference to 3322 dates chip after September 1972.
- [2] Intel (1975). Intel Data Catalog, 3302, 3302-4, 3302-6, 3322, 3322-4, 3322-6 Data Sheet, p. 3-33

Intel i3322A

2048-bit (512 x 4) Static ROM

1975

Specifications

- 2048-bit (512 x 4) Static ROM
- Bipolar (3xxx)
- Fast Access Time - 70ns (3302A, 3322A) Over Temperature and Supply Voltage Variation
- Low Standby Power Dissipation (3302AL6) – 115 μ W/bit
- Fully Decoded – on Chip Address Decode and Buffer
- DTL and TTL Compatible – Input Loading is 0.25 mA max – Output Sink is 15 mA
- Open Collector (3302A, 3302A-4, 3302AL6) and Three State (3322A, 3322A-4, 3322AL6) Outputs
- Simple Memory Expansion – Single Chip Select Input Lead
- ROM equivalent of the Intel 3622A PROM
- 16-pin Dual In-Line Package

Type	Access Time Max.	Power Dissipation Max. Operating/Standby	Supplies [V]
3322A	70ns	735mW	+5
3322A-4	90ns	735mW	+5

The 3302 and 3322 device families are high density 2048-bit (512 words by 4-bit) ROMs. Electrical performance is specified over the complete ambient temperature range of 0°C to 75°C and supply voltage range of 5V \pm 5%. The 3302A and 3322A ROM families are pin compatible with the Intel 3602 and 3622 PROM families. Consequently initial circuit prototyping can be performed using the pin compatible PROMs.

The 3302A-4 and 3322A-4 are ideal for slower performance systems (>90 ns) where low system cost is a prime factor. For those systems requiring low power dissipation, one should consider the 3302AL6/3322AL6. Not only does the 3302AL6/3322AL6 dissipate 20% less active power than the 3302/3322, but it also has an added low standby power dissipation feature. Whenever the 3302AL6/3322AL6 is deselected, power dissipation is reduced 70%.

The 3302A and 3322A device families are manufactured using Schottky barrier diode clamped transistors which results in higher speed performance than equivalent devices made with gold diffusion process [3].

Part Numbers

No Examples Known

References

- [1] Intel (1975). Intel Data Catalog, 3302/3322 Family Data Sheet, p. 3-33. No reference to 3322A/3322AL dates chip after 1975.
- [2] Intel (1975). Intel Memory Design Handbook, 3322A/3322AL Specifications, p. PSG-2.
- [3] Intel (1976). Intel Data Catalog, 3302A, 3302A-4, 3302AL6, 3322A, 3322A-4, 3322AL6 Data Sheet, p. 3-31
- [4] Intel (1977). Intel Data Catalog, 3602/3622 family and 3602A/3622A Family Data Sheet, p. 3-40. 3302/3322 listed as pin compatible ROM equivalents of 3602/3622 and 3602A/3622A.

Intel i3322AL

2048-bit (512 x 4) Static ROM

1975

Specifications

- 2048-bit (512 x 4) Static ROM
- Bipolar (3xxx)
- Fast Access Time - 70ns (3302A, 3322A) Over Temperature and Supply Voltage Variation
- Low Standby Power Dissipation (3302AL6) – 115 μ W/bit
- Fully Decoded – on Chip Address Decode and Buffer
- DTL and TTL Compatible – Input Loading is 0.25 mA max – Output Sink is 15 mA
- Open Collector (3302A, 3302A-4, 3302AL6) and Three State (3322A, 3322A-4, 3322AL6) Outputs
- Simple Memory Expansion – Single Chip Select Input Lead
- ROM equivalent of the Intel 3622A PROM
- 16-pin Dual In-Line Package

Type	Access Time Max.	Power Dissipation Max. Operating/Standby	Supplies [V]
3322AL-6	90ns	580mW/240mW	+5

The 3302 and 3322 device families are high density 2048-bit (512 words by 4-bit) ROMs. Electrical performance is specified over the complete ambient temperature range of 0°C to 75°C and supply voltage range of 5V \pm 5%. The 3302A and 3322A ROM families are pin compatible with the Intel 3602 and 3622 PROM families. Consequently initial circuit prototyping can be performed using the pin compatible PROMs.

The 3302A-4 and 3322A-4 are ideal for slower performance systems (>90 ns) where low system cost is a prime factor. For those systems requiring low power dissipation, one should consider the 3302AL6/3322AL6. Not only does the 3302AL6/3322AL6 dissipate 20% less active power than the 3302/3322, but it also has an added low standby power dissipation feature. Whenever the 3302AL6/3322AL6 is deselected, power dissipation is reduced 70%.

The 3302A and 3322A device families are manufactured using Schottky barrier diode clamped transistors which results in higher speed performance than equivalent devices made with gold diffusion process [3].

Part Numbers

No Examples Known

References

- [1] Intel (1975). Intel Data Catalog, 3302/3322 Family Data Sheet, p. 3-33. No reference to 3322A/3322AL dates chip after 1975.
- [2] Intel (1975). Intel Memory Design Handbook, 3322A/3322AL Specifications, p. PSG-2.
- [3] Intel (1976). Intel Data Catalog, 3302A, 3302A-4, 3302AL6, 3322A, 3322A-4, 3322AL6 Data Sheet, p. 3-31

Intel i3324

4096-bit (512 x 8) Static ROM

1973-75

Specifications

- 4096-bit (512 x 8) Static ROM
- Bipolar (3xxx)
- Three-state Output
- ROM Equivalent of the Intel 3624 PROM
- 24-pin Dual In-Line Package

Type	Access Time Max.	Power Dissipation Max. Operating/Standby	Supplies [V]
3324	-	-	+5

No data sheet known to exist for this part.

Was the 3324 actually produced?

The 1975 Intel Data Catalog contains 3304A/3324A on the same “New Product” data sheet.

In 1975, the 3304 had been around a few years. The 3304 was included in the September 1972 Intel Data Catalog. The 3324 on the other hand, was not included in the September 1972 Intel Data Catalog.

It's possible that the 3324 with introduced as the 3324A in 1975. If this is true then the 3324 does not exist.

Part Numbers

No Examples Known

References

[1] Intel (September 1972). Intel Data Catalog. No reference to 3324 dates chip after September 1972.

[2] Intel (1975). Intel Data Catalog, "New Product" 3304A/3324A Family Data Sheet, p. 3-33. No reference to 3324.

Intel i3324A

4096-bit (512 x 8) Static ROM

1975

Specifications

- 4096-bit (512 x 8) Static ROM
- Bipolar (3xxx)
- Fast Access Time – 70ns (3304A, 3324A) Over Temperature and Supply Voltage Variation
- Low Standby Power Dissipation (3304A-6) – 60μW/bit
- Fully Decoded – On Chip Address Decode and Buffer
- DTL and TTL Compatible –
 - Input Loading is 0.25 mA max –
 - Output Sink is 15mA
- Open Collector (3304A, 3304A-4, 3304A-6) and Three-State (3324A, 3324A-4) Outputs
- Simple Memory Expansion – 4 Chip Select Input Leads
- 24-pin Dual In-Line Package

Type	Access Time Max.	Power Dissipation Max. Operating/Standby	Supplies [V]
3324A	70ns	950mW	+5
3324A-4	90ns	950mW	+5

The 3304A and 3324A device families are high density 4096-bit (512 words by 8-bit) ROMs. Electrical performance is specified over the complete ambient temperature range of 0°C to 75°C and supply voltage range of 5V ±5%. The 3304A and 3324A ROM families are pin compatible with the Intel 3604 and 3624 PROM families. Consequently initial circuit prototyping can be performed using the pin compatible PROMs.

The 3304A-4 and 3324A-4 are ideal for slower performance systems (>90 ns) where low system cost is a prime factor. For those systems requiring low power dissipation, one should consider the 3304A-6. Not only does the 3304A-6 dissipate 20% less active power than the 3304A, but it also has an added low standby power dissipation feature. Whenever the 3304A-6 is deselected, power dissipation is reduced 70%.

The 3304A and 3324A devices are manufactured using Schottky barrier diode clamped transistors, which results in higher speed performance than equivalent devices made with gold diffusion process [2].

Part Numbers

No Examples Known

References

[1] Intel (September 1972). Intel Data Catalog. No reference to 3324A dates chip after September 1972.

[2] Intel (1975). Intel Data Catalog, "New Product" 3304A, 3304A-4, 3304A-6, 3324A, 3324A-4 Data Sheet, p. 3-35

Intel i3404

High-Speed 6-bit Latch

1970

Specifications

- High-Speed 6-bit Latch
- Bipolar (3xxx)
- 12 ns Max. Data to Output Delay Over 0°C to 75°C Temperature
- Directly Compatible with DTL and TTL Logic Circuits
- Low Input Load Current -- .25 mA Max., 1/6 Standard TTL Input Load
- Minimum Line Reflection – Low Voltage Diode Input Clamp
- Outputs Sink 10 mA Min.
- Simple Expansion – Enable Inputs
- 16-pin Dual In-Line Package

Type	Input to Output Delay Max.	Power Dissipation Max.	Supplies [V]
3404	12ns	375mW	+5

The Intel 3404 contains six high-speed latches organized as independent 4-bit and 2-bit latches. They are designed for use as memory data registers, address registers, or other storage elements. The latches act as high-speed inverters when the “Write” input is “low”.

The Intel 3404 is packaged in a standard 16-pin dual-in-line package; and its performance is specified over the temperature range of 0°C to 75°C, ambient. The use of Schottky barrier diode clamped transistors to obtain fast switching speeds results in higher performance than equivalent devices made with a gold diffusion process [1].

History

The 3404 was used in Intel 4004 microcomputer implementations. Intel's 4004-based SIM4-01 and SIM4-02 microcomputers used these latches.

The 3404 was designed for use as memory data registers, address registers, or other storage elements. In practice the 3404 was used as a bus interface, latching or holding data until the system was ready for it. The 3404 actually had two independent latches, a 2-bit latch and a 4-bit latch.

Part Numbers

Type C Packages



Part Number	Package Description	Values
		
C3404	1. Type C white ceramic package w/grey traces, gold cap, gold cap ground strap, and gold pins. Gold dot denotes pin #1. Example shown made in Malaysia and dated 7531.	Ex. Rare (3 Known) \$50-\$200
		
C3404	2. Type C white ceramic package w/gold cap and gold pins. Black double dot denotes pin #1.	Rare \$25-\$100

Type D Packages

Part Number	Package Description	Values
		
D3404	Type D grey ceramic package w/tin pins	\$.75-\$3

Intel i3404

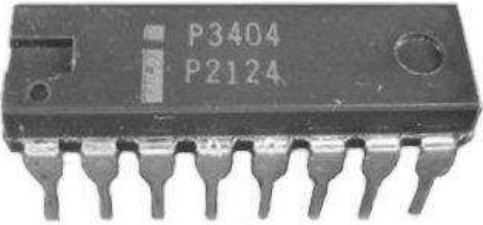
Type P Packages

Part Number	Package Description	Values
P3404	1. Type P grey plastic package w/gold pins. Small round indentation denotes pin #1.	Ex. Rare (1 Known) \$25-\$100
		
P3404	2. Type P grey plastic package w/tin pins. Early package with no denotation for pin #1.	Rare \$10-\$40
		
P3404	3. Type P grey plastic package w/tin pins. Small round indentation denotes pin #1.	\$1.25-\$5
		
P3404	4. Type P black plastic package w/tin pins. Small round indentation denotes pin #1.	\$.75-\$3

References

[1] Intel (September 1972). Intel Data Catalog, 3404 Data Sheet, p. 5-3. C3404 and P3404 listed in ordering information.

[2] Intel (1984). A Revolution in Progress... A History of Intel to Date, 3404 introduced 1970, p. 26

Intel i3405

3-bit Bipolar CTL Register

1971

Specifications

- 3-bit CTL Register
- Bipolar (3xxx)
- Complementary Transistor Logic (CTL)
- PNP Inputs and Emitter-Follower Outputs for High-Speed and High Drive Strength.

No data sheet known to exist for this part.

History

The 3405/3406 were custom parts produced for Burroughs Corp in 1970. Burroughs bought these chips [from Intel] for ten years [3].

Part Numbers

Type C Packages

Part Number	Package Description	Values
		
C3405	1. Type C white ceramic package w/gold cap and gold pins. Example shown made in Malaysia and dated 7739	Ex. Rare \$50-\$200
		
C3405	2. Type C white ceramic package w/gold cap and gold pins. Offset gold cap ground strap.	Ex. Rare \$50-\$200

References

- [1] Intel (September 1972). Intel Data Catalog. No reference to 3405.
- [2] Intel (1984). A Revolution in Progress... A History of Intel to Date, 3405 introduced 1971, p. 26
- [3] Intel (2001). Recollection of Early Chip Development at Intel, p. 5-10.
Available from: http://www.intel.com/technology/itj/q12001/pdf/art_1.pdf [Accessed 2004]

Intel i3406

3-bit Bipolar CTL Arithmetic Unit

1971

Specifications

- 3-bit CTL Arithmetic Unit
- Bipolar (3xxx)
- Complementary Transistor Logic (CTL)
- PNP Inputs and Emitter-Follower Outputs for High-Speed and High Drive Strength.

No data sheet known to exist for this part.

History

The 3405/3406 were custom parts produced for Burroughs Corp in 1970. Burroughs bought these chips [from Intel] for ten years [3].

Part Numbers

Type C Packages

Part Number	Package Description	Values
		
C3406	Type C white ceramic package w/gold cap and gold pins.	Rare \$25-\$100

References

- [1] Intel (September 1972). Intel Data Catalog. No reference to 3406.
- [2] Intel (1984). A Revolution in Progress... A History of Intel to Date, 3406 introduced 1971, p. 26
- [3] Intel (2001). Recollection of Early Chip Development at Intel, p. 5-10.
Available from: http://www.intel.com/technology/itj/q12001/pdf/art_1.pdf [Accessed 2004]

Intel i3408

Hex Sense Amp and Latch for MOS Memories

1970-72

Specifications

- Hex Sense Amp and Latch for MOS Memories
- Bipolar (3xxx)
- Three-state Output
- 18-pin Dual In-Line Package

Type	Input to Output Delay Max.	Power Dissipation Max.	Supplies [V]
3408	-	-	+5

No data sheet known to exist for this part.

Part Numbers

Type P Packages

Part Number	Package Description	Values
P3408	Type P package	Ex. Rare (0 Known) \$\$\$

References

[1] Intel (September 1972). Intel Data Catalog, 3408A Data Sheet, p. 5-11. P3408A listed in ordering information. No reference to 3408.

Intel i3408A

Hex Sense Amp and Latch for MOS Memories

1970-72

Specifications

- Hex Sense Amp and Latch for MOS Memories
- Bipolar (3xxx)
- High Speed – 20 nsec. Max.
- Wire-OR Capability –
 - Open Collector Output – 3208A
 - Three-State Output – 3408A
- Single 5V Power Supply
- Input Level Compatible with 1103 Output
- Two Enable Inputs
- Minimum Line Reflection – Low Voltage Diode Input Clamp
- Schottky TTL
- 18-pin Dual In-Line Package

Type	Input to Output Delay Max.	Power Dissipation Max.	Supplies [V]
3408A	25ns	625mW	+5

The Intel 3208A is a high-speed hex sense amplifier designed to sense the output signals of the 1103 memory. The device features two separate enable inputs each controlling the output state of three sense amplifiers, and a common voltage reference input. OR-tie capability is available with the 3208A open collector TTL compatible output.

The 3408A is a hex amplifier with a latch circuit connected to each amplifier. The sensed data may be stored in the latches through application of a write pulse. The 3408A has three-state TTL outputs, hence in the non-enabled state the outputs float allowing wire-OR memory expansion. The latches may be bypassed by grounding the write input pin. Under this condition, the 3408A functions as a hex sense amplifier.

The 3208A and 3408A operate from a single +5 volt power supply. Device performance is specified over the complete ambient temperature range from 0°C to 70°C and over a supply voltage range of 5 volts $\pm 5\%$. The 3208A and 3408A are packaged in an 18-pin dual in-line package [2].

Intel i3408A

Part Numbers

Type D Packages

Part Number	Package Description	Values
D3408A	Type D package	\$.75-\$3

Type P Packages

Part Number	Package Description	Values
P3408A	Type P package. Single source shows 2 in stock.	Rare (Suspect) \$\$\$

References

[1] Intel (September 1972). Intel Data Catalog, 3408A Data Sheet, p. 5-11. P3408A listed in ordering information.

[2] Intel (1978). Intel Component Data Catalog, 3208A/3408A Data Sheet, p. 6-13

Intel i3496

4-bit Bipolar CTL Register

1971

Specifications

- 4-bit CTL Register
- Bipolar (3xxx)

No data sheet known to exist for this part.

History

Intel Museum's Chronological List of Intel Products lists 3496 as 4-bit CTL Register introduced in 1971.

Part Numbers

No Examples Known

References

[1] Intel (September 1972). Intel Data Catalog. No reference to 3496.

[2] Intel (2004). Chronological List of Intel Products, 3496 listed as 4-bit CTL Register introduced in 1971. Available from:

ftp://download.intel.com/intel/intelis/museum/research/arc_collect/timeline/TimelineChron.pdf [Accessed 2004]

Intel i3601

1024-bit (256 x 4) PROM

1972

Specifications

- 1024-bit (256 x 4) PROM
- Bipolar (3xxx)
- Low Power Dissipation: 0.5 mW/Bit Typical
- OR-Tie Capability – Open Collector Outputs
- Fast Programming: 1 ms/Bit Typically
- Fully Decoded – On Chip Address Decode and Buffer
- DTL and TTL Compatible – Input Loading is .25 mA max. – Outputs sink 15 mA
- Simple Memory Expansion – 2 Chip Select Input Leads
- Minimum Line Reflection – Low Voltage Diode Input Clamp
- Polycrystalline Silicon Fuse
- 16-pin Dual In-Line Package

Type	Access Time Max.	Power Dissipation Max. Operating/Standby	Supplies [V]
3601	70ns	650mW	+5
3601-1	50ns	650mW	+5
M3601	90ns	650mW	+5

The Intel® 3601/3621 is a 1024-bit PROM ideally suited for uses where fast turn-around and pattern experimentation are important, such as in prototypes or in small production volume systems. The 3601 is manufactured with all outputs low, and logic high output levels can be electrically programmed in selected bit locations. The 3621 has its outputs initially high and logic low output levels are programmed. The same address inputs are used for both programming and reading.

A higher system performance is achieved by using the 3601-1 or 3621-1. These PROMs give a 25% system speed improvement over the 3601 or 3621.

The 3601, 3601-1 is pin compatible with the Intel metal mask 3301A ROM. The 3301A is ideal for large volume and lower cost production runs of systems initially using the PROM.

The 3601/3621 is manufactured with the highly reliable polycrystalline silicon fuse and the fast switching Schottky barrier diode technology [2, 3].

Part Numbers

Type C Packages

Part Number	Package Description	Values
		
3601	Type C white ceramic package w/grey traces, gold cap, gold cap ground strap and gold pins. Gold dot denotes pin #1.	Ex. Rare \$50-\$200
		
C3601	Type C white ceramic package w/grey traces, gold cap, gold cap ground strap and gold pins. Gold dot denotes pin #1.	Ex. Rare \$50-\$200

Type D Packages

Part Number	Package Description	Values
D3601	Type D grey ceramic package w/tin pins.	\$.50-\$2
D3601-1	Type D grey ceramic package w/tin pins.	Rare \$10-\$40
MD3601	Type D package	Rare \$15-\$60

References

- [1] Intel (September 1972). Intel Data Catalog, 3601 Data Sheet, p. 3-29. C3601 listed in ordering information, p. 8-5.
- [2] Intel (1975). Intel Data Catalog, 3601/3601-1 Data Sheet, p. 3-27.
- [3] Intel (1977). Intel Component Data Catalog, 3601/3621 Family Data Sheet, p. 3-34.
- [4] Intel (1984). A Revolution in Progress... A History of Intel to Date, 3601 introduced 1972, p. 26.

Intel i3602

2048-bit (512 x 4) PROM

1974-75

Specifications

- 2048-bit (512 x 4) PROM
- Bipolar (3xxx)
- Low Power Dissipation
 - 0.3mW/Bit
- Open Collector (3602A, 3602) or Three-State (3622A, 3622) Outputs
- Simple Memory Expansion – Chip Select Input Lead
- Replaces Two 256 x 4 PROMs Without Increasing Board Area
- Polycrystalline Silicon Fuse For Higher Reliability
- PROM Equivalents of Intel 3302/3322 ROM
- 16-pin Dual In-Line Package

Type	Access Time Max.	Power Dissipation Max. Operating/Standby	Supplies [V]
3602	70ns	650mW	+5
3602-4	90ns	650mW	+5
3602-6	90ns	650mW/240mW	+5
M3602	90ns	770mW	+5
M3602-6	120ns	605mW/250mW	+5

The Intel® 3602A/3622A and 3602/3622 device families are 2048-bit bipolar PROMs organized as 512 words by 4 bits. The fast second-generation 3602A/3622A joins its Intel predecessor, the 3602/3622, featuring 70 ns. A higher speed version, the 3602A-2/3622A-2, is now available at 60 ns. All 3602A/3622A specifications, except programming, are the same as the 3602/3622. Once programmed, the 3602A/3622A are interchangeable with the 3602/3622.

The PROMs are manufactured with all outputs initially logically high. Logic low levels can be electrically programmed in selected bit locations. Both open collector and three-state outputs are available. The power dissipation is typically 0.2mW/bit

The bit density of existing 256 x 4 PROM systems can easily be doubled without an increase in area with the 3602A/3622A. These PROMs like the 256 x 4 PROMs are in 16-pin dual in-line package.

A pin compatible, mask programmable 3302/3322 ROM is available for large volume production systems initially using the 3602/3622 [3].

Part Numbers

Type D Packages

Part Number	Package Description	Values
D3602	Type D grey ceramic package w/tin pins.	Rare \$15-\$60
D3602-4	Type D grey ceramic package w/tin pins.	Rare \$15-\$60

References

- [1] Intel (September 1972). Intel Data Catalog. No Reference to 3602 Dates Chip After September 1972.
- [2] Intel (1975). Intel Data Catalog, 3602 Family Data Sheet, p. 3-32.
- [3] Intel (1977). Intel Data Catalog, 3602A/3622A, 3602/3622 Family Data Sheet, p. 3-40.
- [4] Intel (1978). Intel Component Data Catalog, 3602A/3622A Family Data Sheet, p. 4-55.

Intel i3602L

2048-bit (512 x 4) PROM

1975-76

Specifications

- 2048-bit (512 x 4) PROM
- Bipolar (3xxx)
- Fast Access Time – 70ns (3602, 3622)
- Low Standby Power Dissipation (3602L-6, 3622L-6) – 115 μ W/Bit
- Open Collector (3602, 3602-4, 3602L-6) Outputs
Three-State Output (3622, 3622-4, 3622L) Outputs
- 16-pin Dual In-Line Package

Type	Access Time Max.	Power Dissipation Max. Operating/Standby	Supplies [V]
3602L-6	90ns	580mW/240mW	+5

The 3602 and 3622 families are 512 words by 4-bit PROMs. The PROMs are manufactured with all outputs high and logic low levels can be electrically programmed in selected bit locations [3].

The 3602L-6 and 3622L-6 have the additional capability of reducing power whenever the chip is deselected; i.e., Chip Select (CS) high. The standby power is 236mW, compared to 685mW for the 3602 and 3622 [2].

Part Numbers

No Examples Known

References

[1] Intel (September 1972). Intel Data Catalog. No reference to any version of 3602.

[2] Intel (1975). Intel Memory Design Handbook, PROMs and ROMs, 3602L-6 and 3622L-6 Specifications, p. 8-8.

[3] IC Master (1977). Intel 3602, 3602-4, 3602L-6 Data Sheet, p. 697

[4] Intel (1977). Intel Data Catalog, 3602/3602A and 3622/3622A Family Data Sheet, p. 3-40. No reference 3602L Family.

Intel i3602A

2048-bit (512 x 4) PROM

1976-77

Specifications

- 2048-bit (512 x 4) PROM
- Bipolar (3xxx)
- Low Power Dissipation
 - 0.3mW/Bit
- Open Collector (3602A, 3602) or Three-State (3622A, 3622) Outputs
- Simple Memory Expansion – Chip Select Input Lead
- Replaces Two 256 x 4 PROMs Without Increasing Board Area
- Polycrystalline Silicon Fuse For Higher Reliability
- PROM Equivalents of Intel 3302/3322 ROM
- 16-pin Dual In-Line Package

Type	Access Time Max.	Power Dissipation Max. Operating/Standby	Supplies [V]
3602A	70ns	735mW	+5
3602A-2	60ns	735mW	+5

The Intel® 3602A/3622A and 3602/3622 device families are 2048-bit bipolar PROMs organized as 512 words by 4 bits. The fast second-generation 3602A/3622A joins its Intel predecessor, the 3602/3622, featuring 70 ns. A higher speed version, the 3602A-2/3622A-2, is now available at 60 ns. All 3602A/3622A specifications, except programming, are the same as the 3602/3622. Once programmed, the 3602A/3622A are interchangeable with the 3602/3622.

The PROMs are manufactured with all outputs initially logically high. Logic low levels can be electrically programmed in selected bit locations. Both open collector and three-state outputs are available. The power dissipation is typically 0.2mW/bit

The bit density of existing 256 x 4 PROM systems can easily be doubled without an increase in area with the 3602A/3622A. These PROMs like the 256 x 4 PROMs are in 16-pin dual in-line package.

A pin compatible, mask programmable 3302/3322 ROM is available for large volume production systems initially using the 3602/3622 [3].

Intel i3602A

Part Numbers

Type D Packages

Part Number	Package Description	Values
D3602A	Type D package	\$.75-\$3
D3602A-2	Type D package	Ex. Rare (0 Known) \$\$\$

References

- [1] Intel (1975). Intel Data Catalog, 3602 Family Data Sheet, p. 3-32. No reference to 3602A.
- [2] Intel (1976). Intel Data Catalog, 3602/3602L Data Sheet, p. 3-43. No reference to 3602A.
- [3] Intel (1977). Intel Data Catalog, 3602A/3622A and 3602/3622 Family Data Sheet, p. 3-40.
- [4] Intel (1978). Intel Component Data Catalog, 3602A/3622A Family Data Sheet, p. 4-55.

Intel i3604

4096-bit (512 x 8) PROM

1974

Specifications

- 4096-bit (512 x 8) PROM
- Bipolar (3xxx)
- Fast Access Time: 60 ns Max. (3604A-2, 3624A-2)
- Low Standby Power Dissipation (3604AL) – 32 μ W/Bit Max.
- Open Collector (3604A, 3604) Outputs or Three-State (3624A, 3624) Outputs
- Four Chip Select Inputs For Easy Memory Expansion
- Polycrystalline Silicon Fuse For Higher Reliability
- PROM equivalents of the Intel 3304/3324 ROMs
- 24-pin Dual In-Line Package

Type	Access Time Max.	Power Dissipation Max. Operating/Standby	Supplies [V]
3604	70ns	998mW	+5
3604-4	90ns	998mW	+5
3604-6	-	-	+5
M3604	90ns	1045mW	+5
M3604-6	120ns	770mW/250mW	+5

The Intel® 3604A/3624A and 3604/3624 device families are 4096-bit bipolar PROMs organized as 512 words by 8 bits. The fast second-generation 3604A/3624A joins its Intel predecessor, the 3604/3624, featuring 70 ns. Higher speed PROMs, the 3604A-2/3624A-2, are now available at 60 ns. The 3604A/3624A families are lower in power dissipation than the 3604/3624 families. All 3604A/3624A specifications, except programming, are the same as or better than the 3604/3624. Once programmed, the 3604A/3624A are interchangeable with the 3604/3624.

The PROMs are manufactured with all outputs initially logically high. Logic low levels can be electrically programmed in selected bit locations. Both open collector and three-state outputs are available. Low standby power dissipation can be achieved with either the 3604AL or 3604L-6. The standby power dissipation is approximately 15% of the active power dissipation.

The 3604A/3624A and 3604/3624 families are available in a hermetic 24-pin dual in-line package. These PROMs are manufactured with the time-proven polycrystalline silicon fuse technology. A pin compatible, mask programmable ROM is available for large volume production of systems initially using the 3604/3624 [2].

Part Numbers

Type D Packages

Part Number	Package Description	Values
D3604	Type D package	\$1.25-\$5
D3604-4	Type D package	\$2.50-\$10
D3604-6	Type D package	Rare \$10-\$40

References

- [1] Intel (1975). Intel Data Catalog, 3604, 3604-4, 3604-6 Preliminary Data Sheet, p. 3-32
- [2] Intel (1977). Intel Data Catalog, 3604A, 3604AL, 3604, 3604L, 3624A, 3624 Family Data Sheet, p. 3-43.
- [3] Intel (1984). A Revolution in Progress... A History of Intel to Date, 3604/24 introduced 1974, p. 26.

Intel i3604L

4096-bit (512 x 8) PROM

1975

Specifications

- 4096-bit (512 x 8) PROM
- Bipolar (3xxx)
- Fast Access Time: 60 ns Max. (3604A-2, 3624A-2)
- Low Standby Power Dissipation (3604AL) – 32 μ W/Bit Max.
- Open Collector (3604A, 3604) Outputs or Three-State (3624A, 3624) Outputs
- Four Chip Select Inputs For Easy Memory Expansion
- Polycrystalline Silicon Fuse For Higher Reliability
- 24-pin Dual In-Line Package

Type	Access Time Max.	Power Dissipation Max. Operating/Standby	Supplies [V]
3604L-6	90ns	735mW/240mW	+5

The Intel® 3604A/3624A and 3604/3624 device families are 4096-bit bipolar PROMs organized as 512 words by 8 bits. The fast second-generation 3604A/3624A joins its Intel predecessor, the 3604/3624, featuring 70 ns. Higher speed PROMs, the 3604A-2/3624A-2, are now available at 60 ns. The 3604A/3624A families are lower in power dissipation than the 3604/3624 families. All 3604A/3624A specifications, except programming, are the same as or better than the 3604/3624. Once programmed, the 3604A/3624A are interchangeable with the 3604/3624.

The PROMs are manufactured will all outputs initially logically high. Logic low levels can be electrically programmed in selected bit locations. Both open collector and three-state outputs are available. Low standby power dissipation can be achieved with either the 3604AL or 3604L-6. The standby power dissipation is approximately 15% of the active power dissipation.

The 3604A/3624A and 3604/3624 families are available in a hermetic 24-pin dual in-line package. These PROMs are manufactured with the time-proven polycrystalline silicon fuse technology. A pin compatible, mask programmable ROM is available for large volume production of systems initially using the 3604/3624 [3].

Intel i3604L

Part Numbers

Type D Packages

Part Number	Package Description	Values
D3604L-6	Type D package	Rare \$10-\$40

References

[1] Intel (1975). Intel Data Catalog, 3604, 3604-4, 3604-6 Preliminary Data Sheet, p. 3-34. No reference to 3604L.

[2] Intel (1975). Intel Memory Design Handbook, 3604L Specifications, p. PSG-2

[3] Intel (1977). Intel Data Catalog, 3604A, 3604AL, 3604, 3604L, 3624A, 3624 Family Data Sheet, p. 3-43.

[4] Intel (2002). Intel Museum Archive Collection Chronological Timeline, 3604/24 [introduction] date "01/01/74". Available from: http://www.intel.com/intel/intelis/museum/arc_collect/TimelineChron.pdf [Accessed 10 July 2002].

Intel i3604A

4096-bit (512 x 8) PROM

1976-77

Specifications

- 4096-bit (512 x 8) PROM
- Bipolar (3xxx)
- Fast Access Time: 60 ns Max. (3604A-2, 3624A-2)
- Low Standby Power Dissipation (3604AL) – 32 μ W/Bit Max.
- Open Collector (3604A, 3604) Outputs or Three-State (3624A, 3624) Outputs
- Four Chip Select Inputs For Easy Memory Expansion
- Polycrystalline Silicon Fuse For Higher Reliability
- PROM equivalents of the Intel 3304/3324 ROMs
- 24-pin Dual In-Line Package

Type	Access Time Max.	Power Dissipation Max. Operating/Standby	Supplies [V]
3604A	70ns	895mW	+5
3604A-2	60ns	895mW	+5
M3604A	90ns	1045mW	+5

The Intel® 3604A/3624A and 3604/3624 device families are 4096-bit bipolar PROMs organized as 512 words by 8 bits. The fast second-generation 3604A/3624A joins its Intel predecessor, the 3604/3624, featuring 70 ns. Higher speed PROMs, the 3604A-2/3624A-2, are now available at 60 ns. The 3604A/3624A families are lower in power dissipation than the 3604/3624 families. All 3604A/3624A specifications, except programming, are the same as or better than the 3604/3624. Once programmed, the 3604A/3624A are interchangeable with the 3604/3624.

The PROMs are manufactured will all outputs initially logically high. Logic low levels can be electrically programmed in selected bit locations. Both open collector and three-state outputs are available. Low standby power dissipation can be achieved with either the 3604AL or 3604L-6. The standby power dissipation is approximately 15% of the active power dissipation.

The 3604A/3624A and 3604/3624 families are available in a hermetic 24-pin dual in-line package. These PROMs are manufactured with the time-proven polycrystalline silicon fuse technology. A pin compatible, mask programmable ROM is available for large volume production of systems initially using the 3604/3624 [2].

Intel i3604A

Part Numbers

Type D Packages

Part Number	Package Description	Values
		
D3604A	Type D grey ceramic package w/tin pins. © Intel '77.	\$.75-\$3
D3604A-2	Type D package	Rare \$10-\$40

References

- [1] Intel (1975). Intel Memory Design Handbook. No reference to 3604A.
- [2] Intel (1976). Intel Data Catalog, 3604/3604L Data Sheet, p. 3-46. No reference to 3604A/3604AL.
- [3] Intel (1977). Intel Data Catalog, 3604A, 3604AL, 3604, 3604L, 3624A, 3624 Family Data Sheet, p. 3-43.

Intel i3604AL

4096-bit (512 x 8) PROM

1976-77

Specifications

- 4096-bit (512 x 8) PROM
- Bipolar (3xxx)
- Fast Access Time: 60 ns Max. (3604A-2, 3624A-2)
- Low Standby Power Dissipation (3604AL) – 32 μ W/Bit Max.
- Open Collector (3604A, 3604) Outputs or Three-State (3624A, 3624) Outputs
- Four Chip Select Inputs For Easy Memory Expansion
- Polycrystalline Silicon Fuse For Higher Reliability
- PROM equivalents of the Intel 3304/3324 ROMs
- 24-pin Dual In-Line Package

Type	Access Time Max.	Power Dissipation Max. Operating/Standby	Supplies [V]
3604AL	90ns	685mW/135mW	+5

The Intel® 3604A/3624A and 3604/3624 device families are 4096-bit bipolar PROMs organized as 512 words by 8 bits. The fast second-generation 3604A/3624A joins its Intel predecessor, the 3604/3624, featuring 70 ns. Higher speed PROMs, the 3604A-2/3624A-2, are now available at 60 ns. The 3604A/3624A families are lower in power dissipation than the 3604/3624 families. All 3604A/3624A specifications, except programming, are the same as or better than the 3604/3624. Once programmed, the 3604A/3624A are interchangeable with the 3604/3624.

The PROMs are manufactured will all outputs initially logically high. Logic low levels can be electrically programmed in selected bit locations. Both open collector and three-state outputs are available. Low standby power dissipation can be achieved with either the 3604AL or 3604L-6. The standby power dissipation is approximately 15% of the active power dissipation.

The 3604A/3624A and 3604/3624 families are available in a hermetic 24-pin dual in-line package. These PROMs are manufactured with the time-proven polycrystalline silicon fuse technology. A pin compatible, mask programmable ROM is available for large volume production of systems initially using the 3604/3624 [3].

Intel i3604AL

Part Numbers

Type D Packages

Part Number	Package Description	Values
	 A photograph of a dark grey, rectangular ceramic package with tin pins on all four sides. The package is oriented horizontally. On the top surface, there is a small notch on the left side. The text on the package includes "D3604AL" and "90703" in the upper left, and "© INTEL '77" in the lower left.	
	D3604AL	

References

- [1] Intel (1975). Intel Memory Design Handbook. No reference to 3604AL dates chip after 1975.
- [2] Intel (1976). Intel Data Catalog, 3604/3604L Data Sheet, p. 3-46. No reference to 3604A/3604AL.
- [3] Intel (1977). Intel Data Catalog, 3604A, 3604AL, 3604, 3604L, 3624A, 3624 Family Data Sheet, p. 3-43.

Intel i3605

4096-bit (1024 x 4) PROM

1976

Specifications

- 4096-bit (1024 x 4) PROM
- Bipolar (3xxx)
- Fast Access Time: 45 ns Typically
- Low Power Dissipation: 0.14 mW/Bit Typically
- Simple Memory Expansion – Two Chip Select Inputs
- Open Collector (3605) and Three-State (3625) Outputs
- Polycrystalline Silicon Fuse For Higher Reliability
- 18-pin Dual In-Line Package

Type	Access Time Max.	Power Dissipation Max. Operating/Standby	Supplies [V]
3605	70ns	735mW	+5
3605-2	60ns	735mW	+5

The Intel® 3605 and 3625 families are high density, 4096-bit bipolar PROMs organized as 1024 words by 4 bits. The 1024 by 4 organization gives ideal word or bit modularity for memory array expansion. The 3605 has open collector outputs and the 3625 has three-State Outputs. The 3605 and 3625 are fully specified over the 0°C to 75°C temperature range with ±5% power supply variation. Maximum access times of 60 ns (3605-2/3625-2) and 70 ns (3605/3625) are available. The typical power dissipation is 0.14 mW/bit.

The 3605/3625 are packaged in an 18-pin dual in-line package with 300 milli-inch centers. Thus, twice the bit density can be achieved with the 3605/3625 in the same memory board area as 512 by 8-bit PROMs in 24-pin packages.

The highly reliable polycrystalline silicon fuse technology is used in the manufacturing of the 3605 and 3625 families. All outputs are initially logical high and logic low levels can be electrically programmed in selected bit locations [3].

Part Numbers

No Examples Known

References

- [1] Intel (1975). Intel Data Catalog. No Reference to 3605/3625 Family.
- [2] Intel (1976). Intel Data Catalog, 3605/3625 Preliminary Data Sheet, p. 3-52
- [3] Intel (1977). Intel Data Catalog, 3605/3625 Family Data Sheet, p. 3-48.

Intel i3605A

4096-bit (1024 x 4) PROM

1978-79

Specifications

- 4096-bit (1024 x 4) PROM
- Bipolar (3xxx)
- $\pm 10\%$ Power Supply Tolerance
- Fast Access Time: 40 ns Typically
- Lower Power Dissipation: 0.14 mW/Bit Typically
- Simple Memory Expansion – Two Chip Select Inputs
- Open Collector (3605A) and Three-State (3625A) Outputs
- Polycrystalline Silicon Fuse For Higher Reliability
- 18-pin Dual In-Line Package

Type	Access Time Max.	Power Dissipation Max. Operating/Standby	Supplies [V]
3605A	60ns	-	+5
3605A-1	50ns	-	+5

The Intel® 3605A and 3625A families are high density, 4096-bit bipolar PROMs organized as 1024 words by 4 bits. The 1024 by 4 organization gives ideal word or bit modularity for memory array expansion. The 3605A has open collector outputs and the 3625A has three-state outputs. The 3605A and 3625A are fully specified over the 0°C to 75°C temperature range with $\pm 10\%$ power supply variation. Maximum access times of 50 ns (3605A-1/3625A-1) and 60 ns (3605A/3625A) are available at a typical power dissipation of 0.14 mW/bit.

The 3605A/3625A are packaged in an 18-pin dual in-line hermetic package with 300 milli-inch centers. Thus, twice the bit density can be achieved with the 3605A/3625A in the same memory board areas as 512 by 8-bit PROMs in 24-pin packages.

The highly reliable polycrystalline silicon fuse technology is used in the manufacturing of the 3605A and 3625A families. All outputs are initially a logical high and logic low levels can be electronically programmed in selected bit locations [3].

Intel i3605A

Part Numbers

Type D Packages

Part Number	Package Description	Values
D3605A	Type D package	Rare \$15-\$60
D3605A-1	Type D package	Ex. Rare (0 Known) \$\$\$

References

- [1] Intel (1978). Intel Component Data Catalog, 3605/3625 Data Sheet, p. 4-63. No reference to 3605A.
- [2] Intel (1978). The Semiconductor Memory Book, 3605 Family Data Sheet. No reference to 3605A dates chip after 1978.
- [3] Intel (1979). Intel Component Data Catalog, 3605A, 3625A Data Sheet, p. 4-39
- [4] Intel (1980). Intel Component Data Catalog. 3605A discontinued.
- [5] Netcomponents (2002). Netcomponents. Available from: <http://www.netcomponents.com> [Accessed 10 July 2002] – One hit on D3605A but lots of hits on D3625A and D3625A-1.

Intel i3608

8192-bit (1024 x 8) PROM

1976

Specifications

- 8192-bit (1024 x 8) PROM
- Bipolar (3xxx)
- Fast Access Times: 65 ns Typically
- Low Power Dissipation: 0.09mW/Bit
- Four Chip Select Inputs for Easy Memory Expansion
- Open Collector (3608) and Three-State (3628) Outputs
- Polycrystalline Silicon Fuses for Higher Fuse Reliability
- 24-pin Dual In-Line Package

Type	Access Time Max.	Power Dissipation Max. Operating/Standby	Supplies [V]
3608	80ns	998mW	+5
3608-4	100ns	998mW	+5

The Intel® 3608/3628 are fully decoded 8192-bit PROMs organized as 1024 words by 8 bits. The worst-case access times of 80 ns is specified over the 0°C to 75°C temperature range and 5% power supply tolerances. There are four chip selects provided to facilitate expanding 3608/3628s into larger PROM arrays. The PROMs use Schottky clamped TTL technology with polycrystalline silicon fuses. All outputs are initially high and logic low levels can be electrically programmed in selected bit locations.

Prior to the 8192-bit 3608/2628, the highest density bipolar PROM available was 4096 bits. The high density of the 3608/3628 now easily doubles the capacity without an increase in area on existing designs currently using 512 words by 8-bit PROMs. There is little, if any, penalty in power since the 3608/3628 power/bit is approximately one-half that of 4K PROMs. The 3608/3628 are packaged in a hermetic 24-pin dual in-line package [2].

Part Numbers

No Examples Known

References

- [1] Intel (1975). Intel Memory Design Handbook. No reference to 3608 dates chip after 1975.
- [2] Intel (1977). Intel Data Catalog, Preliminary 3608/3628 Family Data Sheet, p. 3-51.
- [3] Intel (1984). A Revolution in Progress... A History of Intel to Date, 3608/28 introduced 1976, p. 26.

Intel i3621

1024-bit (256 x 4) PROM

1975

Specifications

- 1024-bit (256 x 4) PROM
- Bipolar (3xxx)
- Low Power Dissipation: 0.5 mW/Bit Typical
- Open Collector (3601) and Three-State Outputs (3621)
- Fast Programming: 1 ms/Bit Typically
- Polycrystalline Silicon Fuse
- Three-State Output
- 16-pin Dual In-Line Package

Type	Access Time Max.	Power Dissipation Max. Operating/Standby	Supplies [V]
3621	70ns	685mW	+5
3621-1	50ns	685mW	+5
M3621	90ns	715mW	+5

The Intel® 3601/3621 is a 1024-bit PROM ideally suited for uses where fast turn-around and pattern experimentation are important, such as in prototypes or in small production volume systems. The 3601 is manufactured with all outputs low, and logic high output levels can be electrically programmed in selected bit locations. The 3621 has its outputs initially high and logic low output levels are programmed. The same address inputs are used for both programming and reading.

A higher system performance is achieved by using the 3601-1 or 3621-1. These PROMs give a 25% system speed improvement over the 3601 or 3621.

The 3601/3621 is manufactured with the highly reliable polycrystalline silicon fuse and the fast switching Schottky barrier diode technology [4].

Part Numbers

Type D Packages

Part Number	Package Description	Values
D3621	Type D package	\$1.50-\$6
D3621-1	Type D package	\$2-\$8
MD3621-1	Type D package	Rare \$15-\$60

References

- [1] Intel (1975). Intel Data Catalog, 3601/3601-1 Data Sheet, p. 3-27. No reference to 3621.
- [2] Intel (1975). Intel Memory Design Handbook, 3621/3621-1, p. PSG-2.
- [3] Intel (1976). Intel Data Catalog, 3601, 3621 Data Sheet, p. 3-37
- [4] Intel (1977). Intel Data Catalog, 3601/3621 Family Data Sheet, p. 3-34.

Intel i3622

2048-bit (512 x 4) PROM

1974-75

Specifications

- 2048-bit (512 x 4) PROM
- Bipolar (3xxx)
- Low Power Dissipation
 - 0.3mW/Bit
- Open Collector (3602A, 3602) or Three-State (3622A, 3622) Outputs
- Simple Memory Expansion – Chip Select Input Lead
- Replaces Two 256 x 4 PROMs Without Increasing Board Area
- Polycrystalline Silicon Fuse For Higher Reliability
- PROM Equivalents of Intel 3302/3322 ROMs
- 16-pin Dual In-Line Package

Type	Access Time Max.	Power Dissipation Max. Operating/Standby	Supplies [V]
3622	70ns	650mW	+5
3622-4	90ns	650mW	+5
3622-6	90ns	650mW/240mW	+5
M3622	90ns	770mW	+5
M3622-6	120ns	605mW/250mW	+5

The Intel® 3602A/3622A and 3602/3622 device families are 2048-bit bipolar PROMs organized as 512 words by 4 bits. The fast second-generation 3602A/3622A joins its Intel predecessor, the 3602/3622, featuring 70 ns. A higher speed version, the 3602A-2/3622A-2, is now available at 60 ns. All 3602A/3622A specifications, except programming, are the same as the 3602/3622. Once programmed, the 3602A/3622A are interchangeable with the 3602/3622.

The PROMs are manufactured with all outputs initially logically high. Logic low levels can be electrically programmed in selected bit locations. Both open collector and three-state outputs are available. The power dissipation is typically 0.2mW/bit

The bit density of existing 256 x 4 PROM systems can easily be doubled without an increase in area with the 3602A/3622A. These PROMs like the 256 x 4 PROMs are in 16-pin dual in-line package.

A pin compatible, mask programmable 3302/3322 ROM is available for large volume production systems initially using the 3602/3622 [3].

Part Numbers

Type D Packages

Part Number	Package Description	Values
D3622	Type D package	\$3-\$12
D3622-4	Type D package	Rare \$15-\$60
D3622-6	Type D package	Rare \$15-\$60

References

- [1] Intel (September 1972). Intel Data Catalog. No reference to 3622 dates chip after September 1972.
- [2] Intel (1975). Intel Data Catalog, 3622 Family Data Sheet, p. 3-32.
- [3] Intel (1977). Intel Data Catalog, 3602A/3622A and 3602/3622 Family Data Sheet, p. 3-40.
- [4] Intel (1978). Intel Component Data Catalog, 3602A/3622A Family Data Sheet, p. 4-55.

Intel i3622L

2048-bit (512 x 4) PROM

1975-76

Specifications

- 2048-bit (512 x 4) PROM
- Bipolar (3xxx)
- Fast Access Time – 70ns (3602, 3622)
- Low Standby Power Dissipation (3602L-6, 3622L-6) – 115 μ W/Bit
- Open Collector (3602, 3602-4, 3602L-6) Outputs
Three-State Output (3622, 3622-4, 3622L-6) Outputs
- 16-pin Dual In-Line Package

Type	Access Time Max.	Power Dissipation Max. Operating/Standby	Supplies [V]
3622L-6	90ns	580mW/240mW	+5

The 3602 and 3622 families are 512 words by 4-bit PROMs. The PROMs are manufactured with all outputs high and logic low levels can be electrically programmed in selected bit locations [2].

The 3602L-6 and 3622L-6 have the additional capability of reducing power whenever the chip is deselected; i.e., Chip Select (CS) high. The standby power is 236mW, compared to 685mW for the 3602 and 3622 [3].

Part Numbers

No Examples Known

References

- [1] Intel (September 1972). Intel Data Catalog. No reference to 3602 family.
- [2] Hearst (1977). IC Master, Intel 3602, 3602-4, 3602L-6 Data Sheet, p. 697
- [3] Intel (1975). Intel Memory Design Handbook, 3602L-6/3622L-6 Specifications, p. 8-8.

Intel i3622A

2048-bit (512 x 4) PROM

1976-77

Specifications

- 2048-bit (512 x 4) PROM
- Bipolar (3xxx)
- Low Power Dissipation
 - 0.3mW/Bit
- Open Collector (3602A, 3602) or Three-State (3622A, 3622) Outputs
- Simple Memory Expansion – Chip Select Input Lead
- Replaces Two 256 x 4 PROMs Without Increasing Board Area
- Polycrystalline Silicon Fuse For Higher Reliability
- PROM Equivalents of Intel 3302/3322 ROM
- 16-pin Dual In-Line Package

Type	Access Time Max.	Power Dissipation Max. Operating/Standby	Supplies [V]
3622A	70ns	735mW	+5
3622A-2	60ns	735mW	+5

The Intel® 3602A/3622A and 3602/3622 device families are 2048-bit bipolar PROMs organized as 512 words by 4 bits. The fast second-generation 3602A/3622A joins its Intel predecessor, the 3602/3622, featuring 70 ns. A higher speed version, the 3602A-2/3622A-2, is now available at 60 ns. All 3602A/3622A specifications, except programming, are the same as the 3602/3622. Once programmed, the 3602A/3622A are interchangeable with the 3602/3622.

The PROMs are manufactured with all outputs initially logically high. Logic low levels can be electrically programmed in selected bit locations. Both open collector and three-state outputs are available. The power dissipation is typically 0.2mW/bit

The bit density of existing 256 x 4 PROM systems can easily be doubled without an increase in area with the 3602A/3622A. These PROMs like the 256 x 4 PROMs are in 16-pin dual in-line package.

A pin compatible, mask programmable 3302/3322 ROM is available for large volume production systems initially using the 3602/3622 [3].

Part Numbers

Type D Packages

Part Number	Package Description	Values
D3622A	Type D package	\$.75-\$3
D3622A-2	Type D package	\$5-\$20

References

- [1] Intel (1975). Intel Memory Design Handbook, 3622 Family Specifications, p. PSG-2. No reference to 3622A Family dates chip after 1975.
- [2] Intel (1976). Intel Data Catalog, 3622/3622L Data Sheet, p. 3-43. No reference to 3622A.
- [3] Intel (1977). Intel Data Catalog, 3602A/3622A and 3602/3622 Family Data Sheet, p. 3-40.
- [4] Intel (1978). Intel Component Data Catalog, 3602A/3622A Family Data Sheet, p. 4-55.

Intel i3624

4096-bit (512 x 8) PROM

1974

Specifications

- 4096-bit (512 x 8) PROM
- Bipolar (3xxx)
- Fast Access Time: 60 ns Max. (3604A-2, 3624A-2)
- Low Standby Power Dissipation (3604AL) – 32 μ W/Bit Max.
- Open Collector (3604A, 3604) Outputs or Three-State (3624A, 3624) Outputs
- Four Chip Select Inputs For Easy Memory Expansion
- Polycrystalline Silicon Fuse For Higher Reliability
- PROM equivalents of the Intel 3304/3324 ROM
- 24-pin Dual In-Line Package

Type	Access Time Max.	Power Dissipation Max. Operating/Standby	Supplies [V]
3624	70ns	950mW	+5
3624-4	90ns	950mW	+5
M3624	90ns	1045mW	+5

The Intel® 3604A/3624A and 3604/3624 device families are 4096-bit bipolar PROMs organized as 512 words by 8 bits. The fast second-generation 3604A/3624A joins its Intel predecessor, the 3604/3624, featuring 70 ns. Higher speed PROMs, the 3604A-2/3624A-2, are now available at 60 ns. The 3604A/3624A families are lower in power dissipation than the 3604/3624 families. All 3604A/3624A specifications, except programming, are the same as or better than the 3604/3624. Once programmed, the 3604A/3624A are interchangeable with the 3604/3624.

The PROMs are manufactured will all outputs initially logically high. Logic low levels can be electrically programmed in selected bit locations. Both open collector and three-state outputs are available. Low standby power dissipation can be achieved with either the 3604AL or 3604L-6. The standby power dissipation is approximately 15% of the active power dissipation.

The 3604A/3624A and 3604/3624 families are available in a hermetic 24-pin dual in-line package. These PROMs are manufactured with the time-proven polycrystalline silicon fuse technology. A pin compatible, mask programmable ROM is available for large volume production of systems initially using the 3604/3624 [2].

Part Numbers

Type D Packages

Part Number	Package Description	Values
D3624	Type D package	\$1.50-\$6
D3624-4	Type D package	\$1.50-\$6
MD3624/B	Type D package	Rare \$10-\$40

References

- [1] Intel (1975). Intel Data Catalog, 3624, 3624-4 “New Product” Data Sheet, p. 3-40
- [2] Intel (1977). Intel Data Catalog, 3604A, 3604AL, 3604, 3604L, 3624A, 3624 Family Data Sheet, p. 3-43.
- [3] Intel (1984). A Revolution in Progress... A History of Intel to Date, 3604/24 introduced 1974, p. 26.

Intel i3624A

4096-bit (512 x 8) PROM

1976-77

Specifications

- 4096-bit (512 x 8) PROM
- Bipolar (3xxx)
- Fast Access Time: 60 ns Max. (3604A-2, 3624A-2)
- Low Standby Power Dissipation (3604AL) – 32 μ W/Bit Max.
- Open Collector (3604A, 3604) Outputs or Three-State (3624A, 3624) Outputs
- Four Chip Select Inputs For Easy Memory Expansion
- Polycrystalline Silicon Fuse For Higher Reliability
- PROM equivalents of the Intel 3304/3324 ROMs
- 24-pin Dual In-Line Package

Type	Access Time Max.	Power Dissipation Max. Operating/Standby	Supplies [V]
3624A	70ns	998mW	+5
3624A-2	60ns	998mW	+5
M3624A	90ns	1045mW	+5

The Intel® 3604A/3624A and 3604/3624 device families are 4096-bit bipolar PROMs organized as 512 words by 8 bits. The fast second-generation 3604A/3624A joins its Intel predecessor, the 3604/3624, featuring 70 ns. Higher speed PROMs, the 3604A-2/3624A-2, are now available at 60 ns. The 3604A/3624A families are lower in power dissipation than the 3604/3624 families. All 3604A/3624A specifications, except programming, are the same as or better than the 3604/3624. Once programmed, the 3604A/3624A are interchangeable with the 3604/3624.

The PROMs are manufactured will all outputs initially logically high. Logic low levels can be electrically programmed in selected bit locations. Both open collector and three-state outputs are available. Low standby power dissipation can be achieved with either the 3604AL or 3604L-6. The standby power dissipation is approximately 15% of the active power dissipation.

The 3604A/3624A and 3604/3624 families are available in a hermetic 24-pin dual in-line package. These PROMs are manufactured with the time-proven polycrystalline silicon fuse technology. A pin compatible, mask programmable ROM is available for large volume production of systems initially using the 3604/3624 [2].

Part Numbers

Type D Packages

Part Number	Package Description	Values
D3624A	Type D package	\$.75-\$3
D3624A-2	Type D package	\$1.25-\$5
MD3624A	Type D package	\$5-\$20
MD3624A/B	Type D package	\$2.50-\$10

References

- [1] Intel (1976). Intel Data Catalog, 3624/3624-4 Data Sheet, p. 3-46. No reference to 3624A.
- [2] Intel (1977). Intel Data Catalog, 3604A, 3604AL, 3604, 3604L, 3624A, 3624 Family Data Sheet, p. 3-43.

Intel i3625

4096-bit (1024 x 4) PROM

1976

Specifications

- 4096-bit (1024 x 4) PROM
- Bipolar (3xxx)
- Fast Access Time: 45 ns Typically
- Low Power Dissipation: 0.14 mW/Bit Typically
- Simple Memory Expansion – Two Chip Select Inputs
- Open Collector (3605) and Three-State (3625) Outputs
- Polycrystalline Silicon Fuse For Higher Reliability
- 18-pin Dual In-Line Package

Type	Access Time Max.	Power Dissipation Max. Operating/Standby	Supplies [V]
3625	70ns	735mW	+5
3625-2	60ns	735mW	+5

The Intel® 3605 and 3625 families are high density, 4096-bit bipolar PROMs organized as 1024 words by 4 bits. The 1024 by 4 organization gives ideal word or bit modularity for memory array expansion. The 3605 has open collector outputs and the 3625 has three-State Outputs. The 3605 and 3625 are fully specified over the 0°C to °75C temperature range with ±5% power supply variation. Maximum access times of 60 ns (3605-2/3625-2) and 70 ns (3605/3625) are available. The typical power dissipation is 0.14 mW/bit.

The 3605/3625 are packaged in an 18-pin dual in-line package with 300 milli-inch centers. Thus, twice the bit density can be achieved with the 3605/3625 in the same memory board area as 512 by 8-bit PROMs in 24-pin packages.

The highly reliable polycrystalline silicon fuse technology is used in the manufacturing of the 3605 and 3625 families. All outputs are initially logical high and logic low levels can be electrically programmed in selected bit locations [3].

Part Numbers

Type D Packages

Part Number	Package Description	Values
D3625	Type D grey ceramic package w/tin pins.	\$2.50-\$10
		
D3625-2	Type D grey ceramic package w/tin pins. Example shown made in Malaysia and dated 7731	\$3-\$12

References

- [1] Intel (1975). Intel Data Catalog. No Reference to 3605/3625 Family dates chips after 1975.
- [2] Intel (1976). Intel Data Catalog, 3605/3625 Preliminary Data Sheet, p. 3-52
- [3] Intel (1977). Intel Data Catalog, 3605/3625 Family Data Sheet, p. 3-48. No reference to 3605A/3625A Family.

Intel i3625A

4096-bit (1024 x 4) PROM

1979

Specifications

- 4096-bit (1024 x 4) PROM
- Bipolar (3xxx)
- $\pm 10\%$ Power Supply Tolerance
- Fast Access Time: 40 ns Typically
- Lower Power Dissipation: 0.14 mW/Bit Typically
- Simple Memory Expansion – Two Chip Select Inputs
- Open Collector (3605A) and Three-State (3625A) Outputs
- Polycrystalline Silicon Fuse For Higher Reliability
- 18-pin Dual In-Line Package

Type	Access Time Max.	Power Dissipation Max. Operating/Standby	Supplies [V]
3625A	60ns	-	+5
3625A-1	50ns	-	+5

The Intel® 3605A and 3625A families are high density, 4096-bit bipolar PROMs organized as 1024 words by 4 bits. The 1024 by 4 organization gives ideal word or bit modularity for memory array expansion. The 3605A has open collector outputs and the 3625A has three-state outputs. The 3605A and 3625A are fully specified over the 0°C to 75°C temperature range with $\pm 10\%$ power supply variation. Maximum access times of 50 ns (3605A-1/3625A-1) and 60 ns (3605A/3625A) are available at a typical power dissipation of 0.14 mW/bit.

The 3605A/3625A are packaged in an 18-pin dual in-line hermetic package with 300 milli-inch centers. Thus, twice the bit density can be achieved with the 3605A/3625A in the same memory board areas as 512 by 8-bit PROMs in 24-pin packages.

The highly reliable polycrystalline silicon fuse technology is used in the manufacturing of the 3605A and 3625A families. All outputs are initially a logical high and logic low levels can be electronically programmed in selected bit locations [3].

Intel i3625A

Part Numbers

Type D Packages

Part Number	Package Description	Values
 A black rectangular ceramic chip with 16 pins. The text on the chip reads: D3625A 0050, 8105, and 162205-00.		
D3625A	Type D grey ceramic package w/tin pins.	\$1.50-\$6
 A black rectangular ceramic chip with 16 pins. The text on the chip reads: D3625A-1 and 890B4.		
D3625A-1	Type D grey ceramic package w/tin pins. Example shown made in the Philippines and dated 7922.	\$.75-\$3

References

- [1] Hearst (1977). IC Master, 3625 Family Data Sheet, p. 699. No reference to 3625A family dates 3635A after 1977.
- [2] Intel (1978). Intel Component Data Catalog, 3605/3625 Data Sheet, p. 4-63. No reference to 3625A.
- [3] Intel (1979). Intel Component Data Catalog, 3605A, 3625A Data Sheet, p. 4-39
- [4] Intel (1980). Intel Component Data Catalog, 3605A/3625A discontinued.
- [5] Netcomponents (2002). Netcomponents. Available from: www.netcomponents.com [Accessed 10 July 2002] – Multiple hits on D3625A and D3625A-1.

Intel i3628

8192-bit (1024 x 8) PROM

1976

Specifications

- 8192-bit (1024 x 8) PROM
- Bipolar (3xxx)
- Fast Access Time: 65ns Typically
- Low Power Dissipation: 0.09mW/Bit Typically
- Four Chip Select Inputs for Easy Memory Expansion
- Three-State Outputs
- Polycrystalline Silicon Fuses for Higher Fuse Reliability/Higher Programmability
- 24-pin Dual In-Line Package

Type	Access Time Max.	Power Dissipation Max. Operating/Standby	Supplies [V]
3628	80ns	998mW	+5
3628-4	100ns	998mW	+5

The Intel® 3628 is a fully decoded 8192-bit PROM organized as 1024 words by 8-bits. The worst-case access time of 80ns is specified over the 0°C to 75°C temperature range and 5% power supply tolerances. There are four chip selects provided to facilitate expansion into larger PROM arrays. It uses Schottky clamped TTL technology with polycrystalline silicon fuses. All outputs are initially high and logic low levels can be electrically programmed in selected bit locations.

Prior to the 8192-bit 3628, the highest density bipolar PROM available was 4096-bits. The high density of the 3628 now easily doubles the capacity without an increase in area on existing designs currently using 512 words by 8 bit PROMs. There is also little, if any, penalty in power, since the 3628 power/bit is approximately one-half that of 4K PROMs. The 3628 is packaged in a hermetic 24-pin dual in-line package [2].

Part Numbers

Type C Packages

Part Number	Package Description	Values
		
C3628	Type C grey ceramic package w/black cap and tin pins. © Intel '77.	\$15-\$60
C3628-4	Type C package	\$15-\$60

Type D Packages

Part Number	Package Description	Values
D3628	Type D package	\$1.25-\$5
D3628-4	Type D package	\$2-\$8

References

- [1] Intel (1977). Intel Data Catalog, 3608/3628 Preliminary Data Sheet, p. 3-51
- [2] Intel (1980). Intel Component Data Catalog, 3628 Data Sheet, p. 2-30.
- [3] Intel (1984). A Revolution in Progress... A History of Intel to Date, 3608/28 introduced 1976, p. 26.

Intel i3628A

8192-bit (1024 x 8) PROM

1980

Specifications

- 8192-bit (1024 x 8) PROM
- Bipolar (3xxx)
- Fast Access Time: 40ns Typically
- Low Power Dissipation: 0.08mW/Bit Typically
- Four Chip Select Inputs for Easy Memory Expansion
- Three-State Outputs
- Polycrystalline Silicon Fuses for Higher Fuse Reliability/Higher Programmability
- $\pm 10\%$ Power Supply Tolerance
- 24-pin Dual In-Line Package

Type	Access Time Max.	Power Dissipation Max. Operating/Standby	Supplies [V]
3628A-1	50ns	-	+5
3628A-3	70ns	-	+5
3628A-4	90ns	-	+5

The Intel® 3628A is a fully decoded 8192-bit PROM organized as 1024 words by 8-bits. The worst-case access time of 50ns is specified over the 0°C to 75°C temperature range and 10% power supply tolerances. There are four chip selects provided to facilitate expansion into larger PROM arrays. It uses Schottky clamped TTL technology with polycrystalline silicon fuses. All outputs are initially high and logic low levels can be electrically programmed in selected bit locations.

Prior to the 8192-bit 3628A, the highest density bipolar PROM available was 4096-bits. The high density of the 3628A now easily doubles the capacity without an increase in area on existing designs currently using 512 words by 8 bit PROMs. There is also little, if any, penalty in power, since the 3628A power/bit is approximately one-half that of 4K PROMs. The 3628A is packaged in a hermetic 24-pin dual in-line package [1].

The 3628A supercedes the 3628 high-density PROM. This 8192-bit PROM uses the most advanced technology available. As a result the 3628A combines higher performance and lower power in a small die than the 3628. The 3628A is packaged in a hermetic 24-pin dual in-line package with the exact pin configuration as the 3628 [2].

Intel i3628A

Part Numbers

Type D Packages

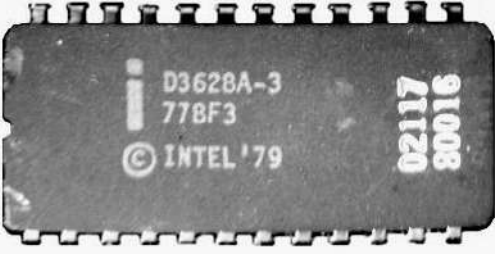
Part Number	Package Description	Values
D3628A-1	Type D package	\$1.25-\$5
 A photograph of a grey ceramic integrated circuit package. The package is rectangular with a notch on the left side and has two rows of pins along the top and bottom edges. The top surface is marked with the following text: 'D3628A-3' and '778F3' on the left; '© INTEL '79' in the center; and '02117' and '80016' on the right.		
D3628A-3	Type D grey ceramic package w/tin pins. © Intel '79	\$1.25-\$5
D3628A-4	Type D package	\$1.25-\$5

References

[1] Intel (1980). Intel Component Data Catalog, 3628A Preliminary Data Sheet, p. 2-33

[2] Intel (October 1981). Intel Memory Solutions Data Catalog, 3628A Data Sheet, p. 2-5

Intel i3628B

8192-bit (1024 x 8) PROM

1981

Specifications

- 8192-bit (1024 x 8) PROM
- Bipolar (3xxx)
- Fast Access Time: 35 ns for 3628B-1
- Low Power Dissipation: 0.08 mW/Bit Typically
- Four Chip Select Inputs for Easy Memory Expansion
- $\pm 10\%$ Power Supply Tolerance
- Three State Outputs
- Polycrystalline Silicon Fuses for Higher Fuse Reliability/Higher Programmability
- 24-pin Dual In-Line Package

Type	Access Time Max.	Power Dissipation Max. Operating/Standby	Supplies [V]
3628B	45ns	-	+5
3628B-1	35ns	-	+5

The Intel® 3628B is a fully decoded 8192-bit PROM organized as 1024 words by 8 bits. The worst case access time of 50 ns is specified over 0°C to 75°C temperature range and 10% power supply tolerances. There are four chip selects provided to facilitate expansion into larger PROM arrays. The PROMs use the Schottky clamped TTL technology with polycrystalline silicon fuses. All outputs are initially high, and logic low levels can be electrically programmed in selected bit locations.

The 3628B is a super-fast, high density PROM. This 8192-bit PROM uses the most advanced technology available. As a result the 3628B combines higher performance and lower power in a smaller die than the 3628. The 3828B is packaged in a hermetic 24-pin dual in-line package with the exact pin configuration as the 3628 [2].

Part Numbers

No Examples Known

References

- [1] Intel (1980). Intel Component Data Catalog. No reference to 3628B dates chip after 1980.
- [2] Intel (October 1981). Intel Memory Solutions Data Catalog, 3628B Data Sheet, p. 2-6.
- [3] Intel (January 1982). Intel Component Data Catalog. No reference to 3628B.

Intel i3636

16384-bit (2048 x 8) PROM

1979

Specifications

- 16384-bit (2048 x 8) PROM
- Bipolar (3xxx)
- Fast Access Time: 50ns Typically
- Low Power Dissipation: 0.05mW/Bit Typically
- Three Chip Select Inputs for Easy Memory Expansion
- $\pm 10\%$ Power Supply Tolerance
- Three-State Output
- Polycrystalline Silicon Fuses for Higher Fuse Reliability/Higher Programmability
- 24-pin Dual In-Line Package

Type	Access Time Max.	Power Dissipation Max. Operating/Standby	Supplies [V]
3636	80ns	-	+5
3636-1	65ns	-	+5
M3636	80ns	-	+5

The Intel® 3636 is a fully decoded 16,384-bit PROM organized as 2048 words by 8-bits. The worst-case access time of 65ns is specified over the 0°C to 75°C temperature range and 10% power supply tolerances. There are three chip selects provided to facilitate expansion into larger PROM arrays. It uses Schottky clamped TTL technology with polycrystalline silicon fuses. All outputs are initially high and logic low levels can be electrically programmed in selected bit locations.

Prior to the 16,384-bit 3636, the highest density bipolar PROM available was 8192-bits. The high density of the 3636 now easily doubles the capacity without an increase in area on existing designs currently using 1024 by 8 bit PROMs. There is also little, if any, penalty in power, since the 3636 power/bit is approximately one-half that of 8K PROMs. The 3636 is packaged in a hermetic 24-pin dual in-line package [2].

Part Numbers

Type D Packages

Part Number	Package Description	Values
D3636	Type D package	\$1-\$4
D3636-1	Type D package	\$1.25-\$5
MD3636/B	Type D package	\$1.50-\$6

References

- [1] Intel (1979). Intel Component Data Catalog, 3636 Preliminary Data Sheet, p. 4-45
- [2] Intel (1980). Intel Component Data Catalog, 3636 Data Sheet, p. 2-36
- [3] Intel (1984). A Revolution in Progress... A History of Intel to Date, 3616/36 introduced 1979, p. 26.

Intel i3636B

16384-bit (2048 x 8) PROM

1981

Specifications

- 16384-bit (2048 x 8) PROM
- Bipolar (3xxx)
- Fast Access Time: 25 ns Typically
- Low Power Dissipation: 0.05 mw/Bit Typically
- Three Chip Select Inputs for Easy Memory Expansion
- $\pm 10\%$ Power Supply Tolerance
- Three-State Output
- Polycrystalline Silicon Fuses for Higher Fuse Reliability/Higher Programmability
- 24-pin Dual In-Line Package

Type	Access Time Max.	Power Dissipation Max. Operating/Standby	Supplies [V]
3636B	55ns	-	+5
3636B-1	35ns	-	+5
3636B-2	45ns	-	+5

The Intel® 3636B is a very fast, fully decoded 16,384-bit PROM organized as 2048 words by 8 bits. The worst-case access time of 35 ns over a temperature range of 0°C to 75°C with 10% power supply tolerances. There are three chip selects provided to facilitate expansion into larger PROM arrays. The PROMs use the Schottky clamped TTL technology with polycrystalline silicon fuses. All outputs are initially high, and logic low levels can be electrically programmed in selected bit locations.

The 3636B is designed for use in performance-based systems. This 16,384-bit PROM uses the most advanced technology available. As a result the 3636B combines higher performance and equivalent power in a smaller die than previous 16K Bipolar PROM designs. The 3636B is packaged in a hermetic 24-pin dual in-line package with the same pin configuration as the 3636 [2].

Intel i3636B

Part Numbers

Type D Packages

Part Number	Package Description	Values
D3636B	Type D package	\$2.50-\$10
D3636B-1	Type D grey ceramic package w/tin pins. © Intel '80	\$.50-\$2
D3636B-2	Type D package	\$1.25-\$5
MD3636/B	Type D package	\$2-\$4

References

[1] Intel (1980). Intel Component Data Catalog, 3636 Data Sheet, p. 2-36. No reference to 3636B dates chip after 1980.

[2] Intel (1981). Intel Memory Solutions Data Catalog, Preliminary 3636B Data Sheet, p. 2-8.

Intel i4001

2048-bit (256 x 8) ROM w/4-bit I/O port

1971

Specifications

- 2048-bit (256 x 8) ROM w/4-bit I/O Port
- PMOS
- Direct Interface to MCS-40™ 4-Bit Data Bus
- I/O Port Low-Power TTL Compatible
- Standard Operating Temperature Range of 0°C to 70°C
- Also Available with -40°C to +85°C Operating Range
- 16-pin Dual In-Line Package

The 4001 performs two basic and distinct functions. As a ROM it stores 256 x 8 words of program or data tables; as a vehicle of communication with peripheral devices it is provided with 4 I/O pins and associated control logic to perform input and output operations. The 4001 is a PMOS device, compatible with all other MCS-40 devices [2].

Part Numbers

Type C Packages

Part Number	Package Description	Values
		
C4001	1. Type C white ceramic package w/grey traces, gold cap, gold cap ground strap, and gold pins. Gold dot denotes pin #1.	Ex. Rare (2 Known) \$75-\$300
		
C4001	2. Type C white ceramic package w/gold cap and gold pins. Black unidentified symbol denotes pin #1.	\$20-\$80
		
C4001	3. Type C white ceramic package w/gold cap, gold cap ground strap, and gold pins. Cap ground strap connection points on both edges of package (only one used). Black '5' at top left corner. Small black dot denotes pin #1.	Ex. Rare \$60-\$240

Intel i4001

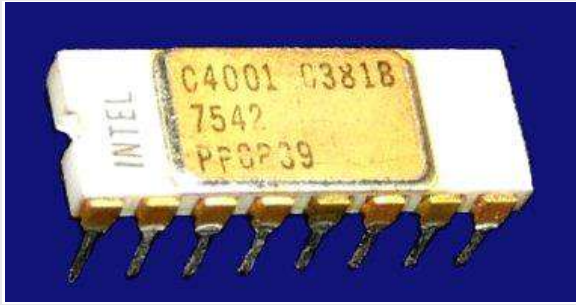

C4001	4. Type C white ceramic package w/gold cap and gold pins. Part number printed on cap. 'INTEL' printed on ceramic.	Ex. Rare \$50-\$200
-------	---	------------------------



C4001	5. Type C white ceramic package w/gold cap and gold pins. Small black dot denotes pin #1.	Ex. Rare \$50-\$200
-------	---	------------------------

Type D Packages

Part Number	Package Description	Values
D4001	Type D package	Ex. Rare (0 Known) \$\$\$

Type P Packages

Part Number	Package Description	Values
<div data-bbox="240 1411 812 1707" data-label="Image"> </div>	1. Type P grey plastic package w/gold pins. Embossed Intel 'i' in key.	Ex. Rare \$30-\$120

Intel i4001



P4001	2. Type P grey plastic package w/gold pins. Embossed Intel 'i' in key. Yellow Intel logo and part number. Example shown from Busicom 141-PF	Ex. Rare (1 known) \$50-\$200
-------	---	-------------------------------------



P4001	3. Type P grey plastic package w/tin pins. Embossed Intel 'i' in key.	Ex. Rare (1 Known) \$25-\$100
-------	---	-------------------------------------

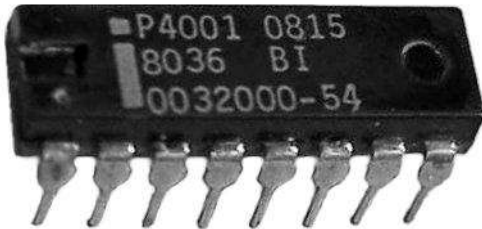

P4001	4. Type P black plastic package w/tin pins. Plain key.	\$1.25-\$5
-------	--	------------

References

- [1] Intel (September 1972). Intel Data Catalog, 4001 Data Sheet, p. 6-3
- [2] Intel (1978). Intel Component Data Catalog, 4001 Data Sheet, p. 9-12.

Intel i4002

320-bit (4 x 80) Static RAM with 4-bit Output Port

1971

Specifications

- 320-bit (4 x 80) Static RAM with 4-Bit output port
- Four Registers of 20 4-bit Characters
- Direct Interface to MCS-40™ 4-Bit Bus
- Output Port Low-Power TTL Compatible
- Standard operating temperature range of 0°C to 70°C
- Also available with -40°C to +85°C operating range
- 16-pin Dual In-line Package

The 4002 performs two distinct functions. As a RAM it stores 320 bits arranged in 4 registers of twenty 4-bit characters each (16 main memory characters and 4 status characters). As a vehicle of communication with peripheral devices, it is provided with 4 output lines and associated control logic to perform output operations. The 4002 is a PMOS device and is compatible with all MCS-40™ components.



The 4002 is available in two options, the 4002-1 and 4002-2. Along with an external pin connected to either V_{dd} or V_{ss}, a two bit chip selection address is provided allowing a maximum of 1280 bits of 4002 RAM on a single MCS-40 CM-RAM line. Thus the four CM-RAM lines give a maximum of 5120 bits of 4002 RAM in a MCS-40 system [2].

Packaging



Only Type P (plastic) versions of these chips were made by Intel, although the ceramic could be special ordered.

Part Numbers

Type C Packages

Part Number	Package Description	Values
		
C4002-1	1. Type C white ceramic package w/grey traces, gold cap, gold cap ground strap, and gold pins. Gold dot denotes pin #1.	Ex. Rare (2 Known) \$75-\$300
		
C4002-1	2. Type C white ceramic package w/gold cap and gold pins. Black unidentified symbol denotes pin #1.	Ex. Rare \$50-\$200
		
C4002-1	3. Type C white ceramic package w/gold cap and gold pins. Half round key. Black unidentified symbol denotes pin #1.	Ex. Rare \$50-\$200

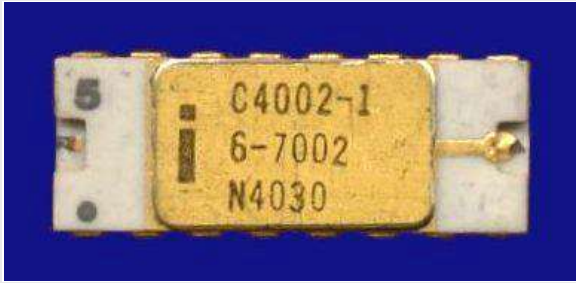
Intel i4002

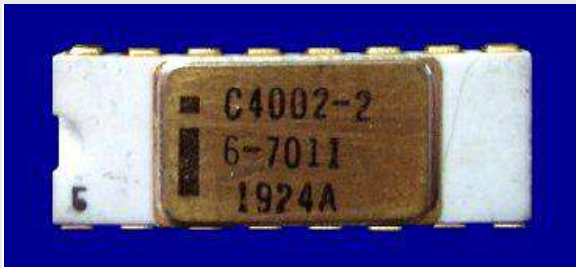
		
C4002-1	4. Type C white ceramic package w/gold cap, gold cap ground strap, and gold pins. Cap ground strap connection points on both edges of package (only one used). Black '5' at top left corner. Black dot denotes pin #1.	Ex. Rare (1 Known) \$60-\$240
		
C4002-2	1. Type C white ceramic package w/gold cap, gold cap ground strap, and gold pins. Black dot denotes pin #1.	Ex. Rare (2 Known) \$75-\$300
		
C4002-2	2. Type C white ceramic package w/gold cap and gold pins. Black unidentified symbol denotes pin #1.	Ex. Rare (4 Known) \$60-\$240
		
C4002-2	3. Type C white ceramic package w/gold cap and gold pins. Half round key. Black unidentified symbol denotes pin #1.	Rare \$30-\$120

Intel i4002





C4002-2	4. Type C white ceramic package w/gold cap, gold cap ground strap, and gold pins. Cap ground strap connection points on both edges of package (only one used). Black '5' at top left corner. Black dot denotes pin #1.	Ex. Rare (2 Known) \$60-\$240
---------	--	-------------------------------------

Type D Packages

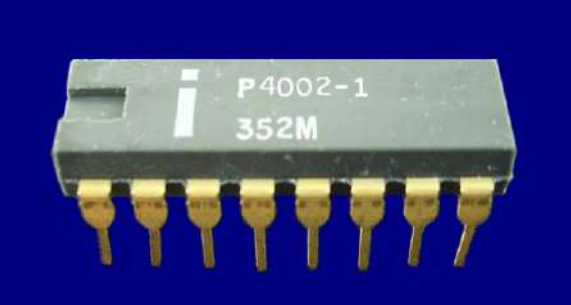

Part Number	Package Description	Values
A photograph of an Intel D4002-1 integrated circuit. It is a Type D grey ceramic package with tin pins. The package is shown from a top-down perspective. The top surface has the part number 'D4002-1' and the date code '2891A' printed on it.		
D4002-1	Type D grey ceramic package w/tin pins	Rare \$15-\$60
A photograph of an Intel D4002-2 integrated circuit. It is a Type D grey ceramic package with tin pins. The package is shown from a top-down perspective. The top surface has the part number 'D4002-2' and the date code 'X1191128' printed on it.		
D4002-2	Type D grey ceramic package w/tin pins. Example shown made in the Philippines and dated 8118.	Ex. Rare \$50-\$200

Intel i4002

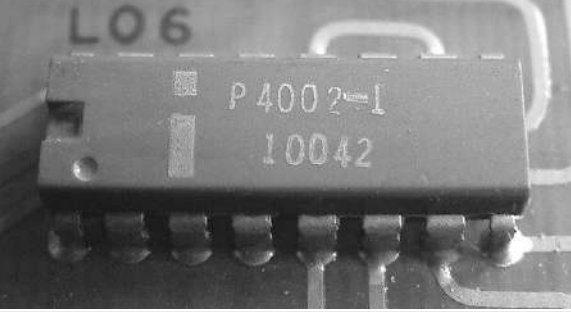
Type P Packages

Part Number	Package Description	Values
		
P4002-1	1. Type P grey plastic package w/gold pins. Plain key. Example shown has no date or country code.	Ex. Rare (2 Known) \$50-\$200
		
P4002-1	2. Type P grey plastic package w/gold pins. Embossed Intel 'i' in key.	Ex. Rare (1 Known) \$50-\$200
		
P4002-1	3. Type P grey plastic package w/tin pins. Small round indentation denotes pin #1. Small square key.	\$30-\$120

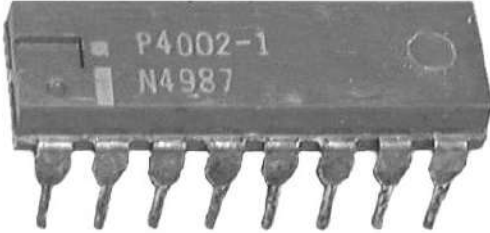
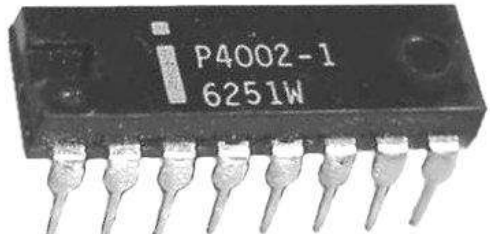
Intel i4002

		
P4002-1	4. Type P grey plastic package w/tin pins. Small round indentation denotes pin #1. Rectangular key.	\$20-\$80
		
P4002-1	5. Type P black plastic package w/tin pins. Small round indentation denotes pin #1.	\$1.25-\$5
		
P4002-2	1. Type P grey plastic package w/gold pins. Example shown has no date or country code.	Ex. Rare (1 Known) \$50-\$200
		
P4002-2	2. Type P grey plastic package w/gold pins. Early package with no denotation for pin #1. Embossed Intel 'i' in key.	Ex. Rare (3 Known) \$50-\$200

Intel i4002

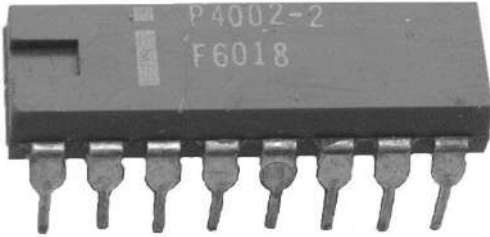
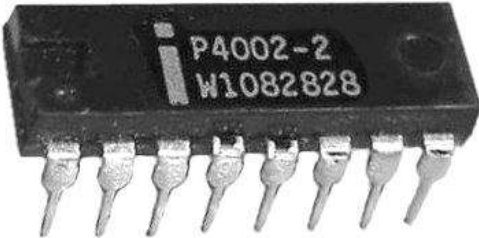
 A grey plastic integrated circuit package with eight pins. The top surface is marked with "P4002-2" and "F6018".		
P4002-2	3. Type P grey plastic package w/tin pins. Early package with no denotation for pin #1.	\$20-\$80
 A black plastic integrated circuit package with eight pins. The top surface is marked with "P4002-2" and "W1082828".		
P4002-2	4. Type P black plastic package w/tin pins. Small round indentation denotes pin #1.	\$1.25-\$5

References

- [1] Intel (September 1972). Intel Data Catalog, 4002 Data Sheet, p. 6-3
- [2] Intel (1978). Intel Component Data Catalog, 4002 Data Sheet, p. 9-11

Intel i4003

10-bit Shift Register/Output Expander

1971

Specifications

- 10-bit Shift Register/Output Expander
- Serial-Out Capability for Additional I/O Expansion
- Easy Expansion of I/O Output Capability
- Enable Output Control
- Standard Operating Temperature Range of 0°C to 70°C
- 16-pin Dual In-Line Package

The 4004 is a 10-bit serial-in, parallel out, serial out shift register with enable logic. The 4003 is used to expand the number of ROM and RAM I/O ports to communicate with peripheral devices such as keyboards, printers, displays, readers, teletypewriters, etc.

The 4003 is a single-phase static shift register; however, the clock pulse (CP) maximum width is limited to 10 msec. Data-in and CP can be simultaneous. To avoid race conditions, CP is internally delayed [2].

Part Numbers

Type C Packages

Part Number	Package Description	Values
		
C4003	1. Type C white ceramic package w/grey traces, gold cap, gold cap ground strap, and gold pins. Gold dot denotes pin #1.	Ex. Rare (3 Known) \$200-\$800
		
C4003	2. Type C white ceramic package w/gold cap and gold pins. Black dot denotes pin #1.	Ex. Rare \$75-\$300
		
C4003	3. Type C white ceramic package w/gold cap and gold pins. Half round key. Black unidentified symbol denotes pin #1.	Ex. Rare \$75-\$300

Intel i4003



C4003	4. Type C white ceramic package w/gold cap, gold cap ground strap, and gold pins. Cap ground strap connection points on both edges of package (only one used). Black '5' at top left corner. Black dot denotes pin #1.	Ex. Rare \$75-\$300
-------	--	------------------------





C4003	5. Type C white ceramic package w/gold cap, gold cap ground strap, and gold pins. Black '5' at top left corner. Black dot denotes pin #1.	Ex. Rare \$75-\$300
-------	---	------------------------

Type D Packages

Part Number	Package Description	Values
D4003	Type D package	Ex. Rare (0 Known) \$50-\$200

Intel i4003

Type P Packages

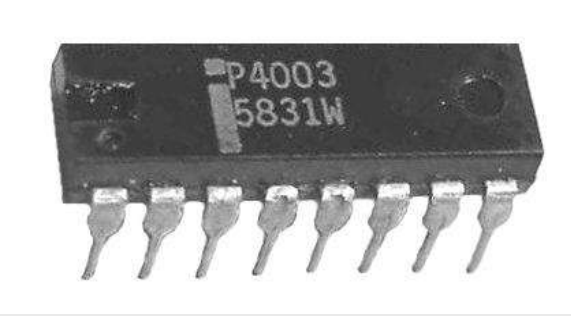
Part Number	Package Description	Values
		
P4003	1. Type P grey plastic package w/gold pins. Rectangular key. Yellow Intel logo and part number. Example shown from 1972 Sperry Display Board.	Ex. Rare (3 Known) \$50-\$200
		
P4003	2. Type P grey plastic package w/tin pins. Small round indentation denotes pin #1. Small square key.	\$20-\$80
		
P4003	3. Type P grey plastic package w/tin pins. Small round indentation denotes pin #1. Rectangular key.	\$15-\$60
		
P4003	4. Type P black plastic package w/tin pins. Rectangular key.	\$1.25-\$5

References

- [1] Intel (September 1972). Intel Data Catalog, 4003 Data Sheet, p. 6-3
- [2] Intel (1978). Intel Component Data Catalog, 4003 Data Sheet, p. 9-5

Intel i4004

4-bit Microprocessor

November 15, 1971

Specifications

- 4-bit Microprocessor
- PMOS
- 2300 Transistors (10 Micron)
- 4-Bit Parallel CPU with 46 Instructions
- Instruction Set Includes Conditional Branching, Jump to Subroutine and Indirect Fetching
- Binary and Decimal Arithmetic Modes
- 10.8 Microsecond Instruction Cycle
- CPU Directly Compatible with MCS-40 ROMs and RAMs
- Easy Expansion – One CPU can Directly Drive up to 32,768 Bits of ROM and up to 5120 Bits of RAM
- Standard Operating Temperature Range of 0°C to 70°C
- Also Available With -40°C to +85°C Operating Range
- 16-pin Dual In-Line Package

Type	Clock	Power Dissipation Max.	Supplies [V]
4004	500 to 740 KHz	450mW	+15 (or -10, +5)

The Intel® 4004 is a complete 4-bit parallel central processing unit (CPU). The 4004 easily interfaces with keyboards, switches, displays, A-D converters, printers and other peripheral equipment.

The CPU can directly address 4K 8-bit instruction words of program memory and 5120 bits of data storage RAM. Sixteen index registers are provided for temporary data storage. Up to 16 4-bit input ports and 16 4-bit output ports may also be directly addressed.

The 4004 is fabricated with P-channel silicon gate MOS technology [2].

Intel 4004 Die

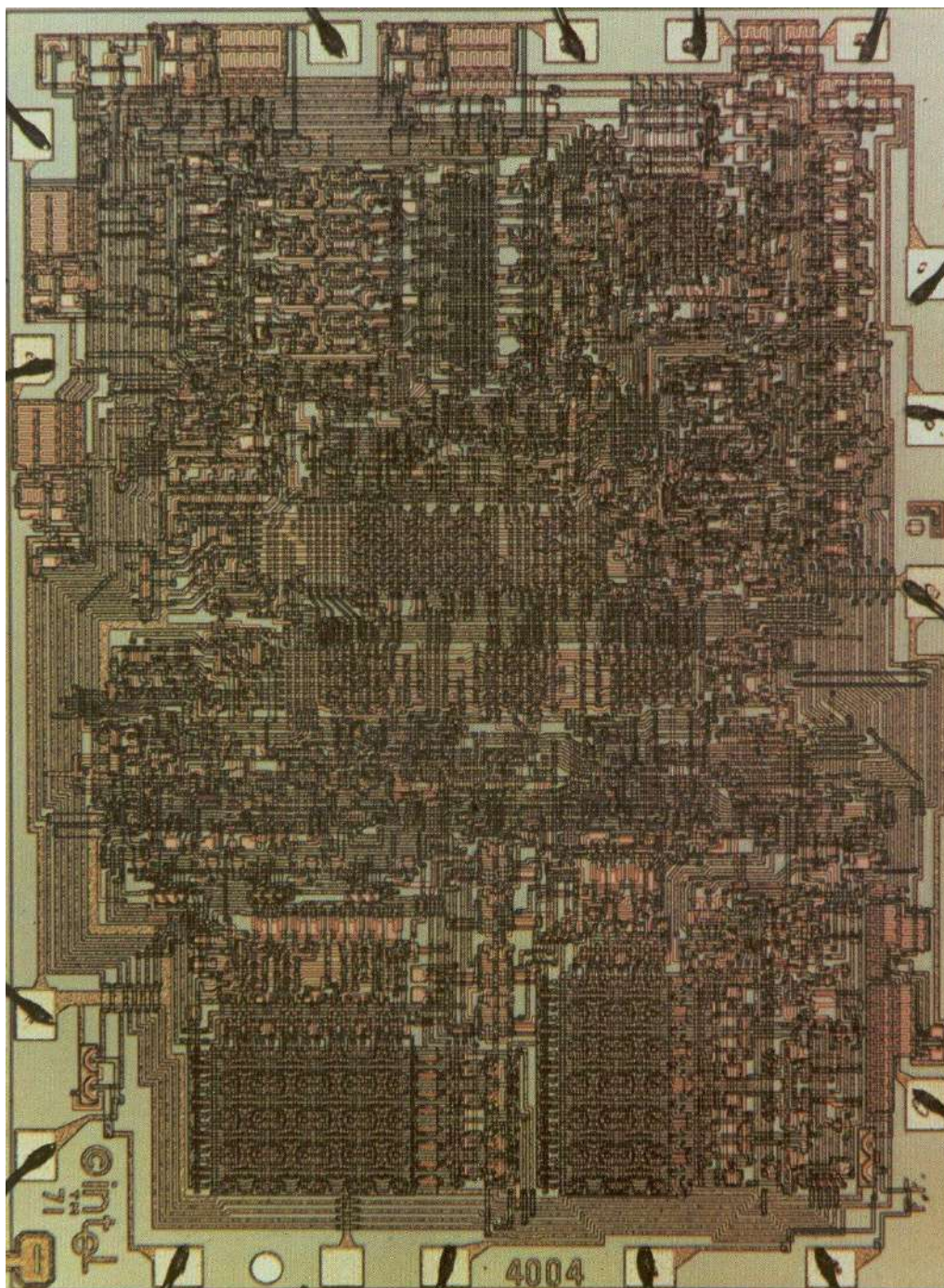

Copyright Intel Corporation

History

Introduced November 15, 1971, the Intel 4004 was the world's first microprocessor.

Designers: Ted Hoff, Federico Faggin, Stan Mazor, and Masatoshi Shima

The Intel i4004 was used in the Intel SIM4-01, SIM4-02 single board computers and the Intel Intellec-4 microcomputer.

The Intel Intellec-8 and its companion, the Intellec-4, which employed the Intel 4004 CPU, were the first American microcomputers ever to be sold and Pre-date the Altair 8800 by almost two years.



Intel Intellec-4

C4004 w/Grey Traces

The Intel C4004 with grey traces is one of the crown jewels of chip collecting. These chips are highly sought after and examples in like new condition are very hard to find at any price.



P4004 in Grey Plastic Package

A grey P4004 with tin pins and a grey P4004 with gold pins are rumored to exist but I have not been able to verify this. There is a grey P4001 with gold pins and a grey P4009 with gold pins has recently surfaced.



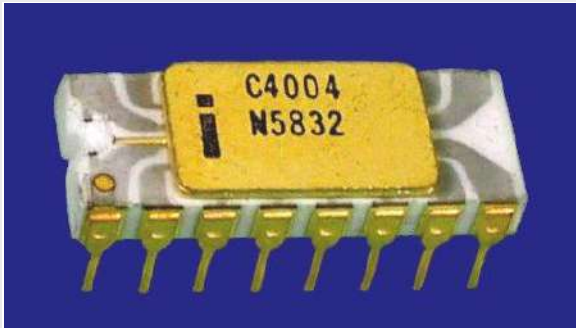

Intel's first data catalog, dated September 1972, shows the 4004 available in type 'C' package only. The same catalog shows the 4001, 4002, and 4003 available in type 'P' package only (Type 'C' could be special ordered). If the 4004 was not initially available in a type 'P' package then when did Intel start making the P4004?

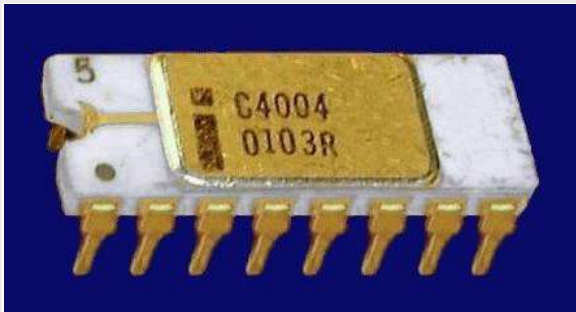
Part Numbers

Type C Packages

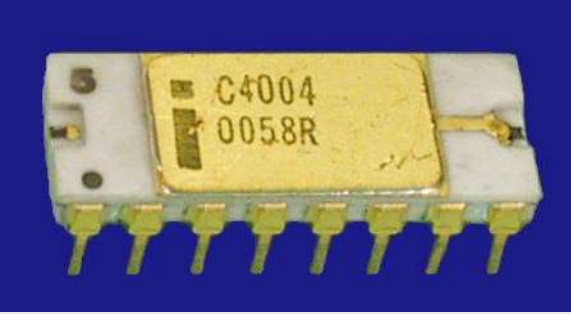
Part Number	Package Description	Values
		
C4004	1. Type C white ceramic package w/gold cap, gold cap ground strap, and gold pins. Gold dot denotes pin #1.	Rare \$250-\$1000
		
C4004	2. Type C white ceramic package w/gold cap, gold cap ground strap, and gold pins. Black dot denotes pin #1. Example shown made in Hong Kong and dated 7535.	Ex. Rare (1 Known) \$300-\$1200
		
C4004	3. Type C white ceramic package w/gold cap, gold cap ground strap, and gold pins. Black '5' at top left corner. Black dot denotes pin #1.	Ex. Rare (2 Known) \$150-\$600

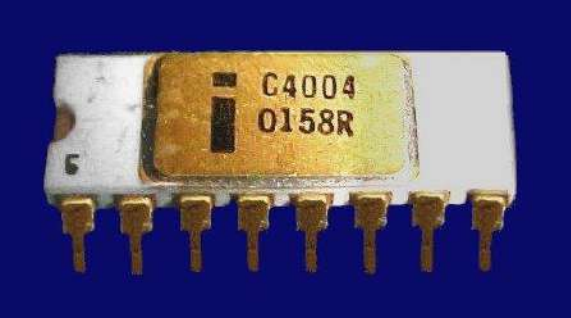
Intel i4004

		
C4004	4. Type C white ceramic package w/gold cap, gold cap ground strap, and gold pins. Cap ground strap connection points on both ends (only one used). Black or gold '5' at top left corner. Black or gold dot denotes pin #1.	Ex. Rare \$150-\$600
		
C4004	5. Type C white ceramic package w/gold cap and gold pins. Black unidentified symbol denotes pin #1.	\$80-\$320
		
C4004	6. Type white ceramic package w/gold cap and gold pins. Half round key. Unidentified black symbol denotes pin #1. Example shown made in Hong Kong and dated 7628.	Ex. Rare (4 Known) \$100-\$400
		
C4004	7. Type C white ceramic package w/gold cap, gold cap ground strap, and gold pins. Black dot denotes pin #1.	Ex. Rare (1 Known) \$150-\$600

Intel i4004



C4004	8. Type C white ceramic package w/gold cap and gold pins. Black dot denotes pin #1.	Ex. Rare (2 Known) \$150-\$600
-------	--	--------------------------------------

Type D Packages

Part Number	Package Description	Values
D4004	Type D grey ceramic package w/tin pins	\$15-\$60

Type P Packages

Part Number	Package Description	Values
P4004	Type P black plastic package w/tin pins	\$10-\$40

References

[1] Intel (September 1972). Intel Data Catalog, 4004 Data Sheet, p. 6-3

[2] Intel (1978). Intel Component Data Catalog, 4004 Data Sheet, p. 9-4

[3] Intel (2002). Intel Museum Archive Collection Chronological Timeline, 4004 [introduction] date "11/15/71". Available from: http://www.intel.com/intel/intelis/museum/arc_collect/TimelineChron.pdf
[Accessed 10 July 2002]

Intel i4008

Standard Memory and I/O Interface for 4004

4th Qtr 1972

Specifications

- Standard Memory and I/O Interface Set (4008/4009)
- Direct Interface to Standard Memories
- Allows Write Program Memory
- Standard Operating Temperature Range of 0°C to 70°C
- 24-pin Dual In-Line Package

The standard memory and I/O interface set (4008/4009) provides the complete control functions performed by the 4001 or 4308 in MCS-40™ systems. The 4008/4009 are completely compatible with other members of the MCS-40 family. All activity is still under control of the CPU. One set of 4008/4009 and several TTL decoders is sufficient to interface to 4K words of program memory, sixteen four-bit input ports and sixteen four-bit output ports [3].

History

The 4008 and 4009 were designed, as a pair, to simplify interfacing the 4004 with standard RAM and ROM devices, like the C2102A (RAM) and C1702A (EPROM). Prior to the 4008/4009, interfacing the 4004 to standard RAMs and ROMs (those other than the 4001 and 4002) was a difficult task that required significant wiring and multiple IC's.

Packaging

Intel only added a package type prefix to its early chips when the chip was available in more than one package type. Given that many Intel chips were initially available only in the type 'C' package, it's not uncommon to come across early Intel chips in the type 'C' package with a missing 'C' prefix. However, It's rare to find an Intel chip in the type 'P' package with a missing 'P' prefix.

When a 4008 in a type 'P' package with no 'P' prefix was discovered, it seemed to indicate that the 4008 in the type 'P' package was introduced before the 4008 in the 'C' package.

An Intel pricelist dated December 1972 seems to confirm this. It lists the P4008 and P4009 but there is no reference to the C4008 or C4009.

Part Numbers

Type C Packages

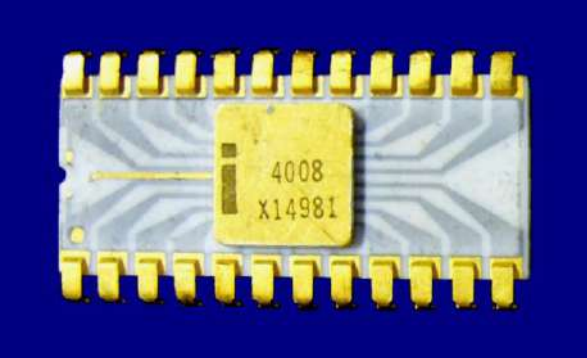
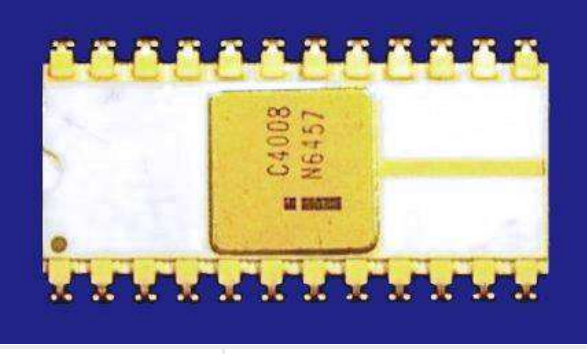
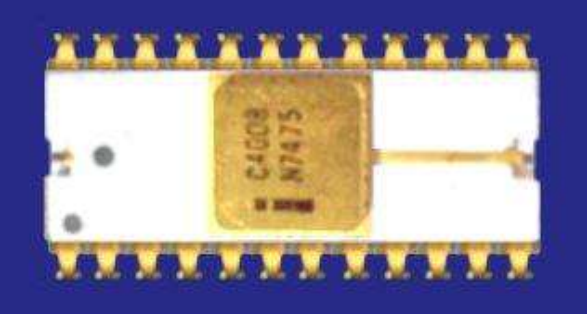
Part Number	Package Description	Values
		
4008	Type C white ceramic package w/grey traces, gold cap, gold cap ground strap, and gold pins. Gold dot denotes pin #1.	Ex. Rare (1 Known) \$75-\$300
		
C4008	1. Type C white ceramic package w/gold cap, gold cap ground strap, and gold pins. Black dot denotes pin #1.	\$30-\$120
		
	2. Type C white ceramic package w/gold cap, gold cap ground strap, and gold pins. Cap ground strap connection points on both edges of package (only one used). Black dot denotes pin #1.	\$30-\$120

Intel i4008

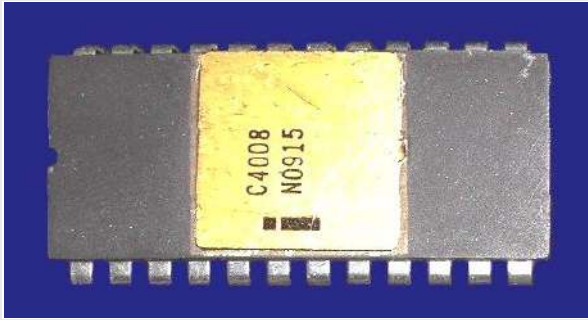

C4008	3. Type C/D hybrid grey ceramic package w/gold cap and tin pins.	Ex. Rare (1 Known) \$75-\$300
-------	--	-------------------------------------

Type D Packages

Part Number	Package Description	Values
D4008	Type D grey ceramic package w/tin pins. No copyright.	\$5-\$20

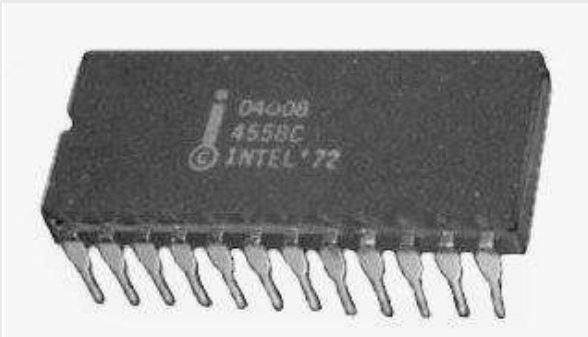

D4008	Type D grey ceramic package w/tin pins. © Intel '72	\$5-\$20
-------	---	----------

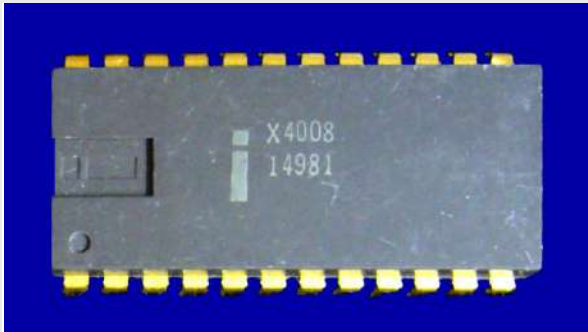

Type P Packages

Part Number	Package Description	Values
-------------	---------------------	--------

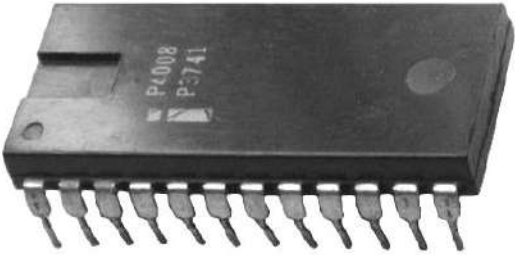

X4008	Type P grey plastic package w/gold pins. Embossed Intel 'i', in key. Small round indentation denotes pin #1. No copyright.	Ex. Rare (1 Known) \$75-\$300
-------	--	-------------------------------------

Intel i4008

4008	Type P grey plastic package w/gold pins. Embossed Intel 'i', in key. Small round indentation denotes pin #1. No copyright.	Ex. Rare (4 Known) \$50-\$200
		
P4008	1. Type P grey plastic package w/tin pins. Embossed Intel 'i', in key. Small round indentation denotes pin #1. No copyright	Rare \$20-\$80
		
P4008	2. Type P black plastic package w/tin pins. Small round indentation denotes pin #1. No copyright	\$5-\$20
		
P4008	3. Type P black plastic package w/tin pins. Small round indentation denotes pin #1. © Intel '72	\$5-\$20

References

- [1] Intel (September 1972). Intel Data Catalog. No Reference to 4008/4009 dates chips after September 1972.
- [2] Intel (December 1972). Intel Micro Computer System Pricing, P4008 and P4009 prices. No reference to C4008 or C4009.
- [3] Intel (1978). Intel Component Data Catalog, 4008/4009 Data Sheet, p. 9-9.

Intel i4009

Standard Memory and I/O Interface for 4004

4th Qtr 1972

Specifications

- Standard Memory and I/O Interface Set (4008/4009)
- Direct Interface to Standard Memories
- Allows Write Program Memory
- Standard Operating Temperature Range of 0°C to 70°C
- 24-pin Dual In-Line Package

The standard memory and I/O interface set (4008/4009) provides the complete control functions performed by the 4001 or 4308 in MCS-40™ systems. The 4008/4009 are completely compatible with other members of the MCS-40 family. All activity is still under control of the CPU. One set of 4008/4009 and several TTL decoders is sufficient to interface to 4K words of program memory, sixteen four-bit input ports and sixteen four-bit output ports [3].

History

The 4008 and 4009 were designed, as a pair, to simplify interfacing the 4004 with standard RAM and ROM devices, like the C2102A (RAM) and C1702A (EPROM). Prior to the 4008/4009, interfacing the 4004 to standard RAMs and ROMs (those other than the 4001 and 4002) was a difficult task that required significant wiring and multiple IC's.

Packaging

The 4009 in type 'P' package was introduced before the 4009 in the 'C' package. See packaging for Intel 4008 for more information.

Part Numbers

Type C Packages

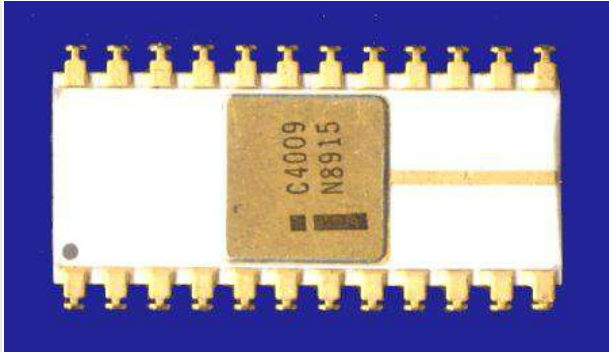
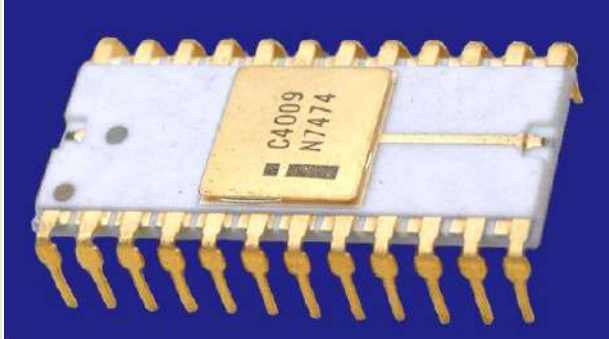
Part Number	Package Description	Values
		
C4009	1. Type C white ceramic package w/gold cap, gold cap ground strap, and gold pins. Black dot denotes pin #1. No copyright.	\$30-\$120
		
C4009	2. Type C white ceramic package w/gold cap, gold cap ground strap, and gold pins. Cap ground strap connection points on both edges of package (only one used). Black dot denotes pin #1. No copyright.	\$30-\$120

Type D Packages

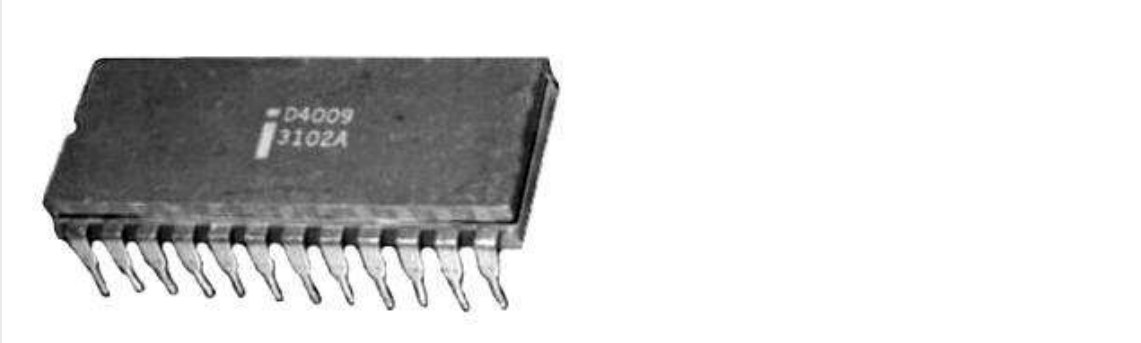
Part Number	Package Description	Values
		
D4009	Type D grey ceramic package w/tin pins. No copyright.	\$25-\$50

Intel i4009

Type P Packages

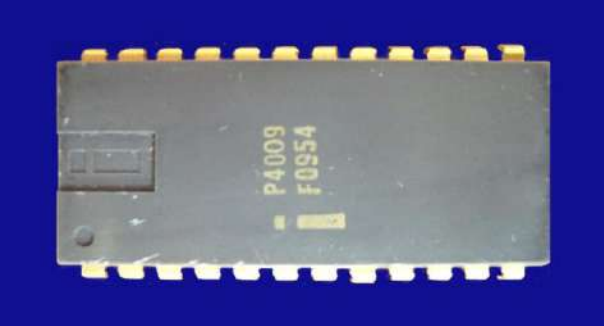
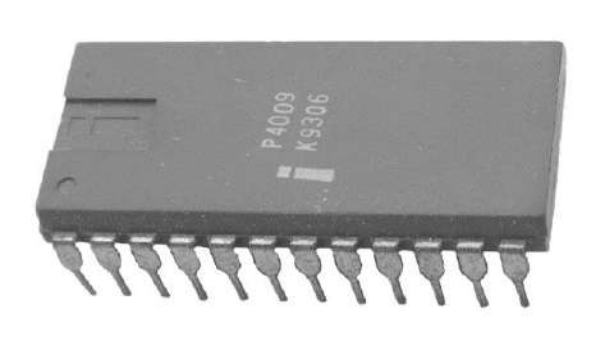
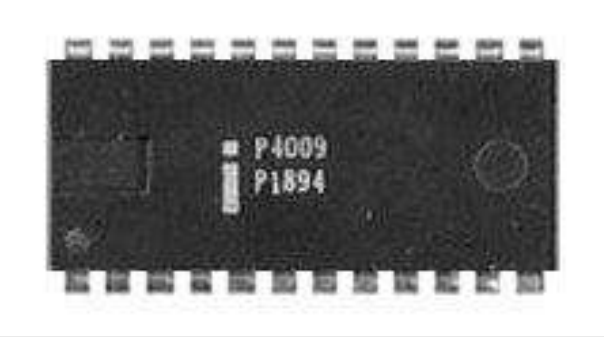
Part Number	Package Description	Values
		
P4009	1. Type P grey plastic package w/gold pins. Embossed Intel 'i', in key. Small round indentation denotes pin #1. No copyright.	Ex. Rare \$75-\$300
		
P4009	2. Type P grey plastic package w/tin pins. Embossed Intel 'i' in key. Small round indentation denotes pin #1. No copyright	Rare \$20-\$80
		
P4009	3. Type P black plastic package w/tin pins. Small round indentation denotes pin #1. No copyright.	\$5-\$20

Intel i4009

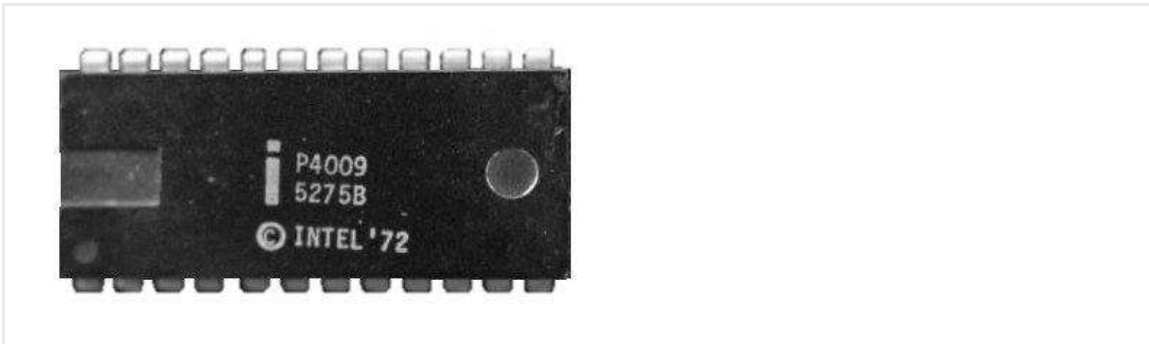

P4009	4. Type P black plastic package w/tin pins. Small round indentation denotes pin #1. © Intel '72	\$5-\$20
-------	---	----------

References

[1] Intel (September 1972). Intel Data Catalog. No Reference to 4008/4009 dates chips after September 1972.

[2] Intel (December 1972). Intel Micro Computer System Pricing, P4008 and P4009 prices. No reference to C4008 or C4009.

[3] Intel (1978). Intel Component Data Catalog, 4008/4009 Data Sheet, p. 9-9.

Intel i4040

4-bit Microprocessor

4th Qtr. 1974

Specifications

- 4-bit Microprocessor
- PMOS
- 3000 Transistors (10 Micron) [4]
- Functionally and Electrically Upward Compatible to 4004 CPU
- 14 Additional Instructions (60 Total) Including Logical Operations and Read Program Memory
- Interrupt Capability
- Single Step Operation
- 8K Byte Memory Addressing Capability
- 24 Index Registers
- Subroutine Nesting to 7 Levels
- Standard Operating Temperature Range of 0°C to 70°C
- Also Available With -40°C to +85°C Operating Range
- 24-pin Dual In-Line Package

Type	Clock	Power Dissipation Max.	Supplies [V]
4040	740 KHz	1000mW	+15 (or -10, +5)

The Intel® 4040 is a complete 4-bit parallel central processing unit (CPU). The CPU can directly address 4K eight-bit instruction words or 8K with a blank switch. Seven levels of subroutine nesting, including interrupt, and 24 randomly accessible index registers (24 x 4) are provided as convenient facilities for the designer. The index registers may be used for addressing or for scratch pad memory for storing computation results. The interrupt feature permits a normal program sequence to be interrupted, with normal program execution continuing after the interrupt service routine is completed. Provisions have also been made to permit single-stepping the CPU using the STOP and ACKNOWLEDGE signals.

The 4040 is an enhanced version of the 4004 and as such retains all the functional capability of that device. It will execute all the 4004 instructions, and is also electrically compatible with all components used with a 4004 CPU [3].

History

Introduced in the 4th Qtr. 1974, the 4040 was an enhanced version of the 4004, adding 14 instructions, larger (8 level) stack, 8K program space, and interrupt abilities.

The Intel 4040 was used in the Intel Intellec 4/40 microcomputer and Intel UPP-103 Universal PROM Programmer.



Intel Intellec 4/40

The Intel 4040 was Introduced After the 8008

The 4040 is often listed as being introduced after the 4004 and before the 8008. This is not correct. The 4040 was introduced in 1974. The 8008 was introduced in 1972.

Intel C4040's are much more rare than common varieties of the Intel C4004, C8008, and C8080A.

Because of its rarity, the Intel C4040 is going to be a key chip in any collection of early Intel processors in the type 'C' package.

Copyrights

Intel started putting copyrights on their chips shortly after the 4040 was introduced.

Intel D4040 and P4040 chips without a copyright are rare compared to Intel D4040 and P4040 chips with a copyright. No copyrighted Intel C4040's are known to exist. This may mean that Intel has discontinued the C4040 by the time they started putting copyrights on their chips.

Part Numbers

Type C Packages

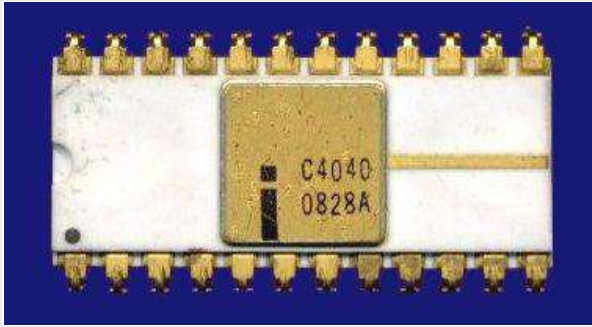
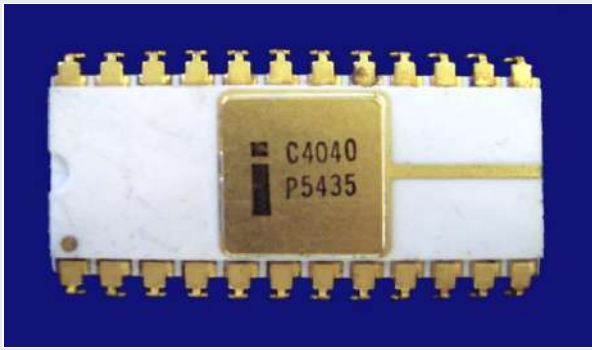
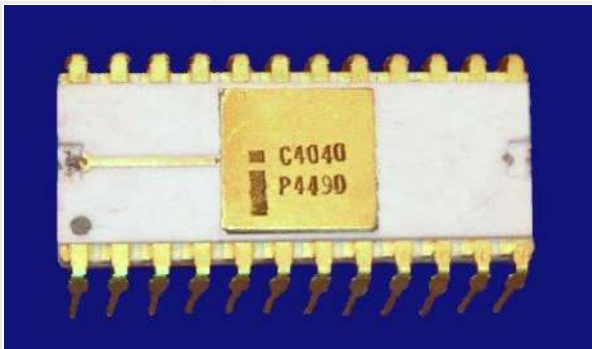
Part Number	Package Description	Values
		
C4040	1. Type C white ceramic package w/gold cap, gold cap ground strap, and gold pins. Black dot denotes pin #1.	Rare \$150-\$600
		
	2. Type C white ceramic package w/gold cap, gold cap ground strap, and gold pins. Gold dot denotes pin #1. Example shown made in Malaysia and dated 7604.	Ex. Rare \$200-\$800
		
C4040	3. Type C white ceramic package w/gold cap, gold cap ground strap, and gold pins. Cap ground strap connection points on both ends (only one used). Black dot denotes pin #1.	Rare \$150-\$600

Intel i4040



C4040	4. Type C/D hybrid grey ceramic package w/gold cap and tin pins. Example shown marked 'ES' for Engineering Sample.	Ex. Rare (3 Known) \$300-\$1200
-------	--	---------------------------------------

Type D Packages

Part Number	Package Description	Values
D4040	1. Type D grey ceramic package w/tin pins. No copyright. Example shown dated 7724.	Rare \$25-\$100
D4040	2. Type D grey ceramic package w/tin pins. © Intel '74	\$10-\$40

Intel i4040

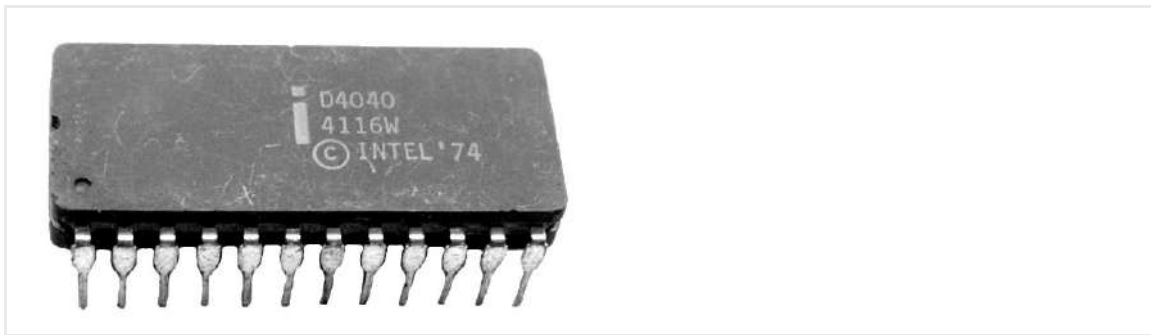

D4040	3. Type D grey ceramic package w/tin pins. Small round indentation denotes pin #1. © Intel '74.	Rare \$20-\$80
-------	---	-------------------

Type P Packages

Part Number	Package Description	Values
P4040	1. Type P black plastic package w/tin pins. No copyright.	Rare \$25-\$100



P4040	2. Type P black plastic package w/tin pins. © Intel '74	\$5-\$20
-------	---	----------

References

[1] Intel (September 1972). Intel Data Catalog. No reference to 4040 dates chip after September 1972.

[2] Intel (November 1974). Intel MCS-40 User's Manual For Logic Designers, 4040 Central Processor, p. 1-5.

[3] Intel (1978). Intel Component Data Catalog, 4040 Data Sheet, p. 9-3

[4] ITP2001 Computing Issues Assessments (n/d). Intel Microprocessor 4004/40, 4040 contains 3000 transistors. Available from: <http://gosh.ex.ac.uk/~SFCornej/itp2001/slides/tsld043.htm>
[Accessed 08/20/2002]

Intel i4101

1024-bit (256 x 4) Static RAM w/Separate I/O

1974

Specifications

- 1024-bit (256 x 4) Static RAM w/Separate I/O
- NMOS
- Access Time – 1µsec Max.
- Single +5V Supply Voltage
- Directly TTL Compatible – All Inputs and Output
- Static MOS – No Clocks or Refreshing Required
- Simple Memory Expansion – Chip Enable Input
- Compatible with the 4289
- Inputs Protected – All Inputs Have Protection Against Static Charge
- Low Power – Typically 150mW
- Three-State Output – OR-Tie Capability
- Output Disable Provided for Ease of Use in Common Data Bus Systems
- 4xxx equivalent of the Intel 2101 Static RAM
- 22-pin Dual In-Line Package

Type	Access Time Max.	Cycle Time Max.	Power Dissipation Max. Operating/Standby	Supplies [V]
4101	1µs	1µs	350mW	+5

The Intel® 4101 is a 256 word by 4-bit static random access memory element using normally off N-channel MOS devices integrated on a monolithic array. It uses fully DC stable (static) circuitry and therefore requires no clocks or refreshing to operate. The data is read out nondestructively and has the same polarity as the input data.

The 4101 is designed for memory applications where high performance, low cost, large bit storage and simple interfacing are important design objectives.

It is directly TTL compatible in all respects: inputs, outputs, and a single +5V supply. Two chip-enables allow easy selection of an individual package when outputs are OR-tied. An output disable is provided so that data inputs and outputs can be tied for common I/O systems. Output disable is then used to eliminate any bi-directional logic.

The Intel 4101 is fabricated with N-channel silicon gate technology. This technology allows the design and production of high performance, easy-to-use MOS circuits and provides a higher functional density on a monolithic chip that either conventional MOS technology or P-channel silicon gate technology.

Intel's silicon gate technology also provides excellent protection against contamination. This permits the use of low cost silicone packaging [3].

Packaging

The November 1974 Intel MCS-40 User's Manual For Logic Designers 4101 Data Sheet indicates that 4101 is available in 22-pin plastic dual in-line configuration.

Part Numbers

No Examples Known

References

[1] Intel (February 1973). Intel MCS-4 User's Manual, Rev. 4. No reference to 4101 dates chip after February 1973.

[2] Intel (November 1974). Intel MCS-40 User's Manual For Logic Designers, 4101 Data Sheet, p. 4-29

[3] Intel (March 1975). Intel MCS-40 User's Manual For Logic Designers, 4101 Data Sheet, p. 4-29.

[4] Hearst (1977). IC Master, 4004/4040 System Components, Intel 4101 listed as 4xxx equivalent of 2101, p. 869.

Intel i4201

4 MHz Clock Generator

1st Qtr. 1975

Specifications



- 4 MHz Clock Generator
- CMOS
- 16-pin Dual In-Line Package

The 4201 is a CMOS MSI integrated circuit designed to fill the clock requirements of the MCS-40™ microcomputer set. The 4201 contains a crystal controller oscillator (XTAL external), clock generation circuitry, and both two-phase MOS and TTL level clock driver circuits.

The 4201 also performs the power on reset function required by MCS-40 components and provides the logic necessary to implement the single-step function of the 4040 central processor unit [2].

Part Numbers

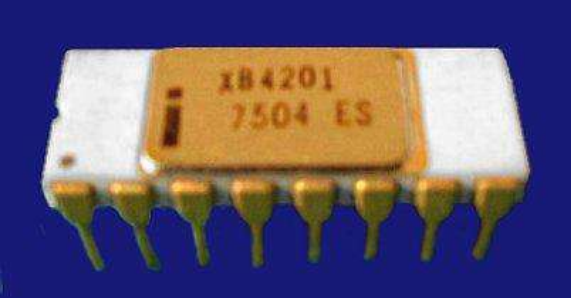
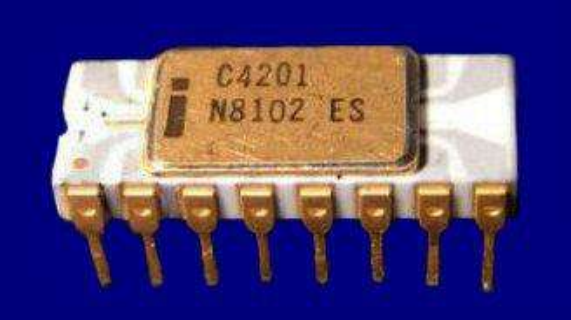
Type C Packages

Part Number	Package Description	Values
		
XB4201	Type C white ceramic package w/gold cap and gold pins. Small black dot denotes pin #1. 'PROTOTYPE' hand written on bottom of package. Example showed marked 'ES' for Engineering Sample.	Ex. Rare (2 Known) \$75-\$300
		
C4201	1. Type C white ceramic package w/grey traces, gold cap and gold pins. Small gold dot denotes pin #1. Example shown marked 'ES' for Engineering Sample.	Ex. Rare (1 Known) \$50-\$200
		
C4201	2. Type C white ceramic package w/gold cap and gold pins. Small black dot denotes pin #1. Example shown marked 'ES' for Engineering Sample.	\$25-\$100

Intel i4201



C4201	3. Type C white ceramic package, w/gold cap, gold cap ground strap, and gold pins. Black dot denotes pin #1.	\$25-\$100
-------	--	------------

References

- [1] Intel (February 1973). Intel MCS-4 User's Manual. No reference to 4201/4201A.
- [2] Intel (November 1974). Intel MCS-40 User's Manual For Logic Designers, 4201 Clock Generator, p. 4-1.
- [3] Intel (1975). Intel Data Catalog, 4201 Data Sheet, p. 6-20. No reference to 4201A.
- [4] Intel (1977). Intel Data Catalog, 4201A Data Sheet, p. 8-61. No reference to 4201.

Intel i4201A

4 MHz Clock Generator

1976-77

Specifications

- 4 MHz Clock Generator
- CMOS
- Complete Clock Requirements for MCS-40™ Systems
- MOS and TTL Level Clock Outputs
- Provides MCS-40 Reset Function Signal
- Standard Operating Temperature Range of 0° to 70°C
- Also Available with -40° to +85C° Operating Range
- 16-pin Dual In-Line Package

The 4201A is a CMOS integrated circuit designed to fill the clock requirements of the MCS-40 microcomputer family. The 4201A contains a crystal controlled oscillator (XTAL external), clock generation circuitry, and both MOS and TTL level clock driver circuits.

The 4201A also performs the power on reset function required by MCS-40 components and provides the logic necessary to implement the single-step function of the 4040 central processor unit [2].

Intel i4201A

Part Numbers

Type D Packages

Part Number	Package Description	Values
		
D4201A	Type D grey ceramic package w/tin pins	\$2-\$8

Type P Packages

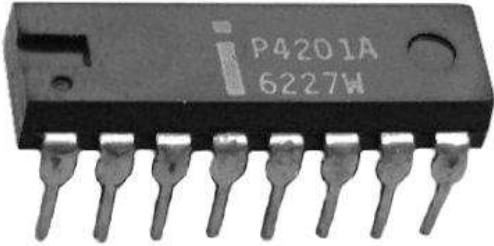
Part Number	Package Description	Values
		
P4201A	Type D black plastic package w/tin pins	\$1.25-\$5

References

[1] Intel (1976). Intel Data Catalog, 4201 Data Sheet, p. 7-53. No reference to 4201A.

[2] Intel (1977). Intel Data Catalog, 4201A Data Sheet, p. 8-61

Intel i4207

General Purpose Byte Output Port

1974

Specifications

- General Purpose Byte Output Port
- PMOS
- 28-pin Dual In-Line Package

The 4207, 4209, 4211 are three PMOS devices designed to greatly expand the I/O Capability of the MCS-40 family. These devices are appended to the CPU via the four-bit internal data bus on one side, and contain a 16-bit TTL compatible I/O interface on the other side. The above devices replace one 4308 or four 4001's on the CM-ROM line. The chips are designated 4308 ROM address 3. The above devices can also reside on a CD-RAM line along with four 4002's per line [1].

Part Numbers

No Examples Known

References

[1] Intel (November 1974). Intel MCS-40 Users Manual For Logic Designers, 4207, 4209, 4211 I/O Devices, p. 4-15.

Intel i4209

General Purpose Byte Input Port

1974

Specifications

- General Purpose Byte Input Port
- PMOS
- 28-pin Dual In-Line Package

The 4207, 4209, 4211 are three PMOS devices designed to greatly expand the I/O Capability of the MCS-40 family. These devices are appended to the CPU via the four-bit internal data bus on one side, and contain a 16-bit TTL compatible I/O interface on the other side. The above devices replace one 4308 or four 4001's on the CM-ROM line. The chips are designated 4308 ROM address 3. The above devices can also reside on a CD-RAM line along with four 4002's per line [1].

Part Numbers

No Examples Known

References

[1] Intel (November 1974). Intel MCS-40 Users Manual For Logic Designers, 4207, 4209, 4211 I/O Devices, p. 4-15.

Intel i4211

General Purpose Byte I/O Port

1974

Specifications

- General Purpose Byte I/O Port
- PMOS
- 28-pin Dual In-Line Package

The 4207, 4209, 4211 are three PMOS devices designed to greatly expand the I/O Capability of the MCS-40 family. These devices are appended to the CPU via the four-bit internal data bus on one side, and contain a 16-bit TTL compatible I/O interface on the other side. The above devices replace one 4308 or four 4001's on the CM-ROM line. The chips are designated 4308 ROM address 3. The above devices can also reside on a CD-RAM line along with four 4002's per line [1].

Part Numbers

No Examples Known

References

[1] Intel (November 1974). Intel MCS-40 Users Manual For Logic Designers, 4207, 4209, 4211 I/O Devices, p. 4-15.

Intel i4265

Programmable General Purpose I/O Device

1976

Specifications

- Programmable General Purpose I/O Device
- Multi-Mode – 14 Operating Modes
- 16 Lines of I/O Capability
- Bit Set/Reset
- Multiplexable Outputs
- Eight Bit Transfer Mode
- Interfaces to 8080 Peripherals
- Synchronous and Asynchronous Interface
- Strobed Buffer Inputs and Outputs
- TTL Interface
- Up to Eight 4265s Per System
- Interface to Standard RAMs
- Standard Operating Temperature 0°C to 70°C
- Also Available with -40°C to +85°C Operating Range
- 28-pin Dual In-Line Package

The 4265 is a general purpose I/O device designed to interface with the MCS-40™ microcomputer family. This device provides four software programmable 4-bit I/O ports which can be configured to allow any one of fourteen unique operating modes for interfacing to data memory or a variety of user peripheral devices.

A single MCS-40 system can accommodate up to four 4265s (one per CM-RAM) without external logic or up to eight 4265s with one external decoder.

The 4265 resides on the MCS-40 data bus and uses the same selection procedure as 4002 RAM device. A valid compare selects the 4265 for MCS-40 I/O commands. As in the case of the 4002 or any MCS-40 peripheral circuit, selection occurs only when the proper SRC code and the CM signal are present simultaneously.

The 4265 provides an extremely flexible, general purpose I/O system capable of handling 4- or 8-bit input or output data.

The 4265 is packaged in a 28-pin dual in-line package [4].

Part Numbers

Type D Packages

Part Number	Package Description	Values
D4265	Type D package	Rare \$20-\$80

Type P Packages

Part Number	Package Description	Values
P4265	1. Type P black plastic package w/tin pins. No copyright.	\$10-\$40

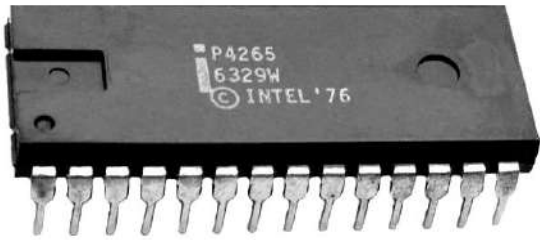

P4265	2. Type P black plastic package w/tin pins. © Intel '76	\$5-\$20
-------	---	----------

References

- [1] Intel (1975). Intel Data Catalog. No reference to 4265.
- [2] Intel (1976). Intel Data Catalog, 4265 Data Sheet, p. 7-22
- [3] Intel (1977). Intel Data Catalog, 4265 Data Sheet, p. 8-28
- [4] Intel (1978). Intel Component Data Catalog, 4265 Data Sheet, p. 9-6

Intel i4269

Programmable Keyboard Display Device

1976

Specifications

- Programmable Keyboard Display Device
- Keyboard Features:
 - Programmable to Interface to Encoded Keyboard (8-bit code), 64-Key Scanned Keyboard (expandable to 128 keys) or Sensor Matrix (64 sensors)
 - 8 Character FIFO Character Buffer (or RAM in Sensor Mode)
 - 2 Key Rollover and Key Debounce
 - External Interrupt Line to Indicate when a Character has Been Entered in Character Buffer
- Display Features:
 - Programmable to Interface to Individually Scanned Displays or Burrough's Self-Scan™ Drive (16,18, or 20 Characters)
 - Two 16 x 4 Display Registers Recirculated Synchronously with Keyboard Scan Lines to Give Automatic Display Refresh
 - Display Registers Loadable and Readable Selectively or Sequentially
- Standard Operating Temperature Range of 0°C to 70°C
- Also Available with -40°C to +85°C Operating Range
- 40-pin Dual In-Line Package

The 4269 has two separate and distinct sections: the keyboard section and the display section. The keyboard section can interface to a range of devices from a matrix of toggle or thumb switches as found on an instrument panel up to a full typewriter style keyboard. The display section can interface to a range of devices from an array of individual LED indicators up to a gas discharge alphanumeric display.

The 4269 Programmable Keyboard Display (PKD) relieves the 4004 or 4040 CPU from continuously scanned a switch array or refreshing a display from software control. This greatly expands the CPU throughput. The 4269 can scan up to an 8 x 8 keyboard or sensor matrix (or a 2 x 8 x 8 keyboard with the use of the shift or control key input). The display portion can continuously refresh either a single 16 x 8 alphanumeric display; a single 8 x 8 alphanumeric display; a dual 16 x 4 digit display; a single 32 x 4 digit display; a 16 x 16, 18 x 6 or 20 x 6 alphanumeric gas discharge display such as the Burroughs Self-Scan™; or an array of 128 indicators [4].

Part Numbers

Type C Packages

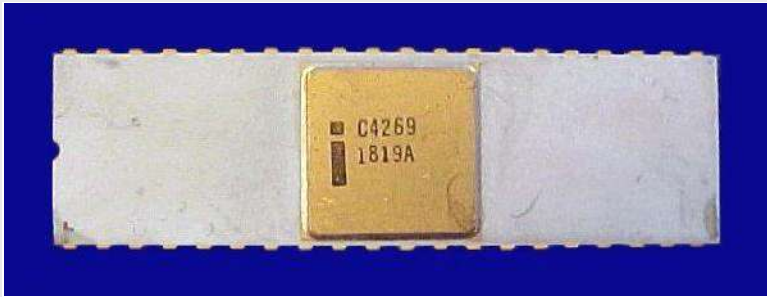
Part Number	Package Description	Values
		
C4269	Type C white ceramic package w/gold cap and gold pins. Small '+' denotes pin #1. No copyright. Example shown made in Malaysia and dated 7630.	Ex. Rare (1 Known) \$50-\$200

Type D Packages

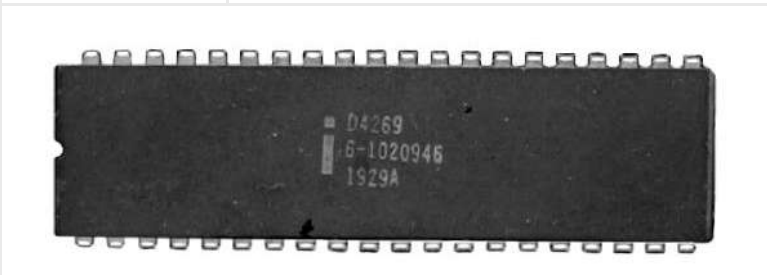
Part Number	Package Description	Values
		
D4269	Type D grey ceramic package w/tin pins.	Rare \$20-\$80

Type P Packages

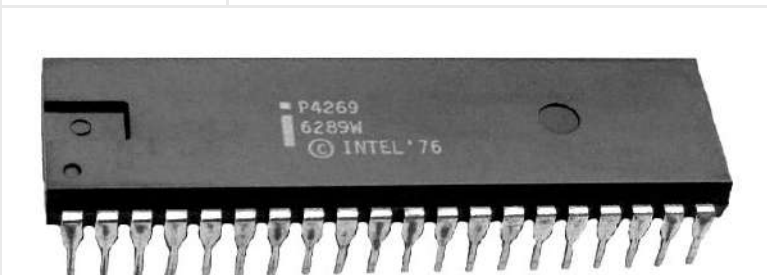
Part Number	Package Description	Values
		
P4269	Type P black plastic package w/tin pins. © Intel '76	\$10-\$40

References

- [1] Intel (1975). Intel Data Catalog. No reference to 4269.
- [2] Intel (1976). Intel Data Catalog, 4269 Data Sheet, p. 7-39
- [3] Intel (1977). Intel Data Catalog, 4269 Data Sheet, p. 8-46
- [4] Intel (1978). Intel Component Data Catalog, 4269 Data Sheet, p. 9-7

Intel i4289

Standard Memory Interface for 4004/4040

1974

Specifications

- Standard Memory Interface for Intel 4004/4040
- Direct Interface to all Standard Memories
- Allows Read and Write Program Memory
- Single Package Equivalent of 4008/4009
- TTL Compatible Address, Chip Select, Program Memory Data Lines
- Standard Operating Temperature Range of 0°C to 70°C
- Also Available with -40°C to +85°C Operating Range
- 40-pin Dual In-Line Package

The 4289 standard memory interface and I/O interface enables the CPU devices to utilize standard memory components as program data memory. Notably, PROMs (4702A), RAMs (2102) and ROMs can be arranged in a memory array to facilitate system development. Programs generated using the 4289 interface can be committed to MCS-40™ ROMs (4308 and 4001) with no change to software.

The 4289 also contains a 4-bit bi-directional I/O port and necessary steering logic to multiplex a host of I/O sources to the CPU. The Read and Write Program Memory instruction allows the user to store data and modify program memory. The device directly addresses 4K of program memory.

The 4289 is packaged in a 40-pin dual in-line package [3].

History

When the Intel 4040, MCS-40, was introduced in late 1974, the 4008/4009 combination was replaced by the 40-pin Intel 4289. The 4008 and 4009 are considered part of the MCS-4 family, whereas the 4289 is considered part of the MCS-40 family.

Intel i4289

Part Numbers

Type C Packages

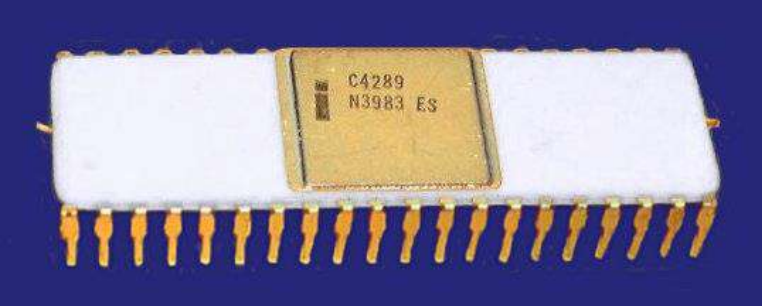
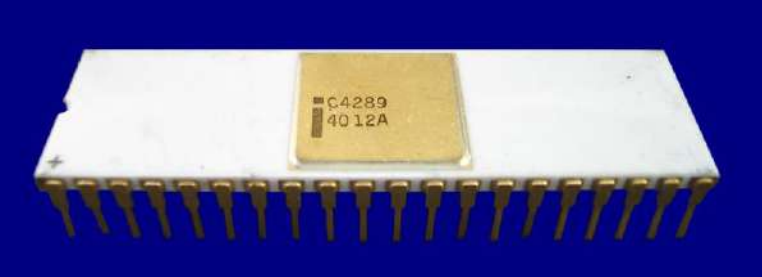
Part Number	Package Description	Values
		
C4289	1. Type C white ceramic package w/gold cap and integrated gold pins. Small raised bump denotes pin #1. Example shown marked 'ES' for Engineering Sample.	Ex. Rare \$50-\$200
		
C4289	2. Type C white ceramic package w/gold cap and gold pins. Small black '+' denotes pin #1.	\$25-\$100

Type D Packages

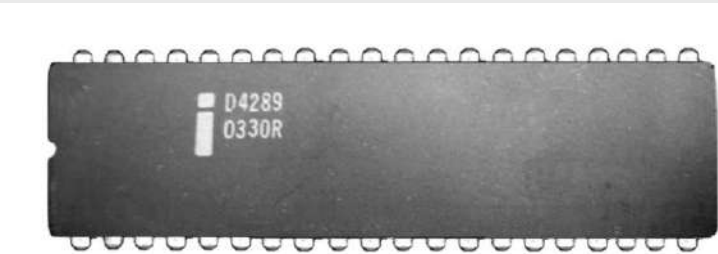
Part Number	Package Description	Values
		
D4289	1. Type D grey ceramic package w/tin pins. No copyright	Rare \$10-\$40

Intel i4289

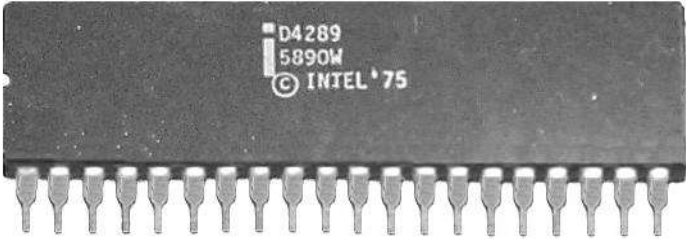
 A black, rectangular integrated circuit chip with 20 pins protruding from the bottom. The top surface is marked with the text: 'D4289', '5890W', and '© INTEL '75'.		
D4289	2. Type D grey ceramic package w/tin pins. © Intel '75	\$3-\$12

References

[1] Intel (February 1973). Intel MCS-4 User's Manual, Rev 4. No reference to 4289 dates chip after February 1973.

[2] Intel (November 1974). Intel MCS-40 User's Manual For Logic Designers, 4289 Standard Memory Interface, p. 4-20

[3] Intel (1978). Intel Component Data Catalog, 4289 Data Sheet, p. 9-10

Intel i4308

8192-bit (1024 x 8) ROM w/4-bit I/O Ports

1974



Specifications

- 8192-bit (1024 x 8) ROM w/4-bit I/O Ports
- Direct Interface to MCS-40™ 4-Bit Data Bus
- Equivalent to Four 4001 ROMs
- Four Independent 4-Bit I/O Ports
- Input I/O Buffer Storage with an Optional Strobe
- I/O Ports Low-Power TTL Compatible
- Standard Operating Temperature Range of 0°C to 70°C
- Also Available with -40°C to +85°C Operating Range
- 28-pin Dual In-Line Package

The 4308 is a 1024 x 8 bit word ROM memory with four I/O ports. It is designed for the MCS-40™ system and is operationally compatible with all existing MCS-40 elements. The 4308 is functionally identical to four 4001 chips. It has 16 I/O lines arranged in four groups of four lines. Port selection and accessibility is accomplished as previously, with the 4001. In addition, 4308 has input I/O buffer storage with an optional strobe. A substitution of four 4001 programs can be incorporated in one 4308, including I/O, with no other consideration [3].

Part Numbers

Type C Packages

Part Number	Package Description	Values
	 <p>A photograph of an Intel i4308 3018 chip. The chip is a gold-colored integrated circuit mounted on a white ceramic package. The package has gold pins on both sides. The chip surface is marked with 'C4308 3018' and '7510 190000'.</p>	
C4308	1. Type C white ceramic package w/gold cap and integrated gold pins. Small raised bump identifies pin #1.	Ex. Rare (1 Known) \$50-\$200
	 <p>A photograph of an Intel i4308 3116 chip. The chip is a gold-colored integrated circuit mounted on a white ceramic package. The package has gold pins on both sides. The chip surface is marked with 'C4308 3116', '7623', and '6-7810'.</p>	
C4308	2. Type C white ceramic package w/gold cap, offset gold cap ground strap, and gold pins. Small black dot denotes pin #1. Back of example shown marked 'USA' and dated 7624	Ex. Rare (1 Known) \$50-\$200
	 <p>A photograph of an Intel i4308 3115 chip. The chip is a gold-colored integrated circuit mounted on a purple ceramic package. The package has gold pins on both sides. The chip surface is marked with 'C4308 3115', '7648', and '6-7814'.</p>	
C4308	3. Type C purple ceramic package w/gold cap and gold pins. Small '+' denotes pin #1.	Ex. Rare (1 Known) \$50-\$200

Intel i4308

Type P Packages

Part Number	Package Description	Values
 A black plastic package with tin pins, labeled P4308 3072 and 7601 190001. The chip is rectangular with a notch on the left side and a circular mark on the right side. It has 28 pins in total, 14 on each long side.		
P4308	Type P black plastic package w/tin pins	\$1.25-\$5

References

- [1] Intel (September 1972). Intel Data Catalog. No reference to 4308 dates chip after September 1972.
- [2] Intel (February 1973). Intel MCS-4 User's Manual, Rev 4. No reference to 4308 dates chip after February 1973.
- [3] Intel (November 1974). Intel MCS-40 User's Manual For Logic Designers, 4308 Read Only Memory, p. 4-7
- [4] Intel (1978). Intel Component Data Catalog, 4308 Data Sheet, p. 9-14.

Intel i4316

16384-bit (2048 x 8) Static ROM

1973-74

Specifications

- 16,384-bit (2048 x 8) Static ROM
- NMOS
- Access Time - 2 μ sec
- Single +5V Power Supply
- Directly TTL Compatible – All Inputs and Outputs
- Low Power Dissipation of 10.7 μ W/Bit Maximum
- Three Programmable Chip Select Inputs for Easy Memory Expansion
- Three-State Output – OR-Tie Capability
- Fully Decoded – On Chip Address Decode
- Inputs Protected – All Inputs Have Protection Against Static Charge
- Compatible with the 4289
- 24-pin Dual In-Line Package

Type	Access Time Max.	Power Dissipation Max. Operating/Standby	Supplies [V]
4316	2 μ s	-	+5

The Intel® 4316 is a 16,384 bit static MOS read only memory organized as 2048 words by 8-bits. This ROM is designed for microcomputer memory applications where high performance, large bit storage, and simple interfacing are important design objectives.

The inputs and outputs are fully TTL compatible. This device operates with a single +5V power supply. The three chip select inputs are programmable. Any combination of active high or low level chip select inputs can be defined and the desired chip select code is fixed during the masking process. These three programmable chip select inputs, as well as OR-tie compatibility on the outputs, facilitate easy memory expansion.

The 4316 read only memory is fabricated with N-channel silicon gate technology. This technology provides the designer with high performance, easy-to-use MOS circuits. Only a single +5V power supply is needed and all devices are directly TTL compatible [4].

Part Numbers

No Examples Known

References

- [1] Intel (September 1972). Intel Data Catalog. No reference to 4316 dates chip after September 1972.
- [2] Intel (February 1973). Intel MCS-4 User's Manual, Rev 4. No reference to 4316 dates chip after February 1973.
- [3] Intel (November 1974). Intel MCS-40 User's Manual For Logic Designers, 4702A Data Sheets references 4316, p. 4-28
- [4] Intel (March 1975). Intel MCS-40 User's Manual For Logic Designers, 4316 Data Sheet, p. 4-30
- [5] Intel (1975). Intel Data Catalog, 4316 Data Sheet, p. 6-14. Access Time 2 μ sec.

Intel i4316A

16384-bit (2048 x 8) Static ROM

1975-76

Specifications

- 16,384-bit (2048 x 8) Static ROM
- NMOS
- Access Time – 850ns Max.
- Single +5V Power Supply
- Directly TTL Compatible – All Inputs and Outputs
- Low Power Dissipation of 31.4 μ W/Bit Maximum
- Three Programmable Chip Select Inputs for Easy memory Expansion
- Three-State Output – OR-Tie Capability
- Fully Decoded – On Chip Address Decode
- Inputs Protected – All Inputs Have Protection Against Static Charge
- 4xxx Equivalent of the Intel 2316A ROM
- 24-pin Dual In-Line Package

Type	Access Time Max.	Power Dissipation Max. Operating/Standby	Supplies [V]
4316A	850ns	515mW	+5

The Intel® 4316A is a 16,384-bit static MOS read only memory organized as 2048 words by 8 bits. This ROM is designed for microcomputer memory applications where high performance, large bit storage, and simple interfacing are important design objectives.

The inputs and outputs are fully TTL compatible. This device operates with a single +5V power supply. This three chip select inputs are programmable. Any combination of active high or low-level chip select inputs can be defined and the desired chip select code is fixed during the masking process. These three programmable chip select inputs, as well as OR-tie compatibility on the inputs, facilitate easy memory expansion.

The 4316A read only memory is fabricated with N-channel silicon gate technology. This technology provides the designer with high performance, easy-to-use MOS circuits. Only a single +5V power supply is needed and all devices are directly TTL compatible.

All 4316A and 8316A specifications are identical to the 2316A specifications [6].

Part Numbers

No Examples Known

References

[1] Intel (September 1972). Intel Data Catalog. No reference to 4316 or 4316A dates chip after September 1972.

[2] Intel (November 1974). Intel MCS-40 User's Manual For Logic Designers, 4702A Data Sheets references 4316, p. 4-28. No reference to 4316A dates chip after November 1974.

[3] Intel (1975). Intel Data Catalog, 4316 Data Sheet, p. 6-14. No reference to 4316A.

[4] Intel (1976). Intel Data Catalog, 4316A Data Sheet, p. 7-104.

[5] Intel (1977). Intel Data Catalog, 4316A Data Sheet, p. 8-109

[6] Intel (1978). Intel Component Data Catalog, 2316A, 4316A, 8316A Data Sheet, p. 4-22

Intel i4702A

2048-bit (256 x 8) EPROM

1974

Specifications

- 2048-bit (256 x 8) Static EPROM
- PMOS
- Access Time: 1.7µsec Max.
- Fast Programming: 2 Minutes for all 2048 Bits
- Ultraviolet Erasable and Electronically Reprogrammable
- Fully Decoded, 256 x 8 Organization
- Static MOS: No Clocks Required
- Inputs and Outputs TTL Compatible
- Three-State Output: OR-Tie Capability
- Standard Operating Temperature Range of 0°C to 70°C
- Also Available with -40°C to +85°C Operating Range
- 4xxx Equivalent of the Intel 1702A EPROM
- 24-pin Dual In-Line Package

Type	Access Time Max.	Power Dissipation Max. Operating/Standby	Supplies [V]
4702A	1.7 µs	-	-10, +5

The 4702A is a 256 word by 8-bit electrically programmable ROM (EPROM) ideally suited for microprocessor system development where fast turn-around and pattern experimentation are important. The 4702A undergoes complete programming and functional testing on each bit position prior to shipment, thus insuring 100% programmability.

The 4702A is packaged in a 24-pin dual in-line package with a transparent quartz lid. The transparent quartz lid allows the user to expose the chip to ultraviolet light to erase the bit pattern. A new pattern can then be written into the device. This procedure can be repeated as many times as required.

The circuitry of the 4702A is entirely static; no clocks are required.

The 4702A is fabricated with silicon gate technology. This low threshold technology allows the design and production of higher performance MOS circuits and provides a higher functional density on a monolithic chip than conventional MOS technologies [3].

History

The Intel 1702A had just been introduced when Intel published the MCS-4 User's Manual, Rev. 4 in February 1973. There's no reference in this manual to the 4702A.

The 4702A does show up about 2 years later as part of the MCS-40 family of 4xxx chips introduced in the Intel MCS-40 User's Manual For Logic Designers published November 1974.

Part Numbers

Type C Packages

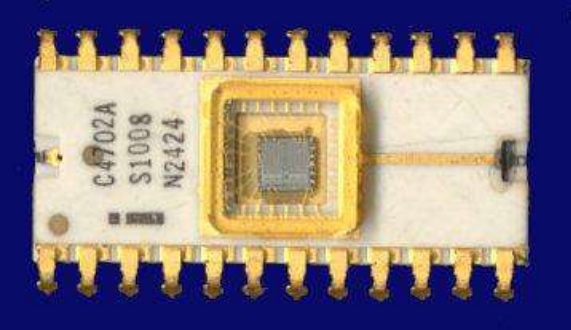
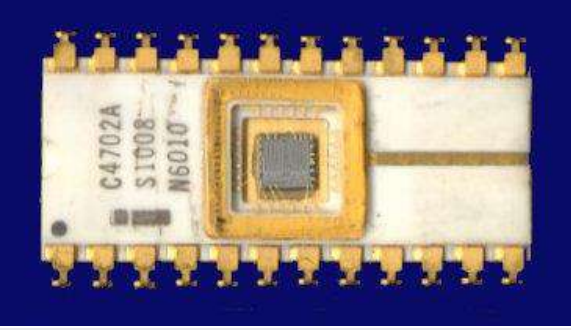
Part Number	Package Description	Values
		
C4702A	1. Type C white ceramic package w/quartz cap, gold cap ground strap, and gold pins. Cap ground strap connection points on both ends of package (only one used). Black dot denotes pin #1.	\$15-\$60
		
C4702A	2. Type C white ceramic package w/quartz cap, gold cap ground strap, and gold pins. Black dot denotes pin #1.	\$15-\$60

Type B Packages

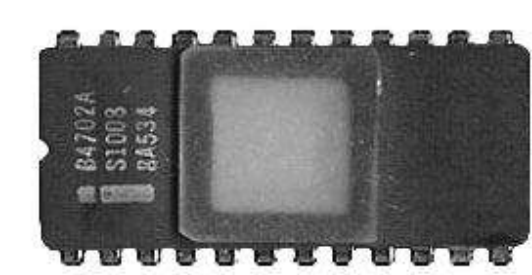
Part Number	Package Description	Values
		
B4702A	Type B grey ceramic package w/tin pins.	\$10-\$40

References

- [1] Intel (September 1972). Intel Data Catalog. No reference to 4702A dates chip after September 1972.
- [2] Intel (February 1973). Intel MCS-4 User's Manual, Rev. 4. No reference to 4702A dates chip after 1973.
- [3] Intel (November 1974). Intel MCS-40 User's Manual for Logic Designers, 4702A Data Sheet, p. 4-28
- [4] Intel (1978). Intel Component Data Catalog, 4702A Data Sheet, p. 4-14

Intel i4801

Clock Generator Crystal for 4004/4201A or 4040/4201A

1976-77

Specifications

- Clock Generator Crystal for 4004/4201A or 4040/4201A
- Fundamental – 5.185 MHz
- “AT” Cut Fundamental Frequency
- Room Temperature Frequency Adjusted Within $\pm .005\%$
- Used With 4201A in MCS-40™ Systems
- Temperature Range -55°C to 125°C
- Two Lead Can

The 4801 is a quartz crystal resonator to be used with 4201A in an MCS-40 microcomputer system. The selection of 5.185 MHz gives a $1.35\mu\text{s}$ clock period (740KHz) for a 4004 or 4040 [5].

Part Numbers

No Examples Known with Intel Logo

References

- [1] Intel (February 1973). Intel MCS-4 User's Manual, Rev 4. No reference to 4801 dates part after February 1973.
- [2] Intel (November 1974). Intel MCS-40 User's Manual For Logic Designers. No reference to 4801 dates chip after November 1974.
- [3] Intel (1975). Intel Data Catalog. No reference to 4801.
- [4] Intel (1976). Intel Data Catalog. No reference to 4801.
- [5] Intel (1977). Intel Data Catalog, 4801 Data Sheet, p. 8-120

Intel i5101

1024-bit (256 x 4) Static RAM

1974

Specifications

- 1024-bit (256 x 4) Static RAM w/Separate I/O
- CMOS
- Single +5V Power Supply
- Ideal for Battery Operation (5101L)
- Directly TTL Compatible – All Inputs and Outputs
- Three-State Output
- CMOS Equivalent of Intel 2101 Static RAM
- Pin compatible to Intel 2101 Static RAM
- 22-pin Dual In-Line Package

Type	Access Time Max.	Cycle Time Max.	Power Dissipation Max. Operating/Standby	Supplies [V]
5101	650ns	650ns	150mW/2.5mW	+5
5101-1	450ns	450ns	-	+5
5101-3	650ns	650ns	142mW/1mW	+5
5101-8	800ns	800ns	150mW/2.5mW	+5
M5101-4	800ns	800ns	168mW/1mW	+5
M5101-5	800ns	800ns	-	+5

The Intel® 5101 is an ultra-low power 1024-bit (256 words x 4-bits) static RAM fabricated with an advanced ion-implanted silicon gate CMOS technology. The device has two chip enable inputs. Minimum standby current is drawn by this device when CE2 is at a low level. When deselected the 5101 draws from a single 5-volt supply only 10 microamps. This device is ideally suited for low power applications where battery operation or battery backup for non-volatility are required.

The 5101 uses fully DC stable (static) circuitry; it is not necessary to pulse chip select for each address transition. The data is read out non-destructively and has the same polarity as the input data. All inputs and outputs are directly TTL compatible. The 5151 has separate data input and data output terminals. An output disable function is provided so that the data inputs and outputs may be OR-ed for use in common I/O systems.

The 5101L has the additional feature of guaranteed data retention at a power supply voltage as low as 2.0 volts.

A pin compatible N-channel static RAM, the Intel® 2101A, is also available for low cost applications where a 256 x 4 organization is needed.



The Intel ion-implanted, silicon gate, Complementary MOS (CMOS) process allows the design and production of ultra-low power high performance memories [3].

History

In 1972, Intel acquired Microma Universal, Inc. and started in the watch business. The circuits required for these watches needed to be very low power. Consequently, a CMOS process was developed. CMOS products were assigned the "5xxx" designation. Chips that didn't have oscillators were "52xx", and chips that worked with a crystal were "58xx." Later, this CMOS process was also used for the 5101 RAM [4].

Part Numbers

Type C Packages

Part Number	Package Description	Values
		
C5101	1. Type C grey ceramic package w/gold cap, gold cap ground strap, and gold pins. Cap ground strap connection points on both ends of package (only one used).	Ex. Rare \$50-\$200
		
C5101	2. Type C purple ceramic package w/gold cap and gold pins.	Ex. Rare \$50-\$200
MC5101-4	Type C package	Ex. Rare (0 Known) \$\$\$

Type B Packages

Part Number	Package Description	Values
B5101-8	Type B package	Ex. Rare (0 Known) \$\$\$

Type P Packages

Part Number	Package Description	Values
P5101	Type P package	\$5-\$20
P5101-3	Type P package	\$5-\$20

Intel i5101



P5101-8	Type P black plastic package w/tin pins.	\$2-\$8
---------	--	---------

References

- [1] Intel (September 1975). Intel MCS-80 User's Manual, 5101, 5101L Family Data Sheet, p. 5-91
- [2] Intel (1975). Intel Memory Design Handbook, M5101-5/M5101L-5, p. 6-18.
- [3] Intel (1977). Intel Data Catalog, 5101, 5101L Family Data Sheet, p. 2-113
- [4] Intel (2002). Intel Recollections of Early Chip Development at Intel. Available from: http://intel.com/technology/itj/q12001/articles/art_1.htm [Accessed 10 July 2002]
- [5] Intel (1984). A Revolution in Progress... A History of Intel to Date, 5101 introduced 1974, p. 26.

Intel i5101L

1024-bit (256 x 4) Static RAM

1974

Specifications

- 1024-bit (256 x 4) Static RAM w/Separate I/O
- CMOS
- Single +5V Power Supply
- Ideal for Battery Operation (5101L)
- Directly TTL Compatible – All Inputs and Outputs
- Three-State Output
- CMOS Equivalent of Intel 2101 Static RAM
- Pin compatible to Intel 2101 Static RAM
- 22-pin Dual In-Line Package

Type	Access Time Max.	Cycle Time Max.	Power Dissipation Max. Operating/Standby	Supplies [V]
5101L	650ns	650ns	135mW/20 μ W	+5
5101L-1	450ns	450ns	135mW/20 μ W	+5
5101L-3	650ns	650ns	135mW/1mW	+5
M5101L-4	800ns	800ns	168mW/400 μ W	+5
M5101L-5	800ns	800ns	-	-

The Intel® 5101 is an ultra-low power 1024-bit (256 words x 4-bits) static RAM fabricated with an advanced ion-implanted silicon gate CMOS technology. The device has two chip enable inputs. Minimum standby current is drawn by this device when CE2 is at a low level. When deselected the 5101 draws from a single 5-volt supply only 10 microamps. This device is ideally suited for low power applications where battery operation or battery backup for non-volatility are required.

The 5101 uses fully DC stable (static) circuitry; it is not necessary to pulse chip select for each address transition. The data is read out non-destructively and has the same polarity as the input data. All inputs and outputs are directly TTL compatible. The 5151 has separate data input and data output terminals. An output disable function is provided so that the data inputs and outputs may be OR-ed for use in common I/O systems.



The 5101L has the additional feature of guaranteed data retention at a power supply voltage as low as 2.0 volts.

A pin compatible N-channel static RAM, the Intel® 2101A, is also available for low cost applications where a 256 x 4 organization is needed.

The Intel ion-implanted, silicon gate, Complementary MOS (CMOS) process allows the design and production of ultra-low power high performance memories [3].

Part Numbers

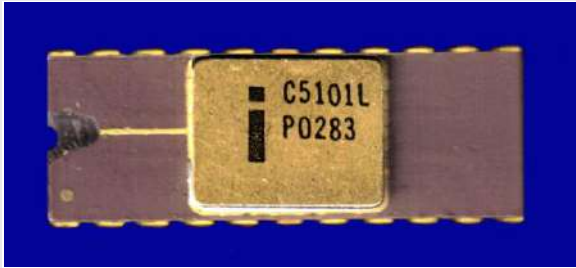
Type C Packages

Part Number	Package Description	Values
		
C5101L	Type C brown ceramic package w/gold cap, gold cap ground strap, and gold pins. Gold dot denotes pin #1.	Ex. Rare (1 Known) \$50-\$200
C5101L-1	1. Type C grey ceramic package w/gold cap, gold cap ground strap, and gold pins. Gold cap ground strap connection points on both ends of package (only one used). Gold or yellow dot denotes pin #1.	Ex. Rare \$50-\$200
		
C5101L-1	2. Type C purple ceramic package w/gold cap and gold pins.	Ex. Rare \$50-\$200
MC5101L-4	Type C package	Ex. Rare (0 Known) \$\$\$

Type B Packages

Part Number	Package Description	Values
B5101L	Type B package	Rare \$15-\$60

Intel i5101L

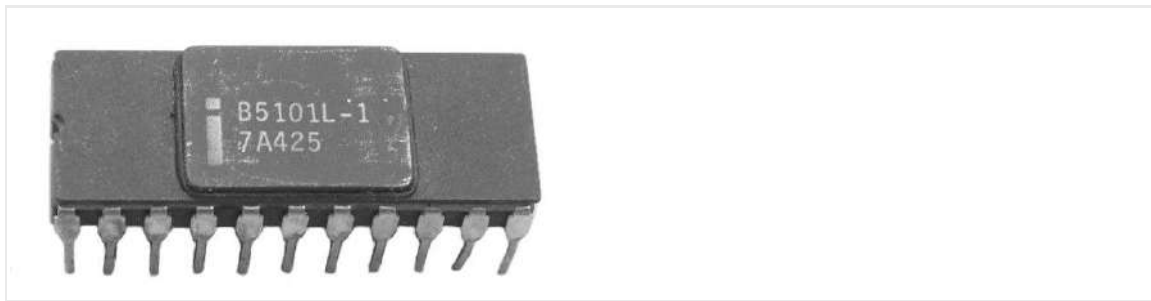

B5101L-1	Type B grey ceramic package w/black cap and tin pins.	\$5-\$20
B5101L-3	Type B package	\$5-\$20
MB5101L-4	Type B package	\$10-\$40
MB5101L-4/B	Type B package	\$10-\$40

Type D Packages

Part Number	Package Description	Values
D5101L	Type D package	\$3-\$12

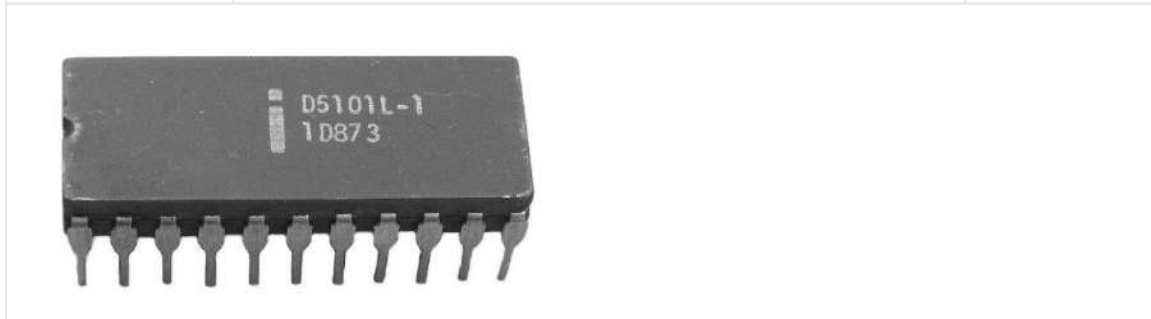

D5101L-1	Type D grey ceramic package w/tin pins	\$3-\$12
D5101L-3	Type D package	\$3-\$12
MD5101L-4	Type D package	\$5-\$20

Type P Packages

Part Number	Package Description	Values
P5101L	Type P black plastic package w/tin pins. Small round indentation denotes pin #1.	\$.75-\$3
P5101L-1	Type P package	\$.75-\$3
P5101L-3	Type P package	\$.75-\$3

References

- [1] Intel (September 1975). Intel MCS-80 User's Manual, 5101, 5101L Family Data Sheet, p. 5-91
- [2] Intel (1975). Intel Memory Design Handbook, M5101-5/M5101L-5, p. 6-18.
- [3] Intel (1977). Intel Data Catalog, 5101, 5101L Family Data Sheet, p. 2-113
- [4] Intel (2002). Intel Recollections of Early Chip Development at Intel. Available from: http://intel.com/technology/itj/q12001/articles/art_1.htm [Accessed 10 July 2002]
- [5] Intel (2002). Intel Museum Archive Collection Chronological Timeline, 5101 [introduction] date "01/01/74". Available from: http://www.intel.com/intel/intelis/museum/arc_collect/TimelineChron.pdf [Accessed 10 July 2002]

Intel i5201

LCD Decoder-Driver

1973

Specifications

- LCD Decoder-Driver
- Advanced Silicon Gate Ion Implanted CMOS Technology
- 5201 and 5202 Drive Dynamic Scattering Displays
- 5201-2 and 5202-2 Drive Field Effect Displays
- 5201 and 5201-2 Display Hours, Minutes and Seconds on Command
- 5202 and 5202-2 Display Hours and Minutes
- Inputs Protected Against Static Charge
- 30-lead Flat Pack Package

The 5201, 5201-2, 5202, and 5202-2 are low power 3 ½ digit liquid crystal display decoder/drivers intended for use in electronic timekeeping applications such as wristwatches and battery-operated clocks. The 5201 and 5202 are specified for operation over the supply voltage range 10 to 15 volts for use with dynamic scattering liquid crystal displays. The 5201-2 and 5202-2 are specified for operation from 6 to 10 volt supply voltages for use with field effect liquid crystal displays.

The 5201 and 5201-2 normally display hours and minutes. On activation of the seconds command switch, seconds are displayed in the minutes position and hours are blanked. Resetting of the seconds command switch restores the display mode to hours and minutes. The 5202 and 5202-2 display hours and minutes only. The colon is flashed at a 1 Hz rate on all four devices.

The decoder/drivers accept a 64 Hz input signal from which they count and decode hours and minutes (and seconds in the case of the 5201 and 5201-2). The decoded signals are used for driving the three 7-segment and one 2-segment display digits. A symmetrical 32 Hz signal is provided to drive the common back plate of the display. Segments to be energized are driven with a symmetrical 32 Hz signal that is out-of-phase with the common signal while unenergized segments are driven with a symmetrical 32 Hz signal in phase with the common signal.

Two inputs allow for time setting and resetting.

These devices are fabricated with complementary MOS silicon gate technology. This extremely low power technology is ideally suited for the manufacture of devices designed to operate from small batteries for long periods of time [1].

Part Numbers

No Examples Known

References

- [1] Intel (1975). Intel Data Catalog, 5201, 5201-2, 5202, 5202-2 Data Sheet, p. 8-3
- [2] Intel (1984). A Revolution in Progress... A History of Intel to Date, 5201 introduced 1973, p. 26

Intel i5202

LCD Decoder-Driver

1973-75

Specifications

- LCD Decoder-Driver
- Advanced Silicon Gate Ion Implanted CMOS Technology
- 5201 and 5202 Drive Dynamic Scattering Displays
- 5201-2 and 5202-2 Drive Field Effect Displays
- 5201 and 5201-2 Display Hours, Minutes and Seconds on Command
- 5202 and 5202-2 Display Hours and Minutes
- Inputs Protected Against Static Charge
- 30-lead Flat Pack Package

The 5201, 5201-2, 5202, and 5202-2 are low power 3 ½ digit liquid crystal display decoder/drivers intended for use in electronic timekeeping applications such as wristwatches and battery-operated clocks. The 5201 and 5202 are specified for operation over the supply voltage range 10 to 15 volts for use with dynamic scattering liquid crystal displays. The 5201-2 and 5202-2 are specified for operation from 6 to 10 volt supply voltages for use with field effect liquid crystal displays.

The 5201 and 5201-2 normally display hours and minutes. On activation of the seconds command switch, seconds are displayed in the minutes position and hours are blanked. Resetting of the seconds command switch restores the display mode to hours and minutes. The 5202 and 5202-2 display hours and minutes only. The colon is flashed at a 1 Hz rate on all four devices.

The decoder/drivers accept a 64 Hz input signal from which they count and decode hours and minutes (and seconds in the case of the 5201 and 5201-2). The decoded signals are used for driving the three 7-segment and one 2-segment display digits. A symmetrical 32 Hz signal is provided to drive the common back plate of the display. Segments to be energized are driven with a symmetrical 32 Hz signal that is out-of-phase with the common signal while unenergized segments are driven with a symmetrical 32 Hz signal in phase with the common signal.

Two inputs allow for time setting and resetting.

These devices are fabricated with complementary MOS silicon gate technology. This extremely low power technology is ideally suited for the manufacture of devices designed to operate from small batteries for long periods of time [1].

Part Numbers

No Examples Known

References

- [1] Intel (1975). Intel Data Catalog, 5201, 5201-2, 5202, 5202-2 Data Sheet, p. 8-3

Intel i5204

Time/Seconds/Date LCD Decoder-Driver

1973-75

Specifications

- Time/Seconds/Date LCD Decoder-Driver
- Advanced Silicon Gate Ion Implanted CMOS Technology
- Displays Hours and Minutes or Seconds or Date
- Pin Compatible with Intel 5201 and 5202
- Anti-Bounce Circuitry on Switch Inputs
- Drives 3 ½ Digit Field Effect Displays
- Inputs Protected Against Static Charge
- 30-lead Flat Pack Package

The 5204 is a low power 3-½ digit liquid crystal display decoder intended for use in 12 hour timekeeping applications such as wristwatches and battery operated clocks.

The 5204 accepts a 64 Hz input signal from which it counts and decodes Seconds, Minutes, Hours, and Date. The decoded signals are used for driving the three 7-segment and one 2-segment display digits. A symmetrical 32 Hz signal is provided to drive the common back plate of the display. Segments to be energized are driven with a symmetrical 32 Hz signal that is out-of-phase with the common signal while unenergized segments are driven with a symmetrical 32 Hz signal in phase with the common signal.

The 5204 will normally display Hours and Minutes. Depression of the D/C command switch will cause Seconds to be displayed in the Minutes position and the Hours will be blanked. A second depression of the D/C command switch will cause the Date to be displayed in the Minutes position and the Hours to be blanked. A third depression of the D/C command switch will cause a return to normal mode displaying Hours and Minutes. The colon is flashed at a 1 Hz rate in all three display modes.

A separate switch is used for timesetting. Thus only two switches are required for operation of the watch.

The 5204 is designed to operate in conjunction with the 5801 oscillator-divider circuit. For information on the 5801 see the 5801 data sheet.

This device is fabricated with complementary MOS silicon gate technology. This extremely low power technology is ideally suited for the manufacture of devices designed to operate from small batteries for long periods of time [1].

Part Numbers

No Examples Known

References

- [1] Intel (1975). Intel Data Catalog, 5204 Data Sheet, p. 8-7

Intel i5234

Quad CMOS-to-MOS Level Shifter and Driver for 4K NMOS RAMs

1975

Specifications

- Quad CMOS-to-MOS Level Shifter and Driver for 4K RAMs
- CMOS Technology for Very Low Power: Suitable for Battery Backup
- High Density: Four Drivers in One Package
- Internal Gating Structure Minimizes Package Count
- CMOS Compatible Inputs
- Only One Power Supply Required, +12V ($\pm 10\%$)
- 16-pin Dual In-Line Package

Type	Input to Output Delay Max.	Power Dissipation Max.	Supplies [V]
5234	100ns	1.4 μ W	+12

The Intel® 5234 is a Quad CMOS-to-MOS driver which accepts CMOS input signals. It provides high output current and voltage suitable for driving the clock inputs of N-channel MOS memories such as the 2107A or 2107B. The circuit operates from a single 12 volt power supply.

The device features two common enable inputs, a refresh select input, and a clock control input for simplified system design.

The Intel ion-implanted, silicon gate, Complementary MOS (CMOS) process allows the design and production of very low power drivers [3].

Part Numbers

No Examples Known

References

- [1] Intel (1975). Intel Data Catalog, No reference to 5234 dates chip after 1975.
- [2] Intel (1975). Intel Memory Design Handbook, 5234/5235 Specifications, p. 11-8.
- [3] Intel (1976). Intel Data Catalog, 5234 Preliminary Data Sheet, p. 5-38
- [4] Intel (1977). Intel Data Catalog, No reference to 5234. Discontinued.

Intel i5235

Quad CMOS TTL-to-MOS Level Shifter and Driver for 4K NMOS RAMs

1975

Specifications

- Quad CMOS TTL-to-MOS Level Shifter and Driver for 4K NMOS RAMs
- CMOS Technology for Very Low Power: Suitable for Battery Backup
- High Density: Four Drivers in One Package
- Internal Gating Structure Minimizes Package Count
- TTL and DTL Compatible Inputs
- Only One Power Supply Required, +12V ($\pm 10\%$)
- CMOS pin-for-pin equivalent of the Intel 3245 [2]
- 16-pin Dual In-Line Package

Type	Input to Output Delay Max.	Power Dissipation Max.	Supplies [V]
5235	125ns	240mW	+12
5235-1	95ns	240mW	+12

The Intel® 5235 and 5235-1 are Low Power Quad TTL-to-MOS drivers which accept TTL and DTL input levels. They provide high output current and voltage suitable for driving the clock inputs on C-channel MOS memories such as the 2107A or 2107C. The circuit operates from a single 12-volt power supply.

The device features two common enable inputs, a refresh select input, and a clock control input for simplified system design. The 5235-1 is a selection of the 5235 and is guaranteed for 95ns maximum delay plus transition time while driving a 250pF load.

The Intel ion-implanted, silicon gate Complementary MOS (CMOS) process allows the design and production of very low power drivers [4].

Part Numbers

Type D Packages

Part Number	Package Description	Values
D5235	Type D package	Rare \$10-\$40

References

- [1] Intel (1975). Intel Data Catalog, No reference to 5235 dates chip after 1975.
- [2] Intel (1975). Intel Memory Design Handbook, 5235 Quad Driver, p. 9-21.
- [3] Intel (1977). Intel Data Catalog, 5235, 5235-1 Data Sheet, p. 5-37
- [4] Intel (1978). Component Data Catalog, 5235, 5235-1 Data Sheet, p. 6-37

Intel i5244

Quad CCD Clock Driver

1975

Specifications

- Quad CCD Clock Driver
- CMOS
- Internal Circuitry Minimizes CCD Clock Cross-Coupling Voltage Transients
- Drives Four 2416s
- Low Standby Power Dissipation: 24mW Typically
- TTL Inputs
- Single +12V Supply
- 16-pin Dual In-Line Package

Type	Input to Output Delay Max.	Power Dissipation Max.	Supplies [V]
5244	TBS	TBS	+12

The 5244 is a quad clock driver which provides high capacitive drive suitable for driving charge-coupled memories. The 5244 features very low D.C. power dissipation from a single 12 V supply with output characteristics directly compatible with the 2416 clock input requirements. Internal circuitry controls the cross-coupled voltage transients between the clock phases generated by the 2416 and limits the transition time so that excessively fast transitions do not occur on the clock line.

The 5244 is fabricated using an advanced ion-implanted, silicon gate, CMOS process [4].

Part Numbers

Type D Packages

Part Number	Package Description	Values
D5244	Type D package	\$1.25-\$5

References

- [1] Intel (1975). Intel Data Catalog. No reference to 5244 dates chip after 1975.
- [2] Intel (1975). Intel Memory Design Handbook, Using the Intel® 5244 as a Clock Phase Driver, p. 9-30
- [3] Intel (1976). Intel Data Catalog, 5244 Preliminary Data Sheet, p. 5-46
- [4] Intel (1978). Intel Component Data Catalog, 5244 Data Sheet, p. 5-41

Intel i5801

Low Power Oscillator-Divider

1973

Specifications

- Low Power Oscillator-Divider
- Advanced Silicon Gate Ion Implanted CMOS Technology
- On Chip Drive and Regulator Circuitry for Up-Converter
- Long Battery Life – Low Current Drain – 5 μ A max.
- Inputs Protected Against Static Discharge
- 10-lead Flat Pack Package

The 5801 is a low power oscillator and 2^9 divider ideally suited for use in battery powered timekeeping applications. The circuitry consists of an inverter stage designed to operate in conjunction with an external quartz crystal and feedback network to form an oscillator, a 9-stage binary ripple carry counter, and control logic. Two outputs are provided: A buffered drive output providing $\frac{1}{2}$ cycle of the oscillator at a repetition rate equal to the frequency of the oscillator divided by 2^5 and an open drain output that is switched on for $\frac{1}{2}$ cycle of the oscillator at a repetition rate of the oscillator divided by 2^9 . The buffered drive output and associated control circuitry are designed for use with external components to implement a regulated voltage up-converter.

The 5801 is manufactured with complementary MOS silicon gate technology. Long term continuous operation from small batteries is made possible by use of this low power technology [1].

Part Numbers

No Examples Known

References

[1] Intel (1975). Intel Data Catalog, 5801 Data Sheet, p. 8-11

[2] Intel (1984). A Revolution in Progress... A History of Intel to Date, 5801 introduced 1973, p. 26

Intel i5810A

Single Chip LCD Time/Seconds/Date Watch Circuit

1975-76

Specifications

- Single Chip LCD Time/Seconds/Date Watch Circuit
- On Chip Voltage Multiplier Provides 4.5V For Driving 3 ½ Digit Field Effect Display
- Only Two Switches Required For Complete Operation Of The Watch
- Operates With 32.768 kHz Quartz Crystal
- Anti-Bounce Protection On Switch Inputs
- AM/PM Indication When Setting Time
- Unpackaged Die

The 5810A is a low power timekeeping circuit intended for use with 7 segment, 3-½ digit field effect liquid crystal displays. All of the circuitry required in a Time/Seconds/Date watch is contained on this single chip.

An on-chip voltage multiplier is incorporated on the 5810A. The multiplier derives a 4 to 4.8 volt display drive supply from the 1.5 volt battery. This multiplier requires only three external capacitors.

The 5810A, in conjunction with an external quartz crystal and trimmer capacitor, oscillates at 32.768 kHz, divides down and decodes Seconds, Minutes, Hours, and Date of Month.

The 5810A will normally display Hours and Minutes. Closure of the D/C command switch will cause Seconds to be displayed in the Minutes Position and the Hours will be blanked. A second closure of the D/C command switch will cause the Date to be displayed in the Minutes position and Hours to be blanked. A third closure of the D/C command switch will cause a return to the normal mode displaying Hours and Minutes. Switch S is used in conjunction with switch D/C for timesetting operations. Thus only two switches are required for complete operation of the watch.

The colon is flashed at a 1Hz rate in all three display modes.

To facilitate testing and calibration a fast test input, reset and oscillator calibrate output are provided.

The 5810A is manufactured with complementary silicon gate MOS. This extremely low power technology is ideally suited for the manufacture of devices designed to operate on small batteries for long periods of time [2].

Part Numbers

Unpackaged Die.

References

- [1] Intel (1975). Intel Data Catalog. No reference to 5810A.
- [2] Intel (1976). Intel Data Catalog, 5810A Data Sheet, p. 11-2

Intel i7110

1,048,576-bit (256 x 4096) Bubble Memory

1979

Specifications

- 1,048,576-bit (256 x 4096) Bubble Memory
- Non-Volatile, Solid-State Memory
- True Binary Organization - 512 Bit Page and 2048 Pages
- Major Track - Minor Loop Architecture
- Redundant Loops with On-Chip Loop Map and Index
- Block Replicate for Read; Block Swap for Write
- Transparent Burst Error Correction
- Small Physical Volume
- Low Power per Bit
- Maximum Data Rate 100 Kbit/sec
- Complete Set of Interface Circuits for Ease of Use
- 20-pin Dual In-Line Leadless Package

Type	Temperature	Supplies [V]
7110	0°-50C°	+5
7110-1	0°-70C°	+5
7110-2	10°-50C°	+5
7110-3	10°-35C°	+5

The Intel Magnetics 7110 is a very high-density 1-megabit non-volatile, solid-state memory utilizing the magnetic bubble technology. The usable data storage capacity is 1,048,576 bits. The defect tolerant design incorporates redundant storage loops. The gross capacity of Intel Magnetics bubble memory is 1,310,720 bits.

The 7110 has a true binary organization to simplify system design, interfacing, and system software. The device is organized as 256 data storage loops each having 4096 storage bits. When used with Intel Magnetics complete family of support electronics the resultant minimum system is configured as 128K bytes of usable data storage. The support circuits also provide automatic error correction and transparent handling of redundant loops.

The 7110 has a major track-minor loop architecture; It has separate read and write tracks. Logically, the data is organized as a 512-bit page with a total of 2048 pages. The redundant loop information is stored on-chip in the bootstrap loop along with an index address code. When power is disconnected, the 7110 retains the data stored and the bubble memory system is restarted when power is restored via the support electronics under software control.

The 7110 is packaged in a dual in-line leadless package complete with permanent magnets and coils for the in-plane rotating field. In addition, the 7110 has a magnetic shield surrounding the bubble memory chip to protect the data from externally induced magnetic fields.



The 7110 operating data rate is 100 Kbit/sec. The 7110 can be operated asynchronously and has start/stop capability [1].

History

"Intel also entered the bubble memory business in 1977. The '7xxx' product family was reserved for bubble memory products, and the 7110 1-megabit bubble memory chip was introduced in 1979." [2]

Intel i7110

Part Numbers

Part Number	Package Description	Values
7110	20 pin leadless package	Rare \$10-\$40
 <p>The image shows a square, leadless integrated circuit chip. The top surface is white with black printed text. On the left side, there is a vertical stamp: '©INTEL MAGNETICS 1980' and 'MADE IN U.S.A.'. The main text on the chip includes the part number '7110-1', the code '9ADA6 8128', and several lines of alphanumeric characters: 'F7FBFFFFFFFFFFFF', 'FFFFFFFFFFFFFFFF', 'FFFFBFFFFFFFFFFFF', 'EEFEBFFFFFFFFE7E6E7', and 'E67FFFEEBBFFFFFF'. The chip has 20 gold-plated pins extending from its sides.</p>		
7110-1	20 pin leadless package. © Intel Magnetics 1980	Rare \$10-\$40
 <p>The image shows a square, leadless integrated circuit chip. The top surface is light blue with black printed text. On the left side, there is a small black dot and the letter 'A'. The main text on the chip includes the Intel logo, the part number '7110-2', the code '8012 1DM8', and the copyright information '© INTEL MAGNETICS, INC. 1979'. The chip has 20 gold-plated pins extending from its sides.</p>		
7110-2	20 pin leadless package. TM Intel Magnetics, Inc. 1979	Ex. Rare \$25-\$100

Intel i7110



7110-4

20 pin leadless package. No copyright.

Rare
\$10-\$40

References

[1] Intel (1980). Intel Component Data Catalog, 7110 Preliminary Data Sheet, p. 3-2

[2] Intel (2001). Recollections of Early Chip Development at Intel. Available from:
http://developer.intel.com/technology/itj/q12001/articles/art_1.htm [Accessed 9 May 2004]

Intel i7110A

1,048,576-bit (256 x 4096) Bubble Memory

1983-84

Specifications

- 1,048,576-bit (256 x 4096) Bubble Memory
- Non-Volatile, Solid-State Memory
- True Binary Organization - 512 Bit Page and 2048 Pages
- Major Track - Minor Loop Architecture
- Redundant Loops with On-Chip Loop Map and Index
- Block Replicate for Read; Block Swap for Write
- Small Physical Volume
- Low Power per Bit
- Maximum Data Rate 100 Kbit/sec
- 20-pin Dual In-Line Leadless Package

The Intel Magnetics 7110 is a very high-density 1-megabit non-volatile, solid-state memory utilizing the magnetic bubble technology. The usable data storage capacity is 1,048,576 bits. The defect tolerant design incorporates redundant storage loops. The gross capacity of Intel Magnetics bubble memory is 1,310,720 bits.

The 7110 has a true binary organization to simplify system design, interfacing, and system software. The device is organized as 256 data storage loops each having 4096 storage bits. When used with Intel Magnetics complete family of support electronics the resultant minimum system is configured as 128K bytes of usable data storage. The support circuits also provide automatic error correction and transparent handling of redundant loops.

The 7110 has a major track-minor loop architecture; It has separate read and write tracks. Logically, the data is organized as a 512-bit page with a total of 2048 pages. The redundant loop information is stored on-chip in the bootstrap loop along with an index address code. When power is disconnected, the 7110 retains the data stored and the bubble memory system is restarted when power is restored via the support electronics under software control.

The 7110 is packaged in a dual in-line leadless package complete with permanent magnets and coils for the in-plane rotating field. In addition, the 7110 has a magnetic shield surrounding the bubble memory chip to protect the data from externally induced magnetic fields. The 7110 operating data rate is 100 Kbit/sec. The 7110 can be operated asynchronously and has start/stop capability [1].

Intel i7110A

Part Numbers

Part Number	Package Description	Values
7110A	20-pin Leadless Package	Rare \$10-\$40
7110A-1	20-pin Leadless Package	Rare \$10-\$40
 A photograph of an Intel i7110A-4 chip, a 20-pin leadless package. The chip is square with a light-colored top surface and a dark green bottom surface. The top surface has several lines of text: "7110A-4" at the top, "8413Z 9A13" below it, and several lines of hexadecimal data: "7777777777777777", "8888888888888888", "9999999999999999", "AABBDDDDDDDDDDDD", "CCCCCCCCCCCCCCCC", "EEEEEEEEEEEEEEEE", and "FFFFFFFFFFFFFFFF". The chip is mounted on a blue background.		
7110A-4	20-pin Leadless Package	Rare \$10-\$40

References

[1] Intel (1980). Intel Component Data Catalog, Preliminary 7110 Data Sheet, p. 3-2. No reference to 7110A dates chip after 1980.

[2] Intel (January 1982). Intel Component Data Catalog. No reference to 7110A.

[3] Hearst (1983). IC Master. Intel 7110, p. 3468. No reference to 7110A.

[4] Hearst (1984). IC Master. Intel 7110, p. 3768. No reference to 7110A.

[5] Hearst (1987). IC Master. Intel 7110, p. 3724-2. No reference to 7110A.

Intel i7220

Bubble Memory Controller for Intel 7110 Bubble Memory

1979

Specifications

- Bubble Memory Controller for Intel 7110 Bubble Memory
- HMOS
- Ideal for IM's Bubble Memories
- Standard 8080/8085/Multibus™ Interface
- Multiple Bubble Module Interface Capability
- Self-Containing Timing Generation
- DMA Handshake Capability
- Single or Multiple Page Block Transfers
- 40-pin Dual In-Line Package

The Intel 7220 is a complete Bubble Memory Controller (BMC) designed to interface with Intel Magnetics Bubble Memories. The interface to the outside world is through the standard 8080/8085/Multibus™

The 7220 is capable of multiple bubble memory interface. It has self-contained timing generation and DMA handshake capability. Single or/or multiple page block transfers are also possible.

The 7220 is capable of interfacing with up to eight 7242 Dual Formatter/Sense Amplifier (FSA) devices. Serial data from the bubble memory via the FSA is reformatted into a nine bit parallel bus (ninth bit is used for parity) at the host CPU interface.



The 7220 utilizes Intel's high performance HMOS technology. The device is packaged as a standard 40-pin dual in-line package. All inputs and outputs are directly TTL compatible and the device uses a single +5 volt supply [1].

Part Numbers

Type C Packages

Part Number	Package Description	Values
C7220	Type C package	Rare \$15-\$60
C7220-1	Type C package	Rare \$15-\$60

Type D Packages

Part Number	Package Description	Values
		
D7220	Type D grey ceramic package w/tin pins. No copyright. Example shown marked 'ES' for Engineering Sample.	Rare \$10-\$40
		
D7220-1	Type D grey ceramic package w/tin pins. © Intel '81	\$1.25-\$5
D7220-5	Type D package	\$1.50-\$6
D7220-6	Type D package	\$1.50-\$6

References

- [1] Intel (1980). Intel Component Data Catalog, 7220 Advance Information, p. 3-8.

Intel i7230

Current Pulse Generator for Intel 7110 Bubble Memory

1979

Specifications





- Current Pulse Generator for Intel 7110 Bubble Memory
- Ideal for Use with IM's Bubble Memories
- TTL Compatible Inputs
- Provides all Pulses for IM's Bubble Memories
 - Replicate, Swap, Generate, Boot Replicate and Bootswap
- Current Sink Outputs Designed to Directly Drive Bubble Memory
- Direct Interface to Bubble Memory Controller
- Power Down and Power Fail Signal
- Operates from +5 and +12 Volts Only
- Schottky Bipolar Technology
- 22-pin Dual In-Line Package

The Intel 7230 is a Current Pulse Generator (CPG) designed to drive Intel Magnetics Bubble Memories. The 7230 is a Schottky Bipolar, TTL input compatible device that converts digital timing signals to analog current pulses ideally suited for bubble memories. The CPG provides all pulses for Intel Magnetic Bubble Memories (7110 Family). These include Replicate, Swap, Generate, Boot Replicate, and Bootswap pulses. The high current sinking outputs directly drive the bubble memory. It also directly interfaces to the Intel Magnetics Bubble Memory Controller (7220) and Formatter/Sense Amplifier (7242).

The 7230 operates from 5-volt and 12-volt power supplies and is in a standard 22-pin dual in-line package [1].

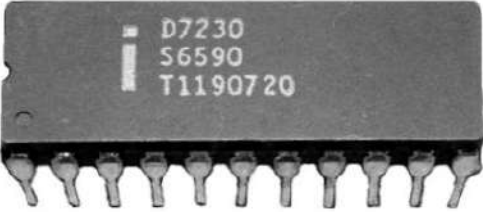
Part Numbers

Type D Packages

Part Number	Package Description	Values
		
D7230	1. Type D grey ceramic package w/tin pins. Small round indentation denotes pin #1. No copyright.	\$.50-\$2
		
D7230	2. Type D grey ceramic package w/tin pins. © Intel '79	\$.50-\$2
		
D7230-1	Type D grey ceramic package w/tin pins. © Intel '79 '86	\$.75-\$3
		
D7230-4	Type D grey ceramic package w/tin pins. © Intel '79	\$.75-\$3

Intel i7230

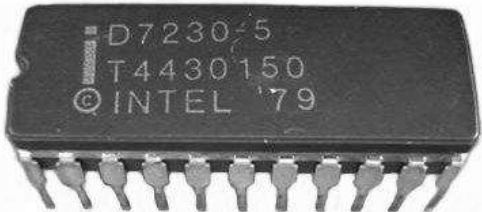
 A black, rectangular integrated circuit chip with a grey ceramic package and ten pins extending from the bottom. The top surface of the chip is marked with the following text: "D7230-5", "T4430150", and "© INTEL '79".		
D7230-5	Type D grey ceramic package w/tin pins. © Intel '79	\$.75-\$3

References

- [1] Intel (1980). Intel Component Data Catalog, 7230 Preliminary Data Sheet, p. 3-15

Intel i7242

Dual Formatter/Sense Amplifier for Intel 7110 Bubble Memory

1979

Specifications

- Dual Formatter/Sense Amplifier for Intel 7110 Bubble Memory
- NMOS
- Ideal for Use with IM's Bubble Memories
- Dual Channel
- On-Chip Sense Amplifiers
- Automatically Handles Redundant Loops
- Error Detection/Correction Done Automatically
- FIFO Data Block Buffer
- Daisy-Chained Selects for Multiple Bubble Memory Systems
- 20-pin Dual In-Line Package

The 7242 is a Dual Formatter/Sense Amplifier (FSA) designed to interface directly with Intel Magnetics Bubble Memories. The 7242 features on-chip sense amplifier for system ease of use and minimization of system part count. The 7242 also provides for automatically handling the bubble memories' redundant loops so they appear transparent to the user. In addition, complete burst error detection and correction can be done automatically by this device.

The 7242 has a full FIFO data block buffer. This device can be daisy-chained for multiple bubble memory systems. Up to eight FSA can be controlled by one 7220 Bubble Memory Controller (BMC).

The 7242 utilizes an advanced NMOS technology to incorporate the on-chip sense amplifiers and other unique features. The device is packaged in a standard high-density 20-pin dual-in-line package [1].

Part Numbers

Type D Packages

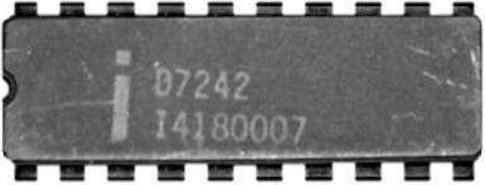
Part Number	Package Description	Values
		
D7242	Type D grey ceramic package w/tin pins	\$.50-\$2
D7242-5	Type D package	\$.75-\$3
D7242-6	Type D package	\$1.25-\$5

References

- [1] Intel (1980). Intel Component Data Catalog, 7242 Preliminary Data Sheet, p. 3-19

Intel i7250

Coil Predriver for Intel 7110 Bubble Memory

1979

Specifications

- Coil Predriver for Intel 7110 Bubble Memory
- CMOS
- Ideal for Use with IM's Bubble Memories
- Very Low Power
- Power Fail Reset for Maximum Protection of Bubble Memory
- TTL Compatible Inputs
- Only One Power Supply Required, +12V
- 16-pin Dual In-Line Package

The Intel 7250 is a low power Coil Pre-Driver (CPD) for use with Intel Magnetics Bubble Memories. The 7250 is controlled by the Intel 7220 Bubble Memory Controller (BMC) and directly drives either Quad VMOS transistor packs or Quad Bipolar transistor packs which are connected to the coils of the bubble memory.

The 7250 is a high voltage, high current driver constructed using CMOS technology. The device has TTL compatible inputs and the outputs are designed to drive either low on-resistance VMOS transistors or bipolar transistors.

The 7250 is in a standard 16-pin dual in-line package [1].

Part Numbers

Type D Packages

Part Number	Package Description	Values
 A black, rectangular Type D package with eight pins extending from the bottom. The top surface is marked with the Intel logo, 'D7250', and 'T4100220S'.		
D7250	Type D grey ceramic package w/tin pins	\$.75-\$3
D7250-5	Type D package	Rare \$5-\$20

References

- [1] Intel (1980). Intel Component Data Catalog, 7250 Preliminary Data Sheet, p. 3-30

Intel i7254

Quad VMOS Drive Transistor Pack for Intel 7110 Bubble Memory 1979

Specifications

- Quad VMOS Drive Transistor Pack for Intel 7110 Bubble Memory
- VMOS FET Technology
- Designed to Drive X and Y Coils of IM's Bubble Memories
- Fast Turn-on and Turn-off – 30ns Max
- Built-in Diode Commutates Coil Current When Transistor is Turned Off
- N-Channel and P-Channel Transistors in the Same Package
- 14-pin Dual In-Line Package

The 7254 is a quad transistor pack designed to drive the X and Y coils of Intel Magnetics Bubble Memories. Two 7254 packages are required for each bubble memory device [1].

Packaging

Have not been able to find any examples of 7254 Drive transistors actually produced by Intel. The Intel Bubble Memory Prototype Kit was supplied with 7254 Drive transistors made by SILICONIX.

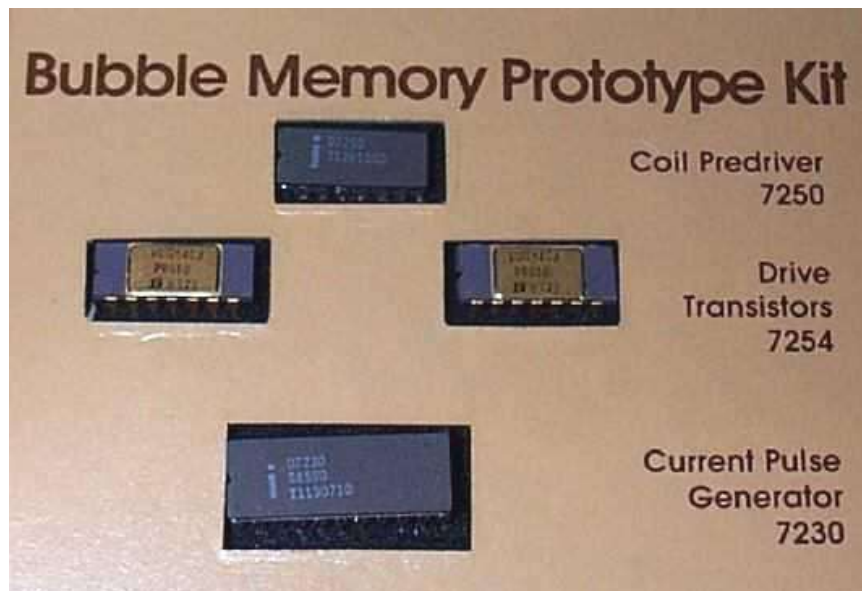

Intel Bubble Memory Prototype Kit with Siliconix Drive Transistors

Intel i7254



SILICONIX VQ7254CJ Drive Transistors on Intel Magnetics Bubble Memory Board



SILICONIX 7254 Drive Transistors marked VQ7254P in Military Bubble Memory Unit

Part Numbers

No Examples Known Marked with Intel Logo

References

- [1] Intel (1980). Intel Component Data Catalog, 7254 Preliminary Data Sheet, p. 3-34

Intel i8008

8-bit Microprocessor

April 1972

Specifications

- 8-bit Microprocessor
- PMOS
- 3500 Transistors (10 Micron)
- Instruction Cycle Time – 1.25 μ sec with 8008-1 or 2.0 μ sec with 8008
- Directly Addresses 16K x 8 Bits of Memory (RAM, ROM, or S.R.)
- Interrupt Capability
- 48 Instructions, Data Oriented
- Address Stack Contains Eight 14-Bit Registers (Including Program Counter) which Permit Nesting of Subroutines Up to 7 Levels
- 18-pin Dual In-Line Package

Type	Clock	Power Dissipation Max.	Supplies [V]
8008	500 KHz	420mW	-9, +5
8008-1	800 KHz	-	-9, +5

The Intel® 8008 is a single chip MOS 8-bit parallel central processor unit (CPU) for the MCS-8 microcomputer system.

This CPU contains six 8-bit data registers, an 8-bit accumulator, two 8-bit temporary registers, 4 flag bits (carry, zero, sign, parity), and an 8-bit parallel binary arithmetic unit, which implements addition, subtraction, and logical operations. A memory stack containing a 14-bit program counter and seven 14-bit words is used internally to store program and subroutine addresses. The 14-bit address permits the direct addressing of 16K words of memory (any mix of RAM, ROM, or S.R.).

The instruction set of the 8008 consists of 48 instructions including data manipulation, binary arithmetic, and jump to subroutine.

The normal program flow of the 8008 may be interrupted through the use of the interrupt control line. This allows the servicing of slow I/O peripheral devices while also executing the main program.

The ready command line synchronizes the 8008 to the memory cycle allowing any type or speed of semiconductor memory to be used [3].

Intel 8008 Die

Look closely and you can see Hal Feeney's Initials (HF) on lower right edge of die

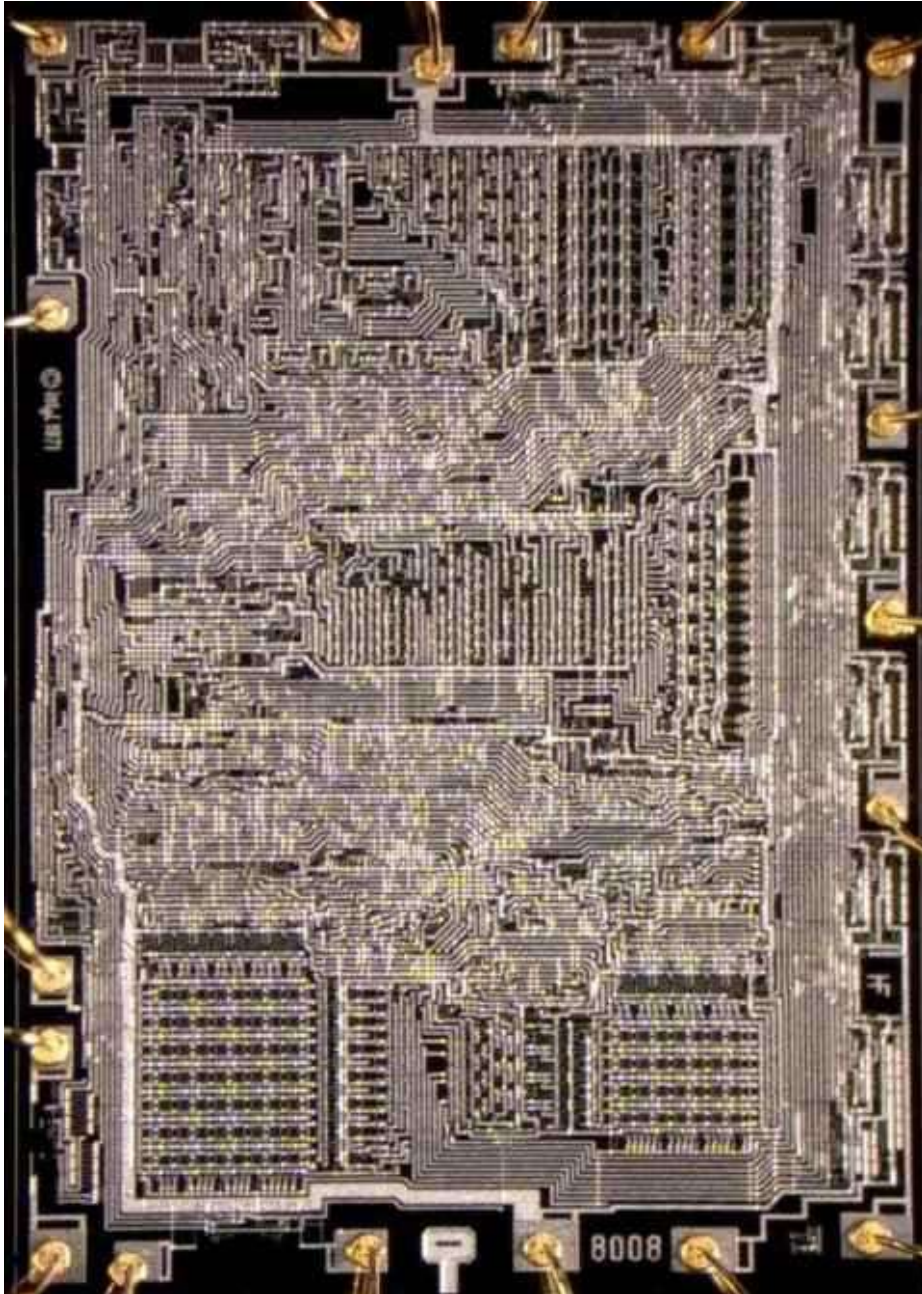

Photo Courtesy <http://www.antiquetech.com/>

History

The 8008 was a member of a family of devices known as the MCS-8 (For Microcomputer Set 8-bit) family. The supporting chips were standard Intel products with different part numbers (8xxx equivalents).

Designers: Ted Hoff, Stan Mazor, Hal Feeney, and Federico Faggin

The 8008 was used in the Intel SIM8-01 single board computer and Intellec-8 microcomputer.

The Intel Intellec-8 and its companion, the Intellec-4, which employed the Intel 4004 CPU, were the first American microcomputers ever to be sold and Pre-date the Altair 8800 by almost two years. The Intellec-8 was introduced in 1973 and originally cost \$2398

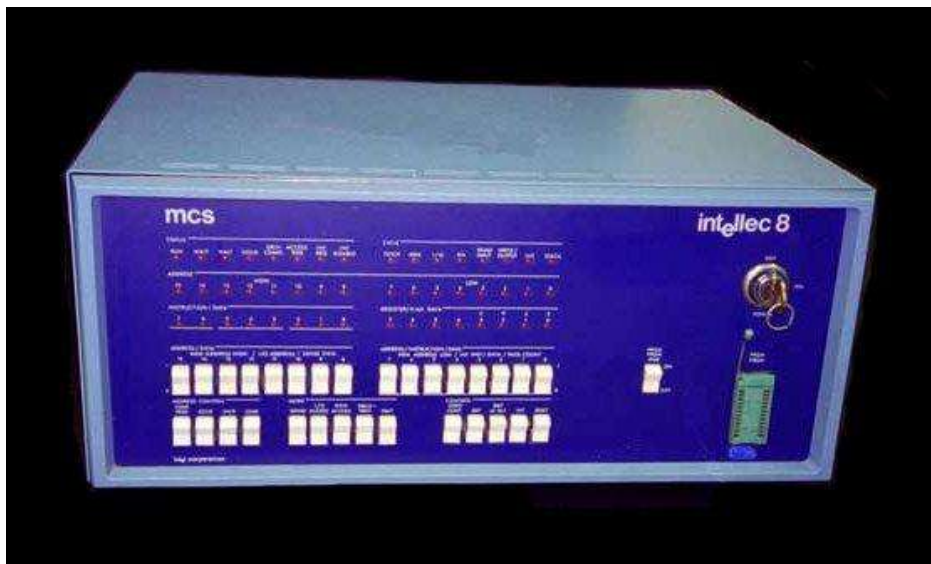

Intel Intellec 8

The “Godbout” G8008

I requested information on the G8008 from the Intel Museum and the Museum referred me to Hal Feeney. Feeney led the design team that built the Intel 8008.

Hal Feeney responded by email “The package you are referring to is an Intel 8008 in the grey (almost black) ceramic cavity package. The package bears no Intel logo identification nor any date code because these devices were special reclaimed “functional only” (with no voltage or temperature margins and no guarantee) units. These devices were sold to Godbout Electronics in Oakland for use and sale in the hobby market. We selected the special marking so that none of the devices would ever find their way into the normal Intel distribution channel. You are correct; the devices were picked up at the front door (or either Santa Clara I or Santa Clara II on Bowers Avenue) with payment by check or, perhaps, cash. The devices were selected from functional devices that failed margin testing and were marked “G8008”. In fact, the package in the photo may even have been a cosmetic reject because of the large chip out of the area near the index mark.” (Hal Feeney, email dated 06/24/2002)

Intel i8008

In reference to the rarity of the G8008, Hal Feeney answers “there were very few devices marked and sold to this [hobby] market, perhaps a few hundred to a thousand. Again, these were not early production devices. The timing of the sales could easily be late '73 or early '74. Godbout dealt in scrap materials from the semiconductor industry. In one of the scrap shipments, he found unmarked devices, opened them to determine what was inside, and then tested some and found that they were functional. One of the devices he found was the 8008. He contacted Intel and we were willing to sell him some specially marked “functional only” devices because his markets did not compete with any of the traditional Intel sales channels.

Scrap material is handled quite differently today, most of it destroyed or crushed before it leaves the production facility.” (Hal Feeney, email dated 06/24/2002).

More information on the G8008 from an email from Jack Rubin “Ray Stevens (founder of RGS Electronics and creator of the RGS-008, subject of the first hardware review in Byte Vol 1:1) hung out with Bill Godbout and Mike Quinn in the early '70s. They were all chasing Silicon Valley surplus for resale. Ray bought a chip printer and printed the G8008 designation on the original blank 8008 culls that Godbout pulled from Intel's discards.” (Jack Rubin, email dated 08/31/2004).

See related information on the “Godbout” G2102 in Intel 2102 Collectors Notes.

The M8008

Some collectors have suggested this could be a military version of the 8008. Another theory is that the lack of an Intel logo on this chip indicates this is another G8008 in that the M8008 is a chip that Intel sold “out the back door” for use and sale in the hobby market? Mark-8 perhaps? Any information would be appreciated.

Packaging

Type D packages were not available at the time the Intel 8008 was introduced.



The Intel 8008 was not produced in a Type P package.

Part Numbers

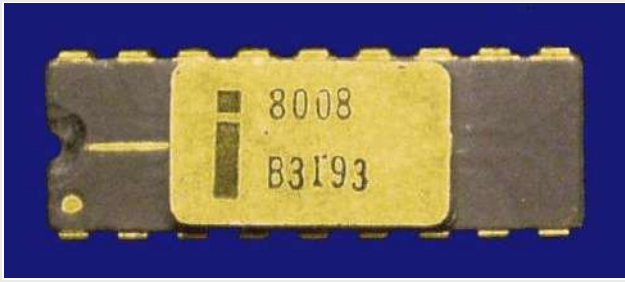
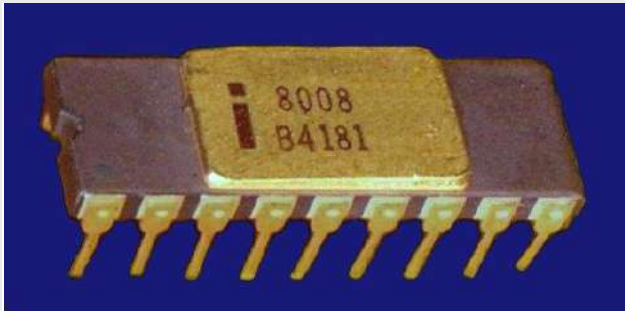

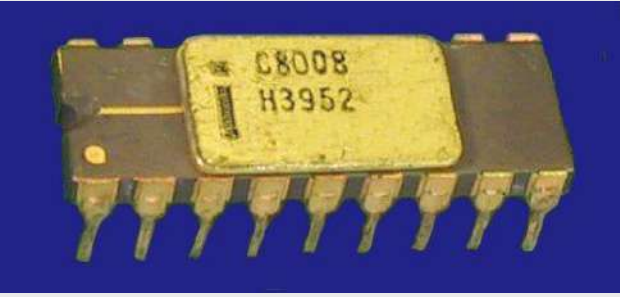
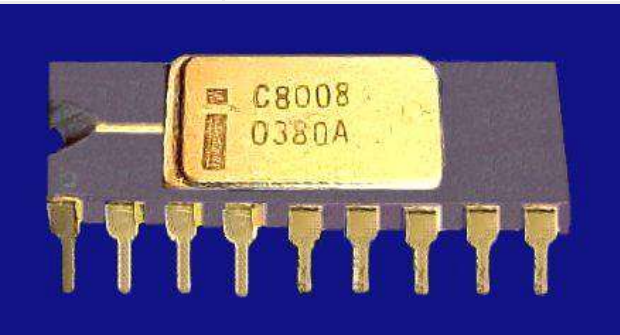

Type C Packages

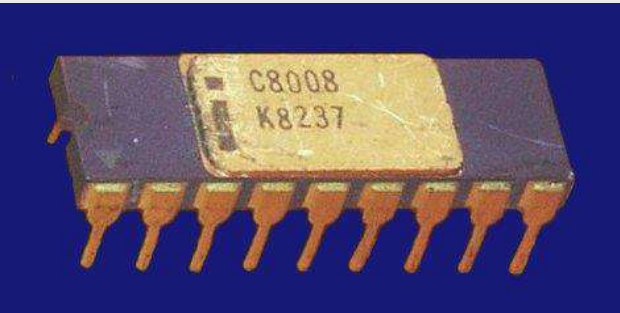
Part Number	Package Description	Values
		
X8008	Type C grey ceramic package w/gold cap, gold cap ground strap, and gold pins. Gold dot denotes pin #1. Prototype. The Intel MCS-8 users manual, Rev 4, dated Nov. 1973 shows this same chip on pg. 142. The chip in this guide is also marked 12914 whereas the example in photo above is marked 13002.	Ex. Rare (2 Known) \$250-\$1000
		
8008	1. Type C brown ceramic package w/gold cap, gold cap ground strap, and gold pins. Gold dot denotes pin #1.	Ex. Rare (2 Known) \$150-\$600
		
8008	2. Type C purple ceramic package w/gold cap and gold pins. Black dot denotes pin #1.	Ex. Rare (1 Known) \$150-\$600

Intel i8008

		
C8008	1. Type C brown ceramic package w/gold cap, gold cap ground strap, and gold pins. Gold dot denotes pin #1.	Rare \$40-\$160
		
C8008	2. Type C purple ceramic package w/gold cap, gold cap ground strap, and gold pins. Black dot denotes pin #1.	\$30-\$120
		
C8008	3. Type C purple ceramic package w/gold cap, offset gold cap ground strap, and gold pins. Small yellow triangle denotes pin #1.	Rare \$40-\$160
		
C8008	4. Type C purple ceramic package w/gold cap and gold pins. Small yellow or black triangle denotes pin #1.	\$25-\$100

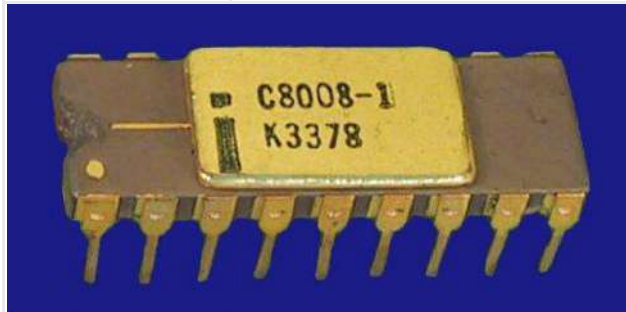
Intel i8008

		
C8008	5. Type C purple ceramic package w/gold cap and gold pins. Small yellow or black triangle denotes pin #1. Half-circle key.	\$25-\$100
C8008	6. Type C grey ceramic package w/gold cap, gold cap ground strap, and gold pins. Yellow '10' denotes pin #1.	Ex. Rare (1 Known) \$125-\$500
		
8008-1	Type C brown ceramic package w/gold cap, gold cap ground strap, and gold pins. Gold dot denotes pin #1.	Ex. Rare (2 Known) \$150-\$600
		
C8008-1	1. Type C brown ceramic package w/gold cap, gold cap ground strap, and gold pins. Gold dot denotes pin #1.	Rare \$40-\$160
		
C8008-1	2. Type C purple ceramic package w/gold cap, gold cap ground strap, and gold pins. Black dot denotes pin #1.	\$30-\$120

Intel i8008



C8008-1	3. Type C purple ceramic package w/gold cap, offset gold cap ground strap, and gold pins. Small yellow triangle denotes pin #1.	Rare \$40-\$160
---------	---	--------------------



C8008-1	4. Type C purple ceramic package w/gold cap and gold pins. Small yellow or black triangle denotes pin #1.	\$25-\$100
---------	---	------------

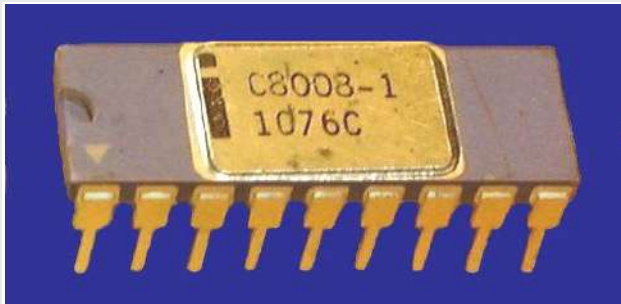



C8008-1	5. Type C purple ceramic package w/gold cap and gold pins. Small yellow or black triangle denotes pin #1. Half-round key.	\$25-\$100
---------	---	------------





C8008-1	6. Type C purple ceramic package w/gold cap and gold pins. Small black triangle denotes pin #1. HP house mark 1820-1221. Example shown made in Hong Kong and dated 7728.	Ex. Rare (2 Known) \$75-\$300
---------	--	-------------------------------------

Intel i8008

 <p>A photograph of an Intel C8008-1 microprocessor. It is a grey ceramic package with a yellow label on top that reads "C8008-1" and "2071A". A yellow "10" is printed on the left side of the package. The package has gold pins extending from the bottom.</p>		
C8008-1	7. Type C grey ceramic package w/gold cap, gold cap ground strap, and gold pins. Yellow '10' denotes pin #1.	Ex. Rare (4 Known) \$125-\$500
 <p>A photograph of an Intel G8008 microprocessor. It is a brown ceramic package with a yellow label on top that reads "G8008". A small gold dot is visible on the left side of the package. The package has gold pins extending from the bottom.</p>		
G8008	Type C brown ceramic package w/gold cap, gold cap ground strap, and gold pins. Gold dot denotes pin #1. No markings other than G8008 part number.	Ex. Rare (4 Known) \$250-\$1000
 <p>A photograph of an Intel M8008 microprocessor. It is a purple ceramic package with a yellow label on top that reads "M8008" and "P1054". A small black triangle is visible on the left side of the package. The package has gold pins extending from the bottom.</p>		
M8008	Type C purple ceramic package w/gold cap and gold pins. Small black triangle denotes pin #1. No Intel logo. Example shown made in Malaysia and dated 7530.	Ex. Rare (1 Known) \$150-\$600

Intel i8008

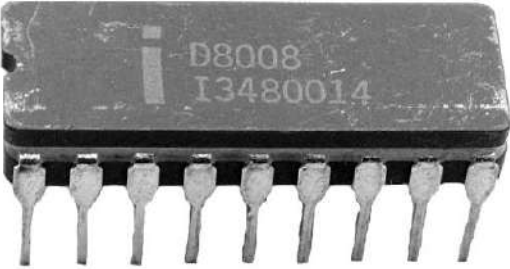
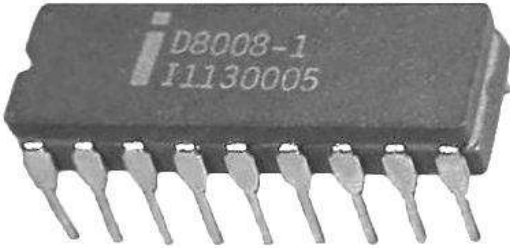
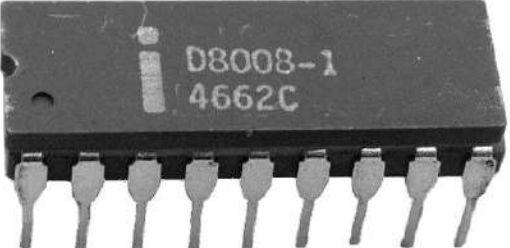
Type D Packages

Part Number	Package Description	Values
		
	D8008	
		
	D8008-1	
		
	D8008-1	
		
	D8008-1	

References

- [1] Intel (September 1972). Intel Data Catalog, 8008 Data Sheet, p. 6-15
- [2] Hearst (1977). IC Master, Master Selection Guide, Intel 8008 power dissipation, supply voltage, fabrication, clock, etc., p. 887.
- [3] Intel (1978). Intel Component Data Catalog, 8008/8008-1 Data Sheet, p. 11-5
- [4] Intel (2002). Intel Museum Archive Collection Chronological Timeline. Available from: http://www.intel.com/intel/intelis/museum/arc_collect/TimelineChron.pdf [Accessed 10 July 2002] – 8008 [introduction] date “01/01/72”

Intel i8021

Single Component 8-Bit Microcomputer

1978-79

Specifications

- Single Component 8-bit Microcomputer
- Single 5V Supply (+4.5V to 6.5V)
- 8.38 μ sec Cycle With 3.58MHz XTAL; All Instructions 1 or 2 Cycles
- Instructions – 8048 Subset
- High Current Drive Capability – 2 Pins
- 1K x 8 ROM, 64 x 8 RAM, 21 I/O Lines
- Interval Timer/Event Counter
- Clock generated With Single Inductor or Crystal
- Zero-Cross Detection Capability
- Easily Expandable I/O
- 28-pin Dual In-Line Package

Type	Clock	Power Dissipation Max.	Supplies [V]
8021	3MHz	-	+5

The Intel® 8021 is a totally self sufficient 8-bit parallel computer fabricated on a single silicon chip using Intel's N-channel silicon gate MOS process. The features of the 8021 include a subset of the 8048 optimized for low cost, high volume applications, plus additional I/O flexibility and power.

The 8021 contains 1K x 8 program memory, a 64 x 8 data memory, 21 I/O lines, and an 8-bit timer/event counter, in addition to on-board oscillator and clock circuits. For systems that require extra I/O capability, the 8021 can be expanded using the 8243 or discrete logic.

This microprocessor is designed to be an efficient controller as well as an arithmetic processor. The 8021 has bit handling capability as well as facilities for both binary and BCD arithmetic. Efficient use of program memory results from an instruction set consisting mostly of single byte instructions and no instructions over two bytes in length.

To minimize the development problems and maximize flexibility, an 8021 system can be easily designed using the 8021 emulation board, the EM-1. The EM-1 contains a 40-pin socket, which can accommodate either the 8748 shipped with the board or an ICE-49 plug. Also, the necessary discrete logic to reproduce the 8021's additional I/O features is included [2].

Intel i8021

Part Numbers

Type P Packages

Part Number	Package Description	Values
		
P8021	Type P black plastic package w/tin pins. © Intel '77	\$1.25-\$5

References

- [1] Intel (1979). Intel Component Data Catalog, 8021 Preliminary Data Sheet, p. 8-4
- [2] Intel (1980). Intel Component Data Catalog, 8021 Preliminary Data Sheet, p. 5-1
- [3] Intel (2002). Intel Museum Archive Collection Chronological Timeline, 8021 [introduction] date "01/01/77". Available from: http://www.intel.com/intel/intelis/museum/arc_collect/TimelineChron.pdf [Accessed 10 July 2002]

Intel i8021H

Single Component 8-Bit Microcomputer

1982-83

Specifications

- Single Component 8-bit Microcomputer
- HMOS
- Single 5V Supply (+4.5V to 6.5V)
- 8.38 μ sec Cycle with 3.58 MHz XTAL; All instructions 1 or 2 Cycles
- 30mA Operation @ 25°C
- Instructions – 8048 Subset
- High Current Drive Capability – 2 Pins
- 1K x 8 ROM, 64 x 8 RAM, 21 I/O Lines
- Interval Timer/Event Counter
- Clock Generated with Single Inductor or Crystal
- Zero-Cross Detection Capability
- Easily Expandable I/O
- 28-pin Dual In-Line Package

Type	Clock	Power Dissipation Max.	Supplies [V]
8021H	3MHz	-	+5

The Intel® 8021H is a totally self sufficient 8-bit parallel computer fabricated on a single silicon chip using Intel's advanced N-channel silicon gate HMOS process. The features of the 8021 include a subset of the 8048 optimized for low cost, high volume applications, plus additional I/O flexibility and power.

The 8021H contains 1K x 8 program memory, a 64 x 8 data memory, 21 I/O lines, and an 8-bit timer/event counter, in addition to on-board oscillator and clock circuits. For systems that require extra I/O capability, the 8021H can be expanded using the 8243 or discrete logic.

This microprocessor is designed to be an efficient controller as well as an arithmetic processor. The 8021H has bit handling capability as well as facilities for both binary and BCD arithmetic. Efficient use of program memory results from an instruction set consisting mostly of single-byte instructions and no instructions over two bytes in length.

To minimize the development problems and maximize flexibility, an 8021H system can be easily designed using the 8021H emulation board, the EM-1. The EM-1 contains a 40-pin socket, which can accommodate either the 8748 shipped with the board or an ICE-49 plug. Also, the necessary discrete logic to reproduce the 8021H's additional I/O features is included [3].

Intel i8021H

Part Numbers

Type P Packages

Part Number	Package Description	Values
	 A photograph of an Intel P8021H 2082 8326 08000021 INTEL '81 integrated circuit. The chip is a black plastic package with 28 pins. The text on the chip reads: P8021H 2082, 8326, 08000021, and ©INTEL '81.	
P8021H	Type P black plastic package w/tin pins. © Intel '81	\$1.25-\$5

References

- [1] Intel (1980). Intel Component Data Catalog, 8021 Preliminary Data Sheet, p. 5-1. No reference to 8021H dates chip after 1980.
- [2] Hearst (1981). IC Master, Intel 8021 Preliminary Data Sheet, p. 708. No reference to 8021H dates chip after 1981.
- [3] Intel (January 1982). Intel Component Data Catalog, 8021H Preliminary Data Sheet, p. 6-8
- [4] Hearst (1983). IC Master, Intel 8021H, p. 1093-89

Intel i8022

Single Component 8-bit Microcomputer with On-Chip A/D Converter

1978-79

Specifications

- Single Component 8-bit Microcomputer with On-Chip A/D Converter
- On-chip 8-bit A/D Converter; Two Input Channels
- 8 Comparator Inputs (Port 0)
- Zero-Cross Detection Capability
- Single 5V Supply (4.5V to 6.5V)
- High Current Drive Capability – 2 Pins
- Two Interrupts – External and Timer
- 16,384-Bit (2048 x 8) ROM, 512-bit (64 x 8) RAM, 28 I/O Lines
- 8.38 μ sec Cycle; All Instructions 1 or 2 Cycles
- Instructions – 8048 Subset
- Interval Timer/Event Counter
- Clock Generated with Single Inductor or Crystal
- Easily Expanded I/O
- 40-pin Dual In-Line Package

The Intel® 8022 is the newest member of the MCS-48™ family of single chip 8-bit microcomputers. It is designed to satisfy the requirements of low cost, high volume applications, which involved analog signals, capacitive touchpanel keyboards, and/or large ROM space. The 8022 addresses these applications by integrating many new functions on-chip, such as A/D conversion, comparator inputs and zero-cross detection.

The features of the 8022 include 2K bytes of program memory (ROM), 64 bytes of data memory (RAM), 28 I/O lines, an on-chip A/D converter with two input channels, an 8-bit port with comparator inputs for interfacing to low voltage capacitive touchpanels or other non-TTL interfaces, external and timer interrupts, and zero-cross detection capability. In addition, it contains the 8-bit interval timer/event counter, on-board oscillator and clock circuitry, single 5V power supply requirement, and easily expandable I/O structure common to all members of the MCS-48 family.

The 8022 is designed to be an efficient controller as well as an arithmetic processor. It has bit handling capability plus facilities for both binary and BCD arithmetic. Efficient use of program memory results from using the MCS-48 instructions set, which consist mostly of single byte instructions, and has extensive conditional jump and direct table lookup capability. Program memory usage is further reduced via the 8022's hard implementation of the A/D converter, which simplifies interfacing to analog signals [2].

Part Numbers

Type D Packages

Part Number	Package Description	Values
ID8022	Type D package	Ex. Rare (0 Known) \$\$\$

Type P Packages

Part Number	Package Description	Values
P8022	Type P package	\$3-\$12

References

- [1] Intel (1979). Intel Component Data Catalog, 8022 Preliminary Data Sheet, p. 8-10
- [2] Intel (1980). Intel Component Data Catalog, 8022 Preliminary Data Sheet, p. 5-8
- [3] Intel (1984). A Revolution in Progress... A History of Intel to Date, 8022 introduced 1978, p. 26.

Intel i8022H

Single Component 8-bit Microcomputer with On-Chip A/D Converter

1982-83

Specifications

- Single Component 8-bit Microcomputer with On-Chip A/D Converter
- HMOS
- On-chip 8-bit A/D Converter; Two Input Channels
- 8 Comparator Inputs (Port 0)
- Zero-Cross Detection Capability
- Single 5V Supply (4.5V to 6.5V)
- Two Interrupts – External and Timer
- 16,384-Bit (2048 x 8) ROM, 512-bit (64 x 8) RAM, 28 I/O Lines
- 5µsec Cycle; All Instructions 1 or 2 Cycles (6 MHz Clock)
- Instructions – 8048 Subset
- Interval Timer/Event Counter
- Clock Generated with Single Inductor or Crystal
- Easily Expanded I/O
- 40-pin Dual In-Line Package

The Intel® 8022H is designed to satisfy the requirements of low cost, high volume applications, which involved analog signals, capacitive touchpanel keyboards, and/or large ROM space. The 8022H addresses these applications by integrating many new functions on-chip, such as A/D conversion, comparator inputs and zero-cross detection.

The features of the 8022H include 2K bytes of program memory (ROM), 64 bytes of data memory (RAM), 28 I/O lines, an on-chip A/D converter with two input channels, an 8-bit port with comparator inputs for interfacing to low voltage capacitive touchpanels or other non-TTL interfaces, external and timer interrupts, and zero-cross detection capability. In addition, it contains the 8-bit interval timer/event counter, on-board oscillator and clock circuitry, single 5V power supply requirement, and easily expandable I/O structure common to all members of the MCS-48 family.

The 8022H is designed to be an efficient controller as well as an arithmetic processor. It has bit handling capability plus facilities for both binary and BCD arithmetic. Efficient use of program memory results from using the MCS-48 instructions set, which consist mostly of single byte instructions, and has extensive conditional jump and direct table lookup capability. Program memory usage is further reduced via the 8022H's hardware implementation of the A/D converter, which simplifies interfacing to analog signals [2].

Part Numbers

No Examples Known

References

[1] Intel (1980). Intel Component Data Catalog, 8022 Preliminary Data Sheet, p. 5-8. No reference to 8022H

[2] Intel (January 1982). Intel Component Data Catalog, 8022H Advance Information, p. 6-23

Intel i8035

Single Component 8-bit Microcomputer w/512-bit (64 x 8) RAM and I/O

1977

Specifications

- Single Component 8-bit Microcomputer w/512-bit (64 x 8) RAM and I/O
- NMOS
- Mask Programmable ROM (8048)
- User Programmable/Erasable EPROM (8748)
- External ROM or EPROM (8035)
- 8-Bit CPU, ROM, RAM, I/O in Single Package
- Interchangeable ROM and EPROM Versions
- Single 5V Supply
- 2.5 μ sec and 5.0 μ sec Cycle Versions:
All Instructions 1 or 2 cycles
- Over 90 Instructions: 70% Single Byte
- 1K x 8 ROM/EPROM
64 x 8 RAM
27 I/O Lines
- Interval Timer/Event Counter
- Easily Expandable Memory and I/O
- Compatible with 8000 Series Peripherals
- Single Level Interrupt
- Equivalent to Intel 8048 without Program Memory and RAM Power Down
- 40-pin Dual In-Line Package

Type	Clock	Power Dissipation Max.	Supplies [V]
8035	3MHz	-	+5
8035-8	-	-	+5
M8035	-	-	+5

The Intel® 8048/8748/8035 is a totally self-sufficient 8-bit parallel computer fabricated on a single silicon chip using Intel's N-channel silicon gate MOS Process.

The 8048 contains a 1K x 8 program memory, a 64 x 8 RAM data memory, 27 I/O lines, and an 8-bit timer/counter in addition to onboard oscillator and clock circuits. For systems that require extra capability, the 8048 can be expanded using standard memories and MCS-80™ (8080A) peripherals. The 8035 is the equivalent of an 8048 without program memory. The 8035L has the RAM power down mode of the 8048 while the 8035 does not.

To reduce development problems to a minimum and provide for maximum flexibility, three interchangeable pin-compatible versions of this single component microcomputer exist: the 8748 with user-programmable and erasable EPROM program memory for prototype and preproduction systems, the 8048 with factory-programmed mask ROM program memory for low cost, high volume production, and the 8035 without program memory for use with external program memories.

Intel i8035

This microcomputer is designed to be an efficient controller as well as an arithmetic processor. The 8048 has extensive bit handling capability as well as facilities for both binary and BCD arithmetic. Efficient use of program memory results from an instruction set consisting mostly of single byte instructions and no instructions over 2 bytes in length [1].

The 8748-4 and the 8035-4 are the equivalent of the 8748 and 8035 except in their ability to interface to an 8243 I/O Expander Device. The Standard 8748/8035 can input or output from the 8243. The 8248-4/8035-4 can use the 8243 as an output expander only [3].

Part Numbers

Type C Packages

Part Number	Package Description	Values
		
C8035	Type C purple ceramic package w/gold cap with quartz porthole and gold pins. © Intel '77.	Ex. Rare (1 Known) \$50-\$200
C8035-8	Type C package	Rare \$15-\$60

Type D Packages

Part Number	Package Description	Values
		
D8035	1. Type D grey ceramic package w/tin pins. © Intel '77	\$.75-\$3
		
D8035	2. Type D grey ceramic package w/porthole and tin pins. © Intel '77	\$.75-\$3

Intel i8035

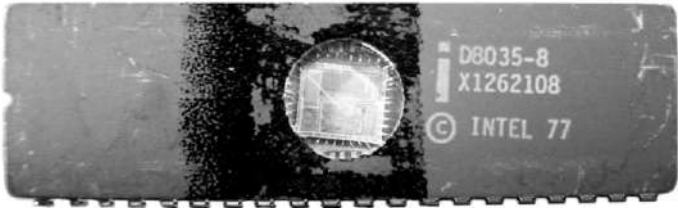
 <p style="text-align: center;">D8035-8 4130W © INTEL '77</p>		
D8035-8	1. Type D grey ceramic package w/tin pins. © Intel '77	\$1.50-\$6
 <p style="text-align: center;">D8035-8 X1262108 © INTEL 77</p>		
D8035	2. Type D grey ceramic package w/porthole and tin pins. © Intel '77	\$1.50-\$6
MD8035	Type D package	\$3-\$12

Type P Packages

Part Number	Package Description	Values
P8035	1. Type P black plastic package w/tin pins. © Intel '76	\$5-\$20
 <p style="text-align: center;">P8035 1965C © INTEL '77</p>		
P8035	2. Type P black plastic package w/tin pins. © Intel '77	\$1.50-\$6
P8035-8	Type P black plastic package w/tin pins. © Intel '77	\$3-\$12

References

- [1] Intel (1977). Intel Data Catalog, Preliminary 8048/8748/8035 Data Sheet, p. 9-4
- [2] Intel (1978). Intel Component Data Catalog, 8748/8748/8035 Data Sheet, p. 10-10
- [3] Intel (1978). Intel Component Data Catalog, 8748-4, 8035-4 Data Sheet, p. 10-18

Intel i8035L

Single Component 8-bit Microcomputer w/512-bit (64 x 8) RAM and I/O

1977-78

Specifications

- Single Component 8-bit Microcomputer w/512-bit (64 x 8) RAM and I/O
- NMOS
- Mask Programmable ROM (8048)
- User Programmable/Erasable EPROM (8748)
- External ROM or EPROM (8035)
- 8-Bit CPU, ROM, RAM, I/O in Single Package
- Interchangeable ROM and EPROM Versions
- Single 5V Supply
- 2.5 μ sec and 5.0 μ sec Cycle Versions:
All Instructions 1 or 2 cycles
- Over 90 Instructions: 70% Single Byte
- 1K x 8 ROM/EPROM
64 x 8 RAM
27 I/O Lines
- Interval Timer/Event Counter
- Easily Expandable Memory and I/O
- Compatible with 8000 Series Peripherals
- Single Level Interrupt
- Equivalent to Intel 8048 without Program Memory
- 40-pin Dual In-Line Package

Type	Clock	Power Dissipation Max.	Supplies [V]
8035L	6 MHz	-	+5
8035L-8	-	-	+5

The Intel® 8048/8748/8035 is a totally self-sufficient 8-bit parallel computer fabricated on a single silicon chip using Intel's N-channel silicon gate MOS Process.

The 8048 contains a 1K x 8 program memory, a 64 x 8 RAM data memory, 27 I/O lines, and an 8-bit timer/counter in addition to onboard oscillator and clock circuits. For systems that require extra capability, the 8048 can be expanded using standard memories and MCS-80™ (8080A) peripherals. The 8035 is the equivalent of an 8048 without program memory. The 8035L has the RAM power down mode of the 8048 while the 8035 does not.

To reduce development problems to a minimum and provide for maximum flexibility, three interchangeable pin-compatible versions of this single component microcomputer exist: the 8748 with user-programmable and erasable EPROM program memory for prototype and preproduction systems, the 8048 with factory-programmed mask ROM program memory for low cost, high volume production, and the 8035 without program memory for use with external program memories.

Intel i8035L

This microcomputer is designed to be an efficient controller as well as an arithmetic processor. The 8048 has extensive bit handling capability as well as facilities for both binary and BCD arithmetic. Efficient use of program memory results from an instruction set consisting mostly of single byte instructions and no instructions over 2 bytes in length [2].

Intel i8035L

Part Numbers

Type D Packages

Part Number	Package Description	Values
		
D8035L	Type D grey ceramic package w/tin pins. © Intel '77.	\$1.25-\$5
D8035L-8	Type D package	\$1.25-\$5
ID8035L	Type D package	\$3-\$12
MD8035L/B	Type D package	\$5-\$20

Type P Packages

Part Number	Package Description	Values
		
P8035L	Type P black plastic package w/tin pins. © Intel '77	\$1.25-\$5

References

[1] Intel (1977). Intel Data Catalog, 8048, 8748, 8035 Preliminary Data Sheet, p. 9-4. No reference to 8035L dates chip after 1977.

[2] Intel (1978). Intel Component Data Catalog, 8048, 8748, 8035, 8035L Preliminary Data Sheet, p. 10-10

Intel i8035H

Single Component 8-bit Microcomputer w/512-bit (64 x 8) RAM and I/O

1982-83

Specifications

- Single Component 8-bit Microcomputer w/512-bit (64 x 8) RAM and I/O
- HMOS
- Mask Programmable ROM (8048H)
- User Programmable/Erasable EPROM (8748H)
- External ROM or EPROM (8035H)
- 1.36 Instruction Cycle
- Over 90 Instructions: 70% Single Byte
- Compatible with 8080/8085 Series Peripherals
- 1K x 8 ROM/EPROM
 - 64 x 8 RAM
 - 27 I/O Lines
- Interval Counter/Event Timer
- Easily Expandable Memory and I/O
- Two Single Level Interrupts
- 40-pin Dual In-Line Package

Type	Clock	Power Dissipation Max.	Supplies [V]
8035H	11MHz	-	+5

The Intel® 8048H is a totally self sufficient, 8-bit parallel computers fabricated on single silicon chips using Intel's advanced N-channel silicon gate HMOS process.

The 8048H contains on-chip a 1K x 8 UV-erasable, user-programmable program memory, a 64 x 8 RAM data memory, 27 I/O lines, 2 interrupt sources, and an 8-bit timer/counter in addition to on-board oscillator and clock circuits. For systems that require extra capability the 8048H can be expanded using standard memories and MCS-80™/MCS-85™ peripherals. The 8035H is the equivalent of the 8048H without program memory and can be used with external ROM and RAM.

To reduce development problems to a minimum and provide maximum flexibility, three interchangeable pin-compatible versions of this single component microcomputer exist: the 8748H with user-programmable and erasable EPROM program memory, the 8048H with factory-programmed mask ROM program memory for low cost, high volume production, and the 8035H without program memory for use with external program memories.

These microcomputers are designed to be efficient controllers as well as arithmetic processors. They have extensive bit handling capability as well as facilities for both binary and BCD arithmetic. Efficient use of program memory results from an instruction set consisting mostly of single bit instructions and no instructions over 2 bytes in length [3].

Intel i8035H

Part Numbers

Type D Packages

Part Number	Package Description	Values
D8035H	Type D package	\$1.25-\$5

Type P Packages

Part Number	Package Description	Values
P8035H	Type P package	\$1.25-\$5

References

[1] Intel (1980). Intel Component Data Catalog, 8048, 8748, 8748-6, 8748-8, 8035, 8035-8, 3035L, Data Sheet, p. 5-20. No reference to 8035H, 8035HL.

[2] Hearst (1981). IC Master, Intel 8048/8048H-1/8035HL/8035HL-1 Preliminary Data Sheet, p. 711. No reference to 8035H dates chip after 1981.

[3] Intel (January 1982). Intel Component Data Catalog, 8748H/8035H Advance Information, p. 6-53

[4] Hearst (1983). IC Master, Intel 8035H, 8035HL, p. 1065

Intel i8035HL

Single Component 8-bit Microcomputer w/512-bit (64 x 8) RAM and I/O

1981

Specifications

- Single Component 8-bit Microcomputer w/512-bit (64 x 8) RAM and I/O
- HMOS
- Mask Programmable ROM (8048H)
- External ROM or EPROM (8035HL)
- Reduced Power Consumption
- 1.4 μ sec and 1.9 μ sec Cycle Versions; All Instructions 1 or 2 Cycles
- Over 90 Instructions: 70% Single Byte
- 1K x 8 ROM/EPROM
64 x 8 RAM
27 I/O Lines
- Interval Counter/Event Timer
- Compatible with 8080/8085 Series Peripherals
- Two Single Level Interrupts
- 40-pin Dual In-Line Package

Type	Clock	Power Dissipation Max.	Supplies [V]
8035HL	8 MHz	-	+5
8035HL-1	-	-	+5
M8035HL	-	-	+5

The Intel® 8048H/8048H-1/8035HL/8035HL-1 are totally self sufficient, 8-bit parallel computers fabricated on single silicon chips using Intel's advanced N-channel silicon gate HMOS process.

The 8048H contains a 1K x 8 program memory, a 64 x 8 RAM data memory, 27 I/O lines, and an 8-bit timer/counter in addition to on-board oscillator and clock circuits. For systems that require extra capability the 8048H can be expanded using standard memories and MCS-80™/MCS-85™ peripherals. The 8035HL is the equivalent of the 8048H without program memory and can be used with external ROM and RAM.

To reduce development problems to a minimum and provide maximum flexibility, a logically and functionally pin compatible version of the 8048H with UV-erasable user-programmable program memory is available. The 8748 will emulate the 8048H up to 6MHz clock frequency with minor differences.

The 8048H is fully compatible with the 8048 when operated at 6 MHz.

These microcomputers are designed to be efficient controllers as well as arithmetic processors. They have extensive bit handling capability as well as facilities for both binary and BCD arithmetic. Efficient use of program memory results from an instruction set consisting mostly of single bit instructions and no instructions over 2 bytes in length [2].

Intel i8035HL

Part Numbers

Type D Packages

Part Number	Package Description	Values
 A black, rectangular ceramic package with a row of pins along the bottom edge. The top surface is marked with the text: "D8035HL", "L344853R", and "©INTEL '77".		
D8035HL	Type D grey ceramic package w/tin pins. © Intel '77	\$1.25-\$5
ID8035HL	Type D package	Ex. Rare (0 Known) \$\$\$
LD8035HL	Type D package	\$1.50-\$6
MD8035HL/B	Type D package	Rare \$10-\$40
QD8035HL	Type D package	\$1.50-\$6

Type P Packages

Part Number	Package Description	Values
 A black, rectangular plastic package with a row of pins along the bottom edge. The top surface is marked with the text: "P8035HL", "L2108682", and "© INTEL 77".		
P8035HL	Type P black plastic package w/tin pins. © Intel '77	\$1.25-\$5
QP8035HL	Type P package	Rare \$10-\$40

References

- [1] Intel (1980). Intel Component Data Catalog, 8048, 8748, 8748-6, 8748-8, 8035, 8035-8, 3035L Data Sheet, p. 5-20. No reference to 8035H, 8035HL.
- [2] Hearst (1981). IC Master, Intel 8048H/8048H-1/8035HL/8035HL-1 Preliminary Datasheet, p. 711.
- [3] Hearst (1983). IC Master, Intel 8035H, 8035HL, p. 1065

Intel i8035AHL

Single Component 8-bit Microcomputer w/512-bit (64 x 8) RAM and I/O

1983-84

Specifications

- Single Component 8-bit Microcomputer w/512-bit (64 x 8) RAM and I/O
- HMOS II
- Interval Time/Event Counter
- Two Single Level Interrupts
- Single +5 Volt Supply
- Over 96 Instructions; 90% Single Byte
- Programmable ROMs using 21V
- Easily Expandable Memory and I/O
- Up to 1.36 μ s Instruction Cycle All Instructions 1 or 2 Cycles
- 40-pin Dual In-Line Package

Type	Clock	Power Dissipation Max.	Supplies [V]
8035AHL	11 MHz	-	+5
M8035AHL	11 MHz	-	+5

The Intel MCS®-48 family are totally self-sufficient, 8-bit parallel computers fabricated on single silicon chips using Intel's advanced N-channel silicon gate HMOS process.

The family contains 27 I/O lines, an 8-bit timer/counter, and on-board oscillator/clock circuits. For systems that require extra capability, the family can be expanded using MCS®-80/MCS®-85 peripherals.





These microcontrollers are available in both masked ROM and ROMless versions as well as a new version, The Programmable ROM. The Programmable ROM provides the user with the capacity of a masked ROM while providing the flexibility of a device that can be programmed at the time of requirement and to the desired data. Programmable ROM's allow the user to lower inventory levels while at the same time decreasing delay times and code risks.

These microcomputers are designed to be efficient controllers as well as arithmetic processors. They have extensive bit handling capability as well as facilities for both binary and BCD arithmetic. Efficient use of program memory results from an instruction set consisting of mostly single byte instructions and no instructions over 2 bytes in length [4].

Intel i8035AHL



Part Numbers

Type D Packages

Part Number	Package Description	Values
		
D8035AHL	1. Type D grey ceramic package w/tin pins. © Intel 1977.	\$1.25-\$5
		
D8035AHL	2. Type D grey ceramic package w/tin pins. © Intel '82.	\$1.25-\$5
		
LD8035AHL	Type D grey ceramic package w/tin pins. © Intel '82.	\$1.50-\$6
MD8035AHL	Type D package	\$1.50-\$6
MD8035AHL/B	Type D grey ceramic package w/tin pins. © Intel '82.	\$1.50-\$6
MD8035AHL/BC	Type D package	\$5-\$20
QD8035AHL	Type D package	\$2.50-\$10
		
TD8035AHL	Type D grey ceramic package w/tin pins. © Intel '82.	\$1.25-\$5

Intel i8035AHL

Type P Packages

Part Number	Package Description	Values
 <p style="text-align: center;">P8035AHL L1970929 INTEL © 1977</p>		
P8035AHL	1. Type P black plastic package w/tin pins. Half-round key. © Intel 1977.	\$1.25-\$5
P8035AHL	2. Type P black plastic package w/tin pins. Rectangular key. © Intel '82.	\$1.25-\$5
 <p style="text-align: center;">P8035AHL L7280719 1820-2176 © INTEL '82</p>		
P8035AHL	3. Type P black plastic package w/tin pins. Half-round key. © Intel '82.	\$1.25-\$5
 <p style="text-align: center;">TP8035AHL L9180324 © INTEL 1980</p>		
TP8035AHL	Type P black plastic package w/tin pins. Half-round key. © Intel 1980.	Rare \$10-\$40

References

[1] Intel (1980). Intel Component Data Catalog, 8048, 8748, 8748-6, 8748-8, 8035, 8035-8, 3035L Data Sheet, p. 5-20. No reference to 8035AHL.

[2] Hearst (1983). IC Master. No reference to Intel 8035AHL dates chips after 1983.

[3] Hearst (1984). IC Master, Intel 8035AHL, p. 1344.

[4] Intel (1990). 8-Bit Embedded Controllers, P8748H/P8749H/8048AH/8035AHL/8049AH/8039AHL/8050AH/8040AHL Data Sheet, p. 4-8

Intel i8039

Single Component 8-bit Microcomputer w/1024-bit (128 x 8) RAM and I/O

1978

Specifications

- Single Component 8-bit Microcomputer w/1024-bit (128 x 8) RAM and I/O
- NMOS
- 8-Bit CPU, ROM, RAM, I/O in Single Package
- Single 5V \pm 10% Supply
- 1.36 μ sec Cycle; All Instructions 1 or 2 Cycles
- Over 90 Instructions: 70% Single Byte
- Pin Compatible with 8048/8748
- 2K x 8 ROM
128 x 8 RAM
27 I/O Lines
- Interval Timer/Event Counter
- Easily Expandable Memory and I/O
- Compatible with MCS Memory and I/O
- Single Level Interrupt
- 40-pin Dual In-Line Package

Type	Clock	Power Dissipation Max.	Supplies [V]
8039	11 MHz	-	+5
8039-6	6 MHz	-	+5

The Intel® 8049/8039/8039-6 is a totally self-sufficient 8-bit parallel computer fabricated on a silicon chip using Intel's N-channel silicon gate MOS technology.



The 8049 contains a 2K x 8 program memory, a 128 x 8 RAM data memory, 27 I/O lines, and an 8-bit timer/counter in addition to on board oscillator and clock circuits. For systems that require extra capability, the 8049 can be expanded using standard memories and MCS-80™/MCS-85™ peripherals. The 8039 is the equivalent to an 8049 without program memory. The 8039-6 is a lower speed (6MHz) version of the 8039.

To reduce development problems to a minimum and provide maximum flexibility, two interchangeable pin-compatible versions of this single component microcomputer exist: the 8049 with factory-programmed mask ROM program memory for low-cost high volume production, and the 8039 without program memory for use with external program memories in prototype and preproduction systems.

This microprocessor is designed to be an efficient controller as well as an arithmetic processor. The 8049 has extensive bit handling capability as well as facilities for both binary and BCD arithmetic. Efficient use of program memory results from an instruction set consisting mostly of single byte instructions and no instructions over two bytes in length [3].

Part Numbers

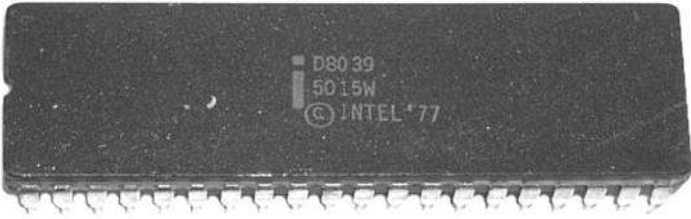
Type D Packages

Part Number	Package Description	Values
		
D8039	Type D grey ceramic package w/tin pins. © Intel '77.	\$1.25-\$5
		
D8039-6	Type D grey ceramic package w/tin pins. © Intel '77.	\$1.50-\$6
ID8039	Type D package	\$1.50-\$6
LD8039	Type D package	\$2.50-\$10

Type P Packages

Part Number	Package Description	Values
		
P8039	Type P black plastic package w/tin pins. © Intel '77.	\$1.25-\$5

Intel i8039

 A black plastic microprocessor chip with 28 pins. The top surface is marked with "P8039-6", "2489W", and "© INTEL '77".		
P8039-6	Type P black plastic package w/tin pins. © Intel '77.	\$2.50-\$10

References

- [1] Intel (1977). Intel Data Catalog. No reference to 8039 dates chip after 1977.
- [2] Intel (1978). Intel Component Data Catalog, 8049/8039 Preliminary Data Sheet, p. 10-23
- [3] Intel (1980). Intel Component Data Catalog, 8049, 8039, 8039-6 Data Sheet, p. 5-29
- [4] Intel (1984). A Revolution in Progress... A History of Intel to Date, 8049 introduced 1981, p. 26. No reference to 8039.

Intel i8039H

Single Component 8-bit Microcomputer w/1024-bit (128 x 8) RAM and I/O

1982-83

Specifications

- Single Component 8-bit Microcomputer w/1024-bit (128 x 8) RAM and I/O
- High Performance HMOS
- 1.4 μ sec and 2.5 μ sec Cycle Versions
- Over 90 Instructions; 70% Single Byte
- Compatible with 8080/8085 Peripherals
- 2K x 8 ROM
128 x 8 RAM
27 I/O Lines
- Interval Timer/Event Counter
- Easily Expandable Memory and I/O
- Two Single Level Interrupts
- 27 I/O Lines
- 40-pin Dual In-Line Package

Type	Clock	Power Dissipation Max.	Supplies [V]
8039H	11 MHz	-	+5
8039H-8	6 MHz	-	+5

The Intel® 8749H/8749H-8 are totally self-sufficient, 8-bit parallel computers fabricated on single silicon chips using Intel's advanced N-channel silicon gate HMOS process.

The 8749H/8749H-8 contains on-chip a 2K x 8 UV-erasable, user-programmable program memory, a 128 x 8 RAM data memory, 27 I/O lines, 2 interrupt sources, and an 8-bit timer/counters in addition to on-board oscillator and clock circuits. For systems that require extra capability the 8749H/8749H-8 can be expanded using standard memories and MCS-80®/MCS-85® peripherals. The 8039H is the equivalent of the 8049H/8049H-8 without program memory and can be used with external ROM and RAM.

To reduce development problems to a minimum and provide maximum flexibility, three interchangeable pin-compatible versions of this single component microcomputer exist: the 8749H with user-programmable and erasable EPROM program memory, the 8049H with factory-programmed mask ROM program memory for low cost, high volume production, and the 8039H without program memory for use with external program memories.

These microcomputers are designed to be efficient controllers as well as arithmetic processors. They have extensive bit handling capability as well as facilities for both binary and BCD arithmetic. Efficient use of program memory results from an instruction set consisting mostly of single byte instructions and no instructions over 2 bytes in length [3].

Intel i8039H

Part Numbers

Type D Packages

Part Number	Package Description	Values
D8039H	Type D package	\$1.25-\$5

Type P Packages

Part Number	Package Description	Values
P8039H	Type P package. Suspect that single source showing a small quantity of this part in stock could be a typo.	Rare (Suspect) \$\$\$

References

- [1] Intel (1980). Intel Component Data Catalog, 8049, 8039, 8039-6 Data Sheet, p. 5-29. No reference to 8039H dates chip after 1980.
- [2] Hearst (1981). IC Master, Intel 8049/8039/8039-6 Data Sheet, p. 712. No reference to Intel 8039H.
- [3] Intel (January 1982). Intel Component Data Catalog, 8749H/8749H-8/8039H/8039H-8 Preliminary Data Sheet, p. 6-76
- [4] Hearst (1983). IC Master, Intel 8039HL, p. 1093-25. No reference to Intel 8039H.
- [5] Hearst (1984). IC Master, Intel 8039HL, p. 1344-7, and 8039AHL, p. 1344-6. No reference to Intel 8039H.
- [6] Hearst (1987). IC Master, Intel 8039HL, p. 1454-45, and 8039AHL, p. 1454-44. No reference to Intel 8039H.

Intel i8039HL

Single Component 8-bit Microcomputer w/1024-bit (128 x 8) RAM and I/O

1982-83

Specifications

- Single Component 8-bit Microcomputer w/1024-bit (128 x 8) RAM and I/O
- HMOS
- Mask Programmable ROM (8049H)
- CPU Only with Power Down Mode (8039HL)
- Reduced Power Consumption
- 1.4 μ sec and 1.9 μ sec Cycle Versions: All Instructions 1 or 2 Cycles
- Over 90 Instructions: 70% Single Byte
- 2K x 8 ROM
128 x 8 RAM
27 I/O Lines
- Interval Timer/Event Counter
- Easily Expandable Memory and I/O
- Compatible with 8080/8085 Series Peripherals
- Two Single Level Interrupts
- 40-pin Dual In-Line Package

Type	Clock	Power Dissipation Max.	Supplies [V]
8039HL	11 MHz	-	+5

The Intel® 8049H/8038HL are totally self-sufficient, 8-bit parallel computers fabricated on single silicon chips using Intel's advanced N-channel silicon gate HMOS process.

The 8049H contains a 2K x 8 program memory, a 128 x 8 RAM data memory, 27 I/O lines, and an 8-bit timer/counter in addition to on-board oscillator and clock circuits. For systems that require extra capability the 8049H can be expanded using standard memories and MCS-80®/MCS-85® peripherals. The 8039HL is the equivalent of the 8049H without program memory and can be used with external ROM and RAM.

To reduce development problems to a minimum and provide maximum flexibility, a logically and functionally pin compatible version of the 8049H with UV-erasable user-programmable EPROM program memory will soon be available. The 8749 will emulate the 8049H up to 11MHz clock frequency with minor differences.

The 8049H is fully compatible with the 8049.

These microcomputers are designed to be efficient controllers as well as arithmetic processors. They have extensive bit handling capability as well as facilities for both binary and BCD arithmetic. Efficient use of program memory results from an instruction set consisting mostly of single byte instructions and no instructions over 2 bytes in length [3].

Intel i8039HL

Part Numbers

Type C Packages

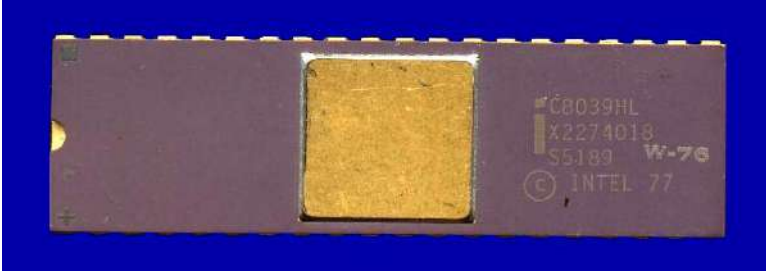
Part Number	Package Description	Values
		
C8039HL	Type C purple ceramic package w/gold cap and gold pins. Small '+' denotes pin #1. © Intel '77.	Ex. Rare \$30-\$120

Type D Packages

		
D8039HL	Type D grey ceramic package w/tin pins. © Intel '77.	\$1.25-\$5
ID8039HL	Type D package	Rare \$10-\$40
LD8039HL	Type D package	\$2.50-\$10
QD8039HL	Type D package	Rare \$10-\$40
TD8039HL	Type D package	\$2.50-\$10

Intel i8039HL

Type P Packages

Part Number	Package Description	Values
 A black plastic integrated circuit chip with a rectangular key and a row of 28 pins. The top surface is marked with "P8039HL", "L3048474", and "© INTEL '77".		
P8039HL	Type P black plastic package w/tin pins. Rectangular key. © Intel '77.	\$1-\$4
QP8039HL	Type P package	\$1.25-\$5
TP8039HL	Type P package	Rare \$10-\$40

References

[1] Intel (1980). Intel Component Data Catalog, 8049, 8039, 8039-6 Data Sheet, p. 5-29. No reference to 8039HL dates chip after 1980.

[2] Hearst (1981). IC Master, Intel 8049/8039/8039-6 Data Sheet, p. 712. No reference to Intel 8039H/8039HL dates chip after 1981.

[3] Intel (January 1982). Intel Component Data Catalog, 8049H/8039HL Preliminary Data Sheet, p. 6-62

[4] Hearst (1983). IC Master, Intel 8039HL, p. 1093-25.

Intel i8039AHL

Single Component 8-bit Microcomputer w/1024-bit (128 x 8) RAM and I/O

1983-84

Specifications

- Single Component 8-bit Microcomputer w/1024-bit (128 x 8) RAM and I/O
- HMOS II
- Interval Time/Event Counter
- Two Single Level Interrupts
- Single +5 Volt Supply
- Over 96 Instructions; 90% Single Byte
- Programmable ROMs using 21V
- Easily Expandable Memory and I/O
- Up to 1.36 μ s Instruction Cycle All Instructions 1 or 2 Cycles
- 40-pin Dual In-Line or 44-lead PLCC Package

Type	Clock	Power Dissipation Max.	Supplies [V]
8039AHL	-	-	+5
M8035AHL	-	-	+5

The Intel MCS®-48 family are totally self-sufficient, 8-bit parallel computers fabricated on single silicon chips using Intel's advanced N-channel silicon gate HMOS process.

The family contains 27 I/O lines, an 8-bit timer/counter, and on-board oscillator/clock circuits. For systems that require extra capability, the family can be expanded using MCS®-80/MCS®-85 peripherals.

These microcontrollers are available in both masked ROM and ROMless versions as well as a new version, The Programmable ROM. The Programmable ROM provides the user with the capacity of a masked ROM while providing the flexibility of a device that can be programmed at the time of requirement and to the desired data. Programmable ROM's allow the user to lower inventory levels while at the same time decreasing delay times and code risks.

These microcomputers are designed to be efficient controllers as well as arithmetic processors. They have extensive bit handling capability as well as facilities for both binary and BCD arithmetic. Efficient use of program memory results from an instruction set consisting of mostly single byte instructions and no instructions over 2 bytes in length [5].

Part Numbers

Type D Packages

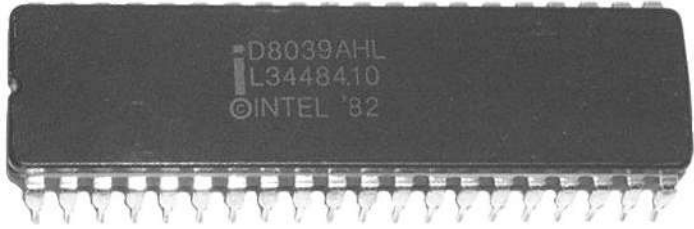
Part Number	Package Description	Values
		
D8039AHL	Type D grey ceramic package w/tin pins. © Intel '82.	\$1.25-\$5
LD8039AHL	Type D package	\$1.25-\$5
MD8039AHL	Type D package	\$1.50-\$6
MD8039AHL/B	Type D package	\$1.50-\$6
QD8039AHL	Type D package	\$1.50-\$6
TD8039AHL	Type D package	\$1.25-\$5

Type P Packages

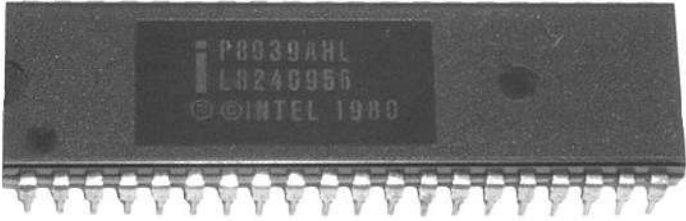
Part Number	Package Description	Values
		
P8039AHL	1. Type P black plastic package w/tin pins. Modified half-round key. © Intel 1977	\$.75-\$3
		
P8039AHL	2. Type P black plastic package w/tin pins. Half-round key. Impressed logo and part number. © Intel 1980.	\$.75-\$3

Intel i8039AHL

QP8039AHL	Type P package. Suspect single source showing 1 in stock.	Ex. Rare (Suspect) \$\$\$
TP8039AHL	Type P package. Suspect single source showing 2 in stock.	Ex. Rare (Suspect) \$\$\$

Type N Packages

Part Number	Package Description	Values
N8039AHL	PLCC	\$.75-\$3

References

[1] Intel (1980). Intel Component Data Catalog, 8049, 8039, 8039-6 Data Sheet, p. 5-29. No reference to 8039AHL dates chip after 1980.

[2] Hearst (1981). IC Master, Intel 8049/8039/8039-6 Data Sheet, p. 712. No reference to Intel 8039A dates chip after 1981.

[3] Hearst (1983). IC master, Intel 8039HL, p. 1093-25. No reference to Intel 8039AHL dates chip after 1983.

[4] Hearst (1984). IC master, Intel 8039AHL, p. 1344-6

[5] Intel (1990). 8-Bit Embedded Controllers, P8748H/P8749H/8048AH/8035AHL/
8049AH/8039AHL/8050AH/8040AHL Data Sheet, p. 4-8

Intel i8041

Universal Peripheral Interface 8-Bit Microcomputer w/8,192-bit (1024 x 8) ROM, 512-bit (64 x 8) RAM and I/O

1978

Specifications

- Universal Peripheral Interface 8-Bit Microcomputer w/8,192-bit (1024 x 8) ROM, 512-bit (64 x 8) RAM and I/O
- Fully Compatible with MCS-80™ and MCS-48™ Microprocessor Families
- Single Level Interrupt
- 8-Bit CPU plus ROM, RAM, I/O, Timer and Clock in a Single Package
- Single 5V Supply
- Alternative to Custom LSI
- Pin Compatible ROM and EPROM Versions
- 1K x 8 ROM/EPROM, 64 x 8 RAM, 18 Programmable I/O Pins
- Asynchronous Data Register for Interface to Master Processor
- Expandable I/O
- 40-pin Dual In-Line Package

Type	Clock	Power Dissipation Max.	Supplies [V]
8041	-	-	+5

The Intel ® 8041/8741 is a general purpose, programmable interface device designed for use with a variety of 8-bit microprocessor systems. It contains a low cost microcomputer with program memory, data memory, 8-bit CPU, I/O ports, timer/counter, and clock in a single 40-pin package. Interface registers are included to enable the UPI device to function as a peripheral controller in MCS-80™, MCS-85™, MCS-48™, and other 8-bit systems.

The UPI-41™ has 1K words of program memory and 64 words of data memory on-chip. To allow full user flexibility the program memory is available as ROM in the 8041 version or as UV-erasable EPROM in the 8741 version. The 8741 and the 8041 are fully pin compatible for easy transition from prototype to production level designs.

The device has two 8-bit, TTL compatible I/O ports and two test inputs. Individual port lines can function as either inputs or outputs under software control. I/O can be expanded with the 8243 device, which is directly compatible and has 16 I/O lines. An 8-bit programmable timer/counter is included in the UPI device for generating timing sequences or counting external inputs. Additional UPI features include: single 5V supply, low power standby mode (in the 8041), single-step mode for debug (in the 8741), and dual working register banks.

Because it's a complete microcomputer, the UPI provides more flexibility for the designer than conventional LSI interface devices. It is designed to be an efficient controller as well as an arithmetic processor. Applications include keyboard scanning, printer control, display multiplexing and similar functions, which involve interfacing peripheral devices to microprocessor systems [1].

Part Numbers

Type D Packages

Part Number	Package Description	Values
D8041	Type D package	\$2-\$8

Type P Packages

Part Number	Package Description	Values
		
P8041	1. Type P black plastic package w/tin pins. Half-round key. © Intel '77	\$1.50-\$6
P8041	2. Type P black plastic package w/tin pins. Rectangular key. © Intel '77. HP house mark 1820-2189.	\$1.50-\$6

References

- [1] Intel (1978). Intel Component Data Catalog, 8041/8741 Preliminary Data Sheet, p. 12-3.
- [2] Intel (1984). A Revolution in Progress... A History of Intel to Date, 8041/8741 introduced 1978, p. 26.

Intel i8041A

Universal Peripheral Interface 8-Bit Microcomputer w/8,192-bit (1024 x 8) ROM, 512-bit (64 x 8) RAM and I/O

1979-80

Specifications

- Universal Peripheral Interface 8-Bit Microcomputer w/8,192-bit (1024 x 8) ROM, 512-bit (64 x 8) RAM and I/O
- 8-Bit CPU plus ROM, RAM, I/O, Timer and Clock in a Single Package
- One 8-Bit Status and Two Data Registers for Asynchronous Slave-to-Master Interface
- DMA, Interrupt, or Polled Operation Supported
- 1024 x 8 ROM (8041A)/PROM (8641A)/EPROM (8741A), 64 x 8 RAM, 8-Bit Timer/Counter, 18 Programmable I/O Pins
- Fully Compatible with MCS-48™, MCS-80™, MCS-85™, and MCS-86™ Microprocessor Families
- Interchangeable ROM, PROM and EPROM Versions
- 3.6 MHz 8741A-8 Available
- Expandable I/O
- RAM Power-Down Capability
- Over 90 Instructions: 70% Single Byte
- Single +5V Power Supply
- 40-pin Dual In-Line Package

Type	Clock	Power Dissipation Max.	Supplies [V]
8041A	6 MHz	-	+5

The Intel © 8041A/8741A is a general purpose, programmable interface device designed for use with a variety of 8-bit microprocessor systems. It contains a low cost microcomputer with program memory, data memory, 8-bit CPU, I/O ports, timer/counter, and clock in a single 40-pin package. Interface registers are included to enable the UPI device to function as a peripheral controller in MCS-48™, MCS-80™, MCS-85™, MCS-86™, and other 8-bit systems.

The UPI-41A™ has 1K words of program memory and 64 words of data memory on-chip. To allow full user flexibility the program memory is available as ROM in the 8041A version or as UV-erasable EPROM in the 8741A version. The 8741A and the 8041A are fully pin compatible for easy transition from prototype to production level designs. The 8641A is a one-time programmable (at the factory) 8741A, which can be ordered as the first 25 pieces of a new 8041A order. The substitution of 8641A's for 8041A's allows for very fast turnaround for initial code verification and evaluation results.

The device has two 8-bit, TTL compatible I/O ports and two test inputs. Individual port lines can function as either inputs or outputs under software control. I/O can be expanded with the 8243 device, which is directly compatible and has 16 I/O lines. An 8-bit programmable timer/counter is included in the UPI device for generating timing sequences or counting external inputs. Additional UPI features include: single 5V supply, low power standby mode (in the 8041A), single-step mode for debug (in the 8741A), and dual working register banks.

Intel i8041A

Because it's a complete microcomputer, the UPI provides more flexibility for the designer than conventional LSI interface devices. It is designed to be an efficient controller as well as an arithmetic processor. Applications include keyboard scanning, printer control, display multiplexing and similar functions, which involve interfacing peripheral devices to microprocessor systems [3].



Intel i8041A

Part Numbers

Type D Packages

Part Number	Package Description	Values
		
D8041A	Type D grey ceramic package w/tin pins. © Intel '77	\$1.25-\$5
D8041A/ 8641A	Type D grey ceramic package w/tin pins. © Intel '77.	\$1.25-\$5

Type P Packages

Part Number	Package Description	Values
		
P8041A	1. Type P black plastic package w/tin pins. © Intel '77	\$.75-\$3
P8041A	2. Type P black plastic package w/tin pins. Rectangular key. © Intel '77. HP House mark 1820-3345.	\$.75-\$3
P8041A	3. Type P black plastic package w/tin pins. Rectangular key. © Intel '77. HP House mark 1820-2263.	\$.75-\$3
		
P8041A	4. Type P black plastic package w/tin pins. Rectangular key. Copyright NCR 1980	\$.75-\$3

References

- [1] Intel (1978). Intel Component Data Catalog, 8041/8741 Preliminary Data Sheet, p. 12-3. No reference to 8041A dates chip after 1978.
- [2] Intel (1979). Intel Component Data Catalog, 8041A/8741A Preliminary Data Sheet, p. 11-3
- [3] Intel (1980). Intel Component Data Catalog, 8041A, 8641A, 8741A Data Sheet, p. 8-1.
- [4] Intel (2002). Intel Museum Archive Collection Chronological Timeline. Available from: http://www.intel.com/intel/intelis/museum/arc_collect/TimelineChron.pdf [Accessed 10 July 2002] – 8041 [introduction] date “01/01/78”

Intel i8041AH

Universal Peripheral Interface 8-Bit Microcomputer w/8,192-bit (1024 x 8) ROM, 512-bit (64 x 8) RAM and I/O

1981-82

Specifications

- Universal Peripheral Interface 8-Bit Microcomputer w/8,192-bit (1024 x 8) ROM, 512-bit (64 x 8) RAM and I/O
- UPI-41: 6 MHz; UPI-42: 12 MHz
- Pin, Software and architecturally Compatible with UPI-41 and UPI-42 Products
- 8-Bit CPU plus ROM/EPROM, RAM, I/O, Timer/Counter and Clock in a Single Package
- 2048 x 8 ROM/EPROM, 256 x 8 RAM on UPI-42, 1024 x 8 ROM/EPROM, 128 x 8 RAM on UPI-41, 8-Bit Timer/Counter, 18 Programmable I/O Pins
- One 8-Bit Status and Two Data Registers for Asynchronous Slave-to-Master Interface
- DMA, Interrupt, or Polled Operation Supported
- Fully Compatible with all Intel and Most Other Microprocessor Families
- Interchangeable ROM and EPROM Versions
- Expandable I/O
- Sync Mode Available
- Over 90 Instructions: 70% Single Byte
- Available in EXPRESS
 - Standard Temperature Range
- Intelligent Programming™ Algorithm
 - Fast EPROM Programming
- 40-pin Dual In-Line Package and 44-Lead Plastic Leaded Chip Carrier Package

Type	Clock	Power Dissipation Max.	Supplies [V]
8041AH	6 MHz	-	+5

The Intel UPI-41 and UPI-42 are general-purpose Universal Peripheral Interfaces that allow the designer to develop customized solutions for peripheral device control.

They are essentially “slave” microcontrollers, or microcontrollers with a slave interface included on the chip. Interface registers are included to enable the UPI device to function as a slave peripheral controller in the MCS™ Modules and iAPX family, as well as other 8-, 16-bit systems.

To allow full user flexibility, the program memory is available in ROM, One-Time Programmable EPROM (OTP) and UV-erasable EPROM. All UPI-41 and UPI-42 devices are fully pin compatible for easy transition from prototype to production level designs [4].

Intel i8041AH

Part Numbers

Type P Packages

Part Number	Package Description	Values
 A black plastic integrated circuit package with tin pins. The top surface is marked with the part number 'P8041AH 1341', the manufacturer's code '88M001B', a lot number 'L9330164', and the Intel logo with '©INTEL '77'.		
P8041AH	Type P black plastic package w/tin pins. © Intel '77	\$1.25-\$5

References

- [1] Hearst (1981). IC Master, Intel 8041A, p. 555-164. No reference to Intel 8041AH.
- [2] Intel (January 1982). Intel Component Data Catalog, 8041AH/8041AH-2/8641A/8741A Preliminary Data Sheet, p. 9-1
- [3] Hearst (1983). IC Master, Intel 8041AH, p. 1094-3
- [4] Intel (1989). Microprocessor and Peripheral Handbook, UPI™-41, 42: 8041AH, 8042AH, 8741AH, 8742AH Preliminary Data Sheet, p. 9-54

Intel i8048

Single Component 8-bit Microcomputer w/8,192-bit (1024 x 8) ROM, 512-bit (64 x 8) RAM, and I/O

1976

Specifications

- Single Component 8-bit Microcomputer w/8,192-bit (1024 x 8) ROM, 512-bit (64 x 8) RAM, and I/O
- NMOS
- Mask Programmable ROM (8048)
- User Programmable/Erasable EPROM (8748)
- External ROM or EPROM (8035)
- 8-Bit CPU, ROM, RAM, I/O in Single Package
- Interchangeable ROM and EPROM Versions
- Single 5V Supply
- 2.5 μ sec and 5.0 μ sec Cycle Versions:
All Instructions 1 or 2 cycles
- Over 90 Instructions: 70% Single Byte
- 1K x 8 ROM/EPROM
64 x 8 RAM
27 I/O Lines
- Interval Timer/Event Counter
- Easily Expandable Memory and I/O
- Compatible with 8000 Series Peripherals
- Single Level Interrupt
- 40-pin Dual In-Line Package

Type	Clock	Power Dissipation Max.	Supplies [V]
8048	-	-	+5

The Intel® 8048/8748/8035 is a totally self-sufficient 8-bit parallel computer fabricated on a single silicon chip using Intel's N-channel silicon gate MOS Process.

The 8048 contains a 1K x 8 program memory, a 64 x 8 RAM data memory, 27 I/O lines, and an 8-bit timer/counter in addition to onboard oscillator and clock circuits. For systems that require extra capability, the 8048 can be expanded using standard memories and MCS-80™ (8080A) peripherals. The 8035 is the equivalent of an 8048 without program memory. The 8035L has the RAM power down mode of the 8048 while the 8035 does not.

To reduce development problems to a minimum and provide for maximum flexibility, three interchangeable pin-compatible versions of this single component microcomputer exist: the 8748 with user-programmable and erasable EPROM program memory for prototype and preproduction systems, the 8048 with factory-programmed mask ROM program memory for low cost, high volume production, and the 8035 without program memory for use with external program memories.

This microcomputer is designed to be an efficient controller as well as an arithmetic processor. The 8048 has extensive bit handling capability as well as facilities for both binary and BCD arithmetic. Efficient use of program memory results from an instruction set consisting mostly of single byte instructions and no instructions over 2 bytes in length [2].

Intel i8048

Part Numbers

Type C Packages

Part Number	Package Description	Values
C8048	Type C package	Rare \$20-\$80

Type D Packages

Part Number	Package Description	Values
		
D8048	Type D grey ceramic package w/tin pins. Vertical © Intel '77	\$.75-\$3
ID8048	Type D package	\$2.50-\$10
MD8048/B	Type D package	Ex. Rare (0 Known) \$\$\$

Type P Packages

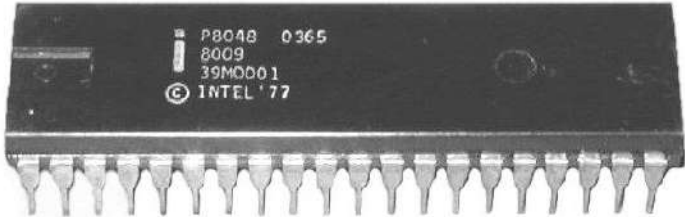
Part Number	Package Description	Values
		
P8048	1. Type P black plastic package w/tin pins. © Intel '77	\$.75-\$3

Intel i8048

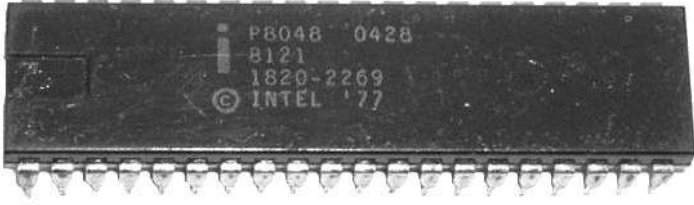
 A black plastic microprocessor chip with 28 pins. The top surface is marked with the following text: P8048 0428, B121, 1820-2269, and INTEL '77. A small HP house mark is visible to the left of the text.		
P8048	2. Type P black plastic package w/tin pins. © Intel '77. Also marked with HP house mark 1820-2269.	\$1.25-\$5

References

- [1] Intel (1977). Intel Data Catalog, 8048/8748/8035 Preliminary Data Sheet, p. 9-4
- [2] Intel (1978). Intel Component Data Catalog, 8048/8748/8035 Preliminary Data Sheet, p. 10-10
- [3] Intel (1984). A Revolution in Progress... A History of Intel to Date, 8048 introduced 1976, p. 26.

Intel i8048L

Single Component 8-bit Microcomputer w/8,192-bit (1024 x 8) ROM, 512-bit (64 x 8) RAM, and I/O

1976-81

Specifications

- Single Component 8-bit Microcomputer w/8,192-bit (1024 x 8) ROM, 512-bit (64 x 8) RAM, and I/O
- NMOS
- Mask Programmable ROM (8048)
- User Programmable/Erasable EPROM (8748)
- External ROM or EPROM (8035)
- 8-Bit CPU, ROM, RAM, I/O in Single Package
- Interchangeable ROM and EPROM Versions
- Single 5V Supply
- 2.5 μ sec and 5.0 μ sec Cycle Versions:
All Instructions 1 or 2 cycles
- Over 90 Instructions: 70% Single Byte
- 1K x 8 ROM/EPROM
64 x 8 RAM
27 I/O Lines
- Interval Timer/Event Counter
- Easily Expandable Memory and I/O
- Compatible with 8000 Series Peripherals
- Single Level Interrupt
- 40-pin Dual In-Line Package

Type	Clock	Power Dissipation Max.	Supplies [V]
8048L	3.6 MHz	-	+5

The Intel® 8048/8748/8035 is a totally self-sufficient 8-bit parallel computer fabricated on a single silicon chip using Intel's N-channel silicon gate MOS Process.

The 8048 contains a 1K x 8 program memory, a 64 x 8 RAM data memory, 27 I/O lines, and an 8-bit timer/counter in addition to onboard oscillator and clock circuits. For systems that require extra capability, the 8048 can be expanded using standard memories and MCS-80™ (8080A) peripherals. The 8035 is the equivalent of an 8048 without program memory. The 8035L has the RAM power down mode of the 8048 while the 8035 does not.

To reduce development problems to a minimum and provide for maximum flexibility, three interchangeable pin-compatible versions of this single component microcomputer exist: the 8748 with user-programmable and erasable EPROM program memory for prototype and preproduction systems, the 8048 with factory-programmed mask ROM program memory for low cost, high volume production, and the 8035 without program memory for use with external program memories.

This microcomputer is designed to be an efficient controller as well as an arithmetic processor. The 8048 has extensive bit handling capability as well as facilities for both binary and BCD arithmetic. Efficient use of program memory results from an instruction set consisting mostly of single byte instructions and no instructions over 2 bytes in length [1].

Intel i8048L

P8048L

This part is listed as a JAN qualified device in the Intel OEM Price List dated January 11, 1982

Intel i8048L

Part Numbers

Type P Packages

Part Number	Package Description	Values
P8048L	Type P package	Rare \$10-\$40

References

[1] Intel (1978). Intel Component Data Catalog, 8048/8748/8035 Preliminary Data Sheet, p. 10-10

[2] Intel (January 11, 1982). Intel OEM Price List, P8048L, p. 6

Intel i8048H

Single Component 8-bit Microcomputer w/8,192-bit (1024 x 8) ROM, 512-bit (64 x 8) RAM, and I/O

1981

Specifications

- Single Component 8-bit Microcomputer w/8,192-bit (1024 x 8) ROM, 512-bit (64 x 8) RAM, and I/O
- HMOS
- Mask Programmable ROM (8048H)
- External ROM or EPROM (8035HL)
- Reduced Power Consumption
- 1.4 μ sec and 1.9 μ sec Cycle Versions; All Instructions 1 or 2 Cycles
- Over 90 Instructions: 70% Single Byte
- 1K x 8 ROM/EPROM
64 x 8 RAM
27 I/O Lines
- Interval Counter/Event Timer
- Compatible with 8080/8085 Series Peripherals
- Two Single Level Interrupts
- 40-pin Dual In-Line Package

Type	Clock	Power Dissipation Max.	Supplies [V]
8048H	8 MHz	-	+5
M8048H	-	-	+5

The Intel® 8048H/8048H-1/8035HL/8035HL-1 are totally self sufficient, 8-bit parallel computers fabricated on single silicon chips using Intel's advanced N-channel silicon gate HMOS process.

The 8048H contains a 1K x 8 program memory, a 64 x 8 RAM data memory, 27 I/O lines, and an 8-bit timer/counter in addition to on-board oscillator and clock circuits. For systems that require extra capability the 8048H can be expanded using standard memories and MCS-80™/MCS-85™ peripherals. The 8035HL is the equivalent of the 8048H without program memory and can be used with external ROM and RAM.

To reduce development problems to a minimum and provide maximum flexibility, a logically and functionally pin compatible version of the 8048H with UV-erasable user-programmable program memory is available. The 8748 will emulate the 8048H up to 6MHz clock frequency with minor differences.

The 8048H is fully compatible with the 8048 when operated at 6 MHz.

These microcomputers are designed to be efficient controllers as well as arithmetic processors. They have extensive bit handling capability as well as facilities for both binary and BCD arithmetic. Efficient use of program memory results from an instruction set consisting mostly of single bit instructions and no instructions over 2 bytes in length [2].

Intel i8048H

Part Numbers

Type D Packages

Part Number	Package Description	Values
D8048H	Type D grey ceramic package w/tin pins. © Intel '77.	Rare \$10-\$40
ID8048H	Type D package.	\$2.50-\$10
LD8048H	Type D package	\$1.50-\$6
MD8048H	Type D package	\$1.50-\$6
MD8048H/B	Type D package	\$1.50-\$6

Type P Packages

Part Number	Package Description	Values
		
P8048H	Type P black plastic package w/tin pins. Rectangular key. © Intel '77	\$1.25-\$5

References

[1] Intel (1980). Intel Component Data Catalog, 8048, 3035L, 8748, 8748-6, 8748-8, 8035, 8035-8 Data Sheet, p. 5-20. No reference to 8048H

[2] Hearst (1981). IC Master, Intel 8048H/8048H-1/8035HL/8035HL-1 Preliminary Datasheet, p. 711.

Intel i8048AH

Single Component 8-bit Microcomputer w/8,192-bit (1024 x 8) ROM, 512-bit (64 x 8) RAM, and I/O

1983-84

Specifications

- Single Component 8-bit Microcomputer w/8,192-bit (1024 x 8) ROM, 512-bit (64 x 8) RAM, and I/O
- HMOS II
- Interval Time/Event Counter
- Two Single Level Interrupts
- Single +5 Volt Supply
- Over 96 Instructions; 90% Single Byte
- Programmable ROMs using 21V
- Easily Expandable Memory and I/O
- Up to 1.36 μ s Instruction Cycle All Instructions 1 or 2 Cycles
- 40-pin Dual In-Line Package

Type	Clock	Power Dissipation Max.	Supplies [V]
8048AH	11 MHz	-	+5
M8048AH	11 MHz	-	+5

The Intel MCS[®]-48 family are totally self-sufficient, 8-bit parallel computers fabricated on single silicon chips using Intel's advanced N-channel silicon gate HMOS process.

The family contains 27 I/O lines, an 8-bit timer/counter, and on-board oscillator/clock circuits. For systems that require extra capability, the family can be expanded using MCS[®]-80/MCS[®]-85 peripherals.

These microcontrollers are available in both masked ROM and ROMless versions as well as a new version, The Programmable ROM. The Programmable ROM provides the user with the capacity of a masked ROM while providing the flexibility of a device that can be programmed at the time of requirement and to the desired data. Programmable ROM's allow the user to lower inventory levels while at the same time decreasing delay times and code risks.

These microcomputers are designed to be efficient controllers as well as arithmetic processors. They have extensive bit handling capability as well as facilities for both binary and BCD arithmetic. Efficient use of program memory results from an instruction set consisting of mostly single byte instructions and no instructions over 2 bytes in length [5].

Intel i8048AH

Part Numbers

Type D Packages

Part Number	Package Description	Values
D8048AH	Type D package	\$1.25-\$5
LD8048AH	Type D package	\$2.50-\$10
MD8048AH/B	Type D package	\$2.50-\$10
QD8048AH	Type D package	\$1.50-\$6

Type P Packages

Part Number	Package Description	Values
		
P8048AH	1. Type P black plastic package w/tin pins. Half-round key. © Intel 1980	\$.75-\$3
P8048AH	2. Type P black plastic package w/tin pins. Rectangular key. © Intel '82.	\$.75-\$3
QP8048AH	Type P package	\$2.50-\$10

References

[1] Intel (1980). Intel Component Data Catalog, 8048, 3035L, 8748, 8748-6, 8748-8, 8035, 8035-8 Data Sheet, p. 5-20. No reference to 8048AH dates chip after 1980.

[2] Hearst (1981). IC Master. No reference to Intel 8048AH dates chip after 1981.

[3] Hearst (1983). IC Master. No reference to Intel 8048AH dates chip after 1983.

[4] Hearst (1984). IC Master, Intel 8048AH, p. 1344-40.

[5] Intel (1990). Intel 8-Bit Embedded Controllers, P8748H/P8749H/8048AH/8035AHL/
8049AH/8039AHL/8050AH/8040AHL Data Sheet, p. 4-8

Intel i8049

Single Component 8-bit Microcomputer w/16,384-bit (2048 x 8) ROM, 1024-bit (128 x 8) RAM and I/O 1978

Specifications

- Single Component 8-bit Microcomputer w/16,384-bit (2048 x 8) ROM, 1024-bit (128 x 8) RAM and I/O
- NMOS
- 8-Bit CPU, ROM, RAM, I/O in Single Package
- Single 5V \pm 10% Supply
- 1.36 μ sec Cycle; All Instructions 1 or 2 Cycles
- Over 90 Instructions: 70% Single Byte
- Pin Compatible with 8048/8748
- 2K x 8 ROM
128 x 8 RAM
27 I/O Lines
- Interval Timer/Event Counter
- Easily Expandable Memory and I/O
- Compatible with MCS Memory and I/O
- Single Level Interrupt
- 40-pin Dual In-Line Package

Type	Clock	Power Dissipation Max.	Supplies [V]
8049	11 MHz	-	+5

The Intel® 8049/8039/8039-6 is a totally self-sufficient 8-bit parallel computer fabricated on a silicon chip using Intel's N-channel silicon gate MOS technology.

The 8049 contains a 2K x 8 program memory, a 128 x 8 RAM data memory, 27 I/O lines, and an 8-bit timer/counter in addition to on board oscillator and clock circuits. For systems that require extra capability, the 8049 can be expanded using standard memories and MCS-80™/MCS-85™ peripherals. The 8039 is the equivalent to an 8049 without program memory. The 8039-6 is a lower speed (6MHz) version of the 8039.

To reduce development problems to a minimum and provide maximum flexibility, two interchangeable pin-compatible versions of this single component microcomputer exist: the 8049 with factory-programmed mask ROM program memory for low-cost high volume production, and the 8039 without program memory for use with external program memories in prototype and preproduction systems.

This microprocessor is designed to be an efficient controller as well as an arithmetic processor. The 8049 has extensive bit handling capability as well as facilities for both binary and BCD arithmetic. Efficient use of program memory results from an instruction set consisting mostly of single byte instructions and no instructions over two bytes in length [1].

Intel i8049

Part Numbers

Type D Packages

Part Number	Package Description	Values
		
D8049	Type D grey ceramic package w/tin pins. © Intel '77	\$2.50-\$10
		
ID8049	Type D grey ceramic package w/tin pins. © Intel '77.	Rare \$10-\$40

Type P Packages

Part Number	Package Description	Values
		
P8049	Type P black package w/tin pins. © Intel '77	\$.75-\$3

References

- [1] Intel (1980). Intel Component Data Catalog, 8049, 8039, 8039-6 Data Sheet, p. 5-29
- [2] Intel (1984). A Revolution in Progress... A History of Intel to Date, 8049 introduced 1978, p. 26.

Intel i8049H

Single Component 8-bit Microcomputer w/16,384-bit (2048 x 8) ROM, 1024-bit (128 x 8) RAM and I/O 1982-83

Specifications

- Single Component 8-bit Microcomputer w/16,384-bit (2048 x 8) ROM, 1024-bit (128 x 8) RAM and I/O
- HMOS
- Mask Programmable ROM (8049H)
- CPU Only with Power Down Mode (8039HL)
- Reduced Power Consumption
- 1.4 μ sec and 1.9 μ sec Cycle Versions: All Instructions 1 or 2 Cycles
- Over 90 Instructions: 70% Single Byte
- 2K x 8 ROM
128 x 8 RAM
27 I/O Lines
- Interval Timer/Event Counter
- Easily Expandable Memory and I/O
- Compatible with 8080/8085 Series Peripherals
- Two Single Level Interrupts
- 40-pin Dual In-Line Package

Type	Clock	Power Dissipation Max.	Supplies [V]
8049H	-	-	+5

The Intel® 8049H/8038HL are totally self-sufficient, 8-bit parallel computers fabricated on single silicon chips using Intel's advanced N-channel silicon gate HMOS process.

The 8049H contains a 2K x 8 program memory, a 128 x 8 RAM data memory, 27 I/O lines, and an 8-bit timer/counter in addition to on-board oscillator and clock circuits. For systems that require extra capability the 8049H can be expanded using standard memories and MCS-80®/MCS-85® peripherals. The 8039HL is the equivalent of the 8049H without program memory and can be used with external ROM and RAM.

To reduce development problems to a minimum and provide maximum flexibility, a logically and functionally pin compatible version of the 8049H with UV-erasable user-programmable EPROM program memory will soon be available. The 8749 will emulate the 8049H up to 11MHz clock frequency with minor differences.

The 8049H is fully compatible with the 8049.

These microcomputers are designed to be efficient controllers as well as arithmetic processors. They have extensive bit handling capability as well as facilities for both binary and BCD arithmetic. Efficient use of program memory results from an instruction set consisting mostly of single byte instructions and no instructions over 2 bytes in length [3].

Intel i8049H

Part Numbers

Type D Packages

Part Number	Package Description	Values
 A photograph of an Intel i8049H chip in a Type D grey ceramic package with tin pins. The chip is dark grey and has white markings: 'D8049H 7166', '8122', 'D 8049 H HTA 3', and 'INTEL '77' with a copyright symbol.		
D8049H	Type D grey ceramic package w/tin pins. © Intel '77	\$3-\$12
ID8049H	Type D package	\$2-\$6
TD8049H	Type D package	\$2-\$6

Type P Packages

Part Number	Package Description	Values
P8049H	Type P package	\$.75-\$3

References

- [1] Intel (1980). Intel Component Data Catalog, 8049, 8039, 8039-6 Data Sheet, p. 5-29. No reference to 8049H dates chip after 1980.
- [2] Hearst (1981). IC Master, Intel 8049 Data Sheet, p. 712. No reference to 8049H dates chip after 1981.
- [3] Intel (January 1982). Intel Component Data Catalog, 8049H/8039HL Preliminary Data Sheet, p. 6-62
- [4] Hearst (1983). IC Master, Intel 8049H, p. 1065-21

Intel i8049AH

Single Component 8-bit Microcomputer w/16,384-bit (2048 x 8) ROM, 1024-bit (128 x 8) RAM and I/O 1983-84

Specifications

- Single Component 8-bit Microcomputer w/16,384-bit (2048 x 8) ROM, 1024-bit (128 x 8) RAM, and I/O
- HMOS II
- Interval Time/Event Counter
- Two Single Level Interrupts
- Single +5 Volt Supply
- Over 96 Instructions; 90% Single Byte
- Programmable ROMs using 21V
- Easily Expandable Memory and I/O
- Up to 1.36 μ s Instruction Cycle All Instructions 1 or 2 Cycles
- 40-pin Dual In-Line or 44-lead PLCC Package

Type	Clock	Power Dissipation Max.	Supplies [V]
8049AH	-	-	+5

The Intel MCS[®]-48 family are totally self-sufficient, 8-bit parallel computers fabricated on single silicon chips using Intel's advanced N-channel silicon gate HMOS process.

The family contains 27 I/O lines, an 8-bit timer/counter, and on-board oscillator/clock circuits. For systems that require extra capability, the family can be expanded using MCS[®]-80/MCS[®]-85 peripherals.

These microcontrollers are available in both masked ROM and ROMless versions as well as a new version, The Programmable ROM. The Programmable ROM provides the user with the capacity of a masked ROM while providing the flexibility of a device that can be programmed at the time of requirement and to the desired data. Programmable ROM's allow the user to lower inventory levels while at the same time decreasing delay times and code risks.

These microcomputers are designed to be efficient controllers as well as arithmetic processors. They have extensive bit handling capability as well as facilities for both binary and BCD arithmetic. Efficient use of program memory results from an instruction set consisting of mostly single byte instructions and no instructions over 2 bytes in length [5].

Intel i8049AH

Part Numbers

Type D Packages

Part Number	Package Description	Values
		
D8049AH	Type D grey ceramic package w/tin pins. © Intel '82	\$1.25-\$5

Type P Packages

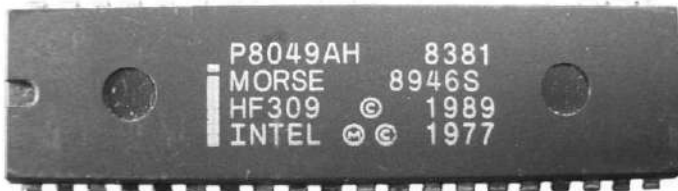
Part Number	Package Description	Values
		
P8049AH	1. Type P black plastic package w/tin pins. Modified half-round key. © Intel 1977.	\$.75-\$3
P8049AH	2. Type P black plastic package w/tin pins. Impressed logo and part number. Half-round key. © Intel 1977.	\$.75-\$3
TP8049AH	Type P package	\$1-\$4

Type N Packages

Part Number	Package Description	Values
N8049AH	PLCC	\$.75-\$3

References

[1] Intel (1980). Intel Component Data Catalog, 8049, 8039, 8039-6 Data Sheet, p. 5-29. No reference to 8049AH dates chip after 1980.

[2] Hearst (1981). IC Master. No reference to Intel 8049AH dates chip after 1981.

[3] Hearst (1983). IC Master. No reference to Intel 8049AH dates chip after 1983.

[4] Hearst (1984). IC Master, Intel 8049AH, p. 1344-42.

[5] Intel (1990). Intel 8-Bit Embedded Controllers, P8748H/P8749H/8048AH/8035AHL/
8049AH/8039AHL/8050AH/8040AHL Data Sheet, p. 4-8

Intel i8080

8-bit Microprocessor

April 1974

Specifications

- 8-bit Microprocessor
- NMOS
- 6000 Transistors (6 Micron)
- 2 μ s Instruction Cycle
- Powerful Problem Solving Instruction Set
- Six General Purpose Registers and an Accumulator
- Sixteen Bit Program Counter for Directly Addressing up to 64K Bytes of Memory
- Sixteen Bit Stack Point and Stack Manipulation Instructions for Rapid Switching of the Program Environment
- Decimal, Binary and Double Precision Arithmetic
- Ability to Provide Priority Vectored Interrupts
- 512 Directly Addressed I/O Ports
- 40-pin Dual In-Line Package

Type	Clock	Power Dissipation Max.	Supplies [V]
8080	2 MHz	-	+12, +5, -5
8080-8	-	-	+12, +5, -5

The Intel 8080 is a complete 8-bit parallel central processing unit (CPU). It is fabricated on a single LSI chip using Intel's n-channel silicon gate MOS process. This offers the user a high performance solution to control and processing applications. The 8080 contains six 8-bit general purpose working registers and an accumulator. The six general-purpose registers may be addressed individually or in pairs providing both single and double precision operators. Arithmetic and logical instructions set or reset four testable flags. A fifth flag provides decimal arithmetic operation.

The 8080 has an external stack feature wherein any portion of memory may be used as a last in/first out stack to store/retrieve the contents of the accumulator, flags, program counter and all of the six general purpose registers. The sixteen-bit stack pointer controls the addressing of this external stack. This stack gives the 8080 the ability to easily handle multiple level priority interrupts by rapidly storing and restoring processor status. It also provides almost unlimited subroutine nesting. This microprocessor has been designed to simplify systems design. Separate 16-line address and 8-line bi-directional data busses are used to facilitate easy interface to memory and I/O. Signals to control the interface to memory and I/O are provided directly by the 8080. Ultimate control of the address and data busses resides with the HOLD signal. It provides the ability to suspend processor operation and force the address and data busses into a high impedance state. This permits OR-tying these busses with other controlling devices for (DMA) direct memory access or multi-processor operation [1].

Intel 8080 Die

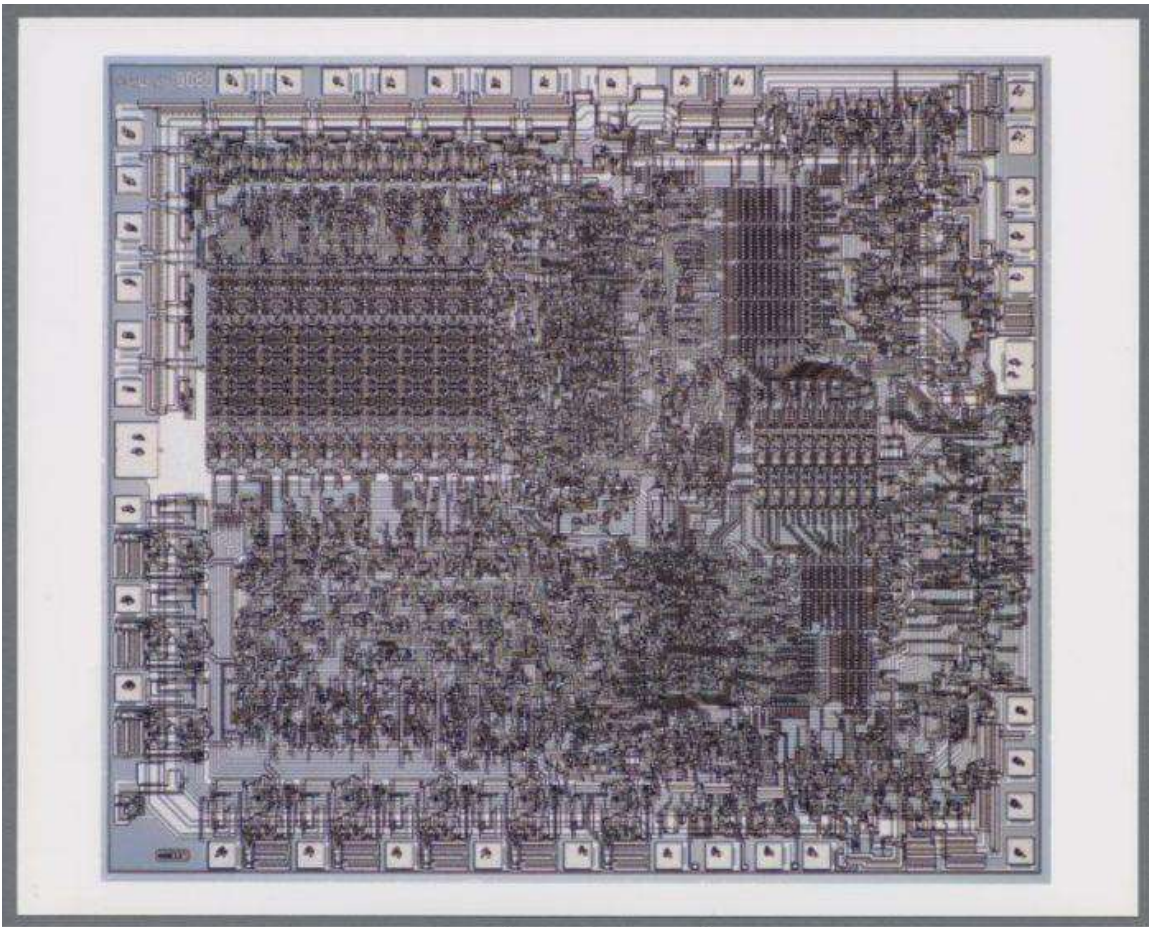

Copyright Intel Corporation

History

1st True General-Purpose Microprocessor

The first run of the 8080 came in December 1973. Intel officially introduced the product in either March or April 1974 [2].

The 8080 required 3 power supplies (+12, +5 and -5), an external clock controller 8224 and a control bus encoder/decoder 8228.

The Intel 8080 and 8080A were used in the MITS Altair 8800. Introduced January 1975, the Altair cost \$397 in kit form. The Altair was the first really affordable computer.

Intel i8080



MITS Altair 8800

The 8080 and 8080A were also used in the IMSAI 8080. The IMSAI 8080, the first Altair-compatible machine, appeared in late 1975. The IMSAI 8080 was featured in the 1983 movie "War Games".



IMSAI 8080

Was the Intel 8080 a PMOS Device?

A number of web sites dedicated to early microprocessors claim that the 8080 was a PMOS device and the 8080A was an NMOS device. This is not true. The 8080 and 8080A were both NMOS microprocessors.

Was the Intel D8080 Really an 8080?

Intel D8080's exist marked © Intel '74 '79. However, I suspect these chips are actually misprinted D8080A's.

The type C package was the only package type listed in the Intel MCS-80 User's Manual dated September 1975 for the 8080A, 8080A-1, 8080A-2, and M8080A. If the 8080A was not yet available in the type D package in September 1975, then it's unlikely the even earlier 8080 would have been available in the type D package. It's even more unlikely that Intel would have still been making 8080's in 1979.

Was there an Intel P8080?

Again, the type 'C' package was the only package type listed in the Intel MCS-80 User's Manual dated September 1975 for the 8080A, 8080A-1, 8080A-2, and M8080A. If the 8080A was not yet available in the type P package in September 1975, then it's unlikely that the even earlier 8080 would have been available in the type P package.

The Meaning of the '-8' Suffix on the Intel C8080-8

The 1975 Intel Data Catalog contains a datasheet for the Intel 8080 but no reference to the 8080-8. Intel C8255-8's are also known to exist but again, no datasheet is known to exist for the 8255-8.

Part Numbers

Type C Packages

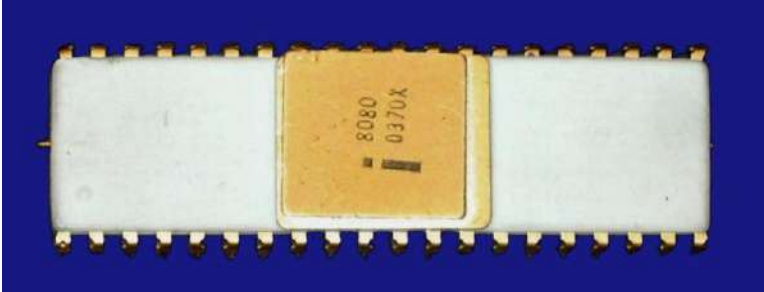
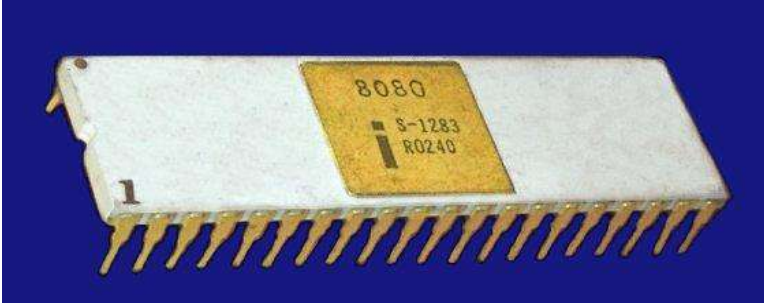
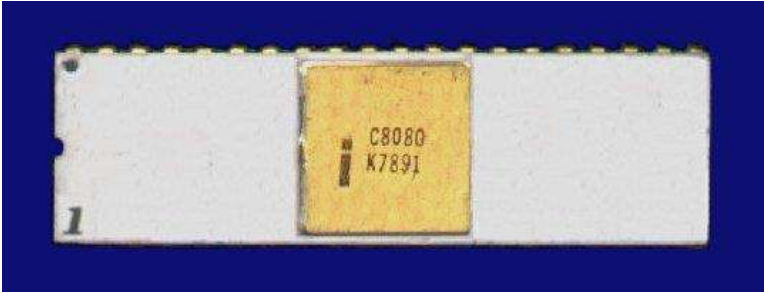
Part Number	Package Description	Values
		
8080	1. Type C white ceramic package w/gold cap and integrated gold pins. Small raised bump denotes pin #1. Vertical logo and part number. No copyright.	Ex. Rare (1 known) \$250-\$1000
		
8080	2. Type C white ceramic package w/gold cap and gold pins. Large '1' denotes pin #1. Small black dot at top left corner. No Copyright.	Ex. Rare (1 known) \$250-\$1000
		
C8080	Type C white ceramic package w/gold cap and gold pins. Large '1' denotes pin #1. Small black dot at top left corner. No Copyright.	Rare \$125-\$500

Intel i8080

		
C8080-8	Type C white ceramic package w/gold cap and gold pins. Small '+' denotes pin #1. No Copyright.	Ex. Rare (4 Known) \$200-\$800

Type D Packages

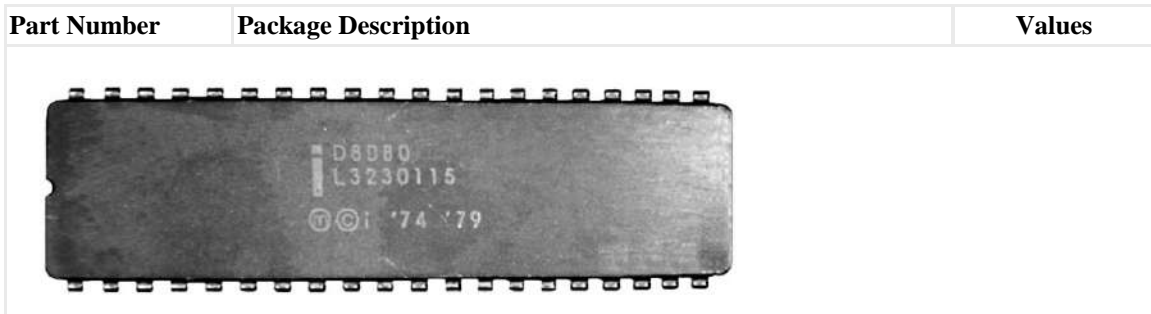
Part Number	Package Description	Values
		
D8080	Type D grey ceramic package w/tin pins. © Intel '74 '79.	Rare \$50-\$100

References

[1] Intel (1974). Intel 8080 Data Sheet, p. 1.

[2] Federico Faggin (n/d), The Birth Of The Microprocessor. Available from:
<http://www.uib.es/c-calculo/scimsgs/fc/tc1/html/MicroProcBirth.html> [Accessed 8 August 2002]

[3] Intel (September 1975). Intel MCS-80 User's Manual. Back of front cover lists 8080A as "New Device".

[4] Intel (1984). A Revolution in Progress... A History of Intel to Date, 8080 introduced 1974, p. 26.

Intel i8080A

8-bit Microprocessor

Early 1975

Specifications

- 8-bit Microprocessor
- NMOS
- TTL Drive Capability
- Instruction Cycle: 2 μ sec (8080A), 1.3 μ sec (8080A-1), 1.5 μ sec (8080A-2)
- Powerful Problem Solving Instruction Set
- 6 General Purpose Registers and an Accumulator
- 16-Bit Program Counter for Directly Addressing up to 64K Bytes of Memory
- 16-Bit Stack Pointer and Stack Manipulation Instructions for Rapid Switching of the Program Environment
- Decimal, Binary, and Double Precision Arithmetic
- Ability to Provide Priority Vectored Interrupts
- 512 Directly Addressed I/O Ports
- 40-pin Dual In-Line Package

Type	Clock	Power Dissipation Max.	Supplies [V]
8080A	2 MHz	780mW	+12, +5, -5
8080A-1	3.125 MHz	-	+12, +5, -5
8080A-2	2.67 MHz	-	+12, +5, -5
M8080A	2 MHz	-	+12, +5, -5

The Intel® 8080A is a complete 8-bit parallel central processing unit (CPU). It is fabricated on a single LSI chip using Intel's n-channel silicon gate MOS process. This offers the user a high performance solution to control and processing applications.

The 8080A contains 6 8-bit general-purpose working registers and an accumulator. The 6 general-purpose registers may be addresses individually or in pairs providing both single and double precision operators. Arithmetic and logical instructions set or reset 4 testable flags. A fifth flag provides decimal arithmetic operation.

The 8080A has an external stack feature wherein any portion of memory may be used as a last in/first out stack to store/retrieve the contents of the accumulator, flags, program counter, and all of the 6 general purpose registers. The 16-bit stack pointer controls the addressing of this external stack. This stack gives the 8080A the ability to easily handle multiple level priority of interrupts by rapidly storing and restoring processor status. It also provides almost unlimited subroutine testing.

The microprocessor has been designed to simplify systems design. Separate 16-line address and 8-line bi-directional data busses are used to facilitate easy interface to memory and I/O. Signals to control the interface to memory and I/O are provided by the 8080A. Ultimate control of the address and data busses resides with the HOLD signal. It provides the ability to suspend processor operation and force the address and data busses into a high impedance state. This permits OR-tying these busses with other controlling devices for (DMA) direct memory access or multiprocessor operation [3].

8080A vs. 8080

In early 1975, Intel revised the 8080 design. The result was the 8080A, which also had somewhat greater speed potential (3.125 MHz).

Other improvements of 8080A vs. 8080 [4]:

- Some improvements in timings to prior specs to improve the yield. Power delivery on-die was made more robust.
- Output buffer size increased to improve IOL to 1.9 mA at 0.45 volts to allow driving a standard TTL load.
- Clock timing between PH1 and PH2 (tD3) improved to make clock generation not a problem.
- INT synchronized to the falling edge of PH2 during the last cycle of the instruction and during HALT. Also, the PC register is not incremented during the interrupt instruction so that any branch instruction can be executed. The MEMR is held inactive during M1 of an interrupt instruction. MEMR can still happen in M2 and M3. The 8228-interface chip blocked MEMR in those cycles and provided the proper INTA signals.
- HOLD was resampled internally during not PH2 to make it fully asynchronous. The signal is sampled on PH2 rising during T2.
- Internal logic changed to allow RESET to be an effective interrupt to address 0 (zero).

Copyrights

Intel started putting a copyright on their chips during production of the Intel 8080A.

Intel 8080A family Type C chips WITH a copyright are harder to find than Intel 8080A family Type C chips without a copyright. This is the exact opposite with the Intel 8080A family type D and P chips which are harder to find WITHOUT the copyright.





Intel i8080A

Part Numbers



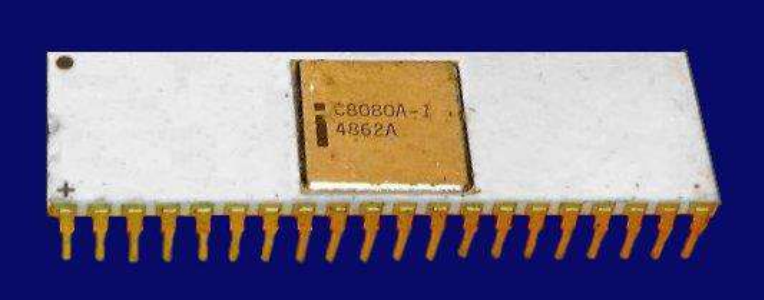

Type C Packages

Part Number	Package	Values
		
8080A	Type C white ceramic package w/gold cap and gold pins. Small '+' denotes pin #1. No copyright. Example shown marked 'CS' for customer sample.	Rare \$75-\$300
		
C8080A	1. Type C white ceramic package w/gold cap and gold pins. Black dot at top left corner. Small '+' denotes pin #1. No copyright. Example shown made in Malaysia and dated 7729.	\$20-\$80
		
C8080A	2. Type C white ceramic package w/gold cap and gold pins. Small '+' denotes pin #1. No copyright. Photo on file of example marked 'CS' for Customer Sample.	\$20-\$80

Intel i8080A

		
C8080A	3. Type C white ceramic package w/gold cap and gold pins. Small '+' denotes pin #1. Black square at top left corner. © Intel '74. Example shown made in Malaysia and dated 7841.	Rare \$30-\$120
		
C8080A	4. Type C purple ceramic package w/gold cap and gold pins. Small '+' denotes pin #1. Gold square at top left corner. © Intel '74. Example shown made in Malaysia and dated 8033.	Ex. Rare (5 Known) \$125-\$500
		
C8080A-1	1. Type C white ceramic package w/gold cap and gold pins. Small '+' denotes pin #1. Black dot at top left corner. No Copyright.	Ex. Rare \$125-\$500
		
C8080A-1	2. Type C white ceramic package w/gold cap and gold pins. Small '+' denotes pin #1. No Copyright.	Ex. Rare \$125-\$500

Intel i8080A

		
C8080A-1	3. Type C white ceramic package w/gold cap and gold pins. Small '+' denotes pin #1. Black circle at top left corner. © Intel '74.	Ex. Rare \$150-\$600
		
C8080A-2	1. Type C white ceramic package w/gold cap and gold pins. Small '+' denotes pin #1. Black dot at top left corner. No copyright.	Rare \$75-\$300
		
C8080A-2	2. Type C white ceramic package w/gold cap and gold pins. Small '+' denotes pin #1. No Copyright. Example shown made in Malaysia and dated 7633	Rare \$75-\$300
C8080A-2	3. Type C purple ceramic package w/gold cap and gold pins. Small '+' denotes pin #1. Gold square at top left corner. © Intel '74. Example known made in Malaysia and dated 8033.	Ex. Rare (1 Known) \$250-\$1000
		
MC8080A	Type C white ceramic package w/gold cap and gold pins. Small '+' denotes pin #1. No copyright. Example shown made in Malaysia and dated 7613	Ex. Rare (2 Known) \$250-\$1000

Intel i8080A



MC8080A/B	Type C white ceramic package w/gold cap and gold pins. Small '+' denotes pin #1. © Intel '74. Example shown made in Malaysia and dated 7630	Ex. Rare (2 Known) \$250-\$1000
-----------	---	---------------------------------------





Type D Packages

Part Number	Package	Values
D8080A	1. Type D grey ceramic package w/tin pins. No copyright.	\$6-\$24
D8080A	2. Type D grey ceramic package w/tin pins. © Intel '74.	\$3-\$12
D8080A	3. Type D grey ceramic package w/tin pins. © Intel 1974	\$2-\$8
D8080A	4. Type D grey ceramic package w/tin pins. Slashed zeroes. © Intel '74 '79.	\$2-\$8



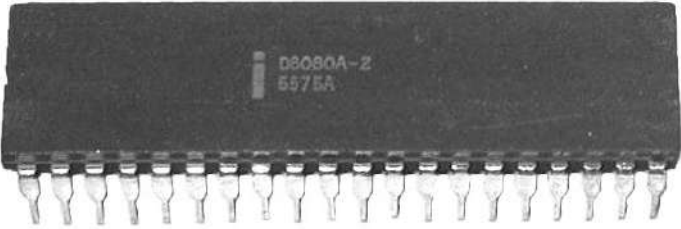

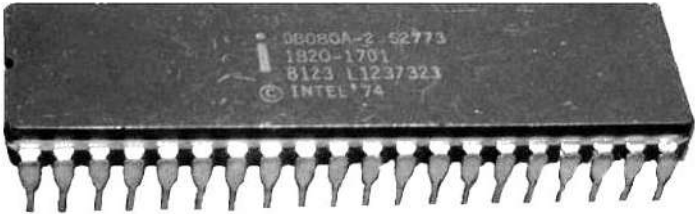
Intel i8080A

 <p style="text-align: center;">D8080A L1227246 © INTEL '79</p>		
D8080A	5. Type D grey ceramic package w/tin pins. © Intel '79.	\$2-\$8
 <p style="text-align: center;">D8080A-1 5577A</p>		
D8080A-1	1. Type D grey ceramic package w/tin pins. No copyright.	\$8-\$32
 <p style="text-align: center;">D8080A-1 1809C © INTEL '74</p>		
D8080A-1	2. Type D grey ceramic package w/tin pins. © Intel '74.	\$4-\$16
D8080A-1	3. Type D grey ceramic package w/tin pins. © Intel 1974.	\$3-\$12
D8080A-1	4. Type D grey ceramic package w/tin pins. © Intel '74 '79	\$3-\$12
 <p style="text-align: center;">D8080A-1 U4285094 © INTEL '79</p>		
D8080A-1	5. Type D grey ceramic package w/tin pins. © Intel '79.	\$3-\$12

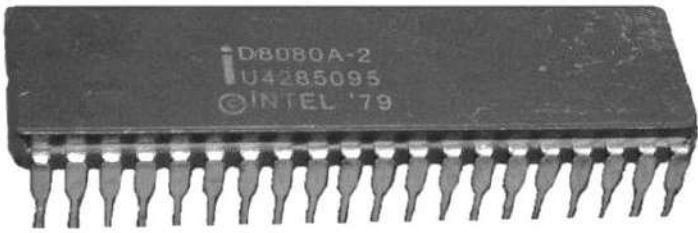

Intel i8080A

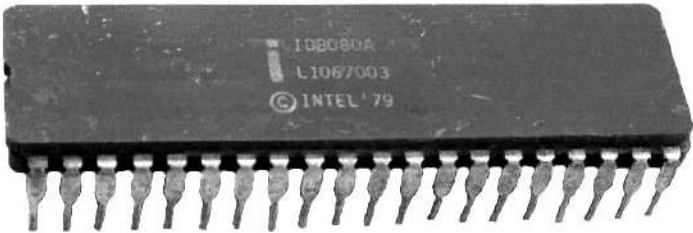
		
D8080A-2	1. Type D grey ceramic package w/tin pins. No copyright.	\$8-\$32
		
D8080A-2	2. Type D grey ceramic package w/tin pins. © Intel '74.	\$4-\$16
		
D8080A-2	3. Type D grey ceramic package w/tin pins. © Intel '74. HP house mark 1820-1701	Rare \$20-\$80
		
D8080A-2	4. Type D grey ceramic package w/tin pins. Slashed zeroes. © Intel '74 '79.	\$3-\$12





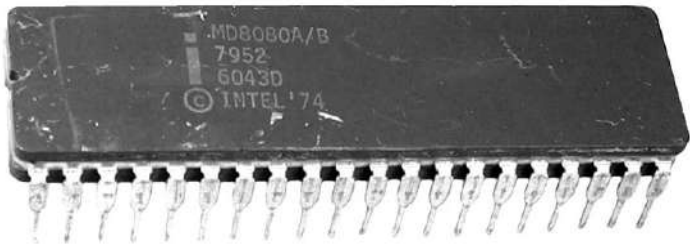

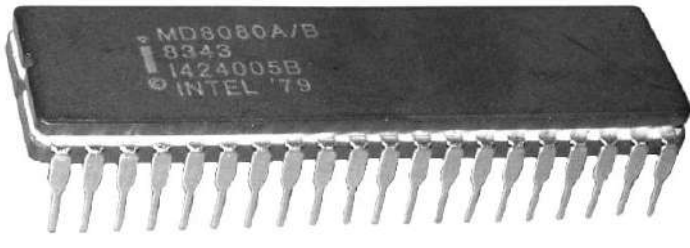

Intel i8080A

 <p style="text-align: center;">D8080A-2 U4285095 © INTEL '79</p>		
D8080A-2	5. Type D grey ceramic package w/tin pins. © Intel '79.	\$3-\$12
D8080A-2	6. Type D grey ceramic package w/tin pins. © Intel '79. HP house mark 1820-1701.	Rare \$20-\$80
 <p style="text-align: center;">I8080A L1067026 © INTEL '74</p>		
ID8080A	1. Type D grey ceramic package w/tin pins. © Intel '74.	Rare \$20-\$80
 <p style="text-align: center;">I8080A L1067003 © INTEL '79</p>		
ID8080A	2. Type D grey ceramic package w/tin pins. © Intel '79.	Rare \$20-\$80
 <p style="text-align: center;">I8080A A1776 © INTEL '80</p>		
ID8080A	3. Type D grey ceramic package w/tin pins. © Intel '80.	Rare \$20-\$80

Intel i8080A

 <p>MD8080A 7833 0034C © INTEL '74</p>		
MD8080A	Type D grey ceramic package w/tin pins. © Intel '74.	Ex. Rare (2 Known) \$25-\$100
 <p>MD8080A/B 7952 6043D © INTEL '74</p>		
MD8080A/B	1. Type D grey ceramic package w/tin pins. © Intel '74.	Rare \$20-\$80
 <p>MD8080A/B 8332 I349013B © INTEL '79</p>		
MD8080A/B	2. Type D grey ceramic package w/tin pins. © Intel '79. Large triangle over Intel logo.	\$15-\$60
 <p>MD8080A/B 8343 I424005B © INTEL '79</p>		
MD8080A/B	3. Type D grey ceramic package w/tin pins. Small triangle over Intel logo. © Intel '79	\$15-\$60

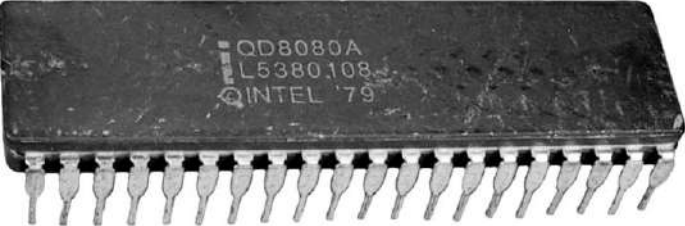

Intel i8080A

 <p style="text-align: center;">  MD8080A/C   INTEL 1974 8930 USA </p>		
MD8080A/C	Type D grey ceramic package w/tin pins. Small triangle denotes pin #1. Copyright Intel 1974.	Ex. Rare (2 known) \$30-\$120
 <p style="text-align: center;"> LTE QD8080A L4261038  INTEL  1974 </p>		
QD8080A	1. Type D grey ceramic package w/tin pins. © Intel 1974. Unusual impressed part number. Remarkd “LTE QD8080A”.	\$15-\$60
 <p style="text-align: center;"> QD8080A L6420236 © 1 '74 '79 </p>		
QD8080A	2. Type D grey ceramic package w/tin pins. © Intel '74 '79. Slashed zeroes.	\$10-\$40
 <p style="text-align: center;"> QD8080A L5380,108 INTEL '79 </p>		
QD8080A	3. Type D grey ceramic package w/tin pins. © Intel '79.	\$10-\$40



Intel i8080A

		
QM8080AD1	Type D grey ceramic package w/tin pins. No Copyright.	Rare \$20-\$80



Type P Packages

Part Number	Package	Values
		
P8080A	1. Type P black plastic package w/tin pins. Rectangular key. No copyright.	\$5-\$20
		
P8080A	2. Type P black plastic package w/tin pins. Rectangular key. © Intel '74.	\$2.50-\$10
		
P8080A	3. Type P black plastic package w/tin pins. Half-round key. Impressed Logo and part number. © Intel 1974.	\$1.50-\$6

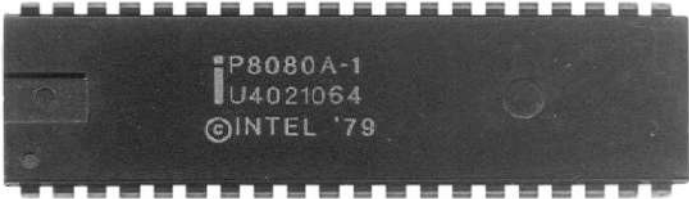
Intel i8080A

		
P8080A	4. Type P black plastic package w/tin pins. Half-round key. Impressed logo and part number. © Intel '74 '79.	\$1.50-\$6
		
P8080A	5. Type P black plastic package w/tin pins. Rectangular key. © Intel '79.	\$1.50-\$6
		
P8080A-1	1. Type P black plastic package w/tin pins. Rectangular key. © Intel '74. Vertical copyright.	Rare \$10-\$40
		
P8080A-1	2. Type P black plastic package w/tin pins. Rectangular key. © Intel '79.	\$1.50-\$6
P8080A-1	3. Type P black plastic package w/tin pins. Rectangular Key. Slashed zeroes. © Intel '79.	\$1.50-\$6

Intel i8080A

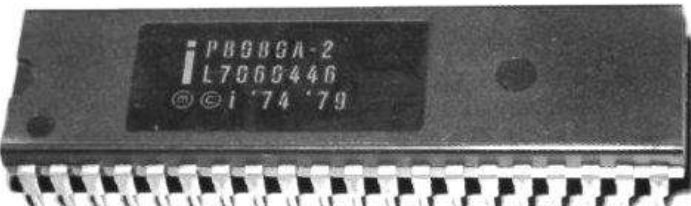
		
P8080A-1	4. Type P black plastic package w/tin pins. Half-round key. © Intel '79.	\$1.50-\$6
		
P8080A-1	5. Type P black plastic package w/tin pins. Half-round key. Impressed logo and part number. © Intel '79.	\$1.50-\$6
		
P8080A-2	1. Type P black plastic package w/tin pins. Rectangular key. © Intel '74.	\$2.50-\$10
		
P8080A-2	2. Type P black plastic package w/tin pins. Half-round key. Impressed logo and part number. © Intel '74 '79.	\$1.50-\$6

Intel i8080A

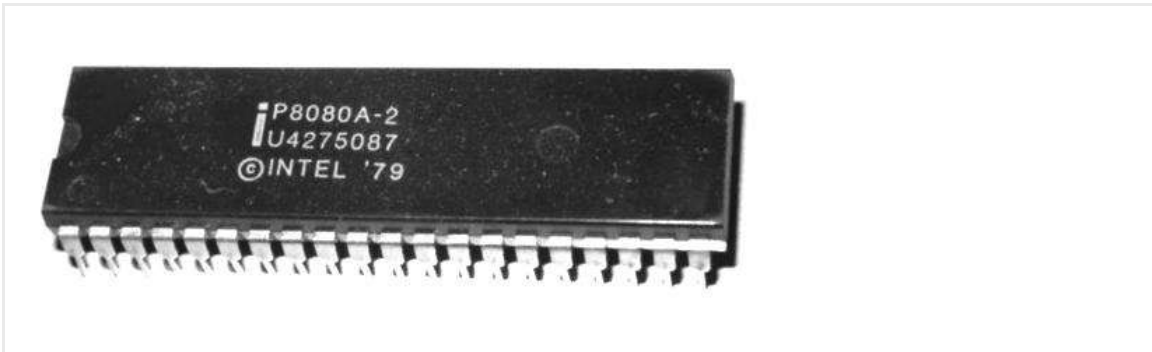

P8080A-2	3. Type P black plastic package w/tin pins. Half-round key. © Intel '79.	\$1.50-\$6
QP8080A	Type P black plastic package w/tin pins. Rectangular key. © Intel '79.	Rare \$15-\$60

References

- [1] Intel (September 1975). Intel MCS-80 User's Manual, 8080A listed under heading "New Devices [that] Further Enhance the 8080 System"
- [2] Intel (1977). Intel Data Catalog, MC8080A Part Number, p. 15-11.
- [3] Intel (1980). Intel Component Data Catalog, 8080A/8080A-1/8080A-2 Data Sheet, p. 6-1
- [4] Andrew Volk (2002), Email to Christian Bassow, Available from: on file

Intel i8080B

8-bit Microprocessor

2nd Qtr 1978

Specifications

- 8-bit Microprocessor
- NMOS
- 40-pin Dual In-Line Package

Type	Clock	Power Dissipation Max.	Supplies [V]
8080B	-	-	+12, +5, -5

No data sheet known to exist for this part.

8080B vs. 8080A

The 2Q 1978, Intel revised the 8080A design. The result was the 8080B [1].

Improvements of 8080B vs. 8080A [1]:

- functional and characterized in the second Quarter of 1978. The design was done through Intel's Israel Design Center.
- Completely compatible with the 8080A (functional and pin compatible).
- Newer process with slightly smaller feature size (still enhancement-mode only transistors.)
- Above results in smaller die size.
- About 30% lower power.
- Timings improved to allow 3 MHz clock speed and significant yield to 4 MHz.
- IOL improved again to 3.2 mA to drive more loads.
- VIH improved to 2.4 V to be more compatible to standard logic types of the period.
- Allows 10% tolerance supplies vs. 5% supplies.

Intel i8080B

Andrew Volk of Intel states that the 8080B was introduced 2Q 1978 and manufactured in Israel [1], but there are some who suspect that the 8080B in the package with the integrated gold pins shown below was produced much earlier than 2Q 1978.

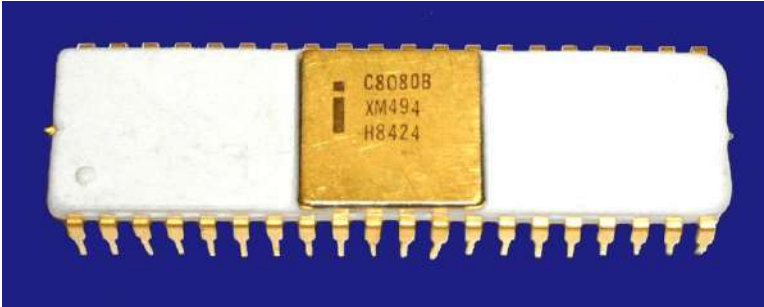

This was an early package and it seems odd that Intel would have still been using this package when the 8080B was introduced in 2Q 1978.

Some Intel old timers have suggested that there may have actually been two different 8080B's. The theory is that the 1st 8080B was the successor to the 8080 and the 'B' in 8080B designated the B stepping of the 8080 (The 8080A was actually the D stepping). This would have been the 8080B that was produced in the Type C package with integrated gold pins.

The 2nd 8080B was the successor to the 8080A, introduced in 2Q 1978, that Andrew Volk says was produced in Israel. This 8080B was produced in the Type C package with side-brazed pins.



On November 11, 2004, an Intel Intellec 8/MOD 80 microcomputer, serial no. 00061, was listed for sale on EBAY. This computer contained an Intel 8080B in the type C package with integrated gold pins. Finding this chip such an early machine will likely add support to the theory that there were two different 8080B's, one of which was produced before 2Q 1978.

Any information would be appreciated as I have been unable to locate any datasheet on the Intel 8080B or references to the 8080B in any Intel literature.

Given the rarity of the 8080B, it is unlikely these processors were produced in quantity and finding an example of this chip will be a challenge for even the most dedicated collector.

Intel i8080B

Part Numbers

Type C Packages

Part Number	Package Description	Values
		
8080B	Type C white ceramic package w/gold cap and gold pins. Large '1' denotes pin #1. Small dot at top left corner. Vertical logo and part number. No copyright. Example shown has no date code or any thing else printed on the bottom of the package.	Ex. Rare (2 known) \$150-\$600
		
C8080B	Type C white ceramic package w/gold cap and integrated gold pins. Raised bump denotes pin #1. Example shown has no date code or any thing else printed on the bottom of the package.	Ex. Rare (5 known) \$150-\$600

References

[1] Andrew Volk (2002), Email to Christian Bassow, Available from: on file

Intel i8085

8-bit Microprocessor

March 1976

Specifications

- 8-bit Microprocessor
- NMOS
- 6500 Transistors (3 Micron)
- Single +5V Power Supply
- 100% Software Compatible with 8080A
- 1.3 μ s Instruction Cycle
- On-Chip Clock Generator (with External Crystal or RC Network)
- On-Chip System Controller
- Four Vectored Interrupts (One is Non-Maskable)
- Serial In/Serial Out Port
- Decimal, Binary and Double Precision Arithmetic
- Direct Addressing Capability to 64K Bytes of Memory
- 40-pin Dual In-Line Package

Type	Clock	Power Dissipation Max.	Supplies [V]
8085	3 MHz	850mW	+5
M8085	3 MHz	-	+5

The Intel® 8085 is a new generation, complete 8 bit parallel central processing unit (CPU). Its instruction set is 100% software compatible with the 8080A microprocessor, and it is designed to improve the present 8080's performance by higher system speed. Its high level of system integration allows a minimum system of three IC's: 8085 (CPU), 8155 (RAM) and 8355 (ROM/PROM).

The 8085 incorporates all of the features that the 8224 (clock generator) and 8228 (system controller) provided for the 8080, thereby offering a high level of system integration.

The 8085 uses a multiplexed Data Bus. The address is split between the 8-bit address bus and the 8-bit data bus. The on-chip address latches of the 8155/8355/8755 memory products allows a direct interface with the 8085 [1].

History

The MCS-85 product family was introduced in March 1976 and included the Intel 8085 microprocessor.

The 8085 was designed to use a single five-volt power supply as opposed to the 8080, which required three (+5V, +12V, and -5V). The 8085 was 100% software compatible with the 8080A. The 8085 incorporated all the features of the 8224 clock generator and 8228 system controller. The 8085 along with the 8156 RAM and 8255/8755 ROM/EPROM constituted a complete system. The on-chip address latch of 8155/8355/8755 memory chips allowed a direct interface with the 8085.

Type C Package with Black Cap

The Intel 8085 (and 8085A) was produced in a type C package with a black cap. The part number and logo printed on this cap tend to “chalk” with age and can be easily rubbed off if the chip is not handled carefully. Due to the fragile nature of the logo and part number, examples of these chips with a bold undamaged logo and part number are very rare.



Intel 825x-5

To interface 825x peripherals to 8085 bus at 3MHz, the user must use a set of MCS-80 peripherals called, “825x-5”. It includes 8251A, 8253-5, 8255A-5, 8257-5 and 8259-5 [2].

Intel i8085

Part Numbers

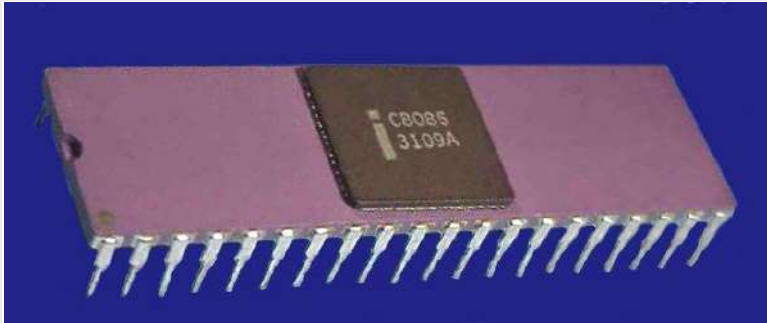
Type C Packages

Part Number	Package Description	Values
		
C8085	1. Type C purple ceramic package w/black cap and tin pins. Black circle denotes pin #1. No copyright	Rare \$75-\$300
		
C8085	2. Type C purple ceramic package w/black cap and tin pins. Black circle denotes pin #1. © Intel '76	Rare \$75-\$300

Type P Packages

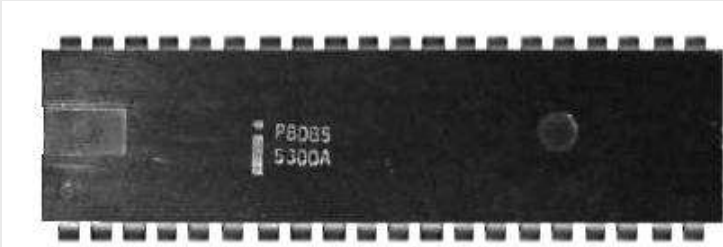
Part Number	Package Description	Values
		
P8085	1. Type P black plastic package w/tin pins. Rectangular key. No copyright.	Rare \$15-\$60

Intel i8085

 A black, rectangular microprocessor chip with a rectangular notch on the left side. The chip is populated with numerous small, silver-colored pins along its top and bottom edges. The top surface of the chip is printed with the following text: 'P8085A' on the first line, '1433D' on the second line, and '© INTEL '76' on the third line. A small, white rectangular key is visible on the left side of the chip.		
P8085	2. Type P black plastic package w/tin pins. Rectangular key. © Intel '76	\$2.50-\$10

References

- [1] Intel (1977). Intel Data Catalog, 8085 Preliminary Data Sheet, p. 10-52.
- [2] Intel (October 1977). Intel MCS-80 User's Manual, p. 5-7
- [3] Intel (1984). A Revolution in Progress... A History of Intel to Date, 8085 introduced 1976, p. 26.

Intel i8085A

8-bit Microprocessor

1978

Specifications

- 8-bit Microprocessor
- NMOS
- Single +5 Volt Power Supply
- 100% Software Compatible with 8080A
- 1.3 μ s Instruction Cycle (8085A);
0.8 μ s Instruction Cycle (8085A-2)
- On-Chip Clock Generator (with External Crystal, LC or RC Network)
- On-Chip System Controller; Advanced Cycle Status Information Available for Large System Control
- Four Vectored Interrupt Inputs (One is Non-Maskable) Plus an 8080A-Compatible Interrupt
- Serial In/Serial Out Port
- Decimal, Binary and Double Precision Arithmetic
- Direct Addressing Capability to 64K Bytes of Memory
- 40-pin Dual In-Line Package

Type	Clock	Power Dissipation Max.	Supplies [V]
8085A	3 MHz	-	+5
8085A-1	6 MHz	-	+5
8085A-2	5 MHz	-	+5
M8085A	3 MHz	-	+5

The Intel® 8085A is a complete 8-bit parallel Central Processing Unit (CPU). Its instruction set is 100% software compatible with the 8080A microprocessor, and it is designed to improve the present 8080A's performance by higher system speed. Its high level of system integration allows a minimum system of three IC's [8085A (CPU), 8156 (RAM/IO) and 8355/8755A (ROM/PROM/IO)] while maintaining total system expandability. The 8085A-2 is a faster version of the 8085A.

The 8085A incorporates all of the features that the 8224 (clock generator) and 8228 (system controller) provided for the 8080A, thereby offering a high level of system integration.

The 8085A uses a multiplexed data bus. The address is split between the 8-bit address bus and the 8-bit data bus. The on-chip address latches of 8155/8156/8355/8755A memory products allow a direct interface with the 8085A [4].

Type C Package with Black Cap

The Intel 8085A (and 8085) was produced in a type C package with a black cap. The part number and logo printed on this cap tend to "chalk" with age and can be easily rubbed off if the chip is not handled carefully. Due to the fragile nature of the logo and part number, examples of these chips with a bold undamaged logo and part number are very rare.

Intel i8085A

Part Numbers

Type C Packages

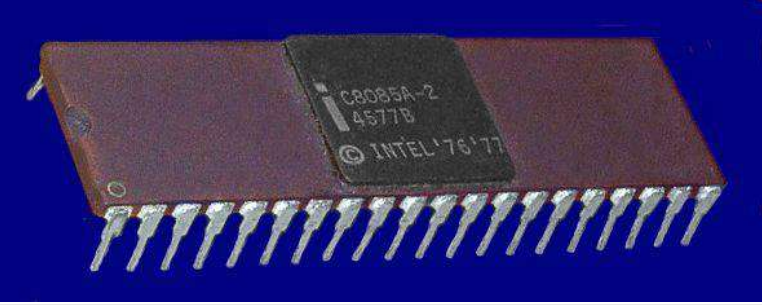
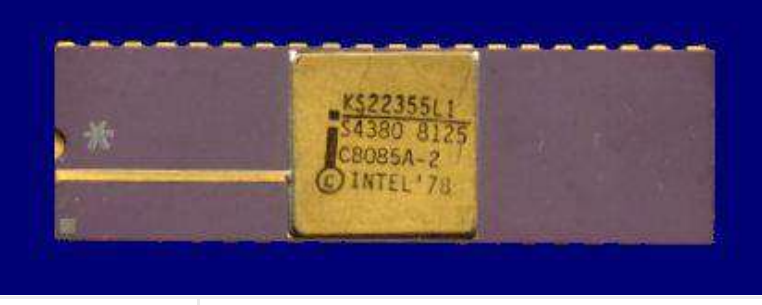

Part Number	Package Description	Values
		
C8085A	Type C purple ceramic package w/tin pins. Small circle denotes pin #1. © Intel '76, '77	Rare \$75-\$300
		
C8085A-2	1. Type C purple ceramic package w/tin pins. Small circle denotes pin #1. © Intel '76, '77	Ex. Rare (3 known) \$125-\$500
		
C8085A-2	2. Type C purple ceramic package w/gold cap, offset gold cap ground strap, and gold pins. Small yellow square denotes pin #1. © Intel '78.	Ex. Rare \$100-\$400

Intel i8085A

Type D Packages



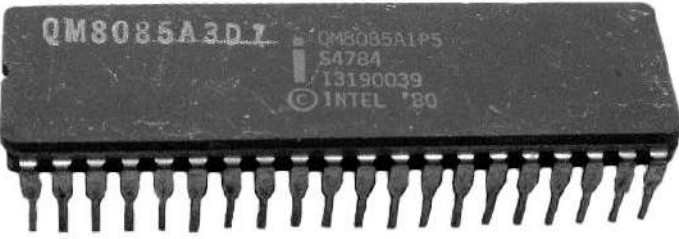

Part Number	Package Description	Values
 <p>The image shows a black, rectangular Type D grey ceramic package with tin pins on all four sides. The top surface is marked with the part number 'D8085A', the lot number 'F1368230', and the copyright notice '© INTEL '76'.</p>		
D8085A	Type D grey ceramic package w/tin pins. © Intel '76.	\$1.50-\$6
 <p>The image shows a black, rectangular Type D grey ceramic package with tin pins on all four sides. The top surface is marked with the part number 'D8085A-2', the lot number '5246D', and the copyright notice '© INTEL '76'.</p>		
D8085A-2	1. Type D grey ceramic package w/tin pins. © Intel '76.	\$1.50-\$6
 <p>The image shows a black, rectangular Type D grey ceramic package with tin pins on all four sides. The top surface is marked with the part number 'D8085A-2', the lot number 'F1368230', and the copyright notice '© INTEL '76 '80'.</p>		
D8085A-2	2. Type D grey ceramic package w/tin pins. © Intel '76 '80.	\$1.50-\$6
 <p>The image shows a black, rectangular Type D grey ceramic package with tin pins on all four sides. The top surface is marked with the part number 'ID8085A', the lot number '79180', and the copyright notice '© INTEL '76'.</p>		
ID8085A	Type D grey ceramic package w/tin pins. © Intel '76.	\$3-\$12

Intel i8085A

MD8085A	Type D package.	Rare \$10-\$40
 <p>A black integrated circuit chip with 40 pins. The top surface is marked with 'MD8085A/B', '1446D', '7927', and 'INTEL '76'.</p>		
MD8085A/B	Type D grey ceramic package w/tin pins. © Intel '76.	\$3-\$12
 <p>A black integrated circuit chip with 40 pins. The top surface is marked with 'QM8085AD1', 'S4740', 'F3496090', and 'INTEL '80'.</p>		
QM8085AD1	Type D grey ceramic package w/tin pins. © Intel '80	\$3-\$12
QM8085A1D1	Unknown package	Ex. Rare (0 Known) \$\$\$
QM8085A2D1	Unknown package	\$3-\$12
QM8085AP5	Unknown package	Ex. Rare (0 Known) \$\$\$
 <p>A black integrated circuit chip with 40 pins. The top surface is marked with 'QM8085A3D1', 'QM8085A1P5', 'S4784', 'I3190039', and 'INTEL '80'.</p>		
QM8085A1P5	Type D grey ceramic package w/tin pins. © Intel '80. Example shown also marked QM8085A3D1	Ex. Rare (1 Known) \$25-\$100
QM8085A2P5	Unknown package	Ex. Rare (0 Known) \$\$\$

Intel i8085A

Type P Packages

Part Number	Package Description	Values
 <p>A black plastic package with 28 pins. The top surface is marked with the Intel logo, 'P8085A', '3523D', and '© INTEL '76'.</p>		
P8085A	1. Type P black plastic package w/tin pins. Rectangular key. © Intel '76	\$1.25-\$5
 <p>A black plastic package with 28 pins. The top surface is marked with the Intel logo, 'P8085A', '1241C', and '© INTEL '76 '77'.</p>		
P8085A	2. Type P black plastic package w/tin pins. Rectangular key. © Intel '76 '77	\$1.25-\$5
 <p>A black plastic package with 28 pins. The top surface is marked with the Intel logo, 'P8085A-2', '8782D', and '© INTEL '76'.</p>		
P8085A-2	1. Type P black plastic package w/tin pins. Rectangular key. © Intel '76	\$1.25-\$5
 <p>A black plastic package with 28 pins. The top surface is marked with the Intel logo, 'P8085A-2', 'ES', '2660B', and '© INTEL '76 '77'.</p>		
P8085A-2	2. Type P black plastic package w/tin pins. Rectangular key. © Intel '76 '77. Example shown is marked 'ES' for engineering sample.	Ex. Rare (1 Known) \$25-\$100

Intel i8085A

 A black plastic microprocessor chip with 40 pins. The top surface is marked with "P8085A-2", "F1158120", and "INTEL '76 '80". A rectangular notch is visible on the left side.		
P8085A-2	3. Type P black plastic package w/tin pins. Rectangular key. © Intel '76 '80.	\$1.25-\$5

References

[1] Intel (October 1977). Intel MCS-80 User's Manual, Preliminary 8085 Data Sheet. No reference to 8085A dates chip after October 1977.

[2] Intel (1977). Intel Data Catalog, 8085 Preliminary Datasheet, p. 10-52. No reference to 8085A dates chip after 1977.

[3] Intel (1978). Intel Component Data Catalog, 8085A data sheet, p. 11-43, 8085A-2 Advance Information, p. 11-57.

[4] Intel (1980). Intel Component Data Catalog, 8085A, 8085A-2 Data Sheet, p. 6-9

Intel i8085AH

8-bit Microprocessor

1980-81

Specifications

- 8-bit Microprocessor
- HMOS
- Single +5V Power Supply with 10% Voltage Margins
- 3 MHz, 5MHz and 6 MHz Selections Available
- 20% Lower Power Consumption than 8085A for 3 MHz and 5 MHz
- 1.3 μ s Instruction Cycle (8085AH); 0.8 μ s (8085AH-2); 0.67 μ s (8085AH-1)
- 100% Software Compatible with 8080A
- On-Chip Clock Generator (with External Crystal, LC or RC Network)
- On-Chip System Controller; Advanced Cycle Status Information Available for Large System Control
- Four Vectored Interrupt Inputs (one is Non-Maskable) Plus an 8080A-Compatible Interrupt
- Serial In/Serial Out Port
- Decimal, Binary and Double Precision Arithmetic
- Direct Addressing Capability to 64K Bytes of Memory
- 40-pin Dual In-Line Package

Type	Clock	Power Dissipation Max.	Supplies [V]
8085AH	3 MHz	-	+5
8085AH-1	6 MHz	-	+5
8085AH-2	5 MHz	-	+5

The Intel 8085AH is a complete 8-bit parallel Central Processing Unit (CPU) implemented in N-channel, depletion load, silicon gate technology (HMOS). Its instruction set is 100% software compatible with the 8080A microprocessor, and it is designed to improve the present 8080A's performance by higher system speed. Its high level of system integration allows a minimum system of three IC's [8085AH (CPU), 8156H (RAM/IO) and 8755A (EPROM/IO)] while maintaining total system expandability. The 8085AH-2 and 8085AH-1 are faster versions of the 8085AH.

The 8085AH incorporates all the features that the 8224 (clock generator) and 8228 (system controller) provided for the 8080A, thereby offering a higher level of system integration.

The 8085AH uses a multiplexed data bus. The address is split between the 8-bit address bus and the 8-bit data bus. The on-chip address latches of the 8155H/8156H/8755A memory products allow a direct interface with the 8085AH [5].



Intel i8085AH

Part Numbers

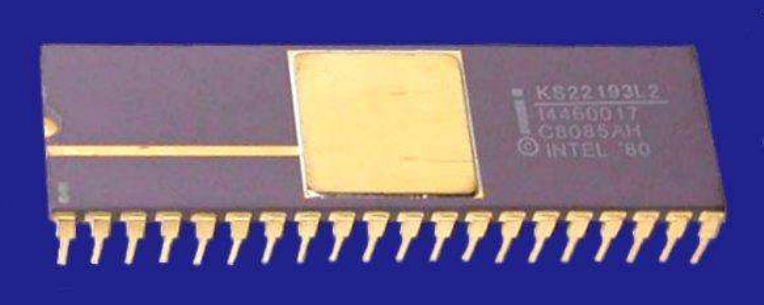
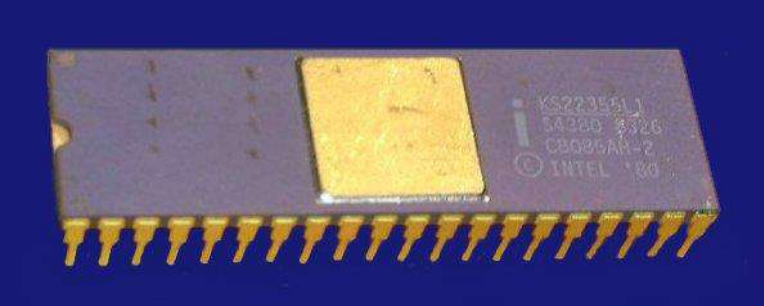
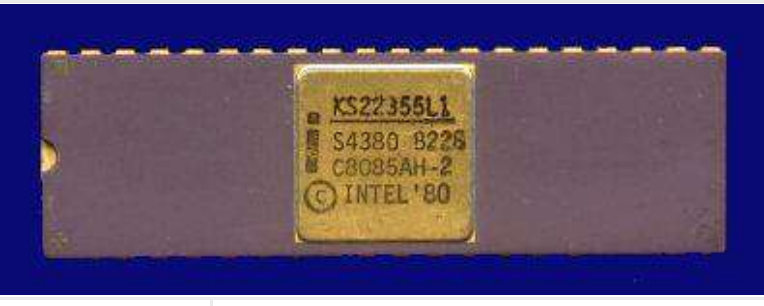
Type C Packages

Part Number	Package Description	Values
		
C8085AH	Type C purple ceramic package w/gold cap, offset gold cap ground strap, and gold pins. Double dot denotes pin #1. Logo and part number printed on ceramic package. © Intel '80	Rare \$50-\$200
C8085AH-1	Type C package	Ex. Rare (0 Known) \$\$\$
		
C8085AH-2	1. Type C purple ceramic package w/gold cap and gold pins. Small '+' denotes pin #1. Small yellow square at top left corner. © Intel '80. Logo and part number printed on ceramic package.	Rare \$50-\$200
		
C8085AH-2	2. Type C purple ceramic package w/gold cap and gold pins. Small '+' denotes pin #1. Small yellow square at top left corner. © Intel '80.	Rare \$50-\$200

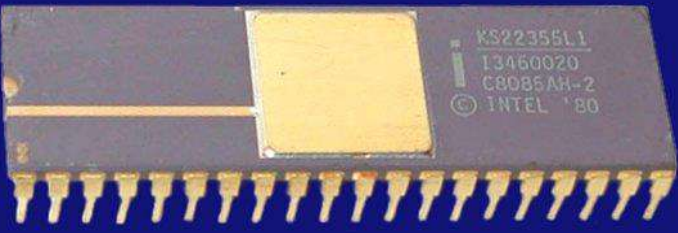
Intel i8085AH





 <p>A photograph of an Intel C8085AH-2 microprocessor. It is a purple ceramic package with a gold cap and gold pins. The chip is marked with 'KS22355L1', 'I3460020', 'C8085AH-2', and '© INTEL '80'.</p>		
C8085AH-2	3. Type C purple ceramic package w/gold cap, offset gold cap ground strap, and gold pins. Double dot denotes pin #1. Logo and part number printed on ceramic package. © Intel '80	Rare \$50-\$200
 <p>A photograph of an Intel C8085A-2 H microprocessor. It is a purple ceramic package with a gold cap and gold pins. The chip is marked with 'KS22355L1', '54380 8130', 'C8085A-2 H', and '© INTEL '80'.</p>		
C8085A-2 H	1. Type C purple ceramic package w/gold cap and gold pins. Small '+' denotes pin #1. Small yellow square at top left corner. © Intel '80	Rare \$50-\$200
 <p>A photograph of an Intel C8085A-2 H microprocessor. It is a purple ceramic package with a black cap and tin pins. The chip is marked with 'JE0857', 'ES H', '1669L', and '© INTEL '77'.</p>		
C8085A-2 H	2. Type C purple ceramic package w/black cap and tin pins. Small circle denotes pin #1. © Intel '77(?) Example shown is marked 'ES' for engineering sample and appears to be marked 'H' to the right of 'ES'.	Ex. Rare (1 Known) \$125-\$500

Intel i8085AH

Type D Packages

Part Number	Package Description	Values
		
D8085AH	1. Type D grey ceramic package w/tin pins. © Intel '76 '80	\$1.25-\$5
		
D8085AH	2. Type D grey ceramic package w/tin pins. © Intel 1976	\$1.25-\$5
		
D8085AH	3. Type D grey ceramic package w/tin pins. © Intel '80	\$1.25-\$5
		
D8085AH-1	1. Type D grey ceramic package w/tin pins. © Intel 1976	\$1.25-\$5



Intel i8085AH

 <p>A black rectangular chip with 40 pins. The top surface is marked with 'D8085AH-1', 'K805626', and '© i '76 '80'.</p>	<p>2. Type D grey ceramic package w/tin pins. © Intel '76 '80</p>	<p>\$1.25-\$5</p>
 <p>A black rectangular chip with 40 pins. The top surface is marked with 'D8085AH-1', 'F5185010', and '© INTEL '80'.</p>	<p>3. Type D grey ceramic package w/tin pins. © Intel '80.</p>	<p>\$1.25-\$5</p>
 <p>A black rectangular chip with 40 pins. The top surface is marked with 'D8085AH-2', 'K118804', and 'INTEL © © 1976'.</p>	<p>1. Type D grey ceramic package w/tin pins. © Intel 1976. Slashed zeroes.</p>	<p>\$1.25-\$5</p>
 <p>A black rectangular chip with 40 pins. The top surface is marked with 'D8085AH-2', 'L7898241', and '© i '76 '80'.</p>	<p>2. Type D grey ceramic package w/tin pins. Slashed zeroes. © Intel '76 '80.</p>	<p>\$1.25-\$5</p>



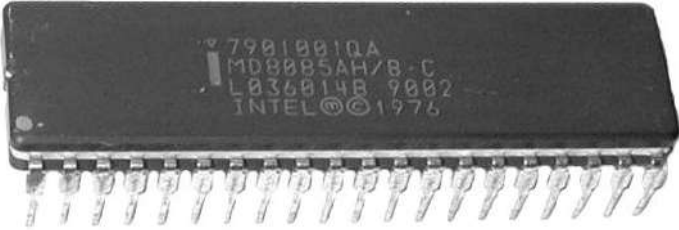

Intel i8085AH

 <p style="text-align: center;">D8085AH-2 L5490635 © INTEL '80</p>		
D8085AH-2	3. Type D grey ceramic package w/tin pins. © Intel '80	\$1.25-\$5
 <p style="text-align: center;">ID8085AH F2227360 © INTEL '80</p>		
ID8085AH	Type D grey ceramic package w/tin pins. © Intel '80	\$2.50-\$10
ID8085AH-2	Type D package	\$2.50-\$10
 <p style="text-align: center;">LD8085AH L9050068X © INTEL '76, '80</p>		
LD8085AH	1. Type D grey ceramic package w/tin pins. Slashed zeroes. © Intel '76, '80.	\$2.50-\$10
 <p style="text-align: center;">LD8085AH 15190016 © INTEL '80</p>		
LD8085AH	2. Type D grey ceramic package w/tin pins. © Intel '80	\$2.50-\$10





Intel i8085AH

 <p style="text-align: center;">LD8085AH-2 K111754 INTEL © © 1976</p>		
LD8085AH-2	1. Type D grey ceramic package w/tin pins. © Intel 1976	\$2.50-\$10
 <p style="text-align: center;">LD8085AH-2 L7340885 © © 1 '76 '80</p>		
LD8085AH-2	2. Type D grey ceramic package w/tin pins. Slashed zeroes. © Intel '76 '80.	\$2.50-\$10
MD8085AH	Type D package	\$2.50-\$10
 <p style="text-align: center;">MD8085AH/B 8444 S8828 1451002BS © INTEL '80</p>		
MD8085AH/B	Type D grey ceramic package w/tin pins. © Intel '80.	\$2.50-\$10
 <p style="text-align: center;">7981881QA MD8085AH/B-C L036014B 9002 INTEL © © 1976</p>		
MD8085AH/BC	Type D grey ceramic package w/tin pins. Slashed zeroes. © Intel 1976.	\$2.50-\$10
MD8085AH-2	Type D package.	\$2.50-\$10
MD8085AH-2/B	Type D package.	\$2.50-\$10

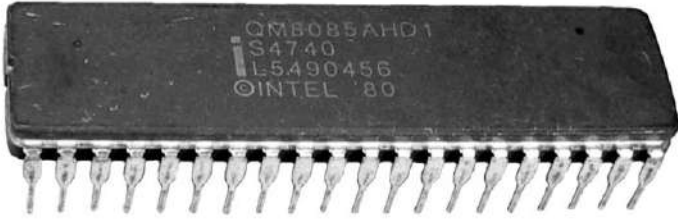

Intel i8085AH

 <p style="text-align: center;">QD8085AH K908636 © INTEL '76 '80</p>		
QD8085AH	1. Type D grey ceramic package w/tin pins. © Intel '76 '80.	\$2.50-\$10
 <p style="text-align: center;">QD8085AH F5035150 © INTEL '80</p>		
QD8085AH	2. Type D grey ceramic package w/tin pins. © Intel '80.	\$2.50-\$10
 <p style="text-align: center;">QD8085AH-2 F2256080 © INTEL '80</p>		
QD8085AH-2	Type D grey ceramic package w/tin pins. © Intel '80.	\$2.50-\$10
 <p style="text-align: center;">QM8085AHD1 S4748 L7148122 © INTEL '76 '80</p>		
QM8085AHD1	1. Type D grey ceramic package w/tin pins. Slashed zeroes. © Intel '76 '80.	\$2.50-\$10

Intel i8085AH

 <p style="text-align: center;">QM8085AHD1 S4740 L5490456 ©INTEL '80</p>		
QM8085AHD1	2. Type D grey ceramic package w/tin pins. © Intel '80.	\$2.50-\$10
 <p style="text-align: center;">QM8085AH-1D1 S4784 L7271155 © 1 '76 '80</p>		
QM8085AH-1D1	Type D grey ceramic package w/tin pins. Slashed zeroes. © Intel '76 '80.	\$2.50-\$10
 <p style="text-align: center;">QM8085AH-2D1 S4741 L6370464 © 1 '76 '80</p>		
QM8085AH-2D1	1. Type D grey ceramic package w/tin pins. Slashed zeroes. © Intel '76 '80.	\$2.50-\$10
 <p style="text-align: center;">QM8085AH-2D1 S4741 L6090617 © 1 '76 '80</p>		
QM8085AH-2D1	2. Type D grey ceramic package w/tin pins. © Intel '76 '80.	\$2.50-\$10

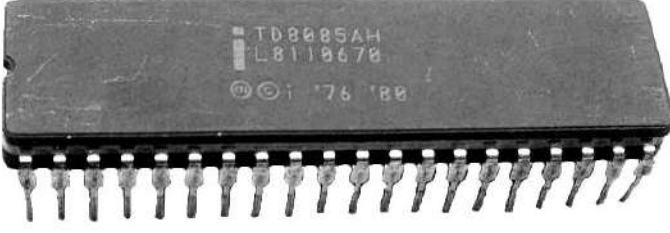
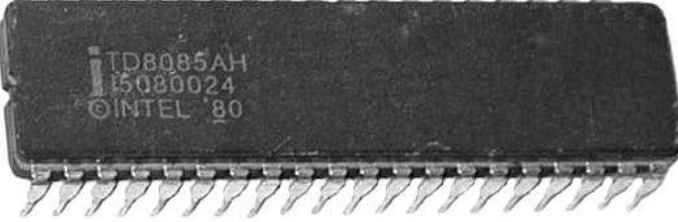

Intel i8085AH

		
TD8085AH	1. Type D grey ceramic package w/tin pins. Slashed zeroes. © Intel '76 '80.	\$2.50-\$10
		
TD8085AH	2. Type D grey ceramic package w/tin pins. © Intel '80.	\$2.50-\$10
		
TD8085AH2	1. Type D grey ceramic package w/tin pins. Slashed zeroes. © Intel 1976. Missing expected hyphen after TD8085AH.	\$2.50-\$10
TD8085AH-2	2. Type D grey ceramic package w/tin pins. Slashed zeroes. © Intel 1976.	\$2.50-\$10
		
TD8085AH-2	3. Type D grey ceramic package w/tin pins. © Intel '76 '80.	\$2.50-\$10

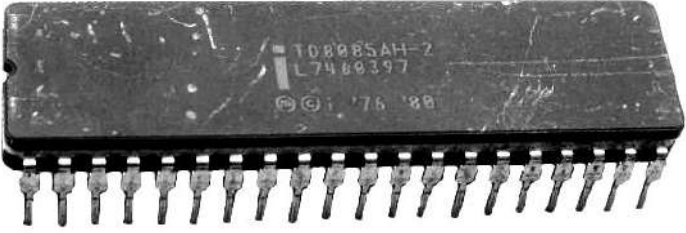
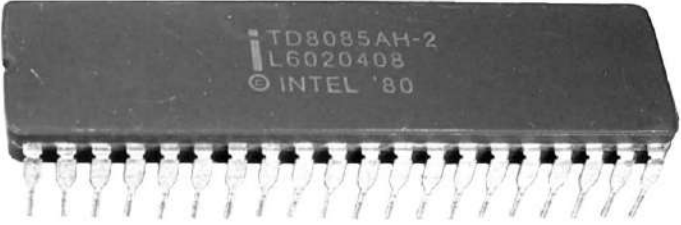



Intel i8085AH

		
TD8085AH-2	4. Type D grey ceramic package w/tin pins. © Intel '76 '80. Slashed zeroes.	\$2.50-\$10
		
TD8085AH-2	5. Type D grey ceramic package w/tin pins. © Intel '80.	\$2.50-\$10





Type P Packages

Part Number	Package Description	Values
		
P8085AH	1. Type P black plastic package w/tin pins. Modified half- round key. © Intel 1976.	\$.25-\$3
		
P8085AH	2. Type P black plastic package w/tin pins. Modified half- round key. © Intel '76 '80.	\$.75-\$3





Intel i8085AH

		
P8085AH	3. Type P black plastic package w/tin pins. Rectangular key. © Intel '80.	\$.75-\$3
		
P8085AH	4. Type P black plastic package w/tin pins. Half-round key. Impressed logo and part number. © Intel '80.	\$.75-\$3
		
P8085AH	5. Type P black plastic package w/tin pins. Half-round key. Impressed logo and part number. © Intel '76 '80. HP Housemark 1820-2074	Rare \$10-\$40
P8085AH-1	1. Type P black plastic package w/tin pins. Half-round key. Impressed logo and part number. © Intel 1976.	\$.75-\$3
		
P8085AH-1	2. Type P black plastic package w/tin pins. Modified half-round key. Copyright Intel '76 '80.	\$.75-\$3



Intel i8085AH

		
P8085AH-2	1. Type P black plastic package w/tin pins. Half-round key. Impressed logo and part number. © Intel 1976.	\$.75-\$3
		
P8085AH-2	2. Type P black plastic package w/tin pins. Half-round key. Impressed logo and part number. © Intel '76 '80.	\$.75-\$3
		
P8085AH-2	3. Type P black plastic package w/tin pins. Modified half- round key. © Intel '76 '80.	\$.75-\$3
		
P8085AH-2	4. Type P black plastic package w/tin pins. Rectangular key. © Intel '80.	\$.75-\$3

Intel i8085AH

 <p style="text-align: center;">P8085AH-2 L5350294 © INTEL '80</p>		
P8085AH-2	5. Type P black plastic package w/tin pins. Half round key. Impressed logo and part number. © Intel '80.	\$.75-\$3
 <p style="text-align: center;">QP8085AH K808680 © i '76 '80</p>		
QP8085AH	Type P black plastic package w/tin pins. Modified half- round key. © Intel '76 '80.	\$5-\$20
QP8085AH-2	1. Type P black plastic package w/tin pins. Modified half- round key. © Intel 1976.	\$2-\$8
 <p style="text-align: center;">QP8085AH-2 K723676 © i '76 '80</p>		
QP8085AH-2	2. Type P black plastic package w/tin pins. Modified half- round key. © Intel '76 '80.	\$2-\$8
 <p style="text-align: center;">QP8085AH-2 L6368042 © i '76 '80</p>		
QP8085AH-2	3. Type P black plastic package w/tin pins. Half-round key. Impressed logo and part number. © Intel '76 '80.	\$2-\$8

Intel i8085AH

 <p>The image shows a top-down view of an Intel QP8085AH-2 chip. It is a black, rectangular integrated circuit with a rectangular notch on the left side. The top surface is marked with the Intel logo, the part number 'QP8085AH-2', the lot number 'F4086160', and the copyright notice '© INTEL '80'.</p>		
QP8085AH-2	4. Type P black plastic package w/tin pins. Rectangular key. © Intel '80.	\$2-\$8
QM8085AH-P5	Unknown package	Rare \$10-\$40
 <p>The image shows a top-down view of an Intel QM8085AH-2P5 chip. It is a black, rectangular integrated circuit with a half-round notch on the left side. The top surface is marked with the Intel logo, the part number 'QM8085AH-2P5', the lot number 'S4741', the lot number 'L6229332', and the copyright notice '© INTEL '76 '80'. The bottom edge of the chip features a row of 28 gold-plated pins.</p>		
QM8085AH-2P5	Type P black plastic package w/tin pins. Half-round key. Impressed logo and part number. © Intel '76 '80.	Rare \$10-\$40

References

- [1] Intel (1980). Intel Component Data Catalog, 8085A, 8085A-2 Data Sheet, p. 6-9. No reference to 8085AH.
- [2] Hearst (1981). IC Master. No reference to Intel 8085AH.
- [3] Intel (January 1982). Intel Component Data Catalog, 8085AH Data Sheet, p. 7-10.
- [4] Hearst (1983). IC Master, Intel 8085AH specifications, p. 1095-1115
- [5] Intel (1984). Microsystems Component Handbook, 8085AH, 8085AH-2, 8085AH-1 Data Sheet, p. 2-10

Intel i8086

16-bit Microprocessor

June 8, 1978

Specifications

- 16-bit Microprocessor
- 29000 Transistors (3 Micron)
- HMOS III
- Direct Addressing Capability 1 Mbyte of Memory
- Architecture Designed for Powerful Assembly Language and Efficient High Level Languages
- 14 Word, by 16-Bit Register Set with Symmetrical Operations
- 24 Operand Addressing Modes
- Bit, Byte, Word, and Block Operations
- 8 and 16-Bit Signed and Unsigned Arithmetic in Binary or Decimal Including Multiply and Divide
- Range of Clock rates:
 - 5 MHz for 8086
 - 4 MHz for 8086-4
 - 8 MHz for 8086-2
 - 10 MHz for 8086-1
- MULTIBUS™ System Compatible Interface
- 40-pin Dual In-Line Package

Type	Clock	Power Dissipation Max.	Supplies [V]
8086	5 MHz	1500mW	+5
8086-1	10 MHz	-	+5
8086-2	8 MHz	-	+5
8086-4	4 MHz	-	+5

The Intel 8086 high performance 16-bit CPU is available in three clock rates: 5, 8, and 10 MHz. The CPU is implemented in N-Channel, depletion load, silicon date technology (HMOS-III), and packaged in a 40-pin CERDIP or plastic package. The 8086 operates in both single processor and multiple processor configurations to achieve high performance levels [1].

History

Intel's 8086 was a major advancement in 1978. The chip brought the x86 instruction set that's still present on x86-compatible chips today. The chip was 16-bit throughout with 29,000 transistors and 16-bit registers, and a 16-bit data bus. The processor had a clock speed of 4 MHz. The 8086 included segmented memory addressing. The chip also contained a 20-bit address bus providing it with 1 MB of memory space. The largest benefit was the 8086 kept assembly language compatible to a certain extent with the previous 8080.

The 8086 was not chosen for the original PC because IBM wanted to keep costs down by going with an 8-bit bus design. The 8086 was used in some PC clones and later on in early IBM PS/2 models, but was never a popular choice for PCs. This is probably because by the time it started to be used, the 80286 was introduced, offering much improved performance over the 8086. The 8086 is architecturally identical to the 8088 aside from the wider data bus.

Intel i8086

IBM would eventually use the 8086 in the IBM PS/2 Model 30. The PS/2 Model 30 used an 8-MHz 8086, was introduced April 2nd 1987, and cost \$2595.



IBM PS/2 Model 30

Type C Package with Black Cap

The Intel 8086 was produced in a type C package with a black cap. The part number and logo printed on this cap tend to “chalk” with age and can be easily rubbed off if the chip is not handled carefully. Due to the fragile nature of the logo and part number, examples of these chips with a bold undamaged logo and part number are very rare.



Intel 8086-4's

Several sources have indicated that the Intel 8086's with the '-4' suffix were available only in MCS-86 design kits. These chips, are extremely rare in any package type.

Intel i8086

Part Numbers

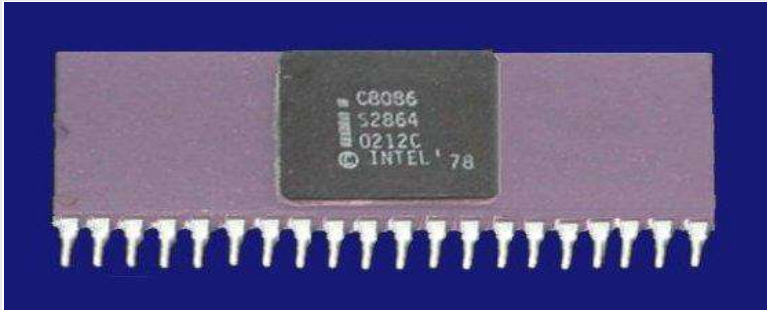

Type C Packages

Part Number	Package Description	Values
		
C8086	Type C purple ceramic package w/black cap and tin pins. Small circle denotes pin #1. © Intel '78.	Rare \$75-\$300
		
C8086-4	Type C purple ceramic package w/black cap and tin pins. Small circle denotes pin #1. © Intel '78.	Ex. Rare \$125-\$500

Type D Packages

Part Number	Package Description	Values
		
D8086	1. Type D grey ceramic package w/tin pins. © Intel '78.	\$1.25-\$5



Intel i8086

		
D8086	2. Type D grey ceramic package w/tin pins. Slashed zeroes. © Intel 1978.	\$1.25-\$5
		
D8086	3. Type D grey ceramic package w/tin pins. © Intel '78 '79.	\$1.25-\$5
		
D8086	4. Type D grey ceramic package w/tin pins. © Intel '78 '84.	\$1.25-\$5
		
D8086-1	1. Type D grey ceramic package w/tin pins. Slashed zeroes. © Intel 1978.	\$1.25-\$5

Intel i8086

 <p style="text-align: center;">D8086-1 I3330012 © INTEL '78 '79</p>		
D8086-1	2. Type D grey ceramic package w/tin pins. © Intel '78 '79.	\$1.25-\$5
 <p style="text-align: center;">D8086-1 L6360292 © INTEL '78 '84</p>		
D8086-1	3. Type D grey ceramic package w/tin pins. © Intel '78 '84.	\$1.25-\$5
 <p style="text-align: center;">D80862 L6273450 INTEL © 1978</p>		
D80862	1. Type D grey ceramic package w/tin pins. Slashed zeroes. © Intel 1978. Missing expected hyphen after D8086.	\$1.25-\$5
 <p style="text-align: center;">D8086-2 L1254066 INTEL © 1978</p>		
D8086-2	1. Type D grey ceramic package w/tin pins. Slashed zeroes. © Intel 1978.	\$1.25-\$5

Intel i8086

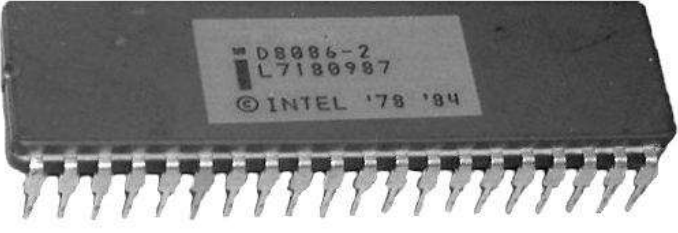
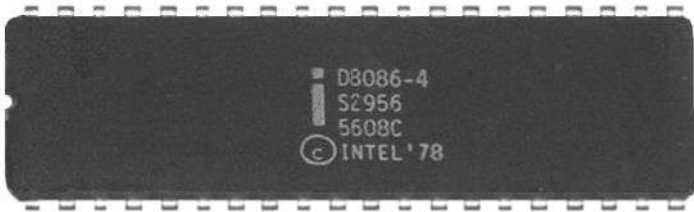
 <p style="text-align: center;">D8086-2 S4164 103964-001 I3240003 © INTEL '78 '79</p>		
D8086-2	2. Type D grey ceramic package w/tin pins. © Intel '78 '79.	\$1.25-\$5
 <p style="text-align: center;">D8086-2 S4800 FD-1079-CU L6370189 © INTEL '78 '84</p>		
D8086-2	3. Type D grey ceramic package w/tin pins. © Intel '78 '84.	\$1.25-\$5
D8086-2	4. Type D grey ceramic package w/tin pins. © Intel '78 '84. Slashed zeroes.	\$1.25-\$5
 <p style="text-align: center;">D8086-2 L7186987 © INTEL '78 '84</p>		
D8086-2	5. Type D grey ceramic package w/tin pins. Slashed zeroes. © Intel '78 '84. Remarkd.	\$3-\$12
 <p style="text-align: center;">D8086-4 S2956 5608C © INTEL '78</p>		
D8086-4	Type D grey ceramic package w/tin pins. © Intel '78.	\$5-\$20 Rare

Intel i8086

 <p style="text-align: center;">I08086 I3490009 © INTEL '78 '79</p>		
ID8086	Type D grey ceramic package w/tin pins. © Intel '78 '79.	\$3-\$12
ID8086-2	Type D package	\$3-\$12
 <p style="text-align: center;">LD8086 L8361498 INTEL © 1978</p>		
LD8086	Type D grey ceramic package w/tin pins. Slashed zeroes. © Intel 1978.	\$2-\$8
LD8086-2	Type D package	\$2-\$8
MD8086	Type D package.	\$2.50-\$10
 <p style="text-align: center;">MD8086/B 8431 X729915B © INTEL '78 '79</p>		
MD8086/B	Type D grey ceramic package w/tin pins. © Intel '78 '79.	\$2.50-\$10
MD8086/BC	Type D package	\$5-\$20
MD8086-1	Type D package.	\$3-\$12
MD8086-1/B	Type D package	\$3-\$12
MD8086-2	Type D package.	\$2.50-\$10
 <p style="text-align: center;">MD8086-2/B L728016B 9728 INTEL © 1978</p>		
MD8086-2/B	Type D grey ceramic package w/tin pins. Slashed zeroes. © Intel 1978.	\$2.50-\$10

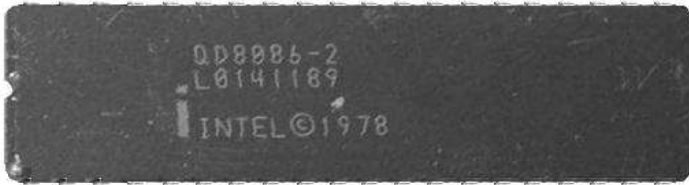

Intel i8086

MD8086-2/BC	Type D package	\$5-\$20
 <p>A black rectangular chip with a notch on the left side. The text on the chip reads: QD8086, 14320010, © INTEL '78 '79.</p>		
QD8086	1. Type D grey ceramic package w/tin pins. © Intel '78 '79.	\$2.50-\$10
 <p>A black rectangular chip with a notch on the left side. The text on the chip reads: QD8086, L8060034, © INTEL '78 '84.</p>		
QD8086	2. Type D grey ceramic package w/tin pins. Slashed zeroes. © Intel '78 '84.	\$2.50-\$10
QD8086-1	Type D package	\$4-\$16
 <p>A black rectangular chip with a notch on the left side. The text on the chip reads: QD8086-2, L0141189, INTEL © 1978.</p>		
QD8086-2	1. Type D grey ceramic package w/tin pins. Slashed zeroes. © Intel 1978.	\$2.50-\$10
 <p>A black rectangular chip with a notch on the left side. The text on the chip reads: QD8086-2, 13260024, © INTEL '78 '79.</p>		
QD8086-2	2. Type D grey ceramic package w/tin pins. © Intel '78 '79.	\$2.50-\$10

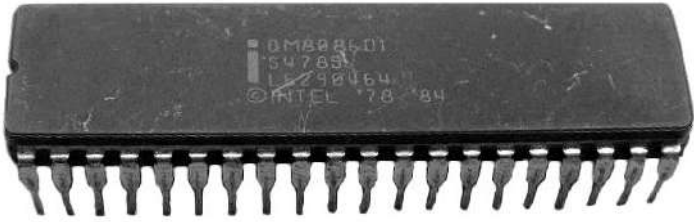
Intel i8086

		
QM8086D1	Type D grey ceramic package w/tin pins. Slashed zeroes. © Intel '78 '84.	\$5-\$20 Rare
TD8086	Type D package	\$2.50-\$10
TD8086-2	Type D package	\$2.50-\$10

Type P Packages

Part Number	Package Description	Values
P8086	1. Type P black plastic package w/tin pins. Half-round key. © Intel 1978.	\$.75-\$3
		
P8086	2. Type P black plastic package w/tin pins. Half-round key, Impressed logo and part number. © Intel '78 '84.	\$.75-\$3
P8086-1	Type P package. Suspect that Intel P8086-1's listed in stock may actually be AMD P8086-1's.	Rare (Suspect) \$\$\$
		
P8086-2	1. Type P black plastic package w/tin pins. Half-round key. Impressed logo and part number. © Intel 1978.	\$.75-\$3

Intel i8086

		
P8086-2	2. Type P black plastic package w/tin pins. Half-round key. Impressed logo and part number. © Intel '78 '84.	\$.75-\$3

References

- [1] Intel (1980). Intel Component Data Catalog, 8086/8086-2/8086-4 Data Sheet, p. 7-1.
- [2] Intel (1984). A Revolution in Progress... A History of Intel to Date, 8086 introduced 1978, p. 26.

Intel i8087

Math Coprocessor

1980

Specifications

- Math Coprocessor
- 1st Implementation in Silicon of the IEEE Standard for Floating Point Mathematics
- HMOS
- High Performance Numeric Data Coprocessor
- Adds Arithmetic, Trigonometric, Exponential, and Logarithmic Instructions to the Standard 8086/8088 and 80186/80188 Instruction Set for All Data Types
- CPU/8087 Supports 7 Data Types: 16-, 32-, 64-Bit Integers, 32-, 64, 80-Bit Floating Point, and 18-Digit BCD Operands
- Compatible with IEEE Floating Point Standard 754
- Available in 5 MHz (8087), 8 MHz (8087-2) and 10 MHz (8087-1): 8 MHz 80186/80188 System Operation Supported with the 8087-1
- Adds 8 x 80-Bit Individually Addressable Register Stack to the 8086/8088 and 80186/80188 Architecture
- 7 Built-in Exception handling Functions
- MULTIBIS® System Compatible Interface
- 40-pin Dual In-Line Package

Type	Clock	Power Dissipation Max.	Supplies [V]
8087	5 MHz	-	+5
8087-1	10 MHz	-	+5
8087-2	8 MHz	-	+5
8087-3	6 MHz	-	+5
8087-4	4 MHz	-	+5
8087-6	-	-	+5
8087-11	2 MHz	-	+5
M8087	5 MHz	-	+5
M8087-1	10 MHz	-	+5
M8087-2	8 MHz	-	+5

The 8087 Numeric Data Coprocessor provides the instructions and data types needed for high performance numeric applications, providing up to 100 times the performance of a CPU alone. The 8087 is implemented in N-channel, depletion load, silicon gate technology (HMOS III), housed in a 40-pin package. Sixty-eight numeric processing instructions are added to the 8086/8088, 80186/80188 instruction sets and eight 80-bit registers are added to the register set. The 8087 is compatible with the IEEE Floating Point Standard 754 [2].

Intel P8087

The P8087 is interesting. I have never actually seen one but have seen enough references to the part number to be convinced they exist. Why are they so rare compared to the 'C' and 'D' type 8087s?

Intel C8087-4

The C8087-4 is another interesting chip. Was this the math co-processor used with the Intel 8086-4?



Intel i8087

Part Numbers

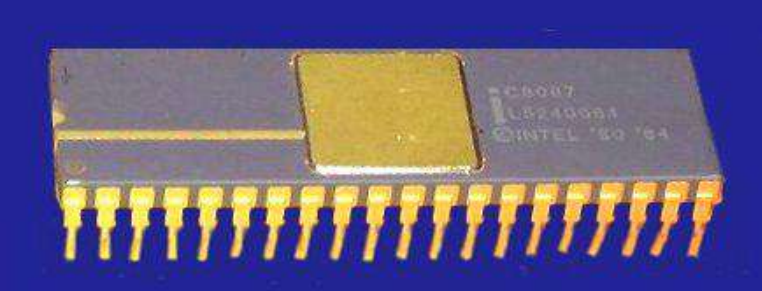
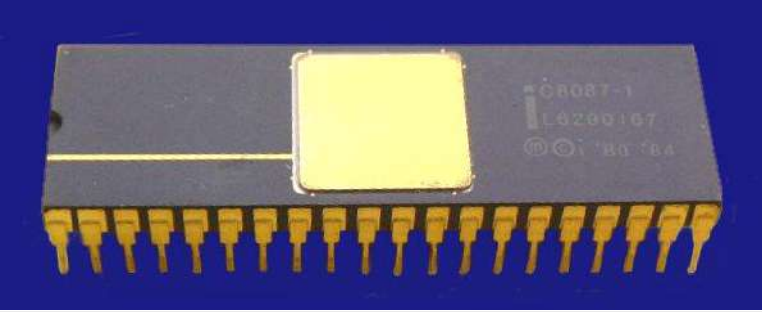
Type C Packages

Part Number	Package Description	Values
 <p>A photograph of an Intel i8087 4MHz ES chip. The chip is a purple ceramic package with a gold cap and gold pins. The markings on the chip include 'C8087 4MHZ', 'ES', '12130015', and '© INTEL '80 '81'.</p>		
C8087	1. Type C purple ceramic package w/gold cap, offset gold cap ground strap, and gold pins. © Intel '80 '81. Example shown marked 'ES' for Engineering Sample.	Ex. Rare (1 Known) \$25-\$100
 <p>A photograph of an Intel i8087 chip. The chip is a purple ceramic package with a gold cap and gold pins. The markings on the chip include 'C8087', '18210081', and '© INTEL '80 '84'.</p>		
C8087	2. Type C purple ceramic package w/gold cap, offset gold cap ground strap, and gold pins. © Intel '80 '84	\$2-\$8
 <p>A photograph of an Intel i8087-1 chip. The chip is a purple ceramic package with a gold cap and gold pins. The markings on the chip include 'C8087-1', '18280167', and '© '80 '84'.</p>		
C8087-1	Type C purple ceramic package w/gold cap, offset gold cap ground strap, and gold pins. © Intel '80 '84	\$2-\$8

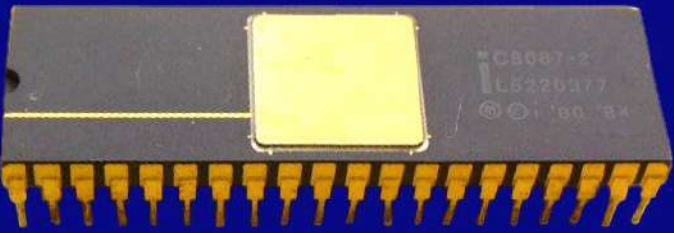
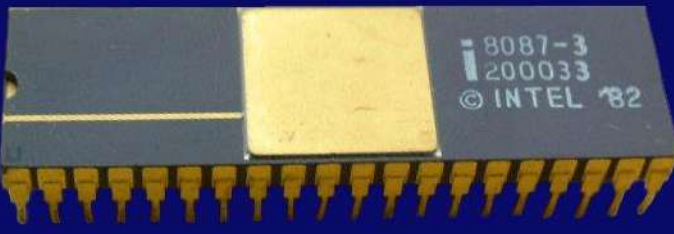
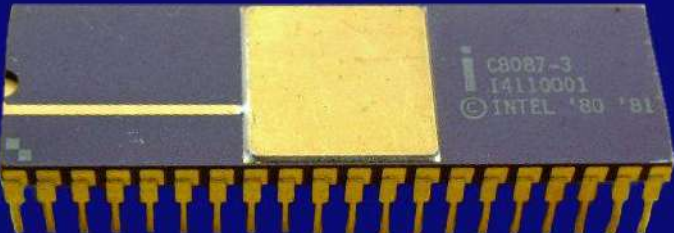
Intel i8087

 <p>A photograph of an Intel C8087-2 floating-point coprocessor. It is a Type C purple ceramic package with a gold cap in the center. The package has a gold ground strap on the left side and gold pins along the bottom edge. The top of the package is marked with 'C8087-2', 'L5220377', and '© INTEL '80 '84'.</p>		
C8087-2	Type C purple ceramic package w/gold cap, offset gold cap ground strap, and gold pins. © Intel '80 '84	\$2-\$8
 <p>A photograph of an Intel 8087-3 floating-point coprocessor. It is a Type C grey ceramic package with a gold cap in the center. The package has a gold ground strap on the left side and gold pins along the bottom edge. The top of the package is marked with '8087-3', '200033', and '© INTEL '82'.</p>		
8087-3	Type C grey ceramic package w/gold cap, offset gold cap ground strap, and gold pins. © Intel '82	\$5-\$20
 <p>A photograph of an Intel C8087-3 floating-point coprocessor. It is a Type C purple ceramic package with a gold cap in the center. The package has a gold ground strap on the left side and gold pins along the bottom edge. The top of the package is marked with 'C8087-3', '14110001', and '© INTEL '80 '81'.</p>		
C8087-3	1. Type C purple ceramic package w/gold cap, offset gold cap ground strap, and gold pins. © Intel '80 '81	\$2-\$8
 <p>A photograph of an Intel C8087-3 floating-point coprocessor. It is a Type C purple ceramic package with a gold cap in the center. The package has a gold ground strap on the left side and gold pins along the bottom edge. The top of the package is marked with 'C8087-3', '11490006', and '© INTEL '80 '81'.</p>		
C8087-3	2. Type C purple ceramic package w/gold cap, offset gold cap ground strap, and gold pins. © Intel '80 '81. Logo and part number printed on cap.	Rare \$15-\$60

Intel i8087

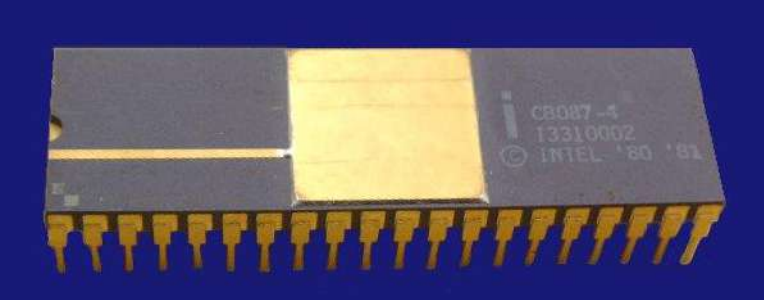
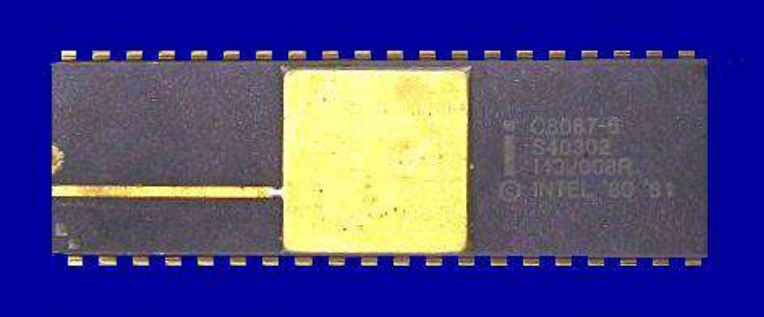
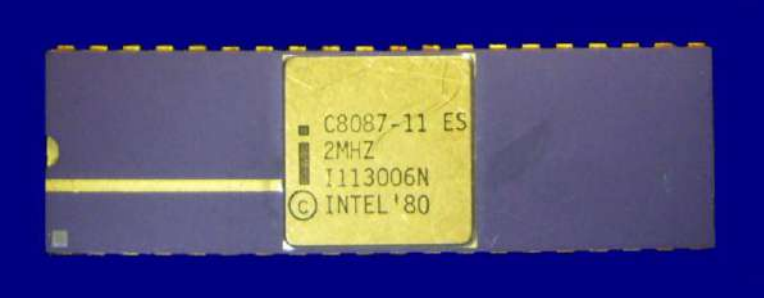
		
C8087-4	Type C purple ceramic package w/gold cap, offset gold cap ground strap, and gold pins. © Intel '80 '81	\$2.50-\$10
		
C8087-6	Type C purple ceramic package w/gold cap, offset gold cap ground strap, and gold pins. © Intel '80 '81	\$2.50-\$10
		
C8087-11	Type C purple ceramic package w/gold cap, offset gold cap ground strap, and gold pins. © Intel '80. Marked '2MHZ'	Ex. Rare (1 Known) \$25-\$100
LC8087	Type C package	Rare \$15-\$60
MC8087	Type C package.	Rare \$15-60

Intel i8087

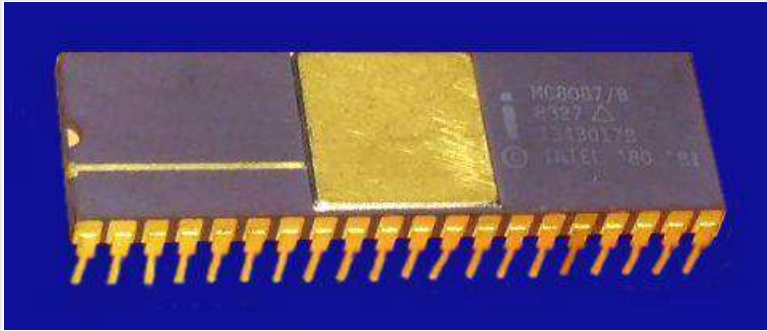
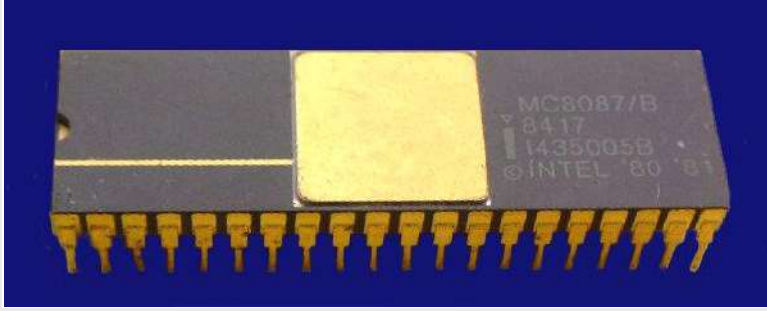
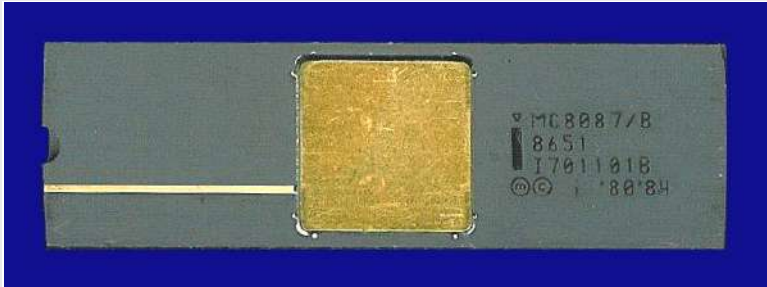
		
MC8087/B	1. Type C purple ceramic package w/gold cap, offset gold cap ground strap, and gold pins. © Intel '80 '81	\$5-\$20
MC8087/B	2. Same as #1 w/vertical part number and logo.	\$5-\$20
		
MC8087/B	3. Type C purple ceramic package w/gold cap, offset gold cap ground strap, and gold pins. Small triangle over Intel 'i'. © Intel '80 '81	\$5-\$20
		
MC8087/B	4. Type C grey ceramic package w/gold cap, offset gold cap ground strap, and tin pins. Small triangle over Intel 'i'. © Intel '80 '84	\$5-\$20
MC8087/BC	Type C package. Suspect this part might exist based on existence of MC8087-2/BC. No hits in part number databases.	Ex. Rare Suspect \$\$\$
MC8087-1	Type C package	Rare \$15-60
MC8087-1/B	Type C package	Rare \$15-60
MC8087-2	Type C package	Rare \$15-60

Intel i8087

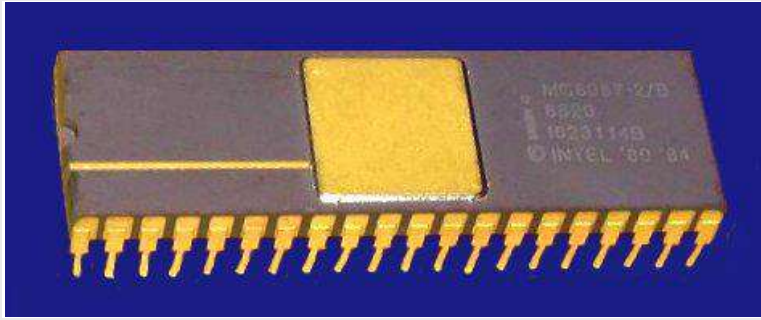

MC8087-2/B	Type C grey ceramic package w/gold cap, offset gold cap ground strap, and gold pins. Small triangle over Intel 'i'. © Intel '80 '84	\$5-\$20
MC8087-2/BC	Type C grey ceramic package w/gold cap, offset gold cap ground strap, and tin pins. Small triangle over Intel 'i'. © Intel 1980.	Rare \$15-\$60

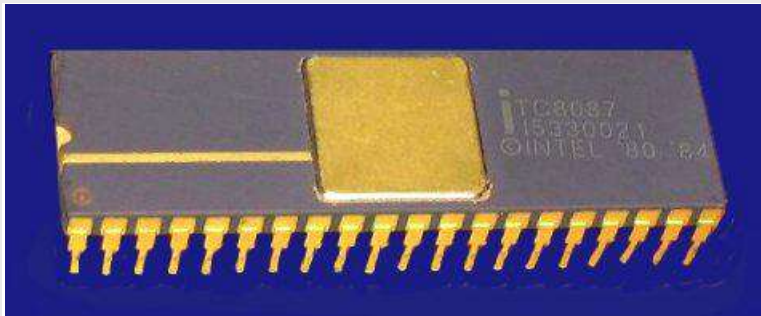

TC8087	Type C purple ceramic package w/gold cap, offset gold cap ground strap, and gold pins. © Intel '80 '84	Rare \$15-\$60
QC8087	Type C package	Rare \$15-\$60
QC8087-2	Type C package	Rare \$15-\$60
QC8087-3	Type C package	Rare \$15-\$60

Type D Packages

Part Number	Package Description	Values
D8087	1. Type D grey ceramic package w/tin pins. © Intel 1980.	\$1.25-\$5

Intel i8087

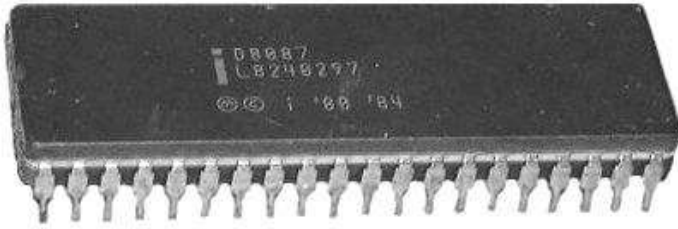

D8087	2. Type D grey ceramic package w/tin pins. © Intel '80 '84	\$1.25-\$5
D8087	3. Type D grey ceramic package w/tin pins. © Intel 1980 1984.	\$1.25-\$5
D8087-1	1. Type D grey ceramic package w/tin pins. © Intel 1980.	\$1.25-\$5

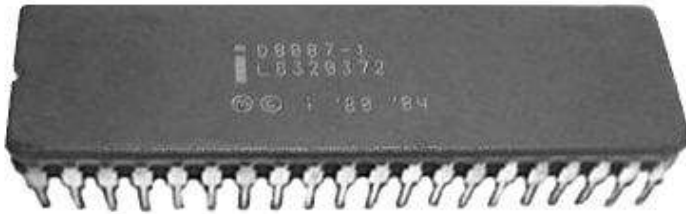

D8087-1	2. Type D grey ceramic package w/tin pins. © Intel '80 '84	\$1.25-\$5
---------	--	------------



D8087-2	1. Type D grey ceramic package w/tin pins. © Intel '1980	\$1.25-\$5
---------	--	------------



D8087-2	2. Type D grey ceramic package w/tin pins. © Intel '80 '84	\$1.25-\$5
---------	--	------------

Intel i8087

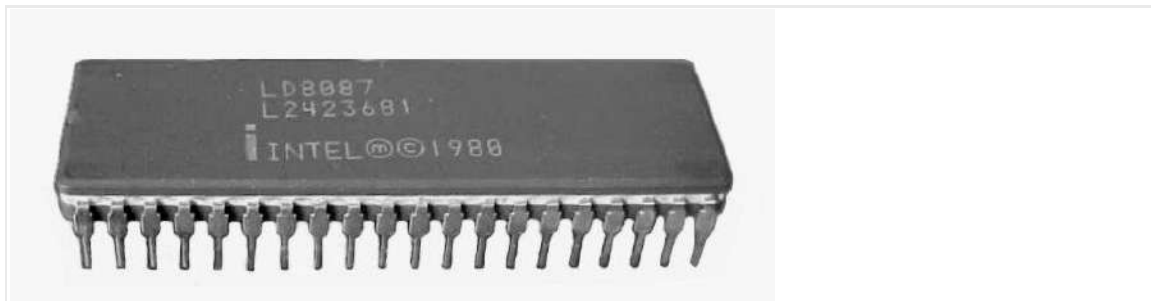

LD8087	Type D grey ceramic package w/tin pins. © Intel 1980	\$2.50-\$10
LD8087-1	Type D package	Rare \$5-\$10
LD8087-2	Type D package	\$2.50-\$10
MD8087	Type D package.	\$2.50-\$10
MD8087/B	Type D package	\$2-\$8
MD8087/BC	Type D package	\$3-\$12
MD8087-1	Type D package	Rare \$5-\$20
MD8087-1/B	Type D package	Rare \$5-\$20
MD8087-2	Type D package.	\$2.50-\$10
MD8087-2/B	Type D package	\$2-\$8
MD8087-2/BC	Type D package	\$3-\$12
QD8087	Type D package	\$2-\$8
QD8087-1	Type D package	\$2-\$8
QD8087-2	Type D package	\$2.50-\$10
TD8087	Type D package	\$2-\$8
TD8087-1	Type D package	\$2-\$8
TD8087-2	Type D package	\$2-\$8

References

- [1] Intel (1980). Intel Component Data Catalog. No reference to 8087 dates chip after 1980.
- [2] Intel (1989). Microprocessor and Peripheral Handbook, p. 2-183
- [3] Intel (1984). A Revolution in Progress... A History of Intel to Date, 8087 introduced 1980, p. 26.

Intel i8088

8/16-bit Microprocessor

June 1979

Specifications

- 16/8-bit Microprocessor
- 29000 Transistors (3 Micron)
- HMOS-II
- 8-bit Data Bus Interface
- 16-bit Internal Architecture
- Direct Addressing Capability to 1 Mbyte of Memory
- Direct Software Compatibility with iAPX 86/10 (8086 CPU)
- 14-word by 16-bit Register Set with Symmetrical Operations
- 24 Operand Addressing Modes
- Byte, Word, and Block Operations
- 8-bit and 16-bit Signed and Unsigned Arithmetic in Binary or Decimal, Including Multiply and Divide
- Two Clock Rates
 - 5 MHz for 8088
 - 8 MHz for 8088-2
- Compatible with 8155-2, 8755A-2 and 8185-2 Multiplexed Peripherals
- 40-pin Dual In-Line Package

Type	Clock	Power Dissipation Max.	Supplies [V]
8088	4.77 MHz	-	+5
8088-1	10 MHz	-	+5
8088-2	8 MHz	-	+5
8088-6	6 MHz	-	+5

The Intel® iAPX 88/10 is a new generation, high performance microprocessor implemented in N-channel, depletion load, silicon gate technology (HMOS), and packaged in a 40-pin CerDIP package. The processor has attributes of both 8 and 16-bit microprocessors. It is directly compatible with iAPX 86/10 (8086 CPU) software and 8080/8085 hardware and peripherals [3].

History

The 8088 operating at 4.77 MHz was IBM's choice for the microprocessor in its first Personal Computer, the IBM PC model 5150 (August 1981). Compared to its predecessor, the 8086, the 8088 microprocessor comes across as a backward step in chip design. The 8088 was identical to the 8086 in every way-16-bit registers, 20 address lines, the same command set-except one. Its data bus was reduced to 8 bits, enabling the 8088 to exploit readily available 8-bit support hardware but effectively halving the speed of memory access.

Intel i8088



IBM PC Model 5150

Packages





Intel only offered the 8088 in “D” and “P” type packages, however, several second sources, including Fujitsu and OKI did offer a ceramic package with gold cap and gold pins.

The 8088 Datasheet in Intel’s iAPX 88 Book dated July 1981 indicates the 8088 is “packaged in a 40-pin CerDIP package”. There is no reference to a type P package. This would seem to indicate the 8088 was initially available in type D package only.

Intel i8088

Part Numbers

Type D Packages

Part Number	Package Description	Values
		
D8088	1. Type D grey ceramic package w/tin pins. © Intel '78	\$1.25-\$5
		
D8088	2. Type D grey ceramic package w/tin pins. © Intel '78 '81.	\$1.25-\$5
		
D8088	3. Type D grey ceramic package w/tin pins. © Intel '78 '83	\$1.25-\$5
D8088-2	1. Type D grey ceramic package w/tin pins. © Intel '78 '81.	\$1.25-\$5
		
D8088-2	2. Type D grey ceramic package w/tin pins. © Intel '78 '83	\$1.25-\$5

Intel i8088

 <p style="text-align: center;">D8088-2 S40377 L7318J26 © INTEL '78 '83</p>		
D8088-2	3. Type D grey ceramic package w/tin pins. Slashed zeroes. © Intel '78 '83.	\$1.25-\$5
 <p style="text-align: center;">LD8088 L4177106 © INTEL '78 '81</p>		
LD8088	Type D grey ceramic package w/tin pins. © Intel '78 '81	\$2-\$8
LD8088-2	Type D package	\$2-\$8
MD8088	Type D package.	\$2.50-\$10
 <p style="text-align: center;">MD8088/B 8341 1407013BS © INTEL '78 '81</p>		
MD8088/B	Type D grey ceramic package w/tin pins. © Intel '78 '81	\$2.50-\$10
MD8088/BC	Type D package	\$5-\$20
MD8088-2	Type D package.	\$2.50-\$10
 <p style="text-align: center;">MD8088-2/B L728016B 9728 INTEL © 1978</p>		
MD8088-2/B	Type D grey ceramic package w/tin pins. Slashed zeroes. © Intel 1978	\$2.50-\$10
MD8088-2/BC	Type D package	\$5-\$20



Intel i8088

 <p style="text-align: center;">QD8088 L4017254 © INTEL '78 '81</p>		
QD8088	Type D grey ceramic package w/tin pins. © Intel '78 '81.	\$2-\$8
 <p style="text-align: center;">QD8088-2 L3457811 © INTEL '78 '81</p>		
QD8088-2	1. Type D grey ceramic package w/tin pins. © Intel '78 '81.	\$2-\$8
 <p style="text-align: center;">QD8088-2 L5100341 © INTEL '78 '83</p>		
QD8088-2	2. Type D grey ceramic package w/tin pins. © Intel '78 '83.	\$2-\$8
 <p style="text-align: center;">QM8088D1 S4785 L6090631 © INTEL '78 '83</p>		
QM8088D1	Type D grey ceramic package w/tin pins. © Intel '78 '83.	\$5-\$20
QM80882D1	Unknown package	\$5-\$20
QM8088P5	Unknown package.	Rare \$10-\$40

Intel i8088

		
TD8088	1. Type D grey ceramic package w/tin pins. Slashed zeroes. © Intel 1978.	\$2-\$8
TD8088	2. Type D grey ceramic package w/tin pins. © Intel '78 '81.	\$2-\$8
TD8088-2	Type D package	\$3-\$12

Type P Packages

Part Number	Package Description	Values
		
P8088	1. Type P black plastic package w/tin pins. Half-round key. Impressed logo and part number. © Intel 1978.	\$1.25-\$5
		
P8088	2. Type P black plastic package w/tin pins. Rectangular key. © Intel '78 '81.	\$1.25-\$5

Intel i8088

		
P8088	3. Type P black plastic package w/tin pins. Half-round key. © Intel '78 '81.	\$1.25-\$5
		
P8088	4. Type P black plastic package w/tin pins. Rectangular key. © Intel '78 '83.	\$1.25-\$5
		
P8088	5. Type P black plastic package w/tin pins. Half-round key. © Intel '78 '83.	\$1.25-\$5
		
P8088	6. Type P black plastic package w/tin pins. Half-round key, Impressed logo and part number. © Intel '78 '83.	\$1.25-\$5
P8088-1	Type P package. Suspect that Intel P8088-1's listed in stock may actually be AMD P8088-1's.	Rare (Suspect) \$\$\$
P8088-2	1. Type P black plastic package w/tin pins. Half-round key. Impressed logo and part number. © Intel 1978.	\$1.25-\$5

Intel i8088



P8088-2	2. Type P black plastic package w/tin pins. Half-round key. Impressed logo and part number. © Intel '78 '83.	\$1.25-\$5
---------	--	------------



P8088-6	Type P black plastic package w/tin pins. Rectangular key. © Intel '78 '81.	Rare \$10-\$40
QP8088	1. Type P black plastic package w/tin pins. Half-round key. Impressed logo and part number. © Intel 1978.	\$2.50-\$10
QP8088	2. Type P black plastic package w/tin pins. Half-round key. Impressed logo and part number. © Intel '78 '83.	\$2.50-\$10

References

- [1] Intel (1979). Intel Component Data Catalog. No reference to 8088.
- [2] Intel (1980). Intel Component Data Catalog, 8088 Preliminary Data Sheet, p. 7-22
- [3] Intel (July 1981). Intel iAPX 88 Book, 8088 Data Sheet, p. 37
- [4] Intel (1984). A Revolution in Progress... A History of Intel to Date, 8088 introduced 1979, p. 26.

Intel i8089

8/16-bit I/O Processor

1979

Specifications

- 16/8-bit I/O Processor
- HMOS
- High Speed DMA Capabilities Including I/O to Memory, Memory to I/O, Memory to Memory, and I/O to I/O
- MCS-80™, MCS085™, MCS-86™ and 8088 Compatible, Removes I/O Overhead
- Allows Mixed Interface of 8/16-bit Peripherals, to 8/16-bit Processor Busses
- 1 Mbyte Addressability
- Memory Based Communication with CPU
- Supports LOCAL or REMOTE I/O Processing
- Flexible, Intelligent DMA Functions Including Translation, Search, Word Assembly/Disassembly
- MULTIBUS™ Compatible System Interface
- 40-pin Dual In-Line Package

Type	Clock	Power Dissipation Max.	Supplies [V]
8089	-	-	+5
8088-2	-	-	+5
8088-3	-	-	+5

The Intel ® 8089 is a revolutionary concept in microprocessor input/output processing. Packaged in a 40-pin DIP package, the 8089 is a high performance processor implemented in N-channel, depletion load silicon gate technology (HMOS). The 8089's instruction set and capabilities are optimized for high speed, flexible and efficient I/O handling. It allows easy interface of Intel's 16-bit 8086 and 8-bit 8088 microprocessors with 8/18-bit peripherals. In the REMOTE configuration, the 8089 bus is user definable allowing it to be compatible with any 8/16-bit Intel microprocessor, interfacing easily to the Intel multiprocessor system bus standard MULTIBUS™

The 8089 performs the function of an intelligent DMA controller for the Intel MCS-86 family and with its processing power, can remove I/O overhead from the 8086 or 8088. It may operate completely in parallel with the CPU, giving dramatically improved performance in I/O intensive applications. The 8089 provides two I/O channels, each supporting a transfer rate up to 1.25 mbyte/sec at the standard clock frequency of 5 MHz.

Memory based communication between the IOP and CPU enhances system flexibility and encourages software modularity, yielding more reliable, easier to develop systems [2].

Part Numbers

Type D Packages

Part Number	Package Description	Values
D8089	Type D package	\$1.25-\$5
		
D8089-3	Type D grey ceramic package w/tin pins. © Intel '79	\$1.25-\$5
ID8089-3	Type D package	\$5-\$20
LD8089	Type D package	\$2-\$8
LD8089-2	Type D package	\$2-\$8
MD8089	Type D package	Rare \$5-\$20
		
MD8089/B	Type D grey ceramic package w/tin pins. Small triangle over Intel logo. © Intel '79.	\$2.50-\$10
MD8089-2	Type D package	Rare \$5-\$20
MD8089-2/B	Type D package	\$2.50-\$10
MD8089-3	Type D package	Rare \$5-\$20
MD8089-3/B	Type D grey ceramic package w/tin pins. © Intel '79.	\$2.50-\$10
QD8089	Type D package	\$2-\$8
QD8089-3	Type D package	\$2-\$8

Type P Packages

Part Number	Package Description	Values
P8089	Type P package. Single source lists small quantity. Possible typo.	Rare (Suspect) \$15-\$60

References

- [1] Intel (1979). Intel Component Data Catalog. No reference to 8089.
- [2] Intel (1980). Intel Component Data Catalog, 8089 Preliminary Data Sheet, p. 7-44
- [3] Intel (1984). A Revolution in Progress... A History of Intel to Date, 8089 introduced 1979, p. 26.

Intel i8089A

8/16-bit I/O Processor

1984-85

Specifications

- 16/8-bit I/O Processor
- 40-pin Dual In-Line Package

Type	Clock	Power Dissipation Max.	Supplies [V]
8089A-3	-	-	+5

No data sheet known to exist for this part.

Intel i8089A

Part Numbers

Type D Packages

Part Number	Package Description	Values
		
D8089A-3	Type D grey ceramic package w/tin pins. © Intel '79 '83	\$1.25-\$5

References

[1] Intel (1980). Intel Component Data Catalog, 8089 Preliminary Data Sheet, p. 7-44. No reference to 8089A.

[2] Intel (1984). Intel Microsystem Components Handbook, 8089 Data Sheet, p. 3-494. No reference to 8089A.

[3] Hearst (1987). IC Master, AMD 8089A-3, p. 1435-3. No reference to Intel 8089A.

Intel i8101

1024-bit (256 x 4) Static RAM w/Separate I/O

3rd Qtr 1974

Specifications

- 1024-bit (256 x 4) Static RAM w/Separate I/O
- NMOS
- 256 x 4 Organization to Meet Needs for Small System Memories
- Access Time – 850 nsec Max. (8101-2)
- Single +5V Supply Voltage
- Directly TTL Compatible – All Inputs and Outputs
- Static MOS – No Clocks or Refreshing Required
- Simple Memory Expansion – Chip Enable Select
- Inputs Protected – All Inputs Have Protection Against Static Charge
- Three-State Output – OR-tie Capability
- Output Disable Provided for Ease of Use in Common Data Bus Systems
- 8xxx equivalent of the Intel 2101 Static RAM
- 22-pin Dual In-Line Package

Type	Access Time Max.	Cycle Time Max.	Power Dissipation Max. Operating/Standby	Supplies [V]
8101	1μs	1μs	350mW	+5
8101-2	850ns	850ns	350mW	+5
8101-8	-	-	-	+5

The Intel® 8101 is a 256 word by 4 bit static random access memory element using normally off N-channel MOS devices integrated on a monolithic array. It uses fully DC stable (static) circuitry and therefore requires no clocks or refreshing to operate. The data is read out nondestructively and the same polarity as the input data.

The 8101 is designed for memory applications where high performance, low cost, large bit storage, and simple interfacing are important design objectives.





It is directly TTL compatible in all respects: inputs, outputs, and a single +5V supply. Two chip-enables allow easy selection of individual packages when outputs are OR-tied. An output disable is provided so that data inputs and outputs can be tied for common I/O systems. Output disable is then used to eliminate any bi-directional logic.

The 8101 is fabricated with N-channel silicon gate technology. This technology allows the design and production of high performance, easy-to-use MOS circuits and provides a higher functional density on a monolithic chip than either conventional MOS technology or P-channel silicon gate technology.

Intel's silicon gate technology also provides excellent protection against contamination. This permits the use of low cost silicone packaging [4].



Part Numbers

Type C Packages

Part Number	Package Description	Values
		
C8101	1. Type C white ceramic package w/grey traces, gold cap, gold cap ground strap, and gold pins. Gold dot denotes pin #1.	Ex. Rare \$75-\$300
		
C8101	2. Type C purple ceramic package w/gold cap and gold pins.	Ex. Rare \$50-\$200
		
C8101-2	Type C white ceramic package w/grey traces, gold cap, gold cap ground strap, and gold pins. Gold dot denotes pin #1. Example shown made in Malaysia and dated 7514.	Ex. Rare \$50-\$200
		
C8101-8	Type C white ceramic package w/grey traces, gold cap, gold cap ground strap, and gold pins. Gold dot denotes pin #1.	Ex. Rare \$75-\$300

Intel i8101

Type P Packages

Part Number	Package Description	Values
		
P8101	1. Type P grey plastic package w/tin pins. Embossed Intel 'i' in key. Small round indentation denotes pin #1.	Ex. Rare \$25-\$100
		
P8101	2. Type P black plastic package w/tin pins.	Ex. Rare \$25-\$100
		
P8101-2	Type P grey plastic package w/tin pins. Embossed Intel 'i' in key. Small round indentation denotes pin #1.	Ex. Rare (5 Known) \$25-\$100
P8101-8	Type P package	Ex. Rare \$25-\$100

References

[1] Intel (1974). Intel Advertisement, "From CPU to Software The 8080 Microcomputer is here". Lists availability date for 8101 as 3rd Qtr.

[2] Intel (1974). From CPU to Software, 8101 Preliminary Data Sheet, p. 28

[3] Intel (November 1974). Intel Static RAMs, 8101 Data Sheet, p. 45. Errata sheet indicates this Data Sheet should read 8101-2.

[4] Intel (September 1975). Intel MCS-80 User's Manual, 8101-2 Data Sheet, p. 5-67.

Intel i8101A

1024-bit (256 x 4) Static RAM w/Separate I/O

1976

Specifications

- 1024-bit (256 x 4) Static RAM w/Separate I/O
- NMOS
- Single +5V Supply Voltage
- Directly TTL Compatible: All Inputs and Outputs
- Static MOS: No Clocks or Refreshing Required
- Simple Memory Expansion: Chip Enable Input
- Powerful Output Drive Capability
- Low Power: Typically 150mW
- Three-State Output: OR-Tie Capability
- Output Disable Provided for Ease of Use in Common Data Bus Systems
- 8xxx equivalent of the Intel 2101A Static RAM
- 22-pin Dual In-Line Package

Type	Access Time Max.	Cycle Time Max.	Power Dissipation Max. Operating/Standby	Supplies [V]
8101A-4	450ns	450ns	300mW	+5

The Intel 8101A-4 is a 256 word by 4-bit static random access memory element using N-channel MOS devices integrated on a monolithic array. It uses full DC stable (static) circuitry and therefore requires no clocks or refreshing to operate. The data is read out nondestructively and has the same polarity as the input data.

The 8101A-4 is designed for microprocessor memory applications where high performance, low cost, large bit storage, and simple interfacing are important design objectives.

It is directly TTL compatible in all respects: inputs, output, and a single +5 volt supply. Two chip enables allows easy selection of an individual package when outputs are OR-tied. An output disable is provided so that data inputs and outputs can be tied for common I/O systems. The output disable function eliminates the need for bi-directional logic in a common I/O system.

The Intel 8101A-4 is fabricated with N-channel silicon gate technology. This technology allows the design and production of high performance, easy-to-use MOS circuits and provides a higher functional density on a monolithic chip than either conventional MOS technology or P-channel silicon gate technology.

Intel's silicon gate technology also provides excellent protection against contamination. This permits the use of lost cost silicone packaging [4].

The 8101A-4 specs are identical to the 2101A-4 specs [5].

Intel i8101A

Part Numbers

Type B Package

Part Number	Package Description	Values
B8101A-4	Type B package. Single source lists small quantity in stock. Possible typo.	Rare (Suspect) \$\$\$

Type D Package

Part Number	Package Description	Values
D8101A-4	Type D package. Single source lists small quantity in stock. Possible typo.	Rare (Suspect) \$\$\$

Type P Package

Part Number	Package Description	Values
P8101A-4	Type P package	\$2.50-\$10

References

- [1] Intel (September 1975). Intel MCS-80 User's manual, 8101-2 Data Sheet, p. 5-67. No reference to 8101A.
- [2] Intel (1975). Intel Data Catalog, 8101 Data Sheet, p. 6-35. No reference to 8101A.
- [3] Intel (1976). Intel Data Catalog, 8101A-4 Preliminary Data Sheet, p. 8-57
- [4] Intel (1977). Intel Data Catalog, 8101A-4 Data Sheet, p. 10-88
- [5] Intel (1978). Intel Component Data Catalog, 2101A/8101A-4 Data Sheet, p. 3-26

Intel i8102

1024-bit (1024 x 1) Static RAM w/Separate I/O

1974

Specifications

- 1024-bit (1024 x 1) Static RAM w/Separate I/O
- NMOS
- Directly TTL Compatible – All Inputs and Output
- Static MOS – No Clocks or Refreshing Required
- Three-State Output – OR-Tie Capability
- Simple Memory Expansion – Chip Enable Input
- 16-pin Dual In-Line Package

Type	Access Time Max.	Cycle Time Max.	Power Dissipation Max. Operating/Standby	Supplies [V]
8102	1300ns	-	-	+5
8102-2	850ns	-	-	+5

The 8102 is a 1024 word by 1-bit random access memory element with an access time of 1300ns.

The 8102-2 has an access time of 850ns.

Both devices use DC stable (static) circuitry and require no clocks or refreshing to operate. Data is read out non-destructively and has the same polarity as the input data. They are designed for high performance, low cost microcomputer systems. They are TTL compatible in all respects. A separate chip enable (CE) allows easy selection of packages when outputs are OR-tied [2].

Intel i8102

Part Numbers

Type P Packages

Part Number	Package Description	Values
 A photograph of an Intel i8102 Type P package. The package is a grey plastic package with tin pins. The markings on the package are "P8102", "S1000", and "P1798".		
P8102	Type P grey plastic package w/tin pins.	Ex. Rare \$25-\$100

References

[1] Intel (1974). Intel Advertisement, "From CPU to Software The 8080 Microcomputer is here". Lists availability date for 8102 as "NOW".

[2] Intel (1975). Intel Data Catalog, 8102, 8102-2 Data Sheet, p. 6-36

[3] Intel (1977). Intel MCS-80 User's Manual, 8102-2 and 8102A-4 shown as components of 8080 Microcomputer System, p. 3-6.

Intel i8102A

1024-bit (1024 x 1) Static RAM w/Separate I/O

1974

Specifications

- 1024-bit (1024 x 1) Static RAM w/Separate I/O
- NMOS
- Access Time – 450ns Max.
- Single +5V Supply Voltage
- Directly TTL Compatible – All Inputs and Output
- Static MOS – No Clocks or Refreshing Required
- Low Power – Typically 150mW
- Three-State Output – OR-Tie Capability
- Simple Memory Expansion – Chip Enable Input
- Fully Decoded – On Chip Address Decode
- Inputs Protected – All Inputs Have Protection Against Static Charge
- 8xxx equivalent of Intel 2102A Static RAM
- 16-pin Dual In-Line Package

Type	Access Time Max.	Cycle Time Max.	Power Dissipation Max. Operating/Standby	Supplies [V]
8102A-4	450ns	450ns	275mW	+5
M8102A-4	450ns	450ns	-	+5

The Intel® 8102A-4 is a 1024 word by 1-bit static random access memory element using normally off N-channel MOS devices integrated on a monolithic array. It uses full DC stable (static) circuitry and therefore requires no clocks or refreshing to operate. The data is read out nondestructively and has the same polarity as the input data.

The 8102A-4 is designed for microprocessor memory applications where high performance, low cost, large bit storage, and simple interfacing are important design objectives.

It is directly TTL compatible in all respects: inputs, output, and a single +5 volt supply. A separate chip enable lead allows easy selection of an individual package when outputs are OR-tied.

The Intel 8102A-4 is fabricated with N-channel silicon gate technology. This technology allows the design and production of high performance, easy-to-use MOS circuits and provides a higher functional density on a monolithic chip than either conventional MOS technology or P-channel silicon gate technology.

Intel's silicon gate technology also provides excellent protection against contamination. This permits the use of lost cost silicone packaging [3].

The 8102A-4 specs are identical to the 2101A-4 specs [5].

Intel i8102A

Part Numbers

Type C Packages

Part Number	Package Description	Values
		
C8102A-4	Type C white ceramic package w/gold cap, gold cap ground strap, and gold pins. Cap ground strap connection points on both edges of package (only one used). Black dot denotes pin #1.	Ex. Rare (1 Known) \$50-\$200

Type D Packages

Part Number	Package Description	Values
		
D8102A-4	Type D grey ceramic package w/tin pins	\$1.25-\$5
MD8102A-4	Type D package	Ex. Rare (0 Known) \$\$\$

Intel i8102A

Type P Packages

Part Number	Package Description	Values
		
P8102A-4	1. Type P grey plastic package w/tin pins. Small round indentation denotes pin #1.	Rare \$15-\$60
P8102A-4	2. Type P black plastic package w/tin pins. Small round indentation denotes pin #1.	Rare \$15-\$60

References

- [1] Intel (November 1974). Intel Static RAMs, 8102A-4 Data Sheet, p. 33
- [2] Intel (January 1975). Intel 8080 Microcomputer System Manual, 8102A-4, Data Sheet, p. 30
- [3] Intel (September 1975). Intel MCS-80 User's Manual, 8102A-4 Data Sheet, p. 5-79
- [4] Intel (1977). Intel Memory Design Handbook, MD8102A-4 listed as member of Intel Military Product Family, p. PSG-5.
- [5] Intel (1978). Intel Component Data Catalog, 2102A, 2102AL / 8102A-4 Data Sheet, p. 3-30

Intel i8107A

4096-bit (4096 x 1) Dynamic RAM

1973-74

Specifications

- 4096-bit (4096 x 1) Fully Decoded Dynamic RAM
- NMOS
- Access Time – 420 ns max.
- Low Cost Per Bit
- Low Standby Power – Typical 7 μ W/Bit
- Only One High Voltage Input Signal – Chip Enable
- All Other Inputs are TTL Compatible
- Address Registers Incorporated on the Chip
- Simple Memory Expansion – Chip Select Input Lead
- Fully Decoded – On Chip Address Decode
- Output is Three State and Compatible with Low Power TTL Gates
- 8xxx equivalent of Intel 2107A
- 22-pin Dual In-Line Package

Type	Access Time Max.	Cycle Time Max.	Power Dissipation Max. Operating/Standby	Supplies [V]
8107A	420ns	-	-	+12, +5, -5

The Intel 8107A is a 4096 word by 1-bit dynamic RAM. It was designed for memory applications where very low cost and large bit storage are important objectives. The 8107A uses dynamic circuitry which reduces the operation and standby power dissipation.

Reading information from the memory is non-destructive. Refreshing is accomplished by performing one read cycle on each of the 64 row addresses. Each row must be refreshed every two milliseconds. The memory is refreshed whether Chip Select is a logic one or a logic zero.

The 8107A is fabricated with N-channel silicon gate technology. This technology allows the design and manufacture of devices using minimum size transistors that have the same performance as devices using much larger transistors [1].

History

The 8107A was introduced as a member of the Intel MCS-80® family and was the 8xxx equivalent of the 2107A.

Intel i8107A

Part Numbers

Type C Packages

Part Number	Package Description	Values
C8107A	Type C package	Ex.Rare \$25-\$100

References

- [1] Intel (January 1975). Intel 8080 Microcomputer System Manual, 8107A Data Sheet, p. 31
- [2] Intel (1975). Intel Data Catalog, 8107A Data Sheet, p. 6-37

Intel i8107B

4096-bit (4096 x 1) Dynamic RAM

1974-75

Specifications

- 4096-bit (4096 x 1) Fully Decoded Dynamic RAM
- NMOS
- Low Cost Per Bit
- Low Standby Power
- Easy System Interface
- Only One High Voltage Input Signal – Chip Enable
- TTL Compatible – All Addresses, Data, Write Enable, Chip Select Inputs
- Read-Modify-Write Cycle Time – 590ns
- Address Registers Incorporated on the Chip
- Simple Memory Expansion – Chip Select Input Lead
- Output is Three-State and TTL Compatible
- 8xxx equivalent of Intel 2107B
- 22-pin Dual In-Line Package

Type	Access Time Max.	Cycle Time Max.	Power Dissipation Max. Operating/Standby	Supplies [V]
8107B-4	270ns	470ns	648mW/4mW	+12, +5, -5

The Intel 8107B is a 4096 word by 1-bit dynamic n-channel MOS RAM. It was designed for memory applications where very low cost and large bit storage are important design objectives. The 8107B uses dynamic circuitry, which reduces the standby power dissipation.

Reading information from memory is non-destructive. Refreshing is most easily accomplished by performing one read cycle on each of the 64 row addresses. Each row address must be refreshed every two milliseconds. The memory is refreshed whether chip select is a logic one or logic zero.

The 8107B is fabricated with n-channel silicon gate technology. This technology allows the design and production of high performance, easy-to-use MOS circuits and provides a higher functional density on a monolithic chip than other MOS technologies. The 8107B uses a single transistor cell to achieve high speed and low cost. It is a replacement for the 8107A [1].

Part Numbers

No Examples Known

References

- [1] Intel (September 1975). Intel MCS-80 User's Manual, 8107B-4 Data Sheet, p. 5-83.
- [2] Hearst (1977). IC Master, Intel 8107B-4 listed as 8xxx equivalent of Intel 2107B, p. 871

Intel i8111

1024-bit (256 x 4) Static RAM w/Common I/O

3rd Qtr 1974

Specifications

- 1024-bit (256 x 4) Static RAM w/Common I/O
- NMOS
- Access Time – 850ns Max. (8111-2)
- Common Data Input and Output
- Single +5V Supply Voltage
- Directly TTL Compatible – All Inputs and Outputs
- Static MOS – No Clocks or Refreshing Required
- Simple Memory Expansion – Chip Enable Input
- Fully Decoded – On Chip Address Decode
- Inputs Protected – All Inputs Have Protection Against Static Charge
- Low Power – Typically 150mW
- Three-State Output – OR-Tie Capability
- 8xxx equivalent to Intel 2111 Static RAM
- 18-pin Dual In-Line Package

Type	Access Time Max.	Cycle Time Max.	Power Dissipation Max. Operating/Standby	Supplies [V]
8111	1µs	1µs	350mW	+5
8111-2	850ns	850ns	350mW	+5

The Intel® 8111 is a 256 word by 4-bit static random access memory element using normally off N-channel MOS devices integrated on a monolithic array. It uses fully DC stable (static) circuitry and therefore requires no clocks or refreshing to operate. The data is read out nondestructively and the same polarity as the input data.

The 8111 is designed for memory applications where high performance, low cost, large bit storage, and simple interfacing are important design objectives.

It is directly TTL compatible in all respects: inputs, outputs, and a single +5V supply. Separate chip enable leads allow easy selection of an individual package when outputs are OR-tied.

The 8111 is fabricated with N-channel silicon gate technology. This technology allows the design and production of high performance, easy-to-use MOS circuits and provides a higher functional density on a monolithic chip than either conventional MOS technology or P-channel silicon gate technology.

Intel's silicon gate technology also provides excellent protection against contamination. This permits the use of low cost silicone packaging [4].

History

The Intel 8111 Static RAM was used in the Intel SBC 80/10; an 8080A based Single Board Computer [5].

Intel i8111

Part Numbers

Type C Packages

Part Number	Package Description	Values
C8111	Type C package	Ex. Rare \$50-\$200
C8111-2	Type C package	Ex. Rare \$50-\$200

Type P Packages

Part Number	Package Description	Values
P8111	Type P package	Ex. Rare \$25-\$100

References

- [1] Intel (1974). Intel Advertisement, "From CPU to Software The 8080 Microcomputer is here". Lists availability date for 8111 as 3rd Qtr.
- [2] Intel (1974). From CPU to Software, 8111 Preliminary Data Sheet, p. 29.
- [3] Intel (November 1974). Intel Static RAMs, 8111 Data Sheet, p. 49. Errata sheet says this should read 8111-2.
- [4] Intel (September 1975). Intel MCS-80 User's Manual, 8111-2 Data Sheet, p. 5-71.
- [5] Intel (1977). Intel Data Catalog, SBC 80/10 Single Board Computer Data Sheet, p. 12-3

Intel i8111A

1024-bit (256 x 4) Static RAM w/Common I/O

1976

Specifications

- 1024-bit (256 x 4) Static RAM w/Common I/O
- NMOS
- Common Data Input and Output
- Single +5V Supply Voltage
- Directly TTL Compatible: All Inputs and Output
- Static MOS: No Clocks or Refreshing Required
- Simple Memory Expansion: Chip Enable Input
- Powerful Output Drive Capability
- Low Power: Typically 150mW
- Three-State Output: OR-Tie Capability
- Output Disable Provided for Ease of Use in Common Data Bus Systems
- 8xxx equivalent to Intel 2111A Static RAM
- 18-pin Dual In-Line Package

Type	Access Time Max.	Cycle Time Max.	Power Dissipation Max. Operating/Standby	Supplies [V]
8111A-4	450ns	450ns	300mW	+5

The Intel® 8111A-4 is a 256 word by 4-bit static random access memory using N-channel MOS devices integrated on a monolithic array. It uses fully DC stable (static) circuitry and therefore requires no clocks or refreshing to operate. The data is read out nondestructively and has the same polarity as the input data. Common input/output pins are provided.

The 8111A-4 is designed for memory applications in small systems where high performance, low cost, large bit storage, and simple interfacing are important design objectives.

It is directly TTL compatible in all respects: inputs, outputs, and a single +5V supply. Separate chip enable leads allow easy selection of an individual package when outputs are OR-tied.

The Intel® 8111A-4 is fabricated with N-channel silicon gate technology. This technology allows the design and production of high performance, easy-to-use MOS circuits and provides a higher functional density on a monolithic chip than either conventional MOS technology or P-channel silicon gate technology.

Intel's silicon gate technology also provides excellent protection against contamination. This permits the use of low cost plastic packaging [3].

All 8111A-4 Specifications are identical to the 2111A-4 specifications [4].

Intel i8111A

Part Numbers

Type C Packages

Part Number	Package Description	Values
C8111A-4	Type C package.	Ex. Rare \$50-\$200
C8111A-8	Type C purple ceramic package w/gold cap and gold pins.	Ex. Rare (1 Known) \$50-\$200

Type D Packages

Part Number	Package Description	Values
D8111A-4	Type D package	\$1.25-\$5

Type P Packages

Part Number	Package Description	Values
P8111A-4	Type P package. Suspect single source showing small quantity in stock.	Rare (Suspect) \$\$\$

References

- [1] Intel (1975). Intel Data Catalog, 8111 Data Sheet, p. 6-35. No reference to 8111A.
- [2] Intel (1976). Intel Data Catalog, 8111A-4 Preliminary Data Sheet, p. 8-63
- [3] Intel (1977). Intel Data Catalog, 8111A-4 Data Sheet, p. 10-95
- [4] Intel (1978). Intel Component Data Catalog, 2111A/8114A-4 Data Sheet, p. 3-85

Intel i8155

2048-bit (256 x 8) Static RAM w/I/O Ports and Timer, CE Active Low

1977

Specifications

- 2048-bit (256 x 8) Static RAM with I/O Ports and Timer, CE Active Low
- NMOS
- Single +5V Power Supply
- Completely Static Operation
- Internal Address Latch
- 2 Programmable 8-bit I/O ports
- 1 Programmable 6-bit I/O port
- Programmable 14-bit Binary Counter/Timer
- Compatible with 8085AH, 8085A and 8088 CPU
- Multiplexed Address and Data Bus
- 40-pin Dual In-Line Package

Type	Access Time Max.	Cycle Time Max.	Power Dissipation Max. Operating/Standby	Supplies [V]
8155	400ns	-	-	+5
8155-2	330ns	-	-	+5



The 8155 and 8156 are RAM and I/O chips to be used in the 8085A and 8088 microprocessor systems. The RAM portion is designed with 2048 static cells organized as 256 x 8. They have a maximum access time of 400ns to permit use with no wait states in the 8085A CPU. The 8155-2 and 8156-2 have maximum access times of 330ns for use with the 8085A-2 and the full speed 5 MHz 8088 CPU.

The I/O portion consists of three general-purpose I/O ports. One of the three ports can be programmed to be status pins, thus allowing the other two ports to operate in handshake mode.

A 14-bit programmable counter/timer is also included on chip to provide either a square wave or terminal count pulse for the CPU system depending on timer mode [2].

Part Numbers

Type C Packages

Part Number	Package Description	Values
		
C8155	1. Type C purple ceramic package w/black cap, and tin pins.	\$20-\$80
		
C8155	2. Type C purple ceramic package w/black cap, and tin pins. © Intel '77.	\$20-\$80
C8155-2	Type C package	Rare \$40-\$160

Type D Packages

Part Number	Package Description	Values
D8155	Type D grey ceramic package w/tin pins. © Intel '77.	\$1.25-\$5
D8155-2	Type D package	\$2.50-\$10
ID8155	Type D grey ceramic package w/tin pins. © Intel '77.	\$2-\$8
LD8155	Type D package	\$2.50-\$10
MD8155	Type D package	\$2.50-\$10
		
MD8155/B	Type D grey ceramic package w/tin pins. © Intel '77	\$2.50-\$10

Intel i8155

QD8155	Type D package	\$2.50-\$10
TD8155	Type D package	\$2-\$8

Type P Packages

Part Number	Package Description	Values
		
P8155	Type P black plastic package w/tin pins. Rectangular key. © Intel '77	\$1.25-\$5
P8155-2	Type P package	\$2.50-\$10

References

[1] Intel (1977). Intel Data Catalog, 8155 Preliminary Data Sheet, p. 10-63

[2] Intel (1980). Intel Component Data Catalog, 8155/8156/8155-2/8156-2 Data Sheet, p. 6-25

Intel i8155H

2048-bit (256 x 8) Static RAM w/I/O Ports and Timer, CE Active Low

1982

Specifications

- 2048-bit (256 x 8) Static RAM with I/O Ports and Timer, CE Active Low
- HMOS
- Single +5V Power Supply with 10% Voltage Margins
- 30% Lower Power Consumption than the 8155 and 8156
- 100% Compatible with 8155 and 8156
- Completely Static Operation
- Internal Address Latch
- 2 Programmable 8-bit I/O ports
- 1 Programmable 6-bit I/O port
- Programmable 14-bit Binary Counter/Timer
- Compatible with 8085AH, 8085A and 8088 CPU
- Multiplexed Address and Data Bus
- 40-pin Dual In-Line Package

Type	Access Time Max.	Cycle Time Max.	Power Dissipation Max. Operating/Standby	Supplies [V]
8155H	400ns	-	-	+5
8155H-2	330ns	-	-	+5

The Intel® 8155H and 8156H are RAM and I/O chips implemented in N-Channel, depletion load, silicon gate technology (HMOS), to be used in the 8085AH and 8088 microprocessor systems. The RAM portion is designed with 2048 static cells organized as 256 x 8. They have a maximum access time of 400 ns to permit use with no wait states in 8085AH CPU. The 8155H-2 and 8156H-2 have maximum access times of 330 ns for use with 8085AH-2 and the 5 MHz 8088 CPU.

The I/O portion consists of three general-purpose I/O ports. Once of the three ports can be programmed to be status pins, thus allowing the other ports to operate in handshake mode.

A 14-bit programmable counter/timer is also included on chip to provide either a square wave or terminal count pulse for the CPU system depending on timer mode [5].

Intel i8155H

Part Numbers

Type D Packages

Part Number	Package Description	Values
		
D8155H	1. Type D grey ceramic package w/tin pins. © Intel '77 '80	\$1.25-\$5
		
D8155H	2. Type D grey ceramic package w/tin pins. © Intel '80	\$1.25-\$5
D8155H-2	Type D package	\$1.25-\$5
ID8155H	Type D package	\$2.50-\$10
ID8155H-2	Type D package	\$2.50-\$10
LD8155H	Type D package	\$1.25-\$5
MD8155H	Type D package	\$1.50-\$6
MD8155H/B	Type D grey ceramic package w/tin pins. Small triangle over Intel logo. © Intel '77 '80.	\$1.50-\$6
MD8155H/BC	Type D package.	\$1.50-\$6
QD8155H	Type D package	\$2-\$8
QD8155H-2	Type D package	\$2-\$8
QM8155HD1	Type D grey ceramic package w/tin pins. © Intel '80.	\$2-\$8
QM8155H2D1	Type D package	Rare \$10-\$40

Intel i8155H

 <p style="text-align: center;">TD8155H K050789 INTEL © © 1977</p>		
TD8155H	Type D grey ceramic package w/tin pins. © Intel 1977	\$1.25-\$5
TD8155H-2	Type D package	\$1.50-\$6

Type P Packages

Part Number	Package Description	Values
 <p style="text-align: center;">P8155H L3377440 © INTEL '80</p>		
P8155H	1. Type P black plastic package w/tin pins. Rectangular key. © Intel '80	\$1.25-\$5
P8155H	2. Type P black plastic package w/tin pins. Half-round key. © Intel '80.	\$1.25-\$5
P8155H-2	Type P black plastic package w/tin pins. Rectangular key. © Intel '80.	\$1.25-\$5
 <p style="text-align: center;">QP8155H K052839 INTEL © © 1977</p>		
QP8155H	1. Type P black plastic package w/tin pins. Modified half-round. © Intel '1977	\$1.50-\$6
QP8155H	2. Type P black plastic package w/tin pins. Half-round key. © Intel '80.	\$1.50-\$6
QP8155H-2	Type P package	\$2-\$8

References

- [1] Intel (1980). Intel Component Data Catalog. 8155/8156/8155-2/8156-2 Data Sheet, p. 6-25. No reference to 8155H dates chip after 1980.
- [2] Hearst (1981). IC Master. Intel 8155/8156, p. 555. No reference to Intel 8155H dates chip after 1981.
- [3] Intel (January 1982). Intel Component Data Catalog, 8155H/8156H/8155H-2/8156H-2 Data Sheet, p. 7-30
- [4] Hearst (1983). IC Master. Intel 8155H/8156H, p. 1093.
- [5] Intel (1984). Intel Microsystem Components Handbook, 8155H/8156H/8155H-2/8156H-2 Data Sheet, p. 2-30

Intel i8156

2048-bit (256 x 8) Static RAM w/I/O Ports and Timer, CE Active High

1977

Specifications

- 2048-bit (256 x 8) Static RAM w/I/O Ports and Timer, CE Active High
- NMOS
- Single +5V Power Supply
- Completely Static Operation
- Internal Address Latch
- 2 Programmable 8-bit I/O ports
- 1 Programmable 6-bit I/O port
- Programmable 14-bit Binary Counter/Timer
- Compatible with 8085AH, 8085A and 8088 CPU
- Multiplexed Address and Data Bus
- 40-pin Dual In-Line Package

Type	Access Time Max.	Cycle Time Max.	Power Dissipation Max. Operating/Standby	Supplies [V]
8156	400ns	-	-	+5
8156-2	330ns	-	-	+5

The 8155 and 8156 are RAM and I/O chips to be used in the 8085A and 8088 microprocessor systems. The RAM portion is designed with 2048 static cells organized as 256 x 8. They have a maximum access time of 400ns to permit use with no wait states in the 8085A CPU. The 8155-2 and 8156-2 have maximum access times of 330ns for use with the 8085A-2 and the full speed 5 MHz 8088 CPU.



The I/O portion consists of three general-purpose I/O ports. One of the three ports can be programmed to be status pins, thus allowing the other two ports to operate in handshake mode.

A 14-bit programmable counter/timer is also included on chip to provide either a square wave or terminal count pulse for the CPU system depending on timer mode [2].

Intel i8156

Part Numbers

Type C Packages

Part Number	Package Description	Values
		
C8156	1. Type C purple ceramic package w/black cap and tin pins. No copyright.	Ex. Rare (1 Known) \$50-\$200
		
C8156	2. Type C purple ceramic package w/black cap and tin pins. © Intel '77.	Ex. Rare (1 Known) \$50-\$200
C8156-2	Type C package	Ex. Rare (0 Known) \$50-\$200

Type D Packages

Part Number	Package Description	Values
D8156	Type D grey ceramic package w/tin pins. © Intel '77.	\$1.25-\$5
D8156-2	Type D package	Ex. Rare (0 Known) \$20-\$80
ID8156	Type D package	Ex. Rare (0 Known) \$\$\$

Intel i8156

Type P Packages

 A black rectangular integrated circuit chip with a rectangular notch on the left side. The top surface is marked with the text: P8156, 0609D, and INTEL '77. The chip has numerous pins along its edges.		
P8156	Type P black plastic package w/tin pins. Rectangular key. © Intel '77	\$1.25-\$5
P8156-2	Type P package	Rare \$10-\$40

References

- [1] Intel (1978). Intel Component Data Catalog, 8155/8156 Data Sheet, p. 11-63
- [2] Intel (1980). Intel Component Data Catalog, 8155/8156/8155-2/8156-2 Data Sheet, p. 6-25

Intel i8156H

2048-bit (256 x 8) Static RAM w/I/O Ports and Timer, CE Active High

1982

Specifications

- 2048-bit (256 x 8) Static RAM with I/O Ports and Timer, CE Active High
- HMOS
- Single +5V Power Supply with 10% Voltage Margins
- 30% Lower Power Consumption than the 8155 and 8156
- 100% Compatible with 8155 and 8156
- Completely Static Operation
- Internal Address Latch
- 2 Programmable 8-bit I/O ports
- 1 Programmable 6-bit I/O port
- Programmable 14-bit Binary Counter/Timer
- Compatible with 8085AH, 8085A and 8088 CPU
- Multiplexed Address and Data Bus
- 40-pin Dual In-Line Package

Type	Access Time Max.	Cycle Time Max.	Power Dissipation Max. Operating/Standby	Supplies [V]
8156H	400ns	-	-	+5
8156H-2	330ns	-	-	+5

The Intel® 8155H and 8156H are RAM and I/O chips implemented in N-Channel, depletion load, silicon gate technology (HMOS), to be used in the 8085AH and 8088 microprocessor systems. The RAM portion is designed with 2048 static cells organized as 256 x 8. They have a maximum access time of 400 ns to permit use with no wait states in 8085AH CPU. The 8155H-2 and 8156H-2 have maximum access times of 330 ns for use with 8085AH-2 and the 5 MHz 8088 CPU.

The I/O portion consists of three general-purpose I/O ports. Once of the three ports can be programmed to be status pins, thus allowing the other ports to operate in handshake mode.

A 14-bit programmable counter/timer is also included on chip to provide either a square wave or terminal count pulse for the CPU system depending on timer mode [5].

Intel i8156H

Part Numbers

Type D Packages

Part Number	Package Description	Values
D8156H	Type D package	\$1.25-\$5
D8156H-2	Type D package	\$2.50-\$10
ID8156H	Type D package	Ex. Rare (0 Known) \$\$\$
ID8156H-2	Type D package	Rare \$10-\$40
LD8156H	Type D package	\$2.50-\$10
QD8156H	Type D package	\$2.50-\$10
QD8156H-2	Type D package	\$5-\$20

Type P Packages

Part Number	Package Description	Values
		
P8156H	Type P package	\$1.25-\$5
P8156H-2	Type P package	\$1.50-\$6
QP8156H	Type P package	\$5-\$20

References

- [1] Intel (1980). Intel Component Data Catalog, 8155/8156/8155-2/8156-2 Data Sheet, p. 6-25. No reference to 8155H dates chip after 1980.
- [2] Hearst (1981). IC Master. Intel 8155/8156, p. 555. No reference to Intel 8156H dates chip after 1981.
- [3] Intel (January 1982). Intel Component Data Catalog, 8155H/8156H/8155H-2/8156H-2 Data Sheet, p. 7-30
- [4] Hearst (1983). IC Master. Intel 8155H/8156H, p. 1093.
- [5] Intel (1984). Intel Microsystem Components Handbook, 8155H/8156H/8155H-2/8156H-2 Data Sheet, p. 2-30

Intel i8185

8192-bit (1024 x 8) Static RAM for MCS-85™

1978-79

Specifications

- 8192-bit (1024 x 8) Static RAM for MCS-85™
- NMOS
- Multiplexed Address and Data Bus
- Directly Compatible with 8085A and 8088 Microprocessors
- Low Operating Power Dissipation
- Low Standby Power Dissipation
- Single +5V Supply
- 18-pin Dual In-Line Package

Type	Access Time Max.	Cycle Time Max.	Power Dissipation Max. Operating/Standby	Supplies [V]
8185	-	-	-	+5
8185-2	-	-	-	+5

The Intel® 8185 is an 8192-bit static random access memory (RAM) organized as 1024 words by 8-bits using N-channel Silicon-Gate MOS technology. The multiplexed address and data bus allows the 8185 to interface directly to the 8085A and 8088 microprocessors to provide a maximum level of system integration.

The low standby power dissipation minimizes system power requirements when the 8185 is disabled.

The 8185-2 is a high-speed selected version of the 8185 that is compatible with the 5 MHz 8085A-2 and the full speed 5 MHz 8088 [4].

Part Numbers

Type C Packages

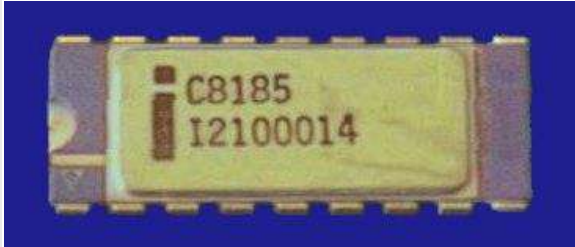
Part Number	Package Description	Values
		
C8185	1. Type C purple ceramic package w/gold cap, offset gold cap ground strap, and gold pins. Small black square denotes pin #1.	\$15-\$60
		
C8185	2. Type C purple ceramic package w/gold cap, offset gold cap ground strap, and gold pins. Small triangle denotes pin #1.	\$15-\$60
		
C8185-2	1. Type C purple ceramic package w/gold cap, offset gold cap ground strap, and gold pins. Small black square denotes pin #1.	\$15-\$60
		
C8185-2	2. Type C purple ceramic package w/gold cap, offset gold cap ground strap, and gold pins. Small triangle denotes pin #1.	\$15-\$60
IC8185	Type C package	Ex. Rare (0 Known) \$\$\$

Intel i8185



MC8185/B	Type C purple ceramic package w/gold cap, offset gold cap ground strap, and gold pins. Small triangle denotes pin #1.	Rare \$25-\$100
----------	---	--------------------

Type D Packages

Part Number	Package Description	Values
D8185	Type C package	Ex. Rare (0 Known) \$\$\$
MD8185/B	Type D package	Rare \$10-\$40

Type P Packages

Part Number	Package Description	Values
P8185	Type P black plastic package w/tin pins.	\$1.25-\$5
P8185-2	Type P black plastic package w/tin pins.	\$1.25-\$5
QP8185	Type P package	Rare \$10-\$40

References

- [1] Intel (1977). Intel Data Catalog. No reference to 8185 dates chip after 1977.
- [2] Intel (January 1978). Preliminary MCS-85™ User's Manual. No reference to 8185 dates chip after January 1978.
- [3] Intel (1979). Intel Component Data Catalog, 8185/8185-2 Preliminary Data Sheet, p. 9-77
- [4] Intel (1980). Intel Component Data Catalog, 8185/8185-2 Data Sheet, p. 6-40

Intel i8202

Dynamic RAM Controller

1978

Specifications

- Dynamic RAM Controller
- Provides all Signals Necessary to Control 2117 or 2118 Dynamic Memories
- Directly addresses and drives up to 128K bytes Without External Drivers
- Provides Address Multiplexing and Strobes
- Provides a Refresh Timer and a Refresh Counter
- Refresh Cycles May be Internally or Externally Requested
- Provides Transparent Refresh Capability
- Fully compatible with Intel® 8080A, 8085A, and 8086 Microprocessors
- Decodes 8085A Status for Advanced Read Capability
- Provides System Acknowledge and Transparent Acknowledge signals
- Internal or External Clock Capability
- 40-pin Dual In-Line Package

The 8202 is a Dynamic RAM System Controller designed to provide all signals necessary to use 2104A, 2117, or 2118 Dynamic RAMs in microcomputer systems. The 8202 provides multiplexed addresses and address strobes, as well as refresh/access arbitration. Refresh cycles can be started internally or externally [2].

History

Intel's 8202 was introduced with the 8086 Family and required since designing discrete Dynamic Memory Controllers was a special talent/skill set, SRAM took up much more board space versus DRAM and the increased memory addressing capability over the MCS 80/85 parts. The non-A part would be quickly replaced, then the 8203 and 8207 followed in '81 to keep up with advances in memory chips.

Intel i8202

Part Numbers

Type D Packages

Part Number	Package Description	Values
		
D8202	Type D grey ceramic package w/tin pins. © Intel '78.	\$1.25-\$5
D8202-2	Type D package. Single source shows 10 in stock.	Rare (Suspect) \$\$\$
D8202-3	Type D package	\$2.50-\$10
D8202-6	Type D package	\$1.25-\$5

Type P Packages

Part Number	Package Description	Values
P8202	Type P package	\$1.25-\$5

References

- [1] Hearst (1979). IC Master, Intel 8202 Preliminary Data Sheet, p. 1938
- [2] Intel (1980). Intel Component Data Catalog, 8202 Preliminary Data Sheet, p. 8-11
- [3] Intel (1984). A Revolution in Progress... A History of Intel to Date, 8202 introduced 1978, p. 26.

Intel i8202A

Dynamic RAM Controller

1981-82

Specifications

- Dynamic RAM Controller
- Provides All Signals Necessary to Control 2117 or 2118 Dynamic Memories
- Directly Addresses and Drives up to 64K bytes Without External Drivers
- Provides Address Multiplexing and Strokes
- Provides a Refresh Timer and a Refresh Counter
- Refresh Cycles May be Internally or Externally Requested
- Provides Transparent Refresh Capability
- Fully Compatible with Intel® 8080A, 8085A, iAPX 88 and iAPX 86 Family Microprocessors
- Decodes CPU status for Advanced Read Capability with the 8202A-1 or 8202A-3
- Provides System Acknowledge and Transparent Acknowledge Signals
- Internal clock capability with the 8202A-1 or 8202A-3
- 40-pin Dual In-Line Package

The Intel® 8202A is a Dynamic Ram System Controller designed to provide all signals necessary to use 2117 or 2118 Dynamic RAMs in microcomputer systems. The 8202A provides multiplexed addresses and address strokes, as well as refresh/access arbitration. The 8202A-1 or 8202A-3 support an internal crystal oscillator [3].

Intel i8202A

Part Numbers

Type D Packages

Part Number	Package Description	Values
D8202A	Type D grey ceramic package w/tin pins. © Intel '80.	\$.75-\$3
		
D8202A-1	Type D grey ceramic package w/pins tins. © Intel '81	\$1-\$4
D8202A-3	Type D package	\$1-\$4
D8202A-6	Type D package. Single source shows 2 in stock	Rare (Suspect) \$\$\$

References

[1] Intel (1980). Intel Component Data Catalog, 8202 Preliminary Data Sheet, p. 8-11. No reference to 8202A.

[2] Hearst (1981). IC Master, Intel 8202, p. 557-42. No reference to Intel 8202A.

[3] Intel (January 1982). Intel Component Data Catalog, 8202A Preliminary Data Sheet, p. 9-69

[4] Intel (1983). Intel Microprocessor and Peripheral Handbook, Preliminary 8202A Data Sheet, p. 6-26

Intel i8205

High Speed 1 out of 8 Binary Decoder

1973-74

Specifications

- High Speed 1-of-8 Binary Decoder
- I/O Port or Memory Expander
- High Speed Schottky Bipolar Technology - 18ns Max. Delay
- Directly Compatible with TTL Logic Circuits
- Low Input Load Current - .25 mA Max., 1/6 Standard TTL Input Load
- Minimum Line Reflection – Low Voltage Diode Input Clamp
- Outputs Sink 10 mA Min.
- Single +5V Supply
- 8xxx Equivalent of Intel 3205
- 16-pin Dual In-Line Package

Type	Input to Output Delay Max.	Power Dissipation Max.	Supplies [V]
8205	18ns	-	+5

The 8205 decoder can be used for expansion of systems, which utilize input ports, output ports, and memory components with active low chip select input. When the 8205 is enabled, one of its eight outputs goes “low”, thus a single row of a memory system is selected. The 3 chip enable inputs on the 8205 allow easy system expansion. For very large systems, 8205 decoders can be cascaded such that each decoder can drive eight other decoders for arbitrary memory expansions.

The Intel® 8205 is packaged in a standard 16-pin dual-in-line package; and its performance is specified over the temperature range of 0°C to +75°C, ambient. The use of Schottky barrier diode clamped transistors to obtain fast switching speeds results in higher performance than equivalent devices made with gold diffusion process [2].

History

Other applications of the 8205 included that of a “state decoder” in an 8008-based system.

Part Numbers

Type C Packages

Part Number	Package Description	Values
		
C8205	Type C white ceramic package w/grey traces, gold cap, gold cap ground strap, and gold pins. Gold dot denotes pin #1.	Rare \$20-\$80

Type D Packages

Part Number	Package Description	Values
D8205	Type D package	\$1.50-\$6

Type P Packages

Part Number	Package Description	Values
		
P8205	Type P grey plastic package w/tin pins.	\$2.50-\$10

References

[1] Intel (1974). Intel Advertisement, "From CPU to Software The 8080 Microcomputer is here". Lists availability date for 8205 as "NOW".

[2] Intel (September 1975). Intel MCS-80 User's Manual, 8205 Data Sheet, p. 5-147

Intel i8210

Quad MOS Driver and Clock driver for 8107 DRAM

1974

Specifications

- Quad MOS Driver and Clock Driver for 8107 DRAM
- Bipolar
- Four Low Voltage Drivers
- One High Voltage Driver
- TTL and DTL Compatible Inputs
- Outputs Compatible with 8107A MOS Memories
- Operates from Standard Bipolar and MOS Power Supplies
- Maximum MOS Device Protection – Output Clamp Diodes
- 8xxx Equivalent of Intel 3210
- 18-pin Dual In-Line Package

The Intel® 8210 is a Bipolar-to-MOS level shifter and high voltage driver which accepts TTL and DTL inputs. It contains four (4) low voltage drivers and one high voltage driver, each with current driving capabilities suitable for driving N-channel MOS memory devices. The 8210 operates from the 5 volt and 12 volt power supplies used to bias the memory devices.

The four low voltage drivers feature two common enable inputs per pair of drivers, which permits address or data encoding. The high voltage driver swings the 12 volts required to drive the chip enable (clock) input for the 8107A.

The 8210 high voltage driver requires an externally connected PNP transistor. The PNP base is connected to pin 12, the collector to pin 11, and the emitter to pin 10. The use of fast switching, high voltage, high current gain PNP, like the 2N5057 is recommended [3].

Part Numbers

Type C Packages

Part Number	Package Description	Values
C8210	Type C package	Rare \$20-\$80

Type D Packages

Part Number	Package Description	Values
D8210	Type D package	Rare \$10-\$40

References

[1] Intel (1974). Intel Advertisement, "From CPU to Software The 8080 Microcomputer is here". Lists availability date for 8210 as "NOW".

[2] Intel (1974). From CPU to Software, 8210 Preliminary Data Sheet, p. 39

[3] Intel (September 1975). Intel MCS-80 User's Manual, 8210 Data Sheet, p. 5-95

Intel i8212

8-bit Input/Output Port

1974

Specifications



- 8-bit Input/Output Port
- Bipolar
- Fully Parallel 8-Bit Data Register and Buffer
- Service Request Flip-Flop for Interrupt Generation
- Three-State Outputs
- Outputs Sink 15mA
- 3.65V Output High Voltage for Direct Interface to 8080 CPU or 8008 CPU
- Asynchronous Register Clear
- Replaces Buffers, Latches and Multiplexers in Microcomputer Systems
- Reduces System Package Count
- 8xxx equivalent of Intel 3212
- 24-pin Dual In-Line Package

The 8212 input/output port consists of an 8-bit latch with 3-state output buffers along with control and device selection logic. Also included is a service request flip-flop for the generation and control of interrupts to the microprocessor.

The 8212 is multimode in nature. It can be used to implement latches, gated buffers or multiplexers. Thus, all of the principal peripheral and input/output functions of a microcomputer system can be implemented with this device [3].

Part Numbers

Type D Packages

Part Number	Package Description	Values
		
D8212	1. Type D grey ceramic package w/tin pins. No copyright. Example shown marked 'CS' for Customer Sample.	\$.75-\$3
		
D8212	2. Type D grey ceramic package w/tin pins. © Intel '74.	\$.75-\$3
ID8212	Type D grey ceramic package w/tin pins. © Intel '74.	\$1.25-\$5
LD8212	Type D package	\$1.25-\$5
MD8212	Type D package	\$2-\$8
MD8212/B	Type D grey ceramic package w/tin pins. © Intel '74.	\$2-\$8
QD8212	Type D package	\$1.25-\$5

Type P Packages

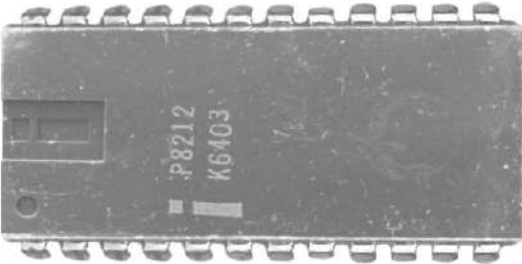
Part Number	Package Description	Values
		
P8212	1. Type P grey plastic package w/tin pins. Intel 'i' embossed in key. No copyright.	\$5-\$20

Intel i8212

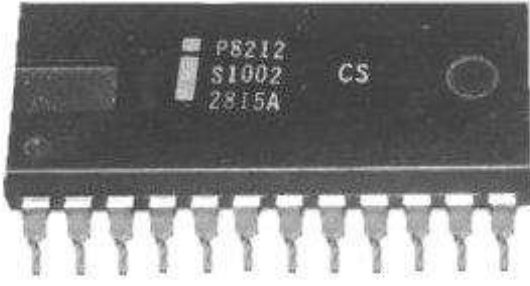
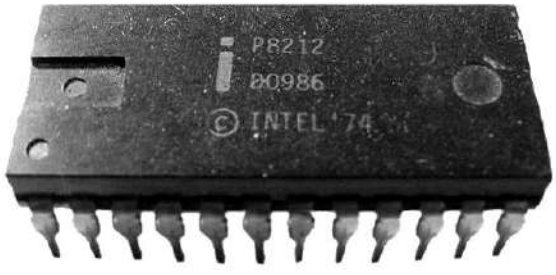
		
P8212	2. Type P grey plastic package w/tin pins. No copyright.	\$2.50-\$10
		
P8212	3. Type P black plastic package w/tin pins. No copyright. Example shown marked 'CS' for Customer Sample.	\$1.25-\$5
		
P8212	4. Type P black plastic package w/tin pins. © Intel '74	\$1.25-\$5
QP8212	Type P package	\$2.50-\$10

References

- [1] Intel (1974). Intel Advertisement, "From CPU to Software The 8080 Microcomputer is here". Lists availability date for 8212 as "NOW".
- [2] Intel (1974). From CPU to Software, 8212 Preliminary Data Sheet, p. 40
- [3] Intel (September 1975). Intel MCS-80 User's Manual, 8212 Data Sheet, p. 5-101.
- [4] Intel (1977). Intel Memory Design Handbook, MD8212 listed as member of Intel Military Product Family, p. PSG-5.
- [5] Intel (1984). A Revolution in Progress... A History of Intel to Date, 8/3212 introduced 1974, p. 26.

Intel i8214

Priority Interrupt Control Unit (PICU)

1974

Specifications

- Priority Interrupt Control Unit (PICU)
- Bipolar
- Eight Priority Levels
- Current Status Register
- Priority Comparator
- Fully Expandable
- High Performance (50ns)
- +5V Supply Voltage
- 8xxx equivalent of Intel 3214
- 24-pin Dual In-Line Package

Type	Input to Output Delay Max.	Power Dissipation Max.	Supplies [V]
8214	50ns	-	+5

The 8214 is an eight level priority interrupt control unit designed to simplify interrupt driven microcomputer systems.

The PICU can accept eight registering levels; determine the highest priority, compare this priority to a software controlled current status register and issue an interrupt to the system along with vector information to identify the service routine.

The 8214 is fully expandable by the use of open collector interrupt output and vector information. Control signals are also provided to simplify this function.



The PICU is designed to support a wide variety of vectored interrupt structures and reduce package count in interrupt driven microcomputer systems [1].

Part Numbers

Type C Packages

Part Number	Package Description	Values
		
C8214	Type C white ceramic package w/gold cap, gold cap ground strap, and gold pins. Black dot denotes pin #1.	Rare \$25-\$100

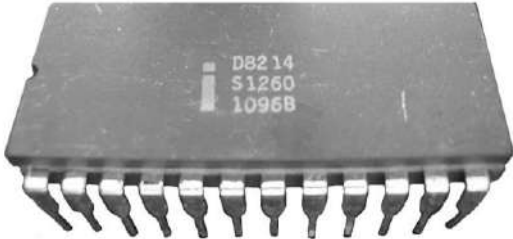
Type D Packages

Part Number	Package Description	Values
		
D8214	1. Type D grey ceramic package w/tin pins. No copyright.	\$.75-\$3
		
D8214	2. Type D grey ceramic package w/tin pins. © Intel '74	\$.75-\$3
LD8214	Type D package	\$2.50-\$10

Intel i8214

MD8214	Type D package	\$2.50-\$10
 <p>The image shows a black, rectangular integrated circuit (IC) package. The top surface is marked with the following text: 'MD8214/B', '8019', '0830T', and 'INTEL '74' with a copyright symbol. The package has a notch on the left side and a row of pins along the bottom edge.</p>		
MD8214/B	Type D grey ceramic package w/tin pins. © Intel '74	\$2-\$8
QD8214	Type D package	\$2.50-\$10

Type P Packages

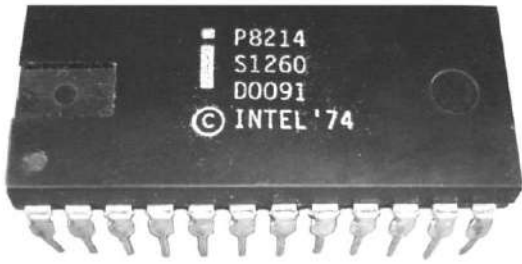
Part Number	Package Description	Values
 <p>The image shows a black, rectangular integrated circuit (IC) package. The top surface is marked with the following text: 'P8214', 'S1260', 'D0091', and 'INTEL '74' with a copyright symbol. The package has a notch on the left side and a row of pins along the bottom edge.</p>		
P8214	Type P black plastic package w/tin pins. © Intel '74.	\$.75-\$3

References

- [1] Intel (September 1975). Intel MCS-80 User's Manual, 8214 Data Sheet, p. 5-153
- [2] Intel (1977). Intel Memory Design Handbook, MD8214 listed as member of Intel Military Product Family, p. PSG-5.
- [3] Intel (1984). A Revolution in Progress... A History of Intel to Date, 8/3214 introduced 1974, p. 26.

Intel i8216

4-bit Non-Inverting Parallel Bi-Directional BUS Driver

3rd Qtr 1974

Specifications

- 4-bit Non-Inverting Parallel Bi-Directional BUS Driver
- Bipolar
- Data Bus Buffer Driver for 8080 CPU
- Low Input Load Current - .25 mA Maximum
- High Output Drive Capability for Driving System Data Bus
- 3.65V Output High Voltage for Direct Interface to 8080 CPU
- Three-State Outputs
- Reduces System package Count
- 8xxx equivalent of Intel 3216
- 16-pin Dual In-Line Package

The 8216/8226 is a 4-bit bi-directional bus driver/receiver

All inputs are low power TTL compatible. For driving MOS, the data outputs provide a high 3.65V, and for high capacitance terminated bus structures, the data bus outputs provide a high 50mA capability.

A non-inverting (8216) and inverting (8226) are available to meet a wide variety of applications for buffering in microcomputer systems [3].

Part Numbers

Type D Packages

Part Number	Package Description	Values
		
D8216	Type D grey ceramic package w/tin pins. Example shown dated Malaysia 7506.	\$.75-\$3
ID8216	Type D package	\$2.50-\$10
LD8216	Type D package	\$2.50-\$10
MD8216	Type D grey ceramic package w/tin pins.	\$2.50-\$10
MD8216/B	Type D grey ceramic package w/tin pins.	\$2-\$8
QD8216	Type D package	\$2.50-\$10

Type P Packages

Part Number	Package Description	Values
		
P8216	1. Type P grey plastic package w/tin pins.	\$1.25-\$5
		
P8216	2. Type P black plastic package w/tin pins	.75-\$3
QP8216	Type P package	\$5-\$20

References

- [1] Intel (1974). Intel Advertisement, “From CPU to Software The 8080 Microcomputer is here”, Lists availability date for 8216 as “3rd Qtr”.
- [2] Intel (1974). From CPU to Software, 8216 Preliminary Data Sheet, p. 41
- [3] Intel (September 1975). Intel MCS-80 User’s Manual, 8216/8226 Data Sheet, p. 5-163
- [4] Intel (1977). Intel Memory Design Handbook, MD8216 listed as member of Intel Military Product Family, p. PSG-5.
- [5] Intel (1984). A Revolution in Progress... A History of Intel to Date, 8/3216 introduced 1974, p. 26.

Intel i8218

Bipolar Microcomputer Bus Controller for MCS-80™

1979

Specifications

- Bipolar Microcomputer Bus Controller for MCS-80™
- Bipolar
- 8218 for use in MCS-80 systems
- 8219 for use in MCS-85 systems
- Coordinates the Sharing of a Common Bus Between Several CPU's
- Reduces Component Count in Multimaster Bus Arbitration Logic
- Single +5V Power Supply
- 28-pin Dual In-Line Package

The 8218 and 8219 Microcomputer Bus Controllers consist of control logic, which allows a bus master device such as a CPU or DMA channel to interface with other masters on a common bus, sharing memory and I/O devices. The 8218 and 8219 consist of:

1. Bus Arbitration Logic, which operates from the Bus Clock and resolves bus contention between devices sharing a common bus.
2. Timing Logic, which when initiated by the bus arbitration logic generates timing signals for the memory and I/O command lines to guarantee set-up and hold times of the address/data lines onto the bus. The timing logic also signals to the bus arbitration logic when the current data transfer is completed and the bus is no longer needed.
3. Output Drive Logic, which contains the logic and output drivers for the memory and I/O command lines.

An external RC time constant is used with the timing logic to generate the guaranteed address set-up and hold times on the bus. The 8219 can interface directly to the 8085A CPU and the 8218 interfaces to the 8080A CPU chip and the 8257 DMA controller [3].

Intel i8218

Part Numbers

Type D Packages

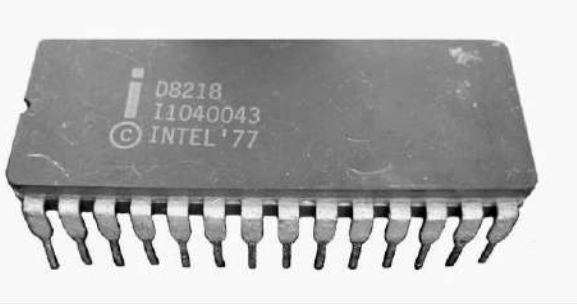
Part Number	Package Description	Values
		
D8218	Type D grey ceramic package w/tin pins. © Intel '77.	\$.75-\$3

References

- [1] Intel (1978). Intel Component Data Catalog. No reference to 8218 dates chip after 1978.
- [2] Intel (1979). Intel Component Data Catalog, 8218/8219 Preliminary Data Sheet, p. 9-81
- [3] Intel (1980). Intel Component Data Catalog, 8218/8219 Data Sheet, p. 6-66

Intel i8219

Bipolar Microcomputer Bus Controller for MCS-85™

1979

Specifications

- Bipolar Microcomputer Bus Controller for MCS-85™
- Bipolar
- 8218 for use in MCS-80 systems
- 8219 for use in MCS-85 systems
- Coordinates the Sharing of a Common Bus Between Several CPU's
- Reduces Component Count in Multimaster Bus Arbitration Logic
- Single +5V Power Supply
- 28-pin Dual In-Line Package

The 8218 and 8219 Microcomputer Bus Controllers consist of control logic, which allows a bus master device such as a CPU or DMA channel to interface with other masters on a common bus, sharing memory and I/O devices. The 8218 and 8219 consist of:

1. Bus Arbitration Logic, which operates from the Bus Clock and resolves bus contention between devices sharing a common bus.
2. Timing Logic, which when initiated by the bus arbitration logic generates timing signals for the memory and I/O command lines to guarantee set-up and hold times of the address/data lines onto the bus. The timing logic also signals to the bus arbitration logic when the current data transfer is completed and the bus is no longer needed.
3. Output Drive Logic, which contains the logic and output drivers for the memory and I/O command lines.

An external RC time constant is used with the timing logic to generate the guaranteed address set-up and hold times on the bus. The 8219 can interface directly to the 8085A CPU and the 8218 interfaces to the 8080A CPU chip and the 8257 DMA controller [3].

Intel i8219

Part Numbers

Type D Packages

Part Number	Package Description	Values
		
D8219	Type D grey ceramic package w/tin pins. © Intel '77	\$.75-\$3
MD8219	Type D package	\$5-\$20
MD8219/B	Type D package	\$2.50-\$10

References

- [1] Intel (1978). Intel Component Data Catalog. No reference to 8218 dates chip after 1978.
- [2] Intel (1979). Intel Component Data Catalog, 8218/8219 Preliminary Data Sheet, p. 9-81
- [3] Intel (1980). Intel Component Data Catalog, 8218/8219 Data Sheet, p. 6-66.

Intel i8222

Refresh Controller for 4K DRAMs

1974-75

Specifications

- Refresh Controller for 4K Dynamic RAMs
- Bipolar
- Adjustable Refresh Request Oscillator
- Ideal for use in 2107A, 2107B, 8107A, 8107B Systems
- Internal Address Multiplexer
- Up to 6 Row Input Addresses (64 x 64 Organization)
- 8xxx equivalent of Intel 3222
- Single +5V Power Supply
- 22-pin Dual In-Line Package

The 8222 is a refresh controller for dynamic RAMs requiring row refresh of up to 6 row input addresses (or 4K bits for 64 x 64 organization). The device contains an accurate refresh timer (whose frequency can be set by an external resistor and capacitor) plus all necessary control and I/O circuitry to provide for the refresh requirements of dynamic RAMs. The chip's high performance makes it especially suitable for use with high speed N-channel RAMs like the 8107B. The 8222 is designed for large, asynchronously driven, dynamic memory systems [1].

Part Numbers

Type D Packages

Part Number	Package Description	Values
D8222	Type D package	\$1.25-\$5

References

- [1] Intel (September 1975). Intel MCS-80 User's Manual, 8222 Data Sheet, p. 5-99

Intel i8224

Single Chip Clock Generator/Driver for 8080A CPU

1974

Specifications

- Single Chip Clock Generator/Driver for 8080A CPU
- Bipolar
- Power-up Reset for CPU
- Ready Synchronizing Flip-Flop
- Advanced Status Strobe
- Oscillator Output for External System Timing
- Crystal Controlled for Stable System Operation
- Reduces System Package Count
- 16-pin Dual In-Line Package

The 8224 is a single chip clock generator/driver for the 8080A CPU. It is controlled by a crystal, selected by the designer, to meet a variety of system speed requirements.

Also included are circuits to provide power-up reset, advance status strobe and synchronization of ready.

The 8224 provides the designer with a significant reduction of packages used to generate clocks and timing for [the] 8080A [1].

Part Numbers

Type C Packages

Part Number	Package Description	Values
		
C8224	Type C white ceramic package w/gold cap and gold pins. Small black dot denotes pin #1. Example shown marked 'ES' for Engineering Sample. Nothing printed on back of package.	Ex. Rare (1 Known) \$50-\$200

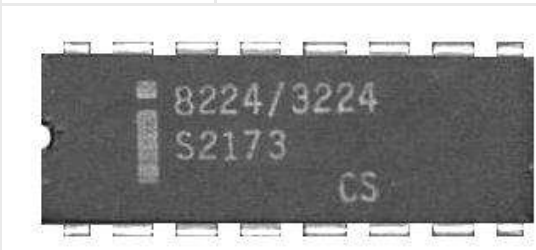
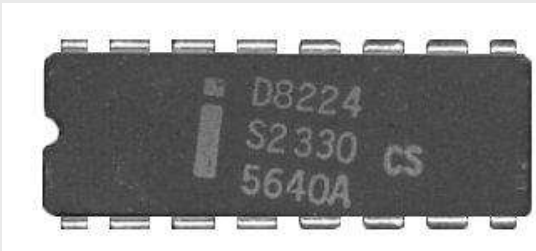

Type D Packages

Part Number	Package Description	Values
		
8224/3224	Type D grey ceramic package w/tin pins. Example shown marked 'CS' for Customer Sample	Rare \$15-\$60
		
D8224	Type D grey ceramic package w/tin pins. Example shown marked 'CS' for Customer Sample.	.75-\$3
MD8224	Type D package	\$2.50-\$10

Intel i8224

MD8224/B	1. Type D grey ceramic package w/tin pins. No copyright.	\$1.50-\$6
		
MD8224/B	2. Type D grey ceramic package w/tin pins. © Intel '74	\$1.50-\$6
MD8224/BC	Type D package	\$5-\$20
QD8224	Type D package	\$1.50-\$5

Type P Packages

Part Number	Package Description	Values
		
8224/3224	Type P black plastic package w/tin pins. Example shown marked 'CS' for Customer Sample	Rare \$15-\$60
		
P8224	Type P black plastic package w/tin pins.	\$1.25-\$5
QP8224	Type P package	\$5-\$20

References

- [1] Intel (September 1975). Intel MCS-80 User's Manual, 8224 Data Sheet, p. 5-1.
- [2] Intel (1977). Intel Memory Design Handbook, MD8224 listed as member of Intel Military Product Family, p. PSG-5.
- [3] Intel (1984). A Revolution in Progress... A History of Intel to Date, 8224 introduced 1973, p. 26.

Intel i8226

4-bit Inverting Parallel Bi-Directional BUS Driver

3rd Qtr 1974

Specifications

- 4-bit Inverting Parallel Bi-Directional BUS Driver
- Bipolar
- Data Bus Buffer Driver for 8080 CPU
- Low Input Load Current - .25 mA Maximum
- High Output Drive Capability for Driving System Data Bus
- 3.65V Output High Voltage for Direct Interface to 8080 CPU
- Three-State Outputs
- Reduces System package Count
- 8xxx equivalent of Intel 3226
- 16-pin Dual In-Line Package

The 8216/8226 is a 4-bit bi-directional bus driver/receiver

All inputs are low power TTL compatible. For driving MOS, the data outputs provide a high 3.65V, and for high capacitance terminated bus structures, the data bus outputs provide a high 50mA capability.



A non-inverting (8216) and inverting (8226) are available to meet a wide variety of applications for buffering in microcomputer systems [2].

Part Numbers

Type D Packages

Part Number	Package Description	Values
		
D8226	Type D grey ceramic package w/tin pins	\$.75-\$3
ID8226	Type D package.	Rare \$5-\$20
MD8226	Type D package	\$2.50-\$10
MD8226/B	Type D package	\$2-\$8
QD8226	Type D package	\$1.50-\$5

Type P Packages

Part Number	Package Description	Values
		
P8226	1. Type P grey plastic package w/tin pins. Small round indentation denotes pin #1.	\$1.25-\$5
		
P8226	2. Type P black plastic package w/tin pins. Small round indentation denotes pin #1.	\$.75-\$3
QP8226	Type P package.	Rare \$8-\$32

References

[1] Intel (1974). Intel Advertisement, “From CPU to Software The 8080 Microcomputer is here”. Ad lists availability date for 8216 as “3rd Qtr”.

[2] Intel (September 1975). Intel MCS-80 User’s Manual, 8216/8226 Data Sheet, p. 5-163

[3] Intel (1984). A Revolution in Progress... A History of Intel to Date, 8/3226 introduced 1974, p. 26.

Intel i8228

System Controller and Bus Driver for 8080A CPU

1975

Specifications

- System Controller and Bus Driver for 8080A CPU
- Bipolar
- Single Chip System Control for MCS-80 Systems
- Built-in Bi-Directional Bus Driver for Data Bus Isolation
- Allows the use of Multiple Byte Instructions (e.g. CALL) for Interrupt Acknowledge
- User Selected Single Level Interrupt Vector (RST 7)
- Reduces System Package Count
- 8238 Has Advanced IOW/MEMW for Large System Timing Control
- 28-pin Dual In-Line Package

The 8228 is a single chip system controller and bus driver for MCS-80. It generates all signals required to directly interface MCS-80 family RAM, ROM, and I/O Components.

A bi-directional bus driver is included to provide high system TTL fan-out. It also provides isolation of the 8080A data bus from memory and I/O. This allows for the optimization of control signals, enabling the systems designer to use slower memory and I/O. The isolation of the bus driver also provides for enhanced system noise immunity.

A user selected single level interrupt vector (RST 7) is provided to simplify real time, interrupt driven, small system requirements. The 8228 also generates the correct control signals to allow the use of multiple byte instructions (e.g. CALL) in response to an INTERRUPT ACKNOWLEDGE by the 8080A. This feature permits large, interrupt driven systems to have an unlimited number of interrupt levels.

The 8228 is designed to support a wide variety of system bus structures and also reduce system package count for cost effective, reliable, design of the MCS-80 systems.



Note: The specifications for the 3228/3238 are identical with those for the 8228/8238 [4].

Part Numbers

Type C Packages

Part Number	Package Description	Values
		
C8228	Type C white ceramic package w/gold cap, and integrated gold pins.	Ex. Rare \$50-\$200

Type D Packages

Part Number	Package Description	Values
		
D8228	1. Type D grey ceramic package w/tin pins. No Copyright.	\$2-\$8
		
D8228	2. Type D grey ceramic package w/tin pins. © Intel '75	\$1.25-\$5
D8228-8	Type D package	Rare \$10-\$40

Intel i8228

MD8228	Type D package	\$2.50-\$10
MD8228/B	Type D grey ceramic package w/tin pins. © Intel '75.	\$2-\$8
QD8228	Type D package	\$1.25-\$5

Type P Packages

Part Number	Package Description	Values
P8228	Type P package	\$.75-\$3
QP8228	Type P package	Rare \$10-\$40

References

- [1] Intel (September 1975). Intel MCS-80 User's Manual, 8228 Data Sheet, p. 5-7
- [2] Intel (1977). Intel Data Catalog, 8228/8238 Data Sheet, p. 10-43
- [3] Intel (1977). Intel Memory Design Handbook, MD8228 listed as member of Intel Military Product Family, p. PSG-5.
- [4] Intel (1980). Intel Component Data Catalog, 8228/8238 Data Sheet, p. 6-81

Intel i8231

Arithmetic Processing Unit

1980

Specifications

- Arithmetic Processing Unit
- NMOS
- Fixed Point Single and Double Precision (16/32-bit)
- Floating Point Single Precision (32-bit)
- Binary Data Formats
- Add, Subtract, Multiply, and Divide
- Trigonometric and Inverse Trigonometric Functions
- Square Roots, Logarithms, Exponentiation
- Float to Fixed and Fixed to Float Conversions
- Stack Oriented Operand Storage
- Compatible with MCS-80™ and MCS-85™ Microprocessor Families
- Direct Memory Access or Programmed I/O Data Transfers
- End of Execution Signal
- General Purpose 8-bit Data Bus Interface
- +12V and +5V Power Supplies
- 24-pin Dual In-Line Package

The Intel © 8321 Arithmetic Processing Unit (APU) is a monolithic HMOS LSI Device that provides high performance fixed and floating point arithmetic and floating point trigonometric operations. It may be used to enhance the mathematical capability of a wide variety of processor-oriented systems. Chebyshev polynomials are used in the implementation of the APU algorithms.

All transfers, including operand, result, status and command information, take place over an 8-bit bi-directional data bus. Operands are pushed onto an internal stack and commands are issued to perform operations on the data in the stack. Results are then available to be retrieved from the stack.

Transfers to and from the APU may be handled by the associated processor using conventional programmed I/O, or may be handled by a direct memory access controller for improved performance. Upon completion of each command, the APU issues an end of execution signal that may be used as an interrupt by the CPU to help coordinate program execution [2].

History

Made by Intel under license by AMD.

The AMD 9511/Intel 8231 used a non-IEEE 32-bit format, and included transcendentals.

The AMD 9512/Intel 8232 used IEEE 64-bit format.

Part Numbers

Type C Packages

Part Number	Package Description	Values
C8231	Type C package	\$8-\$32

References

- [1] Hearst (1979). IC Master. No reference to Intel 8231 dates chip after 1979.
- [2] Intel (1980). Intel Component Data Catalog, 8231 Advance Information, p. 8-22.

Intel i8231A

Arithmetic Processing Unit

1981-82

Specifications

- Arithmetic Processing Unit
- HMOS
- Fixed Point Single and Double Precision (16/32-bit)
- Floating Point Single Precision (32-bit)
- Binary Data Formats
- Add, Subtract, Multiply, and Divide
- Trigonometric and Inverse Trigonometric Functions
- Square Roots, Logarithms, Exponentiation
- Float to Fixed and Fixed to Float Conversions
- Stack Oriented Operand Storage
- Compatible with MCS-80™ and MCS-85™ Microprocessor Families
- Direct Memory Access or Programmed I/O Data Transfers
- End of Execution Signal
- General Purpose 8-bit Data Bus Interface
- +12V and +5V Power Supplies
- 24-pin Dual In-Line Package

Type	Clock	Power Dissipation Max.	Supplies [V]
8231A	4 MHz	-	+12, +5
8231A-8	2 MHz	-	+12, +5

The Intel ® 8231A Arithmetic Processing Unit (APU) is a monolithic HMOS LSI Device that provides high performance fixed and floating point arithmetic and floating point trigonometric operations. It may be used to enhance the mathematical capability of a wide variety of processor-oriented systems. Chebyshev polynomials are used in the implementation of the APU algorithms.

All transfers, including operand, result, status and command information, take place over an 8-bit bi-directional data bus. Operands are pushed onto an internal stack and commands are issued to perform operations on the data in the stack. Results are then available to be retrieved from the stack.

Transfers to and from the APU may be handled by the associated processor using conventional programmed I/O, or may be handled by a direct memory access controller for improved performance. Upon completion of each command, the APU issues an end of execution signal that may be used as an interrupt by the CPU to help coordinate program execution [6].

History

Made by Intel under license by AMD.

The AMD 9511/Intel 8231 used a non-IEEE 32-bit format, and included transcendentals.

The AMD 9512/Intel 8232 used IEEE 64-bit format.

Intel i8231A

Part Numbers

Type C Packages

Part Number	Package Description	Values
		
C8231A	Type C purple ceramic package w/gold cap, offset gold cap ground strap, and gold pins. © AMD '80	\$3-\$12
C8231A-8	Type C package	\$5-\$20
MC8231A	Type C package	\$5-\$20
MC8231A/B	Type C package	\$5-\$20
MC8231A-8/B	Type C package	Ex. Rare (0 Known) \$\$\$

References

- [1] Hearst (1979). IC Master. No reference to 8231 dates part after 1979.
- [2] Intel (1980). Intel Component Data Catalog, 8231 Data Sheet, p. 8-22. No reference to 8231A dates Part after 1980.
- [3] Hearst (1981). IC Master. No reference to Intel 8231/8231A.
- [4] Intel (January 1982). Intel Component Data Catalog, 8231A Preliminary Data Sheet, p. 9-27
- [5] Hearst (1983). IC Master, Intel 8231A, p. 1090-77
- [6] Intel (1992). Intel Peripheral Components, 8231A Data Sheet, p. 3-1.

Intel i8232

Floating Point Processor

1980

Specifications

- Floating Point Processor
- HMOS
- Compatible with Proposed IEEE Format and Existing Intel Floating Point Standard
- Single (32-bit) and Double (64-bit) Precision Capability
- Add, Subtract, Multiply, and Divide Functions
- Stack oriented Operand Storage
- General Purpose 8-bit Data Bus Interface
- Compatible with MCS-80™ and MCS-85™ Microprocessor Families
- Error Interrupt
- Direct Memory Access or Programmed I/O Data Transfers
- End of Execution Signal
- +12V and +5V Power Supplies
- 24-pin Dual In-Line Package

Type	Clock	Power Dissipation Max.	Supplies [V]
8232	4 MHz	-	+12, +5
8232-8	2 MHz	-	+12, +5

The Intel® 8232 is a high performance floating-point processor unit (FPU). It provides single precision (32-bit) and double precision (64-bit) add, subtract, multiply, and divide operations. It can be easily interfaced to enhance the computational capabilities of the host processor.

The operand, result, status and command information transfers take place over an 8-bit bi-directional data bus. Operands are pushed onto an internal stack by the host processor and a command is issued to perform an operation on the data stack. The result of the operation are available to the host processor from the stack.

Information transfers between the 8232 and the host processor can be handled by using programmed I/O or direct memory access techniques. After completing an operation, the 8232 activates an “end of execution” signal that can be used to interrupt the host processor [1].

History

Made by Intel under license by AMD.

The AMD 9511/Intel 8231 used a non-IEEE 32-bit format, and included transcendentals.

The AMD 9512/Intel 8232 used IEEE 64-bit format.

Part Numbers

Type C Packages

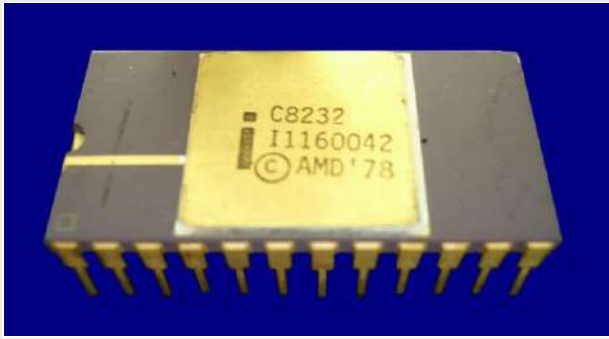
Part Number	Package Description	Values
		
C8232	Type C purple ceramic package w/gold cap, gold pins, and gold cap ground strap. © AMD '78	\$8-\$32

References

- [1] Intel (1978). Intel Component Data Catalog. No Reference to 8232 dates chip after 1978.
- [2] Intel (1980). Intel Component Data Catalog, 8232 Advance Information, p. 8-28

Intel i8237

High Performance Programmable DMA Controller

1979-80

Specifications

- High Performance Programmable DMA Controller
- NMOS
- Enable/Disable Control of Individual DMA Requests
- Four Independent DMA Channels
- Independent Auto-initialization of all Channels
- Memory-to-Memory Transfers
- Memory Block Initialization
- Address Increment or Decrement
- High Performance: Transfers up to 1.6Mbytes/Second with 5 MHz 8237-2
- Directly Expandable to any Number of Channels
- End of Process Input for Terminating Transfers
- Software DMA Requests
- Independent Polarity Control for DREQ and DACK Signals
- +5V Power Supplies
- 40-pin Dual In-Line Package

Type	Clock	Power Dissipation Max.	Supplies [V]
8237	3 MHz	-	+5
8237-2	5 MHz	-	+5
8237-4	-	-	+5
8237-5	-	-	+5

The 8237 Multimode Direct Memory Access (DMA) Controller is a peripheral interface circuit for microprocessor systems. It is designed to improve system performance by allowing external devices to directly transfer information to or from the system memory. Memory-to-memory transfer capability is also provided. The 8237 offers a wide variety of programmable control features to enhance data throughput and system optimization and to allow dynamic reconfiguration under program control.

The 8237 is designed to be used in conjunction with an external 8-bit address register such as the 8282. It contains four independent channels and may be expanded to any number of channels by cascading additional controller chips.

The three basic transfer modes allow programmability of the types of DMA service by the user. Each channel can be individually programmed to auto-initialize to its original condition following an End of Process (EOP).

Each channel has a full 64K address and word count capability.

The 8237-2 is a 5 MHz selected version of the 3 MHz 8237 [3].

Part Numbers

Type D Packages

Part Number	Package Description	Values
D8237	Type D package	\$1.25-\$5
D8237-2	Type D package	\$2.50-\$10
D8237-4	Type D package. <i>Single source shows 3 in stock.</i>	Rare <i>(Suspect)</i> \$10-\$40
D8237-5	Type D package	\$5-\$20
QD8237	Type D package	\$5-\$20
QD8237-5	Type D package. <i>Single source shows 148 in stock.</i>	<i>(Suspect)</i> \$5-\$20

Type P Packages

Part Number	Package Description	Values
P8237	Type P package	\$.75-\$3
P8237-2	Type P package	\$2.50-\$10
P8237-4	Type P package	\$2.50-\$10
P8237-5	Type P package	\$1.25-\$5

References

- [1] Intel (1978). Intel Component Data Catalog. No Reference to 8237 dates chip after 1978.
- [2] Intel (1979). Intel Component Data Catalog. No Reference to 8237.
- [3] Intel (1980). Intel Component Data Catalog, 8237 Data Sheet, p. 6-85

Intel i8237A

High Performance Programmable DMA Controller

1981-82

Specifications

- High Performance Programmable DMA Controller
- NMOS
- Enable/Disable Control of Individual DMA Requests
- Four Independent DMA Channels
- Independent Auto-initialization of all Channels
- Memory-to-Memory Transfers
- Memory Block Initialization
- Address Increment or Decrement
- High Performance: Transfers up to 1.6Mbytes/Second with 5 MHz 8237A-5
- Directly Expandable to any Number of Channels
- End of Process Input for Terminating Transfers
- Software DMA Requests
- Independent Polarity Control for DREQ and DACK Signals
- +5V Power Supplies
- 40-pin Dual In-Line Package

Type	Clock	Power Dissipation Max.	Supplies [V]
8237A	3 MHz	-	+5
8237A-4	4 MHz	-	+5
8237A-5	5 MHz	-	+5

The 8237A Multimode Direct Memory Access (DMA) Controller is a peripheral interface circuit for microprocessor systems. It is designed to improve system performance by allowing external devices to directly transfer information from the system memory. Memory-to-memory transfer capability is also provided. The 8237A offers a wide variety of programmable control features to enhance data throughput and system optimization and to allow dynamic reconfiguration under program control.

The 8237A is designed to be used in conjunction with an external 8-bit address latch. It contains four independent channels and may be expanded to any number of channels by cascading additional controller chips.

The three basic transfer modes allow programmability of the types of DMA service by the user. Each channel can be individually programmed to auto-initialize to its original condition following an End of Process (EOP). Each channel has a full 64K address and word count capability.

The 8237A-4 and 8237A-5 are 4 MHz and 5MHz versions of the standard 3 MHz 8237A respectively [5].

Part Numbers

Type D Packages

Part Number	Package Description	Values
D8237A	Type D package	\$1.25-\$5
D8237A-4	Type D package	\$1.50-\$6
D8237A-5	Type D grey ceramic package w/tin pins. No copyright.	\$.75-\$3
LD8237A-5	Type D package	\$1.25-\$5
MD8237A	Type D package	\$5-\$20
MD8237A/B	Type D package	\$2.50-\$10
MD8237A-5/B	Type D package	\$2.50-\$10
QD8237A	Type D package	\$1.50-\$6
QD8237A-4	Type D package	Rare \$10-\$40
QD8237A-5	Type D package	\$1.25-\$5
TD8237A	Type D package. Single source shows 70 in stock.	(Suspect) \$5-\$20

Type P Packages

Part Number	Package Description	Values
P8237A	Type P package.	\$1.25-\$5
P8237A-4	Type P package	\$.75-\$3
		
P8237A-5	1. Type P black plastic package w/tin pins. Half-round key. Impressed logo and part number. © AMD '80.	\$.75-\$3
P8237A-5	2. Type P black plastic package w/tin pins. Rectangular key. © AMD '80.	\$.75-\$3
P8237A-5	3. Type P black plastic package w/tin pins. Half-round key. Impressed logo and part number. © AMD '79 '83.	\$.75-\$3
QP8237A	Type P package	Rare \$10-\$40
QP8237A-4	Type P package	Rare \$10-\$40
QP8237A-5	Type P package	\$1.50-\$6

References

[1] Intel (1980). Intel Component Data Catalog, 8237/8237-2 Data Sheet, p. 6-85. No reference to 8237A dates chip after 1980.

[2] Hearst (1981). IC Master. No reference to Intel 8237A.

[3] Intel (January 1982). Intel Component Data Catalog. 8237A/8237A-5 Data Sheet, p. 7-88

[4] Hearst (1983). IC Master, Intel 8237A, p. 1096-5

[5] Intel (1992). Intel Peripheral Components, 8237A Data Sheet, p. 3-14

Intel i8238

System Controller and Bus Driver w/Advanced IOW/MEMW for 8080A CPU

1976

Specifications

- System Controller and Bus Driver for 8080A CPU
- Bipolar
- Single Chip System Control for MCS-80 Systems
- Built-in Bi-Directional Bus Driver for Data Bus Isolation
- Allows the use of Multiple Byte Instructions (e.g. CALL) for Interrupt Acknowledge
- User Selected Single Level Interrupt Vector (RST 7)
- Reduces System Package Count
- 8238 Has Advanced IOW/MEMW for Large System Timing Control
- 28-pin Dual In-Line Package

The 8228 is a single chip system controller and bus driver for MCS-80. It generates all signals required to directly interface MCS-80 family RAM, ROM, and I/O Components.

A bi-directional bus driver is included to provide high system TTL fan-out. It also provides isolation of the 8080A data bus from memory and I/O. This allows for the optimization of control signals, enabling the systems designer to use slower memory and I/O. The isolation of the bus driver also provides for enhanced system noise immunity.

A user selected single level interrupt vector (RST 7) is provided to simplify real time, interrupt driven, small system requirements. The 8228 also generates the correct control signals to allow the use of multiple byte instructions (e.g. CALL) in response to an INTERRUPT ACKNOWLEDGE by the 8080A. This feature permits large, interrupt driven systems to have an unlimited number of interrupt levels.

The 8228 is designed to support a wide variety of system bus structures and also reduce system package count for cost effective, reliable, design of the MCS-80 systems.

Note: The specifications for the 3228/3238 are identical with those for the 8228/8238 [4].

Part Numbers

Type C Packages

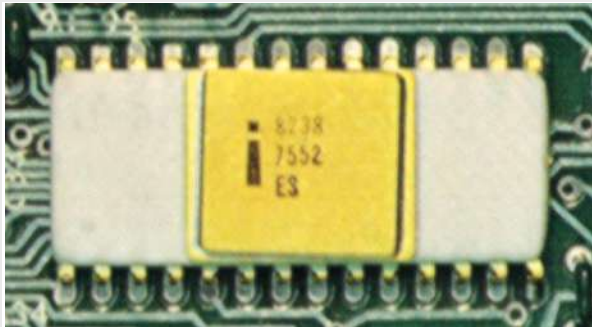
Part Number	Package Description	Values
		
C8238	Type C white ceramic package w/gold cap and embedded gold pins. Small raised bump denotes pin #1. Example shown marked 'ES' for Engineering Sample.	Ex. Rare (1 Known) \$50-\$200

Type D Packages

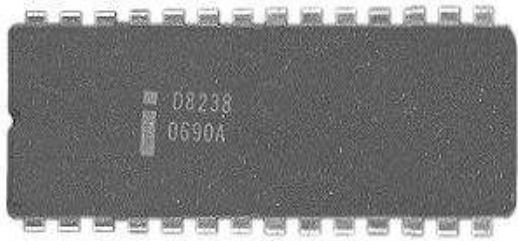
Part Number	Package Description	Values
		
D8238	1. Type D grey ceramic package w/tin pins. No copyright	\$1.25-\$5
D8238	2. Type D grey ceramic package w/tin pins. © Intel '75.	\$1.25-\$5
MD8238/B	Type D package	\$2.50-\$10

Intel i8238

Type P Packages

Part Number	Package Description	Values
P8238	 A black plastic integrated circuit package with tin pins. The top surface is marked with the part number 'P8238', a lot number 'C6031220', and the copyright notice '© Intel '75'. There are three circular marks on the left side and one on the right side of the package.	\$1.25-\$5

References

[1] Intel (September 1975). Intel MCS-80 User's Manual. No Reference to 8238 dates chip after September 1975.

[2] Intel (1976). Intel Data Catalog, 8228/8238 Data Sheet, p. 8-29

[3] Intel (1977). Intel Data Catalog, 8228/8238 Data Sheet, p. 10-43

[4] Intel (1980). Intel Component Data Catalog, 8228/8238 Data Sheet, p. 6-81

Intel i8243

MCS-48™ Input/Output Expander

1977-78

Specifications

- MCS-48™ Input/Output Expander
- NMOS
- Low Cost
- Simple Interface to MCS-48™ Microcomputers
- Four 4-bit I/O Ports
- AND and OR Directly to Ports
- Single 5V Supply
- High Output Drive
- Direct Extension of Resident 8048 I/O Ports
- 24-pin Dual In-Line Package



The Intel® 8243 is an input/output expander designed specifically to provide a low cost means of I/O expansion for the MCS-48™ family of single chip microcomputers. Fabricated in 5 volts NMOS, the 8243 combines low cost, single supply voltage and high drive current capability.

The 8243 consists of four 4-bit bi-directional static I/O ports and one 4-bit port which serves as an interface to the MCS-48 microcomputers. The 4-bit interface requires that only 4 I/O lines of the 8048 be used for I/O expansion, and also allows multiple 8243's to be added to the same bus.

The I/O ports of the 8243 serve as a direct extension of the resident I/O facilities of the MCS-48 microcomputers and are accessed by their own MOV, ANL, and ORL instructions [2].

Part Numbers

Type D Packages

Part Number	Package Description	Values
 <p>A black rectangular chip with 28 pins. The top surface is marked with 'D8243', 'L2038442', and '© INTEL '77'.</p>		
D8243	Type D grey ceramic package w/tin pins. © Intel '77	\$.75-\$3
ID8243	Type D package	\$1.25-\$5
 <p>A black rectangular chip with 28 pins. The top surface is marked with 'LD8243', 'L9220047D', and '© 1977'.</p>		
LD8243	Type D grey ceramic package w/tin pins. © 1977	\$1.25-\$5
MD8243	Type D package	\$2.50-\$10
 <p>A black rectangular chip with 28 pins. The top surface is marked with 'MD8243/B', '8624', 'X626909BS', and '© INTEL '77'.</p>		
MD8243/B	Type D grey ceramic package w/tin pins. © Intel '77	\$1.50-\$6

Intel i8243



MD8243/BC	Type D grey ceramic package w/tin pins. © 1977	\$5-\$20
QD8243	Type D package	\$1.25-\$5



TD8243	Type D grey ceramic package w/tin pins. © Intel '77	\$1.25-\$5
--------	---	------------

Type P Packages

Part Number	Package Description	Values
A black, rectangular integrated circuit (IC) chip with a Type P black plastic package. The top surface is marked with the text: P8243, L83105770, and © INTEL '77. The chip has multiple pins extending from the bottom edge, with a half-round key on the left side.		
P8243	1. Type P black plastic package w/tin pins. Half-round key. © Intel '77	\$.25-\$1

Intel i8243



P8243	2. Type P black plastic package w/tin pins. Rectangular key. © Intel '77	\$.25-\$1
QP8243	Type P package	\$2-\$8
TP8243	Type P package	Rare \$10-\$40

References

- [1] Intel (1977). Intel Data Catalog, 8243 Preliminary Data Sheet, p. 9-9.
- [2] Intel (1980). Intel Component Data Catalog, 8243 Data Sheet, p. 5-35.

Intel i8251

Programmable Communication Interface

1975



Specifications

- Programmable Communication Interface
- NMOS
- Synchronous and Asynchronous Operation
 - Synchronous:
 - 5-8 Bit Characters
 - Internal or External Character Synchronization
 - Automatic Sync Insertion
 - Asynchronous:
 - 5-8 Bit Characters
 - Clock Rate – 1, 16 or 64 Times Baud Rate
 - Break Character Generation
 - 1, 1 ½ or 2 Stop Bits
 - False Start Bit Detection
- Baud Rate – DC to 56k Baud (Sync Mode)
 - DC to 9.6k Baud (Async Mode)
- Full Duplex, Double Buffered, Transmitter and Receiver
- Error Detection – Parity, Overrun, and Framing
- Fully Compatible with 8080 CPU
- All Inputs and Outputs Are TTL Compatible
- Single 5V Power Supply
- Single TTL Clock
- 28-pin Dual In-Line Package

The 8251 is a Universal Synchronous/Asynchronous Receiver/Transmitter (USART) Chip designed for data communications in microcomputer systems. The USART is used as a peripheral device and is programmed by the CPU to operate using virtually any serial data transmission technique presently in use (including IBM Bi-Sync). The USART accepts data characters from the CPU in parallel format and then converts them into a continuous serial data stream for transmission. Simultaneously it can receive serial data streams and convert them into parallel data characters for the CPU. The USART will signal the CPU whenever it can accept a new character for transmission or whenever it has received a character for the CPU. The CPU can read the complete status of the USART at any time. These include data transmission errors and control signals such as SYNDET, TxEMPT. The chip is constructed using N-channel silicon gate technology [2].

Part Numbers

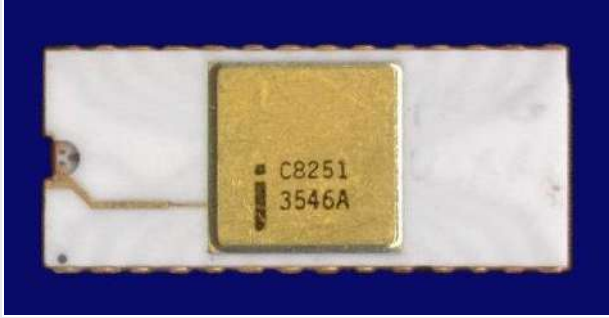
Type C Packages

Part Number	Package Description	Values
		
C8251	1. Type C white ceramic package w/gold cap and embedded gold pins. No copyright.	Ex. Rare (1 Known) \$50-\$200
		
C8251	2. Type C white ceramic package w/gold cap, offset gold cap ground strap, and gold pins. Small black dot denotes pin #1. No copyright.	\$15-\$60
C8251	3. Type C white ceramic package w/gold cap and gold pins. Small black square denotes pin #1. No copyright.	\$15-\$60
		
C8251	4. Type C purple ceramic package w/gold cap and gold pins. No copyright.	\$15-\$60

Intel i8251



C8251	5. Type C purple ceramic package w/gold cap and gold pins. Small '+' denotes pin #1. © Intel '75.	\$15-\$60
MC8251/B	Type C package	Ex. Rare \$30-\$120

Type D Packages

Part Number	Package Description	Values
D8251	Type D package	\$1.25-\$5
ID8251	Type D package	\$5-\$20
LD8251	Type D package	\$1.50-\$6
MD8251	Type D package	\$2.50-\$10
MD8251/B	Type D package	\$2-\$8
QD8251	Type D package	\$1.50-\$6
TD8251	Type D package	\$2.50-\$10

Type P Packages

Part Number	Package Description	Values
P8251	1. Type P black plastic package w/tin pins. Rectangular key. No copyright.	\$.75-\$3
P8251	2. Type P black plastic package w/tin pins. Rectangular key. © Intel '75.	\$.75-\$3

References

- [1] Intel (September 1975). Intel MCS-80 User's Manual, 8251 Data Sheet, p. 5-135
- [2] Intel (1977). Intel Data Catalog, 8251 Data Sheet, p. 10-143
- [3] Intel (1977). Intel Memory Design Handbook, MC8251 listed as member of Intel Military Product Family, p. PSG-5.
- [4] Intel (1984). A Revolution in Progress... A History of Intel to Date, 8251 introduced 1975, p. 26.

Intel i8251A

Programmable Communication Interface

1977

Specifications

- Programmable Communication Interface
- NMOS
- Synchronous and Asynchronous Operation
 - Synchronous:
 - 5-8 Bit Characters
 - Internal or External Character Synchronization
 - Automatic Sync Insertion
 - Asynchronous:
 - 5-8 Bit Characters
 - Clock Rate – 1, 16 or 64 Times Baud Rate
 - Break Character Generation
 - 1, 1 ½ or 2 Stop Bits
 - False Start Bit Detection ; Automatic Break Detect and handling
- Baud Rate – DC to 64k Baud (Sync Mode)
 - DC to 19.2k Baud (Async Mode)
- Full Duplex, Double Buffered, Transmitter and Receiver
- Error Detection – Parity, Overrun, and Framing
- Fully Compatible with 8080/8085 CPU
- All Inputs and Outputs Are TTL Compatible
- Single +5V Power Supply
- Single TTL Clock
- 28-pin Dual In-Line Package

The Intel® 8251A is the enhanced version of the industry standard, Intel® 8251 Universal Synchronous/Asynchronous Receiver/Transmitter (USART), designed for data communications with Intel's new high performance family of microprocessors such as the 8085. The 8251A is used as a peripheral device and is programmed by the CPU to operate using virtually any serial data transmission technique presently in use (including IBM Bi-Sync). The USART accepts data characters from the CPU in parallel format and then converts them into a continuous serial data stream for transmission. Simultaneously it can receive serial data streams and convert them into parallel data characters for the CPU. The USART will signal the CPU whenever it can accept a new character for transmission or whenever it has received a character for the CPU. The CPU can read the complete status of the USART at any time. These include data transmission errors and control signals such as SYNDET, TxEMPT. The chip is constructed using N-channel silicon gate technology [3].

Intel i8251A

Part Numbers

Type C Packages

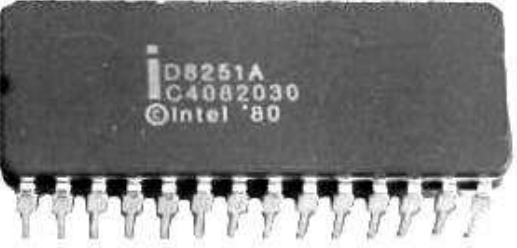

Part Number	Package Description	Values
C8251A	Type C package. Single source shows 1 in stock.	Ex. Rare (Suspect) \$\$\$

Type D Packages

Part Number	Package Description	Values
		
D8251A	1. Type D grey ceramic package w/tin pins. © Intel '77. Small round indentation denotes pin #1.	.75-\$3
D8251A	2. Type D grey ceramic package w/tin pins. © Intel '77. No round indentation denotes pin #1.	.75-\$3
		
D8251A	3. Type D grey ceramic package w/tin pins. © Intel '80	.75-\$3
D8251A-5	Type D package	\$1.25-\$5
ID8251A	Type D package	\$1.25-\$5
LD8251A	Type D package	\$1.25-\$5
MD8251A	Type D package	\$1.25-\$5
MD8251A/B	Type D grey ceramic package w/tin pins. © Intel '83.	\$1.25-\$5
MD8251A/BC	Type D package	\$1.50-\$6
QM8251AD1	Type D package	\$2.50-\$10
QD8251A	Type D package	\$1.25-\$5
TD8251A	Type D package	\$1.25-\$5

Intel i8251A

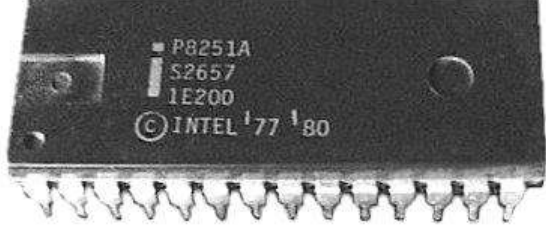
Type P Packages

Part Number	Package Description	Values
P8251A	1. Type P black plastic package w/tin pins. Rectangular key. Small round indentation denotes pin #1. © Intel '77	\$.75-\$3
		
P8251A	2. Type P black plastic package w/tin pins. Rectangular key. Small round indentation denotes pin #1. © Intel '77 '80	\$.75-\$3
P8251A	3. Type P black plastic package w/tin pins. Rectangular key. Small round indentation denotes pin #1. © Intel '80	\$.75-\$3
		
P8251A	4. Type P black plastic package w/tin pins. Half-round key. Small round indentation denotes pin #1. © Intel '83	\$.75-\$3
QP8251A	Type P package	\$2-\$8

References

- [1] Intel (1977). Intel Data Catalog, 8251 Data Sheet, p. 10-143. No reference to 8251A.
- [2] Intel (October 1977). Intel MCS-80 User's Manual, Preliminary 8251A Data Sheet, p. 6-194
- [3] Intel (1980). Intel Component Data Catalog, 8251A Data Sheet, p. 8-34

Intel i8253

Programmable Interval Timer

1976

Specifications

- Programmable Interval Timer
- NMOS
- MCS-85™ Compatible 8253-5
- 3 Independent 16-Bit Counters
- DC to 2 MHz
- Programmable Counter Modes
- Count Binary or BCD
- Single +5V Supply
- 24-pin Dual In-Line Package

Type	Clock	Power Dissipation Max.	Supplies [V]
8253	2 MHz	-	+5
8253-5	3 MHz	-	+5



The Intel® 8253 is a programmable counter/timer chip designed for use as an Intel microcomputer peripheral. It uses NMOS technology with a single +5V supply and is packaged in a 24-pin plastic DIP.

It is organized as 3 independent 16-bit counters, each with a count rate of up to 2 MHz. All modes of operation are software programmable [3].

The 8253 solves one of the most common problems in any microcomputer system, the generation of accurate time delays under software control. Instead of setting up timing loops in systems software, the programmer configures the 8253 to match his requirements, initializes one of the counters of the 8253 with the desired quantity, then upon command the 8253 will count out the delay and interrupt the CPU when it has completed its tasks [2].

Part Numbers



Type C Packages

Part Number	Package Description	Values
		
C8253	1. Type C grey ceramic package w/black cap and tin pins. No Copyright.	\$10-\$40
		
C8253	2. Type C grey ceramic package w/black cap and tin pins. © Intel '76	\$7.50-\$30
C8253-5	Type C package	\$15-\$60

Type D Packages

Part Number	Package Description	Values
		
D8253	1. Type D grey ceramic package w/tin pins. © Intel '76. Small round indentation denotes pin #1.	\$.75-\$3



Intel i8253

D8253	2. Type D grey ceramic package w/tin pins. © Intel '76. No indentation denotes pin #1.	\$.75-\$3
 <p>A black Type D ceramic package with 28 pins. The top surface is marked with 'D8253', 'L7210435', and '© INTEL '88'.</p>		
D8253	3. Type D grey ceramic package w/tin pins. © Intel '80	\$.75-\$3
D8253-5	1. Type D grey ceramic package w/tin pins. © Intel '76.	\$1.25-\$5
 <p>A black Type D ceramic package with 28 pins. The top surface is marked with 'D8253-5', 'U4350217', and '© INTEL '80'.</p>		
D8253-5	2. Type D grey ceramic package w/tin pins. © Intel '80	\$1.25-\$5
ID8253	Type D package	\$1.50-\$6
LD8253	Type D package	\$1.25-\$5
LD8253-5	Type D package	\$1.50-\$6
MD8253	Type D package	\$1.25-\$5
 <p>A black Type D ceramic package with 28 pins. The top surface is marked with 'MD8253/B', '8002', '1H179', and '© INTEL '76'.</p>		
MD8253/B	1. Type D grey ceramic package w/tin pins. © Intel '76. Small round indentation denotes pin #1.	\$1.25-\$5
MD8253/B	2. Type D grey ceramic package w/tin pins. © Intel '80.	\$1.25-\$5
MD8253/BC	Type D package	\$1.50-\$6
MD8253-5	Type D package	\$1.50-\$6
MD8253-5/B	Type D package	\$1.50-\$6

Intel i8253

QM8253D1	Type D package	\$5-\$20
QM8253-5D1	Type D package	\$5-\$20
QD8253	Type D package	\$1.25-\$5
QD8253-5	Type D package	\$1.25-\$5
TD8253	Type D package	\$1.25-\$5
TD8253-5	Type D package	\$5-\$20

Type P Packages

Part Number	Package Description	Values
 <p>A black plastic integrated circuit package with 16 pins. The top surface is marked with 'P8253', '3852C', and 'INTEL '76'.</p>		
P8253	1. Type P black plastic package w/tin pins. Rectangular key. © Intel '76.	\$.75-\$3
P8253	Type P black plastic package w/tin pins. Half-round key. © Intel 1976.	\$.75-\$3
P8253-5	1. Type P black plastic package w/tin pins. Rectangular key. © Intel '76.	\$.75-\$3
 <p>A black plastic integrated circuit package with 16 pins. The top surface is marked with 'P8253-5', 'U3461627', and '© INTEL '80'.</p>		
P8253-5	2. Type P black plastic package w/tin pins. Rectangular key. © Intel '80	\$.75-\$3
QP8253	Type P package	\$1.50-\$6
QP8253-5	Type P package	\$1.25-\$5

References

- [1] Intel (September 1975). Intel MCS-80 User's Manual, 8253 Preliminary Data Sheet, p. 5-169.
- [2] Intel (October 1977). Intel MCS-80 User's Manual, Preliminary 8253, 8253-5 Data Sheet, p. 6-212
- [3] Intel (1978). Intel Component Data Catalog, 8253/8253-5 Data Sheet, p. 12-65
- [4] Intel (1984). A Revolution in Progress... A History of Intel to Date, 8253 introduced 1976, p. 26.

Intel i8255

Programmable Peripheral Interface

1975

Specifications



- Programmable Peripheral Interface
- 24 Programmable I/O Pins
- Completely TTL Compatible
- Fully Compatible with MCSTM-8 and MCSTM-80 Microprocessor Families
- Direct Bit Set/Reset Capability Easing Control Application Interface
- Reduces System Package Count
- 40-pin Dual In-Line Package

The 8255 is a general purpose programmable I/O device designed for use with both the 8008 and 8080 microprocessors. It has 24 I/O pins which may be individually programmed in two groups of twelve and used in three major modes of operation. In the first mode (Mode 0), each group of twelve I/O pins may be programmed in sets of 4 to be input or output. In Mode 1, the second mode, each group may be programmed to have 8 lines of input or output. Of the remaining four pins three are used for handshaking and interrupt control signals. The third mode of operation (Mode 2) is a Bi-directional Bus mode, which uses 8 lines for a bi-directional bus, and five lines, borrowing one from the other group, for handshaking.

Other features of the 8255 include set and reset capability and the ability to source 1mA of current at 1.5 volts. This allows Darlington transistors to be directly driven for applications such as printers and high voltage displays [1].

Part Numbers

Type C Packages

Part Number	Package Description	Values
		
C8255	1. Type C white ceramic package w/gold cap and gold pins. Small '+' denotes pin #1.	\$15-60
		
C8255	2. Type C white ceramic package w/gold cap and gold pins. Large '1' denotes pin #1. Small dot at top left corner of package.	\$15-60
		
C8255-8	Type C white ceramic package w/gold cap and gold pins. Large '1' denotes pin #1. Small dot at top left corner of package.	Rare \$25-\$100
MC8255/B	Type C package	Ex. Rare \$50-\$200

Type D Packages

Part Number	Package Description	Values
D8255	Type D grey ceramic package w/tin pins. No copyright.	\$.75-\$3
D8255-5	Type D package	\$3-\$12
ID8255	Type D package	\$2.50-\$10
LD8255	Type D package	\$2.50-\$10

Intel i8255

MD8255	Type D package	\$1.25-\$5
MD8255/B	Type D package	\$1.50-\$6

Type P Packages

Part Number	Package Description	Values
P8255	Type P package	\$.75-\$3
P8255-5	Type P package	\$1.25-\$5

References

- [1] Intel (September 1975). Intel MCS-80 User's Manual, 8255 Data Sheet, p. 5-113.
- [2] Intel (1977). Intel Memory Design Handbook, MC8255 listed as member of Intel Military Product Family, p. PSG-5.
- [3] Intel (1984). A Revolution in Progress... A History of Intel to Date, 8255 introduced 1975, p. 26.

Intel i8255A

Programmable Peripheral Interface

1976-77

Specifications

- Programmable Peripheral Interface
- 24 Programmable I/O Pins
- Completely TTL Compatible
- Fully Compatible with Intel® Microprocessor Families
- Improved Timing Characteristics
- Direct Bit Set/Reset Capability Easing Control Application Interface
- Reduces System Package Count
- Improved DC Driving Capability
- 40-pin Dual In-Line Package

Type	Clock	Power Dissipation Max.	Supplies [V]
8255A	2 MHz	-	-
8255A-5	3 MHz	-	-

The 8255A is a general-purpose programmable I/O device designed for use with microprocessors. It has 24 I/O pins, which may be individually programmed in two groups of twelve and used in three major modes of operation. In the first mode (Mode 0), each group of twelve I/O pins may be programmed in sets of 4 to be input or output. In Mode 1, the second mode, each group may be programmed to have 8 lines of input or output. Of the remaining four pins three are used for handshaking and interrupt control signals. The third mode of operation (Mode 2) is a Bi-directional Bus mode, which uses 8 lines for a bi-directional bus, and five lines, borrowing one from the other group, for handshaking.

Other features of the 8255A include set and reset capability and the ability to source 1mA of current at 1.5 volts. This allows Darlington transistors to be directly driven for applications such as printers and high voltage displays [2].



Intel i8255A

Part Numbers

Type C Packages

Part Number	Package Description	Values
MC8255A/B	Type C package. Single source shows 10 in stock.	Ex. Rare (Suspect) \$50-\$200



Type D Packages

Part Number	Package Description	Values
		
D8255A	Type D grey ceramic package w/tin pins. © Intel '77	\$.50-\$2
D8255A-2	Type D package	\$.50-\$2
D8255A-5	1. Type D grey ceramic package w/tin pins. © Intel '77.	\$.50-\$2
		
D8255A-5	2. Type D grey ceramic package w/tin pins. © Intel '81	\$.50-\$2
ID8255A	Type D package	\$1.25-\$5
ID8255A-5	Type D package	\$1.25-\$5
LD8255A	Type D package	\$1.25-\$5
LD8255A-5	Type D package	\$1.25-\$5
MD8255A	Type D package	\$1.25-\$5
MD8255A/B	1. Type D grey ceramic package w/tin pins. © Intel 1975	\$1.25-\$5
MD8255A/B	2. Type D grey ceramic package w/tin pins. © Intel '77	\$1.25-\$5
MD8255A/B	3. Type D grey ceramic package w/tin pins. © Intel '81	\$1.25-\$5
MD8255A-5	Type D package	\$1.25-\$5
MD8255A-5/B	Type D package	\$1.25-\$5

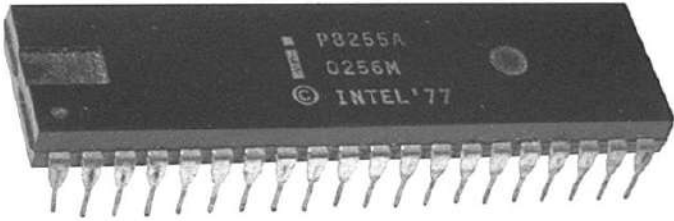

Intel i8255A

QM8255AD1	Type D package	\$2.50-\$10
QM8255A5D1	Type D package. Single source shows 1 in stock.	Rare (Suspect) \$\$\$
QD8255A	Type D package	\$1.25-\$5
QD8255A-5	Type D package	\$1.25-\$5
TD8255A	Type D package	\$1.25-\$5
TD8255A-5	Type D package	\$1.25-\$5

Type P Packages

Part Number	Package Description	Values
		
P8255A	1. Type P black plastic package w/tin pins. Rectangular key. © Intel '77	\$.50-\$2
		
P8255A	2. Type P black plastic package w/tin pins. Rectangular key. © Intel '80	\$.50-\$2
P8255A-2	Type P package	\$.75-\$3
P8255A-5	1. Type P black plastic package w/tin pins. Rectangular key. © Intel 1975.	\$.50-\$2

Intel i8255A

		
P8255A-5	2. Type P black plastic package w/tin pins. Rectangular key. © Intel '77	\$.50-\$2
		
P8255A-5	3. Type P black plastic package w/tin pins. Rectangular key. © Intel '81	\$.50-\$2
P8255A-5	4. Type P black plastic package w/tin pins. Half-round key. Impressed logo and part number. © Intel '81.	\$.50-\$2
QP8255A	Type P black plastic package w/tin pins. Rectangular key. © Intel '81.	\$2.50-\$10
QP8255A-5	Type P package	\$.75-\$3

References

- [1] Intel (1976). Intel Data Catalog, 8255 Data Sheet, p. 8-79. No reference to 8255A.
- [2] Intel (1977). Intel Data Catalog, 8255A Data Sheet, p. 10-170.

Intel i8257

Programmable DMA Controller

1976

Specifications

- Programmable DMA Controller
- MCS-85™ Compatible 8257-5
- 4-Channel DMA Controller
- Priority DMA Request Logic
- Channel Inhibit Logic
- Terminal Count and Modulo 128 Outputs
- Single TTL Clock
- Single +5V Supply
- Auto Load Mode
- 40-pin Dual In-Line Package

Type	Clock	Power Dissipation Max.	Supplies [V]
8257	2 MHz	-	+5
8257-5	3 MHz	-	+5

The Intel® 8257 is a 4-channel direct memory access (DMA) controller. It is specifically designed to simplify the transfer of data at high speeds for the Intel® microcomputer systems. Its primary function is to generate, upon a peripheral request, a sequential memory address, which will allow the peripheral to read or write data directly to or from memory. Acquisition of the system bus is accomplished via the CPU's hold function. The 8257 has priority logic that resolves the peripherals requests and issues a composite hold request to the CPU. It maintains the DMA cycle count for each channel and outputs a control signal to notify the peripheral that the programmed number of DMA cycles is complete. Other output control signals simplify sector data transfers. The 8257 represents a significant savings in component count for DMA-based microcomputer systems and greatly simplifies the transfer of data at high speed between peripherals and memories [1].

Part Numbers

Type C Packages

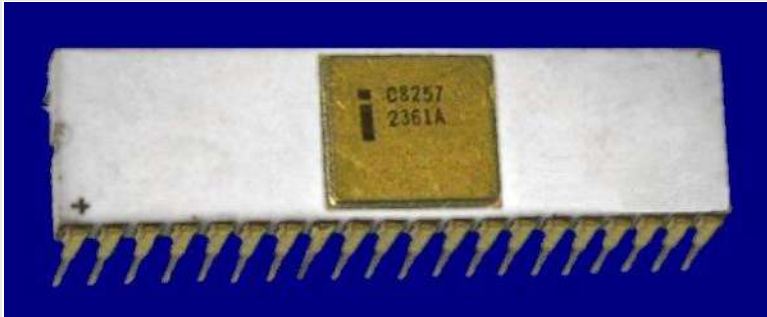
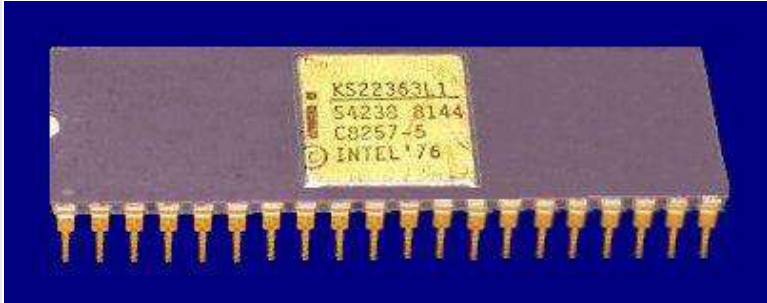
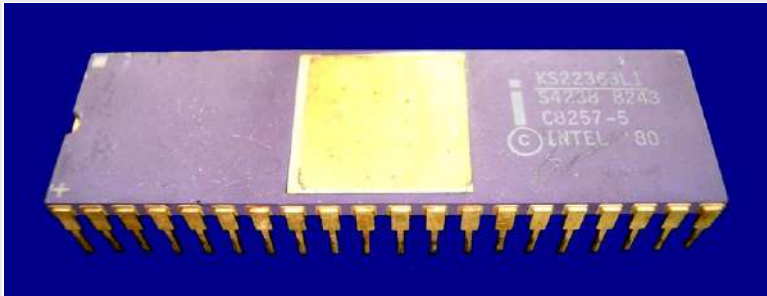
Part Number	Package Description	Values
		
C8257	Type C white ceramic package w/gold cap and gold pins. Small '+' denotes pin #1. No Copyright,	\$25-\$100
		
C8257-5	1. Type C purple ceramic package w/gold cap and gold pins. © Intel '76.	\$20-\$80
		
C8257-5	2. Type C purple ceramic package w/gold cap and gold pins. © Intel '80	\$20-\$80

Intel i8257

Type D Packages

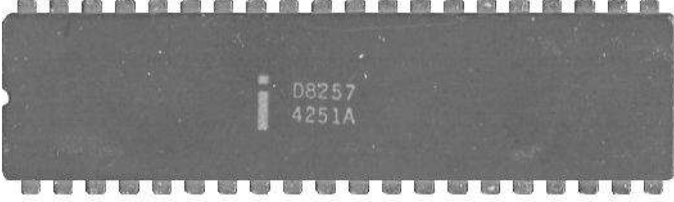
Part Number	Package Description	Values
		
D8257	Type D grey ceramic package w/tin pins. No copyright.	\$.75-\$3
		
D8257-5	Type D grey ceramic package w/tin pins. © Intel '76	\$.75-\$3
ID8257	Type D package	\$2.50-\$10
ID8257-5	Type D package	\$2.50-\$10
LD8257	Type D package	\$2.50-\$10
MD8257	Type D package	\$1.25-\$5
MD8257/B	Type D package	\$1.25-\$5
QM8257-5D1	Type D package	\$2.50-\$10
QD8257	Type D package	\$1.25-\$5
QD8257-5	Type D package	\$2-\$8

Type P Packages

Part Number	Package Description	Values
		
P8257	1. Type P black plastic package w/tin pins. Rectangular key. © Intel '76	\$.75-\$3

Intel i8257



P8257	2. Type P black plastic package w/tin pins. Rectangular key. © Intel '80	\$.75-\$3
P8257-5	Type P package	\$.75-\$3
QP8257	Type P package	\$2.50-\$10
QP8257-5	Type P package	\$1.25-\$5

References

- [1] Intel (September 1975). Intel MCS-80 User's Manual, Preliminary 8257 Data Sheet, p. 5-171.
- [2] Intel (1980). Intel Component Data Catalog, 8257/8257-5 Data Sheet, p. 6-99
- [3] Intel (1984). A Revolution in Progress... A History of Intel to Date, 8257 introduced 1977, p. 26.
Suspect this date is incorrect given that the 1975 Intel Data Catalog contains a preliminary 8257 data sheet.

Intel i8259

Programmable Interrupt Controller

1976

Specifications

- Programmable Interrupt Controller
- NMOS
- MCS-85™ Compatible 8259-5
- 8-Level Priority Controller
- Expandable to 64 Levels
- Programmable Interrupt Modes
- Individual Request Mask Capability
- Single +5V Supply (No Clocks)
- 28-pin Dual In-Line Package

The Intel® 8259 handles up to 8 vectored priority interrupts for the CPU. It is cascadable for up to 64 vectored priority interrupts, without additional circuitry. It will be packaged in a 28-pin plastic DIP, uses NMOS technology and requires a single +5V supply. Circuitry is static, requiring no clock input.

The 8259 is designed to minimize the software and real time overhead in handling multi-level priority interrupts. It has several modes, permitting optimization for a variety of system requirements [2].

Part Numbers

Type C Packages

Part Number	Package Description	Values
C8259	Type C package. Single source shows 3 in stock.	Ex. Rare (Suspect) \$\$\$

Type D Packages

Part Number	Package Description	Values
D8259	Type D package	\$.75-\$3
D8259-5	Type D package	\$1.25-\$5
LD8259	Type D package	\$1.25-\$5
LD8259-5	Type D package	\$2.50-\$10
MD8259	Type D package	\$1.50-\$6
MD8259/B	Type D package	\$2-\$8
MD8259-5/B	Type D package	\$2.50-\$10
QD8259	Type D package	\$1.25-\$5
QD8259-5	Type D package	\$1.50-\$6
TD8259	Type D package	\$1.25-\$5

Type P Packages

Part Number	Package Description	Values
P8259	Type P package	\$.75-\$3

References

- [1] Intel (September 1975). Intel MCS-80 User's Manual, Preliminary 8259 Data Sheet, p. 5-173.
- [2] Intel (1978). Intel Component Data Catalog, 8259/8259-5 Data Sheet, p. 12-111
- [3] Intel (1984). A Revolution in Progress... A History of Intel to Date, 8259 introduced 1977, p. 26.
Suspect this date is incorrect given that the 1975 Intel Data Catalog contains a preliminary 8259 data sheet.

Intel i8259A

Programmable Interrupt Controller

1979

Specifications

- Programmable Interrupt Controller
- NMOS
- 8086 / 8088 Compatible
- MCS-80/85™ Compatible
- 8-Level Priority Controller
- Expandable to 64 Levels
- Programmable Interrupt Modes
- Individual Request Mask Capability
- Single +5V Supply (No Clocks)
- 28-pin Dual In-Line Package and 28-lead PLCC Package

Type	Clock	Power Dissipation Max.	Supplies [V]
8259A	5 MHz	-	+5
8259A-2	8 MHz	-	+5
8259A-8	2 MHz	-	+5

The Intel® 8259A handles up to 8 vectored priority interrupts for the CPU. It is cascadable for up to 64-vectored priority interrupts without additional circuitry. It is packaged in a 28-pin DIP, uses NMOS technology and requires a single +5V supply. Circuitry is static, requiring no clock input.

The 8259A is designed to minimize the software and real time overhead in handling multi-level priority interrupts. It has several modes, permitting optimization for a variety of system requirements.

The 8259A is fully upward compatible with the Intel® 8259. Software originally written for the 8259 will operate the 8259A in all 8259 equivalent modes (MCS-80/85, Non-Buffered, Edge Triggered) [3].

Part Numbers

Type C Packages

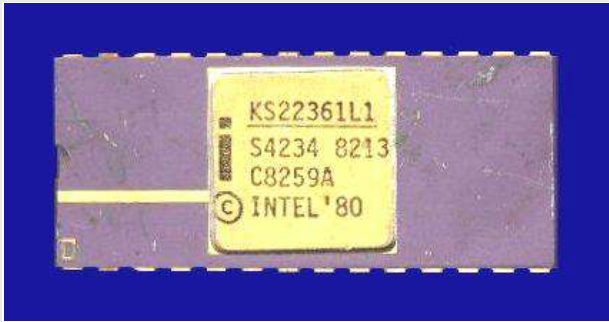
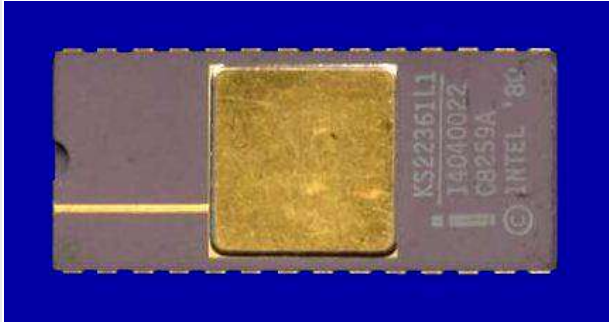
Part Number	Package Description	Values
		
C8259A	1. Type C purple ceramic package w/gold cap, offset gold cap ground strap, and gold pins. © Intel '80. Logo and part number printed on cap.	Rare \$25-\$100
		
C8259A	2. Type C purple ceramic package w/gold cap, offset gold cap ground strap, and gold pins. © Intel '80. Logo and part number printed on ceramic.	Rare \$25-\$100

Type D Packages

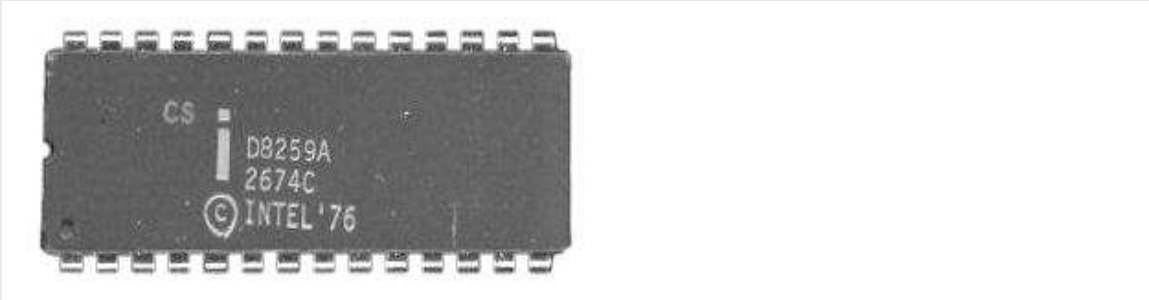

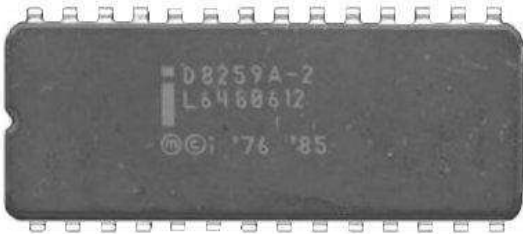

Part Number	Package Description	Values
		
D8259A	1. Type D grey ceramic package w/tin pins. Small round indentation denotes pin #1. © Intel '76. Example shown marked 'CS' for Customer Sample	\$.75-\$3

Intel i8259A

D8259A	2. Type D grey ceramic package w/tin pins. © Intel '80.	\$.75-\$3
 <p>A photograph of an Intel D8259A-2 chip. The chip is a dark grey, rectangular ceramic package with 28 pins. The top surface is marked with 'D8259A-2', 'L5070704', and '© INTEL '80'.</p>		
D8259A-2	1. Type D grey ceramic package w/tin pins. © Intel '80	\$.75-\$3
 <p>A photograph of an Intel D8259A-2 chip. The chip is a dark grey, rectangular ceramic package with 28 pins. The top surface is marked with 'D8259A-2', 'L6468612', and '© i '76 '85'.</p>		
D8259A-2	2. Type D grey ceramic package w/tin pins. © i '76 '85.	\$.75-\$3
D8259A-5	Type D package	\$1.25-\$5
D8259A-8	Type D grey ceramic package w/tin pins. © Intel '76. Small round indentation denotes pin #1.	\$1-\$4
ID8259A	Type D package	\$1.25-\$5
ID8259A-2	Type D package	\$2.50-\$10
LD8259A	Type D package	\$1.25-\$5
LD8259A-2	Type D package	\$1.25-\$5
LD8259A-5	Type D package	\$1.25-\$5
MD8259A	Type D package	\$1.25-\$5
MD8259A/B	Type D grey ceramic package w/tin pins. © Intel '80.	\$1.25-\$5
MD8259A/BC	Type D package	\$1.50-\$6
MD8259A-2	Type D package	\$1.50-\$6
QM8259AD1	Type D package. Single source shows 1 in stock.	Ex. Rare (Suspect) \$\$\$
QD8259A	Type D package	\$1.25-\$5
QD8259A-2	Type D package	\$1.25-\$5
QD8259A-5	Type D package. Single source shows 8 in stock.	Ex. Rare (Suspect) \$\$\$
TD8259A	Type D package	\$1.25-\$5
TD8259A-2	Type D package	\$2.50-\$10
TD8259A-5	Type D package	\$1.25-\$5

Intel i8259A

Type P Packages

Part Number	Package Description	Values
		
P8259A	1. Type P black plastic package w/tin pins. Rectangular key. © Intel '76	\$.50-\$2
P8259A	2. Type P black plastic package w/tin pins. Half-round key. © i 1976.	\$.50-\$2
		
P8259A	3. Type P black plastic package w/tin pins. Half-round key. © Intel '76 '80.	\$.50-\$2
		
P8259A	4. Type P black plastic package w/tin pins. Half-round key. © Intel '80	\$.50-\$2
P8259A	5. Type P black plastic package w/tin pins. Rectangular key. © Intel '80.	\$.50-\$2
		
P8259A-2	Type P black plastic package w/tin pins. Rectangular Key. © Intel '80	\$.50-\$2

Intel i8259A

P8259A-8	Type P black plastic package w/tin pins. Rectangular key. © Intel '76.	\$.75-\$3
QP8259A	Type P package	\$.75-\$3
QP8259A-2	Type P package	\$2.50-\$10

Type N Packages

Part Number	Package Description	Values
N8259A	PLCC	\$.50-\$2
N8259A-2	PLCC	\$.50-\$2

References

[1] Intel (1978). Intel Component Data Catalog, 8259/8259-5 Data Sheet, p. 12-111. No reference to 8259A.

[2] Intel (February 1979). Intel MCS-86 Product Description, 8259A Data Sheet, p. 42

[3] Intel (1980). Intel Component Data Catalog, 8259A/8259A-2/8259A-8 Preliminary Data Sheet, p. 6-116

Intel i8271

Programmable Floppy Disk Controller

1977

Specifications

- Programmable Floppy Disk Controller
- IBM 3740 Soft Sector Format Compatible
- Programmable Record Lengths
- Multi-Sector Capability
- Maintain Dual Drives with Minimum Software Overhead – Expandable to 4 drives
- Automatic Read/Write Head Positioning and Verification
- Internal CRC Generation and Checking
- Programmable Step Rate, Settle-Time, Head load Time, Head Unload Index Count
- Fully Compatible with 8080 CPU
- Single +5V Supply
- 40-pin Dual In-Line Package

Type	Clock	Power Dissipation Max.	Supplies [V]
8271	-	-	+5
8271-6	4 MHz	-	+5

The 8271 Floppy Disk Controller (FDC) is a single chip device designed to interface from one to four floppy disk drives to the 8080 microcomputer system. Its powerful control functions minimize both hardware and software overhead normally associated with floppy disk interface [1].

Intel i8271

Part Numbers

Type C Packages

Part Number	Package Description	Values
		
C8271	Type C purple ceramic package w/black cap and tin pins. © Intel '77. Example shown marked 'ES' for Eng. Sample.	Rare \$25-\$100

Type D Packages

Part Number	Package Description	Values
D8271	Type D grey ceramic package w/tin pins. © Intel '77.	\$1.25-\$5
D8271-6	Type D package	\$2-\$8
D8271-8	Type D package	\$2.50-\$10

Type P Packages

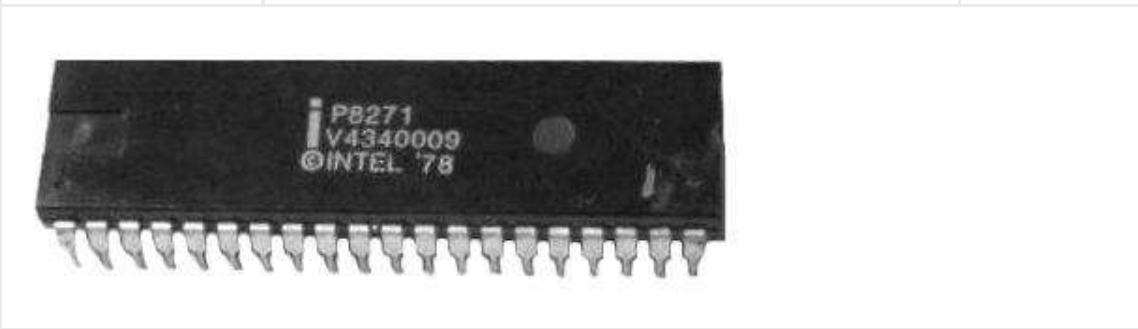
Part Number	Package Description	Values
		
P8271	1. Type P black plastic package w/tin pins. Rectangular key. © Intel '78	\$1.25-\$5

Intel i8271



P8271	2. Type P black plastic package w/tin pins. Half-round key. © Intel '78.	\$1.25-\$5
P8271-6	Type P package	\$5-\$20

References

- [1] Intel (1977). Intel Data Catalog, 8271 Preliminary Data Sheet, p. 10-228
- [2] Intel (1980). Intel Component Data Catalog, 8271 Preliminary Data Sheet, p. 8-82
- [3] Intel (1984). A Revolution in Progress... A History of Intel to Date, 8271 introduced 1977, p. 26.

Intel i8272

Single/Double Density Floppy Disk Controller

1980

Specifications

- Single/Double Density Floppy Disk Controller
- IBM Compatible in Both Single and Double Density Recording Formats
- Programmable Data record Lengths: 128, 256, 512, or 1024 Bytes/Sector
- Multi-Sector and Multi-Track Transfer Capability
- Drive Up to 4 Floppy Disks
- Data Scan Capability – Will Scan a Single Sector or an Entire Cylinder's Worth of Data Fields, Comparing
 - on a Byte by Byte Basis, Data in the Processor's Memory with data Read from the Diskette
- Data transfers in DMA or Non-DMA Mode
- Parallel Seek Operations on Up to Four Drives
- Compatible with Most Microprocessors including 8080A, 8085A, and 8086
- Single Phase 8 MHz Clock
- Single +5 Volt Power Supply
- 40-pin Dual In-Line Package

The 8272 is an LSI Floppy Disk Controller (FDC) Chip, which contains the circuitry and control functions for interfacing a processor to 4 Floppy Disk Drives. It is capable of supporting either IBM 3740 single density format (FM), or IBM System 34 Double Density format (MFM) including double sided recording. The 8272 provides control signals which simplify the design of an external phase locked loop, and write precompensation circuitry. The FDC simplifies and handles most of the burdens associated with implementing a Floppy Disk interface [1].

Part Numbers

Type C Packages

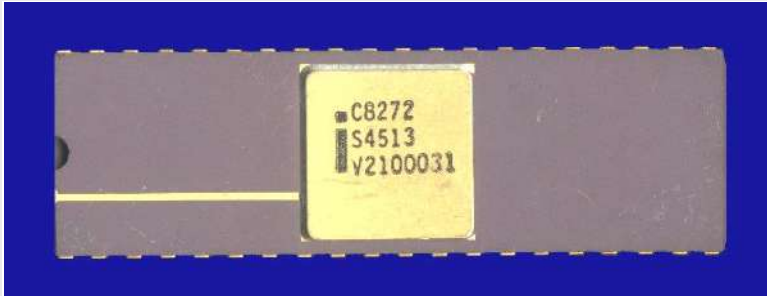
Part Number	Package Description	Values
		
C8272	Type C purple ceramic package w/gold cap, offset gold cap ground strap, and gold pins. Small '1' in circle denotes pin #1.	Rare \$25-\$100

Type D Packages

Part Number	Package Description	Values
D8272	Type D package	\$5-\$20

Type P Packages

Part Number	Package Description	Values
P8272	1. Type P black plastic package w/tin pins. Rectangular key. No Copyright.	\$.75-\$3
P8272	2. Type P black plastic package w/tin pins. Rectangular key. © NEC '79.	\$.75-\$3
QP8272	Type P package. Single source shows 7 in stock.	Ex. Rare (Suspect) \$\$\$

References

[1] Intel (1980). Intel Component Data Catalog, 8272 Advance Information, p. 8-111

[2] Intel (2002). Intel Museum Archive Collection Chronological Timeline, 8272 [introduction] date "01/01/80". Available from: http://www.intel.com/intel/intelis/museum/arc_collect/TimelineChron.pdf
[Accessed 10 July 2002]

Intel i8272A

Single/Double Density Floppy Disk Controller

1982-83

Specifications

- Single/Double Density Floppy Disk Controller
- IBM Compatible in Both Single and Double Density Recording Formats
- Programmable Data record Lengths: 128, 256, 512, or 1024 Bytes/Sector
- Multi-Sector and Multi-Track Transfer Capability
- Drive Up to 4 Floppy or Mini-Floppy Disks
- Controls 8", 5 ¼" and 3 ½" Floppy Disk Drives
- Data transfers in DMA or Non-DMA Mode
- Parallel Seek Operations on Up to Four Drives
- Compatible with all Intel and Most Other Microprocessors
- Single Phase 8 MHz Clock
- Single +5 Volt Power Supply ($\pm 10\%$)
- 40-pin Dual In-Line Package



The 8272A is an LSI Floppy Disk Controller (FDC) Chip, which contains the circuitry and control functions for interfacing a processor to 4 Floppy Disk Drives. It is capable of supporting either IBM 3740 single density format (FM), or IBM System 34 Double Density format (MFM) including double sided recording. The 8272A provides control signals which simplify the design of an external phase locked loop, and write precompensation circuitry. The FDC simplifies and handles most of the burdens associated with implementing a Floppy Disk interface. The 8272A is a pin-compatible upgrade to the 8272 [5].

Part Numbers

Type D Packages

Part Number	Package Description	Values
D8272A	Type D package	\$1-\$4
LD8272A	Type D package	\$2.50-\$10
MD8272A	Type D package	\$2.50-\$10
MD8272A/B	Type D package	\$2.50-\$10
QD8272A	Type D package	\$2.50-\$10
TD8272A	Type D package	\$3-\$12

Type P Packages

Part Number	Package Description	Values
		
P8272A	1. Type P black plastic package w/tin pins. Rectangular key. No copyright.	\$.50-\$2
		
P8272A	2. Type P black plastic package w/tin pins. Half-round key. No copyright.	\$.50-\$2
QP8272A	Type P package	\$2.50-\$10

References

- [1] Intel (1980). Intel Component Data Catalog, 8272 Advance Information, p. 8-111. No reference to 8272A.
- [2] Hearst (1981). IC Master. No reference to Intel 8272A.
- [3] Intel (January 1982). Intel Component Data Catalog, 8272 Data Sheet, p. 9-146. No reference to 8272A.
- [4] Hearst (1983). IC Master, Intel 8272A, p. 1101-126.
- [5] Intel (1989). Intel Microprocessor and Peripheral Handbook, 8272A Data Sheet, p. 7-1

Intel i8273

Programmable HDLC/SDLC Protocol Controller

1977

Specifications



- Programmable HDLC/SDLC Protocol Controller
- CCITT X.25 Compatible
- HDLC/SDLC Compatible
- Full Duplex, Half Duplex, or Loop SDLC Operation
- Up to 64K Baud Synchronous Transfers
- Automatic FCS (CRC) Generation and Checking
- Up to 9.6K Baud with On-Board Phase Locked Loop
- Programmable NRZI Encode/Decode
- Two User Programmable Modem Control Ports
- Digital Phase Locked Loop Clock Recovery
- Minimum CPU Overhead
- Fully Compatible with 8048/8080/8085/8088/8086 CPUs
- Single +5Volt Supply
- 40-pin Dual In-Line Package

Type	Baud Rate	Power Dissipation Max.	Supplies [V]
8273	64K Baud	-	+5
8273-4	56K Baud	-	+5
8273-8	48K Baud	-	+5

The Intel © 8273 Programmable HDLC/SDLC Protocol Controller is a dedicated device designed to support the ISO/CCITT's HDLC and IBM's SDLC communication line protocols. It is fully compatible with Intel's new high performance microcomputer systems such as the MCS-88/86™. A frame level command set is achieved by a unique microprogrammed dual processor chip architecture. The processing capability supported by the 8273 relieves the system CPU of the low level real-time task normally associated with controllers [2].

Part Numbers

Type C Packages

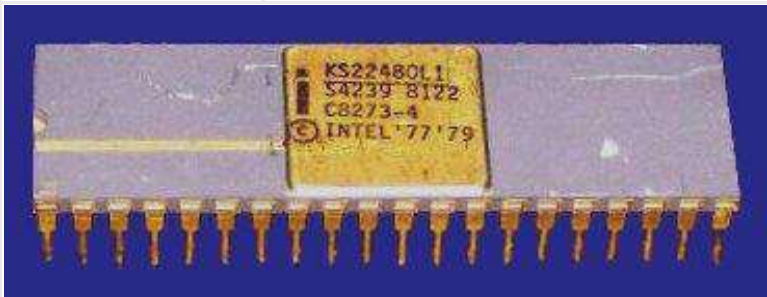
Part Number	Package Description	Values
		
C8273	1. Type C grey ceramic package w/black cap, and tin pins. © Intel '77. Example shown marked 'ES' for Eng. Sample.	Rare \$25-\$100
		
C8273	2. Type C purple ceramic package w/gold cap, offset gold cap ground strap, and gold pins. © Intel '77 '79. Intel logo and part number printed on cap.	Rare \$20-\$80
C8273	3. Type C grey ceramic package w/gold cap, offset gold cap ground strap, and gold pins. © Intel '77, '79. Intel logo and part number printed on ceramic.	Rare \$20-\$80
		
C8273-4	1. Type C purple ceramic package w/gold cap, offset gold cap ground strap, and gold pins. © Intel '77 '79. Intel logo and part number printed on cap.	Rare \$20-\$80
C8273-4	2. Type C purple ceramic package w/gold cap, offset gold cap ground strap, and gold pins. © Intel '77 '79. Intel logo and part number printed on ceramic.	Rare \$20-\$80

Intel i8273

Type D Packages

Part Number	Package Description	Values
D8273	Type D package	\$.75-\$3
D8273-4	Type D package	\$.75-\$3
D8273-8	Type D package	\$2.50-\$10
LD8273	Type D package	\$2.50-\$10
MD8273	Type D package	\$2-\$8
MD8273/B	Type D package	\$2-\$8
QD8273	Type D package.	Ex. Rare \$10-\$40
TD8273	Type D package	\$1.50-\$5

Type P Packages

Part Number	Package Description	Values
P8273	Type P black plastic package w/tin pins. © Intel '77 '79	\$.50-\$2
P8273-4	Type P package	\$.50-\$2
P8273-8	Type P package	\$5-\$20

Type N Packages

Part Number	Package Description	Values
N8273-4	PLCC	\$5-\$20

References

- [1] Intel (1977). Intel Data Catalog, 8273 Preliminary Data Sheet, p. 10-232
- [2] Intel (1980). Intel Component Data Catalog, 8273, 8273-4, 8273-8 Preliminary Data Sheet, p. 8-113.
- [3] Intel (1984). A Revolution in Progress... A History of Intel to Date, 8273 introduced 1977, p. 26.

Intel i8275

Programmable CRT (Video) Controller

1977

Specifications

- Programmable CRT (Video) Controller
- Programmable Screen and Character Formats
- 6 Independent Visual Field Attributes
- 11 Visual Character Attributes (Graphic Capability)
- Cursor Control (4 Types)
- Light Pen Detection and Register
- Dual Row Buffers
- Programmable DMA Burst Mode
- Single +5 Volt Supply
- 40-pin Dual In-Line Package

The 8275 Programmable CRT Controller is a single chip device designed to interface CRT Raster Scan Displays with the 8080 Microcomputer System. Its primary function is to refresh the display by buffering the information from main memory and keeping track of the display position of the screen. The flexibility, designed into the 8275, will allow simple interface almost any Raster Scan Display with a minimum of external hardware and software overhead [2].

Part Numbers

Type C Packages

Part Number	Package Description	Values
		
C8275	1. Type C purple ceramic package w/black cap and tin pins. No Copyright	Rare \$25-\$100
		
C8275	2. Type C purple ceramic package w/black cap and tin pins. © Intel '76	Rare \$25-\$100

Type D Packages

Part Number	Package Description	Values
D8275	Type D grey ceramic package w/tin pins. © Intel '76.	\$1.25-\$5
D8275-2	Type D package	\$.75-\$3
ID8275	Type D package	\$5-\$20
LD8275	Type D package	\$2-\$8
LD8275-2	Type D package	\$2-\$8
MD8275/B	Type D package	\$2-\$8
TD8275-2	Type D package	\$2.50-\$10

Intel i8275

Type P Packages

Part Number	Package Description	Values
 A photograph of an Intel i8275 chip. The chip is a black rectangular integrated circuit with numerous pins along its edges. The top surface of the chip is marked with the text: 'P8275', 'L4099665', and '©INTEL '76'. A small circular mark is visible on the right side of the chip.		
P8275	Type P black plastic package w/tin pins. Rectangular key. © Intel '76.	\$.50-\$2
P8275-2	1. Type P black plastic package w/tin pins. Rectangular key. © Intel '76.	\$.50-\$2
P8275-2	2. Type P black plastic package w/tin pins. Half round key. © Intel '85.	\$.50-\$2

References

- [1] Intel (1976). Intel Data Catalog. No reference to 8275.
- [2] Intel (1977). Intel Data Catalog, 8275 Preliminary Data Sheet, p. 10-236
- [3] Intel (1984). A Revolution in Progress... A History of Intel to Date, 8275 introduced 1977, p. 26.

Intel i8278

Programmable Keyboard Interface

1978

Specifications

- Programmable Keyboard Interface
- Simultaneous Keyboard and Display Operations
- Interface Signals for Contact and Capacitive Coupled Keyboards
- 128-Key Scanning Logic
- 10.7 msec Matrix Scan Time for 128 Keys and 6 MHz Clock
- 8-Character Keyboard FIFO
- N-Key Rollover with Programmable Error Mode on Multiple New Closures
- 16- or 18-Character 7-Segment Display Interface
- Right or Left Entry Display RAM
- Depress/Release Mode Programmable
- Interrupt Output on Key Entry
- 40-pin Dual In-Line Package

The Intel® 8278 is a general purpose programmable keyboard and display interface designed for use with 8-bit microprocessors such as the MCS-80™ and MCS-85™. The keyboard portion can provide a scanned interface to 128-key contact or capacitive-coupled keyboards. The keys are fully debounced with N-key rollover and programmable error generation on multiple new key closures. Keyboard entries are stored in an 8-character FIFO with overrun status indication when more than 8 characters are entered. Key entries set an interrupt request output to the master CPU.

The display portion of the 8278 provides a scanned display interface for LED, incandescent, and other popular display technologies. Both numeric displays and simple indicators may be used. The 8278 has a 16X4 display RAM, which can be loaded or interrogated by the CPU. Both right entry calculator and left entry typewriter display formats are possible. Both read and write of the display RAM can be done with auto-increment of the display RAM address [1].

Intel i8278

Part Numbers

Type D Packages

Part Number	Package Description	Values
D8278	Type D package. Single source shows 1 in stock.	Ex. Rare (Suspect) \$\$\$

Type P Packages

Part Number	Package Description	Values
		
P8278	Type P black plastic package w/tin pins. © Intel '77	\$1.25-\$5

References

- [1] Intel (1978). Intel Component Data Catalog, 8278 Preliminary Data Sheet, p. 12-188

Intel i8279

Programmable Keyboard / Display Interface

1977

Specifications



- Programmable Keyboard/Display Interface
- Simultaneous Keyboard and Display Operations
- Scanned Keyboard Mode
- Scanned Sensor Mode
- Strobed Input Entry Mode
- 8 Character Keyboard FIFO
- 2 Key or N Key Rollover with Contact Debounce
- Dual 8 or 16 Numerical Display
- Single 16 Character Display
- Right or Left Entry 16 Byte Display RAM
- Mode Programmable from CPU
- Programmable Scan Timing
- Interrupt Output on Key Entry
- 40-pin Dual In-Line Package

The 8279 is a general-purpose programmable keyboard and display I/O interface device designed for use with microprocessors. The keyboard portion can provide a scanned interface to a 64 contact key matrix, which can be expanded to 128. The keyboard portion will also interface to an array of sensors or a strobed interface keyboard, such as the Hall effect and Ferrite variety. Key depressions can be 2 key or N key rollover. Keyboard entries are debounced and stored in an 8 character FIFO. If more than 8 characters are entered, over run status is set. Key entries set the interrupt output line to the CPU.

The display portion provides a scanned display interface for LED, incandescent and other popular display technologies. Both numeric and alphanumeric segment displays may be used as well as simple indicators. The 8279 has a 16 x 8 display RAM which can be organized into a dual 16 x 4. The RAM can be loaded or interrogated by the CPU. Both right entry, calculator and left entry typewriter display formats are possible. Both read and write of the display RAM can be done with auto-increment of the display RAM address [1].





Part Numbers

Type D Packages

Part Number	Package Description	Values
		
D8279	1. Type D grey ceramic package w/tin pins. © Intel '76.	\$1.25-\$5
D8279	2. Type D grey ceramic package w/tin pins. © Intel '77.	\$.75-\$3
D8279-5	1. Type D grey ceramic package w/tin pins. © Intel '76.	\$.75-\$3
		
D8279-5	2. Type D grey ceramic package w/tin pins. © Intel '77.	\$.75-\$3
D8279-5	3. Type D grey ceramic package w/tin pins. © Intel '80.	\$.75-\$3
ID8279	Type D package	\$1.25-\$5
ID8279-5	Type D package	\$2-\$8
LD8279	Type D package	\$2.50-\$10
LD8279-5	Type D package	\$1.50-\$6
MD8279	Type D package	Rare \$8-\$32
MD8279-5	Type D package	Rare \$8-\$32
QD8279	Type D package	\$1.25-\$5
QD8279-5	Type D package	\$1.25-\$5
TD8279	Type D package	\$1.25-\$5
TD8279-5	Type D package	\$1.25-\$5

Intel i8279

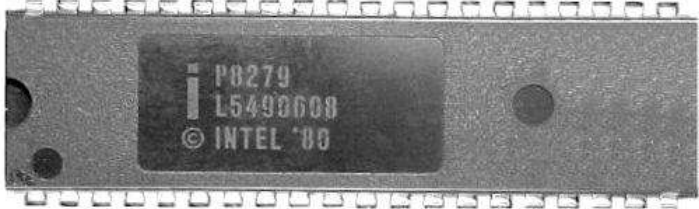
Type P Packages

Part Number	Package Description	Values
		
P8279	1. Type P black plastic package w/tin pins. Rectangular key. © Intel '77	\$.50-\$2
		
P8279	2. Type P black plastic package w/tin pins. Rectangular key. © Intel '80	\$.50-\$2
		
P8279	3. Type P black plastic package w/tin pins. Half-round key. Impressed logo and part number. © Intel '80	\$.50-\$2
		
P8279-5	1. Type P black plastic package w/tin pins. Half-round key. Impressed logo and part number. © Intel 1976	\$.50-\$2

Intel i8279

P8279-5	2. Type P black plastic package w/tin pins. Rectangular key. © Intel '77.	\$.50-\$2
P8279-5	3. Type P black plastic package w/tin pins. Half-round key. Impressed logo and part number. © Intel '80.	\$.50-\$2
QP8279	Type P package	Rare \$8-\$32
QP8279-5	Type P package	\$1.25-\$5

References

[1] Intel (1977). Intel Data Catalog, 8279 Preliminary Data Sheet, p. 10-240.

[2] Intel (1984). A Revolution in Progress... A History of Intel to Date, 8279 introduced 1977, p. 26.

Intel i8282

8-bit Non-Inverting Latch with Output Buffer

1978



Specifications

- 8-bit Non-Inverting Latch with Output Buffer
- Bipolar
- Address Latch for iAPX 86, 88, MCS-80®, MCS-85®, and MCS-48® Families
- High Output Drive Capability for Driving System Data Bus
- Fully Parallel 8-bit Data Register and Buffer
- Transparent during Active Strobe
- Three-State Outputs
- No Output Low Noise when Entering or Leaving High Impedance State
- 20-pin Dual In-Line Package with 0.3" Center

The 8282 and 8283 are 8-bit latches with 3-state output buffers. They can be used to implement latches, buffers or multiplexers. The 8283 inverts the input data as its outputs while the 8282 does not. Thus, all of the principal peripheral and input/output functions of a microcomputer system can be implemented with these devices [2].

Part Numbers

Type D Packages

Part Number	Package Description	Values
		
D8282	1. Type D grey ceramic package w/tin tin pins. Example shown marked 'CS' for Customer Sample.	\$.75-\$3
		
D8282	2. Type D grey ceramic package w/tin pins. © Intel '79.	\$.75-\$3
ID8282	Type D package	Rare \$10-\$40
LD8282	Type D package	\$1.25-\$5
MD8282	Type D package	\$1.25-\$5
MD8282/B	Type D package	\$1.25-\$5
MD8282/BC	Type D package	Rare \$10-\$40
QD8282	Type D package	\$2.50-\$10
TD8282	Type D package	\$1.25-\$5

Type P Packages

Part Number	Package Description	Values
		
P8282	Type P black plastic package w/tin pins.	\$.75-\$3
QP8282	Type P package	Rare \$10-\$40

References

- [1] Hearst (1979). IC Master, Intel 8282/8283 Preliminary Data Sheet, p. 1948
- [2] Intel (July 1981). Intel iAPX 88 Book, 8282/8283 Data Sheet, p. 71
- [3] Intel (1984). A Revolution in Progress... A History of Intel to Date, 8282 introduced 1978, p. 26.

Intel i8283

8-bit Inverting Latch with Output Buffer

1978

Specifications

- 8-bit Inverting Latch with Output Buffer
- Bipolar
- Address Latch for iAPX 86, 88, MCS-80®, MCS-85®, and MCS-48® Families
- High Output Drive Capability for Driving System Data Bus
- Fully Parallel 8-bit Data Register and Buffer
- Transparent during Active Strobe
- Three-State Outputs
- No Output Low Noise when Entering or Leaving High Impedance State
- 20-pin Dual In-Line Package with 0.3” Center

The 8282 and 8283 are 8-bit latches with 3-state output buffers. They can be used to implement latches, buffers or multiplexers. The 8283 inverts the input data as its outputs while the 8282 does not. Thus, all of the principal peripheral and input/output functions of a microcomputer system can be implemented with these devices [2].

Part Numbers

Type D Packages

Part Number	Package Description	Values
		
D8283	Type D grey ceramic package w/tin pins. © '82	\$.75-\$3
ID8283	Type D package	\$1.50-\$6
LD8283	Type D package	\$1.25-\$5
MD8283	Type D package	\$2-\$8
MD8283/B	Type D package	\$1.25-\$5
TD8283	Type D package	\$2.50-\$10

Type P Packages

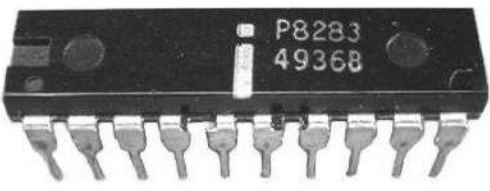
Part Number	Package Description	Values
		
P8283	Type P black plastic package w/tin pins.	\$.75-\$3

References

[1] Hearst (1979). IC Master, Intel 8282/8283 Preliminary Data Sheet, p. 1948

[2] Intel (July 1981). Intel iAPX 88 Book, 8282/8283 Data Sheet, p. 71

Intel i8284

Clock Generator and Driver for iAPX 86/88 Processors

1978

Specifications



- Clock Generator and Driver for iAPX 86/88 Processors
- Bipolar [1]
- Generates the System Clock for the iAPX 86/88 Processors
- Uses a Crystal or a TTL Signal for Frequency Source
- Provides Local READY and Multibus™ READY Synchronization
- Single +5V Power Supply
- Generates System Reset Output from Schmitt Trigger Input
- Capable of Clock Synchronization with Other 8284's
- 18-pin Dual In-Line Package

Type	Clock	Power Dissipation Max.	Supplies [V]
8284	-	-	+5

The 8284 is a bipolar clock generator/driver designed to provide clock signals for the 8086 CPU and peripherals. It also contains READY logic for operation with two MULTIBUS™ systems and provides the 8086's required READY synchronization and timing. Reset logic with hysteresis and synchronization is also provided [1].

Part Numbers

Type D Packages

Part Number	Package Description	Values
		
D8284	1. Type D grey ceramic package w/tin pins. Small round indentation denotes pin #1.	\$.75-\$3
		
D8284	2. Type D grey ceramic package w/tin pins. No denotation for pin #1. Example shown marked 'CS' for Customer Sample	\$.75-\$3
LD8284	Type D package	\$1.25-\$5
MD8284	Type D package	\$1.25-\$5
MD8284/B	Type D package	\$1.25-\$5
TD8284	Type D package	\$1.25-\$5

Type P Packages

Part Number	Package Description	Values
P8284	Type P package	\$.75-\$3

References

[1] Hearst (1979). IC Master, Intel 8284 Preliminary Data Sheet, p. 1948

[2] Intel (2002). Intel Museum Archive Collection Chronological Timeline, 8284A [introduction] date "01/01/78". Available from: http://www.intel.com/intel/intelis/museum/arc_collect/TimelineChron.pdf [Accessed 10 July 2002]"

Intel i8284A

Clock Generator and Driver for iAPX 86/88 Processors

1980-81

Specifications

- Clock Generator and Driver for iAPX 86/88 Processors
- Bipolar [1]
- Generates the System Clock for the iAPX 86, 88 Processors
- Uses a Crystal or a TTL Signal for Frequency Source
- Provides Local READY and Multibus™ READY Synchronization
- Single +5V Power Supply
- Generates System Reset Output from Schmitt Trigger Input
- Capable of Clock Synchronization with Other 8284A's
- 18-pin Dual In-Line Package

Type	Clock	Power Dissipation Max.	Supplies [V]
8284A	5-8 MHz	-	+5
8284A-1	10 MHz	-	+5

The 8284A is a single chip clock generator/driver for the iAPX 86/88 processors. The contains a crystal controlled oscillator, a divide-by-three counter, complete MULTIBUS™ “Ready” synchronization and reset logic [2].

Intel i8284A

Part Numbers

Type D Packages

Part Number	Package Description	Values
		
D8284A	Type D grey ceramic package w/tin pins.	\$.75-\$3
D8284A-1	Type D package	\$1.25-\$5
ID8284A	Type D package	\$5-\$10
LD8284A	Type D package	\$1.25-\$5
MD8284A	Type D package	\$1.25-\$5
MD8284A/B	Type D package	\$1-\$4
MD8284A/BC	Type D package	\$1.25-\$5
QD8284A	Type D package	\$1.25-\$5
QD8284A-1	Type D package. Single sources shows 10 in stock.	Rare (Suspect) \$\$\$
TD8284A	Type D package	\$1.25-\$5

Type P Packages

Part Number	Package Description	Values
		
P8284A	Type P black plastic package w/tin pins.	\$.75-\$3
P8284A-1	Type P package	\$1.50-\$6
QP8284A	Type P package	\$2.50-\$10

References

[1] Intel (1980). Intel Component Data Catalog, 8284 Preliminary Data Sheet, p. 7-62. No reference to 8284A dates chip after 1980.

[2] Intel (July 1981). Intel iAPX 88 Book, 8284A Preliminary Data Sheet, p. 63

[3] Intel (2002). Intel Museum Archive Collection Chronological Timeline. Available from: http://www.intel.com/intel/intelis/museum/arc_collect/TimelineChron.pdf [Accessed 10 July 2002] – 8284A [introduction] date “01/01/78”

Intel i8286

8-bit Non-Inverting Bus Transceiver

1978



Specifications

- 8-bit Non-Inverting Bus Transceiver
- Bipolar
- Data Bus Buffer Driver for iAPX 86, 88, MCS-80™, MCS-85™, and MCS-48™ Families
- High Output Drive Capability for Driving System Data Bus
- Fully Parallel 8-bit Transceivers
- Three-State Output
- No Output Low Noise when Entering or Leaving High Impedance State
- 20-pin Dual In-Line Package with 0.3" Center

The 8286 and 8287 are 8-bit bipolar transceivers with 3-state outputs. The 8287 inverts the input data at its outputs while the 8286 does not. Thus, a wide variety of applications for buffering in microcomputer systems can be met [2].

Part Numbers

Type D Packages

Part Number	Package Description	Values
		
D8286	1. Type D grey ceramic package w/tin pins. Example shown marked 'CS' for Customer Sample.	\$.75-\$3
		
D8286	2. Type D grey ceramic package w/tin pins. © Intel '79.	\$.75-\$3
ID8286	Type D package	\$2.50-\$10
LD8286	Type D package	\$1.25-\$5
MD8286	Type D package	\$1.25-\$5
MD8286/B	Type D package	\$1.25-\$5
QD8286	Type D package	\$2-\$8
TD8286	Type D package	\$1.25-\$5

Type P Packages

Part Number	Package Description	Values
		
P8286	Type P black plastic package w/tin pins. Example shown marked 'CS' for Customer Sample.	\$.50-\$2

References

- [1] Hearst (1979). IC Master, Intel 8286/8287 Preliminary Data Sheet, p. 1948
- [2] Intel (July 1981). Intel iAPX 88 Book, 8286/8287 Data Sheet, p. 76
- [3] Intel (1984). A Revolution in Progress... A History of Intel to Date, 8286 introduced 1978, p. 26.

Intel i8287

8-bit Inverting Bus Transceiver

1978

Specifications

- 8-bit Inverting Bus Transceiver
- Bipolar
- Data Bus Buffer Driver for iAPX 86, 88, MCS-80™, MCS-85™, and MCS-48™ Families
- High Output Drive Capability for Driving System Data Bus
- Fully Parallel 8-bit Transceivers
- Three-State Output
- No Output Low Noise when Entering or Leaving High Impedance State
- 20-pin Dual In-Line Package with 0.3" Center

The 8286 and 8287 are 8-bit bipolar transceivers with 3-state outputs. The 8287 inverts the input data at its outputs while the 8286 does not. Thus, a wide variety of applications for buffering in microcomputer systems can be met [2].

Part Numbers

Type D Packages

Part Number	Package Description	Values
		
D8287	1. Type D grey ceramic package w/tin pins. No copyright.	\$.75-\$3
D8287	2. Type D grey ceramic package w/tin pins. © Intel '79.	\$.75-\$3
ID8287	Type D package	\$1.50-\$6
LD8287	Type D package	\$1.25-\$5
MD8287	Type D package	\$1.25-\$5
MD8287/B	Type D grey ceramic package w/tin pins. No copyright.	\$1.25-\$5
MC8287/BC	Type D package	\$5-\$20
TD8287	Type D package	\$1.25-\$5

Type P Packages

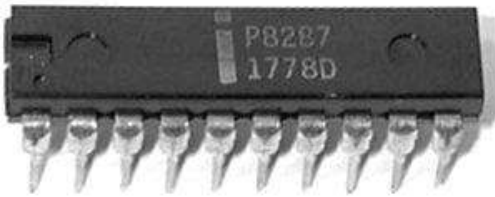
Part Number	Package Description	Values
		
P8287	Type P black plastic package w/tin pins	\$.75-\$3

References

- [1] Hearst (1979). IC Master, Intel 8286/8287 Preliminary Data Sheet, p. 1948
- [2] Intel (July 1981). Intel iAPX 88 Book, 8286/8287 Data Sheet, p. 76
- [3] Intel (1984). A Revolution in Progress... A History of Intel to Date, 8287 introduced 1978, p. 26.

Intel i8288

Bipolar Bus Controller for iAPX 86/88 processors

1978

Specifications

- Bipolar Bus Controller for iAPX 86/88 processors
- Bipolar
- Bipolar drive capability
- Provides advanced commands
- Provides wide flexibility in system configurations
- 3-state command output drivers
- Configurable for use with an I/O bus
- Facilities interface to one or two multi-master busses
- 20-pin Dual In-Line Package

The Intel® 8288 Bus Controller is a 20-pin bipolar component for use with medium-to-large 8086 processing systems. The bus controller provides command and control timing generation as well as bipolar bus drive capability while optimizing system performance.

A strapping option on the bus controller configures it for use with a multi-master system bus and separate I/O bus [1].

Intel i8288

Part Numbers

Type D Packages

Part Number	Package Description	Values
		
D8288	Type D grey ceramic package w/tin pins. © '79.	\$.75-3
D8288-6	Type D package	\$5-\$20
D8288-8	Type D package	\$1.25-\$5
D8288-10	Type D package	\$1.25-\$5
D8288-12	Type D package. Single source shows 27 in stock.	Rare (Suspect) \$\$\$
ID8288	Type D package	\$1.50-\$6
LD8288	Type D package	\$1.25-\$5
MD8288	Type D package	\$1.25-\$5
MD8288/B	Type D package	\$1.25-\$5
MD8288/BC	Type D package	\$2.50-\$10
QD8288	Type D package	\$2.50-\$10
TD8288	Type D package	\$1.25-\$5

Type P Packages

Part Number	Package Description	Values
P8288	Type P package	\$1.25-\$5
QP8288	Type P package. Single source shows 39 in stock.	Rare (Suspect) \$\$\$

References

- [1] Intel (1980). Intel Component Data Catalog, 8288 Preliminary Data Sheet, p. 7-74
- [2] Intel (1984). A Revolution in Progress... A History of Intel to Date, 8288 introduced 1978, p. 26.

Intel i8289

Bus Arbiter for iAPX 86/88 processors

1979

Specifications

- Bus Arbiter for iAPX 86/88 Processors
- Bipolar
- Provides Multi-Master System Bus Protocol
- Synchronizes 8086/8088 Processors with Multi-Master Bus
- Provides Simple Interface with 8288 Bus Controller
- Four Operating Modes For Flexible System Configuration
- Compatible with Intel Bus Standard MULTIBUS™
- Provides System Bus Arbitration For 8089 IOP Remote Mode
- 20-pin Dual In-Line Package

The Intel® 8289 Bus Arbiter is a 20-pin, 5-volt-only bipolar component for use with medium to large 8086/8088 multi-master/multiprocessing systems. The 8289 provides system bus arbitration for systems with multiple bus masters, such as an 8086 CPU with 8089 IOP in its remote mode, while providing bipolar buffering and drive capability [2].

Part Numbers

Type C Packages

Part Number	Package Description	Values
		
C8289	1. Type C purple ceramic package w/gold cap, offset gold cap ground strap, and gold pins. Small black dot denotes pin #1.	\$15-\$60
		
C8289	2. Type C purple ceramic package w/gold cap and gold pins. Small black dot denotes pin #1.	\$15-\$60

Type D Packages

Part Number	Package Description	Values
		
D8289	Type D package	\$.75-\$3
D8289-1	Type D package	\$.75-\$3
LD8289	Type D package	\$1.25-\$5
MD8289	Type D package	\$2-\$8
MD8289/B	Type D package	\$1.25-\$5
MD8289/BC	Type D package	\$2.50-\$10
QD8289	Type D package	\$5-\$20

Intel i8289

Type P Packages

Part Number	Package Description	Values
P8289	Type P package	\$1.25-\$5
P8289-1	Type P package	\$1.50-\$6
QP8289	Type P package. Single source shows 4 in stock.	Rare (Suspect) \$\$\$

References

- [1] Intel (1979). Intel Component Data Catalog. No reference to 8289.
- [2] Intel (1980). Intel Component Data Catalog, 8289 Preliminary Data Sheet, p. 7-80
- [3] Intel (1984). A Revolution in Progress... A History of Intel to Date, 8289 introduced 1979, p. 26.

Intel i8291

GPIB Talker/ Listener

1979

Specifications

- GPIB Talker/ Listener
- Designed to Interface Microprocessors (e.g., 8080, 8085, 8086, 8048) to an IEEE Standard 488 Digital Interface Bus
- Programmable Data Transfer Rate
- Complete Source and Acceptor Handshake
- Complete Talker and Listener Functions with Extended Addressing
- Service Request, Parallel Poll, Device Clear, Device Trigger, Remote/Local Functions
- Selectable Interrupts
- On-Chip Primary and Secondary Address Recognition
- Automatic Handling of Addressing and Handshake Protocol
- Provision for Software Implementation of Additional Features
- 1 – 8 MHz Clock Range
- 16 Registers (8 Read, 8 Write), 2 for Data Transfer, the Rest for Interface Function Control, Status, etc.
- Directly Interfaces to External Non-Inverting Transceivers for Connection to GPIB
- Provides Three Addressing Modes, Allowing the Chip to be Addressed Either as a Major or Minor Talker/Listener with Primary or Secondary Addressing
- DMA Handshake Provision Allows for Bus Transfers without CPU Intervention
- Trigger Output Pin
- On-Chip EOS (End of Sequence) Message Recognition Facilitates Handling of Multi-Byte Transfers
- 40-pin Dual In-Line Package

The 8291 GPIB Talker/Listener is a microprocessor-controlled chip designed to interface microprocessors (e.g., 8080, 8085, 8086, 8048) to an IEEE Standard 486 Instrumentation Interface Bus. It implements all of the standard's interface functions except for the controller [2].

Intel i8291

Part Numbers

Type D Packages

Part Number	Package Description	Values
		
D8291	Type D grey ceramic package w/tin pins. © Intel '78	\$1.25-\$5

Type P Packages

Part Number	Package Description	Values
		
P8291	Type P black plastic package w/tin pins. Rectangular key. © Intel '78.	\$1.25-\$5

References

[1] Intel (February 1979). Intel MCS-86 Product Description, 8291 Preliminary Data Sheet, p. 72

[2] Intel (1980). Intel Component Data Catalog, 8291 Preliminary Data Sheet, p. 8-174

Intel i8291A

GPIB Talker/ Listener

1981-82

Specifications

- GPIB Talker/ Listener
- Designed to Interface Microprocessors (e.g., 8048/49, 8051, 8080/85, 8086/88) to an IEEE Standard 488 Digital Interface Bus
- Programmable Data Transfer Rate
- Complete Source and Acceptor Handshake
- Complete Talker and Listener Functions with Extended Addressing
- Service Request, Parallel Poll, Device Clear, Device Trigger, Remote/Local Functions
- Selectable Interrupts
- On-Chip Primary and Secondary Address Recognition
- Automatic Handling of Addressing and Handshake Protocol
- Provision for Software Implementation of Additional Features
- 1 – 8 MHz Clock Range
- 16 Registers (8 Read, 8 Write), 2 for Data Transfer, the Rest for Interface Function Control, Status, etc.
- Directly Interfaces to External Non-Inverting Transceivers for Connection to GPIB
- Provides Three Addressing Modes, Allowing the Chip to be Addressed Either as a Major or Minor Talker/Listener with Primary or Secondary Addressing
- DMA Handshake Provision Allows for Bus Transfers without CPU Intervention
- Trigger Output Pin
- On-Chip EOS (End of Sequence) Message Recognition Facilitates Handling of Multi-Byte Transfers
- 40-pin Dual In-Line Package

The 8291A is an enhanced version of the 8291 GPIB Talker/Listener designed to interface microprocessors to an IEEE Standard 488 instrumentation Interface Bus. It implements all of the Standard's interface functions except for the controller. The controller function can be added with the 8292 GPIB Controller, and the 8293 GPIB Transceiver performs the electrical interface for Talker/Listener and Talker/Listener/Controller configurations [3].

Intel i8291A

Part Numbers

Type D Packages

Part Number	Package Description	Values
 A photograph of a grey ceramic Type D package. The top surface is marked with 'D8291A', 'L8021096', and '© INTEL '80'.		
D8291A	Type D grey ceramic package w/tin pins. © Intel '80	\$1.25-\$5
LD8291A	Type D package	\$2.50-\$10
MD8291A	Type D package	\$2-\$8
MD8291A/B	Type D package	\$2.50-\$10
QD8291A	Type D package	\$1.50-\$6

Type P Packages

Part Number	Package Description	Values
 A photograph of a black plastic Type P package. The top surface is marked with 'P8291A', 'L5200504', and '© INTEL '80'.		
P8291A	Type P black plastic package w/tin pins. © Intel '80	\$.75-\$3

References

- [1] Intel (1980). Intel Component Data Catalog, 8291 Preliminary Data Sheet, p. 8-174. No reference to 8291A dates chip after 1980.
- [2] Hearst (1981). IC Master. No reference to Intel 8291A dates chip after 1981.
- [3] Intel (January 1982). Intel Component Data Catalog, 8291A Preliminary Data Sheet, p. 9-251
- [4] Intel (1983). Intel Microprocessor and Peripheral Handbook, 8291A Preliminary Data Sheet, p. 6-359

Intel i8292

GPIB Controller

1979

Specifications

- GPIB Controller
- Complete IEEE Standard 488 Controller Function
- Interface Clear (IFC) Sending Capability Allows Seizure of Bus Control and/or Initialization of the Bus
- Responds to Service Requests (SRQ)
- Sends Remote Enable (REN), Allowing Instruments to Switch to Remote Control
- Complete Implementation of Transfer Control Protocol
- Synchronous Control Seizure Prevents the Destruction of Any Data Transmission in Progress
- Connects with 8291 to Form a Complete IEEE Standard 488 Interface Talker/Listener/Controller
- 40-pin Dual In-Line Package

The 8292 GPIB Controller is a microprocessor-controlled chip designed to function with the 8291 GPIB Talker/Listener to implement the full IEEE Standard 488 controller function, including transfer control protocol. The 8292 is a pre-programmed Intel® 8041A [2].

Intel i8292

Part Numbers

Type D Packages

Part Number	Package Description	Values
D8292	Type D grey ceramic package w/tin pins. © Intel '78.	\$1.50-\$6
LD8292	Type D package	\$2-\$8
MD8292	Type D package	\$2-\$8
QD8292	Type D package	\$2.50-\$10

Type P Packages

Part Number	Package Description	Values
		
P8292	Type P black plastic package w/tin pins. Rectangular key. © Intel '78.	\$.75-\$3

References

[1] Intel (1979). Intel Component Data Catalog, 8292 Preliminary Data Sheet, p. 11-189

[2] Intel (1980). Intel Component Data Catalog, 8292 Preliminary Data Sheet, p. 8-198

Intel i8293

GPIB Transceiver

1979-80

Specifications

- GPIB transceiver
- Nine Open-Collector or Three-State Line Drivers
- 48mA Sink Current Capability on Each Line Driver
- Nine Schmitt-type Line Receivers
- High Capacitance Load Driver Capability
- Single 5V Power Supply
- Low Power HMOS Design
- On-chip Decoder for Mode Configuration
- Power up/Power Down Protection to Prevent Disrupting the IEEE Bus
- Connects with the 8291 and 8292 to Form an IEEE Standard 488 Interface Talker/Listener/Controller with no Additional Components
- Only Two 8293's Required per GPIB Interface
- On-Chip IEEE-488 Bus Terminations
- 28-pin package

The Intel® 8293 GPIB Transceiver is a high current, non-inverting buffer chip designed to interface the 8291 GPIB Talker/Listener or the 8292 GPIB Controller with the 8291 to the IEEE Standard 488-1978 Instrumentation Interface Bus. Each GPIB interface would contain two 8293 Bus transceivers. In addition, the 8293 can also be used as a general-purpose bus driver [2].

Part Numbers

Type D Packages

Part Number	Package Description	Values
		
D8293	Type D grey ceramic package w/tin pins. © Intel '80	\$.75-\$3
D8293-3	Type D package	\$2.50-\$10
D8293-10	Type D grey ceramic package w/tin pins. © Intel '80.	\$2-\$8
LD8293	Type D package	\$1.25-\$5
MD8293	Type D package	\$1.25-\$5
QD8293	Type D package	\$1.25-\$5

References

- [1] Intel (1979). Intel Component Data Catalog. No reference to 8292 dates chip after 1979.
- [2] Intel (1980). Intel Component Data Catalog, 8293 Preliminary Data Sheet, p. 8-212

Intel i8294

Data Encryption Unit

1978

Specifications

- Data Encryption Unit.
- Certified by National Bureau of Standards
- 80 Byte/Sec Data Conversion Rate
- 64-bit Data Encryption Using 56-bit Key
- DMA Interface
- 3 Interrupt Outputs to Aid in Loading and Unloading Data
- 7-bit User Output Port
- Single 5V $\pm 10\%$ Power Supply
- Peripheral to MCS-86™, MCS-85™, MCS-80™, and MCS-48™ Processors
- Implements Federal Information Processing Data Encryption Standard (DES)
- Encrypt and Decrypt Modes Available
- 40-pin Dual In-Line Package

The Intel® 8294 Data Encryption Unit (DEU) is a microprocessor peripheral device designed to encrypt and decrypt 64-bit blocks of data using the algorithm specified in the Federal Information Processing Data Encryption Standard. The DEU operates on 64-bit text words using a 56-bit user-specified key to produce 64-bit cipher words. The operation is reversible: if the cipher word is operated upon, the original text word is produced. The algorithm itself is permanently contained in the 8294; however, the 56-bit key is user defined and may be changed at any time.

The 56-bit key and 64-bit message data are transferred to and from the 8294 in 8-bit bytes by way of the system data bus. A DMA interface and three interrupt outputs are available to minimize software overhead associated with data transfer. Also, by using the DMA interface two or more DEUs may be operated in parallel to achieve effective system conversion rates, which are virtually any multiple of 80 bytes/second. The 8294 also has a 7-bit TTL compatible output port for user specified functions.



Because the 8294 implements the NBS encryption algorithm it can be used in a variety of Electronic Funds Transfer applications as well as other electronic banking and data handling applications where data must be encrypted [4].

Algorithm is microcode, which is burned into a 1 Kbyte ROM on a 5 volt, 40-pin chip driven by a 8042 microprocessor [1].

Intel i8294

Part Numbers

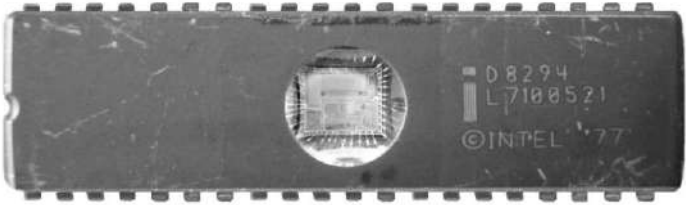
Type D Packages

Part Number	Package Description	Values
		
D8294	1. Type D grey ceramic package w/tin pins and quartz porthole. © Intel '77	\$2.00-\$8
		
D8294	2. Type D grey ceramic package w/tin pins. No porthole. © Intel '77	\$1.25-\$5

Type P Packages

Part Number	Package Description	Values
		
P8294	Type P black plastic package w/tin pins. © Intel '77	\$.75-\$3

References

[1] National Institute of Standards and Technology (2004). Computer Security Resource Center, DES Validated Implementations. <http://csrc.nist.gov/cryptval/des/desval0.html>

[2] Intel (1977). Intel Data Catalog. No Reference to 8284 dates chip after 1977.

[3] Intel (1978). Intel Component Data Catalog, 8294 Data Sheet, p. 12-209. Data Sheet not marked Preliminary.

[4] Intel (1980). Intel Component Data Catalog, 8294 Preliminary Data Sheet, p. 8-225

Intel i8294A

Data Encryption Unit

1982

Specifications

- Data Encryption Unit.
- Certified by National Bureau of Standards
- 400 Byte/Sec Data Conversion Rate
- 64-bit Data Encryption Using 56-bit Key
- DMA Interface
- 3 Interrupt Outputs to Aid in Loading and Unloading Data
- 7-bit User Output Port
- Single 5V $\pm 10\%$ Power Supply
- Fully Compatible with iAPX-86, 88, MCS-85, MCS-80, MCS-51 and MCS-48 Processors
- Implements Federal Information Processing Data Encryption Standard (DES)
- Encrypt and Decrypt Modes Available
- 40-pin Dual In-Line Package

The 8294A is the same as the 8294 except for a maximum data transfer rate of 400 bytes per second [4].

Algorithm is microcode, which is burned into a 1 Kbyte ROM on a 5 volt, 40-pin chip driven by a 8042 microprocessor [4].

Intel i8294A

Part Numbers

Type D Packages

Part Number	Package Description	Values
D8294A	Type D package	\$1.25-\$5

Type P Packages

Part Number	Package Description	Values
 A photograph of an Intel P8294A chip. The chip is a black plastic package with tin pins on the bottom. The top surface of the chip has a dark rectangular area with white text that reads: 'P8294A', 'L140061B', and 'INTEL © '77'. There is a small circular mark on the right side of the chip.		
P8294A	Type P black plastic package w/tin pins. © Intel '77	\$.75-\$3

References

- [1] Intel (1980). Intel Component Data Catalog, 8294 Preliminary Data Sheet, p. 8-225. No reference to 8294A.
- [2] Hearst (1981). IC Master, Intel 8294, p. 557-40. No reference to 8294A.
- [3] Intel (January 1982). Intel Component Data Catalog, 8294 Data Sheet, p. 9-49. No reference to 8294A.
- [4] National Institute of Standards and Technology (2004). Computer Security Resource Center, DES Validated Implementations, 8294A DES validated 6/20/82. <http://csrc.nist.gov/cryptval/des/desval0.html>

Intel i8295

Dot Matrix Printer Controller

1979

Specifications

- Dot Matrix Printer Controller
- Interfaces Dot Matrix Printers to MCS-48™, MCS-80/85™, MCS-86™ Systems
- 40 Character Buffer On Chip
- Serial or Parallel Communication with Host
- DMA Transfer Capability
- Programmable Character Density (10 or 12 Characters/Inch)
- Programmable Print Intensity
- Single or Double Width Printing
- Programmable Multiple Line Feeds
- 3 Tabulations
- 2 General Purpose Outputs
- +5 Volt Power Supply
- 40-pin Dual In-Line Package

The Intel® 8295 Dot Matrix Printer Controller provides as interface for microprocessors to the LRC 7040 Series dot matrix impact printers. It may also be used as an interface to other similar printers.

The chip may be used in a serial or parallel communications mode with the host processor. In parallel mode, data transfers are based on polling, interrupts, or DMA. Furthermore, it provides internal buffering of up to 40 characters and contains a 7 x 7 matrix character generator accommodating 64 ASCII characters [3].

Part Numbers

Type D Packages

Part Number	Package Description	Values
D8295	Type D package. Two sources show total of 3 in stock.	Rare (Suspect) \$\$\$

Type P Packages

Part Number	Package Description	Values
P8295	Type P package	\$1.25-\$5

References

[1] Intel (February 1979). Intel MCS-86 Product Description, 8295 Preliminary Data Sheet, p. 75

[2] Hearst (1979). IC Master. No Reference to Intel 8295.

[3] Intel (1980). Intel Component Data Catalog, 8295 Data Sheet, p. 8-236

Intel i8302

2048-bit (256 x 8) Static ROM

1974

Specifications

- 2048-bit (256 X 8) Static ROM
- PMOS
- Access Time – 1µsec Max.
- Fully Decoded, 256 x 8 Organization
- Inputs and Outputs TTL Compatible
- Three-State Output – OR-tie Capability
- Static MOS – No Clocks Required
- Simple Memory Expansion – Chip Select Input Lead
- 8xxx Equivalent of Intel 1302 ROM [2]
- Pin Compatible with Intel 8702A EPROM
- 24-pin Dual In-Line Package

Type	Access Time Max.	Power Dissipation Max. Operating/Standby	Supplies [V]
8302	1µs	700mW	+5, -9

The Intel ® 8302 is a fully decoded 256 word by 8 bit metal mask ROM. It is ideal for large volume production runs of microcomputer systems initially using the 8702A erasable and electrically programmable ROM. The 8302 is pin compatible with the 8702A.

The 8302 is entirely static – no clocks are required. Inputs and outputs of the 8302 are TTL compatible. The output is three-state for OR-tie capability. A separate chip select input allows easy memory expansion. The 8302 is packaged in a 24-pin dual-in-line hermetically sealed ceramic package.

The 8302 is fabricated with p-channel silicon gate technology. This low threshold allows the design and production of higher performance MOS circuits and provides a higher functional density on a monolithic chip than conventional MOS technologies [2].

History

The 8302 was introduced as a member of the Intel MCS-80® family and was the 8xxx equivalent of the 1302.

Part Numbers

No Examples Known

References

- [1] Intel (January 1975). Intel 8080 Microcomputer Systems Manual, 8302 Data Sheet, p. 32
- [2] Intel (September 1975). Intel MCS-80 User's Manual, 8302 Data Sheet, p. 5-51.
- [3] Hearst (1977). IC Master, Intel 8302 listed as 8xxx equivalent of Intel 1302 in 8080 section of Microprocessor System Components, p. 871

Intel i8308

8096-bit (1024 x 8) Static ROM

3rd Qtr 1974

Specifications

- 8192-bit (1024 x 8) Static ROM
- NMOS
- Fast Access Time: 450ns
- Standard Power Supplies: +12V, ±5V
- TTL Compatible: All Inputs and Outputs
- Programmable Chip Select Input for Easy Memory Expansion
- Three-State Output: OR-Tie Capability
- Full Decoded: On Chip Address Decode
- Inputs Protected: All Inputs Have Protection Against Static Charge
- Three-State Output
- 8xxx equivalent to Intel 2308 ROM
- Pin Compatible to Intel 8708 EPROM
- 24-pin Dual In-Line Package

Type	Access Time Max.	Power Dissipation Max. Operating/Standby	Supplies [V]
8308	450ns	840mW	+12, +5, -5

The Intel® 8308 is a 8192 bit static MOS read only memory organized as 1024 words by 8-bits. This ROM is designed for memory applications where high performance, large bit storage, and simple interfacing are important design objectives.

The inputs and outputs are TTL compatible. The chip select input is programmable. An active high or low-level chip select can be defined by the designer and the desired chip select logic level is fixed at Intel during the masking process. The programmable chip select input, as well as OR-tie compatibility on the outputs, facilitates easy memory expansion. The pin compatible UV erasable 8708 EPROM is available for initial system prototyping.

The 8308 read only memory is fabricated with N-channel silicon gate technology. This technology provides the designer with high performance, easy-to-use MOS circuits [3].



8308 specifications are identical to the 2308 specifications [4].

History

The 8308 was introduced as a member of the Intel MCS-80® family and was the 8xxx equivalent of the 2308.

Part Numbers

Type C Packages

Part Number	Package Description	Values
		
C8308	1. Type C white ceramic package w/gold cap and gold pins. Large '1' denotes pin #1. Black or gold dot at top left corner of package.	\$20-\$80
		
C8308	2. Type C white ceramic package w/gold cap, offset gold cap ground strap, and gold pins. Small black dot denotes pin #1.	\$20-\$80

References

[1] Intel (1974). Intel Advertisement, "From CPU to Software The 8080 Microcomputer is here", Ad Lists availability date for 8308 as "3RD Q".

[2] Intel (September 1975). Intel MCS-80 User's Manual, 8308 Data Sheet, p. 5-59

[3] Intel (1977). Intel Data Catalog, 8308 Data Sheet, p. 10-98

[4] Intel (1978). Intel Component Data Catalog, 2308/8308 Data Sheet, p. 4-18

Intel i8316

16384-bit (2048 x 8) Static ROM

1973-74

Specifications

- 16,384-bit (2048 x 8) Static ROM
- NMOS
- Single +5V Power Supply
- Directly TTL Compatible – All Inputs and Outputs
- Low Power Dissipation of 10.7 μ W/Bit Maximum
- Three Programmable Chip Select Inputs for Easy Memory Expansion
- Three-State Output – OR-Tie Capability
- Fully Decoded – On Chip Address Decode
- Inputs Protected – All Inputs Have Protection Against Static Charge
- 24-pin Dual In-Line Package

Type	Access Time Max.	Power Dissipation Max. Operating/Standby	Supplies [V]
8316	2 μ s	-	+5

The Intel 8316 is a 16,384 bit static MOS read only memory organized as 2048 words by 8-bits. This ROM is designed for microcomputer memory applications where high performance, large bit storage, and simple interfacing are important design objectives.

The inputs and outputs are fully TTL compatible. This device operates with a single +5V power supply. The three chip select inputs are programmable. Any combination of active high or low level chip select inputs can be defined and the desired chip select code is fixed during the masking process. These three programmable chip select inputs, as well as OR-tie compatibility on the outputs, facilitate easy memory expansion

The 8316 read only memory is fabricated with N-channel silicon gate technology. This technology provides the designer with high performance, easy-to-use MOS circuits. Only a single +5V power supply is needed and all devices are directly TTL compatible [3].

Intel i8316

Part Numbers

Type C Packages

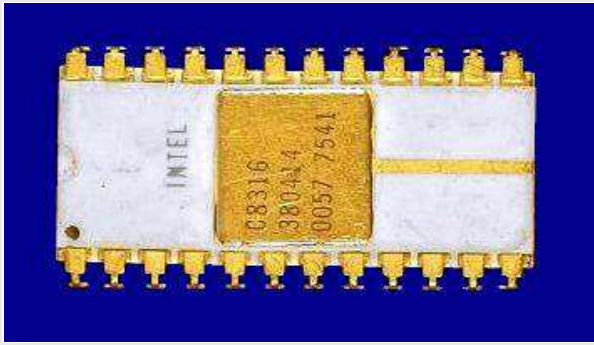
Part Number	Package Description	Values
	 A photograph of an Intel i8316 Type C package. The package is a white ceramic component with a gold-colored cap in the center. The cap has the part number '08316' and other markings '380444' and '0057 7541'. The word 'INTEL' is printed vertically on the left side of the package. The package has gold pins on both the top and bottom edges. A small black dot is visible on the left side of the package, indicating pin #1.	
C8316	Type C white ceramic package w/gold cap, gold cap ground strap, and gold pins. Small black dot denotes pin #1.	Ex. Rare (1 Known) \$75-\$300

References

- [1] Intel (September 1972). Intel Data Catalog. No reference to 8316 dates chip after September 1972.
- [2] Intel (1974). Intel Advertisement, "From CPU to Software The 8080 Microcomputer is here", Ad lists availability date for 8316 as "NOW".
- [3] Intel (January 1975). Intel 8080 Microcomputer System Manual, 8316 Data Sheet, p. 34
- [4] Intel (1975). Intel Data Catalog, 8316 Data Sheet, p. 6-33.

Intel i8316A

16384-bit (2048 x 8) Static ROM

1974-75

Specifications

- 16,384-bit (2048 x 8) Static ROM
- NMOS
- Access Time – 850ns Max.
- Single +5V Power Supply
- Directly TTL Compatible – All Inputs and Outputs
- Low Power Dissipation of 31.4 μ W/Bit Maximum
- Three Programmable Chip Select Inputs for Easy memory Expansion
- Three-State Output – OR-Tie Capability
- Fully Decoded – On Chip Address Decode
- Inputs Protected – All Inputs Have Protection Against Static Charge
- 8xxx Equivalent of Intel 2316A ROM
- 24-pin Dual In-Line Package

Type	Access Time Max.	Power Dissipation Max. Operating/Standby	Supplies [V]
8316A	850ns	515mW	+5

The Intel® 8316A is a 16,384-bit static MOS read only memory organized as 2048 words by 8 bits. This ROM is designed for microcomputer memory applications where high performance, large bit storage, and simple interfacing are important design objectives.

The inputs and outputs are fully TTL compatible. This device operates with a single +5V power supply. This three chip select inputs are programmable. Any combination of active high or low-level chip select inputs can be defined and the desired chip select code is fixed during the masking process. These three programmable chip select inputs, as well as OR-tie compatibility on the inputs, facilitate easy memory expansion.



The 8316A read only memory is fabricated with N-channel silicon gate technology. This technology provides the designer with high performance, easy-to-use MOS circuits. Only a single +5V power supply is needed and all devices are directly TTL compatible.

All 4316A and 8316A specifications are identical to the 2716A specifications [4].

Intel i8316A

Part Numbers

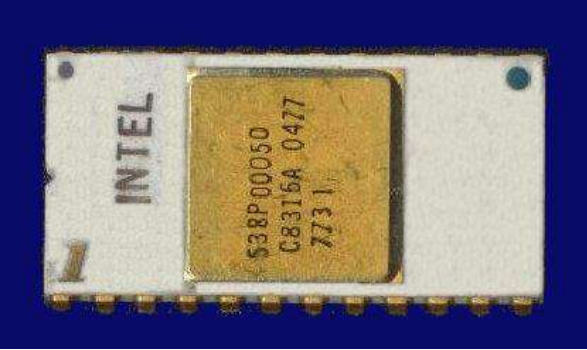
Type C Packages

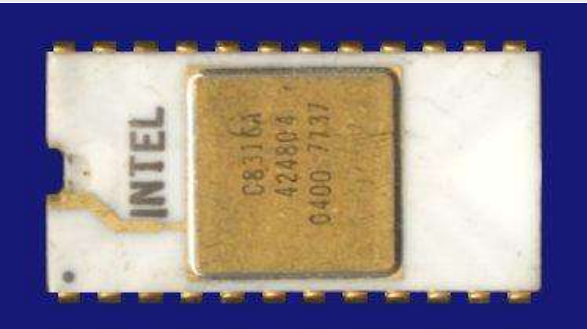
Part Number	Package Description	Values
C8316A	1. Type C white ceramic package w/gold cap, gold cap ground strap, and gold pins. Cap ground strap connection points on both ends of package (only one used). Large black dot denotes pin #1. Part number printed on cap. 'INTEL' printed on package.	\$20-\$80
		
C8316A	2. Type C white ceramic package w/gold cap and gold pins. Large '1' denotes pin #1. Small black dot at top left corner of package. Part number printed on cap. 'INTEL' printed on ceramic.	\$12-\$48
		
C8316A	3. Type C white ceramic package w/gold cap and gold pins. Large '1' denotes pin #1. Small black dot at top left corner of package. 'INTEL' and part number printed on cap.	\$12-\$48
		
C8316A	4. Type C white ceramic package w/gold cap, offset gold cap ground strap, and gold pins. Small black dot denotes pin #1. Part number printed on cap. 'INTEL' printed on ceramic.	\$12-\$48

Intel i8316A

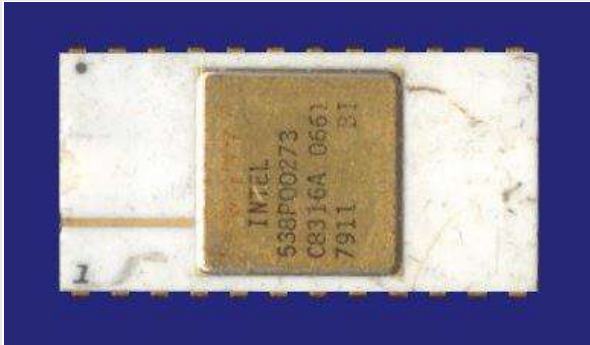

C8316A	5. Type C white ceramic package w/gold cap, offset gold cap ground strap, and gold pins. Small '1' denotes pin #1. Small black dot at top left corner of package. Half-round key.	\$12-\$48
MC8316A	Type C package	Ex. Rare (0 Known) \$\$\$

Type D Packages

Part Number	Package Description	Values
D8316A	Type D package	Rare \$10-\$40

Type P Packages

Part Number	Package Description	Values
P8316A	Type P black package w/tin pins.	\$1.25-\$5

References

- [1] Intel (1974). Intel Advertisement, "From CPU to Software The 8080 Microcomputer is here", Ad lists availability date for 8316 as "NOW".
- [2] Intel (September 1975). Intel MCS-80 User's Manual, 8316A Data Sheet, p. 5-61
- [3] Intel (1977). Memory Design Handbook, MC8316A listed as member of Intel Military Product Family, p. PSG-5.
- [4] Intel (1978). Intel Component Data Catalog, 2316A/4316A/8316A Data Sheet, p. 4-22.
- [5] Netcomponents (2002). Netcomponents, Multiple hits on D8316AL and P8316AL.
Available from: <http://www.netcomponents.com> [Accessed 10 July 2002]

Intel i8355

16,384-bit (2048 x 8) ROM with I/O

1977-78

Specifications

- 16,384-bit (2048 x 8) ROM with I/O
- Single + 5V Power Supply
- Directly Compatible with 8085A and 8088 Microprocessors
- 2 General Purpose 8-bit I/O Ports
- Each I/O Port Line Individually Programmable as Input or Output
- Multiplexed Address and Data Bus
- Internal Address Latch
- ROM equivalent of Intel 8755 EPROM with I/O
- 40-pin Dual In-Line Package

Type	Access Time Max.	Power Dissipation Max. Operating/Standby	Supplies [V]
8355	400ns	-	+5
8355-2	300ns	-	+5

The Intel® 8355 is a ROM and I/O chip to be used in the 8085A and 8088 microprocessor systems. The ROM portion is organized as 2048 words by 8 bits. It has a maximum access time of 400ns to permit use with no wait states in the 8085 CPU.

The I/O portion consists of 2 general-purpose I/O ports. Each I/O port has 8 port lines and each I/O port line is individually programmable as input or output.

The 8355-2 has a 300ns access time for compatibility with the 8085A-2 and full speed 5 MHz 8088 microprocessors [2].

Intel C8355/C8655

The single Intel C8355 listed on Netcomponents is listed as an Intel C8355/C8655.

<http://www.netcomponents.com/> also lists a single C8655-2 (no manufacturer). Cannot find any reference to 8655 in any Intel literature.

Intel i8355

Part Numbers

Type C Packages

Part Number	Package Description	Values
		
C8355	Type C purple ceramic package w/black cap and tin pins. Vertical © Intel '77 stamped on package.	Ex. Rare \$50-\$200

Type D Packages

Part Number	Package Description	Values
		
D8355	1. Type D grey ceramic package w/tin pins. No Copyright	\$2.50-\$10
		
D8355	2. Type D grey ceramic package w/tin pins. © Intel '77	\$2.50-\$10

Type P Packages

Part Number	Package Description	Values
P8355	Type P black plastic package w/tin pins. © Intel '77.	\$1.25-\$5

References

[1] Intel (1977). Intel Data Catalog, 8355 Preliminary Data Sheet, p. 10-75

[2] Intel (1980). Intel Component Data Catalog, 8355/8355-2 Data Sheet, p. 6-134.

Intel i8604

4096-bit (512 x 8) PROM

4th Qtr 1974

Specifications

- 4096-Bit (512 x 8) PROM
- NMOS
- Fast Access Time – 100ns
- Fully Decoded – On Chip Address
- Decode and Buffer
- 24-pin Dual In-Line Package

Type	Access Time Max.	Power Dissipation Max. Operating/Standby	Supplies [V]
8604	100ns	-	+12, +5, -5

The 8604 is a 512 x 8 electrically programmable ROM ideally suited for high performance microcomputer systems where fast turnaround is important for system program development and for small volumes of identical programs in production systems [2].

Part Numbers

No Examples Known

References

[1] Intel (1974). Intel Advertisement, "From CPU to Software The 8080 Microcomputer is here". Lists availability date for 8604 as 4th Qtr.

[2] Intel (January 1975). Intel 8080 Microcomputer Systems Manual, 8604 Data Sheet, p. 37.

[3] Intel (1977). Intel Data Catalog, Referenced in SIM-104 ROM Simulator Data Sheet

Intel i8641A

Universal Peripheral Interface 8-Bit Microcomputer w/8,192-bit (1024 x 8) PROM, 512-bit (64 x 8) RAM and I/O

1979

Specifications

- Universal Peripheral Interface 8-Bit Microcomputer w/8,192-bit (1024 x 8) PROM, 512-bit (64 x 8) RAM and I/O
- 8-Bit CPU plus ROM, RAM, I/O, Timer and Clock in a Single Package
- One 8-Bit Status and Two Data Registers for Asynchronous Slave-to-Master Interface
- DMA, Interrupt, or Polled Operation Supported
- 1024 x 8 ROM (8041A)/PROM (8641A)/EPROM (8741A), 64 x 8 RAM, 8-Bit Timer/Counter, 18 Programmable I/O Pins
- Fully Compatible with MCS-48™, MCS-80™, MCS-85™, and MCS-86™ Microprocessor Families
- Interchangeable ROM, PROM and EPROM Versions
- 3.6 MHz 8741A-8 Available
- Expandable I/O
- RAM Power-Down Capability
- Over 90 Instructions: 70% Single Byte
- Single +5V Power Supply
- 40-pin Dual In-Line Package

Type	Clock	Power Dissipation Max.	Supplies [V]
8641A	-	-	+5

The Intel © 8041A/8741A is a general purpose, programmable interface device designed for use with a variety of 8-bit microprocessor systems. It contains a low cost microcomputer with program memory, data memory, 8-bit CPU, I/O ports, timer/counter, and clock in a single 40-pin package. Interface registers are included to enable the UPI device to function as a peripheral controller in MCS-48™, MCS-80™, MCS-85™, MCS-86™, and other 8-bit systems.

The UPI-41A™ has 1K words of program memory and 64 words of data memory on-chip. To allow full user flexibility the program memory is available as ROM in the 8041A version or as UV-erasable EPROM in the 8741A version. The 8741A and the 8041A are fully pin compatible for easy transition from prototype to production level designs. The 8641A is a one-time programmable (at the factory) 8741A, which can be ordered as the first 25 pieces of a new 8041A order. The substitution of 8641A's for 8041A's allows for very fast turnaround for initial code verification and evaluation results.

The device has two 8-bit, TTL compatible I/O ports and two test inputs. Individual port lines can function as either inputs or outputs under software control. I/O can be expanded with the 8243 device, which is directly compatible and has 16 I/O lines. An 8-bit programmable timer/counter is included in the UPI device for generating timing sequences or counting external inputs. Additional UPI features include: single 5V supply, low power standby mode (in the 8041A), single-step mode for debug (in the 8741A), and dual working register banks.

Intel i8641A

Because it's a complete microcomputer, the UPI provides more flexibility for the designer than conventional LSI interface devices. It is designed to be an efficient controller as well as an arithmetic processor. Applications include keyboard scanning, printer control, display multiplexing and similar functions, which involve interfacing peripheral devices to microprocessor systems [3].

Intel 8641?

The 1978 Intel Data Catalog contains a single preliminary data sheet for the 8041/8741. There's no reference an 8641.

The 1980 Intel Data Catalog contains a single data sheet for the 8041A/8641A/8741A.

There are no known examples or references to an Intel 8641.

Suspect that that the Intel 8641 may have been introduced as the 8641A.

Intel i8641A

Part Numbers

Type D Packages

Part Number	Package Description	Values
D8641A	Type D package	\$1.25-\$5

References

[1] Intel (1978). Intel Component Data Catalog, 8041/8741 Preliminary Data Sheet, p. 12-3. No reference to 8641A dates chip after 1978.

[2] Hearst (1979). IC master. No reference to Intel 8641A dates chip after 1979.

[3] Intel (1980). Intel Component Data Catalog, 8041A/8641A/8741A Family Data Sheet, p. 8-1

Intel i8702A

2048-bit (256 x 8) EPROM

1973-74

Specifications

- 2048-Bit (256 x 8) EPROM
- PMOS
- Access Time – 1.3 μ s Max.
- Fast Programming – 2 Minutes for All 2048 Bits
- Fully Decoded, 256 x 8 Organization
- Static MOS – No Clocks Required
- Inputs and Outputs TTL Compatible
- Three-State Output – OR-Tie Capability
- Simple Memory Expansion Chip Select Input Lead
- 8xxx equivalent to Intel 1702A EPROM
- 24-pin Dual In-Line Package

Type	Access Time Max.	Power Dissipation Max. Operating/Standby	Supplies [V]
8702A	1.3 μ s	-	+5, -9
8702A-4	2.3 μ s	-	+5, -9

The 8702A is a 256 word by 8-bit electrically programmable ROM ideally suited for microcomputer system development where fast turn-around and pattern experimentation are important. The 8702A undergoes complete programming and functional testing on each bit position prior to shipment, thus insuring 100% programmability.

The 8702A is packaged in a 24-pin dual-in line package with a transparent quartz lid. The transparent quartz lid allows the user to expose the chip to ultraviolet light to erase the bit pattern. A new pattern can then be written into the device. This procedure can be repeated as many times as required.

The circuitry of the 8702A is entirely static; no clocks are required.

A pin-for-pin metal mask programmed ROM, the Intel 8302, is ideal for large volume production runs of systems initially using the 8702A.

The 8702A is fabricated with silicon gate technology. This low threshold technology allows the design and production of higher performance MOS circuits and provides a higher functional density on a monolithic chip than conventional MOS technologies [2].

Part Numbers

Type C Packages

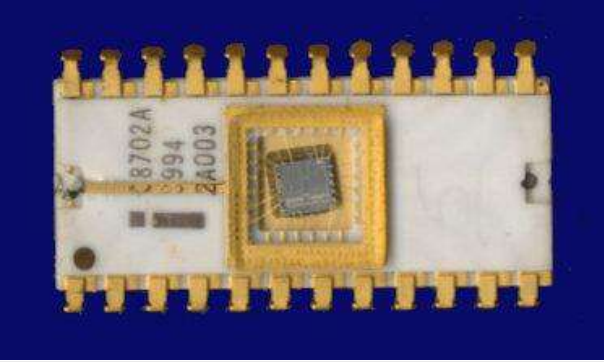
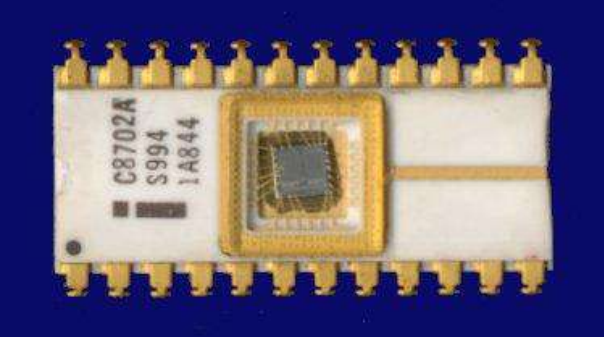
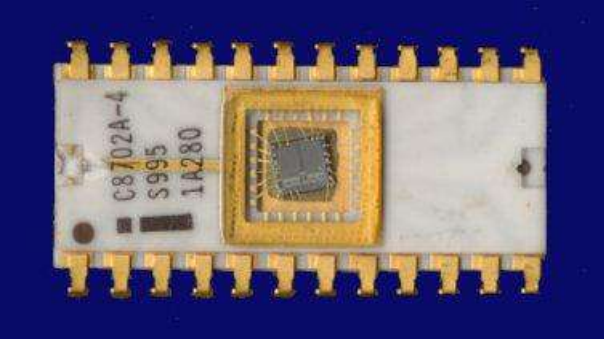
Part Number	Package Description	Values
		
C8702A	1. Type C white ceramic package w/quartz cap, gold cap ground strap, and gold pins. Cap ground strap connection points on both edges of package (only one used). Gold dot denotes pin #1.	\$8-\$32
		
C8702A	2. Type C white ceramic package w/quartz cap, gold cap ground strap, and gold pins. Black dot denotes pin #1.	\$8-\$32
		
C8702A-4	1. Type C white ceramic package w/quartz cap, gold cap ground strap, and gold pins. Cap ground strap connection points on both edges of package (only one used). Black dot denotes pin #1.	\$8-\$32

Intel i8702A

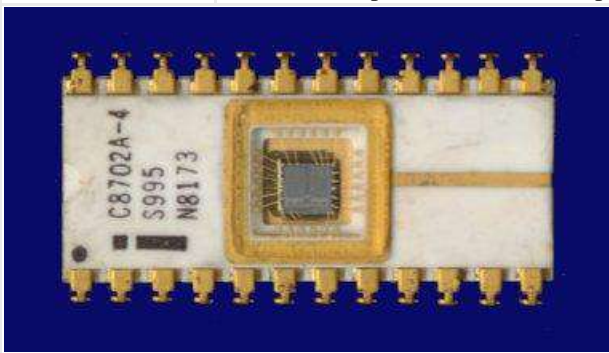
C8702A-4	2. Type C white ceramic package w/quartz cap, gold cap ground strap (painted over), and gold pins. Cap ground strap connection points on both edges of package (only one used). Black dot (painted over) denotes pin #1. Part number painted over and re-stamped.	\$20-\$80
		
C8702A-4	3. Type C white ceramic package w/quartz cap, gold cap ground strap, and gold pins.	\$8-\$32
MC8702A	Type C package	Ex. Rare (0 Known) \$\$\$

Type B Packages

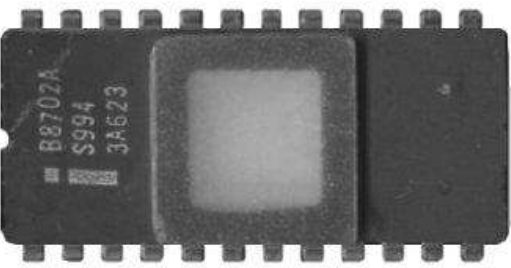
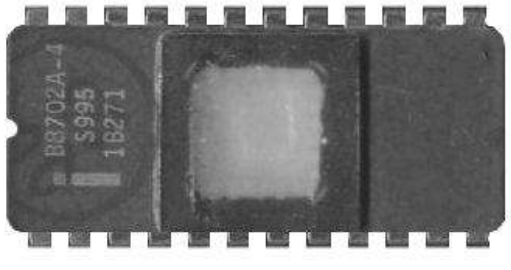
Part Number	Package Description	Values
		
B8702A	Type B grey ceramic package w/quartz cap and tin pins. No copyright.	\$5-\$20
		
B8702A-4	1. Type B grey ceramic package w/tin pins. No copyright.	\$1.50-\$6

Intel i8702A

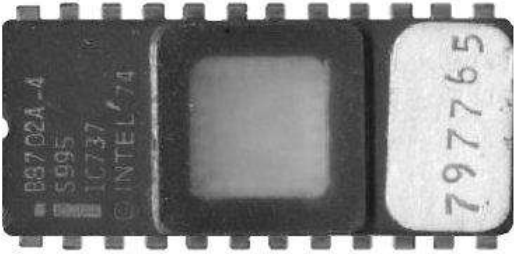
 A photograph of an Intel i8702A integrated circuit chip. The chip is a Type B grey ceramic package with tin pins. It features a central square window and a white label on the right side with the number '797765'. The left side of the chip has markings: 'B8702A -4', 'S995', '1G737', and '© INTEL '74'.		
B8704A-4	2. Type B grey ceramic package/w/tin pins. © Intel '74.	\$1.25-\$5

References

[1] Intel (1974). Intel Advertisement, "From CPU to Software The 8080 Microcomputer is here", Ad lists availability date for 8702 as "NOW".

[2] Intel (September 1975). Intel MCS-80 User's Manual, 8702A Data Sheet, p. 5-37

[3] Intel (1977). Intel Memory Design Handbook, MC8702A listed as member of Intel Military Product Family, p. PSG-5.

Intel i8704

4096-bit (512 x 8) EPROM

4th Qtr 1974

Specifications

- 4096-Bit (512 x 8) EPROM
- NMOS
- Fast Programming –
Typ. 100 sec For All 8K Bits (8708)
- Low Power During Programming
- Access Time – 450ns
- Standard Power Supplies - +12V, ±5V
- Static – No Clocks Required
- Inputs and Outputs TTL Compatible During Both Read and Program Modes
- Three-State Output – OR-Tie Capability
- 8xxx equivalent of Intel 2704
- 24-pin Dual In-Line Package

Type	Access Time Max.	Power Dissipation Max. Operating/Standby	Supplies [V]
8704	450ns	800mW	+12, +5, -5

The Intel® 8708/8704 are high speed 8192/4096-bit erasable and electrically reprogrammable ROM's (EPROM) ideally suited where fast turn-around and pattern experimentation are important requirements.

The 8708/8704 are packaged in a 24-pin dual-in-line package with transparent lid. The transparent lid allows the user to expose the chip to ultraviolet light to erase the bit pattern. A new pattern can then be written into the devices.

A pin-for-pin mask programmed ROM, the Intel® 8308, is available for large volume production runs of systems initially using the 8708.

The 8708/8704 is fabricated with the time proven N-channel silicon gate technology [3].

Part Numbers

No Examples Known

References

[1] Intel (1974). Intel Advertisement, “From CPU to Software The 8080 Microcomputer is here”, Ad lists availability date for 8704 as “4th Qtr”.

[2] Intel (January 1975). Intel 8080 Microcomputer Systems Manual, 8704 Preliminary Data Sheet, p. 36. No reference to 8708.

[3] Intel (September 1975). Intel MCS-80 User’s Manual, 8708/8704 Data Sheet, p. 5-45

Intel i8708

8192-bit (1024 x 8) EPROM

1975

Specifications

- 8192-Bit (1024 x 8) EPROM
- NMOS
- Fast Programming –
Typ. 100 sec For All 8K Bits (8708)
- Low Power During Programming
- Access Time – 450ns
- Standard Power Supplies - +12V, ±5V
- Static – No Clocks Required
- Inputs and Outputs TTL Compatible During Both Read and Program Modes
- Three-State Output – OR-Tie Capability
- 8xxx equivalent of Intel 2708
- 24-pin Dual In-Line Package

Type	Access Time Max.	Power Dissipation Max. Operating/Standby	Supplies [V]
8708	450ns	-	+12, +5, -5

The Intel® 8708/8704 are high speed 8192/4096-bit erasable and electrically reprogrammable ROM's (EPROM) ideally suited where fast turn-around and pattern experimentation are important requirements.

The 8708/8704 are packaged in a 24-pin dual-in-line package with transparent lid. The transparent lid allows the user to expose the chip to ultraviolet light to erase the bit pattern. A new pattern can then be written into the devices.

A pin-for-pin mask programmed ROM, the Intel® 8308, is available for large volume production runs of systems initially using the 8708.

The 8708/8704 is fabricated with the time proven N-channel silicon gate technology [1].

Part Numbers

Type C Packages

Part Number	Package Description	Values
		
C8708	1. Type C white ceramic package w/gold cap with quartz porthole, and gold pins. Large '1' denotes pin #1. Black dot at top left corner of package. No Copyright.	\$8-\$32
C8708	2. Type C white ceramic package w/gold cap with quartz porthole, offset gold cap ground strap, and gold pins. Small black dot at top left corner of package. No Copyright.	\$8-\$32
C8708	3. Type C grey ceramic package w/gold cap with quartz porthole, offset gold cap ground strap, and gold pins. Small black dot at top left corner of package. No Copyright.	Rare \$15-\$60
		
C8708	4. Type C white ceramic package w/gold cap with quartz porthole, offset gold cap ground strap, and gold pins. Small black dot at top left corner of package. © Intel '75	\$8-\$32
C8708	5. Type C purple ceramic package w/gold cap, gold cap ground strap, and gold pins.	Rare \$20-\$80

Intel i8708

		
<p>HC8708</p>	<p>1. Type C white ceramic package w/gold cap with quartz porthole, and gold pins. Large '1' denotes pin #1. Black dot at top left corner of package. No Copyright.</p>	<p>\$15-\$60</p>
		
<p>HC8708</p>	<p>2. Type C white ceramic package w/gold cap with quartz porthole, offset gold cap ground strap, and gold pins. Small black dot at top left corner of package. No copyright.</p>	<p>\$15-\$60</p>
		
<p>MC8708</p>	<p>Type C white ceramic package w/gold cap with quartz porthole, and gold pins. Large '1' denotes pin #1. Black dot at top left corner of package. No Copyright.</p>	<p>Rare \$25-\$100</p>

Intel i8708

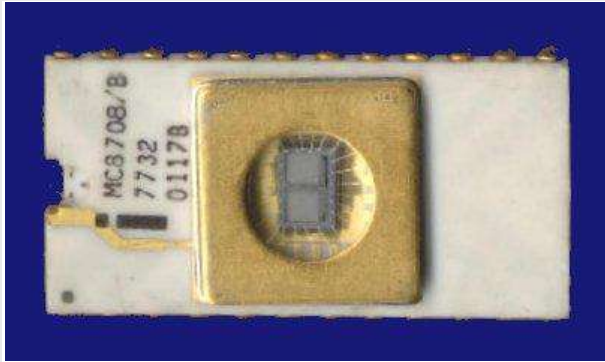

MC8708/B	Type C white ceramic package w/gold cap with quartz porthole, offset gold cap ground strap, and gold pins. Small black dot at top left corner of package. No copyright.	Rare \$25-\$100
----------	---	--------------------

Type B Packages

Part Number	Package Description	Values
B8708	1. Type B grey ceramic package w/tin pins. No copyright.	\$2.50-\$10
B8708	2. Type B grey ceramic package w/tin pins. © Intel '75.	\$2-\$8
HB8708	Type B package. Single source shows 1 in stock.	Ex. Rare (Suspect) \$\$\$

Type D Packages

Part Number	Package Description	Values
D8708	Type D package	\$1.25-\$5

References

[1] Intel (September 1975). Intel MCS-80 User's Manual, 8708/8704 Data Sheet, p. 5-45

[2] Intel (1977). Intel Memory Design Handbook, MC8708 listed as member of Intel Military Product Family, p. PSG-5.

Intel i8741

Universal Peripheral Interface 8-Bit Microcomputer w/8,192-bit (1024 x 8) EPROM, 512-bit (64 x 8) RAM and I/O

1978

Specifications

- Universal Peripheral Interface 8-Bit Microcomputer w/8,192-bit (1024 x 8) EPROM, 512-bit (64 x 8) RAM and I/O
- Fully Compatible with MCS-80™ and MCS-48™ Microprocessor Families
- Single Level Interrupt
- 8-Bit CPU plus ROM, RAM, I/O, Timer and Clock in a Single Package
- Single 5V Supply
- Alternative to Custom LSI
- Pin Compatible ROM and EPROM Versions
- 1K x 8 ROM/EPROM, 64 x 8 RAM, 18 Programmable I/O Pins
- Asynchronous Data Register for Interface to Master Processor
- Expandable I/O
- 40-pin Dual In-Line Package

Type	Clock	Power Dissipation Max.	Supplies [V]
8741	-	-	+5
8741-4	-	-	+5
8741-8	-	-	+5

The Intel © 8041/8741 is a general purpose, programmable interface device designed for use with a variety of 8-bit microprocessor systems. It contains a low cost microcomputer with program memory, data memory, 8-bit CPU, I/O ports, timer/counter, and clock in a single 40-pin package. Interface registers are included to enable the UPI device to function as a peripheral controller in MCS-80™, MCS-85™, MCS-48™, and other 8-bit systems.

The UPI-41™ has 1K words of program memory and 64 words of data memory on-chip. To allow full user flexibility the program memory is available as ROM in the 8041 version or as UV-erasable EPROM in the 8741 version. The 8741 and the 8041 are fully pin compatible for easy transition from prototype to production level designs.

The device has two 8-bit, TTL compatible I/O ports and two test inputs. Individual port lines can function as either inputs or outputs under software control. I/O can be expanded with the 8243 device, which is directly compatible and has 16 I/O lines. An 8-bit programmable timer/counter is included in the UPI device for generating timing sequences or counting external inputs. Additional UPI features include: single 5V supply, low power standby mode (in the 8041), single-step mode for debug (in the 8741), and dual working register banks.

Because it's a complete microcomputer, the UPI provides more flexibility for the designer than conventional LSI interface devices. It is designed to be an efficient controller as well as an arithmetic processor. Applications include keyboard scanning, printer control, display multiplexing and similar functions, which involve interfacing peripheral devices to microprocessor systems [1].

Intel i8741

Part Numbers

Type C Packages

Part Number	Package Description	Values
C8741	Type C grey ceramic package w/gold cap with quartz porthole, and gold pins. © Intel '77.	Rare \$20-\$80
C8741-4	Type C package	Rare \$25-\$100
		
C8741-8	Type C purple ceramic package w/quartz cap and tin pins. © Intel '77.	Rare \$25-\$100

Type D Packages

Part Number	Package Description	Values
D8741	Type D package	\$1.25-\$5

References

- [1] Intel (1978). Intel Component Data Catalog, 8041/8741 Preliminary Data Sheet, p. 12-3.
- [2] Intel (1984). A Revolution in Progress... A History of Intel to Date, 8041/8741 introduced 1978, p. 26.

Intel i8741A

Universal Peripheral Interface 8-Bit Microcomputer w/8,192-bit (1024 x 8) EPROM, 512-bit (64 x 8) RAM and I/O

1979-80

Specifications

- Universal Peripheral Interface 8-Bit Microcomputer w/8,192-bit (1024 x 8) EPROM, 512-bit (64 x 8) RAM and I/O
- 8-Bit CPU plus ROM, RAM, I/O, Timer and Clock in a Single Package
- One 8-Bit Status and Two Data Registers for Asynchronous Slave-to-Master Interface
- DMA, Interrupt, or Polled Operation Supported
- 1024 x 8 ROM (8041A)/PROM (8641A)/EPROM (8741A), 64 x 8 RAM, 8-Bit Timer/Counter, 18 Programmable I/O Pins
- Fully Compatible with MCS-48™, MCS-80™, MCS-85™, and MCS-86™ Microprocessor Families
- Interchangeable ROM, PROM and EPROM Versions
- 3.6 MHz 8741A-8 Available
- Expandable I/O
- RAM Power-Down Capability
- Over 90 Instructions: 70% Single Byte
- Single +5V Power Supply
- 40-pin Dual In-Line Package

Type	Clock	Power Dissipation Max.	Supplies [V]
8741A	6 MHz	-	+5
8741A-8	3.6MHz	-	+5

The Intel © 8041A/8741A is a general purpose, programmable interface device designed for use with a variety of 8-bit microprocessor systems. It contains a low cost microcomputer with program memory, data memory, 8-bit CPU, I/O ports, timer/counter, and clock in a single 40-pin package. Interface registers are included to enable the UPI device to function as a peripheral controller in MCS-48™, MCS-80™, MCS-85™, MCS-86™, and other 8-bit systems.

The UPI-41A™ has 1K words of program memory and 64 words of data memory on-chip. To allow full user flexibility the program memory is available as ROM in the 8041A version or as UV-erasable EPROM in the 8741A version. The 8741A and the 8041A are fully pin compatible for easy transition from prototype to production level designs. The 8641A is a one-time programmable (at the factory) 8741A, which can be ordered as the first 25 pieces of a new 8041A order. The substitution of 8641A's for 8041A's allows for very fast turnaround for initial code verification and evaluation results.

The device has two 8-bit, TTL compatible I/O ports and two test inputs. Individual port lines can function as either inputs or outputs under software control. I/O can be expanded with the 8243 device, which is directly compatible and has 16 I/O lines. An 8-bit programmable timer/counter is included in the UPI device for generating timing sequences or counting external inputs. Additional UPI features include: single 5V supply, low power standby mode (in the 8041A), single-step mode for debug (in the 8741A), and dual working register banks.

Intel i8741A

Because it's a complete microcomputer, the UPI provides more flexibility for the designer than conventional LSI interface devices. It is designed to be an efficient controller as well as an arithmetic processor. Applications include keyboard scanning, printer control, display multiplexing and similar functions, which involve interfacing peripheral devices to microprocessor systems [3].

Intel i8741A

Part Numbers

Type C Packages

Part Number	Package Description	Values
		
C8741A	1. Type C purple ceramic package w/gold cap with quartz porthole, and gold pins. #20 denotes pin #1. © Intel '77.	\$5-\$20
C8741A	2. Type C purple ceramic package w/gold cap with quartz porthole, offset gold cap cap ground strap and gold pins. © Intel '77.	\$5-\$20
		
C8741A-8	Type C purple ceramic package w/gold cap with quartz porthole, offset gold cap ground strap and gold pins. © Intel '77	\$5-\$20

Type D Packages

Part Number	Package Description	Values
		
D8741A	1. Type D grey ceramic package w/porthole and tin pins. © Intel '77	\$.75-\$3

Intel i8741A

D8741A	2. Type D grey ceramic package w/porthole and tin pins. © Intel '80.	\$.75-\$3
D8741A-8	Type D package	\$.75-\$3
ID8741A	Type D package	\$1.25-\$5
LD8741A	Type D package	\$2.50-\$10
MD8741A	Type D package	\$2.50-\$10
MD8741A/B	Type D grey ceramic package w/tin pins. © Intel '80.	\$2-\$8
QD8741A	Type D package	\$1.25-\$5
QD8741A-8	Type D package	\$2.50-\$10

Type P Packages

Part Number	Package Description	Values
P8147A	Type P package	\$1.25-\$5

References

[1] Intel (1978). Intel Component Data Catalog, 8041/8741 Preliminary Data Sheet, p. 12-3. No reference to 8741A dates chip after 1978.

[2] Intel (1979). Intel Component Data Catalog, 8041A/8741A Preliminary Data Sheet, p. 11-3.

[3] Intel (1980). Intel Component Data Catalog, 8041A/8641A/8741A Family Data Sheet, p. 8-1

[4] Intel (2002). Intel Museum Archive Collection Chronological Timeline. Available from: http://www.intel.com/intel/intelis/museum/arc_collect/TimelineChron.pdf [Accessed 10 July 2002] – 8741 [introduction] date “01/01/78”

Intel i8748

Single Component 8-bit Microcomputer w/8,192-bit (1024 x 8) EPROM, 512-bit (64 x 8) RAM, and I/O 1976

Specifications

- Single Component 8-bit Microcomputer w/8,192-bit (1024 x 8) EPROM, 512-bit (64 x 8) RAM, and I/O
- NMOS
- Mask Programmable ROM (8048)
- User Programmable/Erasable EPROM (8748)
- External ROM or EPROM (8035)
- 8-Bit CPU, ROM, RAM, I/O in Single Package
- Interchangeable ROM and EPROM Versions
- Single 5V Supply
- 2.5 μ sec and 5.0 μ sec Cycle Versions:
All Instructions 1 or 2 cycles
- Over 90 Instructions: 70% Single Byte
- 1K x 8 ROM/EPROM
64 x 8 RAM
27 I/O Lines
- Interval Timer/Event Counter
- Easily Expandable Memory and I/O
- Compatible with 8000 Series Peripherals
- Single Level Interrupt
- 40-pin Dual In-Line Package

Type	Clock	Power Dissipation Max.	Supplies [V]
8748	6 MHz (0°C to 70°C)	-	+5
8748-4	-	-	+5
8748-6	6 MHz (0°C to 55°C)	-	+5
8748-8	3.6 MHz	-	+5
M8748	-	-	+5

The Intel® 8048/8748/8035 is a totally self-sufficient 8-bit parallel computer fabricated on a single silicon chip using Intel's N-channel silicon gate MOS Process.

The 8048 contains a 1K x 8 program memory, a 64 x 8 RAM data memory, 27 I/O lines, and an 8-bit timer/counter in addition to onboard oscillator and clock circuits. For systems that require extra capability, the 8048 can be expanded using standard memories and MCS-80™ (8080A) peripherals. The 8035 is the equivalent of an 8048 without program memory. The 8035L has the RAM power down mode of the 8048 while the 8035 does not.

To reduce development problems to a minimum and provide for maximum flexibility, three interchangeable pin-compatible versions of this single component microcomputer exist: the 8748 with user-programmable and erasable EPROM program memory for prototype and preproduction systems, the 8048 with factory-programmed mask ROM program memory for low cost, high volume production, and the 8035 without program memory for use with external program memories.



Intel i8748

This microcomputer is designed to be an efficient controller as well as an arithmetic processor. The 8048 has extensive bit handling capability as well as facilities for both binary and BCD arithmetic. Efficient use of program memory results from an instruction set consisting mostly of single byte instructions and no instructions over 2 bytes in length [1].

The 8748-4 and the 8035-4 are the equivalent of the 8748 and 8035 except in their ability to interface to an 8243 I/O Expander Device. The Standard 8748/8035 can input or output from the 8243. The 8248-4/8035-4 can use the 8243 as an output expander only [3].

Part Numbers

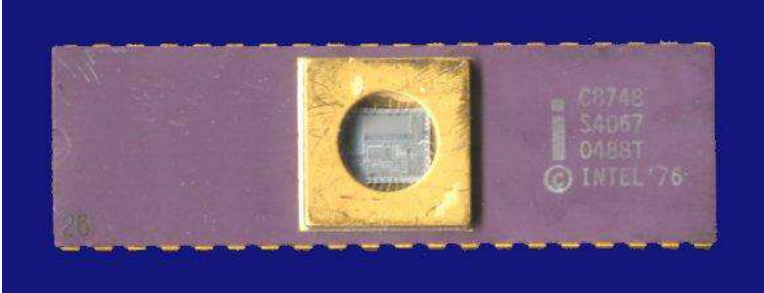
Type C Packages

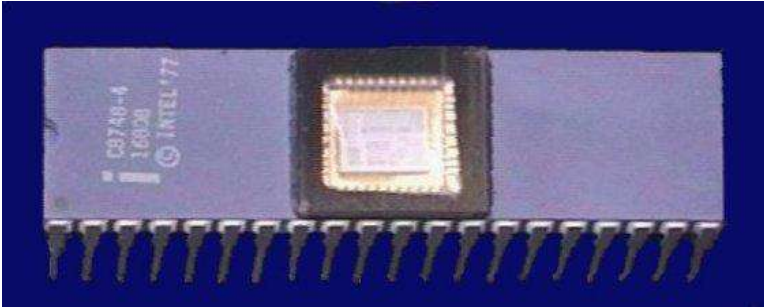
Part Number	Package Description	Values
		
C8748	1. Type C purple ceramic package w/gold cap with quartz porthole and gold pins. © Intel '76	\$5-\$20
		
C8748	2. Type C purple ceramic package w/gold cap with quartz porthole, offset gold cap ground strap, and gold pins. © Intel '76	\$5-\$20
C8748	3. Type C purple ceramic package w/quartz cap and tin pins. Vertical logo and part number. © Intel '76 '77.	\$5-\$20
		
C8748-4	Type C purple ceramic package w/quartz cap and tin pins. Vertical logo and part number. © Intel '77	Ex. Rare \$25-\$100

Intel i8748

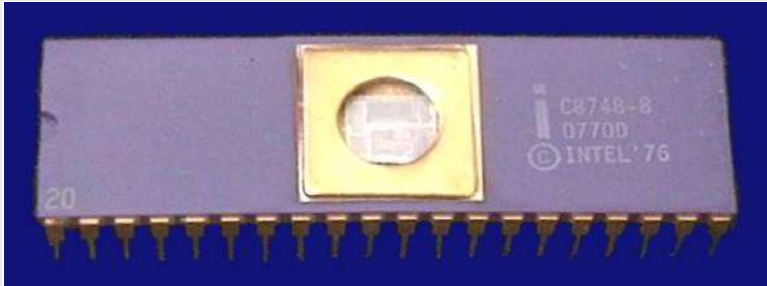
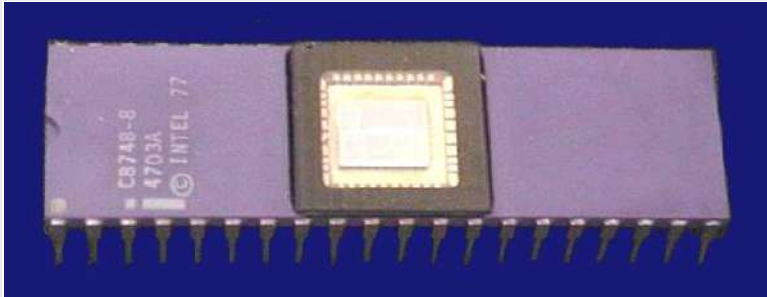
		
C8748-8	1. Type C purple ceramic package w/gold cap with quartz porthole, and gold pins. © Intel '76	\$5-\$20
C8748-8	2. Type C purple ceramic package w/gold cap with quartz porthole, offset gold cap ground strap, and gold pins. © Intel '76.	\$5-\$20
		
C8748-8	3. Type C purple ceramic package w/quartz cap and tin pins. Vertical logo and part number. © Intel '77	\$5-\$20
CC8748-8	Type C purple ceramic package w/gold cap with quartz window, offset gold cap ground strap, and gold pins. © Intel '80. Unusual 'CC' prefix (misprinted?).	Rare \$20-\$80
MC8748/B	Type C package. Single source shows 1 in stock.	Ex. Rare (Suspect) \$\$\$

Type D Packages

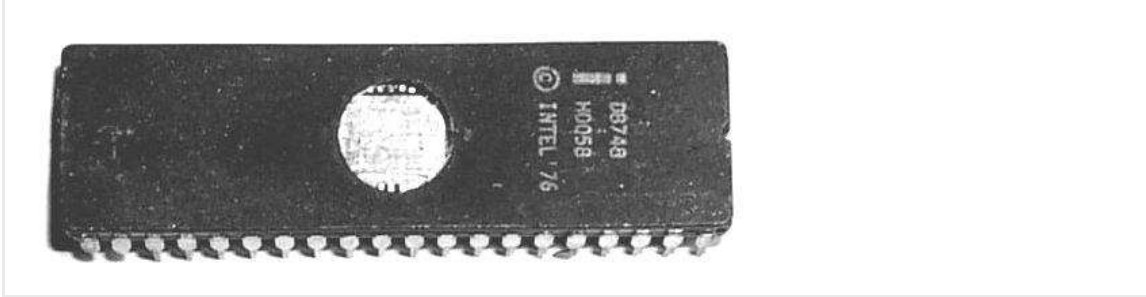
Part Number	Package Description	Values
		
D8748	1. Type D grey ceramic package w/porthole and tin pins. © Intel '76. Vertical logo and part number.	\$.75-\$3

Intel i8748



D8748	2. Type D grey ceramic package w/porthole and tin pins. © Intel '76. Horizontal logo and part number.	\$.75-\$3
D8748	3. Type D grey ceramic package w/porthole and tin pins. © Intel '80.	\$.75-\$3
D8748-6	Type D grey ceramic package w/porthole and tin pins. © Intel '76.	\$1.25-\$5
D8748-8	1. Type D grey ceramic package w/porthole and tin pins. © Intel '76.	\$1.25-\$5
D8748-8	2. Type D grey ceramic package w/porthole and tin pins. © Intel '80.	\$1.25-\$5
ID8748	Type D grey ceramic package w/porthole and tin pins. © Intel '76.	\$1.25-\$5
LD8748	Type D package	\$1.25-\$5
MD8748	Type D package	\$2-\$8

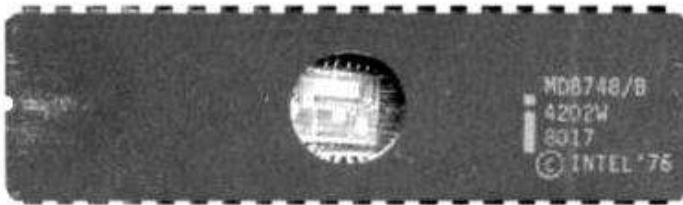

MD8748/B	Type D grey ceramic package w/porthole and tin pins. © Intel '76.	\$1.25-\$5
TD8748	Type D package	\$2.50-\$10
QD8748	Type D package	\$2.50-\$10

Type P Packages

Part Number	Package Description	Values
P8748	Type P package	\$1.25-\$5
P8748-8	Type P package. Single sources shows 5 in stock.	Rare (Suspect) \$\$\$

References

- [1] Intel (1977). Intel Data Catalog, 8048/8748/8035 Preliminary Data Sheet, p. 9-4
- [2] Intel (1978). Intel Component Data Catalog, 8048/8748/8035 Preliminary Data Sheet, p. 10-10
- [3] Intel (1978). Intel Component Data Catalog, 8748-4/8035-4 Data Sheet, p. 10-18
- [4] Intel (1984). A Revolution in Progress... A History of Intel to Date, 8748 introduced 1976, p. 26.

Intel i8748H

Single Component 8-bit Microcomputer w/8,192-bit (1024 x 8) EPROM, 512-bit (64 x 8) RAM, and I/O

1982-83

Specifications

- Single Component 8-bit Microcomputer w/8,192-bit (1024 x 8) EPROM, 512-bit (64 x 8) RAM, and I/O
- HMOS II
- Interval Time/Event Counter
- Two Single Level Interrupts
- Single +5 Volt Supply
- Over 96 Instructions; 90% Single Byte
- Programmable ROMs using 21V
- Easily Expandable Memory and I/O
- Up to 1.36 μ s Instruction Cycle All Instructions 1 or 2 Cycles
- 40-pin Dual In-Line Package

Type	Clock	Power Dissipation Max.	Supplies [V]
8748H	11 MHz	-	+5
M8748H	11 MHz	-	+5

The Intel MCS®-48 family are totally self-sufficient, 8-bit parallel computers fabricated on single silicon chips using Intel's advanced N-channel silicon gate HMOS process.

The family contains 27 I/O lines, an 8-bit timer/counter, and on-board oscillator/clock circuits. For systems that require extra capability, the family can be expanded using MCS®-80/MCS®-85 peripherals.

These microcontrollers are available in both masked ROM and ROMless versions as well as a new version, The Programmable ROM (P8748H). The Programmable ROM provides the user with the capacity of a masked ROM while providing the flexibility of a device that can be programmed at the time of requirement and to the desired data. Programmable ROM's allow the user to lower inventory levels while at the same time decreasing delay times and code risks.

These microcomputers are designed to be efficient controllers as well as arithmetic processors. They have extensive bit handling capability as well as facilities for both binary and BCD arithmetic. Efficient use of program memory results from an instruction set consisting of mostly single byte instructions and no instructions over 2 bytes in length [5].

Intel i8748H

Part Numbers

Type C Packages

Part Number	Package Description	Values
LC8748H	Type C package	Rare \$20-\$80

Type D Packages

Part Number	Package Description	Values
<p>A black ceramic package with a circular window in the center. The text on the package reads: D8748H, L4337582S, ©INTEL '80.</p>		
D8748H	1. Type D grey ceramic package w/tin pins. © Intel '80	\$.75-\$3
<p>A black ceramic package with a circular window in the center. The text on the package reads: D8748H, L7368458, 21 V PROGRAM, ©INTEL '80.</p>		
D8748H	2. Type D grey ceramic package w/tin pins. © Intel '80. Slashed zeroes. Also marked '21 V PROGRAM'.	\$.75-\$3
ID8748H	Type D package. Single source shows 31 in stock.	Rare (Suspect) \$\$\$
LD8748H	Type D package	\$1.25-\$5
MD8748H	Type D package	\$1.25-\$5
MD8748H/B	Type D package	\$1.25-\$5
TD8748H	Type D package	\$1.25-\$5
QD8748H	Type D package	\$1.25-\$5

Intel i8748H

Type P Packages

Part Number	Package Description	Values
P8748H	Type P package	\$.75-\$3

References

- [1] Intel (1980). Intel Component Data Catalog, 8048/8035L/8748/8748-6/8748-8/8035/8035-8 Data Sheet, p. 5-20. No reference to 8748H.
- [2] Hearst (1981). IC Master, Intel 8748, p. 555-101. No reference to Intel 8748H.
- [3] Intel (January 1982). Intel Component Data Catalog, 8748H/8035H Advance Information, p. 6-53
- [4] Hearst (1983). IC Master, Intel 8748H, p. 1093-12
- [5] Intel (1990). Intel 8-Bit Embedded Controllers, P8748H/P8749H/8048AH/8035AHL/
8049AH/8039AHL/8050AH/8040AHL Data Sheet, p. 4-8

Intel i8755

16,384-bit (2048 x 8) EPROM with I/O

1976-77

Specifications

- 16,384-bit (2048 x 8) EPROM with I/O
- NMOS
- Single + 5V Power Supply
- U.V. Erasable and electrically reprogrammable
- Internal Address Latch
- 2 General-Purpose 8-bit I/O Ports
- Each I/O Port Line Individually Programmable as Input or Output
- Multiplexed Address and Data Bus
- 40-pin Dual In-Line Package

The 8755 is an erasable and electrically reprogrammable ROM (EPROM) and I/O chip to be used in the MCS-85™ and MCS-48™ microcomputer systems. The PROM portion is organized as 2048 words by 8-bits. It has a maximum access time of 400ns to permit use with no wait states in an 8085 CPU.

The I/O portion consists of 2 general-purpose I/O ports. Each port has 8 port lines, and each I/O port line is individually programmable as input or output [2].

History

The 8755 combined the 8255 PIO (Program I/O) with the 2716 EPROM thereby reducing board "real estate", reducing production costs and increasing reliability due to fewer interconnects and those inherent with increased levels of VLSI.

Intel i8755

Part Numbers

Type C Packages

Part Number	Package Description	Values
C8755	Type C package	Rare \$25-\$100
C8755-8	Type C package. Single source shows 1 in stock.	Ex. Rare (Suspect) \$\$\$

Type D Packages

Part Number	Package Description	Values
D8755	Type D package	\$.75-\$3
TD8755	Type D package	\$1.25-\$5

References

- [1] Intel (1975). Intel Data Catalog. No reference to 8755 dates chip after 1975.
- [2] Intel (1977). Intel Data Catalog, 8755 Preliminary Data Sheet, p. 10-82

Intel i8755A

16,384-bit (2048 x 8) EPROM with I/O

1978-79

Specifications

- 16,384-bit (2048 x 8) EPROM with I/O
- NMOS
- Single + 5V Power Supply
- Directly Compatible with 8085A and 8088 Microprocessors
- U.V. Erasable and Electrically Reprogrammable
- Internal Address Latch
- 2 General-Purpose 8-bit I/O Ports
- Each I/O Port Line Individually Programmable as Input or Output
- Multiplexed Address and Data Bus
- 40-pin Dual In-Line Package

Type	Clock	Power Dissipation Max.	Supplies [V]
8755A	3 MHz	-	+5
8755A-2	5 MHz		+5



The Intel® 8755A is an erasable and electrically reprogrammable ROM (EPROM) and I/O chip to be used in the MCS-85™ and MCS-48™ microcomputer systems. The PROM portion is organized as 2048 words by 8-bits. It has a maximum access time of 400ns to permit use with no wait states in an 8085A CPU.

The I/O portion consists of 2 general-purpose I/O ports. Each port has 8 port lines, and each I/O port line is individually programmable as input or output [2].

Intel i8755A

Part Numbers

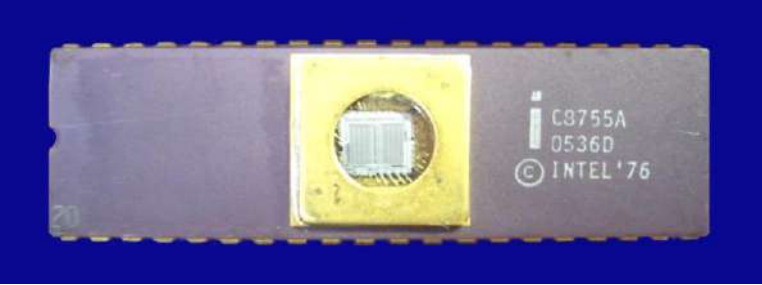
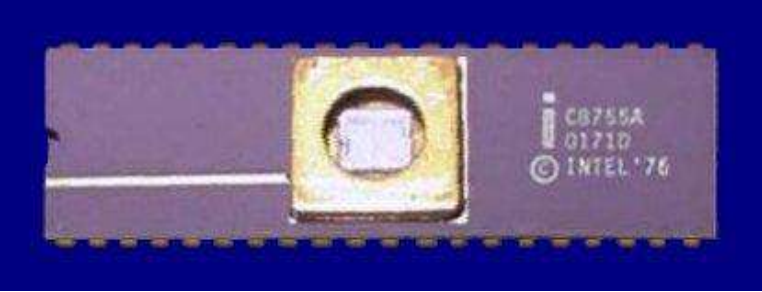
Type C Packages

Part Number	Package Description	Values
		
C8755A	1. Type C purple ceramic package w/gold cap with quartz porthole, and gold pins. #20 denotes pin #1. © Intel '76	\$5-\$20
		
C8755A	2. Type C purple ceramic package w/gold cap with quartz porthole, offset gold cap ground strap, and gold pins. Small black dot denotes pin #1. © Intel '76	\$5-\$20
C8755A	3. Same as #2 with vertical logo and part number printed on ceramic package.	\$5-\$20
		
C8755A	4. Type C purple ceramic package w/quartz cap and tin pins. © Intel '77. Vertical logo and part number. Small black dot denotes pin #1.	\$5-\$20
C8755A	5. Type C purple ceramic package w/gold cap with quartz porthole, offset gold cap ground strap, and gold pins. Horizontal logo and part number printed on ceramic package. © Intel '76 '81.	\$5-\$20

Intel i8755A

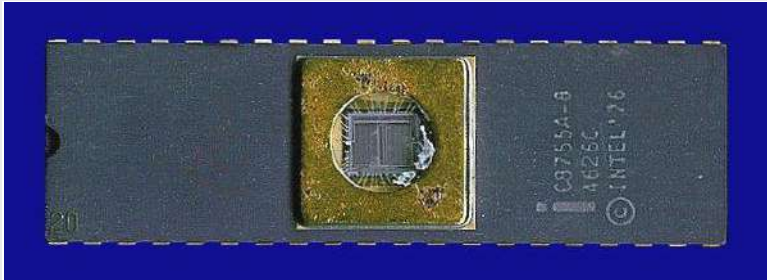
C8755A-2	Type C package	Rare \$20-\$80
		
C8755A-8	Type C purple ceramic package w/gold cap with quartz porthole, and gold pins. #20 denotes pin #1. © Intel '76	Rare \$20-\$80
IC8755A-8	Type C purple ceramic package w/gold cap with quartz porthole, offset gold cap ground strap, and gold pins. Small black dot denotes pin #1. © Intel '76.	Rare \$20-\$80

Type D Packages

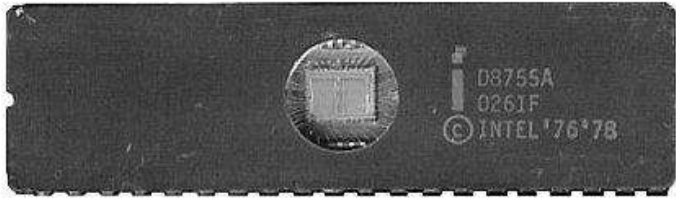
Part Number	Package Description	Values
D8755A	1. Type D grey ceramic package w/quartz porthole and tin pins. © Intel '76.	\$.75-\$3
		
D8755A	2. Type D grey ceramic package w/quartz porthole and tin pins. © Intel '76 '78.	\$.75-\$3
		
D8755A	3. Type D grey ceramic package w/quartz porthole and tin pins. © Intel '76 '81.	\$.75-\$3
D8755A-2	Type D grey ceramic package w/quartz porthole and tin pins. © Intel '78.	\$.75-\$3
D8755A-8	Type D package	\$1.25-\$5

Intel i8755A

D8755A-9	1. Type D grey ceramic package w/quartz porthole and tin pins. © Intel '76 '78.	\$.75-\$3
D8755A-9	2. Type D grey ceramic package w/quartz porthole and tin pins. © Intel '76 '81.	\$.75-\$3
ID8755A	Type D package	Rare \$5-\$20
LD8755A	Type D package	\$1.25-\$5
LD8755A-2	Type D package	\$2.50-\$10
MD8755A	Type D package	\$1.25-\$5
MD8755A/B	Type D package	\$1.25-\$5
QD8755A	Type D package	\$1.25-\$5
TD8755A	Type D package	\$2.50-\$10

References

[1] Intel (1977). Intel Data Catalog, 8755 Preliminary Data Sheet, p. 10-82. No Reference to 8755A dates chip after 1977.

[2] Intel (1978). Intel Component Data Catalog, 8755A Preliminary Data Sheet, p. 11-84

Intel i8801

Clock Generator Crystal for 8224/8080A

1975-77

Specifications

- Clock Generator Crystal for 8224/8080A
- Specifically Selected for Intel® 8224
- 18.432 MHz for 1.95 μ s 8080A Cycle
- Simple Generation of all Standard Communication Baud Rates
- Frequency Deviation $\pm 0.0005\%$
- Fundamental Frequency Mode
- 0°C to 70°C Operating Temperature
- Two Lead Can

The Intel® 8801 is a quartz crystal specifically selected to operate with the 8224 clock generator and the 8080A CPU. It resonates in the fundamental frequency mode at 18.432 MHz. This frequency allows the 8080A at full speed to have a cycle of 1.95 μ s and also simplifies the generation of all standard communication baud rates. The 8801 crystal is exactly matched to the requirements of the 8080A/8224 and provides both high performance and system flexibility for the microcomputer designer [2].

Part Numbers

No Examples Known with Intel Logo

References

- [1] Intel (September 1975). Intel MCS-80 User's Manual. No reference to 8801.
- [2] Intel (1977). Intel Data Catalog, 8801 Data Sheet, p. 10-41

19. Links

Vintage Chip Collecting Sites

Antique Tech

<http://www.antiquetech.com/>

CPU Collection

<http://www.cpu-collection.de/>

CPU Museum. The site that really got me interested in vintage microchips.

<http://www.cpu-museum.com/>

CPU Museum (French)

<http://www.deuttai.com/>

CPU Sammlung

<http://www.cpu-sammlung.de/>

CPU World

<http://cpu-world.com/>

CPU Zone

www.cpu-zone.com

Edgar Elsen's Site (German)

<http://www.edgar-elsen.de/>

IC Collection (Japanese)

<http://www.st.rim.or.jp/~nkomatsu/ICcollection.html>

Intel CPU Museum

<http://www.cpu-museum.net/>

Ito Family Collection

<http://www.itofamily.com/ito/collections/>

KOMZ – Karolo's Old Microprocessor Zone

<http://komz.org/>

The CPU Shack

<http://www.cpushack.net/>

The Intel Collection

<http://www.theintelcollection.com/>

Computer Museums and History

Intel Museum

<http://www.intel.com/museum/index.htm>

Red Hill CPU Index. Information on many early processors and contemporary Processors.

<http://www.redhill.net.au/ju.html>

The History of Modern Computers and their Inventors

<http://inventors.about.com/library/blcoindex.htm?once=true&>

Articles on the History of Electronic Calculators

<http://www.dotpoint.com/xnumber/chistory.htm>

The Official Home Page of IMSAI. Interesting historical information on vintage computers.

<http://www.imsai.net/>