



2102A, 2102AL/8102A-4* 1K x 1 BIT STATIC RAM

P/N	Standby Pwr. (mW)	Operating Pwr. (mW)	Access (ns)
2102AL-4	35	174	450
2102AL	35	174	350
2102AL-2	42	342	250
2102A-2	---	342	250
2102A	---	289	350
2102A-4	---	289	450

- Single +5 Volts Supply Voltage
- Directly TTL Compatible: All Inputs and Output
- Standby Power Mode (2102AL)
- Three-State Output: OR-Tie Capability
- Inputs Protected: All Inputs Have Protection Against Static Charge
- Low Cost Packaging: 16 Pin Dual-In-Line Configuration

The Intel® 2102A is a high speed 1024 word by one bit static random access memory element using N-channel MOS devices integrated on a monolithic array. It uses fully DC stable (static) circuitry and therefore requires no clocks or refreshing to operate. The data is read out nondestructively and has the same polarity as the input data.

The 2102A is designed for memory applications where high performance, low cost, large bit storage, and simple interfacing are important design objectives. A low standby power version (2102AL) is also available. It has all the same operating characteristics of the 2102A with the added feature of 35mW maximum power dissipation in standby and 174mW in operations.

It is directly TTL compatible in all respects: inputs, output, and a single +5 volt supply. A separate chip enable (\overline{CE}) lead allows easy selection of an individual package when outputs are OR-tied.

The Intel® 2102A is fabricated with N-channel silicon gate technology. This technology allows the design and production of high performance easy to use MOS circuits and provides a higher functional density on a monolithic chip than either conventional MOS technology or P-channel silicon gate technology.

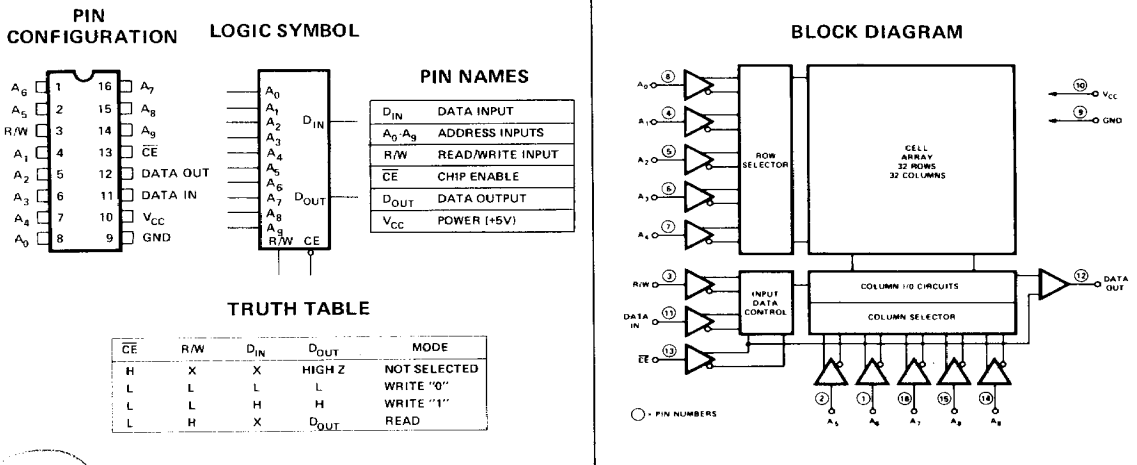

*All 8102A-4 specifications are identical to the 2102A-4 specifications.

2102A FAMILY

Absolute Maximum Ratings*

Ambient Temperature Under Bias	-10°C to 80°C
Storage Temperature	-65°C to +150°C
Voltage On Any Pin With Respect To Ground	-0.5V to +7V
Power Dissipation	1 Watt

*COMMENT:

Stresses above those listed under "Absolute Maximum Rating" may cause permanent damage to the device. This is a stress rating only and functional operation of the device at these or at any other condition above those indicated in the operational sections of this specification is not implied. Exposure to absolute maximum rating conditions for extended periods may affect device reliability.

D. C. and Operating Characteristics

$T_A = 0^\circ\text{C}$ to 70°C , $V_{CC} = 5\text{V} \pm 5\%$ unless otherwise specified.

Symbol	Parameter	2102A, 2102A-4 2102AL, 2102AL-4 Limits			2102A-2, 2102AL-2 Limits			Unit	Test Conditions
		Min.	Typ. [1]	Max.	Min.	Typ. [1]	Max.		
I_{LJ}	Input Load Current		1	10		1	10	μA	$V_{IN} = 0$ to 5.25V
I_{LOH}	Output Leakage Current		1	5		1	5	μA	$\overline{CE} = 2.0\text{V}$, $V_{OUT} = V_{OH}$
I_{LOL}	Output Leakage Current		-1	-10		-1	-10	μA	$\overline{CE} = 2.0\text{V}$, $V_{OUT} = 0.4\text{V}$
I_{CC}	Power Supply Current		33	Note 2		45	65	mA	All Inputs = 5.25V , Data Out Open, $T_A = 0^\circ\text{C}$
V_{IL}	Input Low Voltage	-0.5		0.8	-0.5		0.8	V	
V_{IH}	Input High Voltage	2.0		V_{CC}	2.0		V_{CC}	V	
V_{OL}	Output Low Voltage			0.4			0.4	V	$I_{OL} = 2.1\text{mA}$
V_{OH}	Output High Voltage		2.4		2.4			V	$I_{OH} = -100\mu\text{A}$

Notes: 1. Typical values are for $T_A = 25^\circ\text{C}$ and nominal supply voltage.

2. The maximum I_{CC} value is 55mA for the 2102A and 2102A-4, and 33mA for the 2102AL and 2102AL-4.

Standby Characteristics 2102AL, 2102AL-2, and 2102AL-4 (Available only in the Plastic Package)

$T_A = 0^\circ\text{C}$ to 70°C

Symbol	Parameter	2102AL, 2102AL-4 Limits			2102AL-2 Limits			Unit	Test Conditions
		Min.	Typ. [1]	Max.	Min.	Typ. [1]	Max.		
V_{PD}	V_{CC} in Standby	1.5			1.5			V	
$V_{CES}^{[2]}$	\overline{CE} Bias in Standby	2.0			2.0			V	$2.0\text{V} \leq V_{PD} \leq V_{CC} \text{ Max.}$
				V_{PD}			V_{PD}	V	$1.5\text{V} \leq V_{PD} < 2.0\text{V}$
I_{PD1}	Standby Current		15	23		20	28	mA	All Inputs = $V_{PD1} = 1.5\text{V}$
I_{PD2}	Standby Current		20	30		25	38	mA	All Inputs = $V_{PD2} = 2.0\text{V}$
t_{CP}	Chip Deselect to Standby Time	0			0			ns	
$t_R^{[3]}$	Standby Recovery Time		t_{RC}			t_{RC}		ns	

STANDBY WAVEFORMS

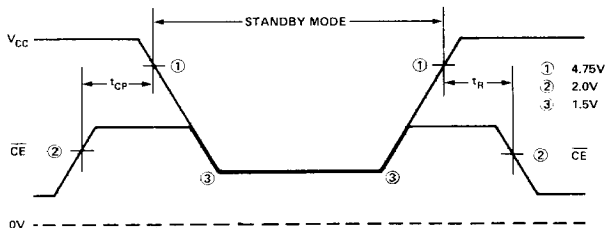

NOTES:

1. Typical values are for $T_A = 25^\circ\text{C}$.
2. Consider the test conditions as shown: If the standby voltage (V_{PD}) is between 5.25V ($V_{CC} \text{ Max.}$) and 2.0V , then \overline{CE} must be held at 2.0V Min. (V_{IH}). If the standby voltage is less than 2.0V but greater than 1.5V ($V_{PD} \text{ Min.}$), then \overline{CE} and standby voltage must be at least the same value or, if they are different, \overline{CE} must be the more positive of the two.
3. $t_R = t_{RC}$ (READ CYCLE TIME).

A. C. Characteristics $T_A = 0^\circ\text{C}$ to 70°C , $V_{CC} = 5\text{V} \pm 5\%$ unless otherwise specified

READ CYCLE

Symbol	Parameter	2102A-2, 2102AL-2 Limits (ns)		2102A, 2102AL Limits (ns)		2102A-4, 2102AL-4 Limits (ns)	
		Min.	Max.	Min.	Max.	Min.	Max.
t_{RC}	Read Cycle	250		350		450	
t_A	Access Time		250		350		450
t_{CO}	Chip Enable to Output Time		130		180		230
t_{OH1}	Previous Read Data Valid with Respect to Address	40		40		40	
t_{OH2}	Previous Read Data Valid with Respect to Chip Enable	0		0		0	

WRITE CYCLE

t_{WC}	Write Cycle	250	350	450
t_{AW}	Address to Write Setup Time	20	20	20
t_{WP}	Write Pulse Width	180	250	300
t_{WR}	Write Recovery Time	0	0	0
t_{DW}	Data Setup Time	180	250	300
t_{DH}	Data Hold Time	0	0	0
t_{CW}	Chip Enable to Write Setup Time	180	250	300

Capacitance^[2] $T_A = 25^\circ\text{C}$, $f = 1\text{MHz}$

SYMBOL	TEST	LIMITS (pF)	
		TYP. ^[1]	MAX.
C_{IN}	INPUT CAPACITANCE (ALL INPUT PINS) $V_{IN} = 0\text{V}$	3	5
C_{OUT}	OUTPUT CAPACITANCE $V_{OUT} = 0\text{V}$	7	10

A. C. CONDITIONS OF TEST

Input Pulse Levels: 0.8 Volt to 2.0 Volt
 Input Rise and Fall Times: 10nsec
 Timing Measurement Inputs: 1.5 Volts
 Reference Levels Output: 0.8 and 2.0 Volts
 Output Load: 1 TTL Gate and $C_L = 100\text{ pF}$

Waveforms

READ CYCLE

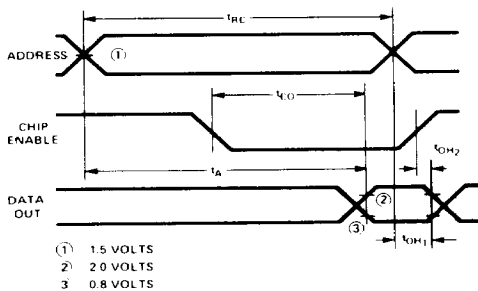

NOTES: 1. Typical values are for $T_A = 25^\circ\text{C}$ and nominal supply voltage.
 2. This parameter is periodically sampled and is not 100% tested.

WRITE CYCLE

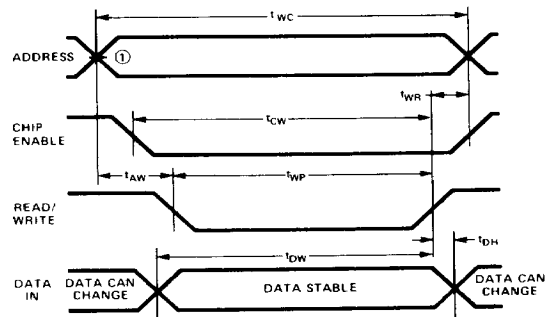

Typical D. C. and A. C. Characteristics

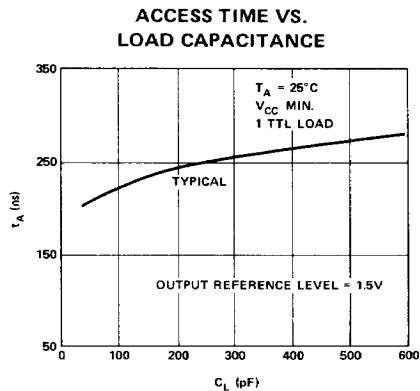
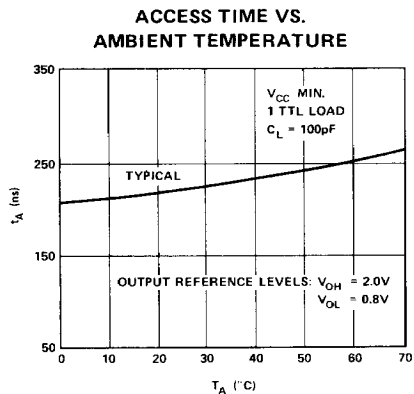
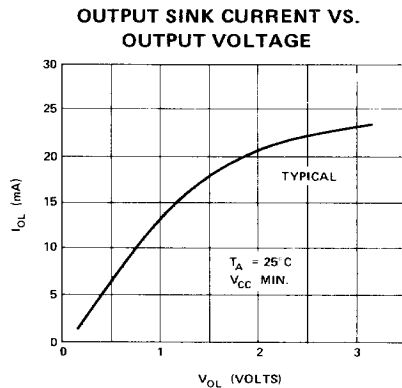
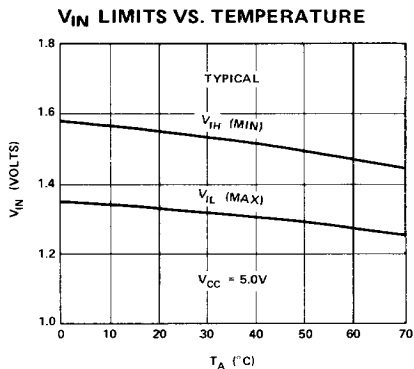
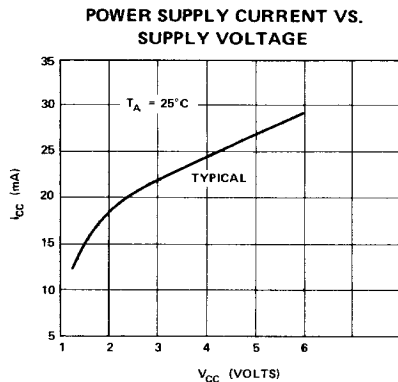
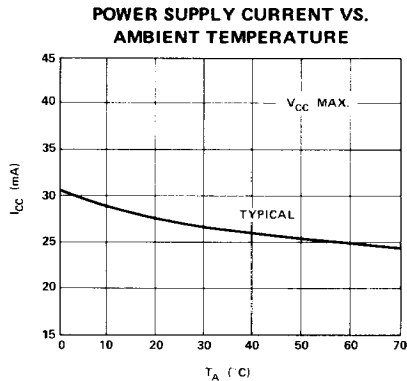

RAM