

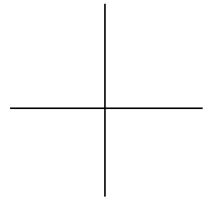

NCDware Reference Manual

Part Number 9300584 Rev. A
October, 1997

Network Computing Devices, Inc.
350 North Bernardo Avenue
Mountain View, California 94043
Telephone (650) 694-0650
FAX (650) 961-7711



Copyright

Copyright © 1997 by Network Computing Devices, Inc. The information contained in this document is subject to change without notice. Network Computing Devices, Inc. shall not be liable for errors contained herein or for incidental or consequential damages in connection with the furnishing, performance, or use of this material. This document contains information which is protected by copyright. All rights are reserved. No part of this document may be photocopied, reproduced, or translated to another language without the prior written consent of Network Computing Devices, Inc.

Trademarks

Explora, Explora Pro, ECX, HMX, HMXpro, HMXpro24, WinCenter, WinCenter Pro, WinCenter Connect, NCDnet, and NCDware are trademarks of Network Computing Devices, Inc. XRemote is a registered trademark of Network Computing Devices, Inc.

All trademarks and service marks are the trademarks and service marks of their respective companies.

All terms mentioned in this book that are known to be trademarks or service marks have been appropriately capitalized. NCD cannot attest to the accuracy of this information. Use of a term in this book should not be regarded as affecting the validity of any trademark or service mark.

Revisions

Revision history of this document:

| Part Number | Revision Date | Description |
|--------------------|----------------------|---|
| 9300584 | Rev. A October, 1997 | First release of this manual for NCDware 5.0. |

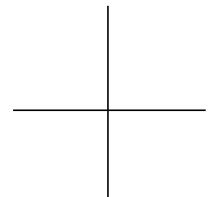

Contents

Chapter 1 About this Manual

- Intended Audience 1-1
- Purpose 1-1
- Contents of this Manual 1-2
- Other NCD Manuals 1-4
- Conventions Used in this Manual 1-5
- Comments on the Manual 1-6

Chapter 2 Booting Defaults

- Summary of Booting Alternatives 2-1

Chapter 3 Booting—Address Discovery

- Summary of Address Discovery Protocols 3-1
- Changing the Order of Network Information Requests 3-2
- Using BOOTP/DHCP for Address Discovery 3-3
 - Making Sure that BOOTP Is Enabled 3-4
 - Adding Options for NCD Terminals to the bootptab File 3-5
 - bootptab Format and Options 3-5
 - Adding Terminal Entries to the bootptab File 3-7
 - Configuring the Gateway Device and Terminal for Booting through a Gateway 3-8
- Using RARP for Address Discovery 3-10
- Storing Addresses in NVRAM 3-11

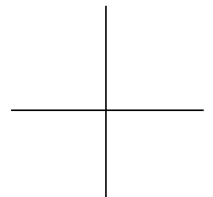

- Setting the Broadcast Address 3-12
- Configuring Subnet Mask Discovery 3-13
 - Using ICMP to Discover the Subnet Mask 3-14
 - Setting the Subnet Mask in NVRAM 3-14
- Communicating with Multi-Homed Hosts 3-15
- Using a Reverse Name Request 3-15
- Chapter 4 Booting—X Server Loading**
- Configuring the Default X Server Loading Sequence 4-1
 - Disabling Automatic Booting 4-4
 - Disabling Broadcast Requests for an X Server 4-4
 - Disabling the MOP Request for an X Server 4-5
 - Disabling Selected TFTP or NFS Requests for an X Server 4-5
 - Specifying a Non-Standard X Server Filename 4-7
 - Specifying a Non-Standard X Server Directory 4-7
 - Keeping the Terminal from Entering the Boot Monitor at Boot Time 4-7
 - Configuring the Sequence of X Server Loading Methods 4-8
- Configuring X Server Module Loading 4-10
 - Changing X Server Module Load Policy 4-10
 - Changing the X Server Module Location 4-11
- Using TFTP for X Server Downloading 4-12
 - Making Sure TFTP is Enabled 4-12
 - Specifying a Custom X Server Directory 4-12
- Using NFS for X Server Downloading 4-13
 - Making Sure NFS is Available 4-13
 - Specifying the Directory to Search for an X Server 4-13
- Linking X Server Files 4-14

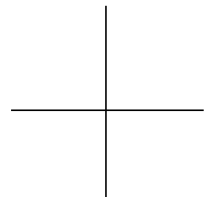

Specifying Boot Hosts 4-16

 Specifying the Initial Boot Host 4-16

 Specifying Backup Boot Hosts 4-16

Booting Manually from the Boot Monitor 4-17

 Manual Boot from a PCMCIA Card 4-18

 Manual Boot Using TFTP or NFS 4-18

Chapter 5 Configuring Network Services

Which Network Services Are Used by NCD Terminals 5-1

Summary of Network Service Defaults and Alternatives 5-3

Configuring the ARP Cache (Resolved Addresses) 5-5

Using a Name Service 5-7

 Making Sure a Name Service is Running on the Local
 Network 5-7

 Making Sure the Terminal Uses the Name Service 5-7

 Selecting the Name Service Protocol 5-8

 Specifying Name Server Hosts 5-8

 Specifying the Default Domain Suffix for DNS 5-9

 Configuring the Name Translation Table (Local Name Cache)
 5-10

 Setting the Name Cache Entry Lifetime 5-10

 Setting the Name Cache Size 5-11

 Setting Name Service Timeouts 5-11

 Discovering the Terminal's Hostname when Booting (Reverse
 Name Request) 5-12

Configuring How a Terminal Accesses Files 5-13

 Configuring the Initial File Servers 5-13

 Configuring the File Service Table 5-15

 Configuring the Matching Method 5-18

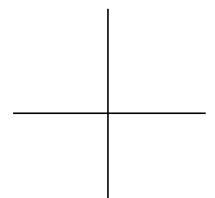

- Configuring File Access through TFTP 5-20
 - Secure versus Non-Secure TFTP 5-20
 - Make Sure TFTP Is Enabled on the Host 5-21
- Configuring File Access through NFS 5-22
 - Configuring the Host for NFS File Access 5-22
 - Setting User and Group IDs for NFS File Access 5-22
 - Setting the Unmount Timer for NFS File Access 5-23
- Changing the Timeout for Failed File Servers 5-24
- Issuing Extended File Service Diagnostic Messages 5-24
- Configuring Routing (Accessing Remote Networks) 5-25
 - Specifying Default Gateways 5-25
 - The IP Routing Table 5-26
 - Finding Routes to Hosts through Proxy ARP 5-29
 - Discovering Neighboring Gateways through Router Discovery 5-30
- Setting TCP Performance Parameters 5-31
 - Adjusting the TCP Send and Receive Buffers 5-31
 - Specifying the TCP Timeout 5-32
 - Specifying TCP Maximum Retransmissions 5-33
 - Specifying the TCP Linger Time 5-33
 - Allowing Larger Segment Sizes 5-33
- Chapter 6 Terminal Configuration Methods**
 - Configuration Methods Overview 6-2
 - Configuration Daemons 6-2
 - Configuration Parameters 6-2
 - Configuration Language 6-2
 - Default Configuration Values 6-2
 - Configuration Methods 6-3

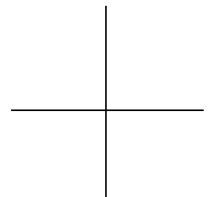

- Access Control for Terminal Configuration Data 6-5
- Parameter Types and Groups 6-5
 - Read/write, Read-only, and Write-only Parameters 6-5
 - Parameter Groups 6-6
- The Configuration Language 6-8
 - Configuration Language Summary 6-8
 - Assigning Values to Configuration Parameters 6-11
 - Simple Assignment Statements 6-11
 - Tables and Rows 6-11
 - Types of Values 6-12
 - Syntax Rules 6-13
 - Comments 6-14
 - Assigning Parameters More than Once 6-14
 - Listing Commands in Order 6-14
 - Saving Parameters in NVRAM 6-15
- Creating Remote Configuration Files 6-16
 - Using the Sample Configuration File 6-17
 - Configuration File Size 6-18
 - Creating a File from the Setup Clients 6-18
 - Nesting Configuration Files 6-19
 - Including the User's Settings in Remote Configuration Files 6-20
- Specifying Hosts for Loading Configuration Files 6-21
- Enabling Persistent Loading of the Configuration File 6-22
- Using Optional Names for Configuration Files 6-23
 - Suggested Uses for Configuration Filenames 6-25
- Disabling Specific Configuration File Download Attempts 6-25
- Specifying a Different Configuration File Directory 6-26

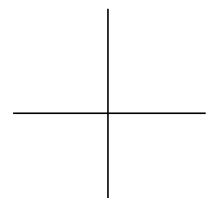

- Disabling All Remote Configuration File Downloads 6-27
- Specifying the File for Loading Configuration Defaults 6-27
- Changing the Ports for Accessing Configuration Daemons 6-28
 - Changing Ports for Access to All Configuration Data 6-28
 - Changing Ports for Access to User Preferences Data Only 6-29
- Setting Up Host-Based Access Control for Configuration Data 6-30
 - Allowing Access from Specified Hosts 6-30
 - Preventing All Remote Access to the Terminal's Configuration Data 6-31
- Protecting Configuration Parameters 6-32
 - Using the protect Command 6-32
 - Using the get-protect Command 6-33
 - Using the set-protect Command 6-33
 - Removing Parameter Protection 6-33
- Disabling the Configuration Utilities or the Console 6-34
- Configuring the Apply Command 6-34
 - Protocols for Auto-Save 6-35
 - Configuring Auto-Save to NVRAM 6-35
 - Configuring Auto-Save to a File 6-36
 - Disabling Auto-Save 6-36
 - Changing the Name of the Auto-Save File 6-36
 - Specifying the Data to Save 6-37

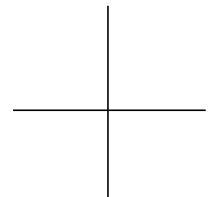

Chapter 7 Bitmap Fonts and the Font Server

- Font Use Overview 7-1
 - Font Access Sequence 7-2
 - Font Names 7-2
 - Wildcards in Font Names 7-4
 - Bitmap and Outline Font Naming 7-4
 - Specifying Fonts for Clients 7-4
 - Obtaining Fonts 7-5
 - Font Download Methods 7-6
 - Considerations in Using Downloaded Fonts 7-6
 - Problems with Client Font Requests 7-6
 - The Font Path 7-6
 - Font Formats 7-7
 - Font Directories and Files 7-8
 - Font Directories 7-8
 - Font Files 7-8
 - Font Management Files 7-9
 - NCD Font Management Utilities 7-10
 - Built-In Fonts Summary 7-11
- Alternative Methods of Changing the Current Font Path 7-11
 - Changing the Current Font Path—Using TELNET 7-11
 - Changing the Current Font Path—Using the xset Client 7-13
- Setting the Default Font 7-13
- Changing the Size of the Font Cache 7-14
- Renaming the Font Management Files 7-15
- Specifying Font Path Aliases 7-16
- Displaying and Logging Font Diagnostic Messages 7-17

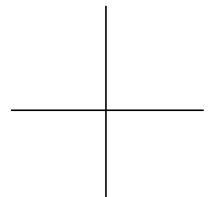

- Getting Font Information 7-17
 - Viewing the Font Path—xset 7-18
 - Listing the Available Fonts—xlsfonts 7-18
 - Displaying the Characters in a Font—xfd 7-18
 - Displaying Samples of a Font and XLFD Names—xfontsel 7-19
- Font Server Issues 7-19
 - How the Font Server Accesses Fonts 7-19
 - Usable Font Formats with a Font Server 7-20
 - Font Server Configuration Issues 7-21
 - Network Considerations 7-21
 - Host Considerations 7-21
 - Default Font Specifications 7-23
 - Error Logging 7-23
 - Example NCD Font Server Configuration File 7-23
 - Configuring Font Server Timeouts 7-25
 - Getting Information about the Font Server 7-26
 - Getting Information about Fonts from the Font Server 7-27
 - Displaying Font Server Fonts 7-27
- Chapter 8 Login and X Session Management**
- XDM Default Actions 8-2
- XDM Overview 8-3
 - Components of XDM 8-4
 - XDMCP Queries and Host Responses 8-4
 - XDM and the DISPLAY Variable 8-5
 - The NCD Login Chooser 8-5
 - The NCD Display Manager 8-5

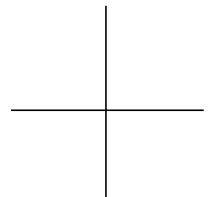

- Configuring XDM Hosts 8-5
 - Installing the XDM Binary File 8-6
 - Installing XDM Configuration Files 8-6
 - Configuring the System-Wide XDM Session Management File 8-7
 - The Default Xsession File 8-8
 - Example Xsession File for the Local NCD Window Manager 8-9
 - Sample Xsession File for OpenWindows 8-10
 - Individual XDM Session Management Files 8-11
 - Configuring the XDM Xaccess File 8-11
 - Contents of an Xaccess File Entry 8-11
 - Types of Xaccess File Entries 8-12
 - Direct and Broadcast Entries in the Xaccess File 8-12
 - Indirect Entries in the Xaccess File 8-13
 - Configuring the xdm-config File 8-13
 - Configuring the Polling Interval 8-14
 - Configuring the Version of xrdp to Use 8-14
 - Configuring the XDM Xresources File 8-14
 - The XDM Error Logging File 8-14
- Starting XDM Manually 8-15
- XDM Access Control 8-15
 - If XDM Cannot Write to a User's Home Directory 8-16
- Configuring Terminals for XDM 8-17
 - Configuring the Login Chooser Redisplay 8-17
 - Configuring the Terminal's Action when XDM Terminates 8-17
 - Configuring XDM Keepalives 8-18
- Using XDM—X11R3 Version 8-19

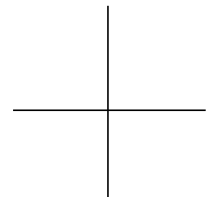

Chapter 9 Using Configuration Menus

Using Change Quick Setup 9-1

Components of the Change Quick Setup Window 9-1

Contents of the Change Quick Setup Hide Boxes 9-3

Booting Parameters 9-3

Files Parameters 9-3

Fonts Parameters 9-4

Licenses Parameters 9-5

Network Parameters 9-5

Session Parameters 9-6

Using Change Setup Parameters 9-7

Components of the Change Setup Parameters Window 9-7

Contents of the Change Setup Parameters Hide Boxes 9-8

Access Control Parameters 9-9

ARP Parameters 9-13

Booting Parameters 9-13

Browser Parameters 9-16

Commands and Startup Parameters 9-18

Configuration Parameters 9-18

Diagnostics Parameters 9-20

Display PostScript Parameters 9-21

File Manager Parameters 9-21

File Service Parameters 9-22

Fonts Parameters 9-23

Input Devices Parameters 9-24

IP Parameters 9-25

Java Parameters 9-27

LAT Parameters 9-27

Licenses Parameters 9-28

Loadable Modules Parameters 9-29

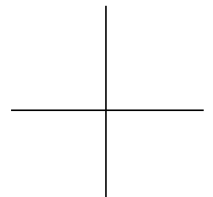

- Login Parameters 9-29
- NCDnet Parameters 9-31
- NCDnet Name Service Parameters 9-32
- Network Interfaces Parameters 9-32
- Parallel Parameters 9-33
- PEX Parameters 9-33
- PEX Color Parameters 9-34
- PPP and SLIP Parameters 9-35
- Serial Parameters 9-35
- TCP Parameters 9-36
- TCP/IP Name Service Parameters 9-37
- Time Parameters 9-38
- Unit Parameters 9-38
- Video Parameters 9-39
- VT320 Terminal Emulation Parameters 9-39
- WinCenter Parameters 9-40
- X and Graphics Parameters 9-40
- XRemote Parameters 9-41
- 3270 Terminal Emulation Parameters 9-42
- Using Change User Preferences 9-43
 - Components of the Change User Preferences Window 9-43
 - Components of the Change User Preferences Hide Boxes 9-44
 - Audio Preferences 9-44
 - Bell Preferences 9-45
 - Compatibility Preferences 9-45
 - Console and Utilities Preferences 9-46
 - Environment Variables Preferences 9-47
 - Font Preferences 9-47
 - Keyboard Preferences 9-47
 - OpenGL Preferences 9-48
 - PEX Preferences 9-50

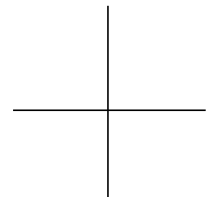

- Pointing Devices Preferences 9-51
- Power Management Preferences 9-52
- Screen Background Preferences 9-52
- Screen Saver Preferences 9-53
- X, SIE, and Graphics Preferences 9-54

Chapter 10 Statistics Menus

- Accessing Statistical Parameters 10-1
- Components of the Show Statistics Window 10-1
- Contents of the Statistics Hide Boxes 10-2
 - Ethernet Statistics 10-2
 - Font Usage Statistics 10-3
 - ICMP Statistics 10-3
 - IP Statistics 10-6
 - Loadable Modules Statistics 10-8
 - NCDnet Statistics 10-9
 - NCDnet Name Service Statistics 10-10
 - Network Buffers Statistics 10-11
 - Network Interfaces Statistics 10-13
 - NFS Statistics 10-13
 - Parallel Daemon Statistics 10-16
 - Serial Statistics 10-17
 - Serial Daemons Statistics 10-17
 - SNMP Statistics 10-18
 - TCP Statistics 10-21
 - TCP/IP Name Service Statistics 10-24
 - TFTP Statistics 10-25
 - Token-Ring Statistics 10-26
 - UDP Statistics 10-26
 - Unit Statistics 10-27
 - Wireless LAN Statistics 10-28

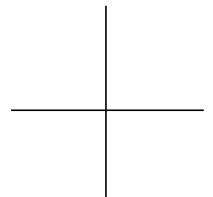

XRemote Statistics 10-30

Chapter 11 Boot Monitor and NVRAM

Boot Monitor Versions 11-1

Boot Monitor Functions 11-2

Automatic Boot Monitor Functions 11-2

Self Tests and Commands for Testing 11-2

Keyboard Controller and Supported Keyboards 11-3

Address Discovery 11-3

X Server Downloading 11-4

Display Blanking 11-5

Interactive Boot Monitor Functions 11-5

Using Boot Monitor Commands 11-6

Starting the Boot Monitor Utility 11-6

Issuing Commands to the Boot Monitor 11-7

Updating the Boot Monitor on Explora Terminals 11-11

Using Boot Monitor Setup Menus to Configure Terminals 11-12

Starting Boot Monitor Setup 11-12

Navigating in Boot Monitor Setup 11-13

Setting the Keyboard Type 11-13

Setting Monitor Resolution and Dots Per Inch 11-13

The Monitor Resolution Window 11-14

The Dots Per Inch Window 11-14

Setting Network Parameters 11-14

Setting Booting Parameters 11-16

Finishing the Boot Monitor Setup Session 11-17

Programming Navigation Keys for Boot Monitor Setup
Menus 11-18

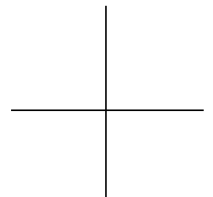

- Using the NVRAM Utility to Configure Terminals 11-20
 - Starting the NVRAM Utility 11-20
 - NVRAM Utility Commands 11-20
 - Sample NVRAM Utility Sessions 11-21
 - Changing Contents Byte by Byte 11-21
 - Changing Individual Bits in a Byte 11-23
 - NVRAM Contents 11-24
 - Keyboard Type Settings 11-32
 - Parameters Saved in the Tagged Strings Area 11-37
 - Remote Configuration Parameters Saved in NVRAM 11-38

Chapter 12 Configuring the NCD Terminal Emulator

- Other Sources of Information on the Terminal Emulator 12-1
- Configuring Local Services in the Terminal Host Chooser 12-2
- Configuring a Terminal for Serial Terminal Emulation 12-3
- Configuring Key Translations 12-4
- Configuring the Terminal Emulator Window and Menus 12-5
 - Terminal Emulator Fonts 12-5
 - Terminal Emulator Scroll Bars 12-6
 - Terminal Emulator Menus 12-6
 - The File Menu 12-6
 - The Options Menu 12-8
 - The Fonts Menu 12-10
 - The Cursors Menu 12-11
 - The Keys Menu 12-11
 - Selecting in the Window 12-12
- Configuring the Window Disconnect Delay 12-12
- Configuring the Answer-Back Message 12-12

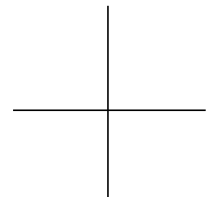

- Using VT320 Terminal Emulator Escape Sequences 12-13
 - Configuring the Status Line 12-27
 - Programming Function Keys on N-108LK Keyboards 12-28
 - Configuring Window and Icon Titles 12-30
 - Configuring Color Text 12-30
- Using Keyboard Escape Sequences 12-34
 - N-101/N-102 Keyboard Escape Sequences 12-35
 - N-108LK (VT220-Style) Keyboard Escape Sequences 12-38
 - N-97/N-Kana Keyboard Escape Sequences 12-42
- Using Compose Key Sequences 12-44
 - Support for Dead Keys 12-44
 - Typing Compose Sequences 12-44
 - Compose Sequence Table 12-45
- VT320 Character Coding Conventions 12-51
 - Character Sets 12-51
 - Character Code Tables 12-52
- Chapter 13 Configuring Display PostScript**
- DPS Overview 13-1
- DPS Requirements 13-2
- Using DPS Support Files 13-3
 - The PostScript Resource File 13-3
 - Sections in the PostScript Resource File 13-3
 - Creating or Updating the PostScript Resource File 13-5
 - The Virtual Memory File 13-7
 - The Color-Rendering File 13-7
 - The Context Initialization File 13-7
- Adobe Fonts for DPS 13-8

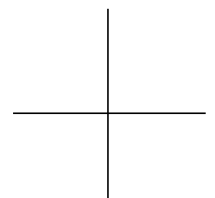

- Configuring the DPS Resource Path 13-10
- Configuring DPS Font Access by X Clients 13-11
- Freeing the DPS Cache 13-12
- Troubleshooting DPS 13-12
 - If the DPS Extension Fails to Start 13-12
 - File Service Problems 13-12
 - DPS Applications on Solaris Systems 13-13
 - Running AnswerBook 13-13
 - Running ImageTool 13-14
 - Running PageView 13-15
- Chapter 14 Configuring PEX**
 - PEX Overview 14-1
 - The PEX X Server Module 14-2
 - PEX Fonts 14-2
 - PEX Requirements 14-3
 - Setting PEX Configuration Parameters 14-3
 - Setting the Parameters Listed in Change Setup Parameters 14-3
 - PEX Color Parameters 14-5
 - Setting the Parameters Listed in Change User Preferences 14-9
 - Specifying the Nominal Line Width 14-9
 - Specifying the Nominal Edge Width 14-9
 - Specifying the Nominal Marker Size 14-10
 - Specifying Surface Dithering 14-10
 - Specifying Surface Interior Style, Shading, and Lighting 14-11
 - Specifying the Color Clipping Method 14-12
 - Specifying the Input Device for PEX 14-13

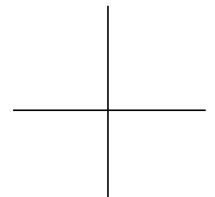

Troubleshooting PEX 14-14

 If the PEX Client Does Not Run 14-14

 If the PEX Client Looks Different 14-14

Chapter 15 Configuring Serial and Parallel Ports

Ports Overview 15-1

 Serial Ports 15-1

 Parallel Port 15-2

Configuring Port Operating Characteristics 15-2

 Identifying Serial Port Numbers 15-2

 Specifying Physical Serial Port Attributes 15-2

 Specifying Serial Port Software Characteristics 15-6

 Configuring the Parallel Port 15-8

Configuring a Terminal for Use as a System Console 15-9

Controlling Access to Serial and Parallel Ports 15-10

Chapter 16 Using SNMP for Terminal Management

SNMP Overview 16-1

 SNMP Components 16-1

 How SNMP Works 16-2

 MIB Contents 16-2

SNMP Host Requirements 16-3

Controlling Access to Terminals through SNMP 16-3

 Configuring Read/Write Access 16-4

 Configuring Read-Only Access 16-5

 Configuring Terminals to Allow Trap Monitoring 16-6

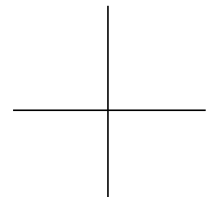

- Using SNMP to Read and Write Variables 16-7
 - Reading a Terminal's SNMP Variables 16-7
 - Using SNMP Management Software 16-7
 - Using the ncdquery Utility 16-7
 - Writing SNMP Variables—Configuring Terminals 16-9
- Using SNMP Remote Reset/Reboot 16-10
 - Configuring a Host for SNMP Remote Reset 16-10
 - Configuring a Terminal for SNMP Remote Reset 16-11
 - Resetting Session and Rebooting Terminals 16-11
 - Using the ncdreset Utility for Remote Reset 16-11
 - Using unit-administrative-status for SNMP Remote Reset 16-12

Chapter 17 Keyboards and Downloadable Keyboard Definitions

- Specifying the Keyboard Type 17-2
- N-97 Keyboard Details 17-4
- N-101 Keyboard Details 17-13
- VT220-Compatible and N-108 Keyboard Details 17-21
 - VT220-Compatible Keyboard 17-21
 - N-108 Keyboard 17-21
- N-107 Sun Type 4-Compatible Keyboard Details 17-36
- N-123 Sun Type 5-Compatible Keyboard Details 17-44
- Using Downloadable Keyboard Description Files 17-54
 - Creating a Keyboard Definition File 17-54
 - Specifying Dead-Key Processing 17-60

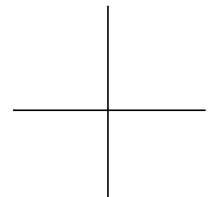

Chapter 18 X Server Messages

Messages and Modules Overview 18-1

The Format of Messages 18-2

Displaying Messages 18-4

 Viewing Messages in the Console Window 18-4

 Viewing Messages through TELNET 18-4

Logging Messages to a File 18-5

Configuring Message Logging 18-5

 Configuring Message Time Stamps 18-5

 Changing the Message Buffer Size 18-6

 Enabling Extended Diagnostics 18-6

Messages Common to All Modules 18-7

CALIBLIGHTPEN Messages 18-15

CALIBTOUCH Messages 18-16

CONFIGD Messages 18-17

CONFUI Messages 18-30

CONSOLE Messages 18-33

DESKTOP Messages 18-36

DHCP Messages 18-37

DIAGD Messages 18-38

DOS Messages 18-38

DTR Messages 18-40

EXECD Messages 18-40

FILED Messages 18-44

FONT Messages 18-48

IROUTE Messages 18-55

JAVA Messages 18-57

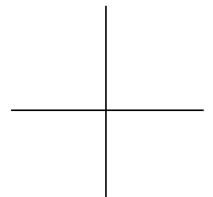

KBM Messages 18-58
KEYMAPPER Messages 18-67
LICENSE Messages 18-67
LOADB Messages 18-74
LOCALDEV Messages 18-77
LOGIN Messages 18-78
MIRROR Messages 18-81
MPEGPLAY Messages 18-82
MWM Messages 18-83
NCD Mosaic Browser Messages 18-84
NCDDM Messages 18-86
NETD Messages 18-87
NETFILE Messages 18-87
NETSRV Messages 18-93
OPENGL Messages 18-94
PPPD Messages 18-96
PRINTAPIS Messages 18-99
RTL D Messages 18-103
SERIALD Messages 18-106
SIE Messages 18-108
SNMPD Messages 18-108
TERM Messages 18-109
TOKENRING Messages 18-122
UI Messages 18-125
VIDEO, VIDEODECODER, and VIDEOPLAYER Messages 18-127
WINCEN Messages 18-127
WIRELESS Messages 18-128

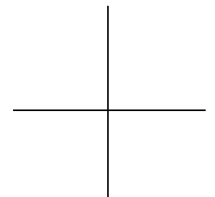

WM Messages 18-133
XREMOTE Messages 18-136
XRPRINTD Messages 18-138
XSERVER Messages 18-139
XT Messages 18-141
Index

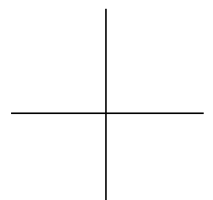

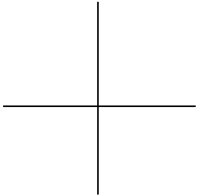

1 About this Manual

This chapter provides information about this manual and other NCD publications.

Intended Audience

This manual is intended for system administrators and network administrators who are responsible for:

- ❑ Setting up NCD network computers (also called NCD terminals in this manual) for networked use
- ❑ Setting up the user's work environment

The manual assumes familiarity with the UNIX operating system, the X Window System (X), TCP/IP, and local area networks—Ethernet or Token-Ring.

If you are not familiar with X, NCD recommends the series of books published by O'Reilly & Associates, Inc. The series includes books for users and for system administrators.

Purpose

In most cases, the *ncdinstall* program is the most efficient way to prepare a terminal for booting and to make sure that necessary network services and files are available. Besides placing NCDware on the boot host, *ncdinstall* prepares terminals for booting, enables network services, add terminals to network databases, and makes host-resident files (such as configuration files and fonts) available to terminals.

While the *NCDware System Administrator's Guide for UNIX Systems* describes the most common terminal configuration tasks, this manual describes how to further customize all aspects of terminal operation. This manual also describes specialized features, such as SNMP, DPS, and PEX.

Contents of this Manual

This manual contains up-to-date reference information about the current release of NCDware. A brief description of each chapter follows.

- ❑ Chapter 1, *About this Manual*, describes the audience, purpose and contents of this manual, other NCD manuals, and conventions used in this manual.
- ❑ Chapter 2, *Booting Defaults*, lists the default actions of the terminal as it boots, including discovering network addresses and other information, loading an X server, loading a configuration file, reading font directories, and displaying a login prompt. For each of these actions, alternatives are listed and references are given to the chapters and other manuals where defaults and alternatives are described.
- ❑ Chapter 3, *Booting—Address Discovery*, describes methods of discovering or specifying network addresses and other network information needed by the terminal when it boots.
- ❑ Chapter 4, *Booting—X Server Loading*, describes the default X server loading sequence and alternatives, loading server modules, booting manually, setting the broadcast address, and setting the Token-Ring speed on HMX terminals.
- ❑ Chapter 5, *Configuring Network Services*, summarizes the protocols and other network services normally required by NCD terminals and provides details about configuring address resolution, name services, file access, communication with multi-homed hosts, routing, and setting TCP performance parameters.
- ❑ Chapter 6, *Terminal Configuration Methods*, gives an overview of terminal configuration methods, describes configuration parameters and configuration language commands, provides options for creating configuration files, and describes optional filenames and directories for configuration files.
- ❑ Chapter 7, *Bitmap Fonts and the Font Server*, describes the conventional method of directly accessing fonts by reading font directories on a host, including font names, font downloading, font directories and files, configuring the font path and other font usage parameters, getting font information, font management utilities, and built-in fonts. The chapter also describes using a font server rather than directly accessing fonts on a

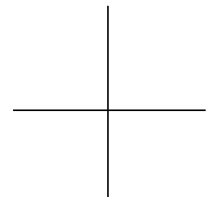

- host, including the font server configuration file, starting the font server, remote configuration parameters for the font server, and getting information about fonts.
- ❑ Chapter 9, Using Configuration Menus, describes the controls, menus, and fields in the three configuration utilities accessed through the Console: Change Quick Setup, Change Setup Parameters, and Change User Preferences. The chapter includes a brief description of each field and the name of the corresponding remote configuration parameter.
 - ❑ Chapter 10, Statistics Menus, describes the controls, menus, and fields in the Show Statistics utility. The chapter includes a brief description of each statistical field and the name of the corresponding remote configuration parameter.
 - ❑ Chapter 11, Boot Monitor and NVRAM, describes the functions and commands of the Boot Monitor, how to use the Boot Monitor Setup menus to quickly configure a terminal, how to use the NVRAM *nv* utility to read and change parameters that are stored in NVRAM, and information about the configuration data stored in NVRAM.
 - ❑ Chapter 8, Login and X Session Management, provides details about XDM (X Display Manager) components and files, how to start XDM manually, and XDM access control.
 - ❑ Chapter 12, Configuring the NCD Terminal Emulator, describes the components of the VT320 terminal emulator, the menus and controls, configuring the emulator with X resources, escape sequences, compose key sequence, and character coding.
 - ❑ Chapter 13, Configuring Display PostScript, describes DPS features, requirements, support files, fonts, configuration parameters, and suggestions for troubleshooting.
 - ❑ Chapter 14, Configuring PEX, describes PEX (PHIGS extension to X, support for 3D graphics applications) and includes information about PEX fonts, requirements, configuration parameters, input devices, and suggestions for troubleshooting.
 - ❑ Chapter 15, Configuring Serial and Parallel Ports, describes the ports on NCD terminals, setting port attributes, and controlling host access to ports.
 - ❑ Chapter 16, Using SNMP for Terminal Management, describes host requirements for using SNMP (Simple Network Management Protocol),

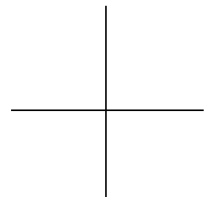

- configuration parameters for SNMP, reading and writing SNMP variables, and using SNMP to remotely reset sessions and reboot terminals.
- ❑ Chapter 17, *Keyboards and Downloadable Keyboard Definitions*, describes NCD keyboards and how to use downloadable keyboard files to use unsupported keyboards.
- ❑ Chapter 18, *X Server Messages*, describes X server messages and message logging.

Other NCD Manuals

This *Reference Manual* and the following manuals contain up-to-date information about this version of NCDware:

- ❑ *NCDware System Administrator's Guide for UNIX Systems*—procedures for managing NCD terminals
- ❑ *NCDware Release Notes*—description of new features added since NCDware 4.1, known problems, and problems fixed
- ❑ NCDware CD Insert—instructions for using NCD installation scripts to install NCDware on UNIX and WinCenter hosts
- ❑ *NCDware User's Guide*—introductory manual providing information to assist users in becoming productive with their NCD terminals.
- ❑ *Remote Configuration Parameter Quick Reference*—description of remote configuration parameters (for terminal configuration)
- ❑ *NCDware Publications Roadmap*—high-level index of major topics in NCD manuals; points the reader to the documents or chapters in which the topics are addressed
- ❑ *FLEXlm End User Manual*—a detailed description of how to use and configure FLEXlm license management software
- ❑ *Using the 3270 Terminal Emulator*—how to use and configure NCD's 3270 terminal emulation software
- ❑ *Installing Your PCMCIA Card*—how to install and use a PCMCIA card with your terminal

In addition, the online man pages have been updated for this release. Man pages are installed along with NCDware.

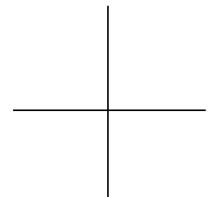

For documents describing NCD's WinCenter software, see the WinCenter manuals accompanying the WinCenter software. (See the *NCDware System Administrator's Guide for UNIX Systems*, the index of this manual and the *NCDware Publications Roadmap* for references to configuring NCDware for use with WinCenter.)

Conventions Used in this Manual

The following typographical conventions are used in this manual.

| Text in This Format | Indicates ... |
|---------------------------|---|
| <code>display text</code> | Text displayed on the screen or text in a file, for example, a field in the Setup menus |
| <code>input text</code> | Text to be typed as shown |
| <i>variable</i> | Portion of a command line or line in a file where you provide the value; for example, a terminal's IP address |
| filename | The name of a system file, directory, or pathname |
| <i>emphasized text</i> | An especially important word or phrase or explanatory text |
| parameter name | The name of a remote configuration parameter |
| "true" | A value assigned to a remote configuration parameter |

Other conventions used in this manual are:

- ❑ When you should press two keys at the same time, they are shown as in this example:
 Ctrl-Z *Press the Control and z key together*
- ❑ You should press Return after all commands.
- ❑ Movement through menus in the Console is shown as a series of arrows. For example, Setup ⇒ Change Setup Parameters ⇒ Serial means to display the Setup menu, select the Change Setup Parameters menu item and open the Serial hide box.

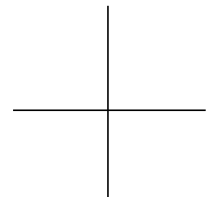

Comments on the Manual

You can send comments, suggestions, or questions about this manual to the NCD Technical Publications Department at techpubs@ncd.com.

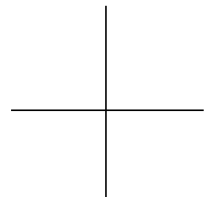

2 Booting Defaults

This chapter provides a summary of the default booting process of an NCD terminal:

- ❑ Address discovery
- ❑ Loading and executing the X server
- ❑ Loading configuration files
- ❑ Obtaining fonts
- ❑ Displaying a login prompt

For each default action, the alternatives (if any) are listed, followed by references that provide information about customizing each action.

Summary of Booting Alternatives

Table 2-1 lists the default booting actions of an NCD terminal and the alternatives to each action. When you add a terminal to the network using *ncdinstall*, the defaults are in effect.

Caution

Do not change the booting and network configuration of your terminal unless you understand the characteristics you are altering. Incorrect settings may make it impossible for your terminal to boot and may also impair network activity.

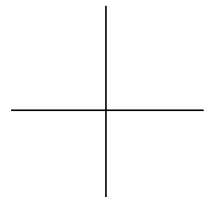

Table 2-1 Chronological Summary of Default Booting Actions and Alternatives

| Default Booting Action | Alternate Action(s) | References |
|--|--|---|
| A user powers on the terminal or reboots it, and booting actions begin automatically. | You can configure the terminal to display a Boot Monitor prompt instead of booting automatically when powered on. | Chapter 4, Booting—X Server Loading |
| The Boot Monitor performs self tests, displays results, and reads NVRAM configuration content. | You can disable some of the self tests. NCD recommends that you do not disable any self tests. | Chapter 11, Boot Monitor and NVRAM |
| <p>The Boot Monitor broadcasts the terminal's physical (Ethernet) address using alternating DHCP, BOOTP, and RARP requests for its IP address.</p> <p>If you use <i>ncdinstall</i> to add terminals, it configures the BOOTP/DCHP database on the boot host to include additional network information.</p> | You can manually configure the BOOTP/DHCP database to provide more information. | Chapter 3, Booting—Address Discovery <i>System Administrator's Guide</i> |
| | Instead of using BOOTP/DHCP responses for determining the IP address and other booting information, you can configure the terminal to use information stored in NVRAM. | Chapter 6, Terminal Configuration Methods Chapter 11, Boot Monitor and NVRAM |
| | Instead of using BOOTP/DHCP responses for determining a subnet mask, you can configure the terminal to use ICMP for subnet mask discovery. | Chapter 3, Booting—Address Discovery |
| | Instead of using the default order of requests (DHCP, BOOTP, then RARP) for its IP address broadcasts, you can change the order through the Boot Monitor Setup menus. | Chapter 11, Boot Monitor and NVRAM |

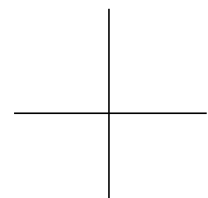

Table 2-1 Chronological Summary of Default Booting Actions and Alternatives

| Default Booting Action | Alternate Action(s) | References |
|--|--|--|
| <p>The Boot Monitor sends a series of requests for an X server, first to the host that answered the request for the IP address, and then to the network. (For more information about the default series of X server requests, see Chapter 4.)</p> | <p>Direct the request for an X server to a specific host. You can also specify a second and third boot host in case the first host is not available.</p> | <p><i>System Administrator's Guide</i> Chapter 4, Booting—X Server Loading</p> |
| | <p>Specify a non-standard X server filename.</p> | <p>Chapter 4, Booting—X Server Loading</p> |
| | <p>Change the default series of searches the Boot Monitor uses to find an X server.</p> | |
| | <p>Configure the terminal so it does not broadcast requests for an X server to the network.</p> | |
| <p>The Boot Monitor downloads an X server file using TFTP from the default TFTP directory (<code>/tftpboot/</code> or <code>/usr/tftpboot/</code>) from the first host to answer a request. If the TFTP attempts fail, the Boot Monitor tries to download an X server using MOP and NFS.</p> | <p>Use a different default method for X server downloading, such as NFS or a local PCMCIA card.</p> | <p>Chapter 4, Booting—X Server Loading</p> |
| | <p>Specify the second and third choices for boot source.</p> | <p><i>System Administrator's Guide</i> Chapter 4, Booting—X Server Loading</p> |
| | <p>Use a different directory from the default when using TFTP to download the X server.</p> | <p>Chapter 4, Booting—X Server Loading</p> |
| | <p>Use a different directory from the default when using NFS to download the X server.</p> | |
| | <p>Prevent the terminal from attempting to download an X server using MOP.</p> | |

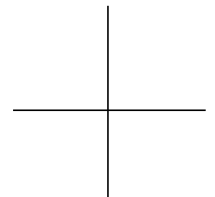

Table 2-1 Chronological Summary of Default Booting Actions and Alternatives

| Default Booting Action | Alternate Action(s) | References |
|--|--|---|
| If the Boot Monitor does not find an X server, it displays its prompt and waits for the user to type a manual boot command. | Set the Boot Monitor to continue attempting to download an X server until the booting process is manually interrupted. When the booting process is interrupted, the terminal displays the Boot Monitor prompt. | Chapter 4, Booting—X Server Loading |
| The Boot Monitor executes the X server, and the X server takes control of the terminal, displaying the name of the X server file and the IP address and hostname of the terminal. | None | None |
| The X server loads a configuration file from the boot host's default configuration directory, <code>/usr/lib/X11/ncd/configs</code> . The X server searches for two default configuration filenames: a terminal-specific file named with the hexadecimal equivalent of the terminal's IP address and a generic file named <code>ncd_std</code> . | Set the X server to download the configuration file from a host other than the boot host by specifying an initial file server host and a secondary file server host. Specifying an initial file server host also allows terminals booted from a local PCMCIA card to download configuration files from a host. | Chapter 5, Configuring Network Services |
| | Use a configuration file with a non-standard or custom filename. | Chapter 6, Terminal Configuration Methods |
| If the terminal does not find a configuration file, it continues to boot without one. | Prevent the terminal from booting without a configuration file. | Chapter 6, Terminal Configuration Methods |

2-4 Booting Defaults

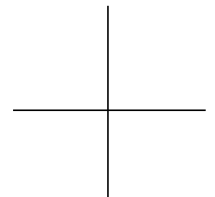
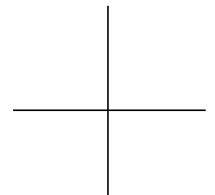
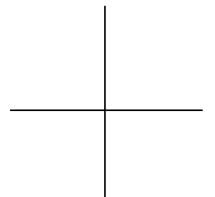

Table 2-1 Chronological Summary of Default Booting Actions and Alternatives

| Default Booting Action | Alternate Action(s) | References |
|--|---|--|
| The X server reads the font directories in its default font path on its boot host. | You can configure the terminal to use a custom font path. | Chapter 7, Bitmap Fonts and the Font Server |
| | Instead of, or in addition to reading font directories directly, you can configure the terminal to use a font server. | Chapter 7, Bitmap Fonts and the Font Server |
| | If a specified font cannot be found, the terminal uses its default font. You can specify a different default font. | Chapter 7, Bitmap Fonts and the Font Server |
| The X server reads the default keysym database file. | Specify an alternate keysym file (xserver-keysym-file parameter). | <i>Remote Configuration Parameter Quick Reference</i> |
| The X server reads the default color database file. | Specify an alternate color database file (xserver-rgb-file parameter). | <i>Remote Configuration Parameter Quick Reference</i> |
| The Console and a Login Chooser appear for the user to select a login host. The Login Chooser displays all the hosts that responded to XDMCP requests from the terminal. | You can specify a customized set of local clients that appear at startup. | <i>System Administrator's Guide</i> |
| | You can configure a customized Login Chooser or specify that only a login banner appears. | Chapter 8, Login and X Session Management <i>System Administrator's Guide</i> |
| | You can configure the terminal to display a Terminal Host Chooser for the user to log in through the NCD Terminal Emulator. | Chapter 12, Configuring the NCD Terminal Emulator <i>System Administrator's Guide</i> |



2-6 Booting Defaults



3 Booting—Address Discovery

This chapter describes alternative methods of obtaining the network information necessary for the terminal to boot and to participate on the network. The following topics are covered in this chapter:

- ❑ “Summary of Address Discovery Protocols” on page 3-1
- ❑ “Changing the Order of Network Information Requests” on page 3-2
- ❑ “Using BOOTP/DHCP for Address Discovery” on page 3-3
- ❑ “Using RARP for Address Discovery” on page 3-10
- ❑ “Storing Addresses in NVRAM” on page 3-11
- ❑ “Setting the Broadcast Address” on page 3-12
- ❑ “Configuring Subnet Mask Discovery” on page 3-13
- ❑ “Communicating with Multi-Homed Hosts” on page 3-15
- ❑ “Using a Reverse Name Request” on page 3-15

Summary of Address Discovery Protocols

When an NCD terminal powers up, it knows only its Ethernet or Token-Ring address, which is set in NVRAM at the factory. To participate on a network, a terminal must be able to discover its network address. Depending on your network setup, the terminal may need other information. The three ways for the terminal to discover addresses and other information before loading the X server are:

- ❑ DHCP (Dynamic Host Configuration Protocol) and BOOTP (Bootstrap Protocol)—DHCP and BOOTP are widely available protocols, and are the recommended methods of address discovery. By default, an NCD terminal broadcasts alternating DHCP, BOOTP, and RARP requests when it boots. These requests contain the terminal’s Ethernet or Token-Ring address. A host running the DHCP or BOOTP daemon and configured with information about the terminal responds with the IP address of the terminal.

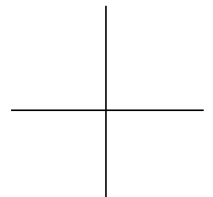

Depending upon the protocol implementation and the information in the host's database, it can return other addresses and permit the terminal to boot from a host on a different subnet. It can also specify the X server that each terminal boots.

For more information about DHCP and BOOTP, see "Using BOOTP/DHCP for Address Discovery" on page 3-3.

- ❑ RARP (Reverse Address Resolution Protocol)—RARP is another widely available address discovery protocol. By default, an NCD terminal automatically broadcasts alternating DHCP, BOOTP, and RARP requests when it boots. These requests contain the terminal's Ethernet address or Token-Ring address. A host running the RARP daemon and configured with information about the terminal responds with the IP address of the terminal.

Unlike BOOTP/DHCP, RARP supplies only the address of the terminal and the address of the host that responded to the terminal's request for an X server. This method is recommended if you do not have BOOTP/DHCP on your network.

For more information about RARP, see "Using RARP for Address Discovery" on page 3-10.

- ❑ NVRAM—You can save all of the necessary network addresses in NVRAM, where they remain even when the terminal is powered off. This method is recommended if:
 - You have no address discovery protocol (BOOTP/DHCP or RARP).
 - You are booting from a host on a different network through a router that cannot pass on the boot request.
 - You are managing a small group of terminals.

For more information about saving addresses in NVRAM, see "Storing Addresses in NVRAM" on page 3-11 and Chapter 11, Boot Monitor and NVRAM.

Changing the Order of Network Information Requests

By default, a terminal sends requests in the following order: first DHCP, then BOOTP, then RARP. You can change the order in which the terminal sends requests using the NVRAM Setup menus. For information about changing the order of requests, see Chapter 11, Boot Monitor and NVRAM.

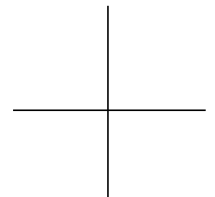

Using BOOTP/DHCP for Address Discovery

This section describes preparations for using BOOTP/DHCP. For BOOTP, you can use the native software on the boot host or the software included in the NCDware distribution.

If you are using DHCP to provide network information, the terminal configuration is the same as for BOOTP, and the terminal must have Boot Monitor version 2.8 or later.

If you are not using *ncdinstall* to prepare hosts and terminals for BOOTP/DHCP service, you need to perform the tasks described in the following subsections. The commands and steps may vary from those outlined in this section depending on your host, your BOOTP/DHCP implementation, and your network. These instructions are guidelines; they are not precise procedures.

NCD terminals send BOOTP/DHCP requests by default; consequently, terminal configuration is unnecessary unless you want to change the order in which the terminal sends requests for network information or specify a second or third source. The default order is first DHCP, then BOOTP, then RARP.

Note Information provided by BOOTP (for example, the subnet mask) is passed to the X server and may be stored in NVRAM, overwriting previous values.

The BOOTP protocol is implemented through daemon programs, such as *bootpd(8)*, and a database file, such as */etc/bootptab*. Hosts configured to use NCD's dynamic IP address allocation for terminals use an additional database file, */etc/bootptab.cfg*.

For specific instructions on using BOOTP, refer to the following sources:

| For Information About: | Refer to: |
|---|--|
| NCD's BOOTP implementation | The <i>bootpd</i> man page in the NCDware distribution |
| The native BOOTP already installed on your host | Your host's documentation |

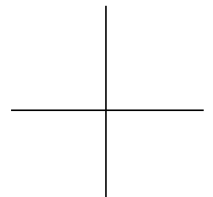

| | |
|--|---|
| BOOTP/DHCP options recognized by NCD terminals | Table 3-1 page 3-6 |
| Dynamic IP address allocation using BOOTP | The <i>bootpd</i> (8) and <i>bootptab.cfg</i> (5) man pages in the NCDware distribution and the <i>System Administrator's Guide</i> . |

For instructions on using DHCP, refer to your host system's documentation.

Making Sure that BOOTP Is Enabled

To verify that BOOTP is enabled on your boot host, check the following:

- ❑ To find out if *bootpd* is running, enter a *ps*(1) command. For example:

```
# ps -axc | grep bootp
```

On some systems, the command is:

```
# ps -ef | grep bootp
```

- ❑ Host operating systems based on the 4.3 BSD UNIX operating system (such as SunOS) require an entry in the */etc/inetd.conf* file for BOOTP. Often, these entries exist, but are rendered ineffective by a comment symbol (#) at the beginning of the entry. If this is the case, remove the #. For example, for SunOS:

```
bootps dgram udp wait root /usr/etc/bootpd bootpd
```

- ❑ Make sure that TCP/IP ports are reserved for the *bootpd* server and client processes in the */etc/services* file.

The usual entries in */etc/services* are:

```
bootps          67/udp
```

```
bootpc          68/udp
```

Remove any comment symbols (#) at the beginning of these entries.

- ❑ If you make any changes in the */etc/inetd.conf* or */etc/services* file, restart the *inetd* daemon.

To restart the daemon, find the *inetd* process ID and send a hangup signal as shown in the following example. This causes the daemon to read the configuration file and use the new information. For example:

```
# ps -axc | grep inetd
```

```
17601 ? I 0:12 inetd
```

```
# kill -HUP 17601
```

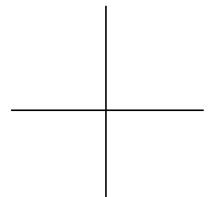

On some systems, the command for finding the process ID is:

```
# ps -ef | grep inetd
```

Adding Options for NCD Terminals to the bootptab File

If you do not use *ncdinstall* to add terminals to the network, you must add BOOTP options for each terminal to the `/etc/bootptab` database file on the boot host.

bootptab Format and Options

For BOOTP configuration on your boot host, see your vendor documentation. The normal rules for `/etc/bootptab` file entries are:

- ❑ A colon (:) indicates the end of a field, and a backslash (\) indicates that the entry is continued on the next line.
- ❑ Spaces are not permitted between the characters on a line.
- ❑ Fields consist of a tag followed by an equals sign (=) and a value. Each tag identifies a unique parameter.
- ❑ The Ethernet address has no internal punctuation, such as periods or dashes.

The typical file structure is one or more template entries, containing information common to all terminals or a group of terminals, followed by individual entries, each containing information about a specific terminal:

```
# Template entry
template.name: \
    tag=value: \
    .
    .
    .
    tag=value

# Entry for an NCD terminal
hostname: \
    tc=template.name: \
    tag=value: \
    .
    .
    .
    tag=value
```

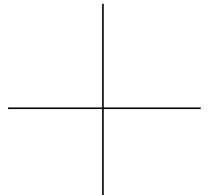

The tags recognized by NCD terminals and supported by the version of *bootpd* provided in the NCDware distribution are listed in Table 3-1. The table lists the normal two-letter tag name or a tag number and a description of the information provided by the tag. Although some versions of *bootpd* may provide additional information, only information listed in the table is used by NCD terminals.

Table 3-1 BOOTP/DHCP Tags Used by NCD Terminals

| Tag Name | Information Returned by BOOTP or DHCP |
|----------|--|
| ip | Terminal IP address |
| ha | Terminal Ethernet address |
| hd | X server directory |
| bf | X server filename |
| sm | Subnet mask |
| gw | Gateway address(es) |
| ns | IEN-116 name server host address(es) |
| ds | Domain name server host address(es) |
| cs | Vendor magic-cookie selector |
| hn | Terminal host name (you do not need to supply a value for this field; it is taken automatically from the first field [up to the first colon]). |
| ts | Names of hosts supplying the current time on UDP port 37 |
| T15 | Domain name suffix |
| T144 | Configuration file name |
| to | Time offset from Coordinated Universal Time |
| ts | Time server host address(es) |
| T31 | ICMP router discovery enabled |
| T28 | IP broadcast address |
| T49 | XDM (X Display Manager) host address(es), listed in order of preference |

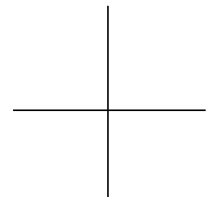

A fragment of an example **bootptab** file follows, with comments identifying the fields.

```
# Template entry
global:\
    gw=192.43.153.1:\
    sm=255.255.255.000:\
    hd=/tftpboot:\
    ht=ether
# Entry for an individual NCD terminal
ncd1:\
    tc=global:\
    ha=0000a70015d5:\
    ip=192.43.153.224:\
    bf=Xncdexpl
```

| | |
|--|--------------------------------|
| | <i>Template entry name</i> |
| | <i>Gateway address</i> |
| | <i>Subnet mask</i> |
| | <i>X server file directory</i> |
| | <i>Interface name</i> |
| | <i>NCD terminal's hostname</i> |
| | <i>Include the template</i> |
| | <i>Ethernet address</i> |
| | <i>IP address</i> |
| | <i>X server filename</i> |

Adding Terminal Entries to the bootptab File

The required and optional entries in the **bootptab** file are:

- One or more template, or global, entries for the information common to all terminals or groups of terminals (optional)
- An entry for each terminal containing at least the terminal's Ethernet address and IP address or its Token-Ring address and IP address

If you do not supply the address and the terminal cannot determine its address through other means (using RARP or reading the address from NVRAM) the terminal will be unable to boot.

Note If the terminal has a TRP board, the current Token-Ring address (also called the active address) is different from the built-in Token-Ring address (also called the static address). When configuring BOOTP, use the current address.

Both addresses are printed on the sticker on the terminal base and on the packing box. The built-in address always begins with 00:00:a7 (for example, 00:00:a7:11:2a:4b). The current address is a bit-reversed version of the built-in address (for example, 00:00:e5:88:54:d2).

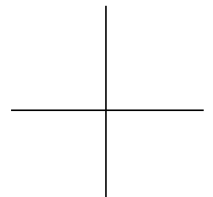

The current address is displayed by the Boot Monitor during booting. Both the current address and the built-in address are displayed in Statistics ⇒ Show Version. The current address is also displayed in Statistics ⇒ Show Statistics ⇒ Network Interfaces ⇒ Interfaces Table and in Statistics ⇒ Show Statistics ⇒ Token-Ring ⇒ Interface Table.

- ❑ If you use BOOTP/DHCP to specify the X server to be downloaded by the terminal, add the X server filename (and the X server directory name, if not specified in the global, or template, entry).

If you do not specify the X server in the `/etc/bootptab` file, the Boot Monitor uses the default X server download sequence. For information about this sequence, see Chapter 4, Booting—X Server Loading.

If you specify an X server file in `/etc/bootptab` and `bootpd` cannot locate the file, the terminal cannot download an X server. In that situation, the Boot Monitor displays its prompt and waits for a manual boot command. Syntax errors in the file may also prevent the terminal from booting.

- ❑ If the terminal is booting through a gateway (that is, servers are installed on a host located on a remote network), make sure the gateway to the boot host and subnet mask (if used) are specified in the `bootptab` file. See the next section for more information about booting through a gateway.

Configuring the Gateway Device and Terminal for Booting through a Gateway

For booting through a gateway, the device serving as the gateway and the `bootptab` file on the boot host must be properly configured.

This section provides an example setup (illustrated in Figure 3-1) for a Cisco router, which is a commonly used gateway device.

The IP addresses of the gateway's Ethernet interfaces are:

- 192.43.157.2 Ethernet Interface 0—for the remote network where the boot host is located.
- 192.43.156.2 Ethernet Interface 1—for the local network where the terminals are located.

The IP address of the boot host is 192.43.157.40.

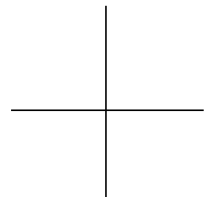

The IP address of the NCD terminal is 192.43.156.171. Its Ethernet address is 0000a70023a3.

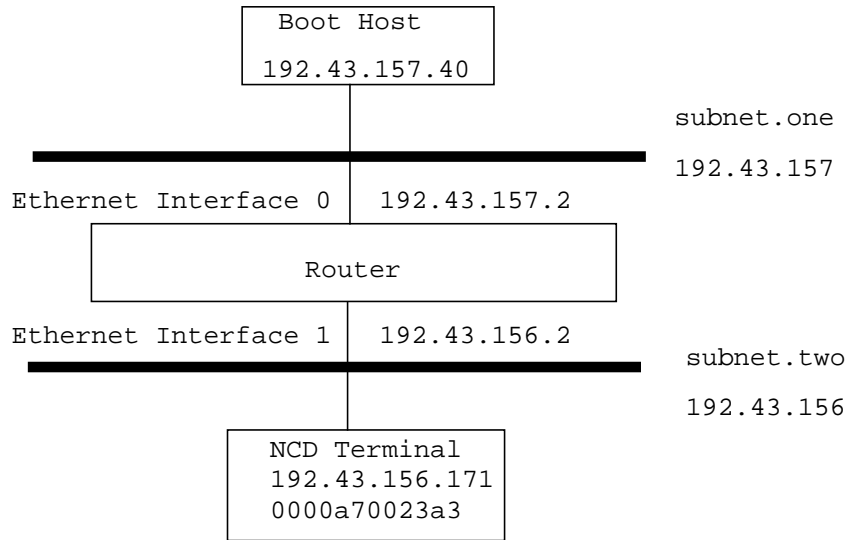

Figure 3-1 Booting Through a Gateway

On the router, set the helper address to the address of the remote boot host by entering the following command:

```
ip helper-address 192.43.157.40
```

On the boot host, the **bootptab** file contains the following entries for this example:

```
# Template entry - every host uses this information
global.dummy:\
    :sm=255.255.255.0:\           Subnet mask
    :hd=/tftpboot/Xncd.4.2.0:    X server file directory

# Entries for each subnet
subnet.one:\
    :tc=global.dummy:gw=192.43.157.2:  Include the template and
                                         specify the gateway address
```

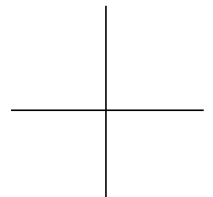

Using RARP for Address Discovery

```
# Template entry - every host uses this information
global.dummy:\
subnet.two:\
    :tc=global.dummy:gw=192.43.156.2:

```

*Include the template and
specify the gateway address*

```
# Entry for an NCD terminal
ncdhmx1: tc=subnet.two:\
    :ht=ethernet:\
    :ha=0000a70023a3:\
    :ip=192.43.156.171:\
    :bf=Xncdhmx

```

*Include the template
Network interface type
Terminal Ethernet address
Terminal IP address
X server filename*

Using RARP for Address Discovery

You can use RARP instead of BOOTP/DHCP to determine addresses; however, RARP returns only the IP address of the terminal and the boot host. You must set other addresses needed by the terminal, such as the gateway and subnet mask, in NVRAM. For information about configuring addresses in NVRAM, see “Storing Addresses in NVRAM” on page 3-11.

You cannot use RARP to specify the X server file to load; instead, the terminal uses the default download sequence to locate an X server. For information about the download sequence, see “Booting—X Server Loading” on page 4-1.

RARP is implemented through a daemon program, *rarpd(8)* that runs on the boot host and a database file called */etc/ethers*.

Complete the following tasks if you are using RARP for address discovery:

1. To verify that RARP is available, check the relevant host startup file. For example, on SunOS systems, the startup file to check is */etc/rc.local*. The entry for RARP is similar to:

```
rarpd
rarpd -a
```
2. If the entry is disabled by a comment symbol (#) at the beginning of the line, remove the comment symbol. Then, start the daemon manually by typing the startup command. For example:

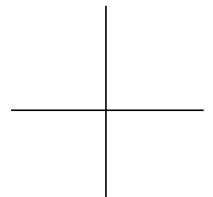

```
# rarpd
# rarpd -a
```

3. If you *are not* running NIS (Network Information Service), add each terminal's Ethernet address and hostname to the `/etc/ethers` file. For example:

```
00:00:A7:00:00:AE ncd1
```

The Ethernet address is entered into NVRAM at the factory. You can display the address through the Console (Statistics ⇒ Show Version). The Ethernet address also appears on a label on the bottom of the terminal base.

4. If you *are* running NIS, add the terminal to the `ethers` map and update the map. For example:

```
# cd /var/yp
# make ethers
```

Storing Addresses in NVRAM

You can manually set all the addresses the terminal needs in NVRAM. This is useful if you have just a few terminals to configure or if address resolution protocols are not running on the boot host. This method is less flexible than discovering addresses from the network because if you move the terminal to another network, you must reconfigure the addresses.

You can place other information in NVRAM, such as the name of an X server to download.

To configure a terminal to obtain addresses from NVRAM, set the following in Setup ⇒ Change Setup Parameters:

Note You can also set addresses in the Boot Monitor Setup menus.

1. In the IP hide box:
 - a. Turn off the `Use Address Discovery` toggle so the terminal does not attempt to discover addresses from the network.
 - b. Enter the addresses you need:

You must enter at least the IP address of the terminal in `IP Address` at `Next Boot`.

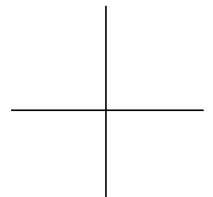

If the terminal is booting through a gateway, set the `Subnet Mask`, `Initial Default Gateway 1`, and `Initial Gateway 2` (if you have more than one gateway). The terminal uses the boot host as a gateway if these fields are left at 0.0.0.0 (the default).

If desired, set the `Broadcast Address`. The default address of 255.255.255.255 works, although the Boot Monitor displays error messages as the terminal boots.

2. In the Booting hide box:
 - a. Make sure `Primary Boot Source` is set to TFTP or NFS.
 - b. Set `TCP/IP Desired Server` to the network address of the boot host. Set the `Secondary` and `Tertiary Server` fields, if desired, to designate backup boot servers.
3. Click on `Apply` to save addresses in NVRAM.

The next time the terminal boots, the Boot Monitor uses the addresses stored in NVRAM.

For more information about saving configuration settings set through the Setup menus or remote configuration files to NVRAM, see the *System Administrator's Guide for UNIX Systems*.

Setting the Broadcast Address

Whenever the terminal broadcasts to the network, for example, when discovering its IP address or broadcasting for an X server, it uses its broadcast address.

The default broadcast address is 255.255.255.255. If this address is not the correct address for your network and the terminal broadcasts for the X server, the server download succeeds but a warning message is displayed.

To prevent the warning message display, the broadcast address must be set to reflect the subnet mask, if any, and the host portion of the address.

If subnetting is used on your network, set the `ip-broadcast-address` parameter (Setup ⇒ Change Setup Parameters ⇒ IP ⇒ Broadcast Address). It should have all 1s in the host field. The parameter is saved in NVRAM.

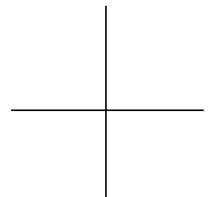

Table 3-2 ip-broadcast-address Parameter

| Possible Values | Result |
|-------------------|--|
| default | 255.255.255.255 or 0xFFFFFFFF |
| <i>IP address</i> | The address used by the terminal when broadcasting to the network. |

For example, in a class B network with the network address 191.40.0.0 and a subnet mask of 0xFFFF0000 (255.255.000.000), the broadcast address setting is:

```
ip-broadcast-address = 191.40.255.255
```

Configuring Subnet Mask Discovery

Subnets are used to extend the network portion of IP addresses. This allows you to divide a physical network into separate subnets. The subnet mask distinguishes the subnet from the rest of the address. If subnetting is used on the local network, the terminal must be able to discover the subnet mask.

If a bit is on in the subnet mask, the equivalent bit in the IP address is interpreted as a network bit. If a bit is off in the mask, the equivalent bit in the IP address is interpreted as part of the host address. Therefore, the subnet mask has 1s in the network and subnet portions of the address and 0s in the host portion.

Subnet masks can be written as hexadecimal numbers or as decimal IP addresses.

For example, if the network portion of a class B address is extended by one byte, the subnet mask is 255.255.255.0. The first two bytes of the address define the class B network address, the third byte defines the subnet portion, and the fourth byte defines the host address.

There are three methods for making sure the terminal can discover the subnet mask:

- ❑ Set the subnet mask in the **bootptab** file (for information about using BOOTP to set the subnet mask, see “Using BOOTP/DHCP for Address Discovery” on page 3-3)

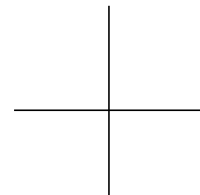

- ❑ Use ICMP to obtain the subnet mask from the network (see “Using ICMP to Discover the Subnet Mask” on page 3-14)
- ❑ Set the subnet mask explicitly in a remote configuration file, the Console Setup menus, or the Boot Monitor Setup menus and save it in NVRAM (see “Setting the Subnet Mask in NVRAM” on page 3-14)

Using ICMP to Discover the Subnet Mask

As an alternative to setting the subnet mask through BOOTP/DHCP or a terminal configuration parameter, the terminal can discover its subnet mask at boot time through ICMP (Internet Control Message Protocol). ICMP is included in the TCP/IP protocol family.

In this method of discovering the subnet mask, an ICMP message is sent to the broadcast address to determine the appropriate subnet mask when the terminal boots.

To discover the subnet mask through ICMP, set the **boot-send-broadcast-icmp-for-subnet-mask** parameter to “true.” This option can produce a lot of network traffic, so you should use it only on networks with a small number of NCD terminals. This parameter is saved in NVRAM.

(Setup ⇒ Change Setup Parameters ⇒ Booting [TCP/IP Boot Options section] ⇒ Send Broadcast ICMP for Subnet Mask).

Table 3-3 boot-send-broadcast-icmp-for-subnet-mask Parameter

| Possible Values | Results |
|-----------------|---|
| default | false |
| false | The terminal does not use an ICMP message to determine the appropriate subnet mask. |
| true | The terminal uses an ICMP message sent to the broadcast address to determine the appropriate subnet mask. |

Setting the Subnet Mask in NVRAM

Use the **ip-subnet-mask** parameter to set the subnet mask explicitly (Setup ⇒ Change Setup Parameters ⇒ IP ⇒ Subnet Mask). This parameter takes effect immediately and is saved in NVRAM.

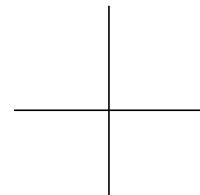

Note You can also set the subnet mask in the Boot Monitor Setup menus.

Table 3-4 ip-subnet-mask Parameter

| Possible Values | Result |
|--|------------------------------|
| default | 0xFFFFFFFF00 (255.255.255.0) |
| <i>hexadecimal constant</i> or <i>decimal IP address</i> | The network subnet mask |

Communicating with Multi-Homed Hosts

If the terminal communicates with hosts that have more than one Ethernet interface on the same subnet, place all of the host addresses or hostnames in the **ip-equivalent-addresses** table. Each row in the table lists the network addresses or hostnames of the interfaces on a given host. This parameter is not saved in NVRAM.

Rows in the **ip-equivalent-addresses** table consist of the addresses or hostnames for all the interfaces on a given host. For example, on a network with two multi-homed hosts:

```
ip-equivalent-addresses = {
    { eagle1 eagle2 eagle3 }
    { peregrine1 peregrine2 }
}
```

Using a Reverse Name Request

The **unit-query-for-name-at-boot** parameter controls whether, at boot time, the terminal sends a reverse name request to the name servers to discover the terminal's hostname.

Using a reverse name request is useful in situations in which the terminal's hostname must be known at boot time; for example, if the terminal should download a configuration file named for its hostname. This parameter is saved in NVRAM.

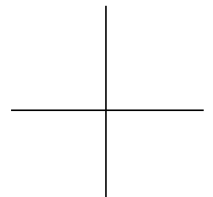

Using a Reverse Name Request

Note The DNS name service must be running for a reverse name request to succeed.

Table 3-5 unit-query-for-name-at-boot Parameter

| Possible Values | Result |
|-----------------|--|
| default | none |
| none | The terminal does not attempt a reverse name query at boot. |
| tcpip | The terminal tries a reverse query to the name server hosts. If no name servers are defined, the terminal tries the TCP/IP boot server, if the boot server is defined. |
| ncdnet | The terminal tries a reverse query to the MOP boot server, if the boot server is defined. |

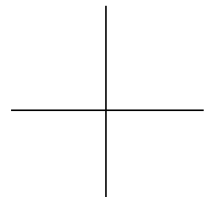

4 Booting—X Server Loading

This chapter describes the defaults and alternatives for loading and executing the X server and X server modules. The following topics are covered in the chapter:

- ❑ “Configuring the Default X Server Loading Sequence” on page 4-1
- ❑ “Configuring X Server Module Loading” on page 4-10
- ❑ “Using TFTP for X Server Downloading” on page 4-12
- ❑ “Using NFS for X Server Downloading” on page 4-13
- ❑ “Linking X Server Files” on page 4-14
- ❑ “Specifying Boot Hosts” on page 4-16
- ❑ “Booting Manually from the Boot Monitor” on page 4-17

Configuring the Default X Server Loading Sequence

The default sequence for finding an X server and loading it into RAM allows the terminal to load an X server the first time it is powered on.

The Boot Monitor first attempts to download an X server from the following sources: TFTP (Trivial File Transfer Protocol), MOP (Maintenance Operations Protocol), NFS (Network File Service), local (PCMCIA card). If a PCMCIA card is installed in the terminal, NVRAM is still set to factory defaults, and the terminal has never booted from the network, the default order is local, TFTP, MOP, NFS.

If all attempts to load an X server fail, the Boot Monitor displays its prompt (>); you can enter a manual boot command.

The default X server loading sequence (listed in Table 4-1) automatically loads the first X server found in the default TFTP directory (usually `/tftpboot`). The default directory is defined by your implementation of TFTP.

After the request for an X server is answered by a host and is downloaded, no further requests are made. You can disable any of the requests.

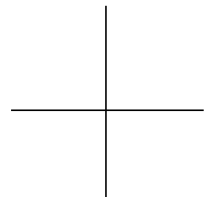

Although the sequence uses predefined pathnames, you can use it to boot an X server located in another directory by linking one of the default pathnames to the X server’s true location. For information about linking, see “Linking X Server Files” on page 4-14.

Table 4-1 Default Server Loading Sequence

| | | |
|----|--|--|
| 1. | TFTP Requests: The Boot Monitor asks TFTP to download an X server. Potentially, the Boot Monitor can issue 16 different requests, as follows. | |
| a. | Requests to the boot host: The Boot Monitor directs the first series of requests to the boot host. The Boot Monitor tries the following pathnames in the order shown. | |
| | Relative pathnames: The first four requests use relative pathnames in the default TFTP X server directory, /tftpboot . | |
| | (1) | A file named using the terminal’s Ethernet address; for example, 0000A701395 . |
| | (2) | A file named using the hexadecimal representation of the terminal’s IP address. For example, C02B997E for the terminal with IP address 192.43.153.126. |
| | (3) | The file named using the terminal’s product name and the terminal’s memory size as a suffix. The memory size is stated in hundreds of kilobytes. For example, 8 megabytes is the same as 8000 kilobytes, yielding a suffix of 80. The resulting filename for an HMX in this example is Xncdhmx.80 . |
| | (4) | The file named using the terminal’s product name alone. For example, Xncdhmx . |
| | Absolute pathnames: The second four requests use the same filenames, but absolute pathnames for the /tftpboot directory. These requests are included for versions of TFTP (such as the System V version) that do not use relative pathnames. | |
| | (5) | For example, /tftpboot/0000A701395 . |
| | (6) | For example, /tftpboot/C02B997E for the terminal with IP address 192.43.153.126. |
| | (7) | For example, /tftpboot/Xncdhmx.80 for an HMX family terminal with 8 megabytes of memory. |
| | (8) | For example, /tftpboot/Xncdhmx . |
| b. | Requests to the broadcast address: The Boot Monitor broadcasts the 8 requests shown in (1) through (8) to the network. | |

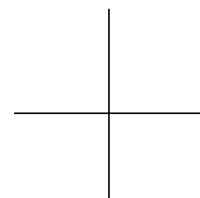
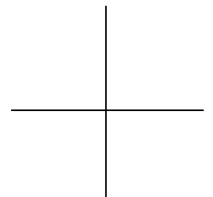

Table 4-1 Default Server Loading Sequence

| | |
|----|--|
| 2. | <p>MOP Requests: The Boot Monitor asks <i>mop_mom</i> to download an X server. Potentially, the Boot Monitor can issue two different multicast requests. The first host responding to a request sends a MOP volunteer packet to the terminal and the terminal attempts to download an X server.</p> <p>a. The first request does not specify a filename.</p> <p>b. The second request specifies the filename Xncdxxx.sys, where xxx represents the product name. For example, Xncdhmx.sys.</p> |
| 3. | <p>NFS Requests: The Boot Monitor asks NFS to download an X server. Potentially, the Boot Monitor can issue 16 different requests, as described for TFTP in Step 1 in this table. The default NFS X server directory is /tftpboot.</p> |
| 4. | <p>Local Booting: The Boot Monitor attempts to boot from a local file system on a PCMCIA card. If the terminal has a PCMCIA card, NVRAM contains factory default settings, and the terminal has not booted from the network, this attempt is made before the TFTP, MOP, and NFS requests.</p> |
| 5. | <p>Boot Monitor: If all attempts to load an X server fail, the Boot Monitor displays its prompt and waits for a command. You can enter a manual boot command.</p> |

Using remote configuration parameters, you can change the default download sequence. The configurable actions are:

- Disabling automatic booting
- Disabling all broadcast attempts
- Disabling the MOP request
- Disabling some of the TFTP or NFS requests
- Specifying a non-standard X server filename
- Specifying a non-standard X server directory
- Configuring the terminal to persist in trying to boot without going to the Boot Monitor when all attempts fail
- Configuring the sequence of boot protocols used (sources)



Disabling Automatic Booting

To prevent the terminal from booting automatically, set the **boot-automatically** parameter to “false” (Setup ⇒ Change Setup Parameters ⇒ Booting ⇒ Boot automatically at power up). If automatic booting is disabled, the terminal displays the Boot Monitor prompt instead of loading an X server. This parameter is saved in NVRAM.

Table 4-2 boot-automatically Parameter

| Possible Values | Result |
|-----------------|--|
| default | true |
| true | The Boot Monitor attempts to download an X server. |
| false | The Boot Monitor does not attempt to download an X server. |

Disabling Broadcast Requests for an X Server

If the boot host does not respond, the Boot Monitor directs X server download requests to the broadcast address.

To prevent broadcasting for an X server, set the **boot-tcpip-broadcast-boot-request** parameter to “false” (Setup ⇒ Change Setup Parameters ⇒ Booting ⇒ TCP/IP Broadcast Boot Request). This parameter is saved in NVRAM.

Table 4-3 boot-tcpip-broadcast-boot-request Parameter

| Possible Values | Result |
|-----------------|--|
| default | true |
| true | The Boot Monitor attempts to download an X server by broadcasting. |
| false | The Boot Monitor does not attempt to download an X server by broadcasting. |

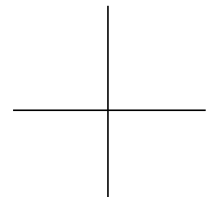

Disabling the MOP Request for an X Server

By default, after trying all of the TFTP requests, the Boot Monitor tries to download an X server using the MOP protocol.

To prevent MOP download requests, set the **boot-mop** parameter to “false” (Setup ⇒ Change Setup Parameters ⇒ Booting [NCDnet Boot Options section] ⇒ Try MOP). This parameter is saved in NVRAM.

Table 4-4 boot-mop Parameter

| Possible Values | Result |
|-----------------|---|
| default | true |
| true | The Boot Monitor tries to download an X server using the MOP protocol. |
| false | The Boot Monitor does not try to download an X server using the MOP protocol. |

Disabling Selected TFTP or NFS Requests for an X Server

The parameters listed in Table 4-5 control the X server filenames that the Boot Monitor requests via TFTP or NFS during the default X server download sequence.

All parameters are “true” by default and are saved NVRAM. To disable a request, set its parameter to “false.” For example:

```
boot-tcpip-unit-address-with-path-file = false
```

Note There are no configuration parameters for the X server file named using the terminal’s Ethernet address. These attempts can only be disabled by using the NVRAM utility. For more information, see Chapter 11, Boot Monitor and NVRAM.

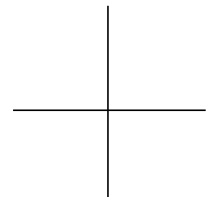
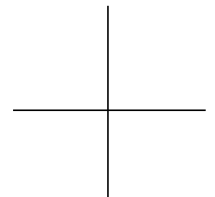

Table 4-5 Download Sequence Parameters

| <i>Relative Pathname Requests</i> | |
|---|---|
| boot-tcpip-unit-address-file (Setup ⇒ Change Setup Parameters ⇒ Booting [TCP/IP Boot Options section] ⇒ Try TCP/IP Unit Address File) | The file named using the hexadecimal representation of the terminal's IP address. |
| boot-tcpip-product-name-and-memory-size-file (Setup ⇒ Change Setup Parameters ⇒ Booting [TCP/IP Boot Options section] ⇒ Try TCP/IP Product Name and Memory Size File) | The file named using the product name with the memory size as a suffix. |
| boot-tcpip-product-name-file (Setup ⇒ Change Setup Parameters ⇒ Booting [TCP/IP Boot Options section] ⇒ Try TCP/IP Product Name File) | The file named using the product name alone. |
| <i>Absolute Pathname Requests</i> | |
| boot-tcpip-unit-address-with-path-file (Setup ⇒ Change Setup Parameters ⇒ Booting [TCP/IP Boot Options section] ⇒ Try TCP/IP Unit Address with Path File) | The file named using the hexadecimal representation of the terminal's IP address, prefixed with /tftpboot . |
| boot-tcpip-product-name-and-memory-size-with-path-file (Setup ⇒ Change Setup Parameters ⇒ Booting [TCP/IP Boot Options section] ⇒ Try TCP/IP Product Name and Memory Size with Path File) | The file named using the product name with the memory size of the terminal as the suffix and prefixed with /tftpboot . |
| boot-tcpip-product-name-with-path-file (Setup ⇒ Change Setup Parameters ⇒ Booting [TCP/IP Boot Options section] ⇒ Try TCP/IP Product Name with Path File) | The file named using the product name, prefixed with /tftpboot . |



Specifying a Non-Standard X Server Filename

To specify a non-standard X server filename (not one of the names listed in Table 4-5), use the **boot-custom-file** parameter (Setup ⇒ Change Setup Parameters ⇒ Booting ⇒ Custom File). This parameter is saved in NVRAM.

Table 4-6 boot-custom-file Parameter

| Possible Values | Result |
|-----------------|--|
| default | nil |
| <i>filename</i> | A non-standard name for the X server file. |

Specifying a Non-Standard X Server Directory

To specify a non-standard X server directory, set the **boot-nfs-directory** parameter or **boot-tftp-directory** parameter. For details, see “Using TFTP for X Server Downloading” on page 4-12 or “Using NFS for X Server Downloading” on page 4-13.

Keeping the Terminal from Entering the Boot Monitor at Boot Time

By default, the Boot Monitor prompt appears when attempts to load an X server are unsuccessful. To configure the terminal to continue attempting to boot until it succeeds, set the **boot-persistent-loading** parameter to “true” (Setup ⇒ Change Setup Parameters ⇒ Booting ⇒ Persist in Loading). This parameter is saved in NVRAM.

Table 4-7 boot-persistent-loading Parameter

| Possible Values | Result |
|-----------------|--|
| default | false |
| false | The Boot Monitor displays its prompt if all download attempts are unsuccessful. |
| true | The Boot Monitor does not display its prompt if all attempts to load an X server are unsuccessful. It keeps trying the default or specified download sequence until you interrupt the process. |

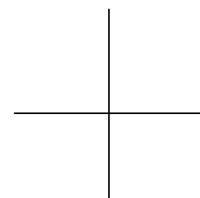

Configuring the Sequence of X Server Loading Methods

The default sequence of methods for finding and loading an X server is configured into NVRAM at the factory to allow the terminal to load an X server the first time it is powered on. The Boot Monitor tries these methods in the following order:

1. TFTP
2. MOP
3. NFS
4. The local file system on a PCMCIA card

If a PCMCIA card is installed, NVRAM values are set to their default values, and the terminal has not booted from the network, the default order is:

1. The local file system on the PCMCIA card
2. TFTP
3. MOP
4. NFS

When booting over a Token-Ring network, the MOP boot attempt is disabled automatically.

You can change the order of booting attempts through the Boot Monitor Setup menus, in a remote configuration file, or in Change Setup Parameters. The changes must be stored in NVRAM.

To specify the first method to try, set the value of the **boot-desired-source** parameter to the desired method (see Table 4-8). (Setup ⇒ Change Setup Parameters ⇒ Booting ⇒ Primary Boot Source or Setup ⇒ Change Quick Setup ⇒ Booting ⇒ Boot From). This parameter is saved in NVRAM.

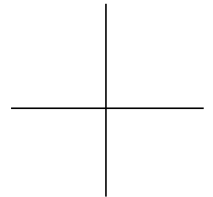

Table 4-8 boot-desired-source Parameter

| Possible Values | Result |
|-----------------|--|
| default | The terminal attempts to boot via TFTP first. |
| tftp (tcpip) | The terminal attempts to boot via TFTP first. (“tcpip” is included for backward compatibility and also results in first attempting TFTP booting.) |
| nfs | The terminal attempts to boot via NFS first. |
| ncdnet | The terminal attempts to boot via MOP over an NCDnet (DECnet) first. |
| local (prom) | The terminal attempts to boot first from a PCMCIA card. (“prom” is included for backward compatibility and results in attempting local booting first.) |

To specify the second and third boot methods to use, set the **boot-second-source** (Setup ⇒ Change Setup Parameters ⇒ Booting ⇒ Secondary Boot Source) and **boot-third-source** parameters (Setup ⇒ Change Setup Parameters ⇒ Booting ⇒ Tertiary Boot Source). These parameters are saved in NVRAM.

The method specified in **boot-second-source** is used if the method specified in **boot-desired-source** does not succeed.

Table 4-9 boot-second-source Parameter

| Possible Values | Result |
|-----------------|--|
| default | None |
| tftp (tcpip) | The terminal attempts to boot via TFTP. (“tcpip” is included for backward compatibility and also results in TFTP booting.) |
| nfs | The terminal attempts to boot via NFS. |
| ncdnet | The terminal attempts to boot via MOP over an NCDnet (DECnet). |
| local (prom) | The terminal attempts to boot from a local file system on a PCMCIA card. (“prom” is included for backward compatibility and results in local booting.) |

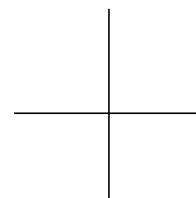

Configuring X Server Module Loading

The method specified in **boot-third-source** is used if the method specified in **boot-second-source** does not succeed.

Table 4-10 boot-third-source Parameter

| Possible Values | Result |
|-----------------|--|
| default | None |
| tftp (tcpip) | The terminal attempts to boot via TFTP. (“tcpip” is included for backward compatibility and also results in TFTP booting.) |
| nfs | The terminal attempts to boot via NFS. |
| ncdnet | The terminal attempts to boot via MOP over an NCDnet (DECnet). |
| local (prom) | The terminal attempts to boot from a local file system on a PCMCIA card. (“prom” is included for backward compatibility and results in local booting.) |

Configuring X Server Module Loading

Most of the local clients, extensions, libraries, and protocols included in NCDware exist as X server modules.

All modules are listed in the online file **modsmodel.doc** (*model* is the model on which the modules run, such as **modshmx.doc** for the HMX family of terminals). This file is installed in the modules directory, which is described in “Changing the X Server Module Location” on page 4-11. The modules are also listed in the *Release Notes*.

The Change Quick Setup, Console, Lock Screen, and Logout local clients are not loadable modules. They are always available unless disabled.

Changing X Server Module Load Policy

By default, the terminal loads X server modules when a user or client needs them and unloads them when the user logs out or when the server needs memory. This load method is called *on-demand*.

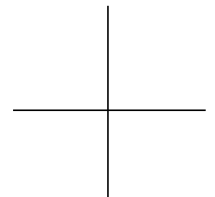

X server modules can also be loaded at boot time. *At-boot* loading is useful for clients that take a long time to load, such as the local Motif Window Manager. The LAT server module must be loaded at boot to be available for use.

You can also *disable* server modules so that they cannot be loaded. Disabled local clients appear in a dithered (grayed-out) font in the Console menus.

To change X server module load policy, list the modules you want to change and the desired load policies in the **modules-load-policy** remote configuration parameter (not saved in NVRAM). The parameter is a table with entries in the format *name policy* where:

name is the name of the module, as listed in the **modsmodel.doc** file.

policy is the load policy: “on-demand,” “at-boot,” or “disable.”

For example, the following table sets the local Motif Window Manager module to load at boot and disables the Change Setup Parameters menu, touch screen module, and PEX module:

```
modules-load-policy = {
    {mwm at-boot}
    {touchscreen disable}
    {PEX disable}
    {setup disable}
}
```

(Setup ⇒ Change Setup Parameters ⇒ Loadable Modules ⇒ Load Policy).

Changing the X Server Module Location

If you install NCDware using *ncdinstall*, X server modules are placed in the **/tftpboot/ncd/release/modsmodel** directory, where:

release is the release version number, such as **Xncd.5.0.xxx**.

model is the terminal model, such as **modshmx** for modules for the HMX series of terminals.

On systems running secure TFTP, *ncdinstall* places the server modules in the **/secure-dir/tftpboot/ncd/release/modsmodel** directory.

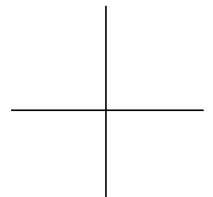

When the terminal boots, it looks first for server modules in the directory specified in the **modules-directory** parameter (not saved in NVRAM). The X server sets the value of **modules-directory** based on the location of the X server boot image. If the modules are not there, the terminal looks in */tftpboot/ncd/release/modsmodel*.

If a terminal cannot find X server modules, error messages result. To find out where the X server is looking for modules and correct the location, you can use the Change Quick Setup local client to display and change the current value of Files ⇒ Loadable Modules Directory (or Change Setup Parameters ⇒ Loadable Modules ⇒ Loadable Modules Directory).

If you change the location of the server modules on the host, you must change the value of the **modules-directory** parameter to the new location. For example:

```
modules-directory = /usr/vendor/ncd/modshmx
```

Changes are automatically recorded in the file service table.

Using TFTP for X Server Downloading

The terminal automatically tries to download the X server first using TFTP. You must configure the terminal if the X server is in a non-standard location.

Making Sure TFTP is Enabled

If you are not certain whether TFTP is enable on the boot host, see Chapter 5, Configuring Network Services, for information about enabling TFTP.

Specifying a Custom X Server Directory

You can specify a custom directory for X servers by changing the default value, which is */tftpboot/* or */usr/tftpboot/*.

If you are using secure TFTP, make sure that the directory is physically under the default TFTP home directory and in the same file system partition.

To specify a different directory, change the **boot-tftp-directory** parameter. [Setup ⇒ Change Setup Parameters ⇒ Booting ⇒ (TCP/IP Boot Options section) ⇒ TFTP Directory]. Save the new value in NVRAM.

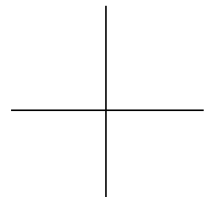

Table 4-11 boot-tftp-directory Parameter

| Possible Values | Result |
|-----------------------|--|
| default | /tftpboot/ or /usr/tftpboot/ |
| <i>directory_path</i> | The directory for X server downloading using TFTP. |

Using NFS for X Server Downloading

To download an X server using NFS, in addition to configuring the terminal for NFS use, you must do the following:

- Specify the default load method as NFS.
- If you do not want to use the default **/tftpboot/** or **/usr/tftpboot/** directories for X servers, specify the directory that NFS should search.
- If you do not want to use default X servers, specify the X server to boot.

Making Sure NFS is Available

If you are not certain whether NFS is available and configured on the boot host, see Chapter 5, Configuring Network Services.

Specifying the Directory to Search for an X Server

To specify the directory that the terminal searches for an X server to download (the NFS mount point), you alter a value in NVRAM. If you do not specify a mount point, the Boot Monitor uses the defaults **/tftpboot/** or **/usr/tftpboot/** directory.

To specify a different directory, set **boot-nfs-directory** to the desired mount point (Setup ⇒ Change Setup Parameters ⇒ Booting ⇒ [TCP/IP Boot Options section] NFS Directory). Save the new value in NVRAM.

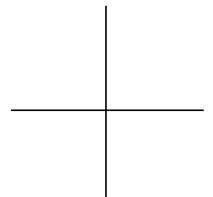

Table 4-12 boot-nfs-directory Parameter

| Possible Values | Result |
|-----------------------|--|
| default | <code>/tftpboot/</code> or <code>/usr/tftpboot/</code> |
| <i>directory_path</i> | The directory for X server downloading using NFS. |

The default X server loading sequence automatically loads the first X server it finds in the mounted NFS directory. If you do not specify a mount point, the Boot Monitor loads the first X server it finds in the default directory, `/tftpboot/` or `/usr/tftpboot/`.

As with TFTP booting, you can boot an X server in another directory by symbolically linking one of the default directory pathnames to the true location of the X server. (“Linking X Server Files” on page 4-14 describes using symbolic links for X server directory pathnames.)

When using NFS for X server download, each directory involved in the linkage between the default pathname and the actual X server image location must be exported.

If any directory is non-exportable, the read operation fails and an error message such as the following results:

```
Failed to mount /usr/nfs/load
```

If the Boot Monitor succeeds in mounting the directory containing the X server image, messages such as the following result:

```
Loading initial file /usr/nfs/load/Xncdhmx
Loading final file /usr/tftpboot/Xncdhmx
```

Linking X Server Files

If X servers are located in directories other than the default or specified directory (such as subdirectories of the default TFTP directory) you need links between the pathnames used in the default loading sequence and the actual pathnames of the X server files. This ensures that the default loading sequence will work properly.

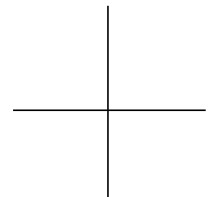

By default, the *ncdinstall* program installs X servers in a subdirectory named for the release, such as */tftpboot/Xncd.5.0.120*. Then, *ncdinstall* creates links for the X servers from this subdirectory to the default location, which is */tftpboot*.

The general format of a link command is:

In *filename server_pathname*

where *filename* is one of the filenames from the default download sequence and *server_pathname* is the actual pathname of the X server file.

If you are assigning an X server to an individual terminal, use the request for the hexadecimal representation of the terminal's IP address, which is unique to each terminal. Link this filename to the pathname of the X server you want this terminal to boot. For example, assuming the servers are in the *Xncd.5.0.120* subdirectory of */tftpboot*:

```
# cd /tftpboot
# ln -s Xncd.5.0.120/Xncdhmx C02B9942
```

The hexadecimal equivalent of the IP address is displayed during boot when the X server attempts to download a configuration file with this name. You also can find the hexadecimal equivalent by converting each octet in the IP address to a hexadecimal number. For example:

| | | | |
|-----|----|-----|----|
| 192 | 43 | 153 | 66 |
| ↓ | ↓ | ↓ | ↓ |
| C0 | 2B | 99 | 42 |

You can use the *bc(1)* utility to convert from decimal notation to hexadecimal. For example:

```
% bc
obase=16
192;43;153;66
C0
2B
99
42
```

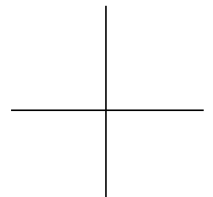

Specifying Boot Hosts

Instead of loading an X server from the first host to respond to the terminal's request or specifying the boot server using BOOTP/DHCP, you can specify the names of the boot hosts.

Specifying the Initial Boot Host

To make sure that the terminal tries to boot first from a specific host, you can set the primary boot host's IP address using the **boot-tcpip-desired-server** parameter (Setup ⇒ Change Setup Parameters ⇒ Booting [TCP/IP Boot Options section] ⇒ TCP/IP Desired Server). Save the new value in NVRAM. This parameter is used for both TFTP and NFS booting.

Table 4-13 boot-tcpip-desired-server Parameter

| Possible Values | Default |
|-------------------|---|
| default | 0.0.0.0 |
| 0.0.0.0 | There is no designated boot host. The terminal uses information from the bootptab file or broadcasts requests for a server to the network. |
| <i>IP address</i> | The IP address of the desired boot host. |

Specifying Backup Boot Hosts

You can specify more than one boot host to use in case the initial boot server is unavailable. There are three methods:

- ❑ Using the **-p** and **-l bootpd** options to specify when a secondary host should respond to the terminal's BOOTP requests.
See the **bootpd (8)** man page for more information.
- ❑ Setting **Second Boot Host IP Address** and **Third Boot Host IP Address** in the **Network** window of the **Boot Monitor Setup** menus.
See **Chapter 11, Boot Monitor and NVRAM**, for more information.
- ❑ Setting the **boot-tcpip-second-server** and **boot-tcpip-third-server** parameters (Setup ⇒ Change Setup Parameters ⇒ Booting [TCP/IP Boot Options

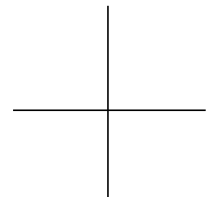

section] Secondary TCP/IP Server and Tertiary TCP/IP Server).Set either or both of the following parameters and save them in NVRAM.

Table 4-14 boot-tcpip-second-server Parameter

| Possible Values | Default |
|--------------------------------------|---|
| default | 0.0.0.0 |
| 0.0.0.0 | There is no designated second boot host. |
| <i>IP address</i> or <i>hostname</i> | If the primary boot host is unavailable, the terminal attempts to boot from the specified host. |

Table 4-15 boot-tcpip-third-server Parameter

| Possible Values | Default |
|--------------------------------------|---|
| default | 0.0.0.0 |
| 0.0.0.0 | There is no designated third boot host. |
| <i>IP address</i> or <i>hostname</i> | If the primary and secondary boot hosts are unavailable, the terminal attempts to boot from the specified host. |

Booting Manually from the Boot Monitor

You can boot a terminal manually from the Boot Monitor prompt (>). This is useful if:

- There is no address determination protocol on the boot host
- You want to boot from a host other than the normal boot host
- You want to load a different X server from the one normally loaded by the terminal
- The terminal cannot locate an X server

You can invoke the Boot Monitor by pressing the Escape key while address requests are being broadcast to the network—before you see the word loaded. After you press the Escape key, the Boot Monitor prompt appears.

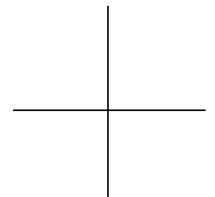

You can access the Boot Monitor after the X server is running by using a key combination, listed in Table 4-16. Accessing the Boot Monitor while clients are running, however, may cause unpredictable behavior.

Table 4-16 Boot Monitor Access Key Combinations

| Keyboard Type | Key Combination |
|--|--------------------------|
| 101-key | Ctrl-Left Alt-Setup |
| Windows 95-compatible, IBM PS/2, US English, and 102-key | CapsLock-Left Alt-Setup |
| VT220-compatible | Ctrl-Compose-F3 |
| 108-key | Ctrl-Left Alt-F3 |
| 97-key | Left Alt-Caps Lock-Setup |
| 107-key (Sun Type-4-compatible) | Stop-A (L1-A) |
| 122-key and 3270-compatible Lexmark | Alt Rule-Home |
| 123-key (Sun Type-5-compatible) | Stop-A (L1-A) |

Manual Boot from a PCMCIA Card

To load the server manually from a PCMCIA card, use the **bl** command:

```
> bl
```

Manual Boot Using TFTP or NFS

To load the server manually using TFTP, use the **bt** command:

```
> bt [ file ] [ terminal_IP host_IP ] [ gateway_IP ] [ subnet_mask ] ]
```

To load the server manually using NFS, use the **bn** command:

```
> bn [ file ] [ terminal_IP host_IP ] [ gateway_IP ] [ subnet_mask ] ]
```

where:

file Is the name of the server to load
terminal_IP Is the IP address of the terminal
host_IP Is the IP address of the boot host

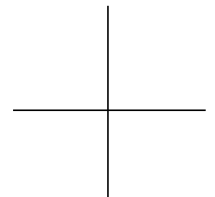

- gateway_IP* Is the IP address of the gateway
- subnet_mask* Is the subnet mask, specified in decimal-dot format or as a hexadecimal number

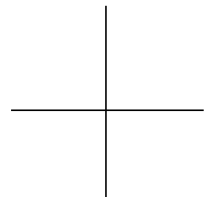

4-20 Booting—X Server Loading

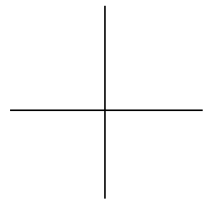

5 Configuring Network Services

This chapter describes the required and optional network services used by NCD terminals. The contents of this chapter are:

- ❑ “Which Network Services Are Used by NCD Terminals” on page 5-1
- ❑ “Summary of Network Service Defaults and Alternatives” on page 5-3
- ❑ “Configuring the ARP Cache (Resolved Addresses)” on page 5-5
- ❑ “Using a Name Service” on page 5-7
- ❑ “Configuring How a Terminal Accesses Files” on page 5-13
- ❑ “Configuring Routing (Accessing Remote Networks)” on page 5-25
- ❑ “Setting TCP Performance Parameters” on page 5-31

The following network services are discussed in other chapters because they are used only when booting: address discovery and subnet mask discovery (Chapter 3, Booting—Address Discovery) and X server download service (Chapter 4, Booting—X Server Loading).

Which Network Services Are Used by NCD Terminals

NCD terminals require that host computers residing on the network provide the following services. Some of the following are optional or depend on the network configuration:

- ❑ Address discovery service—provides terminals with their network addresses and other information at boot time. You can use BOOTP/DHCP or RARP for address discovery, or you can store addresses in NVRAM. For information on address discovery services and storing information in NVRAM, see Chapter 3, Booting—Address Discovery.
- ❑ Subnet mask discovery service—provides the terminal with the subnet mask (if your network uses subnetting) when it boots. Most versions of BOOTP/DHCP allow you to enter the subnet mask in the database file. The alternatives to BOOTP/DHCP are ICMP (Internet Control Message

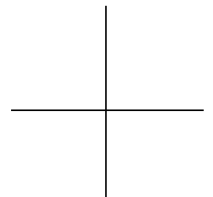

Protocol), which is included in the TCP/IP protocol family, or storing the subnet mask in NVRAM.

For information on the subnet mask, see Chapter 3, *Booting—Address Discovery*.

- ❑ X server download service—NCD terminals use TFTP or NFS for downloading an X server file.

For information about downloading X servers from the network, see Chapter 4, *Booting—X Server Loading*. For basic information on starting and configuring TFTP and NFS, see “Configuring How a Terminal Accesses Files” on page 5-13.

For information on loading an X server locally from a PCMCIA card, see the *NCDware System Administrator’s Guide for UNIX Systems*.

- ❑ File service—NCD terminals use TFTP or NFS for accessing files on network hosts during normal operation and at boot time.

For information on configuring the file service, see “Configuring How a Terminal Accesses Files” on page 5-13.

For information on accessing local files on a PCMCIA card or diskette, see the *System Administrator’s Guide*.

- ❑ Address resolution service—The Address Resolution Protocol (ARP) translates between hardware addresses and IP addresses. Translations can also be configured manually.

For information on address resolution, see “Configuring the ARP Cache (Resolved Addresses)” on page 5-5.

- ❑ Name service—By using a name service, you can specify hostnames instead of network addresses in terminal configuration parameters or in commands that require a network address. NCD terminals can use either the IEN 116 (Internet Engineering Notes) name service or the Domain Name System (DNS). You can also store translations in a terminal’s local name cache.

For information on name service, see “Using a Name Service” on page 5-7.

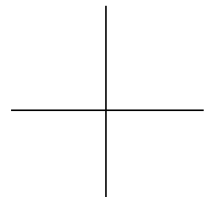

Summary of Network Service Defaults and Alternatives

Table 5-1 lists the default network services setup of an NCD terminal, the alternatives, and where to get more information. When you add a terminal to the network using *ncdinstall*, the defaults are in effect.

Table 5-1 Default Network Services and Alternatives

| Default | Alternatives | References |
|--|--|--|
| <i>Address Resolution Service</i> | | |
| The terminal uses ARP for address resolution. Entries are added to the terminal's ARP cache as addresses are resolved. | Add entries manually to the ARP table. | "Configuring the ARP Cache (Resolved Addresses)" on page 5-5 |
| ARP table entries last for 20 minutes | Change the timeouts for complete and incomplete entries. | |
| <i>Name Service</i> | | |
| The terminal uses IEN 116 protocol for name service unless NVRAM is set to factory defaults and BOOTP/DHCP supplies name server information. | Use DNS instead of IEN 116. | "Using a Name Service" on page 5-7 |
| | Configure the local name cache manually. | |
| The terminal uses the boot host as the name server host. | Specify other name servers. | |
| The fully qualified domain name must be specified when referring to network hosts. | Specify the domain name suffix. | |
| The terminal does not send a reverse name request to discover its own hostname when it boots. | Configure the terminal to send a reverse name request. | "Using a Name Service" on page 5-7 |
| Name cache parameters are set to their default values. | Redefine the name cache parameter values. | |

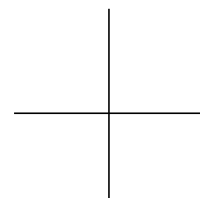
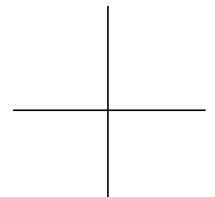

Table 5-1 Default Network Services and Alternatives (Continued)

| Default | Alternatives | References |
|--|---|--|
| <i>File Service</i> | | |
| File service is from the boot host. | Specify initial file servers. | “Configuring How a Terminal Accesses Files” on page 5-13 |
| | Configure the file service table to add other hosts and file systems. | |
| <i>Routing</i> | | |
| Routes are automatically placed into the routing table. | Manually configure the routing table. | “Configuring Routing (Accessing Remote Networks)” on page 5-25 |
| The boot host is the default gateway. | Specify default gateways. | |
| Router discovery is used to discover neighboring gateways. | Turn off router discovery. | |
| <i>TCP Performance</i> | | |
| TCP performance parameters have default values. | Customize the TCP performance parameters. | “Setting TCP Performance Parameters” on page 5-31 |



Configuring the ARP Cache (Resolved Addresses)

A terminal attempting to contact another host broadcasts the IP address of the host via the ARP protocol and receives the host's Ethernet address. These resolved addresses are maintained in the terminal's ARP cache, a local table of resolved addresses. The terminal checks its ARP cache before attempting to contact a host to see if the address has already been resolved.

The **tcPIP-arp-cache** parameter contains all of the addresses that ARP has resolved or attempted to resolve (Setup ⇒ Change Setup Parameters ⇒ ARP ⇒ ARP Cache). Table 5-2 lists the entries in a row in each row of the table.

You can manually add entries to the ARP cache if necessary.

Table 5-2 tcPIP-arp-cache Table Entries

| Table Entry | Possible Values | Result |
|---------------------|-------------------------|--|
| ethernet-address | default | 00:00:00:00:00:00 |
| | <i>ethernet address</i> | The Ethernet address the host supplies in response to the ARP request from the terminal. |
| ip-address | default | 0.0.0.0 |
| | <i>IP address</i> | The IP address broadcast by the terminal. |
| type | default | incomplete |
| | incomplete | The IP address could not be resolved to an Ethernet address. |
| | dynamic | This completed entry is subject to automatic deletion after the timeout elapses. |
| | static | This entry is not subject to automatic deletion. |
| time-since-last-use | default | 0 |
| | <i>integer</i> | The amount of time (in minutes) since this entry was used by the terminal. Range: 0 - 255. |

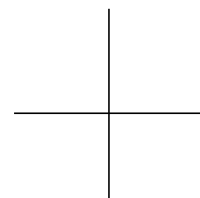

Configuring the ARP Cache (Resolved Addresses)

The lifetimes of the dynamic and incomplete entries in the **tcPIP-arp-cache** table are governed by the following parameters.

The **tcPIP-arp-complete-entry-timeout** parameter specifies how long a dynamic ARP table entry should be allowed to exist without being used before it is automatically deleted (Setup ⇒ Change Setup Parameters ⇒ ARP ⇒ Complete Entry Timeout).

Table 5-3 tcPIP-arp-complete-entry-timeout Parameter

| Possible Values | Result |
|-----------------|---|
| default | 20 |
| <i>integer</i> | How long to wait (in minutes) before deleting an unused complete entry. Range: 1 - 255. |

The **tcPIP-arp-incomplete-entry-timeout** parameter specifies how long an incomplete ARP table entry should be allowed to exist before it is automatically deleted (Setup ⇒ Change Setup Parameters ⇒ ARP ⇒ Incomplete Entry Timeout).

Table 5-4 tcPIP-arp-incomplete-entry-timeout Parameter

| Possible Values | Result |
|-----------------|--|
| default | 1 |
| <i>integer</i> | How long to wait (in minutes) before deleting an incomplete entry. Range: 1 - 255. |

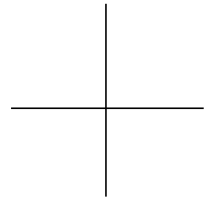

Using a Name Service

A name service translates between IP addresses and hostnames. Name service is optional, but you must use it if you want to specify hosts by their hostnames instead of their IP addresses. It is simpler and more meaningful to specify hostnames in remote configuration files, Setup menus, and commands. If you try to specify a hostname without using a name service, the terminal cannot find the host.

NCD terminals can use both DNS (Domain Name System) and IEN 116 name services.

Making Sure a Name Service is Running on the Local Network

To make sure DNS is available on the name server host:

- ❑ Verify that the daemon (*named* or *in.named*) is configured in the relevant startup file on the name server host. You can use a command similar to the following to find the command line starting up the name daemon:

```
# grep named /etc/rc*
/etc/rc.local: if [-f /usr/etc/in.named -1 -f /etc/named.boot]; then
in.named; echo -n ' named') > /dev/console
```

- ❑ Make sure that the name server host's DNS database files are set up.

To make sure IEN 116 name service is available on the name server host:

- ❑ Verify that the daemon (most commonly, *tnamed*) is configured on the name server host. You can use a command similar to the following to find the entry starting the daemon:

```
# grep tnamed /etc/inetd.conf
name dgram udp wait root /user/etc/in.tnamed in.tnamed
```

- ❑ IEN 116 uses the `/etc/hosts` file as its database. If the terminal is listed, no further database configuration is necessary.

Making Sure the Terminal Uses the Name Service

You should always place name service parameters at the beginning of a remote configuration file, before any parameters that use hostnames. In addition, insert an **apply** command after the name service parameters to make

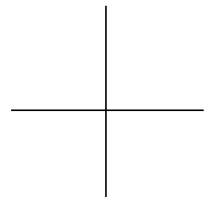

sure the name service is in effect for subsequent parameters that use hostnames.

Selecting the Name Service Protocol

Set the `tcpip-name-server-protocol` parameter to the name service protocol you are using (Setup ⇒ Change Setup Parameters ⇒ TCP/IP Name Service ⇒ Name Server Protocol). This parameter is saved in NVRAM and takes effect immediately if set interactively.

Table 5-5 `tcpip-name-server-protocol` Parameter

| Possible Values | Result |
|-----------------|--|
| default | ien-116 (If the terminal's NVRAM is set to the factory defaults and the BOOTP/DHCP reply contains DNS name servers, the default value is "dns.") |
| ien-116 | The terminal uses the IEN 116 name service method. |
| dns | The terminal uses DNS. |
| both | The terminal uses both IEN 116 and DNS. |

Specifying Name Server Hosts

You can specify as many name server hosts as you need. If you do not specify a name server, the terminal uses the boot host for name service.

Enter the IP addresses of hosts offering name service into the `tcpip-name-servers` table (Setup ⇒ Change Setup Parameters ⇒ TCP/IP Name Service ⇒ Name Servers). If you enter an address of 0.0.0.0, the boot host is used for name service.

If you use BOOTP/DHCP and specify name servers for this terminal in the `bootptab` file, those name servers are placed in the table automatically. This parameter is saved in NVRAM.

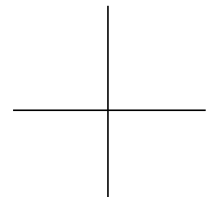

Table 5-6 tcpip-name-servers Parameter

| Table Entry | Possible Values | Result |
|-------------|-------------------|--|
| server | default | 0.0.0.0 |
| | <i>IP address</i> | The name server with this IP address is used to map host IP addresses to symbolic names. |

For example:

```
tcpip-name-servers = {
    { 192.43.150.001 }
    { 192.43.150.005 }
}
```

Specifying the Default Domain Suffix for DNS

If you are using DNS and set this parameter, you do not have to specify a fully qualified domain name when specifying hostnames. Set the **tcpip-dns-default-domain** parameter to the default domain suffix to be appended to hostnames in searches (Setup ⇒ Change Setup Parameters ⇒ TCP/IP Name Service ⇒ DNS Default Domain). The suffix is not appended to fully qualified names (names that contain all the components of the domain name).

The default domain suffix is the same as the domain name obtained from the Internet authority. For example, the parameter setting specifying NCD's default domain suffix is:

```
tcpip-dns-default-domain = ncd.com
```

Table 5-7 tcpip-dns-default-domain Parameter

| Possible Values | Result |
|----------------------|---|
| default | nil |
| nil | No suffix is applied to hostnames in name service searches. |
| <i>domain suffix</i> | The suffix applied to hostnames in name service searches. |

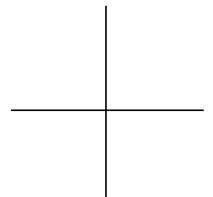

Configuring the Name Translation Table (Local Name Cache)

Translations are automatically placed in the local name cache. If your site does not run a name service, you can place translations into the table manually.

The terminal maintains the local name cache in the **tcPIP-name-local-cache** parameter (Setup ⇒ Change Setup Parameters ⇒ TCP/IP Name Service ⇒ Local Name Cache). Table 5-8 lists the entries in each row of the table.

Table 5-8 tcPIP-name-local-cache Table Entries

| Table Entry | Possible Values | Result |
|-------------|-------------------|--|
| name | default | nil |
| | <i>hostname</i> | Hostname discovered through the name service or added manually. |
| address | default | 0.0.0.0 |
| | <i>IP address</i> | IP address corresponding to the hostname. |
| lifetime | default | 0 |
| | <i>integer</i> | The time (in seconds) (relative to the time the terminal was booted) at which the entry becomes invalid. |

By default, case is considered when the terminal searches for a name in the local name cache. To ignore case, set the **tcPIP-name-cache-ignore-case** parameter to “true.” (Change Setup Parameters ⇒ TCP/IP Name Service ⇒ Ignore Case on Name Cache Lookups).

To customize the local name cache, you can change the following parameters; however, the defaults work well for most sites.

Setting the Name Cache Entry Lifetime

The **tcPIP-name-cache-max-lifetime** parameter controls the maximum amount of time that an entry in the cache is used before it is deleted automatically (Setup ⇒ Change Setup Parameters ⇒ TCP/IP Name Service ⇒ Name Cache Max Lifetime).

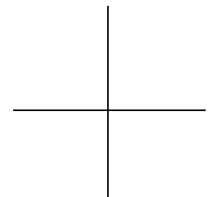

Table 5-9 tcpip-name-cache-max-lifetime Parameter

| Possible Values | Result |
|-----------------|---|
| default | 1800 |
| <i>integer</i> | The maximum lifetime (in seconds) of the name cache. Range: 0 - 4294967295. |

Setting the Name Cache Size

The `tcpip-name-cache-max-size` parameter sets the maximum number of entries allowed in the name cache (Setup ⇒ Change Setup Parameters ⇒ TCP/IP Name Service ⇒ Name Cache Max Size). When the maximum size is reached, the oldest entry is discarded when a new entry is added. You may want to restrict the size of the cache to save memory for other uses.

Table 5-10 tcpip-name-cache-max-size Parameter

| Possible Values | Result |
|-----------------|--|
| default | 32 |
| <i>integer</i> | The maximum number of entries in the name cache. Range: 0 - 4294967295 or until all free memory is consumed. |

Setting Name Service Timeouts

The `tcpip-name-server-retransmission-timeout` parameter determines how long the terminal waits before sending a retransmission if the name server does not respond (Setup ⇒ Change Setup Parameters ⇒ TCP/IP Name Service ⇒ Name Server Retransmission Timeout).

Table 5-11 tcpip-name-server-retransmission-timeout

| Possible Values | Result |
|-----------------|--|
| default | 2 |
| <i>integer</i> | How long to wait (in seconds) before retransmitting a name service request. Range: 1 - 4294967295. |

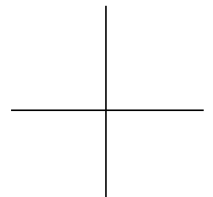

The `tcpip-name-server-transaction-timeout` parameter determines how long the terminal waits for a response from the name server before failure is declared (Setup ⇒ Change Setup Parameters ⇒ TCP/IP Name Service ⇒ Name Server Transaction Timeout). The value of this parameter should be larger than the retransmission timeout.

Table 5-12 tcpip-name-server-transaction-timeout

| Possible Values | Result |
|-----------------|--|
| default | 10 |
| <i>integer</i> | How long (in seconds) to attempt a name service request before declaring a failure condition. Range: 1 - 4294967295. |

Discovering the Terminal's Hostname when Booting (Reverse Name Request)

The `unit-query-for-name-at-boot` parameter controls whether, at boot time, the terminal sends a reverse name request to the DNS name servers to find the terminal's host name (Setup ⇒ Change Setup Parameters ⇒ Unit ⇒ Query for Unit Name at Boot).

Table 5-13 unit-query-for-name-at-boot Parameter

| Possible Values | Result |
|-----------------|---|
| default | none |
| none | The terminal does not attempt a reverse name query at boot. |
| tcpip | The terminal tries a reverse query to the TCP/IP name servers. If no name servers are defined, the terminal tries the TCP/IP boot server, if the boot server is defined. The name service protocol must be DNS. |
| ncdnet | The terminal tries a reverse query to the MOP boot server, if the boot server is defined. |

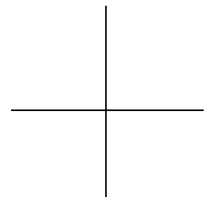

Configuring How a Terminal Accesses Files

This section describes accessing files (other than the X server file) that are located on a network host. For information on local file service (accessing files on a PCMCIA card or local diskette), see the *System Administrator's Guide*.

Configuring the Initial File Servers

The initial file servers are used for loading configuration files, fonts, and the **rgb.txt** file when the terminal boots and for accessing files while the terminal is running. The initial file servers are automatically entered into the file service table described in "Configuring the File Service Table" on page 5-15.

The **file-initial-server-1** and **file-initial-server-2** remote configuration parameters permit you to define the primary and secondary initial file servers (Setup ⇒ Change Setup Parameters ⇒ File Service ⇒ Initial File Server 1, Initial File Server 2).

The **file-initial-protocol-1** and **file-initial-protocol-2** parameters specify the file access method for the initial file servers (Setup ⇒ Change Setup Parameters ⇒ Initial Protocol 1, Initial Protocol 2). The default file access protocol is TFTP. All of these parameters can be saved in NVRAM.

If you specify both file servers and the primary server is not available, the terminal tries to load its configuration file from the secondary server.

If one of the initial file servers is set to IP address 0.0.0.0, the boot host is used as the file server and is automatically entered into the file service table. Normally, you cannot use the boot host for both initial file servers. If the IP addresses of both initial file servers are set to 0.0.0.0, the secondary initial file server is ignored unless they are using different file service protocols.

Table 5-14 file-initial-server-1 Parameter

| Possible Values | Result |
|--------------------------------------|---|
| default | 0.0.0.0 |
| 0.0.0.0 | The boot host is the initial file server. |
| <i>IP address</i> or <i>hostname</i> | The primary initial file server. |

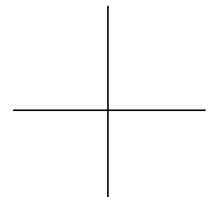

Table 5-15 file-initial-server-2 Parameter

| Possible Values | Result |
|-------------------------------|---|
| default | 0.0.0.0 |
| 0.0.0.0 | The boot host is the secondary file server. |
| <i>IP address or hostname</i> | The secondary initial file server. |

Table 5-16 file-initial-protocol-1 Parameter

| Possible Values | Result |
|-----------------|---|
| default | tftp |
| tftp | Use the TFTP protocol for file access. |
| nfs | Use NFS for file access (using the UDP protocol). |
| nfs/tcp | Use NFS for file access (using the TCP protocol). |
| ncdnet | Use DAP for file access. |

Table 5-17 file-initial-protocol-2 Parameter

| Possible Values | Result |
|-----------------|---|
| default | tftp |
| tftp | Use the TFTP protocol for file access. |
| nfs | Use NFS for file access (using the UDP protocol). |
| nfs/tcp | Use NFS for file access (using the TCP protocol). |
| ncdnet | Use DAP for file access. |

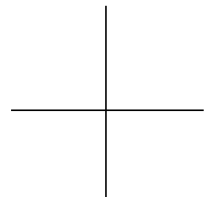

Configuring the File Service Table

After loading an X server, the terminal uses its file service table, defined in the `file-service-table` parameter, for all file access (Setup ⇒ Change Setup Parameters ⇒ File Service ⇒ File Service Table). This table maps the default file locations known to the X server to the actual locations of files on file server hosts. The entries in each row of the file service table are described in Table 5-19.

By default, the terminal uses the boot host as the initial file server on which it searches for files (such as configuration files) during the booting process. After booting, the terminal also uses the boot host by default for all ongoing file requests.

If you have defined initial file servers, as explained in “Configuring the Initial File Servers” on page 5-13, the initial file servers are automatically placed in the file service table. If the terminal is accessing files only from these hosts and the boot host and the files are in their default locations, no further configuration of the file service table is necessary.

If files required by the terminal are not on the boot host or designated initial file servers or are not in their default locations, configure the file service table to map the default file access points known by the X server to the actual file access points and actual host.

The default file locations known to the X server are listed in Table 5-18.

Table 5-18 Default File Locations

| File Type | Default Directory |
|--|---------------------------------------|
| Remote configuration files | <code>/usr/lib/X11/ncd/configs</code> |
| Color definition file (<code>rgb.txt</code>) | <code>/usr/lib/X11/ncd</code> |
| Fonts | <code>/usr/lib/X11/ncd/fonts</code> |
| Diagnostic log file | No default location |
| Keysym file (<code>XKeysymDB</code>) | <code>/usr/lib/X11/ncd</code> |

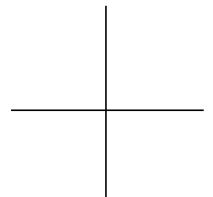

Each entry in the table specifies a file server host, the file access point used by the terminal, the actual file access point on the file server, the protocol used, the retransmission and transaction timeout periods, and the amount of data transmitted on each read and write operation.

To change the file access point and the host:

1. Find the entry in the **file-service-table** parameter (see Table 5-19) that has the default location in the local-unix-mount-point field. For example, if you are placing the remote configuration files in a non-standard location, look for the default location `/usr/lib/X11/ncd/configs` in the local-unix-mount-point field. (In Setup ⇒ Change Setup Parameters ⇒ File Service ⇒ File Service Table, look for Local UNIX Mount Point with the default location.)
2. In the server mount point field, enter the actual file access point on the host. (In the File Service Table, click on the Server Mount Point entry you want to change, then type the actual file access point in the text entry box.)
3. If the actual file access point is on a host other than the boot host or an initial file server, enter the name or IP address of the host in the server field. (In the File Service Table, click on the Server entry you want to change, then type the name or IP address of the host in the text entry box.)

Note Local file systems are not entered into the file service table.

Table 5-19 file-service-table Parameter

| Table Entries | Possible Values | Result |
|------------------------|---|--|
| local-unix-mount-point | default | nil |
| | <i>pathname</i> | The terminal's local UNIX-style pathname for this file service access point. |
| local-vms-mount-point | default | nil |
| | <i>pathname</i> | The terminal's local VMS-style pathname for this file service access point. |
| server | default | nil |
| | <i>network address</i> or <i>hostname</i> | The file server host. |

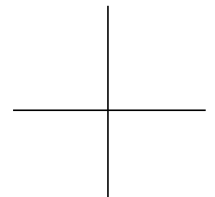

Table 5-19 file-service-table Parameter (Continued)

| Table Entries | Possible Values | Result |
|---|-----------------|---|
| protocol | default | tftp |
| | tftp | TFTP is used for accessing files through this access point. |
| | nfs | NFS/UDP is used for accessing files through this mount point. |
| | nfs/tcp | NFS/TCP is used for accessing files through this mount point. |
| | ncdnet | NCDnet is used for accessing files through this mount point. |
| server-mount-point | default | nil |
| | <i>pathname</i> | Pathname for this file service access point on the file server host. |
| file-name-type (This field is not used if the protocol field is "nfs" or "nfs/tcp.") | default | unknown |
| | unknown | This value works for TFTP or DAP. |
| | unix | The file server uses UNIX-style filenames. |
| | vms | The file server uses VMS-style filenames. |
| retransmission-timeout | default | 3 |
| | <i>integer</i> | The amount of time (in seconds) between successive transmissions of a file service request. This is only used with file service protocols running over connectionless transports (for example, NFS or TFTP). Range: 0 - 4294967295. |
| transaction-timeout | default | 30 |
| | <i>integer</i> | The amount of time (in seconds) to attempt a file service request before a failure situation is declared. Range: 0 - 4294967295. |

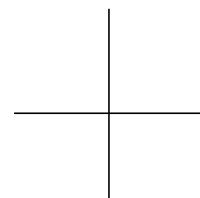

Table 5-19 file-service-table Parameter (Continued)

| Table Entries | Possible Values | Result |
|-------------------------|-----------------|--|
| read-size ¹ | default | 8192 |
| | <i>integer</i> | The amount of data (in bytes) requested in a single read request from the terminal. This parameter is used with NFS, NFS/TCP, and TFTP. Values below 512 bytes cause noticeably slow performance. Range: 0 - 8192. |
| write-size ¹ | default | 8192 |
| | <i>integer</i> | The amount of data (in bytes) requested in a single write request from the terminal. This parameter is only used with NFS or NFS/TCP. Values below 512 bytes cause noticeably slow performance. Range: 0 - 8192. |

¹ If the terminal is having trouble reading files with NFS across gateways, try decreasing read-size and write-size to 1024 bytes.

An example file service table follows:

```
file-service-table = {
    {/usr/lib/X11/ncd/ nil eagle tftp /usr/local/lib/X11/ncd/ unknown 3
30 8192 8192}
    {/var/tmp nil eagle nfs /var/tmp unknown 3 30 8192 8192}
}
```

Configuring the Matching Method

When attempting a file access, the terminal compares the file request with the local mount points in the file service table. By default, the terminal tries only the longest matching pathname (or pathnames, if there are matches of equal length). The longest match is the most complete match, the one that matches most or all of the elements in the pathname. You can configure the terminal to try all matching pathnames instead.

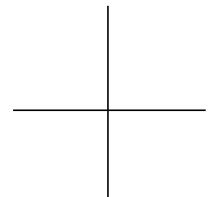

The **file-try-all-matches-on-open** parameter (Setup ⇒ Change Setup Parameters ⇒ File Service ⇒ Try All Matches on Open) controls how the terminal uses file service table entries when trying to access a file.

Table 5-20 file-try-all-matches-on-open Parameter

| Possible Values | Result |
|-----------------|--|
| default | false |
| false | The terminal tries only the longest matches. |
| true | The terminal tries all matching pathnames, beginning with the longest match. |

The two methods of matching are explained in more detail in the following subsections.

Trying Only the Longest Matches

By default, the terminal tries only the longest matches. For example, assume that the pathname of a font requested by a client program is **/usr/lib/X11/ncd/fonts/pcf/100dpi/10x20.pcf**, and the file service table contains the following local mount points:

```
/usr/lib/X11/ncd
/usr/lib/X11/ncd
/usr/lib/X11/ncd
/usr
```

The first three local mount points match the request. The terminal tries the hosts in the order in which they are listed in the file service table, until it succeeds in opening the font file.

You may wish to have several longest matches to ensure that the terminal can always find the font or other data it needs.

Trying All Matches

If the terminal is configured to try all matches, the terminal first finds all the matches. After finding all the matching paths, the terminal sorts the mount points by length and tries the longest path first. If the file is not found there, the next longest is tried and so on. The root directory (/) matches any request.

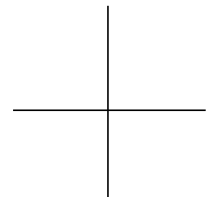

For example, assume that the pathname requested by a client program is `/usr/lib/X11/ncd/fonts/100dpi/10x20.snf`, and the following local mount points are in the file service table:

```
/usr/lib/X11/ncd/fonts/100dpi
/usr/lib/X11/ncd/fonts
/usr/lib/X11/ncd
/usr
/
/ncd
```

The first five mount points match this request and the terminal.

Configuring File Access through TFTP

Terminals can use TFTP to download the X server and other files at boot and for ongoing file access.

NCD does not recommend using TFTP for writing to diagnostic log files.

TFTP is implemented by a daemon program, *tftpd(8)*, and configured in the boot host's `/etc/inetd.conf` file.

Secure versus Non-Secure TFTP

TFTP can run in two modes: secure mode (also called restricted mode) and non-secure mode.

Secure (Restricted) TFTP

Secure TFTP enhances security because it requires that the host perform a *change root* operation (*chroot*[8]) to the directory specified when TFTP is invoked. The directory specified when TFTP is invoked is TFTP's default home directory (usually `/tftpboot`). Because of the *chroot*, all files to be accessed using secure TFTP (including X servers, fonts, and remote configuration files) must be physically installed under the directory and in the same file system partition. Symbolic links do not work.

If installing all files in the secure directory makes the directory too large, you can mount a file system partition, using the secure directory as the mount point. You could also use the secure directory only for X servers and use NFS as the access method for other files and fonts.

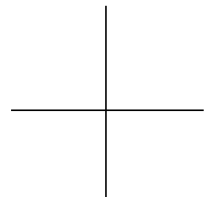

Non-Secure TFTP

Use non-secure TFTP when extra security is unnecessary. Non-secure TFTP is more flexible because *chroot* is not used. With non-secure TFTP, you can put X servers and modules in any directory. Note that when you use a non-standard directory for the X server or server modules, you must configure the terminal to find the files and configure the booting process to place the X server and modules in the desired location(s).

Make Sure TFTP Is Enabled on the Host

Consult your vendor documentation on how to make sure that TFTP is enabled. On some systems, you can use the following procedure:

1. Make sure the *tftpd* daemon has been installed and enabled. Usually, the daemon is enabled in the file `/etc/inetd.conf`; for example:

```
tftp dgram udp wait root /usr/etc/in.tftpd in.tftpd
```

If a comment symbol (#) appears at the beginning of the entry, remove it. Always specify “wait” instead of “no wait.” Otherwise, each *tftpd* request starts a new process, which can cause the host to start processes until it cannot start any more. If you specify “wait,” each request is processed before another is serviced.

Usually, *tftpd* runs under the user ID *root* as indicated in the example command line.

2. Make sure that the X server and module directories and other required files are world-readable.
3. If you make any changes to the `/etc/inetd.conf` file, restart the *inetd* daemon to force it to reread the configuration file and start *tftpd* running. You can restart the daemon by finding its process id and sending it a hangup signal. For example:

```
# ps -acx | grep inetd
17601 ? I 0:12 inetd
# kill -HUP 17601
```

On some systems, the command is `ps -ef | grep inetd`.

4. If you are using secure TFTP, make sure that all files to be accessed through TFTP are installed in the directory specified by the TFTP entry in the `/etc/inetd.conf` file. For example, on SunOS systems, the enabling line in `/etc/inetd.conf` for secure TFTP is:

```
tftp dgram udp wait root /usr/etc/in.tftpd in.tftpd -s /tftpboot
```

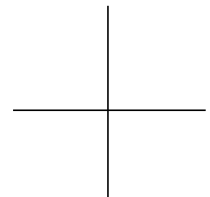

This line makes it impossible for the NCD terminal to access fonts and configuration files because secure TFTP cannot reach `/usr/lib/X11/ncd`. This directory is outside the secure directory, which TFTP treats as its root (`/`) directory. One solution is to change `-s /tftpboot` to `-s /usr/tftpboot`. Restart the *inetd* daemon as directed in Step 3. Then move the X servers to `/usr/tftpboot` and move `/usr/lib/X11/ncd` to `/usr/tftpboot/usr/lib/X11/ncd`.

On HP-UX systems after Version 7, TFTP is secure; the TFTP daemon's home directory is the secure directory `/usr/tftpdir`. Any files that the terminal accesses via TFTP should be placed in this directory.

Configuring File Access through NFS

The terminal can use NFS for accessing all files and for downloading an X server. When accessing files through NFS, the X server temporarily mounts the file system onto its internal path.

Configuring the Host for NFS File Access

For files to be available through NFS, the host directories must be exported. This ensures that NFS clients, such as NCD terminals, can access the directories.

For example, on SunOS:

1. To export the default directory for X server files, add a line describing the directory in the `/etc/exports` file. For example:

```
/tftpboot/
```

or

```
/usr/tftpboot
```

Files can be exported to specific terminals, exported to everyone, or exported to *unknown*, the default name for an NCD terminal.

2. On the host where the directory resides, enter the following command:

```
# exportfs -a
```

Setting User and Group IDs for NFS File Access

If the host exporting the file systems restricts mount requests to certain user or group IDs, set the `file-nfs-uid` and `file-nfs-gid` parameters to the relevant user ID (UID) and group ID (GID). These parameters are not available in the Setup menus.

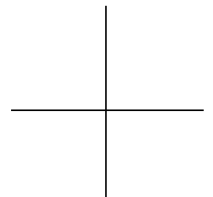

The default value for both parameters is “-2”, which corresponds to *nobody*. NFS handles requests that do not have a valid UID and GID by mapping them to the anonymous user. By default, the anonymous user is *nobody*. With user and group IDs of -2, files and directories must be world-readable and world-writable.

Table 5-21 file-nfs-uid Parameter

| Possible Values | Result |
|-----------------|---|
| default | -2 |
| -2 | Access is the same as the <i>world</i> permissions. |
| <i>integer</i> | The user ID of the requestor. |

Table 5-22 file-nfs-gid Parameter

| Possible Values | Result |
|-----------------|---|
| default | -2 |
| -2 | Access is the same as the <i>world</i> permissions. |
| <i>integer</i> | The group ID of the requestor. |

Setting the Unmount Timer for NFS File Access

The `file-nfs-unmount-timeout` parameter (Setup ⇒ Change Setup Parameters ⇒ File Service ⇒ NFS Unmount Timeout) controls how long to wait before unmounting file systems because of inactivity. The default is 1800 seconds (30 minutes). An unmounted file system is remounted the next time the terminal tries to access a file.

Table 5-23 file-nfs-unmount-timeout Parameter

| Possible Values | Result |
|-----------------|--|
| default | 1800 |
| <i>integer</i> | Timeout (in seconds) before file systems are unmounted due to inactivity. Range: 1 - 3600. |

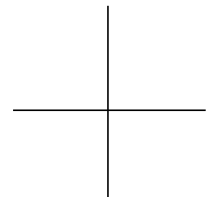

Changing the Timeout for Failed File Servers

The `file-failed-server-ignore-timeout` parameter (Setup ⇒ Change Setup Parameters ⇒ File Service ⇒ Failed Server Ignore Timeout) controls how long the terminal ignores a file server that has failed because of a network timeout error. When the terminal attempts to open a new file, it skips over the ignored servers.

The default timeout period is 120 seconds. A long timeout speeds up booting and session reset when the primary initial file server has failed.

Table 5-24 file-failed-server-ignore-timeout Parameter

| Possible Values | Result |
|-----------------|--|
| default | 120 |
| <i>integer</i> | The amount of time (in seconds) to ignore a file server that has failed because of a network timeout error. Range: 1 - 600. |

Issuing Extended File Service Diagnostic Messages

The `file-extended-diagnostics` parameter (Setup ⇒ Change Setup Parameters ⇒ File Service ⇒ Extended Diagnostics) controls the extent of the file service diagnostics messages issued by the terminal. By default, a minimum number of messages are issued.

If you are having problems with the terminal accessing files, you can arrange to display more specific messages by setting this parameter to “true.”

Table 5-25 file-extended-diagnostics Parameter

| Possible Values | Result |
|-----------------|---|
| default | false |
| false | Minimal file service diagnostic messages are issued. |
| true | Extended file service diagnostic messages are issued. |

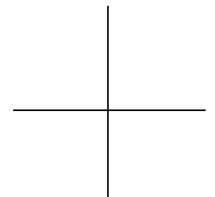

Configuring Routing (Accessing Remote Networks)

If the terminal is communicating with remote networks, make sure that routes to other networks are set up and the subnet mask is set properly.

For most sites, you need only specify the default gateways described in this section. The terminal maintains current routes in the routing table described in “The IP Routing Table” on page 5-26.

Specifying Default Gateways

Default gateways are a reliable way to contact hosts outside the local network. If the terminal cannot find a usable route in the routing table, it contacts the default gateways. You specify the default gateways in the **ip-initial-default-gateway-1** and **ip-initial-default-gateway-2** parameters (Setup ⇒ Change Setup Parameters ⇒ IP ⇒ Initial Default Gateway 1, Initial Default Gateway 2). These parameters can be saved in NVRAM.

If the host named in the **ip-initial-default-gateway-1** parameter is not available, the terminal tries the host listed in **ip-initial-default-gateway-2**.

If one of the default gateways is 0.0.0.0, the terminal uses the boot host as the default gateway. If both gateways are set to 0.0.0.0, the second is ignored.

The default gateways are automatically placed in the routing table and are the initial entries in the table.

Although you can designate only two gateways using these parameters, you can specify as many additional gateways as you need by entering them into the routing table after the initial configuration file is loaded.

Table 5-26 ip-initial-default-gateway-1 Parameter

| Possible Values | Result |
|--------------------------------------|-------------------------------|
| default | 0.0.0.0 |
| 0.0.0.0 | The gateway is the boot host. |
| <i>IP address</i> or <i>hostname</i> | A default gateway. |

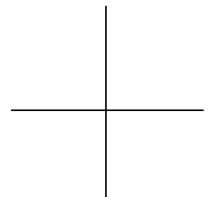

Table 5-27 ip-initial-default-gateway-2 Parameter

| Possible Values | Result |
|-------------------------------|-------------------------------|
| default | 0.0.0.0 |
| 0.0.0.0 | The gateway is the boot host. |
| <i>IP address or hostname</i> | A default gateway. |

The IP Routing Table

NCD terminals maintain an internal routing table that contains current routes to remote hosts and networks. When attempting to reach a host outside the local network, the terminal tries the following methods of finding a route in the order given:

1. A route to the specific host
2. A route to the network or subnet the host is on
3. The default route, either as specified in **ip-initial-default-gateway** or obtained via router discovery
4. Proxy ARP, if enabled by **ip-use-proxy-arp**

The routing table can contain multiple routes to a single destination. If there is more than one matching route, the terminal uses the route with the greatest preference value.

The routing table changes over time due to normal operation. Routes are placed in the table by:

- ❑ Actions of network protocols (proxy ARP, router discovery, and ICMP redirects). See “Finding Routes to Hosts through Proxy ARP” on page 5-29 and “Discovering Neighboring Gateways through Router Discovery” on page 5-30.
- ❑ Default gateway parameter settings. These are the first entries in the table after the terminal boots. For more information about the default gateway parameters, see “Specifying Default Gateways” on page 5-25.
- ❑ The system administrator entering routes into the table manually. Manual changes to the routing table take effect immediately.

The IP routing table is defined in the **ip-routing-table** parameter (Change Setup Parameters ⇒ IP ⇒ Routing Table). Routing table entries include read-only

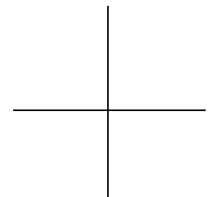

values, which you cannot modify, as well as read/write values. The entries in each row of the routing table are defined in Table 5-28.

Entries with the destination 0.0.0.0 are created from the **ip-initial-default-gateway-1** and **ip-initial-default-gateway-2** parameter settings.

Table 5-28 ip-routing-table Parameter

| Table Entry | Possible Values | Result | Field Type |
|-------------|--|---|------------|
| destination | default | 0.0.0.0 | read/write |
| | 0.0.0.0 | The entry is one of the default gateways. | |
| | <i>IP address</i> or <i>hostname</i> | Address of the host network or name of the host. | |
| gateway | default | 0.0.0.0 | read/write |
| | <i>IP address</i> or <i>hostname</i> | The IP address of the next hop on this route. If the route is bound to an interface that is realized through a broadcast medium, this field contains the agent's IP address on the interface. | |
| preference | default | 0 | read/write |
| | 0 | The midpoint of the preference range. | |
| | <i>integer</i> | Determines which route is preferred when there are multiple routes to a destination. Router discovery messages convey this information dynamically; otherwise, you can configure it statically. The terminal tries higher-numbered routes first. Range: -2147483648 to 2147483647. | |

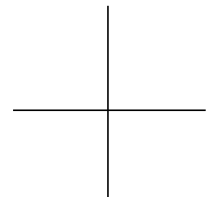

Table 5-28 ip-routing-table Parameter (Continued)

| Table Entry | Possible Values | Result | Field Type |
|------------------|-----------------|--|------------|
| type | default | static | read/write |
| | static | The system administrator created the route and it cannot be deleted or marked unusable. | |
| | dynamic | The network discovered the route (by the proxy ARP, ICMP, or router discovery protocols) and it can be deleted or marked unusable if the terminal detects failures when using the route. | |
| creation-method | default | snmp | read/write |
| | snmp | SNMP set the route. | |
| | icmp | ICMP set the route. | |
| | local | The system administrator created the route. | |
| | proxy-arp | Proxy ARP created the route. | |
| birth | default | 0 | read-only |
| | <i>integer</i> | Amount of time (in seconds) after booting that the route was created. | |
| time-to-live | -1 | The route should not be automatically deleted. | read/write |
| | <i>integer</i> | How long (in seconds) before the route is deleted. This information is conveyed in router discovery messages. Range: 1 - 2147483647 | |
| destination-type | default | network | read/write |
| | network | The destination is a network. Most routes are network routes. | |
| | host | The destination is a host. Proxy ARP routes and the routes used for SLIP (Serial Line Internet Protocol) connections are host routes. | |

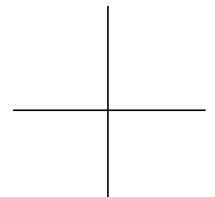

Table 5-28 ip-routing-table Parameter (Continued)

| Table Entry | Possible Values | Result | Field Type |
|-------------|---------------------------|---|------------|
| route-mask | <i>hexadecimal number</i> | A hexadecimal value indicating the bits in the destination address used to determine the route. The mask is logically AND-ed with the destination address before being compared to the value in the gateway field. This field is used by SNMP (Simple Network Management Protocol). | read-only |

An example routing table follows:

```
ip-routing-table = {
  { 0.0.0.0 gateway1.ncd.com -1 dynamic local 42 -1 network }
  { 127.0.0.1 127.0.0.1 0 static local 582 -1 host }
  { 0.0.0.0 eagle.ncd.com -1 dynamic local 42 -1 network }
  { 192.40.157.0 ncdull.ncd.com 0 static local 39 -1 network }
}
```

Finding Routes to Hosts through Proxy ARP

Proxy ARP resolves routes to hosts for which there are no routes in the IP routing table. It redirects the terminal's request to communicate with a host on another network to the gateway that provides the route to the host. Routes discovered through proxy ARP are automatically placed into the routing table and identified as dynamic routes. The terminal uses hosts specified in the default gateway parameters before resorting to proxy ARP.

To configure the terminal to use proxy ARP, set the **ip-use-proxy-arp** parameter to "true" (Setup ⇒ Change Setup Parameters ⇒ IP ⇒ Use Proxy Arp). This parameter is saved in NVRAM.

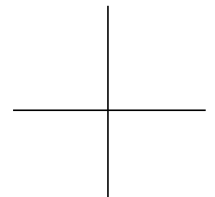

Table 5-29 ip-use-proxy-arp Parameter

| Possible Values | Result |
|-----------------|---|
| default | false |
| false | The terminal does not use proxy ARP to locate gateways. |
| true | The terminal uses proxy ARP to locate gateways. |

Discovering Neighboring Gateways through Router Discovery

Router discovery is an extension to ICMP that enables hosts attached to multicast or broadcast networks to discover the IP addresses of neighboring routers (gateways). If the router discovery daemon is running on your network, you can use this method of discovering routes. The terminal automatically places the routes discovered in the routing table as dynamic routes.

To configure a terminal to use router discovery, make sure the **ip-use-router-discovery** parameter is set to “true” (the default) (Setup ⇒ Change Setup Parameters ⇒ IP ⇒ Use Router Discovery). This parameter can be saved in NVRAM.

Table 5-30 ip-use-router-discovery Parameter

| Possible Values | Result |
|-----------------|--|
| default | true |
| true | The terminal modifies its IP routing table with information received from router discovery messages. |
| false | The terminal does not modify its routing table with information received from router discovery messages. |

If the terminal should use router discovery to solicit for routing information at boot time, make sure **ip-use-router-solicit** is set to “true” (the default) (Setup ⇒ Change Setup Parameters ⇒ IP ⇒ Use Router Solicit). This parameter can be saved in NVRAM.

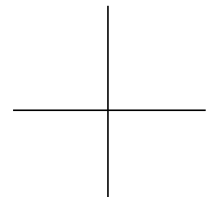

Table 5-31 ip-use-router-solicit Parameter

| Possible Values | Result |
|-----------------|--|
| default | true |
| true | The terminal solicits for routing information. |
| false | The terminal does not solicit for routing information. |

Setting TCP Performance Parameters

To customize the terminal's TCP interactions, you can change the TCP performance parameters described in this section. The default settings work properly for most installations. You should not need to adjust these parameters.

Caution

Setting these parameters incorrectly might cause your terminal to stop working and lead to excess network loading.

Adjusting the TCP Send and Receive Buffers

You can adjust the buffers used by the terminal in sending and receiving TCP packets. The default of 4096 bytes works well for sending images. For text-oriented clients, 2048 bytes works better.

These parameter settings should correspond to the TCP windows advertised by the host.

The `tcp-receive-buffer-size` parameter specifies the maximum amount of received data that a TCP connection buffers in the terminal (Setup ⇒ Change Setup Parameters ⇒ TCP ⇒ Receive Buffer Size). This corresponds to the TCP receive window advertised by the terminal to the peer (device on the other end of the connection).

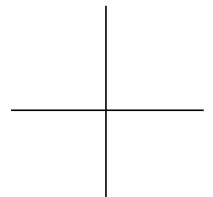

Table 5-32 tcp-receive-buffer-size Parameter

| Possible Values | Result |
|-----------------|---|
| default | 4096 |
| <i>integer</i> | Size of the receive buffer (in bytes). Range: 1024 - 65535. |

The **tcp-send-buffer-size** parameter specifies the maximum amount of data awaiting transmission that a TCP connection buffers in the terminal (Setup ⇒ Change Setup Parameters ⇒ TCP ⇒ Send Buffer Size). This corresponds to the maximum amount of the peer's TCP send window that is used by the terminal.

Table 5-33 tcp-send-buffer-size Parameter

| Possible Values | Result |
|-----------------|--|
| default | 2048 |
| <i>integer</i> | Size of the send buffer (in bytes). Range: 1024 - 65535. |

Specifying the TCP Timeout

The **tcp-connect-timeout** parameter specifies the amount of time that must elapse between a TCP connection attempt and a lack of response before failure is declared (Setup ⇒ Change Setup Parameters ⇒ TCP ⇒ Connect Timeout).

Table 5-34 tcp-connect-timeout Parameter

| Possible Values | Result |
|-----------------|--|
| default | 75 |
| <i>integer</i> | Elapsed time (in seconds) between TCP connection attempts before failure is declared. Range: 1 - 4294967295. |

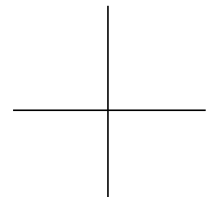

Specifying TCP Maximum Retransmissions

The `tcp-max-retransmissions` parameter specifies the number of retransmissions on a TCP connection before failure is declared (Setup ⇒ Change Setup Parameters ⇒ TCP ⇒ Maximum Retransmissions).

Table 5-35 tcp-max-retransmissions Parameter

| Possible Values | Result |
|-----------------|--|
| default | 12 |
| <i>integer</i> | Retransmissions on a TCP connection before failure is declared. Range: 1 - 4294967295. |

Specifying the TCP Linger Time

The `tcp-default-linger-time` parameter specifies the default time interval during which TCP attempts reliable transmission of outstanding data on the connection's transmit queue after local software closes a connection (Setup ⇒ Change Setup Parameters ⇒ TCP ⇒ Default Linger Time). This timer is optional and higher-level software can configure it for each connection.

Table 5-36 tcp-default-linger-time Parameter

| Possible Values | Result |
|-----------------|---|
| default | 120 |
| <i>integer</i> | Time (in seconds) that TCP continues to attempt transmission after the local software closes the connection. Range: 1 - 4294967295. |

Allowing Larger Segment Sizes

When set to “false,” the `tcp-default-mss-for-non-local` parameter allows segment sizes larger than the default to be used when communicating with non-local hosts (that is, hosts on the other side of a gateway). The default segment size is 536 bytes (Setup ⇒ Change Setup Parameters ⇒ TCP ⇒ Use default maximum segment size for non-local hosts).

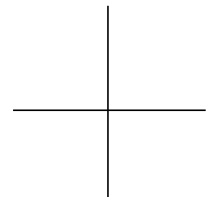
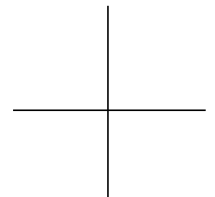

Table 5-37 tcp-default-mss-for-non-local Parameter

| Possible Values | Result |
|-----------------|--|
| default | true |
| true | The default segment size, 536 bytes, is used when communicating with non-local hosts. |
| false | Segment sizes larger than the default can be used when communicating with non-local hosts. |



6 Terminal Configuration Methods

This chapter describes configuration topics that are either not covered or are covered in less detail in the *NCDware System Administrator's Guide for UNIX Systems*.

The following topics are covered in this chapter:

- ❑ “Configuration Methods Overview” on page 6-2
- ❑ “Parameter Types and Groups” on page 6-5
- ❑ “The Configuration Language” on page 6-8
- ❑ “Creating Remote Configuration Files” on page 6-16
- ❑ “Specifying Hosts for Loading Configuration Files” on page 6-21
- ❑ “Enabling Persistent Loading of the Configuration File” on page 6-22
- ❑ “Using Optional Names for Configuration Files” on page 6-23
- ❑ “Disabling Specific Configuration File Download Attempts” on page 6-25
- ❑ “Specifying a Different Configuration File Directory” on page 6-26
- ❑ “Disabling All Remote Configuration File Downloads” on page 6-27
- ❑ “Specifying the File for Loading Configuration Defaults” on page 6-27
- ❑ “Changing the Ports for Accessing Configuration Daemons” on page 6-28
- ❑ “Setting Up Host-Based Access Control for Configuration Data” on page 6-30
- ❑ “Protecting Configuration Parameters” on page 6-32
- ❑ “Disabling the Configuration Utilities or the Console” on page 6-34
- ❑ “Configuring the Apply Command” on page 6-34

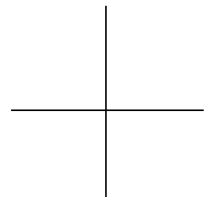

Configuration Methods Overview

All terminal configuration methods operate on the same database of terminal configuration information. Daemons running in the terminal manage the terminal's configuration database.

This section briefly describes configuration system components.

Configuration Daemons

The Configuration daemon loads the initial configuration from NVRAM when the terminal boots and reads the initial configuration file. The daemon also provides both network and local access to all of the terminal's configuration data. The User Preferences daemon provides network and local access to user preferences data only.

Configuration Parameters

The two basic types of parameters are read/write and read-only. Some parameters take single values, others take several, and others are organized into tables of values. The parameters essential for terminal booting are saved in the terminal's NVRAM; others must be loaded from remote configuration files when a terminal boots. Parameters are grouped and named according to their functions; for example, the names of parameters in the "boot" group all start with **boot**. For details about the different types of parameters and about parameter groupings, see "Parameter Types and Groups" on page 6-5.

Configuration Language

Remote configuration files and interactive remote configuration through a TELNET connection use a common language. For details about the language and assignment statements, see "The Configuration Language" on page 6-8.

Default Configuration Values

The default configuration of an NCD terminal is a combination of settings in the terminal's NVRAM and settings in the X server. X server settings take effect after the X server is loaded and executed.

Default configuration values allow the terminal to run with a minimum of configuration effort. Some default values change during operations as a result

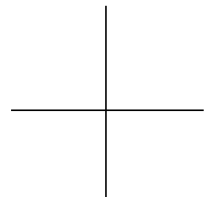

of network operations and the status of processes. For more information about default and optional values for specific parameters, see the alphabetical listing of configuration parameters in the *Remote Configuration Parameter Quick Reference*.

Configuration Methods

The methods of configuring NCD terminals are:

- ❑ Remote configuration files—NCD terminals can download configuration files from network host computers. Values in a downloaded configuration file override the default values in NVRAM and the X server.

Some parameters in remote configuration files can be written to NVRAM, thus altering the values read from NVRAM the next time the terminal boots.

Remote configuration files are described in “Creating Remote Configuration Files” on page 6-16 and in the *NCDware System Administrator’s Guide for UNIX Systems*.

- ❑ Interactive configuration through TELNET—After the server is running, you can use a TELNET connection (via the NCD Terminal Emulator or the TELNET utility on a host computer) to the Configuration daemon or the User Preferences daemon to read or change a terminal’s current configuration parameters. You can write parameters set through a TELNET connection to configuration files and to NVRAM.

Access to configuration data through a TELNET connection is controlled through passwords and host access control.

This method of configuring a terminal is described in the *System Administrator’s Guide*.

- ❑ Interactive configuration through Change Setup Parameters and Change Quick Setup—You can use these local clients, accessible through the Console, for configuring the terminal locally while the X server is running. You can also use these clients as the primary configuration tool and save settings to a configuration file and to NVRAM.

You can allow users to write their own settings to files and control which parameters, if any, they can set. Also, you can completely disable the clients or restrict access to them by enforcing passwords locally.

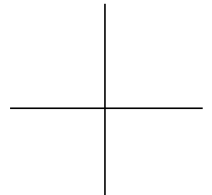

From one terminal's configuration client, you can access another terminal's configuration data remotely. Such access is controlled through passwords and host access control.

The *System Administrator's Guide* describes how to use the Change Setup Parameters and Change Quick Setup local clients. The configuration clients (including all their fields) are described in Chapter 9, Using Configuration Menus.

- ❑ Interactive configuration through Change User Preferences—This local client, accessible through the Console, allows users to configure user preferences parameters (such as keyboard LED usage and mouse acceleration) locally for the current session.

Users can also write their preference settings to a file in their home directories, and you can use the *ncdloadprefs* utility in a startup file to load the file each time the X server resets. This allows users to retain their own preference settings, no matter which terminal they are using. This utility is described in the *System Administrator's Guide*.

From one terminal's Change User Preferences client, you can modify or display another terminal's user preference parameters. You can disable the client or require passwords to use it.

The Change User Preferences client, including all of its fields, is described in the *User's Guide* and in Chapter 9, Using Configuration Menus.

- ❑ The NVRAM utility and Boot Monitor Setup menus—From the Boot Monitor, you can use these utilities to configure many parameters saved in NVRAM. The NVRAM utility allows you to change some parameters that cannot be accessed in any other way.

For information about using the NVRAM utility and Boot Monitor Setup menus, see Chapter 11, Boot Monitor and NVRAM.

- ❑ Interactive configuration through SNMP (Simple Network Management Protocol)—Using NCD's MIB (Management Information Base) and your host-based SNMP utilities, you can set and display configuration parameters. For information on configuring terminals for SNMP, see Chapter 16, Using SNMP for Terminal Management. The SNMP names and paths for all configuration parameters are listed in the *Remote Configuration Parameter Quick Reference*.

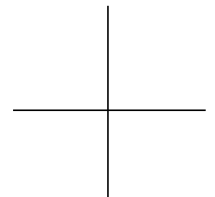

Access Control for Terminal Configuration Data

NCDware provides the following types of access control for terminal configuration data:

- Host-based access control
- User-based access control
- Password protection for local and remote interactive configuration
- Password protection for displaying statistical data
- Protection for specified parameters
- The ability to disable any of the local clients, including the Console

Controlling access to configuration data, statistical data, and local clients is described in the *System Administrator's Guide*, except for parameter protection, which is described in "Protecting Configuration Parameters" on page 6-32.

Parameter Types and Groups

This section describes parameter types and functional groups.

Read/write, Read-only, and Write-only Parameters

Parameters are read/write, read-only, or write-only. The parameters you set when configuring the terminal are read/write parameters. Read-only parameters report various types of statistical information.

Parameters containing passwords and encryption keys are write-only. When displayed through a TELNET connection, write-only parameter values are shown as follows:

- If not set, values are shown as "nil."
- If set, values are shown as "<GET-PROTECTED>."

When displayed through Change Setup Parameters, write-only parameter values are shown as follows:

- If not set, fields are blank.
- If set, fields contain a series of asterisks (*).

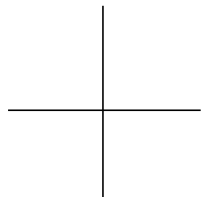

Parameter Groups

The parameter groups are listed in Table 6-1. The name of each parameter within a group begins with the group name. Groups correspond, for the most part, to the hide boxes displayed in Change Setup Parameters when invoked from the Console, except for the pref group, which appears only in Change User Preferences.

Table 6-1 Parameter Groups

| Group Name | Description |
|------------|--|
| boot | Terminal booting |
| browser | The NCD Mosaic Browser |
| config | Terminal configuration, including access control |
| diag | Diagnostics logging, including access control for the Diagnostics daemon |
| dps | DPS (Display PostScript) resource file |
| enet | Read-only Ethernet statistics |
| exec | Execution of and access control for local clients |
| file | File service (including the terminal's local file system) |
| font | Read-only X server font statistics |
| icmp | Read-only ICMP (Internet Control Message Protocol) statistics |
| ip | Internet protocol (including IP addresses and routing) |
| java | Java parameters |
| lat | LAT (Local Area Transport) protocol |
| login | Login services, including XDM (X Display Manager) and the Login Chooser |
| modules | X server module parameters |
| ncd3270 | 3270 terminal emulation parameters |
| ncdnet | NCDnet (DECnet) networking, including name service |
| net | Network interface options |

6-6 Terminal Configuration Methods

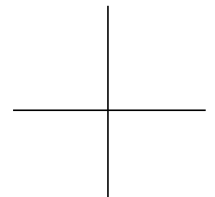
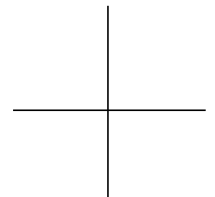

Table 6-1 Parameter Groups (Continued)

| Group Name | Description |
|------------|---|
| nfs | Read-only NFS (Network File Service) statistics |
| parallel | Parallel daemon parameters |
| pex | PEX parameters (some PEX parameters are in the pref group) |
| ppp | PPP (Point-to-Point Protocol) and SLIP (Serial Line Internet Protocol) |
| pref | User preference items (audio, bell, compatibility, console commands, fonts, input devices, OpenGL, PEX, power management, screen saver, screen background, SIE, graphics, and touch screen) |
| pwireless | Read-only wireless statistics |
| serial | Serial daemon, including access control for both the Serial and Parallel daemons, and serial port configuration |
| snmp | SNMP (Simple Network Management Protocol) |
| tcp | TCP (Transmission Control Protocol) statistics and characteristics |
| tcpip | TCP/IP networking, including name service |
| term | VT320 terminal emulation, including terminal emulation choosers |
| tftp | Read-only TFTP (Trivial File Transfer Protocol) statistics |
| time | Time zone and time servers |
| tokring | Read-only Token-Ring interface statistics |
| udp | Read-only UDP (User Datagram Protocol) statistics |
| unit | Miscellaneous terminal attributes |
| video | Playing videos |
| wincenter | WinCenter colors and resources |
| xremote | XRemote configuration and statistics |
| xserver | X server attributes and access control (including graphics, color, fonts, X extensions, keyboard, font server, X resources, input devices, and touch screen) |



The Configuration Language

The configuration language is used in remote configuration files and for interactive configuration through a TELNET connection. The configuration language provides commands for:

- ❑ Assigning and displaying parameter values
- ❑ Reading values from NVRAM and from files
- ❑ Writing values to NVRAM and to files
- ❑ Locking out other clients from the database
- ❑ Protecting parameters from modification or display

Configuration Language Summary

Table 6-2 lists the general-purpose commands you can use in remote configuration files and for interactive configuration through a TELNET connection. Table 6-3 lists commands for interactive configuration through a TELNET connection only. Bold text indicates a parameter name, square brackets ([]) indicate command options, and ***bold italic*** text indicates a variable.

Table 6-2 Configuration Commands for Files and Interactive Use

| Command and Description | |
|---|--|
| set <i>parameter</i> = <i>value</i> | |
| | Sets the value of the specified parameter. If you are modifying parameters interactively, you must use the apply command to put them into effect. The word set is optional. |
| apply | |
| | Applies pending commands to the current configuration. In a configuration file, this command is usually optional; end-of-file implies the apply command. |
| lock ¹ and unlock ¹ | |
| | lock prevents other clients of the Configuration daemon from issuing commands. unlock allows other clients of the Configuration daemon to issue commands. |

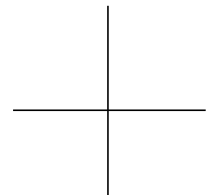

Table 6-2 Configuration Commands for Files and Interactive Use (Continued)

| Command and Description | |
|--|---|
| read nvram read filename | |
| | Reads configuration information from a file or from NVRAM. read nvram ¹ reads all of the configuration information stored in NVRAM. read filename reads the configuration information stored in the specified file. The include command is equivalent to read . |
| write nvram write filename parameter write filename [all group changes] [read-write read-only] | |
| | Writes current configuration information to NVRAM or to the specified filename. write nvram ¹ writes parameters saved in NVRAM from the current configuration. write filename parameter writes a parameter and its current value to a file. write filename [all group changes] [read-write read-only]: <input type="checkbox"/> all writes all parameters. <input type="checkbox"/> group writes all parameters in the specified group(s). <input type="checkbox"/> changes writes only the changes. <input type="checkbox"/> read-write writes only the read/write parameters. <input type="checkbox"/> read-only writes only the read-only parameters. The dump and save commands are equivalent to write . |
| protect [parameter group all] ^{1 2} | |
| | Prevents anyone from reading or modifying the specified parameter(s): <input type="checkbox"/> parameter protects the specified parameter. <input type="checkbox"/> group protects all the parameters in the specified group. <input type="checkbox"/> all protects all parameters. |
| get-protect [parameter group all] ^{1 2} | |
| | Prevents anyone from reading the specified parameter(s): <input type="checkbox"/> parameter protects the specified parameter. <input type="checkbox"/> group protects all the parameters in the specified group. <input type="checkbox"/> all protects all parameters. |

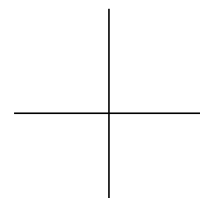

Table 6-2 Configuration Commands for Files and Interactive Use (Continued)

| Command and Description | |
|--|---|
| set-protect [<i>parameter</i> <i>group</i> all] ^{1 2} | |
| | Prevents anyone from modifying the specified parameter(s): <ul style="list-style-type: none"> <input type="checkbox"/> <i>parameter</i> protects the specified parameter. <input type="checkbox"/> <i>group</i> protects all the parameters in the specified group. <input type="checkbox"/> all protects all parameters. |

¹ This command is not available when accessing the Preferences daemon through a TELNET connection

² The **protect** commands are irreversible. You can remove protection only by rebooting the terminal.

Table 6-3 Configuration Commands for Interactive Use Only

| Command and Description | |
|--|---|
| get <i>parameter</i> get [all <i>groupname</i> changes group] [read-write read-only] | |
| | Displays parameters and their current values. get <i>parameter</i> displays the specified parameter (s). get [all <i>groupname</i> changes group] [read-write read-only]: <input type="checkbox"/> all displays all the parameters. <input type="checkbox"/> <i>groupname</i> displays all the parameters in the specified group. <input type="checkbox"/> changes displays only the current changes. <input type="checkbox"/> group displays all of the remote configuration group names. <input type="checkbox"/> read-write displays only the read/write parameters. <input type="checkbox"/> read-only displays only the read-only parameters. The show command is equivalent to get . |
| pending | Displays all changes that have not been applied. |
| cancel | Cancels all pending changes. |
| help | Displays a quick summary of the configuration language. |
| quit | Disconnects from the Configuration or User Preferences daemon. |

6-10 Terminal Configuration Methods

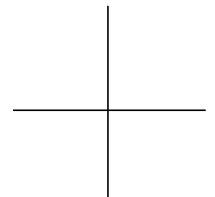

Assigning Values to Configuration Parameters

Values can be set through simple assignment statements or in tables. Parameter names, permitted values, and table entry names for all read/write parameters are given in the *Remote Configuration Parameter Quick Reference*.

Simple Assignment Statements

A simple assignment consists of an optional **set** command, a parameter name followed by an equals sign (=), and a single value. For example:

```
boot-tcpip-desired-server = 192.43.153.16
set boot-tcpip-desired-server = 192.43.153.16
```

The end of a simple assignment statement is indicated by a newline or carriage return.

Tables and Rows

Parameters that can take more than one value or require a series of related values are stored in tables composed of rows. For example, each row in the **exec-startup-commands** table consists of a single local client name or a local client name followed by arguments:

```
exec-startup-commands = {
    { wm }
    { term }
    { "login eagle" }
}
```

When resetting values in a row, resetting an entire row, or adding and deleting rows, you can use the row number as an index into the table. This is useful mainly in configuring a terminal through a TELNET connection. For example, to add a fourth row to the **exec-startup-commands** table:

```
exec-startup-commands[4] = { lat }
```

To add a row to the end of a table, use the index number -1. For example:

```
exec-startup-commands[-1] = { lat }
```

If you represent the parameters in a row as simple assignment statements enclosed in parentheses, their order in the row does not matter. Using assignment statements in a row is especially useful if you are not defining all the parameters in the row. The following example shows how to reset only the

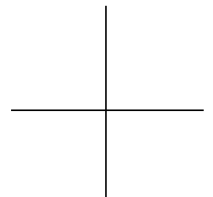

baud rate in row 1 of the **serial-interfaces-table**, while other values in the row retain their current values.

```
serial-interfaces-table[1]baud-rate = 9600
```

In contrast, the following assignment defines the baud rate and resets the other parameters in the row to their default values:

```
serial-interfaces-table[1] = {(baud-rate = 9600)}
```

Specify an empty table or empty row in a table as follows:

- ❑ Empty row in a table: **table[*row number*] = { }**
- ❑ Empty table: **table = { }** or **table = { { } }**

For example:

```
config-access-control-list = { }  
config-access-control-list[2] = { }
```

Types of Values

The following list describes the types of values used in remote configuration parameters.

- ❑ **Strings**—The keywords *null* or *nil* indicate that the parameter has no value. String values that contain embedded white space must be surrounded by double or single quotation marks (“ or ’).
- ❑ **Integers**—To specify integer values, use decimal or hexadecimal notation.
- ❑ **The keyword “default”**—All parameters accept the keyword *default*, which assigns the default value to the parameter. For example, the following assignments have the same effect:

```
boot-automatically = default  
boot-automatically = true
```

- ❑ **Boolean values**—For parameters that have Boolean values, you can use the value pairs “yes/no,” “on/off,” or “true/false.” For example, the following assignments are equivalent:

```
boot-automatically = on  
boot-automatically = true  
boot-automatically = yes
```

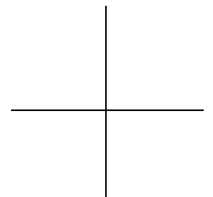

- ❑ Choices—Many parameters take specific choices. For example, the **exec-startup-commands** parameter takes the command names of local clients, such as **term** and **login**.
- ❑ Filenames—For parameters that take filenames as arguments, you can always specify filenames as absolute pathnames in the form **/a/b/c**. Parameters for which there is a default directory accept relative pathnames as well.

Syntax Rules

Syntax rules for setting remote configuration parameter values are described in the following list:

- ❑ Case—Uppercase and lowercase characters are not distinguished in parameter names, choices, or Boolean values. You may enter them in the form you find most readable. For example, the following assignments are identical functionally:

```
boot-automatically = true
Boot-automatically = True
BOOT-AUTOMATICALLY = TRUE
```

When values are not part of the configuration language, however, case is preserved. For example:

- In the **xserver-initial-x-resources** parameter, you can set client resources. Values must follow the same form as the resource settings in a resources file, such as **.Xdefaults**.
- Filenames are interpreted exactly you enter them.
- Quoted strings are interpreted as you enter them.
- ❑ End-of-line—If a statement extends past the end of line, you can use a backslash (\) to prevent interpretation of the newline. This is not necessary for tables, in which curly braces ({}) function as delimiters.
- ❑ White space—White space (the separator between grammatical elements) may be spaces, tabs, newline characters, or carriage returns. White space is not required before or after the equals sign in an assignment statement. For example, the following three assignments are functionally identical:

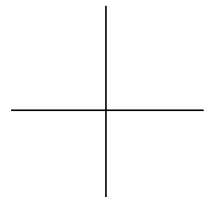

```
boot-automatically=true
boot-automatically      =      true
boot-automatically \
= \
true
```

As the last example shows, an assignment statement may span several lines.

- ❑ Special characters—You can use the C-language convention of a backslash (\) for escaping special characters.

Comments

You can include a comment in a remote configuration file by typing a pound sign (#) at the beginning of each line of comments. For example, to explain why a parameter was set to a specific value, you might type:

```
#Set to local to ensure that terminal
#boots from PCMCIA card instead of network host
boot-desired-source = local
```

Comments can also be appended to a line. For example:

```
boot-desired-source = local      #Boot from PCMCIA
```

Note Do not append comments to a line in statements that extend for more than one line.

Assigning Parameters More than Once

A parameter can be assigned any number of times. Each assignment is processed as it is read, overriding the previous assignment.

The only exception to this rule is the **unit-license-key** parameter, which must be assigned for each license key when using node licensing. For more information about licensing, see the *System Administrator's Guide*.

Listing Commands in Order

Assignment commands are interpreted in the order in which they appear. This affects assignments that depend upon the prior execution of other statements and parameters assigned more than once.

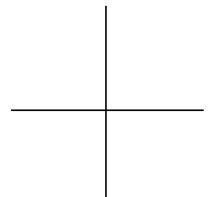

Although most parameters do not depend on other parameters being set previously, there are a few exceptions. For example, when using a name service you may specify hosts by their names instead of their addresses. Before you can refer to a host by its name in the remote configuration file, you must set the name service parameters. For example:

```
#Set the name service parameters
tcpip-name-server-protocol = dns
tcpip-name-servers = { 192.43.153.16 192.43.153.24 }
apply

#Set a parameter to a host name
boot-tcpip-desired-server = peregrine
```

Note The parameters that specify the name service must be followed by an **apply** command.

If a parameter is assigned more than once in a configuration file, the last assignment supersedes all previous assignments.

Saving Parameters in NVRAM

When the X server reads a configuration file, it automatically saves settings to NVRAM when it reaches the end of the file.

When using interactive configuration via TELNET, you must enter an **apply** command to save parameters in NVRAM.

The **config-auto-save-nvram** parameter determines whether parameters are saved automatically to NVRAM (Change Setup Parameters ⇒ Configuration [Configuration Daemon section] ⇒ Auto Save NVRAM) . For more information about auto-save, see “ Configuring the Apply Command” on page 6-34.

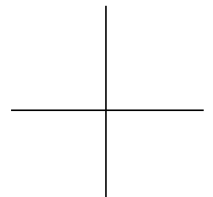

Creating Remote Configuration Files

Remote configuration files allow you to configure all terminals easily from a host computer. Remote configuration files are ASCII files that reside on the boot host or other hosts designated as initial file servers. The default file server is the boot host. For information about designating other file servers, see Chapter 5, *Configuring Network Services*.

Remote configuration files are downloaded using TFTP or NFS after the terminal has loaded an X server.

NCD terminals are configured by default to:

- ❑ Download a configuration file from the boot host (the host from which the X server is downloaded)

Note If the terminal is booting from a PCMCIA card and its NVRAM is set to default values, it automatically loads a configuration file from the local source. If a configuration file is not found on the PCMCIA card, the terminal tries to download a file from a network host.

- ❑ Search for two default configuration filenames in the default directory (`/usr/lib/X11/ncd/configs`):
 - First, the X server searches for a terminal-specific file. The name of the file is the hexadecimal equivalent of the terminal's IP address. For example the server running on a terminal with IP address 192.40.150.4 searches for a configuration file named **C02B994F**.
 - If the server does not find a terminal-specific file, it searches for a generic file named `ncd_std`. The generic file can be downloaded by all terminals in the network.
- ❑ Continue to boot if a configuration file cannot be downloaded

To create and install remote configuration files, using the default behavior of the terminal, see the rest of this section.

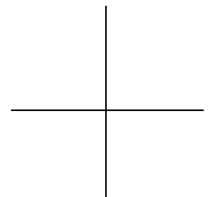

Using the Sample Configuration File

ncdinstall normally creates the following standard configuration files when you add a terminal to the network:

- ❑ A terminal-specific file named for the terminal's IP address converted to hexadecimal format. For example, a terminal with IP address 192.40.150.4 has a configuration file named **C02B994F**.
- ❑ A terminal-specific file for the user's configuration data. This file has the same name as the IP address file plus the suffix **.stp**.
- ❑ The generic file **ncd_std**. If this file already exists, *ncdinstall* does not attempt to create a new one.

If you need to create files manually, this section explains how to create files with the standard filenames and install files in the default directory.

Using the following procedures, you can create a configuration file and have it downloaded the first time the terminal boots. This procedure assumes that you are installing the configuration files on the boot host or on one of the initial file server hosts. See "Specifying Hosts for Loading Configuration Files" on page 6-21 for more information on configuration file hosts, and see Chapter 4, Booting—X Server Loading, for more information on initial file servers.

Complete the following steps to establish a configuration file:

1. If you did not install the example configuration file when you installed NCDware, copy the example configuration file from the NCDware distribution into the **/usr/lib/X11/ncd/configs** directory on the boot host. Follow the directions in the README file included with the example configuration files.
2. Make sure the filename is correct:
 - If this is a generic file, the name is **ncd_std**.
 - If this is a file for an individual terminal, the name is the hexadecimal equivalent of the terminal's IP address. To convert an IP address to its hexadecimal equivalent, convert each octet to a hexadecimal number; for example, to convert the IP address 192.40.154.4, using the UNIX *bc*(1) utility:

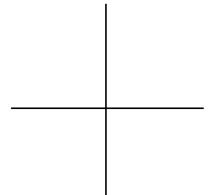

```
% bc
obase=16
192;40;154;4
C0
28
9A
4
```

The resulting filename is **C0289A04**. Each octet of the address must have two characters, so 4 is written as 04.

3. Make any necessary changes to configuration parameter values. You can use any text editor (such as `vi`) to edit the file.
4. Check the file permissions. The file must be world-readable.
5. Boot the terminal. The configuration file is downloaded and the parameter settings in the file take effect.

Configuration File Size

The size of configuration files is limited only by the amount of available terminal memory.

Creating a File from the Setup Clients

You can create a configuration file by invoking Change Setup Parameters or Change Quick Setup, setting parameters, and saving the parameters to a file.

All parameters are saved to the file in alphabetical order by group (that is, parameters in the boot group are listed first and parameters in the xserver group are listed last). Therefore, you may need to rearrange some lines; for example, to put the name server parameters ahead of parameters that use hostnames.

The file must be saved on the boot host, another specified host, or one of the initial file server hosts.

On TCP/IP networks, you can use TFTP or NFS to write the file (depending upon how the initial file servers are set up):

- If you are using TFTP to write the file, the file must exist before it can be written to and must be world-readable and world-writable.
- If you are using NFS to write the file, you must have read/write permission in the directory where you are saving the file.

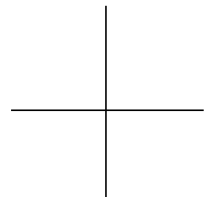

The file is saved into the default configuration file directory unless you specify a complete pathname. The normal default directory is `/usr/lib/X11/ncd/configs`. To change the default directory, see “Specifying a Different Configuration File Directory” on page 6-26.

Complete the following steps to create a file from Change Setup Parameters or Change Quick Setup:

1. Invoke the local client and set parameters as needed.
2. From the File menu, select `Save to File`.
3. In the dialog box displayed, enter the filename.
For automatic downloading when the terminal is rebooted, use the generic filename (`ncd_std`) or the hexadecimal equivalent of the terminal's IP address. For information about converting the IP address, see “Using the Sample Configuration File” on page 6-17.
4. Click on `OK` in the dialog box to save the parameters to the specified file.
5. Click on `Cancel` at the bottom of the Setup Parameters window to exit from the client.
6. The configuration file is saved in the default configuration file directory (`/usr/lib/X11/ncd/configs`).
7. Check the file to make sure all parameter settings are complete and in the correct order.

Nesting Configuration Files

Using the configuration language `read` command, you can include files containing configuration parameters within another configuration file. The included files may have any name you wish, and you can refer to them either as absolute pathnames or as pathnames relative to the configuration file directory. Included files must be accessible through the file service table described in Chapter 5, Configuring Network Services.

Files can be nested to 10 levels.

By combining terminal-specific configuration files and one or more standard files, you can assign individual values to some parameters and maintain the common values in the standard files.

The following example shows two `read` commands in the terminal-specific configuration file `C02B9A57`. Parameters common to all terminals on the

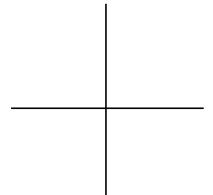

network are in the file `ncd_std`. Parameters common to a subgroup of terminals are in the file `mktg_specific`.

```
# Configuration file for IP address 192.9.200.23
#
read ncd_std
read mktg_specific
#
# Parameter specific to IP address 192.9.200.23
snmp-allow-reset = yes
```

When the terminal is booted, the X server loads the `C02B9A57` file, reads the `ncd_std` file and the `mktg_specific` file, and then resumes reading the `C02B9A57` file. The assignment in the last line of the `C02B9A57` file overrides any assignments in the included files because later assignment takes precedence over earlier assignment.

Including the User's Settings in Remote Configuration Files

You can allow users to save their preferred settings from Change Setup Parameters or Change Quick Setup in a file and include this file in the terminal-specific configuration file.

Users can save their settings by simply clicking on `Apply` in the client window provided that `config-auto-saved-info` is set to "user-changes." The default file in which their settings are saved is the name of the configuration file loaded when the terminal booted plus a filename extension (`.stp`). For example, if the configuration file loaded was called `C02B9A57`, the user's settings are saved in the file `C02B9A57.stp`.

For example, assume that the user of the terminal with the configuration file described in the previous section has saved settings in the file `C02B9A57.stp`. You can add another `read` statement to include the user's file:

```
# Configuration file for IP address 192.9.200.23
#
read ncd_std
read mktg_specific
read C02B9A57.stp
#
# Parameter specific to IP address 192.9.200.23
snmp-allow-reset = yes
```

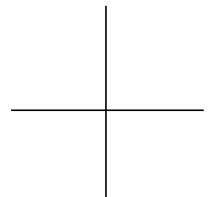

The user's file is loaded after the files controlled by the system administrator. This avoids the possible problem of a **protect all** command in a user's file restricting system administration **set** commands. In addition, the system administration files can use the **protect** command to protect sensitive parameters from user modification. For more information about protecting parameters, see "Protecting Configuration Parameters" on page 6-32.

For any parameter settings made by this user to be overridden by assignments in the two other included files, the other files would have to be listed after the user's files.

For more information about saving files from Change Setup Parameters and Change Quick Setup, see "Configuring the Apply Command" on page 6-34.

Note Users can set and save preference settings using Change User Preferences, and their settings can be loaded at session reset using the *ncdloadprefs*(1) utility invoked from a startup file such as an *.xsession* or *Xsession* file. For more information about saving and loading user preferences, see the *System Administrator's Guide*.

Specifying Hosts for Loading Configuration Files

You can designate one or two hosts (called the primary and secondary initial file servers) from which the terminal can download its configuration file.

Note If you do not designate initial file servers, the terminal attempts to download a configuration file from the boot host (the host from which the terminal downloaded its X server).

The terminal first attempts to download a configuration file from the primary file server host. If that attempt fails, the terminal tries the secondary file server host.

Terminals booted locally from a PCMCIA card can load configuration files from the network if you designate a default file server host.

For information about designating initial file servers and a default file server for a locally booted terminal, see Chapter 5, Configuring Network Services.

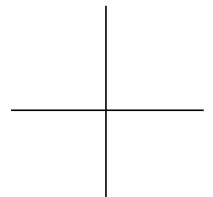

Enabling Persistent Loading of the Configuration File

By default, the terminal displays error messages and continues to boot if it cannot locate a configuration file to download. You can configure a terminal to persist in trying to load a configuration file; in that case, the terminal does not boot until it reads a file successfully. This may be useful in certain environments, including:

- ❑ Situations in which it is not acceptable for a user to have a different environment from the environment specified in the configuration file.
- ❑ A heavily loaded network with many terminals booting at the same time. Persistent loading ensures a file is downloaded in situations where the download request might otherwise time out.
- ❑ Sites where it is necessary to allow time for the file server host to come on line.

To configure a terminal to persist in attempting to load a configuration file, set the **config-persistent-loading** parameter to “true” (Setup ⇒ Change Setup Parameters ⇒ Configuration ⇒ Persistent Loading).

Table 6-4 config-persistent-loading Parameter

| Possible Values | Result |
|-----------------|--|
| default | false |
| false | The X server does not persist in trying to load a configuration file after trying all the files in the specified download sequence. |
| true | The X server persists in trying to load a file, cycling through the specified download sequence until a configuration file is found. |

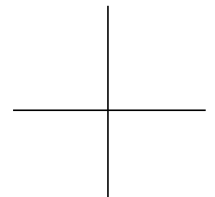

Using Optional Names for Configuration Files

Table 6-5 lists the remote configuration filenames and the order in which the terminal tries to download these files. The table also indicates whether the terminal tries to read the file by default or if the parameter must be enabled to read the file.

The first five attempts listed in the table allow you to specify an individual file for a terminal, while the sixth allows for a standard file that can be booted by many terminals.

Table 6-5 Configuration Filenames and Download Sequence

| Download Order | File Description | Parameter Name | Read by Default |
|----------------|--|---|-----------------|
| 1 | Custom filename ¹ | config-custom-file (Setup ⇒ Change Setup Parameters ⇒ Configuration [Initial Configuration File section] ⇒ Custom File) | No |
| 2 | File named using the terminal's hostname or domain name. For example, nctu21 or nctu21.nct.com . ² | config-unit-name-file (Setup ⇒ Change Setup Parameters ⇒ Configuration [Initial Configuration File section] ⇒ Try Unit Name as Filename) | No |
| | | config-add-domain-to-unit-name-as-filename ³ (Setup ⇒ Change Setup Parameters ⇒ Configuration [Initial Configuration File section] ⇒ Add Domain to Name as Unit Filename) | No |
| 3 | File named using the terminal's Ethernet address. For example, 0000a70040ac . ² | config-unit-ethernet-address-file (Setup ⇒ Change Setup Parameters ⇒ Configuration [Initial Configuration File section] ⇒ Try Unit Ethernet Address as Filename) | No |

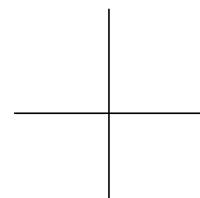
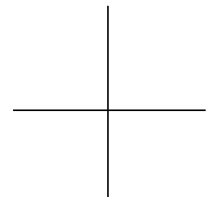

Table 6-5 Configuration Filenames and Download Sequence (Continued)

| Download Order | File Description | Parameter Name | Read by Default |
|----------------|--|---|-----------------|
| 4 | File named using the terminal's IP address, either in hexadecimal notation or in decimal-dot-notation. For example, C02B994F or 192.40.150.4 . | config-unit-ip-address-file (Setup ⇒ Change Setup Parameters ⇒ Configuration [Initial Configuration File section] ⇒ Try Unit IP Address as Filename) | Yes |
| | | config-use-decimal-ip-address-notation-as-filename ³ (Setup ⇒ Change Setup Parameters ⇒ Configuration [Initial Configuration File section] ⇒ Use Decimal IP Address as Filename) | No |
| 5 | File named using the terminal's DECnet address. For example, 01_0079.dat for the DECnet area number and node 1.79. ⁴ | config-unit-ncdnet-address-file (Setup ⇒ Change Setup Parameters ⇒ Configuration [Initial Configuration File section] ⇒ Try Unit NCDnet Address as Filename) | Yes |
| 6 | The generic filename, ncd_std . | config-generic-file (Setup ⇒ Change Setup Parameters ⇒ Configuration [Initial Configuration File section] ⇒ Try Generic Filename) | Yes |

- ¹ This filename consumes space in the optional string area of NVRAM. As this space is limited, you should keep the filename as short as possible. See Chapter 11 for more information.
- ² Using these filenames requires reverse name service, which is available only if you are using DNS. For information on DNS, see Chapter 5.
- ³ This parameter modifies the filename. To use the domain name, set both this parameter and **config-unit-name-file** to "true." To use the decimal-dot-address, set both this parameter and **config-unit-ip-address-file** to "true."
- ⁴ To use this filename, the terminal must be configured with an NCDnet (DECnet) address. If this filename is enabled, the terminal tries this name before trying the terminal IP address filename.



To use optional configuration filenames:

1. To create the file, use the methods described in “Using the Sample Configuration File” on page 6-17 or “Creating a File from the Setup Clients” on page 6-18.
2. Make sure the file has the correct name, as listed in Table 6-5.
3. Set the relevant parameter to “true” so the file will be downloaded the next time the terminal boots.

Suggested Uses for Configuration Filenames

Following are some suggested uses for the default and optional filenames:

- Use a custom filename if the other choices are not appropriate in your environment.
- Use a file named for the IP address if you do not swap terminals between locations or change IP addresses. Use the decimal version if you find it inconvenient to work with hexadecimal addresses.
- Use the Ethernet address filename if the configuration of the terminal applies only to the terminal itself and not to the location where it is used.
- Use the NCDnet address filename if the configuration applies to the location and not the terminal and the terminal is on a DECnet network.
- Use the generic filename if all terminals use the same settings or there are only a few special situations.

Disabling Specific Configuration File Download Attempts

To disable a specific download attempt, set the relevant configuration parameter from Table 6-5 to “false.” For example, to disable the attempt to download the generic file use:

```
config-generic-file = false
```

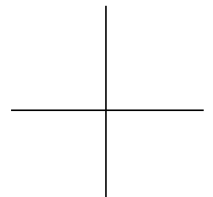

Specifying a Different Configuration File Directory

By default, the X server searches for configuration files in the directory `/usr/lib/X11/ncd/configs` when the terminal is booted. You can specify a different directory, which must be located on one of the initial file server hosts or the boot host. The directory you specify becomes the default directory for saving parameters to a file from Change Setup Parameters, Change Quick Setup, and Change User Preferences.

As this parameter consumes space in the tagged string area of NVRAM, you should keep the filename as short as possible. The tagged string area is described in Chapter 11, Boot Monitor and NVRAM.

To direct the terminal to search a specified directory for configuration files, set the `config-unix-directory` parameter to the absolute pathname of the directory for all configuration files for this terminal (Setup ⇒ Change Setup Parameters ⇒ Configuration [Initial Configuration File section] ⇒ UNIX Directory, Change Quick Setup ⇒ Files ⇒ UNIX Config Directory). The configuration file directory name can also be set in the Boot Monitor Setup menus.

Table 6-6 config-unix-directory Parameter

| Possible Values | Results |
|-----------------|--|
| default | The terminal searches the <code>/usr/lib/X11/ncd/configs</code> directory for configuration files. |
| <i>pathname</i> | The terminal searches the specified directory for configuration files. |

The directory must be world-readable and can be world-writable.

Note The name `/local` is reserved for an optional local file system. Consequently, you cannot use a file system that starts with `/local` for host-resident configuration files.

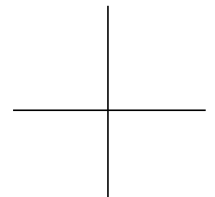

Disabling All Remote Configuration File Downloads

NCD terminals are configured initially to download a configuration file. To disable configuration file download, set the **config-load-initial-file** parameter to “false” (Setup ⇒ Change Setup Parameters ⇒ Configuration [Initial Configuration File section] ⇒ Load Initial File).

Table 6-7 config-load-initial-file Parameter

| Possible Values | Result |
|-----------------|--|
| default | true |
| true | The X server attempts to download a remote configuration file. |
| false | The X server does not attempt to download a remote configuration file. |

The **config-load-initial-file** parameter is saved in NVRAM. If you want the new value to take effect the next time the terminal boots, set the parameter interactively (either through Change Setup Parameters or a TELNET connection) and apply the new value.

Specifying the File for Loading Configuration Defaults

When you select Restore Defaults from the File menu in the Setup Parameters or Quick Setup window, the default action of the terminal is to read the parameter settings in the remote configuration file loaded by the terminal. Using the **config-default-file** parameter, you can specify a different file for this purpose (Setup ⇒ Change Setup Parameters ⇒ Configuration ⇒ [Configuration Daemon Service section] Default File).

Table 6-8 config-default-file Parameter

| Possible Values | Result |
|-----------------|--|
| default | The configuration file loaded by the terminal. |
| <i>filename</i> | The pathname of the file to be used as the default file. |

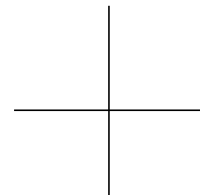

Changing the Ports for Accessing Configuration Daemons

Access to the terminal's Configuration and User Preferences daemons is through the terminal's TELNET and TCP ports. This section explains how to change the default ports.

Changing Ports for Access to All Configuration Data

The default TELNET and TCP ports for accessing all configuration data (including user preferences) are 5999 and 5979, respectively.

To change the TELNET port, use **config-telnet-port** (Setup ⇒ Change Setup Parameters ⇒ Configuration ⇒ Telnet Port Number).

Table 6-9 config-telnet-port Parameter

| Possible Values | Result |
|--------------------|---|
| default | 5999 |
| <i>port number</i> | Access to all of the terminal's configuration data is through the TELNET port specified. Range: 1024 through 65535. |

To change the TCP port, use **config-tcp-port** (Setup ⇒ Change Setup Parameters ⇒ Configuration ⇒ TCP Port Number).

Table 6-10 config-tcp-port Parameter

| Possible Values | Result |
|--------------------|--|
| default | 5979 |
| <i>port number</i> | Access to all of the terminal's configuration data is through the TCP port specified. Range: 1024 through 65535. |

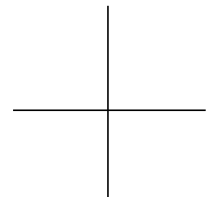

Changing Ports for Access to User Preferences Data Only

The default TELNET and TCP ports for accessing user preferences data only are 5997 and 5977, respectively.

To change the TELNET port for the Preferences daemon, use **config-pref-telnet-port** (Setup ⇒ Change Setup Parameters ⇒ Configuration [User Preferences daemon section] ⇒ Telnet Port Number).

Table 6-11 config-pref-telnet-port Parameter

| Possible Values | Result |
|--------------------|---|
| default | 5997 |
| <i>port number</i> | Access to the terminal's user preferences data is through the TELNET port specified. Range: 1024 through 65535. |

To change the TCP port for the Preferences daemon, use **config-pref-tcp-port** (Setup ⇒ Change Setup Parameters ⇒ Configuration [User Preferences daemon section] ⇒ TCP Port Number).

Table 6-12 config-pref-tcp-port Parameter

| Possible Values | Result |
|--------------------|--|
| default | 5977 |
| <i>port number</i> | Access to the terminal's user preferences data is through the TCP port specified. Range: 1024 through 65535. |

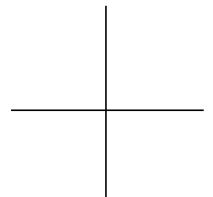

Setting Up Host-Based Access Control for Configuration Data

This section describes how to control which hosts have remote interactive access to a terminal's Configuration and Preferences daemons. Excluding a host from this form of access does not mean that the host cannot download remote configuration files to the terminal; it only prevents remote access through a TELNET connection or Change Setup Parameters, Change Quick Setup, and Change User Preferences.

Host access control is turned off by default, allowing access to configuration data from any host. You can allow access from a list of specified hosts or prevent all access.

Allowing Access from Specified Hosts

To establish a list of hosts that have access to a terminal's configuration data:

- Enable host access control by setting **config-access-control-enabled** to "true" (Setup ⇒ Change Setup Parameters ⇒ Access Control ⇒ [Configuration Daemon section] Enable Config Access Control).

Table 6-13 config-access-control-enabled Parameter

| Possible Values | Result |
|-----------------|---|
| default | false |
| false | Requests from outside the terminal for access to the terminal's configuration data are not checked against the access control list. A user from any host who possesses the proper password may access the daemon. |
| true | Requests from outside the terminal for access to configuration data are checked against the access control list. Only users from listed hosts may access the daemons. |

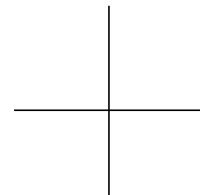

- ❑ List all of the hosts that have access in the **config-access-control-list** table (Setup ⇒ Change Setup Parameters ⇒ Access Control ⇒ [Configuration Daemon section] Config Access Control List).

Table 6-14 config-access-control-list Table Entries

| Entry | Default | Result |
|--------|--------------------------------------|---|
| host | nil | If access control is turned on, no hosts are allowed to access the terminal's Configuration and User Preferences daemons remotely. |
| | hostname or IP_address | A host granted permission to access the terminal's Configuration and User Preferences daemons remotely through a TELNET connection. |
| family | tcpip | This host has access through the TCP/IP protocol family. |
| | ncdnet | This host has access through the DECnet protocol family. |

For example, to allow access from some hosts:

```
config-access-control-enabled = true
config-host-access-control-list = {
    {eagle tcpip}
    {peregrine ncdnet}
    {ncdu21 tcpip}
    {ncdu21 ncdnet}
}
```

Note that a host must have two entries if it is allowed access through both the TCP/IP and DECnet protocol families.

You can now access the terminal's Configuration and User Preferences daemons remotely only from a host listed in the **config-access-control-list** table.

Preventing All Remote Access to the Terminal's Configuration Data

If no hosts should have access to the terminal's configuration data, set the **config-access-control-enabled** parameter to "true" and make sure the **config-access-control-list** table is empty, that is:

```
config-access-control-list = {}
```

The terminal's Configuration and User Preferences daemons can now be accessed only locally through Change Setup Parameters, Change Quick Setup, and Change User Preferences.

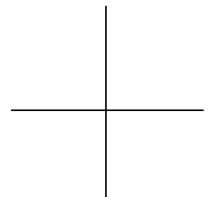

Protecting Configuration Parameters

The following parameter protection commands prevent display or modification of configuration parameters:

- ❑ **protect**—prevents both display and modification
- ❑ **get-protect**—prevents display
- ❑ **set-protect**—prevents modification

Once protected, a parameter can be unprotected only by removing protection and rebooting the terminal.

You can protect parameters in a remote configuration file or through a TELNET connection.

You can use protection commands to protect certain parameters while allowing users to change others. You can protect individual parameters, entire groups, or all parameters.

All protected parameters are commented; that is, a pound sign (#) is inserted in front of their names. If you try to display a parameter that is protected from display, its value is shown as “<GET-PROTECTED>.” If you try to change a parameter that is protected from modification, an error message is displayed.

Using the protect Command

The **protect** command prevents both display and modification of parameter values. The **protect** command has three forms:

| | |
|---------------------------------|--|
| protect <i>parameter</i> | Protects one or more specific parameters from display and modification |
| protect <i>group</i> | Protects one or more groups of parameters |
| protect all | Protects all parameters |

For example, the following command protects all parameters in the serial group, ensuring that serial port configuration is not changed:

```
protect serial
```

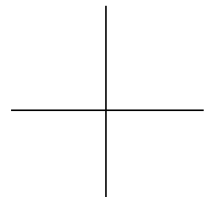

Using the `get-protect` Command

The `get-protect` command prevents display of parameter values. Parameters protected with this command can be modified, but not displayed. The `get-protect` command has three forms:

- `get-protect parameter` Protects one or more specific parameters from display
- `get-protect group` Protects one or more groups of parameters
- `get-protect all` Protects all parameters

Using the `set-protect` Command

The `set-protect` command prevents modification of parameter values. Parameters protected with this command can be displayed, but not modified. The `set-protect` command has three forms:

- `set-protect parameter` Protects one or more specific parameters from modification
- `set-protect group` Protects one or more groups of parameters
- `set-protect all` Protects all parameters

Removing Parameter Protection

Once a parameter is protected, no one can modify (or display) it without resetting the terminal or editing the configuration file. The method for disabling parameter protection depends on whether the `protect` command was written to a configuration file:

- If you protected a parameter through a TELNET connection but did not write the parameter to a file, log out and reboot the terminal. The parameter is no longer protected.
- If you protected a parameter through TELNET and wrote it to a file or a configuration file contains one of the protection commands, edit the configuration file to remove the protection and reboot the terminal. The parameter is no longer protected.

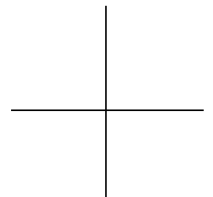

Disabling the Configuration Utilities or the Console

Disabling Change Setup Parameters and Change Quick Setup prevents interactive access to the terminal's Configuration and User Preferences daemons through the Console. Disabling Change User Preferences prevents all interactive access to the terminal's Preferences daemon. Disabling the Console prevents access to all clients through the Console.

To disable the Setup local clients, list them in the **exec-disabled-commands** table, using their command names. The following example disables Change Setup Parameters, Change Quick Setup, and Change User Preferences:

```
exec-disabled-commands = {  
    { setup }  
    { pref }  
    { quicksetup } }
```

In the Console menus, the names of disabled clients are dithered (displayed in a shaded font).

To disable the Console, include it in the **exec-disabled-command** table.

```
exec-disabled-commands = {{ console }}
```

When disabled, the Console does not appear after booting or upon pressing the Setup key or key combination.

Configuring the Apply Command

The configuration language **apply** command:

- Applies changes to the terminal's current configuration
- Writes changes to NVRAM for parameters that are retained in NVRAM
- Writes changes to a file

The default filename is the name of the initial configuration file loaded by the terminal plus the filename extension **.stp** (for example, **C02B9A41.stp**).

By default, the file is located in the **/usr/lib/X11/ncd/configs** directory.

The **apply** command can be used in interactive configuration through a TELNET connection and in configuration files, although in configuration files the **apply** command is automatic at end-of-file. When the user clicks on the

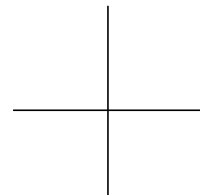

`Apply` button in Change Setup Parameters, Change Quick Setup, or Change User Preferences, an **apply** command is executed.

The extent of the information applied to the current configuration, and written to NVRAM and the default file is configurable. By default, the information written consists of the user changes. User changes are the current contents of the `.stp` file (if any), plus any changes made during the session through a TELNET connection or Change Setup Parameters, Change Quick Setup, or Change User Preferences.

The following sections explain how to change the auto-save defaults.

Protocols for Auto-Save

If you are using TFTP for auto-save, the file must already exist before you write to it and must be world-writable. You can create such a file by using the `touch(1)` utility.

If you are using NFS for auto-save, the directory in which the file is saved should have world-write permission. The auto-save file itself generally is owned by *nobody*; that is, the terminal's default identity.

Configuring Auto-Save to NVRAM

By default, changes are written to NVRAM after an **apply** command. To prevent changes from being written to NVRAM when you use the **apply** command, set the `config-auto-save-nvram` parameter to "false" (Setup ⇒ Change Setup Parameters ⇒ Configuration [Configuration Daemon section] ⇒ Auto Save NVRAM).

Table 6-15 config-auto-save-nvram Parameter

| Possible Values | Results |
|-----------------|--|
| default | true |
| true | Changes made to parameters that are saved in NVRAM are written to NVRAM after an apply command. |
| false | Changes made to parameters that are saved in NVRAM are not written to NVRAM after an apply command. |

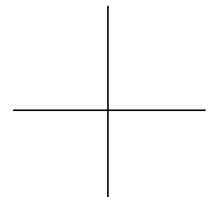

The *Remote Configuration Parameter Quick Reference* shows which parameters can be saved to NVRAM.

Configuring Auto-Save to a File

The following subsections explain how to disable auto-save to a file, change the name of the auto-save file, and change the extent of the data saved to the file.

Disabling Auto-Save

By default, changes are written to the `.stp` file or another specified file after an **apply** command. To prevent changes from being written to a file when you use the **apply** command, set the `config-auto-save-file` parameter to “false” (Setup ⇒ Change Setup Parameters ⇒ Configuration [Configuration Daemon Section] ⇒ Auto Save File).

Table 6-16 `config-auto-save-file` Parameter

| Possible Values | Result |
|-----------------|---|
| default | true |
| true | Any changes made to the terminal's configuration are saved automatically to a file after an apply command. |
| false | No changes made to the terminal's configuration are saved automatically to a file after an apply command. |

Changing the Name of the Auto-Save File

The `config-auto-save-file-name` parameter controls the file to which changes are written. You can specify a different filename from the default (the name of the configuration file loaded plus the `.stp` extension).

The file is written to the default directory for configuration files. To change the default directory, follow the directions in “Specifying a Different Configuration File Directory” on page 6-26.

The file must be accessible through the file service table.

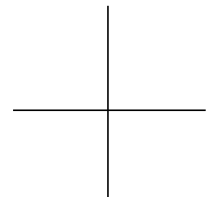

To change the name of the auto-save file, specify the filename in the **config-auto-save-file-name** parameter (Setup ⇒ Change Setup Parameters ⇒ Configuration [Configuration Daemon Section] ⇒ Auto Save File Name).

Table 6-17 config-auto-save-file-name Parameter

| Possible Values | Result |
|-----------------|---|
| default | The file named for the initial configuration file downloaded by the terminal plus the .stp filename extension. |
| <i>filename</i> | Filename or pathname to which configuration data should be written. |

Specifying the Data to Save

The **config-auto-saved-info** parameter controls the extent of the information to save (Setup ⇒ Change Setup Parameters ⇒ Configuration [Configuration Daemon Section] ⇒ Auto Saved Info).

Table 6-18 config-auto-saved-info Parameter

| Possible Values | Result |
|-----------------|---|
| default | user-changes |
| user-changes | Changes made to the terminal's default configuration by using Change Setup Parameters, Change Quick Setup, Change User Preferences or a TELNET connection (including the current contents of the auto-save file, if any) are written to the auto-save file. |
| all-changes | All changes made to the terminal's default configuration (including the current contents of the auto-save file and the initial configuration file downloaded by the terminal) are written to the auto-save file. |
| all-info | All read/write configuration parameters are written to the auto-save file. |

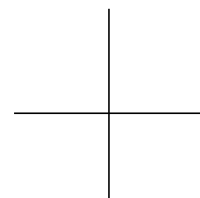

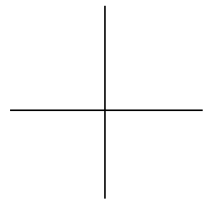

7 Bitmap Fonts and the Font Server

This chapter provides information about conventional bitmap font service and font servers. The following topics are covered in this chapter:

- ❑ “Font Use Overview” on page 7-1
- ❑ “Alternative Methods of Changing the Current Font Path” on page 7-11
- ❑ “Setting the Default Font” on page 7-13
- ❑ “Changing the Size of the Font Cache” on page 7-14
- ❑ “Renaming the Font Management Files” on page 7-15
- ❑ “Specifying Font Path Aliases” on page 7-16
- ❑ “Displaying and Logging Font Diagnostic Messages” on page 7-17
- ❑ “Getting Font Information” on page 7-17
- ❑ “Font Server Issues” on page 7-19

Font Use Overview

The X server depends on downloading fonts from hosts to satisfy most client font requests.

The X server locates fonts by searching the directories in its font path or handing off requests to font servers in its font path. The default font path directs the terminal to search the font directories supplied with the NCDware distribution.

After locating the requested font, the X server displays the requested characters in client windows.

Terminals also have built-in fonts to use with initial installation or to use with clients in case downloaded fonts are not available, and terminals have a default font for clients that do not request fonts.

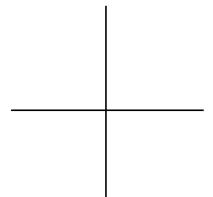

Font Access Sequence

An NCD terminal accesses fonts in the following order:

1. When the terminal is reset, it loads the built-in fonts and uses them for initial displays.
2. When a client requests a font, the X server checks terminal memory to see if the font is already in use by another client. If the font is in use, the X server uses the font in memory for the new font request.

If the font is not in use, the X server checks its font cache to see if the font was in use and was closed. A font is placed in the font cache after it is closed by the last client using it. If the font is in the cache, the X server retrieves it to satisfy the new font request.

If the font is not in use and not in the cache, the X server checks each element (font directory or font server) in its font path.

3. If the requested font is being handled by a font server, the X server hands off the font request to the font server. The font server creates a bitmap in the desired point size and resolution and returns it to the X server.
If the font is not being handled by a font server, the X server directly opens the font file and reads it over the network into terminal memory.
4. When the X server obtains a font, either through direct file access or from a font server, it displays the characters requested by the client on the screen.
5. If the server does not find the font requested by the client, the X server returns an error message to the client. Usually, the client requests another font. If not, you can arrange to provide another font through font aliasing.

Font Names

In the X Window System, fonts are named using the XLFD (X Logical Font Description) conventions. XLFD names supply information about the developer of the font, the font family, and various characteristics of the font, including size, weight, and dots per inch.

An XLFD name consists of 14 fields separated by hyphens. The fields in the following example font name are described in Table 7-1:

```
-adobe-courier-medium-r-normal--8-80-100-100-m-50-iso8859-1
```

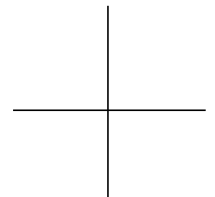
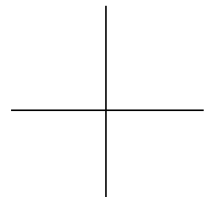

Table 7-1 XLFD Field Descriptions

| Field Name | Example | Description |
|------------------|------------|--|
| Foundry | adobe | Developer of the font, also called the foundry. |
| Family | courier | The font family, such as Courier, Helvetica, or Times. |
| Weight | medium | Weight, usually bold or medium. |
| Slant | r | Slant (i for italic, o or oblique, r for roman, ri for reverse italic, and ot for other). |
| Set-width | normal | Width of the characters: condensed, semi-condensed, narrow, normal, or double-wide. |
| Style | (not used) | Additional information to identify a font: i for informal, r for roman, serif for serif, and sans for sans serif. This field is rarely used; two hyphens are used as a place holder. |
| Pixel size | 8 | Height of the characters in pixels; a zero in this field means the font is a scalable font. |
| Point size | 80 | Height of the font in tenths of a point (decipoints); a zero in this field means the font is scalable. |
| Horizontal dpi | 100 | Horizontal resolution in dpi (dots per inch); a zero in this field indicates a scalable font. |
| Vertical dpi | 100 | Vertical resolution in dpi (dots per inch); a zero in this field indicates a scalable font. |
| Spacing | m | Convention for placing characters next to each other, such as m for monospaced, p for proportional, and c for character-cell monospaced. |
| Average width | 50 | Average width in tenths of a pixel; a zero in this field indicates a scalable font. |
| Charset registry | iso8859 | The organization or standard registering the character set, usually ISO 8859. |
| Charset encoding | 1 | The actual character set. iso8859-1 is ISO Latin-1, an ASCII character set that includes special European characters. |



Wildcards in Font Names

Any field in a font specification can be replaced by a wildcard, which is a special character that allows any font to match the property represented by a wildcard:

- ❑ The asterisk (*) wildcard replaces an entire field.
- ❑ The question mark wildcard (?) replaces any single character.

For example, the font name:

```
--fixed-bold-r-normal--13-120-*-*-*-*--*
```

matches these fonts:

```
-misc-fixed-bold-r-normal--13-120-75-75-c-70-iso8859-1  
-misc-fixed-bold-r-normal--13-120-75-75-c-80-iso8859-1
```

When searching for a font, the X server uses the first font it finds that meets all the criteria specified in the font name. If you use wildcards instead of specifying all properties, the X server uses the first font that matches the properties you specify.

Wildcards provide flexibility because a usable font can be substituted if the intended font is not found. A complete font name specification with no wildcards may cause a client to fail if the X server cannot find the font that exactly matches the specification.

Bitmap and Outline Font Naming

Bitmap font names differ from outline (scalable) font names in the amount of information specified. A bitmap font name has data in all fields. An outline font name has 0s (zeros) in all of the size fields: the size of the characters in pixels, the size in tenths of points, horizontal resolution, vertical resolution, and average width. Outline font names look similar to the following:

```
--courier-*-*--0-0-0-0-m-0-*--*
```

Specifying Fonts for Clients

You can specify fonts for a client as X resources or in the client's command line, with the `-fn` option. When specifying a font you must use the XLFD font name, with or without wildcards. The following examples show font specifications in a resource setting and in a command line:

```
xterm*boldfont: -adobe-courier-bold-r-normal--20-140-100-100-m-110-iso8859-1
```

7-4 Bitmap Fonts and the Font Server

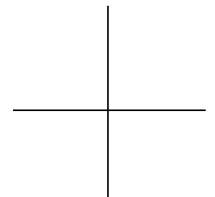

```
% xterm -fn -adobe-courier-bold-r-normal--20-140-100-100-m-110-iso8859-1
```

If you are using a font name with asterisks in a command line, the font name must be surrounded by single quotes to prevent the UNIX shell from interpreting the asterisks. For example:

```
% xterm -fn '-*-courier-bold-r-normal--20-140-*-*-*-*-*'
```

For outline fonts, you must provide a *well-formed* font name in the font specification. A well-formed font name contains all 14 hyphens specified in the XLFDF convention. Wildcards are permitted for any field. For example, this is not a well-formed name because it does not contain all 14 hyphens:

```
-*-helvetica-bold-o-*-*-120-*
```

This is a well-formed name:

```
-*-courier-*-*-0-0-0-0-m-0-*-*-*
```

Obtaining Fonts

The NCDware distribution includes the full set of fonts in the MIT X Window System distribution plus several outline fonts. If you installed fonts when you ran *ncdinstall*, you should have some or all of the following fonts installed:

- Fonts rendered for both 75- and 100-dpi (dots per inch) monitors
- Miscellaneous fonts
- DECwindows fonts
- Java and NCD Mosaic Browser fonts

You can obtain X fonts from vendors of the X Window System, from font vendors, and from the public domain. In addition, your host computers may already have fonts installed on them. Fonts must be in a format that the terminal can use. (See “Font Formats” on page 7-7.)

The NCDware distribution also includes outline, or scalable, fonts. For information about outline fonts, see “Usable Font Formats with a Font Server” on page 7-20.

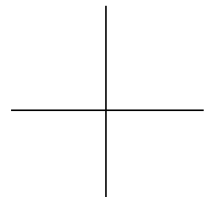

Font Download Methods

Fonts can be accessed from the network by using the file service and network protocols or by using one more font servers. If you are accessing fonts through the file service, you can use the following network protocols:

- ❑ TFTP (Trivial File Transfer Protocol), the default method
- ❑ NFS (Network File Service), usually faster than TFTP
- ❑ DAP (Data Access Protocol), used in DECnet networks only

By default, an NCD terminal searches for fonts on the boot host (the host from which the X server is downloaded). If you have set up initial file server hosts, the terminal also searches for fonts on the initial file servers.

Considerations in Using Downloaded Fonts

Font files require a lot of disk space, so make sure you install only the fonts you need. Fonts in the NCDware distribution may be duplicates of fonts already installed on network hosts.

Fonts can be installed on any computer on the network, and the fonts used by a given terminal can be distributed on several hosts.

The font path uses terminal memory so you should include in the font path only the directories required by clients you are running.

Problems with Client Font Requests

When a client requests a font that the X server cannot find, an error response is sent to the client. Usually, clients continue to run, using the X server's default font. Occasionally, a client crashes when requested fonts are not available.

Problems with client font requests can be overcome by changing the font path, using font aliasing, using X resources to change the fonts requested by the client, using wildcards in font requests, or installing the fonts needed by the client.

The Font Path

A terminal's font path is made up of two types of elements: font directories and font servers. An NCD terminal attempts to access only fonts represented by elements in its font path. The X server searches the font directories (and

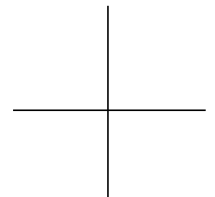

font servers) in the order in which they are listed in the font path and uses the first match it finds.

Fonts are usually stored in subdirectories of the `/usr/lib/X11/ncd/fonts` directory. The default font path for NCD terminals assumes all fonts are located in subdirectories of this directory.

Font Formats

The format of a font is revealed by its filename extension. The font formats a terminal can use depend on whether the terminal is using a host-based font server. For information about fonts you can use with the NCD font server, see “Usable Font Formats with a Font Server” on page 7-20.

Without a font server, NCD terminals use only bitmap fonts. NCD terminals use the bitmap formats listed in Table 7-2, in either uncompressed or compressed format.

Table 7-2 Usable Font Formats without a Font Server

| Font Format | Description | Filename Extension |
|------------------------------|---|--------------------|
| PCF (Portable Compiled Font) | The standard format for X11R5 and the format of fonts in the NCDware distribution. PCF files may be shared among machines with different architectures. | .pcf |
| SNF (Server Normal Font) | A server-dependent format. NCD X servers can still read the SNF fonts supplied on previous NCDware distributions. | .snf |
| DWF (DECWindows Format) | NCD terminals can read these fonts from VMS hosts. | .dwf |

Bitmap fonts are often distributed in BDF (Bitmap Distribution Format), the format used to exchange fonts between systems. BDF fonts are stored as ASCII text. If you are not using a font server, you must convert BDF fonts to a binary format, such as PCF or SNF, before the terminal can use them. A utility for converting BDF to PCF is included in the NCDware distribution. For information about conversion from BDF format, see “NCD Font Management Utilities” on page 7-10.

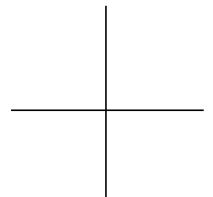

Font Directories and Files

Fonts are organized into font directories. Font directories contain font files and font management files. Font management files are used to locate font files.

Font Directories

Table 7-3 lists the bitmap font directories on the NCDware distribution and describes the fonts in each directory. When using TFTP to access fonts, font directories must be world-executable. When using NFS, permissions may differ. For more information about using TFTP and NFS, see Chapter 5, *Configuring Network Services*.

Table 7-3 Bitmap Font Directories

| Font Directory | Contents |
|---------------------|--|
| pcf/100dpi | Fonts for 100-dpi terminals |
| pcf/75dpi | Fonts for 85-dpi and 75-dpi terminals |
| pcf/Xol | Fonts from AT&T for OPEN LOOK clients |
| pcf/dw100dpi | Fonts for DECwindows applications on 100-dpi terminals |
| pcf/dw75dpi | Fonts for DECwindows applications on 85-dpi and 75-dpi terminals |
| pcf/misc | Miscellaneous fonts |
| pcf/Java | Fonts for Java |
| PEX | Fonts for PEX ¹ |

¹ PEX fonts are in a special PEX format.

Font Files

Font files are compiled in a specific format and must be world-readable. The name of a font file usually indicates the font family, weight, and size of the font and the font format. Font files supplied by NCD are compressed using 12-bit compression. If you add compressed font files, you must use 12-bit compression.

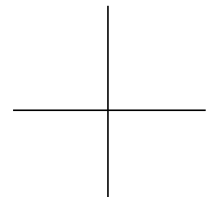

Font Management Files

Font management files enable the X server to locate font files.

The `fonts.dir` File

Each font directory contains a font directory management file called `fonts.dir`, which contains an entry for each font file in the directory. A `fonts.dir` file is required in every font directory for the X server to access any fonts in the directory. When searching for a font, the X server reads the `fonts.dir` files in the directories in the terminal's font path to find out where fonts are located. An example `fonts.dir` file follows.

200

```
courB008.snf      -adobe-courier-bold-o-normal--11-80-100-100-m-60-iso8859-1
courB010.snf     -adobe-courier-bold-o-normal--14-100-100-100-m-90-iso8859-1
courB012.snf     -adobe-courier-bold-o-normal--17-120-100-100-m-100-iso8859-1
courB014.snf     -adobe-courier-bold-o-normal--20-140-100-100-m-110-iso8859-1
courB018.snf     -adobe-courier-bold-o-normal--25-180-100-100-m-150-iso8859-1
courB024.snf     -adobe-courier-bold-o-normal--34-240-100-100-m-200-iso8859-1
```

The first line in the file lists how many bitmap fonts or outline fonts are described by the file. The rest of the file lists the filenames and XLFD names for all the files in the directory. The `.snf` filename extension shows the format in which the font is stored. For more information about font formats, see “Font Formats” on page 7-7.

The font directory management files in bitmap font directories are not designed to be edited by hand. Use the `ncdmkfontdir(1)` utility. Font management utilities are included on the NCDware distribution; their use is described in “NCD Font Management Utilities” on page 7-10.

The `fonts.alias` File

Applications sometimes request unavailable fonts. As a result, the application might use undesirable default fonts, crash, refuse to run, or run poorly. To avoid such problems, you can instruct the server to substitute a different font for the one requested by creating an entry in the font alias management file, called `fonts.alias`, in the font directory where the substitute font resides.

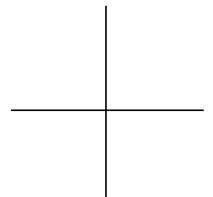

Entries in the font alias management file consist of the name used by the application in the font request and the XLFD description of the substitute font. A portion of an example `fonts.alias` file follows.

```
lucidasans-8 -b&h-lucida-medium-r-normal-sans-11-80-100-100-p-63-iso8859-1
lucidasans-10 -b&h-lucida-medium-r-normal-sans-14-100-100-100-p-80-iso8859-1
lucidasans-12 -b&h-lucida-medium-r-normal-sans-17-120-100-100-p-96-iso8859-1
lucidasans-14 -b&h-lucida-medium-r-normal-sans-20-140-100-100-p-114-iso8859-1
lucidasans-18 -b&h-lucida-medium-r-normal-sans-25-180-100-100-p-142-iso8859-1
lucidasans-24 -b&h-lucida-medium-r-normal-sans-34-240-100-100-p-191-iso8859-1
fixed -misc-fixed-medium-r-semicondensed--13-120-100-100-c-60-iso8859-1
variable -*-helvetica-bold-r-normal-*-*120-*-*-*-*-*
5x8 -misc-fixed-medium-r-normal--8-80-100-100-50-iso8859-1
6x9 -misc-fixed-medium-r-normal--9-90-100-100-c-50-iso8859-1
6x10 -misc-fixed-medium-r-normal--10-100-100-100-c-50-iso8859-1
6x13bold -misc-fixed-bold-r-semicondensed--13-120-100-100-c-50-iso8859-1
```

The first font specification on a line is the unavailable font, and the second is the substitute font. When both font names are too long for one line, the line automatically wraps to the next line.

As illustrated in the example file, you can specify a variety of font names, including names that were used with Releases 1 and 2 of the X11 server (the last six entries).

NCD Font Management Utilities

The following font utilities are installed by *ncdinstall* in `/usr/bin/X11`:

- ❑ *ncdbdftopcf*—Converts fonts from BDF to PCF. For syntax and usage, see the *ncdbdftopcf* (1) man page.
- ❑ *ncdmkfontdir*—Creates a `fonts.dir` file from a directory of font files. For syntax and usage see the *ncdmkfontdir* (1) man page.

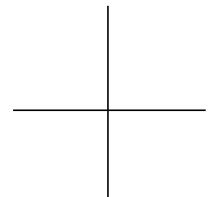

Built-In Fonts Summary

HMX series and Explora series terminals have the following built-in fonts:

10x20.snf
6x10.snf
6x13.snf
8x13.snf
9x15.snf
cursor.snf
helvB10.snf
helvB12.snf
term14.snf

If the terminal is licensed for PEX, the **roman.phont** and **roman_m.phont** built-in fonts are also available.

Alternative Methods of Changing the Current Font Path

The *NCDware System Administrator's Guide for Unix Systems* describes using the **pref-font-path** parameter in a remote configuration file or the Console (Setup ⇒ Change User Preferences ⇒ Fonts ⇒ Current Font Path) to set the current font path. This section describes two additional methods.

Changing the Current Font Path—Using TELNET

You can modify the current font path through TELNET terminal emulation or using TELNET from a host. You can modify the font path of the terminal you are using or a remote terminal.

This method requires the User Preferences daemon read/write password or the Configuration daemon read/write password.

Complete the following steps to modify the current font path using TELNET:

1. Start a TELNET session using one of the following methods:

- Start the NCD Terminal Emulator (Terminals ⇒ New Telnet).

In the `Host` field of the Terminal Emulator window, type the name (or IP address) of the terminal to be configured and the port (5997 is the User Preferences daemon port number and 5999 is the Configuration daemon port number):

```
ncdu10 5997
```

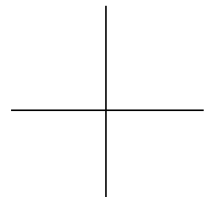

Alternative Methods of Changing the Current Font Path

```
ncdu10 5999
```

Click on **OK**.

- On a host computer, type a TELNET command similar to the following (5997 is the User Preferences daemon port number, and 5999 is the Configuration daemon port number):

```
% telnet ncdu10 5997
```

```
% telnet ncdu10 5999
```

2. After the `password:` prompt, enter the read/write password for the relevant daemon.
3. After the TELNET prompt (`>`), enter the command to modify the **pref-font-path** parameter (not saved in NVRAM). For example:

```
> pref-font-path = {  
  { built-ins }  
  { tcp/mohawk:7000 }  
}
```

Table 7-4 pref-font-path Parameter

| Table Entry | Possible Values | Results |
|-----------------|-----------------|---|
| font-path-entry | default | The same as the font path defined in the xserver-default-font-path table. |
| | font path | A specified font path that may include font servers as well as font directories and built-in fonts. |

4. Enter the **apply** command to put the new current font path into effect:

```
> apply
```
5. Enter a **quit** command to exit from the Terminal Emulator or the TELNET application:

```
> quit
```

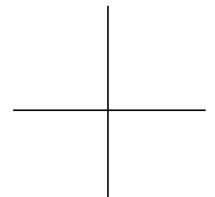

Changing the Current Font Path—Using the xset Client

To modify the current font path using the *xset* client, enter one of the following commands:

Table 7-5 Setting the Current Font Path—*xset* Commands

| Command | Result |
|--|---|
| <code>xset +fp <i>directory</i></code> | Prefixes <i>directory</i> to the font path |
| <code>xset fp+ <i>directory</i></code> | Appends <i>directory</i> to the font path |
| <code>xset -fp <i>directory</i></code> | Deletes <i>directory</i> from the font path |

Setting the Default Font

If a client does not request any fonts, the X server uses its default font. If you do not explicitly set the default font, the X server uses the 10x20 built-in font for HMX series and Explora series terminals.

To change the default font, specify the font name in the **xserver-default-font** parameter (Setup ⇒ Change Setup Parameters ⇒ Fonts ⇒ Default Font).

Table 7-6 xserver-default-font Parameter

| Possible Values | Result |
|------------------|---------------------------|
| default | 10x20 |
| <i>font name</i> | Name of the default font. |

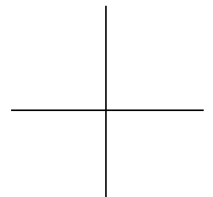

Changing the Size of the Font Cache

Instead of downloading a font each time it is requested by a client, the X server attempts to temporarily store the font in the portion of memory called the font cache. Font caching improves the performance of clients that use large numbers of fonts.

After a font is closed by the last client using it, the font is added to the font cache instead of being freed. When the font is requested again, it is taken from the cache instead of being read from a host.

The font cache is flushed when the X server is reset and when the font path is changed. When the font cache is full, the oldest resident font is replaced with the latest font being inserted into the cache. If the server runs low on memory, it will start reclaiming memory from the cache.

To change the size of the font cache, specify the size (in bytes) in the **xserver-font-cache-max-size** parameter (Setup ⇒ Change Setup Parameters ⇒ Fonts ⇒ Font Cache Maximum Size). The new font cache size takes effect immediately after an **apply** command is entered.

Table 7-7 xserver-font-cache-max-size Parameter

| Possible Values | Result |
|-----------------|---|
| default | 100000 |
| <i>integer</i> | Up to the specified number of bytes are used for caching fonts. Range: 0 - 4294967295. |

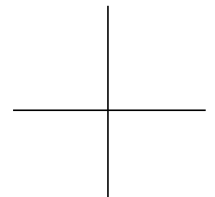

Renaming the Font Management Files

To change the name of the **fonts.dir** file, use the **xserver-font-directory-file-name** parameter to specify the new filename, then rename or copy the **fonts.dir** file to the desired name (Setup ⇒ Change Setup Parameters ⇒ Fonts ⇒ Font Directory File Name).

Table 7-8 xserver-font-directory-file-name Parameter

| Possible Values | Result |
|-----------------|--|
| default | fonts.dir |
| <i>filename</i> | The X server uses the specified filename when attempting to locate the font directory management file. |

To change the name of the **fonts.alias** file, use the **xserver-font-alias-file-name** parameter to specify the new filename, then rename or copy the **fonts.alias** file to the desired name (Setup ⇒ Change Setup Parameters ⇒ Fonts ⇒ Font Alias File Name).

Table 7-9 xserver-font-alias-file-name Parameter

| Possible Values | Result |
|-----------------|--|
| default | fonts.alias |
| <i>filename</i> | The X server uses the specified filename when attempting to locate the font alias management file. |

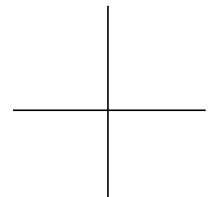

Specifying Font Path Aliases

You can use font path aliases to create simple names for complex font directory names or font server specifications. You can use such names, for example, in the configuration parameters used to set the font path. To create font aliases, enter the aliases and font directory names or font server specifications into the `xserver-font-path-alias-table` (Setup ⇒ Change Setup Parameters ⇒ Fonts ⇒ Font Name Table).

If you use font path aliases in a remote configuration file, define the aliases and include an `apply` command before defining the font path.

Table 7-10 `xserver-font-path-alias-table` Parameter

| Table Entry | Possible Values | Result |
|-----------------|--|--|
| font-path-alias | <i>alias</i> | The alias to be mapped to a font directory or a font server specification. |
| font-path-value | <i>directory</i> or <i>font server</i> | Font directory name or font server specification. |

The following is an example font alias table:

```
xserver-font-path-alias-table = {  
    { misc /usr/lib/X11/fonts/misc }  
    { xview /usr/lib/X11/fonts/xview }  
    { 75dpi /usr/lib/X11/ncd/fonts/75dpi }  
    { 100dpi /usr/lib/X11/ncd/fonts/100dpi }  
    { falcon-fonts tcp/falcon:7000 }  
}
```

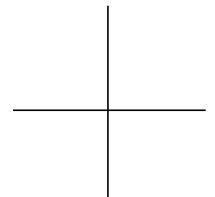

Displaying and Logging Font Diagnostic Messages

Font diagnostic messages report all font actions that require file system or network access. By default, these messages are not displayed in the Console Messages area or logged to the diagnostics log file.

There is no default diagnostics log file. You must set up the file before any messages can be logged. For more information about setting up a diagnostics log file, see Chapter 18, X Server Messages.

To display (and log) font diagnostic messages, set the **pref-font-extended-diagnostics** parameter to “true” (Setup ⇒ Change User Preferences ⇒ Fonts ⇒ Show Extended Font Diagnostics).

Table 7-11 **pref-font-extended-diagnostics** Parameter

| Possible Values | Result |
|-----------------|--|
| default | false |
| false | Font diagnostic messages are not reported in the Console Messages hide box or logged to a diagnostics log file. |
| true | Font diagnostic messages are reported in the Console Messages hide box and logged to a diagnostics log file, if you have set up such a file. |

Getting Font Information

The following X clients, available in the public domain, display information about the font path and fonts:

- ❑ **xset(1)**—displays information about the current font path
- ❑ **xlsfonts(1)**—lists the fonts known to the X server
- ❑ **xfd(1)**—displays the characters in a font
- ❑ **xfontsel(1)**—displays samples of a font

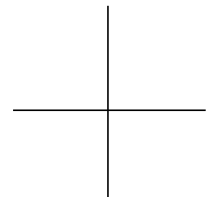

Viewing the Font Path—`xset`

The `xset` command displays the font path and other current server settings.

```
# xset q
.
.
.
Font Path:
  built-ins,/usr/lib/X11/ncd/fonts/pcf/misc/,/usr/
  lib/X11/ncd/fonts/pcf/dw100dpi/,/usr/lib/X11/ncd/
  fonts/pcf/100dpi/,/usr/lib/X11/ncd/fonts/pcf/dw75dpi/,
  /usr/lib/X11/ncd/fonts/pcf/75dpi/
```

Listing the Available Fonts—`xlsfonts`

The `xlsfonts(1)` command lists the fonts currently available to the X server. It has many options for narrowing the search, but its basic form lists the names of all fonts known to the X server:

```
# xlsfonts
```

When run with the argument `-fn pattern`, `xlsfonts` lists only fonts that match *pattern*. The *pattern* may include the wildcard characters `*` (matches any sequence of characters) and `?` (matches any single character). Quote these characters to prevent the shell from expanding them. For example, the following command lists all fonts with names that include the word *helvetica*:

```
# xlsfonts -fn '*helvetica*'
```

Displaying the Characters in a Font—`xfd`

The `xfd(1)` command displays all the characters in a font; its basic syntax is:

```
xfd -fn font_name
```

For example, the following command displays all the characters in the 6x13 font:

```
% xfd -fn 6x13
```

The font specification can include wildcard characters as shown in the example above for `xlsfonts`.

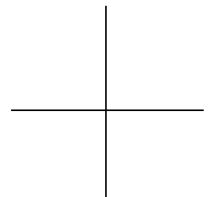

Displaying Samples of a Font and XLFD Names—`xfontsel`

The `xfontsel`(1) client displays the fonts known to the X server, allows you to examine samples of a font, and shows the XLFD name for a font. The command's basic syntax is:

```
xfontsel -pattern font_specification
```

The font specification may include wildcard characters. For example, the following command displays a window in which you can select samples of various bold fonts:

```
% xfontsel -pattern '*bold*'
```

Font Server Issues

This section describes font server usage:

- Font server overview
- Font server configuration issues
- Terminal configuration parameters for font server use
- Utilities for displaying information about the font server and outline fonts

The NCD font server is host-based software that provides fonts to X servers. The font server provides access to more fonts than the X server and decreases the time it takes the X server to display fonts.

The font server was designed at NCD for the X Consortium to simplify font management and to support use of scalable outline fonts. The NCD font server adds functionality to the X Consortium's Sample Implementation and includes enhancements for X11R6.

How the Font Server Accesses Fonts

When an application requests a font, the X server examines its font path to determine where it should look for the font. When the font server is included in the X server's font path, the X server sends the request to the font server. If the font needs scaling, the font server applies the appropriate scaling algorithm and sends the scaled bitmap to the X server.

Using a font server allows the X server to perform other operations while the font server locates, parses, and scales fonts, and then returns the requested bitmaps to the X server. When the X server receives the requested font, it loads

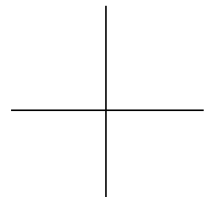

the font into its internal database, making the font available to the client. To the X server, the font server is simply an element in its font path. (See Figure 7-1.)

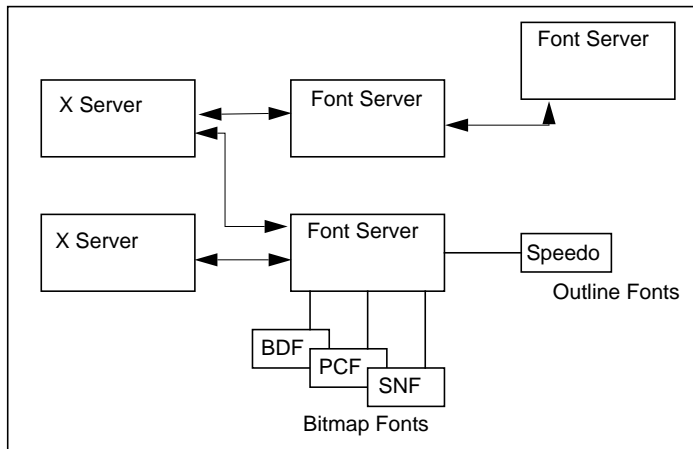

Figure 7-1 Font Server Architecture

The font server can be configured to forward requests that it cannot fulfill to an alternate font server. Such daisy-chained font servers are useful for load sharing and to widen the range of font sources. The font server includes a security feature for limiting the X servers permitted to access fonts.

Usable Font Formats with a Font Server

With a font server, NCD terminals can use the following fonts:

- ❑ Outline fonts:
 - IBM Type 1 (Adobe)
 - Bitstream Speedo
- ❑ Bitmap fonts:
 - NCD SNF (Server Normal Format)
 - PCF (Portable Compiled Format)
 - BDF (Bitmap Distribution Format)
 - DWF (DECwindows Format)
 - HP SNF (Hewlett-Packard SNF)

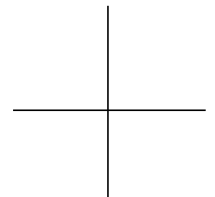

- IBM SNF (International Business Machine SNF)
- DEC SNF (Digital Equipment Corp. SNF)
- SCO SNF (Santa Cruz Operation SNF)
- Sun SNF (not OpenWindows FB fonts)

Bitstream Speedo outline and IBM Type 1 (Adobe) outline formats describe fonts as mathematical algorithms rather than as individual pixels. Consequently, they can be resized by applying the same algorithm on a different scale. The resulting font display is smooth, regardless of point size or resolution.

Outline fonts are in the `/usr/lib/X11/ncd/fonts/Speedo` and `/usr/lib/X11/ncd/fonts/Type1` directories.

Although the ability to use various SNF formats is part of the NCD font server, using SNF font formats from HP, IBM, SCO, and DEC is not part of the X Consortium's Sample Implementation.

The font server can read either compressed or uncompressed font files.

Font Server Configuration Issues

The basic procedures for configuring and starting the font server are described in the *NCDware System Administrator's Guide*.

This section provides more information about some of the font server configuration parameters and includes a sample font server configuration file.

Network Considerations

By distributing NCD font servers on different hosts on the network, system administrators can ensure reliable access to fonts and decrease dependence on any single host. In the font server configuration file, the `alternate-servers` parameter specifies alternate font servers to be tried if the connection to the current font server is lost.

Host Considerations

The following aspects of configuration on the host are addressed in the font server configuration file.

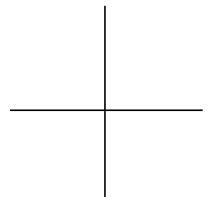

Font Access

The font server must be installed on each host from which fonts are to be accessed and the fonts must be in a format that the font server can read (see “Usable Font Formats with a Font Server” on page 7-20).

For the font server to access the fonts, the font directories must be listed in the font server configuration file under the **catalogue** parameter. The font server accesses the font directories in the order in which they are listed in this parameter.

Host Load

Two font server configuration parameters control the load on each font server and specify how the font server responds to occurrences of imminent overloading. The **client-limit** parameter specifies how many clients can access the font server concurrently before it refuses access. The **clone-self** parameter specifies whether the font server can clone itself, thereby spreading the load over more than one process, when it reaches the limit specified in **client-limit**.

The font server uses a cache to store recently requested fonts. Use of a cache decreases the time needed to access and display fonts. Fonts held in cache are available immediately for use; they do not have to be read from a file or rescaled. The size of the cache used depends on the memory available on the host and is specified (in bytes) using the font server configuration parameter **cache-size**.

Client Connection

On TCP/IP networks, the system administrator or system manager also specifies the TCP port number on which the font server listens for client (X server and host) connections. The font server parameter **port** specifies the port number.

Security

Client access to the font server can be controlled by using a font server parameter called **trusted-clients**. By default, the font server allows any client (X server or host) to connect to it and access fonts. Listing names of clients under the font server **trusted-clients** parameter limits font server access to only those clients.

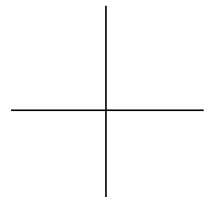

Default Font Specifications

Two font server configuration parameters set defaults for cases in which the point size or resolution (dpi) are not specified. A default point size is set in tenths of a point (sometimes called decipoints) in the **default-point-size** parameter. Supported default resolutions are listed under the **default-resolutions** parameter.

Error Logging

To assist in troubleshooting, you can specify a method for logging errors using two font server configuration parameters. The **error-method** parameter specifies a method of error logging. The permitted methods are:

- Using standard error reporting practices (**stderr**)
- Logging to a named file (the font server parameter **error-file**, described later, specifies the name of a file to which error messages should be logged)
- Using UNIX *syslog* (3)
- No logging

The **error-file** parameter specifies a name of a file for logging error messages when the error handling method (specified using **error-method**) is set to “file.”

Example NCD Font Server Configuration File

Font server configuration data is stored in a font server configuration file called **config** in the directory **/usr/lib/X11/ncd/fs**. All of the parameters that make up the font server configuration file are described in the *NCDware System Administrator's Guide for UNIX Systems*.

The following sample font server configuration file includes values for every font server parameter. The NCDware distribution also contains a sample font server configuration file.

```
# Sample Font Server Configuration File/UNIX Hosts

# The size in bytes of the font server cache.
cache-size = 2000000

# Directories searched for fonts. The first is an SNF font. The second is a
# set of Speedo outlines, the third is a set of misc bitmaps and the last is a
# set of 100dpi bitmaps.
```

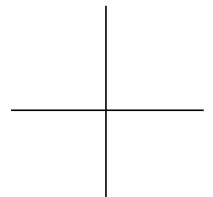

Font Server Issues

```
catalogue = ibm:/usr/lib/X11/ncd/fonts/aix/100dpi,  
            /usr/lib/fonts/speedo,  
            /usr/lib/X11/ncd/fonts/misc,  
            /usr/lib/X11/ncd/fonts/100dpi/  
  
# Names of alternate font servers for clients to use.  
alternate-servers = tcp/green:7001,tcp/green:7002  
  
# Allow a maximum of 10 clients to connect to this font server.  
client-limit = 10  
  
# When this font server reaches its client limit, start up a new one.  
clone-self = on  
  
# The default point size to be used when a font name does not specify point  
# size. The unit of measurement is decipoints.  
default-point-size = 120  
  
# The default resolutions to be used when a font name does not specify  
# resolution. The resolutions specified are 100 x 100 and 75 x 75  
default-resolutions = 100,100,75, 75  
  
# The file to be used for logging errors when "file" is specified.  
error-file = /var/log/fs  
  
# The method of error logging to be used. Possible values are none, file,  
# syslog, opcom, and off.  
error-method = file  
  
# The port number on which the font server listens for connections.  
port = 7001  
  
# The font server should not scale bitmaps.  
scaled-bitmaps = false  
  
# The SNF format is read as NCD SNF (msb, msb, 4, 4).  
snf-format = msb,msb,4,4  
  
# The clients from which the font server accepts connections.  
trusted-clients = green, expo.lcs.mit.edu, focus16
```

7-24 Bitmap Fonts and the Font Server

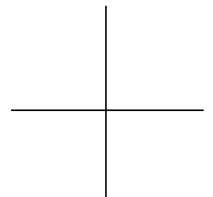

Configuring Font Server Timeouts

The parameters `xserver-fontserver-open-timeout` and `xserver-fontserver-reopen-timeout` control how long the terminal tries to contact a font server (Setup ⇒ Change Setup Parameters ⇒ Fonts [Font Server section] ⇒ Open Timeout, Reopen Timeout).

Table 7-12 `xserver-fontserver-open-timeout` Parameter

| Possible Values | Result |
|-----------------|---|
| default | 30 |
| 30 | The terminal tries to connect to a font server for 30 seconds before failing. |
| <i>integer</i> | How long (in seconds) that the terminal tries to connect to a font server before failing. Range: 0 - 100. |

Table 7-13 `xserver-fontserver-reopen-timeout` Parameter

| Possible Values | Result |
|-----------------|---|
| default | 10 |
| 10 | After a font server fails, the terminal tries for 10 seconds to reopen it before timing out. |
| <i>integer</i> | How long (seconds) the terminal attempts to reopen a font server after a failure before timing out. Range: 0 - 100. |

The `xserver-fontserver-read-timeout` and `xserver-fontserver-retry-attempts` parameters control how long the font server tries to obtain fonts (Setup ⇒ Change Setup Parameters ⇒ Fonts [Font Server section] ⇒ Read Timeout, Reconnect attempts before failure).

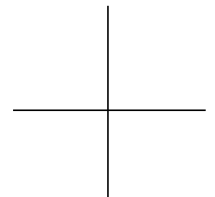

Table 7-14 xserver-fontserver-read-timeout Parameter

| Possible Values | Result |
|-----------------|--|
| default | 20 |
| 20 | The terminal waits 20 seconds to obtain a font from a font server before failing. |
| <i>integer</i> | How long (in seconds) the terminal waits to obtain a font from a font server before failing. Range: 0 - 100. |

Table 7-15 xserver-fontserver-retry-attempts Parameter

| Possible Values | Result |
|-----------------|---|
| default | 5 |
| 5 | The terminal makes five attempts to obtain a font from a font server before giving up. |
| <i>integer</i> | How many attempts the terminal makes to obtain a font from a font server before giving up. Range: 0 - 25. |

Getting Information about the Font Server

The *ncdfsinfo* font server information utility displays information about the font server, including the name of the host and the font server version number, the maximum request size in longwords and bytes, the number and names of catalogues, the number and names of alternate servers, and the number of extensions.

The *ncdfsinfo* utility syntax is:

```
ncdfsinfo [-server font-server ]
```

If you use the *-server* flag, use the syntax `tcp/host:port` for *font-server*, where *host* is the network name or IP address of the host on which the font server resides and *port* is the TCP port on which the font server listens for connections.

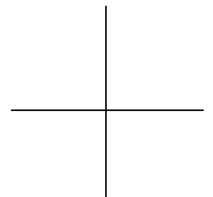

You must set the **FONTSERVER** environment variable to specify the default font server in use for the **ncdfsinfo** utility. Use the syntax described in the preceding paragraph for the **font-server** variable to define the **FONTSERVER** variable.

For more information about **ncdfsinfo**, see the **ncdfsinfo** man page.

Getting Information about Fonts from the Font Server

The **ncdfslsfonts** font information utility lists the fonts available on the font server. You can request a subset of the available fonts by defining a pattern for the utility to match. Additional options specify the name of the font server you wish to query, the level of detail you want in the listing, and the format of the output.

The syntax of the **ncdfslsfonts** utility is:

```
ncdfslsfonts [-options . . .] [-fn pattern ]
```

In specifying a subset of fonts, you can use the * wildcard character to match any sequence of characters (or none) and ? to match a single occurrence of any character. You must put quotation marks around the wildcard characters to prevent them from being expanded by the shell. For detailed information about **ncdfslsfonts**, see the **ncdfslsfonts** man page.

Displaying Font Server Fonts

Two NCD utilities provide ways to examine font server fonts.

The **ncdshowfont** utility reports information about a font and displays a representation of each character in the font. When specifying a font, you can use the asterisk (*) and question mark (?) as wildcard characters. The asterisk matches any sequence of characters; the question mark matches any single character. The wildcard characters must be enclosed in double quote marks.

The syntax for **ncdshowfont** is:

```
ncdshowfont [-options] [-fn font]
```

where **options** are any of the options listed in the **ncdshowfont** man page, and **font** is the XLFD name of the font you want to examine.

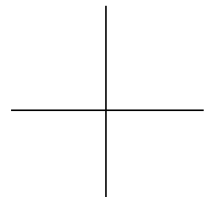

The *ncdfstobdf* utility reads a font from a font server and displays the contents of the font file in BDF format. This allows you to recreate a font and is useful when testing servers, debugging font metrics, and reproducing lost BDF fonts.

The syntax for *ncdfstobdf* is:

```
ncdfstobdf -fn font [-server font_server]
```

where *font* is the XLFd name of the font you want to display, and *font_server* is the host on which the font server resides and the TCP port on which the font server listens for connections. Specify *font_server* as `tcp/host:port`.

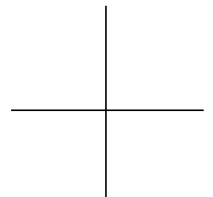

8 Login and X Session Management

This chapter describes the X Display Manager (XDM), which supplies login and session management services.

The following topics are covered in this chapter:

- ❑ “XDM Default Actions” on page 8-2
- ❑ “XDM Overview” on page 8-3
- ❑ “Configuring XDM Hosts” on page 8-5
- ❑ “Starting XDM Manually” on page 8-15
- ❑ “XDM Access Control” on page 8-15
- ❑ “Configuring Terminals for XDM” on page 8-17
- ❑ “Using XDM—X11R3 Version” on page 8-19

The *NCDware System Administrator’s Guide for UNIX Systems* describes the basic usage and configuration of XDM.

The NCD Display Manager is described in the *System Administrator’s Guide*.

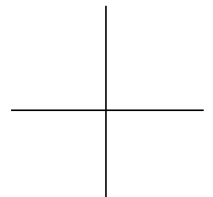

XDM Default Actions

Table 8-1 lists the default XDM actions, the alternatives, and references for more information.

Table 8-1 Summary of XDM Defaults and Alternatives

| Default | Alternative | References |
|--|---|--|
| After booting, the terminal broadcasts an XDM query to the network. | Use direct queries to one or more hosts or use indirect queries. | <i>System Administrator's Guide</i> |
| The terminal displays a login banner for the user to log into the boot host if you use <i>ncdinstall</i> . If you do not use <i>ncdinstall</i> , a Login Chooser is displayed, offering the hosts that responded to the XDM query. | Disable the login chooser. | <i>System Administrator's Guide</i> |
| | Disable indirect or broadcast queries. | <i>System Administrator's Guide</i> |
| | Configure the terminal to send direct or indirect queries. | <i>System Administrator's Guide</i> |
| | Configure the Xaccess file to customize the host's response to indirect queries. | "Configuring the XDM Xaccess File" on page 8-11 |
| | Instead of using XDM, users log in through the NCD Terminal Emulator. | <i>System Administrator's Guide</i> |
| The user is not restricted to the hosts listed in the Login Chooser. | The user is not permitted to log into a host that is not listed in the Login Chooser. | <i>System Administrator's Guide</i> |
| Clients that run before the user logs in (such as the login box) have default characteristics. | Customize client X resources using the Xresources file. | "Configuring the XDM Xresources File" on page 8-14 |

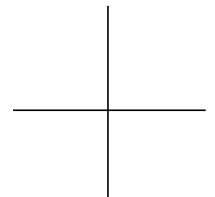

Table 8-1 Summary of XDM Defaults and Alternatives (Continued)

| Default | Alternative | References |
|--|---|--|
| The default system-wide Xsession file sets up the default X session and looks for an individual startup script (.xsession file) in the user's home directory. | Set up individual startup scripts for customizing user sessions. | <i>System Administrator's Guide</i> |
| | Customize the system-wide Xsession file. | <i>System Administrator's Guide</i> "Configuring the System-Wide XDM Session Management File" on page 8-7 |
| XDM sets the terminal's DISPLAY variable. | None. | |
| When the XDM session ends, a dialog box is displayed giving the user choices about how to proceed. | Configure the terminal's behavior when the session ends and the user is logged out. | <i>System Administrator's Guide</i> "Configuring Terminals for XDM" on page 8-17 |
| XDM parameters that control timeouts and keepalives have their default values. | Customize timeouts and keepalives. | <i>System Administrator's Guide</i> "Configuring Terminals for XDM" on page 8-17 |
| Access control is not enforced. Users can run clients from unauthorized hosts on the terminal. | Configure access control on hosts and on the terminal. | <i>System Administrator's Guide</i> "XDM Access Control" on page 8-15 |

XDM Overview

By default, **ncdinstall** checks for the presence of XDM software on the boot host. If XDM is not running, **ncdinstall** can install or enable it.

XDM runs on login hosts and terminals and manages the user's X session from login to logout. XDM can be configured to start clients automatically. When the user logs out, XDM resets the terminal for the next session. The following subsections describe XDM in more detail.

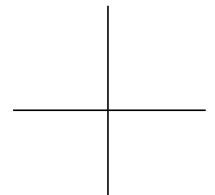

For hosts or networks on which XDM is not available, users can log in through the NCD Terminal Emulator (*ncdterm*). Using the NCD Terminal Emulator to log in is described in the *NCDware User's Guide*, and managing the terminal emulator is described in the *NCDware System Administrator's Guide for UNIX Systems*. Advanced configuration and management of the NCD Terminal Emulator are described in this manual in Chapter 12, Configuring the NCD Terminal Emulator.

Components of XDM

XDM consists of both host and terminal software:

- ❑ Hosts (called managers) that run the *xdm* daemon and offer login services
 - ❑ NCD terminals that run XDMCP (X Display Management Control Protocol)
- Terminals send XDMCP queries requesting display management, and hosts respond to terminal queries.

On XDM manager hosts, configuration files control how XDM works. The X11R5 and X11R6 versions of XDM provide the *chooser* program, which can be configured to display a choice of login hosts on the terminal.

XDMCP Queries and Host Responses

An NCD terminal can send three different types of queries. Depending upon the type of query and the host and terminal configuration, either a login banner or a Login Chooser appears on the terminal.

The three types of terminal queries are:

- ❑ Broadcast query—the terminal sends a general query to the network for any host running XDM to answer
- ❑ Direct query—the terminal requests connection to a specific host
- ❑ Indirect query—the terminal requests connection to a specific host; this host may forward the request to another host, answer the request, or offer a list of hosts

Configuring terminal queries is described in the *NCDware System Administrator's Guide for UNIX Systems*.

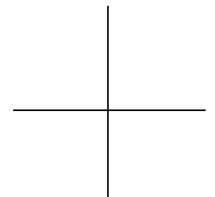

XDM and the DISPLAY Variable

The *DISPLAY* environment variable identifies the terminal on which clients display their windows and must be available to all clients when they start. This variable is set automatically by XDM for clients started on the login host. You must, however, specify the *DISPLAY* variable for clients started on other hosts.

The NCD Login Chooser

The Login Chooser is an NCD local client (**login**). Using the **login** client, you can configure the terminal to offer a choice of login hosts to the user. After the user selects a host, the host displays a login banner, which requests the user's account name and password. You can also configure the terminal so the host displays a login banner immediately and does not offer a choice of hosts.

The NCD Display Manager

The NCD Display Manager (*ncddm*) works with XDM to provide environment variables to local clients that require this information. The environment variables set are the username, the user's home directory, and the UID and GID. The Display Manager is installed by *ncdinstall*; the terminal must be configured to use the Display Manager. For information on the Display Manager, see the *System Administrator's Guide*.

Configuring XDM Hosts

This section summarizes the configuration requirements of X11R4, X11R5, and X11R6 XDM on manager hosts. For more detailed information, see the *X Window System Administrator's Guide* from O'Reilly and Associates. For information about X11R3 XDM, see "Using XDM—X11R3 Version" on page 8-19.

All manager hosts require:

- XDM configuration files installed. Installing XDM binaries and configuration files is an *ncdinstall* option, so you may have already installed the files. If you are already using XDM or you have installed files from other sources, you do not need to reinstall them.
- A system-wide session management file

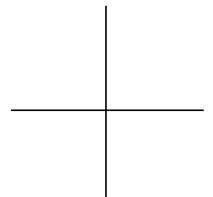

- ❑ An operating XDM daemon. System files should be configured to start the daemon automatically when the host reboots

The following are optional on manager hosts:

- ❑ Customized XDM configuration files
- ❑ Access control to authorize clients to connect to the terminal
- ❑ Individual session management files for users

Installing the XDM Binary File

The *xdm*(1) program binary is installed in the `/usr/bin/X11` directory and must be installed on each XDM manager host.

Installing XDM Configuration Files

XDM binaries and configuration files must be installed on each XDM manager host. Configuration files are installed in the `/usr/lib/X11/xdm` directory.

Table 8-2 lists the files on the NCDware distribution, along with the function of each file and whether it is required.

Table 8-2 XDM Binary and Configuration Files

| File Name | Function | Optional or Required |
|-------------------|--|--|
| <i>xdm</i> | Host software | Required |
| <i>Xsession</i> | Startup script used by all terminals to manage the X session | Required for all versions of XDM |
| <i>.xsession</i> | Startup script for an individual user | Optional |
| <i>xdm-config</i> | Resources for XDM, some of which are pointers to the other configuration files in this table | Required for all versions of XDM |
| <i>Xaccess</i> | Controls how XDM responds to the different types of queries from the terminal and implements the Login Chooser | Required for X11R5 and X11R6 <i>xdm</i> only |
| <i>Xresources</i> | Resources that specify the characteristics of the login banner and Login Chooser | Required for all versions of XDM |
| <i>Xstartup</i> | A script that runs before starting user sessions | Optional |

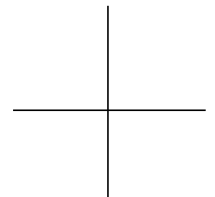

Table 8-2 XDM Binary and Configuration Files (Continued)

| File Name | Function | Optional or Required |
|-----------------|--|----------------------|
| Xreset | A script that runs before ending user sessions | Optional |
| Xservers | A list of terminals to be managed by XDM | X11R3 XDM only |

Configuring the System-Wide XDM Session Management File

This section describes the system-wide **Xsession** file, which typically performs the following functions:

- ❑ Establishes a default X session for all users who log into the host where the file is installed
- ❑ Checks for **.xsession** files in user home directories, in case the user prefers an individual X session
 - If **.xsession** files are present, the **Xsession** file executes them
 - If **.xsession** files are not present, the **Xsession** file defines the user's session

For information about **.xsession** files, see the *NCDware System Administrator's Guide for UNIX Systems*.

- ❑ Invokes **xrdb(1)** to load client resources into the X server, where they are available for all clients. If you do not use **xrdb** to load resources and you have not cross-mounted user home directories, then users must have separate resource files (such as **.Xdefaults**) in their home directory on each host.

You must use **xrdb** to load resources for NCD local clients into the X server; local clients do not read resource files.

- ❑ Starts the initial clients, including a window manager.

If you want to edit the default **Xsession** file:

1. Make sure the file permissions are correct. The **Xsession** file must be world-executable.
2. Edit the file, if necessary, following these general rules for **Xsession** files:
 - Clients that must take effect before starting subsequent clients are executed in the foreground. For example, clients such as **xrdb**, **xset**, and

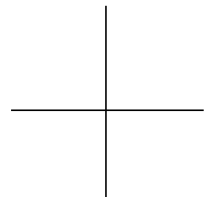

xmodmap run in the foreground because subsequent clients may need the output of these programs.

- All other clients are executed in the background.
- The last client executes in the foreground, the script exits, and the user is logged out.

In NCDware, users can log out by using the Logout utility in the Console menu. If you do not want to use the Logout utility, you can use the logout method described in “The Default Xsession File” on page 8-8.

Note If your **Xsession** file does not execute properly, you may not be able to log in through XDM. You must log in through the NCD Terminal Emulator. For more information about XDM troubleshooting, see the *NCDware System Administrator’s Guide for UNIX Systems*.

The Default Xsession File

The default **Xsession** file included on the NCDware distribution follows. Note that:

- The file is executed by the Bourne shell.
- The file must be world-executable.
- The if-then-else clause attempts to run a **.xsession** file in the user’s home directory; if no **.xsession** file is found, the remaining commands in the **Xsession** file are executed.
- The file starts the *twm* window manager and an *xterm* window on the login host.
- The last client runs in the foreground; when the user exits from this *xterm*, the X session ends and the user is logged out.
- Using **exec** to start clients saves a process slot on the host.

```
#!/bin/sh
# Xsession
if [ -f $HOME/.xsession ]; then
    if [ -x $HOME/.xsession ]; then
        exec $HOME/.xsession
    else
        exec /bin/sh $HOME/.xsession
    fi
fi
```

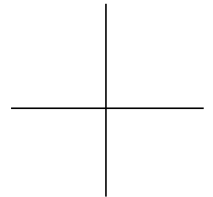

```

else
    twm &
    exec xterm -fn 10x20 -geometry 80x24+20+20 -ls
fi

```

Example Xsession File for the Local NCD Window Manager

The **Xsession** file shown in this section is designed for using the default local NCD Window Manager (*ncdwm*[1]). Note the following:

- ❑ The variable **NCDNAME** (the terminal's hostname) is extracted from the **DISPLAY** variable and is used later in the file in a remote shell command.
- ❑ By exporting **NCDNAME**, you can use it in other commands, for example, in the window manager's menu configuration file.
- ❑ The **PATH** variable must be correct for applications that users need to run.

```

#!/bin/sh
NCDNAME=`echo $DISPLAY | awk '{FS=":"; print $1}'`
PATH=./usr/local/bin:/usr/local/bin/X11:/usr/bin/X11:$PATH
export NCDNAME PATH

if [ -f $HOME/.xsession ]; then
    if [ -x $HOME/.xsession ]; then
        exec $HOME/.xsession
    else
        exec /bin/sh $HOME/.xsession
    fi
else
    # Start the ncdwm local window manager
    ncdrunwm -d $NCDNAME &
    # Start an xterm
    xterm -sb -geometry 80x24-5-150 -fn 9x15bold &
fi

```

To start the local Motif Window Manager instead of the NCD Window Manager, use the **-mwm** option to **ncdrunwm**; for example:

```

# Start the mwm local window manager
#
ncdrunwm -d $NCDNAME -mwm &

```

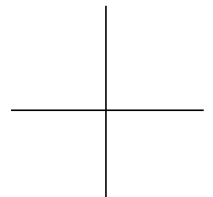

Sample Xsession File for OpenWindows

For OpenWindows, you can change the default **Xsession** file so the environment is OpenWindows or you can install user-specific **.xsession** files to establish the OpenWindows environment.

If you set up an **Xsession** file tailored for OpenWindows, only users who are not using OpenWindows should have **.xsession** files in their home directories. As an alternative, you can leave the default **Xsession** file unchanged and set up **.xsession** files for users who run OpenWindows.

For information about **.xsession** files, see the *NCDware System Administrator's Guide for UNIX Systems*.

The following **Xsession** file is designed for use with the OpenWindows environment. The script starts a command tool and the **olwm** window manager.

```
#!/bin/sh
NCDNAME = `echo $DISPLAY | awk ' {FS=":"; print $1} ' `
#
# Set up variables for running OpenWindows
OPENWINHOME=/usr/openwin
export OPENWINHOME
OW=$OPENWINHOME
export OW
LD_LIBRARY_PATH=$OW/lib:/usr/lib
MANPATH=$OW/man:/usr/man
PATH=$OW/bin:$OW/bin/xview:$OW/demo:/usr/local/bin:/usr/local/bin/X11:/u
sr/bin

export NCDNAME LD_LIBRARY_PATH MANPATH PATH

if [ -f $HOME/.xsession ]; then
    if [ -x $HOME/.xsession ]; then
        exec $HOME/.xsession
    else
        exec /bin/sh $HOME/.xsession
    fi
else
    fi
#
```

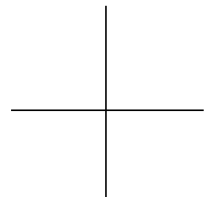

```
# Start a cmdtool session
$OW/bin/cmdtool &
#
# Start OpenLook Window Manager
exec olwm
```

Individual XDM Session Management Files

For information on creating `.xsession` files, see the *NCDware System Administrator's Guide*.

Configuring the XDM Xaccess File

The `Xaccess` file is used only by the X11R5 and X11R6 versions of XDM and is required on all hosts running X11R5 or X11R6 XDM. Its function is to control access to the host.

If you are using the Login Chooser, you do not need to configure this file unless the terminal is sending an indirect query and you want to configure the host's response.

The default file provided on the NCDware distribution is shown here. This file allows all terminals to connect to the host:

```
# XDMCP access file

*          # allow everybody
```

If you edit the `Xaccess` file while XDM is running, XDM automatically re-reads the file and uses the new information the next time a terminal connects to the host.

Contents of an Xaccess File Entry

File entries consist of hostnames, patterns, and macros:

- Hostnames are simple names or complete domain names. To omit a terminal from the list of those allowed to connect to the host, put an exclamation point (!) in front of its name.
- A pattern includes one or more wildcard characters, which are compared with the hostname of the terminal sending the query. The wildcard characters allowed are the asterisk (*) to match any number of characters

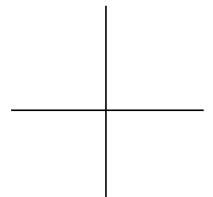

and the question mark (?) to match any single character. For example, *ncd** matches all terminals whose names begin with *ncd*.

- ❑ A macro definition consists of a macro name followed by a list of hostnames. The macro expands to these hostnames when you use it in another entry. Macro names begin with a percent sign (%). For example:

```
%HOSTS atlantic.oceans.com pacific.oceans.com \  
        antarctic.oceans.com
```

Types of Xaccess File Entries

Xaccess files have two types of entries:

- ❑ Entries that control XDM's response to direct and broadcast queries
- ❑ Entries that control XDM's response to indirect queries

In all cases, XDM uses the first entry that matches the terminal name. If the terminal sends an indirect query, only indirect entries in the file can match. If the terminal sends a direct or broadcast query, only direct and broadcast entries can match.

Direct and Broadcast Entries in the Xaccess File

In a direct query, the terminal sends a request directly to a host. In a broadcast query, the terminal sends a request to all hosts on the network.

Direct and broadcast entries consist of a terminal hostname or a pattern representing one or more terminals.

Example Entries

The following entry permits direct and broadcast connections to this host from all terminals on the network:

```
*
```

This entry allows direct or broadcast access to this host from the terminal *ncdu10*:

```
ncdu10.oceans.com
```

This entry allows access from any terminal in the oceans domain:

```
*.oceans.com
```

This entry prevents direct or broadcast access by the terminal *ncdu11*:

```
!ncdu11.oceans.com
```

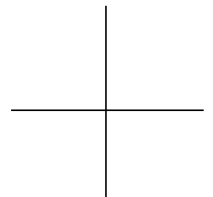

Indirect Entries in the Xaccess File

Indirect entries are forwarded to another host or list of hosts.

Indirect entries consist of terminal hostnames or patterns followed by a list of XDM manager hostnames, macros, or the keyword BROADCAST.

Example Entries

To force a terminal to connect to a specific host, you can assign the terminal sending indirect queries to this host. For example:

```
ncdu12 atlantic.oceans.com
```

This entry disallows indirect access by `ncdu13`:

```
!ncdu13.oceans.com dummy
```

The following example forwards queries from all terminals with names beginning with `ncdu` to the hosts listed in the `%HOSTS` macro.

```
%HOSTS atlantic.oceans.com pacific.oceans.com \  
        antarctic.oceans.com
```

```
ncdu*.oceans.com %HOSTS
```

Configuring the xdm-config File

The `xdm-config` file is the master XDM configuration file. The functions of this file are to set some resources for the `xdm` client and specify the names and locations of all of the other configuration files XDM uses.

You can substitute your own files for the default configuration files. The following is an example.

```
DisplayManager.servers: /usr/lib/X11/xdm/Xservers  
DisplayManager.errorLogFile: /usr/lib/X11/xdm/xdm-errors  
DisplayManager.forwardingMode: false  
DisplayManager*resources: /usr/lib/X11/xdm/Xresources  
DisplayManager*startup: /usr/lib/X11/xdm/Xstartup  
DisplayManager*reset: /usr/lib/X11/xdm/Xreset  
DisplayManager*session: /usr/lib/X11/xdm/Xsession  
DisplayManager*pingInterval: 60  
DisplayManager*pingTimeout: 720  
DisplayManager.keyFile: /usr/lib/X11/xdm/xdm-keys
```

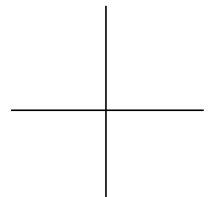

Each resource in the **xdm-config** file has one form for setting the resource for all terminals and another for setting the resource for an individual terminal. For example, the **authorize** resource enables or disables user-based access control. The two lines below disable user-based access control for all terminals and enable access control for the terminal `ncdu15`:

```
DisplayManager*authorize:           false
DisplayManager.ncdu15_0.authorize:  true
```

Note Instead of the colon (:) normally used in specifying the terminal's display name, an underscore (_) is used in the **xdm-config** file. This is because of the colon's special meaning in resource specifications.

Configuring the Polling Interval

The **pingInterval** resource controls how often XDM polls terminals to see if they are still running. The units are minutes.

```
DisplayManager*pingInterval:        60
DisplayManager*pingTimeout:         720
```

Configuring the Version of *xrdb* to Use

For OpenWindows, add the following line to the **xdm-config** file so XDM can find the correct version of **xrdb**, the utility used to load client resources:

```
DisplayManager*xrdb: /usr/openwin/bin/xrdb
```

Configuring the XDM Xresources File

The **Xresources** file sets resources for clients that run before the user logs in (such as the login banner) and is read by each X server as it connects to XDM. The class name for the login prompter is **xlogin**.

You should edit the following entry in the file so the desired greeting is displayed in the login banner:

```
xlogin*greeting: your greeting
```

The XDM Error Logging File

The **xdm-errors** file logs errors reported by XDM. It must be world-writable.

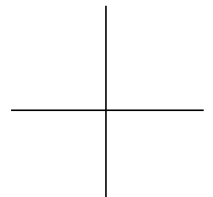

Starting XDM Manually

If you did not use *ncdinstall* to configure system files to start the *xdm* daemon or you need to start the daemon on additional hosts, you can start it manually. To start the daemon on each manager host from a command line, type:

```
# /usr/bin/X11/xdm
```

To determine whether the *xdm* daemon is running, type:

```
# netstat -a | grep xdm
```

To start the daemon automatically when the host reboots, complete the following steps:

1. Make sure there is an entry in a startup file (for example, */etc/rc* or */etc/rc.local*) on each manager host to automatically start the *xdm* daemon. For example:

```
# Start the xdm daemon
if [ -f /usr/bin/X11/xdm ]; then
    /usr/bin/X11/xdm; (echo -n ' xdm') >/dev/console
fi
```

2. On SunOS hosts that have only OpenWindows software (no MIT X Window System software), set *LD_LIBRARY_PATH* in the */etc/rc.local* file to point to *openwinhome/lib/usr/lib*.
3. Make sure there is an entry for *xdm* in the */etc/services* file on each manager host. For example:

```
xdm 177/udp xdmcp # X11 Display Manager
```

XDM Access Control

This section describes how XDM access control works. The *System Administrator's Guide* describes how to configure the host and terminal for XDM access control.

The XDM access control mechanism ensures that only clients started by authorized users from authorized hosts can connect to a terminal.

Access control under XDM employs an authorization key known to the X server running on the user's terminal and to clients started by the user. The

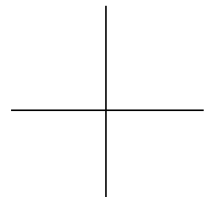

authorization key is generated by XDM, given to the X server, and placed in a file in the user's home directory (the **.Xauthority** file) each time the user logs in. XDM creates this file automatically.

When the user starts a client, the client obtains the authorization key by reading the user's **.Xauthority** file. Before connecting to the X server, clients must present the correct key.

NCDware uses MIT-MAGIC-COOKIE-1 and XDM-AUTHORIZATION-1 authorization methods:

- ❑ XDM-AUTHORIZATION-1 requires X11R5 or X11R6 XDM; this form of authorization uses the DES (Data Encryption Standard) method of encryption to encrypt the key. Encryption prevents anyone from reading the authorization key as it is passed between the X server and clients.
- ❑ MIT-MAGIC-COOKIE-1 does not use encryption and can be used with X11R4, X11R5, or X11R6 XDM.

Both authorization methods are enabled automatically. The XDM-AUTHORIZATION-1 method requires additional configuration steps; you put an encryption key for each terminal in a special file (**xdm-keys**) and enter the same key on the terminal. If a key is present in the file and entered on the terminal and you are using X11R5 or X11R6 XDM, XDM-AUTHORIZATION-1 is used as the authorization method. Otherwise, MIT-MAGIC-COOKIE-1 is used.

For XDM access control to be effective, you must make sure that X server access control is in effect and the list of hosts having access to the X server is empty. X server access control is described in the *NCDware System Administrator's Guide for UNIX Systems*.

If XDM Cannot Write to a User's Home Directory

If XDM is not permitted to write to the user's home directory on your network, you must specify a different directory for storing the **.Xauthority** file. To do this, set the **userAuthDir** resource in the **xdm-config** file to specify the alternate directory. For example:

```
DisplayManager.ncdu85_0:userAuthDir: /u1/xdm.dir
```

This results in creation of an **.Xauthority** file in the alternate directory with the environment variable **XAUTHORITY** pointing to the alternate directory.

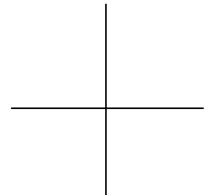

Configuring Terminals for XDM

This section describes remote configuration parameters that affect XDM and are not documented in the *NCDware System Administrator's Guide for UNIX Systems*. The *System Administrator's Guide* has instructions for configuring how XDM displays the login banner and Login Chooser.

Configuring the Login Chooser Redisplay

The **login-window-delay-time** parameter controls the amount of time to wait for a host to display a login banner after the user selects the host from the Login Chooser (Setup ⇒ Change Setup Parameters ⇒ Login ⇒ Window Delay Time). After this time period elapses, the Login Chooser reappears and the user can choose again.

Table 8-3 login-window-delay-time Parameter

| Possible Values | Results |
|-----------------|---|
| default | 3 |
| <i>integer</i> | The amount of time (in seconds) to wait before redisplaying the Login Chooser after selecting a login host. Range: 0 - 4294967295. |

Configuring the Terminal's Action when XDM Terminates

The **login-xdm-action-on-disconnect** parameter controls the terminal's behavior when XDM exits (Setup ⇒ Change Setup Parameters ⇒ Login [XDM section] ⇒ What to do when XDM disconnects). The default action is to present choices to the user. The program may exit for the following reasons:

- The user is trying to log out.
- XDM quits unexpectedly.
- The login host is no longer available.

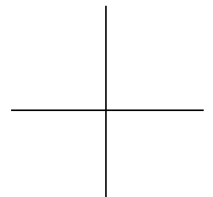

Table 8-4 login-xdm-action-on-disconnect Parameter

| Possible Values | Result |
|-----------------|--|
| default | prompt |
| prompt | The terminal displays a dialog box when the <i>xdm</i> control program exits. The user can display the current X connections, continue with the session, or log out. |
| logout | The session ends without displaying a dialog box. |
| ignore | The terminal does not log the user out and does not display a dialog box. Clients may continue to run unless they were started by XDM. |

Configuring XDM Keepalives

Keepalives are messages that NCD terminals send to verify that the host providing the XDM session to the terminal is still functioning. If the host is unavailable, a dialog box is displayed.

If the terminal has received no client input for a configurable amount of time, the terminal sends an XDMCP keepalive. If the host fails to respond, the terminal takes the specified action.

Complete these steps to configure terminal keepalives:

1. The **login-xdm-keepalives-begin-time** parameter specifies the amount of time after which the terminal verifies that the login host is still running (Setup ⇒ Change Setup Parameters ⇒ Login [XDM section] ⇒ Begin Sending Keepalives after).

Table 8-5 login-xdm-keepalives-begin-time Parameter

| Possible Values | Result |
|-----------------|--|
| default | 3 |
| <i>integer</i> | The amount of time (in minutes) the terminal waits before sending an XDMCP keepalive. Range: 0 - 4294967295. |

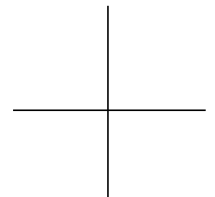

- The **login-xdm-keepalives-wait-time** parameter controls the amount of elapsed time from the start of dead session testing (set in the **login-xdm-keepalives-begin-time** parameter) before the terminal declares the session dead (Setup ⇒ Change Setup Parameters ⇒ Login [XDM section] ⇒ Wait for Keepalive Responses for).

Table 8-6 login-xdm-keepalives-wait-time

| Possible Values | Result |
|-----------------|---|
| default | 30 |
| <i>integer</i> | The amount of time (in seconds) from the start of dead session testing until a session is declared dead. Range: 0 - 4294967295. |

Using XDM—X11R3 Version

If any of your XDM manager hosts are running X11R3, you can configure them as described in “Configuring XDM Hosts” on page 8-5 with the following additional steps:

- Place an entry for each terminal in the **Xservers** file. Entries in this file have the following syntax:
hostname:0 foreign comment
 where **hostname** is the IP address or hostname of the terminal and **comment** is any word. For example:

```
ncdu10:0 foreign magic-cookie
```
- Make sure **login** is not included in the **exec-startup-commands** table (Setup ⇒ Change Setup Parameters ⇒ Commands and Startup ⇒ Startup Commands).

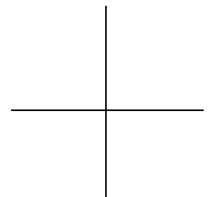

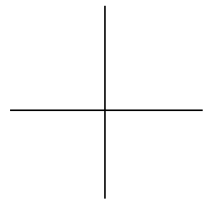

9 Using Configuration Menus

This chapter describes the controls and fields in the Console's configuration menus.

The following topics are covered in this chapter:

- ❑ “Using Change Quick Setup” on page 9-1
- ❑ “Using Change Setup Parameters” on page 9-7
- ❑ “Using Change User Preferences” on page 9-43

Using Change Quick Setup

Change Quick Setup allows you to change the parameters that affect basic terminal operations, a subset of the parameters in Change Setup Parameters and Change User Preferences.

By default, you access Change Quick Setup through the Console, after the NCD terminal has been booted (Setup ⇒ Change Quick Setup). For other ways to display and start local clients and information about disabling local clients, see the *NCDware System Administrator's Guide for UNIX Systems*.

Components of the Change Quick Setup Window

Change Quick Setup contains a series of hide boxes providing access to fields that correspond to remote configuration parameters.

Change Quick Setup has a menu bar with a File menu and a Sections menu, a messages area, and several buttons:

- ❑ The File menu provides commands for writing values to and reading values from files and NVRAM:
 - Save to File—Specifies the name of a file to which all current parameter settings should be written. A popup dialog box presents the default filename or the last filename entered during this session.
 - Save to NVRAM—Saves settings to NVRAM as appropriate.

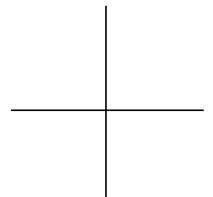

- `Read from File`—Specifies a file from which parameter settings can be loaded into Change Quick Setup. A popup dialog box presents the default filename or the last filename entered during this session.
- `Read from NVRAM`—Loads all NVRAM settings into Change Quick Setup.
- `Restore Defaults`—Loads parameter settings from the file defined in the **config-default-file** parameter. By default, the value in this parameter is the initial configuration file loaded at boot time.
- `Connect to New Unit`—Presents a popup box requesting a terminal name and the **config-read-only-password** or **config-read-write-password** required for configuration data access. Displays that terminal's Change Quick Setup dialog box.
- `Close`—Closes Change Quick Setup.
- The **Sections** menu contains a listing of the Change Quick Setup hide boxes, allowing you an alternative way to select one to open or open or close all hide boxes with one selection.
- The **Messages** area below the hide boxes displays Configuration daemon messages.
- The four buttons along the bottom of the window allow you to commit changes to the current X session, to NVRAM, or to the configuration database:
 - `Apply`—Applies current changes to the current session. Applies changes to NVRAM and to configuration files according to Auto Save settings. Parameters may take effect immediately after you click on `Apply`, at boot time, at session startup, or when a client is initialized. When you click on `Apply`, a message in the Messages area indicates when the change takes effect.
 - `Restart`—Removes changes that have not been applied.
 - `Defaults`—Loads parameter settings from the file defined in the **config-default-file** parameter. By default, the value in this parameter is the initial configuration file loaded at boot time.
 - `Cancel`—Cancels changes that have not been applied and quits the Change Quick Setup utility.

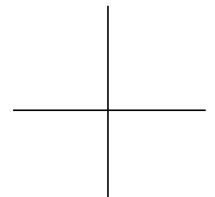

Contents of the Change Quick Setup Hide Boxes

The following sections describe the contents of the Change Quick Setup hide boxes.

The tables in each section include brief descriptions of the fields and the names of the corresponding remote configuration parameters. For the following information about parameters, see the *Remote Configuration Quick Reference*:

- Permitted values
- SNMP variable names and paths
- When the parameter takes effect
- Whether the parameter is saved in NVRAM

Booting Parameters

The Booting hide box contains parameters that affect the terminal's booting process.

| Booting Field | Description | Corresponding Parameter |
|----------------------|--|----------------------------------|
| Boot From | Booting method; that is, the protocol used for booting or whether the terminal boots locally | boot-desired-source |
| Boot Host IP Address | IP address of the boot server | boot-tcpip-desired-server |

Files Parameters

The Files hide box contains parameters that affect how the terminal accesses files.

| Files Field | Description | Corresponding Parameter |
|-----------------------|---|--------------------------------|
| File Service Protocol | Protocol for file exchange with the primary initial file server | file-initial-protocol-1 |
| File Server Address | Address of the primary initial file server | file-initial-server-1 |

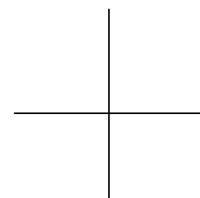

Using Change Quick Setup

| Files Field | Description | Corresponding Parameter |
|------------------------------------|--|--|
| Backup File Service Protocol | Protocol for file exchange with the secondary initial file server | file-initial-protocol-2 |
| Backup File Server Address | Address of the secondary initial file server | file-initial-server-2 |
| Config File | Configuration file downloaded by the terminal | config-default-file |
| UNIX Config Directory | Directory containing the configuration file downloaded by the terminal | config-unix-directory |
| VMS Config Directory | Directory containing the configuration file downloaded by the terminal from a VMS host | config-vms-directory |
| Loadable Modules Directory | Directory that contains the loadable X server modules | modules-directory |
| Name Type for Initial TFTP servers | Type of filenames (UNIX or VMS) sent via TFTP from the initial file servers | file-name-type-for-initial-tftp-servers |
| Extended File Diagnostics | Generates more detailed diagnostic messages about file services | file-extended-diagnostics |

Fonts Parameters

The Fonts hide box defines the default font path.

| Fonts Field | Description | Corresponding Parameter |
|----------------------------|--|----------------------------------|
| Default Font Path at Reset | Default directories that the terminal searches for fonts | xserver-default-font-path |

9-4 Using Configuration Menus

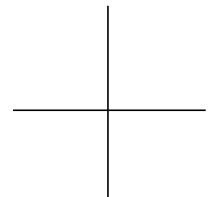

Licenses Parameters

The Licenses hide box contains parameters that affect licensed features.

| Licenses Field | Description | Corresponding Parameter |
|-------------------|--|-------------------------------|
| License Key | License key for the enabled software features that require a license | unit-license-key |
| Licensed Features | Features licensed on the terminal | unit-licensed-features |

Network Parameters

The Network hide box contains parameters that set network addresses and specify hosts that provide services to the terminal. Some of the fields shown below do not appear in the XRemote X server.

| Network Field | Description | Corresponding Parameter |
|----------------------------------|---|-------------------------------------|
| Terminal IP Address At Next Boot | Terminal's IP address the next time it boots | ip-address-at-next-boot |
| Gateway IP Address | Primary default gateway host | ip-initial-default-gateway-1 |
| Subnet Mask | Subnet mask for this network segment | ip-subnet-mask |
| Broadcast IP Address | Broadcast address | ip-broadcast-address |
| Use Address Discovery | Addresses supplied by BOOTP/DHCP or RARP are used by the terminal | ip-use-address-discovery |
| TCP/IP Name Service Protocol | Name service protocol for contacting the name servers | tcpip-name-server-protocol |
| TCP/IP Name Servers | List of name server hosts | tcpip-name-servers |
| NCDnet Address | Current NCDnet address (for terminals on a DECnet network) | ncdnet-address |
| NCDnet Address at Next Boot | NCDnet address for the terminal the next time it boots | ncdnet-address-at-next-boot |

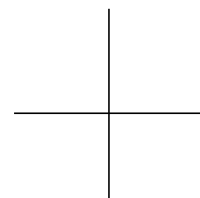

Using Change Quick Setup

| Network Field | Description | Corresponding Parameter |
|-----------------------|---|------------------------------|
| NCDnet Router Address | Default router for terminals on a DECnet network | ncdnet-default-router |
| NCDnet Name Servers | List of name server hosts for terminals on a DECnet network | ncdnet-name-servers |

Session Parameters

The Session hide box contains parameters that start the initial local clients for the user's session.

| Session Field | Description | Corresponding Parameter |
|---|---|------------------------------|
| X Session XDM/DECwindows Hostname | Login host for the XDM login banner | exec-startup-commands |
| Terminal Session Type | Type of terminal emulation for users logging in through a terminal emulator | |
| XRemote Session Start Window Manager | Starts the window manager when a user logs in through XRemote | |

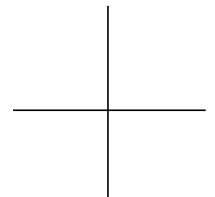

Using Change Setup Parameters

Change Setup Parameters provides access to all terminal configuration parameters. It is especially useful for setting configuration parameters when you have a few easily accessible terminals or when users set some or all configuration parameters themselves.

Procedures for configuring terminals using Change Setup Parameters are described in the *System Administrator's Guide*.

By default, you access Change Setup Parameters through the Console, after the NCD terminal has booted (Setup ⇒ Change Setup Parameters). For other ways of starting and displaying local clients and information about disabling local clients, see the *System Administrator's Guide*.

Components of the Change Setup Parameters Window

Change Setup Parameters is composed of a series of hide boxes, which provide access to fields that correspond to remote configuration parameters.

Change Setup Parameters has a menu bar with a File menu and a Sections menu, a messages area, and several buttons.

- ❑ The File menu provides commands for writing values to and reading values from files and NVRAM:
 - Save to File—Specifies the name of a file to which all current parameter settings should be written. A popup dialog box presents the default filename or the last filename entered during this session.
 - Save to NVRAM—Saves settings to NVRAM as appropriate.
 - Read from File—Specifies a file from which all parameter settings should be read for display in the Change Setup Parameters window. Presents the default filename or the last filename entered during this session.
 - Read from NVRAM—Reads all NVRAM settings and displays them in the Change Setup Parameters window.
 - Restore Defaults—Loads parameter settings from the file defined in the **config-default-file** parameter. By default, the value in this parameter is the initial configuration file loaded at boot time.

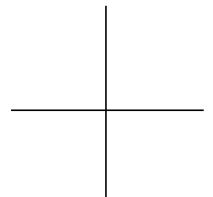

- `Connect to New Unit`—Presents a popup box requesting a terminal name and the `config-read-only-password` or `config-read-write-password` required for configuration data access. Displays the remote terminal's Change Setup Parameters window.
- `Close`—Closes the Change Setup Parameters client.
- ❑ The Sections menu contains a listing of the Change Setup Parameters hide boxes, allowing you an alternative way to select one to open. You can also select to open or hide all hide boxes.
- ❑ The Messages area below the hide boxes displays Configuration daemon messages.
- ❑ The Auto Save File toggle below the Messages area enables or disables the Auto Save feature, described in the *System Administrator's Guide* and in Chapter 6, Terminal Configuration Methods.
- ❑ The four buttons along the bottom of the window allow you to commit changes to the current X session, to NVRAM, or to the configuration database:
 - `Apply`—Applies current changes to the current X session. Applies changes to NVRAM and to configuration files according to specifications set for the Auto Save feature. Parameters may take effect immediately after you click on `Apply`, at boot time, at session startup, or when a client is initialized. When you click on `Apply`, a message in the Messages area indicates when the change takes effect.
 - `Restart`—Removes changes that have not been applied.
 - `Defaults`—Loads parameter settings from the file defined in the `config-default-file` parameter. By default, the value in this parameter is the initial configuration file loaded at boot time.
 - `Cancel`—Removes changes that have not been applied and quits Change Setup Parameters (closes the window).

Contents of the Change Setup Parameters Hide Boxes

The following sections describe the contents of the Change Setup Parameters hide boxes.

The tables describing the hide box contents include a description of each field and the name of the corresponding remote configuration parameter. For the following information about parameters, see the alphabetical configuration parameter descriptions in the *Remote Configuration Quick Reference*:

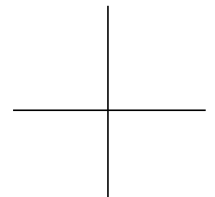

- Permitted values
- SNMP variable names and paths
- When the parameter takes effect
- Whether the parameter is saved in NVRAM

Access Control Parameters

The parameters in the Access Control hide box control access to the terminal configuration database and other terminal functions.

| Access Control Field | Description | Corresponding Parameter |
|-------------------------------------|--|---|
| <i>Unit Password section</i> | | |
| Unit Global Password | Password for read/write access to the Configuration, Preferences, SNMP, and File Manager daemons | unit-global-password |
| <i>X Server section</i> | | |
| XDM Authentication Key | Key used for authorized client connection requests (write-only) | login-xdm-authentication-key |
| Default for Enable X Access Control | Enables host-based access control by default for client connections | xserver-access-control-enabled-default |
| Enable X Access Control | Enables host-based access control for client connections | xserver-access-control-enabled |
| X Access Control List | List of authorized hosts | xserver-access-control-list |
| <i>Config Daemon section</i> | | |
| Config Read-Only Password | Password required for read-only access to the configuration database | config-read-only-password |
| Config Read-Write Password | Password required for read/write access to the configuration database | config-read-write-password |
| Enforce Config Passwords Locally | Requires a password to access configuration information from the terminal | config-enforce-passwords-locally |

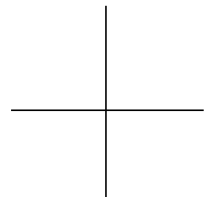

Using Change Setup Parameters

| Access Control Field | Description | Corresponding Parameter |
|--|--|--|
| Enable Config Access Control | Checks remote requests for connections to the Configuration daemon against the access control list | config-access-control-enabled |
| Config Access Control List | Hosts in the Configuration daemon host access list | config-access-control-list |
| <i>User Preferences Daemon section</i> | | |
| User Preferences Read-Only Password | Password required for read-only access to User Preferences information | config-pref-read-only-password |
| User Preferences Read-Write Password | Password required for read/write access to the user preferences daemon | config-pref-read-write-password |
| Enforce User Preferences Passwords Locally | A password is required to access user preferences information from the terminal | config-pref-enforce-passwords-locally |
| <i>Console section</i> | | |
| Console Display Password | Password for displaying the Console (write-only) | config-console-display-password |
| Enforce Console Password Locally | Password for accessing the Console locally | config-console-enforce-password-locally |
| <i>SNMP section</i> | | |
| SNMP Read-Only Community | The first community name for SNMP requests for read-only access to configuration information | snmp-read-only-community |
| SNMP Read-Only Alternative Community | The second community name for SNMP read-only access to configuration information | snmp-read-only-community-alt |

9-10 Using Configuration Menus

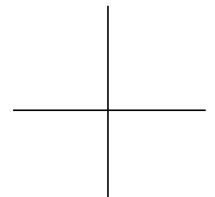

| Access Control Field | Description | Corresponding Parameter |
|---------------------------------------|---|---|
| Enable SNMP Read-Only Access Control | Remote requests for connections to the SNMP daemon are checked against the read-only host access control list | snmp-read-only-access-control-enabled |
| SNMP Read-Only Access Control List | Hosts allowed to use an SNMP read-only community name to access configuration information | snmp-read-only-access-control-list |
| SNMP Read-Write Community | The first community name for SNMP requests for read/write access to configuration information | snmp-read-write-community |
| SNMP Read-Write Alternative Community | The second community name for SNMP read/write access to configuration information | snmp-read-write-community-alt |
| Enable SNMP Read-Write Access Control | Remote requests for connection to the SNMP daemon are checked against the read/write host access control list | snmp-read-write-access-control-enabled |
| SNMP Read-Write Access Control List | Hosts allowed to use an SNMP read/write community name to access configuration information | snmp-read-write-access-control-list |
| Allow SNMP Reset | Enables remote reset via SNMP | snmp-allow-reset |
| SNMP Trap Monitors | Hosts to which SNMP traps are sent | snmp-trap-monitors |
| <i>NCDnet MOP section</i> | | |
| MOP Reset Password | Password included in the MOP reset packet | ncdnet-mop-reset-password |
| <i>Diagnostic Daemon section</i> | | |
| Enable Diagnostic Access Control | Remote requests for access to the Diagnostic daemon are checked against the access control list | diag-access-control-enabled |
| Diagnostic Access Control List | Hosts that can access the Diagnostic daemon | diag-access-control-list |

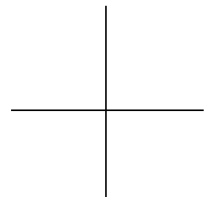

Using Change Setup Parameters

| Access Control Field | Description | Corresponding Parameter |
|---|---|---|
| <i>NFS section</i> | | |
| NFS Server Access Control Default | Default access control policy for requests to the NFS server daemon | file-nfs-access-control-default |
| NFS Server Access Control List | Hosts that do not follow the default access control policy. | file-nfs-access-control list |
| <i>File Manager section</i> | | |
| Password | Password for access to the File Manager daemon | file-manager-password |
| Enable File Manager Access Control List | Enables host-based access control for remote access to the File Manager daemon | file-manager-access-control-enabled |
| File Manager Access Control List | Hosts allowed to access the File Manager daemon | file-manager-access-control-list |
| <i>Local Command Execution Daemon section</i> | | |
| Enable Execution Host Access Control | Access control is enabled for the Local Command Execution daemon | exec-access-control-enabled |
| Execution Access Control List | Hosts allowed to access the Local Command Execution daemon | exec-access-control-list |
| Enable Execution User Access Control | Restricts requests for local command execution to the user logged into the terminal. The NCD Display Manager must be running on the login host. | exec-user-access-control |
| <i>Serial and Parallel Daemon section</i> | | |
| Serial Daemon LAT Service Passwords | LAT service passwords for accessing the Serial daemon | serial-daemons-lat-service-passwords |
| Parallel Daemon LAT Service Passwords | LAT service passwords for accessing the Parallel daemon | parallel-daemons-lat-service-passwords |

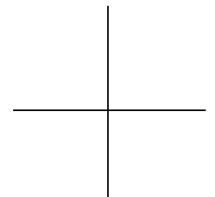

| Access Control Field | Description | Corresponding Parameter |
|---|---|--------------------------------------|
| Enable Serial and Parallel Access Control | Access control is enabled for connecting to the Serial and Parallel daemons | serial-access-control-enabled |
| Serial and Parallel Access Control List | List of hosts from which the Serial and Parallel daemons can be accessed | serial-access-control-list |

ARP Parameters

The ARP (Address Resolution Protocol) hide box affects address resolution.

| Address Resolution Protocol Field | Description | Corresponding Parameter |
|------------------------------------|--|---|
| Complete Entry Timeout (minutes) | Number of minutes a complete ARP table entry can exist without being used | tcpip-arp-complete-entry-timeout |
| Incomplete Entry Timeout (minutes) | Number of minutes an incomplete ARP table entry can exist without being used | tcpip-arp-incomplete-entry-timeout |
| ARP Cache | ARP table used for mapping from IP addresses to physical addresses | tcpip-arp-cache |

Booting Parameters

The Booting hide box contains parameters that affect the Boot Monitor and X server loading.

| Booting Fields | Description | Corresponding Parameter |
|--------------------------------|--|---------------------------|
| Boot automatically at power-up | The terminal boots an X server instead of stopping in the Boot Monitor | boot-automatically |
| Test RAM at power-up | Enables RAM tests at start up | boot-test-ram |

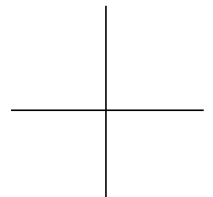

Using Change Setup Parameters

| Booting Fields | Description | Corresponding Parameter |
|------------------------------------|---|--|
| Previous Source | The most recent boot method (read-only) | boot-previous-source |
| Previous Server | The most recent boot server (read-only) | boot-previous-server |
| Primary Boot Source | Method to be used the next time the terminal boots | boot-desired-source |
| Secondary Boot Source | Method used for X server loading if the primary source is not available | boot-second-source |
| Tertiary Boot Source | Method used for X server loading if the primary and secondary sources are not available | boot-third-source |
| Persist in Loading | The terminal keeps trying to boot until it succeeds or is interrupted | boot-persistent-loading |
| Default Server when PROM Booting | Server for downloading configuration files and fonts when the terminal boots locally | boot-default-server-when-prom-booting |
| Boot Monitor Inverse Video | Boot Monitor displays are in inverse video | boot-monitor-inverse-video |
| Custom File | A non-standard filename for the X server boot file | boot-custom-file |
| <i>TCP/IP Boot Options Section</i> | | |
| TCP/IP Desired Server | Boot server to use when the boot source is TFTP or NFS | boot-tcpip-desired-server |
| Secondary TCP/IP Server | Boot server to use when the desired (primary) boot server is not available | boot-tcpip-second-server |
| Tertiary TCP/IP Server | Boot server to use when the primary and secondary boot servers are not available | boot-tcpip-third-server |

9-14 Using Configuration Menus

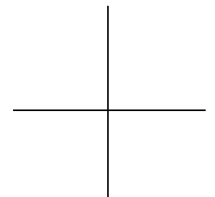

| Booting Fields | Description | Corresponding Parameter |
|--|---|---|
| Try TCP/IP Unit Address File | Puts an X server named for the terminal's IP address (in hexadecimal) in the terminal's booting sequence (relative pathname or prefixed by /tftpboot) | boot-tcpip-unit-address-file |
| Try TCP/IP Unit Address with Path File | | boot-tcpip-unit-address-with-path-file |
| Try TCP/IP Product Name and Memory Size File | Puts an X server named for the model and memory size (as a filename suffix) in the terminal's booting sequence (relative pathname or prefixed by /tftpboot) | boot-tcpip-product-name-and-memory-size-file |
| Try TCP/IP Product Name and Memory Size with Path File | | boot-tcpip-product-name-and-memory-size-with-path-file |
| Try TCP/IP Product Name File | Puts an X server named for the terminal model in the terminal's default booting sequence (relative pathname or prefixed by /tftpboot) | boot-tcpip-product-name-file |
| Try TCP/IP Product Name with Path File | | boot-tcpip-product-name-with-path-file |
| Send Broadcast ICMP for Subnet Mask | The terminal sends an ICMP message to determine the subnet mask at boot | boot-send-broadcast-icmp-for-subnet-mask |
| TCP/IP Broadcast Boot Request | The terminal broadcasts for an X server if the boot server does not respond | boot-tcpip-broadcast-boot-request |
| TFTP Directory | Directory to be searched for an X server when TFTP is the boot source | boot-tftp-directory |
| NFS Directory | Directory to be searched for an X server when NFS is the boot source | boot-nfs-directory |
| <i>NCDnet Boot Options section</i> | | |
| Try MOP | Include MOP as a boot source (DECnet networks only) | boot-mop |
| Try MOP with File Name | Include MOP as a boot source and specify a filename (DECnet networks) | boot-mop-with-file-name |

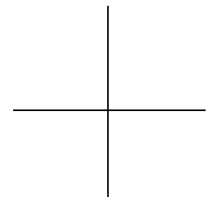

Browser Parameters

The parameters in the Browser hide box affect the NCD Mosaic Browser.

| Browser Fields | Description | Corresponding Parameter |
|--|---|-------------------------------------|
| <i>General section</i> | | |
| Browser Module | Browser module loaded at boot time | browser-module |
| Environment Variables | Browser variables | browser-environment |
| Cache Size Limit (KB) | Maximum size of the memory cache | browser-cache-size |
| Maximum TCP/IP connections | Maximum number of concurrent TCP/IP connections | browser-max-connections |
| <i>User Preference Overrides section</i> | | |
| Automatically load images | Enables automatic loading of images when a new Web page is loaded | browser-auto-load-images |
| Jscript/Javascript routines | Enables execution of JavaScript routines when Web pages are loaded | browser-jscript-active |
| Java applets | Enables execution of Java applets when included in the Web contents | browser-java-applets |
| Show Tool Bar | Enables display of the tool bar | browser-show-tool-bar |
| Default home page | Home page loaded when the browser starts | browser-home-page |
| <i>Network/Proxy Settings section</i> | | |
| HTTP Proxy Host | Host that runs an HTTP proxy server | browser-http-proxy-host |
| HTTP Proxy Host Port | TCP/IP port on which the HTTP proxy server listens for connections | browser-http-proxy-host-port |

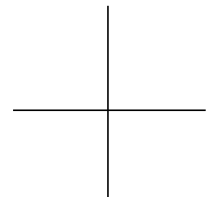

| Browser Fields | Description | Corresponding Parameter |
|-------------------------|--|---------------------------------------|
| HTTP Proxy Overrides | HTTP proxy domains that override or avoid the proxy host | browser-http-proxy-overrides |
| FTP Proxy Host | Host that runs an FTP proxy server | browser-ftp-proxy-host |
| FTP Proxy Host Port | TCP/IP port on which the FTP proxy server listens for connections | browser-ftp-proxy-host-port |
| FTP Proxy Overrides | FTP proxy domains that avoid or override the proxy host | browser-ftp-proxy-overrides |
| Gopher Proxy Host | Host that runs a gopher proxy server | browser-gopher-proxy-host |
| Gopher Proxy Host Port | TCP/IP port on which the gopher proxy server listens for connections | browser-gopher-proxy-host-port |
| Gopher Proxy Overrides | Gopher proxy domains that avoid or override the gopher proxy server | browser-gopher-proxy-overrides |
| SOCKS Host | Host that runs the SOCKS daemon | browser-socks-host |
| SOCKS Port | TCP/IP port on which the SOCKS daemon listens for connections | browser-socks-port |
| SMTP Email Server | SMTP electronic mail server host | browser-smtp-email-server |
| <i>Printers section</i> | | |
| Browser Printer Table | Printers available for printing from the Browser | browser-printer-table |

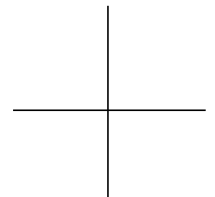

Commands and Startup Parameters

The parameters in the Commands and Startup hide box affect local client availability.

| Commands and Startup Field | Description | Corresponding Parameter |
|----------------------------|--|-------------------------------|
| Startup Commands | Commands executed when a session starts | exec-startup-commands |
| Disabled Commands | Commands users are not permitted to access | exec-disabled-commands |
| Command Menu | Contents of the window manager default root menu | exec-command-menu |

Configuration Parameters

The parameters in the Configuration hide box affect remote configuration files and the actions of the Configuration and Preferences daemons.

| Configuration Fields | Description | Corresponding Parameter |
|---|--|----------------------------------|
| <i>Initial Configuration File section</i> | | |
| Load Initial File | An initial configuration file is downloaded at boot | config-load-initial-file |
| Persistent Loading | The terminal does not boot unless a configuration file is loaded | config-persistent-loading |
| UNIX Directory | Directory searched for a configuration file | config-unix-directory |
| VMS Directory | Directory searched for a configuration file (VMS X server) | config-vms-directory |
| Custom File | Terminal loads a configuration file with a non-standard name | config-custom-file |

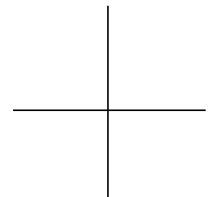

| Configuration Fields | Description | Corresponding Parameter |
|---|--|---|
| Try Unit Name as Filename | The terminal's hostname is used as the filename for the initial configuration file (with or without the domain name as a suffix) | config-unit-name-file |
| Add Domain to Unit Name as Filename | | config-add-domain-to-unit-name-as-filename |
| Try Unit Ethernet Address as Filename | The terminal's Ethernet address is used as the filename for the initial configuration file | config-unit-ethernet-address-file |
| Try Unit IP Address as Filename | The terminal's IP address, in hexadecimal format, is used as the filename for the initial configuration file | config-unit-ip-address-file |
| Use Decimal IP Address Notation as Filename | The terminal's IP address (in decimal format) is used as the filename for the initial configuration file | config-use-decimal-ip-address-notation-as-filename |
| Try Unit NCDnet Address as Filename | The terminal's DECnet address is used as the filename for the initial configuration file | config-unit-ncdnet-address-file |
| Try Generic Filename | The standard configuration filename (ncd_std) is used as the filename for the initial configuration file | config-generic-file |
| <i>Configuration Daemon Service section</i> | | |
| Telnet Port Number | Ports and DECnet object for connections to the terminal's Configuration daemon | config-telnet-port |
| TCP Port Number | | config-tcp-port |
| NCDnet Object Name | | config-ncdnet-object-name |
| Default File | Configuration file that defines the initial terminal configuration | config-default-file |
| Auto Save NVRAM | Changes to parameters that are saved in NVRAM are automatically saved | config-auto-save-nvram |

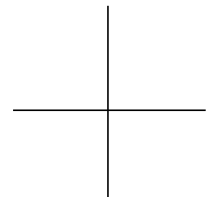

Using Change Setup Parameters

| Configuration Fields | Description | Corresponding Parameter |
|--|--|---------------------------------------|
| Auto Save File | Changes to the configuration are automatically saved to a file, the file to which the changes are saved, and the extent of the information saved | config-auto-save-file |
| Auto Save File Name | | config-auto-save-file-name |
| Auto Saved Info | | config-auto-saved-info |
| <i>User Preferences Daemon Service section</i> | | |
| Telnet Port Number | Ports and DECnet object for connections to the terminal's Preferences daemon | config-pref-telnet-port |
| TCP Port Number | | config-pref-tcp-port |
| NCDnet Object Name | | config-pref-ncdnet-object-name |

Diagnostics Parameters

The parameters in the Diagnostics hide box affect the logging of diagnostic messages and the actions of the Diagnostic daemon.

| Diagnostics Field | Description | Corresponding Parameter |
|-------------------------------|---|---------------------------------|
| Add Timestamps | Adds timestamps to the diagnostic log | diag-add-timestamps |
| Timestamp Frequency (seconds) | Maximum frequency at which timestamps are added to the diagnostic log | diag-timestamp-frequency |
| Buffer Size (bytes) | Maximum size of the diagnostic log | diag-buffer-size |
| Log File | File to which diagnostic messages are written | diag-log-file |
| Telnet Port Number | Port on which the terminal listens for Telnet connections to the Diagnostic daemon | diag-telnet-port |
| TCP Port Number | Port on which the terminal listens for raw TCP connections to the Diagnostic daemon | diag-tcp-port |

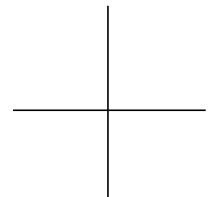

| Diagnostics Field | Description | Corresponding Parameter |
|--------------------------|--|--------------------------------|
| NCDnet Object Name | NCDnet object on which the terminal listens for NCDnet connections to the Diagnostic daemon (DECnet) | diag-ncdnet-object-name |

Display PostScript Parameters

The parameters in the Display PostScript hide box affect the Display PostScript server module. This hide box appears on HMX and Explora 700 terminals only.

| Display PostScript Field | Description | Corresponding Parameter |
|---------------------------------|--|--------------------------------|
| DPS/X resource Path | Path searched for DPS/X resource files | dps-resource-path |

File Manager Parameters

The parameters in the File Manager hide box affect the Local File Manager.

| File Manager Field | Description | Corresponding Parameter |
|---------------------------|---|--|
| Telnet Port Number | Port on which the terminal listens for Telnet connections to the File Manager daemon | file-manager-telnet-port |
| TCP Port Number | Port on which the terminal listens for raw TCP connections to the File Manager daemon | file-manager-tcp-port |
| NCDnet Object Name | NCDnet object on which the terminal listens for NCDnet connections to the File Manager daemon | file-manager-ncdnet-object-name |

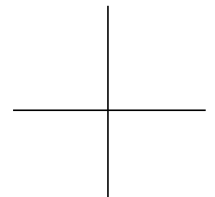

File Service Parameters

The parameters in this hide box affect how the terminal accesses files located in the local file system and on network hosts.

| File Service Field | Description | Corresponding Parameter |
|--|--|--|
| Initial File Server 1 | Primary file server at boot time for loading the initial configuration file | file-initial-server-1 |
| Initial Protocol 1 | Protocol used for file access on the primary file server | file-initial-protocol-1 |
| Initial File Server 2 | Secondary file server at boot time for loading the initial configuration file | file-initial-server-2 |
| Initial Protocol 2 | Protocol used for file access on the secondary file server | file-initial-protocol-2 |
| Name Type for Initial TFTP Servers | Type of filenames sent via TFTP from the initial file servers | file-name-type-for-initial-tftp-servers |
| File Service Table | Configuration parameters for file access on network hosts | file-service-table |
| Extended Diagnostics | The terminal generates more detailed file service diagnostic messages | file-extended-diagnostics |
| Try All Matches on Open | The terminal tries all file service table entries that match when trying to access a file | file-try-all-matches-on-open |
| Failed Server Ignore Timeout (seconds) | How long a file server that has failed due to a network timeout error is ignored | file-failed-server-ignore-timeout |
| NFS Unmount Timeout (seconds) | How long after the last reference to an NFS file service entry that the terminal notifies the server that access is no longer required | file-nfs-unmount-timeout |

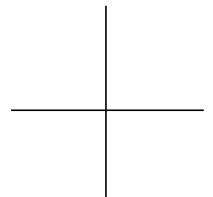

| File Service Field | Description | Corresponding Parameter |
|---------------------------------|--|---|
| Default VMS File Name Extension | Default file extension appended to a filename when accessing a file on a file server that uses VMS-style names | file-default-vms-file-name-extension |
| Enable Floppy Filesystem | Makes the local diskette drive accessible through the Local File Manager or from another host via NFS | file-enable-floppy-filesystem |
| Enable NFS Server | Starts the NFS Server daemon at boot time to permit NFS access to the local file system from remote hosts | file-enable-nfs-server |
| Export Directory List | Export file server mount points for NFS mounts of the local file system (diskette or PCMCIA card) | file-export-directory-list |

Fonts Parameters

The parameters in the Fonts hide box affect how the terminal accesses fonts, both bitmap fonts and fonts supplied by the font server.

| Fonts Field | Description | Corresponding Parameter |
|----------------------------------|--|---|
| Default Font Path | Default directories in which the terminal looks for fonts | xserver-default-font-path |
| Default Font | The X server's default font | xserver-default-font |
| Font Cache Maximum Size (bytes) | Amount of memory used for font caching | xserver-font-cache-max-size |
| Retain Font Path Across Sessions | The X server retains the font path after the last client disconnects | xserver-retain-font-path |
| Font Directory File Name | Alternative filename for the fonts.dir file | xserver-font-directory-file-name |
| Font Alias File Name | Alternative filename for the fonts.alias file. | xserver-font-alias-file-name |

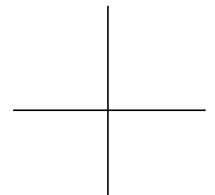

Using Change Setup Parameters

| Fonts Field | Description | Corresponding Parameter |
|-----------------------------------|--|--|
| Font Name Table | Symbolic mappings between user-specified names and font path names | xserver-font-path-alias-table |
| <i>Font Server section</i> | | |
| Reconnect attempts before failure | Number of times to retry a font server request before declaring an error | xserver-fontserver-retry-attempts |
| Read Timeout (seconds) | How long to try reading information from a font server before declaring an error | xserver-fontserver-read-timeout |
| Open Timeout (seconds) | How long to try connecting to a font server before declaring an error | xserver-fontserver-open-timeout |
| Reopen Timeout (seconds) | Timeout before failing to reopen the font server connection | xserver-fontserver-reopen-timeout |

Input Devices Parameters

The parameters in the Input Devices hide box affect the functioning of input devices (such as keyboard and mouse).

| Input Devices Field | Description | Corresponding Parameter |
|-------------------------------------|---|--|
| Keyboard Type | Type of keyboard in use | xserver-keyboard-type |
| Keyboard Description File | Filename of the downloadable keyboard definition file for unsupported keyboards | xserver-keyboard-description-file |
| Write Keyboard Description File ... | Writes a keyboard description file for the keyboard attached to the terminal | none |
| Narrow Keysym Tables | X11R3 two-entry keysym tables are used instead of four-entry keysym tables | xserver-keyboard-narrow-keysym-tables |

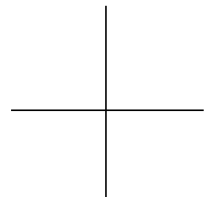

| Input Devices Field | Description | Corresponding Parameter |
|-----------------------------------|---|---|
| Local Dead Key Support | Enables local dead-key processing on keyboards with this feature | xserver-enable-local-dead-key-processing |
| Mouse Buttons | Number of buttons on the mouse | xserver-mouse-buttons |
| Input Extension Device | Input extension device attached to the serial port | xserver-input-extension-device |
| Calibrate Touch Screen | Lower left and upper right coordinates of the touch screen calibration limits | xserver-touchscreen-calibration limits |
| Light Pen Blue Flood ¹ | During calibration, enhances the light pen's ability to distinguish light from dark | xserver-enable-local-lightpen-blue-flood |
| Calibrate Light Pen ¹ | Activates calibration mode for the light pen | none |

¹ Explora, Explora Pro, and Explora 400/450 terminals only

IP Parameters

The parameters in the IP (Internet Protocol) hide box affect terminal communication using IP.

| IP Field | Description | Corresponding Parameter |
|---------------------------|---|-------------------------------------|
| IP Address ¹ | Current IP address of the terminal | ip-address |
| IP Address At Next Boot | The terminal's IP address the next time it boots | ip-address-at-next-boot |
| Subnet Mask | Subnet mask | ip-subnet-mask |
| Broadcast Address | Broadcast address used when sending broadcast packets and for recognizing broadcast packets from a non-standard broadcast address | ip-broadcast-address |
| Initial Default Gateway 1 | Primary default IP gateway | ip-initial-default-gateway-1 |

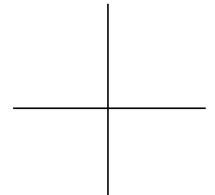

Using Change Setup Parameters

| IP Field | Description | Corresponding Parameter |
|---------------------------------------|---|--|
| Initial Default Gateway 2 | Secondary default IP gateway | ip-initial-default-gateway-2 |
| Use Address Discovery | IP addresses are discovered from the network | ip-use-address-discovery |
| Use Proxy Arp | Proxy ARP is used to resolve routes to hosts for which there are no routes in the IP routing table | ip-use-proxy-arp |
| Use Router Discovery | The terminal modifies its routing table based on receipt of ICMP router discovery messages | ip-use-router-discovery |
| Use Router Solicit | The terminal sends ICMP router discovery solicitation messages at boot time | ip-use-router-solicit |
| Extended Routing Diagnostics | The terminal generates more detailed diagnostic messages about IP routing | ip-extended-routing-diagnostics |
| Default Packet Time-to-Live (seconds) | Value inserted into the IP header's Time-to-Live field of datagrams originating at the terminal | ip-default-packet-time-to-live |
| Respond to Broadcast ICMP | The terminal responds to ICMP messages sent to the broadcast address | ip-respond-to-broadcast-icmp |
| Routing Table | The current routes to remote hosts and networks | ip-routing-table |
| Equivalent IP Addresses | List of IP addresses considered as originating on the same host; used to receive UDP packets from multi-homed hosts | ip-equivalent-addresses |

¹ This field is read-only.

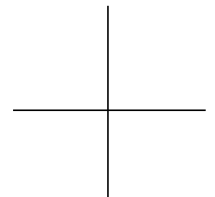

Java Parameters

The parameters in the Java hide box affect the Java local clients.

| Java Field | Description | Corresponding Parameter |
|----------------------|---|----------------------------------|
| Java Directory | Directory in which Java files shipped with NCDware are installed | java-directory |
| AppletViewer Command | Java command line for starting the AppletViewer | java-appletviewer-command |
| Cache Class File | Loads Java classes shipped with NCDware and caches them in memory | java-cache-class-file |

LAT Parameters

The parameters in the LAT hide box affect terminal communications using the LAT (Local Area Transport) protocol.

| LAT Field | Description | Corresponding Parameter |
|--------------------------------------|---|---------------------------------------|
| Service Groups (list) | LAT service advertisements that are added to the LAT service directory | lat-service-groups |
| Service Directory Max Size | Maximum number of entries in the LAT service directory (can only be increased from Change Setup Parameters) | lat-service-directory-max-size |
| Connect Timeout (seconds) | Elapsed time between a connection attempt and a lack of response before failure is declared | lat-connect-timeout |
| Circuit Flush Timeout (milliseconds) | Length of time input characters are queued before the terminal flushes data by sending a packet to the host | lat-circuit-flush-timeout |
| Keepalive Timeout (seconds) | Length of time an established connection is inactive before a keepalive packet is sent | lat-keepalive-timeout |

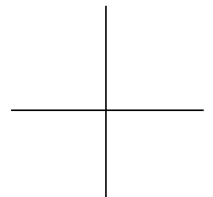

Using Change Setup Parameters

| LAT Field | Description | Corresponding Parameter |
|---------------------------------------|---|-----------------------------------|
| Retransmission Timeout (milliseconds) | Elapsed time between retransmissions of LAT data packets on an established connection | lat-retransmission-timeout |
| Retransmission Limit | Number of times a LAT packet is retransmitted before the connection is considered a failure | lat-retransmission-limit |

Licenses Parameters

The parameters in the Licenses hide box affect the allocation of licenses.

| Licenses Fields | Description | Corresponding Parameter |
|-------------------------------|---|-----------------------------------|
| License Key | License key for licensed software features | unit-license-key |
| License Agents | IP addresses of the hosts on which license server agents are running | unit-license-agents |
| License Agent Port Number | UDP port on which the license server listens | unit-license-agent-port |
| Transaction Timeout (seconds) | How long the terminal waits for a reply from the license agent | unit-license-agent-timeout |
| Maximum Retries | Maximum number of times the terminal tries to get a license from the proxy license server | unit-license-agent-retries |
| Licensed Features | Features currently licensed on the terminal (read-only) | unit-licensed-features |
| Optional Features | Optional software enabled for the terminal | unit-optional-features |

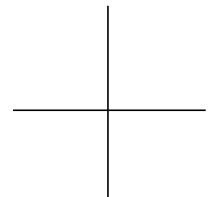

Loadable Modules Parameters

The parameters in the Loadable Modules hide box affect the loading of X server modules.

| Loadable Modules Fields | Description | Corresponding Parameter |
|----------------------------|--|----------------------------|
| Loadable Modules Directory | Directory containing the loadable modules | modules-directory |
| Load Policy | When modules are loaded or if a module is disabled | modules-load-policy |

Login Parameters

The parameters in the Login hide box affect login through XDM and DECwindows.

| Login Field | Description | Corresponding Parameter |
|-----------------------------|--|------------------------------------|
| Default Hosts | Hosts listed in the Login Chooser | login-default-hosts |
| Restrict Host Choices | User is restricted to selecting a login host from those listed in the Login Chooser | login-restrict-host-choices |
| Disabled Networks | Limits network connections for terminals on both TCP/IP and DECnet networks | login-disabled-networks |
| Window Delay Time (seconds) | How long the terminal waits before displaying the login window when starting the <i>login</i> client from a command line | login-window-delay-time |
| <i>XDM section</i> | | |
| XDM Manufacturer Display ID | The XDM manufacturer display ID (read-only) | none |
| XDM Display Class | The XDMCP display class | login-xdm-display-class |

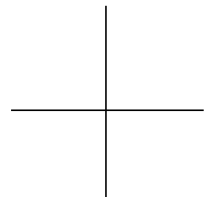

Using Change Setup Parameters

| Login Field | Description | Corresponding Parameter |
|--|---|--|
| Begin Sending Keepalives after (minutes) | Length of time between keepalives sent to verify that the XDM session host is still running | login-xdm-keepalives-begin-time |
| Wait for Keepalive Responses for (seconds) | Elapsed time from the start of XDM dead session testing with no response from the login host before a failure is declared | login-xdm-keepalives-wait-time |
| Wait for Broadcasts for (seconds) | How long the terminal waits for responses to the XDM broadcast query before displaying the results to the user in the Login Chooser | login-xdm-broadcast-wait-time |
| What to do with XDMCP Broadcasts | How the terminal responds to XDM broadcasts | login-xdm-broadcasts |
| What to do with XDMCP Indirects | How the terminal responds to XDM indirect queries | login-xdm-indirects |
| What to do when XDM disconnects | Action taken when the host XDM program disconnects from the terminal | login-xdm-action-on-disconnect |
| <i>DWLOGIN section</i> | | |
| Login Name | Login account name for invoking the VMS DECwindows login banner | login-dwlogin-name |
| Login Password | Login account password for invoking the VMS DECwindows login banner | login-dwlogin-password |
| <i>NCDDM section</i> | | |
| NCD Display Manager Enabled | NCD Display Manager is queried for user-specific information | login-ncddm-enabled |
| NCD Display Manager TCP Port Number | TCP port on which the NCD Display Manager listens for requests | login-ncddm-tcp-port |

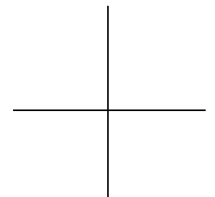

NCDnet Parameters

The parameters in the NCDnet hide box affect terminals in a DECnet network.

| NCDnet Field | Description | Corresponding Parameter |
|--------------------------------|--|------------------------------------|
| NCDnet Address | The terminal's current DECnet address | ncdnet-address |
| NCDnet Address At Next Boot | The DECnet address the next time the terminal boots | ncdnet-address-at-next-boot |
| Default Router | Address or symbolic name of the default router | ncdnet-default-router |
| Connect Timeout (seconds) | Length of time that must elapse between a connection attempt and a lack of response before failure is declared | ncdnet-connect-timeout |
| Retransmission Limit | Number of attempts to retransmit data on an established connection before a failure is declared | ncdnet-retransmission-limit |
| Keepalive Timeout (seconds) | Length of time the terminal remains inactive on an established connection before a keepalive packet is sent | ncdnet-keepalive-timeout |
| Hello Timeout (seconds) | Length of time between successive transmissions of Hello packets | ncdnet-hello-timeout |
| Router Timeout (seconds) | Length of time after a Router Hello message is received that the sending router is used as the default router | ncdnet-router-timeout |
| User Account Name | Account name used in connection attempts | ncdnet-user-account-name |
| MOP Identify Timeout (seconds) | Length of time between transmissions of MOP identify packets | ncdnet-mop-identify-timeout |
| Allow MOP Reset | Allows remote reboot via MOP | ncdnet-mop-allow-reset |

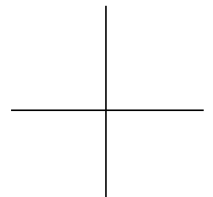

NCDnet Name Service Parameters

The parameters in the NCDnet Name Service hide box affect the NCDnet (DECnet) name service.

| NCDnet Name Service Field | Description | Corresponding Parameter |
|-----------------------------------|--|---|
| Name Cache Max Size | Maximum number of entries in the terminal's name cache | ncdnet-name-cache-max-size |
| Name Cache Max Lifetime (seconds) | How long a name service entry is used before being automatically deleted | ncdnet-name-cache-max-lifetime |
| Local Name Cache | Hostnames, NCDnet addresses, and address lifetimes for the local name cache | ncdnet-name-local-cache |
| Name Server Transaction Timeout | How long the terminal attempts a name service request before a failure is declared | ncdnet-name-server-transaction-timeout |
| Name Servers | List of name servers | ncdnet-name-servers |

Network Interfaces Parameters

The parameters in the Network Interfaces hide box affect the terminal's network interfaces.

| Network Interfaces Field | Description | Corresponding Parameter |
|--|---|--|
| Use SNAP (802.2 LLC) Encapsulation on Ethernet | The terminal sends Ethernet packets using SNAP encapsulation | net-ethernet-snap-encapsulation |
| Token-Ring Speed | Speed at which the Token-Ring interface runs | net-token-ring-speed |
| Roaming Condition ¹ | Speed at which wireless terminals roam from one access point to another | net-roaming-condition |

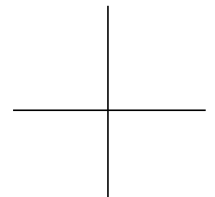

| Network Interfaces Field | Description | Corresponding Parameter |
|-----------------------------|--------------------------------------|---------------------------|
| Domain Channel ¹ | Domain number for wireless terminals | net-domain-channel |

¹ Explora 400/450 terminals only

Parallel Parameters

The Parallel hide box lists the attributes of the Parallel Daemon.

| Parallel Field | Description | Corresponding Parameter |
|------------------------|---|-------------------------------|
| Parallel Daemons Table | Table listing the current characteristics of the Parallel daemon(s) | parallel-daemons-table |

PEX Parameters

The parameters in the PEX hide box govern characteristics of the PEX extension. For other PEX parameters, see “PEX Color Parameters” on page 9-34 and the PEX hide box in the Change User Preferences client. This hide box appears on HMX and Explora 700 terminals only.

| PEX Field | Description | Corresponding Parameter |
|----------------------------|--|-----------------------------------|
| Maximum Model Clip Planes | Maximum number of half-spaces that can be defined for model clipping | pex-max-model-clip-planes |
| Maximum Non-Ambient Lights | Maximum number of non-ambient light sources that can be defined | pex-max-non-ambient-lights |
| Maximum Nameset Names | Maximum number (a power of two) of NameSet names (identifiers) that can be defined | pex-max-nameset-names |

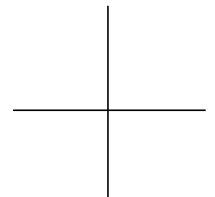

PEX Color Parameters

The parameters in the PEX Color hide box govern monitor reference luminance and chromaticity. For other PEX parameters, see “PEX Parameters” on page 9-33 and the PEX hide box in the Change User Preferences client. This hide box appears on HMX and Explora 700 terminals only.

| PEX Color Field | Description | Corresponding Parameter |
|-----------------------------------|---|--------------------------------------|
| Reference Red Chromaticity (u') | The u' CIE-chromaticity coordinate for the red color component of a properly adjusted monitor | pex-monitor-reference-red-u |
| Reference Red Chromaticity (v') | The v' CIE-chromaticity coordinate for the red color component of a properly adjusted monitor | pex-monitor-reference-red-v |
| Reference Red Luminance (Y) | The Y CIE-luminance coordinate for the red color component of a properly adjusted monitor | pex-monitor-reference-red-y |
| Reference Green Chromaticity (u') | The u' CIE-chromaticity coordinate for the green color component of a properly adjusted monitor | pex-monitor-reference-green-u |
| Reference Green Chromaticity (v') | The v' CIE-chromaticity coordinate for the green color component of a properly adjusted monitor | pex-monitor-reference-green-v |
| Reference Green Luminance (Y) | The Y CIE-luminance coordinate for the green color component of a properly adjusted monitor | pex-monitor-reference-green-y |
| Reference Blue Chromaticity (u') | The u' CIE-chromaticity coordinate for the blue color component of a properly adjusted monitor | pex-monitor-reference-blue-u |
| Reference Blue Chromaticity (v') | The v' CIE-chromaticity coordinate for the blue color component of a properly adjusted monitor | pex-monitor-reference-blue-v |
| Reference Blue Luminance (Y) | The Y CIE-luminance coordinate for the blue color component of a properly adjusted monitor | pex-monitor-reference-blue-y |

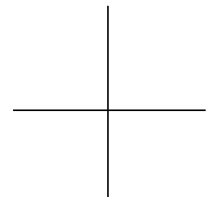

| PEX Color Field | Description | Corresponding Parameter |
|-----------------------------------|---|--------------------------------------|
| Reference White Chromaticity (u') | The u' CIE-chromaticity coordinate for the white color component of a properly adjusted monitor | pex-monitor-reference-white-u |
| Reference White Chromaticity (v') | The v' CIE-chromaticity coordinate for the white color component of a properly adjusted monitor | pex-monitor-reference-white-v |
| Reference White Luminance (Y) | The Y CIE-luminance coordinate for the white color component of a properly adjusted monitor | pex-monitor-reference-white-y |

PPP and SLIP Parameters

The parameters in the PPP and SLIP hide box affect terminal communications using the PPP and SLIP protocols.

| PPP and SLIP Field | Description | Corresponding Parameter |
|-------------------------------|---------------------------------------|----------------------------------|
| PPP and SLIP Interfaces Table | PPP and SLIP configuration parameters | ppp-slip-interfaces-table |
| PPP Interfaces Table | PPP configuration parameters | ppp-interfaces-table |

Serial Parameters

The parameters in the Serial hide box affect the serial port(s) and Serial daemon.

| Serial Hide Field | Description | Corresponding Parameter |
|-------------------------|--------------------------|--------------------------------|
| Serial Interfaces Table | Serial port parameters | serial-interfaces-table |
| Serial Daemons Table | Serial daemon parameters | serial-daemons-table |

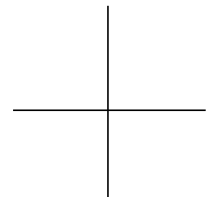

TCP Parameters

The parameters in the TCP hide box affect terminal communications using the TCP protocol.

| Transmission Control Protocol Field | Description | Corresponding Parameter |
|--|---|------------------------------------|
| Receive Buffer Size (bytes) | Bytes of received data that a TCP connection can buffer in the terminal | tcp-receive-buffer-size |
| Send Buffer Size (bytes) | Bytes of data awaiting transmission that the TCP connection can buffer in the terminal | tcp-send-buffer-size |
| Connect Timeout (seconds) | Length of time that must elapse before a TCP connection attempt is declared a failure for lack of response | tcp-connect-timeout |
| Maximum Retransmissions | Number of retransmissions before a failure is declared | tcp-max-retransmissions |
| Keepalive Idle Time (seconds) | Length of time that must elapse on an established connection with no activity before a keepalive packet is generated | tcp-keepalive-idle-time |
| Keepalive Interval (seconds) | Length of time that must elapse between successive transmissions of keepalive packets | tcp-keepalive-interval |
| Maximum Keepalive Idle Time (seconds) | Duration of keepalive transmissions without response before a failure is declared | tcp-max-keepalive-idle-time |
| Default Linger Time (seconds) | Length of time during which TCP continues to transmit outstanding data on the connections transmit queue after local software closes the connection | tcp-default-linger-time |

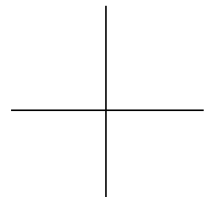

TCP/IP Name Service Parameters

The parameters in the TCP/IP Name Service hide box affect the DNS and IEN 116 name services.

| TCP/IP Name Service Field | Description | Corresponding Parameter |
|--|---|---|
| Name Cache Max Size | Maximum number of entries in the name cache | tcpip-name-cache-max-size |
| Name Cache Max Lifetime (seconds) | How long a name service entry is used before it is automatically deleted | tcpip-name-cache-max-lifetime |
| Ignore Case on TCP/IP Name Cache Lookups | Specifies that case is ignored when searching for a name in the local name cache | tcpip-name-cache |
| Local Name Cache | The terminal's name service cache | tcpip-name-local-cache |
| Name Server Protocol | Name server protocol used when contacting name servers | tcpip-name-server-protocol |
| Name Server Retransmission Timeout (seconds) | How long a name service retransmission is attempted before a failure is declared | tcpip-name-server-retransmission-timeout |
| Name Server Transaction Timeout (seconds) | How long a name service request is attempted before a failure is declared | tcpip-name-server-transaction-timeout |
| Name Servers | List of name servers | tcpip-name-servers |
| DNS Default Domain | Default domain for DNS name service requests | tcpip-dns-default-domain |
| DNS Domain Search | Successively wider searches of the name space are made when attempting to resolve a name with DNS | tcpip-dns-domain-search |

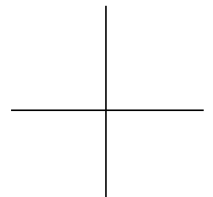

Time Parameters

The Time hide box contains parameters that affect the terminal's communication with a time server.

| Time Field | Description | Corresponding Parameters |
|---|--|-----------------------------|
| Time Server | The hostname or IP address of a host supplying current time from UDP port 37 | time-server |
| Time Server Timeout (seconds) | How long the terminal waits for a reply from the time server | time-server-timeout |
| Time Server Retries | Maximum number of attempts to contact the time server | time-server-retries |
| Timezone | Name of the zone file for the terminal's location | time-zone |
| Offset from Greenwich Mean Time (minutes) | Offset from Greenwich Mean Time (GMT) | time-offset-from-gmt |

Unit Parameters

The Unit hide box contains parameters that provide information about miscellaneous terminal attributes.

| Unit Field | Description | Corresponding Parameter |
|-----------------------------|--|------------------------------------|
| Query for Unit Name at Boot | The terminal requests its hostname at boot time. | unit-query-for-name-at-boot |
| Unit Name | The terminal's hostname | unit-name |
| Physical Location | The physical location of the terminal | unit-location |
| Administrative Contact | Person in charge of the terminal | unit-contact |
| Administrative Status | Administrative status of the terminal | unit-administrative-status |

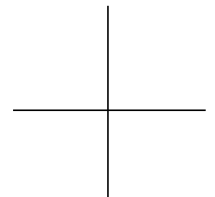

| Unit Field | Description | Corresponding Parameter |
|--|---|------------------------------|
| Show Low Memory Warning Box at (bytes) | Threshold for displaying the Low Memory warning popup | unit-low-memory-level |

Video Parameters

The parameters in the Video hide box affect viewing videos on the terminal. This hide box appears on HMX and Explora 700 terminals only.

| Video Field | Description | Corresponding Parameters |
|--------------------------------------|--|------------------------------------|
| Fast MPEG decoder (requires license) | Use the CompCore fast MPEG video decoder instead of the Berkeley decoder | video-fast-mpeg-decoder |
| Starworks volume file | Filename of the StarWorks volume information file | video-starworks-volume-file |

VT320 Terminal Emulation Parameters

The parameters in the VT320 Terminal Emulation hide box affect login through terminal emulation.

| VT320 Terminal Emulation Field | Description | Corresponding Parameters |
|--|---|-------------------------------------|
| Default Hosts | Hosts listed in the Terminal Host Chooser | term-default-hosts |
| Restrict Host Choices | User is restricted to the hosts listed in the Terminal Host Chooser | term-restrict-host-choices |
| Delay LAT Display after Boot (seconds) | How long after rebooting to display the Terminal Host LAT Chooser | term-delay-lat-display |
| Terminal Default Connect Timeout (seconds) | How long the terminal emulator attempts to establish a connection before declaring an error | term-default-connect-timeout |

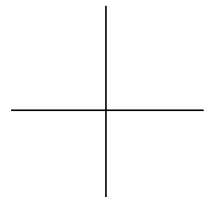

WinCenter Parameters

The parameters in the WinCenter hide box affect characteristics of WinCenter when WinCenter is invoked by XDM or a remote shell command with no overriding arguments.

| Wincenter Field | Description | Corresponding Parameters |
|----------------------|---|--|
| Use WinCenter Colors | Action taken to control colormap flash when using WinCenter and NCDware | wincenter-colors |
| Window Size | Size of the WinCenter window | wincenter-resources (Wincenter resources of the RESOURCE_MANAGER root window property) |
| Number of colors | Number of WinCenter colors or TrueColor | |
| Audio Enabled | Enables audio | |

X and Graphics Parameters

The parameters in the X and Graphics hide box affect X attributes.

| X and Graphics Field | Description | Corresponding Parameter |
|-----------------------------------|--|------------------------------------|
| Disabled X Extensions | X extensions that should be made unavailable | xserver-disabled-extensions |
| Retain X Settings Across Sessions | The X server retains the settings of the resource database, keyboard, mouse, and screen saver when the last client disconnects | xserver-retain-x-settings |
| Arc Cache Maximum Size | Amount of memory used for arc caching | xserver-arc-cache-max-size |
| RGB File | Filename of the color database | xserver-rgb-file |
| Keysym File | Filename of the keysym database used by local clients | xserver-keysym-file |

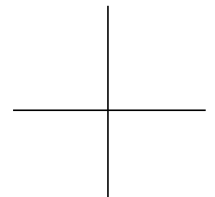

| X and Graphics Field | Description | Corresponding Parameter |
|-----------------------------|--|---------------------------------|
| Default Visual | The terminal's default visual. If Wincenter \Rightarrow Use WinCenter Colors is enabled, it allocates the entries in this table. | xserver-default-visual |
| Default Colormap | Initial contents of the default color map. If Wincenter \Rightarrow Use WinCenter Colors is enabled, it allocates the entries in this table. | xserver-default-colormap |
| Black Pixel | Value reported as BlackPixel on grayscale and color monitors | xserver-black-pixel |
| White Pixel | Value reported as WhitePixel on grayscale and color monitors | xserver-white-pixel |

XRemote Parameters

The parameters in the XRemote hide box affect the use of XRemote.

| XRemote Field | Description | Corresponding Parameters |
|------------------------------|--|--|
| Data Compression Mode | Compression method for XRemote data packets | xremote-data-compression-mode |
| Authorize XRemote Clients | XRemote clients are authenticated | xremote-authorize-xremote-clients |
| Additional Escape Chars | Additional escape characters, besides those in the pre-defined list, are defined | xremote-additional-escape-chars |
| Allow XRemote TCP Connection | XRemote/TCP connections are allowed | xremote-allow-xremotetcp-connection |
| TCP Port Number | TCP port on which the terminal listens for XRemote connections | xremote-tcp-port |

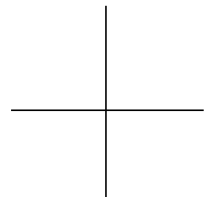

3270 Terminal Emulation Parameters

The parameters in the 3270 Terminal Emulation hide box affect the use of the 3270 terminal emulator.

| 3270 Terminal Emulation Field | Description | Corresponding Parameters |
|--------------------------------------|---|--------------------------------------|
| Enable 3270 Terminal Emulation | Enables 3270 emulation | ncd3270-enable-3270-emulation |
| NCD3270 Default Protocol | Default connection protocol | ncd3270-default-protocol |
| NCD3270 Default Model | Default 3270 model type | ncd3270-default-model |
| TN3270 Default Host | Default host for TN3270 connections | ncd3270-tn-default-host |
| TN3270 Default tcp Port | Default TCP port for TN3270 connections | ncd3270-pu21-default-port |
| PU2.1 Default Host | Default host for Brixton PU2.1 connections | ncd3270-pu21-default-host |
| PU2.1 Default tcp Port | Default TCP port for Brixton PU2.1 connections | ncd3270-pu21-default-port |
| EHLLAPI A Default tcp Port | Default TCP port for EHLLAPI connections | ncd270-ehllapia-default-port |
| Default Hosts | Hosts presented by default in the 3270 Host Chooser | ncd3270-default-hosts |

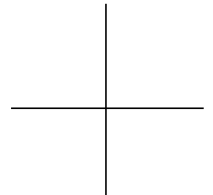

Using Change User Preferences

Change User Preferences allows users or system administrators to set user preferences.

By default, you access Change User Preferences from the Console window's Setup menu (Setup ⇒ Change User Preferences). For other methods of displaying this local client, information about disabling it, and directions for creating a user preferences file that is loaded when the user logs in, see the *System Administrator's Guide*.

Components of the Change User Preferences Window

Change User Preferences is composed of a series of hide boxes providing access to fields that correspond to remote configuration parameters in the pref group.

Change User Preferences has a menu bar with a File menu and a Sections menu, a messages area, and several buttons:

- ❑ The File menu provides commands for writing values to and reading values from files and NVRAM:
 - Save to File—Specifies the name of a file to which all current parameter settings should be written. A popup dialog box presents the default filename or the last filename entered during this session.
 - Read from File—Specifies a file from which all parameter settings should be read for display in the Change User Preferences window. Presents the default filename or the last filename entered during this session.
 - Connect to New Unit—Presents a popup box requesting a terminal name and the **config-pref-read-only-password** or **config-pref-read-write-password** required for configuration data access. Displays that terminal's Change User Preferences window.
 - Close—Closes Change User Preferences.
- ❑ The Sections menu contains a listing of the Change User Preferences hide boxes, allowing you an alternative way to select one to open. You can also select a command to open or hide all hide boxes.

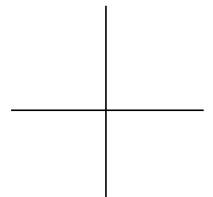

- ❑ The Messages area below the hide boxes displays Preferences daemon messages.
- ❑ The four buttons along the bottom of the window allow you to commit changes to the current X session or to the configuration database:
 - `Apply`—Applies current changes to the current X session. Applies changes to configuration files according to specifications set for the Auto Save feature. Parameters may take effect immediately after you click on `Apply`, at boot time, at session startup, or when a client is initialized. When you click on `Apply`, a message in the Messages area indicates when the change takes effect.
 - `Restart`—Removes changes that have not been applied.
 - `Defaults`—Loads parameter settings from the file defined in the `config-default-file` parameter. By default, the value in this parameter is the initial configuration file loaded at boot time.
 - `Cancel`—Removes changes that have not been applied and quits the Change User Preferences utility (closes the window).

Components of the Change User Preferences Hide Boxes

The following sections describe the Change User Preferences hide boxes and the fields in them. The tables describing the hide box contents include a description of each field and the name of the corresponding remote configuration parameter.

For more information about the preference parameters, see the *Remote Configuration Parameter Quick Reference*.

Audio Preferences

The Audio hide box affects the maximum volume of audio clients.

| Audio Field | Description | Corresponding Parameter |
|------------------------|---------------------------------|--------------------------------------|
| Maximum Gain (percent) | Maximum volume of audio clients | <code>pref-audio-maximum-gain</code> |

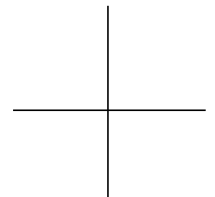

Bell Preferences

The parameters in the Bell hide box affect the terminal bell,

| Bell Field | Description | Corresponding Parameter |
|------------------------------|--|---------------------------|
| Enable Bell | Turns bell on | pref-bell-enable |
| Bell Base Volume (percent) | Bell's base volume as a percentage of the maximum volume | pref-bell-volume |
| Bell Pitch (Hz) | Bell pitch | pref-bell-pitch |
| Bell Duration (milliseconds) | Bell duration | pref-bell-duration |
| Ring Bell | Rings the bell | none |

Compatibility Preferences

The parameters in the Compatibility hide box ensure compatibility with older equipment or software.

| Compatibility Field | Description | Corresponding Parameter |
|---|--|--|
| Permit Old X Bugs | Bypasses error checks on requests that old X clients are not expected to fail | pref-compatibility-permit-old-x-bugs |
| Be Compatible With Old DECwindows Vendor String | Prefixes the display vendor string with DECwindows (for older DECwindows applications) | pref-compatibility-decwindows-vendor-string |
| Be Compatible With Old DECwindows Keyboards | Right modifiers mimic left modifiers (as with old DEC keyboards) | pref-compatibility-decwindows-keyboards |
| Be Compatible With Old DECwindows Images | Incoming X images are byte-swapped (not done by some old DECwindows applications) | pref-compatibility-decwindows-images |

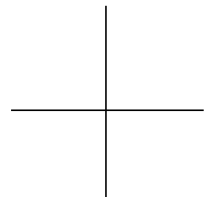

Console and Utilities Preferences

The parameters in the Console and Utilities hide box affect the Console, logout utility, screen lock utility and screen blank utility.

| Console and Utilities Field | Description | Corresponding Parameter |
|---|---|--|
| Console Key Sequence | Non-standard key sequence for displaying the Console | pref-console-key-sequence |
| Automatic Logout After (minutes) | How long the terminal is idle before logging the user out | pref-console-auto-logout-idle-time |
| Automatic Logout Cancel Delay (seconds) | How long the terminal waits for the user to cancel an automatic logout | pref-console-auto-logout-cancel-delay |
| Automatic Lock Screen After (minutes) | How long the terminal is idle before automatically locking the screen | pref-console-auto-lock-idle-time |
| Lock Screen Default Password | Password for locking the screen | pref-console-lock-screen-default-password |
| Delay When Blanking Screen (milliseconds) | How long after the user selects Blank Screen before the screen goes blank | pref-console-blank-screen-delay |
| Show Console Message Timestamps | Timestamps are displayed with Console messages | pref-console-show-timestamps |

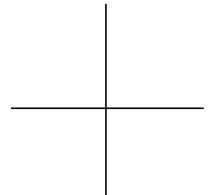

Environment Variables Preferences

The Environment Variables hide box is used to set variables for certain local clients. If you are using the NCD Display Manager, user variables obtained from XDM (such as *HOME* and *USER*) appear in this field.

| Environment Variables Field | Description | Corresponding Parameter |
|-----------------------------|--|-------------------------|
| Environment Variables | Current environment variables for use by local clients | pref-environment |

Font Preferences

The parameters in the Font hide box affect font diagnostic messages and the directories in which the terminal searches for fonts.

| Font Field | Description | Corresponding Parameter |
|--------------------------------|--|---------------------------------------|
| Show Extended Font Diagnostics | All font actions that require file system or network access are reported | pref-font-extended-diagnostics |
| Current Font Path | Current font search path | pref-font-path |

Keyboard Preferences

The parameters in the Keyboard hide box affect keyboard attributes.

| Keyboard Preferences Field | Description | Corresponding Parameter |
|---------------------------------------|---|---|
| Function Key Style | How the X server interprets function keys | pref-keyboard-function-key-style |
| Enable Keyboard Autorepeat | Keys repeat automatically when held down | pref-keyboard-auto-repeat |
| Autorepeat Begin After (milliseconds) | How long a key must be held down before it starts repeating | pref-keyboard-auto-repeat-start |

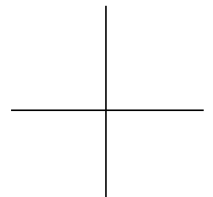

| Keyboard Preferences Field | Description | Corresponding Parameter |
|--|--|---------------------------------------|
| Autorepeat Rate (keys per second) | How many times per second keys repeat when held down | pref-keyboard-auto-repeat-rate |
| Keyclick Volume (percent) | Volume of the keyclick (as a percentage of its maximum volume) | pref-keyboard-keyclick-volume |
| Led 1 Led 2 Led 3 Led 4 (on some keyboards) | The condition indicated by each keyboard LED | pref-keyboard-leds |

OpenGL Preferences

The parameters in the OpenGL hide box control graphics processing by applications that use OpenGL. This hide box appears on HMX and Explora 700 terminals only.

| OpenGL Field | Description | Corresponding Parameter |
|--------------------|---|----------------------------------|
| Allow Dithering | Enables color dithering operations to improve color resolution when rendering to a visual with few color bit planes | pref-opengl-allow-dither |
| Allow Blending | Enables color blending control and operations for hidden surface elimination | pref-opengl-allow-depth |
| Allow Depth Test | Enables Z-buffering control and operations | pref-opengl-allow-depth |
| Allow Alpha Test | Enables alpha test control | pref-opengl-allow-alpha |
| Allow Scissor Test | Enables scissor test control and operation | pref-opengl-allow-scissor |
| Allow Stencil Test | Enables stencil test control and stenciling operation | pref-opengl-allow-stencil |

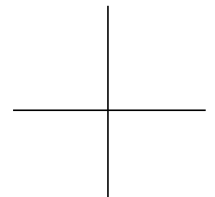

| OpenGL Field | Description | Corresponding Parameter |
|---|---|--|
| Allow Polygon Stipple | Enables stippling operations | pref-opengl-allow-polygon-stipple |
| Allow Logical Operations | Bitwise logical operations are performed on pixels | pref-opengl-logic-operations |
| Fast Perspective Rendering | Enables fast perspective for rendering primitives in perspective viewing situations | pref-opengl-fast-perspective |
| Activate Alpha Buffer for RGBA Visuals | Allows built-in non-zero-depth alpha buffers to be used | pref-opengl-have-alpha-buffer |
| Enable 8-bit Color-Index double buffered Visual | Advertises 8-bit color-index double-buffered visual type to clients | pref-opengl-have-8cidb |
| Enable 8-bit Color-index single buffered visual | Advertises 8-bit color-index single-buffered visual type to clients | pref-opengl-have-8cisb |
| Enable 8-bit RGBA double buffered visual | Advertises 8-bit RGBA double-buffered visual type to clients | pref-opengl-have-8rgbdb |
| Enable 8-bit RGBA single buffered visual | Advertises 8-bit RGBA single-buffered visual type to clients | pref-opengl-have-8rgbsb |
| Enable 24-bit RGBA double buffered Visual | Advertises 24-bit RGBA double-buffered visual type to clients | pref-opengl-have-24rgbdb |
| Enable 24-bit RGBA single buffered Visual | Advertises 24-bit RGBA single-buffered visual type to clients | pref-opengl-have-24rgbdb |

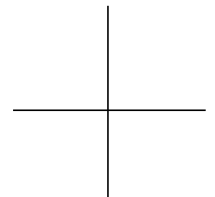

PEX Preferences

The parameters in the PEX hide box control certain aspects of applications that are based on the PEX extension. For descriptions of other PEX options, see “PEX Parameters” on page 9-33 and “PEX Color Parameters” on page 9-34. This hide box appears on HMX and Explora 700 terminals only.

| PEX Preferences Field | Description | Corresponding Parameter |
|------------------------------|--|---|
| Nominal Line Width (pixels) | Sets the standard width of lines and curves | pref-pex-nominal-line-width |
| Nominal Edge Width (pixels) | Sets the standard width of edges of surface primitives when displayed | pref-pex-nominal-edge-width |
| Nominal Marker Size (pixels) | Sets the standard size of marker primitives | pref-pex-nominal-marker-size |
| Dither Flat Shaded Surface | Enables dithering of flat shaded surfaces | pref-pex-dither-flat-shaded-surface |
| Dither Interpolated Surface | Enables dithering of Gouraud-shaded surfaces | pref-pex-dither-interpolated-surface |
| Surface Interior Style | Specifies the rendering style of surface interiors | pref-pex-surface-interior-style |
| Surface Interpolation Method | Specifies shading method for surface interiors | pref-pex-surface-interp-method |
| Surface Reflection Model | Specifies how to apply lighting effects to all surfaces | pref-pex-surface-reflect-model |
| Color Clipping Method | Specifies the method for correcting colors with RGB components outside the acceptable ranges | pref-pex-color-clipping-method |

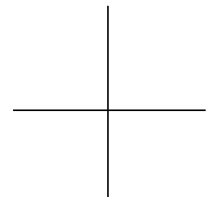

Pointing Devices Preferences

The parameters in the Pointing Devices hide box affect the mouse and other pointing devices.

| Pointing Devices Field | Description | Corresponding Parameter |
|------------------------------|--|--|
| Current Pointing Device | Whether the pointer is a mouse or other device | pref-xserver-current-pointing-device |
| <i>Mouse section</i> | | |
| Threshold Distance (pixels) | Number of pixels the mouse must be moved before the acceleration factor is applied | pref-mouse-threshold |
| Acceleration Ratio (percent) | Percentage by which the mouse motion threshold is multiplied to change the speed at which the pointer is moved | pref-mouse-acceleration |
| Button Arrangement | Right- or left-handed mouse button mapping | pref-mouse-arrangement |
| <i>Touchscreen section</i> | | |
| Button Press Threshold | Relative force exerted on the touchscreen before a button press event is generated | pref-xserver-touchscreen-button-press-threshold |
| Button Release Threshold | Relative force exerted on the touchscreen before a button release event is generated | pref-xserver-touchscreen-button-release-threshold |

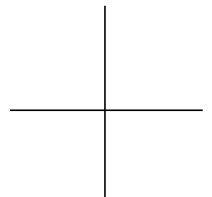

Power Management Preferences

The parameters in the Power Management hide box affect power management on VESA-compliant monitors.

| Power Management Field | Description | Corresponding Parameter |
|--------------------------------------|--|---|
| Enable VESA Monitor Power Management | Enables power management. WARNING: Enabling power management on equipment that is not VESA-compliant can cause serious risk of personal injury or equipment damage. | pref-power-manage-enable |
| Standby After (minutes) | How long the terminal is idle before the transition to the standby state | pref-power-manage-standby-time |
| Suspend After (minutes) | How long the terminal is idle before the transition to the suspend state | pref-power-manage-suspend-time |
| Powerdown After (minutes) | How long the terminal is idle before the transition to the power down state | pref-power-manage-powerdown-time |

Screen Background Preferences

The parameters in the Screen Background hide box affect the screen background.

| Screen Background Field | Description | Corresponding Parameter |
|-------------------------|---|---|
| Screen Background Type | Appearance of the screen background | pref-screen-background-type |
| Solid Color | Color if the screen background type is solid color | pref-screen-background-color |
| Bitmap File | Bitmap file if the screen background type is bitmap | pref-screen-background-bitmap-file |

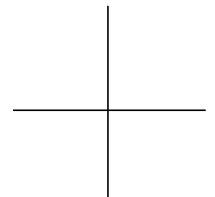

| Screen Background Field | Description | Corresponding Parameter |
|-------------------------|---|---|
| Bitmap Foreground Color | Color of the foreground if the screen background type is bitmap | pref-screen-background-bitmap-foreground |
| Bitmap Background Color | Background color if the screen background type is bitmap | pref-screen-background-bitmap-background |

Screen Saver Preferences

The parameters in the Screen Saver hide box affect the screen saver.

| Screen Saver Field | Description | Corresponding Parameter |
|-------------------------------------|---|-------------------------------------|
| Enable Screen Saver | Turns on the screen saver | pref-screensaver-enable |
| Allow Exposures After Screen Saver | Causes clients to redraw themselves when the screen saver restores the screen | pref-screensaver-exposures |
| Save Screen After (seconds) | How long the terminal is idle before the screen saver starts | pref-screensaver-time |
| Change Screen Saver After (seconds) | How long the screen saver waits before modifying its pattern | pref-screensaver-interval |
| Screen Saver Style | Type of screen saver image | pref-screensaver-style |
| Screen Saver Bitmap File | Bitmap file if screen saver style is bitmap | pref-screensaver-bitmap-file |

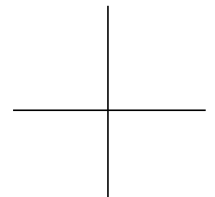

X, SIE, and Graphics Preferences

The parameters in the X, SIE, and Graphics hide box affect X graphics and performance attributes.

| X, SIE, and Graphics Field | Description | Corresponding Parameter |
|-----------------------------------|--|---|
| Enable Benchmark Optimizations | Optimizes some graphics operations for benchmark testing | pref-xserver-benchmark-optimizations |
| Enable Graphics Optimizations | Optimizes some graphics operations with a possible loss in accuracy | pref-xserver-graphics-optimizations |
| Screen Resolution (dots per inch) | The resolution reported by the X server to clients and the font server | pref-xserver-screen-resolution |
| Use Backing Store | How backing store is provided to client windows | pref-xserver-backing-store |
| SIE Sampling Method | SIE sampling method used in scaling | pref-sie-sampling-method |
| SIE Contrast Threshold | Contrast value used in SIE scaling operations | pref-sie-contrast-threshold |

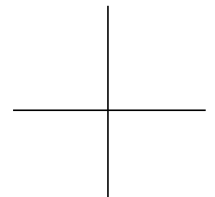

10 Statistics Menus

This chapter describes the controls and fields in the Show Statistics (*stats*) local client. Show Statistics displays statistical parameters that report on terminal functions.

The following topics are covered in this chapter:

- ❑ “Accessing Statistical Parameters” on page 10-1
- ❑ “Components of the Show Statistics Window” on page 10-1
- ❑ “Contents of the Statistics Hide Boxes” on page 10-2

For information about the other menu items under Statistics in the Console menu bar, see the *NCDware System Administrator’s Guide for UNIX Systems*.

Accessing Statistical Parameters

To access the statistical parameters from the Console, select the Show Statistics item in the Console window’s Statistics menu (Statistics ⇒ Show Statistics). Clicking on a hide button displays the contents of the hide box.

For other ways to display and start this client and information about disabling the client, see the *System Administrator’s Guide*.

Components of the Show Statistics Window

Show Statistics is composed of hide boxes providing access to fields that correspond to read-only remote configuration parameters.

The Show Statistics window has a menu bar with a File menu and a Sections menu, a messages area, and several buttons:

- ❑ The File menu provides the following commands:
 - `Connect to New Unit`—Presents a popup box requesting a terminal name and the password required for access to the statistical database on that terminal and displays the terminal’s Show Statistics window.

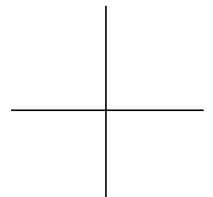

Contents of the Statistics Hide Boxes

You can use the Configuration daemon read/write password, the Configuration daemon read-only password (default is public), or the global password.

- `close`—Closes the Show Statistics window.
- ❑ The Sections menu lists the Show Statistics hide boxes, giving you an alternative way to open or to open or close all hide boxes with one selection.
- ❑ The Messages area located below the hide boxes displays messages from the client.
- ❑ The three buttons along the bottom of the window are:
 - `Update`—Updates the statistical displays
 - `Clear All`—Resets all statistics to zero
 - `Cancel`—Closes the Show Statistics client

Contents of the Statistics Hide Boxes

This section describes the hide boxes in the Show Statistics window, including a description of each parameter and the name of the corresponding remote configuration parameter.

Ethernet Statistics

The parameters in the Ethernet hide box report statistics on the terminal's Ethernet interface.

| Ethernet Field | Description | Corresponding Parameter |
|------------------|--|------------------------------------|
| Interfaces Table | Table of read-only Ethernet interface statistics | <code>enet-interfaces-table</code> |

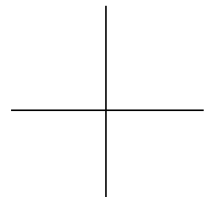

Font Usage Statistics

The parameters in the Font Usage hide box report statistics on font usage.

| Font Usage Field | Description | Corresponding Parameter |
|--------------------------|--|--------------------------------------|
| Cache Size | Size of the font cache (in bytes) | font-cache-size |
| Cache Used | Portion of the font cache in use (in bytes) | font-cache-used |
| Number of Fonts in Cache | Number of fonts in the cache | font-number-of-fonts-in-cache |
| Total Fonts Loaded | Number of fonts loaded since the terminal was last reset | font-total-fonts-loaded |
| Objects Currently in Use | Number of font objects currently in use | font-objects-currently-in-use |
| Cache Hits | Number of font cache hits | font-cache-hits |
| Object Count | Number of font objects | font-object-count |

ICMP Statistics

The parameters in the ICMP hide box report statistics on terminal communications using ICMP.

| ICMP Statistics Field | Description | Corresponding Parameter |
|-----------------------------------|--|---|
| Packets Received | Total number of ICMP messages received by the terminal (including all messages counted by icmp-packets-received-with-errors) | icmp-packets-received |
| Packets Received with Errors | Number of ICMP messages received by the terminal and determined to have ICMP-specific errors | icmp-packets-received-with-errors |
| Destination Unreachables Received | Number of ICMP Destination Unreachable messages received | icmp-destination-unreachables-received |

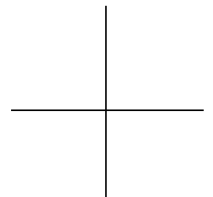

Contents of the Statistics Hide Boxes

| ICMP Statistics Field | Description | Corresponding Parameter |
|----------------------------------|--|--|
| Time Exceededs Received | Number of ICMP Time Exceeded messages received | icmp-time-exceededs-received |
| Parameter Problems Received | Number of ICMP Parameter Problem messages received | icmp-parameter-problems-received |
| Source Quenches Received | Number of ICMP Source Quench messages sent | icmp-source-quenches-received |
| Redirects Received | Number of ICMP Redirect messages received | icmp-redirects-received |
| Echo Requests Received | Number of Echo (request) messages received | icmp-echo-requests-received |
| Echo Replies Received | Number of Echo Reply messages received | icmp-echo-replies-received |
| Timestamps Requests Received | Number of Timestamp (request) messages received | icmp-timestamp-requests-received |
| Timestamp Replies Received | Number of Timestamp (replies) messages received | icmp-timestamp-replies-received |
| Address Mask Requests Received | Number of Address Mask Request messages received | icmp-address-mask-requests-received |
| Address Mask Replies Received | Number of Address Mask Reply messages received | icmp-address-mask-replies-received |
| Packets Transmitted | Total number of ICMP messages that the terminal attempted to send (including messages counted by icmp-packets-unable-to-be-transmitted) | icmp-packets-transmitted |
| Packets Unable to be Transmitted | Number of ICMP messages that the terminal did not send due to problems discovered within ICMP, such as a lack of buffers (does not include errors discovered outside the ICMP layer) | icmp-packets-unable-to-be-transmitted |

10-4 Statistics Menus

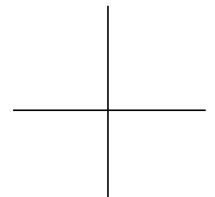

| ICMP Statistics Field | Description | Corresponding Parameter |
|--------------------------------------|--|--|
| Destination Unreachables Transmitted | Number of Destination Unreachable messages sent | icmp-destination-unreachables-transmitted |
| Time Exceededs Transmitted | Number of Time Exceeded messages sent | icmp-time-exceededs-transmitted |
| Parameter Problems Transmitted | Number of Parameter Problem messages sent | icmp-parameter-problems-transmitted |
| Source Quenches Transmitted | Number of Source Quench messages sent | icmp-source-quenches-transmitted |
| Redirects Transmitted | Number of Redirect messages sent (always zero because non-routers do not send redirect messages) | icmp-redirects-transmitted |
| Echo Requests Transmitted | Number of Echo (request) messages sent | icmp-echo-requests-transmitted |
| Echo Replies Transmitted | Number of Echo Reply messages sent | icmp-echo-replies-transmitted |
| Timestamp Requests Transmitted | Number of ICMP Timestamp (request) messages sent | icmp-timestamp-requests-transmitted |
| Timestamp Replies Transmitted | Number of Timestamp Reply messages sent | icmp-timestamp-replies-transmitted |
| Address Mask Requests Transmitted | Number of Address Mask Request messages sent | icmp-address-mask-requests-transmitted |
| Address Mask Replies Transmitted | Number of Address Mask Reply messages sent | icmp-address-mask-replies-transmitted |

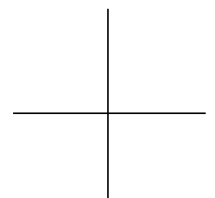

IP Statistics

The parameters in the IP hide box report statistics on terminal communications using IP.

| IP Field | Description | Corresponding Parameter |
|---|--|---|
| IP Forwarding Type | Whether the terminal is acting as an IP gateway when forwarding datagrams that were not addressed to the terminal | ip-forwarding-type |
| Packets Received | Total number of input datagrams received from interfaces (including datagrams received in error) | ip-packets-received |
| Packets Received with Errors in IP Header | Number of input datagrams discarded due to errors in their IP headers (including bad checksums, mismatched version numbers, incorrect format, exceeded time-to-live, and errors discovered in processing their IP options) | ip-packets-received-with-errors-in-ip-header |
| Packets Received with Incorrect Address | Number of input datagrams discarded because of an invalid address for the terminal in the IP header destination field (including invalid addresses, addresses of unsupported classes, and non-local addresses) | ip-packets-received-with-incorrect-address |
| Packets Forwarded | Number of input datagrams for which the terminal was not the final IP destination, resulting in attempts to find routes to forward them to their final destinations | ip-packets-forwarded |
| Packets Received with Unknown Protocols | Number of locally addressed datagrams received successfully but discarded because of an unknown or unsupported protocol | ip-packets-received-with-unknown-protocols |

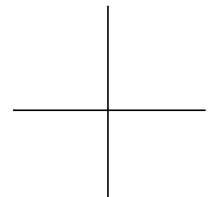

| IP Field | Description | Corresponding Parameter |
|---|--|---|
| Received Packets Discarded | Number of input datagrams for which no problem was encountered to prevent their continued processing, but were discarded anyway; for example, for lack of buffer space (does not include datagrams discarded while awaiting assembly) | ip-packets-received-and-discarded |
| Received Packets Delivered | Number of input datagrams successfully delivered to IP user protocols (including ICMP) | ip-packets-received-and-delivered |
| Packet Transmission Requests | Number of datagrams that local IP user protocols (including ICMP) supplied to IP in requests for transmission (does not include datagrams counted in ip-packets-forwarded) | ip-packet-transmission-requests |
| Packet Transmission Requests Discarded | Number of output datagrams for which no problem was encountered to prevent transmission, but were discarded anyway; for example, for lack of buffer space (includes datagrams counted in ip-packets-forwarded , if such packets met this discretionary discard criterion) | ip-packet-transmission-requests-discarded |
| Packet Transmission Requests without Routes | Number of datagrams discarded because no route could be found to transmit them to their destination. Includes any packets counted in ip-packets-forwarded that met this criterion (including datagrams that a host cannot route because its default gateways are down) | ip-packet-transmission-requests-without-routes |
| Packet Reassembly Timeout | Maximum number of seconds that the terminal holds fragments awaiting reassembly | ip-packet-reassembly-timeout |

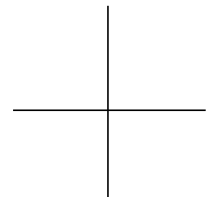

Contents of the Statistics Hide Boxes

| IP Field | Description | Corresponding Parameter |
|-------------------------------------|---|---|
| Packet Reassemblies Required | Number of IP fragments received that need to be reassembled at the terminal | ip-packet-reassemblies-required |
| Packet Reassemblies Completed | Number of datagrams successfully reassembled | ip-packet-reassemblies-completed |
| Packet Reassemblies Not Completed | Number of failures detected by the IP reassembly algorithm | ip-packet-reassemblies-not-completed |
| Packet Fragmentations Completed | Number of datagrams that the terminal successfully fragmented | ip-packet-fragmentations-completed |
| Packet Fragmentations Not Completed | Number of datagrams discarded because they could not be fragmented at the terminal | ip-packet-fragmentations-not-completed |
| Packet Fragments Created | Number of datagram fragments generated as a result of fragmentation at the terminal | ip-packet-fragments-created |
| Subnet Address | Current subnet address for the terminal | ip-subnet-mask |

Loadable Modules Statistics

The statistics in the Loadable Modules hide box report on the modules that are currently loaded.

| Loadable Modules Field | Description | Corresponding Parameter |
|-------------------------------|--|--------------------------------|
| Currently Loaded | Information about currently loaded modules (including module name, memory used, and version) | modules-loaded |

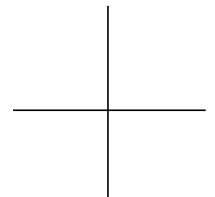

NCDnet Statistics

The parameters in the NCDnet hide box report statistics on terminal communications using NCDnet (DECnet).

| NCDnet Statistics Field | Description | Corresponding Parameter |
|--------------------------------|---|--------------------------------------|
| Node Address | Current DECnet address of the terminal | ncdnet-node-address |
| Data Blocks Sent | Number of data messages sent over DECnet | ncdnet-data-blocks-sent |
| Data Blocks Received | Number of data messages received over DECnet | ncdnet-data-blocks-received |
| Bytes Sent | Number of bytes transmitted over DECnet | ncdnet-bytes-sent |
| Bytes Received | Number of bytes received over DECnet | ncdnet-bytes-received |
| Hello Packets Sent | Number of DECnet Hello packets sent | ncdnet-hello-packets-sent |
| Hello Packets Received | Number of DECnet Hello packets received | ncdnet-hello-packets-received |
| Count Circuit Down | Number of circuit down events that occurred | ncdnet-count-circuit-down |
| Inbound Errors | Number of DECnet receive errors | ncdnet-inbound-errors |
| Outbound Errors | Number of DECnet transmit errors | ncdnet-outbound-errors |
| Seconds Since Zeroed | Number of seconds since the DECnet statistics were last reset to zero | ncdnet-seconds-since-zeroed |

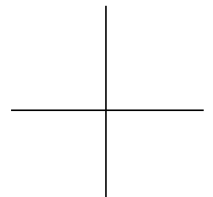

NCDnet Name Service Statistics

The parameters in the NCDnet Name Service hide box report statistics on name service actions in a DECnet network.

| NCDnet Name Service Field | Description | Corresponding Parameter |
|----------------------------------|--|---|
| Name Requests | Number of times the NCD name resolver was invoked | ncdnet-name-requests |
| Numerical Addresses | Number of times the name resolver was invoked with the DECnet name in numerical format, such as 1.17 | ncdnet-name-numerical-addresses |
| Name Cache Hits | Number of local name cache invocations in which the answer was found | ncdnet-name-cache-hits |
| Name Server Hits | Number of times the name resolver was invoked and the answer was found by consulting the name servers | ncdnet-name-server-hits |
| Name Cache Overflows | Number of times a valid entry in the local name cache was deleted to make room for a new entry | ncdnet-name-cache-overflows |
| <i>Errors section</i> | | |
| No Such Name Errors | Number of times the DECnet name servers returned No Such Name error messages in response to name request | ncdnet-name-no-such-name-errors |
| Bad Name Errors | Number of Bad Name errors returned by the name servers (indicates a badly formed name) | ncdnet-name-bad-name-errors |
| Name Server Response Errors | Number of badly formed responses returned by the name servers | ncdnet-name-server-response-errors |
| No Server Responses | Number of times the name servers did not respond to name requests | ncdnet-name-no-server-responses |
| System Errors | Number of times the name resolver encountered a general system error | ncdnet-name-system-errors |

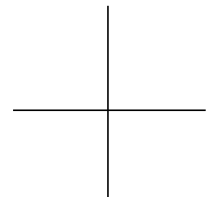

| NCDnet Name Service Field | Description | Corresponding Parameter |
|----------------------------------|--|---|
| Memory Allocation Failures | Number of times the name resolver could not allocate required memory | ncdnet-name-memory-allocation-failures |

Network Buffers Statistics

The parameters in this hide box report statistics on network buffers.

| Network Buffers Field | Description | Corresponding Parameter |
|------------------------------|--|--|
| Total Buffers | Total number of network buffers | net-total-buffers |
| Available Buffers | Number of unallocated network buffers | net-available-buffers |
| Total Cluster Buffers | Total number of large contiguous network buffers in the terminal | net-total-cluster-buffers |
| Available Cluster Buffers | Number of unallocated large contiguous network buffers | net-available-cluster-buffers |
| Reserved Data Buffers | Number of network buffers reserved, but not yet allocated, for storing user data within the protocol stacks | net-reserved-data-buffers |
| Buffer Not Available Errors | Number of times the networking code initiated error recovery procedures because it could not allocate a network buffer | net-buffer-not-available-errors |
| Buffer Waits | Number of times the networking code blocked while waiting for network buffers to become available | net-buffer-waits |

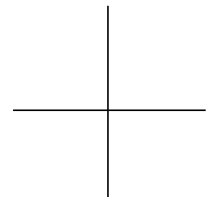

Contents of the Statistics Hide Boxes

| Network Buffers Field | Description | Corresponding Parameter |
|--------------------------------------|--|---|
| <i>Used Buffers section</i> | | |
| Packet Data Buffers | Number of packet data buffers | net-packet-data-buffers |
| Packet Header Buffers | Number of network buffers allocated for storing protocol header information | net-packet-header-buffers |
| Packet Fragment Reassembly Buffers | Number of network buffers allocated for storing IP packet fragments for reassembly | net-packet-fragment-reassembly-buffers |
| Connection Control Structure Buffers | Number of network buffers allocated for storing connection control structures | net-connection-control-structure-buffers |
| Connection Name Buffers | Number of network buffers allocated for storing connection names | net-connection-name-buffers |
| Connection Option Buffers | Number of network buffers allocated for storing connection options | net-connection-option-buffers |
| Protocol Control Structure Buffers | Number of network buffers allocated for storing protocol control structures | net-protocol-control-structure-buffers |
| Interface Address Buffers | Number of buffers allocated for storing network interface address information | net-interface-address-buffers |
| ARP Table Entry Buffers | Number of network buffers allocated for storing ARP table entries | net-arp-table-entry-buffers |

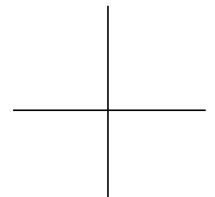

Network Interfaces Statistics

The parameters in this hide box report on network interface statistics.

| Network Interfaces Field | Description | Corresponding Parameter |
|--------------------------|--|---------------------------------|
| Number of Interfaces | Number of network interfaces | net-number-of-interfaces |
| Interfaces Table | Table of network interface characteristics | net-interfaces-table |

NFS Statistics

The parameters in this hide box report statistics on file access using NFS.

| NFS Field | Description | Corresponding Parameter |
|---------------------------|---|------------------------------------|
| <i>Client NFS section</i> | | |
| Null Requests | Number of NFS null operations requested by the NFS Client | nfs-null-requests |
| Get Attributes Requests | Number of NFS Get Attributes operations requested by the NFS client | nfs-get-attributes-requests |
| Set Attributes Requests | Number of NFS Set Attribute operations requested by the NFS client | nfs-set-attributes-requests |
| Get Root Requests | Number of NFS Get File System Root operations requested by the NFS client | nfs-get-root-requests |
| Path Lookup Requests | Number of NFS File Name Component Lookup operations requested by the NFS client | nfs-path-lookup-requests |
| Read Symlink Requests | Number of NFS Read Link operations requested by the NFS client | nfs-read-symlink-requests |

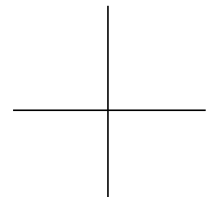

Contents of the Statistics Hide Boxes

| NFS Field | Description | Corresponding Parameter |
|-----------------------------|---|--|
| Read Data Requests | Number of NFS Read operations requested by the NFS client | nfs-read-data-requests |
| Write Data Cache Requests | Number of NFS Write Data Cache operations requested by the NFS client | nfs-write-data-cache-requests |
| Write Data Requests | Number of NFS Write Data Cache operations requested by the NFS client | nfs-write-data-requests |
| File Create Requests | Number of NFS File Create operations requested by the NFS client | nfs-file-create-requests |
| File Remove Requests | Number of NFS File Remove operations requested by the NFS client | nfs-file-remove-requests |
| File Rename Requests | Number of NFS File Rename operations requested by the NFS client | nfs-file-rename-requests |
| Link Create Requests | Number of NFS Create Link operations requested by the NFS client | nfs-link-create-requests |
| Symlink Create Requests | Number of NFS Create Symbolic Link operations requested by the NFS client | nfs-symlink-create-requests |
| Directory Create Requests | Number of NFS Create Directory operations requested by the NFS client | nfs-directory-create-requests |
| Directory Remove Requests | Number of NFS Remove Directory operations requested by the NFS client | nfs-directory-remove-requests |
| Directory Contents Requests | Number of NFS Read Directory operations requested by the NFS client | nfs-directory-contents-requests |

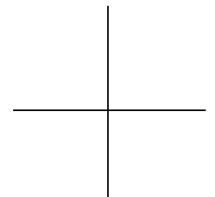

| NFS Field | Description | Corresponding Parameter |
|--------------------------------|---|---|
| Get File System Stats Requests | Number of NFS Stat File System operations requested by the NFS client | nfs-get-file-system-stats-requests |
| <i>Server NFS section</i> | | |
| Null Requests | Number of NFS read directory operations received by the terminal | nfs-received-null-requests |
| Get Attributes Requests | Number of NFS create directory operations received by the terminal | nfs-received-get-attributes-requests |
| Set Attributes Requests | Number of NFS set attribute operations received by the terminal | nfs-received-set-attributes-requests |
| Get Root Requests | Number of NFS get file system root operations received by the terminal | nfs-received-get-root-requests |
| Path Lookup Requests | Number of NFS filename component lookup operations received by the terminal | nfs-received-path-lookup-requests |
| Read Symlink Requests | Number of NFS read link operations received by the terminal | nfs-received-read-symlink-requests |
| Read Data Requests | Number of NFS read operations received by the terminal | nfs-received-read-data-requests |
| Write Data Cache Requests | Number of NFS write data cache operations received by the terminal | nfs-received-write-data-cache-requests |
| Write Data Requests | Number of NFS write data operations received by the terminal | nfs-received-write-data-requests |
| File Create Requests | Number of NFS create file operations received by the terminal | nfs-received-file-create-requests |
| File Remove Requests | Number of NFS remove file operations received by the terminal | nfs-received-file-remove-requests |
| File Rename Requests | Number of file rename operations received by the terminal | nfs-received-file-rename-requests |

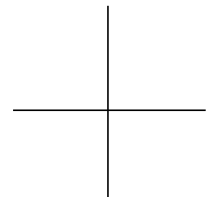

Contents of the Statistics Hide Boxes

| NFS Field | Description | Corresponding Parameter |
|--------------------------------|--|--|
| Link Create Requests | Number of NFS create link operations received by the terminal | nfs-received-link-create-requests |
| Symlink Create Requests | Number of NFS create symbolic link operations received by the terminal | nfs-received-symlink-create-requests |
| Directory Create Requests | Number of NFS create directory operations received by the terminal | nfs-received-directory-create-requests |
| Directory Remove Requests | Number of NFS remove directory operations received by the terminal | nfs-received-directory-remove-requests |
| Directory Contents Requests | Number of NFS read directory operations received by the terminal | nfs-received-directory-contents-requests |
| Get File System Stats Requests | Number of NFS stats file system operations received by the terminal | nfs-received-get-file-system-stats-requests |

Parallel Daemon Statistics

The parameters in this hide box report about parallel port software functions. This hide box contains the Parallel Daemons Statistics table, which corresponds to the **parallel-daemons-statistics-table** parameter.

| Table Entry | Description |
|--|--|
| Port Number | The identifying number of the parallel port |
| Connections Accepted | The number of connections to the Parallel daemon |
| Connections with Access Control Errors | The number of connections closed by the Parallel daemon because the remote address was not in the Parallel daemon's access control list |
| Connections with I/O Errors | The number of connections closed by the Parallel daemon because of a local I/O error, including the user aborting the connection through a local mechanism |
| Connections with Normal Completion | The number of connections closed by the remote host, which is the normal mode of ending a Parallel daemon connection |

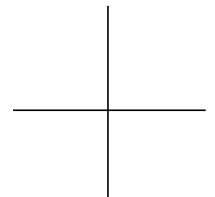

Serial Statistics

The parameters in this hide box report statistics on the physical serial interfaces. This hide box contains the Interface Statistics table, which corresponds to the **serial-interface-statistics-table** parameter.

| Table Entries | Description |
|------------------------------|---|
| Port Number | The identifying number of the serial port |
| Reception Overruns | The number of times an incoming octet overwrote a previously received octet in the UART's buffer |
| Reception Frame Errors | The number of times an incoming octet had bad bit alignment |
| Reception Parity Errors | The number of times the parity bit of an incoming octet was incorrect |
| Reception Break Errors | The number of times a stop bit was not received at the expected time after a start bit and the intervening bits were all zero |
| Total Characters Transmitted | The total number of characters transmitted |
| Total Transmit Interrupts | The total number of transmission interrupts |
| Total Characters Received | The total number of characters received |
| Total Receive Interrupts | The total number of reception interrupts |
| Total Receive Errors | The total number of reception errors |

Serial Daemons Statistics

The parameters in this hide box report statistics on serial port software functions. This hide box contains the Serial Daemons Statistics table, which corresponds to the **serial-daemons-statistics-table** parameter.

| Table Entries | Description |
|----------------------|--|
| Port Number | The identifying number of the serial port |
| Connections Accepted | The number of connections to the Serial daemon |

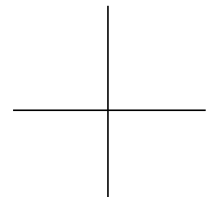

Contents of the Statistics Hide Boxes

| Table Entries | Description |
|--|--|
| Connections with Access Control Errors | The number of connections closed by the Serial daemon because the remote address was not in the Serial daemon's access control list |
| Connections with I/O Errors | The number of connections closed by the Serial daemon because of a local I/O error, including the user aborting the connection through a local mechanism |
| Connections with Normal Completion | The number of connections closed by the remote host, which is the normal mode of ending a Serial daemon connection |

SNMP Statistics

The parameters in this hide box report statistics on SNMP. For statistics that refer to the PDU (Protocol Data Unit), "error-status" field, see SNMP specifications for the relevant error code.

| SNMP Field | Description | Corresponding Parameter |
|---|--|---|
| Packets Received | Total number of messages delivered to SNMP from the transport service | snmp-packets-received |
| Packets Transmitted | Total number of messages passed from SNMP to the transport service | snmp-packets-transmitted |
| Packets Received with Bad Versions | Total number of messages delivered that were for an unsupported SNMP version | snmp-packets-received-with-bad-versions |
| Packets Received with Bad Community Names | Total number of messages delivered to SNMP that used an unknown community name | snmp-packets-received-with-bad-community-names |
| Packets Received with Bad Community Uses | Total number of messages delivered to SNMP that represented an operation that was not allowed by the SNMP community named in the message | snmp-packets-received-with-bad-community-uses |

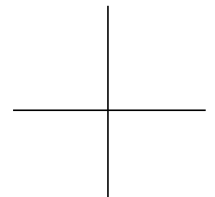

| SNMP Field | Description | Corresponding Parameter |
|--|--|--|
| Packets Received with ASN.1 Errors | Number of ASN.1 or BER errors encountered by SNMP when decoding received messages | snmp-packets-received-with-asn1-errors |
| Packets Received with Bad Variable Types | Number of SNMP PDUs delivered to SNMP that had an unknown PDU type | snmp-packets-received-with-bad-variable-types |
| Too Big Error Responses Received | Number of PDUs generated by SNMP with “tooBig” in the “error-status” field | snmp-too-big-error-responses-received |
| Bad Variable Name Error Responses Received | Number of PDUs delivered to SNMP with the value of “noSuchName” in the “error-status” field | snmp-bad-variable-name-error-responses-received |
| Bad Variable Values Error Responses Received | Number of PDUs delivered to SNMP for which the value of the “error-status” field is “badValue” | snmp-bad-variable-values-error-responses-received |
| Read-Only Variable Error Responses Received | Number of valid PDUs that are delivered to SNMP for which the value of the “error-status” field is “readonly.” Generating such a PDU is a protocol error | snmp-read-only-variable-error-responses-received |
| General Error Responses Received | Total number of PDUs generated for which the value of the “error-status” field is “genErr” | snmp-general-error-responses-received |
| Variable Gets Completed | Total number of MIB objects successfully retrieved as the result of receiving valid “Get-Request” and “Get-Next” PDUs | snmp-variable-gets-completed |
| Variable Sets Completed | Total number of MIB objects changed after receiving valid “Set-Request” PDUs | snmp-variable-sets-completed |
| Get Requests Received | Total number of “Get-Request” PDUs accepted and processed | snmp-get-requests-received |

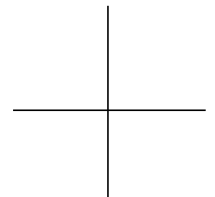

Contents of the Statistics Hide Boxes

| SNMP Field | Description | Corresponding Parameter |
|---|--|---|
| Get-Next Requests Received | Total number of SNMP “Get-Next” PDUs accepted and processed | snmp-get-next-requests-received |
| Set Requests Received | Total number of “Set-Requests” PDUs accepted and processed | snmp-set-requests-received |
| Get Responses Received | Total number of “Get-Responses” PDUs accepted and processed | snmp-get-responses-received |
| Traps Received | Total number of Trap PDUs accepted and processed | snmp-traps-received |
| Too Big Error Responses Transmitted | Total number of PDUs generated with “tooBig” in the “error-status” field | snmp-too-big-error-responses-transmitted |
| Bad Variable Name Error Responses Transmitted | Total number of PDUs generated with “error-status” of “noSuchName” | snmp-bad-variable-name-error-responses-transmitted |
| Bad Variable Values Error Responses Transmitted | Total number of PDUs generated with “error-status” of “badValue” | snmp-bad-variable-values-error-responses-transmitted |
| Read-Only Variable Error Responses Transmitted | Total number of valid PDUs generated with “error-status” of “readonly” | snmp-read-only-variable-error-responses-transmitted |
| General Error Responses Transmitted | Total number of PDUs generated with “error-status” of “genErr” | snmp-general-error-responses-transmitted |
| Get Requests Transmitted | Total number of “Get-Request” PDUs generated | snmp-get-requests-transmitted |
| Get-Next Requests Transmitted | Total number of “Get-Next” PDUs generated | snmp-get-next-requests-transmitted |
| Set Requests Transmitted | Total number of “Set-Requests” PDUs generated | snmp-set-requests-transmitted |
| Get Responses Transmitted | Total number of “Get-Response” PDUs generated | snmp-get-responses-transmitted |

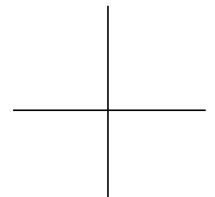

| SNMP Field | Description | Corresponding Parameter |
|-------------------|-------------------------------------|-------------------------------|
| Traps Transmitted | Total number of trap PDUs generated | snmp-traps-transmitted |

TCP Statistics

The parameters in this hide box report statistics on terminal communications using TCP.

| TCP Statistics Field | Description | Corresponding Parameter |
|-------------------------------|--|--|
| Retransmission Algorithm Type | Algorithm that determines the timeout value used for retransmitting unacknowledged octets (only the Van-Jacobson algorithm is supported) | tcp-retransmission-algorithm-type |
| Minimum Retransmission Time | Minimum time (in seconds) permitted for the retransmission timeout) | tcp-minimum-retransmission-time |
| Maximum Retransmission Time | Maximum time (in seconds) permitted for retransmission | tcp-maximum-retransmission-time |
| Maximum Number of Connections | Limit on the total number of TCP connections supported; should be -1 in a terminal whose maximum number of transmissions is dynamic | tcp-maximum-number-of-connections |
| Active Connect Attempts | Number of times TCP connections made a direct transition to the SYN-SENT state from the CLOSED state | tcp-active-connect-attempts |
| Passive Connects Attempts | Number of times TCP connections made a direct transition to the SYN-RCVD state from the LISTEN state | tcp-passive-connects-attempts |

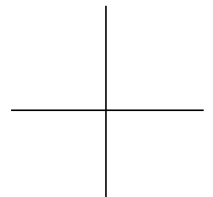

Contents of the Statistics Hide Boxes

| TCP Statistics Field | Description | Corresponding Parameter |
|--|---|---|
| Failed Connect Attempts | Number of times TCP connections made a direct transition to the CLOSED state from either the SYN-SENT state or the SYN-RCVD state and to the LISTEN state from the SYN-RCVD state | tcp-failed-connect-attempts |
| Established Connections | Number of TCP connections whose current state is either ESTABLISHED or CLOSE-WAIT | tcp-established-connections |
| Connections Timed Out on Retransmissions | Number of connections that progressed directly to the CLOSED state because too many retransmissions were sent | tcp-connections-timed-out-on-retransmissions |
| Connections Timed Out on Keepalives | Number of connections that progressed directly to the CLOSED state because too many keepalives were sent | tcp-connections-timed-out-on-keepalives |
| Connections Reset | Number of times connections made a direct transition to the CLOSED state from the established state or the CLOSED-WAIT state | tcp-connections-reset |
| Packets Received | Total number of segments received, including those received in error; includes segments received on currently established connections | tcp-packets-received |
| Packets Transmitted | Total number of segments sent, including those on current connections, but excluding those containing only retransmitted octets | tcp-packets-transmitted |

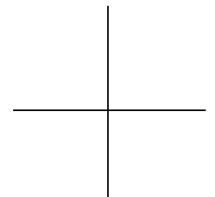

| TCP Statistics Field | Description | Corresponding Parameter |
|-------------------------------|---|--|
| Packets Retransmitted | Total number of segments retransmitted (transmitted containing one or more previously transmitted octets) | tcp-packets-retransmitted |
| Ack Packets Received | Number of packets received that contained no data, only the ACK flag turned on | tcp-ack-packets-received |
| Ack-Only Packets Transmitted | Number of packets transmitted that acknowledged one or more octets of unacknowledged data | tcp-ack-only-packets-transmitted |
| Packets with Errors Received | Total number of segments received in error (such as bad TCP checklists) | tcp-packets-with-errors-received |
| Keepalive Packets Transmitted | Number of TCP keepalive packets transmitted | tcp-keepalive-packets-transmitted |
| Reset Packets Transmitted | Number of segments sent containing the RST flag | tcp-reset-packets-transmitted |
| Connection Table | Table listing TCP connections (including local and remote IP addresses and ports and the state of the connection) | tcp-connection-table |

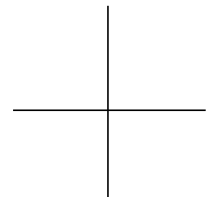

TCP/IP Name Service Statistics

The parameters in this hide box report statistics on name service protocols in a TCP/IP network.

| TCP/IP Name Service Field | Description | Corresponding Parameter |
|----------------------------------|--|--|
| Name Requests | Number of times the name resolver was invoked | tcpip-name-requests |
| Numerical Addresses | Number of invocations in which the name was in numerical format, such as 192.43.154.7 | tcpip-name-numerical-addresses |
| Name Cache Hits | Number of invocations in which the answer was found in the local name cache | tcpip-name-cache-hits |
| Name Server Hits | Number of invocations in which the answer was found by consulting the name servers | tcpip-name-server-hits |
| Name Cache Overflows | Number of times a valid entry in the local name cache was deleted to make room for a new entry | tcpip-name-cache-overflows |
| <i>Errors section</i> | | |
| No Such Name Errors | Number of "No Such Name" errors returned by the name servers | tcpip-no-such-name-errors |
| Bad Name Errors | Number of "Bad Name" errors returned by the name servers | tcpip-name-bad-name-errors |
| Name Server Response Errors | Number of badly formed responses returned by the name servers | tcpip-name-server-response-errors |
| No Server Responses | Number of times no response was received from the name servers | tcpip-name-no-server-responses |
| System Errors | Number of times the name resolver encountered a general system error | tcpip-name-system-errors |

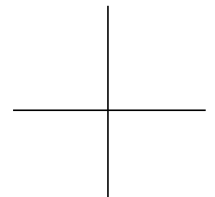

| TCP/IP Name Service Field | Description | Corresponding Parameter |
|----------------------------------|--|--|
| Memory Allocation Failures | Number of times the name resolver was unable to allocate required memory | tcpip-name-memory-allocation-failures |

TFTP Statistics

The parameters in this hide box report statistics on file access using TFTP.

| TFTP Field | Description | Corresponding Parameter |
|-------------------------------------|---|---|
| File Read Requests Transmitted | Number of read requests made by the TFTP client | tftp-file-read-requests-transmitted |
| File Write Requests Transmitted | Number of file write requests made by the TFTP client | tftp-file-write-requests-transmitted |
| Data Packets Received | Number of data packets received by the TFTP client | tftp-data-packets-received |
| Ack Packets Received | Number of TFTP ACK packets received by the TFTP client | tftp-ack-packets-received |
| No File Error Responses Received | Number of times a TFTP client received an error packet with error code "File not found" | tftp-no-file-error-responses-received |
| Bad Access Error Responses Received | Number of times the TFTP client received an error packet with error code "Access violation" | tftp-bad-access-error-responses-received |
| Disk Full Error Responses Received | Number of times a TFTP client received an error packet with error code "Disk full" | tftp-disk-full-error-responses-received |
| No Available Buffer Errors | Number of times a TFTP client failed to allocate a buffer | tftp-no-available-buffer-errors |
| Data Packets Transmitted | Number of TFTP data packets the TFTP client sent | tftp-data-packets-transmitted |

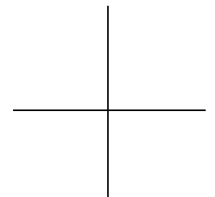

Contents of the Statistics Hide Boxes

| TFTP Field | Description | Corresponding Parameter |
|-------------------------|---|-------------------------------------|
| Ack Packets Transmitted | Number of TFTP ACK packets sent by the TFTP client | tftp-ack-packets-transmitted |
| Packets Retransmitted | Number of times a TFTP client retransmitted a TFTP packet | tftp-packets-retransmitted |

Token-Ring Statistics

The parameters in this hide box report statistics on the Token-Ring interfaces.

| Token-Ring Field | Description | Corresponding Parameter |
|-------------------------|--|---------------------------------|
| Interface Table | Table of status and parameter values for an 802.5 Token-Ring interface | tokring-interface-table |
| Statistics Table | Table of statistics for each 802.5 Token-Ring interface | tokring-statistics-table |

UDP Statistics

The parameters in this hide box report statistics on UDP communications.

| UDP Statistics Field | Description | Corresponding Parameter |
|------------------------------------|--|---|
| Packets Received | Total number of UDP datagrams delivered to UDP applications | udp-packets-received |
| Packets Received with Errors | Number of received UDP datagrams that could not be delivered for reasons other than the lack of an application at the destination port | udp-packets-received-with-errors |
| Packets Received with Unknown Port | Total number of received UDP datagrams for which there were no applications at the destination port | udp-packets-received-with-unknown-port |
| Packets Transmitted | Total number of UDP datagrams sent from the terminal | udp-packets-transmitted |

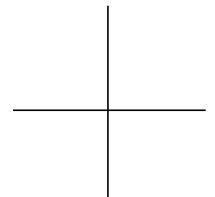

| UDP Statistics Field | Description | Corresponding Parameter |
|----------------------|--|---------------------------|
| Listener Table | Table of IP addresses and ports for the UDP listener | udp-listener-table |

Unit Statistics

The statistics in this hide box report on miscellaneous terminal attributes.

| Unit Field | Description | Corresponding Parameter |
|-------------------------------|--|---|
| Version | Complete specification of the NCDware software version | unit-version |
| Terminal Model | Current terminal model | unit-terminal-model |
| Boot Monitor Version | Boot PROM version number | unit-boot-monitor-version |
| Keyboard Controller Version | Description of the keyboard controller | unit-keyboard-controller-version |
| SNMP System Object Id | Authoritative identification of the SNMP network management subsystem in the terminal | unit-snmp-system-object-id |
| Time Since Boot (seconds) | How long since the terminal last booted | unit-time-since-boot |
| Idle Time (seconds) | Estimated time since booting during which the X server was not performing any useful tasks | unit-idle-time |
| TCP/IP Service Level | A value that indicates the set of network services that the terminal offers | unit-tcpip-service-level |
| Code Memory Installed (bytes) | Amount of code RAM installed in the terminal | unit-code-memory-installed |
| Memory Installed (bytes) | Total amount of installed RAM (does not include special-purpose RAM, such as video memory) | unit-memory-installed |

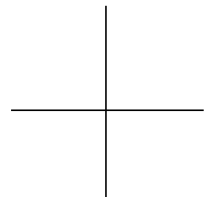

Contents of the Statistics Hide Boxes

| Unit Field | Description | Corresponding Parameter |
|---------------------------|---|--|
| Memory Available (bytes) | Amount of unallocated RAM | unit-memory-available |
| Block of Available Memory | Number of non-contiguous blocks of unallocated memory | unit-blocks-of-available-memory |
| Floating Point Exceptions | Total number of floating-point exceptions | unit-floating-point-exceptions |

Wireless LAN Statistics

The parameters in the Wireless LAN hide box report statistics on wireless operations (Explora 400/450 terminals only).

The Interface Table reports the status of the wireless LAN adapter and corresponds to the **pwireless-interface-table** parameter.

| Wireless Interface Table Entry | Description |
|--------------------------------|---|
| Domain | The domain used by the wireless PCMCIA card |
| Master Name | The current Master (Access Point) name |
| Master Node ID | The current Master (Access Point) node |
| Channel | The current channel |
| Subchannel | The current subchannel |
| ROM Version | The ROM version of the PCMCIA card |
| Country Code | The country code |
| Signal Strength | The signal strength of the last packet received |

The Statistics Table on the next page reports performance statistics for the wireless LAN adapter and corresponds to the **pwireless-statistics-table** parameter.

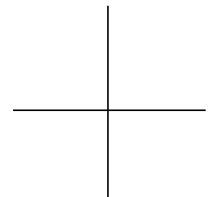

| Wireless Statistics Table Entry | Description |
|--|--|
| Number of Hops | The number of hop periods |
| Number of Searches | The number of searches for other Masters |
| Times Master | The number of times the terminal has been Master |
| Times Resync | The number of times the terminal synchronized to a new master |
| Missed Syncs | The number of sync messages missed |
| RX Packets | The number of data packets received |
| TX Packets | The number of data packets transmitted |
| Lost CTS | The number of times RTS was sent without receiving a CTS |
| CTS Errors | The number of times CTS retries expired |
| ACK Errors | The number of times ACK retries expired |
| SID Mismatch | The number of mismatched security IDs |
| Missed SOBs | The number of Start of B messages missed |
| Corrupted Packets | The number of packets that passed CRC, but not length check |
| Adapter Resets | The number of times the wireless adapter had to reset for initialization or error recovery |
| Send Timeouts | The number of transmit timeouts |
| Receive Timeouts | The number of receive timeouts |
| Antenna Status Changes | The number of antenna status change (connect/disconnect) interrupts received |
| Roam Alarms | The number of roaming alarm packets received, which indicates that the signal strength is weak |
| In Syncs | The number of times the terminal synchronized to a Master station |
| Out Syncs | The number of the times the terminal lost contact with the Master station |

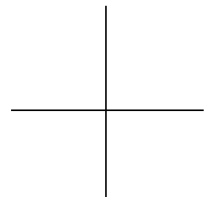

XRemote Statistics

The parameters in this hide box report statistics on XRemote. Except for Packet Round Trip Time, these statistics are reported when XRemote is being used in non-TCP mode.

| XRemote Field | Description | Corresponding Parameter |
|----------------------------------|--|---|
| XRemote version | The version of XRemote protocol in use | xremote-xremote-version |
| State | State of the XRemote connection | xremote-state |
| Packets Transmitted | Number of XRemote packets transmitted, including packets retransmitted | xremote-packets-transmitted |
| Packet Transmission Errors | Number of errors encountered while trying to transmit packets | xremote-packet-transmission-errors |
| Packets Retransmitted | Number of Xremote packets retransmitted | xremote-packets-retransmitted |
| Packets Received | Number of XRemote packets received | xremote-packets-received |
| Packets with Errors Received | Number of XRemote packets received in error | xremote-packets-with-errors-received |
| Packets Received Out of Sequence | Number of XRemote packets received with an incorrect sequence number | xremote-packets-received-out-of-sequence |
| Packet Round Trip Time | Current approximation of the time (in milliseconds) elapsed from sending a packet until acknowledgment is received | xremote-packet-round-trip-time |
| Time-out Length | Current timeout period (in milliseconds). Packets not acknowledged in the timeout period are retransmitted | xremote-time-out-length |
| Transmit Window Size | Number of packets that may be transmitted before acknowledgment by the remote host is required | xremote-transmit-window-size |

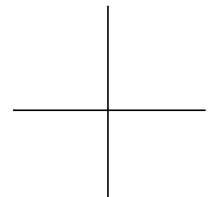

Contents of the Statistics Hide Boxes

| XRemote Field | Description | Corresponding Parameter |
|-------------------------------|--|--|
| Next Transmit Sequence Number | The sequence number of the next packet to be transmitted | xremote-next-transmit-sequence-number |
| Oldest Unacknowledged Packet | The sequence number of the oldest unacknowledged transmitted packet | xremote-oldest-unacknowledged-packet |
| Receive Window Size | Number of packets that may be received from the remote host without acknowledgment | xremote-receive-window-size |
| Next Receive Sequence Number | The expected sequence number of the next packet to be received | xremote-next-receive-sequence-number |

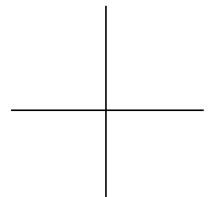

10-32 Statistics Menus

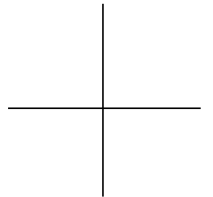

11 Boot Monitor and NVRAM

This chapter describes features of the terminal's Boot Monitor and NVRAM (non-volatile RAM), including Boot Monitor commands and the contents of NVRAM.

The following topics are covered in this chapter:

- ❑ “Boot Monitor Versions” on page 11-1
- ❑ “Boot Monitor Functions” on page 11-2
- ❑ “Using Boot Monitor Commands” on page 11-6
- ❑ “Updating the Boot Monitor on Explora Terminals” on page 11-11
- ❑ “Using Boot Monitor Setup Menus to Configure Terminals” on page 11-12
- ❑ “Using the NVRAM Utility to Configure Terminals” on page 11-20

Boot Monitor Versions

The Boot Monitor version is displayed while the terminal boots. After the terminal boots, you can find the version in the Console's Statistics ⇒ Show Version window.

The Boot Monitor version required for a terminal depends on the terminal model and the interface boards installed in some terminal models. At the time of this manual's publication, Boot Monitor 2.8.3 is installed in all new HMX terminals, and Boot Monitor 2.8.2 is installed in new Explora and Explora Pro terminals. Boot Monitor 2.9.0 is installed in Explora 400/450, and Explora 700 terminals.

Older HMX terminals may have PROMs from version 2.7.1 or later, and older Explora terminals may have PROMs from version 2.7.6 or later.

Terminals with older versions of the Boot Monitor can run the most recent version of NCDware, however, you will not have access to features that require the newer Boot Monitor. See the *NCDware Release Notes* descriptions of new features and for information about Boot Monitor requirements.

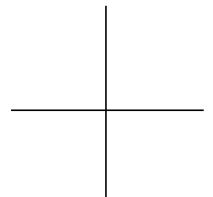

Boot Monitor Functions

The Boot Monitor is firmware code in the terminal's boot PROM. The Boot Monitor performs many functions automatically and provides interactive access to Boot Monitor functions and to configuration information stored in NVRAM (non-volatile RAM).

Automatic Boot Monitor Functions

The Boot Monitor is activated when you turn on the terminal and controls the booting process as the terminal discovers its network address and loads an X server.

This section describes the automatic functions that occur when you turn on or reboot the terminal. The functions are listed in chronological order and described in more detail in the following subsections.

The Boot Monitor automatically:

- ❑ Displays the Boot Monitor version number and keyboard controller version number
- ❑ Runs self-tests, including memory and network interface tests and displays the results of the self-tests
- ❑ Requests or provides the terminal's IP address
- ❑ Requests and loads an X server image
- ❑ Verifies that the downloaded X server image:
 - Fits into the terminal's memory
 - Is the correct one for the terminal model
 - Has not been corrupted
- ❑ Displays the progress of the download process. Beginning with version 2.8, the Boot Monitor reports the size of the X server and displays a graphical bar showing the progress of the X server download process. Earlier versions display progressions of dots.

Self Tests and Commands for Testing

The Boot Monitor tests terminal memory and the terminal's network interface. The specific tests available for and run by default on the terminal depend upon the terminal model.

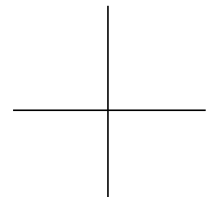

You can disable these tests using the **boot-test-ram** parameter, but this is not recommended.

The Boot Monitor **ex** command displays an Extended Tests menu, which lists the tests available for each terminal. (See Table 11-2 for a list of all the Boot Monitor commands.) NCD Technical Support may ask you to run tests if the results are needed for terminal troubleshooting.

The Boot Monitor's output during terminal booting includes the results of the tests.

Keyboard Controller and Supported Keyboards

The keyboard controller is part of the ASIC (application-specific integrated circuit) in the terminal base and serves as the interface between the terminal and the keyboard hardware.

The Boot Monitor supports the following keyboard types:

- N-101/N-102-key keyboard group, including Windows 95-compatible and foreign language versions
- VT-220 keyboard group, including foreign language versions
- N-108LK keyboard group, including Nokia US, French, and German versions
- N-97 keyboard
- N-107 Sun Type 4-compatible
- N-123 Sun Type 5-compatible
- N-97 Kana and Hitachi Kana
- Nokia 122
- 3270-compatible

Address Discovery

By default, the Boot Monitor seeks the terminal's IP address by broadcasting alternating DHCP (Dynamic Host Configuration Protocol), BOOTP (Bootstrap Protocol) and RARP (Reverse Address Resolution Protocol) requests. These requests contain the terminal's Ethernet or Token-Ring address, which is set in NVRAM at the factory.

A host running BOOTP/DHCP and configured with information about the terminal may respond with the terminal's IP address. Depending on the

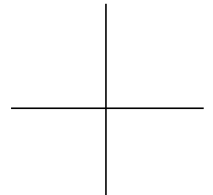

protocol implementation and the information in the host's database, DHCP/BOOTP can return other information as well. For a complete list of supported DHCP/BOOTP options, see Chapter 3, Booting—Address Discovery.

Alternatively, a host running RARP and configured with information about the terminal may respond with the terminal's IP address. RARP responses contain only the address of the terminal and the address of the host that responded to the request.

If the subnet mask is not supplied in a BOOTP/DHCP response or if BOOTP/DHCP is not used for address determination, you can use ICMP (Internet Control Message Protocol) to determine the subnet mask.

Instead of using network protocols, you can set network addresses in the terminal's NVRAM. Addresses can be saved in NVRAM by using remote configuration files, terminal configuration menus, TELNET, the Boot Monitor Setup menus, or the NVRAM utility. Boot Monitor Setup menus are described in "Using Boot Monitor Setup Menus to Configure Terminals" on page 11-12, and the NVRAM utility is described in "Using the NVRAM Utility to Configure Terminals" on page 11-20. The other configuration methods are described in Chapter 6, Terminal Configuration Methods; Chapter 9, Using Configuration Menus; and the *NCDware System Administrator's Guide for UNIX Systems*.

X Server Downloading

After obtaining the terminal's network address and subnet mask, the Boot Monitor sends multiple requests for an X server and loads an X server and support files from a host answering the request or from a local file system on a PCMCIA card.

The Boot Monitor interleaves TFTP (Trivial File Transfer Protocol), NFS (Network File System), and MOP (Maintenance Operation Protocol) requests to download an X server and support files. You can use remote configuration parameters or the Boot Monitor Setup menus to disable file transfer requests selectively, and you can use the Boot Monitor Setup menus to change the order of the requests.

The Boot Monitor supports downloading from multi-homed hosts (hosts with more than one interface on the same network).

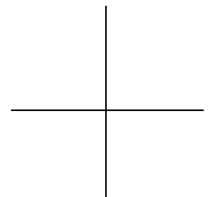

BOOTP/DHCP may also supply a specific X server filename specification. You can use the Boot Monitor's manual boot commands to override the filename specification in the BOOTP/DHCP response.

When downloading an X server using TFTP, the Boot Monitor displays the names of the downloaded file and the boot host after X server download is completed and every time a TFTP transfer is attempted.

When downloading an X server using MOP, the Boot Monitor retains the DECnet node number and displays the node number and name after X server download is completed.

To improve the reliability of downloaded files, the Boot Monitor generates UDP checksums for network packages that it transmits and verifies.

Display Blanking

The Boot Monitor blanks the monitor's display automatically after 10 minutes of idleness to avoid a burn-in effect.

Interactive Boot Monitor Functions

The interactive components of the Boot Monitor are:

- ❑ Boot Monitor commands—Commands for controlling X server downloading, troubleshooting, and testing
- ❑ Boot Monitor Setup—A menu-based utility for simplifying the initial configuration of a terminal when you are using only a few terminals, when you are not using an address discovery protocol, or when booting the terminal from a local file system
- ❑ The NVRAM utility—A command-line utility for reading and changing any information stored in the terminal's NVRAM

The interactive components are described in following sections.

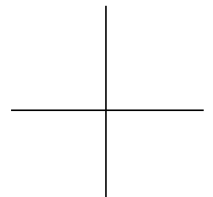

Using Boot Monitor Commands

Boot Monitor utility commands provide access to all interactive Boot Monitor functions, including the Boot Monitor Setup menus (**se** command) and the NVRAM utility (**nv** command).

Starting the Boot Monitor Utility

To start the Boot Monitor utility, use one of the following methods:

- ❑ After the terminal begins to boot, press the Escape key (the F11 key on VT220-style or N-108 keyboards) when one of the following messages appears:

TFTP load <ESC> to abort

NFS load <ESC> to abort

The terminal displays the Boot Monitor prompt (>).

- ❑ Abort a running X server by typing a key combination. The terminal displays the Boot Monitor prompt. Table 11-1 lists the access key combinations for each keyboard type.

Table 11-1 Boot Monitor Access Key Combinations

| Keyboard Type | Key Combination |
|---|--------------------------|
| 101-key | Ctrl-Left Alt-Setup |
| 102-key, Windows-95 compatible, US English, and IBM/PS2 | Caps Lock-Left Alt-Setup |
| VT220-compatible | Ctrl-Compose-F3 |
| 108-key | Ctrl-Left Alt-F3 |
| 97-key | Left Alt-Caps Lock-Setup |
| 107-key (Sun Type-4-compatible) | Stop-A (L1-A) |
| 122-key (3270-compatible Lexmark) | Alt Rule-Home |
| 123-key (Sun Type-5-compatible) | Stop-A (L1-A) |
| Kana | Left Alt-Caps-Setup |

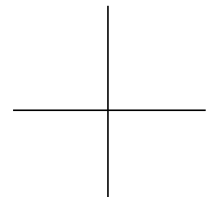

- ❑ Disable automatic booting so the terminal displays the Boot Monitor prompt instead of automatically booting the next time it is reset. Set the value of the **boot-automatically** parameter to “false.” (Setup ⇒ Change Setup Parameters ⇒ Booting ⇒ Boot automatically at power-up)

Issuing Commands to the Boot Monitor

You can type the Boot Monitor commands listed in Table 11-2 after the prompt (>). Follow each command by a carriage return.

Table 11-2 Boot Monitor Commands

| Command | Function |
|--|--|
| bd [<i>file</i>] | Boots the specified X server (<i>file</i>) via MOP. If <i>file</i> is not specified, boots the file identified in the NCP database on the host system for the terminal. |
| bl | Boots the X server stored in the NCD terminal's local file system. |
| bn [<i>file</i> [<i>NCD_IP</i> <i>host_IP</i> [<i>gateway_IP</i> [<i>subnet_mask</i>]]]] | Boots the terminal from the network using NFS. You can specify the X server image file (<i>file</i>), the IP address of the terminal (<i>NCD_IP</i>), and the IP address of the host (<i>host_IP</i>). For example: <pre>bn Xncdhmx 192.43.153.225 192.43.153.23</pre> <p>If you are specifying either the host or the IP address, you must specify both <i>and</i> specify the filename.</p> <p>If you are booting through a gateway, supply the address of the gateway (<i>gateway_IP</i>) and the subnet mask (<i>subnet_mask</i>), if any.</p> <p>If you do not specify a complete pathname, a default value of <code>/tftpboot</code> is used.</p> |

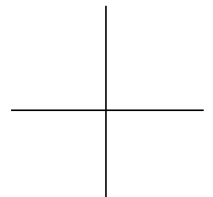

Table 11-2 Boot Monitor Commands (Continued)

| Command | Function |
|---|---|
| bt [<i>file</i> [<i>NCD_IP</i> <i>host_IP</i> [<i>gateway_IP</i> [<i>subnet_mask</i>]]]] | Boots the terminal from the network using TFTP. You can specify the X server image file (<i>file</i>), the IP address of the terminal (<i>NCD_IP</i>), and the IP address of the host (<i>host_IP</i>). For example: bt XncdhmX 192.43.153.225 192.43.153.23 If you are specifying either the host or IP address, you must specify both <i>and</i> specify the filename. If you are booting through a gateway, supply the address of the gateway (<i>gateway_IP</i>) and, if you are using one, the subnet mask (<i>subnet_mask</i>). |
| da | Displays the Ethernet, IP, and node addresses of the terminal, along with the subnet mask and the Ethernet, IP, and node addresses of the boot host. |
| dm [<i>address</i>] | Displays memory. |
| dr | Displays registers. |
| ds | Displays DLC, IP, TFTP, and MOP statistics. |
| ex | Displays the Extended Tests menu. Tests available depend on the terminal from which you run the command. The extended tests are for use of NCD Technical Support. If your terminal requires their use, an NCD Technical Support person will help you to run the test and will interpret the results. |
| km | Maps navigation functions for the Boot Monitor Setup menus. See “Programming Navigation Keys for Boot Monitor Setup Menus” on page 11-18. |
| ks | Displays keyboard statistics. |
| nf <i>readsize</i> | Sets the NFS and TFTP read size. The read size must be from 128 bytes to 8192 bytes. |
| nv | Runs the NVRAM utility for reading and changing the contents of the terminal’s NVRAM. See “Using the NVRAM Utility to Configure Terminals” on page 11-20 for more information. |

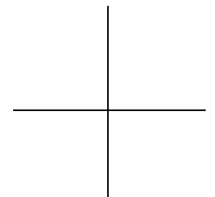

Table 11-2 Boot Monitor Commands (Continued)

| Command | Function |
|---|---|
| pi [<i>timeout</i> <i>NCD_IP</i> <i>host_IP</i> [<i>gateway_IP</i> [<i>subnet_mask</i>]]] | |
| | <p>Using ICMP protocol, pings the host to determine the round-trip time to get to the host and get back. The default time before timing out (<i>timeout</i>) is 10 seconds.</p> <p>Always specify the IP address of the terminal (<i>NCD_IP</i>) and the IP address of the host (<i>host_IP</i>).</p> <p>If you are pinging through a gateway, supply the address of the gateway (<i>gateway_IP</i>) and the subnet mask (<i>subnet_mask</i>), if any.</p> |
| rs | Resets the terminal. |
| se | Displays the initial Boot Monitor Setup menu. See “Using Boot Monitor Setup Menus to Configure Terminals” on page 11-12. |
| sm | Shows the memory configuration. |
| tr 4 16 | Sets the Token-Ring interface speed. |
| ud | Uploads an X server image to a host on a DECnet network. |
| un [<i>file</i> [<i>NCD_IP</i> <i>host_IP</i> [<i>gateway_IP</i> [<i>subnet_mask</i>]]]] | |
| | <p>Uploads an X server image to a host on a TCP/IP network, using NFS. You can specify the X server image file (<i>file</i>), the IP address of the terminal (<i>NCD_IP</i>), and the IP address of the host (<i>host_IP</i>).</p> <p>If you are specifying either the host or IP address, you must specify both <i>and</i> specify the filename.</p> <p>If you are uploading through a gateway, supply the address of the gateway (<i>gateway_IP</i>) and, if you are using one, the subnet mask (<i>subnet_mask</i>).</p> |

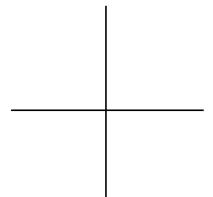
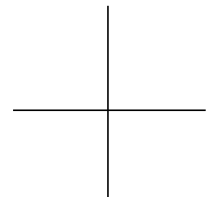

Table 11-2 Boot Monitor Commands (Continued)

| Command | Function |
|--|--|
| <code>up</code> [<i>file</i> [<i>NCD_IP</i> <i>host_IP</i> [<i>gateway_IP</i> [<i>subnet_mask</i>]]]] | <p>Uploads an X server image to a host on a TCP/IP network, using TFTP. You can specify the X server image file (<i>file</i>), the IP address of the terminal (<i>NCD_IP</i>), and the IP address of the host (<i>host_IP</i>).</p> <p>If you are specifying either the host or IP address, you must specify both <i>and</i> specify the filename.</p> <p>If you are uploading through a gateway, supply the address of the gateway (<i>gateway_IP</i>) and, if you are using one, the subnet mask (<i>subnet_mask</i>).</p> |
| <code>wd</code> ¹ | Display or change the wireless domain. |
| <code>wr</code> ¹ | Display or change the roaming configuration of a wireless terminal. |
| <code>ws</code> ¹ | Change or reset the security ID for a wireless terminal. |
| <code>zk</code> | Clear keyboard statistics |
| <code>zs</code> | Clear all statistics gathered during the execution of bn , bt , bd , pi , up , and ud . |
| <code>!</code> | Repeats the last command. |
| <code>?</code> | Lists all Boot Monitor commands. |

¹ These commands are available only if the Boot Monitor supports wireless.



Updating the Boot Monitor on Explora Terminals

On Explora 400/450, and 700 series terminals you can download an updated Boot Monitor from the remote configuration file.

To download a new Boot Monitor version, set the **boot-prom-update-file** parameter to the absolute pathname of a file that contains a new Boot Monitor image. Such files are available from NCD whenever the Boot Monitor is updated. When it boots, the terminal attempts to update its boot PROM with the new image. The update process begins as soon as the terminal receives and verifies the entire update file.

If the X server detects that the Boot Monitor in the terminal is an earlier version, it downloads the new version. If the terminal's Boot Monitor is the same or a later version, no action is taken. The update process takes about 15 seconds.

Caution

Do not turn off power to the terminal while the Boot Monitor is being updated. If the update process is interrupted before the new Boot Monitor is written to PROM, the Boot Monitor will not have the settings necessary to operate the terminal. In that case, you would have to return the base to the factory for rework.

For this reason, NCD recommends that you promptly reboot terminals as soon as you have configured them for Boot Monitor update and that you not configure terminals for Boot Monitor update when power outages are likely to occur.

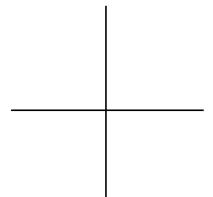

Using Boot Monitor Setup Menus to Configure Terminals

Using the Boot Monitor Setup menus, you can change a subset of terminal configuration parameters. Using Boot Monitor Setup, you can set the following:

- Network addresses required for booting and network communication
- Files and directories needed for booting
- The order of booting attempts
- Monitor resolution and dpi (dots per inch)
- Keyboard type

The Boot Monitor Setup menus provide a help menu and help text for each item.

The content of the Setup menus differs slightly depending on the Boot Monitor version you are using.

Parameters are saved to NVRAM when you exit the Setup menus unless you specify otherwise in the Done submenu.

Starting Boot Monitor Setup

To start Boot Monitor Setup from within the Boot Monitor (at the > prompt), press the Setup key or type the `se` command. The Boot Monitor Setup Menu bar and Help window appear.

The menu bar displays the names of the six submenus:

- Help—how to access the windows, move from item to item within the windows, and exit from Boot Monitor Setup
- Keyboard— keyboard type
- Monitor—monitor resolution, refresh rate, and dpi
- Network— IP and NCDnet addresses
- Boot—names and location of boot and configuration files and specify file transfer protocol preferences
- Done—save changes, reboot the terminal, return to the Boot Monitor, and restore original parameter settings

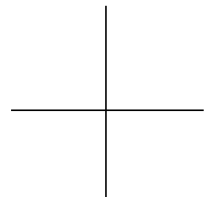

Navigating in Boot Monitor Setup

To move from one menu to the next, use the left and right arrow keys. The active menu name is highlighted, and the corresponding window or submenu appears.

Note If you are using a keyboard that does not have arrow keys, you can remap the movement functions to other keys. See “Programming Navigation Keys for Boot Monitor Setup Menus” on page 11-18.

To move from field to field in a window, use the up and down arrow keys. Below the window, a description of the current field is displayed.

If you enter an out-of-range value in a field, an error message appears. To delete a value in a field, use one of the following methods:

- The Delete key backspaces a character at a time.
- Ctrl-U deletes everything you typed in the current field.
- The Escape key erases everything that you typed and returns to the previous value.

Setting the Keyboard Type

When you select the Keyboard menu, the Keyboard window displays a list of the keyboard types and languages supported by the keyboard group to which the keyboard belongs. The current type is highlighted when you display the window.

To select a keyboard other than the default (usually the US English language type), press the arrow key until you have highlighted the correct type.

Setting Monitor Resolution and Dots Per Inch

When a terminal is first turned on, the display appears at its default resolution (number of pixels in height and width) and refresh rate (in hertz). This setting may not accommodate the highest resolution or refresh rate that your monitor can support. For detailed information about monitor resolution and dpi, see your hardware documentation.

You can use the Monitor menu to select another resolution, refresh rate, or dpi for your monitor.

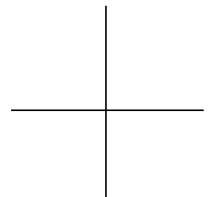

When you select the Monitor menu item, the two Monitor windows described below appear. Use the right and left arrow keys to move from one window to the other.

The Monitor Resolution Window

**Caution**

Selecting an unsupported screen refresh rate or resolution can damage the monitor. Always refer to your monitor installation booklet *and* test to be sure the refresh rate or resolution selection is supported by the monitor. Note that the test grid may appear even though a monitor is not rated to operate at the frequency selected.

The Monitor Resolution window lists the monitor resolutions (in pixels of height and width) and refresh rates (in hertz) that are supported by the video cable attached to your monitor.

To make sure that the resolution or refresh rate you select is supported on the terminal, press Shift-T.

If the resolution or refresh rate that you selected is supported, a grid test pattern appears, labelled with the selected resolution or refresh rate. If the value is not supported, the test grid might not appear.

The Dots Per Inch Window

To change dpi, backspace over the current setting and type the desired dpi.

Setting Network Parameters

Use the Network window to set the basic networking parameters. Table 11-3 lists the fields and how to change them.

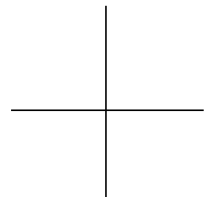

Table 11-3 Boot Monitor Setup Network Window

| Window Item | Purpose and How to Set Value |
|---|--|
| <i>IP Parameters</i> | |
| Get IP Addresses From | Use the Space bar to toggle between the two permitted values: Network and NVRAM. |
| DHCP IP Addressing Order | Backspace through the existing value, then type 1, 2, or 3 to specify the preferred priority of this method. |
| BOOTP IP Addressing Order | Backspace through the existing value, then type 1, 2, or 3 to specify the preferred priority of this method. |
| RARP IP Addressing Order | Backspace through the existing value, then type 1, 2, or 3 to specify the preferred priority of this method. |
| Terminal IP Address | Backspace through the existing value, then type the terminal's IP address in decimal format; for example, 192.43.154.80. |
| First Boot Host IP Address (on versions prior to 2.7.1, this is "Boot Host IP Address") | Backspace through the existing value, then type the first boot host's IP address in decimal format; for example, 192.43.154.99. |
| Second Boot Host IP Address (Boot Monitor 2.7.1 or later) | Backspace through the existing value, then type the secondary boot host's IP address in decimal format. |
| Third Boot Host IP Address (Boot Monitor 2.7.1 or later) | Backspace through the existing value, then type the tertiary boot host's IP address in decimal format. |
| Gateway IP Address | Backspace through the existing value, then type the gateway's IP address in decimal format; for example, 192.43.112.32. |
| Subnet Mask | Backspace through the existing value, then type the network's subnet mask in decimal format; for example, 255.255.255.0. |
| Broadcast IP Address | Backspace through the existing value, then type the broadcast address for this subnet in decimal format; for example, 192.43.154.255. |
| <i>NCDnet Parameters</i> | |
| Terminal NCDnet Address: | Backspace through the existing value, then type the terminal's NCDnet address in the format area.node ; for example, 1.67. Areas range from 1 to 63; nodes, from 1 to 1023. |

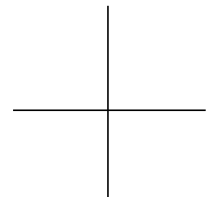

Table 11-3 Boot Monitor Setup Network Window (Continued)

| Window Item | Purpose and How to Set Value |
|--|---|
| Host NCDnet Address | Backspace through the existing value, then type the host's NCDnet address, in the format area.node ; for example, 1.27 . Areas range from 1 to 63; nodes, from 1 to 1023. |
| Router NCDnet Address | Backspace through the existing value, then type the router's NCDnet address, in the format area.node ; for example, 1.59 . Areas range from 1 to 63; nodes, from 1 to 1023. |
| SNAP (802.2 LLC) Encapsulation (Boot Monitor 2.7.6 or later) | Use the space bar to toggle between Yes and No. |

Setting Booting Parameters

Use the Boot window to set the filenames and directories used in booting. Table 11-4 lists the fields and how to set their values.

Table 11-4 Boot Monitor Setup Boot Window

| Window Item | Purpose and How to Set Value |
|------------------------------------|--|
| Boot File ¹ | Backspace through the existing value, then type the name of the X server file; for example, xncdhm.x . Limited to 64 characters. |
| TFTP Boot Directory ¹ | Backspace through the existing value, then type the name of the X server directory for TFTP booting; for example, /tftpboot/ . Limited to 64 characters. |
| NFS Boot Directory ¹ | Backspace through the existing value, then type the name of the X server directory for NFS booting; for example, /tftpboot/ or /usr/tftpboot/ . Limited to 64 characters. |
| Config File ^{1 2} | Backspace through the existing value, then type the name of the remote configuration file; for example ncd_std . The length is limited to 64 characters. |
| UNIX Config Directory ² | Backspace through the existing value, then type the name of the directory containing the configuration file for use with UNIX hosts; for example, /usr/lib/x11/ncd/configs/ . The length is limited to 64 characters. |

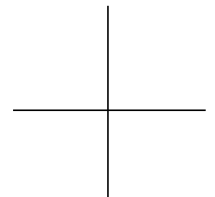

Table 11-4 Boot Monitor Setup Boot Window (Continued)

| Window Item | Purpose and How to Set Value |
|--------------------------------------|--|
| NCDnet Config Directory ² | Backspace through the existing value, then type the name of the directory containing the configuration file for use with VMS hosts on DECnet; for example <code>NCD_ROOT: [CONFIGS]</code> . The length is limited to 64 characters. |
| TFTP Order | Backspace through the existing value, then type a number specifying the order in which the terminal should attempt file transfer protocols. (1 for first, 2 for second, 3 for third, 4 for fourth.) Type <code>D</code> if the transfer method is disabled. The default order is (1) TFTP, (2) MOP, (3) NFS, and (4) local. If a PCMCIA card is installed, the default order is (1) local, (2) TFTP, (3) MOP, and (4) NFS. |
| NFS Order | |
| MOP Order | |
| LOCAL Order | |

¹ The Boot File, TFTP Boot Directory, and NFS Boot Directory items must have a combined length of 128 or fewer characters.

² The Config File, UNIX Config Directory, and NCDnet Config Directory items must have a combined length of 166 or fewer characters.

Finishing the Boot Monitor Setup Session

To save parameter settings, restore old settings, reboot the terminal, or return to the Boot Monitor, use the Done menu item, which displays a Done window. The items in the Done window are described in Table 11-5.

Table 11-5 Boot Monitor Setup's Done Window

| Window Item | Action |
|-------------|--|
| Reboot | Saves parameter settings to NVRAM and reboots after you press Return. |
| Exit | Saves parameter settings to NVRAM and exits to the Boot Monitor prompt (<code>></code>) after you press Return. |
| Undo | Restores the original parameters after you press Return. |

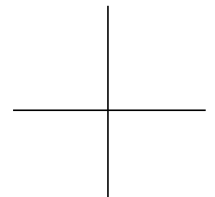

Programming Navigation Keys for Boot Monitor Setup Menus

The Boot Monitor's keymapper allows you to program menu navigation keys for unsupported keyboards that do not have defined arrow keys. You can, however, change the navigation keys for any keyboard.

Please read the following usage notes before you begin:

- ❑ As you assign keys, write down the key assigned to each navigation function in case you forget the new assignments after exiting from the keymapper. This is because the keymapper displays only the keycode, not the legend on the key. For supported keyboards, you can check the keycode against the keyboard maps. For unsupported keyboards, however, there may be no way to find out which key corresponds to a given key code.
- ❑ If you assign a number key to a navigation function, you can no longer use the number key for entering data in the Boot Monitor Setup menus or for entering data with other Boot Monitor commands.
- ❑ Mapping keys and then attaching a keyboard that has a different layout may cause problems if the assigned keys do not exist on the new keyboard.
- ❑ Do not assign one of the defaults to another keymapper function. For example, if you assign the default key for the *left* function to the *right* function but do not assign another key to the left function, pressing *left* causes the cursor to move right. There is now no way to move the cursor left. Be especially careful that you do not lose the *escape* or *setup* functions.

Follow these steps to map the navigation keys:

1. Enter the Boot Monitor and type the following command:

```
> km
```

The current keymap is displayed:

Current keymap:

| Key | Current | Customized |
|-------|-----------|------------|
| left | (default) | no |
| right | (default) | no |
| up | (default) | no |
| down | (default) | no |
| setup | (default) | no |

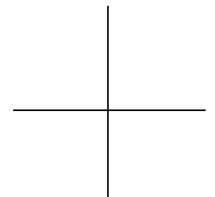

```
escape      (default)    no
backspace   (default)    no
Change any items [y/n]?
```

2. To start changing the keymap, type **y** and follow the directions displayed:

```
Change any items [y/n]? y
Press one of the following keys:
<key>      Key to use for this item (must not be A-Z)
Return     Do not change this item
d          Restore default for this item
q          Quit without any changes
```

When you press a key, its code appears in the **New** column. In this example, the user has remapped all items but one:

| Key | Current | New | Customized |
|-----------|-----------|------|------------|
| left | (default) | 0x6B | yes |
| right | (default) | 0x74 | yes |
| up | (default) | 0x75 | yes |
| down | (default) | | no |
| setup | (default) | 0x76 | yes |
| escape | (default) | 0x77 | yes |
| backspace | (default) | 0x7E | yes |

```
Save new keymap in nvram [y/n]?
```

3. To save the new keymap, type **y**:

```
Save new keymap in nvram [y/n]? y
>
```

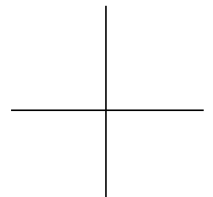

Using the NVRAM Utility to Configure Terminals

The NVRAM utility provides another method of configuring a subset of terminal parameters and provides access to some parameters that are not available through other configuration methods. The utility also allows you to set security levels for the optional security keyboard.

This section describes how to use the NVRAM utility and lists the contents of NVRAM.

Starting the NVRAM Utility

To start the NVRAM utility, type:

```
> nv
NVRAM Utility
C [add] - change location add
D - display contents
Q - return to monitor
L - load defaults
R- reload NVRAM values
S - save new values
->>
```

Type NVRAM utility commands after the ->> prompt, and follow all commands with a carriage return.

NVRAM Utility Commands

Table 11-6 lists NVRAM utility commands, options, syntax, and functions.

NVRAM commands modify a copy of NVRAM residing in RAM. The NVRAM utility does not write changes to NVRAM until you use the **s** (save) command.

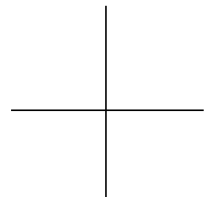

Table 11-6 General-Purpose NVRAM Utility (nv) Commands

| Command | Function |
|--|---|
| c <i>address</i> | Changes the virtual contents of the location <i>address</i> . If you do not include an address, location 0 is used as the starting location. Press Return to continue to the next location. Press hyphen (-), then Return, to go to the previous location. All values shown and data entered are in hexadecimal notation. A non-hexadecimal value terminates the command. |
| d [<i>start</i>] [<i>end</i>] | Displays the virtual contents of NVRAM in hexadecimal. |
| l | Loads the terminal's factory defaults into the virtual NVRAM space. |
| q | Exits the NVRAM utility and displays the Boot Monitor's prompt. |
| r | Reads the entire NVRAM and places it into RAM space reserved for editing. |
| s | Saves the current values of NVRAM. Also calculates a new checksum before loading the values into NVRAM. |

Sample NVRAM Utility Sessions

The following examples show how to use the NVRAM utility. In the NVRAM utility, you enter new values in hexadecimal notation. The symbols used in the examples are:

- > The prompt generated by the Boot Monitor
- > The NVRAM utility prompt
- xx The previous values stored in NVRAM

Changing Contents Byte by Byte

In the following example of how to change NVRAM contents, the terminal's Ethernet address is re-entered after having been accidentally erased. The Ethernet address is 00 00 A7 10 24 14.

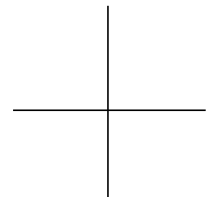

```
> nv
NVRAM Utility
C [add] - change location add
D - display contents
Q - return to monitor
L - load defaults
R - reload NVRAM values
S - save new values
->> l
->> c 04
004: xx ? 00
005: xx ? 00
006: xx ? A7
007: xx ? 10
008: xx ? 24
009: xx ? 14
00A: xx ? q
->> s
Are you sure ? y
->> q
> rs
```

1. Start the NVRAM utility and type **c 04** to start changing the Ethernet address (the Ethernet address starts at location 0x4).
2. Type the first pair of numbers of the Ethernet address and press Return.
3. In the same way, type the remaining pairs. At the prompt 009: xx ? you have typed the entire Ethernet address and you can type **q** to stop entering numbers.
4. Type **s** to save, and **y** after the question, Are you sure?
5. Type **q** to end the NVRAM utility session and resume using the Boot Monitor utility.
6. You can reboot the terminal by typing the **rs** (reset) command.

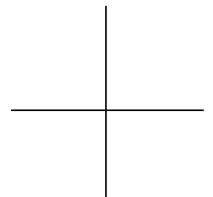

Changing Individual Bits in a Byte

In the following example, the first bit in byte 0x35 is changed. This bit enables the display of the NCD logo at boot time and is set to 1 by default.

```
> nv
NVRAM Utility
C [add] - change location add
D - display contents
Q - return to monitor
L - load defaults
R - reload NVRAM values
S - save new values
->> l
->> c 35
035: 8A ? 0A
036: A0 ? q
->> s
Are you sure ? y
->> q
> rs
```

1. Start the NVRAM utility and type `c 35` to start changing byte 0x35.
2. Compute the new value of the byte in binary and then convert it to hexadecimal. Assuming the other bits have their default values, the new value of the byte is 00001010, or 0A in hexadecimal. Enter the new value.
3. At the next `?` prompt, type `q` to stop entering numbers.
4. Type `s` to save, and `y` after the question, *Are you sure?*
5. Type `q` to end the NVRAM utility session and resume using the Boot Monitor utility.
6. You can reboot the terminal by typing the `rs` (reset) command.

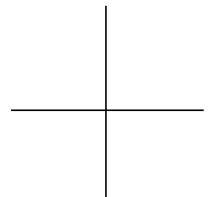

NVRAM Contents

Table 11-7 lists the locations, descriptions, and permitted values for parameters stored in the shared portion of version 4 of the NVRAM layout, which is the current version. The corresponding remote configuration parameters (if any) are also listed.

NVRAM is divided into shared and server-only portions. The shared portion of NVRAM includes data used internally by the Boot Monitor and parameters set by both the Boot Monitor and the X server (that is X server defaults or the changes you make using the X server configuration methods described in Chapter 6, Terminal Configuration Methods). The server-only portion is used by X server configuration methods to write parameters that can be saved in NVRAM.

You should not attempt to change data set automatically by the Boot Monitor. You can change other parameters; see the following cautionary note.

If a remote configuration parameter is listed in the description column, you can set the parameter using the NVRAM utility or X server configuration utilities. A subset of the booting parameters can also be set using the Boot Monitor Setup menus described in “Using Boot Monitor Setup Menus to Configure Terminals” on page 11-12.



Caution

Do not change the contents of NVRAM using the NVRAM utility unless you know how your changes will affect the terminal. Incorrect NVRAM settings can seriously impair the terminal’s operation. Do not change settings in reserved areas or parameters set automatically by the Boot Monitor.

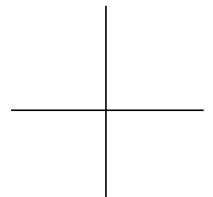

Table 11-7 Shared NVRAM Version 4

| Location | Description | Size | Values (Default in Bold) |
|------------------------------|--|---------|---|
| <i>Header Information</i> | | | |
| 0x0 | Version number of the NVRAM layout | 1 byte | (set automatically by the Boot Monitor) |
| 0x1 | NVRAM checksum (calculated when you use the NVRAM utility; verified when the terminal is powered on) | 1 byte | (set automatically by the Boot Monitor) |
| 0x2 | Reserved | 2 bytes | |
| <i>Network Configuration</i> | | | |
| 0x4 | Factory-set Ethernet address, stored least-significant to most-significant byte. The first three bytes are the series allocated to NCD; the remaining bytes are terminal-specific. | 6 bytes | 00:00:A7:00.00.00 |
| 0xA | Terminal IP address ip-address-at-next-boot | 4 bytes | 0.0.0.0 |
| 0xE | Subnet mask ip-subnet-mask | 4 bytes | 255.255.255.000 |
| 0x12 | Broadcast address ip-broadcast-address | 4 bytes | 255.255.255.255 |
| 0x16 | Primary default gateway ip-initial-default-gateway-1 | 4 bytes | 000.000.000.000 |
| 0x1A | Secondary default gateway ip-initial-default-gateway-2 | 4 bytes | 000.000.000.000 |
| 0x1E | First boot host boot-tcpip-desired-server | 4 bytes | 000.000.000.000 |
| 0x22 | Second boot host boot-tcpip-second-server | 4 bytes | 000.000.000.000 |

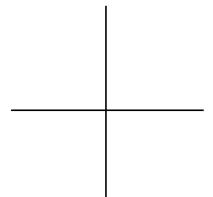

Table 11-7 Shared NVRAM Version 4 (Continued)

| Location | Description | Size | Values (Default in Bold) |
|----------|---|---------|--------------------------------|
| 0x26 | Third boot host boot-tcpip-third-server | 4 bytes | 000.000.000.000 |
| 0x2A | Terminal DECnet address (DEC byte ordering) ncdnet-address-at-next-boot | 2 bytes | 0.0 |
| 0x2C | DECnet router address (DEC byte ordering) ncdnet-default-router | 2 bytes | 0.0 |
| 0x2E | Default DECnet host | 2 bytes | 0.0 |
| 0x30 | Try booting forever boot-persistent-loading | 1 bit | 1 Enabled 0 Disabled |
| | Turns off broadcast booting boot-tcpip-broadcast-boot-request | 1 bit | 1 Disabled 0 Enabled |
| | Turns off absolute product name booting boot-tcpip-product-name-with-path-file | 1 bit | 1 Enabled 0 Disabled |
| | Turns off absolute memory size booting boot-tcpip-product-name-and-memory-size-with-path-file | 1 bit | 1 Enabled 0 Disabled |
| | Turns off absolute hex IP address booting boot-tcpip-unit-address-with-path-file | 1 bit | 1 Enabled 0 Disabled |
| | Turns off relative product name booting boot-tcpip-product-name | 1 bit | 1 Enabled 0 Disabled |
| | Turns off relative memory size booting boot-tcpip-product-name-and-memory-size | 1 bit | 1 Enabled 0 Disabled |
| | Turns off relative hex IP address booting boot-tcpip-unit-address-file | 1 bit | 1 Enabled 0 Disabled |

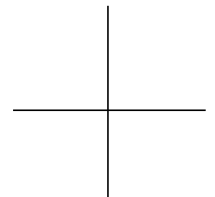

Table 11-7 Shared NVRAM Version 4 (Continued)

| Location | Description | Size | Values (Default in Bold) |
|----------|-----------------------------------|-----------------|--|
| 0x31 | DEC auxiliary boot protocol | 1 bit | 0 TFTP 1 MOP |
| | Monitor power management override | 1 bit | 0 Disabled 1 Enabled |
| | Extra messages from booting | 1 bit | 0 Disabled 1 Enabled |
| | Use DDC data | 1 bit | Hardware-dependent |
| | Absolute Ethernet address booting | 1 bit | 0 Enabled 1 Disabled |
| | Relative Ethernet address booting | 1 bit | 0 Enabled 1 Disabled |
| | Reserved | 2 bits | |
| 0x32 | TFTP boot priority | upper 4 bits | 1 Try TFTP first 2 Try TFTP second 3 Try TFTP third 4 Try TFTP last 15 Disable TFTP booting |
| | NFS boot priority | lower 4 bits | 1 Try NFS first 2 Try NFS second 3 Try NFS third 4 Try NFS last 15 Disable NFS booting |

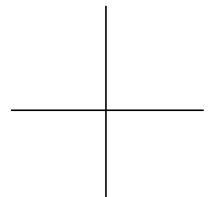

Table 11-7 Shared NVRAM Version 4 (Continued)

| Location | Description | Size | Values (Default in Bold) |
|-----------------------------------|--|-----------------|---|
| 0x33 | MOP boot priority | upper 4 bits | 1 Try MOP first 2 Try MOP second 3 Try MOP third 4 Try MOP last 15 Disable MOP booting |
| | Local boot priority (If a PCMCIA card is installed, NVRAM has default values, and the terminal has not booted from the network, the terminal first tries to boot from the PCMCIA card.) | lower 4 bits | 1 Try local first 2 Try local second 3 Try local third 4 Try local last 15 Disable local booting |
| 0x34 | Reserved | 8 bits | |
| <i>Boot Monitor Configuration</i> | | | |
| 0x35 | NCD logo enable | 1 bit | 0 Disabled 1 Enabled |
| | Use standard NCD path for X server files and directories or a special OEM path. | 1 bit | 0 NCD path 1 OEM path |
| | Test RAM at boot boot-test-ram | 1 bit | 0 Enabled 1 Disabled |
| | Boot source 1 | 1 bit | 0 Network 1 Local file system |
| | Screen saver | 1 bit | 0 Off 1 On |
| | Background | 1 bit | 0 Black 1 White |
| | Auto boot after reset or display Boot Monitor prompt boot-automatically | 1 bit | 0 Boot Monitor 1 Auto boot |
| | MOP boot boot-mop | 1 bit | 0 Enabled 1 Disabled |

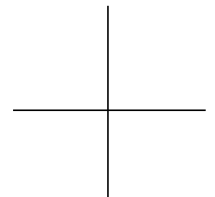

Table 11-7 Shared NVRAM Version 4 (Continued)

| Location | Description | Size | Values (Default in Bold) |
|-----------------------------|---|--------|--|
| 0x36 | Discover IP address from the network or from NVRAM ip-use-address-discovery | 2 bits | 0 NVRAM 1 DHCP/BOOTP/RARP |
| | Default settings | 1 bit | (set by the Boot Monitor) |
| | Use ICMP to determine subnet mask boot-send-broadcast-icmp-for-subnet-mask | 1 bit | 0 Enabled 1 Disabled |
| | Boot via MOP with filename boot-mop-with-file-name | 1 bit | 0 Disabled 1 Enabled |
| | Reserved | 3 bits | |
| 0x37 | Reserved | 1 byte | |
| <i>Device Configuration</i> | | | |
| 0x38 | Type of keyboard attached to the terminal xserver-keyboard-type | 1 byte | See Table 11-8. |
| 0x39 | IBM/PS2 or Windows 95-compatible keyboard (this is the default keyboard and the default for the N-101/N-102 keyboard group) | 1 bit | 0 Other keyboard 1 IBM keyboard |
| | Token-Ring speed valid | 1 bit | (set by the Boot Monitor) |
| | Token-Ring speed ¹ | 1 bit | 0 4 Mbit ring 1 16 Mbit ring |
| | Synchronize monitor on green (HMX and older terminals only) | 1 bit | Hardware-dependent |
| | Use monitor timing | 1 bit | Hardware-dependent |
| | Default keyboard LEDs | 1 bit | (set by the Boot Monitor) |
| | Reserved | 2 bits | |

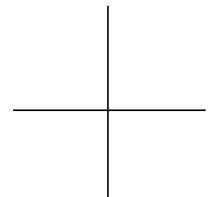

Table 11-7 Shared NVRAM Version 4 (Continued)

| Location | Description | Size | Values (Default in Bold) |
|---|--|-----------|---|
| 0x3A | Monitor type | 1 byte | Use the Boot Monitor Setup menus to set this parameter. |
| 0x3B | Monitor dots-per-inch | 1 byte | Use the Boot Monitor Setup menus to set this parameter. |
| <i>Platform-Specific Monitor Timing</i> | | | |
| 0x3C - 0x50 | Reserved | 24 bytes | |
| <i>Tagged Strings</i> | | | |
| 0x51 | Boot Monitor tagged strings | 128 bytes | Automatically set by the X server. See Table 11-9 for the names of the parameters saved in this area. |
| 0xD1 | Tagged strings 1 | 38 bytes | |
| 0xF7 | Tagged strings 2 | 128 bytes | |
| <i>Keymapper for Boot Monitor Setup Menus</i> | | | |
| 0x177 | Keymap for programmable Setup menu navigation keys | 10 bytes | (Automatically set by the Boot Monitor) |
| <i>Platform-Specific Monitor Timing</i> | | | |
| 0x181 - 0x191 | Reserved | 15 bytes | |

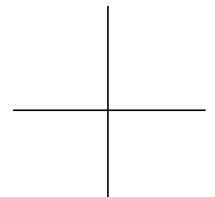
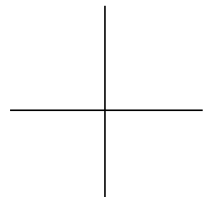

Table 11-7 Shared NVRAM Version 4 (Continued)

| Location | Description | Size | Values (Default in Bold) |
|----------------------|----------------------------------|--------------|--|
| <i>Miscellaneous</i> | | | |
| 0x192 | NFS read size | 2 bytes | Block size set by the Boot Monitor nf command |
| 0x194 | RARP address discovery priority | upper 4 bits | 1 Try RARP first 2 Try RARP second 3 Try RARP last 15 Disable RARP |
| | BOOTP address discovery priority | lower 4 bits | 1 Try BOOTP first 2 Try BOOTP second 3 Try BOOTP last 15 Disable BOOTP |
| 0x195 | DHCP address discovery priority | upper 4 bits | 1 Try DHCP first 2 Try DHCP second 3 Try DHCP last 15 Disable DHCP |
| | Reserved | 4 bits | |
| 0x196 | Reserved | 1 byte | |

¹ In Boot Monitor versions earlier than 2.8.2, the default is 4 MBit.



Keyboard Type Settings

Table 11-8 lists the keyboard-type values for byte 0x38. The default keyboard for the N-101/N-102 keyboard group is the IBM/PS2 or Windows 95-compatible keyboard (byte 0x39). This is also the default keyboard if the terminal cannot sense the type of the attached keyboard.

Table 11-8 Keyboard Type Settings in NVRAM

| Keyboard | NVRAM Value |
|--------------------------|-------------|
| N-101 | 0 |
| VT220 VMS | 1 |
| VT220 ULTRIX | 2 |
| N-97 | 3 |
| N-102 German | 4 |
| N-102 French | 5 |
| N-102 Belgian UK | 6 |
| N-102 Swiss German | 7 |
| N-102 Spanish | 8 |
| N-102 English UK | 9 |
| N-102 Italian | 10 |
| N-102 Canadian | 11 |
| N-102 Norwegian | 12 |
| N-102 Finnish | 13 |
| N-102 Portuguese | 14 |
| N-102 Danish | 15 |
| N-102 Flemish | 16 |
| N-102 Norwegian/Tandberg | 17 |

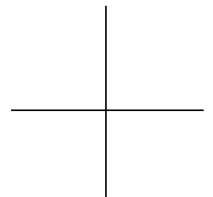

Table 11-8 Keyboard Type Settings in NVRAM (Continued)

| Keyboard | NVRAM Value |
|--------------------|-------------|
| N-108 Nokia | 18 |
| N-108LK | 19 |
| N-Kana | 20 |
| VT220 Danish | 21 |
| VT220 Norwegian | 22 |
| VT220 German | 23 |
| VT220 Swedish | 24 |
| VT220 Spanish | 25 |
| VT220 Flemish | 26 |
| VT220 Portuguese | 27 |
| VT220 French | 28 |
| VT220 Swiss German | 29 |
| VT220 Swiss French | 30 |
| VT220 Italian | 31 |
| VT220 Dutch | 32 |
| VT220 Finnish | 33 |
| VT220 Canadian | 34 |
| VT220 Hebrew | 35 |
| reserved | 36 - 39 |
| VT220 UK | 40 |
| reserved | 41 |
| N-122 Nokia | 42 |

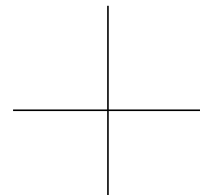

Table 11-8 Keyboard Type Settings in NVRAM (Continued)

| Keyboard | NVRAM Value |
|--------------------------------|--------------------|
| N-102 French Canadian | 43 |
| N-102 Belgian French | 44 |
| N-102 French Canadian CSA 1992 | 45 |
| N-102 Swiss French | 46 |
| N-102 OADG Kana | 47 |
| N-107 Sun Type 4 Compatible | 48 |
| Hitachi Kana | 49 |
| N-108 UK | 50 |
| N-108 Flemish | 51 |
| N-108 Canadian English | 52 |
| N-108 Canadian French | 53 |
| N-108 Danish | 54 |
| N-108 Finnish | 55 |
| N-108 French | 56 |
| N-108 German | 57 |
| N-108 Netherlands | 58 |
| N-108 Italian | 59 |
| N-108 Norwegian | 60 |
| N-108 Portuguese | 61 |
| N-108 Spanish | 62 |
| N-108 Swedish | 63 |
| N-108 Swiss French | 64 |

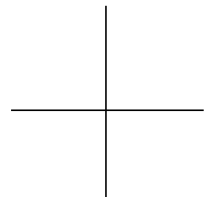

Table 11-8 Keyboard Type Settings in NVRAM (Continued)

| Keyboard | NVRAM Value |
|----------------------------|-------------|
| N-108 Swiss German | 65 |
| Nokia 108 UK | 66 |
| Nokia 108 Flemish | 67 |
| Nokia 108 Canadian English | 68 |
| Nokia 108 Canadian French | 69 |
| Nokia 108 Danish | 70 |
| Nokia 108 Finnish | 71 |
| Nokia 108 French | 72 |
| Nokia 108 German | 73 |
| Nokia 108 Netherlands | 74 |
| Nokia 108 Italian | 75 |
| Nokia 108 Norwegian | 76 |
| Nokia 108 Portuguese | 77 |
| Nokia 108 Spanish | 78 |
| Nokia 108 Swedish | 79 |
| Nokia 108 Swiss French | 80 |
| Nokia 108 Swiss German | 81 |
| unused | 82 - 91 |
| IBM 3270 US | 92 |
| N-123 NA US | 93 |
| N-123 UNIX | 94 |
| N-123 UK | 95 |

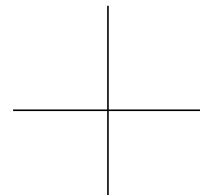
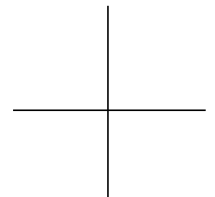

Table 11-8 Keyboard Type Settings in NVRAM (Continued)

| Keyboard | NVRAM Value |
|------------------------------|--------------------|
| N-123 German | 96 |
| N-123 French | 97 |
| N-123 Spanish | 98 |
| N-123 Swiss German | 99 |
| N-123 Swiss French | 100 |
| N-123 Swedish | 101 |
| N-123 Danish | 102 |
| N-123 Italian | 103 |
| N-123 Dutch | 104 |
| N-123 Norwegian | 105 |
| N-123 Portuguese | 106 |
| reserved | 107 |
| N-102 Siemens German | 108 |
| N-102 Spanish Latin American | 109 |
| N-102 Dutch | 110 |
| N-102 Icelandic | 111 |



Parameters Saved in the Tagged Strings Area

Table 11-9 lists all of the strings saved in the tagged string area of NVRAM. Terminals in the HMX and Explora series have 166 bytes available for storing these strings. If you are storing many of these strings in NVRAM, you should keep them short to avoid running out of space. Strings stored in the tagged string space use one byte per character plus two bytes of overhead for each string. For example, a 10-character password uses 12 bytes.

Table 11-9 Parameters in NVRAM Optional String Space

| Parameter Name | Description |
|--|--|
| config-console-display-password | Password for displaying the Console |
| config-custom-file | Custom configuration filename |
| config-pref-read-only-password | Password for read-only access to user preference information |
| config-pref-read-write-password | Password for read/write access to user preference information |
| config-read-only-password | Password for read-only access to all configuration data |
| config-read-write-password | Password for read/write access to all configuration data |
| config-unix-directory | Custom configuration file directory for UNIX |
| config-vms-directory | Custom configuration file directory for VMS |
| file-manager-password | Password for access to the Local File Manager |
| login-xdm-authentication-key | Key for authenticating clients trying to connect to the terminal |
| snmp-read-only-community snmp-read-only-community-alt | Community names for read-only access to configuration data through SNMP |
| snmp-read-write-community snmp-read-write-community-alt | Community names for read/write access to configuration data through SNMP |
| unit-global-password | Global password for read/write access to configuration data and the Local File Manager |

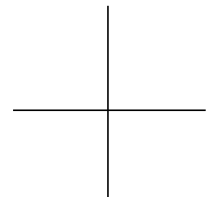

Remote Configuration Parameters Saved in NVRAM

Table 11-10 is an alphabetical listing all of the remote configuration parameters that can be saved in NVRAM, in both the shared and the X server-only areas of NVRAM. For more information about remote configuration parameters, see the *Remote Configuration Parameter Quick Reference*.

Table 11-10 Remote Configuration Parameters Saved in NVRAM

| Group | Parameter Name | |
|--------|---|---|
| boot | boot-automatically boot-custom-file boot-default-server-when-prom-booting boot-desired-source boot-monitor-inverse-video boot-mop boot-mop-with-file-name boot-nfs-directory boot-persistent-loading boot-second-source boot-send-broadcast-icmp-for-subnet-mask boot-tcpip-broadcast-boot-request boot-tcpip-desired-server | boot-tcpip-product-name-and-memory-size-file boot-tcpip-product-name-and-memory-size-with-path-file boot-tcpip-product-name-file boot-tcpip-product-name-with-path-file boot-tcpip-second-server boot-tcpip-third-server boot-tcpip-unit-address-file boot-tcpip-unit-address-with-path-file boot-test-ram boot-tftp-directory boot-third-source |
| config | config-add-domain-to-unit-name-as-filename config-console-display-password config-custom-file config-generic-file config-load-initial-file config-persistent-loading config-pref-read-only-password config-pref-read-write-password config-read-only-password | config-read-write-password config-unit-ethernet-address-file config-unit-ip-address-file config-unit-name-file config-unit-ncdnet-address-file config-unix-directory config-use-decimal-ip-address-notation-as-filename config-vms-directory |
| file | file-extended-diagnostics file-initial-protocol-1 file-initial-protocol-2 file-initial-server-1 | file-initial-server-2 file-manager-password file-name-type-for-initial-tftp-servers |

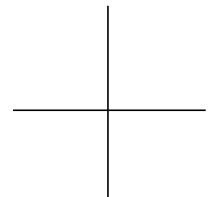
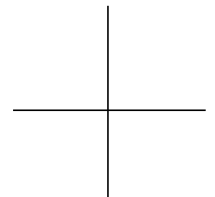
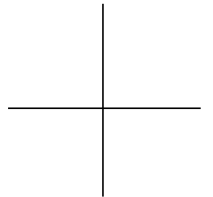

Table 11-10 Remote Configuration Parameters Saved in NVRAM (Continued)

| Group | Parameter Name |
|---------|--|
| ip | ip-address-at-next-boot ip-broadcast-address ip-initial-default-gateway-1 ip-initial-default-gateway-2 ip-subnet-mask ip-use-address-discovery ip-use-proxy-arp ip-use-router-discovery ip-use-router-solicit |
| login | login-xdm-authentication-key |
| ncdnet | ncdnet-address-at-next-boot ncdnet-default-router |
| net | net-ethernet-snap-encapsulation net-token-ring-speed |
| serial | serial-interfaces-table |
| snmp | snmp-read-only-community snmp-read-only-community-alt snmp-read-write-community snmp-read-write-community-alt |
| tcpip | tcpip-name-server-protocol tcpip-name-servers |
| unit | unit-global-password unit-license-key unit-query-for-name-at-boot |
| xserver | xserver-keyboard-type xserver-touchscreen-calibration-limits |



11-40 Boot Monitor and NVRAM



12 Configuring the NCD Terminal Emulator

This chapter describes the local NCD Terminal Emulator (*ncdterm* and *ncdrunterm*), which provides VT320 terminal emulation.

The following topics are covered in this chapter:

- ❑ “Other Sources of Information on the Terminal Emulator” on page 12-1
- ❑ “Configuring Local Services in the Terminal Host Chooser” on page 12-2
- ❑ “Configuring a Terminal for Serial Terminal Emulation” on page 12-3
- ❑ “Configuring Key Translations” on page 12-4
- ❑ “Configuring the Terminal Emulator Window and Menus” on page 12-5
- ❑ “Configuring the Window Disconnect Delay” on page 12-12
- ❑ “Configuring the Answer-Back Message” on page 12-12
- ❑ “Using VT320 Terminal Emulator Escape Sequences” on page 12-13
- ❑ “Using Keyboard Escape Sequences” on page 12-34
- ❑ “Using Compose Key Sequences” on page 12-44
- ❑ “VT320 Character Coding Conventions” on page 12-51

Other Sources of Information on the Terminal Emulator

This chapter describes resources, escape sequences, and character coding for the NCD Terminal Emulator. Other documents and other chapters in this manual contain information about other aspects of the Terminal Emulator:

- ❑ Using the terminal emulator—The *NCDware User’s Guide* describes the appearance and use of the NCD Terminal Emulator choosers and window.
- ❑ Basic configuration and Keymap Editor—The *NCDware System Administrator’s Guide for UNIX Systems* provides information about basic configuration of the NCD Terminal Emulator (including its use for login), using the Keymap Editor, and starting the Terminal Emulator without logging in (*ncdrunterm*).

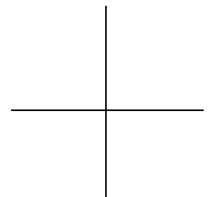

- ❑ Options and resources—The *ncdterm*(1) man page provides details on command-line options and resources.
- ❑ Configuring printing from the Terminal Emulator—Items in the NCD Terminal Emulator’s File menu allow the user to send the current screen or the current session log to a printer attached to the X terminal’s serial or parallel port. For successful printing, you must configure the port and the NCD Terminal Emulator. See the *System Administrator’s Guide* for configuration instructions.
- ❑ Downloadable character sets—The NCD Terminal Emulator supports the use of downloadable character sets (DRCS). See Chapter 17, Keyboards and Downloadable Keyboard Definitions, for more information.
- ❑ Technical details—For more detailed technical information about VT320 terminal emulation, see Digital Equipment Corporation publications.

Configuring Local Services in the Terminal Host Chooser

The Terminal Host Chooser provides easy access to the Local File Manager daemon (*filed*), Diagnostic daemon (*diagd*), and Configuration daemon (*configd*).

The *showLocal* resource must be set to “true” (the default) for these services to be listed automatically in the Terminal Host Chooser. The user can select Show Local from the Chooser’s View menu to control the display locally.

To access the Local File Manager and Configuration daemon through the Terminal Host Chooser, you must first set their passwords in the Console (Setup ⇒ Change Setup Parameters ⇒ Access Control). If you do not set a password and select one of these local services in the Terminal Host Chooser, the terminal emulator window appears briefly, displays an “access denied” message, then disappears.

The resources listed in Table 12-1 control the automatic display of services in the Terminal Host Chooser. Users can select the corresponding View menu item to control the display of services locally.

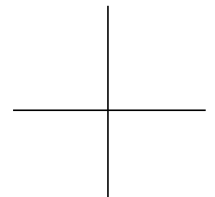

Table 12-1 View Options in the Terminal Host Chooser

| View Menu Name | Description | Default Setting | Resource Name |
|--------------------|---|-----------------|-------------------------|
| Show Local | Controls the automatic display of services available on the terminal | true | showLocal |
| Show Available LAT | Controls the automatic display of LAT services whose availability has been broadcast across the network | true | showAvailableLat |
| Show Default LAT | Controls the automatic display of LAT services listed in the term-default-hosts table | true | showDefaultLat |
| Show CTerm | Controls the automatic display of available CTERM hosts | true | showCTerm |
| Show Serial | Controls the automatic display of available serial sessions | true | showSerial |
| Show Telnet | Controls the automatic display of TELNET services listed in the term-default-hosts table | true | showTelnet |

Configuring a Terminal for Serial Terminal Emulation

To use a serial port for a serial VT320 connection, you can open a serial terminal emulation session through the NCD Terminal Emulator local client. The client's **term -ctype serial** command allows you to log onto a host and run non-X applications. For X over a serial line, use XRemote.

On terminals with more than one serial port, you can configure more than one port for serial terminal emulation. When more than one port is used for serial terminal emulation, the serial terminal emulator displays a Chooser for selecting the desired serial connection.

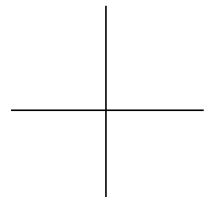

Configuring Key Translations

Configuring an NCD terminal as an ASCII terminal involves making the physical connection and setting the parameters. Follow these steps:

1. Attach the terminal to a host via a modem or direct serial connection.
2. Make sure the **mode** parameter for the port that you wish to use is set to “terminal” in the **serial-interfaces-table**.
3. Set the other parameters in the **serial-interfaces-table** to match the host computer or modem on the other end of the serial line. Use the suggested values shown here or set these attributes to match the computer or modem on the other end of the line:

| | |
|-----------|---------------------------------------|
| baud-rate | 38400 (make this as high as possible) |
| data-bits | 8 |
| stop-bits | 1 |
| parity | None |
| handshake | DTR/DSR, RTS/CTS, or XON/XOFF |

Configuring Key Translations

The Keymap Editor local client displays a layout of a keyboard that has keys labelled with their keycaps and the functions (called actions or translations) assigned to them. The Keymap Editor allows you to change the actions or translations. For detailed information about using the Keymap Editor, see the *System Administrator's Guide*.

If you are changing key translations using X resources instead of the Keymap Editor, note that you can specify key translations using more than one modifier (for example, Shift-Lock-F1).

The keymap action **keymap** (*name*) changes keypress translations while the terminal emulator is running. This action takes a single string argument that names a resource for dynamically defining a new translation table. The resource name is derived by appending the string ‘Keymap’ to *name*. The keymap argument *None* restores the original translation table.

The following example shows how the keymap action can be used to add special keys for entering commonly typed expressions.

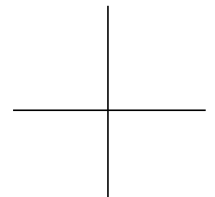

```
NCDterm.Translations: #override <Key>F12: keymap (dbx)
NCDterm.dbxKeymap.translations:\\
  <Key>F14: keymap(None) \\n\\
  <Key>F17: string("next") string(0x0d) \\n\\
  <Key>F18: string("step") string(0x0d) \\n\\
  <Key>F19: string("continue") string(0x0d)
```

Configuring the Terminal Emulator Window and Menus

The NCD Terminal Emulator window provides the same features as an ASCII terminal. The window displays 24 or 25 lines of text in 80 or 132 columns, and you can resize it to display fewer or more rows (changing the height) or columns (changing the width).

The size of the window is affected by several factors, including the font used, escape sequences sent to the terminal emulator (described later), menu selections from the menu bar, and X resource specifications.

In addition, you can use character attributes to make text stand out or to protect fields. You can also choose the cursor.

NCD Terminal Emulator windows provide additional features not found on traditional terminals, including a scroll bar and menu bar.

Terminal Emulator Fonts

The font you choose for a terminal emulator window is important. It controls the size of the characters you see as well as whether certain terminal emulation features appear to work. If you do not know which font to choose, use the default selected by the terminal emulator.

Fonts are specified using a set of X resources: **foundry**, **family**, **pointSize**, and **subFont**. Together with the Fonts menu in the menu bar, these resources control the actual X font used in the display. See “The Fonts Menu” on page 12-10 for more information about fonts.

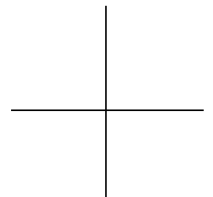

Terminal Emulator Scroll Bars

Scroll bars allow review of information that has passed off the screen. The ability to see past information is affected by some escape sequences (such as those that clear certain regions of the screen) and by how much information the terminal emulator can store.

Scrolling affects terminal memory usage. For more information about scrolling and memory usage, see the description of the **saveLines** resource in the *ncdterm(1)* man page.

To turn off the scroll bars or change their location, use the **scrollbar** resource, also described in the *ncdterm(1)* man page.

Terminal Emulator Menus

The menu bar provides access to menus for controlling other terminal emulation features. The menu bar can be disabled using the **menuBar** resource.

Five menus are accessible from the menu bar: File, Options, Fonts, Cursors, and Keys.

The File Menu

Table 12-2 summarizes the commands in the File menu.

Table 12-2 File Menu

| Menu Item | Action |
|---------------------|--|
| Redraw | Redraws the contents of the display window. |
| Soft Reset | Resets the terminal to the default state. |
| Hard Reset | Does a soft reset, deletes all content, and clears any selection. |
| Close Connection | Closes the current session and returns to the Terminal Host Chooser. This item can be disabled using the disableExits resource. For more information, see the <i>ncdterm(1)</i> man page. |
| Start Debugging Log | Writes the contents of the session to a log file. This function requires special setup to execute correctly. For more information, see the <i>ncdterm(1)</i> man page. |

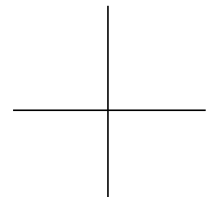
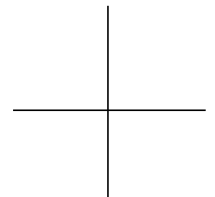

Table 12-2 File Menu (Continued)

| Menu Item | Action |
|--|--|
| Print on Serial Line 1 | Specifies the serial port to be used for printing. |
| Print on Serial Line 2 | <p>Serial line 1 is the Auxiliary serial port. If an ESP board is installed, serial line 2 is the serial port on the ESP board. If a Y connector is in use on an ESP board, the A connector is serial port 2 and the B connector is serial port 3.</p> <p>For terminals with more than one serial port, you can specify the default port by setting the defaultHost resource to the port number. The port can be specified in either of the following forms: n, serial n, or serial/n. For example, you can specify serial port 3 as 3, serial 3, or serial/3.</p> |
| Print on Serial Line 3 | |
| Print on Remote Unit <i>NCD_name:port</i> | |
| Print on Parallel Line 1 | Sends print output to parallel port 1. |
| Print on Parallel Line 2 | Sends print output to parallel port 2 (on terminals with more than one parallel port). |
| Print Screen | Prints the contents of the display window. |
| Print Log Buffer | Prints the contents of the log buffer (the input and output you can see by scrolling). Printing starts at the top visible line and extends through the end of the buffer. |
| Print Selection | Prints selected text in the display window. |
| Send Break | Sends a break character. |
| Exit | Exits from the session. This item can be disabled using the disableExits resource. For more information, see the ncdterm(1) man page. |



The Options Menu

The Options menu offers a variety of terminal mode settings. The selections are all toggles. Options that are set are indicated by filled-in toggle buttons. The initial states of the Options menu selections are controlled by resources.

Table 12-3 summarizes the Options menu modes and names the associated resources.

Table 12-3 Options Menu and Associated Resources

| Menu Item | Resource Name | Action |
|--------------------|---------------------|---|
| Menu Bar | menuBar | Enables the menu bar. |
| Jump Scroll | jumpScroll | Enables the terminal emulator to add lines to the screen quickly. |
| Reverse Video | reverseVideo | Reverses the foreground and background. For example, if your terminal is displaying dark characters on a light background, reverse video displays light characters on a dark background. |
| Visual Bell | visualBell | Specifies flashing instead of an audible bell. |
| Auto Wraparound | autoWrap | Specifies that the character typed after the cursor reaches the right border of the page automatically appears on the next line. By default, autowrap is enabled. If autowrap is turned off, a character typed after the cursor reaches the right border replaces the character at the end of the line. |
| Reverse Wraparound | reverseWrap | Allows the cursor to wrap from the leftmost column on the line to the rightmost column of the previous line, allowing you to backspace to the previous line. |
| Auto Linefeed | autoLineFeed | Generates a linefeed automatically. This is for use with programs that generate carriage returns without dropping down a line on the screen. |

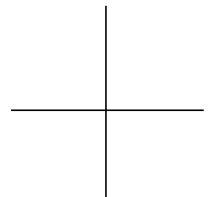

Table 12-3 Options Menu and Associated Resources (Continued)

| Menu Item | Resource Name | Action |
|--------------------------|------------------------------|--|
| Application Cursor Mode | appCursorMode | Generates ANSI escape sequences rather than standard cursor movements when you use arrow keys. |
| Application Keypad Mode | appKeypadMode | Generates control functions rather than numeric characters when the keypad is used. |
| Local Flow Control | localFlowControl | Determines whether flow control characters (such as Ctrl-S) are passed to the host. By default, local flow control is enabled. If local flow control is disabled, flow control characters are passed to the host. |
| Allow 80/132 Switching | c132 | Allows the terminal emulator to display in the 132-column format required by some applications. |
| 80/132 Font Switching | useCondensedFont | Switches from the default font to a condensed font upon receipt of the control sequence that changes the terminal emulator from 80- to 132-column mode. |
| Clear Screen With Blanks | clearScreenWithBlanks | Specifies whether the terminal emulator clears the screen by erasing the entire screen or by inserting a screen full of blanks. Enabling this option allows scrolling to previously displayed information on terminals connected to certain hosts. The drawback to using this option is that it may use up the save-line buffer quickly. The default is "false," which clears the screen by erasing. |
| Curses Emulation | curses | Emulates a bug in the UNIX <i>curses</i> screen-handling package. |
| Margin Bell | marginBell | Rings a bell when the cursor reaches the margin. |

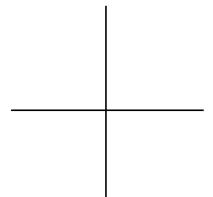

Table 12-3 Options Menu and Associated Resources (Continued)

| Menu Item | Resource Name | Action |
|---------------------|-----------------------|--|
| Strip Parity | stripParity | Strips parity from any data sent from the host so that the terminal emulator looks only at seven-bit bytes. |
| Grab Keyboard Input | secureKeyboard | Directs keyboard input to the terminal emulator window. Prevents another user from seeing key events being sent to the window. |
| ISO Latin 1 Font | latin1Font | Enables use of the ISO Latin Alphabet supplemental character set, which includes letters with accents and diacritical marks required in many European languages. |
| Blink Cursor | blinkCursor | Specifies whether the cursor should blink. |
| Visible Status Line | statusLine | Displays a 25th line at the bottom of the window, used by applications to display status information. |
| Log Output to File | Not applicable | Logs output to the file opened from the File menu. If no file is available for output logging, the item is not active in the Options menu. |

The Fonts Menu

The Fonts menu allows you to change the size of the display font dynamically. The fonts generated through the Fonts menu are defined using a single set of resource specifications. The specification set defines the “Default” menu selection, and the terminal emulator uses the Default to generate the other sizes offered through the menu. The default font is:

```
--terminal-medium*-normal--*-140-***-1
```

Table 12-4 lists the choices available through the menu and the resources for defining the Default item.

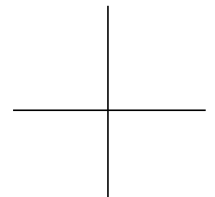

Table 12-4 Fonts Menu and Associated Resources

| Menu Item | Resource Names | Font Selected |
|-----------|--|---|
| Default | foundry, family pointSize, subFont: | 14 point |
| | foundry | The developer of the font; for example, adobe. Default: * (the wildcard character, which ensures that any foundry matches the font request) |
| | family | The family name; for example, courier. Default: terminal |
| | pointSize | The point size of the Default menu selection (in tenths of a point). Default: 140 |
| | subFont | The substitute font used if the requested font cannot be found; should be one of the built-in fonts. Default: 8x13 |
| Small | Not applicable | 10.5 point |
| Large | Not applicable | 14 point |
| Jumbo | Not applicable | 18 point |

The Cursors Menu

The Cursors menu allows you to change the terminal emulator’s cursor by selecting one of the descriptions in the menu.

You can also press Shift-MB3 (mouse button 3) to shift through the nine different types of cursors available.

The Keys Menu

The Keys menu (Keys ⇒ Keymap Editor) provides access to the Keymap Editor (see “Configuring Key Translations” on page 12-4).

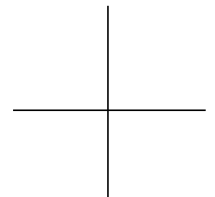

Selecting in the Window

You can select arbitrary rectangular sections of an NCD Terminal Emulator window to cut and paste:

- Shift-MB1 (mouse button 1) starts the rectangular selection. The cursor changes to a plus sign (+).
- MB3 extends the selection. The cursor again changes to a plus sign in the corner of the selection nearest the cursor, allowing you to extend the selection.
- MB2 pastes the selection.

The `rectangularCutLineTerminator` resource allows you to specify the terminator added to the end of each line of the rectangular selection. The default terminator is `\n`, which inserts a carriage return followed by a linefeed.

Configuring the Window Disconnect Delay

The `disconnectDelay` resource allows you to specify the number of seconds to wait before removing a window after disconnecting from the host. The default value is one second.

This resource is useful because you can set the disconnect delay to permit viewing of error messages displayed when the terminal emulator fails to connect to a host. For example, if a user attempts to connect to the Configuration daemon without a password, the window can be set to remain on the terminal long enough for the user to read the message that says a password is required.

Configuring the Answer-Back Message

The terminal emulator includes the control character ENQ, which decodes to 5. When the terminal emulator receives this code from the host, it sends back the string in the `answerbackString` resource.

Typing Ctrl-E causes the terminal to send its answer-back message.

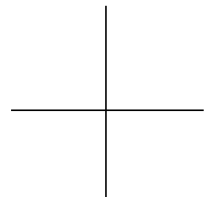

Using VT320 Terminal Emulator Escape Sequences

An escape sequences is a series of non-printing characters, beginning with an Escape character, that sends commands to devices. Escape sequences are used for printing, communications, and display management. The command in an escape sequence results in specified actions by devices. Escape sequences are also called control codes or control sequences.

Escape sequences are most often used in scripts, as in the following examples:

```
cursoroff:    echo "ESC[?25lcursor is off"
cursoron:    echo "ESC[?25hcursor is on"
```

The NCD Terminal Emulator includes a subset of the VT320 command set, as well as NCD-specific sequences. These escape sequences, their actions, and associated functions are listed in Table 12-5. Some of the sequences are described in more detail following the table.

The table lists sequences that differ depending on whether the environment requires eight-bit or seven-bit mode. The eight-bit mode sequence (for example, CSI. . .) is listed first, followed by the equivalent seven-bit mode sequence (for example, Esc[. . .).

Numerical variables are represented as *pn*. Variables representing a number of rows or columns are represented as *pr* or *pc*, respectively. Variables requiring a parameter setting from a number of specific choices are represented by *ps*. Other variable types are defined in the table as required.

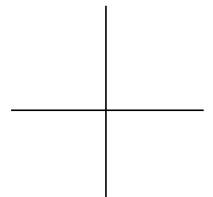

Table 12-5 Escape Sequences

| Escape Sequence | Action | Control Function |
|---|---|------------------|
| CSI <i>pn</i> @ Esc [<i>pn</i> @ | Insert <i>pn</i> blank characters. Default: 1. | ICH |
| CSI <i>ps</i> \$ } Esc [<i>ps</i> \$ } See “Configuring the Status Line” on page 12-27 for more information. | Select the status line. <i>ps</i> specifies the display to which the terminal sends data. Permissible values: 0 Send characters to main display 1 Send characters to status line | |
| CSI <i>ps</i> \$ - Esc [<i>ps</i> \$ - See “Configuring the Status Line” on page 12-27 for more information. | Enable the status line. The variable parameter <i>ps</i> indicates the status line to use. Permissible values: 0 No status line 1 Indicator status line (no-op) 2 Host-writable status line | |
| CSI ! p Esc [! p | Soft reset | |
| CSI > c Esc [> c or CSI > 0 c Esc [> 0 c | Request secondary device attributes. Response is C S I > <i>id</i> , <i>ver</i> , 0 c, in which <i>id</i> is terminal identification and <i>ver</i> is version. Default response: CSI>1;1;0c | DA |
| CSI ? <i>ps</i> J Esc [? <i>ps</i> J | Selective erase in display. Permissible values for <i>ps</i> : 0 Cursor to end of screen 1 Start to cursor 2 Entire screen | DECSER |

12-14 Configuring the NCD Terminal Emulator

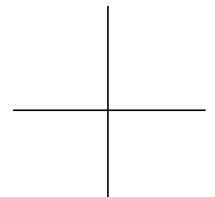

Table 12-5 Escape Sequences (Continued)

| Escape Sequence | Action | Control Function |
|--|--|--|
| CSI ? <i>ps</i> K Esc [<i>ps</i> K | Selective erase in line. Permissible values for <i>ps</i> are: 0 Cursor to end of line 1 Beginning to cursor 2 Entire line | DECSEL |
| CSI ? <i>ps</i> ; <i>ps</i> ... h Esc [? <i>ps</i> ; <i>ps</i> ... h | Set Digital private mode. Permissible values for <i>ps</i> : 1 Cursor keys mode (keypad application) 3 Column mode (132 column) 4 Scrolling mode (smooth scroll) 5 Screen mode (reverse video) 6 Origin mode 7 Autowrap mode 8 Auto-repeat mode 9 Send MIT mouse row and column on button press 25 Text cursor enable mode (cursor visible) 40 Allow 80-to-132 mode 41 curses (1) fix 42 National replacement character set mode (enabled) 44 Turn on margin bell 45 Reverse wraparound mode 46 Start logging 47 Use alternate screen buffer | DECCKM DECCOLM DECSCLM DECSCNM DECOM DECAWM DECARM DECTCEM DECNRCM |
| CSI ? <i>ps</i> i Esc [? <i>ps</i> i | Digital private print control mode. Permissible values for <i>ps</i> are: 1 Print line with cursor 4 Exit autoprint mode 5 Enter autoprint mode 10 Print main display 11 Print main display | |

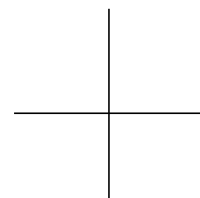

Table 12-5 Escape Sequences (Continued)

| Escape Sequence | Action | Control Function |
|--|---|--|
| CSI ? <i>ps</i> ; <i>ps</i> ... 1 Esc [? <i>ps</i> ; <i>ps</i> ... 1 | Reset Digital private mode. Permissible values for <i>ps</i> include: <ul style="list-style-type: none"> 1 Cursor keys mode (normal cursor keys) 3 Column mode (80 columns) 4 Scrolling mode (jump/fast scroll) 5 Screen mode (normal video) 6 Origin mode (normal cursor) 7 Autowrap mode (wraparound) 8 Auto-repeat mode (disabled) 9 Do not send MIT mouse row, column on button press 10 Text cursor enable mode (cursor invisible) 40 Do not allow 80-to-132 mode 41 No <i>curses</i> (1) fix 42 National replacement character set mode (disabled) 44 Turn off margin bell 45 No reverse wraparound mode 46 Stop logging 47 Use normal screen buffer | DECCKM DECCOLM DECSCLM DECSCNM DECOM DECAWM DECARM DECTCEM DECNRCM |
| CSI ? <i>ps</i> n Esc [? <i>ps</i> n | See CSI <i>ps</i> n . | |

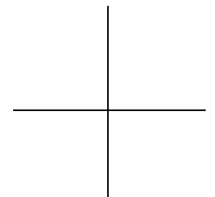

Table 12-5 Escape Sequences (Continued)

| Escape Sequence | Action | Control Function |
|--|---|------------------|
| CSI ? <i>ps</i> ; <i>ps</i> ... r Esc [? <i>ps</i> ; <i>ps</i> ... r | Store Digital private mode. Permissible values for <i>ps</i> : | |
| | 1 Cursor keys mode (normal/application keypad) | DECCKM |
| | 3 Column mode (80/132 columns) | DECCOLM |
| | 4 Scrolling mode (jump (fast)/scroll) | DECSCLM |
| | 5 Screen mode (normal/reverse video) | DECSCNM |
| | 6 Origin mode (normal/origin) | DECOM |
| | 7 Autowrap mode (no wrap/wraparound) | DECAWM |
| | 8 Auto-repeat mode (auto-repeat/no-auto-repeat) | DECARM |
| | 9 Do not send/send MIT mouse row and column on button press | |
| | 25 Not implemented | |
| | 40 Disallow/allow 80-to-132 mode | |
| | 41 Off/on <i>curses</i> (1) fix | |
| | 42 National replacement character set mode (disabled) | DECNRCM |
| | 44 Off/on margin bell | |
| | 45 No reverse-wraparound/reverse wraparound mode | |
| | 46 Stop/start logging | |
| | 47 Use normal/alternate screen buffer | |

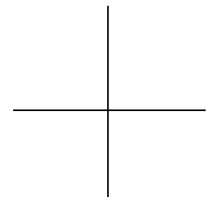

Table 12-5 Escape Sequences (Continued)

| Escape Sequence | Action | Control Function |
|--|---|--|
| CSI ? <i>ps</i> ; <i>ps</i> ... s | Restore Digital private mode. Permissible values for <i>ps</i> : 1 Cursor keys mode (normal/application keypad) 3 Column mode (80/132 columns) 4 Scrolling mode (jump (fast)/scroll) 5 Screen mode (normal/reverse video) 6 Origin mode (normal/origin) 7 Autowrap mode (no wrap/ wraparound) 8 Auto-repeat/no-auto-repeat keys 9 Do not send/send MIT mouse row and column on button press 25 Not implemented 40 Disallow/allow 80-to-132 mode 41 Off/on <i>cursor</i> s (1) fix 42 National replacement character set mode (disabled) 44 Off/on margin bell 45 No reverse-wraparound/reverse wraparound mode 46 Stop/start logging 47 Use normal/alternate screen buffer | DECCKM DECCLM DECSCLM DECSCNM DECOM DECAWM DECARM DECNRCM |
| CSI <i>ps</i> "q Esc [<i>ps</i> " q | Select character protection attribute. Permissible values for <i>ps</i> : 0 Not protected 1 Protected 2 Not protected | DECSCA |
| CSI 0 c CSI <i>pn</i> c Esc [<i>pn</i> c Esc Z | Device attributes/terminal identification. The response is CSI ?62;1;2;6;8c) | DA1 DECID |
| CSI <i>pn</i> A Esc [<i>pn</i> A | Cursor up <i>pn</i> times. Default: 1. | CUU |

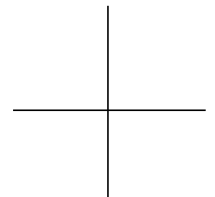

Table 12-5 Escape Sequences (Continued)

| Escape Sequence | Action | Control Function |
|--|--|------------------|
| CSI <i>pn</i> B Esc [<i>pn</i> B | Cursor down <i>pn</i> times. Default: 1. | CUD |
| CSI <i>pn</i> C Esc [<i>pn</i> C | Cursor forward <i>pn</i> times. Default: 1. | CUF |
| CSI <i>pn</i> D Esc [<i>pn</i> D | Cursor backward <i>pn</i> times. Default: 1. | CUB |
| CSI <i>pr</i> ; <i>pc</i> H Esc [<i>pr</i> ; <i>pc</i> H | Cursor position. Default: [1,1]. | CUP |
| CSI <i>ps</i> J Esc [<i>ps</i> J | Erase in display. Permissible values for <i>ps</i> : 0 Cursor to end of screen (default) 1 Start to cursor 2 Entire screen | ED |
| CSI <i>ps</i> K Esc [<i>ps</i> K | Erase in line. Permissible values for <i>ps</i> : 0 Cursor to end of line (default) 1 Beginning to cursor 2 Entire line | EL |
| CSI <i>pn</i> L Esc [<i>pn</i> L | Insert <i>pn</i> lines. Default: 1. | IL |
| CSI <i>pn</i> M Esc [<i>pn</i> M | Delete <i>pn</i> lines. Default: 1. | DL |
| CSI <i>pn</i> P Esc [<i>pn</i> P | Delete <i>pn</i> characters. Default: 1. | DCH |
| CSI <i>pn</i> X Esc [<i>pn</i> X | Erase <i>pn</i> characters. | ECH |
| CSI <i>pr</i> ; <i>pc</i> f Esc [<i>pr</i> ; <i>pc</i> f | Horizontal and vertical position. | HVP |

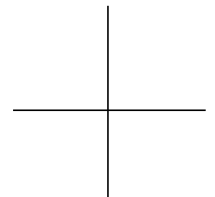

Table 12-5 Escape Sequences (Continued)

| Escape Sequence | Action | Control Function |
|--|---|------------------|
| CSI <i>ps</i> g Esc [<i>ps</i> g | Tab clear. Permissible values for <i>ps</i> : 0 Clear current tab stop (default) 2 Clear all tab stops 3 Clear all tab stops | TBC |
| CSI <i>ps ; ps ; ps ... h</i> Esc [<i>ps ; ps ; ps ... h</i> | Set Mode. Permissible values for <i>ps</i> : 4 Insert mode 20 Line feed/new line | IRM LNM |
| CSI <i>ps i</i> Esc [<i>ps i</i> | Print control mode. Permissible values for <i>ps</i> : 0 Print page that has cursor 4 Exit printer controller mode 5 Enter printer controller mode | |
| CSI <i>ps ; ps ; ps ... l</i> Esc [<i>ps ; ps ; ps ... l</i> | Reset Mode. Permissible values for <i>ps</i> : 4 Replace mode 20 No line feed/no new line | IRM LNM |

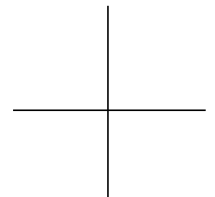

Table 12-5 Escape Sequences (Continued)

| Escape Sequence | Action | Control Function |
|---|---|------------------|
| CSI <i>ps ; ps ; ps . . . m</i> Esc [<i>ps ; ps ; ps . . . m</i> (For more information, see "Configuring Color Text" on page 12-30.) | Select graphic rendition (visual attributes). Permissible values for <i>ps</i> : 0 Normal; clear all attributes 1 Bold 4 Underscore 5 Blink 7 Reverse video 22 Normal intensity, not bold 24 Not underlined 25 Not blinking 27 Normal video Foreground text color: 30 Black 31 Red 32 Green 33 Yellow 34 Blue 35 Magenta 36 Cyan 37 White Background text color: 40 Black 41 Red 42 Green 43 Yellow 44 Blue 45 Magenta 46 Cyan 47 White | SGR |
| (continued on next page) | | |

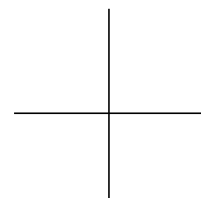

Table 12-5 Escape Sequences (Continued)

| Escape Sequence | Action | Control Function |
|--|---|------------------|
| <p><i>(continued from previous page)</i> CSI <i>ps ; ps ; ps . . . m</i> Esc [<i>ps ; ps ; ps . . . m</i></p> | <p>Select graphic rendition (visual attributes).</p> <p>Color-pair selection (NCD-specific values):</p> <p>90 Color-pair0 91 Color-pair1 92 Color-pair2 93 Color-pair3 94 Color-pair4 95 Color-pair5 96 Color-pair6 97 Color-pair7</p> | |

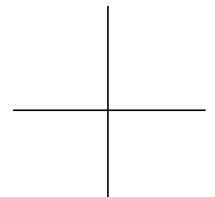

Table 12-5 Escape Sequences (Continued)

| Escape Sequence | Action | Control Function | | | | | | | | | | | | | | | | | | | | | | | | | | | | | | | | | | | | | | | | | | | | | | | | | | | | | |
|--|--|------------------------|---------|----------|---|---------------|---------|---|------------------------|-----------|----|---------------|------------|--|------------|---------------|----|------------------------------------|------------|----|------------------|------------------------|---|----------------|---|---------|---|---------|---|-----------------|---|--------|---|---------|---|--------|---|-------|---|---------|----|----------------|----|----------------|----|---------|----|-----------|----|----------------|----|---------|----|------------|-----|
| CSI <i>ps</i> n Esc [<i>ps</i> n or CSI ? <i>ps</i> n Esc [? <i>ps</i> n | Device status reports. <table> <thead> <tr> <th><i>ps</i></th> <th>Meaning</th> <th>Response</th> </tr> </thead> <tbody> <tr> <td>5</td> <td>Status report</td> <td>CSI 0 n</td> </tr> <tr> <td>6</td> <td>Cursor position report</td> <td>CSI r c R</td> </tr> <tr> <td>15</td> <td>Printer ready</td> <td>CSI ? 10 n</td> </tr> <tr> <td></td> <td>No printer</td> <td>CSI ? 13 n 00</td> </tr> <tr> <td>25</td> <td>User-defined key status (unlocked)</td> <td>CSI ? 20 n</td> </tr> <tr> <td>26</td> <td>Keyboard dialect</td> <td>CSI ? 27 <i>type</i> n</td> </tr> </tbody> </table> Permissible values for <i>type</i> : <table> <tbody> <tr><td>1</td><td>North American</td></tr> <tr><td>2</td><td>British</td></tr> <tr><td>3</td><td>Flemish</td></tr> <tr><td>4</td><td>Canadian French</td></tr> <tr><td>5</td><td>Danish</td></tr> <tr><td>6</td><td>Finnish</td></tr> <tr><td>7</td><td>German</td></tr> <tr><td>8</td><td>Dutch</td></tr> <tr><td>9</td><td>Italian</td></tr> <tr><td>10</td><td>Swiss (French)</td></tr> <tr><td>11</td><td>Swiss (German)</td></tr> <tr><td>12</td><td>Swedish</td></tr> <tr><td>13</td><td>Norwegian</td></tr> <tr><td>14</td><td>French/Belgian</td></tr> <tr><td>15</td><td>Spanish</td></tr> <tr><td>16</td><td>Portuguese</td></tr> </tbody> </table> | <i>ps</i> | Meaning | Response | 5 | Status report | CSI 0 n | 6 | Cursor position report | CSI r c R | 15 | Printer ready | CSI ? 10 n | | No printer | CSI ? 13 n 00 | 25 | User-defined key status (unlocked) | CSI ? 20 n | 26 | Keyboard dialect | CSI ? 27 <i>type</i> n | 1 | North American | 2 | British | 3 | Flemish | 4 | Canadian French | 5 | Danish | 6 | Finnish | 7 | German | 8 | Dutch | 9 | Italian | 10 | Swiss (French) | 11 | Swiss (German) | 12 | Swedish | 13 | Norwegian | 14 | French/Belgian | 15 | Spanish | 16 | Portuguese | DSR |
| <i>ps</i> | Meaning | Response | | | | | | | | | | | | | | | | | | | | | | | | | | | | | | | | | | | | | | | | | | | | | | | | | | | | | |
| 5 | Status report | CSI 0 n | | | | | | | | | | | | | | | | | | | | | | | | | | | | | | | | | | | | | | | | | | | | | | | | | | | | | |
| 6 | Cursor position report | CSI r c R | | | | | | | | | | | | | | | | | | | | | | | | | | | | | | | | | | | | | | | | | | | | | | | | | | | | | |
| 15 | Printer ready | CSI ? 10 n | | | | | | | | | | | | | | | | | | | | | | | | | | | | | | | | | | | | | | | | | | | | | | | | | | | | | |
| | No printer | CSI ? 13 n 00 | | | | | | | | | | | | | | | | | | | | | | | | | | | | | | | | | | | | | | | | | | | | | | | | | | | | | |
| 25 | User-defined key status (unlocked) | CSI ? 20 n | | | | | | | | | | | | | | | | | | | | | | | | | | | | | | | | | | | | | | | | | | | | | | | | | | | | | |
| 26 | Keyboard dialect | CSI ? 27 <i>type</i> n | | | | | | | | | | | | | | | | | | | | | | | | | | | | | | | | | | | | | | | | | | | | | | | | | | | | | |
| 1 | North American | | | | | | | | | | | | | | | | | | | | | | | | | | | | | | | | | | | | | | | | | | | | | | | | | | | | | | |
| 2 | British | | | | | | | | | | | | | | | | | | | | | | | | | | | | | | | | | | | | | | | | | | | | | | | | | | | | | | |
| 3 | Flemish | | | | | | | | | | | | | | | | | | | | | | | | | | | | | | | | | | | | | | | | | | | | | | | | | | | | | | |
| 4 | Canadian French | | | | | | | | | | | | | | | | | | | | | | | | | | | | | | | | | | | | | | | | | | | | | | | | | | | | | | |
| 5 | Danish | | | | | | | | | | | | | | | | | | | | | | | | | | | | | | | | | | | | | | | | | | | | | | | | | | | | | | |
| 6 | Finnish | | | | | | | | | | | | | | | | | | | | | | | | | | | | | | | | | | | | | | | | | | | | | | | | | | | | | | |
| 7 | German | | | | | | | | | | | | | | | | | | | | | | | | | | | | | | | | | | | | | | | | | | | | | | | | | | | | | | |
| 8 | Dutch | | | | | | | | | | | | | | | | | | | | | | | | | | | | | | | | | | | | | | | | | | | | | | | | | | | | | | |
| 9 | Italian | | | | | | | | | | | | | | | | | | | | | | | | | | | | | | | | | | | | | | | | | | | | | | | | | | | | | | |
| 10 | Swiss (French) | | | | | | | | | | | | | | | | | | | | | | | | | | | | | | | | | | | | | | | | | | | | | | | | | | | | | | |
| 11 | Swiss (German) | | | | | | | | | | | | | | | | | | | | | | | | | | | | | | | | | | | | | | | | | | | | | | | | | | | | | | |
| 12 | Swedish | | | | | | | | | | | | | | | | | | | | | | | | | | | | | | | | | | | | | | | | | | | | | | | | | | | | | | |
| 13 | Norwegian | | | | | | | | | | | | | | | | | | | | | | | | | | | | | | | | | | | | | | | | | | | | | | | | | | | | | | |
| 14 | French/Belgian | | | | | | | | | | | | | | | | | | | | | | | | | | | | | | | | | | | | | | | | | | | | | | | | | | | | | | |
| 15 | Spanish | | | | | | | | | | | | | | | | | | | | | | | | | | | | | | | | | | | | | | | | | | | | | | | | | | | | | | |
| 16 | Portuguese | | | | | | | | | | | | | | | | | | | | | | | | | | | | | | | | | | | | | | | | | | | | | | | | | | | | | | |
| CSI <i>pt</i> ; <i>pb</i> r Esc [<i>pt</i> ; <i>pb</i> r | Set top and bottom margins (<i>pt</i> =top; <i>bp</i> =bottom). Default: full-size window. | DECSTBM | | | | | | | | | | | | | | | | | | | | | | | | | | | | | | | | | | | | | | | | | | | | | | | | | | | | | |

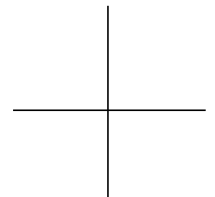

Table 12-5 Escape Sequences (Continued)

| Escape Sequence | Action | Control Function |
|---|---|------------------|
| 8-bit mode: <i>DCS pc ; pl Ky1 / St1 ; ... Kyn / Stn ST</i> or <i>DCS pc ; pl Ky1 \ St1 ; ... Kyn \ Stn ST</i> 7-bit mode: <i>Esc P pc ; pl Ky1 / St1 ; ... Kyn / Stn ST</i> or <i>Esc P pc ; pl Ky1 \ St1 ; ... Kyn \ Stn ST</i> (See "Programming Function Keys on N-108LK Keyboards" on page 12-28 for more information.) | User-defined keys (F6-F14, Do, Help, F17-F20): pc Clear parameter. Permissible values: 0 Clear all keys before starting (resetting) 1 Clear one key at a time, as overwritten pl Lock parameter (no-op). Permissible values: 0 Lock the keys 1 Unlock the keys Ky1/St1 or Ky1\St1 Key definition strings ST String terminator character or ESC \ | DECUDK |
| Esc G (<i>embedded space required</i>) | Sending 8-bit C1 control characters | S8C1T |
| Esc F (<i>embedded space required</i>) | Sending 7-bit C1 control characters | S7C1T |
| Esc } | Select locking shift of G2 character set, right | LS2R |
| Esc = | Keypad application mode | DECKPAM |
| Esc > | Keypad numeric mode | DECPNM |
| Esc # 3 | Double-width, single-height line, top | DECDHL |
| Esc # 4 | Double-width, single-height line, bottom | DECDHL |
| Esc # 5 | Single-width, single-height line | DECSWL |
| Esc # 6 | Double-width, single-height line | DECDWL |
| Esc # 8 | Screen alignment pattern | DECALN |

12-24 Configuring the NCD Terminal Emulator

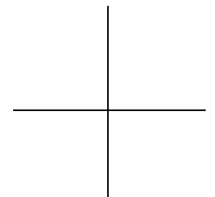

Table 12-5 Escape Sequences (Continued)

| Escape Sequence | Action | Control Function |
|--|--|------------------|
| Esc (<i>ps</i> Esc) <i>ps</i> Esc * <i>ps</i> Esc + <i>ps</i> | Designate character sets: Select character set G0. Select character set G1. Select character set G2. Select character set G3. Permitted values for <i>ps</i> : <i>ps</i> <u>Character set</u> B ASCII %5 Digital supplementary < Digital user supplementary 0 Digital graphics A United Kingdom 4 Dutch C FINNISH 5 FINNISH 2 R French Q French Canadian 9 French Canadian 2 K German Y Italian E Norwegian 6 Norwegian 2 \ Norwegian 3 %6 Portuguese Z Spanish H Swedish 7 Swedish 2 = Swiss | SCS |
| Esc | Select locking shift of G3 character set, right | LS3R |
| Esc ~ | Select locking shift of G1 character set, right | LS1R |
| Esc 7 | Save cursor | DECSC |
| Esc 8 | Restore cursor | DECRC |

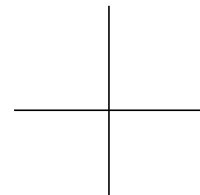
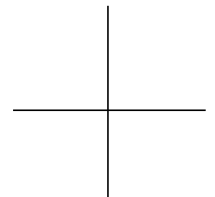

Table 12-5 Escape Sequences (Continued)

| Escape Sequence | Action | Control Function |
|---|---|------------------|
| Esc D | Index | IND |
| Esc E | New line | NEL |
| Esc H | Horizontal tab set | HTS |
| Esc M | Reverse index | RI |
| Esc N | Select single-shift of G2 character set | SS2 |
| Esc O | Select single-shift of G3 character set | SS3 |
| Esc Z Esc [c | Send device attributes/terminal identification. Response: CSI?62;1;2;6;8c | DECID |
| Esc c | Hard reset | RIS |
| Esc n | Select locking shift of G2 character set | LS2 |
| Esc o | Select locking shift of G3 character set | LS3 |
| OSC <i>ps</i> ; <i>string</i> NP Esc] <i>ps</i> ; <i>string</i> NP (For more information, see “Configuring Window and Icon Titles” on page 12-30.) | OSC Mode—Set icon and window titles. Parameter variables are: NP —Any non-printing character (discarded) string —ASCII printable string (maximum 511 characters) ps 0 Use string as new icon name and title 1 Use string as new icon name only 2 Use string as new title only | |
| OSC <i>ps</i> ND <i>string</i> NP Esc] <i>ps</i> ND <i>string</i> NP (For more information, see “Configuring Color Text” on page 12-30.) | Color-pair specification (NCD-specific) Parameter variables are defined as follows: ps 90 to 97 ND Any non-digit character string <i>foreground/ background</i> NP Any non-printing character | |



Configuring the Status Line

The status line is referred to in Digital documents as “the 25th line of the display.” Because NCD Terminal Emulator windows may have more than 24 lines, the status line must be treated as the hardware status line instead of line 25.

The NCD implementation of the status line allows the programmer to create a new line that appears at the bottom of the window. Normal programmatic editing operations are available for this line, but different character modes (such as blinking or bold) are not supported. To enter characters into the status line, the programmer switches from the main display to the status line display, then uses normal cursor control and text to add characters.

By default, the status line is not visible on the screen.

To use the status line, enable or disable it with the following sequence:

```
CSI ps $ -
```

where *ps* indicates which status line to use (or none):

- 0 No status line available
- 1 Indicator status line (no-op)
- 2 Host-writable status line

Hence, the value 2 makes the status line appear, and 0 makes it disappear. Note that content is not retained when the status line is hidden; the line is emptied.

To select the status line, use the following sequence:

```
CSI ps $ }
```

where *ps* represents the display area to which the terminal sends data:

- 0 Send characters to the main display
- 1 Send characters to the status line

Once the status line is selected, all character input is directed there until the main display is selected.

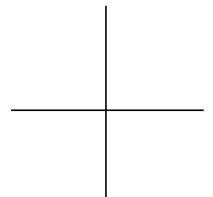

Programming Function Keys on N-108LK Keyboards

Fifteen of the twenty function keys on the N-108LK keyboards can be redefined by the user. The definable function keys are:

- F6 through F14
- Do and Help
- F17 through F20

When redefined, the shifted state of these keys takes on the defined values. The unshifted keys still work as usual; you cannot programmatically rebind the unshifted state.

The two permissible formats of the escape sequences follow:

DCS *pc* ; *pl* | *Ky1* / *St1* ; ... *Kyn* / *Stn* *ST*

DCS *pc* ; *pl* | *Ky1* \ *St1* ; ... *Kyn* / *Stn* *ST*

The parts of a function key definition are:

| | |
|---|--|
| DCS | Device control string |
| pc | Clear parameter: 0 Clear all keys before starting (reset) 1 Clear one key at a time, as overwritten |
| pl | Lock parameter (no-op on NCD terminals): 0 Lock the keys 1 Unlock the keys |
| <i>Ky1/St1</i> or <i>Ky1\St1</i> | Key definition string. There can be <i>n</i> of these, separated by semicolons. The format is a key selector number, a slash, then the rebinding. (See Table 12-6). The <i>Ky1/St1</i> version requires that you supply the hexadecimal values of the letters in the key definition string. NCD has added another option, <i>Ky1\St1</i> , which allows you to supply ASCII characters for the string. |
| ST | String terminator character, or ESC \ |

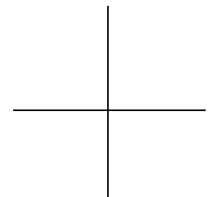
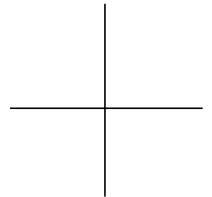

Table 12-6 Key Selector Numbers

| Key | Value |
|------|-------|
| F6 | 17 |
| F7 | 18 |
| F8 | 19 |
| F9 | 20 |
| F10 | 21 |
| F11 | 23 |
| F12 | 24 |
| F13 | 25 |
| F14 | 26 |
| Help | 28 |
| Do | 29 |
| F17 | 31 |
| F18 | 32 |
| F19 | 33 |
| F20 | 34 |

Examples of function key definitions follow (spaces have been inserted for legibility, but must not be included in the definition):

| | |
|---|-------------------------------------|
| <code>DCS 0 ; 1 ST</code> | Clears all key rebindings |
| <code>DCS 1 ; 0 ESC \</code> | Locks keys (no-op on NCD terminals) |
| <code>DCS 1 ; 1 34\ Print ST</code> | Rebinds F20 to string "Print" |
| <code>DCS 1 ; 1 34/5052494E54 ST</code> | Rebinds F20 to string "Print" |



In the Digital implementation, there is a limitation of 256 characters combined for all programmable function keys. NCD has a limitation of 256 characters per rebound key.

With Digital computers, key locking and unlocking can be set through hardware. Because NCD does not have this hardware, this function does not work. Locking is not enforced.

Configuring Window and Icon Titles

Icon and window titles can be configured through the following escape sequence:

`OSC ps ND string NP`

where:

- ps*** Determines how the string is used:
- 0—Uses *string* as the new icon name and window title
 - 1—Uses *string* as the new icon name only
 - 2—Uses *string* as the new window name only
- ND*** Is any non-alphanumeric character (and is discarded)
- string*** Becomes the icon name and window title (or icon name only). This is an ASCII printable string that contains a maximum of 511 characters.
- NP*** Is any non-printing character (and is also discarded)

Configuring Color Text

You can specify color text programmatically. This feature is based on the SGR (select graphic rendition) paradigm used to control blinking, bold, inverse, and other text attributes.

There are two methods of setting text color:

- Using a subset of the ISO 6429 standard for selection of basic colors for foreground and background
- The Hewlett-Packard color-pair model in which you can select pairs of any X colors for text (X colors are listed in the file `/usr/lib/X11/ncd/rgb.txt`.)

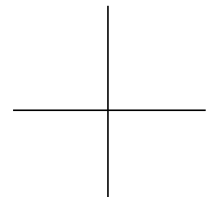

The color selection code is limited to eight combinations of colors at any given time.

The number of combinations can be effectively doubled by using the inverse graphics rendition, but the number of colors that can be displayed on the screen simultaneously is limited.

ISO 6429 Color Usage

The ISO specification defines SGR sequences to change the foreground and the background pens, as listed in Table 12-7.

Table 12-7 SGR Sequences for Foreground and Background Pens

| Foreground Selection | | Background Selection | |
|----------------------|---------|----------------------|---------|
| 30 | black | 40 | black |
| 31 | red | 41 | red |
| 32 | green | 42 | green |
| 33 | yellow | 43 | yellow |
| 34 | blue | 44 | blue |
| 35 | magenta | 45 | magenta |
| 36 | cyan | 46 | cyan |
| 37 | white | 47 | white |

For example:

`CSI 31 m` or `ESC[31 m`

renders foreground text in red, and

`CSI 44 m` or `ESC[44 m`

renders background text in blue.

These selections can be mixed to use combinations of the foreground and background colors when rendering text. However, only eight combinations are permitted simultaneously on the screen. The eight color cells are reused as needed.

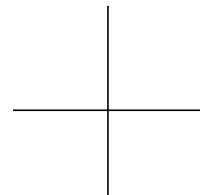

Note also that the combination of black text on a white background is always reserved for the first color cell; hence, there are really only seven combinations of these colors that you can select.

If you attempt to use more than seven combinations at one time, the resulting text is displayed using color cell zero (black on white).

Hewlett-Packard Color-Pair Usage

The eight available color cells can be assigned to any combination of foreground and background colors using NCDware-specific functionality.

This functionality builds on the SGR method of text specification with the addition of the range of new selections listed in Table 12-8.

Table 12-8 New Color-Pair Selection

| Color Pair Selector | Color Pair |
|---------------------|-------------|
| 90 | color-pair0 |
| 91 | color-pair1 |
| 92 | color-pair2 |
| 93 | color-pair3 |
| 94 | color-pair4 |
| 95 | color-pair5 |
| 96 | color-pair6 |
| 97 | color-pair7 |

For example:

```
CSI 91 m or ESC[ 91 m
```

uses color-pair1 for rendering text.

Specify the colors associated with the selections by using an extension of the OSC functions in the following format:

```
OSC ps ND string NP
```

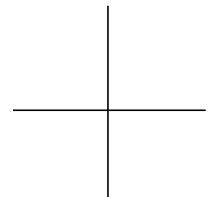

where:

- ps*** ranges from 90 to 97 for the color-pair selection
- ND*** is any non-alphanumeric character (and is discarded)
- string*** is in the format foreground/background
- NP*** is any non-printing character (and is discarded)

For example:

```
OSC 91 ; orange/brown ^G or
```

```
ESC] 91 ; orange/brown ^G
```

sets color-pair1 to foreground orange, background brown.

The first color, color cell 0 (zero), is special—it is the default used for normal text. In addition, the background of the window is reset to the background specified with this color. In the ISO 6429 model, color cell 0 is always used for text specified as black text on a white background. Note that this may have been changed using the Hewlett-Packard method, which results in black text on a white background being stored in color-pair0.

You can use the two models together, but this is somewhat tricky in terms of cell reuse. The zero cell is never reused, but others are available to be reused if a free cell is needed and there are no matching colors for an existing cell on the screen. (The code scans the screen to determine if a color cell is in use when it needs to allocate a new color selection.) As a rule, you should limit color to eight combinations at any given time, or twice that using inverse text. If you attempt to use more colors, the result is plain color text.

Set up new color cells as early as possible and not within loops.

Reverse video inverts all the colors that are set programmatically. The user can select reverse video from the Options menu or use the **reverseVideo** resource.

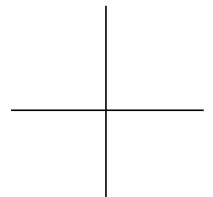

Using Keyboard Escape Sequences

An escape sequence is a series of non-printing characters, beginning with an Escape character, that sends a command to a device. Escape sequences are used by some legacy applications for printing, communications, and display management. The command in an escape sequence results in specified actions by devices. Escape sequences are also called control codes or control sequences.

The tables in this section describe the escape sequences sent to the terminal emulator from the following NCD keyboards: N-101/N-102, VT220/N-108LK, and N-97/N-Kana.

Escape key sequences are sent by the following types of keys:

- ❑ Pressing a function key sends an escape sequence to the terminal emulator. The following tables list the function key escape sequences for NCD keyboards:

Table 12-10 N-101/N-102 keyboard

Table 12-14 VT220/N-108LK keyboard

Table 12-19 N-97/N-Kana keyboard

- ❑ The keypad can be set in one of two modes: numeric or application. In numeric mode, pressing a keypad key results in a digit, numeric operator, or enter character. In application mode, the keypad keys are similar to the function keys in that pressing a key generates an escape sequence. The **appCursorMode** resource controls the mode; the Options menu includes a toggle (Application Cursor Mode) for local control.

The following tables list the keypad escape sequences for NCD keyboards:

Table 12-9 N-101/N-102 keyboard

Table 12-13 VT220 keyboard

Table 12-18 N-97/N-Kana keyboard

- ❑ Pressing a key in the cursor keypad or edit keypad results in an escape sequence. The cursor keypad can also be used in either application mode or non-application mode. The Options menu includes a toggle (Application Cursor Mode) to alter the mode.

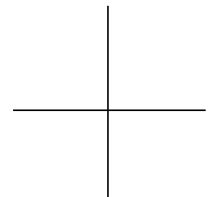

The following tables list the edit keypad escape sequences:

Table 12-11 N-101/N-102 keyboard

Table 12-17 N-108LK keyboard

The following tables list the cursor keypad escape sequences:

Table 12-12 N-101/N-102 keyboard

Table 12-15 N-108LK keyboard

- ❑ Escape sequences for the Break, Shift, and Control keys for the N-108LK keyboard in the serial terminal emulator are listed in Table 12-16.

N-101/N-102 Keyboard Escape Sequences

The tables in this section list escape sequences for N-101/N-102 keyboards.

Table 12-9 N-101/N-102 Keypad Escape Sequences

| Key | Application Mode Reset | Application Mode Set | |
|-------|------------------------|----------------------|---------|
| | | 8-bit | 7-bit |
| 0 | 0 | SS3 p | Esc O p |
| 1 | 1 | SS3 q | Esc O q |
| 2 | 2 | SS3 r | Esc O t |
| 3 | 3 | SS3 s | Esc O s |
| 4 | 4 | SS3 t | Esc O t |
| 5 | 5 | SS3 u | Esc O u |
| 6 | 6 | SS3 v | Esc O v |
| 7 | 7 | SS3 w | Esc O w |
| 8 | 8 | SS3 x | Esc O x |
| 9 | 9 | SS3 y | Esc O y |
| Enter | Return | SS3 M | Esc O M |
| - | - | SS3 m | Esc O m |
| . | . | SS3 n | Esc O n |
| + | + | + | + |

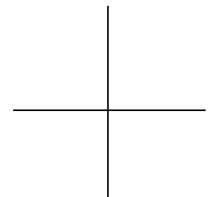

Table 12-9 N-101/N-102 Keypad Escape Sequences (Continued)

| Key | Application Mode Reset | Application Mode Set | |
|-----|------------------------|----------------------|-------|
| | | 8-bit | 7-bit |
| / | / | / | / |
| * | * | * | * |

Table 12-10 N-101/N-102 Function Key Escape Sequences

| Key | Escape Sequence | |
|-----|-----------------|-------------|
| | 8-bit | 7-bit |
| F1 | CSI 1 1 ~ | Esc [1 1 ~ |
| F2 | CSI 1 2 ~ | Esc [1 2 ~ |
| F3 | CSI 1 3 ~ | Esc [1 3 ~ |
| F4 | CSI 1 4 ~ | Esc [1 4 ~ |
| F5 | CSI 1 5 ~ | Esc [1 5 ~ |
| F6 | CSI 1 7 ~ | Esc [1 7 ~ |
| F7 | CSI 1 8 ~ | Esc [1 8 ~ |
| F8 | CSI 1 9 ~ | Esc [1 9 ~ |
| F9 | CSI 2 0 ~ | Esc [2 0 ~ |
| F10 | CSI 2 1 ~ | Esc [2 1 ~ |
| F11 | CSI 2 3 ~ | Esc [2 3 ~ |
| F12 | CSI 2 4 ~ | Esc [2 4 ~ |

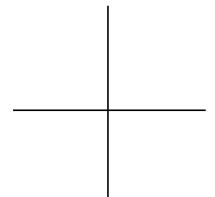
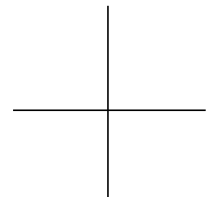

Table 12-11 N-101/N-102 Editing Keypad Escape Sequences

| Key | Escape Sequence | |
|-----------|-----------------|-----------|
| | 8-bit | 7-bit |
| Insert | CSI 2 ~ | Esc [2 ~ |
| Home | CSI ^ A | Esc [^ A |
| Page Up | CSI 5 ~ | Esc [5 ~ |
| Delete | CSI ^ ? | Esc [^ ? |
| End | CSI ^ B | Esc [^ B |
| Page Down | CSI 6 ~ | Esc [6 ~ |

Table 12-12 N-101/N-102 Cursor Keypad Sequences

| Arrow Key | Escape Sequence | |
|-----------|-----------------|---------|
| | 8-bit | 7-bit |
| Up | CSI A | Esc [A |
| Down | CSI B | Esc [B |
| Right | CSI C | Esc [C |
| Left | CSI D | Esc [D |



N-108LK (VT220-Style) Keyboard Escape Sequences

The tables in this section list escape sequences for N-108LK and VT220 keyboards.

Table 12-13 N-108LK Keypad Escape Sequences

| Key | Application Mode Reset | | Application Mode Set | |
|-------|------------------------|---------|----------------------|---------|
| | 8-bit | 7-bit | 8-bit | 7-bit |
| 0 | 0 | 0 | SS3 p | Esc O p |
| 1 | 1 | 1 | SS3 q | Esc O q |
| 2 | 2 | 2 | SS3 r | Esc O r |
| 3 | 3 | 3 | SS3 s | Esc O s |
| 4 | 4 | 4 | SS3 t | Esc O t |
| 5 | 5 | 5 | SS3 u | Esc O u |
| 6 | 6 | 6 | SS3 v | Esc O v |
| 7 | 7 | 7 | SS3 w | Esc O w |
| 8 | 8 | 8 | SS3 x | Esc O x |
| 9 | 9 | 9 | SS3 y | Esc O y |
| , | , | , | SS3 l | Esc O l |
| - | _ | _ | SS3 m | Esc O m |
| . | . | . | SS3 n | Esc O n |
| Enter | Return | Return | SS3 M | Esc O M |
| PF1 | SS3 P | Esc O P | SS3 P | Esc O P |
| PF2 | SS3 Q | Esc O Q | SS3 Q | Esc O Q |
| PF3 | SS3 R | Esc O R | SS3 R | Esc O R |
| PF4 | SS3 S | Esc O S | SS3 S | Esc O S |

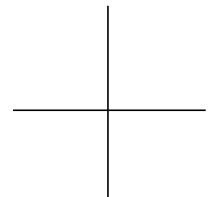

Table 12-14 N-108LK Function Key Escape Sequences

| Key | VMS | | ULTRIX | |
|------|--------------|--------------|--------------|--------------|
| | 8-bit | 7-bit | 8-bit | 7-bit |
| F1 | hold screen | hold screen | hold screen | hold screen |
| F2 | print screen | print screen | print screen | print screen |
| F3 | | | | |
| F4 | | | | |
| F5* | Break | Break | Break | Break |
| F6 | CSI 1 7 ~ | Esc [1 7 ~ | CSI 1 7 ~ | Esc [1 7 ~ |
| F7 | CSI 1 8 ~ | Esc [1 8 ~ | CSI 1 8 ~ | Esc [1 8 ~ |
| F8 | CSI 1 9 ~ | Esc [1 9 ~ | CSI 1 9 ~ | Esc [1 9 ~ |
| F9 | CSI 2 0 ~ | Esc [2 0 ~ | CSI 2 0 ~ | Esc [2 0 ~ |
| F10 | CSI 2 1 ~ | Esc [2 1 ~ | CSI 2 1 ~ | Esc [2 1 ~ |
| F11 | CSI 2 3 ~ | Esc [2 3 ~ | Esc _ | Esc _ |
| F12 | CSI 2 4 ~ | Esc [2 4 ~ | Backspace | Backspace |
| F13 | CSI 2 5 ~ | Esc [2 5 ~ | Newline | Newline |
| F14 | CSI 2 6 ~ | Esc [2 6 ~ | CSI 2 6 ~ | Esc [2 6 ~ |
| Help | CSI 2 8 ~ | Esc [2 8 ~ | CSI 2 8 ~ | Esc [2 8 ~ |
| Do | CSI 2 9 ~ | Esc [2 9 ~ | CSI 2 9 ~ | Esc [2 9 ~ |
| F17 | CSI 3 1 ~ | Esc [3 1 ~ | CSI 3 1 ~ | Esc [3 1 ~ |
| F18 | CSI 3 2 ~ | Esc [3 2 ~ | CSI 3 2 ~ | Esc [3 2 ~ |
| F19 | CSI 3 3 ~ | Esc [3 3 ~ | CSI 3 3 ~ | Esc [3 3 ~ |
| F20 | CSI 3 4 ~ | Esc [3 4 ~ | CSI 3 4 ~ | Esc [3 4 ~ |

*F5 is the break key in a serial terminal emulator only.

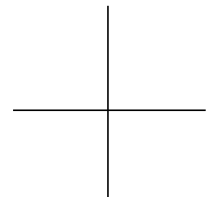

Table 12-15 N-108LK Cursor Keypad Sequences

| Arrow Key | Cursor Key Mode Reset | | Cursor Key Mode Set | |
|-----------|-----------------------|---------|---------------------|---------|
| | 8-bit | 7-bit | 8-bit | 7-bit |
| Up | CSI A | Esc [A | SS3 A | Esc O A |
| Down | CSI B | Esc [B | SS3 B | Esc O B |
| Right | CSI C | Esc [C | SS3 C | Esc O C |
| Left | CSI D | Esc [D | SS3 D | Esc O D |

Table 12-16 N-108LK Escape Sequences—Break, Shift, and Control

| Key | Code Sent |
|---------------------|-----------------------------|
| Break* | 250 millisecond Break |
| Shift-Break* | 3.5 second Break & drop DTR |
| Control-@ | NULL |
| Control-Space | NULL |
| Control-Shift-Space | NULL |

* Break and Shift-Break apply to the serial terminal emulator only.

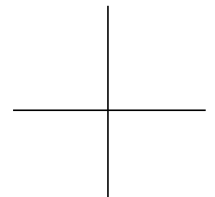
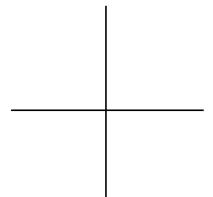

Table 12-17 N-108LK Editing Keypad Escape Sequences

| Key | VMS | | ULTRIX | |
|--------|---------|-----------|---------|-----------|
| | 8-bit | 7-bit | 8-bit | 7-bit |
| Find | CSI 1 ~ | Esc [1 ~ | CSI 1 ~ | Esc [1 ~ |
| Insert | CSI 2 ~ | Esc [2 ~ | CSI 2 ~ | Esc [2 ~ |
| Remove | CSI 3 ~ | Esc [3 ~ | CSI 3 ~ | Esc [3 ~ |
| Select | CSI 4 ~ | Esc [4 ~ | CSI 4 ~ | Esc [4 ~ |
| Prior | CSI 5 ~ | Esc [5 ~ | CSI 5 ~ | Esc [5 ~ |
| Next | CSI 6 ~ | Esc [6 ~ | CSI 6 ~ | Esc [6 ~ |



N-97/N-Kana Keyboard Escape Sequences

The tables in this section list escape sequences for N-97 and N-Kana keyboards.

Table 12-18 N-97/N-Kana Keypad Escape Sequences

| Key | Application Mode Reset | | Application Mode Set | |
|-------|------------------------|---------|----------------------|---------|
| | 8-bit | 7-bit | 8-bit | 7-bit |
| 0 | 0 | 0 | SS3 p | Esc O p |
| 1 | 1 | 1 | SS3 q | Esc O q |
| 2 | 2 | 2 | SS3 r | Esc O r |
| 3 | 3 | 3 | SS3 s | Esc O s |
| 4 | 4 | 4 | SS3 t | Esc O t |
| 5 | 5 | 5 | SS3 u | Esc O u |
| 6 | 6 | 6 | SS3 v | Esc O v |
| 7 | 7 | 7 | SS3 w | Esc O w |
| 8 | 8 | 8 | SS3 x | Esc O x |
| 9 | 9 | 9 | SS3 y | Esc O y |
| , | , | , | SS3 l | Esc O l |
| - | - | - | SS3 m | Esc O m |
| . | . | . | SS3 n | Esc O n |
| Enter | Return | Return | SS3 M | Esc O M |
| PF1 | SS3 P | Esc O P | SS3 P | Esc O P |
| PF2 | SS3 Q | Esc O Q | SS3 Q | Esc O Q |
| PF3 | SS3 R | Esc O R | SS3 R | Esc O R |
| PF4 | SS3 S | Esc O S | SS3 S | Esc O S |

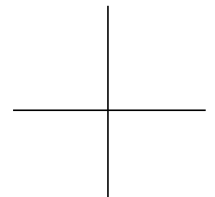
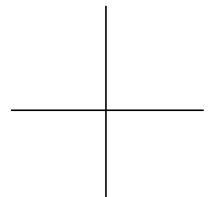

Table 12-19 N-97/N-Kana Function Key Escape Sequences

| Key | Escape Sequence | |
|-----|-----------------|-------------|
| | 8-bit | 7-bit |
| F1 | CSI 1 1 ~ | Esc [1 1 ~ |
| F2 | CSI 1 2 ~ | Esc [1 2 ~ |
| F3 | CSI 1 3 ~ | Esc [1 3 ~ |
| F4 | CSI 1 4 ~ | Esc [1 4 ~ |
| F5 | CSI 1 5 ~ | Esc [1 5 ~ |
| F6 | CSI 1 7 ~ | Esc [1 7 ~ |
| F7 | CSI 1 8 ~ | Esc [1 8 ~ |
| F8 | CSI 1 9 ~ | Esc [1 9 ~ |
| F9 | CSI 2 0 ~ | Esc [2 0 ~ |
| F10 | CSI 2 1 ~ | Esc [2 1 ~ |
| F11 | CSI 2 3 ~ | Esc [2 3 ~ |
| F12 | CSI 2 4 ~ | Esc [2 4 ~ |



Using Compose Key Sequences

Compose sequences, available on all keyboards, allow you to type more characters than appear on the keyboard by using a sequence of keystrokes to compose a single special character. You can use compose sequences in the NCD Terminal Emulator (*ncdterm* or *ncdrunterm*).

Support for Dead Keys

Special characters called dead keys create automatic compose sequences. When a dead key is pressed, the next key you press determines the composed character. The N-102 French and Swiss keyboards provide dead-key support for the following accent marks:

- ❑ On the French keyboard, the dieresis (¨) and circumflex (ˆ)
- ❑ On the Swiss keyboard, the acute accent (´), grave accent (`), circumflex (ˆ), tilde (~), and dieresis (¨)

When using these keyboards, you must first set the keyboard type to French or Swiss by using the Boot Monitor keyboard menu before booting. For information about the Boot Monitor keyboard menu, see Chapter 11, Boot Monitor and NVRAM.

Typing Compose Sequences

To quickly test compose sequences, display the Terminal Host Chooser (Console ⇒ Terminals ⇒ New Terminal). Type the compose sequences in the Service: window.

To type compose sequences in an NCD Terminal Emulator window (*ncdterm* or *ncdrunterm*):

1. Make sure the **eightBitInput** resource is set to “true.” For example:
`NCDrunterm*eightBitInput: true`
2. Start the NCD Terminal Emulator and type:
`% stty -istrip cs8`
3. If you are using the *vi* text editor to enter the compose sequences, set the environment variable `LC_CTYPE` to “iso_8859_1.”

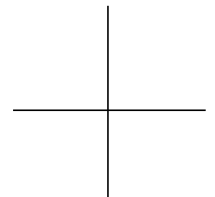

4. Find the character you want in the Character column in Table 12-20.
 - On the N-108LK keyboard, press the Compose Character key; then type the two characters in the third column.
 - On any other type of keyboard, press Left/Alt and a space (hold down Left/Alt while pressing the space bar); then type the two characters in the Keystrokes column.

Note that the notation (*sp*) in the Keystrokes column in Table 12-20 indicates that you must press the space bar.

Compose Sequence Table

Table 12-20 on page 12-46 lists the characters you can compose and the keystrokes to use.

Note The compose sequences for the currency sign and the registered trademark symbol do not work.

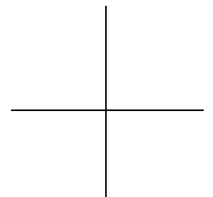

Table 12-20 Compose Sequences

| Character | Name | Keystrokes |
|-----------|----------------------------|----------------|
| " | quotation mark | "(sp) |
| # | number sign | ++ |
| ' | apostrophe | '(sp) |
| @ | commercial at | AA |
| [| opening bracket | ((|
| \ | backslash | // or /< |
|] | closing bracket |)) |
| ^ | circumflex accent | ^(sp) |
| ` | grave accent | '(sp) |
| { | opening brace | (- |
| | vertical line | /^ |
| } | closing brace |)- |
| ~ | tilde | ~(sp) |
| ¡ | inverted ! | !! |
| ¢ | cent sign | C/ or C |
| £ | pound sign | L- or L= |
| § | section sign | SO or S! or S0 |
| ¥ | yen | Y- or Y= |
| ¤ | currency sign ¹ | XO or X0 |
| © | copyright sign | CO or C0 |
| ª | female ordinal | A_ |
| « | open angle brackets | « |
| ° | degree sign | 0^ |

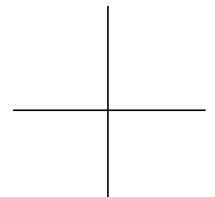

Table 12-20 Compose Sequences (Continued)

| Character | Name | Keystrokes |
|-----------|-----------------------|------------|
| ± | plus or minus sign | + - |
| ² | superscript 2 | 2^ |
| ³ | superscript 3 | 3^ |
| μ | micro sign | /U* |
| ¶ | paragraph sign | P! |
| • | middle dot | .^ |
| ¹ | superscript one | 1^ |
| º | masculine ordinal | O_ |
| » | closed angle brackets | » |
| ¼ | fraction one-quarter | 1 4* |
| ½ | fraction one-half | 1 2* |
| ¿ | inverted ? | ?? |
| À | A grave | A ` |
| Á | A acute | A ´ |
| Â | A circumflex | A ^ |
| Ã | A tilde | A ~ |
| Ä | A umlaut | A" |
| Å | A ring | A* |
| Æ | AE diphthong | AE* |
| Ç | C cedilla | C, |
| È | E grave | E ` |

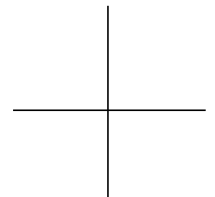

Table 12-20 Compose Sequences (Continued)

| Character | Name | Keystrokes |
|-----------|----------------------|------------|
| Ë | E umlaut | E " |
| Ì | I grave | I ` |
| Í | I acute | I ´ |
| Î | I circumflex | I ^ |
| Ï | I umlaut | I " |
| Ñ | N tilde | N ~ |
| Ò | O grave | O ` |
| Ó | O acute | O ´ |
| Ô | O circumflex | O ^ |
| Õ | O tilde | O ~ |
| Ö | O umlaut | O " |
| Œ | OE diphthong † | OE * |
| Ø | O slash | O / |
| Ù | U grave | U ` |
| Ú | U acute | U ´ |
| Û | U circumflex | U ^ |
| Ü | U umlaut | U " |
| ÿ | Y umlaut † | Y " |
| ß | German small sharp s | ss |
| à | a grave | a ` |
| á | a acute | a ´ |
| â | a circumflex | a ^ |
| ã | a tilde | a ~ |

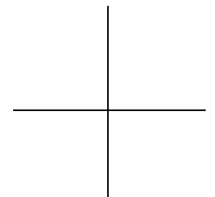

Table 12-20 Compose Sequences (Continued)

| Character | Name | Keystrokes |
|-----------|----------------|------------|
| ä | a umlaut | a " |
| à | a ring | a * |
| æ | ae diphthong | ae* |
| ç | c cedilla | c, |
| è | e grave | e ` |
| é | e acute | e ´ |
| ê | e circumflex | e ^ |
| ë | e umlaut | e " |
| ì | i grave | i ` |
| í | i acute | i ´ |
| î | i circumflex | i ^ |
| ï | i umlaut | i " |
| ñ | n tilde | n ~ |
| ò | o grave | o ` |
| ó | o acute | o ´ |
| ô | o circumflex | o ^ |
| õ | o tilde | o ~ |
| ö | o umlaut | o " |
| œ | oe diphthong † | oe * |
| ø | o slash | o/ |
| ù | u grave | u ` |
| ú | u acute | u ´ |
| û | u circumflex | u ^ |

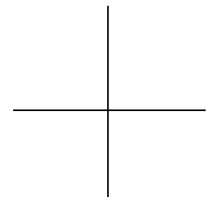
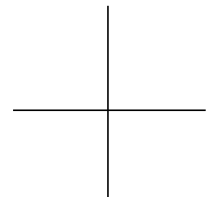

Table 12-20 Compose Sequences (Continued)

| Character | Name | Keystrokes |
|-----------|-----------------------------------|------------|
| ü | u umlaut | u " |
| ÿ | y umlaut | y " |
| | no break space | sp sp |
| | broken vertical bar | or ! |
| ¬ | logical not | -,* |
| - | soft (syllable) hyphen | - - |
| ® | registered trademark ¹ | RO |
| - | macron | _ ^ |
| ¾ | fraction three-quarters | 3 4* |
| ÷ | division sign | -: |
| × | multiplication sign | xx |
| ´ | acute accent | " |
| ¸ | cedilla | " |
| ¨ | diaeresis | " " |
| Ý | Y acute | Y ´ |
| ý | y acute | y ´ |
| þ | capital Icelandic thorn | TH |
| þ | small Icelandic thorn | th |
| Ð | capital Icelandic Eth | - D |
| ð | small Icelandic Eth | - d |

¹ The compose sequences for the currency sign and registered trademark symbol do not work.

12-50 Configuring the NCD Terminal Emulator



VT320 Character Coding Conventions

This section introduces VT320 character coding conventions and NCD Terminal Emulator character sets. It also includes code tables for NCD Terminal Emulator character sets.

VT320 character coding, conventions, and standards are described in detail in Digital publications.

Character Sets

The NCD Terminal Emulator includes the following character sets:

- ASCII (7-bit and 8-bit)
- DEC Supplemental Graphic
- ISO Latin Alphabet 1 supplemental graphic
- 12 National Replacement Character sets

The default character set configuration in the NCD Terminal Emulator is called the Digital Multinational character set. It is composed of the ASCII character set and the Digital Supplemental Graphic character set. The NCD Terminal Emulator maps the ASCII character set into the left side of the character table (see Table 12-21) as the GL codes. It maps the Digital Supplemental Graphic set into the right half (see Table 12-23) as the GR codes.

The ISO Latin Alphabet 1 supplemental graphic set is composed of the ASCII set and the ISO Latin-1 supplemental set. (See Table 12-22.) It includes many of the accented characters and diacritical marks used in European languages. To use the ISO Latin Alphabet 1 supplemental graphic character set, you select the ISO Latin 1 Font toggle in the Options menu.

By default, the NCD Terminal Emulator's ASCII character set is 8-bit ASCII. To change to 7-bit mode, use the Strip Parity toggle in the Options menu.

The 12 National Replacement Character sets are 7-bit character sets used with European language keyboards. (See Table 12-24.) Each varies slightly from the ASCII character set as required by the European language for which it is used.

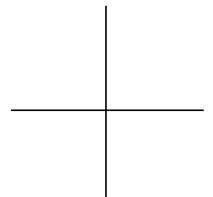

Character Code Tables

The code tables in this section describe the character codes for the character sets included in NCD Terminal Emulator. The following conventions are used in the code tables:

- ❑ Columns and rows are numbered in the top row and right-most or left-most columns. The character codes are sometimes referred to by *columnnumber/rownumber*. For example, in the Digital Multinational Character set, Table 12-21, the character 1/0 is the control character DLE.
- ❑ The binary representation of a character is obtained by finding the character code in the table, then looking at the binary representations next to the character's column and row numbers.
- ❑ The octal, decimal, and hexadecimal representations of each character are listed to its right; the octal representation is the top number, decimal representation is the middle number, and the hexadecimal representation is the bottom number. For example:

| | | |
|-----|-----|-------------|
| ESC | 107 | Octal |
| | 71 | Decimal |
| | 45 | Hexadecimal |

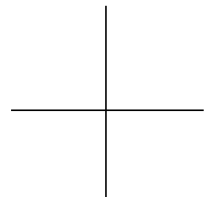

Table 12-21 Digital Multinational Character Set: C0 and GL Codes

| Column | 0 | 1 | 2 | 3 | 4 | 5 | 6 | 7 | | |
|--------|--|---------------------|-----------------------|----------------------|---------------------|--------------------------|----------------------|-----------------------|-----------------------|--|
| Row | b8 BITS b7 b6 b5 b4 b3 b2 b1 | 0 0 0 0 | 0 0 0 1 | 0 0 1 0 | 0 0 1 1 | 0 1 0 0 | 0 1 0 1 | 0 1 1 0 | 0 1 1 1 | |
| 0 | 0 0 0 0 | NUL o o o | DLE 20 16 10 | SP 40 32 20 | 0 60 48 30 | @ 100 64 40 | P 120 80 50 | ` 140 96 60 | p 160 112 70 | |
| 1 | 0 0 0 1 | SOH 1 1 1 | DC1 21 17 11 | ! 41 33 21 | 1 61 49 31 | A 101 65 41 | Q 121 81 51 | a 141 97 61 | q 161 113 71 | |
| 2 | 0 0 1 0 | STX 2 2 2 | DC2 22 18 12 | " 42 34 22 | 2 62 50 32 | B 102 66 42 | R 122 82 52 | b 142 98 62 | r 162 114 72 | |
| 3 | 0 0 1 1 | ETX 3 3 3 | DC3 23 19 13 | # 43 35 23 | 3 63 51 33 | C 103 67 43 | S 123 83 53 | c 143 99 63 | s 163 115 73 | |
| 4 | 0 1 0 0 | EOT 4 4 4 | DC4 24 20 14 | \$ 44 36 24 | 4 64 52 34 | D 104 68 44 | T 124 84 54 | d 144 100 64 | t 164 116 74 | |
| 5 | 0 1 0 1 | ENQ 5 5 5 | NAK 25 21 15 | % 45 37 25 | 5 65 53 35 | E 105 69 45 | U 125 85 55 | e 145 101 65 | u 165 117 75 | |
| 6 | 0 1 1 0 | ACK 6 6 6 | SYN 26 22 16 | & 46 38 26 | 6 66 54 36 | F 106 70 46 | V 126 86 56 | f 146 102 66 | v 166 118 76 | |
| 7 | 0 1 1 1 | BEL 7 7 7 | ETB 27 23 17 | ' 47 39 27 | 7 67 55 37 | G 107 71 47 | W 127 87 57 | g 147 103 67 | w 167 119 77 | |
| 8 | 1 0 0 0 | BS 10 8 8 | CAN 30 24 18 | (50 40 28 | 8 70 56 38 | H 110 72 48 | X 130 88 58 | h 150 104 68 | x 170 120 78 | |
| 9 | 1 0 0 1 | HT 11 9 9 | EM 31 25 19 |) 51 41 29 | 9 71 57 39 | I 111 73 49 | Y 131 89 59 | i 151 105 69 | y 171 121 79 | |
| 10 | 1 0 1 0 | LF 12 10 A | SUB 32 26 1A | * 52 42 2A | : 72 58 3A | J 112 74 4A | Z 132 90 5A | j 152 106 6A | z 172 122 7A | |
| 11 | 1 0 1 1 | VT 13 11 B | ESC 33 27 1B | + 53 43 2B | ; 73 59 3B | K 113 75 4B | [133 91 5B | k 153 107 6B | { 173 123 7B | |
| 12 | 1 1 0 0 | FF 14 12 C | FS 34 28 1C | , 54 44 2C | < 74 60 3C | L 114 76 4C | \ 134 92 5C | l 154 108 6C | 174 124 7C | |
| 13 | 1 1 0 1 | CR 15 13 D | GS 35 29 1D | - 55 45 2D | = 75 61 3D | M 115 77 4D |] 135 93 5D | m 155 109 6D | } 175 125 7D | |
| | | | CO CODES | | | GL CODES (ASCII GRAPHIC) | | | | |

VT320 Character Coding Conventions

Table 12-21 Digital Multinational Character Set: C0 and GL Codes (Continued)

| Column | | 0 | | 1 | | 2 | | 3 | | 4 | | 5 | | 6 | | 7 | |
|--------|-------------|----|---------------|----------|----------------|---|----------------|--------------------------|----------------|---|-----------------|---|-----------------|---|------------------|-----|------------------|
| Row | b8 BITS | 0 | | 0 | | 0 | | 0 | | 0 | | 0 | | 0 | | 0 | |
| | b7 | 0 | | 0 | | 0 | | 0 | | 1 | | 1 | | 1 | | 1 | |
| | b6 | 0 | | 0 | | 1 | | 1 | | 0 | | 0 | | 1 | | 1 | |
| | b5 | 0 | | 1 | | 0 | | 1 | | 0 | | 1 | | 0 | | 1 | |
| | b4 b3 b2 b1 | 0 | | 1 | | 0 | | 1 | | 0 | | 1 | | 0 | | 1 | |
| 14 | 1 1 1 0 | SO | 16 14 E | RS | 36 30 1E | . | 56 46 2E | > | 76 62 3E | N | 116 78 4E | ^ | 136 94 5E | n | 156 110 6E | ~ | 176 126 7E |
| 15 | 1 1 1 1 | S1 | 17 15 F | US | 37 31 1F | / | 57 47 2F | ? | 77 63 3F | O | 117 79 4F | _ | 137 95 5F | o | 157 111 6F | DEL | 177 127 7F |
| | | | | CO CODES | | | | GL CODES (ASCII GRAPHIC) | | | | | | | | | |

12-54 Configuring the NCD Terminal Emulator

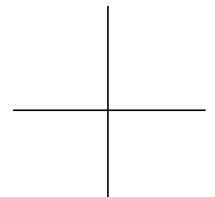

Table 12-22 Digital Multinational Character Set: C1 and GR Codes

| 8 | | 9 | | 10 | | 11 | | 12 | | 13 | | 14 | | 15 | | Column | | | | Row |
|------------------|------------------|------------------|--|------------------|------------------|------------------|------------------|------------------|------------------|------------------|------------------|------------------|------------------|-------------------------------------|------------------|--------|---|---|---|-----|
| 1 0 0 0 | 1 0 0 1 | 1 0 1 0 | 1 0 1 1 | 1 1 0 0 | 1 1 0 1 | 1 1 0 0 | 1 1 0 1 | 1 1 0 0 | 1 1 0 1 | 1 1 0 0 | 1 1 0 1 | 1 1 0 1 | 1 1 0 1 | b8 b7 b6 b5 b4 b3 b2 b1 | | | | | | |
| | 200 128 80 | DCS | 220 144 90 | | 240 160 A0 | ° | 260 176 B0 | À | 300 192 C0 | | 320 208 D0 | à | 340 224 E0 | | 360 240 F0 | 0 | 0 | 0 | 0 | 0 |
| | 201 129 81 | PU1 | 221 145 91 | ì | 241 161 A1 | | 261 177 B1 | Á | 301 193 C1 | Ñ | 321 209 D1 | á | 341 225 E1 | ñ | 361 241 F1 | 0 | 0 | 0 | 1 | 1 |
| | 202 130 82 | PU2 | 222 146 92 | ç | 242 162 A2 | 2 | 262 178 B2 | Â | 302 194 C2 | Ò | 322 210 D2 | â | 342 226 E2 | ò | 362 242 F2 | 0 | 0 | 1 | 0 | 2 |
| | 203 131 83 | STS | 223 147 93 | £ | 243 163 A3 | 3 | 263 179 B3 | Ã | 303 195 C3 | Ó | 323 211 D3 | ã | 343 227 E3 | ó | 363 243 F3 | 0 | 0 | 1 | 1 | 3 |
| IND | 204 132 84 | CCH | 224 148 94 | | 244 164 A4 | | 264 180 B4 | Ä | 304 196 C4 | Ô | 324 212 D4 | ä | 344 228 E4 | ô | 364 244 F4 | 0 | 1 | 0 | 0 | 4 |
| NEL | 205 133 85 | MW | 225 149 95 | ¥ | 245 165 A5 | µ | 265 181 B5 | Å | 305 197 C5 | Õ | 325 213 D5 | å | 345 229 E5 | ö | 365 245 F5 | 0 | 1 | 0 | 1 | 5 |
| SSA | 206 134 86 | SPA | 226 150 96 | | 246 166 A6 | ¶ | 266 182 B6 | Æ | 306 198 C6 | Ö | 326 214 D6 | æ | 346 230 E6 | ö | 366 246 F6 | 0 | 1 | 1 | 0 | 6 |
| ESA | 207 135 87 | EPA | 227 151 97 | § | 247 167 A7 | . | 267 183 B7 | Ç | 307 199 C7 | Ɔ | 327 215 D7 | ç | 347 231 E7 | œ | 367 247 F7 | 0 | 1 | 1 | 1 | 7 |
| HTS | 210 136 88 | | 230 152 98 | ¤ | 250 168 A8 | | 270 184 B8 | È | 310 200 C8 | ø | 330 216 D8 | è | 350 232 E8 | ø | 370 248 F | 1 | 0 | 0 | 0 | 8 |
| HTJ | 211 137 89 | | 231 153 99 | © | 251 169 A9 | 1 | 271 185 B9 | É | 311 201 C9 | Û | 331 217 D9 | é | 351 233 E9 | ù | 371 249 F9 | 1 | 0 | 0 | 1 | 9 |
| VTS | 212 138 8A | | 232 154 9A | ª | 252 170 AA | º | 272 186 BA | Ê | 312 202 CA | Ú | 332 218 DA | ê | 352 234 EA | ú | 372 250 FA | 1 | 0 | 1 | 0 | 10 |
| PLD | 213 139 8B | CSI | 233 155 9B | « | 253 171 AB | » | 273 187 BB | Ë | 313 203 CB | Û | 333 219 DB | ë | 353 235 EB | û | 373 251 FB | 1 | 0 | 1 | 1 | 11 |
| PLU | 214 140 8C | ST | 234 156 9C | | 254 172 AC | ¼ | 274 188 BC | Ì | 314 204 CC | Ü | 334 220 DC | ì | 354 236 EC | ü | 374 252 FC | 1 | 1 | 0 | 0 | 12 |
| RI | 215 141 8D | OSC | 235 157 9D | | 255 173 AD | ½ | 275 189 BD | Í | 315 205 CD | Ý | 335 221 DD | í | 355 237 ED | ÿ | 375 253 FD | 1 | 1 | 0 | 1 | 13 |
| C1 CODES | | | GR CODES (Digital SUPPLEMENTAL GRAPHICS) | | | | | | | | | | | | | | | | | |

VT320 Character Coding Conventions

Table 12-22 Digital Multinational Character Set: C1 and GR Codes (Continued)

| 8 | | 9 | | 10 | | 11 | | 12 | | 13 | | 14 | | 15 | | Column | | | | Row |
|------------------|------------------|------------------|------------------|--|------------------|------------------|------------------|------------------|------------------|------------------|------------------|------------------|------------------|------------------|------------------|--|---|---|---|-----|
| 1 0 0 0 | | 1 0 0 1 | | 1 0 1 0 | | 1 0 1 1 | | 1 1 0 0 | | 1 1 0 1 | | 1 1 1 0 | | 1 1 1 1 | | b8 BITS b7 b6 b5 b4 b3 b2 b1 | | | | |
| SS2 | 216 142 8E | PM | 236 158 9E | | 256 174 AE | | 276 190 BE | İ | 316 206 CE | | 336 222 DE | î | 356 238 EE | | 376 254 FE | 1 | 1 | 1 | 0 | 14 |
| SS3 | 217 143 8F | APC | 237 159 9F | | 257 175 AF | ç | 277 191 BF | Ï | 317 207 CF | ß | 337 223 DF | ï | 357 239 EF | | 377 255 FF | 1 | 1 | 1 | 1 | 15 |
| C1 CODES | | | | GR CODES (Digital SUPPLEMENTAL GRAPHICS) | | | | | | | | | | | | | | | | |

12-56 Configuring the NCD Terminal Emulator

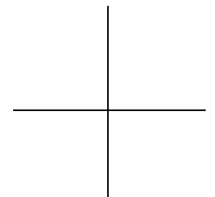

Table 12-23 ISO Latin-1 Supplemental Character Set: C1 and GR Codes

| 8 | | 9 | | 10 | | 11 | | 12 | | 13 | | 14 | | 15 | | Column | | | | Row | | | | | |
|----------|------------------|-----|------------------|--|------------------|----|------------------|----|------------------|-----------------------------|------------------|----|------------------|---------------------------|------------------|--------|----|----|----|-----|----|----|----|----|----|
| 1 | 0 | 1 | 0 | 1 | 0 | 1 | 0 | 1 | 0 | 1 | 0 | 1 | 0 | 1 | 0 | 1 | b8 | b7 | b6 | | b5 | b4 | b3 | b2 | b1 |
| | 200 128 80 | DCS | 220 144 90 | NBSP | 240 160 A0 | ° | 260 176 B0 | À | 300 192 C0 | capital Iceland. eth* | 320 208 D0 | à | 340 224 E0 | small Iceland. eth* | 360 240 F0 | 0 | 0 | 0 | 0 | 0 | 0 | 0 | 0 | 0 | 0 |
| | 201 129 81 | PU1 | 221 145 91 | ı | 241 161 A1 | | 261 177 B1 | Á | 301 193 C1 | Ñ | 321 209 D1 | á | 341 225 E1 | ñ | 361 241 F1 | 0 | 0 | 0 | 1 | 1 | 1 | 1 | 1 | 1 | 1 |
| | 202 130 82 | PU2 | 222 146 92 | ç | 242 162 A2 | 2 | 262 178 B2 | Â | 302 194 C2 | Û | 322 210 D2 | â | 342 226 E2 | ò | 362 242 F2 | 0 | 0 | 1 | 0 | 0 | 0 | 0 | 0 | 0 | 2 |
| | 203 131 83 | STS | 223 147 93 | £ | 243 163 A3 | 3 | 263 179 B3 | Ã | 303 195 C3 | Ó | 323 211 D3 | ã | 343 227 E3 | ó | 363 243 F3 | 0 | 0 | 1 | 1 | 1 | 1 | 1 | 1 | 1 | 3 |
| IND | 204 132 84 | CCH | 224 148 94 | ¤ | 244 164 A4 | ´ | 264 180 B4 | Ä | 304 196 C4 | Ô | 324 212 D4 | ä | 344 228 E4 | ô | 364 244 F4 | 0 | 1 | 0 | 0 | 0 | 0 | 0 | 0 | 0 | 4 |
| NEL | 205 133 85 | MW | 225 149 95 | ¥ | 245 165 A5 | | 265 181 B5 | Å | 305 197 C5 | Õ | 325 213 D5 | å | 345 229 E5 | õ | 365 245 F5 | 0 | 1 | 0 | 1 | 1 | 1 | 1 | 1 | 1 | 5 |
| SSA | 206 134 86 | SPA | 226 150 96 | broken bar* | 246 166 A6 | ¶ | 266 182 B6 | Æ | 306 198 C6 | Ö | 326 214 D6 | æ | 346 230 E6 | ö | 366 246 F6 | 0 | 1 | 1 | 0 | 0 | 0 | 0 | 0 | 0 | 6 |
| ESA | 207 135 87 | EPA | 227 151 97 | § | 247 167 A7 | . | 267 183 B7 | Ç | 307 199 C7 | X | 327 215 D7 | ç | 347 231 E7 | | 367 247 F7 | 0 | 1 | 1 | 1 | 1 | 1 | 1 | 1 | 1 | 7 |
| HTS | 210 136 88 | | 230 152 98 | “ | 250 168 A8 | ´ | 270 184 B8 | È | 310 200 C8 | ø | 330 216 D8 | è | 350 232 E8 | ø | 370 248 F8 | 1 | 0 | 0 | 0 | 0 | 0 | 0 | 0 | 0 | 8 |
| HTJ | 211 137 89 | | 231 153 99 | © | 251 169 A9 | 1 | 271 185 B9 | É | 311 201 C9 | Û | 331 217 D9 | é | 351 233 E9 | ù | 371 249 F9 | 1 | 0 | 0 | 1 | 1 | 1 | 1 | 1 | 1 | 9 |
| VTS | 212 138 8A | | 232 154 9A | ª | 252 170 AA | º | 272 186 BA | Ê | 312 202 CA | Û | 332 218 DA | ê | 352 234 EA | ú | 372 250 FA | 1 | 0 | 1 | 0 | 0 | 0 | 0 | 0 | 0 | 10 |
| PLD | 213 139 8B | CSI | 233 155 9B | « | 253 171 AB | » | 273 187 BB | Ë | 313 203 CB | Û | 333 219 DB | ë | 353 235 EB | û | 373 251 FB | 1 | 0 | 1 | 1 | 1 | 1 | 1 | 1 | 1 | 11 |
| PLU | 214 140 8C | ST | 234 156 9C | ¬ | 254 172 AC | ¼ | 274 188 BC | Ì | 314 204 CC | Û | 334 220 DC | ì | 354 236 EC | ü | 374 252 FC | 1 | 1 | 0 | 0 | 0 | 0 | 0 | 0 | 0 | 12 |
| C1 CODES | | | | GR CODES (ISO LATIN-1 SUPPLEMENTAL GRAPHICS) | | | | | | | | | | | | | | | | | | | | | |

* This character is illustrated in Table 12-20.

VT320 Character Coding Conventions

Table 12-23 ISO Latin-1 Supplemental Character Set: C1 and GR Codes (Continued)

| 8 | | 9 | | 10 | | 11 | | 12 | | 13 | | 14 | | 15 | | Column | Row |
|-------------------------|-------------------------|--|-------------------------|-----------------------|---------------------------------|-----------------------|--|------------------|------------------|------------------|------------------|-------------------------------------|--|----|--|--------|-----|
| 1 0 0 0 | 1 0 0 1 | 1 0 1 0 | 1 0 1 0 | 1 0 1 1 | 1 0 1 0 | 1 1 0 1 | 1 0 0 1 | 1 1 1 0 | 1 1 0 1 | 1 1 1 0 | 1 1 1 1 | b8 b7 b6 b5 b4 b3 b2 b1 | | | | | |
| RI 215 141 8D | OSC 235 157 9D | — 255 173 AD | 1/2 275 189 BD | Ï 315 205 CD | Y acute* 335 221 DD | í 355 237 ED | y acute* 375 253 FD | 1 1 0 1 | 13 | | | | | | | | |
| SS2 216 142 8E | PM 236 158 9E | ® 256 174 AE | 3/4 276 190 BE | Î 316 206 CE | EC 336 222 DE | î 356 238 EE | small lcelandic thorn* 376 254 FE | 1 1 1 0 | 14 | | | | | | | | |
| SS3 217 143 8F | APC 237 159 9F | — 257 175 AF | ç 277 191 BF | ÿ 317 207 CF | ß 337 223 DF | ï 357 239 EF | ÿ 377 255 FF | 1 1 1 1 | 15 | | | | | | | | |
| C1 CODES | | GR CODES (ISO LATIN-1 SUPPLEMENTAL GRAPHICS) | | | | | | | | | | | | | | | |

* This character is illustrated in Table 12-20.

12-58 Configuring the NCD Terminal Emulator

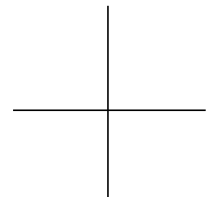
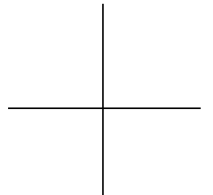
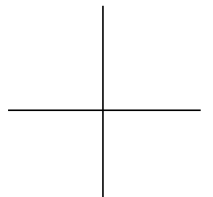

Table 12-24 National Replacement Character Sets

| Character Set | 2/3 | 4/0 | 5/11 | 5/12 | 5/13 | 5/14 | 5/15 | 6/0 | 7/11 | 7/12 | 7/13 | 7/14 |
|----------------------|-----|------|------|------|------|------|------|-----|------|------|------|------|
| ASCII | # | @ | [| \ |] | ^ | - | ` | { | | } | ~ |
| United Kingdom | £ | @ | [| \ |] | ^ | - | ` | { | | } | ~ |
| Dutch | £ | 3\$4 | ÿ | 1/2 | | ^ | - | ` | “ | f | 1/4 | ´ |
| Finnish | # | @ | Ä | Ö | Å | Ü | - | é | ä | ö | á | ü |
| French | £ | à | ° | ç | § | ^ | - | ` | é | ù | è | “ |
| French Canadian | # | à | â | ç | ê | î | - | ô | é | ù | è | û |
| German | # | § | Ä | Ö | Ü | ^ | - | ` | ä | ö | ü | ß |
| Italian | £ | § | | ç | é | ^ | - | ù | à | ò | è | ì |
| Norwegian/ Danish | # | @ | Æ | Ø | Å | ^ | - | ` | æ | ø | á | ~ |
| Portuguese | # | @ | Ã | Ç | Õ | ^ | - | ` | ã | ç | õ | ~ |
| Spanish | £ | § | ı | Ñ | ı | ^ | - | ` | ˘ | ° | ñ | ç |
| Swedish | # | É | Ä | Ö | Å | Ü | - | é | ä | ö | á | ü |
| Swiss | ù | à | é | ç | ê | î | è | ô | ä | ö | ü | û |



12-60 Configuring the NCD Terminal Emulator



13 Configuring Display PostScript

This chapter describes the DPS (Display PostScript) X server module. The following topics are covered in this chapter:

- ❑ “DPS Overview” on page 13-1
- ❑ “DPS Requirements” on page 13-2
- ❑ “Using DPS Support Files” on page 13-3
- ❑ “Adobe Fonts for DPS” on page 13-8
- ❑ “Configuring the DPS Resource Path” on page 13-10
- ❑ “Configuring DPS Font Access by X Clients” on page 13-11
- ❑ “Freeing the DPS Cache” on page 13-12
- ❑ “Troubleshooting DPS” on page 13-12

DPS is available on HMX and Explora 700 terminals only.

DPS Overview

The DPS X server module allows PostScript applications to display their output on NCD terminals. Such local servicing of DPS requests speeds application processing and reduces host and network loading.

NCD’s DPS extension is based on Adobe’s Display PostScript Level 2 software, supports true WYSIWYG two-dimensional graphics, and provides access to all Type 1 Scaled Font Libraries.

The Display PostScript imaging model is device-independent, allowing graphics to look the same on any supported platform. An application that uses Display PostScript works and appears the same on all supported platforms without modification of the application.

Display PostScript performs the following functions:

- ❑ Allows applications to scale, rotate, and render text, graphics, and scanned images at any angle
- ❑ Scales fonts to any point size

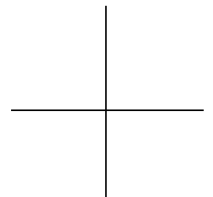

- ❑ Automatically adjusts the colors appearing in color graphics and scanned images on monochrome or grayscale monitors or on monitors with limited color selections
 - ❑ Renders graphics that use Bézier curves
 - ❑ Allows users to import and display Encapsulated PostScript (EPS) files in applications that support this format
 - ❑ Automatically adjusts output to the current screen resolution so that an application looks the same on any screen
 - ❑ Allows easy porting of application programs to other DPS environments
- NCDware includes the following components for DPS:
- ❑ DPS X server modules—For information on managing X server modules, see Chapter 4, Booting—X Server Loading and the *NCDware System Administrator's Guide for UNIX Systems*.
 - ❑ DPS support files—For information on support files, see “Using DPS Support Files” on page 13-3.
 - ❑ Adobe font files—For information on DPS fonts, see “Configuring DPS Font Access by X Clients” on page 13-11.

DPS Requirements

The requirements for using DPS on an NCD terminal are:

- ❑ Using DPS requires a valid license. To add a DPS *node* license to a terminal's configuration, use the **unit-license-key** parameter (Setup ⇒ Change Setup Parameters ⇒ Licenses ⇒ License Key). If the terminal has more than one node license, include one instance of this parameter for each license key. This parameter is saved in NVRAM.
After adding the DPS license, reboot the terminal so that the X server can read the PostScript resource file.
If you are using site licensing or floating licenses, see the *NCDware System Administrator's Guide for UNIX Systems* for instructions.
- ❑ Additional terminal memory may be required. For information on the amount of terminal memory required to use DPS, see the *Release Notes*.

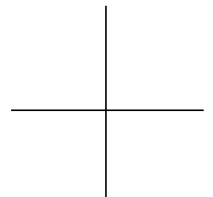

- ❑ You must use NFS (Network File Service) as the file transfer protocol for DPS. See Chapter 5, *Configuring Network Services*, for information about setting up file services.

Using DPS Support Files

The following DPS support files are included with NCDware and reside by default in `/usr/lib/X11/ncd/dps`:

- ❑ **PSres.upr**—the PostScript resource file
- ❑ **VM_3_2.SNF**—the virtual memory file
- ❑ **CIE-dict19c.dat**—the color-rendering file
- ❑ **InitProc.dat**—the context initialization file

The following sections describe these files in more detail.

The PostScript Resource File

This section describes the PostScript resource file, **PSres.upr**, which is essential for DPS operation, and the NCD utility for creating a new resource file or updating a resource file. When working with this file, keep the following in mind:

- ❑ If you change the default locations of the DPS support files or DPS font files, you must modify the contents of the PostScript resource file to reflect the changes. You may also need to add new file service table entries; for information on the terminal's file service table, see Chapter 5, *Configuring Network Services*.
- ❑ If you use other PostScript resource files, make sure they follow the ***.upr** naming convention.

For more information about PostScript resource files, refer to *Programming the Display PostScript System with X* from Adobe Systems Incorporated.

Sections in the PostScript Resource File

The PostScript resource file contains the following sections:

- ❑ **DPSVM**—This section identifies the VM (Virtual Memory) file. The VM file must be loaded for DPS to work correctly. For example:

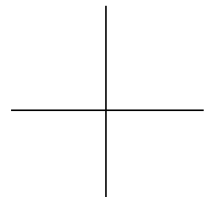

```
DSPVM
local=VM_3_2_.snf
master=VM_3_2_.snf
```

- ❑ **ColorRendering**—This section identifies the file containing color-rendering information. The identified file aids the DPS extension in rendering colors in a device-independent manner. For example:

```
ColorRendering
DefaultCIE=CIE-dict19c.dat
ColorCIE=CIE-dict19c.dat
```

- ❑ **ContextInit**—This section identifies the context initialization file used when a context is created. For example:

```
ContextInit
InitProc=InitProc.dat
```

- ❑ **FontAFM**—This section identifies the locations of the Adobe Font Metric (AFM) files. Some applications that use the PostScript language need these files for proper operation. The section lists each font name and font location. For example:

```
FontAFM
AvantGarde-BoldObl=fonts/AFM/AGWO____.afm
AvantGarde-Book=fonts/AFM/AGW____.afm
AvantGarde-Demi=fonts/AFM/AGD____.afm
AvantGarde-DemiOblique=fonts/AFM/AGDO____.afm
```

- ❑ **FontFamily**—This section identifies the supported font families and additional typefaces. For example:

```
FontFamily
Courier=Bold Oblique,Courier-BoldOblique,Bold,CourierBold,Medium,Courier,
Oblique,Courier-Oblique
.
```

- ❑ **FontOutline**—This section identifies the locations of the available outline font files. It lists each outline font name and the font location. For example:

```
FontOutline
AvantGarde-Book=fonts/AGW____.pfa
AvantGarde-BookOblique=fonts/AGWO____.pfa
AvantGarde-Demi=fonts/AGD____.pfa
AvantGarde-DemiOblique=fonts/AGDO____.pfa
```

- ❑ **FontPrebuilt**—This section identifies the locations of the available hand-tuned, bitmap fonts. It lists each font name and the font location. For example:

13-4 Configuring Display PostScript

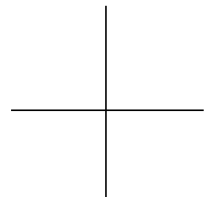

```
FontPrebuilt
Courier-BoldOblique=prebuilts/COBO____.bepf
Courier-Bold=prebuilts/COB____.bepf
Courier=prebuilts/COM____.bepf
Courier-Oblique=prebuilts/COO____.bepf
```

Creating or Updating the PostScript Resource File

The *makepsres* utility allows you to make a new PostScript resource file or update an existing file. The following example shows how to use this utility to update the *PSres.upr* file so that DPS servers can access more fonts:

1. Change to the directory to which you will be adding fonts.

Note NCD recommends that you use a directory under */usr/lib/X11/ncd*. Otherwise, the DPS module may not be able to locate the PostScript resource file. If you must place the fonts in another location, make sure that each terminal can access the new fonts through its file service table.

2. Add the desired fonts to the directory.
3. While in the directory, invoke *makepsres*:

```
> /usr/lib/X11/makepsres
```

In response, *makepsres* creates a new PostScript resource file in the current directory. If the current directory contains an existing PostScript resource file, *makepsres* merges the contents of the existing file with the information from the new fonts and produces a new *PSres.upr* file.

4. Add the DPSVM section to the resulting *PSres.upr* file if that section does not already exist.

If you invoke *makepsres* in a directory that does not contain an existing *PSres.upr* file, you must include information identifying the location of the VM file. To do this, add DPSVM to the beginning of the *PSres.upr* file where it lists all sections of the file. For example:

```
PS-Resources-1.0
DPSVM
FontAFM
FontFamily
FontOutline
```

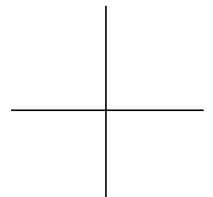

Add the DPSVM section to the file; for example:

```
DPSVM
local=VM_3_2_beta2.snf
master=VM_3_2_beta2.snf
```

When you finish modifying this file, it should resemble the following example:

```
PS-Resources-1.0DPSVM
ColorRendering
ContextInit
FontAFM
FontFamily
FontOutline
FontPrebuilt
.
DPSVM
local=VM_3_2_beta2.snf
master=VM_3_2_beta2.snf
.
ColorRendering
%DefaultCIE=CIE-dict19c
ColorCIE=CIE-dict19c.dat
.
.
.
```

If necessary, modify the **dps-resource-path** parameter on all terminals using DPS so the DPS module can locate the resource files. For information on setting this parameter, see “Configuring the DPS Resource Path” on page 13-10.

5. Reboot the affected terminals so they can read the new **PSres.upr** file.

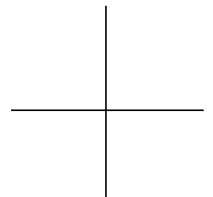

The Virtual Memory File

The virtual memory file, **VM_3_2.SNF**, provides information about the VM (Virtual Memory) space that Display PostScript needs for operation. The DPS extension uses two types of virtual memory:

- Shared VM holds system fonts and other resources shared by all contexts.
- Private VM holds fonts specific to each context.

The Color-Rendering File

The color-rendering file, **CIE-dict19c.dat**, contains a PostScript rendering dictionary that allows the DPS extension to provide device-independent color. This file is loaded for each DPS context. The information in the file allows all requests for color to be honored. The output generated by DPS depends on the output device:

- On monochrome monitors, the output consists of dithered, halftone patterns of black and white pixels.
- On grayscale monitors, the output consists of halftone patterns using gray levels.
- On color monitors, the output consists of the requested color or a dithered pattern of RGB pixels that approximates the color.

The Context Initialization File

The context initialization file, **InitProc.dat**, executes arbitrary PostScript code when a context is created. You can use the file to set various user parameters or to initialize local virtual memory.

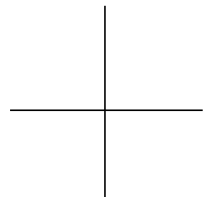

Adobe Fonts for DPS

NCDware includes the following fonts for use with the DPS extension:

- Adobe outline fonts
- Font metrics in AFM (Adobe Font Metric) format
- Adobe fonts in hand-tuned, bitmap format

Table 13-1 lists the fonts included in the distribution in both outline and AFM formats.

Table 13-1 Adobe Outline Fonts for Display PostScript

| Font Family | Additional Typefaces | | |
|------------------------|----------------------|---------|--------------|
| Helvetica | Bold | Oblique | Bold Oblique |
| Helvetica Condensed | Bold | Oblique | Bold Oblique |
| Times Roman | Bold | Italic | Bold Italic |
| Courier | Bold | Oblique | Bold Oblique |
| New Century SchoolBook | Bold | Italic | Bold Italic |
| Avant Garde Gothic | Demi | Oblique | Demi Oblique |
| Bookman | Demi | Italic | Demi Italic |
| Palatino | Bold | Italic | Bold Italic |
| Zapf Chancery | | | |
| Zapf Dingbats | | | |
| Symbol | | | |

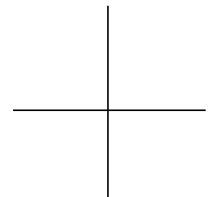

Table 13-2 lists the fonts included in the distribution in prebuilt bitmap format.

Table 13-2 Bitmap Fonts for Display PostScript

| Font Family | Additional Typefaces | | |
|------------------------|----------------------|---------|--------------|
| Helvetica | Bold | Oblique | Bold Oblique |
| Times Roman | Bold | Italic | Bold Italic |
| Courier | Bold | Oblique | Bold Oblique |
| New Century SchoolBook | Bold | Italic | Bold Italic |
| Palatino | Bold | Italic | Bold Italic |
| Symbol | | | |

Table 13-3 lists the default font locations.

Table 13-3 Default Locations of Adobe Fonts

| Font | Path |
|----------------------|---------------------------------------|
| Type 1 outline fonts | /usr/lib/X11/ncd/dps/fonts/*.pfa |
| AFM font files | /usr/lib/X11/ncd/dps/fonts/AFM/*.afm |
| Prebuilt fonts | /usr/lib/X11/ncd/dps/prebuilts/*.bepf |

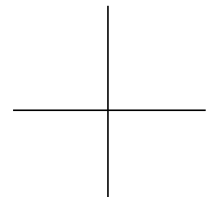

Configuring the DPS Resource Path

The **dps-resource-path** remote configuration parameter specifies the location of the DPS resource files (Setup ⇒ Change Setup Parameters ⇒ Display PostScript ⇒ DPS/X Resource Path). By default, the files reside in **/usr/lib/X11/ncd/dps**.

Because the **dps-resource-path** parameter recognizes colons as significant characters, adhere to the following conventions when assigning values to this parameter:

- ❑ Use one colon (:) to separate directory specifications in which DPS resource files reside. For example, the assignment:

```
dps-resource-path = /usr/coe/ps:/usr/lib/X11/ncd/dps
```

indicates that the DPS module should look first in **/usr/coe/ps** for a DPS resource file and then in **/usr/lib/X11/ncd/dps**.

- ❑ Use two colons (::) to indicate that the DPS extension should look at the system default location for the DPS resource file. For example, the default entry:

```
dps-resource-path = /usr/lib/X11/ncd/dps::
```

indicates that the DPS module should look first in **/usr/lib/X11/ncd/dps** for a DPS resource file and then in the system default location.

If you modify this parameter:

- ❑ Make sure the file service table equates the directories specified with this parameter with the mount points on the host system.
- ❑ Reboot the terminal so the new values can take effect. The **dps-resource-path** parameter is not saved in NVRAM.

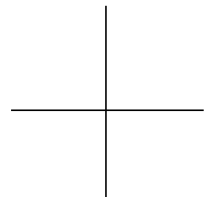

Table 13-4 dps-resource-path Parameter

| Possible Values | Results |
|------------------------|---|
| default | /usr/lib/X11/ncd/dps:: |
| /usr/lib/X11/ncd/dps:: | When attempting to locate DPS resource files, the X server looks first in /usr/lib/X11/ncd/dps and then in the default system location. |
| path[:path[:path...]] | The X server looks in the specified directory or directories when loading DPS resource files. |

Configuring DPS Font Access by X Clients

To configure your environment so that X clients can access DPS outline fonts, complete the following steps:

Note If you add new outline fonts, you must complete all of the following steps. If you use only the outline fonts included with the NCDware distribution, you need only perform Step 5.

1. Set your current working directory to the directory in which the DPS outline fonts reside; by default, /usr/lib/X11/ncd/dps/fonts.
2. Make sure that each outline font file has a .pfa (PostScript Font ASCII) extension.
3. Use the *ncdmkfdir* (1) utility to add an entry to the **fonts.scale** file for each link or file created in the previous step.

```
% ncdmkfdir currentworkingdir
```

The **fonts.scale** file, which resides in the font directory, has an entry for each font file that pairs the file with its XLFD name, such as:

```
Symbol.pfa -adobe-Symbol-Medium-r-normal-*-0-0-0-0-P-0-adobe-fontspecific
```

ncdmkfdir works well with Adobe outline fonts. If you use it on fonts from other sources in which the key values may be inaccurate, the resulting **fonts.scale** file may need to be corrected by hand.

4. While still in the font directory, invoke the *ncdmkfontdir* utility. This utility reads the contents of the **fonts.scale** file and any bitmap font files and then enters them in the **fonts.dir** file.

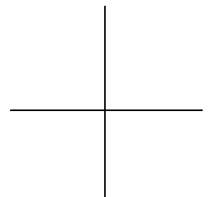

5. Add the font directory to the terminal's font path:
 - To change the terminal's current font path, use the **pref-font-path** parameter (Setup ⇒ Change User Preferences ⇒ Fonts ⇒ Current Font Path).
 - To change the terminal's default font path, use the **xserver-default-font-path** parameter (Setup ⇒ Change Setup Parameters ⇒ Fonts ⇒ Default Font Path).
- If you change the default font path only, you must reset the terminal before the change takes effect.

X clients can now access the DPS outline fonts.

Freeing the DPS Cache

By default, the DPS module caches the contents of the color-rendering file and the context initialization file when it is invoked for the first instance. It also caches fonts as it uses them. Caching this information speeds processing for subsequent contexts.

To free the font memory in the cache, from the Console, select Utilities ⇒ Free DPS Memory.

Troubleshooting DPS

If the DPS Extension Fails to Start

If the DPS extension fails to start on a licensed terminal, the X server generates an error message and displays it in the Console Messages hide box. If the DPS extension fails to start because no license key has been entered, no error messages appear; the application simply does not access the DPS extension. Check Statistics ⇒ Show Version ⇒ Licensable Features to see if DPS is listed.

File Service Problems

Most DPS failures are caused by file service problems. To see all messages related to file service, enable extended file diagnostics. The parameter is **file-extended-diagnostics** (Setup ⇒ Change Setup Parameters ⇒ File Service ⇒

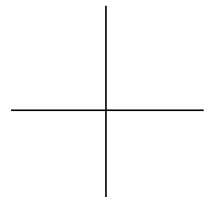

Extended Diagnostics). After enabling Extended Diagnostics, reboot the terminal and restart the application to see the additional messages.

DPS file service messages resemble the following examples:

```
%NETFILE-I-OPENATTEMPT, attempting open for /usr/lib/X11/ncd/dps/fonts/Helvetica
%NETFILE-I-MATCHATTEMPT, attempting NFS open of
/usr/lib/X11/ncd/dps/fonts/Helvetica on 191.42.155.70 for
/usr/lib/X11/ncd/dps/fonts/Helvetica
%NETFILE-I-OPENSUCCESS, open succeeded for /usr/lib/X11/ncd/dps/fonts/Helvetica
```

DPS Applications on Solaris Systems

This section describes how to use AnswerBook, ImageTool, and PageView on an NCD terminal if the applications are running on a Solaris system.

Running AnswerBook

Problems with this application derive from incorrect setting of the *OPENWINHOME* environment variable or failing to set the variable at all.

If *OPENWINHOME* is set incorrectly, an error message is displayed as shown in the following example:

```
% setenv OPENWINHOME /u/ken
% answerbook
Verifying AnswerBook environment
Could not find the AnswerBook administration utility
"ab_admin" in /u/ken/bin
%
```

If *OPENWINHOME* is not set, the following messages are displayed:

```
% answerbook
Verifying AnswerBook environment
The "OPENWINHOME" environment variable is not set.
Are you running OpenWindows?
Check/reset the value of OPENWINHOME, then rerun
"AnswerBook".
%
```

No special fonts are needed for AnswerBook.

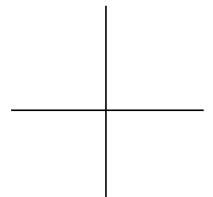

Running ImageTool

Problems with this application are caused by unavailable fonts, colormap flash, and incorrect setting of *OPENWINHOME*.

Font Problems

If the required fonts are not in the terminal's font path or are not in the correct order in the font path, the image appears briefly and the application shuts down. Error messages similar to the following are displayed:

```
% imagetool
X error of failed request: BadValue (integer parameter out of range for operation
  Major opcode of failed request: 94 (X_CreateGlyphCursor)
  Minor opcode of failed request: 0
  Resource id in failed request: 0xc
  Serial number of failed request: 1869
  Current serial number in output stream: 1873
.
.
.
%
```

You need the following fonts and font management files, and the font directory must be second in the font path (*xserver-default-font-path*), right after built-ins:

OLCursor46.pcf
fonts.alias
fonts.dir

See Chapter 7, Bitmap Fonts and the Font Server, for more information about fonts.

Colormap Flash

To get the proper colors, make the window with the picture the focus window and press Alt-F12.

OPENWINHOME Variable

If *OPENWINHOME* is not set or is set incorrectly:

- ❑ When you try to open an image from the ImageTool File ⇒ Open menu, the following error message appears:

File format not found. Use Open As option to choose file

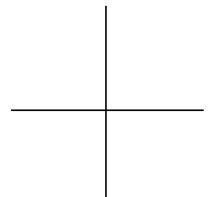

- ❑ If you use Open As to choose a file, the following error message appears:

```
Error opening /usr/openwin/share/images/PostScript/file.ps
```

To solve this problem, exit from ImageTool and set the *OPENWINHOME* variable. Restart the application.

Running PageView

Problems with this application are described in the following subsections. No special fonts are required for PageView, and you need not set the *OPENWINHOME* variable.

Displaying the Images

Run PageView from the */usr/openwin/bin* directory. When prompted by a “goto” request, enter the path to the images; for example, */usr/openwin/share/images/PostScript*.

Support Files

If the proper support files are not installed, images are not displayed. Make sure the following files are in the NCD PostScript directory; the default directory is */usr/lib/X11/ncd/dps*:

CIE-dict19c.dat
InitProc.dat
NCDFILE.MAP
PSres.upr
VM_3_2.snf
fonts
prebuilts

If any of the files are not installed, copy them from the NCDware distribution CD-ROM.

Colormap Flash

You can fix colormap flash problems by clicking in another window and then clicking in the PageView main Window. Also, try pressing Alt-F12 when the focus is on the PageView window.

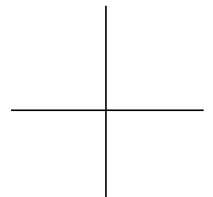

13-16 Configuring Display PostScript

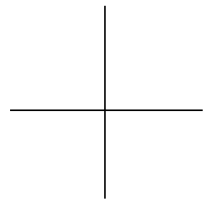

14 Configuring PEX

This chapter introduces PEX and describes configuring terminals for using PEX applications. The following topics are covered in this chapter:

- ❑ “PEX Overview” on page 14-1
- ❑ “PEX Requirements” on page 14-3
- ❑ “Setting PEX Configuration Parameters” on page 14-3
- ❑ “Specifying the Input Device for PEX” on page 14-13
- ❑ “Troubleshooting PEX” on page 14-14

PEX is supported on HMX and Explora 700 terminals only.

PEX Overview

The PEX extension to the X protocol provides support for 3D graphics applications. Using the PEX X server module, NCD terminals can display 3D drawing applications written for PEX. 3D applications provide such features as 3D objects, transformations, floating-point color, and lighting.

Applications that use PEX include 3D drawing programs, CAD (computer-aided design) programs, and scientific visualization programs. When considering 3D clients to be run on NCD X terminals, make sure they are based on PEX. Only applications that generate the PEX protocol can access the PEX functional extensions in the PEX server.

As with the core X protocol, software for running PEX applications is required on the terminal and on the host computer where the application is running.

The PEX acronym stands for PHIGS Extension to X. PHIGS was the original API (application programming interface) for PEX. Since the origin of PEX, other APIs have been implemented and PEX is no longer based solely on PHIGS.

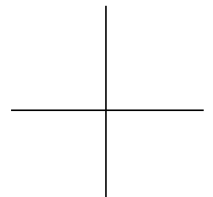

The PEX X Server Module

The PEX X server module allows you to display PEX images along with standard X images on your NCD terminal.

The PEX module supports PEX protocol versions 5.0 and 5.1. The PEX module supports all of the subsets of PEX: immediate mode (the Renderer Subset), structure mode (the Structure Subset), and workstation mode (the PHIGS Workstation Subset). These subsets provide a variety of 3D and 2D graphics capabilities.

Data can be rendered immediately as it is transmitted to the terminal (immediate mode rendering) or it can be stored as data in the terminal (structure mode), where it can be quickly updated and re-rendered. Workstation mode is similar to structure mode and provides additional control of scene updating.

The PEX module includes two other X extensions:

- ❑ MBX (the MultiBuffer Extension to X)—Provides an invisible drawing buffer for rendering one scene while another scene is displayed. This enables clients to provide smooth animation with little effort.
- ❑ XInput (the Input Extension to X)—Provides support for the sophisticated input devices required by some PEX clients. In NCDware, Summagraphics-compatible digitizing tablets and the Logitech 3D mouse are supported.

The PEX module provides both terminal configuration parameters and user preference parameters for PEX. “Setting PEX Configuration Parameters” on page 14-3 describes the parameters in detail.

PEX Fonts

The PEX module uses stroke fonts, which are scalable fonts defined as coordinates of line segments. The fonts required by PEX are built into the X server, so no additional font paths or font definitions are required. The PEX fonts available in NCDware are roman (a proportionally spaced font) and roman_m (a monospaced font).

The same two fonts are supplied on NCDware distribution media as downloadable font files. All fonts in the NCD PEX font format have filenames with the **.phont** suffix. The two font files available in NCDware are named **Roman.phont** and **Roman_M.phont**. These fonts are normally installed in the **/usr/lib/X11/ncd/fonts/PEX** directory during software installation.

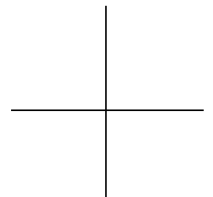

PEX Requirements

Using PEX requires a valid license. To add a PEX node license, use the **unit-license-key** parameter (Setup ⇒ Change Setup Parameters ⇒ Licenses ⇒ License Key). If the terminal has more than one node license, include one instance of this parameter for each license key. The parameter is saved in NVRAM.

After adding the PEX license, reboot the terminal so that the X server can read the PostScript resource file.

If you are using site licensing or floating licenses, see the *NCDware System Administrator's Guide for UNIX Systems* for instructions.

Additional terminal memory may be required. For information on the amount of terminal memory required to use PEX, see the *Release Notes*.

Setting PEX Configuration Parameters

This section describes the PEX remote configuration parameters. In the Setup menus, some PEX parameters are in Change Setup Parameters (in the PEX and PEX Colors hide boxes), and some are in Change User Preferences (in the PEX hide box). PEX parameters are not saved in NVRAM.

Setting the Parameters Listed in Change Setup Parameters

The PEX parameters in Change Setup Parameters take effect after rebooting, so they must be set in a remote configuration file.

The parameters described in this section control the maximum number of half-spaces for model clipping, the maximum number of name set identifiers, and the maximum number of non-ambient light sources. The default values of these parameters are the defaults specified by the PHIGS standard and should work for most applications.

The recommended terminal memory listed in the *Release Notes* is based on the default values of these parameters. Increasing the values of these parameters places increased demands on terminal memory.

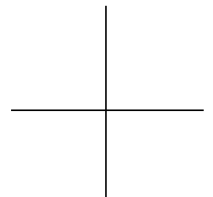

Specifying the Number of Clipping Planes

The `pex-max-model-clip-planes` parameter specifies the maximum number of half-spaces that can be defined for the purpose of model clipping. Half-spaces are defined by the clipping plane. A half-space is an infinite region of modeling coordinate space bounded on one side by the clipping plane.

Table 14-1 `pex-max-model-clip-planes` Parameter

| Possible Values | Result |
|-----------------|--|
| default | 64 |
| <i>integer</i> | The maximum number of model clipping half-spaces that can be defined. Range: 6 to 65535. |

Specifying the Number of Name Sets

The `pex-max-nameset-names` parameter specifies the maximum number of name set identifiers that can be defined. This value must be a power of two. Setting this parameter to an integer that is not a power of two causes the parameter setting to be ignored.

A name set provides an identifier (unique name) for an individual primitive or a group of primitives. The identifier can then be used to pick or highlight all the primitives in the group or make them invisible.

Table 14-2 `pex-max-nameset-names` Parameter

| Possible Values | Result |
|--|--|
| default | 256 |
| 64, 128, 256, 512, 1024, 2048, 4096, 8192, 16384, or 32768 | The maximum number of identifiers that can be defined. |

Specifying the Number of Non-Ambient Light Sources

The `pex-max-non-ambient-lights` parameter specifies the maximum number of non-ambient light sources that can be defined.

The non-ambient light source types are directional light, positional light, and spot light.

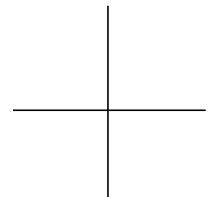

Table 14-3 pex-max-non-ambient-lights Parameter

| Possible Values | Result |
|-----------------|--|
| default | 64 |
| <i>integer</i> | The maximum number of non-ambient lights that can be defined. Range: 0 to 65535. |

PEX Color Parameters

You may need to adjust PEX color parameters if:

- You are not using a monitor supplied by NCD.
- The factory setting of the monitor's brightness control is changed.
- The natural aging of the monitor causes its color display to change.

Color parameters specify the color components of the properly adjusted display monitor according to the CIE (Commission Internationale de l'Eclairage) color space definition. The three color components (red, green, and blue) and the reference white value each consist of three coordinates (values). Each value is a floating point number ranging from a minimum of 0.0 to a maximum of 1.0. The three values are:

- Y—the luminance value
- u'—the chromaticity value on the u' axis
- v'—the chromaticity value on the v' axis

Color parameters do not directly affect colors displayed on the terminal. A client can use these values (for example, to set up a colormap to send to the server), but it is not required to use them.

Blue Color Component

The following parameters specify the three values that make up the blue color component of the properly adjusted display monitor. Each value can range from 0.0 to 1.0.

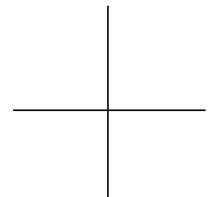

Table 14-4 pex-monitor-reference-blue-u Parameter

| Possible Values | Result |
|------------------------------|---|
| default | 0.1756 |
| <i>floating point number</i> | The u' CIE-chromaticity coordinate for the blue color component of the properly adjusted display monitor. |

Table 14-5 pex-monitor-reference-blue-v Parameter

| Possible Values | Result |
|------------------------------|---|
| default | 0.1785 |
| <i>floating point number</i> | The v' CIE-chromaticity coordinate for the blue color component of the properly adjusted display monitor. |

Table 14-6 pex-monitor-reference-blue-y Parameter

| Possible Values | Result |
|------------------------------|---|
| default | 1.0 |
| <i>floating point number</i> | The Y CIE-luminance coordinate for the blue color component of the properly adjusted display monitor. |

Green Color Component

The following parameters specify the three values that make up the green color component of the properly adjusted display monitor. Each value can range from 0.0 to 1.0.

Table 14-7 pex-monitor-reference-green-u Parameter

| Possible Values | Result |
|------------------------------|--|
| default | 0.1169 |
| <i>floating point number</i> | The u' CIE-chromaticity coordinate for the green color component of the properly adjusted display monitor. |

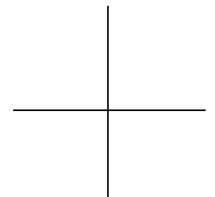

Table 14-8 pex-monitor-reference-green-v Parameter

| Possible Values | Result |
|------------------------------|--|
| default | 0.559 |
| <i>floating point number</i> | The v' CIE-chromaticity coordinate for the green color component of the properly adjusted display monitor. |

Table 14-9 pex-monitor-reference-green-y Parameter

| Possible Values | Result |
|------------------------------|--|
| default | 1.0 |
| <i>floating point number</i> | The Y CIE-luminance coordinate for the green color component of the properly adjusted display monitor. |

Red Color Component

The following parameters specify the three values that make up the red color component of the properly adjusted display monitor. Each value can range from 0.0 to 1.0.

Table 14-10 pex-monitor-reference-red-u Parameter

| Possible Values | Result |
|------------------------------|--|
| default | 0.4288 |
| <i>floating point number</i> | The u' CIE-chromaticity coordinate for the red color component of the properly adjusted display monitor. |

Table 14-11 pex-monitor-reference-red-v Parameter

| Possible Values | Result |
|------------------------------|--|
| default | 0.5249 |
| <i>floating point number</i> | The v' CIE-chromaticity coordinate for the red color component of the properly adjusted display monitor. |

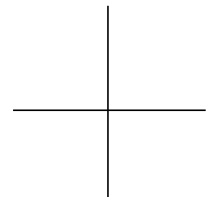

Table 14-12 pex-monitor-reference-red-y Parameter

| Possible Values | Result |
|------------------------------|--|
| default | 1.0 |
| <i>floating point number</i> | The Y CIE-luminance coordinate for the red color component of the properly adjusted display monitor. |

Reference White Value

The following parameters specify the three values that make up the reference white value of the properly adjusted display monitor. Each value can range from 0.0 to 1.0.

Table 14-13 pex-monitor-reference-white-u Parameter

| Possible Values | Result |
|------------------------------|--|
| default | 0.1884 |
| <i>floating point number</i> | The u' CIE-chromaticity coordinate for the reference white value of the properly adjusted display monitor. |

Table 14-14 pex-monitor-reference-white-v Parameter

| Possible Values | Result |
|------------------------------|--|
| default | 0.4463 |
| <i>floating point number</i> | The v' CIE-chromaticity coordinate for the reference white value of the properly adjusted display monitor. |

Table 14-15 pex-monitor-reference-white-y Parameter

| Possible Values | Result |
|------------------------------|--|
| default | 1.0 |
| <i>floating point number</i> | The Y CIE-luminance coordinate for the reference white value of the properly adjusted display monitor. |

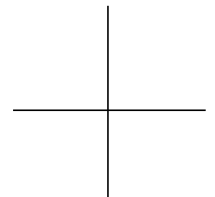

Setting the Parameters Listed in Change User Preferences

PEX user preference parameters allow users to manipulate PEX rendering by setting attributes such as shading, dithering, and light sources.

When set through Change User Preferences (Setup ⇒ Change User Preferences), these parameters offer dynamic control over the client. All of the PEX preference parameters take effect immediately after they are applied.

Specifying the Nominal Line Width

The **pref-pex-nominal-line-width** parameter controls the nominal width (in pixels) of lines and curves. The nominal line width is a default size from which other line sizes are derived by applying a scaling factor (Setup ⇒ Change User Preferences ⇒ PEX ⇒ Nominal Line Width).

This parameter allows you to match the appearance of lines and curves on an NCD terminal to their appearance on other displays.

Table 14-16 pref-pex-nominal-line-width Parameter

| Possible Values | Result |
|-----------------|---|
| default | 1 |
| <i>integer</i> | Standard width of lines and curves (in pixels). Range: 1 to 64. |

Specifying the Nominal Edge Width

The **pref-pex-nominal-edge-width** parameter controls the nominal width (in pixels) of edges of surface primitives when such edges are displayed. The nominal edge width is a default width from which other edge sizes are derived by applying a scaling factor (Setup ⇒ Change User Preferences ⇒ PEX ⇒ Nominal Line Width).

Table 14-17 pref-pex-nominal-edge-width Parameter

| Possible Values | Result |
|-----------------|---|
| default | 1 |
| <i>integer</i> | Standard width of surface primitive edges (in pixels) when edges are displayed. Range: 1 to 64. |

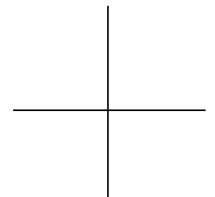

Specifying the Nominal Marker Size

The **pref-pex-nominal-marker-size** parameter controls the nominal size (in pixels) of marker primitives. For example, if a + (plus) marker is 3 pixels wide, a nominal marker size of 2 makes the plus marker 6 pixels wide. Other marker types (except for dot markers) are scaled accordingly (Setup ⇒ Change User Preferences ⇒ PEX ⇒ Nominal Marker Size).

Table 14-18 **pref-pex-nominal-marker-size** Parameter

| Possible Values | Result |
|-----------------|--|
| default | 1 |
| <i>integer</i> | Standard width of marker primitives (in pixels). Range: 1 to 64. |

Specifying Surface Dithering

The **pref-pex-dither-flat-shaded-surface** parameter controls flat-shaded surface dithering (Setup ⇒ Change User Preferences ⇒ PEX ⇒ Dither Flat Shaded Surface).

Table 14-19 **pref-pex-dither-flat-shaded-surface** Parameter

| Possible Values | Result |
|-----------------|---|
| default | by-request |
| by-request | Flat-shaded surfaces are dithered only when the client requests it. |
| off | Flat-shaded surfaces are never dithered. |
| on | Flat-shaded surfaces are always dithered. |

The **pref-pex-dither-interpolated-surface** parameter controls Gouraud-shaded surface dithering (half-toning) (Setup ⇒ Change User Preferences ⇒ PEX ⇒ Dither Interpolated Surface).

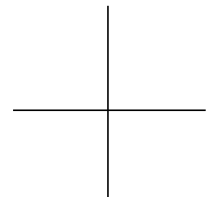

Table 14-20 pref-pex-dither-interpolated-surface Parameter

| Possible Values | Result |
|-----------------|--|
| default | on |
| on | Gouraud-shaded surfaces are always dithered. |
| by-request | Gouraud-shaded surfaces are dithered only when the client requests it. |
| off | Gouraud-shaded surfaces are never dithered. |

Specifying Surface Interior Style, Shading, and Lighting

The **pref-pex-surface-interior-style** parameter specifies how to render the interiors of surfaces (Setup ⇒ Change User Preferences ⇒ PEX ⇒ Surface Interior Style).

Table 14-21 pref-pex-surface-interior-style Parameter

| Possible Values | Result |
|-----------------|--|
| default | by-request |
| by-request | Surface interiors are rendered as requested by the client. |
| hollow | All surface interiors are rendered hollow. |
| solid | All surface interiors are rendered solid. |
| empty | All surface interiors are rendered empty. |

The **pref-pex-surface-interp-method** parameter specifies how to shade the interiors of surfaces (Setup ⇒ Change User Preferences ⇒ PEX ⇒ Surface Interpolation Method).

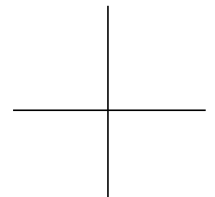

Table 14-22 pref-pex-surface-interp-method Parameter

| Possible Values | Result |
|-----------------|--|
| default | by-request |
| by-request | Surface interiors are shaded as requested by the client. |
| none | All surface interiors are flat-shaded. |
| color | All surface interiors are Gouraud-shaded. |

The **pref-pex-surface-reflect-model** parameter specifies how to apply lighting effects to all surfaces (Setup ⇒ Change User Preferences ⇒ PEX ⇒ Surface Reflection Model).

Table 14-23 pref-pex-surface-reflect-model Parameter

| Possible Values | Result |
|-----------------|--|
| default | by-request |
| by-request | Surface lighting effects are applied as requested by the client. |
| none | Surfaces are not lighted. |
| ambient | Only ambient lighting is used. |
| diffuse | Ambient and diffuse lighting are used. |
| specular | All lighting effects are used. |

Specifying the Color Clipping Method

The **pref-pex-color-clipping-method** parameter specifies the method for clipping colors that cannot be displayed because their RGB (red, green, blue) components are outside the displayable range (0.0 through 1.0). Although the display hardware automatically clips values that are out of range, the resulting displayed color is unpredictable (Setup ⇒ Change User Preferences ⇒ PEX ⇒ Color Clipping Method).

Color components may exceed the displayable range, for example, when numerous light sources are applied.

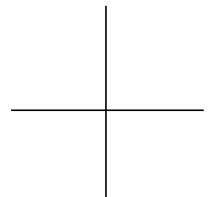

Table 14-24 pref-pex-color-clipping-method Parameter

| Possible Values | Result |
|-----------------|---|
| default | none |
| none | The RGB components are not corrected. |
| scale | The RGB components are scaled proportionately if any components exceed 1.0. For example, if the red component has a value of 1.2, it is scaled to 1 and the green and blue components are scaled by the same percentage. Hue and saturation are maintained, while intensity is clipped. |
| desaturate | The color saturation (contrast) of the RGB components is clipped, while the hue and intensity are maintained. |
| clamp | The RGB components are set to 0 if they are less than 0.0 or to 1.0 if they are greater than 1.0. Clamping can potentially alter hue, saturation, and intensity. |

Specifying the Input Device for PEX

When using the PEX server, you can attach one of the following special input devices to the serial port: a Summagraphics-compatible digitizing tablet or a Logitech 3D mouse. If you are using one of these input devices:

- ❑ Make sure the input device is specified in the **xserver-input-extension-device** parameter (Setup ⇒ Change Setup Parameters ⇒ Input Devices ⇒ Input Extension Device). This parameter is not saved in NVRAM.

Table 14-25 xserver-input-extension-device Parameter

| Possible Values | Results |
|-----------------|---|
| default | tablet |
| tablet | Specifies a Summagraphics-compatible digitizing tablet. |
| 3d-mouse | Specifies a Logitech 3D mouse. |

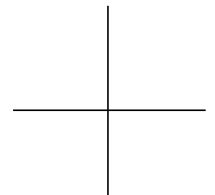

- ❑ Set the mode of the serial port to “input-device” in the **serial-interfaces-table** parameter (Setup ⇒ Change Setup Parameters ⇒ Serial ⇒ Serial Interfaces Table). This parameter is saved in NVRAM.

For example:

```
serial-interfaces-table = {1 input-device input-device 9600 8 1 none none none}
```

Troubleshooting PEX

The most common problems experienced in running PEX clients are clients that do not run and clients that run but look different on an NCD terminal.

If the PEX Client Does Not Run

If you have trouble running a PEX client and cannot figure out why, check the client documentation. Common conditions that prevent clients from running are:

- ❑ Some clients require that a variable be set in the user’s environment.
- ❑ Some clients require a pre-existing error output file.
- ❑ Occasionally, a client written for a 24-bit display does not set up the proper colormap for 8-bit displays such as the current NCD terminals.

If the PEX Client Looks Different

The PEX protocol defines a full range of graphics functions and allows a server to comply with the protocol without implementing all functions. If the NCD PEX module does not implement the same function subset as another server, the client may look different on the two displays.

For example, the shading methods defined by the PEX protocol are color (Gouraud shading), dot product, and normal (Phong). The NCD PEX module supports Gouraud shading. Clients can run in the absence of the other shading methods because clients default to one of the methods supported by the server.

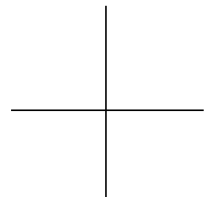

15 Configuring Serial and Parallel Ports

This chapter describes serial and parallel ports. The following topics are covered in this chapter:

- ❑ “Ports Overview” on page 15-1
- ❑ “Configuring Port Operating Characteristics” on page 15-2
- ❑ “Configuring a Terminal for Use as a System Console” on page 15-9
- ❑ “Controlling Access to Serial and Parallel Ports” on page 15-10

For information on serial and parallel port pinouts, see the hardware documentation for your terminal.

Ports Overview

All NCD Explora and HMX terminals are equipped with at least one serial port and one parallel port.

Serial Ports

You can configure a serial port to:

- ❑ Run serial terminal emulation through the NCD Terminal Emulator. See Chapter 12, *Configuring the NCD Terminal Emulator*.
- ❑ Attach a printer. See the *NCDware System Administrator's Guide for UNIX Systems*.
- ❑ Use the terminal as a console for controlling a host system. See “Configuring a Terminal for Use as a System Console” on page 15-9.
- ❑ Use XRemote, NCD's optional software for running both X clients and non-X applications. See the *NCDware System Administrator's Guide for UNIX Systems*.
- ❑ Use an alternative input device. For information about the input devices you can attach to a serial port, see the *NCDware User's Guide*. For input device configuration parameters, see the *Remote Configuration Parameter Quick Reference* and Chapter 9, *Using Configuration Menus*.

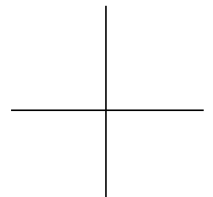

Parallel Port

Parallel ports are Centronics-compatible. You can configure the parallel port for printing or for a floppy drive. “Configuring the Parallel Port” on page 15-8 explains how to configure general parallel-port attributes. For information about configuring the parallel port for a floppy drive or printer, see the *NCDware System Administrator’s Guide for UNIX Systems*.

Configuring Port Operating Characteristics

This section describes how to identify terminal ports and the parameters used for configuring them

Identifying Serial Port Numbers

The Auxiliary Serial Port on all terminals is serial port 1.

For terminals with more than one serial port, the ports are identified in NCDware displays and configuration parameters as follows:

- ❑ The serial port on an ESP board is serial port 2.
- ❑ If a Y cable is attached to an ESP board’s serial port, the A connector is serial port 2 and the B connector is serial port 3.

Specifying Physical Serial Port Attributes

The `serial-interfaces-table` controls physical aspects of serial-line communication (Setup ⇒ Change Setup Parameters ⇒ Serial ⇒ Serial Interfaces Table). The table is saved in NVRAM and changes to the table take effect as soon as they are applied.

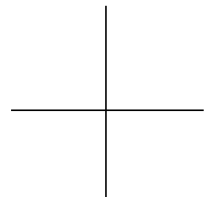
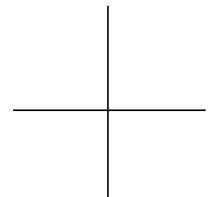

Table 15-1 serial-interfaces-table Parameter

| Table Entries | Possible Values | Results |
|---------------|--|--|
| port-number | Range: 1 - 3 (read-only) | The identifying number of the serial port. |
| mode | Controls the function of the auxiliary serial port, and takes effect at boot time. (The current-mode field specifies the immediate use of the port.) | |
| | default | terminal |
| | terminal | The X server uses the serial port for a serial VT320 terminal connection, usually for connection to a modem, to a host system as a system console, or to a terminal multiplexer. |
| | printer | The X server uses the serial port for an attached printer. This option is the same as "serial-daemon." |
| | serial-daemon | The X server uses the serial port for an attached printer. This option is the same as "printer." |
| | slip | Configures the port for SLIP. |
| | console | The X server sends diagnostic messages to the serial port. This option is for the use of NCD Technical Support only. |
| | input-device | Configures the port to support one of the input devices selected in the xserver-input-extension-device parameter. |
| | xremote | Configures the port for XRemote. NCD recommends that you do not set the mode choice to "xremote." The X server automatically changes current-mode to "xremote" when the user enters an xinitremote command. |
| | ppp | Configures the port for PPP. |



Configuring Port Operating Characteristics

Table 15-1 serial-interfaces-table Parameter (Continued)

| Table Entries | Possible Values | Results |
|---------------|-----------------|---|
| current-mode | | Controls the immediate function of the auxiliary serial port. (The “mode” entry takes precedence at boot time.) |
| | default | terminal |
| | terminal | The X server uses the serial port for serial, VT320 terminal connection, usually for connection to a modem, directly to a host system, or to a terminal multiplexer. |
| | printer | The X server uses the serial port for an attached printer. This option is the same as “serial-daemon.” |
| | serial-daemon | The X server uses the serial port for an attached printer. This option is the same as “printer.” |
| | slip | Configures the port for SLIP. |
| | console | The X server sends diagnostic messages to the serial port. This mode choice is for the use of NCD Technical Support. |
| | input-device | Configures the port for one of the input devices selected in the xserver-input-extension-device parameter. |
| | xremote | Configures the port for XRemote. |
| | ppp | Configures the port for PPP. |
| baud-rate | default | 9600 |
| | baud-rate | The baud rates for Serial Port 1 are 50, 75, 110, 134.5, 150, 200, 300, 600, 1050, 1200, 1800, 2000, 2400, 4800, 7200, 9600, 14400, 19200, 38400, 57600. Optional serial ports 2 and 3 can operate at the following additional baud rates: 76800, and 115200. |
| data-bits | default | 8 |
| | 8 | The serial port transmits characters with eight data bits. |
| | 7 | The serial port transmits characters with seven data bits. |

15-4 Configuring Serial and Parallel Ports

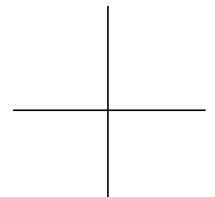

Table 15-1 serial-interfaces-table Parameter (Continued)

| Table Entries | Possible Values | Results |
|---------------|-----------------|---|
| stop-bits | default | 1 |
| | 1 | The serial port uses one stop bit per character. |
| | 2 | The serial port uses two stop bits per character. |
| parity | default | none |
| | none | No parity is generated. |
| | odd | The serial port requires an odd number of 1s (ones) for each byte. |
| | even | The serial port requires an even number of 1s (ones) for each byte. |
| | space | The serial port uses a 0 (zero) for each parity bit. |
| | mark | The serial port uses a 1 (one) for each parity bit. |
| handshake | default | none |
| | none | Flow control is disabled. |
| | xon/xoff | The terminal sends an XON (^Q) signal when input buffers are available and an XOFF (^S) signal when input buffers are nearly full. |
| | dtr/dsr | The terminal raises the DTR (Data Terminal Ready) signal when input buffers are available and lowers DTR when input buffers are nearly full. In addition, the DCE (Data Communication Equipment, the device with which the terminal communicates), raises the DSR (Data Set Ready) signal when it can receive data from the terminal. The terminal stops sending data when the DCE lowers the DSR signal. |
| | rts/cts | The terminal raises the RTS (Ready to Send) signal when input buffers are available and lowers RTS when input buffers are nearly full. |

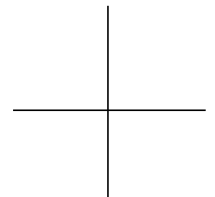

Table 15-1 serial-interfaces-table Parameter (Continued)

| Table Entries | Possible Values | Results |
|---------------|-----------------|--|
| hangup | default | none |
| | none | Neither the Serial daemon nor the NCD Terminal Emulator performs any action when the serial connection is closed by either the host or the X server. |
| | drop-dtr | Depending on the value assigned to the mode field, either the Serial daemon or the NCD terminal emulator drops the Data Terminal Ready signal on the specified serial port when either the host system or the X server closes the serial connection. |
| | send-break | Depending on the value assigned to the mode field, either the Serial daemon or the NCD Terminal Emulator sends a three-second break from the specified serial port when either the host system or the X server closes the serial connection. |

The default **serial-interfaces-table** is:

```
serial-interfaces-table = {  
    { 1 terminal terminal 9600 8 1 none none none }  
    { 2 terminal terminal 9600 8 1 none none none }  
    { 3 terminal terminal 9600 8 1 none none none }  
}
```

Specifying Serial Port Software Characteristics

The **serial-daemons-table** specifies Serial daemon operating characteristics for each port (Setup ⇒ Change Setup Parameters ⇒ Serial ⇒ Serial Daemons Table).

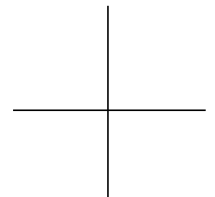
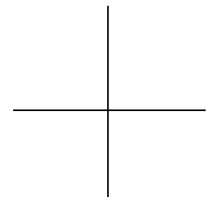

Table 15-2 serial-daemons-table Parameter

| Table Entries | Possible Values | Results |
|---------------------|----------------------------|--|
| port-number | Range: 1- 3 (read-only) | The identifying number of the serial port. |
| use-serial-protocol | default | false |
| | false | A protocol for reporting serial status to host printing software is not used. |
| | true | A protocol for reporting serial status to host printing software is used. This does not work unless hostside printing software has been enabled. (For more information about hostside printing software, contact NCD Technical Support.) |
| tcp-port | default | Port 1: 87 Port 2: 5962 Port 3: 5963 |
| | <i>integer</i> | TCP/IP port number used by the hosts connecting to the Serial daemon. Range: 1 to 65535. |
| ncdnet-object-name | default | seriald |
| | <i>string</i> | The NCDnet object used by hosts connecting to the Serial daemon. |
| enable-lat-service | default | false |
| | true | LAT service is enabled for the Serial daemon. Supports VMS print service for the terminal. |
| | false | LAT service is not enabled for the Serial daemon. |
| lat-service-name | default | nil |
| | <i>string</i> | The name of the Serial daemon LAT service. |
| lat-service-rating | default | 50 |
| | <i>integer</i> | The X server uses the specified LAT service rating when advertising LAT service for the terminal's Serial daemon. |



The default `serial-daemons-table` is:

```
serial-daemons-table = {  
  { 1 false 87 seriald false nil 50 }  
  { 2 false 87 seriald false nil 50 }  
  { 3 false 87 seriald false nil 50 }  
}
```

Configuring the Parallel Port

The `parallel-daemons-table` specifies operating characteristics for the parallel port (Setup ⇒ Change Setup Parameters ⇒ Parallel ⇒ Parallel Daemons Table).

Table 15-3 `parallel-daemons-table` Parameter

| Table Entries | Possible Values | Results |
|-----------------------|-----------------------------|--|
| port-number | Range: 1 - 2 (read-only) | The identifying number of the parallel port. |
| use-parallel-protocol | default | false |
| | false | A protocol for reporting status to host printing software is not used. This is the recommended setting when a printer is attached to the parallel port. |
| | true | A protocol for reporting status to host printing software is used. This value does not work unless hostside printing software has been enabled. This is the recommended setting when a floppy drive is attached to the parallel port (For more information about hostside printing software, contact NCD Technical Support.) |
| tcp-port | default | 5964 |
| | <i>integer</i> | TCP/IP port number used by the hosts connecting to the Parallel daemon. Range: 1 - 65535. |

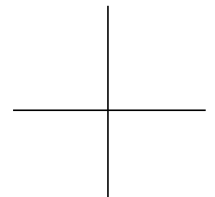

Table 15-3 parallel-daemons-table Parameter

| Table Entries | Possible Values | Results |
|--------------------|-----------------|---|
| ncdnet-object-name | default | paralleld |
| | <i>string</i> | The NCDnet object used by hosts connecting to the Parallel daemon. |
| enable-lat-service | default | false |
| | true | The terminal enables a LAT service for the Parallel daemon. This LAT service is used to support VMS print service for the terminal. |
| | false | The terminal does not enable a LAT service for its Parallel daemon to the LAT network. |
| lat-service-name | default | nil |
| | <i>string</i> | The name of the Parallel daemon LAT service. |
| lat-service-rating | default | 50 |
| | <i>integer</i> | The X server uses the specified LAT service rating when advertising LAT service for the terminal's Parallel daemon. |

The default **parallel-daemons-table** is:

```
parallel-daemons-table = {{ 1 false 5964 paralleld false nil 50 }}
```

Configuring a Terminal for Use as a System Console

By connecting a serial port of an NCD terminal to a host system, you can use the terminal as the system console.

Complete the following steps to configure an NCD terminal to operate as the system console:

1. Connect the terminal to the host using a null-modem cable.
2. Make sure the X server boots from a PCMCIA card. With a local server, the terminal can reboot even if the host system is down.

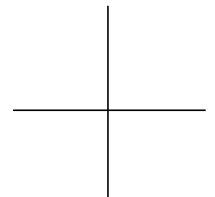

3. Make sure the **config-auto-save-nvram** parameter is set to “true,” so the **serial-interfaces-table** is written to NVRAM.
4. Set the **mode** parameter in the **serial-interfaces-table** to “terminal” for the port that you wish to use. Table 15-1 on page 15-3 lists the values for serial port attributes in the **serial-interfaces-table**.

When an NCD terminal is used as the system console, you should make sure security is enforced. Without security, a user on another terminal connected to the host could execute the NCD Terminal Emulator on the console and display its output on the user’s own terminal.

To prevent a user from invoking the **term -ctype** command on a terminal being used as a system console, use **exec-access-control-disabled** and **exec-access-control-list** as described in the *System Administrator’s Guide*.

Controlling Access to Serial and Parallel Ports

This section describes the parameters that control access to a terminal’s serial and parallel ports from other network hosts. These parameters are not saved in NVRAM.

To restrict access to a terminal’s serial ports or prevent all access from outside the terminal, complete the following steps:

1. To establish access control for a terminal’s ports, set the **serial-access-control-enabled** parameter to “true” (Setup ⇒ Change Setup Parameters ⇒ [Serial and Parallel Daemon section] ⇒ Enable Serial and Parallel Access Control).

Table 15-4 serial-access-control-enabled Parameter

| Possible Values | Result |
|-----------------|---|
| default | false |
| false | New requests for connection to the terminal’s ports are not checked against the list of hosts defined in the serial-access-control-list parameter. |
| true | Requests to access the terminal’s ports are honored only from hosts listed in the serial-access-control-list parameter. |

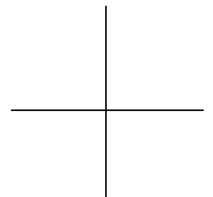

- In the **serial-access-control-list** parameter, specify the hosts permitted to access the terminal's ports. You must list all hosts that have access (including other terminals). A separate entry is required for each protocol family (TCP/IP, DECnet, and LAT). For example, a host that has both TCP/IP and DECnet access must have two entries (Setup ⇒ Change Setup Parameters ⇒ Access Control [Serial and Parallel Daemon section] ⇒ Serial and Parallel Access Control List).

Table 15-5 serial-access-control-list Parameter

| Table Entries | Possible Values | Result |
|---------------|-----------------|--|
| host | default | (empty list) |
| | host | Host permitted to access the terminal's serial ports, specified by hostname, IP address, or DECnet address. DECnet host names must have "::" appended to them. |
| family | default | tcpip |
| | tcpip | The host can connect to the serial ports via TCP/IP. |
| | ncdnet | The host can connect to the serial ports via DECnet. |
| | lat | The host can connect to the serial ports via LAT. |

For example:

```
serial-access-control-list = {
    { eagle    tcpip }
    { eagle    lat   }
    { ncd23    tcpip }
}
```

In the following example, only local access to the terminal is allowed:

```
serial-access-control-list = {{127.0.0.1 tcpip}}
```

- To prevent access from all hosts, leave the **serial-access-control-list** table empty:

```
serial-access-control-list = {}
```

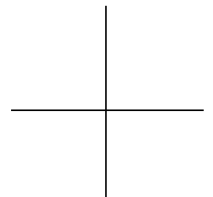

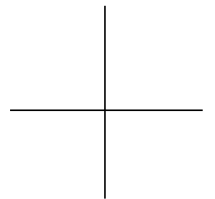

16 Using SNMP for Terminal Management

This chapter describes using SNMP (Simple Network Management Protocol) to manage NCD terminals over the network. The following topics are covered in this chapter:

- ❑ “SNMP Overview” on page 16-1
- ❑ “SNMP Host Requirements” on page 16-3
- ❑ “Controlling Access to Terminals through SNMP” on page 16-3
- ❑ “Using SNMP to Read and Write Variables” on page 16-7
- ❑ “Using SNMP Remote Reset/Reboot” on page 16-10

SNMP Overview

SNMP is an industry-standard set of protocols for network management in TCP/IP network environments. It provides mechanisms for monitoring and controlling terminals from a central location.

Using SNMP from a network host, you can:

- ❑ Display or modify the values of all terminal configuration parameters
- ❑ Obtain additional information, including network traffic levels, network error levels, basic system and network configuration data, and the state of the font cache
- ❑ Configure network-oriented timers
- ❑ Remotely reset NCD terminals

SNMP Components

SNMP consists of four interrelated parts:

- ❑ An SNMP agent in the X server
- ❑ SNMP manager software, located on a host computer and available from a number of vendors. Most management software includes utilities for

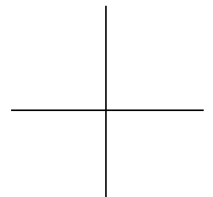

- collecting information from agents. Some management software also includes utilities for generating reports and setting variables.
- ❑ MIB (Management Information Base), information defined by standard variables mandated in RFC 1212, plus variables added by NCD. The NCDware distribution includes two versions of the MIB:
 - The combined NCDware MIB and MIB II file, with the following name and default location: `/usr/lib/X11/ncd/snmp/mib.txt`
 - The new, updated NCDware-only MIB file that includes SNMP variables for all NCD remote configuration parameters, with the following name and default location: `/usr/lib/X11/ncd/snmp/mib.my`
 - ❑ The protocol that connects the manager with agents
- The NCDware distribution also includes two utilities: `ncdreset(1)` for remotely resetting terminals and `ncdquery(1)` for displaying the values of certain NCD-specific variables.

How SNMP Works

NCD terminals respond to queries from hosts running SNMP management software. Manager hosts have read/write access; monitor hosts have read-only access; and trap monitors receive information about significant events.

The SNMP manager initiates information gathering by sending a request for information to the SNMP agent in the terminal. When the request is received, the agent collects data as specified in the MIB and sends it to the manager. Using SNMP utilities, the system administrator can read or write variables.

NCDware provides an access control mechanism that you can use to prevent read/write or read-only access to the SNMP agent from outside the terminal or restrict access to a specified list of hosts. Both levels of access are further controlled by passwords called community names.

MIB Contents

All of the mandatory variables are included in NCD's SNMP agent except for the `ifAdminStatus` variable. Read-only access is provided for this variable, but write access can cause security problems and is not necessary on NCD terminals, which have only one network interface.

The NCDware MIB file contains SNMP variables for all NCD configuration parameters. Each configuration parameter has a unique SNMP variable name

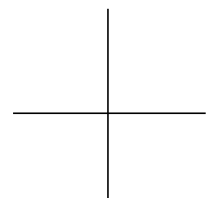

and path; for example, the SNMP variable name and path for the **boot-desired-source** parameter are: **ncdBootDesiredSource** and **ncdBoot 5**.

The SNMP variable name and path for each parameter are listed in the *Remote Configuration Parameter Quick Reference*.

SNMP Host Requirements

Hosts that access the terminal's SNMP information or need to access the terminal for reset purposes must have both SNMP management software and the NCD MIB installed. The MIB is installed during the NCDware installation process.

If you are not using the default MIB file (*/etc/mib.txt*), you should set the `MIBFILE` environment variable to the pathname of the MIB file or specify the pathname of the MIB in the command line for SNMP utilities.

Controlling Access to Terminals through SNMP

By default, any host on the network can read and write an NCD terminal's SNMP variables. You can restrict this access using the procedures in this section.

This section also provides a procedure for configuring terminals to send notification of traps to specified hosts. Traps are responses to significant events and are generated by the terminal.

SNMP passwords (community names) are saved into a limited area in the terminal's NVRAM. To save space, you can define a global password that provides read/write access to SNMP variables as well as access to other terminal functions (Setup ⇒ Change Setup Parameters ⇒ Access Control ⇒ Unit Global Password). For more information about setting a global password, see the *System Administrator's Guide*. For information about the special area in NVRAM for saving passwords and certain other strings, see Chapter 11, Boot Monitor and NVRAM.

Except for the community names, the parameters described in the following procedures are not saved in NVRAM.

Configuring Read/Write Access

A host with read/write access to a terminal's MIB variables is called a manager. You can establish a list of hosts allowed to access the terminal or prevent access from all hosts. Access control is disabled by default.

To establish read/write access control to a terminal's SNMP variables:

1. To establish access control, set the **snmp-read-write-access-control-enabled** parameter to "true" (Setup ⇒ Change Setup Parameters ⇒ Access Control ⇒ Enable SNMP Read-Write Access Control).

Table 16-1 snmp-read-write-access-control-enabled Parameter

| Possible Values | Results |
|-----------------|---|
| default | false |
| false | Requests for connections to the SNMP daemon from outside the terminal are not checked against the read/write access list. |
| true | Requests for connections to the SNMP daemon from outside the terminal are checked against the read/write access list. |

2. The **snmp-read-write-access-control-list** table contains the names of all hosts with read/write access to SNMP variables (Setup ⇒ Change Setup Parameters ⇒ Access Control ⇒ SNMP Read-Write Access Control List). If read/write access control is enabled, only hosts in the table have read/write access to the terminal.

Table 16-2 snmp-read-write-access-control-list Parameter

| Table Entries | Possible Values | Results |
|---------------|--------------------------------------|--|
| host | default | (empty list) |
| | hostname or IP address | The network name or address of a host granted read/write access to the terminal's SNMP daemon. |

Note To disallow read/write access by all hosts, leave the table empty and make sure **snmp-read-write-access-control-enabled** is set to "true."

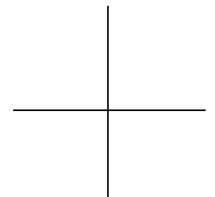

3. A community name must be specified in SNMP requests to obtain read/write access to the terminal's configuration information when access control is enabled. You can specify up to two community names. A community string is a string of alphanumeric characters of arbitrary length.
 - Set the first community name in Setup ⇒ Change Setup Parameters ⇒ Access Control ⇒ SNMP Read-Write Community.
 - Set the second community name in Setup ⇒ Change Setup Parameters ⇒ Access Control ⇒ SNMP Read-Write Alternative Community.

Configuring Read-Only Access

A host with read-only access to a terminal's MIB variables is called a monitor. The default is to allow any host read-only access to the terminal through SNMP. You can establish a list of hosts allowed to access the terminal or prevent access from all hosts. Access control is disabled by default.

You can use the default read-only password, called a community name, or specify a different one.

Complete the following steps to configure read-only access to a terminal's SNMP variables:

1. To establish access control, set the **snmp-read-only-access-control-enabled** parameter to "true" (Setup ⇒ Change Setup Parameters ⇒ Access Control [SNMP section] ⇒ Enable SNMP Read-Only Access).

Table 16-3 snmp-read-only-access-control-enabled Parameter

| Possible Values | Results |
|-----------------|--|
| default | false |
| false | Requests for connections to the SNMP daemon from outside the terminal are not checked against the read-only access list. |
| true | Requests for connections to the SNMP daemon from outside the terminal are checked against the read-only access list. |

2. The **snmp-read-only-access-control-list** table contains the names of all hosts with read-only access to SNMP variables (Setup ⇒ Change Setup

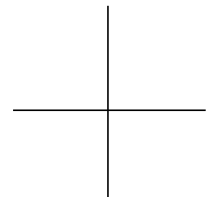

Controlling Access to Terminals through SNMP

Parameters ⇒ Access Control [SNMP section] ⇒ SNMP Read-Only Access Control List). If read-only access control is enabled, only hosts in the table have read-only access to the terminal.

Table 16-4 snmp-read-only-access-control-list Parameter

| Table Entries | Possible Values | Results |
|---------------|--------------------------------------|---|
| host | default | (empty list) |
| | <i>hostname</i> or <i>IP address</i> | The network name or address of a host granted read-only access to the terminal's SNMP daemon. |

Note To disallow read-only access by all hosts, leave the table empty and make sure **snmp-read-only-access-control-enabled** is set to "true."

3. The community name must be specified in SNMP requests to obtain read-only access to the terminal's configuration information. You can specify up to two community names. A community name is a string of alphanumeric characters of any length.
 - If you do not wish to use the default community name for read-only access, set the community name in Setup ⇒ Change Setup Parameters ⇒ Access Control ⇒ SNMP Read-Only Community.
 - Set the second community name in Setup ⇒ Change Setup Parameters ⇒ Access Control ⇒ SNMP Read-Only Alternative Community.

Configuring Terminals to Allow Trap Monitoring

The two trap events defined for NCD terminals are:

- The cold start trap, sent when the terminal is powered on
- The authentication failure trap, sent when an attempt to access the terminal using SNMP fails

To designate a host as a trap monitor, list its hostname or IP address and a community name (password) in Setup ⇒ Change Setup Parameters ⇒ Access Control ⇒ SNMP Trap Monitors. A community name is an alphanumeric string of arbitrary length.

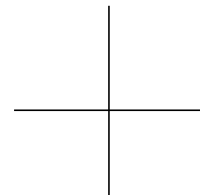

Note If any of the trap monitor hosts are also manager or monitor hosts, use the community names already specified for those hosts. For information about manager and monitor hosts, see “Configuring Read/Write Access” on page 16-4 and “Configuring Read-Only Access” on page 16-5.

Using SNMP to Read and Write Variables

You can read and write SNMP variables using the SNMP utilities provided with your SNMP host software. In addition, you can read a few variables using the *ncdquery*(1) utility provided on the NCDware distribution.

Reading a Terminal’s SNMP Variables

The following sections describe how to use SNMP management software or the *ncdquery* utility to read a terminal’s SNMP variables.

Using SNMP Management Software

A host’s SNMP management software usually includes a **get** command that allows you to read a terminal’s SNMP variables. Reading variables requires read-only or read/write access to the terminal, which is allowed by default.

Using the *ncdquery* Utility

The *ncdquery* utility allows you to display the contents of a few MIB variables for a specified terminal. An *ncdquery* command must be executed from a host designated as an SNMP manager or monitor:

- ❑ When executing the command from a manager host, you must supply the read/write community string.
- ❑ When executing the command from a monitor host, you must supply the read-only community name.

For more information about community names, see “Configuring Read/Write Access” on page 16-4 and “Configuring Read-Only Access” on page 16-5.

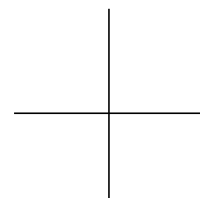

The command syntax is:

```
ncdquery [ -V -v -c community -d variable_options ] hostname
```

where:

- V** Displays version information for *ncdquery*
- v** Displays the hostname
- c *community*** Is the community name. If the community name is not one of the defaults (manager for manager hosts and public for monitor hosts), you must supply the community name.
- d** Displays debugging information
- variable_options*** Specifies the variable(s) to display. The default is to display the X server version. The options and variables displayed by each are:
 - s** X server version
 - b** Boot Monitor version
 - k** Keyboard controller version
 - i** Amount of memory installed
 - h** Memory fragments
 - f** Amount of free memory
 - a** All of the above
- hostname*** Is the hostname of the terminal.

For example, the following command displays the X server and Boot Monitor versions, assuming the default community name and MIB file:

```
% ncdquery -s -b ncd60
server version: NCD19c server 3.1.0 03/12/91 downloaded
boot monitor version: Boot PROM V2.2.4
```

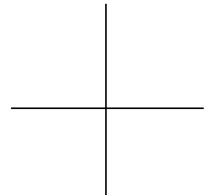

For more information about the *ncdquery* command and its options, see the man page.

Writing SNMP Variables—Configuring Terminals

You can modify an NCD terminal's SNMP variables using your host SNMP management software. Host SNMP software usually includes a **set** command for modifying variables. Modifying variables requires read/write access to the terminal, which is allowed by default.

Consult your SNMP management documentation for information about commands to use for modifying SNMP variables.

Each remote configuration parameter has a variable name and path assigned to it. You can obtain SNMP variable names and paths for the read/write parameters from the *Remote Configuration Parameter Quick Reference*.

Depending on the SNMP management software at your site, you may need to assign numerical values to parameters that accept choices or Boolean values. To assign numerical values to a parameter, complete the following steps:

1. Identify the values available for the desired parameter.
2. If required by your SNMP management software, assign numerical values to the available choices:
 - For Boolean values, use 1 for “false,” “no,” and “off.” Use 2 for “true,” “yes,” and “on.”
 - For choice values, assign 1 to the first choice, 2 to the second choice, and so on, unless otherwise specified. Use the order of choices listed in the *Remote Configuration Parameter Quick Reference*.

For example, the following numerical values correspond to the choices for **boot-desired-source**:

- 1 = tcpip
- 2 = tftp
- 3 = nfs
- 4 = ncdnet
- 5 = local
- 6 = prom

For more information about assigning values to parameters, refer to the documentation for your SNMP management software.

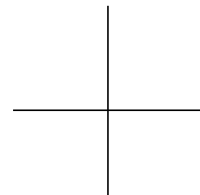

3. Enter the command, using the appropriate value. For example, a command using host-based SNMP management software to change the **boot-desired-source** parameter to “local” is:

```
% xsnmpi -a 191.42.153.147 -c manager set ncdBootDesiredSource.0=5
```

where:

| | |
|----------------------|--|
| 191.42.153.147 | Is the IP address of the terminal |
| -c manager | Is the community name for read/write permission |
| ncdBootDesiredSource | Is the SNMP variable name for the boot-desired-source parameter |
| 5 | Is the choice “local” |

Using SNMP Remote Reset/Reboot

On a TCP/IP network, terminals can be reset remotely using SNMP and the **ncdreset(1)** command. The host from which terminals are reset must be an SNMP manager host. **ncdreset(1)** provides the following choices:

- Establishing an SNMP connection without restarting the session
- Restarting the X session
- Rebooting the terminal after all clients exit
- Rebooting the terminal immediately

The following sections describe the host and terminal configuration required before you can reset a terminal remotely.

Configuring a Host for SNMP Remote Reset

Complete the following steps to set up the host from which the remote reset command is issued:

1. Install the **ncdreset** executable and the NCD MIB from the NCDware distribution, if necessary. They are installed when you install NCDware with the **ncdinstall** script.
2. Make sure the host has SNMP management software.

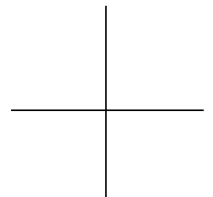

Configuring a Terminal for SNMP Remote Reset

Complete the following steps to configure a terminal for remote reset:

1. Set the **snmp-allow-reset** parameter to “true” (Setup ⇒ Change Setup Parameters ⇒ Access Control [SNMP section] ⇒ Allow SNMP Reset). Reset is disabled by default.
2. The default is to allow reset from any host and by any user. To restrict access to the reset function, do the following:
 - To restrict access to certain hosts, make sure the hosts are included in the **snmp-read-write-access-control-list** table if SNMP write access is enabled. Write access is enabled if **snmp-read-write-access-control-enabled** is set to “true.”
 - To prevent other users from resetting the terminal, set a password, in the **snmp-read-write-community** parameter.

These parameters are described in “Controlling Access to Terminals through SNMP” on page 16-3.

Resetting Session and Rebooting Terminals

You can use the **ncdreset** utility or the **unit-administrative-status** remote configuration parameter to reset terminals remotely.

Using the **ncdreset** Utility for Remote Reset

To use **ncdreset** to remotely reset a terminal or restart the X session, enter an **ncdreset** command from a host designated as an SNMP manager. The default action of this command is to reset the terminal after the last client closes.

Note The reset process is irreversible. You cannot change to another reset level after resetting the terminal.

The syntax of **ncdreset** is:

```
ncdreset [ -V -v -c community -r reset_level ] hostname
```

where:

-V Prints version information for the program on the standard output.

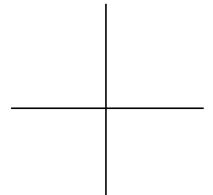

- v** Prints a message on the standard output when the terminal is actually reset.
- c *community*** Is the community name. If the community name is not the default (manager), you must supply the community name.
- hostname*** Is the hostname of the terminal being reset.
- r *reset_level*** Is the reset level. The values are:
 - 1 Establishes an SNMP connection without resetting the terminal.
 - 2 Restarts the X session.
 - 3 Reboots the terminal when the last client closes. This is the default reset level.
 - 4 Reboots the terminal immediately.

For example, the following command reboots the terminal when the last client closes and prints a message on the standard output when the terminal resets:

```
# ncdreset -v -r3 ncd203
```

Using **unit-administrative-status** for SNMP Remote Reset

The **unit-administrative-status** remote configuration parameter (Setup ⇒ Change Setup Parameters ⇒ Unit ⇒ Administrative Status) both displays the SNMP administrative status of terminals and provides for immediate or delayed resetting of terminals from a remote location.

Use of **unit-administrative-status** for remote reset requires that the **snmp-allow-reset** parameter be set to “true.” The possible values for this parameter are described in Table 16-5. The parameter is not saved in NVRAM.

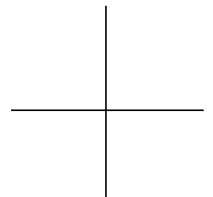
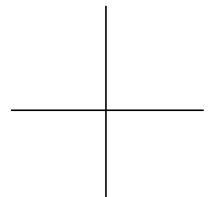
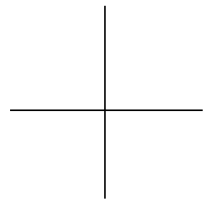

Table 16-5 unit-administrative-status Parameter Values

| Possible Values | Results |
|-------------------------|---|
| default | running |
| running | The terminal is running; no reset commands are pending. |
| session-reset | The terminal restarts the session. This option is the same as logging out of the current session (in the Console, select Login ⇒ Logout). |
| last-client-close-reset | The terminal reboots when the last client closes. |
| unit-reset | The terminal reboots immediately. This option is the same as rebooting the terminal (in the Console, select Console ⇒ Reboot). |



16-14 Using SNMP for Terminal Management



17 Keyboards and Downloadable Keyboard Definitions

This chapter describes NCD-supported keyboards and downloadable keyboard files. For the N-97, N-101, VT220, N-108, N-107, and N-123 keyboard groups, there are illustrations showing keycap legends and associated decimal keycodes for the US version in each keyboard group, tables listing the keysyms that result when the terminal uses the default keymap for the US version in each group, default LED values, key combinations for accessing the Boot Monitor, and key combinations for accessing the Console from keyboards lacking a Setup key.

The following topics are described in this chapter:

- ❑ “Specifying the Keyboard Type” on page 17-2
- ❑ “N-97 Keyboard Details” on page 17-4
- ❑ “N-101 Keyboard Details” on page 17-13
- ❑ “VT220-Compatible and N-108 Keyboard Details” on page 17-21
- ❑ “N-107 Sun Type 4-Compatible Keyboard Details” on page 17-36
- ❑ “N-123 Sun Type 5-Compatible Keyboard Details” on page 17-44
- ❑ “Using Downloadable Keyboard Description Files” on page 17-54

This chapter does not describe keysyms for the foreign language versions of NCD keyboards. To see a keymap of a foreign language keyboard, use the X Window System utility *xmodmap*(1).

The *NCDware System Administrator’s Guide for UNIX Systems* and the *NCDware User’s Guide* describe concepts needed for understanding keyboard usage and keyboard attachment and configuration. The *System Administrator’s Guide* also shows how to use the X utilities such as *xmodmap* and *xev* for keyboard configuration.

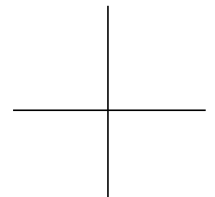

Specifying the Keyboard Type

The Boot Monitor senses the general type (group) of the keyboard attached to the terminal. It is only necessary to explicitly set the **keyboard-type** if you are using a keyboard that is not the US version (or the IBM PS/2 version for the N-101 group). If the terminal cannot sense the keyboard type, it defaults to the “IBM PS/2” type in the N-101/N-102 group.

The keyboard types in each keyboard group (for use with the **xserver-keyboard-type** parameter or in Setup Parameters ⇒ Input Devices ⇒ Keyboard Type) are listed in Table 17-1.

Table 17-1 Specifying Keyboards

| Group | Keyboard Type | | | | | | | | | | | | | | | | | | | | | | | | | | |
|----------------------------|--|------------|-----------------|-------------------------|-------------------|----------------|--------------------|------------------|----------------------|-----------------|-----------------|-----------------|----------------------|----------------------------|----------------------|----------------------------|------------|----------------|-------------------------|---------|-------------------|-----------|----------------|----------|----------------|----------|--|
| Capella | “N-97” | | | | | | | | | | | | | | | | | | | | | | | | | | |
| N-101/N-102 | <table border="0"> <tr> <td>“N-101”</td> <td>“Icelandic”</td> </tr> <tr> <td>“IBM PS/2”¹</td> <td>“Italian”</td> </tr> <tr> <td>“Belgian UK”</td> <td>“Norwegian”</td> </tr> <tr> <td>“Belgian French”</td> <td>“Norwegian/Tandberg”</td> </tr> <tr> <td>“English UK”</td> <td>“OADG Kana”</td> </tr> <tr> <td>“Canadian”</td> <td>“Portuguese”</td> </tr> <tr> <td>“Canadian French CSA 1988”</td> <td>“Siemens German”</td> </tr> <tr> <td>“Canadian French CSA 1992”</td> <td>“Spanish”</td> </tr> <tr> <td>“Danish”</td> <td>“Spanish Latin America”</td> </tr> <tr> <td>“Dutch”</td> <td>“Swedish/Finnish”</td> </tr> <tr> <td>“Flemish”</td> <td>“Swiss French”</td> </tr> <tr> <td>“French”</td> <td>“Swiss German”</td> </tr> <tr> <td>“German”</td> <td></td> </tr> </table> | “N-101” | “Icelandic” | “IBM PS/2” ¹ | “Italian” | “Belgian UK” | “Norwegian” | “Belgian French” | “Norwegian/Tandberg” | “English UK” | “OADG Kana” | “Canadian” | “Portuguese” | “Canadian French CSA 1988” | “Siemens German” | “Canadian French CSA 1992” | “Spanish” | “Danish” | “Spanish Latin America” | “Dutch” | “Swedish/Finnish” | “Flemish” | “Swiss French” | “French” | “Swiss German” | “German” | |
| “N-101” | “Icelandic” | | | | | | | | | | | | | | | | | | | | | | | | | | |
| “IBM PS/2” ¹ | “Italian” | | | | | | | | | | | | | | | | | | | | | | | | | | |
| “Belgian UK” | “Norwegian” | | | | | | | | | | | | | | | | | | | | | | | | | | |
| “Belgian French” | “Norwegian/Tandberg” | | | | | | | | | | | | | | | | | | | | | | | | | | |
| “English UK” | “OADG Kana” | | | | | | | | | | | | | | | | | | | | | | | | | | |
| “Canadian” | “Portuguese” | | | | | | | | | | | | | | | | | | | | | | | | | | |
| “Canadian French CSA 1988” | “Siemens German” | | | | | | | | | | | | | | | | | | | | | | | | | | |
| “Canadian French CSA 1992” | “Spanish” | | | | | | | | | | | | | | | | | | | | | | | | | | |
| “Danish” | “Spanish Latin America” | | | | | | | | | | | | | | | | | | | | | | | | | | |
| “Dutch” | “Swedish/Finnish” | | | | | | | | | | | | | | | | | | | | | | | | | | |
| “Flemish” | “Swiss French” | | | | | | | | | | | | | | | | | | | | | | | | | | |
| “French” | “Swiss German” | | | | | | | | | | | | | | | | | | | | | | | | | | |
| “German” | | | | | | | | | | | | | | | | | | | | | | | | | | | |
| VT-220 | <table border="0"> <tr> <td>“VT220 US”</td> <td>“VT220 Italian”</td> </tr> <tr> <td>“VT220 Canadian”</td> <td>“VT220 Norwegian”</td> </tr> <tr> <td>“VT220 Danish”</td> <td>“VT220 Portuguese”</td> </tr> <tr> <td>“VT220 Dutch”</td> <td>“VT220 Spanish”</td> </tr> <tr> <td>“VT220 Finnish”</td> <td>“VT220 Swedish”</td> </tr> <tr> <td>“VT220 Flemish”</td> <td>“VT220 Swiss French”</td> </tr> <tr> <td>“VT220 French”</td> <td>“VT220 Swiss German”</td> </tr> <tr> <td>“VT220 German”</td> <td>“VT220 UK”</td> </tr> <tr> <td>“VT220 Hebrew”</td> <td></td> </tr> </table> | “VT220 US” | “VT220 Italian” | “VT220 Canadian” | “VT220 Norwegian” | “VT220 Danish” | “VT220 Portuguese” | “VT220 Dutch” | “VT220 Spanish” | “VT220 Finnish” | “VT220 Swedish” | “VT220 Flemish” | “VT220 Swiss French” | “VT220 French” | “VT220 Swiss German” | “VT220 German” | “VT220 UK” | “VT220 Hebrew” | | | | | | | | | |
| “VT220 US” | “VT220 Italian” | | | | | | | | | | | | | | | | | | | | | | | | | | |
| “VT220 Canadian” | “VT220 Norwegian” | | | | | | | | | | | | | | | | | | | | | | | | | | |
| “VT220 Danish” | “VT220 Portuguese” | | | | | | | | | | | | | | | | | | | | | | | | | | |
| “VT220 Dutch” | “VT220 Spanish” | | | | | | | | | | | | | | | | | | | | | | | | | | |
| “VT220 Finnish” | “VT220 Swedish” | | | | | | | | | | | | | | | | | | | | | | | | | | |
| “VT220 Flemish” | “VT220 Swiss French” | | | | | | | | | | | | | | | | | | | | | | | | | | |
| “VT220 French” | “VT220 Swiss German” | | | | | | | | | | | | | | | | | | | | | | | | | | |
| “VT220 German” | “VT220 UK” | | | | | | | | | | | | | | | | | | | | | | | | | | |
| “VT220 Hebrew” | | | | | | | | | | | | | | | | | | | | | | | | | | | |

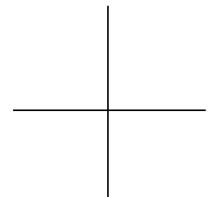
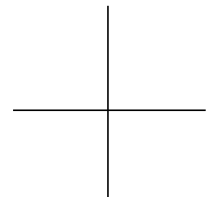

Table 17-1 Specifying Keyboards (Continued)

| Group | Keyboard Type |
|--------------|---|
| N-108 | “N-108 US” “N-108 Belgian” “N-108 Canadian English” “N-108 Canadian French” “N-108 Danish” “N-108 Finnish” “N-108 French” “N-108 German” “N-108 Italian” “N-108 Norwegian” “N-108 Portuguese” “N-108 Spanish” “N-108 Swedish” “N-108 Swiss French” “N-108 Swiss German” “N-108 UK” |
| Nokia 108 | “108 US” “108 Belgian” “108 Canadian English” “108 Canadian French” “108 Danish” “108 Finnish” “108 French” “108 German” “108 Italian” “108 Norwegian” “108 Portuguese” “108 Spanish” “108 Swedish” “108 Swiss French” “108 Swiss German” “108 UK” |
| Sun Type 4 | “N-107 US” |
| Sun Type 5 | “N-123 North American” “N-123 Unix” “N-123 Danish” “N-123 Dutch” “N-123 French” “N-123 German” “N-123 Italian” “N-123 Norwegian” “N-123 Portuguese” “N-123 Spanish” “N-123 Swedish” “N-123 Swiss French” “N-123 Swiss German” “N-123 UK” |
| Kana | “Kana” |
| Nokia 122 | “US 122” |
| Hitachi Kana | “H-123” |
| 3270 | “Lexmark-3270 US” |

¹ Use “IBM PS/2” for the Windows 95-compatible keyboard.



N-97 Keyboard Details

The legends and keycodes for the US-type 97-key keyboard are illustrated in Figure 17-1. Table 17-2 lists the N-97 keysyms when the default mapping for the US type is in use.

The 97-key keyboards have three LEDs. Their default values are:

LED1 Net on all HMX series, X1 on all Explora series

LED2 Caps Lock

LED3 x3

To access the Boot Monitor from an N-97 keyboard when the X server is running, use the Left Alt-Caps Lock-Setup key combination.

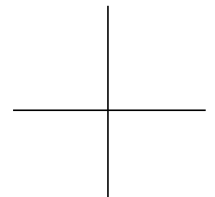

N-97 Keyboard Details

| | | | | | | | | | | | | | | | |
|-----------------|-----------|----------|----------|----------|----------|----------|----------|----------|-----------|-----------|-------------|--------------|-----------------|-------------------|--------------|
| F1 16 | F2 15 | F3 23 | F4 31 | F5 39 | F6 47 | F7 55 | F8 63 | F9 71 | F10 79 | F11 86 | F12 94 | Break 95 | Setup 98 | | |
| Esc 8 | ! 22 | @ 30 | # 38 | \$ 37 | % 46 | ^ 54 | & 61 | * 62 | (70 |) 69 | - 78 | + = 85 | ~ ` 14 | Back Space 102 | |
| Tab 13 | Q 21 | W 29 | E 36 | R 45 | T 44 | Y 53 | U 60 | I 67 | O 68 | P 77 | { [84 | }] 91 | \ 92 | Del 100 | |
| Ctrl 17 | A 28 | S 27 | D 35 | F 43 | G 52 | H 51 | J 59 | K 66 | L 75 | : ; 76 | “ ’ 82 | Return 90 | Line Feed 87 | | |
| Shift 18 | Z 26 | X 34 | C 33 | V 42 | B 50 | N 49 | M 58 | < , 65 | > . 73 | ? / 74 | Shift 89 | ↑ 99 | Option 88 | | |
| Caps Lock 20 | Alt 25 | | | | | | | | | | | Alt 57 | ← 97 | ↓ 96 | ⇒ 106 |
| | | | | | | | | | | | | PF1 118 | PF2 119 | PF3 126 | PF4 124 |
| | | | | | | | | | | | | 7 108 | 8 117 | 9 125 | - 132 |
| | | | | | | | | | | | | 4 107 | 5 115 | 6 116 | , 109 |
| | | | | | | | | | | | | 1 105 | 2 114 | 3 122 | Enter 121 |
| | | | | | | | | | | | | 0 112 | . 113 | | |

Figure 17-1 N-97 Keyboard Legends and Keycodes

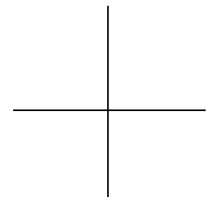

Table 17-2 N-97 Default Keymapping

| Keycode Value | Keysym | Shifted Keysym |
|---------------|-----------|----------------|
| 8 | Escape | |
| 9 | | |
| 10 | | |
| 11 | | |
| 12 | | |
| 13 | Tab | |
| 14 | quoteleft | asciitilde |
| 15 | F2 | |
| 16 | F1 | |
| 17 | Control_L | |
| 18 | Shift_L | |
| 19 | | |
| 20 | Caps_Lock | |
| 21 | q | Q |
| 22 | l | exclam |
| 23 | F3 | |
| 24 | | |
| 25 | Alt_L | Meta_L |
| 26 | z | Z |
| 27 | s | S |
| 28 | a | A |
| 29 | w | W |

17-6 Keyboards and Downloadable Keyboard Definitions

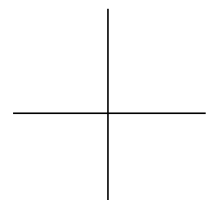

Table 17-2 N-97 Default Keymapping (Continued)

| Keycode Value | Keysym | Shifted Keysym |
|---------------|--------|----------------|
| 30 | 2 | at |
| 31 | F4 | |
| 32 | | |
| 33 | c | C |
| 34 | x | X |
| 35 | d | D |
| 36 | e | E |
| 37 | 4 | dollar |
| 38 | 3 | numbersign |
| 39 | F5 | |
| 40 | | |
| 41 | space | |
| 42 | v | V |
| 43 | f | F |
| 44 | t | T |
| 45 | r | R |
| 46 | 5 | percent |
| 47 | F6 | |
| 48 | | |
| 49 | n | N |
| 50 | b | B |
| 51 | h | H |
| 52 | g | G |

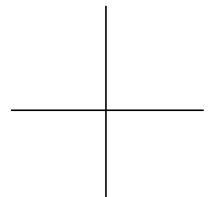

Table 17-2 N-97 Default Keymapping (Continued)

| Keycode Value | Keysym | Shifted Keysym |
|---------------|--------------------|---------------------|
| 53 | y | Y |
| 54 | 6 | asciicircum |
| 55 | F7 | |
| 56 | | |
| 57 | Alt_R ¹ | Meta_R ¹ |
| 58 | m | M |
| 59 | j | J |
| 60 | u | U |
| 61 | 7 | ampersand |
| 35 | d | D |
| 36 | e | E |
| 37 | 4 | dollar |
| 38 | 3 | numbersign |
| 39 | F5 | |
| 40 | | |
| 41 | space | |
| 42 | v | V |
| 43 | f | F |
| 44 | t | T |
| 45 | r | R |
| 46 | 5 | percent |
| 47 | F6 | |
| 48 | | |

17-8 Keyboards and Downloadable Keyboard Definitions

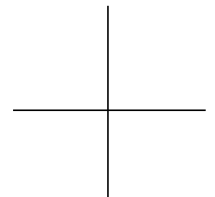

Table 17-2 N-97 Default Keymapping (Continued)

| Keycode Value | Keysym | Shifted Keysym |
|---------------|--------------------|---------------------|
| 49 | n | N |
| 50 | b | B |
| 51 | h | H |
| 52 | g | G |
| 53 | y | Y |
| 54 | 6 | asciicircum |
| 55 | F7 | |
| 56 | | |
| 57 | Alt_R ¹ | Meta_R ¹ |
| 58 | m | M |
| 59 | j | J |
| 60 | u | U |
| 61 | 7 | ampersand |
| 62 | 8 | asterisk |
| 63 | F8 | |
| 64 | | |
| 65 | comma | less |
| 66 | k | K |
| 67 | i | I |
| 68 | o | O |
| 69 | 0 | parenright |
| 70 | 9 | parenleft |
| 71 | F9 | |

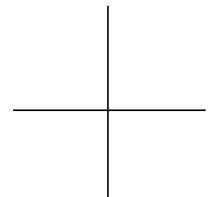

Table 17-2 N-97 Default Keymapping (Continued)

| Keycode Value | Keysym | Shifted Keysym |
|---------------|------------------------|----------------|
| 72 | | |
| 73 | period | greater |
| 74 | slash | question |
| 75 | l | L |
| 76 | semicolon | colon |
| 77 | p | P |
| 78 | minus | underscore |
| 79 | F10 | |
| 80 | | |
| 81 | | |
| 82 | quoteright | quotedbl |
| 83 | | |
| 84 | bracketleft | braceleft |
| 85 | equal | plus |
| 86 | F11 | |
| 87 | Linefeed | |
| 88 | Control_R ¹ | |
| 89 | Shift_R ¹ | |
| 90 | Return | |
| 91 | bracketright | braceright |
| 92 | backslash | bar |
| 93 | | |
| 94 | F12 | |

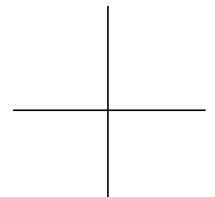

Table 17-2 N-97 Default Keymapping (Continued)

| Keycode Value | Keysym | Shifted Keysym |
|---------------|--------------|----------------|
| 95 | Break | |
| 96 | Down | |
| 97 | Left | |
| 98 | | |
| 99 | Up | |
| 100 | Delete | |
| 101 | | |
| 102 | BackSpace | |
| 103 | | |
| 104 | | |
| 105 | KP_1 | |
| 106 | Right | |
| 107 | KP_4 | |
| 108 | KP_7 | |
| 109 | KP_Separator | |
| 110 | | |
| 111 | | |
| 112 | KP_0 | |
| 113 | KP_Decimal | |
| 114 | KP_2 | |
| 115 | KP_5 | |
| 116 | KP_6 | |
| 117 | KP_8 | |

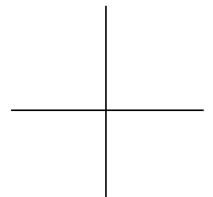
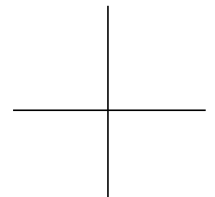

Table 17-2 N-97 Default Keymapping (Continued)

| Keycode Value | Keysym | Shifted Keysym |
|---------------|-------------|----------------|
| 118 | KP_F1 | |
| 119 | KP_F2 | |
| 120 | | |
| 121 | KP_Enter | |
| 122 | KP_3 | |
| 123 | | |
| 124 | KP_F4 | |
| 125 | KP_9 | |
| 126 | KP_F3 | |
| 127 | | |
| 128 | | |
| 129 | | |
| 130 | | |
| 131 | | |
| 132 | KP_Subtract | |

¹ If the `pref-compatibility-decwindows-keyboard` parameter is set to “true,” this right modifier is translated to a left modifier.



N-101 Keyboard Details

NCD has two US types of 101-key keyboards: the N-101 and the English US type. The English US is the same as the IBM PS/2 and the Windows 95-compatible (except for three Windows-specific keys).

Figure 17-2 illustrates the legends and keycodes for the N-101 type. The English US and Windows 95-compatible keyboards differ from the N-101 keyboard illustrated in Figure 17-2 as follows:

- ❑ The Caps Lock and Ctrl keys are swapped.
- ❑ The Line Feed key bears the legend “Print Screen.”
- ❑ The Break key bears the legend “Scroll Lock.”
- ❑ The Setup key bears the legend “Pause/Break.”
- ❑ The Return key bears the legend “Enter.”
- ❑ The Option key bears the label “Ctrl.”
- ❑ The Windows 95 keyboard has three additional keys: two “Windows” keys and one menu key.

Table 17-3 lists the N-101 and English US keysyms when default mapping is in effect.

The 101-key keyboards have three LEDs. Their default values are:

| | |
|------|---|
| LED1 | Net on all HMX series, X1 on all Explora series |
| LED2 | Caps |
| LED3 | Num |

To access the Boot Monitor from an N-101 keyboard when the X server is running, use the Ctrl-Left Alt-Setup key combination. To access the Boot Monitor from the 102-key, English US, IBM/PS2, and Windows 95-compatible versions, use CapsLock-Left Alt-Setup.

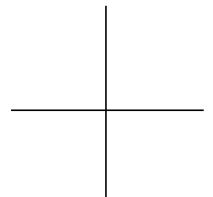

N-101 Keyboard Details

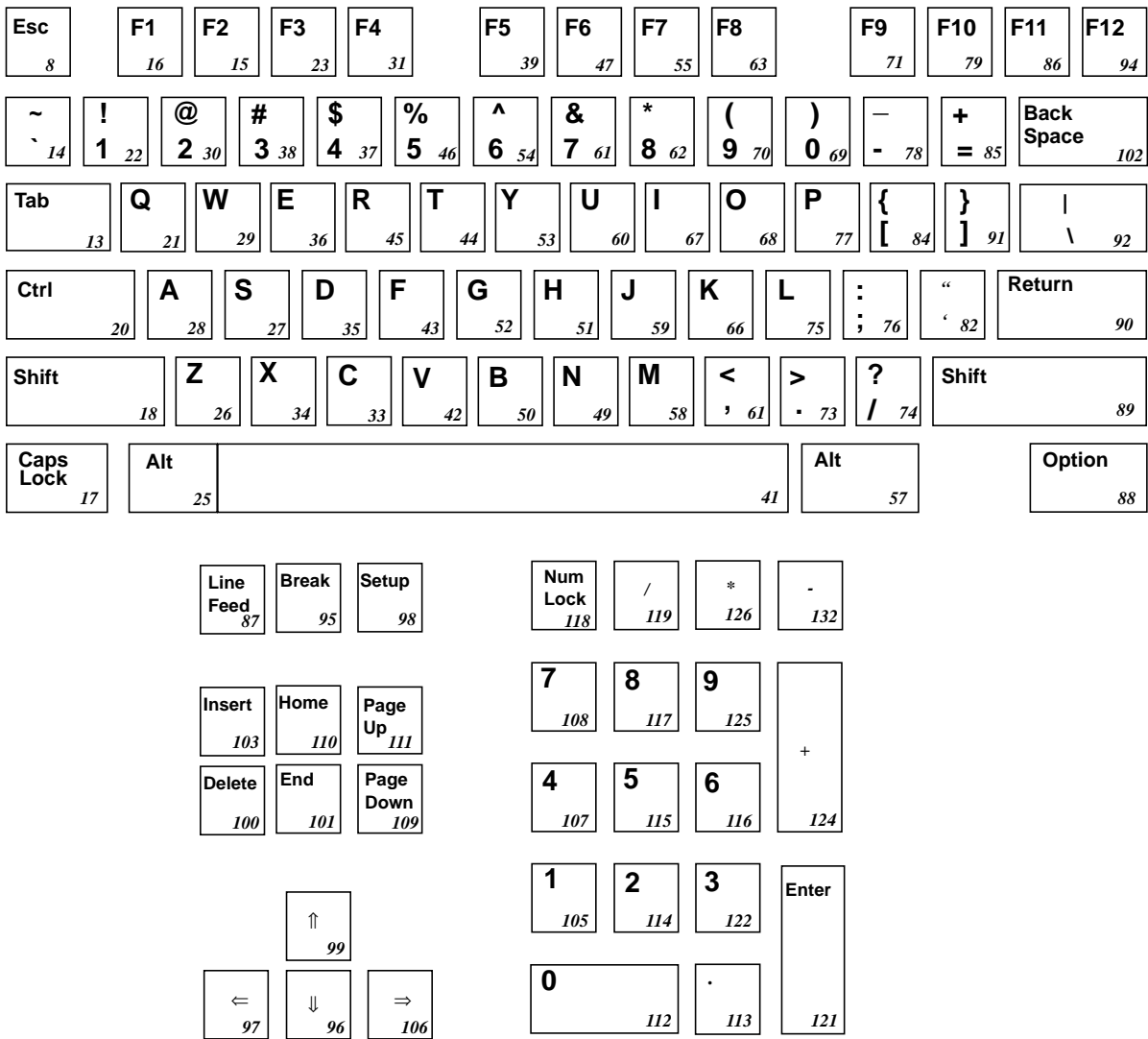

Figure 17-2 N-101 Default Keyboard Legends and Keycodes

17-14 Keyboards and Downloadable Keyboard Definitions

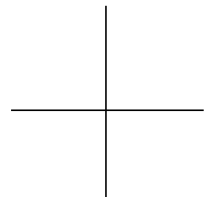

Table 17-3 N-101US and N-101PS Default Keymapping

| Keycode Value | Keysyms | Shifted Keysyms |
|---------------|--|-----------------|
| 8 | Escape | |
| 9 | | |
| 10 | | |
| 11 | | |
| 12 | | |
| 13 | Tab | |
| 14 | quoteleft | asciitilde |
| 15 | F2 | |
| 16 | F1 | |
| 17 | Caps_Lock (Control_L on the N-101PS and Windows 95-compatible) | |
| 18 | Shift_L | |
| 19 | | |
| 20 | Control_L (Caps_Lock on the N-101PS and Windows 95-compatible) | |
| 21 | Q | |
| 22 | 1 | exclam |
| 23 | F3 | |
| 24 | | |
| 25 | Alt_L | Meta_L |
| 26 | Z | |

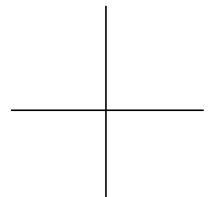

Table 17-3 N-101US and N-101PS Default Keymapping (Continued)

| Keycode Value | Keysyms | Shifted Keysyms |
|---------------|---------|-----------------|
| 27 | S | |
| 28 | A | |
| 29 | W | |
| 30 | 2 | at |
| 31 | F4 | |
| 32 | | |
| 33 | C | |
| 34 | X | |
| 35 | D | |
| 36 | E | |
| 37 | 4 | dollar |
| 38 | 3 | numbersign |
| 39 | F5 | |
| 40 | | |
| 41 | space | |
| 42 | V | |
| 43 | F | |
| 44 | T | |
| 45 | R | |
| 46 | 5 | percent |
| 47 | F6 | |
| 48 | | |
| 49 | N | |

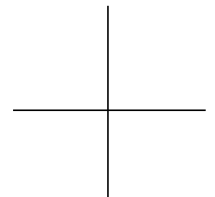

Table 17-3 N-101US and N-101PS Default Keymapping (Continued)

| Keycode Value | Keysyms | Shifted Keysyms |
|---------------|--------------------|---------------------|
| 50 | B | |
| 51 | H | |
| 52 | G | |
| 53 | Y | |
| 54 | 6 | asciicircum |
| 55 | F7 | |
| 56 | | |
| 57 | Alt_R ¹ | Meta_R ¹ |
| 58 | M | |
| 59 | J | |
| 60 | U | |
| 61 | 7 | ampersand |
| 62 | 8 | asterisk |
| 63 | F8 | |
| 64 | | |
| 65 | comma | less |
| 66 | K | |
| 67 | I | |
| 68 | O | |
| 69 | 0 | parenright |
| 70 | 9 | parenleft |
| 71 | F9 | |
| 72 | | |

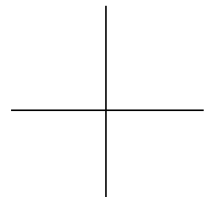

Table 17-3 N-101US and N-101PS Default Keymapping (Continued)

| Keycode Value | Keysyms | Shifted Keysyms |
|---------------|--|--|
| 73 | period | greater |
| 74 | slash | question |
| 75 | L | |
| 76 | semicolon | colon |
| 77 | P | |
| 78 | minus | underscore |
| 79 | F10 | |
| 80 | | |
| 81 | | |
| 82 | quoteright | quotedbl |
| 83 | | |
| 84 | bracketleft | braceleft |
| 85 | equal | plus |
| 86 | F11 | |
| 87 | Linefeed (Print Screen on the N-101PS and Windows 95-compatible) | |
| 88 | Control_R ¹ | |
| 89 | Shift_R ¹ | |
| 90 | Return | |
| 91 | bracketright | braceright |
| 92 | backslash | bar (unless bar and broken bar exist on same keyboard) |

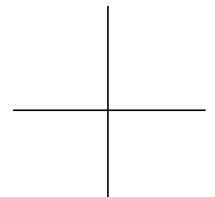

Table 17-3 N-101US and N-101PS Default Keymapping (Continued)

| Keycode Value | Keysyms | Shifted Keysyms |
|---------------|--|-----------------|
| 93 | | |
| 94 | F12 | |
| 95 | Break (Scroll Lock on the N-101PS and Windows 95-compatible) | |
| 96 | Down | |
| 97 | Left | |
| 98 | Setup | |
| 99 | Up | |
| 100 | Delete | |
| 101 | End | |
| 102 | Backspace | |
| 103 | Insert | |
| 104 | | |
| 105 | KP_1 | |
| 106 | Right | |
| 107 | KP_4 | |
| 108 | KP_7 | |
| 109 | Page Down | |
| 110 | Home | |
| 111 | Page Up | |
| 112 | KP_0 | |
| 113 | KP_Decimal | |

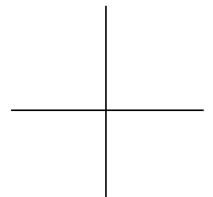
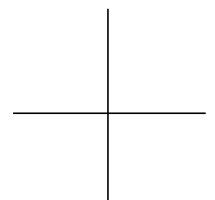

Table 17-3 N-101US and N-101PS Default Keymapping (Continued)

| Keycode Value | Keysyms | Shifted Keysyms |
|---------------|-------------|-----------------|
| 114 | KP_2 | |
| 115 | KP_5 | |
| 116 | KP_6 | |
| 117 | KP_8 | |
| 118 | Num_Lock | |
| 119 | KP_Divide | |
| 120 | | |
| 121 | KP_Enter | |
| 122 | KP_3 | |
| 123 | | |
| 124 | KP_Add | |
| 125 | KP_9 | |
| 126 | KP_Multiply | |
| 127 | | |
| 128 | | |
| 129 | | |
| 130 | | |
| 131 | | |
| 132 | KP_Subtract | |

¹ If the **pref-compatibility-decwindows-keyboard** parameter is set to true, this right modifier is translated to a left modifier.



VT220-Compatible and N-108 Keyboard Details

The VT220-compatible keyboard and N-108 keyboard are Digital-style keyboards that may be used with either VMS or ULTRIX keymaps. The default keymap differs depending on whether the server host is running the VMS or ULTRIX operating system. (See Table 17-4 and Table 17-5.)

VT220-Compatible Keyboard

Figure 17-3 illustrates the legends and keycodes on the US type of the VT220-compatible keyboard. The VT220-compatible keyboard has four LEDs. Their default values are:

| | |
|------|---|
| LED1 | Net on all HMX series, X1 on all Explora series |
| LED2 | Caps |
| LED3 | x2 |
| LED4 | x4 |

The Setup key combination for the VT220-compatible keyboard is Compose-F3. To access the Boot Monitor from a VT220-compatible keyboard after booting, use the Ctrl-Compose-F3 key combination.

N-108 Keyboard

Figure 17-4 illustrates the legends and keycodes of the N-108 keyboard.

The 108-key keyboards have four LEDs. Their default values are:

| | |
|------|---|
| LED1 | Net on all HMX series, X1 on all Explora series |
| LED2 | x2 |
| LED3 | Caps Lock |
| LED4 | x4 |

The Setup key combination for an N-108 keyboard is Alt-F3. To access the Boot Monitor from an N-108 keyboard after booting, use the Ctrl-Left Alt-F3 key combination.

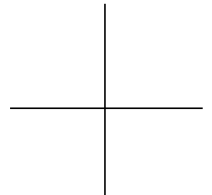

VT220-Compatible and N-108 Keyboard Details

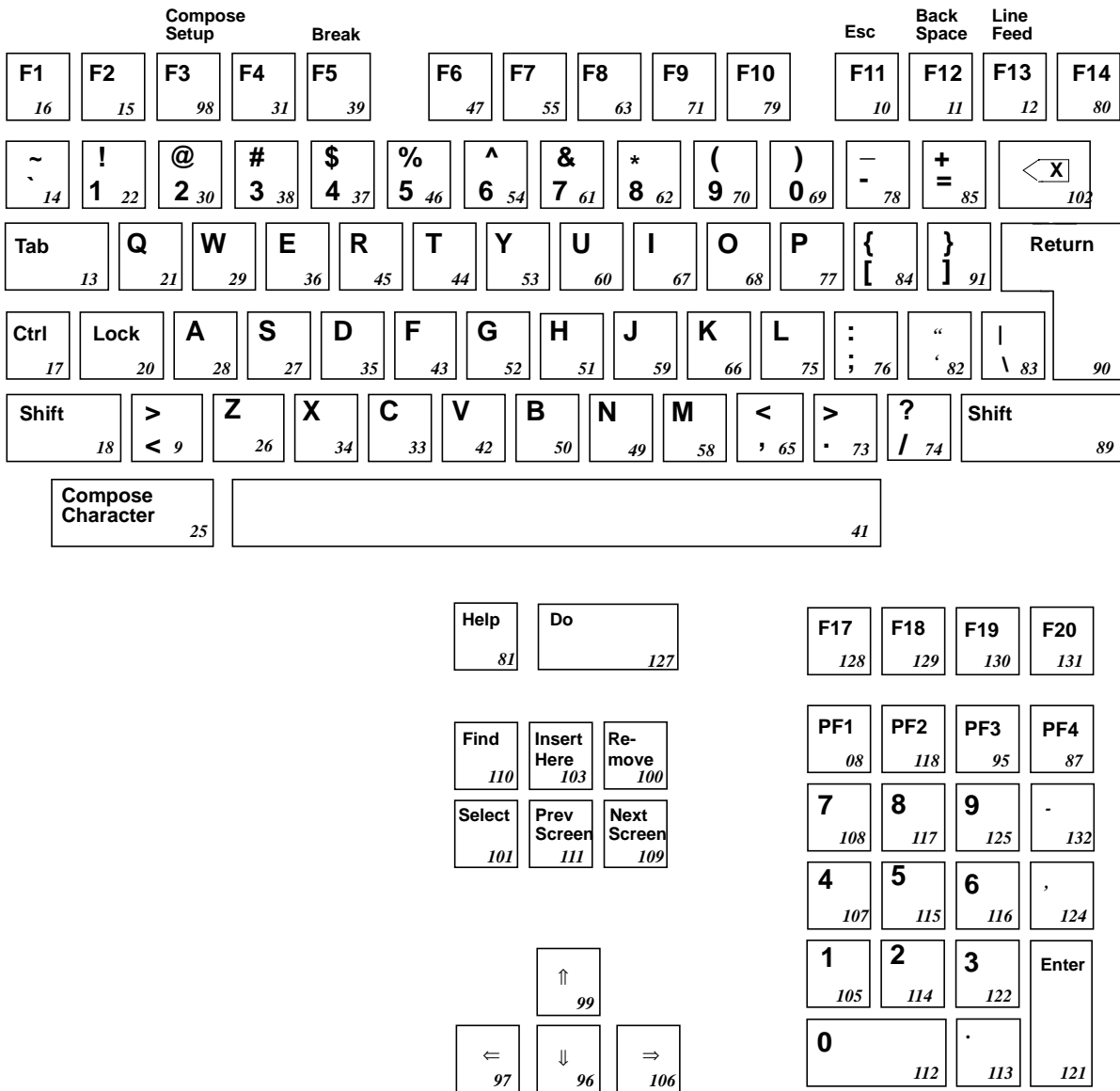
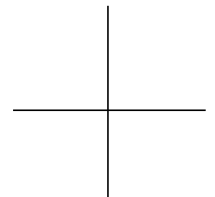

Figure 17-3 VT220-Compatible Keyboard Legends and Keycodes

17-22 Keyboards and Downloadable Keyboard Definitions



VT220-Compatible and N-108 Keyboard Details

| | | | | | | | | | | | | | | | |
|--------------------------|------------|----------|----------|----------|----------|----------|----------|----------|-----------|-----------|-----------|-------------|--------------------------|------------|-----------|
| Compose Setup | | | | | Break | | | | | Esc | | | | Back Space | Line Feed |
| F1 16 | F2 15 | F3 98 | F4 31 | F5 39 | F6 47 | F7 55 | F8 63 | F9 71 | F10 79 | F11 10 | F12 11 | F13 12 | F14 80 | | |
| ~ 14 | ! 22 | @ 30 | # 38 | \$ 37 | % 46 | ^ 54 | & 61 | * 62 | (70 |) 69 | - 78 | + 85 | X 102 | | |
| Tab 13 | Q 21 | W 29 | E 36 | R 45 | T 44 | Y 53 | U 60 | I 67 | O 68 | P 77 | { 84 | } 91 | Return 90 | | |
| Ctrl 17 | Lock 20 | A 28 | S 27 | D 35 | F 43 | G 52 | H 51 | J 59 | K 66 | L 75 | : 76 | " 82 | 83 | | |
| Shift 18 | > 9 | Z 26 | X 34 | C 33 | V 42 | B 50 | N 49 | M 58 | < 65 | > 73 | ? 74 | Shift 89 | | | |
| Compose Character 119 | Alt 25 | | | | | | | | | | | Alt 57 | Compose Character 120 | | |

| | | | | | |
|------------|-----------|------------|------------|------------|------------|
| Help 81 | Do 127 | F17 128 | F18 129 | F19 130 | F20 131 |
|------------|-----------|------------|------------|------------|------------|

| | | | | | | |
|---------------|--------------------|----------------|----------|------------|-----------|--------------|
| Find 110 | Insert Here 103 | Re-move 100 | PF1 8 | PF2 118 | PF3 95 | PF4 87 |
| Select 101 | Prev 111 | Next 109 | 7 108 | 8 117 | 9 125 | - 132 |
| | | | 4 107 | 5 115 | 6 116 | , 124 |
| | | | 1 105 | 2 114 | 3 122 | Enter 121 |
| | | | 0 112 | . 113 | | |

| | | |
|---------|---------|----------|
| | ↑ 99 | |
| ← 97 | ↓ 96 | ⇒ 106 |

Figure 17-4 N-108 Keyboard Legends and Keycodes

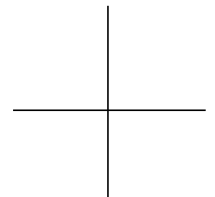

Table 17-4 VT220-Compatible/N-108 Default Keysyms for ULTRIX

| Keycode Value | Keysym | Shifted Keysym |
|---------------|-----------|----------------|
| 8 | KP_PF1 | |
| 9 | less | greater |
| 10 | Escape | |
| 11 | Backspace | |
| 12 | Linefeed | |
| 13 | Tab | |
| 14 | quoteleft | asciitilde |
| 15 | F2 | |
| 16 | F1 | |
| 17 | Control_L | |
| 18 | Shift_L | |
| 19 | | |
| 20 | Caps_Lock | |
| 21 | Q | |
| 22 | 1 | exclam |
| 23 | | |
| 24 | | |
| 25 | Alt_L | Meta_L |
| 26 | Z | |
| 27 | S | |
| 28 | A | |
| 29 | W | |

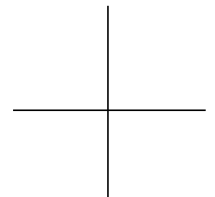

Table 17-4 VT220-Compatible/N-108 Default Keysyms for ULTRIX (Continued)

| Keycode Value | Keysym | Shifted Keysym |
|---------------|--------|----------------|
| 30 | 2 | at |
| 31 | F4 | |
| 32 | | |
| 33 | C | |
| 34 | X | |
| 35 | D | |
| 36 | E | |
| 37 | 4 | dollar |
| 38 | 3 | numbersign |
| 39 | F5 | |
| 40 | | |
| 41 | space | |
| 42 | V | |
| 43 | F | |
| 44 | T | |
| 45 | R | |
| 46 | 5 | percent |
| 47 | F6 | |
| 48 | | |
| 49 | N | |
| 50 | B | |
| 51 | H | |
| 52 | G | |

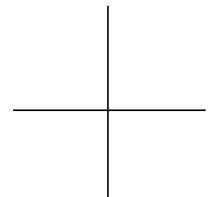

Table 17-4 VT220-Compatible/N-108 Default Keysyms for ULTRIX (Continued)

| Keycode Value | Keysym | Shifted Keysym |
|---------------|----------------------|-----------------------|
| 53 | Y | |
| 54 | 6 | asciicircum |
| 55 | F7 | |
| 56 | | |
| 57 | Alt_R ^{1 2} | Meta_R ^{1 2} |
| 58 | M | |
| 59 | J | |
| 60 | U | |
| 61 | 7 | ampersand |
| 62 | 8 | asterisk |
| 63 | F8 | |
| 64 | | |
| 65 | comma | less |
| 66 | K | |
| 67 | I | |
| 68 | O | |
| 69 | 0 | parenright |
| 70 | 9 | parenleft |
| 71 | F9 | |
| 72 | | |
| 73 | period | greater |
| 74 | slash | question |
| 75 | L | |

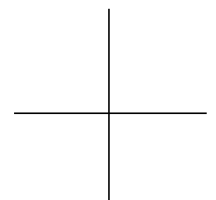

Table 17-4 VT220-Compatible/N-108 Default Keysyms for ULTRIX (Continued)

| Keycode Value | Keysym | Shifted Keysym |
|---------------|----------------------|----------------|
| 76 | semicolon | colon |
| 77 | P | |
| 78 | minus | underscore |
| 79 | F10 | |
| 80 | F14 | |
| 81 | Help | |
| 82 | quoteright | quotedbl |
| 83 | backslash | bar |
| 84 | bracketleft | braceleft |
| 85 | equal | plus |
| 86 | | |
| 87 | KP_F4 | |
| 88 | | |
| 89 | Shift_R ¹ | |
| 90 | Return | |
| 91 | bracketright | braceright |
| 92 | | |
| 93 | | |
| 94 | | |
| 95 | KP_F3 | |
| 96 | Down | |
| 97 | Left | |
| 98 | F3 | |

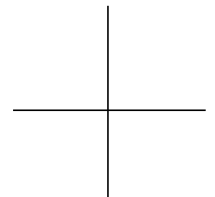

Table 17-4 VT220-Compatible/N-108 Default Keysyms for ULTRIX (Continued)

| Keycode Value | Keysym | Shifted Keysym |
|---------------|------------------------|----------------|
| 99 | Up | |
| 100 | Remove | |
| 101 | Select | |
| 102 | Delete | |
| 103 | Insert | |
| 104 | | |
| 105 | KP_1 | |
| 106 | Right | |
| 107 | KP_4 | |
| 108 | KP_7 | |
| 109 | Next | |
| 110 | Find | |
| 111 | Prior | |
| 112 | KP_0 | |
| 113 | KP_Decimal | |
| 114 | KP_2 | |
| 115 | KP_5 | |
| 116 | KP_6 | |
| 117 | KP_8 | |
| 118 | KP_F2 | |
| 119 | Multi_Key ² | |
| 120 | Multi_Key ² | |
| 121 | KP_Enter | |

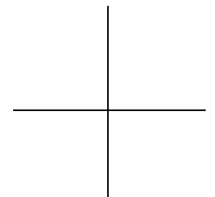

Table 17-4 VT220-Compatible/N-108 Default Keysyms for ULTRIX (Continued)

| Keycode Value | Keysym | Shifted Keysym |
|---------------|--------------|----------------|
| 122 | KP_3 | |
| 123 | | |
| 124 | KP_Separator | |
| 125 | KP_9 | |
| 126 | | |
| 127 | Menu | |
| 128 | F17 | |
| 129 | F18 | |
| 130 | F19 | |
| 131 | F20 | |
| 132 | KP_Subtract | |

¹ If the **pref-compatibility-decwindows-keyboard** parameter is set to “true,” this right modifier is translated to a left modifier.

² This keysym exists only for the N-108 keyboard.

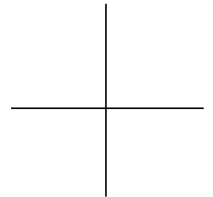

Table 17-5 VT220-Compatible/N-108 Keysyms for VMS

| Keycode Value | Keysym | Shifted Keysym |
|---------------|-----------|----------------|
| 8 | KP_PF1 | |
| 9 | less | greater |
| 10 | F11 | |
| 11 | F12 | |
| 12 | F13 | |
| 13 | Tab | |
| 14 | quoteleft | asciitilde |
| 15 | F2 | |
| 16 | F1 | |
| 17 | Control_L | |
| 18 | Shift_L | |
| 19 | | |
| 20 | Caps_Lock | |
| 21 | Q | |
| 22 | 1 | exclam |
| 23 | | |
| 24 | | |
| 25 | Alt_L | Meta_L |
| 26 | Z | |
| 27 | S | |
| 28 | A | |
| 29 | W | |
| 30 | 2 | at |

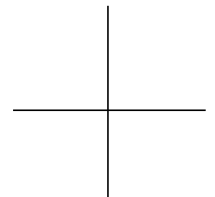

Table 17-5 VT220-Compatible/N-108 Keysyms for VMS (Continued)

| Keycode Value | Keysym | Shifted Keysym |
|---------------|--------|----------------|
| 31 | F4 | |
| 32 | | |
| 33 | C | |
| 34 | X | |
| 35 | D | |
| 36 | E | |
| 37 | 4 | dollar |
| 38 | 3 | numbersign |
| 39 | F5 | |
| 40 | | |
| 41 | space | |
| 42 | V | |
| 43 | F | |
| 44 | T | |
| 45 | R | |
| 46 | 5 | percent |
| 47 | F6 | |
| 48 | | |
| 49 | N | |
| 50 | B | |
| 51 | H | |
| 52 | G | |
| 53 | Y | |

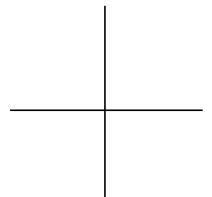

Table 17-5 VT220-Compatible/N-108 Keysyms for VMS (Continued)

| Keycode Value | Keysym | Shifted Keysym |
|---------------|----------------------|-----------------------|
| 54 | 6 | asciicircum |
| 55 | F7 | |
| 56 | | |
| 57 | Alt_R ^{1 2} | Meta_R ^{1 2} |
| 58 | M | |
| 59 | J | |
| 60 | U | |
| 61 | 7 | ampersand |
| 62 | 8 | asterisk |
| 63 | F8 | |
| 64 | | |
| 65 | comma | less |
| 66 | K | |
| 67 | I | |
| 68 | O | |
| 69 | 0 | parenright |
| 70 | 9 | parenleft |
| 71 | F9 | |
| 72 | | |
| 73 | period | greater |
| 74 | slash | question |
| 75 | L | |
| 76 | semicolon | colon |

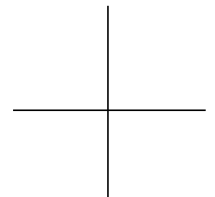

Table 17-5 VT220-Compatible/N-108 Keysyms for VMS (Continued)

| Keycode Value | Keysym | Shifted Keysym |
|---------------|----------------------|----------------|
| 77 | P | |
| 78 | minus | underscore |
| 79 | F10 | |
| 80 | F14 | |
| 81 | Help | |
| 82 | quoteright | quotedbl |
| 83 | backslash | bar |
| 84 | bracketleft | braceleft |
| 85 | equal | plus |
| 86 | | |
| 87 | KP_F4 | |
| 88 | | |
| 89 | Shift_R ¹ | |
| 90 | Return | |
| 91 | bracketright | braceright |
| 92 | | |
| 93 | | |
| 94 | | |
| 95 | KP_F3 | |
| 96 | Down | |
| 97 | Left | |
| 98 | F3 | |
| 99 | Up | |

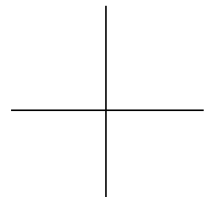

Table 17-5 VT220-Compatible/N-108 Keysyms for VMS (Continued)

| Keycode Value | Keysym | Shifted Keysym |
|---------------|------------|----------------|
| 100 | Remove | |
| 101 | Select | |
| 102 | Delete | |
| 103 | Insert | |
| 104 | | |
| 105 | KP_1 | |
| 106 | Right | |
| 107 | KP_4 | |
| 108 | KP_7 | |
| 109 | Next | |
| 110 | Find | |
| 111 | Prior | |
| 112 | KP_0 | |
| 113 | KP_Decimal | |
| 114 | KP_2 | |
| 115 | KP_5 | |
| 116 | KP_6 | |
| 117 | KP_8 | |
| 118 | KP_F2 | |
| 119 | Multi_key† | |
| 120 | Multi_key† | |
| 121 | KP_Enter | |
| 122 | KP_3 | |

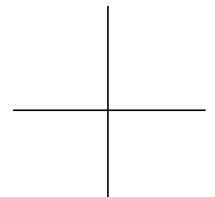
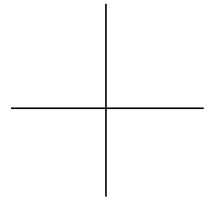

Table 17-5 VT220-Compatible/N-108 Keysyms for VMS (Continued)

| Keycode Value | Keysym | Shifted Keysym |
|---------------|--------------|----------------|
| 123 | | |
| 124 | KP_Separator | |
| 125 | KP_9 | |
| 126 | | |
| 127 | Menu | |
| 128 | F17 | |
| 129 | F18 | |
| 130 | F19 | |
| 131 | F20 | |
| 132 | KP_Subtract | |

¹ If the **pref-compatibility-decwindows-keyboard** parameter is set to “true,” this right modifier is translated to a left modifier.

² This keysym exists only for the N-108 keyboard.



N-107 Sun Type 4-Compatible Keyboard Details

Figure 17-5 illustrates the N-107 keyboard legends and keycodes.

Table 17-6 lists the N-107 keysyms when the default mapping is in use.

An N-107 keyboard has four LEDs built into keycaps. Their default values are:

| | |
|------|---|
| LED1 | Net on HMX series, X1 on all Explora series |
| LED2 | Num Lock |
| LED3 | Caps Lock |
| LED4 | x4 |

To access the Boot Monitor from the N-107 keyboard after booting, use the Stop-A (L1-A) key combination.

The Setup key combination for the N-107 keyboard is Alt Graph Help/Setup.

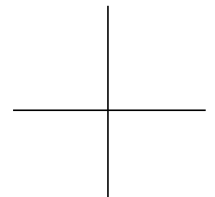

N-107 Sun Type 4-Compatible Keyboard Details

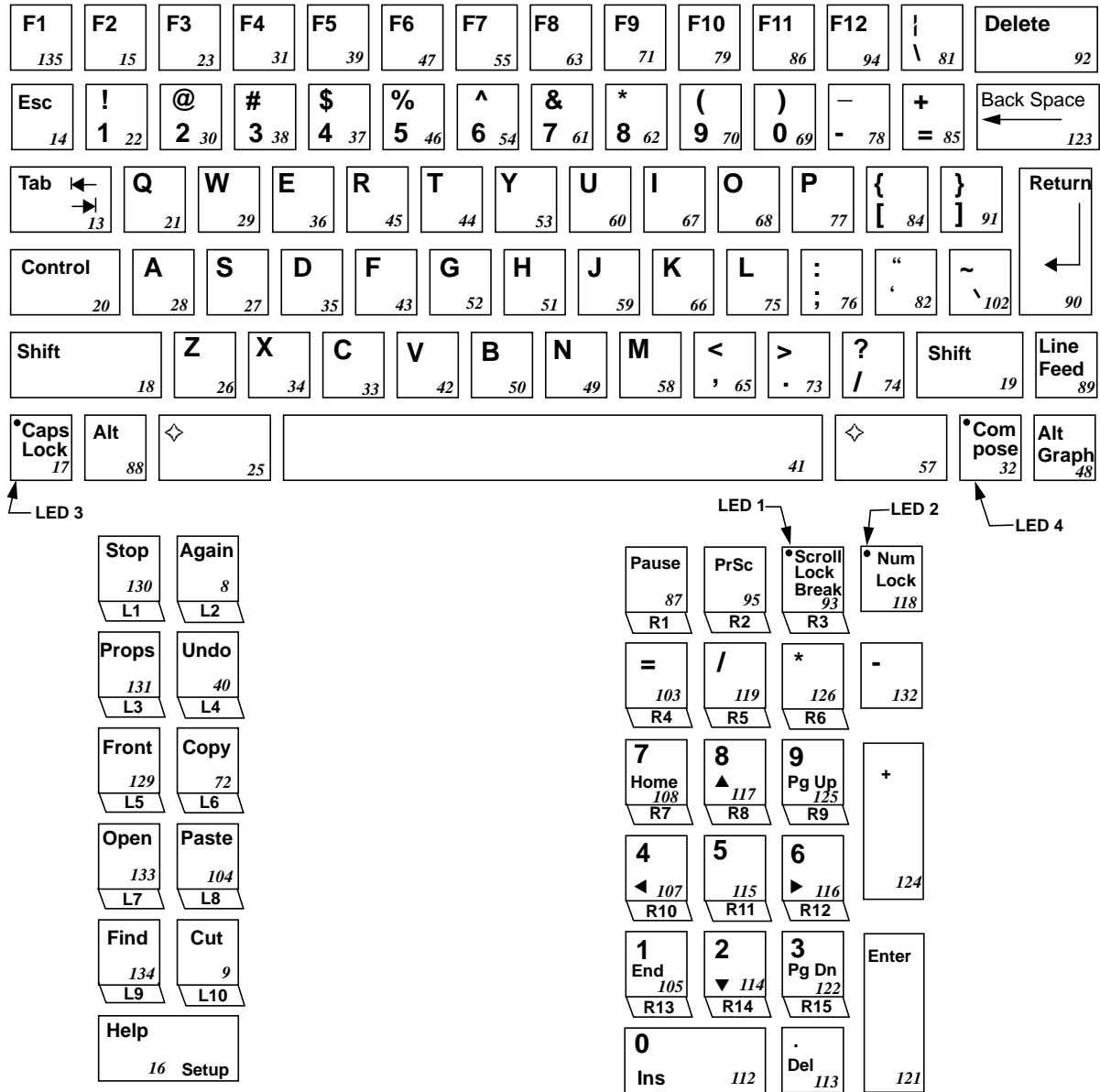

Figure 17-5 N-107 Default Keyboard Legends and Keycodes

Table 17-6 N-107 Default Keymapping

| Keycode Value | Keysym | Shifted Keysym | Alt Keysym | Shifted Alt Keysym |
|----------------|-----------|----------------|------------|--------------------|
| 8 ¹ | F12 | F12 | Redo | |
| 9 | F20 | F20 | SunCut | |
| 10 | | | | |
| 11 | | | | |
| 12 | | | | |
| 13 | Tab | | | |
| 14 | Escape | | | |
| 15 | F2 | | | |
| 16 | Help | | | |
| 17 | Caps_Lock | | | |
| 18 | Shift_L | | | |
| 19 | Shift_R | | | |
| 20 | Control_L | | | |
| 21 | Q | | | |
| 22 | 1 | exclam | | |
| 23 | F3 | | | |
| 24 | | | | |
| 25 | Meta_L | | | |
| 26 | Z | | | |
| 27 | X | | | |
| 28 | A | | | |
| 29 | W | | | |

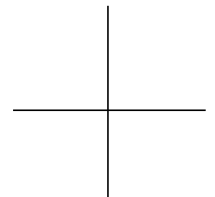
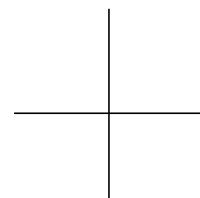

Table 17-6 N-107 Default Keymapping (Continued)

| Keycode Value | Keysym | Shifted Keysym | Alt Keysym | Shifted Alt Keysym |
|---------------|-------------|----------------|------------|--------------------|
| 30 | 2 | at | | |
| 31 | F4 | | | |
| 32 | Multi_key | | | |
| 33 | C | | | |
| 34 | X | | | |
| 35 | D | | | |
| 36 | E | | | |
| 37 | 4 | dollar | | |
| 38 | 3 | numbersign | | |
| 39 | F5 | | | |
| 40 | F14 | F14 | Undo | |
| 41 | Space | | | |
| 42 | V | | | |
| 43 | F | | | |
| 44 | T | | | |
| 45 | R | | | |
| 46 | 5 | percent | | |
| 47 | F6 | | | |
| 48 | Mode_switch | | | |
| 49 | N | | | |
| 50 | B | | | |
| 51 | H | | | |
| 52 | G | | | |



N-107 Sun Type 4-Compatible Keyboard Details

Table 17-6 N-107 Default Keymapping (Continued)

| Keycode Value | Keysym | Shifted Keysym | Alt Keysym | Shifted Alt Keysym |
|---------------|--------|----------------|------------|--------------------|
| 53 | Y | | | |
| 54 | 6 | asciicircum | | |
| 55 | F7 | | | |
| 56 | | | | |
| 57 | Meta_R | | | |
| 58 | M | | | |
| 59 | J | | | |
| 60 | U | | | |
| 61 | 7 | ampersand | | |
| 62 | 8 | asterisk | | |
| 63 | F8 | | | |
| 64 | | | | |
| 65 | comma | less | | |
| 66 | K | | | |
| 67 | I | | | |
| 68 | O | | | |
| 69 | 0 | parenright | | |
| 70 | 9 | parenleft | | |
| 71 | F9 | | | |
| 72 | F16 | F16 | SunCopy | |
| 73 | period | greater | | |
| 74 | slash | question | | |
| 75 | L | | | |

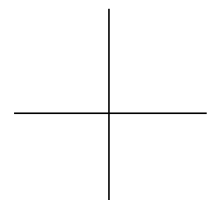
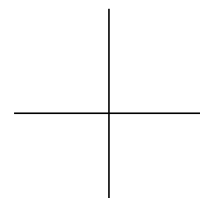

Table 17-6 N-107 Default Keymapping (Continued)

| Keycode Value | Keysym | Shifted Keysym | Alt Keysym | Shifted Alt Keysym |
|-----------------|--------------|----------------|-------------|--------------------|
| 76 | semicolon | colon | | |
| 77 | P | | | |
| 78 | minus | underscore | | |
| 79 | F10 | | | |
| 80 | | | | |
| 81 | backslash | bar | | |
| 82 | quoteleft | quotedbl | | |
| 83 | | | | |
| 84 | bracketleft | braceleft | | |
| 85 | equal | plus | | |
| 86 ¹ | SunF36 | | | |
| 87 | F21 | F21 | Pause | |
| 88 | Alt_L | | | |
| 89 | Line Feed | | | |
| 90 | Return | | | |
| 91 | bracketright | braceright | | |
| 92 | Delete | | | |
| 93 | F23 | F23 | Scroll_Lock | Break |
| 94 ¹ | SunF37 | | | |
| 95 | F22 | F22 | Print | |
| 96 | | | | |
| 97 | | | | |
| 98 | | | | |



N-107 Sun Type 4-Compatible Keyboard Details

Table 17-6 N-107 Default Keymapping (Continued)

| Keycode Value | Keysym | Shifted Keysym | Alt Keysym | Shifted Alt Keysym |
|---------------|------------|----------------|------------|--------------------|
| 99 | | | | |
| 100 | | | | |
| 101 | | | | |
| 102 | quoteright | asciitilde | | |
| 103 | F24 | F24 | KP_Equal | |
| 104 | F18 | F18 | SunPaste | |
| 105 | F33 | F33 | KP_1 | End |
| 106 | | | | |
| 107 | Left | F30 | KP_4 | |
| 108 | F27 | F27 | KP_7 | Home |
| 109 | | | | |
| 110 | | | | |
| 111 | | | | |
| 112 | Insert | Insert | KP_0 | |
| 113 | Delete | Delete | KP_Decimal | |
| 114 | Down | F34 | KP_2 | |
| 115 | F31 | F31 | KP_5 | |
| 116 | Right | F32 | KP_6 | |
| 117 | Up | F28 | KP_8 | |
| 118 | Num_Lock | | | |
| 119 | F25 | F25 | KP_Divide | |
| 120 | | | | |
| 121 | KP_Enter | | | |

17-42 Keyboards and Downloadable Keyboard Definitions

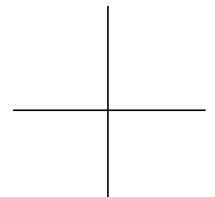
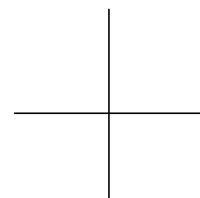

Table 17-6 N-107 Default Keymapping (Continued)

| Keycode Value | Keysym | Shifted Keysym | Alt Keysym | Shifted Alt Keysym |
|------------------|-------------|----------------|-------------|--------------------|
| 122 | F35 | F35 | KP_3 | Next |
| 123 | Back Space | | | |
| 124 | KP_Add | | | |
| 125 | F29 | F29 | KP_9 | Prior |
| 126 | F26 | F26 | KP_Multiply | |
| 127 | | | | |
| 128 | | | | |
| 129 | F15 | F15 | SunFront | |
| 130 ¹ | F11 | F11 | Cancel | |
| 131 | F13 | F13 | SunProp | |
| 132 | KP_Subtract | | | |
| 133 | F17 | F17 | SunOpen | |
| 134 | F19 | F19 | Find | |
| 135 | Help | | | |

¹ OpenWindows compatibility necessitates that these keycodes do not match the key legends: F12 for keycode 8, SunF36 for keycode 86, SunF37 for keycode 94, and F11 for keycode 130.



N-123 Sun Type 5-Compatible Keyboard Details

N-123 Sun Type 5-compatible keyboard group contains 123-key keyboards.

Figure 17-6 illustrates the key legends and keycodes for the N-123 US (North American) type (N-123NA).

Table 17-7 lists the keysyms for an N-123NA keyboard when used with OpenWindows.

N-123 keyboards have four LEDs. Their default values are:

LED 1 Net on HMX series, X1 on all Explora series

LED 2 Caps lock

LED 3 Num lock

LED 4 x4

To access the Boot Monitor from an N-123 keyboard after booting, use the Stop A (L1-A) key combination.

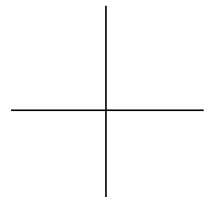

N-123 Sun Type 5-Compatible Keyboard Details

| | | | | | | | | | | | | | |
|-----------------|-----------|-----------|-----------|------------|-----------|-----------|-----------|-----------|-----------|-----------|-----------------|-----------------|---------------------|
| Esc 08 | F1 135 | F2 15 | F3 23 | F4 31 | F5 39 | F6 47 | F7 55 | F8 63 | F9 71 | F10 79 | F11 86 | F12 94 | |
| ~ ' 14 | ! 1 22 | @ 2 30 | # 3 38 | \$ 4 37 | % 5 46 | ^ 6 54 | & 7 61 | * 8 62 | (9 70 |) 0 69 | - _ 78 | + = 85 | Back Space ← 102 |
| Tab ↔ 13 | Q 21 | W 29 | E 36 | R 45 | T 44 | Y 53 | U 60 | I 67 | O 68 | P 77 | { [84 | }] 91 | \ 92 |
| Caps Lock 20 | A 28 | S 27 | D 35 | F 43 | G 52 | H 51 | J 59 | K 66 | L 75 | : ; 76 | " ' 82 | Enter ↵ 90 | |
| Shift ↑ 18 | Z 26 | X 34 | C 33 | V 42 | B 50 | N 49 | M 58 | < , 65 | > . 73 | ? / 74 | Shift ↑ 89 | | |
| Control 17 | Alt 25 | ◆ 64 | | | | | | ◆ 41 | | ◆ 72 | Com- pose 57 | Alt Graph 88 | |

| | | | | | | | | |
|-------------|---------------------------------|----------------------|----------------------|---------------------|--------------------|-----------------|-------------------|----------|
| Help 09 | Print Screen Sys Rq 87 | Scroll Lock 95 | Pause Break 98 | 80 | 81 | 83 | Setup 93 | |
| Stop 10 | Again 11 | Insert 103 | Home 110 | Page Up 111 | Num Lock 118 | / 119 | * 126 | - 132 |
| Props 12 | Undo 16 | Del 100 | End 101 | Page Down 109 | 7 Home 108 | 8 ↑ 117 | 9 Pg Up 125 | + |
| Front 19 | Copy 24 | 128 | 129 | 130 | 4 ← 107 | 5 115 | 6 ⇒ 116 | 124 |
| Open 32 | Paste 40 | 127 | ↑ 99 | 131 | 1 End 105 | 2 ↓ 114 | 3 Pg Dn 122 | Enter |
| Find 48 | Cut 56 | ← 97 | ↓ 96 | ⇒ 106 | 0 Ins 112 | · Del 113 | 121 | |

Figure 17-6 N-123 Default Keyboard Legends and Keycodes

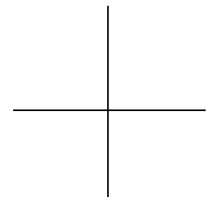

Table 17-7 N-123NA Keycodes and Keysyms with OpenWindows

| Keycode Value | Keysym | Shifted Keysym | Alt Keysym | Shifted Alt Keysym |
|-----------------|-----------|----------------|------------|--------------------|
| 8 | Escape | | | |
| 9 | Help | | | |
| 10 ¹ | F11 | F11 | Cancel | |
| 11 ¹ | F12 | F12 | Redo | |
| 12 | F13 | F13 | SunProps | |
| 13 | Tab | | | |
| 14 | grave | asciitilde | | |
| 15 | F2 | | | |
| 16 | F14 | F14 | Undo | |
| 17 | Control_L | | | |
| 18 | Shift_L | | | |
| 19 | F15 | F15 | SunFront | |
| 20 | Caps_Lock | | | |
| 21 | Q | | | |
| 22 | 1 | exclam | | |
| 23 | F3 | | | |
| 24 | F16 | F16 | SunCopy | |
| 25 | Alt_L | | | |
| 26 | Z | | | |
| 27 | S | | | |
| 28 | A | | | |
| 29 | W | | | |

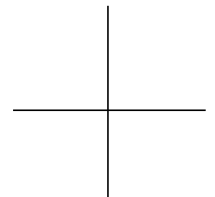
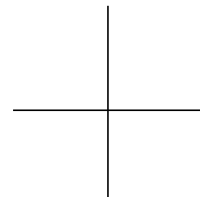

Table 17-7 N-123NA Keycodes and Keysyms with OpenWindows (Continued)

| Keycode Value | Keysym | Shifted Keysym | Alt Keysym | Shifted Alt Keysym |
|---------------|--------|----------------|------------|--------------------|
| 30 | 2 | at | | |
| 31 | F4 | | | |
| 32 | F17 | F17 | SunOpen | |
| 33 | C | | | |
| 34 | X | | | |
| 35 | D | | | |
| 36 | E | | | |
| 37 | 4 | dollar | | |
| 38 | 3 | numbersign | | |
| 39 | F5 | | | |
| 40 | F18 | F18 | SunPaste | |
| 41 | space | | | |
| 42 | V | | | |
| 43 | F | | | |
| 44 | T | | | |
| 45 | R | | | |
| 46 | 5 | percent | | |
| 47 | F6 | | | |
| 48 | F19 | F19 | Find | |
| 49 | N | | | |
| 50 | B | | | |
| 51 | H | | | |
| 52 | G | | | |



N-123 Sun Type 5-Compatible Keyboard Details

Table 17-7 N-123NA Keycodes and Keysyms with OpenWindows (Continued)

| Keycode Value | Keysym | Shifted Keysym | Alt Keysym | Shifted Alt Keysym |
|---------------|-----------|----------------|------------|--------------------|
| 53 | Y | | | |
| 54 | 6 | asciicircum | | |
| 55 | F7 | | | |
| 56 | F20 | F20 | SunCut | |
| 57 | Multi_key | | | |
| 58 | M | | | |
| 59 | J | | | |
| 60 | U | | | |
| 61 | 7 | ampersand | | |
| 62 | 8 | asterisk | | |
| 63 | F8 | | | |
| 64 | Meta_L | | | |
| 65 | comma | less | | |
| 66 | K | | | |
| 67 | I | | | |
| 68 | O | | | |
| 69 | 0 | parenright | | |
| 70 | 9 | parenleft | | |
| 71 | F9 | | | |
| 72 | Meta_R | | | |
| 73 | period | greater | | |
| 74 | slash | question | | |
| 75 | L | | | |

17-48 Keyboards and Downloadable Keyboard Definitions

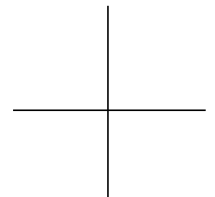
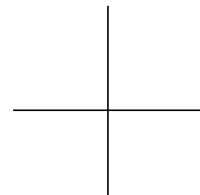

Table 17-7 N-123NA Keycodes and Keysyms with OpenWindows (Continued)

| Keycode Value | Keysym | Shifted Keysym | Alt Keysym | Shifted Alt Keysym |
|-----------------|-----------------------|----------------|-------------|--------------------|
| 76 | semicolon | colon | | |
| 77 | P | | | |
| 78 | minus | underscore | | |
| 79 | F10 | | | |
| 80 | no assigned keysym | | | |
| 81 | no assigned keysym | | | |
| 82 | apostrophe | quotedbl | | |
| 83 | no assigned keysym | | | |
| 84 | bracketleft | braceleft | | |
| 85 | equal | plus | | |
| 86 ¹ | SunF36 | | | |
| 87 | F22 | F22 | Print | SunSys_Req |
| 88 | Mode_switch | | | |
| 89 | Shift_R | | | |
| 90 | Return | | | |
| 91 | bracketright | braceright | | |
| 92 | backslash | bar | brokenbar | |
| 93 | WYSetup ³ | | | |
| 94 ¹ | SunF37 | | | |
| 95 | F23 | F23 | Scroll_Lock | |
| 96 | Down | | | |



N-123 Sun Type 5-Compatible Keyboard Details**Table 17-7 N-123NA Keycodes and Keysyms with OpenWindows (Continued)**

| Keycode Value | Keysym | Shifted Keysym | Alt Keysym | Shifted Alt Keysym |
|---------------|-----------|----------------|------------|--------------------|
| 97 | Left | | | |
| 98 | F21 | F21 | Pause | Break |
| 99 | Up | | | |
| 100 | Delete | | | |
| 101 | End | | | |
| 102 | Backspace | | | |
| 103 | Insert | | | |
| 104 | | | | |
| 105 | F33 | F33 | KP_1 | End |
| 106 | Right | | | |
| 107 | Left | F30 | KP_4 | |
| 108 | F27 | F27 | KP_7 | Home |
| 109 | Next | | | |
| 110 | Home | | | |
| 111 | Prior | | | |
| 112 | Insert | Insert | KP_0 | |
| 113 | Delete | Delete | KP_Decimal | |
| 114 | Down | F34 | KP_2 | |
| 115 | F31 | F31 | KP_5 | |
| 116 | Right | F32 | KP_6 | |
| 117 | Up | F28 | KP_8 | |
| 118 | Num_Lock | | | |
| 119 | F25 | F25 | KP_Divide | |

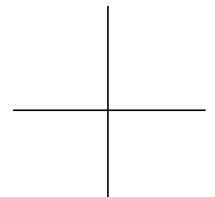

Table 17-7 N-123NA Keycodes and Keysyms with OpenWindows (Continued)

| Keycode Value | Keysym | Shifted Keysym | Alt Keysym | Shifted Alt Keysym |
|------------------|------------------------|----------------|-------------|--------------------|
| 120 ² | | | | |
| 121 | KP_Enter | | | |
| 122 | F35 | F35 | KP_3 | Next |
| 123 | | | | |
| 124 | KP_Add | | | |
| 125 | F29 | F29 | KP_9 | Prior |
| 126 | F26 | F26 | KP_Multiply | |
| 127 | no assigned keysyms | | | |
| 128 | no assigned keysyms | | | |
| 129 | no assigned keysyms | | | |
| 130 | no assigned keysyms | | | |
| 131 | no assigned keysyms | | | |
| 132 | F24 | F24 | KP_Subtract | |
| 133 | | | | |
| 134 | | | | |
| 135 | F1 | | | |

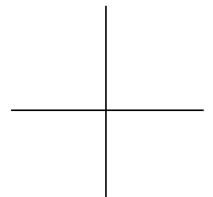

Table 17-7 N-123NA Keycodes and Keysyms with OpenWindows (Continued)

| Keycode Value | Keysym | Shifted Keysym | Alt Keysym | Shifted Alt Keysym |
|---|-------------|----------------|------------|--------------------|
| Keycodes 218 through 248 are used only for compose sequences that create European characters not available on North American keyboards. | | | | |
| 218 | agrave | Agrave | | |
| 219 | egrave | Egrave | | |
| 220 | igrave | Igrave | | |
| 221 | ograve | Ograve | | |
| 222 | ugrave | Ugrave | | |
| 223 | grave | | | |
| 224 | acircumflex | Acircumflex | | |
| 225 | ecircumflex | Ecircumflex | | |
| 226 | icircumflex | Icircumflex | | |
| 227 | ocircumflex | Ocircumflex | | |
| 228 | ucircumflex | Ucircumflex | | |
| 229 | asciicircum | | | |
| 230 | adiaeresis | Adiaeresis | | |
| 231 | ediaeresis | Ediaeresis | | |
| 232 | idiaeresis | Idiaeresis | | |
| 233 | odiaeresis | Odiaeresis | | |
| 234 | udiaeresis | Udiaeresis | | |
| 235 | ydiaeresis | | | |
| 236 | diaeresis | diaeresis | | |
| 237 | atilde | Atilde | | |
| 238 | ntilde | ntilde | | |

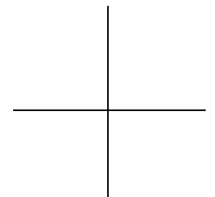
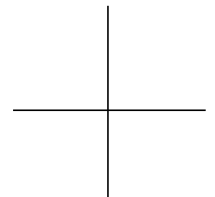

Table 17-7 N-123NA Keycodes and Keysyms with OpenWindows (Continued)

| Keycode Value | Keysym | Shifted Keysym | Alt Keysym | Shifted Alt Keysym |
|---------------|------------|----------------|------------|--------------------|
| 239 | otilde | Otilde | | |
| 240 | asciitilde | | | |
| 241 | aacute | Aacute | | |
| 242 | eacute | Eacute | | |
| 243 | iacute | Iacute | | |
| 244 | oacute | Oacute | | |
| 245 | uacute | Uacute | | |
| 246 | acute | | | |
| 247 | ccedilla | Ccedilla | | |
| 248 | cedilla | | | |

- ¹ OpenWindows compatibility necessitates that these keycodes do not match the key legends: Stop for keycode 10, Again for keycode 11, SunF36 for keycode 86, and SunF37 for keycode 94.
- ² Keycode 120 is available only on European language keyboards.
- ³ WYSetup is an NCD-specific keysym mapped to the NCD Setup keysym.



Using Downloadable Keyboard Description Files

NCDware provides a mechanism for experienced system administrators to configure terminals to work with keyboards that are not explicitly supported in the NCD X server, such as some international keyboards.

This appendix describes how to use a keyboard description file downloaded from the host during terminal booting to support such keyboard usage. Keyboard description files may be available from the NCD FTP site or from other vendors.

To use an unsupported keyboard, you need to:

1. Find or prepare a keyboard description file describing the behavior of the keyboard. See the content and format descriptions later in this appendix. Make sure that the file is world-readable.
2. Make sure that the directory containing the keyboard description file is accessible through the **file-service-table** parameter (Setup ⇒ Change Setup Parameters ⇒ File Service ⇒ File Service Table). For information about this parameter, see Chapter 5, Configuring Network Services.
3. Configure the terminal to read the keyboard description file during booting. In a remote configuration file, set the **xserver-keyboard-description-file** parameter to the name of the keyboard definition file (Setup ⇒ Change Setup Parameters ⇒ Input Devices ⇒ Keyboard Description File).
4. Plug in the keyboard.
5. Reboot the terminal. The first time you boot the terminal after using a new keyboard description file, check the `Messages` hide box in the Console to make sure that the file was read without error.

Creating a Keyboard Definition File

This section describes how to manually create or edit a keyboard description file.

Note You can also create a keyboard description file for the keyboard attached to the terminal from Change Setup Parameters. In the Input hide box, click on `Write Keyboard Description File`. In the dialog box that appears, type the pathname of the file and click on `OK`.

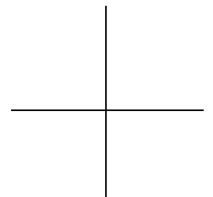

A keyboard description file is an ASCII file containing statements defining keyboard behavior. The statements describe the following keyboard characteristics:

| | |
|--------------------|---|
| Scancode table | Used by the keyboard driver to map hardware scancodes of range [0..255] into X keycodes of range [8..254]. Also used to make one keyboard imitate another. |
| Keycode table | Used by applications to convert X keycodes into keysyms. Also used by the X server when internal dead-key processing is enabled. Keycodes are the codes assigned to the physical keys. Keysyms are the actions taken when keys are pressed. Dead-keys are keys pressed before other key presses (such as an accent and a vowel) to produce an accented vowel letter, as required in many European languages. |
| Dead-key sequences | Sequences of keys intercepted by the keyboard driver and replaced by another key. |
| Modifiers table | Keys that are treated as modifiers, such as Shift, Lock, Control, Mod1-5. Typical values are: Shift Shift_L Shift_R Lock Caps_Lock Control Control_L Control_R The following values vary depending on the keyboard: Mod1 Alt_L Alt_R Meta_L Meta_R Mod4 Num_Lock Mod5 Mode_switch |
| Clicking list | Keys that click through the base speaker when pressed. |
| Locking list | Keys that lock when pressed, requiring a second press to release, usually used with modifier keys. By default, all keysyms containing the name "lock" are locking keys. |

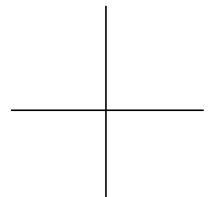

- Latching list Keys that are treated as locking until the next key is released, usually used with modifier keys. By default, the Mode_switch keysym latches.
- Repeating list Keys that autorepeat.
- LED actions table Maps LED number to the state that causes that LED to light.

The format of a keyboard definition file is similar to an **xmodmap** file:

- Each line consists of a keyword and values.
- Blank lines are ignored. Use an exclamation point anywhere on a line to cause the remainder of the line to be ignored.
- Use a backslash (\) at the end of the line to continue a statement past the end of a line. The backslash, following carriage return, newline, and any leading white space are replaced with a single space.

Table 17-8 summarizes the statements permitted in a keyboard definition file. A statement consists of one or more keywords and values. The values permitted in the statements are defined in Table 17-9.

Table 17-8 Keyboard Description File Statements

| Statement (Keyword/Value) | Description |
|-----------------------------|---|
| name <i>QUOTEDSTRING</i> | Specifies the name of the keyboard; typically, the first line in the file. |
| include <i>QUOTEDSTRING</i> | Reads in other files needed to assemble a keyboard description from other files such as deadkeys.kbd or a personal keyboard file such as my.kbd . |
| initialize | Sets keyboard state tables to known values: <ul style="list-style-type: none"> <input type="checkbox"/> All keys repeat and click <input type="checkbox"/> No keys lock or latch <input type="checkbox"/> Dead-key, setup, debug, keysym, and modifier tables are cleared <input type="checkbox"/> The scancodes map one-to-one with keycodes |

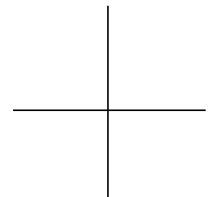

Table 17-8 Keyboard Description File Statements (Continued)

| Statement (Keyword/Value) | Description |
|---|--|
| <p>scancode SCANCODE = KEYCODE</p> <p>scancode LISTofSCANCODE = LISTofKEYCODE</p> | <p>Sets values in the scancode-to-keycode table used by the keyboard driver. By default, scancodes are used as keycode values. Individual scancodes can be replaced by individual values. Destination keycodes must be in the range 8 to 254 for X operations.</p> <p>LISTofSCANCODE and LISTofKEYCODE must be separated by blanks and must be equal in length and represent a one-to-one correspondence of scancode to keycode. Scancodes are in a range of 0 to 255.</p> |
| <p>keycode KEYCODE = LISTofKEYSYM</p> | <p>Sets a row in the keycode-to-keysym table that X applications use to convert keycodes into keysyms. The list of keysyms can contain 0, 1, 2, 3, or 4 keysyms. Keycodes must be in a range of 8 to 254.</p> |
| <p>keysym KEYSYM = LISTofKEYSYM</p> | <p>Changes an existing keyboard configuration by replacing a keysym that is currently bound to a keycode with one or more new keysyms. It is usually placed at the end of the keyboard definition file.</p> |
| <p>deadkey KEYSYM LISTofKEYSYM = KEYSYM</p> | <p>Specifies a sequence of keys to press to generate another key when local dead-key processing is enabled. For more information about this statement, see “Specifying Dead-Key Processing” on page 17-60.</p> |
| <p>modifier MODIFIER = LISTofKEYSYM</p> <p>modifier add MODIFIER = LISTofKEYSYM</p> | <p>Specifies the list of keys associated with an X modifier. All of the keycodes containing any of the keysyms are set, added to, or removed from the indicated modifier list. The modifier list is actually constructed at the end of all keyboard file processing so that it can use the final keysym table values.</p> |
| <p>modifier remove MODIFIER = LISTofKEYSYM</p> | <p>Removes a key from the modifier list.</p> |
| <p>modifier clear MODIFIER</p> | <p>Clears the existing list.</p> |
| <p>click = LISTofKEYSYM</p> | <p>Specifies keys that should click when pressed and clears any already existing list of clickable keys.</p> |

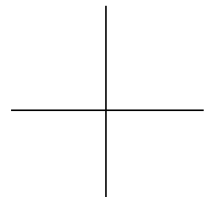

Table 17-8 Keyboard Description File Statements (Continued)

| Statement (Keyword/Value) | Description |
|---------------------------------------|---|
| click add = <i>LISTofKEYSYM</i> | Specifies additional keys that should click without clearing the click list. |
| click remove = <i>LISTofKEYSYM</i> | Removes a key from the click list. |
| click clear | Clears the existing list. |
| lock = <i>LISTofKEYSYM</i> | Specifies keysyms that should ignore release events, requiring a second press for release. By default, all keys with keysyms with the word “lock” are locking. |
| lock add = <i>LISTofKEYSYM</i> | Specifies additional keys that should lock without clearing the lock list. |
| lock remove = <i>LISTofKEYSYM</i> | Removes a key from the lock list. |
| latch = <i>LISTofKEYSYM</i> | Specifies keysyms that are treated as latching, with a release that is delayed until the next key is released. By default, the Mode_switch key is latched. |
| latch add = <i>LISTofKEYSYM</i> | Specifies additional keys that should latch without clearing the latch list. |
| latch remove = <i>LISTofKEYSYM</i> | Removes a key from the latch list. |
| repeat = <i>LISTofKEYSYM</i> | Specifies keys that should repeat automatically when pressed. |
| repeat add = <i>LISTofKEYSYM</i> | Specifies additional keys that should repeat without clearing the repeat list. |
| repeat remove = <i>LISTofKEYSYM</i> | Removes a key from the repeat list. |
| led <i>NUMBER</i> = <i>LED ACTION</i> | Specifies when keyboard LEDs should light up. <i>NUMBER</i> is the LED number (1, 2, 3, or 4) and <i>LED ACTION</i> is one of the following: “x1” “x2” “x3” “x4” “control” “num” “warn” “net” “shift” “caps” “mod1” “mod2” “mod3” “mod4” “mod5” |

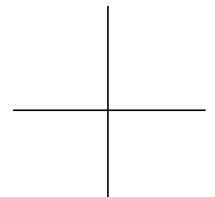

Table 17-8 Keyboard Description File Statements (Continued)

| Statement (Keyword/Value) | Description |
|---|--|
| led map <i>NUMBER</i> = <i>NUMBER</i> | Changes the mapping of the LEDs for keyboards in which the LEDs are not in sequential number. |
| led invert <i>NUMBER</i> | Reverses the sense of the LED for keyboards with inverted LED sense. |
| led total <i>NUMBER</i> | Sets the maximum number of LEDs that the keyboard supports. |
| led enable | Enables the led commands if they have been disabled. |
| led disable | Disables led commands to the keyboard. |
| setup = <i>Setup key</i> + <i>modifiers</i> | Displays the NCDware Console. To disable this command, do not define a Setup key and modifiers (setup =). |
| debug = <i>Debug key</i> + <i>modifiers</i> | Aborts the X server, placing the terminal in the control of the Boot Monitor. To disable this command, do not define a debug key and modifiers (debug =). |

Table 17-9 Permitted Values in Keyboard Description Files

| Value | Syntax |
|---------------------|--|
| <i>QUOTEDSTRING</i> | An ASCII string of characters within quotes (““) |
| <i>NUMBER</i> | A positive integer |
| <i>SCANCODE</i> | <i>NUMBER</i> |
| <i>KEYCODE</i> | <i>NUMBER</i> |
| <i>KEYSYM</i> | A string representing an X keysym name |

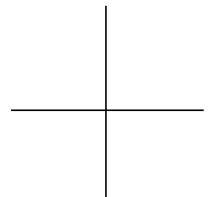

Table 17-9 Permitted Values in Keyboard Description Files (Continued)

| Value | Syntax |
|---------------------|---|
| <i>LISTofKEYSYM</i> | Any of the following: KEYSYM KEYSYM, LISTofKEYSYM KEYSYM LISTofKEYSYM <i>LISTofKEYSYM</i> can also be an empty list. |
| <i>MODIFIER</i> | Any of the following: “shift” “mod2” “control” “mod3” “lock” “mod4” “mod1” “mod5” |

Specifying Dead-Key Processing

The following keyboard description file statement specifies a sequence of keys to press to generate another key when local dead-key processing is enabled:

```
deadkey KEYSYM LISTofKEYSYM = KEYSYM
```

The range of *LISTofKEYSYM* is 1, 2. The resulting keysym must have been defined before this command so that the resulting table can be correctly populated.

In this mode, the keyboard driver looks at each key press as it is entered, intercepting keysyms for sequences of keys that match those specified in the dead-key statement. The first keysym on the left of the equals sign (=) is usually either the keysym `Multi_key` (for Digital-style triple-key compose sequences) or one of the dead-accent keysyms listed in Table 17-10.

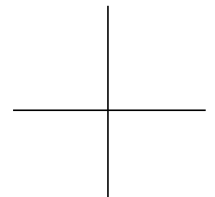

Table 17-10 Dead-Key Accent Keysyms

| Old Digital Versions: | New X11R6 Standard Versions: | |
|-----------------------|------------------------------|------------------|
| Dring_acent | dead_abovering | dead_macron |
| Dcircumflex_accent | dead_circumflex | dead_breve |
| Dcedilla_accent | dead_cedilla | dead_abovedot |
| Dacute_accent | dead_acute | dead_doubleacute |
| Dgrave_accent | dead_grave | dead_caron |
| Dtilde | dead_tilde | dead_ogonek |
| Ddieresis | dead_dieresis | dead_iota |
| | dead_voiced_sound | |
| | dead_semivoiced_sound | |

The keysyms for accented vowels produced using dead-keys differ from those used when the accent is a standalone character (degree, asciicircum, cedilla, acute, grave, asciitilde, and dieresis).

When you type a dead keysym, the keyboard driver delays processing of the keyboard events until it either completes a dead-key sequence or encounters a non-modifier keysym that does not match a sequence containing the keys typed so far. If no match is found, the bell rings and the delayed keyboard events are processed separately. Otherwise, if a full sequence is recognized, the keyboard driver replaces the recognized sequence with events that generate the keysym specified on the right (except when the keysym isn't on the keyboard).

The Shift, Lock, and Mode_switch bits in the modifier mask of the replacement event are synthesized as necessary to obtain the desired keysym; all other bits in the modifier mask are the same as in the final event in the recognized sequence.

When conflicts arise over whether the keyboard driver should complete one sequence or continue to process for a longer superset, the driver completes the shorter set.

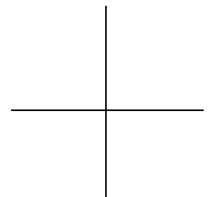

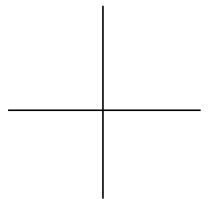

18 X Server Messages

This chapter lists messages issued by modules of the X server. The following topics are covered in this chapter:

- ❑ “Messages and Modules Overview” on page 18-1
- ❑ “The Format of Messages” on page 18-2
- ❑ “Displaying Messages” on page 18-4
- ❑ “Logging Messages to a File” on page 18-5
- ❑ “Configuring Message Logging” on page 18-5
- ❑ “Messages Common to All Modules” on page 18-7
- ❑ A section for each module that issues its own unique messages, beginning with “CALIBLIGHTPEN Messages” on page 18-15. These sections and the messages within each section are listed alphabetically.

For more help in troubleshooting your terminal, refer to the *NCDware System Administrator’s Guide for UNIX Systems*. Also refer to the *Roadmap* to see if information on the functional area you are having trouble with is available in other NCDware documents.

For information about host-related management tasks, such as checking that a utility is running on the host, refer to your host system administration manual.

Messages and Modules Overview

As part of its ongoing activities, the X server issues messages about its operations. As the X server executes, each module (for example, the Configuration daemon) generates its own messages. The information reported includes successful completion of user requests, unsuccessful attempts to perform an action, or fatal errors that cause the X server to crash.

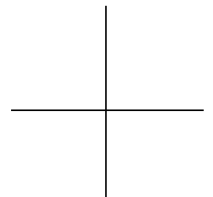

Note The modules that issue messages are not necessarily X server modules, although many of them are. A reporting module may also be a daemon, such as the Configuration daemon, or simply a discrete function of the X server.

The messages are stored in an internal buffer and forwarded to the Console Messages hide box. If there is an existing TELNET connection, the messages are sent there as well.

You can also configure the terminal to write messages to a log file. Console messages are the same as messages logged to a file, except that Console messages do not include a time stamp.

Many of the messages displayed in the Console are issued by the terminal as it boots, after the X server is executed. These messages show how the terminal reads its configuration file, keymap file, color definition file, and fonts. Other messages in the Console reflect ongoing operations, such as starting clients and loading fonts as clients request them.

Messages are listed by module and alphabetically within each module section. The text of each message is followed by a table listing the severity, the explanation, and the recommended user action, if any.

The first section of messages describes those that are common to many modules, followed by a separate section for each module that issues its own unique messages.

The Format of Messages

X server messages follow the format:

%MODULE-L-ABBREV, full message text

where:

MODULE Is the NCDware module issuing the message, such as CONFIGD or FILED.

L Is the message's level of severity:

I An informational message. The activity was successful.

W A warning message. The activity may not have been successful. You should verify the results.

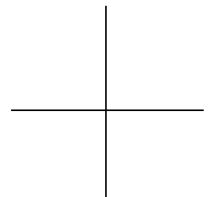

E An error. The module did not complete the activity but is attempting to continue.

F A fatal error. The module did not complete the activity and cannot continue.

ABBREV Is the abbreviated message; for example, READ for an operation that involved reading a file.

Some example messages of different levels of severity are shown in the following list; they were all issued by the Configuration daemon:

- Informational message—The module performed the activity successfully.

`%CONFIGD-I-IPADDR, IP address for this unit: 192.40.50.12`

- Warning message—The module may have completed some, but not all, of the requested activity.

`%CONFIGD-W-BADPASSWD, incorrect password entered`

- Error message—The module did not complete the requested activity but is attempting to continue.

`%CONFIGD-E-GATEWAYBADNET, gateway 89.0.0.1 is not on local net`

- Fatal message—The module did not complete the requested activity and cannot continue.

`%CONFIGD-F-INITUI, unable to initialize user interface`

You should take steps to resolve messages with severity levels E and F. Contact NCD Technical Support if you need assistance.

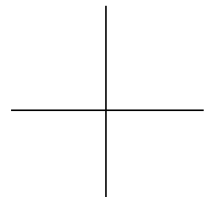

Displaying Messages

You can display current messages in the Console or by connecting to the terminal's Diagnostic daemon using TELNET.

Viewing Messages in the Console Window

You can see current messages by opening the `Messages` hide box:

1. In the Console, click on `Messages`.
2. To see more messages, scroll through messages in the window or enlarge the window.

Console ⇒ Clear Messages clears messages from the message area. Console ⇒ Rescan Messages redisplay messages that were cleared previously.

Viewing Messages through TELNET

You can see current messages by connecting directly to the diagnostic module through a TELNET connection:

1. In the Console, select `Terminals` ⇒ `New Terminal`.
2. To view current messages for the local terminal, click on the line beginning with `Diag` in the `Default Hosts` window.
3. To view current messages for a remote terminal, enter its hostname or IP address and the number of the diagnostics port in the `Service:` field. The default port number is 5998. For example:

```
ncdu10 5998
```

4. Click on `OK`. The current messages appear in a `Terminal Emulator` window. To view more messages, use the window scroll bar.

While you are connected to a remote terminal, you can ask the user to perform the action causing the problem. You can read the messages as they are issued.

5. When you are finished, close the TELNET connection and the `Terminal Emulator` window by selecting `Exit` from the `File` menu.

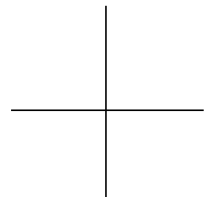

Logging Messages to a File

You can log messages to a file using the NFS protocol:

1. Specify the filename in the **diag-log-file** parameter (Setup ⇒ Change Setup Parameters ⇒ Diagnostics ⇒ Log File). There is no default filename or directory, so you must specify the complete pathname.
2. The log file must be accessible through the file access table described in the *NCDware System Administrator's Guide for UNIX Systems* and Chapter 5, Configuring Network Services.

Configuring Message Logging

You can configure:

- Time stamps attached to the messages
- Size of the buffer used for saving messages in the terminal
- Extended messages for file and font access

Configuring Message Time Stamps

Messages collected in the buffer have time stamps appended to them, although time stamps are not displayed in the Console message area. Time stamps indicate when the message was issued relative to the last reboot of the terminal. Time stamps follow the format **+d:hh:mm:ss** (days, hours, minutes, and seconds).

Some messages may have no time stamps because the next time stamp is not written until one second has elapsed. This time interval is called the time stamp frequency.

By default, time stamps are entered every second. You can change the frequency with the **diag-timestamp-frequency** parameter (Setup ⇒ Change Setup Parameters ⇒ Diagnostics ⇒ Timestamp Frequency). Specify the number of seconds as an integer.

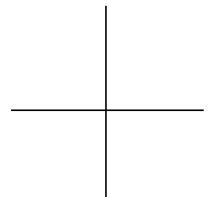

Changing the Message Buffer Size

The default size of the internal buffer used for logging messages is 8,192 bytes. If you are not capturing all the messages you need, you can change the size of the buffer with the **diag-buffer-size** parameter (Setup ⇒ Change Setup Parameters ⇒ Diagnostics ⇒ Buffer Size). Specify the number of bytes as an integer.

Enabling Extended Diagnostics

You can configure a terminal to issue more detailed messages about the following services:

- ❑ File service—To generate more detailed messages about the file service, set the **file-extended-diagnostics** parameter to “true” (Setup ⇒ Change Setup Parameters ⇒ File Service ⇒ Extended Diagnostics).
- ❑ Font service—To generate more detailed messages about fonts, set the **pref-font-extended-diagnostics** parameter to “true” (Setup ⇒ Change User Preferences ⇒ Fonts ⇒ Show Extended Font Diagnostics). NCD recommends enabling extended font diagnostics only if you have a font problem. This parameter generates a large number of messages.
- ❑ IP routing—Extended diagnostic messages for IP routing are turned off by default. If you want to see such messages, make sure **ip-extended-routing-diagnostics** is set to “true” (Setup ⇒ Change Setup Parameters ⇒ IP ⇒ Extended Routing Diagnostics).

The extended diagnostics parameter settings take effect immediately. Only **file-extended-diagnostics** is saved to NVRAM. To make the other parameter settings permanent, set them in a remote configuration file.

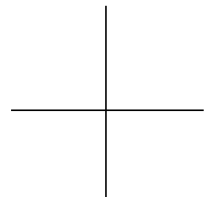

Messages Common to All Modules

This section is an alphabetical listing of X server messages common to all modules. If you are looking for a message that is not listed here, refer to the sections that follow.

BADACCEPT, unable to accept on *protocol* socket: *message*

Severity: Error

Explanation: The reporting module cannot accept a connection on the specified network socket. The included message describes the reason for the error.

User Action: If you encounter this error message, please contact NCD Technical Support.

BADBIND, unable to bind *protocol* socket: *message*

Severity: Error

Explanation: The reporting module cannot assign a name to the specified network socket. The included message describes the reason for the error.

User Action: If you encounter this error message, please contact NCD Technical Support.

BADCOMPFMT, invalid compression format in file: *file*

Severity: Error

Explanation: The specified file does not contain the expected compression factor, and therefore the X server cannot confirm that the file is compressed.

User Action: Confirm that the specified file is compressed.

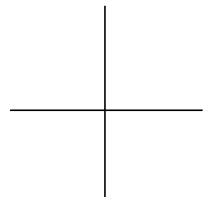

Messages Common to All Modules

BADCOMPFSIZE, wrong compression factor (use 12 bits) in file: *file*

Severity: Error

Explanation: The specified file indicates that it is using a compression factor different from that which the X server expects; NCDware software uses a 12-bit compression factor.

User Action: Confirm that 12-bit compression was specified when the file was compressed (for example, by the command-line option `-b12`).

BADCONNECT, unable to connect to *protocol* socket: *message*

Severity: Error

Explanation: The X server cannot connect to the specified network socket for the reason given.

User Action: Verify that the network address is correct and confirm that the desired host is available on the network.

BADGETSOCKETOPT, unable to get *protocol* socket option *option*: *message*

Severity: Error

Explanation: The reporting module cannot use the specified socket option for the reason given.

User Action: If you encounter this message, please contact NCD Technical Support.

BADLISTEN, unable to listen on *protocol* socket: *message*

Severity: Error

Explanation: The reporting module is unable to listen for network connections.

User Action: If you encounter this message, please contact NCD Technical Support.

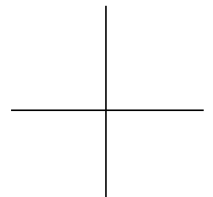

BADNET, *client*, unknown network: *message*

Severity: Error

Explanation: The specified client could not create a connection to the specified transport. This situation usually occurs with the DECwindows login client.

User Action: If you encounter this message, please contact NCD Technical Support.

BADREAD, read error on *file*: *message*

Severity: Error

Explanation: The X server cannot read the specified file for the reason given.

User Action: Verify that:

- The filename is specified correctly.
- The file service table contains an entry for the specified file.
- The file has read access.

BADREFCNT, *resource*, bad reference count *n*

Severity: Error

Explanation: The X server cannot reconcile the reference count for the specified resource. This message typically appears when the reference count should be zero because no one is using the resource, but the reported count is greater than zero.

User Action: If you encounter this message, please contact NCD Technical Support.

BADSETSOCKETOPT, unable to set *protocol* socket option *option*: *message*

Severity: Error

Explanation: The reporting module cannot set the specified socket option for the reason given.

User Action: If you encounter this message, please contact NCD Technical Support.

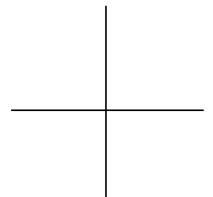

Messages Common to All Modules

BADSOCKET, *module*: unable to create *protocol* socket: *message*

Severity: Error

Explanation: The X server cannot create the specified socket for the reason given.

User Action: If the reason given is “no buffer space,” try increasing the buffers allocated in the **net-minimum-data-buffers** parameter. Otherwise, please contact NCD Technical Support.

BADWRITE, write error on *file*: *message*

Severity: Error

Explanation: The X server cannot write to the specified file for the reason given. This situation usually occurs if the file does not have write access or if there is not enough memory.

User Action: Verify that:

- The file has write access.
- The filename is specified correctly.
- There is sufficient memory to perform the operation.

CLOSE, closing *file_type*: *file*

Severity: Information

Explanation: The reporting module is closing the specified file as requested.

User Action: None

INITUI, unable to initialize user interface

Severity: Fatal

Explanation: The reporting module cannot create a dialog box to display an X server message. The message appears but it is not contained in a dialog box. This situation usually occurs when the terminal is low on memory.

User Action: Check the terminal’s memory level. Close any inactive local clients to free local memory.

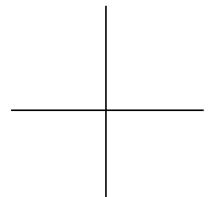

NOACCESS, access denied to *font_server font_server_name*

Severity: Error

Explanation: The terminal cannot access *font_server_name*.

User Action: Make sure that the named font server is available.

NODECOMP, error installing decompression for file *file: message*

Severity: Error

Explanation: The X server cannot decompress the specified file for the reason given. This message usually indicates the terminal is low on memory.

User Action: Check the available memory to make sure that it is sufficient to perform the desired decompression. Close any local clients that are not being used to free memory.

NOHOSTADDR, unable to find address for host name: *host*

Severity: Error

Explanation: The reporting module cannot locate the network address for the specified host.

User Action: Make sure the hostname is correct. If it is, verify that the terminal's configuration database correctly identifies the system that is to provide name service for the terminal.

NOLICENSE, this unit not licensed for *feature*

Severity: Error

Explanation: The terminal does not have a license for the specified feature, such as DPS.

User Action: Contact NCD to obtain a valid license for the specified feature and enter it in the terminal's configuration file, NVRAM, or *license.dat* file.

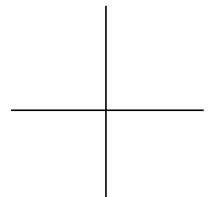

Messages Common to All Modules

NOMEM, *function*, out of memory for *data_structure*

Severity: Error

Explanation: The X server does not have sufficient memory to perform the requested function.

User Action: Close any unused local clients to free memory for the desired function.

NOOPEN, unable to open *file_type*: *file*

Severity: Error

Explanation: The reporting module cannot open the specified file.

User Action: Make sure:

- The filename is correct.
- The file exists in the specified directory.
- The file service table contains an entry for the specified directory.
- The specified file has read access.

NOPROC, unable to create new process for *client*

Severity: Error

Explanation: The X server cannot start the requested client. This situation generally occurs when the X server is running low on memory or when there are too many clients running for the amount of available memory.

User Action: Close any unused local clients to free memory for the desired function.

NOREAD, unable to read *file_type*: *file*

Severity: Error

Explanation: The reporting module cannot read the specified file.

User Action: Make sure:

- The filename is correct.
- The file exists in the specified directory.
- The file service table contains an entry for the specified directory.

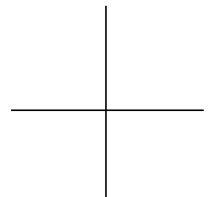

- The specified file has read access.

NOWRITE, unable to write *file_type*: *file*, *message*

Severity: Error

Explanation: The reporting module cannot write information to the specified file for the specified reason.

User Action: Make sure:

- The filename is correct.
- The file exists in the specified directory.
- The file service table contains an entry for the specified directory.
- The specified file has write access.

NOX, unable to connect to display *display*

Severity: Fatal

Explanation: The reporting module cannot connect to the specified terminal.

User Action: Make sure that the name specified is correct for the desired terminal. If the terminal name is correct, verify that the network is operational and that the terminal is running and is connected to the network.

OPEN, opening *file_type*: *file*

Severity: Information

Explanation: The reporting module is opening the specified file as requested.

User Action: None

READ, reading *file_type*: *file*

Severity: Information

Explanation: The reporting module is reading the specified file as requested.

User Action: None

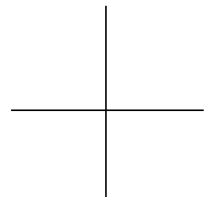

Messages Common to All Modules

START, starting up

Severity: Information

Explanation: The specified module is starting as requested.

User Action: None

STOP, shutting down

Severity: Information

Explanation: The specified module is shutting down as requested.

User Action: None

WRITE, writing *file_type*: *file*

Severity: Information

Explanation: The specified module is writing information to the specified file.

User Action: None

XKILLED, connection closed by X server

Severity: Fatal

Explanation: In the process of shutting down, the X server has stopped the reporting module.

User Action: Check the application(s) that were running when the X server closed the connection to ensure that the clients exited gracefully and did not lose any information.

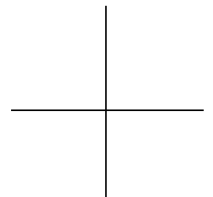

CALIBLIGHTPEN Messages

CALIBLIGHTPEN messages pertain to light pen support. For messages that refer to the CALIBLIGHTPEN module but do not appear here, refer to “Messages Common to All Modules” on page 18-7.

NODISPLAY, Could not open display

Severity: Fatal

Explanation: The X server cannot find the X display, so light pen support is not operating.

User Action: If you encounter this message, please contact NCD Technical Support.

NOLIGHTPEN, Could not open light pen

Severity: Fatal

Explanation: The X server cannot find the light pen.

User Action: Make sure the light pen is properly attached.

NOXINPUT, **extension** not present when listing input devices

Severity: Fatal

Explanation: The X server could not find the light pen module.

User Action: Check the terminal’s configuration and/or the Console Messages to make sure that the light pen module (**lightpen**) was loaded.

UNKWNCLASS, Unknown class: **class**

Severity: Warning

Explanation: The light pen support is not operating.

User Action: Please contact NCD Technical Support.

CALIBTOUCH Messages

CALIBTOUCH messages pertain to the touch screen software support. If you are looking for a message that refers to the CALIBTOUCH module but does not appear here, refer to “Messages Common to All Modules” on page 18-7.

NODISPLAY, Could not open display

Severity: Fatal

Explanation: The X server cannot find the X display and the touch screen support is not operating.

User Action: If you encounter this message, please contact NCD Technical Support.

NOTOUCH, Could not open touchscreen

Severity: Fatal

Explanation: The X server cannot find the touch screen monitor.

User Action: Make sure that the terminal is configured for touch screen support. See the *User's Guide* for specific instructions.

NOXINPUT, **extension** not present when listing input devices

Severity: Fatal

Explanation: The X server could not find the X Input Extensions.

User Action: Check the terminal's configuration and/or the Console Messages to make sure that the X Input Extension module (**xinput**) has been loaded.

UNKWNCLASS, Unknown class: **class**

Severity: Warning

Explanation: The input device class is neither Key, Button, nor Valuator. The touch screen support is probably not operating.

User Action: If you encounter this message, please contact NCD Technical Support.

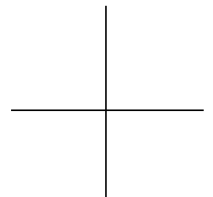

CONFIGD Messages

CONFIGD messages pertain to the Configuration daemon. If you are looking for a message that refers to the CONFIGD module but does not appear here, refer to “Messages Common to All Modules” on page 18-7.

BADADDRROUTE, can't add route: *message*

Severity: Error

Explanation: The X server cannot add the requested route, perhaps due to low memory.

User Action: Verify the terminal has enough memory to perform the operation. If there is sufficient memory, and the message appears repeatedly, please contact NCD Technical Support.

BADCREATE, error creating row *parameter[row#]field: string*

Severity: Error

Explanation: The Configuration daemon cannot add the requested table entry to the specified parameter at the designated row. This situation usually occurs when the row number in the entry is incorrect.

User Action: Verify that the correct row is specified when adding information to a parameter table. To add a row to the end of a table, use the index number -1.

BADDELETE, error deleting row *parameter[row#]field: string*

Severity: Error

Explanation: The Configuration daemon cannot delete the requested table entry from the specified parameter. This usually occurs when the row number in the entry is incorrect for the given parameter.

User Action: Verify that the correct row is specified when removing information from a parameter table.

CONFIGD Messages

BADMTESVRPROTO, **network** server doesn't match file transfer protocol **protocol**

Severity: Error

Explanation: The Configuration daemon expected to use the specified file transfer protocol, but the specified network (such as TCP/IP or DECnet) does not support that protocol. This message appears only at boot time.

User Action: Verify the initial file protocols are established correctly for the system(s) providing boot services.

BADPARAM, line **n**: unknown parameter **parameter**

Severity: Error

Explanation: The Configuration daemon does not recognize the specified parameter that appears at the specified line in the configuration file.

User Action:

- Verify the parameter name is correct, specifically checking for typographical errors or other mistakes.
- Verify that you are not trying to connect to a terminal that is running a pre-5.0 version of NCDware.

BADPASSWD, incorrect password entered

Severity: Warning

Explanation: The password that has been entered for the Configuration daemon is incorrect.

User Action: Confirm that the password is correct for access to the terminal's configuration information.

BADSET, error setting parameter **parameter: message**

Severity: Error

Explanation: The X server cannot set the specified parameter for the reason given.

User Action: If you encounter this message, please contact NCD Technical Support.

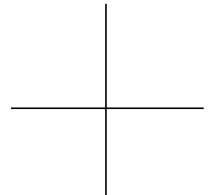

BADVALUE, line *n*: value *value* is invalid for parameter *parameter*

Severity: Error

Explanation: The value specified for the parameter on the given line is incorrect. This message usually occurs when the parameter accepts only specific choices and the value entered is not one of the acceptable choices.

User Action: Verify the acceptable values for the specified parameter.

CLASSLOAD, loading java class file into memory

Severity: Information

Explanation: The Java class files are being loaded.

User Action: None

CLASSLOADFAIL, failed to cache java class file into memory: *reason*

Severity: Error

Explanation: The *classes.zip* file could not be loaded into memory. This would improve Java performance.

User Action: Make sure the terminal has enough memory and that the file is accessible through the file service table.

DIRNAMETOOLONG, directory name *directory* is too long

Severity: Error

Explanation: The specified directory name exceeds the maximum acceptable length for directory names.

User Action: Keep the directory name to 255 or fewer characters. If necessary, assign a logical on the host system so that the name is within the acceptable range.

DOMAIN, DNS default domain name for this unit: *domain_name*

Severity: Information

Explanation: The X server is using the specified domain for this terminal.

User Action: None

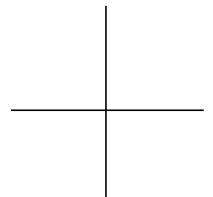

CONFIGD Messages

FORMATFAILED, failed to format *filesystem_name* filesystem

Severity: Error

Explanation: The X server cannot format the specified file system as requested.

User Action: If you encounter this message, please contact NCD Technical Support.

FORMATSUCCESS, successfully formatted *filesystem_name* filesystem

Severity: Information

Explanation: The X server successfully formatted the specified file system as requested.

User Action: None

FORMATTING, formatting *filesystem_name* filesystem

Severity: Information

Explanation: The X server is formatting the specified file system as requested.

User Action: None

GATEWAYBADNET, gateway *nnn.nnn.nnn.nnn* is not on local net

Severity: Error

Explanation: The specified gateway does not reside on the local network.

User Action: Correct the gateway address.

GETONLY, line *n*: parameter *parameter* is get-only

Severity: Error

Explanation: The specified parameter on the given line has read-only access; it cannot be changed to a different value.

User Action: To change the value of the parameter, first remove the get-only protection, reboot the terminal, then change the parameter's value.

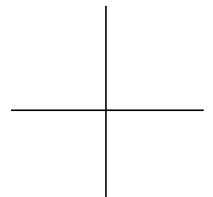

HOSTNAME, hostname for this unit: *hostname*

Severity: Information

Explanation: The X server is using the specified hostname for the terminal.

User Action: None

INVPARAM, invalid table parameter for operation at line *n*

Severity: Error

Explanation: The user selected an invalid or protected table parameter at line *n*.

User Action: Verify the line number of the desired parameter.

IPADDR, IP address for this unit: *nnn.nnn.nnn.nnn*

Severity: Information

Explanation: The X server is using the specified IP address for the terminal.

User Action: None

MOUNTFAILED, failed to mount *filesystem_name* filesystem

Severity: Error

Explanation: The X server cannot mount the specified file system.

User Action: If you encounter this message, please contact NCD Technical Support.

NCDNETADDR, NCDnet address for this unit: *aa.nnnn*

Severity: Information

Explanation: The X server is using the specified DECnet address for the terminal.

User Action: None

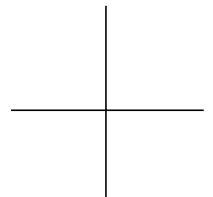

CONFIGD Messages

NOACCESS, can't perform operation with current access level

Severity: Error

Explanation: A user with read-only access attempted to perform an operation requiring write access. For example, the user tried to change a parameter's value or write information to NVRAM.

User Action: Verify that the user has the appropriate level of access.

NOCLIENTDISABLE, local client *client* can not be disabled

Severity: Error

Explanation: The specified local client cannot be disabled.

User Action: Verify that the name of the specified local client is correct.

NOCTRLSOCK, unable to connect to *protocol* control socket

Severity: Fatal

Explanation: The X server has detected an internal error when connecting to the specified control socket.

User Action: If you encounter this message, please contact NCD Technical Support.

NODFLTFILE, no default file defined

Severity: Error

Explanation: The X server cannot read the default configuration file as requested.

User Action: Verify that the terminal's configuration database specifies a default configuration file.

NOFILESSELECTED, no file names selected

Severity: Warning

Explanation: The X server is configured to load an initial configuration file, but none of the possible configuration filenames is enabled.

User Action: Enable the appropriate configuration filename parameter.

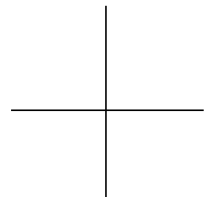

NOINITFILE, could not read any initial file

Severity: Error

Explanation: The X server attempted to read all enabled configuration filenames but could not read any of them.

User Action: Verify that:

- The names of the desired configuration files agree with the configuration filename parameters that are enabled.
- The configuration files have read/write or read access.
- File service is configured properly on the terminal.

NOIPHOSTNAME, unable to find host name for IP address *nnn.nnn.nnn.nnn*

Severity: Warning

Explanation: The Configuration daemon cannot find the network name of the system or terminal specified by the IP address.

User Action: Verify that:

- The IP address is correct.
- The terminal's configuration database identifies the system that is to provide name service for the terminal.
- The name server is running and is accessible via the network.

NOIPLOOPBACK, unable to set interface address for inet loopback: *message*

Severity: Error

Explanation: The X server cannot set the Internet loopback address.

User Action: If you encounter this message, please contact NCD Technical Support.

NOIPNETWORK, unable to set IP address, IP interface disabled *message*

Severity: Error

Explanation: The message should either be empty or "address in use by another host."

User Action: If the message is "address in use by another host," please contact NCD Technical Support. Otherwise, no action is needed.

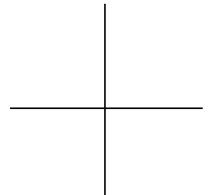

CONFIGD Messages

NOLATGROUP, unable to set LAT group codes: *message*

Severity: Error

Explanation: The X server cannot set up the terminal as part of a LAT service group as requested.

User Action: If you encounter this message, please contact NCD Technical Support.

NOLOCALCONFIG, no config file on local file system, trying network

Severity: Information

Explanation: The X server cannot locate a configuration file on the local file system, so it is trying to locate one on the network.

User Action: None

NOMULTICAST, unable to set *protocol* multicast address: *message*

Severity: Error

Explanation: The X server cannot set the multicast address for the specified protocol as requested.

User Action: If you encounter this message, please contact NCD Technical Support.

NONCDNETHOSTNAME, unable to find host name for NCDnet address: *aa.nnnn*

Severity: Warning

Explanation: The Configuration daemon cannot find the network name of the node specified by the DECnet address.

User Action: Verify that:

- The DECnet address is correct.
- The terminal's configuration database identifies the system that is to provide name service for the terminal.
- The name server is running and is accessible via the network.

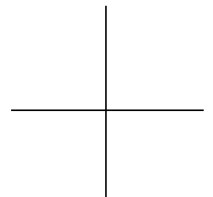

NONET, no network interfaces have been enabled

Severity: Warning

Explanation: The X server expects to communicate via a network or over a serial line, but the terminal is not configured for communications via a network or for communications over a serial line.

User Action: Configure the terminal for network or serial communications. If you require assistance, please contact NCD Technical Support.

NOPASSWDS, no passwords configured, denying access

Severity: Warning

Explanation: The terminal does not have read/write or read-only passwords specified for access to the terminal's Configuration daemon and therefore is denying access to the configuration information.

User Action: Establish a read/write or read-only password for the terminal.

NOROW, row *n* does not exist

Severity: Error

Explanation: The specified row does not exist for a parameter that is being modified.

User Action: Verify the row numbers of the desired parameter.

NOSUCHCLIENT, no such local client *client*

Severity: Error

Explanation: The specified client does not exist.

User Action: Verify that the name of the client is correct.

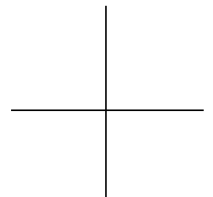

CONFIGD Messages

NOTIME, unable to get current time from *IP_address of time server*

Severity: Error

Explanation: The time server did not respond, so the internal clock was not set. Could affect Java applications and other applications that rely on the correct time.

User Action: Check the configuration of the terminal's time parameters. Check the network connection to the time server and the host's configuration.

NVRAMTSS, length exceeds available NVRAM space by *n* characters

Severity: Error

Explanation: The string value entered exceeds the amount of optional string space available in NVRAM by the specified number of characters.

User Action: Either shorten the value assigned to the parameter you are modifying, or review the other values held in optional string space in NVRAM and shorten one of them so that the new value will fit.

OKPASSWD, correct *access_level* password entered

Severity: Information

Explanation: The correct password has been entered for the specified level of access; that is, either read-only or read/write access.

User Action: None

OPENFAILED, failed to open *filesystem_name* filesystem for verification

Severity: Error

Explanation: The X server cannot open the specified file system as requested.

User Action: If you encounter this message, please contact NCD Technical Support.

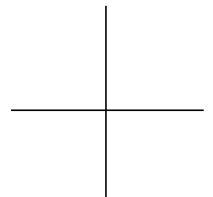

PARAMNOTTABLE, line *n*: parameter *parameter* is not a table

Severity: Error

Explanation: The entry on the given line treats the specified parameter as if it were a table when it is not.

User Action: Re-enter the information using a simple statement: *parameter* = *value*

READNVRAM, read in NVRAM settings

Severity: Information

Explanation: The *setup* client or *configd* is reading the values saved in NVRAM as requested.

User Action: None

SETGROUP, line *n*: can't set a group

Severity: Error

Explanation: The command entered on the given line attempts to set a value for an entire parameter group.

User Action: Set values for parameters individually.

SETPROTECTED, line *n*, parameter *parameter* is set-protected

Severity: Error

Explanation: The specified parameter on the given line has been protected against setting it to a different value.

User Action: To change the value, first remove the parameter's protection, reboot the terminal, and then change its value.

SETSYSSTATUS, host *nnn.nnn.nnn.nnn* set system status to *status*

Severity: Information

Explanation: Reports the SNMP reset status of the terminal. See the *ncdreset* man page for more information.

User Action: None

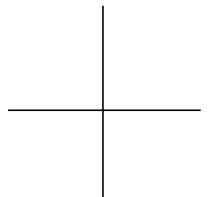

CONFIGD Messages

SYNTAX, line *n*: syntax error at *string*

Severity: Error

Explanation: The specified line contains an error beginning with the specified string.

User Action: Make sure that the parameter, its value(s), and the commands are correct.

TIMEZONEFAIL, unable to set time zone to *timezone file*

Severity: Error

Explanation: The terminal was unable to load the timezone file specified by the *time-zone* configuration parameter.

User Action: Check to make sure that the timezone files were installed correctly and are accessible through the terminal's file service table.

TOOMANYREADS, nested file reads exceeded limit of *n*, ignoring file *file*

Severity: Error

Explanation: The Configuration daemon accepts nested files up to ten levels and does not read included files that exceed this limit.

User Action: Do not nest files to more than ten levels.

VERIFYFAILED, failed to verify *filesystem_name* filesystem

Severity: Error

Explanation: The X server cannot verify the structure of the specified file system as requested.

User Action: If you encounter this message, please contact NCD Technical Support.

VERIFYING, verifying *filesystem_name* filesystem

Severity: Information

Explanation: The X server is verifying the structure of the specified file system as requested.

User Action: None

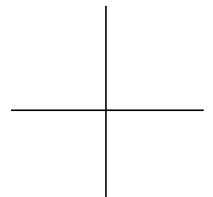

VERIFYSUCCESS, successfully verified *filesystem_name* filesystem

Severity: Information

Explanation: The X server has verified the structure of the specified file system as requested.

User Action: None

WRONGBOOTMON, current Boot Monitor does not support *parameter*
or

WRONGBOOTMON, current Boot Monitor does not support NFS

Severity: Error

Explanation: You are trying to set a configuration parameter that is not supported by the Boot Monitor installed in the terminal.

User Action: Obtain upgraded an Boot Monitor or use another method of network service such as TFTP.

WROTENVRAM, wrote settings to NVRAM

Severity: Information

Explanation: The configuration settings selected have been written to NVRAM.

User Action: None

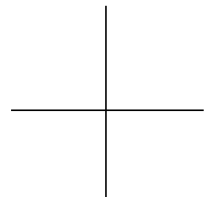

CONFUI Messages

CONFUI messages pertain to the Configuration daemon user interface. If you are looking for a message that refers to the CONFUI module but does not appear here, refer to “Messages Common to All Modules” on page 18-7.

ALRDYUP, already running

Severity: Error

Explanation: The Configuration daemon user interface is already running on this terminal.

User Action: Use the existing user interface, or shut it down and invoke it again.

BADPASS, wrong password for host *host*

Severity: Error

Explanation: The password that has been entered is incorrect for the specified terminal.

User Action: Obtain the correct password for the terminal to which you are trying to connect.

CONN, can not create connection to host *host*

Severity: Error

Explanation: The CONFUI module cannot connect to the specified terminal.

User Action: Make sure that the specified terminal name is correct. Confirm that the specified terminal is operational. If it is, confirm that the terminal is connected to the network and that the network is working.

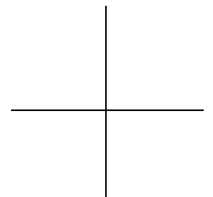

CONNECT, conflib_connect_*type parameter* failed

Severity: Error

Explanation: The X server has detected an internal error. In this message, *type* refers to the value type, such as Boolean, floating point integer, string, or table.

User Action: If you encounter this message, please contact NCD Technical Support.

GET, conflib_get_*type parameter* failed

Severity: Warning

Explanation: The X server does not support the specified configuration parameter, perhaps because the parameter is from a previous version of the X server. In this message, *type* refers to the value type, such as Boolean, floating point integer, string, or table.

User Action: If you encounter this message, please contact NCD Technical Support.

LOSTCONN, lost connection to host *host*

Severity: Error

Explanation: The CONFUI module has lost its connection to the specified terminal.

User Action: Confirm that the specified terminal is running. If it is, confirm that the terminal is connected to the network and that the network is operational.

NOCONN, Not connected to any terminal

Severity: Error

Explanation: The X server has detected an internal error.

User Action: If you encounter this message, please contact NCD Technical Support.

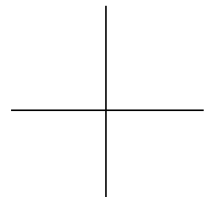

CONFUI Messages

NOEXT, can not get NCD-SETUP extension

Severity: Warning

Explanation: The X server has detected an internal error.

User Action: If you encounter this message, please contact NCD Technical Support.

NOFONT, can not create font *font*

Severity: Error

Explanation: The specified font is not available.

User Action: Use the default font or specify a substitute font.

SET, conflib_set_*type parameter* failed

Severity: Error

Explanation: The X server cannot set the specified parameter to the requested value. In this message, *type* refers to the value type, such as Boolean, floating point integer, string, or table.

User Action: Verify that the value requested is the type of value accepted by the parameter.

TEST, conflib_test_*type parameter* failed

Severity: Error

Explanation: The X server cannot set the specified parameter to the requested value. In this message, *type* refers to the value type, such as Boolean, floating point integer, string, or table.

User Action: Verify that the value requested is the type of value accepted by the parameter.

XERROR, *X_name* error, request code *n.n*, value *value*

Severity: Error

Explanation: An error has occurred in the MIT X server.

User Action: Refer to Xlib documentation for information on the specified error.

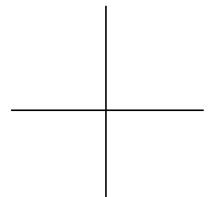

CONSOLE Messages

CONSOLE messages pertain to the actions of the Console, Utilities ⇒ Lock Screen, and Login ⇒ Logout... , Console ⇒ Reboot, and Utilities ⇒ Rescan Current Font Path.

If you are looking for a message that refers to the CONSOLE module but does not appear here, refer to “Messages Common to All Modules” on page 18-7.

AUTOLOCK, automatic lock screen after *n* minutes, *n* seconds idle time

Severity: Warning

Explanation: Utilities ⇒ Lock Screen is locking the screen after waiting the specified amount of idle time as configured.

User Action: None

AUTOLOGOUT, automatic logout after *n* minutes, *n* seconds idle time

Severity: Warning

Explanation: Login ⇒ Logout... is logging the user out of the current X session after waiting the specified length of idle time as configured.

User Action: None

BADKEYSEQ, bad console key sequence *key_sequence*, using default

Severity: Error

Explanation: The CONSOLE module does not recognize the specified key sequence for invoking the Console and is using the default key sequence instead.

User Action: Verify that the identified key sequence is entered correctly.

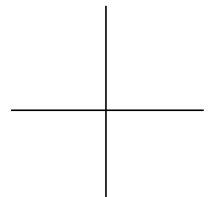

CONSOLE Messages

BADSEL, unknown selection *selection_name* or target *information_type*

Severity: Error

Explanation: An application has requested the specified, unknown type of information from the Console.

User Action: Modify the application so that it requests the correct information.

FIONREAD, data from diagd missing, errno = *n*

Severity: Error

Explanation: The X server has detected an internal error.

User Action: If you encounter this message, please contact NCD Technical Support.

LOCKED, screen locked

Severity: Information

Explanation: Utilities ⇒ Lock Screen has locked the terminal's screen as requested.

User Action: None

LOGOUT, shutting down all windows

Severity: Information

Explanation: The X server is shutting down all windows as requested.

User Action: None

NOFONTPATH, unable to rescan font path

Severity: Error

Explanation: The X server cannot rescan the font path as requested because there is no current font path configured for the terminal.

User Action: Verify that the terminal is configured for a default font path and a current font path.

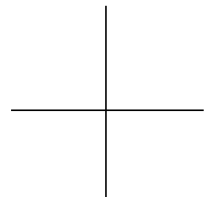

POWERMANAGE, automatic powerdown to state *state* after *n* minutes idle time

Severity: Warning

Explanation: The X server is powering the terminal to the state *state* after *n* minutes of idle time. This occurs on VESA-compliant monitors only.

User Action: None

REBOOT, shutting down and rebooting

Severity: Warning

Explanation: The X server is shutting down the terminal and rebooting it as requested.

User Action: None

SELSTOLEN, selection *selection_name* stolen from console

Severity: Error

Explanation: An application is attempting to prevent other applications from requesting information from the Console.

User Action: Modify the application that is preventing other applications from requesting information from the Console.

UNLOCKED, screen unlocked

Severity: Information

Explanation: The X server has unlocked the terminal's screen as requested.

User Action: None

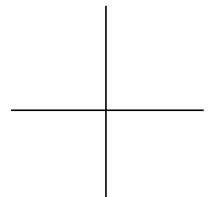

DESKTOP Messages

DESKTOP messages pertain to the Java Virtual Machine (JVM). If you are looking for a message that refers to the DESKTOP module but does not appear here, refer to “Messages Common to All Modules” on page 18-7.

BADPORT bad port specified - using default value *integer*

Severity: Warning

Explanation: The port that was specified for contacting the JVM is invalid, and the desktop code will use the default port specified in the message.

User Action: Make sure that you are using a valid unused socket.

CLONG command too long - greater than 2048 bytes

Severity: Error

Explanation: The command string sent to the JVM exceeds the maximum command-line length.

User Action: Try to reduce the length of the path to the Java modules.

NOMEM could not allocate buffer for command string

Severity: Error

Explanation: The desktop launcher was not able to allocate space for the command buffer to be sent to the JVM.

User Action: Close local clients or remote clients to free memory.

NOURL no URL specified

Severity: Error

Explanation: No URL that contains an applet was sent to the desktop code.

User Action: Specify an URL when calling the desktop code.

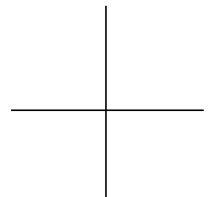

DHCP Messages

DHCP module messages pertain to the DHCP (Dynamic Host Configuration Protocol) support. If you are looking for a message that refers to the DHCP module but does not appear here, refer to “Messages Common to All Modules” on page 18-7.

INFLEASE, Infinite IP address lease acquired.

Severity: Information

Explanation: The terminal has acquired an IP address that it does not need to renew.

User Action: None

NEWLEASE, New IP address lease acquired, expires in *n* seconds.

Severity: Information

Explanation: The terminal has acquired an IP address that it is permitted to use for *n* seconds before it must renew the lease.

User Action: None

NOLEASE, Unable to renew IP address lease, TCP/IP network being halted.

Severity: Fatal

Explanation: The terminal was unable to renew its lease so it must disable its TCP/IP protocol stack.

User Action: Make sure that the DHCP server is responding.

NORESPONSE, DHCP server *nnn.nnn.nnn.nnn* or any others not responding: *n* seconds until lease expires.

Severity: Warning

Explanation: The terminal is unable to renew its IP address lease.

User Action: Make sure that the DHCP server is responding.

DIAGD Messages

DIAGD module messages pertain to the Diagnostic daemon. If you are looking for a message that refers to the DIAGD module but does not appear here, refer to “Messages Common to All Modules” on page 18-7.

STAMP, *days:hours:minutes:seconds*

Severity: Information

Explanation: When the Console Messages Time Stamp feature is active, the DIAGD module time stamps messages using the specified format. The time reported is the elapsed time since the last boot of the X server.

User Action: None

DOS Messages

This section lists the X server messages generated by the DOS module. These messages pertain to use of a local file system on a floppy drive.

If you are looking for a message that refers to the DOS module but does not appear here, refer to “Messages Common to All Modules” on page 18-7.

ALLOCERR, not enough sectors allocated for *file*

Severity: Error

Explanation: The file is corrupted.

User Action: Reformat or replace the floppy disk.

CORRUPT, Corrupted file system detected, *message*

Severity: Error

Explanation: The X server detected invalid file system data structures. Message includes additional information, such as `invalid structure`.

User Action: Reformat or replace the floppy disk.

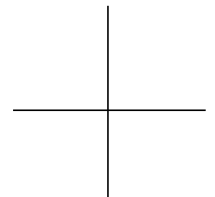

FATERR, Unable to write FAT, probable data loss

Severity: Error

Explanation: The X server cannot update the primary copy of the file allocation table (FAT). The floppy disk may be corrupted.

User Action: Reformat or replace the floppy disk.

FATWARN, Warning, unable to write backup FAT

Severity: Warning

Explanation: The floppy file system keeps two copies of the file allocation table (FAT). The X server is unable to update the second copy.

User Action: The potentially bad floppy may need to be replaced.

FORMAT, Format failed, *var*

Severity: Error

Explanation: The floppy disk cannot be reformatted because it is corrupted.

User Action: Replace the floppy disk.

NOPARENT, unable to find parent directory of *dir_name*

Severity: Error

Explanation: The file system state is inconsistent.

User Action: Reformat or replace the floppy disk.

WRITEFAIL, Disk write failed, (*n* sectors bad at *sector_n*)

Severity: Error

Explanation: The X server failed to write data to disk and files may be corrupted.

User Action: The floppy disk may be bad and need to be reformatted or replaced.

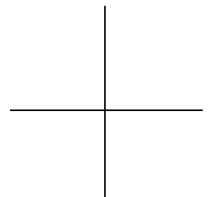

DTR Messages

DTR module messages pertain to the DTR network test utility. If you are looking for a message that refers to the DTR module but does not appear here, refer to “Messages Common to All Modules” on page 18-7.

MSGSRCVD, received *n* messages

Severity: Information

Explanation: The DTR module has received the specified number (*n*) of messages.

User Action: None

EXECD Messages

EXECD messages pertain to the execution of local clients. If you are looking for a message that refers to the EXECD module but does not appear here, refer to “Messages Common to All Modules” on page 18-7.

BADCMD, invalid command: *command*

Severity: Error

Explanation: The EXEC daemon does not recognize the specified command, usually a local client command.

User Action: Check the *System Administrator’s Guide for UNIX Systems* or the client man page to determine the correct command for the desired local client.

BADERRPORT, invalid error port number in request

Severity: Error

Explanation: The X server has detected an internal error.

User Action: If you encounter this message, please contact NCD Technical Support.

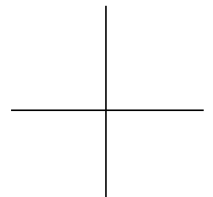

BADLICENSE, terminal not licensed for: *feature*

Severity: Error

Explanation: The terminal does not have a license for the specified feature, such as DPS.

User Action: Contact NCD to obtain a valid license for the desired feature and enter it in the terminal's remote configuration file, NVRAM, or **license.dat** file.

BADMODDIR, bad modules directory: *dir*

Severity: Error

Explanation: The X server was unable to load modules from the configured directory.

User Action: Make sure that the modules are in the correct location and accessible.

BADPARAMS, invalid parameters given for: *client*

Severity: Error

Explanation: The specified local client does not recognize the command-line options it received through the EXEC daemon.

User Action: Verify that the command-line options are correct for the specified client.

BADPORT, refused request from *nnn.nnn.nnn.nnn* on bad port *n*

Severity: Error

Explanation: The EXEC daemon has received a request for connection from the specified host. The EXEC daemon is refusing the request because the request did not originate from a privileged TCP port on the host. Specifically, the requesting TCP port number is equal to or greater than 1024.

User Action: Verify the host system is using the correct TCP port.

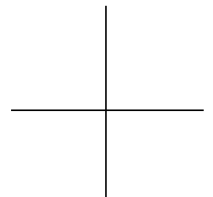

EXEC D Messages

DISABLEDCMD, command has been disabled: *command*

Severity: Error

Explanation: *Command* cannot be executed because it has been configured as disabled.

User Action: Remove *command* from the `exec-disabled-commands` remote configuration parameter.

LOADCMD, error loading command: *command*

Severity: Error

Explanation: The X server is unable to load a module needed to run the command.

User Action: Make sure that the modules are present and in the correct location.

LOADDISABLED, loading of module *module* has been disabled

Severity: Error

Explanation: The module has been configured to be disabled.

User Action: Change the load policy for the module in the `modules-load-policy` remote configuration parameter.

LONGCMD, command string too long

Severity: Error

Explanation: The command that has been entered exceeds the limit of 512 characters.

User Action: Re-enter the command, limiting the entry to 512 characters.

LONGUSER, user name too long

Severity: Error

Explanation: The user name that has been entered is too long.

User Action: Re-enter the user name, limiting the entry to 16 characters.

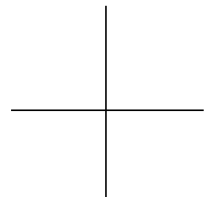

NOERRCONN, unable to connect to error socket: *message*

Severity: Error

Explanation: The network connection has failed.

User Action: Verify that the host is operational, that it is communicating on the network, and that the network is working.

NOERRPORT, unable to read port number from request

Severity: Error

Explanation: The X server has detected an internal error.

User Action: If you encounter this message, please contact NCD Technical Support.

NONIPERRPORT, error port given on non-IP connection

Severity: Error

Explanation: The X server has specified a port number when communicating across a DECnet network.

User Action: If you encounter this message, please contact NCD Technical Support.

NORESPORT, no reserved ports available

Severity: Error

Explanation: The X server has detected an internal error.

User Action: If you encounter this message, please contact NCD Technical Support.

OPENMODFAIL, unable to open module *module*

Severity: Error

Explanation: The X server cannot find *module*.

User Action: Make sure that the module is in the modules directory.

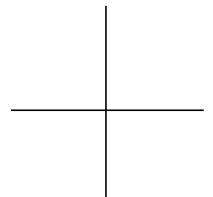

FILED Messages

PROCLIM, too many copies already running: *client*

Severity: Error

Explanation: The user has requested a local client when the maximum number of the client's processes already exist.

User Action: Use an existing client process, or close one of the existing client processes and open a new one.

START, running command: *command*

Severity: Information

Explanation: The EXECD module has started the specified command as requested.

User Action: None

UNKNOWNERR, unknown error for: *client*

Severity: Error

Explanation: The specified local client has failed with an unknown error code.

User Action: If you encounter this message, please contact NCD Technical Support.

FILED Messages

FILED messages pertain to the local file system and Local File Manager. If you are looking for a message that refers to the FILED module but does not appear here, refer to "Messages Common to All Modules" on page 18-7.

BADARG, invalid arguments to command

Severity: Error

Explanation: The X server does not recognize arguments of the command.

User Action: Retype the command with correct arguments.

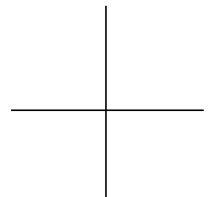

BADNUMARGS, invalid number of arguments

Severity: Error

Explanation: An incorrect number of arguments was given with the command.

User Action: Retype the command with the correct number of arguments.

BADPASSWORD, incorrect password entered

Severity: Warning

Explanation: The password that has been entered for the local file system is incorrect.

User Action: Confirm that you are using the correct password for access to the local file system.

FORMATABORT, format aborted, no data changed

Severity: Information

Explanation: The user entered the **format** command, but then entered **no** in response to the `Proceed with format?` prompt. In response, the FILED module aborted the formatting process.

User Action: None

FORMATFAILED, failed to format local, *action*, *message*

Severity: Error

Explanation: The Local File Manager could not perform the specified action when it attempted to format the PCMCIA card. This situation occurs if:

- The PCMCIA card is inserted incorrectly.
- The PCMCIA card is write-protected.
- The user has read-only access to the local file system. Read-only access occurs with One-Time Programmable (OTP) cards, and with cards that the X server does not support.

User Action: Verify that: the PCMCIA card is seated properly in its slot, the write-protect switch on the PCMCIA card is write-enabled, and the card is supported by the current version of the X server.

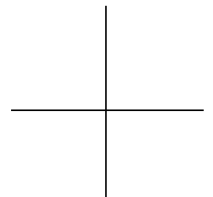

FILED Messages

FORMATSUCCESS, format completed successfully

Severity: Information

Explanation: The local file manager formatted the PCMCIA card successfully as requested.

User Action: None

INFOFAILED, failed to read local info, *action* failed, *message*

Severity: Error

Explanation: The local file manager could not perform the specified action when it attempted to obtain information about the PCMCIA card. This situation may occur if no PCMCIA card is installed in the terminal base or if the PCMCIA card is unformatted.

User Action: Verify that the PCMCIA card is installed, that it is properly seated in the socket, and that it is formatted.

LISTFAILED, failed to list *device*, *action* failed, *message*

Severity: Error

Explanation: The Local File Manager could not perform the specified action when it attempted to list the files on the specified device. This situation may occur if no PCMCIA card is installed in the terminal base or if the PCMCIA card is unformatted.

User Action: Verify that the PCMCIA card is installed, that it is properly seated in the socket, and that it is formatted.

NOPASSWD, no password configured, denying access

Severity: Warning

Explanation: The terminal's configuration database does not have a password specified for access to the local file manager and therefore is denying access.

User Action: Establish a password for access to the terminal's Local File Manager in the terminal's configuration database.

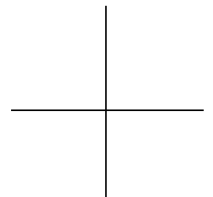

OKPASSWORD, correct password entered

Severity: Information

Explanation: The correct password has been entered for access to the local file manager.

User Action: None

OPFAILED, *var*, *var*, *var*

Severity: Error

Explanation: Typically the variables state either (1) an operation that failed, (2) a file or directory operation failed, or (3) an error. For example, the user may have entered a bad file or directory name.

User Action: Correct the error indicated in the message.

RECLAIMFAILED, failed to reclaim local dirty space, *action* failed, *message*

Severity: Error

Explanation: The Local File Manager could not perform the specified action when it attempted to reclaim unused file space.

User Action: If you encounter this message, please contact NCD Technical Support.

RECLAIMSUCCESS, reclaim completed successfully

Severity: Information

Explanation: The Local File Manager has reclaimed previously used file space as requested.

User Action: None

SYNTAX, line *n*: syntax error at *string*

Severity: Error

Explanation: The specified line contains an error beginning with the specified string.

User Action: Make sure that the command entered is correct.

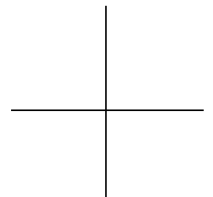

FONT Messages

VERIFYFAILED, failed to verify local, **action** failed, **message**

Severity: Error

Explanation: The Local File Manager could not perform the specified action when it attempted to verify the structure of the local file system. This situation may occur if the PCMCIA card is not installed or if the PCMCIA card is not formatted.

User Action: Verify that the PCMCIA card is installed, that it is properly seated in the socket, and that it is formatted. If no card is installed, you may ignore this message.

VERIFYSUCCESS, verify completed successfully

Severity: Information

Explanation: The Local File Manager verified its contents successfully as requested.

User Action: None

FONT Messages

FONT messages pertain to font service and the NCD font server. Most of the messages listed here appear only if the extended font diagnostics feature is enabled through the **pref-font-extended-diagnostics** parameter (Setup ⇒ Change User Preferences ⇒ Fonts ⇒ Show Extended Font Diagnostics).

If you are looking for a message that refers to the FONT module but does not appear here, refer to “Messages Common to All Modules” on page 18-7.

BADALIAS, failed to load font alias file **file**

Severity: Error

Explanation: The X server cannot load the specified font alias file.

User Action: Verify that:

- The font alias file is specified correctly.
- The font alias file resides in the specified location.
- The file service table contains an entry for the desired font alias file.
- The desired file has read access.

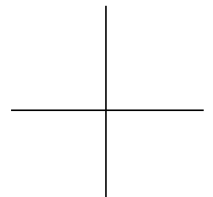

BADFONTDATA, bad data in font *font*

Severity: Error

Explanation: The X server attempted to read another vendor's SNF font file and was unsuccessful.

User Action: If your site uses another vendor's SNF fonts, convert them to NCD's SNF font format before using them. The NCD font server can provide the necessary conversion.

BADFONTFILE, cannot recognize data in font file *file*

Severity: Error

Explanation: The X server does not understand the information contained in the specified font file. This message occurs only when reading font files from the local file system.

User Action: Make sure the specified font file contains the correct font information. If the X server still cannot read the font file, create a **fonts.dir** file to identify the fonts residing in the local file system.

BADTYPE, unrecognized font type in file *file*

Severity: Error

Explanation: This message occurs when either of the following is true:

- The specified font file contains an incorrect font name.
- The X server is running low on memory.

User Action: Verify that the font name in the specified font file is correct. Verify that the X server has enough memory to access the font. If memory is running low, close any unused local clients to free local memory.

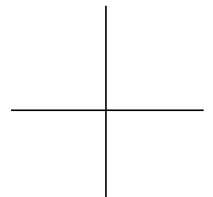

FONT Messages

FONTEMPTYDIR, no fonts found in directory *directory*

Severity: Information

Explanation: The X server cannot find any fonts in the specified directory. This message occurs only when the X server attempts to find fonts residing in the local file system and the local file system does not contain any font files.

User Action: If the font path specifies the local file system, make sure that fonts reside in the local file system. If the font path specifies the local file system when it should not, remove the local file system entry.

FONTMISSINGNAME, no FONT property in font *file* using *font*

Severity: Warning

Explanation: The specified font file does not contain the specified font name. This message occurs only when the X server attempts to find a font residing in the local file system.

User Action: None

FSBADCONN, failed to connect to font server: *font_server*

Severity: Error

Explanation: The X server cannot connect to the specified font server either because the font server name is incorrect, the font server is not running, the network is not working, or the X server is running low on memory.

User Action: Verify that:

- The the font server name is correct.
- The font server is running.
- The font server is accessible via the network.
- The X server has sufficient memory to access the font server.

FSBADNAME, font server name *font_server* illegal or unresolvable

Severity: Error

Explanation: The X server does not recognize the specified font server.

User Action: Make sure the font server name is correct and conforms to the following guidelines:

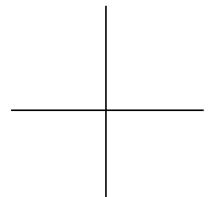

- ❑ Font server names are case-sensitive; make sure the desired name is typed correctly.
- ❑ Font servers residing on DECnet networks require two colons (::) after the hostname or address while those residing on TCP/IP networks require one colon (:).
- ❑ The DECnet object name for a font server residing on a DECnet network must contain the prefix FONTS.

FSCANCEL, flushing pending requests to font server: *font_server*

Severity: Information

Explanation: The font server has stopped running, current applications are waiting for fonts from the font server, and the user has selected the Abort Waiting Fonts option in the Console window (Console ⇒ Abort Waiting Fonts).

User Action: None

FSCLOSECONN, disconnecting from font server: *font_server*

Severity: Information

Explanation: The X server is shutting down communications with the specified font server.

User Action: None

FSCONN, connecting to font server: *font_server*

Severity: Information

Explanation: The X server is establishing communications with the specified font server.

User Action: None

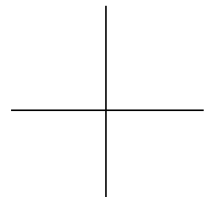

FONT Messages

FSCONNTIMEOUT, timed out connecting to font server

Severity: Warning

Explanation: The X server attempted to connect to a font server but the connect time exceeded the open connection time-out limit, which is defined in the `xserver-fontserver-open-timeout` parameter.

User Action: Verify that the font server is running, that it is accessible via the network, and that the time-out limit specifies a reasonable amount of time, such as the default 30.

FSINITERROR, failed to set font server catalogue "font_server"

Severity: Warning

Explanation: The X server has failed to initialize a font server connection.

User Action: Verify that the font server is accessible over the network.

FSLIST, listing fonts (on server *font_server*): *font*

Severity: Information

Explanation: The X server is listing the available fonts on the specified font server as requested by the *xlsfonts* client.

User Action: None

FSLISTINFO, listing fonts with info (on server *font_server*): *font*

Severity: Information

Explanation: The X server is listing the available fonts on the specified font server and additional information as requested by the *xlsfonts* client with the `-I` command-line option.

User Action: None

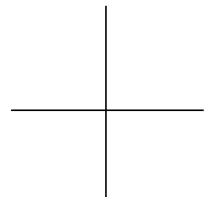

FSREADTIMEOUT, timed out reading from font server

Severity: Warning

Explanation: The X server requested a font from a font server but the response time exceeded the read font time-out limit, which is defined in the **xserver-fontserver-read-timeout** parameter.

User Action: Verify that the font server is running, that it is accessible via the network, and that the read time-out limit specifies a reasonable amount of time, such as the default of 20.

FSREQ, requesting font (on server *font_server*): *font*

Severity: Information

Explanation: The X server is requesting the specified font from the specified font server.

User Action: None

FSREQTIMEOUT, timed out in servicing request from font server

Severity: Warning

Explanation: The X server requested a font from a font server but the response time exceeded the time limit specified for response from the font server.

User Action: Verify that the font server is running, that it is accessible via the network, and that the request time-out limit specifies a reasonable amount of time.

FSRESETCONN, resetting connection to font server: *font_server*

Severity: Information

Explanation: The X server is resetting status information, such as dpi, as requested.

User Action: None

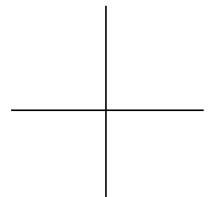

FONT Messages

LIST, listing fonts on pattern: *font_pattern*

Severity: Information

Explanation: The X server is listing fonts that match the specified pattern as requested.

User Action: None

LISTINFO, listing fonts with info on pattern: *font_pattern*

Severity: Information

Explanation: The X server is listing fonts that match the specified pattern and providing additional information as requested.

User Action: None

LOSTCONNECTION, lost connection to font server *font_server*

Severity: Error

Explanation: The connection to the font server failed.

User Action: Verify that the font server is running and that it is accessible to the network.

NOACCESS, denied access to font server *font_server*

Severity: Error

Explanation: The X server is not included in the list of trusted clients that the font server maintains and is therefore refused access to the font server.

User Action: Add the terminal to the font server's list of trusted clients, maintained in the **trusted-clients** parameter in the font server configuration file, if the terminal should have access to the fonts on that font server. (If no values are in the parameter, the default is to accept any connection.)

REQ, requesting font: *font*

Severity: Information

Explanation: The X server is requesting the specified font for display on the screen.

User Action: None

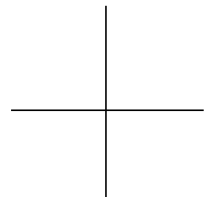

RETAINFONTS, retained font path over server reset

Severity: Information

Explanation: As requested, the X server retained the default font path even though the X server was reset.

User Action: None

RETAINFONTSFAIL, failed to retain font path over server reset

Severity: Information

Explanation: The X server attempted to retain the default font path after the X server was reset, but could not. This usually occurs when a font server is included in the font path or if the font path has changed since the last reset of the X server.

User Action: None

TRYINGALTERNATE, attempting connection to alternate font server *font_server*

Severity: Information

Explanation: The original font server connection has failed. The X server is trying to connect to the alternate font server.

User Action: Check to see why the original font server is no longer functioning.

IPROUTE Messages

IPROUTE messages appear only if extended IP routing diagnostics are enabled by setting the **ip-extended-routing-diagnostics** parameter to “true.” If you are looking for a message that refers to the IPROUTE module but does not appear here, refer to “Messages Common to All Modules” on page 18-7.

ADDING, adding route to *nnn.nnn.nnn.nnn* thru gateway *nnn.nnn.nnn.nnn*

Severity: Information

Explanation: The X server is adding the specified route to its IP routing table as requested.

User Action: None

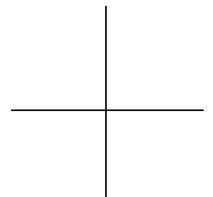

IPROUTE Messages

HOLDDOWN, no response from *nnn.nnn.nnn.nnn*: temporarily disabling default route thru gateway *nnn.nnn.nnn.nnn*

Severity: Information

Explanation: The X server is no longer trying to route packets to the specified default gateway. This may be because of network problems or because of problems on the gateway. The X server uses the second default gateway (defined by *ip-initial-default-gateway-2*) when the initial default gateway (*ip-initial-default-gateway-1*) fails. When the X server verifies via *ping* that the gateway machine *nnn.nnn.nnn.nnn* is operating, it again routes packets there.

User Action: None

NORESPONSE, no response from *nnn.nnn.nnn.nnn* using route to *nnn.nnn.nnn.nnn* thru gateway *nnn.nnn.nnn.nnn*: deleting route

Severity: Information

Explanation: The X server has not received a response from the specified destination using the specified gateway, and is deleting the route from its IP routing table. The three IP addresses specified are the destination host, the destination network, and the gateway.

User Action: None

RESTORE, restoring default route thru gateway *nnn.nnn.nnn.nnn*

Severity: Information

Explanation: The X server has reestablished a stable network connection with the specified default gateway.

User Action: None

TIMEDOUT, route to *nnn.nnn.nnn.nnn* through gateway *nnn.nnn.nnn.nnn* timed out: deleting route

Severity: Information

Explanation: The route to the specified destination has timed out, and the X server is removing the route from its IP routing table.

User Action: None

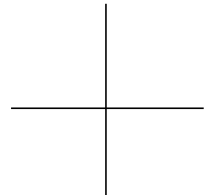

JAVA Messages

JAVA messages pertain to use of Java. If you are looking for a message that refers to the JAVA module, but is not listed here, see “Messages Common to All Modules” on page 18-7.

ABORT, aborting java virtual machine

Severity: Fatal

Explanation: The Java module has experienced a fatal internal error.

User Action: Please contact NCD Technical Support.

NOMEM, unable to allocate enough memory

Severity: Fatal

Explanation: There is not enough memory for Java to operate.

User Action: Add memory to the terminal or exit from other applications.

NOZIPFILEUSE, unable to use zip file *filename*

Severity: Warning

Explanation: The Java module cannot open the compressed class files.

User Action: Use TFTP instead of NFS for accessing class files.

ZIPERR, error reading zip file *filename message*

Severity: Error

Explanation: There is an error in the compressed file; the file is probably corrupted.

User Action: Reinstall the zip file from the NCDware distribution CD-ROM.

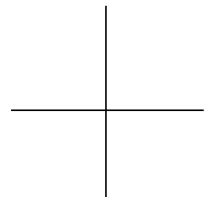

KBM Messages

KBM messages pertain to usage of downloadable keyboard description files.

For more information about using downloadable keyboard descriptions, see Chapter 17, Keyboards and Downloadable Keyboard Definitions.

If you are looking for a message that refers to the KBM module but does not appear here, refer to “Messages Common to All Modules” on page 18-7.

ARGUMENT, Line *n*: argument found where end of line is expected: *arg*

Severity: Error

Explanation: At line *n*, the X server encountered an extra command-line argument *arg*.

User Action: Check the syntax and usage of the keyboard definition statement in line *n*.

CLOSEINCLUDE, Closing include file: *file*

Severity: Information

Explanation: Reports that the file, which is an include file referred to in the primary keyboard description file, was read completely.

User Action: None

COPYNOMEMORY, Line *n*: no memory to copy string: *string*

Severity: Error

Explanation: The terminal ran out of memory for temporary string storage.

User Action: Check the amount of available memory. If possible, close some local clients to free more memory. You may need to add memory to the terminal.

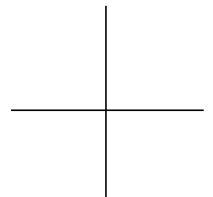

DEADKEYNOMEMORY, Line *n*: no memory for deadkey list: *list*

Severity: Error

Explanation: The terminal ran out of memory for the deadkey list.

User Action: Check the amount of available memory. If possible, close some local clients to free more memory. You may need to add memory to the terminal.

DEBUGDISABLE, Debug operation disabled

Severity: Warning

Explanation: Reports that the ability to invoke the Boot Monitor from the keyboard while the X server is running has been disabled.

User Action: Verify that Boot Monitor access key combination was disabled intentionally.

ENDOFFILE, Line *n*: unexpected end of file

Severity: Error

Explanation: At line *n*, an end-of-file was reached before parsing was complete.

User Action: Check the syntax and usage of the keyboard definition statements in line *n*.

EXPECTEQUAL, Line *n*: expecting "=" instead of: *arg*

Severity: Error

Explanation: At line *n*, an equals sign (=) is needed instead of *arg*.

User Action: Check the syntax and usage of the keyboard definition statement in line *n*.

EXPECTNUMBER, Line *n*: expecting number instead of: *arg*

Severity: Error

Explanation: At line *n*, a number-type argument is needed instead of *arg*.

User Action: Check the syntax and usage of the keyboard definition statement in line *n*.

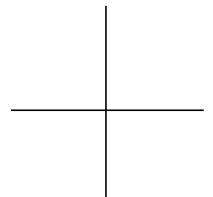

KBM Messages

EXPECTQUOTE, Line *n*: expecting quoted string instead of: *arg*

Severity: Error

Explanation: At line *n*, a quoted string, such as a filename, is needed instead of *arg*.

User Action: Check the syntax and usage of the keyboard definition statement in line *n*.

INVALIDLEDCMD, Line *n*: invalid LED command: *command*

Severity: Error

Explanation: The LED command is an invalid operation.

User Action: Check the syntax and usage of the LED command in line *n*.

INVALIDLEDFUNC, Line *n*: invalid LED function: *function*

Severity: Error

Explanation: The LED function is an invalid action.

User Action: Check the syntax and usage of the LED function in line *n*.

INVALIDLEDNUM, Line *n*: invalid LED number: *LEDn*, must be in the range of 1 to *n*

Severity: Error

Explanation: The LED commands must refer to LEDs numbered in the range of 1 to the maximum number of LEDs (*n*). *LEDn* does not fall in that range.

User Action: Check the syntax and usage of the LED command in line *n*.

INVALIDNUMLED, Line *n*: invalid number of LEDs: *LEDn*, must be in the range of 0 to 4

Severity: Error

Explanation: At line *n*, the number of LEDs must be in the range of 0 - 4.

User Action: Check the syntax and usage of the LED command in line *n*.

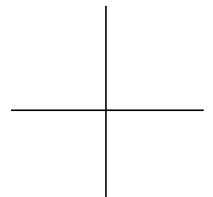

KEYCODERANGE, Line *n*: keycodes must be in the range of 0 to 254 instead of:
key_n

Severity: Error

Explanation: At line *n*, the keycode (*key_n*) must be in the correct range of 0 to 254.

User Action: Check the syntax and usage of the keycode definition statement in line *n*.

KEYSYMLISTEMPTY, Line *n*: provided keysym list is empty

Severity: Error

Explanation: You must provide at least one keysym for each of the following keyboard definition file statements: `modifier`, `repeat`, `lock`, `latch`, `click`, `click add`, and `click remove`.

User Action: Make sure that each of the statements listed has at least one keysym.

KEYSYMNOMEMORY, Line *n*: no memory for keysym list: *list*

Severity: Error

Explanation: The terminal ran out of memory for the keysym list.

User Action: Check the amount of available memory. If possible, close some local clients to free more memory. You may need to add memory to the terminal.

KEYWORD, Line *n*: unknown keyword: *keyword*

Severity: Error

Explanation: The keymapper file has an unknown command at line *n*.

User Action: Check the syntax and usage of *keyword* in line *n*.

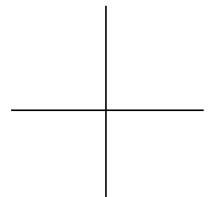

KBM Messages

MAXDEBUGKEYS, Line *n*: found *debug_n* debug combination keys, *max_n* maximum

Severity: Error

Explanation: At line *n*, *debug_n* keys, more than the maximum (usually four) keys, are used to define a Boot Monitor access key combination.

User Action: Change the Boot Monitor access key combination definition to *max_n* or fewer keys.

MAXSETUPKEYS, Line *n*: found *setup_n* setup combination keys, *max_n* maximum

Severity: Error

Explanation: At line *n*, *setup_n*, more than the maximum (usually four) keys, are used to define a Setup key combination.

User Action: Change the Setup key combination definition to *max_n* or fewer keys.

MOREKEYSCAN, Line *n*: more keycodes (*key_n*) given than scancodes (*scan_n*)

Severity: Error

Explanation: At line *n*, the scancode command has more keycodes (*key_n*) than scancodes (*scan_n*).

User Action: Check the syntax and usage of the keyboard definition statement in line *n*.

MORESCANKEY, Line *n*: more scancodes (*scan_n*) given than keycodes (*key_n*)

Severity: Error

Explanation: At line *n*, the scancode command has more scancodes than keycodes.

User Action: Check the syntax and usage of the keyboard definition statement in line *n*.

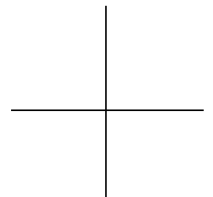

NODEADKEYSYET, Line *n*: warning no deadkeys defined yet

Severity: Warning

Explanation: A dead-key command used a dead-key keysym that had not already been defined in the keyboard definition file.

User Action: Define the dead-key keysym in the keycode section of the file.

NOFILE, Cannot open file: *file*

Severity: Error

Explanation: The file does not exist or the file service table is not configured to ensure access to it.

User Action: Make sure that the file exists and the file service table is configured for access to it (Setup ⇒ Change Setup Parameters ⇒ File Service ⇒ File Service Table).

NOFILEINC, Line *n*: cannot open file: *file*

Severity: Error

Explanation: The include file referred to in line *n* does not exist or the file service table is not configured to ensure access to it.

User Action: Make sure that the file exists and the file service table is configured for access to it (Setup ⇒ Change Setup Parameters ⇒ File Service ⇒ File Service Table).

NOKEYSYM, Line *n*: keysym not found in keycode table *name*

Severity: Error

Explanation: At line *n*, the keysym located in a command was not defined in the keycode portion of the file.

User Action: Define the keysym in a higher location in the file than its first use.

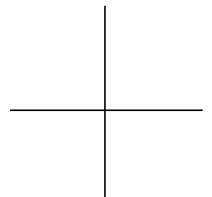

KBM Messages

NOKESYMINTABLE, Line *n*: found no occurrence of keysym in table: *keysym*

Severity: Error

Explanation: At line *n*, the keysym was not found in the keycode table.

User Action: Check the syntax and usage of the keyboard definition statement in line *n*.

NOMEMORY, No memory for temporary keyboard table

Severity: Fatal

Explanation: The terminal ran out of memory for internal tables.

User Action: Check the amount of available memory. If possible, close some local clients to free more memory. You may need to add memory to the terminal.

NOMODIFIERSYET, Line *n*: warning no modifiers defined yet

Severity: Warning

Explanation: At line *n*, the modifier command included a keysym that had not already been defined in the keycode section of the file.

User Action: Define the keysym in the keycode section of the file.

NOOPERATION, Line *n*: unknown *command* operation:*var*

Severity: Error

Explanation: At line *n*, the operation requested for the command is invalid.

User Action: Check the syntax and usage of *command* in line *n*.

NUMERRORS, Total errors: *n*

Severity: Information

Explanation: Reports the number of parsing errors the X server encountered during reading the file.

User Action: None

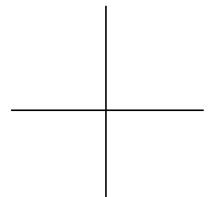

ONEKEYCODE, Line *n*: must have at least one keycode

Severity: Error

Explanation: At line *n*, the scancode command requires at least one *scancode* to *keycode* value definition.

User Action: Check the syntax and usage of scancode command in line *n*.

ONESCancode, Line *n*: must have at least one scancode

Severity: Error

Explanation: At line *n*, the scancode command requires at least one *scancode* to *keycode* value definition.

User Action: Check the syntax and usage of the scancode command in line *n*.

OPENINCLUDE, Opening include file: *file*

Severity: Information

Explanation: Reports the full pathname of an include file *file* that is referred to in the main file.

User Action: None

READINGFILE, Reading file: *file*

Severity: Information

Explanation: Reports the full pathname of the file being read.

User Action: None

SCANCODERANGE, Line *n*: scancodes must be in the range of 0 to 255 instead of: *scan_n*

Severity: Error

Explanation: At line *n*, the scancode *scan_n* is not in the range of 0 to 255.

User Action: Check the syntax and usage of the scancode command in line *n*.

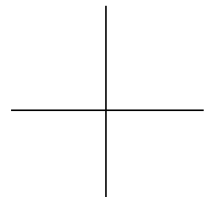

KBM Messages

SETUPDISABLE, Setup operation disabled

Severity: Warning

Explanation: Reports that keyboard access to the Setup menus has been disabled.

User Action: Verify that the menu access was disabled intentionally.

SUBNOSYMBOL, Line *n*: cannot substitute "NoSymbol" keysym

Severity: Error

Explanation: At line *n*, the keysym command cannot make a substitute of NoSymbol, which is a default.

User Action: Select another keysym.

TOOFEWKEYSYMS, Line *n*: not enough keysyms provided

Severity: Error

Explanation: At line *n*, the deadkey command has too few keysyms.

User Action: Correct the keyboard description file deadkey command.

TOOMANYKEYCODE, Line *n*: too many keycodes, found *key_n*

Severity: Error

Explanation: At line *n*, the scancode command has *key_n* keycodes, which is more than the maximum of 256.

User Action: Check the syntax and usage of the keyboard definition statement in line *n*.

TOOMANYKEYSYMS, Line *n*: the maximum number of keysyms per keycode is *key_n*

Severity: Error

Explanation: At line *n*, the keysym or keycode command exceeded the maximum of four keysyms per command.

User Action: Check the syntax and usage of the keyboard definition statement in line *n*.

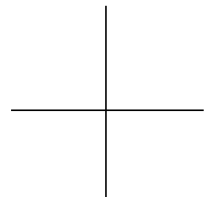

TOOMANYSCAN, Line *n*: too many scancodes, found *scan_n*

Severity: Error

Explanation: At line *n*, the scancode command has *scan_n* scancodes, more than the maximum of 256.

User Action: Check the syntax and usage of the scancode command in line *n*.

UNKNOWNKEYSYM, Line *n*: unknown keysym name: *name*

Severity: Error

Explanation: At line *n*, the terminal does not recognize the keysym name *name*.

User Action: Check the syntax and usage of *keysym* in line *n*.

KEYMAPPER Messages

KEYMAPPER messages pertain to the Keymap Editor. If you are looking for a message that refers to the KEYMAPPER module but does not appear here, refer to “Messages Common to All Modules” on page 18-7.

USAGE, *usage_syntax*

Severity: Fatal

Explanation: The user included an incorrect command-line option.

User Action: Review the usage and syntax instructions in the command’s man page for the correct options and usage.

LICENSE Messages

LICENSE messages pertain to use of the license management software.

If you need to call NCD Technical Support for a problem related to the LICENSE module, make sure you have the output from the *lmgrd* daemon containing messages sent to the log file. The error log file is specified when starting the license server. For more information, see the *NCDware System Administrator’s Guide for UNIX Systems*. NCD Technical Support needs the information contained in the log file to assist in diagnosing problems.

LICENSE Messages

For messages that refer to the LICENSE module but do not appear here, refer to “Messages Common to All Modules” on page 18-7. Additional information about FLEXlm messages is contained in the *FLEXlm End User Manual*.

ATTEMPTCON, Requesting **feature** license from ncdlicense at **host_IP**

Severity: Information

Explanation: The X server is trying to obtain a license for **feature** from the license daemon running on **host_ip**.

User Action: None

BADFEATMASK, Received packet with wrong feature or request

Severity: Error

Explanation: The terminal sent a request to **ncdlicense**, which responded with the wrong feature or request.

User Action: Try again. If the problem persists, contact NCD Technical Support.

BADLICENSE, invalid license string: **license_string**

Severity: Error

Explanation: The license string (**license_string**) is invalid.

User Action: Correct the license string in the remote configuration file, NVRAM, or the **license.dat** file. For floating and site licenses, you must use the **lmreread** utility to instruct the terminal to reread the **license.dat** file and you must restart **ncdlicense**.

ERRBIND, bind () failed: **message**

Severity: Error

Explanation: The **bind ()** system call failed on the terminal. **Message** is the UNIX error description.

User Action: Reboot the terminal. If the problem persists, contact NCD Technical Support.

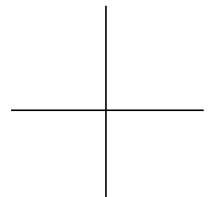

ERRORSENDPKT, sendto () failed: *message*

Severity: Error

Explanation: The `sendto ()` system call failed on the terminal. *Message* is the UNIX error description.

User Action: Reboot the terminal. If the problem persists, contact NCD Technical Support.

ERRPORTACCESS, access to port *port_n* denied

Severity: Error

Explanation: Access to *port_n* was denied.

User Action: Reboot the terminal. If the problem persists, contact NCD Technical Support.

ERRRECVPKT, recvfrom () failed: *message*

Severity: Error

Explanation: The `recvfrom ()` system call failed on the terminal. *Message* is the UNIX error description.

User Action: Try again. If the problem persists, contact NCD Technical Support.

ERRRECVZERO, empty packet received: *message*

Severity: Error

Explanation: The license packet received by the terminal was empty. *Message* is the UNIX error description.

User Action: Reboot the terminal. If the problem persists, contact NCD Technical Support.

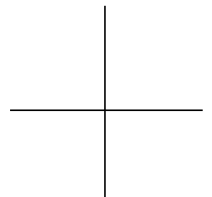

LICENSE Messages

ERRSENTDO, sendto () failed: *message*

Severity: Error

Explanation: The `sendto ()` system call failed on the terminal. *Message* is the UNIX error description.

User Action: Reboot the terminal. If the problem persists, contact NCD Technical Support.

ERRSHORTPKT, recvfrom () received short packet

Severity: Error

Explanation: The terminal received a truncated license packet.

User Action: Try again. If the problem occurs again, restart *ncdlicense* on the license host.

ERRSOCKET, socket () failed: *message*

Severity: Error

Explanation: The `socket ()` system call failed on the terminal. *Message* is the UNIX error description.

User Action: Reboot the terminal. If the problem persists, contact NCD Technical Support.

FAILCHECKOUT, license checkout failed, received NACK

Severity: Error

Explanation: *ncdlicense* refused to license the requested feature.

User Action: Make sure that you have a license for the feature.

FLEXMSG, FLEXlm: *message*

Severity: Information

Explanation: The X server is reporting the most recent FLEXlm error message, including the error numbers. FLEXlm errors are described in the *FLEXlm End*

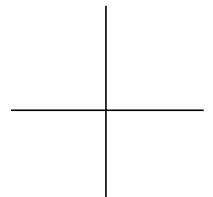

User Manual. If a UNIX operating system error is also involved, the X server message also includes the UNIX error message and number.

User Action: Check the *FLEXlm End User Manual* for a description of the problem.

INVLICENSE, *n*, invalid license string: *license_string*

Severity: Error

Explanation: *n* is an error value. The license string (*license_string*) is invalid.

User Action: Correct the license string in the remote configuration file, NVRAM, or the *license.dat* file. For floating and site licenses, you must use the *lmreread* utility to instruct *lmgrd* to reread the *license.dat* file and you must restart *ncdlicense*.

LICBADCHAR, bad character *char* in license string

Severity: Error

Explanation: The license string contained an invalid character. Valid characters for 16-character license strings are: abcdefABCDEF0123456789. Valid characters for 12-character license strings are: abcdefghijklm ABCDEFGHIJKLM.

User Action: Correct the license string in the remote configuration file or the *license.dat* file. For floating and site licenses, you must use the *lmreread* utility to instruct the *lmgrd* to reread the *license.dat* file and you must restart *ncdlicense*.

LICREMOVE, could not validate license, disabling features

Severity: Error

Explanation: The terminal tried to return a license, but the FLEXlm license manager did not accept it.

User Action: None.

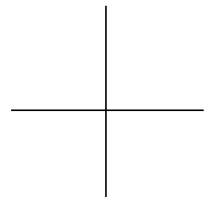

LICENSE Messages

LICWRONGLENGTH, license string is not *n* characters

Severity: Error

Explanation: The license string contained in the remote configuration file or the `license.dat` file has the wrong number (*n*) of characters.

User Action: Correct the license string in the remote configuration file or the `license.dat` file. For floating and site licenses, you must use the `lmreread` utility to instruct `lmgrd` to reread the `license.dat` file and you must restart `ncdlicense`.

NACK, received NACK: *integer*

Severity: Information

Explanation: Licenses for the requested feature are unavailable. The integer must be interpreted by NCD Technical Support.

User Action: None

NOCONN, connection to *host_IP* failed: *message*

Severity: Error

Explanation: The terminal failed to connect to the license agent running on *host_IP*. The X server reports the UNIX error description (*message*).

User Action: Verify that `ncdlicense` and `lmgrd` are running on *host_IP*.

NOFORFEIT, failed to send LM_FORFEIT

Severity: Error

Explanation: The terminal was unable to return a license to the license manager. The terminal will not include the feature in its heartbeat (routine status message) to `ncdlicense`, so the license eventually returns to the license pool.

User Action: None

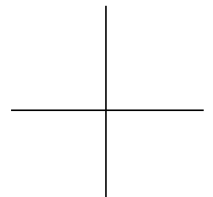

NOHEARTBEAT, failed to send LM_HEARTBEAT

Severity: Error

Explanation: The terminal failed to send a heartbeat (routine status message) to *ncdlicense*, which results in its licenses being returned to the license manager. The terminal must then request new licenses.

User Action: If the problem persists, reboot the terminal. If it continues after rebooting, contact NCD Technical Support.

NOLICENSE, failed to obtain license for *featureA*

Severity: Error

Explanation: The terminal did not obtain a license for *featureA*.

User Action: Make sure that you are licensed for *featureA*.

NONCDNET, NCDnet being DISABLED - not licensed!!

Severity: Error

Explanation: The terminal does not have a license for NCDnet (also called DECnet).

User Action: Make sure that you have a valid NCDnet license. Enter the valid license string into the terminal's NVRAM or a remote configuration file.

NORESPONSE, no response from license host *host_IP*

Severity: Error

Explanation: *ncdlicense* at the address *host_IP* did not respond to the terminal's license request.

User Action: Make sure that *ncdlicense* and *lmgrd* are both running on the host *host_IP*.

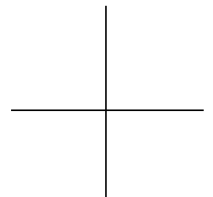

LOADB Messages

SELECTERR, select () failed: *message*

Severity: Error

Explanation: The `selecterr ()` system call failed on the terminal. *Message* is the UNIX error description.

User Action: Reboot the terminal. If the problem persists, contact NCD Technical Support.

LOADB Messages

LOADB messages pertain to loading of the NCD Mosaic Browser. If you are looking for messages that refer to the LOADB module but do not appear here, refer to “Messages Common to All Modules” on page 18-7.

BROWSER using browser: *string*

Severity: Information

Explanation: Tells which browser module is being loaded.

User Action: None

ENVNOT Cannot resolve: *string=string* Environment variable *\$string* not found

Severity: Warning

Explanation: An environment variable was specified in `pref-environment` with no value.

User Action: Make sure that all environment variables specified in the `pref-environment` parameter have values.

GOODURL The browser is currently loading, the URL will result in a new browser pane after the browser loads.

Severity: Information

Explanation: You tried to open two different URL pages on the browser while it is still loading.

User Action: None

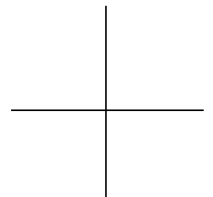

IGNURL The browser is currently loading and the requested URL is already being processed. This URL request will be ignored.

Severity: Information

Explanation: The browser was started again with the same URL that is being loaded before the first URL could be loaded. It is assumed that only one of the windows is desired.

User Action: If you want multiple copies of the same URL, wait until the first is loaded before loading the others.

NOLOAD loadb called with nothing to load

Severity: Error

Explanation: *loadb* requires a local client command name if called directly.

User Action: Specify the local client to load.

NOMEM Not enough memory for URL string. This URL request will be ignored

Severity: Error

Explanation: In the process of trying to send a URL string to the running browser, *loadb* could not allocate enough memory.

User Action: Start closing local clients or remote clients until the terminal has more memory available.

NOW The browser is running, if you wish to start a new window pane include the *-w* parameter as the first parameter in the command.

Severity: Warning

Explanation: Only one copy of the browser can run at any time; you must use the *-w* flag to open a new window.

User Action: If you want to open a new window after the browser is already running, specify *-w* as the first flag after the **browser** command to open a new window in the currently running browser. Only the current URL flag will be forwarded to the browser.

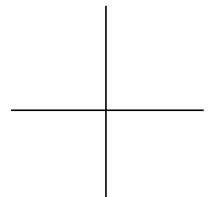

LOADB Messages

PARMMEM Not enough free memory for browser parameter string. Loading of browser terminated

Severity: Error

Explanation: The browser ran out of memory before it started to load.

User Action: Stop local clients and remote clients to free more memory.

PROURL The requested URL is already being processed. This URL request will be ignored.

Severity: Information

Explanation: The browser was started again with the same URL that is being loaded. It is assumed that only one of the windows is desired.

User Action: If you want multiple copies of the same URL, wait until the first is loaded before loading any others.

TIMEOUT Timeout sending URL to browser.

Severity: Error

Explanation: The browser seems to be running but is not able to accept a new URL from the command line. Either the current browser is not working or it is too busy.

User Action: Either wait until the browser is less busy, or stop the browser and restart it.

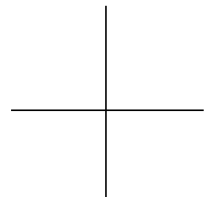

LOCALDEV Messages

LOCALDEV messages pertain to a terminal's local file system on a PCMCIA card. If you are looking for messages that refer to the LOCALDEV module but do not appear here, refer to "Messages Common to All Modules" on page 18-7.

FLASH, *n* megabyte flash memory card: manufacturers id *id*, devcode *code*

Severity: Information

Explanation: Identifies the PCMCIA card and the amount of memory available.

User Action: None

READONLY, *n* megabyte read only memory card

Severity: Information

Explanation: Identifies the card as read-only.

User Action: None

UNKNOWN, *n* megabyte memory card of unknown type

Severity: Information

Explanation: Reports that the card type is unknown to the X server, but identifies the amount of available memory.

User Action: None

UNSUPPORTED, unsupported memory card: manufacturers id *id*, device *dev*

Severity: Error

Explanation: The current version of the X server does not support the memory card installed in the terminal base. The memory card is identified by its manufacturer's identification and its device code.

User Action: Replace the current memory card with one supported by the current version of NCDware. NCD Technical Support can provide you with a list of the supported memory cards.

LOGIN Messages

WRITEERROR, error flushing data to flash card

Severity: Error

Explanation: A write error occurred when writing to the PCMCIA card. The PCMCIA card may be corrupted.

User Action: You may need to reformat the card and recopy the contents onto it.

LOGIN Messages

LOGIN messages pertain to the *login* local client (Login ⇒ Login New X Session).

For messages that start with LOGIN but do not appear here, refer to “Messages Common to All Modules” on page 18-7.

BDAUTHENTICATION, bad *authentication_type* authentication given by XDMCP host

Severity: Warning

Explanation: The specified type of authentication has failed during initial connection, usually due to an incorrect password.

User Action: Verify that the password being entered is correct for the desired type of authentication.

BDAUTHORIZATION, bad *authorization_type* authorization given by XDMCP host

Severity: Warning

Explanation: The authorization information contained in the packet from the host system is incorrect.

User Action: Verify that the passwords contained on the host system and in the X server are the same.

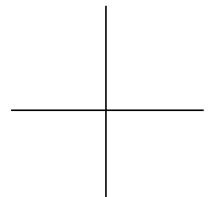

DWBADAUTHORIZATION, unable to login to DECWindows host: *host*

Severity: Error

Explanation: The specified DECwindows host has refused the user's login attempt. This message usually occurs when the user's password is incorrect.

User Action: Verify that the user enters the correct password when logging in to the DECwindows host.

DWERROR, *n* error while *action* host: *host*

Severity: Error

Explanation: The X server detected the specified error (indicated by the error number) while attempting to connect to the specified host.

User Action: Make sure that the host is connected to the network, that the network is running, and that the host system's NCP database contains the correct network addresses for the terminal and the host system.

KEEPALIVEOK, login host finally responding to keepalives

Severity: Information

Explanation: The host is responding to XDM keepalive packets.

User Action: None

NOAUTHORIZATION, no authorization; allowing access to host "*host*"

Severity: Warning

Explanation: The user attempted to connect to the specified host with XDM-AUTHORIZATION-1 but the attempt failed. Access is granted using MIT-MAGIC-COOKIE-1 authorization instead.

User Action: Verify that the password being entered is correct for the desired type of authentication.

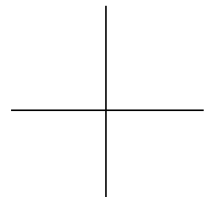

LOGIN Messages

NOSESSION, login prompter on host "*host*" failed to start session

Severity: Fatal

Explanation: The specified host has not started the login program because it detects other clients running on the terminal.

User Action: Close any existing client connections to the terminal before requesting login services.

XDMCPFAIL, XDMCP error: *message*: *status*

Severity: Error

Explanation: The X server has detected the specified XMDCP error.

User Action: Use the information contained in the message to determine the best course of action.

XDMCPNOBROADCAST, unable to set broadcast option on XDMCP socket

Severity: Error

Explanation: The X server cannot set the broadcast option for XDMCP requests for service.

User Action: If you encounter this message, please contact NCD Technical Support.

XDMCPNOSOCKET, unable to create *protocol* socket for XDMCP

Severity: Error

Explanation: The X server cannot create the required socket for XDMCP communications.

User Action: If you encounter this message, check the XDM error logging file *xdm-error*. If you need additional assistance, please contact NCD Technical Support.

XSESSFIND, asking host "*host*" to find a *protocol* login host

Severity: Information

Explanation: When the X server issues indirect requests for login services, it asks an intermediate host to locate a host offering login services. This message

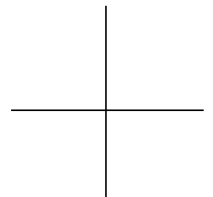

indicates that the X server is asking the specified indirect host to locate a system offering login services using the specified protocol.

User Action: None

XSESSREQ, asking host "*host*" for *protocol* session

Severity: Information

Explanation: The X server is requesting login services from the specified host using the specified protocol, usually either XDMCP or DECwindows.

User Action: None

XSESSSTART, *protocol* session started on host "*host*"

Severity: Information

Explanation: The specified host has established an X session with the X server using the specified protocol, either XDMCP or DECwindows.

User Action: None

MIRROR Messages

MIRROR messages pertain to the MIRROR daemon and loopback testing of connections on a DECnet network. If you are looking for a message that refers to the MIRROR module but that does not appear here, refer to "Messages Common to All Modules" on page 18-7.

MSGSRCVD, received *n* messages

Severity: Information

Explanation: The MIRROR daemon has received the specified number (*n*) of messages.

User Action: None

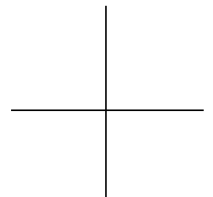

MPEGPLAY Messages

MPEGPLAY messages pertain to video software support. If you are looking for a message that refers to the MPEGPLAY module but that does not appear here, refer to “Messages Common to All Modules” on page 18-7.

BADENDCODE, Improper or missing sequence end code

Severity: Fatal

Explanation: The decoder could not find the MPEG I end code.

User Action: Make sure that the file is terminated properly with the MPEG I end code.

BADFLAG, Un-recognized flag *flag*

Severity: Fatal

Explanation: The user included an incorrect command-line option.

User Action: Review the usage and syntax instructions in the command’s man page for the correct options and usage.

NODISPLAY, Could not open display

Severity: Fatal

Explanation: The application could not open the display.

User Action: Make sure that the correct display is set by checking the *DISPLAY* environment variable.

NOFILE, Could not open file *file*

Severity: Fatal

Explanation: The X server failed to open the file specified.

User Action: Make sure that:

- The file exists.
- The file service table is configured for access to the file (Setup ⇒ Change Setup Parameters ⇒ File Service ⇒ File Service Table).
- The file is terminated properly with the MPEG I end code.

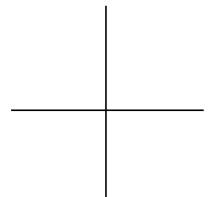

NOTMPEG, This is not an MPEG stream

Severity: Fatal

Explanation: The decoder could not find the MPEG I start code.

User Action: Make sure that the file is either an MPEG I video stream or an MPEG 1 interleaved audio and video stream.

PRIVCM, Using private colormap

Severity: Information

Explanation: The decoder installed a private colormap.

User Action: None

MWM Messages

MWM messages pertain to the local Motif Window Manager (*mwm*). If you are looking for a message that refers to the MWM module but that does not appear here, refer to “Messages Common to All Modules” on page 18-7.

ALREADY, window manager is already running

Severity: Fatal

Explanation: The X server has received a request to start the local Motif Window Manager when it is already running. The duplicate request has failed.

User Action: Locate the duplicate request for starting the local Motif Window Manager and remove it.

ERROR, *message*

Severity: Error

Explanation: The X server may not have been able to save all arguments necessary for a proper restart of the local Motif Window Manager.

User Action: Verify that the terminal has sufficient memory to perform the desired action.

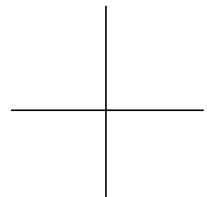

NCD Mosaic Browser Messages

RESTART, restarting

Severity: Information

Explanation: The local Motif Window Manager is restarting as requested.

User Action: None

WARNING, *message*

Severity: Warning

Explanation: The MWM module has encountered some difficulty as described in the message.

User Action: Use the information contained in the message to resolve the problem. Verify:

- The terminal is not running low on memory.
- The X server can locate, open, and read files as requested.
- The *mwm* resource file is free of errors.
- The configuration file is free of errors.

NCD Mosaic Browser Messages

Browser messages pertain to the NCD Mosaic Browser. These messages are not formatted in the same way as other messages. Messages are not preceded by a module name; they appear in the Console as shown in this section.

Modifying *application/octet-stream* is not allowed.

Explanation: The user attempted to change the helper application for *application/octet-stream*.

Unable to save *file*. Disk may be full.

Explanation: An attempt to create a file has failed because the disk is full.

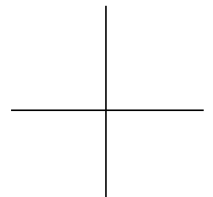

The main cache directory is invalid (not a directory).

or

The main cache directory is invalid (you have insufficient access rights).

Explanation: The user is editing the browser configuration files to change the main cache directory manually.

The main cache directory did not exist and an error was encountered while creating the directory.

Explanation: The user is editing the browser configuration files to change the main cache directory manually.

No main cache directory provided.

Explanation: The user is editing the browser configuration files to change the main cache directory manually.

file could not be found.

Explanation: The browser tried to open a file but could not find it.

Please enter a non-empty string to search for.

Explanation: The user searched for an empty string.

There is already a hotlist item with this URL.

Explanation: the user tried to create a hotlist item with the same name as one already in existence.

Invalid directory selected.

Explanation: The user tried to configure a directory in preferences, but the directory does not exist.

The About URL is not set correctly.

Explanation: The About URL is not specified in the preference file.

Unable to locate Help directory.

Explanation: The Help path must be specified in the X resource settings.

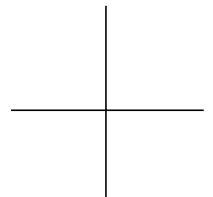

NCDDM Messages

The Help URL is not set correctly.

Explanation: The Help URL must be specified in the preference file.

Insufficient memory for requested operation. Close unused applications and try again.

Explanation: The terminal has run out of memory.

Invalid file name *file*. Specify a correct file name.

Explanation: The user specified an incorrect filename.

URL is longer than 1024 bytes.

Explanation: The user typed an URL path that is too long.

NCDDM Messages

NCDDM messages pertain to the NCD Display Manager. If you are looking for a message that refers to the NCDDM module but is not listed here, see “Messages Common to All Modules” on page 18-7.

COMERR, communication error with ncddm server *message*

Severity: Error

Explanation: The X server was unable to connect to the *ncddm* daemon or experienced a read or write error after the connection was established. The message specifies which of these possible errors occurred.

User Action: Check for network problems. Check to make sure the daemon was started.

PROTOERR, protocol error with ncddm server *message*

Severity: Error

Explanation: There was an internal problem in either the *ncddm* daemon running on the host or the *ncddm* client running in the terminal. The message gives specific information.

User Action: Please contact NCD Technical Support.

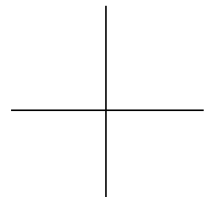

REQFAIL, ncddm server returned failed request

Severity: Error

Explanation: The *ncddm* daemon was unable to respond with appropriate information. Check the *ncddm* error logs or turn on debugging. Debugging is turned on through command-line options; see the *ncddm* man page.

User Action: Please contact NCD Technical Support.

NETD Messages

NETD messages pertain to the *netd* daemon, which listens for network connection requests and launches the client or daemon assigned to handle them. If you are looking for a message that refers to the NETD module but that does not appear here, refer to “Messages Common to All Modules” on page 18-7.

BADVERSION, bad version info *var*

Severity: Error

Explanation: The version of *ncdrunwm* being run on the host is not supported by the X server.

User Action: Make sure that the correct version of *ncdrunwm* is in use.

NETFILE Messages

NETFILE messages pertain to network file services. If you are looking for a message that refers to the NETFILE module but does not appear here, refer to “Messages Common to All Modules” on page 18-7.

BADALLOC, open failed, allocation failure: *message*

Severity: Error

Explanation: The X server tried to open a file and failed for the specified reason. This message usually indicates that the terminal is low on memory.

User Action: Check the amount of available memory. If possible, close some local clients to free more memory.

NETFILE Messages

BADNAME, open failed, badly formed name *file*

Severity: Error

Explanation: The X server does not recognize the specified filename as being either a VMS or UNIX filename.

User Action: Verify that all references to the specified file in configuration files are correct; that is, confirm that the filename is either a valid UNIX filename or a valid VMS filename wherever it appears in a terminal's configuration database.

BADSERVERTYPE, *protocol*: file server *aa.nnnn* disagrees with configured file system type

Severity: Error

Explanation: The X server has been configured to expect one file system type (such as a VMS file system or a UNIX file system) when communicating with the specified file server, but upon connection, discovers that the other file system type is in use.

User Action: Let the X server determine the correct file system type dynamically.

DAPERROR, NCDnet DAP error: *octal:octal octal*

Severity: Error

Explanation: The X server has encountered an error (identified by the specified octal values) when attempting to communicate using the DAP protocol.

User Action: Refer to the DAP specification for information on the specified error and suggestions for resolution.

DAPNOTENABLED, unable to perform DAP operation: NCDnet not enabled

Severity: Error

Explanation: The terminal was unable to perform a DAP operation because an NCDnet license has not been entered into the **license-key** parameter.

User Action: Enter a license key into the **license-key** parameter.

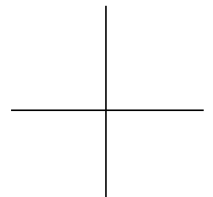

DAPWAITERROR, NCDnet DAP write error waiting for socket buffer space

Severity: Error

Explanation: The terminal was unable to send a DAP packet to the host.

User Action: Make sure that the host is operating properly.

LOCALERROR, open for *file* failed: *message*

Severity: Error

Explanation: The X server cannot open the specified file in the terminal's local file system. This message appears only if extended file diagnostics is enabled.

User Action: Make sure the specified file exists in the terminal's local file system, that its name is entered correctly, and that the file service table is properly configured for access to the local file system.

MATCHATTEMPT, attempting *protocol* open of *file1* on *host* for *file2*

Severity: Information

Explanation: The X server is using the specified protocol to open the specified file (*file1*) on the specified host using *file2* (the name of the file as the host system recognizes it). The values for *file1* and *file2* are usually the same.

User Action: None

MATCHFAIL, *protocol* open attempt for *file* returns: *message*

Severity: Warning

Explanation: The X server matched the specified filename with an entry in the file service table, but failed to open the specified file.

User Action: Verify that the file exists in the correct location on the host system and that it has the correct permission assigned.

MKDIRATTEMPT, attempting mkdir for *file*

Severity: Information

Explanation: The X server is attempting to create a directory.

User Action: None

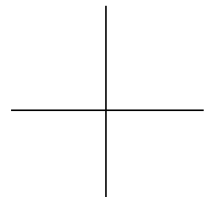

NETFILE Messages

MKDIRSUCCESS, mkdir succeeded for *file*

Severity: Information

Explanation: The X server created a directory.

User Action: None

NOMATCHES, open failed, no file table matches for *file*

Severity: Error

Explanation: The X server cannot match the specified filename with an entry in the file service table.

User Action: Verify that the filename was entered correctly. Verify that an accurate entry for the file exists in the file service table.

OPENATTEMPT, attempting open for *file*

Severity: Information

Explanation: The X server is attempting to open the specified file.

User Action: None

OPENSUCCESS, open succeeded for *file*

Severity: Information

Explanation: The X server has successfully opened the specified file.

User Action: None

OUTOFMATCHES, open failed, no more matches for *file*

Severity: Error

Explanation: The X server matched the specified filename with some entries in the file service table, but none of the entries worked.

User Action: Verify that the filename was entered correctly. Verify that the file exists in the correct location on the host system and that it has the correct permission assigned.

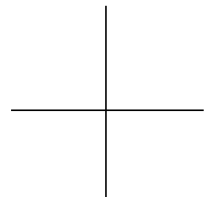

PERMCHKATTEMPT, attempting permission check for *file*

Severity: Information

Explanation: The X server is checking permissions for the file.

User Action: Information

PERMCHKSUCCESS, permission check succeeded for *file*

Severity: Information

Explanation: The X server successfully checked permissions on the file.

User Action: Information

READSYMLINK, read symbolic link *link*, new path is *path*

Severity: Information

Explanation: The X server has identified the symbolic link and is using the newly specified path. This message occurs only when using NFS file servers.

User Action: None

REMOVEATTEMPT, attempting remove for *file*

Severity: Information

Explanation: The X server is attempting to remove a file.

User Action: Information

RMDIRSUCCESS, remove succeeded for *file*

Severity: Information

Explanation: The X server removed a file.

User Action: Information

RENAMEATTEMPT, attempting rename for *file* to *file*

Severity: Information

Explanation: The X server is attempting to rename a file.

User Action: Information

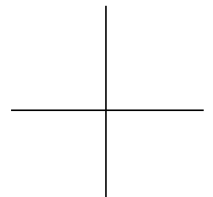

NETFILE Messages

RENAMESUCCESS, rename succeeded for *file* to *file*

Severity: Information

Explanation: The X server renamed a file.

User Action: None

RMDIRATTEMPT, attempting rmdir for *file*

Severity: Information

Explanation: The X server is attempting to remove a directory.

User Action: None

RMDIRSUCCESS, rmdir succeeded for *file*

Severity: Information

Explanation: The X server removed a directory.

User Action: None

RPCERROR, NFS RPC Error: *message*

Severity: Error

Explanation: The X server has encountered a lower-level NFS networking failure. *Message* defines the error more more completely and suggests a course of action.

User Action: Use the information contained in the message to determine the action to take.

STATATTEMPT, attempting stat for *file*

Severity: Information

Explanation: The X server is attempting to read the file's attributes.

User Action: None

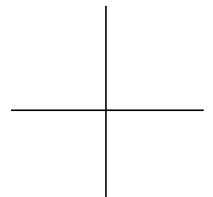

STATSUCCESS, stat succeeded for *file*

Severity: Information

Explanation: The X server successfully read the file's attributes.

User Action: None

NETSRV Messages

NETSRV messages pertain to the library shared by NCDware daemons. If you are looking for a message that refers to the NETSRV module but does not appear here, refer to "Messages Common to All Modules" on page 18-7.

ACCEPT, accepting *module* connection from *host*

Severity: Information

Explanation: The NETSRV module has accepted the specified connection from the specified terminal.

User Action: None

REFUSE, refusing *module* connection from *host*

Severity: Warning

Explanation: The NETSRV module has refused the specified connection from the specified terminal. This situation usually occurs when access control is enabled, but the specified host is not in the list of hosts granted access privileges.

User Action: If the specified host should be granted access, enter the host system's name in the appropriate access control list.

SYSERROR, *location* error on *module* connection: *message*

Severity: Error

Explanation: The X server has detected an internal error.

User Action: If you encounter this message, please contact NCD Technical Support.

OpenGL Messages

OpenGL messages pertain to use of applications using the OpenGL extension. If you are looking for a message that refers to the OpenGL module but does not appear here, refer to “Messages Common to All Modules” on page 18-7.

`BADALLOCBUFFER`, Out of memory while creating or resizing *type* buffer

Severity: Warning

Explanation: Memory was exhausted while creating or resizing a buffer of one of the type *type*.

User Action: Reduce the size of the windows and/or install more memory in the terminal.

`BADALLOCCONTEXT`, Out of memory while creating graphics context

Severity: Error

Explanation: The terminal ran out of memory during OpenGL rendering context initialization.

User Action: Perform one or more of the following actions:

- Modify the application to reduce the number of GLX rendering contexts.
- Reduce window sizes.
- Reduce the complexity of data.
- Install more memory.

`BADALLOCRENDER`, Out of memory while rendering or creating display list

Severity: Warning

Explanation: The terminal ran out of memory while rendering or creating the display list.

User Action: Reduce the complexity of geometric data and/or install more memory in the terminal.

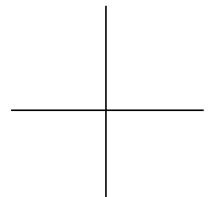

IMPLEMENTATION, Implementation error: *var*

Severity: Fatal

Explanation: The X server has detected an internal error.

User Action: If you encounter this message, please contact NCD Technical Support.

INTERNAL, Internal error: *var*

Severity: Fatal

Explanation: The X server has detected an internal error.

User Action: If you encounter this message, please contact NCD Technical Support.

PREFSETTING, User has turned off *feature*

Severity: Information

Explanation: The user has disabled *feature* through Setup ⇒ Change User Preferences ⇒ OpenGL.

User Action: None

UNIMPLEMENTED, Unimplemented function: *function* ()

Severity: Warning

Explanation: A function that is unimplemented in the OpenGL module has been called. The OpenGL application may not function properly.

User Action: If you encounter this message, please contact NCD Technical Support.

WINDOWCLIPPING, Error computing window-clip parameters

Severity: Warning

Explanation: An internal error occurred while computing window-clip parameters. It may have damaged the occluding windows.

User Action: If you encounter this message, please contact NCD Technical Support.

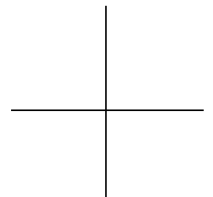

PPPD Messages

PPPD messages pertain to communications using Point-to-Point Protocol (PPP) or Serial Line Interface Protocol (SLIP). If you are looking for a message that refers to the PPPD module but does not appear here, refer to “Messages Common to All Modules” on page 18-7.

BADIOCTL, Port *n*: internal I/O error - *message*

Severity: Error

Explanation: The X server has detected an internal error.

User Action: If you encounter this message, please contact NCD Technical Support.

BADLDISC, Port *n*: unable to start *protocol* line discipline

Severity: Error

Explanation: The X server has detected an internal error.

User Action: If you encounter this message, please contact NCD Technical Support.

BADOPEN, Unable to open serial port *n*

Severity: Error

Explanation: The X server has detected an internal error.

User Action: If you encounter this message, please contact NCD Technical Support.

BADREAD, Port *n*: read error

Severity: Error

Explanation: The X server has detected an internal error.

User Action: If you encounter this message, please contact NCD Technical Support.

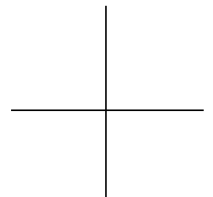

BADSPMGR, Error talking to Serial Port Manager - *message*

Severity: Error

Explanation: The X server has detected an internal error.

User Action: If you encounter this message, please contact NCD Technical Support.

CNFGFAIL, Port *n*: config error - *message*

Severity: Error

Explanation: The X server has detected a configuration error on the specified port as described in the message.

User Action: Refer to the message for guidance in resolving the problem. If you need additional assistance, please contact NCD Technical Support.

IPCPFAIL, Port *n*: IPCP config failure - *message*

Severity: Error

Explanation: The X server has encountered difficulties during communications negotiations due to either host or terminal IPCP (Internet Protocol Control Protocol) configuration errors.

User Action: Verify that both the host and terminal are configured correctly for IPCP communications. If you need additional assistance, refer to your PPP product documentation or contact NCD Technical Support.

LCPFAIL, Port *n*: LCP config failure - *message*

Severity: Error

Explanation: The X server has encountered difficulties during communications negotiations due to either host or terminal LCP configuration errors.

User Action: Verify that both the host and terminal are configured correctly for LCP (Link Control Protocol) communications. If you need additional assistance, refer to your PPP product documentation or contact NCD Technical Support.

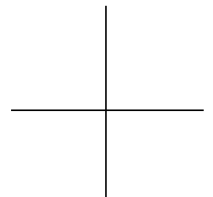

PPPD Messages

LOOPBACK, Port *n*: the line appears to be looped back

Severity: Warning

Explanation: The specified port is configured incorrectly for negotiations between the host system and the terminal.

User Action: Verify that both the host and terminal are configured correctly for PPP communications. If you need additional assistance, refer to your PPP product documentation or contact NCD Technical Support.

NOCTLSOCK, Unable to create IP control socket

Severity: Error

Explanation: The X server has encountered an internal error.

User Action: If you encounter this message, please contact NCD Technical Support.

NOLOCALADDR, Port *n*: no local IP address

Severity: Error

Explanation: The X server does not have an IP address assigned.

User Action: Assign the X server's IP address in one of two ways:

- Make sure the terminal's PPP-SLIP Interfaces Table contains the terminal's IP address.
- If the IP address is assigned by the host system, verify that the host-resident PPP product assigns IP addresses correctly.

NOMEM, Not enough memory

Severity: Error

Explanation: The X server does not have sufficient memory to perform the requested action.

User Action: Close any unused local clients to free memory for the desired function.

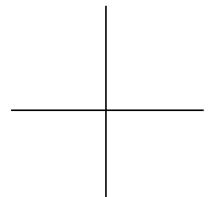

RESTART, Port *n*: *protocol_layer* is being restarted

Severity: Information

Explanation: The remote host sent a termination message which closed the connection; the X server is attempting to re-establish communications at the specified communications protocol layer.

User Action: None

TERMREQ, Port *n*: *protocol_layer* terminate-request received

Severity: Information

Explanation: The terminal has received a termination message from the remote host.

User Action: None

UP, Port *n*: local = *nnn.nnn.nnn.nnn*, remote = *nnn.nnn.nnn.nnn*

Severity: Information

Explanation: The X server has established communications on the specified port using the specified IP addresses for the terminal and the remote host.

User Action: None

PRINTAPIS Messages

The PRINTAPIS library gives local clients (such as the browser) the ability to print via the parallel port or to a remote host running LPD. If you are looking for a message that refers to the PRINTAPIS library but that does not appear here, refer to “Messages Common to All Modules” on page 18-7.

CFILECMDFAIL, failed to init transfer of control file to remote queue.

Severity: Fatal

Explanation: The LPD on the remote print server did not accept the Receive Control File command.

User Action: Make sure that the network and the remote print server are operational. If so, try the print job again. If the problem persists, please contact Technical Support.

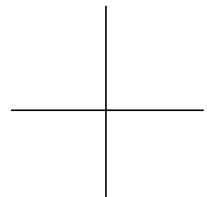

PRINTAPIS Messages

CFILEXFERFAIL, failed to complete transfer of control file to remote queue

Severity: Fatal

Explanation: The end of control information was not acknowledged.

User Action: Make sure that the network and the remote print server are operational. If so, try the print job again. If the problem persists, please contact Technical Support.

CONNBLOCKED, connection is blocked.

Severity: Error

Explanation: The local print device is unable to accept more data at this time.

User Action: Keep trying to send the data. If the problem persists, please contact Technical Support.

DFILECMDFAIL, failed to init transfer of data file to remote queue.

Severity: Fatal

Explanation: The LPD on the remote print server did not accept the Receive Data File command.

User Action: Make sure that the network and the remote print server are operational. If so, try the print job again. If the problem persists, please contact Technical Support.

DATAXFERFAIL, failed to transfer data to remote queue.

Severity: Fatal

Explanation: The terminal was unable to transfer all the print data to the remote print server.

User Action: Make sure that the network and the remote print server are operational. If so, try the print job again. If the problem persists, please contact Technical Support.

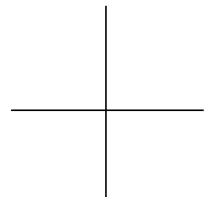

DATAXFERCPLTFAIL, failed to complete transfer of data file to remote queue.

Severity: Fatal

Explanation: The end of data transmission was not acknowledged.

User Action: Make sure that the network and the remote print server are operational. If so, try the print job again. If the problem persists, please contact Technical Support.

GBMALLOCFAIL, malloc of *print buffer size* bytes for print gather buffer failed

Severity: Fatal

Explanation: The print job is first gathered into a buffer, then sent to the remote print server. In this case, not enough memory could be allocated for the print gather buffer.

User Action: Free terminal memory by closing unused local or remote clients.

GBREALLOCOK, adjusted gather buffer size to gb_size = *new print buffer size*

Severity: Information

Explanation: The request for more memory for the print gather buffer was successful.

User Action: None

LOSTCONN, lost connection.

Severity: Warning

Explanation: The connection to the LPD on the remote print server was lost.

User Action: None

LPDCONNECT, sending to *print server*, *print queue*.

Severity: Information

Explanation: A connection to the remote print server was established, and the job will be spooled to the identified queue.

User Action: None

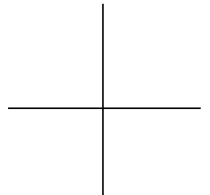

PRINTAPIS Messages

MEMCPFAIL, memcpy of printer data failed.

Severity: Error

Explanation: The printer data could not be placed in the print gather buffer.

User Action: Try the print job again. If the problem persists, please contact Technical Support.

MOREMEM, realloc'ing for more print buffer space, total_bytes = **bytes placed in print buffer**, length = **amount of additional data to be placed in print buffer**, gb_size = **current print buffer size**.

Severity: Information

Explanation: The print job exceeded the initial print gather buffer allocation, so more memory is being obtained for the buffer.

User Action: None

MOREMEMFAIL, realloc failed.

Severity: Error

Explanation: There was not enough contiguous memory to expand the print gather buffer to the required size.

User Action: Free terminal memory by closing unused clients.

NOPRINTER, printer device off line or out of paper

Severity: Fatal

Explanation: The status lines of the parallel port indicate that the printer is either turned off or out of paper.

User Action: Make sure that power is applied to the printer and that the printer has paper.

REMNORESP, remote printer not responding

Severity: Fatal

Explanation: Couldn't connect to the LPD port on the remote print server.

User Action: Make sure the remote print server is configured to accept print jobs from the terminal. For example, LPD must be running on the remote print

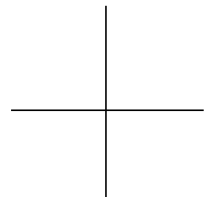

server and the terminal must be listed in the `/etc/hosts.lpd` file. Also, make sure the hostname for the remote print server is correct in the **browser-printer-table**.

SERIALDCMD, error writing to seriald: couldn't check device status.

Severity: Error

Explanation: Local print jobs are spooled via the Serial daemon to the parallel port. Before any data is sent to the parallel port, a command is sent to the daemon to check the status of the parallel port.

User Action: If the job does not print, try again. If the problem persists, please contact Technical Support.

UNKHOST, unknown host *hostname*

Severity: Fatal

Explanation: The terminal could not resolve the hostname of the remote print server.

User Action: Examine the **browser-printer-table** entry, and make sure that the hostname of the remote print server is correct.

RTLD Messages

RTLD messages pertain to the dynamic loader, which is responsible for loading X server modules. If you are looking for a message that refers to the RTLD module but that does not appear here, refer to “Messages Common to All Modules” on page 18-7.

BADEXPMOD, incorrect exports module loaded

Severity: Error

Explanation: The export module that was found is incorrect for the current X server.

User Action: Make sure that the X server is loading modules from the correct directory.

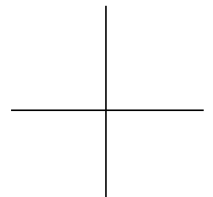

RTLD Messages

DISABLED, loading for *module* has been disabled

Severity: Warning

Explanation: *Module* cannot be loaded because it has been disabled.

User Action: Make sure that the desired module load policy has been configured through the **modules-load-policy** remote configuration parameter.

ERRLOAD, error loading *module*

Severity: Error

Explanation: An error occurred while loading the module.

User Action: Make sure that the host file system is accessible to the terminal. Also make sure that you are using the correct server module versions.

ERROPEN, error opening module file for *module*

Severity: Error

Explanation: The X server cannot open the module file for *module*.

User Action: Make sure that the modules directory is configured correctly and accessible.

ERROR, *error*

Severity: Error

Explanation: The error described in *error* (for example, CRC error) was encountered by the loader.

User Action: User action varies depending upon the specific error encountered. Generally, make sure that the modules directory has been configured correctly and is accessible.

INITFAIL, could not register free cache routine

Severity: Error

Explanation: The X server has detected an internal error.

User Action: If you encounter this message, please contact NCD Technical Support.

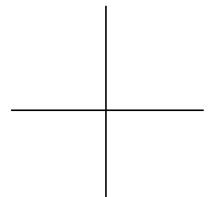

LOADED, loaded `version`

Severity: Information

Explanation: The module described by the version information has been loaded into memory.

User Action: None

LOADING, loading *module* from *file*

Severity: Information

Explanation: The module *module* is being unloaded from the file *file*.

User Action: None

NAMENULL, cannot autoload, name does not exist

Severity: Error

Explanation: An invalid module name was supplied.

User Action: Make sure that the module name used is correct.

RETRY, module load failed, retrying from default location

Severity: Information

Explanation: The loader was unable to load the module and tries to load from the default installation directory.

User Action: None

UNLOAD, unloading *module*

Severity: Information

Explanation: The module is being unloaded from memory.

User Action: None

UNLOADFAIL, unable to unload module *module*

Severity: Error

Explanation: The module could not be unloaded.

User Action: None

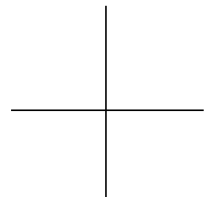

SERIALD Messages

SERIALD messages pertain to the terminal's serial port(s) and the Serial daemon. If you are looking for a message that refers to the SERIALD module but that does not appear here, refer to "Messages Common to All Modules" on page 18-7.

BADCMD, **port**: bad cmd *hex_value*

Severity: Error

Explanation: The Serial or Parallel daemon has received an invalid serial or parallel protocol command.

User Action: Make sure that your host-side print program is properly configured to use the serial/parallel protocol.

BADCONFIG, **port** not enabled for printing

Severity: Error

Explanation: The specified port on the terminal is not configured for printing.

User Action: Configure the terminal for printing to the specified port. Make sure any host-side requirements are in place.

DNETCLOSE, **port**: closed session from *aa.nnnn*

Severity: Information

Explanation: The Serial daemon has closed the serial session with the specified DECnet host on the specified serial port.

User Action: None

DNETOPEN, **port**: opened session from *aa.nnnn*

Severity: Information

Explanation: The Serial daemon has opened a serial session with the specified DECnet host on the specified serial port.

User Action: None

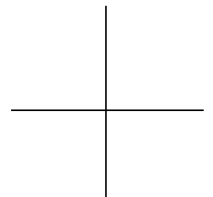

INETCLOSE, **port**: closed session from *nnn.nnn.nnn.nnn*

Severity: Information

Explanation: The Serial daemon has closed the serial session with the specified IP host on the specified serial port.

User Action: None

INETOPEN, **port**: opened session from *nnn.nnn.nnn.nnn*

Severity: Information

Explanation: The Serial daemon has opened a serial session with the specified IP host on the specified serial port.

User Action: None

LATCLOSE, **port**: closed session from *host*

Severity: Information

Explanation: The Serial daemon has closed a serial session with the specified LAT host on the specified serial port.

User Action: None

LATOPEN, **port**: opened session from *host*

Severity: Information

Explanation: The Serial daemon has established a serial session with the specified LAT host on the specified serial port.

User Action: None

LOSTSTATUS, **port**: lost status *hex_value*

Severity: Information

Explanation: The specified port, using the serial protocol, requested status of the RS-232 C line. The buffer had no room for this information.

User Action: None

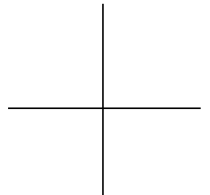

SIE Messages

SIE messages pertain to the Simple Imaging Extension. If you are looking for a message that refers to the SIE module but that does not appear here, refer to “Messages Common to All Modules” on page 18-7.

TIMING, image **action** took **n** milliseconds

Severity: Information

Explanation: The specified action took the specified length of time to complete.

User Action: None

SNMPD Messages

SNMPD messages pertain to the SNMP daemon. If you are looking for a message that refers to the SNMPD module but that does not appear here, refer to “Messages Common to All Modules” on page 18-7.

AUTHFAILURE, authentication failure from **nnn.nnn.nnn.nnn**

Severity: Information

Explanation: The SNMP daemon received an SNMP packet from the SNMP manager, but the packet contains the wrong community string, or access control is enabled and the specified host is not included in the list of approved hosts.

User Action: Verify that the SNMP manager is sending the correct community string, and that the host is included in the appropriate access control list of approved hosts.

NORESOLVE, could not resolve address **address**

Severity: Error

Explanation: The SNMPD module has received an address that it cannot identify.

User Action: Verify that the correct address has been specified.

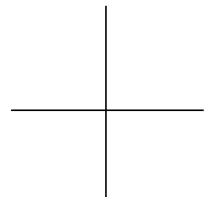

OPDISABLED, requested operation is currently disabled

Severity: Warning

Explanation: A user has attempted to reset the terminal using *ncdreset* while the SNMP reset option is disabled.

User Action: If the terminal should be enabled for remote reset via *ncdreset*, enable the SNMP reset option.

TERM Messages

TERM messages pertain to the NCD Terminal Emulator (*ncdterm*). If you are looking for a message that refers to the TERM module but that does not appear here, refer to “Messages Common to All Modules” on page 18-7.

BADCMD, unknown command line argument '*command_option*'

Severity: Warning

Explanation: The TERM module does not recognize the specified command-line option.

User Action: Refer to the *ncdterm* man page for a complete list of acceptable command-line options for the NCD Terminal Emulator.

BADGC, Can't create a graphics context

Severity: Fatal

Explanation: The TERM module has insufficient memory to perform the requested operation.

User Action: Verify that the terminal has enough memory to perform the operation. Close any unused local clients to free memory for the desired function.

BADTABLE, Bad table at index '*opcode*' (*opcode_name*)

Severity: Warning

Explanation: The X server has detected an internal error.

User Action: If you encounter this message, please contact NCD Technical Support.

TERM Messages

COLORCEL, Error allocating necessary color cell

Severity: Error

Explanation: The NCD Terminal Emulator color table is full.

User Action: Free colors so that the NCD Terminal Emulator can create a color as requested.

CONNERR, Can't connect to host *host*

Severity: Error

Explanation: The TERM module cannot connect to the specified host as requested.

User Action: Verify that the hostname is entered correctly and that the desired host is accessible via the network.

CONREAD, Error reading from the network connection

Severity: Error

Explanation: The TERM module has detected a problem with the network.

User Action: Verify that the network is operational and that the terminal and the host system are securely attached to the network.

CONWRITE, Error writing to the network connection

Severity: Error

Explanation: The TERM module has detected a problem with the network.

User Action: Verify that the network is operational and that the terminal is securely attached to the network.

DFLTFONT, No font *font1*, using default *font2*

Severity: Warning

Explanation: The desired font, *font1*, is not available; the TERM module is using the default font, *font2*, instead.

User Action: Verify that the desired font is in the user's font path and that it is located in the correct directory, has read access, and is available via the

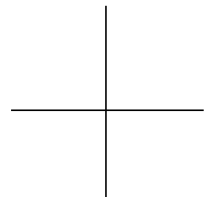

network. If the terminal is configured to obtain fonts from a font server, verify that the font server is running and that it is accessible via the network.

DISPLAY, Can't open the display connection

Severity: Fatal

Explanation: The user has specified the incorrect display variable or the display specified on the command line is incorrect.

User Action: Verify that the correct display name is specified.

DSTRCORR, Object input buffer corrupted - internal error

Severity: Error

Explanation: Internal TERM memory is corrupted.

User Action: Start the NCD Terminal Emulator a second time. If the situation persists, please contact NCD Technical Support.

EIGNORE, End of DCS ignore download mode

Severity: Error

Explanation: When the TERM module received a request for downloaded character sets, it entered the DCS ignore download mode. This message signifies the end of that mode.

User Action: If possible, use an alternate application that does not require downloaded character sets.

FONTFAML, Font family is invalid - internal error

Severity: Fatal

Explanation: The TERM module has detected an internal error.

User Action: If you encounter this message, please contact NCD Technical Support.

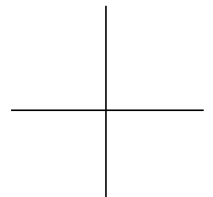

TERM Messages

FONTINFO, Cannot find the information for font

Severity: Fatal

Explanation: The TERM module cannot find the desired or default font.

User Action: Verify that the desired font is in the user's font path and that it is located in the correct directory, has read access, and is available via the network. If the terminal is configured to obtain fonts from a font server, verify that the font server is running and is accessible via the network.

INETCONN, Can't initialize network connection

Severity: Error

Explanation: The TERM module has detected a problem with the network.

User Action: Verify that the network is running and that the terminal is securely attached to the network.

INTFACE, Can't create an interface button

Severity: Fatal

Explanation: The TERM module cannot create the desired interface feature, specifically one or more of the interface buttons. This situation usually occurs when the terminal is running low on memory.

User Action: Verify that the terminal has sufficient memory to perform the desired action. Close any unused local clients to free local memory.

LINECORR, Object line buffers corrupted - internal error

Severity: Error

Explanation: Internal TERM memory is corrupted.

User Action: Start the NCD Terminal Emulator a second time. If the situation persists, please contact NCD Technical Support.

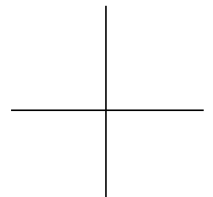

LINERR, Lines are out of order - internal error

Severity: Fatal

Explanation: The TERM module has detected an internal error.

User Action: If you encounter this message, please contact NCD Technical Support.

LOGDIR, Logfile directory is *directory*

Severity: Information

Explanation: The TERM module is using the specified directory for its logfile.

User Action: None

LOGFILE, Can't open logfile for session

Severity: Error

Explanation: The TERM module cannot open a file for logging information about the current NCD Terminal Emulator session.

User Action: Verify that:

- The directory to which the logfile should be written has world write access.
- The terminal's file service table contains an entry for the desired directory.
- The file service entry specifies NFS transport.
- The NFS protocol is available on the network on which the terminal resides.

LOWMEM, Memory very low. Can't allocate selection buffer

Severity: Warning

Explanation: The X server is running low on memory and cannot allocate enough memory for the selection buffer.

User Action: Verify that the terminal has sufficient memory to perform the desired action. Close any unused local clients to free local memory.

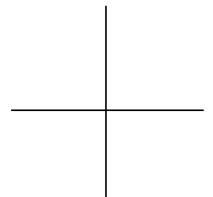

TERM Messages

MENUBAR, Can't create the interface menubar

Severity: Fatal

Explanation: The TERM module cannot create the menu bar. This situation usually occurs when the terminal is running low on memory.

User Action: Verify that the terminal has sufficient memory to perform the action. Close any unused local clients to free local memory.

MENUS, Can't create the interface menus

Severity: Fatal

Explanation: The TERM module cannot create the menus. This situation usually occurs when the terminal is running low on memory.

User Action: Verify that the terminal has sufficient memory to perform the action. Close any unused local clients to free local memory.

MISSARG, Missing argument for '*option*'

Severity: Warning

Explanation: The specified command-line option does not include the necessary argument.

User Action: Re-enter the command with the necessary argument.

MLCONN, Can't initialize toolkit connection

Severity: Fatal

Explanation: The TERM module does not have sufficient memory to execute properly.

User Action: Verify that the terminal has sufficient memory. Close any unused local clients to free local memory.

NETCONN, Can't create network connection

Severity: Error

Explanation: The TERM module has detected a problem with the network.

User Action: Verify that the network is running and that the terminal is securely attached to the network.

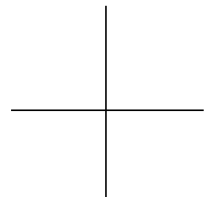

NOLOGDIR, Can't create log directory '*directory*'

Severity: Warning

Explanation: The TERM module cannot create the specified log directory as requested.

User Action: Confirm that the file service table contains an entry for the log directory; this directory must be accessible via NFS. Verify that the directory exists, is available to the network, and has the appropriate permissions.

NOLSTLOG, Can't create lastlog file '*logfile_name*' (*error_number*)

Severity: Warning

Explanation: The TERM module cannot create the specified log file as requested.

User Action: Confirm that the file service table contains an entry for the directory in which the log file resides; this file must be accessible via NFS. Verify that the file exists, is available via the network, and has the appropriate permissions.

NOMEMRY, Can't allocate memory for needed structure

Severity: Fatal

Explanation: The TERM module does not have sufficient memory to perform the desired action.

User Action: Verify that the terminal has sufficient memory. Close any unused local clients to free local memory.

OBJCORR, Object data has been corrupted - internal error

Severity: Error

Explanation: The TERM module has detected an internal error.

User Action: If you encounter this message, please contact NCD Technical Support.

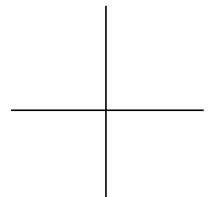

TERM Messages

OPCODERR, Opcode lookup out of range - internal error

Severity: Fatal

Explanation: The TERM module has detected an internal error.

User Action: If you encounter this message, please contact NCD Technical Support.

OPTABERR, Opcode table out of sequence - internal error

Severity: Fatal

Explanation: The TERM module has detected an internal error.

User Action: If you encounter this message, please contact NCD Technical Support.

OPTERR, Can't combine telnet port and -display option

Severity: Fatal

Explanation: The command that has been entered specifies a TELNET port and uses the **-display** command-line option. This is an invalid command.

User Action: Re-enter the command, making sure that it specifies either a TELNET port or the **-display** command-line option. Do not use both.

PARSEFONT, Couldn't parse font '*font*'

Severity: Warning

Explanation: The TERM module cannot interpret or identify the specified font.

User Action: Make sure the font specified is entered correctly and that it is known to the X server.

PROCESS, Can't initialize the process

Severity: Fatal

Explanation: The TERM module does not have sufficient memory to perform the desired action.

User Action: Verify that the terminal has sufficient memory. Close any local clients that are not being used to free local memory.

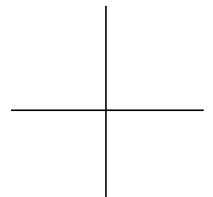

PROCTABERR, Process table corrupted - internal error

Severity: Fatal

Explanation: The X server has detected an internal error.

User Action: If you encounter this message, please contact NCD Technical Support.

PRTINUSE, The printer is in use

Severity: Information

Explanation: The specified printer is currently in use.

User Action: None

PRTOFFLN, Printer offline or not responding (*message*)

Severity: Warning

Explanation: The specified printer is offline or otherwise not responding to the print request as specified in the message.

User Action: Verify that the correct port is specified for the printer and that printer resources are assigned correctly. For a printer attached to a serial port, verify that the user has selected the correct print option.

REGIS, Regis graphics is not supported

Severity: Error

Explanation: The X server does not support ReGIS graphics.

User Action: If possible, use an alternate application that does not require ReGIS graphics.

SCRLBAR, Can't create the interface scrollbar

Severity: Fatal

Explanation: The TERM module cannot create the scroll bar. This situation usually indicates that the terminal is running low on memory.

User Action: Verify the terminal has sufficient memory to perform the action. Close any unused local clients to free local memory.

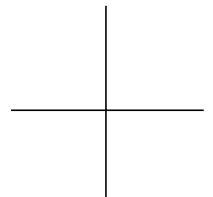

TERM Messages

SELECTER, Selection buffer overrun - internal error

Severity: Error

Explanation: The TERM module has detected an internal error.

User Action: If you encounter this message, please contact NCD Technical Support.

SERIALERR, Internal error -- *message*

Severity: Warning

Explanation: The TERM module has detected an internal error.

User Action: If you encounter this message, please contact NCD Technical Support.

SERIALINF, Switching to *mode* mode ...

Severity: Information

Explanation: The serial interface is communicating via XRemote or PPP as requested.

User Action: None

SESSION, Can't initialize the session

Severity: Fatal

Explanation: The TERM module cannot create an NCD Terminal Emulator session. This occurs if the terminal is low on memory or if a network problem exists.

User Action: Verify there is sufficient memory for the terminal emulator. If memory is low, close any unused clients to free local memory. If there is sufficient memory, invoke the terminal emulator a second time. If the situation persists, please contact NCD Technical Support.

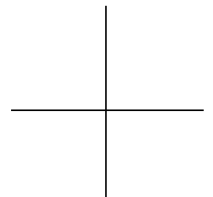

SETADDR, Can't set the address for the network connection

Severity: Error

Explanation: The hostname entered in the terminal chooser does not exist or the host cannot be accessed.

User Action: Verify that the name of the desired host is spelled correctly and that the network is operational.

SETTERM, Can't set the terminal for network connection

Severity: Error

Explanation: The TERM module has detected an error with the network.

User Action: Verify that the network is running and that the terminal is securely attached to the network.

SHELLPRC, Can't create connection subshell process

Severity: Fatal

Explanation: The TERM module does not have enough memory to perform the desired action.

User Action: Verify that the terminal has sufficient memory to perform the desired action. Close any unused local clients to free local memory.

SIXEL, Sixel graphics is not supported

Severity: Error

Explanation: The X server does not support sixel graphics.

User Action: If possible, use an alternate application that does not require sixel graphics.

STARTLOG, Start logging to *file*

Severity: Information

Explanation: The TERM module is logging information to the specified file as requested.

User Action: None

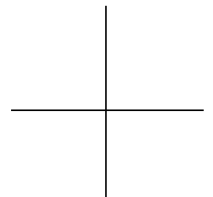

TERM Messages

STATUSLN, Can't create the interface status line

Severity: Error

Explanation: The TERM module cannot create the VT320 terminal emulator status line. This usually occurs if the terminal is running low on memory.

User Action: Verify that the terminal has sufficient memory to perform the action. Close any unused local clients to free local memory.

STOPLOG, Stop logging to *file*

Severity: Information

Explanation: The TERM module has stopped logging information to the specified file.

User Action: None

SUBFONT, Specified substitute font not found

Severity: Fatal

Explanation: The TERM module cannot locate the desired substitute font.

User Action: Make sure that the desired font resides in one of the directories included in the terminal's current font path and that the file service table contains an entry for the font directory.

TEL8ACT, Eight bit telnet mode is *status*

Severity: Information

Explanation: The TERM module has detected that eight-bit TELNET mode is either enabled or not available as specified by the status.

User Action: None

TEL8REQ, Requesting eight bit telnet connection (*operating_system*)

Severity: Information

Explanation: The TERM module is requesting an eight-bit TELNET connection as requested.

User Action: None

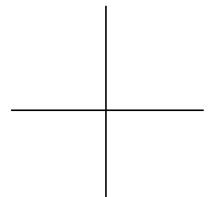

TELNTBIN, Set Telnet connection to binary mode

Severity: Information

Explanation: The TERM module's current connection is in binary mode.

User Action: None

UNKWNFONT, Unknown font '*font*'

Severity: Warning

Explanation: The TERM module does not recognize the specified font.

User Action: Make sure the font is entered correctly and that it is recognized by the X server.

UNRECESC, Escape sequence unrecognized '*escape_sequence*'

Severity: Warning

Explanation: The TERM module has received the specified, unknown escape sequence from an application.

User Action: Verify that the application issues only recognized escape sequences.

WINDOW, Can't create the interface window

Severity: Fatal

Explanation: The X server has insufficient memory to perform the desired action.

User Action: Verify that the terminal has sufficient memory. Close any unused local clients to free local memory.

XLATESTSTR, Error with Translation Management

Severity: Error

Explanation: The TERM module has encountered an error in an X resource translation string.

User Action: Make sure that the terminal's TERM X resource translations use the correct names, format, and syntax.

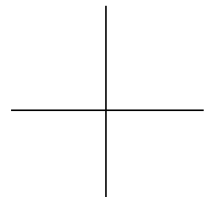

TOKENRING Messages

XLATETAB, Terminal lookup table corrupt - internal error

Severity: Fatal

Explanation: The TERM module has detected an internal error.

User Action: If you encounter this message, please contact NCD Technical Support.

TOKENRING Messages

TOKENRING messages pertain to Token-Ring communications. If you are looking for a message that refers to the TOKENRING module but does not appear here, refer to “Messages Common to All Modules” on page 18-7.

ACCESS, adapter access violation

Severity: Error

Explanation: The X server attempted to access Token-Ring reserved, read-only memory.

User Action: If you encounter this message, please contact NCD Technical Support.

ADAPTERFAIL, PCMCIA adapter initialization failed

Severity: Fatal

Explanation: The Token-Ring adapter failed or the X server has detected an internal error.

User Action: If you encounter this message, please contact NCD Technical Support.

ADDRESS, address for this unit: **00:00:E5:nn:nn:nn**

Severity: Information

Explanation: The terminal is using the specified Token-Ring address.

User Action: None

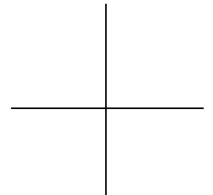

CHECK, adapter CHECK error: *hex_values*

Severity: Error

Explanation: The X server has detected an internal adapter error.

User Action: If you encounter this message, please contact NCD Technical Support.

CLOSED, adapter closed, interface inactive

Severity: Error

Explanation: The Token-Ring controller on the TRP board has detected a cable fault and has shut itself down.

User Action: Verify that the cable is intact and securely fastened to the terminal.

ERROR, internal adapter error

Severity: Error

Explanation: The Token-Ring controller on the TRP board has detected an internal error.

User Action: If you encounter this message, please contact NCD Technical Support.

INITFAIL, adapter initialization failed: *message*

Severity: Fatal

Explanation: The Token-Ring controller on the TRP board has detected an internal error.

User Action: If you encounter this message, please contact NCD Technical Support.

OPEN, adapter open, interface active

Severity: Information

Explanation: The Token-Ring controller on the TRP board is working successfully.

User Action: None

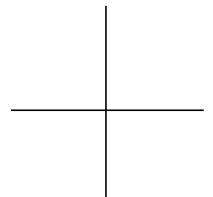

TOKENRING Messages

OPENFAIL, adapter open failed: *message1* [*message2*]

Severity: Fatal

Explanation: The Token-Ring controller on the TRP board has encountered an error while attempting to connect to the Token-Ring network. This error is described in *message1*. If the error is irrecoverable, additional information is provided in *message2*.

This message may appear if the Token-Ring controller detects a cable fault or if the terminal is attempting to connect at the wrong ring speed.

User Action: Verify that the terminal is securely attached to the Token-Ring network and that the terminal is set to the correct speed for communications across a Token-Ring physical network.

PCMCIAFAIL, PCMCIA initialization failed

Severity: Fatal

Explanation: The PCMCIA card interface failed. The X server has detected an internal error.

User Action: If you encounter this message, please contact NCD Technical Support.

STRAYCMD, stray *command_type* command: *command_code*

Severity: Warning

Explanation: The Token-Ring controller on the TRP board has detected an internal error.

User Action: If you encounter this message, please contact NCD Technical Support.

STRAYINT, stray *interrupt_type* interrupt

Severity: Warning

Explanation: The Token-Ring controller on the TRP board has detected an internal error.

User Action: If you encounter this message, please contact NCD Technical Support.

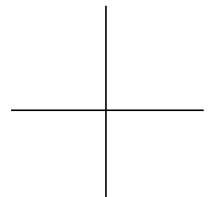

TXFAIL, transmit failed: *message*

Severity: Error

Explanation: The Token-Ring controller on the TRP board has detected an internal error.

User Action: If you encounter this message, please contact NCD Technical Support.

WAITING, waiting for adapter initialization

Severity: Information

Explanation: The X server is initializing the Token-Ring adapter as requested.

User Action: None

UI Messages

UI messages pertain to the X server's user interface. If you are looking for a message that refers to the UI module but that does not appear here, refer to "Messages Common to All Modules" on page 18-7.

BADGCFLAGS, *routine*, invalid GC flags

Severity: Warning

Explanation: The specified routine has attempted to create an X internal structure with inappropriate properties.

User Action: If you encounter this message, please contact NCD Technical Support.

BADGCMODE, *routine*, gc must be readonly or writable

Severity: Warning

Explanation: The specified routine has attempted to create an X internal structure with incorrect protection.

User Action: If you encounter this message, please contact NCD Technical Support.

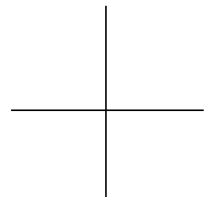

UI Messages

BADITEM, *routine*, invalid item number *n*

Severity: Warning

Explanation: The specified routine attempted to set an entry to an unacceptable value (for example, less than zero or greater than the acceptable maximum).

User Action: If you encounter this message, please contact NCD Technical Support.

BADTRANSLATION, translation syntax error: *translation*

Severity: Error

Explanation: The UI module has encountered an error in the specified resource translation string.

User Action: Make sure the terminal's resource translations use the correct names, format, and syntax.

INITCONN, unable to initialize connection to display

Severity: Fatal

Explanation: The UI module created but could not initialize the requested connection to the display.

User Action: Verify that the terminal has sufficient memory. If the memory level is adequate and you encounter this message frequently, please contact NCD Technical Support.

NOCONN, unable to connect to display "*display*"

Severity: Fatal

Explanation: The UI module cannot connect to the specified display.

User Action: Verify that the requested display name is correct. Verify that the specified display is running, and that it is accessible via the network.

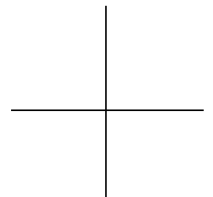

XERROR, *description* error from request code *nn.nn* on value *hex_value*

Severity: Error

Explanation: This message indicates there is an error in the MIT X server.

User Action: Refer to Xlib documentation for information about the specified error.

VIDEO, VIDEODECODER, and VIDEOPLAYER Messages

Messages that pertain to video software support, including VIDEO, VIDEODECODER, VIDEOPLAYER, and MPEGPLAY modules, are all listed in “MPEGPLAY Messages” on page 18-82.

WINCEN Messages

WINCEN messages pertain to starting WinCenter from the terminal using the **wincen** command. For messages that refer to WINCEN but do not appear here, see “Messages Common to All Modules” on page 18-7.

CMDLINE sending command *command*

Severity: Information

Explanation: A **wincen** local command is being sent to start WinCenter from the terminal

User Action: None

USAGE Usage: wincen WinCenterhost [optional arguments] [-- initial program]

Severity: Error

Explanation: The user typed an incorrect **wincen** command.

User Action: Retype the command line correctly.

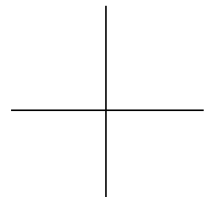

WIRELESS Messages

WIRELESS messages pertain to the wireless LAN adapter. For messages that refer to WIRELESS, but do not appear here, see “Messages Common to All Modules” on page 18-7.

ACCESS, access point error

Severity: Error

Explanation: The software detected an error reported by the Access Point. Usually the LAN adapter is restarted in an attempt to recover from this error.

User Action: Make sure that the terminal and Access Point are properly configured and that there are enough Access Points to provide adequate coverage of the area. If the problem persists, please contact your service personnel or NCD Technical Support.

ANTCHG, antenna status change

Severity: Information

Explanation: Displayed on a terminal with a RangeLAN 7200 LAN adapter installed when the terminal detects a change in the antenna status.

User Action: Make sure the antenna is securely attached to the LAN adapter card. If the message persists, please contact your service personnel or NCD Technical Support.

ANTCON, antenna connected

Severity: Information

Explanation: Displayed on a terminal with a RangeLAN 7200 LAN adapter installed when the antenna is reconnected.

User Action: None.

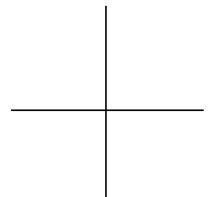

ANTDIS, antenna disconnected

Severity: Information

Explanation: Displayed on a terminal with a RangeLAN 7200 LAN adapter installed when the terminal detects that the antenna is disconnected.

User Action: Make sure that the antenna is securely attached to the LAN adapter card. If the message persists, please contact your service personnel or NCD Technical Support.

IBUFFER, internal buffer error: *reason_code*

Severity: Error

Explanation: The software detected an internal buffer error. Usually the LAN adapter is restarted in an attempt to recover from this error.

User Action: If this problem persists, please contact NCD Technical Support.

IMBUF, mbuf error: *reason_code*

Severity: Error

Explanation: The software detected a communication buffer error. Usually the LAN adapter is restarted in an attempt to recover from this error.

User Action: If this problem persists, please contact NCD Technical Support.

INACTIVITY, wireless inactivity time out

Severity: Information

Explanation: The LAN adapter has issued an inactivity time out.

User Action: None; the terminal software ignores this message.

INITFAIL, initialization failure: *reason_code*

Severity: Fatal

Explanation: The terminal failed to initialize the LAN adapter card.

User Action: Try the following remedies, in the order given:

1. Make sure the LAN adapter card is fully inserted in the slot and the antenna is properly connected.
2. Make sure the terminal is properly configured for wireless use.

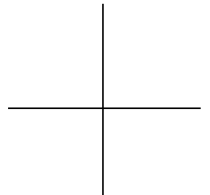

WIRELESS Messages

3. Make sure the Access Point is properly configured.
4. Test the wireless system to make sure the terminal is within the range of an Access Point.

If you cannot find the source of the problem, please call your service personnel or NCD Technical Support.

INSTACK, internal stack error: *reason_code*

Severity: Warning

Explanation: The software detected an internal stack error. Usually, the adapter is restarted in an attempt to overcome this error.

User Action: If the problem persists, please contact NCD Technical Support.

INTERRUPT, unexpected interrupt

Severity: Warning

Explanation: The terminal received an unexpected interrupt from the LAN adapter card.

User Action: None; the terminal software ignores this command. If the message persists, please contact your service personnel or NCD Technical Support.

INVALID, invalid command *command_ID*

Severity: Warning

Explanation: The terminal received an invalid command from the LAN adapter card.

User Action: None; the terminal software ignores this command. If the message persists, please contact your service personnel or NCD Technical Support.

ISTATUS, internal status error: *reason_code*

Severity: Warning

Explanation: The software detected an internal stack error. Usually, the adapter is restarted in an attempt to overcome this error.

User Action: If the problem persists, please contact NCD Technical Support.

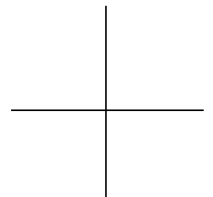

RECEIVE, receive error: *reason_code*

Severity: Error

Explanation: The software detected a receive status error. Usually, the LAN adapter is restarted in an attempt to recover from this error. This problem may be caused by intermittent communication between the terminal and the Access Point and may indicate that there are not enough Access Points to provide adequate coverage of the area.

User Action: If this problem persists, please contact NCD Technical Support.

RESFAIL, reset failure: *reason_code*

Severity: Fatal

Explanation: The terminal failed to reset the LAN adapter card.

User Action: None, but if the message persists, please contact your service personnel or NCD Technical Support.

RESTARTED, wireless adapter restarted

Severity: Information

Explanation: The wireless adapter has restarted. This usually occurs when the adapter is recovering from a communication error.

User Action: Make sure the LAN adapter card is fully inserted in the slot and the antenna is properly connected. If the problem persists, please contact your service personnel or NCD Technical Support.

RTIMEOUT, receive timeout error: *reason_code*

Severity: Error

Explanation: The software timed out on receipt of a packet. Usually, the LAN adapter is restarted in an attempt to recover from this error. This problem may be caused by intermittent communication between the terminal and the Access Point and may indicate that there are not enough Access Points to provide adequate coverage of the area.

User Action: If this problem persists, please contact NCD Technical Support.

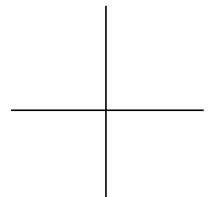

WIRELESS Messages

TOFAIL, timeout waiting for interrupt

Severity: Fatal

Explanation: The terminal timed out waiting for an interrupt.

User Action: Try the following remedies in the order given:

1. Make sure the LAN adapter card is fully inserted in the slot and the antenna is properly connected.
2. Make sure the terminal is properly configured for wireless use.
3. Make sure the Access Point is properly configured.
4. Test the wireless system to make sure the terminal is within the range of an Access Point.

If you cannot find the source of the problem, please contact your service personnel or NCD Technical Support.

TRANSMIT, transmit error

Severity: Fatal

Explanation: The terminal detected a transmit error to the Access Point.

User Action: Try the following remedies in the order given:

1. Make sure the LAN adapter card is fully inserted in the slot and the antenna is properly connected.
2. Make sure the terminal is properly configured for wireless use.
3. Make sure the Access Point is properly configured.
4. Test the wireless system to make sure the terminal is within the range of an Access Point.

If you cannot find the source of the problem, please contact your service personnel or NCD Technical Support.

TTIMEOUT, transmit timeout error: *reason_code*

Severity: Error

Explanation: The software timed out on transmit of a packet. Usually, the LAN adapter is restarted in an attempt to recover from this error. This problem may be caused by intermittent communication between the terminal and the

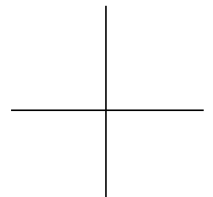

Access Point and may indicate that there are not enough Access Points to provide adequate coverage of the area.

User Action: If this problem persists, please contact NCD Technical Support.

WM Messages

WM messages pertain to the local NCD Window Manager and application launcher. If you are looking for a message that refers to the WM module but that does not appear here, refer to “Messages Common to All Modules” on page 18-7.

ALREADY, window manager is already running

Severity: Fatal

Explanation: The X server has received a request to start the local NCD Window Manager when it is already running. The duplicate request has failed.

User Action: Locate the duplicate request for starting the local NCD Window Manager and remove it.

BADCMD, unable to run command "*command*"

Severity: Error

Explanation: The application launcher cannot run the specified command.

User Action: Verify that the command is correct in the `.launchrc` or `LAUNCHRC.DAT` file.

BADCOMMAND, Unrecognized launcher function *n*

Severity: Warning

Explanation: The WM module has encountered an unrecognized function with the specified function number.

User Action: If you encounter this message, please contact NCD Technical Support.

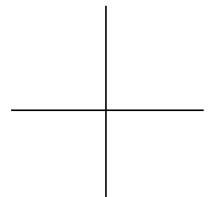

WM Messages

BADCONFIG, launcher config file *file*

Severity: Error

Explanation: The WM module has discovered an irrecoverable error in the specified launcher configuration file.

User Action: Verify that all entries in the launcher configuration file are correct and complete.

BADCONNECTION, launcher connection *message*

Severity: Error

Explanation: The application launcher cannot connect to the local NCD Window Manager due to a catastrophic problem with the socket; either the socket cannot be created or the socket has disappeared.

User Action: Refer to the message to determine the best course of action.

BADGEOMETRY, Geometry for *tool* is out of range

Severity: Warning

Explanation: The values for the size of the specified tool are not valid. This message usually occurs when the specified size of an icon box exceeds 2048x2048.

User Action: Correct the values specifying the size of the icon box. The size of the icon box is measured in number of icons, not pixels.

BADGRAB, bad grab count *n* on grab server

Severity: Error

Explanation: The X server has detected an internal error.

User Action: If you encounter this message, please contact NCD Technical Support.

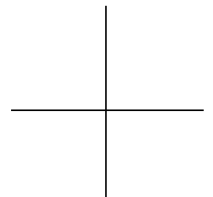

BADUNGRAB, bad grab count *n* on ungrab server

Severity: Error

Explanation: The X server has detected an internal error.

User Action: If you encounter this message, please contact NCD Technical Support.

NOMENU, no such menu "*menu*"

Severity: Error

Explanation: The launcher configuration file (.launchrc or LAUNCHRC.DAT) associates a button with a menu, but selecting the button reveals no menu has been defined.

User Action: Verify that the launcher configuration file contains the specified menu.

RESTART, restarting

Severity: Information

Explanation: The local NCD Window Manager is restarting as requested.

User Action: None

SOCKETERROR, error *message1* socket *n*: *message2*

Severity: Error

Explanation: The X server has determined that communications across the specified socket are resulting in bad data.

User Action: Check the socket on the host to verify that it is working properly.

VERSION, protocol mismatch. Got *protocol1* expected *protocol2*.

Severity: Warning

Explanation: The local NCD Window Manager encountered *protocol1* when it expected to use a different network protocol (*protocol2*).

User Action: If you encounter this message, please contact NCD Technical Support.

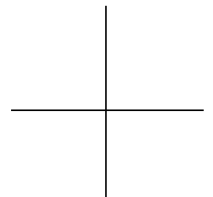

XREMOTE Messages

XREMOTE messages pertain to communications using XRemote software. If you are looking for a message that refers to the XREMOTE module but does not appear here, refer to “Messages Common to All Modules” on page 18-7.

CONNFAIL, connection from *host* failed - host not authorized

Severity: Error

Explanation: The terminal’s X access control list does not include an entry for the XRemote host, thereby preventing connection.

User Action: Verify that the terminal is attempting to connect to the correct XRemote host. If it is, modify the host access list on the terminal so that it includes an entry for the XRemote host.

CONNREJ, new client connection rejected = *message*

Severity: Information

Explanation: An XRemote client is attempting to connect to the X server but is unsuccessful as detailed in the message. This situation usually occurs if the terminal is low on memory.

User Action: Refer to the message for more information about the situation. If the terminal is running low on memory, close any unused local clients to free memory for the XRemote client connection.

FILETXFER, error during file transfer - *message*

Severity: Error

Explanation: The X server has detected an internal error.

User Action: If you encounter this message, please contact NCD Technical Support for assistance.

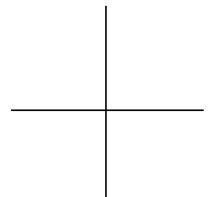

NOMEM, out of memory - *message*

Severity: Error

Explanation: The X server does not have sufficient memory to perform the requested action.

User Action: Close any unused local clients to free memory for the desired function.

NOMORE, new *connection_type* connection refused - XRemote already running

Severity: Error

Explanation: The X server has received a request to initiate XRemote communications when it is already running.

User Action: Either use the original XRemote session or close the original XRemote session and start a new one.

REFUSE, New *network* connection refused - *message*

Severity: Error

Explanation: This message usually appears when the X server is not configured correctly for XRemote communications.

User Action: Verify that the X server is configured correctly for XRemote communications. Specifically verify that the terminal is configured for XRemote communications via TCP.

TXPORT, *message*

Severity: Warning

Explanation: The X server has encountered difficulties in the transport layer of XRemote software as specified in the message.

User Action: Use the information contained in the message to resolve the problem. If you require further assistance, please contact NCD Technical Support.

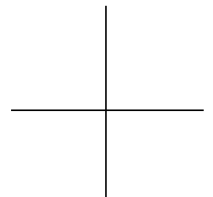

XRPRINTD Messages

XRPRINTD messages pertain to the XRemote print daemon. If you are looking for a message that refers to the XRPRINTD module but does not appear here, refer to “Messages Common to All Modules” on page 18-7.

CLOSE, closed session on *port*

Severity: Information

Explanation: The print daemon closed the connection to the serial/parallel daemon on the specified port.

User Action: None

NOCONNECT, unable to connect to print daemon on *port*

Severity: Error

Explanation: The XRemote print daemon is unable to connect to the serial/parallel daemon on the specified port.

User Action: Make sure that the serial port mode (Setup ⇒ Change Setup Parameters ⇒ Serial ⇒ Serial Interfaces Table ⇒ Current Port Use) has been configured for printing.

OPEN, opened session on *port*

Severity: Information

Explanation: The print daemon connected to the Serial or Parallel daemon on the specified port.

User Action: None

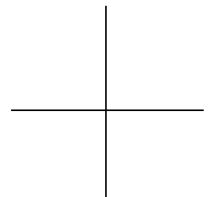

XSERVER Messages

XSERVER messages pertain to MIT X server code. If you are looking for a message that refers to the XSERVER module but does not appear here, refer to “Messages Common to All Modules” on page 18-7.

AUDIOINITFAIL, unable to initialize Network Audio Server

Severity: Error

Explanation: The audio X server module was not loaded.

User Action: Make sure the audio module is loaded.

BDAUTH, host *host_address* tried to connect with bad *n* authorization

Severity: Warning

Explanation: The X server received a request from an unauthorized client.

User Action: Verify that the authorization level is correct for the client that is attempting to connect.

BADFONTPATH, failed to set default font path *font_path*

Severity: Error

Explanation: The X server cannot set the specified font path as requested.

User Action: Verify that the font path is set correctly and that the file service table is configured appropriately. If the font path specifies a font server, make sure that the entry uses the proper syntax and that the font server is accessible via the network.

BADFONTPATHELEMENT, failed to add *font_path_entry* to font path

Severity: Error

Explanation: The X server cannot add the specified entry to the font path.

User Action: Verify that the font path entry is typed correctly and that the file service table is configured appropriately. If the entry is for a font server, make sure the entry uses the proper syntax and that the font server is accessible via the network.

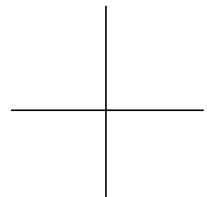

XSERVER Messages

BADWINDOWSIZE, window dimensions *n n* too large

Severity: Error

Explanation: The specified window dimensions are too large for the display.

User Action: Specify the window size again, using appropriate dimensions.

CMDSRUNNING, *n* local commands are still running

Severity: Warning

Explanation: The X server has determined that clients are not disconnecting as requested; the specified number of clients are hung processes.

User Action: Stop the hung processes.

NEWCLIENT, host *host* connected with *authorization_type* authorization

Severity: Information

Explanation: The specified host has connected to the X server with the specified type of authorization.

User Action: None

NOCONSOLE, unable to find console window

Severity: Error

Explanation: The X server cannot display the Console window.

User Action: Reboot the terminal. If the situation persists, please contact NCD Technical Support.

NOEXTENSION, client attempted to use non-existent extension *extension_name*

Severity: Warning

Explanation: A client application is looking for the specified extension; the extension is not provided by the current X server.

User Action: Determine if another X server image available for the terminal will provide the desired extension.

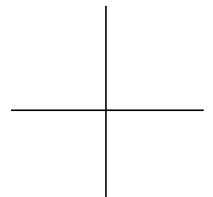

NOWARNING, unable to find warning box window

Severity: Error

Explanation: The X server cannot display the low-on-memory warning window.

User Action: Reboot the terminal. If the situation persists, please contact NCD Technical Support.

RESET, resetting X server to defaults for new session

Severity: Information

Explanation: The X server is resetting its configuration information to its default values as requested.

User Action: None

XT Messages

XT messages pertain to the X Toolkit libraries. If you are looking for a message that refers to the XT module but does not appear here, refer to “Messages Common to All Modules” on page 18-7.

ERROR, *message*

Severity: Error

Explanation: The X Toolkit library has reported an error as described in the message.

User Action: Refer to X Toolkit documentation for more information about the specified error. If you require more assistance, please contact NCD Technical Support.

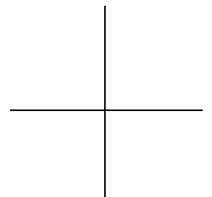

XT Messages

WARNING, *message*

Severity: Warning

Explanation: The X Toolkit library has generated a warning as specified in the message.

User Action: Refer to X Toolkit documentation for more information about the specified error. If you require more assistance, please contact NCD Technical Support.

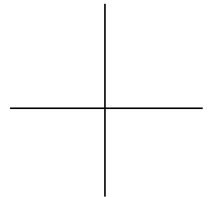

Index

Symbols

- ! command (Boot Monitor) 11-10
- ? command (Boot Monitor) 11-10

Numerics

- 3270 terminal emulation, configuration parameters for 9-42

A

- Acceleration Ratio (Change User Preferences) 9-51
- access control
 - configuration parameters for 9-9 to 9-13
 - font server 7-22
 - local clients, disabling 6-34
 - parallel port 15-10
 - serial ports 15-10
 - SNMP 16-3 to 16-7
 - terminal configuration data 6-30 to 6-34
 - XDM (X Display Manager) 8-15 to 8-16
see also passwords
- Activate Alpha Buffer for RGBA Visuals (Change User Preferences) 9-49
- Add Domain to Unit Name as Filename (Change Setup Parameters) 9-19
- Add Timestamps (Change Setup Parameters) 9-20
- Additional Escape Chars (Change Setup Parameters) 9-41

- address discovery
 - addresses in NVRAM 3-11
 - BOOTP/DHCP 3-3 to 3-10
 - broadcast address 3-12
 - configuring in Boot Monitor Setup 11-15
 - protocols
 - order of use 3-2
 - overview 3-1 to 3-2
 - RARP 3-10
 - subnet mask 3-13
- address resolution 5-5
- addresses, *see* Ethernet; IP (Internet Protocol); Token-Ring
- Administrative Contact (Change Setup Parameters) 9-38
- Administrative Status (Change Setup Parameters) 9-38
- Allow Alpha Test (Change User Preferences) 9-48
- Allow Blending (Change User Preferences) 9-48
- Allow Depth Test (Change User Preferences) 9-48
- Allow Dithering (Change User Preferences) 9-48
- Allow Exposures After Screen Saver (Change User Preferences) 9-53
- Allow Logical Operations (Change User Preferences) 9-49
- Allow MOP Reset (Change Setup Parameters) 9-31
- Allow Polygon Stipple (Change User Preferences) 9-49

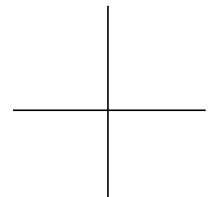

Allow Scissor Test (Change User Preferences) 9-48
Allow SNMP Reset (Change Setup Parameters) 9-11
Allow Stencil Test (Change User Preferences) 9-48
Allow XRemote TCP Connection (Change Setup Parameters) 9-41
AppletViewer Command (Change Setup Parameters) 9-27
apply command (Configuration language) 6-34 to 6-37
Arc Cache Maximum Size (Change Setup Parameters) 9-40
arc caching, memory used for 9-40
ARP (Address Resolution Protocol)
 ARP cache 5-5 to 5-6
 configuration parameters for 9-13
 proxy ARP 5-29
ARP Cache (Change Setup Parameters) 9-13
Audio Enabled (Change Setup Parameters) 9-40
Authorize XRemote Clients (Change Setup Parameters) 9-41
Auto Save (Change Setup Parameters) 9-8
Auto Save File (Change Setup Parameters) 9-20
Auto Save File Name (Change Setup Parameters) 9-20
Auto Save NVRAM (Change Setup Menus) 9-19
Auto Saved Info (Change Setup Parameters) 9-20
Automatic Lock Screen After (Change User Preferences) 9-46
Automatic Logout After (Change User Preferences) 9-46
Automatic Logout Cancel Delay (Change User Preferences) 9-46
Automatically load images (Change Setup Parameters) 9-16

Autorepeat Begin After (Change User Preferences) 9-47
Autorepeat Rate (Change User Preferences) 9-48
auto-save
 configuring 6-34 to 6-37
 disabling 6-35
 extent of data saved 6-37
 protocols for 6-35
 saving parameters to a file 6-35 to 6-36
 saving parameters to NVRAM 6-35

B

backing store, configuring 9-54
Backup File Server Address (Change Quick Setup) 9-4
Backup File Service Protocol (Change Quick Setup) 9-4
backward compatibility, parameters for 9-45
bd command (Boot Monitor) 11-7
Be Compatible With Old DECwindows Images (Change User Preferences) 9-45
Be Compatible With Old DECwindows Keyboards (Change User Preferences) 9-45
Be Compatible With Old DECwindows Vendor String (Change User Preferences) 9-45
Begin Sending Keepalives after (Change Setup Parameters) 9-30
Bell Base Volume (Change User Preferences) 9-45
Bell Duration (Change User Preferences) 9-45
Bell Pitch (Change User Preferences) 9-45
bell, configuration parameters for 9-45
Bitmap Background Color (Change User Preferences) 9-53
Bitmap File (Change User Preferences) 9-52

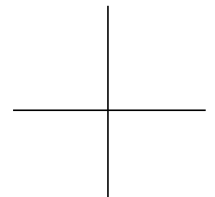

- Bitmap Foreground Color (Change User Preferences) 9-53
- bl** command (Boot Monitor) 11-7
- Black Pixel (Change Setup Parameters) 9-41
- bn** command (Boot Monitor) 11-7
- Boot automatically at power-up (Change Setup Parameters) 9-13
- Boot From (Change Quick Setup) 9-3
- boot host
 - backup hosts 4-16
 - first host to try 4-16
- Boot Host IP Address (Change Quick Setup) 9-3
- Boot Monitor
 - accessing 4-18, 11-6
 - booting from 4-17
 - commands 11-7 to 11-10
 - displaying 11-2
 - functions of 11-2 to 11-5
 - NVRAM utility
 - commands 11-20
 - sample sessions 11-21
 - starting 11-20
 - Setup
 - Boot window 11-16
 - exiting 11-17
 - keyboard type, setting 11-13
 - keymapper for 11-18
 - monitor dpi and resolution 11-13
 - navigating in 11-13
 - Network window 11-14 to 11-16
 - rebooting from 11-17
 - saving changes 11-17
 - starting 11-12
 - submenus 11-12
 - updating (Explora 400/450 and 700) 11-11
 - version, displaying 16-8
 - versions 11-1
- Boot Monitor Inverse Video (Change Setup Parameters) 9-14
- boot-automatically** 9-13, 11-7
- boot-custom-file** 9-14
- boot-default-server-when-prom-booting** 9-14
- boot-desired-source** 4-8, 9-3, 9-14
- booting
 - absolute pathname requests 4-2, 4-6
 - automatic boot, disabling 4-4
 - boot hosts 4-16
 - booting sequence, default 2-1, 4-8
 - BOOTP/DHCP 3-3 to 3-10
 - broadcast requests, disabling 4-4
 - color database file, loading 2-5
 - configuration files, loading 6-21 to 6-27
 - configuration parameters for 9-3, 9-13 to 9-15
 - configuring in Boot Monitor Setup 11-16
 - default actions 2-1 to 2-5
 - from PCMCIA
 - manual boot 4-18
 - order of 4-8
 - manual
 - from PCMCIA 4-18
 - overview 4-17
 - using MOP 11-7
 - using NFS 4-18, 11-7
 - using TFTP 4-18, 11-8
 - modules, load policy 4-10
 - MOP requests
 - default 4-3
 - disabling 4-5
 - manual boot 11-7
 - order of 4-8
 - NFS requests
 - default 4-3
 - disabling 4-5
 - location of X servers 4-13
 - manual boot 4-18
 - order of 4-8
 - persistent, enabling 4-7

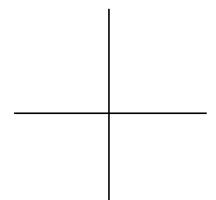

booting (continued)
 protocols
 backup choices 4-9
 first choice 4-9
 order of 4-2, 4-8 to 4-10
 RARP 3-10
 relative pathname requests 4-2, 4-6
 remote reset 16-10 to 16-13
 using *ncdreset* 16-11 to 16-12
 using *unit-administrative-status* 16-12
 reverse name request 3-15, 5-12
 TFTP requests
 default 4-2
 disabling 4-5
 location of X servers 4-12
 manual boot 4-18
 order of 4-8
 through a gateway 3-8 to 3-10, 11-7, 11-8
 X server loading 4-1 to 4-15
 see also address discovery; X server
boot-monitor-inverse-video 9-14
boot-mop 4-5, 9-15
boot-mop-with-file-name 9-15
boot-nfs-directory 9-15
BOOTP/DHCP
 /etc/*bootptab* file 3-5 to 3-10
 diagnostic messages 18-37
 enabling 3-4
 entry, example 3-7, 3-9
 option tags supported 3-6
bootpd (8)
 backup boot host, specifying 4-16
 enabling 3-4
boot-persistent-loading 9-14
boot-previous-server 9-14
boot-previous-source 9-14
boot-second-source 9-14
boot-send-broadcast-icmp-for-subnet-mask 3-14, 9-15
boot-tcpip-broadcast-boot-request 4-4, 9-15

boot-tcpip-desired-server 9-3, 9-14
boot-tcpip-product-name-and-memory-size-file 4-6, 9-15
boot-tcpip-product-name-and-memory-size-with-path-file 4-6, 9-15
boot-tcpip-product-name-file 4-6, 9-15
boot-tcpip-product-name-with-path-file 4-6, 9-15
boot-tcpip-second-server 9-14
boot-tcpip-third-server 9-14
boot-tcpip-unit-address-file 4-6, 9-15
boot-tcpip-unit-address-with-path-file 4-6, 9-15
boot-test-ram 9-13
boot-tftp-directory 9-15
boot-third-source 9-14
broadcast address 3-12
Broadcast Address (Change Setup Parameters) 9-25
Broadcast IP Address (Change Quick Setup) 9-5
Browser Module (Change Setup Parameters) 9-16
Browser Printer Table (Change Setup Parameters) 9-17
bt command (Boot Monitor) 11-8
Buffer Size (Change Setup Parameters) 9-20
Button Arrangement (Change User Preferences) 9-51
Button Press Threshold (Change User Preferences) 9-51
Button Release Threshold (Change User Preferences) 9-51

C

Cache Class File (Change Setup Parameters) 9-27
Cache Size Limit (Change Setup Parameters) 9-16
CALIBLIGHTPEN messages 18-15

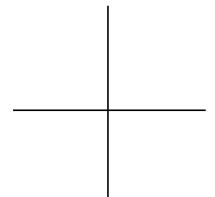

- Calibrate Light Pen (Change Setup Parameters) 9-25
- Calibrate Touch Screen (Change Setup Parameters) 9-25
- CALIBTOUCH messages 18-16
- Change Quick Setup, *see* Setup menus (Console)
- Change Screen Saver After (Change User Preferences) 9-53
- Change Setup Parameters, *see* Setup menus (Console)
- Change User Preferences, *see* Setup menus (Console)
- Circuit Flush Timeout (Change Setup Parameters) 9-27
- Clear Messages command (Console) 18-4
- clients
 - font requests 7-4, 7-6
 - old X clients, error checks 9-45
 - X resources, loading 8-7
 - see also* local clients
- color
 - color text in Terminal Emulator 12-30
 - colormap, default 9-41
 - database file for 2-5, 5-15, 9-40
 - screen background 9-52, 9-53
 - with WinCenter 9-40
- Color Clipping Method (Change User Preferences) 9-50
- Command Menu (Change Setup Parameters) 9-18
- Complete Entry Timeout (minutes) (Change Setup Parameters) 9-13
- Config Access Control List (Change Setup Parameters) 9-10
- Config File (Change Quick Setup) 9-4
- config** file (font server) 7-23
- Config Read-Only Password (Change Setup Parameters) 9-9
- Config Read-Write Password (Change Setup Parameters) 9-9
- config-access-control-enabled** 6-30, 6-31, 9-10, 9-19
- config-access-control-list** 6-31, 9-10
- config-add-domain-to-unit-name-as-filename** 6-23, 9-20
- config-auto-saved-info** 6-37, 9-20
- config-auto-save-file** 6-36, 9-20
- config-auto-save-file-name** 6-36, 9-20
- config-auto-save-nvram** 6-35, 9-19
- config-custom-file** 6-23, 9-18
- CONFIGD messages 18-17
- config-default-file** 9-2, 9-4, 9-7, 9-8, 9-19, 9-44
- config-enforce-passwords-locally** 9-9
- config-generic-file** 6-24, 9-19
- config-load-initial-file** 6-27, 9-18
- config-ncdnet-object-name** 9-19
- config-persistent-loading** 6-22, 9-18
- config-pref-enforce-passwords-locally** 9-10
- config-pref-ncdnet-object-name** 9-20
- config-pref-read-only-password** 9-10
- config-pref-read-write-password** 9-10
- config-pref-tcp-port** 6-29, 9-20
- config-pref-telnet-port** 6-29, 9-20
- config-read-only-password** 9-8, 9-9, 9-43
- config-read-write-password** 9-8, 9-9, 9-43
- config-tcp-port** 6-28, 9-19
- config-telnet-port** 6-27, 6-28, 9-19
- config-unit-ethernet-address-file** 6-23, 9-19
- config-unit-ip-address-file** 6-24, 9-19
- config-unit-name-file** 6-23, 9-19
- config-unit-ncdnet-address-file** 6-24, 9-19
- config-unix-directory** 6-26, 9-4, 9-18
- Configuration daemon
 - configuration parameters for 9-19
 - defined 6-2
 - diagnostic messages 18-17
 - ports for accessing 6-28
 - starting from Terminal Emulator 12-2
- configuration file directory 6-26

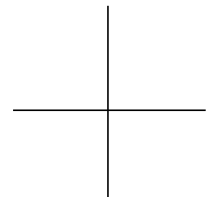

configuring terminals, *see* terminal
configuration; remote
configuration; remote
configuration files; Setup menus
(Console); Setup (Boot Monitor);
NVRAM utility
**config-use-decimal-ip-address-notation-as-
filename** 6-24, 9-19
config-vms-directory 9-4, 9-18
CONFUI messages 18-30
Connect Timeout (Change Setup
Parameters) 9-27, 9-31, 9-36
Console
configuration parameters for 9-10,
9-46
diagnostic messages 18-33
disabling 6-34
key sequence for displaying 9-46
Console Display Password (Change Setup
Parameters) 9-10
Console Key Sequence (Change User
Preferences) 9-46
CONSOLE messages 18-33
CTERM
Terminal Host Chooser, automatic
display of hosts 12-3
see also Terminal Emulator
Current Font Path (Change User
Preferences) 9-47
Current Pointing Device (Change User
Preferences) 9-51
Custom File (Change Setup Parameters)
remote configuration file 9-18
X server file 9-14

D

da command (Boot Monitor) 11-8
Data Compression Mode (Change Setup
Parameters) 9-41

DECnet
configuration parameters for 9-31 to
9-32
statistics 10-9 to 10-11
DECwindows
configuration parameters for 9-30,
9-45
Default Colormap (Change Setup
Parameters) 9-41
Default File (Change Setup
Parameters) 9-19
Default Font Path at Reset (Change Quick
Setup) 9-4
Default for Enable X Access Control
(Change Setup Parameters) 9-9
Default home page (Change Setup
Parameters) 9-16
Default Hosts (Change Setup Parameters)
for 3270 Host Chooser 9-42
for Login Chooser 9-29
for login through the Terminal
Emulator 9-39
Default Linger Time (Change Setup
Parameters) 9-36
Default Packet Time-to-Live (Change
Setup Parameters) 9-26
Default Router (Change Setup
Parameters) 9-31
Default Server when PROM Booting
(Change Setup Parameters) 9-14
Default Visual (Change Setup
Parameters) 9-41
Default VMS File Name Extension (Change
Setup Parameters) 9-23
Delay LAT Display after Boot (Change
Setup Parameters) 9-39
Delay When Blanking Screen (Change
User Preferences) 9-46
DESKTOP messages 18-36
DHCP
messages 18-37
see also BOOTP/DHCP

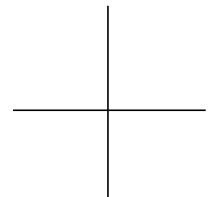

- diag-access-control-enabled** 9-11
- diag-access-control-list** 9-11
- diag-add-timestamps** 9-20
- diag-buffer-size** 9-20, 18-6
- diag-log-file** 9-20, 18-5
- diag-ncdnet-object-name** 9-21
- Diagnostic Access Control List (Change Setup Parameters) 9-11
- Diagnostic daemon
 - configuration parameters for 9-20
 - messages about 18-38
 - starting from Terminal Emulator 12-2
 - TELNET connection to 18-4
- diagnostic messages, *see* messages
- diag-tcp-port** 9-20
- diag-telnet-port** 9-20
- diag-timestamp-frequency** 9-20, 18-5
- Disabled Commands (Change Setup Parameters) 9-18
- Disabled Networks (Change Setup Parameters) 9-29
- Disabled X Extensions (Change Setup Parameters) 9-40
- display background, configuration parameters for 9-52
- DISPLAY** environment variable
 - set by XDM 8-5
- Dither Flat Shaded Surface (Change User Preferences) 9-50
- Dither Interpolated Surface (Change User Preferences) 9-50
- dm** command (Boot Monitor) 11-8
- DNS (Domain Name System)
 - configuration parameters for 9-37
 - domain suffix, default 5-9
 - enabling 5-7
 - name server hosts, specifying 5-8
 - name space, widening searches of 9-37
 - reverse name request 3-15, 5-12
 - selecting 5-8
- DNS Default Domain (Change Setup Parameters) 9-37
- DNS Domain Search (Change Setup Parameters) 9-37
- documentation
 - conventions 1-5
 - how to comment on 1-6
 - intended audience 1-1
 - license server 1-4
 - NCDware manuals 1-4
 - WinCenter 1-5
- Domain Channel (Change Setup Parameters) 9-33
- DOS messages 18-38
- DPS (Display PostScript)
 - cache, freeing 13-12
 - CIE-dict19c.dat** file 13-7
 - configuration parameter for 9-21
 - file access protocols 13-3
 - fonts
 - adding 13-11
 - client access, configuring 13-11
 - directories 13-9
 - included in NCDware distribution 13-8
 - InitProc.dat** file 13-7
 - licensing 13-2
 - PSres.upr** file 13-3 to 13-6
 - resource path 13-10
 - Solaris systems, running applications on 13-13
 - support files 13-3 to 13-7, 13-10
 - terminals supported 13-1
 - troubleshooting 13-12
 - VM_3_2.SNF** file 13-7
- dps-resource-path** 9-21, 13-10
- dr** command (Boot Monitor) 11-8
- ds** command (Boot Monitor) 11-8
- DTR messages 18-40

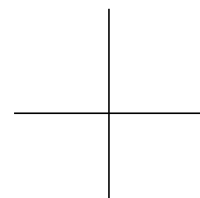

E

- EHLLAPI A Default tcp Port (Change Setup Parameters) 9-42
- Enable 24-bit RGBA (Change User Preferences) 9-49
- Enable 3270 Terminal Emulation (Change Setup Parameters) 9-42
- Enable 8-bit Color-Index (Change User Preferences) 9-49
- Enable 8-bit RGBA (Change User Preferences) 9-49
- Enable Bell (Change User Preferences) 9-45
- Enable Benchmark Optimizations (Change User Preferences) 9-54
- Enable Config Access Control (Change Setup Parameters) 9-10
- Enable Diagnostic Access Control (Change Setup Parameters) 9-11
- Enable Execution Host Access Control (Change Setup Parameters) 9-12
- Enable Execution User Access Control (Change Setup Parameters) 9-12
- Enable File Manager Access Control List (Change Setup Parameters) 9-12
- Enable Floppy Filesystem (Change Setup Parameters) 9-23
- Enable Graphics Optimizations (Change User Preferences) 9-54
- Enable Keyboard Autorepeat (Change User Preferences) 9-47
- Enable NFS Server (Change Setup Parameters) 9-23
- Enable Screen Saver (Change User Preferences) 9-53
- Enable Serial and Parallel Access Control (Change Setup Parameters) 9-13
- Enable SNMP Read-Only Access Control (Change Setup Parameters) 9-11
- Enable SNMP Read-Write Access Control (Change Setup Parameters) 9-11
- Enable VESA Monitor Power Management 9-52
- Enable X Access Control (Change Setup Parameters) 9-9
- enet-interfaces-table** 10-2
- Enforce Config Passwords Locally (Change Setup Parameters) 9-9
- Enforce Console Password Locally (Change Setup Parameters) 9-10
- Enforce User Preferences Passwords Locally (Change Setup Parameters) 9-10
- Environment Variables (Change Setup Parameters), for the NCD Mosaic Browser 9-16
- Environment Variables (Change User Preferences), for local clients 9-47
- Equivalent IP Addresses (Change Setup Parameters) 9-26
- /etc/bootptab** file 3-5 to 3-10
- /etc/bootptab.cfg** file 3-3
- /etc/ethers** file 3-11
- /etc/services** file 3-4
- Ethernet
 - address
 - displaying 3-11
 - on terminal base 3-11
 - restoring 11-21 to 11-22
 - interfaces
 - configuration parameters for 9-32
 - statistics 10-13
- ex** command (Boot Monitor) 11-8
- exec-access-control-enabled** 9-12
- exec-access-control-list** 9-12
- exec-command-menu** 9-18
- EXECD messages 18-40
- exec-disabled-commands** 6-34, 9-18
- exec-startup-commands** 9-6, 9-18
- exec-user-access-control** 9-12
- Execution Access Control List (Change Setup Parameters) 9-12

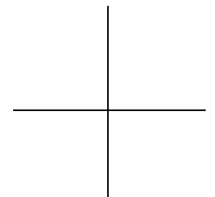

- Export Directory List (Change Setup Parameters) 9-23
- Extended Diagnostics (Change Setup Parameters) 9-22
- Extended File Diagnostics (Change Quick Setup) 9-4
- Extended Routing Diagnostics (Change Setup Parameters) 9-26
- F**
- Failed Server Ignore Timeout (Change Setup Parameters) 9-22
- Fast MPEG decoder (Change Setup Parameters) 9-39
- Fast Perspective Rendering (Change User Preferences) 9-49
- File Manager Access Control List (Change Setup Parameters) 9-12
- File Server Address (Change Quick Setup) 9-3
- file service
 - configuration parameters for 9-3, 9-22
 - diagnostic messages 18-87
 - diagnostic messages, extended 5-24
 - file server hosts 5-13 to 5-20
 - boot host 5-13
 - in file service table 5-15
 - initial file servers 5-13
 - file service table 5-15 to 5-20
 - locations of files, default 5-15
 - matching filenames to file service table entries 5-18 to 5-20
- NFS
 - configuring 5-22 to 5-23
 - statistics 10-13
- TFTP
 - configuring 5-20 to 5-22
 - statistics 10-25
 - timeouts, configuring 5-24
- File Service Protocol (Change Quick Setup) 9-3
- File Service Table (Change Setup Parameters) 9-22
- FILED messages 18-44
- file-default-vms-file-name-extension** 9-23
- file-enable-floppy-filesystem** 9-23
- file-enable-nfs-server** 9-23
- file-export-directory-list** 9-23
- file-extended-diagnostics** 5-24, 9-4, 9-22, 13-12, 18-6
- file-failed-server-ignore-timeout** 5-24, 9-22
- file-initial-protocol-1** 9-3, 9-22
- file-initial-protocol-2** 9-4, 9-22
- file-initial-server-1** 9-3, 9-22
- file-initial-server-2** 9-4, 9-22
- file-manager-access-control-enabled** 9-12
- file-manager-access-control-list** 9-12
- file-manager-ncdnet-object-name** 9-21
- file-manager-password** 9-12
- file-manager-tcp-port** 9-21
- file-manager-telnet-port** 9-21
- file-name-type-for-initial-tftp-servers** 9-4, 9-22
- file-nfs-access-control list** 9-12
- file-nfs-access-control-default** 9-12
- file-nfs-gid** 5-23
- file-nfs-uid** 5-23
- file-nfs-unmount-timeout** 5-23, 9-22
- file-service-table** 5-16, 9-22
- file-try-all-matches-on-open** 5-19, 9-22
- floppy drive, diagnostic messages 18-38
- FONT messages 18-48
- Font Name Table (Change Setup Parameters) 9-24
- font server
 - access control for 7-22
 - architecture (illustration) 7-20
 - backup font servers 7-21
 - bitmap font format 7-21
 - Bitstream Speedo outline fonts 7-21
 - compressed font files 7-21
 - configuration file, example 7-23
 - configuration parameters for 9-24

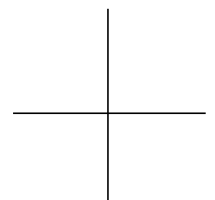

- font server (continued)
 - defined 7-19 to 7-20
 - diagnostic messages
 - explanations of 18-48
 - displaying fonts 7-27
 - error logging 7-23
 - font formats 7-20 to 7-21
 - host load, configuring 7-22
 - IBM Type 1 (Adobe) outline fonts 7-21
 - installation 7-22
 - listing fonts 7-27
 - ncdfsinfo(1)** 7-26
 - ncdfsfonts** 7-27
 - outline fonts 7-20, 7-21
 - point size, default 7-23
 - resolution, default 7-23
 - SNF fonts 7-21
 - timeouts, configuring 7-25 to 7-26
- font-cache-hits** 10-3
- font-cache-size** 10-3
- font-cache-used** 10-3
- font-extended-diagnostics** 18-6
- font-number-of-fonts-in-cache** 10-3
- font-object-count** 10-3
- font-objects-currently-in-use** 10-3
- fonts
 - access sequence 7-2
 - available fonts, listing 7-18
 - BDF format
 - converting to PCF 7-10
 - defined 7-7
 - built-in 7-11
 - cache 7-14
 - characters in a font, displaying 7-18
 - client font requests 7-4, 7-6
 - configuration parameters for 9-4, 9-23, 9-47
 - default font 7-13
 - diagnostic messages
 - displaying 7-17
 - explanations of 18-48
 - logging 7-17

- fonts (continued)
 - directories for 7-8
 - downloading, protocols for 7-6
 - DPS fonts 13-8, 13-11
 - DWF format 7-7
 - files 7-8 to 7-10
 - font information, displaying 7-17 to 7-19
 - font names 7-2 to 7-5
 - font path
 - aliases for, creating 7-16
 - current 7-11 to 7-13
 - defined 7-6
 - displaying 7-18
 - xset(1)**, setting current font path 7-13
 - fonts.alias** file
 - defined 7-9
 - name, changing 7-15
 - fonts.dir** file
 - creating 7-10
 - defined 7-9
 - name, changing 7-15
 - formats 7-7
 - initial file server hosts 5-13
 - NCDware distribution, fonts included 7-8
 - outline fonts
 - see* font server
 - PCF fonts 7-7
 - PEX fonts 14-2
 - samples of a font, displaying 7-19
 - SNF format 7-7
 - statistics 10-3
 - XLFD (X Logical Font Description) 7-2, 7-19
 - see also* font server
 - fonts.alias** file 7-9 to 7-10, 7-15
 - fonts.dir** file 7-9, 7-10, 7-15
 - font-total-fonts-loaded** 10-3
- FTP Proxy Overrides (Change Setup Parameters) 9-17

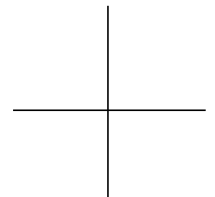

FTP Proxy Host (Change Setup Parameters) 9-17
 FTP Proxy Host Port (Change Setup Parameters) 9-17
 Function Key Style (Change User Preferences) 9-47

G

gateway
 booting through 3-8, 11-7, 11-8
 configuration parameters for 9-25
 default gateways 5-25
 router discovery 5-30
 see also routing
 Gateway IP Address (Change Quick Setup) 9-5
 get-protect command (Configuration language) 6-32, 6-33
 GET-PROTECTED parameter value 6-5
 Gopher Proxy Host (Change Setup Parameters) 9-17
 Gopher Proxy Host Port (Change Setup Parameters) 9-17
 Gopher Proxy Overrides (Change Setup Parameters) 9-17
 graphics optimizations, configuration parameters for 9-54

H

Hello Timeout (Change Setup Parameters) 9-31
 hostnames
 name service 5-7 to 5-10
 terminal
 configuration parameters for 9-38
 reverse name request 3-15, 5-12
 HTTP Proxy Host (Change Setup Parameters) 9-16
 HTTP Proxy Host Port (Change Setup Parameters) 9-16
 HTTP Proxy Overrides (Change Setup Parameters) 9-17

I

ICMP (Internet Control Message Protocol)
 configuration parameters for 9-26
 router discovery 5-30
 statistics 10-3 to 10-5
 subnet mask discovery 3-14
 icmp-address-mask-replies-received 10-4
 icmp-address-mask-replies-transmitted 10-5
 icmp-address-mask-requests-received 10-4
 icmp-address-mask-requests-transmitted 10-5
 icmp-destination-unreachables-received 10-3
 icmp-destination-unreachables-transmitted 10-5
 icmp-echo-replies-received 10-4
 icmp-echo-replies-transmitted 10-5
 icmp-echo-requests-received 10-4
 icmp-echo-requests-transmitted 10-5
 icmp-packets-received 10-3
 icmp-packets-received-with-errors 10-3
 icmp-packets-transmitted 10-4
 icmp-packets-unable-to-be-transmitted 10-4
 icmp-parameter-problems-received 10-4
 icmp-parameter-problems-transmitted 10-5
 icmp-redirects-received 10-4
 icmp-redirects-transmitted 10-5
 icmp-source-quenches-received 10-4
 icmp-source-quenches-transmitted 10-5
 icmp-time-exceededs-received 10-4
 icmp-time-exceededs-transmitted 10-5
 icmp-timestamp-replies-received 10-4
 icmp-timestamp-replies-transmitted 10-5
 icmp-timestamp-requests-transmitted 10-5
 icmp-timestamps-requests-received 10-4
 IEN 116 name service
 configuration parameters for 9-37
 enabling 5-7
 name server hosts, specifying 5-8
 selecting 5-8

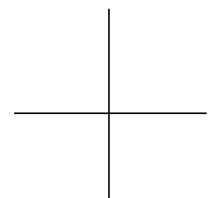

Ignore Case on TCP/IP Name Cache Lookups (Change Setup Parameters) 9-37

Incomplete Entry Timeout (minutes) (Change Setup Parameters) 9-13

Initial Default Gateway 1 (Change Setup Parameters) 9-25

Initial Default Gateway 2 (Change Setup Parameters) 9-26

Initial File Server 1 (Change Setup Parameters) 9-22

Initial File Server 2 (Change Setup Parameters) 9-22

initial file servers, *see* file service

Initial Protocol 1 (Change Setup Parameters) 9-22

Initial Protocol 2 (Change Setup Parameters) 9-22

Input Extension Device (Change Setup Parameters) 9-25

IP (Internet Protocol)

- addresses
 - configuration parameters for 9-25
 - hexadecimal, converting to 4-15
 - multi-homed hosts 3-15
 - see also* address discovery
- routing table 5-26 to 5-29
- statistics 10-6 to 10-8

IP Address (Change Setup Parameters) 9-25

IP Address At Next Boot (Change Setup Parameters) 9-25

ip-address 9-25

ip-address-at-next-boot 9-5, 9-25

ip-broadcast-address 3-12, 3-13, 9-5, 9-25

ip-default-packet-time-to-live 9-26

ip-equivalent-address 3-15

ip-equivalent-addresses 9-26

ip-extended-routing-diagnostics 9-26, 18-6, 18-55

ip-forwarding-type 10-6

ip-initial-default-gateway-1 5-25, 9-5, 9-25

ip-initial-default-gateway-2 5-25, 9-26

ip-packet-fragmentations-completed 10-8

ip-packet-fragmentations-not-completed 10-8

ip-packet-fragments-created 10-8

ip-packet-reassemblies-completed 10-8

ip-packet-reassemblies-not-completed 10-8

ip-packet-reassemblies-required 10-8

ip-packet-reassembly-timeout 10-7

ip-packets-forwarded 10-6

ip-packets-received 10-6

ip-packets-received-and-delivered 10-7

ip-packets-received-and-discarded 10-7

ip-packets-received-with-errors-in-ip-header 10-6

ip-packets-received-with-incorrect-address 10-6

ip-packets-received-with-unknown-protocols 10-6

ip-packet-transmission-requests 10-7

ip-packet-transmission-requests-discarded 10-7

ip-packet-transmission-requests-without-routes 10-7

ip-respond-to-broadcast-icmp 9-26

IPROUTE messages 18-55

ip-routing-table 5-27

ip-routing-table 5-27, 9-26

ip-subnet-mask 9-5, 9-25, 10-8

ip-use-address-discovery 9-26

ip-use-proxy-arp 5-30, 9-26

ip-use-router-discovery 5-30, 9-26

ip-use-router-solicit 5-30, 9-26

J

Java

- configuration parameters for 9-27
- diagnostic messages 18-36, 18-57

Java applets (Change Setup Parameters) 9-16

Java Directory (Change Setup Parameters) 9-27

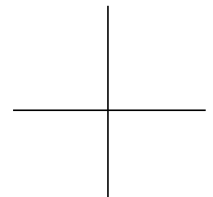

JAVA messages 18-57
java-appletviewer-command 9-27
java-cache-class-file 9-27
java-directory 9-27
 Jscript/Javascript routines (Change Setup Parameters) 9-16

K

KBM messages 18-58
 Keepalive Idle Time (Change Setup Parameters) 9-36
 Keepalive Interval (Change Setup Parameters) 9-36
 Keepalive Timeout (Change Setup Parameters) 9-27, 9-31
 Keyboard Description File (Change Setup Parameters) 9-24
 Keyboard Type (Change Setup Parameters) 9-24
 keyboards
 compose sequences for Terminal Emulator 12-44 to 12-50
 configuration parameters for 9-24, 9-47
 dead-key processing 17-60 to 17-61
 downloadable keyboard description files
 creating 17-54 to 17-61
 diagnostic messages 18-58
 escape sequences for Terminal Emulator 12-34 to 12-43
 keyboard controller version, displaying 16-8
 keysym file 5-15, 9-40
 keysyms
 file 5-15, 9-40
 foreign language keyboards 17-1
 LEDs, configuring 9-48
 N-101, details 17-13 to 17-20
 N-107, details 17-36 to 17-43
 N-108, details 17-21 to 17-35

keyboards (continued)
 N-108LK function keys,
 programming 12-28 to 12-30
 N-123, details 17-44 to 17-53
 N-97, details 17-4 to 17-12
 type, setting
 in Boot Monitor Setup 11-13
 xserver-keyboard-type
 parameter 17-2
 VT220-compatible, details 17-21 to 17-35
 Windows 95-compatible 17-13
 Keyclick Volume (Change User Preferences) 9-48
 Keymap Editor
 messages 18-67
 KEYMAPPER messages 18-67
 keymapper, Boot Monitor 11-18
 Keysym File (Change Setup Parameters) 9-40
 keysyms
 file 2-5, 5-15
 foreign-language keyboards 17-1
 keysyms file 9-40
km command (Boot Monitor) 11-8, 11-18
ks command (Boot Monitor) 11-8

L

LAT
 configuration parameters for 9-27
 passwords 9-12
 services in Terminal Host Chooser 12-3
lat-circuit-flush-timeout 9-27
lat-connect-timeout 9-27
lat-keepalive-timeout 9-27
lat-retransmission-limit 9-28
lat-retransmission-timeout 9-28
lat-service-directory-max-size 9-27
lat-service-groups 9-27
 launcher, diagnostic messages 18-133

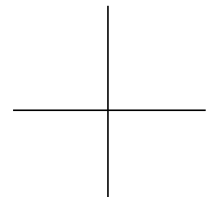

- Led 1, Led 2, Led 3, Led 4 (Change User Preferences) 9-48
- License Agent Port Number (Change Setup Parameters) 9-28
- License Agents (Change Setup Parameters) 9-28
- License Key (Change Quick Setup) 9-5
- License Key (Change Setup Parameters) 9-28
- LICENSE messages 18-67
- Licensed Features (Change Quick Setup) 9-5
- Licensed Features (Change Setup Parameters) 9-28
- licenses
 - configuration parameters for 9-5, 9-28
 - diagnostic messages 18-67
 - error log file 18-67
 - license server, supplemental documentation for 1-4
- light pen
 - configuration parameters for 9-25
 - diagnostic messages 18-15
- Light Pen Blue Flood (Change Setup Parameters) 9-25
- Load Initial File (Change Setup Parameters) 9-18
- Load Policy (Change Setup Parameters) 9-29
- Loadable Modules Directory (Change Quick Setup) 9-4
- Loadable Modules Directory (Change Setup Parameters) 9-29
- LOADB messages 18-74
- loader, diagnostic messages 18-103
- local clients
 - configuration parameters for 9-18
 - diagnostic messages 18-40
 - environment variables, setting 9-47
- Local Dead Key Support (Change Setup Parameters) 9-25
- Local File Manager
 - configuration parameters for 9-21
 - diagnostic messages 18-44
 - starting from Terminal Emulator 12-2
 - see also* local file system
- local file system
 - booting from 11-7
 - configuration parameters for 9-22
 - diagnostic messages 18-77
 - messages 18-44
 - see also* Local File Manager
- Local Name Cache (Change Setup Parameters) 9-32, 9-37
- LOCALDEV messages 18-77
- Lock Screen Default Password (Change User Preferences) 9-46
- lock screen, configuration parameters for 9-46
- Log File (Change Setup Parameters) 9-20
- Login (Console)
 - diagnostic messages 18-78
- LOGIN messages 18-78
- Login Name (Change Setup Parameters) 9-30
- Login Password (Change Setup Parameters) 9-30
- login, *see* XDM
- login-default-hosts** 9-29
- login-disabled-networks** 9-29
- login-dwlogin-name** 9-30
- login-dwlogin-password** 9-30
- login-ncddm-enabled** 9-30
- login-ncddm-tcp-port** 9-30
- login-restrict-host-choices** 9-29
- login-window-delay-time** 8-17, 9-29
- login-xdm-action-on-disconnect** 8-17, 9-30
- login-xdm-authentication-key** 9-9
- login-xdm-broadcasts** 9-30
- login-xdm-broadcast-wait-time** 9-30
- login-xdm-display-class** 9-29
- login-xdm-indirects** 9-30
- login-xdm-keepalives-begin-time** 8-18, 9-30

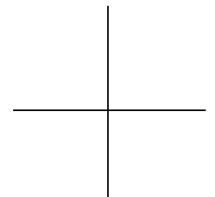

login-xdm-keepalives-wait-time 8-19, 9-30
logout, configuration parameters for 9-46

M

makepsres(1) 13-5

Maximum Gain (Change User Preferences) 9-44

Maximum Keepalive Idle Time (Change Setup Parameters) 9-36

Maximum Model Clip Planes (Change Setup Parameters) 9-33

Maximum Nameset Names (Change Setup Parameters) 9-33

Maximum Non-Ambient Lights (Change Setup Parameters) 9-33

Maximum Retransmissions (Change Setup Parameters) 9-36

Maximum Retries (Change Setup Parameters) 9-28

Maximum TCP/IP connections (Change Setup Parameters) 9-16

memory

displaying 11-8, 11-9

information, displaying 16-8

statistics 10-27

messages

buffer, size of 18-6

common to all modules 18-7 to 18-14

configuration parameters for 9-20, 9-46

configuring 18-5 to 18-6

displaying

Console Messages area 18-4

TELNET connection 18-4

explanations of

CALIBLIGHTPEN 18-15

CALIBTOUCH 18-16

CONFIGD 18-17

CONFUI 18-30

CONSOLE 18-33

DESKTOP 18-36

DHCP 18-37

messages (continued)

explanations of (continued)

DIAGD 18-38

DOS 18-38

downloadable keyboard
description files 18-58

DTR 18-40

EXECD 18-40

file service 18-87

FILED 18-44

floppy disk drive 18-38

FONT 18-48

font server 18-48

IROUTE 18-55

JAVA 18-57

KBM 18-58

Keymap Editor 18-67

KEYMAPPER 18-67

launcher 18-133

LICENSE 18-67

LOADB 18-74

local client execution 18-40

Local File Manager 18-44

local file system 18-44, 18-77

LOCALDEV 18-77

LOGIN 18-78

MIRRORD 18-81

module loader 18-103

Motif Window Manager 18-83

MPEGPLAY 18-82

MWM 18-83

NCD Display Manager 18-86

NCD Mosaic Browser 18-74, 18-84,
18-99

NCD Window Manager 18-133

NCDDM 18-86

ncdwm 18-133

NETD 18-87

NETFILE 18-87

NETSRV 18-93

OPENGL 18-94

PCMCIA card 18-77

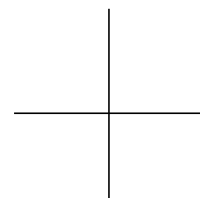

messages (continued)
 explanations of (continued)
 PPP 18-96
 PRINTAPIS 18-99
 routing 18-55
 RTLD 18-103
 SERIALD 18-106
 SIE 18-108
 SLIP 18-96
 SNMPD 18-108
 TERM 18-109
 Terminal Emulator 18-109
 TOKENRING 18-122
 touch screen 18-16
 UI 18-125
 VIDEO 18-82
 VIDEODECODER 18-82
 VIDEOPLAYER 18-82
 WINCEN 18-127
 WIRELESS 18-128
 WM 18-133
 XPRIND 18-138
 XREMOTE 18-136
 XSERVER 18-139
 XT 18-141
 extended 18-6
 format 18-2 to 18-3
 logging 18-5
 overview 18-1 to 18-2
 time stamps 18-5
MIRRORD messages 18-81
modules, X server, *see* X server
modules-directory 9-4, 9-29
modules-loaded 10-8
modules-load-policy 9-29
monitor
 dots-per-inch, setting 11-13
 power management, configuration
 parameters for 9-52
 resolution, setting 11-13

MOP (Maintenance Operations Protocol)
 boot requests, disabling 4-5
 order of use in booting 4-8
 server download sequence 4-1, 4-3
MOP Identify Timeout (Change Setup
 Parameters) 9-31
MOP Reset Password (Change Setup
 Parameters) 9-11
Motif Window Manager, diagnostic
 messages 18-83
Mouse Buttons (Change Setup
 Parameters) 9-25
mouse, configuration parameters for 9-25,
 9-51
MPEGPLAY messages 18-82
multi-homed hosts 3-15
MWM messages 18-83

N

N-101 keyboards
 Boot Monitor, accessing from 17-13
 escape sequences (in Terminal
 Emulator) 12-35 to 12-37
 keycodes 17-14
 keymap 17-15 to 17-20
 LEDs 17-13
 legends 17-14
 Setup key combination 17-13
 Windows 95-compatible version 17-13
N-102 keyboards
 dead keys (in Terminal
 Emulator) 12-44
 escape sequences (in Terminal
 Emulator) 12-35 to 12-37
N-107 keyboards
 Boot Monitor, accessing from 17-36
 keycodes 17-37
 keymap 17-38 to 17-43
 LEDs 17-36
 legends 17-37
 Setup key combination 17-36

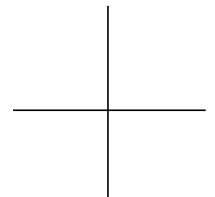

- N-108 keyboards
 - Boot Monitor, accessing from 17-21
 - keycodes 17-23
 - keymap 17-24 to 17-35
 - LEDs 17-21
 - legends 17-23
 - N-108LK escape sequences (in Terminal Emulator) 12-38 to 12-41
 - N-108LK function keys (in Terminal Emulator) 12-28
 - Setup key combination 17-21
- N-123 keyboards
 - Boot Monitor, accessing from 17-44
 - keycodes 17-45
 - keymap (with OpenWindows) 17-46 to 17-53
 - LEDs 17-44
 - legends 17-45
- N-97 keyboards
 - Boot Monitor, accessing from 17-4
 - escape sequences (in Terminal Emulator) 12-42 to 12-43
 - keycodes 17-5
 - keymap 17-6 to 17-12
 - LEDs 17-4
 - legends 17-5
- name cache 5-10 to 5-11
- Name Cache Max Lifetime (Change Setup Parameters) 9-32, 9-37
- Name Cache Max Size (Change Setup Parameters) 9-32, 9-37
- Name Server Protocol (Change Setup Parameters) 9-37
- Name Server Retransmission Timeout (Change Setup Parameters) 9-37
- Name Server Transaction Timeout (Change Setup Parameters)
 - for DECnet name service 9-32
 - for TCP/IP name service 9-37
- Name Servers (Change Setup Parameters)
 - for DECnet name service 9-32
 - for TCP/IP name service 9-37
- name service
 - configuration parameters for 9-37
 - enabling 5-7
 - name cache, local 5-10 to 5-12
 - name server hosts, specifying 5-8
 - protocol, selecting 5-8
 - remote configuration file entries for 5-7
 - reverse name request 5-12
 - statistics 10-24 to 10-25
- Name Type for Initial TFTP servers (Change Quick Setup) 9-4
- Name Type for Initial TFTP Servers (Change Setup Parameters) 9-22
- Narrow Keysym Tables (Change Setup Parameters) 9-24
- NCD Display Manager
 - configuration parameters for 9-30
 - defined 8-5
 - diagnostic messages 18-86
- NCD Display Manager Enabled (Change Setup Parameters) 9-30
- NCD Display Manager TCP Port Number 9-30
- NCD Mosaic Browser
 - configuration parameters for 9-16 to 9-17
 - diagnostic messages 18-74, 18-84, 18-99
- NCD Terminal Emulator, *see* Terminal Emulator
- NCD Window Manager, diagnostic messages 18-133
- ncd_std** remote configuration file 6-24
- NCD3270 Default Model (Change Setup Parameters) 9-42
- NCD3270 Default Protocol (Change Setup Parameters) 9-42
- NCDDM messages 18-86

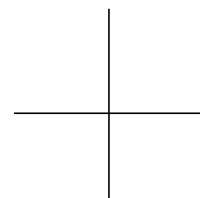

- nccdm*(1)**
 - configuration parameters for 9-30
 - defined 8-5
 - diagnostic messages 18-86
- ncloadprefs*(1)** 6-21
- ncdmkfd*(1)** 13-11
- NCDnet Address (Change Quick Setup) 9-5
- NCDnet Address (Change Setup Parameters) 9-31
- NCDnet Address at Next Boot (Change Quick Setup) 9-5
- NCDnet Address At Next Boot (Change Setup Parameters) 9-31
- NCDnet Name Servers (Change Quick Setup) 9-6
- NCDnet Object Name (Change Setup Parameters)
 - for Configuration daemon 9-19
 - for Diagnostic daemon 9-21
 - for Local File Manager 9-21
 - for Preferences daemon 9-20
- NCDnet Router Address (Change Quick Setup) 9-6
- NCDnet, *see* DECnet
- ncdnet-address*** 9-5, 9-31
- ncdnet-address-at-next-boot*** 9-5, 9-31
- ncdnet-bytes-received*** 10-9
- ncdnet-bytes-sent*** 10-9
- ncdnet-connect-timeout*** 9-31
- ncdnet-count-circuit-down*** 10-9
- ncdnet-data-blocks-received*** 10-9
- ncdnet-data-blocks-sent*** 10-9
- ncdnet-default-router*** 9-6, 9-31
- ncdnet-hello-packets-received*** 10-9
- ncdnet-hello-packets-sent*** 10-9
- ncdnet-hello-timeout*** 9-31
- ncdnet-inbound-errors*** 10-9
- ncdnet-keepalive-timeout*** 9-31
- ncdnet-mop-allow-reset*** 9-31
- ncdnet-mop-identify-timeout*** 9-31
- ncdnet-mop-reset-password*** 9-11
- ncdnet-name-bad-name-errors*** 10-10
- ncdnet-name-cache-hits*** 10-10
- ncdnet-name-cache-max-lifetime*** 9-32
- ncdnet-name-cache-max-size*** 9-32
- ncdnet-name-cache-overflows*** 10-10
- ncdnet-name-local-cache*** 9-32
- ncdnet-name-memory-allocation-failures*** 10-11
- ncdnet-name-no-server-responses*** 10-10
- ncdnet-name-no-such-name-errors*** 10-10
- ncdnet-name-numerical-addresses*** 10-10
- ncdnet-name-requests*** 10-10
- ncdnet-name-server-hits*** 10-10
- ncdnet-name-server-response-errors*** 10-10
- ncdnet-name-servers*** 9-6, 9-32
- ncdnet-name-server-transaction-timeout*** 9-32
- ncdnet-name-system-errors*** 10-10
- ncdnet-node-address*** 10-9
- ncdnet-outbound-errors*** 10-9
- ncdnet-retransmission-limit*** 9-31
- ncdnet-router-timeout*** 9-31
- ncdnet-seconds-since-zeroed*** 10-9
- ncdnet-user-account-name*** 9-31
- ncdquery*(1)** 16-7
- ncdreset*(1)** 16-10 to 16-12
- ncdterm***, *see* Terminal Emulator
- ncdrunterm***, *see* Terminal Emulator
- ncdwm*(1)**
 - diagnostic messages 18-133
 - in XDM session management files 8-9
- net-arp-table-entry-buffers*** 10-12
- net-available-buffers*** 10-11
- net-available-cluster-buffers*** 10-11
- net-buffer-not-available-errors*** 10-11
- net-buffer-waits*** 10-11
- net-connection-control-structure-buffers*** 10-12
- net-connection-name-buffers*** 10-12
- net-connection-option-buffers*** 10-12
- NETD messages 18-87
- net-domain-channel*** 9-33

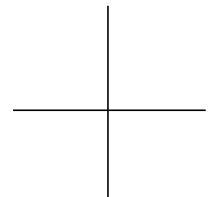

- net-ethernet-snap-encapsulation** 9-32
- NETFILE messages 18-87
- net-interface-address-buffers** 10-12
- net-interfaces-table** 10-13
- net-number-of-interfaces** 10-13
- net-packet-data-buffers** 10-12
- net-packet-fragment-reassembly-buffers** 10-12
- net-packet-header-buffers** 10-12
- net-protocol-control-structure-buffers** 10-12
- net-reserved-data-buffers** 10-11
- net-roaming-condition** 9-32
- NETSRV messages 18-93
- net-token-ring-speed** 9-32
- net-total-buffers** 10-11
- net-total-cluster-buffers** 10-11
- network
 - buffers, statistics 10-11
 - connection requests, diagnostic daemons 18-87
 - interfaces, statistics 10-13
 - TCP performance tuning 5-31 to 5-34
- network services
 - address discovery 3-1 to 3-16
 - address resolution 5-5 to 5-6
 - booting 4-1 to 4-19
 - defaults 5-3 to 5-4
 - file access 5-13 to 5-24
 - name service 5-7 to 5-12
 - overview 5-1 to 5-2
 - routing 5-25 to 5-31
 - time service 9-38
 - X server loading 4-1 to 4-19
- nf** command (Boot Monitor) 11-8
- NFS (Network File System)
 - auto-save of configuration data 6-35
 - booting 4-3, 4-5, 4-8, 4-13
 - file service 5-22 to 5-23
 - font service 7-6
 - message logging 18-5
 - statistics 10-13 to 10-16
 - unmount timer 5-23
- NFS Directory (Change Setup Parameters) 9-15
- NFS Server Access Control Default (Change Setup Parameters) 9-12
- NFS Server Access Control List (Change Setup Parameters) 9-12
- NFS Unmount Timeout (Change Setup Parameters) 9-22
- nfs-directory-contents-requests** 10-14
- nfs-directory-create-requests** 10-14
- nfs-directory-remove-requests** 10-14
- nfs-file-create-requests** 10-14
- nfs-file-remove-requests** 10-14
- nfs-file-rename-requests** 10-14
- nfs-get-attributes-requests** 10-13
- nfs-get-file-system-stats-requests** 10-15
- nfs-get-root-requests** 10-13
- nfs-link-create-requests** 10-14
- nfs-null-requests** 10-13
- nfs-path-lookup-requests** 10-13
- nfs-read-data-requests** 10-14
- nfs-read-symlink-requests** 10-13
- nfs-received-directory-contents-requests** 10-16
- nfs-received-directory-create-requests** 10-16
- nfs-received-directory-remove-requests** 10-16
- nfs-received-file-create-requests** 10-15
- nfs-received-file-remove-requests** 10-15
- nfs-received-file-rename-requests** 10-15
- nfs-received-get-attributes-requests** 10-15
- nfs-received-get-file-system-stats-requests** 10-16
- nfs-received-get-root-requests** 10-15
- nfs-received-link-create-requests** 10-16
- nfs-received-null-requests** 10-15
- nfs-received-path-lookup-requests** 10-15
- nfs-received-read-data-requests** 10-15
- nfs-received-read-symlink-requests** 10-15
- nfs-received-set-attributes-requests** 10-15
- nfs-received-symlink-create-requests** 10-16
- nfs-received-write-data-cache-requests** 10-15

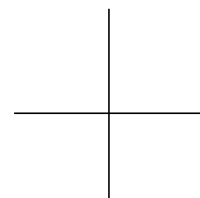

nfs-received-write-data-requests 10-15
nfs-set-attributes-requests 10-13
nfs-symlink-create-requests 10-14
nfs-write-data-cache-requests 10-14
nfs-write-data-requests 10-14
Nominal Edge Width (Change User Preferences) 9-50
Nominal Line Width (Change User Preferences) 9-50
Nominal Marker Size (Change User Preferences) 9-50
Number of colors (Change Setup Parameters) 9-40
nv command (Boot Monitor) 11-8, 11-20
NVRAM
 addresses, storing in 3-11, 11-14
 configuration parameters saved in 11-38
 contents of 11-24 to 11-39
 optional string space 11-37
 reading values from 9-7
 saving data to 6-35, 11-12
NVRAM utility
 commands 11-20 to 11-21
 sample sessions 11-21
 starting 11-20

O

Offset from Greenwich Mean Time (Change Setup Parameters) 9-38
Open Timeout (Change Setup Parameters) 9-24
OpenGL
 configuration parameters for 9-48
 diagnostic messages 18-94
Optional Features (Change Setup Parameters) 9-28
outline fonts, *see* font server

P

Parallel Daemon LAT Service Passwords (Change Setup Parameters) 9-12

Parallel Daemons Table (Change Setup Parameters) 9-33
parallel port
 access control 15-10
 configuration parameters for 9-33
 configuring 15-8
 statistics 10-16
 uses for 15-2
parallel-daemons-lat-service-passwords 9-12
parallel-daemons-table 9-33
Password (Change Setup Parameters, File Manager Section) 9-12
passwords
 displaying 6-5
 LAT 9-12
 lock screen 9-46
 saved in NVRAM optional string space 11-37
 SNMP community names 16-5, 16-6
PCMCIA cards
 messages 18-77
 see also local file system; Local File Manager
Permit Old X Bugs (Change User Preferences) 9-45
Persist in Loading (Change Setup Parameters) 9-14
Persistent Loading (Change Setup Parameters) 9-18
PEX
 3D mouse 14-13
 configuration parameters for 9-33 to 9-35, 9-50, 14-3 to 14-13
 digitizing tablet 14-13
 fonts 14-2
 input devices 14-13
 licensing 14-3
 requirements 14-3
 terminals supported on 14-1
 troubleshooting 14-14
pex-max-model-clip-planes 9-33, 14-4
pex-max-nameset-names 9-33, 14-4

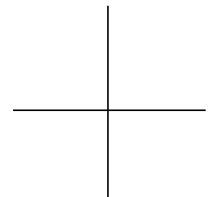

- pex-max-non-ambient-lights** 9-33, 14-4
- pex-monitor-reference-blue-u** 9-34, 14-6
- pex-monitor-reference-blue-v** 9-34, 14-6
- pex-monitor-reference-blue-y** 9-34, 14-6
- pex-monitor-reference-green-u** 9-34, 14-6
- pex-monitor-reference-green-v** 9-34, 14-7
- pex-monitor-reference-green-y** 9-34, 14-7
- pex-monitor-reference-red-u** 9-34, 14-7
- pex-monitor-reference-red-v** 9-34, 14-7
- pex-monitor-reference-red-y** 9-34, 14-8
- pex-monitor-reference-white-u** 9-35, 14-8
- pex-monitor-reference-white-v** 9-35, 14-8
- pex-monitor-reference-white-y** 9-35, 14-8
- Physical Location (Change Setup Parameters) 9-38
- pi** command (Boot Monitor) 11-9
- pointing devices, configuration parameters for 9-51
- ports
 - 3270 terminal emulator 9-42
 - Configuration daemon 6-28
 - NCD Display Manager 9-30
 - Preferences daemon 6-29
 - XRemote 9-41
 - see also* serial port; parallel port
- power management (monitor), configuration parameters for 9-52
- Powerdown After (Change User Preferences) 9-52
- PPP
 - configuration parameters for 9-35
 - diagnostic messages 18-96
- PPP and SLIP Interfaces Table (Change Setup Parameters) 9-35
- PPP Interfaces Table (Change Setup Parameters) 9-35
- PPPD messages 18-96
- ppp-interfaces-table** 9-35
- ppp-slip-interfaces-table** 9-35
- pref-audio-maximum-gain** 9-44
- pref-bell-duration** 9-45
- pref-bell-enable** 9-45
- pref-bell-pitch** 9-45
- pref-bell-volume** 9-45
- pref-compatibility-decwindows-images** 9-45
- pref-compatibility-decwindows-keyboard** 17-12, 17-20, 17-29, 17-35
- pref-compatibility-decwindows-keyboards** 9-45
- pref-compatibility-decwindows-vendor-string** 9-45
- pref-compatibility-permit-old-x-bugs** 9-45
- pref-console-auto-lock-idle-time** 9-46
- pref-console-auto-logout-cancel-delay** 9-46
- pref-console-auto-logout-idle-time** 9-46
- pref-console-blank-screen-delay** 9-46
- pref-console-key-sequence** 9-46
- pref-console-lock-screen-default-password** 9-46
- pref-console-show-timestamps** 9-46
- pref-environment** 9-47
- Preferences daemon
 - configuration parameters for 9-20
 - defined 6-2
 - ports for accessing 6-29
 - starting from Terminal Emulator 12-2
- pref-font-extended-diagnostics** 7-17, 9-47
- pref-font-path** 7-12, 9-47
- pref-keyboard-auto-repeat** 9-47
- pref-keyboard-auto-repeat-rate** 9-48
- pref-keyboard-auto-repeat-start** 9-47
- pref-keyboard-function-key-style** 9-47
- pref-keyboard-keyclick-volume** 9-48
- pref-keyboard-leds** 9-48
- pref-mouse-acceleration** 9-51
- pref-mouse-arrangement** 9-51
- pref-mouse-threshold** 9-51
- pref-pex-color-clipping-method** 9-50, 14-12
- pref-pex-dither-flat-shaded-surface** 9-50, 14-10
- pref-pex-dither-interpolated-surface** 9-50, 14-10
- pref-pex-nominal-edge-width** 9-50, 14-9

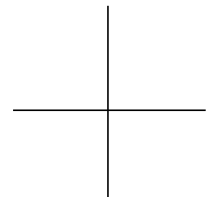

pref-pex-nominal-line-width 9-50, 14-9, 14-10
pref-pex-nominal-marker-size 9-50
pref-pex-surface-interior-style 9-50, 14-11
pref-pex-surface-interp-method 9-50, 14-11
pref-pex-surface-reflect-model 9-50, 14-12
pref-power-manage-enable 9-52
pref-power-manage-powerdown-time 9-52
pref-power-manage-standby-time 9-52
pref-power-manage-suspend-time 9-52
pref-screen-background-bitmap-background 9-53
pref-screen-background-bitmap-file 9-52
pref-screen-background-bitmap-foreground 9-53
pref-screen-background-color 9-52
pref-screen-background-type 9-52
pref-screensaver-bitmap-file 9-53
pref-screensaver-enable 9-53
pref-screensaver-exposures 9-53
pref-screensaver-interval 9-53
pref-screensaver-style 9-53
pref-screensaver-time 9-53
pref-sie-contrast-threshold 9-54
pref-sie-sampling-method 9-54
pref-xserver-backing-store 9-54
pref-xserver-benchmark-optimizations 9-54
pref-xserver-current-pointing-device 9-51
pref-xserver-graphics-optimizations 9-54
pref-xserver-screen-resolution 9-54
pref-xserver-touchscreen-button-press-threshold 9-51
pref-xserver-touchscreen-button-release-threshold 9-51
Previous Server (Change Setup Parameters) 9-14
Previous Source (Change Setup Parameters) 9-14
Primary Boot Source (Change Setup Parameters) 9-14
PRINTAPIS messages 18-99

protect command (Configuration language) 6-32
PU2.1 Default Host (Change Setup Parameters) 9-42
PU2.1 Default tcp Port (Change Setup Parameters) 9-42
pwireless-interface-table 10-28
pwireless-statistics-table 10-28

Q

Query for Unit Name at Boot (Change Setup Parameters) 9-38

R

RARP (Address Resolution Protocol) 3-10
rarpd(8) 3-10
read command (Configuration language) 6-19 to 6-20
Read Timeout (Change Setup Parameters) 9-24
Receive Buffer Size (Change Setup Parameters) 9-36
Reconnect attempts before failure (Change Setup Parameters) 9-24
Reference Blue Chromaticity (Change Setup Parameters) 9-34
Reference Blue Luminance (Change Setup Parameters) 9-34
Reference Green Chromaticity (Change Setup Parameters) 9-34
Reference Green Luminance (Change Setup Parameters) 9-34
Reference Red Chromaticity (Change Setup Parameters) 9-34
Reference Red Luminance (Change Setup Parameters) 9-34
Reference White Chromaticity (Change Setup Parameters) 9-35
Reference White Luminance (Change Setup Parameters) 9-35
registers, displaying 11-8

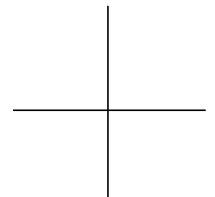

- remote configuration
 - apply** command 6-34
 - assignment statements 6-11, 6-14
 - assignments, order of 6-14
 - auto-save 6-34 to 6-37
 - configuration commands 6-8 to 6-10
 - get-protect** command 6-33
 - parameters
 - "<GET-PROTECTED>" value 6-32
 - "default" parameter value 6-12
 - "nil" parameter value 6-5
 - accessing through SNMP 16-10
 - assigning values 6-11 to 6-12
 - default values 6-12
 - filenames as parameter
 - values 6-13
 - groups 6-6
 - multiple assignments of same
 - parameter 6-14
 - protecting 6-32 to 6-33
 - saved in NVRAM 11-38
 - saved in optional string area 11-37
 - tables, assigning values 6-11 to 6-12
 - write-only 6-5
 - protect** command 6-32
 - read** command 6-19 to 6-20
 - remote terminal, accessing 9-8
 - set-protect** command 6-33
 - syntax rules 6-13 to 6-15
 - see also* remote configuration files
- remote configuration files
 - auto-save file 6-36
 - comments in 6-14
 - configuration parameters for 9-18
 - creating 6-16 to 6-21
 - by *ncdinstall* 6-17
 - from sample file 6-17
 - from Setup menus 6-18
 - directory for 6-26
- remote configuration files (continued)
 - downloading
 - disabling 6-25, 6-27
 - hosts for 6-21
 - initial file servers 5-13, 6-21
 - persistent 6-22
 - sequence of filenames 6-23
 - file permissions 6-18
 - file size not restricted 6-18
 - filenames
 - custom 6-23
 - hexadecimal, converting to 6-17
 - optional 6-23
 - standard 6-16, 6-23 to 6-25
 - hexadecimal, converting IP address
 - to 6-17
 - ncd_std** generic file 6-24
 - nesting files 6-19
 - NVRAM, saving data to 6-15
 - Restore Defaults, file for 6-27
 - sample file 6-17
 - .stp** file 6-36
 - user's file, including 6-20
 - see also* remote configuration; Setup menus (Console)
- remote reset (using SNMP) 16-10 to 16-12
- Reopen Timeout (Change Setup Parameters) 9-24
- Rescan Messages command (Console) 18-4
- reset, remote 16-10 to 16-12
- Respond to Broadcast ICMP (Change Setup Parameters) 9-26
- Restore Defaults (Setup menus) 6-27
- Restrict Host Choices (Change Setup Parameters)
 - for login through the Terminal Emulator 9-39
 - for login through XDM 9-29
- Retain X Settings Across Sessions (Change Setup Parameters) 9-40

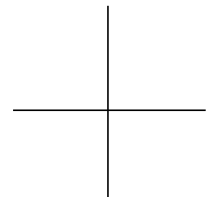

Retransmission Limit (Change Setup Parameters) 9-28, 9-31
Retransmission Timeout (Change Setup Parameters) 9-28
reverse name request 3-15
RGB File (Change Setup Parameters) 9-40
rgb.txt file
 default location 5-15
 initial file server hosts 5-13
 renaming 9-40
Ring Bell (Change User Preferences) 9-45
Roaming Condition (Change Setup Parameters) 9-32
Router Timeout (Change Setup Parameters) 9-31
routing
 configuration parameters for 9-25
 gateways
 default 5-25
 boot host, used as gateway 5-25
 messages 18-55
 proxy ARP 5-29
 router discovery 5-30
 routing table 5-26 to 5-29
Routing Table (Change Setup Parameters) 9-26
rs command (Boot Monitor) 11-9
RTLD messages 18-103

S

Save Screen After (Change User Preferences) 9-53
Screen Background Type (Change User Preferences) 9-52
screen background, configuration parameters for 9-52
screen resolution
 displaying 9-54
 setting 11-13
Screen Resolution (Change User Preferences) 9-54

Screen Saver Bitmap File (Change User Preferences) 9-53
Screen Saver Style (Change User Preferences) 9-53
screen saver, configuration parameters for 9-53
se command (Boot Monitor) 11-9, 11-12
Secondary Boot Source (Change Setup Parameters) 9-14
Secondary TCP/IP Server (Change Setup Parameters) 9-14
security, *see* assess control; passwords
Send Broadcast ICMP for Subnet Mask (Change Setup Parameters) 9-15
Send Buffer Size (Change Setup Parameters) 9-36
Serial and Parallel Access Control List (Change Setup Parameters) 9-13
Serial Daemon LAT Service Passwords (Change Setup Parameters) 9-12
Serial Daemons Table (Change Setup Parameters) 9-35
Serial Interfaces Table (Change Setup Parameters) 9-35
serial port
 access control 15-10
 configuration parameters for 9-35
 configuring
 serial-daemons-table 15-6 to 15-8
 serial-interfaces-table 15-2 to 15-6
 diagnostic messages 18-106
 numbering (1 through 3) 15-2
 serial sessions, automatic display in Terminal Host Chooser 12-3
 serial terminal emulation, configuring 12-3
 statistics 10-17 to 10-18
 system console, configuring terminal as 15-9
 uses for 15-1
serial-access-control-enabled 9-13, 15-10
serial-access-control-list 9-13

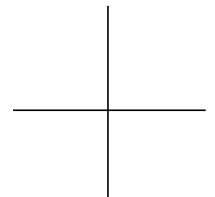

- SERIALD messages 18-106
- serial-daemons-lat-service-passwords** 9-12
- serial-daemons-table** 9-35
- serial-interfaces-table** 9-35, 12-4, 15-2, 15-10
- Service Directory Max Size (Change Setup Parameters) 9-27
- Service Groups (Change Setup Parameters) 9-27
- set-protect** command (Configuration language) 6-32, 6-33
- Setup (Boot Monitor)
 - keymapper for 11-18
 - navigating in 11-13
 - setting parameters 11-13 to 11-17
 - starting 11-12
- Setup menus (Console)
 - auto-save 6-34 to 6-37
 - Change Quick Setup
 - commands and buttons 9-1 to 9-2
 - fields, corresponding parameters 9-3 to 9-6
 - fields, described 9-3 to 9-6
 - remote terminal, configuring 9-2
 - Change Setup Parameters
 - commands and buttons 9-7 to 9-8
 - fields, corresponding parameters 9-8 to 9-42
 - fields, described 9-8 to 9-42
 - remote terminal, configuring 9-8
 - Change User Preferences
 - commands and buttons 9-43 to 9-44
 - fields, corresponding parameters 9-44 to 9-54
 - fields, described 9-44 to 9-54
 - remote terminal, configuring 9-43
 - connecting to remote terminal through 9-2
 - disabling 6-34
 - Restore Defaults 6-27
 - see also* terminal configuration; remote configuration
- Show Console Message Timestamps (Change User Preferences) 9-46
- Show Extended Font Diagnostics (Change User Preferences) 9-47
- Show Low Memory Warning Box at (Change Setup Parameters) 9-39
- Show Statistics (Console)
 - commands and buttons 10-1 to 10-2
 - fields, corresponding parameters 10-2 to 10-31
 - fields, descriptions 10-2 to 10-31
 - remote terminal, connecting to 10-1
 - starting 10-1
- Show Tool Bar (Change Setup Parameters) 9-16
- SIE
 - configuration parameters for 9-54
 - diagnostic messages 18-108
- SIE Contrast Threshold (Change User Preferences) 9-54
- SIE Sampling Method (Change User Preferences) 9-54
- SLIP
 - configuration parameters for 9-35
 - diagnostic messages 18-96
- sm** command (Boot Monitor) 11-9
- SMTP Email Server (Change Setup Parameters) 9-17
- SNMP Read-Only Community (Change Setup Parameters) 9-10
- SNMP (Simple Network Management Protocol)
 - access control 16-3 to 16-7
 - community names 16-3 to 16-7
 - components 16-1
 - connecting to a terminal 16-10
 - diagnostic messages 18-108
 - host requirements 16-1, 16-3
 - manager hosts 16-4

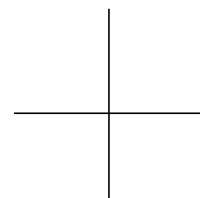

- SNMP (Simple Network Management Protocol) (continued)
 - MIB files
 - default locations 16-2
 - defined 16-2
 - mib.my** file 16-2
 - mib.txt** file 16-2
 - MIBFILE** environment variable 16-3
 - monitor hosts 16-5 to 16-6
 - ncdquery** 16-7 to 16-9
 - ncdreset** 16-10, 16-11
 - object names and paths for
 - configuration parameters 16-2
 - overview 16-1 to 16-3
 - rebooting 16-10
 - remote reset/reboot 16-10 to 16-12
 - statistics 10-18 to 10-21
 - trap events 16-6
 - variables
 - reading 16-7
 - writing 16-9
 - X session, restarting 16-10
- SNMP Read-Only Access Control List (Change Setup Parameters) 9-11
- SNMP Read-Only Alternative Community (Change Setup Parameters) 9-10
- SNMP Read-Write Access Control List (Change Setup Parameters) 9-11
- SNMP Read-Write Alternative Community (Change Setup Parameters) 9-11
- SNMP Read-Write Community (Change Setup Parameters) 9-11
- SNMP Trap Monitors (Change Setup Parameters) 9-11
- snmp-allow-reset** 9-11, 16-11, 16-12
- snmp-bad-variable-name-error-responses-received** 10-19
- snmp-bad-variable-name-error-responses-transmitted** 10-20
- snmp-bad-variable-values-error-responses-received** 10-19
- snmp-bad-variable-values-error-responses-transmitted** 10-20
- SNMPD messages 18-108
- snmp-general-error-responses-received** 10-19
- snmp-general-error-responses-transmitted** 10-20
- snmp-get-next-requests-received** 10-20
- snmp-get-next-requests-transmitted** 10-20
- snmp-get-requests-received** 10-19
- snmp-get-requests-transmitted** 10-20
- snmp-get-responses-received** 10-20
- snmp-get-responses-transmitted** 10-20
- snmp-packets-received** 10-18
- snmp-packets-received-with-asn1-errors** 10-19
- snmp-packets-received-with-bad-community-names** 10-18
- snmp-packets-received-with-bad-community-uses** 10-18
- snmp-packets-received-with-bad-variable-types** 10-19
- snmp-packets-received-with-bad-versions** 10-18
- snmp-packets-transmitted** 10-18
- snmp-read-only-access-control-enabled** 9-11, 16-5
- snmp-read-only-access-control-list** 9-11, 16-5
- snmp-read-only-community** 9-10
- snmp-read-only-community-alt** 9-10
- snmp-read-only-variable-error-responses-received** 10-19
- snmp-read-only-variable-error-responses-transmitted** 10-20
- snmp-read-write-access-control-enabled** 9-11, 16-4, 16-11
- snmp-read-write-access-control-list** 16-4, 16-11
- snmp-read-write-community** 9-11, 16-11
- snmp-read-write-community-alt** 9-11
- snmp-set-requests-received** 10-20
- snmp-set-requests-transmitted** 10-20

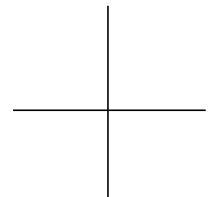

- snmp-too-big-error-responses-received** 10-19
 - snmp-too-big-error-responses-transmitted** 10-20
 - snmp-trap-monitors** 9-11
 - snmp-traps-received** 10-20
 - snmp-traps-transmitted** 10-21
 - snmp-variable-gets-completed** 10-19
 - snmp-variable-sets-completed** 10-19
 - SOCKS Host (Change Setup Parameters) 9-17
 - SOCKS Port (Change Setup Parameters) 9-17
 - Solid Color (Change User Preferences) 9-52
 - Standby After (Change User Preferences) 9-52
 - Startup Commands (Change Setup Parameters) 9-18
 - Starworks volume file (Change Setup Parameters) 9-39
 - statistics
 - DECnet 10-9 to 10-11
 - displaying 10-1
 - Ethernet 10-2
 - font usage 10-3
 - ICMP 10-3 to 10-5
 - IP 10-6, 10-8
 - memory 10-27
 - name service 10-24 to 10-25
 - network buffers 10-11
 - network interfaces 10-13
 - NFS 10-13
 - parallel port 10-16
 - serial port 10-17 to 10-18
 - SNMP 10-18, 10-21
 - TCP 10-21 to 10-23
 - TFTP 10-25
 - UDP 10-26
 - wireless 10-28 to 10-29
 - X server modules 10-8
 - XRemote 10-30 to 10-31
 - subnet mask
 - setting 3-13 to 3-15
 - storing in NVRAM 3-11
 - Subnet Mask (Change Quick Setup) 9-5
 - Subnet Mask (Change Setup Parameters) 9-25
 - Sun Type 4-compatible keyboard 17-36
 - Sun Type 5-compatible keyboard 17-44
 - Surface Interior Style (Change User Preferences) 9-50
 - Surface Interpolation Method (Change User Preferences) 9-50
 - Surface Reflection Model (Change User Preferences) 9-50
 - Suspend After (Change User Preferences) 9-52
 - system console, configuring terminal as 15-9
- T**
- TCP
 - configuration parameters for 9-36
 - default linger time, configuring 5-33
 - maximum retransmissions, configuring 5-33
 - performance tuning 5-31 to 5-34
 - ports
 - 3270 terminal emulator 9-42
 - Configuration daemon 9-19
 - Diagnostic daemon 9-20
 - for configuring terminals 6-28 to 6-29
 - Local File Manager 9-21
 - NCD Display Manager 9-30
 - User Preferences daemon 9-20
 - XRemote 9-41
 - segment sizes larger than the default 5-33
 - send and receive buffers 5-31
 - statistics 10-21 to 10-23
 - timeout, configuring 5-32

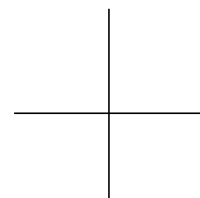

- TCP Port Number (Change Setup Parameters)
 - for Configuration daemon 9-19
 - for Diagnostics daemon 9-20
 - for Local File Manager 9-21
 - for User Preferences daemon 9-20
 - for XRemote 9-41
- TCP/IP Name Servers (Change Quick Setup) 9-5
- TCP/IP Name Service Protocol (Change Quick Setup) 9-5
- TCP/IP Broadcast Boot Request (Change Setup Parameters) 9-15
- TCP/IP Desired Server (Change Setup Parameters) 9-14
- tcp-ack-only-packets-transmitted 10-23
- tcp-ack-packets-received 10-23
- tcp-active-connect-attempts 10-21
- tcp-connections-reset 10-22
- tcp-connections-timed-out-on-keepalives 10-22
- tcp-connections-timed-out-on-retransmissions 10-22
- tcp-connection-table 10-23
- tcp-connect-timeout 5-32, 9-36
- tcp-default-linger-time 5-33, 9-36
- tcp-default-mss-for-non-local 5-33
- tcp-established-connections 10-22
- tcp-failed-connect-attempts 10-22
- tcpip-arp-cache 5-5, 9-13
- tcpip-arp-complete-entry-timeout 5-6, 9-13
- tcpip-arp-incomplete-entry-timeout 5-6, 9-13
- tcpip-dns-default-domain 5-9, 9-37
- tcpip-dns-domain-search 9-37
- tcpip-name-bad-name-errors 10-24
- tcpip-name-cache-hits 10-24
- tcpip-name-cache-max-lifetime 5-10, 9-37
- tcpip-name-cache-max-size 5-11, 9-37
- tcpip-name-cache-overflows 10-24
- tcpip-name-local-cache 9-37
- tcpip-name-memory-allocation-failures 10-25
- tcpip-name-no-server-responses 10-24
- tcpip-name-numerical-addresses 10-24
- tcpip-name-requests 10-24
- tcpip-name-server-hits 10-24
- tcpip-name-server-protocol 5-8, 9-5, 9-37
- tcpip-name-server-response-errors 10-24
- tcpip-name-server-retransmission-timeout 5-11, 9-37
- tcpip-name-servers 5-8, 9-5, 9-37
- tcpip-name-server-transaction-timeout 5-12, 9-37
- tcpip-name-system-errors 10-24
- tcpip-no-such-name-errors 10-24
- tcp-keepalive-idle-time 9-36
- tcp-keepalive-interval 9-36
- tcp-keepalive-packets-transmitted 10-23
- tcp-maximum-number-of-connections 10-21
- tcp-maximum-retransmission-time 10-21
- tcp-max-keepalive-idle-time 9-36
- tcp-max-retransmissions 5-33, 9-36
- tcp-minimum-retransmission-time 10-21
- tcp-packets-received 10-22
- tcp-packets-retransmitted 10-23
- tcp-packets-transmitted 10-22
- tcp-packets-with-errors-received 10-23
- tcp-passive-connects-attempts 10-21
- tcp-receive-buffer-size 5-31, 9-36
- tcp-reset-packets-transmitted 10-23
- tcp-retransmission-algorithm-type 10-21
- tcp-send-buffer-size 5-32, 9-36
- TELNET
 - for terminal configuration 6-28
 - for viewing messages 18-4
- ports
 - Configuration daemon 9-19
 - Diagnostic daemon 9-20
 - for configuring terminals 6-28 to 6-29
 - Local File Manager 9-21
 - User Preferences daemon 9-20
- services in Terminal Host Chooser 12-3

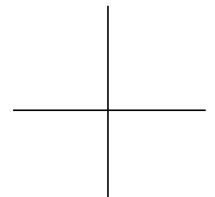

- Telnet Port Number (Change Setup Parameters)
 - for Configuration daemon 9-19
 - for Diagnostic daemon 9-20
 - for Local File Manager 9-21
 - for User Preferences daemon 9-20
- TERM messages 18-109
- term**, *see* Terminal Emulator
- term-default-connect-timeout** 9-39
- term-default-hosts** 9-39
- term-delay-lat-display** 9-39
- terminal configuration
 - access control 6-30 to 6-34
 - Boot Monitor Setup menus 11-12 to 11-19
 - default terminal configuration, defined 6-2
 - diagnostic messages 18-17
 - methods overview 6-2 to 6-5
 - NVRAM utility 11-20 to 11-37
 - parameters
 - groups 6-6 to 6-7
 - types 6-5
 - Setup menus (Console) 9-1 to 9-54
 - using SNMP 16-7
 - using TELNET 6-28
 - see also* remote configuration; remote configuration files; Setup menus (Console); Setup (Boot Monitor); NVRAM Utility
- Terminal Default Connect Timeout (Change Setup Parameters) 9-39
- Terminal Emulator
 - answer-back message 12-12
 - character coding 12-51 to 12-59
 - character sets supported 12-51
 - color text, configuring 12-30
 - configuration parameters for 9-6, 9-39
 - Cursors menu 12-11
 - dead-key support 12-44
 - diagnostic messages 18-109
 - disconnecting, delay 12-12
 - Terminal Emulator (continued)
 - escape sequences 12-13 to 12-33
 - File menu, configuring 12-6
 - fonts
 - choosing 12-5
 - Default 12-10
 - Fonts menu 12-10
 - icon titles, configuring 12-30
 - key translations 12-4
 - keyboards
 - compose sequences 12-44 to 12-50
 - downloadable descriptions 17-54
 - escape sequences 12-34 to 12-43
 - Keys menu 12-11
 - N-108LK function keys, programming 12-28
 - Options menu, configuring 12-8
 - resources
 - answerbackString** 12-12
 - appCursorMode** 12-9
 - appKeypadMode** 12-9
 - autoLineFeed** 12-8
 - autoWrap** 12-8
 - blinkCursor** 12-10
 - c132** 12-9
 - clearScreenWithBlanks** 12-9
 - curses** 12-9
 - defaultHost** 12-7
 - disableExits** 12-6, 12-7
 - disconnectDelay** 12-12
 - family** 12-11
 - foundry** 12-11
 - jumpScroll** 12-8
 - latin1Font** 12-10
 - localFlowControl** 12-9
 - marginBell** 12-9
 - menuBar** 12-6, 12-8
 - pointSize** 12-11
 - printerHost** 12-7
 - rectangularCutLineTerminator** 12-12
 - reverseVideo** 12-8

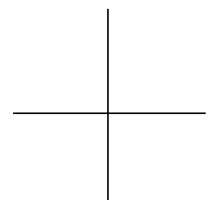

- Terminal Emulator (continued)
 - resources (continued)
 - reverseWrap** 12-8
 - saveLines** 12-6
 - scrollbar** 12-6
 - secureKeyboard** 12-10
 - showAvailableLat** 12-3
 - showCTerm** 12-3
 - showDefaultLat** 12-3
 - showLocal** 12-2
 - showSerial** 12-3
 - showTelnet** 12-3
 - statusLine** 12-10
 - stripParity** 12-10
 - subFont** 12-11
 - useCondensedFont** 12-9
 - visualBell** 12-8
 - scroll bars, configuring 12-6
 - selecting text, terminator for 12-12
 - serial connections, configuring 12-3
 - status line, configuring 12-27
- Terminal Host Chooser
 - local service connections 12-2
 - X resources for 12-3
 - window titles, configuring 12-30
- Terminal IP Address At Next Boot (Change Quick Setup) 9-5
- Terminal Session (Change Quick Setup) 9-6
- term-restrict-host-choices** 9-39
- Tertiary Boot Source (Change Setup Parameters) 9-14
- Tertiary TCP/IP Server (Change Setup Parameters) 9-14
- Test RAM at power-up (Change Setup Parameters) 9-13
- TFTP
 - auto-save of configuration data 6-35
 - booting 4-2, 4-5, 4-8, 4-12
 - file service 5-20 to 5-22
 - statistics 10-25
 - TFTP Directory (Change Setup Parameters) 9-15
 - tftp-ack-packets-received** 10-25
 - tftp-ack-packets-transmitted** 10-26
 - tftp-bad-access-error-responses-received** 10-25
 - /tftpboot** directory 4-15
 - tftpd(8)** 5-21
 - tftp-data-packets-received** 10-25
 - tftp-data-packets-transmitted** 10-25
 - tftp-disk-full-error-responses-received** 10-25
 - tftp-file-read-requests-transmitted** 10-25
 - tftp-file-write-requests-transmitted** 10-25
 - tftp-no-available-buffer-errors** 10-25
 - tftp-no-file-error-responses-received** 10-25
 - tftp-packets-retransmitted** 10-26
 - Threshold Distance (Change User Preferences) 9-51
 - Time Server (Change Setup Parameters) 9-38
 - Time Server Retries (Change Setup Parameters) 9-38
 - Time Server Timeout (Change Setup Parameters) 9-38
 - time service, configuration parameters for 9-38
 - time-offset-from-gmt** 9-38
 - time-server** 9-38
 - time-server-retries** 9-38
 - time-server-timeout** 9-38
 - Timestamp Frequency (Change Setup Parameters) 9-20
 - time-zone** 9-38
 - Timezone (Change Setup Parameters) 9-38
 - TN3270 Default Host (Change Setup Parameters) 9-42
 - TN3270 Default tcp Port (Change Setup Parameters) 9-42

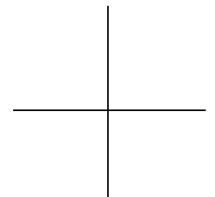

Token-Ring
 configuration parameters for 9-32
 current and built-in addresses 3-7
 diagnostic messages 18-122
 interface speed, setting (HMX terminals) 11-9
TOKENRING messages 18-122
Token-Ring Speed (Change Setup Parameters) 9-32
tokring-interface-table 10-26
tokring-statistics-table 10-26
touch screen
 configuration parameters for 9-25, 9-51
 diagnostic messages 18-16
tr command (Boot Monitor) 11-9
Transaction Timeout (Change Setup Parameters) 9-28
Try All Matches on Open (Change Setup Parameters) 9-22
Try Generic Filename (Change Setup Parameters) 9-19
Try MOP (Change Setup Parameters) 9-15
Try MOP with File Name (Change Setup Parameters) 9-15
Try TCP/IP Product Name and Memory Size File (Change Setup Parameters) 9-15
Try TCP/IP Product Name and Memory Size with Path File (Change Setup Parameters) 9-15
Try TCP/IP Product Name File (Change Setup Parameters) 9-15
Try TCP/IP Product Name with Path File (Change Setup Parameters) 9-15
Try TCP/IP Unit Address File (Change Setup Parameters) 9-15
Try TCP/IP Unit Address with Path File (Change Setup Parameters) 9-15
Try Unit Ethernet Address as Filename (Change Setup Parameters) 9-19
Try Unit IP Address as Filename 9-19

Try Unit Name as Filename (Change Setup Parameters) 9-19
Try Unit NCDnet Address as Filename (Change Setup Parameters) 9-19

U

ud command (Boot Monitor) 11-9
UDP, statistics 10-26
udp-listener-table 10-27
udp-packets-received 10-26
udp-packets-received-with-errors 10-26
udp-packets-received-with-unknown-port 10-26
udp-packets-transmitted 10-26
UI messages 18-125
Unit Global Password (Change Setup Parameters) 9-9
Unit Name (Change Setup Parameters) 9-38
unit-administrative-status 9-38, 16-11, 16-12
unit-blocks-of-available-memory 10-28
unit-boot-monitor-version 10-27
unit-code-memory-installed 10-27
unit-contact 9-38
unit-floating-point-exceptions 10-28
unit-global-password 9-9
unit-idle-time 10-27
unit-keyboard-controller-version 10-27
unit-licensed-features 9-5, 9-28
unit-license-key 9-5, 9-28
unit-location 9-38
unit-low-memory-level 9-39
unit-memory-available 10-28
unit-memory-installed 10-27
unit-name 9-38
unit-optional-features 9-28
unit-query-for-name-at-boot 3-15, 5-12, 9-38
unit-snmp-system-object-id 10-27
unit-tcpip-service-level 10-27
unit-terminal-model 10-27
unit-time-since-boot 10-27
unit-version 10-27

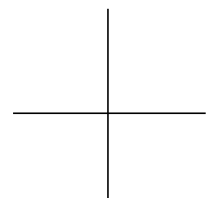

- UNIX Config Directory (Change Quick Setup) 9-4
- UNIX Directory (Change Setup Parameters) 9-18
- up** command (Boot Monitor) 11-9, 11-10
- Use Address Discovery (Change Quick Setup) 9-5
- Use Address Discovery (Change Setup Parameters) 9-26
- Use Backing Store (Change User Preferences) 9-54
- Use Decimal IP Address Notation as Filename (Change Setup Parameters) 9-19
- Use Proxy Arp (Change Setup Parameters) 9-26
- Use Router Discovery (Change Setup Parameters) 9-26
- Use Router Solicit (Change Setup Parameters) 9-26
- Use SNAP (802.2 LLC) Encapsulation on Ethernet (Change Setup Parameters) 9-32
- Use WinCenter Colors (Change Setup Parameters) 9-40
- User Account Name (Change Setup Parameters) 9-31
- User Preferences daemon
 - configuration parameters for 9-20
 - defined 6-2
 - ports for accessing 6-29
 - starting from Terminal Emulator 12-2
- User Preferences Read-Only Password (Change Setup Parameters) 9-10
- User Preferences Read-Write Password (Change Setup Parameters) 9-10
- /usr/lib/X11/ncd/configs** directory 6-26
- /usr/lib/X11/ncd/dps** (DPS directory) 13-10
- /usr/lib/X11/ncd/fs** (font server directory) 7-23
- /usr/lib/x11/ncd/snmp/** (SNMP directory) 16-2

V

- video
 - configuration parameters for 9-39
 - diagnostic messages 18-82
- VIDEO messages 18-82
- VIDEODECODER messages 18-82
- VIDEOPAYER messages 18-82
- visual, default 9-41
- VMS Config Directory (Change Quick Setup) 9-4
- VMS Directory (Change Setup Parameters) 9-18
- VT220-compatible keyboards
 - Boot Monitor, accessing from 17-21
 - keycodes 17-22
 - keymap 17-24 to 17-35
 - LEDs 17-21
 - legends 17-22
 - Setup key combination 17-21
- VT320 terminal emulation, *see* Terminal Emulator

W

- Wait for Broadcasts for (Change Setup Parameters) 9-30
- Wait for Keepalive Responses for (Change Setup Parameters) 9-30
- wd** command (Boot Monitor) 11-10
- What to do when XDM disconnects (Change Setup Parameters) 9-30
- What to do with XDMCP Broadcasts (Change Setup Parameters) 9-30
- What to do with XDMCP Indirects (Change Setup Parameters) 9-30
- White Pixel (Change Setup Parameters) 9-41
- wincen** command, diagnostic messages 18-127
- WINCEN messages 18-127
- WinCenter, configuration parameters for 9-40

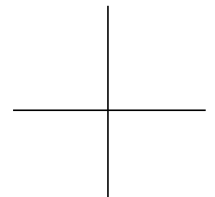

wincenter-colors 9-40
wincenter-resources 9-40
Window Delay Time (Change Setup Parameters) 9-29
window managers
 Motif Window Manager, diagnostic messages 18-83
 NCD Window Manager
 diagnostic messages 18-133
 in session management files 8-9
Window Size (Change Setup Parameters) 9-40
Windows 95-compatible keyboard 17-13
wireless
 configuration parameters for 9-32
 diagnostic messages 18-128
 statistics 10-28 to 10-29
WIRELESS messages 18-128
WM messages 18-133
wr command (Boot Monitor) 11-10
Write Keyboard Description File (Change Setup Parameters) 9-24, 17-54
ws command (Boot Monitor) 11-10

X

X Access Control List (Change Setup Parameters) 9-9
X extensions, disabling 9-40
X resources, loading 8-7
X server
 diagnostic messages 18-1
 directory
 default 4-2, 4-3
 non-standard 4-7, 4-14
 filename links 4-14
 filenames 4-2
 default 4-2
 disabling filenames 4-5
 non-standard 4-7
 location of 4-7, 4-12, 4-13

X server (continued)
 modules
 configuration parameters for 9-29
 load policy 4-10 to 4-12
 loading, diagnostic messages 18-103
 statistics 10-8
 protocols for loading 4-1
 screen resolution reported by 9-54
 version, displaying 16-8
 see also booting
X session
 restarting with SNMP 16-10
 see also XDM (X Display Manager)
X Session (Change Quick Setup) 9-6
X settings, retaining 9-40
Xaccess file 8-11 to 8-13
XAUTHORITY environment variable 8-16
XDM Authentication Key (Change Setup Parameters) 9-9
XDM (X Display Manager)
 access control 8-15 to 8-16
 components of 8-4
 configuration files 8-6 to 8-14
 configuration parameters for 9-6, 9-29
 defaults 8-2
 defined 8-3
 diagnostic messages 18-78
 disconnecting, terminal actions 8-17
 DISPLAY variable automatically set 8-5
 error message log 8-14
 hosts
 configuring 8-5 to 8-15
 controlling access to 8-11 to 8-13
 keepalives 8-18 to 8-19
 login banner
 configuring 8-14
 delay before displaying 8-17
 Login Chooser, redisplay of 8-17
 MIT-MAGIC-COOKIE-1 8-16
 OpenWindows environment 8-14, 8-15

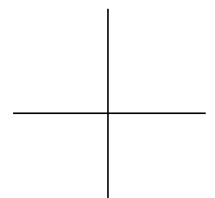

- XDM (X Display Manager) (continued)
 - polling interval, configuring 8-14
 - queries, types of 8-4
 - resources
 - loading from session management files 8-7
 - login box 8-14
 - xdm* program 8-13
 - userAuthDir** resource 8-16
- X session
 - ending 8-17
 - session management files, system-wide 8-7 to 8-11
- X11R3 version 8-19
- Xaccess** file 8-11 to 8-13
- .Xauthority** file 8-16
- XAUTHORITY** environment variable 8-16
- xdm** daemon
 - configuring 8-13 to 8-14
 - starting 8-15
- XDM-AUTHORIZATION-1 8-16
- xdm-config** file 8-13 to 8-14, 8-16
- XDMCP, defined 8-4
- xdm-errors** file 8-14
- xrdb(1)** 8-14
- Xreset** file 8-7
- Xresources** file 8-14
- Xservers** file 8-19
- .xsession** file 8-7
- Xsession** file
 - configuring 8-7 to 8-11
 - for NCD local window manager 8-9
 - for OpenWindows 8-10
- Xstartup** file 8-7
- xdm** (XDM daemon) 8-6, 8-13 to 8-14
- XDM Display Class (Change Setup Parameters) 9-29
- XDM Manufacturer Display ID (Change Setup Parameters) 9-29
- xdm-config** file 8-13 to 8-14, 8-16
- xdm-errors** file 8-14
- xfd(1)** 7-18
- xfontsel(1)** 7-19
- XKeysymDB** file 5-15
- XLFD (X Logical Font Description) 7-2, 7-19
- xlsfonts(1)** 7-18
- xrdb(1)**
 - OpenWindows version 8-14
 - X resources, loading 8-7
- XRemote
 - configuration parameters for 9-6, 9-41
 - diagnostic messages 18-136, 18-138
 - statistics 10-30 to 10-31
- XREMOTE messages 18-136
- XRemote Session (Change Quick Setup) 9-6
- xremote-additional-escape-chars** 9-41
- xremote-authorize-xremote-clients** 9-41
- xremote-data-compression-mode** 9-41
- xremote-next-receive-sequence-number** 10-31
- xremote-next-transmit-sequence-number** 10-31
- xremote-oldest-unacknowledged-packet** 10-31
- xremote-packet-round-trip-time** 10-30
- xremote-packets-received** 10-30
- xremote-packets-received-out-of-sequence** 10-30
- xremote-packets-retransmitted** 10-30
- xremote-packets-transmitted** 10-30
- xremote-packets-with-errors-received** 10-30
- xremote-packet-transmission-errors** 10-30
- xremote-receive-window-size** 10-31
- xremote-state** 10-30
- xremote-tcp-port** 9-41
- xremote-time-out-length** 10-30
- xremote-transmit-window-size** 10-30
- xremote-xremotetcp-connections** 9-41
- xremote-xremote-version** 10-30
- Xreset** file 8-7

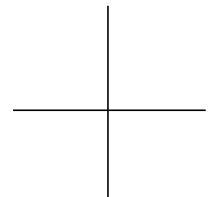

Xresources file 8-14
XRPRINTD messages 18-138
XSERVER messages 18-139
xserver-access-control-enabled 9-9
xserver-access-control-enabled-default 9-9
xserver-access-control-list 9-9
xserver-arc-cache-max-size 9-40
xserver-black-pixel 9-41
xserver-default-colormap 9-41
xserver-default-font 7-13, 9-23
xserver-default-font-path 9-4, 9-23
xserver-default-visual 9-41
xserver-disabled-extensions 9-40
xserver-enable-local-dead-key-processing 9-25
xserver-enable-local-lightpen-blue-flood 9-25
xserver-font-alias-file-name 9-23
xserver-font-cache-max-size 7-14, 9-23
xserver-font-directory-file-name 9-23
xserver-font-path-alias-table 9-24
xserver-fontserver-open-timeout 7-25, 9-24
xserver-fontserver-read-timeout 7-26, 9-24
xserver-fontserver-reopen-timeout 7-25, 9-24
xserver-fontserver-retry-attempts 7-26, 9-24
xserver-input-extension-device 9-25, 15-3, 15-4
xserver-keyboard-description-file 9-24
xserver-keyboard-narrow-keysym-tables 9-24
xserver-keyboard-type 9-24
xserver-keysym-file 2-5, 9-40
xserver-mouse-buttons 9-25
xserver-retain-font-path 9-23
xserver-retain-x-settings 9-40
xserver-rgb-file 2-5, 9-40
Xservers file 8-7, 8-19
xserver-touchscreen-calibration limits 9-25
xserver-white-pixel 9-41
.xsession file 8-6, 8-7
Xsession file 8-6

xset(1)
 displaying the font path 7-18
 modifying current font path 7-13
Xstartup file 8-6
XT messages 18-141

Z

zk command (Boot Monitor) 11-10
zs command (Boot Monitor) 11-10

