



User's Guide

Note:

Before using this information and the product it supports, be sure to read the general information under “Notices.”

It is the policy of Boundless Technologies, Inc. to improve products as new technology, components, software, and firmware become available. Boundless Technologies, therefore, reserves the right to change specifications without prior notice.

All features, functions, and operations described herein may not be marketed by Boundless Technologies in all parts of the world. In some instances, photographs are of equipment prototypes. Therefore, before using this document, consult your Boundless Technologies representative or Boundless Technologies office for information that is applicable and current.

Note that Boundless Technologies appreciates receiving suggestions and comments on its publications. After reading this guide, please comment and return the comment sheet that has been provided.

Copyright © Boundless Technologies, Inc., 2007-2009.

Phelps, New York

All rights reserved.

Contents

User's Guide	Title
Contents	ii
Note to Installers	v
Site Preparation	v
Preface	v
Notices	vi
Trademarks and Service Marks	vi
Electronic Emission Notices.....	vii
Federal Communication Commission (FCC) Statement.....	vii
Canadian Department of Communications Compliance Statement.....	vii
Avis de conformité aux normes du ministère des Communications du Canada	vii
Japanese Voluntary Control Council for Interference (VCCI) Statement.....	vii
Korean Government Ministry of Communication (MOC) Statement.....	vii
Safety Notices	viii
Danger Notices	viii
How to Connect or Disconnect the Terminal	ix
Chapter 1	2
Introduction	2
Features	2
Compatibility	2
Display.....	2
Character Sets.....	3
Communications.....	3
Keyboards.....	3
Desk Accessories	3
Physical Features.....	4
Keyboards	4
Usage Notes	6
Understanding Communications.....	7
Receive Flow Control.....	7
Transmit Flow Control.....	7
Host/Printer Port 1	7
Host/Printer Port 2.....	8
Parallel Printer Port	8
Terminal to Modem (DCE) or Host.....	9
Terminal to Host (DTE) or Printer	9
Understanding Screen Display and Pages.....	10
Bottom Status/Label Line Display.....	10
Visual Effects of Screen and Page Lengths.....	10
Chapter 2.....	11
Installing	11
STEP 1 – Determining Your Devices	11
STEP 2 – Setting Physical Connections	11
STEP 4 – Setting the No Printer Option	11
STEP 5 – Determining Your Serial Port Protocol	11
STEP 6 – Using Communications Setup.....	12

Setting Connection A: Host DCE.....	12
Setting Connection B: Host DTE.....	12
Setting Connection C: RS-232 with Modem.....	12
Setting Connection D: RS-232-C with Modem.....	12
Setting Connection E: Printer.....	12
Setting Connection F: RS-232-C Printer.....	12
Setting Connections G and H: Parallel Printer.....	12
STEP 7 – Using Emulation Setup.....	13
STEP 8 – Using Additional Setup Options.....	13
STEP 9 – Saving Parameters.....	13
STEP 10 – Establishing Communications.....	13
Common Configurations.....	13
Host/Printer Connection Guide.....	14
User Settings Chart.....	15
Chapter 3.....	16
Using Setup.....	16
Overview.....	16
Entering and Exiting Setup.....	16
Saving Parameters.....	16
Using Menus.....	16
Action Fields.....	16
Setup Map.....	17
Quick Menu (F1).....	18
General Menu (F2).....	19
Display Menu (F3).....	20
Keyboard Menu (F4).....	21
Keys Menu (F5).....	22
Ports Menu (F6).....	24
Host Menu (F7).....	25
Print Menu (F8).....	26
Emulation Menu (F9).....	26
ASCII Emulations.....	26
ANSI Emulations.....	27
Tabs Menu (F10).....	28
Answerback Menu (F11).....	28
Program Menu (F12).....	29
Execute Menu (Prnt Scrn).....	30
Edit Fields.....	31
Glossary of Terms.....	31
Page Reset.....	31
Terminal Parameters.....	31
Emulation Parameters.....	31
Chapter 4.....	32
Desk Accessories.....	32
Overview.....	32
Desk Accessory Menu.....	32
Direct Access.....	32
Moving an Accessory Window.....	33
Exiting an Accessory Window.....	33
Blocking Access.....	33
Calendar.....	33

Clock	34
Calculator.....	35
ASCII Chart	36
Diagnostic Window	36
Appendix.....	37
Local Keys.....	37
Page Configurations	40
Technical Support.....	41
Index	42

Note to Installers

This equipment complies with the FCC Regulation for Class A devices, Subpart J of Part 15. Shielded, grounded interface cables were used on all ports for FCC radiated emission testing. **Only qualified service personnel should perform installations.**

The manufacturer is not responsible for any violation of the FCC Regulation for Class A devices that is caused by unauthorized modification of the equipment, or caused by equipment installation not in accordance with the instructions in this manual.

This equipment generates, uses, and can radiate radio frequency energy and may cause radio or television interference. All user equipment that interfaces with other products should be connected with shielded cables. (Contact a local dealer for more information on shielded cable assemblies and their availability.)

There is no guarantee that interference will not occur. If radio or television interference occurs (this can be determined by turning the equipment off and on while the radio or television is on), the user is solely responsible for correcting the interference and is encouraged to take one or more of these measures:

- Reorient the receiving antenna.
- Relocate the equipment, or move the equipment away from the receiver.
- Plug the equipment into a different outlet so the unit and receiver are on different branch circuits.
- Consult the dealer or an experienced radio/television technician.

It is also suggested that the user read the FCC booklet entitled “How to Identify and Resolve Radio-TV Interference Problems.” The booklet is available from the US Government Printing Office, Washington, DC 20402. (When ordering the booklet, specify stock number 04-000-00345-4.)

Site Preparation

The screen display geometry on terminal products is aligned using magnetic devices. External magnetic fields created by other types of electronic equipment, such as printers, in very close proximity to the terminal, may cause minor display distortion.

Examples of display distortion include:

- Shaky video
- Wavy lines
- Tilted display

This magnetic field interaction only occurs over a very short distance, normally less than twelve inches, and can be corrected by separating the equipment and/or slightly reorienting the display.

Preface

This product conforms with the protection requirements of EU Council Directive 89/336/EEC on the approximation of the laws of the Member States relating to electromagnetic compatibility.

Boundless Technologies cannot accept responsibility for any failure to satisfy the protection requirements resulting from a non-recommended modification of the product, including the fitting of option cards not made by Boundless Technologies.

This product had been tested and found to comply with the limits for Class B Information Technology Equipment according to CISPR 22/European Standards EN 55022. The limits for Class B equipment were derived for typical environments to provide reasonable protection against interference with licensed communication devices.

This manual contains all the information necessary to install, set up, and use an ADDS 60 terminal.

More detailed information on programming with control codes and escape sequences, default strings and character sets, international language support, etc. can be obtained by calling the following numbers:

- USA and Canada: 1-800-231-5445
- International: 1-315-548-6189

Request the following:

260xx Programmer's Reference Guide
Part Number: 598-0005035

OR visit <http://support.boundless.com> to download the guide.

Notices

References in this publication to Boundless Technologies products, programs, or services do not imply that Boundless Technologies intends to make these available to all countries in which Boundless Technologies operates. Unless expressly stated, any reference to a Boundless Technologies product, program, or service is not intended to state or imply that only Boundless Technologies' product, program, or service may be used. Any functionally equivalent product, program, or service that does not infringe upon any of Boundless Technologies' intellectual property rights may be used instead of a Boundless Technologies product, program, or service. Evaluation and verification of operation in conjunction with other products, except those expressly designated by Boundless Technologies, are the user's responsibility.

This publication could contain technical inaccuracies or typographical errors. Please report any such problems to Boundless Technologies.

This publication may refer to products that are announced but are not currently available in your country. Boundless Technologies makes no commitment to make available any unannounced products referred to herein. The final decision to announce any product is based on Boundless Technologies' business and technical judgment.

All the information contained in this document, including the drawings and specifications, may not be reproduced in whole or in part without the written permission of Boundless Technologies.

Trademarks and Service Marks

The following table indicates which companies own which product names, as denoted by **TM** in this publication:

Term	Trademark Owner
ADDS Viewpoint	Boundless Technologies, Inc.
Centronics	Centronics Data Computer Corporation
CSA	Canadian Standards Association
DEC	Digital Equipment Corporation
IBM	International Business Machines Corporation
MENTOR	Boundless Technologies, Inc.
SCO	Santa Cruz Operations
TVI 925	TeleVideo Systems, Inc.
UL	Underwriters Laboratories, Inc.
VT320/220/100	Digital Equipment Corporation
WYSE 50/60/120/150	Wyse Technology, Inc.

Electronic Emission Notices

Federal Communication Commission (FCC) Statement

This equipment has been tested and found to comply with the limits for a Class A digital device, pursuant to Part 15 of the FCC Rules. These limits are designed to provide reasonable protection against harmful interference when the equipment is operated in a commercial environment. This equipment generates, uses, and can radiate radio frequency energy and, if not installed and used in accordance with the instruction manual, may cause harmful interference to radio communications. Operation of this equipment in a residential area is likely to cause harmful interference, in which case the user will be required to correct the interference at his own expense.

Properly shielded and grounded cables and connectors must be used in order to meet FCC emission limits. Boundless Technologies is not responsible for any radio or television interference caused by using other than recommended cables and connectors or by unauthorized changes or modifications to this equipment. Unauthorized changes or modifications could void the user's authority to operate the equipment.

This device complies with Part 15 of the FCC Rules. Operation is subject to the following two conditions: (1) this device may not cause harmful interference, and (2) this device must accept any interference received, including interference that may cause undesired operation.

Canadian Department of Communications Compliance Statement

This equipment does not exceed Class A limits per radio noise emissions for digital apparatus, set out in the Radio Interference Regulation of the Canadian Department of Communications.

Avis de conformité aux normes du ministère des Communications du Canada

Cet équipement ne dépasse pas les limites de Classe A d'émission de bruits radioélectriques pour les appareils numériques, telles que prescrites par le Règlement sur le brouillage radioélectrique établi par le ministère des Communications du Canada.

Japanese Voluntary Control Council for Interference (VCCI) Statement

This equipment is Class 1 Equipment (information equipment to be used in commercial and industrial districts) which is in conformance with the standard set by Voluntary Control for Interference by Data Processing Equipment and Electronic Office Machines (VCCI) with an aim to prevent radio interference in commercial and industrial districts.

This equipment could cause interference to radio and television receivers when used in and around residential districts.

Please handle the equipment properly according to the instruction manual.

Korean Government Ministry of Communication (MOC) Statement

Please note that this device has been approved for business purposes with regard to electromagnetic interference. If you find this is not suitable for your use, you may exchange it for a non-business purpose one.

Safety Notices

Danger Notices

A danger notice indicates a hazard that could possibly cause death or serious personal injury.

The following danger notices are used throughout this manual:



DANGER:

To prevent a possible electrical shock when installing the device, ensure that the power cord for that device is unplugged before installing signal cables.



DANGER:

To prevent a possible electrical shock when adding the device to a system, disconnect all power cords, if possible, from the existing system before connecting the signal cable to that device.



DANGER:

To prevent a possible electrical shock during an electrical storm, do not connect or disconnect cables or station protectors for communication lines, display stations, printers, or telephones.



DANGER:

To prevent a possible electrical shock from touching two surfaces with different electrical grounds, use one hand, when possible, to connect or disconnect signal cables.



DANGER:

To avoid a shock hazard:

- The power cord must be connected to a properly wired and earthed receptacle.
 - Any equipment to which this product will be attached must also be connected to properly wired receptacles.
-



DANGER:

Electrical current from power, telephone, and communication cables is hazardous. To avoid shock hazard, connect and disconnect cables as shown on the following page when installing, moving, or opening the covers of this product or attached devices.



DANGER:

The switch mounted on the front of the device is not the main disconnect. The device's main power disconnect is the detachable line cord. Disconnect the line cord from the power receptacle before performing any maintenance. When installing the device, to prevent a possible electrical shock, ensure that the power cord for the device is unplugged before installing signal cables.

Caution Notice

A caution notice indicates a hazard that could possibly cause minor personal injury.

CAUTION:

This product contains a lithium battery. Do not attempt to exchange or charge the battery. Discard the product as instructed by local regulations for limited lithium batteries. Do not burn.

Warning Notice

A warning notice indicates the possibility of damage to a program, device, system, or data.

How to Connect or Disconnect the Terminal

To Connect:

First, turn everything OFF.



Attach all cables to devices.

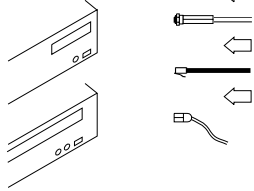

Attach signal cables to receptacles.

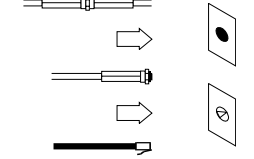

Attach power cord to outlet.

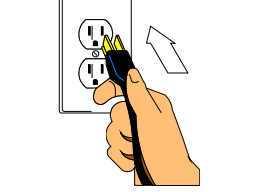

Turn device ON.

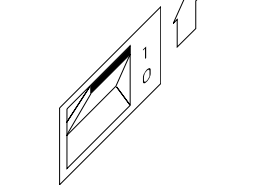

Note: In the UK, by law, the telephone cable must be connected after the power cord.

To Disconnect:

First, turn everything OFF.



Remove power cord from outlet.

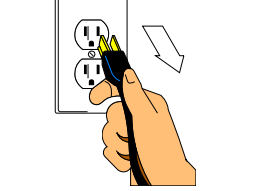

Remove signal cables from receptacles.

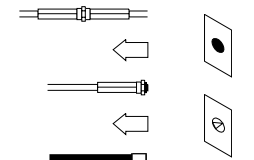

Remove all cables from devices.

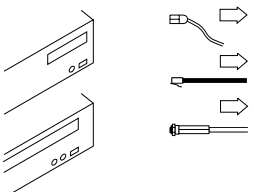

You may now take it with you.



Note: In the UK, by law, the power cord must be disconnected after the telephone line cable.

Chapter 1

Introduction

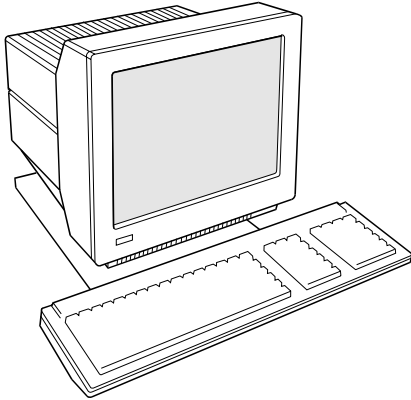

This terminal can emulate a number of ASCII and ANSI terminals, including PC-Term and SCO™ Console. The keyboards supported by the terminal include the 101/102 key extended PC (EPC), the 106/107 PC/+, the VT220™-style ANSI keyboards, and ASCII keyboards.

Clock, calendar, calculator, ASCII chart, and diagnostic desk accessories are provided. Another feature is the selectable overscan border, which can provide bezel-to-bezel video.

This terminal also features an easy-to-use Setup menu that is configuration dependent — only the options that are valid for a given emulation or hardware configuration are presented.

Setup also has a Quick menu that summarizes the options most critical to the operation of the terminal. The function keys at the top of every menu facilitate movement between the menus.

Features

Compatibility

The ADDS 60 terminal is compatible with the following terminals:

- ADDS-Viewpoint™
- Wyse™ 60, Wyse 50/50+
- DEC™ VT-320, VT-220, VT-100
- PC Terminal
- SCO™-Console, AT386
- TVI™-925

Display

The ADDS 60 has the following display features:

- 100 Hz refresh rate (flicker-free)
- Selectable overscan borders
- Selectable screen saver
- 26, 30, 44, or 52 row display with top and bottom status lines
- 80 or 132 column display
- Double high/double wide display
- Up to 10 pages of memory
- Small footprint, tilt and swivel base

Character Sets

The ADDS 60 terminal supports the following character sets:

- Numerous standard, graphic, and supplemental character sets
- Support for different keyboard languages: US (English), UK (English), Danish, Finnish, French, German, Norwegian, Portuguese, Spanish, Swedish, Dutch, Belgian-Flemish, French-Canadian, Italian, Latin American, Swiss-French, Swiss-German, Turkish, Greek, Hungarian, Czech, Slovak, Polish, Rumanian, Slovenian, Croatian, Bosnian, Serbian Latin, Russian, Hebrew

Communications

The ADDS 60 terminal features the following communication ports:

- Serial RS-232-C host/printer port 1, operating from 110 to 134,400 baud
- Serial RS-232-C host/printer port 2, operating from 110 to 38,400 baud
- Parallel IBM™/Centronics™ compatible printer port

Keyboards

The ADDS 60 terminal supports the following keyboards:

- EPC 101/102-key keyboard for use in the US and internationally
- PC/+ 106/107-key keyboard for use in the US and internationally
- ANSI (VT220 style) keyboard
- ASCII keyboard for use in the US and internationally
- Up to 35 shiftable and programmable edit and function keys

Desk Accessories

The ADDS 60 terminal includes the following desktop accessories:

- Calculator capable of transmitting results
- Monthly Calendar
- Clock with alarm settings
- ASCII and Diagnostic charts

Physical Features

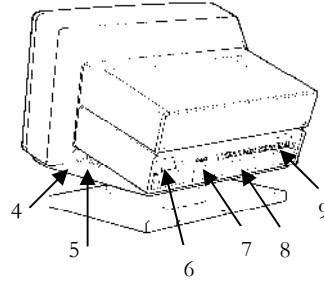
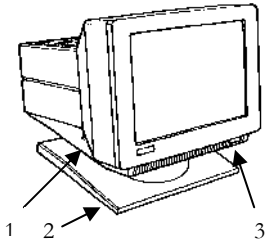

1. Keyboard Connector – insert the keyboard connector here.
2. Tilt and Swivel Base – use the tilt and swivel arrangement to adjust the viewing angle. Grasp the lower corners of the terminal and push up or down or twist left or right.
3. Power Switch – “0” is off; “1” is on.

Note:

Leave the terminal’s power switch in the off position (“0”) until you have connected the power, keyboard, and communication cables.

4. Contrast Dial – adjust the contrast between characters of different intensities by rotating the dial.
 5. Brightness Dial – adjust the overall screen brightness by rotating the dial.
 6. Power Connection – plug the female end of the power cord into this connector and the male end of the cord into a properly grounded receptacle.
-

Note:

The Canadian Standards Association (CSA) recommends that the power outlet be near the terminal and easily accessible at all times.

7. Parallel Printer Port – connect the cable from the IBM/Centronics compatible parallel printer to this port. See “Chapter 2: Installation” on page 11 for options.
8. Host/Printer Port 1 – connect the cable from a host or serial printer here. See “Chapter 2: Installation” on page 11 for options.
9. Host/Printer Port 2 – connect the cable from the first host or serial printer here. See “Chapter 2: Installation” on page 11 for options.

Keyboards

The “PC” keyboards, including the EPC (101- or 102-key) and the PC/+ (106- or 107-key), are similar in style and feature a number of key groups.

The alphanumeric keypad is the main typewriter keypad, while the function key group lies along the top of the keyboard and can be programmed locally or by downloading from the host. The numeric keypad is the calculator-style set of keys on the right-hand side of the keyboard, used to enter numeric data.

The cursor and edit keypads, located to the left of the numeric keypad, allows users to edit text and move around in the document. The communication key group, above the edit keypad, is used to control communications with the host or printer.

The ANSI keyboard varies from the PC keyboard styles mainly in that it features 20 function keys, a set of PF-keys, and a different style of numeric keypad.

The ASCII keyboard has 16 function keys and is smaller than the PC keyboard because it has no navigation keys between the alphanumeric portion and the keypad portion.

For each keyboard, there is a set of local “hot-keys.” They perform a variety of terminal functions, such as “Print Screen” and “Enter Setup.” (See the Appendix for a complete list of local functions.)

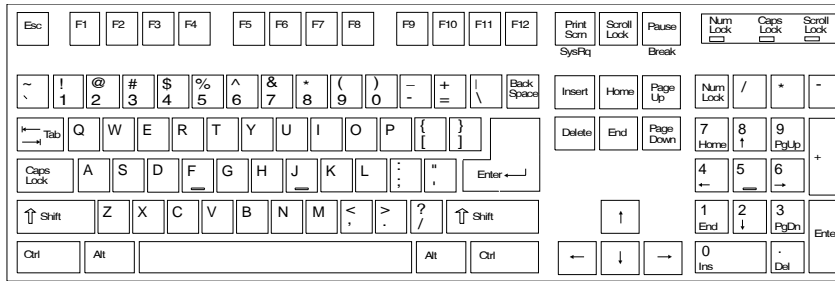

101-key EPC Keyboard - U.S.

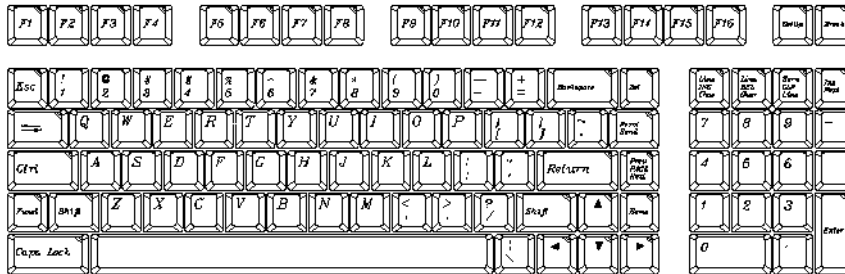

ASCII Keyboard

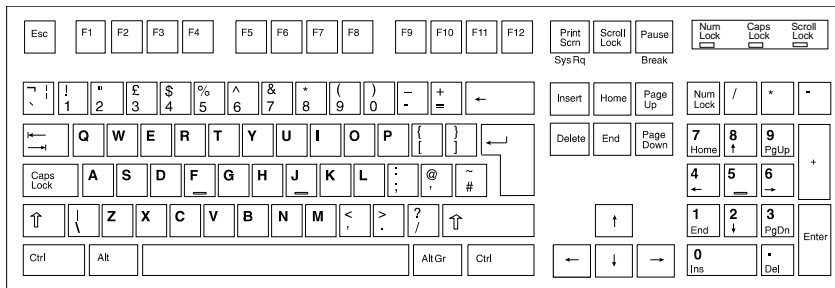

102-key EPC Keyboard - International

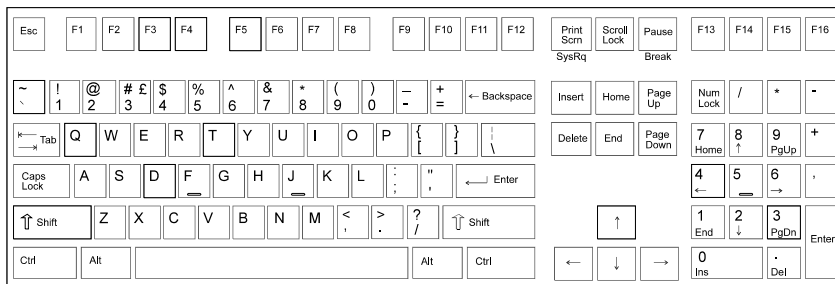



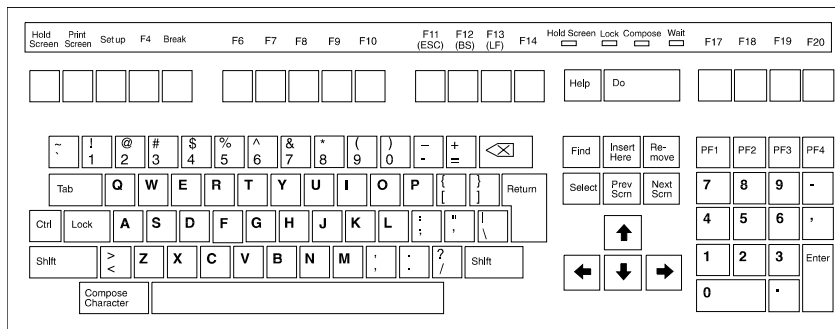





106-key PC/+ Keyboard - U.S.



ANSI Keyboard

Usage Notes

The following notations and symbols are used in this manual:

- Ctrl+F1: the two keys, Ctrl and F1, are to be pressed simultaneously.
- 1-num or 1-alpha: specifies that the number must be generated either from the numeric or alphanumeric keypads.
- 23h: the number 23 is a hexadecimal (hex) number (23h is 35 in decimal notation).
-  applies to ASCII emulations only: ADDS-VP, Wyse 50+, Wyse 60, PC Term, and TVI-925.
-  applies to ANSI emulations only: VT300/8, VT300/7, VT200/8, VT200/7, VT100, SCO Console, and AT386.
-  applies to SCO Console and AT386.
-  applies to parallel attribute emulations only: includes all emulations except ADDS-VP, TVI 925 and Wyse 50+ (which are field attribute emulations).
-  applies to ASCII key mode only.
-  applies only to Scan Code key mode.
-  applies to the PC/+ or EPC keyboards only.
-  applies to the ANSI keyboard only.
-  Applies to the ASCII keyboard only.

Understanding Communications

This terminal is equipped with three ports. The two serial ports are intended for connecting to a host, a modem, or a serial printer. The remaining port is a Centronics-compatible printer port. The port you use as the printer port depends on whether you have a serial or a parallel interface to the printer. Also, if you use the parallel port for a printer (or don't connect to a printer), you can use the serial ports to connect to two host computers.

The first host/printer serial port (SES1-EIA) can communicate with your computer or printer at a baud rate of 110 to 134,400 baud. The second host/printer serial port (SES2-AUX) can communicate at speeds from 110 baud to 38,400 baud. Either port can be used to connect to a host computer/modem or serial printer.

You have the choice of using either the second serial port or the parallel printer port as your printer interface. Refer to the following sections for further information on these ports.

Receive Flow Control

Because devices can receive data faster than they can process it, data flow control (selectable in the PORTS menu of Setup) should be used to prevent data loss. Software flow control relies on the Xon and Xoff characters ("g" and "e" characters in Scan Code key mode) to indicate when the terminal is able or unable to store further data. The Xon signal transmits the DC1 character (11h) and the Xoff signal transmits DC3 (13h).

When you set "EIA (or Aux) Rcv" in the Setup menu for PORTS to "Xon-Xoff," the terminal issues an Xoff character, indicating to the host that it should stop transmitting data. The terminal then continues to process data until its receive buffer is empty. It then issues an Xon character to the host, indicating that it can resume sending data to the terminal.

Note:

If you set the "EIA (or Aux) Rcv" in Setup to "No Protocol", the terminal will continue to accept characters into its receive buffer until it is full. Additional characters will be lost. Xon-Xoff protocol must also be set on the host computer or printer for proper handshaking.

The serial/host printer ports support both software- and hardware-based "receive" flow control (Xon-Xoff). The SES1-EIA port has an outgoing DTR (Data Terminal Ready) signal. If you set "EIA Rec" to "DTR" in Setup and the terminal's receive buffer fills to the level mentioned above, the terminal will set the DTR signal low to inform the host (serial) device to stop sending data. On the SES2-AUX port, if you set "Aux Rcv" to "DSR" in Setup, the outgoing DSR (Data Set Ready) signal signals the host (serial) device that the terminal is not ready to receive more data.

Transmit Flow Control

In a fashion similar to that described under "Receive Flow Control," the terminal understands the Xon and Xoff requests from the host when it is transmitting data (provided you set the "EIA (or Aux) Xmt" to in Setup "Xon-Xoff"). This arrangement is referred to as "transmit" flow control.

This terminal stops transmitting data to the host or printer when it receives an Xoff (DC3) code. However, if the terminal needs to send a receive protocol character, it transmits that character even if it has received an Xoff code. When the terminal stops transmitting, the data resides in the transmit buffer. Once the buffer is full, additional keyboard data is lost. When an Xon (DC1) character is received, the terminal can again send data to the attached serial device.

The serial host/printer ports supports both software- and hardware-based "transmit" flow control (Xon-Xoff). To control the flow of data to the serial/host ports, enable DSR on the SES1-EIA port and DTR on the SES2-AUX port monitor serial (provided EIA and AUX Xmit are "DSR" and "DTR", respectively, in Setup).

For parallel printers, this terminal monitors the BUSY and ERROR signals that are sent by the printer to determine when data transmission should be stopped or resumed.

Host/Printer Port 1

This port, labeled "SES1-EIA," is designed for connection to the host (computer or modem) or a serial printer via a 25-pin D-shell (DB25P) female connector. This port uses an RS-232-C communication interface, is configured as a DTE (Data Terminal Equipment) device, and can operate from 110 to 134,400 baud. The supported pins are shown below:

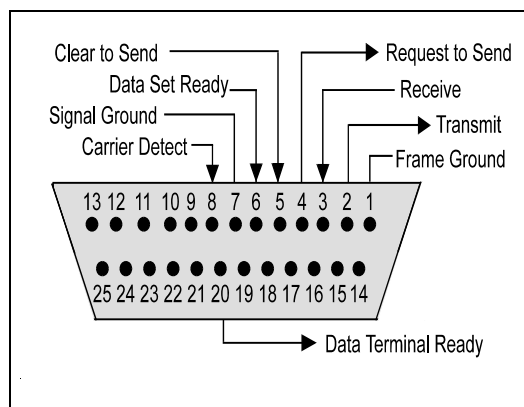

Host/Printer Port 1 Pin Assignments

Host/Printer Port 2

This port, labeled “SES2-AUX,” is designed to connect to a host connection (computer or modem) or a serial printer, and can operate from 110 to 38,400 baud. This port uses an RS-232-C interface via a DB25P female connector, and is configured as a DCE (Data Communication Equipment) device. The following illustration shows the pins assignments:

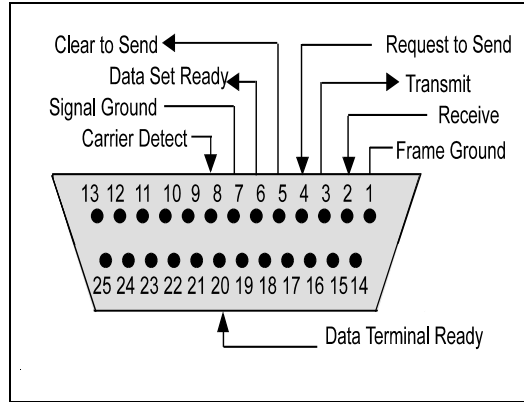

Host/Printer Port 2 Pin Assignments

Note:

See “Chapter 2: Installation” on page 11 for details on connecting ports to serial devices (hosts, modems, or printers).

Parallel Printer Port

This port, labeled “PAR,” is designed for connection to a parallel printer, which has a Centronics interface with a 25-pin D-shell female connector. This port, unlike the others, is a uni-directional device—it only serves to output data to the printer and cannot receive data. The following illustration shows the supported pins and signals:

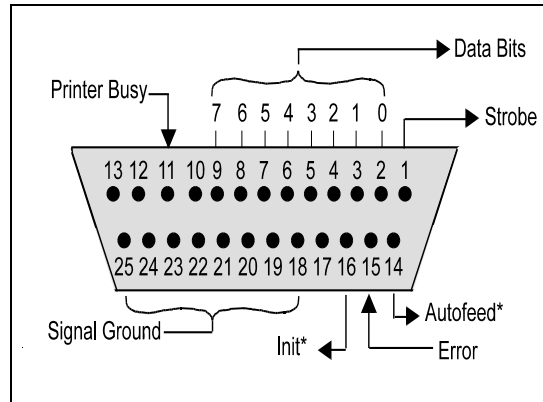

Parallel Port Pin Assignments

* These signals are held high, in an inactive state.

Note:

If you use a parallel printer, but it is not connected, an error message will appear on the status line for each PRINT operation. To clear the message, press **Ctrl+Shift+Tab**.

Terminal to Modem (DCE) or Host

Refer to the diagram below to understand why you may need a null modem adapter when connecting the second serial port (SES2-AUX) to a modem or a DCE host. The first host connects directly without a null modem since it is a DTE device.

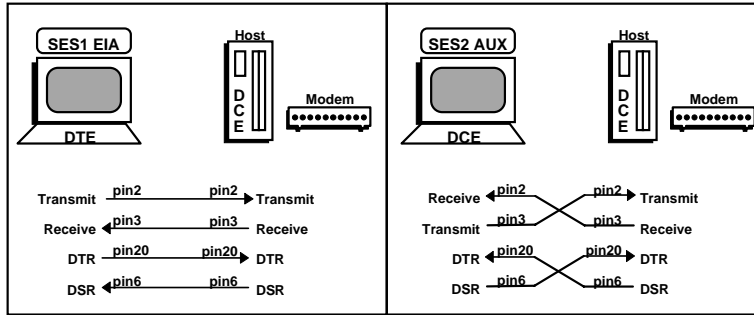

Terminal to Host (DTE) or Printer

Refer to the diagram below to understand why a null modem adapter may be needed when connecting the first serial port (SES1-EIA) to a host port without a modem (most serial printers are DTE devices and most hosts are not). The second port (AUX) will connect directly, without a null modem, since it is a DCE device.

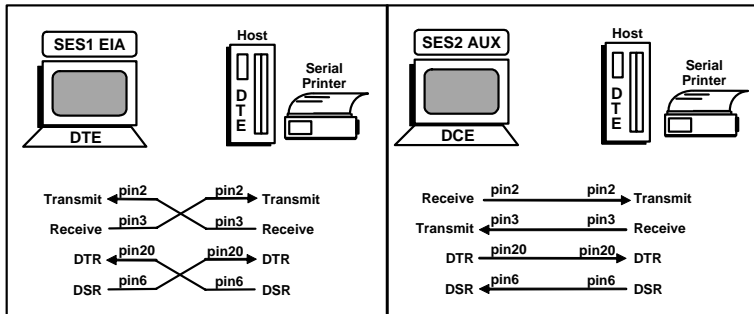

Understanding Screen Display and Pages

This terminal offers a variety of screen lengths, including 26, 30, 44, or 52 lines. These numbers include the top and bottom status lines (or label line), as well as the lines used to display data. A “page” of terminal memory represents the total number of lines that can be accessed, whether or not they are all viewable on the screen at once. See Appendix A for the number and lengths of pages available for your setup.

The page length is comprised of a base page length multiplied by 1,2,4, or 8. For instance, in certain modes, 24 (24x1), 48 (24x2), and 96 (24x4) are available, the same way that 25(25x1), 50 (25x2), and 100 (25x4) are. The base page length and the screen size determine whether a bottom status line (or label line) is displayed or not.

Bottom Status/Label Line Display

With a screen length of “26 lines,” the page lengths that are multiples of 24 allow the bottom status/label line to appear, while those that are multiples of 25 do not. The same idea applies with the 44-line screen size. A page length with 42 lines as a base page size leaves room for a label line, while the 43 line base page length does not. The label line appears if the screen length is significantly larger than the page size, such as if the screen is 44 lines and the page length is 25 lines.

The figure below represents the entire page memory of a 48 line page (24 base page length times a multiplier of 2) and the portion of the page that is viewable on the display screen, when “26 Lines” is selected. Notice that the label line is visible in this mode.

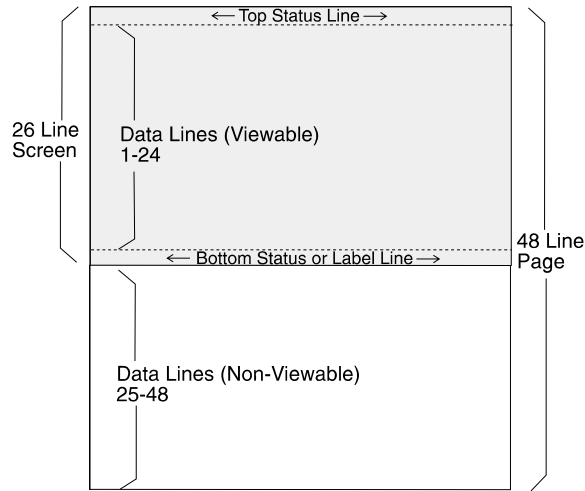

Visual Effects of Screen and Page Lengths

The interaction of page and screen lengths influences the number of displayable data lines. For example, if the page length is 50 (25 x 2), and the screen length is 44 lines, the number of data lines that are visible at any one time is 43, with no label line (the other line is used for the top status line). On a 52-line screen, 50 of the 52 data lines are visible at one time in single session mode.

If the page length is shorter than the screen length, blank lines are present below the data line or status/label line. If the page length is larger than the allowable number of data lines, some of the rows are out of view. In order to bring them into view, scroll or pan up or down as necessary.

Note:

An important difference exists between scrolling and panning. When you scroll (with \uparrow or \downarrow), you cannot return to the text that scrolls off the screen. When you pan (with **Ctrl+ \uparrow** and **Ctrl+ \downarrow**), you can return to text that has disappeared from view.

Scrolling or panning causes a new line to come into view when the cursor advances past the last or first row on the page. If the cursor moves beyond the last row, the top row of text disappears. If the cursor moves above the first row, the bottom row of text disappears (if you enabled Auto Scroll in Setup).

If the current page or portion of the page is longer than the screen display or window in which it is displayed, use **Ctrl+ \uparrow** and **Ctrl+ \downarrow** to pan the window up or down.

The figure below represents the display screen with a 48-line page length on a 44-line screen, after panning the window down 2 lines.

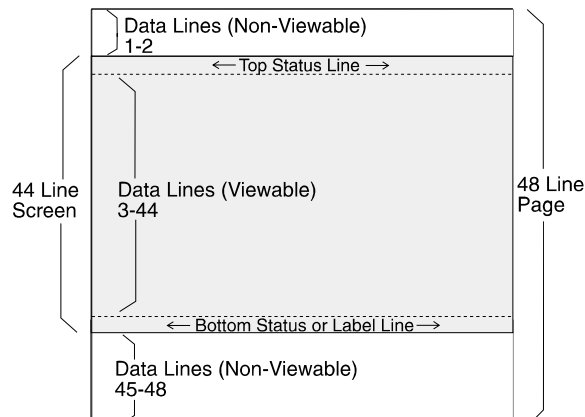

Chapter 2

Installing

This chapter provides a walk-through approach to the installation of your terminal. This approach enables you to physically connect the terminal to a printer and a host computer or modem, as well as to configure the Setup menu to suit your requirements and preferences.

The terminal offers considerable flexibility. For example, either the EIA or Aux ports can be used to connect either to a host or a printer port..

This chapter describes the most common procedures, including conventional single and dual host setups, with or without a printer. You may need to alter the steps shown here to meet your needs.

STEP 1 – Determining Your Devices

First, determine what type of serial ports you are connecting to the terminal. The Communications section in the “Chapter 1: Introduction” (page 2) describes the differences between a DTE and a DCE serial device. Then determine what type of devices you are using (a DTE host, a DCE modem, a DTE printer, a parallel printer, etc.).

STEP 2 – Setting Physical Connections

Depending on the types of serial interfaces of your devices, you may need one or more “null modem” adapters to communicate properly.

First, refer to “Communications Setup Selections,” (page 12, later in this chapter). If one or more of these situations matches your needs, make the connections as shown in the diagrams by referring to the diagram shown under “Physical Features” (page 4). Each cable connection in the diagram (the lines with arrows on each end) has a letter next to it. The letters correspond to the letters in the Host/Printer Connection Guide (page 14). If these settings don’t apply, choose the appropriate connections in the Host/Printer Connection Guide.

STEP 3 – Choosing a Port
First, you have to decide which serial port to assign to your first host in Session 1 (either EIA, Aux, or None). Next, determine which port to use as the printer port (EIA, Aux, Parallel, None).

STEP 4 – Setting the No Printer Option

If you did not opt to install a printer (did not complete portions E, F, G, or H under “Communication Setup Selections” on page 12), you must set the Printer portion of the Host/Printer selection in the Quick (F1) Setup menu to “None.” Choose the combination of Host and Printer that properly represents which terminal port you are connecting the host to. Then choose None as the printer. For example, if the EIA port is connected to the host or a modem, the setting would be “EIA/None.”

If you are running in dual session mode, press **Ctrl+Enter** (on the numeric keypad). Then set the Printer portion of Host/Printer to None in Session 2, preserving the current Host setting.

STEP 5 – Determining Your Serial Port Protocol

Consult your system administrator to find out the communication settings on all the serial devices you are connected to, including EIA (or Aux) baud, data bits, stop bits, parity, parity checking on/off, and the transmit and receive flow control protocol. This could include one or two hosts or modems or a serial printer. Record this information for use in the next step.

STEP 6 – Using Communications Setup

To complete this step, you must recall the letters next to the connections that you made in Step 2. Also, you must be aware of the port/session designations made in Step 3 (see the Host/Printer Connection diagrams later in this chapter).

The procedures below correspond directly to the individual connections made. Notice that only certain connection procedures are to be followed, not all of them. For example, if you have made connections “C” and “F” to a modem and a serial printer, then follow connection procedures “C” and “F” below.

Note:

Only follow the steps (A-H) that apply to your connections.

Note:

To access the Setup menu, press **Ctrl+Scroll Lock** on a PC keyboard or **F3** on an ANSI keyboard.

Setting Connection A: Host DCE

1. Enter the Setup menu. In the Setup Quick (press **F1**) menu, set the Host portion of the “Host/Printer” selection to “EIA” without changing the current Printer option (“EIA/xxxx”). You can set the printer in a different connection procedure, if necessary.
2. In the Ports (press **F6**) menu, set the proper communications settings for the EIA Baud, EIA Data Format, EIA Parity Check, EIA Recv, and EIA Xmt selections. See the Setup chapter for more information on the individual settings.

Setting Connection B: Host DTE

1. Enter the Setup menu.
2. In the Setup Quick (press **F1**) menu, set the Host portion of the “Host/Printer” selection to “Aux” without changing the current Printer option (“Aux/xxxx”). You can set the printer in a different connection procedure, if necessary.
3. In the Ports (press **F6**) menu, set the proper communications settings for the Aux Baud, Aux Data Format, Aux Parity Check, Aux Recv, and Aux Xmt. See “Chapter 3: Setup” (page 16) for more information on the individual settings.

Setting Connection C: RS-232 with Modem

1. Enter the Setup menu. If the EIA port is to be assigned to Session 2, then switch sessions (press **Ctrl+Enter** on the numeric keypad). Remain in session 1, if it is to be assigned to that session.
2. In the Setup Quick (press **F1**) menu, set the Host portion of the “Host/Printer” selection to “EIA” without changing the current Printer option (“EIA/xxxx”). You can set the printer in a different connection procedure, if necessary.
3. In the Ports (press **F6**) menu, set the proper communications settings for the EIA Baud, EIA Data Format, EIA Parity Check, EIA Recv, and EIA Xmt selections. See the Setup chapter for more information on the individual settings.
4. If you are connecting to a modem, set the “EIA Modem Control” parameter to “On” in the Ports (press **F6**) menu.

Setting Connection D: RS-232-C with Modem

1. Enter the Setup menu. If you need to assign the Aux port to Session 2, then switch sessions (press **Ctrl+Enter** on the numeric keypad) to the session where you need it to be assigned.
2. In the Setup Quick (press **F1**) menu, set the Host portion of the “Host/Printer” selection to “Aux” without changing the current Printer option (“Aux/xxxx”). You can set the printer in a different connection procedure, if necessary.
3. In the Ports (press **F6**) menu, set the proper communications settings for the Aux Baud, Aux Data Format, Aux Parity Check, Aux Recv, and Aux Xmt. See “Chapter 3: Setup” (page 16) for more information on the individual settings.
4. If you are connecting to a modem, set the “Aux Modem Control” parameter to “On” in the Ports (press **F6**) menu.

Setting Connection E: Printer

1. In the Setup Quick (press **F1**) menu, set the Printer portion of the “Host/Printer” selection to “EIA” without changing the current Host option (“xxxx/EIA”). The Host will be set in another connection procedure if needed.
2. In the Ports (press **F6**) menu, set the proper communications settings for the EIA Baud, EIA Data Format, EIA Parity Check, EIA Recv, and EIA Xmt selections. See the Setup chapter for more information on the individual settings.

Setting Connection F: RS-232-C Printer

1. In the Setup Quick (press **F1**) menu, set the Printer portion of the “Host/Printer” selection to “Aux” without changing the current Host option (“xxxx/Aux”). The Host will be set in another connection procedure if needed.
2. In the Ports (press **F6**) menu, set the proper communications settings for the Aux Baud, Aux Data Format, Aux Parity Check, Aux Recv, and Aux Xmt. See “Chapter 3: Setup” (page 16) for more information on the individual settings.

Setting Connections G and H: Parallel Printer

1. Enter the Setup menu.

- In the Setup Quick (press **F1**) menu, set the Printer portion of the “Host/Printer” selection to “Para” without changing the current Host option (“xxxx/Para”).

STEP 7 – Using Emulation Setup

This step requires setting a selection in the Setup menu to configure the “Emulation” of the terminal. Determine the emulations with which your applications run.

- Enter the Setup menu and set the “Emulation” parameter in the Quick (press **F1**) menu, to match your requirements.
- If you are running in dual session mode, press **Ctrl+Enter** on the numeric keypad.
- If necessary, repeat steps 1 and 2 for Session 2.

STEP 8 – Using Additional Setup Options

At this point, you should proceed to the Setup chapter and continue to set up your own selections for any other parameters, such as those for the display, keyboard, function/edit keys, and tabs.

Use **Ctrl+Enter** on the numeric keypad to access this set of parameters.

STEP 9 – Saving Parameters

Save your Setup parameters in permanent memory, so that they can be recovered if the terminal is powered down.

When you exit the Setup menu, the prompt “Save all? (Y/N)” appears. Press **Y**.

Note:

Remember to save your Setup settings after the entire installation process.

STEP 10 – Establishing Communications

Your installation is now complete. By pressing the Return or Enter key, you should be able to communicate with the host computer(s). The printer should respond to the local print command, which is **Shift+Ctrl+Del** (on the numeric keypad).

If, for some reason, your installation was not successful, make sure that

- Your physical connections are secure.
- The communications protocol settings match your devices.
- You chose the Setup selections that provide a proper interface between the terminal and your devices.



If you continue to have problems installing the terminal, call your local dealer for technical support.

Common Configurations

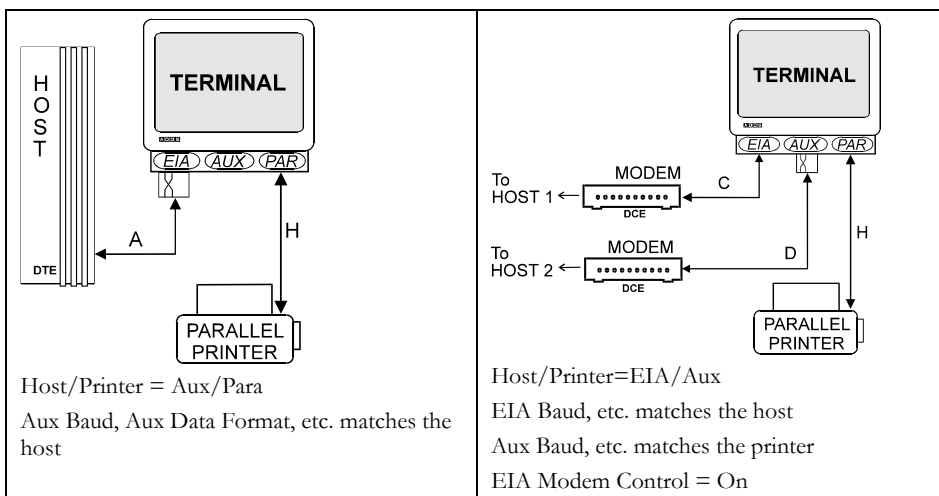
The two illustrations below show the most common arrangements for connecting a terminal to a host and to a printer.

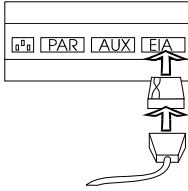
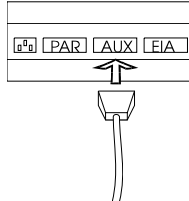
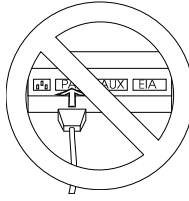

Host/Printer Connection Guide

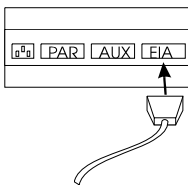
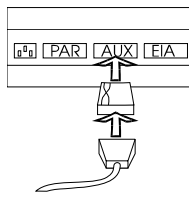
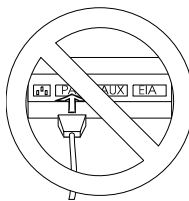
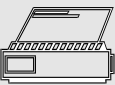
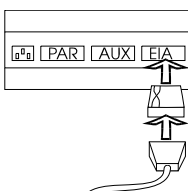
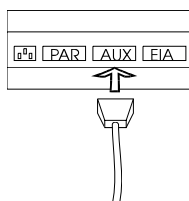
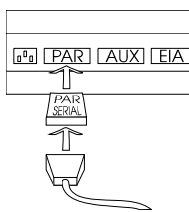
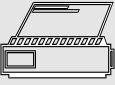
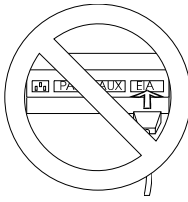
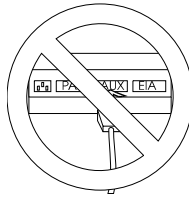
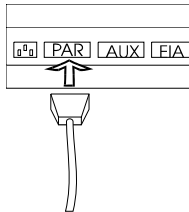
	SES1-EIA (DTE)	SES2-AUX (DCE)	PAR
DTE Host* 	 <p>Connection A: Connect a null modem adapter between the host cable and the EIA port.</p>	 <p>Connection B: Connect the host cable directly to the AUX port.</p>	 <p>Not applicable.</p>
DCE Host or Modem 	 <p>Connection C: Connect the host or modem cable directly to the EIA port.</p>	 <p>Connection D: Connect a null modem adapter between the host or modem cable and the AUX port.</p>	 <p>Not applicable.</p>
DTE Serial Printer** 	 <p>Connection E: Connect a null modem adapter between the serial printer cable and the EIA port.</p>	 <p>Connection F: Connect the serial printer cable directly to the AUX port.</p>	 <p>Connection G: This is an option if you connect a parallel-to-serial converter between the serial printer cable and the PAR port.</p>
Parallel Printer (Centronics/IBM) 	 <p>Not applicable.</p>	 <p>Not applicable.</p>	 <p>Connection H: Connect the parallel printer cable to the PAR port.</p>

* Most host computers are configured as a DTE device. The Mentor® System is an example of a DCE host system.

** Most serial printers are configured as DTE devices.

User Settings Chart

Use the following chart to document your system and terminal settings:

Parameters	Examples	Your Settings
Connections made	C and H	
Host/Printer	EIA/Para	
Emulations	ADDS-VP	
Baud	9600	
Data Bits	8	
Stop Bits	1	
Parity	None	
Parity Check	Off	
Flow Control (In)*	Xon-Xoff	
Flow Control (Out)**	Xon-Xoff	
Modem Control	On	

* Incoming flow control on the host should correspond to "EIA (or Aux) Rcv."

** Outgoing flow control on the host should correspond to "EIA (or Aux) Xmt."

Chapter 3

Using Setup

The Setup menu serves as your control panel for this terminal. From the setup menu, you can configure the terminal to communicate with the host computer and set your personal preferences.

Overview

As you use the thirteen menus within the setup menu, keep in mind the following:

- The Quick menu is the first screen upon entry. It contains the parameters critical to connecting the terminal with the host.
- Function keys appear at the top of every menu and provide easy access to any menu.
- Each setup menu provides only the options that are valid for the hardware and current emulation. If you need a different menu option, you need to change the hardware and/or emulation settings.
- Keystroke reminders and Help Messages appear at the bottom of every menu.
- When you highlight a parameter, the valid choices for that parameter appear at the bottom of the menu.

Entering and Exiting Setup



EPC Keyboard: Press **Ctrl+Scroll Lock** to enter or exit setup. You can also press **F14** or **Pause** to exit.



ANSI Keyboard depends on the Setup selections, as follows:

- When “F1 to F5 keys” = Local, press **F1** to enter.
- When “F1 to F5 keys” = FKey, press **Ctrl+F3** to enter.
- When “Key Mode” = Scan Code, press **Ctrl+Select** to enter.



ASCII Keyboard: Press **Shift+Setup** to enter or exit the setup menu. You can also press **F14** to exit.

Saving Parameters

When you exit setup mode, the prompt “Save All (Y/N)” appears. Press **Y** to exit setup and save settings in the permanent (non-volatile) memory. Press **C** to cancel the exit request. Press **N** to ignore any changes you made and exit setup mode. If you press **N**, the changes take effect, but they are lost if the terminal is reset or turned off.

Note:

For changes to function and edit keys and answerback message programming, the terminal saves your changes no matter how you exit Setup.

Using Menus

F1 through F12: Select the menu that corresponds to the function key. Depending on your keyboard, another key, either F13 (on the ANSI keyboard) or Print Screen (on the EPC keyboard) becomes available to access the “EXEC” menu. These keys always work within Setup and appear at the top of each menu.

Cursor Control Keys (↑ ← ↓ →): Use these keys to highlight parameters within the menu. When you highlight a parameter, a dark field (called a selection bar) surrounds it. This selection bar wraps to the other side of the menu at the top, bottom, and side boundaries. You always have at least two choices for each parameter. As you highlight each parameter, the available choices appear in the area above the help bar.

Note:

Some parameters are action fields and have no choices. See “Action Fields” (on the next page).

Space and Shift+Space: Cycle through the list of choices (same as Enter and Shift+Enter).

Enter and Shift+Enter: Use these keys to move through the choices for a highlighted parameter.

Tab and Shift+Tab: Move from one menu to another without using the function keys.

Note:

Changing a parameter makes the new setting take effect as soon as you leave the field. As a result, the screen may redraw itself when you make certain choices.

Action Fields

Certain parameters are action fields instead of selections. When you highlight and then select an action field, the action is taken. Depending on the action, a “WAIT” message may appear in the top right portion of the screen. When the action is completed, a “DONE” message appears. When you highlight another parameter or action field, these messages disappear.

Setup Map

Key	Menu	Parameters Available
(Not all items appear for every emulation, keyboard, or video mode.)		
F1	Quick	Emulation, Comm Mode, EIA/AUX Baud Rate, Enhanced, EIA/AUX Data Format, Language, Sessions, Host/Printer
F2	General	Emulation, Enhanced, Auto Wrap , Auto Font Load, Auto Page, Auto Scroll , Monitor Mode, Screen Saver, Bell Volume , Warning Bell, Host/Printer, Bell Length, Cursor Dir, Setup Language
F3	Display	Page Length, Screen Video, Cursor, Display Cursor, Scroll, Overscan Borders, Columns, Width Change Clear, Auto Adjust Cursor, Screen Length , Speed, Scroll Speed, , Refresh Rate
F4	Keyboard	Language, Key Repeat, Keyclick, Margin Bell, Key Mode, Char Set Mode, Key Lock, Key Rate, Caps Lock, Num Lock, Keyboard Layout, Code Page
F5	Keys (PC)	Enter Key, Return Key, Backspace , Alt Key, Pound Key, Local Leadin , Return Key Repeat, Desk Acc, Disconnect , UDKs
	Keys (ANSI)	Enter Key, Return Key, DEL key, Compose Key, Pound Key, Local Leadin, Return Key Repeat, F1 to F5 keys, Disconnect, .. and ,, key, ` and ~, <> key, UDKs
	Keys (ASCII)	Enter Key, Return Key, Backspace , Funct Key, Pound Key, Local Leadin , Return Key Repeat, Desk Acc, Disconnect , UDKs
F6	Ports	EIA Baud Rate, EIA Data Format, EIA Parity Check, Aux Baud Rate, Aux Data Format, Aux Parity Check, EIA Xmt , EIA Recv , EIA Xmt Pace, Aux Xmit, Aux Recv, Aux Xmt Pace, EIA Break, EIA Modem Control, EIA Disconnect, Aux Break, Aux Modem Control, Aux Disconnect
F7	Host	Comm Mode, Local, Recv <CR>, , Recv , Send ACK, Send Line Term, Send Block Term, Send Region, Send End, Null Suppress, Alt Input Data
F8	Print	Prnt Line Term, Prnt Block Term, Prnt Region, Prnt Mode, Secondary Recv
F9	Emulation (ASCII)	Attribute, Bright Video, Enhanced Attributes, Page Edit, WPRT Intensity, WPRT Reverse, WPRT Underline, WPRT Blink, Display NV Labels, Save Labels, Char Set, Status Line, Fkey Speed, WP-Graphics
	Emulation (ANSI)	Numeric Kpd, Cursor Kpd, Send Data, Print, ANSI-ID, Function Key Lock, Key Usage, Feature Lock, Char Set, Status Line, WP-Graphics
Key	Menu	Parameters Available
F10	Tabs	Auto Init Tabs, Default Tabs
F11	Answerback	Answerback Mode, Answerback Conceal
F12	Program	KeyProgram, Key Dir
PrtSc	Execute	Save Terminal Recall Terminal Default Terminal Save Emulation Recall Emulation Default Emulation Reset Terminal Reset Emulation Reset Ports Clear Screen Default Emulation UDKs
Pause	Exit Setup	Save all parameters? (Y/N)

Quick Menu (F1)

F1 Quick	F2 Genrl	F3 Disp	F4 Kybd	F5 Keys	F6 Ports	F7 Host	F8 Print	F9 Emul	F10 Tabs	F11 AnsBk	F12 Prog	F13 Exec
Parameters												
Emulation = Wyse-60			Comm Mode = Full Duplex				EIA Baud Rate = 9600					
Aux Baud Rate = 9600			Enhanced = On				EIA Data Format = 8/1/N					
Aux Data Format = 8/1/N			Language = U.S.				Sessions = One					
Host/Printer = EIA/Para												
Choices												
ADDS-VP		Wyse-60	Wyse-50+	PC-Term	VT-300-7	VT-300-8	VT-200-7					
VT-200-8		VT-100	SCO-Console									
Select												
↑→↓← : Parameter				Enter/S-Enter: Next/Prev Choice					Exit: F14			

Emulation: ADDS VP, Wyse 60, Wyse 50+, PC Term, VT300/8, VT300/7, VT200/8, VT200/7, VT100, SCO Console, AT386, TVI 925

Choose the “personality” of the terminal (the way in which it responds to commands). Note that SCO Console and AT386 emulations are not available with the ANSI keyboard. If you are using PC-Term emulation, refer to the Local Leadin selection in the Keys Menu (F5), which is described on page 22, for access to local “hot keys.”

Note:

All associated defaults are loaded when the emulation is changed. Default choices appear in bold. Some defaults may vary depending on the selected emulation.

Comm Mode: Full Duplex, Half Duplex, Full Block, Half Block

Choose the method of communication that matches the host computer.

EIA Baud Rate: 134,400, 115,200, 76800, 57,600, 38400, 19200, 9600, 4800, 2400, 2000, 1800, 1200, 600, 300, 150, 110

Choose the number of bits communicated per second to match the speed at which the primary host or printer expects to communicate.

AUX Baud Rate: [38400, 19200, 9600, 4800, 2400, 2000, 1800, 1200, 600, 300, 150, 134.5, 110]

Choose the speed at which the secondary host or printer expects to communicate.

Enhanced: On, Off

Normally, the terminal responds to a set of commands that correspond to the emulation selected.

EIA Data Format: 7/1/N, 7/1/O, 7/1/E, 7/1/M, 7/1/S, 7/2/N, 7/2/O, 7/2/E, 7/2/M, 7/2/S, 8/1/N, 8/1/O, 8/1/E, 8/1/M, 8/1/S, 8/2/N, 8/2/O, 8/2/E, 8/2/M, 8/2/S

Choose a data bits/stop bits/parity combination which matches the data format of the primary host or printer. Parity abbreviations are: O = odd, E = even, S = space, M = mark, and N = none.

AUX Data Format: 7/1/O, 7/1/E, 7/1/M, 7/1/S, 7/2/N, 7/2/O, 7/2/E, 7/2/M, 7/2/S, 8/1/N, 8/1/O, 8/1/E, 8/1/M, 8/1/S, 8/2/N

Select a data bits/parity bits/stop combination that matches the data format of the secondary host or printer. The Parity abbreviations are as follows: O = odd, E = even, S = space, M = mark, and N = none.



Language: U.S., U.K., Danish, Finnish, French, German, Norwegian, Portuguese, Spanish, Swedish, Dutch, Belgian-Flemish, Fr-Canadian, Italian, Latin American, Swiss-French, Swiss-German, Turkish

Select the language type that matches your keyboard’s layout.



Language: U.S., U.K., Danish, Dutch, Finnish, Belgian-Flemish, French, Fr-Canadian, German, Italian, Norwegian, Spanish, Swedish, Swiss-German, Swiss-French, Turkish

Select the language type that matches your keyboard’s layout.



Language: US, UK, Danish, French, German, Norwegian, Spanish, Swedish, Belgian-Flemish, French-Canadian, Italian, Swiss-German, Swiss-French.

Select the language type that matches your keyboard’s layout.

Host/Printer: EIA/Aux, EIA/Para, EIA/None, Aux/EIA, Aux/Para, Aux/None, None/EIA, None/Aux, None/Para, None/None

The first part of the selection indicates the host (either the EIA port or the AUX port). The second part of the selection indicates the printer port. If a serial printer is used, either the EIA or Aux port can be used to connect to the printer. If a parallel printer is being used, the PAR port should be used. EIA/Para is the default for session 1. Aux/None is the default.

General Menu (F2)

Note:

This chapter lists all possible parameters for each menu, and all possible choices for each parameter. Depending on the emulation selected, and the key mode (ASCII or ScanCode), Setup will only present the valid set of parameters and choices in each menu.

Emulation

Choose the “personality” of the terminal. See the description under Quick Menu (F1), on page 18.

Enhanced

Choose whether the terminal can respond to commands beyond the limitations of the current emulation. See the description under Quick Menu (F1), on page 18.

Auto Wrap: On, Off

Choose whether the cursor drops to the next line when it reaches the right margin or continues to display characters at the right margin. In ANSI emulation, the default is off.

Auto Font Load: On, Off

Choose whether the four font banks (0-3) should automatically be loaded when the screen size or the emulation is changed.

Auto Page: On, Off

When Auto Page mode is on and the cursor is moved off the page using a command that includes scroll, the screen displays the new page. These pages are numbered from 0 to a maximum of 9. When on, Auto Page tracks the page even if Auto Scroll is off. The up arrow key does not have an embedded scroll command, so you cannot use it to view the previous page even when Auto Page is on.

Auto Scroll: On, Off

Choose whether the terminal updates the display when the cursor is moved beyond the boundaries of the currently viewed screen.

Monitor Mode: On, Off

Choose whether control codes appear as their graphic representations or are acted upon as terminal/cursor commands.

Screen Saver: Off, 2 min, 5 min, 15 min, 30 min

Choose whether the screen will go blank after lack of activity (from the keyboard or the host) for the selected period of time. The first key typed at the keyboard when the screen is blank reactivates the display, but the key is not transmitted to the host. The Caps Lock LED (or Lock on the ANSI keyboard) flashes when Screen Saver is active.

Note:

20 minutes after the screen saver is activated, Energy Star, a power saving feature, is activated. The first key typed at the keyboard restores the energy level.

Bell Volume: 0, 1, 2, 3, 4, 5, 6, 7, 8, 9

Choose the bell volume from off [0] to high [9]. This sets the volume for alarm tones, warning bells, and keyclicks.

Warning Bell: On, Off

Choose whether a warning bell is sounded when errors (such as an invalid compose sequence) are encountered.

Host/Printer

Designates physical ports to the host and printer. See the description under Quick Menu (F1), on page 18.

Bell Length: 140 ms, 350 ms, 570 ms, 780 ms

Denotes duration of bell sound.

Setup Lang: US, French, German, Italian, Spanish, Portuguese

Affects setup and status lines.

Cursor Dir: right to left, left to right

This feature affects the direction in which the text is entered (it defaults to right to left when Hebrew language is chosen).

Display Menu (F3)

Page Length: 24, 25, 42, 43, 48, 50, 84, 86, 96, 100, (168), (172), (192), (200), *24, *25, *42, *43

Choose the number of lines per page. As many as ten pages (0-9) may be available, but the number of pages in memory depends on the number of lines per page, the type of emulation, and whether 80-Only is selected for columns. The total lines used (Lines/Page times Number of Pages) cannot exceed 240. See the Page Configurations in Appendix A (page 40).

Page lengths that are multiples of 24 or 25 and those that are multiples of 42 or 43 are displayed by default on a 26-line or 44-line screen, respectively. The extra one or two lines on the screen can be used as status lines.

The selections shown in parentheses () are not available in dual session mode. If you choose a page length preceded by an asterisk (*24, *25, *42, or *43), the total number of pages will be two, where the first page contains the number of lines in the selection (24,25,42, or 43) and the second page contains the remaining allowable lines. (See the Appendix, on page 37.)

Screen Length: 26 Lines, 30 Lines, 44 Lines, 52 Lines

Select the number of lines that can be displayed on the screen at one time. The page length affects the default screen length.

Screen Video: Normal, Reverse

Choose between bright characters on a dark background (normal) and dark characters on a bright background (reverse). In reverse video mode only, the Enhanced Attributes parameter is available (see page 3-8).

Display Cursor: On, Off

Choose whether the cursor will be displayed.

Cursor: Blink Block, Steady Block, Blink Line, Steady Line

Choose the appearance of the cursor.

Auto Adjust Cursor: On, Off

Choose whether the screen attempts to follow the cursor down the page by scrolling just enough to keep the cursor in view.

Columns: 80, 132, 80-Only

Choose the number of columns that the screen can display. 80-Only provides more pages in memory for a given page length by disallowing changes to 132-column display.

Width Change Clear: On, Off

Choose whether the screen is to be cleared when the number of columns on the screen is changed from 80 to 132 or vice versa.

Note:

Changing columns from/to 80-only forces the screen to clear independent of Width Change Clear.

Speed: Fast, Normal

Choosing “fast” improves the speed at which screen display occurs at the expense of minor, temporary distortion of text called “tearing.”

Scroll: Jump, Smooth

Choose whether the data on the screen scrolls smoothly or “jumps” to accommodate data at the rate it is received.

Scroll Speed: Smooth 1, Smooth 2, Smooth 4, Smooth 8

Select the number of scan lines per second the page scrolls up when smooth scroll is selected. Smooth 1 is the slowest rate and Smooth 8 is the fastest rate.

Refresh Rate: 60 Hz, 71 Hz, 82 Hz, 100 Hz

Choose the rate (number of times per second) at which the image on your terminal’s display is updated. This selection is only available in 26 or 30 line display mode.

Overscan Borders: On, Off

Choose whether the overscan borders are active. The borders extend video from one edge of the screen to the next. (To see the borders, select reverse for Screen Video.)

Keyboard Menu (F4)



Language: U.S., U.K., Danish, Finnish, French, German, Norwegian, Portuguese, Spanish, Swedish, Dutch, Belgian-Flemish, Fr-Canadian, Italian, Latin American, Swiss-French, Swiss-German, Turkish

Choose the language type that matches your keyboard's layout.



Language: U.S., U.K., Danish, Dutch, Finnish, Belgian-Flemish, French, Fr-Canadian, German, Italian, Norwegian, Spanish, Swedish, Swiss-German, Swiss-French, Turkish

Choose the language type which matches your keyboard's layout.



Language: US, UK, Danish, French, German, Norwegian, Spanish, Swedish, Belgian-Flemish, French-Canadian, Italian, Swiss-German, Swiss-French.

Choose the language type that matches your keyboard's layout.

Char Set Mode: PC, ANSI, ASCII

Choose which NRC set to use. This selection is only available in National Mode and foreign languages. In VT emulations, the default is ANSI. To determine which sets are loaded for each mode, refer to the 260xx Programmer's Reference Guide.

Key Mode: ASCII, ScanCode

Choose whether keys transmit ASCII codes or the ScanCode. The ScanCode transmits a "make code" when a key is pressed and a "break code" upon its release. When ScanCode is selected, "Comm Mode" is forced to Full Duplex and "Character Set" is forced to Multinational (8-bit).

Keyclick: On, Off

Choose whether pressing a key results in a clicking sound. The default is off in SCO Console emulation.

Key Repeat: On, Off

Choose whether keys, including function keys, repeat when pressed for more than half a second. This setting does not affect the following keys on the EPC keyboard: Caps Lock, Scroll Lock, Num Lock, Shift keys, Ctrl keys, Alt keys, Return, Print Screen, Pause. On the ANSI keyboard, the following keys are unaffected: Lock, F1–F5, Shift keys, Control, Compose, and Return.

Key Rate: 15 cps, 20 cps, 30 cps

When "Key Repeat" is on, a key that is pressed for more than half a second will automatically repeat. This selection allows you to choose the number of characters that are generated per second when a key is auto repeating.

Keyboard Layout: Q, F

This selection only becomes available when the Turkish keyboard is selected. Q and F refer to the two Turkish keyboard layouts available. Q and F correspond to the top left key on the alphanumeric keypad.

Margin Bell: On, Off

Choose whether a bell tone sounds when the cursor is nine positions away from the right margin.

Key Lock: Caps, Reverse, Shift

This setting effects the state of alphanumeric keys when Caps Lock is engaged.

- **Caps** causes alphabetic keys to be uppercase regardless of the Shift key.
- **Reverse** causes the Shift key to generate lowercase alphabetic keys.
- **Shift** causes all alphanumeric keys to be generated as uppercase (or shifted, in the case of numbers). If the Shift key is hit, while Shift is selected, Caps-Lock will be disengaged.

Caps Lock: Toggle, Always On, Always Off

This setting effects the state of the Caps Lock key. When set to always on or always off the key has no effect. When set to toggle, the terminal will power on in the off mode and pressing the key will alternate between the off mode and the on mode.

Num Lock: Toggle, Always On, Always Off

This setting effects the state of the Num Lock key. When set to always on or always off the key has no effect. When set to toggle, the terminal will power on in the off mode and pressing the key will alternate between the off mode and the on mode.

Code Page: CP 437, CP 850/858, CP 852, CP 857, CP 860, CP 861, CP 862, CP 863, CP 865, CP 866, CP 869, ISO-1, ISO-2, ISO-5, ISO-9, ISO-Hebrew, ISO-Cyrillic, ISO-Greek, DEC Multi

This selection is only available in 8-bit emulations in Multinational Mode. The default code page is based upon language and emulation selected. To determine which sets are loaded for each code page, refer to the 260xx Programmer's Reference Guide.

Keys Menu (F5)

Enter Key: CR, CR-LF, TAB

Choose the code the Enter key in the numeric keypad transmits.

Return Key: CR, CR-LF, TAB

Choose the code the Return key in the main alphanumeric keypad transmits.

Alt Key (left): Meta, Compose, Funct, Scroll-Lock, Alt Key

Choose how the left ALT key (or the Compose key on the ANSI keyboard) behaves.

- **Meta** sets the most significant bit for the next character and allows 8-bit data to be generated from the keyboard.
- **Compose** precedes sequences of keys to create a character that is not on the keyboard but is available in the active character set.
- **Scroll Lock** causes the Alt key to function as the Scroll Lock key, and is a toggle to hold/free data on the screen. It requires the use of flow control for the host port **Rcv Prtcl**.
- **Funct** causes the Alt key to function as the Funct key on an ASCII keyboard.
- **Alt Key** causes the left Alt key to behave identically to the right Alt key.

Pound Key: U.S., British

Choose the character transmitted for 23h—the US pound (#) or the British pound (£).

Return Key Repeat: On, Off

Choose whether the Return key located on the alphanumeric keypad will repeat when held down for more than half a second (only selectable when “Key Repeat” = On).

 **Local Leadin:** On, Off

You can choose this parameter only when Key Mode (in the Keyboard menu) is ScanCode. If Local Leadin is off, the only local function, as shown in Appendix A, is Ctrl+Scroll Lock (Ctrl+Select on the ANSI keyboard and Shift+Setup on the ASCII keyboard) to enter Setup. If Local Leadin is on, the Setup keystroke disguises the keystroke as local and then local functions can be generated using the keystrokes listed in the Appendix.

For example, to enter Setup when ScanCode and Local Leadin are on, press **Ctrl+Scroll Lock (Ctrl+Select)** on the ANSI keyboard) to introduce this as a local function (“LEAD” appears in the status line). Then press **Ctrl+Scroll Lock (Ctrl+Select)** on the ANSI keyboard and **Shift+Setup** on the ASCII keyboard) to enter Setup.

Note:

Local Leadin does not work if the Comm Mode is set to Half Block or Full Block.

UDKs: Emul Dependent, User Dependent

Choose whether the UDKs should get defaulted when the host changes the emulation.



The following selections apply to the PC keyboards:

Disconnect: Disabled, Pause, Alt+Pause

Choose the keystroke that will generate a modem disconnect.

Backspace: BS/DEL, DEL/BS, DEL/CAN, BS/BS

Choose the codes sent by the backspace key in the normal/shifted positions.

Desk Acc: Shift+Ctrl+Fkeys, Ctrl+←, Disabled

Choose how the Desk Accessories can be accessed. This selection does not appear when SCO Console emulation is selected. In SCO Console emulation, pressing Ctrl+← is the only access method.

The default allows the desk accessories to be accessed through a menu that appears when you press Ctrl+→. This displays a window, where you can choose the specific accessory that can be activated from that menu item by pressing F1 to F5. The Shift+Ctrl+Fkeys option, when selected, allows direct access to desk accessories (bypassing the menu) by pressing Shift+Ctrl+F1 through Shift+Ctrl+F5. Selecting Disabled inhibits entry to desk accessories. Once a desk accessory is displayed, you can access any other desk accessory by pressing only the function key associated with it (without pressing Shift+Ctrl).



The following selections apply only to the ANSI keyboard:

Disconnect: Disabled, Shift+F5

Choose to allow the keystroke that generates a modem disconnect on the ANSI keyboard or to disable the Disconnect function. Note that if “F1 to F5 keys” is Fkey in Setup, the Disconnect function is remapped to Ctrl+Shift+F5.

F1 to F5 keys: Local, Fkey

This selection determines whether the first five keys, labeled F1–F5, serve as local keystrokes (for example, F3 allows access to Setup) or will serve as function keys that are loaded with the default strings. (Only reprogrammed strings are visible in the text area for a given function or edit key. The default strings are not visible in Setup.)

Note:

If you choose Fkey, then the keystroke to enter Setup becomes **Ctrl+F3** on the ANSI keyboard.

With the three re-mapping selections, keys that are available on a PC keyboard are now available on the ANSI keyboard: [ESC] [~] [, and .].

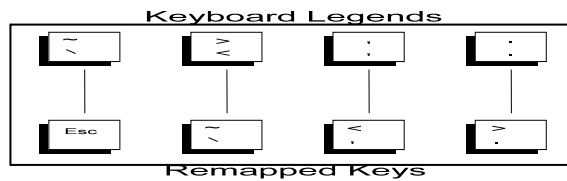

The three selections should either be kept in their defaults (as they appear on the keyboard), or all three should be changed to follow the mapping scheme described here.

~ Key: ` and ~ or ESC

Choose the characters sent by the tic/tilde key.

<or> Key: < and > or ` and ~

Choose the characters sent by the triangle bracket key in the normal and shifted positions.

,, and .. Keys: ,, and .. or ,< and .>

Choose the character sent by the comma and period keys in the normal and shifted mode.

Backspace: BS/DEL, DEL/BS, DEL/CAN

Choose the codes sent by the key in the normal/shifted positions.

Compose Key: [Meta, Compose, Funct, Scroll-Lock, Alt Key]

This selection indicates the role that the Compose key will play. The explanation of choices is the same as for the Alt Key (left) selection, which is discussed earlier in this section.



The following selections apply to the ASCII keyboards:

Disconnect:

Backspace: BS/DEL, DEL/BS, DEL/CAN, BS/BS

Choose the codes sent by the backspace key in the normal/shifted positions.

Desk Acc: Shift+Ctrl+Fkeys, Ctrl+←, Disabled

Choose how the Desk Accessories can be accessed. This selection does not appear when SCO Console emulation is selected. In SCO Console emulation, pressing Ctrl+← is the only access method.

The default allows the desk accessories to be accessed through a menu that appears when you press Ctrl+→. This displays a window, where you can choose the specific accessory that can be activated from that menu item by pressing F1 to F5. The Shift+Ctrl+Fkeys option, when selected, allows direct access to desk accessories (bypassing the menu) by pressing Shift+Ctrl+F1 through Shift+Ctrl+F5. Selecting Disabled inhibits entry to desk accessories. Once a desk accessory is displayed, you can access any other desk accessory by pressing only the function key associated with it (without pressing Shift+Ctrl).

Funct Key: [Meta, Compose, Funct, Scroll-Lock, Alt Key]

This selection indicates the role that the Funct key will play. The explanation of choices is the same as for the left Alt Key selection, which is discussed earlier in this section.

Ports Menu (F6)

EIA Baud Rate: 134400, 115200, 76800, 57600, 38400, 19200, 9600, 4800, 2400, 2000, 1800, 1200, 600, 300, 150, 110

See the Quick menu earlier in this chapter.

EIA Data Format: 7/1/N, 7/1/O, 7/1/E, 7/1/M, 7/1/S, 7/2/N, 7/2/O, 7/2/E, 7/2/M, 7/2/S, 8/1/N, 8/1/O, 8/1/E, 8/1/M, 8/1/S, 8/2/M, 8/2/N, 8/2/O, 8/2/E, 8/2/S

See the description under Quick Menu (F1), on page 18.**EIA (Aux) Parity Check:** On, Off

Choose whether the parity bit will be checked. When parity check is on and the parity bit received is inconsistent with the data received, indicating an error in communications, an asterisk (*) 2Ah is displayed instead of the character.

Aux Baud Rate: 38400, 19200, 9600, 4800, 2400, 2000, 1800, 1200, 600, 300, 150, 134.5, 110

See the description under Quick Menu (F1), on page 18.

AUX Data Format: 7/1/O, 7/1/E, 7/1/M, 7/1/S, 7/2/N, 7/2/O, 7/2/E, 7/2/M, 7/2/S, 8/1/N, 8/1/O, 8/1/E, 8/1/M, 8/1/S, 8/2/N

See the description under Quick Menu (F1), on page 18.

EIA (Aux) Recv: No Protocol Xon-Xoff (XPC), Xany-Xoff (XPC), DTR (DSR), Xany-Xoff/DTR (DSR)

Choose the form of flow control for data received from the primary or secondary host. Software flow control uses Xon-Xoff DC1 (11h) and DC3 (13h). XPC is used by “Scan Code” mode because it uses DC1 and DC3 as data. Xany-Xoff (XPC) is similar to Xon-Xoff, except that any character transmitted to the host is treated as an Xon, so data from the terminal is buffered, rather than being sent to the host. DTR (DSR for Aux) relies on the hardware signal DTR or DSR (pin 20 or pin 6) from the device. Xany-Xoff/DTR (DSR) uses software and hardware flow control.

Note:

Flow control is recommended to protect against data loss.

EIA (Aux) Xmit: No Protocol, Xon-Xoff, DSR (DTR), Both

This is similar to EIA (Aux) Recv, except that it applies to the data transmitted from the terminal to the primary or secondary host or printer. DSR is the hardware signal for Data Set Ready (pin 6).

Note:

In ADDS™ VP emulation and WP-Graphics mode, DC1 and DC3 can be interpreted as data and should not be selected as a form of protocol.

EIA (Aux) Break: 250 ms, 170 ms, 500 ms, Off

Choose the duration of the break signal in milliseconds. This is an interruption in data flow, and can be disabled.

EIA (Aux) Modem Control: On, Off

If you use a modem to communicate with the primary or secondary host, you should turn on modem control. To perform a disconnect, the terminal drops the DTR signal. In full duplex, the terminal keeps RTS high and checks for a CD signal before sending data to the modem. In half duplex, it raises RTS and awaits a clear-to-send (CTS) signal from the modem before sending data.

EIA (Aux) Xmt Pace: Baud, 35 cps, 60 cps, 150 cps

Define the maximum number of characters per second that the terminal can transmit. When a character limit (35 cps, 60 cps, or 135 cps) is set, the delays are averaged between characters for the selected baud rate. This is also known as “pacing.” The Baud option provides no pacing, allowing data to be transmitted at the specified baud rate.

EIA (Aux) Disconnect: 2sec, 60ms

Select the maximum time period that the modem can be disconnected (or the modem line be down) before the terminal performs a Modem Disconnect. This occurs if EIA (Aux) Modem Control is on.

Host Menu (F7)

Comm Mode: Full Duplex, Half Duplex, Full Block, Half Block

Select the communications mode.

Note:

Half-duplex is not available when KeyMode is set to ScanCode.

Receive <CR>: <CR>, <CR><LF>

Select the way in which carriage returns received will be interpreted.

Receive : Ignore, Destruct <BS>

Choose to ignore the DEL control code (7Fh) when received or to treat it as a Destructive Backspace code.

Send ACK: Off, On

Decide whether the terminal should respond to inquiry (05h) or when certain terminal functions are performed (configuring the EIA (Aux) ports, splitting screen, etc.) with the ACK (06h) character.

Null Suppress: On, Off

In the default mode (On), the host ignores all received nulls (00 hex). When you choose Off, the terminal accepts all received nulls and acts upon them according to the selected emulation.

Send Line Term: <US>, <CR><LF>

Choose which line terminator is sent. <US> is 1Fh and <CR><LF> is 0Dh 0Ah.

Local: Off, On

Choose whether keyed data is interpreted locally by the terminal and not sent to the host. Data sent by the host is lost, if Local is on. The ability to print data is not affected by this mode.



Send Block Term: <ETX>, <CR>

Choose which character indicates the end of a block.

Or



Send Block Term: None, FF

Choose which character indicates the end of a block.



Send End: Cursor, Region

Choose whether the end is indicated by the scroll region or by the cursor location.



Send Region: Screen, Scroll

Choose whether the terminal sends data from the entire screen or from the scrolling region.

Alt Input Data: On, Off

Choose whether data from second serial port is sent to the host.

Print Menu (F8)



Print Mode: Normal, Auto, Controller

Choose how printing is controlled:

- Normal indicates that printing is to occur when a print request (such as print screen) is received.
- Auto prints a line when the terminal receives a LF, a FF, or a VT code, or when autowrap occurs.
- Controller indicates that host data is sent to the printer (pass through mode). The host computer controls printing.



Print Block Term: <ETX>, <CR>

Choose the character that tells the printer that the block of data to be printed has ended.

Or



Print Block Term: None, <FF>

Choose the character that tells the printer that the block of data to be printed has ended.



Print Region: Screen, Scroll

Indicate the region of the screen that is to be printed: the entire screen or a certain section of it called the scrolling region. A scrolling region is a limited portion of the screen which applications (such as word processors) may designate to be the user's.



Print Line Term: <US>, <CR><LF>

Indicate the character that <R>is to terminate a line of print.

Secondary Recv: Off, On

When you choose On, the data received from the serial printer goes to the port assigned for the host. This data does not appear on the screen and is transparent to you. When you choose Off, the data received from the printer port is ignored.

Emulation Menu (F9)

The parameters displayed in this menu depend upon the current emulation. This section is divided between parameters for ASCII and ANSI emulations.

ASCII Emulations

Page Edit: Off, On

When page edit is on, edit features such as insert act upon text to the end of the current page.

WPRT Intensity: Dim, Normal, Suppress

Choose the intensity of write protected characters. Suppress indicates that the character's foreground is the same as its background with the effect of "suppressing" output.

WPRT Underline: Off, On

Choose whether write-protected characters are underlined.

WPRT Blink: Off, On

Choose whether write-protected characters blink.

WPRT Reverse: Off, On

Choose whether write-protected characters display in reverse video.

Fkey Speed: Fast, Normal

Choose the speed at which function keys and labels are programmed by the host. Fast mode increases the speed for Wyse 50 compatibility but limits the amount of space in each function key and answerback message to 8 bytes. The edit keys are not available for programming in fast mode. Changing this selection changes the defaults for all the function keys, edit keys, and function key labels.

Save Labels: Off, On

When on, labels that are downloaded by the host will be saved in non-volatile memory. If this selection and Display NV Labels are off, labels written by the host would be lost upon entry and exit to Setup.

Attribute: Char, Line, Page

Choose the extent to which attributes are propagated. (The only parallel ASCII emulations are PC Term and Wyse 60.)

Display NV Labels: On, Off

Choose whether the labels in non-volatile memory appear on the lowest line. When you choose Off, any existing labels remain on the screen until you select On, when they refresh. On a 26-line screen, they appear below line 24. On a 44-line screen, labels appear below line 42. On a 52-line screen, they appear below line 50. (The top line is the top status line and cannot be used for data.) If the page length used is a multiple of 25 (instead of 24) and the screen length is 26 lines, then the last data line is used for data and labels do not appear, regardless of this setting. The same is true for a page length that is a multiple of 43 (instead of 42) with a screen length of 44 lines.

Status Line: Standard, Extended, Off

Choose the type of the status line. In standard, cursor row and column, emulation indicator, print indicator, Caps Lock, and communications mode appear. In extended, only emulation indicator, Caps Lock, communications mode, protect, and write protect appear.

Char Set: National, Multinational

Choose whether the character set used is the 7-bit national chart or the 8-bit multinational chart when Language is not U.S. If you choose U.S., the character set becomes Multinational.

Enhanced Attributes: Off, On

When you change this setting to On, it displays a better presentation in overscan and reverse video modes. The blink and dim video attributes affect the foreground text instead of the background. This selection is only available in reverse video mode, on a per-session basis, and is disabled in a “split” display screen.

Bright Video: Off, On

Provides a brighter display when set to on. Both normal and dim text is brighter than in the standard mode. This parameter setting affects both sessions, but will not affect an ANSI emulation in the inactive session.

WP-Graphics: Off, On

Choose whether Word Perfect Graphics commands are processed or ignored.

ANSI Emulations

Numeric Kpd: Numeric, Application

Choose the set of strings sent by the numeric keypad.

Cursor Kpd: Cursor, Application

Choose the set of strings sent by the cursor control keypad.

Send Data: All, Erasable

Choose whether the data sent to the host is all data (erasable and selectively erasable) or only those characters tagged as erasable.

Print: National, Line Drawing, Multinational

Choose the set of characters used when printing.

ANSI-ID: VT100, VT101, VT102, VT220, VT320

Choose the terminal's identification.

Function Key Lock: Off, On

Choose whether the function keys are locked or are modifiable by the host.



Key Usage: Typewriter, Data Process

This selection is available for all language selections except U.S. It applies to keys that have two characters printed side by side to select which character is sent by that key. Typewriter selects the character printed on the left side while Data Process selects the character printed on the right side of the keycap.

Char Set: Multinational, National

Choose whether the character set used is from the 7-bit national chart or the 8-bit multinational chart. The default is the 8-bit multinational character set except when the emulation is VT100.

Feature Lock: Off, On

When on, the host cannot change user features: key repeat, scroll speed, screen background, tab stops, and keyboard lock.

Status Line: Off, Indicator, Host-Write, Both

Specify the way in which the status line is to be used: for host messages [host-write], as a cursor position indicator [indicator], for [both] or off.

WP-Graphics: Off, On

Selects whether Word Perfect Graphics commands are processed or ignored.

Tabs Menu (F10)

F1 Quick	F2 Genrl	F3 Disp	F4 Kybd	F5 Keys	F6 Ports	F7 Host	F8 Print	F9 Emul	F10 Tabs	F11 AnsBk	F12 Prog	Prnt Scrn Exec
Parameters												
Auto Init Tabs = Off		Default Tabs										
<pre> 10 20 30 40 50 60 ↓ ↓ ↓ ↓ ↓ ↓ T T T T T T T T ↑ ↑ ↑ ↑ ↑ ↑ 70 80 90 100 110 120 130 </pre>												
Choices												
Off		On										
Select												
↑→↓← : Parameter				Enter/S-Enter: Next/Prev Choice				Exit: Pause				

Auto Init Tabs: On, Off

When on, the tab settings always default at power up, as described under the next setting.

Default Tabs: This action field sets tabs at every eighth column starting at column 9.

When the cursor is placed in the Tab Map, the keys below will appear in the Choices field:

- <Space> – clear the current tab setting.
- <Shift> <Backspace> – clear all tab settings.
- <T or t> – set a tab at the current location.
- <↑ → ↓ ←> – move the cursor on the Tab map or back to a Parameter field above the map.

Answerback Menu (F11)

F1 Quick	F2 Genrl	F3 Disp	F4 Kybd	F5 Keys	F6 Ports	F7 Host	F8 Print	F9 Emul	F10 Tabs	F11 AnsBk	F12 Prog	Prnt Scrn Exec
Parameters												
Answerback Mode = Off		Answerback Conceal										
<p>Answerback Message: _____</p> <p style="text-align: right;">Bytes Remaining: 0542</p>												
Choices												
Off		On										
Select												
↑→↓← : Parameter				Enter/S-Enter: Next/Prev Choice				Exit: Pause				

Answerback Mode: On, Off

Choose whether the answerback message (which is sent to the host at terminal reset or power up) mode is on. This can be used to log-in to the system.

Answerback Conceal

This action parameter displays “Concealed” in the answerback edit field. Once it is concealed, the message cannot be re-displayed. This is a security measure for those who use answerback to send their login names and passwords to the host.

Answerback Message

This is a 30-character field that can be edited. (See Edit Fields on page 31.)



When “Fkey Speed” is Fast in the Emul (F9) menu, the answerback edit field is limited to 8 bytes.

Program Menu (F12)

F1	F2	F3	F4	F5	F6	F7	F8	F9	F10	F11	F12	Prnt			
Quick	Genrl	Disp	Kybd	Keys	Ports	Host	Print	Emul	Tabs	AnsBk	Prog	Scrn			
Parameters															
Key = F1		Program = F/Key					Key Dir = Comm Dependent								
Text: _____															
Text: _____															
Text: _____															
Label: _____ Bytes Remaining: 0542															
Choices															
F1	F2	F3	F4	F5	F6	F7	F8	F9	F10	F11	F12	F13	F14	F15	F16
Select															
↑→↓← : Parameter				Enter/S-Enter: Next/Prev Choice					Exit: Pause						

Program: F/Key, Sh-F/Key, Edit Key, Sh-Edit Key

Specify the type of key to be programmed—function or edit key in its normal or shifted state.



When Fkey Speed is Fast in the EMUL (F9) menu, the Program options are F/Key and Sh-F/Key.



When SCO Console emulation is selected, the Program options are F/Key, Sh-F/Key, Ctl-F/Key, Ctl-Sh-F/Key, and Edit Key.

Key Dir: [Comm Depend, Host, Printer, Printer & Host, Screen, Host & Screen, Printer & Screen, All]

Choose the destination of the contents of the function or edit key. Comm Dependent will cause the direction of the key data to correspond to the “Comm Mode” of the current emulation. For example, if the “Comm Mode” is Full Block, the contents of the key will be channeled to the screen only. If it were Full Duplex, then the contents would be sent to the host only.

Text:

This field is an edit field that permits up to 255 characters. Once the overall text limit (up to 542 characters) is reached, the terminal beeps and accepts no more text. If the text is deleted with the backspace key, the default code is no longer programmed. Shift+Backspace restores the default. See Edit Fields (page 31) or “Fkey Speed” under “Emulation (F9),” on page 26.

Label:

You can type a label of up to 7 characters for function keys in ASCII emulations only. See “Display NV Labels” in the “Emulation (F9)” section (page 26).

- <Backspace> – delete
- <Shift> <Back> – default field

Key:

Choose the key to be programmed. The keys that are listed as choices depend upon the Program parameter as shown below:



When a PC style keyboard is attached, the choices are:

- When Program = *F/Key or Sh-F/Key*, the choices are [F1, F2, F3, F4, F5, F6, F7, F8, F9, F10, F11, F12, F13, F14, F15, F16].
- When Program = *Edit Key or Sh-Edit Key*, the choices are [Tab, Esc, Backspace, Delete, Return, Home, ↑, ↓, ←, →, EnterKpd, Insert, PageDown, PageUp, End, Print].



When an ANSI keyboard is attached, the following choices apply:

- When Program = *F/Key or Sh-F/Key*, the choices are [F1, F2, F3, F4, F5, F6, F7, F8, F9, F10, F11, F12, F13, F14, Help, Do, F17, F18, F19, F20].
- When Program = *Edit Key or Sh-Edit key*, the choices are [Tab, <X>, Select, Return, ↑, ↓, ←, →, Enter, Next Screen, Remove, PF1, PF2, PF3, PF4].



When a PC style keyboard is attached, the choices are:

- When Program = *F/Key or Sh-F/Key*, the choices are [F1, F2, F3, F4, F5, F6, F7, F8, F9, F10, F11, F12, F13, F14, F15, F16].
- When Program = *Edit Key or Sh-Edit Key*, the choices are Tab, ESC, Backspace, Return, Home, ↓, ←, →, Clear, Repl, Page, Send, Insert, Delete, Enter, Del.



When the SCO emulation is selected (PC keyboard only), the following choices apply:

- When Program = *F/Key, Sh-F/Key, Ctrl+F/Key, or Ctrl+Sh-F/Key*, the choices are [F1, F2, F3, F4, F5, F6, F7, F8, F9, F10, F11, F12].
- When Program = *Edit Key or Sh-Edit key*, the choices are [Home, Insert, PageDown, PageUp, End, ↑, ↓, ←, →].

Hint:

- To program an ESC (escape) character into the key text, press **Ctrl+[**.
 - To program a DEL character into the text field, press **Ctrl+Shift+*** (alphanumeric keypad).
 - To program a carriage return or line feed into the key text field, press **Ctrl+M** or **Ctrl+J**, respectively.
 - To program the **Print Screen** key to perform a local print screen (page) function; in the key text field, press **Ctrl+[** and then **P**. Next, set the “Key Dir”=Screen option.
-

Execute Menu (Prnt Scrn)

F1 Quick	F2 Genrl	F3 Disp	F4 Kybd	F5 Keys	F6 Ports	F7 Host	F8 Print	F9 Emul	F10 Tabs	F11 AnsBk	F12 Prog	Prnt Scrn Exec
Parameters												
Save Terminal				Recall Terminal				Default Terminal				
Save Session				Recall Session				Default Session				
Reset Terminal				Reset Session				Reset Ports				
Clear Screen				Default Session UDKS								
Choices												
Use Enter Key to Execute Action												
Select												
↑→↓← : Parameter				Enter/S-Enter: Next/Prev Choice					Exit: Pause			

This menu consists entirely of action parameters. Terminal parameters affect all settings, including the emulation. Emulation choices affect only settings that relate to the chosen emulation.

Save Terminal:

Saves all settings in non-volatile (permanent) memory.

Reset Terminal:

Initializes all terminal parameters. This command also resets pages and restores the default modes.

Recall Terminal:

Reverts to all terminal and session settings that were saved in nonvolatile memory. This command also performs a “Reset Terminal” action. Called a hard reset, it has the same effect as turning the terminal off and back on.

Default Terminal:

Loads all the defaults for the terminal and session, including the emulation. This command also performs a “Reset Terminal” action. Called a hard reset, it has the same effect as turning the terminal off and back on.

Save Emulation:

Saves all the settings associated with the highlighted session.

Reset Emulation:

Initializes all session settings. Called a Soft Reset, this action also performs page resets and restores the default modes. “Mode” specifies the parameters used by a session that are not selectable through Setup, such as Insert-Mode, Split-Screen, and Graphics-Mode.

Recall Emulation:

Loads the previously saved settings associated with the chosen emulation. This action also performs a Reset Session command.

Default Emulation:

Loads all the defaults associated with the highlighted session.

Reset Ports:

Clears the transmit buffers for the host and printer port and the receive buffer for the host port. Unlocks the keyboard and clears its buffer data.

Clear Screen:

Clears the screen and the entire page.

Default UDKs:

Sets the contents of all the function and edit keys associated with the highlighted session to their factory default states.

Edit Fields

Setup uses overwrite mode in text editing fields. That is, the cursor keys cannot be used to move to a location in the text to insert characters. Upon entry to a text field, the cursor is placed at the last text location. Use the following keystrokes:

- **Backspace** – move cursor left by deleting that character.
- **Shift+Backspace** – reset the field to its default value.
- **Alphanumeric keys** – enter text in the normal, shifted, or control states. To generate a control character (00h - 1Fh) add 40h and use Ctrl with the character in the new position (40h – 5Fh). For example, to insert CR-LF (0Dh, 0Ah) codes, press Ctrl+M, Ctrl+J (4Dh, 4Ah). You can also use the compose and meta functions to generate 8-bit characters.

Glossary of Terms

Some of the terms that are used in the Exec (PrtSc) menu are defined below.

Page Reset

Page resets are executed when the session or terminal is reset or defaulted. When a page reset is performed, it affects all pages, and the following events occur: the page is erased, the cursor is homed, and scrolling regions are defaulted. All line attributes (such as double-high/wide, locked lines) are reset to normal. Split screens are cleared to a normal, single screen and protect mode is turned off.

Terminal Parameters

Terminal parameters include session parameters (defined later) and non-session parameters that affect the terminal globally without regard to the session. The non-session parameters and their defaults are listed below:

- **Setup Parameters:** Bell Volume (6), Screen Saver (5 min), Overscan Borders (on), Language (U.S.), Keyclick (on), EIA(Aux) Baud Rate (9600), EIA (Aux) Data Format (8/1/N), EIA (Aux) Parity Check (off), EIA(Aux) Rcv Prtcl (Xon-Xoff/XPC), EIA (Aux) Xmit Prtcl (none), EIA (Aux) Break (250 ms), EIA (Aux) Xmit Pace (baud), EIA (Aux) Disconnect (2 sec), EIA (Aux) Modem Control (off), Session Display (full), Emulation Display (full), Refresh Rate (70 Hz), Bright Video (off), Enhanced Attributes (on), Setup Language (U.S.), Sessions (1), Caps Lock (Toggle), Num Lock (Toggle), Key Repeat (On), Speed (fast).
- **Desk Accessory Parameters:** Clock Display (off), Clock Type (12 hour), Clock Location (column 48), Date, Time (not saved), Alarm Time (12 PM), Tone (alarm/hourly), Calculator (printer off, tape on), and the row and column in which each accessory is displayed.

Emulation Parameters

Emulation Parameters are parameters that are specific to the emulation selected in the current session. These include three types of parameters: Setup-Edit keys, Setup, and Modes.

- **Setup-Edit Keys:** Function and Edit keys and the Answerback message.
- **Setup Parameters:** All other Setup variables that are not included in Setup Parameters in Terminal Parameters (all global settings).
- **Mode Parameters:** Variables that are used by an emulation's emulation, but are not selectable through Setup. Some examples are Protect Mode, Graphics Mode, Insert Mode, Aux Mode, Split-Screen, Transparent Mode, Character Set mappings, Setup Language, and Sessions.

Chapter 4

Desk Accessories

This terminal features five desk accessories, which can be accessed one at a time through pop-up windows.

Overview

Desk Accessory Menu

To see a menu listing the five desk accessories, press **Ctrl+←**.

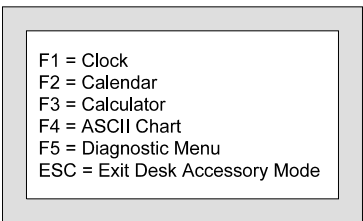

This function key:	Displays this accessory:
F1	Clock
F2	Calendar
F3	Calculator
F4	ASCII Chart
F5	Diagnostic Menu

Note:

To access this menu (with a PC keyboard), the selection “Desk Acc = ←” must be chosen in the KEYS (F5) Setup menu. This menu is always available with the ANSI keyboard.

Direct Access

To display any desk accessory directly, without the desk accessory menu, the following keystrokes are used:

Press these keys:	For direct access to this accessory:
Ctrl+Shift+F1	Clock
Ctrl+Shift+F2	Calendar
Ctrl+Shift+F3	Calculator
Ctrl+Shift+F4	ASCII Chart
Ctrl+Shift+F5	Diagnostic Menu

You may also use a function key (F1-F5) to enter another desk accessory window, once you have entered any desk accessory window.

Note:

To use these keystrokes with a PC keyboard, choose the “Desk Acc = Shift+Ctrl+Fkeys” option in the KEYS (F5) Setup menu. If an ANSI keyboard is attached, choose the “F1 to F5 keys = Local” option in the KEYS (F5) Setup menu.

Moving an Accessory Window

To reposition any desk accessory window on your screen, hold down the **Shift** key while pressing a cursor control (arrow) key.

Exiting an Accessory Window

To exit any window and restore the original screen:



On the PC keyboard, press **Esc**.



On the ANSI keyboard, press **F11**.



On the ASCII keyboard, press **Esc**.

Blocking Access

You can block access to the desk accessories by selecting the “Disabled” value for the “Desk Acc” option in the Setup menu.

Calendar

This desk accessory consists of a calendar for any month from the years 1900 to 2099. The current date is displayed at the bottom. The following keys control the calendar:

Press this key:	To do this:
← (right arrow)	Display the previous month
→ (left arrow)	Display the next month
↑ (up arrow)	Display the same month of the previous year
↓ (down arrow)	Display the same month of the next year
Esc	Close the Calendar window

The calendar (shown below) updates as you make choices.

JANUARY 1995						
SUN	MON	TUES	WED	THUR	FRI	SAT
					1	2
3	4	5	6	7	8	9
10	11	12	13	14	15	16
17	18	19	20	21	22	23
24	25	26	27	28	29	30
31						
Current Date: Jan. 01, 1995						

Clock

The clock menu (shown below) contains seven lines that you can modify:

Date	Jan. 1, 1995
Time	08:00:00 AM
Display	Off
Type	12
Column	48
Alarm Set	12:00 PM
Tone	Off

The following table describes the values you can set in the various fields:

This field:	Lets you:
Date	Set the current date. The host can also set the date.
Time	Set the current time. The host can also set the time.
Display	Choose whether only the Time, only the Date, or both the Time and the Date appear on the top status line. You can also turn off the Date/Time display. The host can set the date display.
Type	Choose whether the clock uses a 12- or a 24-hour display.
Column	Set the column (36–99) in which the date/time appears.
Alarm Set	Choose the time when an alarm (a 1-2 second bell tone) sounds.
Tone	Set when the alarm should sound: every hour, on the Alarm setting only, or both on the Alarm setting and hourly. You can also turn off the alarm.

Note:

The terminal resets the clock to 08:00 AM at power-up. Also, due to hardware limitations, the clock may drift by 15 seconds per day. We recommend setting the terminal's time as part of the system login process.

The following table shows the keys you can use to change the values of the fields:

Press this key:	To do this:
← (right arrow)	Highlight the previous field
→ (left arrow)	Highlight the next field
↑ (up arrow)	Highlight the previous line
↓ (down arrow)	Highlight the next line
Spacebar	Choose the previous option for the highlighted field
Shift+spacebar	Choose the next option for the highlighted field
Enter (on the numeric keypad)	Revert to the default setting for the current field
Esc	Save your changes and close the window

Calculator

The numeric keypad located on the right side of your keyboard serves as your calculator. See the figures below to relate the display to the keys on the numeric keypad that control it.

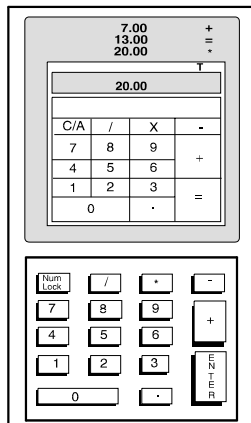

Calculator Display (EPC keyboard)

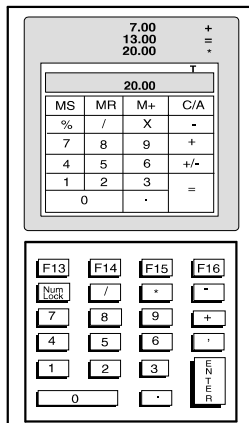

Calculator Display (PC/+ keyboard)

Note:

The ANSI keyboard calculator display is identical to the PC/+ keyboard, save that the controlling keys on the numeric keypad differ: The ANSI keyboard control keys include PF1-PF4 keys and function keys F16-F20.

The calculator can process up to 10 digits to the left of the decimal point and up to 9 to the right. When you press a number or number operator, it momentarily highlights on the display.

The following table shows the number operators:

This operator:	Does this:
+, -, /, *	Adds, subtracts, divides, or multiplies.
MS	Stores the displayed value in memory.
MR	Displays the stored value.
M+	Adds the displayed value to the value in memory.
+/-	Make a number positive if it is negative and negative if it is positive.
C/A	Displays 0.0 when pressed once. When pressed twice, it clears memory.

In addition to the numbers and operators on the keypad, you can use some keys on the alphanumeric portion of the keyboard, as described in the following table:

Press this key:	To do this:
T	Toggles Tape mode on and off. The results of your calculations scroll above the display.
P	Toggle Printer mode on and off. The results of your calculations go to the printer.
X	Transmits your most recent result to the current application and closes the calculator.
Ctrl+(number on the numeric keypad)	Specifies the precision, where the number of decimal places to be displayed is equal to the number pressed with the Ctrl key.
Esc	Closes the calculator.

Note:

Use the printer option only when a printer is connected. Press **Ctrl+Shift+Tab** to clear a printer error.

ASCII Chart

When you open the ASCII Chart window (shown below), it appears centered on the character on which your cursor was last placed, and that character is highlighted.

FONT BANK 0				
DEC	OCT	HEX	BINARY	CHAR
126	176	7E	01111110	~
127	177	7F	01111111	ÿ
000	000	00	00000000	
001	001	01	00000001	ÿ
002	002	02	00000010	ÿ

Characters appear in decimal, octal, hexadecimal, and binary number representations. The CHAR column contains the ASCII representation of the character.

Use the following keys to change the display of the ASCII chart:

The following keys control the ASCII Chart:

Press this key:	To do this:
↑	Move to the previous character in the ASCII Chart.
↓	Move to the next character in the ASCII Chart.
←	Move to the previous font in the terminal's font list.
→	Move to the next font in the terminal's font list.
Ctrl+↑	Move the cursor up one line. The ASCII Chart moves to re-center itself on the new character.
Ctrl+↓	Move the cursor down one line. The ASCII Chart moves to re-center itself on the new character.
Ctrl+←	Move the cursor to the previous character. The ASCII Chart moves to re-center itself on the new character.
Ctrl+→	Move the cursor to the next character. The ASCII Chart moves to re-center itself on the new character.
Esc	Close the Calendar window.

Note:

Upon exit, the cursor will be restored to its previous location at the time of entry to the desk accessories.

Diagnostic Window

This desk accessory (shown below) lets you see terminal configuration information, such as the amount of memory (RAM) in the terminal, the style of keyboard that you are using, and the firmware revision level.

Boundless 60		
Screen RAM		
Character	32K	P0000
Attribute	32K	P0000
CGENRAM	8K	P0000
Scratch RAM	32K	P0000
NVRAM		P0000
Code Rom x.xx	256K	P0000
Keyboard Type	EPC	P0000
Video Timing		000000
EIA port		P0000
AUX port		P0000
PARALLEL port		P0000
598-000xxxx		000000

If you require technical support, this menu provides a means for our support team to quickly assess your terminal installed options.

To close the Diagnostics window, press **Esc**.

Appendix

Local Keys

Action	Scan Code Mode	PC Keyboard	ANSI Keyboard	ASCII Keyboard
Toggle Caps Lock	No	Lock	Lock	Lock
Toggle Num Lock	No	Num+Lock		
Toggle Scroll Lock ¹	No	Scroll+Lock	F1	
Toggle Auto Print ²	Yes	Ctrl+Print+Screen	Ctrl+F2*	Ctrl+Print or Ctrl+Send
Toggle Block Mode	Yes	Ctrl+Shift+Pause	F4*	Shift+Break
Toggle Monitor Mode	Yes	Ctrl+Shift+1 or Ctrl+Shift+End	Ctrl+Shift+1 (on the numeric keypad)	Ctrl+Shift+1 (on the numeric keypad)
Toggle Ins/Replace	No	Ctrl+Insert	Ctrl+PF4	Ctrl+Ins/Repl
Instant Screen Saver ³	Yes	Ctrl+Shift+	Ctrl+Shift+PF3	Ctrl+Clear Screen or Ctrl+Line
Soft Reset ⁴	No	Shift+Scroll Lock	Shift+F3*	Ctrl+Setup
Hard Reset (Power On)	No	Ctrl+Shift+Scroll Lock	Ctrl+F3*	Shift+Ctrl+Setup
Break ⁵	Yes	Ctrl+Pause	F5*	Break
Modem-Disconnect ⁶	No	Pause	Shift+F5*	Ctrl+Break
Send Answerback	No	Shift+Pause	Ctrl+F5*	Shift+Ctrl+Break
Print Page	Yes	Ctrl+Shift+Del	Ctrl+Shift+Del (on the numeric keypad)	Ctrl+Shift+Del (on the numeric keypad)
Increment Scroll Rate ⁷	Yes	Ctrl+Shift+↑	Ctrl+Shift+↑	Ctrl+Shift+↑
Decrement Scroll Rate ⁷	Yes	Ctrl+Shift+↓	Ctrl+Shift+↓	Ctrl+Shift+↓
Raise Split ⁸	Yes	Ctrl+- (on the numeric keypad)	Ctrl+- (on the numeric keypad)	Ctrl+- (on the numeric keypad)
Lower Split ⁸	Yes	Ctrl+, (on the numeric keypad)	Ctrl+, (on the numeric keypad)	Ctrl+, (on the numeric keypad)
Split-Full Toggle ⁸	Yes	Ctrl+Shift+- (on the numeric keypad)	Ctrl+Shift+- (on the numeric keypad)	Ctrl+Shift+- (on the numeric keypad)
Roll-Window-Up ⁸	Yes	Ctrl+↑	Ctrl+↑	Ctrl+↑
Roll-Window-Down ⁸	Yes	Ctrl+↓	Ctrl+↓	Ctrl+↓
Change Status Line ⁹	Yes	Ctrl+→	Ctrl+→	Ctrl+→
Home & Clear Page	Yes	Ctrl+Shift+Home		Ctrl+Shift+Home
Auto Adjust Window	Yes	Ctrl+Home		Ctrl+Home
Enter Desk Accessory Mode	Yes	Ctrl+←	Ctrl+←	Ctrl+←

Action	Scan Code Mode	PC Keyboard	ANSI Keyboard	ASCII Keyboard
Enter Desk Accessory Mode	Yes	Ctrl+←	Ctrl+←	Ctrl+←
Enter Setup Mode ¹⁰	Yes	Ctrl+Scroll Lock	F3*	Shift+Setup
Exit Setup Mode ¹⁰	Yes	Pause	F14	F14
Enter Clock ¹¹	Yes	Ctrl+Shift+F1	Ctrl+Shift+F1*	Ctrl+Shift+F1
Enter Calendar ¹¹	Yes	Ctrl+Shift+F2	Ctrl+Shift+F2*	Ctrl+Shift+F2
Enter Calculator ¹¹	Yes	Ctrl+Shift+F3	Ctrl+Shift+F3*	Ctrl+Shift+F3
Enter ASCII Chart ¹¹	Yes	Ctrl+Shift+F4	Ctrl+Shift+F4*	Ctrl+Shift+F4
Enter Diagnostics ¹¹	Yes	Ctrl+Shift+F5	Ctrl+Shift+F5*	Ctrl+Shift+F5
Exit Any Desk Accessory	Yes	Esc	F11 (Esc)	Esc
Next Page ¹²	No	Ctrl+Page Down	Ctrl+Next Screen	Ctrl+Prev or Ctrl+Next
Previous Page ¹²	No	Ctrl+Page Up	Ctrl+Prev Screen	Shift+Ctrl+Prev or Shift+Ctrl+Next
Display Page 0 ¹³	No	Ctrl+0\Ins	Ctrl+0 (on the numeric keypad)	Ctrl+0 (on the numeric keypad)
Display Page 1 ¹³	No	Ctrl+1\End	Ctrl+1 (on the numeric keypad)	Ctrl+1 (on the numeric keypad)
Display Page 2 ¹³	No	Ctrl+2\↓	Ctrl+2 (on the numeric keypad)	Ctrl+2 (on the numeric keypad)
Display Page 3 ¹³	No	Ctrl+3\Page Down	Ctrl+3 (on the numeric keypad)	Ctrl+3 (on the numeric keypad)
Display Page 4 ¹³	No	Ctrl+4\←	Ctrl+4 (on the numeric keypad)	Ctrl+4 (on the numeric keypad)
Display Page 5 ¹³	No	Ctrl+5	Ctrl+5 (on the numeric keypad)	Ctrl+5 (on the numeric keypad)
Display Page 6 ¹³	No	Ctrl+6\→	Ctrl+6 (on the numeric keypad)	Ctrl+6 (on the numeric keypad)
Display Page 7 ¹³	No	Ctrl+7\Home	Ctrl+7 (on the numeric keypad)	Ctrl+7 (on the numeric keypad)
Display Page 8 ¹³	No	Ctrl+8\↑	Ctrl+8 (on the numeric keypad)	Ctrl+8 (on the numeric keypad)
Display Page 9 ¹³	No	Ctrl+9\Page Up	Ctrl+9 (on the numeric keypad)	Ctrl+9 (on the numeric keypad)
Program Banner	No	Ctrl+Tab	Ctrl+Tab	Ctrl+Tab
Local Block Copy	No	Alt+Home	Alt+Select**	Alt+Home***
Line Copy	No	Alt+Delete	Alt+F _{ind} **	Alt+Del***
Paste from Buffer	No	Alt+Insert	Alt+Insert Here**	Alt+Ins***

Note:

In Scan Code Mode, this chart applies only when Local Leadin is on.

NOTES:

- * This key has this function only if “F1 to F5 keys” = Local in Setup. See Chapter 3, “Using Setup” (page 16).
 - ** For this function to work, the Compose key selection (in the F5 setup menu) must be equal to Alt.
 - *** By default, Funct = Alt in the F5 (Keys) menu. If you change that setting, these key combinations change to match whatever setting you make in the F5 (Keys) menu.
- 1 This function is operational only if EIA (Aux) Rcv-Prtcl = Xon-Xoff/XPC or DTR.
 - 2 In ANSI emulations, this keystroke toggles in and out of Auto Print Mode.
 - 3 This function is operational even if Screen Saver is set to off.
 - 4 This function unlocks the keyboard, turns off all print modes and re-initializes the serial ports for setup parameters.
 - 5 The length of the Break Signal is dependent on the setup parameter of “EIA (Aux) Break.”
 - 6 This keystroke is dependent on the “Disconnect” setting in the “Keys” (F5) setup menu.
 - 7 The Increment Scroll Rate toggles the scroll rate to the fastest smooth scroll. This function also stops at the jump scroll. The Decrement Scroll Rate toggles from jump scroll to the fastest smooth scroll toward the slowest smooth scroll.
 - 8 These functions are not available in ANSI emulations.
 - 9 The Change Status Line function will toggle in the status line display from “Indicator” to “Host Write” to “Both” to “Off” in ANSI Emulations and “Standard” to “Extended” to “Off” on ASCII Emulations.
 - 10 For other keystrokes for these functions, see the Setup chapter.
 - 11 Keystrokes for these functions are only operational if the “Desk Acc= Shift+Ctrl+Fkeys” in the setup menu.
 - 12 When a Split Screen is not enabled, these keys select the next or previous pages. Wrapping takes place from the last page to the first and vice versa.
 - 13 These local functions are operational only if the selected page is available.

Page Configurations

Lines per Page	Number of Pages	
	80/132	80-only
24	8	10
48	4	5
96	2	2
192	1	1
*24	2 (24/176)	2 (24/216)
25	8	9
50	4	4
100	2	2
200	1	1
*25	2 (25/175)	2 (25/215)
42	5	5
84	2	2
168	1	1
*42	2 (42/158)	2 (42/198)
43	5	5
86	2	2
172	1	1
*43	2 (43/157)	2 (43/197)

Note:

When a page length (in the first column) is preceded by an asterisk (*), two pages are available. The first page contains the selected number of lines and the second page contains the remaining allowable lines in memory. For those combinations, this chart lists the number of lines as first page/second page, (for example, (43/57)).

Technical Support

Questions about this product should be directed to the Technical Support Department of the distributor from which you obtained your Boundless Technologies equipment. When requesting assistance, please have all pertinent information available including any error messages that may have appeared either on the terminal or the host.

If your distributor fails to provide adequate support for your needs, please contact the Boundless Technologies Technical Support Department directly. You will be required to provide the name of your distributor, and a description of the problem as described above.

Please refer to the Boundless Technologies Guide to Support Services packaged with the terminal.

Boundless Technologies can be reached at:

Boundless Technologies, Inc.
Technical Support Department
100 Marcus Blvd.
Hauppauge, NY 11788

(800) 231-5445 ext. 7259 (voice) ⇔ (631) 342-7259
(631) 342-7378 (fax) ⇔ (631) 342-7395

Email: support@boundless.com
FTP: <ftp.boundless.com>
Web site: <http://www.boundless.com>

Index

A

- Accessories, Desk, 32
- Accessory Window
 - Exiting, 33
 - Moving, 33
- Accessory Windows
 - Blocking Access, 33
- Accessory, Desk
 - ASCII Chart, 36
 - Calculator, 35
 - Calendar, 33
 - Clock, 34
 - Diagnostic Window, 36
- Accessory, Desk, Menu, 32
- Action Fields, 16
- ANSI Emulations (F9 - Emulation Menu), 27
- Answerback Menu (F11), 28
- ASCII Chart (Desk Accessory), 36
- ASCII Emulation (F9 - Emulation Menu), 26

B

- Blocking Access (to Accessory Windows), 33
- Bottom Status/Label Line Display, 10

C

- Calculator (Desk Accessory), 35
- Calendar (Desk Accessory), 33
- Caution Notice, viii
- Chart, User Settings, 15
- Choosing a Port (Installing), 11
- Clock (Desk Accessory), 34
- Common Configurations, 13
- Communications Setup, Using (Installing), 12
- Communications, Establishing (Installing), 13
- Communications, Understanding, 7
- Configurations, Common, 13
- Configurations, Page, 40
- Connect or Disconnect the Terminal, How to, ix
- Connection Guide, Host/Printer, 14
- Connections, Physical, Setting (Installing), 11
- Control, Flow
 - Receive, 7
 - Transmit, 7

D

- Danger Notices, viii
- Desk Accessories, 32
- Desk Accessories, Direct Access to, 32
- Desk Accessory
 - ASCII Chart, 36
 - Calculator, 35
 - Calendar, 33
 - Clock, 34
 - Diagnostic Window, 36
- Desk Accessory Menu, 32
- Determining Your Devices (Installing), 11
- Determining Your Serial Port Protocol (Installing), 11
- Devices, Determining (Installing), 11
- Diagnostic Window (Desk Accessory), 36
- Direct Access (to Desk Accessories), 32
- Disconnect or Connect the Terminal, How to, ix

- Display Menu (F3), 20
- Display, Bottom Status/Label Line, 10

E

- Edit Fields, 31
- Emulation Menu (F9), 26
- Emulation Setup, Using (Installing), 13
- Emulations, ANSI (F9 - Emulation Menu), 27
- Emulations, ASCII (F9 - Emulation Menu), 26
- Entering and Exiting Setup, 16
- Establishing Communications (Installing), 13
- Execute Menu (Prnt Scrn), 30
- Exiting an Accessory Window, 33

F

- F1 (Quick Menu), 18
- F10 (Tabs Menu), 28
- F11 (Answerback Menu), 28
- F12 (Program Menu), 29
- F2 (General Menu), 19
- F3 (Display Menu), 20
- F4 (Keyboard Menu), 21
- F5 (Keys Menu), 22
- F6 (Ports Menu), 24
- F7 (Host Menu), 25
- F8 (Print Menu), 26
- F9 - Emulation Menu (ANSI), 27
- F9 - Emulation Menu (ASCII), 26
- F9 (Emulation Menu), 26
- Fields
 - Action, 16
 - Edit, 31
- Flow Control
 - Receive, 7
 - Transmit, 7

G

- General Menu (F2), 19

H

- Help. *See* Technical Support
- Host (DTE) or Printer, Terminal to, 9
- Host DCE (Connection A), Setting, 12
- Host DTE (Connection B), Setting, 12
- Host Menu (F7), 25
- Host or Modem (DCE), Terminal to, 9
- Host/Printer Connection Guide, 14
- Host/Printer Port 1, 7
- Host/Printer Port 2, 8
- How to Connect or Disconnect the Terminal, ix

I

- Installers, Note to, v
- Installing, 11
 - Choosing a Port, 11
 - Determining Your Devices, 11
 - Determining Your Serial Port Protocol, 11
 - Establishing Communications, 13
 - Saving Parameters, 13
 - Setting Connection A (Host DCE), 12

- Setting Connection B (Host DTE), 12
- Setting Connection C (RS-232 with Modem), 12
- Setting Connection D (RS-232-C with Modem), 12
- Setting Connection E (Printer), 12
- Setting Connection F (RS-232-C Printer), 12
- Setting Connections G and H (Parallel Printer), 12
- Setting Physical Connections, 11
- Setting the No Printer Option, 11
- Using Communications Setup, 12
- Using Emulation Setup, 13

K

- Keyboard Menu (F4), 21
- Keys
 - Menu (F5), 22
- Keys, Local, 37
- Keys, Setup, 17

L

- Label Line/Bottom Status, Display, 10
- Local Keys, 37

M

- Map, Setup, 17
- Menu
 - Answerback (F11), 28
 - Desk Accessory, 32
 - Display (F3), 20
 - Emulation (F9), 26
 - Execute (Prnt Scrn), 30
 - General (F2), 19
 - Host (F7), 25
 - Keyboard (F4), 21
 - Keys (F5), 22
 - Ports (F6), 24
 - Print (F8), 26
 - Program (F12), 29
 - Quick (F1), 18
 - Tabs (F10), 28
- Menus, Using, 16
- Modem (DCE) or Host, Terminal to, 9
- Moving an Accessory Window, 33

N

- No Printer Option, Setting (Installing), 11
- Note to Installers, v
- Notes, Usage, 6
- Notice
 - Caution, viii
 - Warning, viii
- Notices
 - Danger, viii
 - Safety, viii

O

- Options, Additional Setup, Using (Installing), 13

P

- Page and Screen Lengths, Visual Effects of, 10
- Page Configurations, 40
- Pages and Screen Display, Understanding, 10
- Parallel Printer (Connections G and H), Setting, 12
- Parallel Printer Port, 8

- Parameters
 - Saving (Installing), 13
 - Setup, Saving, 16
- Port
 - Choosing (Installing), 11
 - Parallel Printer, 8
- Port 1, Host/Printer, 7
- Port 2, Host/Printer, 8
- Ports Menu (F6), 24
- Preparation, Site, v
- Print Menu (F8), 26
- Printer (Connection E), Setting, 12
- Printer or Host (DTE), Terminal to, 9
- Printer Port, Parallel, 8
- Printer/Host Connection Guide, 14
- Prnt Scrn (Execute Menu), 30
- Program Menu (F12), 29

Q

- Quick Menu (F1), 18

R

- Receive Flow Control, 7
- RS-232 with Modem (Connection C), Setting, 12
- RS-232-C Printer (Connection F), Setting, 12
- RS-232-C with Modem (Connection D), Setting, 12

S

- Safety Notices, viii
- Saving Parameters
 - Installing, 13
 - Setup, 16
- Screen and Page Lengths, Visual Effects of, 10
- Screen Display and Pages, Understanding, 10
- Serial Port Protocol, Determining (Installing), 11
- Setting
 - Connection A: Host DCE, 12
 - Connection B: Host DTE, 12
 - Connection C: RS-232 with Modem, 12
 - Connection D: RS-232-C with Modem, 12
 - Connection E: Printer, 12
 - Connection F: RS-232-C Printer, 12
 - Connections G and H: Parallel Printer, 12
 - Setting Physical Connections (Installing), 11
 - Setting the No Printer Option (Installing), 11
- Settings, User, Chart, 15
- Setup. *See also* Installing
 - Entering and Exiting, 16
 - Map, 17
 - Note to Installers, v
 - Saving Parameters, 16
 - Site Preparation, v
 - Using, 16
- Setup Options, Additional, Using (Installing), 13
- Site Preparation, v
- Support, Technical, 41

T

- Tabs Menu (F10), 28
- Technical Support, 41
- Terminal
 - How to Connect or Disconnect, ix
- Terminal to Host (DTE) or Printer, 9
- Terminal to Modem (DCE) or Host, 9
- Transmit Flow Control, 7

U

Understanding

Communications, 7

Screen Display and Pages, 10

Usage Notes, 6

User Settings Chart, 15

Using

Additional Setup Options (Installing), 13

Communications Setup (Installing), 12

Emulation Setup (Installing), 13

Menus, 16

Setup, 16

V

Visual Effects of Screen and Page Lengths, 10

W

Warning Notice, viii

Window, Accessory

Exiting, 33

Moving, 33

Boundless Technologies, Inc
Technical Support Department
1916 Route 96
Phelps, NY 14532-9705

Toll Free 1-800-231-5445
Phone (315) 548-6189
Fax (315) 548-5100

Email support@BoundlessTerminals.com
Web www.BoundlessTerminals.com



Part Number: 598-0013003