

**RX8/RX11
floppy disk system
user's manual**

EK-RX01-OP-001

Copyright © 1976 by Digital Equipment Corporation

The material in this manual is for informational purposes and is subject to change without notice.

Digital Equipment Corporation assumes no responsibility for any errors which may appear in this manual.

Printed in U.S.A.

The following are trademarks of Digital Equipment Corporation, Maynard, Massachusetts:

DEC	DECtape	PDP
DECCOMM	DECUS	RSTS
DECsystem-10	DIGITAL	TYPESET-8
DECSYSTEM-20	MASSBUS	TYPESET-11
		UNIBUS

CONTENTS

	Page
CHAPTER 1	GENERAL INFORMATION
1.1	INTRODUCTION 1-1
1.2	PHYSICAL DESCRIPTION 1-1
1.2.1	RX8E/RX11 Interfaces 1-2
1.2.2	Microprogrammed Controller 1-2
1.2.3	Read/Write Electronics 1-2
1.2.4	Electro-Mechanical Drive 1-2
1.2.5	Power Supply 1-3
1.3	SYSTEMS COMPATIBILITY 1-3
1.3.1	Media 1-3
1.3.2	Recording Scheme 1-10
1.3.3	Logical Format 1-10
1.3.3.1	Header Description 1-10
1.3.3.2	Data Field Description 1-11
1.3.3.3	Track Usage 1-11
1.3.3.4	CRC Capability 1-12
1.4	APPLICABLE INSTRUCTION MANUALS 1-12
1.5	CONFIGURATION 1-12
1.6	SPECIFICATIONS 1-13
CHAPTER 2	INSTALLATION AND OPERATION
2.1	PURPOSE AND ORGANIZATION 2-1
2.2	SITE PREPARATION 2-1
2.2.1	Space 2-1
2.2.2	Cabling 2-1
2.2.3	AC Power 2-1
2.2.4	Fire and Safety Precautions 2-2
2.3	ENVIRONMENTAL CONSIDERATIONS 2-2
2.3.1	General 2-2
2.3.2	Temperature, Relative Humidity 2-3
2.3.3	Heat Dissipation 2-4
2.3.4	Radiated Emissions 2-4
2.3.5	Cleanliness 2-4
2.4	INSTALLATION 2-4
2.4.1	General 2-4
2.4.2	Tools 2-4
2.4.3	Unpacking and Inspection 2-4
2.4.3.1	Cabinet-Mounted 2-4
2.4.3.2	Separate Container 2-6
2.4.4	Installation 2-6
2.5	OPERATION 2-8
2.5.1	Operator Control 2-8
2.5.2	Diskette Handling Practices and Precautions 2-8
2.5.3	Diskette Storage 2-12
2.5.3.1	Short Term (Available for Immediate Use) 2-12
2.5.3.2	Long Term 2-12
2.5.4	Shipping Diskettes 2-12

CONTENTS (Cont)

	Page
CHAPTER 3	RX11 INTERFACE PROGRAMMING INFORMATION
3.1	REGISTER AND VECTOR ADDRESSES 3-1
3.2	REGISTER DESCRIPTION 3-2
3.2.1	RXCS – Command and Status (177170) 3-2
3.2.2	RXDB – Data Buffer Register (177172) 3-3
3.2.2.1	RXTA – RX Track Address 3-3
3.2.2.2	RXSA – RX Sector Address 3-3
3.2.2.3	RXDB – RX Data Buffer 3-4
3.2.2.4	RXES – RX Error and Status 3-4
3.3	FUNCTION CODES 3-5
3.3.1	Fill Buffer (000) 3-5
3.3.2	Empty Buffer (001) 3-5
3.3.3	Write Sector (010) 3-6
3.3.4	Read Sector (011) 3-6
3.3.5	Read Status (101) 3-7
3.3.6	Write Sector with Deleted Data (110) 3-7
3.3.7	Read Error Register Function (111) 3-7
3.3.8	Power Fail 3-7
3.4	PROGRAMMING EXAMPLES 3-8
3.4.1	Read Data/Write Data 3-8
3.4.2	Empty Buffer Function 3-8
3.4.3	Fill Buffer Function 3-11
3.5	RESTRICTIONS AND PROGRAMMING PITFALLS 3-11
3.6	ERROR RECOVERY 3-11
CHAPTER 4	RX8E INTERFACE PROGRAMMING INFORMATION
4.1	DEVICE CODES 4-1
4.2	INSTRUCTION SET 4-2
4.2.1	Load Command (LCD) 4-2
4.2.2	Transfer Data Register (XDR) 4-2
4.2.3	STR 4-3
4.2.4	SER 4-3
4.2.5	SDN 4-3
4.2.6	INTR 4-3
4.2.7	INIT 4-3
4.3	REGISTER DESCRIPTION 4-3
4.3.1	Command Register 4-3
4.3.2	Error Code Register 4-4
4.3.3	RXTA – RX Track Address 4-5
4.3.4	RXSA – RX Sector Address 4-5
4.3.5	RXDB – RX Data Buffer 4-6
4.3.6	RX Error and Status 4-6
4.4	FUNCTION CODE DESCRIPTION 4-7
4.4.1	Fill Buffer (000) 4-7
4.4.2	Empty Buffer (001) 4-8
4.4.3	Write Sector (010) 4-8
4.4.4	Read Sector (011) 4-9
4.4.5	Read Status (101) 4-9

CONTENTS (Cont)

		Page
4.4.6	Write Deleted Data Sector (110)	4-9
4.4.7	Read Error Register Function (111)	4-9
4.4.8	Power Fail	4-9
4.5	PROGRAMMING EXAMPLES	4-10
4.5.1	Write/Write Deleted Data/Read Functions	4-10
4.5.2	Empty Buffer Function	4-10
4.5.3	Fill Buffer Function	4-10
4.6	RESTRICTIONS AND PROGRAMMING PITFALLS	4-15
4.7	ERROR RECOVERY	4-16

ILLUSTRATIONS

Figure No.	Title	Page
1-1	Floppy Disk System Configuration	1-2
1-2	Front View of the Floppy Disk System	1-3
1-3	M8357 Module (RX8E Interface)	1-4
1-4	M7846 Module (RX11 Interface)	1-5
1-5	Top View of the RX01	1-6
1-6	Underside View of Drive	1-7
1-7	Top View of Drive	1-8
1-8	Diskette Media	1-9
1-9	Flux Reversal Patterns	1-10
1-10	Track Format (Each Track)	1-10
1-11	Sector Format (Each Sector)	1-11
2-1	RX01	2-2
2-2	Cabinet Layout Dimensions	2-3
2-3	RX01 Shipping Restraints	2-5
2-4	RX8/RX11 Unpacking	2-7
2-5	RX01 Cabinet Mounting Information	2-8
2-6	Cable Routing, BC05L-15	2-9
2-7	Flexible Diskette Insertion	2-11
3-1	RXCS Format (RX11)	3-2
3-2	RXTA Format (RX11)	3-3
3-3	RXSA Format (RX11)	3-3
3-4	RXDB Format (RX11)	3-4
3-5	RXES Format (RX11)	3-4
3-6	RX11 Write/Write Deleted Data/Read Example	3-9
3-7	RX11 Empty Buffer Example	3-10
3-8	RX11 Fill Buffer Example	3-13
4-1	LCD Word Format (RX8E)	4-2
4-2	Command Register Format (RX8E)	4-3
4-3	Error Code Register Format	4-4
4-4	RXTA Format (RX8E)	4-5
4-5	RXSA Format (RX8E)	4-5
4-6	RXDB Format (RX8E)	4-6
4-7	RXES Format (RX8E)	4-6
4-8	RX8E Write/Write Deleted Data/Read Example	4-11
4-9	RX8E Empty Buffer Example	4-13
4-10	Fill Buffer Example	4-14

TABLES

Table No.	Title	Page
2-1	Interface Code/Jumper Configuration	2-10
4-1	Device Code Switch Selection	4-1

CHAPTER 1

GENERAL INFORMATION

This manual presents information on the installation, operation, and programming of the RX8 or RX11 Floppy Disk System. Chapter 2 (Installation and Operation) should be consulted for unpacking and installation information. Chapter 2 also provides information on the proper care of the media and should be read carefully.

1.1 INTRODUCTION

The RX8 and RX11 Floppy Disk Systems consist of an RX01 subsystem and either an RX8E interface for a PDP-8 system or an RX11 interface for a PDP-11 system.

The RX01 is a low cost, random access, mass memory device that stores data in fixed length blocks on a preformatted, IBM-compatible, flexible diskette. Each drive can store and retrieve up to 256K 8-bit bytes of data (PDP-11 or PDP-8) or 128K 12-bit words (PDP-8). The RX01 consists of one or two flexible disk drives, a single read/write electronics module, a microprogrammed controller module, and a power supply, enclosed in a rack-mountable, 10-1/2 inch, self-cooled chassis. A cable is included for connection to either a PDP-8 interface module for use on the PDP-8 Omnibus or a PDP-11 interface for use on the PDP-11 Unibus.

The RX01 performs implied seeks. Given an absolute sector address, the RX01 locates the desired sector and performs the indicated function, including automatic head position verification and hardware calculation and verification of the Cyclic Redundancy Check (CRC) character. The CRC character that is read and generated is compatible with IBM 3740 equipment.

The RX01 connects to the M8357 Omnibus interface module, which converts the RX01 I/O bus to a PDP-8 family Omnibus structure. It controls interrupts to the CPU initiated by the RX01, controls data interchange between the RX01 and the host CPU, and handles I/O transfers used to test status conditions.

The RX01 connects to the M7846 Unibus interface module, which converts the RX01 I/O bus to a PDP-11 Unibus structure. It controls interrupts to the CPU initiated by the RX01, decodes Unibus addresses for register selection, and handles data interchange between the RX01 and the host CPU.

The interface modules are dc powered by their host processor.

1.2 PHYSICAL DESCRIPTION

A complete system consists of the following components:

- M7726 controller module
- M7727 read/write electronics module
- H771A or B power supply
- RX01-CA floppy disk drive (60 Hz, max of 2)
- RX01-CC floppy disk drive (50 Hz, max of 2)
- M8357 (RX8E) or M7846 (RX11) interfaces

All components except the interface are housed in a 10-1/2 in. rack-mountable box. The power supply, M7726 module, and M7727 module are mounted above the drives. Interconnection from the RX01 to the interface is with a 40-conductor BC05L-15 cable of standard length (15 ft). Figure 1-1 is a configuration drawing of the system, and Figure 1-2 is a front view of a dual drive system.

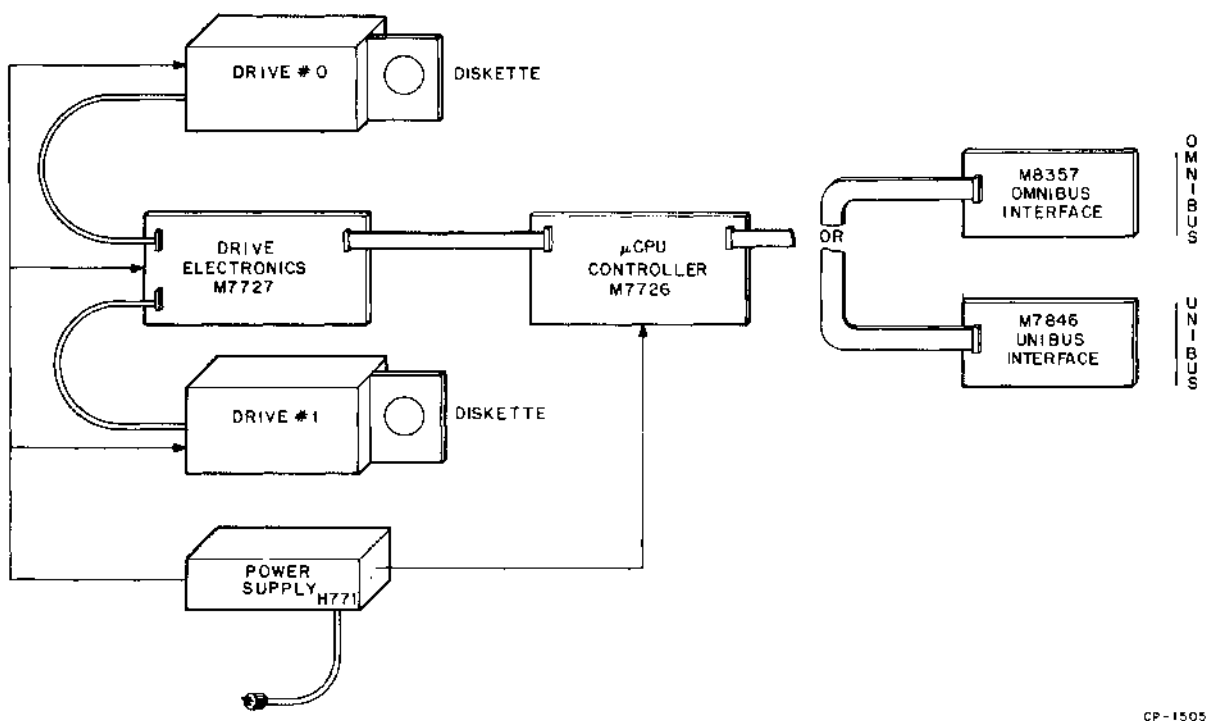

Figure 1-1 Floppy Disk System Configuration

1.2.1 RX8E/RX11 Interfaces

Interface modules M8357 (RX8E) and M7846 (RX11) are both quad modules. The M8357 plugs into an Omnibus slot and allows the RX01 to be used on the PDP-8 processors. The M7846 plugs into an SPC (small peripheral controller) slot with any PDP-11 processor. Figure 1-3 shows the M8357 module and its major sections. Figure 1-4 shows the M7846 module and its major sections.

1.2.2 Microprogrammed Controller

The M7726 microprogrammed controller module is located in the RX01 cabinet as shown in Figure 1-5. The M7726 is hinged on the left side and lifts up for access to the M7727 read/write electronics module.

1.2.3 Read/Write Electronics

The M7727 read/write electronics module is located in the RX01 cabinet as shown in Figure 1-5.

1.2.4 Electro-Mechanical Drive

A maximum of two drives can be attached to the read/write electronics. The electro-mechanical drives are mounted side by side under the read/write electronics board (M7727). Figure 1-6, which is an underside view of the drive, shows the drive motor connected to the spindle by a belt. (This belt and the small pulley are different on the 50 Hz and 60 Hz units; see Paragraph 2.2.3.2 for complete input power modification requirements.) Figure 1-7 is the top view showing the electro-mechanical components of the drive.

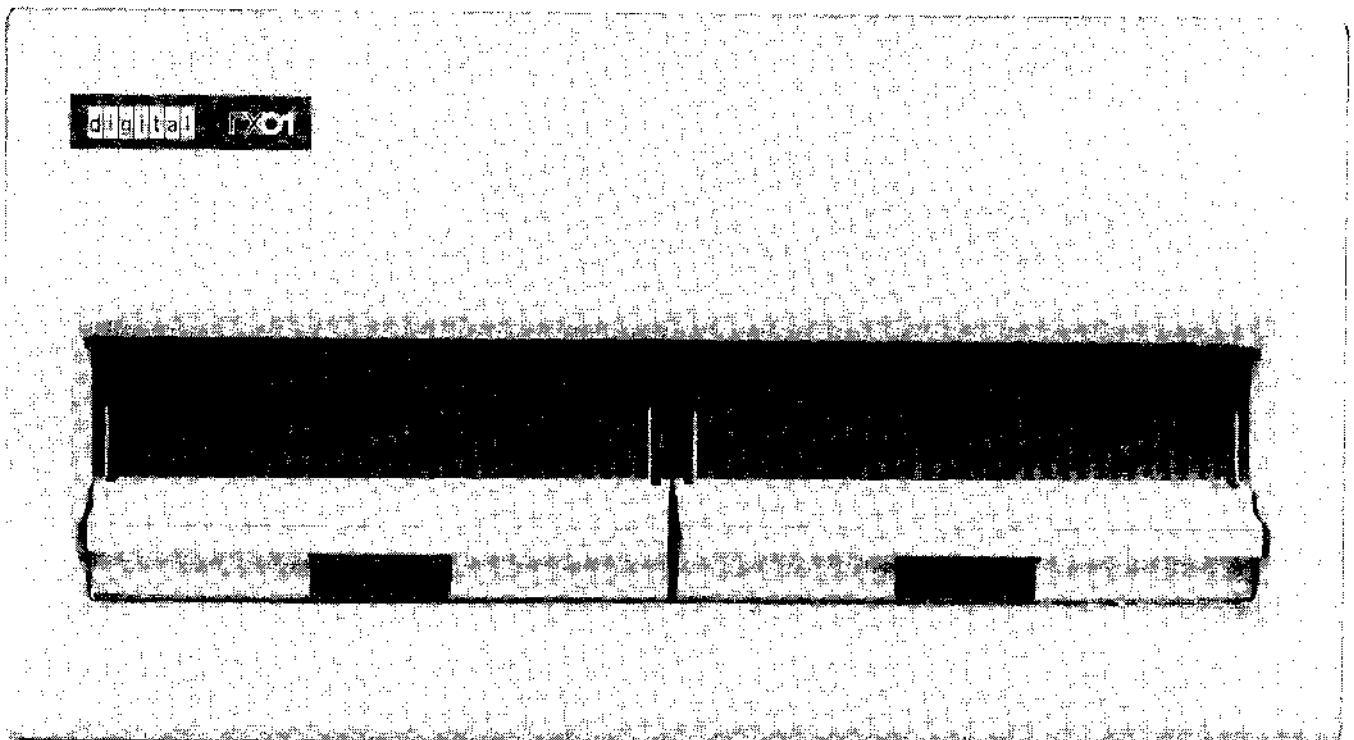

7408-1

Figure 1-2 Front View of the Floppy Disk System

1.2.5 Power Supply

The H771 power supply is mounted at the rear of the RX01 cabinet as shown in Figure 1-5. The H771A is rated at 60 Hz \pm 1/2 Hz over a voltage range of 90–132 Vac. The H771C and D are rated at 50 Hz \pm 1/2 Hz over four voltage ranges:

90–120 Vac	} 3.5 A circuit breaker; H771C
100–132 Vac	
180–240 Vac	} 1.75 A circuit breaker; H771D
200–264 Vac	

Two power harnesses are provided to adapt the H771C or D to each voltage range. This is not applicable to the H771A. See Paragraph 2.2.3.2 for complete input power modification requirements.

1.3 SYSTEMS COMPATIBILITY

This section describes the physical, electrical, and logical aspects of IBM compatibility as defined for data interchange with IBM system 3740 devices.

1.3.1 Media

The media used on the RX8 or RX11 Floppy Disk System is compatible with the IBM 3740 family of equipment and is shown in Figure 1-8.

The “diskette” media was designed by applying tape technology to disk architecture. This resulted in a flexible oxide-on-mylar surface encased in a plastic envelope with a hole for the read/write head, a hole for the drive spindle hub, and a hole for the hard index mark. The envelope is lined with a fiber material that cleans the diskette surface. The media is supplied to the customer preformatted and pretested.

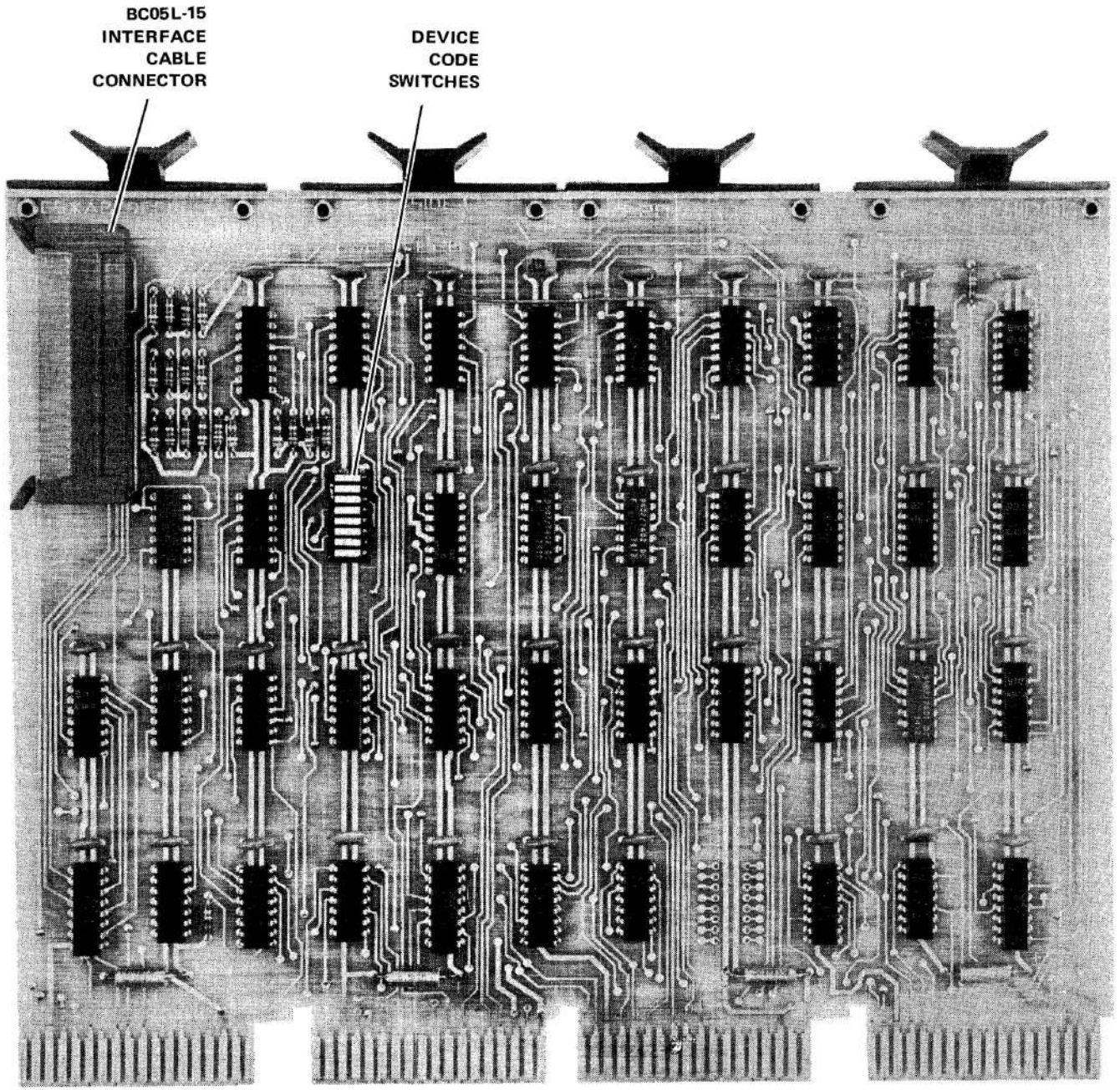

7408-3

Figure 1-3 M8357 Module (RX8E Interface)

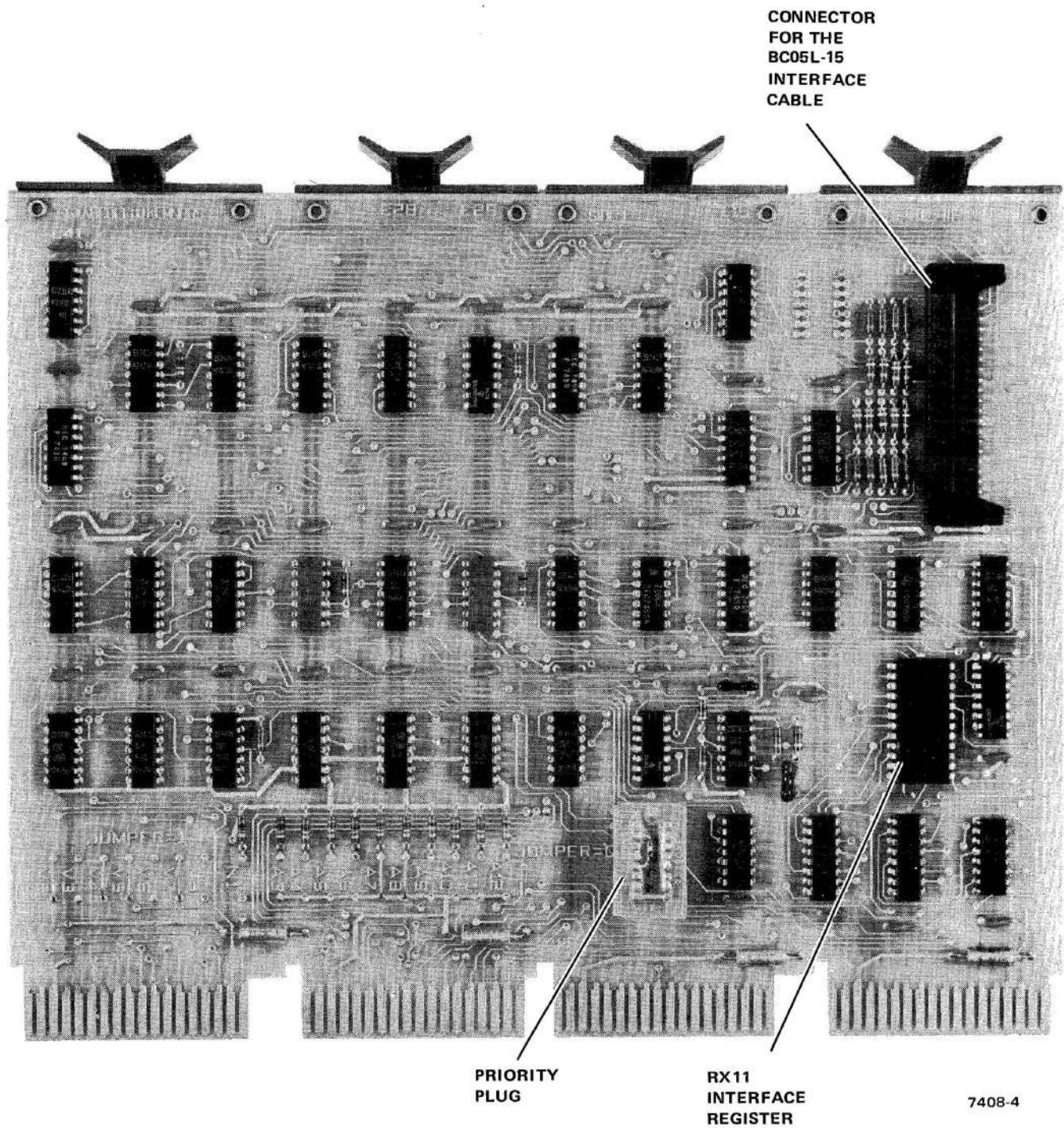
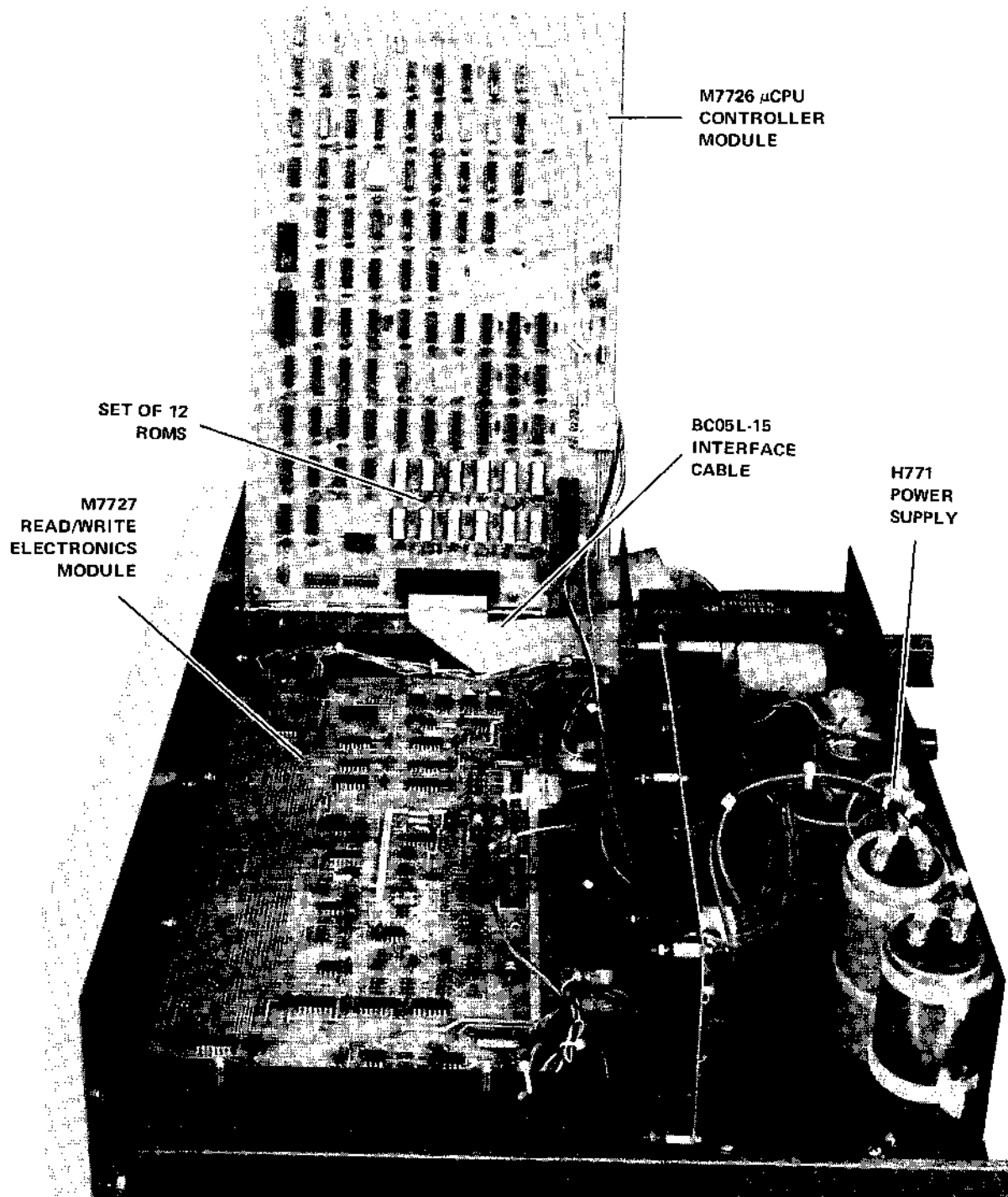

Figure 1-4 M7846 Module (RX11 Interface)



M7726 μ CPU
CONTROLLER
MODULE

SET OF 12
ROMS

M7727
READ/WRITE
ELECTRONICS
MODULE

BC05L-15
INTERFACE
CABLE

H771
POWER
SUPPLY

7408-8

Figure 1-5 Top View of the RX01

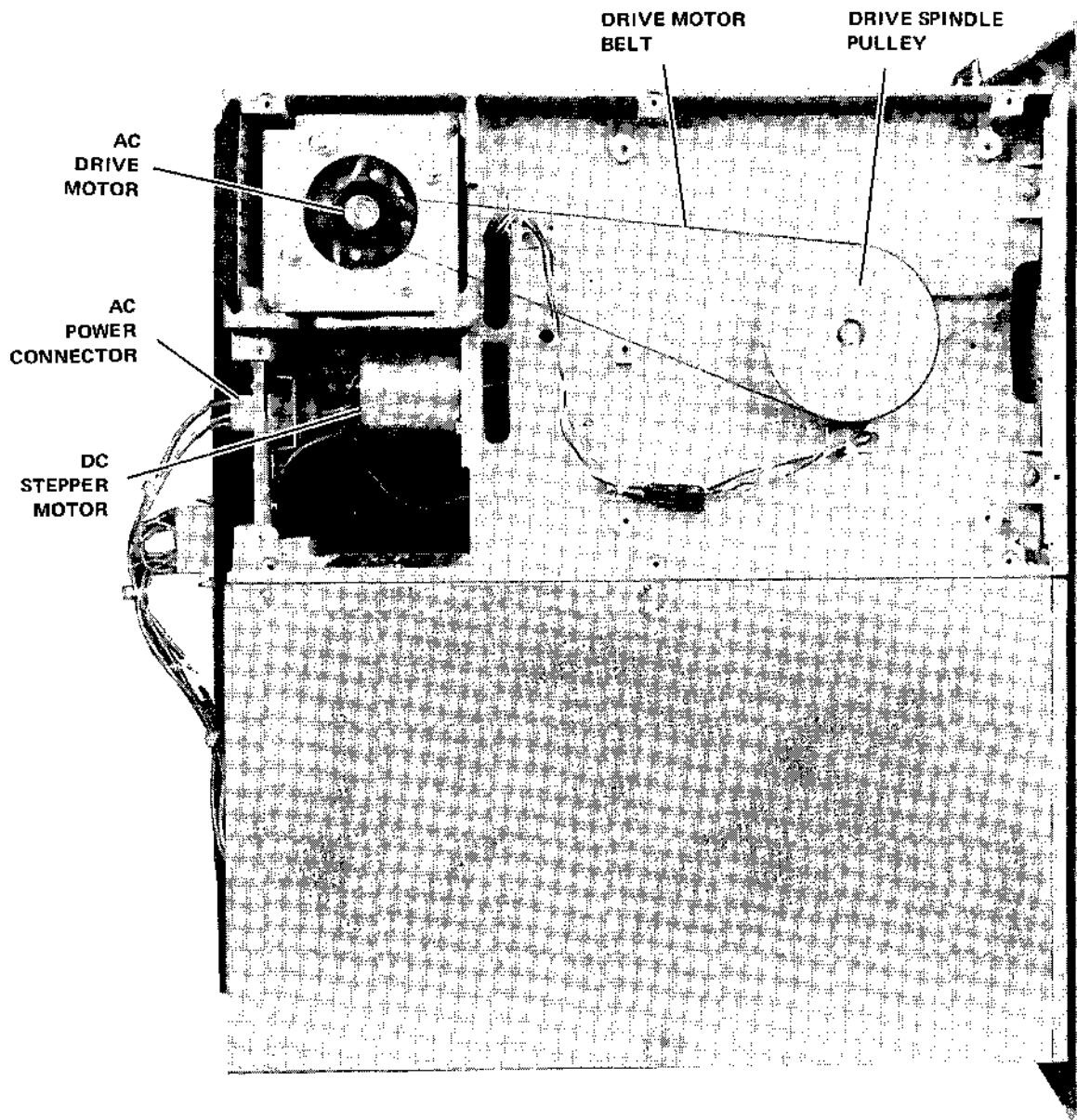

7408-5

Figure 1-6 Underside View of Drive

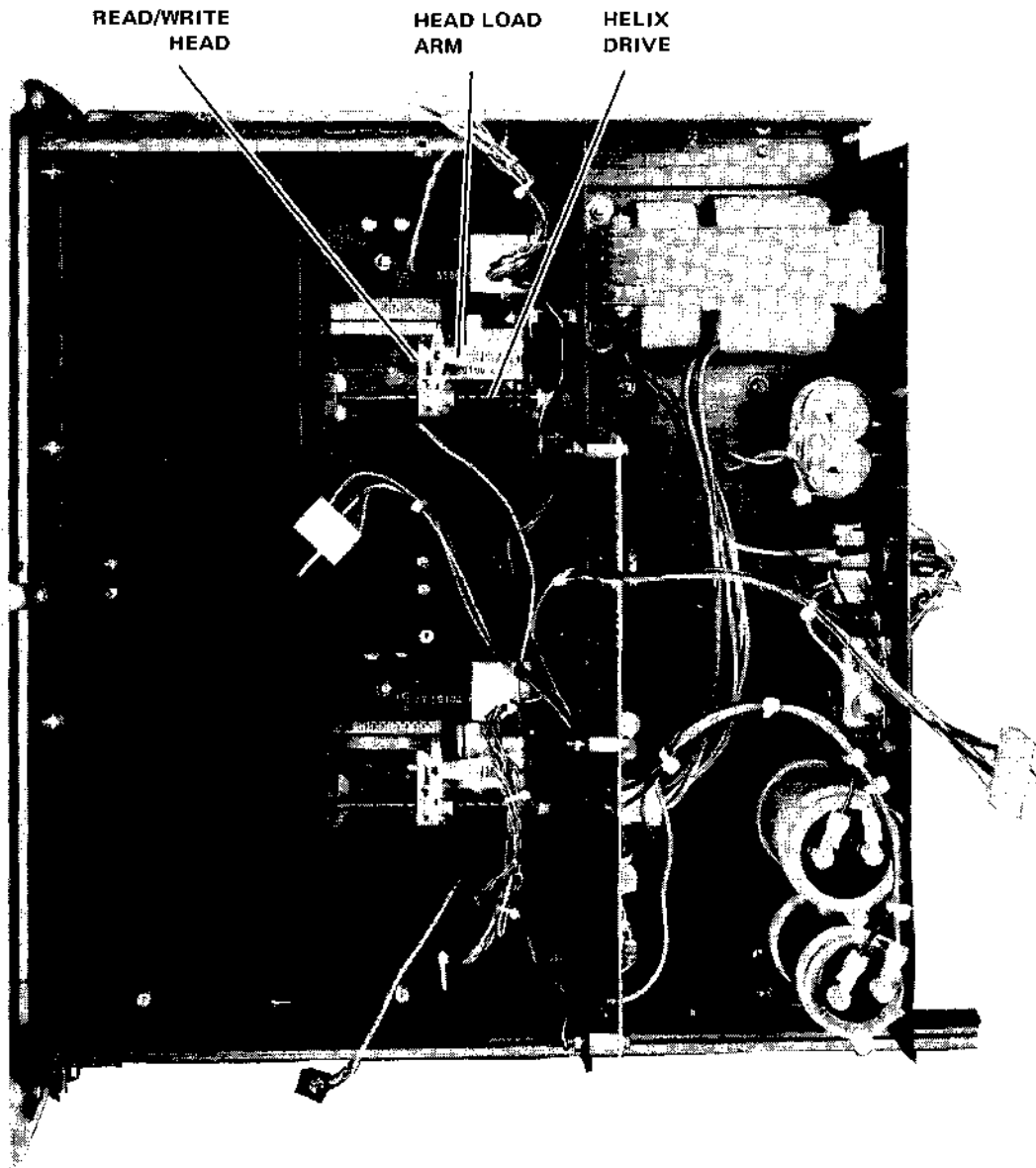

7408-7

Figure 1-7 Top View of Drive

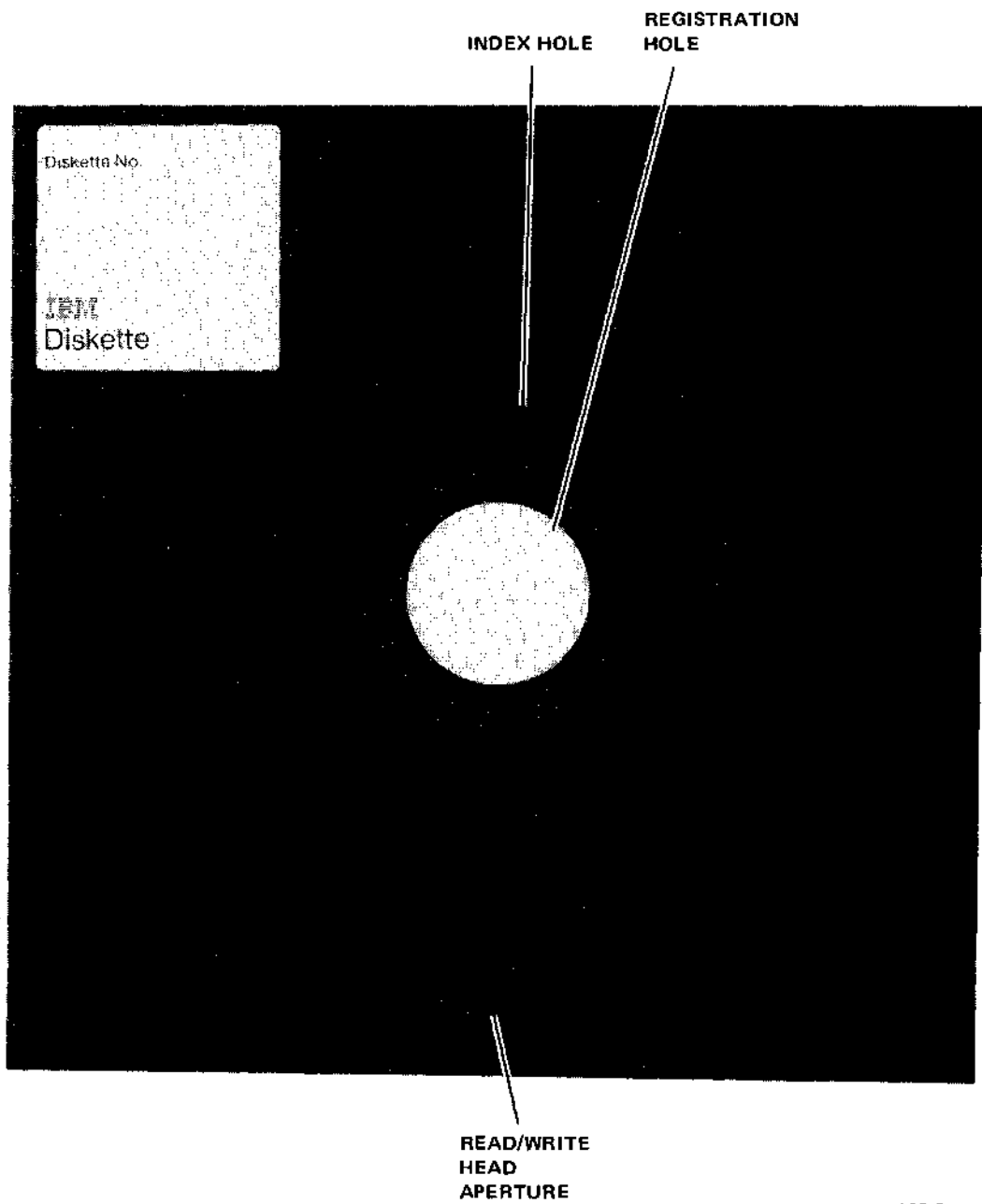

7408-2

Figure 1-8 Diskette Media

1.3.2 Recording Scheme

The recording scheme used is "double frequency." In this method, data is recorded between bits of a constant clock stream. The clock stream consists of a continuous pattern of 1 flux reversal every $4 \mu\text{s}$ (Figure 1-9). A data "one" is indicated by an additional reversal between clocks (i.e., doubling the bit stream frequency; hence the name). A data "zero" is indicated by no flux reversal between clocks.

A continuous stream of ones, shown in the bottom waveform in Figure 1-9, would appear as a "2F" bit stream, and a continuous stream of zeros, shown in the top waveform in Figure 1-9, would appear as a "1F" or fundamental frequency bit stream.

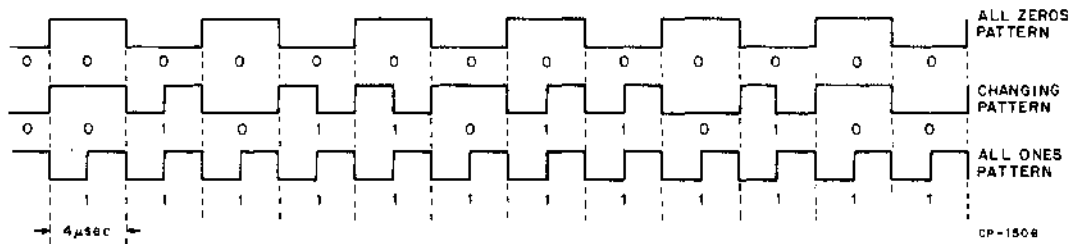

Figure 1-9 Flux Reversal Patterns

1.3.3 Logical Format

The logical format of the RX8 and RX11 Floppy Disk Systems is the same as that used in the IBM 3740.

Data is recorded on only one side of the diskette. This surface is divided into 77 concentric circles or "tracks" numbered 0–76. Each track is divided into 26 sectors numbered 1–26 (Figure 1-10). Each sector contains two major fields: the header field and the data field (Figure 1-11).

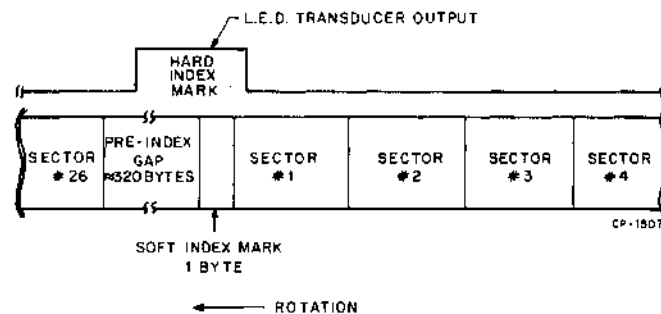

Figure 1-10 Track Format (Each Track)

1.3.3.1 Header Description – The header field is broken into seven bytes (eight bits/byte) of information and is preceded by a field of zeros for synchronization.

1. **Byte No. 1: ID Address Mark** – This is a unique stream of flux reversals (not a string of data bits) that is decoded by the controller to identify the beginning of the header field.
2. **Byte No. 2: Track Address** – This is the absolute ($0-114_8$) binary track address. Each sector contains track address information to identify its location on 1 of the 77 tracks.

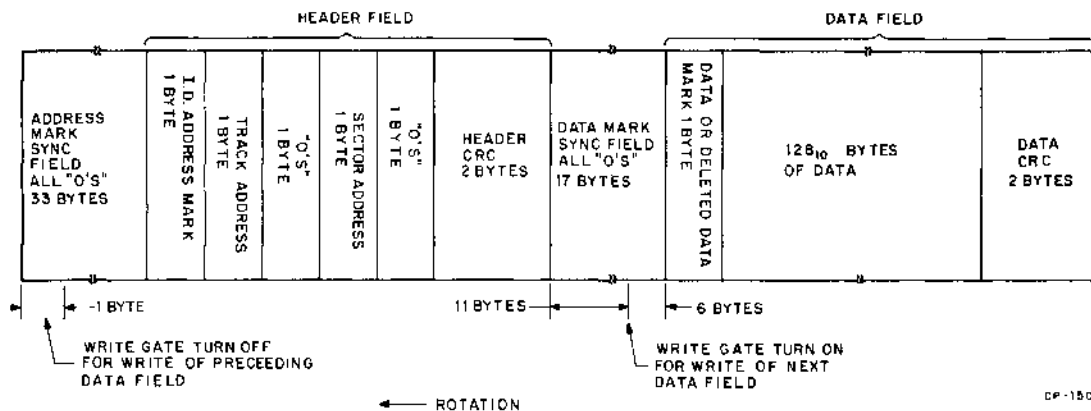

Figure 1-11 Sector Format (Each Sector)

3. Byte No. 3 – Zeros (one byte)
4. Byte No. 4: Sector Address This is the absolute binary sector address (1–32₈). Each sector contains sector address information to identify its circumferential position on a track.
5. Byte No. 5 – Zeros (one byte)
6. Bytes No. 6 and 7: CRC – This is the Cyclic Redundancy Check character that is calculated for each sector from the first five header bytes using a polynomial division algorithm designed to detect the types of failures most likely to occur with “double frequency” recorded data and the floppy media. The CRC is compatible with IBM 3740 series equipment.

1.3.3.2 Data Field Description – The data field is broken into 131 bytes of information and is preceded by a field of zeros for synchronization and the header field (Figure 1-11).

1. Byte No. 1: Data or Deleted Data Address Mark – This is a unique string of flux reversals (not a string of data bits) that is decoded by the controller to identify the beginning of the data field. The deleted data mark is not used during normal operation but the RX01 can identify and write deleted data marks under program control, as required. The deleted data mark is only included in the RX8/RX11 system to be IBM compatible. One or the other data address marks precedes each data field.
2. Bytes No. 2–129 – These bytes comprise the data field used to store 128 8-bit bytes of information.

NOTE

Partial data fields are not recorded.

3. Bytes No. 130 and 131 – These bytes comprise the CRC character that is calculated for each sector from the first 129 data field bytes using the industry standard polynomial division algorithm designed to detect the types of failures most likely to occur in double frequency recording on the floppy media.

1.3.3.3 Track Usage – In the IBM 3740 system, some tracks are commonly designated for special purposes such as error information, directories, spares, or unused tracks. The RX01 is capable of recreating any system structure through the use of special systems programs, but normal operation will make use of all the available tracks as data tracks. Any special file structures must be accomplished through user software.

1.3.3.4 CRC Capability – Each sector has a two-byte header CRC character and a two-byte data CRC character to ensure data integrity. The CRC characters are generated by the hardware during a write operation and checked to ensure all bits were read correctly during a read operation. The CRC character is the same as that used in the IBM 3740 series of equipment.

1.4 APPLICABLE INSTRUCTION MANUALS

This manual is designed to be used in conjunction with the RX8/RX11 Engineering Drawings. Other documents useful in operating and understanding the RX8/RX11 system are:

PDP-11 Processor Handbook*
PDP-11 Peripherals Handbook
PDP-8 Small Computer Handbook
PDP-8A User Manual

1.5 CONFIGURATION

Option number designations are as follows:

PDP-8 Systems

RX8-AA	Single drive system, 115 V, 60 Hz
RX8-AD	Single drive system, 50 Hz
RX8-BA	Dual drive system, 115 V/60 Hz
RX8-BD	Dual drive system, 50 Hz

PDP-11 Systems

RX11-AA	Single drive system, 115 V/60 Hz
RX11-AC	Single drive system, 50 Hz
RX11-BA	Dual drive system, 115 V/60 Hz
RX11-BD	Dual drive system, 50 Hz

NOTE

50 Hz versions are available in voltages of 105, 115, 220, 240 Vac by field pluggable conversion. See Paragraph 2.2.3.2 for complete input power modification requirements.

*Appropriate handbook for the particular processor used with the system.

1.6 SPECIFICATIONS

System Reliability

Minimum number of revolutions per track	1 million/media (head loaded)
Seek error rate	1 in 10^6 seeks
Soft read error rate	1 in 10^9 bits read
Hard read error rate	1 in 10^{12} bits read

NOTE

The above error rates *only* apply to media that is properly cared for. Seek error and soft read errors are usually attributable to random effects in the head/media interface, such as electrical noise, dirt, or dust. Both are called "soft" errors if the error is recoverable in ten additional tries or less. "Hard" errors cannot be recovered. Seek error retries should be preceded by an Initialize.

Drive Performance

Capacity	8-bit bytes	12-bit words
Per diskette	256,256 bytes	128,128 words
Per track	3,328 bytes	1,664 words
Per sector	128 bytes	64 words

Data transfer rate	
Diskette to controller buffer	4 μ s/data bit (250K bps)
Buffer to CPU interface	2 μ s/bit (500K bps)
CPU interface to I/O bus	18 μ s/8-bit byte (>50K bytes/sec)

NOTE

PDP-8 interface can operate in 8- or 12-bit modes under software control. The transfer rate is 23 μ s per 12-bit word (>40K bytes/sec).

Track-to-track move	10 ms/track maximum
Head settle time	20 ms maximum
Rotational speed	360 rpm \pm 2.5%; 166 ms/rev nominal
Recording surfaces per disk	1
Tracks per disk	77 (0-76) or (0-114 ₈)
Sectors per track	26 (1-26) or (1-32 ₈)
Recording technique	Double frequency
Bit density	3200 bpi at inner track
Track density	48 tracks/in.
Average access	488 ms, computed as follows:
	Seek Settle Rotate
	(77 tks/2) \times 10 ms + 20 ms + (166 ms/2) = 488 ms

Environmental Characteristics

Temperature

RX01, operating	15° to 32° C (59° to 90° F) ambient; maximum temperature gradient = 20° F/hr (11.1° C/hr)
RX01, nonoperating	-35° to +60° C (-30° to +140° F)
Media, operating	10° to 52° C (50° to 125° F)
Media, nonoperating	-35° to +52° C (-30° to +125° F)

NOTE

Media temperature must be within operating temperature range before use.

Relative humidity

RX01, operating	25° C (77° F) maximum wet bulb 2° C (36° F) minimum dew point 20% to 80% relative humidity
RX01, nonoperating	5% to 98% relative humidity (no condensation)
Media, nonoperating	10% to 80% relative humidity

Magnetic field

Media exposed to a magnetic field strength of 50 oersteds or greater may lose data.

Interface modules

Operating temperature	5° to 50° C (41° to 122° F)
Relative humidity	10% to 90%
Maximum wet bulb	32° C (90° F)
Minimum dew point	2° C (36° F)

Electrical

Power consumption

RX01	3 A at 24 V (dual), 75W; 5 A at 5 V, 25 W
PDP-11 interface (M7846)	Not more than 1.5 A at 5 Vdc
PDP-8 interface (M8357)	Not more than 1.5 A at 5 Vdc

AC power input

4 A at 115 Vac
2 A at 230 Vac

CHAPTER 2

INSTALLATION AND OPERATION

2.1 PURPOSE AND ORGANIZATION

This chapter provides information on installing and operating the RX8/RX11 Floppy Disk System. This information is organized into four sections as outlined below.

1. Site Preparation – The planning required to make the installation site suitable for operation of the floppy disk system, including space, cabling, and power requirements, and fire and safety precautions.
2. Environmental Considerations – The specific environmental characteristics of the floppy disk systems, i.e., temperature, relative humidity, air conditioning and/or heat dissipation, and cleanliness.
3. Installation – The actual step-by-step process of installing the floppy disk system from unpacking through the preliminary installation checks, power conversion techniques, and acceptance testing.
4. Operation Practices – The recommended practices for using the floppy disk system, handling the media, and shipping and storing the diskettes.

2.2 SITE PREPARATION

2.2.1 Space

The RX01 is a cabinet-mountable unit that may be installed in a standard Digital Equipment Corporation cabinet. This rack-mountable version is approximately 10-1/2 in. (28 cm) high, 19 in. (48 cm) wide, and 16-1/2 in. (42 cm) deep (Figure 2-1).

Provision should be made for service clearances of approximately 22 in. (56 cm) at the front and rear of the cabinet (Figure 2-2).

2.2.2 Cabling

The standard interface cable provided with an RX8/RX11 (BC05L-15) is 15 ft (4.6 m) in length, and the positioning of the RX01 in relation to the central processor should be planned to take this into consideration. The RX01 should be placed near the control console or keyboard so that the operator will have easy access to load or unload disks. The position immediately above the CPU is preferred. The ac power cord will be about 9 ft (2.7 m) long.

2.2.3 AC Power

2.2.3.1 Power Requirements – The RX01 is designed to use either a 60 Hz or a 50 Hz power source. The 60 Hz version (RX01-A) will operate from 90 to 132 Vac, without modifications, and will use less than 4 A operating. The 50 Hz version (RX01-D) will operate within four voltage ratings and will require field verification/modification to ensure that the correct voltage option is selected. The voltage ranges of 90 to 120 Vac and 180 to 240 Vac will use less than 4 A operating. The voltage ranges of 100–132 Vac and 200–264 Vac will use less than 2 A. Both versions of the RX01 will be required to receive the input power from an ac source (e.g., 861 power control) that is controlled by the system's power switch.

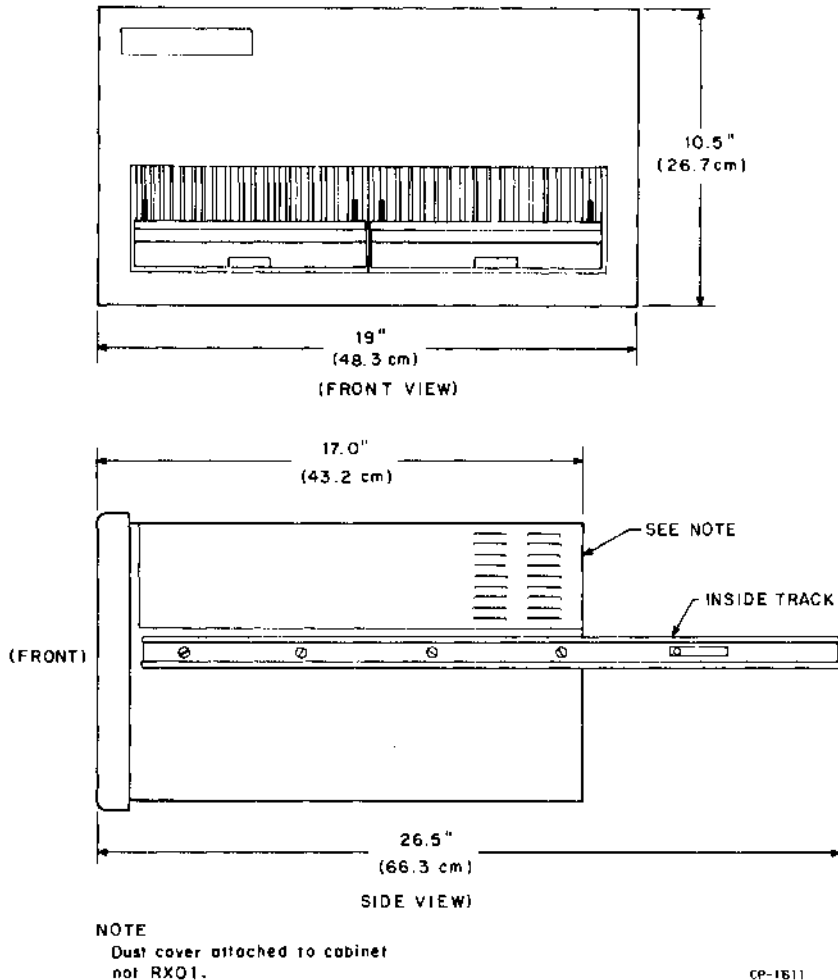

Figure 2-1 RX01

2.2.3.2 Input Power Modification Requirements – The 60 Hz version of the RX01 uses the H771A power supply and will operate on 90 to 132 Vac, without modification. To convert to operate on a 50 Hz power source in the field, the H771A supply must be replaced with an H771C or D (Figure 1-5) and the drive motor belt and drive motor pulley must be replaced (Figure 1-6). The 50 Hz version of the RX01 uses either the H771C or D power supply. The H771C operates on a 90–120 Vac or 100–132 Vac power source. The H771D operates on a 180–240 Vac or 200–264 Vac power source. To convert the H771C to the higher voltage ranges or the H771D to the lower voltage ranges, the power harness and circuit breaker must be changed. See Figure 2-3 for appropriate power harness and circuit breaker.

2.2.4 Fire and Safety Precautions

The RX8/RX11 Floppy Disk System presents no additional fire or safety hazards to an existing computer system. Wiring should be carefully checked, however, to ensure that the capacity is adequate for the added load and for any contemplated expansion.

2.3 ENVIRONMENTAL CONSIDERATIONS

2.3.1 General

The RX8/RX11 is capable of efficient operation in computer environments; however, the parameters of the operating environment must be determined by the most restrictive facets of the system, which in this case are the diskettes.

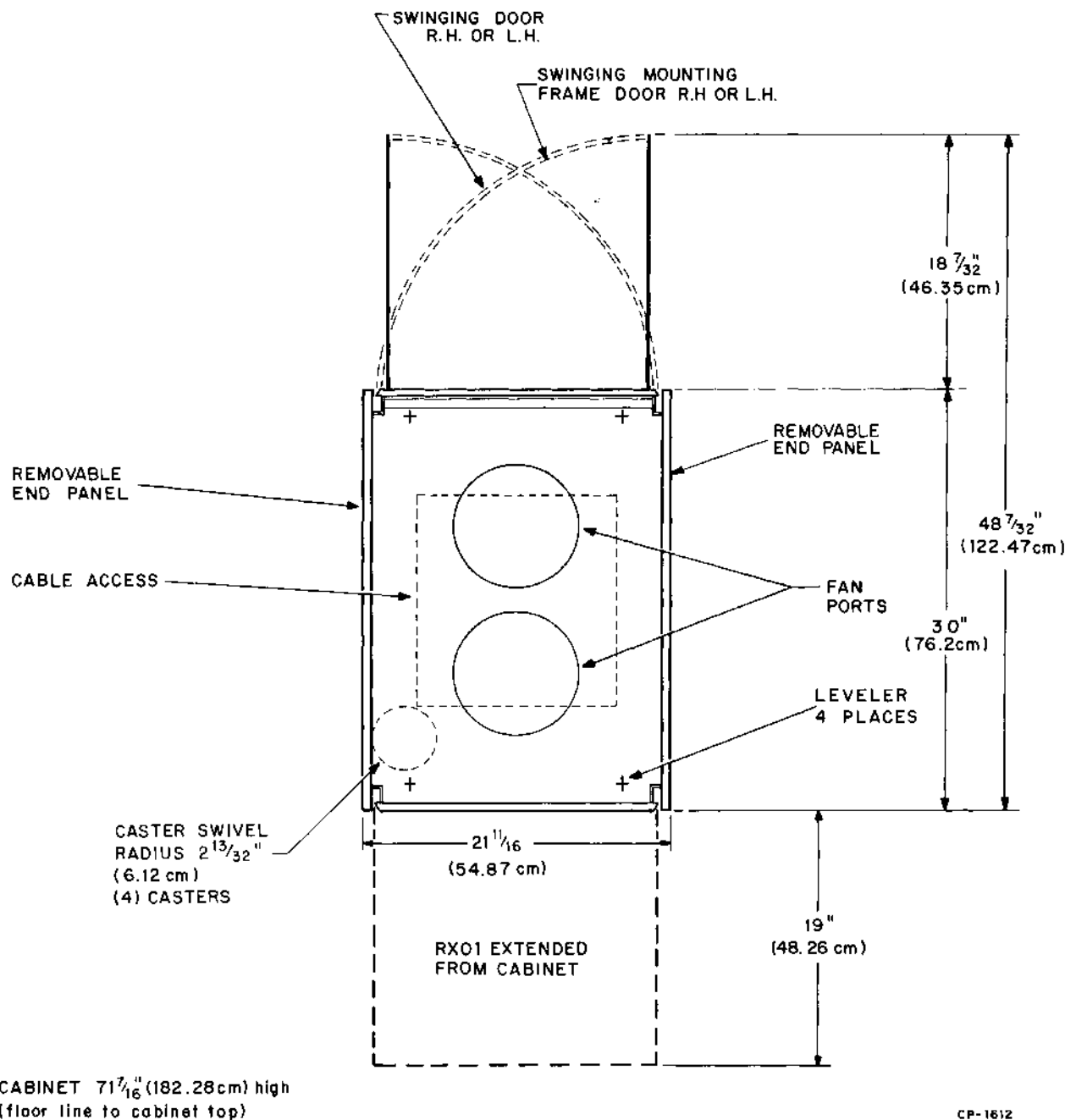

Figure 2-2 Cabinet Layout Dimensions

2.3.2 Temperature, Relative Humidity

The operating ambient temperature range of the diskette is 59° to 90° F (15° to 32° C) with a maximum temperature gradient of 20° F/hr (-6.7° C/hr).

The media nonoperating temperature range (storage) is increased to -30° to 125° F (-34.4° to 51.6° C), but care must be taken to ensure that the media has stabilized within the operating temperature range before use. This range will ensure that the media will not be operated above its absolute temperature limit of 125° F.

Humidity control is important in any system because static electricity can cause errors in any CPU with memory. The RX01 is designed to operate efficiently within a relative humidity range of 20 to 80 percent, with a maximum wet bulb temperature of 77° F (25° C) and a maximum dew point of 36° F (2° C).

2.3.3 Heat Dissipation

The heat dissipation factor for the RX01 Floppy Disk System is less than 225 Btu/hr. By adding this figure to the total heat dissipation for the other system components and then adjusting the result to compensate for such factors as the number of personnel, the heat radiation from adjoining areas, and sun exposure through windows, the approximate cooling requirements for the system can be determined. It is advisable to allow a safety margin of at least 25 percent above the maximum estimated requirements.

2.3.4 Radiated Emissions

Sources of radiation, such as FM, vehicle ignitions, and radar transmitters located close to the computer system, may affect the performance of the RX8/RX11 Floppy Disk System because of the possible adverse effects magnetic fields can have on diskettes. A magnetic field with an intensity of 50 oersteds or greater might destroy all or some of the information recorded on the diskette.

2.3.5 Cleanliness

Although cleanliness is important in all facets of a computer system, it is particularly important in the case of moving magnetic media, such as the RX01. Diskettes are not sealed units and are vulnerable to dirt. Such minute obstructions as dust specks or fingerprint smudges may cause data errors. Therefore, the RX01 should not be subjected to unusually contaminated atmospheres, especially one with abrasive airborne particles. (Refer to Paragraph 2.5.2.)

NOTE

Removable media involve use, handling, and maintenance which are beyond DEC's direct control. DEC disclaims responsibility for performance of the equipment when operated with media not meeting DEC specifications or with media not maintained in accordance with procedures approved by DEC. DEC shall not be liable for damages to the equipment or to media resulting from such operation.

2.4 INSTALLATION

2.4.1 General

The RX8/RX11 Floppy Disk System can be shipped in a cabinet as an integral part of a system or in a separate container. If the RX01 is shipped in a cabinet, the cabinet should be positioned in the final installation location before proceeding with the installation.

2.4.2 Tools

Installation of an RX8/RX11 Floppy Disk System requires no special tools or equipment. Normal hand tools are all that are necessary. However, a forklift truck or pallet handling equipment may be needed for receiving and installing a cabinet-mounted system.

2.4.3 Unpacking and Inspection

2.4.3.1 Cabinet-Mounted

1. Remove the protective covering over the cabinet.
2. Remove the restraint on the rear door latch and open the door.

3. Remove the two bolts on the cabinet's lower side rails that attach the cabinet to the pallet.
4. Raise the four levelers at the corners of the cabinet, allowing the cabinet to roll on the casters.
5. Carefully roll the cabinet off the pallet; if a forklift is available, it should be used to lift and move the cabinet.
6. Remove the shipping restraint from the RX01 and save it for possible reuse (Figure 2-3).
7. Slide the RX01 out on the chassis slides and visually inspect for any damage, loose screws, loose wiring, etc.

NOTE

If any shipping damage is found, the customer should be notified at this time so he can contact the carrier, and record the information on the acceptance form.

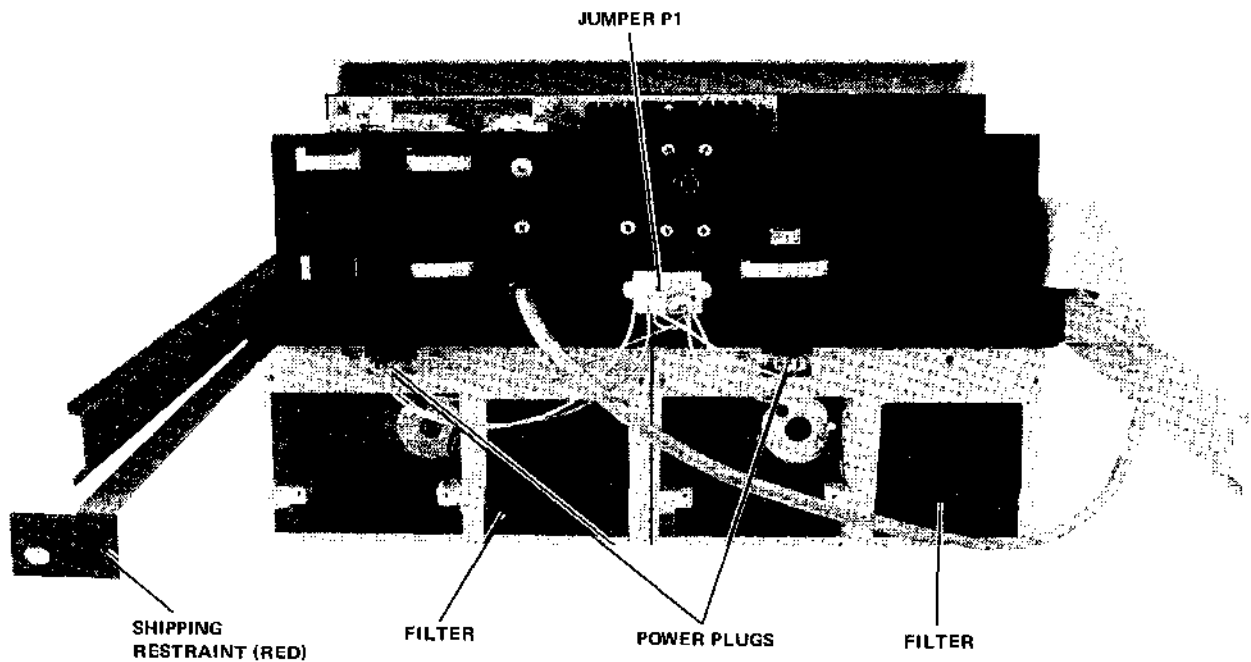

7436-12

VOLTAGE (Vac)	POWER HARNESS	CIRCUIT BREAKER
90-120	70-10696-02	3.5 A, 12-12301-01
100-132	70-10696-01	3.5 A, 12-12301-01
180-240	70-10696-04	1.75 A, 12-12301-00
200-264	70-10696-03	1.75 A, 12-12301-00

Figure 2-3 RX01 Shipping Restraints

2.4.3.2 Separate Container

1. Open the carton (Figure 2-4) and remove the corrugated packing pieces.
2. Lift the RX01 out of the carton and remove the plastic shipping bag.
3. Remove the shipping fixtures from both sides of the RX01 and inspect for shipping damage.
4. Attach the inside tracks of the chassis slides provided in the carton to the RX01 (Figure 2-1).
5. Locating the proper holes in the cabinet rails (Figure 2-5), attach the outside tracks to the cabinet.
6. Place the tracks attached to the RX01 inside the extended cabinet tracks and slide the unit in until the tracks lock in the extended position.
7. Locate the RX01 cover in the cabinet above the unit and secure it to the cabinet rails (Figure 2-3).

2.4.4 Installation

1. Loosen the screws securing the upper module (M7726) and swing it up on the hinge.
2. Inspect the wiring and connectors for proper routing and ensure that they are seated correctly.
3. This step is for 50 Hz versions only. Check the power configuration to ensure that the proper power harness and the correct circuit breaker are installed (Figure 2-3).
4. Connect the BC05L-15 cable to the M7726 module and route it through the back of the RX01 (Figure 2-6) to the CPU, then connect it to the interface module (RX8E, M8357; RX11, M7846).
5. Refer to Table 2-1 for correct device code or addressing jumpers.
6. Ensure that power for the system is off.
7. Insert the interface module into the Omnibus (RX8E) or available SPC slot (RX11). (Refer to *PDP-11 Processor Handbook*, Specifications, Chapter 9.)
8. Connect the RX01 ac power cord into a switched power source.
9. Turn the power on, watching for head movement on the drive(s) during the power up, initialize phase. The head(s) should move ten tracks toward the center and back to track 0.
10. Perform the diagnostic in the sequence listed below for the number of passes (time) indicated. If any errors occur, refer to Chapter 6 for corrective action.

RX8 or RX11 Diagnostic – 2 passes
Data Reliability/Exerciser – 3 passes
DECX-8 or DECX-11 – 10 minutes

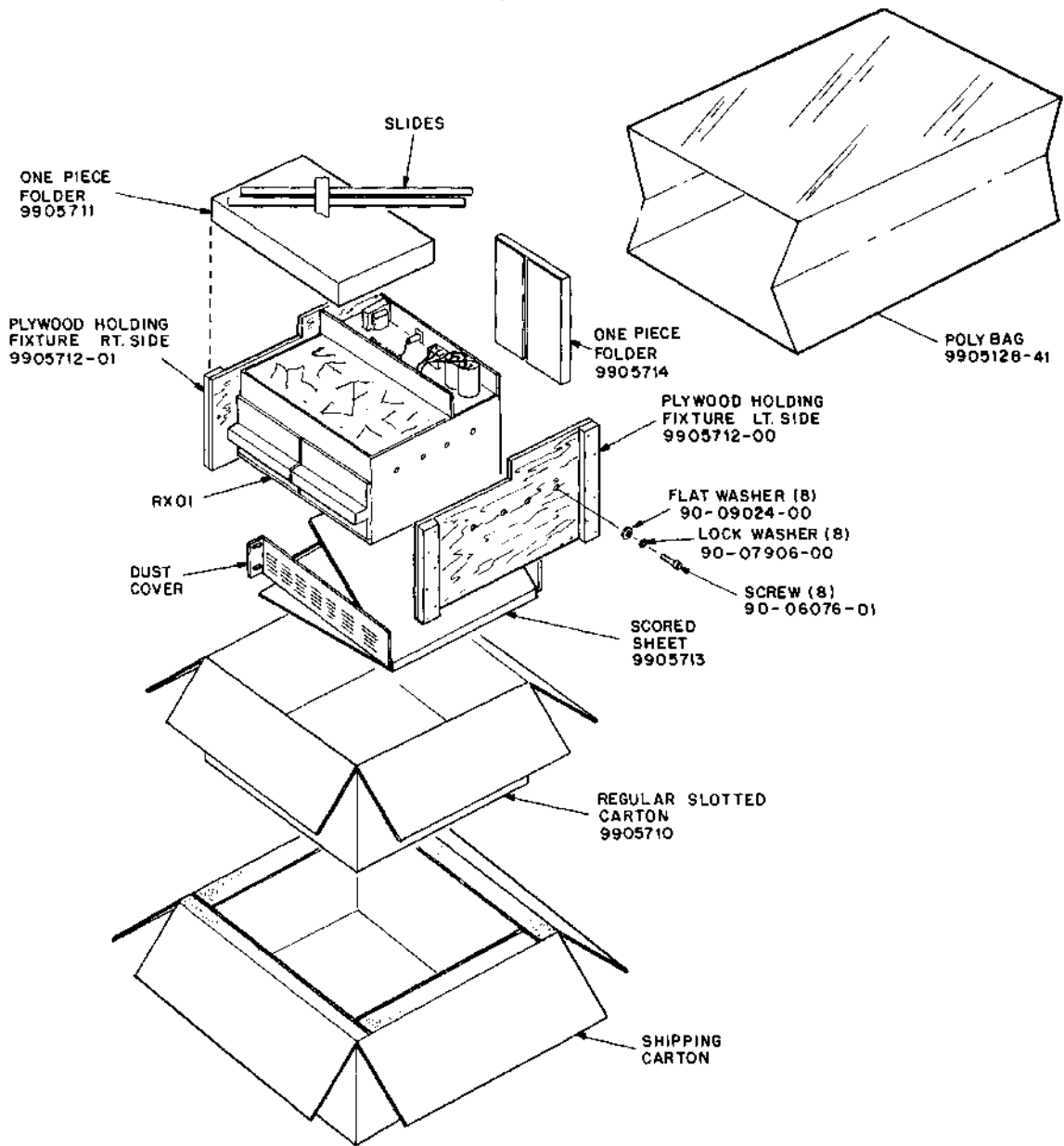

CP-1596

Figure 2-4 RX8/RX11 Unpacking

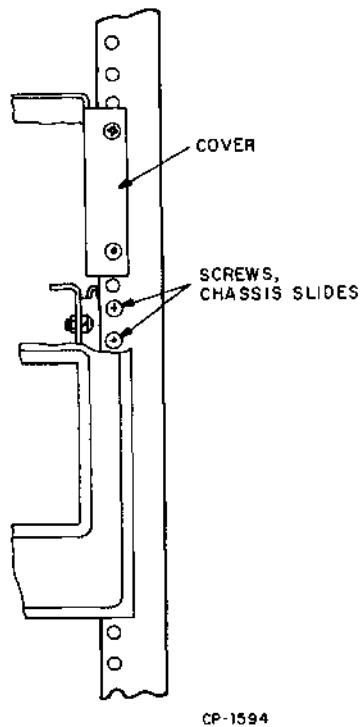

Figure 2-5 RX01 Cabinet Mounting Information

2.5 OPERATION

2.5.1 Operator Control

The simplicity of the RX01 precludes the necessity of operator controls and indicators. A convenient method of opening the unit for diskette insertion and removal is provided. On each drive is a simple pushbutton, which is compressed to allow the spring-loaded front cover to open. The diskette may be inserted or removed, as shown in Figure 2-7, with the label up. The front cover will automatically lock when the bar is pushed down.

CAUTION

The drive(s) should not be opened while they are being accessed because data may be incorrectly recorded, resulting in a CRC error when the sector is read.

2.5.2 Diskette Handling Practices and Precautions

To prolong the diskette life and prevent errors when recording or reading, reasonable care should be taken when handling the media. The following handling recommendations should be followed to prevent unnecessary loss of data or interruptions of system operation.

1. Do not write on the envelope containing the diskette. Write any information on a label prior to affixing it to the diskette.
2. Paper clips should not be used on the diskette.
3. Do not use writing instruments that leave flakes, such as lead or grease pencils, on the jacket of the media.

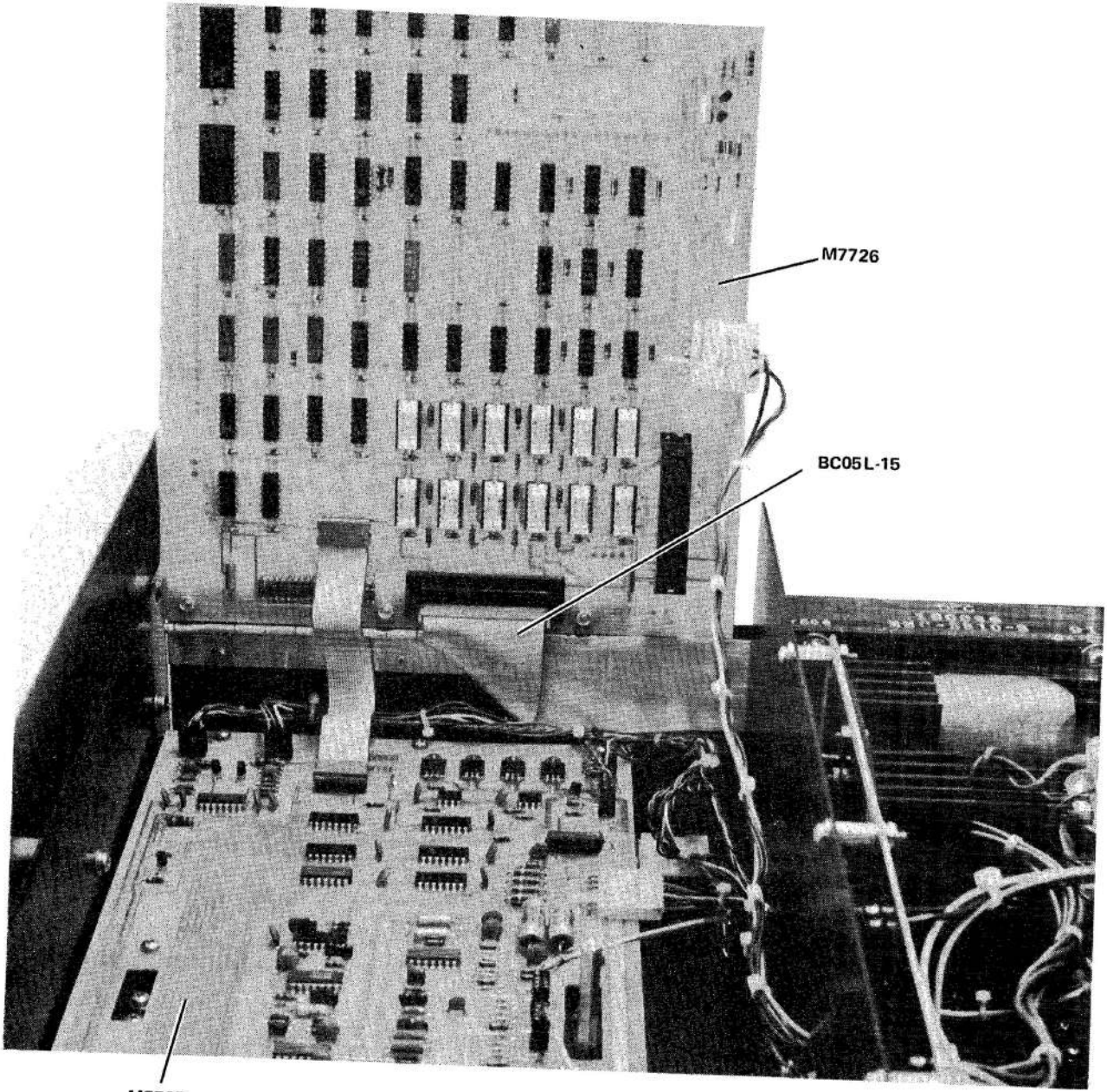

M7727

M7726

BC05L-15

Figure 2-6 Cable Routing, BC05L-15

7436-18

Table 2-1
Interface Code/Jumper Configuration

RX11 (M7846)

BR Priority

BR7 – 54-08782
 BR6 – 54-08780
 *BR5 – 54-08778
 BR4 57-08776

RX8E (M8357)

Device Codes

	SW1	SW2	SW3	SW4	SW5	SW6
*670X	ON	ON	ON	OFF	OFF	OFF
671X	ON	ON	OFF	OFF	OFF	ON
672X	ON	OFF	ON	OFF	ON	OFF
673X	ON	OFF	OFF	OFF	ON	ON
674X	OFF	ON	ON	ON	OFF	OFF
675X	OFF	ON	OFF	ON	OFF	ON
676X	OFF	OFF	ON	ON	ON	OFF
677X	OFF	OFF	OFF	ON	ON	ON

**Unibus Address 17717X*

A12/W18 – Removed
 A11/W17 – Removed
 A10/W16 – Removed
 A9/W15 – Removed
 A8/W14 -- Installed
 A7/W13 – Installed
 A6/W12 – Removed
 A5/W11 – Removed
 A4/W10 – Removed
 A3/W9 – Removed

**Vector Address (264₈)*

V2/W1 – Installed
 V3/W2 – Installed
 V4/W3 – Removed
 V5/W4 – Installed
 V6/W5 – Removed
 V7/W6 – Installed
 V8/W7 – Removed

*Standard

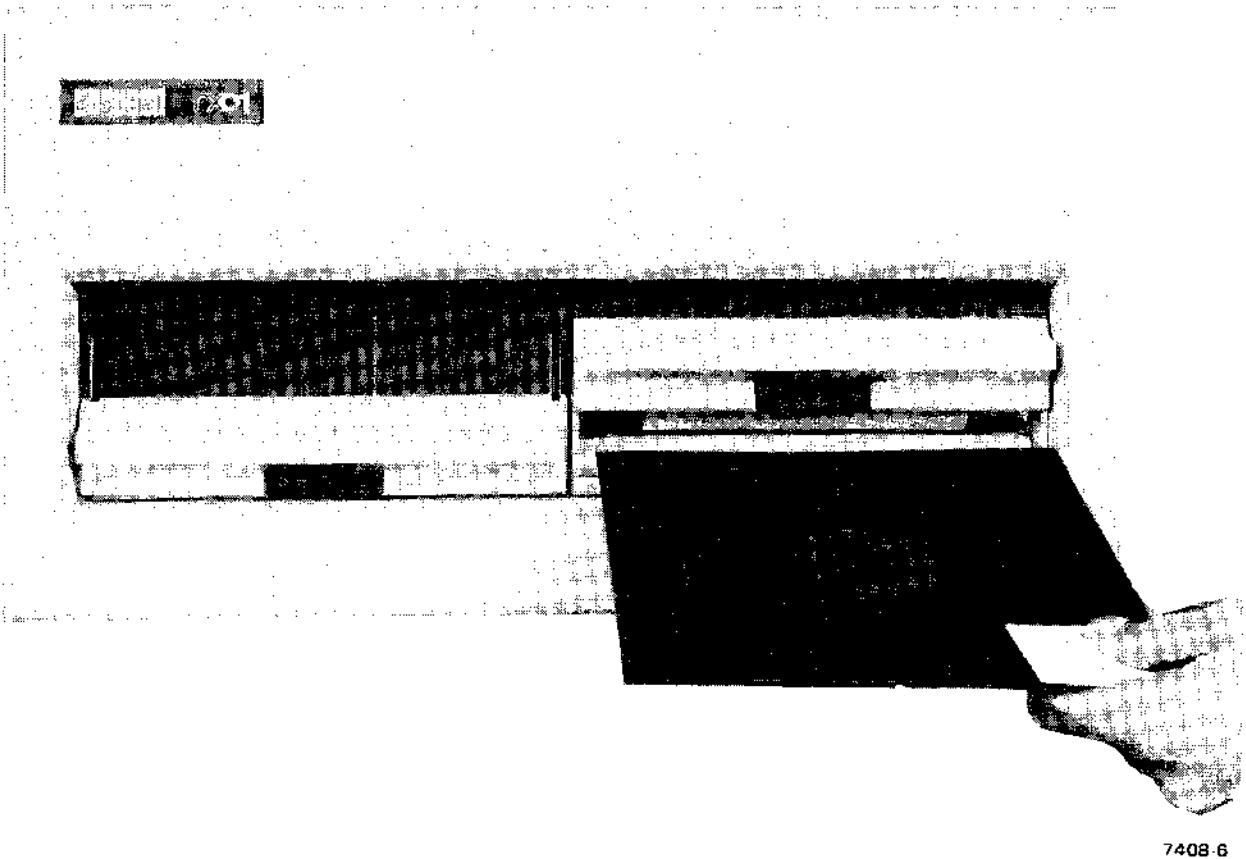

Figure 2-7 Flexible Diskette Insertion

4. Do not touch the disk surface exposed in the diskette slot or index hole.
5. Do not clean the disk in any manner.
6. Keep the diskette away from magnets or tools that may have become magnetized. Any disk exposed to a magnetic field may lose information.
7. Do not expose the diskette to a heat source or sunlight.
8. Always return the diskette to the envelope supplied with it to protect the disk from dust and dirt. Diskettes not being used should be stored in the file box if possible.
9. When the diskette is in use, protect the empty envelope from liquids, dust, and metallic materials.
10. Do not place heavy items on the diskette.
11. Do not store diskettes on top of computer cabinets or in places where dirt can be blown by fans into the diskette interior.
12. If a diskette has been exposed to temperatures outside of the operating range, allow 5 minutes for thermal stabilization before use. The diskette should be removed from its packaging during this time.

2.5.3 Diskette Storage

2.5.3.1 Short Term (Available for Immediate Use)

1. Store diskettes in their envelopes.
2. Store horizontally, in piles of ten or less. If vertical storage is necessary, the diskettes should be supported so that they do not lean or sag, but should not be subjected to compressive forces. Permanent deformation may result from improper storage.
3. Store in an environment similar to that of the operating system; at a minimum, store within the operating environment range.

2.5.3.2 Long Term – When diskettes do not need to be available for immediate use, they should be stored in their original shipping containers within the nonoperating range of the media.

2.5.4 Shipping Diskettes

Data recorded on disks may be degraded by exposure to any sort of small magnet brought into close contact with the disk surface. If diskettes are to be shipped in the cargo hold of an aircraft, take precautions against possible exposure to magnetic sources. Because physical separation from the magnetic source is the best protection against accidental erasure of a diskette, diskettes should be packed at least 3 in. within the outer box. This separation should be adequate to protect against any magnetic sources likely to be encountered during transportation, making it generally unnecessary to ship diskettes in specially shielded boxes.

When shipping, be sure to label the package:

DO NOT EXPOSE TO PROLONGED HEAT OR SUNLIGHT.

When received, the carton should be examined for damage. Deformation of the carton should alert the receiver to possible damage of the diskette. The carton should be retained, if it is intact, for storage of the diskette or for future shipping.

CHAPTER 3

RX11 INTERFACE

PROGRAMMING INFORMATION

This chapter describes device registers, register and vector address assignments, programming specifications, and programming examples for the RX11 interface.

All software control of the RX11 is performed by means of two device registers: the RX11 Command and Status register (RXCS) and a multipurpose RX11 Data Buffer register (RXDB). These registers have been assigned bus addresses and can be read or loaded, with certain exceptions, using any instruction referring to their addresses.

The RX01, which includes the mechanical drive(s), read/write electronics, and μ CPU controller, contains all the control circuitry required for implied seeks, automatic head position verification, and calculation and verification of the CRC; it has a buffer large enough to hold one full sector of diskette data (128 8-bit bytes). Information is serially passed between the interface and the RX01.

A typical diskette write sequence, which is initiated by a user program, would occur in two steps:

1. **Fill Buffer** – A command to fill the buffer is moved into the RXCS. The Go bit (Paragraph 3.2.1) must be set. The program tests for Transfer Request (TR). When TR is detected, the program moves the first of 128 bytes of data to the RXDB. TR goes false while the byte is moved into the RX01. The program retests TR and moves another byte of data when TR is true. When the RX01 sector buffer is full, the Done bit will set, and an interrupt will occur if the program has enabled interrupts.
2. **Write Sector** – A command to write the contents of the buffer onto the disk is issued to the RXCS. Again the Go bit must be set. The program tests TR, and when TR is true, the program moves the desired sector address to the RXDB. TR goes false while the RX01 handles the sector address. The program again waits for TR and moves the desired track address to the RXDB, and again TR is negated. The RX01 locates the desired track and sector, verifies its location, and writes the contents of the sector buffer onto the diskette. When this is done, an interrupt will occur if the program has enabled interrupts.

A typical diskette read occurs in just the reverse way: first locating and reading a sector into the buffer (Read Sector) and then unloading the buffer into core (Empty Buffer). In either case, the content of the buffer is not valid if Power Fail or Initialize follows a Fill Buffer or Read Sector function.

3.1 REGISTER AND VECTOR ADDRESSES

The RXCS register is normally assigned Unibus address 177170, and the RXDB register is assigned Unibus address 177172. The normal BR priority level is 5, but it can be changed by insertion of a different priority plug located on the interface module. The vector address is 264.

3.2 REGISTER DESCRIPTION

3.2.1 RXCS – Command and Status (177170)

Loading this register while the RX01 is not busy and with bit 0 = 1 will initiate a function as described below and indicated in Figure 3-1. Bits 0--4 write-only bits.

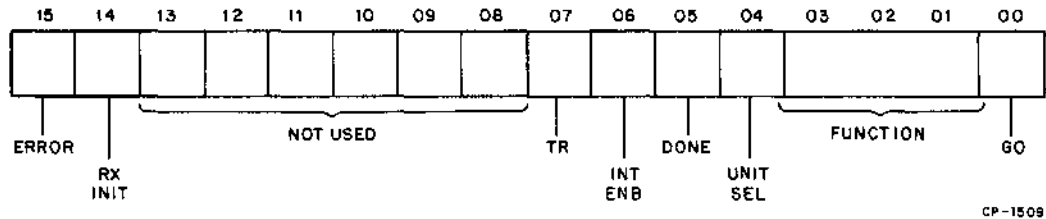

Figure 3-1 RXCS Format (RX11)

Bit No.	Description																		
0	Go – Initiates a command to RX01. This is a write-only bit.																		
1–3	Function Select – These bits code one of the eight possible functions described in Paragraph 3.3 and listed below. These are write-only bits.																		
	<table border="1"> <thead> <tr> <th>Code</th> <th>Function</th> </tr> </thead> <tbody> <tr> <td>000</td> <td>Fill Buffer</td> </tr> <tr> <td>001</td> <td>Empty Buffer</td> </tr> <tr> <td>010</td> <td>Write Sector</td> </tr> <tr> <td>011</td> <td>Read Sector</td> </tr> <tr> <td>100</td> <td>Not used</td> </tr> <tr> <td>101</td> <td>Read Status</td> </tr> <tr> <td>110</td> <td>Write Deleted Data Sector</td> </tr> <tr> <td>111</td> <td>Read Error Register</td> </tr> </tbody> </table>	Code	Function	000	Fill Buffer	001	Empty Buffer	010	Write Sector	011	Read Sector	100	Not used	101	Read Status	110	Write Deleted Data Sector	111	Read Error Register
Code	Function																		
000	Fill Buffer																		
001	Empty Buffer																		
010	Write Sector																		
011	Read Sector																		
100	Not used																		
101	Read Status																		
110	Write Deleted Data Sector																		
111	Read Error Register																		
4	Unit select – This bit selects one of the two possible disks for execution of the desired function. This is a write-only bit. Unit 0 is physically the left-hand unit in the rack.																		
5	Done -- This bit indicates the completion of a function. Done will generate an interrupt when asserted if Interrupt Enable (RXCS bit 6) is set. This is a read-only bit.																		
6	Interrupt Enable – This bit is set by the program to enable an interrupt when the RX01 has completed an operation (Done). The condition of this bit is normally determined at the time a function is initiated. This bit is cleared by Initialize and is a read/write bit.																		
7	Transfer Request – This bit signifies that the RX11 needs data or has data available. This is a read-only bit.																		
8–13	Unused																		

Bit No.	Description
14	RX11 Initialize – This bit is set by the program to initialize the RX11 without initializing all of the devices on the Unibus. This is a write-only bit.

CAUTION

Loading the lower byte of the RXCS will also load the upper byte of the RXCS.

Upon setting this bit in the RXCS, the RX11 will negate Done and move the head position mechanism of drive 1 (if two are available) to track 0. Upon completion of a successful Initialize, the RX01 will zero the Error and Status register, set Initialize Done, and set RXES bit 7 (DRV RDY) if unit 0 is ready. It will also read sector 1 of track 1 on drive 0.

15	Error – This bit is set by the RX01 to indicate that an error has occurred during an attempt to execute a command. This read-only bit is cleared by the initiation of a new command or an Initialize (Paragraph 3.6).
----	--

3.2.2 RXDB – Data Buffer Register (177172)

This register serves as a general purpose data path between the RX01 and the interface. It may represent one of four RX01 registers according to the protocol of the function in progress (Paragraph 3.3).

This register is read/write if the RX01 is not in the process of executing a command; that is, it may be manipulated without affecting the RX01 subsystem. If the RX01 is actively executing a command, this register will only accept data if RXCS bit 7 (TR) is set. In addition, valid data can only be read when TR is set.

CAUTION

Violation of protocol in manipulation of this register may cause permanent data loss.

3.2.2.1 RXTA – RX Track Address (Figure 3-2) – This register is loaded to indicate on which of the 115₈ tracks a given function is to operate. It can be addressed only under the protocol of the function in progress (Paragraph 3.3). Bits 8 through 15 are unused and are ignored by the control.

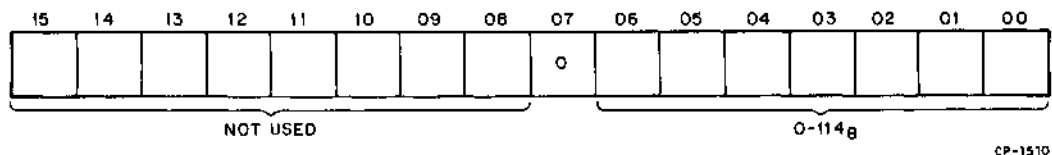

Figure 3-2 RXTA Format (RX11)

3.2.2.2 RXSA – RX Sector Address (Figure 3-3) – This register is loaded to indicate on which of the 32₈ sectors a given function is to operate. It can be addressed only under the protocol of the function in progress (Paragraph 3.3). Bits 8 through 15 are unused and are ignored by the control.

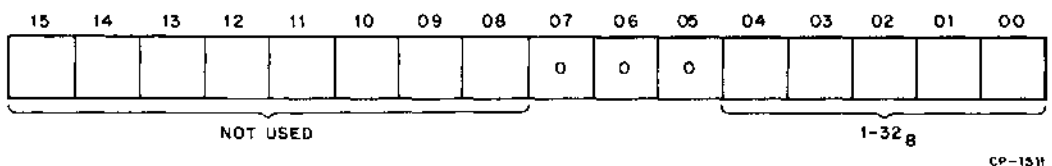

Figure 3-3 RXSA Format (RX11)

3.2.2.3 **RXDB – RX Data Buffer** (Figure 3-4) – All information transferred to and from the floppy media passes through this register and is addressable only under the protocol of the function in progress (Paragraph 3.3).

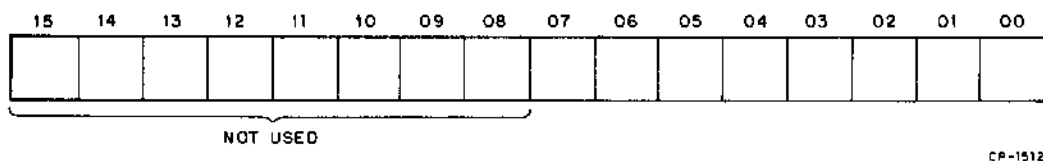

Figure 3-4 RXDB Format (RX11)

3.2.2.4 **RXES – RX Error and Status** (Figure 3-5) – This register contains the current error and status conditions of the drive selected by bit 4 (Unit Select) of the RXCS. This read-only register can be addressed only under the protocol of the function in progress (Paragraph 3.3). The RXES is located in the RXDB upon completion of a function.

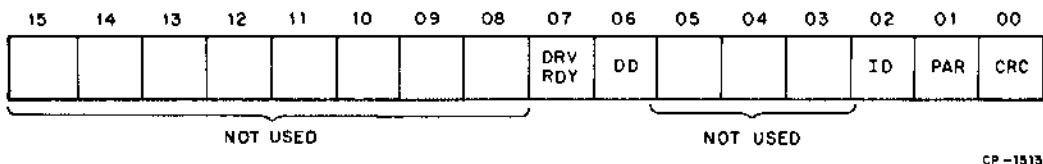

Figure 3-5 RXES Format (RX11)

RXES bit assignments are:

Bit No.	Description
0	CRC Error – A cyclic redundancy check error was detected as information was retrieved from a data field of the diskette. The RXES is moved to the RXDB, and Error and Done are asserted.
1	Parity Error – A parity error was detected on command or address information being transferred to the RX01 from the Unibus interface. A parity error indication means that there is a problem in the interface cable between the RX01 and the interface. Upon detection of a parity error, the current function is terminated; the RXES is moved to the RXDB, and Error and Done are asserted.
2	Initialize Done – This bit is asserted in the RXES to indicate completion of the Initialize routine which can be caused by RX01 power failure, system power failure, or programmable or Unibus Initialize.
3–5	Unused
6	Deleted Data Detected – During data recovery, the identification mark preceding the data field was decoded as a deleted data mark (Paragraph 1.3.3).

Bit No.	Description
7	Drive Ready – This bit is asserted if the unit currently selected exists, is properly supplied with power, has a diskette installed correctly, has its door closed, and has a diskette up to speed.

NOTE 1

The Drive Ready bit is only valid when retrieved via a Read Status function or at completion of Initialize when it indicates status of drive 0.

NOTE 2

If the Error bit was set in the RXCS but Error bits are not set in the RXES, then specific error conditions can be accessed via a Read Error Register function (Paragraph 3.3.7).

3.3 FUNCTION CODES

Following the strict protocol of the individual function, data storage and recovery on the RX11 occur with careful manipulation of the RXCS and RXDB registers. The penalty for violation of protocol can be permanent data loss.

A summary of the function codes is presented below:

000	Fill Buffer
001	Empty Buffer
010	Write Sector
011	Read Sector
100	Not used
101	Read Status
110	Write Deleted Data Sector
111	Read Error Register

The following paragraphs describe in detail the programming protocol associated with each function encoded and written into RXCS bits 1–3 if Done is set.

3.3.1 Fill Buffer (000)

This function is used to fill the RX01 buffer with 128 8-bit bytes of data from the host processor. Fill Buffer is a complete function in itself; the function ends when the buffer has been filled. The contents of the buffer can be written onto the diskette by means of a subsequent Write Sector function, or the contents can be returned to the host processor by an Empty Buffer function.

RXCS bit 4 (Unit Select) does not affect this function, since no diskette drive is involved. When the command has been loaded, RXCS bit 5 (Done) is negated. When the TR bit is asserted, the first byte of the data may be loaded into the data buffer. The same TR cycle will occur as each byte of data is loaded. The RX01 counts the bytes transferred; it will not accept less than 128 bytes and will ignore those in excess. Any read of the RXDB during the cycle of 128 transfers is ignored by the RX11.

3.3.2 Empty Buffer (001)

This function is used to empty the internal buffer of the 128 data bytes loaded from a previous Read Sector or Fill Buffer command. This function will ignore RXCS bit 4 (Unit Select) and negate Done.

When TR sets, the program may unload the first of 128 data bytes from the RXDB. Then the RX11 again negates TR. When TR resets, the second byte of data may be unloaded from the RXDB, which again negates TR. Alternate checks on TR and data transfers from the RXDB continue until 128 bytes of data have been moved from the RXDB. Done sets, ending the operation and initiating an interrupt if RXCS bit 6 (Interrupt Enable) is set.

NOTE

The Empty Buffer function does *not* destroy the contents of the sector buffer.

3.3.3 Write Sector (010)

This function is used to locate a desired track and sector and write the sector with the contents of the internal sector buffer. The initiation of this function clears bits 0, 1, and 6 of RXES (CRC Error, Parity Error, and Deleted Data Detected) and negates Done.

When TR is asserted, the program must move the desired sector address into the RXDB, which will negate TR. When TR is again asserted, the program must load the desired track address into the RXDB, which will negate TR. If the desired track is not found, the RX11 will abort the operation, move the contents of the RXES to the RXDB, set RXCS bit 15 (Error), assert Done, and initiate an interrupt if RXCS bit 6 (Interrupt Enable) is set.

TR will remain negated while the RX01 attempts to locate the desired sector. If the RX01 is unable to locate the desired sector within two diskette revolutions, the RX11 will abort the operation, move the contents of the RXES to the RXDB, set RXCS bit 15 (Error), assert Done, and initiate an interrupt if RXCS bit 6 (Interrupt Enable) is set.

If the desired sector is successfully located, the RX11 will write the 128 bytes stored in the internal buffer followed by a 16-bit CRC character that is automatically calculated by the RX01. The RX11 ends the function by asserting Done and initiating an interrupt if RXCS bit 6 (Interrupt Enable) is set.

NOTE 1

The contents of the sector buffer are not valid data after a power loss has been detected by the RX01. The Write Sector function, however, will be accepted as a valid function, and the random contents of the buffer will be written, followed by a valid CRC.

NOTE 2

The Write Sector function does *not* destroy the contents of the sector buffer.

3.3.4 Read Sector (011)

This function is used to locate a desired track and sector and transfer the contents of the data field to the μ CPU controller sector buffer. The initiation of this function clears bits 0, 1, and 6 of RXES (CRC Error, Parity Error, Deleted Data Detected) and negates Done.

When TR is asserted, the program must load the desired sector address into the RXDB, which will negate TR. When TR is again asserted, the program must load the desired track address into the RXDB, which will negate TR.

If the desired track is not found, the RX11 will abort the operation, move the contents of the RXES to the RXDB, set RXCS bit 15 (Error), assert Done, and initiate an interrupt if RXCS bit 6 (Interrupt Enable) is set.

TR and Done will remain negated while the RX01 attempts to locate the desired track and sector. If the RX01 is unable to locate the desired sector within two diskette revolutions after locating the presumably correct track, the RX11 will abort the operation, move the contents of the RXES to the RXDB, set RXCS bit 15 (Error), assert Done, and initiate an interrupt if RXCS bit 6 (Interrupt Enable) is set.

If the desired sector is successfully located, the control will attempt to locate a standard data address mark or a deleted data address mark. If either mark is properly located, the control will read data from the sector into the sector buffer.

If the deleted data address mark was detected, the control will assert RXES bit 6 (DD). As data enters the sector buffer, a CRC is computed, based on the data field and CRC bytes previously recorded. A non-zero residue indicates that a read error has occurred. The control sets RXES bit 0 (CRC Error) and RXCS bit 15 (Error). The RX11 ends the operation by moving the contents of the RXES to the RXDB, sets Done, and initiates an interrupt if RXCS bit 6 (Interrupt Enable) is set.

3.3.5 Read Status (101)

The RX11 will negate RXCS bit 5 (Done) and begin to assemble the current contents of the RXES into the RXDB. RXES bit 7 (Drive Ready) will reflect the status of the drive selected by RXCS bit 4 (Unit Select) at the time the function was given. All other RXES bits will reflect the conditions created by the last command. RXES may be sampled when RXCS bit 5 (Done) is again asserted. An interrupt will occur if RXCS bit 6 (Interrupt Enable) is set. RXES bits are defined in Paragraph 3.2.2.

NOTE

The average time for this function is 250 ms. Excessive use of this function will result in substantially reduced throughput.

3.3.6 Write Sector with Deleted Data (110)

This operation is identical to function 010 (Write Sector) with the exception that a deleted data address mark precedes the data field instead of a standard data address mark (Paragraph 1.3.3.2).

3.3.7 Read Error Register Function (111)

The Read Error Register function can be used to retrieve explicit error information provided by the μ CPU controller upon detection of the general error bit. The function is initiated, and bits 0–6 of the RXES are cleared. Out is asserted and Done is negated. The controller then generates the appropriate number of shift pulses to transfer the specific error code to the Interface register and completes the function by asserting Done. The Interface register can now be read and the error code interrogated to determine the type of failure that occurred (Paragraph 3.6).

NOTE

Care should be exercised in use of this function since, under certain conditions, erroneous error information may result (Paragraph 3.5).

3.3.8 Power Fail

There is no actual function code associated with Power Fail. When the RX01 senses a loss of power, it will unload the head and abort all controller action. All status signals are invalid while power is low.

When the RX01 senses the return of power, it will remove Done and begin a sequence to:

1. Move drive 1 head position mechanism to track 0.
2. Clear any active error bits.

3. Read sector 1 of track 1 of drive 0 into the sector buffer.
4. Set RXES bit 02 (Initialize Done) (Paragraph 3.2.2.4) after which Done is again asserted.
5. Set Drive Ready of the RXES according to the status of drive 0.

There is no guarantee that information being written at the time of a power failure will be retrievable. However, all other information on the diskette will remain unaltered.

A method of aborting a function is through the use of RXCS bit 14 (RX11 Initialize). Another method is through the use of the system Initialize signal that is generated by the PDP-11 RESET instruction, the console START key, or system power failure.

3.4 PROGRAMMING EXAMPLES

3.4.1 Read Data/Write Data

Figure 3-6 presents a program for implementing a Write, Write Deleted Data, or a Read function, depending on the function code that is used. The first instructions set up the error retry counters, PTRY, CTRY, and STRY. The instruction RETRY moves the command word for a Write, Write Deleted Data, or Read into the RXCS.

The set of three instructions beginning at the label 1\$ moves the sector address to the RX11 after Transfer Request (TR), which is bit 7, has been set. The three instructions beginning at the label 2\$ move the track address to the RX11 after TR has been set. The group of instructions beginning at the label 3\$ looks for the Done flag to set and checks for errors.

An error condition, indicated by bit 15 setting, is checked beginning at ERFLAG. If bit 0 is set, a CRC error has occurred, and a branch is made to CRCER. If bit 1 is set, a parity error has occurred, and a branch is made to PARER. If neither of the above bits is set, a seek error is assumed to have occurred and a branch is made to SEEKER, where the system is initialized. In the case of a Write function, the sector buffer is refilled by a JMP to FILLBUF. In the case of a Read function, a JMP is made to EMPBUFF.

In each of the PAR, CRC, and SEEK routines, the command sequence is retried ten times by decrementing the respective retry counter. If an error persists after ten tries, it is a hard error. The retry counters can be set up to retry as many times as desired.

NOTE

A Fill Buffer function is performed before a Write function, and an Empty Buffer function is performed after a Read function.

3.4.2 Empty Buffer Function

Figure 3-7 shows a program for implementing an Empty Buffer function. The first instruction sets the number of error retries to ten. The address of the memory buffer is placed in register R0, and the Empty Buffer command is placed in the RXCS. Existence of a parity error is checked starting at instruction 3\$. If a parity error is detected, the Empty Buffer command is loaded again. If an error persists for ten retries, the error is considered hard.

```

1
2
3
4
5
6
7
8
9
10
11
12
13
14
15
16
17
18
19
20
21
22
23
24
25
26
27
28
29
30
31
32
33
34
35
36
37
38
39
40
41
42
43
44
45
46
47
48
49
50
51
52
53
54
55
56
57
58
59
60
61
62
63
64
65
66
67
68
69
70
71
72
73
74
75
76
77
78
79
80
81
82
83
84
85
86
87
88
89
90
91
92
93
94
95
96
97
98
99
100
101
102
103
104
105
106
107
108
109

```

```

      .ABS
;PROGRAMMING EXAMPLES FOR THE RX11/RX01 FLEXIBLE DISKETTE
;
;THE FOLLOWING IS THE RX11 STANDARD DEVICE ADDRESS AND VECTOR ADDRESS
;
RXCS=177170      ; COMMAND STATUS REGISTER
RXDB=177172      ; DATA BUFFER REGISTER
RXSA=177172      ; SECTOR ADDRESS REGISTER
RXTA=177172      ; TRACK ADDRESS REGISTER
RXES=177172      ; ERROR STATUS REGISTER
;
;THE FOLLOWING IS A PROGRAMMING EXAMPLE OF THE PROTOCOL REQUIRED
;TO WRITE, WRITE DELETED DATA, OR READ AT SECTOR "B" (THE CONTENTS OF PROGRAM
;LOCATION SECTOR) OF TRACK "T" (THE CONTENTS OF PROGRAM LOCATION TRACK)
;
16 000000 012747 177770 000320 START: MOV #=10, PTRY      ; PARITY RETRY COUNTER
17 000000 012747 177770 000314      MOV #=10, CTRY      ; CRC RETRY COUNTER
18 000014 012747 177770 000310      MOV #=10, STRY      ; SEEK RETRY COUNTER
;
;WRITE, WRITE DELETED DATA, OR READ
;
; BITS 4 THRU 1 OF PROGRAM LOCATION COMMAND CONTAIN THE FUNCTION
;
; BIT 4 = 1 MEANS UNIT 1 ( = 0 MEANS UNIT 0 )
;
; BITS 3 THRU 1 IS THE COMMAND ( 4 = WRITE, 14 = WRITE DELETED DATA, 6 = READ)
;
000022 016767 000300 177140 RETRY: MOV COMMAND, RXCS      ; UNIT = (WRITE, WRITE DELETED DATA, OR READ)
;
;WAIT FOR THE TRANSFER REQUEST FLAG THEN TRANSFER THE SECTOR ADDRESS
;
32 000030 100767 177134 10:  TSTB RXCS      ; TEST FOR THE TRANSFER REQUEST FLAG
33 000034 001770      BEQ 10      ; BEQ UNTIL THE TRANSFER REQUEST FLAG SETS
34 000036 116767 000274 177126      MOVB SECTOR, RXSA      ; LOAD SECTOR ADDRESS
;
;WAIT FOR THE TRANSFER REQUEST FLAG THEN TRANSFER THE TRACK ADDRESS
;
38 000044 100767 177120 20:  TSTB RXCS      ; TEST FOR THE TRANSFER REQUEST FLAG
39 000050 001770      BEQ 20      ; BEQ UNTIL THE TRANSFER REQUEST FLAG SETS
40 000052 116767 000262 177112      MOVB TRACK, RXTA      ; LOAD TRACK ADDRESS
;
;THE SECTOR AND TRACK ADDRESSES HAVE BEEN TRANSFERRED TO THE RX01
;
;INSAIT FOR THE DONE FLAG AND CHECK FOR ANY ERRORS
;
;IF THE FUNCTION HAS COMPLETED SUCCESSFULLY (NO ERROR FLAG) THEN HALT
;
48 000060 032767 000040 177102 30:  BIT #DONEBIT, RXCS      ; TEST FOR THE DONE FLAG
49 000064 001774      BEQ 30      ; BEQ UNTIL THE DONE FLAG SETS
50 000070 000767 177074      TST RXCS      ; TEST FOR THE ERROR FLAG
51 000074 001001      BNE ENFLAG      ; BNE IF AN ERROR HAS OCCURED
52 000076 000000      HALT      ; OK = COMPLETED
;
;THE ERROR FLAG IS SET
;
;THE CONTENTS OF THE RXES IS THE ERROR STATUS
;
;IF THE RXES BITS 1 AND 0 = 0 THEN SOME TYPE OF SEEK ERROR OCCURED
;IF THE RXES BIT 0 = 1 THEN A CRC ERROR HAS OCCURED
;IF THE RXES BIT 1 = 1 THEN A PARITY ERROR HAS OCCURED
;
62 000100 032767 000003 177064 ENFLAG: BIT #3, RXES      ; TEST FOR CRC AND PARITY ERRORS
63 000106 001414      BEQ SEEK      ; NOT A PARITY OR CRC (MUST) BE A SEEK
64 000110 032767 000002 177054      BIT #2, RXES      ; TEST FOR PARITY ERROR
65 000116 001404      BEQ CRC      ; NOT A PARITY ERROR (MUST) BE A CRC
;
;A PARITY ERROR HAS OCCURED
;
;INCREMENT AND TEST THE PARITY ERROR RETRY COUNTER PROGRAM LOCATION " PTRY "
;
;AND RETRY THE " COMMAND " UNTIL THE PARITY ERROR RECOVERS
;
;OR UNTIL THE PTRY COUNTER OVERFLOWS TO 0
;
75 000120 000267 000202      INC PTRY
76 000124 001350      BNE RETRY      ; RETRY THE COMMAND
77 000126 000000      HALT      ; HARD PARITY ERROR
;
;A CRC ERROR HAS OCCURED
;
;INCREMENT AND TEST THE CRC ERROR RETRY COUNTER PROGRAM LOCATION " CTRY "
;
;AND RETRY THE COMMAND UNTIL THE CRC ERROR RECOVERS
;
;OR UNTIL THE CTRY COUNTER OVERFLOWS TO 0
;
87 000130 000267 000174      INC CTRY
88 000134 001332      BNE RETRY      ; RETRY THE COMMAND
89 000136 000000      HALT      ; HARD CRC ERROR
;
;THE ERROR FLAG IS SET
;
;THE ERROR IS (NOT) A PARITY ERROR AND IS (NOT) A CRC ERROR
;
;THEREFORE IT MUST BE A SEEK ERROR
;
; (STATE OF RXCS BITS 0 AND 1 ARE 0)
;
000140 012767 040000 177022 SEEK:  MOV #INIT, RXCS      ; INITIALIZE
;
;INCREMENT AND TEST THE SEEK ERROR RETRY COUNTER PROGRAM LOCATION " STRY "
;
;AND RETRY THE COMMAND UNTIL THE SEEK ERROR RECOVERS
;
;OR UNTIL THE STRY COUNTER OVERFLOWS TO 0
;
107 000144 000267 000160      INC STRY
108 000152 001323      BNE RETRY      ; RETRY THE COMMAND
109 000154 000000      HALT      ; HARD SEEK ERROR

```

Figure 3-6 RX11 Write/Write Deleted Data/Read Example

```

158 ;THE FOLLOWING IS A PROGRAMMING EXAMPLE OF PROTOCOL REQUIRED TO
161 ;
162 ;EMPTY THE SECTOR BUFFER OF 128 8-BIT BYTES
163 ;
164 000242 012767 177770 000056 EENTRY: MOV #10, PTRY ; 0 TRYS TO EMPTY THE SECTOR BUFFER
165 000250 012700 000342 ESETUP: MOV #BUFFER, R0 ; PROGRAMS DATA BUFFER
166 000254 016767 000054 176706 MOV COMMAND, RXCS ; ISSUE THE COMMAND
167 ;
168 ;WAIT FOR A TRANSFER REQUEST FLAG BEFORE TRANSFERRING DATA TO THE PROGRAMS
169 ;
170 ;DATA BUFFER FROM THE RX01 SECTOR BUFFER
171 ;
172 ;WAIT FOR A DONE FLAG TO INDICATE THE COMPLETION OF THE EMPTY BUFFER COMMAND
173 ;
174 ;PRIOR TO TESTING THE ERROR FLAG
175 ;
176 000262 100767 176702 ELOOP: TSTB RXCS ; TEST FOR TRANSFER REQUEST FLAG
177 000266 001014 BHI EMPTY ; BNE IF TRANSFER REQUEST FLAG IS SET
178 000270 032767 000040 176672 BIT #D0NEBIT, RXCS ; TEST FOR DONE FLAG
179 000276 001771 BEQ ELOOP ; BEQ UNTIL THE DONE FLAG SETS
180 ;
181 ;THE DONE FLAG IS SET
182 ;
183 ;TEST FOR ANY ERRORS (ONLY ERROR POSSIBLE IS A PARITY ERROR)
184 ;
185 000300 000767 176664 TST RXCS
186 000304 001001 BNE IS
187 000306 000000 HALT ; NO ERRORS = OK = COMPLETE
188 ;
189 ;INCREMENT AND TEST THE PARITY ERROR RETRY PROGRAM LOCATION " PTRY "
190 ;
191 ;AND RETRY THE COMMAND UNTIL THE ERROR RECOVERS
192 ;
193 ;OR UNTIL THE PTRY COUNTER OVERFLOWS TO 0
194 ;
195 000310 000267 000012 IS: INC PTRY
196 000314 001355 BNE ESETUP ; RETRY TO EMPTY THE SECTOR BUFFER
197 000316 000000 HALT ; HARD PARITY ERROR
198 ;
199 ;THE TRANSFER REQUEST FLAG IS SET
200 ;
201 ;TRANSFER DATA TO THE PROGRAM DATA BUFFER FROM THE RX01 SECTOR BUFFER
202 ;
203 000320 116730 176646 EMPTY: MOVB RX0B, *(R0)+
204 000324 000756 BR ELOOP
205 ;
206 ;THE FOLLOWING 3 PROGRAM LOCATIONS ARE THE ERROR RETRY COUNTERS
207 ;
208 000326 000000 PTRY: 0 ; PARITY ERROR RETRY COUNTER
209 000330 000000 CTRY: 0 ; CRC ERROR RETRY COUNTER
210 000332 000000 STRY: 0 ; SEEK ERROR RETRY COUNTER
211 ;
212 ;PROGRAM LOCATION " COMMAND " CONTAINS THE COMMAND TO BE ISSUED VIA THE LCD I/O
213 ;
214 ;WRITE (4), WRITE DELETED DATA (14), OR READ (6), OR EMPTY BUFFER (2)
215 ;
216 000334 000000 COMMAND: 0 ; 4, 14, 6, OR 2 + (GO BIT 1 = 1)
217 ;
218 ;PROGRAM LOCATION " SECTOR " CONTAINS THE SECTOR ADDRESS (1 TO 32 OCTAL)
219 ;
220 000336 000000 SECTOR: 0 ; 1 TO 32 OCTAL
221 ;
222 ;PROGRAM LOCATION " TRACK " CONTAINS THE TRACK ADDRESS (0 TO 114 OCTAL)
223 ;
224 000340 000000 TRACK: 0 ; 0 TO 114 OCTAL
225 ;
226 ;PROGRAM EQUIVALENTS
227 ;
228 000340 D0NEBIT#48
229 000340 INIT#40000
230 000342 BUFFER#
231 000342 ,#BUFFER+200
232 000001 ;END

```

Figure 3-7 RX11 Empty Buffer Example

If no error is indicated, the program looks for the Transfer Request (TR) flag to set. The Error flag is retested if TR is not set. Once TR sets, a byte is moved from the RX11 sector buffer to the core locations of BUFFER. The process continues until the sector buffer is empty and the Done bit is set.

3.4.3 Fill Buffer Function

Figure 3-8 presents a program to implement a Fill Buffer function. It is very similar to the Empty Buffer example.

3.5 RESTRICTIONS AND PROGRAMMING PITFALLS

A set of restrictions and programming pitfalls for the RX11 is presented below.

1. Depending on how much data handling is done by the program between sectors, the minimum interleave of two sectors may be used, but to be safe a three-sector interleave is recommended.
2. If an error occurs and the program executes a Read Error Register function (111), a parity error may occur for that command. The error status would not be for the error in which the Read Error Register function was originally required.
3. The DRV SEL RDY bit is present only at the time of a Read Status function (101) for both drives, and after an Initialize, depending on the status of drive 0.
4. It is not required to load the Drive Select bit into the RXCS when the command is Fill Buffer (000) or Empty Buffer (010).
5. Sector Addressing: 1–26 (*No sector 0*)
Track Addressing: 0–76
6. A power failure causing the recalibration of the drives will result in a Done condition, the same as finishing reading a sector. However, during a power failure, RXES bit 2 (Initialize Done) will set. Checking this bit will indicate a power fail condition.
7. Excessive usage of the Read Status function (101) will result in drastically decreased throughput, because a Read Status function requires between one and two diskette revolutions or about 250 ms to complete.

3.6 ERROR RECOVERY

There are two error indications given by the RX11 system. The Read Status function (Paragraph 3.3.5) will assemble the current contents of the RXES (Paragraph 3.2.2), which can be sampled to determine errors. The Read Error Register function (Paragraph 3.3.7) can also be used to retrieve explicit error information. The RX11 Interface register can be interrogated to determine the type of failure that occurred.

A list of error codes is presented on the following page.

NOTE

A Read Status function is not necessary if the DRV RDY bit is not going to be interrogated, because the RXES is in the Interface register at the completion of every function.

Octal Code	Error Code Meaning
0010	Drive 0 failed to see home on Initialize.
0020	Drive 1 failed to see home on Initialize.
0030	Found home when stepping out 10 tracks for INIT.
0040	Tried to access a track greater than 77.
0050	Home was found before desired track was reached.
0060	Self-diagnostic error.
0070	Desired sector could not be found after looking at 52 headers (2 revolutions).
0110	More than 40 μ s and no SEP clock seen.
0120	A preamble could not be found.
0130	Preamble found but no I/O mark found within allowable time span.
0140	CRC error on what we thought was a header.
0150	The header track address of a good header does not compare with the desired track.
0160	Too many tries for an IDAM (identifies header).
0170	Data AM not found in allotted time.
0200	CRC error on reading the sector from the disk. No code appears in the ERREG.
0210	All parity errors.

```

111                                     ;THE FOLLOWING IS A PROGRAMMING EXAMPLE OF THE PROTOCOL REQUIRED TO
112                                     ;
113                                     ;FILL THE SECTOR BUFFER WITH 128 8-BIT BYTES
114                                     ;
115                                     ; NOTE: THE DATA TO FILL THE SECTOR BUFFER CAN BE ASSEMBLED IN ONE IN THE
116                                     ; EVEN ADDRESSES BYTES OF 128 WORDS OR IN BOTH BYTES OF 64 WORDS
117                                     ;
118 000156 012767 177770 000142 FENTRY: MOV #-10, PTRY          ; B TRYS TO FILL THE SECTOR BUFFER
119 000164 012700 000342          SETUP: MOV #BUFFER, R0           ; PROGRAMS DATA BUFFER
120 000170 016767 000140 176772          MOV COMMAND, RXCS        ; ISSUE THE COMMAND
121                                     ;
122                                     ;WAIT FOR A TRANSFER REQUEST FLAG BEFORE TRANSFERRING DATA FROM THE PROGRAMS
123                                     ;
124                                     ;DATA BUFFER TO THE RX01 SECTOR BUFFER
125                                     ;
126                                     ;WAIT FOR A DONE FLAG TO INDICATE THE COMPLETION OF THE FILL BUFFER COMMAND
127                                     ;
128                                     ;PRIOR TO TESTING THE ERROR FLAG
129                                     ;
130 000176 100767 176766          LOOP1: TSTB RXCS           ; TEST FOR TRANSFER REQUEST FLAG
131 000202 001414                  BHI FILL             ; BEG IF TRANSFER REQUEST FLAG SET
132 000204 032767 000040 176756          BIT #DONEBIT, RXCS      ; TEST FOR THE DONE FLAG
133 000212 001771                  BEQ LOOP             ; BEQ UNTIL THE DONE FLAG SETS
134                                     ;
135                                     ;THE DONE FLAG IS SET
136                                     ;
137                                     ;TEST FOR ANY ERRORS (ONLY ERROR POSSIBLE IS A PARITY ERROR)
138                                     ;
139 000214 000767 176750          TST RXCS
140 000220 001001                  BNE IS
141 000222 000000                  HALT                ; NO ERRORS = OK = COMPLETE
142                                     ;
143                                     ;INCREMENT AND TEST THE PARITY ERROR RETRY PROGRAM LOCATION " PTRY "
144                                     ;
145                                     ;AND RETRY THE COMMAND UNTIL THE ERROR RECOVERS
146                                     ;
147                                     ;OR UNTIL THE PTRY COUNTER OVERFLOWS TO 0
148                                     ;
149 000224 000267 000076          IS:   INC PTRY
150 000230 001395                  BNE SETUP          ; RETRY TO FILL THE SECTOR BUFFER
151 000232 000000                  HALT                ; HARD PARITY ERROR
152                                     ;
153                                     ;THE TRANSFER REQUEST FLAG IS SET
154                                     ;
155                                     ;TRANSFER DATA FROM THE PROGRAMS DATA BUFFER TO THE RX01 SECTOR BUFFER
156                                     ;
157 000234 113067 176732          FILL:  MOVB @(R0)+, RX0B      ; PROGRAMS DATA BUFFER IS 64 WORDS IN LENGTH
158 000240 000756                  BR LOOP

```

Figure 3-8 RX11 Fill Buffer Example

CHAPTER 4

RX8E INTERFACE

PROGRAMMING INFORMATION

The RX8E interface allows two modes of data transfer: 8-bit word length and 12-bit word length. In the 12-bit mode, 64 words are written in a diskette sector, thus requiring two sectors to store one page of information. The diskette capacity in this mode is 128,128 12-bit words (1,001 pages). In the 8-bit transfer mode, 128 8-bit words are written in each sector. Disk capacity is 256,256 8-bit words, which is a 33 percent increase in disk capacity over the 12-bit mode. Eight-bit mode must be used for generating IBM-compatible diskettes, since 12-bit mode does not fully pack the sectors with data. The hardware puts in the extra 0s. Data transfer requests occur 23 μ s after the previous request was serviced for 12-bit mode (18 μ s for 8-bit mode). There is no maximum time between the transfer request from the RX01 and servicing of that request by the host processor. This allows the data transfer to and from the RX01 to be interrupted without loss of data.

4.1 DEVICE CODES

The eight possible device codes that can be assigned to the interface are 70–77. These device codes define address locations of a specific device and allow up to eight RX8E interfaces to be used on a single PDP-8. These multiple device codes are also shared with other devices. Depending on what other devices are on the system, the RX8E device code can be selected to avoid conflicts. (Refer to the *PDP-8 Small Computer Handbook* for specific device codes.)

The device codes are selected by switches according to Table 4-1. These switches control AC bits 6–8, while AC bits 3–5 are fixed at 1s. The device code is initially selected to be 70. Switches 7 and 8 are not connected and will not affect the device selection code. The switches are all located on a single DIP switch package that is located on the M8357 RX8E interface board.

Table 4-1
Device Code Switch Selection

Device Code	S1	S2	S3	S4	S5	S6	S7	S8
77	0	0	0	1	1	1	X	X
76	0	0	1	1	1	0	X	X
75	0	1	0	1	0	1	X	X
74	0	1	1	1	0	0	X	X
73	1	0	0	0	1	1	X	X
72	1	0	1	0	1	0	X	X
71	1	1	0	0	0	1	X	X
70	1	1	1	0	0	0	X	X

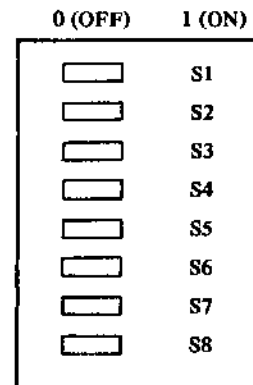

4.2 INSTRUCTION SET

The RX8E instruction set is listed below and described in the following paragraphs.

IOT	Mnemonic	Description
67x0		No Operation
67x1	LCD	Load Command, Clear AC
67x2	XDR	Transfer Data Register
67x3	STR	Skip on Transfer Request Flag, Clear Flag
67x4	SER	Skip on Error Flag, Clear Flag
67x5	SDN	Skip on Done Flag, Clear Flag
67x6	INTR	Enable or Disable Disk Interrupts
67x7	INIT	Initialize Controller and Interface

4.2.1 Load Command (LCD) – 67x1

This command transfers the contents of the AC to the Interface register and clears the AC. The RX01 begins to execute the function specified in AC 8, 9, and 10 on the drive specified by AC 7. A new function cannot be initiated unless the RX01 has completed the previous function. The command word is defined as shown in Figure 4-1.

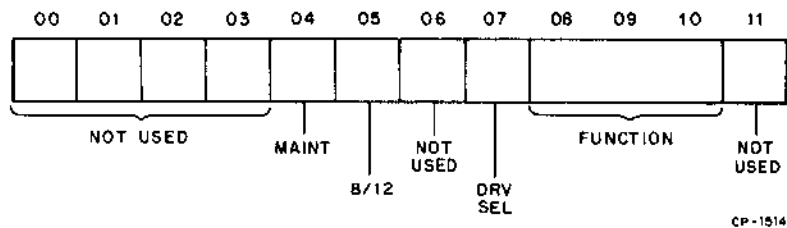

Figure 4-1 LCD Word Format (RX8E)

The command word is described in greater detail in Paragraph 4.3.1.

4.2.2 Transfer Data Register (XDR) – 67x2

With the Maintenance flip-flop cleared, this instruction operates as follows. A word is transferred between the AC and the Interface register. The direction of the transfer is governed by the RX01, and the length of the word transferred is governed by the mode selected (8-bit or 12-bit). When Done is negated, executing this instruction indicates to the RX01:

1. That the last data word supplied by the RX01 has been accepted by the PDP-8, and the RX01 can proceed, or
2. That the data or address word requested by the RX01 has been provided by the PDP-8, and the RX01 can proceed.

A data transfer (XDR) from the AC always leaves the AC unchanged. If operation is in 8-bit mode, AC 0–3 are transferred to the Interface register but are ignored by the RX01. Transfers into the AC are 12-bit jam transfers when in 12-bit mode. When in 8-bit mode, the 8-bit word is ORed into AC 4–11, and AC 0–3 remain unchanged. When the RX01 is done, this instruction can be used to transfer the RXES status word from the Interface register to the AC. The selected mode controls this transfer as indicated above.

4.2.3 STR – 67x3

This instruction causes the next instruction to be skipped if the Transfer Request (TR) flag has been set by RX01 and clears the flag. The TR flag should be tested prior to transferring data or address words with the XDR instruction to ensure the data or address has been received or transferred, or after an LCD instruction to ensure the command is in the Interface register. In cases where an XDR follows an LCD, the TR flag needs to be tested only once between the two instructions. (See programming example in Paragraph 4.5.1.)

4.2.4 SER – 67x4

This instruction causes the next instruction to be skipped if the Error flag has been set by an error condition in the RX01 and clears the flag. An error also causes the Done flag to be set (Paragraph 4.3.6).

4.2.5 SDN – 67x5

This instruction causes the next instruction to be skipped if the Done flag has been set by the RX01 indicating the completion of a function or detection of an error condition. If the Done flag is set, it is cleared by the SDN instruction. This flag will interrupt if interrupts are enabled.

4.2.6 INTR – 67x6

This instruction enables interrupts by the Done flag if AC 11 = 1. It disables interrupts if AC 11 = 0.

4.2.7 INIT – 67x7

The instruction initializes the RX01 by moving the head position mechanism of drive 1 (if drive 1 is available) to track 0. It reads track 1, sector 1 of drive 0. It zeros the Error and Status register and sets Done upon successful completion of Initialize. Up to 1.8 seconds may elapse before the RX01 returns to the Done state. Initialize can be generated programmably or by the Omnibus Initialize.

4.3 REGISTER DESCRIPTION

Only one physical register (the Interface register) exists in the RX8E, but it may represent one of the six RX01 registers described in the following paragraphs, according to the protocol of the function in progress.

4.3.1 Command Register (Figure 4-2)

The command is loaded into the Interface register by the LCD instruction (Paragraph 4.2.1).

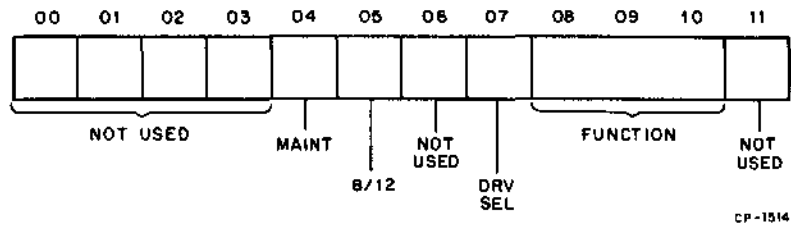

Figure 4-2 Command Register Format (RX8E)

The function codes (bits 8, 9, 10) are summarized below and described in Paragraph 4.4.

Code	Function
000	Fill Buffer
001	Empty Buffer
010	Write Sector
011	Read Sector
100	Not used
101	Read Status
110	Write Deleted Data Sector
111	Read Error Register

The DRV SEL bit (bit 7) selects one of the two drives upon which the function will be performed:

AC 7 = 0	Select drive 0
AC 7 = 1	Select drive 1

The 8/12 bit (bit 5) selects the length of the data word.

AC 5 = 0	Twelve-bit mode selected
AC 5 = 1	Eight-bit mode selected

The RX8E will initialize into 12-bit mode.

4.3.2 Error Code Register (Figure 4-3)

Specific error codes can be accessed by use of the Rear Error Register function (111) (Paragraph 4.4.7). The specific octal error codes are given in Paragraph 4.7.

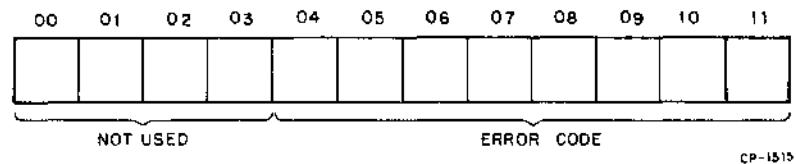

Figure 4-3 Error Code Register Format

The Maintenance bit (M bit) can be used to diagnose the RX8E interface under off-line and on-line conditions. The off-line condition exists when the BC05L-15 cable is disconnected from the RX01; the on-line condition exists when the cable is connected to the RX01.

If an LCD IOT (I/O Transfer) is issued with AC 4 = 1, the Maintenance flip-flop is set. When the Maintenance flip-flop is set, the assertion of RUN on *following* XDR instructions is inhibited, and all data register transfers (XDR) are forced into the AC. The Maintenance bit allows the Interface register to be written and read for maintenance checks. The Maintenance flip-flop is cleared by Initialize or by an LCD IOT with AC 4 = 0.

The following paragraphs describe more explicitly how to use the Maintenance bit in an off-line mode.

The contents of the interface buffer cannot be guaranteed immediately following the first LCD IOT, which sets the Maintenance flip-flop. However, successive LCD IOTs will guarantee the contents of the Interface register. The contents of the Interface register can then be verified by using the XDR IOT to transfer those contents into the AC.

In addition, the Maintenance flip-flop directly sets the Skip flags, which will remain set as long as the Maintenance flip-flop is set. Skipping in these flags as long as the Maintenance flip-flop is set will not clear the flags. Setting and then clearing the Maintenance flip-flop will leave the Skip flags in a set condition. The skip IOTs can then be issued to determine whether or not a large portion of the interface skip logic is working correctly.

The Maintenance flip-flop can also be used to determine if the interface is capable of generating an interrupt on the Omnibus. The Maintenance flip-flop is set, thus causing the Done flag to set. The Interrupt Enable flip-flop can be set by issuing an INTR IOT with AC bit 11 = 1. The combination of Done and Interrupt Enable should generate an interrupt.

The Maintenance flip-flop can also be used to test the INIT IOT. The Maintenance flip-flop is set and cleared to generate the flags, and INIT IOT is then executed. If execution of INIT IOT is internally successful, all of the flags and the Interrupt Enable flip-flop should be cleared if they were previously set.

In the on-line mode, use of the Maintenance bit should be restricted to writing and reading the Interface register. The same procedure described to write and read the Interface register in the off-line mode should be implemented in the on-line mode. Additional testing of the RX8E in the on-line mode should reference the appropriate circuit schematics. Exiting from the on-line Maintenance bit mode should be finalized by an initialize to the RX01.

4.3.3 RXTA – RX Track Address (Figure 4-4)

This register is loaded to indicate on which of the 77 tracks a given function is to operate. It can be addressed only under the protocol of the function in progress (Paragraph 4.4). Bits 0 through 3 are unused and are ignored by the control.

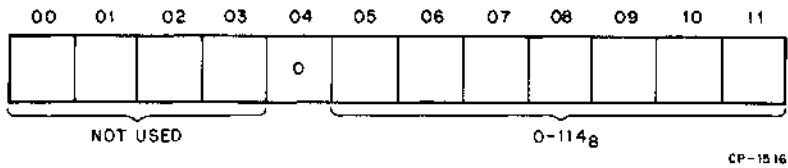

Figure 4-4 RXTA Format (RX8E)

4.3.4 RXSA – RX Sector Address (Figure 4-5)

This register is loaded to indicate on which of the 26 sectors a given function is to operate. It can be addressed only under the protocol of the function in progress (Paragraph 4.4). Bits 0 through 3 are unused and are ignored by the control.

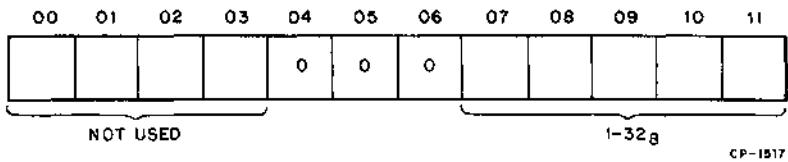

Figure 4-5 RXSA Format (RX8E)

4.3.5 RXDB – RX Data Buffer (Figure 4-6)

All information transferred to and from the floppy media passes through this register and is addressable only under the protocol of the function in progress. The length of data transfer is either 8 or 12 bits, depending on the state of bit 5 of the Command register when the LCD IOT is issued (Paragraph 4.3.1).

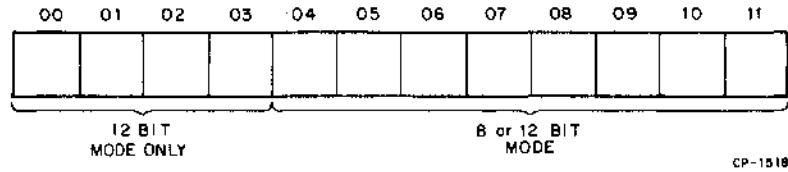

Figure 4-6 RXDB Format (RX8E)

4.3.6 RX Error and Status (Figure 4-7)

The RXES contains the current error and status conditions of the selected drive. This read-only register can be accessed by the Read Status function (101). The RXES is also available in the Interface register upon completion of any function. The RXES is accessed by the XDR instruction. The meaning of the error bits is given below.

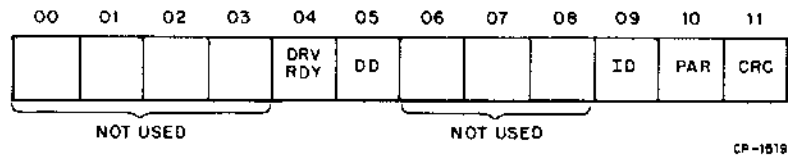

Figure 4-7 RXES Format (RX8E)

Bit No.	Description
11	CRC Error – The cyclic redundancy check at the end of the header or data field has indicated an error. The header or data must be considered invalid; it is suggested that the data transfer be retried up to ten times, as most data errors are recoverable (soft). (See Chapter 6).
10	Parity Error – When status bit 10 = 1, a parity error has been detected on command and address information being transferred to the RX01 μ CPU controller from the RX8E interface. Upon detection of a parity error, the current function is terminated, the RXES status word is moved to the Interface register, and the Error and Done flags are set. The function can be retried to determine if the parity error is a soft or hard error. A parity error indication means that there is a problem in the interface cable between the RX01 and the interface.
9	Initialize Done – This bit indicates completion of the Initialize routine. It can be asserted due to RX01 power failure, system power failure, or programmable or bus Initialize. This bit is <i>not</i> available within the RXES from a Read Status function.

Bit No.	Description
5	Deleted Data (DD) – In the course of reading data, a deleted data mark was detected in the identification field. The data following will be collected and transferred normally, as the deleted data mark has no further significance within the RX01. Any alteration of files or actual deletion of data due to this mark must be accomplished by user software. This bit will be set if a successful or unsuccessful Write Deleted Data function is performed.
4	Drive Ready – This bit is asserted if the unit currently selected exists, is properly supplied with power, has a diskette installed properly, has its door closed, and has a diskette up to speed.

NOTE 1

This bit is only valid for either drive when retrieved via a Read Status function or for drive 0 upon completion of an Initialize.

NOTE 2

If the Error bit was set in the RXCS but Error bits are not set in the RXES, then specific error conditions can be accessed via a Read Error Register function.

4.4 FUNCTION CODE DESCRIPTION

RX8E functions are initiated by means of the Load Command IOT (LCD). The Done flag should be tested and cleared with the SDN instruction in order to verify that the RX8E is in the Done state prior to issuing the LCD instruction. Upon receiving an LCD instruction while in the Done state, the RX8E enters the Not Done state while the command is decoded. Each of the eight functions summarized below requires that a strict protocol be followed for the successful transfer of data, status, and address information. The protocol for each function is described in the following sections, and a summary table is presented below.

Octal	AC			Function
	8	9	10	
0	0	0	0	Fill Buffer
2	0	0	1	Empty Buffer
4	0	1	0	Write Sector
6	0	1	1	Read Sector
10	1	0	0	Not Used
12	1	0	1	Read Status
14	1	1	0	Write Deleted Data Sector
16	1	1	1	Read Error Register

NOTE

AC bit 11 is assumed to be 0 in the above octal codes, since AC bit 11 can be 0 or 1.

4.4.1 Fill Buffer (000)

This function is used to load the RX01 sector buffer from the host processor with 64 12-bit words if in 12-bit mode or 128 8-bit words if in 8-bit mode. This instruction only loads the sector buffer. In order to complete the transfer to the diskette, another function, Write Sector, must be performed. The buffer may also be read back by means of the Empty Buffer function in order to verify the data.

Upon decoding the Fill Buffer function, the RX01 will set the Transfer Request (TR) flag, signaling a request for the first data word. The TR flag must be tested and cleared by the host processor with the STR instructions prior to each successive XDR IOT (Paragraph 4.2.3). The data word can then be transferred to the Interface register by means of the XDR IOT. The RX01 next moves the data word from the Interface register to the sector buffer and sets the TR flag as a request for the next data word. The sequence above is repeated until the sector buffer has been loaded (64 data transfers for 12-bit mode or 128 data transfers for 8-bit mode). After the 64th (or 128th) word has been loaded into the sector buffer, the RXES is moved to the Interface register, and the RX01 sets the Done flag to indicate the completion of the function. It is, therefore, unnecessary for the host processor to keep a count of the data transfers. Any XDR commands after Done is set will result in the RXES status word being loaded in the AC. The sector buffer must be completely loaded before the RX8E will set Done and recognize a new command. An interrupt would now occur if Interrupt Enable were set.

4.4.2 Empty Buffer (001)

This function moves the contents of the sector buffer to the host processor. Upon decoding this function, RXES bits 10 and 11 (Parity Error and CRC Error) are cleared, and the TR flag is set with the first data word in the Interface register. This TR flag signifies the request for a data transfer from the RX8E to the host processor. The flag must be tested and cleared, then the word can be moved to the AC by an XDR command. The direction of the transfer for an XDR command is controlled by the RX01. The TR flag is set again with the next word in the Interface register. The above sequence is repeated until 64 words (128 bytes if 8-bit mode) have been transferred, thus emptying the sector buffer. The Done flag is then set after the RXES is moved in the Interface register to indicate the end of the function. An interrupt would now occur if Interrupt Enable were set.

NOTE

The Empty Buffer function does *not* destroy the contents of the sector buffer.

4.4.3 Write Sector (010)

This function transfers the contents of the sector buffer to a specific track and sector on the diskette. Upon decoding this function, the RX8E clears bits 10 and 11 (Parity Error and CRC Error) of the RXES and sets the TR flag, signifying a request for the sector address. The TR flag must be tested and cleared before the binary sector address can be loaded into the Interface register by means of the XDR command. The sector address must be within the limits $1-32_8$.

The TR flag is set, signifying a request for the track address. The TR flag must be tested and cleared, then the binary track address may be loaded into the Interface register by means of the XDR command. The track address must be within the limits $0-114_8$.

The RX01 tests the supplied track address to determine if it is within the allowable limits. If it is not, the RXES is moved to the Interface register, the Error and Done flags are set, and the function is terminated.

If the track address is legal, the RX01 moves the head of the selected drive to the selected track, locates the requested sector, transfers the contents of the sector buffer and a CRC character to that sector, and sets Done. Any errors encountered in the seek operation will cause the function to cease, the RXES to be loaded into the Interface register, and the Error and Done flags to be set. If no errors are encountered, the RXES is loaded into the Interface register and only the Done flag is set.

NOTE

The Write Sector function does *not* destroy the contents of the sector buffer.

4.4.4 Read Sector (011)

This function moves a sector of data from a specified track and sector to the sector buffer. Upon decoding this function, the RX8E clears RXES bits 5, 10, 11 (Deleted Data, Parity Error, CRC Error) and sets the TR flag, signifying the request for the sector address. The flag must be tested and cleared. The sector address is then loaded into the Interface register by means of the XDR command. The TR flag is set, signifying a request for the track address. The flag is tested and cleared by the host processor, and the track address is then loaded into the Interface register by an XDR command. The legality of the track address is checked by the RX01. If illegal, the Error and Done flags are set with the RXES moved to the Interface register, and the function is terminated. Otherwise, the RX01 moves the head to the specified track, locates the specified sector, transfers the data to the sector buffer, computes and checks CRC for the data. If no errors occur, the Done flag is set with the RXES in the Interface register. If an error occurs anytime during the execution of the function, the function is terminated by setting the Error and Done flags with RXES in the Interface register. A detection of CRC error results in RXES bit 11 being set. If a deleted data mark was encountered at the beginning of the desired data field, RXES bit 5 is set.

4.4.5 Read Status (101)

Upon decoding this function, the RX01 moves the RXES to the RX8E Interface register and sets the Done flag. The RXES can then be read by the Transfer Data Register command (XDR). The bits are defined in Paragraph 4.3.6.

NOTE

The average time for this function is 250 ms. Excessive use of this function will result in substantially reduced throughput.

4.4.6 Write Deleted Data Sector (110)

This function is identical to the Write Data function except that a deleted data mark is written prior to the data field rather than the normal data mark (Paragraph 1.3.3.2). RXES bit 5 (Deleted Data) will be set in the RX8E Interface register upon completion of the function.

4.4.7 Read Error Register Function (111)

The Read Error Register function can be used to retrieve explicit error information upon detection of the Error flag. Upon receiving this function, the RX01 moves an error code to the Interface register and sets Done. The Interface register can then be read via an XDR command and the code interrogated to determine which type of failure occurred (Paragraph 4.7).

NOTE

Care should be exercised in use of this function because, under certain conditions, erroneous error information may result (Paragraph 4.6).

4.4.8 Power Fail

There is no actual function code associated with Power Fail. When the RX01 senses a loss of power, it will unload the head and abort all controller action. All status signals are invalid while power is low.

When the RX01 senses the return of power, it will remove Done and begin a sequence to:

1. Move drive 1 head position mechanism to track 0.
2. Clear any active error bits.
3. Read sector 1 of track 1 of drive 0.
4. Set Initialize Done bit of the RXES, after which Done is again asserted.

There is no guarantee that information being written at the time of a power failure will be retrievable. However, all other information on the diskette will remain unaltered.

A method of aborting an incomplete function is with the INIT IOT (Paragraph 4.2.7).

4.5 PROGRAMMING EXAMPLES

4.5.1 Write/Write Deleted Data/Read Functions

Figure 4-8 presents a program for implementing a Write, Write Deleted Data, or a Read function with interrupts turned off (IOF). The first three steps preset the PTRY, CTRY, and STRY retry counters, which are set at ten retries but can be changed to any number. Starting at RETRY, the program tests for 8- or 12-bit mode, type of function, and drive. Once the command is loaded, the program waits in a loop for the controller to respond with Transfer Request (TR). When TR is set, the sector address is loaded and the AC is cleared. The program loops while waiting for the controller to respond with another TR. When TR is reset, the track address is loaded, and the AC is cleared again. The program loops to wait for the Done condition.

When the Done flag is set, the program checks for an error condition, indicated by the Error flag being set. If the AC = 0000, then the error is a seek error; if bit 10 of the AC is set, the error is a parity error; and if bit 11 of the AC is set, the error is a CRC error. Error status from the RXES is saved and tested to determine the error (Paragraph 4.3.6). The RXES will not include the Select Drive Ready bit. If a parity error is detected, the program increments and tests the PTRY retry counter. If a parity error persists after ten tries, it is considered a hard error. If ten retries have not occurred, a branch is made to RETRY and the sequence repeated.

If the Parity Error bit of the RXES is not set, then the program tests to see if the CRC Error bit is set. If a CRC error is detected, the program increments and tests the CTRY retry counter. If a CRC error persists after ten retries, it is considered a hard error. If ten retries have not occurred, a branch is made to RETRY and the sequence repeated.

A seek error is assumed if neither a CRC nor a parity error is detected. An Initialize (INIT) instruction is performed (Paragraph 4.2.7). During a Write or Write Deleted Data function, the sector buffer must be refilled, because INIT will cause sector 1 of track 1 of drive 0 to be read, which will destroy the previous contents of the sector buffer. The instruction sequence for a Fill Buffer function is not included in Figure 4-8, but is presented in Figure 4-10. After the system has been initialized, the program increments and tests the STRY retry counter. If a seek error persists after ten tries, it is considered a hard error. If ten retries have not occurred, a branch is made to RETRY and the sequence repeated.

4.5.2 Empty Buffer Function

Figure 4-9 shows a program for implementing an Empty Buffer function with interrupts turned off (IOF). The first instruction sets the number of retries at ten. A 2 is set in the AC to indicate an Empty Buffer command, and the command is loaded. When TR is set, the program jumps to EMPTY to transfer a word to the BUFFER location. A jump is made back to loop to wait for another TR. This process continues until either 64 words or 128 bytes have been emptied from the sector buffer. When Done is set, the program tests to see if the Error bit is set. If the Error bit is set, the program retries ten times. If the error persists, a hard parity error is assumed, indicating a problem in the interface cable.

4.5.3 Fill Buffer Function

Figure 4-10 presents a program to implement a Fill Buffer function. It is very similar to the Empty Buffer example.

```

1      /PROGRAMMING EXAMPLES FOR THE RX8/RX01 FLEXIBLE DISKETTE
2      /
3      /THE FOLLOWING ARE RX01 IOT CODE DEFINITIONS
4      /
5      /THE STANDARD IOT DEVICE CODE IS 670-
6      /
7      6701      LCD=6701      /IOT TO LOAD THE COMMAND, (AC) IS THE COMMAND
8      6702      XDR=6702      /IOT TO LOAD OR READ THE TRANSFER REGISTER
9      6703      S*P=6703      /IOT TO SKIP ON A TRANSFER REQUEST FLAG
10     6704      SER=6704      /IOT TO SKIP ON AN ERROR FLAG
11     6705      SDN=6705      /IOT TO SKIP ON THE DONE FLAG
12     6706      INTR=6706     / (AC) = 0 INTERRUPT ENABLE OFF/ (AC) = 1 MEANS ON
13     6707      INIT=6707     /IOT TO INITIALIZE THE RX0/RX01 SUBSYSTEM
14     /
15     /THE FOLLOWING IS A PROGRAMMING EXAMPLE OF THE PROTOCOL REQUIRED
16     /
17     /TO WRITE, WRITE DELETED DATA, OR READ AT SECTOR "S" (THE CONTENTS OF PROGRAM
18     /LOCATION SECTOR) OF TRACK "T" (THE CONTENTS OF PROGRAM LOCATION TRACK)
19     /
20     /IN 8 OR 12 BIT MODE
21     /
22     /
23     0200 1254  START,  TAD KMSB      / *10
24     0201 3255      DCA PTRY      /PARITY RETRY COUNTER
25     0202 1254      TAD KMSB
26     0203 3256      DCA CTRY      /CRC RETRY COUNTER
27     0204 1254      TAD KMSB
28     0205 3257      DCA STRY      /SEEK RETRY COUNTER
29     /
30     /WRITE, WRITE DELETED DATA, OR READ
31     /
32     0206 1260      RETRY,  TAD MDDE      /0 IF 12-BIT, 10B IF 8-BIT
33     0207 1261      TAD COMMAND      / * IF WRITE, 14 IF WRITE DELETED
34     /                                /DATA, OR 8 IF READ
35     0210 1262      TAD UNIT          / 0 IF UNIT 8, 20 IF UNIT 1
36     0211 6701      LCD              /IOT 67X1 TO LOAD THE COMMAND
37     /
38     /WAIT FOR THE TRANSFER REQUEST FLAG THEN TRANSFER THE SECTOR ADDRESS
39     /
40     0212 6703      STR              /IOT 67X3 TO
41     0213 5212      JMP ,-1          /WAIT FOR TRANSFER REQUEST FLAG
42     0214 1263      TAD SECTOR      / 1 TO 32(OCTAL)
43     0215 6702      XDR            /IOT TO LOAD SECTOR
44     0216 7200      CLA            /CLA BECAUSE IOT XOR DOESN'T
45     /
46     /WAIT FOR THE TRANSFER REQUEST FLAG THEN TRANSFER THE TRACK ADDRESS
47     /
48     0217 6703      STR              /IOT 67X3 TO
49     0220 5217      JMP ,-1          /WAIT FOR TRANSFER REQUEST
50     0221 1264      TAD TRACK       / 0 TO 114(OCTAL)
51     0222 6702      XDR            /IOT TO LOAD TRACK
52     0223 7200      CLA            /CLA BECAUSE IOT XOR DOESN'T
53     /
54     /THE SECTOR AND TRACK ADDRESSES HAVE BEEN TRANSFERRED TO THE RX01 VIA THE XDR IOT
55     /
56     /WAIT FOR THE DONE FLAG AND CHECK FOR ANY ERRORS
57     /
58     /IF THE FUNCTION HAS COMPLETED SUCCESSFULLY (NO ERROR FLAG) THEN HALT
59     /
60     0224 6705      SDN              /IOT 67X5 TO
61     0225 5224      JMP ,-1          /WAIT FOR DONE FLAG
62     0226 6704      SER              /IOT 67X4 SAMPLES ERROR FLAG
63     0227 7402      HLT              /OK = COMPLETED
64     /
65     /THE ERROR FLAG IS SET
66     /
67     /THE CONTENTS OF THE TRANSFER REGISTER IS THE ERROR STATUS
68     /
69     /IF TRANSFER REGISTER BITS 10, AND 11 = 0 THEN SOME TYPE OF SEEK ERROR HAS OCCURED,
70     /IF TRANSFER REGISTER BIT 11 = 1 THEN A CRC ERROR HAS OCCURED,
71     /IF TRANSFER REGISTER BIT 10 = 1 THEN A PARITY ERROR HAS OCCURED
72     /
73     0230 6702      XDR              /GET CONTENTS OF TR (ERROR STATUS)
74     0231 3265      DCA ASTATUS      /AND SAVE
75     0232 7305      CLL CLA IAC RAL / 2
76     0233 0265      AND ASTATUS      /TEST FOR PARITY ERROR
77     0234 7690      SNA CLA         /SKIP IF PARITY ERROR
78     0235 5241      JMP TCRC        /NOT A PARITY ERROR - MAYBE CRC
79     /
80     /A PARITY ERROR HAS OCCURED
81     /
82     /INCREMENT AND TEST THE PARITY ERROR RETRY COUNTER PROGRAM LOCATION " PTRY "
83     /
84     /AND RETRY THE " COMMAND " UNTIL THE PARITY ERROR RECOVERS
85     /
86     /OR UNTIL THE PTRY COUNTER OVERFLOWS TO 0
87     /
88     0236 2255      ISE PTRY         /RETRY THE COMMAND
89     0237 5206      JMP RETRY        /HARD PARITY ERROR
90     0240 7402      HLT
91     /
92     /THE ERROR FLAG IS SET BUT THE ERROR IS NOT A PARITY ERROR
93     /
94     /TEST FOR A CRC ERROR
95     /
96     0241 7301      TCRC,  CLL CLA IAC / 1
97     0242 0265      AND ASTATUS      /TEST FOR A CRC ERROR
98     0243 7690      SNA CLA         /SKIP IF A CRC ERROR
99     0244 5250      JMP SEEK        /NOT A CRC - MUST BE A SEEK

```

Figure 4-8 RX8E Write/Write Deleted Data/Read Example (Sheet 1 of 2)

```

99          /A CRC ERROR HAS OCCURED
100         /
101         /INCREMENT AND TEST THE CRC ERROR RETRY COUNTER PROGRAM LOCATION " CTRY "
102         /
103         /AND RETRY THE COMMAND UNTIL THE CRC ERROR RECOVERS
104         /
105         /OR UNTIL THE CTRY COUNTER OVERFLOWS TO 0
106         /
107         0245 2256             ISE CTRY
108         0246 5206             JMP RETRY           /RETRY THE COMMAND
109         0247 7402             HLT                 /HARD CRC ERROR
110         /
111         /THE ERROR FLAG IS SET
112         /
113         /THE ERROR IS (NOT) A PARITY ERROR AND IS (NOT) A CRC ERROR
114         /
115         /THEREFORE IS MUST BE A SEEK ERROR
116         /
117         / (CONTENTS OF THE TRANSFER REGISTER BITS 10, AND 11 = 0)
118         /
119         0250 6707             SEEK,  INIT           /IOT 67X7 TO INITIALIZE
120         /
121         /INCREMENT AND TEST THE SEEK ERROR RETRY COUNTER PROGRAM LOCATION " STRY "
122         /
123         /AND RETRY THE COMMAND UNTIL THE SEEK ERROR RECOVERS
124         /
125         /OR UNTIL THE CTRY COUNTER OVERFLOWS TO 0
126         /
127         0251 2257             ISE STRY
128         0252 5206             JMP RETRY           /RETRY THE COMMAND
129         0253 7402             HLT                 /HARD SEEK ERROR
130         /
131         /THE FOLLOWING PROGRAM LOCATIONS ARE REFERENCED WITHIN THIS EXAMPLE
132         /
133         0254 7770             K410,  =10
134         /
135         /THE FOLLOWING 3 PROGRAM LOCATIONS ARE THE ERROR RETRY COUNTERS
136         /
137         0255 0000             PTRY,  0           /PARITY ERROR RETRY COUNTER
138         0256 0000             CTRY,  0           /CRC ERROR RETRY COUNTER
139         0257 0000             STRY,  0           /SEEK ERROR RETRY COUNTER
140         /
141         /PROGRAM LOCATION " MODE " CONTAINS A 0 IF 12-BIT MODE, OR
142         /CONTAINS A 100 IF 8-BIT MODE
143         0260 0000             MODE,  0           / 0 OR 100
144         /
145         /PROGRAM LOCATION " COMMAND " CONTAINS THE COMMAND TO BE ISSUED VIA THE LCD IOT
146         /WRITE (4), WRITE DELETED DATA (14), OR READ (6), OR EMPTY BUFFER (2)
147         /
148         0261 0000             COMMAND, 0         / 4, 14, OR 6, OR 2
149         /
150         /PROGRAM LOCATION " UNIT " CONTAINS THE UNIT DESIGNATION
151         /
152         /UNIT 0 (0), OR UNIT 1 (20)
153         0262 0000             UNIT,  0           / 0, OR 20
154         /
155         /PROGRAM LOCATION " SECTOR " CONTAINS THE SECTOR ADDRESS (1 TO 32 OCTAL)
156         /
157         0263 0000             SECTOR, 0         / 1 TO 32 OCTAL
158         /
159         /PROGRAM LOCATION " TRACK " CONTAINS THE TRACK ADDRESS (0 TO 114 OCTAL)
160         /
161         0264 0000             TRACK,  0         / 0 TO 114 OCTAL
162         /
163         /PROGRAM LOCATION " ASTATUS " CONTAINS THE CONTENTS OF THE TRANSFER REGISTER
164         /
165         /AT THE DETECTION OF AN ERROR (ERROR FLAG = 1) WHICH CORRESPONDS TO THE
166         /ERROR STATUS
167         /
168         / = 0 IF SEEK ERROR, 1 IF CRC ERROR, 2 IF PARITY ERROR
169         /
170         0265 0000             ASTATUS, 0        /STATUS AT ERROR
171         /
172         /
173         /

```

Figure 4-8 RX8E Write/Write Deleted Data/Read Example (Sheet 2 of 2)

```

228 /THE FOLLOWING IS A PROGRAMMING EXAMPLE OF PROTOCOL REQUIRED TO
229 /
230 /EMPTY THE SECTOR BUFFER OF 64 12-BIT WORDS (12 BIT MODE), OR
231 /
232 /EMPTY THE SECTOR BUFFER OF 128 8-BIT BYTES (8 BIT MODE)
233 /
234 0312 1254 EENTRY, TAD KMI0 / 0 TRYS TO EMPTY THE SECTOR BUFFER
235 0313 3295 DCA PTRY /PARITY ERROR RETRY COUNTER
236 0314 1377 ESETUP, TAD (BUFFER-1) /PROGRAMS DATA BUFFER
237 0315 3010 DCA A10 /AUTO INDEX REGISTER 10
238 0316 1260 TAD MODE / 0 IF 12-BIT, 100 IF 8 BIT
239 0317 1261 TAD COMMAND / 2 MEANS EMPTY BUFFER
240 0320 6701 LCP /NOT TO ISSUE THE COMMAND
241 /
242 /WAIT FOR A TRANSFER REQUEST FLAG BEFORE TRANSFERRING DATA TO THE PROGRAMS
243 /
244 /DATA BUFFER FROM THE RX01 SECTOR BUFFER
245 /
246 /WAIT FOR A DONE FLAG TO INDICATE THE COMPLETION OF THE EMPTY BUFFER COMMAND PRIOR TO
247 /
248 /TESTING THE ERROR FLAG
249 /
250 0321 6703 ELOOP, STR /TEST FOR TR FLAG
251 0322 7410 SKP /TR NOT SET, TEST FOR DONE FLAG
252 0323 5333 JMP EMPTY /TR FLAG SET
253 0324 6709 SQN /TEST FOR DONE FLAG
254 0325 5274 JMP ELOOP /NOT TR, OR DONE YET
255 /
256 /THE DONE FLAG IS SET
257 /
258 /TEST FOR ANY ERRORS (ONLY ERROR POSSIBLE IS A PARITY ERROR)
259 /
260 0326 6704 SER /TEST FOR THE ERROR FLAG
261 0327 7402 HLT /NO ERRORS - OK
262 /
263 /INCREMENT AND TEST THE PARITY ERROR RETRY PROGRAM LOCATION " PTRY "
264 /
265 /AND RETRY THE COMMAND UNTIL THE ERROR RECOVERS
266 /
267 /OR UNTIL THE PTRY COUNTER OVERFLOWS TO 0
268 /
269 0330 2255 ISB PTRY /RETRY TO EMPTY THE SECTOR BUFFER
270 0331 5314 JMP ESETUP /HARD PARITY ERROR
271 0332 7402 HLT
272 /
273 /THE TRANSFER REQUEST FLAG IS SET
274 /
275 /TRANSFER DATA TO THE PROGRAMS DATA BUFFER FROM THE RX01 SECTOR BUFFER
276 /
277 0333 6702 EMPTY, XDR /FROM THE RX01 SECTOR BUFFER
278 0334 3410 DCA I A10 /TO THE PROGRAMS DATA BUFFER
279 0335 5321 JMP ELOOP /LOOP UNTIL THE DONE FLAG SETS
280 0377 0377 PAGE
281 /
282 /THE FOLLOWING PROGRAM LOCATIONS ARE RESERVED FOR THE PROGRAMS DATA BUFFER
283 0400 0000 BUFFER, 0
284 0600 0600 #BUFFER+200
285 5

```

Figure 4-9 RX8E Empty Buffer Example

```

174          /THE FOLLOWING IS A PROGRAMMING EXAMPLE OF PROTOCJL REQUIRED TO
175          /
176          /FILL THE SECTOR BUFFER WITH 64 12-BIT WORDS (12 BIT MODE), OR
177          /
178          /FILL THE SECTOR BUFFER WITH 128 8-BIT BYTES (8 BIT MODE)
179          /
180          0010  A10=A10
181          /
182          0266 1254  FENTRY, TAD KM10          / 8 TRYS TO FILL THE SECTOR BUFFER
183          0267 3255          DCA PTRY          /PARITY ERROR RETRY COUNTER
184          0270 1377  SETUP, TAD (BUFFER-1)    /PROGRAMS DATA BUFFER
185          0271 3010          DCA A10          /AUTO INDEX REGISTER 10
186          0272 1260          TAD MODE          / 0 IF 12-BIT, 100 IF 8 BIT
187          0273 6701          LCC              /IOT TO ISSUE THE COMMAND
188          /
189          /WAIT FOR A TRANSFER REQUEST FLAG BEFORE TRANSFERRING DATA FROM THE PROGRAMS
190          /
191          /DATA BUFFER TO THE RX01 SECTOR BUFFER
192          /
193          /WAIT FOR A DONE FLAG TO INDICATE THE COMPLETION OF THE FILL BUFFER COMMAND PRIOR TO
194          /
195          /TESTING THE ERROR FLAG
196          /
197          0274 6703  LOOP,  STR              /TEST FOR TR FLAG
198          0275 7410          SKP              /TR NOT SET, TEST FOR DONE FLAG
199          0276 9306          JMP FILL        /TR FLAG SET
200          0277 6705          SON              /TEST FOR DONE FLAG
201          0300 9274          JMP LOOP        /NOT TR, OR DONE YET
202          /
203          /THE DONE FLAG IS SET
204          /
205          /TEST FOR ANY ERRORS (ONLY ERROR POSSIBLE IS A PARITY ERROR)
206          /
207          0301 6704          SER              /TEST FOR THE ERROR FLAG
208          0302 7402          HLT              /NO ERRORS = OK
209          /
210          /INCREMENT AND TEST THE PARITY ERROR RETRY PROGRAM LOCATION " PTRY "
211          /
212          /AND RETRY THE COMMAND UNTIL THE ERROR RECOVERS
213          /
214          /OR UNTIL THE PTRY COUNTER OVERFLOWS TO 0
215          /
216          0303 2255          ISB PTRY
217          0304 9270          JMP SETUP        /RETRY TO FILL THE SECTOR BUFFER
218          0305 7402          HLT              /HARD PARITY ERROR
219          /
220          /THE TRANSFER REQUEST FLAG IS SET
221          /
222          /TRANSFER DATA FROM THE PROGRAMS DATA BUFFER TO THE RX01 SECTOR BUFFER
223          /
224          0306 1410  FILL,  TAD I A10        /VIA AUTO INDEX REGISTER 10
225          0307 6702          XDR            /TO THE RX01 SECTOR BUFFER
226          0310 7200          CLA            /CLA BECAUSE IOT XDR DOESN'T
227          0311 9274          JMP LOOP        /LOOP UNTIL THE DONE FLAG SETS

```

Figure 4-10 Fill Buffer Example

4.6 RESTRICTIONS AND PROGRAMMING PITFALLS

A set of 11 restrictions and programming pitfalls for the RX8E is presented below.

1. When performing the following sequence of instructions, interrupts *must* be off.

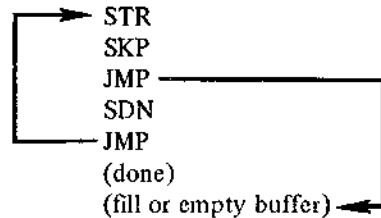

If interrupts are not off, the following sequence of events will occur. Assume interrupts are enabled and the RX8E issues an interrupt request just before the SDN instruction. The SDN instruction will be executed as the last legal instruction before the processor takes over. However, since the Done flag is cleared by the SDN instruction, the processor will not find the device that issued the interrupt.

2. The program must issue an SER instruction to test for errors following an SDN instruction.
3. For maximum data throughput for consecutive writes or reads in 8-bit mode, interleave every three sectors; in 12-bit mode, interleave every two sectors. (This of course depends on program overhead.)
4. When issuing the IOT XDR at the end of a function to test the status, the instruction AND 377 must be given, because the most significant bits (0–3) contain part of the previous command word.
5. If an error occurs and the program executes a Read Error Register function (111) (Paragraph 4.4.7), a parity error may occur for that command. The error code coming back would not be for the original error in which the Read Error Register function was issued, but for the parity error resulting from the Read Error Register function. Therefore, check for parity error with the Read Status function (101) before checking for errors with the Read Error Register function (111).
6. The SEL DRV RDY bit is present only at the time of the Read Status function (101) for either drive, or at completion of an Initialize for drive 0.
7. It is not necessary to load the Drive Select bit into the command word when the command is Fill Buffer (000) or Empty Buffer (001).
8. Sector Addressing: 1–26 or 1–32₈ (No sector 0)
Track Addressing: 0–76 or 1–114₈
9. If a Read Error Register function (111) is desired, the program must perform this function before a Read Status function (101), because the content of the Error register is always modified by a Read Status function.
10. The instructions STR, SDN, SER also clear the respective flags after testing, so that the software must store these flags if future reference to them is needed after performing one of these instructions.
11. Excessive use of the Read Status function (101) will result in drastically decreased throughput, because a Read Status function requires between one and two diskette revolutions or about 250 ms to complete.

4.7 ERROR RECOVERY

There are two error indications given by the RX8E system. The Read Status function (Paragraph 4.4.5) will assemble the current contents of the RXES (Paragraph 4.3.6), which can be sampled to determine errors. The Read Error Register function (Paragraph 4.4.7) can also be used to retrieve explicit error information.

The results of the Read Status function or the Read Error Register function are in the Interface register when Done sets, indicating the completion of the function. The XDR IOT must be issued to transfer the contents of the Interface register to the PDP-8's AC.

NOTE

A Read Status function is not necessary if the DRV RDY bit is not going to be interrogated, because the RXES is in the Interface register at the completion of every function.

The error codes for the Read Error Register function are presented below.

Octal Code	Error Code Meaning
0010	Drive 0 failed to see home on Initialize.
0020	Drive 1 failed to see home on Initialize.
0030	Found home when stepping out 10 tracks for INIT.
0040	Tried to access a track greater than 77.
0050	Home was found before desired track was reached.
0060	Self-diagnostic error.
0070	Desired sector could not be found after looking at 52 headers (2 revolutions).
0110	More than 40 μ s and no SEP clock seen.
0120	A preamble could not be found.
0130	Preamble found but no I/O mark found within allowable time span.
0140	CRC error on what we thought was a header.
0150	The header track address of a good header does not compare with the desired track.
0160	Too many tries for an IDAM (identifies header).
0170	Data AM not found in allotted time.
0200	CRC error on reading the sector from the disk. No code appears in the ERREG.
0210	All parity errors.

Reader's Comments

**RX8/RX11 Floppy Disk System
User's Manual
EK-RX01-OP-001**

Your comments and suggestions will help us in our continuous effort to improve the quality and usefulness of our publications.

What is your general reaction to this manual? In your judgment is it complete, accurate, well organized, well written, etc.? Is it easy to use? _____

What features are most useful? _____

What faults do you find with the manual? _____

Does this manual satisfy the need you think it was intended to satisfy? _____

Does it satisfy *your* needs? _____ Why? _____

Would you please indicate any factual errors you have found. _____

Please describe your position. _____

Name _____ Organization _____

Street _____ Department _____

City _____ State _____ Zip or Country _____

CUT OUT ON DOTTED LINE

Fold Here -----

Do Not Tear - Fold Here and Staple -----

**FIRST CLASS
PERMIT NO. 33
MAYNARD, MASS.**

**BUSINESS REPLY MAIL
NO POSTAGE STAMP NECESSARY IF MAILED IN THE UNITED STATES**

Postage will be paid by:

**Digital Equipment Corporation
Technical Documentation Department
146 Main Street
Maynard, Massachusetts 01754**

