

PDP-12
MAINTENANCE MANUAL
VOLUME II
INSTALLATION AND MAINTENANCE

Copyright © 1971 by Digital Equipment Corporation

The material in this manual is for information purposes and is subject to change without notice.

The following are trademarks of Digital Equipment Corporation, Maynard, Massachusetts:

DEC	PDP
FLIP CHIP	FOCAL
DIGITAL	COMPUTER LAB

CONTENTS

	Page
CHAPTER 1 INSTALLATION	
1.1	Planning 1-1
1.1.1	Site Considerations 1-1
1.1.2	Space Requirements 1-1
1.1.3	Floor Construction 1-1
1.1.4	System Layout 1-3
1.1.5	Fire and Safety Precautions 1-3
1.1.6	Installation Constraints 1-4
1.1.7	Environmental Considerations 1-4
1.2	System Configurations 1-5
1.2.1	Standard Configurations 1-5
1.2.2	System Expansion 1-6
1.2.3	I/O Interface 1-6
1.3	Predelivery Preparation 1-6
1.3.1	Preliminary Procedures 1-6
1.3.2	Shipping and Receiving Constraints 1-8
1.3.3	System Power Requirements 1-9
1.3.4	Source Power Requirements 1-9
1.3.5	Primary ac Power Cables 1-11
1.3.6	Service Outlets 1-11
1.3.7	Cabling 1-11
1.4	Unpacking, Installation and Inspection 1-12
1.4.1	General 1-12
1.4.2	Cabinet Unpacking 1-12
1.4.3	Cabinet Installation 1-13
1.4.4	Cabinet Inspection 1-13
1.4.5	Teletype Unpacking 1-14
1.4.6	Teletype Installation and Setup 1-14
1.4.7	Prewired Option Installation 1-15
1.4.8	Peripheral Equipment Inspection 1-15
1.4.9	Miscellaneous Items 1-15
1.5	Checkout 1-15
1.5.1	Preliminary Operating Checks 1-15
1.5.2	Teletype Test 1-16
1.5.3	Computer Memory Test 1-16
1.5.4	RIM Loader 1-16
1.5.5	Running MAINDECs 1-17
CHAPTER 2 MAINTENANCE	
2.1	Introduction 2-1
2.2	Maintenance Equipment 2-1

CONTENTS (Cont)

	Page	
2.2.1	Maintenance Test Programs	2-2
2.2.2	Mounting DIAL MAINTENANCE Tapes	2-3
2.3	Preventive Maintenance	2-3
2.3.1	Scheduled Maintenance	2-4
2.4	Corrective Maintenance	2-5
2.4.1	Preliminary Investigation	2-6
2.4.2	System Troubleshooting	2-6
2.5	Troubleshooting Techniques	2-6
2.5.1	Introduction	2-6
2.5.2	Console Checks	2-7
2.5.3	LINC-Mode Processing	2-8
2.5.4	8-Mode Processing	2-9
2.5.5	TC12 Tape Subprocessor	2-9
2.5.6	TC12 Console Checks	2-10
2.5.7	Logic Troubleshooting	2-12
2.5.8	Module (Circuit) Troubleshooting	2-12
2.5.9	Repairs and Replacements	2-13
2.5.10	Validation Tests	2-14
2.5.11	Log Book Recording	2-14
 CHAPTER 3 ADJUSTMENTS		
3.1	Memory Current and Strobe	3-1
3.1.1	Initial Current Adjustments	3-1
3.1.2	Initial Strobe Adjustment	3-2
3.1.3	Memory Strobe Adjustments	3-2
3.1.4	Final Current Adjustments	3-4
3.1.5	Memory Margins and Final Strobe Adjustments	3-6
3.2	Power OK	3-6
3.2.1	Check Procedure	3-6
3.2.2	Adjustment Procedure	3-6
3.3	Extended Memory MC12	3-7
3.3.1	Set-up and Adjustment Procedure	3-7
3.4	Teletype Clock	3-8
3.5	LINCtape	3-9
3.5.1	Tape Timing Pulses	3-9
3.5.2	LTD XTLK Delay	3-11
3.5.3	LTD TTOK Delay	3-12
3.5.4	LTD TAPE FAIL Delay	3-13
3.5.5	LTD ACIP Delay	3-14
3.5.6	Mark Clock Adjustment	3-16
3.6	TU55 Tape Transport	3-17
3.6.1	TU55 Brake Adjustment	3-18
3.6.2	TU55 Torque Adjustments	3-19

CONTENTS (Cont)

	Page	
3.6.3	TU55 Transport Head Replacement and Adjustment Procedures	3-21
3.7	TU56 Tape Transport	3-24
3.7.1	TU56 Brake Adjustment	3-24
3.7.2	Oscillator Adjustment	3-26
3.8	Analog (AD12) and Display (VR12,VC12)	3-26
3.8.1	Digital-to-Analog Adjustment Procedure (A615)	3-27
3.8.2	VR12 Size and Position Adjustments	3-29
3.8.3	Brightness and Brightness Preset Adjustment	3-29
3.8.4	Deflection Amplifier Quiescent Current Adjustment (VR12)	3-30
3.8.5	Analog-to-Digital Adjustment Procedure	3-30
3.8.6	Sample and Hold Adjustment Procedure (A404)	3-32
3.8.7	External Analog Channel Adjustment Procedure	3-32
3.9	Extended Analog (AG12,AM12)	3-33
3.9.1	Set-up Procedure	3-33
3.9.2	Adjustment Procedure	3-34
 CHAPTER 4 FIELD INSTALLATION AND CHECKOUT OF PREWIRED OPTIONS		
4.1	Unpacking	4-1
4.2	Installation	4-2
4.2.1	Installation of Panels and Cables	4-6
4.2.2	Unit and Cable Installation for TU55 and VR12	4-8
4.2.3	TU56 Unit and Cable Installation	4-11
4.3	Checkout	4-14
4.3.1	Checkout of the DP12-B	4-14
4.3.2	Checkout of TC12-F	4-15
4.3.3	Checkout of the LINtapes System	4-15
4.3.4	Checkout of VR12	4-17
 CHAPTER 5 TELETYPE MAINTENANCE MODELS ASR 33 AND 35		
5.1	Equipment	5-1
5.2	Preventive Maintenance	5-2
5.2.1	Weekly Tasks	5-2
5.2.2	Preventive Maintenance Tasks	5-2
5.3	Corrective Maintenance	5-3
5.4	Teletype Parts	5-5
 APPENDIX A MAINTENANCE AND SERVICE OPTIONS		
A.1	Service Contracts	A-1
A.1.1	Service Contract Options	A-1
A.1.2	Eligibility for Service Contract Coverage	A-2

APPENDIX (Cont)

		Page
A.2	Per-Call Coverage	A-2
A.3	Depot Repair	A-2
A.4	Field Installation of Additional DEC Options	A-3

APPENDIX B CUSTOMER ACCEPTANCE

B.1	Special Customer Requirements	B-1
B.2	Customer Programs	B-1
B.3	Special Customer Acceptance Testing	B-1
B.4	Diagnostics	B-1
B.5	System Software Acceptance	B-2

APPENDIX C FORMS AND CHECKLISTS

C.1	Customer Acceptance Forms	C-1
C.2	Customer Data Forms	C-1
C.3	Software Trouble Reports	C-2
C.4	DECUS Information	C-2
C.5	Basic Accessory Checklist	C-2
C.6	Optional Equipment Checklist	C-2
C.7	Software Checklist	C-2
C.8	Final Distribution of Forms	C-2

APPENDIX D SOFTWARE AND PREWIRED OPTION DIAGNOSTICS

ILLUSTRATIONS

Figure No.	Title	Art No.	Page
1-1	Pedestal Flooring	10-0479	1-2
1-2	Raceway Flooring	10-0478	1-2
1-3	PDP-12 Expanded Equipment Layout	12-0255	1-7
1-4	Minimum PDP-12 Equipment Floor Plan Requirements	12-0256	1-7
1-5	Packing Details		1-8
1-6	Hubbell Wall Receptacle Connector Diagram	09-0414	1-10
2-1	Integrated Circuit Location	12-0133	2-13
2-2	Integrated Circuit Pin Location – Top View	12-0134	2-13
3-1	Ground Reference		3-2
3-2	MEM START and STROBE		3-4
3-3	Positive Memory Current		3-5
3-4	Negative Memory Current		3-5
3-5	Teletype Clock (Sweep at .5 ms)		3-9
3-6	LTT TP0/TP2 Pulse Duration		3-10
3-7	LTT TP3/TP4 Pulse Duration		3-11

ILLUSTRATIONS (Cont)

Figure No.	Title	Art No.	Page
3-8	LTD XTLK Delay Time	12-0261	3-12
3-9	LTD TTOK Delay		3-13
3-10	LTD Tape Fail Delay		3-15
3-11	LTD ACIP Delay		3-16
3-12	Mark Clock		3-17
3-13	TU55 Brake Adjustment		3-18
3-14	TU55 Torque Adjustment Tabs		3-20
3-15	TU55 Stop Delay Adjustment		3-21
3-16	Skew Checker Schematic Diagram	12-0127	3-23
3-17	Skew Checker Output	12-0126	3-24
3-18	80 ms Brake Delay Adjustment		3-25
3-19	25 ms Oscillator Adjustment		3-26
3-20	D/A Line Display	12-0086	3-27
3-21	Sample and Hold Adjustments		3-28
3-22	A-to-D Display		3-31
4-1	PDP-12 Equipment Layout	12-0260	4-7
4-2	TU55 LINctape Transport		4-9
4-3	VR12		4-9
4-4	TU55 and VR12 Mounting Assembly	12-0253	4-10
4-5	TU56 LINctape Transport		4-11
4-6	Front Assembly of TU56	12-0258	4-12
4-7	Rear Plate Assembly of TU56	12-0257	4-12
4-8	Top View of TU56 Rest Plate Assembly	12-0254	4-13
5-1	Teletype Connections	12-0088	5-4
5-2	Teletype Signal Waveform and Bit Relationship for the Character "U"	8I-0010	5-5

TABLES

Table No.	Title	Page
1-1	Standard PDP-12 Shipping Specifications	1-9
1-2	Hubbell Wall Receptacle Part Numbers	1-10
1-3	Power Cable Line Identification	1-11
2-1	Maintenance Equipment	2-1
2-2	Power Supply Specifications	2-5
3-1	Memory Diagnostics	3-8
3-2	Monitor Table for Channels 20 through 37	3-34
4-1	Prewired Options	4-1
4-2	Option MAINDECs Checklist	4-2
4-3	Option Module and Cable List	4-3
4-4	Interconnections of TU55	4-10
4-5	DC Voltage Connections	4-14
4-6	TU56 Logic Cable Connections	4-14

TABLES (Cont)

Table No.	Title	Page
4-7	Format Conversion Table	4-15
4-8	VR12 Controls	4-17
5-1	Teletype Maintenance Tools	5-1
5-2	Maintenance Programs	5-2
5-3	Spare Parts for Keyboard Model 33 ASR Teletype	5-6
D-1	Options Diagnostics	D-4

FOREWORD

The *PDP-12 Maintenance Manual*, published in four separate volumes, is a guide for Field Service Engineers or other personnel involved with the care and maintenance of the PDP-12 Computer. The Maintenance Manual is organized as follows:

VOLUME I PRINCIPLES OF OPERATION

This volume contains a description of PDP-12 logic. An overall view of the system is presented in seven chapters entitled Central Processor, Memory, Input/Output, Teletype, LINC Devices, Tape Processor, and Prewired I/O Bus Options. The text describes logical relationships among the various elements of the PDP-12.

VOLUME II INSTALLATION AND MAINTENANCE

The first chapters of this volume describe the unpacking, installation, and preliminary check-out procedures for the PDP-12. The remainder of the volume comprises procedures used in the day-to-day maintenance, adjustment, and repair of the computer.

VOLUME III LOGIC SCHEMATICS

Volume III consists primarily of flow charts and block schematics that describe the PDP-12. The block schematics, lists, and flow charts in Volume III are reduced (11 in. x 17 in.) versions of engineering drawings.

VOLUME IV MODULE SCHEMATICS

The circuit schematics in Volume IV describe all the module types used in the PDP-12, including both the regular production DEC modules and those designed especially for the PDP-12.

WARNING

Maintenance procedures should be performed by qualified service personnel only.

High voltages are present within the equipment and are potentially dangerous. All safety precautions must be observed.

Inherent implosion protection is considered in the CRT design. However, the tube may be damaged if it is subjected to rough treatment or dropped while being removed from or installed in the display. Caution, therefore, must be exercised during these operations.

CHAPTER 1

INSTALLATION

This chapter presents planning, installation, and interface information for the PDP-12 and its options.

1.1 PLANNING

1.1.1 Site Considerations

Adequate site planning and preparation can simplify the installation process and result in an efficient, reliable PDP-12 System installation. DEC Sales Engineers and/or Field Service personnel are available for counseling and consultation with customer-designated personnel regarding the installation.

Site planning should include a list of the components to be used in the installation, such as: tape-storage cabinets, Teletype[®] supplies, work tables and any other items pertinent to the user's computer application.

Primary planning considerations are: the availability and location of adequate power, and the existence of fire protection. If the existing environmental conditions dictate, air-conditioning and/or humidifying equipment installation can become part of the site-planning program (see Paragraph 1.1.7).

1.1.2 Space Requirements

Space requirements are determined by the specific system configuration to be installed and, when applicable, provision for future expansion. To determine the exact area required for a specific configuration, a floor plan layout of the proposed computer room is helpful. When applicable, space must be provided for storage of tape reels, printer forms, card files, etc.

In large installations where test equipment is maintained, DEC recommends that the test equipment storage area be within or adjacent to the computer room.

1.1.3 Floor Construction

Although the PDP-12 System does not require special flooring, a raised floor is preferable for the following reasons:

- a. Minimum cost of future layout changes
- b. Protection of power and interconnecting cables
- c. Safety of personnel (no cabling to trip over)
- d. Enhancement of the computer site

[®]Teletype is a registered trademark of Teletype Corporation.

One type of flooring suitable for a PDP-12 site is the pedestal type shown in Figure 1-1. This flooring allows cable routing in any direction (e.g., under the floor); it also allows flexibility in the system layout, and minimizes cable lengths.

Another type of flooring available is the raceway type shown in Figure 1-2. This type of flooring however, does not allow the cable routing flexibility provided by the pedestal type.

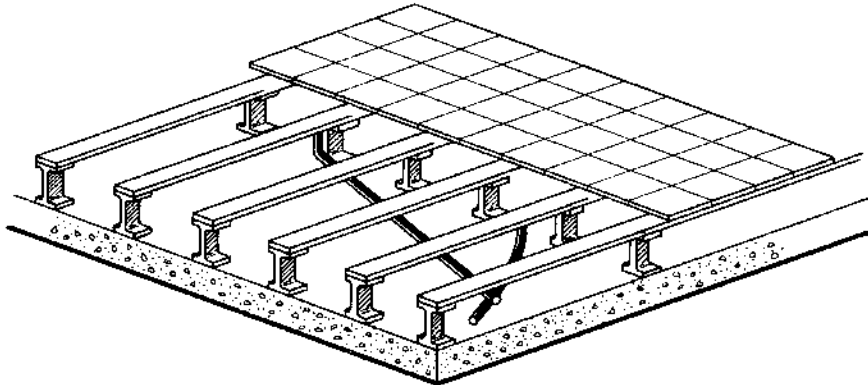

10-0479

Figure 1-1 Pedestal Flooring

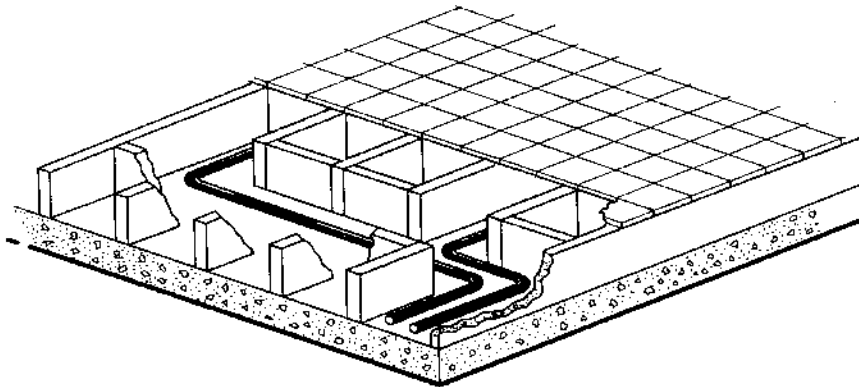

10-0478

Figure 1-2 Raceway Flooring

The floor should be constructed to allow access to the cabling and be capable of withstanding the weight requirements of the system, personnel, and any other equipment which is to be positioned on the raised floor.

1.1.4 System Layout

PDP-12 Systems can be ordered under three types of layout plans. The three types are:

Plan A – an unmodified, standard PDP-12 System, or the PDP-12/10, /20, /30, /40 series. This plan provides a standard configuration, including standard cable lengths to free-standing peripherals (shown in System Drawings PDP12-0-1 through 5, Volume III of this maintenance manual);

Plan B – a configuration similar to *Plan A* except that either the cabinet-mounted peripheral configuration, or the free-standing peripheral locations differ from DEC specifications;

Plan C – a special PDP-12 installation dictated by the customer's application and built by DEC's Computer Special Systems group. For such a plan, the customer should prepare a layout of PDP-12 cabinet and peripheral equipment locations, and submit the layout to DEC for approval. If the PDP-12 computer console is to be remotely located, the distance from the console to the peripherals must be specified by the customer; the appropriate interconnecting cable can then be supplied by DEC.

Operational requirements determine the specific location of the various free-standing peripherals of the system.

The following points should be considered when planning the PDP-12 layout:

- a. Easy observation of I/O devices by operating personnel
- b. Adequate work area for installing tapes, disks, allowing access to console, etc.
- c. Proximity of the cabinets and peripherals to any humidity-controlling or air-conditioning equipment

The final layout is then reviewed by the DEC Sales Engineer and factory engineering personnel to ensure that cable limitations are not exceeded, and that proper clearances are maintained. When applicable, the DEC Field Service Branch Manager provides a scaled layout of the Field Service Engineering equipment to be installed in the computer room.

NOTE

If additional system or console Teletypes are to be located more than six ft from the computer, inform the Sales Engineer and DEC will provide the additional cable lengths.

1.1.5 Fire and Safety Precautions

The following fire and safety precautions are presented as an aid in providing an installation that affords adequate operational safeguards for personnel and system components. Compliance with industry-acceptable and local regulations are the responsibility of the system user.

- a. If an overhead sprinkler system is used, a "dry pipe" system is recommended. This type of system, upon detection of a fire, removes source power from the room and then opens a master valve to fill the room's overhead sprinklers.
- b. If the fire detection system is of the type that shuts off the power to the installation, a battery-operated emergency light source should be provided.
- c. If an automatic carbon-dioxide fire protection system is used, an alarm should sound on release of the CO₂ to warn personnel within the area.
- d. If power connections are made beneath the floor of a raised-floor installation, waterproof electrical receptacles and connections should be used.

(continued on next page)

- e. An adequate earth ground connection should be provided for the protection of operating personnel.

NOTE

In view of the value of this system, it may be advisable for the user to consult with his insurance underwriter concerning security, loss due to fire, flood, etc., or other related considerations.

1.1.6 Installation Constraints

The route that the equipment is to travel from the receiving area to the installation site should be studied and measurements taken to facilitate delivery of the equipment. All measurements and floor plans should be made available to the DEC Sales Engineer to ensure that the equipment is packed to suit the installation site facilities. Any restrictions, (such as bends or obstructions in the hallways, elevator or room door openings, and floor loading restrictions, etc.) should be highlighted. If an elevator is to be used for transferring the PDP-12 and its related equipment to the installation site, the size and gross weight limitations of the elevator must be compared with those of the computer equipment.

1.1.7 Environmental Consideration

An ideal computer room environment has an air-distribution system which provides cool, well-filtered, humidity-controlled air. The room air pressure should be kept higher than the pressure of adjacent areas, to prevent dust infiltration.

Humidity and Temperature – The PDP-12 System is designed to operate in a temperature range of from 50°F (10°C) to 110°F (43°C), at a relative humidity of 20 to 90 percent with no condensation. However, typical system configurations using I/O devices, such as magnetic tape units, card readers, etc., require an operational temperature range between 65°F (18°C) and 80°F (27.5°C), with 40 to 60 percent relative humidity. Nominal operating conditions for a typical system are a temperature of 70°F ± 5°F (21°C), with a noncondensation relative humidity of 45 percent ± 5 percent.

Air-Conditioning System – Paragraph 1.3.3 describes the heat dissipation factors of the PDP-12 System. When used, computer room air-conditioning equipment should conform to the requirements of the “Standard for the Installation of Air-Conditioning and Ventilating Systems (nonresidential)”, N.F.P.A. No. 90A; as well as to the requirements of the “Standard for Electronic Computer Systems”, N.F.P.A. No. 75.

Acoustical Damping – Some peripheral devices (such as line printers) have a high noise level. In installations that use a group of high noise-level devices, an acoustically dampened ceiling that reduces noise should be considered for personnel comfort.

Lighting – A cathode-ray tube display device employing a variable intensity feature is a part of most PDP-12 Systems; the illumination surrounding the computer should, therefore, be capable of being varied to enable the operator to adjust the ambient light level for comfortable long-term viewing.

Special Mounting Conditions – If the PDP-12 will be subjected to rolling, pitching, or vibration of the mounting surface (e.g., aboard ship), all cabinetry should be securely anchored to the installation floor by mounting bolts. Because such installations could require modifications to the system cabinets, DEC should be notified of the special condition upon placement of the order.

Cleanliness – The following precautions are recommended by DEC to ensure optimum PDP-12 operation:

- a. Do not use steel wool for cleaning floors in the computer room. The metal fibers can enter the cabinets and possibly short the electrical components.
- b. To prevent air flow interference, do not place any material on top of the system cabinets.
- c. Use a nonconductor-type nozzle when vacuuming to minimize the possibility of an electrical accident.
- d. Avoid spilling liquids (coffee, soda, etc.) on the equipment and operating controls.
- e. If available, filtered air should be provided to the computer room.

Static Electricity – Static electricity can be an annoyance to computer room personnel and may (in extreme cases) affect the operational characteristics of the PDP-12 and related peripheral equipment. If carpeting is installed on the installation room floor, it should be of a type designed to minimize the effects of static electricity. Flooring consisting of metal panels or flooring with metal edges should be adequately grounded.

1.2 SYSTEM CONFIGURATIONS

1.2.1 Standard Configurations

There are three standard PDP-12 System configurations; components are detailed in the Systems Drawings, Volume III of this maintenance manual.

System	Drawing Number
a. PDP-12C Basic System	PDP12-0-1 Sheet 2 of 4
b. PDP-12B Intermediate System	PDP12-0-1 Sheet 1 of 4
c. PDP-12A LINC System	PDP12-0-1 Sheet 1 of 4

NOTE

The PDP-12/10, /20, /30, /40 configurations are listed below.

PDP-12/10 Basic Laboratory Instrument System
PDP-12 Dual Instruction set Central Processor
4096 12-bit, 1.6 μ s Core Memory
Direct Memory Access Channel
6 Sense Switches
Hardware Signed Multiply Instruction (9 μ s)
15 Auto-Index Registers
12 Sense Line Inputs
30-in. Free-standing Cabinet
AD12 Analog to Digital
DR12
33 ASR Teletypewriter, 10 Char/Sec Paper Tape Reader and Punch

PDP-12/20 Laboratory Instrument Computer-LINC

Includes all of the features of PDP-12/10 plus:

TC12
TU56
VC14
VR14
API-12 Multiple level automatic priority interrupt

(continued on next page)

PDP-12 Advanced LINC

Includes all of the features of PDP-12/20 plus:

- MC12 4K memory extension
- KW12-A Real Time Clock

PDP-12 Super LINC

Includes all of the features of PDP-12/30 plus:

- FPP-12 Floating Point Processor

1.2.2 System Expansion

As shown in the drawing referenced on Page 1-5 (Sheets 1 through 4), a PDP-12 System can be expanded by addition of the options which are housed in H961-C Expander Cabinets. A system can also be expanded with the use of stand-alone expander cabinets or free-standing peripherals. However, it is important that the maximum cable lengths between the PDP-12 Cabinet and any additional peripherals be carefully considered. Attention is directed to System Drawing PDP12-0-2, Sheet 2, which lists some of the cables and the lengths. Careful consultation with the DEC Sales Engineer will eliminate any problems that might otherwise be encountered when expanding a PDP-12 System.

1.2.3 I/O Interface

A complete discussion of the interface requirements of the PDP-12 is presented in Chapter Six of the *PDP-12 System Reference Manual* (also supplied with each system). Discussed are: the I/O Bus, I/O Cables, logic level converters and their drive capabilities, etc.

1.3 PREDELIVERY PREPARATION

The size of the system to be installed is the prime consideration in determining the degree of planning and site preparation required. The following general information is presented as a guide in site preparation and planning.

1.3.1 Preliminary Procedures

Prior to receiving the equipment, the customer should:

- a. Determine the location of the installation and the system configuration. If applicable, make an installation layout diagram, using the information in Paragraph 1-2. Figures 1-3 and 1-4 illustrate PDP-12 Cabinet dimensions and equipment layouts.
- b. Determine the placement of air-conditioning, lighting, power receptacles, etc.
- c. Check the size of doors, passageways, elevators, etc., that could create receiving and/or installation problems. If a problem is noted, DEC must be informed at the time the equipment is ordered. Special packing/shipping provisions can then be implemented.
- d. Determine the power requirements of the entire system. This information is provided in Paragraph 1.3.3, System Power Requirements.

The DEC Sales Engineer usually visits the installation site at the time of the sales order and again one month prior to delivery, to determine the specific requirements for moving system components from the delivery van to the installation site. Any installation site restrictions or constraints should be noted and reported to the DEC Sales Engineer.

One week prior to delivery, installation of air-conditioning equipment, electrical and power facilities, lighting, etc. should be completed.

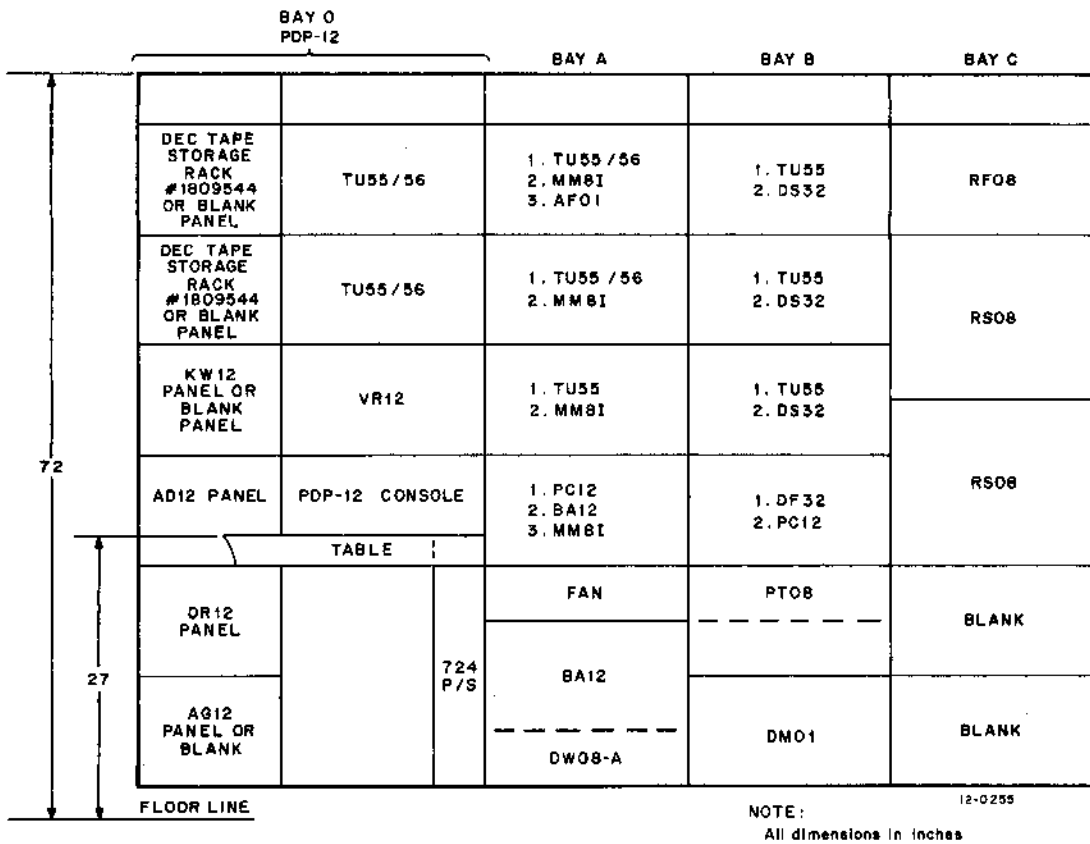

Figure 1-3 PDP-12 Expanded Equipment Layout (see Drawing PDP12-0-2)

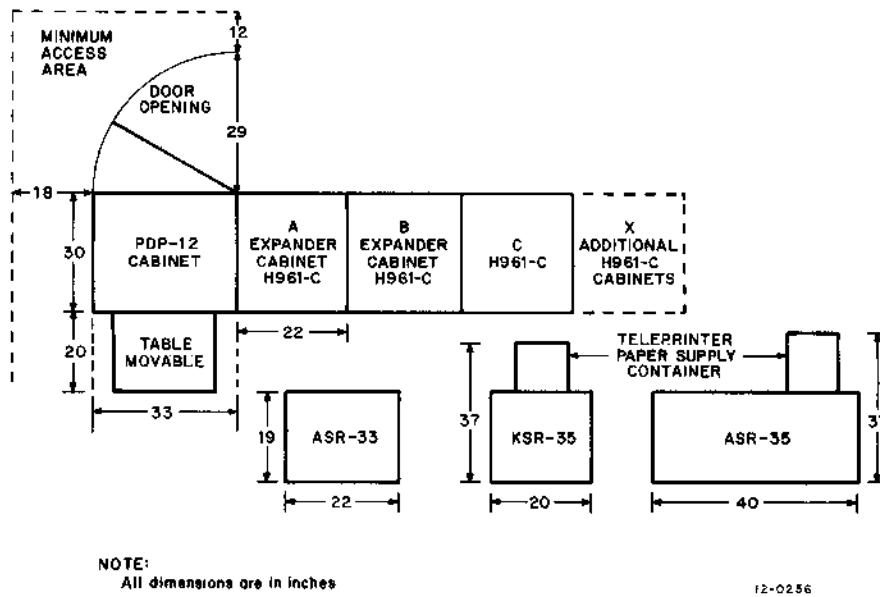

Figure 1-4 Minimum PDP-12 Equipment Floor Plan Requirements (See Volume III, Drawing PDP12-0-2)

1.3.2 Shipping and Receiving Constraints

Unless otherwise specified to the DEC Sales Engineer at the time of the order, PDP-12 Systems are shipped in the following manner (see Figure 1-5):

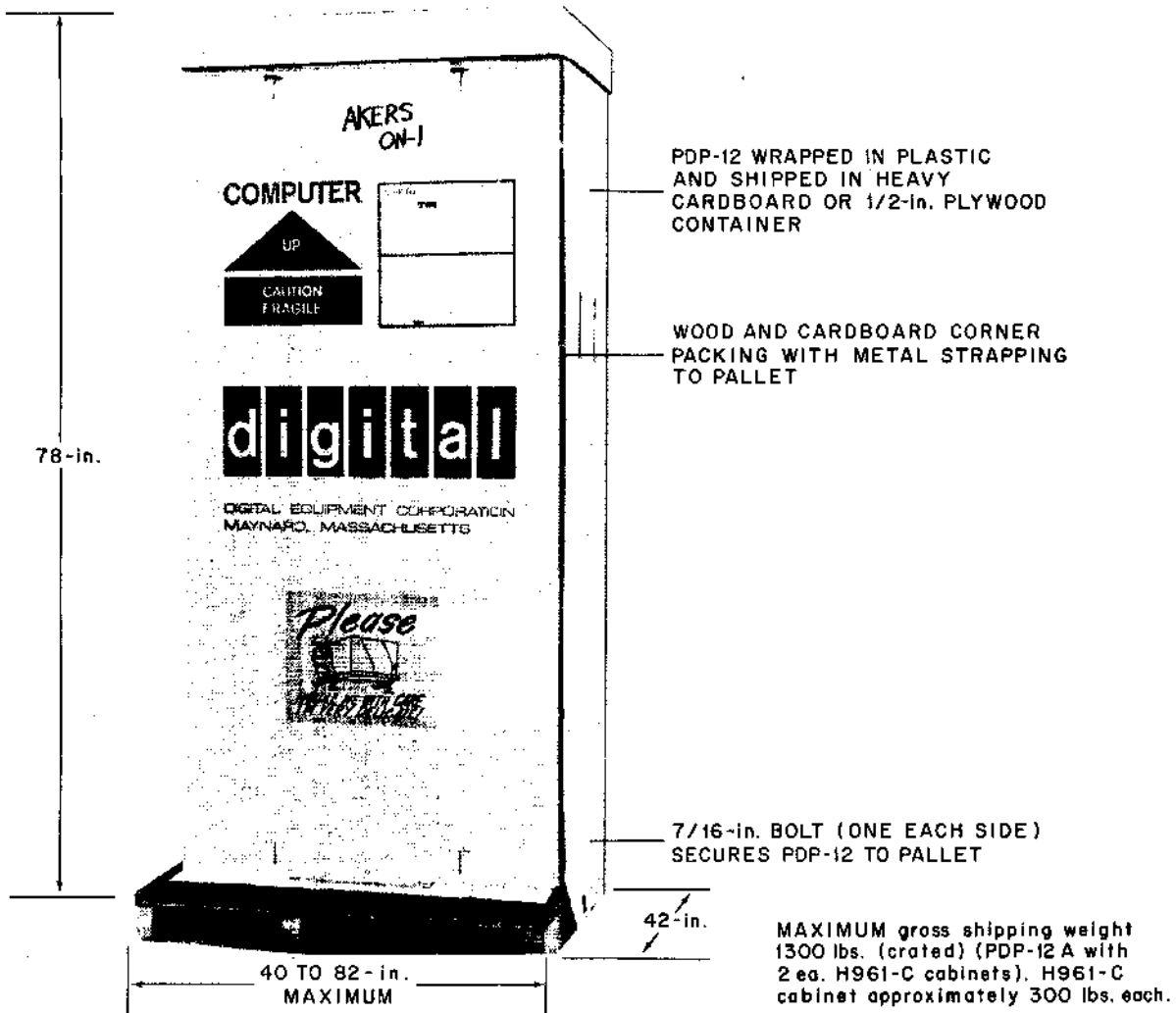

Figure 1-5 Packing Details

Domestic and North America

- a. *Motor Freight and Padded Van* — PDP-12 Systems are shipped as a single integrated package. The largest configuration normally packed and shipped is the basic PDP-12 Cabinet and two H961-C Expander Cabinets, terminated and bolted together, and mounted on the same shipping pallet. If additional expander cabinets are included, they will be shipped terminated and bolted and (to the extent possible) on the same pallet, up to a total of three H961-C Expander Cabinets. Free-standing or additional peripherals are shipped individually on their own pallets. Packing materials that are used in motor freight or padded van shipments are: plastic wrapping, cardboard packing, metal strapping, and a cardboard enclosure; bolted to a wooden shipping pallet.

Domestic and North American (Cont)

b. *Air Freight* – All air freight shipments are crated as described below.

Foreign

a. *Air Freight and Sea Going* – All air freight and sea-going shipments are terminated and mounted together on shipping pallets as described above; wrapped in plastic, secured with cardboard packing and metal strapping, and crated with 1/2-in. plywood.

Table 1-1 provides general information concerning approximate shipping dimensions and gross weights. These specifications apply only to standard packing and shipping practices. If the user's constraints dictate, other shipping methods can be implemented. However, close liaison with the user, DEC Sales Engineer, and DEC manufacturing with reasonable lead time is required.

**Table 1-1
Standard PDP-12 Shipping Specifications**

PDP-12	Dimensions			Weight	Storage Temperature
	Height	Width	Depth		
C, /10	78 in.	45 in.	42 in.	600 lb*	40° to 110°F (5° to 45°C)
B, /20	78 in.	45 in.	42 in.	900 lb*	40° to 110°F
A, /30	78 in.	45 in.	42 in.	1000 lb*	40° to 110° F
Expanded Systems					
/40, LDP	78 in.	45 in.	64 in.	1600 lb*	40° to 110°F
2 II961-C Expander Cabinets	78 in.	45 in.	82 in.	1800 lb*	40° to 110°F

*Includes the packing and crating materials.

1.3.3 System Power Requirements

The total current required by the PDP-12 installation can be determined by adding together all current requirements associated with each cabinet and peripheral device. From this data, the type and quantity of ac power connectors and receptacles can be determined. A minimum of one ac connector for each cabinet and one ac connector for each free-standing peripheral should be provided.

PDP-12 Cabinet Power Requirement – A standard PDP-12 Single Processor Computer System requires up to 3000 Btu/hr average, up to 6000 Btu/hr maximum, and up to 17.5A at 115 Vac, 60 Hz.

1.3.4 Source Power Requirements

The PDP-12 can be operated from a 100, 115, 200, 215, or 230V, 50 Hz ac power source; or from a 120/240V 60-Hz ac power source. The primary ac operational voltages should be maintained as closely as possible to the nominal value. Line-voltage tolerance must be maintained within ±10 percent of the nominal values, and the 50/60 Hz line frequency should not vary more than ±2 Hz.

Primary power to the system should be provided on a line separate from lighting, air-conditioning, etc., so that computer operation will not be affected by voltage surges or fluctuations.

The PDP-12 Cabinet ground should be connected to the building power transformer ground. Any questions regarding power requirements and installation wiring should be directed to the DEC Sales Engineer.

Primary Power Receptacles – The installation site primary power line must terminate in Hubbell Wall receptacles (or equivalent) to be compatible with the PDP-12 power line Hubbell connector. The Hubbell wall receptacle part numbers are shown in Table 1-2. Figure 1-6 shows the primary power wall receptacles and the points where the site primary power lines are terminated. One receptacle is required for each cabinet and each free-standing peripheral.

Table 1-2
Hubbell Wall Receptacle Part Numbers

Line Voltage	Hubbell Receptacle Part Numbers
100–200 Vac, 50–60 Hz, 30A Service	Receptacle 3330-G (3330 may be used) Cap 3331-G (3331 may be used)
200–240 Vac, 50–60 Hz, 20A Service	Receptacle 7310-G (7310 may be used) Cap 3321-G (3321 may be used)

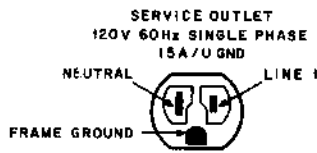

CAUTION
When neutral is not available for the above service, a receptacle of the above design shall be used, but both parallel slots shall be short to prevent polarized parallel blade plugs (caps) from fitting.

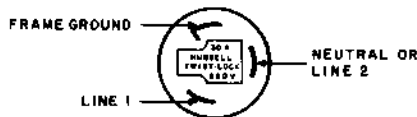

RECEPTACLE No. 3330-G
CAP No. 3331-G
115V 60Hz SINGLE PHASE
30A TWIST-LOCK



RECEPTACLE No. 7310-G
CAP No. 3321-G
230V 50Hz SINGLE PHASE
20A TWIST-LOCK

03-0414

Figure 1-6 Hubbell Wall Receptacle Connector Diagram

1.3.5 Primary ac Power Cables

Primary ac power cables are three-wire cables that interconnect the installation-site source power to the PDP-12 power supplies. The cables are connected at the factory to the PDP-12 power supplies for either 50 Hz or 60 Hz operation. All cabinets (excluding cabinets having only DECTapes) have a self-contained power supply and an ac power cable.

Each wire in the power cable is color-coded (refer to Table 1-3). The cable for the PDP-12 Model 724 Power Supply is connected to circuit breaker CB1 (see Drawing D-CS-724-0-1, Volume III).

**Table 1-3
Power Cable Line Identification**

Pigtail Information		Terminal Strip Nomenclature
Line	Wire Color	
Green	Frame Ground	Frame Ground
White	Neutral/Line 2	Neutral or Line 2
Black	Line 1	Line 1

CAUTION

a. The green wire is the cabinet frame ground and does not carry load current; however, it must be connected for safety reasons. This wire must be securely connected from the PDP-12 Cabinet to the grounding point on the primary power source.

b. The white or light gray wire is the neutral lead (common, ac return, or cold lead) and must never be used for purposes of grounding the PDP-12 Cabinet.

1.3.6 Service Outlets

Duplex ac convenience outlets should be provided to power test equipment when maintenance tasks are performed. The duplex outlet (see Figure 1-6) should be located near the PDP-12 and its related equipment, and should be rated at 120 Vac \pm 15 percent 50/60 Hz, 20A. These outlets should be separately fused.

1.3.7 Cabling

DEC cabinet interconnecting cables are of standard lengths and are factory-installed. If the cabinets must be shipped separately because of shipping or receiving conditions, the cabinet interconnecting cables are reconnected at the installation site. The termination point of each cable is identified. Cables for an expanded system are measured and ordered in accordance with the DEC-approved installation layout. The part number and required cable length are specified by the DEC Sales Engineer for each cable or group in the PDP-12 System.

BC08A-D and W033 cables provide signal connections between the computer and the optional equipment in expander cabinets or free-standing peripherals. These cables are connected by plugging the respective connectors into standard module receptacles. Cables connect to cabinets through a drop panel in the bottom of the cabinet. Subflooring, while recommended, is not absolutely necessary because cabinet levelers and casters elevate the cabinets high enough from the floor to provide sufficient cable clearance. Cable detail discussions are included in Chapter 5 of the *PDP-12 System Reference Manual*.

1.4 UNPACKING, INSTALLATION AND INSPECTION

1.4.1 General

The shipping containers may be handled by a fork-lift truck or other pallet-handling equipment. The containers should be taken to the installation site and placed near the final locations of the equipment cabinets.

IMPORTANT

Do not attempt to unpack or install the system until DEC has been notified and a Field Service Representative is present, or the equipment warranty may be affected. Consult with the DEC Sales Engineer concerning warranties.

1.4.2 Cabinet Unpacking

The following procedures should be followed for unpacking the PDP-12 Cabinet:

Step	Procedure
1	Remove the outer shipping container.
	<p style="text-align: center;">NOTE</p> <p style="text-align: center;">The container may be either heavy corrugated cardboard or 1/2-in. plywood. In either case, remove all metal strapping first, and then remove any fasteners and cleats securing the container to the pallet. If applicable, remove the wood framing and supports from around the cabinet perimeter.</p>
2	After removing the outer container (if applicable), remove the cardboard containing the console table.
3	Remove the polyethylene cover from the cabinets.
4	Remove the tape or plastic shipping pins, as applicable, from the cabinet(s) rear panel door, and open the door.
5	On the PDP-12 Cabinet, unscrew the shipping locks which hold the module rack (plenum door). Open the plenum door and remove all packing materials from inside the cabinet. Strip the tape from the modules and remove the plastic foam packing.
6	Remove the travel clip from the front panel door. The clear plastic mask which covers the Data Terminal Panel may be removed or left in place, if desired, as added protection.
7	Unbolt the cabinet(s) from the shipping pallet. Access to the bolts, located on the lower supporting siderails, is through the rear panel doors. Remove the bolts.
8	Use wooden blocks and planks to form a ramp from the shipping pallet to the floor.
9	Raise the leveling feet above the level of the roll-around casters and carefully roll the cabinet(s) onto the floor.
10	Roll the system to the proper location for installation.

1.4.3 Cabinet Installation

The PDP-12 Cabinets are provided with roll-around casters and adjustable leveling feet. It is not necessary to bolt the cabinet to the floor unless conditions indicate otherwise (e.g., shipboard installation). Cabinet installation procedures are as follows:

Step	Procedure
1	With the cabinets positioned in the room, install, if applicable, the filler strips between cabinet groups (filler strips are attached to the end of a cabinet group). Remove the four bolts securing the front and rear filler strips, butt the cabinet groups together while holding the filler strips in place, and rebolt through both cabinets and the filler strips. Do not tighten the bolts securely at this time.
2	Lower the leveling feet, making sure that the cabinet(s) are not resting on the roll-around casters but are supported on the leveling feet.
3	Level all cabinets with a spirit level and ensure that all leveling feet are seated firmly on the floor.
4	Tighten the bolts that secure the cabinet groups together and then recheck the cabinet leveling. Again ensure that all leveling feet are seated firmly on the floor.
5	Examine all modules and connectors in the main computer cabinet to be certain that they are all properly seated in their slots. Check to see that no packing material or other loose items may have fallen into the interior.
6	Connect the power cord to the 30-A Hubbell twist-lock receptacle. The computer is now ready for preliminary checkout.

1.4.4 Cabinet Inspection

After removing the equipment packing material, inspect the equipment. Report any damage to the local DEC sales office. Inspection procedures are as follows:

Step	Procedure
1	Inspect the external surfaces of the cabinets and related equipment for surface, bezel, switch, and light damage, etc.
2	Remove any remaining shipping bolts from the rear door and open the rear door of the cabinet. Inspect the cabinet internally for console, processor, and interconnecting cable damage; loose mounting rails; loose or broken modules; blower or fan damage; loose nuts, bolts, screws, etc.
3	Inspect the wiring side of the logic panels for bent pins, cut wires, loose external components, and foreign material. Remedy any defects found.
4	Inspect the power supply for the proper seating of fuses and the proper seating of power-connecting plugs.
5	Remove any shipping bolts and tape from the side runners of the tape transports and display units, if part of the system.
6	Place the table under the control console.

1.4.5 Teletype Unpacking

Step	Procedure
1	Open the Teletype carton, and remove the packing material. Remove the back cover from the stand. Remove and unwrap the copyholder, chad box, and power pack. Remove the stand from the shipping carton. Remove the Teletype console from the carton, holding it by means of the pallet attached to the bottom. Snap the power pack in place at the top of the inside front of the Teletype stand. Remove the Teletype console from the pallet, and mount it on the stand. Connect the Teletype console to the power pack (a six-lead cable attached at the console is connected to the power pack by means of a white plastic Molex 1375 Female Connector which mates with a male output plug on the power pack). Pass the three-wire power cable, and the seven-conductor signal cable (which is terminated in a type W076 Cable Connector Module) through the opening at the lower left-hand corner of the Teletype stand; then replace the back cover of the stand by means of the two mounting screws.
2	Dress the Teletype cable under the PDP-12 Cabinet, through the large opening and into logic frame slot N2. It is necessary that this cable be dressed through the cable clamp at the lower rear corner of the logic frame where the power cables are secured. A second clamp may be desirable at the bottom of the PDP-12 Cabinet to ensure that sufficient strain relief is provided regardless of Teletype position.
3	Connect the three-prong male connector of the Teletype power cable to the receptacle at the rear of the computer power supply chassis.
4	Install a roll of printed paper into the Teletype keyboard/printer, and install a tape in the punch as described in the Teletype technical manual.

1.4.6 Teletype Installation and Setup

The following procedures describe the sequence for preparing the Teletype(s) for power turn-on. Procedures for installing paper in the printer and in the reader/punch are included in Paragraph 1.5.2.

Models 33 ASR and 33 KSR – Perform the steps listed below.

Step	Procedure
1	After unpacking the Teletype, lift the cover and remove the wires that secure the type carriage and punch levers.
2	Inspect the Teletype for external damage; loose screws, nuts, bolts, or code bars.

NOTE

Included with the DEC manuals are three Teletype manuals concerning the Teletype Model 33 ASR. Volume 1 gives instructions for installing the console and preparing it for operation.

Teletype Console – The Teletype console has been modified at DEC, checked out, and repacked, using the original materials and containers. After assembling the Teletype console and stand, follow the instructions of

the Teletype manual Volume 1, Chapter 2; however, the following considerations must be observed as listed in the Procedure column:

Step	Procedure
1	Disregard Sections 2.03 through 2.13 and 2.15 of the Teletype Manual. The answer-back drum need not be coded.
2	Disregard Sections 2.21 through 2.23; the electrical connections to the DEC-supplied cable and connector have been made.
3	Observe the notes in Sections 3.01 and 3.02. The paper is friction-fed.
4	Disregard Sections 3.16 through 3.21 and Section 4.

NOTE

At this point, the operation of the Teletype keyboard, printer, tape reader, and tape punch, may be tested off-line, following the procedure described in Paragraph 1.5.2.

1.4.7 Prewired Option Installation

The installation of the internal options involves the addition of the logic modules in the proper prewired locations and is usually performed at the factory. *The computer must be turned off before inserting or removing any modules in the logic frame.* Refer to the module utilization drawings in Volume III of this Maintenance Manual for the locations of each module of all internal options; refer to Chapters 3 and 4 of this volume for specific installation and checkout procedures.

1.4.8 Peripheral Equipment Inspection

All peripheral equipment should be inspected for internal and external damage. This includes inspection of magnetic tape and DECtape transport heads, motors, paper-tape sprockets, etc.

CAUTION

Do not operate any peripheral device that employs motors, tape heads, sprockets, etc., if the latter are damaged.

1.4.9 Miscellaneous Items

Open the other cardboard boxes containing program tapes, Teletype paper, blank paper tape, manuals, etc. Check the contents of each box against its enclosed packing list. Note any missing items, and bring them to the attention of the DEC Sales Office.

1.5 CHECKOUT

1.5.1 Preliminary Operating Checks

Set the main circuit breaker CB1, located on the rear of the 724 Power Supply chassis, to ON. CB1 applies ac power to the power supply only, and may be left on continuously. Prior to applying power, measure each power bus and ensure that no direct short exists across any bus (minimum 2 ohms).

Insert the power key into the OFF/ON/LOCK switch lock on the computer console; turn the key to the ON position. The panel lights should glow in a random pattern; the fans inside the cabinet will start, and the Teletype motor will start unless the Teletype switch is turned OFF.

1.5.2 Teletype Test

Insert a roll of printer paper in the Teletype console, and a roll of paper tape in the tape punch (refer to the Teletype manual for the loading procedure). Turn the Teletype power switch ON. Set the LINE/OFF/LOCAL switch to LINE, and depress the tape punch ON button. Strike several keys; there should be no action by the punch or the printing wheel.

Set the LINE/OFF/LOCAL switch to LOCAL. Strike each key in succession. Printer characters should appear on the Teleprinter paper, and corresponding codes should be punched in the paper tape. After a few inches of tape have been punched, press the punch OFF button. Press RELEASE; pull out several inches of the punched paper tape and tear it off. Place the punched tape in the paper-tape reader so that the beginning of the punched section appears at the reading station. Set the reader switch to START. As the tape is read, a duplicate of the original printed sequence should appear on the paper. When it appears that the Teletype is operating properly, stop the reader and remove the tape. Set the console switch to LINE.

1.5.3 Computer Memory Test

Turn the console power key ON. Test the addressing and memory read/write functions as follows:

Step	Procedure
1	Set the LEFT SWITCHES to 0400.
2	Set the RIGHT SWITCHES to 0000 (all depressed).
3	Depress FILL once.
4	Depress and release FILL STEP eight (8) times.
5	Set the RIGHT SWITCHES to 7777 (all up).
6	Depress and release FILL STEP eight (8) times.
7	Depress EXAM once.
8	Depress and release STEP EXAM 16 times, and observe the contents of the MEMORY ADDRESS and MEMORY BUFFER register indicators after each time. The MA should start with 0400 to 0407, and 7777 while the MA steps from 0410 to 0417.

NOTE

Complete memory operating checks are contained in Paragraph 3.1.

1.5.4 RIM Loader

Using the console switches, enter the RIM Loader in memory as follows:

Step	Procedure
1	Set the LEFT SWITCHES to 7756.
2	Set the RIGHT SWITCHES to 6032 (the first instruction of the RIM Loader program). Actuate FILL key once, followed by FILL STEP key.
3	Repeat Step 2 for each succeeding instruction in the program, as shown in the sample program following, but using only the FILL STEP key. Check the MA and MB indicators after each instruction is deposited. The MA should step from 7756 to 7775; the MB should contain the code of the instruction just deposited.

(continued on next page)

Step	Procedure
4	Check the entire program by repeating Step 1, then depressing the EXAM key followed by STEP EXAM (same as Step 3), examining the MB and comparing it with the program below.

Address (MA)	Instruction (Right Switches)
7756	6032
7757	6031
7760	5357
7761	6036
7762	7106
7763	7006
7764	7510
7765	5357
7766	7006
7767	6031
7770	5367
7771	6034
7772	7420
7773	3776
7774	3376
7775	5356

1.5.5 Running MAINDECs

The set of MAINDEC diagnostic programs is used to check out the operations of each section of the PDP-12 System. Each tape is in one of two formats: RIM or Binary. Each requires a different loading procedure.

RIM – RIM (Read In Mode Loader) tapes are identified by the fact that channel 7 of the first and every fourth tape character is punched.

Step	Procedure
1	Set the MODE switch to 8 MODE.
2	Depress and release the I/O PRESET key.
3	Place the punched tape in the paper-tape reader, with leader (section of tape with only channel 8 punched) positioned at the Read station; push down the cap until it latches; be certain that the drive sprocket engages the feed holes.
4	Set the reader switch to START.
5	Set the LEFT SWITCHES to 7756. Make certain that no stop keys (FETCH, EXECUTE, SING. CYCLE or STOP) are depressed.
6	Press START LS. The tape will move through the reader as the program is loaded into memory.
7	When the trailer section of the tape (channel 8 punched) reaches the Read station, press and reset the console STOP key, move the reader switch to FREE, and remove the tape. The program is ready to run.

BIN – BIN (Binary) tapes have leaders and trailers similar to RIM tapes, but they must be loaded by a special program. The Binary Loader is itself in RIM format, and is loaded by the procedure above. Once it is in memory, any Binary tape may be loaded as follows:

Step	Procedure
1	Set the LEFT SWITCHES to 7777.
2	Set the MODE switch to 8 MODE.
3	Depress and release the I/O PRESET key.
4	Mount the tape as described in RIM loading procedures.
5	Depress and release START LS.
6	When the program is loaded, the tape stops automatically when the first trailer code is sensed.
7	After the tape stops, examine the Accumulator indicator lights. They should all be off. If they are not, try reloading the tape. (The state of the LINK indicator light is not significant.)

Once it has been determined that both RIM and Binary tapes can be loaded successfully, run the MAINDFCs in sequence as listed in Appendix D. Follow the operating instructions provided in the write-ups for each program.

CHAPTER 2

MAINTENANCE

2.1 INTRODUCTION

This chapter provides instructions for the service and maintenance of the PDP-12 Computer System; these instructions are written for persons who are familiar with the PDP-12 equipment. Lengthy descriptions explaining the use of test equipment have been avoided, except where special test setups are required. This chapter is divided into the following sections:

Section 1	Introduction
Section 2	Equipment
Section 3	Preventive Maintenance
Section 4	Corrective Maintenance
Section 5	Troubleshooting

From a maintenance standpoint, the PDP-12 has combined two functional subsystems into a common processor: a PDP-8/I general-purpose computer and a LINC (Laboratory INstrument Computer). In such a system, interactive hardware and software and modes of operation (8-Mode and LINC-Mode) demand that a systematic maintenance program be initiated upon installation and faithfully followed thereafter. A systematic preventive maintenance program is a deterrent to system failures. Proper application of such a program is an aid to both maintenance personnel and the user because detection and prevention of probable failures can reduce maintenance and downtime to a minimum. All units of the PDP-12 System are designed to realize a high reliability.

2.2 MAINTENANCE EQUIPMENT

Special tools and test equipment required for maintenance are listed in Table 2-1. Except for DEC equipment, suggested commercial brands are given for purposes of specification only; their being mentioned in this manual does not constitute exclusive endorsement.

Table 2-1
Maintenance Equipment

Equipment	Specification	Model or Type
Multimeter	10K ohms/V – 20K ohms/V	Triplet Model 310
Oscilloscope	DC to 50 mc with calibrated deflection factors from 5 mV to 10V/div. Maximum horizontal sweep rate of 0.1 μ s/div. Delaying sweep is desirable and dual trace is a necessity.	Tektronix Type 453

(continued on next page)

**Table 2-1 (Cont)
Maintenance Equipment**

Equipment	Specification	Model or Type
Probes	X10 with response characteristics matched to oscilloscope	Tektronix Type P6010
Clip-on Current Probe	2 mA, mV or 10 mA, mV	Tektronix Type P6019 with passive terminator
Recessed Probe Tip (2 ea.)		Tektronix
Unwrapping Tool	30 gauge	Gardner-Denver 505-244-475
	24 gauge	Gardner-Denver 500130
Wire-Wrap Tool	30 gauge	Gardner-Denver A-20557-29
	24 gauge	Gardner-Denver A-20557-12
30-Gauge Bit for Wrap Tool		Gardner-Denver 504221
Sleeve for 30-Gauge Bit		Gardner-Denver 500350
Spray Paint	Yellow	
Spray Paint	Green	
Spray Paint		DEC black
Module Extender (2)		DEC No. W982
Jumper Wires		Assorted lengths affixed with 30- and 24-gauge termi-point connectors
Screwdriver	6-in. non-conductive shaft	
Field Service Kit		DEC Type 142
Precision Voltage Source	-1V to +1V 0.1%	Electronic Development Co.
PDP-12 DIAL Maintenance LINCtape, Assorted Write-ups and Back-up Paper Tapes*		
*Supplied with the PDP-12A, PDP-12B, /20, /30, and /40.		

2.2.1 Maintenance Test Programs

Appendix D lists the software designated DEC**; collectively, these programs provide a complete check of the logic for the PDP-12, and the prewired options and software.

Functionally, the programs fall into two categories: diagnostic and reliability. The diagnostic tests isolate the genuine go/no-go type of hardware failures that are easily recognizable. The reliability programs isolate failures

**See Appendix D for a detailed listing.

that are more difficult to detect because they are marginal in nature and/or occur infrequently or sporadically. The family of test programs is written so that, when run successively, they test the processor, beginning with small portions of the hardware and gradually expanding until they involve the entire system.

The test programs are made up of numerous self-contained routines. In those programs that are diagnostic in nature, each routine is involved with a specific circuit or logic function. In the simplest form, for example, a single routine is used to check each leg of an AND gate. When the diagnostics have been run to completion, the processor has been exercised to the extent that it has been proved capable of executing all instructions. However, such proof is conditional, because it is based on the execution of instructions using pre-established constants as operands.

Further tests are necessary to establish that the computer properly executes instructions, using operands and various combinations of operands other than those used in the diagnostics. The reliability test programs provide this additional testing. Primarily, each routine in the reliability test programs establishes a loop whereby a specific instruction or group of instructions is repeated many times. Each repeat is executed using operands, the magnitudes of which are established by a pseudo-random number generator, or a binary upcount. This procedure makes certain that machine capabilities are checked under a maximum number of unique conditions.

When an error is detected with diagnostics, the program halts or enters an error handling routine. The reason for the error may then be determined by using the console controls and indicators, maintenance switches, error type-outs on Teletype, and the program listings included in the software package. The use of the data switches for selecting error handling is defined in the MAINDEC write-ups provided with the software package.

2.2.2 Mounting DIAL MAINTENANCE Tapes

The following procedure is to be used when loading tapes on the LINCtape transports:

Step	Procedure
1	Mount a LAP6-DIAL MAINTENANCE tape on any tape transport. Advance tape (right to left) out of the end zone (Approx. 6 ft).
2	Set WRITE ENABLE on, turn the thumbwheel switch (unit selector) to 0, depress REMOTE.
3	Set 0701 (RCG) in the LEFT SWITCHES, set 7300 in the RIGHT SWITCHES (all other switches to 0).
4	Set MODE switch to LINC; depress I/O PRESET.
5	Depress DO key; when tape motion stops, depress I/O PRESET followed by START 20.

NOTE

A copy of the DIAL MAINTENANCE LINCtape is provided to PDP-12A, PDP-12B, /20, /30 and /40 users. Users of PDP-12C, /10 configurations will be provided with the appropriate paper tapes.

2.3 PREVENTIVE MAINTENANCE

Preventive maintenance consists of procedures that are performed prior to the initial operation of the computer, and periodically during its operating life. These procedures include visual inspections, cleaning, mechanical checks, and operational testing. A log which indicates the performance history and rate of deterioration must be kept for recording specific data; such a record can be used to determine the need and time for performing corrective maintenance on the system.

Scheduling of computer usage should always include specific time intervals that are set aside for scheduled maintenance purposes. Careful diagnostic testing programs can then reveal problems which may occur only intermittently during on-line operation.

2.3.1 Scheduled Maintenance

The PDP-12 must receive certain routine maintenance attention to ensure maximum life and reliability to the computer system. DEC suggests a schedule of 1000 hours for electrical inspection, and 500 hours (or every month) for mechanical inspection.

Daily Maintenance – The LINCTape heads and guides should be cleaned whenever they are dirty; typically, once a day.

Weekly Maintenance – Time should be scheduled each week to operate the applicable MAINDEC programs as listed in Appendix D. Run each program for a minimum of five minutes; take any corrective action necessary at this time; and log the results. External cleanliness of the system should also be maintained on a weekly basis.

Preventive Maintenance Tasks – The following tasks should be performed on at least a three-month schedule:

Step	Procedure
1	Clean the exterior and interior of the computer cabinet, using a vacuum cleaner and/or clean cloths moistened in nonflammable solvent.
2	Clean the air filter. Use a vacuum cleaner to remove accumulated dirt and dust, or wash with clean hot water.
3	Lubricate slide mechanisms and casters with a light machine oil. Wipe off excess oil.
4	Visually inspect equipment for general condition. Repaint any scratched areas with DEC black, yellow, green, or Krylon glossy white No. 1501.
5	Inspect all wiring and cables for cuts, breaks, fraying, wear, deterioration, kinks, strains, and mechanical security. Tape, solder, or replace any defective wiring or cable covering.
6	Inspect the following for mechanical security: key switches, control knobs, lamps, connectors, transformers, fans, capacitors, etc. Tighten or replace as required.
7	Inspect all module mounting panels to be sure that each module is securely seated in its connector. Remove and clean any module which may have collected excess dirt or dust.
8	Inspect power supply components for leaky capacitors, overheated resistors, etc. Replace any defective components after correcting any fault condition.
9	Check the output of the 724 Power Supply as specified in Table 2-2, Power Supply Specifications. Use a multimeter to make these measurements without disconnecting the load. The outputs of the supply are not adjustable; therefore, if any output voltage is not within tolerance, the supply is considered defective, and corrective maintenance should be performed.
10	Run all MAINDEC programs to verify proper computer operation. Each program should be allowed to run for at least five minutes.
11	Perform all preventive maintenance operations for each peripheral device included in the PDP-12 System, as directed in the individual maintenance instructions supplied with each peripheral device.
12	Enter preventive maintenance results in the log book.

**Table 2-2
Power Supply Specifications**

Voltage	Current	Use
15V (rms) \pm 20%	5A	Panel Lights
+5V, \pm 5%	20A	Logic
-15V \pm 10%	5A	Keys and Switches Sense Amplifier Main Supply
-15V \pm 10%	5A	Sense Amplifier Slice Reader Clock
-30V \pm 10%	6A	Memory Supply, (-) Teletype
+10V \pm 20%	1A	R-Series Modules

2.4 CORRECTIVE MAINTENANCE

The PDP-12 is constructed of reliable TTL M-series modules. Proven reliability of this circuitry ensures relatively little equipment downtime due to logic failure. If a malfunction occurs, maintenance personnel should analyze the condition and correct it as indicated in the following procedures. Table 2-1 lists the equipment and tools necessary for this task; however, the best corrective maintenance tool is a thorough understanding of the physical and electrical characteristics of the equipment. Personnel responsible for maintenance should be familiar with the system concept, the logic drawings, the theory of operation of the specific module circuits, and location of mechanical and electrical components.

The first step in repairing a reported malfunction is to isolate the problem. In a hardware-software system environment such as the PDP-12, the first step is to determine whether the problem lies in the hardware, the software, or both. The only practical way of accomplishing this is by maintaining good communications between the operator/programmer and maintenance personnel.

Until the problem is isolated to either hardware or software, the cooperation of all parties concerned is essential. A step-by-step procedure should be used to trace the problem until a point is reached where all the inputs (conditions) to an element are correct, but the output is not correct. The faulty element should then be repaired. Where necessary, the element itself may be subjected to step-by-step fault location (from output to input) until the source of the problem is found.

It is virtually impossible to outline all specific procedures for locating faults within digital systems such as the PDP-12. However, diagnosis and remedial action for a faulty condition can be undertaken logically and systematically in the following phases:

- a. Preliminary Investigation
- b. System Troubleshooting
- c. Logic Troubleshooting
- d. Circuit Troubleshooting
- e. Repairs and Replacement
- f. Validation Tests
- g. Recording

2.4.1 Preliminary Investigation

Before beginning troubleshooting procedures, explore every possible source of information. Gather all available information from those users who have encountered the same problem and check the system log book for any previous references to the problem or to a similar one.

Do not attempt to troubleshoot by using complex system programs. Run the MAINDEC programs and select the shortest, simplest program available to exhibit the error condition. MAINDEC programs are carefully written to include program loops for assistance in system and logic troubleshooting.

2.4.2 System Troubleshooting

Once the problem is understood and the proper program is selected, the logical section of the system at fault should be determined. Obviously, the program which has been selected gives a reasonable idea of what section of the system is failing. However, faults in equipment which transmits or receives information, or improper connection of the system, will frequently yield indications similar to those caused by computer malfunctions.

Reduce the program to its simplest scope loop and duplicate this loop in a dissimilar portion of memory to verify, for instance, that an operation failure is not dependent upon memory location. This process can aid in distinguishing memory failures from processor failures. Use of this technique often pinpoints the problem to a few modules.

System troubleshooting is the first step towards isolating and repairing a machine malfunction. If the machine cannot be started, refer to Section 2.5.2. If the machine is running, determine that hardware, not software, is causing the problem. If the problem is occurring with DEC software (LAP6-DIAL, FORTRAN, etc.), obtain a certified copy of the program, in good condition, and attempt to repeat the malfunction. Generally, a recurring problem indicates a logic failure. If the problem occurs only with the user's software, an analysis of the failing program must be made. Use of the FETCH STOP, EXECUTE STOP, and SINGLE STEP is recommended. Some other items to check in the user's software are special bit assignments and functions. Are TRAP, NO PAUSE, etc., being used properly? Are memory fields being used properly? Is the program making unwarranted assumptions; i.e., assuming that the accumulator will be clear on start-up, etc.?

In general, attempt to isolate the problem to a major system; then exercise that system with the MAINDEC diagnostics. If necessary, proceed to logic troubleshooting and repair.

2.5 TROUBLESHOOTING TECHNIQUES

2.5.1 Introduction

A prerequisite to this section is a thorough understanding of the information in Section 2.4. This section assumes a cold start, i.e., the machine has just been unpacked (see Chapter 1), or it was previously shut off. The procedure is arranged in a definite order of precedence, and should be followed as closely as possible.

WARNING

Maintenance procedures should be performed by qualified service personnel only.

High voltages are present within portions of the equipment and are potentially dangerous. All safety precautions must be observed.

Inherent implosion protection is considered in the CRT design. However, the tube may be damaged if it is subjected to rough treatment or dropped while being removed from or installed in the display. Caution, therefore, must be exercised during these operations.

2.5.2 Console Checks

Assuming a cold start, check the following console functions. If any malfunctions occur, repair the problem before continuing with the procedure.

Step	Procedure
1	Power on – Are IR bits 0, 1, and 2 set (on), and is the CP in 8 MODE; is RUN off*, and is power up to specification (refer to Table 2-2)?
2	I/O PRESET – Does the AC clear? Does it set the INST FIELD and DATA FIELD to 2 and 3, respectively? Are the INSTRUCTION REGISTER bits 0, 1, and 2 still set to the one state (on) (ignore any other bits)? Can both modes be selected? Do all other indicators remain unchanged?
3	FILL – Do the RIGHT SWITCHES transfer to the MB? Do the LEFT SWITCHES transfer to the MA?
4	EXAM – Do the LEFT SWITCHES transfer to the MA? Do the contents of the location addressed by the MA transfer to the MB?
5	FILL STEP – Do the RIGHT SWITCHES transfer to the MB? Do the RUN and INT PAUSE lights illuminate? Do the contents of the MA increment? Do the contents of the new location addressed by the MA transfer to the MB?
6	STEP EXAM – Do the contents of the MA increment? Do the contents of the new location addressed by the MA transfer to the MB?
7	AUTO RESTART – Can FILL STEP and STEP EXAM be auto-restarted? Does the AUTO light illuminate?
8	Set the MODE switch to 8 MODE and depress and release I/O PRESET. While depressing both the AUTO and the FILL STEP keys, sequentially set the AUTO RESTART DELAY – COARSE (starting at position 4) to position 3; then to position 2, then to position 1. Note that the MEMORY ADDRESS register fills (counts up) at a slower rate as the AUTO RESTART DELAY – COARSE selector is moved through the four positions. Check the AUTO RESTART DELAY – FINE vernier adjustment in all COARSE positions.
9	Examine memory for any bits that may be picked up.
10	Set RIGHT SWITCHES to 7777 (all 1s); repeat Steps 8 and 9.
11	Examine memory for any bits that may be dropped.
12	Depress SING STEP key.
13	Depress START 20. <ol style="list-style-type: none">Does the MA = 0020?Does the PC = 0021?Does the MB = 7777?Does the IR = 7777?
14	Reset SING STEP; clear memory; depress STOP key.

(continued on next page)

*Unless the KP12 Power Fail Option is installed and switched ON.

Step	Procedure
15	Depress START 400. <ol style="list-style-type: none"> <li data-bbox="558 254 841 281">a. Does the MA = 0400? <li data-bbox="558 302 841 329">b. Does the PC = 0401? <li data-bbox="558 350 841 378">c. Does the MB = 0000? <li data-bbox="558 399 841 426">d. Does the IR = 0000?
16	Reset STOP; depress CONT. <ol style="list-style-type: none"> <li data-bbox="558 485 943 512">a. Does the RUN light illuminate? <li data-bbox="558 533 1154 560">b. Does the MA and PC cycle through 4K or memory? <li data-bbox="558 581 971 609">c. Do the AC indicators glow dimly? <li data-bbox="558 630 1175 657">d. Are the FETCH and EXECUTE indicators set (glow)?
17	Set and reset STOP key; depress I/O PRESET key with MODE switch set to LINC Mode; fill LINC memory field 2 with 0016s (NOP).
18	Depress the STOP key.
19	Depress START 20. <ol style="list-style-type: none"> <li data-bbox="558 842 841 869">a. Does the MA = 4020? <li data-bbox="558 890 841 917">b. Does the PC = 4021? <li data-bbox="558 938 841 966">c. Does the MB = 0016? <li data-bbox="558 987 841 1014">d. Does the IR = 0016?
20	Reset the STOP key; depress CONT. <ol style="list-style-type: none"> <li data-bbox="558 1073 943 1100">a. Does the RUN light illuminate? <li data-bbox="558 1121 1289 1148">b. Do the MA and PC cycle through 1K of memory? (4000–5777) <li data-bbox="558 1169 915 1197">c. Does the AC remain cleared?
21	Depress SING STEP. Does the computer stop?
22	Depress CONT repeatedly. Does the computer appear to stay in the FETCH state?
23	Depress and hold AUTO RESTART; depress CONT; release all switches. Does the computer cycle through 1K of memory at a rate determined by AUTO RESTART DELAY, COARSE and FINE adjustments?
24	Set several different instructions into the LEFT SWITCHES; depress DO. (Be sure that the CP is in the proper mode for each instruction.) Does the CP react to each instruction as expected? If the CP performs these operations successfully, manual timing, memory timing, and CP timing are approximately correct. Proceed with system troubleshooting.

2.5.3 LINC-Mode Processing

LINC-Mode processing encompasses the entire LINC instruction set, the A/D converters, and D/A converters.

Troubleshooting the LINC-Mode portion of the PDP-12 is best achieved by using the diagnostic programs stored on magnetic tape, thus providing the most rapid method of exercising the processor. If the LINCtape portion of

the computer is inoperative and the tapes cannot be read in any manner, refer to Paragraph 2.5.5, TC12 Tape Subprocessor. Other methods of reading tape include reading entire tests manually, or reading single blocks. If necessary, read a block using the RDE instruction, thereby bypassing the checksum logic.

A confidence check of module and timing stability can be made by using MAINDEC-12-DOBA (Instruction Test). This program exercises most of the instructions and addressing modes used in LINC-Mode processing. If no failure can be found with this test, use of the more advanced diagnostics is necessary. Refer to Appendix D for a description and applications of these tests.

Aggravation (vibration or heating) of the system is advisable only when an intermittent failure cannot be found with the LINC-Mode diagnostics. Vibrate the modules, using a nonconducting rod 8 to 12 in. long. Extreme caution should be followed when vibrating memory or single modules.

2.5.4 8-Mode Processing

8-Mode processing includes the entire PDP-8 family instruction set, memory, Teletype, and most of the available (standard and optional) peripherals.

Since most of the 8-Mode diagnostics are relatively short, it is not necessary to have either the TC12 (LINCtape Control) or the LINC-Mode processing facility operational. However, if they are available, use of the LINCtape DIAL MAINTENANCE diagnostics is recommended.

The 8-Mode MAINDEC diagnostic programs are written and arranged so that each test will, in turn, exercise and verify those portions of the processor logic to be used in each succeeding test. Therefore, they should be used in order: Instruction test 1A, 2, 2A, 2B, Random JMP-JMS, Random JMP, Random ISZ, followed by the peripheral MAINDEC programs.

If memory problems are suspected, and the system employs the Extended Memory MC-12 option, the standard MAINDEC tests should be employed first and the problem extensively checked to be sure that timing and currents are correct; then the extended memory tests can be employed. Note that the 8-Mode diagnostics use less addressing logic than the LINC-Mode diagnostics.

Teletype and peripheral equipment can be evaluated and checked by running the specific diagnostic program for each item. Before attempting to exercise a peripheral with its specific diagnostic, a check of the IOP logic should be made to verify pulse width, height, and timing.

2.5.5 TC12 Tape Subprocessor

Troubleshooting the tape subprocessor *must* begin at the operator's console. Using the DO switch, exercise all of the tape instructions. Follow the tape state indicators and compare them with the tape flow diagram (TC12-0-10). Watch the tape movement and direction. Is it in accordance with the tape state indicators on the console? Review the problem repeatedly to be certain that the problem is understood and that you know what the tape subprocessor and tape transport are doing!

Tape Register Control Test MAINDEC-12-D3AD, Parts I and II, checks almost all of the tape logic, with the exception of the reader-writers. If a problem can be duplicated using this diagnostic, the scope loop option may be useful.

If a problem in timing or data transfer seems to exist, programming a long read or write loop will give the most stable scope trace. For example:

```

*4020
4020/0700   RDC           /READ AND CHECK
4021/1000   1000          /QN & BLOCK NUMBER
4022/1020   LDA I
4023/0001   0001          /INCR BN
4024/1140   ADM
4025/0021
4026/1460   SAE I       /INITIALIZE LOC 21
4027/7777   7777          /WHEN IT REACHES 7777
4030/6020   JMP 20
4031/1020   LDA I
4032/1000   1000
4032/1021   STC I 1
4034/6020   JMP 24       /RESTART

```

This routine reads contiguous blocks from 0 to 777, thus allowing time to check timing and data transfers before turnaround.

2.5.6 TC12 Console Checks

Step	Procedure
1	Clear memory (using the FILL-STEP, AUTO, and RIGHT SWITCHES = 0000).
2	With all tape units set to OFF LINE, set MODE switch to LINC and depress I/O PRESET.
3	Place 0700 in the LEFT SWITCHES, and 0000 in the RIGHT SWITCHES.
4	Depress DO. <ul style="list-style-type: none"> a. Do the LEFT SWITCHES transfer to the IR? b. Do the RUN and INT PAUSE lights glow? c. Does the TAPE IR go to 000? d. Does the IP (In Progress) light glow?
5	Set the following constants into the LEFT SWITCHES; depress I/O PRESET and DO. Observe that all combinations of bits transfer to the TAPE IR. <ul style="list-style-type: none"> a. 0701 (TAPE IR = 001) b. 0702 (TAPE IR = 010) c. 0703 (TAPE IR = 011) d. 0704 (TAPE IR = 100) e. 0705 (TAPE IR = 101) f. 0706 (TAPE IR = 110) g. 0707 (TAPE IR = 111)
6	Mount a marked tape on tape unit 0; place 0700 in the LEFT SWITCHES; 0777 in the RIGHT SWITCHES; depress I/O PRESET.

(continued on next page)

Step	Procedure
7	<p>Depress DO.</p> <ol style="list-style-type: none"> a. Does the tape begin to move backwards initially (left to right)? b. Does the tape then reverse direction and clock into the SEARCH mode? Inability to sense direction may be caused by loss of the mark track, a bad direction flip-flop, or loss of block numbers. The tape changing direction in random fashion generally indicates that the block numbers are not being read correctly (i.e., bad mark track). c. While in the SEARCH mode, does the MB = 0777? (This is the block number from the RIGHT SWITCHES.) Does the IR = 0700? d. At the end of the SEARCH mode, does the tape transport enter the BLOCK mode? e. At the completion of the instruction, does the MA = 4377, indicating correct address transfer and memory incrementation? f. Does the IR clear to 0s? (MB will equal data transferred from tape to location 4377.) Does the TAPE INST = 000? g. Does the AC = 7777 at the completion of the tape instruction? AC \neq 7777 indicates a failure of the TAC-to-AC transfer. If the tape instruction cycles from SEARCH to BLOCK to IDLE to SEARCH, a bad checksum on the tape is indicated. Try using another block number in RIGHT SWITCHES bits 03 through 11.
8	<p>Set 0701 into the LEFT SWITCHES, set 7000 into the RIGHT SWITCHES, and depress DO.</p> <ol style="list-style-type: none"> a. At the completion of the instruction, does the MA go to 7777? b. Note the number in the MB and examine the location addressed by the MA (=7777); this location should contain what was in the MB, indicating proper data transfer. c. Does the IR clear to 0000?
9	<p>Clear memory; set 0705 into the LEFT SWITCHES, 7000 into the RIGHT SWITCHES; and depress DO.</p> <ol style="list-style-type: none"> a. Does the tape clock into SEARCH-BLOCK modes twice (once for WRITE, once for CHECK)? b. Does the MA count from 4000 to 0000? If so, this indicates proper cycle break. c. Does the AC set to 7777 at the end of the instruction, indicating a good checksum?
10	<p>Set 0701 into the LEFT SWITCHES, 7000 into the RIGHT SWITCHES. Depress DO.</p> <ol style="list-style-type: none"> a. Does the MA count to 7777? b. Examine locations 4000 to 7777. Are they all 0s? c. Fill memory with 7777 and repeat Steps 10, 10a., and 10b. Memory should still be all 0s. Failure at this point indicates either bad reader-writers or poor memory.

(continued on next page)

Step	Procedure
11	When tapes have been verified up to this point, execution of the RDC, WRC, RCG and WRG instructions should be checked, using varied combinations of the instructions with the I-bit both on, and off, and various quarter and block numbers.
	<p>NOTE Execution of a tape instruction with the I-bit on, using the DO key, does not cause tape motion to continue due to RUN being cleared.</p>
12	Execute MAINDEC-12-D3DA-PB, TAPE EXERCISER, to confirm LINCTape control reliability.

2.5.7 Logic Troubleshooting

Logic troubleshooting in the PDP-12 is best accomplished using the technique of "reverse signal tracing". That is, when a malfunction has been isolated to a section of logic, some duplication of that type of failure using either the DO-AUTO switch combination, a small program, or a scope loop option in a diagnostic MAINDEC should be performed. Then, by comparing the logic engineering drawings with the machine status, and tracing the faulty signal back to the failing gate, that portion of logic which is causing the failure becomes evident.

NOTE
 An unconnected input to a gate, if not tied to a terminator, floats at approximately +2.0V.

Before attempting to troubleshoot the logic, make sure that proper and calibrated test equipment is available. Always calibrate the vertical preamplifier and probes of the oscilloscope before using. Make certain that the oscilloscope has a good ac ground, and keep the dc ground from the probe as short as possible.

Use the oscilloscope to trace signal flow through the suspected logic element. Oscilloscope sweep can be synchronized by control pulses or by level transitions which are available at individual module terminals on the wiring side of the logic. Care should be exercised when probing the logic to prevent shorting between pins. Shorting of signal pins to power supply pins can result in damaged components. Within modules, unused gate inputs are held at +3V.

WARNING
 Standard safety practices should be observed when working with energized equipment. Remember that peripherals are not always connected to the mainframe power control and may be energized when the PDP-12 is off.

2.5.8 Module (Circuit) Troubleshooting

Engineering schematic diagrams of each module are supplied with the PDP-12 System and should be referenced for detailed circuit information. Copies of engineering schematic diagrams are contained in Volume III of this Maintenance Manual.

Visually inspect the module on both the component side and the printed-wiring side to check for overheated or broken components, etc. If this inspection fails to reveal any signs of trouble or fails to confirm a fault condition observed, use the multimeter to measure resistance.

CAUTION
 Do not use the lowest or highest resistance ranges of the multimeter when checking semiconductor devices. The X10 range is suggested. Failure to heed this warning may result in damage to components.

Measure the forward and reverse resistance of diodes. Diodes should measure approximately 20 ohms forward and more than 1000 ohms reverse. (Front-to-back ratio should always be greater than 10 to 1.) If readings in each direction are the same and no parallel circuit paths exist, replace the diode.

Measure in both directions the emitter-collector, collector-base, and emitter-base resistances to transistors. Short circuits between collector and emitter or an open circuit in the base-emitter path cause most failures. A good transistor indicates an open circuit in both directions between collector and emitter. Normally 50 to 100 ohms exist between the emitter and the base, or between the collector and the base in the forward direction, and an open circuit condition exists in the reverse direction. To determine forward and reverse directions, consider a transistor as two diodes connected back to back. In this analogy, PNP transistors would have cathodes connected together to form the base, and both the emitter and collector would assume the function of an anode. In NPN transistors, the base would be a common-anode connection; and both the emitter and collector would be the cathode.

Multimeter polarity must be checked before measuring resistance because many meters apply a positive voltage to the common lead when in the resistance mode.

Since integrated circuits contain complex circuits with only the input, output, and power terminals available, static multimeter testing is limited to continuity checks for shorts between terminals. Integrated circuit checking is best done under dynamic conditions and using a module extender to make terminals readily accessible. Using PDP-12 engineering drawings (Volume III) and the M-series module schematics (Volume IV), an integrated circuit is located on a circuit board in the following manner:

Hold the module with the handle in your left hand (the component side facing you). Integrated circuits are numbered starting at the contact end of the board in the upper right corner; the numbers increase toward the handle. When a row is complete, the next integrated circuit is located in the next row at the contact end of the board (refer to Figure 2-1). The pins on each integrated circuit are located as shown in Figure 2-2.

2.5.9 Repairs and Replacements

NOTE

DEC recommends replacing defective modules with modules of known quality on a one-for-one basis and returning the suspect module to a DEC field office for subsequent repair and/or replacement. If, however, for expediency, field repairs must be performed, it is imperative to take the following precautions.

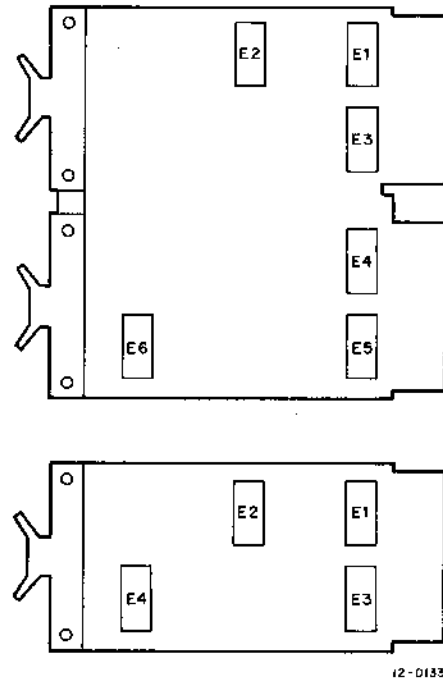

Figure 2-1 Integrated Circuit Location

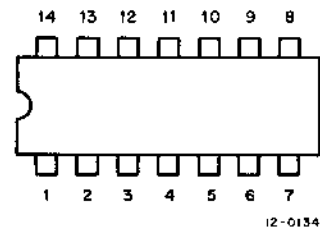

Figure 2-2 Integrated Circuit Pin Location Top View

When soldering semiconductor devices (transistors, diodes, or rectifiers, any of which may be damaged easily by heat, physical shock, or excessive electrical current), take the following special precautions:

- a. Use a heat sink, such as a pair of pliers, to grip the lead between the nearest joint and device soldered.
- b. Use a 6V iron with an isolation transformer. Use the smallest iron adequate for the work. Use of an iron without an isolation transformer may result in excessive voltages present at the iron tip.
- c. Perform the soldering operation in the shortest possible time, to prevent damage to the component and delamination of the module-etched wiring.
- d. Integrated circuits may be easily removed by using a solder puller to remove all excessive solder from contacts. Then, by straightening the leads, lift the integrated circuit from its terminal points. If it is not desirable to save the defective integrated circuit for test purposes, then the terminals may be cut at the integrated body and each terminal removed from the board individually. Be sure to orient the new integrated circuit in the same position as the removed one.

CAUTION

Never attempt to remove solder from terminal points by heating and rapping modules against another surface. This practice usually results in module or component damage. Always remove solder with a solder-sucking tool.

When removing any part of the equipment for repair and replacement, make sure that all leads or wires which are unsoldered, or otherwise disconnected, are legibly tagged or marked for identification with their respective terminals. Replace defective components with parts of equal or better quality and tolerance.

In all soldering and unsoldering operations in the repair and replacement of parts, avoid placing excessive solder or flux on adjacent parts or service lines. When the repair has been completed, remove all excess flux by washing junctions with a solvent such as trichlorethylene. Be very careful not to expose painted or plastic surfaces to this solvent.

2.5.10 Validation Tests

Always return repaired modules to the location from which they were taken. If a defective module is replaced by a new one during a repair period, tag the defective module, noting the location it was taken from and the nature of the failure. When repairs are complete, return the repaired module to its original location and determine whether or not the repairs have corrected the problem.

To confirm the fact that repairs have been completed, run all tests which originally showed up the problem. If modules were moved during the troubleshooting period, return them to their original positions before running the validation tests.

Any time that a module is replaced by one from spares, return the module to its original location to confirm its defectiveness before initiating a repair procedure.

2.5.11 Log Book Recording

A log book is supplied with each PDP-12 System. Corrective maintenance is not complete until all activities are recorded in the log book. Record all data, indicating the symptoms displayed by the fault, the method of fault detection, the component at fault, and any comments which would be helpful in maintaining the equipment in the future. The log should be maintained on a daily basis, recording all operator usage and preventive maintenance results.

CHAPTER 3

ADJUSTMENTS

Adjustments of the PDP-12 should not be undertaken until it has been confirmed that a failure is due to misalignment of one or more of the following adjustments rather than to a faulty component. Where pertinent, Volume III system drawings will be referenced with the last three letters of the drawing designation enclosed in parentheses.

NOTE

The measurements and adjustments in the following paragraphs are analog in nature, and are not of the on-off, high-low, or two-state conditions. The values stated are nominal and may vary up to $\pm 10\%$, depending on the specific configuration of the system, or the device being checked.

3.1 MEMORY CURRENT AND STROBE

Testing and adjusting of the PDP-12 memory section are accomplished by running the memory address tests and memory checkerboard tests. Adjustment of the read/write currents may be necessary to tune the memory for optimum performance. Paragraphs 3.1.1 through 3.1.5 provide the checks and adjustments that can be performed in the field.

3.1.1 Initial Current Adjustments

Step	Procedure
1	Turn on the computer, but do not execute any programs.
2	Adjust the oscilloscope as follows: <ol style="list-style-type: none">Trigger: Channel 1 onlyMode: Channel 1Channel 1: 5V/DivisionSet ground reference sweep on 1 cm above center horizontal graticule (see Figure 3-1).Sweep: 0.5 ms
3	Connect scope probe to Channel 1, location F2M2.

Adjust the rightmost trimpot (if there are two) on module G826, locations E2 and F2, for approximately -12V. Turning the trimpot counterclockwise increases the voltage (refer to Paragraph 3.2.1).

CHAPTER 3

ADJUSTMENTS

Adjustments of the PDP-12 should not be undertaken until it has been confirmed that a failure is due to misalignment of one or more of the following adjustments rather than to a faulty component. Where pertinent, Volume III system drawings will be referenced with the last three letters of the drawing designation enclosed in parentheses.

NOTE

The measurements and adjustments in the following paragraphs are analog in nature, and are not of the on-off, high-low, or two-state conditions. The values stated are nominal and may vary up to $\pm 10\%$, depending on the specific configuration of the system, or the device being checked.

3.1 MEMORY CURRENT AND STROBE

Testing and adjusting of the PDP-12 memory section are accomplished by running the memory address tests and memory checkerboard tests. Adjustment of the read/write currents may be necessary to tune the memory for optimum performance. Paragraphs 3.1.1 through 3.1.5 provide the checks and adjustments that can be performed in the field.

3.1.1 Initial Current Adjustments

Step	Procedure
1	Turn on the computer, but do not execute any programs.
2	Adjust the oscilloscope as follows: <ol style="list-style-type: none">Trigger: Channel 1 onlyMode: Channel 1Channel 1: 5V/DivisionSet ground reference sweep on 1 cm above center horizontal graticule (see Figure 3-1).Sweep: 0.5 ms
3	Connect scope probe to Channel 1, location F2M2.

Adjust the rightmost trimpot (if there are two) on module G826, locations E2 and F2, for approximately -12V. Turning the trimpot counterclockwise increases the voltage (refer to Paragraph 3.2.1).

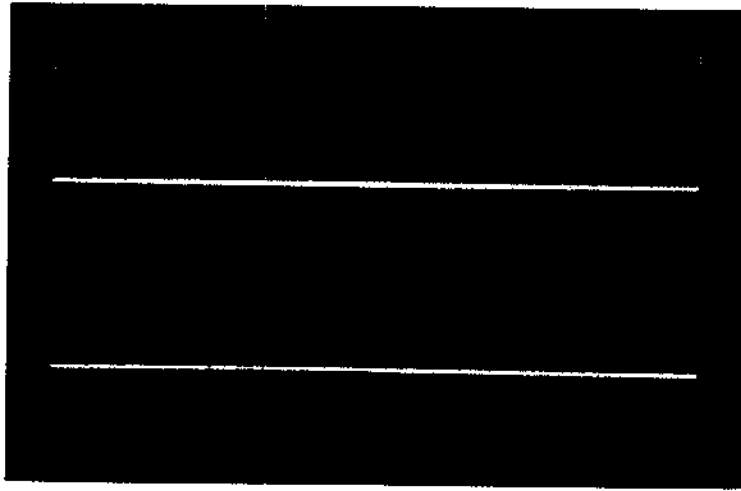

Figure 3-1 Ground Reference

3.1.2 Initial Strobe Adjustment

Step	Procedure
1	Turn off the computer and remove power.
2	Remove module M360 at location E14 (<i>MCT</i>) and turn the potentiometer fully CCW.
3	Turn the potentiometer CW five full turns.
4	Return the module to location E14.

The above action sets STROBE approximately. For further fine adjustment, see Paragraph 3.2.1.

3.1.3 Memory Strobe Adjustments

Step	Procedure
1	Load the RIM LOADER in core memory by use of the console keys and switches as follows: <ol style="list-style-type: none">Set starting address 7756 in the LEFT SWITCHES.Set 6032 (first instruction) in the RIGHT SWITCHES.Depress FILL, followed by FILL STEP.Set the next instruction in the RIGHT SWITCHES.Depress FILL STEP.Repeat Steps 1d. and 1e. until the program is loaded.

(continued on next page)

Step

Procedure

1 (cont)

RIM LOADER

Address	Instruction
7756	/6032 KCC /CLEAR AC & KBD FLAG
7757	/6031 KSF /SKIP ON KBD FLAG
7760	/5357 JMP . -1 /NOT UP; WAIT
7761	/6036 KRB /CLEAR AC, KBD, READER BUF→AC
7762	/7106 CLL RTL /CLEAR LINK, ROTATE 2 LEFT
7763	/7006 RTL /ROTATE TWO LEFT (AC and LINK)
7764	/7510 SPA /LEADER CODE?
7765	/5357 JMP . -6 /YES, READ NEXT BYTE
7766	/7006 RTL /NO, ROTATE TWO LEFT (AC and LINK)
7767	/6031 KSF /SKIP ON KBD FLAG
7770	/5367 JMP . -1 /NOT UP; WAIT
7771	/6034 KRS /READER BUF→AC
7772	/7420 SNL /IS THIS AN ADDRESS WORD?
7773	/3776 DCA I . +3 /NO, USE INDIRECT
7774	/3376 DCA . +2 /YES, SET UP ADDRESS
7775	/5356 JMP . -17 /JUMP BACK

- 2 Set 7756 in the LEFT SWITCHES.
- 3 Set 0000 in the RIGHT SWITCHES.
- 4 Insert the basic CHECKERBOARD LOW in the Teletype reader (MAINDEC-08-D1L1).
- 5 Turn the Teletype ON LINE.
- 6 Set the reader to START.
- 7 Set the MODE switch to 8 MODE.
- 8 Depress the I/O PRESET.
- 9 Depress the START LS.
- 10 After the paper tape has been read in, halt the computer.
- 11 Set 0005 in the LEFT SWITCHES.
- 12 Set 0101 in the RIGHT SWITCHES.
- 13 Depress I/O PRESET; then START LS.
- 14 Set the oscilloscope as follows:
 - a. Trigger: Channel 1 only
 - b. Mode: ALT
 - c. Sweep: 0.1 μ s
 - d. Slope: Positive; Coupling: LF Reject; Source: Internal
 - e. On the scope, set the Channel 1 GND reference 1 cm above the center graticule.
 - f. On the scope, set the Channel 2 GND reference 2 cm below the center graticule.
 - g. The oscilloscope should appear as shown in Figure 3-1.

(continued on next page)

Step	Procedure
15	Attach the Channel 1 scope probe to B16J1 (CPTP START MEMORY H).
16	Attach the Channel 1 scope probe to E14S2 (MCT STROBE FIELD 0 H).

Set the leading edge of the MEM START (*MCT*) as shown in Figure 3-2. Adjust the STROBE approximately 550 ns after MEM START.

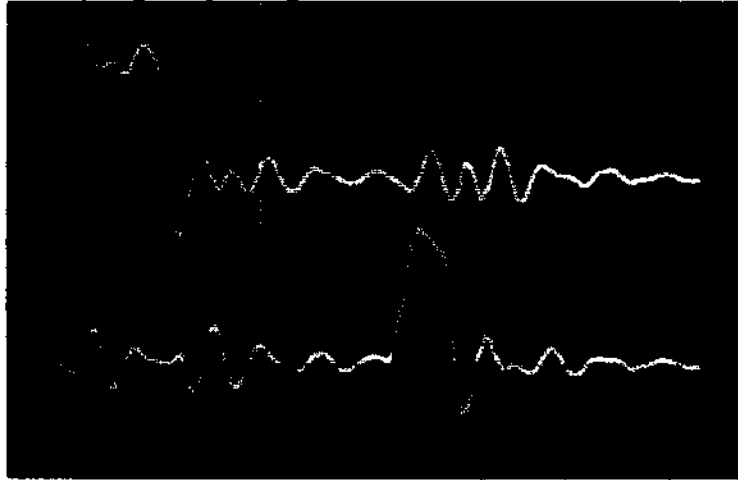

Figure 3-2 MEM START and STROBE

3.1.4 Final Current Adjustments

Step	Procedure
1	Perform the set-up procedure for the memory strobe (Steps 1 through 3 in Paragraph 3.1.3).
2	The oscilloscope is set as follows: <ul style="list-style-type: none"> a. Trigger: Channel 1 only b. Mode: Channel 2 only c. Channel 1: 2V/cm d. Channel 2: 50 mV/cm e. Channel 2 GND reference: 2 cm below center graticule (see Figure 3-1) f. Current probe terminator to 2 mA/mV g. Sweep: 2 μs h. Slope: Positive; Source: Internal i. Attach the current probe to Channel 2.
3	Attach the Channel 1 scope probe to B16J1 (CPTP START MEMORY H).

(continued on next page)

Step

Procedure

- 4 Attach the current probe to the loop provided from C1K1 to C7T2, with the arrow toward C7T2.
- 5 Adjust rightmost trimpot R28 on module G826 (locations E2 and F2) until the positive waveform is 320 mA +5%, as shown in Figure 3-3. (Turning the potentiometer CW increases the current.)
- 6 At the scope, set the Channel 2 GND reference 2 cm above the center graticule and observe the negative waveform. As shown in Figure 3-4, it should be approximately 350 mA +5%.

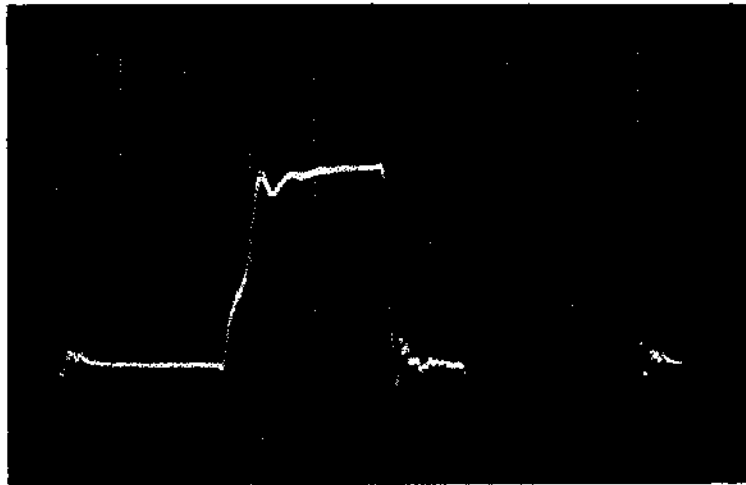

Figure 3-3 Positive Memory Current

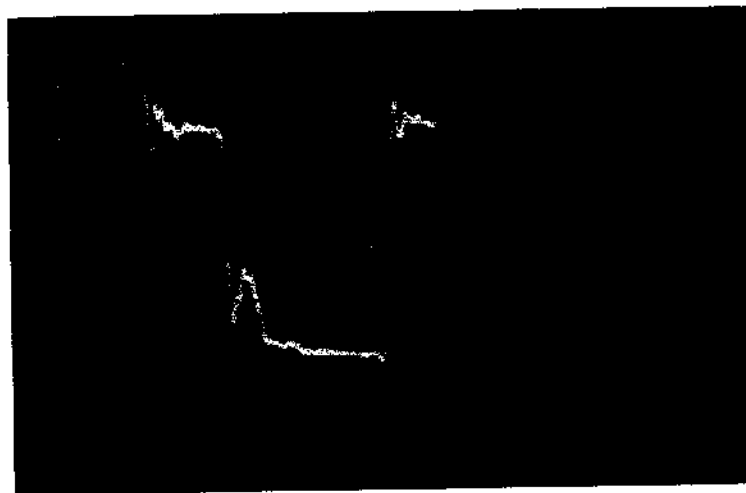

Figure 3-4 Negative Memory Current

3.1.5 Memory Margins and Final Strobe Adjustments

Step	Procedure
1	Repeat the set-up procedure for the memory strobe (Paragraph 3.1.3).
2	With the Memory Checkerboard Program properly running, the memory margins and final strobe adjustments are made as follows: <ol style="list-style-type: none">Monitor the strobe relationship to MEM START.Slowly increase the STROBE until the program fails. Record this reading.Turn the potentiometer two turns in the opposite direction and restart the program.Slowly decrease the STROBE until the program fails again. Record this value.

The final STROBE adjustment is $D + 1/2 (B-D)$. For example: if the bottom reading (2d.) was 400 ns, and the top (2b.) was 500 ns, the STROBE setting would be approximately 450 ns after the MEM START.

If current is incorrect, bits may be picked up or lost. If STROBE is not correctly adjusted, whole words may be lost. Reading may also produce all MB bits set when they should be cleared.

3.2 POWER OK

The Regulator Control Module, G826 (location E and F02), may require adjusting if applying or removing primary power causes the contents of memory to be destroyed or the RUN flip-flop to be erroneously cleared.

3.2.1 Check Procedure

If the E02J2 output is +3V, the regulator control has detected a power failure on the +5 or -15V bus. Check the +5 and -15V power supplies; if the outputs are within specification (see Table 2-2), adjust the G826 Module as directed in Paragraph 3.7.2.

NOTE

There are two types of G826 Modules: The revision H modules employ one trimpot (located on the right) for setting memory currents. The POWER OK adjustment is a single-turn potentiometer, located in the center of the module and requiring a double extender card to permit adjustment. On later revision K modules, the POWER OK adjustment (a 10-turn helipot), is located between the module plastic handles, permitting adjustment without requiring the extender card.

3.2.2 Adjustment Procedure

While observing an oscilloscope or meter at E02J2 (POWER OK H), turn the potentiometer CCW until the signal goes high (+3V) (MCT). Then slowly turn the potentiometer clockwise until the signal just goes low; continue a few degrees (approximately one hour on a 12-hour dial) more for the single-turn revision H modules, or 1/2 turn more for the 10-turn helipot revision K modules.

Run the Power On/Off MAINDEC program to check the adjustment. Tap the module to determine if the potentiometer is stable. Apply a small daub of paint or nail polish to seal the setting of the potentiometer.

If POWER OK becomes high, symptoms may include loss of the instruction and data fields, 0 → contents of AC, 0 → RUN flip-flop, 1 → 8 Mode and 1 → FETCH (i.e., I/O PRESET).

3.3 EXTENDED MEMORY MC12

If the MC12 Memory Extension Control (alone, or with the MM8I-A and/or MM8I-B options) is included in the user's system, the following procedure should be performed as a part of the memory current and strobe adjustments.

3.3.1 Set-up and Adjustment Procedure

Step	Procedure
1	Repeat Steps 1 through 13 of the Memory Strobe Set-up Procedure (Paragraph 3.1.3).
2	Be certain the Checkerboard Program operates properly in the lower memory.
3	Halt the Computer.
4	Load the following program, using the procedure specified in Step 1 of the Memory Strobe Set-up Procedure: 7700/6201 CHANGE DATA FIELD TO 0 7701/1670 TAD INDIRECT LOC 0070 7702/6211 CHANGE DATA FIELD TO 1 7703/3670 DCA INDIRECT LOC 0070 7704/2270 INCREMENT LOC 0070 7705/5300 JMP . -5 7706/7402 HALT TRANSFER COMPLETE 7670/0000
5	Set 0005 in the RIGHT SWITCHES.
6	Set 0101 in the LEFT SWITCHES.
7	Set 1 in the INST FIELD.
8	Depress the START LEFT SWITCHES.
9	Connect the Channel 2 probe of the scope to E15S2 (MCT STROBE FIELD 1 H).

NOTE

Do not depress the I/O PRESET.

The adjustment procedure is identical to Initial Current Adjustments and Final Current Adjustment Procedure (Paragraphs 3.1.1 and 3.1.4, respectively).

Upon completion of the Memory Adjustments, run the following MAINDECs (see Table 3-1). If a failure occurs, tune memory to run these diagnostics by varying current and STROBE adjustments approximately ±10%.

**Table 3-1
Memory Diagnostics**

Program	MAINDEC	Function
CBH	DEC-08-D1L2-PM	Tests Stack 0 for noise at low end
CBL	DEC-08-D1L1-PM	Tests Stack 0 for noise at high end
ADDRSHI	DEC-08-D1BZ-PM	Tests Stack 0 low end addressing
ADDRSLO	DEC-08-D1B1-PM	Tests Stack 0 high end addressing
MEMDATA	DEC-12-D1EA-PB	Test Stacks 0+1 for random data (see Writeup DEC-12-D1EA-D)
EXT CB	DEC-08-D1DA-PB	Tests Stacks 0+1 for noise
EXT AT	DEC-08-D1HA-PB	Tests Stacks 0+1 for addressing
JMPSELF	DEC-12-D1BA-PB	Tests Stacks 0+1 for address select speed
<p>NOTE PB – Paper-tape Binary PM – Paper-tape RIM D – Document</p>		

3.4 TELETYPE CLOCK

Step	Procedure
1	Oscilloscope set-up: <ul style="list-style-type: none"> a. Trigger: Normal b. Mode: Channel 2 only c. Sweep: 1.0 ms d. Slope: Positive; Coupling: LF Reject; Source: Internal e. Channel 2 GND reference: 2 cm below center graticule f. Channel 2: 2V/cm
2	Connect the Channel 1 scope to N8R2 (TTO TTI CLOCK II).
3	Connect the Channel 2 scope probe to N8K2 (TTO CLOCK L).

Adjust the potentiometer on M452 L-J N8 for a frequency of 4.5 ms (*TTO*). Turning the potentiometer CCW decreases the clock frequency. (Refer to Figure 3-5).

The 4.5 ms clock synchronizes the CP with the Teletype data transmission; thereby assuring that bits will not be picked up or lost during transmission.

NOTE
 Diagnostics, DEC-08-D2PE-PB (Teletype Test Part 1) and DEC-08-D2QD-PB (Teletype Test Part 2) should be run to check the Teletype. For more information, see Chapter 5.

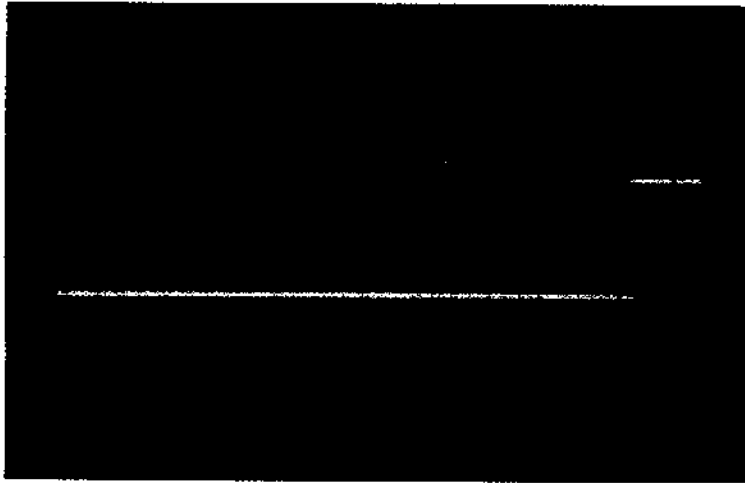

Figure 3-5 Teletype Clock (Sweep at .5 ms)

3.5 LINCtape

Paragraphs 3.5 through 3.7.2 provide the checks and adjustment procedures for the LINCtape control and tape transports. Maintenance personnel must be thoroughly familiar with the LINCtape transports and associated control circuitry before attempting any maintenance checks or adjustments.

NOTE

Adjustments to the LINCtape are performed only after a thorough cleaning of the tape guides and tape heads, thereby minimizing tape skew, a frequent source of LINCtape problems.

3.5.1 Tape Timing Pulses

When the tape reaches its normal operating speed, tape timing pulses are generated and used for synchronization of all LINCtape operations.

NOTE

This procedure is only a check to make certain that all the tape timing pulses are present. Replacement of a module is the only corrective adjustment.

Step	Procedure
1	Load the following program in core memory via the console keys and switches: <ol style="list-style-type: none"> a. Set 0000 in the LEFT SWITCHES (0000 / = Starting Address). b. Set 7300 in the RIGHT SWITCHES (7300 is the first instruction). c. Depress FILL; then depress FILL STEP. d. Set 7404 in the RIGHT SWITCHES (7404 is the next instruction). e. Depress FILL STEP key.

(continued on next page)

Step	Procedure
1 (cont)	<p><i>f.</i> Repeat Steps 1<i>d.</i> and 1<i>e.</i> until the program is loaded.</p> <p>0000/7300 /CLEAR THE AC & LINK 0001/7404 RIGHT SWITCHES TO THE AC 0002/6151 TAPE MAINTENANCE IOT 0003/5000 JMP -3 AND REPEAT PROGRAM</p>
2	Set 0000 in the LEFT SWITCHES.
3	Set 0040 in the RIGHT SWITCHES (simulates LTT TP0).
4	Set the MODE switch to 8 MODE, I/O PRESET.
5	Depress START LS (LEFT SWITCHES).
6	Set up the oscilloscope as follows: <ul style="list-style-type: none"> <i>a.</i> Trigger: Channel 1 only <i>b.</i> Mode: Alternate <i>c.</i> Slope: Negative; Source: Internal <i>d.</i> Sweep: 0.5 μs <i>e.</i> Channels 1 and 2: 2V/cm
7	Connect the Channel 1 scope probe to C18M1 (LTT TP0 L) and the Channel 2 scope probe to C20N1 (LTT TP2 L).
8	As shown in Figure 3-6, LTT TP0 should be a negative pulse, approximately 100 ns duration. LTT TP2 L should be a negative pulse, approximately 1 μ s in duration (LTT).
9	Set 0020 in the RIGHT SWITCHES (simulates LTT TP3).
10	Connect the Channel 1 scope probe to C18N1 (LTT TP3 L) and the Channel 2 scope probe to (LTT TP4 L) on C19N1.
11	Set the scope sweep to 0.1 μ s.
12	LTT TP3, as shown in Figure 3-7, should be a negative pulse of approximately 100 ns duration. LTT TP4 should be the same duration (LTT).

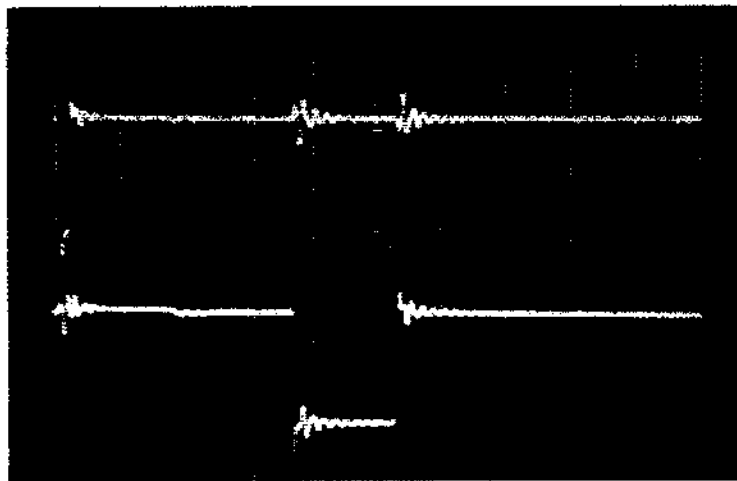
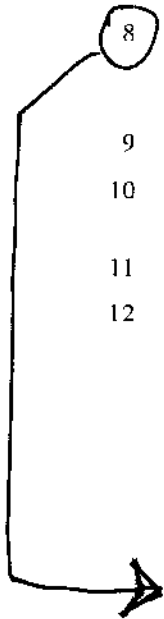

Figure 3-6 LTT TP0/TP2 Pulse Duration

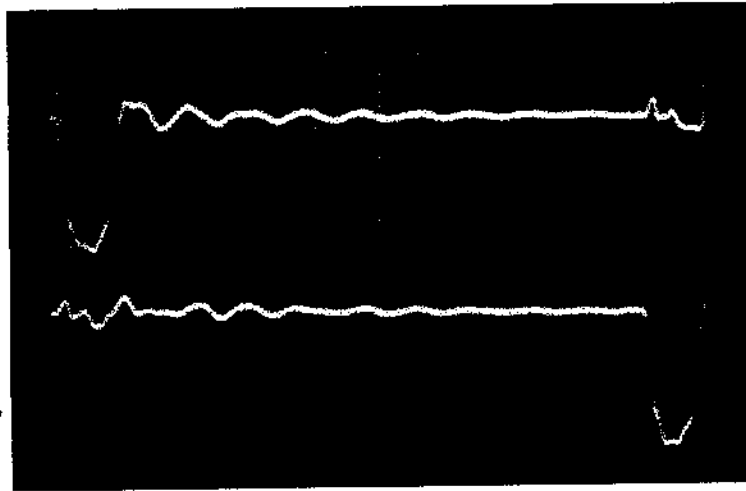

Figure 3-7 LTT TP3/TP4 Pulse Duration

3.5.2 LTD XTLK Delay

The Cross Talk (XTLK) delay (*LTD*), when initialized, ensures that there will be only one T_{T0} or T_{T1} for a given zero crossover on the tape (during read and write). XTLK is the most important TC12 adjustment and must be correct.

Step	Procedure
1	Load the program as specified in the Set-up Procedure in Paragraph 3.5.1.
2	Set 0040 in the RIGHT SWITCHES (simulates TP0).
3	Set 0000 in the LEFT SWITCHES and depress the 8 MODE switch.
4	Depress I/O PRESET and START LS switches.
5	Set up the oscilloscope as follows: <ol style="list-style-type: none"> Trigger: Channel 1 only Mode: Alternate Slope: Negative; Source: Internal Sweep: 1 μs Channel 1 GND reference at the center graticule Channel 2 GND reference 3 cm below the center graticule
6	Connect the Channel 1 scope probe to C28U1 (LTT TP0 L) and the Channel 2 scope probe to C28H2 (LTD XTLK H).

Adjust the right potentiometer of M307 (location C28) for 9 μ s (*LTD*). Turning the potentiometer CCW increases the delay time, as shown in Figure 3-8.

N BETTER AT 9.5 μ s TP45

The crosstalk delay ensures that only data on the tape is being read. If the delay is improperly adjusted, data may not be read; if data is read, it may not be correct and the LINCtape control may not find the correct block, or improperly write data onto tape.

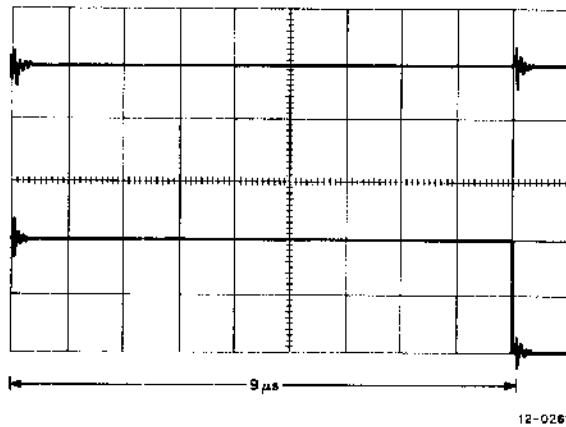

Figure 3-8 LTD XTLK Delay Time

3.5.3 LTD TTOK Delay

The TTOK (Tape Timing OK) monitors tape speed, inhibiting any data transfers (Read or Write) if proper tape velocity over the read/write heads is not maintained.

The 48 μ s TTOK delay ensures that tapes are moving at correct speed (within 50 percent) and that TP0 and TP3 are being read. If the tape rocks in one position, or if IDLE and SEARCH are intermittent, the TTOK delay may be suspected.

Step	Procedure
1	Halt the computer; turn off power.
2	Remove W603, at location F16.
3	Restore power.
4	Load the program as directed in Paragraph 3.5.1.
5	Set 0000 in the LEFT SWITCHES.
6	Set 0040 in the RIGHT SWITCHES (simulating LTT TP0).
7	Set the AUTO RESTART delay as follows: <ul style="list-style-type: none"> a. Set the COARSE selector to 3. b. Set the FINE control to FAST.
8	Set SING STEP and START LS.
9	Depress AUTO and hold it down.
10	Depress CONT; then release the AUTO key.
11	Set the oscilloscope as follows: <ul style="list-style-type: none"> a. Trigger: Channel 1 only b. Mode: Channel 2 only

(continued on next page)

Step	Procedure
11 (cont)	<ul style="list-style-type: none"> c. Slope: Negative; Source: Internal d. Sweep: 5 μs e. Channel 2 GND reference 1 cm below the center graticule f. Sweep Mode: Normal
12	Connect the Channel 1 scope probe to C28U1 (LTT TP0 L) and the Channel 2 scope probe to C28E2 (LTD TTOK L).
13	If this delay is set for 48 μ s (LTD), refer to Step 16.
14	Adjust the left potentiometer of M307 (location C28) for 48 μ s. Turning the potentiometer CCW increases the delay.
15	Refer to Figure 3-9.
16	Halt the computer, remove power.
17	Reinstall the W603, at location F16.

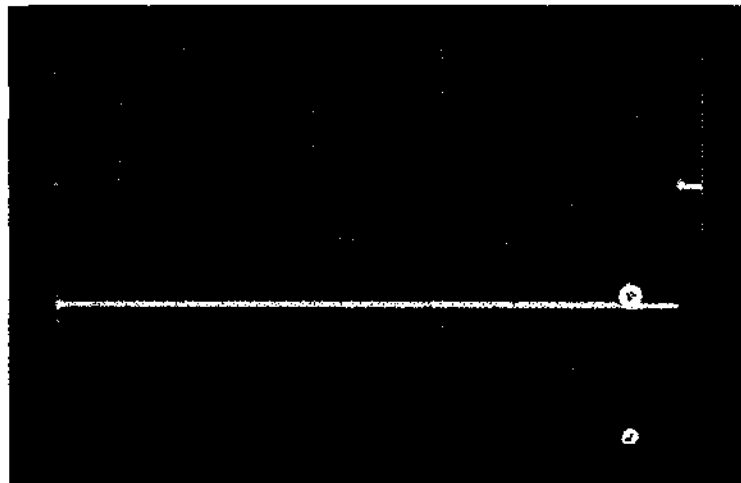

Figure 3-9 LTD TTOK Delay

3.5.4 LTD TAPE FAIL Delay

A Tape Fail Delay signal results in a tape motion stop if:

- a. The tape transport programmed to run is not selected,
- b. The tape timing (TTO) pulses are lost.

The delay is set up as follows:

Step	Procedure
1	Turn off the computer power and remove M304 Module at location C17.
2	Restore power to the computer.

(continued on next page)

Step	Procedure
3	Load the program as directed in Paragraph 3.5.1.
4	Set 0000 in the LEFT SWITCHES.
5	Set 0040 in the RIGHT SWITCHES (simulating LTT TP0).
6	Set the AUTO RESTART delay as follows: <ul style="list-style-type: none"> a. Set COARSE control to position 2. b. Set FINE control to SLOW.
7	Set SING STEP; then set START LS.
8	Depress AUTO and hold it down.
9	Depress CONT; then release AUTO.
10	Set the oscilloscope as follows: <ul style="list-style-type: none"> a. Trigger: Channel 1 only b. Mode: Channel 2 only c. Sweep: 50 ms d. Slope: Negative; Source: Internal e. Set Channel 2 reference GND to center graticule f. Set Channels 1 and 2 to 2V/cm g. Sweep Mode: Normal
11	Connect Channel 1 scope probe to C30U1 (LTT TP0 L).
12	Connect Channel 2 scope probe to C30F2 (LTD TAPE FAIL L) (LTD).
13	If the delay is 300 ms, refer to Step 16.
14	Slowly increase the FINE AUTO RESTART delay until the trace is stable. Increasing the AUTO RESTART delay past 300 ms inhibits the delay. Adjust the right potentiometer of the M307 Module, at C30, for 300 ms. Turning the potentiometer CCW increases the delay.
15	Refer to Figure 3-10.
16	Halt the computer; remove power.
17	Reinstall the M304 Module at location C17.

3.5.5 LTD ACIP Delay

The ACIP (ACceleration In Progress) delay signal inhibits tape timing during any change in tape direction (starting or tape turn-around).

If the ACIP delay is not adjusted correctly it may result in the inability to read blocks, or in erratic tape motion.

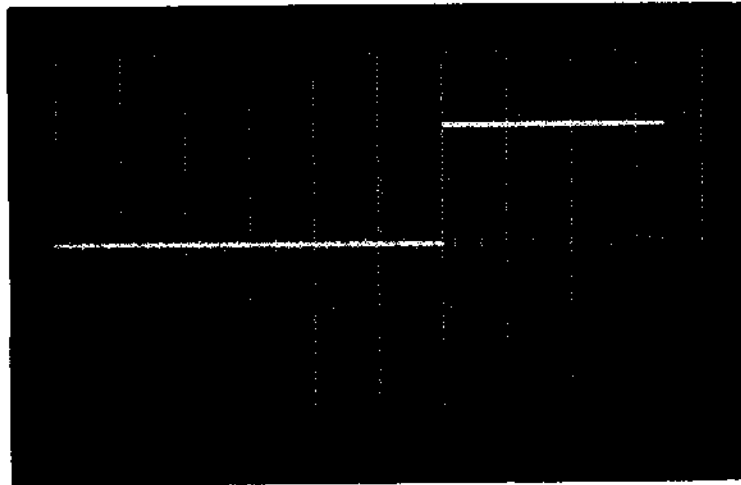

Figure 3-10 LTD Tape Fail Delay

- | Step | Procedure | | | | | | | | | | | | | | |
|-----------|---|-----------|-----------------|-----------|-------------------|-----------|---------------------------------------|-----------|--------------------------|-----------|--------------------------------------|-----------|-------------------|-----------|-----|
| 1 | Load the following program: <table border="0" style="margin-left: 40px;"> <tr> <td>0000/7300</td> <td>CLEAR AC & LINK</td> </tr> <tr> <td>0001/1006</td> <td>TAD K20 AC = 0020</td> </tr> <tr> <td>0002/6152</td> <td>TAPE MAINT. IOT (set motion backward)</td> </tr> <tr> <td>0003/7006</td> <td>ROTATE 2 LEFT, AC = 0100</td> </tr> <tr> <td>0004/6152</td> <td>TAPE MAINT. IOT (set motion reverse)</td> </tr> <tr> <td>0005/5000</td> <td>JMP . -5 & REPEAT</td> </tr> <tr> <td>0006/0020</td> <td>K20</td> </tr> </table> | 0000/7300 | CLEAR AC & LINK | 0001/1006 | TAD K20 AC = 0020 | 0002/6152 | TAPE MAINT. IOT (set motion backward) | 0003/7006 | ROTATE 2 LEFT, AC = 0100 | 0004/6152 | TAPE MAINT. IOT (set motion reverse) | 0005/5000 | JMP . -5 & REPEAT | 0006/0020 | K20 |
| 0000/7300 | CLEAR AC & LINK | | | | | | | | | | | | | | |
| 0001/1006 | TAD K20 AC = 0020 | | | | | | | | | | | | | | |
| 0002/6152 | TAPE MAINT. IOT (set motion backward) | | | | | | | | | | | | | | |
| 0003/7006 | ROTATE 2 LEFT, AC = 0100 | | | | | | | | | | | | | | |
| 0004/6152 | TAPE MAINT. IOT (set motion reverse) | | | | | | | | | | | | | | |
| 0005/5000 | JMP . -5 & REPEAT | | | | | | | | | | | | | | |
| 0006/0020 | K20 | | | | | | | | | | | | | | |
| 2 | Set 0000 in RIGHT SWITCHES. | | | | | | | | | | | | | | |
| 3 | Set the AUTO RESTART delay as follows: <ol style="list-style-type: none"> a. Set the COARSE selector to 2. b. Set the FINE control to SLOW. | | | | | | | | | | | | | | |
| 4 | Set the SING STEP, MODE switch to 8 MODE and depress I/O PRESET. | | | | | | | | | | | | | | |
| 5 | Depress START LS; depress and hold AUTO key. | | | | | | | | | | | | | | |
| 6 | Depress CONT; then release AUTO. | | | | | | | | | | | | | | |
| 7 | Set the oscilloscope as follows: <ol style="list-style-type: none"> a. Trigger: Channel 1 only b. Mode: Channel 2 only c. Sweep: 20 ms d. Slope: Negative; Coupling: LF Reject; Source: Internal e. Channel GND reference 1 cm below the center graticule f. Channels 1 and 2 to 2V/cm | | | | | | | | | | | | | | |
| 8 | Connect Channel 1 scope probe to C30K2 (LMU DIRECTION 0 L). | | | | | | | | | | | | | | |

(continued on next page)

Step	Procedure
9	Connect Channel 2 scope probe to C30 ^{C31} E2 (LTD ACIP L).
10	Adjust the left potentiometer of the M307 Module, at location C30 (LTD), for a 180-ms delay. Turning the potentiometer CCW decreases the delay.
11	Refer to Figure 3-11.

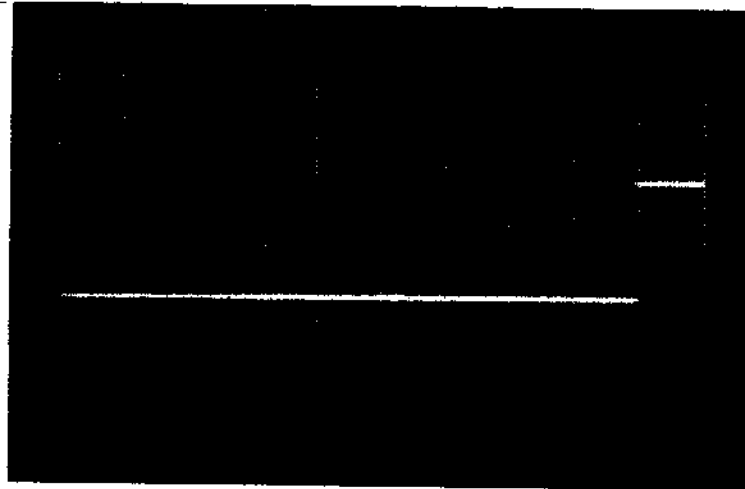

Figure 3-11 LTD ACIP Delay.

3.5.6 Mark Clock Adjustment

The mark clock (*LTS*) establishes tape timing and mark track signals when formatting virgin tape.

If the MARK flip-flop period is longer than $7.5 \mu\text{s} \pm 5$ percent when virgin tape is marked, the marking process will not finish before end-of-tape is reached.

If the MARK flip-flop duration is shorter than $7.5 \mu\text{s}$, data will not transfer to virgin tape correctly, i.e., running a PIP copy program.

CAUTION

Remove all tapes before starting this adjustment.

Step	Procedure
1	Halt the computer. Turn off the power.
2	Install a jumper from E21K2 to E21T1.
3	Turn on the computer.
4	Set up the oscilloscope as follows: <ul style="list-style-type: none"> a. Trigger: Channel 1 only b. Mode: Channel 1 only c. Sweep: $1 \mu\text{s}$

(continued on next page)

Step	Procedure
4 (cont)	<ul style="list-style-type: none"> d. Slope: Positive; Source: Internal e. Channel 1: 2V/cm f. GND reference of Channel 1 at the center graticule
5	Connect Channel 1 scope probe to E21D2.
6	Adjust the M401 Module at location E21 for 7.5 μ s as shown in Figure 3-12. Turning the potentiometer CCW increases the clock frequency.
7	Turn off the power and remove the jumper installed in Step 2 of the Set-up Procedure.

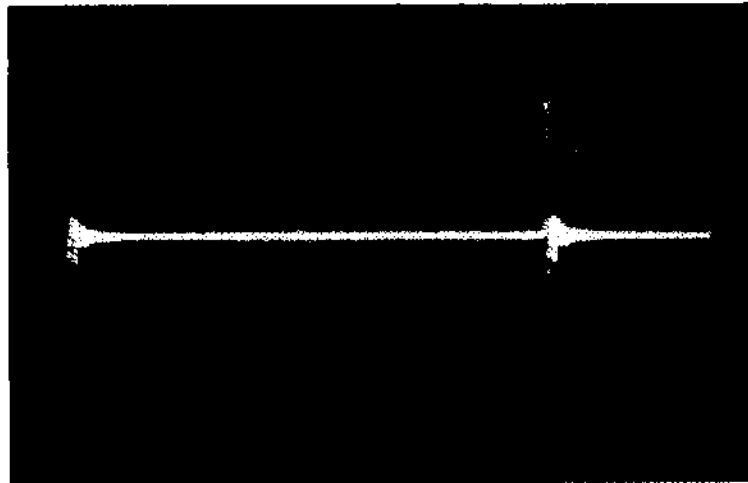

Figure 3-12 Mark Clock

NOTE

The diagnostics TC12-I and TC12-II should be used as a final test on the TC12 LINCtape Control.

3.6 TU55 TAPE TRANSPORT

NOTE

Before any mechanical adjustments are performed, user maintenance personnel are directed to check the model of the tape transport provided with their system. Some PDP-12 systems are equipped with the TU55 tape transports; other PDP-12 systems employ the TU56 transport. Users are directed to the TU55 or TU56 Maintenance Manuals for complete maintenance information concerning the tape transports.

Each of the LINCtape transports contains a pair of tape reel hubs driven by an induction motor. The tape motors are relatively high torque and low inertia, which allows the tape to be started and stopped quickly. Correct operation of the tape system requires the tape to be rapidly started and stopped, without its being lifted off the heads. Tape lifting can be a frequent source of problems for the LINCtape system, and also one of the most difficult to discern.

The following mechanical adjustment procedures (Paragraphs 3.6.1 through 3.6.3) provide those mechanical adjustments that can be performed by competent field maintenance personnel.

The hub shaft assembly and motor should be adjusted so that they spin freely, with no appreciable amount of friction, do not bind, and are mechanically quiet when operating.

3.6.1 TU55 Brake Adjustment

Step	Procedure
1	Turn off the power to the transport that is to be adjusted. Tapes should not be mounted on the transports.
2	Slide the transport fully forward.
3	Remove the 115-Vac line cord from the transport.

NOTE

The brake shoes are located on the motor shafts as shown in Figure 3-13. The brake shoes follow the rotation of the motor shaft (hubs).

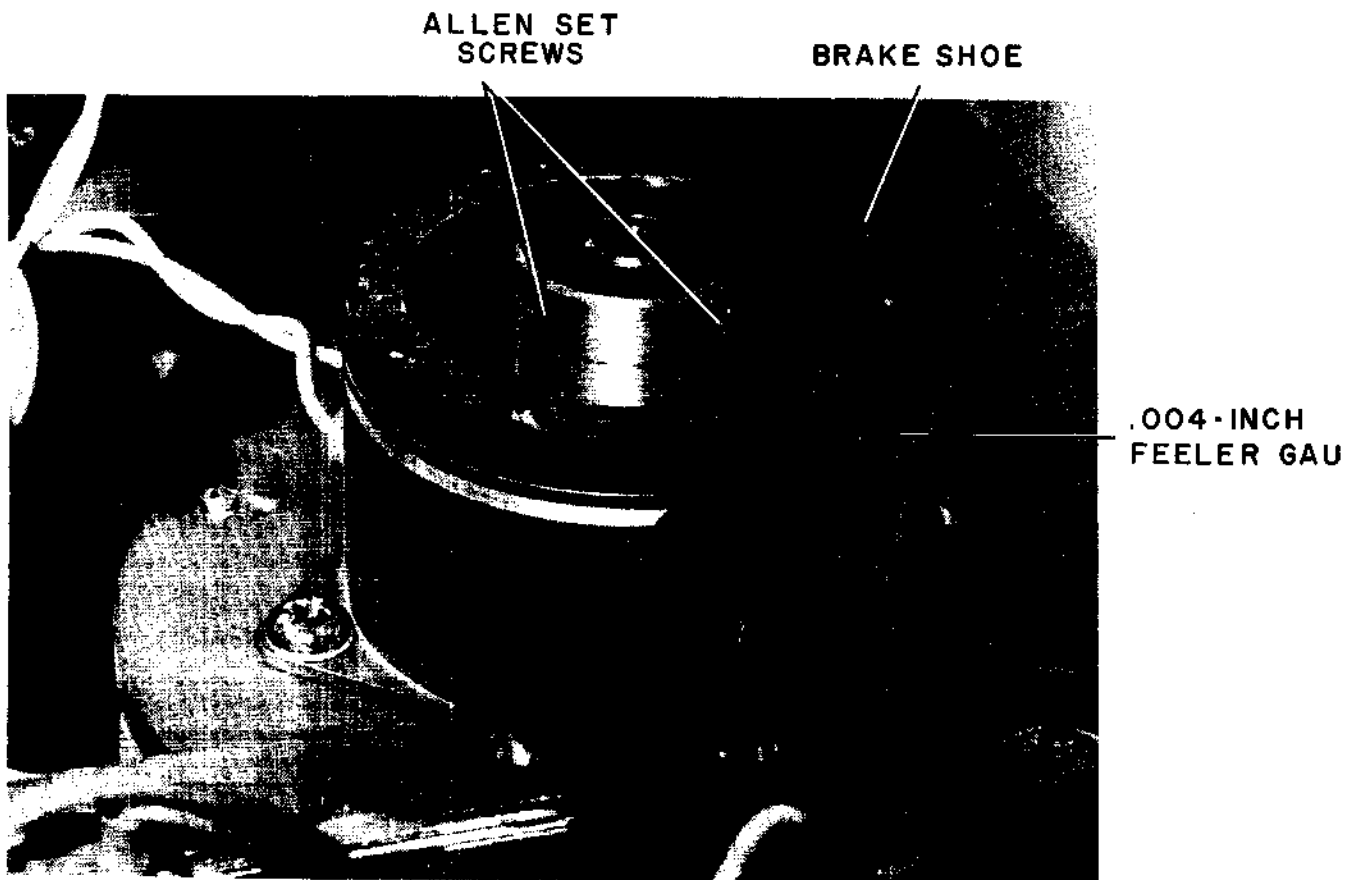

Figure 3-13 TU55 Brake Adjustment

(continued on next page)

Step	Procedure
4	Insert a .004-in. feeler gauge between the brake shoe and brake surface.
5	Adjust the brake for proper clearance by loosening the two Allen setscrews on the brake shoe and moving the brake in and out along the shaft.
6	After the adjustment is made and the Allen setscrews are secured, rotate the hub several revolutions by hand to be certain that there is no binding and that the motor turns freely.
7	Set the FUNCTION control to LOCAL and pulse the DIRECTION switch. A properly adjusted brake should produce a minimum of "clicking."
8	Repeat this procedure for each hub on all the TU55 transports.
9	Reinstall 115-Vac line cord.

3.6.2 TU55 Torque Adjustments

The following equipment is required:

- a. VOM or VTVM with a set of insulated clip leads
- b. Small long-shaft (6-in.) screwdriver
- c. Oscilloscope

Stop-Torque Adjustment

Step	Procedure
1	Line voltage (ac) to TU55 on.
2	Scratch tape installed on both hubs.
3	Brake gap set as described in Paragraph 3.6.1.
4	Switch the unit to LOCAL.
5	Connect the VOM to the tab terminals of Module G850 at location A12 (right motor) as shown in Figure 3-14. Expect a reading of approximately 60 Vac.
6	Depress FWD → switch and release.
7	Adjust trimpot nearer the G850 handle for meter reading of 50 Vac.
8	Connect the VOM to the terminals of Module G850 in location A11 (left motor) as shown in Figure 3-14.
9	Depress the REV ← switch and release.
10	Adjust the trimpot nearer the G850 handle for a meter reading of 60 Vac.

COMMON (GND) TERMINAL

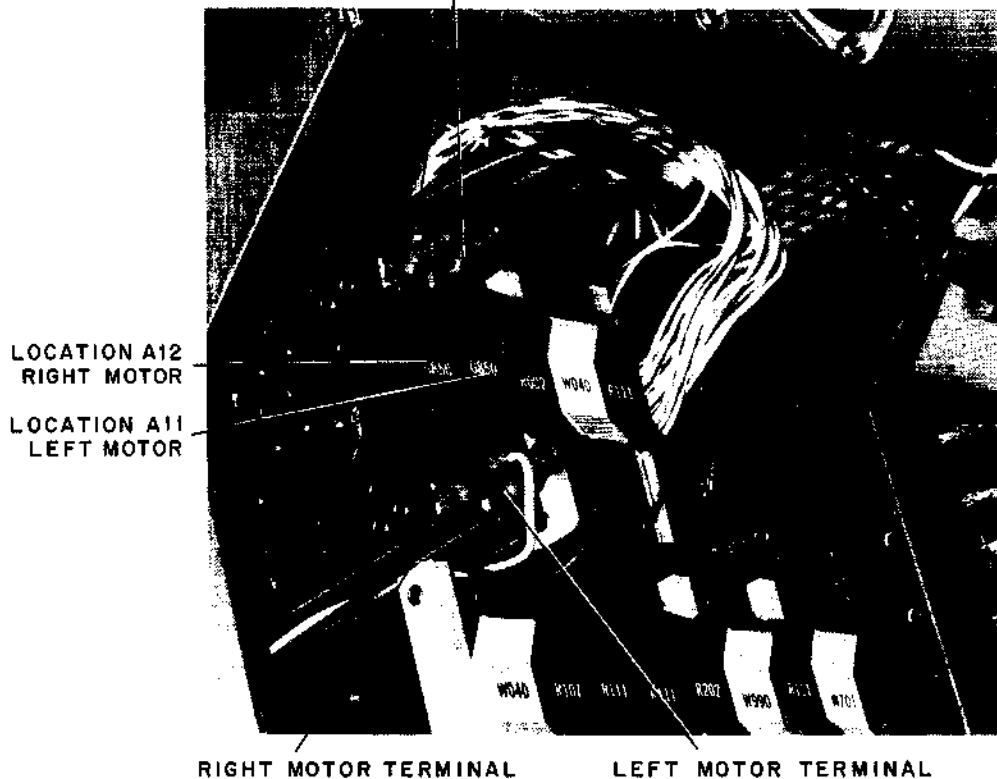

Figure 3-14 TU55 Torque Adjustment Tabs

Trailing Torque Adjustments

Step	Procedure
1	Connect the VOM to tab terminals of the G850 Module in location A12 (right motor). Expect 85 Vac.
2	Rewind the scratch tape so that the right reel is nearly full.
3	Depress and hold the REV ← switch so that the tape is winding onto the left reel as the following adjustment is made.
4	Adjust the potentiometer farthest from the G850 Module handle. Make certain that the tape is still in motion while the adjustment is made. Adjust for 85 Vac.
5	Connect the VOM to the tabs of the G850 Module in location A11 (left motor).
6	Wind the scratch tape so that the left reel is nearly full of tape.
7	Depress and hold the FWD → switch so that the tape is winding onto the right reel as this adjustment is made.
8	Adjust the potentiometer farthest from the G850 Module handle for a meter reading of 85 Vac (Figure 3-15). Make certain that the tape is still in motion during the adjustment.

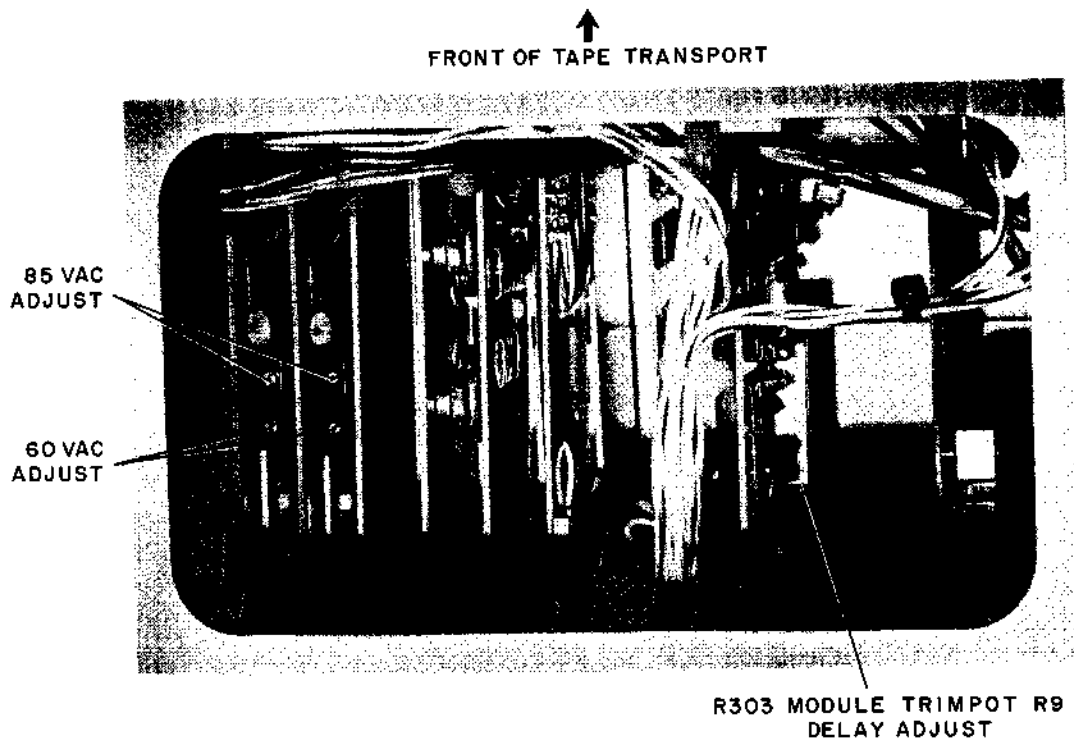

Figure 3-15 TU55 Stop Delay Adjustment

Stop Delay Adjustment

Step	Procedure
1	Switch the tape unit to LOCAL.
2	Set the oscilloscope as follows: <ol style="list-style-type: none"> a. Trigger: Channel 1 b. Mode: Channel 1 c. Channel 1: 2V/cm d. Sweep: 10 ms
3	Connect the scope probe to A04D.
4	Depress and release FWD → switch.
5	Adjust potentiometer R303 for approximately 80 ms delay, as shown in Figure 3-15, or until tape snapping is minimal.

3.6.3 TU55 Transport Head Replacement and Adjustment Procedures

These procedures outline the steps necessary to effect a field (on-site) replacement and/or alignment of the read/write tape head on the TU55 Tape Transport. The need for adjustment is indicated when the following specifications are exceeded:

- a. The tape head is to be vertically aligned between the tape guides, projecting 1/8 in. above the guide edges.
- b. The maximum amount of tape skew should not exceed $\pm 3 \mu\text{s}$.

Head Removal

Step	Procedure
1	At the tape transport control panel, set the REMOTE/OFF/LOCAL switch to the OFF position and remove ac power to the computer.
2	Disconnect the ribbon connector from the G851 Relay Board.
3	Remove one of the two head clamps; loosen the other clamp.
4	Remove the tape head from the transport.

Head Installation

Step	Procedure
1	Replace the tape head with a new assembly, reversing Steps 3 and 4 above.
2	Secure the mounting clamps.
3	While tightening the clamps, make certain that the tape head is vertically aligned between the tape guides and that it is projecting 1/8 in. above the tape guides.

NOTE

This procedure applies only to GJM heads or Western magnetic tape heads. Set the selector switch on the skew checker to GJM. (Refer to Figure 3-16).

Head Skew Adjustment

Step	Procedure
1	Mount a DEC-certified master skew tape on the transport.
2	Connect the skew checker to the tape head ribbon connector and the tape transport dc supply terminals. <ol style="list-style-type: none"> a. Pin A of the checker connector should mate with the pin closest to the larger end of the tape head connector. b. In most installations, the power wiring is color-coded to correspond with the TU55 wiring. In some transports, however, the +10V lead may be read; in this case, this will be a green wire connection to the checker. c. Connect the oscilloscope probe to the point marked SKEW. Connect the scope ground to the point marked GND (black). Adjust the scope for a 1-$\mu\text{s}/\text{cm}$ horizontal sweep and a 1V/cm vertical sensitivity.

(continued on next page)

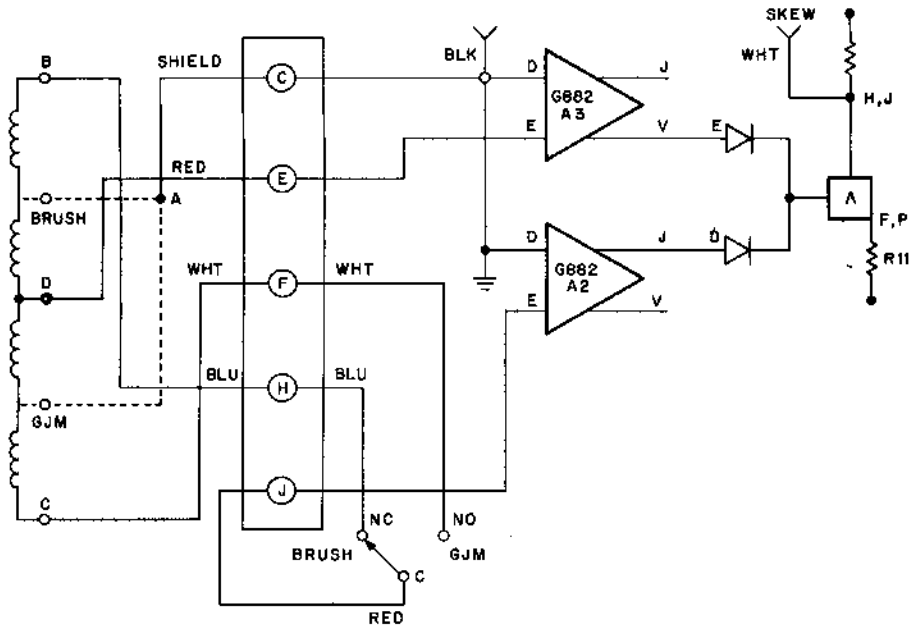

12-0127

Figure 3-16 Skew Checker Schematic Diagram

Step

Procedure

2 (cont)

- d. Restore ac power to the computer and place the tape transport REMOTE/OFF/LOCAL switch to the LOCAL position. While observing the oscilloscope, move the master skew tape back and forth across the tape head. Note that the output of the skew checker (as presented on the scope) does not exceed $\pm 3 \mu\text{s}$. (Refer to Figure 3-17).
- e. If the skew appears to be on the edge of the tape guides or slightly out of specification, some skew adjustment can be made by moving the tape head slightly to one side or the other and/or alternately loosening and retightening the mounting screws of the tape head clamps. In most cases, this action changes the skew $\pm 1 \mu\text{s}$. If a large amount of skew is present, shimming of the tape head becomes necessary.

3

Shim the Tape Head

- a. To determine the direction in which to shim, lightly press against the moving tape on either side of the head. If skew is reduced when pressing at the right side of the head, shim the right rail of the head block. If the skew is reduced when pressing at the left side of the head, remove the shim stock from the right rail. Use 1/2-mil shim stock (available as "Scotch Tape Marker"), and shim only the right rail of the head.

(continued on next page)

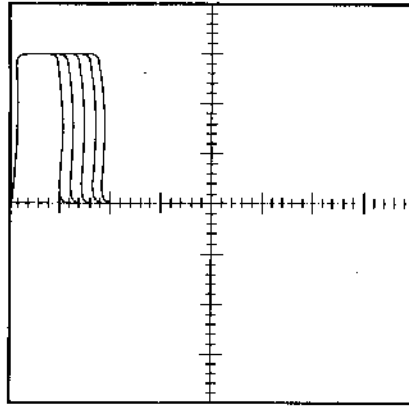

NOTE: A RAGGED TRAILING EDGE
IS CAUSED BY TAPE BOUNCE

12-0126

Figure 3-17 Skew Checker Output

Step	Procedure
3 (cont)	<ol style="list-style-type: none"> b. After shimming the head, realign the tape head (as directed in Steps 2 and 3 of Paragraph 3.6.3, Head Installation) and re-check the skew. The skew must be less than 3 μs in both directions.

3.7 TU56 TAPE TRANSPORT

Complete service and adjustment and other maintenance information can be found in the *TU56 Maintenance Manual DEC-00-HRTA-D*. For convenience of maintenance personnel, the TU56 Brake and Oscillator Adjustments are provided below:

3.7.1 TU56 Brake Adjustment

Step	Procedure
1	Mount a scratch tape on the transport.
2	Tilt the tape transport front panel forward.
3	Set the oscilloscope as follows: <ol style="list-style-type: none"> a. Trigger: Normal b. Mode: Channel 1 c. Sweep: 10 ms d. Slope: Positive; Coupling: LF Reject; Source: Internal e. Trace for Channel 1 GND reference adjusted on the center horizontal graticule f. Set Channel 1 to 2V/cm

(continued on next page)

- | Step | Procedure | | | | | | | | | | | | |
|---------------------|--|-----------|-----|-----------|-----------|-----------|---------|------------|--|----------|--|---------------------|--|
| 4 | Connect the Channel 1 scope probe to B08F2. (See drawing D-BS-TU56-0-TLD). | | | | | | | | | | | | |
| 5 | Enter the following routine: <table border="0" style="margin-left: 40px;"> <tr> <td>4020/0703</td> <td>MTB</td> </tr> <tr> <td>4021/0300</td> <td>Block 300</td> </tr> <tr> <td>4020/6020</td> <td>JMP .-2</td> </tr> <tr> <td>I/O PRESET</td> <td></td> </tr> <tr> <td>START 20</td> <td></td> </tr> <tr> <td>Unit Set to UNIT 0.</td> <td></td> </tr> </table> | 4020/0703 | MTB | 4021/0300 | Block 300 | 4020/6020 | JMP .-2 | I/O PRESET | | START 20 | | Unit Set to UNIT 0. | |
| 4020/0703 | MTB | | | | | | | | | | | | |
| 4021/0300 | Block 300 | | | | | | | | | | | | |
| 4020/6020 | JMP .-2 | | | | | | | | | | | | |
| I/O PRESET | | | | | | | | | | | | | |
| START 20 | | | | | | | | | | | | | |
| Unit Set to UNIT 0. | | | | | | | | | | | | | |

The above routine will cause the tape unit to oscillate (or rock) between two blocks, causing the brake delay to be repeatedly displayed (about 3-times/s) on the scope.

This rocking action will permit the viewer to conclude the brake delay adjustment procedure without repeatedly advancing and rewinding the tape hubs manually.

- | | |
|---|---|
| 6 | To adjust the left hub brake delay, turn the upper potentiometer for a delay of 80 ms (see Figure 3-18). |
| 7 | Connect the scope probe (Channel 1) to B08T2. |
| 8 | To adjust the right hub brake delay, turn the lower potentiometer for a delay of 80 ms (see Figure 3-18). |
| 9 | Repeat the procedure for each pair of tape hubs. |

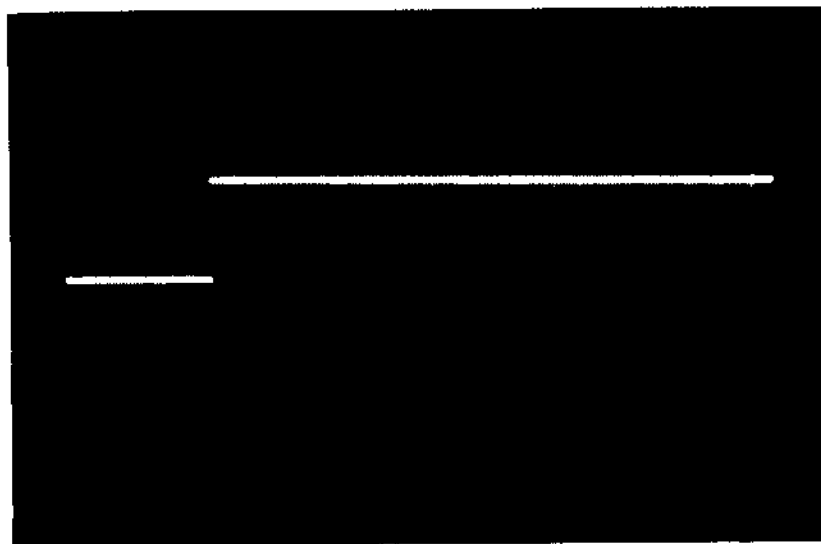

Figure 3-18 80 ms Brake Delay Adjustment

3.7.2 Oscillator Adjustment

Step	Procedure
1	Set the oscilloscope as follows: <ol style="list-style-type: none">Trigger: NormalMode: Channel 1Sweep: 5 msSlope: Positive; Coupling: LF Reject; Source: InternalChannel 1 GND reference adjusted on the center horizontal graticuleChannel 1 to 2V/cmConnect the scope probe to A03M2 of the TU56 transport logic
2	Adjust the potentiometer to 25 ms as shown in Figure 3-19.

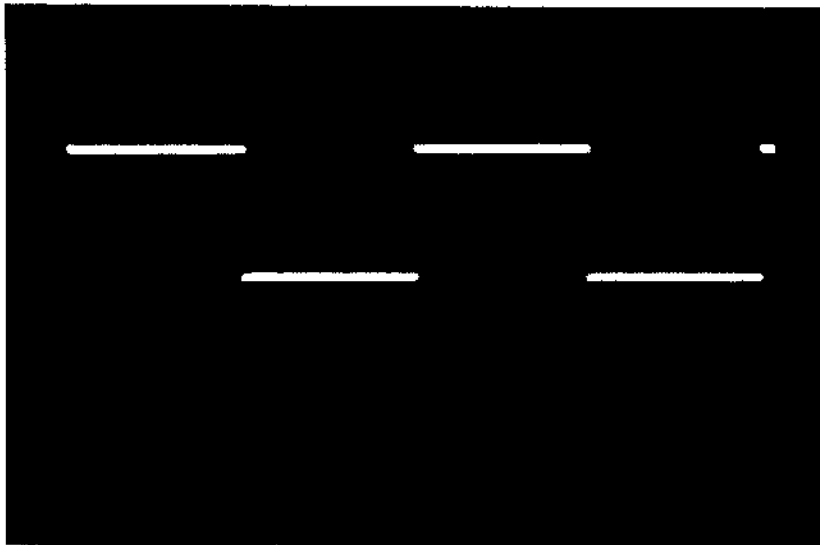

Figure 3-19 25 ms Oscillator Adjustment

3.8 ANALOG (AD12) AND DISPLAY (VR12, VC12)

Paragraph 3.8.1 provides the checks and adjustments to be performed in the field. Included are the A/D circuits (preamps and optional multiplexer channels) and the VR12 display and control adjustment procedures. The information contained in this adjustment manual provides for only those adjustments which are to be performed to the A/D circuits and the video display circuits jointly. Complete maintenance information for the VR12 display system is available in the *VR12 Point Plot Display Maintenance Manual (DEC-CR-H6AA-D)*.

3.8.1 Digital-to-Analog Adjustment Procedure (A615)

Step	Procedure
1	Load the following program: 4020/0162 DISPLAY A POINT & INCREMENT 4021/6020 JMP . -1 & REPEAT
2	Set the RIGHT and LEFT SWITCHES to 0.
3	Set the MODE switch to LINC; depress the I/O PRESET; depress ST 20.
4	Turn on the VR12 and set the brightness potentiometer approximately 3/4 of a turn from off.
5	Set the CHANNEL SELECT to 1 and 2.
6	Depress START 20.
7	A straight line will be displayed. If the line is of uniform brightness and continues from one side of the screen to the other without gaps, refer to Step 2 of this procedure. If the line displayed appears as E of Figure 3-20, refer to Step 1 of Adjustment Procedure, Paragraph 3.8.2.

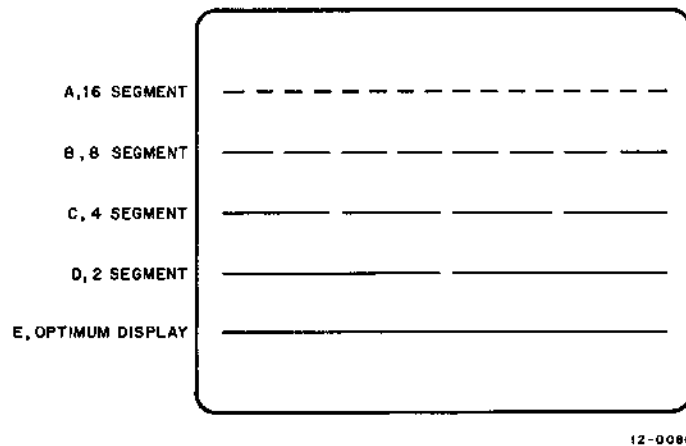

Figure 3-20 D/A Line Display

The four most significant bits of Module A615, Digital-to-Analog Converter, are adjustable (R37 through R40 in Figure 3-21); bit 3 being the most significant, and bit 6 being the least significant. A misadjusted A615 displays a line either with gaps or overlays, or a combination of both. Figure 3-20 provides an example of all four significant bits being set too short. Data bit 3, being too short, divides the line into two equal halves (D). Data bit 5 divides the line into 8 segments (B) and, likewise, bit 6 divides the line into 16 equal segments (A).

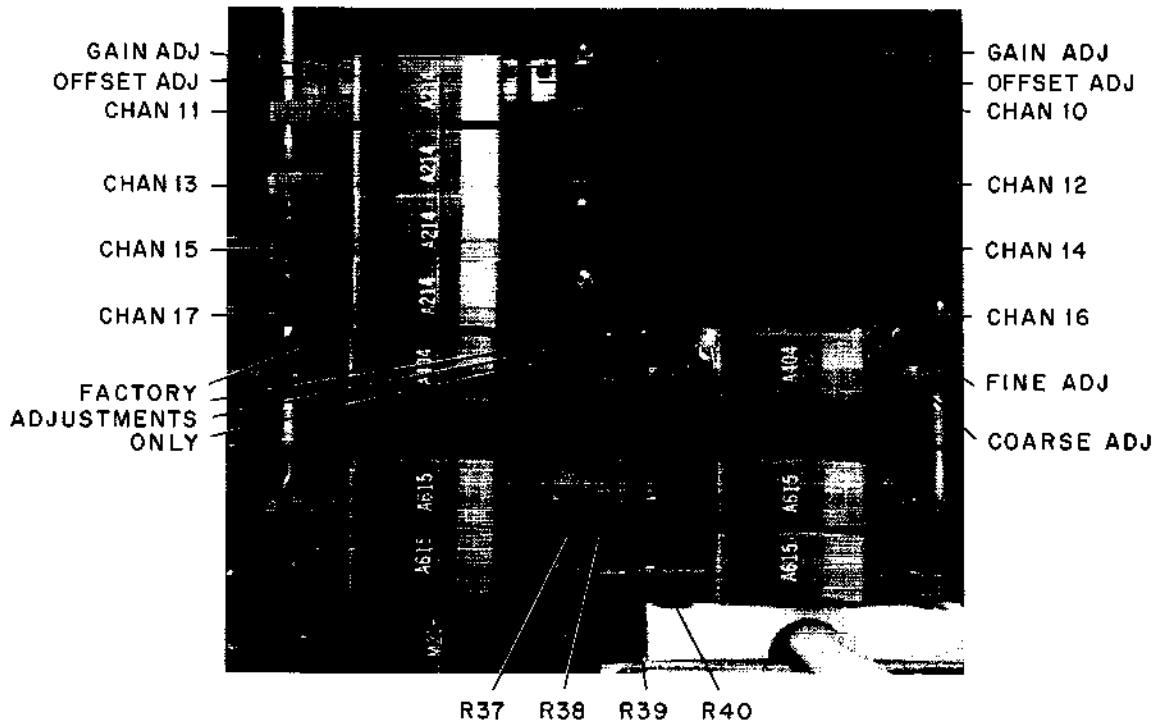

Figure 3-21 Sample and Hold Adjustments

Step	Procedure
1	The A615 is adjusted, starting with bit 6, the least significant bit, and adjusting toward the most significant bit, bit 3. Note the 16 segments of A of Figure 3-20. Adjust potentiometer R37 of Module A615, locations E and F37 (bottom of A615), until only eight segments are displayed as shown in B of Figure 3-20.
2	Adjust potentiometer R38 until only four segments are displayed, as shown in C of Figure 3-20.
3	Adjust potentiometer R39 until only two segments are displayed, as shown in D of Figure 3-20.
4	Adjust potentiometer R40 until the line is complete (straight and unbroken). Potentiometers R39, R38, and R37 may require minor touching up, as some interaction is possible; the overlays are adjusted in the same manner except that the settings must be decreased.
5	After setting Module A615 at locations E and F37, halt the computer and turn off the power. Swap Module A615 in locations E and F37 with the Module A615 in locations E and F36. Repeat the entire A615 Adjustment Procedure.

3.8.2 VR12 Size and Position Adjustments

Step	Procedure
1	Size can be adjusted to the user's requirements by adjusting the X- and Y-Position potentiometers.
2	On Module M711 (locations C and D37), set the three switches for normal operation as listed below: <ol style="list-style-type: none">Set PRR switch to FAST.Set WIDTH switch to MIN.Set POL switch to -.

3.8.3 Brightness and Brightness Preset Adjustment

Load the display test (using the LAP6-DIAL MAINTENANCE tape) as follows:

Step	Procedure
1	Mount a LAP6-DIAL MAINTENANCE tape on any tape transport.
2	WRITE ENABLE on, turn the thumbwheel switch to 0, REMOTE depressed.
3	Set 0701 in the LEFT SWITCHES (RCG).
4	Set 7300 in the RIGHT SWITCHES (all other switches are set to 0).
5	Set MODE switch to LINC; depress I/O PRESET.
6	Depress DO key; when tape motion stops, depress I/O PRESET; then START 20. (At this point, a 1 should be displayed at the left of the screen. Directly across from it, a bar (-) will also be displayed. If this does not occur, check to be sure that CHANNEL 1 is selected and the BRIGHTNESS potentiometer is fully CW.)
7	On the Teletype, type LINE FEED (an arrow will appear at the bottom left of the screen).
8	Type LO (space) DISPTST; then 0 (Example: > LO DISPTST, > 0).
9	Type a carriage return.
10	Depress I/O PRESET to LINC mode; depress START 20. The first display is a full-screen grid pattern.
11	When the grid pattern appears on the screen, at the Teletype, type an F. (This action freezes the pattern being displayed.)

NOTE

For a more detailed explanation, refer to the DISPLAY TEST write-up (MAINDEC-12-D6BA-D).

12	Set the CHANNEL SELECT control to 1 and 2.
13	Set the BRIGHTNESS control fully CW.
14	Remove the retaining pin, at the rear of the computer.
15	Slowly slide the VR12 video display unit forward until it stops. (The BRIGHTNESS PRESET adjustment is located on the top of the VR12.)

(continued on next page)

Step	Procedure
16	Adjust the BRIGHTNESS PRESET control for the highest brightness level level possible that does not cause blooming of the presentation.

CAUTION

Excessive brightness or blooming can shorten the life of the CRT.

The FOCUS adjustment is located next to the BRIGHTNESS PRESET control, and should be adjusted for the sharpest overall presentation.

3.8.4 Deflection Amplifier Quiescent Current Adjustment (VR12)

Step	Procedure
1	Load the display test as specified in the adjustment procedure, but do not freeze the pattern. The test cycles through three different display patterns.
2	When the X pattern appears on the display, type an F to freeze the pattern.
3	Set the potentiometers on both G912 Deflection Amplifiers fully CCW by inserting a screwdriver with an insulated shaft into the hole on the heat sink.
4	Adjust the potentiometer for straight lines at the crossover points and for a minimum amount of noise.

3.8.5 Analog-to-Digital Adjustment Procedure

Step	Procedure
1	Mount a LAP6-DIAL MAINTENANCE tape on the right hub of any available LINCtape transport.
2	On the transport, set WRITE ENABLE on, turn the thumbwheel switch to 0, and REMOTE to on.
3	Set 0701 in the LEFT SWITCHES (RCG).
4	Set 7300 in the RIGHT SWITCHES.
5	Set all other switches to 0.
6	Set the MODE switch to LINC and depress I/O PRESET and DO switch. When the tape motion stops, proceed to next step.
7	Depress START 20. (At this point, a 1 is displayed to the left of the screen. A program may be in the LAP6-DIAL work area; if this is true, the last number of the program is displayed at the left of the screen.)
8	At the Teletype, type a LINE FEED. An arrow will be displayed at the bottom left of the screen.
9	After the arrow appears, type LOADTST,0 then RETURN. The A/D TEST is a self-starting program.
10	Turn knobs 00-07 fully CW. Channels 00 through 07 should read $+777_8$ (see Figure 3-22).

(continued on Page 3-32)

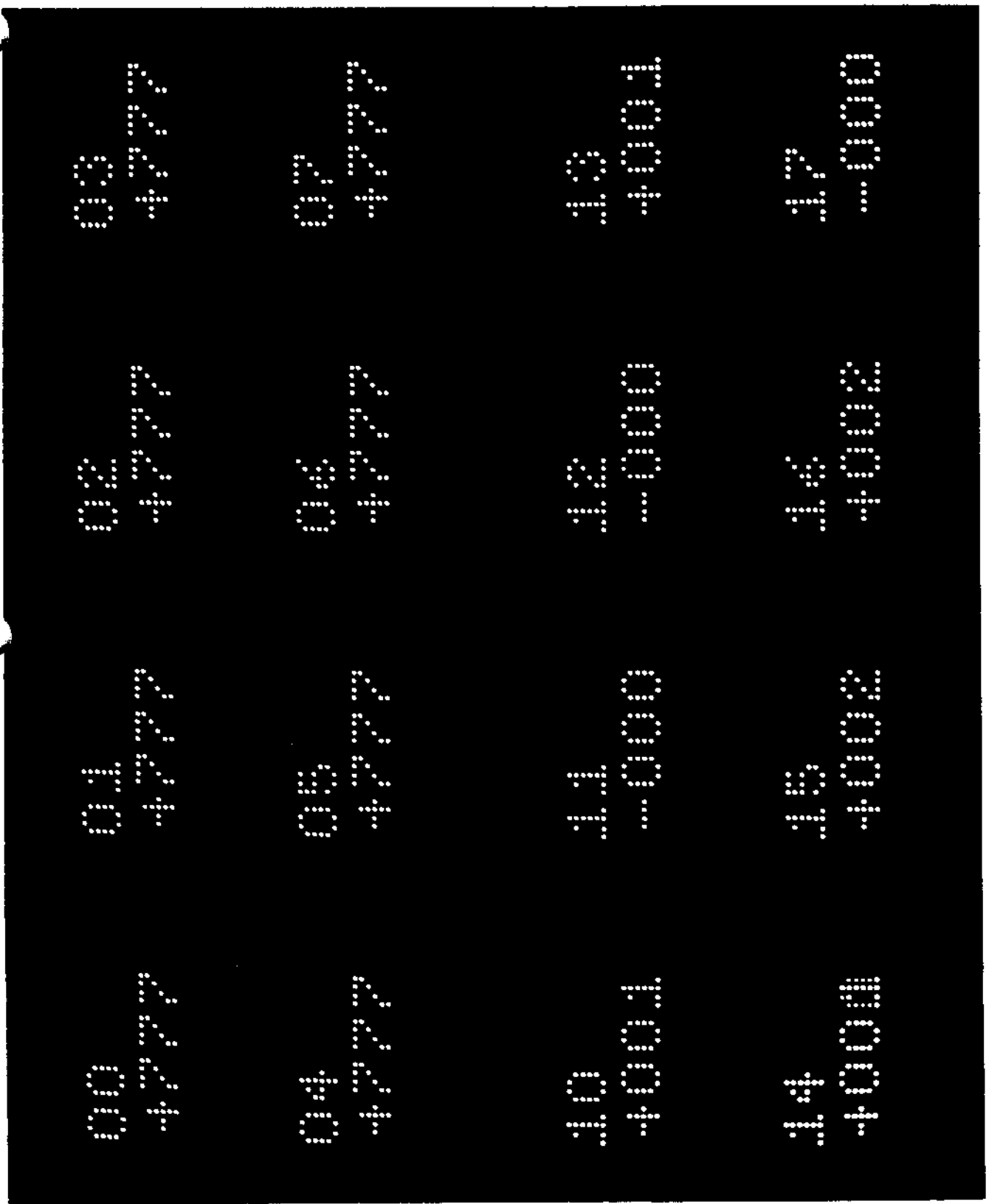

Figure 3-22 Auto-D Display

Step	Procedure
11	Note the starting position of knob 00. Turn the potentiometer slowly CCW, monitoring Channel 00 on the screen until it reads $+776_8$. The change must occur 3/4 to 1-1/2 turns from the full CW position. Repeat this procedure with the potentiometer set fully CCW. If, by slowly turning knob 0, the least significant number can be made to hold solidly, proceed. But, if both top (+) and bottom (-) are within the ranges specified, refer to the adjustment procedure for the external Channels 10 through 17. If the above test fails (potentiometers fail to be within the above limits), refer to the Sample and Hold Adjustment Procedure.

3.8.6 Sample and Hold Adjustment Procedure (A404)

CAUTION

Do not adjust any other controls except those specifically mentioned in Paragraph 3.8.7 and shown in Figure 3-21. If compensating trimpots located on Module A404 are disturbed, the module must be returned to DEC for proper calibration.

NOTE

This adjustment affects all the external analog channels.

Step	Procedure
1	Load the A/D TEST as specified in Steps 1 through 9 of the Set-up Procedure, Paragraph 3.8.5.
2	After making certain that the A/D TEST is running properly, halt the computer and turn off the power.
3	Remove Module A214 at location E33.
4	Install a jumper from D32R2 to D32F2.
5	Turn on the computer and depress the I/O PRESET.
6	Depress START 20. This should restart the A/D TEST.
7	While monitoring Channel 17, adjust the COARSE ADJ (see Figure 3-21) Module A404 (locations E and F34) until Channel 17 displays 000 (see Figure 3-21). Then adjust the FINE ADJ until the sign of the Channel 17 000 display oscillates between + and -. This oscillation indicates proper adjustment.
8	Halt the computer and remove the power.
9	Remove the jumper installed in Step 4 of the Set-up Procedure, above.
10	Proceed to the External Analog Channel Adjustment Procedure.

3.8.7 External Analog Channel Adjustment Procedure

To perform the following procedure, use a precision dc mV standard, or equivalent (Electronic Development Corp. Model MV-1005), and a standard input jack.

Step	Procedure
1	Load the A/D TEST as outlined in Steps 1 through 9 of the Set-up Procedure, Paragraph 3.8.5.
2	Allow the voltage source five min. to warm up.
3	Connect the input cable to the output voltage terminals of the voltage source.
4	Set the output polarity switch to 0.
5	Monitor Channel 10, and adjust the right OFFSET potentiometer of Module A214, at location E30, for a -000. Turning the trimpot (shown in Figure 3-21) CCW increases the number.
6	Set the EDC (mV standard) for 0.9850.
7	Set the OUTPUT selector to +.
8	Adjust the right GAIN potentiometer for a reading of +776 ₈ ; turning the potentiometer CW decreases the number.
9	Set the OUTPUT selector to -.
10	This value should be -776. If it is not, adjust the OFFSET until the + and - values are equal. The GAIN should be adjusted for a stable reading of + and - 776 ₈ . The optimum zero value should be an oscillating + - sign.
11	Set the EDC for 0.995V.
12	If the GAIN is properly adjusted, the + and - values will equal 777 ₈ .
13	Repeat the above procedure for the remaining channels.

Location	Left Potentiometers	Right Potentiometers
E30	Channel 11	Channel 10
E31	Channel 13	Channel 12
E32	Channel 15	Channel 14
E33	Channel 17	Channel 16

3.9 EXTENDED ANALOG (AG12, AM12)

3.9.1 Set-up Procedure

Channels 20 through 37 require an extra panel mounted on the bottom left of the PDP-12 Data Terminal Panel. The cables plug into the following locations:

Channels	Location
20 through 27	F31
20 through 37	F30

The conversion box used to adjust these channels contains a cable with a G783 Connector mounted on one end, and a 8-position (Channel 0 through 7) potentiometer connected at the other end. An Amphenol Jack leads to the proper receptacles on the Data Terminal Panel from this 8-channel potentiometer. The procedure in Section 3.8.7 is used with the following addition: SENSE SWITCHES set to 00=1; Channels 20 through 37 will be displayed.

3.9.2 Adjustment Procedure

- | Step | Procedure |
|------|---|
| 1 | Monitor Channel 20 by plugging the cables for the conversion box into F31 and setting the 8-position potentiometer to Channel 0 (see Table 3-2). |
| 2 | The EDC setting and the adjustment for Channels 20 through 27 remain the same as for 10 through 17. |
| 3 | To adjust Channels 30 through 37, insert the G783 cables from the conversion box into slot F30, and repeat the procedure as outlined in Paragraphs 3.9.2 and 3.8.7. |

Table 3-2
Monitor Table for Channels 20 through 37

Channels	Switch Setting
20 and 30	0
21 and 31	1
22 and 32	2
23 and 33	3
24 and 34	4
25 and 35	5
26 and 36	6
27 and 37	7

CHAPTER 4

FIELD INSTALLATION AND CHECKOUT OF PREWIRED OPTIONS

Table 4-1 contains a list of the prewired options which are discussed in this chapter.

Table 4-1
Prewired Options

Type	Name
AD12	A-D Control
AG12	Preamplifier
AM12	Expanded Multiplexer
DP12-A	TTY Dataphone
DP12-E	TTY Dataphone (EEA-level)
DR12	Relays and Control
KE12	Extended Arithmetic Element
KP12	Power Fail Restart
KT12	Time-Sharing Option
KW12-A	Real Time Clock
KW12-B	Simple Clock (limited frequency range)
KW12-C	Simple Clock (no frequency range)
MC12	Memory Extension Control
TC12	MAGtape Control
TC12-F	Extended Tape Control
TU55	Single Unit DECTape
TU56	Double Unit DECTape
VC12	Scope Control
VR12	Scope
XY12	Incremental Plotter
503	Scope

4.1 UNPACKING

When unpacking any prewired options, the following procedure should be used.

Step	Procedure
1	Unpack the kit and inspect it for any shipping damage.
2	Compare the kit contents with the packing list enclosed in the package. Notify the DEC Sales Office if any discrepancy is noted.

4.2 INSTALLATION

When installing prewired options, the general procedure below is used.

CAUTION

Remove power before installing any prewired options, to prevent possible circuit damage to the modules, panels, and units. Installation procedures should be performed by qualified service personnel only.

WARNING

High voltages are present within the equipment and are potentially dangerous. All safety precautions must be observed.

Step	Procedure
1	Before installing any option in the field, remove power from the PDP-12.
2	Ensure that the CP and memory are at the ECO (Engineering Change Order) level required for the proper operation of the option (refer to the DEC ECO Log).
3	Prior to installation, run all of the appropriate MAINDECs listed below for the option(s) to be installed (Table 4-2).
4	Install the modules and cables for the option as listed in Table 4-3.

Table 4-2
Option MAINDECs Checklist

Option	Pre-Diagnostic Check	Time
AD12	CPTS3	5 min
AG12		
AM12	INSTST	5 min
DP12-A	2A	2 min
DP12-B	CPTS3 TTY1 and 2	2 min N/A
DR12	2A CPTS3 INSTST	5 min 5 min 5 min
KE12	All diagnostics applicable to system configuration	2 min each
KP12	Memory ON/OFF	N/A
KT12	All diagnostics applicable to system configuration	Time is test-dependent
KW12-A	2B	2 min
KW12-B	2B	2 min
KW12-C	2B	2 min

(continued on next page)

Table 4-2 (Cont)
Option MAINDECs Checklist

Option	Pre-Diagnostics Check	Time
MC12	CBL	5 min
	CBH	5 min
	ADDRSLO	5 min
	ADDRSHI	5 min
	FLTI 0	5 min
	JMPSLF	5 min
TC12	All tests applicable to PDP-12 configuration	Time is test-dependent
TC12-F	2A	2 min
	CPTS2	2 min
	CPTS3	2 min
	TC12-1	5 min
	TC12-2	5 min
	MARK12	As Required
	Tape Data II (Tape Exercisor)	10 min
	PIP COPY (UNIT 0 → UNIT 1)	As Required
TU55	Power Checks	As Required
TU56	Power Checks	As Required
VC12	All tests applicable to PDP-12 configuration	N/A
XY12	2A	2 min
	2B	2 min
	CPTST	2 min
	CPTS2	5 min
	CPTS3	5 min

Table 4-3
Option Module and Cable List

Option	Module	Note	Location
AD12 ¹	A214 (4-ea)	Preamplifier	E30, E31, E32, E33
	A131 (2-ea)	Multiplexer	D32, D33
	A215	Filter	D34
	A404	Sample & Hold	E-F34
	A811	A/D Converter	C-D35
	M760	Control	C36
	G783	Analog Cable	F33
	G783	Relay Cable	F32
AG12 ²	A214 (8-ea)	Preamplifier	E26, E27, E28, E29, F26, F27, F28, F29
	G783	Channels 30-37	F30
	G783	Channels 20-27	F31

Notes: 1. Panel AD12 is shipped with both the AD12 and DR12.
2. The AG12 is a separate panel.

(continued on next page)

Table 4-3 (Cont)
Option Module and Cable List

Option	Module	Note	Location
AM12	A131 (2-ea)	Multiplexer	D30, D31
	G783	Channels 30-37	F30
	G783	Channels 20-27	F31
DP12-A ³	G718	Jumper (110 baud)	N11
	M706	Receiver	M-N09
	M707	Transmitter	M-N10
	W076	Cable	N03
DP12-B ³	M405	Crystal	N11
	M706	Receiver	M-N09
	M707	Transmitter	M-N10
	M216	Flip-Flops	N12
	W076	Cable	N03
DR12 ¹	M216	Flip-Flops	L04
	G783	Analog Cable	F33
	G783	Relay Cable	F32
KE12	M111		L33
	M113 (3-ea)		L35, L36, M33
	M115 (2-ea)		L34, L29
	M117 (2-ea)		M34, L30
	M121		L31
	M160 (3-ea)		L37, M35, M36
	M216	Flip-Flops	M37
	M906	(Remove)	K27
KP12	M703	Schmitt Trigger	F03
KT12	M117		H27
	M216	Flip-Flops	H29
KW12-A	M103	Selector	D25
	M113 (2-ea)		D24, D29
	M115		D23
	M117		D22
	M216 (2-ea)	Flip-Flops	F09, F19
	M217 (3-ca)		E03, E04, E07
	M304 (2-ea)	Amplifier	D27, D28
	M405	Crystal	F18
	M719 (3-ea)	Channel Select	F20, F21, F22

Notes: 1. Panel AD12 is shipped with both the AD12 and the DR12.

3. DP12-A – When the DP12-A is used to drive a Teletype at 110 baud, the M405 (location N11) and M216 (location N12) are not used. The G718 Module is placed in location N11, thereby connecting the PDP-12 Teletype to the DP12 input and output module.

DP12-B – When the DP12-B is used at other baud rates (0 → 10,000), the crystal clock (M405, N11) is selected to be 128 times the baud rate.

For baud rates between 10,000 – 100,000, the wire from N12L2 to N12M1 is removed, and a wire from N12L2 to N11D2 is added. The crystal clock rate is then selected to be 16 times the baud rate.

Use cable BC01A-25 for interconnection to Dataphone.

(continued on next page)

Table 4-3 (Cont)
Option Module and Cable List

Option	Module	Note	Location
KW12-A (cont)	M503	Schmitt Trigger	F24
	M617		D17
	M623	Level Converter	D26
	G783	Cable	F25
	W023	Jumper Board (Delete)	E07
KW12-B	M401	RC Clock	F18
	M103	Selector	D25
	M870	Control	F25
KW12-C	M405	Crystal	F18
	M103	Selector	D25
	M870		F25
MC12	G020 (6-ea)	Delete	A07, A08, A09, B07, B08, B09
	W023	Delete	M26
	G021 (6-ca)		A07, A08, A09, B07, B08, B09
	G228 (3-ea)	Axis Select	A13, B13, B14
	G624 (3-ea)	Resistors	A14, A15, B15
	M113		M27
	M121		M28
	M169		M32
	M216 (3-ea)	Flip-Flops	M29, M30, M31
	M360	Delay	E15
	M617 (5-ea)		M22, M23, M24, M25, M26,
	M720	Non-Exist Memory 4K STACK	411 C-D11, C-D13
	W025	Sense Stack Cable	A-B11
W025	Inhibit Stack Cable	A-B12	
TC12	M111 (2-ea)		A35, C21
	M112 (3-ea)		A33, C24, D16
	M113 (7-ea)		A26, A36, B24, B26, B38, D29, C16
	M115 (7-ea)		A27, A32, B27, B34, C25, C27, C29
	M117 (8-ea)		A25, A37, B33, B35, B36, C23, E16, E17
	M119 (2-ea)		A31, C22
	M121 (5-ea)		A34, B25, B32, C26, E19
	M160		B29
	M161	Decoder	A29
	M169		A16
	M212	Flip-Flops	A38
	M222 (6-ea)	Registers	A-B18, A-B19, A-B20, A-B21, A-B22, A-B23
	M216 (9-ea)	Flip-Flops	A28, A30, B31, B37, D19, D20, E18, E20, E25
	M304 (5-ca)	Schmitt Trigger	C17, C18, C19, C20, D18

(continued on next page)

Table 4-3 (Cont)
Option Module and Cable List

Option	Module	Note	Location
TC12 (cont)	M307 (2-ea)	Delays	C28, C30
	M401		E21
	M602	Schmitt Trigger	B30
	M617 (4-ea)		A23, A24, B23, B28
	M901	Connector Cable	A40
	G853	Unit Selector	F10
	G882 (5-ea)	Readers/Writers	F04, F05, F07, F08, F09
	W023	Cable (Con)	E05
	W032	Cable	E-F06
	W512 (3-ea)	Level Converters	F13, F14, F15
	W520	Comparator	F11
	W603	Amplifier	F16
	R107	Delay	F12
TC12-F	M216	Flip-Flops	C32, C33
TU55 ⁴			
TU56 ⁴			
VC12	M101	Interface	C38
	M113		D29
	M115		C29
	M216 (2-ea)	Flip-Flops	D38, E38
	M711 (5-ea)	Control	C-D37
	A615 (6-ea)	D/A Converter	E-F36, E-F37
	G783	VR12 Cable	F38
VR12 ⁴	C783	503 Cable	F39
XY12	M704	Control	M-N05
	W023	Cable	N04
503 ⁴			

Notes: 4. This option has modules already installed. Remove the tape and install the cables as described in Paragraph 4.2.1.

4.2.1 Installation of Panels and Cables

Panels are installed for the KW12-A, AG12, AD12, and DR12 options. These panels are installed on the PDP-12 as shown in Figure 4-1.

Use the following procedure when mounting these panels:

Step	Procedure
1	Remove screws and nylon washers from blank panel and save them.
2	Remove blank panel carefully, so as not to scratch the face of the panel or damage any components (silicon wafer switches, wires, or jacks). Install new panel.

(continued on next page)

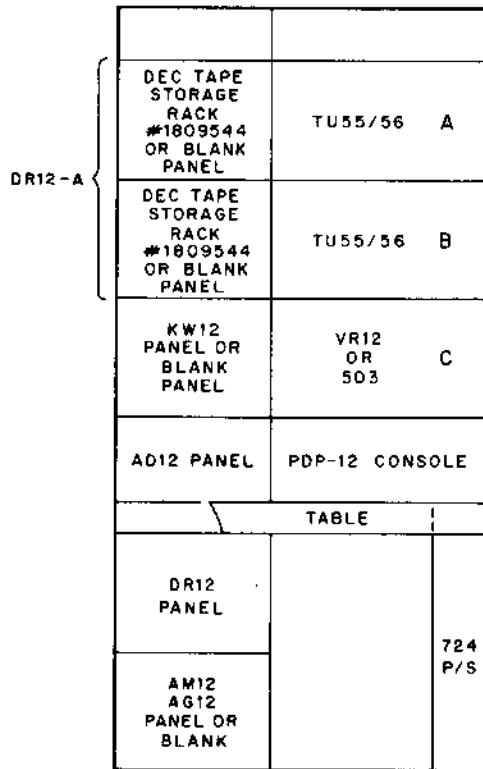

12-0260

Figure 4-1 PDP-12 Equipment Layout

Step	Procedure
3	Before tightening screws, align panel sides parallel to panel above and below it, and equalize any space between upper and lower panels.
4	Tighten screws, making sure nylon washer is between screw head and panel.
5	Remove any plastic covering which may have adhered to the front of the panel.
6	Inspect all switches and jacks for damage.
7	Check all knobs and jacks for proper alignment, tightness, and operation. If a knob adjustment is necessary, loosen Allen set screws and adjust accordingly, then retighten Allen set screws. If jacks are loose, check for damage, then tighten nuts. Be careful not to scratch front of panel.
8	For the KW12-A panel, a red wire will be taped to the cable on the back of the panel. Remove the tape and route wire to the ON/OFF switch. This wire is a +10V tap from the switch to the panel. Locate +10V on the switch and install wire. Install the white ground wire to the 6.3 Vac transformer in the 724 Power Supply.

(continued on next page)

Step	Procedure
9	Uncoil cables and remove any excessive tape at this time. Route cables through the trough to the CP and memory. Install cables in their respective slots.
10	With the plenum door fully open, secure cables together with tie wraps.
11	Shut door, retying cables if necessary to prevent interference.
12	If cables are not marked, mark them at this time with slot location.

4.2.2 Unit and Cable Installation for TU55 and VR12

The TU55 (Figure 4-2) and VR12 (Figure 4-3) have mounting racks with slides attached, as shown in Figure 4-4. These slides must be mounted before attempting to install the unit. The following procedure describes the installation of the units.

Step	Procedure
1	Assume a single cabinet (Bay 0) PDP-12 System configuration (Figure 4-1). Sections marked A, B, and C respectively in Figure 4-1 initially contain blank filler panels.
2	Remove the blank panels by grasping both sides of the panel and pulling straight out.
3	Remove the blank snap brackets.
4	For mounting two TU55s and a VR12, mount clip-nuts and insert screws in the 3rd, 6th, 11th, 14th, 19th, 22nd, 27th, 30th, 35th, 38th, 43rd, and 46th holes on each side of the frame. Do not tighten screws at this time.
5	Orient the left bracket (shown in Figure 4-4) to align the four slots with the top four screws.
6	Pushing inward and upward, tighten screws. Use the same procedure for the other brackets.
7	Extend the right and left tracks on slide brackets all the way forward until they stop.
8	Align tracks on TU55 with cabinet brackets and slide unit in until it locks (loud click will be heard).

CAUTION

The VR12 weighs 70 lbs; therefore, two men are required to lift and install it in the PDP-12.

9	To install VR12, follow Steps 7 and 8 above.
10	Slide all units inward and check for clearance. Readjust one side at a time until units properly clear one another.
11	Check all knobs and switches as described in Steps 6 and 7. Remove tape from modules and check them for complete insertion in their respective locations.
12	Connect TU55s together with ac cord in back of TU55 (3-ft cord). Connect bottom TU55 to power supply (6 ft). Route last cable neatly and use tie wrap when necessary.

(continued on Page 4-10)

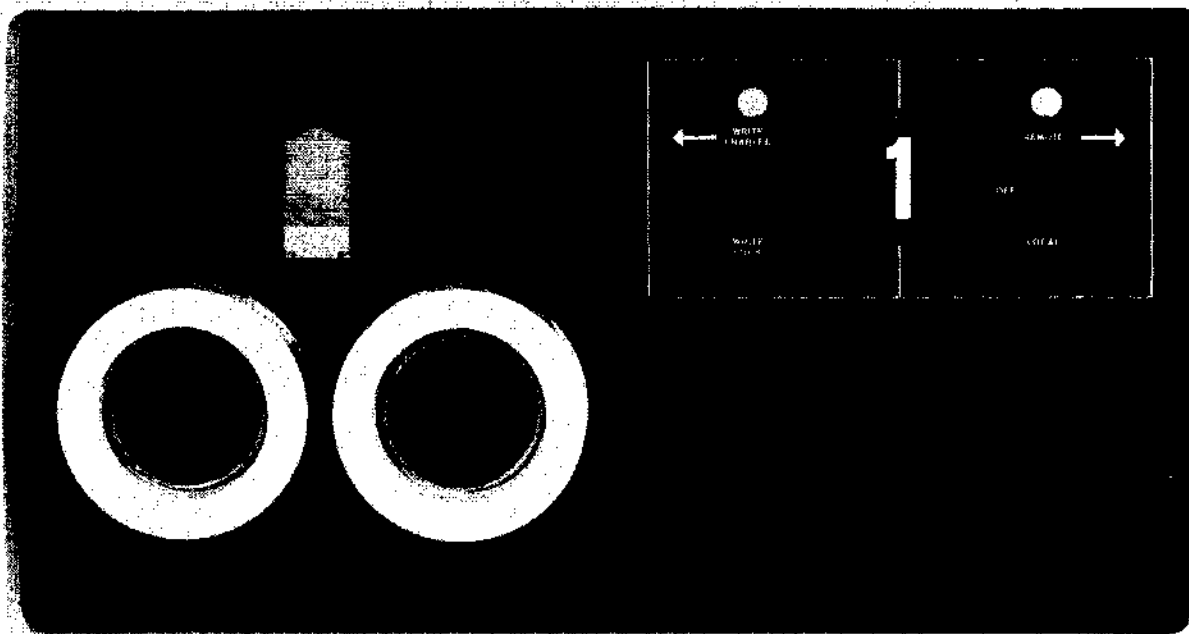

Figure 4-2 TU55 LINtape Transport

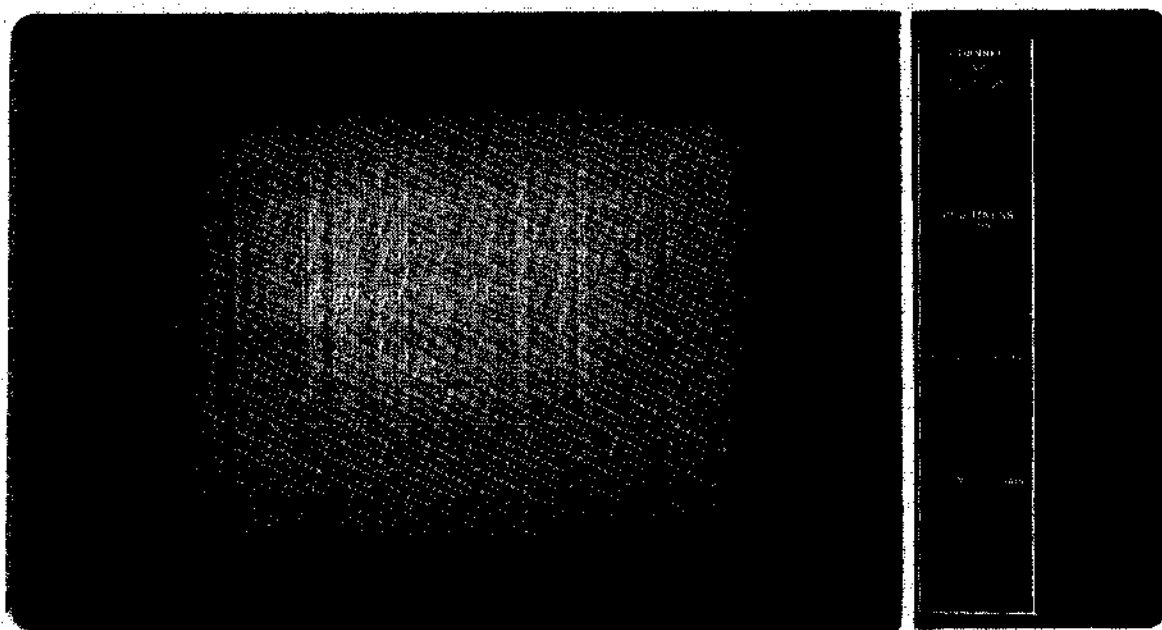

Figure 4-3 VR12

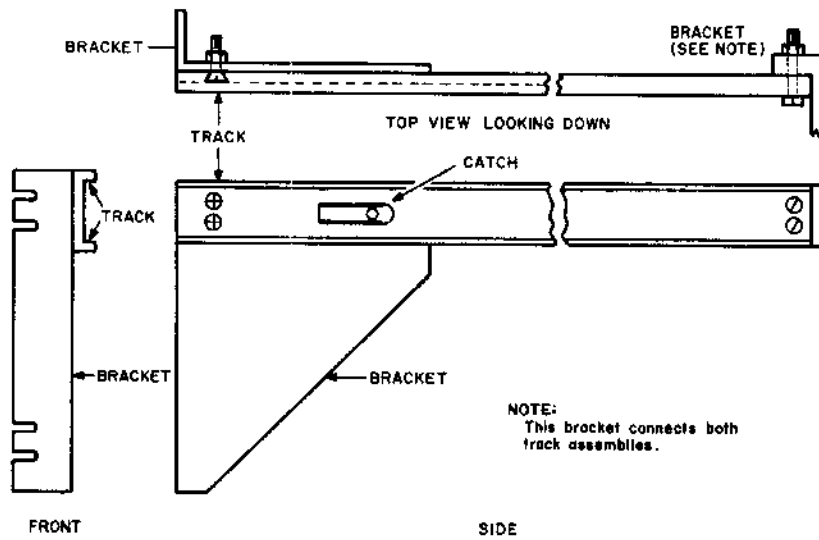

Figure 4-4 TU55 and VR12 Mounting Assembly

- | Step | Procedure |
|------|---|
| 13 | Connect 3-ft dc cable to the top of the TU55 with green wire to +10V, black wire to GND, and blue wire to -15V connectors. Route cable to bottom TU55 and connect as described above. Connect 6-ft dc cable to power supply and route neatly (using tie wraps) to bottom TU55. |
| 14 | Ensure the TU55 transports can still be fully extended until they lock in the maintenance position, without strain or interference with dc or ac cables. |
| 15 | Logic connection for the TU55s is as shown in Table 4-4. Cables such as those in A6 and A3 through B3 are 3 ft in length. Cables in the A5 and A2 through B2 are 6 ft in length. Be sure the cables do not interfere with opening of the TU55 and the rear plenum door. |
| 16 | Adjustments to the TU55 can be found in Paragraph 3.6. |
| 17 | The VR12 ac power cord (4 ft) should be routed to the power supply in such a manner that it does not interfere with the opening of the VR12. The cable in slot F38 is connected to the back of the display. All switches on the back of the display should be set in the downward position. The M711 Display Module switches should be set as described in Paragraph 3.8. |

Table 4-4
Interconnections of TU55

Top TU55 Location	Bottom TU55 Location	Mem Logic Location
A6	A6	
	A5	E05
A-B3	A-B3	
	A-B2	E-F06

4.2.3 TU56 Unit and Cable Installation

The TU56 transports are mounted similarly to the TU55, except that special brackets are used. These special brackets, however, do not allow the TU56 (Figure 4-5) to be extended on tracks as the TU55.

CAUTION

TU56 weighs approximately 70 lbs; therefore, two men are required to lift and install it.

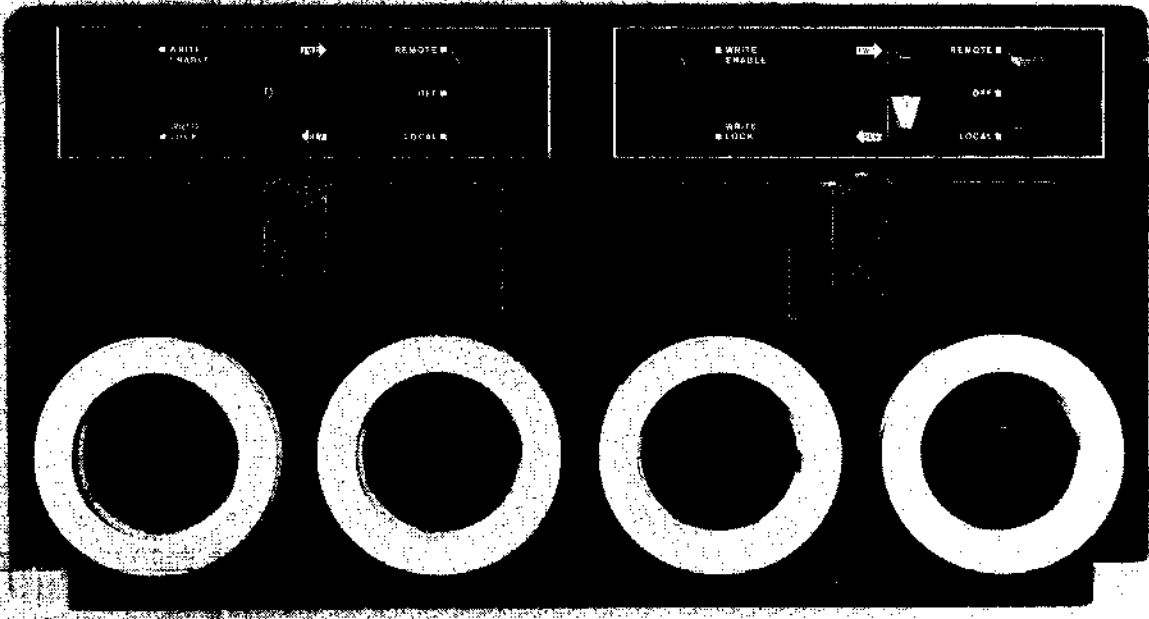

Figure 4-5 TU56 LINtape Transport

Step	Procedure
1	Performs Steps 1 through 4 of Paragraph 4.2.2.
2	Insert clip-nuts in both the front and rear frames in the 18th and 36th holes (from the top). See Figure 4-6.
3	Install rear plate support block as shown in Figure 4-7.
4	Install rest plate front support as shown in Figure 4-6.
5	Align holes at rear of rest plate with those at rear of rest plate support block, as shown in Figure 4-8. Insert screws.
6	Tighten rear and front plate support block screws.
7	Slide the TU56 (Figure 4-5) onto rest plate and push unit in.
8	Turn lock nuts on sides of door until door can swing open (downward).

(continued on Page 4-13)

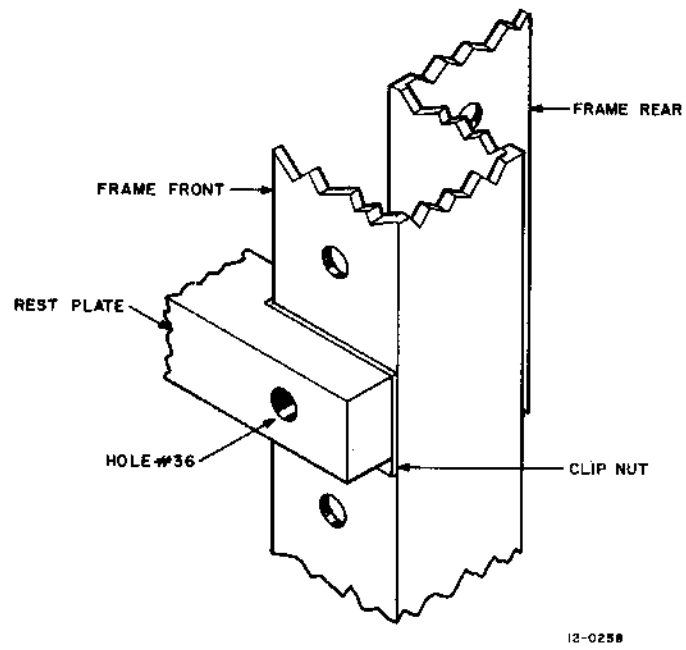

Figure 4-6 Front Assembly of TU56

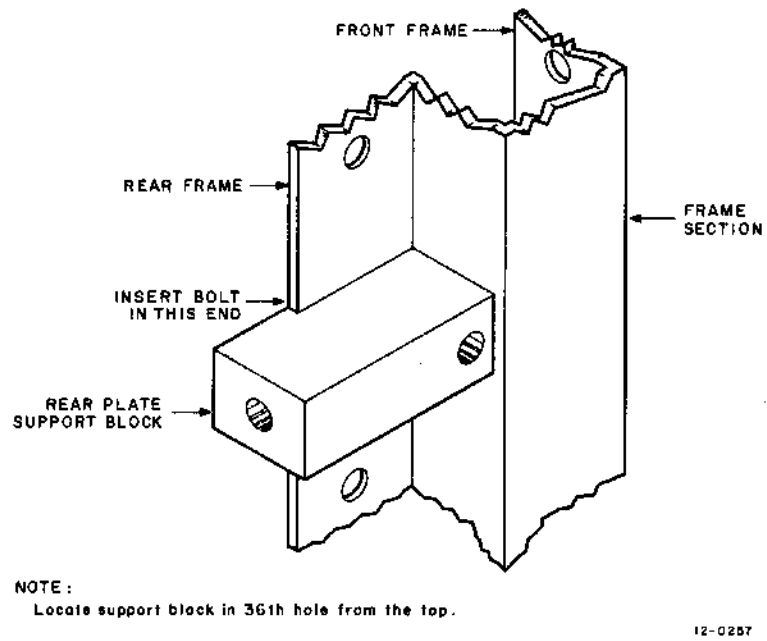

Figure 4-7 Rear Plate Assembly of TU56

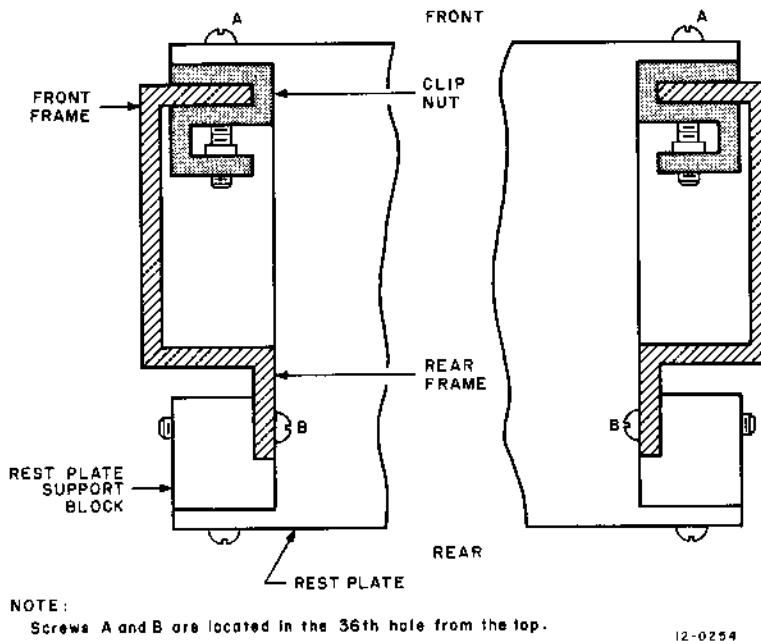

Figure 4-8 Top View of TU56 Rest Plate Assembly

- | Step | Procedure |
|------|---|
| 9 | Align (with help because of its weight) the bottom TU56 with the clip-nuts and insert screws. |
| 10 | Tighten screws, using a long Phillips screwdriver. |
| 11 | Adjust front door to open without hitting the equipment panel below it. |
| 12 | If door does not shut firmly, readjust lock slots on top of the TU56. |
| 13 | Connect dc cord to back of TU56 as in Table 4-5. Connect dc cord to power supply. |

CAUTION

With the TU56, the green wire is +5V, not +10V as for the TU55. Be certain when connecting end of cable in power supply, that green is connected to +5V.

- | | |
|----|---|
| 14 | Connect ac cords similarly as with the TU55, but route and tie these cables to the cabinet frame (the TU56 does not move). Connections are discussed in Step 12, Paragraph 4.2.2. |
| 15 | Route logic cable connections and place as shown in Table 4-6. |
| 16 | Partial adjustments of the TU56 are provided in Paragraph 3.7 of this manual. |

**Table 4-5
DC Voltage Connections**

Voltage	Wire Color
-15V	Blue
GND	Black
+5V	Green

**Table 4-6
TU56 Logic Cable Connections**

Top TU56 Location	Bottom TU56 Location	Mem Logic Location
A06	A06	
A05		E05*
A-B09	A-B09	
A-B10		E-F06
*This cable is not a 1-to-1 cable. When inserting, place end marked TU56 in TU56 slot.		

4.3 CHECKOUT

There are 20 prewired options for the PDP-12. The options (listed in Table 4-3) are checked out using the Adjustment Procedures in Chapter 3 and the write-ups supplied. Only the DP12-B, TC12-F, TU55, TU56 and VR12 options will be discussed here.

4.3.1 Checkout of the DP12-B

Before commencing checkout of the DP12-B, determine the baud rate by using the following formulas.

For baud rates of 110 to 10,000:

$$B = F/128$$

where B = baud rate
F = frequency of M405 crystal

For baud rates of 10,000 to 100,000:

$$B = F/16$$

where B = baud rate
F = frequency of M405 crystal

If the baud rate is in the 10,000 to 100,000 range, the wire from N12L2 to N12M1 is removed. A jumper is then installed from N12L2 to N11D2. Run PT08 Dataphone Test (DEC-08-D8PA-PB) for the ranges of 100 → 100,000. For further information, see the PT08 test write-up (DEC-08-D8PA-PB).

4.3.2 Checkout of TC12-F

Step	Procedure
1	Load the TC12-F diagnostic (MAINDEC-12-D3EA-P3) and, following the instructions contained in the write-up, allow the test to run for ten minutes minimum.
2	Load the TC12-F conversion program PRTC12-F (12-YIYB-PB) and, after following the procedure in the write-up, convert a copy of the LAP6-DIAL tape included in this kit to PDP-10 format and then back to PDP-12 format (see Table 4-7).
3	Restart the LAP6-DIAL editor contained on the last converted PDP-12 format tape and type \rightarrow CL \downarrow . When the work area is clear, type \rightarrow AP \downarrow PRTC12-F, 0 \downarrow .
4	Mount a scratch tape (LAP6-DIAL format) on UNIT 1.
5	When the program has been added to the working area, type \rightarrow AS \downarrow . When the program has assembled without an error, type \rightarrow LO \downarrow . Then depress I/O PRESET LINC MODE - START 20. The first frame of the PRTC12-F program should be displayed. This completes the check-out and acceptance of the TC12-F option.

Table 4-7
Format Conversion Table

Read from Format	Block Number	Number of Blocks	Write to Format	Block Number
PDP-12	0	1000 ₈	PDP-10	0
PDP-10	0	526 ₈	PDP-12	0

4.3.3 Checkout of the LINCtape System

PDP-12 LINCtape Systems are comprised of the TC12 LINCtape Automatic Control; and,

- a. TU55 transports or,
- b. TU56 transports or,
- c. TU55 and TU56 transports together;

with or without a VR12 Point Plot Display System.

Therefore, the LINCtape System configuration is important to note when using the following procedure:

NOTE

If the system has only one TU55, with or without a VR12 Display, use only the MARK12 section to test the tape unit.

If the LINCtape system has any other combination of tape transports and video display, all of the following procedures are used.

Step**Procedure**

- 1 If the system has two TU55s or two TU56s, skip to Step 3.
- 2 If the system has a TU55 and TU56, check out both sections of the TU56 first, then do the TU55 with one TU56 section selected.
- 3 Turn UNIT SELECT switches until UNIT 0 is the bottom (or right tape transport) and UNIT 1 is the top (or left tape transport).
- 4 Place LAP6-DIAL MAINTENANCE tape (DEC-12-D7AC-UO) on UNIT 0 and install a scratch tape on UNIT 1 as described in Paragraph 2.2.2.
- 5 Start LAP6-DIAL as directed in Paragraph 2.2.2.
- 6 Type → LO MARK12, 0) .
- 7 Ensure that WRITE ENABLED on both selected transports is selected, and that both units are in REMOTE.
- 8 If a video display is in the system, the MARK12 program will be displayed on the screen; skip to Step 10. If not, continue through Step 9.

- a. Displayed is the following:

<p>1 – STD LINCTAPE FORMAT 2 – 128 WORD FORMAT</p>
--

- b. Press Teletype key 1 for standard LINCTape format.
- c. Press Teletype key LINE FEED to exit to MARK12 program.
- d. Tape on UNIT 1 will vibrate. Press the MARK key on the PDP-12 Console.
- e. When program is finished (tapes will stop) the following will be displayed (approximate running time – 3 min).

GOOD COPY
<p>1 – MARK ANOTHER TAPE 2 – EXIT TO DIAL</p>

- f. Press Teletype key 2 and LINE FEED.

- 9 When tape stops, type → LO PIP, 0) .
- 10 Advance tape on UNIT 1 to the left about 3 ft.
- 11 When UNIT 0 stops, the following will be displayed.

<p>PIP A – AUXILIARY MODE B – BINARY MODE S – SOURCE MODE</p>
--

- 12 Type A\$) .

(continued on next page)

- | Step | Procedure |
|------|---|
| 13 | PIP will then display the following:
<div style="border: 1px solid black; padding: 5px; margin: 5px 0;"> <p>PIP</p> <p>C – COPY SPECIFIED BLOCKS</p> <p>D – DUPLICATE UNIT 0 ON UNIT 1</p> <p>S – COPY SYSTEM</p> </div> |
| 14 | Type D . |
| 15 | UNIT 0 will rewind. Then UNIT 1 will rewind to block 000 and begin copying UNIT 0 on UNIT 1. The approximate copy time is 5 min. If the tape stops before the 5 min is up, without initiating a return and LINE FEED to the Teletype, an error has occurred. Displayed will be the following:
<div style="border: 1px solid black; padding: 5px; margin: 5px 0;"> <p>TYPE OF ERROR</p> <p>ERROR: BLOCK NUMBER</p> <p style="text-align: right;">XXX</p> <p>A – ACCEPT AS IS</p> <p>R – TRY AGAIN</p> <p>S – SKIP PAST FAULTY BLOCK</p> </div> <p>Try to recopy the block by typing R . If the failure persists, try to skip past faulty block and investigate tape.</p> |
| 16 | Reverse the UNIT SELECT numbers and repeat Steps 9 through 15. |
| 17 | When more than two LINCtape transports are available in the system, repeat the applicable steps for all combinations of units. |

4.3.4 Checkout of VR12

The VR12 is illustrated in Figure 4-3. Table 4-8 contains a description of the front knobs and adjustments. Refer also to Paragraph 3.8 for VR12 adjustments.

Table 4-8
VR12 Controls

Control	Function
CHANNEL	Selects one or both channels for scope display
BRIGHTNESS	Controls level of brightness
X GAIN	Controls horizontal size of display
X POS	Controls horizontal position of display
Y GAIN	Controls vertical size of display
Y POS	Controls vertical position of display

To checkout the VR12, use **DISPTST** on the LAP6-DIAL maintenance tape (DEC-12-D7AC-UO). Also use **PIP** and **MARK12** displays. Check the displays for the following:

- a.* Evenness of lines
- b.* Continuity of lines and characters
- c.* Clarity of lines and characters
- d.* Focus
- e.* Brightness
- f.* Flicker
- g.* M711 switch settings

CHAPTER 5

TELETYPE MAINTENANCE

MODELS ASR 33 AND 35

This chapter contains information pertinent to the maintenance of the Teletype Models 33 ASR and 35 ASR, and associated control logic.

5.1 EQUIPMENT

Table 5-1 lists the special tools needed for maintenance of the Teletype. All of these items can be obtained from Digital Equipment Corporation or from the Teletype Corporation.

Table 5-1
Teletype Maintenance Tools

Item	Part No.
8 oz. scale	110443
32 oz. scale	110444
64 oz. scale	82711
Set of gauges	117781
Offset screwdriver	94644
Offset screwdriver	94645
Handwheel	161430
Handwheel adaptor	181465
Contact adjustment tool	172060
Gauge	180587
Gauge	180588
Gauge	183103
Bending Tool	180993
Extractor	182697
Tweezer	151392
Spring hook (push)	142555
Spring hook (pull)	142554
Screw holder	151384

Table 5-2 lists the maintenance programs supplied by DEC to aid in maintaining the Teletype Models 33 ASR and 35 ASR and associated control logic.

**Table 5-2
Maintenance Programs**

Program Test	DEC Number	Use
Reader	MAINDEC-8I-D2PB	Function test and exercisor for the 33 and 35 ASR Teletype paper-tape reader
Punch	MAINDEC-8I-D2QB	Function test and exercisor for the 33 and 35 ASR Teletype paper-tape punch
Keyboard	MAINDEC-8I-D2RB	Function test and exercisor for the 33 and 35 ASR Teletype keyboard
Combination	MAINDEC-8I-D2TB	Exercisor program used to test simultaneously the 33 and 35 ASR Teletype printer and punch

5.2 PREVENTIVE MAINTENANCE

Preventive maintenance of the Teletype is scheduled on the same frequency as discussed in Chapter 2.

CAUTION

Do not use alcohol, mineral spirits, or other solvents to clean plastic parts with protective decorative finishes. A soft cloth should be used to remove dust, oil and grease on parts or sub-assemblies that are usually clean.

To clean plastic surfaces, use any one of several household cleaner-waxer liquids, such as "Jubilee" or "Jato". To clean the printer platen, a lacquer thinner is recommended.

During an overhaul, subassemblies and metal parts can be cleaned in a bath of trichlorethylene. Proper lubrication should be performed often.

5.2.1 Weekly Tasks

Step	Procedure
1	Inspect the platen and paper guide; wipe clean, using a soft dry cloth.
2	Clean external areas of the paper-tape punch and reader, using a soft brush or cloth.
3	Remove and empty the paper-tape punch chad box.
4	Run Teletype combination test (MAINDEC-8I-D2TB) for approximately 15 minutes.

5.2.2 Preventive Maintenance Tasks

Step	Procedure
1	Inspect the platen and paper guides. Clean the platen, using a lacquer thinner to restore its surface.
2	Clean ribbon guides and replace the ribbon if necessary.
3	Remove the cover and check for vibration effects such as loose nuts, screws, retaining clips, etc.

(continued on next page)

- | Step | Procedure |
|------|--|
| 4 | Remove distributor rotor and clean disk surface, using cotton swabs moistened in freon or trichlorethylene. |
| 5 | Check selector magnet coil for signs of overheating. |
| 6 | Clean between the selector magnet pole piece and armature with bond paper to remove any lubricant or dirt. |
| 7 | Clean and lubricate the Teletype as outlined in Teletype Bulletin 273B. Follow instructions literally to prevent over-lubrication. |
| 8 | The following adjustments should be checked; the pages cited are from Bulletin 273B, Volume 2. |

Part	Part Number	Page Number
Trip Shaft	574-122-700	13
Trip Lever	574-122-700	14
Brush Holder (Distributor)	574-122-700	15
Clutches	574-122-700	16-24
Code Bar Reset	574-122-700	30-34
Print Suppression	574-122-700	35
Blocking Levers	574-122-700	37
Print Suppression	574-122-700	43
Carriage Drive Bail	574-122-700	44
Print Trip Lever	574-122-700	61-62
Dashpot	574-122-700	78
Final Printing Alignment	574-122-700	85
Line Feed	574-122-700	89-95
Keyboard Trip Lever	574-122-700	141
Reader Trip Lever	574-124-700	6-9
Detent Lever	574-124-700	10
Sensing Pin	574-124-700	15
Tape Lid Latch Handle	574-124-700	18
Feed Pawl	574-125-700	11
Registration	574-125-700	12

- | | |
|----|---|
| 9 | Run each of the Teletype MAINDEC Programs for at least two passes each. |
| 10 | Check that the tape holes are being punched cleanly. |

5.3 CORRECTIVE MAINTENANCE

Figure 5-1 is a simplified schematic drawing of the control circuits for the Teletype. Details of the cable connector are included to show how a Teletype is modified to operate with the PDP-12. During off-line operation, the keyboard distributor effectively drives the printer selector magnet. As a result, any character received from the keyboard or paper-tape reader is automatically reproduced on the printer and paper-tape punch. During on-line operation, this continuity is broken and a Teletype receiver (M706) is used to accept the input from the reader or keyboard while a Teletype transmitter (M707) is used to drive the printer and paper-tape punch. The clock (M452) develops a TTI clock (880 Hz) and a TTO clock (220 Hz).

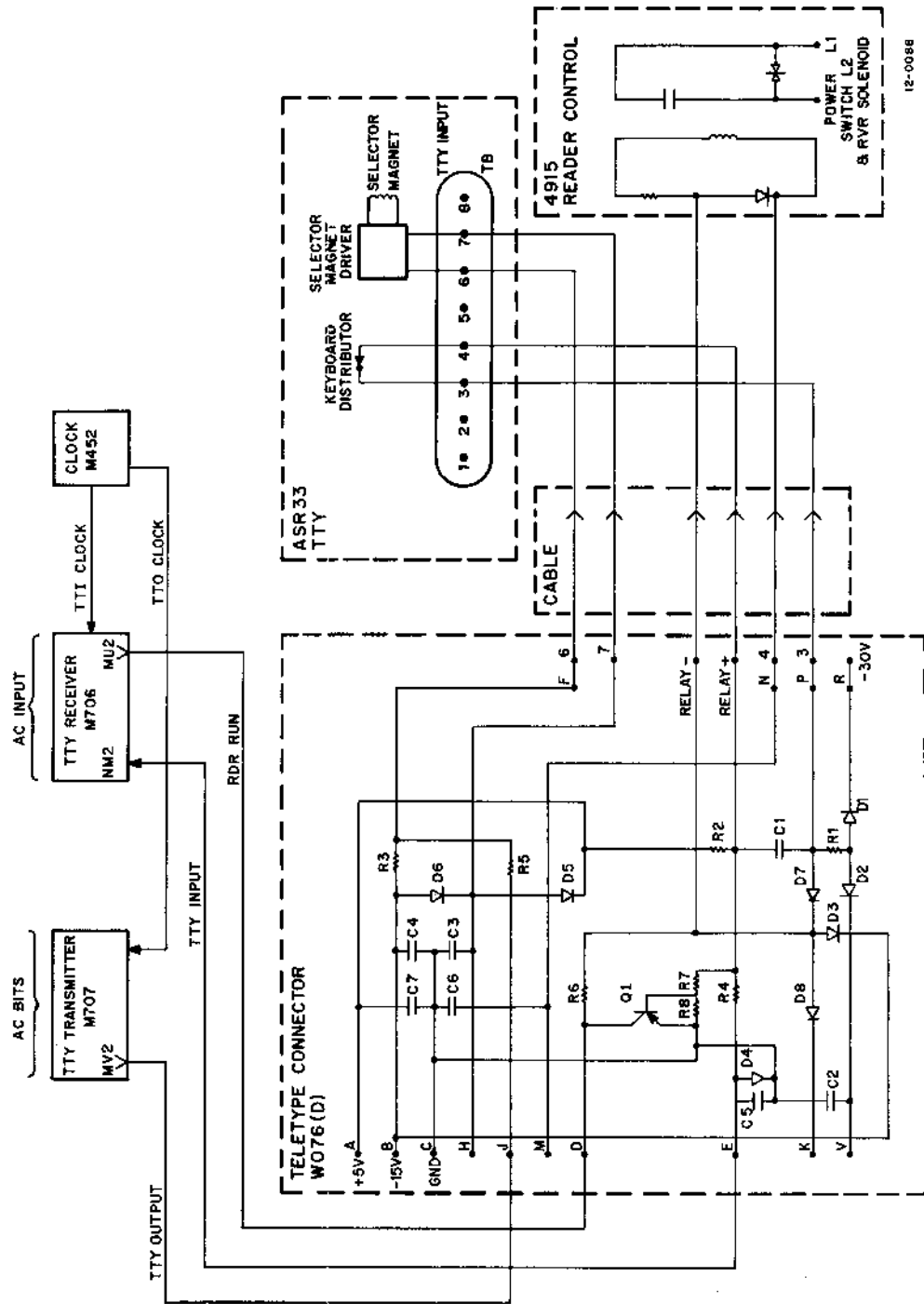

Figure 5-1 Teletype Connections

These clocks are used to shift the bits through the transmitter and receiver buffers. Adjustment is made by viewing the TTO clock output with the oscilloscope probe on N08K2 and adjusting the trimpot for a 4.5-ms to 4.6-ms repetition rate. Most Teletype problems can be traced to one of the four areas listed:

- a. 33 and 35 ASR Keyboard or Reader
- b. 33 and 35 ASR Printer or Punch
- c. M706 Reader
- d. M707 Transmitter

Isolation of bit-related problems is fairly simple. Off-line duplication can usually determine whether the problem is in the Teletype or the control logic. Steps may also be taken to isolate the problem to subassemblies within the Teletype. Picking up bits during a Read operation can be caused if any of three sets of contacts, which are tied in parallel, are defective. Reader, keyboard, and answer-back contacts provide parallel inputs to the distributor contact disk. Bit pick-up problems can be isolated to one of these three areas by disengaging the related contact from the suspected contact set.

Printer/punch problems can sometimes be isolated by comparing the printed character with the output of the paper-tape punch. If the printed character agrees with the punch output, and both are incorrect, then the problem lies in the selector mechanism or in the Teletype Transmitter Module (M707). If the printed character and the paper-tape punch output disagree, and the paper-tape punch output is correct, the problem lies within the printer assembly.

Figure 5-2 illustrates the Teletype interface with the computer.

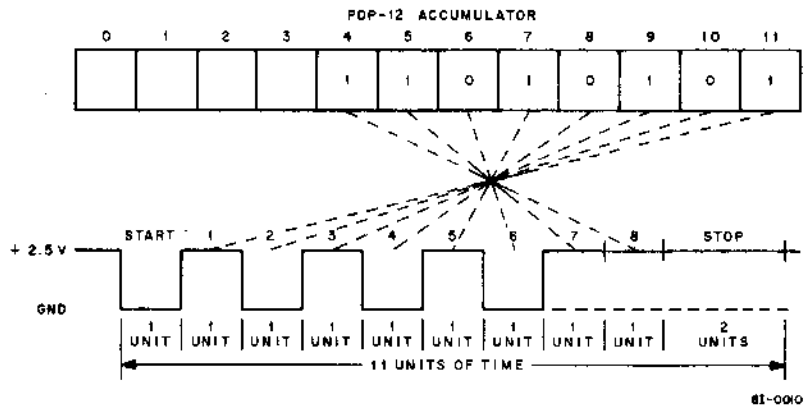

Figure 5-2 Teletype Signal Waveform and Bit Relationship for the Character "U"

5.4 TELETYPE PARTS

Users who do not have personnel trained in the maintenance and repair of Teletype units should keep a complete spare Teletype unit near the computer. If the on-line unit becomes defective, substitute the spare to avoid computer down-time. However, many users have facilities for the maintenance of Teletype units, in which case it is suggested that spare parts be stocked as listed in Table 5-3, and that one of each of the Teletype maintenance tools listed in Table 5-1 be stocked. All of these items can be obtained from the Digital Equipment Corporation, or from the Teletype Corporation.

Table 5-3
Spare Parts for Keyboard Model 33 ASR Teletype

Quantity	Item	Part Number
1	Circuit Board	181821
2	Tape Feed Sprocket	183071
2	Lever, universal	182240
2	Fuse (3.2A)	120167
2	Distributor Brush	180979
1	Belt-Driven Gear	181420
1	Drive Gear	181411
2	Belt	181409
1	Shaft	181007
2	Bearing	181002

APPENDIX A

MAINTENANCE AND SERVICE OPTIONS

Digital Equipment Corporation's Field Service organization offers a wide range of services for DEC equipment users. Customers may choose from a broad selection of service contract options and Per-Call Service or Depot Repair Maintenance plans to ensure optimum operating efficiency for their DEC equipment.

A.1 SERVICE CONTRACTS

Service contracts are tailored to the user's individual operation. In addition to providing all the necessary parts, labor, and test equipment required for remedial maintenance, service contracts also ensure system reliability by providing scheduled, systematic preventive maintenance. Planning and budgeting are greatly simplified because these contracts allow the user to fill his maintenance needs at a fixed, monthly charge.

A.1.1 Service Contract Options

On-call service contract coverage provides remedial maintenance when the customer notifies DEC of a system malfunction. Preventive maintenance is scheduled and performed during the period selected by the user. The principal period of coverage consists of eight consecutive hours of on-call coverage during the period 7 a.m. through 6 p.m., Monday through Friday. The user can extend his coverage from the principal period by selecting:

- a. 12 consecutive hours of on-call coverage
- b. 16 consecutive hours of on-call coverage
- c. 20 consecutive hours of on-call coverage
- d. 24 consecutive hours of on-call coverage

Coverage of 24 consecutive hours, Monday through Friday, begins on Monday of each week at 7 a.m. and terminates on Saturday of each week at 7 a.m.

The Saturday and Sunday periods of coverage consist of eight consecutive hours of on-call coverage during the period 7 a.m. through 6 p.m. As with the principal period of coverage, Saturday/Sunday coverage can be extended to 12, 16, 20 and 24 hours.

An on-site resident engineer plan can be implemented if the size, complexity, and/or critical nature of an installation require such a plan. The services of a resident engineer consist of 40 hours of coverage during the normal work week. In addition, all necessary spare parts, materials, and test equipment are physically stationed at the user's site to further ensure prompt and efficient remedial and preventive maintenance services. Monthly rates for contracted coverage are supplied on request.

There are no additional charges for travel in connection with service contracts except for remote installations. Remote installations are defined as installations located at a distance greater than 100 miles from a DEC Field Service Office.

A.1.2 Eligibility for Service Contract Coverage

A pre-service contract inspection is required for installations that were not under DEC's maintenance responsibility immediately prior to the requested commencement date of the service agreement. All charges associated with this inspection (including travel, labor, and parts) are billed to the user at the prevailing standard DEC rates. A minimum charge is associated with the pre-service contract inspection. No inspection is required for service agreements that are scheduled to commence immediately after the expiration of a standard DEC warranty or service contract.

A.2 PER-CALL COVERAGE

Per-call coverage is designed to permit the users of DEC equipment to obtain service on a time and materials basis. Requests for per-call coverage are considered after requests for service contract coverage; thus, only users with their own service capabilities or users who are not critically tied to their equipment are encouraged to use this form of coverage. All charges for per-call coverage are computed on a portal-to-portal basis. Commercial travel expenses related to the performance of services are billed as incurred. Material and parts consumption associated with per-call coverage is charged to the user at the prevailing prices listed in the DEC Spare Parts Catalogue. Labor charges for per-call service are on an hourly basis and are available on request.

A minimum charge for per-call service applies to each service call; in addition, DEC neither implies nor guarantees the availability of per-call coverage outside the hours of 7 a.m. through 6 p.m., Monday through Friday. Users in need of extended periods of coverage are encouraged to use the many service contract options available.

Users receive an invoice for all service rendered under per-call coverage. It is the responsibility of the user to inform the DEC Field Service Office servicing the equipment of any special billing instructions related to the use of per-call coverage. Such notification must be rendered before the commencement of any services on the part of DEC; in the absence of such notification, invoicing shall be accomplished in accordance with procedures determined by DEC. Installations requiring Purchase Orders for the authorization of work performed on a time and materials basis are encouraged to submit a blanket order for one year's duration to cover such services. There will be no additional charge for processing and administering such blanket orders. Terms for all services provided on a per-call basis are net 30 days. In addition to the charges outlined above, customers are also charged for all federal, state, municipal, or other government, excise, sales, use, occupational, or like taxes, now in force or enacted in the future, incurred as a result of the performance of per-call service. Installations enjoying tax exemption are requested to present their current exemption certificate number at the time that per-call service is rendered or with the submission of the blanket Purchase Order.

A.3 DEPOT REPAIR

Depot repair facilities have been strategically located throughout the world to enable users of DEC equipment to receive prompt, efficient service on many standard DEC options. Depots are also fully equipped to service and completely rebuild, if necessary, ASR and KSR Teletypes. Further, users of DEC equipment interested in purchasing rebuilt ASR and KSR Teletypes, or using their existing Teletypes on a trade-in basis toward the purchase of new machines, are urged to contact their nearest DEC Field Service Office for further information.

Depots are fully equipped and staffed with experienced personnel to offer rapid and economical repair services to the DEC customer. At the user's option, a national transportation firm, contracted by DEC, can be used to route equipment to and from the depot facility.

Charges for depot service, in addition to freight and insurance both ways, are computed per hour for labor, parts, and material consumed. There is no minimum charge for the use of the depot repair facility.

Customers wishing to use the depot facilities are requested to contact the nearest depot and furnish the following:

- a.* Customer name
- b.* Customer address
- c.* Purchase Order number
- d.* Billing address
- e.* Name and telephone number of individual
- f.* Type, Model Number, and Serial Number of equipment to be serviced
- g.* Brief description of service problem or malfunction
- h.* Mode of transportation to be used (DEC carrier or other)

Upon receiving the above information, the depot issues a return authorization number that enables the user to ship the equipment for servicing.

A.4 FIELD INSTALLATION OF ADDITIONAL DEC OPTIONS

Customers wishing to expand their existing systems by purchasing additional DEC options may elect to have the installation of the new equipment performed at a fixed rate to facilitate the budgeting and purchasing processes.

Field installation rates are available on request. To compute the installation charges for an option or group of options, the total charge is equal to the sum of the option installation charges plus a one-time travel charge.

For the purpose of performing field installations, remote locations are defined as areas outside those areas normally serviced by DEC or its subsidiaries. Requests for installations in remote locations are considered on an individual basis. Field installations are performed from 7 a.m. to 6 p.m., Monday through Friday. A minimum charge is associated with a field installation.

APPENDIX B

CUSTOMER ACCEPTANCE

Customer acceptance of the PDP-12 consists of a demonstration of machine operation by running all diagnostics and an operating test of the system software. Some of the symbolic tapes provided with the software package are not used; these tapes are usually subroutines used in conjunction with main programs, and are verified when produced.

B.1 SPECIAL CUSTOMER REQUIREMENTS

Any special customer acceptance requirements must be submitted to DEC at least 30 days prior to final acceptance. All customer acceptance requirements must be approved by the DEC PDP-12 Product Line Manager and Product Support Manager. Approved customer-specified acceptance requirements are listed on the construction requisition with proper reference to detailed documents.

B.2 CUSTOMER PROGRAMS

Acceptance tests are not contingent upon any customer programs unless these programs and their write-ups are supplied at least 30 days in advance of final acceptance, and are approved by the DEC PDP-12 Product Line Manager; this statement includes those programs and documents the customer deems "classified material". The programs must include ASCII and binary tapes, write-ups, and listings. These tapes are returned to the customer with the machine. In the event of difficulties, the customer must agree to send a capable representative to DEC in Maynard, Mass.

The DECUS library receives copies of all programs submitted, and the librarian obtains written customer approval before publication.

B.3 SPECIAL CUSTOMER ACCEPTANCE TESTING

All special on-site acceptances must be listed on the construction requisition with reference to detailed documents and will be exactly duplicated in-plant prior to shipment. Any special apparatus and test descriptions necessary for acceptance must be supplied, with full documentation, to DEC thirty days prior to customer acceptance. This documentation shall include: programs, listings, prints, block schematics, circuit schematics, manuals, and comprehensive operating and interfacing instructions. Any deviations must be waived by the DEC PDP-12 Product Line Manager and the DEC Field Service Manager or their assigned representatives.

B.4 DIAGNOSTICS

All diagnostics are operated in the order and for the time duration specified for the appropriate PDP-12 machine configuration. If a machine configuration is not standard, then the appropriate diagnostics for the option are supplied; these programs are run for the amount of time indicated for the PDP-12 System.

A diagnostic program tape and write-up are included with any standard or special option. A *standard option* is an option supplied by DEC but not included as a basic option of a PDP-12 System (e.g., a line printer). *Special options* are defined as hardware designed from customer specifications to fulfill a specific requirement, or standard option that is modified in any way. An acceptance procedure and accessory checklist are provided for such options. The installation information includes the interfacing of the option to the PDP-12.

The acceptance procedure outlines the programs to be run and the time duration for acceptance of the option. The accessory checklist contains a list of all manuals, prints, programs, etc., that are normally supplied with the option.

Consult the appropriate diagnostic write-up for operating procedures and correct operation indications.

B.5 SYSTEM SOFTWARE ACCEPTANCE

The system software acceptance is provided in a system acceptance document for the appropriate PDP-12 System. Each document is designed to demonstrate the operation of the system software for the particular configuration, to exercise the machine to its fullest capabilities, and to use the various routines supplied in the software.

NOTE

All PDP-12 programs have been previously checked and certified as being error free.

Successful completion of Sections B.4 and B.5 shall constitute system acceptance. Discrepancies must be listed as "exceptions" on the Customer Acceptance Form.

APPENDIX C

FORMS AND CHECKLISTS

A large envelope, enclosed with the PDP-12 Accessory Kits, contains the following items:

- a.* Customer Acceptance Forms
- b.* Key Sheet
- c.* Customer Data Forms
- d.* Software Trouble Reports
- e.* DECUS Information
- f.* Basic Accessory Checklists
- g.* Optional Equipment Checklists
- h.* Software Checklists
- i.* Final Distribution Lists

Each of the items listed is discussed in the following paragraphs. The sole intent of this information is to produce uniformity in customer acceptance procedures.

C.1 CUSTOMER ACCEPTANCE FORMS

The Customer Acceptance Forms are logged at DEC in Maynard, Massachusetts, prior to equipment acceptance. The form lists the equipment items that are included in the shipment. The customer name, the DEC installation code, the DEC order number, and the customer purchase orders are also included on the form. Personnel installing the equipment must check the keyed equipment serial numbers listing against the serial number on the equipment and enter the serial numbers in the appropriate column on the Customer Acceptance Form. All serial numbers, including those on vendor-supplied material, are verified in this manner.

All future PDP-12 System additions, modifications, and inquiries are solely dependent on the accuracy of the Key Sheet, which lists all system components by model and serial number, and the Acceptance Forms. Upon successful completion of acceptance testing, any "exceptions" are listed in the appropriate section on the Customer Acceptance Form. The "exceptions" should include missing manuals or prints and any hardware, etc., that was not acceptable.

C.2 CUSTOMER DATA FORMS

The Customer Data Form is used to establish an accurate mailing list and customer contact file. The form should be completely filled out and the appropriate copy returned to DEC's Field Service Organization in Maynard, Massachusetts.

C.3 SOFTWARE TROUBLE REPORTS

Software Trouble Reports enable the customer to communicate directly with the DEC Software Group. Any software problems should be described in detail and, if possible, examples attached.

C.4 DECUS INFORMATION

The DECUS information and introductory letter familiarizes the user with the Digital Equipment Computer Users Society. The letter invites membership and includes application forms.

C.5 BASIC ACCESSORY CHECKLIST

The Basic Accessory Checklist contains an accurate list of all items that are normally supplied with the basic PDP-12. DEC personnel check each item on this list with the customer, and the customer then signs the complete form. The appropriate copy is then returned to DEC in Maynard, Massachusetts. The remaining copies should be distributed as indicated on the bottom of the form. Specified items that are not included should be listed as "exceptions" on the Customer Acceptance Forms.

C.6 OPTIONAL EQUIPMENT CHECKLIST

Accessory checklists for each option are supplied. The Basic Accessory Checklist procedures apply.

C.7 SOFTWARE CHECKLIST

The Software Checklist enclosed has been checked at the factory and is rechecked with the customer. Any items missing should be listed as "exceptions". This form is also signed by the customer and returned to DEC in Maynard, Massachusetts. Requests for additional copies of programs should be submitted to the DEC Program Library.

C.8 FINAL DISTRIBUTION OF FORMS

The return-addressed envelope is sent to DEC in Maynard, Massachusetts with the following completed forms:

- a.* Customer Acceptance Forms
- b.* Customer Data Forms
- c.* Basic Accessory List
- d.* Optional Equipment Checklist
- e.* Software Checklist
- f.* Installation Report
- g.* Final Distribution Lists

All of the items above, except *b.* and *f.*, require the customer's signature. Only items listed as "exceptions" are replaced at no cost. All other items must be substantiated by a Customer Purchase Order.

A complete set of prints is supplied with the PDP-12 System. The Key Sheet should be used to reference the Master Drawing List (MDL) for each subsection (I/O, CP, MEMORY) or option in the PDP-12 System. Wire lists, parts lists, and mechanical assembly prints are not supplied with any print set. These may be obtained only by special order.

APPENDIX D

SOFTWARE AND PREWIRED OPTION DIAGNOSTICS

The following is a list of PDP-12 Software, designating exactly what tapes and write-ups are involved in the PDP-12 Software Kit. Included also is the list of MAINDECs for the Prewired Options. Also included is a list of the programs available on the LINCtapes (Pages D-5 -- D-11). For a complete discussion of user programs available on the PDP-12, refer to Chapter 7 of *PDP-12 System Reference Manual (DEC-12-SRZA-D)* (note that later revisions may be shipped).

PDP-12 SOFTWARE

NOTE

- D Document
- DN Document Change Notice
- PA Paper Tape ASCII
- PB Paper Tape BINARY
- PM Paper Tape READ-IN-MODE
- UO LINCtape

LINC-8 PROGRAMMING MANUAL	I-L85
PROGRAMMING LANGUAGES	
INTRODUCTION TO PROGRAMMING	
LOGIC HANDBOOK	
FORMS AND CHECKLIST ENVELOPE	
GETTING ON THE AIR WITH YOUR PDP-12	
LINCTAPES (see Pages A-9 A-15)	
LAP6-DIAL USER PROGRAMS	DEC-12-SE2D-UO DEC-12-SE3A-UO DEC-12-SE4A-UO DEC-12-SE5A-UO DEC-12-UXZA-UO DEC-12-MRZA-UO
DEMO PROGRAMS	MAINDEC-12-D7AC-UO MAINDEC-12-D8GA-UO
MAINTENANCE PROGRAMS	
PDP-12 SIGNAL PROC. MANUALS	
CATACAL	DEC-12-UW1A-D
CATACAL ADDENDUM	DEC-12-UW1A-DL
ADTAPE AND ADCON	DEC-12-UW2A-D
TISA	DEC-12-UW3A-D
SINPRE	DEC-12-UW4A-D DEC-12-UW5A-D
MAGSPY	DEC-12-UZSA-D
SIGNAL AVERAGER USER'S GUIDE	DEC-12-UZ1A-D

(continued on next page)

PDP-12 SYSTEMS-DEMO MANUALS

PDP-12 SYSTEM REFERENCE MANUAL
LAP6-DIAL MANUAL

FRED
MILDRED
CONVERT
LINC-8 SIMULATOR TRAP PROCESSOR
MARK12-A
PATCH
CREF12
PRTC12-F
DEMO 12 USER'S GUIDE
DEMO 12 USER'S GUIDE ADDENDUM
DEMO 12 MONITOR SYSTEM TECHNICAL REFERENCE
MANUAL

DEC-12-SRZA-D
DEC-12-SE2D-D
DEC-12-FISA-D
DEC-12-FZFA-D
DEC-12-FZDA-D
DEC-12-ESYB-D
DEC-12-S11B-D
DEC-12-Y1TA-D
DEC-12-YU2A-D
DEC-12-FRZA-D
DEC-12-YIYA-D
DEC-12-UXZA-D
DEC-12-UXZA-DN

DEC-12-MRZA-D

PDP-8 SYSTEM SOFTWARE

SOFTWARE PERFORMANCE SUMMARY
SYSTEM USER'S GUIDE
DDT
DDT CHANGE NOTICE
ODT-8
SYMBOLIC EDITOR
SYMBOLIC EDITOR CHANGE NOTICE
BINARY LOADER (TWO COPIES)
"HELP" LOADER
READ-IN-MODE LOADER
4K FORTRAN
READ-IN-MODE (RIM) PUNCH
BINARY PUNCH
OCTAL MEMORY DUMP

VOLUME 2: #3
DEC-08-NGGC-D
DEC-08-CDDB-D
DEC-08-CDDB-DN
DEC-08-COCO-D
DEC-08-ESAB-D
DEC-08-ESAB-DN
DEC-08-LBAA-D
DEC-08-LHAA-D
DEC-08-LRAA-D
DEC-08-AFCO-D
DEC-08-PMPO-D
DEC-08-YXYA-D
DEC-08-YPPA-D

PDP-12 MAINTENANCE MANUALS

PDP-12 CP TEST 2 (SKIP AND DATA HANDLING)
INSTRUCTION TEST PART 1
PDP-12 CP TEST 3
JMP SELF
PDP-12 CHECKERBOARD
FLOAT 1'S & 0'S THROUGH MEMORY
PDP-12 TAPE CONTROL TEST (PART 1 of 2)
VR12 DISPLAY TEST
A TO D TEST
PDP-12 RELAY REGISTER TEST
PDP-12 OPERATING PROCEDURE

INSTRUCTION TEST 1
INSTRUCTION TEST 2

PDP-8 INSTRUCTION TEST PART 2B
RANDOM JMP TEST
RANDOM JMP-JMS TEST

MAINDEC-12-DOAB-D
MAINDEC-12-DOBA-D
MAINDEC-12-DOCA-D
MAINDEC-12-D1BA-D
MAINDEC-12-D1DA-D
MAINDEC-12-D1EA-D
MAINDEC-12-D3AE-D
MAINDEC-12-D6BA-D
MAINDEC-12-D6CB-D
MAINDEC-12-D8AB-D
MAINDEC-12-D9CA-D

MAINDEC-8I-DO1C-D
MAINDEC-8I-DO2B-D

MAINDEC-08-DO2B-D
MAINDEC-08-DO4B-D
MAINDEC-08-DO5B-D

(continued on next page)

RANDOM ISZ TEST	MAINDEC-08-DO7B-D
MEMORY ADDRESS TEST	MAINDEC-08-D1BO-D
BASIC PDP-8, 8/I MEMORY CHECKERBOARD	MAINDEC-08-D1LO-D
PDP-8 MEMORY POWER ON/OFF TEST	MAINDEC-08-D1AC-D
FAMILY-OF-ASR 33/35 TELETYPE TESTS PART 1	MAINDEC-08-D2PE-D
FAMILY-OF-ASR 33/35 TELETYPE TESTS PART 2	MAINDEC-08-D2QD-D
PDP-12 SYSTEM TAPES	
FORTRAN COMPILER	DEC-08-AFC1-PB
FORTRAN SYMBOL PRINT	DEC-08-AFA2-PB
FORTRAN OPERATING SYSTEM	DEC-08-AFC3-PB
SAMPLE PROGRAM FORTRAN SYM DESK CALCULATOR	
FOCAL, 1969 & INIT 4K INIT	DEC-08-AJAE-PB
UTILITY OVERLAYS FOR FOCAL, 1969 (4 WORD, 8K)	DEC-08-AJ1E-PB
PAL III	DEC-08-ASC1-BP
PAL III EXTENDED SYMBOLS	DEC-08-ASC2-PA
DDT-8	DEC-08-CDDB-PB
MACRO-8 LOW SPEED	DEC-08-CMA1-PB
ODT (LOW)	DEC-08-COC1-PB
ODT (HIGH)	DEC-08-COC2-PB
SYMBOLIC EDITOR	DEC-08-ESAC-PB
BINARY LOADER (2 COPIES)	DEC-08-LBAA-PM
HELP BOOTSTRAP LOADER	DEC-08-LHA1-PB
HELP GENERATOR	DEC-08-LHA2-PB
READ-IN-MODE (RIM) PUNCH	
LOW MEMORY -33	DEC-08-PMP1-PB
HIGH MEMORY RIM PUNCH -33	DEC-08-PMP2-PB
OCTAL MEMORY DUMP	DEC-08-YPPA-PB
BINARY PUNCH-TELETYPE (ASR-33)	DEC-08-YX1A-PB
PDP-8 FLOATING POINT PACKAGE	
PACKAGE 1: BASIC PACKAGE (BASIC I/O PLUS	
INTERPRETER	DEC-08-YQ1B-PB
PACKAGE 2: BASIC PACKAGE PLUS CONTROLLER	DEC-08-YQ2B-PB
PACKAGE 3: BASIC PACKAGE PLUS EXTENDED FUNCTIONS	DEC-08-YQ3B-PB
PACKAGE 4: BASIC PACKAGE PLUS CONTROLLER &	
EXTENDER FUNCTIONS	DEC-08-YQ4B-PB
PDP-12 DIAGNOSTICS	
PDP-12 CP TEST 2 (SKIP AND DATA TEST)	MAINDEC-12-DOAB-PB
INSTRUCTION TEST 1	MAINDEC-12-DOBA-PB
CP TEST III	MAINDEC-12-DOCA-PB
JMP SELF	MAINDEC-12-D1BA-PB
PDP-12 CHECKERBOARD	MAINDEC-12-D1DA-PB
FLOAT 1'S and 0'S THROUGH MEMORY	MAINDEC-12-D1EA-PB
TAPE CONTROL TEST	MAINDEC-12-D3AE-PB

(continued on next page)

DISPLAY TEST (VR12)	MAINDEC-12-D6BA-PB
A-TO-D TEST	MAINDEC-12-D6CB-PB
DR12 RELAY REGISTER TEST	MAINDEC-12-D8AB-PB
INSTRUCTION TEST 1	MAINDEC-8I-DO1C-PB
INSTRUCTION TEST 2	MAINDEC-8I-DO2B-PB
INSTRUCTION TEST PART 2B	MAINDEC-08-DO2B-PB
RANDOM JMP TEST	MAINDEC-08-DO4B-PB
RANDOM JMP-JMS TEST	MAINDEC-08-DO5B-PB
RANDOM ISZ TEST	MAINDEC-08-DO7B-PB
PDP-8 MEMORY POWER ON/OFF TEST	MAINDEC-08-D1AC-PB
MEMORY ADDRESS TEST (LOW)	MAINDEC-08-D1B1-PM
MEMORY ADDRESS TEST (HIGH)	MAINDEC-08-D1B2-PM
BASIC PDP-8, 8I BASIC MEMORY CHECKERBOARD (LOW)	MAINDEC-08-D1L1-PM
BASIC PDP-8, 8I BASIC MEMORY CHECKERBOARD (HIGH)	MAINDEC-08-D1L2-PM
FAMILY OF 8 ASR 33/35 TELETYPE TEST PART 1	MAINDEC-08-D2PE-PB
FAMILY OF 8 ASR 33/35 TELETYPE TEST PART 2	MAINDEC-08-D2QD-PB
TAPE CONTROL TESTS PART 1	MAINDEC-12-D3AC-PB
PART 2	MAINDEC-12-D3AC-D

Table D-1
Options Diagnostics

Option and Program Name	Mnemonic	DEC Number	Use
MC12			
PDP-12 Extended Memory Control	EXTMC12 writeup	DEC-12-D1AC-PB DEC-12-D1AC-D	Tests Control Logics for Extended Memory
Extended Memory Control (8I)	EXTMC writeup	DEC-08-D1CA-PB DEC-08-D1CA-D	Tests Control Logics for Extended Memory
Extended Memory Checkerboard	EXTCB writeup	DEC-08-D1DA-PB DEC-08-D1DA-D	Tests Extended Memory Stacks for noise
Extended Memory Address Test	EXTAT writeup	DEC-08-D1HA-PB DEC-08-D1HA-D	Tests Addressing for Extended Memory Stacks
KW12-B-C	clock	DEC-12-D8EA-PB	
KW12 Clock Control test	KW12 D8CB writeup	DEC-12-D8LB-PB DEC-12-D8CB-D	Tests all logic for KW12
Calcomp 1	Calcomp writeup	DEC-08-D6CB-PB DEC-08-D6CB-D	Plotter Test
Calcomp 2	OCALCOMP writeup	DEC-08-12-U-PA DEC-08-12-U-D	Plotter subroutine Tests
KE12 EAE Test, Part 3A	EAE 3A writeup	DEC-08-DOAA-PB DEC-08-DOAA-D	Tests Extended Arithmetic Control logic
EAE Test, Part 3B	EAE 3B writeup	DEC-08-DOBA-PB DEC-08-DOBA-D	More extensive test of EAE Control logic

(continued on next page)

Table D-1 (Cont)
Option Diagnostics

Option and Program Name	Mnemonic	DEC Number	Use
FOCAL FOCAL 4K	FOCAL 4K writeup	DEC-08-AFCO-PB DEC-08-AFLO-D	FOCAL using 4K of Memory
FOCAL 8K	FOCAL 8K writeup	DEC-08-KFXB-PB DEC-08-KFXB-D	FOCAL using 8K of Memory
KP12	PNRFAIL writeup	DEC-08-DIK1-PB DEC-08-D1K1-D	Tests ability to retain and restart program after power failure
KT12	Option test writeup writeup Hardware test Monitor Man.	DEC-T8-D8AA-PB DEC-T8-D8AA-D DEC-T8-D8BB-D DEC-T8-D8BB-PB DEC-T8-MRFB-D	Tests Time Sharing System control logic and hardware
DP12-A	Teletype tests writeup	DEC-08-D2AA-PB DEC-08-D2AA-D	
DP12-B	PT08 Test writeup	DEC-08-D8PA-PB DEC-08-D8PA-D	Tests Dataphones control logic and punch and read logic
Extended Tape Control	PRTC12-F	DEC-12-YIYA-UO	Tape Conversion Test
Extended Tape Control	TCV12-F	DEC-12-D3EA-PB	Tests TC12-F logic
TC12-F writeup	Program Diagnostic	DEC-12-YIYA-D DEC-12-D3EA-D	

User Programs

DEC-12-SE2D-UO

Name	Source		Binary	
	BN	BLKS	BN	BLKS
PIP			247	21
LSSIM	470	14		
DIAL-MS	246	1		
MAGSPY	504	36		
MARK12	171	47	656	7
PATCH	542	24		
PRTC12-F	566	65		
CONVERT	142	27		
DIAL V2	245	1		
DIAL-MS4			122	20
DIAL-MS3			114	6
DIAL-MS2			74	20

(continued on next page)

DEC-12-SE2D-UO (Cont)

Name	Source		Binary	
	BN	BLKS	BN	BLKS
DIAL-MS1			54	20
GENASYS			240	5
CATACAL			665	21
SIGAVG	711	65		
SINPRE	16	36		
CNTRL2	653	3		
CNTRL4	12	4		
DIALMS	11	1		

DEC-12-SE3A-UO

Name	Source		Binary	
	BN	BLKS	BN	BLKS
PIP			247	21
MARK12			470	7
FOCAL4K	173	1	477	21
FOCAL8K	172	1	116	22
L8SIM			207	3
QANDA	534	17	213	3
CONVERT			520	5
MAGSPY			216	10
DIALV2	226	1		
FORCOM	206	1	553	20
FRED	702	40	525	3
FORSYS	205	1	154	16
BINLOAD	201	1	202	3
PATCH			243	4
PRTC12-F			230	12
FMAA-PA	530	2		
FM8A-PA	176	3		
FMC8-PA	573	4		
FMDA-PA	577	10		
FMEA-PA	145	7		
FMFC-PA	607	10		
FMGB-PA	142	3		
FMHA-PB			617	7
FMIA-PA	227	1		
FMJA-PA	626	3		
FMKA-PA	532	2		
IOUASCH	212	1		
11UASCH	631	4		
15UASCH	635	5		
14UASCH	112	4		
21-U-BIN			642	3
21UASCH	645	5		
19UASCH	107	3		
18UASCH	103	4		

(continued on next page)

DEC-12-SE3A-UO (Cont)

Name	Source		Binary	
	BN	BLKS	BN	BLKS
22UASCII	652	3		
23UASCII	76	5		
24UASCII	655	6		
29UASCII	64	12		
25UASCII	663	10		
28UASCII	673	7		
MILDRED			742	3
YQ1A-PB			20	7
YQ2A-PB			11	7
YQ3A-PB			0	11
YQ4A-PB			745	11
25F-EAE1			55	7
25F-EAE2			45	7
25F-EAE3			35	11
25F-EAE4			756	11

DEC-12-SE4A-UO

Name	Source		Binary	
	BN	BLKS	BN	BLKS
ADTAPE	6	71	252	16
ADCON	470	46		
SIGAVG1			242	10
SIGAVG2			232	10
SIGAVG4			220	12
NMRSIM			536	20
NMR2	160	40		
NMR3	556	52		
CAT2	77	61		
CAT3	630	65		
SINPRE			715	12
CAT1E			727	7
CAT1			736	7

DEC-12-SE5A-UO

Name	Source		Binary	
	BN	BLKS	BN	BLKS
TISA			250	20
TIP1	470	73		
TIP2	173	55		
MILDRED	563	35		
NMRSIME			153	20
CATACALE			132	21

(continued on next page)

Demonstration Programs

DEC-12-UXZA-UO

Name	Source		Binary	
	BN	BLKS	BN	BLKS
LOADER.			0	1
SEG01-3.			1	3
SEG11-4.			4	4
INITLIZ.			10	1
GREETIN.			11	1
BALLOON.			12	5
SEG04-4.			17	1
DMOINDX.			20	2
Q AND A.			22	2
.DA-DTST	24	2	165	3
.DDATA12	24	4	37	6
.DMAGSPY	32	2	153	10
.DFRQANA	35	2	72	11
.DDIAL	45	1	163	2
.FFREQ12	46	2	170	3
.EWAVES	50	2	173	3
.EB.BALL	52	1	176	3
.EBASMEM	53	1	201	5
.FSOLACE	54	1	206	2
.FMUSIC	55	1	210	6
.FKALEID	56	1	216	2
.FDRAW12	57	2	220	3
.FECHASK	61	2	223	3
.FSPCWAR	63	3	226	16
.TDAYCOM	66	1	244	4
.TSTPWCH	67	2	250	6
.FCLOCK	71	1	256	5
SCRATCH.	103	50		
GREETING			776	1
INDEXSRC	263	5		
DIAL-V2	522	2		
MARK12			511	7
PIP			470	21
EX.PROG.	526	1	520	2
AD DEMO	527	1	614	3
BINLOAD			535	3
L8SIM			540	3
CONVERT			543	5
FOCAL8K			550	23
FOCAL4K			573	21
CAROLS			617	11
LOADER	635	2	637	2
INITLIZE	641	17	660	3
SEG0	663	34	717	7
SEG1	725	36	763	6
BALLOON			771	5
04-01-70	527	2		

(continued on next page)

DEC-12-MRZA-UO

Name	Source		Binary	
	BN	BLKS	BN	BLKS
OMAGSPY	160	37		
DRAW12	540	6		
KALIED	520	1		
REMAKE			141	17
BALLOON			507	5
H-DIAL	514	1		
H-FRQANA	515	2		
H-FREQ12	521	2		
H-B.BALL	517	1		
H-ECHASK	523	2		
H-DAYCOM	527	1		
H-STPWCH	530	1		
H-DRAW12	531	2		
H-SOLACE	533	1		
H-CLOCK	534	1		
H-BASMEM	561	1		
H-MAGSPY	137	2		
H-A-DTST	136	1		
DATA12	244	17		
ECHASK	535	3		
H-DATA12	621	3		
MARK12			127	7
PIP			470	17
EX.PROG.	525	1		
AD DEMO	526	1		
KW12SUBC	630	5		
LOADER	635	2	557	2
INITLIZE	102	17	546	3
SEG0	637	34	613	6
SEG1	44	36	551	6
STPWCH	217	25		
FROANA	562	31		
INDEXSRC	263	5		

Maintenance Programs

DEC-12-D7AC-UO (basic diagnostics)

Name	Source		Binary	
	BN	BLKS	BN	BLKS
PIP	604	1	251	17
MARK12	603	1	470	7
RIMLDR	605	1	477	3
BINLDR	606	1	502	3
CBL	607	1	505	3
CBH	104	1	245	4
ADDRSLO	612	1	510	3

(continued on next page)

DEC-12-D7AC-UO (Cont)

Name	Source		Binary	
	BN	BLKS	BN	BLKS
ADDRSHI	103	1	241	4
ADDRS12	611	1	513	2
RANISZ	101	1	515	5
RANJMP	102	1	235	4
JMPJMS	100	1	522	4
JMPSELF	610	1	233	2
MEMDATA	613	1	231	2
INST1	614	1	526	13
INST2	77	1	217	12
INST2A	726	1	203	14
INST2B	602	1	541	6
EAE3A	106	1	547	15
EAE3B	105	1	167	14
CPTST1	712	1	564	4
CPTST2	713	1	146	21
CPTST3	725	1	131	15
TTY1	714	1	570	7
TTY2	715	1	615	13
TC12F	30	1	121	10
DP12A	27	1	630	14
PWRFAIL	716	1	577	3
EXTMC	717	1	113	6
EXTAT	720	1	644	10
EXTCB	721	1	654	11
EXTMC12	35	1	107	4
TAPECNTL	722	1	56	21
ADTST	34	1	665	5
RELAYTST	723	1	672	4
DISPTST	33	1	676	4
KW12TST	724	1	46	10
KW12BC	727	1	702	5
ONOFF	32	1	707	3
CALCOMP	31	1	36	10

DEC-12-D8GA-UO (option diagnostics)

Name	Source		Binary	
	BN	BLKS	BN	BLKS
PIP	42	1	251	17
MARK12	41	1	470	7
RIMLDR	37	1	477	3
BINLDR	40	1	502	3
DB12	250	1	505	5
DC02	147	1	242	6
DC04	155	1	512	11
HSRDPUN	154	1	230	12
DF32DD	150	1	523	21

(continued on next page)

DEC-12-D8GA-UO (Cont)

Name	Source		Binary	
	BN	BLKS	BN	BLKS
DF32DL	153	1	216	12
RF08DD	604	1	203	13
RF08MD	152	1	544	13
LINEPNTR	605	1	177	4
CARDREAD	151	1	557	6
PECITRE	146	1	170	7
PECITIT	145	1	565	11
PECITDRT	144	1	156	12
PECITDT	143	1	576	6

INDEX

- A**
- Acceptance
 - Customer Programs, B-1
 - Diagnostics, B-1
 - Software, B-2
 - Forms, Customer, C-1
 - Testing, B-1
 - Acoustical Damping, 1-4
 - A/D Adjustments, 3-30
 - A/D Sample & Hold Adj., 3-30
 - Adjustments, Chapter 3, 3-1
 - Memory Current & Strobe, 3-1
 - Air Conditioning, 1-4
 - Analog Adj., Extended, 3-33
 - Analog and Display Adj. & Checks, 3-26
 - Analog Channel Adj., External, 3-32
- B**
- BIN, Loading, 1-17
- C**
- Cabinet
 - Installation, 1-13, 1-5
 - Inspection, 1-13
 - Unpacking, 1-12
 - Cabling, 1-11
 - Checklist, Software, C-2
 - Checkout, 1-15
 - Checks
 - Console, 2-7
 - 8-Mode Processing, 2-9
 - LINC-Mode Processing, 2-8
 - TC12 Console, 2-10
 - TC12 Tape Subprocessor, 2-9
 - Circuit Breaker CB1, 1-15
 - Cleanliness, 1-5
 - Configurations, System, 1-5
 - Console Checks, 2-7
 - Constraints, Installation, 1-4
 - Corrective Maintenance, 2-5
 - Teletype, 5-3
 - Customer Acceptance, B-1
- D**
- D/A (AD12) Adj. & Checks, 3-26
 - D/A Adj. Procedures, 3-27
 - Daily Maintenance, 2-4
 - Data Forms, Customer, C-1
 - DECUS Information, C-2
 - Demonstration Programs, List, D-8
 - Depot Repair, A-2
 - Diagnostics
 - Memory, 3-8
 - Prewired Option Software List, D-1
 - Display
 - Brightness & Preset Adj., 3-29
 - Size & Position Adj., 3-29
 - (VR12) Adjust. & Checks, 3-26
 - DP12-B Checkout, 4-14
- E**
- 8-Mode Processing, 2-9
 - Environmental Consideration, 1-4
 - Equipment
 - Checklists, Optional, C-2
 - Maintenance, 2-1
 - Expanded Equipment Layout, 1-7
 - Expansion, System, 1-6
 - Extended Analog Adj. (AG12, AM12), 3-33
 - Extended Memory MC12 Adjustments, 3-7
 - External Analog Chan. Adj., 3-32
- F**
- Fire and Safety Precautions, 1-3
 - "Floating" Signals, 2-2
 - Floor Construction, Planning, 1-1
 - Floor Plan Requirements, 1-7
 - Forms, Distribution of, C-2
 - Forms & Checklists, C-1
- H**
- Humidity, 1-4

INDEX (Cont)

I

- I/O Interface, 1-6
- Initial Memory Current Adjustments, 3-1
- Initial Strobe Adjustments, 3-2
- Inspection
 - Cabinet, 1-13
 - Peripheral Equipment, 1-15
- Installation, 1-1
 - Cabinet, 1-13
 - Options, 1-15
 - Prewired Options, 4-1
 - Teletype, 1-14
 - Constraints, 1-4

L

- LAP6-DIAL Maintenance, 3-29
- LAP6-DIAL MAINTENANCE Tapes, Mounting, 2-3
- Lighting, 1-4
- LINC-Mode Processing, 2-8
- LINCtape
 - ACIP Delay Adj., 3-14
 - Adjustments, 3-9
 - LTD Tape Fail Delay Adj., 3-13
 - LTD TTOK Delay Adj., 3-12
 - LTD XTLK Delay Adjustments, 3-11
 - System Checkout, 4-15
- Loading
 - BIN, 1-17
 - RIM Loader, 1-16
- Log Book, 2-14
- Logic Troubleshooting, 2-12

M

- MAINDECs, Loading, 1-17
- Maintenance, Chapter 2, 2-1
 - Corrective, 2-5
 - Daily, 2-4
 - LAP6-DIAL, 3-29
 - Preventive, 2-3
 - Scheduled, 2-4
 - Weekly, 2-4
 - Service Options, A-1
 - Equipment, 2-1
 - Programs, list of, D-9
 - Programs, Teletype, 5-2
 - Tasks, Preventive, 2-4

- Test Programs, 2-2
- Tools, Teletype, 5-1
- Mark Clock Adj., 3-16
- Memory
 - Current Adjustments, Initial, 3-2
 - Current Adjustments, Final, 3-4
 - Current and Strobe Adjustments, 3-1
 - Diagnostics, 3-8
 - Extended, Adjustments, 3-7
 - Margins & Final Strobe Adjustments, 3-6
 - Strobe Adjustments, 3-2
 - Tests, 1-16
- Module Troubleshooting, 2-12
- Mounting LINCtape, 2-3

O

- Operating Checks, Preliminary, 1-15
- Option
 - Checkout, 4-14
 - Installation, 1-15
 - Module and Cable List, 4-3
- Optional Equipment Checklists, C-2
- Options
 - DEC Field Installation, A-3
 - MAINDEC list, 4-1

P

- Packing Details, 1-8
- Panels & Cables, Installation of, 4-6
- Pedestal Type Flooring, 1-1
- Peripheral Inspection, 1-15
- Planning, Installation, 1-1
- Power
 - Cable Line Identification, 1-11
 - Cabling, 1-11
 - OK Adjustment, 3-6
 - Receptacle Part Numbers, 1-10
 - Receptacles, 1-10
 - Requirements, Source & System 1-9
 - Supply Specifications, 2-5
- Predelivery Preparation, 1-6
- Preliminary Operating Checks, 1-15
- Preparation, Predelivery Procedures, 1-6
- Preventive Maintenance, 2-3
 - Teletype, 5-2
 - Tasks, 2-4

INDEX (Cont)

P (cont)

Prewired Options

- Installation, 4-1, 1-15
- Software Diagnostics, D-1
- List of, 4-1
- Unpacking, 4-1
- Checkout, 4-14

Printer/Punch Corrective Maintenance, 5-5

Programs

- Customer, B-1
- Demonstration list of, D-8
- Maintenance list of, D-9
- Maintenance Test, 2-2
- User list of, D-5

R

Raceway Type Flooring, 1-2

Receiving Constraints, 1-8

Receptacles, Power, 1-10

Repairs & Replacements, 2-13

Requirements, Power, 1-9

RIM Loader, Loading, 1-16

Running MAINDECs, 1-17

S

Safety and Fire Precautions, 1-3

Scheduled Maintenance, 2-4

Service Contracts

- Depot Repair, A-2
- Eligibility, A-2
- Options, A-1
- Per-Call Coverage, A-2

Service Outlets, AC, 1-11

Shipping and Receiving Constraints, 1-8

Shipping Methods

- Domestic & North America, 1-8
- Overseas & Air Freight, 1-9

Site Considerations, Planning, 1-1

Software

- Acceptance, B-2
- Prewired Option Diagnostics, D-1
- Checklist, C-2
- Trouble Reports, C-2

Soldering Techniques, 2-14

Source Power Requirements, 1-9

Space Requirements, 1-1

Special Mounting Considerations, 1-4

Specifications, Power Supply, 2-5

Standard Configurations, 1-5

Strobe Adjustments, 3-2

System

- Configurations, 1-5
- Expansion, 1-6
- Layout, Planning, 1-3
- Power Requirements, 1-9
- Troubleshooting, 2-6

T

Tape Timing Pulses Adjustment, 3-9

TC12-F Checkout, 4-15

TC12

- Console Checks, 2-10
- Tape Subprocessor Checks, 2-9

Teletype

- Clock Adjustments, 3-8
- Console Installation, 1-14
- Corrective Maintenance, 5-3
- Equipment, 5-1
- Installation, 1-14
- Keyboard Spares, 5-6
- Maintenance, 5-1
- Maintenance Programs, 5-2
- Maintenance Tools, 5-1
- Preventive Maintenance, 5-2
- Replacement Parts, 5-5
- Test, 1-16
- Unpacking, 1-14

Temperature, 1-4

Test Programs, Maintenance, 2-2

Tests,

- Computer Memory, 1-16
- Teletype, 1-16
- Validation, 2-14

Trouble Reports, Software, C-1

Troubleshooting

- Logic, 2-12
- System, 2-6
- Modules, 2-12
- Techniques, 2-6

TU55

- Brake Adj., 3-18
- Head Installation, 3-22

INDEX (Cont)

T (cont)

TU55 (cont)

- Head Removal, 3-22
- Head Skew Adj., 3-22
- Interconnections, 4-10
- Stop Delay Adj., 3-21
- Stop Torque Adj., 3-19
- Tape Transport Adj., 3-17
- Torque Adj., 3-19
- Trailing Torque Adj., 3-20
- Transport Head Replacement Adj., 3-21
- Unit & Cable Installation, 4-8

TU56

- Brake Adjustment, 3-24
- LINCtape Transport, 3-24
- Oscillator Adj., 3-26
- Unit & Cable Installation, 4-11

U

Unpacking

- Installation & Inspection, 1-12
- Teletype, 1-14

User Program List, D-5

V

Validation Tests, 2-14

VR12

- Brightness & Preset Adj., 3-29
- Checkout, 4-17
- Deflection Adj., 3-30
- Display Focus Adj., 3-30
- Size & Position Adj., 3-29
- Unit and Cable Installation, 4-8

W

Weekly Maintenance, 2-4