

The SOL-PCB documentation enclosed is for the printed circuit board shown in the July 1976, Popular Electronics article. After completing the original SOL printed circuit board (Feb. '76) we made numerous improvements to the original design. We have added:

- more RAM, 2048 8-bit bytes is standard
- ROM personality module for easier expansion
- completely compatible bus expansion for additional memory and I/O
- on card optional audio cassette interface (Byte/CUTS/Kansas City type) with motor control.

Since the printed circuit board and the parts list have changed considerably, we do not recommend construction of the printed circuit boards as originally shown.

All orders for the SOL-PCB received before August 31, 1976 will be filled with boards of the new design. No orders for the printed circuit board only (i.e. SOL-PCB) will be accepted after that date.



BOTTOM

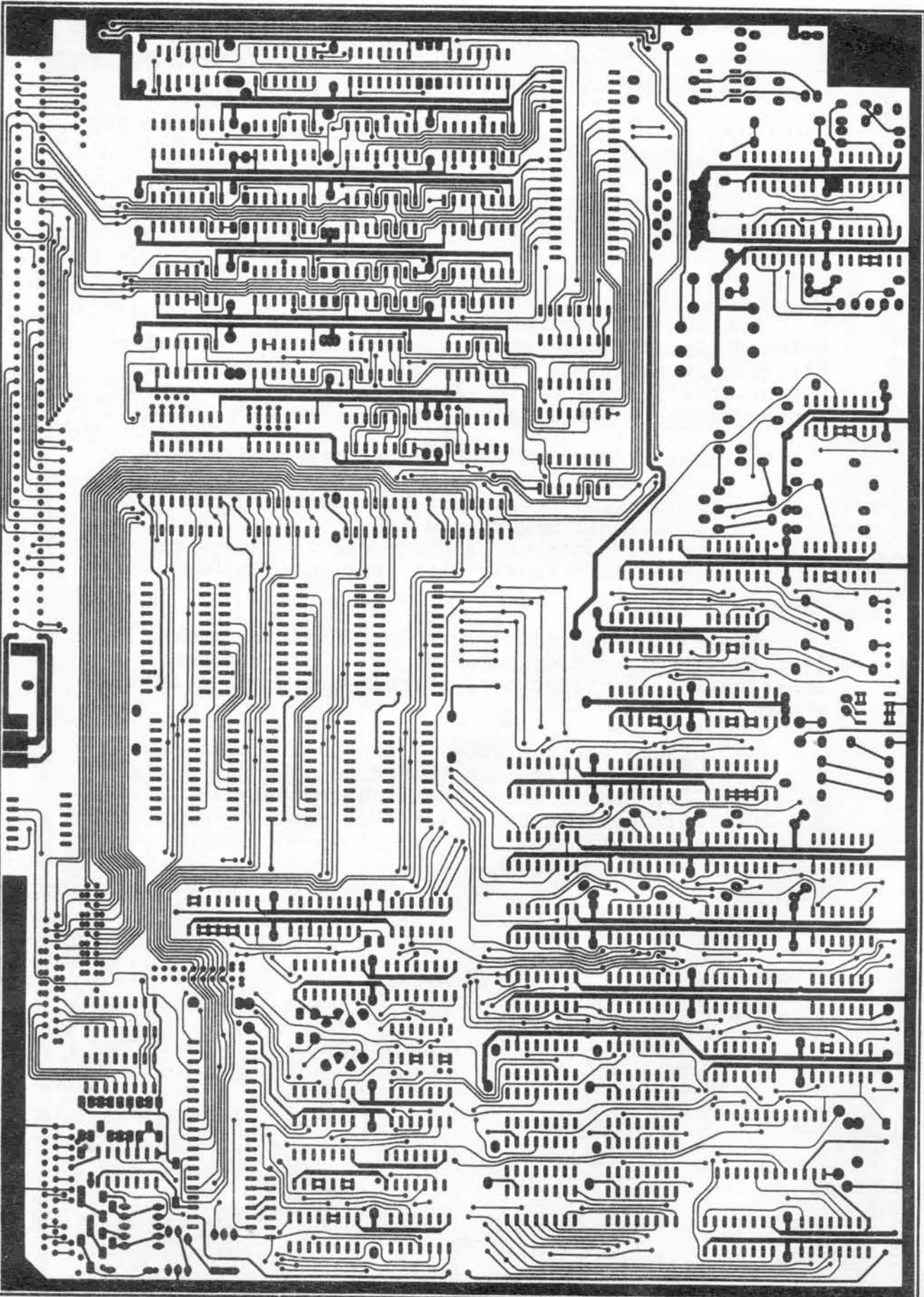

9.50"

13.25"

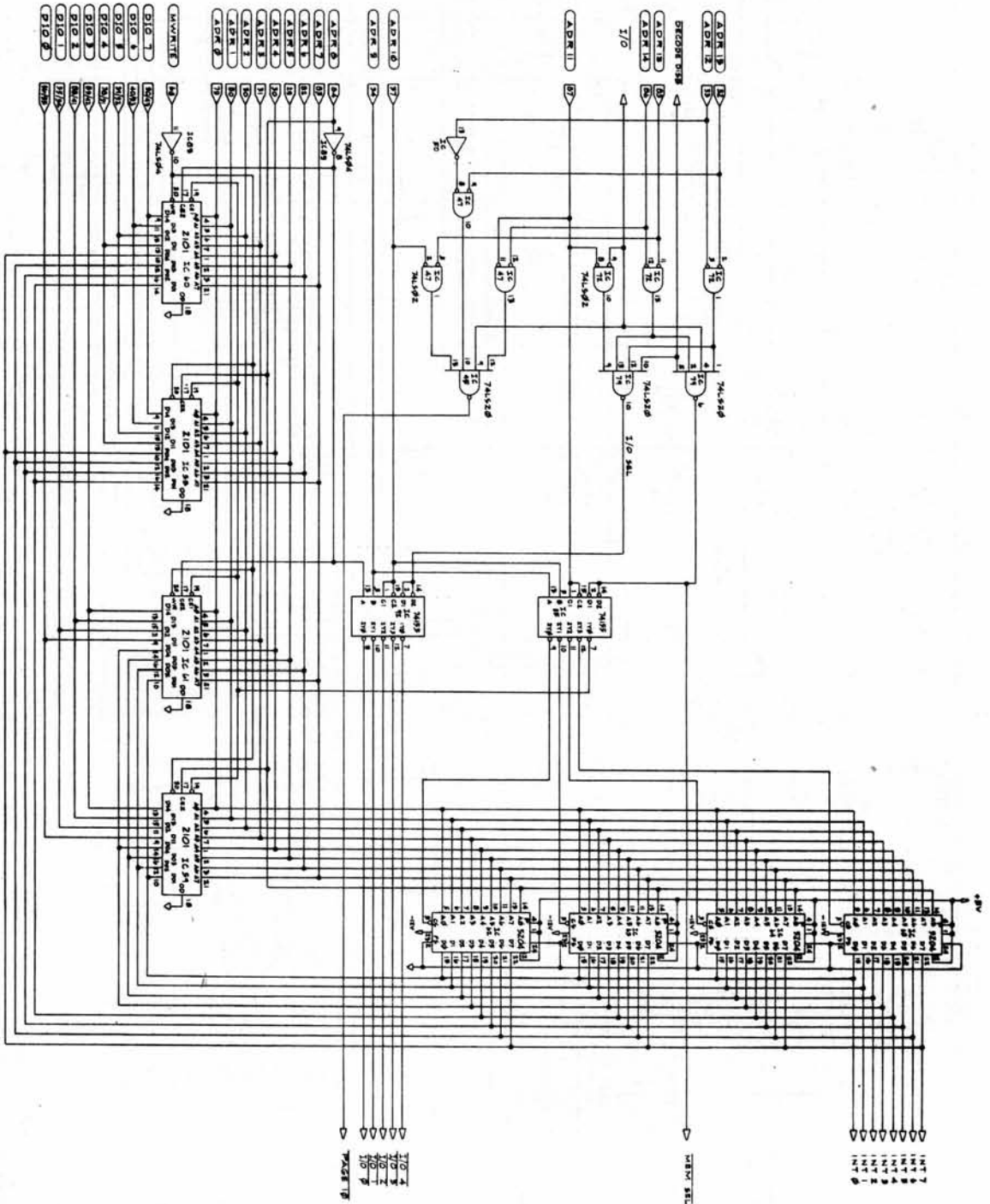

SCHEMATIC MEMORY, 501 - I

ROBERT W. MARSH

PROCESSOR TECHNOLOGY

© 1974

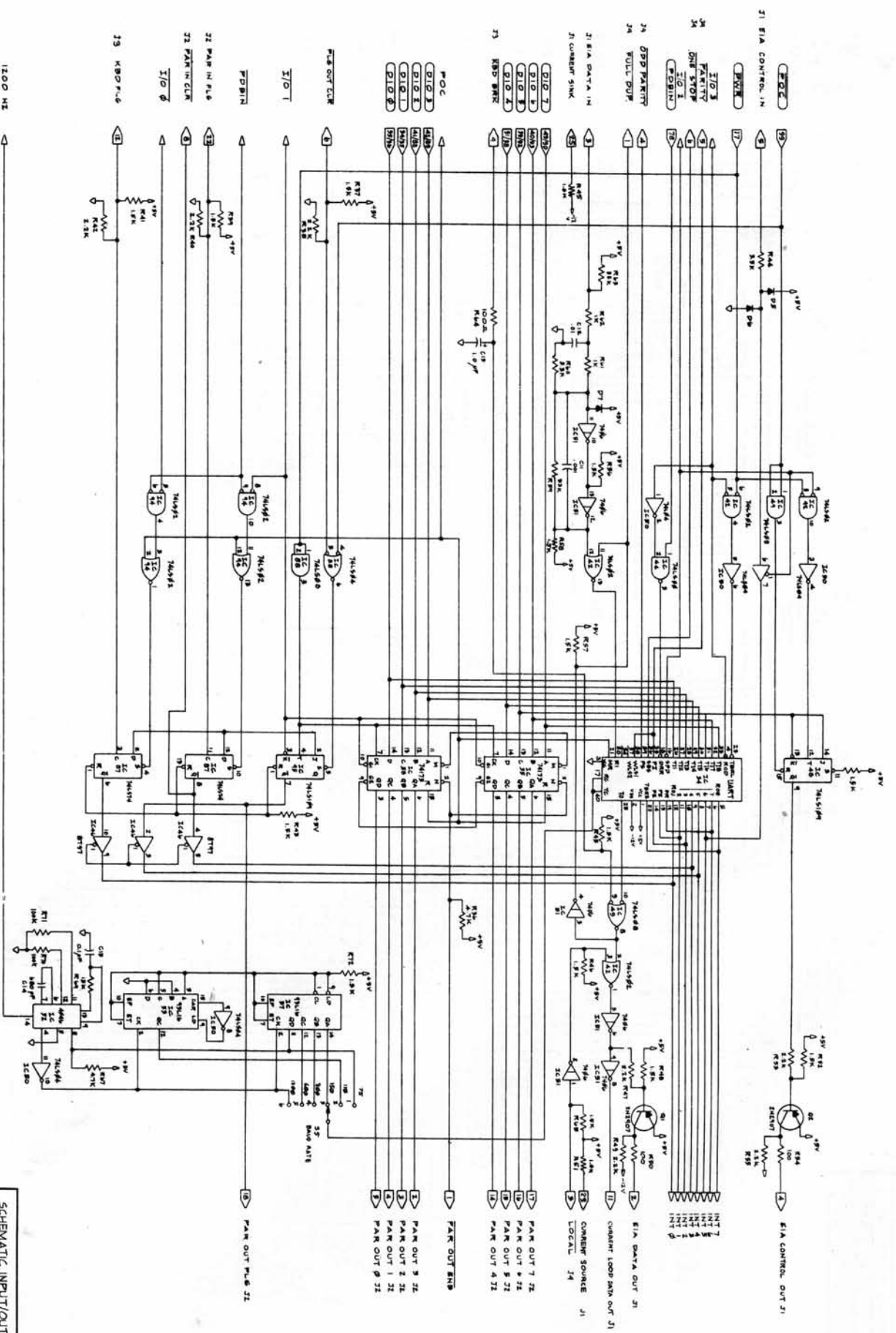

SCHEMATIC INPUT/OUTPUT Sol-I
 ROBERT M. MARSH
 PROCESSOR TECHNOLOGY

SPECIFICATIONS

Sol System Specifications

Display

16 lines of 64 characters per line, black on white or reverse.

96 printable ASCII upper and lower case characters, plus 32 control characters.

Cursor is solid video inversion (switch selectable blink); cursors are programmable.

Display output is standard EIA; 1.0 to 2.5 volts pp with composite negative sync, 7 MHz nominal signal bandwidth.

Microprocessor

8080, 8080A or 9080A

Internal Memory

RAM 1024 8-bit words of System RAM
1024 8-bit words of Display RAM

ROM up to 2048 bytes of ROM, EPROM or PROM on 1.6" x 3" plug-in personality modules.

External Memory

Expandable up to a total of 57344 8-bit words of either RAM or ROM.

Serial Interface

RS-232 and 20ma current loop, 75 to 9600 baud (switch selectable), asynchronous.

25 pin EIA connector included on the card.

Parallel Interface

Eight bits each, input and output, plus control handshaking signals. Output lines are three-state TTL for bi-directional interfaces.

25 pin connector included on card.

Keyboard Interface

Seven level ASCII encoded, TTL levels, eighth bit indicates special not transmitted control code. Strobe must be a pulse of between 2 and 10 micro-seconds duration after data is stable.

Keyboard

70 keys (15 key arithmetic pad optional) 8 level USASCII coded, upper and lower case with shift lock and upper case only mode. Full cursor control; up, down, right, left, home, clear, included.

Sol-ACI Audio Cassette Interface

Dual rate: 300 or 1200 bits per second, program controlled.

Recording technique: "CUTS/Byte standard" compatible, asynchronously Manchester coded at 1200/2400 Hertz or 600/1200 Hertz.

Self-clocking with phase-lock loop.

Automatic-Level Control used in both playback and record modes.

Power Required

(Sol-PC unit only)
+ 5 volts \pm 5% at 2.5A
+ 12 volts \pm 5% at 150mA
- 12 volts \pm 5% at 200mA

ORDER FORM

Sol Systems Order Form

Name _____

Organization (if any) _____

Mailing Address:

Street _____

City _____ State _____ Zip _____

Shipping Address (if different)

Street _____

City _____ State _____ Zip _____

- I am enclosing full payment. I understand shipments of Sol products will begin in September 1976, and that I may cancel my order for a full refund at any time before shipment.
- I am enclosing 25% deposit. Please ship my order with the balance and freight charges, COD. (USA only.)
- Please charge to my credit card. **Processor Technology** will not process billing until your shipment is ready.

Master Charge # _____

Expiration date _____

Valid date (if any) _____

Signature _____

International orders: We will acknowledge your order with a quotation of shipping charges.

Prices, specifications and terms subject to change without notice.

Is this your first order from **Processor Technology**? yes no

PRICE LIST

SOL SYSTEM PRICE LIST

Valid Only Until Aug. 31, 1976
Prices Shown are Net

Sol Terminal Computer

Personality Module Option

	CONSOL™	SOLED™	SOLOS™
Sol-PC Single Board Terminal Computer™ without IC Sockets.....	\$297	\$435	\$435
Sol-10 Terminal Computer™ includes Sol-PC, cabinet power supply and 70 key keyboard (without IC sockets).....	\$497	\$635	\$635
Sol-20 Terminal Computer™ Mainframe, Sol-10 with additional expansion power supply, card case, and five-slot backplane with connectors, and cooling fan. (Sockets included for all IC's.).....	\$750	\$888	\$888

Sol Personality Modules (if purchased separately)

SOLED Terminal Computer Editor System Module.....	\$150
SOLOS Sol Operating System Module.....	\$150

Sol Optional Accessories

Sol-SS IC Socket Kit for all Sol units; low profile, premium quality sockets (highly recommended for kit construction).....	\$40
Sol-ACI Audio Cassette Interface for two recorders.....	\$55
Sol-KP Fifteen key Arithmetic Keypad.....	\$35

Prices, specifications subject to change without notice.

ORDER FORM

We pay shipping on prepaid orders;
USA, Canada only. (Normally UPS.)

Quan.	Part No.	Description	Price	Amount

D Processor Technology
6200 Hollis Street
Emeryville, CA 94608
(415) 652-8080

Subtotal
Calif. residents add 6% tax
COD orders, add \$5.00 handling charge
Orders under \$50, add \$5.00 handling charge
Total
Amount Enclosed
US Funds only.

How Far Can You Go

Find out—by adding 8080 compatible

3P+S Input/Output Module

Our 3P+S is a simple inexpensive answer to handling a variety of peripheral devices. It has **two 8-bit parallel I/O ports**, with full handshaking logic. Plus, it has a **serial I/O port**, with a data rate range from 35 to 9600 Baud. Simultaneously handle a paper tape reader, a keyboard, a TV terminal, a tape punch, **and** a telephone coupler! Available with premium grade low-profile IC sockets, **\$149**. Owner's Manual, **\$4.95***

ALS-8 Assembly Language Operating System

Just turn on the switch, and instantly you have the power to **write, edit, assemble, de-bug, and run your own programs**. The **ALS-8** is the most **useful** software development tool available today. Optional firmware includes **SIM-1**, an interpretive simulator, that simulates programs without running them in real time. Thus, errors encountered during testing do not endanger your entire system. The **TXT-2** firmware adds the dimension of text editing. Insert, delete, move entire lines or single characters, and much more! **ALS-8** (assembled only), **\$425**. **SIM-1**, **\$95**. **TXT-2**, **\$95**.

VDM-1 Video Display Module

If you're setting up just the system you really want, don't fall short by limiting its communicating ability. The **VDM-1** is an **ultra-high speed** video output device. Its **16 display lines** have **64 characters each, upper and lower case**. 1024 bytes of random access memory are on the card. It scrolls up or down, **even to 2000 lines per minute!** Any combination of the 1024 cursors can be displayed as black-on-white or vice versa. **Free terminal mode software is included**, along with premium grade, low-profile IC sockets. **\$199**. Owner's Manual, **\$4.95***

8KRA Static Memory Module

We now offer a low-power static memory module, with a **full 8192 bytes of memory**.

It has an exclusive **KSET™** address selection DIP switch, so you can conveniently set address boundaries in increments of 1K. **Our low-power RAM's typically require one-third less power** than those commonly used by our competitors. They'll even retain memory for 4-5 hours when powered by two "D" flashlight cells. **On-board recharging circuitry and battery connectors** make it possible to protect your data against sudden power loss. Each RAM has its own IC socket, too, for easier assembly and repair. **\$295**. Owner's Manual, **\$4.95***

2KRO EPROM Module

The **2KRO Read Only Memory** will accept up to eight 1702A or 5203 EPROM's (not included), providing 2048 eight-bit words of non-volatile storage for monitor, executive, loader and other programs. Programming services available from your dealer or write us for details. **\$65**. Owner's Manual, **\$4.95***

4KRA Static Memory Module

The **4KRA** (4096 bytes) was our first static memory module. It's still very popular, and uses the same **low-power static RAM's** as the 8KRA. Plus, we've added a **DIP switch**, and **every RAM now has its own premium grade, low profile IC socket**. **On-board recharging circuitry** (with battery backup) makes it possible to retain memory for 8-10 hours during power failure. **\$159**. Owner's Manual, **\$4.95***

MB-1 Mother Board

Our single piece **Mother Board** for the Altair 8800 gives you 16-card capacity in one single installation. Available with 12 (**MB-12**) or 16 (**MB-1**) slots. **\$70**. (Discontinued; limited to stock on hand.)

Wire Wrap Board

Do your own wire wrap prototyping with the **WWB Wire Wrap Board**. Up to 62 16-pin sockets or various combinations of 14, 16, 24 and 40-pin sockets. **\$40**.

EXB Extender Board

The **EXB Extender Board** allows accessibility in servicing any 8080-compatible module. **\$35**.

*Fully descriptive Owner's Manual available separately. Price refundable with purchase of kit.

On The 8080 Bus?

products from Processor Technology.

Whether your minicomputer system is Sol, IMSAI, or Altair, its real capabilities depend on what goes inside. **Processor Technology Corp.** now offers a full line of 8080-compatible components. From fine static memories to a unique assembly language operating system. We also have a variety of useful software packages, available for little more than copying costs.

Kit Prices are shown, and they include the **Owner's Manual.** Assembled units available at slightly higher prices.

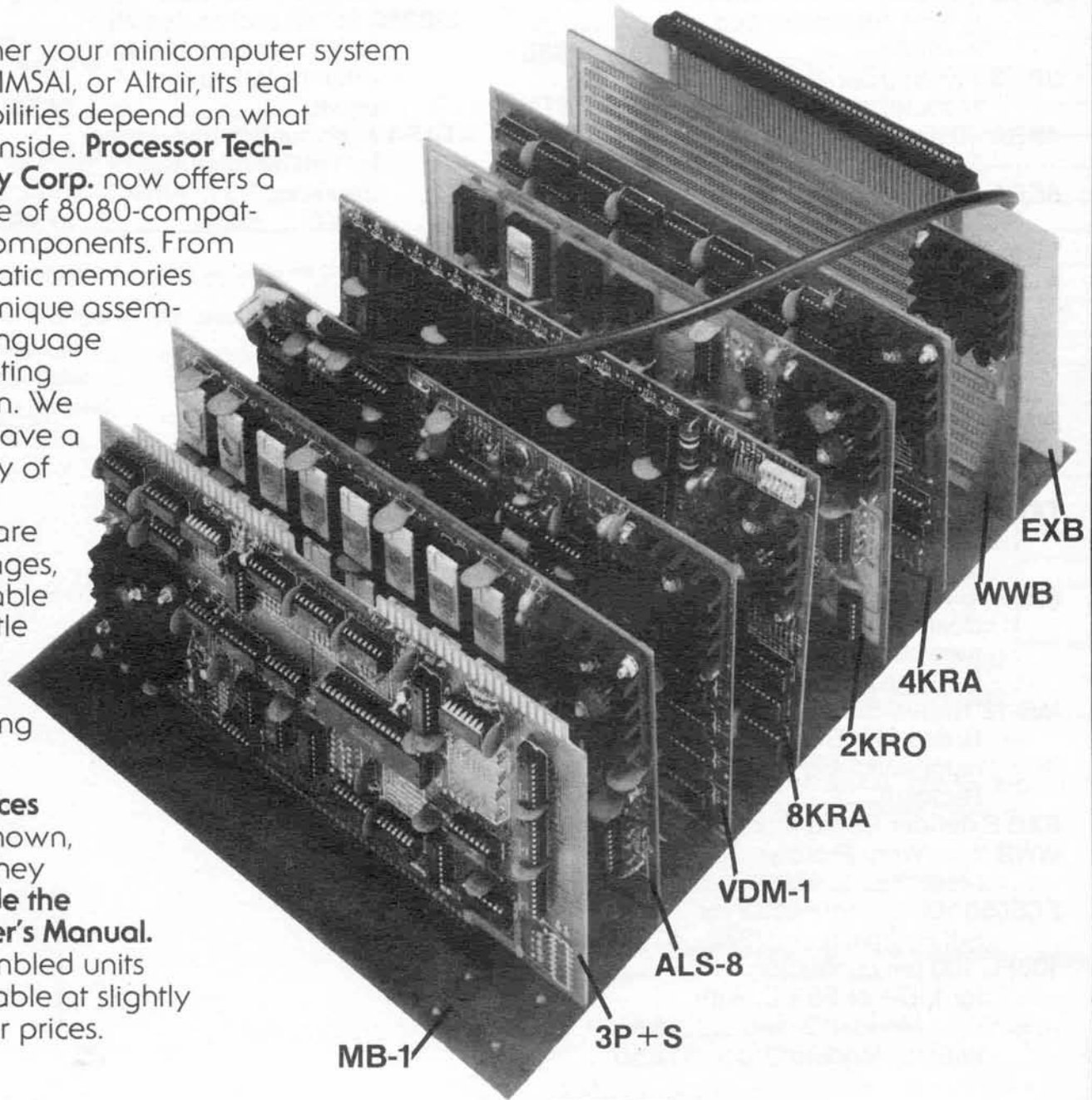

Write Us for further details on all our 8080-compatible products, and for the dealer nearest you.

Processor Technology
6200 Hollis Street
Emeryville, CA 94608

PRICE LIST

PRICE LIST

Effective August 1, 1976

	Kit Price	Assembled
2KRO Erasable PROM Module (TRF-1 recommended in Altairs)_____	\$65	\$89
3P+S Parallel/Serial I/O Module**_____	\$149	\$199
4KRA 4096-Word Low-Power Static RAM Memory____	\$159	\$195
8KRA 8192-Word Low-Power Static RAM Memory____	\$295	\$375
VDM-1 Video Display Module_	\$199	\$295
ALS-8 Assembly Language Operating System Firmware Module (TRF-1 required in Altair 8800)_____	na	\$425
SIM-1 Interpretive Simulator Firmware Expansion Module for ALS-8_____	na	\$95
TXT-2 Text Editing and VDM Interface Firmware Expansion Module	na	\$95
MB-1* Sixteen-Slot Mother Board with Bus Terminator and Card Guide Package_____	\$70	na
MB-12* Twelve-Slot Mother Board with Bus Terminator and Card Guide Package_____	\$70	na
EXB Extender Board Module_	\$35	\$45
WWB Wire Wrap Prototyping Module_____	\$40	
EC5050 100 pin connector for Sol System and IMSAI_	\$7	
100PC 100 pin connector; for MB-1 or 88-EC. With Module Order_____	\$8.95	
Without Module Order	\$12.50	

**44PC 44 pin edge connector; two required with 3P+S. \$3.00

DB25P 25 pin plug and hood (male) for cables plugging into DB25S_____ \$4.50

DB25S 25 pin socket (female) for I/O connections on Altair or IMSAI rear panel_____ \$4.50

TRF-1 High current transformer for PROM modules (replaces T-3 in Altair 8800)._____ \$7.95

*MB-1 and MB-12 are being discontinued. Orders will be accepted only until present stock is depleted.

 **Processor Technology**
6200 Hollis Street
Emeryville, CA 94608
(415) 652-8080

MOST COMPUTER TERMINALS ARE DUMB, BUT OUR TERMINAL COMPUTER CAN LEARN TO THINK FOR ITSELF.

Terminal Computer?

As the name implies, the *Sol Terminal Computer*[™] is both terminal and computer. When used as a terminal, the *Sol* computer intelligence is placed between the keyboard, the video display and the on-line connection.

To a beginner, this intelligence means faster learning and a smoother operation of the strange unfamiliar beast he is facing. A stored program can allow him to enter lines on the screen, edit his mistakes and then, when ready, send the line or lines to the computer. Also, the System Error messages can be received by the same program, interpreted, and explained in simpler terms or with more detail by the intelligence of the terminal.

To an experienced user, the *Sol* intelligence represents a great increase in both the power and efficiency of his expensive on-line computer time. With the proper program, the terminal allows off-line editing, storage and data messaging. In some cases, the main computer is used only on a "batch" basis to receive the processed data for re-entry to the data base.

The *Sol* was introduced as an *Intelligent Terminal* and the implementation, as well as software support, rival all such terminals presently on the market.

A Stand Alone Computer?

The *Sol Terminal Computer*[™] is an excellent single board micro-computer. In keeping with Processor Technology's strict design standards, every aspect of the circuitry was engineered specifically for its role in this versatile, expandable system. Expansion capability is guaranteed by *Sol*'s plug-in compatibility with Processor Technology's full line of memory and interface modules. Processor Technology makes virtually everything you need to build complete turn-key computer systems.

The basic *Sol* includes these features:

1. An 8080 micro-processor chip supported by circuitry to allow full implementation of every 8080 function.
2. 1024 words of **static, low power RAM**, capable of full speed operation.

3. A **UART** controlled serial I/O port with multiple baud rates.
4. A **video display** circuit identical to the **VDM-1** sold by Processor Technology. This includes an additional 1024 words of RAM making a total of 2048 words on board.
5. A **parallel input-output port** for data communications with fully implemented handshaking circuitry.
6. A **keyboard input port**.
7. A PROM/ROM plug-in personality module for up to 2048 words of stored program.
8. **Audio cassette tape interface** (circuitry optional) on the board.
9. **Bus compatibility** with all **Processor Technology** hardware and firmware products.

Add to these features, the handsome cabinet (which includes a power supply and specially designed 70-key solid state keyboard), and you have a stand-alone computer as capable as any 8080 system sold today. Admittedly, there are no flashing lights or toggle switches (our lights are numbers on the screen, and our switches are the keys of the keyboard), but the *Sol* can be configured to run *any* 8080 software and is talking to you when power is first turned on.

To sum it up . . .

***Sol* is a low cost CRT terminal for teletype replacement.**

***Sol* is an editing terminal with off-line mass storage, auxiliary hardcopy output and customized communications protocol.**

***Sol* is a stand-alone microcomputer system for small business record keeping, control of heating and lighting systems, solution of complex statistical or engineering problems, or sophisticated game playing.**

***Sol* is a powerful educational tool for learning about computers.**

Sol can be any or all of these, because it is both a terminal and powerful programmable micro-computer at once!

 **Processor
Technology**
6200 Hollis Street
Emeryville, CA 94608
(415) 652-8080

THE DETAILS

Here Are The Details . . .

At the heart of the *Sol System* is an 8080 microprocessor, a single integrated circuit which controls all internal *Sol* functions as well as routing data to/from the keyboard, CRT and external peripheral devices. All of these functions are controlled and determined by modular, internally stored programs.

Other on-board circuitry converts signals representing operator information into a video signal for display on a standard video monitor or modified television set. This presentation occurs at a rate so close to instantaneous that part of the operating program is used to allow display rate selection.

Basic system operating modes are stored in ROM or PROM on plug-in personality modules with a capacity of up to 2048 words. These modules may be changed in a few seconds to totally reconfigure the system for different applications. Also, other operating programs, such as **BASIC** and **FOCAL** high level languages, can be loaded automatically into read/write memory (RAM) from cassette tape or floppy disc.

All *Sol System* hardware elements are implemented on a single 10" x 16" printed circuit board. This board supports the 8080 microprocessor, expansion bus interface, both parallel and serial communications interfaces, 2048 words of internal random access memory (1024 words for display), up to 2048 words of Read Only Memory on personality modules, keyboard interface, video display generator and audio cassette tape storage option.

Software control programs for the operation of *Sol* are designed for three different levels of use. The first program, **CONSOL**[™], is contained on a single

PROM and is designed to allow simple terminal operations. In addition, **CONSOL** allows direct control of the basic computer functions for entering data to, or examining data in, any memory location, or executing a program stored at a known location in memory.

The second level, designed for advanced terminal operations, is the **SOLED**[™] editing terminal system. **SOLED** uses the full 2048 word capacity of a personality module and contains code to allow screen, file and cassette tape editing/transmission operations.

The stand-alone operating system, **SOLOS**[™], turns the *Sol* into a versatile computer that is easier to use, but every bit as powerful as any 8080-based system available today. Using **SOLOS** and the built-in cassette interface, **BASIC** can be loaded in less than a minute following power-on. **BASIC** programs can be both saved and executed from cassette. (We include this special version of **BASIC 5** with each cassette interface sold.) The *Sol* operating under **SOLOS**, brings true 8080 computer power away from hardware tinkering to direct application and problem solving.

The systems are available in three minimum hardware configurations.

1. A single board micro-computer/terminal, *Sol-PC*, with all standard features including the **CONSOL** personality module.
2. The *Sol-10*, which adds a beautiful cabinet, power supply and 70-key solid state keyboard (expandable to 85 keys) to the *Sol-PC*. Both the cabinet and keyboard were designed and manufactured specifically for the *Sol System*.
3. *Sol-20*, the expandable *Sol*, is designed especially for stand alone or extended terminal applications where additional memory and special interfaces are desirable. The *Sol-20* adds all *Sol-10* components to the *Sol-PC*, as well as 8 amps of additional power supply capacity and, inside the case, a five slot expansion chassis and card frame. All Processor Technology bus compatible modules plug in through a special access door at the rear of the *Sol* cabinet. All components remain within the case, cooled by the integral *Sol-fan*. (Our modules work in the Altair 8800 and IMSAI 8080, too!)



6200 Hollis Street
Emeryville, CA 94608
(415) 652-8080

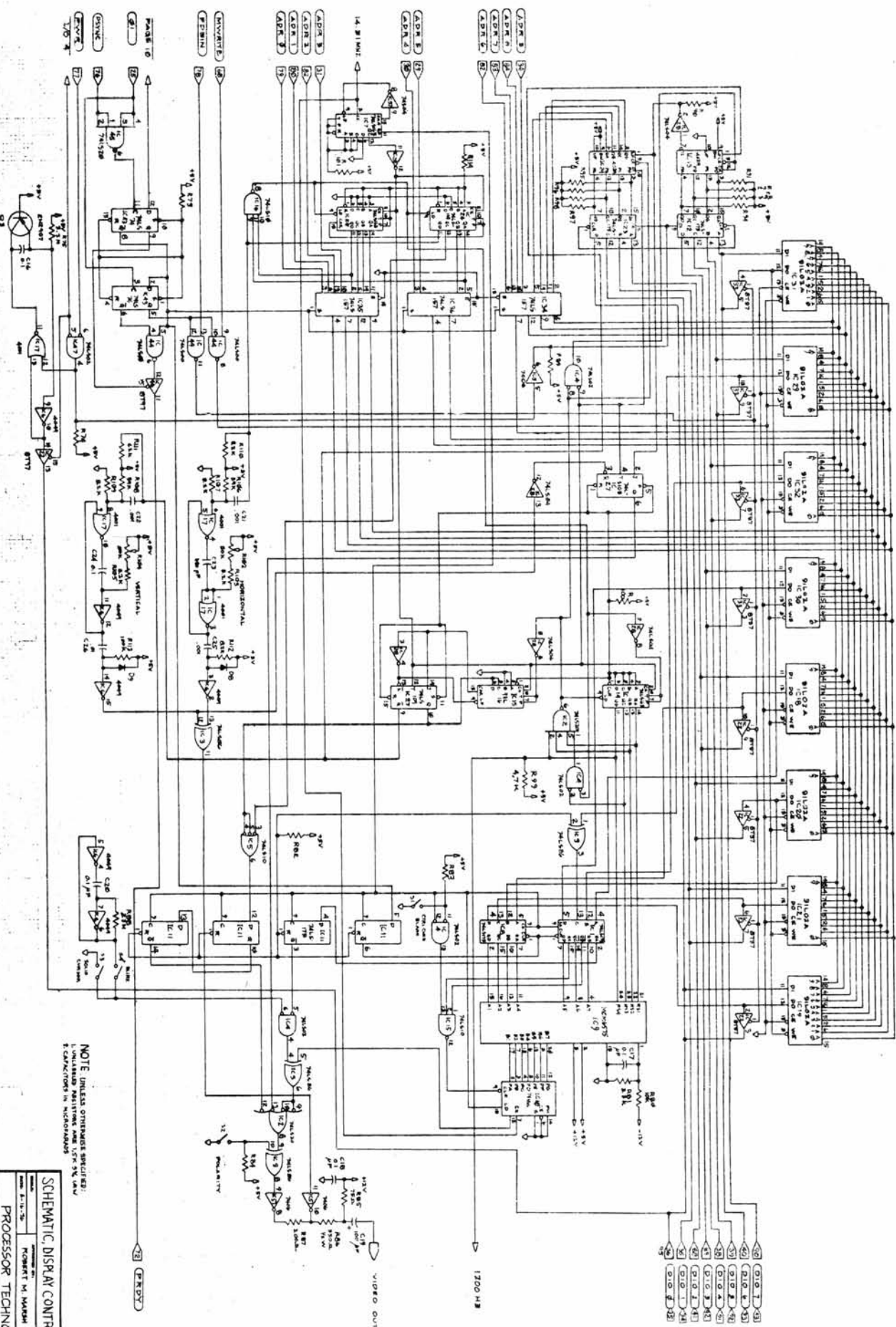

NOTE: UNLESS OTHERWISE SPECIFIED:
 1. UNLESS INDICATED OTHERWISE, ALL RESISTORS ARE 1/4W 5% VOLTAGE
 2. CAPACITORS IN MICROFARADS

SCHEMATIC, DISPLAY CONTROL, S-1-1
 DATE: 4-11-76
 ROBERT M. MARSH
 PROCESSOR TECHNOLOGY

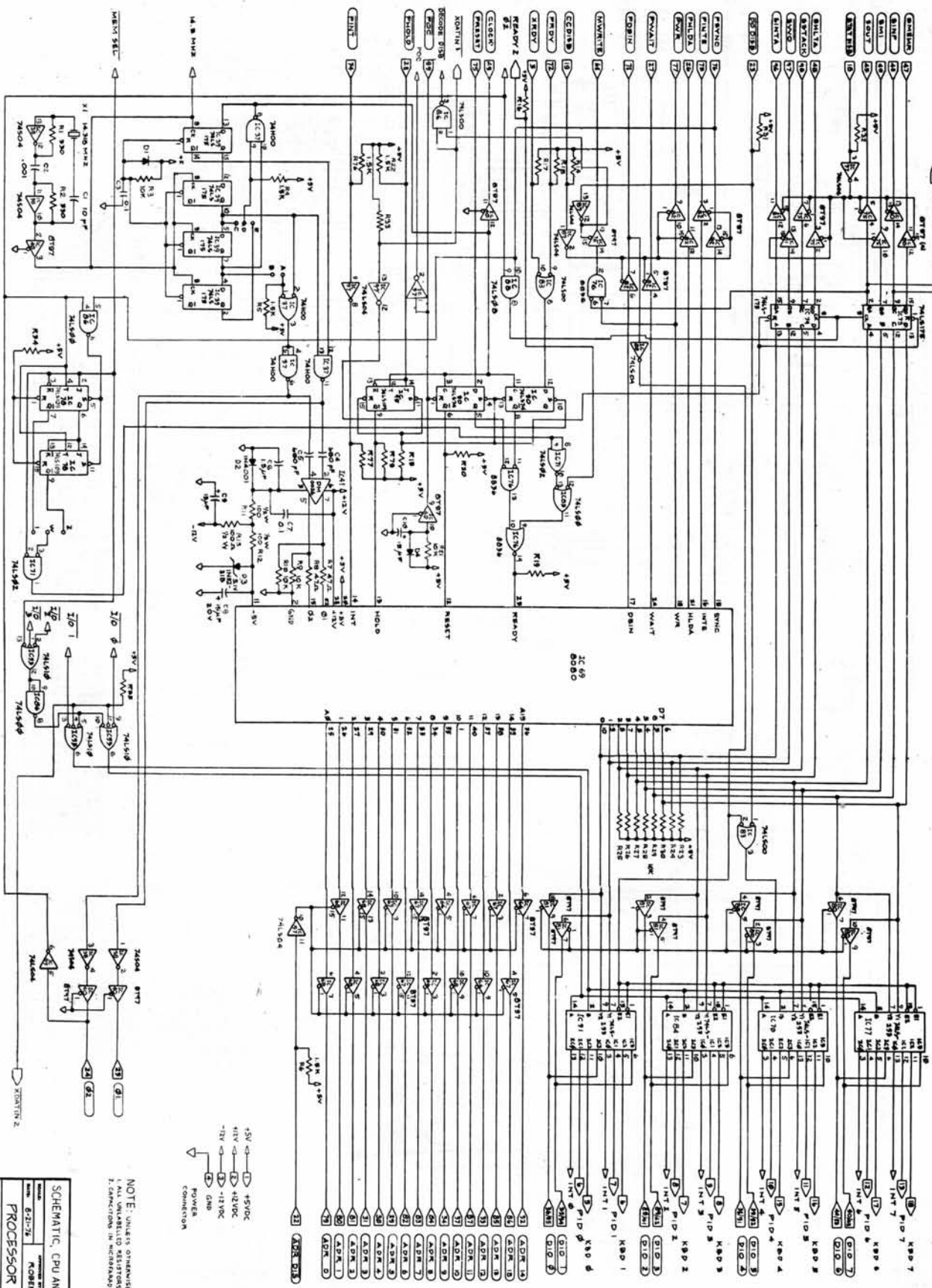

NOTE: UNLESS OTHERWISE SPECIFIED:
 1. ALL UNLABELLED RESISTORS 1.5% 1/4W 0.8%
 2. CAPACITORS IN MICROFARADS

SCHEMATIC, CPU AND BUS, Sol - I
 DATE: 8-21-78
 DRAWN BY: ROBERT W. MARSH
 CHECKED BY: [Blank]
 APPROVED BY: [Blank]
 PROJECT: PROCESSOR TECHNOLOGY



TOP

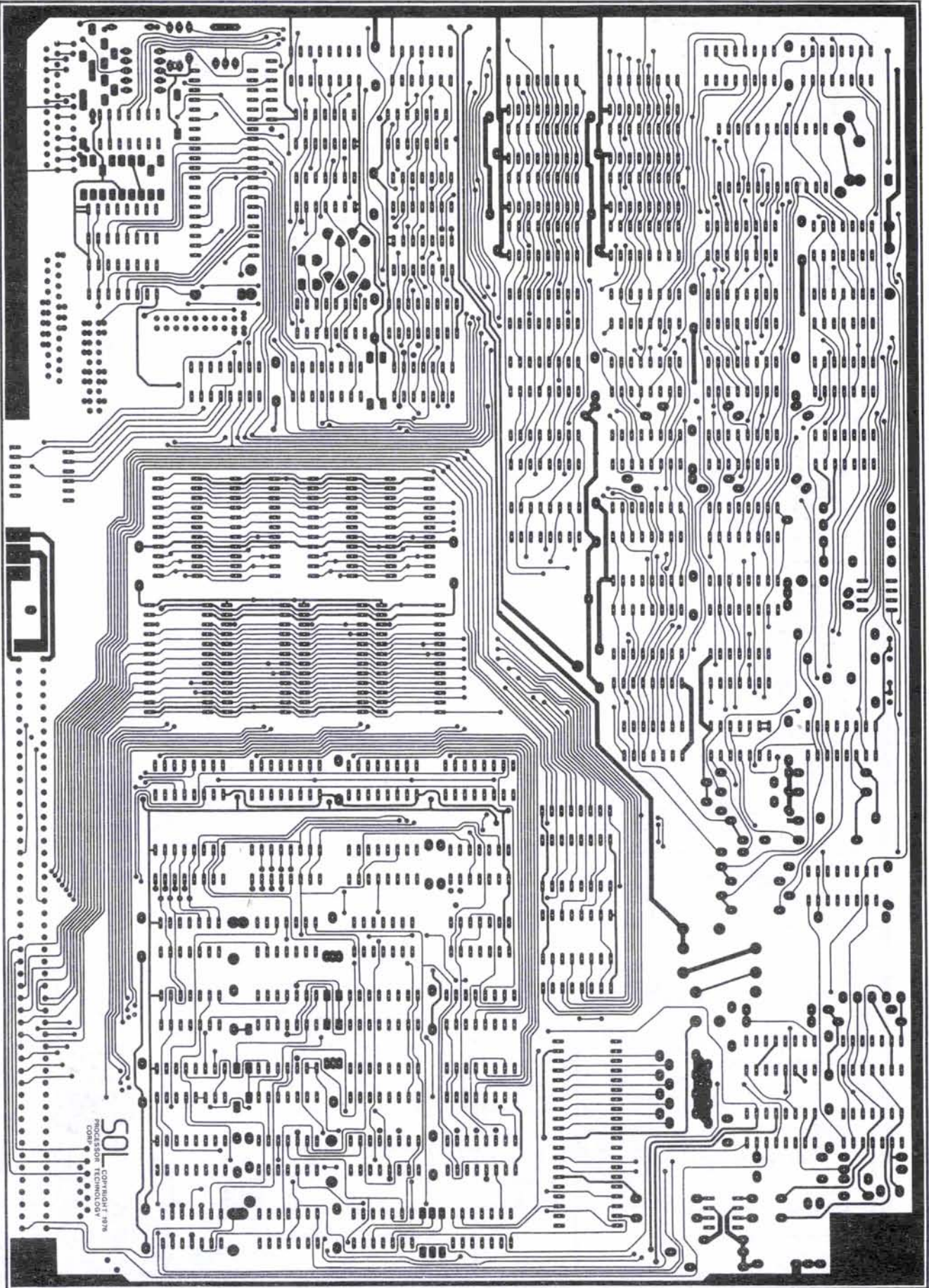

50
 COPYRIGHT © 1978
 PROCESSOR TECHNOLOGY
 CORP.



517222

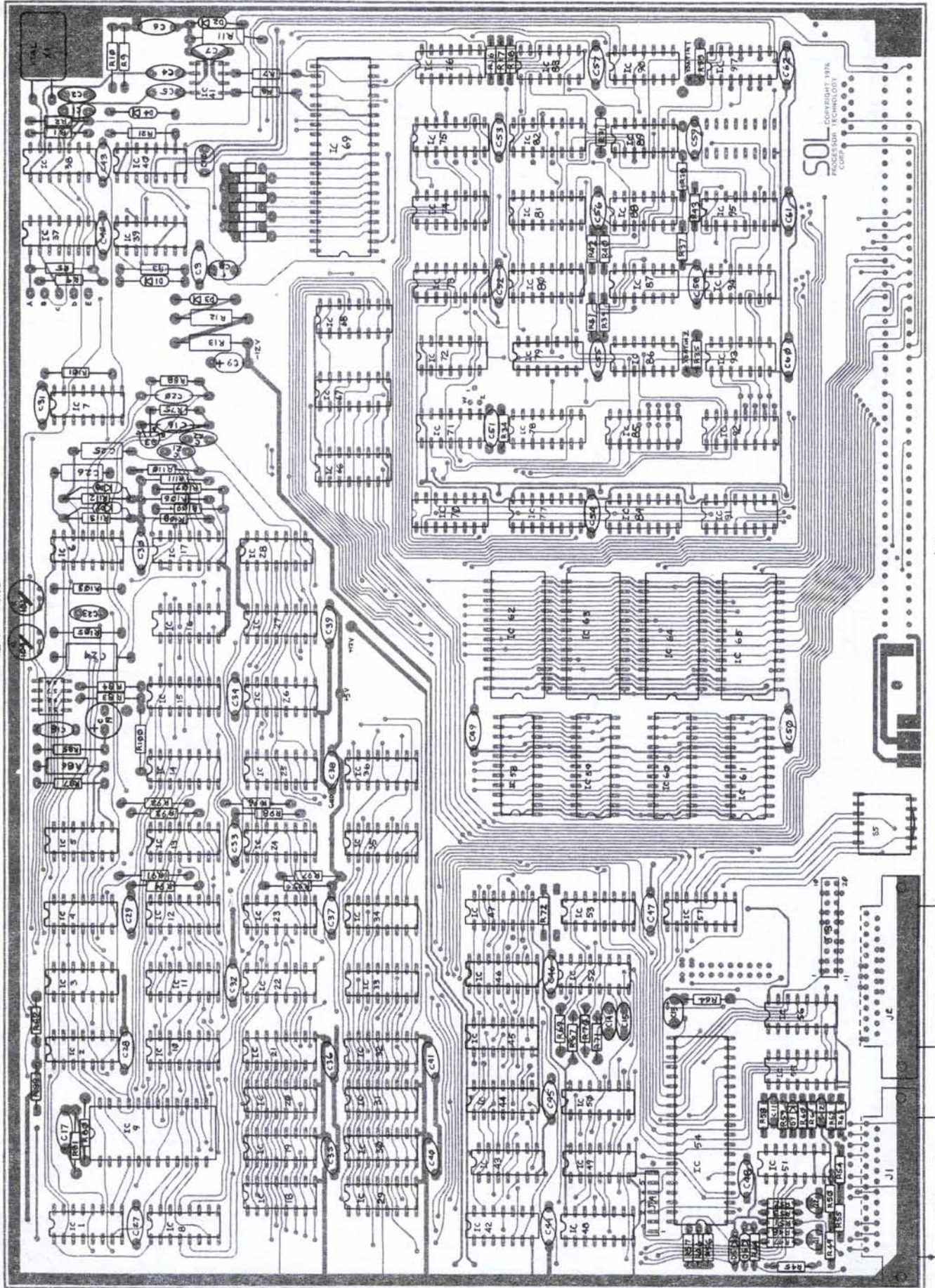

COMPONENT LOCATION DIAGRAM Sol - I

TOP

SOL
COMBRIGHT 1974
PROFESSOR TECHNOLOGY
CORP.

VERT. HORZ.