

# **Cromemco's**

# **Z-1**

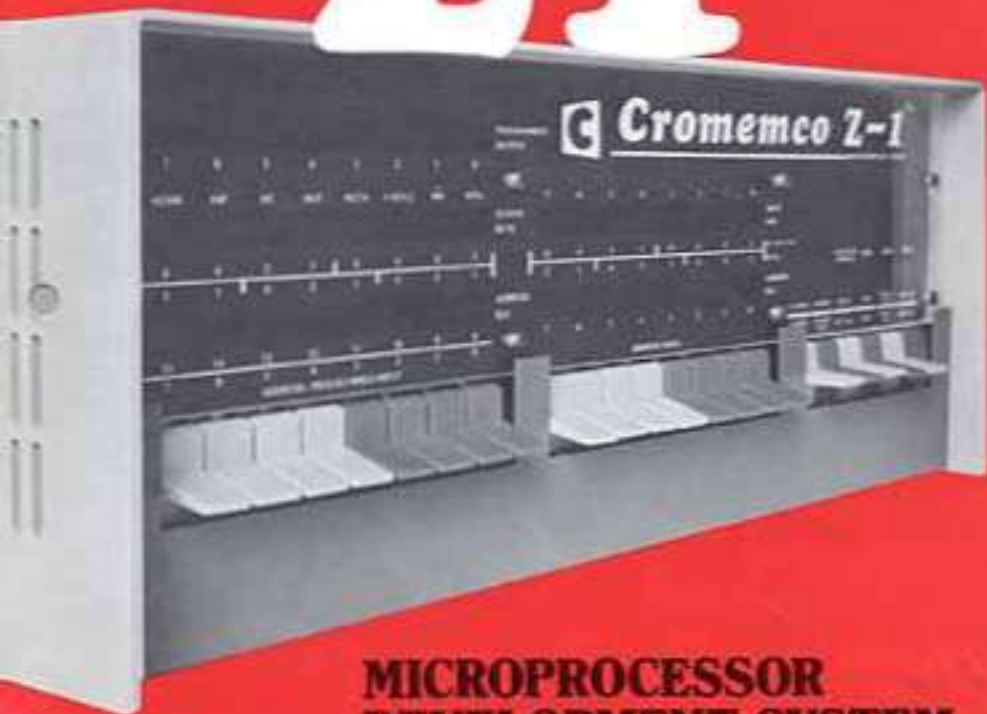

## **MICROPROCESSOR DEVELOPMENT SYSTEM for the Z-80 Microprocessor**

The easiest, fastest and most economical tool  
available to assist you in engineering your  
circuits or system  
around the Z-80 microprocessor.

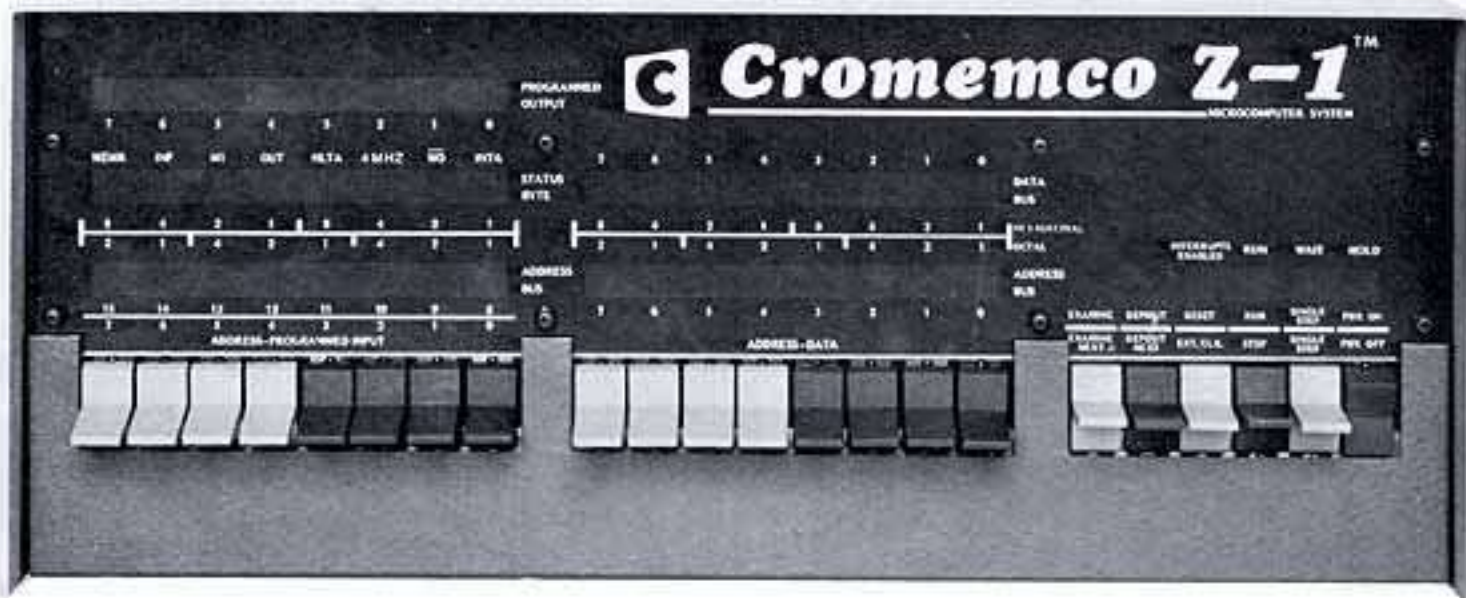

## A new type of laboratory tool

### Both a powerful microcomputer and a full system with broad peripheral support

The Cromemco Z-1 is an important new laboratory tool that greatly expedites engineering work with the recently announced Z-80 microprocessor.

Basically, the Cromemco Z-1 is a powerful microcomputer — in fact, the most powerful one around.

But it is also much more. It is a microcomputer that is electrically and physically arranged to be ideal for doing development work with the new Z-80 in the easiest and fastest way.

And it is also a *system* — one that has the broad peripheral support needed when you're doing development work.

#### 22 card sockets

To begin with, the Z-1 has 22 card sockets available for your uses. These are tied to the computer bus and located in a rugged card cage on a motherboard fed from a heavy-duty 28-amp power supply — ample power for virtually any group of circuit cards you may wish to work with.

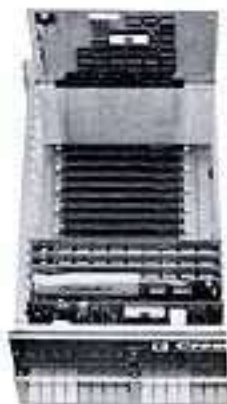

Rugged card cage of Z-1 has 22 card sockets to receive a wide variety of peripherals and/or circuits under design. At rear of cage Cromemco Extender Card is used to raise card for easy access for instrument probes for troubleshooting, soldering, etc.

#### Just plug in peripherals

These 22 sockets give you enormous flexibility and convenience in your work. They let you plug in the wide variety of circuits that are often necessary when customizing a microprocessor system to your particular application.

In addition to breadboard circuits, for example, you can plug in additional memory, additional input/output interface cards, additional programmed read-only memory (firmware), or other peripherals.

#### A powerful microcomputer with much higher throughput

Note, too, that the Z-1 is a powerful microcomputer in its own right. And it has important features not found in other microcomputers.

First, the Z-1 uses as its own CPU a special high-speed version of the Z-80 CPU. This version is known as the Z80/4 and is certified by its manufacturer to operate at a 4 MHz clock rate. That in itself gives you twice the throughput of 2 MHz-rate computers. In addition, the greatly increased power of the Z-80 instruction set offers you another large increase in throughput.

#### Selectable 2 or 4 MHz clock

In the Z-1 we give you a switch that lets you choose either a 2 MHz or 4 MHz clock rate. This choice lets you continue to use the Z-1 with present systems that operate at a 2 MHz rate.

An important aspect of the new Z-1 is that it is a fully professional computer-grade system. Minimum instruction execution time, for example, is 1 microsecond and memory is expandable to 64K bytes.

#### PROM Programmer

One of the many conveniences of the Z-1 is that it contains its own PROM programmer. You can immediately put your programs into permanent memory. Further, the PROMs used are the high-speed type 2708s that are the industry standard.



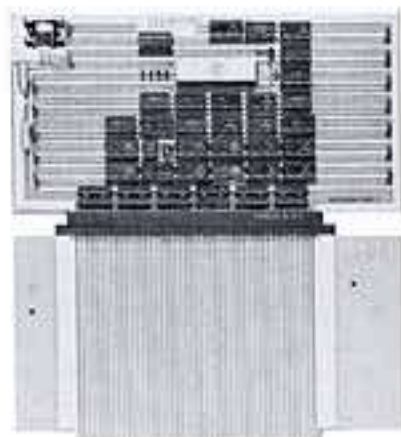
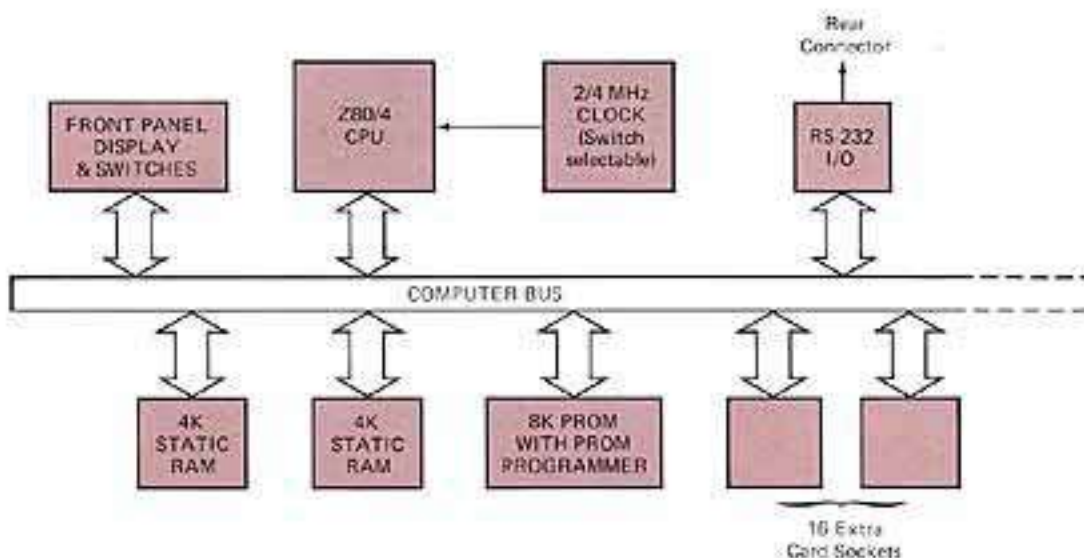

Prototype circuits readily plug into Cromemco EXC-2W Extender Card for easy access.

### Z-1 COMPONENTS

The new Cromemco Z-1 includes the following:

- Z80/4 central processor unit
- 8K static RAM memory (two 4K cards)
- 8K PROM memory (capacity for 8 2708 PROMs)
- PROM programmer
- Resident monitor (in PROM)
- RS-232 serial I/O interface

### STAND-ALONE, READY TO USE, EASILY EXPANDABLE

The Z-1 is a complete, stand-alone, ready-to-use system (but one that is easily expandable). When plugged into a 110-volt power line, it is ready to use.

If you wish to use a terminal with the Z-1, just plug it into the rear connector. The RS-232 interface puts the terminal into immediate operation. **No other connections are required.**

Some fields where the new Cromemco Z-1 is valuable in customizing microprocessor systems:

- 'smart' instrumentation
- process control
- medical electronics
- automotive diagnostics
- applied industrial control
- image processing

### Broad peripheral support

Here's a list of the peripherals that Cromemco offers for the Z-1. Note that these are all plug-compatible with the Z-1 — just plug them into the card sockets (or cards in some cases).

- 8K PROM card with programmer
- 4K RAM card
- BASIC firmware module
- Analog I/O board
- Joystick console
- Color graphic terminal interface
- Optical data digitizer

### Other peripheral support

The Z-1 is not limited to the peripherals offered by Cromemco. The Z-1 bus structure is standard and peripherals from more than a dozen other manufacturers are compatible.

### Practical, convenient working cards

Cromemco also has two cards that are highly useful in practical work. These are the WWB-2W wire-wrap card and the EXC-2W extender card. The wire-wrap card is convenient when constructing circuits. The extender card is handy for raising circuit cards above the cabinet for troubleshooting, soldering, etc.

### Proven, rugged mainframe

The Z-1 is housed in a thoroughly field-tested rugged mainframe that has a card cage widely respected for its ruggedness and usability.

### Low-priced

Despite its wide range of features, the \$2495 price of the Z-1 is well below minicomputer level — as is the price level of the support peripherals available for it.

New Cromemco Z-1 Development System is ready to use as received. If a terminal is desired, it can merely be plugged into RS-232 I/O socket on back of Z-1 cabinet.





## Cromemco Peripherals for the Z-1 Microprocessor Development System

The support Cromemco offers for the Z-1 includes the following wide range of peripherals:

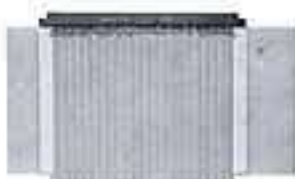
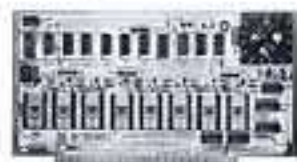

- 8K PROM card with programmer. Gives you additional memory in 8 high-speed 2708 PROMs. \$845. Model 8KBS-W.
- BASIC firmware module. This BASIC interpreter is supplied in three PROMs which plug into positions on the PROM card supplied with the Z-1. \$225. Model BFW-1
- High-speed 4K static RAM card. For use in either 2 MHz or 4 MHz operation. \$295. Model 4KZ-W.
- Fast 7-channel digital-analog I/O. Extremely useful I/O board that inputs 7 analog channels into the Z-1 and outputs 7 Z-1 ports as analog channels for external use. Only 5.5 microsecond conversion time. Also has 8-bit parallel digital channel. \$245. Model D+7A-W.
- Joystick console with speaker. Two axis. This is not merely a joystick by itself but also has 4 pushbutton switches and a built-in speaker with speaker amplifier. Can be used for games, interactive graphics, cursor positioning, and process control. Note that this console will give you an acoustic output which can greatly enhance games and other positioning applications. Interface console to Z-1 with D+7A I/O card. Requires only about one-quarter of card channels — two joysticks take only half of card channels. \$95. Model JS-1-W.
- Color graphics interface. Lets you use ordinary color TV set as a full-color computer graphics terminal. You can have full-color games, charts, graphs, educational displays on an extremely modest budget. \$350. Model CGI-W.
- Low-cost optical data digitizer. A small, rugged camera useful for image recognition, process control, or other industrial applications. Uses IC image sensor array that produces 1024-element (32 x 32) picture. Interface controller board also available to give software control of exposure, frame rate and memory allocation. Model 88-ACC-W. \$295 w/o controller. Model 88-CCC-W controller. \$295.
- Wire-wrap card. A quality wire-wrap card for constructing your own circuits. Holds over 70 integrated circuits. 5-volt power supply included on card. Cromemco quality with tantalum decoupling capacitors and disc ceramic bypass capacitors. Can be used with extender card below. \$45. Model WWB-2W
- Extender card. Immensely useful when experimenting or troubleshooting. Extends computer cards including above wire-wrap card above computer cabinet for easy soldering or connecting voltmeter, probe, scope, etc. \$45. Model EXC-2W.

Data subject to change without notice. Prices f.o.b. factory.



# Cromemco

Specialists in computers and peripherals

2432 CHARLESTON RD., MOUNTAIN VIEW, CA 94043 • (415) 964-7400

THE MICRO STORE

634 S. CENTRAL EXPRESSWAY

RICHARDSON, TEXAS 75080