

*Cromemco*<sup>®</sup>  
**SYSTEM THREE**  
Instruction Manual

CROMEMCO, Inc.  
280 Bernardo Avenue  
Mountain View, CA. 94043

Part No. 023-6038

March 1983

Copyright © 1982, 1983  
CROMEMCO, Inc.  
All Rights Reserved

This manual was produced using a Cromemco System Three computer with a Cromemco HDD-22 Hard Disk Storage System running under the Cromemco Cromix® Operating System. The text was edited with the Cromemco Cromix Screen Editor. The edited text was proofread by the Cromemco SpellMaster™ Program and formatted by the Cromemco Word Processing System Formatter II. Camera-ready copy was printed on a Cromemco 3355B printer.

Cromix® is a registered trademark of Cromemco, Inc.

CP/M™ is a trademark of Digital Research, Inc.

UNIX® is a registered trademark of Bell Telephone Laboratories.

## TABLE OF CONTENTS

<b>Chapter 1: INTRODUCTION</b>	<b>1</b>
The System Three	2
Disk Drive	2
Processor	3
Operating System	3
Using this Manual	3
<b>Chapter 2: SETTING UP THE SYSTEM</b>	<b>5</b>
Positioning the System	5
Unpacking the System	5
Specifying the Line Voltage	6
Connecting the Terminal(s)	9
Turning On the System	11
Using Floppy Diskettes	13
Parts of the Diskette	13
Diskette Preparation	15
Inserting a Diskette	15
Removing a Diskette	16
<b>Chapter 3: TESTING THE SYSTEM</b>	<b>17</b>
Testing the Connections	17
Testing the Memory and Disk Drives	18
Loading RDOS	18
Memory Test	19
Floppy Diskette Read Test	20
Floppy Diskette Write Test	22
<b>Chapter 4: LOADING THE OPERATING SYSTEM</b>	<b>25</b>
Loading the CDOS Operating System	25
Loading the Cromix Operating System	26
<b>Chapter 5: USING THE DISK DRIVES</b>	<b>29</b>
Using Disk Drives under the CDOS Operating System	29
The Current Drive	29
Transferring Files under the CDOS Operating System	30
Using Disk Drives under the Cromix Operating System	30
Copying the System Diskette onto the Hard Disk	31
Transferring Files under the Cromix Operating System	32

<b>Appendix A: THE BACK PANEL</b>	35
Tags and Labels	35
Fuses	37
Reset Switch	37
Locations for Input/Output Connectors	37
<b>Appendix B: ADDING BOARDS TO THE SYSTEM</b>	39
<b>Appendix C: CONNECTING A PRINTER</b>	43
<b>Appendix D: POWER SUPPLY AND FUSES</b>	45
Fuses	45
Line Fuse	45
Power Supply Fuses	46
Hard Disk Drive Fuse	46
Power Supply LEDs	47
<b>Appendix E: SUMMARY OF BOARDS INSTALLED IN SYSTEM                   THREE MODELS</b>	49
<b>Appendix F: SWITCH SETTINGS AND CABLE CONNECTIONS</b>	51
Switch Settings	51
Cable Connections	58
Priority Interrupt Cable	58
MCU and MSU M-Bus Cable	59
<b>Appendix G: ADVANCED FEATURES OF THE RDOS BOOT                   COMMAND</b>	61
<b>INDEX</b>	63
<b>LIMITED WARRANTY</b>	
<b>SCHEMATICS</b>	

## LIST OF FIGURES

Figure 1-1:	The System Three with Two Floppy Disk Drives	1
Figure 2-1:	Opening the Front Panel	7
Figure 2-2:	Removing the System Cover	8
Figure 2-3:	The Tap-Select Cable	8
Figure 2-4:	Terminal Cable Connectors	10
Figure 2-5:	Location of Line Cord Socket and Power Switch	11
Figure 2-6:	Turnkey Power Switch	12
Figure 2-7:	The 8-Inch Floppy Diskette	14
Figure 2-8:	Inserting the Diskette and Closing the Latch	16
Figure A-1:	The Back Panel	36
Figure B-1:	Extending the Card Cage and Removing the Retaining Bar	40
Figure B-2:	Inserting a Circuit Board	40
Figure B-3:	The Cable Guide	42
Figure C-1:	The PRI Printer Interface Board	44
Figure D-1:	Location of Line Fuse and Power Supply Fuses	46
Figure D-2:	Location of Hard Disk Drive Fuse	47
Figure D-3:	Location of Power Supply LEDS	48
Figure F-1:	Switch Settings for the ZPU Board	52
Figure F-2:	Switch Settings for 64KZ-II Boards in CDOS Operating Systems	52
Figure F-3:	Switch Settings for 64KZ-II Boards in Cromix Operating Systems	53
Figure F-4:	Switch Settings for 256KZ Boards in Z80-based Systems	55
Figure F-5:	Switch Settings for 256KZ Boards in 68000-based Systems	55
Figure F-6:	Switch Settings for 256MSU Boards	56
Figure F-7:	Switch Settings for 512MSU Boards	57
Figure F-8:	Switch Settings for the 64FDC Boards	57
Figure F-9:	Switch Settings for TU-ART Boards	58
Figure F-10:	Installing the M-Bus Cable	59



## Chapter 1

### INTRODUCTION

The Cromemco System Three is a powerful microcomputer system, designed to be at home in any environment. It comes ready for use with a central processor, memory, disk drives, and boards that support the operation of one or more terminals.

Depending on the model, your System Three can run either Cromemco's CDOS or Cromix Operating System. That alone gives it the power to run most of Cromemco's software packages. If you need even more capability, you can expand the system by adding printers, floppy disk drives, terminals, memory boards, or an Input/Output Processor for better throughput on multiuser systems.

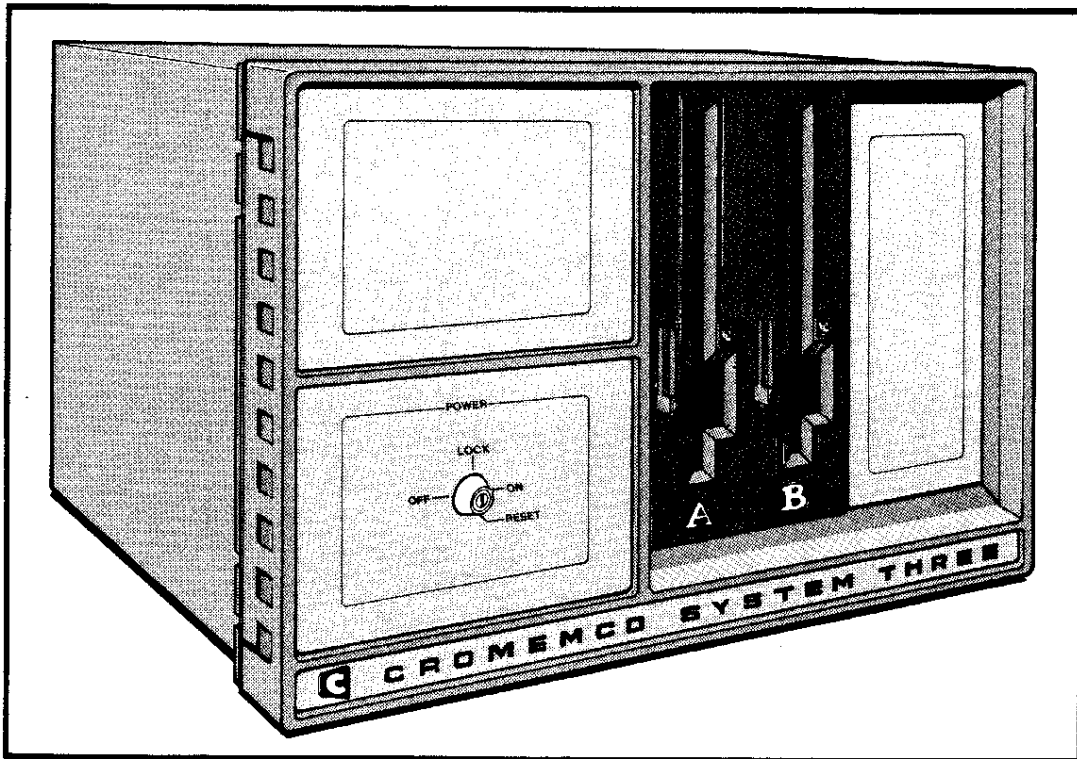

Figure 1-1: THE SYSTEM THREE WITH  
TWO FLOPPY DISK DRIVES

## **THE SYSTEM THREE**

Cromemco designed the System Three to be rugged and reliable. The panels and the interior housings are made of metal. Three fans cool the circuit boards, power supply, and disk drives. A cable guide ensures that the cables leading from the circuit boards to the connectors on the rear panel lay flat.

The System Three is flexible enough to meet your needs. The card cage has 21 slots for circuit boards. The back panel has locations for 20 DB-25 input/output connectors (for connecting additional terminals, printers, or modems), locations for two DB-37 input/output connectors (for connecting additional disk drives), and locations for four BNC connectors (for connecting an RGB color monitor). The power supply can be set up to work with any line voltage, anywhere in the world, by simply connecting the power supply cable with the proper set of pins.

The flexibility of the System Three extends to its basic configuration. Instead of a single model, the System Three has six, giving you a choice of disk drives, processors, and operating systems. The following paragraphs describe these models.

### **Disk Drive**

Disk drives are mass memory devices that store information on the surfaces of magnetic disks. Floppy disk drives use interchangeable diskettes, while hard disk drives contain hermetically sealed nonremovable platters.

The System Three comes with one of two sets of disk drives. The models CS-3A, CS-3D2, and CS-3D5E have two floppy disk drives. These drives use 8-inch diskettes and can record data on one or two sides, at single or double density. One diskette, with information recorded on two sides in a double-density format, has a storage capacity of 1.2 megabytes.

The models CS-3H, CS-3HD2, and CS-3HD5E have one floppy disk drive teamed with one Winchester hard disk drive. The hard disk can hold over 20 megabytes of data and can access the data about 10 times faster than a floppy disk drive.



## **Processor**

The processor (also known as the central processing unit, or CPU) performs all mathematical and logical operations, and interprets and executes successive program instructions.

The System Three comes with either a ZPU or DPU processor board. The models that have the ZPU board have a single, 8-bit Z80A microprocessor. The models that have the DPU board have both the Z80A and the 32-bit 68000 microprocessor.

The models CS-3A and CS-3H come with the ZPU processor board. All other models come with the DPU processor board.

## **Operating System**

The operating system is a supervisory program that handles chores such as file management, diagnostics, and Input/Output processing for terminals, disk drives, printers, and other peripheral devices.

The System Three comes with one of three operating systems. Models CS-3A and CS-3H can run either of Cromemco's 8-bit operating systems: the CDOS Operating System, which is similar to CP/M 2.2, or the Cromix Operating System, which is similar to Unix. (The 8-bit Cromix Operating System requires multiple 64KZ-II boards or a 256KZ board, and possibly one or more TU-ART boards.) All other models can run the Cromemco D-Series 68000 Cromix Operating System.

Whatever model you purchase, it comes with the full complement of circuit boards needed to run its operating system. Appendix E summarizes the boards supplied with each model, and Appendix F describes these boards and their switch settings.

## **USING THIS MANUAL**

This manual gives the information necessary to set up and start running your Cromemco System Three computer. Unless otherwise noted, the material in this manual applies to all models of the System Three. This manual does not detail the operation of any specific Cromemco software packages; this information may be found in the manuals accompanying the software.

Cromemco System Three Instruction Manual  
1. Introduction

The body of the manual, Chapters 2 through 4, gives instructions on setting up your system for use. The Appendices give you information you need to know to use your system effectively.

In this manual, you will find references to other Cromemco publications. The following list gives the title and part numbers of these manuals. You can obtain copies from your Cromemco dealer.

- Cromemco 256KZ Random Access Memory Manual  
part number 023-2021
- Cromemco 3355A Driver Manual  
part number 023-4005
- Cromemco 64FDC Floppy Disk Controller Manual  
part number 023-2022
- Cromemco 64KZ-II Random Access Memory Manual  
part number 023-2020
- Cromemco 68000 Board Family Manual  
part number 023-2016
- Cromemco CDOS Operating System Manual  
part number 023-0036
- Cromemco Cromix Operating System Manual  
part number 023-4022
- Cromemco HD5 5" Hard Disk Specification Manual  
part number 023-6028
- Cromemco PRI Printer Interface Manual  
part number 023-0055
- Cromemco TM848 Disk Drive Technical Manual  
part number 023-6040
- Cromemco WDI-II Winchester Disk Interface Manual  
part number 023-2011
- Cromemco ZPU Central Processing Unit Manual  
part number 023-0012

## Chapter 2

### SETTING UP THE SYSTEM

Cromemco designed the System Three to be easy to set up. By following the instructions in this chapter, you can have your system ready for use in a short time.

#### POSITIONING THE SYSTEM

The System Three should be accessible to its operators and have electrical power readily available. If you have a printer, you may want to provide noise abatement. All computer equipment generates heat, which is very hard on integrated circuits. Cromemco equipment is rugged, but it must not be installed in a hot place. The cooling vents on the top and bottom of the System Three must not be blocked. In addition, the computer must be protected from liquids and noxious gasses.

#### UNPACKING THE SYSTEM

The work surface where the unit will be used should be cleared and ready to receive the system. As you unpack, save all of the shipping and packing materials. They will be useful later if you have to move the unit.

The box the System Three comes in contains a packing invoice, a System Three manual, and a plastic package containing the line cord, warranty card, final inspection report, keys, and extra fuses. Find and save all these items. Check the contents of the box against the packing invoice. If anything is missing, contact your dealer.

Take this opportunity to verify the serial numbers written on the back of the unit, on the shipping container, on the final inspection report, and on the warranty card. If these four numbers do not match, call your Cromemco dealer for assistance. Record these serial numbers on the inside front cover of this manual. Once the system is installed and tested, fill out and mail the warranty card as soon as possible.

Cromemco System Three Instruction Manual  
2. Setting up the System

If you follow these steps as you unpack, you'll find it easier to set up the system:

1. Place the System Three on the work surface so that you can easily reach the rear panel.
2. Place the line cord next to the unit.
3. Store all packing materials.
4. Keep all paperwork associated with the unit in a safe place.
5. Store the spare fuses in a safe place.

#### **SPECIFYING THE LINE VOLTAGE**

The System Three is designed to accommodate all standard international voltages. By changing the line-voltage setting as described in this section, you can plug the System Three into any standard voltage supply anywhere in the world.

Before shipment, your system was set for the line voltage available in your area. A label on the back of the system specifies this setting (see Appendix A for details). The setting may be slightly higher than your actual line voltage. If your system has only a few circuit boards, they will run cooler with a slightly higher line-voltage setting. Don't change the setting unless your line voltage is substantially different from the preset value or unless you add several boards to the system.

You cannot damage the system by operating it with the wrong voltage setting. If the setting is too high, the system simply won't operate until you specify a lower voltage. If the setting is too low, you may blow a line fuse, but no permanent damage will result.

If the preselected line voltage is not the one you will be using, specify a new line voltage as follows:

1. Turn the system off and unplug it.
2. Open the front panel of the system by pushing up on the button located just beneath the lower right-hand corner of the front panel (Figure 2-1). The panel is hinged so that it swings to the left.

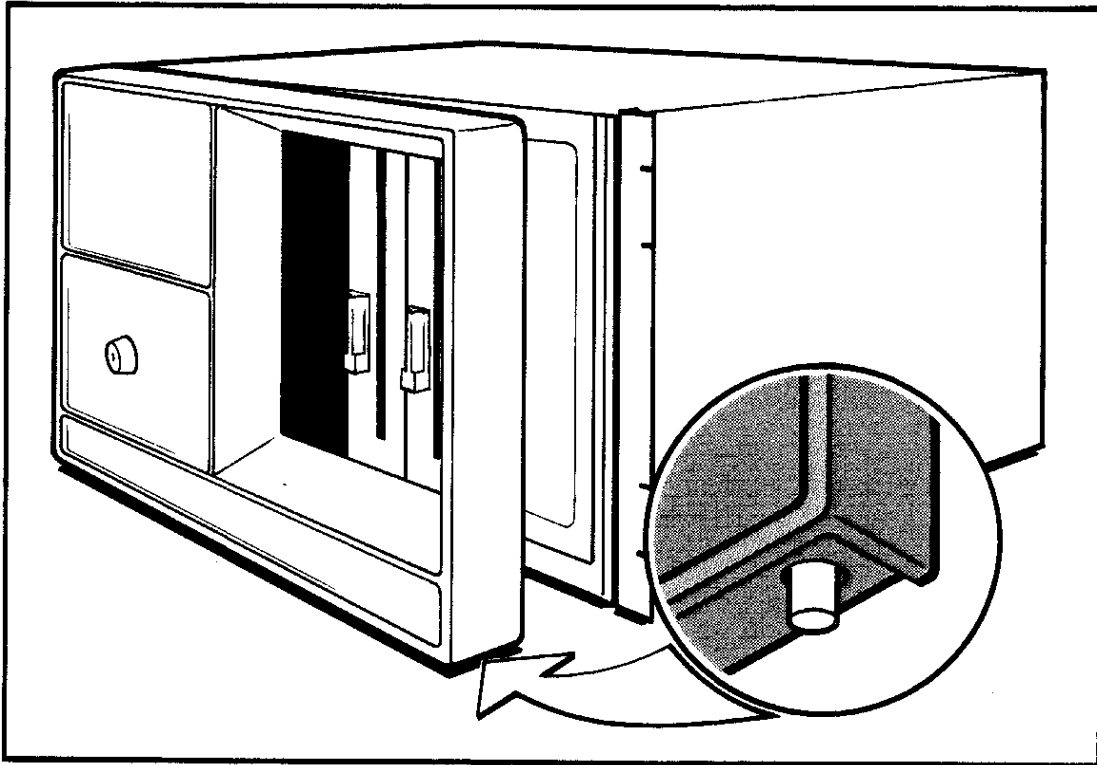

Figure 2-1: OPENING THE FRONT PANEL

3. Remove the eleven screws securing the system cover (Figure 2-2). Then lift off the cover.
4. Find the tap-select cable (Figure 2-3). It is a yellow cable located on a shelf at the right rear of the system, behind the disk drives. To select the new line voltage, unplug the connector from its current position and connect it to the row of pins marked with the correct voltage. If you find it difficult to remove the cable from its original position, gently wiggle the connector to loosen it. Do not force the connector or pull on the wires.
5. Replace the system cover.
6. Close the front panel.
7. Plug one end of the line cord into the back of the system and the other end into a wall socket.

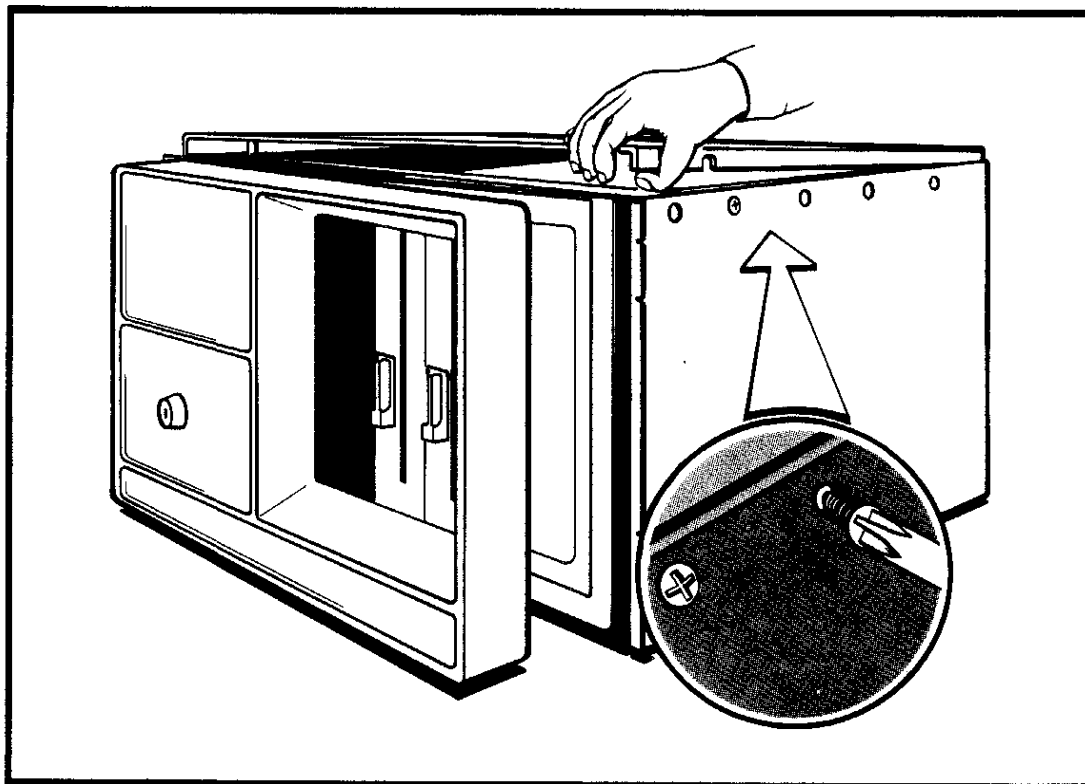

Figure 2-2: REMOVING THE SYSTEM'S COVER

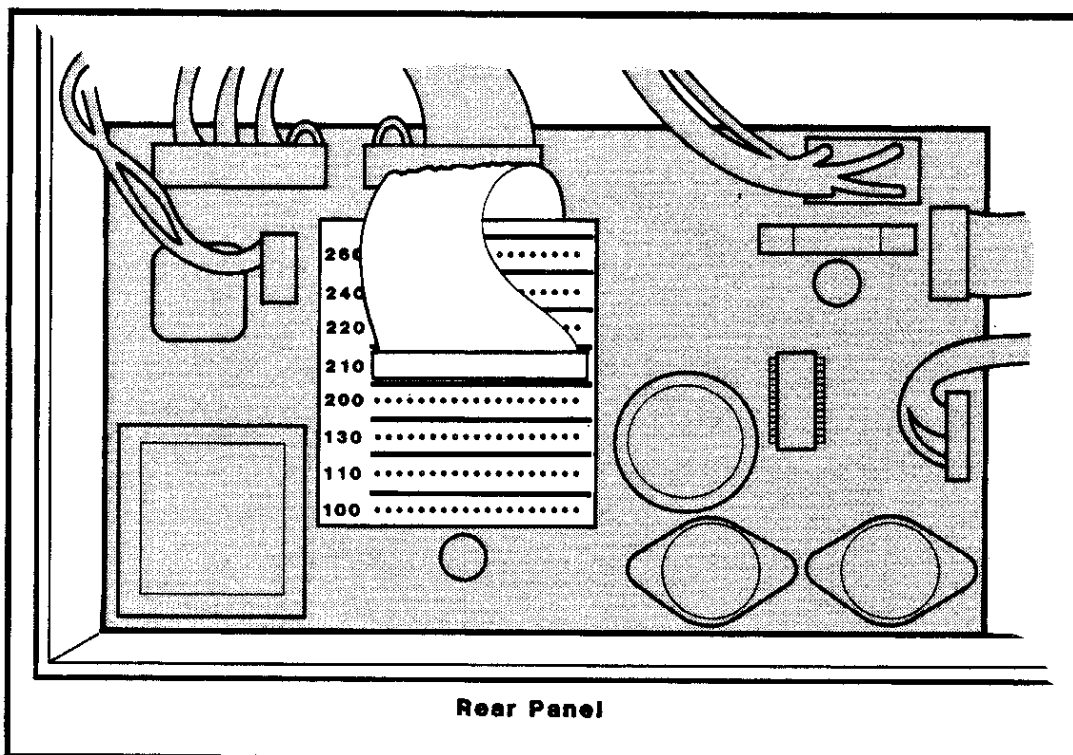

Figure 2-3: THE TAP-SELECT CABLE

Cromemco System Three Instruction Manual  
2. Setting up the System

If you change the voltage setting from the 110 volt range to the 220 volt range or vice versa, you must replace the line fuse. (The 110 volt range covers the 100, 110, and 130 volt settings. The 220 volt range covers the 200, 210, 220, 240, and 260 volt settings.) The line fuse is located on the back panel of the system, and is described in detail in Appendix D. For the 110 volt range, the fuse should be rated at 5 amps. For the 220 volt range, the fuse should be rated at 3 amps. The system comes with fuses of both ratings.

**CONNECTING THE TERMINAL(S)**

The terminal is connected to the System Two using the RS-232C standard interface. The proper interface cable is shipped with your Cromemco terminal. If you use another manufacturer's terminal, chances are it can be connected using the RS-232C standard interface. If not, please refer to the Cromemco 64FDC Floppy Disk Controller manual for interfacing instructions.

Before connecting any terminals to your system, make sure that both the System Three and the terminals are turned off and unplugged.

First, connect the **system terminal**. This terminal is used to load the operating system and receive any system messages generated by the operating system. (If your setup has just one terminal, that terminal is the system terminal). To connect the terminal, attach one end of a terminal cable to the proper socket on the rear of the terminal. (See your terminal manual for information on which socket to use. On terminals that have MAIN and AUXILIARY sockets, such as the Cromemco 3102, attach the cable to the socket labeled MAIN.) Connect the other end of the cable to the connector labeled 1 on the back of the System Three.

Cromemco System Three Instruction Manual  
2. Setting up the System

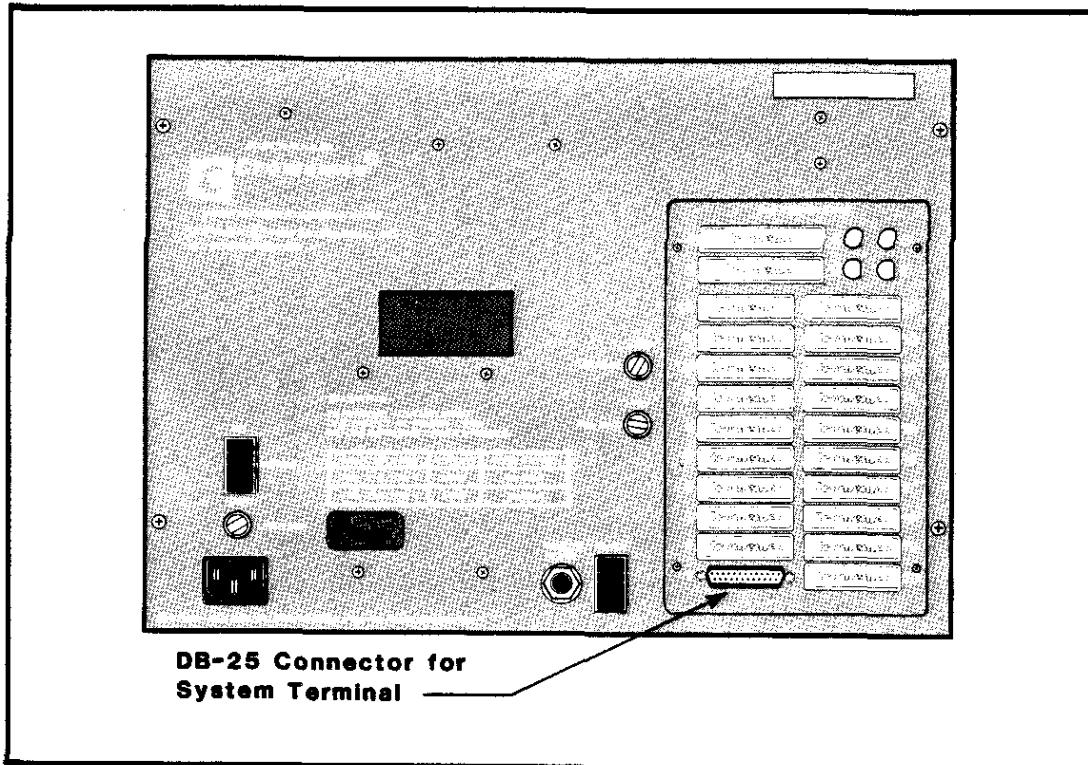

Figure 2-4: TERMINAL CABLE CONNECTORS

Once the system terminal is connected, connect any other terminals in your setup the same way. Additional terminal cables can be plugged into any of the other DB-25 connectors provided (see Appendix A for further information on DB-25 connectors).

Once a terminal is connected to the system, plug its line cord into a wall socket. You can now turn on the terminal.

If you are using more than one terminal under the Cromix Operating System, you must make a change to the file named `/etc/ttys`. Refer to Chapter 6 of the Cromix Operating System Instruction Manual.



### TURNING ON THE SYSTEM

Before turning the system on for the first time, remove the head load card from each floppy disk drive. These cards protect the read/write heads from damage during shipping. To remove the head load card, first turn the latch covering the drive slot counterclockwise, to the vertical position. Place the card(s) back in the diskette drives anytime you move the system.

Never leave floppy diskettes in the drives when turning the system on or off. If diskettes are in the drives when the system is turned on or off, data can be lost.

Before turning the system on, plug one end of the line cord into the back of the system and the other end into an electrical outlet. Figure 2-5 shows the location of the line cord socket.

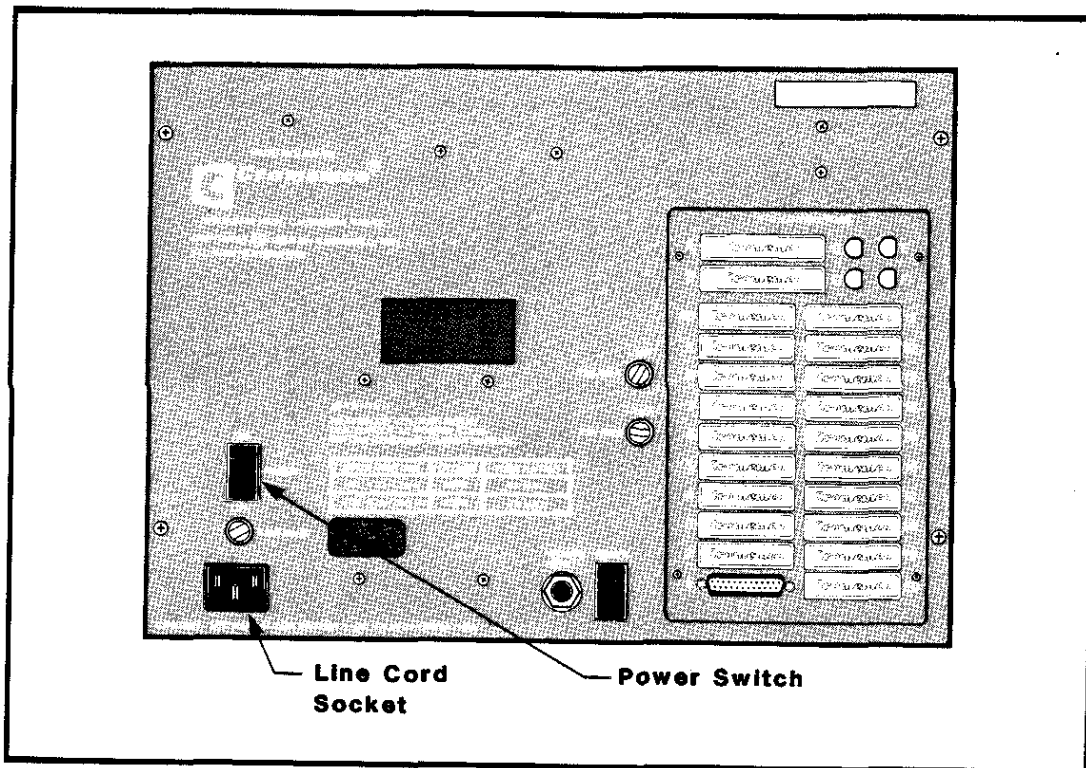

Figure 2-5: LOCATION OF LINE CORD SOCKET AND POWER SWITCH

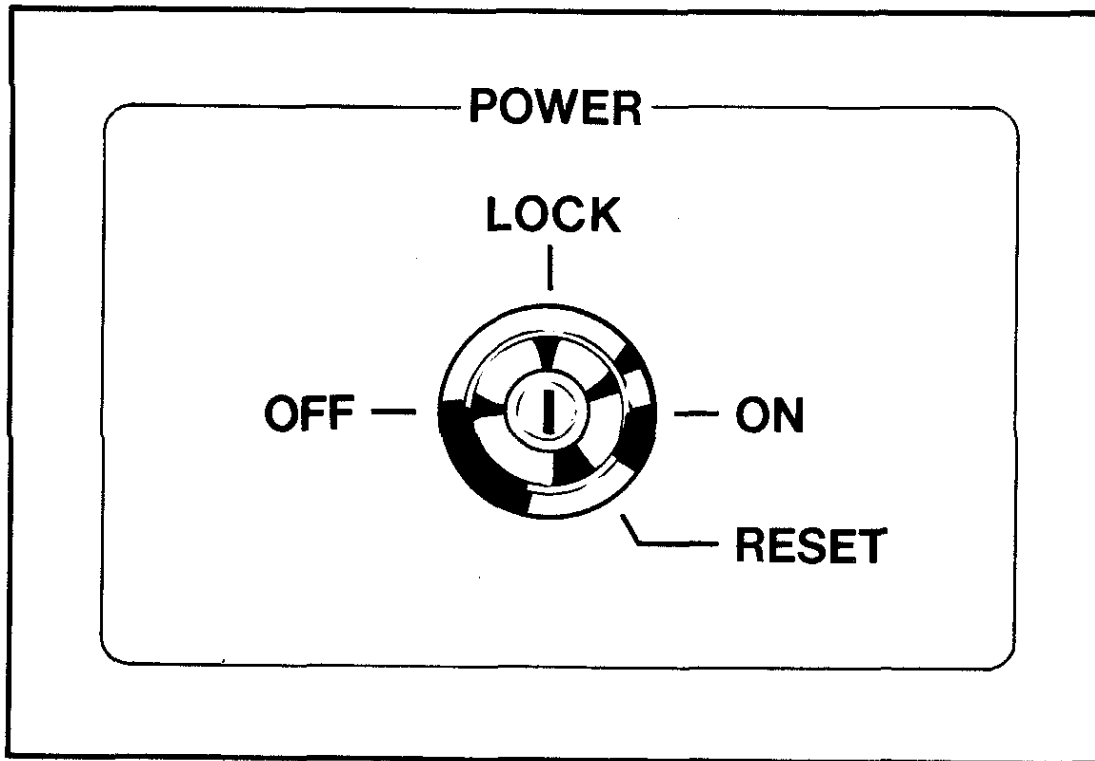

Figure 2-6: TURNKEY POWER SWITCH

Two switches turn the system on and off. The first is a red power switch located on the system's rear panel (Figure 2-5). The second switch is a turnkey located on the front of the system (Figure 2-6). Both switches must be on for the system to operate. There are four positions for the turnkey power switch. In clockwise order, they are:

- OFF** Turns off the power.
- LOCK** Turns on the power and allows the key to be removed.
- ON** Turns on the power.
- RESET** Resets the system. If the operating system disk is in drive A, the operating system will be loaded. Once the key is turned to RESET and released, it springs back to the ON position.

Follow these steps to turn the system on:

1. Turn the red power switch on the back of the system to the ON position.
2. Turn the turnkey on the front of the system to RESET. Press in on the key slightly as you turn it. Once the key is at the RESET position, let it spring back to the ON position.

Leave the key at the ON or LOCK position whenever you're using the system. It doesn't hurt the system to be running idle, overnight or over a weekend. Cromemco recommends that you leave the power on if you use the system daily. This keeps the components at a constant temperature and reduces the occurrence of transient voltages.

Turn off the system whenever you won't be using it for a long time or when you want to move or dismantle it. If you are turning it off because you won't be using it, turn the turnkey power switch to OFF but leave the red switch on the rear of the system in the ON position. If you are dismantling the system, turn both the turnkey power switch and the red power switch to their OFF positions. Then unplug the system.

## **USING FLOPPY DISKETTES**

The diskette drive(s) use 8-inch floppy diskettes such as the one shown in Figure 2-7. Each of the major parts of the diskette is described below.

### **Parts of the Diskette**

**The Read/Write Slot** - The System Three accesses the information on the diskette through this slot. Be careful never to touch or scratch the surface of the diskette. If you do, you may destroy information recorded on it. When a diskette is not in the system, keep it in the protective envelope that comes with it.

**The Write Protect Notch** - When the write protect notch is not covered by an opaque piece of tape, the system cannot write to the diskette or erase information contained on it. It can only read information from the diskette.

Cromemco System Three Instruction Manual  
2. Setting up the System

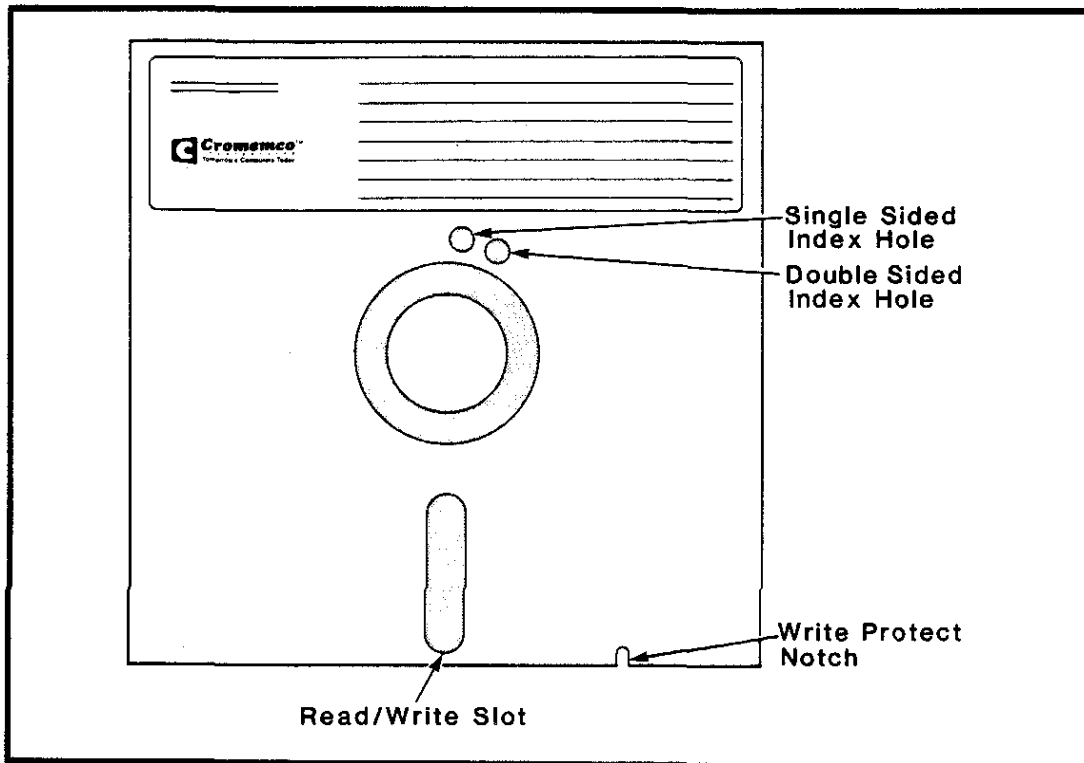

Figure 2-7: THE 8-INCH FLOPPY DISKETTE

When the write protect notch is covered, the system can write to and erase information from the diskette, as well as read information.

Always maintain a write-protected copy of diskettes that contain information that is difficult to replace.

**The Index Holes** - These holes indicate whether the information on the diskette is recorded on one or two sides. If the single-sided hole is covered, the information is recorded on two sides. If the double-sided hole is covered, the information is recorded on one side. One of the two holes must be covered to use the diskette, and both of the holes must not be covered at the same time.

The diskette drives require that index holes be covered with foil-backed labels specifically made for this purpose. Using the old paper-backed labels will cause errors. You can identify the new labels by peeling off the paper backing to expose the label's sticky surface. This surface is silver on the new labels and white on the old labels.

### Diskette Preparation

Blank diskettes must be formatted by the Init utility before they can be used to record information. See either the CDOS or Cromix Operating System manual for more information.

Release diskettes (that is, already formatted Cromemco diskettes that come with software recorded on them) can be used to load the operating system. These diskettes, however, are write-protected, which makes them unsuitable for many applications. Cromemco suggests that you copy all release diskettes onto other disks and use the copies. That way, the release diskettes serve as write-protected backup copies. See your operating system manual for a description of the utilities used for copying diskettes.

### Inserting a Diskette

To insert a diskette in the System Three, follow these instructions:

1. If it is not already turned to the vertical position, turn the latch covering the drive slot you want to use, counterclockwise, to uncover the drive's opening.
2. Remove the diskette from the protective envelope.
3. With its label to the left and toward you, insert the diskette in the drive slot (Figure 2-8). Gently push the diskette all the way in, until it comes to a stop. **DO NOT FORCE THE DISKETTE.**
4. Close the latch over the drive slot.

The diskette is now ready for use.

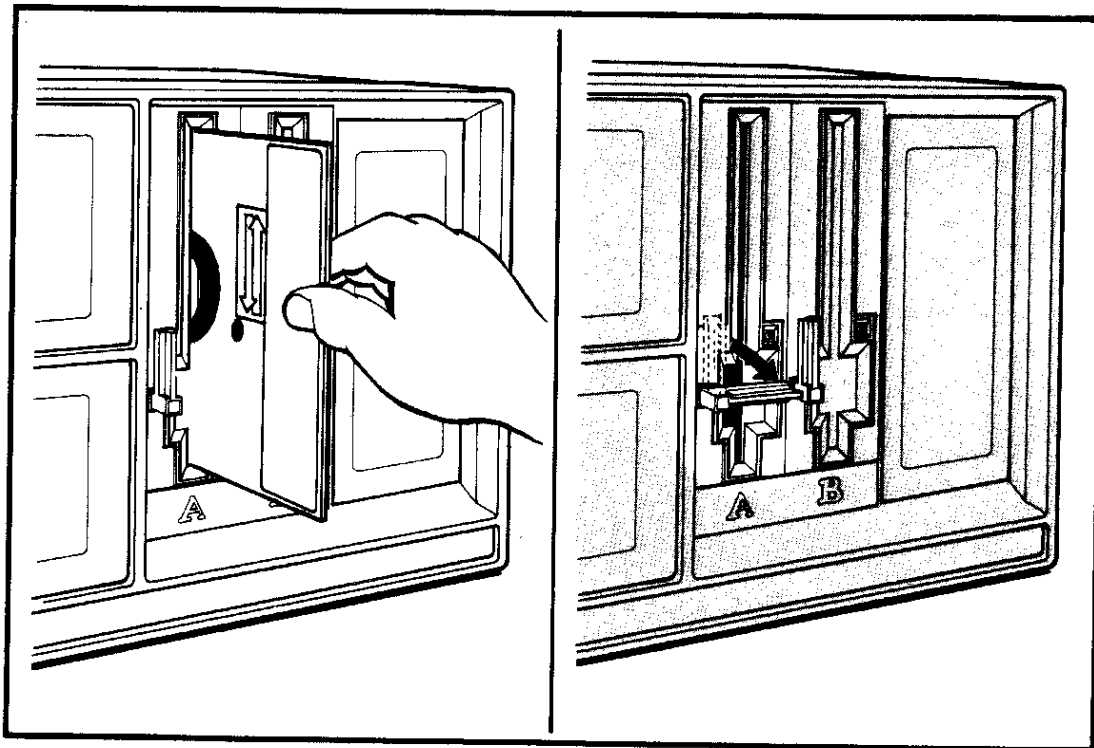

Figure 2-8: INSERTING THE DISKETTE  
AND CLOSING THE LATCH

### Removing a Diskette

**Caution:** Never remove the diskette when the red light next to the drive is lit. When the light is on, it means the diskette is in use and should not be removed. Once the light goes out, you can safely remove the diskette.

To remove the diskette, reverse the steps used to insert it:

1. Turn the latch covering the drive slot counterclockwise, to the vertical position. When you do this, the diskette will pop out slightly.
2. Gently pull the diskette out from the drive slot.
3. Put the diskette back in its protective envelope.

## Chapter 3

### TESTING THE SYSTEM

The System Three is now ready for use. The tests described in this chapter will ensure that it is working correctly.

#### TESTING THE CONNECTIONS

You can check the connections and a large portion of the system's hardware by turning on the system. To do this, first turn on the system terminal. Next, push the red power switch on the rear of the system to the ON position. Then turn the turnkey switch on the front of the system to the RESET position and let it spring back to the ON position. The following message will appear on the screen of the system terminal.

Preparing to Boot, ESC to abort

If you do not get this message, press the RETURN key on the terminal several times.

If you get the appropriate display on your screen, the connections and most of the hardware are functioning properly. If the message doesn't appear, something is not working properly.

The most common cause of problems is a poor cable connection between the terminal and the computer. Turn off the power to ALL devices and check this connection. Turn the power on again and make sure that all devices are turned on. If you still do not see the appropriate display, turn off all devices, check all of the connections, and if you can't find the problem, call your Cromemco dealer or authorized service facility.

### TESTING THE MEMORY AND DISK DRIVES

Once you know the connections are correct, test the system memory and disk drives. A unique feature of all Cromemco computers is a built-in, self-test diagnostic program. This program is part of the Resident Disk Operating System (RDOS) supplied with the System Three. The rest of this chapter describes the use of the RDOS self-test program.

Cromemco recommends that you periodically test the memory and disk drives. It will aid in identifying potential problems before they affect your data. It will also help in isolating system malfunctions, should they occur.

### Loading RDOS

To load RDOS, turn the turnkey power switch located on the front of the system to the RESET position and then let the switch go back to the ON position. Cromemco 3102, C-1, and C-10 terminals automatically send signals to the computer to establish the data (or baud) rate. The following message appears on the system terminal.

Preparing to Boot, ESC to abort

If you do not get this message, try pressing the RETURN key on the terminal several times to establish the baud rate.

Once this message appears, RDOS tries to load, or "boot", the disk operating system into memory, from the diskette in drive A. The following tests use RDOS rather than the disk operating system, so you must interrupt the automatic booting process. To do this, press the ESCAPE key as soon as the following message appears.

Preparing to Boot, ESC to abort

You have approximately one second in which to press the ESCAPE key before the system begins loading the operating system. If the RDOS prompt, a semicolon (;), does not appear after you've pressed the ESCAPE key, turn the System Three turnkey switch to the RESET position and let it return to ON. The program will restart and give you another chance to press the ESCAPE



key in time. For some terminals, you must re-establish the baud rate each time you reset the system by pressing the **RETURN** key several times, in order to cause the boot message to come up again.

When the boot procedure has been aborted, the following message will appear. The version number that appears on your screen may differ from the one shown.

```
Cromemco RDOS 02.52
```

```
;
```

RDOS is now ready to test the system. Press the key marked **t** (for "test"), followed by the key marked **RETURN**. (This will subsequently be referred to as "type **t RETURN**".) RDOS will start with the memory test and automatically go from one test to the next.

#### Memory Test

The memory test checks the first 64K bytes of memory in your system. For systems with one 64KZ-II memory board, this means that RDOS tests the entire board. For systems with multiple 64KZ-II boards, RDOS tests just the first board. For systems with one or more 256MSU, 512MSU, or 256KZ memory boards, RDOS tests just the bottom 64K bytes of memory.

When the memory test begins, RDOS displays the following on the system terminal.

```
Memory:  0 1 2 3 4 5 6 7 8 9 A B C D E F
```

Each number or letter represents 4096 (4K) bytes of memory. The test will erase whatever is in the first 64K bytes of memory. During the test, the system will place one of two characters under each number or letter.

^ indicates a successful test  
x indicates a failure

A successfully completed series of tests appears as follows.

Cromemco System Three Instruction Manual  
3. Testing the System

```
Memory:  0 1 2 3 4 5 6 7 8 9 A B C D E F  
         ^ ^ ^ ^ ^ ^ ^ ^ ^ ^ ^ ^ ^ ^ ^
```

If any x's appear, there is a problem with memory. Memory problems are usually caused by:

1. Improper switch settings on the memory board.
2. A bad memory chip in the affected block of the memory board.

If the test fails, repeat it by typing **ESCAPE t RETURN**. If the problem persists, contact your Cromemco dealer or authorized service facility.

#### Floppy Diskette Read Test

The second RDOS test checks whether the system is able to read data from a floppy diskette. Before RDOS can perform this test, you must place a diskette in drive A. Any kind of program or data can be recorded on the diskette, as long as the diskette has been formatted. Because the write test can erase information from the diskette, use a blank, formatted diskette. (The write test erases data only if there is a problem with the drive. Erasing data is not a normal result of the test.) If you don't have a blank diskette, go ahead and perform the read test, but abort the write test using the instructions given later in this chapter.

If you have purchased one of the System Three models with two floppy diskette drives, repeat the entire RDOS test sequence for each drive. The procedure is the same except that you substitute the letter B for the letter A in the commands.

When RDOS is ready to begin the read test, it presents the following display.

```
Specify disk (e.g., A; or A;; or A;;;)
```

A represents a disk drive (A or B) and the number of semicolons represents the speed of access.

Cromemco System Three Instruction Manual  
3. Testing the System

To begin this test, enter

**a;; RETURN**

in response to the request for disk specification. To stop the test, press the **ESCAPE** key.

A successful read test generates the following display.

```
Seek tests:
01:OK 02:OK 03:OK 04:OK 05:OK
06:OK 07:OK 08:OK 09:OK 00:OK
27:OK 00:OK 15:OK 00:OK 01:OK
Restore:OK
27:OK
Read/Write Tests
Data read OK
Write test MAY DESTROY data
ESC=Abort RETURN=proceed
```

If the read test is successful, proceed to the write test in the following section. If a malfunction occurs, one of three messages will appear on the screen. In each case, **xx** stands for the error code number. Always write down any error-code message displayed on the screen. It will be helpful to your Cromemco dealer when you call for assistance.

**Step/Seek Error** - The following message indicates that an error has occurred during the step/seek portion of the test.

```
nn:error xx
```

The floppy disk drive has not performed properly. The cylinder number where the test failed is designated by **nn**. For more information, refer to the 64FDC Manual.

**Restore Error** - The following message indicates that the system failed to execute the **restore** command properly.

```
Restore:error xx
```

**Read Error** - The following message indicates that a read error has occurred.

Data read error xx

### **Floppy Diskette Write Test**

The third RDOS test checks whether the system can write data to a floppy diskette. If the write test is performed, there is the risk of losing data stored on the diskette. Do not use a diskette containing information that is difficult to replace. The write test will use whatever diskette it finds in the disk drive specified during the read test that was just completed. You can remove the diskette in that disk drive and replace it with another formatted diskette, as long as the new diskette has the same density and is recorded on the same number of sides as the diskette being replaced. The write-protect notch, located on the edge of the diskette, must be covered.

Press **ESCAPE** to abort the test sequence. RDOS will display the letter designation of the drive that was being tested, followed by two semicolons. You can load the operating system at this point by following the instructions in Chapter 4 or you can give RDOS another command.

Press **RETURN** to continue the test. A successful write test generates the following display.

```
pattern write OK
pattern read OK
pattern compare OK
data write OK
A;;
```

The letter **A** will be replaced by **B** if drive **B** is being tested. You can load the operating system at this point by following the instructions in Chapter 4, or you can give RDOS another command.

If RDOS encounters a problem, it displays one of the messages described below. In each case, record the error-code information and refer to the section titled Write-Test Errors.

**Write Error** - The following message indicates that the system was unable to write the test data pattern on the diskette.

Pattern write error xx

**Read Error** - The following message indicates that the system was unable to read the test data pattern from the diskette.

Pattern read error xx

**Rewrite Error** - The following message indicates that the system was unable to rewrite data on the diskette.

Data write error xx

During this operation, the system first moved any user data from the area on the disk that was to be tested to a storage location in memory. The error message indicates that the system has failed to write that user data back into its original location properly.

**Write-Test Errors** - The following message will appear directly beneath any of the preceding error messages.

Test failed  
Disk data at CCSS H may have been destroyed  
Original is located at YYYYSZZZZ in memory

1. **CCSS H** is the location on the diskette where the test was performed. CC is the cylinder number, SS is the sector number, and H is the surface number.
2. **YYYY** indicates the location in memory where the original user data is stored.
3. **S** stands for swath.
4. **ZZZZ** indicates the length of the sector affected.

Note the values displayed and call your Cromemco dealer or authorized service facility for assistance.



## Chapter 4

### LOADING THE OPERATING SYSTEM

This chapter describes how to load the Cromemco CDOS or Cromix Operating System. As you read this chapter, have your operating system manual handy. Many of the terms, procedures, and utility programs mentioned here are described in detail in the operating system manual.

Before loading either operating system, turn on the power switch located on the rear of the system, as described in Chapter 2.

#### LOADING THE CDOS OPERATING SYSTEM

Follow these steps to load the CDOS Operating System.

1. Turn the turnkey switch on the front of the system to the ON position. Never insert a diskette into the drives unless this switch is in either the ON or LOCK position.
2. Insert a CDOS Operating System diskette into drive A. Refer to Figure 2-8 and accompanying text if you are not familiar with the correct procedure. In those models with two floppy disk drives, drive A is the drive on the left. In those models with one floppy disk drive, drive A is the only disk drive.
3. Close the latch over drive A.
4. Turn the key on the System Three to the RESET position. Press in on the key slightly as you turn it. Once the key is at the RESET position, let it spring back to the ON position. Cromemco 3102 and C-10 terminals automatically send signals to the computer to establish the data (or baud) rate. The following message appears on the screen of the system terminal.

Cromemco System Three Instruction Manual  
4. Loading the Operating System

Preparing to Boot, ESC to abort

If you do not get this message, press the **RETURN** key on the terminal several times to establish the baud rate.

The light next to drive A comes on and clicking sounds come from the drive as the disk is read.

Once the system starts to boot, the following messages appear. The version number and copyright date that appear on your screen may differ from the ones shown here. However, **do not** use versions of CDOS less than 2.54.

Standby

CDOS version 02.54  
Cromemco Disk Operating System

Copyright (c) 1978, 1982 Cromemco, Inc.

A.

CDOS displays the system prompt **A.** to indicate that it is ready for use. If the system does not boot, check to see that you inserted the diskette properly and closed the latch over the drive slot. Check to see that all the connections between various pieces of equipment are made correctly. If the connections are correct and the system won't boot, perform the diagnostic tests described in Chapter 3. If the problem remains, call your Cromemco dealer or authorized service facility.

**LOADING THE CROMIX OPERATING SYSTEM**

To load the Cromix Operating System, you will need the Cromix Operating System diskette. The disk must not be write-protected (see Chapter 2).

Follow these steps to load the operating system.

1. Turn the turnkey switch on the front of the system to the ON position. Never insert a diskette into the drives unless this switch is in either the ON or LOCK position.



Cromemco System Three Instruction Manual  
4. Loading the Operating System

2. Insert the Cromix Operating System diskette into drive A. Refer to Figure 2-8 and accompanying text if you are not familiar with the correct procedure. In those models with two floppy disk drives, drive A is the drive on the left. In those models with one floppy disk drive, drive A is the only disk drive.
3. Close the latch over drive A.
4. Turn the key on the System Three to the RESET position. Press in on the key slightly as you turn it. Once the key is at the RESET position, let it spring back to the ON position. Cromemco 3102 and C-10 terminals will automatically send signals to the computer to establish the data (or baud) rate. The following message appears on the screen of the system terminal.

Preparing to Boot, ESC to abort

If you do not get this message, press the **RETURN** key on the terminal several times to establish the baud rate. The light next to drive A goes on and clicking sounds come from the system as the disk is read.

Once the system starts to boot, the following message appears. The version number and copyright date that appear on your screen may differ from the ones shown here.

Standby

CROMIX Operating System version 11.11  
Copyright (c) 1980, 1982 Cromemco, Inc.

After a few seconds, the disk light will go out and the terminal will display the following message.

DATE (mm/dd/yy):

Enter the date. Separate the month, day, and year by spaces. Press the RETURN key when you are finished entering the date.

Cromemco System Three Instruction Manual  
4. Loading the Operating System

Next, the Cromix Operating System displays a prompt for the time.

TIME (hh:mm:ss):

Enter the time the same way you entered the date. The seconds are optional.

The system now displays the following messages, ending with the login prompt.

Type "system", "user1", or "user2" to log in initially.

For information about this version of Cromix, log in as "newuser". Any user may access this same information by typing "help newuser" once logged in.

CROMIX Operating System version 11.11  
Copyright (c) 1980, 1982 Cromemco, Inc.

Login:

Once you see the **Login:** prompt, log in to the system. When the operating system is first used, log in as **system**, **user1**, or **user2**. Initially, there are no passwords for these login names. Enter **system** to log in as a privileged user. After entering the login name, you are given a Cromix prompt.

# is the prompt for the privileged user **system**.

% is the prompt for **user1**, **user2**, and other nonprivileged users.

After logging in, set up the system by referring to the instructions in the Cromix Operating System manual.

## Chapter 5

### USING THE DISK DRIVES

This chapter describes how to get started using floppy and hard disk drives with Cromemco CDOS and Cromix Operating Systems. As you read this chapter, have your operating system manual handy. Many of the terms, procedures, and utility programs mentioned here are described in detail in that manual.

Before using the procedures in this chapter, load the operating system by following the directions in Chapter 4.

#### USING DISK DRIVES UNDER THE CDOS OPERATING SYSTEM

This section describes how to get started using both floppy and hard disk drives under the CDOS Operating System and explains how to transfer files from one disk to another.

##### The Current Drive

If you have two floppy disk drives, the drive on the left is drive A and the drive on the right is drive B. If you have one floppy disk drive and one hard disk drive, the floppy disk drive is drive A and the hard disk drive is drive B.

The **current drive** is the disk drive that you are currently working from. The letter of the CDOS prompt (for example, A. or B.) will always indicate which is the current drive.

To make another drive the current drive, type the letter of the desired drive followed by a colon, as shown below.

A. b:  
B.

### **Transferring Files under the CDOS Operating System**

This section describes how to copy files from a disk in one drive to a disk in another. The procedure is the same whether the disks are floppy or hard.

Step 1 only needs to be done if the diskette is a new, blank one that has not been previously formatted or if it is formatted incorrectly for your system. **Formatting destroys all data stored on the disk**, so be careful not to format a disk containing data that can't be replaced.

1. Format the diskette using the Init command (described in section 6.2.3 of the CDOS User's Manual). This is done only once, before the first use of the diskette.
2. Use the Xfer utility to transfer one or more files from one disk to another. This command is described in detail in section 6.2.6 of the CDOS User's Manual. The following examples show the general format of this command.

**A. xfer a:file.new=b:file.old**

The above command copies the file **file.old** from drive B to drive A, naming the new copy **file.new**.

**A. xfer b:=a:\*.txt**

The above command copies all files with the filename extension **txt** from drive A to drive B. Each of the copied files will have the same filename and filename extension as each of the source files.

### **USING DISK DRIVES UNDER THE CROMIX OPERATING SYSTEM**

If your system contains a hard disk drive, you will want to take advantage of the speed and reliability which it provides by copying the Cromix Operating System onto the hard disk. The following sections describe how to do this and show how to transfer files from one disk to another.

### Copying the System Diskette onto the Hard Disk

This section describes how to copy the Cromix Operating System onto the hard disk. More detailed information can be found in Chapter 6 of the Cromix Operating System Manual.

To copy the System diskette onto the hard disk, first make sure that the Cromix Operating System diskette is in drive A. Boot up system and log in as described in the previous chapter. Respond to the # prompt by typing the following command.

```
# newdisk hd0
```

The name `hd0` (hard disk zero) is the device name for the first hard disk in the system.

`Newdisk` begins by executing the `Init` utility and prompts you for the name of the disk to be initialized. The proper response is again `hd0`, the designation for the first hard disk drive. All other questions can be assigned the default value by pressing `RETURN` in response to the prompts. After the `Init` utility has finished, `Newdisk` copies all files from the operating system diskette in drive A onto the hard disk. When finished, the following message is displayed.

```
finished creating disk hd0
```

Now execute the following command to make the system default to `hd0` as the root device.

```
# /gen/default /cromix.sys 2 0
```

The Cromix Operating System now resides on the hard disk and can be booted using the hard disk as the root device instead of the floppy disk. A floppy disk is still required as a boot disk, however, since `RDOS` does not allow you to boot up directly from a hard disk. The operating system disk can be used as the boot disk, or you can create one using the instructions in Chapter 6 of the Cromix Operating System Manual.

### Transferring Files under the Cromix Operating System

This section describes how to copy files between floppy disks and the hard disk. The procedure is different depending on whether the floppy diskette has a Cromix format or a CDOS format.

**Using Cromix-formatted Floppy Diskettes** - Follow these instructions to read from or write to a Cromix-formatted diskette on a Cromix system. Steps 1 and 2 only need to be done if the diskette is a new, blank one that has not been previously formatted or if it is formatted incorrectly for your system. **Formatting destroys all data stored on the disk**, so be careful not to format a disk containing data that can't be replaced.

1. Format the diskette using the Init utility (described in Chapter 9 of the Cromix Operating System manual). This is done only once, before use).
2. Write a Cromix file system to the diskette using the Makfs utility (described in Chapter 9 of the Cromix Operating System manual). This is also done only once, before use.

```
# makfs sfda
```

3. Mount the diskette into an existing dummy Cromix file using the Mount utility (described in Chapter 9 of the Cromix Operating System manual). If a dummy file does not exist, create one using the Create utility before mounting the diskette.

```
# create /a  
# mount sfda /a
```

In the above example, **sfda** is the entry in the **/dev** directory for small floppy disk A.

While the diskette is mounted, you can change the current directory to the floppy disk by typing

```
# dir /b
```

To make the hard disk the current directory once again, type the following. Two periods stand for the **home directory**.

```
# dir ..
```

4. Read from or write to the diskette with either the Copy or Cptree utility. The Copy utility copies individual files to and from diskette, while the Cptree utility copies a directory, including its files and subdirectories.

```
# copy /usr/oldfile /b/newfile
```

This copies the file **usr/oldfile** from hard disk to floppy diskette file **b/newfile**.

5. When you are done transferring files, unmount the diskette using the Unmount utility, then remove the diskette from the drive. Make sure the dummy file is not the current directory when the Unmount utility is issued, otherwise the Unmount utility will not work.

**Using CDOS-formatted Floppy Diskettes** - Follow these instructions to read from or write to a CDOS-formatted diskette on a Cromix system. Step 1 only needs to be done if the disk is a new, blank one that has not been previously formatted or if it is formatted incorrectly for your system. **Formatting destroys all data stored on the disk**, so be careful not to format a disk containing data that can't be replaced.

**Do not mount or unmount CDOS-formatted floppy diskettes.** You can only transfer CDOS-formatted floppy diskette files by first translating them to or from Cromix format, using the Cdoscopy utility.

1. Format the CDOS diskette using the Init utility (This is done only once, before use).

2. To write from a CDOS-formatted diskette to the Cromix hard disk, use the Cdoscopy utility.

```
# cdoscopy sfda file.1
```

This command copies `file.1` from the CDOS disk in drive A to the current directory on the hard disk. The copied file is in the Cromix format.

3. To write from the Cromix hard disk to a CDOS-formatted diskette, use the Cdoscopy command with the "-w" option.

```
# cdoscopy sfda -w /usr/tom/memo
```

This command copies `usr/tom/memo` from the current directory on the hard disk to the CDOS disk in drive A. The copied file is in CDOS format.



## Appendix A

### THE BACK PANEL

This appendix describes the items located on the back panel. Figure A-1 shows the location of the items described in the following paragraphs.

#### TAGS AND LABELS

Three important pieces of information are given on the back panel:

1. **The serial number** - You will need this number if you ever need to correspond with Cromemco about the System Three.
2. **The line voltage label** - This label gives the voltage the System Three is set up to use. The setting might not correspond exactly to the line voltage. Depending on the number of circuit boards in your system, the specified voltage can be somewhat higher than your actual line voltage.

If you add boards to your system, or if the setting is in the wrong range for your line voltage, change the setting by following the instructions in Chapter 2. Once you do so, place a label on the back panel giving the new setting.

3. **The fuse rating label** - This gives the rating of the line fuse. Use a 5-amp fuse for a line voltage of 110 volts. Use a 3-amp fuse for a line voltage of 220 volts. If you change the System Three voltage setting, and therefore must replace the fuse with one of a different rating, place a label giving the new rating next to the line fuse.

Cromemco System Three Instruction Manual  
 A. The Back Panel

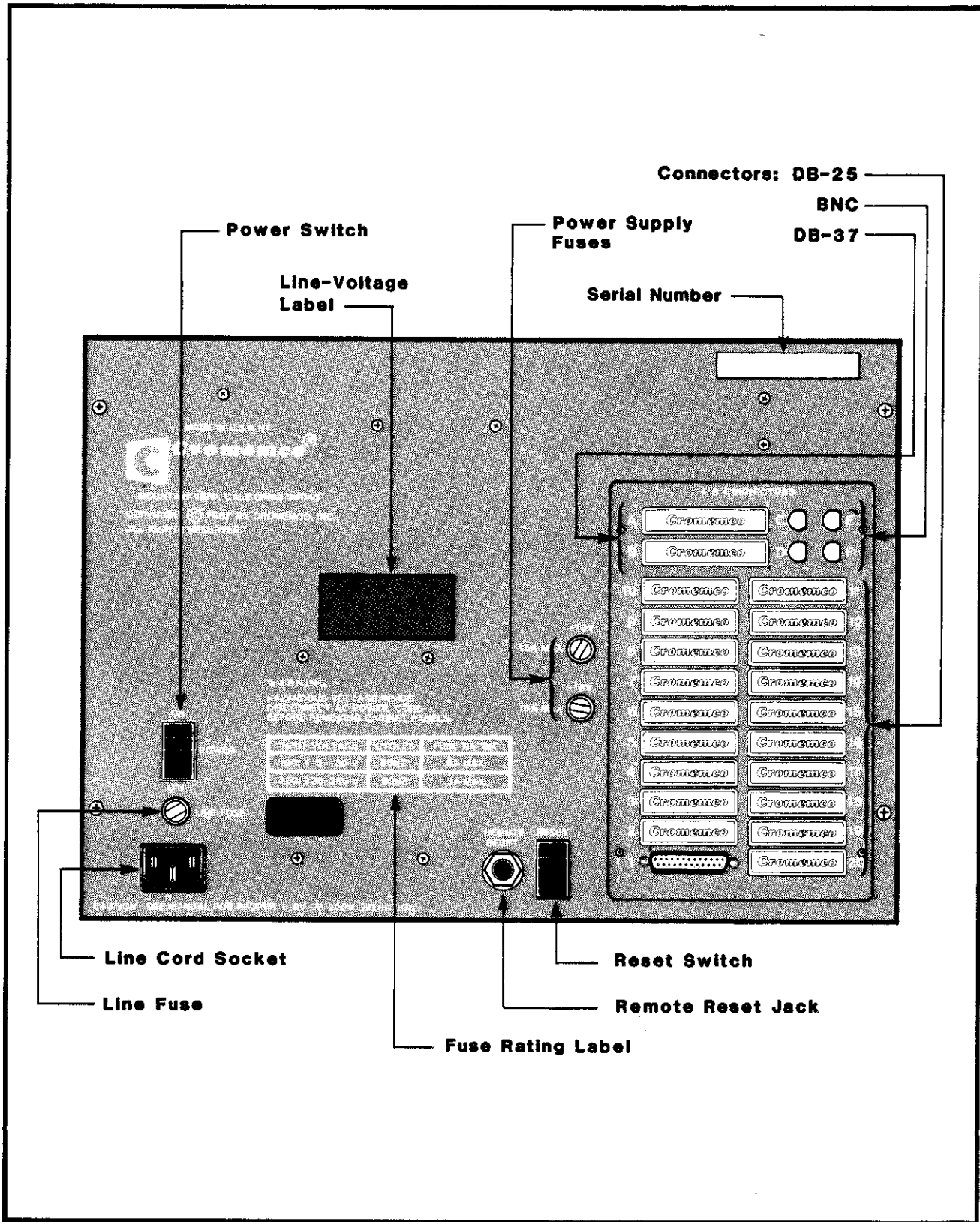

Figure A-1: THE BACK PANEL

## FUSES

The line fuse and power supply fuses are located on the back panel. Appendix D describes these fuses in detail.

## RESET SWITCH

Pressing the reset switch causes a Power-On Clear (POC) and normally loads RDOS. This white switch on the back panel performs the same function as turning the front panel turnkey to the RESET position. To use the switch installed on the back panel, press in all the way on the protruding lower half of the switch. It will spring back up when you release it.

The back panel also has a 1/4" phone jack socket for a remote reset switch.

## LOCATIONS FOR INPUT/OUTPUT CONNECTORS

The back panel has locations for three types of input/output connectors:

1. **DB-25 connectors** - The System Three has 20 access holes in which DB-25 connectors may be mounted. The access holes are labeled 1 through 20. As the system is shipped, at least one DB-25 connector is already in place. The one at location 1 is for the system terminal. Systems set up for the Cromix Operating System may have connectors for additional terminals.
2. **DB-37 connectors** - The System Three has two access holes in which DB-37 connectors (for additional disk drives) may be mounted. The locations are labeled A and B.
3. **BNC color monitor connectors** - The System Three has access holes in which BNC connectors may be mounted. These connectors are used for the red, green, blue, and synchronization cables to an RGB monitor.



## Appendix B

### ADDING BOARDS TO THE SYSTEM

You can expand your System Three's capabilities by adding circuit boards to the complement supplied with the system. Follow these steps to add a board:

1. Turn off both the turnkey switch and the power switch. Unplug the system. **Never** remove or insert boards while the power is on or while the system is plugged in.
2. Open the front panel of the system by pushing up on the button located just beneath the lower right-hand corner of the front panel (see Figure 2-1).
3. Pull the card cage out toward you until it stops. Then remove the retaining bar securing the circuit boards. To do this, pull back on the spring-loaded bolt holding the bar while pulling out on the bar (see Figure B-1).
4. Insert the board into one of the slots. The edge connector side of the board goes in first, with the integrated circuits toward you (Figure B-2). Make sure that the board is positioned properly in the board guides. If it isn't, pull the board out and reinsert it.

Push the board in gently, but firmly. When the board is almost all the way in, it may seem to jam as it enters the connector on the bus. This tightness ensures a good connection between the board and the connector. Continue to push firmly on the board until it is all the way in and is even with the other boards in the system.

Cromemco System Three Instruction Manual  
B. Adding Boards to the System

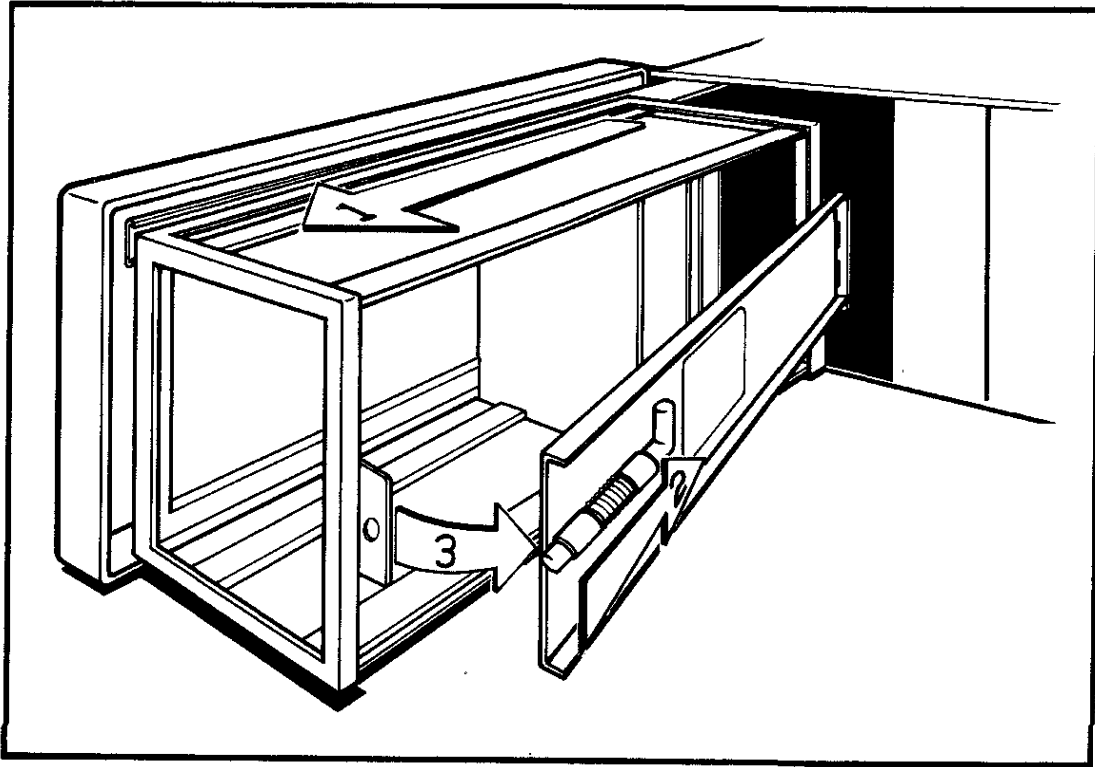

**Figure B-1: ACCESSING THE CARD CAGE  
AND REMOVING THE RETAINING BAR**

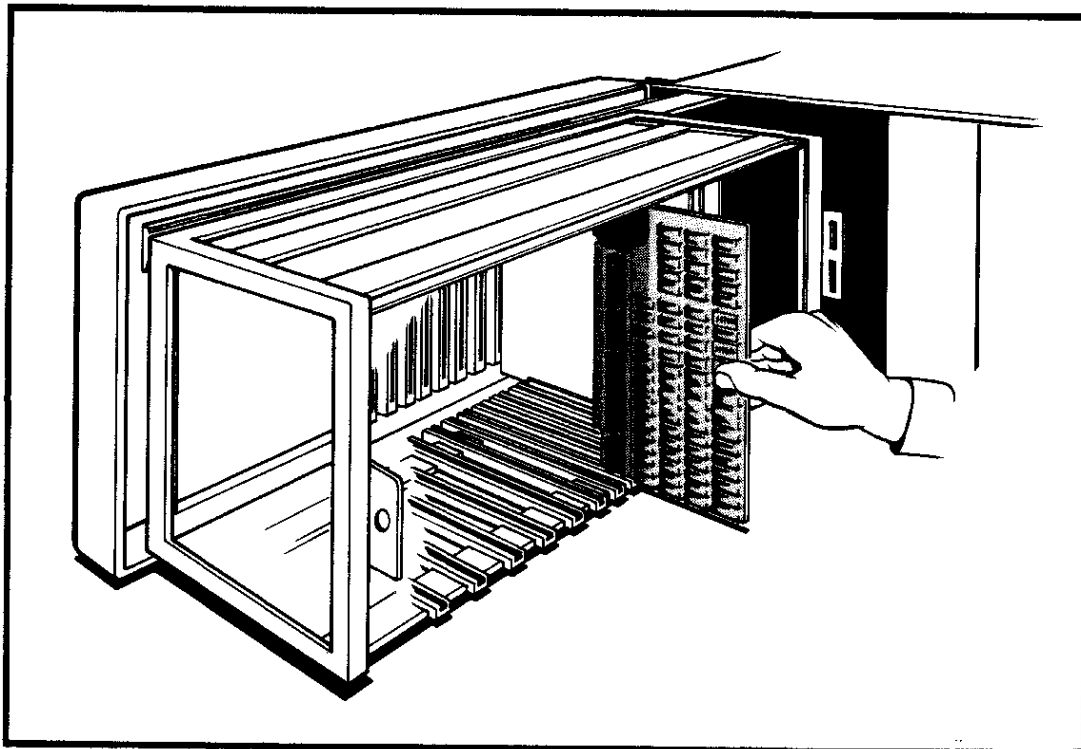

**Figure B-2: INSERTING A CIRCUIT BOARD**

Cromemco System Three Instruction Manual  
B. Adding Boards to the System

5. If any cables connect to the board, make the connections now, using the instructions that come with the board. If a cable goes from the board to the input/output connectors on the rear of the system, follow these instructions:
  - a. Remove the System Three cover by unscrewing the screws securing it (see Figure 2-2).
  - b. Connect the cable to the board.
  - c. Pry out the plastic tab covering one of the DB-connector holes on the back of the system. Remove the screw and nut on one end of the DB connector and loosen the other one slightly. Then slide the connector into the hole such that the remaining screw and nut can be tightened. Insert the second screw and nut and tighten.
  - d. Label the card-cage end of the cable with the connector location number for future reference.
  - e. Cut the cable ties on the cable guide (Figure B-3). Lay the new cable on the guide. Slide the card cage in and out several times to ensure that the cables don't bind. Once the cables are properly positioned secure them with new cable ties.
6. Replace the retaining bar by pulling back on the bolt, fitting the bar onto its mounts, and then letting the bolt slip back into its hole (see Figure B-1). Then slide the card cage completely back into the system.
7. Replace the system cover and the screws securing it.
8. Close the front panel.
9. Plug the system back into an electrical outlet, and turn the system on. If the system doesn't operate properly, try specifying a new line voltage using the instructions in Chapter 2. If the system still doesn't function properly, the new board may not be working. Contact your Cromemco dealer or authorized service facility.
10. Test the new board by running an application that uses it.

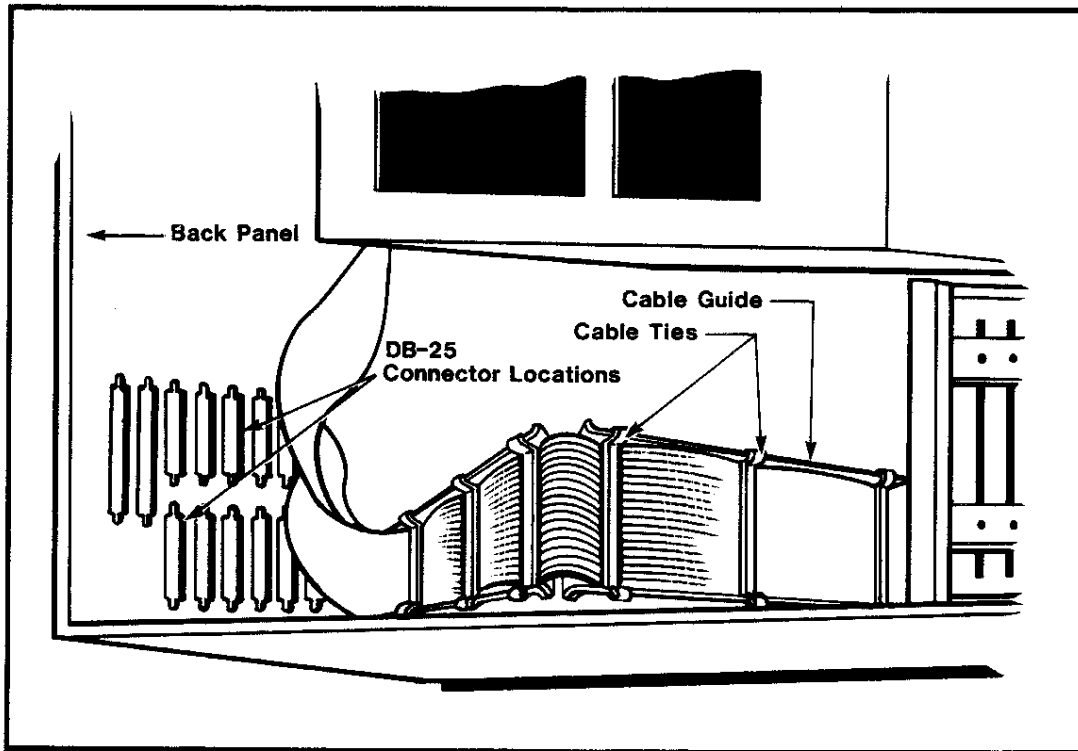

Figure B-3: THE CABLE GUIDE



## Appendix C

### CONNECTING A PRINTER

If you wish, you can connect a printer to the System Three. The proper DB-25 connector and interface cables are shipped with your Cromemco printer and Cromemco PRI Interface board. If you use another manufacturer's printer, please refer to the Cromemco PRI manual for interfacing instructions.

Before connecting a printer to the System Three, install the PRI Interface board and connect it with a cable to a DB-25 connector on the back of the system. Follow these instructions:

1. Make sure that the system is turned off and unplugged.
2. Turn off all the switches on the PRI board (see Figure C-1).
3. Following the instructions in Appendix B, insert the PRI board in the card cage (steps 1-4), install the DB-25 connector on the back of the system and connect the ribbon cable to the PRI board (step 5 in Appendix B). If you are using a dot matrix printer (Cromemco Models 3703 or 3715), connect the ribbon cable to J1 on the PRI board. If you are using a fully formed character printer (Cromemco Models 3355A or 3355B), connect the ribbon cable to J2 on the PRI board (see Figure C-1).
4. If the PRI board is installed in a Cromemco Cromix system, the existing priority interrupt jumper cable should be used. The PRI board should be located in the interrupt priority chain after the last TU-ART in the bus. The priority jumper cable for the priority out connector on the last TU-ART should be connected to IN J3 on the PRI board (refer to Figure C-1). See Appendix F for more information about the priority interrupt cable.
5. Replace the retaining bar and cover, and close the front panel (steps 6-8 in Appendix B).

Cromemco System Three Instruction Manual  
 C. Connecting a Printer

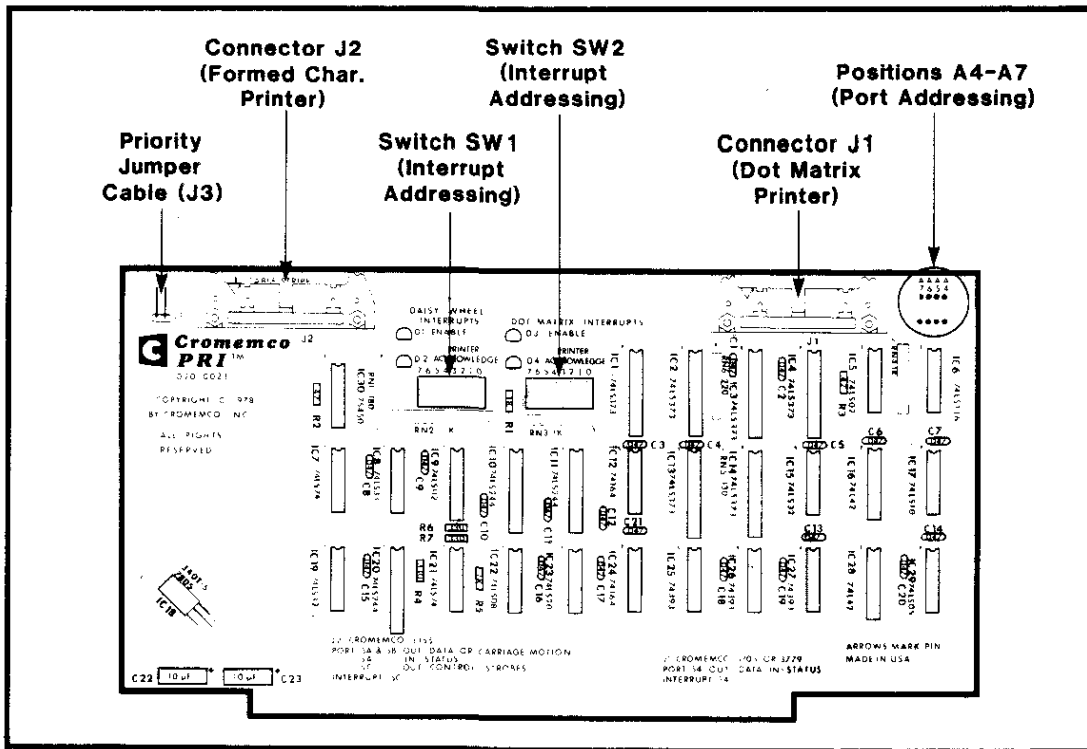

Figure C-1: THE PRI PRINTER INTERFACE BOARD

Before connecting the printer, make sure that both the System Three and the printer are turned off and unplugged. Connect one end of the printer cable to the socket on the rear of the printer. Connect the other end of the cable to the DB-25 connector on the back of the system. Once the printer is connected to the system, plug both the System Three and the printer into electrical outlets. Turn on both machines and test the new board by running an application that uses it.

If you are using a Cromemco 3355A or 3355B printer under the CDOS Operating System, you must load the 3355A driver each time you load the operating system. You can do this either by entering the command `3355A`, or by executing the command file `startup.cmd` that comes with the 3355A program.

If you are using a printer under the Cromix Operating System, you must make a change to the `/dev` directory. Refer to Chapter 6 of the Cromix Operating System Manual.

## Appendix D

### POWER SUPPLY AND FUSES

The System Three power supply provides reliable direct current power to the computer circuit boards and floppy disk drives. The high reliability of the power supply is due to very low stress on components, efficient thermal design that keeps component temperatures low, and the use of components with proven reliability. The use of large filter capacitors allows reduced direct current to be delivered to the computer circuit boards; the boards, in turn, dissipate less heat. Because of its reliability, the power supply improves the reliability of the System Three as a whole.

All outputs of the power supply are protected either by fuses or active current limiting devices to protect against abuse or load faults.

#### FUSES

The System Three comes with three types of fuses: a line fuse, two power supply fuses, and a fuse protecting the hard disk drive. The proper fuses for any line voltage come with the System Three as shipped. The floppy disk drives in all models are protected by active current limiters, not fuses.

#### Line Fuse

The line fuse interrupts power to the system in either of two situations: (1) if a power supply component fails by shorting; and (2) if you specify a line voltage that is lower than the voltage in your area.

The System Three uses one of two fuses for the line fuse. If the system is using a line voltage in the 110 volt range (which corresponds to the 100, 110, and 130 volt settings on the power supply) then a 5-amp fuse is used. If the system is using a voltage in the 220 volt range (which corresponds to the 200, 210, 220, 240, and 260 volt settings on the power supply) then a 3-amp fuse is used.

### Power Supply Fuses

The power supply fuses protect the power supply from load faults (such as a short circuit) on the circuit boards. One fuse protects the +18 volt line and the other one protects the -18 volt line. Both are 5-amp fuses.

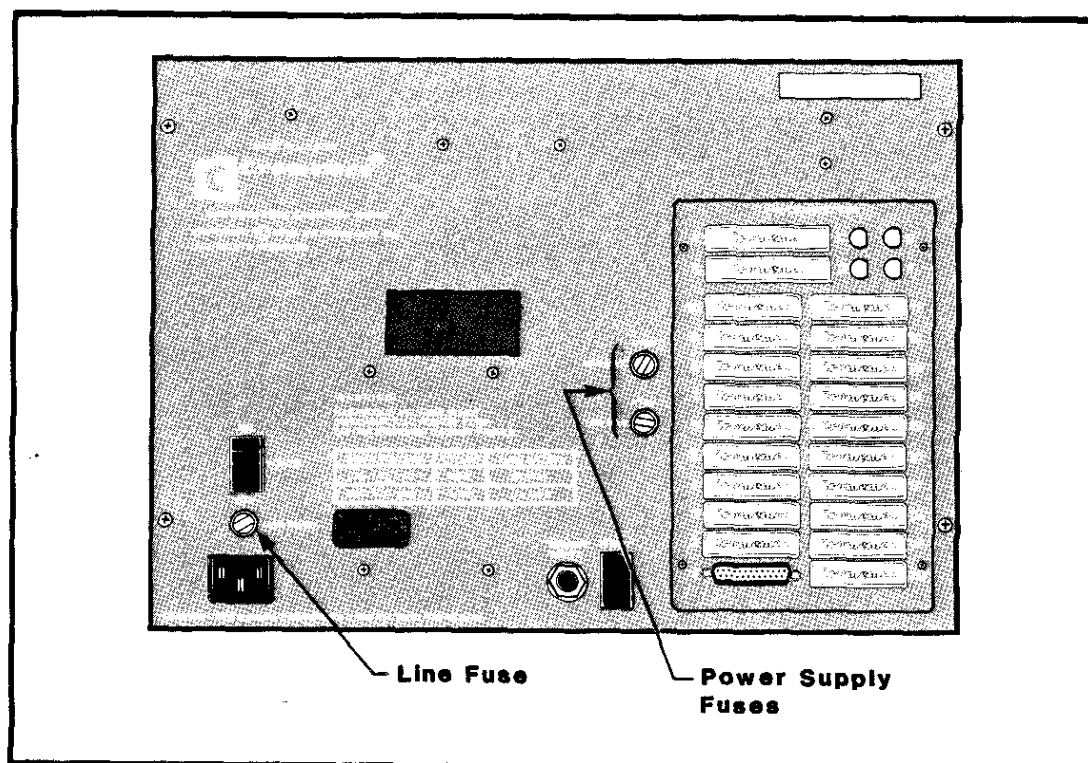

**Figure D-1: LOCATION OF LINE FUSE  
AND POWER SUPPLY FUSES**

### Hard Disk Drive Fuse

The line to the hard disk drive is protected by a 3-amp fuse located on the DPS3 board of the power supply next to the yellow voltage tap selector (Figure D-2). This fuse is supplied in all models of the System Three, regardless of whether they come with a hard disk drive or not. To change the fuse, turn off the turnkey switch and the power switch, unplug the System Three, remove the screws securing the system's cover, and lift the cover off, as described in Chapter 2. After changing the fuse, replace the cover and insert the screws that secure it.

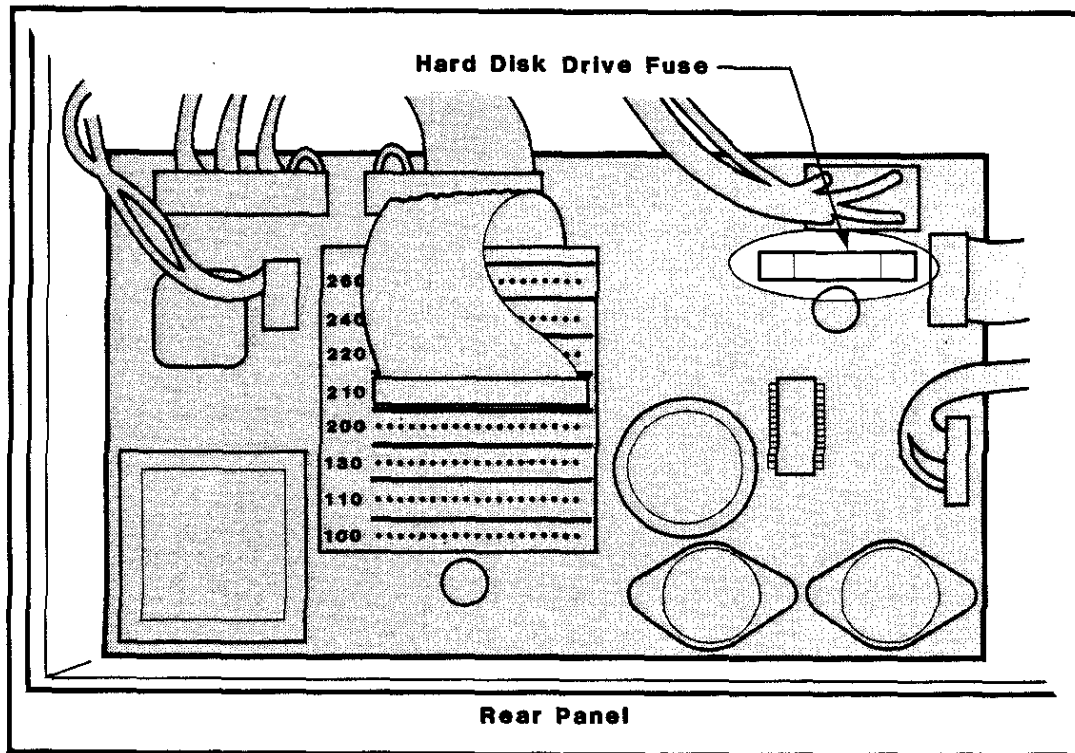

Figure D-2: LOCATION OF HARD DISK DRIVE FUSE

#### POWER SUPPLY LEDS

There are three green light-emitting diodes (LEDs) mounted on the front edge of the motherboard (see Figure D-3). Each LED is labelled, and corresponds to a certain voltage. When the power supply is functioning properly, all three lights are lit. If any of these LEDs is not lit when the system is turned on, it means that the power supply is not providing the indicated voltage. Check first to see if the corresponding power supply fuse is blown. If it is, replace it. If the LED still doesn't light, or if the fuse blows again after a short time, contact your Cromemco dealer or authorized service facility for assistance.

Cromemco System Three Instruction Manual  
D. Power Supply and Fuses

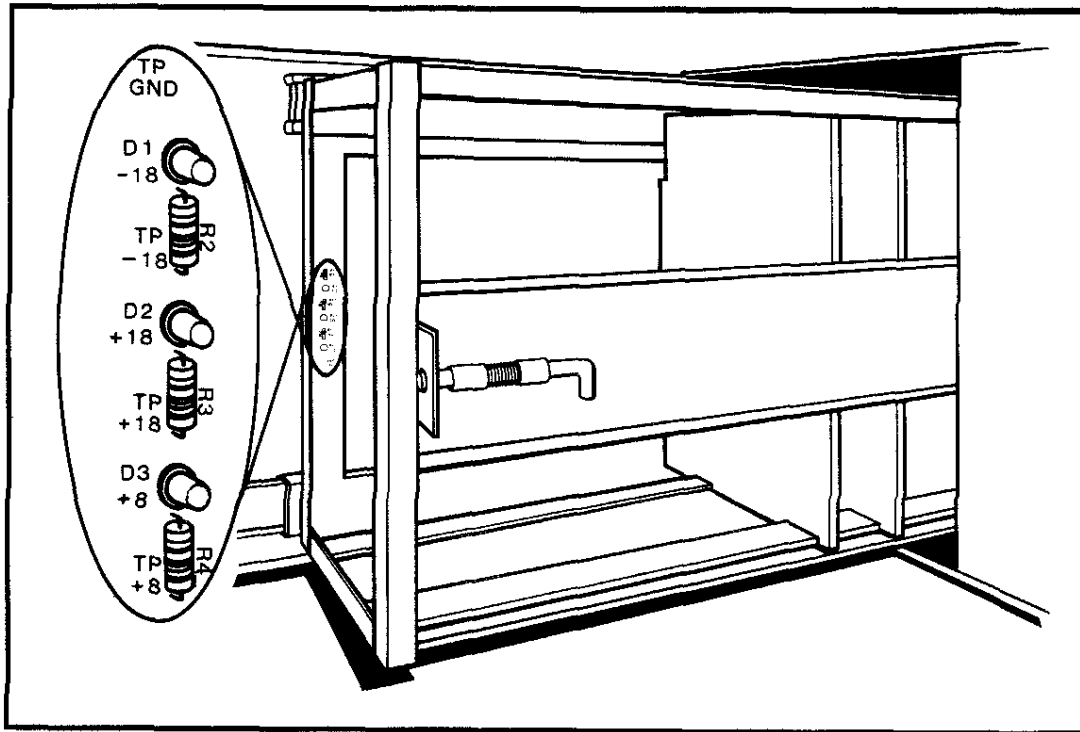

Figure D-3: LOCATION OF POWER SUPPLY LEDS

**Appendix E**

**SUMMARY OF BOARDS INSTALLED IN SYSTEM THREE MODELS**

This appendix summarizes the processor, memory, and interface boards included with each model of the System Three.

**Models with Two Floppy Disk Drives:**

	CS-3	CS-3D2	CS-3D5E
<b>Processor:</b>	ZPU	DPU	DPU
<b>Memory:</b>	64KZ-II	256KZ	512MSU

**Models with Two Floppy Disk Drives  
and One Hard Disk Drive:**

	CS-3H	CS-3HD2	CS-3HD5E
<b>Processor:</b>	ZPU	DPU	DPU
<b>Memory:</b>	64KZ-II	256KZ	512MSU

The 64KZ-II memory board is supplied with models CS-3A and CS-3H. The CDOS Operating System requires one 64KZ-II board. The 8-bit Cromix Operating System requires one 64KZ-II board for the operating system plus one for each potential user.

One 256KZ memory board is included with models CS-3D2 and CS-3HD2.

The MCU (memory control unit) board is included with models CS-3D5E and CS-3HD5E.

The WDI-II interface board is included with all models that have a hard disk drive.





## Appendix F

### SWITCH SETTINGS AND CABLE CONNECTIONS

The circuit boards supplied with your system come ready to use with their switches, if any, set to support the System Three. If you replace any of the boards, check to see that the switches are set as described in this appendix. For more information on any board, see the appropriate Cromemco board manual listed in the Introduction. The Cromix Operating System manual also gives additional information on using the 64KZ-II and TU-ART boards with that operating system.

#### SWITCH SETTINGS

The following paragraphs describe the purpose of each board and its switch settings.

**ZPU Board** - This is a central processing unit with an 8-bit Z80A microprocessor. This board comes with models CS-3A and CS-3H. Figure F-1 shows the proper switch settings for this board.

**DPU Board** - This is the Cromemco Dual Processing Unit with both a 32-bit 68000 microprocessor and an 8-bit Z80A microprocessor. This board comes with models CS-3D2, CS-3HD2, CS-3D5E, and CS-3HD5E. This board does not have any switches on it.

**64KZ-II Board** - This is a Random Access Memory (RAM) board with 64K bytes of memory. This board comes with models CS-3A and CS-3H. Systems running the CDOS Operating System have one 64KZ-II board. Figure F-2 shows the proper switch settings for these systems. Systems running the 8-bit Cromix Operating System have a minimum of two 64KZ-II boards and a maximum of seven boards. Figure F-3 shows the proper switch settings for these systems.

Cromemco System Three Instruction Manual  
 F. Switch Settings and Cable Connections

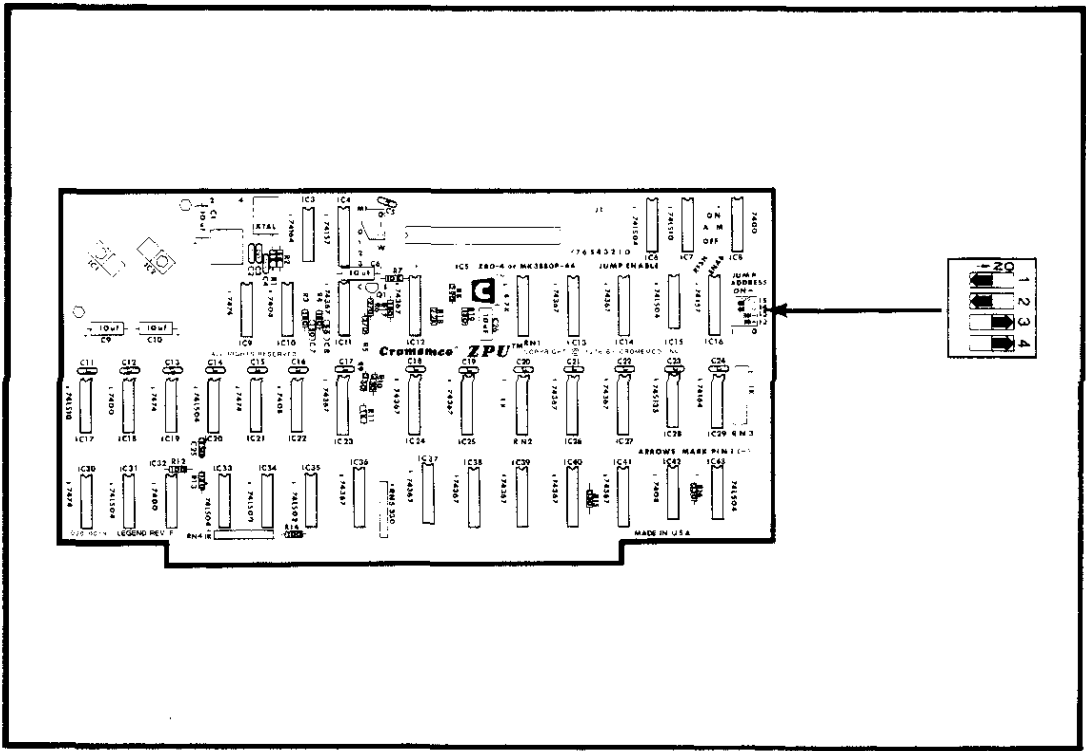

Figure F-1: SWITCH SETTINGS FOR THE ZPU BOARD

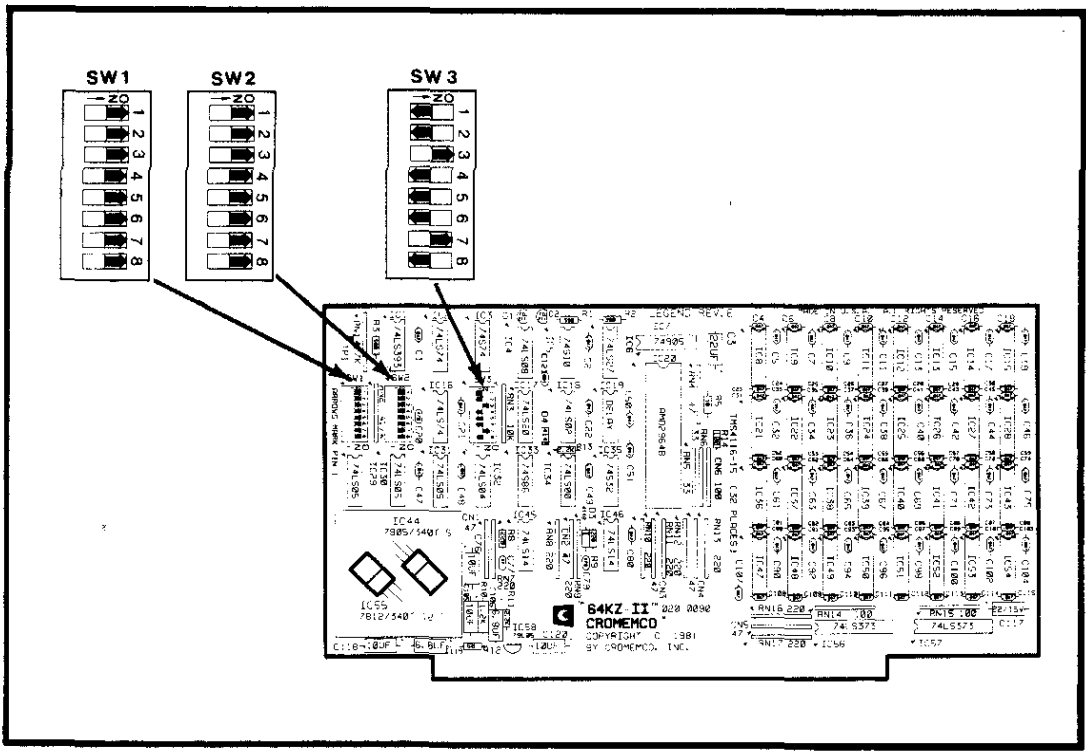
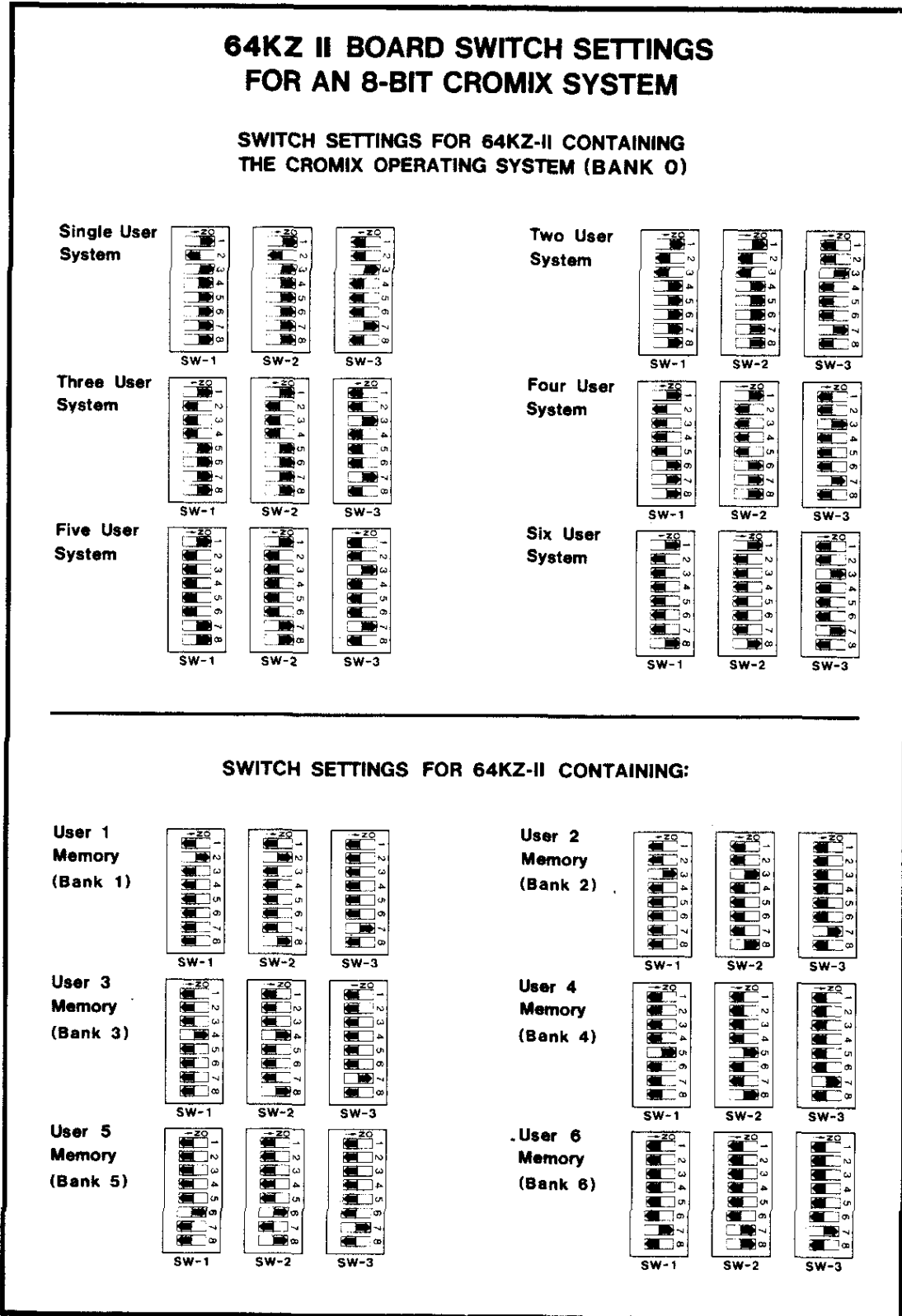

Figure F-2: SWITCH SETTINGS FOR 64KZ-II BOARDS  
 IN CDOS OPERATING SYSTEMS



**Figure F-3: SWITCH SETTINGS FOR 64KZ-II BOARDS  
 IN CROMIX OPERATING SYSTEMS**

**256KZ Board** - This is a Random Access Memory board with 256K bytes of memory. One of these boards comes with models CS-3D2 and CS-3HD2. Figure F-4 shows the proper switch settings for 256KZ boards in a Z80-based system. Figure F-5 shows the proper switch settings for up to four 256KZ boards in a 68000-based system. If more than four 256KZ boards are used, refer to the 256KZ manual for the proper switch settings.

The 256KZ board comes already set up to operate with your system configuration. However, if you switch processors or add memory boards, the PROM in the IC39 socket may have to be changed. The following table indicates the correct PROM number for each configuration.

**Table F-1: IC39 PROM NUMBERS FOR 256KZ BOARDS**

System Configuration	256KZ #1	256KZ #2
Z80A 3-user Cromix	74947	n/a
Z80A 4-user Cromix (with one 64KZ-II)	74949	n/a
Z80A 5-user Cromix (with two 64KZ-II)	74950	n/a
Z80A 6-user Cromix	74948	74949
68000 Cromix	74947	n/a

Refer to the 256KZ manual for further information.

**256MSU Board** - This is a Memory Storage Unit with 256K bytes of error-correcting memory. All switches on a single 256MSU board should be OFF. If more than one 256MSU board is used, the switches should be set according to Figure F-6. Use of the 256MSU board requires the MCU board described as follows.

**512MSU Board** - This is a Memory Storage Unit with 512K bytes of error-correcting memory. This board comes with models CS-3D5E and CS-3HD5E. All switches on a single 512MSU board should be OFF. If more than one 512MSU board is used, the switches should be set according to Figure F-7. Use of the 512MSU board requires the MCU board described as follows.

Cromemco System Three Instruction Manual  
 F. Switch Settings and Cable Connections

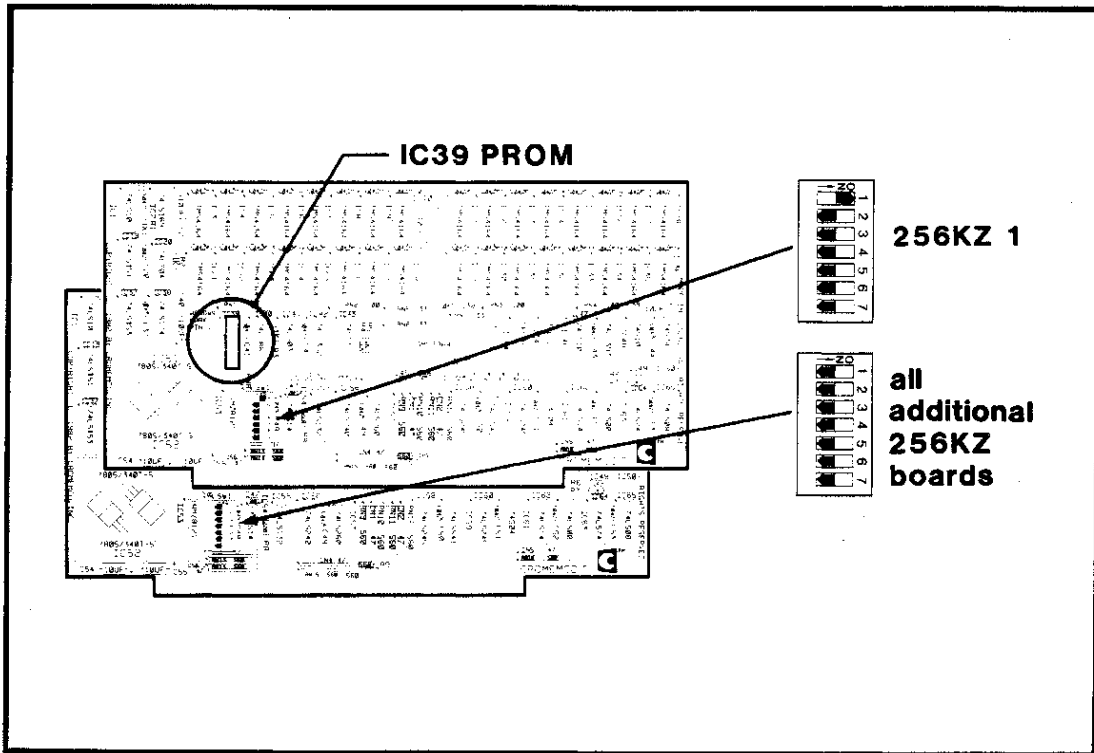

Figure F-4: SWITCH SETTINGS FOR 256KZ BOARDS  
 IN Z80-BASED SYSTEMS

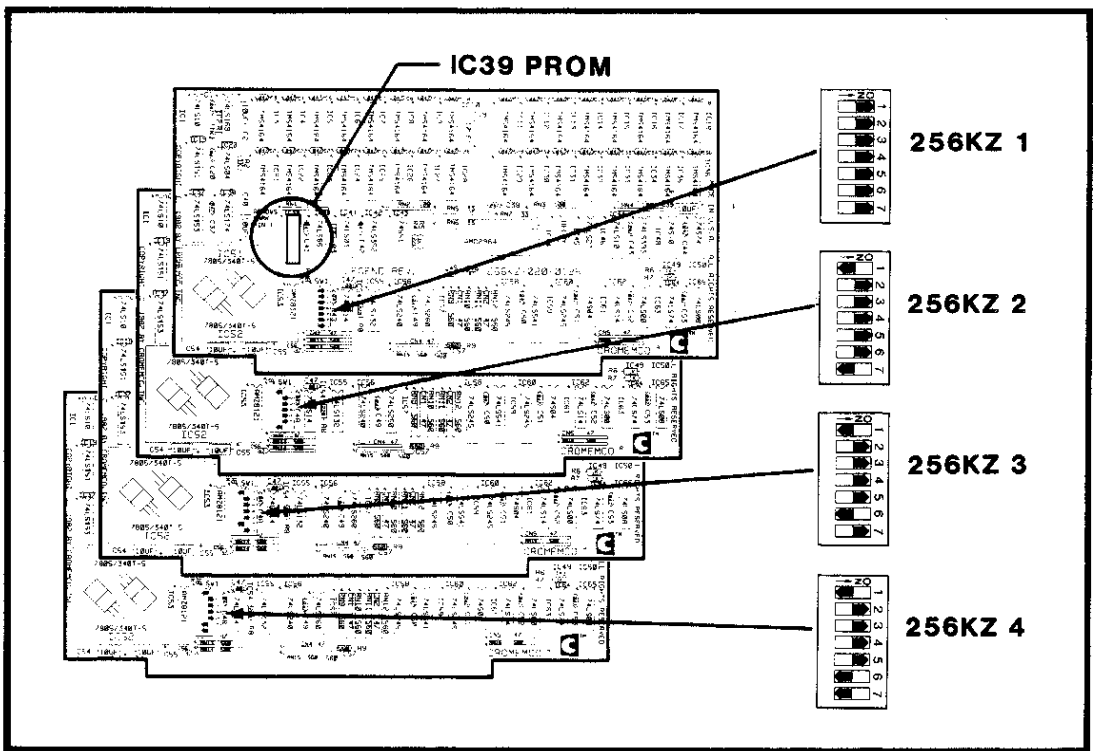

Figure F-5: SWITCH SETTINGS FOR 256KZ BOARDS  
 IN 68000-BASED SYSTEMS

Cromemco System Three Instruction Manual  
F. Switch Settings and Cable Connections

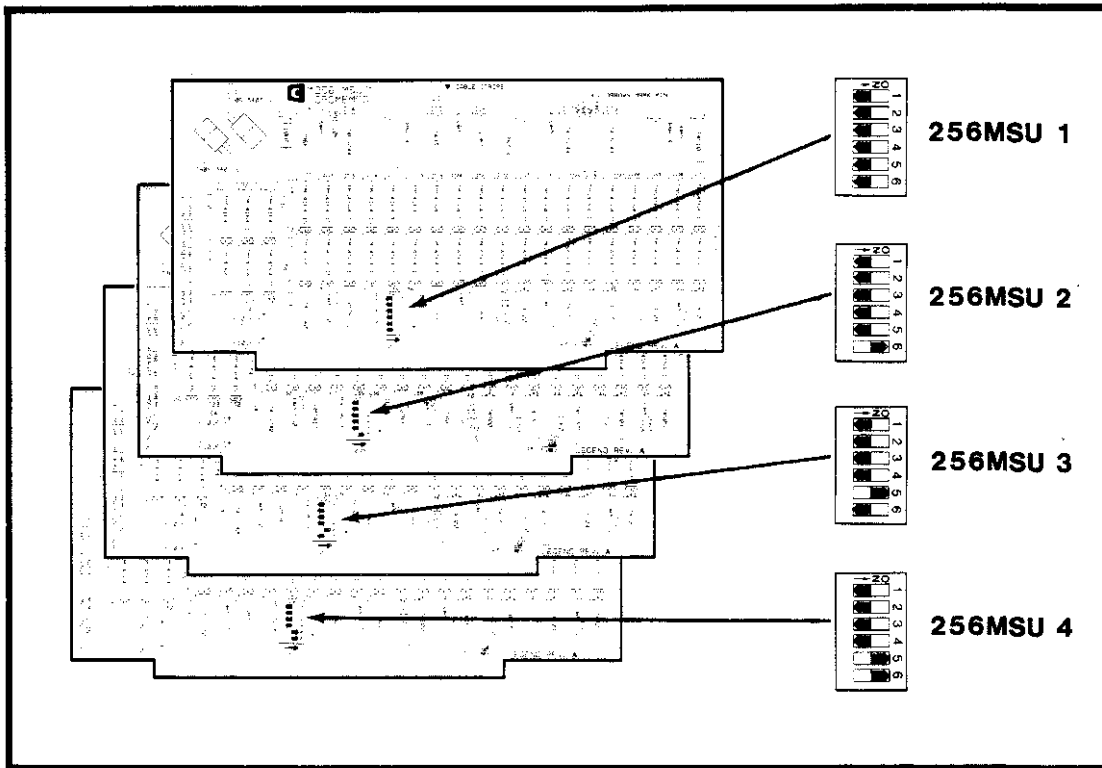

Figure F-6: SWITCH SETTINGS FOR 256MSU BOARDS

**MCU Board** - This is the Memory Control Unit for 256MSU and 512MSU boards. This board comes with models CS-3D5E and CS-3HD5E. This board doesn't have any switches.

**WDI-II Board** - This is the interface board for the Winchester hard disk drive. This board comes with models CS-3H, CS-3HD2, CS-3HD5, CS-3HD2E, and CS-3HD5E. This board doesn't have any switches.

**64FDC Board** - This is the interface board for the floppy disk drive(s). This board comes with all models. All switches should be OFF, as shown in Figure F-8.

**TU-ART Board** - This is an interface board for two terminals. Figure F-9 shows the proper switch settings for this board.

Cromemco System Three Instruction Manual  
 F. Switch Settings and Cable Connections

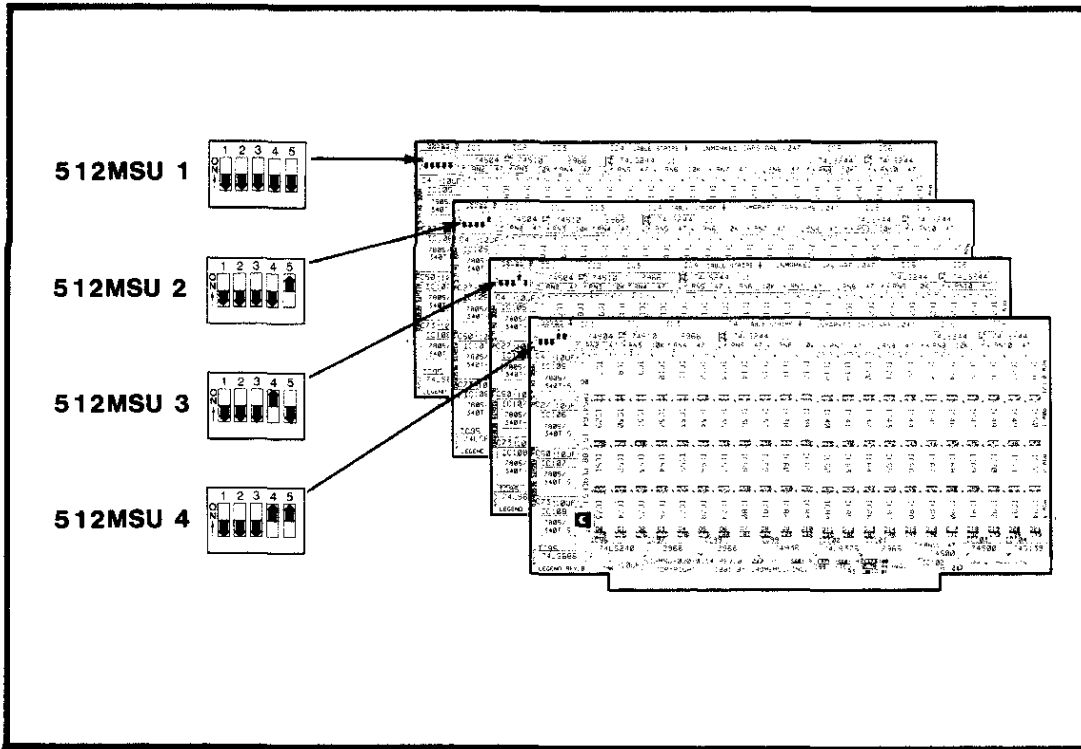

Figure F-7: SWITCH SETTINGS FOR 512MSU BOARD

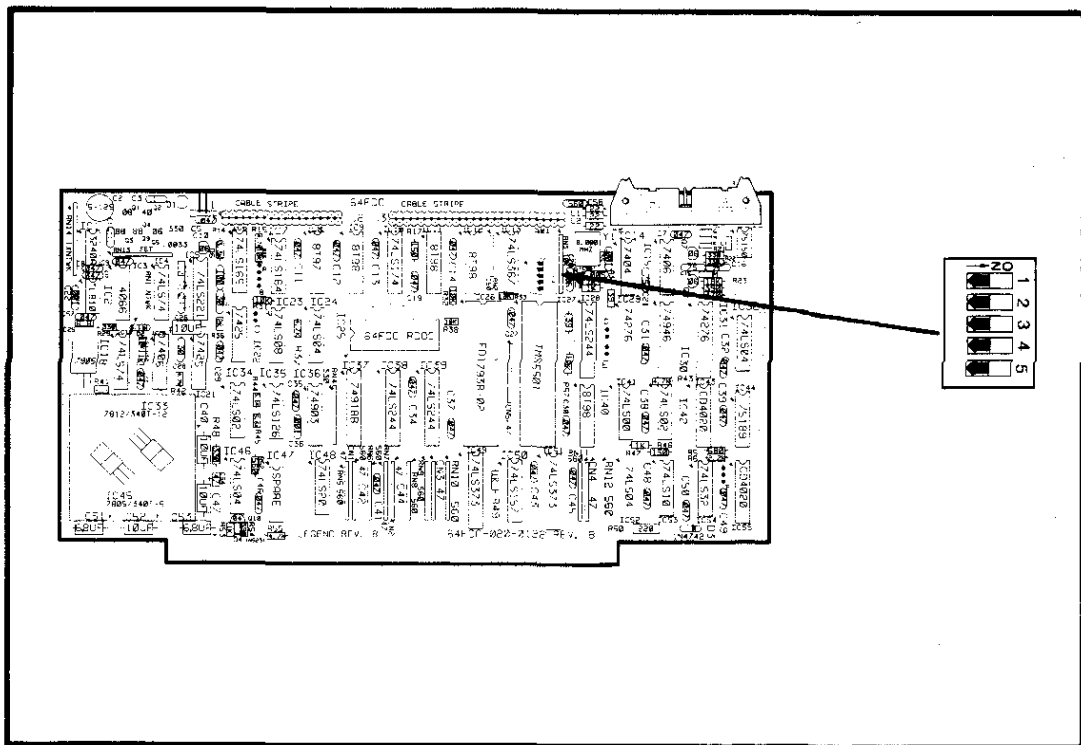

Figure F-8: SWITCH SETTINGS FOR THE 64FDC BOARDS

Cromemco System Three Instruction Manual  
F. Switch Settings and Cable Connections

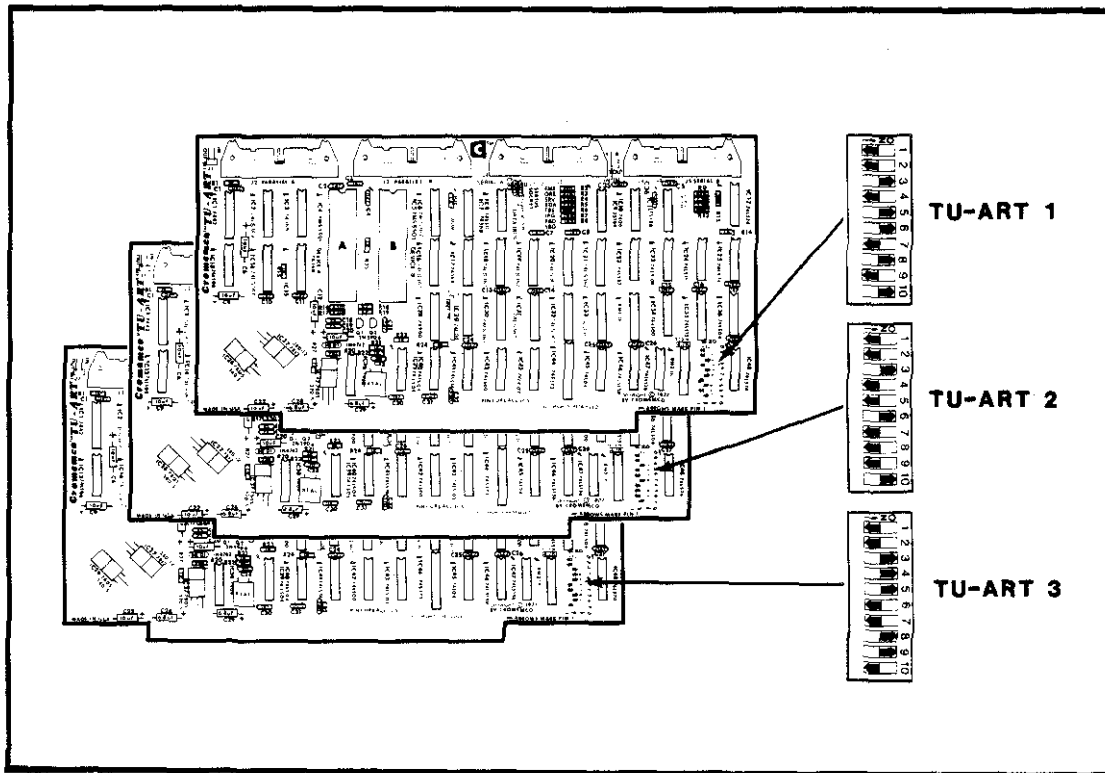

Figure F-9: SWITCH SETTINGS FOR TU-ART BOARDS

**CABLE CONNECTIONS**

The following information applies only to users of the Cromix Operating System.

**Priority Interrupt Cable**

The priority interrupt cable is a single wire with several connectors at regular intervals along its length. This cable must run between all of the following boards in a Cromix system: 16FDC or 64FDC, all IOPs, all TU-ARTs, all CTIs, and the PRI. If the system has no PRI, IOPs, CTIs or TU-ARTs, then no priority interrupt cable is required.

The priority interrupt cable must not be connected to the WDI, WDI-II or any QUADARTs.



The cable must go from the priority interrupt cable connector **out** pin on the 16FDC or 64FDC board to the **in** pin on the next board in sequence, and so on. Note that the positions of the in and out pins on the 16FDC board are reversed from the in and out pin positions on the other boards. The priority interrupt cable should run from the 16FDC or 64FDC to the TU-ART(s) to the IOP(s) to the CTI(s) to the PRI.

### MCU and MSU M-Bus Cable

The MCU and MSU boards share a common cable and therefore must be installed in a physical group. The order and spacing is not important, but they must be close enough together to be connected by the overhead M-bus cable. When all MCU and MSU boards are installed, press the M-bus cable firmly onto the boards as shown in Figure F-10. Your M-bus cable will probably have a small green terminator card (part number 520-0128) attached to the back surface. In this case, the installation procedure is exactly the same. Do not remove the terminator card from the M-bus cable. Cromemco supplies a standard M-bus cable (part number 519-0150) with each MCU board for use in systems with MSU boards.

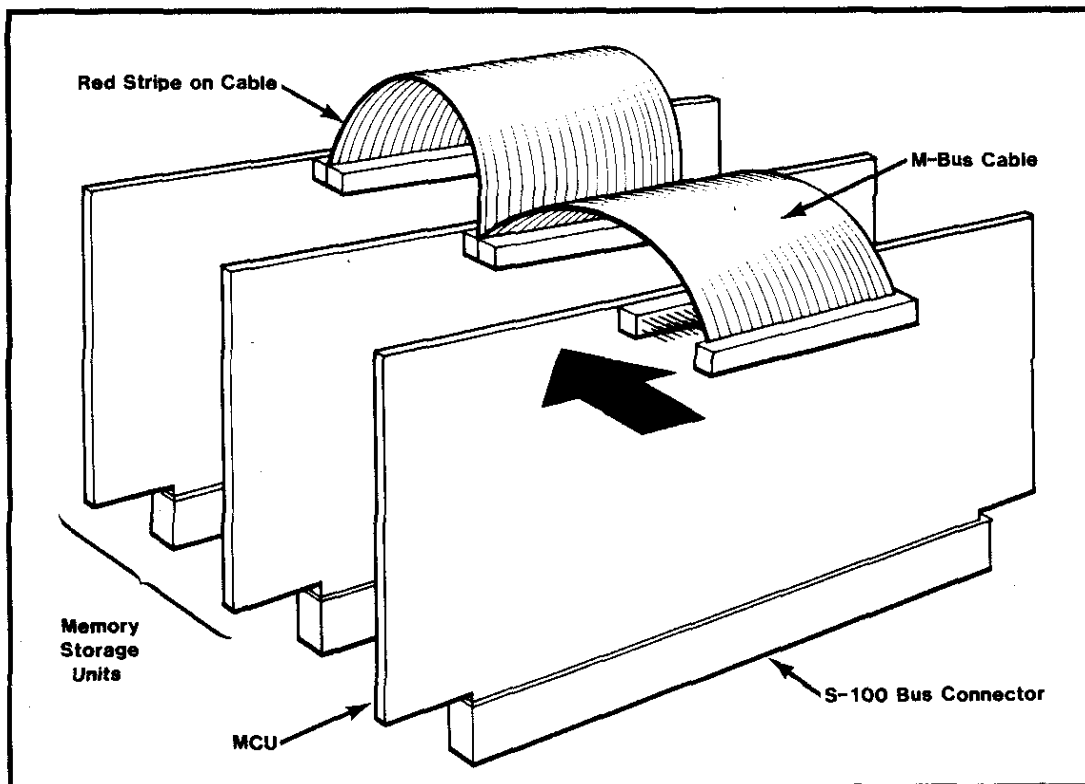

Figure F-10: INSTALLING THE M-BUS CABLE



## Appendix G

### ADVANCED FEATURES OF THE RDOS BOOT COMMAND

The RDOS boot command can load the operating system manually in response to the RDOS prompt, as well as automatically upon power-on or reset. In either case, the operating system can be booted from floppy disk drive A, B, C, or D. These options are explained below.

The format of the RDOS Boot command when given manually is

**Bx**

followed by a RETURN, where **x** is an optional disk drive specifier. If **x** is omitted, RDOS will boot from the drive specified by switches 2, 3, and 4 of the 64FDC disk controller (for settings, see below).

The parameter **x** should be a floppy disk drive letter (in the range A through D). If this parameter is specified, RDOS will attempt to boot from that drive. For example, the command **BC** will attempt to boot the system from drive C.

The boot command is normally performed automatically by the system. Jumper location 3 on the 64FDC board is the AUTOMATIC BOOT control. There is a trace in this position, which causes RDOS to load the operating system automatically upon power-on or reset. If the trace is cut, RDOS enters a diagnostic monitor mode and waits for further commands.

When the system is booted automatically, or when a disk drive specifier is not indicated as part of the manual boot command, switches 2, 3, and 4 on the 64FDC board indicate which drive is to be used for booting the system. Switch 2 should always be set **OFF** to tell RDOS to attempt the boot from a floppy disk. Switches 3 and 4 then determine the disk to be used. Refer to the following table.

Cromemco System Three Instruction Manual  
G. Advanced Features of the RDOS Boot Command

Switch 2	Switch 3	Switch 4	Drive
Off	Off	Off	Floppy disk A
Off	Off	On	Floppy disk B
Off	On	Off	Floppy disk C
Off	On	On	Floppy disk D

After receiving the boot command (whether manual or automatic), RDOS will display the message "Preparing to boot, ESC to abort," indicating the boot command has been received. RDOS will then pause for a few seconds while determining the type of disk drive specified (8" or 5") and the type of seek. Once RDOS has read the system boot information from the disk into memory, it will display "Standby," indicating that the boot is proceeding normally.

At this point, you might also receive the message "No boot," indicating that the disk being used does not contain the boot information; or the message "Unable to boot," indicating that RDOS is unable to read the boot information from the disk. Either of these two conditions must be remedied by booting from another disk and then correcting or repairing the original disk.

Between display of the messages "Preparing to boot" and "Standby," you can abort the boot (even if the boot command is being performed automatically) and return control to RDOS by pressing the ESCAPE key on the keyboard. If the boot is not aborted and proceeds normally, the operating system being used should come up and display its prompt.

Cromemco System Three Instruction Manual  
Index

256KZ board, manual, 4  
256KZ memory board, 54  
256MSU memory board, 54

3355A printer driver, 44  
3355A printer driver, manual, 4

512MSU memory board, 3, 54

64FDC board, manual, 4  
64FDC floppy disk controller board, 56  
64FDC floppy diskette controller board, 3  
64KZ-II board, manual, 4  
64KZ-II memory board, 3, 51  
68000 microprocessor, 3  
68000 microprocessor, manual, 4

Adding circuit boards, 39

Back panel, 35  
Baud rate, determining, 17, 18, 25, 27  
Boards, adding, 39  
Boards, system configuration, 49  
Boot track, 25  
Booting the system, 12, 18

Cable connections, 58  
Cable guide, 41  
Card cage, 2  
Card cage, extending, 39  
CDOS Operating System, 3  
CDOS Operating System, 64KZ-II board, 51  
CDOS Operating System, loading, 25  
CDOS Operating System, manual, 4, 15, 25  
Central processing unit boards, 3  
Circuit boards, adding, 39  
Circuit boards, switch settings, 51  
Color monitor connectors, 2, 37  
Connecting a printer, 43  
Connecting a terminal, 9  
Connections, testing, 17  
Connectors, 2  
Connectors, color monitor, 37  
Connectors, DB-25, 10, 37  
Connectors, DB-37, 37  
Connectors, locations for, 37  
Cooling, 2, 5

Cromemco System Three Instruction Manual  
Index

Cover, removing, 7, 41  
Cromix 68000 Operating System, 3  
Cromix 8-bit Operating System, 3  
Cromix Operating System, 64KZ-II board, 51  
Cromix Operating System, loading, 26  
Cromix Operating System, manual, 4, 15, 25  
CS-3A model, 2, 51  
CS-3D2 model, 2, 51  
CS-3D5E model, 2, 51  
CS-3H model, 2, 51  
CS-3HD2 model, 2, 51  
CS-3HD5E model, 2, 51

DB-25 connectors, 2, 10, 37  
DB-37 connectors, 2, 37  
Determining baud rate, 17, 18, 25, 27  
Disk drives, 2  
Disk drives, testing, 18  
Diskettes, inserting, 15  
Diskettes, preparation, 15  
Diskettes, release, 15  
Diskettes, removing, 16  
DPU microprocessor board, 3, 51  
Driver, 3355A printer, 44

Expanding the system, 2  
Extending the card cage, 39

Fans, 2  
Floppy diskette drives, 2  
Floppy diskette read test, 20  
Floppy diskette write test, 22  
Floppy diskettes, 11, 13  
Front panel, opening, 6, 39  
Fuse-rating label, 35  
Fuses, 6, 9, 37, 45

Hard disk drive, 2  
Hard disk drive fuse, 46  
HD5 5" hard disk, manual, 4  
Head load card(s), 11  
Heat, 5

Index holes, floppy diskettes, 14  
Init utility, 15  
Inserting diskettes, 15  
Introduction, 1

Cromemco System Three Instruction Manual  
Index

Line cord, 6, 11  
Line fuses, 45  
Line voltage setting label, 35  
Line voltage, specifying, 6  
Loading RDOS, 18  
Loading the CDOS Operating System, 25  
Loading the Cromix Operating System, 26  
Locations for input/output connectors, 37  
LOCK turnkey position, 12

M bus cable, 59  
MCU memory control board, 3, 56  
Memory problems, 20  
Memory test, 19  
Models, System Three, 2, 51  
Monitor connectors, 2, 37  
Motorola 68000 microprocessor, 3

Nonprivileged user, 28

OFF turnkey position, 12  
ON turnkey position, 12  
Opening the front panel, 6, 39  
Operating system, loading, 12, 25  
Operating systems, 3

Power, 5  
Power supply, 45  
Power supply, fuses, 46  
Power supply, switch, 12, 13, 17  
Preparing diskettes, 15  
PRI printer interface board, 3, 43  
PRI printer interface, manual, 4  
Printer driver, 3355A, 44  
Printer interface circuit board, 43  
Printer, connecting, 43  
Priority interrupt cable, 58  
Privileged user, 28  
Problems with the memory, 20  
Processors, 3

RDOS boot command, 61  
RDOS program, 18  
RDOS, loading, 18  
Read error message, 22, 23  
Read/write slot, floppy diskettes, 13  
Release diskettes, 15

Cromemco System Three Instruction Manual  
Index

Removing diskettes, 16  
Removing the cover, 7, 41  
Reset switch, 37  
RESET turnkey position, 12  
Restore error message, 21  
Rewrite error message, 23

Serial number, 5, 35  
Setting up the system, 5  
Specifying line voltage, 6  
Step/seek error message, 21  
Switch settings for circuit boards, 51  
System terminal, 9  
System, booting, 12

Tap select cable, 7  
Terminal cable, 9  
Terminal, connecting, 9  
Testing floppy disk drives, 20, 22  
Testing memory and disk drives, 18  
Testing the connections, 17  
Testing the memory, 19  
Testing the system, 17  
TM848 floppy disk drive, manual, 4  
TU-ART terminal interface board, 3, 56  
Turning on the system, 17  
Turning the system off, 13  
Turning the system on, 11, 12  
Turnkey power switch, 12, 13, 17

Unpacking the system, 5  
User, nonprivileged, 28  
User, privileged, 28  
Using this manual, 3

Voltage setting, 6, 9, 35

Warranty card, 5  
WDI-II hard disk controller board, 3, 56  
WDI-II hard disk controller, manual, 4  
Winchester disk interface board, 3  
Write error message, 23  
Write protect notch, floppy diskettes, 13

Z80A microprocessor, 3  
ZPU microprocessor board, 3, 51  
ZPU microprocessor, manual, 4



# Cromemco System Three Instruction Manual Limited Warranty

## LIMITED WARRANTY

Cromemco, Inc. ("Cromemco") warrants this product against defects in material and workmanship to the original purchaser for ninety (90) days from the date of purchase, subject to the following terms and conditions.

### What Is Covered By This Warranty:

During the ninety (90) day warranty period Cromemco will, at its option, repair or replace this Cromemco product or repair or replace with new or used parts any parts or components, manufactured by Cromemco, which prove to be defective, provided the product is returned to an Authorized Cromemco Dealer as set forth below.

### How To Obtain Warranty Service:

You should immediately notify IN WRITING your Authorized Cromemco Dealer or Cromemco of problems encountered during the warranty period. In order to obtain warranty service, first obtain a return authorization number by contacting the Authorized Cromemco Dealer from whom you purchased the product. Then attach to the product:

1. Your name, address and telephone number,
2. the return authorization number,
3. a description of the problem, and
4. proof of the date of retail purchase.

Ship or otherwise return the product, transportation and insurance costs prepaid, to the Authorized Cromemco Dealer. If you are unable to receive warranty repair from the Authorized Cromemco Dealer from whom you purchased the product, you should contact Cromemco Customer Support at: Cromemco, Inc., 280 Bernardo Ave., Mountain View, Ca. 94043.

### What Is Not Covered By This Warranty:

Cromemco does not warrant any products, components or parts not manufactured by Cromemco.

This warranty does not apply if the product has been damaged by accident, abuse, misuse, modification or misapplication; by damage during shipment; or by improper service. This product is not warranted to operate satisfactorily with peripherals or products not manufactured by Cromemco. Transportation and insurance charges incurred in transporting the product to and from the Authorized Cromemco Dealer or Cromemco are not covered by this Warranty.

### Exclusion of Liability, Damages, and Other Warranties:

THIS WARRANTY IS IN LIEU OF ALL OTHER WARRANTIES, WHETHER ORAL OR WRITTEN, EXPRESS OR IMPLIED. ANY IMPLIED WARRANTIES, INCLUDING IMPLIED WARRANTIES OF MERCHANTABILITY AND FITNESS FOR A PARTICULAR PURPOSE, ARE LIMITED IN DURATION TO NINETY (90) DAYS FROM THE DATE OF PURCHASE OF THIS PRODUCT. IF THIS PRODUCT IS NOT IN GOOD WORKING ORDER AS WARRANTED ABOVE, YOUR SOLE REMEDY SHALL BE REPAIR OR REPLACEMENT AS PROVIDED ABOVE. CROMEMCO SHALL NOT BE LIABLE FOR INCIDENTAL AND/OR CONSEQUENTIAL DAMAGES FOR THE BREACH OF ANY EXPRESS OR IMPLIED WARRANTY, INCLUDING DAMAGE TO PROPERTY AND, TO THE EXTENT PERMITTED BY LAW, DAMAGES FOR PERSONAL INJURY, EVEN IF CROMEMCO HAS BEEN ADVISED OF THE POSSIBILITY OF SUCH DAMAGES. THE AGENTS, DEALERS, AND EMPLOYEES OF CROMEMCO ARE NOT AUTHORIZED TO MAKE MODIFICATIONS TO THIS WARRANTY, OR ADDITIONAL WARRANTIES BINDING ON CROMEMCO ABOUT OR FOR PRODUCTS SOLD OR LICENSED BY CROMEMCO. ACCORDINGLY, ADDITIONAL STATEMENTS WHETHER ORAL OR WRITTEN EXCEPT SIGNED WRITTEN STATEMENTS FROM AN OFFICER OF CROMEMCO DO NOT CONSTITUTE WARRANTIES AND SHOULD NOT BE RELIED UPON. SOFTWARE, TECHNICAL INFORMATION AND FIRMWARE ARE LICENSED ONLY BY A SEPARATE AGREEMENT ON AN "AS IS" BASIS.

### Limitation on Statute of Limitation and Transferability:

This warranty and the statute of limitations shall run concurrently with any acceptance period. This warranty is not transferable. No suit, litigation, or action shall be brought based on the alleged breach of this warranty or implied warranties more than one year after the date of purchase in those jurisdictions allowing such a limitation, otherwise no such action shall be brought more than one year after the expiration of this warranty.

### Other Important Provisions:

Some states do not allow the exclusion or limitation of incidental or consequential damages or limitations on how long an implied warranty lasts, so the above limitation or exclusion may not apply to you. This warranty shall not be applicable to the extent that any provision of this warranty is prohibited by any federal, state or municipal law which cannot be preempted. This warranty gives you specific legal rights, and you may also have other rights which vary from state to state.



REV	DESCRIPTION	DATE	APPROVAL
A	PRODUCTION RELEASE	C. WHITE 2-25-82	
B	POWER LEDS TO SWITCH BU	PS 5-17-82	
C	DPSS FROM REV C TO REV F	PS 4-9-82	
D	DPSS FROM REV E TO REV G	PS 5-10-82	
E	DPSS FROM REV G TO REV H	PS 6-15-82	
F	DPSS FROM REV H TO REV J	PS 9-17-82 REV 158	

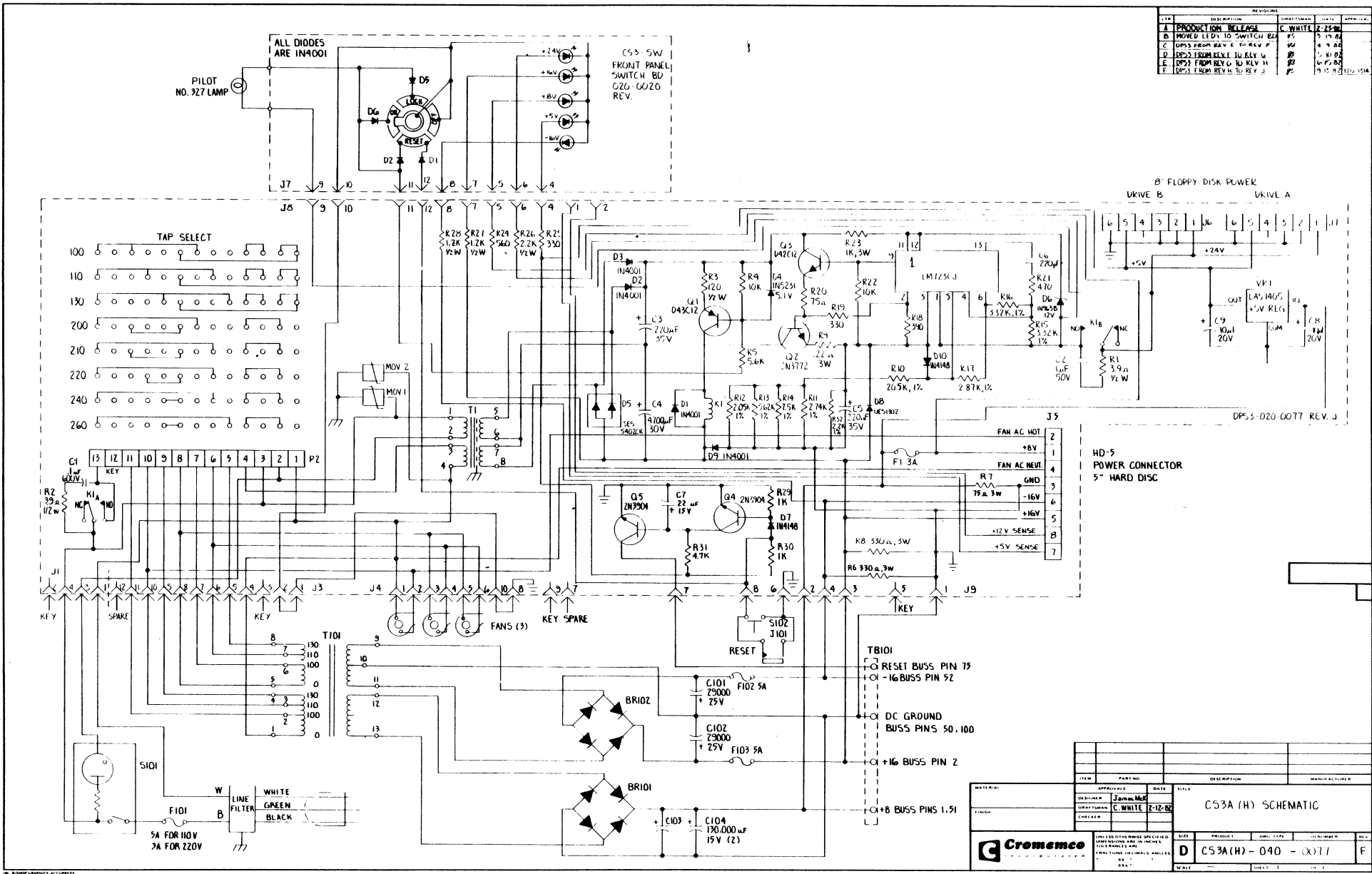

ITEM	PART NO.	DESCRIPTION	MANUFACTURER
DESIGNER	JAMES MURPHY		
DRAWN BY	C. WHITE	2-12-82	
CHECKED			
<b>C53A (H) SCHEMATIC</b>			
<b>Cromenco</b> <small>UNLESS OTHERWISE SPECIFIED          DIMENSIONS ARE IN INCHES          DECIMALS AND ANGLES          UNLESS OTHERWISE SPECIFIED</small>		DATE: _____ PRODUCT: C53A(H)-040-0077 SCALE: _____	SHEET: 1 OF: 1













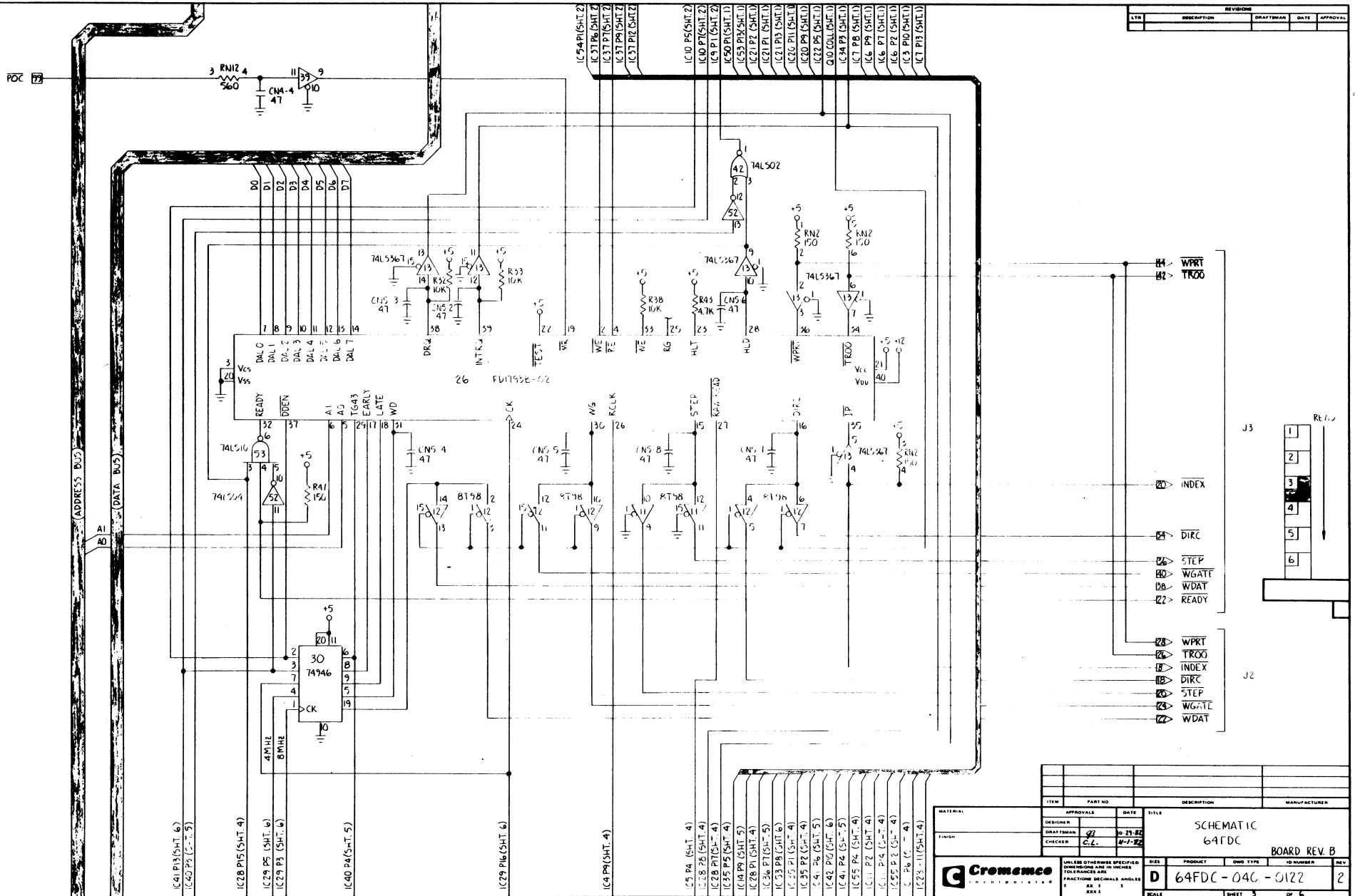

REVISIONS				
LTN	DESCRIPTION	DRAWNMAN	DATE	APPROVAL

- 84 WPRT
- 82 TROO
- 20 INDEX
- 54 DIRC
- 26 STEP
- 80 WGATE
- 88 WDAT
- 22 READY
- 28 WPRT
- 26 TROO
- 18 INDEX
- 18 DIRC
- 20 STEP
- 24 WGATE
- 22 WDAT

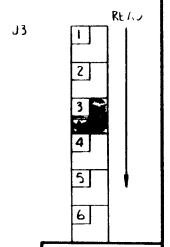

ITEM	PART NO	DESCRIPTION	MANUFACTURER

APPROVALS	DATE	TITLE
DESIGNER		
DRAWNMAN	02 10 21 82	SCHEMATIC
CHECKER	C.L.	64FDC

SIZE	PRODUCT	DWG TYPE	ID NUMBER	REV
D	64FDC-04C-0122			2

BOARD REV. B



UNLESS OTHERWISE SPECIFIED  
DIMENSIONS ARE IN INCHES  
FRACTIONS DECIMALS ANGLES  
SER 1 1  
SER 2

SCALE SHEET 3 OF 6

















ZPU

COPYRIGHT 1976 BY CROMEMCO  
U.S. PATENT PENDING  
SCHEMATIC REV 7  
BOARD REV F.  
ZPU - 040-0019

