

# M980 PROM Programmer

## USER'S MANUAL

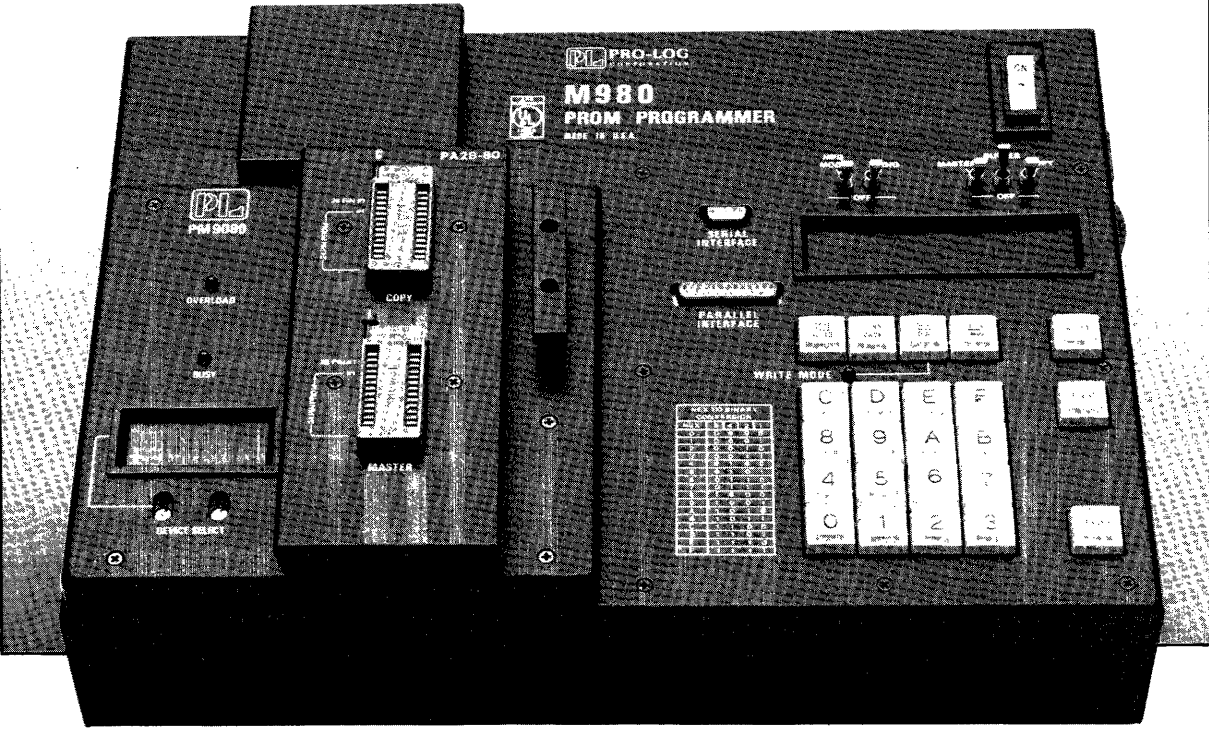

The information in this manual has been carefully reviewed and is believed to be entirely reliable. However, no responsibility is assumed for inaccuracies. Furthermore, such information does not convey to the purchaser of the equipment described any license under the patent right of Pro-Log Corporation or others.

The material in this manual is subject to change and Pro-Log Corporation reserves the right to change specifications without notice.

## Warranty

**Warranty:** Seller warrants that the articles furnished hereunder are free from defects in material and workmanship and perform to applicable, published Pro-Log specifications for TWO YEARS FROM DATE OF SHIPMENT. This warranty is in lieu of any other warranty expressed or implied. In no event will Seller be liable for special or consequential damages as a result of any alleged breach of this warranty provision. The liability of Seller hereunder shall be limited to replacing or repairing, at its option, any defective units which are returned F.O.B. Seller's plant. Equipment or parts which have been subject to abuse, misuse, accident, alteration, neglect, unauthorized repair or installation are not covered by warranty. Seller shall have the right of final determination as to the existence and cause of defect. As to items repaired or replaced, the warranty shall continue in effect for the remainder of the warranty period, or for ninety (90) days following date of shipment by Seller or the repaired or replaced part whichever period is longer. No liability is assumed for expendable items such as lamps and fuses. No warranty is made with respect to custom equipment or products produced to Buyer's specifications except as specifically stated in writing by Seller and contained in the contract.

# M980 PROM Programmer







# Contents

|                                                             | Page |                                                                           | Page |
|-------------------------------------------------------------|------|---------------------------------------------------------------------------|------|
| <b>SECTION 1—Purpose and Main Features</b> .....            | 1-1  | Duplicating a PROM from a Master PROM .....                               | 5-8  |
| Description .....                                           | 1-1  | Comparing a Copy PROM with a Master PROM.....                             | 5-10 |
| Features.....                                               | 1-1  | Performing a Checksum on a Master PROM.....                               | 5-12 |
| Operational Modes.....                                      | 1-2  | Performing a Checksum on a Copy PROM .....                                | 5-14 |
| Personality Modules.....                                    | 1-2  | Performing a Blank Check on a Master PROM.....                            | 5-16 |
| Optional Accessories .....                                  | 1-2  | Performing a Blank Check on a Copy PROM .....                             | 5-18 |
| Physical Specifications .....                               | 1-3  | Performing an Illegal Bit Check on a Copy PROM from the Master PROM ..... | 5-20 |
| <b>SECTION 2—Operating Panel Description</b> .....          | 2-1  | <b>SECTION 6—Buffer Operations To/From a Copy or Master PROM</b> .....    | 6-1  |
| Panel .....                                                 | 2-1  | Description .....                                                         | 6-1  |
| Panel Displays, Indicators and Controls.....                | 2-2  | Duplicating the RAM Buffer from a Master PROM.....                        | 6-2  |
| Hexadecimal Notation.....                                   | 2-3  | Comparing the RAM Buffer with a Master PROM.....                          | 6-4  |
| <b>SECTION 3—Personality Module Description</b> .....       | 3-1  | Duplicating the RAM Buffer into a Copy PROM.....                          | 6-6  |
| Personality Module Types.....                               | 3-1  | Comparing the RAM Buffer to a Copy PROM .....                             | 6-8  |
| Dedicated Modules .....                                     | 3-1  | Performing an Illegal Bit Check on a Copy PROM from the Buffer .....      | 6-10 |
| Generic Modules .....                                       | 3-2  | <b>SECTION 7—Additional Buffer Operations</b> .....                       | 7-1  |
| Dedicated Gang Modules.....                                 | 3-4  | Description .....                                                         | 7-1  |
| Generic Gang Modules.....                                   | 3-5  | Programming the RAM Buffer using the M980 Keyboard.....                   | 7-2  |
| 5V MOS Generic Module .....                                 | 3-6  | Reading the RAM Buffer using the M980 Keyboard.....                       | 7-4  |
| Special Personality Modules .....                           | 3-7  | Performing a Read/Modify on the RAM Buffer .....                          | 7-6  |
| PROM Handling .....                                         | 3-7  | Performing a Checksum on the M980 RAM Buffer .....                        | 7-8  |
| ZIF Sockets.....                                            | 3-7  | Buffer Edit Functions .....                                               | 7-10 |
| <b>SECTION 4—Address Field Definition</b> .....             | 4-1  | Buffer Edit—Set Word Size.....                                            | 7-11 |
| Full Address Operation .....                                | 4-1  | Buffer Edit—Invert (Complement) .....                                     | 7-12 |
| Partial Address Operation.....                              | 4-1  | Buffer Edit—Fill Buffer .....                                             | 7-14 |
| Clear Key Operations .....                                  | 4-2  | Buffer Edit—Insert .....                                                  | 7-16 |
| <b>SECTION 5—Copy and Master Socket Operations</b> .....    | 5-1  | Buffer Edit—Delete .....                                                  | 7-20 |
| Description .....                                           | 5-1  | Buffer Edit—Block Move.....                                               | 7-24 |
| Master and Copy Socket Modes .....                          | 5-1  | Buffer Edit—Nibble Swap .....                                             | 7-28 |
| Audio/Manufacturing Toggle Switches .....                   | 5-1  | Buffer Edit—Hex Pack.....                                                 | 7-30 |
| Master/Buffer/Copy Source Destination Toggle Switches ..... | 5-2  | Buffer Edit—Hex Unpack .....                                              | 7-32 |
| Programming a PROM.....                                     | 5-2  |                                                                           |      |
| Reading a Copy PROM in the COPY Socket.....                 | 5-4  |                                                                           |      |
| Reading a Master PROM in the MASTER Socket .....            | 5-6  |                                                                           |      |

# Contents

(Continued)

|                                                               | Page |                                                           | Page  |
|---------------------------------------------------------------|------|-----------------------------------------------------------|-------|
| Buffer Edit—RAM Split.....                                    | 7-34 | <b>SECTION 14—M980 Interface Software Selection</b> ..... | 14-1  |
| Buffer Edit—RAM Interleave.....                               | 7-36 | Selecting Type and Format.....                            | 14-1  |
| <b>SECTION 8—Buffer Applications</b> .....                    | 8-1  | Interface Format Numbers .....                            | 14-3  |
| Description .....                                             | 8-1  | Pro-Log and Industry Format Description .....             | 14-4  |
| Example 1 .....                                               | 8-1  | <b>SECTION 15—9811 Paper Tape Reader</b> .....            | 15-1  |
| Example 2 .....                                               | 8-1  | 9811 Paper Tape Reader .....                              | 15-1  |
| <b>SECTION 9—Manufacturing Mode</b> .....                     | 9-1  | Parallel Interface Connector.....                         | 15-1  |
| Description .....                                             | 9-1  | Controls .....                                            | 15-2  |
| Automatic Sequencing Operation .....                          | 9-2  | Indicators.....                                           | 15-2  |
| Single Operation.....                                         | 9-4  | Formats .....                                             | 15-2  |
| <b>SECTION 10—Engineering Auto-Sequencing Mode</b> .....      | 10-1 | Operating Sequences .....                                 | 15-4  |
| Description .....                                             | 10-1 | Error Indication .....                                    | 15-5  |
| Buffer to Copy Operation .....                                | 10-2 | <b>SECTION 16—9812-02 TTY Interface</b> .....             | 16-1  |
| Master to Copy Operation.....                                 | 10-4 | 9812 Auto-Baud TTY.....                                   | 16-1  |
| <b>SECTION 11—Failure to Program</b> .....                    | 11-1 | Controls and Indicators.....                              | 16-1  |
| Fusible PROMs.....                                            | 11-1 | Paper Tape Format .....                                   | 16-2  |
| UV Erasable PROMs .....                                       | 11-1 | Keyboard Commands .....                                   | 16-2  |
| Example of Error during Duplication .....                     | 11-2 | Operating Modes .....                                     | 16-3  |
| PM9005A and PM9053A Modules.....                              | 11-3 | Operating Sequences .....                                 | 16-3  |
| PM9051A, PM9060A, PM9075A and PM9076A Modules .....           | 11-3 | TTY Errors.....                                           | 16-4  |
| <b>SECTION 12—Error Indications and Operation Codes</b> ..... | 12-1 | Options and Modifications .....                           | 16-4  |
| Error Indications .....                                       | 12-1 | Removing TTY Housing .....                                | 16-5  |
| Operation Codes .....                                         | 12-1 | Current Loop—Without Elapsed Time Meter .....             | 16-7  |
| <b>SECTION 13—Self-Test Operations</b> .....                  | 13-1 | Current Loop—With Elapsed Time Meter.....                 | 16-9  |
| Description .....                                             | 13-1 | Full Duplex Option .....                                  | 16-10 |
| Keyboard Self-Test Selection.....                             | 13-1 | Remote Reader Control.....                                | 16-10 |
| Toggle Switch Test .....                                      | 13-1 | Manual Reader Operation.....                              | 16-11 |
| Keyboard (Keyswitch) Test .....                               | 13-1 | Auto Reader Operation .....                               | 16-12 |
| Display Test .....                                            | 13-1 | <b>SECTION 17—9814 Computer Interface</b> .....           | 17-1  |
| RAM Buffer Test.....                                          | 13-2 | Master or Slave Operation .....                           | 17-1  |
|                                                               |      | Summary of Operation .....                                | 17-4  |
|                                                               |      | 9814 Interfacing .....                                    | 17-6  |
|                                                               |      | Signal Definitions .....                                  | 17-8  |
|                                                               |      | Pin 114 Applications Note.....                            | 17-12 |

# Contents

(Continued)

|                                                 | Page  |                                                   | Page              |
|-------------------------------------------------|-------|---------------------------------------------------|-------------------|
| <b>SECTION 18—Communication Interface</b> ..... | 18-1  | Motorola Format (“L” List) .....                  | 18-29             |
| <b>9818 RS-232-C Communications Interface</b>   |       | MOS Technology Format Description.....            | 18-31             |
| <b>(General)</b> .....                          | 18-1  | <b>M980 RS-232-C Remote Control</b> .....         | 18-33             |
| Functional Description.....                     | 18-1  | Description .....                                 | 18-33             |
| M304 Panel Description .....                    | 18-1  | Duplicate Function.....                           | 18-33             |
| DTE and DCE Operation and Connection .....      | 18-2  | Remote Control Operation .....                    | 18-34             |
| Simple Hook-up for DTE and DCE .....            | 18-4  | Typical Remote Load and Program.....              | 18-34             |
| Character Structure .....                       | 18-4  | <b>RS-232-C Interface Application Notes</b> ..... | 18-35             |
| ASCII Code Assignments .....                    | 18-5  | Intel MDS 200 Series .....                        | 18-35             |
| How to Select the Interface and Formats.....    | 18-6  | Tektronix 8002A MDL .....                         | 18-38             |
| Downloading .....                               | 18-8  | Tektronix 8550 .....                              | 18-39             |
| Uploading .....                                 | 18-8  | AMC Systems 8 and 29.....                         | 18-41             |
| <b>Pro-Log Format Descriptions</b> .....        | 18-11 | Motorola EXORciser II .....                       | 18-42             |
| RS-232-C Format Descriptions .....              | 18-11 | Motorola EXORmacs .....                           | 18-44             |
| 4-Bit Data Programming .....                    | 18-11 | CP/M-Based Systems .....                          | 18-44             |
| “L” List .....                                  | 18-13 | 16K Wraparound Features of the M980 RAM           |                   |
| “M” List .....                                  | 18-14 | Buffer .....                                      | 18-45             |
| “S” List.....                                   | 18-15 | <b>M304 Adapter</b> .....                         | 18-47             |
| “N” List.....                                   | 18-16 | Parity and Stop Bits .....                        | 18-47             |
| “X” List.....                                   | 18-17 | Signal Discipline.....                            | 18-48             |
| “P” Program .....                               | 18-18 | Electrical Specifications .....                   | 18-49             |
| “CR/LF” Program .....                           | 18-19 | Mechanical Specifications .....                   | 18-49             |
| <b>Industrial Format Descriptions</b> .....     | 18-21 | Environmental Specifications.....                 | 18-49             |
| Description .....                               | 18-21 | <b>SECTION 19—9103A UV Erase Light</b> .....      | 19-1              |
| 4-Bit Data Programming .....                    | 18-22 | Description .....                                 | 19-1              |
| Intel-Hex Format Description .....              | 18-22 | Physical Characteristics .....                    | 19-1              |
| Intel #10 Format Selection .....                | 18-24 | Controls .....                                    | 19-1              |
| Intel #11 Format Selection .....                | 18-24 | Operating Instructions.....                       | 19-1              |
| Intel #12 Format Selection .....                | 18-25 | Lamp Characteristics .....                        | 19-2              |
| Intel #13 Format Selection .....                | 18-25 | Power Requirements .....                          | 19-2              |
| Tek-Hex Format Description .....                | 18-25 | ASCII Code Assignments and Error                  |                   |
| Tek-Hex Format Selection .....                  | 18-27 | Indications .....                                 | Inside Back Cover |
| Motorola Format Description (“S” Record) .....  | 18-27 |                                                   |                   |



# Figures

| Figure |                                                          | Page | Figure |                                                                  | Page  |
|--------|----------------------------------------------------------|------|--------|------------------------------------------------------------------|-------|
| 1-1    | M980 PROM Programmer .....                               | 1-1  | 15-5   | Binary Tape Format .....                                         | 15-3  |
| 1-2    | M980 Operating Modes .....                               | 1-2  | 15-6   | MDS Format .....                                                 | 15-3  |
| 2-1    | M980 Operating Panel .....                               | 2-1  | 16-1   | M980 with TTY .....                                              | 16-1  |
| 2-1    | M980 Operating Panel .....                               | 2-1  | 16-2   | Operating Modes .....                                            | 16-3  |
| 2-2    | Conversion Table<br>(Hex/Binary/Decimal) .....           | 2-3  | 16-3   | Top View—TTY with Housing<br>Removed .....                       | 16-5  |
| 2-3    | Conversion Table<br>(Hex/Binary/Decimal) .....           | 2-3  | 16-4   | TTY Interface Circuit .....                                      | 16-6  |
| 3-1    | Dedicated Module .....                                   | 3-1  | 16-5   | Current Loop Option (Situation 1) .....                          | 16-7  |
| 3-2    | Installation and Removal of<br>Personality Module .....  | 3-2  | 16-6   | Side View—TTY with Housing<br>Removed .....                      | 16-8  |
| 3-3    | Generic Module .....                                     | 3-2  | 16-7   | Current Loop Option (Situation 2) .....                          | 16-9  |
| 3-4    | Base Module .....                                        | 3-3  | 16-8   | TTY Half-Duplex Option .....                                     | 16-10 |
| 3-5    | Pinout Adapter .....                                     | 3-3  | 16-9   | TTY Full-Duplex Option .....                                     | 16-10 |
| 3-6    | Configurator .....                                       | 3-3  | 16-10  | TTY Modification (Manual Reader) .....                           | 16-11 |
| 3-7    | Dedicated Gang Module .....                              | 3-4  | 16-11  | TTY Modification (Auto Reader) .....                             | 16-12 |
| 3-8    | Generic Gang Module and Gang<br>Configurators .....      | 3-5  | 17-1   | Computer Interface .....                                         | 17-1  |
| 3-9    | ZIF Socket .....                                         | 3-6  | 17-2   | 9814 Format Selection .....                                      | 17-1  |
| 3-10   | PM9080 5V MOS Generic Module .....                       | 3-7  | 17-3   | M980 Configured as a Slave Unit .....                            | 17-2  |
| 4-1    | PROM Size Field Definition .....                         | 4-1  | 17-4   | M980 Configured as a Master<br>Controller .....                  | 17-3  |
| 6-1    | Buffer Operations (To/From Copy or<br>Master PROM) ..... | 6-1  | 17-5   | Data Signals for Address Definition .....                        | 17-4  |
| 7-1    | Buffer Operations via Hex Keyboard .....                 | 7-1  | 17-6   | Connector Interface Pin List for M980<br>Slave Unit .....        | 17-7  |
| 7-2    | Buffer Edit—Set Word Size .....                          | 7-10 | 17-7   | Connector Interface Pin List for M980<br>Master Controller ..... | 17-7  |
| 7-3    | Illustration of Edit Insert .....                        | 7-18 | 17-8   | Data Transfer Waveforms .....                                    | 17-9  |
| 7-4    | Illustration of Delete Operation .....                   | 7-22 | 17-9   | Initialization .....                                             | 17-10 |
| 7-5    | Illustration of Buffer Block Move<br>Operations .....    | 7-26 | 17-10  | Mode Select .....                                                | 17-10 |
| 7-6    | Illustration of Nibble Swap .....                        | 7-29 | 17-11  | Address Definition .....                                         | 17-10 |
| 7-7    | Illustration of Hex Pack .....                           | 7-31 | 17-12  | Read .....                                                       | 17-11 |
| 7-8    | Illustration of Hex Unpack .....                         | 7-33 | 17-13  | Write .....                                                      | 17-11 |
| 7-9    | Illustration of RAM Split .....                          | 7-35 | 17-14  | PIN 114 Parallel Interface System .....                          | 17-12 |
| 7-10   | Illustration of RAM Interleave .....                     | 7-37 | 17-15  | PIN 114 Connected to a Pro-Log PROM<br>Programmer .....          | 17-13 |
| 15-1   | M301 Paper Tape Reader .....                             | 15-1 | 17-16  | PIN 114 System Interconnect .....                                | 17-13 |
| 15-2   | Paper Tape Reader Interface .....                        | 15-1 | 17-17  | RC50-6 Keying .....                                              | 17-14 |
| 15-3   | ASCII Hex Format .....                                   | 15-2 | 17-18  | Pin 114 Bit and Port Assignments .....                           | 17-14 |
| 15-4   | ASCII BNPF .....                                         | 15-2 |        |                                                                  |       |

# Figures

(Continued)

| Figure | Page                                                                                   | Figure | Page                                                                                  |
|--------|----------------------------------------------------------------------------------------|--------|---------------------------------------------------------------------------------------|
| 18-1   | M304 RS-232-C Communications Adapter ..... 18-1                                        | 18-14  | Example of 8K RAM Buffer and Addresses Accepted as Valid for Loading Data ..... 18-46 |
| 18-2   | M304 Signal Paths ..... 18-3                                                           | 18-15  | Example of 4K RAM Buffer and Addresses Accepted as Valid for Loading Data ..... 18-46 |
| 18-3   | Hook-Up for DTE and DCE ..... 18-4                                                     | 18-16  | Character Format ..... 18-47                                                          |
| 18-4   | ASCII Code Assignments ..... 18-5                                                      | 18-17  | Character Variations Using jumper ..... 18-48                                         |
| 18-5   | Address Offset Download ..... 18-9                                                     | 18-18  | Signal Discipline ..... 18-49                                                         |
| 18-6   | Address Offset Upload ..... 18-9                                                       | 18-19  | Terminal/Modem/I/O Specifications ..... 18-50                                         |
| 18-7   | M304/MDS Interconnect ..... 18-35                                                      | 18-20  | M304 I/O Specifications ..... 18-50                                                   |
| 18-8   | Serial CH1 Lines and Jumpers ..... 18-36                                               | 19-1   | 9103A (mounted in case) ..... 19-1                                                    |
| 18-9   | Connecting to MDS ..... 18-38                                                          | 19-2   | 9103A UV Erase Light ..... 19-1                                                       |
| 18-10  | M980/8002 Interconnect ..... 18-39                                                     | 19-3   | Recommended PROM Arrangement and Erase Times ..... 19-2                               |
| 18-11  | M980/8550 Interconnect ..... 18-40                                                     |        |                                                                                       |
| 18-12  | M980/EXORcisor II Interconnect ..... 18-42                                             |        |                                                                                       |
| 18-13  | Example of 16K RAM Buffer and Addresses Accepted as Valid for Loading Data ..... 18-45 |        |                                                                                       |

# SECTION 1

## Purpose and Main Features

### DESCRIPTION

The M980 PROM Programmer (Figure 1-1) is a compact, portable microprocessor-based Control Unit that utilizes a series of plug-in Personality Modules to program, copy and test bipolar and MOS PROMs and other programmable devices. There are essentially six types of personality modules designed for use with the M980: Dedicated, Generic, Dedicated Gang, Generic Gang, 5V MOS Generic and Special. The M980 also easily interfaces with a variety of external sources including computers, development systems, paper tape readers and TTYs. The functional operating panel contains all of the controls, indicators and displays necessary for ease of keyboard operation plus integral connectors for remote control options. Various key-selectable data formats, Pro-Log as well as industry-compatible, are available for the many communication modes. The M980 features a Buffer Memory which allows data manipulation prior to PROM programming. It is highly efficient for many applications from design engineering to field service, and is ideally suited to the manufacturing environment.

### FEATURES

- Program, compare, read and duplicate more than 450 different devices, including PROMs, PALs, and microprocessors containing programmable memory
- Perform blank checks, six-digit checksums, and illegal-bit checks
- Edit data in the CMOS RAM buffer memory, including move, insert, delete, and nibble swap
- Retain data in the CMOS RAM buffer for 7 days with power off
- Interface with computers, development systems, paper-tape readers and TTYs
- Utilize visible and audible prompting to ensure proper programming operations
- Use the manufacturing mode for single keystroke duplicating
- Select built-in self-test functions
- Operate with a safe, UL-listed product

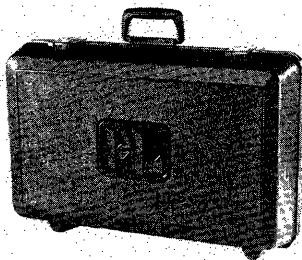

ATTACHE CARRYING CASE

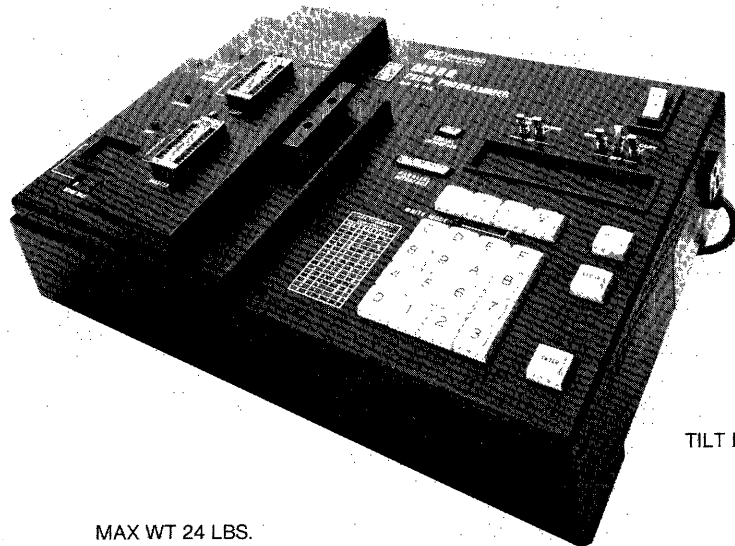

TILT BAR

MAX WT 24 LBS.

Figure 1-1. The M980 PROM Programmer

## OPERATIONAL MODES

The M980 features three main operating modes: Manual, Automatic and Manufacturing (see Figure 1-2).

| M980 MODES                              |                                                  |                           |
|-----------------------------------------|--------------------------------------------------|---------------------------|
| MANUAL                                  | AUTOMATIC                                        | MANUFACTURING             |
| Read (see Sect. 5-5)                    | Compare (see Sect. 5)                            | Auto (see Sect. 9)        |
| Program (see Sect. 5)                   | Duplicate (see Sect. 5)                          | Blank Check (see Sect. 5) |
| Read/Modify (see Sect. 5) (Buffer only) | Auto (see Sect. 9)                               | Duplicate (see Sect. 5)   |
|                                         | Blank Check (see Sect. 5) (Copy and Master only) | Compare (see Sect. 5)     |
|                                         | Illegal Bit Check (see Sect. 5)                  |                           |
|                                         | Checksum (see Sect. 5)                           |                           |
|                                         | Buffer Edit Options (see Sect. 7)                |                           |
|                                         | Self-test (see Sect. 13)                         |                           |

All modes have repeat capabilities.

Figure 1-2. M980 Operating Modes

## PERSONALITY MODULES

These plug-in modules include the circuitry for timing, voltages and currents necessary to program a PROM when the module is coupled with the M980. Each of the six categories of modules offer alternatives for specific programming applications. These modules also include individual Zero Insertion Force PROM Sockets for Master and Copy PROMs and control switches as required to allow special functions (see Section 3 for detailed description).

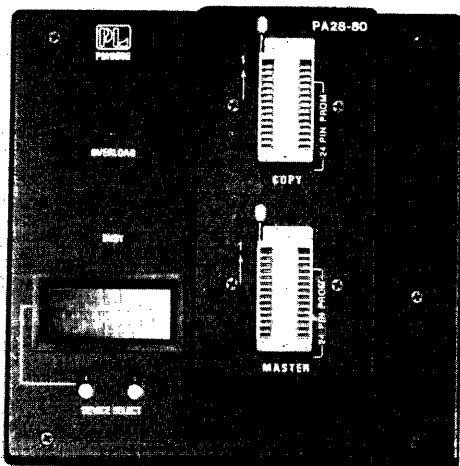

## OPTIONAL ACCESSORIES

The M980 software for the following optional accessories is factory installed. This equipment has been designed to configure the programmer to a variety of external sources.

**M301 Paper Tape Reader:** Combines with 9811 software in the M980 to allow Duplicate and Compare operations from paper tape. Multiple Formats (see Section 15 for detailed description).

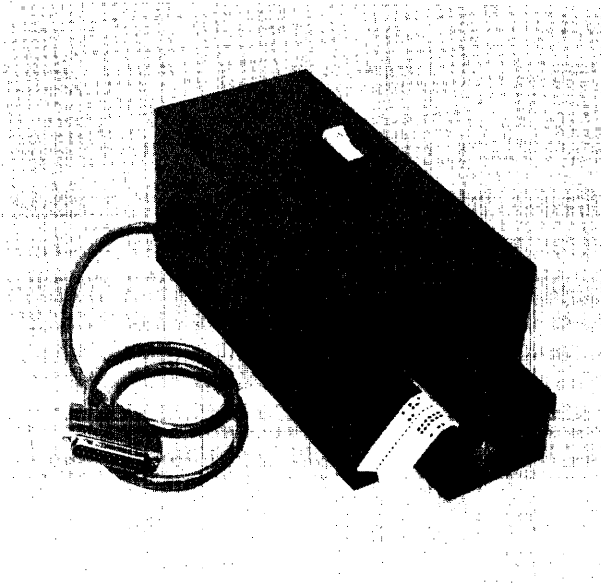

**M304 RS-232-C Adapter:** Combines with 9818 software in the M980 to allow Program and List operations via the RS-232-C interface. Multiple formats (see Section 18 for detailed description).

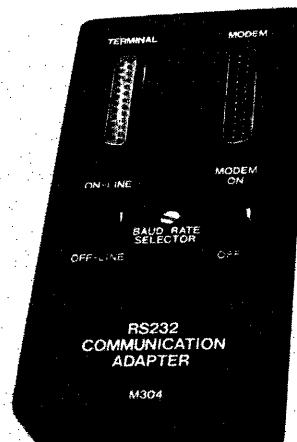



**9103A UV Erase Light System:** Ultra-violet light source with timer for erasing MOS PROMs (see Section 19 for detailed description).

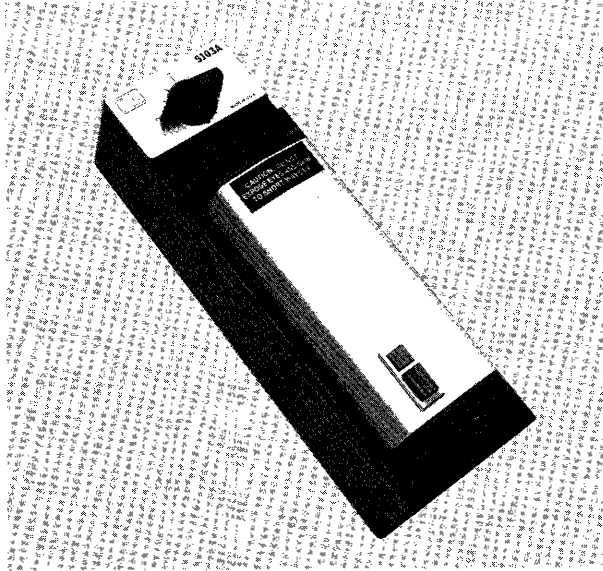

**RC18 Cable:** 25 wire cable with lead male and female connectors. For use with 9814 or 9818 computer interfaces.

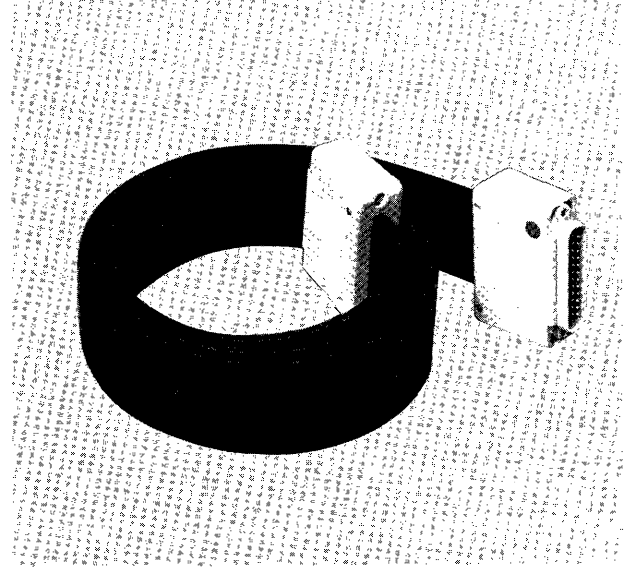

**RC12 TTY Cable:** Combines with 9812-2 software to allow Read, Program, Duplicate, and Compare operations from ASR33-type machines. The cable provides three circuit connections, using six wires to allow:

- Data to TTY
- Reader Control to TTY, 15V DC neutral loop

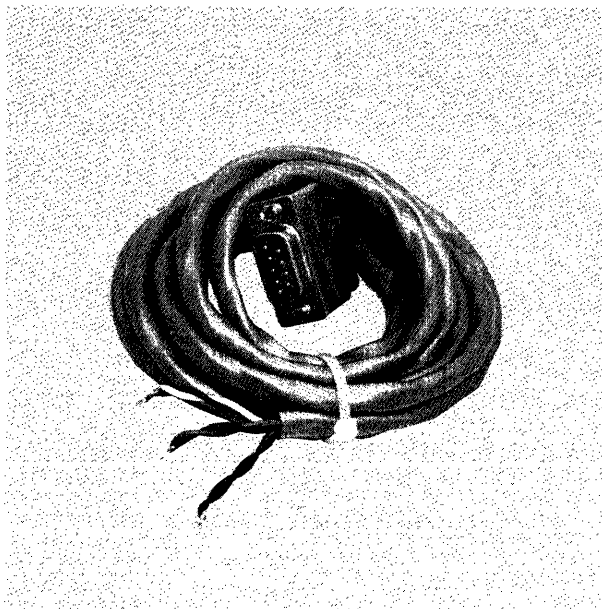

## PHYSICAL SPECIFICATIONS

**Dimensions:** 23x12x6.5 inch — housed in a high-impact carrying case.

**Weight:** 24 lbs — maximum weight with personality module and erase light.

**Power:** Factory wired for either 117V 50-60Hz, or 220V 50-60Hz (100V 50Hz optional). Maximum power: 100W.



# SECTION 2

## Operating Panel Description

### PANEL

The M980 Operating Panel (see Figure 2-1) contains the controls, indicators, and displays necessary for ease of panel operation, plus integral connectors for remote control operations. The keyboard utilizes hex-

adecimal notation, and a convenient HEX to BINARY conversion table is located adjacent to the keyboard to assist the operator in programming operations. Figure 2-1 shows the panel with a dedicated personality module inserted.

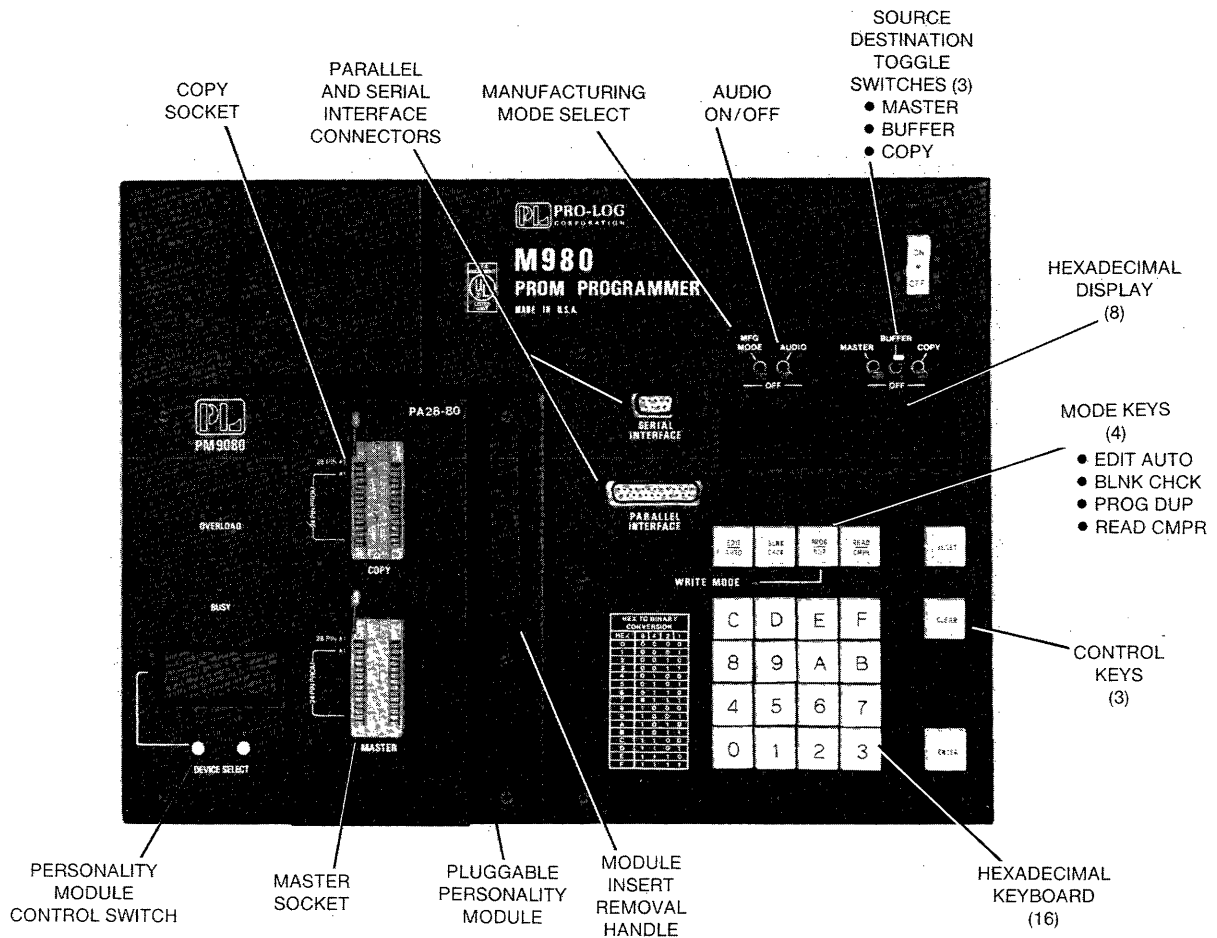

Figure 2-1. M980 Operating Panel

## PANEL DISPLAYS, INDICATORS AND CONTROLS

### Displays and Indicators

**Write Mode LED:** An individual indicator located above the keyboard which lights during a write operation.

**Hexadecimal Display:** An 8-digit character display capable of showing the hex characters 0-9, A, B, C, D, E, F. This display is located above the keyboard and is used to indicate address, error, option selection, operation and data information.

**Binary Data Display:** Located on some Personality Modules. It displays data depending on the mode.

### Source Destination Toggle Switches (down = off; up = on)

**MANUFACTURING Mode:** Locks out hex keyboard and CLEAR key entries. Allows only Automatic (AUTO), Blank Check (BLNK CHCK), Duplicate (DUP), and Compare (CMPR) operations.

**AUDIO:** Activates a tone generator located inside the M980 unit. This tone generator will then produce audio tones when an error occurs or an operation is finished.

**MASTER/BUFFER/COPY:** A single switch ON will indicate the Destination on which the operation is being performed. Two switches ON will indicate the Source and Destination for Duplicate and Compare operations. The left-most switch is the Source and the right-most is the Destination. No switches or all switches ON will result in an error "E0" code displayed, and a chirping of the tone generator.

### Control Keys

**RESET:** A control key that cancels operation in progress, without altering the RAM Buffer. RESET clears the hex display.

**CLEAR:** A multi-function key used to clear data entries manually, decrement the address in the Read mode, or abort from an error in Duplicate and Program operations. See Section 4 for further information.

**ENTER:** A key used to initiate or repeat operations; also used to increment the address in the Read and Program modes.

### Programmer Mode Keys (Active after Power ON or RESET)

**READ/CMPR:** A dual-function key. When two toggle switches (MASTER/BUFFER/COPY) are ON, this key acts to select the Compare mode in which the source contents are compared, one location at a time, against the destination contents. When only one toggle switch is ON, the Read mode is selected. In the Read mode a non-volatile read is made of the Destination selected, one location at a time. In the Read mode, and when the BUFFER toggle switch is ON, a Read/Modify may be performed.

**PROG/DUP:** A dual-function key. When two toggle switches (MASTER/BUFFER/COPY) are ON, this key acts to select the Duplicate mode in which the source contents are copied into the destination. When only one toggle switch is ON the Program mode is selected. In the Program mode, data is written into either the Buffer or Copy PROM.

**BLNK CHCK:** A dual-function key. If one switch is ON (MASTER or COPY), a check of the PROM for the unprogrammed state will be performed. If any bit in the PROM is found to be in the programmed state, an error will be indicated. When used with the MASTER socket, the Blank Check mode may safely be used for incoming inspection of new PROMs, with no danger of accidental programming. If two switches are ON (MASTER and COPY or BUFFER and COPY) an illegal bit check will be performed on the Copy PROM. The Illegal Bit Check will determine from the erased state of the PROM if the data in the Copy PROM can be successfully overwritten. This dual function does not apply to gang modules. If an attempt is made to Illegal Bit Check with a gang module an "E0" will be displayed. During the IBC operation, no attempt will be made to actually write data to the Copy PROM. Check PROM manufacturers specifications before overwriting any PROM.

**EDIT/AUTO:** A dual-function key used to select automatic sequencing of the Blank Check, Duplicate, and Compare modes. Two toggle switches (MASTER/BUFFER/COPY) must be in the ON position. Also used to select Buffer Edit functions when only the Buffer switch is in the ON position.

**Hexadecimal keyboard:** This keyboard has several dual-purpose switches. In addition to normal data entry, the keys are used to select modes for interface selection (see Section 14). Key C is used to select the Checksum mode. In this mode, a checksum may be made over any defined address field on the Master or Copy PROM or the Buffer.

### Hexadecimal Notation

The M980 uses hexadecimal notation to represent the PROM binary address and data. Hexadecimal notation is a convenient operator language which reduces data handling by representing 16 combinations of four bits with a single character for each combination. The character set for displaying hexadecimal consists of the characters 0 through 9 to represent the binary combinations 0 through 9 and the characters A, B, C, D, E, and F to represent the number combinations 10 through 15 (see Figure 2-2).

| HEXADECIMAL<br>CHARACTERS | BINARY BITS | DECIMAL<br>CHARACTERS |
|---------------------------|-------------|-----------------------|
|                           | 8 4 2 1     |                       |
| 0                         | 0 0 0 0     | 0                     |
| 1                         | 0 0 0 1     | 1                     |
| 2                         | 0 0 1 0     | 2                     |
| 3                         | 0 0 1 1     | 3                     |
| 4                         | 0 1 0 0     | 4                     |
| 5                         | 0 1 0 1     | 5                     |
| 6                         | 0 1 1 0     | 6                     |
| 7                         | 0 1 1 1     | 7                     |
| 8                         | 1 0 0 0     | 8                     |
| 9                         | 1 0 0 1     | 9                     |
| A                         | 1 0 1 0     | 10                    |
| B                         | 1 0 1 1     | 11                    |
| C                         | 1 1 0 0     | 12                    |
| D                         | 1 1 0 1     | 13                    |
| E                         | 1 1 1 0     | 14                    |
| F                         | 1 1 1 1     | 15                    |

Figure 2-2. Conversion Table

As an extension of this technique, all 256 combinations of 8 bits can be represented by two hexadecimal characters, as shown in the following examples (see Figure 2-3).

| HEXADECIMAL<br>CHARACTERS | BINARY<br>BITS | DECIMAL<br>CHARACTERS |
|---------------------------|----------------|-----------------------|
| 00                        | 0000 0000      | 0                     |
| 01                        | 0000 0001      | 1                     |
| 3E                        | 0011 1110      | 62                    |
| 42                        | 0100 0010      | 66                    |
| E1                        | 1110 0001      | 225                   |
| FF                        | 1111 1111      | 255                   |

Figure 2-3. Conversion Table

All 4,096 combinations of 12 bits can be represented by three hexadecimal characters. This technique can be extended indefinitely by adding one hexadecimal character for each four bits of information.



# SECTION 3

## Personality Module Description

### PERSONALITY MODULE TYPES

Six types of plug-in personality modules are available for use with the M980 Programmer.

- **Dedicated Module:** configured to program one or more non-generic bipolar and MOS PROMs with identical pinouts
- **Generic Module:** programs a specific manufacturers' PROM using pinout adapters and configurators to accommodate different PROM sizes, bit structures, and pin arrangements
- **Dedicated Gang Module:** programs multiple PROMs (usually eight) simultaneously
- **Generic Gang Module:** uses configurators to simultaneously program like PROMs (usually eight) of a generic family
- **5V MOS Generic Module:** programs families of PROMS from various manufacturers whose devices have similar pinouts and programming algorithms
- **Special Module:** programs \*PALs™.

The M980 includes provisions for allowing a module to assume control of the programmer. The PM9080 generic personality module is an example of this feature.

In every case, the personality module interface with the control unit provides the specific voltages required to program and read a particular PROM, automatically accommodating the various interface options integral to the control unit.

Each module is designed to plug into a control unit, using the three proven and reliable "D" type connectors. Each module has one or more COPY sockets and one MASTER socket. In order to protect the master PROM, programming voltages are never applied to the MASTER socket.

Newer modules feature cold sockets (power off) during PROM insertion or removal.

\*PAL™ is a Trade Mark of Monolithic Memories Inc.

### DEDICATED MODULES

Dedicated modules (see Figure 3-1) are configured to program one or several PROMs with identical pinouts. In some modules, a switch is used to permit one module to program two PROMs of the same family (e.g., 256x4 and 512x4), when the pinouts are compatible. In some cases, the switch is used to set the operating conditions to satisfy multiple manufacturers' products.

The COPY socket is located on the upper half of the module mounting plate: Pin 1 is located adjacent to the locking lever on the Zero Insertion Force (ZIF) socket. Binary lights are located to the left of the COPY socket on some personality modules and display the contents of the COPY socket. Either four or eight LEDs are used, depending on the configuration of the PROM to be programmed. The MASTER socket is located on the lower half of the module mounting plate; its ZIF socket is indexed in the same manner as the COPY socket.

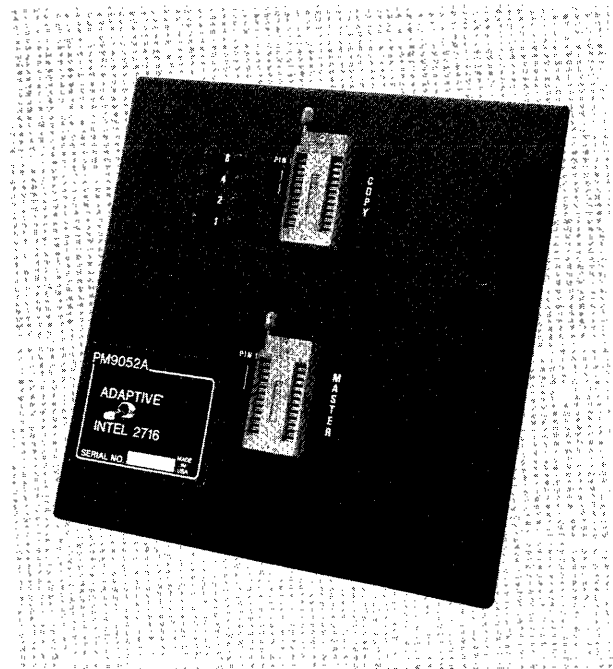

Figure 3-1. Dedicated Module

The handle affixed to the personality module plate is designed to assist in insertion and removal of the module from the control unit, by being mounted coaxially with the "D" type connectors. Removal of the module is accomplished with a direct upwards pull or slight back-and-forth motion (see Figure 3-2). To insert the module, push downward with a slight back-and-forth motion, being careful to ensure that the "D" type connection shells are properly mated before applying force to seat the module. When properly seated, the module plate lies flat against the top of the unit.

Certain dedicated modules have special features or functions, and therefore have special operating instructions. These operating instructions are provided with each module.

### NOTE

Insert or remove personality module only when M980 power is OFF.

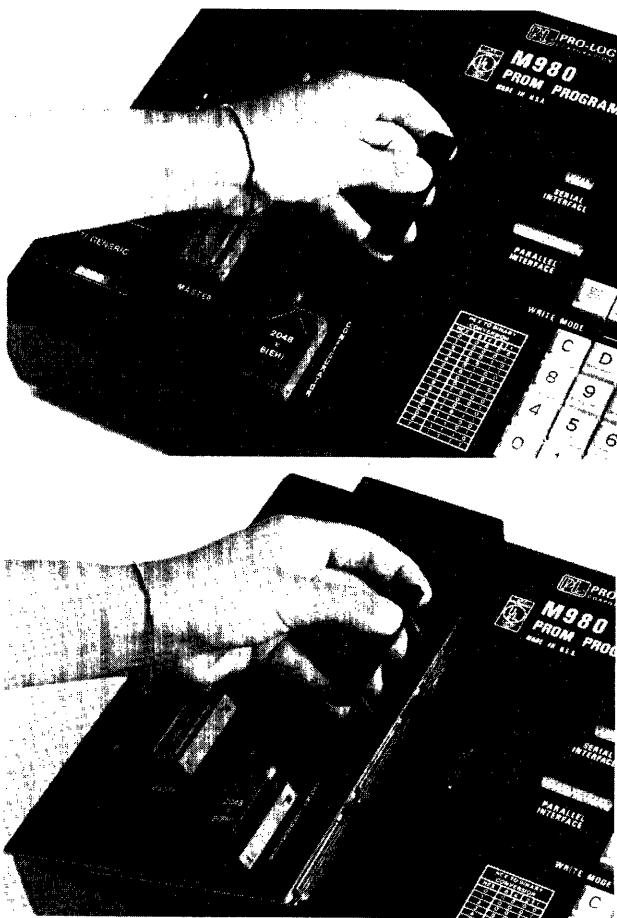

Figure 3-2. Installation and Removal of Personality Module

## GENERIC MODULES

Generic modules (see Figure 3-3) are designed to program all PROM types of a particular manufacturer. Adapters are used to conform to specific pinouts and configurators used to allow the control unit to automatically accommodate different sizes and types of PROMs (e.g., 512x4, or 1024x8). The polarity of unprogrammed PROM locations and the PROM type (bipolar or MOS) are also contained in the configurator (refer to the Pro-Log Price List/Short Form Catalog or the Personality Module Wall Chart for specific pinout adapter and configurator types for particular PROM types).

Signals are passed from the base module (see Figure 3-4) to the pinout adapter (see Figure 3-5) via two 25-pin "D" type connectors; the same type used to connect the personality module to the control unit. The configurator (see Figure 3-6) is mounted via a ZIF socket located on the bottom right of the module mounting plate. The configurator must be mounted as shown in Figure 3-3 for the module to function properly. It should also be the proper size and type (e.g., 2048x8(H) for 2716).

With the proper pinout adapter and configurator installed, the generic module functions the same as a dedicated module of the same type. Additional pinout adapters and configurators are constantly being added to accommodate the ever-broadening line of PROMs being manufactured.

Those modules having special features or requiring special operating techniques are furnished with special operating instructions.

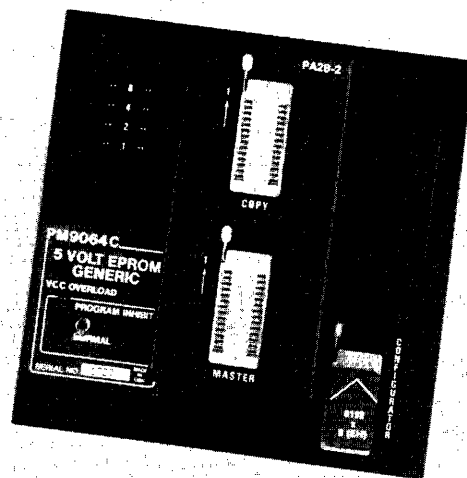

Figure 3-3. Generic Module



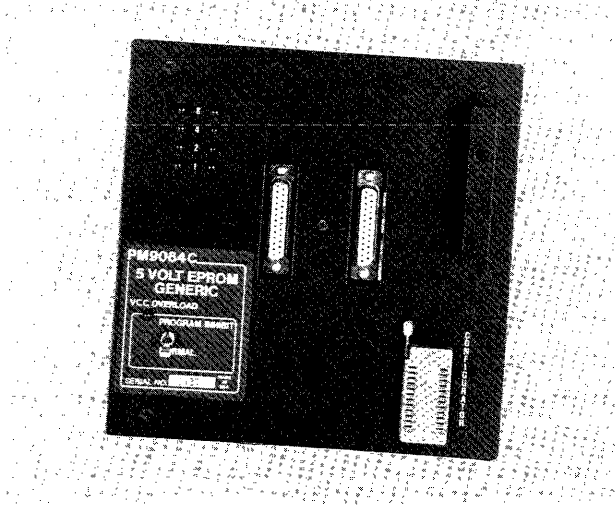

Figure 3-4. Base Module

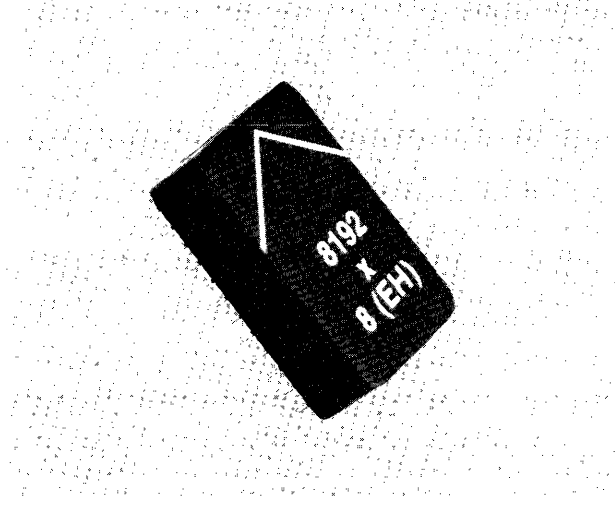

Figure 3-6. Configurator

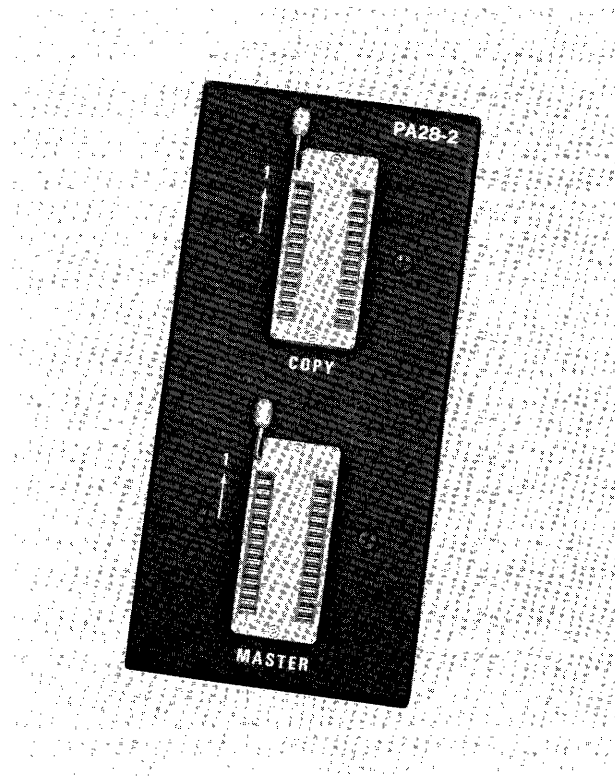

Figure 3-5. Pinout Adapter

### DEDICATED GANG MODULES

Dedicated gang modules (see Figure 3-7) are designed to program multiple PROMs simultaneously. The operation of each is tailored to the PROM being programmed, and each has its own special operating instructions.

#### NOTE

The M980 Control Unit performs the blank check, duplicate, and compare functions on four or eight parts<sup>1</sup> at one time. If one or more of the sockets being operated on is left empty, a FAIL indication occurs at the completion of the function<sup>2</sup>. For further failure instructions, see the operating instructions for that particular personality module.

<sup>1</sup>Some gang personality modules (e.g., PM9061A) may duplicate two banks of four PROMS.

<sup>2</sup>If the PROM to be programmed is normally FF (all ones) in the unprogrammed state, the BLNK CHCK mode does not fail on an empty socket. In the AUTO mode, a PROM that fails to program does not cause a failure indication until CMPR operation is completed.

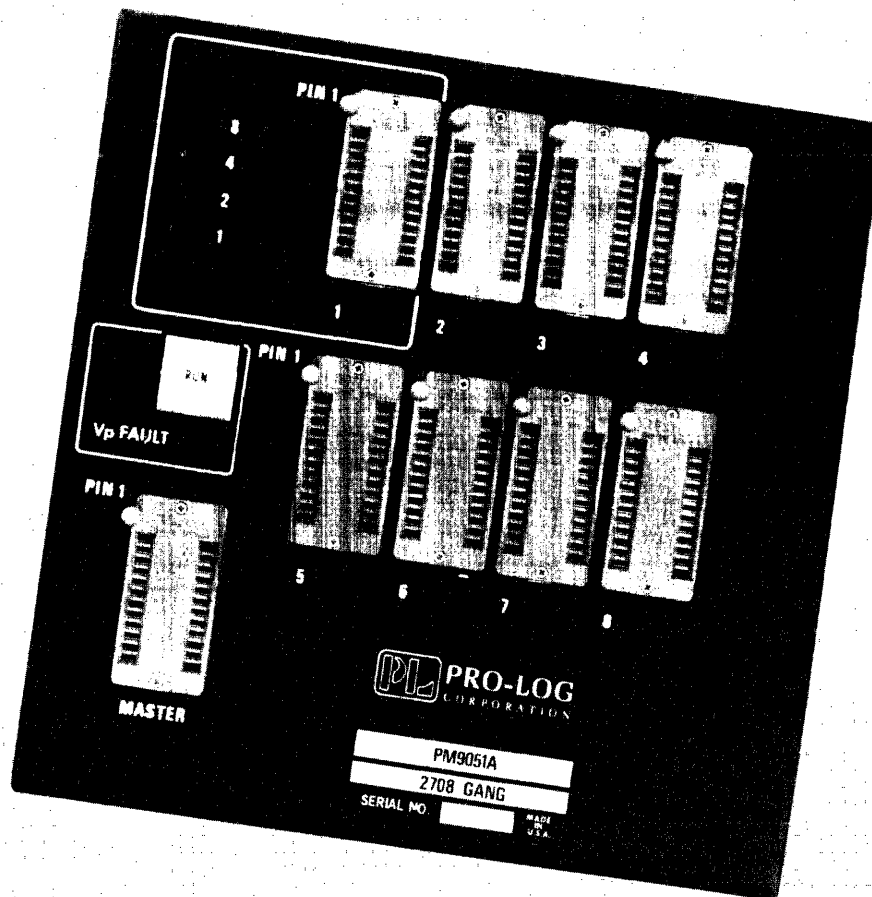

Figure 3-7. Dedicated Gang Module

## GENERIC GANG MODULES

Generic gang modules (see Figure 3-8) are capable of simultaneously programming multiple PROMS from a generic family. Programming algorithms and PROM pinouts are reconfigured by inserting the appropriate 40-pin gang configurator (GC). These modules are available in a 24- and a 24/28-pin version.

### NOTE

Generic gang modules will function only in the M980 and M910A master control units.

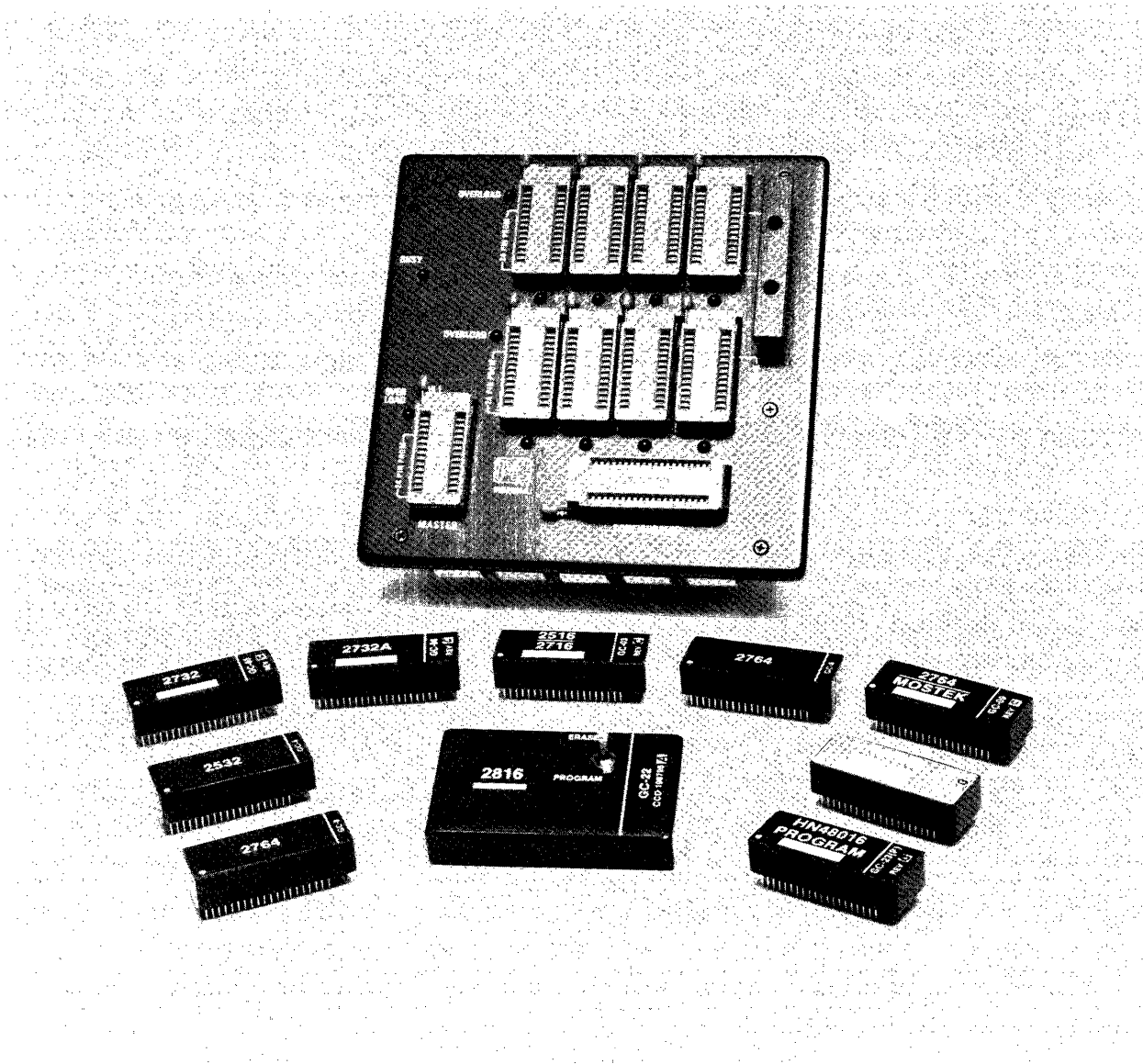

Figure 3-8. Generic Gang Module and Gang Configurators

### 5V MOS GENERIC MODULE

The PM9080 Module (see Figure 3-9) programs many similar 5V MOS device families from several manufacturers. The manufacturers' programming algorithms are very similar, but the pin assignments and the number of pins vary. The PM9080 uses plug-in pinout adapters to accommodate the varying pin assignments and number of pins for each device.

#### WARNING

Use only the appropriate pinout adapter as shown in PM9080 User's Manual, Appendix A, Device Selection Guide. Insertion of a pinout adapter other than those listed may damage the PM9080 and will void the Pro-Log warranty.

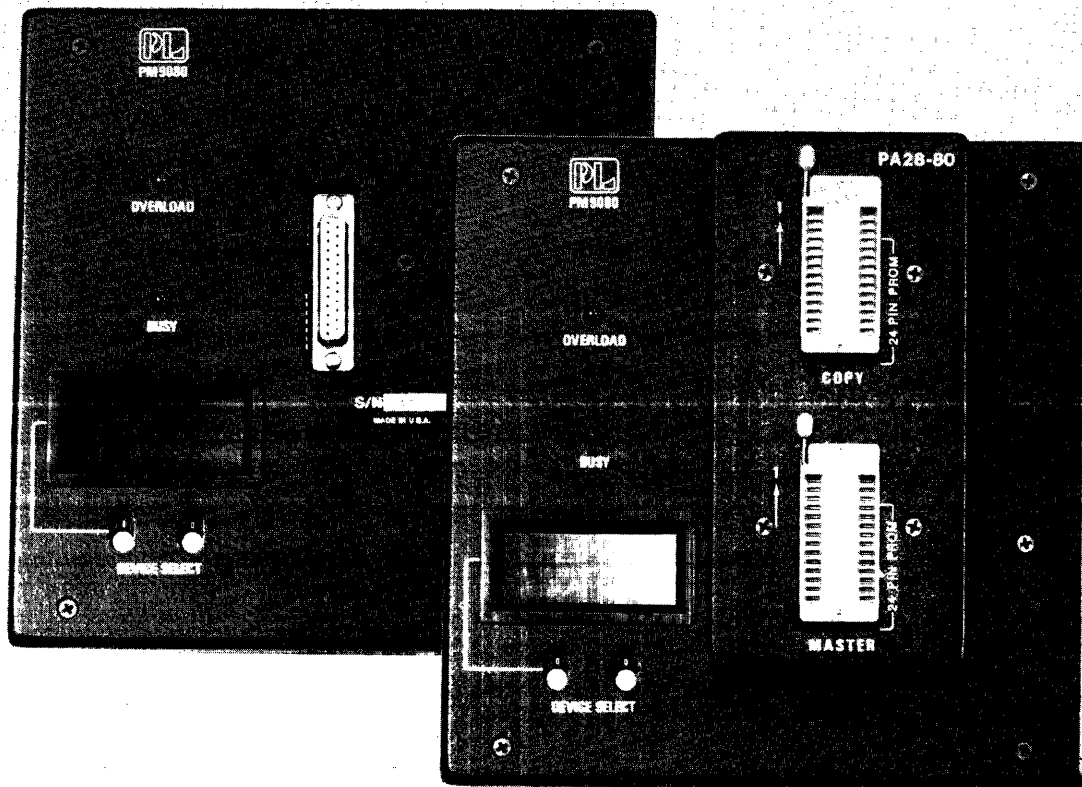

Figure 3-9 PM9080 5V MOS Generic Module

## SPECIAL PERSONALITY MODULES

The M980 was designed to be compatible with all Personality Modules produced by Pro-Log. However, many of the software routines within the M980 Control Unit have been streamlined, and new modes of operation designed. As a result, some modules operate differently in the M980 than in other Series 90 programmers. Those differences are described here.

### PM9005A Module

This module has two modes of operation: Block and Normal. When in Block Mode, all operations of the M980 are as described in the manual. In Normal Mode, programming does not occur unless data is entered for location 3FF. Therefore, all operations that involve programming the PROM must take this into account.

It is suggested that for ease of operation, use only the Normal Mode when copying the entire PROM.

In Engineering Auto-Sequencing Mode (see Section 10) the Last Address must be 3FF.

In any programming mode, should errors be detected by the module, a special display sequence is begun. For further details refer to Section 11, Failure to Program Operations.

### PM9051A Module

The PM9051A is a gang 2708 module and requires data to be entered for location 3FF in order for programming to take place. For ease of operation, all programming and duplication operations should use a Last Address of 3FF.

In the Engineering Auto-Sequence Mode (see Section 10) the Last Address must be 3FF. In any programming mode, should errors be detected by the module, a special display sequence is begun. For further details refer to Section 11, Failure to Program Operations.

### PM9053A Module

In any programming mode, should errors be detected by the module, a special display sequence is begun. For further details refer to Section 11, Failure to Program Operations.

### PM9060A Module

The PM9060A is a TMS2716 Gang Module and requires data to be entered for location 7FF in order for programming to take place. For ease of operation, all programming and duplication operations should use the Last Address of 7FF.

In the Engineering Auto-Sequencing Mode (see Section 10) the Last Address must be 7FF. In any programming mode, should errors be detected by the module, a special display sequence is begun. For further details refer to Section 11, Failure to Program Operations.

## PROM Handling

PROMs can be separated into two major categories: MOS and Bipolar. The MOS PROMs include all EPROMs and some CMOS fusible-link PROMs. Care should be taken when handling MOS devices, as most of them are susceptible to damage due to static charges. When not plugged in, keep the PROMs on a pad of conductive foam.

Pro-Log has pioneered the two-socket approach, where the MASTER socket is never subjected to programming voltages, and so the chances of ruining a master PROM are minimal.

## ZIF Sockets

All Pro-Log Personality Modules utilize Zero Insertion Force (ZIF) sockets (see Figure 3-10) for both Master and Copy sockets. These sockets are activated by a handle, located adjacent to pin 1 of the socket. When the handle is raised or in the up position, the contacts are open, and the PROM may be inserted. Lowering the handle engages the contacts and locks the PROM in place.

In sockets subjected to severe environmental conditions or after extensive use, the contacts may become corroded or bent. Periodic inspection of the sockets is suggested. In case they are worn, the design of the modules permits replacement of individual sockets. (Contact Pro-Log Customer Service if this is the case.)

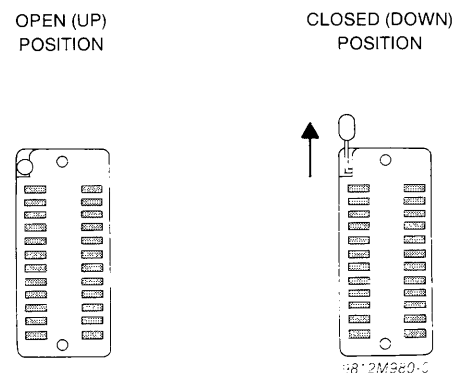

Figure 3-10. — ZIF Socket



# SECTION 4

## Address Field Definition

All keyboard operations with the exception of the Manufacturing mode and some of the remote control options allow the operator to select a partial address field. If the operator does not select a partial field, the full address range will be used. The M980 refers to the Personality Module for Master and Copy PROM size.

### Full Address Operation

Whenever a mode is selected, the hexadecimal display indicates the full PROM size to the operator by automatically displaying the First Address and the Last Address. The First Address is always zeros and the Last Address is always ones, represented in hexadecimal notation. The hexadecimal values for the First and Last Addresses of all PROMs are given in Figure 4-1.

| PROM SIZE  | HEXADECIMAL FULL PROM FIELD ADDRESS |              |
|------------|-------------------------------------|--------------|
|            | FIRST ADDRESS                       | LAST ADDRESS |
| 16 by X    | 0                                   | F            |
| 32 by X    | 00                                  | 1F           |
| 64 by X    | 00                                  | 3F           |
| 128 by X   | 00                                  | 7F           |
| 256 by X   | 00                                  | FF           |
| 512 by X   | 000                                 | 1FF          |
| 1024 by X  | 000                                 | 3FF          |
| 2048 by X  | 000                                 | 7FF          |
| 4096 by X  | 000                                 | FFF          |
| 8192 by X  | 0000                                | 1FFF         |
| 16384 by X | 0000                                | 3FFF         |
| 32768 by X | 0000                                | 7FFF         |
| 65536 by X | 0000                                | FFFF         |

Figure 4-1. PROM Size Field Definition

The full address field indicates to the operator that all addresses of the PROM will be operated on. The operator may accept the full address or select a partial address.

### Partial Address Operation

The operator has the option of changing the full address to a partial field before initiating the operation. A partial field may be as small as a single location and as large as the full address field.

When the First Address and Last Address appear in the hex display, the operator can redefine the field by keying in a Start Address and End Address. The Start and End Addresses define the new field to be operated on. If the Start and End Addresses are equal, a single location will be operated on.

The M980 can recall the previous operation Start and End Addresses by not depressing RESET between operations. After completing an operation, depress the next mode key and the previous Start and End Addresses are recalled. The operator may now perform another operation on the same address field.

### EXAMPLE: Keyboard Strokes for an Operation over a Limited Field (for a 2Kx8 PROM)

1. Depress RESET. The 8 hex displays will be blank.

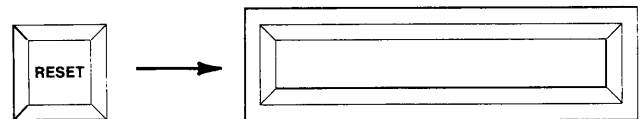

2. Depress the desired Mode key. The First and Last Addresses of the Copy PROM will be displayed.
3. If the entire address range is to be operated on, depress ENTER and the First and Last Addresses shown will be accepted as the Start and End Address for the operation. If a limited field is desired, continue.

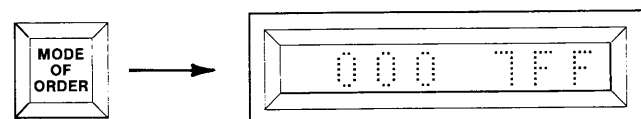

- Using the hex keyboard, key in a new Start Address, MSD first. When the first key is depressed, the left-most displays will be blanked and the character corresponding to the key depressed will be displayed. Continue to key in the necessary characters to fill the Start Address displays.

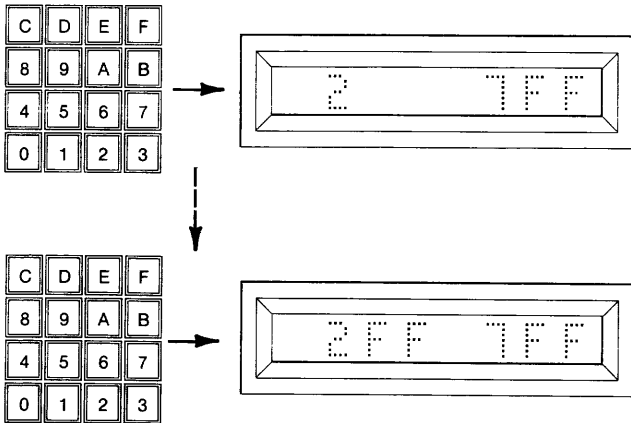

- If a new End Address is needed, use the keyboard to key in a new End Address. When the next key is depressed, the right-most displays will be blanked and the character corresponding to the key depressed will be displayed. Continue until the entire address is keyed in. Depress ENTER and the displayed addresses will be accepted as the Start and End Addresses.

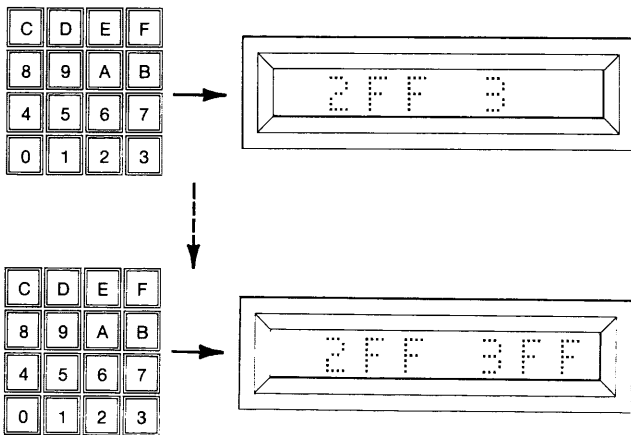

## CLEAR KEY OPERATIONS

In the M980 the Clear operation is defined as: An operation that removes the present condition and allows a correction of that condition to be implemented without resetting all of the previous operations.

The CLEAR key on the M980 has several functions, depending upon the mode of the M980. In keyboard entry situations, it allows the correction of hex keyboard entries. In the Read mode, it allows recall of the previous address and data (decrement). Finally, it is used to abort Duplicate or Program modes upon an error indication, without changing any of the previous operation of sequences.

The CLEAR key is active to clear the displays after a hex key is used to key in information and before the ENTER key is depressed. In this mode, after the hex character is displayed, the CLEAR key may be used to clear that character and any characters to the left, one character for each depression of the CLEAR key (see the following example for a step-by-step explanation).

In the Read mode the CLEAR key is active to decrement the address. By depressing the CLEAR key, the previous address and its corresponding data is displayed.

In the Duplicate and Program modes, the CLEAR key can be used to abort the mode when an error is indicated. When the error is displayed, the depression of CLEAR automatically aborts the operation and displays "F" for Finished. The previous Start and End Addresses of the operation are still intact in the M980's memory. By depressing the ENTER key, a repeat of the operation may be implemented, starting with the address field definition. For more information on procedures during a programming failure, see Section 11.

### Example of CLEAR Key Operation in Read Mode

- Insert Personality Module and select the switches as shown. AUDIO switch is optional. Insert the PROM to be read into the MASTER socket of the Personality Module.

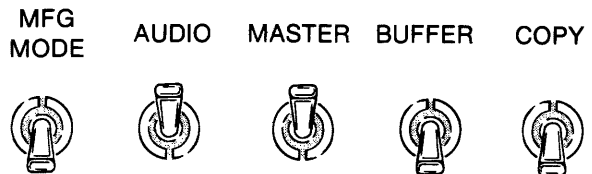



2. Depress RESET. The 8 hex displays are blank.

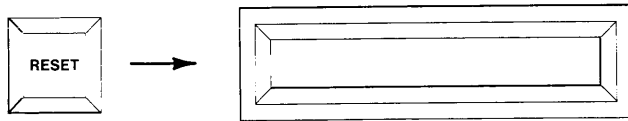

6. Use the hex keyboard to key in a revised address.

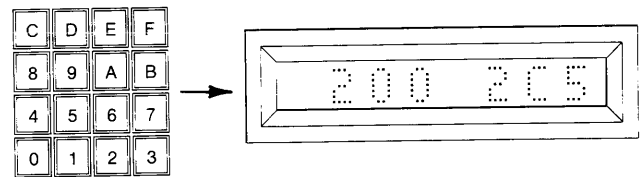

3. Depress READ. The First and Last Addresses of the Master are displayed.

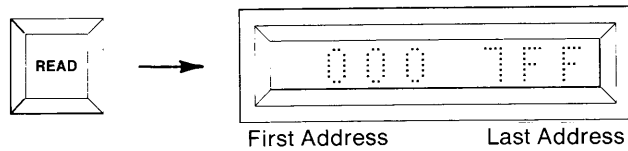

7. Depressing ENTER will cause the operation to proceed over the revised range.

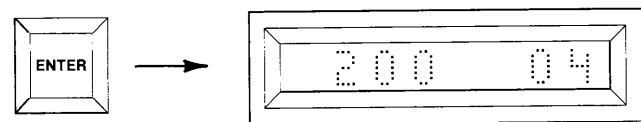

4. To Read the entire contents of the Master PROM, starting with the First Address, depress ENTER. To Read a limited address field use the hex keyboard to key in a new Start and End Address, MSD first. If an incorrect character is keyed, use the CLEAR key to correct it.

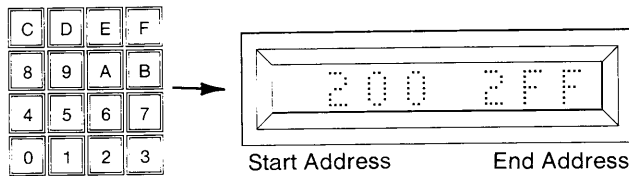

5. Depress the CLEAR key twice. The right-most two characters are cleared. Depressing the CLEAR key additional times will clear correspondingly more digits.

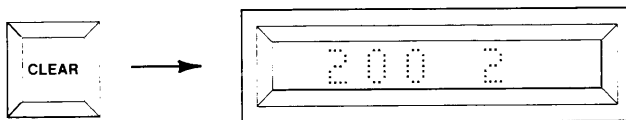
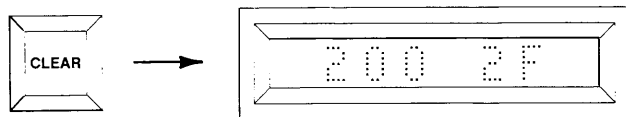



# SECTION 5

## Copy and Master Socket Operations

### DESCRIPTION

This section describes those modes involving the MASTER and COPY sockets. For a description of the modes involving the Buffer, see Section 6.

The COPY socket is used to program PROMs and other devices such as PALs. A PROM should not be put into the COPY socket unless it is to be programmed. A Copy PROM may be programmed from the keyboard, Master PROM, or Buffer. The Copy PROM can be read to the display one location at a time and it can be compared automatically with the Master PROM or Buffer. Checksum, Blank Check or Illegal Bit Check can be performed on the Copy PROM.

The MASTER socket is used to provide input from a Master PROM for writing to either the Copy PROM or Buffer. Checksum or Blank Check can be performed on the Master PROM.

### MASTER and COPY Socket Modes

**RESET:** Halts all operations. The RESET key is an overriding hardware input to the M980 that halts all operations and returns the programmer to the idle state. RESET can be used to stop any automatic operation. RESET does not affect the Buffer contents.

**CLEAR:** Corrects miskeyed address/data, decrements address in READ, aborts from Duplicate, Compare, and Program modes after failure. The CLEAR key is active to clear the displays only at those times when a hex key is used to key in address or data information. After the hex character is displayed, the CLEAR key may be used to clear that character and any characters to the left of the first character cleared. For additional uses of the CLEAR key, see Section 4.

### AUDIO/MANUFACTURING Toggle Switches

**MANUFACTURING Mode.** When ON, this toggle switch will reconfigure the M980 into a manufacturing PROM Programmer. When in the OFF position, the M980 becomes a multifunctional and versatile tool for programming any type of programmable device. See Section 9 for Manufacturing Mode operations.

**AUDIO.** This toggle switch activates a tone generator located inside the M980 Unit. When any error occurs, a warbling tone will be generated for approximately 4 seconds. When any operation is finished successfully, a steady tone will be generated for approximately 4 seconds. An operator error in mode selection will cause a high-pitched tone for 4 seconds.

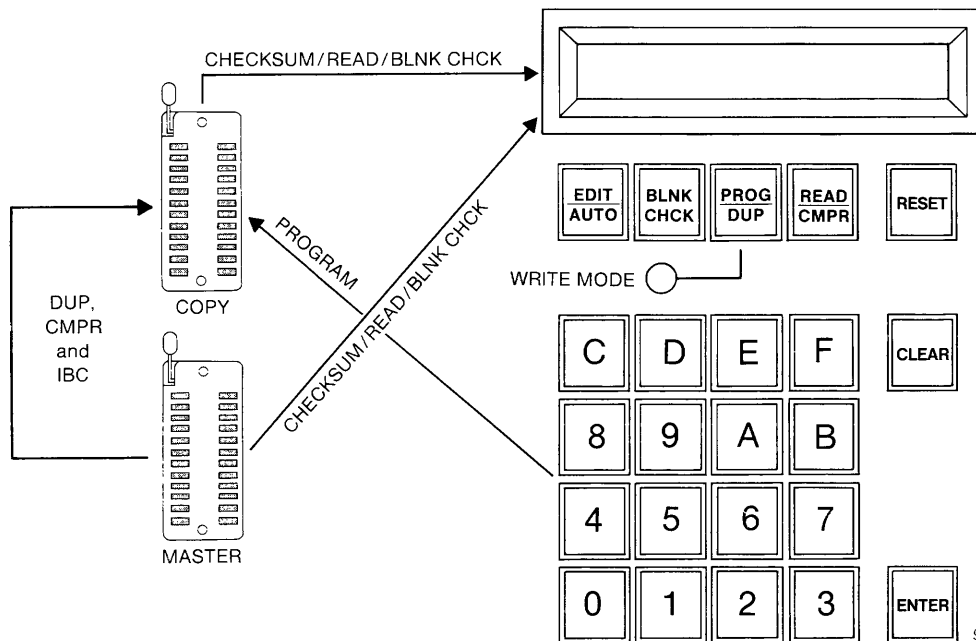

**MASTER/BUFFER/COPY Source Destination Toggle Switches**

If only one toggle switch is in the ON position, it becomes the Destination of the operation. If two toggle switches are in the ON position, the left-most switch becomes the Source and the right-most switch becomes the Destination. (If three switches are ON/OFF, and ENTER is depressed, an error code "EO" will be indicated in the display, and the warbling tone will sound.)

**MASTER.** When only this toggle switch is selected, the MASTER socket becomes the Destination. With two switches selected, the MASTER socket becomes the Source.

**BUFFER.** When this toggle switch is selected, the Buffer becomes the Source if the COPY switch is ON. At all other times the Buffer becomes the Destination.

**COPY.** When this toggle switch is selected, the COPY socket becomes the Destination.

**Programming a PROM using the M980 Keyboard (example shown is for a 2Kx8 PROM)**

1. Select the switches as shown. Insert the appropriate Personality Module. Insert the PROM to be written into in the COPY socket. The Audio switch is optional.

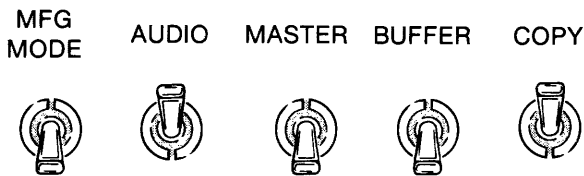

2. Depress RESET. The 8 hex displays are blank.

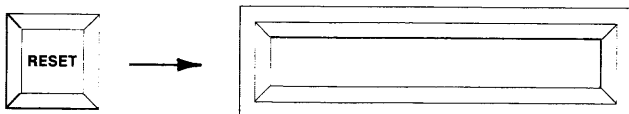

3. Depress PROG. The First and Last Addresses of the Copy PROM will be displayed.

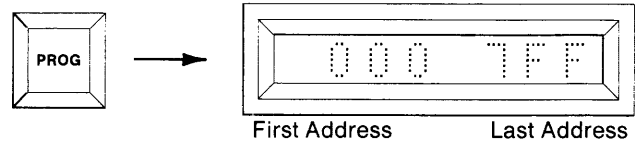

4. To operate over the entire contents of the Copy PROM, starting with the First Address, go to step 5. To operate over a limited field, use the hex keyboard to key in a new Start and End Address, MSD first.

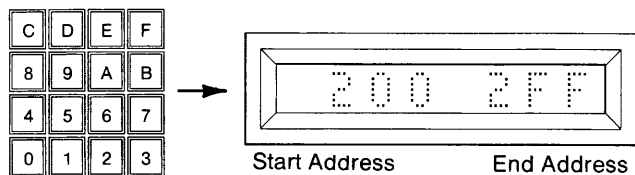

5. Depress ENTER. The displayed addresses will be accepted as the Start and End Addresses for the operation. The display will show the Start Address in the left-most displays. The Write Mode LED is lit.

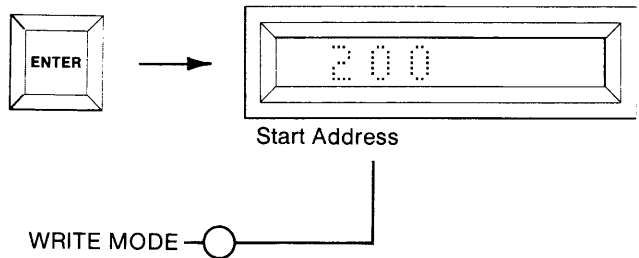

6. To program the address displayed, key in the desired data, MSD first, using the CLEAR key to correct mistakes. To step over a location continue to step 7.

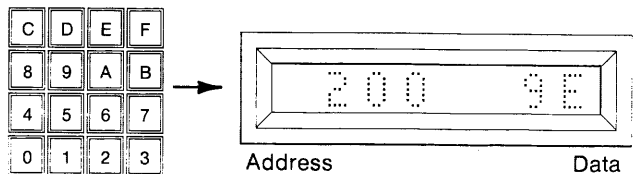

- Depress ENTER to initiate programming of the displayed data, or to step over an address without altering it. The next sequential address will be displayed. Repeat steps 6 and 7 for each address. If an address cannot be programmed with the data displayed, the M980 will not increment the address, and the error tone will sound, if Audio switch is ON. See Failure to Program Operations, Section 11.

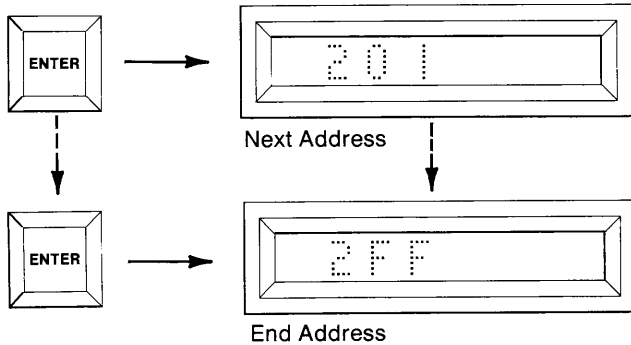

- When the End Address is displayed and step 6 and/or 7 are initiated, an "F" will appear to indicate that the Program mode has been performed over the entire Start and End Address fields.

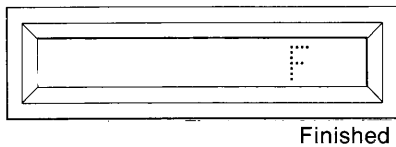

- To repeat the Read mode without resetting, depress the ENTER key when the "F" appears. The previous Start and End Addresses will be displayed. Continue with step 4 and/or 5.

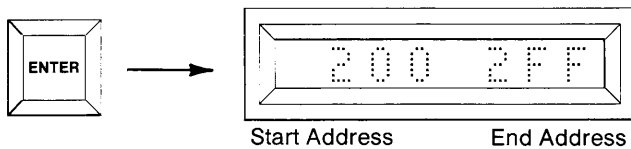

### Summary of Programming a PROM using the M980 Keyboard

- Insert Personality Module, PROM, and select switches; MFG MODE (OFF), AUDIO (optional ON/OFF), MASTER (OFF), BUFFER (OFF), COPY (ON).
- Depress RESET. Displays are blank.
- Depress PROG/DUP. First and Last Addresses are shown.
- Optional. Redefine Start and End Addresses via the hex keyboard.
- Depress ENTER. Address shown accepted. Start Address displayed.
- Optional. Key in data to be programmed.
- Depress ENTER. This will program previously keyed data or step over the displayed address. Repeat for every address.
- Last Address reached and "F" is displayed to indicate Finished.
- Optional. Depress ENTER to show previous Start and End Addresses, and to return to step 4 and/or 5.

**Reading a Copy PROM in the COPY Socket (example shown is for a 2Kx8 PROM)**

1. Insert Personality Module and select switches as shown. Insert the PROM to be read into the COPY socket of the Personality Module. The AUDIO switch is optional.

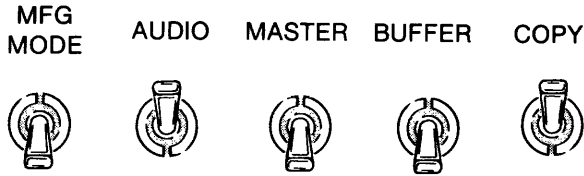

2. Depress RESET. The 8 hex displays are blank.

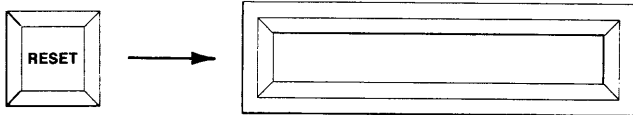

3. Depress READ. The 8 hex displays show the First and Last Addresses of the Copy PROM.

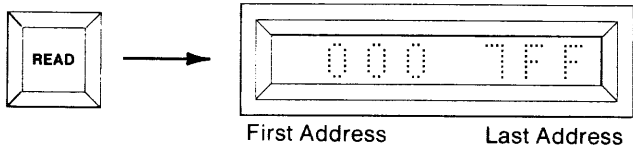

4. To Read the entire contents of the Copy PROM, starting with the First Address, go to step 5. To Read a limited field, use the hex keyboard to key in a new Start and End Address, MSD first.

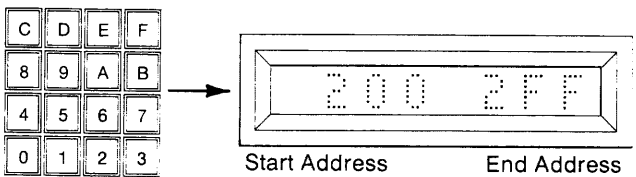

5. Depress ENTER. The displayed addresses will be accepted as the Start and End Addresses for the operation. The display will show the Start Address in the left-most displays. The data located at that address will be displayed in the right-most displays. Repeat step 5 and the next sequential address and data will be displayed. Repeat until the End Address is reached, Reset occurs, OR

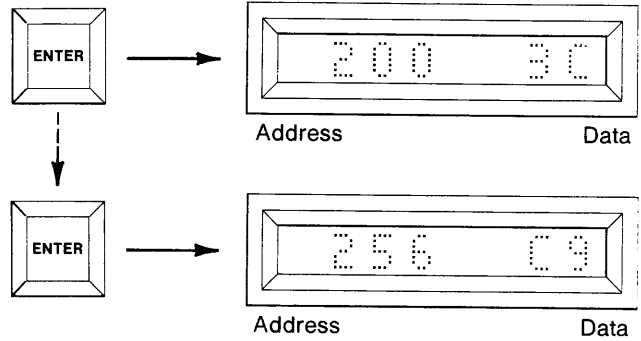

6. Depress the CLEAR key during the Read operation. The address will be decremented and the data at that address will be displayed. The M980 can decrement past the defined Start Address. Wrap-around will occur if an all-zero address is reached and decremented again.

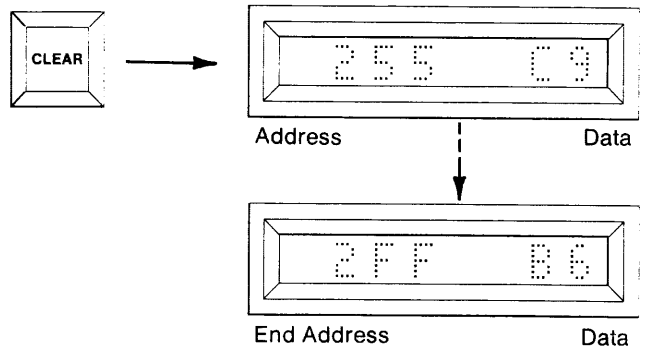

7. When the End Address is reached, its data displayed, and ENTER is depressed, an "F" will appear in the display to indicate Finished.

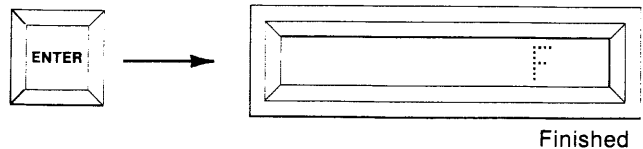

- To repeat the Read mode without resetting, depress the ENTER key when the "F" appears. The previous Start and End Addresses will be displayed. Continue with step 4 and/or 5.

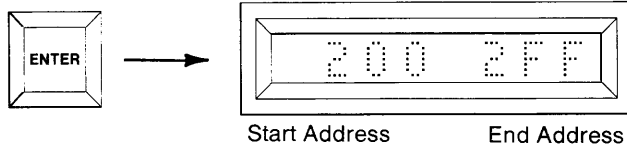

### Summary of Reading a Copy PROM in the COPY Socket

- Insert Personality Module, PROM, and select switches; MFG MODE (OFF), AUDIO (optional ON/OFF), MASTER (OFF), BUFFER (OFF), COPY (ON).
- Depress RESET. Displays are blank.
- Depress READ/CMPR. First and Last Addresses are shown.
- Optional. Redefine Start and End Addresses via the hex keyboard.
- Depress ENTER. The Start Address and its corresponding data are displayed. Repeat for each sequential address OR
- Optional. Depress CLEAR to decrement the address and show its data.
- End address is reached and ENTER is depressed. An "F" is displayed for Finished.
- Optional. Depress ENTER to show previous Start and End Addresses, and to return to step 4 and/or 5.

**Reading a Master PROM in the MASTER Socket (example shown is for a 2kx8 PROM)**

1. Insert Personality Module and select switches as shown. Insert the device to be read into the MASTER socket of the Personality Module. The AUDIO switch is optional.

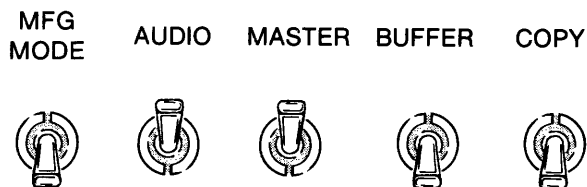

2. Depress RESET. The 8 hex displays are blank.

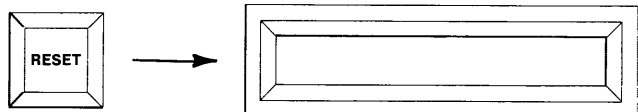

3. Depress READ. The 8 hex displays show the First and Last Addresses of the Master PROM.

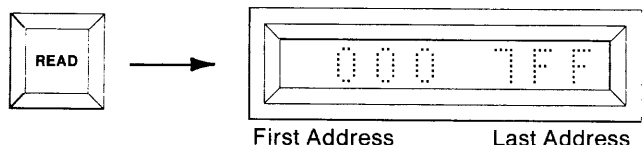

4. To Read the entire contents of the Master PROM, starting with its First Address, go to step 5. To Read a limited address field, use the hex keyboard to key in a new Start Address, MSD first. Repeat for End Address.

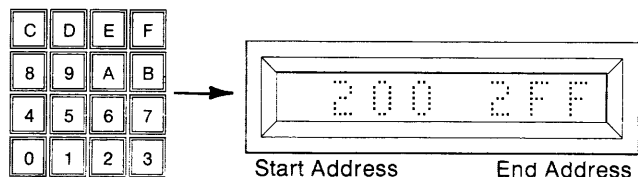

5. Depress ENTER. The M980 will accept the displayed data as the Start and End Addresses for the operation. The display will show the Start Address in the left-most displays. The data located at that address will be displayed in the right-most displays. Repeat step 5 and the next sequential address and data will be displayed. Repeat until the End Address is reached, Reset occurs, OR

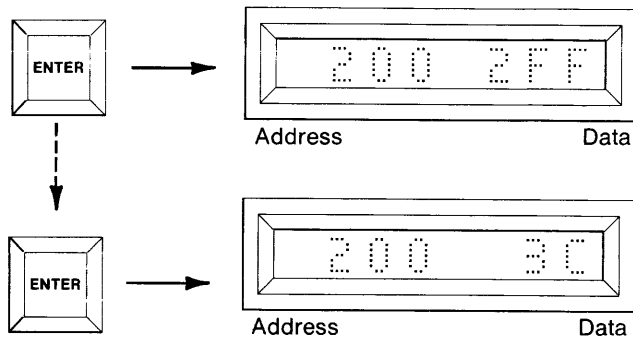

6. Depress the CLEAR key during the Read operation. The address will be decremented and the data at that address will be displayed. The M980 can decrement past the defined Start Address. Wrap-around will occur if an all-zero address is reached and decremented again.

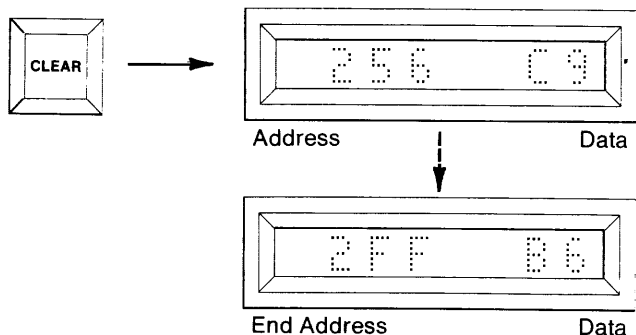

7. When the End Address is reached, its data displayed, and ENTER is depressed, an "F" will appear in the display to indicate Finished.

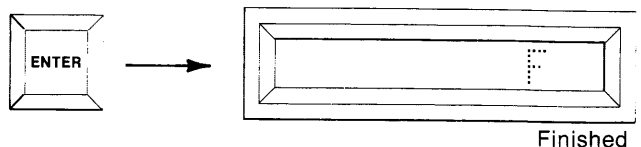



8. To repeat the Read mode without resetting, depress the ENTER key when the "F" appears. The previous Start and End Addresses will be displayed. Continue with step 4 and/or 5.

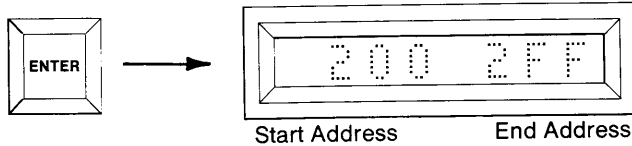

### Summary of Reading the Master PROM in the Master Socket

1. Insert Personality Module, PROM, and select switches; MFG MODE (OFF), AUDIO (optional ON/OFF), MASTER (ON), BUFFER (OFF), COPY (OFF).
2. Depress RESET. Displays are blank.
3. Depress READ. First and Last Addresses are shown.
4. Optional. Redefine Start and End Addresses.
5. Depress ENTER. The Start Address and its corresponding data are displayed. Repeat each sequential address OR
6. Optional. Depress CLEAR to decrement the address and show its data.
7. End Address is reached and ENTER is depressed. An "F" is displayed to indicate Finished.
8. Optional. Depress ENTER to show previous Start and End Addresses, and to return to step 4 and/or 5.

### Duplicating a PROM from a Master PROM (example shown is for a 2Kx8 PROM)

1. Select the switches as shown. Insert the appropriate Personality Module. Insert the PROM to be used as Master in the MASTER socket. Insert the PROM to be written into in the COPY socket. The AUDIO switch is optional.

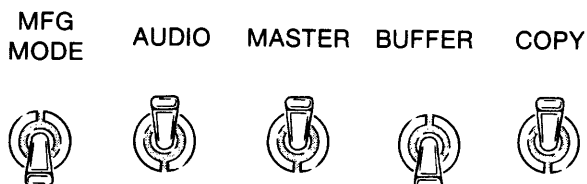

2. Depress RESET. The 8 hex displays are blank.

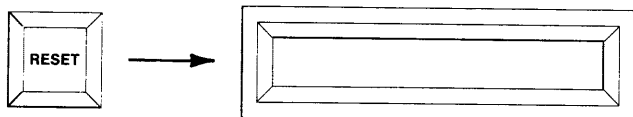

3. Depress DUP. The First and Last Addresses of the Master and Copy PROM will be displayed.

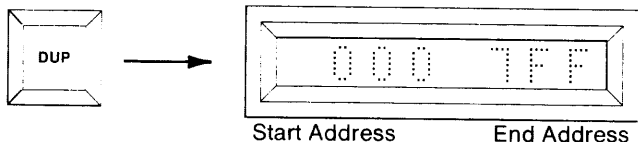

4. To Duplicate the entire contents of the Master PROM into the Copy PROM, starting with the First Address, go to step 5. To Duplicate over a limited field, use the hex keyboard to key in a new Starting and Ending Address, MSD first.

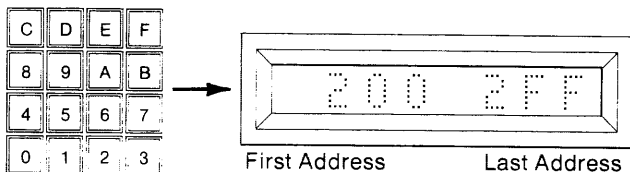

5. Depress ENTER. The displayed addresses will be accepted as the Start and End Addresses for the operation. "C1" will be displayed to indicate Change #1. If there is no reason to change any of the data being duplicated, go to step 8.

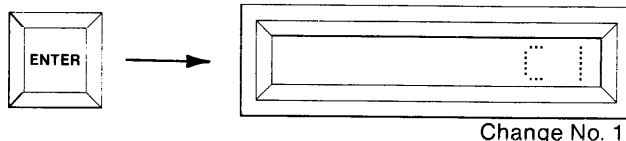

6. New data may now be substituted for up to eight addresses in the defined address field. Using the hex keyboard, key in the address at which you wish to substitute data. The address will be displayed in the left-most displays. Now key in the data to be substituted. The data will be displayed in the right-most displays. If an incorrect character is keyed in, use the CLEAR key to correct it.

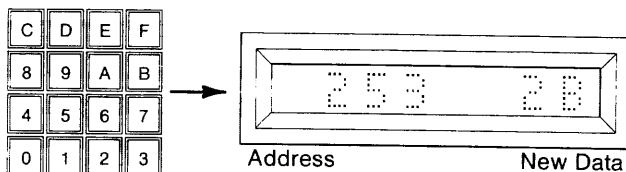

7. Depress ENTER. The change will be stored in scratch pad RAM and the next change will be displayed (C2, C3, C4, ...C8). Repeat step 6 for up to 8 changes or go to step 8. Step 8 will start automatically after the eighth change is keyed in and ENTER is depressed.

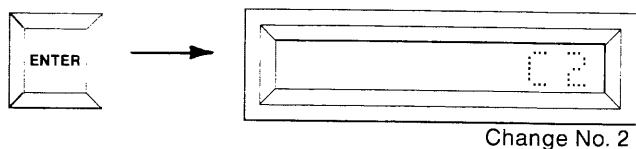

8. Depress ENTER. The display will show "D AAA" to indicate that the Duplicate (D) mode is Active (AAA). The Write Mode LED is lit. When the Duplicate mode is finished "D F" will be displayed. The Write Mode LED is extinguished.

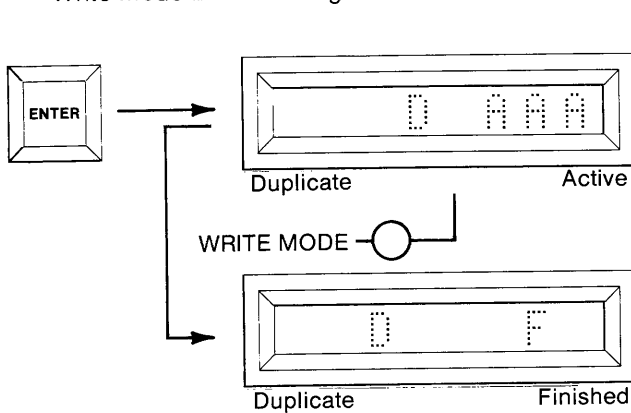

9. To repeat the Duplicate mode without resetting, depress ENTER again. This will display the previous Start and End Address and return you to step 4 and/or 5. After step 5, the change code will indicate the number of changes entered previously, plus one. Additional changes may now be entered if desired.

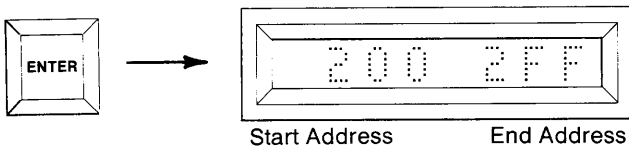

10. If an error should occur, the address and the data of the Master PROM where the error occurred will be displayed. Depressing key C will show the copy data at that address. Depressing key A will show the master data again.

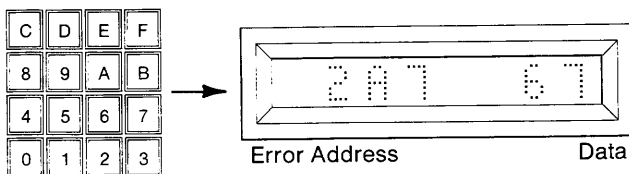

11. Depress ENTER to resume the Duplicate operation and to return to step 8, OR depress CLEAR to abort to Duplicate Finished. See Failure to Program Operations, Section 11.

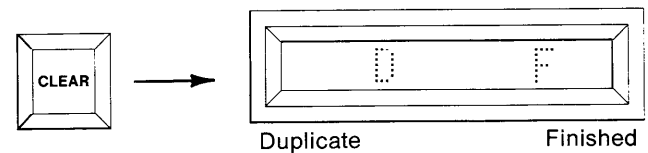
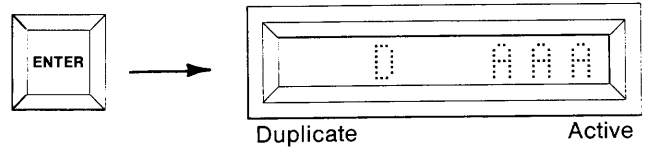

### Summary of Duplicating a PROM from a Master PROM

1. Insert Personality Module, Master and Copy PROMs, and select switches; MFG MODE (OFF), AUDIO (optional ON/OFF), MASTER (ON), BUFFER (OFF), COPY (ON).
2. Depress RESET. Displays are blank.
3. Depress PROG/DUP. First and Last Addresses are displayed.
4. Optional. Key in new Start and/or End Addresses.
5. Depress ENTER. C1 is displayed asking for change #1. If no changes go to step 8.
6. Optional. Key in substitution address and data.
7. Depress ENTER. C2, C3, C4, ...C8, will be displayed asking for more changes. Repeat step 6 for more changes or go to step 8.
8. Depress Enter. "D AAA" will be displayed for DUP ACTIVE. "D F" will be displayed for Dup Finished.
9. Optional. Depress ENTER to recall Start and End Addresses and go to step 4 and/or 5 if you wish to repeat the Duplicate mode.
10. If an error should occur the address and data of the error will be displayed. Key A will show master data and Key C will show copy data.
11. Optional. Depress ENTER to continue with DUP after an error or depress CLEAR to abort to Dup Finished, without losing original address limits and changes.

### Comparing a Copy PROM with a Master PROM (example shown is for a 2Kx8 PROM)

1. Select the switches as shown. Insert the appropriate Personality Module. Insert the PROM to be used as Master in the MASTER socket. Insert the PROM to be written into the COPY socket. The AUDIO switch is optional.

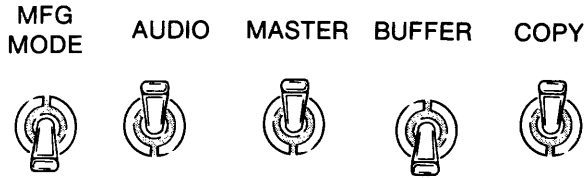

2. Depress RESET. The 8 hex displays are blank.

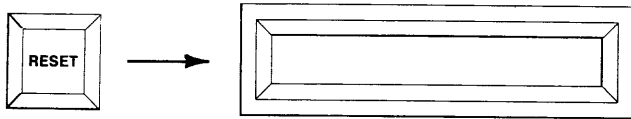

3. Depress CMPR. The First and Last Addresses of the Master and Copy PROMs will be displayed.

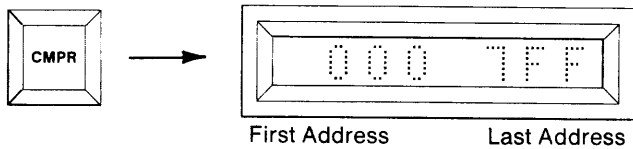

4. To Compare the entire contents of the Master PROM against the Copy PROM, starting with the First Address, go to step 5. To Compare a limited field, use the hex keyboard to key in a new Start and End Address, MSD first.

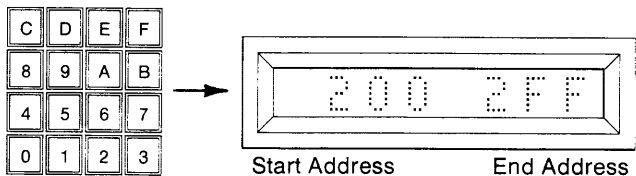

5. Depress ENTER. The displayed addresses will be accepted as the Start and End Addresses for the operation. "C AAA" will be displayed to indicate Compare (C) Active (AAA). When the Compare mode is finished, "C F" will be displayed for Compare (C) Finished (F).

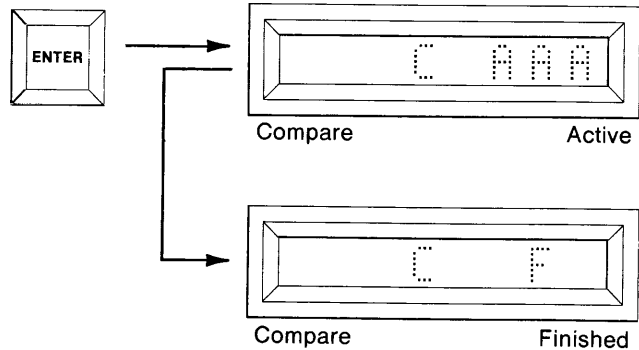

6. To repeat the Compare mode after "C F" is displayed, depress ENTER. The previous Start and End Addresses will be displayed. Continue with step 4 and/or 5.

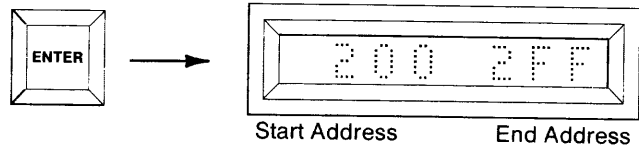

7. If a non-compare occurs, the address and data of the Master PROM where the non-compare occurred will be displayed. Key C will display the copy data and key A will display the master data.

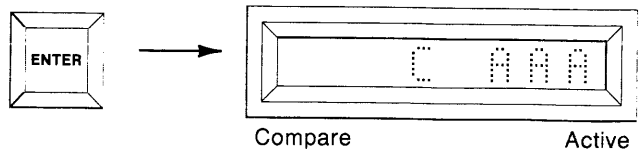
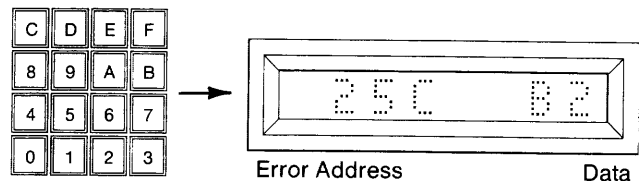

8. Depress ENTER to continue with the Compare operation and to return back to step 4 and/or 5, OR depress CLEAR to abort to Compare Finished.

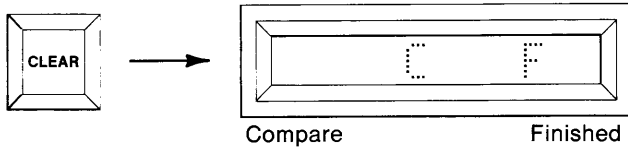

### Summary of Comparing a Copy PROM with a Master PROM

1. Insert Personality Module, Master and Copy PROMs, and select switches; MFG MODE (OFF), AUDIO (optional ON/OFF), MASTER (ON), BUFFER (OFF), COPY (ON).
2. Depress RESET. The hex displays are blank.
3. Depress READ/CMPR. First and Last Addresses are displayed.
4. Optional. Key in new Start and/or End Addresses.
5. Depress ENTER. "C AAA" is displayed. When finished "C F" is displayed.
6. Optional. Depress ENTER to repeat operation over previously selected address field.
7. If a non-compare occurs the address and data of the Master PROM are displayed. Key C displays copy data and key A displays master data.
8. Optional. Depress ENTER to continue Comparing or depress CLEAR to abort to Compare Finished, without losing original address limits.

**Performing a Checksum on a Master PROM  
(example shown is for a 2Kx8 PROM)**

1. Select the switches as shown. Insert the appropriate Personality Module. Insert the PROM to be used as Master PROM in the MASTER socket. The AUDIO switch is optional.

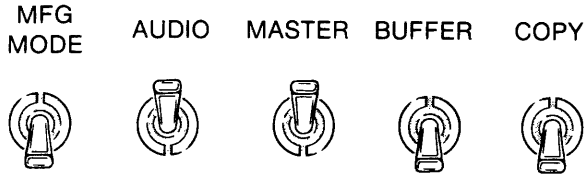

2. Depress RESET. The 8 hex displays are blank.

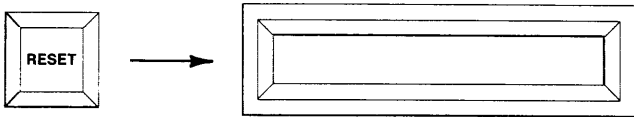

3. Depress Key C. The Start and End Addresses of the Master PROM will be displayed.

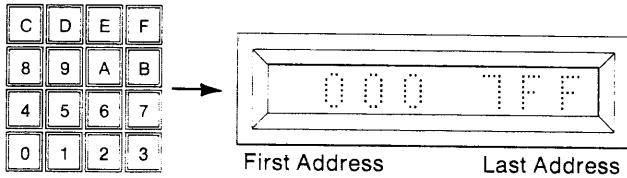

4. To Checksum the entire contents of the Master PROM, starting with the Start Address, go to step 5. To Checksum over a limited field, use the hex keyboard to key in a new Start and End Address, MSD first.

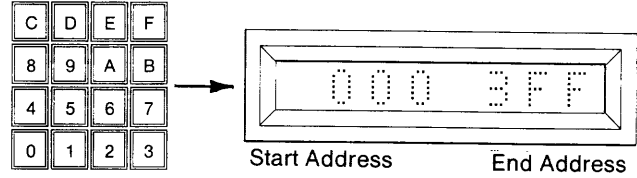

5. Depress ENTER. The M980 will accept the displayed data as the Start and End Addresses for the operation. The display will show "CC AAA" to indicate Checksum (CC) Active (AAA). When the Checksum is complete, the six digit hex equivalent will be displayed with the MSD's that are not used indicating 0's.

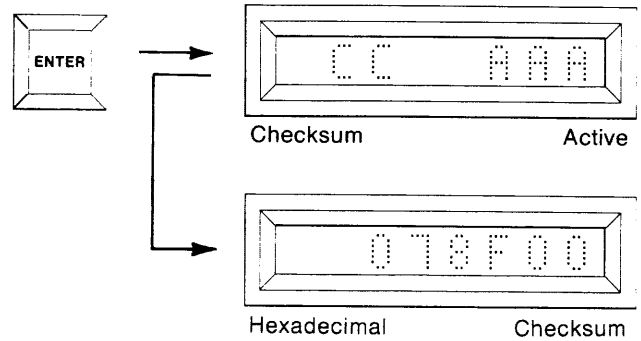

### Summary of Performing a Checksum on a Master PROM

1. Insert Personality Module, Master PROM, and select switches; MFG MODE (OFF), AUDIO (optional ON/OFF), MASTER (ON), BUFFER (OFF), COPY (OFF).
2. Depress RESET. Displays are blank.
3. Depress key C. First and Last Addresses are displayed.
4. Optional. Redefine Start and End Addresses.
5. Depress ENTER. "CC AAA" is displayed while active. Hexadecimal Checksum is displayed when finished.

**Performing a Checksum on a Copy PROM  
(example shown is for a 2Kx8 PROM)**

1. Select the switches as shown. Insert the appropriate Personality Module. Insert the Copy PROM into the COPY socket of the Personality Module. The AUDIO switch is optional.

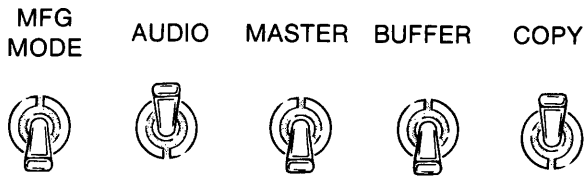

2. Depress RESET. The 8 hex displays are blank.

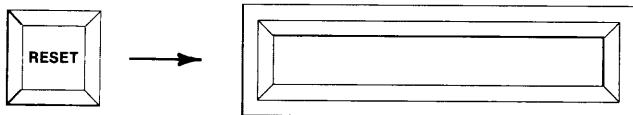

3. Depress KEY C. The First and Last Addresses of the Copy PROM will be displayed.

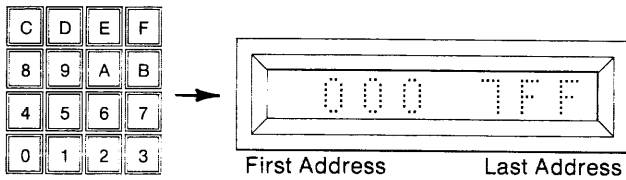

4. To Checksum the entire contents of the Copy PROM, starting with the First Address, go to step 5. To Checksum over a limited field, use the hex keyboard to key in a new Start and End Address, MSD first.

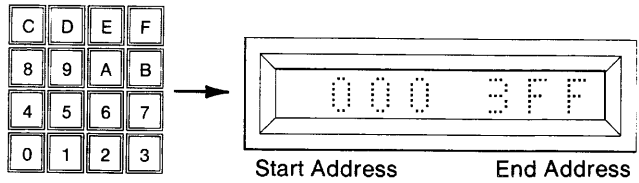

5. Depress ENTER. The M980 will accept the displayed data as the Start and End Addresses for the operation. The display will show "CC AAA" to indicate Checksum (CC) Active (AAA). When the Checksum is complete, the six digit hex equivalent will be displayed.

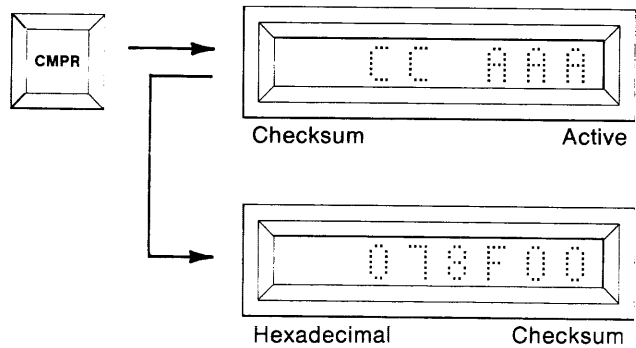



### Summary of Performing a Checksum on a Copy PROM

1. Insert Personality Module, Copy PROM, and select switches; MFG MODE (OFF), AUDIO (optional ON/OFF), MASTER (OFF), BUFFER (OFF), COPY (ON).
2. Depress RESET. Displays are blank.
3. Depress key C. First and Last Addresses are displayed.
4. Optional. Redefine Start and End Addresses.
5. Depress ENTER. "CC AAA" is displayed while active. Hexadecimal Checksum is displayed when finished.

**Performing a Blank Check on a Master PROM (example shown is for a 2Kx8 PROM)**

1. Select the switches as shown. Insert the appropriate Personality Module. Insert the PROM to be Blank Checked into the MASTER socket. The AUDIO switch is optional.

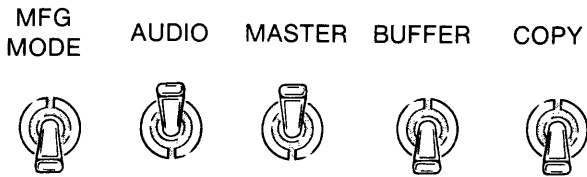

2. Depress RESET. The 8 hex displays are blank.

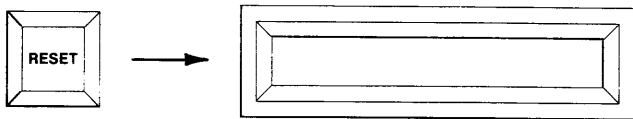

3. Depress BLNK CHCK. The First and Last Addresses of the Master PROM will be displayed.

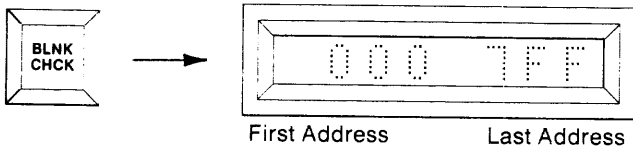

4. To Blank Check the entire contents of the Master PROM, starting with the first location, go to step 5. To Blank Check a limited field, continue. Use the hex keyboard to key in a new Start Address, MSD first. Repeat for the Ending Address.

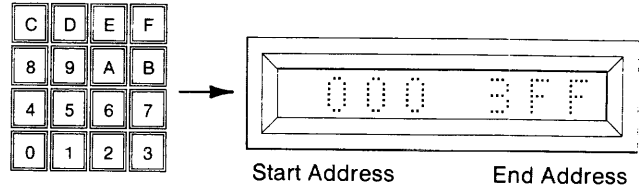

5. Depress ENTER. The M980 will accept the displayed data as the Start and End Addresses for the operation. The display will show "B AAA" to indicate Blank Check (B) Active (AAA). "B F" will be displayed for Blank Check Finished.

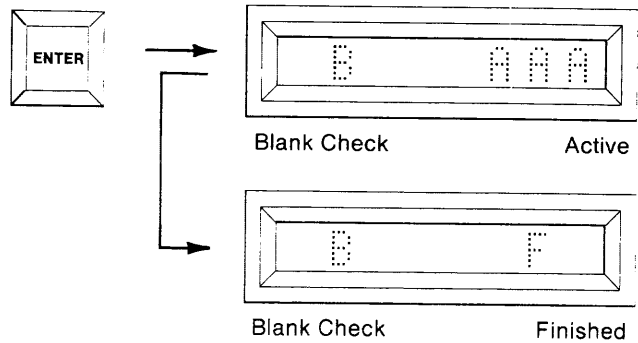

6. To repeat the Blank Check operation, depress ENTER when "B F" appears. The previous Start and End Addresses will be displayed and you may continue with step 4 and/or 5.

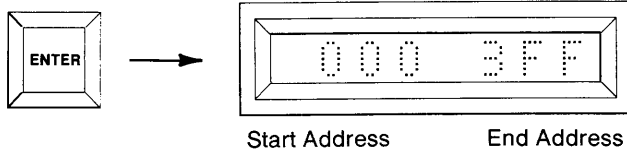

7. If a non-blank address is found, the address and data are displayed. Return to step 5 to continue or RESET.

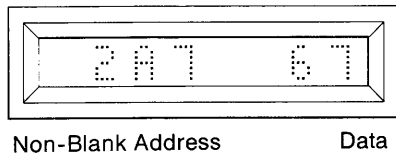

### Summary of Performing a Blank Check on a Master PROM

1. Insert Personality Module, Master PROM, and select switches; MFG MODE (OFF), AUDIO (optional ON/OFF), MASTER (ON), BUFFER (OFF), COPY (OFF).
2. Depress RESET. Displays are blank.
3. Depress BLNK CHCK. First and Last Addresses of Master PROM are displayed.
4. Optional. Redefine Start and End Addresses.
5. Depress ENTER. "B AAA" is displayed while active. "B F" displayed for Blank Check Finished.
6. Optional. Depress Enter to repeat Blank Check and go to step 4 and/or 5.
7. If non-blank address is found, it will be displayed. Return to step 5 to continue or RESET.

**Performing a Blank Check on a Copy PROM (example shown is for a 2Kx8 PROM)**

1. Select the switches as shown. Insert the appropriate Personality Module. Insert the Copy PROM to be Blank Checked into the COPY Socket. The AUDIO switch is optional.

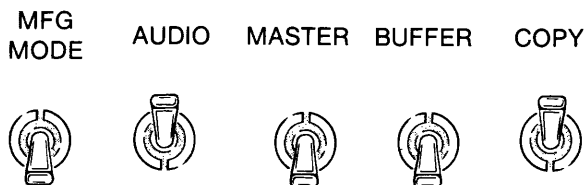

2. Depress RESET. The 8 hex displays are blank.

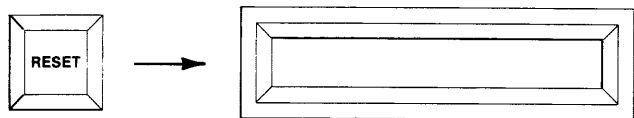

3. Depress BLNK CHCK. The First and Last Addresses of the Copy PROM will be displayed.

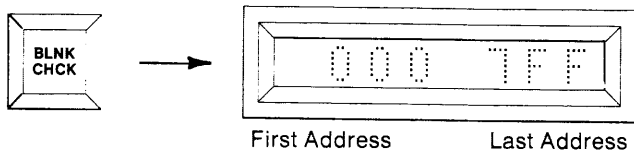

4. To Blank Check the entire contents of the Copy PROM, starting with the first location, go to step 5. To Blank Check a limited field, continue. Use the hex keyboard to key in a new Start Address, MSD first. Repeat for the End Address.

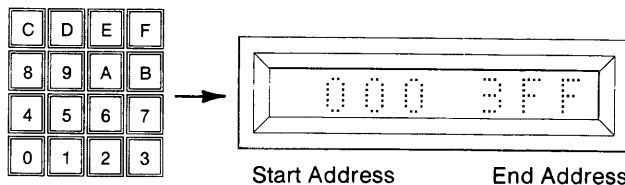

5. Depress ENTER. The M980 will accept the displayed data as the Start and End Addresses for the operation. The display will show "B AAA" to indicate Blank Check (B) Active (AAA). "B F" will be displayed for Blank Check Finished.

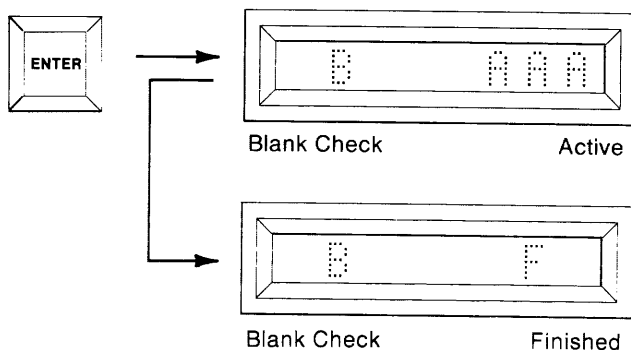

- To repeat the Blank Check operation, depress ENTER when "B F" appears. The previous Start and End Address will be displayed and you may continue with step 4 and/or 5.

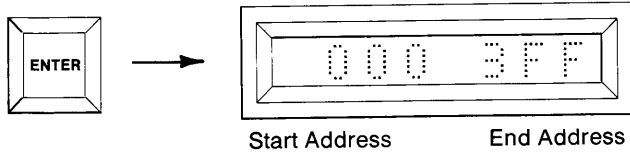

- If a non-blank address is found, the address and data will be displayed. Return to step 5 to continue or RESET.

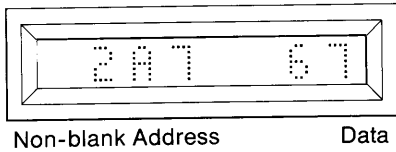

### Summary of Performing a Blank Check on a Copy PROM

- Insert Personality Module, Copy PROM, and select switches; MFG MODE (OFF), AUDIO (optional ON/OFF), MASTER (OFF), BUFFER (OFF), COPY (ON).
- Depress RESET. Displays are blank.
- Depress BLNK CHCK. First and Last Addresses of Copy PROM are displayed.
- Optional. Redefine Start and End Addresses.
- Depress ENTER. "B AAA" is displayed while active. "B F" displayed for Blank Check Finished.
- Optional. Depress ENTER to repeat Blank Check and go to step 4 and/or 5.
- If non-blank address is found, it will be displayed. Return to step 5 to continue or RESET.

### Performing an Illegal Bit Check on Copy PROM from the Master PROM (example shown is for a 2Kx8 PROM)

The Illegal Bit Check operation checks for the possibility of overwriting the PROM in the copy socket over the defined field with data from the master PROM. Illegal Bit Check determines the erased state of the PROM under consideration from the lookup table in the personality module. If the copy PROM has a non-erased location that has an erased state to be written, an error condition will occur. No attempt will be made to actually write data to the copy PROM during Illegal Bit Check.

**NOTE**

Illegal Bit Check does not apply to gang modules. If attempted, an "EO" will be displayed.

1. Select switches as shown.

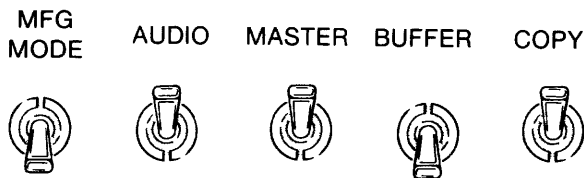

2. Depress RESET. The 8 hex displays are blank.



3. Press BLNK CHCK. The first and last addresses of the Copy PROM will be displayed.

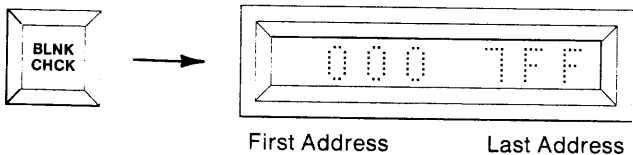

4. To perform an Illegal Bit Check (IBC) over displayed field, go to step 5. To change address field, use keyboard to enter new Start and End Addresses. See SECTION 3 for more details. Use CLEAR key for corrections. When the complete field is defined, go on to the next step.

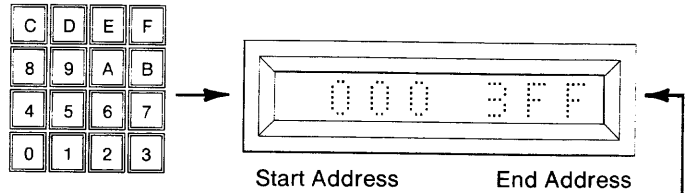

5. Depress ENTER. The M980 will accept the Start/End Address displayed as the field over which the Illegal Bit Check will be performed. "B AAA" shows that IBC is active. "B F" shows that IBC has been completed.

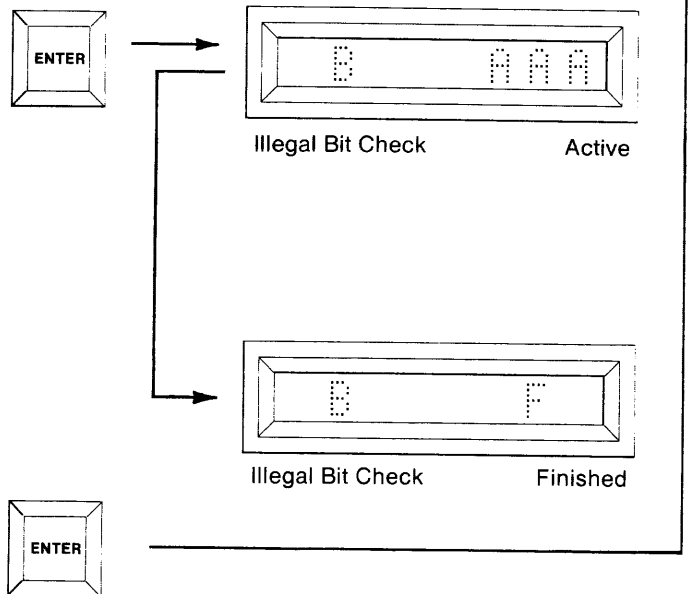

6. To repeat IBC operation, depress ENTER after "B F" appears. The previous Start/End Address will be displayed. Continue at step 4.

7. The Illegal Bit Check is performed at sequential addresses beginning with the Start Address. If a location is found that can't be overwritten, that address is shown along with the Master data. Depress key "C" on the hex keyboard to display Copy data. Depress key "A" to restore Master data. Depress ENTER to continue IBC operation or CLEAR to force finish. Then depress ENTER to continue at Step 4.

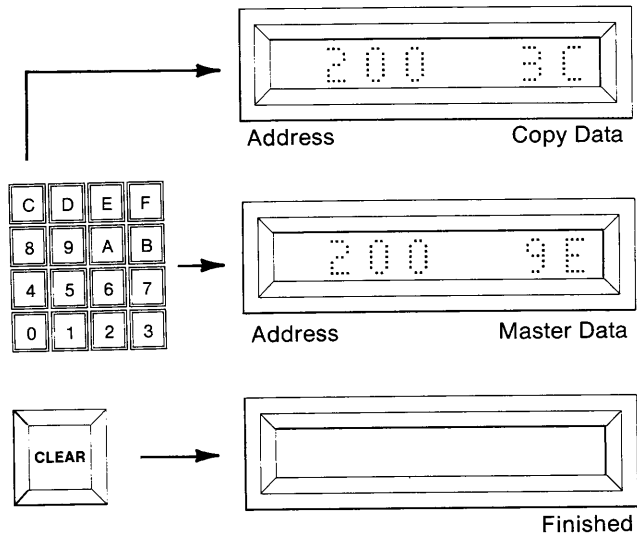

### Summary of Illegal Bit Checking a Copy PROM from a Master PROM

1. Insert Personality Module, Master and Copy PROMs, and select switches; MFG MODE (OFF), AUDIO (optional ON/OFF), MASTER (ON), BUFFER (OFF), COPY (ON).
2. Depress RESET The hex displays are blank.
3. Depress BLNK CHCK. First and Last Addresses are displayed.
4. Optional. Key in new Start and/or End Address.
5. Depress ENTER. "B AAA" is displayed. When finished "B F" is displayed.
6. Optional. Depress ENTER to repeat operation over previously selected address field.
7. If an illegal condition occurs, the address and data of the Master PROM are displayed. Key C displays copy data and key A displays master data.
8. Optional. Depress ENTER to continue Illegal Bit Check or depress CLEAR to abort to IBC Finished, without losing original address limits.





# SECTION 6

## Buffer Operations to/from a Copy or Master Prom

### DESCRIPTION

The CMOS RAM Buffer of the M980 provides a workspace (8Kx8 standard, 16Kx8 and 32Kx8 optional) where PROM code can be accumulated and manipulated prior to programming a blank PROM. The Buffer can be loaded from the M980 keyboard, Master PROM, or the remote interfaces 9811, 9812, 9814, and 9818. The M980 features Data Displacement during Buffer input and output operations, and enables edit functions to change that data. The M980 power may be switched OFF for at least one week without losing Buffer data. It is recommended that the Buffer be cleared to the erased state of the PROM type used prior to loading valid data into the Buffer. See Fill Buffer Operations in Section 7. RESET does not affect the Buffer contents.

The following operations are described in detail to allow the user to perform this transfer of data. These operations may also be used to transfer parts of several different PROMs into the Buffer and to transfer their total sum into one PROM (see Figure 6-1).

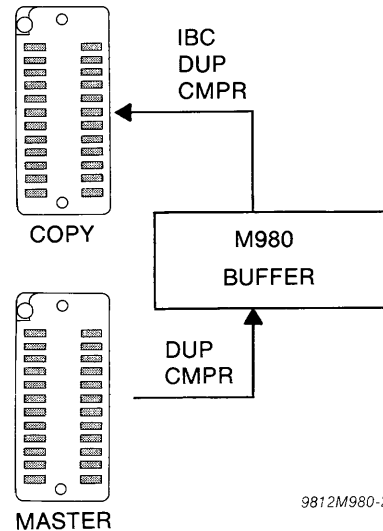
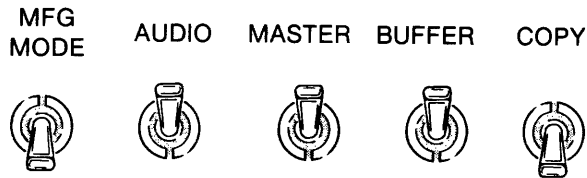

Figure 6-1. Buffer Operations  
(to/from Copy or Master Prom)

**Duplicating the RAM Buffer from a Master PROM (example shown is for a 16Kx8 RAM Buffer and a 2Kx8 Master PROM)**

1. Select the switches as shown. Insert the appropriate Personality Module. Insert the PROM into the MASTER socket. The RAM Buffer may be filled with any data prior to this operation by using "Fill Buffer" a Buffer Edit operation described in Section 7. The AUDIO switch is optional.



2. Depress RESET. The 8 hex displays are blank.

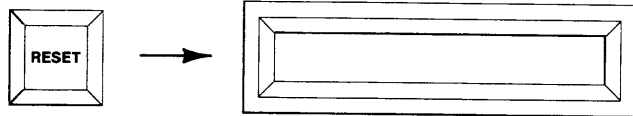

3. Depress DUP. The First and Last Addresses of the Master PROM are displayed.

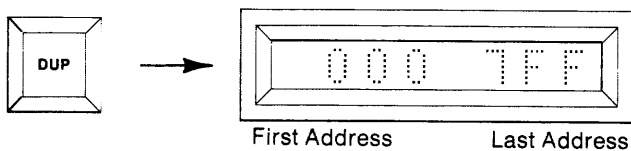

4. To Duplicate the entire contents of the Master PROM into the Buffer go to step 5. To Duplicate over a limited field, use the hex keyboard to key in a new Start and End Address, MSD first.

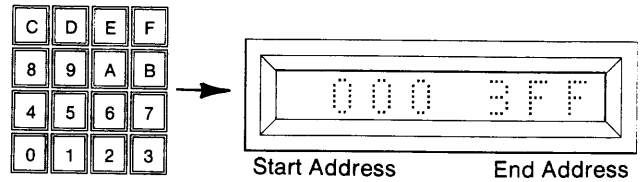

5. Depress ENTER. The M980 accepts the displayed data as the Start and End Addresses for the operation. The display shows "0000" which is the First Address of the RAM Buffer.

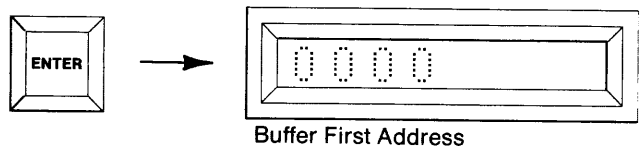

6. If you wish the Duplicate operation to start at the first location of the RAM Buffer, continue to step 7. To redefine the Start Address of the Buffer, use the hex keyboard to key in a new Start Address, MSD first.

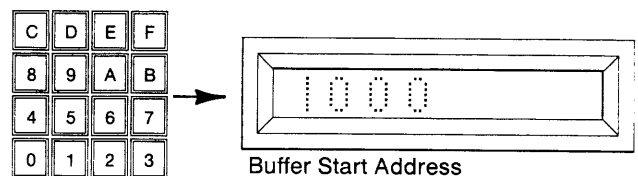

7. Depress ENTER. The displayed Start Address for the RAM Buffer is accepted by the M980. "D AAA" is displayed to indicate Duplicate (D) Active (AAA). Write Mode LED is lit. The M980 starts duplicating from the Master Start Address into the Start Address of the RAM Buffer. This continues until the end address of the Master is reached. When finished the display shows "D F."

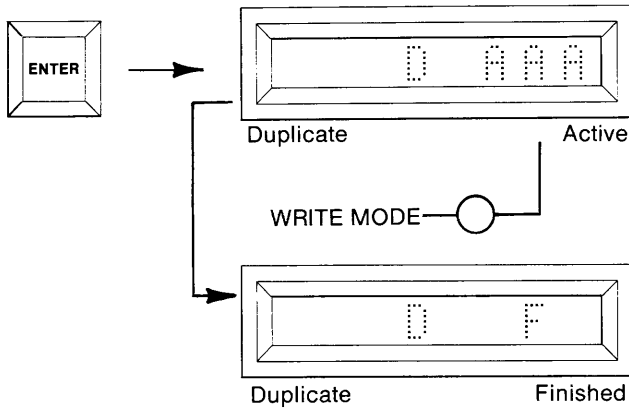

8. To repeat the Duplicate operation without resetting, depress ENTER. The hex display shows the previous Start and End Addresses used. You may now redefine the Start and End Addresses as in step 4 or you may depress ENTER again and the previous Buffer Start Address is displayed.

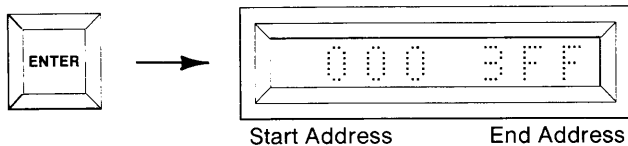

9. It is possible now to redefine the Buffer Start Address as in step 6, or depress ENTER to start the Duplicate function as in step 7.

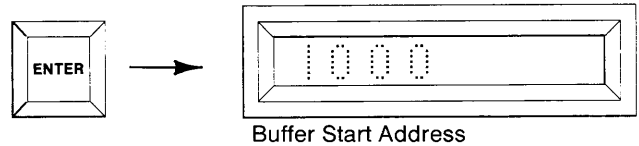

### Summary of Duplicating the RAM Buffer from a Master PROM

1. Insert Personality Module, Master PROM, and select switches; MFG MODE (OFF), AUDIO (optional ON/OFF), MASTER (ON), BUFFER (ON), COPY (OFF).
2. Depress RESET. Displays are blank.
3. Depress DUP. First and Last Addresses of Master PROM are displayed.
4. Optional. Redefine Start and End Addresses of the Master.
5. Depress ENTER. Start Address of RAM Buffer is displayed.
6. Optional. Redefine the Buffer Start Address.
7. Depress ENTER. "D AAA" is displayed for DUP Active. "D F" is displayed when finished.
8. Optional. Depress ENTER to repeat Master, Start and End Address.
9. Optional. Depress ENTER to repeat Buffer Start Address, beginning of Duplicate operation.

**Comparing the RAM Buffer with a Master PROM (example shown is for a 16Kx8 RAM Buffer and a 2Kx8 Master PROM)**

1. Select the switches as shown. Insert the appropriate Personality Module. Insert the Master PROM into the MASTER socket. The AUDIO switch is optional.

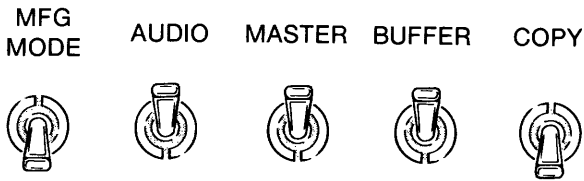

2. Depress RESET. The 8 hex displays are blank.

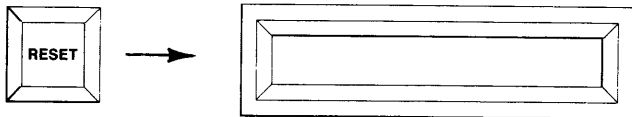

3. Depress CMPR. The 8 hex displays show the First and Last Addresses of the Master PROM.

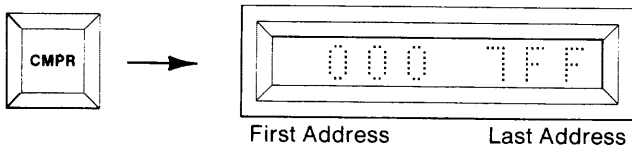

4. If the entire contents of the Master PROM are to be Compared with the Buffer go to step 5. To compare a limited field, use the hex keyboard to key in a new Start and End Address, MSD first.

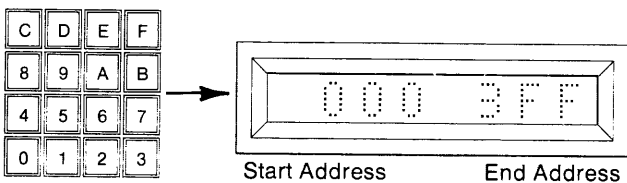

5. Depress ENTER. The M980 accepts the displayed data as the Start and End Addresses for the operation. The display shows "0000" which is the First Address of the RAM Buffer.

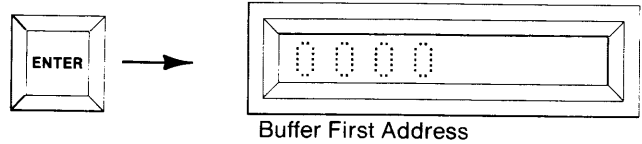

6. To have the compare operation begin at the first location of the RAM Buffer, continue to step 7. To redefine the Start Address of the Buffer, use the hex keyboard to key in a new Start Address, MSD first.

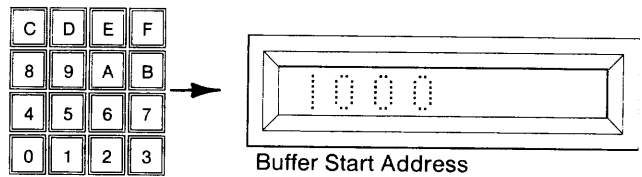

7. Depress ENTER. The displayed Start Address for the RAM Buffer is accepted by the M980. "C AAA" is displayed to indicate Compare (C) Active (AAA). The M980 starts Comparing from the Master PROM Start Address with the Start Address of the RAM Buffer. This continues until the End Address of the Master PROM is reached. When finished the display shows "C F".

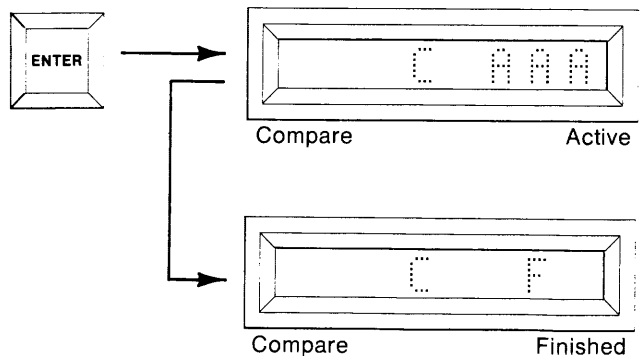

- If a non-compare occurs, the address and data of the Master location is displayed. By depressing key B, the Buffer address and data may be seen. Depress ENTER to continue, or CLEAR to abort.

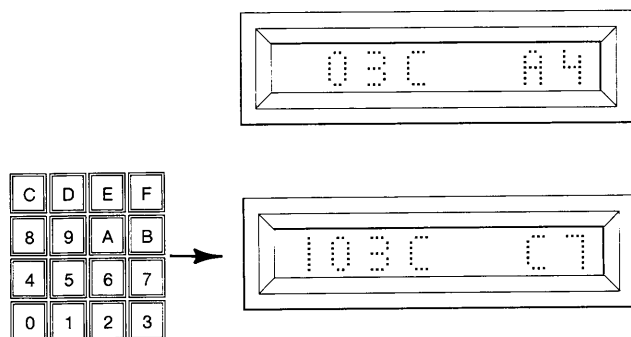

- To repeat the Compare operation without resetting, depress ENTER. The hex display shows the previous Start and End addresses used. Now redefine the Start and End Addresses as in step 4 or depress ENTER again and the previous Buffer Start Address is displayed. It is possible to redefine the Buffer Start Address as in step 6 and/or go to step 7.

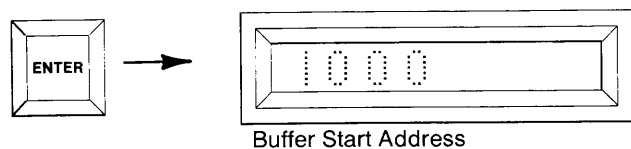
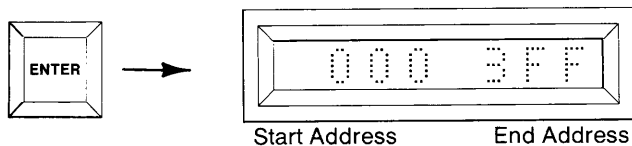

### Summary of Comparing the RAM Buffer with a Master PROM

- Insert Personality Module, Master PROM, and select switches; MFG MODE (OFF), AUDIO (optional ON/OFF), MASTER (ON), BUFFER (ON), COPY (OFF).
- Depress RESET. Displays are blank.
- Depress CMPR. First and Last Addresses of Master PROM are displayed.
- Optional. Redefine Start and End Addresses of the Master PROM.
- Depress ENTER. Start Address of RAM Buffer is displayed.
- Optional. Redefine the Buffer Start Address.
- Depress ENTER. "C AAA" is displayed for CMPR Active. "C F" is displayed when finished.
- Error displayed if non-compare occurs.
- Optional. Depress ENTER to repeat Compare operation.

**Duplicating the RAM Buffer into a Copy PROM (example shown is for a 16Kx8 RAM Buffer and a 2Kx8 Copy PROM)**

1. Select the switches as shown. Insert the appropriate Personality Module. Insert the Copy PROM into the Copy socket. The AUDIO switch is optional.

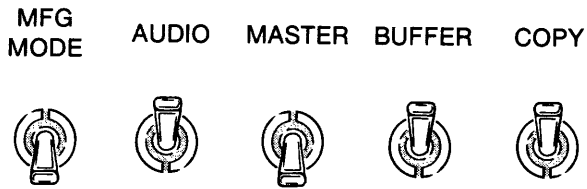

2. Depress RESET. The 8 hex displays are blank.

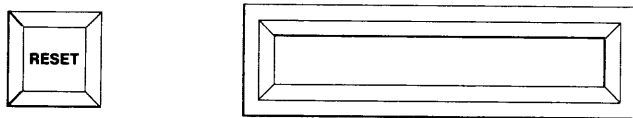

3. Depress DUP. The First and Last Addresses of the Copy PROM are displayed.

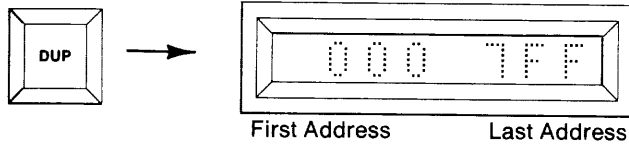

4. To Duplicate the entire contents of the Copy PROM from the Buffer go to step 5. To Duplicate over a limited field, use the hex keyboard to key in a new Start and End Address, MSD first.

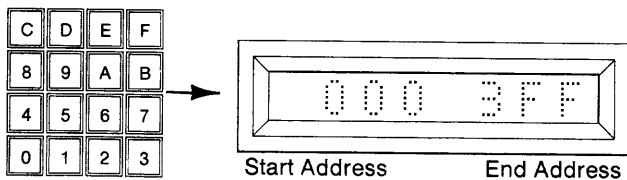

5. Depress ENTER. The M980 accepts the displayed data as the Start and End Addresses for the operation. The display shows "0000" which is the First Address of the RAM Buffer.

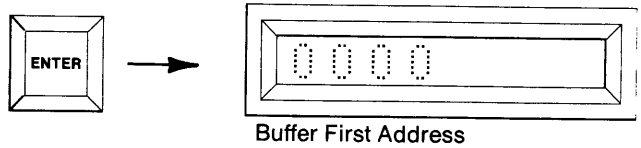

6. To have the Duplicate operation start at the first location of the RAM Buffer, continue to step 7. To redefine the Start Address of the Buffer, use the hex keyboard to key in a new Start Address, MSD first.

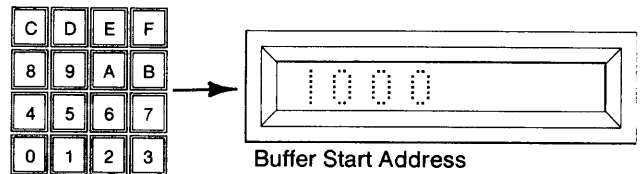

7. Depress ENTER. The displayed Start Address for the RAM Buffer is accepted by the M980. "D AAA" is displayed to indicate Duplicate (D) Active (AAA). The write mode LED is lit. The M980 starts duplicating to the Copy PROM's Start Address from the Start Address of the RAM Buffer. This continues until the End Address of the Copy PROM is reached. When finished the display shows "D F".

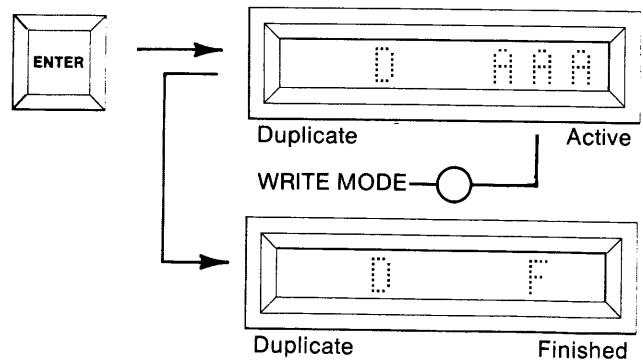

8. To repeat the Duplicate operation without resetting, depress ENTER. The hex display shows the previous Start and End Addresses used. Now redefine the Start and End Addresses as in step 4 or depress ENTER again and the previous Buffer Start Address is displayed. It is possible to redefine the Buffer Start Address as in step 6 and/or go to step 7.

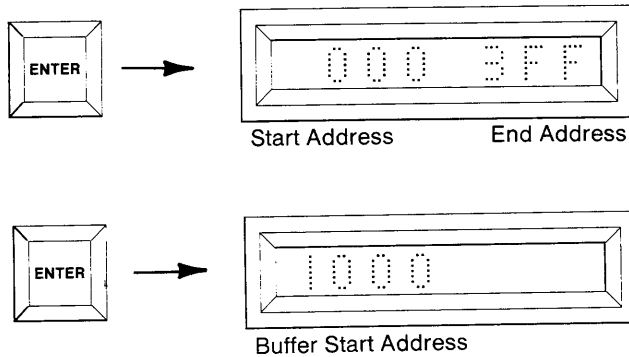

9. If an error should occur, the address and the data of the Buffer where the error occurred are displayed. Depressing key C shows the copy data and address. Depressing key B shows the Buffer data again (see Section 8).

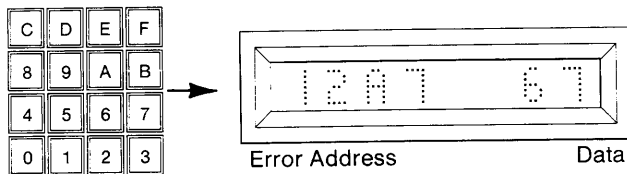

10. Depress ENTER to resume duplication and to return to step 8, or depress CLEAR to abort to Duplicate Finished ("D F"). See Failure to Program Operations in Section 11.

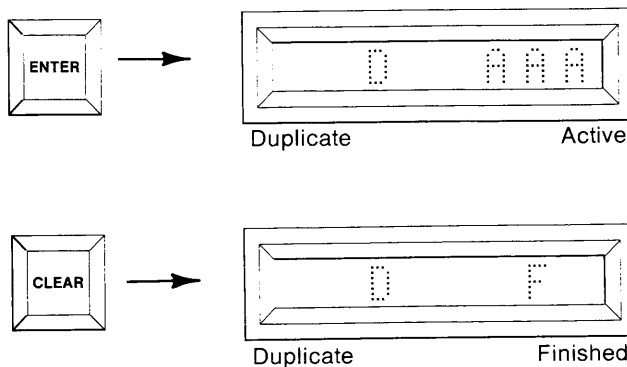

### Summary of Duplicating the RAM Buffer into a Copy PROM

1. Insert Personality Module, Copy PROM, and select switches; MFG MODE (OFF), AUDIO (optional ON/OFF), MASTER (OFF), BUFFER (ON), COPY (ON).
2. Depress RESET. Displays are blank.
3. Depress DUP. First and Last Addresses of Copy PROM are displayed.
4. Optional. Key in Start and End Addresses.
5. Depress ENTER. First Address of the Buffer is displayed.
6. Optional. Key in the new Buffer Start Address.
7. Depress ENTER. "D AAA" is displayed for Duplicate Active. "D F" is displayed when Finished.
8. Optional. Depress ENTER to repeat the start and End Addresses of the Copy PROM. Depress ENTER again to repeat the Start Address of the Buffer. Return to step 7 to continue the Duplicate operation.
9. If an error occurs, the address and data of the error are displayed. Depress key C to view copy address and data; depress key B to view Buffer address and data.
10. Optional. Depress ENTER to continue with the Duplicate operation or depress CLEAR to abort to Dup Finished.

### Comparing the RAM Buffer to a Copy PROM (example shown is for a 16Kx8 RAM Buffer and a 2Kx8 Copy PROM)

1. Select the switches as shown. Insert the appropriate Personality Module. Insert the Copy PROM in the COPY socket. The AUDIO switch is optional.

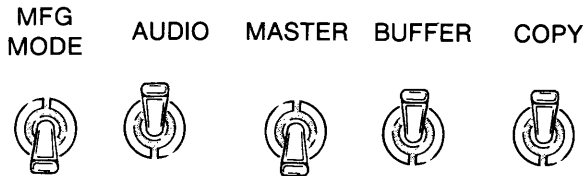

2. Depress RESET. The 8 hex displays are blank.

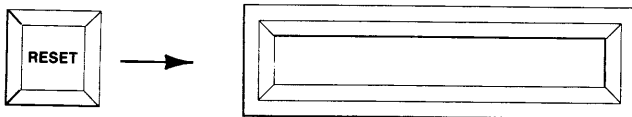

3. Depress CMPR. The 8 hex displays show the First and Last Addresses of the Copy PROM.

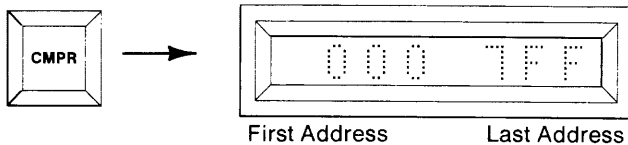

4. To Compare the entire contents of the Copy PROM with the Buffer, go to step 5. To Compare a limited field, use the hex keyboard to key in a new Start and End Address, MSD first.

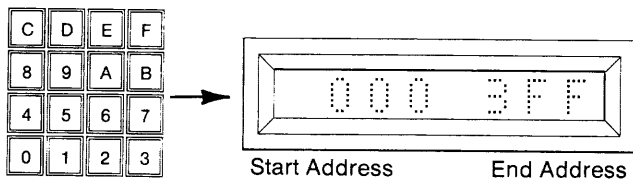

5. Depress ENTER. The M980 accepts the displayed data as the Start and End Addresses for the operation. The display shows "0000" which is the First Address of the RAM Buffer.

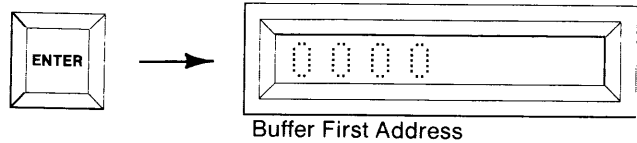

6. To have the Compare operation start with the first location of the RAM Buffer, continue to step 7. To redefine the Start Address of the Buffer, use the hex keyboard to key in a new Start Address, MSD first.

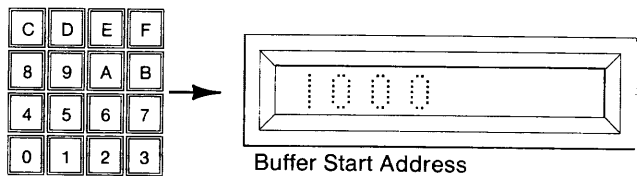

7. Depress ENTER. The displayed Start Address for the RAM Buffer is accepted by the M980. "C AAA" is displayed to indicate Compare (C) Active (AAA). The M980 begins comparing the Start Address of the Buffer with the Start Address of the Copy PROM. This continues until the End Address of the Copy PROM is reached. When finished the display shows "C F".

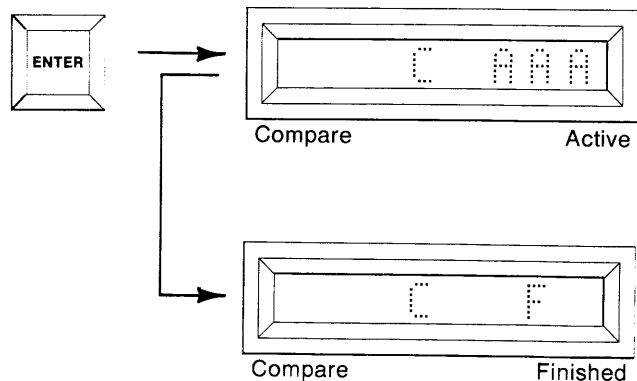



- To repeat the Compare operation without resetting, depress ENTER. The hex display shows the previous Start and End Addresses used. Now redefine the Start and End Addresses as in step 4 OR depress ENTER again and the previous Buffer Start Address is displayed. It is possible to redefine the Buffer Start Address as in step 6 and/or go to step 7.

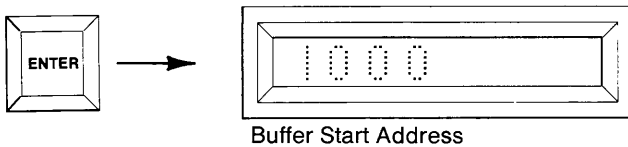
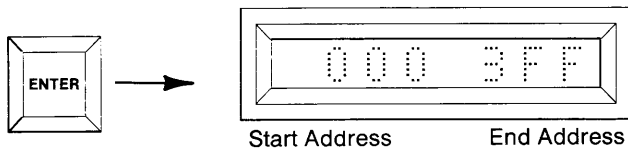

- If an error should occur, the address and the data of the Buffer where the error occurred are displayed. Depressing key C shows the copy data and address. Depressing key B shows the Buffer data and address (see Section 8).

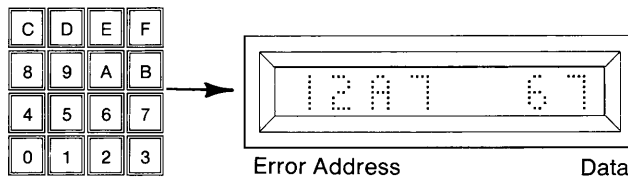

- Depress ENTER to resume Compare operations and to return to step 8 OR depress CLEAR to abort to Compare Finished. See Failure to Program Operations in Section 11.

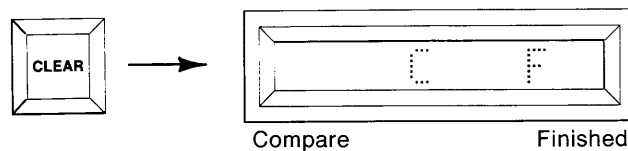
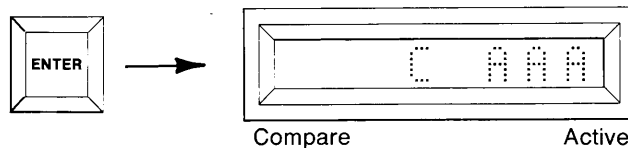

### Summary of Comparing the RAM Buffer with a Copy PROM

- Insert Personality Module, Copy PROM, and select switches: MFG MODE (OFF), AUDIO (optional ON/OFF), MASTER (OFF), BUFFER (ON), COPY (ON).
- Depress RESET. All displays are blank.
- Depress CMPR. First and Last Addresses of the Copy PROM are displayed.
- Optional. Key in the new Start and End Addresses.
- Depress ENTER. The First Address of the Buffer is displayed.
- Optional. Key in the new Buffer Start Address.
- Depress ENTER. "C AAA" is displayed for Compare Active. "C F" is displayed when finished.
- Optional. Depress ENTER to repeat the Start and End Addresses of the Copy PROM. Depress ENTER again to repeat the Start Address of the Buffer. Go to step 7 to continue the Compare operation.
- If an error occurs, the address and data of the error are displayed. Depress key C to view copy data and key B to view Buffer data.
- Optional. Depress ENTER to continue with the Compare operation or depress CLEAR to abort to Compare Finished.

**Performing an Illegal Bit Check on a Copy PROM from the Buffer (example shown is for a 16Kx8 RAM Buffer and a 2Kx8 Copy PROM)**

The illegal Bit Check operation checks for the possibility of overwriting the PROM in the copy socket over the defined field with data from the buffer. Illegal Bit Check determines the erased state of the PROM under consideration from the lookup table in the personality module. If the copy PROM has a nonerased location that has an erased state to be written, an error condition will occur. No attempt will be made to actually write data to the copy PROM during illegal bit check.

**NOTE**

Illegal Bit Check does not apply to Gang Modules. If attempted, an "EO" will be displayed.

1. Select switches as shown.

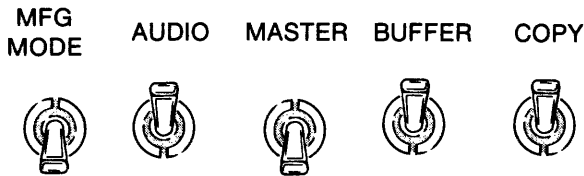

2. Depress RESET. The 8 hex displays are blank.

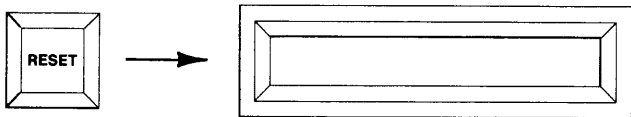

3. Press BLNK CHCK. The first and last addresses of the Copy PROM will be displayed.

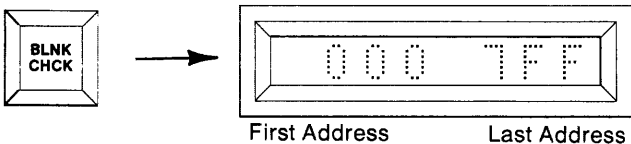

4. To perform Illegal Bit Check over displayed field, go to step 5. To change address field, use keyboard to enter new Start and End Address. See Section 3 for more details. Use CLEAR key for corrections. When the complete field is defined, go on to the next step.

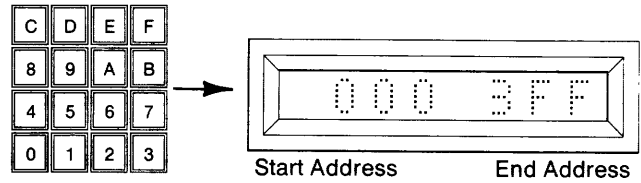

5. Depress ENTER. The M980 will accept the Start/End Address displayed as the field over which the IBC will be performed. The display shows "0000", the first address of the RAM Buffer.

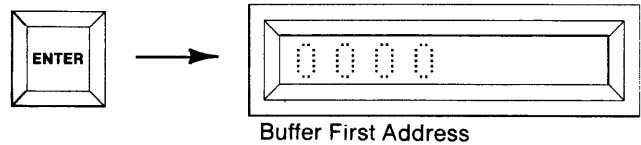

6. To have the IBC begin at the Buffer location shown, go to step 7. To redefine the Start Address of the Buffer, use hex keyboard to key in new Buffer Start Address, MSD first. Use CLEAR key if corrections are needed.

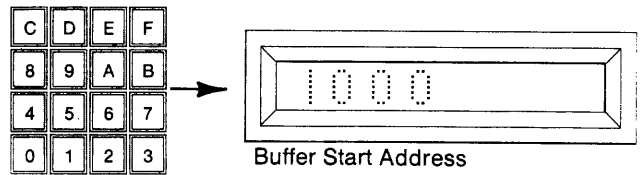

7. Depress ENTER. The displayed Start Address for the RAM Buffer is accepted. "B AAA" is displayed to show that the IBC is being performed over the addresses accepted. The M980 performs the IBC between the Start Address of the copy PROM and the Start Address of the Buffer in sequential order. When finished, the display shows "B F."

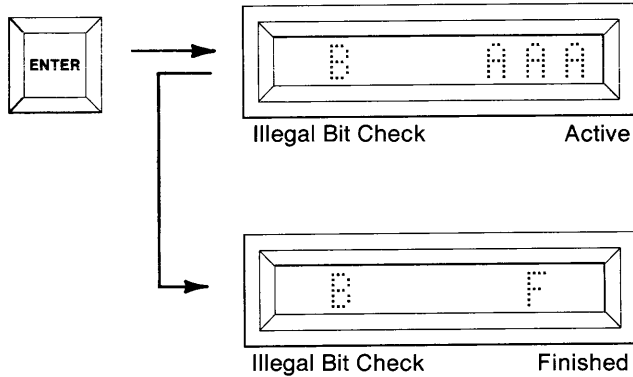

9. Depress ENTER to continue IBC, or CLEAR to force finish ("B F"), then depress ENTER to return to step 4.

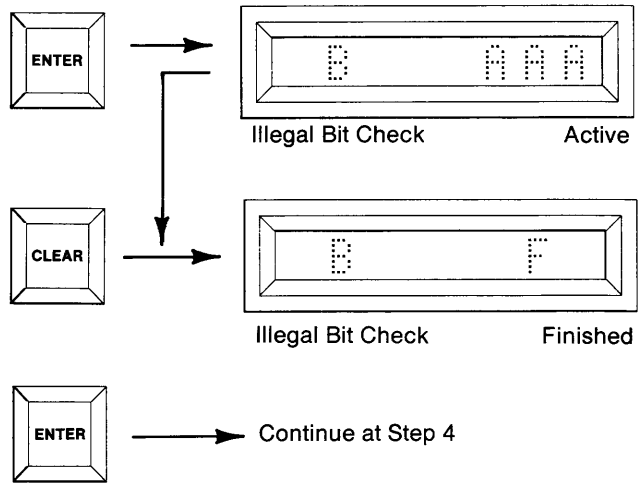

8. If the Illegal Bit Check finds a location that can't be overwritten, the address and data of the Buffer at that location is shown. Depressing key "C" shows the corresponding location of the Copy PROM address and data. Pressing key "B" will restore Buffer address and data to the display.

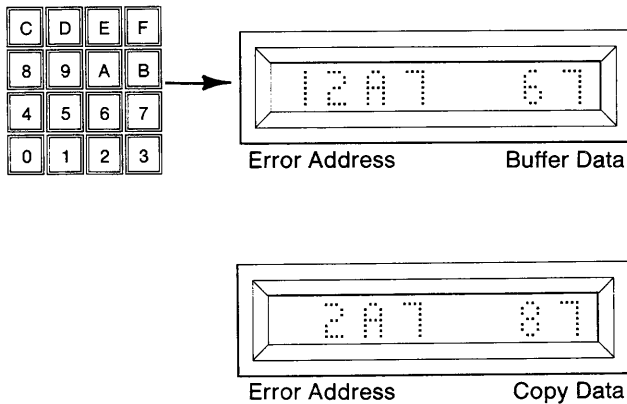

### Summary of Illegal Bit Checking the RAM Buffer to a Copy PROM

1. Insert Personality Module, Copy PROM, and select switches; MFG MODE (OFF), AUDIO (optional ON/OFF), MASTER (OFF), BUFFER (ON) COPY (ON).
2. Depress RESET. All displays are blank.
3. Depress BLNK CHCK. First and Last Addresses of the Copy PROM are displayed.
4. Optional. Key in the new Start and End Addresses.
5. Depress ENTER. The First Address of the Buffer is displayed.
6. Optional. Key in the new Buffer Start Address.
7. Depress ENTER. "B AAA" is displayed for IBC Active. "B F" is displayed when finished.
8. Optional. Depress ENTER to repeat the Start and End Addresses of the Copy PROM. Depress ENTER again to repeat the Start Address of the Buffer. Go to step 7 to continue the IBC operation.
9. If an illegal condition occurs, the address and data of the error are displayed. Depress Key C to view copy data and Key B to view Buffer data.
10. Optional. Depress ENTER to continue with the IBC operation or depress CLEAR to abort to IBC Finished.



# SECTION 7

## Additional Buffer Operations

### DESCRIPTION

The CMOS RAM Buffer of the M980 provides a workspace (8Kx8 standard, 16Kx8 and 32Kx8 optional) where PROM code can be accumulated and manipulated prior to programming a blank PROM. The Buffer can be loaded from the M980 keyboard, Master PROM, or the remote interfaces 9811, 9812, 9814, and 9818. The M980 features Data Displacement during Buffer input and output operations, and enables edit functions to change that data. The M980 power may be switched OFF for at least one week without losing Buffer data. It is recommended that the Buffer be cleared to the erased state of the PROM type used prior to loading

valid data into the Buffer. See Fill Buffer Operation. RESET does not affect the Buffer contents.

The M980 Buffer Edit operations are selected via the hex keyboard after RESET and the EDIT key are depressed. In its present configuration the M980 RAM Buffer is seen as an 8-bit Buffer when performing Invert, Insert, Delete, and Fill Buffer operations. The Nibble Swap, Hex Pack, and Hex Unpack operations are provided for 4-bit manipulation.

Only the Buffer is involved in the following operations; it is not mandatory that a Personality Module be installed, a warning "E4" is displayed; this can be overridden by continuing with the operation.

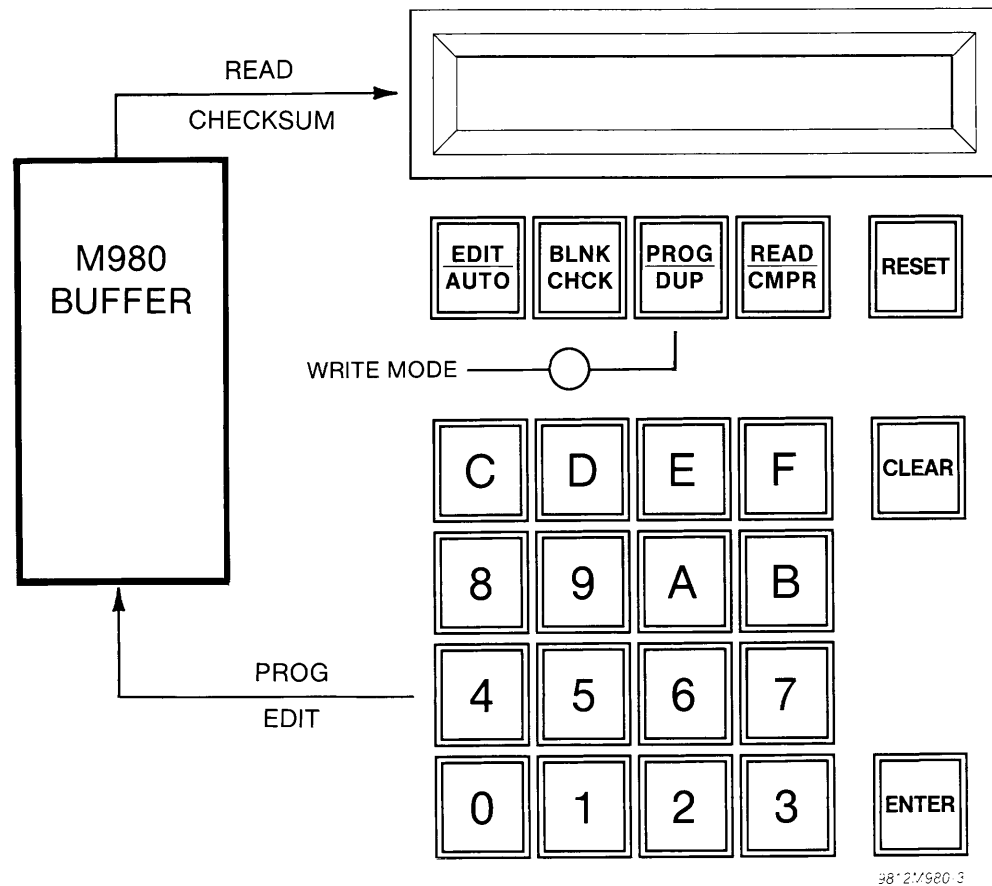
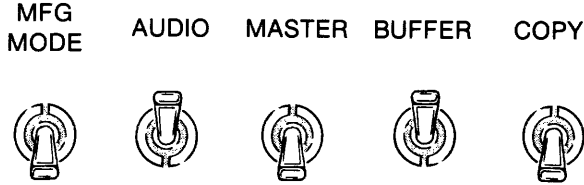

Figure 7-1. Buffer Operations via Hex Keyboard

**Programming the RAM Buffer using the M980 Keyboard (example shown is for 8Kx8 RAM Buffer)**

1. Select the switches as shown. The AUDIO switch is optional.



2. Depress RESET. The 8 hex displays are blank. A Personality Module is not necessary. "E4" is displayed if a Personality Module is not present. A warbling tone will sound if the AUDIO switch is ON. You may now continue.

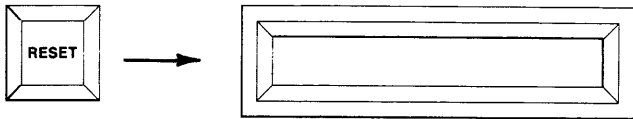

3. Depress PROG. The 8 hex displays should show the First and Last Addresses of the RAM Buffer.

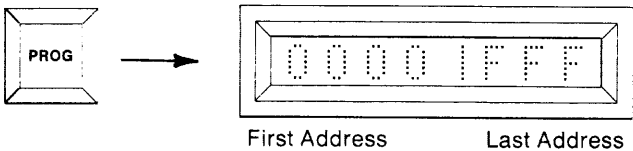

4. To Program the entire contents of the RAM Buffer, starting with the First Address, go to step 5. To Program a limited field, use the hex keyboard to key in a new Start and End Address, MSD first.

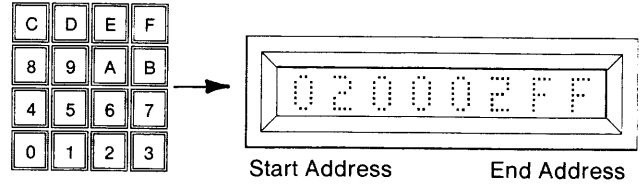

5. Depress ENTER. The M980 accepts the displayed data as the Start and End Addresses for the operation. The display shows the Start Address in the left-most display. The Write Mode LED is lit.

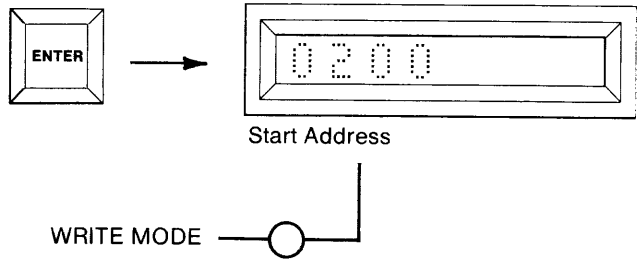

6. To Program the address displayed, key in the desired data, MSD first, using the CLEAR key to correct mistakes. To step over a location, continue to step 7.

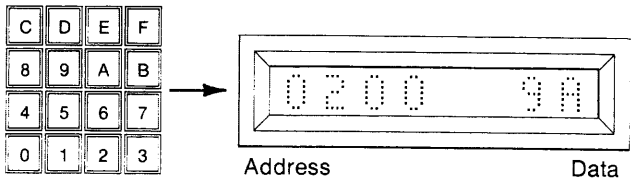

7. Depress ENTER to initiate Programming of the displayed data, or to step over an address without altering it. The next sequential address is displayed. Repeat steps 6 and/or 7 for each address.

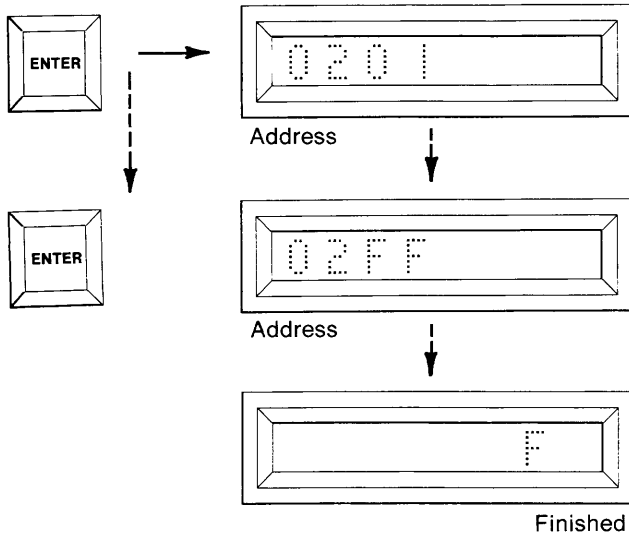

8. When the End Address is displayed and steps 6 and/or 7 are initiated, an "F" appears to indicate that the Program mode has been performed over the specified Address field.

9. To repeat the Program operation without resetting, depress ENTER when "F" is displayed. This displays the Start and End Address field previously used (identical to step 4). The Start and End Address field can be redefined or you can continue with the displayed Start and End Addresses.

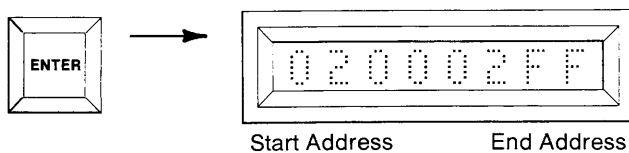

### Summary of Programming the RAM Buffer using the M980 Keyboard

1. Set select switches: MFG MODE (OFF), AUDIO (optional ON/OFF), MASTER (OFF), BUFFER (ON), COPY (OFF).
2. Depress RESET. All displays are blank.
3. Depress PROG. First and Last Addresses are displayed.
4. Optional. Redefine the the Start and End Addresses via the hex keyboard.
5. Depress ENTER. The address shown is accepted and the Start Address is displayed.
6. Optional. Key in the data to be programmed.
7. Depress ENTER. This programs the previously keyed data or step over the displayed address. Repeat for every address.
8. The End Address is reached and "F" is displayed to indicate Finished.
9. Depress ENTER to return to step 4 if desired.

**Reading the RAM Buffer using the M980 Keyboard (example shown is for an 8Kx8 RAM Buffer)**

1. Select the switches as shown. The AUDIO switch is optional.

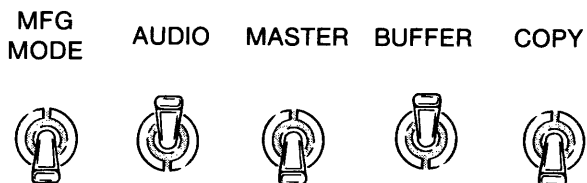

2. Depress RESET. The 8 hex displays are blank. A Personality Module is not necessary. "E4" is displayed if a Personality Module is not present. A warbling tone will sound if the AUDIO switch is ON. You may now continue.

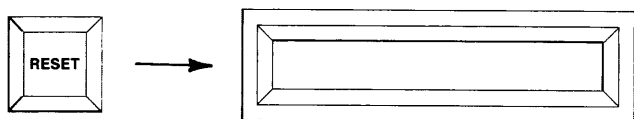

3. Depress READ. The 8 hex displays show the First and Last Addresses of the RAM Buffer.

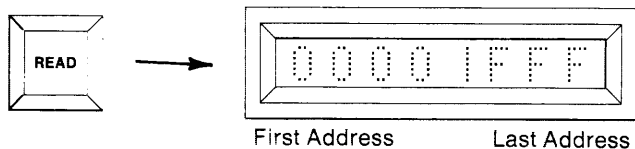

4. To Read the entire contents of the RAM Buffer, starting with the First Address, go to step 5. To Read a limited field, use the hex keyboard to key in a new Start and End Address, MSD first.

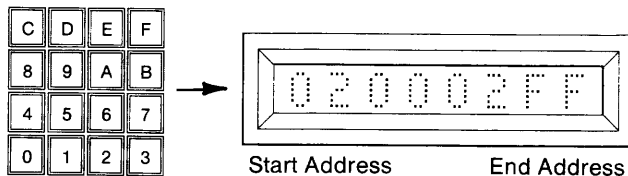

5. Depress ENTER. The M980 accepts the displayed data as the Start and End Addresses for the operation. The display shows the Start Address in the left-most display. The data located at that address is displayed in the right-most display. Repeat step 5 and the next sequential address and data are displayed. Repeat until the End Address is reached, RESET occurs, OR

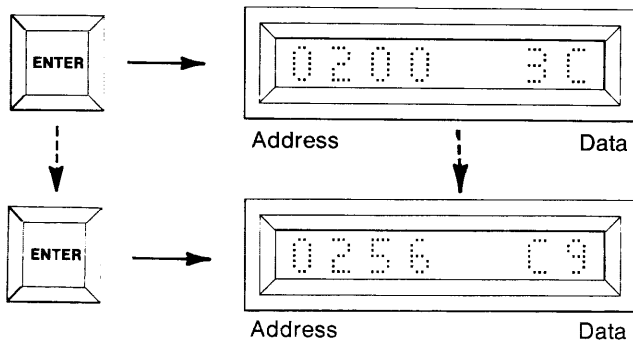



- By Depressing CLEAR during the Read operation the addresses are decremented and the data at that address is displayed. The M980 can decrement past the defined Start Address. Wrap-around occurs if an all-zero address is reached and decremented again.

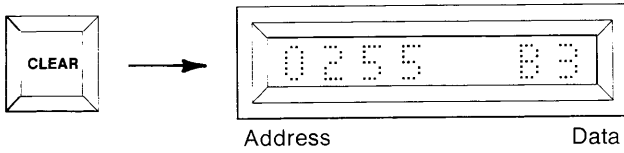

- When the End Address is reached, its data displayed, and ENTER is depressed, an "F" is displayed to indicate Finished.

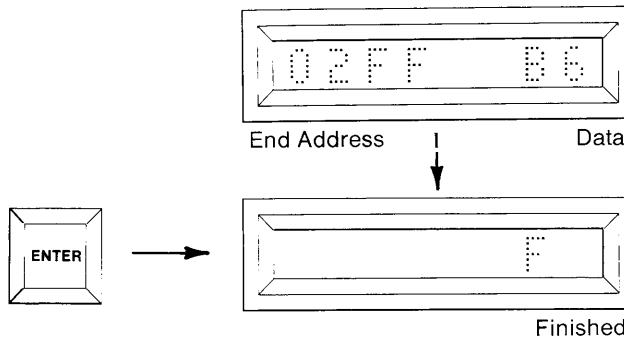

- To repeat the Read mode without resetting, depress ENTER when the "F" appears. The previous Start and End Addresses are displayed. Continue with step 4 and/or 5.

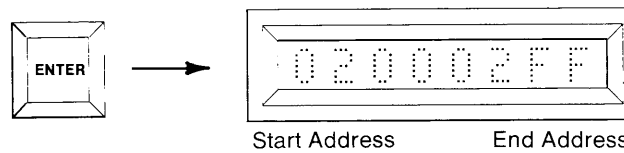

### Summary of Reading the RAM Buffer using the M980 Keyboard

- Set select switches: MFG MODE (OFF), AUDIO (optional ON/OFF), MASTER (OFF), BUFFER (ON), COPY (OFF).
- Depress RESET. Displays are blank.
- Depress READ. First and Last Addresses are displayed.
- Optional. Redefine the Start and End Addresses.
- Depress ENTER. The Start Address and its corresponding data are displayed. Repeat for each sequential address OR
- Optional. Depress CLEAR to decrement the address and display its data.
- End Address is reached and ENTER is depressed. An "F" is displayed to indicate Finished.
- Optional. Depress ENTER to show the previous Start and End Addresses and return to step 4 and/or 5.

**Performing a Read/Modify on the RAM Buffer  
(example shown is for an 8Kx8 RAM Buffer)**

1. Repeat steps 1 through 5 of the Read Buffer operation (page 7-5) until the desired address is reached.

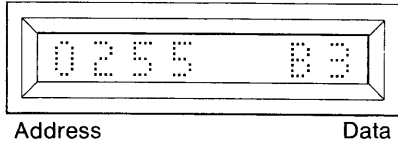

2. The display now shows the address and data of the location to be modified. Enter new data by using the hex keyboard, MSD first, until the data displays are filled with the desired data. As soon as a hex key is depressed, the Write Mode LED is lit.

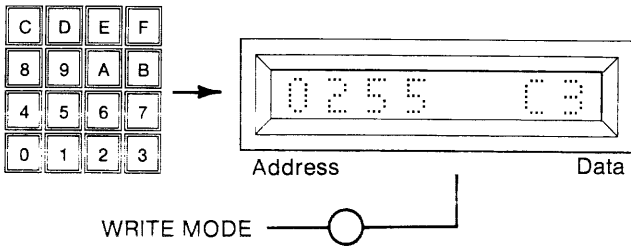

3. Depress ENTER. The data displayed is written into the RAM Buffer at the displayed address. The next sequential address and data are displayed. The Write Mode LED is extinguished. Continue until the End Address is reached.

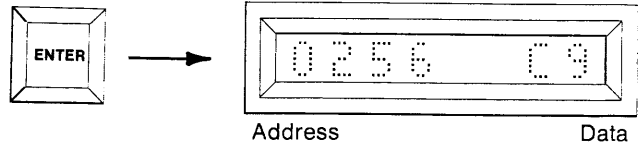

*(Operations Continued Next Page)*

### Performing a Checksum on the M980 RAM Buffer (example shown is for an 8Kx8 RAM Buffer)

1. Select the switches as shown. The AUDIO switch is optional.

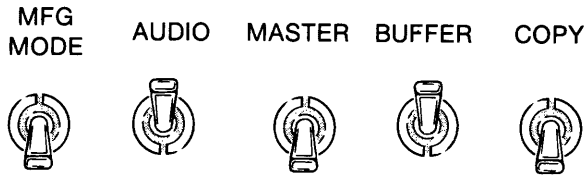

2. Depress RESET. The 8 hex displays are blank. A Personality Module is not necessary. "E4" is displayed if a Personality Module is not present. A warbling tone will sound if the AUDIO switch is ON. You may now continue.

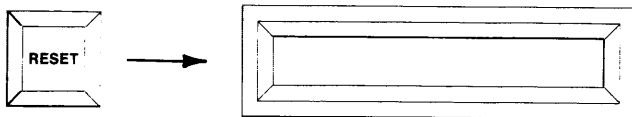

3. Depress key C. The First and Last Addresses of the RAM Buffer are displayed.

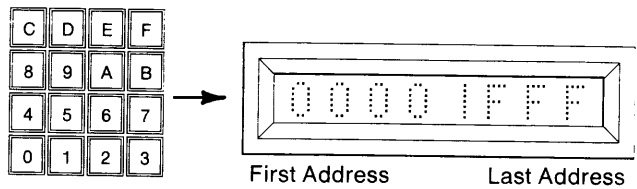

4. To Checksum the entire contents of the RAM Buffer, starting with the First Address, go to step 5. To Checksum a limited field, use the hex keyboard to key in a new Start and End Address, MSD first.

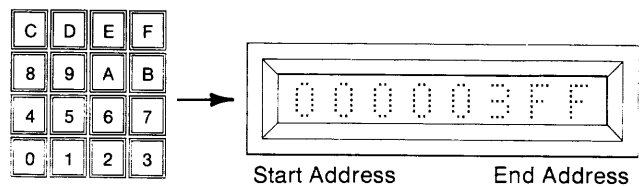

5. Depress ENTER. The M980 accepts the displayed data as the Start and End Addresses for the operation. The display shows "CC AAA" to indicate Checksum (CC) Active (AAA). When the Checksum is complete, the six digit hex equivalent is displayed.

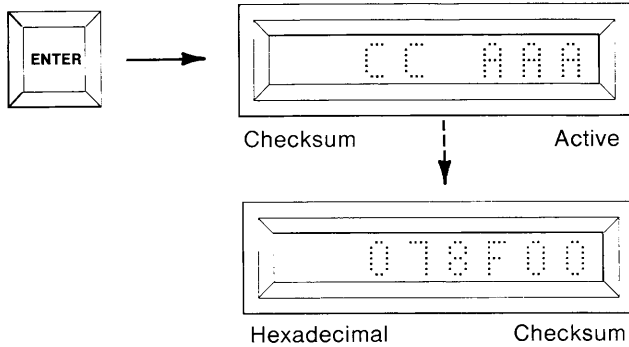

### Summary of Performing a Checksum on the RAM Buffer

1. Set select switches: MFG MODE (OFF), AUDIO (optional ON/OFF), MASTER (OFF), BUFFER (ON), COPY (OFF).
2. Depress RESET. All displays are blank.
3. Depress key C. First and Last Addresses are displayed.
4. Optional. Redefine the Start and End Addresses.
5. Depress ENTER. "CC AAA" is displayed while active. Hexadecimal Checksum is displayed when finished.

## BUFFER EDIT FUNCTIONS

Buffer Edit functions are provided for manipulating Buffer data into a more useful form. Currently, there are eleven Buffer Edit modes, summarized below (see Figure 7-2). The word length of the Buffer is always 8 bits in the Edit mode.

The Set Word Size mode configures the Buffer word length for 4, 8, 12 or 16 bits. When the RESET key is depressed, the Buffer word length defaults to the Personality Module word size. If no Personality Module is installed, then the defaulted word size is 8 bit. Programming and Reading of the Buffer is dependent on the word size setting.

| HEX KEY CODE | EDIT MODE      | DESCRIPTION                                                           |
|--------------|----------------|-----------------------------------------------------------------------|
| 00           | SET WORD SIZE  | Set Buffer word size to 4, 8, 12 or 16 bits.                          |
| 01           | INVERT         | Complement a data field.                                              |
| 02           | FILL BUFFER    | Load Buffer field with specific data byte.                            |
| 03           | INSERT         | Insert a block of data into a specified address field.                |
| 04           | DELETE         | Delete a block of data and close within a specified address field.    |
| 05           | BLOCK MOVE     | Move a block of data from one address field to another address field. |
| 06           | NIBBLE SWAP    | Exchange upper and lower hex digits within an address field.          |
| 07           | HEX PACK       | Combine unpacked digits from two defined address fields.              |
| 08           | HEX UNPACK     | Separate packed digits to form two unpacked address fields.           |
| 11           | RAM SPLIT      | Separate one WORD (16 bit) field into two BYTE (8 bit) fields.        |
| 12           | RAM INTERLEAVE | Combine two BYTE (8 bit) fields into one WORD (16 bit) field.         |

Figure 7-2. Buffer Edit—Set Word Size

**Buffer Edit—Set Word Size**

**Example: Read the Buffer with 4 bit word lengths.**

1. Select the switches as shown. The AUDIO switch is optional.

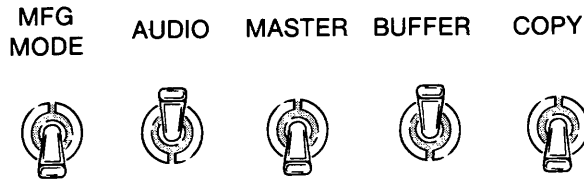

2. Depress RESET. The 8 hex displays are blank.

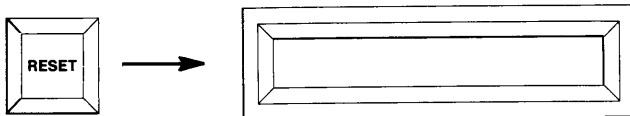

3. Depress EDIT. "E 00" is displayed to indicate Edit mode 00.

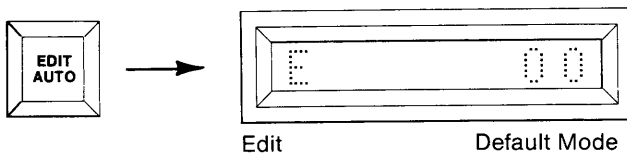

4. Depress ENTER. The display shows "E 00" to indicate Edit Word Size.

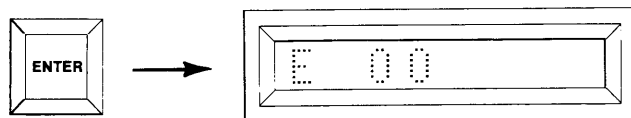

5. Use the hex keyboard to key in the desired word size 4, 8, 12 or 16 bit.

- Hex key 1 04
- Hex key 2 08
- Hex key 3 12
- Hex key 4 16

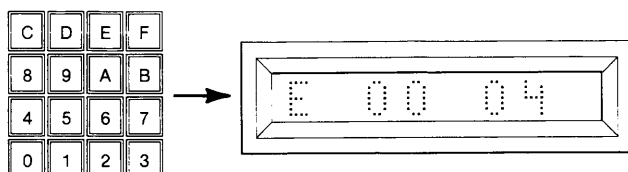

6. Depress the ENTER key. The previously selected word size is now accepted. A steady tone sounds if the AUDIO switch is ON. The "F" indicates finished.

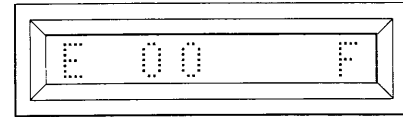

**Summary: Read the Buffer with 4-bit Lengths**

1. Set Select Switches: MFG MODE (OFF); AUDIO (optional ON/OFF); MASTER (OFF); BUFFER (ON); COPY (OFF).
2. Depress RESET. All displays blank.
3. Depress EDIT. "E00" displays to indicate Edit Mode 00.
4. Depress ENTER. "E 00" displayed to indicate Edit Set Word Size.
5. Use keyboard to key in desired word size.
6. Depress ENTER. Word size accepted, tone sounds if AUDIO (ON), "F" indicates finished.

**Buffer Edit — Invert (Complement)**  
 (example shown is for a 2K block of data in an 8Kx8 RAM Buffer)

1. Select the switches as shown. The AUDIO switch is optional.

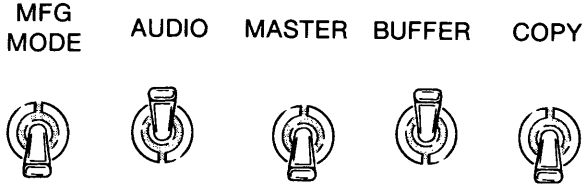

2. Depress RESET. The 8 hex displays are blank. A Personality Module is not necessary. "E4" is displayed if a Personality Module is not present. A warbling tone will sound if the AUDIO switch is ON. Now continue to step 3.

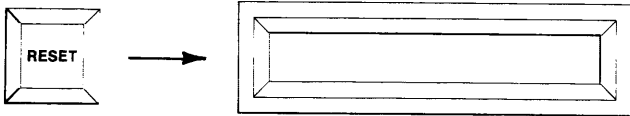

3. Depress EDIT. "E 00" is displayed to indicate Edit mode 00.

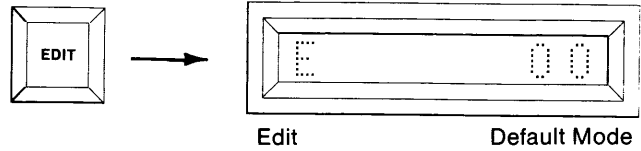

4. Using the hex keyboard, key in "01" to select Invert mode.

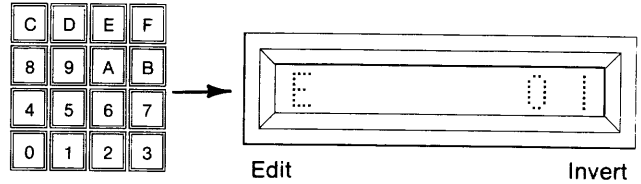

5. Depress ENTER. Invert Mode is accepted and the First and Last Addresses of the Buffer are displayed.

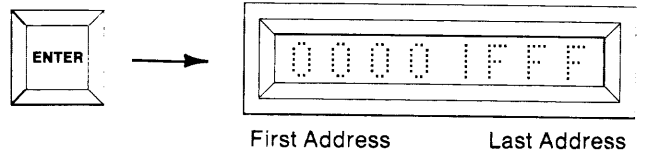



- To perform the Invert operation over the entire contents of the Buffer, starting with the First Address, go to step 7. To Invert a limited field, use the hex keyboard to key in a new Start and End Address field, MSD first.

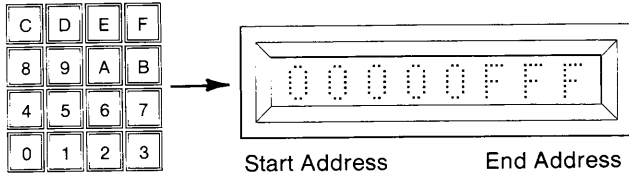

- Depress ENTER. The displayed address is accepted as the Start and End Addresses for the operation. "E 01 AAA" is displayed to indicate Edit Invert Active. The Write Mode LED is lit. Upon completion of Mode of operation, "E01 F" is displayed to indicate Finished. A steady tone sounds if the AUDIO switch is ON. The Write Mode LED is extinguished.

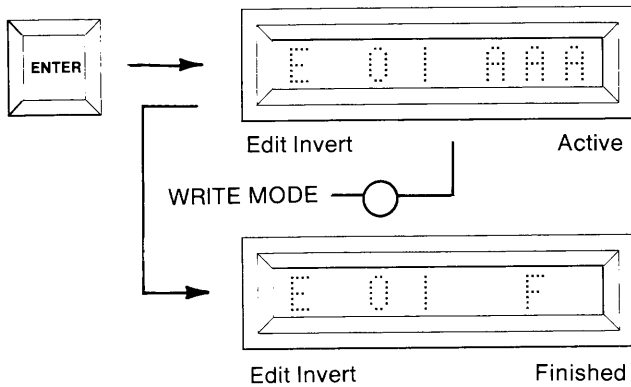

### Summary of Buffer Edit-Invert (Complement)

- Set select switches: MFG MODE (OFF), AUDIO (optional ON/OFF), MASTER (OFF), BUFFER (ON), COPY (OFF).
- Depress RESET. All displays are blank.
- Depress EDIT. Display indicates "E 00".
- Key in 01 using the HEX keyboard.
- Depress ENTER. First and Last RAM Buffer Addresses are displayed.
- Optional. Redefine the Start and End Addresses via the Hex keyboard.
- Depress ENTER. Data in the RAM Buffer is inverted over the defined Start and Ending addresses.

**Buffer Edit—Fill Buffer (example shown is for a 2K block of data in an 8Kx8 RAM Buffer)**

1. Select the switches as shown. The AUDIO switch is optional.

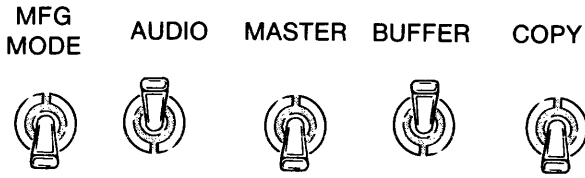

2. Depress RESET. The 8 hex displays are blank. A Personality Module is not necessary. "E4" is displayed if a Personality Module is not present. A warbling tone will sound if the AUDIO switch is ON. Now continue to step 3.

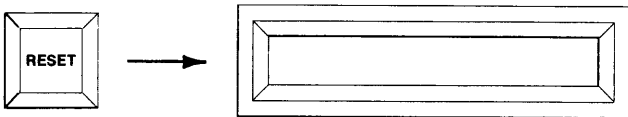

3. Depress EDIT. "E 00" is displayed to indicate Edit Mode 00.

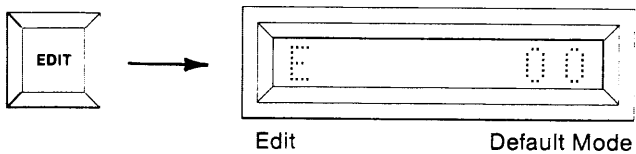

4. Using the hex keyboard, key in "02" to select Fill Buffer Mode.

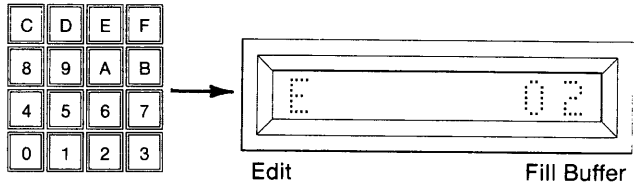

5. Depress ENTER. The Fill Buffer Mode is accepted and the First and Last Addresses of the Buffer are displayed.

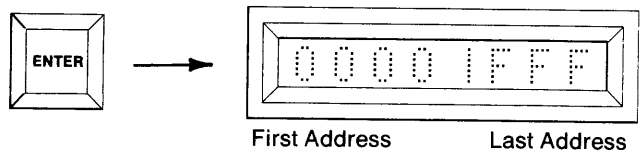

6. To perform the Fill Buffer operation over the entire contents of the Buffer, go to step 7. To operate over a limited field, use the hex keyboard to key in a new Start and End Address field, MSD first.

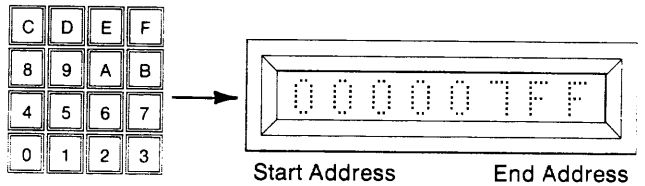

- Depress ENTER. The display shows "E 02 FF" to indicate the Edit Fill Buffer Mode and the data to be loaded into the Buffer as default data.

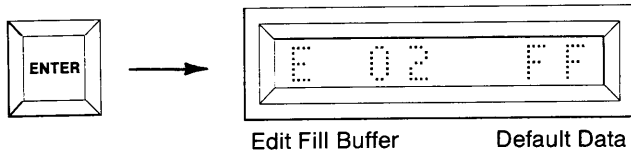

- Use the hex keyboard to key in new data or default to FF.

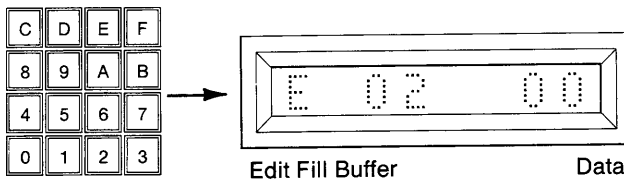

- Depress ENTER. (Write Mode LED is lit.) The data is accepted and replaced with "AAA" to indicate Edit Fill Buffer Active. The Write Mode LED is lit. Upon completion of the operation, the "AAA" is replaced with "F" to indicate Finished. A steady tone sounds if the AUDIO switch is ON. The Write Mode LED is extinguished.

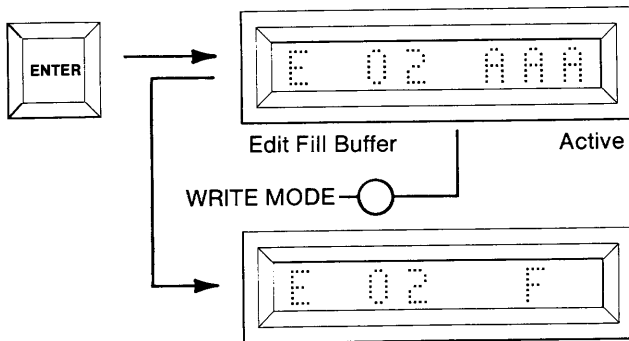

### Summary of Buffer Edit-Fill Buffer

- Set select switches: MFG MODE (OFF), AUDIO (optional ON/OFF), MASTER (OFF), BUFFER (ON), COPY (OFF).
- Depress RESET. All displays are blank.
- Depress EDIT. Display indicates "E 00".
- Key in 02 using the HEX keyboard.
- Depress ENTER. First and Last RAM Buffer Addresses are displayed.
- Optional. Redefine the Start and End Addresses via the Hex keyboard.
- Depress ENTER. "E 02 FF" is displayed.
- Optional. Redefine the data to be loaded into all RAM Buffer locations. Default data is FF.
- Depress ENTER. The RAM Buffer is filled with the same data over the defined Start and Ending Addresses.

**Buffer Edit — Insert (example shown is for an 8Kx8 RAM Buffer)**

In the Insert Mode of operation up to 32 eight bit data bytes may be inserted. The operation can be defined to operate over any defined Buffer address field. The Start Address should always be the first location at which an insertion is made. If a Buffer address field is not given the entire Buffer is operated on. The same number of locations inserted will be lost from the end of the defined Buffer address. All insertions must be sequential, starting with the First Address of the defined Buffer address (see Figure 7-3). The example shown is over the defined Buffer address field of 1000 to 10FF. Figure 7-3 shows the insertion of three data bytes at locations 1000, 1001, and 1002. In this case locations 10FD, 10FE, and 10FF are lost from the end of the Buffer address field.

1. Select the switches as shown. The AUDIO switch is optional.

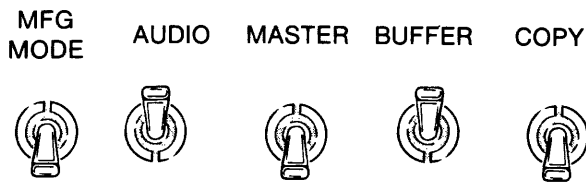

2. Depress RESET. The 8 hex displays are blank. A Personality Module is not necessary. "E4" is displayed if a Personality Module is not present. A warbling tone will sound if the AUDIO switch is ON. Now continue to step 3.

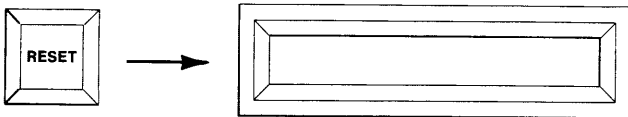

3. Depress EDIT. "E 00" is displayed to indicate Edit Mode 00.

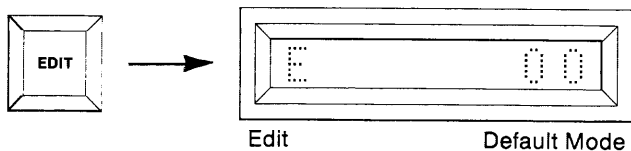

4. Using the hex keyboard, key in "03" to select the Insert Mode.

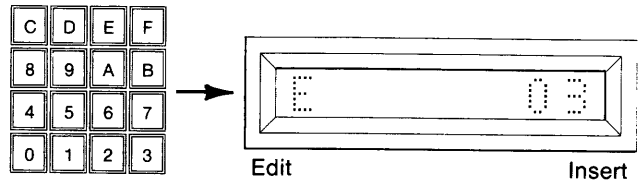

5. Depress ENTER. Insert is accepted and the First and Last Addresses of the Buffer are displayed.

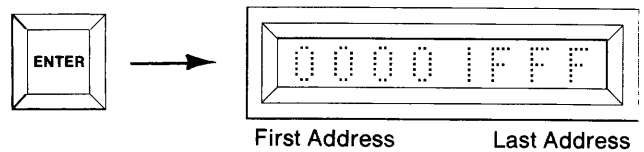

6. Use the hex keyboard to key in a new Start and End Address field, MSD first. It is not possible to insert over the full address range of the Buffer without creating wraparound. If this is tried, the M980 will display an "E3" during step 9.

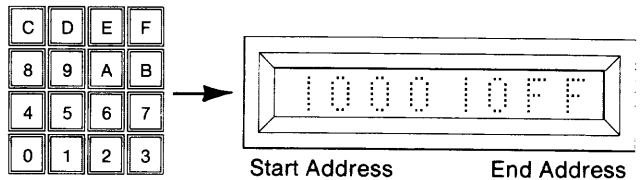

7. Depress ENTER. The Start and End Addresses are accepted. The display shows the block Start Address.

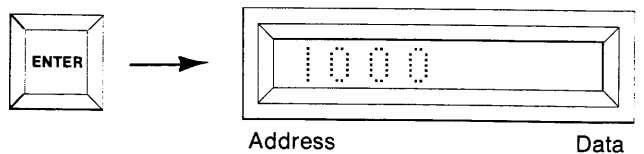

8. Use the keyboard to key in the new data to be inserted.

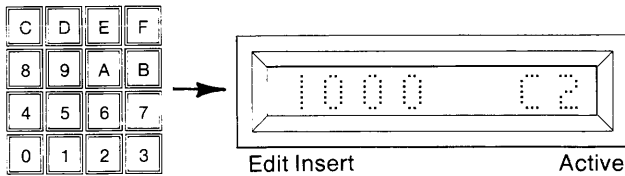

9. Depress ENTER. The address and data are accepted. The next sequential address is displayed. If more insertions are desired, repeat steps 8 and 9 for up to 32 insertions OR

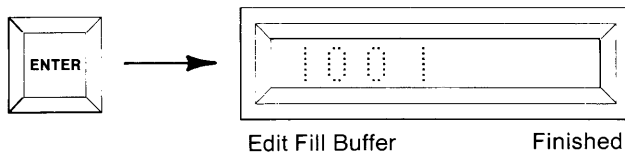

10. Depress ENTER. The display shows "E 03 AAA" to indicate Edit Insert Active. The write Mode LED is lit. Upon completion of the operation the "AAA" is replaced with "F" to indicate Finished. A steady tone sounds if the AUDIO switch is ON. The Write Mode LED is extinguished.

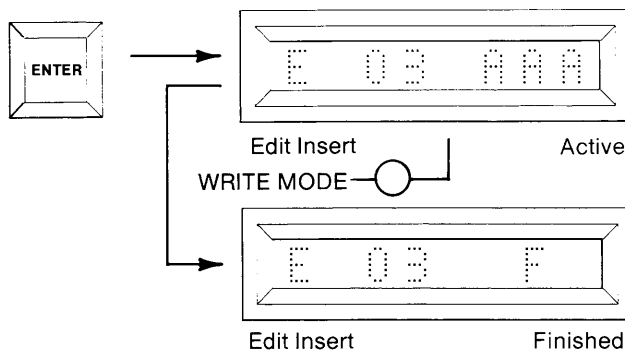

**NOTE**

Depending on size of block to be inserted, the operation may require as much as 60 seconds to perform.

**CAUTION**

When inserting data into RAM, the same number of data bytes inserted will be lost from the end of the address locations immediately following the defined block. Define your block end address accordingly.

**Summary of Buffer Edit-Insert**

1. Set select switches: MFG MODE (OFF), AUDIO (optional ON/OFF), MASTER (OFF), BUFFER (ON), COPY (OFF).
2. Depress RESET. All displays are blank.
3. Depress EDIT. Display indicates "E 00".
4. Key in 03 using the HEX keyboard.
5. Depress ENTER. First and Last RAM Buffer Addresses are displayed.
6. Key in a new Start and End address field. The Start address is the first address at which data is to be inserted.
7. Depress ENTER. The Start address is displayed.
8. Enter data to be inserted at this address via the HEX keyboard.
9. Depress ENTER. The next sequential address is displayed.
10. Optional. Repeat steps 8 and 9 for up to 32 insertions or
11. Depress ENTER. The data previously keyed in will be inserted at the address indicated.

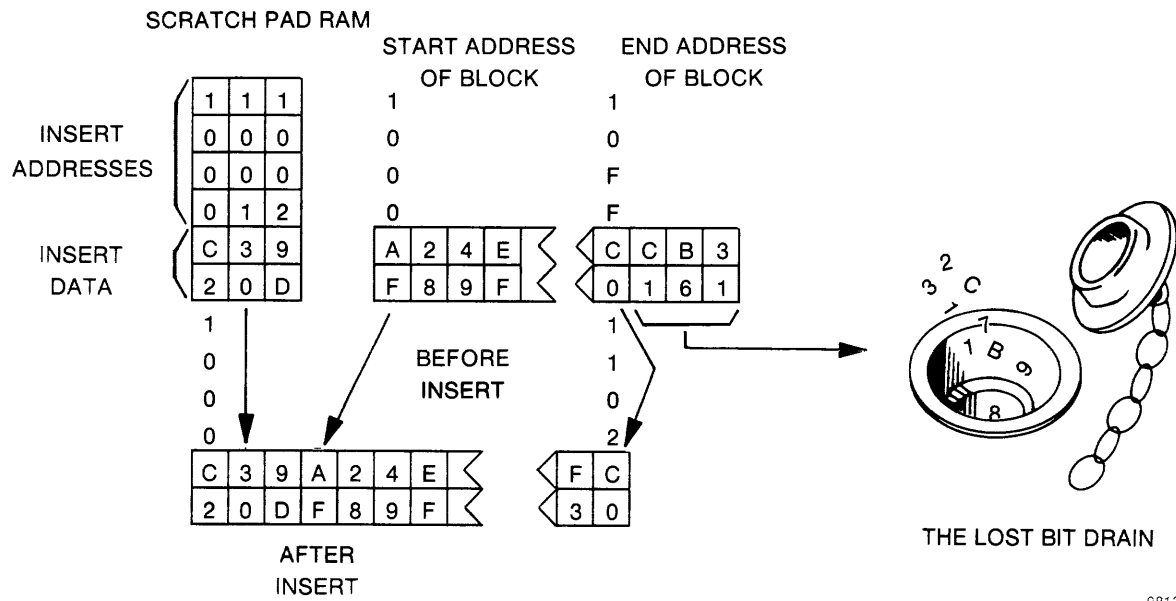

Figure 7-3. Illustration of Edit Insert

*(Operations Continued Next Page)*

**Buffer Edit — Delete (example shown is for an 8kx8 RAM Buffer)**

When deleting information, the data locations vacated when all data is moved up are filled with a user-defined value. The example shown is for deleting locations 1000 through 100F and operating over a block of 256 locations (1000-10FF). The data used to fill in the vacated locations is 00 (See Figure 7-4).

1. Select the switches as shown. The AUDIO switch is optional.

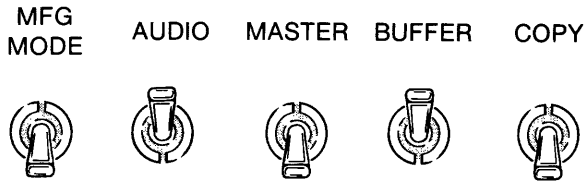

2. Depress RESET. The 8 hex displays are blank. A Personality Module is not necessary. "E4" is displayed if a Personality Module is not present. A warbling tone will sound if the AUDIO switch is ON. Now continue to step 3.

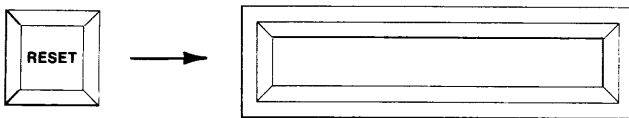

3. Depress EDIT. "E 00" is displayed to indicate Edit Mode 00.

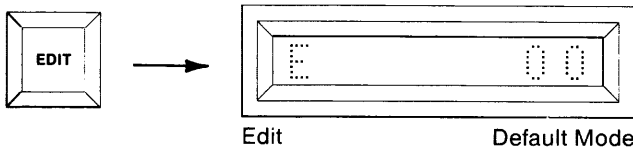

4. Using the hex keyboard, key in "04" to select the Delete operation.

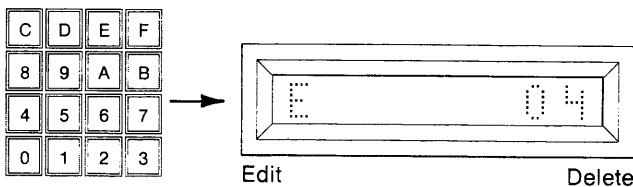

5. Depress ENTER. The Delete Mode is accepted and the First and Last Addresses of the Buffer are displayed.

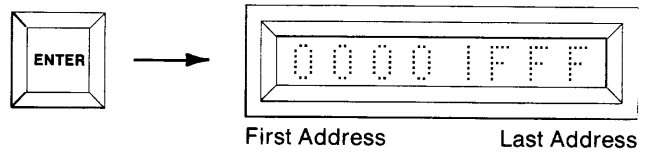

6. Using the hex keyboard, key in the Start and End Address limits of the data block to be affected or default to the entire Buffer. The Start Address should be the First Address at which data is to be deleted.

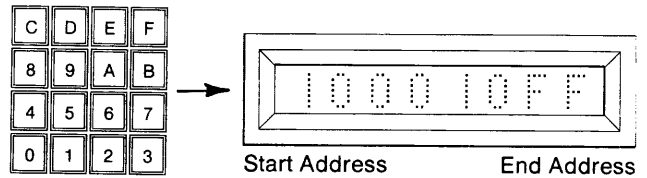

7. Depress ENTER. The Start and End Addresses of the block are accepted and the Start Address of the block is displayed.

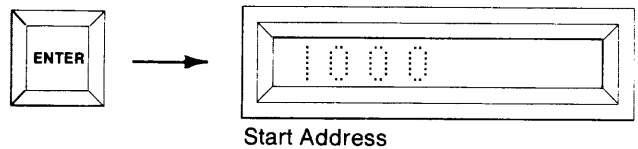

8. Use the keyboard to key in the desired Start Address of the block to be moved up. See Figure 7-3 for additional explanation.

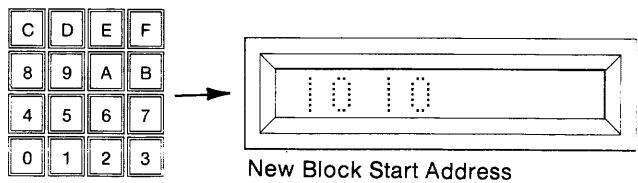



9. Depress ENTER. The default data to fill the vacated location(s) is displayed.

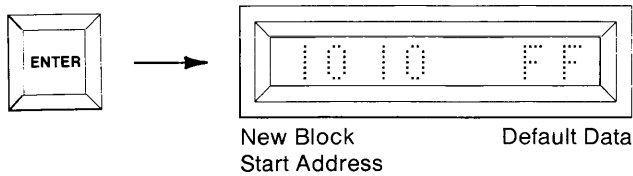

10. If desired, use the keyboard to key in other data to be used to fill vacated locations.

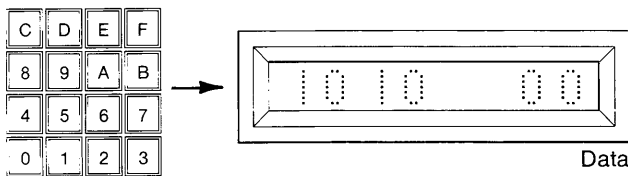

11. Depress ENTER. The previous data is accepted and the display shows "E 04 AAA" to indicate Edit Delete Active. The Write Mode LED is lit. The M980 deletes all of the data between the block Start Address and the address keyed in step 8. It then fills all of the vacated locations with the data in the display prior to step 11. Upon completion of the operation, the "AAA" in the display is replaced with "F" to indicate Finished. A steady tone sounds if the AUDIO switch is ON. The Write Mode LED is extinguished.

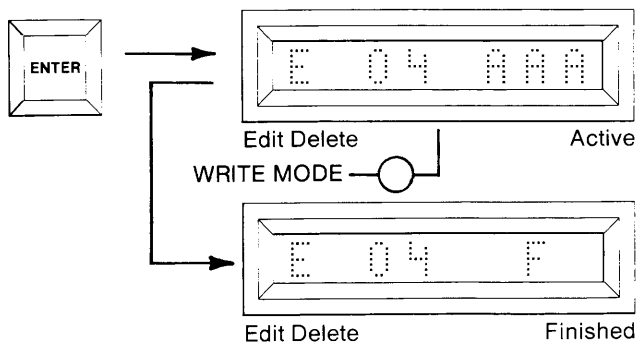

**NOTE**

Depending upon the size of the block to be deleted, this operation may take up to 60 seconds to perform.

**Summary of Buffer Edit—Delete**

1. Set select switches: MFG (OFF), AUDIO (Optional ON/OFF), MASTER (OFF), BUFFER (ON), COPY (OFF).
2. Depress RESET. All displays are blank.
3. Depress EDIT. Display indicates "E 00".
4. Key in 04 using the hex keyboard.
5. Depress ENTER. First and last RAM Buffer addresses are displayed.
6. Key in the start and end address of the data block to remain unaffected.
7. Depress ENTER. Key in the new start address for this block.
8. Depress ENTER. Key in the new data to replace the vacated address or default to FFH.
9. Depress ENTER. The data in the block defined in step #6 is moved to start at the address defined in step #7. The locations vacated by this move are filled with the data defined by step #8.

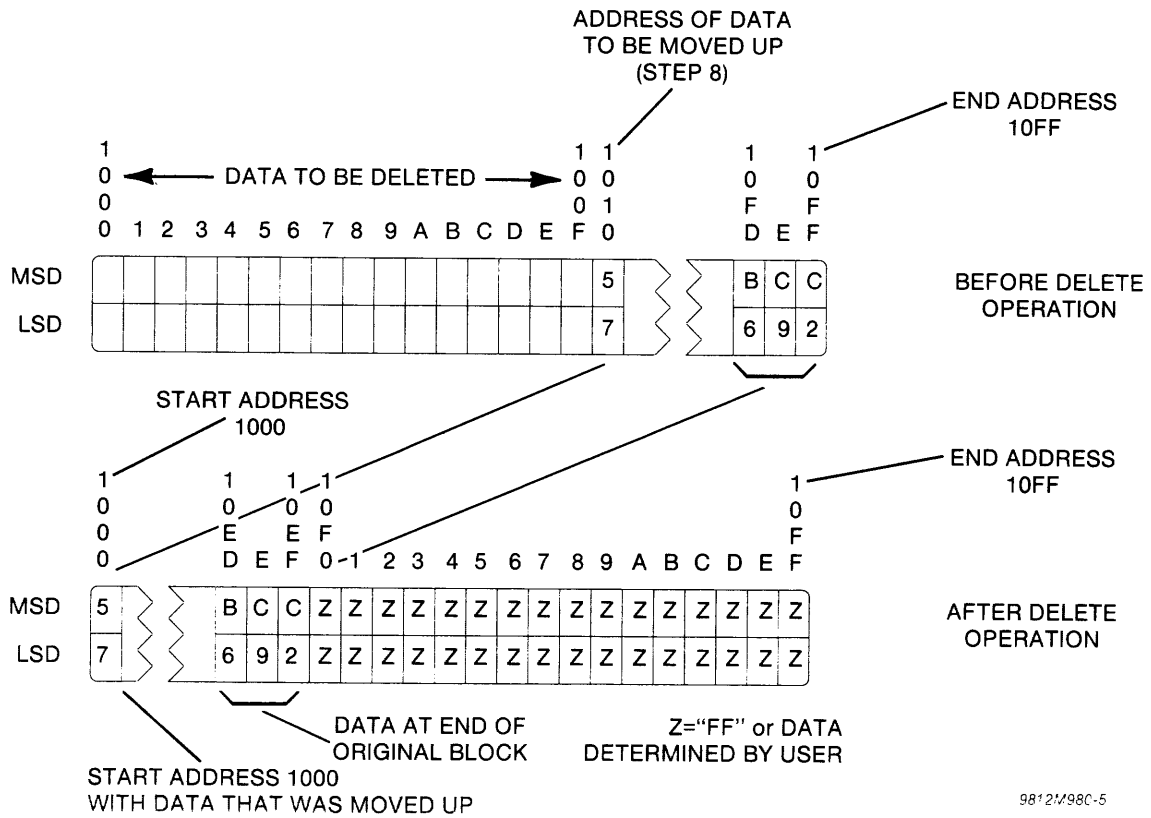

Figure 7-4. Illustration of Delete Operation

*(Operations Continued Next Page)*

**Buffer Edit — Block Move (example shown is for an 8Kx8 RAM Buffer)**

When Block Moving data, the original data is left intact unless overlapping occurs. The example shown in Figure 7-5 is for moving address locations 1000 through 12FF to addresses 1800 through 1AFF.

1. Select the switches as shown. The AUDIO switch is optional.

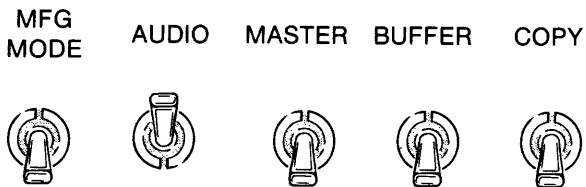

2. Depress RESET. The 8 hex displays are blank. A Personality Module is not necessary. "E4" is displayed if a Personality Module is not present. A warbling tone will sound if the AUDIO switch is ON. Now continue to step 3.

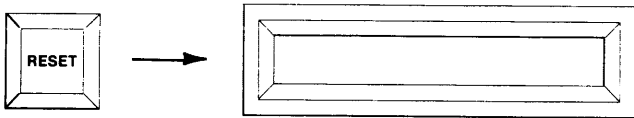

3. Depress EDIT. "E 00" is displayed to indicate Edit Mode 00.

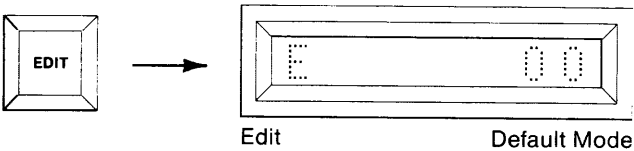

4. Using the hex keyboard, key in "05" to select Block Move Mode.

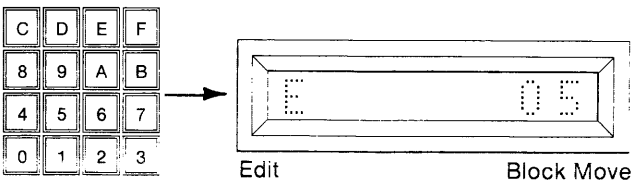

5. Depress ENTER. Block Move is accepted and the First and Last Addresses of the Buffer are displayed.

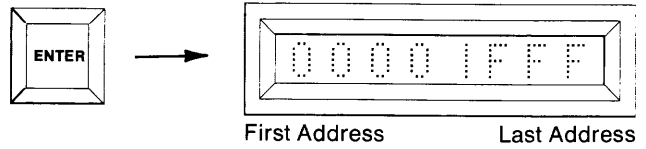

6. Use the hex keyboard to key in the Start and End Addresses of the block to be moved.

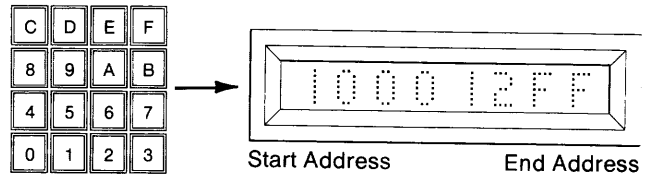

7. Depress ENTER. The Start and End Addresses are accepted and the Start Address of the block is displayed.

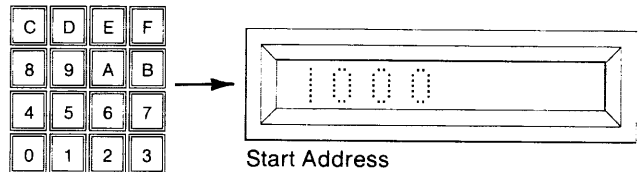

8. Use the hex keyboard to key in the address at which the new block starts.

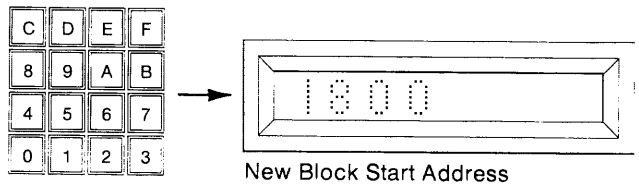

9. Depress ENTER. The new block Start Address is accepted and "E 05 AAA" is displayed to indicate Edit Block Move Active. The Write Mode LED is lit. Upon completion of the operation, the "AAA" is replaced with "F" to indicate Finished. A steady tone sounds if the AUDIO switch is ON, and the Write Mode LED is extinguished.

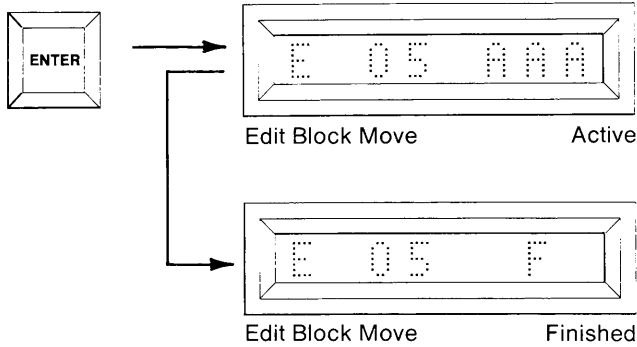

#### NOTE

Depending upon the size of the block to be moved, this operation may take up to 60 seconds to program.

#### Summary of Buffer Edit—Block Move

1. Set select switches: MFG (OFF), AUDIO (Optional ON/OFF), MASTER (OFF), BUFFER (ON), COPY (OFF).
2. Depress RESET. All displays are blank.
3. Depress EDIT. Display indicates "E 00".
4. Key in 05 using the hex keyboard.
5. Depress ENTER. First and last RAM Buffer addresses are displayed.
6. Key in the start and end address for the block of data to be moved.
7. Depress ENTER. Key in the new start address for this block.
8. Depress ENTER. The data block defined in step #6 is moved to start at the address defined in step #7.

A) Block Move forward without overlapping. Both areas finish with block data.

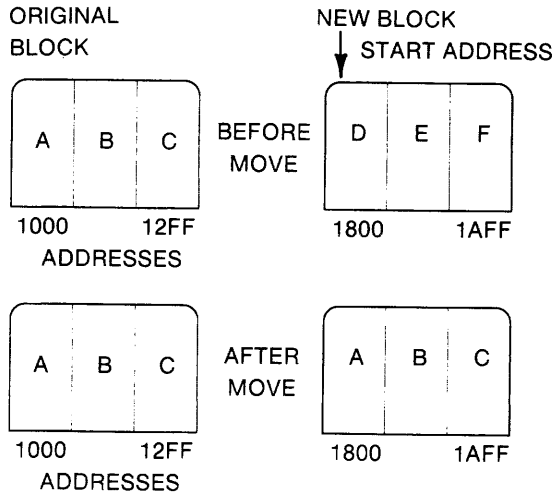

B) Block Move forward with overlapping. New block overwrites original.

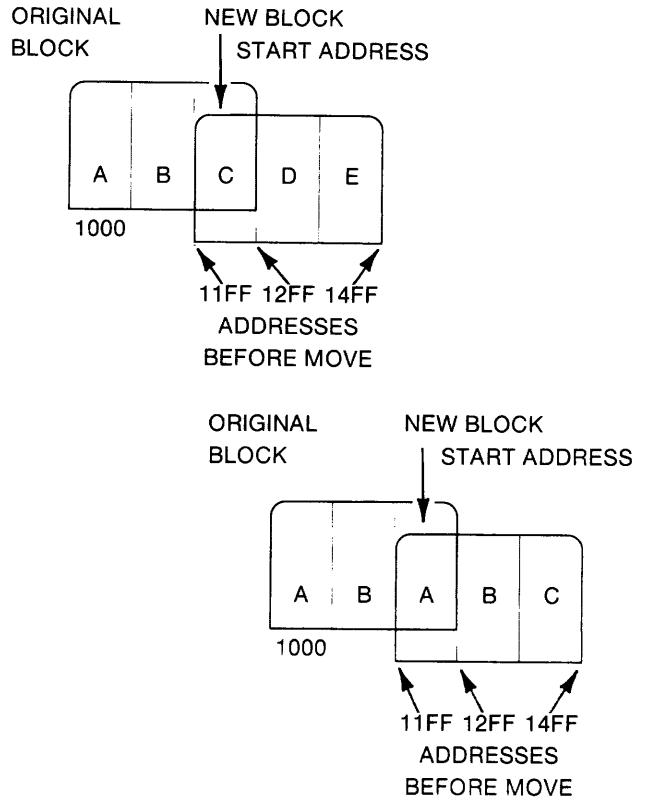
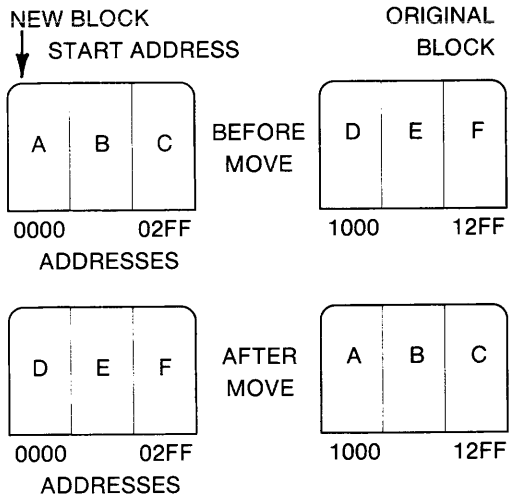

Figure 7-5. Illustrations of Buffer Block Move Operations  
(In the examples, each internal lettered block is equal to 256 locations.)

C) Block Move backwards without overlapping. Both areas finish with block data.



D) Block Move backwards with overlapping. New block overwrites original.

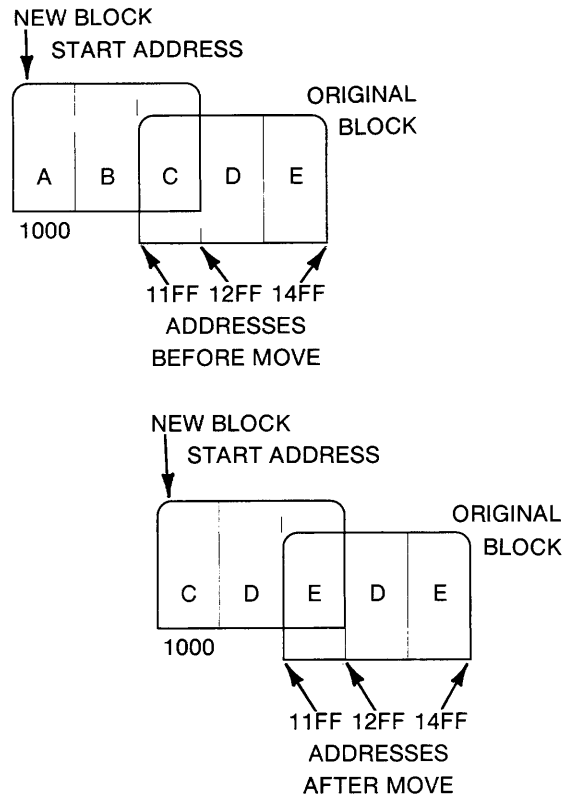

Figure 7-5 (continued). Illustrations of Buffer Block Move Operations  
 (In the examples, each internal lettered block is equal to 256 locations.)

**Buffer Edit — Nibble Swap (example shown is for an 8Kx8 RAM Buffer)**

In the Nibble Swap operation, the MSD of each 8-bit Buffer location is swapped with the LSD of the same location (see Figure 7-6).

1. Select the switches as shown. The AUDIO switch is optional.

MFG MODE    AUDIO    MASTER    BUFFER    COPY



2. Depress RESET. The 8 hex displays are blank. A Personality Module is not necessary. "E4" is displayed if a Personality Module is not present. A warbling tone will sound if the AUDIO switch is ON. Now continue to step 3.

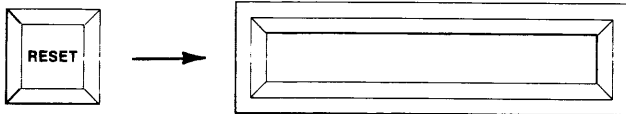

3. Depress EDIT. "E 00" is displayed to indicate Edit Mode 00.

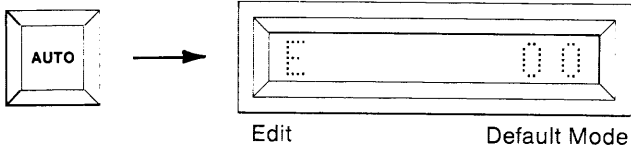

4. Using the hex keyboard, key in "06" to select Nibble Swap Mode.

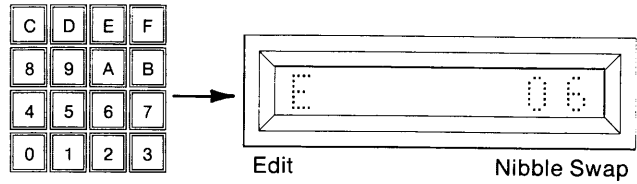

5. Depress ENTER. Nibble Swap is accepted and the First and Last Addresses of the Buffer are displayed.

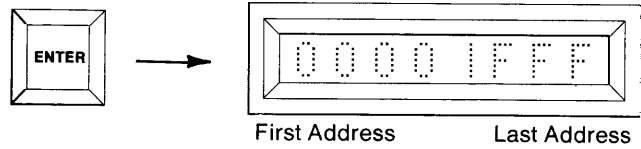

6. To Nibble Swap the entire contents of the Buffer, go to step 7. To Nibble Swap a limited field, use the hex keyboard to key in new Start and End Addresses.

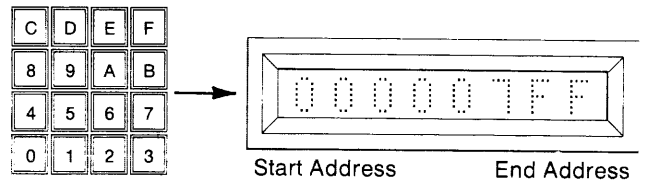



- Depress ENTER. The Start and End Addresses are accepted and "E 06 AAA" is displayed to indicate Edit Nibble Swap Active. The Write Mode LED is lit. Upon completion of the operation, the "AAA" is replaced with "F" to indicate Finished. A steady tone sounds if the AUDIO switch is ON. The Write Mode LED is extinguished.

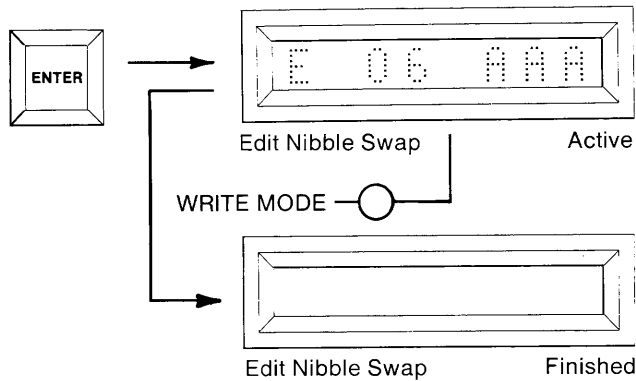

### Summary of Buffer Edit—Nibble Swap

- Set select switches: MFG (OFF), AUDIO (Optional ON/OFF), MASTER (OFF), BUFFER (ON), COPY (OFF).
- Depress RESET. All displays are blank.
- Depress EDIT. Display indicates "E 00".
- Key in 06 using the hex keyboard.
- Depress ENTER. The default start and end addresses for the RAM Buffer installed are displayed.
- Optional. Key in a new address field to be split.
- Depress ENTER. The data in the addresses defined in steps #5 or #6 will be split. All even address bytes will be placed in the third quarter of the RAM Buffer and all odd address bytes will be placed in the fourth quarter.

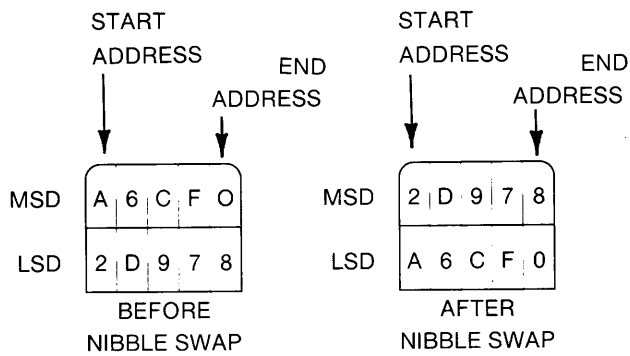

Figure 7-6. Illustration of Nibble Swap

### Buffer Edit — Hex Pack

An 8 bit byte of data may be expressed as two hexadecimal digits. For example, 01100111 is expressed in hexadecimal notation as 67. If both hexadecimal digits have meaning, then the 8 bit data byte is referred to as being in a Packed form. When the least significant hexadecimal digit has meaning and the most significant digit is treated as "don't care", the 8 bit data byte is referred to as being in the Unpacked form.

In the Hex Pack mode of operation, the Buffer Start/End Addresses of the least significant digit field and the Start Address of the most significant digit field are selected. When the Hex Pack operation is complete, the Buffer address field defined for the least significant digit will contain the Hex Packed data. The most significant digit address field remains unaltered (see Figure 7-7).

1. Select the switches as shown. The AUDIO switch is optional.

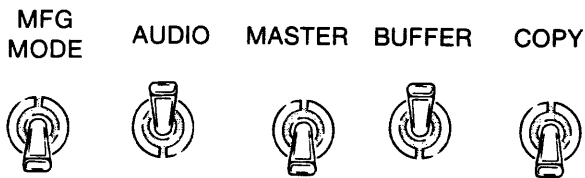

2. Depress RESET. The 8 hex displays are blank.

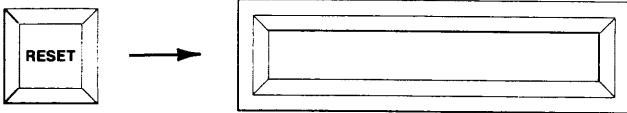

3. Depress EDIT. "E 00" is displayed to indicate Edit mode 00.

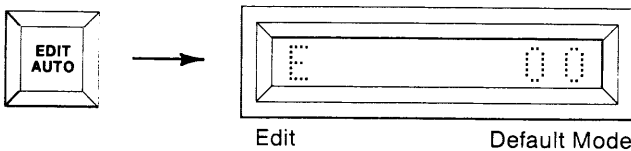

4. Using the hex keyboard, key in "07" to select the Hex Pack mode.

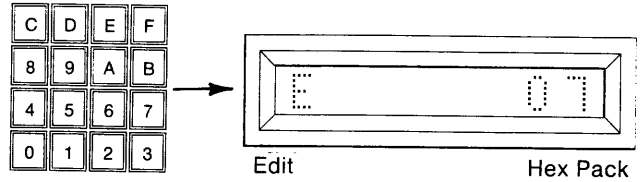

5. Depress ENTER. Hex Pack is accepted and the First and Last Addresses of the Buffer are displayed.

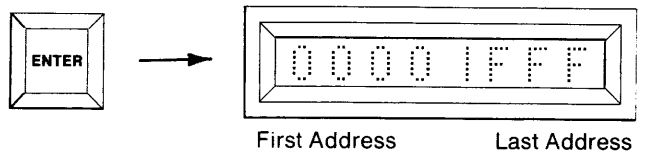

6. Use the hex keyboard to key a Start and End Address for the least significant digit of the Packed field. Use the CLEAR key to clear miskeyed characters. See Section 4 for further information.

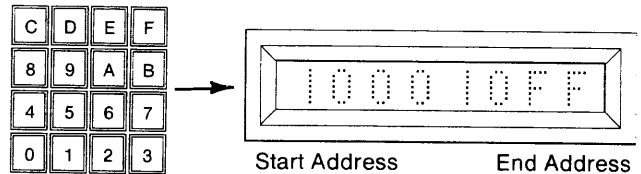

7. Depress ENTER. The Start and End Addresses are accepted. The display shows the Start Address for the second field containing the most significant digit which is to be Packed.

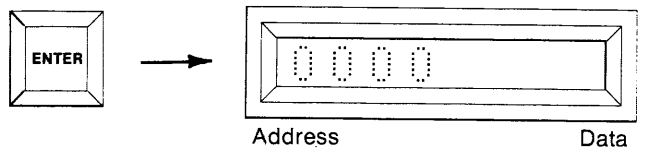

- Use the hex keyboard to key the second field Start Address. Use the CLEAR key to clear miskeyed characters.

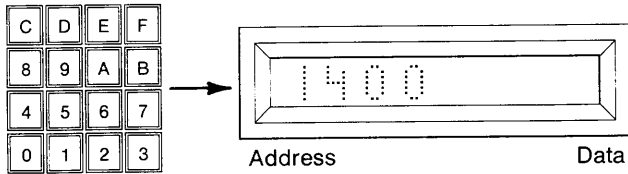

- Depress ENTER. The Write mode LED is ON. The display shows "E 07 AAA" to indicate Edit Hex Pack Active. Upon completion of the operation, the "AAA" is replaced with an "F" to indicate Finished. A steady tone sounds if the AUDIO switch is ON. The Write mode LED is switched OFF.

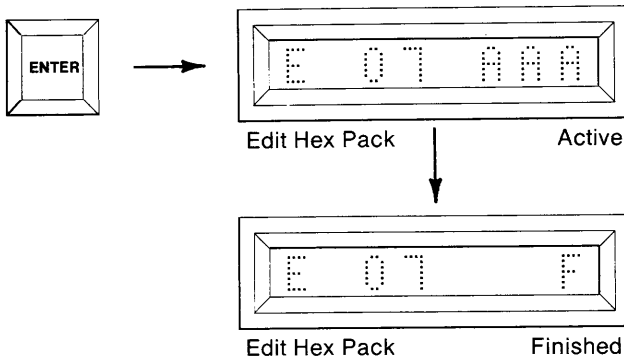

### Summary of Buffer Edit—Hex Pack

- Set select switches: MFG (OFF), AUDIO (Optional ON/OFF), MASTER (OFF), BUFFER (ON), COPY (OFF).
- Depress RESET. All displays are blank.
- Depress EDIT. Display indicates "E 00".
- Key in 07 using the hex keyboard.
- Depress ENTER. First and last RAM Buffer addresses are displayed.
- Key in the start and ending address of the RAM Buffer data block containing the LSD.
- Depress ENTER. Key in the starting address of the RAM Buffer data block containing the MSD.
- Depress ENTER. The MSD in the second block is programmed into the MSD in the first block.

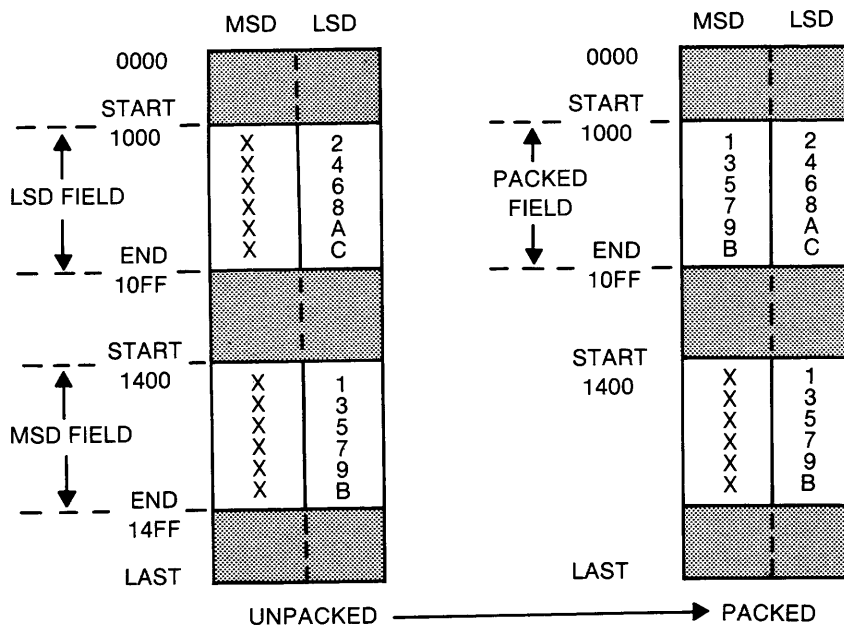

9812M980-6

Figure 7-7. Illustration of Hex Pack

### Buffer Edit — Hex Unpack

In the Hex Unpack mode of operation, the Buffer address field is defined for the data block to be unpacked. A Start Address is then defined for the beginning of the Buffer address field where the the most significant digit in unpacked form is stored. The least significant digit is stored in the unpacked form in the same address field as that of the data block that is unpacked (see Figure 7-8).

1. Select the switches as shown. The AUDIO switch is optional.

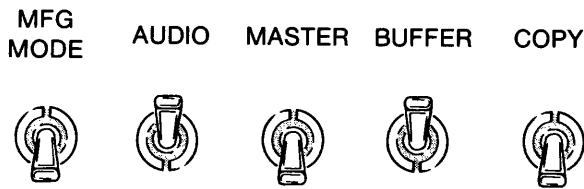

2. Depress RESET. The 8 hex displays are blank.

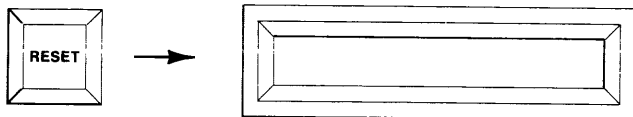

3. Depress EDIT. "E 00" is displayed to indicate Edit mode 00.

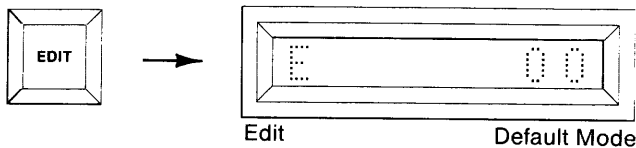

4. Using the hex keyboard, key in "08" to select the Hex Unpack mode.

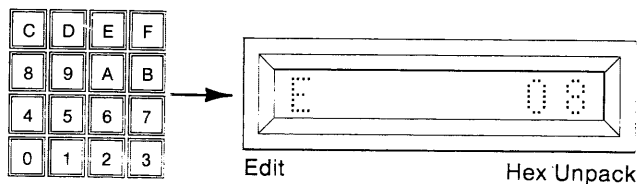

5. Depress ENTER. Hex Unpack is accepted and the First and Last Addresses of the Buffer are displayed.

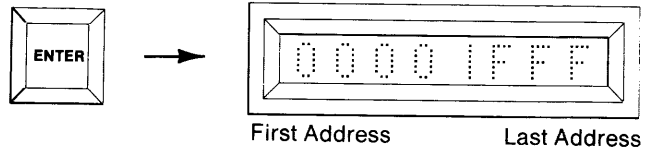

6. Use the hex keyboard to begin a Start and End Address field for the block of data to be Unpacked. Use the CLEAR key to clear miskeyed characters. See Section 4 for further information.

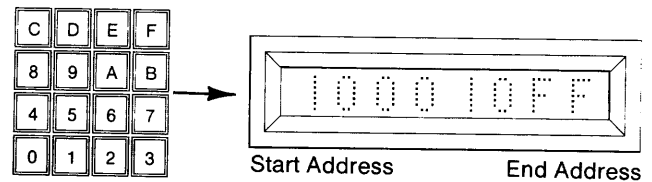

**NOTE**  
Keyed-in field must reside within first half of the total RAM Buffer.

7. Depress ENTER. The Start and End Addresses are accepted. The display shows the Start Address for the second field where the most significant digit in Unpacked form is stored.

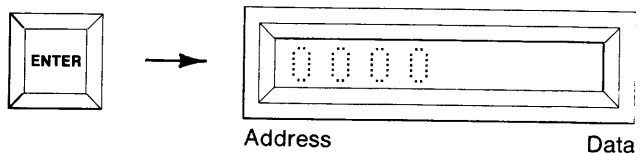

8. Use the hex keyboard to key the second field Start Address. Use the CLEAR key to clear miskeyed characters.

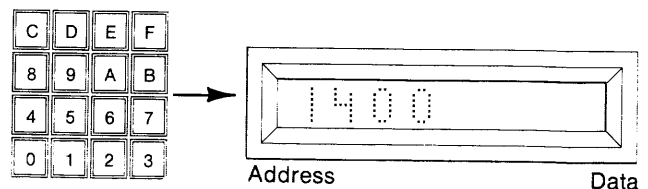

9. Depress ENTER. The Write mode LED is ON. The display shows "E 08 AAA" to indicate Edit Hex Pack Active. Upon completion of the operation, the "AAA" is replaced with an "F" to indicate finished. A steady tone sounds if the AUDIO switch is ON. The Write mode LED is switched OFF.

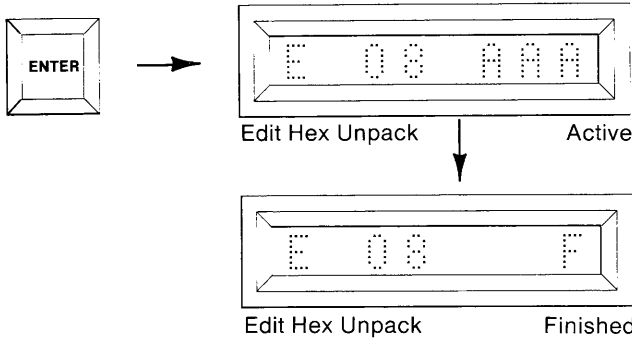

**Summary of Buffer Edit—Hex Unpack**

1. Set select switches: MFG (OFF), AUDIO (Optional ON/OFF), MASTER (OFF), BUFFER (ON), COPY (OFF).
2. Depress RESET. All displays are blank.
3. Depress EDIT. Display indicates "E 00".
4. Key in 08 using the hex keyboard.
5. Depress ENTER. First and last RAM Buffer addresses are displayed.
6. Key in the starting and ending addresses of the RAM Buffer data block to be unpacked.
7. Depress ENTER. Key in the starting address of RAM Buffer data block that will contain the MSD of the unpacked data.
8. Depress ENTER. The MSD contained in the RAM Buffer block defined in step #6 is loaded into the RAM Buffer starting at the address defined in step #7.

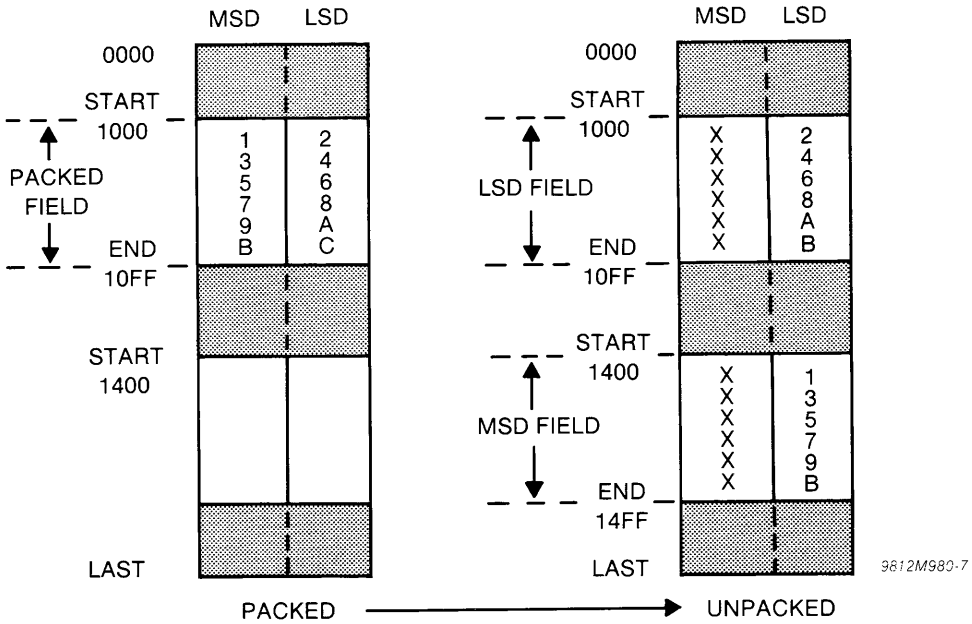
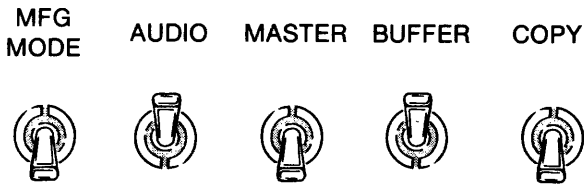

Figure 7-8. Illustration of Hex Unpack

### Buffer Edit — RAM Split

The RAM Split allows data stored anywhere in the first half of the RAM Buffer to be divided into two separate blocks. The two blocks always start at exactly half and three-quarters of the total RAM Buffer, respectively. The block starting at half of the total RAM contains the data originally resident at the start address and every other address in the block that is split. The block starting at three-quarters of the total RAM contains the start address plus 1, and every other address in the block that is split (see Figure 7-9).

1. Select the switches as shown.



2. Depress RESET: The 8 hex displays are blank.

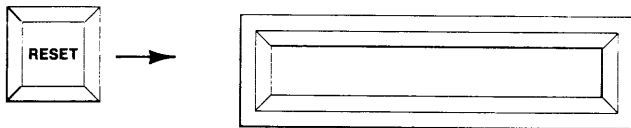

3. Depress EDIT: "E 00" is displayed to indicate Edit mode.

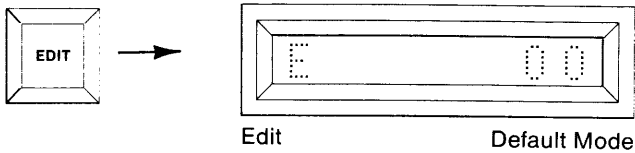

4. Using the hex keyboard, key in "10" to select the RAM Split mode.

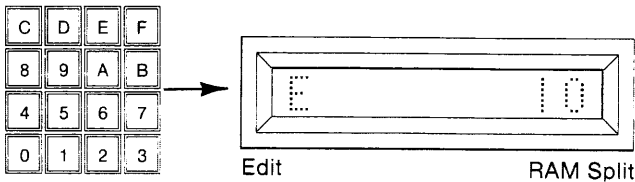

5. Depress ENTER. Display shows the Default start and end Addresses of the RAM data field to be split (Default size is one half of Buffer size).

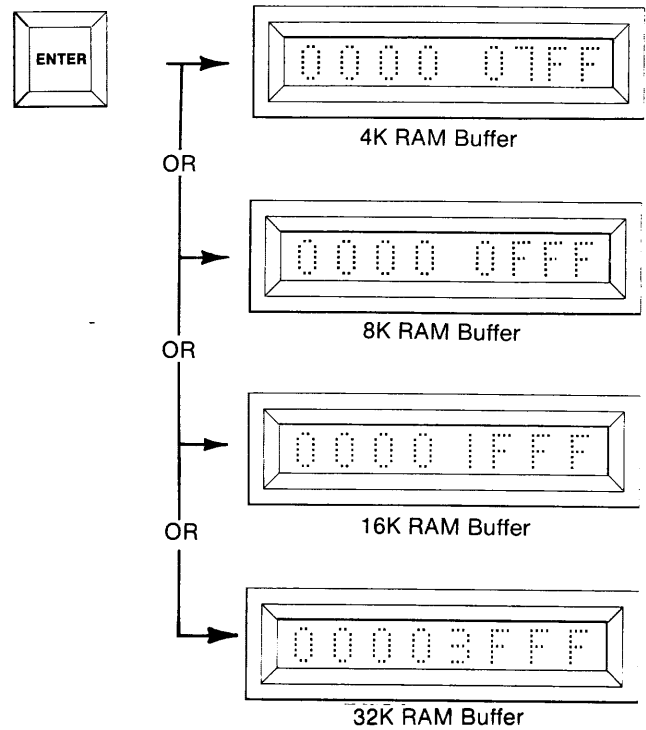

6. Accept Default field by pressing ENTER, or redefine using hex keyboard; then press ENTER to accept new field.

**NOTE**

Keyed-in field must reside within first half of the total RAM Buffer.

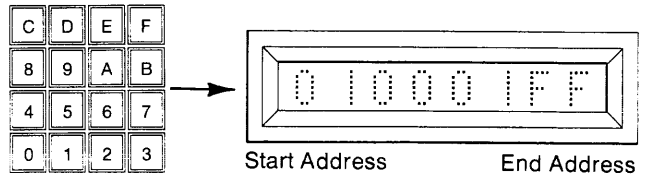

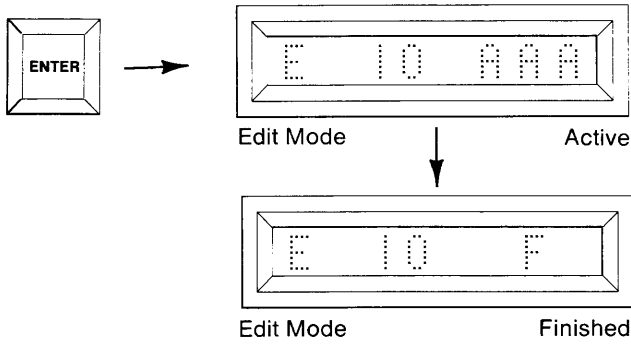

c. 16K BUFFER EXAMPLE: (DEFAULT SIZE)

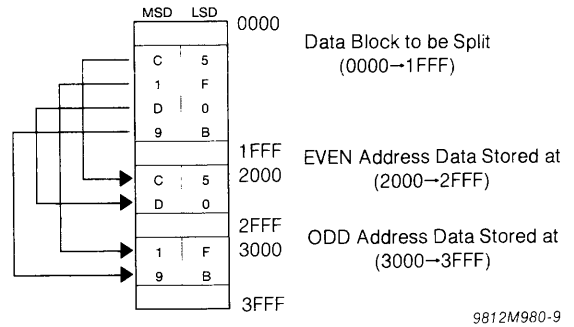

9812M980-9

Figure 7-9 (continued).

7. When RAM Split operation is complete, the display indicates "F" for finished.

a. 4K BUFFER EXAMPLE: (DEFAULT SIZE)

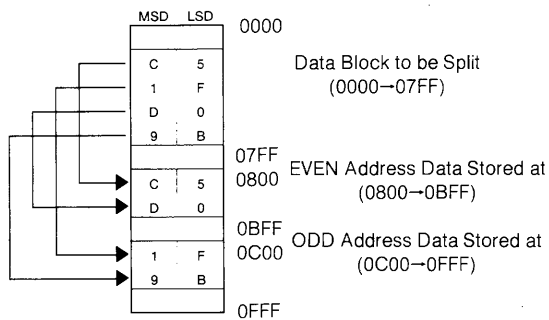

b. 8K BUFFER EXAMPLE: (DEFAULT SIZE)

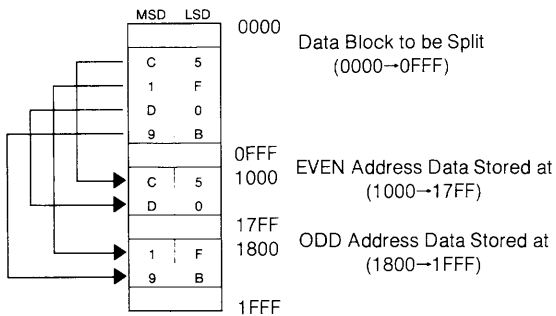

Figure 7-9. Illustration of RAM Split

### Summary of Buffer Edit—RAM Split

1. Set select switches: MFG (OFF), AUDIO (Optional ON/OFF), MASTER (OFF), BUFFER (ON), COPY (OFF).
2. Depress RESET. All displays are blank.
3. Depress EDIT. Display indicates "E 00".
4. Key in 10 using the hex keyboard.
5. Depress ENTER. The default start and end addresses for the RAM Buffer installed are displayed.
6. Optional. Key in a new address field to be split.
7. Depress ENTER. The data in the addresses defined in steps #5 or #6 will be split. All even address bytes will be placed in the third quarter of the RAM Buffer and all odd address bytes will be placed in the fourth quarter.

### Buffer Edit — RAM Interleave

The RAM Interleave allows data stored in two separate blocks to be alternately stored in a defined area in the first half of the RAM Buffer. The two blocks always start at exactly half and three-quarters of the total RAM Buffer, respectively. The block starting at half of the total RAM contains the start address and every other address in the block to be interleaved. The block starting at three-quarters of the total RAM contains the start address plus 1, and every other address in the block to be interleaved (see Figure 7-10).

1. Select the switches as shown.

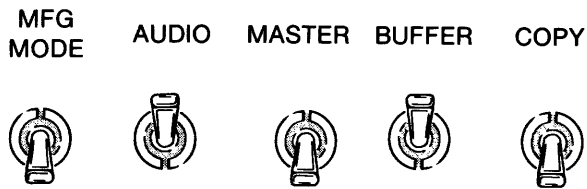

2. Depress RESET: The 8 hex displays are blank.

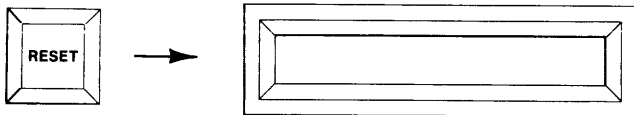

3. Depress EDIT: "E 00" is displayed to indicate Edit mode.

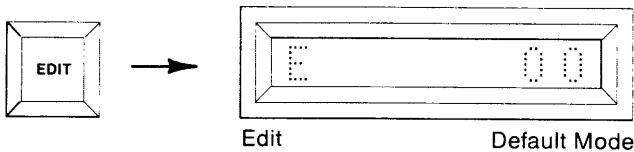

4. Using the hex keyboard, key in "11" to select the RAM Split mode.

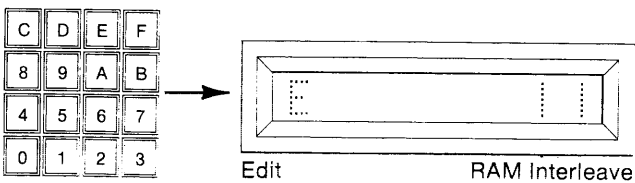

5. Depress ENTER. Display shows the Default start and end Addresses of the RAM Buffer where the data will be stored (Default size is one half of Buffer size).

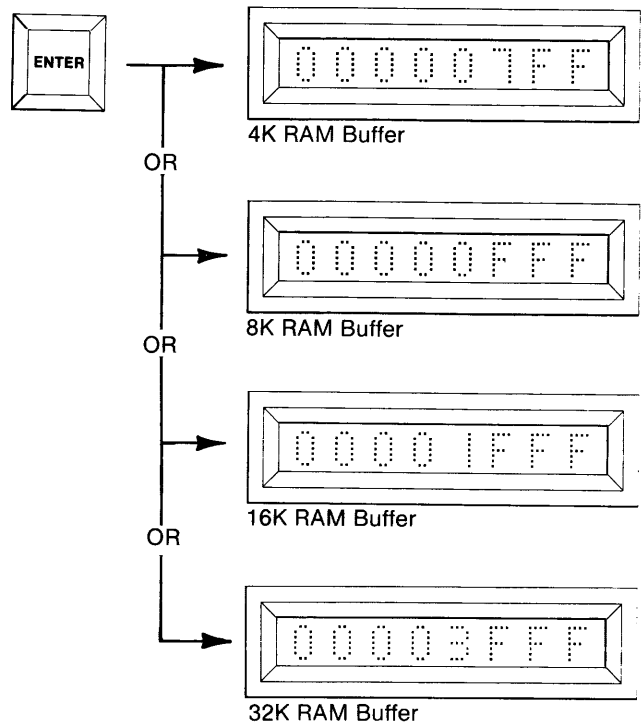

6. Accept Default field by pressing ENTER, or redefine using hex keyboard; then press ENTER to accept new field.

**NOTE**

Keyed-in field must reside within first half of the total RAM Buffer.

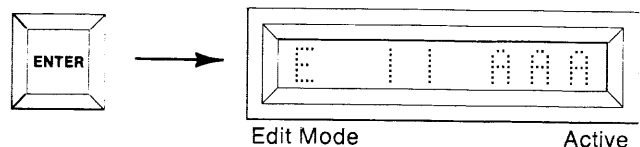
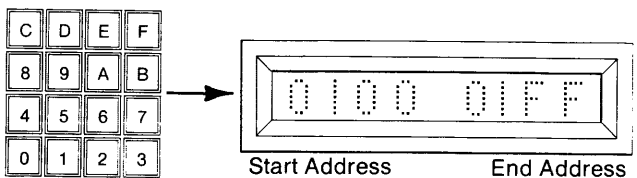



7. When RAM Split operation is complete, the display indicates "F" for finished.

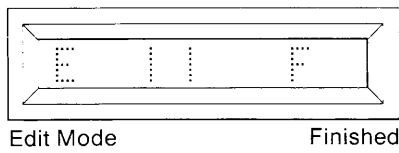

a. 4K BUFFER EXAMPLE: (DEFAULT SIZE)

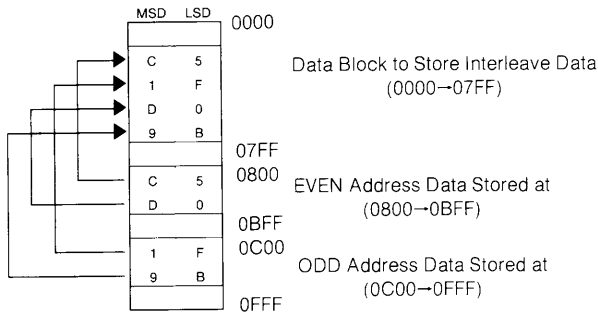

b. 8K BUFFER EXAMPLE: (DEFAULT SIZE)

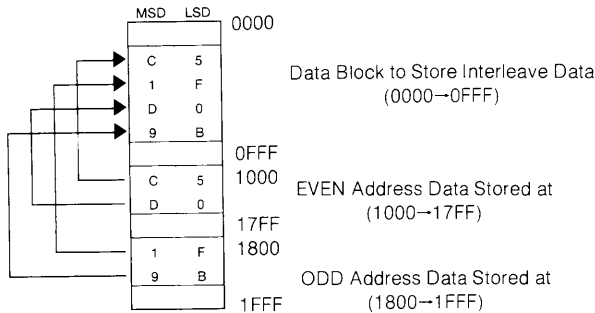

c. 16K BUFFER EXAMPLE: (DEFAULT SIZE)

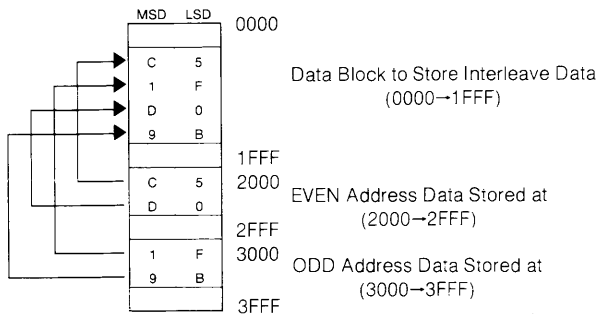

98\*2M980-8

### Summary of Buffer Edit—RAM Interleave

1. Set select switches: MFG (OFF), AUDIO (Optional ON/OFF), MASTER (OFF), BUFFER (ON), COPY (OFF).
2. Depress RESET. All displays are blank.
3. Depress EDIT. Display indicates "E 00".
4. Key in 11 using the hex keyboard.
5. Depress ENTER. The default start and end addresses for the RAM Buffer installed are displayed.
6. Optional. Key in a new address field to contain the interleaved data.
7. Depress ENTER. The data in the third quarter is loaded into the even addresses and data in the fourth quarter is loaded into the odd addresses of the RAM Buffer address field defined in steps #5 and #6.

Figure 7-10. Illustration of RAM Interleave



# SECTION 8

## BUFFER APPLICATIONS

### DESCRIPTION

The CMOS Buffer included in the M980 PROM Programmer allows useful data retention characteristics—its battery back-up retains data for a minimum of seven days with power removed from the M980. Thus, Personality Modules may be exchanged without RAM Buffer data loss, permitting the exchange of data between different types of PROMs without resorting to paper tape or other alternative storage media. The M980 editing features (see Section 7) permit 8-bit data to be programmed into two 4-bit PROMs with ease. Further expansion of the concept, to 16-bit PROMs, is also provided.

The applications presented in this section are indicative of the utility of these features.

### EXAMPLE 1

A 74S471 PROM (256x8) is to replace two 74S287 PROMs (256x4 each). Configure the control unit for a 74S287 and perform the following steps.

1. Insert the first 74S287 into the Master socket. This PROM's data will become the most significant nibbles in each location of the 74S471.
2. Duplicate the contents of the first 74S287 into the RAM Buffer (see Section 6 "Duplicating the RAM Buffer from a Master PROM").
3. Perform the Nibble Swap edit operation on the first 256 bytes of the RAM Buffer (0000 through 00FF). This will place the contents of the first PROM into the high order nibbles of each RAM location (see Section 7 "Buffer Edit—Nibble Swap").
4. Insert the second 74S287 into the Master socket. This PROM's data will become the least significant nibbles in each location of the 74S471.
5. Duplicate the contents of the second 74S287 into the RAM Buffer (see Section 6 "Duplicating the RAM Buffer from a Master PROM").
6. Turn the control unit's POWER OFF.
7. Reconfigure the control unit to program a 74S471.
8. Turn the control unit's POWER ON.
9. Insert the 74S471 into the Copy Socket.
10. Duplicate the contents of the RAM Buffer into the 74S471 (see Section 6 "Duplicating the Ram Buffer into a Copy PROM").

The 74S471 now contains the first 74S287 in its high order nibbles and the second 74S287 in its low order nibbles.

### EXAMPLE 2

A 2732A PROM (4Kx8) is to replace four 2708's (1Kx8 each). Configure the control unit for a 2708 EPROM and perform the following steps.

1. Insert the first 2708 into the Master socket. This PROM's data will reside in the first 1K bytes of the 2732.
2. Duplicate the contents of the first 2708 into the RAM Buffer starting with address 0000H (see Section 6 "Duplicating the RAM Buffer from a Master PROM").
3. Replace the first 2708 with the second 2708.
4. Duplicate the contents of the second 2708 into the RAM Buffer starting with address 0400H.
5. Replace the second 2708 with the third 2708.
6. Duplicate the contents of the third 2708 into the RAM Buffer starting with address 0800H.
7. Replace the third 2708 with the fourth 2708.
8. Duplicate the contents of the fourth 2708 into the RAM Buffer starting with address 0C00H.
9. Turn the control unit's POWER OFF.
10. Reconfigure the control unit to program a 2732.
11. Turn the control unit's POWER ON.
12. Insert an unprogrammed 2732 into the Copy Socket.
13. Duplicate the contents of the RAM Buffer into the 2732. (see Section 6 "Duplicating the RAM Buffer into a Copy PROM").



# SECTION 9

## Manufacturing Mode

### DESCRIPTION

The Manufacturing Mode is a mode which operates with minimum operator interaction. To achieve this operating simplicity, the mode is restricted to:

1. Master-to-Copy operations only
2. Full PROM field only

In the Manufacturing Mode, the M980 can operate in one of four sub-modes: Blank Check, Duplicate, Compare, or Automatic (a mode which sequences automatically through the other operations). The AUDIO tone, selected by a toggle switch, is optional.

### Manufacturing Mode — Automatic Sequencing Operation

1. Insert the appropriate Personality Module and select switches as shown. Insert the PROM to be used as the Master PROM into the MASTER socket and the PROM to be copied in the COPY socket.

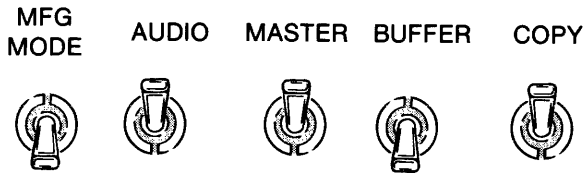

2. Depress RESET. The 8 hex displays are blank.

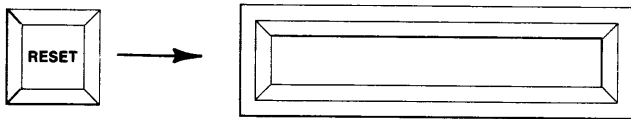

3. Depress AUTO. An "A" appears in the display.

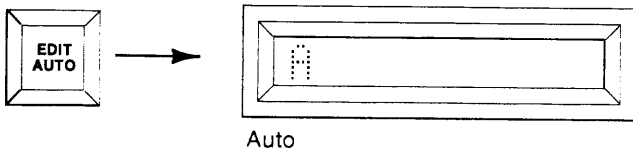

4. Depress ENTER. This initiates an automatic sequence progressing from: Blank Check to Duplicate (Write Mode LED lit) to Compare.

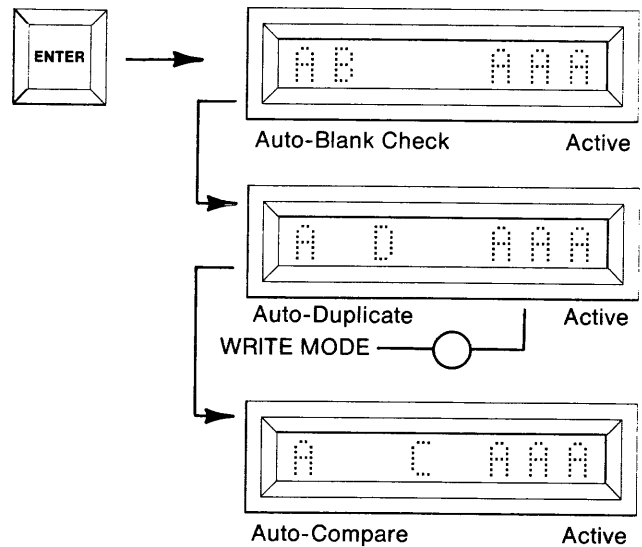

5. Upon the successful conclusion of the operation an "F" is displayed replacing the "AAA". A steady tone sounds if the AUDIO switch is ON.

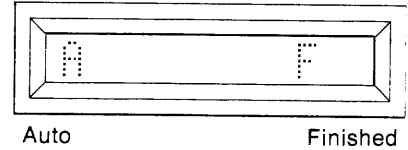

- If an error is detected, the M980 halts and displays the operation code "B" (Blank Check) or "C" (Compare) and "E1" to denote Error. A warbling tone sounds if the AUDIO toggle switch is in the ON position.

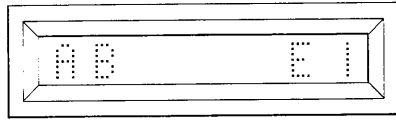

Auto-Blank Check

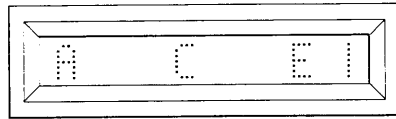

Auto-Compare

Error

**NOTE**

All modules that program the 2708 and TMS2716 (PM9005A, PM9053A, PM9051A, and PM9060A) respond differently. Refer to Section 11, Failure to Program Operations. Also, Gang Modules for PROMs other than the 2708 or TMS2716 continue through to the end of the operation before halting.

- To repeat the entire sequence with new Copy PROM, return to step 4.

**Summary of Automatic Sequencing Operation**

- Insert Personality Module, PROM to be programmed, PROM to be copied, and select switches as follows; MFG MODE (ON), AUDIO (optional), MASTER (ON), BUFFER (OFF), COPY (ON).
- Depress RESET. Display is blank.
- Depress AUTO. "A" is displayed.
- Depress ENTER. Automatic sequencing commences. The display shows "AB AAA", "AD AAA", "AC AAA".
- When complete, "A F" is displayed.
- If an error is detected "B" or "C" and "E1" are displayed.
- Optional. Load new Copy PROM. Depress ENTER to repeat Blank Check to Duplicate to Compare operation.

### Manufacturing Mode — Single Operation (Blank Check, Duplicate, Compare)

1. Insert the appropriate Personality Module and select switches as shown. Insert the PROM to be used as the Master PROM into the MASTER socket and the PROM to be copied into the COPY socket.

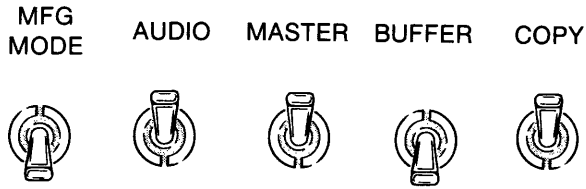

2. Depress RESET. The 8 hex displays are blank.

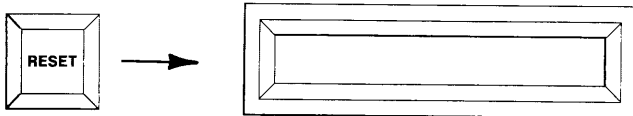

3. Depress BLNK CHCK(Blank Check), DUP(Duplicate) or CMPR(Compare). A "B", "D", or "C" is displayed to indicate the mode key depressed.

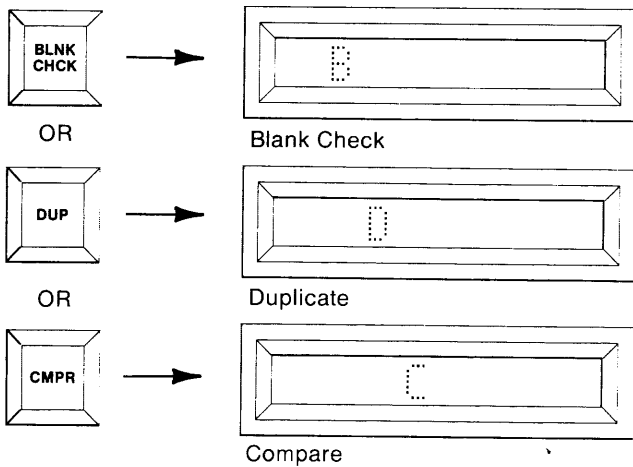

4. Depress ENTER. The operation automatically begins and "AAA" is displayed in the right-most display to indicate Active.

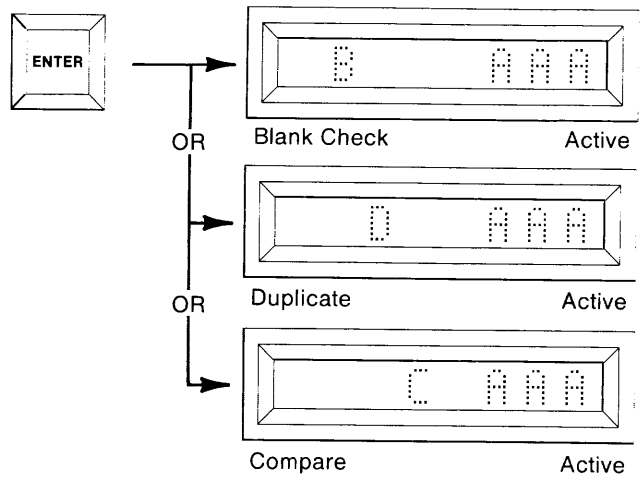

5. Upon the successful conclusion of the operation an "F" is displayed replacing the "AAA". A steady tone sounds if the AUDIO switch is ON.

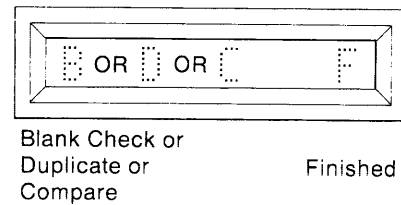



6. To repeat the entire sequence, return to step 4.

7. If an error is detected, the M980 halts and displays the operation code "B", "D" or "C" and "E1" to denote Error. A warbling tone sounds if the AUDIO toggle switch is in the ON position.

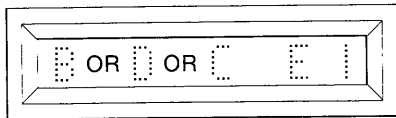

Blank Check or  
Duplicate or  
Compare

Error

### Summary of Single Operation

1. Insert Personality Module, PROM to be programmed, PROM to be copied, and select switches as follows; MFG MODE (ON), AUDIO (optional), MASTER (ON), BUFFER (OFF), COPY (ON).
2. Depress RESET. Display is blank.
3. Depress BLNK CHCK, DUP, or CMPR. The display shows "B", "D", or "C".
4. Depress ENTER. The display shows "B AAA", "D AAA", "C AAA".
5. When complete, "A F" is displayed.
6. Optional. Depress ENTER to repeat the operation.
7. If an error is detected "B", "D", or "C" and "E1" are displayed.



# SECTION 10

## Engineering Auto-Sequencing Mode

### DESCRIPTION

The Engineering Automatic sequencing Mode provides the convenience of the Manufacturing Mode without the restrictions on data source and address field size. As in the other operational modes the use of the AUDIO tone is optional. Some gang modules may vary from these operations. See the individual operating instructions.

**Engineering Auto-Sequence Mode—Buffer to Copy Operation (example shown is for 2Kx8 PROM)**

1. Insert the appropriate Personality Module and select switches as shown. Insert the PROM to be copied in the COPY socket.

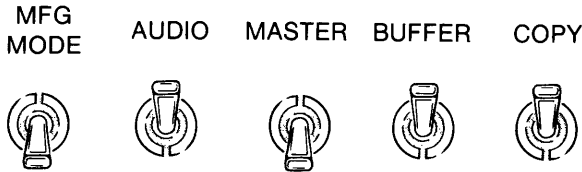

2. Depress RESET. The 8 hex displays are blank.

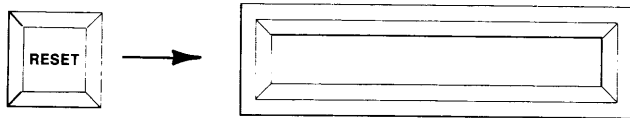

3. Depress AUTO. The displays show the First and Last Addresses of the Copy PROM.

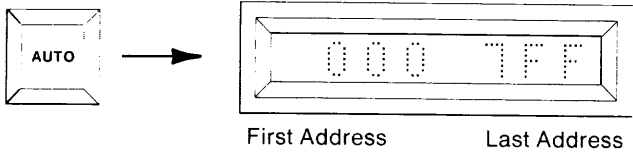

4. To Program the entire contents of the Copy PROM go to step 5. To operate over a limited field use the hex keyboard to key in a new Start and End Address, MSD first.

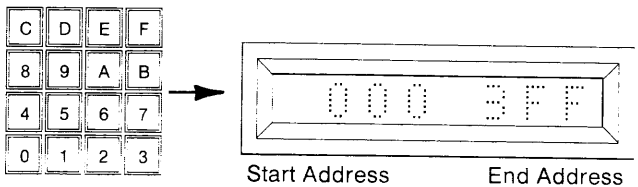

5. Depress ENTER. "0000" is displayed to indicate the default Buffer First Address.

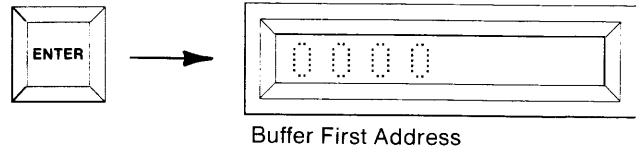

6. If a different Buffer Start Address is desired, use the keyboard to key in a new Start Address. Otherwise, proceed to step 7.

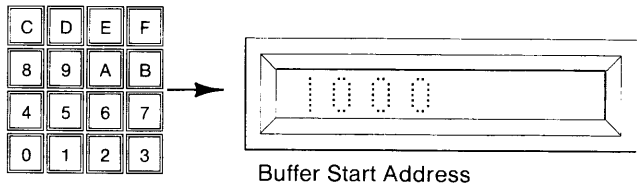

7. Depress ENTER. The displayed Buffer Start Address is accepted and Automatic Sequencing begins.

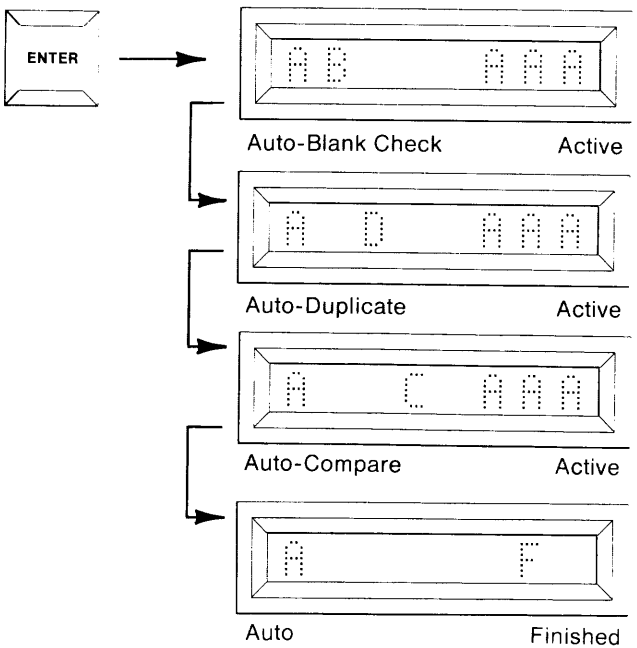

8. Upon completion of the sequence, an "F" replaces the "AAA" to indicate Finished. A steady tone sounds if the AUDIO switch is ON.

- Depress ENTER to repeat the operation. The previous Start and End Addresses of the Copy PROM are displayed. Now continue with step 4. Each depression of ENTER recalls the next previous address.

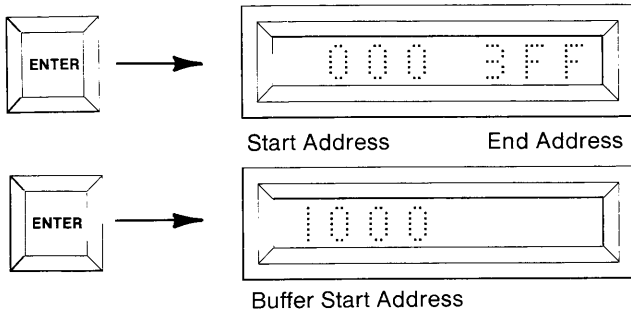

- If an error is detected, the Buffer address and data are displayed. Gang modules respond differently at this point. A warbling tone sounds if the AUDIO switch is ON. Depress Key C to display the copy address and data.

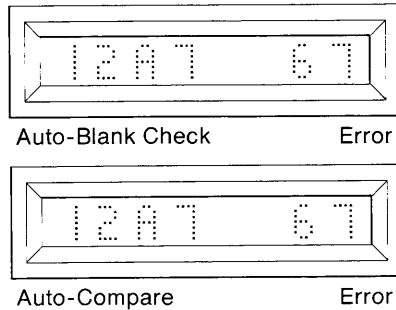

**NOTE**

All modules that program the 2708 and TMS2716 (PM9005A, PM9053A, PM9051A, and PM9060A) respond differently. Refer to Section 11, Failure to Program Operations. Also, Gang Modules for PROMs other than the 2708 or TMS2716 continue through to the end of the operation before halting.

**Summary of Buffer to Copy Operation**

- Insert Personality Module, PROM to be programmed, and select switches as follows; MFG MODE (OFF), AUDIO (optional), MASTER (OFF), BUFFER (ON), COPY (ON).
- Depress RESET. Display is blank.
- Depress AUTO. The First and Last Addresses of the Copy PROM are displayed.
- Key in new Start and End Addresses if desired.
- Depress ENTER. The First Address of the Buffer is displayed.
- Key in a new Buffer Start Address if desired.
- Depress ENTER. The Auto sequencing begins. The display shows "AB AAA", "AD AAA", or AC AAA".
- When complete the "AAA" is replaced with "F" to indicate Finished.
- Optional. Depress ENTER to repeat the operation and return to step 4.
- If an error is detected, the address and data are displayed.

### Engineering Auto-Sequence Mode Master to Copy Operation (example shown is for a 2Kx8 PROM)

1. Insert the appropriate Personality Module and select switches as shown. Insert the PROM to be copied into the Copy socket.

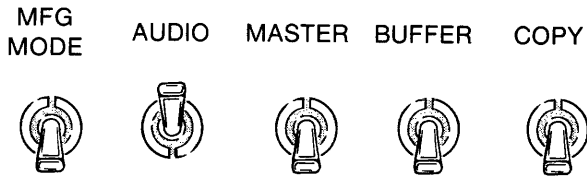

2. Depress RESET. The 8 hex displays are blank.

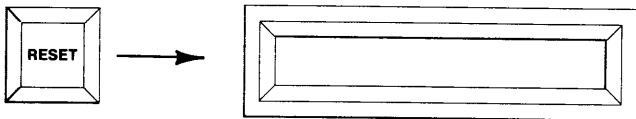

3. Depress AUTO. The displays show the First and Last Addresses of the Copy PROM.

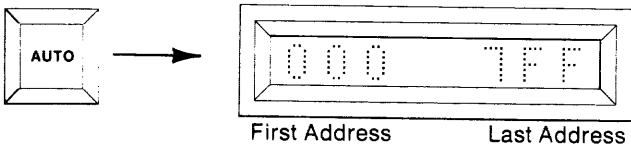

4. To Duplicate the entire contents of the Copy PROM, go to step 5. To Duplicate a limited field, use the hex keyboard to key in a new Start and End Address, MSD first.

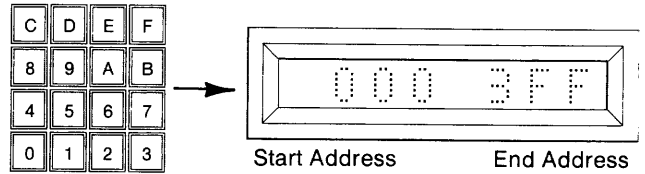

5. Depress ENTER. This initiates the Auto-Sequencing operation.

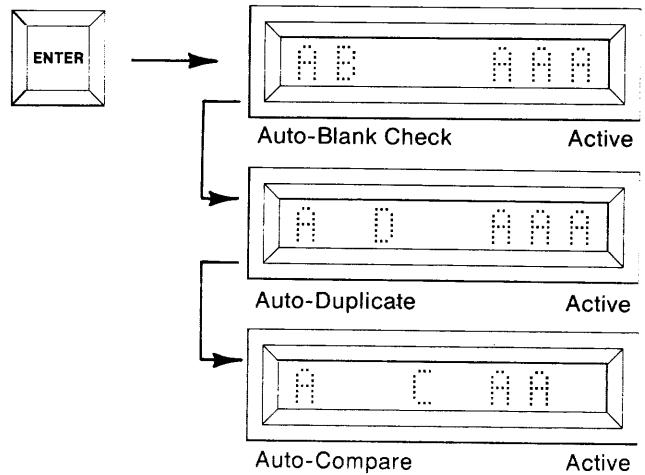

6. Upon completion of the sequence, an "F" replaces the "AAA" to indicate Finished. A steady tone sounds if the AUDIO switch is ON.

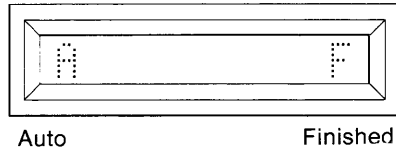

7. Depress ENTER to repeat the Automatic Mode without resetting. This displays the previous Start and End Addresses and returns to step 4 and/or 5.

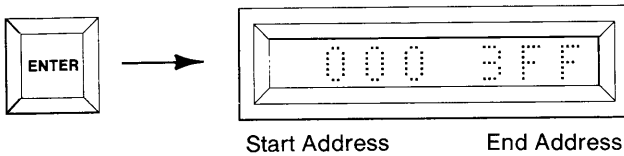

8. If an error is detected, the M980 halts and displays the Master address and data. A warbling tone sounds if the AUDIO switch is ON. Depress Key C to display the Copy address and data.

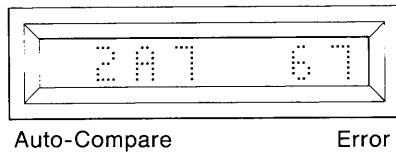
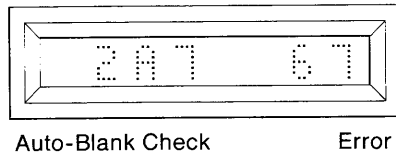

**NOTE**

All modules that program the 2708 and TMS2716 (PM9005A, PM9053A, PM9051A, and PM9060A) respond differently. Refer to Section 11, Failure to Program Operations. Also, Gang Modules for PROMs other than the 2708 or TMS2716 continue through to the end of the operation before halting.

**Summary of Master to Copy Operation**

1. Insert Personality Module, PROM to be programmed, PROM to be copied, select switches as follows; MFG MODE (OFF), AUDIO (optional), MASTER (ON), BUFFER (OFF), COPY (ON).
2. Depress RESET. Display is blank.
3. Depress AUTO. First and Last Addresses of the Master/Copy are shown.
4. Depress ENTER. The display will show "AB AAA", "AD AAA", "AC AAA".
5. When complete, the "AAA" will be replaced with "F".
6. To repeat, depress ENTER. You are now back to step 4. The M980 halts and displays the address and data to indicate an error.





# SECTION 11

## Failure to Program Operations

### FUSIBLE PROMS:

As it attempts to program the bad location, the M980 typically takes less than a second before indicating error, although delays of up to 12 seconds are possible. With many bipolar PROMs the operator may retry the failed location by depressing ENTER (check PROM manufacturers specifications to determine whether re-try is permissible). The display will then indicate the next sequential address if re-try is successful, or "AAA" is displayed if in DUP mode. If unsuccessful, the error indication is displayed again. To step over the failed location, the operator may depress the CLEAR key and an "F" will appear for Finished. The operator may now reselect the mode and redefine the address field, using the address after the failed location as a Start Address. In the Duplicate mode the operator may examine data in the corresponding address in Master PROM, Buffer, or Copy PROM by depressing key A to see Master PROM data, key B to see Buffer data, or key C to see Copy PROM data (refer to the example shown below).

### UV ERASABLE PROMS:

Following an unsuccessful attempt at programming a location, the operator may step over a failed location by depressing the ENTER key. In the Duplicate mode the operator may see what is in the corresponding address in the Master PROM, Buffer, or Copy PROM by depressing key A to see Master data, key B to see Buffer data, or key C to see Copy PROM data.

To step to the end of the operation, the operator may depress the CLEAR key and an "F" appears to indicate Finished. However, some Personality Modules have special software routines that prevent this operation. They include the PM9005A, PM9053A, PM9051A and PM9060A. For these modules it is necessary to depress RESET to abort a duplication process. The display for these PROMs also differs from the normal display (refer to their respective Failure Instructions at the end of this section).

**NOTE**

Do not try to reprogram a failed UV Erasable PROM without complete erasure since this will result in a marginal data condition.

3. The operator may examine the Master PROM data by depressing key A, OR

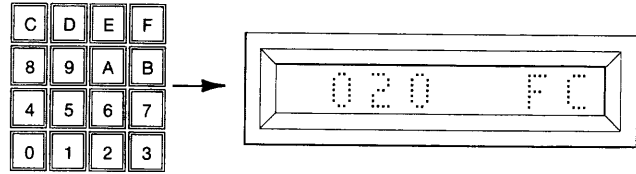

**Example: Example of Error During Duplication**

1. An error occurs in address 020. The M980 halts and displays the address and the source (Master) data for that address. (Example: "FC")

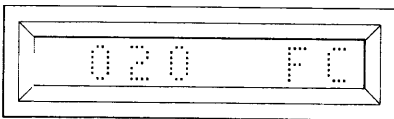
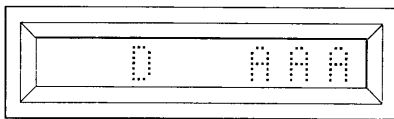

4. Depress ENTER to bypass the location (for UV and some bipolar PROMs). The M980 steps over the failed location and tries the next sequential location. For bipolar PROMs, depressing ENTER will retry to program the same location again. If the re-try or next location fail to program, the previous steps may be followed.

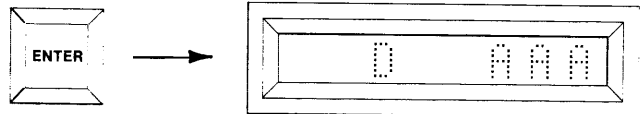

2. The operator may now examine the Copy PROM data by depressing key C. (Example "FF")

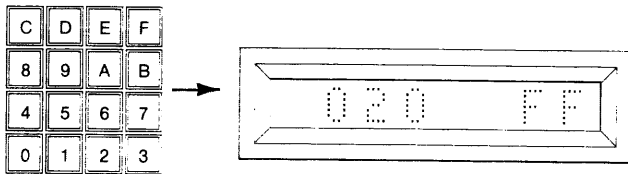

5. The operator may abort the operation (without pressing RESET, to re-enter the mode and address information) by depressing the CLEAR key. This causes the M980 to step to the end of the operation, displaying an "F" for Finished.

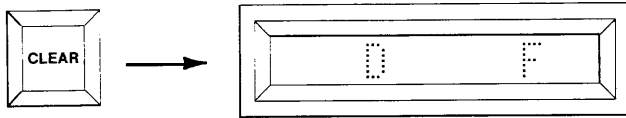

All 2708 and TMS2716 Modules show a programming count of 00-99 when programming. After the 99th pass the program carried by these modules performs a complete Compare operation independent of the M980. The display is blanked for Gang Personality Modules while the module performs its own Compare.

## PM9005A AND PM9053A MODULES

The address and data for the earliest failed location are displayed. Since this operation is independent of the M980, a tone does not sound, regardless of the position of the AUDIO switch. Depressing ENTER sequences to the next failed location. In either Manufacturing or Engineering Auto Sequencing mode, the operator may have to depress ENTER many times in order to reach the point where the automatic sequence resumes. It is therefore suggested that the operator abort these operations by pressing RESET with this module.

## PM9051A, PM9060A, PM9075A AND PM9076A MODULES

Any error results in a display of "E"; a tone will not sound. Depressing ENTER causes the M980 to display "F" (or continue in Manufacturing or Engineering Auto Sequence). The LEDs below each COPY socket or the Gang Module indicate which PROM has failed (on = fail; off = pass).



# SECTION 12

## Error Indications and Operation Modes

### ERROR INDICATIONS (Also see inside back cover)

| CODE | EXPLANATION                                                                                                                                                                                                                                                 |
|------|-------------------------------------------------------------------------------------------------------------------------------------------------------------------------------------------------------------------------------------------------------------|
| E0   | Set-up error. The Source, Destination, or MFG toggle switches are not in the proper position, e.g. a non-valid operation such as program MASTER.                                                                                                            |
| E1   | Data error. A failure to Blank Check, Program, Compare.                                                                                                                                                                                                     |
| E2   | No option. Option selected does not exist.                                                                                                                                                                                                                  |
| E3   | Address error. Performing an operation and the address given cannot be complied with. Example: Duplicate Master to Buffer. If you try to move a 2K program into the last 1K of Buffer, this error indication will appear prior to attempting the operation. |
| E4   | No Personality Module. A Personality Module is not installed. Buffer operation may continue.                                                                                                                                                                |
| E5   | Option Interface not ready. Option selected, but when checked, the interface is not properly hooked up. Example: 9818 RS-232-C adapter installed but ON-LINE/OFF-LINE switch is in the OFF-LINE position.                                                   |
| E6   | Communication CHECKSUM error. When using one of the interfaces, in which the checksum of each line is sent over the interface, and the checksum does not match, this error will be displayed. An example: Intel Format RS-232-C.                            |
| E7   | Remote control error indication: Response to the QXN command.                                                                                                                                                                                               |
| E8   | Personality Module Overload Failure (see individual operating instruction).                                                                                                                                                                                 |
| E9   | Invalid Buffer Data during PM9080 Update.                                                                                                                                                                                                                   |
| EA   | Programming Error in updating PM9080 PROMs.                                                                                                                                                                                                                 |

### OPERATION CODES

| CODE (DISPLAY)    | EXPLANATION                             |
|-------------------|-----------------------------------------|
| A - - - - - - - - | Auto Mode Selected.                     |
| A B - - - - A A A | Auto Blank Check Active.                |
| A B - - - - E 1   | Auto Blank Check Error (MFG Mode only). |
| A - - C - - A A A | Auto Compare Active.                    |
| A - - C - - E 1   | Auto Compare Error (MFG Mode only).     |
| A - D - - A A A   | Auto Duplicate Active.                  |
| A - D - - E 1     | Auto Duplicate Error (MFG Mode only).   |
| A - - - - - F -   | Auto Mode Finished.                     |
| - B - - - - - -   | Blank Check Selected.                   |
| - B - - - - A A A | Blank Check Active.                     |
| - B - - - - E 1   | Blank Check Error (MFG Mode only).      |
| - B - - - - F -   | Blank Check Finished.                   |
| - - - C - - - - - | Compare Selected.                       |
| - - - C - A A A   | Compare Active.                         |
| - - - C - - E 1   | Compare Error (MFG Mode only).          |
| - - - C - - F -   | Compare Finished.                       |
| - - D - - - - -   | Duplicate Selected.                     |
| - - D - - A A A   | Duplicate Active.                       |
| - - D - - E 1     | Duplicate Error (MFG Mode only).        |
| - - D - - F -     | Duplicate Finished.                     |

Note: A hyphen (-) denotes a blank display.

Error and Operation Codes

OPERATION CODES (cont.)

| CODE (DISPLAY) |   |   |   |   |   |   |   |  |  | EXPLANATION                                           |
|----------------|---|---|---|---|---|---|---|--|--|-------------------------------------------------------|
| E              | - | - | - | - | - | 0 | 0 |  |  | Edit Reset Default Mode. Word Size.                   |
| E              | 0 | 0 | - | - | - | - | - |  |  | Edit Word Size Selected.                              |
| E              | 0 | 0 | - | - | - | 0 | 4 |  |  | Edit Word Size 4 bit.                                 |
| E              | 0 | 0 | - | - | - | 0 | 8 |  |  | Edit Word Size 8 bit.                                 |
| E              | 0 | 0 | - | - | - | 1 | 2 |  |  | Edit Word Size 12 bit.                                |
| E              | 0 | 0 | - | - | - | 1 | 6 |  |  | Edit Word Size 16 bit.                                |
| E              | 0 | 0 | - | - | - | F | - |  |  | Edit Word Size Finished.                              |
| E              | - | - | - | - | - | 0 | 1 |  |  | Edit Invert Mode Selected.                            |
| E              | 0 | 1 | - | - | A | A | A |  |  | Edit Invert Mode Active.                              |
| E              | 0 | 1 | - | - | - | F | - |  |  | Edit Invert Mode Finished.                            |
| E              | - | - | - | - | - | 0 | 2 |  |  | Edit Fill Buffer Mode Selected.                       |
| E              | 0 | 2 | - | - | A | A | A |  |  | Edit Fill Buffer Mode Active.                         |
| E              | 0 | 2 | - | - | - | F | - |  |  | Edit Fill Buffer Mode Finished.                       |
| E              | - | - | - | - | - | 0 | 3 |  |  | Edit Insert Selected.                                 |
| E              | 0 | 3 | - | - | A | A | A |  |  | Edit Insert Active.                                   |
| E              | 0 | 3 | - | - | - | F | - |  |  | Edit Insert Finished.                                 |
| E              | - | - | - | - | - | 0 | 4 |  |  | Edit Delete Selected.                                 |
| E              | 0 | 4 | - | - | A | A | A |  |  | Edit Delete Active.                                   |
| E              | 0 | 4 | - | - | - | F | - |  |  | Edit Delete Finished.                                 |
| E              | - | - | - | - | - | 0 | 5 |  |  | Edit Block Mode Selected.                             |
| E              | 0 | 5 | - | - | A | A | A |  |  | Edit Block Mode Active.                               |
| E              | 0 | 5 | - | - | - | F | - |  |  | Edit Block Mode Finished.                             |
| E              | - | - | - | - | - | 0 | 6 |  |  | Edit Nibble Swap Selected.                            |
| E              | 0 | 6 | - | - | A | A | A |  |  | Edit Nibble Swap Active.                              |
| E              | 0 | 6 | - | - | - | F | - |  |  | Edit Nibble Swap Finished.                            |
| E              | - | - | - | - | - | 0 | 7 |  |  | Edit Hex Pack Selected.                               |
| E              | 0 | 7 | - | - | A | A | A |  |  | Edit Hex Pack Active.                                 |
| E              | 0 | 7 | - | - | - | F | - |  |  | Edit Hex Pack Finished.                               |
| E              | - | - | - | - | - | 0 | 8 |  |  | Edit Hex Unpack Selected.                             |
| E              | 0 | 8 | - | - | A | A | A |  |  | Edit Hex Unpack Active.                               |
| E              | 0 | 8 | - | - | - | F | - |  |  | Edit Hex Unpack Finished.                             |
| E              | - | - | - | - | - | 1 | 0 |  |  | Edit RAM Split Selected.                              |
| E              | 1 | 0 | - | - | A | A | A |  |  | Edit RAM Split Active.                                |
| E              | 1 | 0 | - | - | - | F | - |  |  | Edit RAM Split Finished.                              |
| E              | - | - | - | - | - | 1 | 1 |  |  | Edit RAM Interleave Selected.                         |
| E              | 1 | 1 | - | - | A | A | A |  |  | Edit RAM Interleave Active.                           |
| E              | 1 | 1 | - | - | - | F | - |  |  | Edit RAM Interleave Finished.                         |
| -              | - | - | - | - | - | F | - |  |  | Finished.                                             |
| 9              | 8 | 1 | 1 | - | - | d | d |  |  | Paper Tape Reader Interface Selected.                 |
| 9              | 8 | 1 | 2 | - | - | d | d |  |  | TTY Interface Selected.                               |
| 9              | 8 | 1 | 4 | - | - | d | d |  |  | Parallel I/O Interface Selected.                      |
| 9              | 8 | 1 | 8 | - | - | d | d |  |  | RS-232-C Interface Selected.                          |
| 0              | - | d | d | - | A | A | A |  |  | Interface Option "dd" Output Active (see Section 15). |
| -              | - | d | d | - | A | A | A |  |  | No Zero or One indicates Active Idle.                 |
| D              | - | d | d | - | A | A | A |  |  | Remote Control Active.                                |
| 1              | - | d | d | - | A | A | A |  |  | Interface Option "dd" Input Active (see Section 15).  |

Note: A hyphen (-) denotes a blank display.

# SECTION 13

## Self Test Operations

### DESCRIPTION

During normal operation of the M980, if malfunctions occur, they are easily detected. This section describes tests which may be used for confidence testing or for troubleshooting. They are:

- Keyboard Test
- Display Test
- Toggle Switch Test
- Ram Buffer Test

### Keyboard Self-Test Selection

These test routines are located in software and are designed to interact with the user to test various hardware sections of the M980. The basic functioning of the keyboard involves strobing of the X-Y matrix formed by the keyboard switches. All tests are initiated in the same manner — if a key is found to be closed upon power up or RESET. While depressing any hex key, depress and release the RESET key. The hex key depressed (down) is displayed in all of the hex displays until released. When the key is released, the Self-Test mode is active. Display shows 0 0 0 0.

### Toggle Switch Test

Depressing Key 1 initiates the Toggle Switch Test, where the display corresponding to each toggle switch reflects the position of the switch (0 = down; 1 = up).

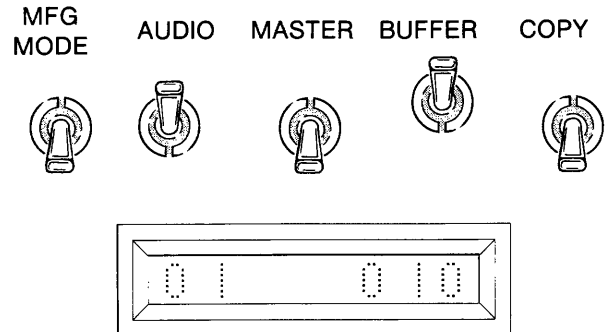

Depress CLEAR to return to Self-Test Selection and to display alternating 0's.

### Keyboard (Keyswitch) Test

Depressing key 2 enters the Keyboard Test. As this test begins, the displays are blank. Any hex key depressed is shown in the display and shifts from left to right, as additional keys are depressed and released. The function keys will respond as follows: EDIT/AUTO = 4; BLNK CHCK = 5; PROG/DUP = 6; READ/CMPR = 7; and ENTER = 0. When depressed the CLEAR key terminates this test and returns the M980 to the Self-Test Selection.

### Display Test

Depressing Key 0 causes the Display Test to begin. In this test, all 8 displays cycle from 0 through F and repeat, allowing the operator to determine if any display segment, character, or display is not operating properly. When depressed, the CLEAR key terminates this test and returns the M980 to the Self-Test Selection.

*(Operations Continued Next Page)*

## RAM Buffer Test

When this test is performed, all existing data in the Buffer is altered (time for this test is ~ 5 min. for 16K). Depressing key 3 enters the RAM Buffer Test. The display will show the full buffer address range. Depress enter. The displays show "B DD AAA" while the test is in progress. The M980 writes all 0's into the Buffer and checks that the RAMs will accept the data. The next test writes alternating 1's into specified blocks and checks that block for data retention and all other blocks to make sure no other RAMs have the pattern.

When finished with data test (Display B DD AAA), an address test is initiated (Display B AA AAA), which tests the chip address lines for shorts and opens.

When Finished, the displays indicate "B AA F", then 0 0 0 0. The audio tone will sound when finished if selected.

If an error is found, the M980 indicates the address of the error, the data written to that location, and the data read back from that location in the following manner.

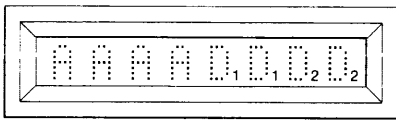

- "AAAA" = Address of failure.
- "D<sub>1</sub>" = Data written to that address.
- "D<sub>2</sub>" = Data read back from that address.

An error during the address test is shown.

- A<sup>1</sup>A<sup>1</sup>A<sup>1</sup>A<sup>1</sup> = Correct address.
- A<sup>2</sup>A<sup>2</sup>A<sup>2</sup>A<sup>2</sup> = Incorrect address.

Depressing ENTER will continue the RAM Buffer Test, displaying "B DD AAA".

Depressing CLEAR will terminate this test and return the M980 to the Self-Test Selection.



# Section 14

## M980 Interface

### Software Selection

#### SELECTING TYPE AND FORMAT

The M980 contains several software packages to interface the M980 to peripheral equipment. This interface may be directly from the M980 (example: 9812 TTY or 9814 Parallel I/O) or via additional hardware (example: 9811 with M301 Paper Tape Reader, or 9818 with M304 RS-232-C adapter).

The 9812 TTY Interface uses the 9 Pin "D" type connector located on the front panel to interface directly to TTY machines (ASR-33). The 9814 parallel I/O uses the 25 Pin "D" type connector to interface to intelligent equipment via a TTL Parallel I/O handshake interface. This TTL connector is used to drive and read from the M301 Paper Tape Reader or M304 RS-232-C adapter.

The M980 interface type and format are selected via the hex keyboard. After RESET, the depression of keys 1, 2, 4, and 8 selects either the 9811, 9812, 9814 or 9818 software routines. The interface type selected is displayed in the left-most displays. In the right-most displays a default format number is displayed. The user may elect to use the default format or choose any one of the formats listed at the end of this section (see Sections 15 through 18 for detailed descriptions of the various formats available for each interface).

The following is a step-by-step example of the key strokes required for selecting a format:

1. Select the switches as shown. Connect and activate the interface to be selected. The 9811 is activated by connecting the M301, turning ON the M301 Power and the Reader head. The 9812 is activated by plugging in the RC12 TTY cable or jumpering Pin 2 to Pin 8 on the 9-pin "D" type connector. The 9814 is activated by pulling interlock low on the 25-pin "D" type connector. The 9818 is activated by plugging in the M304, pulling DTR or CTS high, turning M304 ON-LINE and/or Modem ON (see appropriate section for more detailed information).

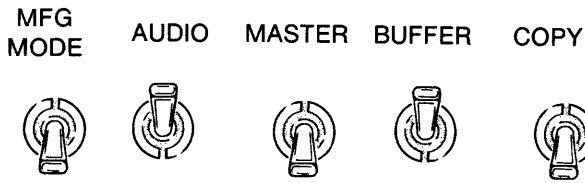

2. Depress RESET. The 8 hex displays are blank.

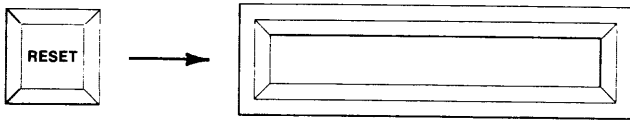

3. Depress 1 for 9811, 2 for 9812, 4 for 9814, or 8 for 9818 (Example is for 9818 RS-232-C.) The interface selected is displayed in the left-most displays and "01" is displayed in the right-most displays.

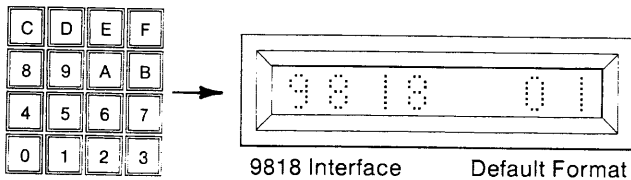

4. If the default format is desired, go to step 5. If a new format is required, use the hex keyboard to key in a new format number (see format number listing at the end of this section).

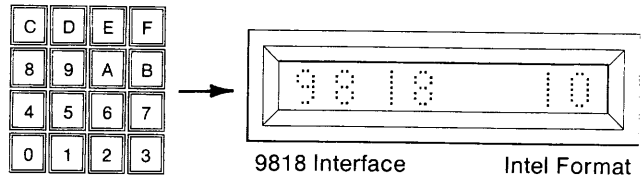

5. Depress ENTER. The displayed format will be accepted. The display will show the format number and "AAA" for active. The interface is now active to receive information remotely. When remotely interfacing with the M980, any output of data will be indicated by a "0" in the left-most display. Any input of data will be indicated by a "1" in the left-most display. Upon completion, the "0" or "1" will be removed from the display. The interface and format will remain active until the M980 is reset. In formats that use checksums, an "E6" error will disable the format until ENTER is depressed.

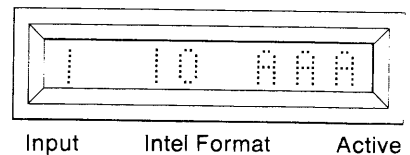
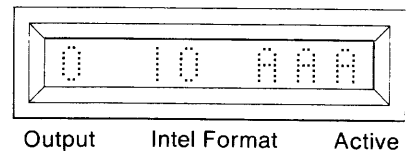
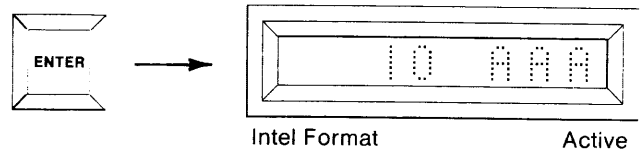

6. For some formats — those not requiring that the address information be sent over the interface — the user may elect to define the Buffer address limits via the hex keyboard. If local address field definition is desired, continue.

7. Depress ENTER. The First and Last Addresses of the Buffer are displayed.

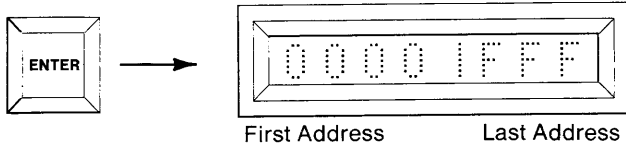

8. If the entire contents of the Buffer are to be operated on, go to step 9. For a limited field, use the hex keyboard to key in a new Start and End Address field for the operation.

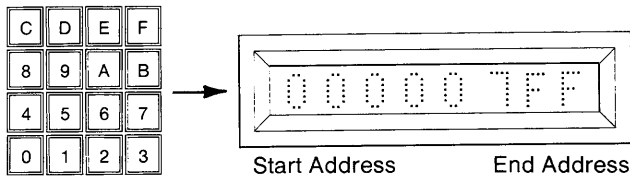

9. Depress ENTER. This initiates the format selected over the indicated address range. A zero or 1 is displayed in the left-most display to indicate output or input as described in step 5.

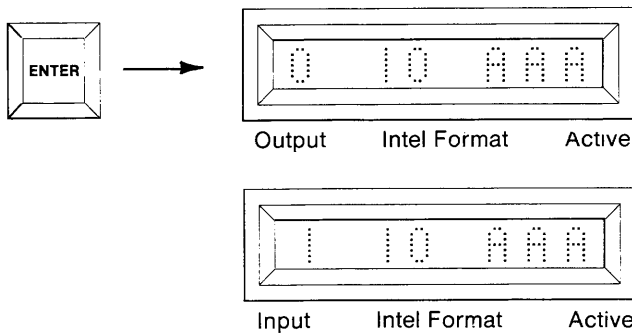

### INTERFACE FORMAT NUMBERS

| 9811 PAPER TAPE READER |                             |
|------------------------|-----------------------------|
| NUMBER                 | DESCRIPTION                 |
| 00                     | ASCII Hex Local — Duplicate |
| 01                     | ASCII Hex Local — Compare   |
| 02                     | BNPF Local — Duplicate      |
| 03                     | BNPF Local — Compare        |
| 04                     | BINARY Local — Duplicate    |
| 05                     | BINARY Local — Compare      |
| 06                     | INTEL MDS — Duplicate       |
| 07                     | INTEL MDS — Compare         |

| 9812 TTY |                                                      |
|----------|------------------------------------------------------|
| NUMBER   | DESCRIPTION                                          |
| 02       | Data Only — Remote Duplicate, List, Program, Compare |

| 9814 PARALLEL I/O |                                         |
|-------------------|-----------------------------------------|
| NUMBER            | DESCRIPTION                             |
| 00                | Parallel — Remote Read, Program (Slave) |
| 01                | Parallel — Master Write                 |
| 02                | Parallel — Master Read                  |

## PRO-LOG AND INDUSTRY FORMAT DESCRIPTION

| KEY SELECT              | REMOTE CODE | 9818 RS-232-C<br>PRO-LOG FORMAT DESCRIPTION                                                                                                                                                                                                                                                                                                                                                                                                                                                                                                                                               |
|-------------------------|-------------|-------------------------------------------------------------------------------------------------------------------------------------------------------------------------------------------------------------------------------------------------------------------------------------------------------------------------------------------------------------------------------------------------------------------------------------------------------------------------------------------------------------------------------------------------------------------------------------------|
| 9818-00                 | P           | M980 accepts ASCII hexadecimal characters as data to be written to the buffer. Each ASCII character represents 4 bits of data. Non-hexadecimal characters sent between characters are discarded.                                                                                                                                                                                                                                                                                                                                                                                          |
| 9818-01                 | S           | M980 lists selected buffer field in ASCII hexadecimal characters formatted in 256-byte data blocks. Each data block is preceded by a header to separate columns, and each data line is preceded by the line starting address. Each line consists of 16 data bytes separated by spaces. Output operation halts after each block. A "SPACE" received via the interface or the ENTER key on the M980 causes the next block to be sent. Operation terminates when the end address is reached, when the M980 is reset, or when any character other than "SPACE" is received via the interface. |
| 9818-02                 | L           | M980 lists selected buffer field in ASCII hexadecimal characters formatted in 16-byte lines. Each line consists of 16 data bytes separated by spaces. Each line is followed by a carriage return and line feed. Output operation runs continuously until the end address is reached.                                                                                                                                                                                                                                                                                                      |
| 9818-03                 | M           | M980 lists selected buffer field in ASCII hexadecimal characters formatted in 256-byte data blocks. Format and operation are identical to those of the 9818-01, except that output operation does not stop with each block but runs until the end address is reached.                                                                                                                                                                                                                                                                                                                     |
| 9818-04                 | N           | M980 lists selected buffer field in ASCII hexadecimal characters. Data is output in a continuous stream, without any control characters, from the start address to the end address.                                                                                                                                                                                                                                                                                                                                                                                                       |
| 9818-05                 | X           | M980 lists selected buffer field in ASCII hexadecimal characters formatted in 16-byte lines. Each line consists of 16 data bytes separated by spaces. Each line is followed by a carriage return and a line feed. M980 outputs one line each time an XON character is received. Operation terminates when the end address is received.                                                                                                                                                                                                                                                    |
| 9818-06                 | —           | M980 sends a carriage return to initiate data transfer and then waits to receive ASCII hexadecimal characters as data to be written to the buffer.                                                                                                                                                                                                                                                                                                                                                                                                                                        |
| <b>INDUSTRY FORMATS</b> |             |                                                                                                                                                                                                                                                                                                                                                                                                                                                                                                                                                                                           |
| 9818-10                 |             | Intel HEX basic — M980 sends or receives data in the Intel HEX block format, without any special control operations. This version is compatible with Intel HEX files based by systems other than MDS. For example, CPM-based systems can write UFN-HEX files to the M980 buffer, via TYPE UFN.HEX1P, or read and write HEX files using the peripheral interchange program (PIP).                                                                                                                                                                                                          |
| 9818-11                 |             | Intel HEX with "ACK" or "NAK" response to checksum — M980 sends or receives data in the Intel HEX block format. In the receive mode, the M980 sends an "ACK" to acknowledge a correct checksum, and a "NAK" to acknowledge an incorrect checksum. This feature is intended to assist communication over a remote link, e.g., through a modem.                                                                                                                                                                                                                                             |
| 9818-12                 |             | Intel-Hex with "CONTROL Z" end-of-file terminator—M980 sends or receives data in the Intel HEX block format. In the local LIST operation, a "CONTROL Z" character is sent after the end-of-file record is sent; this is required by the Intel MDS to terminate the copy mode.                                                                                                                                                                                                                                                                                                             |
| 9818-13                 |             | Intel Extended (8086).                                                                                                                                                                                                                                                                                                                                                                                                                                                                                                                                                                    |
| 9818-14                 |             | TEK-HEX—can be used with the Tektronix 8001, and 8002 systems via the built-in commands of RHEX and WHEX.                                                                                                                                                                                                                                                                                                                                                                                                                                                                                 |
| 9818-15                 |             | Motorola S2 (68000)—can be used with Motorola EXORmacs.                                                                                                                                                                                                                                                                                                                                                                                                                                                                                                                                   |
| 9818-16                 |             | Motorola S1—can be used with Motorola EXORcisor.                                                                                                                                                                                                                                                                                                                                                                                                                                                                                                                                          |
| 9818-18                 |             | MOS Technology                                                                                                                                                                                                                                                                                                                                                                                                                                                                                                                                                                            |

# SECTION 15

## 9811, PAPER TAPE READER

### 9811, PAPER TAPE READER

The M980 9811 provides an interface with the M301 Paper Tape Reader (PTR).

With the M301 PTR (see Figure 15-1), the M980 can input data at a rate greater than 100 characters per second for use in the Duplicate or Compare Modes.

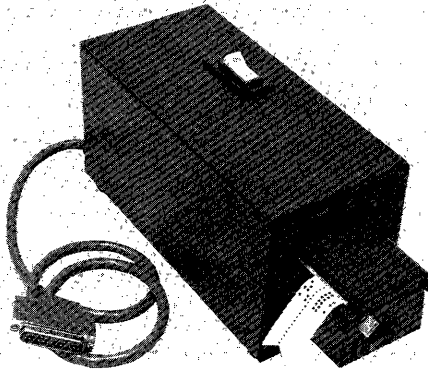

Figure 15-1. M301 Paper Tape Reader

### PAPER TAPE CONNECTOR (PARALLEL INTERFACE)

The M301 PTR connects to the M980 programmer via the 25-pin "D"-type connector located in the center of the programmer control panel.

The connector provides four drive lines for reader stepping control, eight data lines, one sprocket line, and logic power connections (see Figure 15-2).

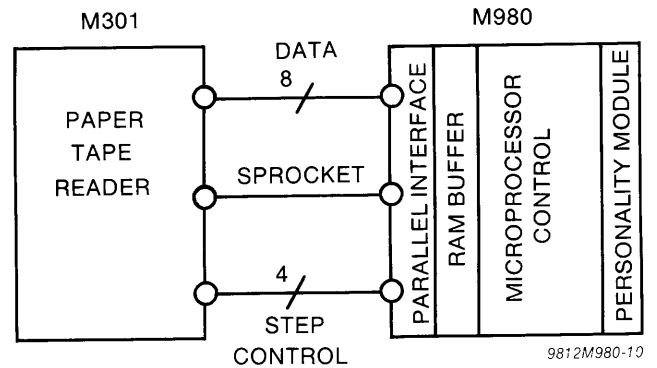

Figure 15-2. Paper Tape Reader Interface

### PAPER TAPE CONTROLS

The M301 reader has two switches, READER POWER and READER ENABLE.

**READER POWER Switch:** A rocker switch on the top side of the reader chassis; it controls the power supply for the reader stepping motor.

**READER ENABLE Switch:** A rocker switch on the front of the reader mechanism; it enables the light source for the photo-reader in the ON position.

**KEY 1:** Interface selection key that puts the system into the PTR operating sequence. Active after Power ON or RESET.

### PAPER TAPE INDICATOR

**Reader Ready:** A red indicator located on the reader mechanism. Indicates reader ready condition.

### PAPER TAPE FORMATS

**ASCII hex format (9811—00/01)** requires 8-level, ASCII data coding where only the hexadecimal characters represent data to be operated on (see Figure 15-3).

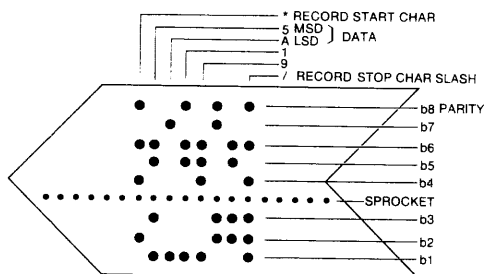

9812M960-11

Figure 15-3. ASCII HEX Format

**Address:** Address information must not be on the tape. The M980 keeps sequential address count for each location operated on.

**8-Bit Data:** Each 8-bit location to be operated on requires two sequential ASCII hex characters on the tape. Non-hex characters are allowed and ignored but must not occur between the two hex data characters to be programmed.

**4-Bit Data:** Each ASCII hex character on the tape is loaded to the lower half of the Buffer; the upper half is unaffected.

**Start Character:** The ASCII character asterisk (\*) must occur as the start character at the beginning of the data stream. Header information is allowed on the paper tape if it precedes the asterisk start character.

**End Character:** The Tape Read operation can be terminated by the ASCII character slash (/).

**ASCII BNPF format (9811—02/03)** requires 8-level ASCII data coding where the characters B, N, P, and F are used to encode and control binary data words. Other characters are allowed on the tape but must not occur within the data word (see Figure 15-4).

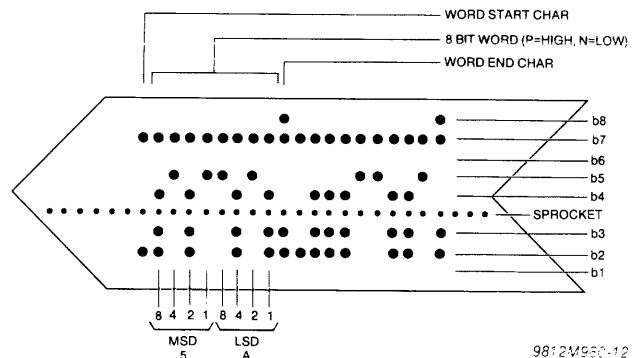

9812M960-12

Figure 15-4. ASCII BNPF

**Address:** Address information must not be on the tape. The M980 keeps sequential address count for each location operated on.

**8-Bit Data:** Eight ASCII P's or N's preceded by a B and followed by an F.

**4-Bit Data:** Four ASCII P's or N's preceded by a B and followed by an F.

**Binary tape format (9811—04/05)** requires 8-level, binary characters on punched tape (see Figure 15-5).

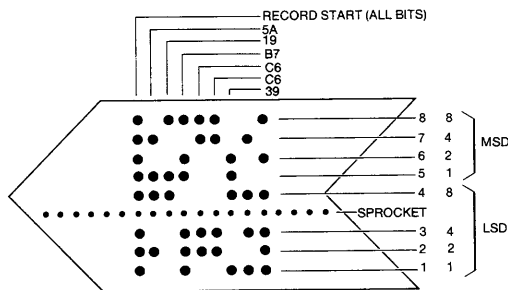

9812M980-13

Figure 15-5. Binary Tape Format

**Address:** Address information must not be on tape. The M980 keeps sequential address count for each location operated on.

**8-Bit Data:** Each 8-bit location is represented by an 8-bit binary character on tape. All binary combinations are legal for data.

**4-Bit Data:** Only the lower four bits are stored; the upper half of the Buffer is unaffected.

**Start Character:** The ASCII character "delete" must occur at the beginning of the data stream. Header information is allowed on the paper tape if it precedes the "Delete" character. (Note that "delete" is all holes punched.)

**End Character:** There is no ending character; the reader continues until the end of the defined field, even if blank tape is installed.

Intel MDS format (9811—06/07) provides an interface to the Pro-Log M301 PTR for reading MDS format paper tapes (see Figure 15-6).

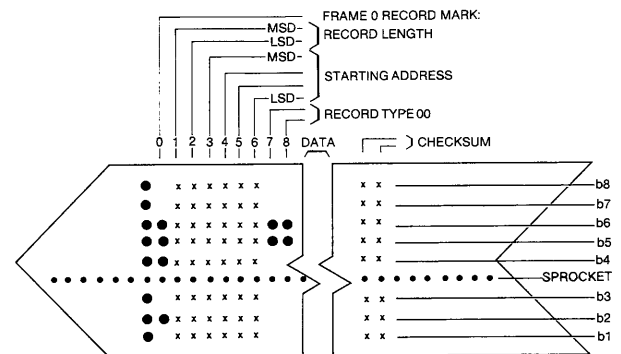

9812M980-14

Figure 15-6. MDS Format

**MDS - ASCII HEX format** requires 8-level, ASCII data coding where only the hexadecimal characters represent data to be operated on.

**Address:** Starting at the tape-defined address, the M980 keeps sequential address count for each location operated on until byte count is exhausted, at which time a new line is searched for. If a Compare error occurs, RAM address and tape data are displayed until ENTER key is depressed, at which time comparing continues.

**8-Bit Data:** Each 8-bit location to be operated on requires two sequential ASCII hex characters on tape. Non-hex characters are allowed and ignored but must occur as a start character at the beginning of the block stream. Header information is allowed on the paper tape, if it precedes the start character.

### Frame 0

Record Mark = ASCII colon (:) marks the start of a record block.

### Frames 1 and 2

Frame 1 = High Order Digit

Frame 2 = Low Order Digit

Record length in hexadecimal count of data bytes in this record block.

### Frames 3 through 6 - Load Address

Frame 3 = High Order Digit

Frame 6 = Low Order Digit

The first data byte will load at this address; next byte in ascending order, etc.

### Frames 7 and 8 - Record Type

At this time, all record types are 00. This field may be used for future expansion.

### Frames 9 Upwards

These are for data digits. Each pair represents one 8-bit data byte in hexadecimal.

### Final 2 Frames

These are the checksum. The checksum is the negative of the sum of all 8-bit bytes in the record evaluated module 256. The sum of all bytes in the record added to the checksum should be zero.

## PAPER TAPE OPERATING SEQUENCES (9811—00 through 05 only)

**DUPLICATE operating sequence:** In the Duplicate operations (00, 02 or 04) data from the paper tape is programmed into the RAM Buffer in the following sequence:

1. Mount the paper tape, with the pattern to be programmed, on the M301 reader. Note that the tape is loaded with the Bit 1 (b1) row of holes closest to the unit, and feeds from left to right.
2. Turn the Reader Power and Reader Enable switches ON.
3. Depress RESET, the displays are blank.
4. Depress Key 1, "9811—00" is displayed.
5. Key in new format (02 or 04) if desired.
6. Depress ENTER, the First and Last Addresses of the Buffer are displayed.
7. Key in new Start and End Addresses for operation, using the hex keyboard.

8. Depress ENTER, the display indicates "1 FF AAA" for Input-Format-Active.
9. When completed, the display shows "9811—FF" for paper tape format. NOTE: FF = default format "00" or format keyed in during step 5. After "9811—FF" is displayed, a new format can be keyed in (example: Compare "01").

**COMPARE operating sequence:** In the Compare operations (01, 03 or 05) data from the paper tape is compared with the RAM Buffer in the following sequence:

1. Mount the paper tape with the pattern to be programmed on the M301 reader. Note that the tape is loaded with the Bit 1 (b1) row of holes closest to the unit, and feeds from left to right.
2. Turn the Reader Power and Reader Enable switches ON.
3. Depress RESET, the displays are blank.
4. Depress Key 1, "9811—00" is displayed.
5. Key in new format (01, 03 or 05) if desired.
6. Depress ENTER, the First and Last Addresses of the Buffer are displayed.
7. Key in new Start and End Addresses for operation using the hex keyboard.
8. Depress ENTER, the display indicates "0 FF AAA" for Output-Format-Active.
9. When completed, the display shows "9811—FF" for Paper Tape Format. NOTE: FF = default format 00 or format keyed in during step 5.

If a Compare error occurs, RAM address and tape data are displayed until the ENTER key is depressed, at which time comparing continues.

## PAPER TAPE OPERATING SEQUENCES (9811—06 and 07)

**DUPLICATE operating sequence:** In the Duplicate operation (06), data from the paper tape is programmed into the RAM Buffer in the following sequence:

1. Mount the paper tape with the pattern to be programmed on the M301 reader. Note that the tape is loaded with the Bit 1 (b1) row of holes closest to the unit, and feeds from left to right.
2. Turn the Reader Power and Reader Enable switches ON.
3. Depress RESET, the displays are blank.
4. Depress Key 1, "9811—00" is displayed.
5. Key in "06" using the hex keyboard.
6. Depress ENTER, the display indicates "1 06 AAA" for Input-Intel MDS-Active.
7. When completed, the display shows "9811—06." NOTE: When "9811—06" is displayed, a new format may be keyed in (example: Compare "07").



**COMPARE operating sequence:** In the Compare operation (07) data from the paper tape is compared with the RAM Buffer in the following sequence:

1. Mount the paper tape, with the pattern to be programmed on the M301 reader. Note that the tape is loaded with the Bit 1 (b1) row of holes closest to the unit, and feeds from left to right.
2. Turn the Reader Power and Reader Enable switches ON.
3. Depress RESET, the displays are blank.
4. Depress Key 1, "9811—00" is displayed.
5. Key in "07" using the hex keyboard.
6. Depress ENTER, the display indicates "0 07 AAA" for Output-INTEL MDS-Active.
7. When completed, the display shows "9811—07."  
NOTE: When "9811—07" is displayed, a new format may be keyed in.

### ERROR INDICATION

If a Checksum error should occur during Duplicate operation, an "E6" is displayed. A warbling tone sounds if the Audio switch is ON.

If a Compare error occurs, RAM address and tape data are displayed until ENTER key is depressed, at which time comparing continues.



# SECTION 16

## 9812-02 TTY INTERFACE

### 9812 AUTO-BAUD TTY

The 9812 to the M980 PROM programmer provides an ASCII-HEX coded TTY interface with automatic baud rate selection from 1 to 300 baud (see Figure 16-1).

#### Auto-Baud

- Data Rate Range: 1 to 300 baud
- Auto-baud sense character: CARRIAGE RETURN, or any character with an odd hex code (B, D, F, H, 1, 3, 5, etc.)

#### Electrical Interface (Serial Interface Connector)

- Keyboard input: Polar, 20mA; input resistance 5.1k $\Omega$ ; open circuit voltage (pins 5 and 9 to pin 4); 18.2V maximum.

- Printer output: Polar, 20mA; output resistance 220 ohms; output current forcing compliance voltage +5.8V maximum.

- Relay Driver: connector pin 1 supplies -12.4V to relay coil; connector pin 6 sinks up to 60 mA maximum relay coil current.

#### TTY CONTROLS AND INDICATORS

##### Mode Switch:

A three position rotary switch located in the lower right of the TTY keyboard.

- LOCAL position allows local TTY control.
- OFF position disables the TTY.
- LINE position allows remote control of the TTY and is the setting for operating with the M980.

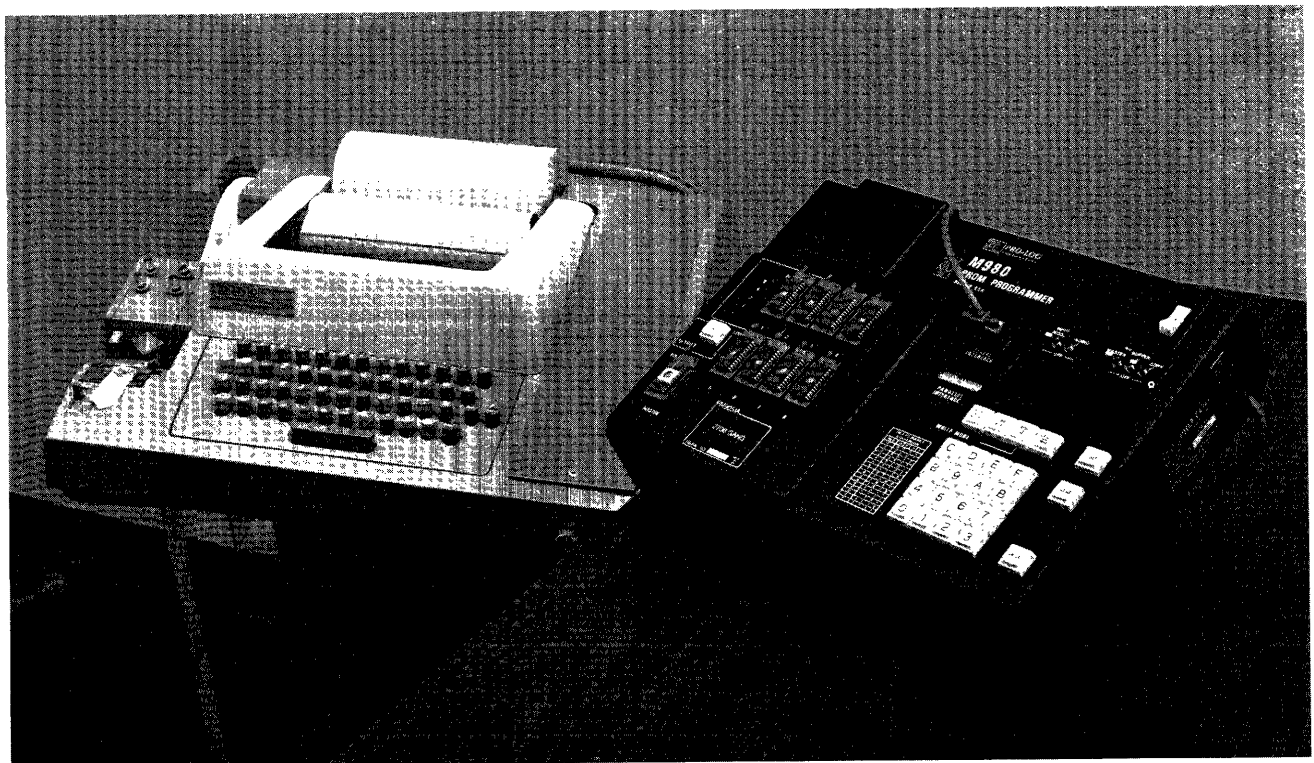

Figure 16-1. M980 with TTY

## Reader Control Switch

A multi-position switch located on the TTY paper tape reader. Manual and automatic readers have different controls.

**Manual Reader:** A three-position lever switch.

- ON is the reader on position.
- OFF is the reader off position.
- FREE is the position for loading and unloading paper tape.

**Auto Reader:** A four-position lever switch.

- MANUAL START is a momentary contact to start the reader in Local.
- AUTO is the normal position for remote operation.
- MANUAL STOP is a momentary contact to stop the reader in Local.
- FREE is the position for loading and unloading paper tape.

**Punch Controls:** Four push-buttons located on the punch.

- ON enables the punch.
- OFF disables the punch.
- RELEASE disengages the punch drive for tape loading.
- BACK SPACE moves tape backward one character.

## TTY PAPER TAPE FORMAT (9812-02)

Requires 8 level ASCII data coding where the hexadecimal characters represent data to be operated on. When a tape is generated in the LIST mode the actual format becomes: data, space, data, space ... with sixteen locations followed by a Carriage Return and Line Feed.

**Address:** Address information must not be on the tape. The M980 keeps sequential address count for each location operated on.

**8-Bit Data:** Each 8-bit location to be operated on requires two sequential ASCII hex characters on tape. Non-hex characters are allowed and ignored but must not occur between the two hex data characters to be programmed.

**4-Bit Data:** Each 4-bit location to be operated on requires one ASCII hex character on tape. Non-hex characters are allowed and ignored.

**End Character:** The data stream can be terminated by the ASCII character slash (/) if less than a full PROM is to be operated on.

## TTY KEYBOARD COMMANDS

Commands to the M980 from the TTY keyboard consist of a 4-digit hex Start Address, followed (without spaces) by a 4-digit hex End Address, followed by a single letter command which designates an operation (see Figure 16-2).

The Start and End Addresses define the portion of the RAM Buffer to be operated on. This may be as small as one location, in which case the Start and End Address are the same; or as large as the entire Buffer.

After the user types the desired Start and End Address, the M980 types a space and waits for one of the following single letter operation codes:

- L - List (M980 — TTY)
- P - Program (TTY — M980)
- D - Duplicate (Tape — M980)
- C - Compare (Tape — M980)
- T - Tape Punch (M980 — Punch)

The M980 can operate without a Personality Module installed. The PROM data width (generally 4 bits or 8 bits) is defined by the Personality Module, which in turn defines the width of the RAM Buffer.

If no Personality Module is installed, the data width is 8 bits. If a 4-bit Personality Module is installed, the M980 regards one Buffer location as a 4-bit word, which is the equivalent of one hex character. Thus the M980 prints and accepts one hex character per Buffer location with 4-bit Personality Modules. The four least significant Buffer bits are used at each location.

8-bit Personality Modules establish an 8-bit data width (one byte) for the Buffer. Thus the M980 prints, and accepts two hex characters per Buffer location when an 8-bit Personality Module is installed.

| TTY KEY | MODE       | 9812-02 OPERATION                                                                                                                                                                                                                                                                                                                                |
|---------|------------|--------------------------------------------------------------------------------------------------------------------------------------------------------------------------------------------------------------------------------------------------------------------------------------------------------------------------------------------------|
| L       | LIST       | Prints the content of the Buffer from the Start address to the End Address. Sixteen Buffer locations are printed on each line, with the content of each location separated by a space. Leading spaces are inserted on the first line to maintain the hex address orientation of the printout. Buffer memory pages are separated by a blank line. |
| P       | PROGRAM    | Loads the Buffer from the Start Address to the End Address with hex data typed from the TTY keyboard. The current Buffer Address is printed by the M980, followed by a Space. The user then types the hex data to be loaded into the Buffer, and the M980 responds with Carriage Return-Line Feed and proceeds to the next Address.              |
| D       | DUPLICATE  | Loads the Buffer with ASCII-hex data from a paper tape. The M980 recognizes all ASCII-hex characters as data and stores them sequentially beginning at the Start Address and finishing when End Address or a slash (/) is reached. Non-hex characters are ignored.                                                                               |
| C       | COMPARE    | Compares Buffer content to paper tape ASCII-HEX data. The tape data is compared Address by Address to the data in the Buffer beginning at the Start Address and finishing at the End Address or a slash (/) is reached.                                                                                                                          |
| T       | TAPE PUNCH | This Mode is similar to LIST but is used with the Tape Punch turned ON. A 64-character leader and a second * (Asterisk) precedes the data printout, which is followed by additional leader. Tape memory pages are separated by 16 null Characters to improve readability of the paper tape.                                                      |

Figure 16-2. Operating Modes

### TTY OPERATING SEQUENCES (DATA ONLY) 9812-02

The TTY takes control of the M980 whenever the following sequence is followed:

1. Connect TTY machine to 9 Pin "D"-type connector as shown on Figure 16-1.
2. Depress RESET on M980, the 8 hex displays are blank.
3. Depress Key 2, 9812-02 is displayed.
4. Depress ENTER, the display shows "A 02 AAA" for Auto-Baud.
5. Send CR from TTY. The M980 responds with a CR, LF, and displays "02 AAA".

At this point, the user has established contact with the M980 and has selected the Format and Baud rate.

### LIST OPERATING SEQUENCE:

1. Type in the hex characters that define the Starting and Ending Addresses of the field to be listed, from the TTY keyboard.
2. The TTY responds with a Space (SP).
3. Type in an "L" (upper case). The TTY does a CR, LF, and begins to automatically list the Buffer contents over the previously defined Address field. The display shows "0 02 AAA" to indicate Output-02 Format-Active. If it is desired to punch a tape, the Punch should not be turned ON after the entry of the last character in the field definition. This ensures that the field information will not be on the tape where it would be interpreted as valid data.
5. When the TTY reaches the end of the field, it does a Space (SP), Slash (/), CR, LF.

EXAMPLE of 9812-02 List:

```
00000013 L
00 01 02 03 04 05 06 07 08 09 0A 0B 0C 0D 0E 0F
10 11 12 13 /
```

**PROGRAM OPERATING SEQUENCE:**

1. Type in hex characters that define the Starting and Ending Addresses of the field to be programmed from the TTY keyboard.
2. The TTY responds with a Space (SP).
3. Type in a "P" (upper case). The TTY does a CR, LF, and prints the First Address and another Space (SP).
4. Type in the data to be programmed, MSD first, the M980 responds with a CR, LF, and prints the next sequential Address.
5. When the End Address is reached, the TTY does a Space (SP), Slash (/), CR, LF.

EXAMPLE of 9812-02 Program:

```
01000106 P
 0100 00
 0101 01
 0102 02
 0103 03
 0104 04
 0105 05
 0106 06 /
```

**DUPLICATE OPERATING SEQUENCE:**

1. Load the paper tape to be duplicated on the TTY Paper Tape Reader.
2. Place the Paper Tape Reader Control Switch in the AUTO position.
3. Type in the hex characters that define the Starting and Ending Addresses for the field to be Duplicated from the TTY keyboard. The TTY responds with a Space (SP).
4. Type the letter "D" (upper case) on the TTY keyboard. The reader begins to read the data information. The M980 automatically increments the Address. (If the TTY is not equipped with a modification for Tape Reader Control, it must be manually started at this point.)
5. The Duplicate operation ends with the TTY printing a Slash (/), CR, LF.

EXAMPLE of 9812-02 Duplicate:

```
000003FF D/
```

**COMPARE OPERATING SEQUENCE:**

1. Load the paper tape to be compared to the Buffer.
2. Place the Paper Tape Reader Control Switch in the AUTO position.
3. Type in the hex characters that define the Starting and Ending Addresses for the field to be compared from the TTY keyboard. The TTY responds with a Space (SP).

4. Type the letter "C" (upper case) from the TTY keyboard. The Reader begins to read the data information and compares it to the data in the Buffer, one Address at a time from Start to End (if the TTY is not equipped with a modification for reader tape control, the Reader should be manually started). The M980 automatically increments the Address. If the data on the tape and the Buffer data do not compare, the TTY prints the Buffer Address and data. The Compare operation does not stop on non-compare.
5. The Compare operation ends with the TTY printing a Slash (/), CR, LF.

EXAMPLE of 9812-02 Compare:

```
000007FF C
0100 D9      Location 0100 does not compare with
/           the tape.
           Data shown is from Buffer.
```

**TTY ERRORS**

If a Duplicate or Compare error occurs, and the Paper Tape Reader modification is not installed, the tape continues to step and the M980 displays the address and data of the tape. The tape runs until the end and the M980 ignores any information past the error location.

"E5" is displayed if the TTY cable is not connected when the Interface is selected.

"E6" is displayed if the Baud rate of the CR sent is below 1 Baud (possibly a shorted cable) or above 300 Baud.

Any non-hex character sent during the address field definition will cause the M980 to respond with a ?, CR, LF. The address field may now be redefined.

Any non-hex character sent during the data transmission causes the M980 to respond with a CR, LF, and reprint the Current Address to be programmed, and a Space (SP).

**TTY OPTIONS AND MODIFICATIONS**

The TTY Interface requires the following options and modification in the Teletype Unit:

1. 20mA Current Loop Option.
2. Full Duplex Option.
3. Remote Reader Control modifications.

The 20mA Current Loop and the Full Duplex Connection are options available on the Teletype Unit. The Remote Reader Control requires the addition of a 12 to 15 volt DC relay capable of switching the high voltage reader circuit inside the TTY (see Figure 16-4).

A number of mini-computers specify a similar interface; thus, many teletypes already have the required configuration. Detailed instructions for modifying a TTY to this configuration are given in the following paragraphs.

### REMOVING THE TTY HOUSING

It is necessary to remove the TTY housing to inspect or modify the TTY options.

1. Unplug the TTY from any power source.
2. Remove the roll of TTY printer paper from its cradle.
3. Remove the manual paper feed knob by pulling firmly.
4. Remove the Mode select knob located on the right front by pulling firmly.
5. Remove the metal trim panel behind the Mode select knob by prying downward.
6. Remove the 4 screws under the metal trim panel.
7. Remove the screw on the left side of the paper tape reader housing.
8. Remove the four knurled knobs along the lower rear edge of the housing.
9. Lift upward on the housing to remove, being careful of the controls on the Paper Tape Reader as they clear their openings in the housing (see Figures 16-3 and 16-6).

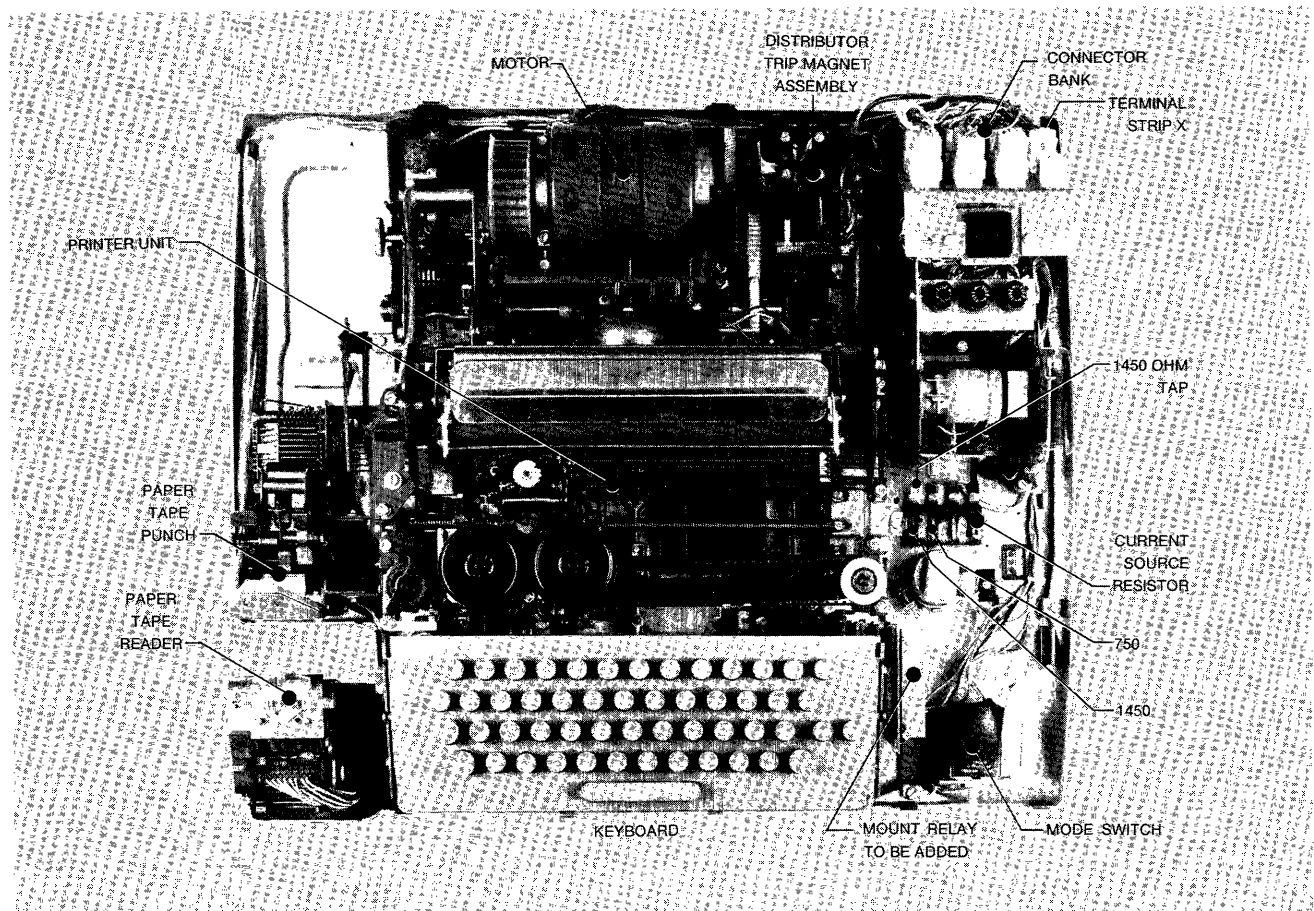
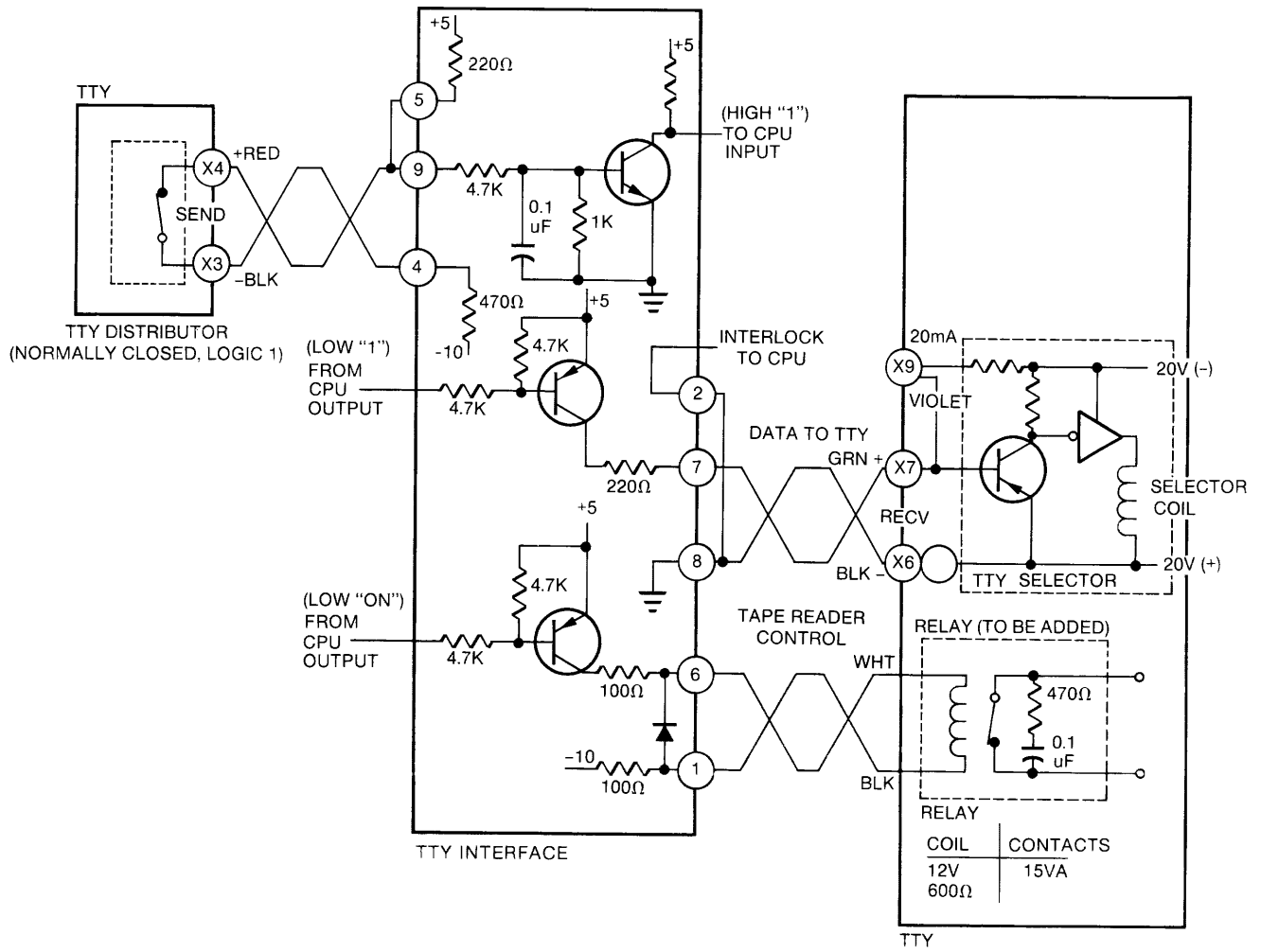

Figure 16-3. Top View - TTY with Housing Removed



38-21-980-15

Figure 16-4. TTY Interface Circuit



### Current Loop Option

The TTY Send and Receive Current Loop can be optionally selected to work from either 20mA or 60mA. When the selection is made, both the Internal Current Source and the Selector Drive Current Bias must be modified to be compatible (see Figure 16-5 and 16-7).

### Internal Current Source

The Internal Current Source is set to 20mA by putting the blue wire on the 1450 ohm tap of Power Resistor R1 located on the right side of the TTY.

### Selector Drive Current Bias

The Selector Drive Current Bias is set to 20mA by optional wiring on Terminal Strip X located below the Connector Bank in the right rear corner of the TTY. In making this change various wiring configurations may be encountered as shown in Figure 16-5 depending on whether the unit has an Elapsed Time Meter.

### TTY Without Elapsed Time Meter

If wired as 1A: Do nothing; this is the correct connection for 20mA without an Elapsed Time Meter.

If wired as 1B: Remove the violet wire from Terminal X8 and move it to X9 with the yellow wire.

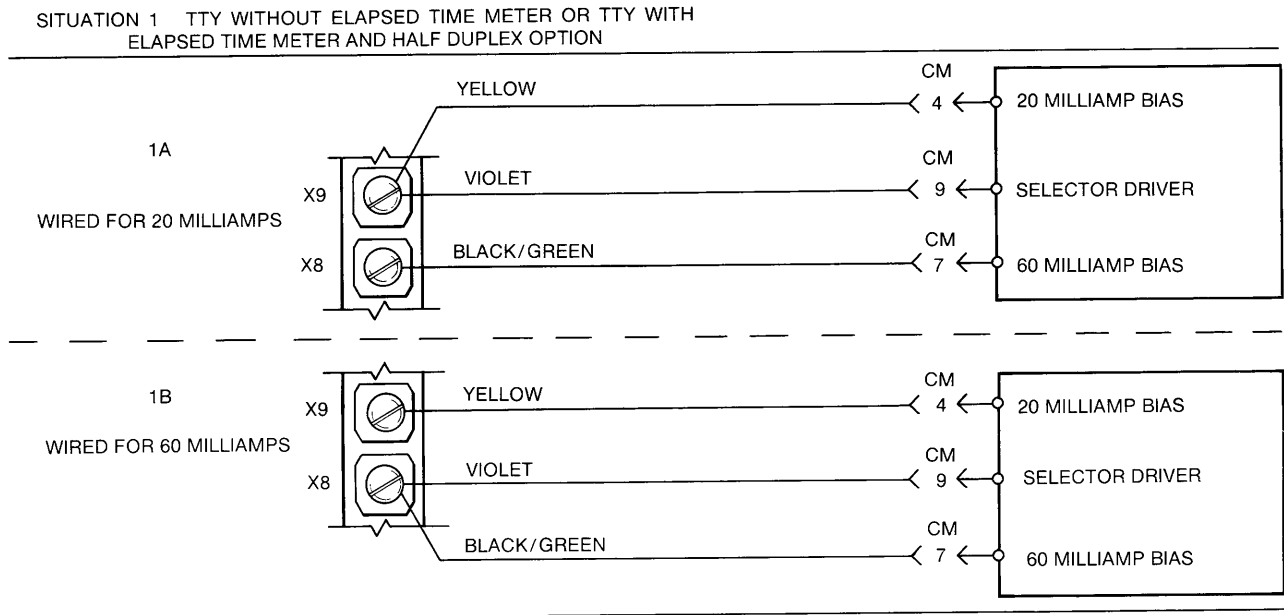

9812M980-16

Figure 16-5. Current Loop Option (Situation 1)

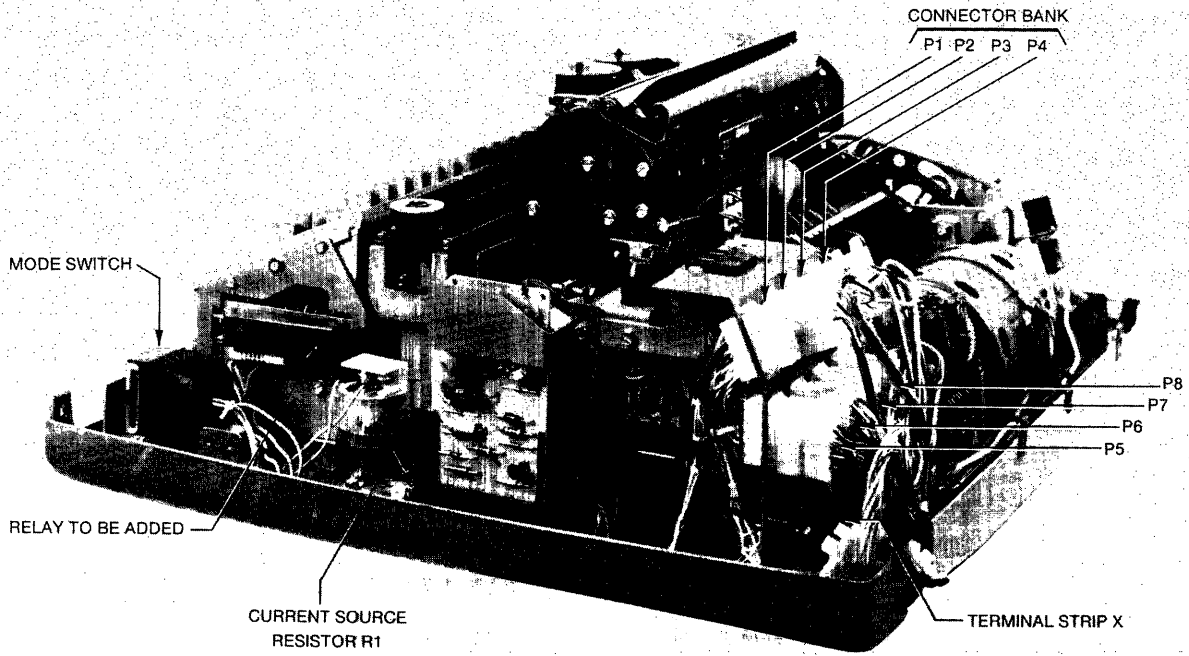
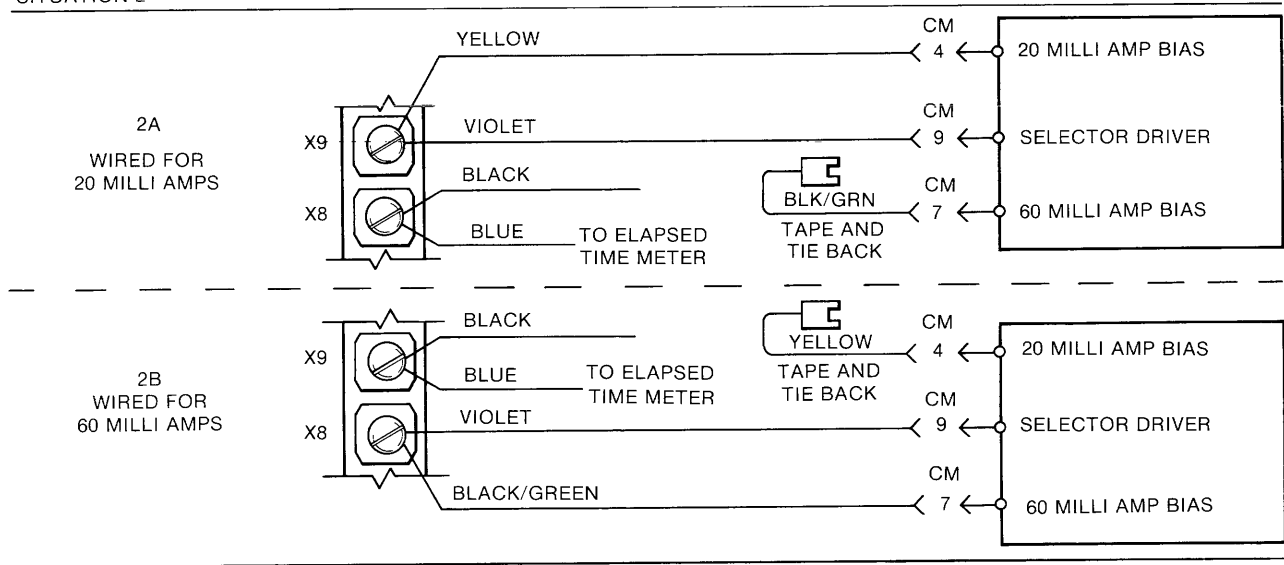

Figure 16-6. Side View—TTY with Housing Removed

## SITUATION 2 TTY WITH ELAPSED TIME METER AND FULL DUPLEX



9812M980-17

Figure 16-7. Current Loop Option (Situation 2)

**TTY With Elapsed Time Meter**

A TTY with an Elapsed Time Meter may be wired as 1A, 1B, 2A or 2B. To modify for 20mA:

If wired as 1A: Remove the black/green wire from Terminal X8, tape the exposed end and tie back into the wire bundle. Locate a black wire and a blue wire on Terminal X5. Move both wires from X5 to X8.

If wired as 1B: Remove the violet wire from Terminal X8 and move it to X9. Remove the black/green wire from X8, tape the exposed end and tie back into the wire bundle. Locate a black wire and a blue wire connected on X5. Move both wires from X5 to X8.

If wired as 2A: Do nothing; this is the correct connection for 20mA with an Elapsed Time Meter.

If wired as 2B: Remove the black wire and blue wire from X9. Remove the violet wire and black/green wire from X8. Connect the black wire and blue wire to X8. Connect the violet wire to X9. Locate the yellow wire taped back into the wire bundle. Connect the yellow wire to X9. Tape the exposed end of the black/green wire and tie back into wire bundle.

### Full Duplex Option

The Full Duplex Option is wired into the TTY on Terminal Strip X located below the Connector Bank in the right rear corner of the unit.

If the TTY is wired for Half-Duplex, Terminal Strip X should appear as in Figure 16-8.

If the TTY is wired for Full-Duplex, Terminal Strip X should appear as in Figure 16-9.

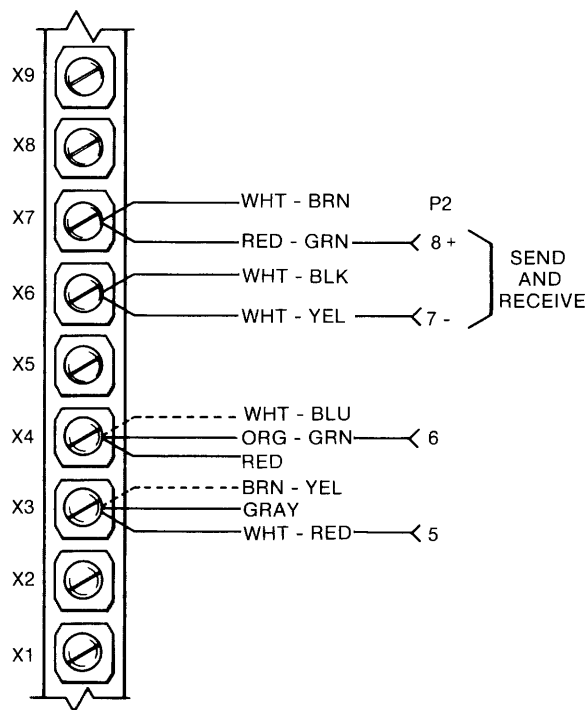

9812M980-18

Figure 16-8. TTY Half-Duplex Option

To convert from Half-Duplex to Full-Duplex:

1. Confirm that screw lug X5 has no wires connected. If there is a black wire and a blue wire on X5, an Elapsed Time Meter is installed. Refer to the Current Loop Option for instructions on moving the black wire and blue wire from X5 to X8.
2. Move the white/blue wire from screw lug X4 to X5.
3. Move the brown/yellow wire from screw lug X3 to X5.

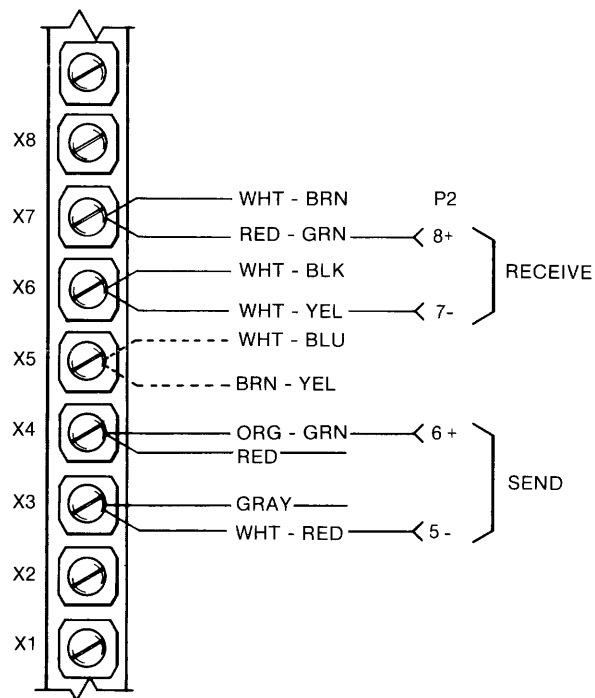

9812M980-19

Figure 16-9. TTY Full-Duplex Option

### Remote TTY Reader Control

The wiring of standard teletype does not allow the TTY Paper Tape Reader to be used remotely as a stand-alone input device. By modifying the distributor trip circuit for remote operation, the TTY Reader can be advanced one character at a time for total reader control.

TTY circuits operate from 115 VAC or 48 VDC requiring remote logic control circuits to be relay-buffered. Two basic reader circuits will be encountered in TTY reader modification: Manual and Automatic. The Manual and Automatic Readers are identified by the Reader Control switch located on the Paper Tape Reader. The Manual Reader has a three-position switch labeled ON, OFF, FREE. The Automatic Reader has a four-position switch labeled MANUAL START, AUTO, MANUAL STOP, FREE.

### Manual Reader Operation

The 115 VAC Manual Reader Circuit is operated in either the Line or Local Modes by the ON-OFF switch located on the Reader.

The Manual Reader Circuit can be controlled remotely by adding a Relay to control the reader trip coil in the Line Mode. Modifying the reader circuit as shown in Figure 16-10 allows normal operation in the Local Mode and remote control in the Line Mode.

### Manual Reader Modification

1. Locate Plug P4.  
Locate the blue wire connection P4 pin 3 and P4 pin 11.  
Locate the orange wire on screw lug L1 of the Mode switch.  
Locate the L2 of the Mode switch (no wires).  
Locate the orange/gray wire on screw lug 1 of the Mode switch.  
If the wire colors do not agree, do not proceed with this modification unless the connections can be verified to agree with those of Figure 16-10.
2. Cut the blue wire near P4 pin 3.
3. Splice wire A from the new Relay to the portion of the blue wire still connected to P4 pin 11.
4. Connect wire B to screw lug L1 of the Mode switch.
5. Connect wire C to screw lug L2 of the Mode switch.

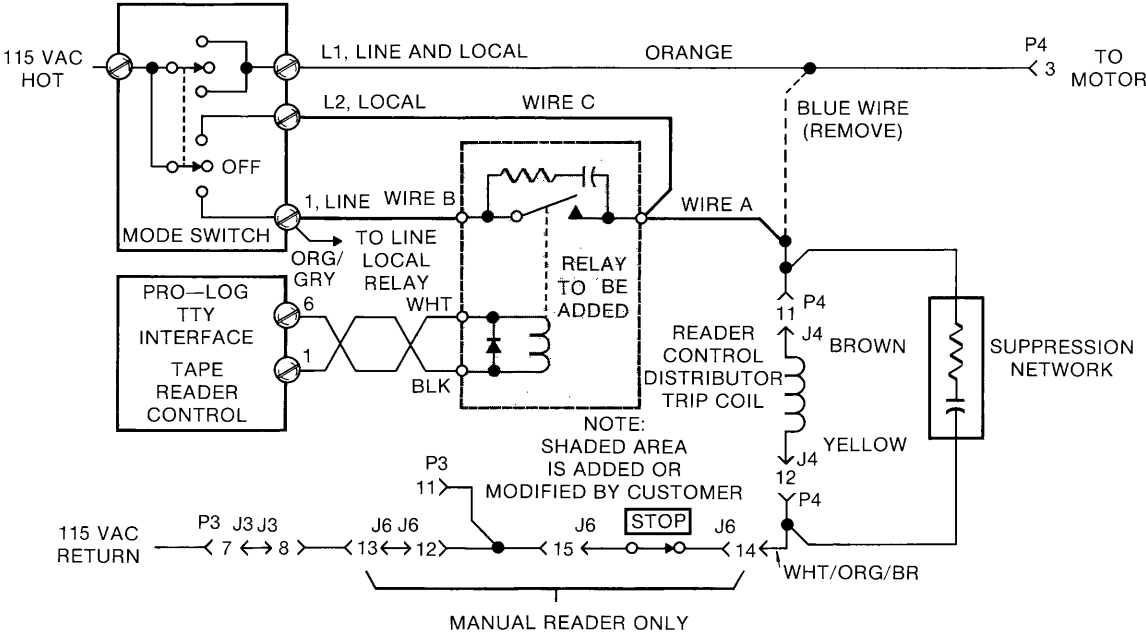

9812M980-20

Figure 16-10. TTY Modification (Manual Reader)

### Auto Reader Operation

The 115 VAC Automatic Reader Circuit is normally open due to the TDC Relay contact. The 48 VDC TDC Relay can be operated by the momentary Manual Start switch on the Reader or by the DC1 data function. Once the TDC Relay operates, it holds itself energized until the momentary Manual Stop switch on the Reader is activated. The DC3 and ENQ data functions will also stop the Reader.

The Automatic Reader circuit can be controlled remotely by adding a Relay to control a contact closure in parallel across the TDC Relay contact as shown in Figure 16-11.

### Auto Reader Modification

1. Locate jack J6 connected to plug P6.  
 Locate the yellow/green wire at J6-13.  
 Locate the blue wire at J6-14.  
 If the wire colors do not agree, do not proceed with this modification unless the connection can be verified to agree with those of Figure 16-11.
2. Connect wire A from the new Relay to the blue wire at J6-14.
3. Connect wire B from the new Relay to the yellow/-green wire at J6-13.

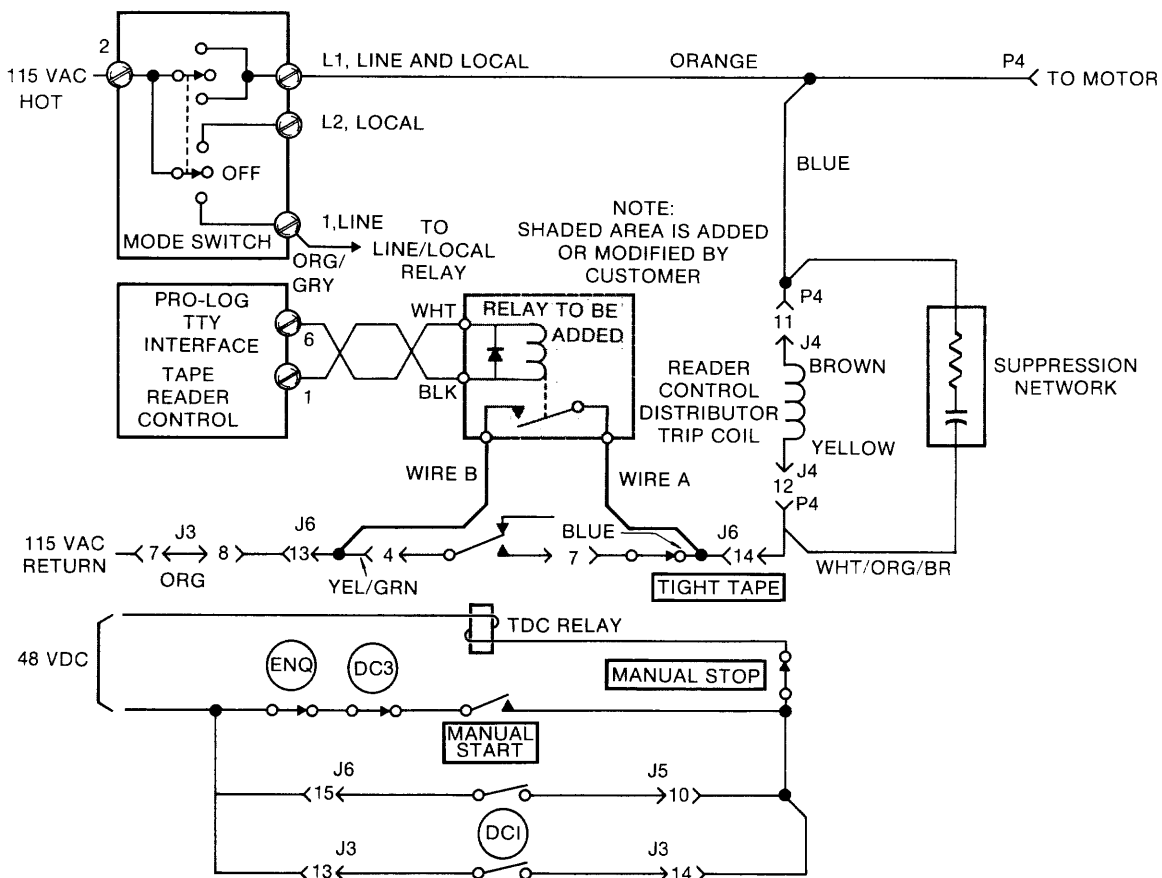

9812M980-21

Figure 16-11. TTY Modification (Auto Reader)

# SECTION 17

## 9814, COMPUTER INTERFACE

The 9814 computer interface (Figure 17-1) provides an 8-bit parallel data path for transferring data to or from a computer and to or from the M980 RAM Buffer.

### Master or Slave Operation

The M980, through its parallel interface, can be configured as a Master Controller or a Slave Unit to a remote computer. The configuration is controlled by the cable interconnection and the keyboard selected formats of the M980 are shown in Figure 17-2.

| FORMAT  | CONFIGURATION                          |
|---------|----------------------------------------|
| 9814-00 | Slave Unit (default format)            |
| 9814-01 | Master Controller write to Slave Unit  |
| 9814-02 | Master Controller read from Slave Unit |

Figure 17-2. 9814 Format Selection

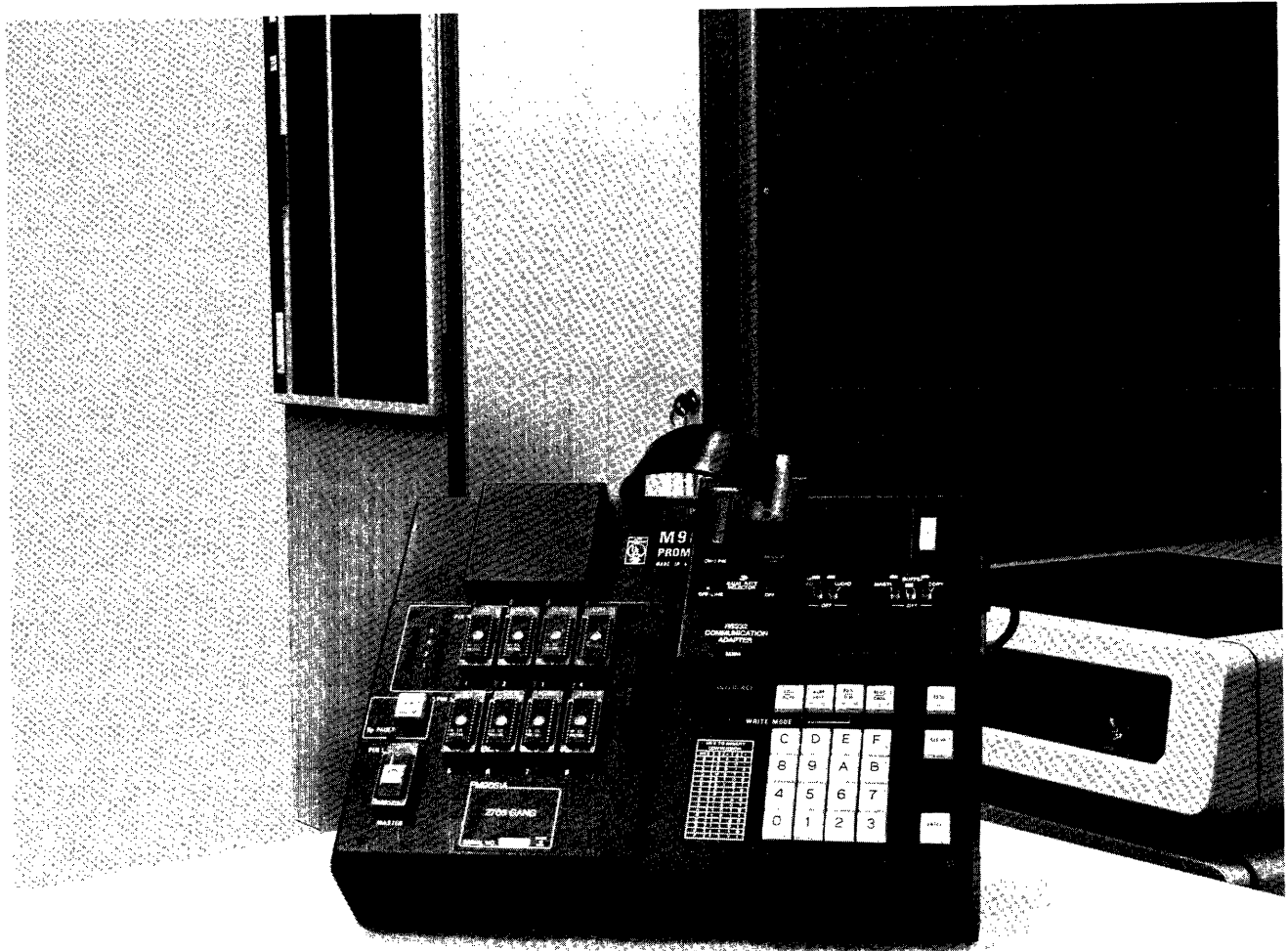
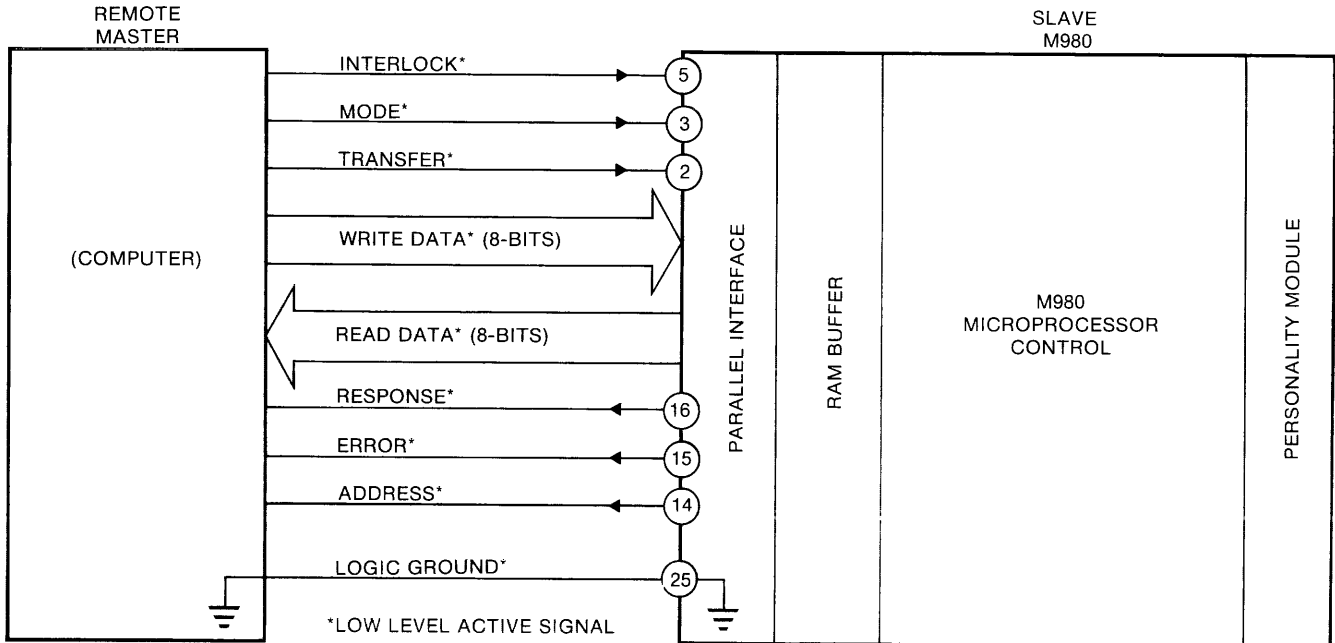

Figure 17-1. Computer Interface

9814-00, M980 Slave Unit Operation

The default format 9814-00 configures the M980 as a Slave Unit (see Figure 17-3), allowing a remote Master Controller to either write data to the M980 Buffer or read data from the M980 Buffer. This configuration puts the remote computer in command of the M980.



98-2M980.22

Figure 17-3. M980 Configured as a Slave Unit



### 9814-01 and 9814-02, M980 Master Controller Operation

Master formats 9814-01 and 9814-02 allow the M980 to be configured as a Master Controller (see Figure 17-4), to send data from its Buffer to a remote Slave Unit or to receive data into its Buffer from a remote Slave Unit. This configuration puts the M980 in command of the remote computer.

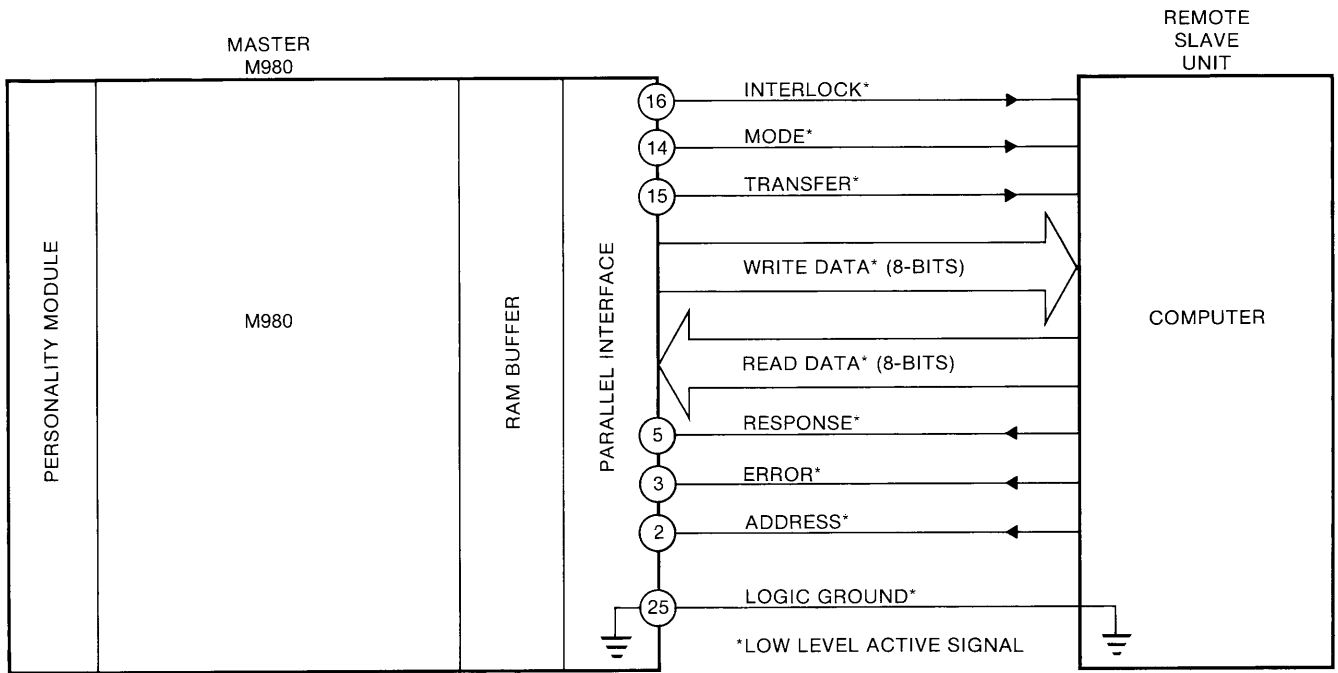

9812M980-23

Figure 17-4. M980 Configured as a Master Controller

### SUMMARY OF OPERATION

The Master Controller sends a Start Address and an End Address to the Slave Unit to define the field size for the M980 Buffer memory. When address field definition is completed, the Master Controller selects either the Write or Read Mode and initiates the data transfer between the M980 Buffer and the remote computer. Eight bits of data are transferred for each address location.

When the complete field of data has been transferred, the M980 Slave Unit resets to the address field definition for the next operation. The M980 Master Controller returns to select another format or repeat the same format.

### Address Field Definition

The address field of the M980 Buffer must be defined with a Start Address and an End Address, by the Master Controller for each operation. The address field is sent as eight hexadecimal characters, in which each hex character represents four bits of the binary address. In the 8-bit character sent to the M980 for field definition, the low-order 4 bits contain the hex address character (see Figure 17-5).

### M980/M900B Recognition Code ("0A")

The M980 Slave Unit places an "0A" (binary 0000 1010) on the read data lines to signify that this unit is a 9814 option, as opposed to a 9114 option used on the M900B programmer.

The "0A" occurs just before Address goes low and remains during the address portion of the operation.

The M980 requires eight characters to define the address field, whereas the M900B only requires six characters. The "0A" recognition code allows the Master Controller to identify which model is connected. The recognition code can be ignored if M900B compatibility does not matter.

### 9814-00 Operating Procedure (M980 Slave Unit)

Connect the Master Controller to the M980 via the parallel interface connector. Depress Key 4 on the M980 keyboard. The M980 display shows "9814-00." Ensure that the Master Controller is conditioned to hold the INTERLOCK signal low. Depress the ENTER key. The display shows "A 00 AAA." If the interface connection is unsuccessful, the display shows "E5" to indicate Not Ready and you must verify that the Master Controller is holding the INTERLOCK low. The left-most display "A" indicates that the interface is looking for the controller to send a 4-digit Start Address, followed by a 4-digit End Address; this defines the Buffer address range to be operated on.

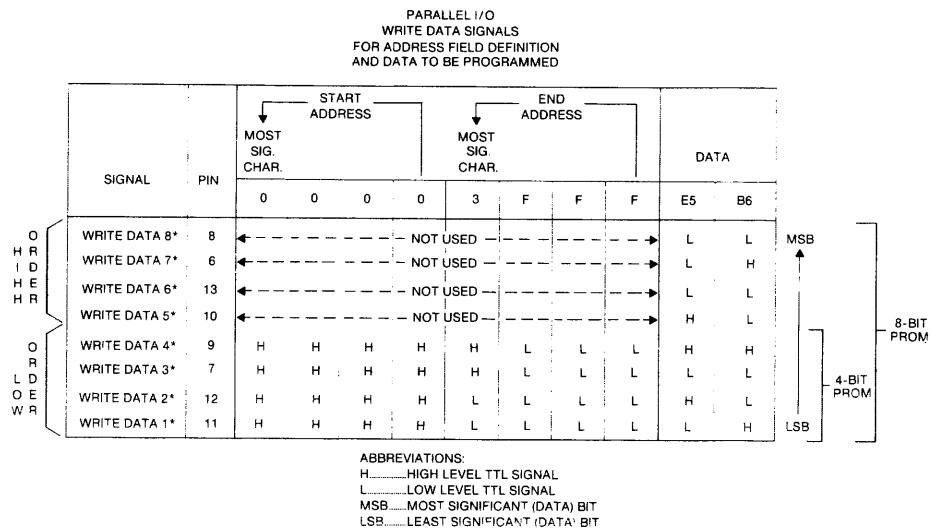

9812V960-24

Figure 17-5. Data Signals for Address Definition

The Master Controller selects either the Read Mode to read data from the Buffer, or the Write Mode to send data to the Buffer.

The display on the Slave M980 shows "1 00 AAA" to indicate that it is inputting data to the Buffer in the Write Mode. The display shows "0 00 AAA" to indicate that it is outputting data from the Buffer in the Read Mode. When the operation is completed, the display shows "1 00 F" for Write Mode Finished and "0 00 F" for Read Mode Finished.

After the M980 Slave has recognized the interface, by raising INTERLOCK the M980 displays "A 00 E5" to indicate Not Ready. By lowering INTERLOCK, the M980 returns to the address field definition phase of the operation and displays "A 00 AAA." Waveform diagrams and flow charts for the Controller are shown on the following pages (see Figures 17-8 through 17-13).

### 9814-01 and 9814-02 Operating Procedure (M980 Master Controller)

Connect the Slave Unit to the M980 via the parallel interface connector. Depress Key 4 on the Master keyboard. The M908 display shows "9814 00." Key in the "01" format for sending to the Slave Unit, or "02" format for receiving from the Slave Unit. Depress ENTER. At this point, the M980 Master Controller activates the INTERLOCK line. The M980 display shows the First and Last Addresses of the RAM Buffer. The desired Start and End Address of the field to be transferred can now be entered from the M980 keyboard. Depress ENTER to accept the address field. The display shows "A XX AAA," where "XX" is format "01" or "02." If the Slave Unit is ready, the display shows "0 01 AAA" for data output to the Slave, and "1 02 AAA" for data input from the Slave.

When the operation is completed, the display shows "0 01 F" for Write Mode Finished, and "1 02 F" for Read Mode Finished.

The M980 Master Controller releases the INTERLOCK after each operation.

| 9814—00 M980 Slave Unit Displays Messages |     |                                                                                        |
|-------------------------------------------|-----|----------------------------------------------------------------------------------------|
| 9814                                      | 00  | Slave Unit selected.                                                                   |
| 00                                        | E5  | Slave Unit finds INTERLOCK not ready. Reselect option.                                 |
| A 00                                      | E5  | Slave Unit reset by INTERLOCK. Normal waiting state. Slave Unit waiting for INTERLOCK. |
| A 00                                      | AAA | Slave Unit ready to receive address from Master Controller.                            |
| 1 00                                      | AAA | Slave Unit receiving data.                                                             |
| 0 00                                      | AAA | Slave Unit sending data.                                                               |
| A 00                                      | E3  | Mode line error during address field definition. Reselect option.                      |

| 9814—01 M980 Master Controller Display Messages (Write) |     |                                                                           |
|---------------------------------------------------------|-----|---------------------------------------------------------------------------|
| 9814                                                    | 01  | Master Controller Selected (Write).                                       |
| A 01                                                    | AAA | Master Controller waiting for Slave Unit to accept address.               |
| A 01                                                    | E3  | Master Controller senses incorrect Address or Error line from Slave Unit. |
| 0 01                                                    | AAA | Master Controller sending data.                                           |
| 0 01                                                    | F   | Write operation completed.                                                |
| 0 01                                                    | E1  | Master Controller senses Error line during data transfer.                 |

| 9814—02 M980 Master Controller Display Messages (Read) |     |                                                                           |
|--------------------------------------------------------|-----|---------------------------------------------------------------------------|
| 9814                                                   | 02  | Master Controller Selected (Read).                                        |
| A 02                                                   | AAA | Master Controller waiting for Slave Unit to accept address.               |
| A 02                                                   | E3  | Master Controller senses incorrect address or Error line from Slave Unit. |
| 1 02                                                   | AAA | Master Controller receiving data.                                         |
| 1 02                                                   | F   | Read operation completed.                                                 |
| 1 02                                                   | E1  | Master Controller senses error line during data transfer.                 |

## 9814 INTERFACING

The 9814 interface is a TTL signal compatible interface as defined in the connector tables of Figures 17-6 and 17-7. You must choose the correct cable connection, depending on whether the unit is to be a Master Controller or a Slave Unit.

You can make two M980s talk to each other using a cross-wired cable with each end appropriately wired. With a cross-wired cable, either of the M980s may take the role of Master Controller. Do not connect a straight-wired cable between two M980s, since it may damage the interface circuitry.

We have included signal definitions, timing diagrams, and flow-charts to assist you in designing the remote interface (see Figures 17-6 through 17-13).

## INPUTS (active low level logic, 1 TTL load)

| PIN | SIGNAL        | INPUT PORT ADDRESS | COMMENT |
|-----|---------------|--------------------|---------|
| 8   | WRITE DATA 8* | IN 2-8             | MSB     |
| 6   | WRITE DATA 7* | IN 2-4             |         |
| 13  | WRITE DATA 6* | IN 2-2             |         |
| 10  | WRITE DATA 5* | IN 2-1             |         |
| 9   | WRITE DATA 4* | IN 3-8             |         |
| 7   | WRITE DATA 3* | IN 3-4             |         |
| 12  | WRITE DATA 2* | IN 3-2             |         |
| 11  | WRITE DATA 1* | IN 3-1             | LSB     |
| 2   | TRANSFER*     | IN 4-8             |         |
| 3   | MODE*         | IN 4-4             |         |
| 5   | INTERLOCK*    | IN 4-1             |         |

## OUTPUTS (active low level logic, 10 TTL load drive)

| PIN | SIGNAL       | INPUT PORT ADDRESS | COMMENT |
|-----|--------------|--------------------|---------|
| 22  | READ DATA 8* | OUT 4-8            | MSB     |
| 21  | READ DATA 7* | OUT 4-4            |         |
| 24  | READ DATA 6* | OUT 4-2            |         |
| 23  | READ DATA 5* | OUT 4-1            |         |
| 18  | READ DATA 4* | OUT 5-8            |         |
| 17  | READ DATA 3* | OUT 5-4            |         |
| 20  | READ DATA 2* | OUT 5-2            |         |
| 19  | READ DATA 1* | OUT 5-1            | LSB     |
| 15  | ADDRESS*     | OUT 6-8            |         |
| 14  | ERROR*       | OUT 6-4            |         |
| 16  | RESPONSE*    | OUT 6-1            |         |

## POWER OUTPUTS

| PIN | SIGNAL       | COMMENT                    |
|-----|--------------|----------------------------|
| 1   | +5 volts     | No connection              |
| 25  | LOGIC GROUND | Connect for reference only |
| 4   | -12 volts    | No connection              |

\* low level active indicator

Figure 17-6. Connector Interface Pin List for M980 Slave Unit

## INPUTS (active low level logic, 1 TTL load)

| PIN | SIGNAL       | INPUT PORT ADDRESS | COMMENT |
|-----|--------------|--------------------|---------|
| 8   | READ DATA 8* | IN 2-8             | MSB     |
| 6   | READ DATA 7* | IN 2-4             |         |
| 13  | READ DATA 6* | IN 2-2             |         |
| 10  | READ DATA 5* | IN 2-1             |         |
| 9   | READ DATA 4* | IN 3-8             |         |
| 7   | READ DATA 3* | IN 3-4             |         |
| 12  | READ DATA 2* | IN 3-2             |         |
| 11  | READ DATA 1* | IN 3-1             | LSB     |
| 2   | ADDRESS*     | IN 4-8             |         |
| 3   | ERROR*       | IN 4-4             |         |
| 5   | RESPONSE*    | IN 4-1             |         |

## OUTPUTS (active low level logic, 10 TTL load drive)

| PIN | SIGNAL        | INPUT PORT ADDRESS | COMMENT |
|-----|---------------|--------------------|---------|
| 22  | WRITE DATA 8* | OUT 4-8            | MSB     |
| 21  | WRITE DATA 7* | OUT 4-4            |         |
| 24  | WRITE DATA 6* | OUT 4-2            |         |
| 23  | WRITE DATA 5* | OUT 4-1            |         |
| 18  | WRITE DATA 4* | OUT 5-8            |         |
| 17  | WRITE DATA 3* | OUT 5-4            |         |
| 20  | WRITE DATA 2* | OUT 5-2            |         |
| 19  | WRITE DATA 1* | OUT 5-1            | LSB     |
| 15  | TRANSFER*     | OUT 6-8            |         |
| 14  | MODE*         | OUT 6-4            |         |
| 16  | INTERLOCK*    | OUT 6-1            |         |

## POWER OUTPUTS

| PIN | SIGNAL       | COMMENT                    |
|-----|--------------|----------------------------|
| 1   | +5 volts     | No connection              |
| 25  | LOGIC GROUND | Connect for reference only |
| 4   | -12 volts    | No connection              |

\*low level active indicator

Figure 17-7. Connector Interface Pin List for M980 Master Controller

## SIGNAL DEFINITIONS

INTERLOCK is a signal line from the Master Controller that causes the Slave Unit to recognize the Remote interface. The Master Controller acquires control of the Slave Unit by holding INTERLOCK low, and it can then use the INTERLOCK to reset the Slave Unit to the address field definition phase of the operation if any error is detected.

MODE is a signal line from the Master Controller that indicates to the Slave Unit the direction of data transfer. It must be held low during Address field definition and in the Write Mode, and it must be held high in the Read Mode of operation.

TRANSFER is a signal line from the Master Controller which indicates to the Slave Unit that the Remote Controller is ready to effect a data transfer either to or from the Slave Unit, as indicated by the Mode line. The TRANSFER line must not change from high to low unless RESPONSE is high; it should be held low until the Master Controller detects a low RESPONSE signal. If the Master Controller is sending data to the Slave Unit, the WRITE DATA lines must be stable before TRANSFER occurs. If data is being requested by the Master Controller, the READ DATA lines should be read after the RESPONSE signal goes low and before TRANSFER is removed (high signal).

RESPONSE is a signal sent by the Slave Unit as a response to the TRANSFER line. During address field definition, it indicates that the address character has been accepted. RESPONSE remains low until the last address character has been accepted. In the Write Mode, RESPONSE indicates that data has been accepted and stored by the Slave Unit. In the Read Mode, RESPONSE indicates that data is available on the READ DATA lines.

ADDRESS is a signal sent by the Slave Unit to indicate that address field definition is required. It occurs in response to detection of the INTERLOCK signal, whenever the 9814 is selected. ADDRESS remains active until all field definition characters have been transferred to the Slave Unit. It terminates prematurely if the MODE line is in the incorrect state (high).

ERROR is a signal sent by the Slave Unit to indicate an error condition. ERROR occurs in combination with RESPONSE and ADDRESS to indicate Error Mode during address field definition. It may also occur in combination with RESPONSE, to indicate error during data transfer.

WRITE DATA consists of eight data lines from the Master Controller for transferring address information and data information to the Slave Unit. Address information is sent as a series of hex characters. The low-order data lines send the hex address characters. Data to be written is sent as binary data. All 8 data lines are used for 8-bit words and the low-order four lines are used for 4-bit data. The most significant character is sent first, when defining the address.

READ DATA consists of eight data lines to the Master Controller for transferring data from the Slave Unit. Data is sent as binary data. All eight lines are used for 8-bit words and the low-order four lines are used for 4-bit data.

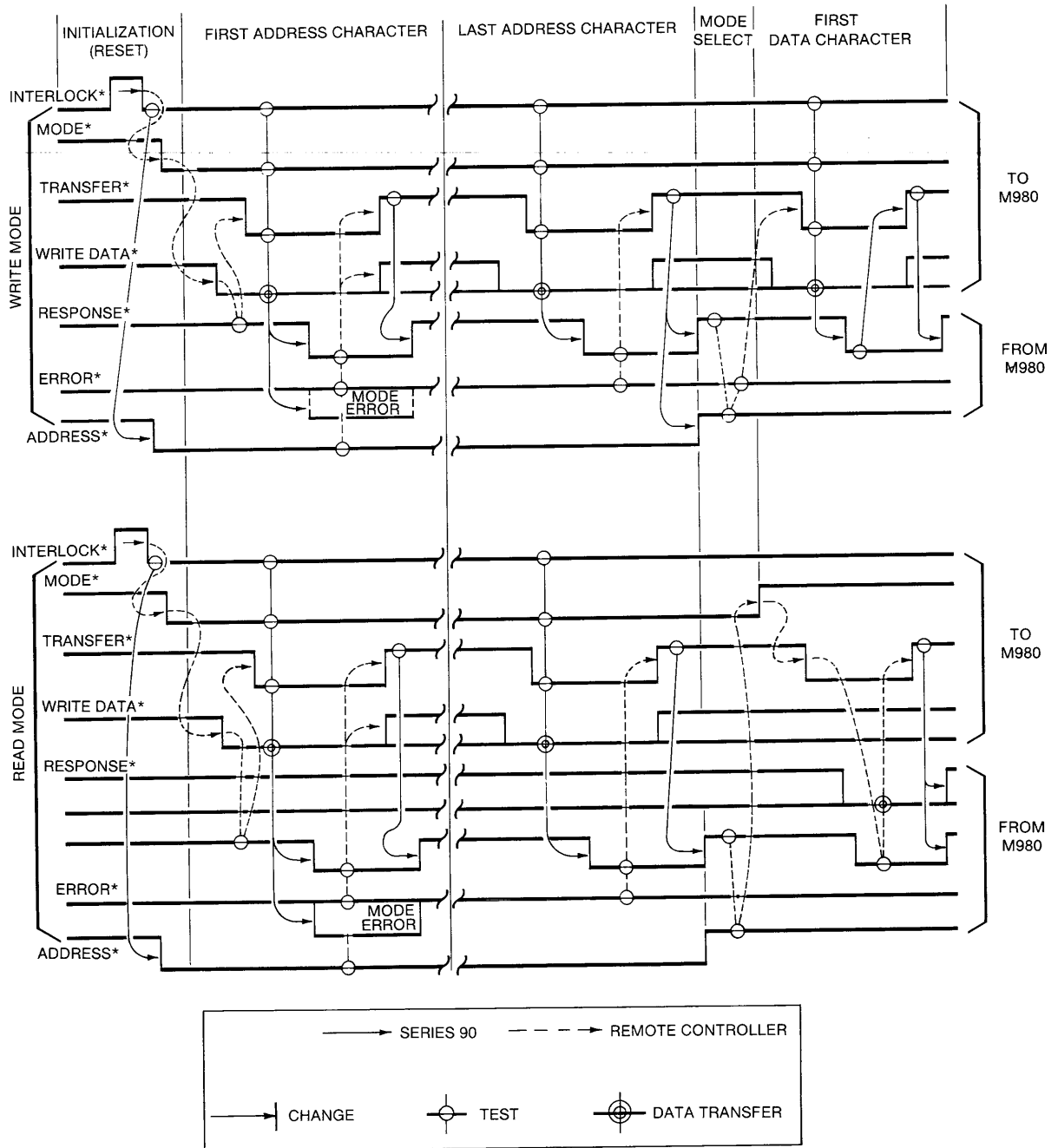

9812M980-25

Figure 17-8. Data Transfer Waveforms

The following flow diagrams represent the required sequence a remote controller must use for Read and Write operations. Note: All signals are low-level active TTL signals.

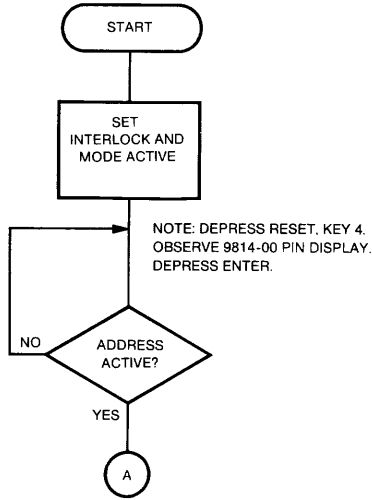

Figure 17-9. Initialization

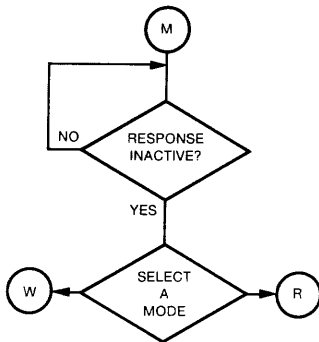

Figure 17-10. Mode Select

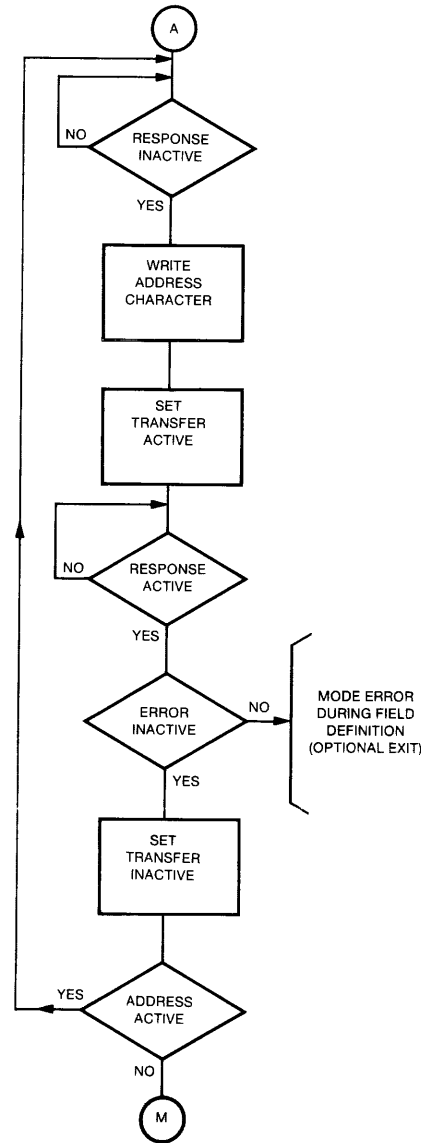

Figure 17-11. Address Definition



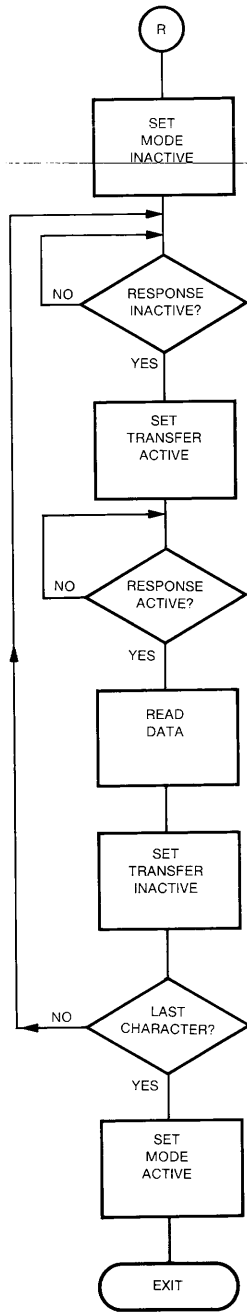

Figure 17-12. Read

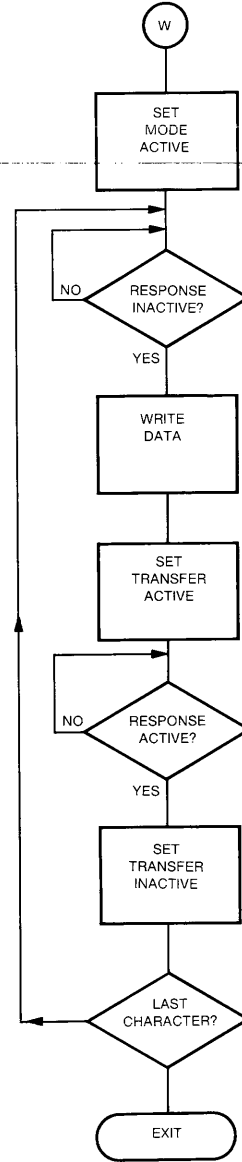

Figure 17-13. Write

9812/980-26

### PIN114 (PARALLEL INTERFACE OPTION) APPLICATIONS NOTE

#### Description

The PIN114 supplies an 8-bit parallel interface between STD BUS Systems and Pro-Log's M980 PROM Programmer. The PIN114 provides the hardware interface that allows a bidirectional transfer of data fields between the user's STD BUS System and the PROM Programmer. Data transfer is asynchronously controlled through handshake lines.

The PIN114 is immediately operational when interconnected to the STD BUS Prototyping Systems. Software to implement the interface is resident within the Prototyping System Monitor Program and PROM Programmer. A listing of this software is also shipped with the PIN114.

The PIN114 consists of 3 separate Pro-Log products: the 7507 I/O Card, RC50-6 Ribbon Cable, and 7140 Parallel Interface Adapter (see Figures 17-14, 17-15 and 17-16).

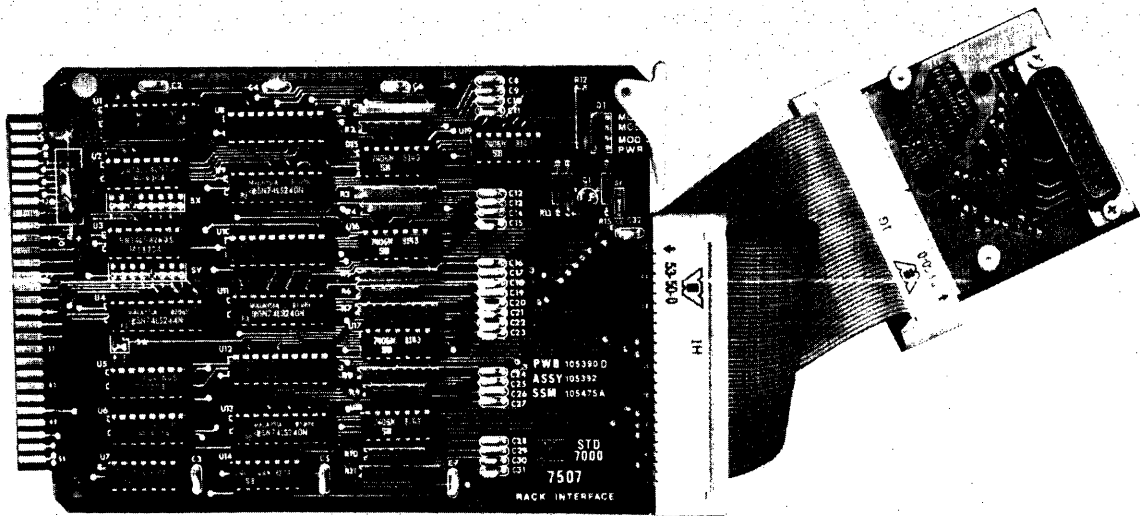
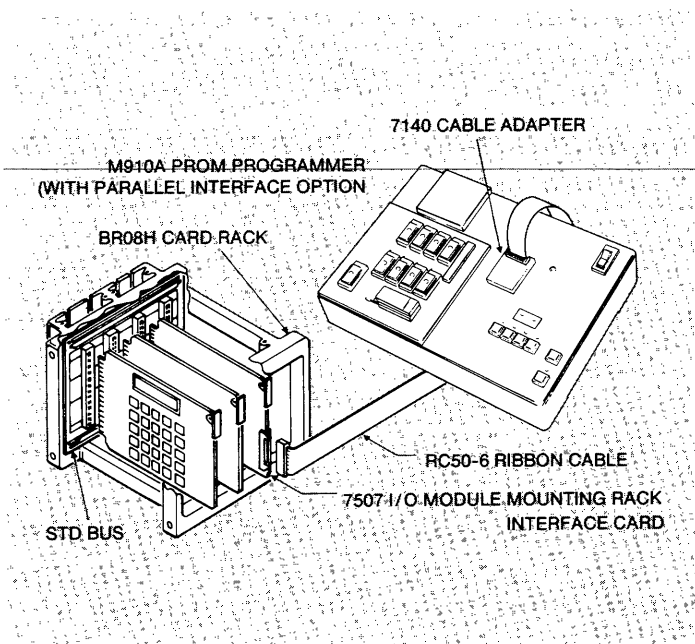
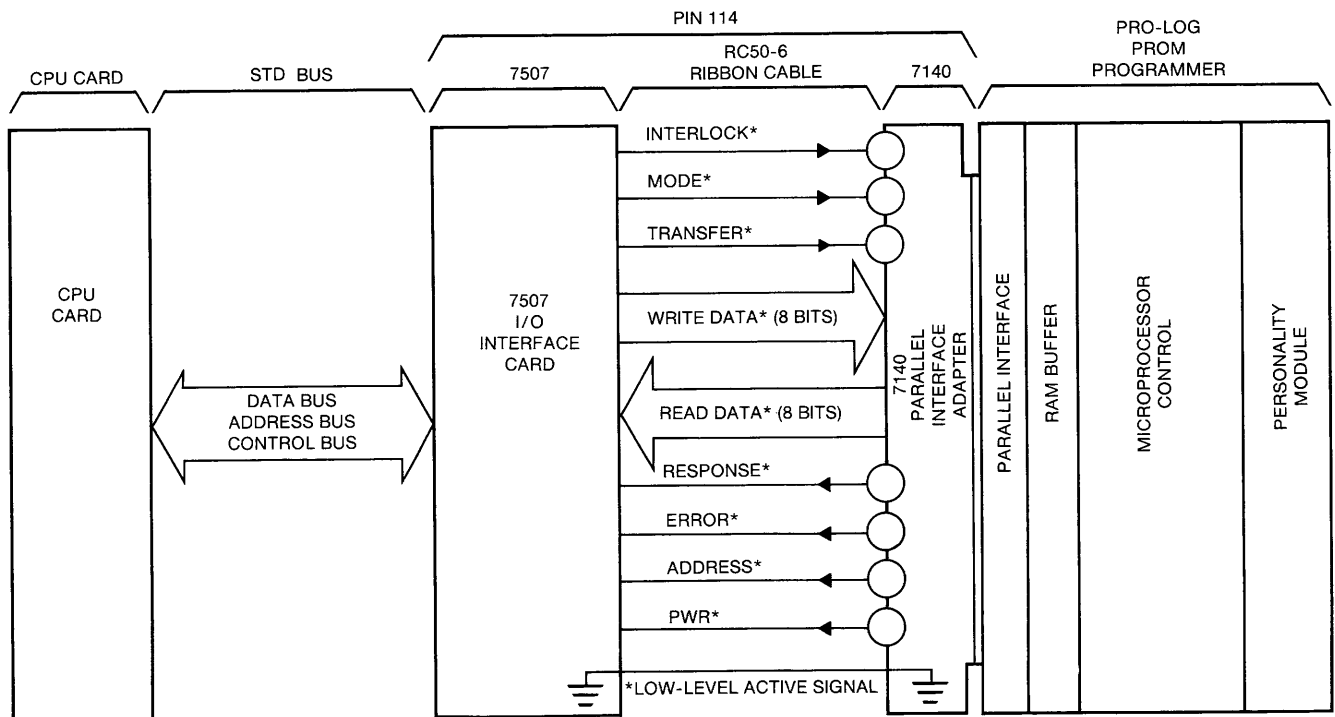

Figure 17-14. PIN 114 Parallel Interface System



9812M980-27

Figure 17-15. PIN 114 Connected to a Pro-Log PROM Programmer



9812M980-28

Figure 17-16. PIN 114 System Interconnect

## 7140 Parallel Interface Adapter

The 7140 Adapter simply connects the proper signal lines from the RC50-6 cable to the proper pins on the programmer's 25-Pin D Connector (see Figure 17-15).

## 7507 I/O Card

The 7507 is an STD BUS card which is used in the PIN114 as the STD BUS interface (see Figure 17-15). For information on installation and specifications of the 7507 card, see Section 2 of the 7507 User's Manual.

## RC50-6 Ribbon Cable

The RC50-6 is a six-foot-long ribbon cable with a 50-pin edge connector at each end (see Figure 17-15). This cable is used to connect the 7507 card, at the STD BUS, to the 7140 adapter at the PROM programmer. Six keys are included with RC50-6 Ribbon Cable. These keys are inserted into one of the slots on the face of the connector and the tab is then broken off. After the tab has been removed, the key should be glued into the slot if it does not fit securely.

Both the 7507 card and the 7140 adapter have key slots. These key slots are located between fingers 24 and 26 of both the 7507 and 7140. Using the RC50-6 polarizing keys insures connectors being inserted correctly. Figure 17-17 shows installation of the RC50-6 polarizing keys.

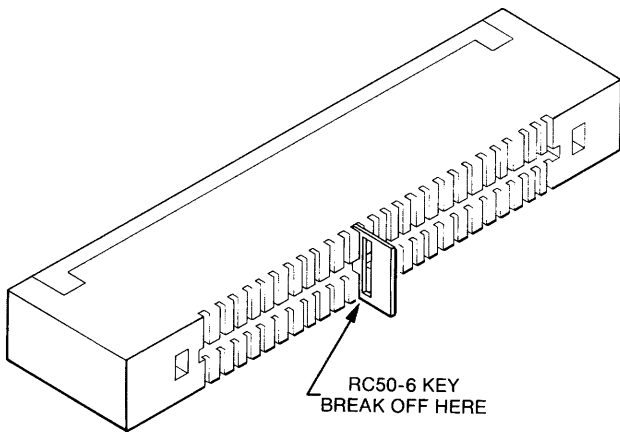

9812M980-29

Figure 17-17. RC50-6 Keying

## PIN114 Bit and Port Assignments

The PIN114 uses the 7507 I/O card for all communications with the STD BUS System. Figure 17-18 is a bit map which shows the bit and port assignments for each of the interface signals.

| PORT 50 <sup>1</sup> —WRITE DATA |    |    |    |       |    |    |    |
|----------------------------------|----|----|----|-------|----|----|----|
| D7                               | D6 | D5 | D4 | D3    | D2 | D1 | D0 |
| Bit 7                            |    |    |    | Bit 0 |    |    |    |

| PORT 51 <sup>1</sup> —WRITE HANDSHAKE |   |   |              |       |   |   |   |
|---------------------------------------|---|---|--------------|-------|---|---|---|
| T                                     | M | I | <sup>2</sup> | PWR   | A | E | R |
| Out                                   |   |   |              | In    |   |   |   |
| Bit 7                                 |   |   |              | Bit 0 |   |   |   |

| PORT 52 <sup>1</sup> —READ DATA |    |    |    |       |    |    |    |
|---------------------------------|----|----|----|-------|----|----|----|
| D7                              | D6 | D5 | D4 | D3    | D2 | D1 | D0 |
| Bit 7                           |    |    |    | Bit 0 |    |    |    |

| BIT | SOURCE         | LOGIC STATE <sup>3</sup>                                                                                           |
|-----|----------------|--------------------------------------------------------------------------------------------------------------------|
| I   | STD BUS System | 1=INTERLOCK* Active (low voltage)<br>0=INTERLOCK* Inactive (high voltage)                                          |
| M   | STD BUS System | 1=MODE* Active (low voltage)<br>0=MODE* Inactive (high voltage)                                                    |
| T   | STD BUS System | 1=TRANSFER* Active (low voltage)<br>0=TRANSFER* Inactive (high voltage)                                            |
| PWR | Programmer     | 1=Programmer power on<br>0=Programmer power off                                                                    |
| A   | Programmer     | 1=ADDRESS* Active (low voltage)<br>0=ADDRESS* Inactive (high voltage)<br>(ADDRESS* Inactive means data is present) |
| E   | Programmer     | 1=ERROR* Active (low voltage)<br>0=ERROR* Inactive (high voltage)                                                  |
| R   | Programmer     | 1=RESPONSE* Active (low voltage)<br>0=RESPONSE* Inactive (high voltage)                                            |

<sup>1</sup>The 7507 is mapped to address 50-52 when shipped.

<sup>2</sup>Don't care

<sup>3</sup>Handshake lines are active low electrically, active high on the STD Data Bus or the processor's accumulator.

\*Low Level Active

Figure 17-18. PIN 114 Bit and Port Assignments

### NOTE

When not used for the PROM programmer interface, the 7507 and RC50-6 can be used as an industrial I/O interface to OPTO-22, or equivalent module mounting racks, or as a general purpose TTL I/O card with 24 bit-programmable bidirectional lines.

# SECTION 18

## Communication Interface

### 9818 RS-232-C Communication Interface (General)

#### FUNCTIONAL DESCRIPTION

The M980 uses the M304 adapter (See Figure 18-1) as an RS-232-C interface between the programmer and a terminal and/or a modem. In the M304, a 25-pin D-type male connector for the terminal and a 25-pin D-type female connector for the modem permit simultaneous communication between the M980 and both connectors.

#### FEATURES

- Switch-selectable baud rate from 50 to 9600
- Program Buffer from terminal and/or modem
- Remote control programming of devices from terminal and/or computer
- List buffer to terminal and/or computer
- Selectable formats



Figure 18-1. M304 RS-232-C Communications Adapter

The communications interface consists of three functional elements: the Control Program located in the M980; the M304 adapter (see pages 18-47 through 18-50 for mechanical and electrical specifications) which plugs into the interface connector on the M980; and the RAM Buffer located in the M980. The M304 adapter interfaces the TTL level ports of the M980 with the RS-232-C type levels of a terminal/computer and/or modem/computer. Along with signal-level conversion, the M304 adapter provides switching capabilities for baud-rate selection, and for switching the modem and/or M980 On-Line or Off-Line. All data transfers are between the remote unit and the M980 RAM Buffer. Remote control commands are available to duplicate the RAM Buffer data into a device. All data transfers are in Half-Duplex. All data characters sent to or from the M980 are ASCII coded hexadecimal characters (0 through 9 and A through F) which are a subset of the larger ASCII character set. The M980 takes 4 bits of hexadecimal data and converts it into a ASCII coded character (8 serial bits) for transmission to the remote unit. See the ASCII Code Assignments (Figure 18-4) and the inside back cover of this manual.

#### M304 PANEL DESCRIPTION

##### ON—LINE/OFF-LINE Switch (S1)

This switch controls the Data Terminal Ready (DTR) line from the terminal connector, the Clear-to-Send (CTS) line from the modem connector, and data flow from the terminal and modem to the M980 inputs.

In the On-Line position, data is connected from the terminal connector to the input of the M980. In this position the DTR and/or CTS lines are wire OR'd and connected to the M980 inputs for On-Line recognition of the remote unit.

In the Off-Line position, the DTR line from the terminal connector and the CTS line from the modem connector are not connected to the M980 inputs and the interface will not be recognized. In this position the Transmit Data (TD) and Receive Data (RD) lines are also disconnected from the M980 inputs.

**BAUD-RATE SELECTOR Switch (S2)**

The baud-rate selector switch is a 16-position rotary switch, recessed behind the panel on the M304 adapter, and requires a screwdriver to rotate it. As the switch rotates, a Hex-coded number appears in the window just above the screwdriver slot. Refer to the table below for baud-rate versus position.

**NOTE**

Some formats will not operate at 9600 baud.

**Baud Rate Selection**

|               |     |      |      |       |       |      |      |
|---------------|-----|------|------|-------|-------|------|------|
| POSITION (S2) | D   | C    | 0    | B     | 1     | A    | 2    |
| BAUD RATE     | 50  | 75   | 110* | 134.5 | 150*  | 200  | 300* |
| POSITION (S2) | 9   | 4    | 5    | 8     | 3     | 6    | 7    |
| BAUD RATE     | 600 | 1200 | 1800 | 2400  | 2400* | 4800 | 9600 |

\*These positions cause the software to insert a 200-ms delay (in List Mode) after appropriate carriage returns and line feeds to accommodate mechanical terminals.

**MODEM ON/OFF Switch (S3)**

This switch controls data flow to and from the modem connector. In the OFF position, the modem computer is isolated from the data path between the terminal and the M980. However, since modem control lines are unaffected by S3, the modem can remain active.

**DTE/DCE Operation and Connection**

The combination of the M304 adapter, the M980 interface software, and the RAM Buffer, turns the M980 into either DTE (Data Terminal Equipment) or DCE (Data Communications Equipment). The terminal connector looks like a DCE and the modem connector looks like a DTE. When both DTE and DCE are connected, the M980 is transparent. The M980 monitors both TD (Transmitted Data) and RD (Receive Data) for valid data. These two lines are OR'd together to form the M980's receive data line. Therefore, only one piece of equipment may be sending data at any given time for the M980 to correctly recognize it as valid data. The M980 also transmits data on both TD (towards the modem) and RD (towards the terminal) and when the M980 transmits, neither DTE or DCE can transmit at the same time. All data transmissions are in half-duplex. Some DTE and DCE require DTR (Data Terminal Ready) or CTS (Clear to Send) in order to operate. The M304 adapter provides these signals if needed. However, the M980 must see either DTR or CTS to recognize a valid connection. Where the user's equipment does not or cannot provide these signals, a jumper scheme is shown in Figure 18-3 (Simple Hook-Up for DTE and DCE).

The simplified logic diagram (Figure 18-2) shows the M304 adapter and how the interconnecting signals are used. The pins not shown are as follows: pin 7 is chassis-ground; pins 9 through 19, and 11 through 25 are connected directly across from the terminal connector to the modem connector; pins 6 and 8 are pulled up to +Vcc on the terminal connector and are floating on the modem connector; pin 4 is pulled up to +Vcc on the modem connector and is floating on the terminal connector.

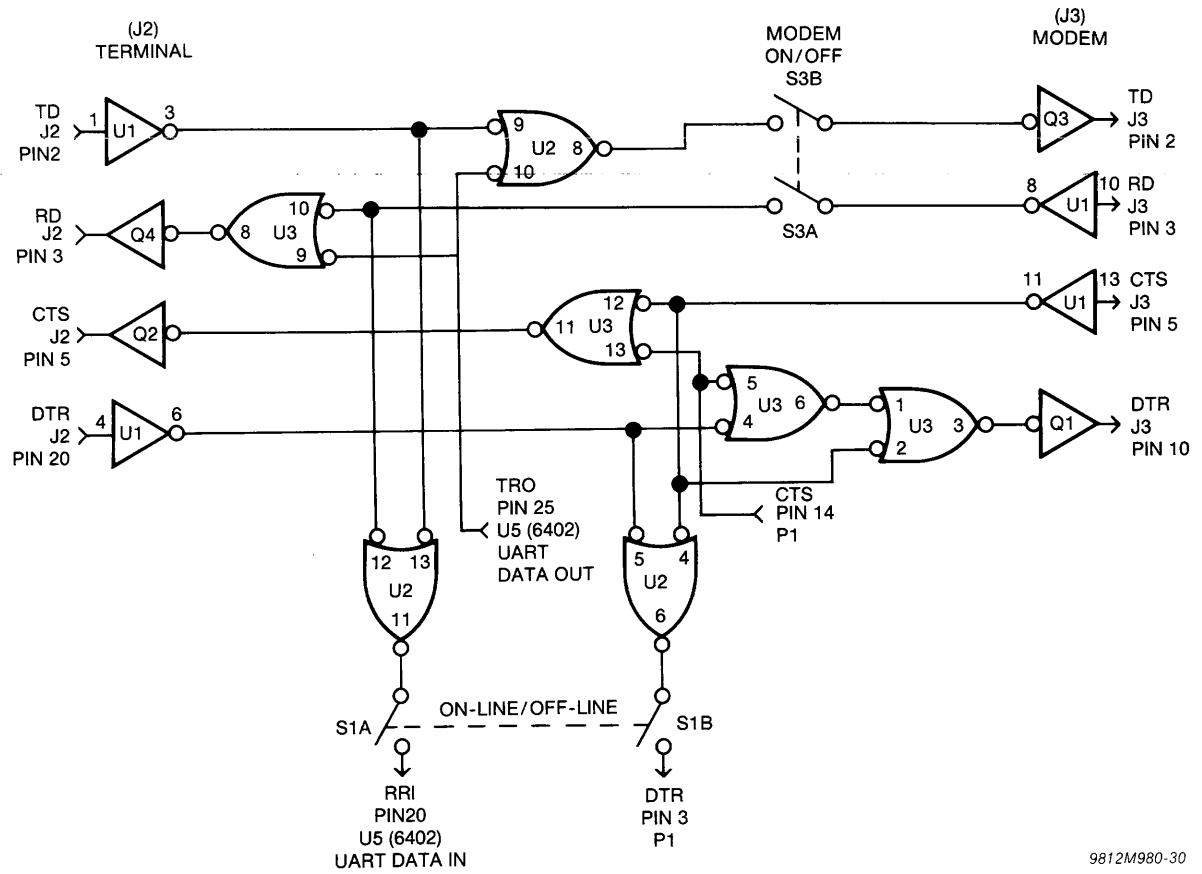

9812M980-30

Figure 18-2. M304 Signal Paths

### SIMPLE HOOK-UP FOR DTE AND DCE

Some DTE (Data Terminal Equipment) and DCE (Data Communications Equipment) can't provide the signals DTR or CTS needed by the M980 to recognize that a connection has been made. DTR and/or CTS must be pulled high (active) for the M980 to recognize it. Figure 18-3 shows how to connect these to the M304 Adapter.

**Example 1:** This example shows a DCE (modem) that cannot source CTS. CTS must be pulled high (active) so that the M304 adapter recognizes it.

**Example 2:** This example shows a DTE (terminal) that cannot source DTR. DTR must be pulled high (active) so that the M304 adapter recognizes it.

### CHARACTER STRUCTURE

All characters sent to and from the M980 RAM Buffer via the RS-232-C adapter are ASCII Coded characters (see Figure 18-4). Each character contains 8 bits consisting of 7 data bits and a parity bit. Parity is set to be EVEN when ASCII characters are sent by the M980 and can be ODD or EVEN when being received by the M980. One stop and start bit are sent by the M980 for each character and more than one stop character may be received by the M980. All data and address characters must be ASCII coded, Hexidecimal characters. Data characters A through F are upper case letters. See example below. To modify the character structure see pages 18-48.

**Example:**

| BINARY DATA<br>(Memory) | HEXIDECIMAL EQUIV.<br>(Displayed) | ASCII EQUIV.<br>(Serial Communications) |
|-------------------------|-----------------------------------|-----------------------------------------|
| 10110010                | B2                                | 01000010 10110010<br>(B) (2)            |
| 11111110                | FE                                | 11000110 11000101<br>(F) (E)            |

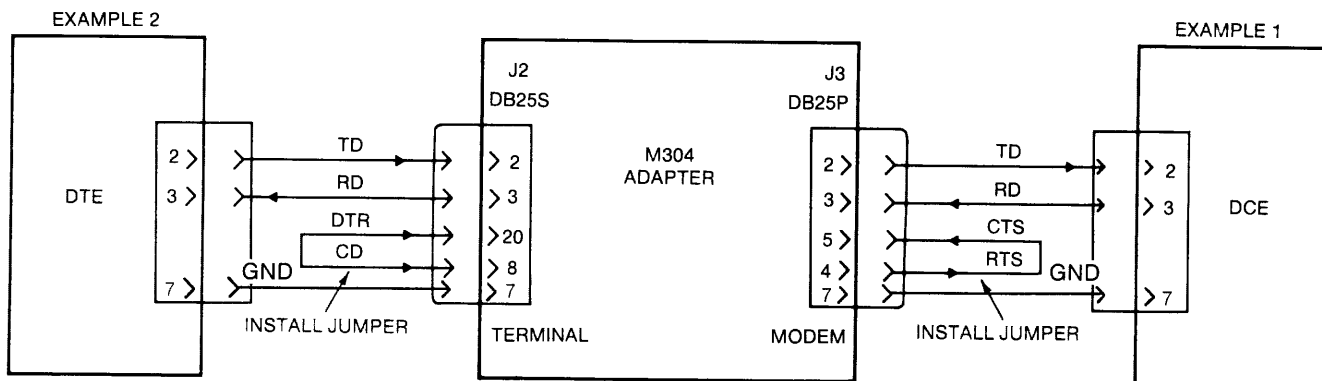

98-21-980-31

Figure 18-3. Hook-Up for DTE and DCE



| HEX | MSD  |    |    |    | p=1 | 8   | 9  | A | B | C | D | E   | F |
|-----|------|----|----|----|-----|-----|----|---|---|---|---|-----|---|
|     | BITS |    |    |    | p=0 | 0   | 1  | 2 | 3 | 4 | 5 | 6   | 7 |
| LSD | b4   | b3 | b2 | b1 | b8  | p   | p  | p | p | p | p | p   | p |
|     |      |    |    |    | b7  | 0   | 0  | 0 | 0 | 1 | 1 | 1   | 1 |
|     |      |    |    |    | b6  | 0   | 0  | 1 | 1 | 0 | 0 | 1   | 1 |
|     |      |    |    |    | b5  | 0   | 1  | 0 | 1 | 0 | 1 | 0   | 1 |
| 0   | 0    | 0  | 0  | 0  | NUL | DLE | SP | 0 | @ | P | ' | p   |   |
| 1   | 0    | 0  | 0  | 1  | SOH | DC1 | !  | 1 | A | Q | a | q   |   |
| 2   | 0    | 0  | 1  | 0  | STX | DC2 | '' | 2 | B | R | b | r   |   |
| 3   | 0    | 0  | 1  | 1  | ETX | DC3 | #  | 3 | C | S | c | s   |   |
| 4   | 0    | 1  | 0  | 0  | EOT | DC4 | \$ | 4 | D | T | d | t   |   |
| 5   | 0    | 1  | 0  | 1  | ENQ | NAK | %  | 5 | E | U | e | u   |   |
| 6   | 0    | 1  | 1  | 0  | ACK | SYN | &  | 6 | F | V | f | v   |   |
| 7   | 0    | 1  | 1  | 1  | BEL | ETB | ,  | 7 | G | W | g | w   |   |
| 8   | 1    | 0  | 0  | 0  | BS  | CAN | (  | 8 | H | X | h | x   |   |
| 9   | 1    | 0  | 0  | 1  | HT  | EM  | )  | 9 | I | Y | i | y   |   |
| A   | 1    | 0  | 1  | 0  | LF  | SUB | *  | : | J | Z | j | z   |   |
| B   | 1    | 0  | 1  | 1  | VT  | ESC | +  | ; | K | [ | k | {   |   |
| C   | 1    | 1  | 0  | 0  | FF  | FS  | ,  | < | L | \ | l |     |   |
| D   | 1    | 1  | 0  | 1  | CR  | GS  | -  | = | M | ] | m | }   |   |
| E   | 1    | 1  | 1  | 0  | SO  | RS  | .  | > | N | ^ | n | ~   |   |
| F   | 1    | 1  | 1  | 1  | SI  | US  | /  | ? | O | _ | o | DEL |   |

| CONTROL CHARACTERS |                                           |     |                           |
|--------------------|-------------------------------------------|-----|---------------------------|
| NUL                | Null                                      | FF  | Form Feed                 |
| SOH                | Start of Heading                          | CR  | Carriage Return           |
| STX                | Start of Text                             | SO  | Shift Out                 |
| ETX                | End of Text                               | SI  | Shift In                  |
| EOT                | End of Transmission                       | DLE | Data Link Escape          |
| ENQ                | Enquiry                                   | DC1 | Device Control 1          |
| ACK                | Acknowledge                               | DC2 | Device Control 2          |
| BEL                | Bell (audible or attention signal)        | DC3 | Device Control 3          |
| BS                 | Backspace                                 | DC4 | Device Control 4 (Stop)   |
| HT                 | Horizontal Tabulation (punched card skip) | NAK | Negative Acknowledge      |
| LF                 | Line Feed                                 | SYN | Synchronous Idle          |
| VT                 | Vertical Tabulation                       | ETB | End of Transmission Block |
|                    |                                           | CAN | Cancel                    |
|                    |                                           | EM  | End of Medium             |
|                    |                                           | SUB | Substitute                |
|                    |                                           | ESC | Escape                    |
|                    |                                           | FS  | File Separator            |
|                    |                                           | GS  | Group Separator           |
|                    |                                           | RS  | Record Separator          |
|                    |                                           | US  | Unit Separator            |
|                    |                                           | DEL | Delete                    |

Figure 18-4. ASCII Code Assignments

## HOW TO SELECT THE COMMUNICATIONS INTERFACE AND FORMATS

The following description shows how to select the RS-232-C interface and formats. For detailed information on each format, see the format descriptions on the following pages.

This sequence also allows the substitution of a Default Address for the First Address received or listed in any industrial format, i.e., INTEL. The Address Offset is automatically determined by the M980 and is subtracted from, or added to, all Data Record addresses in the Receive and List modes until the M980 is reset and a new Default Address is selected.

### Operation

1. Install the M304 adapter on the M980 (power must be OFF), using RC-18 cable or equivalent. Connect to system via M304 terminal or modem connector, whichever is appropriate. Turn the M304 on-line switch ON and modem ON if attached. Select the switches as shown.

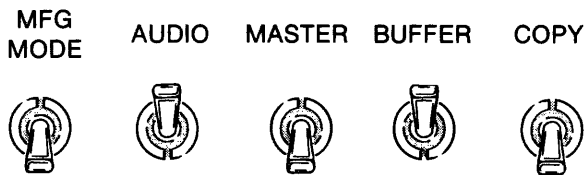

2. Turn M980 power ON, Depress RESET. The 8 hex displays are blank.

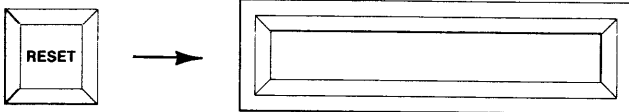

3. Depress key 8 to select the 9818 RS-232-C option. Display shows "9818 01" as a Default format.

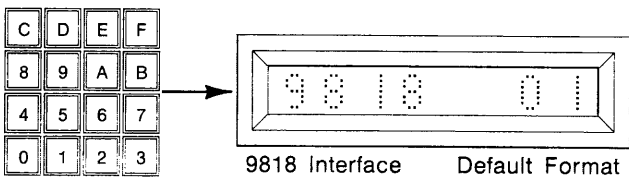

4. Select a new format number by using the hex key pad. Intel format 9818-10 is shown. Note: If an "E5" is displayed, check that the CTS and/or DTR lines are in the active (high) state. If no Address Offset is required, go to step #7.

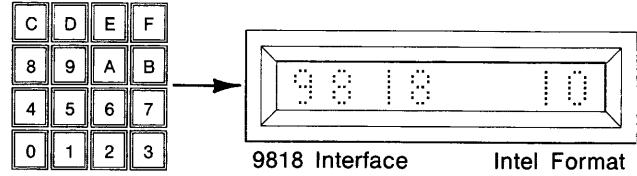

5. Depress the EDIT key to accept the selected format. The display shows all "0's" to indicate the Default Offset Address (see Page 18-8).

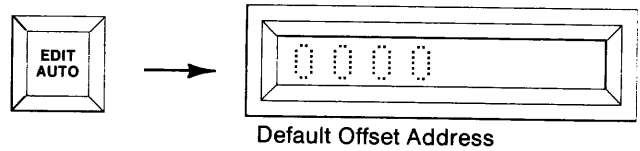

6. If a different Offset Start Address is desired, use the hex key pad to enter this address. The example shown uses address "0100" as the Offset Address (See Page 18-8).

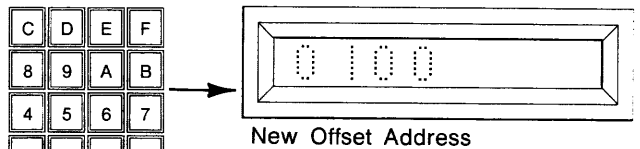

7. Depress ENTER. If a Default Offset Address was selected it is now accepted. The selected format is now active for downloading (receiving) or remotely uploading (listing) the M980 Buffer data. See the specific format description for proper data transfer sequence.

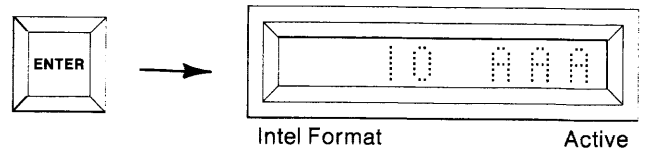

- To initiate a data upload (list) from the M980 Keyboard, depress ENTER. The First and Last Addresses or the previously selected Start and End Addresses (step 9) of the M980 RAM Buffer are displayed. The example shown is from reset, and with a 16K RAM Buffer installed.

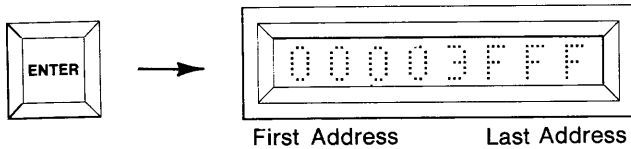

- To upload a limited address field, key in new Start and End Addresses, using the Hex keys.

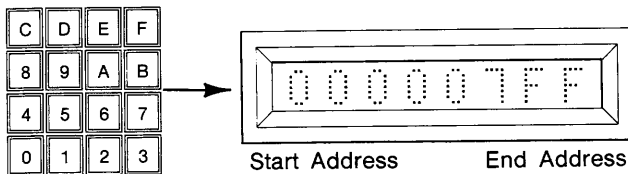

- Depress ENTER. The data located between the previously displayed addresses are uploaded to the remote source in the selected format. A "0" is displayed in the left-most display.

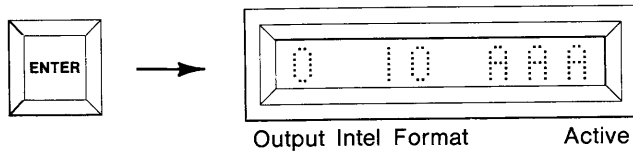

- Any output of data is indicated by a "0" in the left-most display. Any input of data is indicated by a "1" in the left-most display. Upon completion, the "0" or "1" is removed from the display. The format is now active again for downloading or uploading.

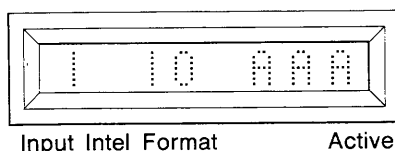
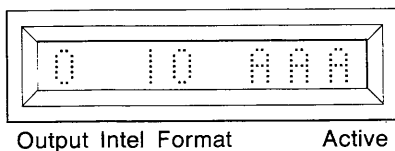

### Summary of How to Select the Communications Interface and Formats

- Install and connect the RS-232-C adapter and cable connections. Select switches MFG (OFF), AUDIO (OPTIONAL), MASTER (OFF), BUFFER (ON), COPY (OFF).
- Turn Power ON. Displays are blank.
- Depress key 8. "9818 01" is displayed.
- Select the desired format by using the Hex Keyboard.
- Optional. Depress EDIT key. "0000" is displayed.
- Optional. Key in new address for default start address.
- Depress ENTER. The format number selected is displayed with "AAA." The M980 is now ready to receive data in this format.

To initiate a data output from the M980 Keyboard perform the following in addition to steps 1 thru 7.

- Depress ENTER. The full address field of the RAM Buffer is displayed.
- Key in the starting and ending address field of the RAM Buffer to be outputted.
- Depress ENTER. The display indicates "0 XX AAA" where XX is format #. The data in the RAM Buffer is now outputted in the format selected.

## Downloading (Receiving)

The Default Offset Address "0000," or the entered Offset Address (step 6), is compared to the First Incoming Address. If the Default Offset Address is smaller than the First Incoming Address, the difference (Offset) is subtracted from all incoming addresses. If the Offset Address is greater than the First Incoming Addresses, the difference (Offset) is added to all incoming addresses. The result of this addition or subtraction is then used as the Absolute Address of the RAM Buffer.

EXAMPLE: Using the Intel format 9818-10, the Offset Address (step 6) is "0100." The incoming addresses are between "E000" and "FFFF" (see Figure 18-5).

E000=First Address received.  
-0100=Offset Address.  
 DF00=Offset.  
 E000=First Address received.  
-DF00=Offset.  
 0100=Absolute Address of RAM Buffer.  
 FFF0=Last Address received.  
-DF00=Offset.  
 20F0=Absolute Address of RAM Buffer.

### NOTE

If an upload is performed after a download and before reset, the same address offset is used. This allows outgoing addresses to match incoming addresses without reinitializing an Offset Address.

## Uploading (Listing)

When uploading data from the M980 RAM Buffer, the Offset Address is compared to the RAM Buffer Start Address. If the Offset Address is smaller than the RAM Buffer Start Address, the difference (Offset) is subtracted from all outgoing addresses. If the Offset Address is greater than the RAM Buffer Start Address, the difference (Offset) is added to all outgoing addresses. The result of this subtraction or addition is then used as the Absolute Address to be sent.

EXAMPLE: Using the Intel format 9818-10, the Offset Address (step 6) is "E000." The RAM Buffer Start and End Addresses (step 9) are "0100" and "20FF," respectively (see Figure 18-6).

E000=Offset Address.  
-0100=First (Start) Address of RAM Buffer.  
 DF00=Offset.  
 0100=First Address of RAM Buffer to be sent.  
+DF00=Offset.  
 E000=First Absolute Address sent.  
 20F0=Last Address of RAM Buffer to be sent.  
+DF00=Offset.  
 FFF0=Last Absolute Address sent.

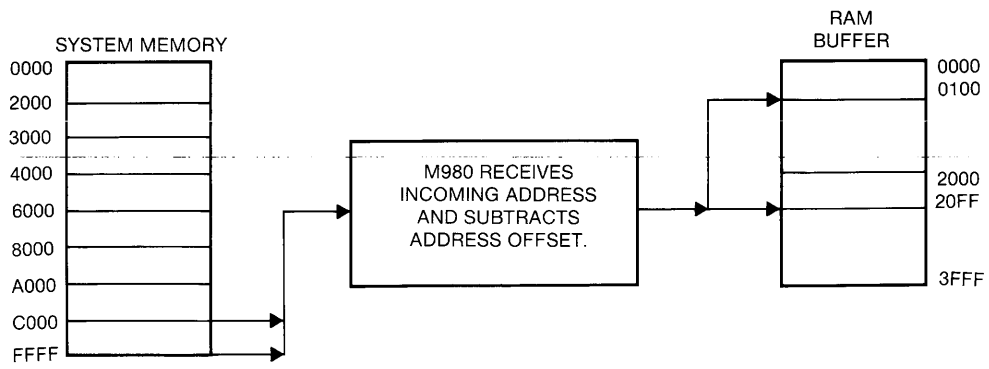
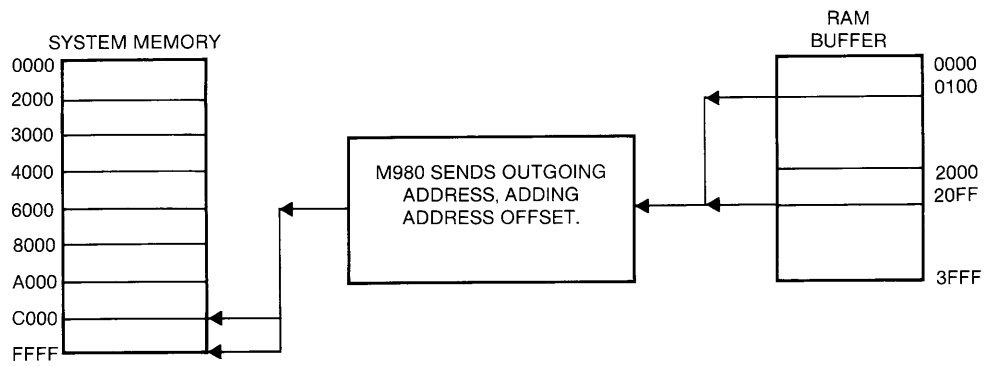

Figure 18-5. Address Offset Download



9812M980-32

Figure 18-6. Address Offset Upload



# Communications Interface Pro-Log Format Descriptions

## RS-232-C FORMAT DESCRIPTIONS

Pro-Log formats allow several forms of listing and programming. All Pro-Log formats can be remotely selected when any of the Pro-Log formats are active. All Pro-Log formats, when selected remotely, have the following recognition format: When active, all Pro-Log formats sample the data lines TD and RD for an ASCII Hex character. When the first ASCII Hex character is found, it is accepted as the first character (digit) of the Start Address of the Buffer that is to be acted upon. The first eight ASCII Hex characters are accepted as the Start and End Addresses for the operation to be performed (this is based on a 64K address field). The first four characters are accepted as the Start Address, Most Significant Digit (MSD) first. The next four characters are accepted as the End Address, MSD first\*. The M980 then looks for a command character to determine the type of operation to be performed. The present valid command characters are; "P," "L," "M," "S," "N," and "X." There is one format that cannot be controlled remotely. This format is the program CR/LF. In this format, the M980 sends a CR/LF and then looks for valid data to be loaded into the RAM Buffer (see the description on page 18-19). While downloading (programming) data into the RAM Buffer, a "1" is displayed in the left-most display. While uploading (listing) data from the RAM Buffer a "0" is displayed in the left-most display.

## 4-BIT DATA PROGRAMMING VIA RS-232-C

### Receiving 4-Bit Data from a Remote Source

When receiving data via RS-232-C from a remote source, the M980 accepts one byte per location (2 ASCII Hex Characters). The first ASCII Hex character sent will be placed into the most significant 4 bits of the RAM Buffer location. The second ASCII Hex character will be placed into the least significant 4 bits of the same RAM Buffer location. The first ASCII Hex character (most significant character for each RAM Buffer location) must be sent but is not used for 4 bit programming.

Example 1: Programming 5 locations in a 256x4 PROM via RS-232-C, Remote Control\*\*, using pro-Log "P" Program format.

Send the ASCII characters: 00000004 P 05 0C 02 07 0E. These characters will be accepted.

Send ASCII characters: QXDB0004. The M980 will program locations 00 through 04 in the PROM with the data characters: 5,C,2,7,E. The most significant characters ("0's") sent are not used.

\*Any non-HEX character sent during the address definition will cause the M980 to abort to the beginning of the address definition.  
\*\*See Page 18-33 for Remote Control description.

### Listing 4-Bit Data from the M980 RAM Buffer (4-Bit Personality Module installed in the M980)

In the Pro-Log list formats, only the least significant 4 bits from each RAM Buffer location are sent.

Example 2: Using the data sent to the M980 in example 1 and the "L" List and "S" Scroll Formats.

Send the ASCII characters; 00000004 L. The M980 responds with: 5 C 2 7 E.

Send the ASCII characters: 00000004 S. The M980 responds with:

```
0 1 2 3 4 5 6 7 8 9 A B C D E F
/0000 5 C 2 7 E
```

Pro-Log Format Descriptions

| KEY SELECT              | REMOTE CODE | 9818 RS-232-C<br>PRO-LOG FORMAT DESCRIPTION                                                                                                                                                                                                                                                                                                                                                                                                                                                                                                                                               |
|-------------------------|-------------|-------------------------------------------------------------------------------------------------------------------------------------------------------------------------------------------------------------------------------------------------------------------------------------------------------------------------------------------------------------------------------------------------------------------------------------------------------------------------------------------------------------------------------------------------------------------------------------------|
| 9818-00                 | P           | M980 accepts ASCII hexadecimal characters as data to be written to the buffer. Each ASCII character represents 4 bits of data. Non-hexadecimal characters sent between characters are discarded.                                                                                                                                                                                                                                                                                                                                                                                          |
| 9818-01                 | S           | M980 lists selected buffer field in ASCII hexadecimal characters formatted in 256-byte data blocks. Each data block is preceded by a header to separate columns, and each data line is preceded by the line starting address. Each line consists of 16 data bytes separated by spaces. Output operation halts after each block. A "SPACE" received via the interface or the ENTER key on the M980 causes the next block to be sent. Operation terminates when the end address is reached, when the M980 is reset, or when any character other than "SPACE" is received via the interface. |
| 9818-02                 | L           | M980 lists selected buffer field in ASCII hexadecimal characters formatted in 16-byte lines. Each line consists of 16 data bytes separated by spaces. Each line is followed by a carriage return and line feed. Output operation runs continuously until the end address is reached.                                                                                                                                                                                                                                                                                                      |
| 9818-03                 | M           | M980 lists selected buffer field in ASCII hexadecimal characters formatted in 256-byte data blocks. Format and operation are identical to those of the 9818-01, except that output operation does not stop with each block but runs until the end address is reached.                                                                                                                                                                                                                                                                                                                     |
| 9818-04                 | N           | M980 lists selected buffer field in ASCII hexadecimal characters. Data is output in a continuous stream, without any control characters, from the start address to the end address.                                                                                                                                                                                                                                                                                                                                                                                                       |
| 9818-05                 | X           | M980 lists selected buffer field in ASCII hexadecimal characters formatted in 16-byte lines. Each line consists of 16 data bytes separated by spaces. Each line is followed by a carriage return and a line feed. M980 outputs one line each time an XON character is received. Operation terminates when the end address is received.                                                                                                                                                                                                                                                    |
| 9818-06                 | —           | M980 sends a carriage return to initiate data transfer and then waits to receive ASCII hexadecimal characters as data to be written to the buffer.                                                                                                                                                                                                                                                                                                                                                                                                                                        |
| <b>INDUSTRY FORMATS</b> |             |                                                                                                                                                                                                                                                                                                                                                                                                                                                                                                                                                                                           |
| 9818-10                 |             | Intel HEX basic — M980 sends or receives data in the Intel HEX block format, without any special control operations. This version is compatible with Intel HEX files based by systems other than MDS. For example, CPM-based systems can write UFN-HEX files to the M980 buffer, via TYPE UFN.HEX1P, or read and write HEX files using the peripheral interchange program (PIP).                                                                                                                                                                                                          |
| 9818-11                 |             | Intel HEX with "ACK" or "NAK" response to checksum — M980 sends or receives data in the Intel HEX block format. In the receive mode, the M980 sends an "ACK" to acknowledge a correct checksum, and a "NAK" to acknowledge an incorrect checksum. This feature is intended to assist communication over a remote link, e.g., through a modem.                                                                                                                                                                                                                                             |
| 9818-12                 |             | Intel-Hex with "CONTROL Z" end-of-file terminator—M980 sends or receives data in the Intel HEX block format. In the local LIST operation, a "CONTROL Z" character is sent after the end-of-file record is sent; this is required by the Intel MDS to terminate the copy mode.                                                                                                                                                                                                                                                                                                             |
| 9818-13                 |             | Intel Extended (8086).                                                                                                                                                                                                                                                                                                                                                                                                                                                                                                                                                                    |
| 9818-14                 |             | TEK-HEX—can be used with the Tektronix 8001, and 8002 systems via the built-in commands of RHEX and WHEX.                                                                                                                                                                                                                                                                                                                                                                                                                                                                                 |
| 9818-15                 |             | Motorola S2 (68000).                                                                                                                                                                                                                                                                                                                                                                                                                                                                                                                                                                      |
| 9818-16                 |             | Motorola S1                                                                                                                                                                                                                                                                                                                                                                                                                                                                                                                                                                               |
| 9818-18                 |             | MOS Technology                                                                                                                                                                                                                                                                                                                                                                                                                                                                                                                                                                            |



## “L” LIST

The “L” List format was developed to output (list) data to terminals, printers, and other equipment. It was developed for Pro-Log PROM programmers and has been available in all units with RS-232-C interfaces. It is a general-purpose format for listing data but has drawbacks when listing data fields over 256 bytes since there is no address indexing information. For listing large data fields, use “M” List or “S” Scroll which produces a memory-mapped listing.

When this format is selected via the control unit keyboard or the remote interface, the control unit outputs RAM Buffer data in ASCII characters, MSD first (each ASCII HEX character sent represents 4 bits of an 8-bit data byte), 16 bytes per line. A space (SP) character is sent after each data byte and a carriage return (CR), line feed (LF) is sent after receiving the “L” command character and after each 16 bytes. A CR and LF are also sent after the last data byte sent. The list begins with the selected start address and continues until the selected end address is reached. The spaces, carriage returns, and line feeds are sent for structure and clarity only and are not printable.

## Local “L” List:

Select Format 02 active using steps 1 through 7 on page 18-6. Depress ENTER. The start and end address limits of the control unit RAM Buffer will be displayed. Key in the start and end addresses of the RAM Buffer data field to be listed. Depress ENTER. The operation commences as described. While uploading data, the control unit will display a “0” in the left-most display to indicate that the control unit is uploading (Output).

## Remote “L” List:

Select Format 02 active using steps 1 through 7 on page 18-6. The format is now active to receive the list command. From the remote unit, send eight ASCII Hex characters for the Start and End addresses of the RAM Buffer field to be listed. Next, send an ASCII L (uppercase letter). The operation commences as described. While uploading data, the control unit will display a “0” in the left-most display to indicate that the control unit is uploading (Output).

### Example of Remote “L” List from a terminal:

```
INPUT: 00000015 L
OUTPUT: 00 01 02 03 04 05 06 07 08 09 0A 0B 0C
        0D 0E 0F (CR,LF)
        10 11 12 13 14 15 (CR,LF)
        ■ (Cursor location after list is completed)
```

## “M” LIST

The “M” (Memory Mapped) List format was developed to output to printers or CRTs. This format is particularly helpful for making hard (paper) copies of programs since its address indexing allows the reader to quickly find data anywhere in the listing.

When this format is selected via the control unit keyboard or via remote interface, the control unit outputs data in 256 byte blocks (one page). Each block of data is preceded by a header and each line of data is preceded by the starting address of the line. Each line of data consists of 16 data bytes (each ASCII coded hexadecimal character sent represents 4 bits of an 8-bit data byte) separated by spaces and followed by a carriage return (CR) and line feed (LF). After each block of data is sent, several line feeds are sent to separate the blocks. The list begins with the selected start address and continues until the selected end address is reached. The start address’s LSD is always rounded off to 0 so the list will commence at the beginning of a line.

### Local “M” List:

Select Format 03 active using steps 1 through 7 on page 18-6. Depress ENTER. The start and end address limits of the control unit RAM Buffer will be displayed. Key in the start and end addresses of the RAM Buffer data field to be listed. While uploading data, the control unit will display a “0” in the left-most display to indicate that the control unit is uploading (Output).

### Remote “M” List:

Select Format 03 active using steps 1 through 7 on page 18-6. The format is now active to receive the list command. From the remote unit, send eight ASCII coded hexadecimal characters for the Start and End addresses of the RAM Buffer field to be listed. Next, send an ASCII M (upper-case letter). The operation commences as described. While uploading data, the control unit will display a “0” in the left-most display to indicate that the control unit is uploading (Output).

#### Example of Remote “M” List:

```

INPUT:      00E501F8 M
OUTPUT:           0  1  2  3  4  5  6  7  8  9  A  B  C  D  E  F  (CR,LF,LF)
                /00E0 E0 E1 E2 E3 E4 E5 E6 E7 E8 E9 EA EB EC ED EE EF  (CR,LF)
OUTPUT:      /00F0 F0 F1 F2 F3 F4 F5 F6 F7 F8 F9 FA FB FC FD FE FF  (CR,LF)
                .
                .
                .
                /01D0 D0 D1 D2 D3 D4 D5 D6 D7 D8 D9 DA DB DC DD DE DF  (CR,LF)
                0  1  2  3  4  5  6  7  8  9  A  B  C  D  E  F  (CR,LF,LF)
                /00E0 E0 E1 E2 E3 E4 E5 E6 E7 E8 E9 EA EB EC ED EE EF  (CR,LF)
                /01F0 F0 F1 F2 F3 F4 F5 F6 F7 F8                          (CR,LF)
                ■ (Cursor location after list is completed)
    
```

## “S” SCROLL

The “S” Scroll format was developed to output data to terminals in a Memory Mapped structure. Since a terminal screen cannot display an entire program, only one page (256 bytes) of data is sent to the terminal at a time. When the control unit receives a space (SP) character or the ENTER key is depressed on the M980, another page of data will be sent. The format structure is the same as “M” List.

When this format is selected via the control unit keyboard or the remote interface, the control unit outputs data in 256 byte blocks (one page). Each block of data is preceded by a header and each line of data is preceded by the starting address of the line. Each line of data consists of 16 data bytes (each ASCII coded hexadecimal character sent represents 4 bits of an 8-bit data byte), separated by spaces and followed by a carriage return (CR) and line feed (LF). After each block of data is sent, the control unit waits to receive a space (SP) character from the terminal. Upon receipt of the space from the terminal, the control unit responds by sending the next sequential block of data. An “S” Scroll list begins with the selected start address and continues until the selected end address is reached.

## Local “S” List:

Select Format 01 active using steps 1 through 7 on page 18-6. Depress ENTER. The start and end address limits of the control unit RAM Buffer will be displayed. Key in the start and end addresses of the RAM Buffer data field to be listed. Depress ENTER. The operation commences as described. While uploading data, the control unit will display a “0” in the left-most display to indicate that the control unit is uploading (Output).

## Remote “S” List:

Select Format 01 active using steps 1 through 7 on page 18-6. The format is now active to receive the list command. From the terminal, send eight ASCII Hex characters for the Start and End addresses of the RAM Buffer field to be listed. Next, send an ASCII S (uppercase letter). The operation commences as described. While uploading data, the control unit will display a “0” in the left-most display to indicate that the control unit is uploading (Output).

### Example of Remote “S” List from a terminal:

```

INPUT:          0000011F S
OUTPUT:         0  1  2  3  4  5  6  7  8  9  A  B  C  D  E  F  (CR,LF,LF)
                /0000 00 01 02 03 04 05 06 07 08 09 0A 0B 0C 0D 0E 0F  (CR,LF)
                /0010 10 11 12 13 14 15 16 17 18 19 1A 1B 1C 1D 1E 1F  (CR,LF)
                .
                .
                .
                /00F0 F0 F1 F2 F3 F4 F5 F6 F7 F8 F9 FA FB FC FD FE FF  (CR,LF)
INPUT:          (Space)
OUTPUT:         (CR,LF,LF,LF)
                /0000 0  1  2  3  4  5  6  7  8  9  A  B  C  D  E  F  (CR,LF,LF)
                /0100 00 01 02 03 04 05 06 07 08 09 0A 0B 0C 0D 0E 0F  (CR,LF)
                /0110 10 11 12 13 14 15 16 17 18 19 1A 1B 1C 1D 1E 1F  (CR,LF)
                ■ (Cursor location after list is completed)

```

## "N" LIST

The "N" List was developed to output data to computers and contains NO control characters. Since most computers do not need these control characters (ie; CR, LF, SP,), the sending would only consume time.

When this format is selected via the control unit keyboard or the remote interface, the control unit outputs RAM Buffer data in ASCII characters, MSD first (each ASCII coded hexadecimal character sent represents 4 bits of an 8-bit data byte), starting with the selected start address and continues until the selected end address is reached. Before sending the first data byte the control unit sends a carriage return (CR) and line feed (LF) for terminal screen clarity.

## Local "N" List:

Select Format 04 active using steps 1 through 7 on page 18-6. Depress ENTER. The start and end address limits of the control unit RAM Buffer will be displayed. Key in the start and end addresses of the RAM Buffer data field to be listed. Depress ENTER. The operation commences as described. While uploading data, the control unit will display a "0" in the left-most display to indicate that the control unit is uploading (Output).

## Remote "N" List:

Select Format 04 active using steps 1 through 7 on page 18-6. The format is now active to receive the list command. From the remote unit, send eight ASCII coded hexadecimal characters for the Start and End addresses of the RAM Buffer field to be listed. Next, send an ASCII N (upper-case letter). The operation commences as described. While uploading data, the control unit will display a "0" in the left-most display to indicate that the control unit is uploading (Output).

### Example of Remote "N" List to a computer:

```
INPUT:          0100012F N
OUTPUT:         000102030405060708090A0B0C0D0E0F101112131415161718191A1B1C1D1E1F20212223
                245262728292A2B2C2D2E2F
```

## “X” LIST

The “X” List was developed to output a predetermined amount of data to a remote unit every time a Transmit ON character (Control Q keyboard entry from a terminal, or the ASCII character Device Control 1) is received. This allows the remote unit to respond to other devices and ask for data when it is ready.

When this format is selected via the control unit keyboard or the remote interface, the control unit outputs RAM Buffer data, MSD first (each ASCII HEX character sent represents 4 bits of an 8-bit data byte), 16 bytes at a time. A space (SP) character is sent after each byte and a carriage return (CR) and line feed (LF) are sent after the last byte. The control unit then waits to receive a Transmit ON character. After the Transmit ON character is received, the control unit sends the next line. The list begins with the selected start address and continues until the selected end address is reached.

### Local “X” List:

Select Format 05 active using steps 1 through 7 on page 18-6. Depress ENTER. The start and end address limits of the control unit RAM Buffer will be displayed. Key in the start and end addresses of the RAM Buffer data field to be listed. Depress ENTER. A single line of data (16 bytes) will be uploaded. The operation commences as described. While uploading data, the control unit will display a “0” in the left-most display to indicate that the control unit is uploading (Output).

### Remote “X” List:

Select Format 05 active using steps 1 through 7 on page 18-6. The format is now active to receive the list command. From the remote source, send eight ASCII coded hexadecimal characters for the Start and End addresses of the RAM Buffer field to be listed. Next, send an ASCII X (upper-case letter). The operation commences as described.

#### Example of Remote “X” List:

```

INPUT:          00100036 X
OUTPUT:         10 11 12 13 14 15 16 17 18 19 1A 1B 1C 1D 1E 1F (CR,LF)
INPUT:          (Transmit ON character)
OUTPUT:         20 21 22 23 24 25 26 27 28 29 2A 2B 2C 2D 2E 2F (CR,LF)
INPUT:          (Transmit ON character)
OUTPUT:         30 31 32 33 34 35 36 (CR,LF)
                █ (Cursor location after list is completed)

```

### “P” PROGRAM (4800 BAUD MAXIMUM\*)

The “P” Program format was developed to load ASCII coded hexadecimal data characters into the M980 RAM Buffer. The control unit looks for two ASCII Hex characters per RAM Buffer location (each ASCII coded hexadecimal character received is translated into 4 bits of an 8-bit byte). The MSD character is received first. The control unit keeps track of addressing the RAM Buffer by incrementing the address once for every two ASCII Hex characters received.

When this format is selected via the control unit keyboard or the remote interface, the control unit will accept two ASCII coded hexadecimal characters for each address in the RAM Buffer to be loaded. The control unit will begin loading data at the selected start address and will continue loading data until the selected end address is reached. The control unit will respond with a CR and LF after receiving the last data character. Non-Hex ASCII characters may be sent between data characters for control and will be ignored by the control unit.

### Local “P” Program:

Select Format 00 active using steps 1 through 7 on page 18-6. Depress ENTER. The start and end address limits of the control unit RAM Buffer will be displayed. Key in the start and end addresses of the RAM Buffer data field to be listed. Depress ENTER. The control unit is now active to receive data to be loaded into the RAM Buffer. While downloading to the RAM Buffer, the control unit will display a “1” in the left-most display to indicate that the remote unit is downloading (Input). The control unit will respond with a CR,LF after receiving the last data character.

### Remote “P” Program:

Select Format 00 active using steps 1 through 7 on page 18-6. The control unit is now active to receive the program command. From the remote unit, send eight ASCII coded hexadecimal characters for the Start and End addresses of the RAM Buffer field to be programmed. Next, send an ASCII P (upper-case letter). Then send the data to be loaded into the RAM Buffer addresses selected. Send MSD first. While downloading to the RAM Buffer, the control unit will display a “1” in the left-most display to indicate that the remote unit is downloading (Input). The control unit will respond with a CR,LF after receiving the last data character.

### Example of Remote “P” Program:

```
INPUT:                00000009 P
                        00 01 02 03 04 05 06 07 08 09
OUTPUT: (CR,LF)      █ (Cursor location after program is completed)
```

\*9600 Baud may be achieved by inserting at least three space characters after the last address character sent and before sending the “P” character.

**“CR/LF” PROGRAM**

The Program CR/LF format was developed for remote units that could not send starting and ending load addresses. The remote unit has only to send the data to be loaded, MSD first, as ASCII coded hexadecimal characters (each ASCII coded hexadecimal character received is translated into 4 bits of an 8-bit data byte). Unless a new address is keyed in, the control unit assumes the RAM Buffer's entire size as the start and end address, then acts like the “P” Program format when receiving data.

When this format is selected via the control unit's keyboard, the control unit sends to the remote unit a carriage return (CR) and line feed (LF) to indicate that it is ready to receive data. The first two data characters received are placed into the starting address, the control unit automatically increments the address and accepts the next two characters. This continues until the end address is reached. The control unit will respond with a CR and LF after receiving the last data character. If data transmission stops before sending enough data to reach the end address, the M980 cannot respond with a CR, LF. Non-Hex ASCII characters may be sent between data characters for control and will be ignored by the control unit.

**Local Program CR/LF:**

Select Format 06 active using steps 1 through 7 on page 18-6. The start and end address limits of the control unit RAM Buffer will be displayed. Key in the start and end addresses of the RAM Buffer data field to be programmed. Depress ENTER. The control unit will output a CR and LF to the remote unit. The control unit is now active to receive ASCII coded hexadecimal data characters, MSD first. While downloading data to the RAM Buffer, the control unit will display a “1” in the left-most display to indicate that the remote unit is downloading (Input). The control unit will respond with a CR and LF after receiving the last data character.

**Example of Local CR/LF Program:**

```

OUTPUT:                (CR,LF)
INPUT                  09A9B7.....DFE42C
OUTPUT:                (CR,LF) █ (Cursor location after program is completed).

```





# Communications Interface Industrial Format Descriptions

## DESCRIPTION

The formats described on the following pages are standard formats developed by several manufacturers to facilitate communications with their equipment. All of these formats can be uploaded (listed) locally or remotely and downloaded (programmed) remotely. In the local list mode (initiated from the M980 keyboard), the RAM Buffer data is uploaded beginning with the start address and terminating with the end address. A remote list can upload any amount of data from the RAM Buffer. When downloading data in any industrial format, the first address received can be used to establish an address offset. This offset is added or subtracted from all incoming addresses including the first (see page 18-8 for details). All Termination Blocks, End-of-File Records, and Abort Blocks are ignored by the M980 while receiving. Only Data Records/Blocks are accepted. Each Data Record/Block is received separately, therefore, the M980 is active to receive another Data Record/Block, or Remote command after each Data Record/Block received. The only exceptions are the INTEL 11 which responds with an "ACK," "NAK," and CR,LF after each Data Record or if the M980 detects a checksum error in any other industry format. If a checksum error should occur during downloading, the M980 will activate a fail sequence and will not accept further data transmissions. In this case, the M980 must be RESET, the format reselected and the download performed again.

If a local list is initiated after downloading and prior to RESET, the address offset, if selected, will be added or subtracted to all outgoing addresses. This allows uploading with the same addresses and data that were downloaded. While downloading data to the RAM Buffer, the control unit will display a "1" in the left-most display to indicate that the remote unit is downloading (Input). While uploading data from the RAM Buffer, the control unit will display a "0" in the left-most display to indicate that the control unit is uploading (Output).

### NOTE

In a local list, a carriage return (CR) and line feed (LF) are sent after each line of data and a 200ms delay is added. An End-of-File Record or Termination Block is sent after the last Data Record/Block. Most vendor formats operate at 4800 baud maximum when downloading to the M980. See the specific format description for details.

### 4-BIT DATA PROGRAMMING VIA RS-232-C

In the Industrial Formats, all data transfers are structured for 8-bit (1 byte) data per location. When receiving 4-bit data using these formats, the least significant characters for each byte area used for programming 4-bit data. The most significant characters for each byte are accepted but not used for 4-bit device programming.

### Receiving Data from a Remote Source

When receiving data via RS-232-C from a remote source, the M980 accepts one byte per location (2 ASCII Hex Characters). The first ASCII Hex character sent will be placed into the most significant 4 bits of the RAM Buffer location. The second ASCII Hex character will be placed into the least significant 4 bits of the same RAM Buffer location. The first ASCII Hex character (most significant character for each RAM Buffer location) must be sent but is not used for 4-bit programming.

#### Example of Programming 5 locations in a 256x4 PROM via RS-232-C Remote Control\* using INTEL 10 format:

SEND: :1000100000E3E1F579174F7827477D176F76176768

All of the data sent will be accepted.

Send the ASCII characters: QXDB0004.

The M980 will program locations 00 through 04 in the device with the data characters; 0,3,1,5,9.

\*For further details, see Remote Control Section, page 18-33.

### INTEL-HEX FORMAT DESCRIPTION (4800 BAUD MAXIMUM)

The Intel hexadecimal format is a method of encoding data in ASCII form. The three types of records permitted in the INTEL-HEX are DATA Records, Extended Address Records, and End-of-File Records. When data is being uploaded (listed) locally from the M980 keyboard, a carriage return (CR) and line feed (LF) are sent and a 200ms delay is implemented prior to sending the

next line of data. An end-of-file record is sent after the last data record. The M980 recognizes Data/Extended Address records and is active to receive remote commands immediately after receiving any Data Record.

#### Data Record Format

This record specifies data being sent and the start address where the data is to be loaded.

| RECORD MARK      | RECORD LENGTH                                                     | STARTING LOAD ADDRESS                                                                   | RECORD TYPE                                                   | DATA                                                          | CHECKSUM                                                                                                                                                                             |
|------------------|-------------------------------------------------------------------|-----------------------------------------------------------------------------------------|---------------------------------------------------------------|---------------------------------------------------------------|--------------------------------------------------------------------------------------------------------------------------------------------------------------------------------------|
| ASCII colon (:). | Two Hex digits indicating the number of data bytes in the record. | Four hex digits indicating the starting address of the block of data to be transferred. | Two Hex digits. Data records are signified by record type 00. | 2 to 64 Hex digits (32 data bytes) coded as ASCII 0-9 or A-F. | A two-digit Hex number representing the two's complement of the 8-bit sum (modulo 256) of the 8-bit bytes that result from the record length field to the last data byte, inclusive. |

Example:

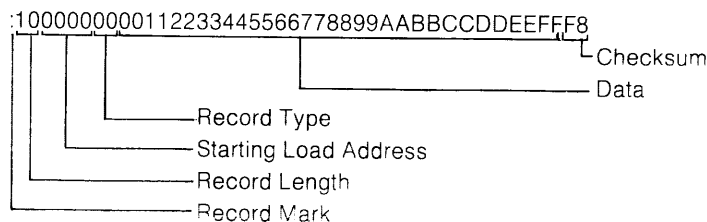

### End-of-File Record Format\*

This record specifies the end of data transmissions, that is, no further data records follow.

| RECORD MARK      | RECORD LENGTH | STARTING LOAD ADDRESS    | RECORD TYPE                                   | CHECKSUM                                                    |
|------------------|---------------|--------------------------|-----------------------------------------------|-------------------------------------------------------------|
| ASCII colon (:). | Always "00."  | Four hex digits (zeros). | Always 01, identifies the end-of-file record. | Calculated the same way as the Data Record Format checksum. |

### Example of End-of-File Record Format

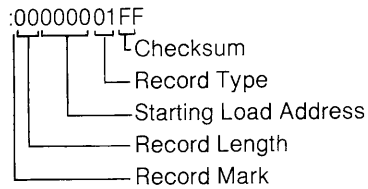

\*This record is ignored while receiving and is sent by the M980 after the last data record is sent in a local list.

### Extended Address Record Format

This record specifies the Upper Segment Base Address (USBA) used to offset the Data records that follow.

**NOTE**

The extended address record takes precedence over any previous address offset.

| RECORD MARK         | RECORD LENGTH                                 | ZEROES "0000"                          | RECORD TYPE  | USBA                                                                                                                                                                                                                                           | CHECKSUM                                                      |
|---------------------|-----------------------------------------------|----------------------------------------|--------------|------------------------------------------------------------------------------------------------------------------------------------------------------------------------------------------------------------------------------------------------|---------------------------------------------------------------|
| Always a colon (:). | Always 02. Indicates 2 address bytes in USBA. | The Load Address Field is always "0s". | Always "02". | Specifies the upper bits (4-19) of the Base Address bits (0-19). Where bits 0-3 are always "0s" and bits 4-19 are represented by four ASCII hexadecimal digits. See INTEL document "MCS-86™ Absolute Object File Formats" for further details. | Checksum of the Record Length, Zeroes, Record Type, and USBA. |

### INTEL #10 LOCAL LIST/REMOTE: "L" LIST AND PROGRAM

This format, when selected via the M980 keyboard, lists or programs the M980 RAM Buffer with INTEL-HEX formatted data. See INTEL-HEX description on page 18-22.

#### Local List:

Select Format 10 active using steps 1 through 7 on page 18-6. Depress ENTER. The start and end address limits of the control unit RAM Buffer will be displayed. Key in the start and end addresses of the RAM Buffer data field to be listed. Depress ENTER. The RAM Buffer contents will be uploaded to the remote unit in the INTEL format. While uploading data, the control unit will display a "0" in the left-most display to indicate that the control unit is uploading (Output). If a local list is initiated after a download but prior to RESET, the address offset determined previously will be added or subtracted to all outgoing addresses. See Industrial Format Description on page 18-21.

#### Remote "L" List:

Select Format 10 active using steps 1 through 7 on page 18-6. The M980 is now active to receive the remote list command. From the remote unit, send an ASCII L (upper-case letter) followed by four ASCII coded hexadecimal characters for the start address of the list. Upon receiving the L and four digit address, the M980 will send 16 bytes of data in the INTEL-HEX format beginning with the start address received. After sending the checksum, the M980 will send a carriage return (CR) and line feed (LF). See example below.

#### Remote Program:

Select Format 10 active using steps 1 through 7 on page 18-6. The M980 is now active to receive data formatted in INTEL-HEX to be loaded into the RAM Buffer. While downloading data, the control unit will indicate a "1" in the left-most display. When the last data record is sent the "1" will be removed.

#### Example of Remote "L" List:

```
INPUT:      L0000
OUTPUT:     :1000000000112233445566778899AABBCCDDEEFF8 (CR,LF)
```

### INTEL #11 LOCAL LIST/REMOTE: "L" LIST AND PROGRAM WITH "ACK"/"NAK"

This format, when selected via the M980 keyboard, lists or programs the Buffer with INTEL-HEX formatted data. In the program (download) operation an "ACK" or "NAK," a carriage return (CR), and line feed (LF) sent by the control unit indicates that the received checksum is correct ("ACK") or incorrect ("NAK"). It is up to the remote unit to resend a line of data if it is not

received correctly. The Local List and Remote "L" list are the same as those described in the INTEL #10 description. See INTEL-HEX format description on page 18-22.

#### Remote Program:

Select Format 11 active using steps 1 through 7 on page 18-6. The M980 is now active to receive data formatted in INTEL-HEX to be loaded into the RAM Buffer starting at address 0000. An "ACK" or "NAK" and CR,LF will be sent after receiving the checksum characters.

#### Example of Remote Program with "ACK" or "NAK" CR, LF:

```
INPUT:      :1000000000112233445566778899AABBCCDDEEFF8
OUTPUT:     ACK CR LF (ACK, CR, and LF are non-printable characters)
```

**INTEL #12 LOCAL LIST W/CONTROL Z, REMOTE: "L" LIST AND PROGRAM**

This format, when selected via the M980 keyboard, lists or programs the Buffer with INTEL-HEX formatted data. In the local list (upload) operation, a Control Z character is transmitted after the end-of-file record is sent. This is required by the INTEL MDS and other systems to terminate a file upload. The remote program and remote "L" list are the same as those described in the INTEL #10 format.

**Local List:**

Select Format 12 active using steps 1 through 7 on page 18-6. Depress ENTER. The start and end address limits of the control unit RAM Buffer will be displayed. Key in the start and end addresses of the RAM Buffer data field to be listed. Depress ENTER. The RAM Buffer contents will be uploaded to the remote unit in the INTEL format. A Control Z character will be sent following the end-of-file record. While uploading data, the control unit will display a "0" in the left-most display to indicate that the control unit is uploading (Output). If a local list is initiated after a download but prior to RESET,

the address offset determined previously will be added to all outgoing addresses. See Industrial Format Description on page 18-21.

**INTEL #13 LOCAL UPLOAD OF EXTENDED ADDRESS RECORD**

This format, when selected, allows the user to upload an extended address record. This record may be used by an 8086 or other 16-bit system to offset and adjust uploaded data into a larger memory field. The extended address is always four ASCII hexadecimal digits, which represent 16 bits, and are defined as the Upper Segment Base Address (USBA). See INTEL's *Absolute Object File Formats* description for further details.

**LOCAL UPLOAD:**

Select the INTEL #13 active by using steps 1 through 5 starting on page 18-6. Four "0"s should be shown in the left-most displays. Using the hexadecimal keyboard, key in the USBA to be uploaded. Depress ENTER. The extended address record will be uploaded and the INTEL #10 format will be selected.

**TEK-HEX FORMAT DESCRIPTION (4800 BAUD MAXIMUM)**

The Tektronix hexadecimal format is a method of encoding data in ASCII form. The three types of message blocks are: Data, Termination, and Abort. When data is being uploaded (listed) locally from the M980 keyboard, a carriage return (CR) and line feed (LF) are sent and a 200ms delay is implemented prior to send-

ing the next block. A Termination Block is sent after the last data block. The M980 only recognizes Data Blocks and is active to receive remote commands immediately after receiving any Data Block.

**Data Block Format**

This block specifies the data being sent and the start address where the data is to be stored.

| RECORD           | LOCATION                                                             | BYTE COUNT                                                            | FIRST CHECKSUM                                                                   | DATA                                                          | SECOND CHECKSUM                                                                                     |
|------------------|----------------------------------------------------------------------|-----------------------------------------------------------------------|----------------------------------------------------------------------------------|---------------------------------------------------------------|-----------------------------------------------------------------------------------------------------|
| ASCII slash (/). | Four Hex digits indicating the Start Address of data in PROM memory. | Two Hex digits indicating the number of data bytes to be transferred. | A two-digit Hex number representing the Hex sum of the preceding six Hex digits. | 2 to 64 Hex digits (32 data bytes) coded as ASCII 0-9 or A-F. | A two-digit Hex number representing the Hex sum (modulo 256) of the Hex digits comprising the data. |

**Example of Tek-Hex Format**

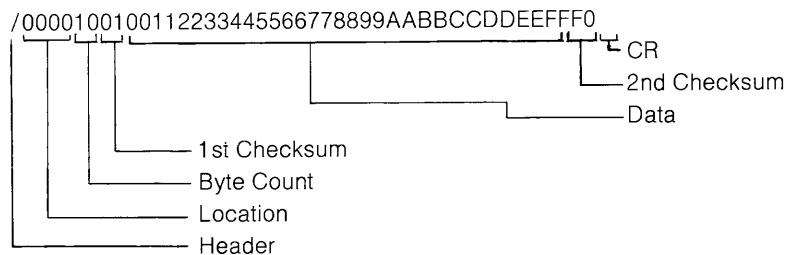

**Termination Block Format\***

This block specifies the end-of-data transmission, that is, no further data block follows.

| HEADER           | TRANSFER ADDRESS                                                                                     | BYTE COUNT                                         | CHECKSUM                                                                              |
|------------------|------------------------------------------------------------------------------------------------------|----------------------------------------------------|---------------------------------------------------------------------------------------|
| ASCII slash (/). | Four Hex digits indicating the starting execution address of the code represented in the data block. | Always 00, which identifies the termination block. | A two-digit number representing the sum (modulo 256) of the preceding six Hex digits. |

**Example of Termination Block Format:**

EXAMPLE                                          /00000000

**Abort Block\*\***

This block specifies abnormal data termination, and is designed to accommodate error message conveyance.

| HEADER           | HEADER           | MESSAGE                                                                          |
|------------------|------------------|----------------------------------------------------------------------------------|
| ASCII slash (/). | ASCII slash (/). | A maximum of 69 ASCII characters comprising a programmer-defined message string. |

**Example of Abort Block Format:**

EXAMPLE                                          // (message)

\*This Block is ignored while receiving and is sent by the M980 after sending the last data block.

\*\*This block is not used at all by the M980.

**TEK-HEX LOCAL LIST/REMOTE: "L" LIST and PROGRAM**

This format, when selected via the M980 keyboard, lists or programs the M980 RAM Buffer with TEK-HEX formatted data. See TEK-HEX description on page 18-25.

**Local List**

Select Format 14 active using steps 1 through 7 on page 18-6. Depress ENTER. The start and end address limits of the control unit RAM Buffer will be displayed. Key in the start and end addresses of the RAM Buffer data field to be listed. Depress ENTER. The RAM Buffer contents will be uploaded to the remote unit in the TEK-HEX format. While uploading data, the control unit will display a "0" in the left-most display to indicate that the control unit is uploading (Output). If a local list is initiated after a download but prior to RESET, the address offset determined prior will be added to all outgoing addresses. See Industrial Format Description on page 18-21.

**Remote "L" List:**

Select Format 14 active using steps 1 through 7 on page 18-6. The M980 is now active to receive the remote list command. From the remote unit send an ASCII L (upper-case letter) followed by four ASCII coded hexadecimal characters for the start address of the list. Upon receiving the L and four digit address, the M980 will send 16 bytes of data in the TEK-HEX format beginning with the start address received. After sending the checksum, the M980 will send a carriage return (CR) and line feed (LF). See example below.

**Remote Program:**

Select Format 14 active using steps 1 through 7 on page 18-6. The M980 is now active to receive data formatted in TEK-HEX to be loaded into the RAM Buffer. While downloading data, the control unit will indicate a "1" in the left-most display. When the last data record is sent the "1" will be removed.

**Example of Remote "L" List:**

```
INPUT          L0000
OUTPUT         /0000100100112233445566778899AABBCCDDEEFF0 (CR,LF)
```

**MOTOROLA FORMAT DESCRIPTION (4800 BAUD MAXIMUM)**

The MOTOROLA format (sometimes referred to as the S format) is a method of encoding data in ASCII form. The M980 sends three types of records: S1 Data record, S2 Data record, and End-of-File Record. When data is being uploaded (listed) locally from the M980 keyboard, a carriage return (CR) and line feed (LF) are

sent and a 200ms delay is implemented prior to sending the next data record. An end-of-file record is sent after the last data record. The M980 only recognizes Data Records and is active to receive remote commands immediately after receiving any Data Record.

**S1 Data Record**

This record specifies data being sent and the start address where the data is to be loaded.

| HEADER | BYTE COUNT                                                                                             | ADDRESS                                                                                 | DATA                                                         | CHECKSUM                                                                                                                                                   |
|--------|--------------------------------------------------------------------------------------------------------|-----------------------------------------------------------------------------------------|--------------------------------------------------------------|------------------------------------------------------------------------------------------------------------------------------------------------------------|
| An S1. | Two Hex digits indicating the number of bytes in the record from the byte count to the last data byte. | Four Hex digits indicating the starting address of the block of data to be transferred. | 2 to 64 Hex digits (32 data bytes) coded as ASCII 0-9 or A-F | A two-digit Hex number representing the one's complement (modulo 256) of the 8-bit bytes that result from the byte count to the last data byte, inclusive. |

**Example of Motorola Format**

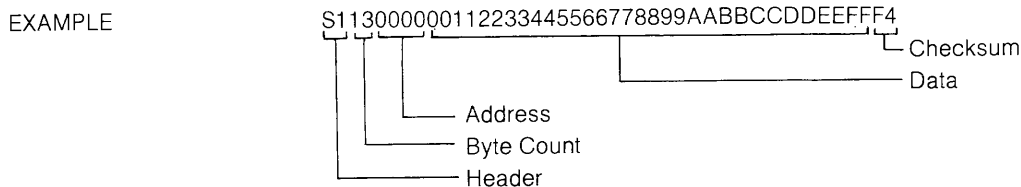

### S2 Data Record

This record specifies data being sent and the start address where the data is to be loaded.

| HEADER | BYTE COUNT                                                                                             | ADDRESS                                                                                | DATA                                                         | CHECKSUM                                                                                                                                                                    |
|--------|--------------------------------------------------------------------------------------------------------|----------------------------------------------------------------------------------------|--------------------------------------------------------------|-----------------------------------------------------------------------------------------------------------------------------------------------------------------------------|
| An S2. | Two Hex digits indicating the number of bytes in the record from the byte count to the last data byte. | Six Hex digits indicating the starting address of the block of data to be transferred. | 2 to 64 Hex digits (32 data bytes) coded as ASCII 0-9 or A-F | A two-digit Hex number representing the one's complement of the 8-bit sum (modulo 256) of the 8-bit bytes that result from the byte count to the last data byte, inclusive. |

Example of S2 Data Record Format:

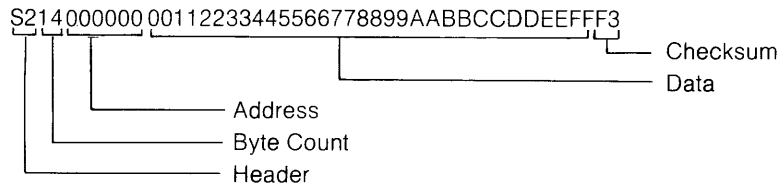

### End-of-File Record

This record specifies the end of data transmissions, that is, no further data records follow.

| HEADER                                                                           | BYTE COUNT                         | ADDRESS                              | CHECKSUM                                                                                                                                                                    |
|----------------------------------------------------------------------------------|------------------------------------|--------------------------------------|-----------------------------------------------------------------------------------------------------------------------------------------------------------------------------|
| An S followed by a Hex number. End-of-File records are signified by a record S9. | Always 03 for end-of-file records. | Always 0000 for end-of-file records. | A two-digit Hex number representing the one's complement of the 8-bit sum (modulo 256) of the 8-bit bytes that result from the byte count to the last data byte, inclusive. |

Example of End-of-File Record:

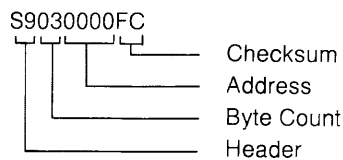



## MOTOROLA LOCAL LIST/REMOTE: "L" LIST AND PROGRAM

This format, when selected via the M980 keyboard, lists or programs the M980 RAM Buffer in MOTOROLA S1 or S2 formatted data. See MOTOROLA description on page 18-27.

### Local List

Select Format 15 or 16 active using steps 1 through 7 on page 19-6. Depress ENTER. The start and end address limits of the control unit RAM Buffer will be displayed. Key in the start and end addresses of the RAM Buffer data field to be listed. Depress ENTER. The RAM Buffer contents will be uploaded to the remote unit in the MOTOROLA format. While uploading data, the control unit will display a "0" in the left-most display to indicate that the control unit is uploading (Output). If a local list is initiated after a download but prior to RESET, the address offset determined previously will be added to or subtracted from all outgoing addresses. See Industrial Format Description on page 18-21.

### Remote "L" List:

Select Format 15 or 16 active using steps 1 through 7 on page 18-6. The M980 is now active to receive the remote list command. From the remote unit send an ASCII L (upper-case letter) followed by four ASCII coded hexadecimal characters for the start address of the list. Upon receiving the L and four digit address, the M980 will send 16 bytes of data in the MOTOROLA format beginning with the start address received. After sending the checksum, the M980 will send a carriage return (CR) and line feed (LF). See example below.

### Remote Program:

Select Format 15 or 16 active using steps 1 through 7 on page 18-6. The M980 is now active to receive data formatted in MOTOROLA to be loaded into the RAM Buffer. While downloading data, the control unit will indicate a "1" in the left-most display. When the last data record is sent the "1" will be removed.

#### Example of Remote "L" List:

```
INPUT:      L0000
OUTPUT:     :S11300000112233445566778899AABBCCDDEEFF4 (CR,LF)
```

**MOS TECHNOLOGY FORMAT  
DESCRIPTION (4800 BAUD MAXIMUM)**

The MOS TECHNOLOGY format is a method of encoding data in ASCII form. The two types of records permitted in the MOS TECHNOLOGY format are: Data, and End-of-File. When data is being uploaded (listed) locally from the M980 keyboard, a carriage return (CR)

and line feed (LF) are sent and a 200ms delay is implemented prior to sending the next data record. An end-of-file record is sent after the last data record.

**Data Record Format**

This record specifies data being sent and the start address where the data is to be loaded.

| RECORD MARK          | RECORD LENGTH                                                     | STARTING LOAD ADDRESS                                                        | DATA                                                          | CHECKSUM                                                                                                                                                                                                |
|----------------------|-------------------------------------------------------------------|------------------------------------------------------------------------------|---------------------------------------------------------------|---------------------------------------------------------------------------------------------------------------------------------------------------------------------------------------------------------|
| ASCII semicolon (;). | Two Hex digits indicating the number of data bytes in the record. | Four Hex digits indicating the Start Address of the block to be transferred. | 2 to 64 Hex digits (32 data bytes) coded as ASCII 0-9 or A-F. | A 4-digit Hex number representing the sum of 8-bit bytes that result from converting each pair of ASCII Hex digits to one byte of binary, from the record length field to the last data byte inclusive. |

**Example of MOS Technology Format**

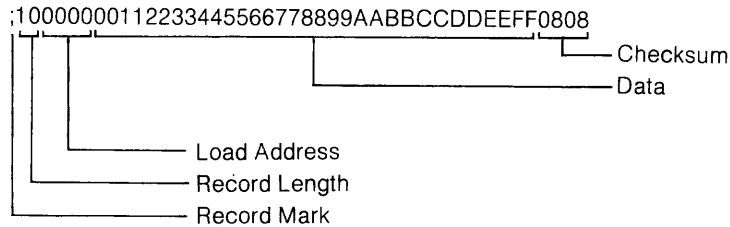

**End-of-File Record**

This record specifies the end of data transmissions, that is, no further data records follow.

| RECORD MARK          | RECORD LENGTH                                       | STARTING LOAD ADDRESS | CHECKSUM         |
|----------------------|-----------------------------------------------------|-----------------------|------------------|
| ASCII semicolon (;). | Always 00, which identifies the end-of-file record. | Four Hex digits.      | Four hex digits. |

**Example of End-of-File Record Format:**

Example: `;0000000000`

## MOS TECHNOLOGY LOCAL LIST/REMOTE: “L” LIST AND PROGRAM

This format, when selected via the M980 keyboard, lists or programs the M980 RAM Buffer in MOS TECHNOLOGY formatted data. See MOS TECHNOLOGY description on page 18-30.

### Local List

Select Format 18 active using steps 1 through 7 on page 19-6. Depress ENTER. The start and end address limits of the control unit RAM Buffer will be displayed. Key in the start and end addresses of the RAM Buffer data field to be listed. Depress ENTER. The RAM Buffer contents will be uploaded to the remote unit in the MOS TECHNOLOGY format. While uploading data, the control unit will display a “0” in the left-most display to indicate that the control unit is uploading (Output). If a local list is initiated after a download but prior to RESET, the address offset determined previously will be added to or subtracted from all outgoing addresses. See Industrial Format Description on page 18-21.

### Remote “L” List:

Select Format 18 active using steps 1 through 7 on page 18-6. The M980 is now active to receive the remote list command. From the remote unit send an ASCII L (upper-case letter) followed by four ASCII coded hexadecimal characters for the start address of the list. Upon receiving the L and four digit address, the M980 will send 16 bytes of data in the MOS TECHNOLOGY format beginning with the start address received. After sending the checksum, the M980 will send a carriage return (CR) and line feed (LF). See example below.

### Remote Program:

Select Format 18 active using steps 1 through 7 on page 18-6. The M980 is now active to receive data formatted in MOS TECHNOLOGY to be loaded into the RAM Buffer. While downloading data, the control unit will indicate a “1” in the left-most display. When the last data record is sent the “1” will be removed.

#### Example of Remote “L” List:

```
INPUT:      L0000
OUTPUT:     ;10000000112233445566778899AABBCCDDEEFF0808 (CR,LF)
```



# Communications Interface

## M980 RS-232-C Remote Control

### DESCRIPTION

The M980 Remote Control Mode allows an external control, via the M304 RS-232-C adapter, to gain limited control of the M980 and perform duplication functions remotely. The Remote Control commands can only be sent while the selected RS-232-C format is active to receive a command.

When one of the RS-232-C formats is in the active state, the external device can obtain control by sending the ASCII characters indicated below. All operations start at RAM Buffer location 0000.

| DUPLICATE FUNCTION                         | REMOTE COMMAND |
|--------------------------------------------|----------------|
| 1. Master to Buffer over the defined field | QXDMsssseeee*  |
| 2. Master to Buffer over DEVICE field      | QXDMX          |
| 3. Buffer to Copy over the defined field   | QXDBsssseeee*  |
| 4. Buffer to Copy over the DEVICE field    | QXDBX          |
| 5. Copy to Buffer over the DEVICE field    | QXDC           |

\*sss=The Start address of the Copy or Master DEVICE to be duplicated to or from. Where ssss is a variable number of characters needed to define the start address (see examples below).

eeee=The End address of the Copy or Master DEVICE to be duplicated to or from. Where eeee is a variable number of characters needed to define the end address (see examples below).

| DEVICE FIELD SIZE | sss = | eeee = |
|-------------------|-------|--------|
| 256               | 00    | FF     |
| 512               | 000   | 1FF    |
| 1024 (1K)         | 000   | 3FF    |
| 2048 (2K)         | 000   | 7FF    |
| 4096 (4K)         | 000   | FFF    |
| 8192 (8K)         | 0000  | 1FFF   |
| 16384 (16K)       | 0000  | 3FFF   |

### NOTE

Personality Modules models PM9075A and greater may require four start and four end address characters regardless of the DEVICE size. See the Personality Module USER'S MANUAL for further details.

After completing one of the Duplication functions, the M980 control unit will respond with an acknowledgement. In response to the successful completion of the function, the M980 control unit will send; "Y," "BELL," Carriage Return/Line Feed. In response to an unsuccessful completion of a function, the M980 will send; "N," "BELL," Carriage Return/Line Feed. After responding, the previously selected format is now active again.

The remote control unit may, after receiving one of the M980 responses, send a remote command to initiate a PASS or FAIL indication on the control unit. To command the M980 control unit to initiate a PASS indication send: "QXY." To command the M980 control unit to initiate a FAIL indication send: "QXN." The M980 will perform the following:

### Remote Command M980 Response

**QXY** = An "F" (Finished) is displayed and the pass tone is sounded. Depress ENTER. The M980 responds with a "CRLF" "BELL." The previously selected format is now active again.

**QXN** = An "E7" is displayed and the fail tone is sounded. Depress ENTER. The M980 responds with a "CRLF" "BELL." The previously selected format is now active again.

### Remote Control Operation

1. The M304 adapter is installed and the format selected and active using steps 1 through 7 on page 18-6.
2. The remote unit downloads the data to be programmed.
3. The remote unit sends one of the duplicate remote control commands to the M980.
4. The M980 responds with either "Y," "BELL," "CRLF" for successful or "N," "BELL," "CRLF" for unsuccessful. The previously selected format is now active again.
5. The remote unit may send "QXY" to indicate successful or "QXN" to indicate unsuccessful. The programmed device is removed and a new blank device is placed into the copy socket. The operator depresses ENTER. The M980 responds with a "CRLF" "BELL." The previously selected format is now active again.
4. The remote unit is finished sending the data to be programmed into the Copy DEVICE when it sends "QXDBX." The M980 control unit duplicates the contents of the RAM Buffer into the Copy DEVICE starting with the first address of the RAM Buffer and Copy DEVICE, and ending when the DEVICE is completely programmed.
5. The M980 responds with a "Y," "BELL," "CRLF."
6. The remote unit sends "QXY." The M980 responds by displaying an "F," sounding the pass tone.

**Example:** Using Pro-Log Program CR/LF format and programming a 2716 EPROM remotely.

1. Select format 06 active. Depress the ENTER key. Key in the Starting and Ending address 000007FF. Depress ENTER.
2. M980 responds by sending: "CRLF."
3. Remote unit sends 2K bytes of data:  
C3E5078F----F3F7C30870.
4. M980 responds by sending: "CRLF."
5. Remote unit sends: "QXDBX."
6. The M980 programs the 2716 EPROM and responds: "Y" "BELL" "CRLF."
7. Remote unit sends: "QXY."
8. The M980 displays an "F," sounds the Pass tone.

### Typical Remote Load and Program

1. Connect M304 adapter and select INTEL #11 Format.
2. Insert a blank PROM into the Copy socket of the installed personality module.
3. The remote unit sends data to the M980 RAM Buffer in the INTEL format. Note: The INTEL #11 (ACK/NAK) is recommended for data transfers over long distances. The M980 handles each data record separately and is active to receive a remote control command after responding to each data record.

# Communications Interface

## RS-232-C Interface Application Notes

The various industrial formats can be used to connect to almost any development system. Some representative examples describing specific applications are presented here. If you have a system that uses any of the supplied formats, apply the following examples as a guide. Contact Pro-Log if you require assistance.

### INTEL MDS 200 SERIES

Interfacing the M980 with M304 adapter and RAM Buffer to the INTEL MDS for downloading requires the addition of one jumper to the MDS IOB or M304 adapter. This jumper addition allows downloading to the M980 at 110 baud. Two methods can increase the baud rate, if faster data transfer is required. One

method is via the software, the other is via the monitor firmware. These changes (the jumper and baud rate) allow the M980 to accept data from the MDS in INTEL-HEX format. If the user wishes to upload data from the M980 Buffer to an MDS file, the INTEL #2 Local List transmits a Control Z, which is required by the MDS to terminate the Copy Mode.

### Configuring the Serial Interface

As shipped from Intel, J2 (Serial 1) is jumpered for a standard TTY terminal configuration. This is used for INTEL #12. Format Serial 2 is not used by the M980. See Figures 18-7 through 18-9 for interconnect information.

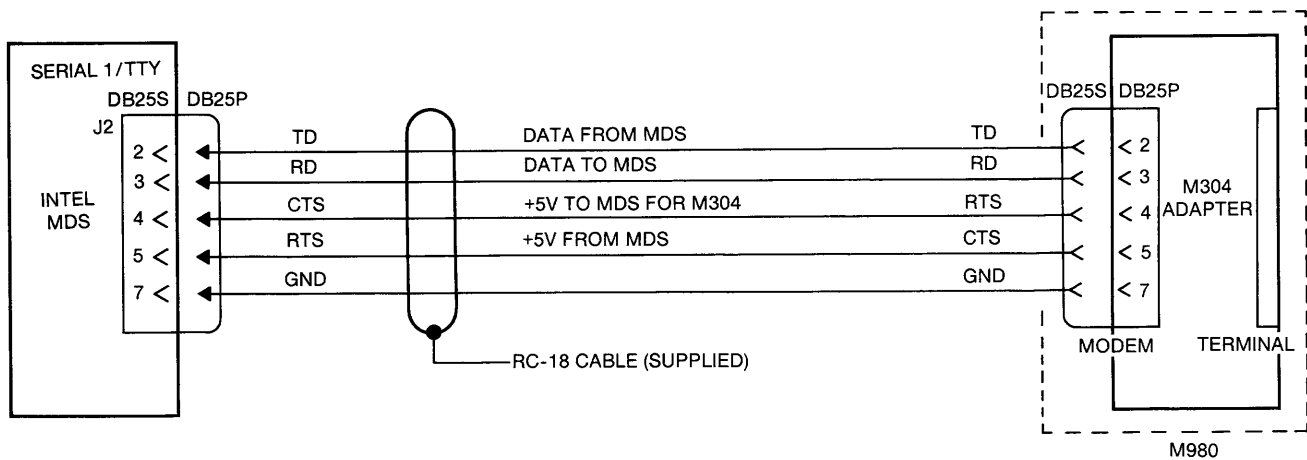

9812M980-33

Figure 18-7. M304/MDS Interconnect

The jumpers for configuring the MDS Serial Interface are located at the top right corner of the IOC board and are accessible by removing the main-chassis top cover. Figure 18-8 shows the lines and jumpers as they are shipped from Intel. We recommend that the user determine if the jumpers are as shown. The jumper between W5B and W5D must be installed at this time. (Refer to Intellec Series II Installation and Service Manual A1/A2 for further information.) The added jumper causes the CTS signal used by the M980 to be supplied by the RTS line, which is normally held high by the M304 adapter. As an alternative, this jumper may be installed between pins 4 and 5 on the M304 MODEM connector.

### Baud Rate

As supplied from Intel, the Serial 1 port is set for TTY, 110 baud. However, if a higher rate is desired, there are two methods by which the MDS may be modified to achieve a higher baud rate.

One method consists of inputting, assembling, linking, loading, and executing a baud-rate program at each power-on or system reset. This program writes the control words to change the rate of the Serial 1 UART. However, the UART is recoded back to 110 baud by the system monitor at each system reset or power-on. Contact Intel for a listing of the baud-rate change program.

The second method to achieve a higher baud rate entails changing the monitor program UART constants in the Monitor PROM. With this change in effect, the MDS initializes to the new baud rate each time it is reset or turned on. To accomplish this, unplug the MDS and remove its front panel by turning both mounting screws one-half turn counterclockwise. Remove the IPB board. This is the top board in the rack with the interrupt and reset switches mounted on its front edge. Locate IC A57, for MDS 230, A82 for MDS 235 and 245. Duplicate this PROM with the appropriate changes. (These changes apply to Intellec Series II Boot/Monitor Version 1.2.)

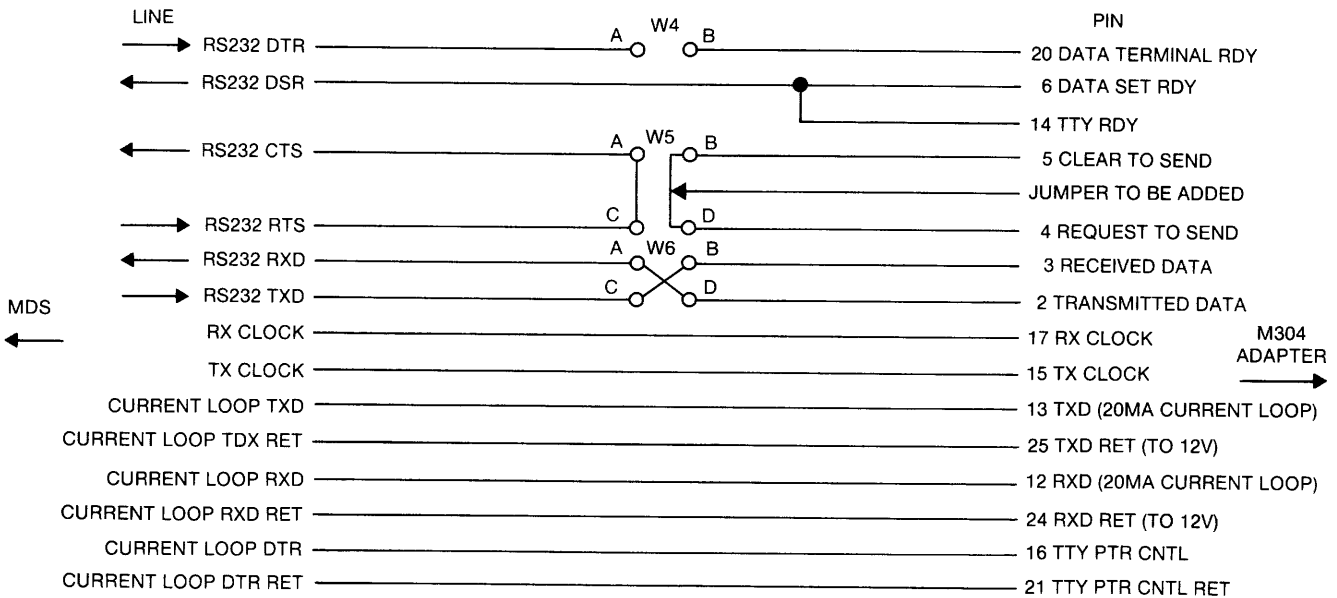

Figure 18-8. Serial CH1 Lines and Jumpers

9812M980-34



| Location<br>MDS 230 | Download<br>Only<br>110 Baud<br>As Supplied | Up/<br>Download<br>110 Baud | Up/<br>Download<br>1200 Baud | Download<br>Only<br>4800 Baud |
|---------------------|---------------------------------------------|-----------------------------|------------------------------|-------------------------------|
| E886(086)           | BA                                          | BA                          | 10                           | 10                            |
| E887(087)           | 02                                          | 02                          | 00                           | 00                            |
| E88F(08F)           | CE                                          | 4E                          | 4F                           | 4E                            |
| MDS235/45           |                                             |                             |                              |                               |
| E89A(09A)           | BA                                          | BA                          | 10                           | 10                            |
| E89B(09B)           | 02                                          | 02                          | 00                           | 00                            |
| E8A3(0A3)           | CE                                          | 4E                          | 4F                           | 4E                            |

**NOTE**

Each time the MDS is initialized, the message "failure boot checksum" is displayed to serve as a reminder that the firmware has been changed, thereby affecting the checksum of the monitor program.

It is suggested that an EPROM duplicate of the Monitor be made (with changes) and the original be kept, so that 110 baud will still be available by changing PROMs, whenever required.

**Operating Sequence****NOTE**

Do not plug M304 adapter into M980 unless power is OFF.

1. Implement jumper and baud rate changes as previously described.
2. Install M304 adapter into M980 parallel interface connector. Plug an RC-18 cable or equivalent into the M304 modem connector and to the (J2) Serial 1/TTY connector on the MDS. Turn the M980 ON.
3. Set the M304 to the desired baud rate. Switch the M304 On-Line modem switch ON. Download from the MDS or upload to the MDS according to the following instructions.

**To Download to M980**

To download a source program that has been assembled, first convert the source program from executable binary to INTEL-HEX format ASCII characters. Intel has provided a utility program called OBJHEX to convert from object code to INTEL-HEX. To implement:

1. Input to MDS:

OBJHEX:F?XXXX.OBJ to :F? YYYY.HEX (CR)

Where: F?:=Drive F0, F1

XXXX.OBJ=Source

YYYY.HEX=New INTEL HEX file

This generates a new file in INTEL HEX, ready to download to the M980.

2. Select INTEL #12 Active. See procedure on page 18-6.

3. Input to the MDS: Copy :F?:YYYY.HEX to :TO:(CR)

Data transfers as previously described. Upon completion of the Copy operation, the MDS displays COPIED :F?:YYYY.HEX to :TO:. If a checksum error occurs, failure is indicated on the M980. The M980 and MDS must then be reset and the operation performed again.

**NOTE**

The MDS also downloads to :TO: (M980) from MDS RAM using the Monitor Write command "W." Input to the MDS "WAAAA, BBBB (CR)." The "W" command writes to Serial 1 port, in INTEL HEX format, the RAM contents starting at AAAA and ending at BBBB.

**To Upload to MDS**

1. Enter to MDS: COPY:TI: to :F1:NNEW.FIL (CR)
2. On the M980, select INTEL #12 active. See procedure on page 20-6.
3. Depress the RUN key.
4. Data transfers as previously described. Upon completion of the copy operation, the MDS displays: COPIED :TI: to F1:NNEW.FIL.

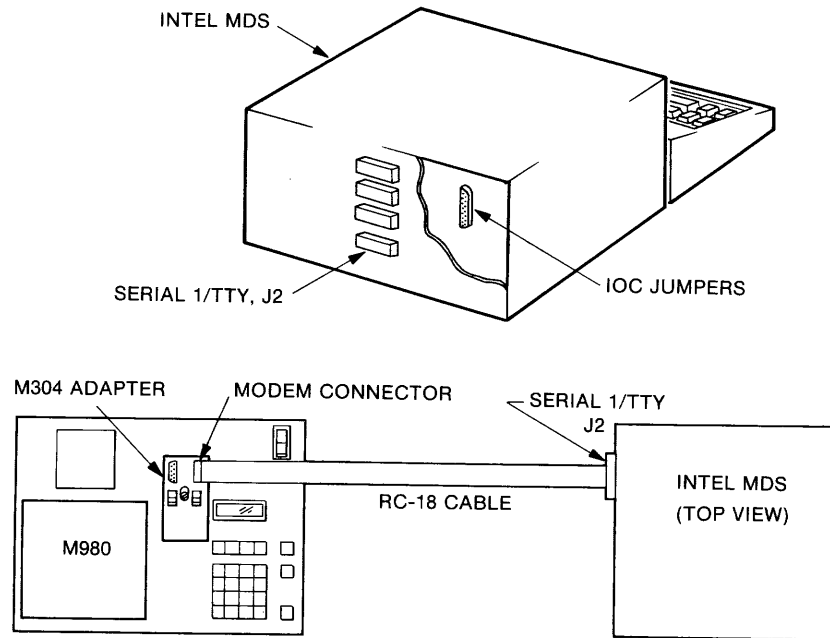

Figure 18-9. Connecting to MDS

9812M980-35

### TEKTRONIX 8002A MDL

Interfacing the M980 RAM Buffer to the Tektronix 8002A MDL requires no modifications to either unit (see Figure 18-10). Select the baud rate (up to 4800) and make certain both units have the same baud rate.

### Operating Sequence

#### NOTE

Do not install M304 adapter with M980 power ON.

1. Install the M304 adapter in the parallel interface connector. Connect the terminal connector to J101 of the Tektronix 8002A MDL via an RC-18 cable or equivalent.
2. Switch power ON, turn on-line modem ON.

### To Download to M980

The 8002A executes the WHEX command, to dump the file J101 and thereby to the M980 RAM Buffer.

1. Select TEK HEX format active, using the procedure on page 18-6.

2. Enter to the 8002A: WHEX (Start Address) (End Address) 00 REMO.

Data in the program memory from the Start Address to the End Address, inclusive, transfers in TEK-HEX format to the M980 RAM Buffer, one line at a time. If a checksum error occurs, a failure is indicated on the M980. The M980 and 8002A must then be reset and the operation performed again. When the operation is completed, the 8002A prints: \*WHEX\* EOJ.

### To Upload to 8002A

Execution of the RHEX command by the 8002A, before a local list operation, will initiate the upload operation.

1. Enter to the 8002A: RHEX REMI.
2. Select TEK HEX format active, using the procedure on page 20-6.
3. Depress the ENTER key.
4. Define the RAM Buffer start and end address limits to be uploaded.
5. Depress the ENTER key.

The M980 outputs the RAM Buffer data to the 8002A's system memory, line by line in TEK HEX format. When uploading is completed, the 8002A prints: \*RHEX\* EOJ.

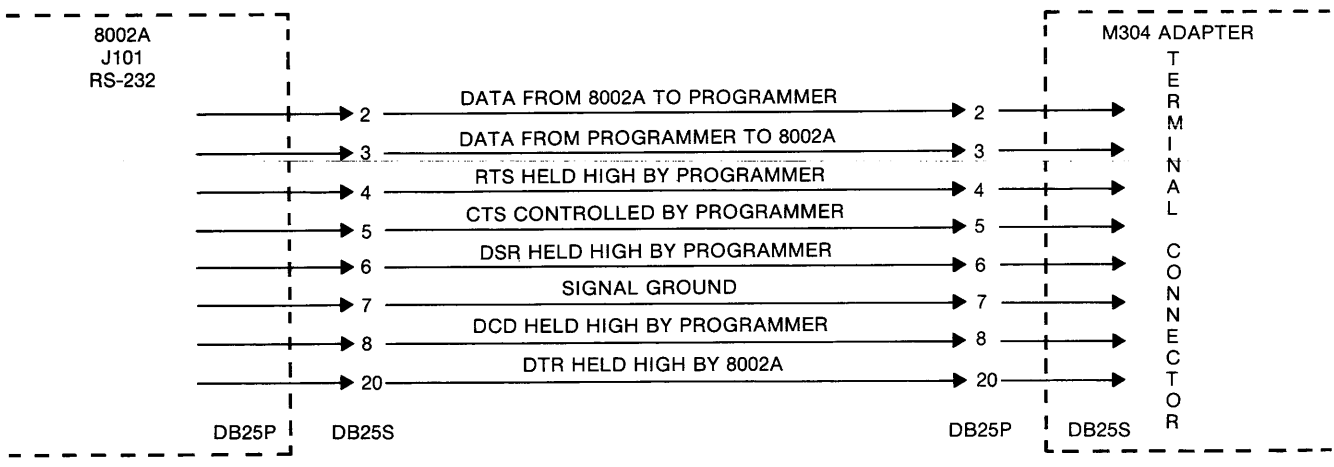

9812M980-36

Figure 18-10. M980/8002 Interconnect

**TEKTRONIX 8550 to M980 INTERFACE**

There are two methods for interfacing the M980 with the Tektronix 8550. One requires no modifications. The other requires a jumper from pin 8 to pin 20 on the M304 adapter terminal connector. See Figure 18-11.

**METHOD 1 (NO MODIFICATIONS)**

**Operating Sequence**

**NOTE**  
Do not install M304 adapter with M980 power ON.

1. Install the M304 adapter in the parallel interface connector. Connect the terminal connector to J101 of the Tektronix 8550 DOS/50 via an RC-18 cable or equivalent.
2. Switch power ON, and turn the on-line modem switch ON.

**To Download to the M980 from the Tektronix 8550**

The 8550 executes the WHEX command, to dump the file to J101 and thereby to the M980 RAM Buffer.

1. On the M980, select one of the following formats active, using the procedure on page 18-6.
2. The 8550 is capable of downloading data to the M980 RAM Buffer in three formats. To dump in:
  - a. TEK HEX format, enter to the 8550:  
WHEX: REMO (Start Address) (End Address) 00
  - b. INTEL format, enter to the 8550:  
WHEX: I REMO (Start Address) (End Address) 00
  - c. MOTOROLA format, enter to the 8550:  
WHEX: M REMO (Start Address) (End Address) 00

Data in the program memory from the Start Address to the End Address, inclusive, transfers in the selected format to the M980 RAM Buffer, one line at a time. If a checksum error occurs, the fail tone will sound and the FAIL indication will be displayed. The M980 and 8550 must then be reset and the operation rerun. When the operation is completed, the 8550 prints the DOS/50 Prompt ( ).

### To Upload to the Tektronix 8550 from the M980

Execution of the RHEX command by the 8550, before a local list operation, initiates the upload operation.

1. The 8550 is capable of receiving data from the M980 RAM Buffer in three formats. To upload in:
  - a. TEK HEX format, enter to the 8550:  
RHEX: REM1
  - b. INTEL format, enter to the 8550:  
RHEX: I REM1
  - c. MOTOROLA format, enter to the 8550:  
RHEX: M REM1
2. On the M980, select one of the above formats active, using the procedure on page 18-6.
3. Depress the ENTER key on the M980.
4. Define the RAM Buffer start and end address limits to be uploaded.
5. Depress the ENTER key.

The M980 outputs the RAM Buffer data to the 8550's system memory, line by line in the selected format. The RUN indicator on the M980 will flash on and off with each line transferred. When uploading is completed, the 8550 prints the DOS/50 Prompt ( ).

### METHOD 2 (MODIFICATIONS)

#### Operating Sequence

**NOTE**  
Do not install M304 adapter with M980 power ON.

1. Install the M304 adapter in the parallel interface connector. Connect the modem connector to J103 (paper tape port) of the Tektronix 8550 via an RC-18 cable or equivalent. A jumper must be added between pins 8 and 20 on the terminal connector of the M304 adapter.
2. Switch power ON, and turn the on-line modem switch ON.

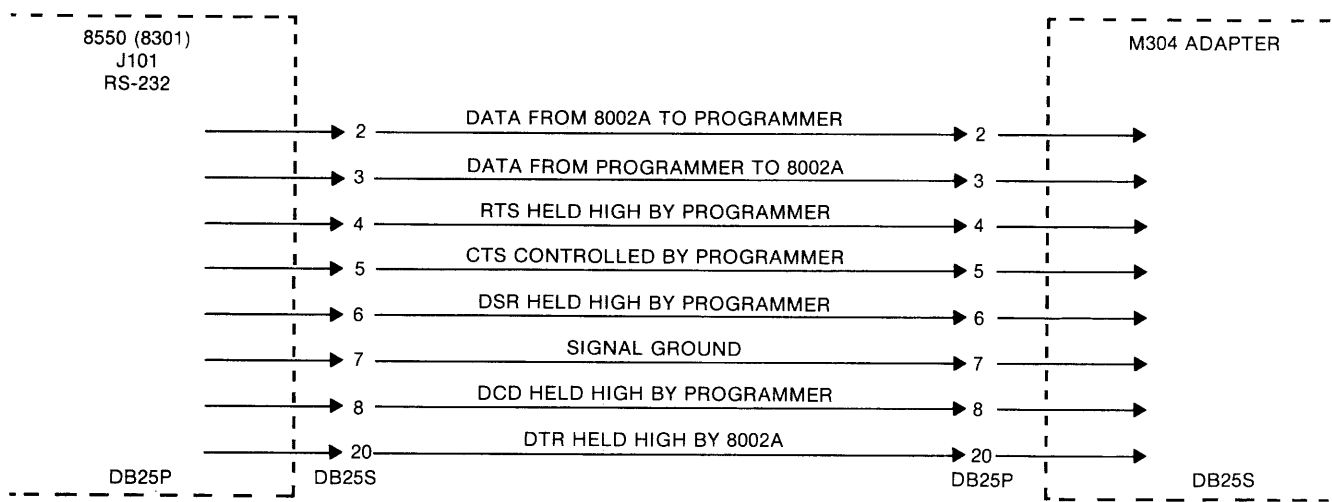

Figure 18-11. M980/8550 Interconnect

9812/1980-37

## To Download to the M980 from the Tektronix 8550

The 8550 executes the WHEX command, to dump the file to J103 and thereby to the M980 RAM Buffer.

1. Select TEK HEX format active, using the procedure on page 18-6.
2. Enter to the 8550: WHEX (Start Address) (End Address) PPTP.

Data in the program memory from the Start Address to the End Address, inclusive, transfers in TEK-HEX format to the M980 RAM Buffer, one line at a time. If a checksum error occurs, the fail tone will sound and the FAIL indication will be displayed. The M980 and 8550 must then be reset and the operation rerun. When the operation is completed, the 8550 prints: \*WHEX\* EOJ.

## To Upload to the Tektronix 8550 from the M980

Execution of the RHEX command by the 8550, before a local list operation, initiates the upload operation.

1. Enter to the 8550: RHEX PPTR.
2. On the M980 select the TEK HEX format active, using the procedure on page 18-6.
3. Depress the ENTER key on the M980.
4. Define the RAM Buffer start and end address limits to be uploaded.
5. Depress the ENTER key.

The M980 outputs the RAM Buffer data located between the Start and End Addresses to the 8550's system memory, line by line in TEK-HEX format. When uploading is completed, the 8550 prints: \*RHEX\* EOJ.

## AMC SYSTEMS 8 & 29 INTERFACE WITH M980

When interfacing the M980 with AMC systems:

1. Use the M304 adapter and an RC-18 or equivalent cable.
2. Make certain that the AMC system has an RS-232-C port available. Set the port for 4800 baud maximum, and even parity.
3. Connect the assigned AMC RS-232-C port to the M304 modem connector via the RS-232-C cable.
4. Plug the M304 adapter into the parallel I/O connector on the M980.
5. Turn power ON both the M980 and the AMC system.

### NOTE

Do not install M304 adapter with M980 power ON.

6. Place the M304 switches in the ON-LINE and MODEM ON positions.

## To Download to the M980 RAM Buffer from AMC Systems 8 or 29

1. Determine the assigned RS-232-C port name on the AMC system. Example: UPI:
2. On the M980 select the MOS TECH format active, using the procedure on page 18-6.
3. Type on the AMC console: STAT PUN: = UPI: PIP PUN: = (file name to be downloaded).

The data stored in the file named is downloaded to the M980 RAM Buffer in the MOS TECH format. When completed, the previously selected format will be active again.

## To Upload to AMC System 8 or 9 from the M980 RAM Buffer

1. Determine the assigned RS-232-C port name on the AMC system. Example: URI:
2. Type on the AMC console: STAT RDR: = URI: PIP (file name) = RDR:
3. On the M980 select the INTEL #12 format active, using the procedure on page 18-6.
4. Depress the ENTER key on the M980.
5. Define the RAM Buffer start and end address limits to be uploaded.
6. Depress the ENTER key.

The data stored in the M980 RAM Buffer is transferred to the AMC system in the INTEL HEX format (this format sends a "Control Z" character, which is required by the AMC system to terminate a transfer). When completed, the previously selected format will be active.

## MOTOROLA EXORCISER II

Transfer of data between the M980 and the EXORciser II can be accomplished in two ways. One method utilizes EXbug and system memory; the other uses MDOS and disk files. Both interface with the M980's Motorola format.

To perform the following operations, you will need Motorola's user manuals on EXbug and EXORdisk. For EXbug, an understanding of the commands, PNCH and LOAD is necessary. For EXORdisk/MDOS, a knowledge of the COPY and BINEX operations is necessary.

The Motorola data-record format contains the Start Load Address as part of the header on each data record. This address is the absolute location at which data will begin to sequentially store. This address is automatically offset to start at location 0000 in the M980's RAM Buffer.

Interfacing the M980 with the EXORciser II for data transfer to the RAM Buffer requires the M304 adapter, RAM Buffer, an RC-18 cable, and an additional cable (see Figure 18-12). The M980/M304 is "T" connected in the data path between the EXORciser II system and the system terminal.

The additional RS-232-C cable requires one end to have a DB25P connector to allow insertion into the terminal connector on the M304 adapter. The other end needs the appropriate connector for the system terminal.

Set all units to 4800 baud. On the M304 adapter, set ON LINE and MODEM switches ON.

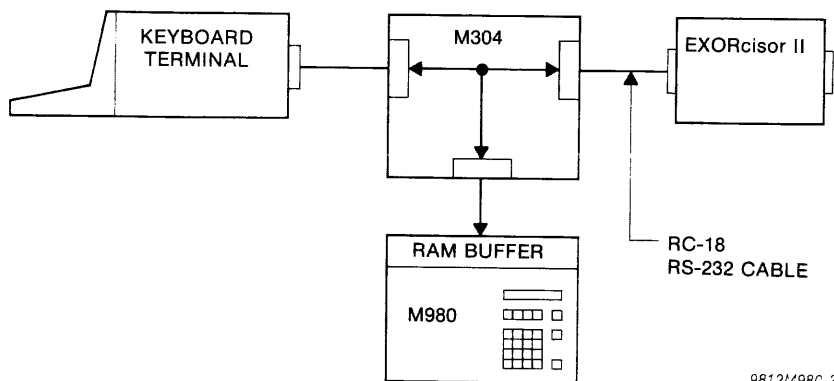

9812/M980-38

Figure 18-12. M980/EXORciser II Interconnect

### To download with EXbug, use the PNCH command:

1. Select the Motorola format active on the M980
2. Enter the PNCH command in the system terminal as follows:

```
EXbug 2.1
*E PNCH
BEG 0300 (Key in Start Address)
END 03FF (Key in End Address)
HDR= (No header required, key: return)
```

Data in the system memory is downloaded to the M980's Buffer over the operator-defined field. An "O" is shown in the left-most display on the M980 as each line is written to the Buffer, and confirms that data is being transferred. If a checksum error occurs, a failure is indicated on the M980. To continue, RESET the EXORciser II and the M980 and restart the operation.

### To upload with EXbug, use the LOAD command:

1. On the M304 adapter, turn the ON LINE switch OFF and the MODEM switch ON.
2. On the system terminal, enter:
 

```
EXbug 2.1
*E LOAD
S/C S (S=single record, C=continuous record)
The EXORciser II is now ready to receive data in the
Motorola format.
```
3. On the M304 adapter, turn the ON LINE switch ON.
4. Select the Motorola Format active on the M980.
5. Depress ENTER on the M980.
6. Define the RAM Buffer start and end address limits to be uploaded.
7. Depress the ENTER key.

Data is transferred to the EXORciser memory in 16-byte lines in Motorola format. As the EXORciser II echoes all data, the system terminal displays invalid and garbled information during the data transfer. When the transfer is complete, the last information displayed is "\*E."

During data transfer, the M980 shows an "O" in the left-most display.

To upload the M980 Buffer to a disk file, complete the previous six steps under EXbug. Turn ON-LINE switch OFF, key in MDOS, and use the ROLLOUT command to create a UFN.LO file. Use the BINEX

command to create a UFN.LX file. The UFN.LX file is now on disk and can be downloaded, if desired, as follows:

```
*E MDOS
=Rollout UFN
Start Address 3000
End Address 30FF
Are you sure (Y, N, Q)?
Y
```

8. Use BINEX UFN.LO to create a downloadable file. See the example on downloading disk files in the EXORdisk section.

### Operation Instructions for Using the EXOR-disk II/III-Operating system to transfer data to the M980 RAM Buffer.

Before downloading, convert the source data files that are to be written to a device to the Motorola record format, using the Motorola conversion program BINEX. The conversion is of the form: BINEX NAME 1 NAME 2, WHERE NAME 1=File to be converted, NAME 2=Newly created file.

It is suggested that the section on BINEX in Motorola's advanced MDOS user's guide be read before using BINEX. (UFN=Unambiguous file name.)

EXAMPLE:=BINEX UFN.CM, UFN results in the creation of UFN.LX, which is ready to be downloaded to the M980 as follows. The command line: =COPY UFN.LX, #CN downloads, in Motorola format, the file UFN.LX to the M980 Buffer as well as to the system terminal. The download operation is as follows:

1. On the M304, set the ON-LINE switch OFF and the MODEM switch ON.
2. Prepare the file to be downloaded, using BINEX.
3. On the system terminal, key in the command line: =COPY UFN.LX, #CN (do not key return).
4. On the M304, turn ON-LINE switch ON.
5. Select the Motorola format active.
6. Key RETURN on the system terminal. Data in the file UFN.LX now transfers to the M980 RAM Buffer.

A "1" is shown in the left-most display on the M980, as each line is written to the Buffer, and confirms that data is being transferred. If a checksum error occurs a failure is indicated on the M980. To continue, RESET the EXORciser II and the M980 and restart the operation.

## MOTOROLA EXORmacs

Data is transferred between the M980 and the EXORmacs utilizing the COPY utility. A standard RC-18 or equivalent cable is used to interface one of the EXORmacs ports to the Modem connector of the M304 RS-232-C adapter on the M980. The EXORmacs port used must be configured to look like a modem and can be set to transfer data up to 2400 baud. A M68K MCCM module is required to interface to the M980.

## EXORmacs CONFIGURATION

To configure the EXORmacs to port to operate at 2400 baud in the Modem Configuration.

1. Call PATCH VERSADOS.SY.
2. Find MCCM configuration Area. This is found near address 014E90, within several hundred bytes.
3. Determine which MCCM port to use. Use PORT 4 (CN13) as an example.
4. Scroll the display until the port (example CN13) in 4 consecutive bytes is located.
5. Add HEX 66 to the address corresponding to the C (CN13) in the port designation.
6. Find this new address ("C" address + 66H). At this location and the next three locations, patch as follows:

| RELATIVE ADDRESS TO "C" (CN1X) | WAS | CHANGE TO |
|--------------------------------|-----|-----------|
| 66H                            | 00  | 8E        |
| 67H                            | 00  | 0A        |
| 68H                            | 00  | 03        |
| 69H                            | 00  | 51        |

## To Download to the M980 from the EXORmacs (M980 Power OFF)

1. Assure that the EXORmacs port to be used is configured to send data between 50 and 2400 baud and is set up as a modem.
2. Connect the port on the EXORmacs to the MODEM connector of the M304 adapter on the M980 using an RC-18 or equivalent cable.
3. Turn the M980 Power ON, the M304 adapter ON-LINE and MODEM ON.
4. On the M980, select the 9818-15 active ("15 AAA") to receive the file to be downloaded.

### NOTE

The file must be configured in the S2 Data Record format. If configured in S1 Data Records, select the 9818-16 active.

5. On the EXORmacs terminal type the following: COPY (FILE NAME).SA, #CN13 (CR). A "1" will flash in the M980's left-most display as data is being downloaded to the M980. When the "1" stops flashing, the transfer is complete. The selected format is again active (" 16 AAA") to receive data.

## To Upload to the EXORmacs from the M980 (M980 Power OFF)

1. Complete steps 1 through 4 above.
2. On the EXORmacs terminal type the following: COPY #CN13, (FILE NAME). SA (CR).
3. On the M980, depress ENTER. The Start and End address limits of the installed RAM Buffer are displayed. Using the HEX keyboard on the M980, key in the desired start and end addresses of the RAM data to be uploaded to the EXORmacs. Depress ENTER.

An "0" will flash in the M980's left-most display as data is being uploaded to the EXORmacs. When the "0" stops flashing, the transfer is complete. The selected format is again active (" 16 AAA") to receive data.

To terminate the upload, enter a BREAK on the EXORmacs terminal. This will close the new file.

## CP/M-BASED SYSTEMS

Systems using Digital Research's CP/M DOS, interface via any available system RS-232-C port. CP/M assembler's create hexadecimal files that are compatible with the M980's INTEL #12 format.

In order to RS-232-C interface, the DTR signal (pin 20) on the M304 adapter terminal connector, or the CTS signal (pin 5) on the modem connector, must be held high. If the selected system port does not provide this signal, refer to page 18-4 for "Simple Hook-up for DTE and DCE."

### NOTE

Do not install the M304 with the M980 power ON.



**Operation**

1. Install M304 adapter on the M980 using RC-18 cable or equivalent.
2. Connect to system via M304 terminal or modem connector, whichever is appropriate.
3. Turn ON-LINE switch on.
4. Select INTEL #12 format active using procedure on page 18-6.
5. The M980 is ready to receive in Intel HEX. To download, continue with step 6. To upload, go to step 7.
6. On the system keyboard, key in TYPE UFN.HEX Control P Return. A "1" is shown in the left-most display as data is downloaded to the Buffer. Or, use PIP as follows: on the system keyboard, key in PIP (Port)=UFN.HEX Return. The M980 responds as above.
7. To upload, key in the following to the system terminal: PIP UFN.HEX=(port) Return. Depress ENTER on M980. The M980 shows a "0" in the left-most display to confirm it is outputting data to your system. When the upload is complete, the previously selected format will be active.

The M980 RAM Buffer is addressed with a 14-bit address bus. When the Absolute Address (16 bit) is received, the two high-order address bits are ignored. When 16K boundaries are crossed, the Buffer is addressed at location 0000 hex. For example: Absolute Address 4000 hex (0100 0000 0000 0000) addresses the buffer at address 0000 hex (0000 0000 0000 0000).

These bits are ignored by the M980.

As a result, data wraparound occurs at 16K boundaries. If the buffer is less than 16K, data written to nonbuffered locations are lost.

**M980 Buffer Size Considerations (When not using Address Offset)**

**16K RAM Buffer:** All absolute addresses and their associated data are accepted and wraparound occurs after addresses 3FFF, 7FFF, BFFF, and FFFF (see Figure 18-13).

**8K RAM Buffer:** Only absolute addresses 0000 through 1FFF, 4000 through 5FFF, 8000 through 9FFF, and C000 through DFFF are accepted. All other absolute addresses and their data are lost (see Figure 18-14).

**4K RAM Buffer:** Only absolute addresses 0000 through 0FFF, 4000 through 5FFF, 8000 through 8FFF, and C000 through CFFF are accepted. All other absolute addresses and their data are lost (see Figure 18-15).

**16K WRAPAROUND FEATURES OF M980 RAM BUFFER**

In all RS-232-C Industrial formats where the address information is presented with the incoming data stream (Intel, Motorola, Tek-Hex, etc.), the Absolute Addresses can be offset to start at RAM location 0000 HEX (See Address Offset description on pages 18-59 and 18-60 for further details). Wraparound will occur after the end of each 16K boundary is reached (i.e., addresses 3FFF, 7FFF, BFFF, and FFFF).

| BUFFER ADDRESSES |         | ABSOLUTE ADDRESSES |      |      |      |                                                                |
|------------------|---------|--------------------|------|------|------|----------------------------------------------------------------|
| 3FFFF            | 16K RAM | 3FFF               | 7FFF | BFFF | FFFF | All absolute addresses and their associated data are accepted. |
| 0000             |         | 0000               | 4000 | 8000 | C000 |                                                                |
| VALID ADDRESSES  |         |                    |      |      |      |                                                                |

Figure 18-13. Example of 16K RAM Buffer and Addresses Accepted as Valid Addresses for Loading Data

| BUFFER ADDRESSES |                      | ABSOLUTE ADDRESSES |      |      |      |                                                                  |
|------------------|----------------------|--------------------|------|------|------|------------------------------------------------------------------|
| 3FFF             | 8K RAM not installed | 3FFF               | 7FFF | BFFF | FFFF | These absolute addresses and their associated data are lost.     |
| 2000             |                      | INVALID ADDRESSES  |      |      |      |                                                                  |
| 1FFF             | 8K RAM               | 1FFF               | 5FFF | 9FFF | DFFF | These absolute addresses and their associated data are accepted. |
| 0000             |                      | VALID ADDRESSES    |      |      |      |                                                                  |
|                  |                      | 0000               | 4000 | 8000 | C000 |                                                                  |

Figure 18-14. Example of 8K RAM Buffer and the Addresses Accepted as Valid Addresses for Loading Data

| BUFFER ADDRESSES |                       | ABSOLUTE ADDRESSES |      |      |      |                                                                  |
|------------------|-----------------------|--------------------|------|------|------|------------------------------------------------------------------|
| 3FFF             | 12K RAM not installed | 3FFF               | 7FFF | BFFF | FFFF | These absolute addresses and their associated data are lost.     |
| 1000             |                       | INVALID ADDRESSES  |      |      |      |                                                                  |
| 0FFF             | Standard 4K RAM       | 0FFF               | 4FFF | 8FFF | CFFF | These absolute addresses and their associated data are accepted. |
| 0000             |                       | VALID ADDRESSES    |      |      |      |                                                                  |
|                  |                       | 0000               | 4000 | 8000 | C000 |                                                                  |

Figure 18-15. Example of 4K RAM Buffer and the Addresses Accepted as Valid Addresses for Loading Data

# Communications Interface M304 Adapter

## JUMPER-SELECTED PARITY AND STOP BITS

In addition to the three panel switches, there are 9 user-accessible jumpers located on the top of the M304 adapter board. These are provided for special configuring by the user, if needed, but should rarely be changed. To change a jumper, unscrew the three mounting screws and remove the cover of the M304; the jumpers that are in place are unsoldered and can be removed or clipped with side cutters. To install a new jumper, solder short pieces of insulated wire in place. A functional description of each jumper follows.

The M304 character format as shipped from Pro-Log is shown in Figure 18-6. Even parity is generated and sent. However, on Receive, parity is not used but must be sent (either odd, even or fixed) to provide the proper timing for the stop-bit position.

**Even Parity Enable (EPE)** — Selects whether even or odd parity is generated. The M304 is shipped in the even parity enable position. To select odd parity, remove jumper between E19, E20, and install between E20, E21. Parity is not used by the M980 when receiving. However, it must be sent either ODD, EVEN, or fixed.

**Stop-Bit Select (SBS)** — Selects whether there are one or two stop bits sent or required when receiving. The M304 is shipped in the one-stop-bit mode. To select two stop bits, remove the jumper between E17, E16, and install a jumper between E17, E18. When transmitting to the M980, the stop bit can be of any length, provided that it is a minimum length of one bit in the one's position, and two bits in the two's position.

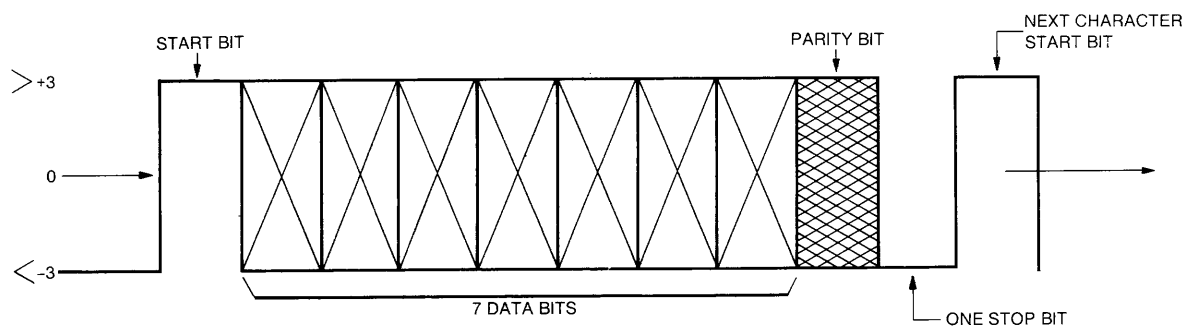

9812M980-39

Figure 18-16. Character Format

**Parity (P1)** — Selects whether parity is generated or not. The M304 is shipped in the parity enable mode. To inhibit parity generation, remove jumper between E14, E15, and install between E14, E13.

By selecting jumper positions, the following character variations are possible (see Figure 18-17 and 20-14).

1. One start bit, seven data bits, one stop bit (E16, E17) (E14, E13).
2. One start bit, seven data bits, two stop bits (E17, E18) (E14, E13).
3. One start bit, seven data bits, one stop bit, even parity, (E20, E19) (E17, E16) (E14, E15).
4. One start bit, seven data bits, two stop bits, even parity, (E17, E18) (E20, E19) (E14, E15).
5. One start bit, seven data bits, one stop bit, odd parity (E16, E17) (E14, E15) (E20, E21).
6. One start bit, seven data bits, two stop bits, odd parity (E17, E18) (E14, E15) (E21, E20).

Please refer to the M304 schematic for the following jumper descriptions:

**(E12-E11) (E10-E9):** These jumpers affect the Request To Send (RTS) line. The M304 is shipped with this line forced high by direct connection to +5V through a resistor. This line is not used by the M980. However, most modems require this line to be high to allow the modems to transmit. If this line is required, by protocol or other requirements, to be directly connected from the modem through to the terminal, remove jumper between E11, E12 and install between E10, E9.

**(E1-E2) (E3-E4):** These jumpers affect the Carrier Detect (CD) line. The M304 is shipped with this line forced high by direct connection to +5V through a resistor. This line is not used by the M980. However, some terminals may require this line to be high for operation. If this line is required, by protocol or other requirements, to be directly connected from the modem through to the terminal, remove jumper between E1, E2 and install between E3, E4.

**(E5-E6) (E7-E8):** These jumpers affect the Data Set Ready (DSR) line. The M304 is shipped with this line forced high by direct connection to +5V through a resistor. This line is not used by the M980. However, some terminals may require this line to be high for operation. If this line is required, by protocol or other requirements, to be directly connected from the modem through to the terminal, remove jumper between E5, E6 and install between E7, E8.

### Signal Discipline

The RS-232-C signals (see Figure 18-18) that are provided by the M304 are used by the M980 as follows:

TRANSMIT DATA is used by the terminal to send address, control and data characters to the M980 and/or modem. It is also used by the M980 to send data to the modem.

RECEIVE DATA is used by the M980 to send control and data characters to the terminal. It is also used by the modem to send data to the terminal and M980.

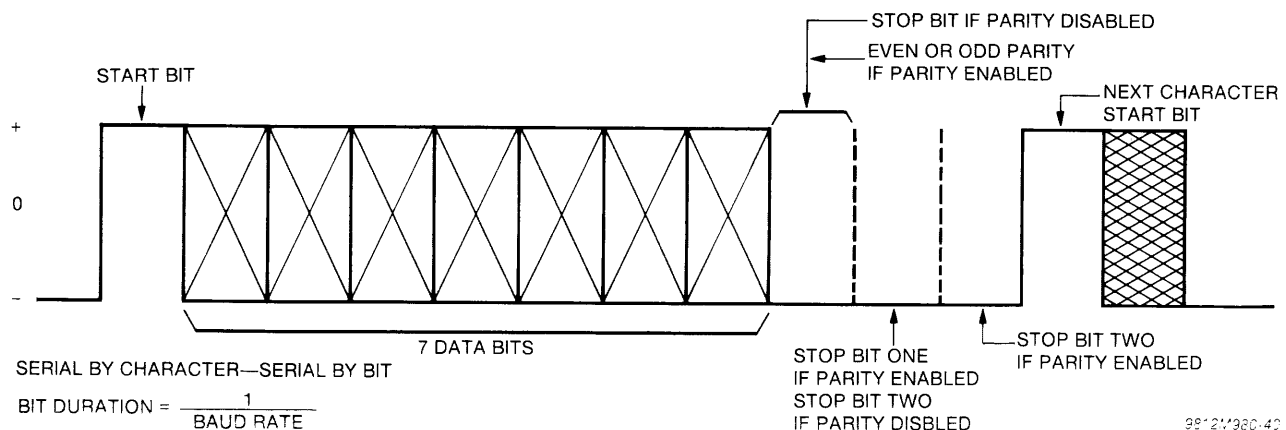

Figure 18-17. Character Variations Using Jumper

REQUEST TO SEND is held high by the M304 for the modem if required, or can be connected by jumper through to the terminal.

CLEAR TO SEND is used by the M980 to indicate to the terminal it is ready to receive characters. This line is used to indicate the M980 is in the Receive Mode. CTS is also used by the modem.

DATA TERMINAL READY is used by the M980 to determine that the interface is connected and ready to operate. This line should be held continuously high. Operation with the M980 can be aborted by dropping this signal low.

CARRIER DETECT is not used, but is held high by the M304 or can be connected by jumper through to the terminal.

DATA SET READY is not used, but is held high by the M304 or can be connected by jumper through the modem.

| M304 ADAPTER RS232C INTERFACE CONNECTORS |    |            |                   |
|------------------------------------------|----|------------|-------------------|
| PIN NUMBER                               |    | PIN NUMBER |                   |
| SIGNAL                                   |    |            | SIGNAL            |
|                                          | 1  | 14         |                   |
| TRANSMIT DATA*                           | 2  | 15         |                   |
| RECEIVE DATA*                            | 3  | 16         |                   |
| REQUEST TO SEND                          | 4  | 17         |                   |
| CLEAR TO SEND                            | 5  | 18         |                   |
| DATA SET READY                           | 6  | 19         |                   |
| SIGNAL GROUND                            | 7  | 20         | DATA TERMINAL RDY |
| CARRIER DETECT                           | 8  | 21         |                   |
|                                          | 9  | 22         |                   |
|                                          | 10 | 23         |                   |
|                                          | 11 | 24         |                   |
|                                          | 12 | 25         |                   |
|                                          | 13 |            |                   |

\*Designates Low-Level Logic

Figure 18-18. Signal Discipline

## ELECTRICAL SPECIFICATIONS

The M304 is designed to work with a high input level of from +3V to +25V and a low input of from -3V to -25V. The output levels of the M304 are approximately +4V for high-level and -4V for low-level. The signals used and the pin assignments for the terminal and modem connectors may be found in the Signal Discipline Section. Signal lines not listed are wired directly from the terminal connector to the modem connector by the M304 adapter (see Figures 18-19 and 18-20).

The M304 provides connection for one modem and connection for one terminal, along with the following Baud rates: 50, 75, 110, 134.5, 150, 200, 300, 600, 1200, 1800, 2400, 4800, 9600.

## MECHANICAL SPECIFICATIONS

Height: Approx. 1 inch

Length: 6 inches

Width: 3.1 inches

## ENVIRONMENTAL SPECIFICATIONS

Temperature: Operating: 0°C to +50°C

Storage: -20°C to +60°C

| PARAMETER |                                                                                      | MIN  | MAX      | UNITS          |
|-----------|--------------------------------------------------------------------------------------|------|----------|----------------|
| VOH       | High-level output voltage <sup>1</sup>                                               | +3   | 4.6      | V              |
| VOL       | Low-level output voltage <sup>1</sup>                                                | -6.6 | -3       | V              |
| IOS       | Output short circuit current, output connected to $\pm 12V$ (duration 1 second max.) |      | 80       | mA             |
| CL        | Output load capacitance <sup>2</sup>                                                 |      | 2500     | pF             |
| Tr<br>Tf  | Output rate of change                                                                |      | 30       | V/ $\mu s$     |
| VIH       | Input high-level voltage                                                             | +3   | +25      | V              |
| VIL       | Input low-level voltage                                                              | -3   | -25      | V              |
| IIH       | Input high-level current                                                             | +0.5 | +8.5     | mA             |
| IIL       | Input low-level current                                                              | -0.5 | -8.5     | mA             |
| EL        | Output termination bias                                                              | -2.0 | +2.0     | V              |
|           | BAUD rate (bits/second)                                                              | 50   | 9600     | baud           |
|           | Recommended cable length                                                             |      | 50<br>16 | feet<br>meters |
| VO        | Driver open circuit output voltage                                                   | -12  | +5       | V              |
| RO        | Driver output resistance, power off                                                  | 300  |          | ohms           |
| RL        | Input load resistance                                                                | 3K   | 7K       | ohms           |

<sup>1</sup>Minimum load resistance 3K ohms

<sup>2</sup>Includes cable and terminator capacitance

Figure 18-19. Terminal/Modem/I/O Specifications

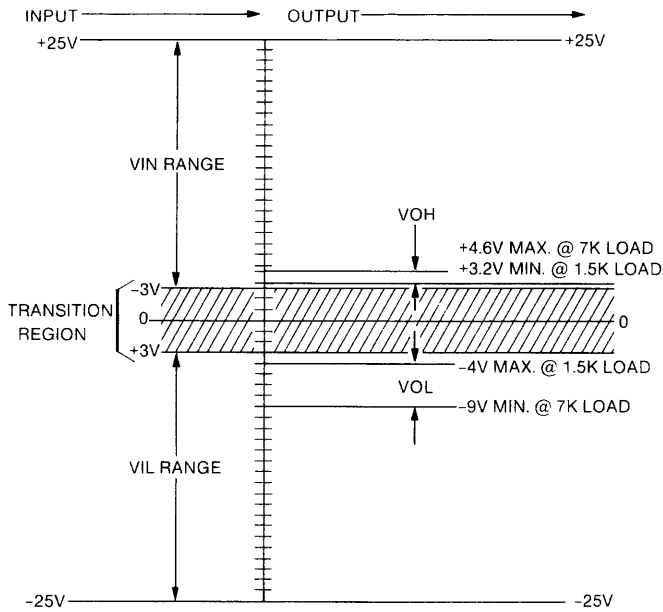

9812V980-41

Figure 18-20. M304 I/O Specification

# SECTION 19

## 9103A UV Erase Light

### DESCRIPTION

Model 9103A is an ultraviolet erase lamp designed to accommodate a quantity of UV Eraseable PROMS. The unit consists of dual high-intensity UV lamps mounted in an enclosed case with hinged lid and safety interlock, a presettable 0-60 minute timer, ON and OFF controls, and AC power connector.

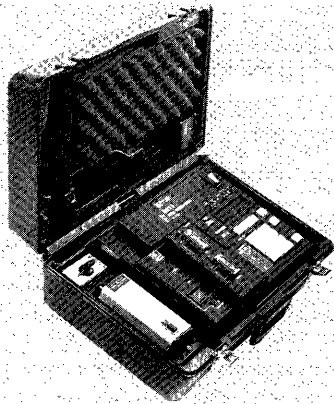

Figure 19-1. 9103A  
(Mounted in the M980 Programmer Case)

### PHYSICAL CHARACTERISTICS

- Housed in an 11.5-in. (29.2 cm.) by 3.5-in. (8.9 cm.) by 4 in. (10.2 cm.) aluminum case.
- Weight: 2.5 pounds
- Conductive foam pad for EPROMs is 3.5 in. (8.9 cm.) by 2.5 in. (6.4 cm.) and accepts up to 10 24-pin dual-in-line packages or equivalent.

### CONTROLS

- **TIMER SET** is a rotary control at the top rear of the unit that adjusts the UV lamp on-time from 0-60 minutes. The control is continuously variable with dial markings in 15-minute increments. Timer set can be adjusted during operation to lengthen or terminate erasure. Lamp power is removed when the control reaches zero.

The Model 9103A is designed as an accessory to the Series 90 PROM Programmer attache case; the 9103A-1 is a stand-alone erase light unit with a 6-foot power line cord, and the 9103A-2 is a stand-alone erase light unit with a 6-foot power line cord for 230V.



Figure 19-2. 9103A UV Erase Light

- **LAMP ON/OFF:** LAMP ON (black push button) starts the UV lamp, only if the timer has been set to the desired erase time first (see table). LAMP OFF (red push button) can be used to remove lamp power.
- **SAFETY INTERLOCK** is an internal switch that removes lamp power when the chamber lid is raised. The lamp must be restarted using LAMP ON after reclosing the lid.

### OPERATING INSTRUCTIONS

1. Proper PROM erasure is the result of timed exposure to a UV light source of critical wavelength and intensity (see Figure 19-3).

2. PROMs that are inadequately erased retain partial changes that may affect the data pattern later. The condition of inadequate erasure is often not detectable when the PROM is reprogrammed.
3. Use the Recommended Erase Time shown below as a minimum timer setting for your PROM type.
4. In order to ensure compliance with the conditions required for the recommended erase times, the following placement procedure should be used:
  - a. A  $\frac{3}{8}$ " thick loose pad (supplied) is placed on top of the fixed pad in the 9103A and centered.
  - b. Ensure PROM windows are free of labels and are clean.
  - c. PROMs to be erased (with or without a carrier socket) are placed on the loose pad but not pressed into it. This gives the proper clearance from the erasing tubes (within  $\frac{1}{2}$ ").
  - d. The PROM window must be up and directly on the centerline of one of the erasing tubes. Lines have been printed on the loose pad to show the position and extent of proper placement for the window. Try not to go beyond these lines.
  - e. Up to 10 24-pin or 28-pin PROMs can be erased using the arrangement shown in Figure 3.
5. Close the lid, set the timer, and hold the LAMP ON button down until a blue glow is observed through the view hole near the lid knob. Unit operation will then be automatically terminated by the timer.
6. If the lid is raised before the timer stops the 9103A, LAMP ON must be used to restart the lamp. Readjust timer setting if necessary.
7. Replace the UV lamp yearly with normal use to maintain recommended erase time, or test the lamp with a UV intensity meter such as the Spectronics DM-245N, or equivalent\*. Alternately, the erase times can be proportionately lengthened to accommodate the reduced intensity.

\*Minimum reading:  $6750 \mu\text{W}/\text{cm}^2$ , measured with the sensor on axis, in the center of the tube,  $\frac{1}{8}$ " from the tube body to sensor body, 100 seconds from cold start.

### LAMP CHARACTERISTICS

- Unfiltered short wave ultraviolet light
- $\lambda=254$  nanometers (2540 Angstroms)
- Lamp type: UVS-11 or Spectronics 2537S

### POWER REQUIREMENTS

115 VAC, 60 Hz, 0.20 ampere

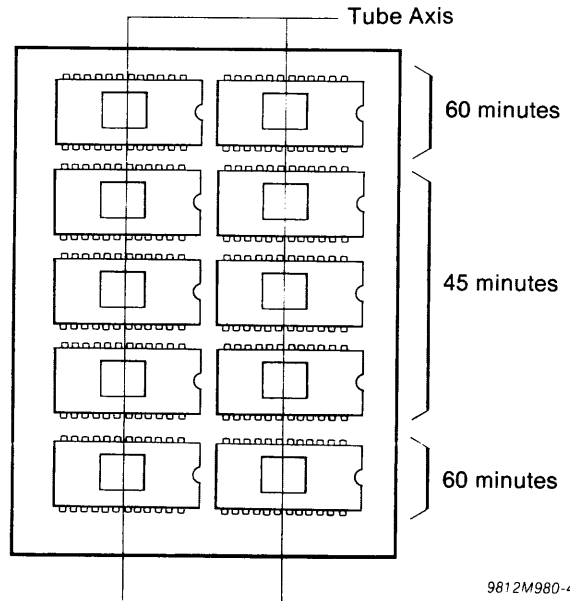

Figure 19-3. Recommended PROM Arrangement and Erase Times\*\*

**\*\*ASSUMPTIONS:**

1. Average irradiation in the first one hour after turn on is 85% of the reading after 100 seconds.
2. Degradation of 25% is allowed after 6-700 hours of usage.
3. PROM erasure requires at least 15 W/sec.
4. PROM die is no more than  $\frac{1}{2}$ " from erase tube surface.

**CAUTION**

Ultraviolet light is harmful to eyes and other tissue. Do not defeat the purpose of the 9103A lid interlock or operate unit if the interlock is defective.



## ASCII Code Assignments

| HEX | MSD  |    |    |    | p=1 | 8   | 9  | A | B | C | D | E   | F |
|-----|------|----|----|----|-----|-----|----|---|---|---|---|-----|---|
|     | BITS |    |    |    | p=0 | 0   | 1  | 2 | 3 | 4 | 5 | 6   | 7 |
| LSD | BITS |    |    |    | b8  | p   | p  | p | p | p | p | p   | p |
|     | b4   | b3 | b2 | b1 | b7  | 0   | 0  | 0 | 0 | 1 | 1 | 1   | 1 |
|     |      |    |    |    | b6  | 0   | 0  | 1 | 1 | 0 | 0 | 1   | 1 |
|     |      |    |    |    | b5  | 0   | 1  | 0 | 1 | 0 | 1 | 0   | 1 |
|     |      |    |    |    | b4  | 0   | 1  | 0 | 1 | 0 | 1 | 0   | 1 |
| 0   | 0    | 0  | 0  | 0  | NUL | DLE | SP | 0 | @ | P | ' | p   |   |
| 1   | 0    | 0  | 0  | 1  | SOH | DC1 | !  | 1 | A | Q | a | q   |   |
| 2   | 0    | 0  | 1  | 0  | STX | DC2 | '' | 2 | B | R | b | r   |   |
| 3   | 0    | 0  | 1  | 1  | ETX | DC3 | #  | 3 | C | S | c | s   |   |
| 4   | 0    | 1  | 0  | 0  | EOT | DC4 | \$ | 4 | D | T | d | t   |   |
| 5   | 0    | 1  | 0  | 1  | ENQ | NAK | %  | 5 | E | U | e | u   |   |
| 6   | 0    | 1  | 1  | 0  | ACK | SYN | &  | 6 | F | V | f | v   |   |
| 7   | 0    | 1  | 1  | 1  | BEL | ETB | ,  | 7 | G | W | g | w   |   |
| 8   | 1    | 0  | 0  | 0  | BS  | CAN | (  | 8 | H | X | h | x   |   |
| 9   | 1    | 0  | 0  | 1  | HT  | EM  | )  | 9 | I | Y | i | y   |   |
| A   | 1    | 0  | 1  | 0  | LF  | SUB | *  | : | J | Z | j | z   |   |
| B   | 1    | 0  | 1  | 1  | VT  | ESC | +  | ; | K | [ | k | {   |   |
| C   | 1    | 1  | 0  | 0  | FF  | FS  | ,  | < | L | \ | l |     |   |
| D   | 1    | 1  | 0  | 1  | CR  | GS  | -  | = | M | ] | m | }   |   |
| E   | 1    | 1  | 1  | 0  | SO  | RS  | .  | > | N | ^ | n | ~   |   |
| F   | 1    | 1  | 1  | 1  | SI  | US  | /  | ? | O | _ | o | DEL |   |

### CONTROL CHARACTERS

|            |                                           |            |                           |            |                  |
|------------|-------------------------------------------|------------|---------------------------|------------|------------------|
| <b>NUL</b> | Null                                      | <b>FF</b>  | Form Feed                 | <b>CAN</b> | Cancel           |
| <b>SOH</b> | Start of Heading                          | <b>CR</b>  | Carriage Return           | <b>EM</b>  | End of Medium    |
| <b>STX</b> | Start of Text                             | <b>SO</b>  | Shift Out                 | <b>SUB</b> | Substitute       |
| <b>ETX</b> | End of Text                               | <b>SI</b>  | Shift In                  | <b>ESC</b> | Escape           |
| <b>EOT</b> | End of Transmission                       | <b>DLE</b> | Data Link Escape          | <b>FS</b>  | File Separator   |
| <b>ENQ</b> | Enquiry                                   | <b>DC1</b> | Device Control 1          | <b>GS</b>  | Group Separator  |
| <b>ACK</b> | Acknowledge                               | <b>DC2</b> | Device Control 2          | <b>RS</b>  | Record Separator |
| <b>BEL</b> | Bell (audible or attention signal)        | <b>DC3</b> | Device Control 3          | <b>US</b>  | Unit Separator   |
| <b>BS</b>  | Backspace                                 | <b>DC4</b> | Device Control 4 (Stop)   | <b>DEL</b> | Delete           |
| <b>HT</b>  | Horizontal Tabulation (punched card skip) | <b>NAK</b> | Negative Acknowledge      |            |                  |
| <b>LF</b>  | Line Feed                                 | <b>SYN</b> | Synchronous Idle          |            |                  |
| <b>VT</b>  | Vertical Tabulation                       | <b>ETB</b> | End of Transmission Block |            |                  |

## Error Indications

| CODE | EXPLANATION                                                                                                                                                                                                                                                 |
|------|-------------------------------------------------------------------------------------------------------------------------------------------------------------------------------------------------------------------------------------------------------------|
| E0   | Set-up error. The Source, Destination, or MFG toggle switches are not in the proper position, e.g. a non-valid operation such as program MASTER.                                                                                                            |
| E1   | Data error. A failure to Blank Check, Program, Compare.                                                                                                                                                                                                     |
| E2   | No option. Option selected does not exist.                                                                                                                                                                                                                  |
| E3   | Address error. Performing an operation and the address given cannot be complied with. Example: Duplicate Master to Buffer. If you try to move a 2K program into the last 1K of Buffer, this error indication will appear prior to attempting the operation. |
| E4   | No Personality Module. A Personality Module is not installed. Buffer operation may continue.                                                                                                                                                                |
| E5   | Option Interface not ready. Option selected, but when checked, the interface is not properly hooked up. Example: 9818 RS-232-C adapter installed but ON-LINE/OFF-LINE switch is in the OFF-LINE position.                                                   |
| E6   | Communication CHECKSUM error. When using one of the interfaces in which the checksum of each line is sent over the interface and the checksum does not match, this error will be displayed. An example: Intel Format RS-232-C.                              |
| E7   | Remote control error indication: Response to the QXN command.                                                                                                                                                                                               |
| E8   | Personality Module Overload Failure (see individual operating instruction).                                                                                                                                                                                 |
| E9   | Invalid Buffer Data during PM9080 update.                                                                                                                                                                                                                   |
| EA   | Programming Error in updating PM9080 PROMs.                                                                                                                                                                                                                 |

(Cut Here)



**PRO-LOG**<sup>®</sup>  
CORPORATION

*Yes, I'm interested in Pro-Log*

*Please send me more information about your:*

- STD BUS Product Line
    - 7000 Series STD BUS
    - CMOS 7000 Series
    - STD BUS Accessories
    - Packaging Solutions
  - Pro-Log User's Software (PLUS)
  - Designer Software (MDM 1.0)
  - Programmer Product Line
  - Design Courses & Seminars
  - Other \_\_\_\_\_
- I am currently using Pro-Log equipment
  - Add my name to your mailing list
  - Please have a Sales Representative contact me

FOLD

Reader Comments \_\_\_\_\_

---

---

---

---

---

---

---

---

---

---

---

---

---

---

---

---

---

---

---

---

---

---

---

---

---

---

---

---

---

---

FOLD

Name \_\_\_\_\_ City \_\_\_\_\_  
 Company \_\_\_\_\_ State \_\_\_\_\_ Zip \_\_\_\_\_  
 Address \_\_\_\_\_ Telephone \_\_\_\_\_

*Fold*

*Fold*

**PLACE  
POSTAGE  
HERE**

 **PRO-LOG<sup>®</sup>**  
CORPORATION  
2411 Garden Road  
Monterey, CA 93940

Attn: Literature Department

*Staple here.*



2411 Garden Rd., Monterey, CA 93940  
Phone: (408) 372-4593, (800) 538-9570  
TWX: 910-360-7082, Telex: 171879