

GOULD

**PRECISION
TEST AND
MEASUREMENT
EQUIPMENT**

**OSCILLOSCOPES
AND RECORDING
SYSTEMS**

1992 - 93



GOULD
Electronics

GOULD PROVIDES SOLUTIONS FOR YOUR APPLICATIONS

To succeed in today's highly competitive business environment, manufacturers must not compromise when it comes to satisfying customer needs. As one of the world's premier suppliers of oscillographic, array, waveform and strip chart recorders, digital storage oscilloscopes and data acquisition systems, Gould Test and Measurement has adapted and improved the very latest techniques to meet the demands and the dynamics of the market.

At Gould, advanced technology for design and manufacturing benefit the instrument user. CAE, CASE tools, ASIC technology, automated surface mount assembly and ATE are employed to ensure the highest quality standards. In addition, we have invested in the personnel and the training to keep us in the forefront of high quality, high technology test and measurement companies, providing the products and services that exceed your expectations.

Gould's Test and Measurement products address applications in many industries — from mainstream electronics, aerospace and defense to auto manufacturing, general industry, utilities, medical research, computing and telecommunications. Our broad range of high

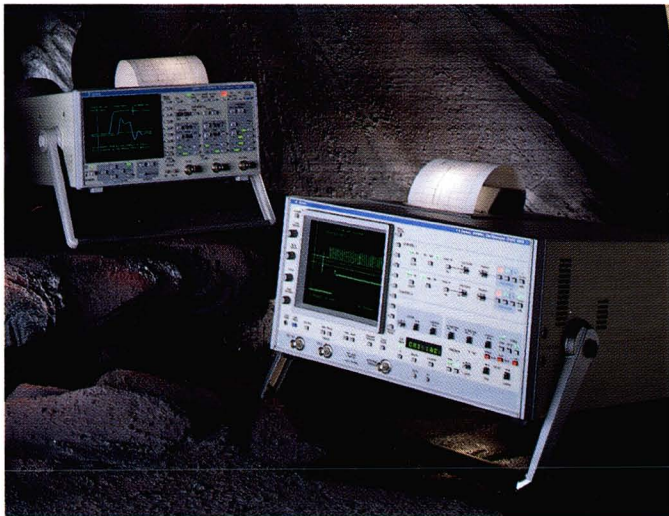

quality equipment is supported by many years of application experience in all of these sectors.

Gould makes extensive use of automation, essential to today's complex designs. Workstation networks and the latest software are used for electronic and mechanical design, printed circuit board layout and software development. One of our strengths is the design and simulation of both analog and digital ASICs — vital components for compact, reliable, and sophisticated measurement instruments.

Gould ensures that all the differing functional requirements of product design are covered through the use of



cross-functional teams. Aspects, such as EMC, stress loading, thermal management, environmental protection, mechanical construction and software maintainability, are all treated as basic to the design.

Direct communications between Gould's engineering and manufacturing systems smooth the transition of the design from development into full production. Our JIT methods and process control systems are coupled with extensive use of automated assembly, test and calibration to ensure quality is carried through the entire manufacturing process.

Gould has sales and service teams in Austria, France, Germany, Italy, Japan, United Kingdom and United States, and fully trained representatives throughout the rest of the world. Each team offers experienced product and application specialists, backed up by efficient service organizations to provide a first class level of support and service.

Committed to Quality

Gould is a company committed to quality. Throughout the entire design and manufacturing process, quality is paramount. We design not only to meet the desired performance and cost, but also for reliability, manufacturability and serviceability. Once a product is introduced into production, our JIT processes ensure that delivery times are short and predictable. Investment in technology, such as fully automated surface mount assembly, in-circuit and functional ATE and auto-calibration, ensures that all products are manufactured in a highly efficient, traceable and repeatable way. Sophisticated product testing, environmental stressing and statistical process control are used to check that the quality and reliability are maintained throughout the entire manufacturing process. Our approach not only guarantees quality, it also minimizes manufacturing cost, enabling us to offer exceptional products at attractive prices.

TABLE OF CONTENTS

Contents		Computer-Based Recording and Analysis	86
Solutions for Users	2	DASA 4600 Digital Recorders	87
Alphabetical Index	3	DataGraf II Digital Recorders	89
Model Number Index	5	View II Signal Analysis Software	91
New Products	7	Medical Products and Systems	95
Digital Storage Oscilloscopes	11	Special Systems	106
Digital Recording Oscilloscopes	12	Time Codes	108
Oscilloscope Software	34	Communications Interfaces	112
Oscilloscope Accessories	36	Chart Papers and Supplies	114
Graphic Recorders	39	Customer Service	125
Recorder Selection Chart	42	Rent-to-Buy Program	126
Array Recorders	43	Reconditioned Instruments	127
Oscillographic Recorders	60	Shipping, Prices, Terms and Conditions	128
Signal Conditioners	63	Warranties	129
Applications Chart	66	Sales and Service Offices	130
6600 Series Signal Conditioners	68		
5700 Programmable Signal Conditioners	73		
4600 Series Signal Conditioners	79		

ALPHABETICAL INDEX

Description	Page	Description	Page
AC/DC RMS Signal Conditioners	68-70	Data Acquisition	86
AC/DC Signal Conditioners	68-70	DataGraf II Digital Recorders	89
Accessories, oscilloscopes	36-38	DC Signal Conditioner	73, 78-80, 101
Accessories, signal conditioner	84	Demo Instruments	127
Amplifiers	63-85, 98-105	Demodulator Signal Conditioner	84
Application Charts	66, 96	Differential Input Oscilloscopes	27
Array Recorders	43-59	Differentiator Signal Conditioner	103
Belcore Agreement	128	Digital Recording Oscilloscopes	12, 29
Bioelectric Signal Conditioner	98	Digital Storage Oscilloscopes	11-28
Biotach Signal Conditioner	101, 102	Disk-to-Recorder Analog Output Kit	93
Bridge Signal Conditioner	70, 74, 79	DSF-to-ASCII Signal Conversion Software	94
Carrier Signal Conditioner	104	Dual Channel Signal Conditioners	68, 76
Cart, oscilloscope	38	EasyGraf Recorder	43
Cases, signal conditioner	85	ECG Signal Conditioner	102
Cath Lab Systems	111	ECG/Biotach Signal Conditioner	102
Chart Papers and Supplies	114	Electrostatic Recorders	54
Chart Papers	116-124	EP/Cath Lab Physiological Recording System	111
Chart Recorders	39-62	Extended Warranty Agreements	126
Communications Interfaces	112	FAMOS Software	35
Computer-Based Recording and Analysis	86	Floating Input Oscilloscopes	28
Coupler, 6600 series	68	Frequency Converter	72, 83
DASA 4600 Digital Recorders	87	Frequency Deviation Converter	83

ALPHABETICAL INDEX

Description	Page	Description	Page
Graphic Recorders	39-62	Rent-to-Buy Program	126
GSA Contracts	128	RMS Signal Conditioners	75, 80
Hardware Warranty	129	RS- Interfaces	112
High Gain DC Signal Conditioner	80	Sales Offices	130
High Speed Storage Oscilloscopes	20-22	Selection Chart, 400 Series Oscilloscopes	13
High Voltage DC Signal Conditioner	79	Selection Chart, 1600/2600 Series Oscilloscopes	24
High Voltage Probe	69	Selection Chart, 4060 Series Oscilloscopes	18
IEEE-488 Interface	112	Selection Chart, 4070A, 4090 Series Oscilloscopes	20
Ink	117-124	Selection Chart, Digital Recording Oscilloscopes	12
Ink Pens	117-124	Selection Chart, Digital Storage Oscilloscopes	11
Ink Recorders	60-62	Selection Chart, graphic recorders	42
Input/Output Panels	105	Selection Chart, signal conditioners	66
Integrator Signal Conditioner	103	Service	125
IRIG Codes	108	Service Offices	130
LabWindows Software	34	Shipping	128
Lease Program	127	Signal Conditioner Accessories	84
Log-Linear Signal Conditioner	82	Signal Conditioner Cases	85
Medical Instrumentation Chart	96-97	Signal Conditioners	63-84, 98-104
Medical Monitors	104	Software Warranty	129
Medical Products and Systems	95	Software, FAMOS	35
Medical Signal Conditioners	96-104	Software, LabWindows	34
Modules, ES2000 recorder	56-58	Software, oscilloscopes	34-35
Modules, TA4000 recorder	50-51	Software, View II signal analysis	91
Monitors, 4 and 8-channel	104	Software, waveform generation	31
Multi-channel Signal Conditioner	77	Special Systems	106
NASA36 Codes	108	Starter Kits	116-120
Offices	130	Telemetry and Simulation Data Display Systems	108
Ordering Information	128	Temperature Signal Conditioners	71, 81, 100
Oscillographic Recorders	60-62	Terms and Conditions	128
Oscilloscope Accessories	36-38	Thermal Array Recorders	43, 45, 48, 53
Oscilloscope Probes	36-37	Thermal Pen Recorders	60-62
Oscilloscopes	11-29	Thermal Pens	117-124
Oscilloscope Software	34-35	Thermocouple Signal Conditioners	71, 76, 81
Papers	116-124	Time Codes	108
Pens	117-124	Transducer Signal Conditioner	74, 98, 99
Phase Sensitive Demodulator	84	Transmitter Signal Conditioner	82
Portable Oscilloscopes	13-17	Triggering, digital oscilloscopes	23
Portable Recorders	43	Universal Signal Conditioner	99
Pressure Processor	100	View II Graphics and Analysis Software	91
Prices	128	Warranty	126, 129
Probe, high voltage	69	Waveform Generation Software	31
Probes, oscilloscopes	36-37, 116	Waveform Generator	30
Programmable Signal Conditioners	73-76	Waveform Mass Storage	33
Reconditioned Instruments	127	Waveform Processors	32
Recorders	12, 29, 39-62	Waveform Storage	50
		WindoGraf Recorders	45

MODEL NUMBER INDEX

Model Number and Description	Page	Model Number and Description	Page
-369500-17013 Clamp-on Ammeter	84	23-22101-1 PB860 8 Channel Digital Input	59
11-1605-3x Input/Output Panel	105	23-22101-3 PB150 Time Code Interface	59
11-4183-09 Signal Conditioner Case	85	23-26121-1 ES2000 EW Writing Unit	59
11-4781-1 Signal Conditioner Case	85	23-27121-2 ES2000 V12 Monitor	59
11-5407-70 Probe	69	23-27121-3 ES2000 V20 Monitor	59
11-5407-71 Probe	69	23-28101-3 MW2000 Multiple Writing Unit Interface	59
13-4616-00 Phase Sensitive Demodulator	84	23-28101-4 HR2000 High Resolution Copy Board	59
13-6615-2 Coupler	68	23-28101-5 CRT2000 Video Controller Board	59
13-6615-10S AC/DC Signal Conditioner	69	23-29121-1 ES2000 KB Keyboard	59
13-6615-11 AC/DC Signal Conditioner	68	23-31205-1 AP800 8 Channel DC Amplifier	52
13-6615-12 Dual Channel AC/DC Signal Conditioner	68	23-31205-2 AM400 4 Channel Waveform Storage Amplifier	52
13-6615-20S AC/DC RMS Signal Conditioner	70	23-32205-1 TD100 Time Code Interface	52
13-6615-21 AC/DC RMS Signal Conditioner	68	23-32205-2 DP800 8 Channel Digital Input	52
13-6615-22 Dual Channel AC/DC Signal Conditioner	68	23-32205-03 DP800/488 8 channel Digital Input	52
13-6615-30 DC Bridge Signal Conditioner	70	30-V7202-11 Ink 2 Channel Recorder	62
13-6615-40 Thermocouple Signal Conditioner	71	30-V7404-11 Ink 4 Channel Recorder	62
13-6615-45 Pt100 Signal Conditioner	71	30-V7808-11 Ink 8 Channel Recorder	62
13-6615-50 Transducer Signal Conditioner	98	30-V8202-11 Thermal 2 Channel Recorder	62
13-6615-58 Bioelectric Signal Conditioner	98	30-V8404-11 Thermal 4 Channel Recorder	62
13-6615-60 Frequency Converter	71	30-V8808-11 Thermal 8 Channel Recorder	62
13-G4614-01 Log-Linear Signal Conditioner	82	35-V7202-10 Ink 2 Channel Recorder	62
13-G4615-20 High Gain DC Signal Conditioner	80	35-V7404-10 Ink 4 Channel Recorder	62
13-G4615-30 DC Bridge Signal Conditioner	79	35-V7808-10 Ink 8 Channel Recorder	62
13-G4615-40 Thermocouple Signal Conditioner	81	35-V8202-10 Thermal 8 Channel Recorder	62
13-G4615-66 Biotach Signal Conditioner	101	35-V8404-10 Thermal 8 Channel Recorder	62
13-G4615-70 Integrator Signal Conditioner	103	35-V8808-10 Thermal 8 Channel Recorder	62
13-G4615-71 Differentiator Signal Conditioner	103	40-8474-00 WindoGraf Recorder	47
13-G4615-90 High Voltage DC Signal Conditioner	79	40-8474-20 WindoGraf Medical Recorder	47
13-G4615-474029 Temperature Signal Conditioner	81	42-8240-10 TA240 2 Channel Recorder	44
13-G4615-474029 Temperature Signal Conditioner	100	42-8440-10 TA240 4 Channel Recorder	44
13-G4618- Frequency Deviation Converter	83	48-8400- 8 Channel DC Signal Conditioner	77
13-G4618-10 True RMS Signal Conditioner	80	51-3183-10 8 Channel Monitor	104
13-G4618-20 Frequency-to-Voltage Converter	83	51-3283-10 8 Channel Monitor	104
13-G4618-40 Transmitter Signal Conditioner	82	51-4142-20 4 Channel Monitor	104
18-4183-3 Signal Conditioner Case	85	57-1300- Programmable DC Signal Conditioner	73
18-5407-58 Isolated Input Preamplifier	99	57-1301- DC/Bridge/Transducer Signal Conditioner	74
20-4615-35 Carrier Signal Conditioner	104	57-1302- Programmable RMS Signal Conditioner	75
20-4615-50 Transducer Signal Conditioner	99	57-1303- Programmable Thermocouple Signal Conditioner	76
20-4615-58 Universal Signal Conditioner	99	57-1340- DC Signal Conditioner	78
20-4615-65 ECG Signal Conditioner	102	57-1340-6158 DC Signal Conditioner	101
20-4615-65 ECG/Biotach Signal Conditioner	102	57-1440- DC Signal Conditioner	78
20-4615-526611 Pressure Processor	100	57-1440-6158 DC Signal Conditioner	101
23-20121-1 ES2000 CP Controller	59	104 Color Plotter Rack Mounted	37
23-21101-1 PB400 4 Channel Analog Input	59		
23-21101-3 PB200 2 Channel DC Amplifier	59		

MODEL NUMBER INDEX

Model Number and Description	Page	Model Number and Description	Page
107 Battery Option	38	CL-615422-1 View II Signal Analysis Software	91
260 Waveform Processor	32	CL-615422-2 DSF-to-ASCII signal conversion software	94
270 Waveform Processor	32	CL-615423-1 DASA 4600 Acquisition Kit	92
400 Digital Storage Oscilloscope	13	CL-713446- Disk-to-Recorder Analog Output Kit	93
420 Digital Storage Oscilloscope	13		
450 Digital Storage Oscilloscope	13	DP800 8-Channel Digital Input	51
465 Digital Storage Oscilloscope	13, 16	DSU 112 Disk Storage Unit	33
475 Digital Storage Oscilloscope	13, 16	DWG-7000 Generator	30
1602/108 2 Channel Digital Recording Oscilloscope	29	ES2000 Electrostatic Recorder	54
1602 2 Channel Digital Storage Oscilloscope	24	FAMOS Software	35
1604/108 4 Channel Digital Recording Oscilloscope	29	HR2000 High Resolution Hard Copy Board	56
1604 4 Channel Digital Storage Oscilloscope	24	IS Series DC Signal Conditioners	78
1624/108 4 Channel Digital Recording Oscilloscope	29	LabWindows Software	34
1624 4 Channel Digital Storage Oscilloscope	27	MW2000 Multiple Writing Unit Interface	56
2608 8 Channel Isolating Digital Recording Oscilloscope	29	PB20 Oscilloscope Probe	36
2608 8 Channel Isolating Digital Storage Oscilloscope	28	PB27 Oscilloscope Probe	36
3008-7510-43 TA2000 Thermal Array Recorder	53	PB36 Oscilloscope Probe	36
3008-A1500- TA4000 Basic Recorder	52	PB38 Oscilloscope Probe	36
3008-B1500- 8 Channel TA4000 Recorder	52	PB39 Oscilloscope Probe	36
3009-A1140-17 Basic ES2000 System	59	PB45 Oscilloscope Probe	36
4060 Series Digital Storage Oscilloscopes	18	PB46 Oscilloscope Probe	36
4062 2 Channel Digital Storage Oscilloscope	18	PB48 Oscilloscope Probe	36
4064 4 Channel Digital Storage Oscilloscope	18	PB49 Oscilloscope Probe	36
4072A 2 Channel Digital Storage Oscilloscope	20	PB50 Oscilloscope Probe	37
4074A 4 Channel Digital Storage Oscilloscope	20	PB51 Oscilloscope Probe	37
4090 Digital Storage Oscilloscope	20	PB59 Oscilloscope Probe	37
4092 Digital Storage Oscilloscope	20	PB150 Time Code Interface	57
4094 Digital Storage Oscilloscope	20	PB200 2 Channel DC Amplifier	58
4096 Digital Storage Oscilloscope	20	PB400 4 Channel Analog Input	58
4600 Series Signal Conditioners	79-84, 99-104	PB860 8 Channel Digital Input	57
5700 Series Signal Conditioners	73-78	R4 Waveform Generator Software	31
6600 Series Signal Conditioners	68-72, 98	RS3000 Recorders	60
9020-2172-02 DASA 4600 System	92	RS3200 Recorders	62
9020-3172-02 DASA 4600 System	92	RS3400 Recorders	62
9311-1210-01 DataGraf II Recorder	89	RS3800 Recorders	62
ACQ-DSO Software	35	TA240 EasyGraf Recorder	43
AM400 4-Channel Waveform Storage Amplifier	50	TA2000 Thermal Array Recorder	53
AP800 8-Channel DC Amplifier	50	TA4000 Thermal Array Recorder	48
		TD100 Time Code Interface	51
		TR7 Oscilloscope Cart	38

10 NEW DIGITAL STORAGE OSCILLOSCOPES INTRODUCED SINCE 1990

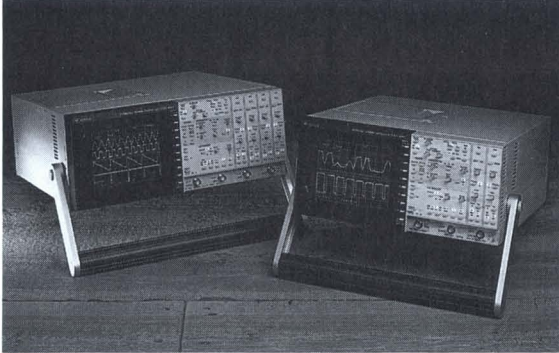

4060 series. 150 MHz bandwidth, 2 and 4 channel models, combined with up to 400 MS/s sampling rates make the 4060 series the obvious choice in medium priced modern oscilloscopes. Easy to use, with comprehensive built-in measurements, including "absolute" measurements referenced to ground, the 4060s can be programmed via IEEE-488.2 and are available with a built-in color or thermal plotter. Refer to page 18 for complete information and specifications.

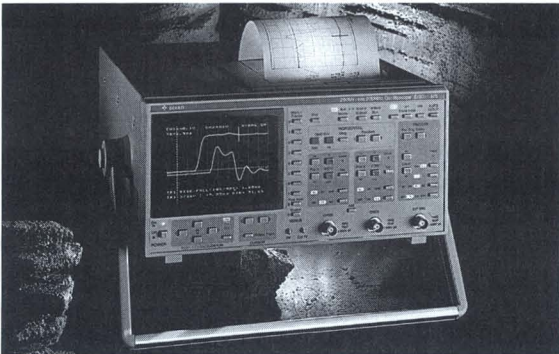

465, 475. These are the latest additions to the highly successful 400 series. The 465 has a 100 MHz bandwidth and a very fast 200 MS/s sample rate. The 475 is even faster with a full 200 MHz bandwidth and a selectable 20 MHz bandlimit. Both instruments are very compact and lightweight powerhouses. They are available with full IEEE-488.2 (SCPI) interfaces, a battery pack for field operation, built-in 4-color plotter, and a variety of carrying cases, probes, etc. See page 13 for complete information and specifications.

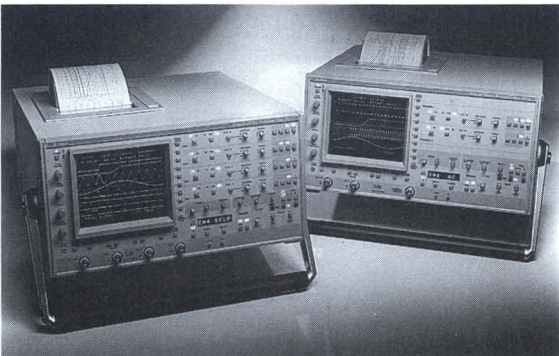

4070A series. All 4070A's have 200 MHz bandwidth and up to 400 MS/s sample rates. They have sophisticated trigger facilities and are easy to use. An optional 270 keypad offers a large number of cursor measurements, as well as the ability to run a programmed sequence of measurements and FFT. Further details, including complete specifications, begin on page 20.

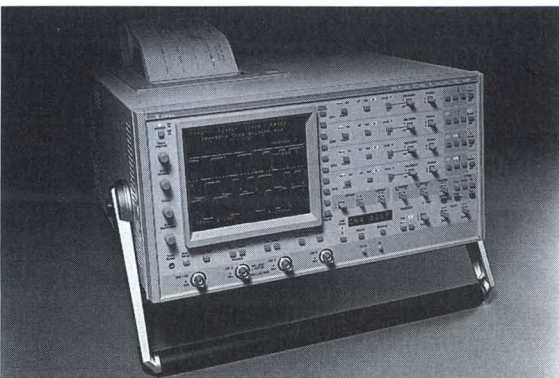

4090 series. The 4090 series consists of both 2 and 4-channel models, with sampling rates from 400 MS/s to 1.6 GS/s. This series of DSOs is one of the fastest sampling series of 200 MHz bandwidth DSOs available today. These oscilloscopes can cope with the most awkward trigger conditions, capturing the desired signals through their alternate sweep dual timebase system, and displaying them clearly on a large 7-in. CRT. See page 20 for more information and specifications.

NEW ACCESSORIES FOR 1992/93

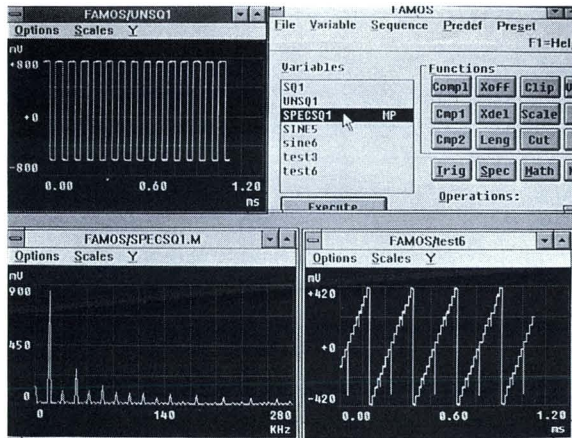
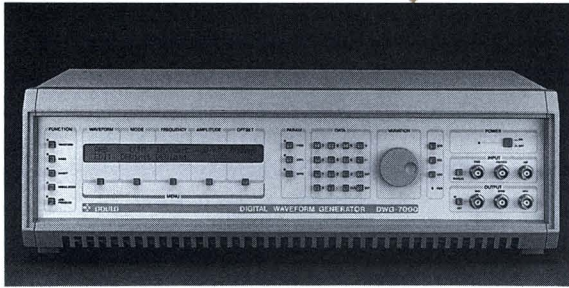

Signal Generation. The DWG-7000 arbitrary waveform generator, and its complementary PC waveform generation and manipulation program "R4," work interactively with Gould DSOs in many test situations. For example, the changing voltage of a car's electrical system during starting can be captured with a 1600 series DSO. The waveform can then be transferred to the DWG-7000, modified if required, and replayed repeatedly to test ancillary car electronics under simulated starting conditions. Alternatively, a signal can be designed in R4 rather than using an actual signal captured by a DSO. See page 30 for more data.

Signal Analysis. ACQ-DSO is a PC program which can transfer acquired data from a Gould DSO to a PC for further analysis. FAMOS (Fast Acquisition and Monitoring of Signals) is a comprehensive analysis program. Both ACQ-DSO and FAMOS run under MS-Windows and are very easy to use. More information is contained on page 35.

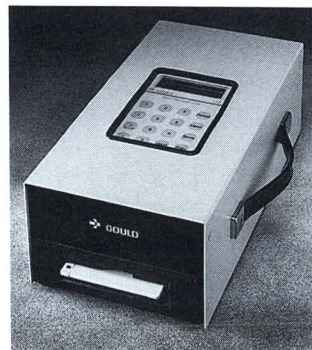

Signal Archiving. Several Gould DSOs are available with optional waveform storage modules. The new DSU 112 unit interfaces to both the 4000 and 1600 series of DSOs and increases the number of waveforms which can be stored from typically 50 with a storage module to several hundred. Waveforms are stored in a DOS compatible format. Complete specifications are on page 33.

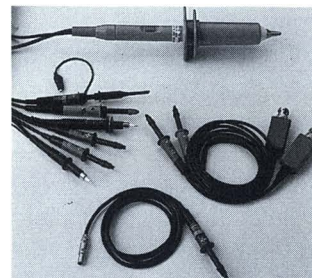

Probing. The use of inappropriate probes is a common cause of signal degradation. Active (FET) probes ensure minimum loading of the signal source, especially for high frequency signals associated with a relatively high source impedance. Two new FET probes, the PB50 (x 10) and the PB51 (switched x 1, x 10) both offer 500 MHz bandwidth with 10 M Ω and a low 3 pF input capacitance at the probe tip. (See page 37.)

For measurement of off-ground, floating differential signals, the new PB59 differential probe can be used with any Gould DSO, and allows balanced probing of signals up to 500 Volts off ground.



EasyGraf Recorders are the new easy to use, easy to carry, and easy to configure units from Gould. These lightweight, rugged, thermal array recorders can be used in many applications to monitor up to four analog input and six event channels. An optional battery pack allows line-free operation in the most remote locations.

Configurations are for two or four channels. Chart speeds are selectable from 0.01 mm/s to 125 mm/s. Whether your application is troubleshooting production lines, routine machine maintenance or research and development, EasyGraf recorders from Gould provide you with answers without operating headaches. See page 43 for more information and complete specifications.

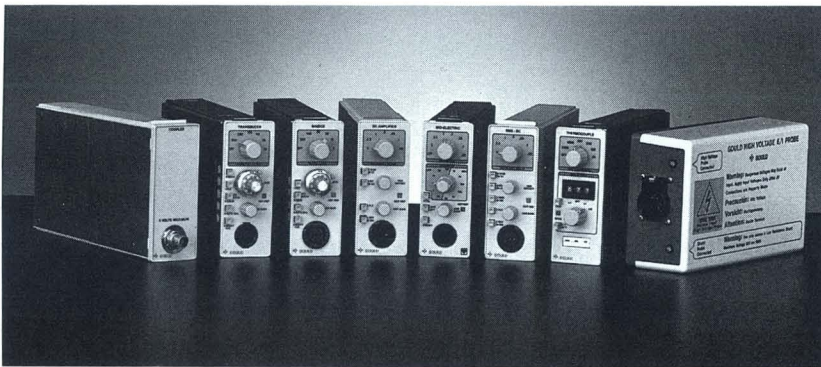

New 6600 series signal conditioners offer high performance in an economical, compact package. All these signal conditioners are compatible with every recording product from Gould. They are especially designed to be plugged into the new WindoGraf and EasyGraf recorders.

The series includes a selection of DC and AC RMS signal conditioners, bridge, transducer, temperature, bioelectric and frequency converter modules. A coupler allows the WindoGraf or EasyGraf recorders to accept inputs from any 5700 or 4600 series signal conditioner.

Complete information and specifications for the 6600 series signal conditioners begin on page 68.



The **DataGraf II digital recorder** is designed and built in the Gould tradition: simple power in a rugged package. The DASA (Data Acquisition and Signal Analysis) 4600 technology provides the DataGraf II recorder with the features needed to handle traditional recording and to address application requirements well beyond the capabilities of standard recorders.

The DataGraf II recorder supports up to 16 analog channels; continuous recording to disk; real-time scrolling monitor; sophisticated triggering; test sequence automation; composite signals; and built-in report generation. The analysis and report generation features help you quickly find critical information and present it in the most appropriate format. Specifications and complete information begin on page 89.

WindoGraf recorders from Gould are a totally new concept in recording. They combine the best features of chart recorder and DSO technologies to form the first effective bridge between conventional recorders and data acquisition instruments. The WindoGraf recorder delivers the power of data acquisition with the simplicity of a traditional recorder.

Continuously monitor your signals on the built-in CRT without running the chart or recording signals to disk. When you wish to record critical signals, simply push a button to start the chart or to record to disk; or, the WindoGraf recorder can automatically trigger and record your signals for you.

Never has so much power been available in such a simple package. See page 45 for complete information and specifications.

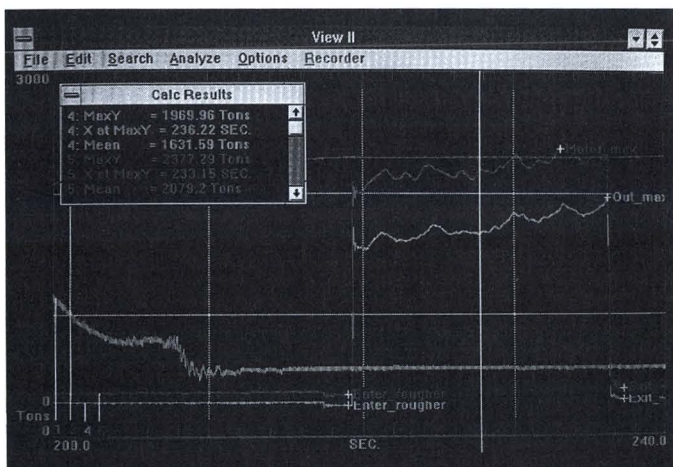

The **View II Signal Analysis software** from Gould is built into the DataGraf II recorder and the DASA 4600 desktop and rack mount recorders. Instead of visually interpreting charts and manually annotating, analyzing and documenting test results, the View II software makes it possible and reasonable to perform a wide range of these procedures and more with computer speed and accuracy.

The View II software operates on all or any portion of 1 to 16 signals. Functions include signal display and manipulation with grids, labels, scales, and both y-t and x-y formats; cursor measurements; standard calculations; math formulas for generating composite signals; ASCII signal values and graphic export; printer output; and optional analog output from disk. See page 91 for complete information and specifications.



- DSOs with 800 MS/s 8-bit converters
- 2, 4 and 8 channel versions
- Automatic cursor measurements
- Extensive waveform processing
- Built-in color plotters

Digital Storage Oscilloscopes Selection Chart

Gould brings you a complete selection of applications-oriented scopes that function as real time scopes, digital storage scopes, transient recorders and electronic chart recorders. Using the optional Waveform Processors, you can do filtering, signal averaging, waveform comparison, TV line capture, FFTs,

programmable sequences, and inter-channel mathematical operations. Programmable models can be interfaced to computers via either RS-423 (RS-232C) or GPIB (IEEE-488) for mass storage, customized signal processing and automatic test applications.

Model No.	Bandwidth MHz	No. of Channels	Memory Size per Channel k words	Vertical Resolution Bits	Max. Sample Rate MS/s	Reference Memories (non-volatile)	RS-423 and IEEE-488 Interfaces	Special Features	Page No.
400	20	2	0.5	8	100	2	Yes	Cursor measurements, data transfer, DC Operation	13
420	20	2	0.5	8	100	2	Yes	Waveform measurements, data transfer, DC operation color plotter, persistence	13
450	50	2	0.5	8	100	2	Yes	Same as 420	13
465	100	2	0.5	8	200	2	Yes	Same as 420	16
475	200	2	0.5	8	200	2	Yes	Same as 420	16
1602	20	2	10	8	20	50	Yes	Fully programmable, built-in color plotter, waveform processing, external clocking	24
1604	20	4	10	8	20	50	Yes	Same as 1602	24
1624	20	4	10	8	20	50	Yes	Fully programmable, built-in color plotter, waveform processing, differential inputs	27
2608	7	8	10	8	20	50	Yes	Fully programmable, built-in color plotter, dual trigger, waveform processing	28
4062	150	2	0.5	8	400 (1 ch)	16	Yes	Fully programmable, built-in color plotter, waveform processing, dual timebase	18
4064	150	4	0.5	8	400 (2 ch)	16	Yes	Same as 4062	20
4072A	200	2	1	8	400	8	Yes	Same as 4062	20
4074A	200	4	1	8	400	8	Yes	Same as 4062	20
4090	200	2	1	8	800 (1 ch)	8	Yes	Same as 4062	20
4092	200	2	1	8	800 (2 ch)	8	Yes	Same as 4062	20
4094	200	4	1	8	800 (2 ch)	8	Yes	Same as 4062	20
4096	200	2	1	8	1600 (1 ch)	8	Yes	Same as 4062	20

12 DIGITAL RECORDING OSCILLOSCOPES



- Continuous high speed recording
- 4 and 8-channel versions
- Differential or floating inputs
- Extensive waveform processing

Digital Recording Oscilloscopes Selection Chart

Our new line of DROs provides a unique combination of high speed capture and recording to thermal paper for hard copy. The models are fully programmable and

can be interfaced to computers via either RS-423 (RS-232C) or IEEE-488.

GENERAL					OSCILLOSCOPE		RECORDER (thermal)				
Model No.	No. of Channels	Glitch Capture	Vertical Resolution Bits	Interface RS-423 IEEE-488	Memory Size per Channel k words	Bandwidth MHz	Chart Length Meters	Max Chart Speed mm/s	Bandwidth Hz	Special Features	Page No.
1602	2	50 ns	8	Both	10	20	30	50	250	Fully programmable, waveform processing	29
1604	4	50 ns	8	Both	10	20	30	50	250	Same as 1602	29
1624	4	50 ns	8	Both	10	20	30	50	250	Fully programmable, waveform processing, differential inputs	27
2608	8	50 ns	8	Both	10	7	30	50	250	Fully programmable, waveform processing, floating inputs	28

These DSOs and DROs are ideal for a multitude of exacting applications, such as:

Mechanical: Stress, vibration, and shock testing and analysis.

Electrical: Contact bounce, voltage breakdown, life/destructive testing, and transient analysis.

Electronic: Testing and development of microprocessor-based systems and communications products, power supplies, consumer electronics, part characterizations, etc.

Medical: Nerve studies, cardiac response, lung function, retina research, and speech pattern analysis.

Scientific: Tensile/compression, acceleration and displacement temperature and ultrasonic testing.

Gould Waveform Processors: To convert the Gould Digital Storage Oscilloscope into an even more powerful analysis system, see page 32 for more details.

Oscilloscope Accessories: See page 38 for details.

Software packages

To simplify the interfacing of the Gould DSO to a computer we offer two types of software package.

Analysis Package — A sophisticated software package that can take your captured signal and perform advanced signal processing.

Control Package — For the user who is building a test system we offer a high level package which greatly accelerates the integration of the DSO into the system.

See Page 34 for details.

HIGH SPEED, PORTABLE OSCILLOSCOPES 400 SERIES

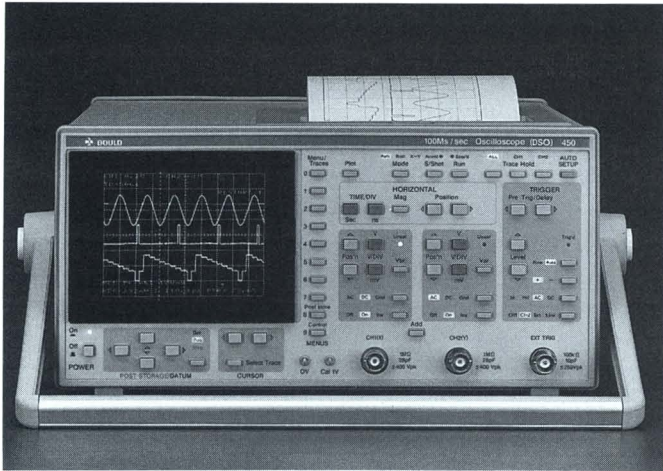

450 Digital Storage Oscilloscope offers 50 MHz bandwidth.

- 200 MS/s transient, 2 GS/s repetitive sampling
- 200 MHz storage bandwidth
- Low cost, small size
- Cursor measurements
- 4 color plotter, real time clock
- RS-423 and IEEE-488 interfaces
- DC or AC powered

400 Series Selection Guide

Model No.	Bandwidth MHz	Input C pF	Sampling Rate MS/s	Timebase ns/div	ETS	Sampling ETS MS/s	RS-423	IEEE-488.2	Battery Pack	4-Color Plotter	IEEE 194-1977 Measurements
400	20	28	100	500	100	500	Std.	Opt.	Opt.	Opt.	N/A
420	20	28	100	500	100	500	Std.	Opt.	Opt.	Opt.	Std.
450	50	15	100	500	50	1000	Std.	Opt.	Opt.	Opt.	Std.
465	100	15	200	250	25	2000	Std.	Opt.	Opt.	Opt.	Std.
475	200	15	200	250	25	2000	Std.	Opt.	Opt.	Opt.	Std.

High speed and portable

All the 400 series oscilloscopes from Gould are truly portable, running from 12 to 33 VDC and weighing from only 5.5 kg to 7 kg., yet their large feature sets allow even very difficult measurement problems to be solved. Pre- and post-trigger delay allows acquisition of only that data which is of interest. Stored traces may be re-positioned in both X and Y, and scaled in Y. Traces can be stored in two non-volatile backup memories for recall later. A separate reference trace can be displayed as well as the normal two channels to aid comparison of signals.

Accurate on-screen measurements

Whether stored or "live" traces are being displayed, the 400 cursor system performs Δt and ΔV measurements on the selected trace with respect to user-positioned datum lines. In addition to Δt and ΔV , IEEE standard 194-1977 measurements of Peak-Peak, RMS, Area, Frequency, Duty Cycle, Period, Rise and Fall-times, and Pulse Width are available. (Not for 400.)

In all 400 series oscilloscopes, periodic auto-calibration ensures measurement accuracy.

Limits testing

Traces can be compared point by point against upper and lower limits which can be down-loaded from a PC. Traces which fail this limits test can be automatically plotted out.

Display persistence

Persistence display is also available. This mode of working displays the complete history of past acquisitions over a user-selected period of time, or for a number of past acquisitions. It's the ideal way to observe total read-pulse jitter, for example, in a disk drive.

Easy to use

Controls on all 400 series oscilloscopes are logically grouped, and to ensure easy operation, "Auto-Setup" has been included. Simply press the blue button. The oscilloscope will choose the timebase and vertical sensitivities which best suit the input signals.

Unique, variable pressure push buttons are used to control vertical trace shift, trigger level and delay, and cursor and datum position. To shift a trace faster, push the button harder.

Additional features such as max-min (glitch detect), dot joining, display trace/alpha/graticule intensities and averaging are controlled via an easy to use two level menu system.

Archive data

The HP-GL plot output is configured through the "Plot Options" menu and a full screen copy can be made on a digital plotter. The optional built-in 4-color plotter is by

far the most convenient means of obtaining a paper copy of the displayed traces. The time as kept by an internal real time clock is stamped on each trace when plotted.

Link to a computer

Trace data can be transferred to a computer for analysis via the RS-423 interface, and from the computer to the oscilloscope for display of results.

New IEEE-488.2 SCPI commands are used for the optional IEEE-488 interface. All oscilloscope functions are controllable remotely, and data can be transferred to and from the oscilloscope. See page 35 for oscilloscope software.

400 SERIES SPECIFICATIONS

These specifications apply to all 400 series oscilloscopes. For a table of differences, see page 13.

VERTICAL DEFLECTION

Two identical input channels CH1, CH2 (invert provided for both channels).

Bandwidth: DC: 0 - Bandwidth MHz. See Table, page 13.
AC: 4 Hz - Bandwidth.

Sensitivity: 2 mV/div to 5 V/div.

Input Impedance: 1 M Ω // Input C. See Table, page 13.

Input Protection: 400 VDC or pk AC.

Vertical Position Range: ± 12 div.

Expansion: Post Storage x 0.062 to x 4.0.

DISPLAY

CRT: 8 x 10 divisions rectangular with electronically generated graticule.

Intensity: Separate trace, graticule and alpha controls.

DISPLAY MODES

Alphanumeric display of channel sensitivity, coupling, timebase, status.

Roll: Stored data and display updated continuously.

Refresh: Stored data and display updated by triggered sweep.

X-Y: CH1 for X, CH2 for Y. 8 x 8 div.

Interpolation: Linear.

Display Resolution: 8 bits x 501 words per channel (256 x 501).

Hold: "ALL" freezes both channels. "CH1", "CH2" freeze appropriate channel.

Single Trace: CH1 or CH2.

Dual Trace: CH1 and CH2.

Add: CH1 and CH2 added after digitization.

Cursor Measurement Display: ΔV and Δt .

Optional Measurements:

Peak-peak

Max-Min

Rise time (Fall time) Overshoot (Preshoot)

Pulse Width

Frequency, Period, Duty Cycle

RMS

Area

Trigger Indication: Separate trigger level and position indicators on screen.

ACQUISITION SYSTEM

Acquisition Memory: 501 words per channel.

Maximum Sample Rate: 100 to 200 M Samples/s. See Table page 13.

ETS Sample Rate: Equivalent to 500 M samples/s to 2 G samples/s for repetitive signals only. See Table page 13.

Vertical Resolution: 8 bits (1 in 256).

Peak Detection (Glitch Capture): Capture of positive and negative glitches to 1- μ s pulse width.

Waveforms: A reference trace can be stored and displayed in addition to input channel displays.

Back-up Stores: 2 non-volatile stores are available for waveform storage.

Averaging: From 2 to 256 acquisitions can be averaged to reduce noise.

Trace Manipulation: (Not 400).

Filter

Invert

Integrate

Trace Arithmetic: (Not 400).

Add

Subtract

Multiply

Limits Testing: (Not 400). Compares acquired traces point by point with upper and lower waveform limits.

Persistence: (Not 400). Emulates a Tube Storage oscilloscope display. Shows history of events, not just envelope.

Set-Up: The current set-up is restored on power-up.

400 Series Specifications

HORIZONTAL DEFLECTION

Sweep Rate: 250 ns to 50 s/div. See Table page 13.

ETS Sweep Rate: 25 to 200 ns/div. See Table page 13.

Expansion: x 10 in either ETS or normal acquisition.

TRIGGER

Variable level control with Auto/Normal facility.

Source: CH1, CH2, External, Line.

Slope: +ve or -ve.

Coupling: DC, DC HF rej, AC, AC HF rej.

Post-Trigger Delay

Time: 0 to 5000 s, 20 ns resolution.

Pre-Trigger: 0-98% in 0.4% steps.

DIGITAL PLOTTER OUTPUT

The instrument can directly output to HP-GL format plotters via the RS-423 interface port.

Optional Internal Plotter: Direct digital screen copy of waveforms with annotation of range-scales, labels, and graticule selected by menu. 4 color pens.

Plot Mode: Manual or Automatic after acquisition.

Colors: Color pens automatically selected.

Labels: Range scaling, measurements, labels and graticule information selected by menu.

POWER REQUIREMENTS

AC Voltage: 90 - 130 V and 190 - 265 V.

Frequency: 45 - 400 Hz.

DC Voltage: 12 - 33 V.

Power: 85 VA approx.

INTERFACE (RS-423)

Serial interface port for bi-directional waveform data transfer and associated range parameters.

Baud Rate: Selectable via menu 75 to 9600.

INTERFACE (IEEE-488.2 SCPI)

High speed IEEE port for control of instrument functionality and data transfer. NEW SCPI control language includes powerful high level "Measure" command to simplify control programming.

ORDERING INFORMATION

Description	Price
400 Digital Storage Oscilloscope , 20 MHz bandwidth, 100 MS/s	\$2490
420 Digital Storage Oscilloscope , 20 MHz bandwidth, 100 MS/s, measurement software, real time clock	\$2690
450 Digital Storage Oscilloscope , same as 420 DSO, but 50 MHz bandwidth with additional magnetic screening	\$2990
465 Digital Storage Oscilloscope , same as 450 DSO, but 100 MHz bandwidth, 200 MS/s	\$3490
475 Digital Storage Oscilloscope , same as 450 DSO, but 200 MHz bandwidth, 200 MS/s	\$3990
Options	
103 IEEE-488.2 (SCPI Standard) interface	\$395
104 Internal multi-color plotter	\$495
107 Battery	\$1275

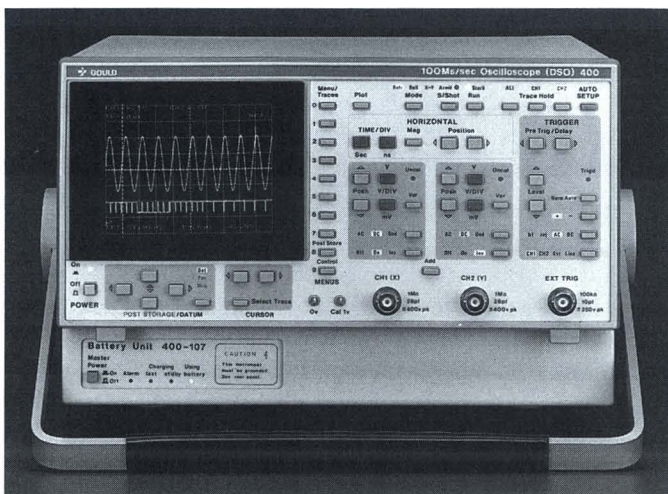

400 Digital Storage Oscilloscope. Optional 107 battery pack fits conveniently under chassis.

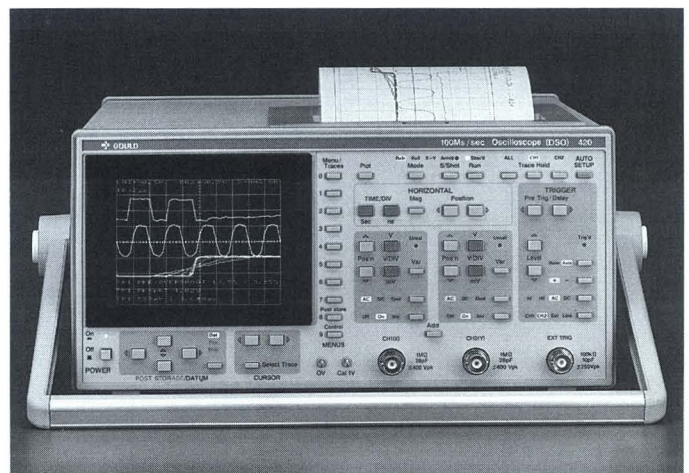

420 Digital Storage Oscilloscope.

465 and 475 DIGITAL STORAGE OSCILLOSCOPES

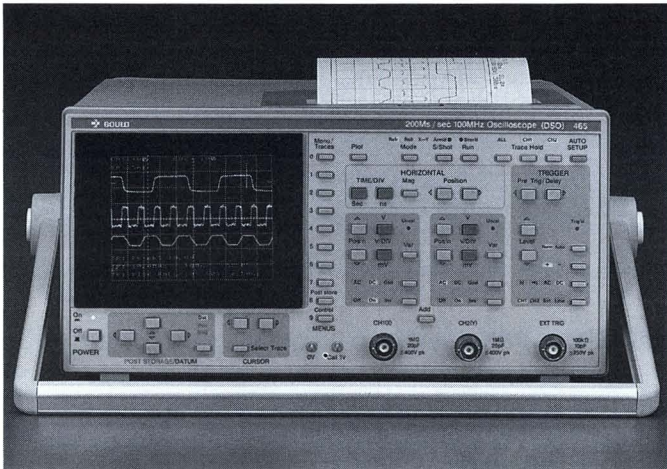

- 100 MHz and 200 MHz bandwidths
- 200 Megasamples/s sample rate (2 GS/s for repetitive signals)
- Built-in 4-color plotter
- Fully programmable via IEEE-488.2 SCPI Interface and RS-423
- Waveform measurement and analysis
- Persistence display mode

465 and 475 = FAST, low cost DSOs

The new 465 and 475 DSOs share all the 400 series features presented on pages 13 and 14. In addition, they have very much higher bandwidths and sampling rates to preserve the fidelity of your test signals.

Bandwidth

The analog circuitry ahead of the analog-to-digital converter usually determines an oscilloscope's bandwidth. The 465 and 475 use high speed ADCs which, together with the input circuitry, provide 100 MHz or 200 MHz overall bandwidth, respectively.

From the figure it's easy to see that the commonly

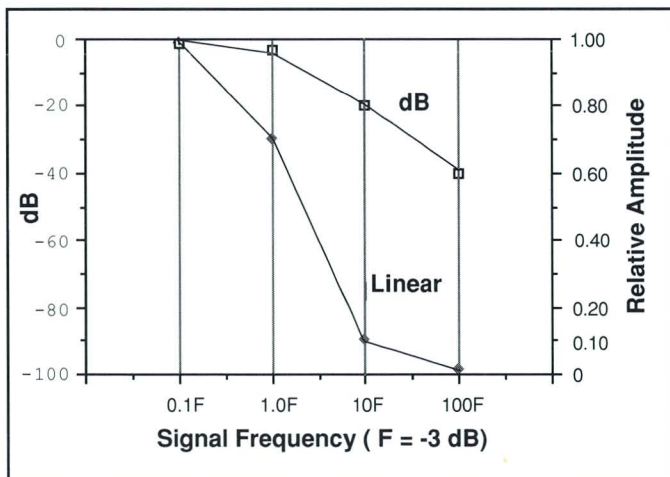

Signal frequency as a function of dB bandwidth and relative waveform amplitude.

quoted *3 dB bandwidth* specification refers to that frequency where the waveform's amplitude as acquired by the oscilloscope is only about 70% of the actual input amplitude. Moving up in frequency by a factor of 10 results in the amplitude of the acquired waveform being only 10% of the actual input.

These facts become important if you are working with complex waveforms which contain many harmonics.

Clearly, even if you have only a 10 MHz μ P clock signal, because it's basically a square wave, it will contain odd harmonics, and up to the 7th or 9th will still contribute significantly to the overall waveform. Without even considering extraneous noise and its effect upon the clock waveform, just viewing the first few harmonics will require a 100 MHz bandwidth oscilloscope. 200 MHz is better yet. For viewing lower frequency signals, where high frequency noise might be a distraction, a 20 MHz band limit is available on the 475.

Sampling rate

To acquire a waveform which may occur only once, there simply have to be enough sample points to define the level of waveform detail which is required. Some manufacturers talk about *digital bandwidth* being from 1/10 to 1/4 of the sampling rate, e. g., a 100 MS/s oscilloscope has a 10 MHz to 25 MHz *digital bandwidth*. It's important to determine how many samples are needed for your own waveform, however, because for a complex signal even 10 points could be far too few. Analog bandwidth is defined as the -3 dB frequency — the same definition as for analog oscilloscopes, and not to be confused with the more arbitrary and not universal

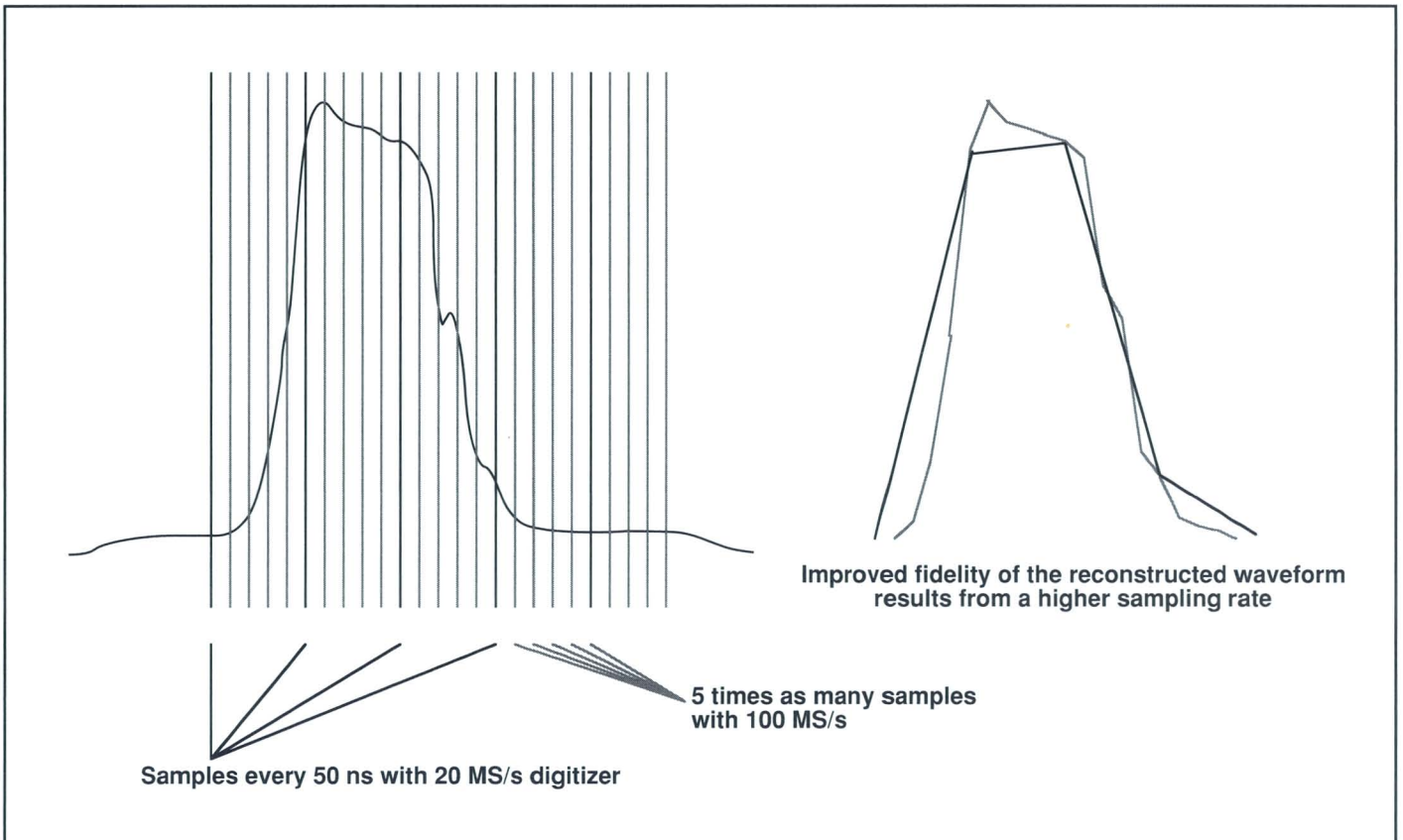

Sample rates of 20 MS/s digitizer compared to a 100 MS/s digitizer.

term of “digital bandwidth”. Notice the greatly increased fidelity of the reconstructed signal when five times as many samples were used.

Equivalent Time Sampling (ETS)

Equivalent Time Sampling relies on the input signal being repetitive. A detailed picture of the waveform is built up over a number of cycles from samples taken at progressively later points in time, on different cycles of the same waveform. This approach is similar to that used in conventional analog sampling oscilloscopes, but there are two basic differences. First, because the trigger and the sampling clock are not related in time, the position of the first sample after the trigger will be random. Instead of deliberately providing a pre-determined amount of delay as in a sampling oscilloscope, ETS sorts out acquisitions after they are made according to the (random) delay from trigger to sample clock. The diagram shows how samples can be grouped to represent one cycle of the waveform. The other difference is that in practice, many points are used from each acquisition — not just one as shown for simplicity. ETS can provide pre-trigger information because of random sampling, and ETS pictures can build up quite quickly because of the large number of points used from each acquisition.

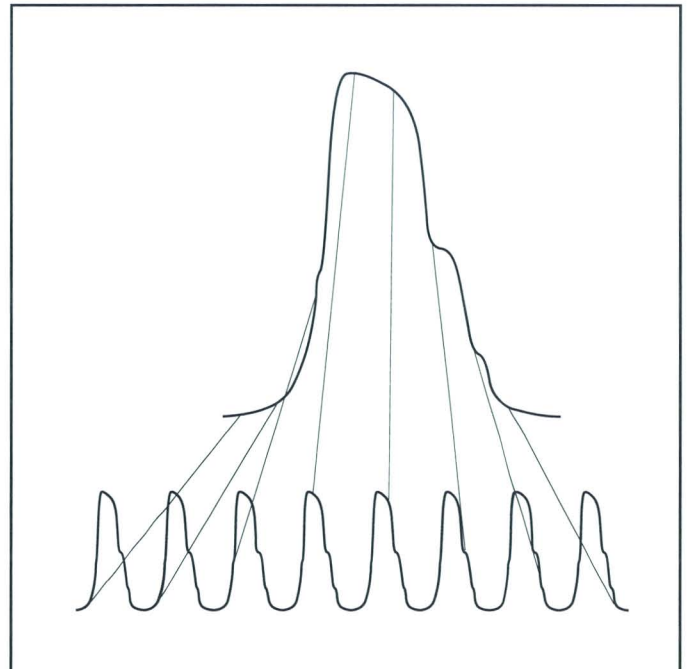

Sampling a repetitive waveform (Equivalent Time Sampling).

4060 SERIES OSCILLOSCOPES

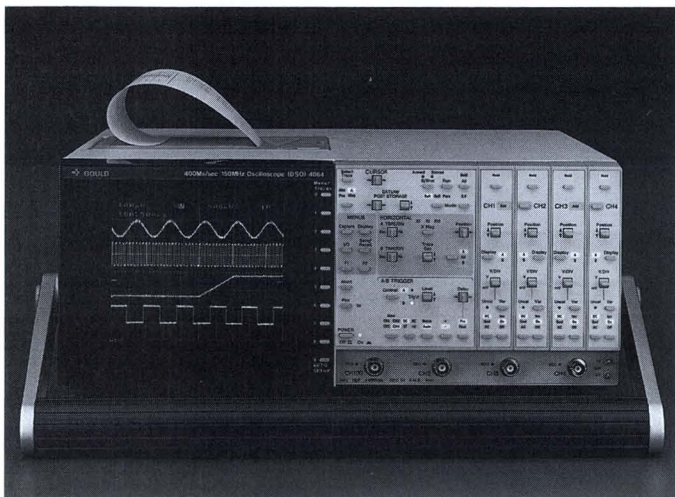

Four channel 4064 digital storage oscilloscope.

- 150 MHz bandwidth
- 400 Megasamples/s maximum ADC rate
- 2 or 4 input channels
- 8 bit vertical resolution at all input sensitivities
- Sophisticated trigger system
- Large display
- Persistence mode
- Internal thermal or 4 color plotter

Gould 4060 Series Selection Guide

Model No.	Bandwidth MHz	No. of Channels	Sampling Rate MS/s	Timebase ns/div	ETS ns/div	Sampling ETS GS/s	RS-423	IEEE-488.2	Internal Plotter	Special Features
4062	150	2	200 (400, 1 ch)	250	20	2.5	Opt.	Opt.	Opt.	Fast IEEE data transfer rate
4064	150	4	200 (400, 2 ch)	250	20	2.5	Opt.	Opt.	Opt.	>50 kbytes/s (burst mode)

Capture the signal you want

The 4060 series of scopes makes it easy to capture the signal you want. As systems become more complex, it is important to see the relationship between more than two parameters. The 4060 has two variants: the 2 channel 4062 and the 4 channel 4064. The series has dual timebase operation to see both an overview of the signal and fine detail in the signal. The B sweep can start with up to 1000 s delay after a trigger point. To qualify the trigger further, the series can use a trigger signal to enable the B trigger system to accept a trigger pulse. The user can also view pre-trigger data. This makes it easy to see the signal before a trigger point.

See the signal you want

Once the signal has been captured, it is important to see detail on the signal. The series has 8 bit vertical resolution at all input sensitivities, so that the signal is captured with all its detail. To make it easy to see the fine detail, there is a 7-inch diagonal CRT. Persistence mode allows you to capture and display all acquisitions and see changes or intermittent signals.

Keep control of the scope

For easy operation of the scope, there is auto-setup. This will evaluate the incoming signal and set the

vertical sensitivity, timebase and triggering to give a stable display. The front panel has been designed to give quick and easy direct control of the scope. For the secondary controls, there is a shallow menu system.

Measure the signal rapidly

The 4060 series can measure signals with respect to either ground or on-screen datum lines. There is a wide range of automatic measurements to make it easy to characterize a signal. The standard pulse measurements are performed according to IEEE standard 194-1977 "IEEE Standard Pulse Terms and Definitions."

Output the signal

To archive the signal, the 4060 series plots waveforms to an internal high speed thermal or four color plotter. For larger plots, there is an HP-GL output available via the IEEE-488.2 or RS-423 (RS-232C) interfaces. For archiving or further data processing, there are computer interfaces. The command syntax corresponds to the IEEE-488.2 standard and the interface can transmit data at more than 50 kbytes/s in burst mode.

4060 SERIES SPECIFICATIONS

VERTICAL DEFLECTION

Identical input channels, CH1, CH2 - 4062; CH1, CH2, CH3, CH4 - 4064 (invert provided for all channels).

Bandwidth: DC: 0-150 MHz; AC: 2 Hz - 150 MHz.

Sensitivity: 2 mV/div to 5 V/div.

Input Impedance: 1 M Ω // 18 pF or 50 Ω .

Input Protection: 400 VDC or pk AC.

Vertical Position Range: ± 8 div.

Accuracy: $\pm 2\%$.

DISPLAY:

7-in. diagonal CRT with electronic graticule.

DISPLAY MODES

Roll: Stored data and display updated continuously.

Refresh: Data and display updated by triggered sweep.

X-Y Display: CH1; X, CH2, CH3 and CH4; Y deflection.

Persistence: All sweeps retained from 500 ms to 90 s or for 2 to 256 sweeps. Either option can be set to infinite.

Persisted Average: The highlighted trace will show the averaged data with all unaveraged traces persisted.

Interpolation: Linear.

Display Resolution: 256 x 501 points.

Display Hold: Freezes total store.

Channel Hold: Freezes individual selected channel.

Datum Cursors: Independent vert. and hor. cursor lines.

Measurement Cursor: Assigned to trace.

Cursor Measurement Display: ΔV and ΔT , relative to ground and trigger point or relative to datum cursors.

Trigger Indication: On-screen trig level and trig point.

STORAGE FACILITIES

Acquisition System

Memory: 501 words per channel.

Sample Rate: 400 Megasamples/s max.

Resolution: 8 bits (1 in 256) vertical.

Peak Detection (Glitch Capture): Glitches $> 1\mu\text{s}$ min.

Waveforms: 16 waveforms, non-volatile memory.

Set-ups: 8 set-ups, non-volatile memory.

HORIZONTAL DEFLECTION

There are two sweeps; A and B sweep.

Sweep Rate: 20 ns/div to 50 s/div.

Horizontal Expansion: x 1, x 2, x 5, x 10.

CURSOR MEASUREMENTS

Absolute: Voltage with respect to ground; time with respect to the trigger point.

Relative: Voltage and time with respect to the on-screen datum cursors.

Automatic: 4060 will calculate and display up to three measurements simultaneously. (IEEE standard 194-1977, "IEEE Standard Pulse Terms and Definitions.")

Parameters Measured: Rise time, fall time, frequency, period, duty cycle, pulse width, peak-to-peak voltage, area and RMS voltage.

POWER REQUIREMENTS

Voltage: 90 - 132 V and 190 - 265 V, 45 - 440 Hz.

Power: 70 VA approx.

TRIGGER

Variable level control with Auto/Normal facility. A/B dual sweep, start on A, A gate B after delay.

Source: CH1, CH2, CH3, CH4, ext (4062 only), line.

Slope: +ve or -ve.

Coupling: DC, DCLP, AC, ACLP, TV Frame, TV Line.

Post Trigger Delay

Time: 0 to 999 s.

Pre-trigger: 0 to 100% in 0.2% steps.

INTERNAL SCREEN PLOTTER

Direct digital screen copy of waveforms with annotation of ranges, scales, labels and graticule selected by menu.

Plotter Buffer: Permits scope to be used while plotting.

Plot Size: 89 mm. wide by 102 mm. long (approx.)

No. of Pens: 4 colors automatically selected.

DIGITAL PLOTTER OUTPUT

(Available with an interface option): The instrument can directly output to HP-GL format plotters via the IEEE-488 or RS-423 Interface ports.

Plot Mode: Manual or automatic after acquisition.

Colors: Automatically selected when available.

Labels: Range, measurements, labels and graticule.

Auto Plot: Initiates a plot at the end of acquisition and re-arms the instrument at the end of the plot cycle.

OPTION 103 — IEEE-488 INTERFACE

Read and Write Functions

All front panel and menu controls except Power on/off.

All on-screen alphanumeric can be read remotely.

Data Transfer Rate: Greater than 50 kbyte/s (burst).

RS-423 (RS-232C) Interface: There is an interface socket for plotting the data to an HP-GL plotter only.

OPTION 102 — RS-423(RS-232C) INTERFACE

Two ports are provided

1. Output only, e.g., for plotter or printer.

2. Input/output for control as IEEE specification.

Baud Rate: Selectable via menu. 110 to 9600.

ORDERING INFORMATION

Description	Price
4062 2 Channel Digital Storage Oscilloscope , 150 MHz bandwidth, 400 MS/s with on-screen measurements	\$5300
4064 4 Channel Digital Storage Oscilloscope , 150 MHz bandwidth, 400 MS/s with on-screen measurements	\$7200
Options	
102 RS-423 (RS-232C) interface	\$685
103 IEEE-488.2 (SCPI Standard) interface	\$685
104 Internal multi-color plotter	\$600
108 Internal thermal plotter	\$950

HIGH SPEED DIGITAL STORAGE OSCILLOSCOPES 4070A AND 4090 SERIES

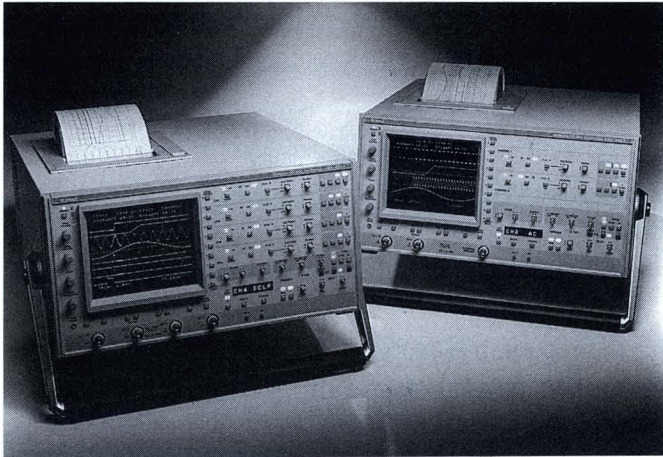

Four channel 4074A and two channel 4072A digital storage oscilloscopes from Gould.

- Time resolution to 625 picoseconds
- 2 or 4 channel versions
- 200 MHz bandwidth
- Two timebases
- Waveform processing
- Sophisticated dual triggering system

The 4070A and 4090 series from Gould provide application flexibility to meet a wide range of needs, including high speed and processing capabilities for design and test applications. These scopes also provide

full programmability for laboratory automation or ATE, the portability needed for field service, and the ruggedness and easy operation required for manufacturing applications.

4070A, 4090 Selection Guide

Model No.	Bandwidth MHz	No. of Channels	Sampling Rate MS/s	Timebase ns/div	ETS ns/div	Sampling ETS GS/s	RS-423	IEEE-488	Waveform Processor	4-color Plotter	Special Features
4072A	200	2	400	250	20	5.0	Std.	Std.	Opt.	Opt.	Complex trigger gated, delay by
4074A	200	4	400	250	20	5.0	Std.	Std.	Opt.	Opt.	time, events, divide by n, TV synchron
4090	200	2	400 (800, 1 ch)	250 (125)	20	5.0	Std.	Std.	Opt.	Opt.	2 mV sensitivity, high bandwidth and sample rate.
4092	200	2	800	250	20	5.0	Std.	Std.	Opt.	Opt.	
4094	200	4	400 (800, 2 ch)	250 (125)	20	5.0	Std.	Std.	Opt.	Opt.	
4096	200	2	800 (1600 1 ch)	125 (62.5)	20	5.0	Std	Std	Opt.	Opt.	

Best performance around

The 4090 series features 400 Megasamples/second to 1.6 Gigasamples/second digitizers, enabling signals to be acquired with a time resolution of up to 625 ps. This also ensures true 200 MHz bandwidth accuracy for both transient and continuous signals in real time. To obtain the best results from fast signals, there are sine and linear interpolators; less than 200 ps jitter to give high accuracy equivalent time sampling to 2 ns/div resolution; 5 ns glitch capture and much more.

Exceptional triggering capability

To complement the signal capture performance, this series offers one of the most sophisticated triggering systems available on any oscilloscope today. Two timebases with separate trigger inputs are available, which can run synchronously or asynchronously and offer full delay facilities, such as delay by time, delay by events and gating. When delay by events is selected, the Gould 4090 series and 4070A series will either trigger after the Nth event, so that individual pulses can be stored from logic trains, or trigger every Nth event for

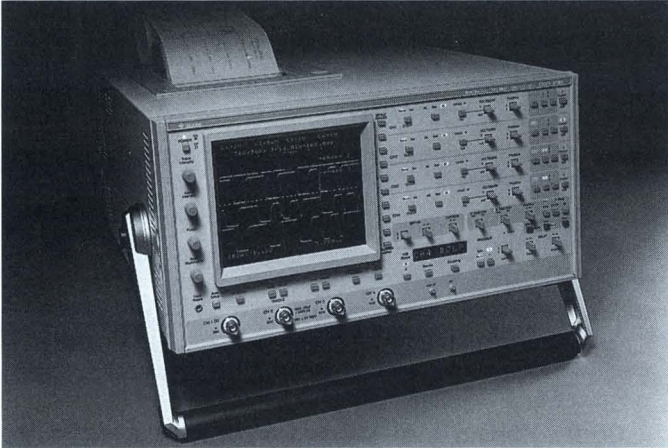

Four channel 4094 digital storage oscilloscope

the display of individual lines of TV signals.

Four channels makes digital development easier.

You can measure timing across four channels, which is more useful than having to do it two channels at a time.

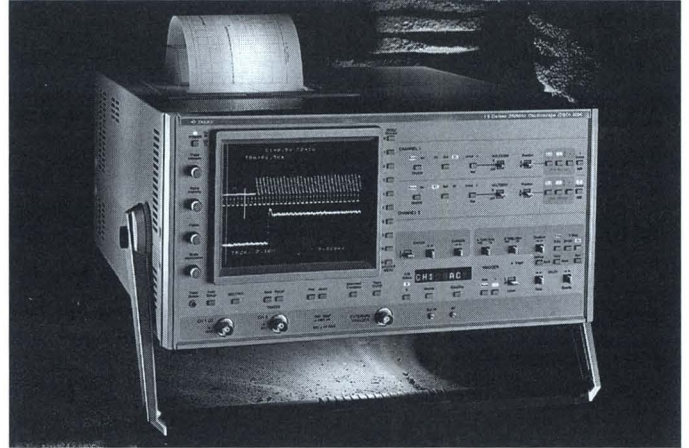

The 4096 digital storage oscilloscope from Gould offers 1.6 Gigasamples/second sampling rate.

Advantage of dual timebase used with trigger delay system.

Use the Waveform Processor to trigger the 4070A on any preselected TV or video line. The fine detail of the color burst on the lower trace was achieved using the dual timebase facility in combination with the flexible trigger delay system.

SERIES 4070A AND 4090 SPECIFICATIONS

Unless otherwise stated, the specifications of the 4072A, 4074A, 4090, 4092, 4094 and 4096 are identical.

VERTICAL SYSTEM

Input:

4072A/90/92/96: 2 Channels, BNC connectors.
4074A/94: 4 Channels, BNC connectors.

Bandwidth:

DC: 0 - 200 MHz (-3 dB).
AC: 4 Hz - 200 MHz (-3 dB).

Sensitivity: 2 mV/div to 5 V/div in a 1-2-5 sequence.

Input Impedance: 1 M Ω // 18 pF.

Input Protection: 400 VDC or pk AC.

Vertical Position Range: ± 8 divisions.

DISPLAY

CRT: 10 x 12 cm rectangular.

Intensity: Separate controls for traces, graticule and alphanumeric.

Readout: On-screen readout of the current vertical and timebase settings and cursor measurements.

DISPLAY MODES

Single Trace: CH1, CH2, CH3 or CH4.

Multi-Trace: Any combination of the available channels.

Reference Traces: Up to eight reference traces. There is a maximum total of 8 "live" traces and reference traces.

Add: CH1 + CH2 and/or CH3 + CH4.

Invert: Any channel may be inverted.

X-Y: CH1 gives X, CH2, CH3 and CH4 give Y deflection.

Interpolation: Selectable either sine, linear or no interpolation.

ACQUISITION SYSTEM

Maximum Sample Rate:

4072A/4074A: 400 Megasamples/s on each input channel at 250 ns/div.

4090: 800 Megasamples/s on channel 1 at 125 ns/div.

4092: 800 Megasamples/s on channels 1 and 2 at 125 ns/div.

4094: 800 Megasamples/s on channels 1 and 3 at 125 ns/div.

4096: 1.6 Gigasamples/s on channel 1 at 62.5 ns/div.

Vertical Resolution: 8 Bits (0.4%).

Record Length:

4072A/4074A: 1 kword per channel.

4090, 4092, 4094, 4096: 1 kword per channel. At 125 ns/div, the record length is 2 kwords.

ACQUISITION MODES

Refresh: Stored data and display updated by trigger event.

Roll: Stored data and display updated continually.

Pre-trigger Roll Mode: As per the roll mode in the pre-trigger part of the display. Then entire display is frozen as in the refresh mode upon receipt of trigger.

Glitch Capture: Capture of either positive, negative or alternate positive and negative glitches. Typically a 5-ns pulse can be captured with 80% confidence. There is a 100% confidence of capture to 95% of amplitude for a 30-ns pulse.

Averaging: Continuous weighted average is available. The user can set the weighting factor from 2 to 256 in a binary sequence.

4070A and 4090 Series Specifications

NON-VOLATILE MEMORY

Waveforms: 8 traces can be stored.

Set-Ups: 4 set-ups can be stored.

HORIZONTAL SYSTEM

Horizontal Display Modes: A, A intensified by B, A alt B, B only, X-Y, Refresh, Roll.

Sweep Rates: 20 ns/div to 20 s/div.

4072A, 4074A: Sweep rates faster than 250 ns/div use equivalent time sampling (ETS).

4090, 4092, 4094: Sweep rates faster than 125 ns/div use ETS.

4096: Sweep rates faster than 62.5 ns/div use ETS.

Horizontal Display Accuracy: $\pm 3\%$.

Horizontal Expansion: x 2 to x 20 times to a maximum of 2 ns/div.

Post Trigger Display: The A or B sweep start can be delayed from either Trigger A or Trigger B.

Time

Timebase Range	Max. Delay
20 s to 0.1 ms/div	99.9 s
50 μ s to 50 ns/div	0.99 s
20 ns/div	0.4 s

Delay by Events: 1 to 999999 events with a maximum trigger frequency of 200 MHz.

Pre-Trigger Delay: 0 to 98% with 0.1% resolution.

TRIGGER

Source: 4072A, 4090, 4092, 4096: CH1, CH2, EXT, LINE
4074A, 4094: CH1, CH2, CH3, CH4, LINE

Coupling: AC, DC, DCLP, ACLP, ACHP, TV Line, TV Field 1.
DCLP, ACLP <15 kHz
ACHP >15 kHz.

Slope: +ve or -ve.

Trigger Level: Variable over $> \pm 4$ divisions. Level indicated by on-screen marker.

External Input Impedance: 1 M Ω //20 pF.

External Input Protection: 200 VDC or pk AC.

CURSOR MEASUREMENTS

Voltage and Time Difference with respect to the voltage and time data are displayed on screen.

IEEE-488 INTERFACE

Read and Write Functions: All front panel controls are fully programmable.

Data can be written in and read from all of the memories.

All on-screen alpha-numerics can be read remotely.

The computer can put messages on the screen in 14 lines of 32 characters each.

RS-423 (232C) INTERFACE

Specification: All of the functions available via the IEEE-488 Interface are available via the RS-423 Interface.

Baud Rate: 50, 110, 135, 150, 300, 600, 1200, 2400, 4800, 9600 selectable via menu.

DIGITAL PLOTTER OUTPUT

The DSOs can directly address HP-GL format plotters via either the IEEE-488 or RS-423 interface. This plots either menus or traces. The trace plots include cursor information, range settings, date and time.

Color: Different colors selected for traces and the grid when multicolor plotters are used.

INTERNAL SCREEN PLOTTER 104

Direct digital plots to the internal multicolor plotter can be selected by the menu to be in the same format as above.

POWER REQUIREMENTS

Voltage: 90 V to 260 V AC. No switching between voltage ranges.

Frequency: 45 - 440 Hz.

Power: 200 W max.

ORDERING INFORMATION

Model Number	Price
4072A 2 Channel Digital Storage Oscilloscope , 200 MHz bandwidth, 400 MS/s	\$6950
4074A 4 Channel Digital Storage Oscilloscope , 200 MHz, 400 MS/s	\$8200
4090 Digital Storage Oscilloscope , same as 4072A DSO but 800 MS/s on 1 channel	\$8950
4092 Digital Storage Oscilloscope , same as 4072A DSO but 800 MS/s on 2 channels	\$9950
4094 Digital Storage Oscilloscope , same as 4074A DSO but 800 MS/s on 2 channels	\$10950
4096 Digital Storage Oscilloscope , same as 4092 DSO but 1.6 GS/s on 1 channel	\$10950
Standard with instrument	
102 RS-423 (RS-232C) interface	
103 IEEE-488.2 (SCPI Standard) interface	
Options	
104 Internal multi-color plotter	\$620
270 Waveform processor (refer to page 32 for more information)	*

* Consult factory.

POWERFUL TRIGGERING TO CAPTURE DISK DRIVE SIGNALS

A disk drive contains a rotating magnetic medium, on which signals are recorded to store the digital data. When a blank disk (whether a floppy disk or hard disk) is formatted, the surface of the disk is split into sectors (Figure 1). To synchronize the disk, there is also an

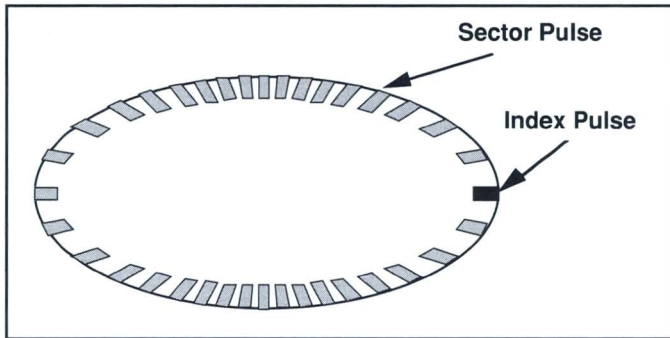

Figure 1. When blank disk is formatted, surface is split into sectors. Index pulse synchronizes disk.

index pulse recorded at a fixed position on the disk, so there is one index pulse per revolution. There is also one sector pulse per sector.

There are three approaches to capturing the data from a specific sector.

The simplest is to trigger the scope from the index pulse and set a time delay to capture the data from the required sector (Figure 2). Many scopes can do this, but there are problems with this technique. If there are small

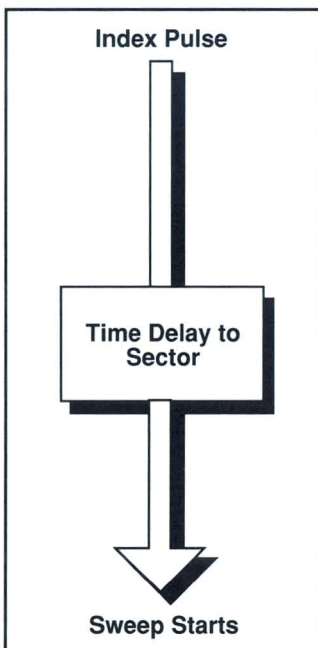

Figure 2. Scope triggered from index pulse with set time delay.

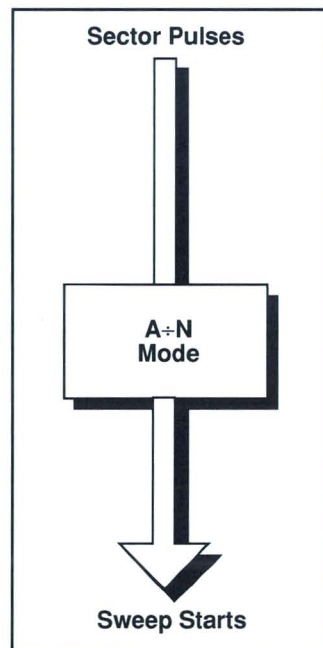

Figure 3. A=N trigger mode.

changes in the rotation speed of the disk, the display will move and make it difficult to see a stable display.

The second technique uses the A=N trigger mode (Figure 3). This trigger mode will synchronize the scope to a repetitive pattern. Set N to the number of sectors per disk and the scope sweep will start at the same sector. The scope has a stable display, because it is digitally locked to these sector pulses, and is immune to changes in the speed of the disk. The main problem is that you do not know to which sector it is synchronized. The sector can be changed by using the phase+ or phase- controls, but the sector is not known.

The third method uses a combination of gating and delay by events and gives the best results (Figure 4). The index pulse is used to enable the gate for the B trigger input. This allows sector pulses to be counted. The counter can be set to the sector number (e.g., 43), and the A sweep will always capture sector 43. The scope is now locked to the disk drive and the user can easily capture any sector on the disk drive.

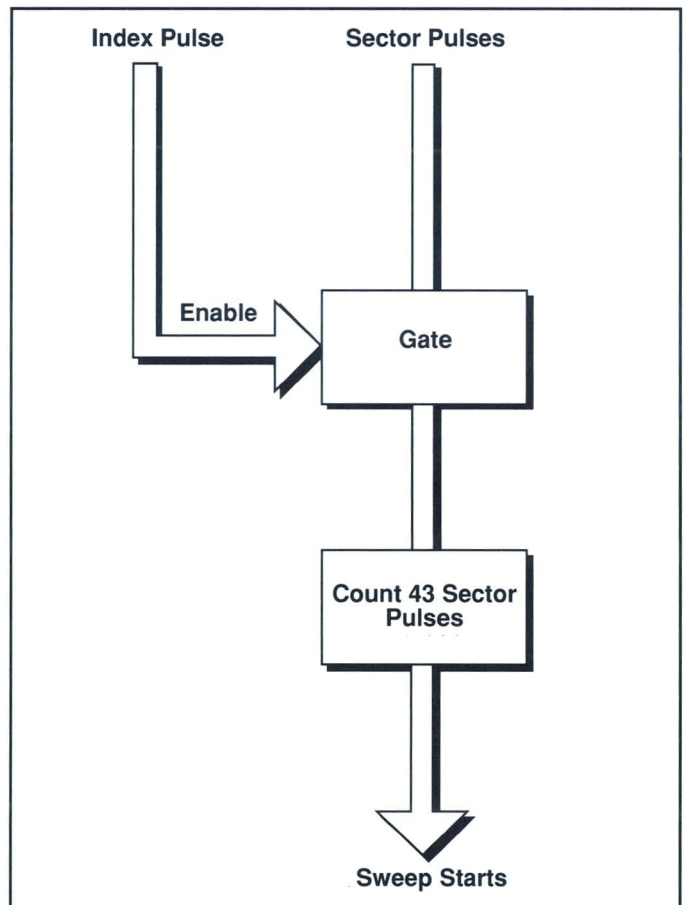
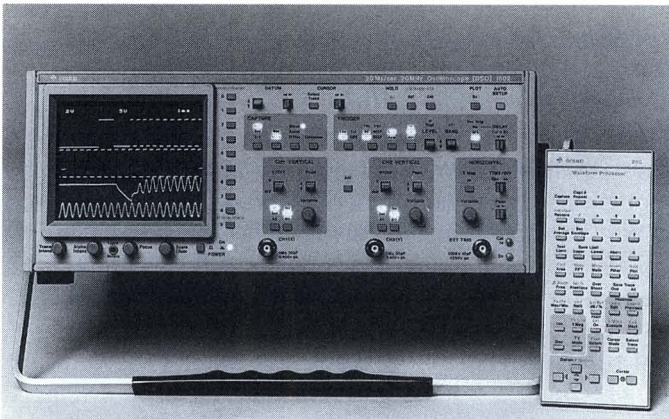

Figure 4. Combination of gating and delay by events gives best results.

1600 SERIES OSCILLOSCOPES



Two channel 1602 digital storage oscilloscope with 160 waveform processor

- Advanced analysis capability
- 10 k word memories on every channel
- Available in 2, 4 and 8 channel versions
- Exceptional trigger flexibility
- Fully programmable
- Integral color plotter
- Differential and floating input versions

1600/2600 Series Selection Guide

Model No.	Bandwidth MHz	No. of Channels	Real Time and DSO	Sampling Rate MS/s	Timebase μ s/div	External Clock	RS-423	IEEE-488	Waveform Processor	4-Color Plotter	Special Features
1602	20	2	Yes	10 (20, 1 ch)	50 (0.2, RTO)	Yes	Opt.	Opt.	260 Opt.	Opt.	10 k memory per channel. Trace math, measurement, manipulation. Also RTO
1604	20	4	Yes	10 (20, 2 ch)	50 (0.2, RTO)	Yes	Opt.	Opt.	260 Opt.	Opt.	Differential inputs and single ended 1604
1624	20 (3, diff.)	4	Yes	10 (20, 2 ch)	50 (0.2, RTO)	Yes	Opt.	Opt.	260 Opt.	Opt.	500 V isolation to ground and between channels
2608	7	8	No	10 (20, 4 ch)	50	Yes	Opt.	Opt.	260 Opt.	Opt.	

Others display data —

The 1600 displays information

This series of Digital Storage Oscilloscopes improves efficiency by providing answers, not just data. For looking at signals in either low frequency electronics or from a transducer, the 1600 gives you a powerful combination of signal capture coupled with extensive data analysis and archiving capabilities.

Massive memories for more resolution

With 10 k word memory on each channel, it allows examination of detail with expansion factors up to x200 and resolution down to 0.05 μ s. A glitch detector ensures that 1600 series scopes can capture high speed pulses even at the slowest time base speeds.

Acquire only the data needed

Run the data acquisition system continuously and tell it when to freeze. The 1600 series scopes can use a trigger to acquire all the data that occurs before it (pre-

trigger) or to show data that occurs up to 1000 s after it. It can even simultaneously show data that occurs both before and after the trigger and count triggers to show the data that occurs up to 16383 trigger events later.

There is no need to waste chart paper or spend time scanning data that is not required.

The 1600 series can also store up to 50 traces in the backup memories of the Waveform Processor with the date of occurrence, or plot them out automatically to a strip chart recorder, before re-arming itself for the next trigger. It can, therefore, make available full details of signal activity without the need to have an operator present.

External clocking

Tailor the 1600 series oscilloscopes to the application using the external clock input to generate your own timebase. Clock pulses synchronized to the revolutions of a machine can give answers related to degrees of

rotation. Compress data by clocking the 1600 series oscilloscopes only during the points of interest.

And it's easy to use

Press the blue button and the 1600 series will automatically evaluate the incoming signal and position the fully programmable controls to give the optimum setting for that particular input, while also displaying the set up characteristics on the front panel.

It makes measurements automatically

Cursors can be positioned anywhere on the display to show the difference in voltage and time between them. When fitted with the 260 Waveform Processor, they can also show rise times, fall times, peak-to-peak measurements, overshoot, pulse widths, frequencies, area under curve and RMS values.

It provides more information with its Waveform Processor

The hand-held keypad also allows the ability to average up to 1024 traces, so that signals buried deep in noise can be analyzed in detail. Also, for transient events a built-in algorithm enables signals to be filtered in a number of selectable steps even after storage.

Individual lines of TV transmission can also be selected and stored in the large memories.

And the 1600 series is fully programmable for use with personal computers

Optional IEEE-488 or RS-423 interfaces enable the 1600 series to communicate its data and fully

programmable control functions with virtually all computers used in scientific areas. The 1600 series can therefore be used for customized data analysis, mass storage or for integration as an acquisition component in an automatic test system.

The 1600 series makes it easy to keep records of the data

When fitted with the Waveform Processor, the 1600 series can store up to 50 traces (even when the power is switched off, the information is still retained). This optional plug-in waveform memory can be easily removed from the 1600 series and sent from a remote site to base and the waveforms recalled to another 1600 model — ideal in remote monitoring applications. For visual records a multi-color plotter is built into the instrument and enables each trace to be plotted in a different color, along with full information as to time and date and the range settings at the time of acquisition of each trace — a grid is also printed in another color so that any printing or paper registration problems are eliminated.

Alternatively, the 2608 contains the intelligence to drive an HP-GL plotter automatically, and can output information in the same form as above. The 1600 series can even output information direct to analog strip chart or XY recorders, along with full control of the pen so that over-plotting or fly back corruption are eliminated.

1600 SERIES SPECIFICATIONS

VERTICAL DEFLECTION

Identical input channels, CH1, CH2 - 1602; CH1, CH2, CH3, CH4 - 1604 (invert provided for all channels).

Bandwidth: DC: 0 - 20 MHz.

AC: 2 Hz - 20 MHz.

Sensitivity: 2 mV/div to 20 V/div.

Input Impedance: 1 M Ω //30 pF.

Input Protection: 400 VDC or pk AC.

Vertical Position Range: ± 8 div.

Accuracy: $\pm 2\%$.

DISPLAY

CRT: 8 x 10 cm rectangular.

NON-STORAGE DISPLAY MODES

Single Trace: CH1 or CH2, or CH3 or CH4.

Multi-Trace: Any combination of the four available channels in Normal, Chopped or Alternate Modes, is automatically selected by the Timebase.

Add: CH1 + CH2 and/or CH3 + CH4.

Invert: Any channel may be inverted. When used in

conjunction with ADD Mode, it gives the algebraic difference of the two channels.

X-Y: CH1 gives X, CH2, CH3 and CH4 give Y deflections. Alphanumeric display of input voltage range and timebase range.

STORAGE DISPLAY MODES

Roll: Stored data and display updated continually.

Refreshed: Stored data and display updated by triggered sweep.

X-Y Display: As Non-Storage 8 bit x 8 bit (256 x 256).

Interpolation: Linear.

Display Resolution: 8 bits x1 k per channel (256 x 1024).

Display Hold: Freezes total store.

Channel Hold: Freezes individual selected channel.

Datum Cursors: Independent vertical and horizontal cursor lines.

Measurement Cursor: Assigned to trace.

Cursor Measurement Display: ΔV and ΔT displayed on screen.

Trigger Indication: Trigger level indication on-screen. On-trace trigger point bright-up indication.

1600 Series Specifications

STORAGE FACILITIES

Acquisition System

- Acquisition Memory:** 10 k words per channel.
- Maximum Sample Rate:** 20 M samples/s.
- Vertical Resolution:** 8 bits (1 in. 256).
- Peak Detection (Glitch Capture):** Capture of positive and/or negative glitches to 50 ns pulse width.
- Waveforms:** Two reference traces can be stored and displayed in addition to input channel display.
- Set-Ups:** A total of 4 set-ups can be stored in non-volatile memory.

EXTERNAL CLOCK

- Provides an input for Ext. clock signals to control the acquisition sample speed.
- Selected by time base control.
- Clock rate, DC to 2 MHz re-clocked internally at 20 MHz rate.
- Input +5 V amplitude CMOS.

HORIZONTAL DEFLECTION

Non-Storage

- Sweep Rate:** 0.2 μ s/div to 10 ms/div.
- Expansion:** x5 gives fastest range sweep speed of 40 ns/div.

Storage

- Sweep Rate:** 50 μ s/div - 200 s/div.
- Expansion:** x 1, x 2, x 5, x 10, x 20, x 50, x 100, x 200.

TRIGGER

- Variable level control with Auto/Normal facility.
- Source:** Internal CH1, CH2, CH3, CH4, Ext, Line.
- Slope:** +ve or -ve.
- Band Trigger:** ± 0.25 div. to ± 4 div.
- Coupling:** DC, DCLP, AC, ACLP, TV Frame, TV Line.
- Post-Trigger Delay**
- Time:** 0 to 1000 s.
- Events:** 1-16383 trigger events.
- Trigger:** Divide by N (N = 2 to 16383).
- Pre-Trigger:** 0-100% in 0.1% steps.

INTERNAL SCREEN PLOTTER 104

- Direct digital screen copy of waveforms with annotation of range scales, labels and graticule selected by menu.
- Plotter Buffer:** Permits oscilloscope to be used while plotting a screen.
- Plot Size:** 89 mm wide by 102 mm long (approx.).
- No. of Pens:** 4 colors automatically selected.

ANALOG OUTPUT

- Analog output of the stored displays for plotters and recorders.
- Y Output:** Parallel output of up to 4 channels. Serial output CH1 through CH4.
- X Output:** X ramp output.

DIGITAL PLOTTER OUTPUT

(Available with an Interface Option): The instrument can directly output to HP-GL format plotters via the IEEE-488 or RS-423 Interface Ports.

- Plot Mode:** Manual or Automatic after acquisition.
- Colors:** Color pens automatically selected when available.
- Labels:** Range scaling, measurements, labels and graticule information selected by menu.
- Auto Plot:** Initiates a plot at the end of acquisition and re-arms the instrument at the end of the plot cycle.

POWER REQUIREMENTS

- Voltage:** 100 V, 120 V, 220 V and 240 V.
- Frequency:** 45—400 Hz.
- Power:** 70 VA approx.

OPTION 103B — IEEE-488 INTERFACE

- Read and Write Functions
- All front panel controls with the exception of:
 - Variable Timebase Non-Storage
 - Variable Input Attenuation
 - Power On/Off
 - Trace Intensity
 - Scale Illumination
 - Trace Rotation
 - Alphanumeric Intensity.

All menu selections are programmable. Memory data is programmable. On-screen alpha- numerics can be read. Alpha-numeric 16 line x 32 characters are programmable for display messages.

OPTION 102B — RS-423 (RS-232C) SERIAL INTERFACE

- Two Ports are provided:
 1. Output only, e.g. for plotter or printer.
 2. Input/output for control as IEEE-488 specification.
- Baud Rate:** Selectable via menu. 300 to 9600.

ORDERING INFORMATION

Part Number	Price
1602 2 Channel Digital Storage Oscilloscope	\$4795
1604 4 Channel Digital Storage Oscilloscope	\$6595
Options	
102 RS-423 (RS-232C) interface	\$685
103 IEEE-488.2 (SCPI Standard) interface	\$685
104 Internal multi-color plotter	\$600
260 Waveform processor type 260 (see page 32 for more information)	\$500
205 Waveform processor module type 205/260	\$495

1624 DIGITAL STORAGE OSCILLOSCOPE DIFFERENTIAL INPUT

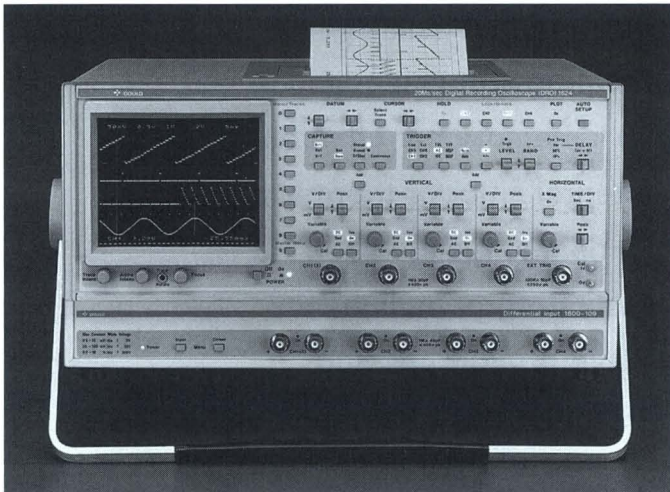

- Four differential or single ended inputs
- 500 $\mu\text{V}/\text{div}$ sensitivity
- Signal offsetting
- Noise rejection
- 3 MHz differential and 20 MHz single ended bandwidth

Differential measurements

The differential inputs provide isolation enabling off-ground measurements. The 3 MHz bandwidth is suitable for a wide range of applications from low frequency transduced measurements to electrical/electronic applications in power control systems.

High resolution

The large offset range and high input sensitivity (500 $\mu\text{V}/\text{div}$) allows small signals superimposed on DC levels to be examined in detail.

Noise rejection

The differential inputs reject common mode noise which ensures low level signals are captured in noisy electrical environments.

MODEL 1624 SPECIFICATIONS

The specifications of the 1624 are identical to the 1600 series of Digital Storage Oscilloscopes (see pages 25 and 26) with the following additions.

VERTICAL DEFLECTION

Any combination of the four input channels can be selected for differential or single ended operation.

DIFFERENTIAL INPUT

Four identical Input Channels: CH1, CH2, CH3, CH4

Bandwidth:

DC: DC - 3 MHz.
AC: 2 Hz - 3 MHz.

Bandwidth Limit: 30 kHz per channel.

Sensitivity: 500 $\mu\text{V}/\text{div}$ to 10 V/div.

Accuracy: $\pm 3\%$ of full scale.

Input Impedance: 1 M Ω $\pm 0.1\%$, 50 pF ± 4 pF.

Common Mode Rejection: 72 dB at 50 Hz (typical): 60 dB at 1 kHz.

Input Coupling: AC, DC, or Ground on either input.

Input Protection: ± 400 VDC or peak AC.

Offset: ± 200 div up to ± 200 Volts max

Common Mode Input Voltage Range:

± 3 V for 500 μV to 10 mV/div;
 ± 30 V for 20 mV to 100 mV/div;
 ± 300 V for 200 mV to 10 V/div.

ORDERING INFORMATION

Model Number	Price
1624 4 Channel Digital Storage Oscilloscope with differential inputs	\$8195
Options	
102 RS-423 (RS-232C) interface	\$685
103 IEEE-488.2 (SCPI Standard) interface	\$685
104 Internal multi-color plotter	\$575
260 Waveform processor type 260 (see page 32 for more information)	\$500

2608 DIGITAL STORAGE OSCILLOSCOPE FLOATING INPUT

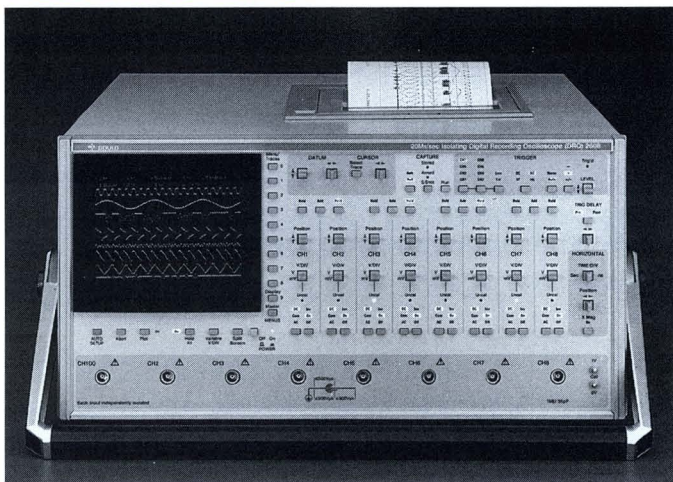

- Full 8 channel operation
- Floating inputs isolated to 500 V
- 10 k memory per channel
- Integral color or thermal plotter
- 50 ns glitch capture
- Fully programmable
- Waveform processing
- 48 x 10 k trace storage module

The need for isolated measurement channels

In many systems, some measurements have to be made relative to a reference level other than ground. Because each channel in the 2608 can be "floated" independently to a different reference level, the voltage

across a shunt and ground referenced logic signals can now be measured at the same time. The isolation eliminates "ground loops", even for low level measurements.

MODEL 2608 SPECIFICATIONS

The specifications of the 2608 are identical to the 1600 series of Digital Storage Oscilloscopes (see pages 25 and 26) with the following additions.

VERTICAL SYSTEM

Eight identical isolated input channels, CH1, CH2, CH3, CH4, CH5, CH6, CH7 and CH8.

Sensitivity: 10 mV/div to 5 V/div.

Input Impedance: 1 M Ω //35 pF input to common, single ended, isolated.

Input Coupling: AC, DC, Common (Input is shorted to floating common).

Bandwidth: DC: 0 - 7 MHz (-3 dB).
AC: 4 Hz - 7 MHz (-3 dB).

Input Protection: 500 VDC or peak AC, common to chassis ground (mains earth); 500 VDC or peak AC, input to common of a channel.

TRIGGER SYSTEM

Variable level control with auto/normal facility

Source: CH1-8, External, Line.

Coupling: AC, DC, ACLP, DCLP.

Slope: +ve, -ve or band (0.5 to 4 div).

Dual-Or'd Trigger: Trigger on one of CH1, 3, 5, 7 or one of CH2, 4, 6, 8 simultaneously.

DISPLAY MODES

X-Y: CH1 is used as the X and other channels are used as the Y deflection.

Split Screen: Display of CH1 to CH8 can be independently compressed by 2, 4 or 8 into part of the screen.

Add: Any of the channel pairs CH1/CH2, CH3/CH4, CH5/CH6 or CH7/CH8 may be independently added.

MEMORY

Waveform Memory: 8 non-volatile trace reference memories.

Set-Up: 4 control setups can be stored in non-volatile memory. The current set up is retained on power down.

POWER REQUIREMENTS

AC Voltage: 100 V, 120 V, 220 V or 240 VRMS \pm 10%.

Frequency: 45 to 400 Hz.

Power: 200 W.

Weight: 21 kg (46 lb approx).

ORDERING INFORMATION

Model Number	Price
2608 8 Channel Isolating Digital Storage Oscilloscope	\$14520
Options	
102 RS-423 (RS-232C) interface	\$685
103 IEEE-488.2 (SCPI Standard) interface	\$685
104 Internal multi-color plotter	\$660
260 Waveform processor type 260 (see page 32 for more information)	\$500
205 Waveform storage module type 205/260 (50k)	\$495
215 Waveform storage module type 215/260 (500k)	\$995

1600/2600 SERIES DIGITAL RECORDING OSCILLOSCOPES

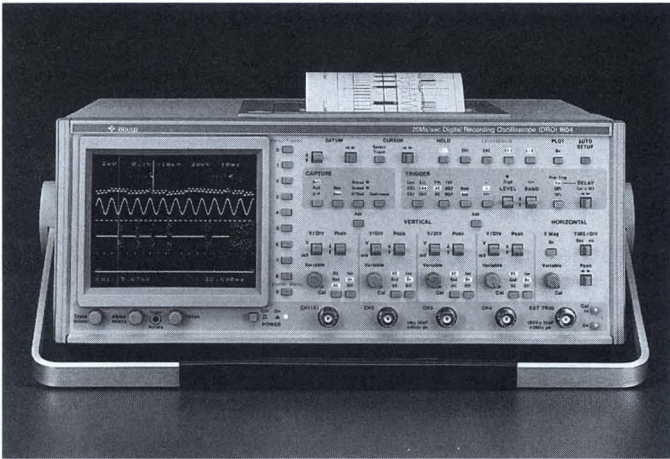

1604 Digital Recording Oscilloscope.

- 4 and 8 channel versions
- Continuous plotting
- High speed storage
- Differential or floating inputs
- Extensive waveform processing

Fast or slow

The frequency response in continuous recording mode is 7 MHz direct to paper, utilizing the oscilloscope acquisition system. This means that slow changes in very fast signals, or an envelope waveform can be reproduced at any paper speed.

Total recall

The DRO can plot out the entire contents of its 10 k memories, with all the detail, up to the full 20 MHz sample rate. This results in a 1.7 meter plot with a sample resolution of 0.162 mm/dot and an equivalent paper speed of an incredible 3.4 kilometers per second (11,155 feet/second).

DIGITAL RECORDING OSCILLOSCOPE SPECIFICATIONS

THERMAL PLOTTER

All 1600 series DSOs are available with built-in thermal plotters — *DROs*. Direct digital copy of waveforms with annotation. Plots can be screen dumps, or continuous “rolling plot” emulating a strip chart recorder.

Plotter Buffer: Permits oscilloscope to be used while plotting a screen.

Plot Size: 114 mm wide, up to 30 m long (approx.)

Screen Dump Mode: Plots 1 k data on screen, all 10 k of data or only data between cursors. Menu selectable.

Continuous Plot: “Continuous” plots up to an entire roll of paper — 30 m — for timebase speeds >200 ms/div. Or, plots of 1, 2, 5, 10, 20, 50 screens of data may be selected via menu.

Annotation: Time and date of plot (repeating for long plots), channel range scaling, screen No. (for multi-screen plots). Menu selectable.

Grid: Solid, broken lines, off, Menu selectable.

Auto Plot: Initiates a plot at the end of acquisition and re-arms the instrument as soon as possible (after data transfer to buffer in single screen dump mode, or at the end of the plot cycle).

ENVIRONMENTAL

Temperature

Operating: +5°C to +35°C

Full Specification: +15°C to +35°C

Storage: -20°C to +60°C

Humidity: Tested to IEC 68-2 Ca operating at 35°C at 85% RH. Tested to IEC 68-2-Db cycling. Non-operating 25°C to 45°C. 85% RH. 6 cycles (144 hours).

Safety: Designed for IEC348 CAT1 standards.

POWER REQUIREMENTS

Voltage: 100 V, 120 V, 220 V and 240 V.

Frequency: 45-440 Hz.

Power: 130 VA nom. (1624). 240 VA nom. (2608).

Weight: 18 kg (40.8 lb. approx) 1624;
25 kg (55 lb approx) 2608.

ORDERING INFORMATION

Model Number	Price
1602/108 2 Channel Digital Recording Oscilloscope	\$6810
1604/108 4 Channel Digital Recording Oscilloscope	\$8790
1624/108 4 Channel Digital Recording Oscilloscope with differential inputs	\$9895
2608/108 8 Channel Isolating Digital Recording Oscilloscope	\$16160

WAVEFORM GENERATION

DIGITAL WAVEFORM GENERATOR DWG-7000

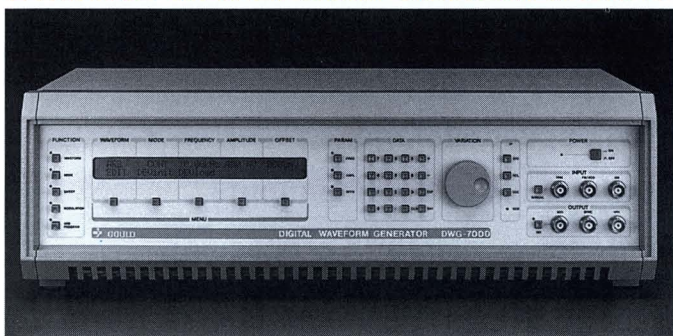

- 9 built-in standard waveforms
- Fully programmable via IEEE-488 and/or RS-232C
- 12-bit vertical resolution
- 16 k memory length
- 100 ns per point arbitrary rate
- Sequence mode
- Easy to use controls
- 10 non-volatile machine set-ups
- Phase locked loop control

The DWG-7000 from Gould is a high performance signal source which provides both "standard" sine, square, triangle, sawtooth, and pulse waveforms as well as user-defined arbitrary waveforms. Typical uses for this generator often involve capture and repetitive replay

of test waveforms. For example, the forces resulting from running a railroad car into a buffer can be recorded and then played back as the drive to a hydraulic actuator which simulates the action of the buffer upon car couplings.

MODEL DWG-7000 SPECIFICATIONS

STANDARD WAVEFORMS

Sine, Square, Triangle, \pm Ramp (Sawtooth), \pm Pulse.

Frequency

- 10 μ Hz to 10 MHz: Sine, Square, Triangle.
- 10 μ Hz to 100 kHz: \pm Rectangular Pulse.
- 10 μ Hz to 10 kHz: \pm Sawtooth.

Resolution: 4 digits, min. 10 μ Hz.

Accuracy: 100 Hz - 10 MHz, \pm 0.5%. <100 Hz, \pm 1%.

Stability: \pm 0.5% of reading for 24 hours.

ARBITRARY WAVEFORMS

Digital Rate: 100 ns to 100 s per point.

Memory Length: 16k points.

Start/Stop Addr: Selectable 0 - 16382.

Vertical Resolution: 12 bits (4096 levels).

Programming: From Gould DSO, IEEE-488, RS-232C.

SWEEP MODES

Phase continuous output within one frequency decade.

Linear, Log: 4 markers.

Start/Stop: 0.1 Hz to 10 MHz.

Sweep Time: 15 ms to 1500 s.

Digital (Arbitrary): 1000:1 Sweep Width.

Start/Stop Addr: 0 to 16382.

Point Duration: 500 ns to 1000 s.

OUTPUT CHARACTERISTICS

Impedance: 50 Ω .

Load Capability: Short circuit proof.

Max. Voltage: \pm 15 V cut-off.

OPERATIONAL MODES

Continuous: Output continuous at programmed Frequency, Amplitude, Offset.

Triggered Int/Ext: One cycle after int, ext, IEEE, RS-232, or manual trigger.

Gated Int/Ext: As Triggered Int/Ext above, but signal duration is gate length.

NBurst Int/Ext: As Triggered Int/Ext, but programmed for 2 to 65535 cycles.

Sequence: Up to 200 steps can be made in selectable increments, 10 ms to 65,535 s.

INTERFACE CAPABILITIES

All functions and characteristics controllable.

IEEE-488: AH1, L4, SH1, T6, SR1, RL2.

Address: Dip-switch settable.

RS-232C: 300 to 19200 Baud rate.

MISCELLANEOUS

Temperature: +5°C to +60°C, operating.

Power: 100, 120, 220, 240 VAC, 50 to 400 Hz.

Dimensions: 13.5 cm H x 44.9 cm W x 35.9 cm D (5.3 in. H x 17.7 in. W x 14.1 in. D).

Weight: 6.8 kg.

ORDERING INFORMATION

Model Number	Price
4120033 DWG-7000-1 Generator	\$4950
4101288 Soft protective carrying case	\$110
4101289 Metal transit case	\$500
4101290 PC programming software R4	\$1495
4108105 GPIB (IEEE-488) 2 m cable	\$110

WAVEFORM GENERATION SOFTWARE

R4 PC SOFTWARE FOR THE DWG-7000 GENERATOR

- **Compatible with 1600 series oscilloscopes**
- **Series of standard waveforms built-in**
- **Mouse driven**
- **Freehand sketching**
- **Complex waveforms from equations**
- **Zooming**
- **Vertical/horizontal expansion/compression**

The R4 waveform generation software program has been specifically designed for arbitrary function generators. It is highly interactive and easy to use, allowing the user to create complex waveforms by using a mouse or by entering equations into the equation

editor. R4 contains drivers supporting waveform transfer between MS-DOS based computers, the DWG-7000 generator, and Gould 1600 series oscilloscopes, allowing the user to capture, store, modify, and generate complex waveforms.

MODEL R4 SOFTWARE SPECIFICATIONS

WAVEFORM CREATION AND EDITING

Inputs: Mouse, freehand sketch, equations, line mode.

Capabilities: Zooming, Duplicate regions, expansion, compression.

FILE OPERATIONS

Load/Save: Waveforms and Configurations.

System: DOS Shell.

Data Transfer: Up load from 1600 series oscilloscopes. Down load to DWG-7000 generator.

GENERATE WAVEFORMS

Signal Types: DC, Gaussian Pulse, Parabola, Sin(x)/x pulse, Sine, Square, Triangle, Sawtooth, User defined (equations), Noise, FM, Code 39 Bar code.

PROCESS WAVEFORMS

Operations: Invert, Scale into engineering units, Limit (Clipping), Moving Average.

COMBINE WAVEFORMS

Operations: Copy, Add, Subtract, Multiply, Divide, Convolve.

RESOLUTION

Vertical: Up to 20 bits.

Horizontal: 5 x 32 k waveforms.

SYSTEM REQUIREMENTS COMPUTER

IBM PC/XT/AT or 100% compatible, or IBM PS/2 model. 50/60/80 with MS-DOS operating system. Hard disk recommended.

INTERFACE

National Instruments PC-IIA GPIB card.

DISPLAY

EGA/VGA or Hercules graphics adapter.

MOUSE

Microsoft or Mouse Systems compatible.

RAM MEMORY

512 k min., 640 k recommended.

ORDERING INFORMATION

Model Number	Price
4101290 R4 Waveform Generation Software and manual. (Includes DWG-7000 and DSO drivers)	\$1495
4101237 National Instruments PC-IIA IEEE-488 card	\$695
4108105 GPIB (IEEE-488) 2 m cable	\$110

WAVEFORM PROCESSORS MODELS 260 AND 270

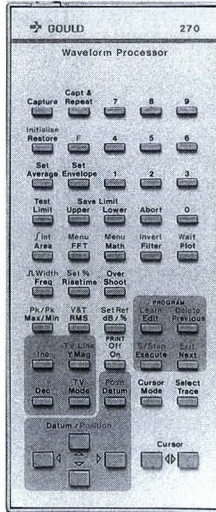

- Fast Fourier Transform
- Programmable sequence
- Automatic pulse parameter measurements
- Waveform arithmetic
- Digital filtering
- Signal averaging
- Envelope mode
- Automatic test limits capability

The Waveform Processors will transform your 1600, 2600, 4070A or 4090 series DSO from a signal acquisition device into a powerful signal capture, measurement and analysis system. A sequence of up to 24 keypad functions can easily be learned and executed

to provide advanced test and signal analysis capabilities. The measurement functions eliminate the need for a wide range of test equipment, from voltmeters to spectrum analyzers, and they'll enable you to make measurements on even the most complex waveforms.

MODELS 260 AND 270 SPECIFICATIONS

Compatibility: The Waveform Processors are compatible with the following DSOs.

260: 1602, 1604, 1624, 2608.

270: 4072A, 4074A, 4090, 4092, 4094.

Initialize: Resets averaging, filtering, envelope and magnification. Also returns to the captured signal in 260.

SIGNAL ACQUISITION CAPABILITIES

Averaging: To 256 in 270, to 1024 in 260.

Capture: Arms the DSO for a single capture of the signal. Capture and Repeat: Uses last applied trace function.

TV Setup TV Line: PAL, SECAM, NTSC selectable.

Limits Testing: Signal in/out pre-defined test band.

Envelope: Max and Min of up to 256 acquisitions.

Post Storage Analysis Functions

Filter: 6 Selectable stages of low pass filtering.

Restore: Undoes the last post-storage trace manipulation.

Vertical Trace Magnification/Attenuation: x 0.06 to 4.0.

Trace Math: Add, subtract, multiply two traces.

Invert: Inverts the trace about the center line.

Position: Moves the trace and datum in X and Y planes.

Integration: Calculates the indefinite integral.

Fast Fourier Transform (FFT): Hanning, Rect., log, lin.

PROGRAMMABLE SEQUENCE

This enables a sequence of up to 24 keystrokes to be entered and executed. Learn, Edit, Print, Scroll.

POST STORAGE MEASUREMENTS

Rise/Fall Time: 10 and 90% points of the signal.

Set Percentage Points: 1% steps, 0 to 99%.

Overshoot: As a percentage of 100% point.

Preshoot: As a percent of 100% point.

Frequency: Average frequency, period, duty cycle%.

Pulse Width: Time between 50% points.

Max/Min: Maximum and minimum voltage excursion.

Peak-Peak: Peak-to-peak voltage of the waveform.

RMS: Root mean square (RMS) voltage of a waveform.

Area: Calculates the area of a waveform segment.

Measurement in dB or %: dBV or % of 100% point.

Cursor Modes: Measure voltages and times.

Voltage at Time Datum: Voltage where Dt crosses trace.

Delta Time Mode: Time Dt to next point same voltage.

ARCHIVING.

Plot: Same as the PLOT function in the instrument.

Print: Prints measurement results with date and time.

Reference Memory: 50 kbytes waveform store: Not 260/205. 500 kbytes waveform store: 260/215.

Save Trace: Saves either all or selected traces: Not 260/215.

Real Time Clock: 24 hour and date set via menu.

Programmability: Via IEEE-488 or RS-423 interface.

WAVEFORM MASS STORAGE MODEL DSU 112 DISK STORAGE UNIT

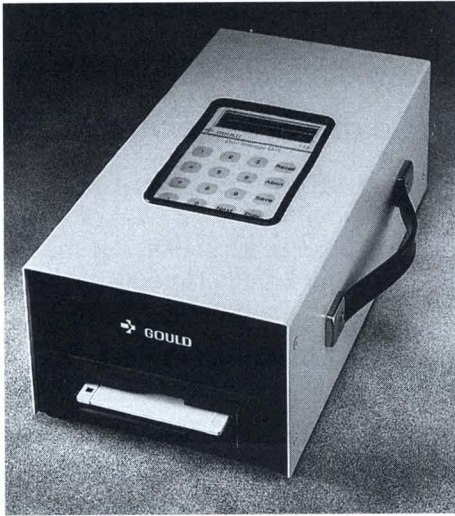

- Compatible with 1600 series oscilloscopes
- Compatible with 4070A, 4090 series
- 3.5 in. or 5.25-in. disk drive
- Built-in disk formatting capability
- Built-in LCD display
- Easy to use keypad
- Automatic numbering of files
- Auto capture mode

The DSU 112 allows transfer of both waveform data and machine setups to and from Gould 1600, 4070A and 4090 series scopes. Any waveform displayed on the oscilloscope can be transferred to the unit for

archiving or for reviewing at a later date. Saving machine setups along with experimental data is particularly useful where a number of different oscilloscope test setups are used.

MODEL DSU 112 SPECIFICATIONS

DISK FORMAT

Standard IBM Disk format. DSU 112 has built-in formatting capability.

DISK CAPABILITY

5.25-in. Drive 1.2 Mbyte formatted.

3.5-in. Drive 1.4 Mbyte formatted.

(High density or double sided.)

POWER REQUIREMENTS

85-264 V Switched mode supply, 2.0 A slow blow fuse.

Power: 50 VA.

Size: 4 in. H x 6 in. W x 10 in. D.

OPERATING ENVIRONMENT

Temperature: 10°C to 45°C.

Temperature Gradient: 10°C/hour.

Relative Humidity: 20% to 80%, non-condensing.

Shock: <5 G peak, 10 ms max.

STORAGE ENVIRONMENT

Temperature: -22°C to +60°C.

Relative Humidity: 10% to 95%, non-condensing.

Shock: <20 G peak, 10 ms max.

RELIABILITY

Drive: Highly reliable Teac floppy drive.

Hard Error Rate: 1 in 109.

Media Life: 3 million passes.

Meantime to Failure: 10,000 hours.

Meantime to Repair: 1 hour.

Error Detection: Standard CRC character.

ORDERING INFORMATION

Model Number	Price
4120040 3.5-in. floppy disk unit	\$1795
4120041 5.25-in. floppy disk unit	\$1795
4108105 GPIB (IEEE-488) 2 m cable (not supplied as standard.)	\$110

OSCILLOSCOPE SOFTWARE

LabWindows

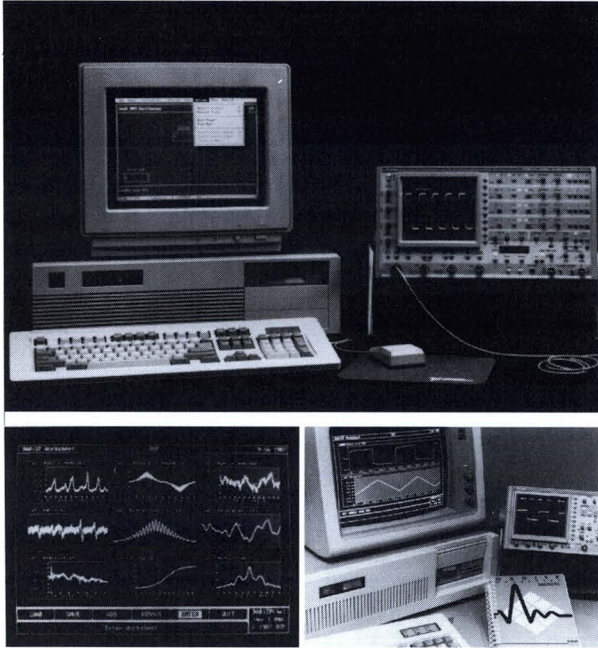

- **Extend post-acquisition capabilities**
- **Reduce software development time**
- **Save waveforms on computer disc**
- **Comprehensive analysis capabilities**

Gould offers two types of software package to meet the needs of scope users who want to increase their productivity by using personal computers:

- **Control Software** — For users who wish to incorporate a scope into a test system without writing the low level scope driver software himself.
- **Analysis Software** — A software package for the user who needs sophisticated post-storage processing capabilities.

Control Software

For the user who is building an IEEE-488 test system, we offer the National Instruments LabWindows™ program. This is a high level control software package which makes the development of test systems easy by using virtual instruments. The user can quickly model the test system and develop the software.

The advantage is that the user can concentrate upon the operation of the system and not concern himself with communications between the scope and computer.

There are instrument drivers available for the 1600 and 4070A series of scopes which make the communication between the scope and computer easier for the user.

SOFTWARE SPECIFICATIONS

LabWindows™ comprises five components:

1. Interactive development environment.
A test program can be written in either QuickBASIC or C.
2. Instrument library.
There is a library of instrument drivers available for a wide range of test equipment.
3. Data Analysis library.
There are two analysis libraries. The standard (supplied with LabWindows™) and the Advanced Analysis Library available as a separate package.
4. Graphics library.
A range of plotting functions are available.
5. GPIB library.
A complete range of IEEE-488 functions.

2. 512 kbytes memory.
3. Graphics Adapter — supports CGA, EGA, MCGA, VGA and Hercules.
4. MS-DOS™ operating system.
5. GPIB Interface Card — preferably National Instruments PCII/IIA.

ORDERING INFORMATION

Model Number	Price
04101233 LabWindows™ Control Software	\$2250
04101234 Instrument driver Modules for 4070A and 1600 series	\$115
04101235 Advanced Analysis Library for LabWindows™	\$2750

COMPUTER REQUIREMENT

The minimum Hardware requirements are:

1. IBM-PC/XT/AT or compatible.

OSCILLOSCOPE SOFTWARE FAMOS



- Transfer data easily from your Gould DSO through ACQ-DSO
- Process data of any length
- Macros to automate repetitive tasks
- Works in the MS-Windows® environment
- Create reports with text, graphics and curves to a printer or plotter

Advanced analysis and signal processing

FAMOS has a range of advanced signal analysis and processing capabilities to give you full information from your captured waveforms.

Rapid data transfer from Gould DSOs

ACQ-DSO multi-tasks within the MS-Windows® environment to transfer data from the Gould DSO into the computer. The data can be saved to disk or it can be processed immediately by FAMOS using the Dynamic Data Exchange (DDE) capability of MS-Windows.

ACQ-DSO can be set to transfer a signal upon request or it can use the Baby-Sitting mode to capture all signals over a period of time or for a number of triggers.

Macro capability

A sequence (or macro) can be written in FAMOS. This is a sequence of commands that can run automatically. These can be simple FAMOS commands or conditional statements can be used to change the processing if a condition is met.

Report generation

FAMOS has advanced layout functions to make it easy to produce an advanced report. Plots and text can be included within the report, making it simple to obtain a fully annotated report. Once designed, the report can be output to any printer, laser printer or plotter supported by MS-Windows®.

FAMOS SPECIFICATIONS

DISPLAY OF DATA

- Display of curves in any number of windows
- Up to 4 curves per window
- X-Y or Y-T plots, Polar display
- Linear or logarithmic scaling

CALCULATIONS

- Simple and complex mathematical functions
- Trigonometric Functions
- Waveform Parameter (e.g., Max/min values)
- Differentiation and Integration
- Linear Regression, Correlation
- FFT and Inverse FFT, Selectable FFT Windows

SPECIAL FUNCTIONS

- X and Y zoom
- Two measurement cursors per window
- Random length data records
- Integrated help function
- Flow control (i.e., loops, conditions)
- Print curves

DATA FORMATS

- FAMOS
- ASCII
- Binary

COMPUTER REQUIREMENTS

- IBM-AT or 100% compatible
- At least 640 kbytes of RAM
- Hard Disk with at least 2 Mbyte free disk space
- High density disk drive
- Graphics card supported by MS-Windows
- MS-DOS version 3.0 or greater
- MS-Windows version 2.0 or greater.

ORDERING INFORMATION

Model Number	Price
04101320 FAMOS (English Language Version)	\$2995
04101321 FAMOS (German Language Version)	\$2995
04099642 ACQ-DSO (English Language Version)	\$495
04099641 ACQ-DSO (German Language Version)	\$495

ACCESSORIES AND CONSUMABLES

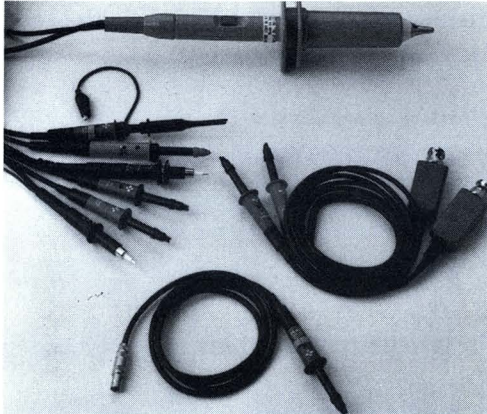

- Probes: active, passive, differential
- Leads and terminations
- Panel covers and carrying cases
- Instrument cart
- TV trigger pod
- Differential amplifier
- Battery pack
- Paper, pens

A comprehensive range of accessories is available to ensure that you get the best from your Gould oscilloscope.

Passive Probes

Probe Type	PB20		PB27	PB36	PB38	
Switch	x 10 position	x 1 position	N/A	N/A	x 10 position	x 1 position
Bandwidth (-3 dB)	DC - 250 MHz	DC - 10 MHz	DC - 5 MHz typ	DC - 300 MHz	DC - 50 MHz	
Attenuation Ratio	10:1	1:1	1000:1	10:1	10:1	1:1
Rise Time	1.4 ns	35 ns	70 ns	1.2 ns	7 ns	
Input R (with 1M Ω DSO)	10 M Ω	1 M Ω	500 M Ω approx.	10 M Ω	10 M Ω	1 M Ω
Input C	Nom. 18 pF	40 pF + DSO input capacitance	Nom. 3 pF	Nom. 16 pF	Typical 12 pF	Typical 40 pF
Input C Reactance at -3 dB	35 Ω	<320 Ω	7600 Ω	33 Ω	265 Ω	
DSO C Compensation at -3 dB	10 - 60 pF	—	15 - 50 pF	10 - 60 pF	30 - 50 pF	
Max. Input Voltage	600 V, including peak AC, derating with frequency		15 kV including peak AC, derating above 55 kHz	600 V including peak AC, derating with frequency	500 V including peak AC, derating with frequency	
Cable Length	1.2 m		1.5 m	1.5 m	1.2 m	
Small, Modular Construction	Yes		No	Yes	Yes	
Automatic Gain Sensing	No		No	Yes	No	
Model No. / Price	04101128 / \$75		04101154 / \$235	04101187 / \$95	04101259 / \$110	
Comments					Lemo connector for 2608 DSO	

Probe Type	PB39	PB45 (SP150)		PB46	PB48	PB49
Switched	N/A	x 10 position	x 1 position	N/A	N/A	N/A
Bandwidth (-3 dB)	DC - 100 MHz	DC - 150 MHz	DC - 15 MHz	DC - 300 MHz	DC - 20 MHz	DC - 5 MHz
Attenuation Ratio	10:1	10:1	1:1	10:1	100:1	100:1
Rise Time	3.5 ns	1.5 ns	20 ns	1.2 ns		55 ns
Input R (with 1 M Ω DSO)	10 M Ω	10 M Ω	1 M Ω	10 M Ω	100 M Ω	10 M Ω
Input C	Nom. 16 pF	Nom. 12 pF	Nom. 100 pF	Nom. 16 pF	Nom. 5.5 pF	Nom. 10 pF
Input C Reactance at -3 dB	100 Ω	84 Ω	106 Ω	33 Ω	1450 Ω	3183 Ω
DSO C Compensation Range	20 - 60 pF	10 - 40 pF		10 - 60 pF	15 - 50 pF	15 - 50 pF
Max. Input Voltage	600 V including peak AC, derating with frequency	600 V including peak AC operating with frequency	600 V including peak AC operating with frequency	600 V pk including peak AC operating with frequency	1200 V, including 600 V including	600 V operate 3.2 kV safety
Cable Length	1.2 m each	1.2 m each		1.5 m each	1.5 m each	3 m each
Small, Modular, Construction	Yes	Small		Yes	Yes	No
Automatic Gain Sensing	No	No		No	No	No
Model No. / Price	04101260 / \$220	04101280 / \$55		04101278 / \$90	04101297 / \$150	04101296 / \$120
Comments	Differential pair for 1624. Common mode adj.			As PB36, but no gain sense	Lemo Connector for 2608	Large, heavy grabber on end. Has gain R adj.

Probes

ACTIVE PROBES (Low input capacitance reduces circuit loading)

Bandwidth: DC to 500 MHz.

Attenuation: x 10 model; or x 1, x 10 switched model.

Input R: 10 M Ω x10 model; 1 M Ω switched model.

Input C: Typically <3 pF.

Input Range: <200 V pk x10, <150 V switched model.

DIFFERENTIAL PROBE (Use with single-ended input oscilloscopes.)

Bandwidth: DC to 15 MHz.

Attenuation: 0.05, 0.005, switched.

Input Impedance: 2 M Ω // 2.5 pF, each side to ground.

Input Range: <70 V, .05 atten., <700 V, .005 atten.

Common Mode V: 500 VRMS, max.

Model Number	Price
PB50 x10 500 MHz, active FET probe	\$795
PB51 x1, x10 switched active probe	\$1395
PB59 Differential Probe, 15 MHz	\$445

Protective Cases

PROTECTIVE CARRYING CASES (soft padded)

Model Number	Price
04101221 400 Series Protective Carrying Case	\$130
04101250 400-107 DSO Protective Carrying Case	\$130
04101176 1600 Series Protective Carrying Case	\$130
04101256 1624 DSO Protective Carrying Case	\$130
04101273 4060 Series Protective Carrying Case	\$130
04101172 4070, 4080, 4090 2608 Series Case	\$130
04101280 DWG-7000 Case	*

PROTECTIVE TRANSIT CASES (Hard)

Model Number	Price
04101195 Protective Case for 1600 Series	\$715
04101268 Protective Case for 1624 DSO	\$715
04101274 Protective Case for 4060 Series	\$715
04101196 Case for 4070, 4080, 4090, 2608 Series	\$715
04101289 Protective Case for DWG-7000	\$500

PROTECTIVE CARRYING CASE (Hard)

Model Number	Price
04101222 Suitcase-style Case for 400 Series	\$315
04101286 Suitcase-style Case for 400/107 DSO	\$400
04101249 400 Series Protective Carrying Case	\$195

These are protective carrying cases which allow the oscilloscope to operate when it's fitted.

ACCESSORY POUCH

Model Number	Price
04101223 Accessory Pouch (not for use with plotters)	\$45

Front Panel Covers

 (Hard plastic, clip-on)

Model Number	Price
04101220 400 Series Front Panel Cover	\$33
04101177 1604 DSO Front Panel Cover	\$33
04101276 4062 DSO Front Panel Cover	\$33
04101275 4064 DSO Front Panel Cover	\$33
04101262 4070, 4080, 4090, 2608 Series Front Cover	\$33

Rack Mount Support

 (fixed flanges, 19-in. rack)

Part Number	Price
04090490 400 Series Rack Mount Kit	\$220
04091631 1600 Series Rack Mount Kit	\$220

Rack Mount Support

 (with slides, 19-in. rack)

Part Number	Price
(For 24 in. depth. 5 units total height.)	
04090486 Rack Mount with slides for 400 Series	\$350
04091632 Rack Mount with slides for 1604 DSO	\$475
04091633 Rack Mount with slides for 1624 DSO	\$450
04094960 Rack Mount with slides for 4062 DSO	\$450
04094961 Rack Mount with slides for 4064 DSO	\$450
04094732 For 4070, 4080, 4090, 2608 Series	\$475

104 Color Plotter Rack Mounted

The rack mount plotter is designed for vertical panel mounting for systems use. The kit comprises the plotter assembly, fixing screws for the plotter, and connecting cable. (The panel is not supplied.)

Model Number	Price
04090483 104/400 RMK Color Plotter for 400 Series DSO	\$1075
04090484 104/1600-4060 RMK Color Plotter for 1600 or 4060 Series DSO	\$1075
04090485 104/4070A-4090 RMK Color Plotter for 4070/4080 Series DSO	\$1075

Internal Plotter Consumables

Model Number	Price
04101175 Pack of 4 pens (4 colors)	\$18
04101265 Pack of 4 black pens	\$18
04101165 Pack of 10 rolls of plain paper	\$51.50
04101251 Pack of 8 rolls of thermal paper (for use with DROs)	\$79

Service Manuals

Model Number	Price
04101224 Service Manual for 400	\$110
04101264 Service Manual for 420	\$110
04101266 Service Manual for 450	\$110
04101320 Service Manual for 465	\$110
04101198 Service Manual for 1600	\$110
04101263 Service Manual for 1624	\$110
04101255 Service Manual for 2608	\$110
04101299 Service Manual for 4060	\$110
04101303 Service Manual for 4070A, 4090	\$110

Leads and Terminations

Model Number	Price
04101090 PL43 lead: BNC-BNC 50- Ω lead, 1 m length	\$19
04101091 PL44 lead: BNC-Crocodile Clips. 50- Ω lead, 1 m length	\$19
Cable Number	Price
04101232 RS-423 (400/6120) cable 2 m length	\$33
04101197 RS-423 (1600/6120) cable 2 m length	\$33
04101193 RS-423 (4070/6120) cable 2 m length	\$33
04108105 IEEE-IEEE cable 2 m length	\$110
04101300 BNC-LEMO (2608) cable 2 m length	\$39
Model Number	Price
04101126 TP24 50- Ω termination. A 50- Ω through-termination for connecting a high impedance input in a transmission system.	\$33

TV Trigger Pod

This option accepts trigger inputs from composite video or from frame-related signals. It provides "synch-separated" output pulses to the oscilloscope EXT TRIG input at the frame or line rate.

FEATURES:

- Selectable NTSC (525 line), PAL/SECAM (625 lines), and "high definition" (1249) TV standards (not Japanese HDTV)
- Selectable normal or inverted synch input
- Selectable frame, or frame + line output
- Wide dynamic input range: 0.25 V to 3.0 V pk-pk.
- 1 M Ω //24 pF input impedance: allows use of standard 1:1 probes
- \pm 250 V pK input protection
- Operates from long life PP3 battery for at least 100 hours

Model Number	Price
4101245	\$355



Type TR7 Cart

A purpose designed instrument cart incorporating a unique mechanism for adjusting the viewing angle without reducing the intrinsic stability of the cart or the safety of an instrument.

SPECIFICATIONS

Size of Instrument Tray: 45 cm (wide) x 50 cm (17-1/2 x 19-1/2 in).

Height of Tray: 74 cm (29 in.).

Rear Wheels: Rubber tired (20-cm diameter).

Front Wheels: Rubber tired castors with brake. 10-cm diameter.

Bottom Tray: Removable with non-slip rubber mat.

Top Tray: Fully adjustable angle (-5° to -65°) by unique "lead-screw" mechanism. Fitted with non-slip rubber mat.

Safety: 2-in. wide nylon safety belt. 2 adjustable rear stop handles.

Finish: Epoxy powder stove enamel.

Color: Grey.

Model Number

04101053

Price

\$530

Battery Pack for 400 Series (Option 107)

The 107 option battery pack for the 400 is built into the bottom of the case, making an integral unit. The battery pack contains Nickel Cadmium cells and a charger unit. This provides uninterrupted operation in the event of an AC supply failure. Battery life is protected by an automatic cut-off against excessive discharge.

Operating time of 400 from a fully charged battery: nominally 1.5 hours.

Recharge time from a full discharge: 5 hours.

Price

\$1275

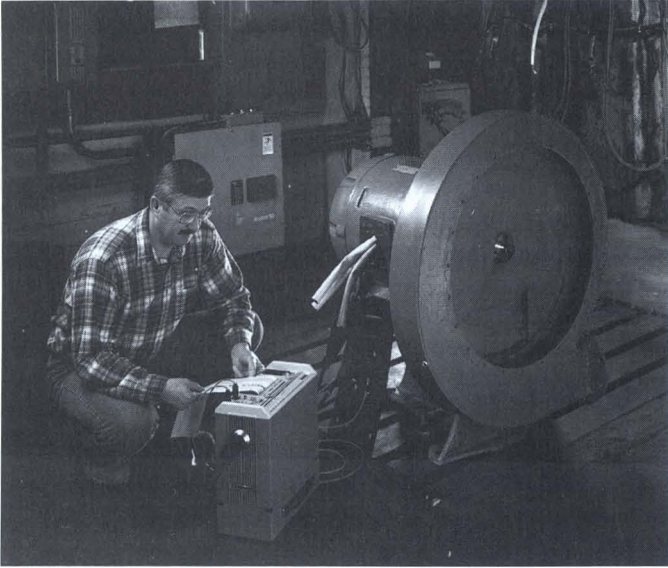

- **Broad range of recording technologies**
—Ink and thermal direct writing systems
—Thermal and electrostatic array systems
- **Input frequency ranges from DC to 35 kHz**
- **Channel widths up to 374 mm**
- **Discrete and overlapping traces**
- **Wide range of options**
- **Fully compatible with 6600, 5700 and 4600 Series signal conditioners**

A tradition of making the best better

For more than 50 years, Gould Electronics — and Brush Instruments before it — has carried on a tradition of quality and innovation. We've supplied the recording instruments you've relied on for accurate test and measurement performance. We've developed advanced technology to create instruments that provide you with meaningful information . . . not mere data.

We've built a heritage of technical leadership proven by a series of industry firsts:

- developing in 1937 the first portable electrocardiograph, forerunner of today's high performance direct writing recording instruments;
- creating a patented pressurized ink writing system that produces accurate, clear, smudge-free rectilinear traces of uniform width at all pen velocities;
- and the newest achievements, patented writing systems for thermal array and electrostatic array.

Definition

Graphic recorders can be defined as instruments that display on paper or similar media a real-time and permanent graphic representation of the magnitude of changing analog input signals. Typically, they are classified by input frequency and writing technology. Low frequency process recorders cover the spectrum of DC to 5 Hz and use felt tip, thermal stylus or ink jet writing techniques. High frequency oscillographic recorders cover the spectrum of DC to 35 kHz.

Because there are many recording technologies available, it is important to weigh the advantages and disadvantages of each. The following points can help guide you to match recorder to application.

- Number of channels
- Chart speeds
- Annotation
- Programmability
- Linearity
- Dynamic response
- Overshoot
- Resolution
- Configurability/Expandability
- Channel width
- Grids
- Digital communication
- Rise time
- Paper type/cost
- Archivability
- Weight/size (portability)

With these points in mind, let's look at some of the writing technologies available to produce hard copies.

Potentiometric recorders

Strip chart recording systems have been used almost exclusively in the industrial and process control environment as long-term trend recorders. They are typically potentiometric devices.

Writing is usually with a fiber pen. In systems with more than one channel, it is convenient to have separate channels displayed in different colors. Full-scale overlap of channels requires that the pens be offset, and this introduces a time displacement between channels. This is overcome by a pen offset compensation time delay, thus restoring synchronization between channels and retaining full overlap capability.

The frequency response of the strip chart recorder is

relatively slow. Maximum response is about 0.33 s at 99% full scale.

Thermal stylus and pressure ink recording

Oscillographic recording systems can be subdivided into two groups: direct writing and indirect writing. Thermal stylus and pressure ink recording systems, both direct writing devices, can achieve a frequency response of 150 Hz.

Pressurized ink provides the highest quality permanent trace. Recent innovations minimize pen tip drying and clogging, allowing ink systems to write dry to the touch, and eliminating the need for lapping and pen pressure adjustment. The paper used on the pressure ink system is, however, special. It has a smooth surface under which lies a porous clay coating. The pen tip on the surface of the paper exerts a fairly high pressure, forming a liquid seal around the pen with a completely closed hydraulic system. With a fluid pressure of 17 to 21 psi (1.17 to 1.43 bars), the ink is forced under the surface of the paper 50 millionth of an inch (1.3 μm) into the clay coating. This produces a trace of superb quality which dries immediately.

Thermal writing systems provide low-maintenance operation and improved trace quality based on a closed loop feedback system, where stylus heat is a function of stylus velocity, stylus acceleration and chart speed. Thermal writing uses thermally sensitive paper on which the heated stylus rests.

Direct writing techniques can give a true real time representation of a signal with excellent trace reproduction. However, they have relatively low frequency response with limited annotation facilities and no trace overlapping is possible.

The fully programmable RS3000 series direct writing oscillograph from Gould is the industry standard. It is designed with a unique pressurized ink system for clear uniform traces, high gain servo system for high response speed, and Metrisite position transducers for infinite resolution. Together these technologies provide a true rectilinear trace with 99.65% linearity and less than 1% overshoot on square waves and transients. Additional features include signal amplitude triggering; IRIG time code interface; and signal polarity reversal.

UV recording

Indirect writing systems commonly use a halogen or ultraviolet light beam. More correctly termed light beam oscillographs, their beam is reflected off a moving mirror on to photosensitive paper. The mirror is mounted on a galvanometric device and, since this has a much lower mass than a pen motor, the frequency response of the system can be as high as 25 kHz. However, the signal deflection is limited to only a few millimeters due to the mirror's mass.

Fiber optic oscillographs also transmit and focus light onto photo-sensitive paper. Light travels from the source to the faceplate of a special CRT which is continually scanned and turned on whenever it intersects the level of an input signal. The light falling on the paper produces what appears to be a continuous trace.

Very high chart speeds can be achieved with these recording systems, in excess of 3 m/s. However, the set up time can be lengthy and much paper is wasted. The photosensitive paper itself is very specialized. It needs to be developed and fixed in order to see the traces. Due to the high paper cost, this procedure can be relatively expensive.

Digital linear array recorders

Linear array technology uses digital circuitry to eliminate the response limitation inherent to traditional direct and indirect recording technology. Array recorders have no moving parts, except for the actual chart drive; they are characterized by high frequency response, overlapping traces, comprehensive annotation, direct digital input and digital communications. Inertia, hysteresis and overshoot are eliminated and bandwidth is limited only by the A/D sample rate and the system print rate.

Thermal array writing is a single step process that uses a fixed linear array of programmable heating elements (styli) that are activated by a composite digital signal and interact with chemically coated, heat sensitive paper to simultaneously produce multiple analog traces, text and grids.

After signal conditioning, up to eight analog signals are multiplexed into a single A/D converter and then stored individually in buffer memory. Max/min circuitry selects the lowest and highest amplitude values among the samples. At each print cycle, a line segment of connected dots displays the amplitude excursion of the signal since the last print cycle. Fixed array heating elements now provide chart widths up to 15 in. (380 mm) with densities of 4 to 8 dots/mm.

One of the main problems of thermal array technology is the instantaneous power that the head requires. For this reason, the head must be controlled to rapidly adjust the amount of energy delivered to each element in the array. A technique known as dot skipping is used to avoid overheating individual heaters. However, if dots are skipped too frequently the element is allowed to cool and a dotted line trace results.

Gould uses a much more effective method of controlling the head, called Micropulsing[®]. Each individual element can be controlled by small heat increments, thus prolonging head life and producing higher quality contrast printing.

Full trace overlap can be achieved with thermal array technology in addition to conventional oscillographic

mode. Extensive annotation can be made and fast transients can be recorded into memory and played back at equivalent paper speeds of more than 200 m/s. It is for this reason that array recording systems are superseding UV recorders. The need for ease of use, cost effectiveness and quality of trace are all important factors in the increasing use of array recording.

Electrostatic array writing is a three-step process using a fixed array of electrodes (styli), two rows of copper shoes, toner and a vacuum knife to produce high quality, non-fade chart records.

The imaging head is an linear array of styli spaced 8 mm apart over the total 256-mm head width. On each side of the array are copper bars called shoes. When a positive charge is applied to specific shoes and a negative charge is applied to certain array points which lie between the shoes, a resultant point negative charge is applied to the electrostatic paper. The toning head allows positively charged toner to flow over this area of the paper, depositing toner where the paper was charged. A vacuum knife then removes any excess toner, leaving the charged particle image.

The array head allows extensive annotation, including trace identification with procedural notes or simply on-the-fly messages. Traces can be positioned anywhere on the paper, therefore full overlapping is achievable.

As with all array technologies there is a slight viewing delay of the traces due to the head location. However, the electrostatic paper is relatively low cost and the versatility of these systems has proved extremely effective in a variety of industrial, medical, scientific, aerospace and research applications.

The EasyGraf, WindoGraf, TA4000, TA2000 and ES2000 linear array recorders from Gould use digital technology to provide high performance and unique features. A stationary imaging head with an array of closely spaced writing elements (styli) generate permanent chart records of multiple analog signals. In the thermal EasyGraf, WindoGraf and TA4000 recorders, the styli are heating elements and the recording medium is heat-sensitive paper. In the electrostatic ES2000, the styli are electrodes that place charges on a dielectric-coated paper medium that attract toner. Unique features include high frequency response (independent of the number of channels), high peak capture capability, overlapping traces, simultaneous generation of grids, timing marks, and traces and comprehensive annotation.

Digital recording oscilloscopes

This is a relatively new concept in recording. A conventional digital storage oscilloscope with at least 10 kbytes of memory can be configured to include a thermal array recording mechanism in its cover. This

provides a very fast plot of the screen, and also the entire contents of the memory can be viewed.

Every sample taken by the scope is recorded on paper and a very long plot is then produced. To save paper, a portion of the trace can be selected by cursors and printed. The oscilloscope can acquire data at its maximum rate of 20 MS/s and print the transient similar to traditional thermal array recorders. Since the acquisition rate is far greater, the maximum corresponding *equivalent* chart speed is 3.4 km/s.

The digital recording oscilloscope can also provide continuous recording. The thermal array technology has all the advantages of other thermal devices. With the oscilloscope set in rolling mode, a continuous plot can be obtained to a maximum rate of 200 ms/div.

Attenuation settings, time base settings, time and date annotation and channel identification can all be included. Because the instrument is also a digital storage oscilloscope, 7 MHz recorder bandwidth is achieved with the capability to record glitches up to 50 ns.

X-Y recorders

X-Y recorders typically are used as peripherals to analytical instrumentation to display two or three measured quantities against each other. Their primary advantage is the ability to display relationships between test parameters, rather than plotting them against time. In applications measuring speed and torque, or pressure and flow, data often becomes easier to study when presented in this format.

These advantages of X-Y recorders are now present in DataGraf recorders from Gould. Data are recorded and stored in hard disk format. Using View II software, the user can then manipulate the information mathematically to generate reports. In addition, data can be converted to ASCII code and placed directly into spreadsheets. And only necessary information need be printed.

Which to choose?

The user would think with all the different technologies available, the choice would be simple. However, the application and the end user's preferences play the major part.

If differentiation of signals is required, a color plotter or strip chart recorder may be the best solution. If extremely high quality traces are important, a pressure ink recording system is ideal. If true real time representation is needed, then direct writing is necessary. And if the application dictates a fast response time with overlapped traces, then the choice would have to be a linear array type device or digital recording oscilloscope.

Whatever your choice, Gould's technology will continue to advance. For a very long time to come, hard copy of your test and measurements results will be necessary in your scientific, industrial and medical applications.

SELECTION GUIDE TO GOULD RECORDING TECHNOLOGY

	EasyGraf Recorders	WindoGraf Recorders	DataGraf Recorders	TA4000 Recorders	ES2000 Recorders	RS3000 Series Recorders
Recording technology	Thermal array	Thermal array; digital storage	Digital storage	Thermal array	Electrostatic array	Ink and thermal pens
Frequency response	500 Hz	500 Hz	4 kHz	35 kHz	35 kHz	60 Hz
Chart speeds	0.01 mm/s to 125 mm/mn; ±100	0.01 mm/s to 125 mm/mn; display speed to 200 mm/s	Optional D/A to any recorder; speeds recorder dependent	1 mm/s to 500 mm/h	0.25 mm/s to 500 mm/h	0.005 mm/s to 500 mm/s
Maximum channel width	100 mm	100 mm	None	374 mm	256 mm	100 mm
Input type	Signal conditioners	Signal conditioners	5 direct settings; signal conditioners	Direct input modules; signal conditioners	Direct input modules; signal conditioners	3 direct settings; signal conditioners
Typical input impedance with signal conditioners	1 MΩ	2 MΩ	1 MΩ	100 kΩ; 2 MΩ	100 kΩ; 2 MΩ	100 kΩ
Annotation	Edge and interchannel	Edge and interchannel	Interchannel post analysis	Interchannel and full page	Line and full page	Edge and interchannel
Event markers	Edge and interchannel	Edge and interchannel	1 TTL	Interchannel	Up to 44 markers	Edge and interchannel
Number of channels	1 to 4 analog 1 to 6 digital	1 to 4 analog; 1 to 7 digital	1 to 16 analog digital marks	1 to 24 analog 1 to 24 digital	1 to 40 analog 1 to 80 digital	1 to 8 analog 1 to 8 digital
Remote control	None	IEEE-488, RS-232C opt	Computer control, TTL	IEEE-488, RS-422, TTL	IEEE-488, RS-422, TTL	IEEE-488, RS-232C, TTL
Paper type	Z fold	Z fold	None	Rolls, Z fold	Rolls, Z fold	Rolls, Z fold, semi- perforated rolls
Real time monitor	None	4 channel, 7 in. built in	8 channel color built in	None	40 channel 12 or 20 in. opt.	None
Waveform storage	None	1.44 Mb 3.5-in disk	40 Mb or opt. 80 Mb	AM400 module	HR2000 module	None
See page for more information	43	45	87	48	54	60

EasyGraf™ THERMAL ARRAY RECORDERS TA240 2 AND 4 CHANNELS

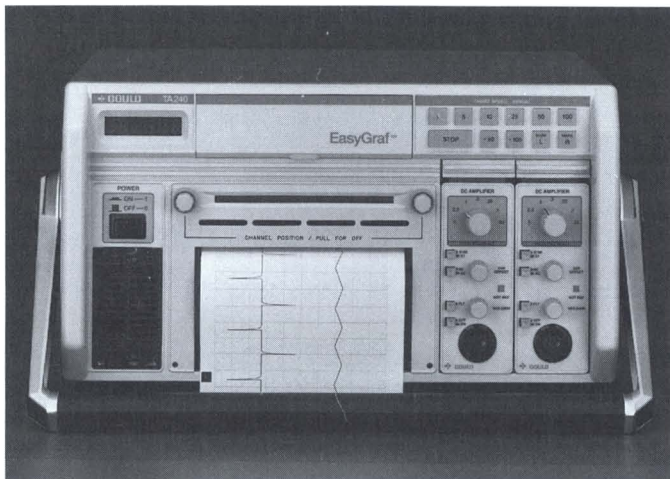

- Two and four channel versions to fit your specific application requirements
- User selectable push buttons to choose 21 chart speeds from 0.01 mm/s to 125 mm/s
- Optional battery pack for remote line-free operation
- Accommodates a wide selection of 6600 series signal conditioners offering isolated, differential inputs
- Rugged metal construction and protective front panel allows operation in many environments

Easy to use

EasyGraf recorders are easy to use, easy to carry, easy to configure, and very affordable. These lightweight, rugged, thermal array recorders can be used in a variety of applications to monitor up to four analog inputs and six event channels.

Whether your application is troubleshooting production lines, routine machine maintenance, motor set-up, or research and development, EasyGraf recorders provide you with answers without operating headaches.

EasyGraf recorders feature high frequency thermal array recording, extensive chart annotation, high performance plug-in signal conditioning and 21 chart speeds from 0.01 mm/s to 125 mm/mn.

Easy to carry

EasyGraf recorders are lightweight and compact. The power supply is designed for 100-240 VAC, 50/60 or 400 Hz line; and 10 to 30 VDC operation. An optional battery pack allows line-free operation in the most remote locations. Its rugged metal construction and protective front panel cover allow you to take EasyGraf recorders anywhere. And it operates horizontally or vertically.

Easy to configure

Choose the EasyGraf recorder right for you: Basic (two channels or real time recording); 2+2 (two or four channel with extension case); and 4S (four channels of compact realtime recording in a single package). Using two 6600 series dual channel AC/DC signal conditioners converts the basic 2-channel recorder to a compact 4-channel unit.

Easily affordable

EasyGraf recorders are the result of 50 years of high quality recorder experience. Gould offers the most economical high performance field recorder available.

In addition, Gould provides you with experienced world-wide support and service. And our applications engineers and service organization are readily available to assist you throughout the world.

Battery pack

The battery pack quickly attaches, providing up to eight hours of line-free operation in the field. When connected to a power line, the EasyGraf recorder will operate while the battery pack is automatically charged. If external power is interrupted, the battery supply takes over automatically, without disturbing recorder operation. And a compact battery charger is available for off line recharging.

6600 series signal conditioners

Compact 6600 series signal conditioners with differential inputs fit virtually any industrial, scientific or medical application. These signal conditioners automatically report their status on the chart paper, along with a five digit channel identification number.

In addition, a low cost coupler with BNC input connectors permits use of 4600 or 5700 series signal conditioners with the EasyGraf recorder.

Protective cover

The protective cover permits the unit to be carried without risk of damaging the front panel. It provides operating instructions and a convenient storage for input cables and paper.

EasyGraf RECORDER SPECIFICATIONS

Number of Channels: Select from 1 to 4 channels.

Chart Width: 120 mm (4.75 inches).

Usable Chart Width: 104 mm (4.09 inches)

Writing Method: Direct thermal array.

Vertical Resolution: 8 dots/mm.

Horizontal Resolution (time axis): 32 to 8 dots/mm.

Chart Speeds: 1, 5, 10, 25, 50, 100, 125 mm/s, mm/mn and ± 100 .

Chart Capacity: Fan fold only: 300 sheets 120 x 150 mm (45 m or 148 ft).

Chart Formats: 100 mm overlap, 2 x 40 mm or 4 x 20 mm.

Real Time Display: LED array showing the position of each trace.

Channel Position: 0 to $\pm 100\%$ full scale.

Number of Event Channels: 6 standard with TTL low or contact closure input, two actuated via front panel.

Input Sensitivity: 20 mV to 500 V full scale with 6600 DC signal conditioner. For other 6600 series signal conditioners, consult pages 68 to 72 and page 98.

Input Type: Isolated input to output, differential; 2 x 1 M Ω impedance with 6600 DC signal conditioner.

Input Connectors: 8- or 14-pin DIN with 6600 series signal conditioners.

Sampling Frequency: 5 kHz per channel.

Frequency Response: DC to 500 Hz full scale $\pm 2\%$ (recorder only).

Time Marks: 1 and 10 s, 1 and 10 mn depending on chart speed selected.

System Annotation: Time, date, chart speed, chart paper page number.

Channel Identification: Channel number, status from 6600 Signal Conditioner, at bottom of channel with line joining the trace to the number.

Grid Patterns: 100 mm, 2 x 40 mm and 4 x 20 mm.

Remote Control: TTL low active/contact closure: chart stop, event markers.

Input Power: 100 to 240 V, 50/60 or 400 Hz and 10 to 30 VDC.

Power Requirement: 150 W maximum

Dimensions:

2 channel: 7.63 in. H x 15 in. W x 15 in. D (19.4 cm H x 38.1 cm W x 38.1 cm D)

4 channel: 7.63 in. H x 19 in. W x 15 in. D (19.4 cm H x 48.3 cm W x 38.1 cm D).

Weight

two-channel recorder: 22 lb (10 kg) with two signal conditioners and cover.

four-channel recorder: 31 lb (14.1 kg) with four signal conditioners and cover.

battery pack: 20 lb (9.1 kg).

Operating Temperature: 5° to 45°C (41° to 113°F).

Storage Temperature: -40° to 85°C (-40° to 185°F).

Relative Humidity: 10 to 90% non-condensing.

Shock and Vibration: Meets MIL Spec. 810E.

Accessories Supplied with Recorder: Front panel protective cover, mating connectors and one pack of paper.

ORDERING INFORMATION

Model Number	Price
42-8240-10 TA240, 2-Channel Recorder without signal conditioners, 100 - 240 V, 50/60 Hz and 10 - 30 VDC (Order with one or two 6600 series signal conditioners.)	\$4295
42-8240-40 TA240 , same model as 42-8240-10 plus 400 Hz line operation	\$4295
42-8440-10 TA240, 4-Channel Recorder without signal conditioners, 100 - 240 V, 50/60 Hz and 10 - 30 VDC (Order with up to four 6600 series signal conditioners.)	\$5495
42-8440-40 TA240 , same model as 42-8440-10 plus 400 Hz line operation	\$5495
Accessories	
CL-814223- Two-channel extension case with power cable to recorder	\$895
CL-814224- Battery pack	\$795
CL-714591- Battery charger	\$295
CL-814593-1 2-channel recorder 19-in. RETMA standard rack-mount kit	\$175
CL-814593-2 4-channel recorder 19-in. RETMA standard rack-mount kit	\$175
CL-614592- Cigarette lighter adapter for DC operation	\$50
CL-814555- Protective front cover (provided standard with 2-channel recorder)	\$75
CL-815270- Protective front cover (provided standard with 4-channel recorder)	\$75
13-6615-9 Blank module	\$45

For 6600 series signal conditioners, refer to pages 68 to 72 and page 98.

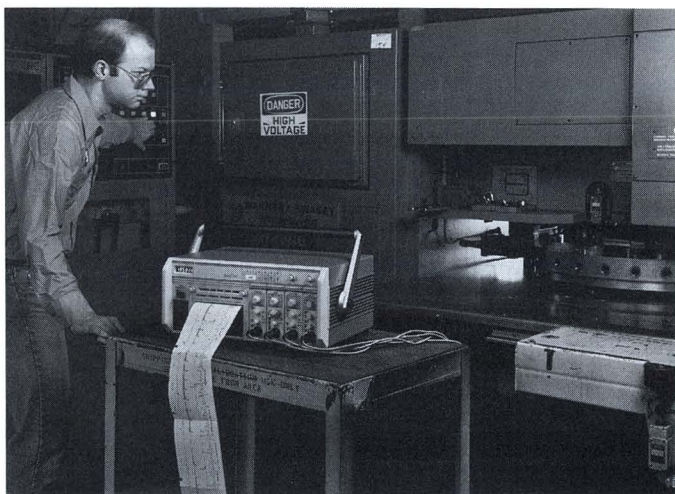

Four-channel EasyGraf recorder is a compact instrument, rugged enough to work precisely even in harsh conditions. A variety of 6600 series signal conditioners allow configuring an instrument to exactly meet your application.

WindoGraf® RECORDERS

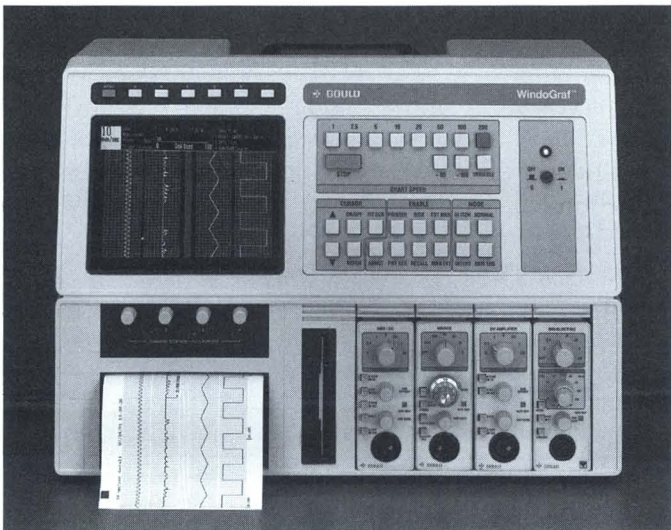

Bridging Recording and Data Acquisition

- Real time monitor with independent scrolling speeds up to 200 mm/s
- Thermal array recorder provides separate or overlapped traces with chart speeds to 125 mm/s
- Acquire up to 161 kS/channel to standard 3.5 in., 1.44 Mb DSO-compatible disk at rates up to 4.5 ksamples/s/channel
- Play back acquired data from disk. Use two cursors for timing/frequency measurements
- Perform advanced analysis on PC with

A totally new concept in recording from Gould. The WindoGraf recorder combines the best features of recorder and oscilloscope technologies to form the first effective bridge between conventional recorders and data acquisition instruments. The WindoGraf recorder delivers the power of data acquisition with the simplicity of a traditional recorder.

Continuously monitor your signals on the built-in CRT without running the chart or acquiring data to disk. When you wish to acquire critical data, simply push a button to start acquisition.

Or, the WindoGraf recorder can automatically trigger and acquire your data for you. Acquired data can be replayed for review on the monitor or for hard copy output on the recorder. The data is stored on a standard 3.5 in., 1.44 Mb DOS-compatible disk. This data can be easily transferred to a standard PC for comprehensive analysis using View II software from Gould.

Never has so much power been available in such a simple package.

Simple power

Data recording need not be difficult. The WindoGraf recorder has user-friendly push buttons to control traditional recorder operations. Simple, logical menus tailor special functions to your particular application requirements. Menu controlled functions include grids, variable speed, X-Y display, trigger set-up, monitoring mode and interfaces.

Real time monitor

Decrease cost per test and setup time. The WindoGraf recorder's built-in, CRT displays signals in

real time, regardless of whether you are recording data to paper or to disk. Sampled signals appear immediately at the top of the display and scroll downward.

Signal time lag, inherent in array recording instruments, is a thing of the past. The monitor is always active. A lag display mode is also available; at slow chart speeds, signals can be monitored and the recorder started after the signal appears on the monitor. The data on the monitor is output and the recorder continues, lagging the display by one screen.

For easy reference, recorder status and signal conditioner type and settings are continuously displayed.

Signal conditioning

You can not analyze what you can not see. The first requirement in solving any application problem is the accurate conversion of data into voltage signals usable by a recording instrument. The WindoGraf recorder uses the new high performance 6600 series signal conditioners from Gould. Regardless of whether you need to record industrial signals — such as RMS levels, high voltage, pressure, flow, temperature, or rotational speed — or medical signals — such as blood pressure, EMG, or ECG — there is a 6600 series signal conditioner to suit your needs. As your test requirements change, simply plug in different signal conditioner modules.

Recording

Whether you require data logging or high-speed acquisition, the WindoGraf recorder from Gould can handle it. The fixed head thermographic process offers

high contrast recording on low cost paper. You select the monitor/chart format that fits your application. Up to four analog and eight event channels can be recorded simultaneously. Any channel can be turned on or off. All signals can be overlapped for maximum resolution and easier timing measurements. To ensure that critical data will not be obscured by another signal, choose four discrete channels or two overlapping signals in two discrete channels.

The WindoGraf recorder simultaneously prints signals, grids, and annotation for increased accuracy and complete chart records. Mechanical parts are minimized. The WindoGraf recorder is fast and virtually maintenance free.

Data acquisition

The WindoGraf recorder can acquire your data to disk either independent of — or in conjunction with — real time chart recording. Signals are acquired with 12-bit resolution. Three modes of operation allow you to match the data acquisition process to your particular application.

Normal mode is a good compromise between waveform capture and recording time; it will handle most traditional recording tasks.

Intensified mode offers the maximum time resolution for the best waveform representation of stored data.

Glitch mode is unique in the WindoGraf recorder for storing only the min/max pairs acquired over a time period which varies with chart speed. Thus, high speed transients can be acquired while recording low frequency or steady-state signals. Glitch mode is especially suited for applications, such as flaw detection, where extended tests also require the capture of high speed pulses at true amplitude.

Instant review

After data is recorded to disk, you can review it on the monitor simply by pushing the Recall button; then you can make a hard copy of specific excerpts with a single keystroke by pushing the Print Screen button. The WindoGraf recorder's disk is the key to detailed analysis.

For easier interpretation, place a cursor at the start and end of a data segment to expand/compress it to fit the screen. Timing/frequency measurements and signal values are computed and displayed using the two cursors. In addition, any data signals, such as force and displacement, can be displayed in X-YYY format, and output on paper, for easier analysis.

Advanced analysis

The path from a mass of test data to test solutions was never smoother. Acquired data can be transmitted from the WindoGraf recorder's disk to a computer via standard RS-232C or IEEE-488.2 interfaces; or, simply remove the WindoGraf disk, take it with you, and insert it in your own PC. Either way, the data can be analyzed in depth using the View II analysis software from Gould or the DSF to ASCII software from Gould.

The View II analysis software is a Microsoft® Windows™ 3.0 application that reads WindoGraf recorder data directly. Signals can be presented and reviewed to optimize their interpretation. Trends or relationships can be easily uncovered by using extensive display manipulation. Data can be marked with text to make your permanent records complete.

Since all data is stored with 12-bit resolution, the y-axis expansion function will show detail at any critical point. All standard measurements — min., max., dY/dX, RMS, etc. — are included. In addition, the View II software can generate composite signals, such as power or force, from existing traces. When critical data is identified, you can manipulate your signals in the frequency domain with functions such as FFT and cross correlation.

The DSF to ASCII software is a Microsoft Windows 3.0 application that converts the WindoGraf recorder signal values to ASCII text. If you need to use custom or existing analysis software, these ASCII text files can be easily imported into most applications.

Report generation

The View II analysis software and Microsoft Windows 3.0 make it a snap to copy a signal segment to other Windows applications. Select a segment, then copy the values to Microsoft Excel for Windows for further analysis; or, copy a "picture" of the segment to Microsoft Word for Windows and add text for a complete report.

Hard copy output

After analysis, hard copy output is often needed. Whether this is a traditional chart-paper recording or a report output to a printer or digital plotter, the View II analysis software offers a solution to meet your hard copy output needs.

Versatility

With its light weight, rugged construction and optional DC power supply, the WindoGraf recorder is the ideal device for mobile use.

If you require more than a chart-paper recorder, without increased complexity, the WindoGraf recorder is for you. Crossover the bridge from data to results.

WindoGraf RECORDER SPECIFICATIONS

Number of Channels: Up to 4 analog and 8 event (TTL low or contact closure input).

System Resolution: 12 bits.

Analog Bandwidth:

Normal Mode: DC to 200 Hz full scale $\pm 2\%$, -3 dB at 460 Hz.
Intensified and Glitch Mode: DC to 300 Hz full scale $\pm 2\%$, -1.5 dB at 2 kHz.

Sample Rate:

Normal Mode: 800 S/s/channel.
Intensified Mode: 10 kS/s/channel to paper, 4500 S/s/channel to disk.
Glitch Mode: 10 kS/s/channel, min/max pairs to disk, rate varies with chart speed.

Data Storage: 164,736 S/channel. MS-DOS diskette, 3.5 in., 1.44 Mb.

Monitoring Modes:

Continuous: Manual control.
Alternating: Toggle chart speed on time.
Triggered Alternating: Toggle chart speed on trigger and time.

Trigger Source: Any channel (level and slope), external event or interface.

Trigger Coupling: AC, DC, Low freq reject (50/60 Hz), Low freq reject (400 Hz), High freq reject (50/60 Hz).

Pretrigger: 0 to 100%.

Monitor/Chart Formats: 100 mm overlap (3 grid selections), 2 x 40 mm and 4 x 20 mm discrete.

Real Time Monitor: CRT, 7 in., 800 x 350 pixels. Signals scroll from top to bottom from 1 mm/s to 200 mm/mn.

Recorder: Direct thermal array, 104 mm (4.09 in.) wide.

Recorder Modes: Y/T, X/Y and print screen.

Chart Speeds: 1, 2.5, 5, 10, 25, 50, 100, 125, 200 (monitor only) mm/s, mm/mn and $\div 100$.

Annotation: Date, time, chart speed, channel identification, trigger point, time marks and signal conditioner status.

Chart Paper: 120 mm (4.75 in.) W x 45 m (148 ft.) L, fan fold.

Operating Temperature: 5° to 45°C (41° to 113°F).

Storage Temperature: -40° to 60°C (-40° to 140°F).

Relative Humidity: 10 to 90%, non-condensing.

Input Power: 100 to 240 V, 50/60 Hz; and 10 to 30 VDC depending on model.

Dimensions: 12 in. H x 17 in. W x 12 in. D (30.5 cm H x 43.2 cm W x 30.5 cm D).

Weight: 30 lb (13.6 kg) less signal conditioners.

Safety: Designed to meet UL, CSA, TUV, and VDE certification.

Emission: Designed to meet FCC Rules CFR 47 and VDE Class A emissions tests.

Shock and Vibration: Meets and exceeds MIL Spec. 810E and IEC-348; vertical acceleration limit 30G.

ORDERING INFORMATION

Model Number	Price
40-8474-02 WindoGraf Recorder , basic, AC power; without RS-232C and IEEE-488.2 interfaces, analog out, digital remote control	\$7995
40-8474-00 WindoGraf Recorder , AC power; with RS-232C and IEEE-488.2 interfaces, analog out, digital remote control	\$9295
40-8474-10 WindoGraf Recorder , AC/DC power; with RS-232C and IEEE-488.2 interfaces, analog out, digital remote control	\$9790
40-8474-20 WindoGraf Medical Recorder , isolated power; with RS-232C and IEEE-488.2 interfaces, analog out, digital remote control	\$9790
Accessories	
CL-813966- Protective front cover	\$175
CL-413967- Shipping case	\$595
CL-715140- DC power input cable, 6 ft.	\$45
CL-215209-1 RS-232C cable, 9 pin to 9 pin, 6 ft.	\$75
-297007-1 IEEE-488 cable, 2 m.	\$125
CL-615422-1 View II analysis software kit (see page 89)	\$2995
CL-615422-2 DSF-to-ASCII conversion software kit	\$295

For 6600 series signal conditioners, refer to pgs. 68 to 72 and 98.

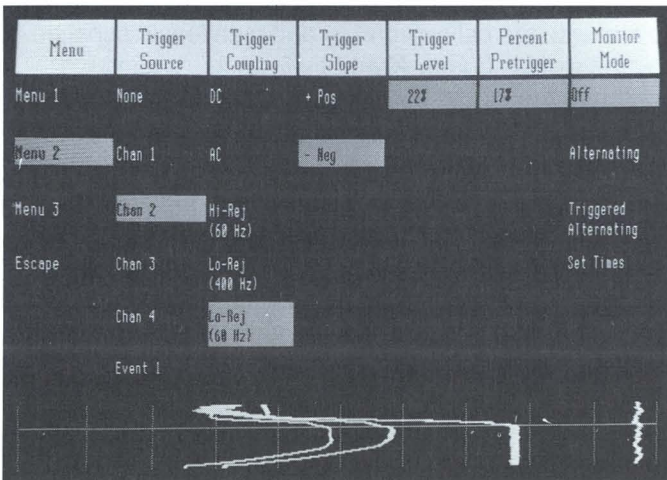

Three simple menus control setup of all special recording, acquisition and interface functions of the WindoGraf recorder.

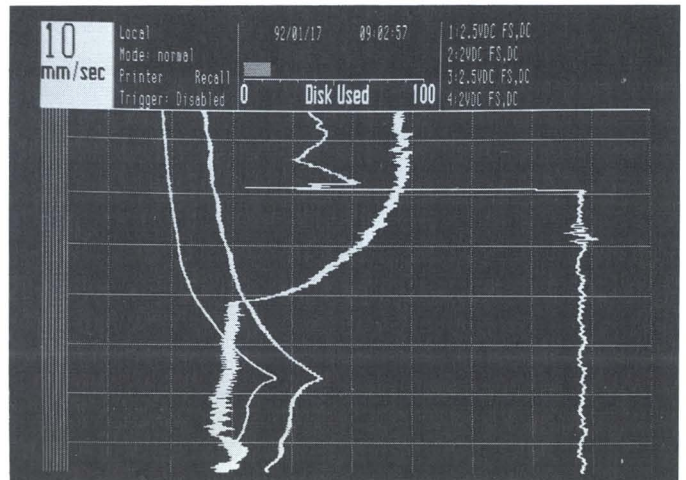

The WindoGraf recorder's real time monitor displays both signals and recording status. You record data on paper or acquire data to disk only when desired.

THERMAL ARRAY RECORDERS

TA4000

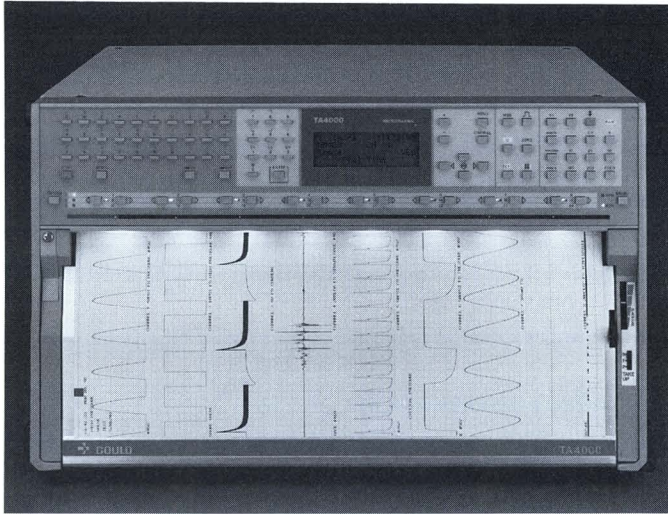

- Single 15-inch thermal head
- Up to 24 channels, analog or digitized
- 8 x 40 mm or full overlap presentation
- Micropulsing® print head control technique
- Automatic calibration with user's signals
- Extensive user annotation
- Compatible with 6600, 5700 and 4600 series signal conditioners from Gould

The TA4000 from Gould is a modular, single print head, 15-inch thermal array recorder that can be configured for a wide range of applications. Up to 24 analog traces from analog signal sources or directly from a computer can be recorded in 8 x 40 mm channel format or simultaneously across the entire chart. Print head safety and contrast quality is permanently controlled by Micropulsing, a proprietary design (patent no. 4,937,590) developed by Gould for this recorder.

Full programmability via IEEE-488 or RS-422A interfaces together with features such as automatic calibration or auto-ranging insure that user intervention can be reduced to a minimum. The TA4000 is fully compatible with 6600, 5700 and 4600 series signal conditioners from Gould. This provides excellent flexibility to match specific recording requirements for Medical, Industrial or Aerospace applications.

The TA4000 has three slots to receive any combination of the three input modules:

- AP800, 8-channel DC amplifier with 8 event markers.
- AM400, 4-channel DC amplifier with 4 event markers and digitized data storage.
- DP800, 8-channel digital input with 8 event markers (discrete channels).

An additional option, the TD100 time code interface, can be directly mounted on the CPU board.

The TA4000 single print head allows traces, grids and characters to print anywhere on the chart. In 8 x 40 mm channel mode, any bank of eight channels can be displayed at once. In Overlap mode, trace limiters are used to generate any channel format, including the ability to expand any trace up to full chart width.

Micropulsing is a process that continually controls the temperature of the print head heaters so that they remain in the safe zone and do not deteriorate from thermal stress. This virtually eliminates head breakdown and ensures the best contrast at all chart speeds and signal frequencies.

Using the auto-calibration feature, a complete recording system (with transducers and signal conditioners) can be automatically calibrated in gain and offset with the calibration low and high levels supplied by the signal source. Alternatively, auto-ranging will calibrate the inputs with an external periodic signal.

The most extensive user annotations can be entered using the friendly front panel keyboard and simultaneously printed with traces and grids: these include channel identification in engineering units, one page of text printed periodically, one message printed on-the-fly upon command. In addition, pages of text can be sent from a computer for immediate printing with or without traces and grids.

TA4000 SPECIFICATIONS

Number of Analog Channels: 1 to 24 with AP800 8-channel inputs.

Number of Event Markers: 1 to 25, 1 actuated via front panel.

Chart Width: 384 mm (15-1/8 in.).

Usable Chart Width: 374 mm (14-3/4 in.).

Resolution: 8 dots/mm along the Y axis — 1600 dots/s maximum along the time axis.

Type of Paper:

Roll: 100 m (328 ft);

Fanfold: 500 sheets x 216 mm (108 m or 354 ft);

Perforated roll: 100 m (328 ft).

Motor: Microstep drive.

Chart Speeds: 1, 2.5, 5, 10, 25, 50, 100, 200 mm/s, mm/mn, mm/h (for higher speed, consult Gould sales office); two user-edited speeds with 1-mm resolution; external speed (pulse drive — 1 pulse = 1/64 mm). Optional 500 mm/s.

Chart Format: 8 x 40 mm or full overlap. In the overlap mode, traces can be positioned anywhere across the usable chart width.

Channel Identification: Interchannel (8-channel mode) or bottom of chart (overlap mode). Input sensitivity or engineering units (128 characters per channel total).

Time Markers: 4, 2, 1-mm marks on both sides of the chart every 10, 1, 0.1 s, mn or h, depending on chart speed range selected (/s, /mn or /h).

Event Markers: System marker actuated by front panel push-button; other markers are added with each plug-in input.

System Annotation: Time, date, chart speed and time scale (second/cm) printed at all speeds including external.

Periodic Text: One page of 81 x 80 characters (in 8-40mm channel mode) printed every other page.

On-the-fly Message: Prints immediately 1 line of 128 characters upon pressing a key. Can be positioned anywhere on the chart.

Text Dump: ASCII text can be sent from a computer via the IEEE-488 or serial interface for immediate printing, with or without recording traces.

Grid Lines: 16 patterns.

Speed Modes: Alternate, single-speed and dual-speed.

Front Panel Lock: User may lock all front panel keys except chart drive and speed selection.

Battery Back-up: Stores last recorder set-up.

Remote Control: Via IEEE-488, RS-422A: all front panel functions. TTL low active: chart drive in and out, chart speeds, external speed input/output.

Digital Outputs: 4 including Alarm, Low Paper, Chart Paper Out and Trigger.

Line Voltage: 100 to 240 V; 50/60/400 Hz. Optional, 10 to 20 VDC or 21 to 56 VDC.

Power: Up to 400 VA, 200 VA typical.

Dimensions: 10.5 in. H x 19.5 in. W x 19.7 in. D. (26.6 cm H x 44.5 cm W x 50 cm D).

Weight: 62 pounds (28 kg), fully configured.

Options: Chart take-up full roll with slanted table (independent drive); Fanfold catch tray rack-mount; Fanfold basket and slanted table.

Operating Temperature: 5° to 40°C (41° to 104°F).

Storage Temperature: -40° to 70°C (-40° to 158°F)

Relative Humidity: 20 to 80% at 25°C (68°F) non-condensing.

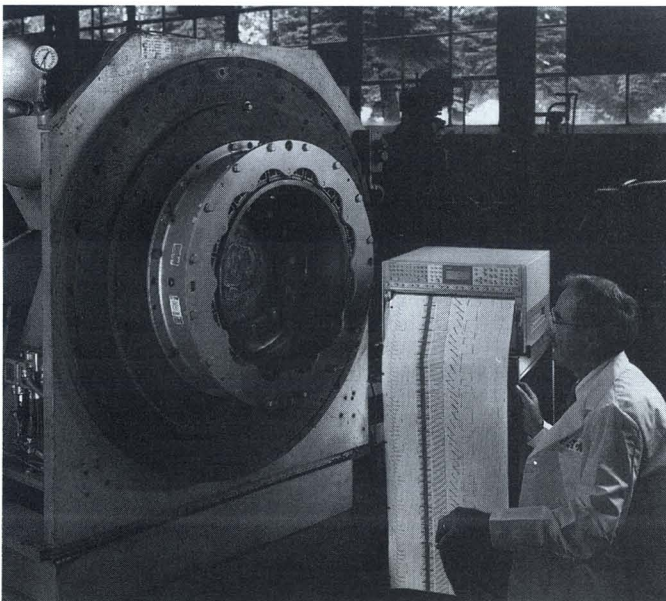

TA4000 allows multiple measurements — up to 24 channels — on its 15-inch chart width. Rugged design and ease of operation allow you to record precise data even in hard environments.

AM400 4-Channel Waveform Storage Amplifier



- **Balanced inputs 200 mV to 250 V full scale**
- **Sampling rate from 2 S/s to 100 kS/s**
- **Segmentable memory up to 128k**
- **Pretrigger and trigger delay**
- **Up to 12 analog channels**
- **Background acquisition and transmission of stored data**
- **XY recording**

This programmable 4-channel DC amplifier and 4 event channels is designed for acquisition of high-frequency signals up to 35 kHz into its memory of 128k words of 12 bits without interruption of real time recording on the TA4000 recorder. After acquisition, selected portions of stored data can be replayed either in YT (8 x 40 mm channel or overlap format) or XY mode, and subsequently transmitted to an external computer for further storage and analysis. The TA4000 can accept up to 3 AM400s, giving a system capacity of 12 channels. AM400 features include: full programmability, auto-calibration and auto-ranging with external calibration source, operation off-ground up to 125 V, variable sensitivity from 200 mV to 40 V full scale (8 x 40 mm mode) and maximum reading of 250 V in overlap mode, pre-trigger from 0 to 100%.

AM400 SPECIFICATIONS

Number of Channels: 4 analog and 4 event.
Input Circuit: Balanced to ground, 2x1 MΩ impedance.
Measurement Range: 200 mV to 40 VFS (8x40mm Channel Mode); 50 mV/cm to 10 V/cm, up to 250 VFS (differential), 125 V each input to ground (Overlap Mode); Calibrated Vernier with 1% resolution.
Frequency Response: -3 dB at 35 kHz.
Peak Capture: 25 μs minimum.
Maximum Safe Input Voltage: 200 VDC or peak each input to ground; 400 V differential.
Trace Position: From -52% to +52% of full scale (8-channel format) with 0.25% steps. From 0 to 373.9 mm with 1/8-mm steps
Channel Identification: Status and user text (128 characters).
Event Marker Inputs: TTL low or high level active.
Sampling Frequency: 2 S/s to 100 kS/s and external (one time base per recorder)
Sampling Resolution: 12 bits.
Memory: 32 kS per channel maximum; can be limited to 1,2,4,8 16 kS per ch; up to 128 kS for 1 ch or 64 kS for 2 ch.
Triggering Sources: Any analog input (on positive or negative slope or window) or event marker.
Trigger Level: From -50% to +50% of full scale width in 8-Channel Mode; anywhere on the chart in Overlap Mode.
Pretrigger Position: 0, 12.5, 25, 50, 75 or 100%.
Background Capturing: Data can be acquired and stored in memory without interference with real time chart recording.
Recording Modes: Manual or automatic (unit rearms after end of replay of data on paper); replay can be in Y-T (recording versus time) or X-YYY (XY plot of 3 channels versus one).
Transmission of Digitized Analog Signals: Via the TA4000 IEEE-488 or RS-422A interface.

AP800 8-Channel DC Amplifier



- **Fully programmable**
- **10 kHz bandwidth, 70 μs peak capture**
- **200 mV to 250 VFS**
- **Auto-calibration and auto-ranging**
- **Up to 24 analog channels**

This programmable 8-channel DC amplifier with 8 event channels is the standard input for real time recording on the TA4000 recorder. The TA4000 can accept up to three AP800s, giving a system capacity of 24 channels. Gould AP800 features include: full programmability, auto-calibration and auto-ranging with external calibration source, single-ended to ground inputs, variable sensitivity with a resolution better than 1%, from 200 mV to 40 V full scale (8 x 40 mm mode) and a maximum reading of 250 V in overlap mode.

AP800 SPECIFICATIONS

Number of Channels: 8 analog and 8 event.
Input Circuit: Single ended to ground, 100 kΩ impedance.
Measurement Range: 200 mV to 40 V full scale (8 x 40 mm Channel Mode); 50 mV/cm to 10 V/cm, up to 250 V full scale (Overlap Mode); Calibrated Vernier with 1% resolution.
Maximum Safe Input Voltage: 300 VDC or peak.
Accuracy: ±0.5% of full scale.
Noise: ≤3 dots at 50 mV/cm.
Trace Control: Direct or reverse polarity, trace off and zero.
Trace Position: From -52% to +52% of full scale (8-Channel Mode) with 0.25% steps. From 0 to 373.9 mm with 1/8-mm steps (Overlap Mode).
Channel Limiters: ±52% of full scale (8-Channel Mode); 0 to 373.9 mm (Overlap Mode).
Frequency Response: -3 dB at 10 kHz.
Peak Capture: 70 μs minimum.
Channel Identification: Status and user text (128 characters).
Auto-Calibration: Automatically sets position (offset) and sensitivity so that low and high match 2 cal signals supplied by user's signal source.
Auto-Ranging: Automatically sets position and sensitivity so that a periodic signal sent to recorder is tangent to channel edges.
Grid Scaling: Prints high, middle and low values across channel in engineering units (8-Channel Mode only).
Event Marker Inputs: TTL low or high level active.
Input Signal Connectors: 37-pin SubD and 25-pin SubD.

DP800 8-Channel Digital Input



- Up to 12 bits resolution
- Acquisition speed down to 2 ms per data word
- Continuous traces, peak capturing at high speed
- Adjustable scale and position
- Up to 24 traces and 24 discrete channels
- Compatible with DR11 interfaces and most computers
- IEEE-488 input option

Digitized analog data stored and processed by computers are often required to be displayed in a chart format for analysis. The DP800 offers input capability for up to 8 independent channels via a 16-bit parallel Input/Output or a DR11 compatible interface. Eight continuous traces are generated with peak capturing. Minimum channel update rate is 2 μ s. The TA4000 can accept up to three DP800s, giving a system capacity of 24 channels. Records on the TA4000 can be made with speeds ranging from 1 mm/h to 200 mm/s. Depending on preference, the user can set position and scale of each trace either locally via the control interface or via the data input interface.

DP800 SPECIFICATIONS

Number of Channels: 8 digital with 12-bit resolution and 8 discrete.

Input Interfaces: 16-bit parallel, DR11 compatible with differential drivers (RS422) and 16-bit parallel, TTL level with 3-line handshake (STROBE, BUSY and READY).

Connectors: 2x40-pin male HE10 (input); 37-pin female Sub-D (input/output to DP800's); IEEE-488 (*DP800/488 option*).

Maximum Distance from Computer: 1000 ft (300 m); 50 ft (15m) (*DP800/488 option*).

Number of Modules on the Bus: One only (DR11 interface); up to 16 (16-bit parallel); up to 14 (*DP800/488 option*).

Data Acquisition Rate: 2 μ s per data word minimum; 125 μ s (*DP800/488 option*).

Channel Address Identification: By address bits or automatic scanning of all 8 channels.

Full Scale Amplitude: 5 to 2048 mm by binary steps via front panel or remote control.

Trace Position: \pm 52% channel width (8-Channel Mode); 0 to 373.9 mm (Overlap Mode) via front panel or via remote control.

Trace Authorization: Each trace via front panel or remote control.

Channel Limiters: Each channel via front panel

Polarity Reversal: Each trace via front panel

Trace Identification: Vertical line + 128 characters per channel in overlap mode; 128 characters per channel between channels in 8-channel mode.

Discrete Channels: Positioned between channels in 8-Channel Mode; at bottom of chart in Overlap Mode.

TD100 Time Code Interface



- Reads IRIG A, B, E, H and NASA 36, modulated and demodulated
- Allows up to 24 channels
- Prints and displays time and date
- Tape search and control

This time code interface from Gould is a versatile time-code reading unit that mounts directly on the TA4000 CPU board. As a result, all of the slots for input module are available for up to 24 channels. Time and date information from IRIG A, B, E or H or NASA 36 code is printed on the TA4000 chart and displayed on the front panel. A time triggering feature enables to control TA4000 functions, such as chart drive and a tape recorder.

TD100 SPECIFICATIONS

Supported Time Code Formats: Modulated and demodulated IRIG A, B, E, H and NASA 36.

Modulated Input Level: 300 mV P-P min (logic level=0), 25 V P-P max. (logic level=1).

Modulation Ratio: 1÷2 to 1÷6.

Demodulated Code Input Level: TTL.

Time Reference Accuracy: 625 ms.

Annotation Positioning: Anyone of 80 lines (in 8 x 40 mm mode).

Time Display: On LCD screen (replaces real time).

Time Triggering: 2 independent settings for control of 1) TA4000 chart drive and speed 2) external device (e.g., tape recorder)

Time Code Input: 100 k Ω , TA4000 auxiliary connector.

TA4000 ORDERING INFORMATION

TA4000 Basic Recorders (no plug-in module)

Model Number	Price
3008-A1500-17 Basic unit portable, 100-240 V, 50-400 Hz	\$12495
3008-A1500-14 Basic unit portable, 100-240 V, 50-400 Hz or 10-20 VDC	\$16995
3008-A1500-15 Basic unit portable, 100-240 V, 50-400 Hz or 21-56 VDC	\$16995
3008-A1501-17 Basic unit with enclosure	\$12995
3008-A1506-17 19-in RETMA standard rack-mount unit	\$16490
3008-A1507-17 European rack-mount unit	*
TA4000 Recorders, 8-channel analog (includes 1 AP800)	
3008-B1500-17 8-channel unit, portable	\$16490
3008-B1506-17 8-channel 19-in RETMA standard rack-mount unit	\$16490
3008-B1507-17 8-channel European rack-mount unit	*
Plug-in Modules	
23-31205-1 AP800 8-Channel DC Amplifier (see page 50)	\$3995
23-31205-2 AM400, 4-Channel DC Amplifier with Waveform Storage (see page 50)	\$3995
23-32205-1 TD100 Time Code Interface (see page 51)	\$1295
23-32205-2 DP800, 8-Channel Digital Input (see page 51)	\$3995
23-32205-03 DP800/488, 8-Channel Digital Input (see page 51)	\$4295
Option 500 mm/s chart speed	*

* Consult factory.

ACCESSORIES AND OPTIONS

Model Number	Price
11-1202-41 19-in RETMA standard rack-mount kit, TA4000	\$225
11-1605-206534 Input/Output panel, 8-channel, direct/tape play-back.	\$4195
11-1605-32 Input/Output panel, 8-channel, front mount	\$2750
11-1605-33 Input/Output panel, 8-channel, rear mount	\$2750
11-4310-22 Cable AP800 to 8 Molex, 3 m (10 ft)	\$125
11-4310-23 Cable Molex to spade lug	\$15
11-4310-25 Cable Molex to BNC (need 8 per AP800)	\$45
11-6405-6 Mobile cart, TA4000	\$1395
23-22101-7 RS-422/RS-232C interface converter	\$395
23-33205-4 Chart take-up, full roll with slanted table (factory mounted)	\$695
23-33205-2 Fanfold paper basket	\$125
23-33205-3 Slanted writing table (not usable with chart take-up)	\$195
23-33235-2 Fanfold paper catch tray, European rack-mount	*
23-33245-2 Fanfold paper catch tray, 19-in RETMA standard rack mount	\$640
-297007-1 IEEE-488 cable, 2 m (7 ft)	\$125
M16905 IEEE-488 cable, 4 m (13 ft)	\$325
CL-712315- Cable AP800 to 8 BNC, 1 m (4 ft)	\$340
CL-713497- Cable AP800 to 8 BNC, 1.8 m (6 ft)	\$425
CL-714744- Cable AP800 to 4600 cage	\$495
CL-813522- Kit, enclosure for TA4000	\$475
X52589** European rack-mount kit, TA4000	*
X52678 Input cable, AP800, unterminated, 2 m (7 ft)	\$125
X80083D** User's manual (German)	\$65
X80083F** User's manual (French)	\$65
X80084E Service manual	\$210
Z00108 Reusable shipping container	\$695
Z00109 Protective carrying case	\$195
MU3008-A1500-17 User's manual, TA4000 (English)	\$35
MU23-32205-1 User's manual, TD100 (English)	\$35
MU23-31205-2 User's manual, AM400 (English)	\$35
MU23-32205-2 User's manual, DP800 (English)	\$35
X52836-24 Isolator, 8 event markers, 24 V	\$525
X52836-48 Isolator, 8 event markers, 48 V	\$525
X52836-5 Isolator, 8 event markers, 5 V	\$525
X52836-60 Isolator, 8 event markers, 60 V	\$525
X52842 Cable, isolator to AP800 marker input	\$125
X52838 Cable, isolator to two AM400 marker inputs	\$195
** PA-xxxxxx instead of xxxxxx in North America	

THERMAL ARRAY RECORDERS

TA2000

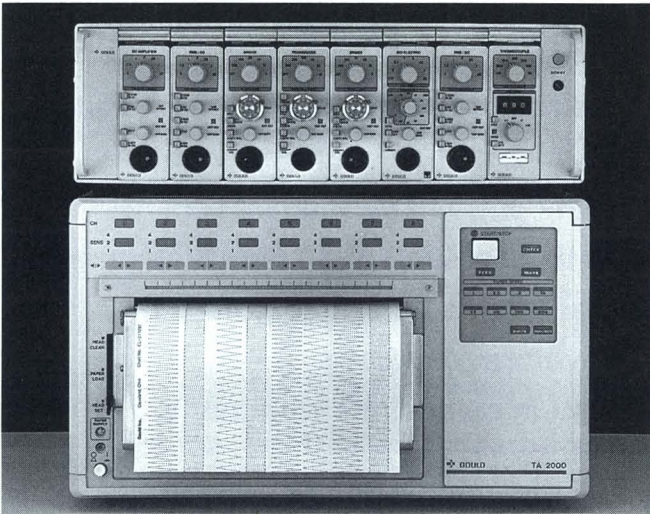

TA2000 recorder with 6600 series signal conditioners combine to form compact high performance instrument package.

The TA2000 from Gould is an 8-channel thermal array recorder that incorporates the latest digital writing technology to meet growing demands for a highly versatile recorder. It provides high frequency response, fast peak capture, complete alphanumeric annotation, RS-232C computer interface, full-scale overlapping traces, high resolution, multiple grid patterns and low cost thermal paper.

The front panel has instantly recognizable keys that provide positive audible, tactile and visual feedback. Position keys allow movement of the traces across the chart, making formatting a simple task. A row of LEDs

- 1 to 8 channels of high quality, penless thermal array recording
- Frequency response 5 kHz
- Peak capture events from 150 μ s or longer
- 200 dots/in. amplitude resolution (8 dots/mm)
- 16 chart speeds from 1 mm/s to 200 mm/mn
- Trace overlapping for detailed signal comparison
- Compatible with 6600, 5700 and 4600

follows all signals in real time, eliminating the need to run the chart during setup.

Three modes of chart operation allow continuous recording or paper conservation when ongoing recording is not needed. The user simply programs the chart to run and stop or change speeds at specific time intervals. Chart mode emulates a 4-channel pen recorder with separate 40-mm channel grids.

Combined with the 6600, 5700 and 4600 series signal conditioners from Gould, the TA2000 provides unparalleled application flexibility to meet your specific recording requirements.

TA2000 SPECIFICATIONS

No. of Analog Channels: 1 to 8 channels real time recording.

Event Marker: 2 mm mark at left chart edge with Mark key or activated via remote control connector.

Marking Method: Single fixed thermal array head.

Recording Width: 200 mm FS (recording is possible across full 8.5 in. of chart paper).

Amplitude Resolution: 200 dots/in. (8 dots/mm).

Time Axis Resolution: 8 lines/mm (at 200 mm/s). 48 lines/mm (at 25 mm/s).

Frequency Response: -3 dB at 5 kHz. Peak capture of events 150 μ s or longer.

Analog Inputs: Single ended, grounded ± 5 VFS (10-V span). In Chart mode, ± 2.5 VFS.

Input Impedance: 100 k Ω $\pm 10\%$.

Sensitivity: 1 V/cm; 0.5 V/cm; 0.25 V/cm.

Chart Speeds: 1, 2.5, 5, 10, 25, 50, 100, 200 mm/s and mm/mn.

Recording Modes: Continuous - Manual chart drive start/stop from front panel. Periodic - Chart drive starts and stops automatically at time intervals selected from front panel. Alternate - Chart drive switches between two chart speeds at time intervals selected from front panel. Chart - emulates pen recorder with four 40-mm channels.

Grid Line Printing: Grids OFF, 10 x 10 mm and 5 x 10 mm grids, each with selectable 1 x 1 mm fine grid.

Annotation: Date, Time and Chart Speed are printed once per page. User defined full page (48 lines x 80 columns) and 8 character parameter identification via RS-232C interface.

Remote Control: Chart Start/Stop and Event Mark can be controlled from rear panel remote connector via contact closure.

Operating Input Voltage: 100 - 125 VAC, 50/60 Hz. 200 - 240 VAC, 50/60 Hz.

Battery Back-up: Maintains front panel settings and time/date for 30 days.

Weight: 53 lbs (24 kg).

Dimensions: 10 in. H x 17 in. W x 17 in. D (24.8 cm H x 43 cm W x 43 cm D).

ORDERING INFORMATION

Model Number	Price
3008-8510-43 Stand Alone Unit, 115 V, 50/60 Hz	\$11995
3008-8510-44 Stand Alone Unit, 230 V, 50/60 Hz	\$11995
11-1202-37 19-in. RETMA standard rack mount kit for stand alone unit	\$695
CL-810971- Input cable ("Blue Ribbon" to 8 Molex)	\$150
11-4310-25 Molex to BNC cable	\$45
-369500-21508 RS232-C cable (TA2000 - IBM AT)	\$60

REAL TIME DISPLAY AND RECORDING SYSTEMS

ES2000 ELECTROSTATIC

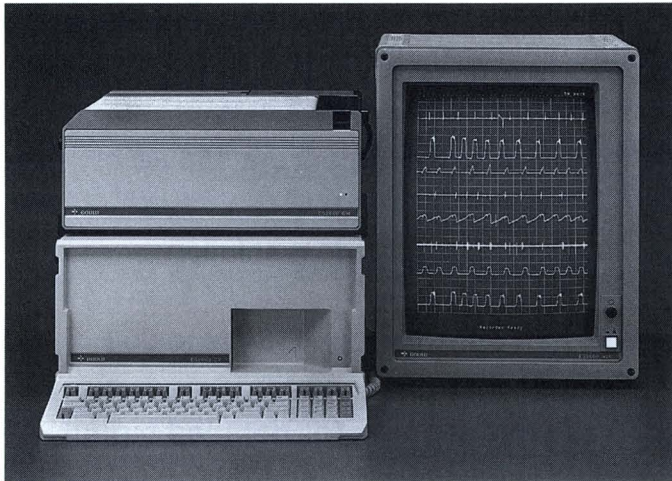

- Preconfigured settings stored on built-in diskette
- Full remote and local programmability
- High frequency, real time monitor
- High contrast, permanent records
- Up to 40 analog or 80 digital channels
- Real time transfer of digitized data
- Waveform capture
- System extensions with multiple monitors and up to three recorders
- Fully customized hard copy outputs

ES2000 from Gould is a modular real time display and recording system based on a very decentralized architecture to accommodate present and future applications. Its totally programmable design allows setup configurations combining trace positioning, texts, grids and trigger conditions to be stored on a built-in 3.5-in. diskette. Full remote programmability is achieved via the standard IEEE-488 or RS-422A interfaces.

An integrated non-fade, high-frequency video monitor displays real-time data, including all traces, text and grids. The monitor is simultaneously used as a terminal to program all system functions.

The system hard copy output consists of a patented high-performance electrostatic writing unit. Gould electrostatic technology has a high reliability proven by more than ten years of use from thousands of recorders. The high-contrast records over the full 264 mm (10-3/8 in.) usable chart width are truly permanent and easily reproducible by office copiers. Its 8.5 x 11 in. (216 x 279 mm) page format is especially suitable for filing and publication. Paper cost is only a fraction of photosensitive papers used in light beam oscillographs. Powerful text capability and programmable grid patterns allow the user to produce custom records.

The system Controller can house up to 11 plug-in modules in any combination to match input configuration with every application. Current module selection includes:

- CRT2000, Video Controller Board
- MW2000, Multiple Writing Unit Interface

- HR2000, High Resolution Hard-Copy Board
- PB400, 4-channel Analog Input
- PB200, 2-channel DC Amplifier
- PB860, 8-channel Digital Input
- PB150, Time Code Interface

The ES2000 Basic System is composed of a Controller, Writing Unit, Monitor and Keyboard. Available physical system configurations include benchtop, console and vertical cabinet. Every system component may be located up to 20 meters away.

The ES2000 is fully compatible with the 6600, 5700 and 4600 series signal conditioners from Gould. This combination allows systems to be configured to meet specific requirements for the industrial, medical and aerospace markets.

Local programmability

The system's 3.5-in. disk drive is used to store many "set-ups" including all trace parameters settings, text, grids and trigger conditions. These pre-configured settings reduce set-up time and potential for operator error.

Amplitude, event (on/off) and time based triggers — supported by AND/OR logic — can either initiate or dynamically alter recorder and display functions. In addition to reducing operator intervention, this conserves chart paper and simplifies analysis by recording only pertinent data

Real time display

The (12 or 20 in.) high resolution, non-fade monitors from Gould display signals, event markers, grids, and

alphanumerics in real time, with chart running or not. These are displayed exactly as they are on the chart. The monitors are also being used to program all system functions. For instance, text can be entered and accurately positioned with respect to overlaying scrolling traces.

Using more than one CRT2000 (Video Controller Board), different subsets of recorded channels can be displayed on the monitors connected to each CRT Board. The display sweep speed may be independent from each other and from the chart speed.

Customized hard copy outputs

The ES2000 gives the most flexibility in annotating and customizing chart records. User may program his own grid patterns, store them on 3.5-in. diskette and retrieve them when needed. Chart records include chart speed, real time and date, channel number, input sensitivity and parameter identification of up to five lines of 25 characters per channel.

Up to 12 pages of user text can be entered and printed once as a header or repeated periodically. Up to

32 "on-the-fly" messages each containing up to 51 lines of 52 characters can be printed at reception of a command (keystroke, contact closure, etc.) All text is part of the set-up and, as such, is saved on 3.5-in. diskette.

In addition, the ES2000 can be used as a page printer with text sent via IEEE-488/RS-422A interface or entered via the keyboard. Text can also be printed in real time on a single line, along the chart with characters entered via keystrokes or one of the interfaces.

Digitized data output

Digitized analog data from the PB400 or PB200 input modules can be transferred to a computer for storage and analysis via IEEE-488 interface at rates up to 2,000 samples/channel/second with 12-bit resolution. Maximum aggregate rate is 40,000 samples/second.

Waveform recording

Waveform capture modules can be used to expand the ES2000 into a high-performance waveform recording system.

ES2000 SPECIFICATIONS

Chart Paper Width: 279.4 mm (11 in.)

Usable Chart Width: 264 mm (10-3/8 in.)

Resolution: 8 dots/mm along the Y axis - 2000 dots/s max. along the time axis.

Number of Electrodes: 2112.

Writing Method: Electrostatic.

Type of Paper: Fan-fold (1000 sheets 216 x 279 mm; 8-1/2 x 11 in. total length: 216 m or 707 ft). Roll (122 m; 400 ft), plain, perforated or translucent.

Motor: Microstep drive.

Chart Speeds: 0.25, 0.5, 1, 2.5, 5, 10, 25, 50, 100, 250, 500 mm/s; accuracy: $\pm 0.25\%$; external variable speed control with analog voltage (0-10 V) or pulse train (TTL).

Number of Slots for optional plug-in boards: 11.

Channel Identification: By two characters (channel number), sensitivity and up to 5 lines of text: 1) along lower edge of the chart and joining the corresponding trace by a thin line; or 2) table printed on demand.

Time Markers: 4, 2, 1-mm marks every 10 s, 1 s, 0.1 s (upper edge of the chart) or 1 s, 0.1 s, 0.01 s (both edges).

Event Marker: System marker actuated by push-button; other markers are added with every plug-in input.

Grid Lines: Standard pattern: 5 x 5 mm; an infinite number of other patterns may be programmed and stored 4 per configuration; vertical lines spacing range: 1 to 99 mm; horizontal lines programming step: 1/8 mm.

Annotations: Chart speed, time and date (or elapsed time), up to 12 pages of user text, up to 32 "on-the-fly" messages, parameter identification.

Characters: Set of 256 characters in 20 x 28 matrix.

Single Line Printer: Provides for continuous printing of one line of text along the chart at a preset location.

Page Printer: Printing of pages of text in comic mode simultaneously with chart recording (input via RS-422A/ IEEE-488 interface).

Data Acquisition: Transfer of digitized data from PB200/PB400 via IEEE-488 interface; maximum throughput: 40k samples/s; 2k S/s/ch maximum; data resolution: 12 bits.

Configurations: Unlimited number of system configurations can be stored on 3.5-in. disk drive (5 per diskette); each configuration includes complete set-up with annotations, grid patterns and input settings.

Remote Programming: All system functions and settings (except printing contrast) may be controlled via standard IEEE-488/RS-422A interface.

Toner Capacity: 2 liters.

Line Voltage: 100 to 240 V; 50/60/400 Hz.

Power: Controller: 100 VA min, 375 VA max.; Writing Unit: 160 VA; V12 Monitor: 18 VA; V20: 60 VA.

Dimensions:

Controller: 45.3 W x 53.5 D x 24 cm H (17.9 x 21.1 x 9.5 in.)

Writing Unit: 45 W x 45 D x 19.5 cm H (17.5 x 17.7 x 7.6 in.)

Keyboard: 45.3 W x 21.6 D x 3 cm H (17.9 x 8.5 x 1.2 in.)

V12: 26.2 W x 35.4 D x 36 cm H (10.3 x 14 x 14.2 in.)

V20: 40 W x 47.5 D x 52 cm H (15.8 x 18.7 x 20.5 in.)

Weight:

Controller: 15 to 21 kg (33 to 45 lbs).

Writing Unit: 16 kg (35 lbs) without toner and paper.

V12: 12 kg (25 lbs).

V20: 26 kg (56 lbs).

HR2000 High Resolution Hard Copy Board



- Full resolution two-screen memory
- Hard Copy and Deferred Recording modes
- Minimizes use of chart
- Operation controlled by keyboard, computer or user defined program

The HR2000 stores up to two full screens of ES2000 information, including all traces, grids and text for hard copy of frozen data in memory or deferred recording. In hardcopy mode, the screen display is frozen and 1 or 2-page hard copy is obtained on paper. In deferred recording mode, the chart is started and receives data flowing through the HR2000 memory (instead of real time). Data is continuously printed with 1 or 2-screen delay. This process provides a "pretrigger" feature of up to two pages of complete ES2000 data, including traces, grids and text.

Operation of the HR2000 is best performed by observing the ES2000 monitor screen. Continuous stream of data is monitored without running the chart. If an event occurs or if an important pattern is recognized, the chart may be started in deferred recording mode and run continuously as long as data is considered as important. Up to two pages of critical data (with full resolution) occurring before the chart is started will be recorded on paper for further analysis and correlation with post event data.

HR2000 SPECIFICATIONS

Memory: Bit map, 16 Mbits.

Amplitude Resolution: 1/8 mm.

Time Resolution: 1/16 mm for 2-page memory; 1/8 mm for 4-page memory; 1/4 mm for 8-page memory.

Operating Modes: Hard copy of frozen screen(s) (1 or 2) or Deferred recording (1 or 2 screens delay).

MW2000 Multiple Writing Unit Interface



- Expands ES2000 up to 3 Writing Units
- Fully independent operation
- Synchronized recording
- One screen per Writing Unit
- Lower per-channel system cost

The MW2000 allows you to add up to three ES2000 EW electrostatic writing units to a basic ES2000 system. All three writing units are fully independent: different grids, texts and traces can be printed; they can be run at different chart speeds or, if desired, slaved to the first unit. Use of a common system clock insures an accurately synchronized recording on all three writing units.

The addition of CRT2000 video controllers gives the possibility to associate one monitor to each writing unit. The MW2000 is ideal for multiple recorder applications and enables control of the system by a single operator. It lowers per-channel system cost, too.

MW2000 SPECIFICATIONS

Character Generators: Two (one per EW) with sets of 256 characters.

Grid Generators: Two (one per EW).

Connectors: 2 x 15-pin sub D for EW #2 and EW #3.

PB860 8-Channel Digital Input



- Up to 12-bit resolution
- High acquisition speed: 2 μ s per data word
- Continuous traces, peak capturing at high speed.
- 16-bit parallel and IEEE-488
- Adjustable scale and position

PB150 Time Code Interface



- Reads IRIG A, B, E, H and NASA 36
- x8 to \pm 32 speed range
- Time and date display
- Synchronized time lines
- DC and Slow Code outputs
- Slow Code trace
- Tape search and control

Digitized analog data stored and processed by computers are often required to be displayed in a chart format for analysis. The PB860 offers input capability for up to eight independent channels via GPIB interface (IEEE-488) or 16-bit parallel interface. Eight continuous traces are generated with peak capturing. Minimum channel update rate is 2 μ s. Trace format can be programmed via input interface or regular ES2000 system controls.

This time code interface is a versatile time code reading unit. Time information from a variety of codes is printed on the ES2000 chart and displayed on the ES2000 Monitor. Alphanumeric printed data is supplemented by synchronized time lines and slow code trace. A time triggering feature enables control of ES2000 functions, such as chart drive and a tape recorder.

PB860 SPECIFICATIONS

Number of Channels: 8 digital with 12-bit resolution and 8 discrete. Up to 88 channels per ES2000.

Input Interfaces: Standard IEEE-488 and 16-bit parallel TTL level with 2-line handshake (STROBE and BUSY).

Input Connectors: IEEE-488 and 37-pin sub-D female.

Data Acquisition Rate: 2 μ s per word (parallel input).

Channel Address Identification:

- 1) By 3 bits or
- 2) Automatic scanning of all 8 channels.

Module Address Identification: By 4 bits.

ES2000 CP Address Identification:

- 1) By 5 bits
- 2) By IEEE-488 device address (IEEE-488 interface only).

Trace Position: From 0 to 248 mm in 8-mm steps. Selection by ES2000 System controls or remote control.

Trace Scale: From 4 to 256 mm in binary steps. Selection by ES2000 System controls or remote control.

Trace Authorization: Every trace may be individually authorized or cancelled via ES2000 system controls or remote control.

Channel Set-up Selection: By remote control.

Discrete Channel (Event marker): Marker position and height are programmable using ES2000 controls.

PB150 SPECIFICATIONS

Supported Time Code Formats: Modulated and demodulated IRIG A,B,E,H and NASA 36.

Time Code Frequency: x 8 to \pm 32 basic code frequency (IRIG A: x1 to \pm 32).

Modulated Input Level: 200 mV p-p minimum (logic level=0), 50 V p-p max. (logic level=1).

Modulation Ratio: 1 \pm 2 to 1 \pm 6.

Demodulated Code Input Level: TTL.

Time Reference Accuracy: 500 μ s.

Annotation Positioning: Any one of 52 lines.

Time Lines: Synchronized with time code. Spacing adjusts automatically with chart speed.

Time Display: Line, Table or Large Table format on ES2000 Monitor screen. Programmable position.

Demodulated Code Output: TTL level, BNC connector.

Slow Code Recording: Amplitude: up to 256 mm. Positioning: anywhere on the chart (1/8-mm steps).

Formats: 1 s to 3600 s.

Slow Code Output Levels (BNC connector): \pm 10 V, 0 V.

Time Triggering: 2 independent settings for control

- 1) ES2000 sequence programming
- 2) external device (e. g., tape recorder) via Sub-D connector.

Time Code Input (BNC connector): 100 k Ω .

PB200 2-Channel DC Amplifier



- Fully programmable
- Operates off ground to 750 V
- 35 kHz bandwidth, 25 ms peak capture
- 5 mV/cm to 625 V full scale
- Amplitude triggering
- Calibrated zero suppression
- Digitized data output
- Two event channels

This 2-channel DC amplifier with two event channels is an ideal front-end for general purpose voltage measurements. Each amplifier is fully isolated input-to-output and operates up to 750 V off ground. Outstanding features of the PB200 include: full programmability and complete set-up storage on ES2000 system disk; true calibrated zero suppression and operation up to 750 V off-ground; 5 mV/cm to 25 V/cm sensitivity (up to 625 V full scale); signal triggering on positive and negative slope; digitized analog data available for continuous transfer to a micro or minicomputer for storage and further analysis.

PB200 SPECIFICATIONS

Number of Channels: 2 analog and 2 event.
Input Circuit: Balanced to floating common and guarded.
Input Impedance: 2 M Ω differential.
Channel Position: 0 to 255.9 mm with 0.1-mm steps.
Channel Width: 0 to 256 mm with switchable limiters.
Measurement Range: 5 mV/cm to 25 V/cm or 625 V FS in 5-10-25 steps. Vernier with 1% resolution.
Maximum Input Voltage: 700 V DC or peak differential.
Zero Suppression: $\pm 1,000$ V.
Gain Accuracy: $\pm 0.5\%$.
Output Noise: ≤ 3 styli with inputs shorted.
Frequency Response: -3 dB at 35 kHz.
Sampling Frequency: 100 kS/s with peak capturing; peak capture: 25 ms minimum.
Filter: Switchable, low pass, -10 dB at 50 Hz, 12 dB/octave.
Common Mode Rejection: >90 dB at 50Hz.
Crosstalk: <90 dB.
Amplitude Triggering: On positive slope and negative slope; from -50% to +50% of full-scale width.
Transmission of Digitized Analog Signals: Up to 2,000 S/s with 12-bit resolution via IEEE-488 interface.
Channel Identification: Status and 125 character user text.
Event Marker Input: TTL low/high level active.
Marker Position and Height: From 0 to 255 mm.

PB400 4-Channel Analog Input



- Fully programmable
- 10 kHz bandwidth, 70 ms peak capture
- 40 mV/cm to 250 V full scale
- Amplifier and Coupler mode
- Amplitude triggering
- Digitized analog data output
- Four event channels

This versatile 4-channel analog input has four event channels, designed to receive input signals from all signal conditioners by Gould or other preconditioned signals (Coupler Mode). In Amplifier Mode the PB400 can be used for direct DC voltage measurements. PB400 features include: full programmability and complete set-up storage on ES2000 system disk; 40 mV/cm to 10 V/cm sensitivity (up to 250 V full scale); signal triggering on positive and negative slope; digitized analog data available for continuous transfer to a micro or mini computer for storage and further analysis.

PB400 SPECIFICATIONS

Number of Channels: 4 analog and 4 event.
Input Circuit: Single-ended to ground.
Input Impedance: 100 k Ω .
Channel Position: 0 to 255.9 mm with 0.1-mm steps.
Channel Width: 0 to 256 mm with switchable limiters.
Measurement Range: 40 mV/cm to 10 V/cm or 250 V full scale 1 V, 5 V and 10 V range settings for coupler mode.
Maximum Input Voltage: 260 VDC or peak (10 V range); 130 V (5 V range); 26 V (1 V range).
Gain Accuracy: $\pm 0.5\%$ full scale.
Output Noise: ≤ 3 styli with inputs shorted.
Frequency Response: -3 dB at 10 kHz.
Sampling Frequency: 30 kS/s with peak capturing.
Peak Capture: 70 ms minimum.
Amplitude Triggering: On positive slope and negative slope; from -50% to +50% of full-scale width with 0.1% resolution.
Transmission of Digitized Analog Signals: Up to 2,000 S/s with 12-bit resolution via IEEE-488 interface.
Channel Identification: Status and 125 character user text.
Event Marker Input Circuit: TTL low or high level active.
Marker Position and Height: From 0 to 255 mm.

ES2000 ORDERING INFORMATION

Model Number	Price	Model Number	Price
ES2000 BASIC SYSTEMS			
3009-A1140-17 Basic ES2000, portable, includes Controller, Writing Unit, 12-in. Monitor, Keyboard and Video Controller Board, 100-240 V, 50/60 Hz	\$24995	23-22101-7 RS422/RS-232C interface converter	\$395
3009-A1141-17* Above integrated in Vertical Console, 110 V line supply	\$29995	23-23101-1 RE2000, full roll chart take-up	\$1395
3009-A1143-17* Above integrated in Vertical Cabinet, 110 V line supply	\$29995	23-23101-2 FB2000, folding fan-fold paper basket (compact)	\$175
Consult your local Gould Sales Office for other systems and configurations.		23-23101-3 Fan fold paper basket, full-pack	\$295
* -16 instead of -17, 220 V line supply.		23-24131-4 Mobile cart for ES2000 portable system	\$2195
ES2000 SYSTEM COMPONENTS			
23-20121-1* ES2000 CP, Controller, 100-240 V, 50/60 Hz, portable	\$8195	23-29121-2 ES2000 RC, remote control keypad	\$995
23-26121-1* ES2000 EW, Writing Unit, 100-240 V, 50/60 Hz, portable	\$11295	-297007-1 IEEE-488 cable, 2 m (7 ft)	\$125
23-27121-2* ES2000 V12, 12-in. Monitor, 100-240 V, 50/60 Hz, portable	\$2495	M16905 IEEE-488 cable, 4 m (13 ft)	\$325
23-27121-3* ES2000 V20, 20-in. Monitor, 100-240 V, 50/60 Hz, portable	\$3695	CL-713493-6543 Event marker switch box for PB400/PB200	***
23-29121-1* ES2000 KB, Keyboard, portable	\$995	X52359 Swivel base kit, V12 monitor	\$295
EW, V12, V20 and KB subsystems are supplied with 2 m cable to CP.		X51792 Video cable, 20 m (66 ft)	\$195
* -2X131- instead of -2X121-: European rack-mount;		X51905 Video cable, 5 m (16 ft)	\$100
-2X141- instead of -2X121-: RETMA rack-mount.		X52298 EW extender card kit	\$595
PLUG-IN MODULES			
23-21101-1 PB400, 4-channel Analog Input with 4 event channels; for interfacing signal conditioners; with input cables (see page 58)	\$2995	X52397 Module extender card	\$790
23-21101-3 PB200, 2-channel DC Amplifier with 2 event channels; with input cables (see page 58)	\$3995	X52398 CPU extender card	\$790
23-22101-1 PB860, 8-channel Digital Input with 8 event channels, IEEE-488 and 16-bit parallel interfaces (see page 57)	\$3995	X52267 EW-to-CP Cable, 20 m (66 ft)	\$375
23-22101-3 PB150, Time Code Interface (see page 57)	\$2595	X52300 KB-to-CP Cable, 20 m (66 ft)	\$60
23-28101-3 MW2000, Multiple Writing Unit Interface (see page 56)	\$4995	X52301 KB-to-CP Cable, 5 m (16 ft)	\$25
23-28101-4 HR2000, High Resolution Hard Copy Board (see page 56)	\$2595	X52303 EW-to-CP Cable, 5 m (16 ft)	\$175
23-28101-5 CRT2000, Video Controller Board	\$2195	X52373 EW-to-CP Cable, 2 m (7 ft) rack mount	\$175
ACCESSORIES			
11-1202-42 19-in. RETMA standard rack-mount kit, ES2000 CP	\$350	X52472 RC-to-CP Cable, 20 m (66 ft)	\$125
11-1202-43 19-in. RETMA standard rack-mount kit, ES2000 EW	\$1925	X52474 RC-to-CP Cable, 50 m (164 ft)	\$295
11-1202-44 19-in. RETMA standard rack-mount kit, ES2000 KB	\$525	X52839 Cable, isolator to two PB400 marker inputs	\$145
		X52840 Cable, isolator to four PB200 marker inputs	\$245
		X52836-24 Isolator, 8 event markers, 24 V	\$525
		X52836-48 Isolator, 8 event markers, 48 V	\$525
		X52836-5 Isolator, 8 event markers, 5 V	\$525
		X52836-60 Isolator, 8 event markers, 60 V	\$525
		X80067E** Service manual	\$240
		X80066-D User's manual, German	\$85
		X80066F User's manual, French	\$85
		MU3009-A1140-17 User's manual, English	\$35
		Z00084 Reusable shipping container for EW	\$1095
		Z00085 Reusable shipping container for CP	\$1095
		Z00086 Reusable shipping container for V12	\$895
		Z00087 Protective carrying case for EW	\$295
		Z00088 Protective carrying case for CP	\$295
		Z00089 Protective carrying case for V12	\$195
		** PA-xxxxx instead of xxxxx in North America	
		*** Consult factory.	

INK AND THERMAL OSCILLOGRAPHIC RECORDERS

RS3000 SERIES

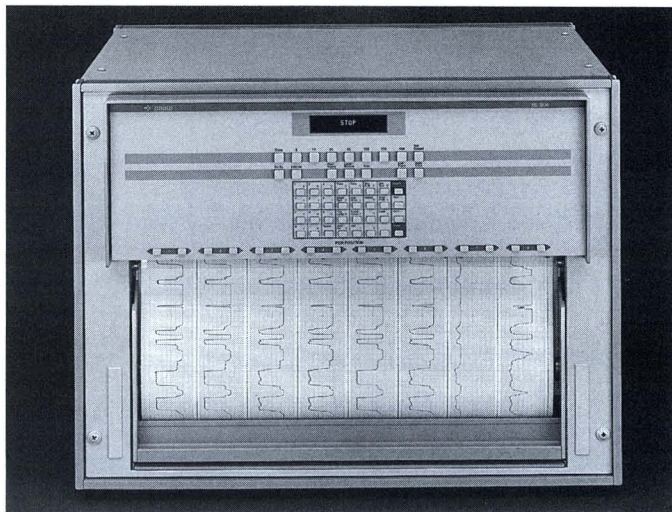

- High quality oscillographic performance, convenient test set up and systems integration capability
- 19-in. RETMA rack mount or portable models
- Pressurized ink or thermal writing produce accurate, clear traces at all pen velocities
- Option inter-channel event markers or alphanumeric annotation
- Total remote control via IEEE-488 or RS-232C interfaces
- Programmable amplitude triggering

Intelligent

The RS3000 series recorders from Gould set new standards for intelligent direct writing recorders. Microprocessor controlled, it features programmable amplitude triggering so you record only the data of interest. In addition your chart record can be completely annotated with chart speed, date, time, test number and a user message up to 256 characters long. With the optional interchannel annotation feature, signal conditioner gain and other settings can also be recorded alphanumerically. User text messages are added through the convenient front-panel keypad, or via RS-232C or IEEE-488 interfaces. A recorder self test can be performed at the push of a button. All front panel settings are retained by non-volatile RAM.

Performance

Gould is the only manufacturer to provide users a choice between permanent pressurized ink or thermal writing. Either writing method gives you easy-to-read uniform traces that Gould has been providing users for over 50 years. The RS3000's linearity and accuracy specifications are the best available! And we guarantee to meet them! Our patented Metrisite™ non-contact position sensor provides precise feedback control. Gould's rugged construction means you'll continue getting the same response after your RS3000's been on the job for years.

Our patented stepper motor drive offers 14 front-panel selectable chart speeds with four chart speed modes. In addition, the RS3000's exclusive variable chart speed allows selection between fixed speeds!

Maximum chart speed is 500 mm/s so you can measure 2 ms timing differences between channels. For long-term, unattended monitoring, the RS3000 Recorder can run continuously for more than 6000 hours on a single roll of chart paper.

Direct writing systems recorder

The RS3000 is an ideal system output device. Completely programmable, it can supply permanent hard copy test data on demand under standard IEEE-488 or RS-232C computer control. IRIG time code signals can be continuously decoded and printed in alphanumeric format.

When used with an external pulse train, RS3000 Recorders can function in an XY mode, with chart movement controlled by the unit under test. This is ideal for well logging, measurements on rotating equipment, and process monitoring in metal rolling, paper coating and similar applications.

Easy to use

Pen positions are easily set with right/left push-buttons. If inputs are accidentally reversed it's no problem with the RS3000's polarity reversal feature.

You can quickly and easily load either roll or fanfold chart paper. All recorders have a built-in pen guard that prevents accidental pen damage when loading paper.

Depending upon the recorder, up to seven bi-directional event markers or eight interchannel annotation heads can be added. A built-in timer allows synchronization with time signals and has seven switch-selectable time periods.

RS3000 SPECIFICATIONS

Note: Specifications are for Recorders without Signal Conditioners.

Standard Analog Channel Configurations:

- RS3800: Eight 40-mm channels.
- RS3400: Four 50-mm channels.
- RS3200: Two 50-mm channels.

Number of Event Marker Channels: Standard: one bi-directional on right side of chart. Optional: up to seven interchannel event markers on 8-channel recorder.

Frequency Response:

- At 100-mm full scale: Flat to 30 Hz.
- At 50-mm full scale: Flat to 50 Hz.
- At 40-mm full scale: Flat to 60 Hz.
- At 10-mm amplitude: -3 dB at 140 Hz.

Linearity: >99.65% of full scale.

Direct Recorder Input Signal: Internally selected 2, 5, and 10-V span for 50 or 40-mm channels.

Direct Input Impedance: 100 kΩ.

Zero Stability (recorder only):

- With Time: ±0.1% per 24 hrs.
- With Temperature: ±0.025% per °C.
- With Line Voltage: ±0.1% per 10% change in line.

Gain Stability (recorder only):

- With Time: ±0.1% per 24 hrs.
- With Temperature: ±0.05% per °C.
- With Line Voltage: ±0.05% per 10% change in line.

Annotation: Left chart edge. 5x7 dot matrix. Date, time, chart speed plus comments, up to 256 characters total.

Maximum Annotation Speed: 500 mm/s less than 0.1-mm delay.

Interchannel Annotation: Optional; up to eight additional on 8-channel recorder.

Marking Method: Pressurized ink or thermal.

Color: Blue (ink); black (thermal trace).

Trace Presentation: Rectilinear.

Trace Width (ink): 0.01 mm nominal.

Chart Speeds: Push button selected, from 0.005 mm/s to 500 mm/s. 1000 mm/s also available as an option.

Chart Speeds (mm/s):

Panel	±1	±60	±100	±1000
5	5	0.083	0.05	0.005
10	10	0.167	0.1	0.01
25	25	0.417	0.25	0.025
50	50	0.833	0.5	0.05
100	100	1.667	1.0	0.1
250	250	4.167	2.5	0.25
500	500	8.333	5.0	0.5

Chart Speed Inaccuracy: ±0.25% at 25°C, ±10°C.

Chart Wander: ±0.25 mm roll, ±0.5 mm fanfold, max.

Paper:

- Pressurized Ink:** 275 ft. (84 m) cast coated rolls, non-perforated or semi-perforated.
- Thermal Roll:** 350 ft. (107 m) high performance blue trace; 350 ft. high performance black trace.
- Thermal Z-fold:** 250 ft. (76 m) internal supply.
- Time Lines:** 1 mm accentuated every 5 mm and 100 mm.

IRIG Time Code Interface Decoder (optional): Accepts IRIG A, B, E and NASA 36, modulated or unmodulated on one board, automatically.

Triggering: Adjustable amplitude trigger with programmable chart speed and run time. Maximum input voltage, 15 VDC. Minimum cycle time, 100 ms. High or contact open (edge triggered) to start chart active in local or remote.

Variable Speed Control: 5 mm/s to 500 mm/s in 5 mm/s increments. Enabled by front-panel "Var Speed" push button. Speed entered via front-panel keypad.

Stop: TTL low, or contact closure to stop chart. Active in both local and remote modes.

External Chart Drive: One microstep per pulse. TTL signal level. 80 microsteps per millimeter of chart. Chart speed of 0 to 500 mm/s. Microstep occurs on negative transition of input pulse.

Remote Synchronization: Positive going TTL pulses with a minimum duration of 10 μs, indicates a motor step is initiated.

Environmental:

- Operating Temperature:** 0° to +50°C.
- Storage Temperature:** -40° to +70°C.
- Humidity:** 10% to 90% relative humidity, at 65°F non-condensing.

Signal Input Connectors: 37-pin D type (accepts Signal Conditioner output) and 2-wire sub-miniature phone plug (supplied) directly to pen drive amplifiers.

Input Connector (Supplied): Two wire sub-miniature phone plugs or signal conditioner output (Manufacturer model no. 290144).

Front Panel Settings Backup: Non-volatile RAM.

Clock Backup: Battery (10 years).

Power Requirement (RS3800 recorder only): 400 W.

Hardware Configurations: Portable, 19-in. RETMA standard rack mount or cabinet.

Dimensions:

RS3800 Recorder:

- Portable: 15 in. H x 19.75 in. W x 17.25 in. D (38.1 cm H x 50.2 cm W x 43.8 cm D).
- Rack Mounted: 14 in. H x 19 in. W x 15.5 in. D (35.6 cm H x 48.3 cm W x 39.4 cm D).
- Chassis Only: 14 in. H x 19 in. W x 14.5 in. D (35.6 cm H x 48.3 cm W x 36.8 cm D).

RS3400 Recorder:

- Portable: 15 in. H x 19.75 in. W x 17.25 in. D (38.1 cm H x 50.2 cm W x 43.8 cm D).
- Chassis Only: 14 in. H x 17.5 in. W x 14.5 in. D (35.6 cm H x 44.4 cm W x 36.8 cm D).

RS3200 Recorder:

- Portable: 15 in. H x 14 in. W x 17.25 in. D (38.1 cm H x 35.6 cm W x 43.8 cm D).
- Chassis Only: 14 in. H x 12 in. W x 14.5 in. D (35.6 cm H x 30.5 cm W x 36.8 cm D).
- Rack Mounted: 7 in. H x 19 in. W x 18 in. D (17.8 cm H x 48.3 cm W x 45.7 cm D).

Weight:

- RS3800 recorder only: 80 lbs. (36.3 kg).
- RS3400 recorder only: 62 lbs. (28.2 kg).
- RS3200 recorder only: 41 lbs. (18.6 kg).

RS3000 OSCILLOGRAPHIC RECORDERS ORDERING INFORMATION

STANDARD RECORDER MODELS

Model Number	Price	Model Number	Price
RS3800 RECORDER			
8 Channels (40 mm)			
35-V7808-10 Ink, Portable, stand alone	\$13995	11-6223-3 Interchannel event marker kit, thermal, 40 mm	\$275
35-V8808-10 Thermal, Portable, stand alone	\$13995	11-6223-4 Interchannel event marker kit, ink, 40 mm	\$275
30-V7808-11 Ink, 19-in RETMA standard rack mount, stand alone	\$13995	11-6293-1 Interchannel annotation head, thermal	\$295
30-V8808-11 Thermal, 19-in RETMA standard rack mount, stand alone	\$13995	11-6293-2 Interchannel annotation head, ink	\$295
35-V7808-12 Ink, Portable, with 5900 Signal Conditioner Case	\$15995	11-6293-3 Interchannel (annotation) drive kit, thermal	\$125
35-V8808-12 Thermal, Portable, with 5900 Signal Conditioner Case	\$15395	11-6293-4 Interchannel (annotation) driver kit, ink	\$125
30-V7808-13 Ink, 19-in RETMA standard rack mount, with 5900 Signal Conditioner Case	\$15995	11-1202-38 19-in RETMA standard rack mount kit (RS3800 recorder)	\$650
30-V8808-13 Thermal, 19-in RETMA standard rack mount, with 5900 Signal Conditioner Case	\$15395	11-1202-39 19-in RETMA standard rack mount kit (RS3400 recorder)	\$650
RS3400 RECORDER			
Signal Conditioner Case built into Recorder			
35-V7404-10 Ink, Portable, four 50-mm channels	\$10495	11-1202-40 19-in RETMA standard rack mount kit (RS3200 recorder)	\$650
35-V8404-10 Thermal, Portable, four 50-mm channels	\$10495	11-1605-32 Input/Output panel, front mount	\$2750
30-V7404-11 Ink, 19-in RETMA standard rack mount, four 50-mm channels	\$10795	11-1605-33 Input/Output panel, rear mount	\$2750
30-V8404-11 Thermal, 19-in RETMA standard rack mount, four 50-mm channels	\$10795	11-2273-1 Z-fold basket for RS3200 recorder	\$195
RS3200 RECORDER			
Signal Conditioner Case built into Recorder			
35-V7202-10 Ink, Portable, two 50-mm channels	\$6495	11-2273-2 Z-fold basket for RS3400 recorder	\$195
35-V8202-10 Thermal, Portable, two 50-mm channels	\$6495	11-2273-3 Z-fold basket for RS3800 recorder	\$195
30-V7202-11 Ink, 19-in RETMA standard rack mount, two 50-mm channels	\$6995	11-6402-16 Chart take-up for RS3200 recorder	\$250
30-V8202-11 Thermal, 19-in RETMA standard rack mount, two 50-mm channels	\$6995	11-6402-17 Chart take-up for RS3400 recorder	\$250
RS3000 RECORDER OPTIONS AND ACCESSORIES			
11-6283-1 Interface kit, IEEE-488	\$650	11-6402-18 Chart take-up for RS3800 recorder	\$250
11-6283-2 Interface kit, RS-232C	\$650	11-6405-6 Mobile cart	\$1395
11-6283-3 Interface kit, IRIG time decoder	\$495	CL-412045-1 Shipping case for RS3200 recorder	\$750
11-4221- RS3000 Interpreter/Controller board kit (for RS3200 and RS3400 recorders)	\$650	CL-412045-2 Shipping case for RS3400 recorder	\$750
11-6223-1 Interchannel event marker kit, thermal, 50 mm	\$275	CL-412045-3 Shipping case for RS3800 recorder	\$950
11-6223-2 Interchannel event marker kit, ink, 50 mm	\$275	CL-412045-4 Shipping case for 5900 case	\$750
		CL-412341- Vinyl dust cover for RS3800 recorder with 5900 case	\$45
		CL-412346-1 Vinyl dust cover for RS3200 recorder	\$45
		CL-412346-2 Vinyl dust cover for RS3400 recorder	\$45
		CL-412346-3 Vinyl dust cover for RS3800 without 5900 case	\$45
		CL-712557-2 Advanced features kit, all RS3000 models	\$425
		CL-812620- Isolated power kit, 19-in RETMA standard rack mount, 115 VAC, 1500 W	\$1895
		CL-812621- Isolated power kit, portable, 115 VAC, 1500 W	\$2195
		-290144- Phone plug	\$10
		-369500-9501 Mobile utility cart/table	\$450
		MU30-V0202- User's manual, RS3000 series	\$35

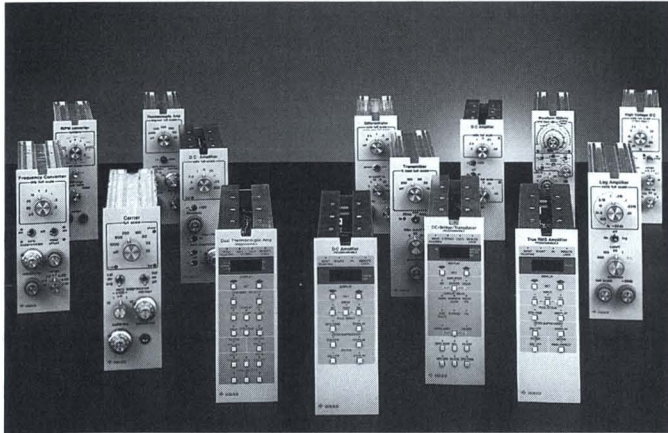

- **Wide range of modules for industrial and biomedical applications**
- **Completely modular for maximum flexibility to fit application requirements**
- **New 6600 series offers compact size and excellent value**
- **5700 series completely programmable for quick, error-free test set-up**
- **Dependable 4600 series offers time-tested reliability for today's applications**
- **Signal conditioner cases function as stand-alone front-ends or with all**

Gould, the established leader in signal conditioning, sets a new standard of excellence with the 6600, 5700 and 4600 series signal conditioners. Our full complement of general and special purpose signal conditioners has long been recognized as the industry standard for applications in industrial, medical and aerospace environments.

The new compact 6600 series offers even more value, especially when used with the new WindoGraf, EasyGraf and DataGraf recorders.

The 5700 series is fully programmable and can be operated remotely via computer. Significant benefits include consistent and repeatable setup; reduced setup time; and elimination of "useless" data from improper front-panel settings.

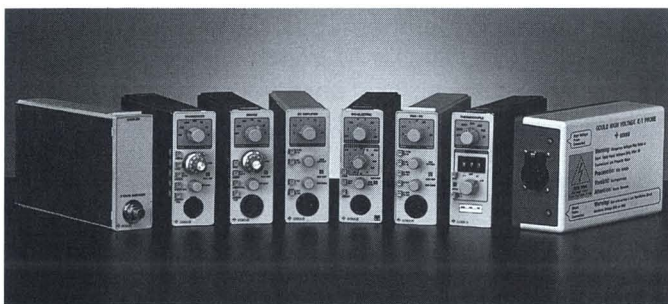

New high performance 6600 series signal conditioners from Gould fit a wide range of scientific, industrial and medical applications.

The 4600 series special purpose signal conditioners are designed to fit exacting requirements in your application.

The broad range of signal conditioners from Gould are engineered to insure signal integrity. Features include floating and guarded input, high common mode rejection, excellent linearity, low noise output, and insensitivity to environmental changes.

All signal conditioners and cases are compatible with every recording product from Gould. From DC to AC voltage/current to integration, Gould has a signal conditioner to meet your measurement requirements.

Use the Selection Chart on the following pages to choose the appropriate signal conditioner for your general and special purpose applications. Use the Selection Chart on pages 96 and 97 to choose the appropriate signal conditioner for your medical

SIGNAL CONDITIONERS: A BRIEF OUTLINE

Today's increased emphasis on product quality and reliability requires the instrument user to obtain the most accurate measurements possible from a test or process. From the design phase to the manufacture of a product, there is a direct correlation between the quality of the signal and the reliability of the information collected. The first step toward measurement accuracy, therefore, is selecting the proper signal conditioner. Since sensors and signal conditioners constitute the most basic and permanent components of a measuring system, they must be highly precise and also flexible enough to meet both current and future requirements.

Traditionally, signal conditioners have been used to measure and record analog data. The wide selection currently available from Gould makes it possible to acquire virtually any signal. This broad choice, however, means that users must take particular care in choosing the unit that is right for their application.

Instrumentation signal conditioners are the basic building blocks of electronic measuring and recording instruments and computer based data acquisition systems. They are used to measure output from transducers that convert physical phenomena such as stress, strain, force, pressure, vibration, and temperature into equivalent electrical output signals for conventional recording devices and computer based analysis systems.

Signal conditioners must perform a variety of functions, including amplification of low-level signals, attenuation of high voltage levels, linearization, rejection of common-mode components, and zero suppression of the static component of a complex signal. Computational processes, such as integration, differentiation, pressure processing, and RMS conversions designed into signal conditioners from Gould, provide analog data reduction to free the computer from these time-consuming functions.

Classification of transducers

A transducer provides a usable electrical output in response to a specified physical measurement. The two general classes of transducers include self-generating devices (e. g., thermocouples, photoelectric devices, and piezoelectric transducers) and sensors that require external excitation (e. g., strain gauges, LVDTs, variable reluctance and resistance temperature sensors). Low-impedance devices are generally preferred, because they reduce system noise and minimize the loading or shunting effect that the measuring instrument imposes on the source.

Transducer output configurations

Transducer output configuration fall into six classes of signal sources:

The *single-ended grounded signal source* has two output terminals, one of which is connected to source ground. A typical example is an AC line powered signal generator with a two-terminal, grounded output.

The *single-ended floating source* has two output terminals that are isolated from ground. A floating output can be reversed or grounded without disturbing the circuit. A battery, the output from a magnetic head, or a two-terminal, battery powered signal generator are typical examples.

A *single-ended driven off-ground signal* has two output terminals that are driven off ground by a second voltage. A driven off-ground signal can never be grounded. A resistive shunt installed on the hot side of a power line or a DC bus for measuring current are representative examples.

A *balanced grounded source* has two output terminals with equal impedance to a common ground. The output terminals can be reversed without disturbing the circuit. An example is a 4-arm Wheatstone bridge output that is excited from a grounded power supply.

A *balanced floating signal source* has two output terminals that have equal impedance to a common point that is floating. The terminals can be reversed or the common point can be grounded without disturbing the circuit. A 4-arm Wheatstone bridge output that is excited from a floating power supply or a center-tapped transformer secondary are examples.

A *balanced driven off-ground signal* has two active output terminals that have equal impedance to a common point that is driven off ground by a second voltage. The active terminals can be reversed to invert signal polarity, but can never be grounded without disturbing or destroying the signal source. One example is a differential output signal conditioner that produces an output of plus and minus 30 VDC, but operates at 60 VDC above ground.

Basic signal conditioner types

Signal conditioners range from basic types such as low-gain DC to specialized units like phase sensitive demodulators. They may be linear or logarithmic, high gain, or DC bridge signal conditioner, but all fall into the following basic categories:

An *AC coupled signal conditioner* has a minimum frequency at which it will operate.

Chopper stabilized DC signal conditioners are widely used for low-level inputs and feature high gain, negligible drift, and excellent common mode rejection. Because their bandwidth is limited by the chopper frequency, they are not used for high-frequency applications.

Carrier signal conditioners are used with transducers that require an external source of AC excitation. They can operate with resistive, inductive or capacitive transducers. Frequency response is limited by the carrier frequency.

DC bridge signal conditioners are used with resistive transducers that require external DC excitation. They typically have high-frequency response.

AC level signal conditioners measure RMS levels of AC signals with crest factors as high as 10:1. (Crest factor is the ratio of peak signal amplitude to the true RMS value.) They extend the range of direct writing recorders to the frequency response of the signal conditioner.

Specialized signal conditioners

Among the growing array of specialized signal conditioners are:

True RMS converters compute the true RMS value of AC signals, regardless of waveshape.

DC bridge signal conditioners can be used with strain gauges, strain gauge-based transducers, RTDs, and low-level signals.

Carrier signal conditioners supply AC excitation and can be used with LVDTs, variable reluctance, and strain gauge based transducers.

Log-linear signal conditioners can measure signal levels from microvolts to hundreds of volts. They can be used as wide-band AC or DC signal conditioners with logarithmic output.

Frequency-to-voltage converters convert any incoming frequency into a DC voltage directly proportional to frequency.

Integrator signal conditioners accept any dynamic input voltage, compute its time integral and output the integral as amplitude x time = area.

Differentiator signal conditioners perform the function of differentiation; they produce an output signal proportional to the rate of change of the input function and provide a calibrated first derivative output in units/second.

Factors to consider in signal conditioner selection

In addition to input configurations, the user must also consider:

What measurement range or sensitivity is required? This is the statement of upper and lower limits between which a signal conditioner's input may be received and for which it is calibrated, e. g., 25 mV to 200 V.

What frequency response is needed? This is the portion of the frequency spectrum that can be processed by a device within specified amplitude errors, e. g., DC to 250 kHz.

Is AC or DC excitation necessary?

Will filtering be needed? High pass, low pass, notch or bandpass?

Is zero suppression required? Zero suppression is a technique of suppressing the static part of an incoming signal so that the dynamic component may be amplified and displayed with greater resolution.

Does the signal conditioner have sufficient common mode rejection (CMR)? A common-mode signal appears simultaneously and in phase at both signal conditioner input terminals. It is normally caused by circulating currents in the ground path between the sensor and the measurement point. Common-mode voltage can produce two effects in the data acquisition system: an error in measurement or catastrophic failure. The signal conditioner's ability to reject a common-mode component from a normal mode is called CMR and is normally expressed in decibels. Common-mode voltage is most effectively rejected by employing a totally floating and shielded input stage for the signal conditioner. If possible, a signal source with low impedance should be selected. The output cable should be twisted and shielded and kept as short as possible.

Is isolation needed? When two devices are both insulated and mutually unable to produce a current, EMF, or magnetic flux in each other, they are said to be in a state of isolation. Isolation in signal conditioners includes input-to-output and input-to-chassis. Isolated signal conditioners have a significant advantage in their ability to be used with signal sources that are grounded, floating or driven off ground without experiencing ground loops, damaged equipment, or problems normally associated with grounded input circuits. The user is thus able to safely measure signals at potentials different from the output device.

Is programmability needed? Fully programmable signal conditioners are now available to permit the user to control all amplifier operating modes by means of a computer. Programmable signal conditioners also reduce set-up time and minimize operator error.

Summary

An instrumentation signal conditioner is the interface between a transducer and an output device, such as an oscillographic recorder, tape recorder, or computer based data acquisition system. As such, it must provide signal integrity for the precise measurement of physical phenomena, e. g., temperature, force, pressure, strain, stress, and vibration. The wide array of signal conditioners available today provides the user with flexibility and functionality for measuring dynamic random events.

Signal Conditioners

Both 5700 and 4600 series signal conditioners have identical dimensions: 6.1 in. H x 2.18 in. W x 13 in. D (15.5 cm H x 5.5 cm W x 33 cm D), and weigh 3 to 4 lbs. The 6600 series signal conditioners are 4.28 in. H x 1.7 in. W x 8 in. D (10.9 cm H x 4.4 cm W x 20.4 cm D) and weigh 1.5 to 2 pounds.

	<i>AC Voltage</i>	<i>AC Current</i>	<i>DC Voltage</i>	<i>DC Current</i>	<i>Power</i>	<i>Strain</i>	<i>Force</i>	<i>Pressure</i>
Programmable AC/DC (pg 73)	■	■	■	■	■			■
Programmable RMS/DC (pg 75)	■	■	■	■	■			
Programmable DC/Bridge/Transducer (pg 74)			■			■	■	■
Programmable Thermocouple (pg 76)								
8 Channel AC/DC (pg 77)	■	■	■	■				■
Medium Gain AC/DC (pgs 68, 69, 78)	■	■	■	■				
High Gain DC (pg 80)			■	■				
High Voltage (pg 79)	■	■	■	■				■
RMS (pg 70, 80)	■	■	■	■	■			
Bridge (pgs 70, 79)						■	■	■
Carrier (pg 104)						■	■	■
Transducer (pgs 98, 99)						■	■	■
Universal (pgs 98, 99)	■		■			■	■	■
Thermocouple (pgs 71, 81)								
Temperature (pgs 71, 81)								
Frequency Deviation (pg 83)								
Frequency/Voltage (pgs 72, 83)								
Log-Linear (pg 82)	■	■	■	■				
Transmitter (pg 82)			■	■				
Integrator (pg 103)			■					
Differentiator (pg 103)			■					
Phase Sensitive (pg 84)			■					

Torque	Flow	Temperature	Frequency	Humidity	Viscosity	Noise	Acceleration	Velocity	Displacement	
■	■				■					Programmable AC/DC
					■					Programmable RMS/DC
■	■						■			Programmable Transducer
		■								Programmable Thermocouple
■	■				■					8 Channel AC/DC
										Medium Gain AC/DC
										High Gain DC
■	■				■					High Voltage
					■					RMS
■	■						■			Bridge/Transducer
■	■						■			Carrier
■	■						■			Transducer
■	■						■			Universal
		■								Thermocouple
		■								Temperature
			■							Frequency Deviation
			■							Frequency/Voltage
						■				Log-Linear
				■						Transmitter
								■	■	Integrator
								■	■	Differentiator
		■								Phase Sensitive

6600 SERIES BASIC SINGLE AND DUAL CHANNEL AC/DC AND AC/DC RMS SIGNAL CONDITIONERS

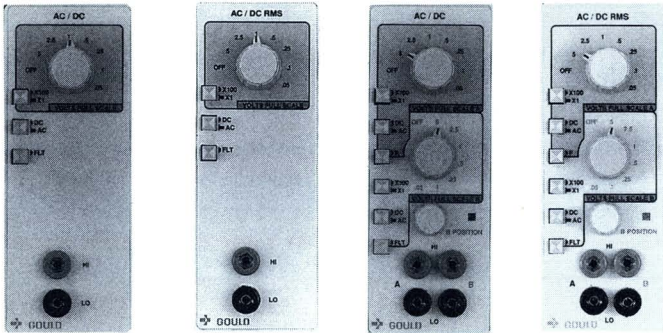

- Accurate AC and DC measurements from 50 mV to 500 V
- Precise true RMS level measurements of AC voltage and current waveforms
- 5 kHz frequency response
- Front panel selectable AC or DC coupling
- User selectable AC/DC or RMS measurement modes
- Front panel selectable 20-Hz low pass filter

The single and dual channel AC/DC and AC/DC RMS signal conditioners are compact, low-cost units that are versatile and easy-to-use for simple AC/DC or RMS voltage measurements. All models have a floating common input and 500 Volts isolation-to-chassis, which permit these signal conditioners to be used with signal sources that are grounded, floating or driven off ground.

A user selectable 20-Hz low-pass filter may be used to eliminate unwanted high frequencies. All single and dual channel AC/DC and AC/DC RMS signal conditioners are designed to be used with WindoGraf or EasyGraf recorders or in the 6600 series 8-channel case with any recorder.

SPECIFICATIONS

INPUT

AC/DC Measurement Range: 50 mV to 500 V full scale.

RMS Measurement Range: 50 mV to 500 V full scale.

Attenuator Steps: 0.05, 0.1, 0.25, 0.5, 1, 2.5 and 5 Volts; Off, x 1 and x 100 multiplier switch.

Circuit: Single ended, floating common.

Input Impedance: 1 M Ω .

Coupling: Front panel selectable for AC or DC.

Common Mode Rejection: -70 dB at 60 Hz with 1-k Ω unbalance.

Isolation: \pm 500 VDC or peak AC.

OUTPUT

Voltage: 2.5 VDC full scale.

Frequency Response: -3 dB at 5 kHz.

Filter: 20 Hz, low pass, -12 dB/octave.

DC Inaccuracy: \pm 1% of full scale.

RMS Inaccuracy: DC inaccuracy \pm 1% with sine wave inputs.

Offset: \pm 200 mV.

AC/DC Zero Drift: 50 μ V/ $^{\circ}$ C referred to input at maximum sensitivity.

AC/DC Gain Drift: 0.05% per $^{\circ}$ C referred to input.

ENVIRONMENT

Temperature

Storage: -20 $^{\circ}$ C to +80 $^{\circ}$ C.

Operating: 0 $^{\circ}$ C to +50 $^{\circ}$ C.

Humidity (Non-condensing) Operating: 10 to 70% RHD

PHYSICAL CHARACTERISTICS

Dimensions: 4.28 in. H x 1.7 in. W x 8 in. D (10.9 cm H x 4.4 cm W x 20.4 cm D).

ORDERING INFORMATION

Model Number

13-6615-11 Basic Single Channel AC/DC Signal Conditioner

13-6615-12 Basic Dual Channel AC/DC Signal Conditioner

13-6615-21 Basic Single Channel AC/DC RMS Signal Conditioner

13-6615-22 Basic Dual Channel AC/DC RMS Signal Conditioner

13-6615-2 Coupler permits the WindoGraf or EasyGraf recorders to accept inputs with any 5700 or 4600 series signal conditioners, or from any signal source with an output of \pm 5 Volts. Frequency response is -3 dB at 10 kHz. The input connector is BNC.

Price

*

*

*

*

\$225

* Consult factory.

6600 SERIES AC/DC

13-6615-10S



- Measurement range: 50 mV to 500 V
- DC to 10 kHz frequency response
- AC or DC coupling
- Calibrated zero suppression
- Input to output isolation: 500 Volts
- Low pass filter
- Reports front panel status

The 13-6615-10S is a high performance module designed for a wide variety of application requirements. The fully floating, differential input and 500-Volt isolation to chassis permit this signal conditioner to be used with signal sources that are grounded, floating or driven off ground. Zero suppression allows the user to offset the static component of the signal and expand the dynamic portion for greater resolution. Unwanted high frequencies can be eliminated with the use of a low-pass filter.

13-6615-10S SPECIFICATIONS

INPUT

Measurement Range: 50 mV to 500 V full scale.
Ranges: 0.05, 0.1, 0.25, 0.5, 1, 2.5, 5 and OFF.
Variable Gain: x 1 to x 2.5; allows 20-mV full scale measurement range.
Coupling: AC/DC.
Circuit: Differential, balanced to floating common.
Impedance: 2 M Ω .
CMRR: -80 dB at 60 Hz with 1-k Ω unbalance.
Zero Suppression: 0 - 5 V at x1; 0 - 500 V at x100.

OUTPUT

Frequency Response: -3 dB at 10 kHz.
Filter: 20 Hz low pass, -30 dB/octave.
Voltage: 2.5 VDC full scale.
Offset: \pm 20 mV DC at 25 $^{\circ}$ C.
DC Inaccuracy: \pm 1% of full scale.
Zero Drift: \pm 40 μ V/ $^{\circ}$ C referred to input at max. gain.
Gain Drift: \pm 0.01% of reading/ $^{\circ}$ C.

ORDERING INFORMATION

Model Number
13-6615-10S AC/DC Signal Conditioner with zero suppression
CL-614521-6 8-pin DIN male connector

Price
 Consult
 factory
 \$10

6600 SERIES HIGH VOLTAGE

11-5407-70/71

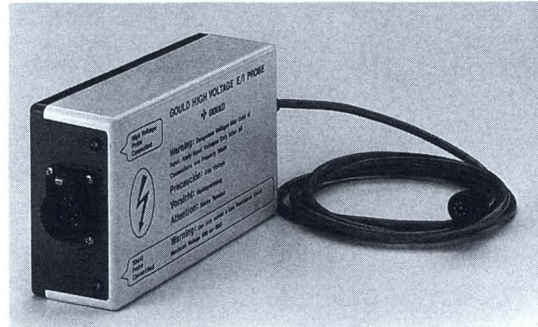

- Accurate and reliable voltage and current measurements
- Expands measurement range to 2500 Volts RMS
- Frequency response: -3 dB at 2.5 kHz
- Maximum isolation voltage: 2500 Volts

The 11-5407-70 Probe permits the user to extend the measurement range of the 6600 AC/DC or AC/DC RMS Signal Conditioners from 500 to 2500 VRMS. Model **11-5407-71** measures up to 1000 VRMS and meets CSA and VDE specifications. In addition, the probes may be used to make shunt current measurements, floating at voltages up to 2500 Volts. In the current mode, the probe may be used with shunt outputs from 50 mV to 500 mV.

11-5407-70/71 SPECIFICATIONS

INPUT	High Voltage Mode	Current Mode
Range:		
11-5407-70	2500 VRMS	Max. 500 mV input
11-5407-71	1000 VRMS	Max. 500 mV input
Impedance:	15 M Ω	13 k Ω nominal
Circuit:	Single ended floating	Single ended floating
Attenuation:	1000:1	x 10 gain
OUTPUT		
Impedance:	100 Ω nominal	100 Ω nominal
Circuit:	Single ended, ref. to ground	
Offset:	\leq 1 millivolt at 25 $^{\circ}$ C	\leq 5 millivolts at 25 $^{\circ}$ C
Frequency	-3 dB at 2.5 kHz	-3 dB at 2.5 kHz
Inaccuracy:	0.25% of full scale at 25 $^{\circ}$ C	
CMRR:	-60 dB at 60 Hz	-120 dB at 60 Hz
Isolation Voltage:		
11-5407-70	2500 VRMS	2500 VRMS
11-5407-71	1000 VRMS	1000 VRMS
Dimensions, Weight:	7.4 in. D x 4.33 in. W x 2.36 in. H (1.88 x 11.0 x 6.0 cm). 1.25 lbs (0.57 kg).	
Model Number		Price
11-5407-70 Probe		\$695
11-5407-71 Probe		\$695
CL-714245- 15 ft. Cable for high voltage measurements		\$150
CL-714246- 15 ft. Cable for current (shunt) measurements		\$150
Cables are terminated in alligator clips and BantaMate connector		

6600 SERIES AC/DC RMS

13-6615-20S



- AC/DC and True RMS modes
- Measurement range: 50 mV to 500 V RMS
- Frequency response: DC to 10 kHz
- Selectable AC and DC coupling
- Calibrated zero suppression
- Input-to-output isolation
- Reports front panel status

This wideband AC/DC RMS signal conditioner is an excellent choice for accurate measurements of dynamic signals with crest factors as high as 10:1. It measures signals containing both AC and DC components. The fully floating, differential input provides measurements free from ground loops and prevents this signal conditioner from being disturbed by signal sources that may be floating, driven off ground or referenced to ground. The front panel mounted mode switch quickly converts the signal conditioner from RMS or AC/DC.

13-6615-20S SPECIFICATIONS

INPUT

Measurement Range: 50 mV to 500 V.

Ranges: 0.05, 0.1, 0.25, 0.5, 1, 2.5, 5, Off.

Variable Gain: x 1 to x 2.5; allows 20 mV FS measurement range.

Coupling: AC/DC.

Circuit: Differential, balanced to floating common.

Impedance: 2 M Ω .

CMRR: -90 dB at 60 Hz with 1-k Ω unbalance.

Zero Suppression: 0 - 5 V at x1; 0 - 500 V at x100.

OUTPUT

Frequency Response: -3 dB at 10 kHz.

Filter: 20 Hz low pass, -30 dB/octave.

Voltage: 2.5 VDC full scale.

Offset: ± 20 mV DC at 25°C.

DC Inaccuracy: $\pm 1\%$ of full scale.

RMS Inaccuracy: DC inaccuracy $\pm 0.1\%$ with sine wave inputs.

Zero Drift: ± 40 $\mu\text{V}/^\circ\text{C}$ referred to input at max. gain.

Gain Drift: $\pm 0.01\%$ of reading/ $^\circ\text{C}$.

ORDERING INFORMATION

Model Number

13-6615-20S AC/DC RMS Signal Conditioner

CL-614521-6 8-pin DIN male connector

Price

\$750

\$10

6600 SERIES DC BRIDGE

13-6615-30



- Measurement range: 250 microvolts to 1 Volt DC
- Selectable excitation voltage
- Front panel calibration
- Push button auto balance
- Calibrated zero suppression
- Local or remote sensing
- Reports front panel status

The DC bridge signal conditioner is versatile and easy to use. Inputs may be from strain gages, strain gage based transducers or voltage levels as low as 250 microvolts. The signal conditioner has internal switching for the selection of 1, 2, 5 or 10 VDC excitation. An input unbalance up to 500 millivolts may be nulled simply by pushing the Auto-balance switch. Front panel settings (status) can be printed, thus eliminating all possible signal conditioner set-up errors in data analysis.

13-6615-30 SPECIFICATIONS

INPUT:

Measurement Range: 250 μV to 1 VDC.

Ranges: OFF, 200, 100, 50, 20, 10 & 5 % of full scale.

Circuit: Differential, balanced to common.

Impedance: 2 M Ω .

Max. Input Voltage: 12 VDC or AC P-P.

CMRR: -80 dB at 60 Hz with 100- Ω unbalance.

Zero Suppression: 0 - 5 V at x1; 0 - 500 at x100.

OUTPUT:

Frequency Response: DC to -3 dB at 5 kHz.

Filter: 2 pole Bessel. low pass, -3 dB at 15 Hz.

Voltage: 2.5 VDC full scale.

Inaccuracy: $\pm 0.1\%$ of full scale.

Non-linearity: $\pm 0.1\%$ of full scale.

Noise: 1 mV at 1 VDC.

Excitation: Off, 1, 2, 5 and 10 VDC ± 10 mV at 100 mA.

AUTO BALANCE RANGE:

Sensitivity X 1: ± 50 mV referred to input.

Sensitivity X 10: ± 500 mV referred to input.

ORDERING INFORMATION

Model Number

13-6615-30 DC Bridge Signal Conditioner

CL-811124- Bridge completion board

CL-614521-2 8-pin DIN male connector

Price

\$825

\$20

\$10

Pt100 TEMPERATURE

13-6615-45



- **Measurement range:** -100° to +500°C
- **Uses 100-Ω Platinum RTD for maximum accuracy and minimum drift**
- **Adjustable °C offset**
- **Isolated to 1500 VDC or Peak AC**
- **Reports front panel status**

The 13-6615-45 Pt100 signal conditioner from Gould is an easy-to-use signal conditioner, designed to accurately measure temperatures from -100° to +500° Celsius using a 100-Ω Platinum RTD. RTD devices are much more stable, more accurate and more linear than thermocouple devices. Therefore, they provide more precise and more repeatable test results. The Pt100 has a calibrated offset to suppress the static portion of any complex temperature signal, allowing the dynamic portion to be expanded for more detailed evaluation.

13-6615-45 SPECIFICATIONS

INPUT:

Measurement Range: -100°C to +500°C, with 100-Ω Platinum RTD.

Ranges: 25°, 50°, 100°, 250°, 500° and Off.

Circuit: Differential.

Impedance: 2 MΩ.

Input Protection: 240 VAC RMS maximum for 1 min.

Degree Offset: -100° to +500°C in 1°C increments.

Common Mode Rejection: -140 dB at 60 Hz.

Excitation Current: 1.0 mA.

OUTPUT:

Frequency Response: -3 dB at 7 Hz.

Voltage: 2.5 VDC full scale.

Inaccuracy: ±0.3% of full scale.

Non-linearity: ±1°C of full scale.

Offset Error at 0°C: ±0.5°C.

Drift: 0.02% per °C.

ORDERING INFORMATION:

Model Number

13-6615-45 Pt100 Signal Conditioner

CL-215243- 4-pin DIN male connector

Price

\$695

\$10

THERMOCOUPLE CONDITIONER

13-6615-40



- **Measurement range:** -148° to +1852°F or -100° to +1000°C
- **User selectable for J, K and T Thermocouples**
- **Calibrated offset for more detailed measurements**
- **Front panel LED reporting open thermocouple status**
- **Input-to-output isolation to 500 VDC**
- **Reports front panel status**

The 13-6615-40 thermocouple signal conditioner accurately measures temperature from -100° to +1000° Celsius or -148° to +1832° Fahrenheit using J (iron-constantan), K (chrome-alumel) and T (copper-constantan) thermocouples. Thermocouples are rugged, inexpensive devices, available in a wide variety with extensive temperature ranges. This easy-to-use unit has a 250-Hz sampling rate with built-in cold-junction compensation and linearization for accurate, reliable temperature measurements in virtually any industrial application.

13-6615-40 SPECIFICATIONS

INPUT:

Thermocouple Types: J, K and T.

Measurement Range: -100° to +1000°C or -148° to +1832°F, depending on thermocouple type.

Full-scale Ranges: 50°, 100°, 250°, 500°, 1000°, 2500°C, OFF.

Circuit: Single ended, isolated.

Isolation: 500 VDC, input to output.

Impedance: 1 MΩ.

Max. Input Voltage: 500 VDC or peak AC.

Temperature Offset: -100° to +1000°C or -148° to +1832°F in 1° increments.

Common Mode Rejection: -100 dB at 60 Hz, 100 Ω unbalance.

Sample Rate: Up to 250 samples/s.

OUTPUT:

Frequency Response: -3 dB at 25 Hz.

Filter: 2-pole Butterworth, low pass, -3 dB at 10 Hz; 20 dB/octave

Noise: ±1% full scale

ORDERING INFORMATION:

Model Number

13-6615-40 Thermocouple Signal Conditioner

CL-212755-10 Thermocouple Input Connector

Price

\$995

\$10

6600 SERIES FREQUENCY CONVERTER

13-6615-60

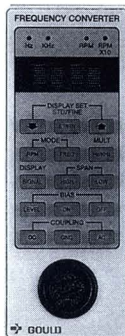

- Accurate and reliable measurements of frequency and revolutions per minute
- Wide measurement ranges: 1 Hz to 100 kHz or 60 to 99900 RPM
- Push button front panel controls, illuminated alphanumeric display and mode LEDs
- Selectable AC/DC coupling and adjustable bias level
- Excitation source for optical couplers, motion sensors and transducers
- Reports front panel status

The frequency converter signal conditioner from Gould provides direct measurement of wide-band frequency and revolutions per minute (RPM) from input voltages of 100 millivolts to 500 Volts RMS. The frequency converter detects the zero crossing of any AC waveform and converts the input signal to a corresponding DC output voltage. Front panel push

buttons are used for selecting measurement modes, AC/DC coupling, high/low range settings and bias level. The lightweight and compact frequency converter is designed to work with the WindoGraf and EasyGraf recorders or the 6600 series 8-channel case from Gould.

PRELIMINARY 13-6615-60 SPECIFICATIONS

INPUT

Measurement Range: 1 Hz to 100 kHz or 60 RPM to 99900 RPM full scale.

Type: Differential, balanced to isolated common.

Coupling: Selectable AC/DC.

Input Voltage: 100 millivolts to 500 Volts RMS.

Bias: ± 10 Volts.

Impedance: 100 k Ω .

Isolation: 500 VDC input-to-output.

Maximum Input Signal: 500 VAC RMS.

Common Mode Rejection: 100 dB at 60 Hz.

OUTPUT

Voltage: 2.5 Volts DC full scale.

Response Time: Less than 200 ms at 100 Hz.

Inaccuracy: 0.5% of full scale

Resolution: $\pm 0.1\%$.

Excitation: +12 VDC at 50 mA.

Status Reporting: Frequency Converter will generate a status report string over a serial link.

ENVIRONMENT

Temperature

Storage: 0°C to +70°C.

Operation: 0°C to +40°C.

Humidity

Operating: Non-condensing up to 70% RHD.

ORDERING INFORMATION

Model Number

13-6615-60 Frequency Converter

* Consult factory.

Price

*

5700 SERIES PROGRAMMABLE DC SIGNAL CONDITIONER 57-1300-

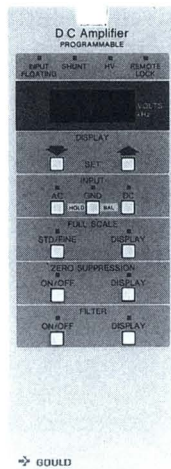

- Set up and control parameters from computer or front panel
- Measurement range 10 mV to 750 V
- Internal memory for saving setup parameters
- 250 kHz bandwidth (non-isolated)
- User selectable AC/DC coupling
- Input to output isolation
- Q position low-pass filter
- Reports front panel status

The 5700 series DC signal conditioner can be operated manually from the front panel, or it is fully programmable via RS-232C or IEEE-488 interfaces. Used with a 5900 case from Gould, it provides full remote programmability and status annotation of signal conditioner settings. Moreover, its 250-kHz frequency response makes it an ideal front end for stand-alone use with other equipment.

Special features of the DC signal conditioner include: microprocessor control of gain and operating modes; integral LED indicators and 4-1/2 digit display; true zero suppression; selectable low pass filter; input-to-output isolation; high impedance differential or single-ended inputs; 10 mV to 750 VRMS full-scale sensitivity (up to 1500 V with high voltage options); and selectable AC/DC coupling.

57-1300- SPECIFICATIONS

INPUT

Measurement Ranges

Isolated: 10mV to 750 V full scale.

Non-isolated: 10 mV to 100 V full scale.

Standard Ranges: 10, 25, 50, 100, 250 and 500 mV; 1, 2.5, 5, 10, 25, 50, 100, 250, 500 and 1000 V.

Fine Adjustments (calibrated)

1-mV steps between 10 mV and 1 V full scale.

10-mV steps between 1 V and 10 V full scale.

100-mV steps between 10 V and 100 V full scale.

1-V steps between 100 V and 1000 V full scale.

Circuit: Differential and balanced-to-common.

Coupling: AC, DC, and GND.

Input-to-Output Isolation: 1400 VAC.

Impedance

Differential: 2 M Ω shunted by 11 pF.

Single Ended: 1 M Ω shunted by 22 pF.

Maximum Allowable Input Voltage: 100 VRMS or \pm 100 VDC \leq 1 V full scale; 1000 VRMS or \pm 1000 VDC \geq 1 (differential input).

Zero Suppression: 0 - 1000 V.

Common Mode Rejection: -100 dB at 60 Hz with 1-k Ω unbalance.

OUTPUT

Frequency Response: -3 dB at 10 kHz.

Voltage: 5 VDC full scale.

Filter: 2-pole Bessel; -12 dB/octave roll-off.

Non-linearity: \pm 0.03% of full-scale output.

Output Noise: Less than 10 μ V P-P, 0.1 Hz to 100 Hz. Less than 30 μ V P-P, 0.1 Hz to 10 kHz.

ORDERING INFORMATION

Model Number

57-1300- Programmable DC Signal Conditioner

CL-810413- Isolated high voltage connector

CL-810414- Non-isolated high voltage connector

Price

\$1595

\$975

\$825

PROGRAMMABLE DC/BRIDGE/TRANSDUCER

57-1301-

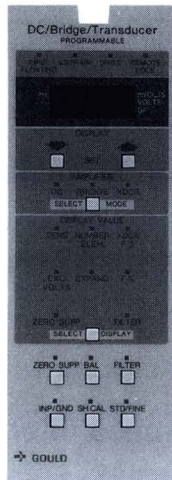

- Set up and control parameters from computer or front panel
- Measurement range from 100 μV to 1 V
- Direct front-panel calibration in gage factor or mV/volt
- Output scaled in engineering units
- User selectable bridge excitation
- Auto balance and calibration
- ± 500 VDC input-to-output isolation
- Reports front panel status

The versatile DC/bridge/transducer signal conditioner is designed to measure low-level signals using a wide variety of resistive strain gages, strain-gage based transducers, and resistance temperature devices (RTDs).

An internal plug-in board provides the connections for the bridge completion and shunt calibration resistors. The signal conditioner can be used with 1/4, 1/2 or full bridge strain gage transducers.

The programmable DC/bridge/transducer signal conditioner is equipped with auto balance with a range of

$\pm 50\%$ of normalized full-scale. To simplify data reduction, you can scale the output in engineering units. Input-to-output isolation is standard, and a fully programmable filter permits the user to eliminate all unwanted high-frequency signals.

The user can operate it manually from the front panel, or it is fully programmable via RS-232C or IEEE-488 interfaces. In addition, the user has the option of using this signal conditioner as a stable, high-gain DC amplifier with full-scale sensitivity from 100 μV to 1 Volt.

57-1301- SPECIFICATIONS

INPUTS TO AMPLIFIER

Strain Gages: 1/4, 1/2 or full bridge.

Transducer: Foil or piezoresistive strain gage type.

Low-level DC signals.

INPUT

Measurement Range: 100 microvolts to 1 Volt full scale.

Circuit: Differential, balanced to circuit common.

Impedance: Greater than 100 M Ω shunted by 45 pF.

Maximum Safe Input Voltage

Normal Mode Signal: 50 VDC or peak AC.

Common Mode Signal: 500 VDC or peak-to-peak (isolated).

Zero Suppression

Range: 0 - 1000 V.

Inaccuracy: $\pm 0.3\%$ of full scale.

Non-linearity: $\pm 0.025\%$ of full scale.

Common Mode Rejection: -110 dB at 60 Hz with 100 Ω balanced to common.

Bias Current: Less than 15 nanoamperes.

OUTPUT

Frequency Response: -3 dB at 50 kHz without isolation; -3 dB at 10 kHz with isolation.

Filter: 2 pole Bessel; -12 dB/octave roll-off.

Circuit: Single ended to common (short circuit proof to output common).

Voltage: 5 VDC full scale.

Noise: $\pm 0.4\%$ from DC to 10 kHz.

Bridge Excitation

Voltage Range: ± 1 to ± 10 VDC in 0.1 V increments at 100 milliamperes.

Voltage Sensing

Internal: Automatic.

Remote: \pm sense lines are available via the input connector.

ORDERING INFORMATION

Model Number	Price
57-1301- DC/Bridge/Transducer Signal Conditioner	\$2295
11-5407-68 Input connector	\$55

PROGRAMMABLE RMS SIGNAL CONDITIONER

57-1302-

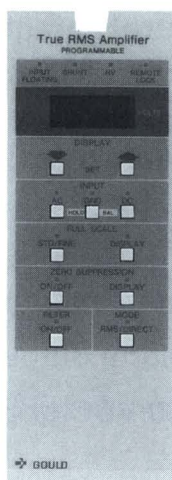

- Set up and control parameters from computer or front panel
- Wide measurement range: 10 mV to 750 VRMS full scale
- 250 kHz frequency response in RMS mode
- Rise-time response less than 15 ms
- 1400 VAC input-to-output isolation
- Calibrated zero suppression
- Reports front panel status

The 5700 series RMS signal conditioner from Gould expands functions and performance in signal conditioning. It can be computer controlled via IEEE-488 or RS-232C interfaces, or operated manually from the front panel. Used with a 5900 series case from Gould, it provides full remote programmability and status annotation of amplifier settings.

Its DC-to-250 kHz frequency response makes it an ideal front end for data acquisition systems. Input-to-output isolation permits off-ground measurements up to

750 Volts — or 1500 Volts with an optional high voltage connector. Calibrated zero suppression, AC or DC coupling, and a 15-ms rise time are some of the special features that make the programmable RMS signal conditioner the industry standard. This wide-band RMS signal conditioner permits precise amplitude measurements of dynamic signals with crest factors as high as 10:1. A push of a switch turns the signal conditioner into a fully programmable, isolated DC amplifier.

57-1302- SPECIFICATIONS

INPUT

Measurement Ranges: 10 mV to 750 V RMS.

Standard Ranges: 10, 25, 50, 100, 250 and 500 mV; 1, 2.5, 5, 10, 25, 50, 100, 250, 500 and 1000 V.

Fine Adjustments:

- 1-mV steps between 10 mV and 1 V full scale.
- 10-mV steps between 1 V and 10 V full scale.
- 100-mV steps between 10 V and 100 V full scale.
- 1-V steps between 100 V and 1000 V full scale.

Circuit: Differential, balanced-to-common.

Coupling: AC, DC, and GND.

Input to Output Isolation: 1400 V peak AC.

Impedance:

Differential: 2 M Ω shunted by 11 pF.

Single Ended: 1 M Ω shunted by 22 pF.

Maximum Allowable Input Voltage:

For full scale \leq 1 V FS: 100 VRMS.

For full scale $>$ 1 V FS: 750 VRMS each input to common or 1000 VRMS between inputs.

Zero Suppression: 0 - 1000 V.

Common Mode Rejection: 100 dB at 60 Hz with 1 k Ω unbalance.

OUTPUT

Frequency Response:

RMS Mode: 30 Hz to 250 kHz (-3 dB) for full scale up to 100 V; 30 Hz to 100 kHz (-3 dB) for full scale over 100 V.

Direct Mode: DC to 10 kHz (-3 dB).

Voltage: 5 VDC full scale.

Impedance: Less than 2 M Ω shunted by 11 pF differential.

Non-linearity: $\pm 0.15\%$ of full-scale output.

Output Noise: Less than 50 μ V peak-peak, 0.1 Hz to 10 kHz.

ORDERING INFORMATION

Model Number	Price
57-1302- Programmable RMS Signal Conditioner	\$1795
CL-810413- Isolated high voltage connector	\$975
CL-810414- Non-isolated high voltage connector	\$825

PROGRAMMABLE THERMOCOUPLE SIGNAL CONDITIONER

57-1303-

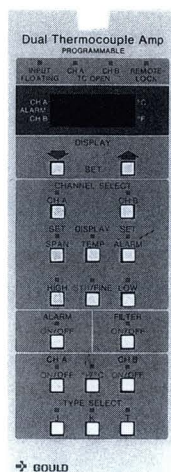

- Set up and control parameters from computer or front panel
- Dual channel signal conditioner in one compact package
- User selectable for J, K and T thermocouples
- 750 Hz frequency response
- High and low alarm outputs
- Can operate 500 VDC or peak AC off ground
- Reports front panel status

The 57-1303- is a 2-channel thermocouple signal conditioner, designed specifically for J, K, and T type thermocouples. Reference junction compensation and linearization are provided. The user can make temperature measurements in degrees Celsius or Fahrenheit. Some of the features that make this signal conditioner the ideal front end for high quality

temperature measurements are frequency response of 750 Hz, 500 VDC input-to-output isolation, and high and low alarms outputs for each channel.

This signal conditioner may be operated manually from the front panel or computer controlled via IEEE-488 or RS-232C interface.

57-1303- SPECIFICATIONS

INPUT

Measurement Range:

Type J thermocouple: -150° to +1200°C.

Type K thermocouple: -150° to +1300°C.

Type T thermocouple: -200° to + 400°C.

Minimum Measurement Span: 50°C or °F.

Inaccuracy: ±2°C of full scale.

Circuit: Single ended, floating common.

Impedance: 100 MΩ.

Maximum Input Voltage: ±500 VDC or peak AC.

Common Mode Rejection

AC CMR: -120 dB with 100-Ω unbalance at 60 Hz.

DC CMR: -140 dB with 100-Ω unbalance.

OUTPUT

Frequency Response

Filter Off: -3 dB at 750 Hz.

Filter On: -3 dB at 6 Hz.

Voltage: 0.5, 2.5 or 5 Volts full scale with 2-kΩ load.

Circuit Configuration: Single ended to common.

Noise: ±50 mV.

ALARM

Channel A or B: Separate high and low outputs for each channel.

High Limit:

Normally Open — when temperature is less than high limit set point.

Closed — when temperature exceeds high limit.

Low Limit:

Normally Open — when temperature is greater than low limit set point.

Closed — when temperature is less than the low limit.

Input Connector: Dual 2 prong copper bayonet type mounted on the rear of the signal conditioner.

ORDERING INFORMATION

Model Number	Price
57-1303- Programmable Thermocouple Signal Conditioner	\$2395
CL-212755-10 Input connector	\$10

8-CHANNEL DC SIGNAL CONDITIONER

48-8400-1 AND 48-8400-2

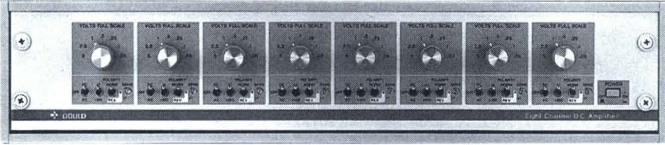

- Accurate and reliable AC or DC voltage measurements from 50 mV to 500 V
- User selectable AC/DC coupling and polarity reversal
- Totally isolated from input-to-output and channel-to-channel
- 5 kHz frequency response
- Compact portable or rack mount configurations for application flexibility

The 8-channel DC signal conditioner from Gould is a compact, low-profile unit, designed to accurately measure AC or DC voltages from 50 millivolts to 500 Volts. This versatile 8-channel unit has a 5-kHz frequency response with 1-M Ω input impedance and is totally isolated from chassis input-to-output and

channel-to-channel. Additional features include AC/DC coupling and polarity reversal. An excitation voltage of 12 Volts at 1 Ampere is optional. Sensitivity control is provided, allowing full-scale adjustment from 20 millivolts to 500 Volts.

48-8400-1 AND 48-8400-2 SPECIFICATIONS

INPUT

Measurement Range: 50 mV to 500 V.

Ranges: 0.05, 0.1, 0.25, 0.5, 1, 2.5, 5 V, Off, plus x 100 switch

Coupling: AC/DC.

Circuit: Single ended, floating common.

Impedance: 1 M Ω shunted by less than 150 pF.

Range-to-Range Inaccuracy: $\pm 0.5\%$ of full scale.

Common Mode Rejection:

AC: 90 dB at 60 Hz with 1-k Ω unbalance.

DC: 140 dB at DC with 1-k Ω unbalance.

OUTPUT

Frequency Response: -3 dB at 5 kHz.

Voltage: 5 Volts full scale (up to 10 V with plug-in resistor).

Circuit: Single ended referenced to common.

Non-linearity: 0.4% of full scale.

Inaccuracy: 0.5% of full scale.

Zero Stability

With Temperature: $\pm 50 \mu\text{V}/^\circ\text{C}$, referred to input.

With Line: 0.1% full scale for 10% line change.

With Time: Less than 50 $\mu\text{V}/24$ hours.

Gain Stability

With Temperature: $\pm 0.02\%/^\circ\text{C}$.

With Line: $\pm 0.01\%$ for 10% line change.

With Time: $\pm 0.05\%/1000$ hours.

Noise: 0.2% full scale, 0.1 to 10 Hz, referred to input.

CHANNEL TO CHANNEL CROSSTALK:

Input switch at x 1: 100 dB down at 5 kHz sine.

Input switch at x 100: 75 dB down at 5 kHz sine.

PHYSICAL CHARACTERISTICS

Dimensions: 3.5 in. H x 19 in. W x 16 in. D (8.9 cm H x 48.3 cm W x 40.6 cm D).

Weight: 10 lbs. (4.5 kg).

ORDERING INFORMATION

Model Number	Price
48-8400-1 8-Channel DC Signal Conditioner, 19-in. RETMA standard rack mount	\$3995
48-8400-2 8-Channel DC Signal Conditioner, portable	\$4295
CL-211126-12 Input connector	\$29.70
CL-211125-12 Mating connector	\$7.35

IS SERIES DC SIGNAL CONDITIONERS

57-1340- AND 57-1440-

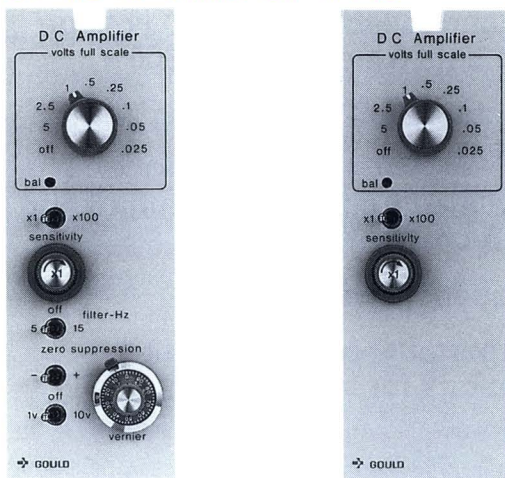

- Excellent choice for accurate measurements of DC voltages
- Wide measurement range: 25 mV to 500 V
- Calibrated zero suppression
- Input-to-output isolation
- 10 kHz frequency response
- Reports front panel status to all Gould recorders

Basic and general purpose DC signal conditioners are designed to be used in the 5900 series case as a stand-alone unit or with any direct writing recorder from Gould. Each signal conditioner is isolated from input-to-output and operates up to 500 V off ground. A user selectable low-pass filter is provided to eliminate objectionable high frequency signal components.

The optional Status Reporting Board supplies all front

panel status information to any recorder from Gould for hardcopy output.

The **57-1340- DC signal conditioner** has calibrated zero suppression, with a resolution of one part per thousand. This allows the static portion of a complex signal to be suppressed a known amount and the dynamic portion to be amplified for a more detailed evaluation.

57-1340- AND 57-1440- SPECIFICATIONS

FOR 57-1440- BASIC DC SIGNAL CONDITIONER AND 57-1340- GENERAL PURPOSE DC SIGNAL CONDITIONER

INPUT

Measurement Range: 25 mV to 500 V.

Attenuator Steps: 0.025, 0.05, 0.1, 0.25, 0.5, 1.0, 2.5 and 5 Volts full scale, Off, x 100 multiplier.

Sensitivity Vernier: Provides up to 2.5 times calibrated setting.

Input Impedance:

x 1 Multiplier: 2 M Ω differential.

x 100 Multiplier: 100 M Ω differential.

Max. Allowable Input Voltage: 500 VDC or peak AC.

Common Mode Rejection: 100 dB at 60 Hz with 1-k Ω unbalance.

OUTPUT

Frequency Response:

With Isolator Module: -3 dB at 10 kHz.

Without Isolator Module: -3 dB at 35 kHz.

Voltage: 5 VDC full scale.

FOR 57-1340- SIGNAL CONDITIONER ONLY

Zero Suppression Ranges: 0 - 5 V at x1; 0 - 500 V at x10.
Resolution: $\pm 0.1\%$ of full suppression range.

ORDERING INFORMATION

Model Number	Price
57-1340- General Purpose DC Signal Conditioner with zero suppression	\$695
57-1440- Basic DC Signal Conditioner	\$495
11-4220- Status Kit (optional)	\$250

DC BRIDGE SIGNAL CONDITIONER

13-G4615-30



- Accurately measures from 25 to 10,000 microinches/in.
- Direct front panel balance and calibration
- Selectable bridge excitation voltage
- Selectable low-pass output filter
- Adjustable shunt calibration
- Calibrated zero suppression

The high-gain DC bridge signal conditioner is designed for operation with strain gages, passive transducers, resistance temperature devices and low-level DC input signals. This signal conditioner has internal switching for selection of 5 or 10 VDC excitation, positive or negative shunt calibration and bridge polarity reversal. Internal binding posts are provided for mounting bridge completion resistors assuring compatibility with virtually all transducers including half bridge and quarter bridge.

13-G4615-30 SPECIFICATIONS

INPUT

Measurement Range: 250 μ V to 100 mV FS; 25 μ inches per inch to 10,000 μ inches per inch FS.

Attenuator Steps: 5, 10, 20, 50, 100 and 200% of full-scale load, Off.

Attenuator Inaccuracy: \pm 0.5% of calibrated step.

Input Circuit: Differential, floating common.

Input Impedance: 50 k Ω .

Sensitivity or Gage Factor: Direct front panel calibration from 1 mV/V to 10 mV/V sensitivity. (100 Ω to 1000 Ω strain gage based transducers).

Calibrate Vernier: Provides calibrated sensitivity adjustment from 1 mV/V to 10 mV/V.

Max. Allowable Input Voltage: 50 VDC or peak AC across input terminals. 500 VDC or peak AC from common to chassis.

Calibrated Zero Suppression: 0 - 5 V at x1; 0 - 500 V at x10.

Common Mode Rejection

DC at 350- Ω unbalance: >130 dB on most sensitive range.

60 Hz at 350- Ω unbalance: >100 dB on most sensitive range.

OUTPUT

Frequency Response

Without Filter: DC to 100 Hz \pm 0.5% (-3 dB at 5 kHz).

With Internal 5 Hz Filter: -3 dB at 5 Hz \pm 10%.

Filter Roll-off: 12 dB/octave or 40 dB/decade.

ORDERING INFORMATION

Model Number

13-G4615-30 DC Bridge Signal Conditioner

Price

\$895

Gould Test and Measurement Group

HIGH VOLTAGE SIGNAL

13-G4615-90



- Wide measurement range: 2.5 mV to 1500 VDC
- Five low-pass output filters
- Operates up to 1500 V off ground
- Calibrated zero suppression
- High input impedance
- "High-Pot" tested at 4000 VDC

The High Voltage DC signal conditioner is a medium bandwidth, differential amplifier with an isolated output and fully floating, guarded input, capable of rejecting common mode voltages up to \pm 1500 V full scale. This rugged special purpose DC conditioner has a common mode rejection greater than 140 dB and is designed to provide clean, crisp output signals in hostile industrial environments or in areas where high inrush currents, high voltages or other electrical noise is expected.

13-G4615-90 SPECIFICATIONS

INPUT

Measurement Range: 2.5 mV to 1500 V FS.

Attenuator Steps: 0.025, 0.05, 0.1, 0.25, 0.5, 1, 2.5, 5, 10, 25 V FS, Off, x 100 multiplier.

Attenuator Inaccuracy: \pm 0.4% of calibrated step.

Sensitivity Vernier: Provides up to 2.5 times calibrated setting.

Input Circuit: Fully floating, isolated, guarded and fused.

Input Impedance: 1 M Ω in x 1 and 10 M Ω in x 100 multiplier position.

Rated Input Voltage: \pm 1500 VDC or peak AC.

Calibrated Zero Suppression: 0 - 5 V at x1; 0 - 500 V at x10.

Common Mode Voltage: \pm 1500 VDC or peak AC.

Common Mode Rejection

DC at 1-k Ω unbalance: Greater than 140 dB.

60 Hz at 1-k Ω unbalance: Greater than 120 dB.

High Pot. Test (all inputs to chassis): 4000 VDC for 10 s.

OUTPUT

Frequency Response

With filter at 1 kHz: 6 dB down at 1.0 kHz \pm 10%.

With filter at 100 Hz: 6 dB down at 100 Hz \pm 10%.

With filter at 25 Hz: 6 dB down at 25 Hz \pm 10%.

Filter Roll-off: 12 dB/octave, 40 dB/decade.

Voltage: 5 VDC full scale.

ORDERING INFORMATION

Model Number

13-G4615-90 High Voltage DC Signal Conditioner

Price

\$1995

(216) 328-7000

TRUE RMS SIGNAL CONDITIONER

13-G4618-10

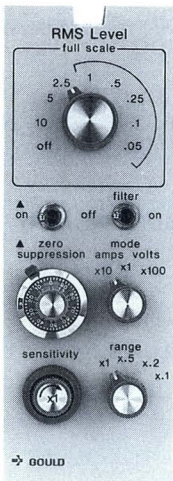

- 10 kHz frequency response
- Input protected to 1000 VRMS
- Full floating 1500 V off ground
- Measures crest factors up to 10:1
- Wide measurement range: 5 mV to 100 VRMS or 50 mA to 10 A RMS
- Calibrated zero suppression

This wide-band true RMS level signal conditioner permits precise amplitude measurements of AC voltage and current waveforms with crest factors as high as 10:1. The true RMS value of any incoming AC waveform is calculated by continuously squaring the input signal, averaging the result and extracting the square root. This becomes a DC voltage level that is the true RMS value of the incoming waveform. Fast response time (less than 25 ms) allows the true RMS signal conditioner to detect power line surge or sag anomalies.

13-G4618-10 SPECIFICATIONS

INPUT

Measurement Range: 5 mVRMS to 1000 VRMS FS; 50 mA to 10 A FS.

Attenuator Steps: 0.05, 0.1, 0.25, 0.5, 1, 2.5, 5, 10 V FS, Off plus x 100 multiplier and 0.5, 1, 2.5, 5, 10 A FS and Off.

Range Steps: x 1, x 0.5, x0.2, x 0.1.

Attenuator Inaccuracy: x 1 V Mode: $\pm 0.2\%$ reading; x 100 V Mode: $\pm 1.5\%$ reading; x 10 A Mode: $\pm 1.5\%$ reading.

Sensitivity Vernier: Provides up to 2.5 times calibrated setting.

Circuit: Differential, floating and shielded.

Input Impedance: x 100 V Mode: 1 M Ω . x 1 V Mode: 100 k Ω .

Current Mode: 0.1 Ω .

Crest Factor: 10 to 1.

Calibrated Zero Suppression: 0 - 5 V at x1; 0 - 500 V at x10.

Common Mode Rejection Voltage (60 Hz with 100 Ω unbalance): 80 dB on most sensitive range.

Max. Allowable Input Voltage: 1000 VRMS on any range.

Input Voltage Isolation: 1500 V peak AC, from input to output.

OUTPUT

Frequency Response: 50 Hz to 5,000 Hz (-3 dB).

Output Noise (at 50 Hz)

Filter Switch Off: Less than 25 mV FS on x1 range.

Filter Switch On: Less than 2.5 mV FS on x1 range.

Rise Time (10% to 90% full scale)

Filter Switch Off: Less than 25 ms.

Filter Switch On: Less than 60 ms.

Model Number

13-G4618-10 True RMS Signal Conditioner

Price
\$1495

Gould Test and Measurement Group

HIGH GAIN DC SIGNAL

13-G4615-20



- Accurately measures 50 μ V to 250 V full scale
- Common mode rejection >160 dB
- Solid state input chopper for precise measurements
- Calibrated zero suppression
- Input/output isolation
- Low-pass output filter — 5 positions from 5 Hz to 120 Hz

This versatile high gain DC signal conditioner has a measurement range from 50 μ V to 250 V full scale with low output noise and excellent zero line stability. The solid-state input chopper does not wear out, become noisy or require periodic replacement. The input circuit is differential, fully floating, isolated from input to output, and guarded by an internal floating shield. It can be operated up to 250 V off ground at any sensitivity or up to 250 V between input to output. Calibrated zero suppression is available for a more detailed evaluation.

13-G4615-20 SPECIFICATIONS

INPUT

Measurement Range: 50 μ V to 250 V full scale.

Attenuator Steps: 0.05, 0.1, 0.25, 0.5, 1, 2.5, 5, 10, 25, 50, 100, 250 V FS and Off, plus millivolts/Volts multiplier switch.

Attenuator Inaccuracy: ± 0.05 of calibrated step.

Sensitivity Vernier: Provides up to 2.5 times calibrated setting.

Input Circuit: Differential, floating, isolated and guarded.

Input Impedance: 1 M Ω on all ranges.

Common Mode Rejection

DC at 1 k Ω unbalance: >160 dB on most sensitive range.

60 Hz at 1-k Ω unbalance: >140 dB on most sensitive range

Max. Input Voltage: 120 VRMS on millivolt ranges.

250 VRMS on Volt ranges. 250 VDC or peak AC.

Calibrated Zero Suppression: 0 - 5 V at x1; 0 - 500 V at x10.

OUTPUT

Frequency Response: DC to 120 Hz, -3 dB.

Filter Selector Switch: -3 dB at 120 Hz, 50 Hz, 25 Hz, 10 Hz or 5 Hz.

Filter Rolloff: 12 dB/octave or 40 dB/decade.

Output Noise: <3% of full scale, peak-to-peak at max. sensitivity, DC to 50 Hz.

ORDERING INFORMATION

Model Number

13-G4615-20 High Gain DC Signal Conditioner

Price
\$2695

(216) 328-7000

THERMOCOUPLE

13-G4615-40



- Accurate, efficient temperature measurements using J thermocouples
- Cold junction compensation and electronic linearization
- Direct read-out in °F or °C
- Front panel indicator reporting open thermocouple status
- Calibrated zero suppression for more detailed evaluations

This high gain J-type thermocouple signal conditioner permits precise temperature measurements in degrees Fahrenheit or Celsius from -250 to +2500 full scale. Cold junction compensation and electronic linearizer provides automatic correction for the non-linearity of the thermocouple device. Calibrated zero suppression is provided to suppress the static portion of any complex temperature signal, allowing the dynamic portion to be expanded for more detailed evaluation. The 13-G4615-40 comes complete with a heavy duty, quick disconnect thermocouple input connector and mating connector.

13-G4615-40 SPECIFICATIONS

INPUT

Measurement Range: -250 to +2500 °F or °C, dependent on thermocouple type.

Attenuator Steps: 50, 100, 250, 500, 1000 and 2500° FS, plus Off.

Sensitivity Vernier: Provides up to x 2.5 calibrated setting.

Input Circuit: Single-ended, floating common.

Input Impedance: 1 MΩ.

Maximum Source Resistance: 100 Ω.

Common Mode Rejection

DC at 100-Ω unbalance: Greater than 120 dB.

60 Hz at 100-Ω unbalance: Greater than 80 dB.

Maximum Input Voltage: 500 VDC or peak AC.

Calibrated Zero Suppression: -250° to +2500° with 0.1% resolution.

OUTPUT

Frequency Response: -3 dB at 200 Hz; 6 dB/octave.

Inaccuracy: ±0.25% of calibrated step.

Non-linearity (over linearized range): Within 0.55°C or 1.0°F.

Voltage: 5 VDC full scale.

Noise: ±0.5% of full scale.

Filter: -3 dB at 5 Hz ±10%, low pass.

Gain Drift: ±0.03% of reading/24 hrs.

Zero Drift: ±0.1°C /24 hrs.

Model Number

13-G4615-40 Thermocouple Signal Conditioner

Price
\$1095

Gould Test and Measurement Group

TEMPERATURE SIGNAL

13-G4615-474029



- Maximum temperature measurement sensitivity — up to 2° full scale
- Digital zero suppression with 1° resolution
- Accurate temperature measurements using 100, 200, 500 or 1000-Ω RTDs
- Input floats 500 V off ground
- Precise temperature resolution of 0.1°

The temperature signal conditioner from Gould is an excellent choice in applications where maximum temperature resolution is required. Temperature resolution at 2° is 0.01 of a degree and can be attained in normal operation without any special calibration. The 4600 series temperature signal conditioner offers digital zero suppression with a range from ±1° to ±999° and precise electronic linearization, up to 0.2% of full scale for platinum RTDs. A front panel selector switch provides direct readout in either degrees Fahrenheit or Celsius.

13-G4615-474029 SPECIFICATIONS

INPUT

Measurement Range (directly in °F or °C): ±2° to ±1000°.

Attenuator Steps: 2, 5, 10, 25, 50, 100, 250, 500, 1000° FS, plus Off.

Standard Input Sensors: 100, 200, 500 and 1000 Ω, 4-wire, Platinum RTDs or Yellow Springs Instrument (YSI) 400 series thermistor probes.

Sensitivity Vernier: Multiplies calibrated setting up to x 2.5.

Isolation: 500 VDC or peak AC.

Input Circuit: 4-wire, differential to floating common.

Input Impedance: 1 MΩ.

Maximum Input Voltage: 260 VRMS.

Calibrated Zero Suppression: 0 to ±999° in 1-degree steps.

Platinum RTD Excitation Current: 2 mA at 100 Ω; 1 mA at 200 Ω; 0.4 mA at 500 Ω; 0.2 mA at 1 kΩ.

OUTPUT

Frequency Response: 3 dB down at 10 Hz.

Inaccuracy: ±0.25% of calibrated step.

Noise (on most sensitive range): ±0.2% of full scale.

Voltage: 5 VDC full scale.

Thermistor Probe Operation: YSI 400 series Thermistor Probes.

Range: 0-42°C.

Linearity: Within ±0.5°C from 4°C to 40°C. Within ±1°C from 0°C to 42°C.

Excitation: Approx. 765 mVDC.

Model Number

13-G4615-474029 Temperature Signal Conditioner

Price
\$1395

(216) 328-7000

TRANSMITTER SIGNAL

13-G4618-40

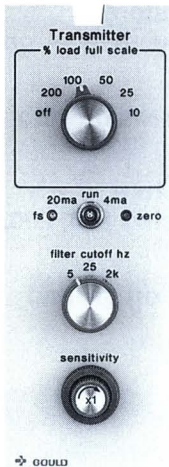

- Accurate and reliable measurements using industrial transmitters and transducers
- Easily adapts to all standard current output transmitters
- Provides excitation for 2 and 4-wire transmitters
- Calibrated zero suppression for more detailed measurements
- Selectable low pass output filter at 5 Hz, 25 Hz and 2 kHz
- Low-gain DC amplifier

The transmitter signal conditioner is designed to accurately and dependably measure process data from industrial transmitters and high signal output transducers. Measurement resolution is provided by a five-step front panel sensitivity control which has a range from 10 to 200% of rated full scale input. A selectable excitation voltage is provided for up to ± 15 VDC at 50 mA or 28 VDC at 40 mA for 2- and 4-wire transmitters. In addition to its use with transmitters and transducers, this unit may be used as a low-gain DC amplifier with a measurement range from 500 millivolts to 10 Volts full scale.

13-G4618-40 SPECIFICATIONS

INPUT

Measurement Range: 1-5 mA, 4-20 mA, 10-50 mA and 0.5 VDC (Internally Selectable).

Attenuator Steps: 10, 25, 50, 100 and 200% of load FS plus Off.

Sensitivity Vernier: Provides up to 2.5 times calibrated setting with a maximum of 200% percent of load full scale.

Input Circuit

Current Mode: Single ended, floating common.

Voltage Mode: Differential, floating.

Input Impedance

1-5 mA Range: 1000 Ω .

4-20 mA Range: 250 Ω .

10-50 mA Range: 100 Ω .

0-5 VDC: 1 M Ω .

Common Mode Rej.: 65 dB at DC with 350- Ω unbalance; 80 dB at 60 Hz with 350- Ω unbalance.

Maximum Input Voltage

Current Mode: 28 VDC or peak AC normal mode or 500 V peak common mode.

Voltage Mode: 200 VDC or peak AC normal mode.

Excitation: ± 15 V at 50 mA and 28 VDC at 40 mA.

OUTPUT

Frequency Response: DC to 100 Hz $\pm 0.5\%$.

Voltage: 5 VDC full scale.

Model Number

13-G4618-40 Transmitter Signal Conditioner

Price
\$1495

Gould Test and Measurement Group

LOG-LINEAR SIGNAL CONDITIONER

13-G4614-01

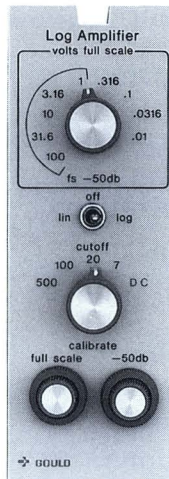

- Accurately measures vibrations, acoustics and high frequency AC
- AC log-linear operation from 10 to 100 kHz
- DC log-linear operation from DC to 400 Hz
- Selectable AC calibration
- 10 M Ω input impedance and isolated from chassis
- Four user selectable high pass filters

The log-linear signal conditioner is a specialized wide-band direct-coupled AC/DC amplifier whose logarithmic output is calibrated in decibels below a preset full-scale value. When operated as a log amplifier, the preset full-scale amplitude appears on the left chart edge, and right chart edge is an amplitude which is exactly 50 dB down from the full-scale value. In the AC mode it senses the average value of incoming signals and is calibrated in terms of the RMS values of a sinusoidal waveform. A front panel AC calibration is provided to ensure readout accuracy.

13-G4615-01 SPECIFICATIONS

INPUT

Measurement Range

AC: 10 mV to 100 VRMS FS.

DC: 1 V to 100 V FS.

Attenuator Steps: 0.01, 0.0316, 0.1, 0.316, 1, 3.16, 10, 31.6, 100 VRMS FS plus full-scale calibrate, and -50 dB.

Maximum Sensitivity: Log: 50 dB FS. AC: 10mV FS. DC: 1 V FS.

Input Circuit: Single ended to common.

Input Impedance: 10 M Ω shunted by less than 80 pF.

Maximum Input Voltage: 100 VDC or peak AC on 0.01 to 1 V ranges; 300 V on 3.16 to 100 V ranges.

Maximum Off-Ground Voltage: 500 V to chassis.

OUTPUT

Frequency Response

AC Mode: >1 dB down at 100 kHz. >3 dB down at 150 kHz.

DC Mode: >1 dB down at 200 Hz. >3 dB down at 400 Hz.

Rise Time (10-90%) for 50 dB Change

Filter position in 7 Hz Cut-off: Less than 400 ms.

Filter Position in 20 Hz Cut-off: Less than 100 ms.

Filter Position in 100 Hz Cut-off: Less than 20 ms.

Filter Position in 500 Hz Cut-off: Less than 4 ms.

Filter Position in DC Cut-off: Less than 2 ms.

Internal Calibration: 1 VRMS at 1000 Hz/1 VDC.

Inaccuracy: ± 0.2 dB.

Model Number

13-G4614-01 Log-Linear Signal Conditioner

Price
\$2495

(216) 328-7000

FREQUENCY DEVIATION

13-G4618-

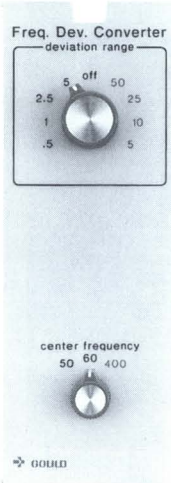

- Accurately measures low frequency signals
- Simple operation for monitoring all standard AC power sources
- Three user selectable center frequencies
- Accepts input voltages from 10 to 500 VRMS
- Excellent response time and frequency resolution
- Isolated to 1500 V input-to-output

The 4600 series frequency deviation converter detects the zero crossing of any AC waveform and outputs a DC voltage directly proportional to the standard center frequencies of 50, 60 or 400 Hz. A fully floating, high impedance input circuit, electrically isolated from input to output, and the ability to measure any AC waveform from 10 to 500 VRMS make this signal conditioner ideal for monitoring any low frequency source. This unit is useful for detecting fluctuations in frequency due to system instability.

13-G4618- SPECIFICATIONS

INPUT

Center Frequency (factory preset): 50 Hz, 60 Hz, or 400 Hz $\pm 0.025\%$.

Measurement Ranges (full scale): 49.5-50.5, 49-51, 47.5-52.5 or 45-55 Hz; 59.5-60.5, 59-61, 57.5-62.5 or 55-65 Hz; 395-405, 390-410, 375-425 or 350-450 Hz.

Circuit: Fully floating and isolated from output.

Impedance: 100 k Ω .

Common Mode Rejection

DC at 1000- Ω unbalance: 120 dB at 100-V input.

60 Hz at 1000- Ω unbalance: 80 dB at 100-V input.

Input Voltage: 10 to 500 VRMS.

Maximum Safe Input Voltage: 700 VRMS.

Isolation: 1500 VAC, from input to output or input to chassis.

OUTPUT

Rise Time: <100 ms.

Inaccuracy: $\pm 0.2\%$ of full scale.

Noise (peak-to-peak): <10 mV.

Overshoot: <0.5% of selected range.

Zero Drift: $\pm 0.02\%$ of center frequency per $^{\circ}\text{C}$.

Gain Drift: $\pm 0.08\%$ of reading per $^{\circ}\text{C}$.

Voltage: 5 VDC full scale.

Model Number

13-G4618- Frequency Deviation Converter

Price
\$1095

FREQUENCY-TO-VOLTAGE

13-G4618-20



- Accuracy and reliability for wideband frequency measurements
- Accepts input voltages from 10 mV to 500 V
- Calibrated zero suppression for more detailed evaluation
- Fully floating input isolated to 1500 V from input-to-output
- Uses standard frequency producing accessories

This wideband frequency-to-voltage converter permits direct measurement of *frequency* or signal repetition rate over the entire range from 10 Hz to 50 kHz. It detects the zero crossing of any AC waveform and outputs an analog DC voltage which is directly proportional to input frequency. Any convenient frequency or frequency range between 10 Hz and 50 kHz can be selected on one of 36 ranges to produce a full-scale output of 5 VDC. Calibrated zero suppression, which suppresses the static portion of any complex signal, allows the dynamic portion to be expanded for more detailed evaluation.

13-G4618-20 SPECIFICATIONS

INPUT

Measurement Range: 10 Hz to 50 kHz FS.

Attenuator Steps: 0.1, 0.2, 0.5, 1, 2, 5, 10, 50 kHz full scale.

Range Steps: x 1, x 0.5, x 0.2, x 0.1.

Sensitivity Vernier: Provides up to 2.5 times calibrated setting.

Input Circuit: Input No. 1: Single ended floating.

Input No. 2: For use with optical couples.

Isolation: 1500 V peak from input to output or input to chassis.

Impedance: 100 k Ω .

Maximum Input Voltage: 700 VDC or peak AC.

Common Mode Rejection: 80 dB at 60 Hz with 1-k Ω unbalance.

Input Voltage: 10 mV to 500 VRMS.

Calibrated Zero Suppression: 0 - 5 V at x1; 0 - 500 V at x10.

OUTPUT

Rise Time: 0.1, 0.2, 0.5 kHz FS: <200 ms. 1, 2, 5 kHz FS: <20 ms. 10, 20, 50 kHz FS: <2 ms.

Noise: Less than 5 mV peak-to-peak.

Inaccuracy: $\pm 0.01\%$.

Output: 5 VDC full scale.

Model Number

13-G4618-20 Frequency-to-Voltage Converter

Price
\$1095

PHASE SENSITIVE DEMODULATOR

13-4616-00

- **Totally independent demodulator and DC amplifier sections**
- **Selectable reference frequency for 60 Hz, 400 Hz, 1200 Hz**
- **Internal calibration: 1% voltage and frequency with set zero position**
- **Accurately measures DC voltages from 50 mV to 500 V**
- **High input impedance and isolated from input to output**

The 4600 series phase sensitive demodulator will accurately measure both frequency modulation and DC voltages all in one compact package. This signal conditioner has independent circuitry for error signals and reference signals, each isolated from its respective source. Internal controls are provided for setting signal polarity, calibration polarity, carrier band select and filter cutoffs. The 13-4616-00 will measure signals from servo systems, gyros, accelerometers, computers and similar mechanisms where output magnitudes and phase must be measured.

13-4616-00 SPECIFICATIONS

AC SPECIFICATIONS

Reference Channel

Circuit: Differential, balanced to floating common.

Impedance: 1 M Ω .

Measurement Range: 10 to 120 VRMS.

Frequency Range: Selectable for 60 Hz, 400 Hz, 1200 Hz.

Error Channel

Circuit: Differential, floating common.

Impedance: 1 M Ω .

Measurement Range: 25 mV to 125 V peak full scale.

Common Mode Rejection:

DC: 140 dB at 1-k Ω unbalance.

AC: 90 dB at 1-k Ω unbalance.

Phase Shift: 0 to -165° min. at 60, 400 and 1200 Hz.

DC SPECIFICATIONS

Input Circuit: Differential, balanced to floating common.

Impedance: 2 M Ω differential; 1 M Ω each input to common.

Voltage Range: 25 mV to 500 V peak full scale.

Max. Safe Input Voltage: 500 V peak AC or DC.

Attenuator Inaccuracy: $\pm 1\%$.

DC Common Mode Rejection: >90 dB with 1-k Ω unbalance.

ORDERING INFORMATION

Model Number	Price
13-4616-00 Phase Sensitive Demodulator	\$4395

Gould Test and Measurement Group

SIGNAL CONDITIONER

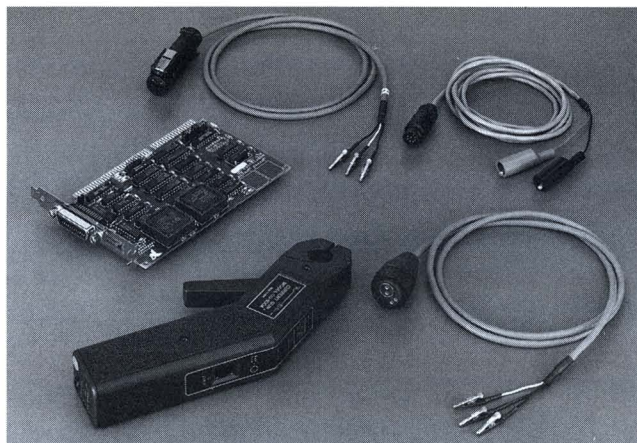

DC AND TRUE RMS ACCESSORIES

Model Number	Price
11-5407-2 Connector (4-pin and guard), mates with 13-G4615-20, and 13-G4615-90 signal conditioner input connectors	\$35
11-5407-3 Connector (7-pin and guard), mates with 13-G4618-10 signal conditioner input connectors	\$35
11-5407-9 Connector Adapter, 3 binding posts to Gould connector 11-5407-2	\$75
11-5407-50 Connector (12-pin Deutsch), mates with 20-4615-58, 13-G4615-70 and 13-G4615-71 signal conditioner input connectors	\$65
11-5407-55 Connector Adapter, 3-pin binding posts to 12-pin Deutsch connector	\$275
11-5407-67 Connector for 5700 series signal conditioners	\$35

HIGH VOLTAGE AC INPUT CABLES FOR 13-G4618-10

-369500-17013 Clamp-on Ammeter; measures 10 - 100 Amperes	\$595
-369500-17016 Dual Range Clamp-on Ammeter; measures 100 - 1000 Amperes	\$595

TRANSDUCER SIGNAL CONDITIONER ACCESSORIES

11-5407-10 Connector (14-pin), mates with 20-4616-50 signal conditioner input connector	\$35
11-5407-6 Connector adapter, adapts input connector (11-5407-3) to 6-pin Cannon connector receptacle	\$150
-369500-104 Adapter cable, 6-pin Cannon to 12-pin Deutsch (transducer signal conditioner)	\$195

TEMPERATURE SIGNAL CONDITIONER ACCESSORIES

Conversion Kit Assembly

11-4308-41 Chromel-Alumel (Type K)	\$250
11-4308-42 Copper-Constantan (Type T)	\$250

HIGH VOLTAGE CONNECTORS FOR 5700 PROGRAMMABLE SIGNAL CONDITIONERS

-892684-1 Cable assembly, 25 ft. long, for 13-G4615-90	\$150
CL-810413- Isolated high voltage connector. Allows shunt measurements from 50 mV to 500 mV to be made in presence of high common mode voltages up to 1500 V peak. It has voltage gain of 10.	\$975
CL-810414- High voltage connector (non-isolated): Allows safe high voltage measurements up to 1500 VAC. It is a passive system with an attenuation of 1000:1.	\$825

(216) 328-7000

6600 SIGNAL CONDITIONER CASE

11-4183-09

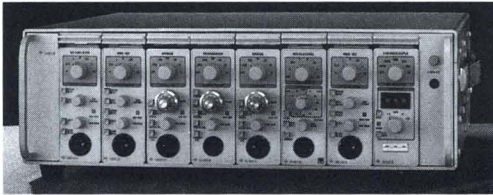

- Portable or rack mount case
- Supports all 6600 series signal conditioners
- User selectable output voltages to all recorders
- Light weight and compact for stand-alone or front-end applications

The 8-channel case is a rugged, low profile unit designed specifically for the 6600 series signal conditioners. The signal conditioners are easily inserted or removed via the front panel, providing maximum user convenience. The case provides three user selectable output voltages, available on three separate output connectors for application flexibility. The 6600 series case status kit, with communications interface option, will allow signal conditioner status reporting via the RS-232C/422 or IEEE-488 ports of the signal conditioner case to chart recorders or remote computers.

6600 CASE SPECIFICATIONS

OUTPUT:

- Frequency Response:** -3 dB at 10 kHz.
- Offset:** ±10 mV DC.
- Inaccuracy:** ±0.2%.
- Selectable Output Voltage:** 2.5, 5 or 10 VDC full scale.
- Output Connectors:** 37-pin D, 8 BNCs or 8 Multi-terminal Blocks.

GENERAL:

- Power Requirements:** 90-130 VAC or 200-265 VAC, 50-60 Hz.
- Dimensions:** 5.25 in. H x 16.75 in. W x 16 in. D (13.3 cm H x 42.4 cm W x 40.6 cm D).
- Weight:** 15 lbs. (7 kg).

ORDERING INFORMATION:

Model Number	Price
11-4183-09 6600 Series 8-Channel Case	\$1595
Options and Accessories	
11-4781-07 19-in. RETMA standard rack mount kit	\$160
11-4221-07 Status Kit with RS-232C/422 communications interface	*
11-4221-08 Status Kit with IEEE-488 Communications Interface	*
Cable Assemblies	
CL-311222-1 37-pin D to 37-pin D connector (3 ft)	\$85
CL-311222-2 37-pin D to 37-pin D connector (6 ft)	\$100
CL-712315- 8-BNC to 37-pin D connector (4 ft)	\$340
CL-713497- 8-BNC to 37-pin D connector (6 ft)	\$425
X51319 3-pin LEMO to unterminated (3 ft)	\$125

* Consult factory.

4600/5700 SIGNAL CONDITIONER

MODEL 5900

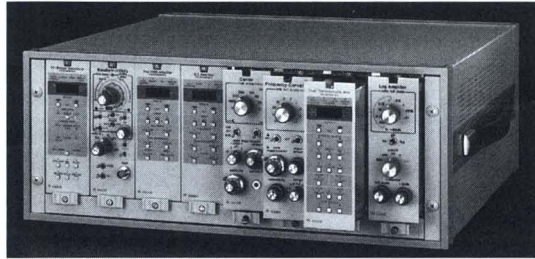

- Portable or rack mount case
- Supports all 5700 and 4600 signal conditioners
- Reports front-panel status of 5700 series signal conditioners
- Convenient insertion and removal of signal conditioners via front panel.

The 5900 signal conditioner case is designed for both the 4600 and 5700 series signal conditioners. The 5900 case provides the user with three signal conditioner outputs from BNC connectors, 10-pin terminal block, or 37-pin D shell connectors. This rugged case can be used for stand alone or front end applications with all recorders from Gould. The 5900 case is designed for remote control of the 5700 series signal conditioners via RS-232C or IEEE-488 interfaces.

MODEL 5900 SPECIFICATIONS

Dimensions

- Portable:** 8.13 in. H x 20 in. W x 19 in. D (20.6 cm H x 50.8 cm W x 48.2 cm D).
- Rack Mount:** 7 in. H x 18 in. W x 17.8 in. D.(17.8 cm H x 45.7 cm W x 45.2 cm D).

Number of Signal Conditioner Slots: 8.

Power Requirements: 90 to 130 VAC and 200 to 260 VAC, 45 to 445 Hz.

Weight: 27 lbs.

ORDERING INFORMATION

Model Number	Price
5900 Signal Conditioner Case	
18-4183-3 Portable with RS3000 interface board and cable to RS3000 or TA4000	\$2495
11-4781-1 19-in. RETMA standard rack mount with RS3000 interface board and cable to RS3000 or TA4000	\$2295
Options and Accessories	
CL-311222-1 37-pin D to 37-pin D connector (3 ft)	\$85
CL-311222-2 37-pin D to 37-pin D connector (6 ft)	\$100
11-4221-1 Interpreter board	\$195
11-4221-3 RS-232C interface board kit	\$895
11-4221-4 IEEE-488 interface board kit	\$895
11-4221-6 RS3000-to-5900 interface board kit	\$75



- Continuously record data directly to personal-computer (PC) disk
- Transfer data to PC disk from DSOs and recorder, wave form-capture modules
- Perform extensive PC-based data analysis
- Output data from PC disk to recorder for traditional hard copy
- Export data to other PC applications for further analysis or report generation

Traditional industrial and life-science research applications are analog-trace oriented. Often these applications require an experienced operator to visually interpret charts and manually annotate, analyze and document test results. While these procedures are typically straightforward, it can be difficult to analyze a long chart, to correlate information between signals or to perform more complex analysis; and creating composite signals is essentially not an option. With the Data Acquisition and Signal Analysis (DASA) 4600 technology from Gould, all recording, storage, analysis, and report generation can be accomplished with computer speed and accuracy, thus making it reasonable to perform all of the above procedures and more.

Digital recorders based on the DASA 4600 technology are designed and built in the Gould tradition of simple power in versatile packages. The DASA 4600 technology provides the features needed to handle traditional recording and additional features to address

application requirements well beyond the capabilities of standard graphic recorders.

The DASA 4600 technology includes interactive software modules for signal recording, analysis, conversion, and management. Each module is designed to require minimum knowledge of computer operation; the PC becomes a digital recorder. Use the DASA 4600 hardware/software to set-up signals with real-time scrolling display and automate the test sequence with sophisticated triggering and control continuous recording to PC disk. The View II software displays, manipulates and analyzes signals and generates composite signals and reports. The DSF-to-ASCII software converts signals to text values. The DASA Utilities software lists, copies and deletes acquisitions. The Disk-to-Recorder software continuously outputs analog signals from PC disk.

DASA 4600 technology from Gould: hardware and software products that meet your application requirements from signal recording and real-time display to signal display, analysis and hard copy.

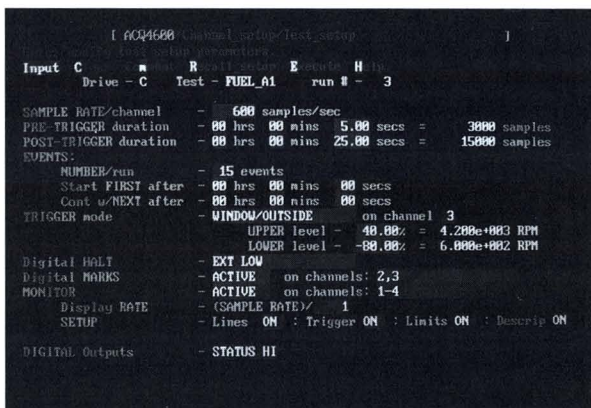

Simple menu system allows quick function selection. Setup is easy with on-line help available each step. You can operate in the units and descriptions you define.

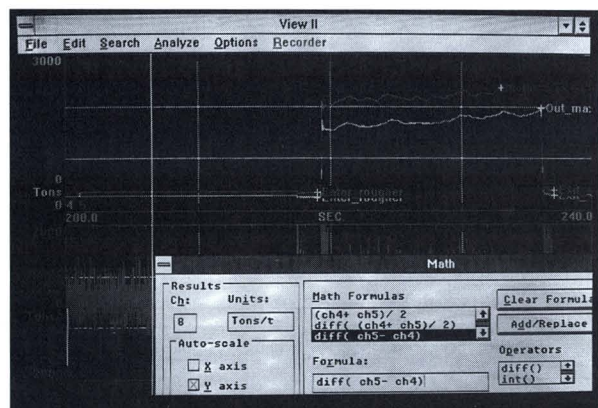

Mathematic functions generate composite signals from stored signals. Operate on all or part of your data. Save math formulas specific to your test with the signal data.

DASA 4600 DIGITAL RECORDERS

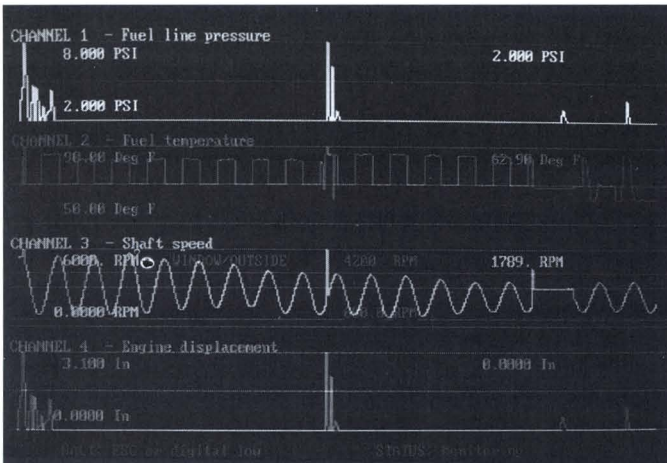

Display real-time signals on the DASA 4600 recorder's color monitor while monitoring or while recording signals to disk.

- **Multiple configurations: desktop, rack mount and portable (DataGraf II)**
- **Record up to 16 channels while viewing any 8 on real time monitor**
- **Record continuously, directly to disk at 80 ksamples/s aggregate (DC to 10 kHz)**
- **Advanced analysis built in: cursor measurements, math, frequency domain**
- **Extensive triggering: pre-trigger, signal level, event, manual**
- **Optional analog output from disk for playback to other instrumentation**

Digital recorders based on the DASA 4600 technology are designed and built in the Gould tradition of simple power in versatile packages. The DASA 4600 technology provides the features needed to handle traditional recording and additional features to address application requirements well beyond the capabilities of standard graphic recorders: continuous recording to PC disk; real-time scrolling monitor; sophisticated triggering; test sequence automation; composite signals; and built-in report generation.

Simple power

From data logging to high-speed acquisition, the DASA 4600 recorder combines up to 16 analog input channels of high-frequency recording with laboratory precision. The DASA 4600 recorder is available in several packages: the portable DataGraf II, fully factory installed and tested desktop and rack mount PCs, and hardware/software kits for installation in existing PCs.

Using the DASA 4600 recorder is simple: the PC keyboard and an optional mouse operate menus and fill-in forms to specify speed, number of channels, start/stop of recording, etc. The analysis and report generation features help you quickly find critical information and present it in the most appropriate format.

Real-time monitor

The color monitor of the DASA 4600 recorder displays signals in real time, either while simply monitoring or while recording data to disk. Sampled signals appear immediately at the right edge of the display. Checking system setup is easy. The individual DVM-like readouts for each channel allow precise transducer calibration. Signals are easily differentiated by color and annotation.

Signal conditioning

You can not analyze what you can not see. The first requirement in solving any application problem is the

accurate conversion of data into voltage signals usable by a recording instrument. With the DASA 4600 recorder, either use the built-in, simple signal conditioning or externally connect any of the signal conditioner lines from Gould. The new, high performance 6600 series signal conditioners and 8-channel case offer an especially compact package to use in front of the DASA 4600 recorder. See page 68 to 72 for complete information on 6600 series signal conditioners.

Easy setup

The DASA 4600 recorder uses a simple menu system for quick function selection. Setup is easy with on-line help available each step of the way. Repetitive tests are a snap, since the DASA 4600 recorder allows you to save and recall your signal and test setup.

Choose your measurement

From start to finish, the DASA 4600 recorder operates in the engineering units and descriptions you specify. Whether displaying values or generating computed signals, the results are in the format you choose.

Graphical display

Integrated within the DASA 4600 recorder is the View II signal analysis program. See page 91 for details on the graphical presentation capabilities of the View II software: review up to 16 traces; manipulate signals with expansion/compression, overlay, or time shifting; mark data for permanent record keeping; discover critical data by finding levels, times or pre-marked data points.

Advanced analysis

Integrated within the DASA 4600 recorder is the View II signal analysis program. See page 91 for details on the advanced analysis capabilities of the View II software: cursor measurements with engineering units, frequency domain calculations, mathematically combine channels with user-specified formula, and standard

measurements: min., max., RMS, dy/dx, area, standard deviation, etc.

Report generation

Report generation was never easier. The View II software and Microsoft Windows 3.x make it a snap to cut and copy a segment of your signal to other Windows applications. Select a portion of your data and copy it to Microsoft Excel for further analysis. The View II software will convert it to ASCII data and place it directly into the spreadsheet. Or, copy the 'picture' of a segment of your signal directly to Microsoft Word for Windows and add text for a complete report document.

Hard copy output

After acquisition and analysis, there is often a need for hard copy output. Whether this is in the form of continuous graphical recording paper or as a report generated by laser printer or digital plotter, the DASA 4600 recorder offers a solution to meet your reporting requirements. For report output, any printer or plotter required by Microsoft Windows can be used. If traditional hard copy is desired, the DASA 4600 recorder offers a unique disk-to-recorder option. This option simultaneously outputs up to eight channels of data from disk to almost any analog recorder. See page 94 for details on the Disk-to-Recorder Analog Output option.

DASA 4600 SPECIFICATIONS

DATA RECORDING

See the DataGraf II Recorder (page 89) for complete specifications on data recording to disk.

DATA REVIEW

See the View II Software (page 91) for complete specifications on data review from disk.

ANALYSIS

Time Domain

Frequency Domain

See the View II Software (page 91) for complete analysis specifications.

PHYSICAL CHARACTERISTICS (With 9030-x172-02 Recorder)

Operating Temperature: 0 to +50°C at 10% to 90% RH.

Input Power: 115 or 220 V, 50/60 Hz.

Dimensions: 6.25 in. H x 21.25 in. W x 16.5 in. D (15.9 cm H x 54 cm W x 41.9 cm D).

Weight: Less than 30 lbs. (13.6 kg).

ORDERING INFORMATION

Description	Price
9020-2172-02 DASA 4600 System , Compaq 386/25M, 120 Mb hard drive	\$13495
9020-3172-02 DASA 4600 System , Compaq 386/25M, 320 Mb hard drive	\$16495
99030-2172-02 DASA 4600 System , Desktop 386/25 CPU, 105 Mb hard drive	*
9030-3172-02 DASA 4600 System , Desktop 386/25 CPU, 240 Mb hard drive	*
Note: Above systems include: 1.44 Mb 3.5 in. diskette drive, 1.2 Mb 5.25 in. diskette drive, 4 Mb RAM, 80387 math co-processor, 14 in. color monitor, mouse, DASA 4600 Acquisition Kit, Real-time Scroller card, View II Analysis Kit, MS-DOS, Microsoft Windows 3.x.	
9021-2272-02 DASA 4600 System , 19-in. RETMA standard rack mount 386/25 CPU, 105 Mb hard drive	*
9021-3272-02 DASA 4600 System , 19-in. RETMA standard rack mount 386/25 CPU, 240 Mb hard drive	*
Note: Above systems include: same as 9030-x172-02 except without 1.2 Mb 5.25 in. diskette drive.	

* Consult Factory.

Model Number	Price
CL-715126-01 Optional 3.5 in., 1.44 Mb diskette drive	\$195
CL-715126-04 Optional hard drive, 210 Mb	\$1695
CL-715126-20 Memory expansion, 4 Mb	\$495
CL-615423-1 DASA 4600 acquisition kit: Acquire 4600 software and A/D hardware	\$3495
CL-615422-1 View II analysis kit	\$2995
CL-615422-2 DSF-to-ASCII conversion kit	\$295
Note: View II and DSF-to-ASCII Kits include DASA utilities.	
CL-714173- Card, EGA video	\$295
CL-710342-1 Card, Real-time scroller	\$1895
CL-614297 Card, IEEE-488, National AT-GPIB, 16-bit ISA bus	\$795
CL-712450- Card, IEEE-488, National PC2A, 8-bit ISA bus	\$695
CL-712406- Card, IEEE-488, National MC-GPIB, microchannel bus	\$795
CL-212419- Color monitor, multisync, 14 in.	\$1095
CL-212451- Mouse, Microsoft serial	\$250
-369500-91001 Cable, Centronic printer, 6 ft.	\$50
CL-311222-1 Cable, input, 37-pin D-shell to 37-pin D-shell, 3 ft.	\$85
CL-311222-2 Cable, input, 37-pin D-shell to 37-pin D-shell, 6 ft.	\$100
-797293- Cable, input, 37-pin D-shell to 37-pin D-shell, 10 ft.	\$95
CL-713497- Cable, input, 37-pin D-shell to 8 BNC, 6 ft.	\$425
11-4310-22 Cable, input, 37-pin D-Shell to 8 Molex, 9 ft.	\$125
11-4310-23 Cable, input, Molex to spade lug, 6 in.	\$15
11-4310-25 Cable, input, Molex to BNC, 6 in.	\$45
11-4310-27 Cable, input, Molex to Quick Disconnect, 6 in.	\$15
11-4310-29 Cable, input, Molex to bare wire, 6 in.	\$10
11-4310-33 Cable, input, Molex to spade lug with RFI filter, 6 in.	\$100
11-4310-28 Cable, Acquire 4600 to 2000S recorder control	\$50
11-4310-30 Cable, Acquire 4600 to RS3000 recorder control	\$75

DataGraf II DIGITAL RECORDERS



- Rugged construction for shop-floor, in-vehicle and shipping integrity
- Portable design: one package, stand-up operation with fold-out keyboard
- Record up to 16 channels while viewing any 8 on real time monitor
- Record continuously, direct to disk at 80 ksamples/s aggregate (DC to 10 kHz)
- Advanced analysis built in: cursor measurements, math, frequency domain
- Scale each channel in engineering units
- Extensive triggering: pre-trigger, signal level, event, manual

The DataGraf II digital recorder is designed and built in the Gould tradition: simple power in a rugged package. The Data Acquisition and Signal Analysis (DASA) 4600 technology from Gould provides the DataGraf II with the features needed to handle traditional recording and with additional features to address application requirements well beyond the capabilities of standard graphic recorders: continuous recording to PC disk; real-time scrolling monitor; sophisticated triggering; test sequence automation; composite signals; and built-in report generation.

Simple power

From data logging to high-speed acquisition, the DataGraf II recorder combines up to 16 analog input channels of high-frequency recording with laboratory precision. The DataGraf II recorder is packaged to provide the flexibility and ruggedness you expect from Gould recorders: carry it around; stand it up on the shop floor; operate it in a moving vehicle; use it on a bench.

Using the DataGraf II recorder is simple: a PC-style keyboard and an optional mouse operate menus and fill-in forms to specify speed, number of channels, start/stop of recording, etc. The analysis and report generation features help you quickly find critical information and present it in the most appropriate format.

Real time monitor

The internal color monitor of the DataGraf II recorder displays signals in real time, either while simply monitoring or while recording data to disk. Sampled signals appear immediately at the right edge of the display. Checking system setup is easy. The individual DVM-like

readouts for each channel allow precise transducer calibration. Signals are easily differentiated by color and annotation.

Signal conditioning

You can not analyze what you can not see. The first requirement in solving any application problem is the accurate conversion of data into voltage signals usable by a recording instrument. With the DataGraf II recorder, use either the built-in, simple signal conditioning or externally any of the signal conditioner lines from Gould. The new, high performance 6600 series signal conditioners and 8-channel case offer an especially compact package to use in front of the DataGraf II recorder. See pages 68 to 72 for complete information on 6600 series signal conditioners.

Easy setup

The DataGraf II recorder uses a simple menu system for quick function selection. Setup is easy with on-line help available each step of the way. Repetitive tests are a snap, since the DataGraf II recorder allows you to save and recall your signal and test setup.

Choose your measurement

From start to finish, the DataGraf II recorder operates in the engineering units and descriptions you specify. Whether displaying values or generating computed signals, the results are presented with the scaling you specify.

Graphical display

Integrated within the DataGraf II recorder is the View II signal analysis program. See page 91 for details on the graphical presentation capabilities of the View II

software: review up to 16 traces; manipulate signals with expansion/compression, overlay, or time shifting; mark data for permanent record keeping; discover critical data by finding levels, times or pre-marked data points.

Advanced analysis

Integrated within the DataGraf II recorder is the View II signal analysis program. See page 91 for details on the advanced analysis capabilities of the View II software: cursor measurements with engineering units, frequency domain calculations, mathematically combine channels with user-specified formula, and standard measurements: min., max., RMS, dy/dx, area, standard deviation, etc.

Report generation

Report generation was never easier. The View II software and Microsoft Windows 3.0 make it a snap to cut and copy a segment of your signal to other Windows

applications. Select a portion of your data and copy it to Microsoft Excel for further analysis. The View II software will convert it to ASCII data and place it directly into the spreadsheet. Or, copy the "picture" of a segment of your signal directly to Microsoft Word for Windows and add text for a complete report document.

Hard copy output

After acquisition and analysis, there is often a need for hard copy output. Whether this is in the form of continuous graphical recording paper or as a report generated by laser printer or digital plotter, the DataGraf II recorder offers a solution to meet your reporting requirements. For report output, any printer or plotter supported by Microsoft Windows can be used. If traditional hard copy is desired, the DataGraf II recorder offers a unique disk-to-recorder option. This option simultaneously outputs up to eight channels of data from disk to almost any analog recorder. See page 94 for details on the Disk-to-Recorder Analog Output option.

DataGraf II SPECIFICATIONS

RECORDER

System Controller: Intel 80386, 25 MHz CPU, 80387, 25 MHz Math Co-processor, 4 Mb RAM (expandable to 8 Mb).

Diskette Drive: 1.44 Mbyte, 3.5 in.

Hard Drive: 52, 105, or 210 Mb.

Operating System: MS-DOS, Microsoft Windows.

Acquisition Channels: 16 single ended, 8 differential.

Monitor Channels: 1 to 8; any combination of acquisition channels.

Monitor: 7 in. diagonal; 640 x 350 (EGA) pixels; 0.28 dot pitch.

Recording Length: 1 sample up to available disk space

Accuracy: 12 \pm 1/2 bit.

Non-linearity: \pm 1 bit.

Input Range: Bipolar 10, 5, 2.5, 1, 0.5 V; unipolar 10, 5, 2, 1 V (factory set to bipolar 5 V).

Over Voltage: \pm 35 V continuous.

Input Current: 250 nA at 25°C.

Input Impedance: 10 Megohm.

Conversion Rate: 0.01 to 80,000 samples/s, aggregate.

Interchannel Skew: Fixed at 10 μ s.

Triggering: Keystroke, time, external digital, level (above, below, inside window, outside window).

Control Outputs: 4 x TTL level. Status: start/end test, pretrigger filled, trigger occurred, post trigger filled. Gould 3000 Series chart recorder control: chart start/stop, chart speed.

Analog Outputs (optional): 1 to 8 channels. See Disk-to-Recorder Kit (page 93).

ANALYSIS

Time Domain

Frequency Domain

Note: See the View II software (page 91) for complete analysis specifications.

PHYSICAL CHARACTERISTICS

Operating Temperature: 0 to +50°C at 10 to 90% RH.

Input Power: 115 or 220 V, 50/60 Hz.

Dimensions: 8 in. H x 18.5 in. W x 24 in. D (20.3 cm H x 47.0 cm W x 61.0 cm D).

Weight: Less than 50 lb. (22.7 kg).

Shock and Vibration: Meets MIL-STD-810D.

ORDERING INFORMATION

Model Number	Price
9311-1210-01 DataGraf II Digital Recorder, 105 Mb hard drive	\$13995
9311-1310-01 DataGraf II Digital Recorder, 210 Mb hard drive	\$14995
CL-715126-01 Optional 3.5 in. 1.44 Mb diskette drive	\$195
CL-715126-04 Optional hard drive, 210 Mb	\$1695
CL-715126-20 Memory expansion, 4 Mb	\$495
CL-212451- Mouse, Microsoft serial	\$250
CL-311222-1 Cable, input, 37-pin D-shell to 37-pin D-shell, 3 ft.	\$85
CL-311222-2 Cable, input, 37-pin D-shell to 37-pin D-shell, 6 ft.	\$100
-797293- Cable, input, 37-pin D-shell to 37-pin D-shell, 10 ft.	\$95
CL-713497- Cable, input, 37-pin D-shell to 8 BNC, 6 ft.	\$425
11-4310-22 Cable, input, 37-pin D-shell to 8 Molex, 9 ft.	\$125
11-4310-23 Cable, input, Molex to spade lug, 6 in.	\$15
11-4310-25 Cable, input, Molex to BNC, 6 in.	\$45
11-4310-27 Cable, input, Molex to Quick Disconnect, 6 in.	\$15
11-4310-29 Cable, input, Molex to bare wire, 6 in.	\$10
11-4310-33 Cable, input, Molex to spade lug with RFI filter, 6 in.	\$100
-369500-91001 Cable, Centronic printer, 6 ft.	\$50

VIEW II SIGNAL ANALYSIS SOFTWARE

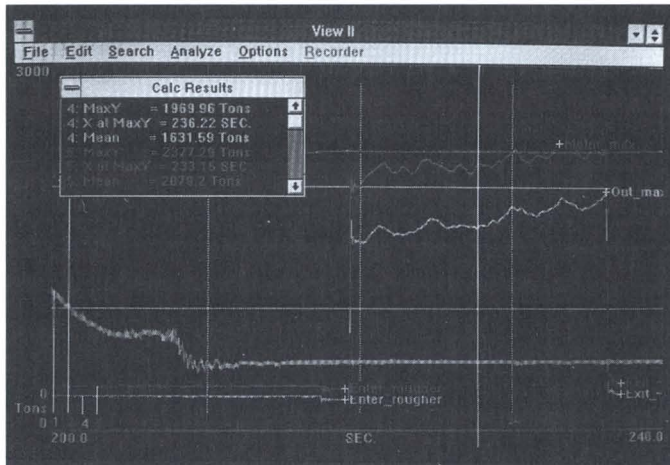

Standard calculation results performed over critical signal segments are displayed in a window and stored on disk.

- Displays 1 to 16 channels
- Up to 512 MS/channel analysis capacity
- Labels, grids and cursor measurements with engineering units
- Displays signals separated or overlapped in y-t or x-y formats
- Frequency domain calculations: FFT/inverse FFT, power spectrum, etc.
- Standard measurements: min., max., RMS, dy/dx, area, standard deviation, etc.
- Mathematically combine channels with

Traditional industrial and life-science research applications are analog-trace oriented. Often these applications require an experienced operator to visually interpret charts and manually annotate, analyze and document test results. While these procedures are typically straightforward, it can be difficult to analyze a long chart, to correlate information between signals or to perform more complex analysis; and creating composite signals is essentially not an option. The View II Signal Analysis software from Gould makes it possible and reasonable to perform a wide range of the above procedures and more with computer speed and accuracy.

Compatibility

The View II software is built into the DataGraf II recorder and the DASA 4600 desktop and rack mount recorders. The View II software operates with signal data stored on disk by the WindoGraf recorder, the Acquire DSO signal transfer software and the CAS 4000 signal transfer software.

Signal display and manipulation

The View II software operates on all or any portion of one to 16 signals. For convenient comparison and analysis, these signals can be a mix from different acquisitions or even different recorders: a signal from today, yesterday and last year; relatively slow signals from a DataGraf II recorder and faster ones from a 1624 DSO. All signal information are displayed in the units specified when the signals were stored on disk.

Each signal is displayed within its own "window." These windows can be sized and either tiled adjacently, overlapped or shifted in time to optimize signal interpretation and easily uncover trends or relationships.

Each window contains a user-specified amount of data and can be configured using several display attribute functions: grids, labels, scales, both y-t and x-y formats. The y-axis and x-axis expansion/compression functions can show an overview of the signal or detail at any critical points. Points of interest can be marked with text to make your permanent records complete.

Search for points of interest

Finding points of interest often requires an experienced operator to visually scan signals and interpret a complex wave shape. But, this process can be made more efficient by using simple search criteria to jump to a potential point of interest. The View II software has functions that can simultaneously search any combination of the signals for the first occurrence of a signal level, a previously marked point, a point in time or the trigger point.

Signal analysis

The View II software provides several tools for signal analysis. The results of all analysis functions are presented in the units of the signal being analyzed.

A cursor is the tool for making amplitude and time measurements. Manual interpretation and long-hand math are no longer required; just position the cursor and read it directly.

Another tool is a set of standard calculations — area, mean, RMS, std. dev., max. y, min. y, etc. — that can be performed over a user-defined segment of a signal. The results are displayed in a separate window and can be stored on disk for later report generation.

Another tool is user-specified formulas that can be used to mathematically combine existing signals to gen-

erate composite signals like power or force. And, signals can be manipulated in the frequency domain with FFT, cross correlation, etc.

Default setups

For any given group of signals, there may be setups that are particular to those signals. Each time these signals are opened, you may want the display scaled to specific values; a specific set of calculations selected; or math formulas pre-defined. Any of these configurations can be defined as the View II software's default setup. Also, previously saved setups can be recalled by name to quickly change the View II configuration to a known state.

Report generation

The task of generating reports can be easier, more efficient and produce higher quality results. The View II software and Microsoft Windows 3.x make it a snap to cut and copy a segment of your signal to other Windows applications.

Select a portion of one or more signals, then select the Copy function. The View II software will convert the signals to ASCII-text values and place them into the

Windows Clipboard. From there they can be pasted into a Microsoft Excel spreadsheet for further analysis or into other text-based applications. Or, copy the 'picture' of the signals displayed by View II, then paste this graphic into a graphics package or a Microsoft Word for Windows document and add text for a complete report.

Hard copy output

After analysis, hard copy output is often needed. The signals and all other information displayed by the View II software can be output to any printer, plotter or other output device supported by Microsoft Windows. The View II software does not simply perform a screen dump; the signals are recreated using the resolution of the output device to provide as much signal detail as possible.

Analog output

If traditional, chart recorder hard copy is desired, a unique disk-to-recorder option is available for the View II software. This option simultaneously outputs up to eight channels of data from disk to almost any analog recorder. See page 94 for details on the Disk-to-Recorder Analog Output option.

VIEW II SPECIFICATIONS

DISPLAY

Channels: 1 to 16; mix and match from any test.

Format: y-t and x-y; tile/overlay any combination.

Expansion/Compression: Independent per channel; x- and y-axes; user specified limits .

Reference Line: User specified DC-level; one per channel.

Annotation Options: Channel ID, x- and y-axis scale, mark IDs, grid, sample points only or line join.

Grid: User specified, independent number of divisions per x- and y-axis; tick marks only or grid lines; independent per channel.

Mark IDs: 1 to 20 characters/sample; unlimited number.

X-axis Shift: Shift any channel relative to others; shift any point on all channels relative to display screen.

ANALYSIS

Time Domain

Search: Any mix of channels; first occurrence; forward or backward.

Search Criteria: Sample number, time, ID marks, trigger point or signal level.

Cursor Measurements: Channel ID, event no., sample no., time and date of trigger, x and y value, x- and y-axis limits.

Per Channel Calculations: Area, mean, RMS, std. dev., max. y, min. y, max. y - min. y, x at max. y, x at min. y, dy/dx, delta x, 1/delta x, y at reference, ASCII text.

Calculation Endpoints: Left edge, right edge, beginning of data, end of data, mark ID, time, sample number, cursor.

Per Channel Math: Operate on all or on part of channels; user specified formula; unlimited level of parentheses.

Math Operators: +, -, *, /, (,), abs(), diff(), exp(), int(), log(), log 10(), pow 10(), sq rt(), sinr(), rad to deg(), deg to rad().

Frequency Domain

Calculation Functions: FFT, inverse FFT, power spectrum, cross power spectrum, transfer function, impulse response, coherence, auto correlation, cross correlation.

Display Output: Real, imaginary, magnitude, dB or phase vs. frequency.

Filters: Kaiser-Bessel, Blackman, Blackman-Harris, Hamming, square (box car).

FFT Point Size: 16 samples to 8 ksamples.

SETUPS

Definition: User specified as startup default or use-at-will; unlimited number; can be saved with test.

Selections: Annotation options, signals to review, display format, calculations and calculation endpoints, math formulas.

DATA EXPORT

Graphics: User selected rectangular portion of signal display; copied to Windows clipboard.

ASCII Text: Any portion of displayed signals; formatted in columns, optional text header.

Text Header: Test name, run number, device name, channel number, event number, number of samples, start sample number, end sample number, trigger date, trigger time, time at start sample, sample separation, x-axis units, y-axis upper limit, y-axis lower limit, y-axis max. value, y-axis min. value, y-axis units.

ORDERING INFORMATION

Model Number	Price
CL-615422-1 View II Analysis kit (includes DASA Utilities).	\$2995
CL-214635-1 Microsoft Windows 3.x, 3.5 in. diskettes	\$195
CL-212451- Mouse, Microsoft serial	\$250

DISK-TO-RECORDER ANALOG OUTPUT KIT

- Output 1 to 8 analog signals from data stored on disk
- Output composite signals along with original signals
- One 12-bit DAC per channel for high resolution analog output
- Four-pole reconstruction filter
- Save recorder paper; playback only significant portion of signals
- Control recorder start/stop, chart speeds and more

Now gain all of the advantages of digital data storage, manipulation and analysis and still meet government or internal requirements for strip-chart paper recording. The Disk-to-Recorder Kit from Gould works with the View II software (part of all DASA 4600 and DataGraf II recorders) to reconstruct analog signals directly from disk. Virtually any pen, thermal array or electrostatic recorder can be used for continuous output of large signal files. This state-of-the-art option faithfully reproduces signals as if they were being recorded in real time.

Because the signals are stored on disk, they can be cut, edited and rearranged prior to output; again and again. Signals created by the View II software's Math function can also be output to a recorder, allowing, for the first time, composite signals (e. g., force, watts, etc.) to be right along side their component signals.

Save paper by plotting only relevant information. Any portion of the original data from a few microseconds to

hours can be reconstructed and output to the recorder for crisp, clean archiving. Also, since the View II software handles each signal independently, signals can be placed in any order, selected from any acquisition and plotted on any recorder channel. This means that signals acquired months or seconds apart can be placed side by side or overlaid on the recorder for comparison.

To help insure the output is recorded correctly on the chart, any of the following control mechanisms can be used: digital, RS-232C or IEEE-488. Digital control is provided by 8, TTL outputs. For most recorders, these should allow control of chart start/stop and chart speed. A user-specified command string can be sent across the RS-232C or IEEE-488 interface at the start and another at the end of the plot. Depending on the recorder, multiple commands could be sent at the same time to perform more complex recorder setup before plotting: grid formats, annotation, channel IDs, etc.

DISK-TO-RECORDER ANALOG OUTPUT KIT SPECIFICATIONS

ANALOG OUTPUT

Output Channels: 1 to 8; 1 DAC per channel, simultaneously latched.

Output Range: ± 2.5 or ± 5 V, selectable per channel.

DAC Resolution: 12 bits.

DAC Accuracy: $\pm 0.1\%$.

DAC Output Settling Time: 3 μ s (typical).

Reconstruction Filter: Low-pass, 4-pole, active filter; 24 dB/octave.

Output Rate: 1 to 400 samples/s/channel.

CONTROL OUTPUT

Digital: 8 TTL outputs. User-specified, 8-bit pattern set at the start and another at the end of signal output.

Interface: RS-232C or IEEE-488. User-specified command string sent at the start and another at the end of signal output.

Start/End Command Length: Max. 110 characters.

SYSTEM CONFIGURATION

Compatibility: PC/AT or 100% compatibles.

Environment: Microsoft Windows 3.x with View II or other DDE client.

PHYSICAL/ENVIRONMENT

Bus Utilization: 1, 8-bit ISA long slot.

Analog Output: 9-pin D-shell.

Control Output: 15-pin D-shell.

Operating Temperature: 0 to $+70^{\circ}\text{C}$.

ORDERING INFORMATION

Model Number	Price
CL-713446- Disk-to-Recorder Analog Output Kit	\$2995
CL-615422-1 View II Analysis kit (includes DASA Utilities)	\$2995
CL-214635-1 Microsoft Windows 3.x, 3.5 in. diskettes	\$195
CL-212451- Mouse, Microsoft serial	\$250

Disk-to-Recorder Analog Output Kit Specifications

Model Number	Price	Model Number	Price
CL-614041-1 Cable kit, disk-to-recorder to RS3000 recorder	\$295	CL-713747- Cable, analog only, disk-recorder to 2000S recorder	\$195
CL-614041-2 Cable kit, disk-recorder to 2000S recorder	\$295	CL-613719- Cable, analog only, disk-recorder to RS3000 recorder	\$95
CL-614041-3 Cable kit, disk-recorder to ES2000 recorder	\$395	11-4310-28 Cable, Acquire 4600 to 2000S recorder control	\$50
CL-614041-4 Cable kit, disk-recorder to TA4000 recorder	\$295	11-4310-30 Cable, Acquire 4600 to RS3000 recorder control	\$75
CL-614041-5 Cable kit, disk-recorder to TA2000 recorder	\$295		

DSF-TO-ASCII SIGNAL CONVERSION SOFTWARE

- Convert 1 to 8 signals stored on disk to standard ASCII text file
- Convert only significant data; select any portion of the signals
- Optional text header of detailed information identifying each channel
- ASCII data values scaled in signal's real-world units
- Microsoft Windows 3.x application

Perform further analysis and report generation by exporting signals stored on disk to other applications. The DSF-to-ASCII signal conversion software converts signals stored on PC disk by Gould products. Specify any portions of one to eight signals to convert from Gould-specific database formats to ASCII-text values.

The converted values are scaled in the signal's real-world units and formatted in columns, one per signal, in the output file. These ASCII-text, output files can be easily imported into most applications: existing custom or third-party data analysis, database, spreadsheet, word-processing or report generation software.

DSF-TO-ASCII SIGNAL CONVERSION SOFTWARE SPECIFICATIONS

SIGNAL EXPORT

Export Channels: 1 to 8.

Endpoints: Mark ID or sample number; select multiple segments, any portion of signals.

ASCII Text: Formatted in columns, optional text header.

Text Header: Test name, run number, device name, event number, start sample number, end sample number, trigger date, trigger time, time at start sample, sample separation, x-axis units.

Operating System: MS-DOS, Microsoft Windows.

ORDERING INFORMATION

Model Number	Price
CL-615422-2 DSF-to-ASCII Conversion Kit (includes DASA Utilities)	\$295
CL-214635-1 Microsoft Windows 3.x, 3.5 in. diskettes	\$195
CL-212451- Mouse, Microsoft serial	\$250

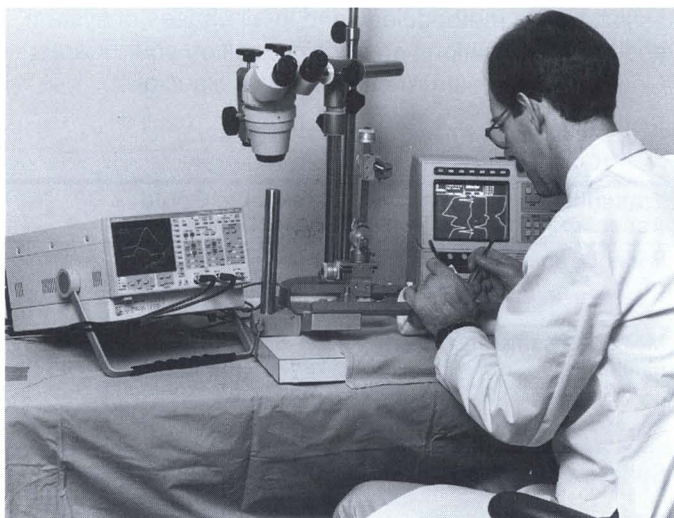

- **The industry leader with over 50 years experience in medical instrumentation and recording systems**
- **Complete systems for medical research, clinical and student teaching applications**
- **Broadest range of high quality ink and thermal array recorders**
- **Widest selection available of easy-to-use medical signal conditioners**
- **Worldwide sales and service support**
- **On-site operator training and toll free**

Gould's involvement in high-quality medical instrumentation dates back to the 1930s, when we introduced the first practical, portable electrocardiograph. Since then, we have developed a full line of medical instrumentation for accurately measuring, displaying, and recording a wide range of variables in the medical research, clinical, and teaching environments.

Quality, accuracy, and reliability are hallmarks of all medical products from Gould — one reason why our instrumentation is used in leading research centers, hospitals, and medical schools throughout the world.

Our commitment to the highest quality, state-of-the-art equipment, plus a worldwide sales and service

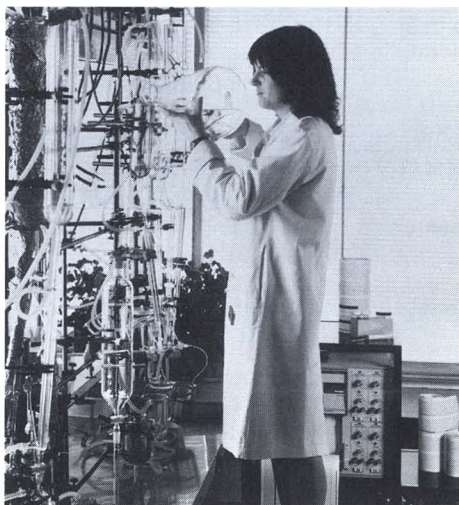

Because of their quality, accuracy and reliability, medical instruments from Gould are used in research centers throughout the world.

network, offer a total solution for your medical instrumentation requirements. Our complete product-plus-support approach assists you from system specification and selection through installation and post-sale service.

The medical instrumentation described on these pages represents our most current products. Large mainframe systems, recorders, signal conditioners, digital displays, and accessories provide the widest selection of medical instrumentation products to meet your specific application requirements.

All 6600, 5700 and 4600 series Medical Instrumentation signal conditioners are designed specifically for life science research and clinical applications. Our EasyGraf, WindoGraf, DataGraf, RS3000, TA2000, TA4000 and ES2000 recorders can be operated on a bench top or in rack-mounted systems.

Medical Systems and Medical Instrumentation products from Gould meet your exact investigative, diagnostic or student teaching requirements. For more detailed information on our medical products, consult the Gould Medical Products Catalog: Instrumentation and Accessories for Biomedical Research and Clinical Cardiology. Request a copy from your nearest sales office or from the Valley View address on the back cover.

We welcome and value your comments and suggestions concerning our Medical Instrumentation products. If you need more information or help, please contact your local Gould Medical Sales Specialist.

GOULD INSTRUMENTATION CHART FOR MONITORING PHYSIOLOGICAL SIGNALS

Use these definitive charts to determine which of the wide variety of Signal Conditioners from Gould you can combine with an appropriate transducer and recorder to meet your specific physiological recording needs. For

assistance in methodology and in all phases of system design, specifications and pricing, call on your nearest Gould Medical Instrumentation Sales Specialist.

Bioelectric Measurements

Application/Description	Frequency Range	Transducer/Accessory	Applicable Gould Signal Conditioner
Electrocardiogram (ECG or EKG) - Record of electrical activity of heart, usually recorded from body surface electrodes	0.05-500 Hz	Patient Cable Kit	20-4615-64 ECG 20-4615-65 ECG/Biotach
Electrophysiology (EP) - Invasive study of electrical activity of heart. Electrode tipped catheters are placed inside heart to record local potentials. Electrodes may be surgically placed on or in heart muscle (myocardium)	0.05-1000 Hz	Multipolar catheter, custom electrodes	20-4615-58 Universal with 18-5407-58 Isolated Preamp 13-6615-58 Bioelectric
Electroencephalogram (EEG) - Record of electrical activity of brain. Recorded from surface electrodes on scalp	1-100 Hz	Surface electrodes	20-4615-58 Universal with 18-5407-58 Isolated Preamp 13-6615-58 Bioelectric
Electromyogram (EMG) - Record of electrical activity of a muscle. An index of total activity can be obtained by integrating the primary signal	5-2000 Hz	Surface electrodes, needle electrodes, or custom electrodes	20-4615-58 Universal with 18-5407-58 Isolated Preamp 13-6615-58 Bioelectric 13-G4615-70 Integrator
Electronystagmogram (ENG) - Record of changes in eye position using electrodes placed near eyes. Rate of movement is calculated by differentiating primary signal	DC-100 Hz	Ag/AgCl surface electrodes	20-4615-58 Universal with 18-5407-58 Isolated Preamp 13-6615-58 Bioelectric 13-G4615-71 Differentiator
Electroretinogram (ERG) - Record of electrical activity of retina	0.01-200 Hz	Custom "contact lens" electrodes	20-4615-58 Universal with 18-5407-58 Isolated Preamp 13-6615-58 Bioelectric
Direct Nerve Recordings - Record of electrical activity of single nerve or nerve bundle made by placing electrodes directly on or in the nerve or bundle. An index of activity can be obtained by integrating primary signal	DC-10,000 Hz	Custom electrodes	20-4615-58 Universal with 18-5407-58 Isolated Preamp 13-6615-58 Bioelectric 13-G4615-70 Integrator

Computed Measurements (Pre-conditioned signals obtained from other medical signal conditioners.)

Application/Description	Primary Signal	Applicable Gould Signal Conditioners
Heart Rate - Beats per minute (beat-by-beat or average)	ECG waveform, Pulsatile pressure waveform or Pulsatile blood flow waveform	20-4615-65 ECG/Biotach 13-G4615-66 Biotach
Respiratory Rate - Breaths per minute	Respiratory flow waveform, Chest movement or Respiratory activity waveform	13-G4615-66 Biotach
Respiratory Volume - Volume of air expired in single breath or per minute	Respiratory flow (pneumotach)	13-G4615-70 Integrator
LV dP/dt - Index of myocardial contractility computed using first derivative of left ventricular blood pressure	Left ventricular blood pressure	13-G4615-71 Differentiator
Rate of Muscle Contraction - Index of isotonic muscle contraction computed using first derivative of muscle length signal	Muscle length (isotonic signal)	13-G4615-71 Differentiator
d force/dt - Rate at which a muscle develops force while length is held constant	Force of contraction (isometric signal)	13-G4615-71 Differentiator
Nerve Activity - Index is developed by measuring area under curve (integral) representing sum of nerve action potentials	Direct nerve recording	13-G4615-70 Integrator
Muscle Activity - Index is developed by measuring area under curve)	Electromyogram	13-G4615-70 Integrator

6600, 5700, 4600 Series Medical Instrumentation Signal Conditioners

Gould, the established leader in signal conditioning, sets a new standard of excellence with the 6600, 5700 and 4600 series signal conditioners. Our full complement of signal conditioners has long been recognized as the industry standard for applications in clinical, medical and research applications.

The new compact 6600 series offers even more value, especially when used with the WindoGraf, DataGraf and EasyGraf recorders.

The 5700 series is fully programmable and can be operated remotely via computer. Significant benefits include consistent and repeatable setup; reduced setup time; and elimination of "useless" data from improper front-panel settings.

The 4600 series signal conditioners are designed to fit exacting requirements in your medical application.

All signal conditioner series and cases are compatible with every recording product from Gould.

Transduced Measurements

Application/Description	Primary Signal	Frequency Range	Applicable Gould Signal Conditioner
Blood Pressure - Hydrostatic pressure of blood in any vessel of body	Pressure transducers	DC-200 Hz	20-4615-35 Carrier 20-4615-58 Universal 20-4615-50 or 13-6615-50 Transducer 20-4615-526611/12 Pressure Processor
Phonocardiogram - Record of heart sounds. May be taken from the chest surface, using microphone or invasively using transducer-tipped catheter.	Heart sound microphone; Transducer-tipped catheter	16-2000 Hz	20-4615-58 Universal 13-6615-50 Transducer
Carotid Pulse/Apex Pulse - Indirect recording of blood pressure pulse waveform in the carotid artery, or mechanical movement of heart	Apex/carotid pulse sensor	0.1-60 Hz	20-4615-58 Universal 20-4615-64 ECG 20-4615-65 ECG/Biotach 13-G4615-66 Biotach
Photoplethysmograph - Qualitative recording of arterial pulse waveform made by sensing changes in volume of blood in finger, ear lobe, etc.	Photoelectric finger, radial, or ear pulse sensors	0.05-30 Hz	20-4615-64 ECG 20-4615-65 ECG/Biotach 13-G4615-66 Biotach
Respiratory Flows and Volumes - Primary signal is rate of flow of air into or out of lungs in liters/seconds. Integrating this signal gives volumes of air expired (inspired) in liters	Pneumotach with differential pressure transducer	DC-40 Hz	20-4615-35 Carrier with 13-G4615-70 Integrator
Respiratory Activity - Motion of chest associated with respiration - qualitative only	Pneumotrace respiratory belt	DC-2 Hz	57-1340-6158 DC or 57-1440-6158 DC
Temperature - Body temperature, or temperature of an organ, region, water bath, or chemical reaction	YSI thermistor; RTD	DC-10 Hz	13-G4615-474029 Temperature
Isotonic Muscle Contraction - Change in muscle length while holding force constant	Gould Metripak®	DC-200 Hz	57-1340-6158 or 57-1440-6158 DC 20-4615-58 Universal 20-4615-50 Transducer
Isometric Muscle Contraction - Force of contraction of muscle held at constant length	Gould Metrigram®	DC-200 Hz	20-4615-58 Universal 20-4615-50 or 13-6615-50 Transducer 20-4615-35 Carrier
Esophageal Pressure - Force exerted by esophagus when moving food from mouth to stomach	Multi-lumen catheter, infusion system and pressure transducers or multi-transducer catheter	DC-20 Hz	20-4615-50 or 13-6615-50 Transducer 20-4615-35 Carrier 20-4615-58 Universal

Preconditioned Measurements

Transcutaneous blood gases; Respiratory O₂, CO₂; pH; organ blood flows are quantities that are preconditioned using specialized external amplifiers with DC outputs. Examples of specific applications are:

Application/Description	Specialized Signal Conditioner	Applicable Gould Signal Conditioner
Stroke Volume - Volume of blood ejected by heart in one beat	Blood flow signal from electromagnetic flow meter around ascending aorta	13-G4615-70 Integrator
Cardiac Output - Volume of blood pumped by heart per minute	Blood flow signal from electromagnetic flow meter around ascending aorta	13-G4615-70 Integrator
Cardiac Output (indicator dilution) - Volume of blood pumped by heart per minute	Dye or thermal dilution signal from cuvette densitometer or cardiac output computer	57-1340-6158 DC 13-6615-10S DC 20-4615-58 Universal

BIOELECTRIC SIGNAL

13-6615-58



- Accuracy and versatility for the measurement of ECG, EEG, ENG, EMG and other bioelectric potentials
- Measurement range: 50 μ V to 5 V, AC coupled input
- Input leakage current: meets ANSI/AAMI safe current limits for electromedical instrumentation
- Defibrillation protected and automatic baseline reset
- Selectable bandpass filters
- Reports front panel status

The bioelectric signal conditioner provides high input impedance, selectable bandwidth filters and low noise necessary for the demanding requirements of medical research and clinical applications. This high gain Signal Conditioner accurately measures bioelectric potentials as low as 50 μ VAC with simple front panel controls that makes operation quick and easy. The lightweight and compact bioelectric signal conditioner from Gould is designed for use with the WindoGraf and EasyGraf recorders or the 6600 series 8-channel signal conditioner case.

13-6615-58 SPECIFICATIONS

INPUT:

Measurement Range: 50 μ V to 5 V full scale.

Ranges: 0.05, 0.1, 0.25, 0.5, 1, 2.5, 5 V, Off.

Circuit: AC Coupled, Differential, Balanced to Isolated Common.

Impedance: >10 M Ω .

Sensitivity: Variable gain control from x 1 to x 2.5.

Input Leakage Current: <10 μ A at 240 VAC, 60 Hz. Meets ANSI/AAMI Safe Current Limits for Electromedical Instrumentation.

CMRR: >100 dB at 60 Hz.

Selectable Filters: 12 dB/octave filter.

Low Cutoff: 0.05, 0.5, 1, 10, 30, 100 Hz.

High Cutoff: 10, 30, 100, 300, 1000, 5000 Hz.

Noise: <20 μ V P-P at 0.05 Hz to 5 kHz.

OUTPUT:

Bandwidth: -3dB at 0.05 to 5000 Hz.

Internal Calibration Signal: 1 mV and 1 V.

Baseline Reset: Automatic on Overvoltage in mV range; Manual via Front Panel Switch in mV and V ranges.

ORDERING INFORMATION

Model Number

13-6615-58 Bioelectric Signal Conditioner

CL-615061- 3 Lead ECG cable kit

CL-214611- Input connector 14-pin DIN male

Price

\$975

\$210

\$10

Gould Test and Measurement Group

TRANSDUCER SIGNAL

13-6615-50



- Accurately measures pressure, force and displacement
- Measurement range: 1 to 5000 mmHg
- Push button auto balance and calibration
- Select mean and low-pass filters from front panel
- Selectable excitation voltage: 1, 2, 5 or 10 VDC
- Reports front panel status

The 6600 series transducer signal conditioner has been specifically designed to meet the demanding requirements of medical research and clinical applications. This amplifier provides accurate, high quality, measurement of pressure, force and displacement using all commonly available transducers. Auto balance and front panel calibration make set-up and operation quick and easy. Convenient mean pressure measurements, with standard 3.2 s time constant, are push-button easy. A low pass filter may be selected to eliminate unwanted noise, giving exceptionally clear signals.

13-6615-50 SPECIFICATIONS

INPUT

Sensitivity: 100 μ V to 0.5 VDC full scale.

Ranges: 10, 25, 50, 100, 250, 500, 1000 & 5000 mmHg full scale.

Circuit: Differential.

Impedance: 4 M Ω , differential.

Max. Input Voltage: 12 VDC or AC P-P.

CMRR: -80 dB at 60 Hz with 100- Ω unbalance.

Excitation Voltage:

Voltage: Off, 1, 2, 5 and 10 VDC (user selectable).

Current: Continuous 100 mA. Short Circuit Limited to 175 mA.

Low Pass Filter: 100 Hz. Low pass 2 pole Bessel.

OUTPUT

Frequency Response

Unfiltered: DC to -3 dB at 5 kHz.

Mean Filter: 0.05 Hz. low pass (3.2 s TC, user selectable).

Inaccuracy: <0.1% of full scale.

Non-linearity: <0.1% of full scale.

Auto Balance Range: Sens. x 1 \pm 2,000 mmHg (5 μ V/mmHg, 5 V Exc.). Sens. x 10 \pm 20,000 mmHg (5 μ V/mmHg, 5 V Exc.)

ORDERING INFORMATION

Model Number

13-6615-50 Transducer Signal Conditioner

CL-811124- Bridge completion board

CL-214611- Input connector 14-pin DIN male

11-5407-72 Deutsch to DIN adapter cable

Price

\$850

\$20

\$10

\$225

(216) 328-7000

UNIVERSAL™ SIGNAL

20-4615-58

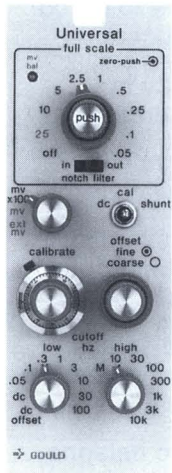

- Accurately measures input signals from 25 mV to 10 V AC or DC
- Measures pressure, force and displacement from strain gage transducers directly in units of measure
- Measures bioelectric potentials from high frequency nerve potentials to DC coupled eye potentials
- Provides high input impedance, selectable bandwidth, filters, low noise and low drift

The universal signal conditioner provides high input impedance, high gain, and low noise characteristics required for recording bioelectric potential including HIS Bundle, EMG, EOG, EEG, ENG and ECG. A stable DC excitation provides precise measurements of pressure, force and position. An optional isolated preamplifier provides patient isolation* and true AC coupling, by putting the first gain stage close to the signal source. This configuration reduces signal loss and noise associated with long signal cables, high impedance electrodes and non-isolated amplifiers.

*For bioelectric recordings only. For pressure measurements, patient isolation is provided by the transducer.

20-4615-58/18-5407-58 SPECIFICATIONS

INPUT

- Measurement Range:** 25 mV to 10 V full scale.
- Ranges:** 0.05, 0.1, 0.25, 0.5, 1, 2.5, 5, 10, 25 V, Off.
- Circuit:** Isolated and guarded, differential and balanced to isolated reference.
- Sink Risk Leakage Current:** <10 mA at 230 VRMS, 60 Hz, input to chassis.
- Input Impedance:** DC coupled: >1000 MΩ shunted by <30 pF. AC coupled: ≈100 MΩ shunted by <30 pF.
- Max. Safe Input Voltage:** 50 V peak input to reference. 500 V peak input to chassis.
- Internal Calibration Signal:** Internally selectable 50 μV or 1 mV ±1%.
- Shunt:** Connects shunt calibration resistor across one arm of bridge circuit for user selectable calibration signal.
- Bridge Excitation:** 5 VDC ±5 mV (adjustable via plug-in resistor), polarity reversible.
- Notch Filter:** On/Off switch for 60-Hz noise rejection.

OUTPUT

- Frequency Response (Adjustable):** DC to 10 kHz (-6 dB).
- Recorder and Monitor Outputs:** 5 V into 50 kΩ, single ended to ground.

ORDERING INFORMATION

Model Number	Price
20-4615-58 Universal Signal Conditioner	\$1595
18-5407-58 Isolated input preamplifier	\$930

TRANSDUCER SIGNAL

20-4615-50



- Accurately measures pressure, force, and position using standard transducers
- Simple, precise calibration directly in mmHg, grams, cm
- Front panel selection of direct or average (mean)
- Calibrated zero suppression in units of measure
- Selectable low pass output filter
- Multiple outputs for recorder, digital display, monitor, and computer

The transducer signal conditioner is a precision module for accurately measuring pressure, force, or position. A stable excitation voltage is provided for DC strain gage transducers while providing for plug-in bridge completion resistors. Precision calibration directly in mmHg, grams, or cm is provided by the front-panel controls. Calibrated zero suppression permits adding or subtracting a constant from the input signal, which is especially useful for moving the baseline without interrupting a procedure or recalibrating. A 2-pole, low pass filter is available to eliminate high-frequency signal components.

20-4615-50 SPECIFICATIONS

INPUT

- Measurement Range:** 50 μV to 5 V full scale (10 mmHg to 500 mmHg full scale with Gould blood pressure transducers).
- Ranges:** Off, 500, 250, 100, 50, 25, 10, balance.
- Circuit:** Differential balanced to ground.
- Input Impedance:** 50 kΩ.
- Calibrated Zero Suppression:** 0 to ±100 or 0 to ±1000 units.
- Calibration Sensitivity:** 50 to 250 μV/V/cmHg.
- Bridge Excitation:** ±2.5 VDC standard (variable to ±5.0 VDC with plug-in resistor) regulated to ±0.05%.

OUTPUT

- Frequency Response**
 - Direct Mode:** DC to -3 dB at 1 kHz internally selected filter.
 - Average Mode:** Mean pressure (3.2-s time constant).
- Recorder and Monitor Outputs:** 5 V single-ended to ground into 2 kΩ or greater.
- Display Output:** 10 mV/unit or 100 mV/unit into 2 kΩ or greater (internally selected).

ORDERING INFORMATION

Model Number	Price
20-4615-50 Transducer Signal Conditioner	\$1195
CL-213447- P23XL pressure transducer	\$1195
CL-213448- P10EZ pressure transducer	\$1195

TEMPERATURE SIGNAL

13-G4615-474029

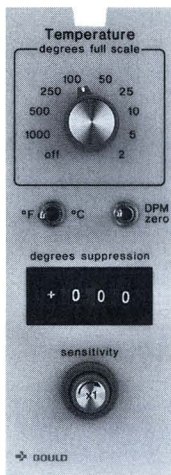

- Accurately measures temperature using YSI 400 and 500 series thermistor probes
- High sensitivity and wide measurement range — from 2° to 1000°C or °F full scale
- Digital zero suppression — 0 to ±999°C or °F
- Direct readout in degrees Celsius or Fahrenheit
- Direct measurement with no calibration required

This signal conditioner has a broad measurement range for widely fluctuating temperatures or measures small temperature changes at the most sensitive range setting. Front panel controls simplify calibration, which is accomplished directly in degrees Celsius or Fahrenheit, as desired. The 4600 series temperature signal conditioner offers a digital zero suppression from ±1° to ±999° and precise electronic linearization, up to 0.2% full scale. For applications outside the range of YSI probes and thermistors, the signal conditioner uses platinum RTDs for environmental temperature measure-

13-G4615-474029 SPECIFICATIONS

INPUT

Measurement Range: ±2° to ±1000°C or °F.

Ranges: 2, 5, 10, 25, 50, 100, 250, 500, 1000°, Off.

Standard Input Sensors: 100, 200, 500, or 1000 Ω, 4-wire Platinum (385 RTDs) or Yellow Springs Instrument (YSI) 400 or selected 500 series Thermistor Probes.

Circuit: 4-wire, differential to floating common.

Input Impedance: 1 MΩ.

Calibrated Zero Suppression: 0° to ±999° in 1° steps (°F or °C).

OUTPUT

Frequency Response: DC to -3 dB at 10 Hz ±20%.

Output Voltage: 5 V into 2 kΩ.

Display Output (internally selected): 10 or 100 mV/°F or °C, 10 V max.

Thermistor Probe Operations: YSI 400 and 500 series Thermistor Probes.

Range: 0° to 42°C

Linearity: Within ±0.5°C from 4°C to 40°C; within ±1°C from 0°C to 42°C.

ORDERING INFORMATION

Model Number	Price
13-G4615-474029 Temperature Signal Conditioner	\$1395
11-5407-54 Deutsch to phone jack adapter for YSI probes	\$175

Gould Test and Measurement Group

PRESSURE PROCESSOR

20-4615-526611/526612



- Connects directly to blood pressure transducers
- Calibrated directly in millimeters of mercury
- Computes parameters of blood pressure waveform
- User selectable systolic, diastolic, mean, and pulse pressure modes
- Calculates and displays parameters beat-by-beat or on 2-, 4-, or 8-beat average
- Push button auto balance and one-step calibration

The pressure processor extracts the discrete parameters of the dynamic arterial blood pressure waveform from strain gage blood pressure transducers. In addition to amplifying the signal and displaying the waveform in the direct mode, the following outputs are available for graphic display on a recorder, or independently, for numeric readout on a digital display: systolic pressure, diastolic pressure, mean pressure, pulse pressure, and heart rate. All outputs are simultaneously available for use with remote digital displays. The 13-4615-526612 automatically updates changes in full scale settings.

20-4615-526611/526612 SPECIFICATIONS

INPUT

Measurement Range: 125 mV to 7.5 V full scale.

Attenuator Steps: 20, 40, 200, 400 mmHg or bpm full scale.

Circuit: Differential and balanced to ground.

Input Impedance: 1 MΩ shunted by 200 pF to ground.

Bridge Excitation: ±2.5 VDC standard, polarity reversible, regulated to ±0.05%.

Trigger Requirements (dP/dt): Minimum signal for reliable trigger: a pulse pressure greater than 25 mmHg and changing at greater than 100 mmHg/second.

Display Update Pulse: TTL compatible positive pulse, ≈10 ms in duration initiated by dP/dt pulse.

OUTPUT

Frequency Response: -3 dB at 100 Hz ±20% (12 dB/octave). Mean: 2 s time constant or computed as S-D÷3+D selected internally.

Recorder Output: 5 V into 50 kΩ or greater, single-ended to ground.

Display Output: 10 V into 50 kΩ or greater. Scaled at 10 or 100 mV/mmHg or bpm (internally selected).

ORDERING INFORMATION

Model Number	Price
20-4615-526611 Pressure Processor	\$2695

(216) 328-7000

DC SIGNAL CONDITIONERS

57-1440-6158 AND 57-1340-6158

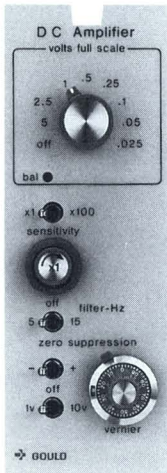

- Wide measurement range with excellent sensitivity full scale
- Calibrated zero suppression for more detailed evaluations
- User selectable low pass output filter
- Easy to use for accurate low voltage measurements
- Excellent for direct measurement of preconditioned signals
- Reports front panel status

These economical, direct-coupled signal conditioners are useful for general purpose monitoring and recording of DC voltages in the laboratory and other medical research applications. Up to 16 factory-set, fixed-gain measurement ranges are provided, plus a variable sensitivity control that permits operation at any point between the fixed-gain ranges. Low-pass output filtering is selectable to eliminate objectionable high-frequency signal components. The optimal status reporting board supplies all front panel status information to any recorder from Gould for hardcopy output.

57-1440-6158/57-1340-6158 SPECIFICATIONS

INPUT

Measurement Range: 25 mV to 500 V full scale.
Ranges: 0.025, 0.05, 0.1, 0.25, 0.5, 1, 2.5, 5 V, Off
Circuit: Differential, balanced to ground.
Sensitivity: Expands measurement up to x 2.5 calibrated setting.
Input Impedance: 2 MΩ.
Calibrated Zero Suppression (57-1340-6158 only): 0 - 5 V at x1; 0 - 500 V at x10.
CMRR: 100 dB at 60 Hz with 1-kΩ unbalance.

OUTPUT

Frequency Response:
57-1440-6158: Filter out: DC to 35 kHz. Filter in: user selectable plug-in component.
57-1340-6158: Filter out: DC to 35 kHz. Filter in: -3 dB at 15 kHz; -3 dB at 5 Hz; 12 dB/octave.
Output Voltage: 5 V full scale into 2 kΩ or greater, single ended to ground.
Inaccuracy: ±0.5% of calibrated setting.

ORDERING INFORMATION

Model Number	Price
57-1340-6158 DC Signal Conditioner with suppression	\$695
57-1440-6158 DC Signal Conditioner	\$495
11-4220-1 Isolation kit	\$95
11-4220- Status kit	\$250

BIOTACH™ SIGNAL CONDITIONER

13-G4615-66



- Computes biological rates beat-by-beat or time averaged from hummingbirds to whales
- User selectable ECG, pulse and respiration rate modes
- Peripheral pulse sensor input
- Excellent measurement sensitivity from 20 bpm to 2000 bpm full scale
- Five separate simultaneous outputs
- TTL compatible sync pulse for system control
- Alarm mode

The biotach signal conditioner accurately measures the beat-by-beat or average rate of repetitive physiological events, including cardiac and respiratory. Input signals originating from ECG, pulse, and respiratory events, may come from other signal conditioners or directly from photoelectric pulse sensors. The biotach is designed with special circuitry that ensures that only a legitimate input event triggers the signal conditioner for accurate rate computation. Multiple simultaneous outputs are: direct reproduction of the input signal; computed rate for recorder or monitor; and 10 mV/bpm rate signal for digital display.

13-G4615-66 SPECIFICATIONS

INPUT

Signal Input Sensitivity: 2.5 mV to 5 V FS plus x 1 to x 2.5 vernier (single ended to ground).
Photoelectric Pulse Sensor Excitation Current: 25 mA DC ±5 mA.
Rate Sensitivity: 20 to 1000 bpm FS plus x 1 to x 2.5 vernier.
Rate Trigger Requirement (min. signal):
ECG Mode: 15% of full scale, changing at 30 mV/s.
Pulse Mode: 10% of full scale, changing at 3 mV/s.
Respiration Mode: 15% of full scale, changing at 1 mV/s.

OUTPUT

Frequency Response (-3 dB):
ECG Mode: 0.05 Hz to 200 Hz, ±20%.
Pulse Model: 0.5 Hz to 20 Hz, ±20%.
Respiration Mode: 0.05 Hz to 10 Hz, ±20%.
Sync Output: TTL compatible, 20 ms (±20%) positive pulse remains high in alarm mode.
Recorder and Direct Monitor Outputs: 5 V FS.
Rate Display Output: Single ended to ground. 0 to +10 V. Rate signal only for digital display, 10 mV = 1 bpm. Either beat-by-beat or average.
Rate Monitor Output: 5.0 V FS; single ended to ground. Beat-by-beat or average selected by internal jumper.

ORDERING INFORMATION

Model Number	Price
13-G4615-66 Biotach Signal Conditioner	\$1795

ECG AND ECG/BIOTACH SIGNAL CONDITIONERS

20-4615-64 AND 20-4615-65

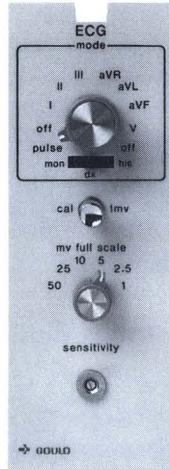

- Complete 12-lead ECG capability
- Arterial pulse sensor input
- Patient isolated and defibrillator protected
- Selectable Monitor/Diagnostic/HIS bandwidths
- Automatic reset on overload or lead change
- TTL compatible QRS sync pulse output

20-4615-65 —

- Two signal conditioners in one with independent outputs for ECG waveforms and rate
- Physiologic rate determination from ECG, arterial pulse or high level signals from other signal conditioners, such as pressure or flow

The **isolated ECG** signal conditioner offers the flexibility to accurately measure a full 12-lead ECG or a peripheral pulse. Specifications exceed American Heart Association's recommendation for electrocardiography. Full isolation per ANSI/AAMI safe current limits for electro-medical apparatus is standard, as is defibrillator protection. The TTL sync pulse, when triggered by the R-wave or the rising portion of the pulse waveform, is useful for resetting integrators, synchronizing defibrillators, or for computer control. A built-in pulse circuit receives inputs from finger, ear, radial or carotid pulse sensors to provide blood pressure waveforms as a second method for monitoring the heart during electrocautery or stress-producing procedures.

The **isolated ECG/Biotach** is a versatile, multifunction signal conditioner with an ECG mode and a physiological rate measurement mode. Two separate outputs are available for simultaneous recording and monitoring of waveform and rate. Rate outputs are in two forms: an analog rate signal for recording, and a 10-mV/bpm signal for digital rate display. Additional available outputs include blood pressure waveforms from finger, ear or radial pulse sensors; a sync pulse coincident with the R-wave or the rising portion of a blood pressure waveform to control other equipment per cardiac cycle; and a 10 mV/bpm signal for digital display of computed beat-by-beat or average rate.

20-4615-64 / 20-4615-65 SPECIFICATIONS

20-4615-64 and -65 Signal Conditioners	ECG (Normal)	ECG (Fetal)	Pulse	External Input
Step Sensitivity FS	1, 2.5, 5, 10, 25, 50 mV	500 μ V, 1.25, 2.5, 5.0, 12.5, 25 mV	2, 5, 10, 20, 50, 100 mV	20, 50, 100, 200, 500 mV, 1 V
Input Circuit Configuration	Five ECG leads electrically isolated from chassis and power		Single ended to chassis	
Frequency Response (-3 dB)	0.5 Hz to 30 Hz		0.75 Hz to 20 Hz	0.5 Hz to 100 Hz
Monitor ($\pm 20\%$)	0.05 Hz to 500 Hz		0.5 Hz to 20 Hz	0.05 Hz to 100 Hz
Diagnostic ($\pm 20\%$)	30 Hz to 500 Hz			
HIS ($\pm 20\%$)				
Common Mode Rejection	Isolated inputs to chassis: 140 dB at 60 Hz Isolated inputs to reference leads: 85 dB with 5-k Ω unbalance		Not applicable	
Sync Pulse Trigger*	15% of full scale, changing at 30 mV/s		20% of full scale, changing at 3 mV/s	
Amplifier Output Configuration	5 V, single ended to chassis, 50 Ω .			
Overload Recovery	Automatic reset restores baseline in less than 1 s. Manual reset via the CAL pushbutton or lead selector change.			

*Rate Trigger on -65, Minimum Requirement.

(20-4615-65 ECG/BIOTACH SIGNAL CONDITIONER ONLY)

Rate Measurement Range: 20, 50, 100, 200, 500, 1000 bpm FS plus x1 to x2.5 vernier between steps.

Time to Alarm: 5 s $\pm 20\%$. Variable by changing internal plug-in resistor.

ORDERING INFORMATION

Model Number

20-4615-64 ECG Signal Conditioner

20-4615-65 ECG/Biotach Signal Conditioner

Price

\$1795

\$2295

INTEGRATOR SIGNAL

13-G4615-70

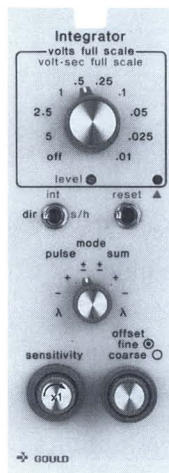

- Single-step calibration
- Simple front panel controls for integration measurements
- Programmable reset timer
- Full-wave rectified mode
- Preview of signal to be integrated (DIRECT)
- Peak integral recording (SAMPLE/HOLD)
- 10 mV · s to 50 V · s full scale integrate range
- Accurately measures 10 mV to 50 VDC

The integrator determines the area under an input function waveform per unit of time. Whether the input signal is positive, negative, or bipolar, the signal may be offset, half-wave rectified, or full-wave rectified before integration. The integral can be reset externally via switch closure or TTL pulse, or internally via amplitude level, zero crossing, or internal timer. In addition, the value of the integral may be sampled and held prior to any reset function, thus allowing for use with digital displays. Some applications include: determination of stroke volume from aortic blood flow; expiratory or inspiratory volume from respiratory air flow; or even the relative index of activity from electromyograms or neurograms.

13-G4615-70 SPECIFICATIONS

INPUT

Measurement Range: Direct: 10 mV to 50 V FS. Integrate: 10 mV·s to 50 V·s FS.
Ranges: 0.01, 0.025, 0.05, 0.1, 0.25, 0.5, 1, 2.5, 5 V, Off.
Circuit: Single ended to ground. Impedance: 1 MΩ.
Mode Selector (Direct or Integrate Functions): Selects both the Direct waveform to be integrated and Integrate reset method employed. Adjusts for signals > reference zero (+), < reference zero (-) or bipolar about reference zero (±). Permits full wave rectification of bipolar signal to determine its absolute value.
Pulse: Reset of integrator with zero crossing — may be offset.
Sum: Reset of integrator on time, external TTL pulse, or integral amplitude (level).
Level: 10% to 100% of full scale.
Time: In 1-s to 63-s increments; 1/60 s to 1-s increments (1/50 for 50 Hz operation).

OUTPUT

Frequency Response: DC to -3 dB at 8 kHz to integrator. DC to -3 dB at 300 Hz in DIRECT at amplifier output.
Amplifier Outputs (single ended to ground)
Recorder or Monitor: 5 VDC into 50 kΩ or greater.
Digital Display: 10 V into 50 kΩ or greater.
Noise (DC to 1 kHz): <50 μV P-P referred to input with 50-Ω source.

ORDERING INFORMATION

13-G4615-70 Integrator Signal Conditioner Price
\$1595

DIFFERENTIATOR SIGNAL

13-G4615-71

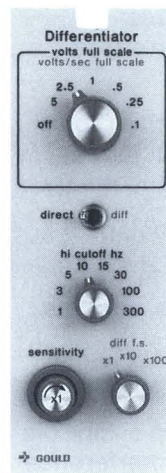

- Single-step calibration
- Simple front-panel controls for differentiation measurements
- 100 mV/s to 500 V/s differentiate range
- Selectable low pass filters for application flexibility
- Accurately measures rate of change for many physiological procedures
- Measures blood acceleration, blood flow and cardiac function

The differentiator determines the rate of change of an input function to determine acceleration from velocity or velocity from position. Some common applications include the determination of blood acceleration from blood flow, the determination of eye velocity from eye position while recording the electronystagmogram or as an index of contractility by taking the first derivative of pressure from the left ventricle of the heart. The unique feature of the Differentiator is the ease with which it may be calibrated when used with other signal conditioners. This eliminates the need for auxiliary test equipment and tedious calibrations. In the direct mode, the differentiator will measure 100-mV to 5 VDC.

13-G4615-71 SPECIFICATIONS

INPUT

Measurement Range (plus x1 to x2.5 vernier)
Direct Mode: 100 mV FS to 5 V FS.
Differentiate Mode: 100 mV/s FS to 500 V/s FS.
Range: 0.1, 0.25, 0.5, 1, 2.5, 5, Off.
Circuit: Single ended to ground.
Input Impedance: 1 MΩ.
Sensitivity: Variable gain control from x 1 to x 2.5.
High Cutoff Frequency: Selectable 3 pole. Low pass filters: 1, 3, 5, 10, 15, 30, 100, 300 Hz.

OUTPUT

Frequency Response (high cutoff): -3 dB at 1, 3, 5, 10, 15, 30, 100, 300 Hz, ±20% with -18 dB/octave nominal rolloff.
Amplifier Outputs
Recorder: 5 V FS into 50 kΩ.
Monitor: 5 V FS into 50 kΩ.
Noise (100 mV or 100 mV/s FS, input shorted)
Direct Mode: 50 μV P-P referred to input.
Differentiate Mode: 50 μV/s P-P at 1 Hz increasing to 6 mV/s P-P at 100 Hz referred to input.

ORDERING INFORMATION

Model Number Price
 13-G4615-71 Differentiator Signal Conditioner \$1495

CARRIER SIGNAL CONDITIONER

20-4615-35

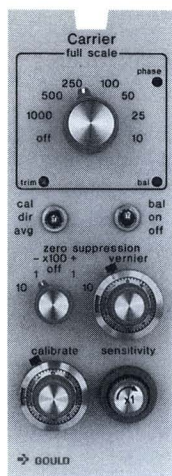

- Accurate and reliable measurement of pressure, force and position
- Provides AC excitation for LVDT, variable reluctance and strain gage transducers
- Push-button auto balance
- Simple calibration in physiological units, such as mmHg, grams, cm
- Calibrated zero suppression
- Easy synchronization of multiple units to eliminate interference

Carrier signal conditioner accurately measures pressure, force, and displacement, and is easy to use. It provides unique features for users of AC excited transducers; interactive R and C balance controls with electronic auto balance, as well as auto phase lock of excitation and signal. The carrier eliminates time consuming setup or phase errors; with just a flip of a switch, it's balanced. Calibration in physiological units is a simple, one-step process, and it works equally well with LVDT, variable reluctance, and strain gage transducers. In multiple transducer applications, carrier oscillators can be synchronized to eliminate interference, and all carrier signal conditioners can be balanced with a single command.

20-4615-35 SPECIFICATIONS

INPUT

Measurement Range: 50 μ V to 10.5 VRMS FS, plus internally selectable $\times 1 / \times 100$ input divider.

Ranges: 10, 25, 50, 100, 250, 500, 1000, Off.

Circuit: Differential balanced to common, isolated from ground.

Impedance: 1 M Ω .

Leakage Current: <10 μ A at 120 VRMS, 60 Hz between any input and chassis.

Noise: 10 μ V P-P at 350- Ω unbalance referred to input.

CMRR: >120 dB at 60 Hz with 350- Ω unbalance at 100 μ VRMS FS.

Zero Suppression: 0 to ± 100 or 0 to ± 1000 units plus "Off".

Auto Balance

Range: 0 to ± 10 mVRMS referred to input (R and C balance), variable via plug-in balance resistor.

Transducer Excitation

Voltage: Adjustable from 2 to 10 VRMS, isolated from chassis.

Frequency: 2500 Hz $\pm 5\%$ sine wave.

OUTPUT

Frequency Response: DC to -3 dB at 200 Hz. Mean: 3.2-s time constant.

ORDERING INFORMATION

Model Number

20-4615-35 Carrier Signal Conditioner

Price

\$1895

4 AND 8-CHANNEL MONITORS

51-4142-20 4-Channel Portable

51-3183-10 8-Channel Portable

51-3283-10 8-Channel Rackmount

- 9 and 20-in. oscilloscope monitors for portable and rackmount configurations
- High resolution CRT display
- Front panel trace position and variable gain control
- 300-Hz frequency response
- Selectable 25, 50 and 100 mm/s sweep speeds
- Overlapping traces for more detailed evaluations

The 4 and 8-channel monitors feature a non-glare, bright phosphor displays and a high frequency response for monitoring intracardiac electrograms and other high frequency recordings in the medical research laboratory. Front panel trace position and variable gain controls permit maximum versatility for setting up the display. The high resolution CRT display provides excellent viewability from a distance. The 4 and 8-channel monitors complement any of the Medical Instrumentation Recording Systems from Gould for the medical or clinical research laboratory.

4 AND 8-CHANNEL MONITOR SPECIFICATIONS

Viewing Dimensions: 4-channel: 20 cm x 25 cm; 8-channel: 29 cm x 37 cm.

Input Impedance: 4-channel: 100 k Ω single ended; 8-channel: 1 M Ω , single ended.

Maximum Input: 4-channel: 30 V; 8-channel: 100 V.

Frequency Response: 4-channel: >90 Hz at 50 mm/s; 8-channel: DC to -3 dB at 300 Hz.

Dimensions: 4-channel: 9.5 in. H x 13.0 in. W x 14.5 in. D (24.1 cm H x 33.0 cm W x 36.8 cm D). 8-channel: 19.5 in. H x 17.8 in. W x 17.6 in. D (49.5 cm H x 45.2 cm W x 44.7 cm D).

Weight: 4-channel: 31 lbs. (14 kg); 8-channel: 60.0 lbs. (27.2 kg).

Cables (must be ordered separately)
All cables are 20 m long.

ORDERING INFORMATION

Model Number

51-4142-20 4-Channel Monitor, portable with numerics

51-3183-10 8-Channel Monitor, portable

51-3283-10 8-Channel Monitor, 19-in. RETMA standard rack mount

CL-711183-2 15-pin D shell to 4 BNCs

CL-711185-2 15-pin D shell to 8 BNCs

Price

\$7995

\$5995

\$5995

\$235

\$400

MEDICAL INSTRUMENTATION FOR RESEARCH

RS3000 RECORDING SYSTEM

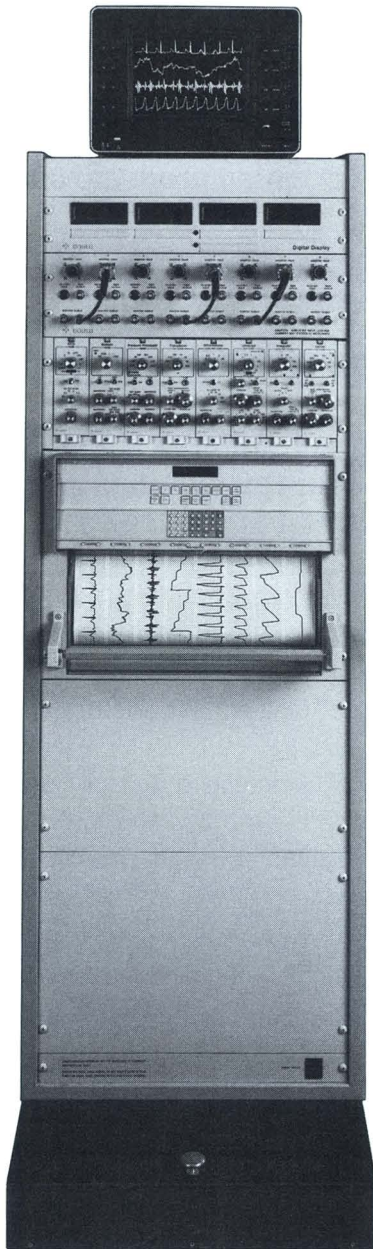

- Pressurized ink or thermal pen writing system
- Front panel push buttons for pen position and speed control
- Select from 1 to 8 channels with 40, 50 or 100 mm channel widths
- Unmatched frequency response
- Standard alphanumeric chart annotation
- Totally programmable system parameters
- Setup and change parameters from front

Gould is the industry leader in providing direct writing oscillographic recorders to the medical research community. Our exclusive pressurized ink and thermal pen writing systems produce the crisp, uniform traces required for testing and publication. The 6600, 5700 and 4600 series Medical Instrumentation signal conditioners have been accepted as the state-of-the-art choice for the exacting requirements of the medical and clinical researcher. Gould proudly offers the RS3000 recorder for the medical research laboratory. Whether you choose the rugged bench top recorder or customize a system for a complete solution to your recording needs, you can be assured of the highest quality from the leader in medical research instrumentation.

MEDICAL INSTRUMENTATION INPUT/OUTPUT PANELS

Medical Instrumentation Input/Output Panels simplify connections to and from the signal conditioners and the recorder. Front or rear mounting of the panel provides safe, convenient access to the signal conditioners. Direct access to the drive circuit or the recorder is as easy as inserting a standard phone plug. Outputs are available on three BNC connectors for connection to tape recorders, computers, monitors or other signal conditioners. All input connections are clearly labeled for easy identification.

ORDERING INFORMATION

Model Number	Price
11-1605-32 Input/Output Panel for RS3000 and TA4000, front mount	\$2750
11-1605-33 Input/Output Panel for RS3000 and TA4000, rear mount	\$2750
11-1605-34 Input/Output Panel for TA2000, front mount	\$2750
11-1605-35 Input/Output Panel for TA2000, rear mount	\$2750
11-1605-206460 Input/Output Panel for ES2000	\$2500

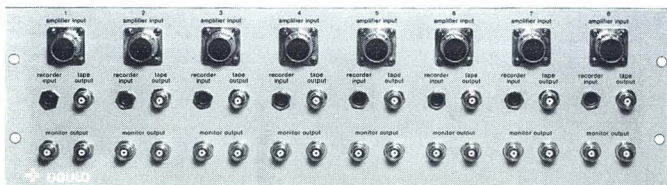

- **Complete industrial and medical systems**
- **Signal monitoring and data acquisition systems**
- **Application oriented products and systems**
- **19-in. RETMA standard system configuration**
- **Time saving hardware and software options**
- **Graphical programming systems for instrument control and data acquisition applications**

Gould offers application oriented systems and solutions for a wide variety of manufacturing and research settings. Gould has more than 50 years of experience in providing its customers with proven products and solutions, designed to increase productivity and improve quality. Working with customers in medical, industrial and aerospace applications, Gould has developed the products, the people and the expertise necessary to meet your specific application requirements.

Your experienced Gould Sales Engineer has a wide array of proven products and services designed to make your operation more efficient and effective.

In addition Gould provides you with experienced world-wide support and service. And our Applications Engineering and Service organizations are readily available to assist you throughout the world.

Complete Product Offering:

These high quality, proven performers offer the reliability which only comes from 50 years of supplying

test and measurement equipment to a broad customer base.

- Multi-Channel, Transient, Waveform Capture Instrumentation
- Wide Range of General and Special Purpose Signal Conditioning
- High Speed, Computer Based, Data Acquisition Devices
- Data Acquisition and Signal Analysis Software
- Hard Copy Graphic Recording Instrumentation

Worldwide sales support and service, combined with Gould's comprehensive line of measurement and monitoring instruments, provide our customers with proven performance and solutions. Call your local Gould Sales Engineer and let Gould's 50 years of experience and product development benefit your operation.

SYSTEM SERVICES

Training services are available to assist customers in the technical understanding and operation of the individual products and systems. Training services are normally included in the quotation for complete system installations, but may be added whenever required by the customer. Training service charges are based on pre-determined rates and the number of units required for specific products or systems. All training charges are subject to required minimums. Consult with your Gould Sales Engineer.

Engineering services are available for the modification of standard products to meet specific requirements. These services will be quoted from the Gould factory through your local Gould Sales Engineer.

Integration services are available from Gould for custom assembly of hardware and software to meet your requirements. The system is completely tested and functionally verified at the factory.

Installation services are also available from Gould Customer Service. Refer to page 125 for details.

Maintenance and Service Agreements are available from Gould Customer Service. Refer to page 125 for details.

Extended Warranty Agreements are available. Refer to page 126 for details.



Working with customers in medical, industrial and aerospace applications, Gould has developed the products, the people and the expertise necessary to meet your specific application requirements.

Examples of solutions Gould offers include:

Automated, fast response temperature monitoring. Gould designed a 96-channel monitoring system, using high speed programmable signal conditioning with dual alarm set points per channel. Monitoring is performed using multiple high resolution CRT displays. For archival purposes, ES2000 electrostatic recorders provide hardcopy output of key data. All functions are directed from one workstation.

Automated recording for emission control testing. Gould developed a TA4000 thermal array recorder with 20 input signals. The recorder and programmable signal conditioners are computer controlled. In addition, critical data channels are recorded directly to disk, using Gould's DASA based data acquisition system.

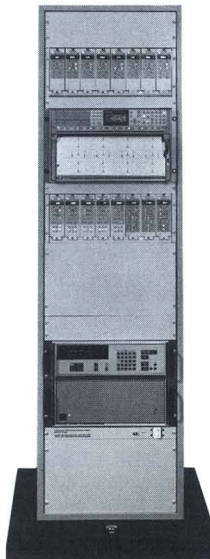

TELEMETRY AND SIMULATION DATA DISPLAY SYSTEM



- State-of-the-art system monitors and records simulated or telemetric signals
- Displays up to 40 analog or 80 digitized and 80 discrete channels plus alphanumeric time code
- Provides customized hard-copy output with programmable channel widths, grid patterns and extensive annotation
- Advanced Real Time Monitor provides flexible "quick-look" capability
- Transient capture capability
- Full local and remote programmability

Telemetry and Simulation Data Systems from Gould are the most advanced recording and display systems available for the aerospace and aviation industries. These systems are designed to provide the utmost in flexibility for your tests and data processing needs.

The systems accept signals from analog tape, data reduction computer, or directly from your front-end equipment. They provide basic DC signal conditioning for analog signals and formatting for digital signals. Time codes are read, displayed on the system monitor(s) and translated into alphanumeric print by our special interface. A time-controlled output provides for tape search capability.

Extensive annotation capability enables you to document your hard-copy outputs with all the information you need. You may select from pre-entered messages and

data identification to be printed periodically or on-the-fly (upon a keystroke or reception of a command from a computer). Also text can be entered on-line via the system keyboard or received from a computer.

The high resolution video Monitor provides "quick-look" display of simulated/telemetric signals that are identical to those on the moving chart. A special hard copy feature starts the chart only when recording is required and without losing any data. Optional slave monitors can be remotely located.

Our exclusive transient capture feature allows simultaneous real time monitoring and storage of data. Stored data can be later retrieved for more detailed analysis.

Specifications and Ordering Information

Consult your Gould Sales Office or Representative for more information.

TIME CODES

In many test applications, it is critically important to record time information together with physical data from the device under test. This gives a means of correlating data recorded on various media such as magnetic tapes, computer disk drives, chart recorders, printer/plotters. Without an accurate and reliable time reference, effectively correlating these data would just be impossible.

Over the past 30 years, time code formats have been developed to meet the need for interchange of test data among the various test ranges, contractors, laboratories and universities. The most popular codes have been adopted by the IRIG — Inter Range Instrumentation Group in 1959 (NASA Codes), 1960 and 1970 (IRIG

Codes).

IRIG Code formats are alphabetically designated: A, B, D, E, G and H. Among NASA Codes, only NASA36 is currently in use. Each code format is available in two signal forms:

- pulse, width coded often designated as DC level shift or DC code;
- sine wave, amplitude modulated with a recommended carrier frequency specific for each format.

The code time frame is composed of 100 elements. The time reference point is the leading edge of each element. There are three types of elements: binary "0" (2 ms long with IRIG B), binary "1" (5 ms long with

IRIG B) and position identifier (8 ms with IRIG B). The beginning of each frame is identified by two consecutive position identifiers. The reference time is at the leading edge of the second position identifier. This time is read by decoding the combination of binary "0" and binary "1" in the time frame that follows. The coding range is a function of the time code used. See IRIG Time Code "B" diagram below.

Slow Code

In addition to standard code formats, an interpretation of the time codes has been popular for a long time that is specially suitable for chart recording: it is called "slow code." Time code instruments generate this code to directly drive a recorder event marker. The slow code frame rate is selectable so that the marker deflection is easily interpreted at the chart speed selected.

Play-back ratio

Test data recorded on tape together with the time code (on one track) may be played back at a different speed from the original recording speed. In case of high frequency data, it is generally done to expand the time scale and allows for more detailed analysis. In case of long-term monitoring, it is done to zoom on the entire test data. Instrumentation used for display of test data must then be capable of reading time code information with a play-back ratio corresponding to play-back speed/recording speed. Ratio ranges typically from x8 to ÷16.

Time Code format	Time frame	Coding range	Optional coding	Modulated carrier fcy
IRIG A	100ms	0.1s–100 days	binary second of day	10 kHz
IRIG B	1s	1s–100 days	binary second of day	1 kHz
IRIG E	10s	10s–100 days	N/A	100 Hz
IRIG G	10ms	0.01s–100 days	N/A	100 kHz
IRIG H	1mn	1mn–100 days	N/A	100 Hz
NASA36	1s	1s–100 days	N/A	1 kHz

Table of Most Common Time Codes.

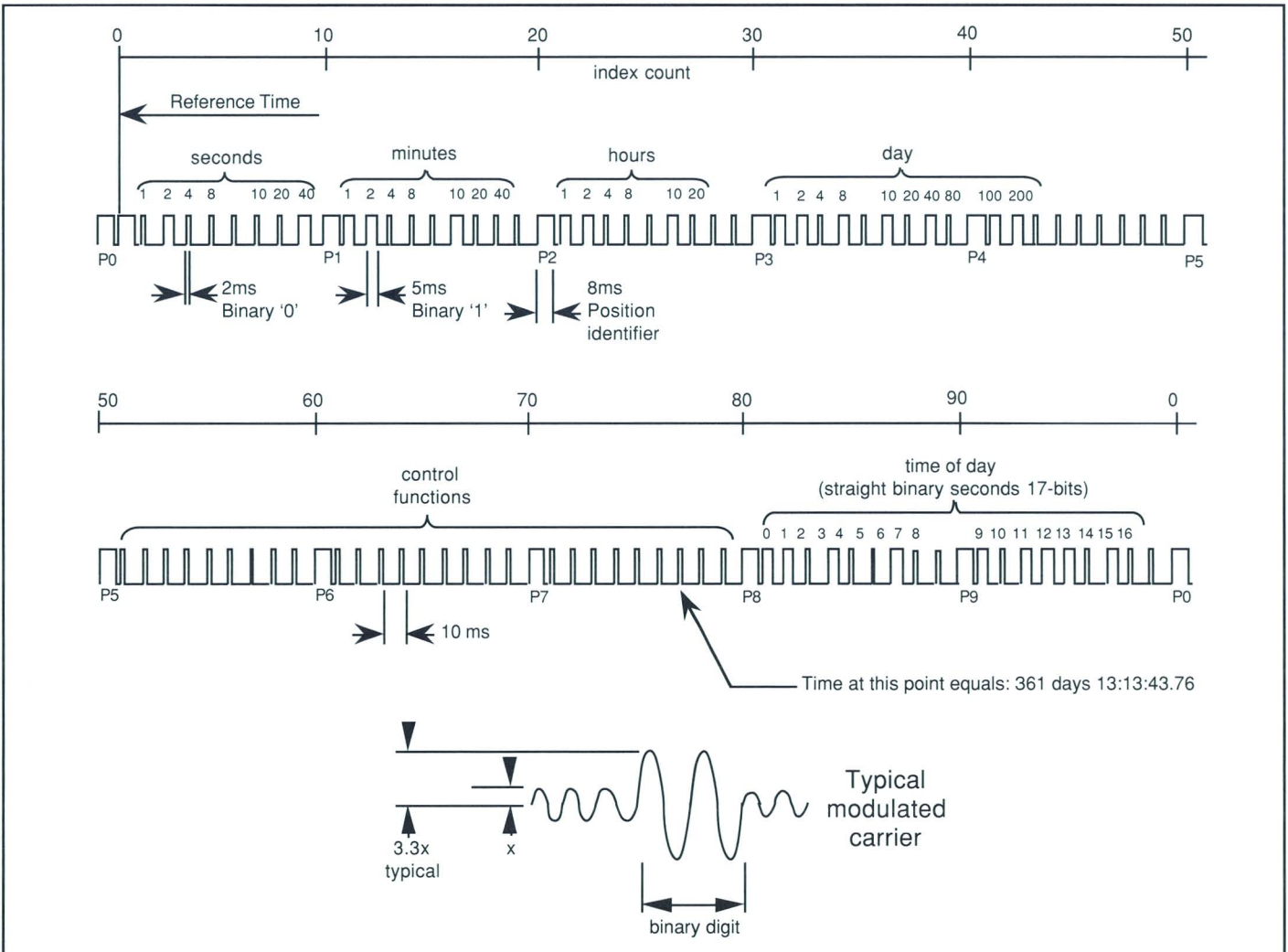

IRIG Standard Time Code. Format B. Reference IRIG Document 104-70.

RECORDING SYSTEMS FOR MEDICAL RESEARCH

ES2000 SYSTEMS

- Programmable set-ups saved on disk
- Up to 40 channels
- Digitized data output
- 10 kHz frequency response
- Real time, non-fade monitor
- High-contrast, hard copy for archives
- Full annotation capability
- User-programmable grids
- Fully compatible with 6600, 5700 and 4600 Series medical signal conditioners from Gould



When multiple custom set-ups are frequently used, if eight channels aren't enough and if high frequency response is needed, then the ES2000 Medical Systems are the ideal choice. Proven in medical research and clinical laboratories for the last twelve years, these systems from Gould have been at the forefront in the fields of electrophysiology and nerve traffic research.

High-contrast electrostatic hard copy, full compatibility with Medical Signal Conditioners from Gould, and the exclusive Non-fade Digital Monitor make this system ideal for any medical research application. Choose from the benchtop model or other system configurations to suit your specific requirements.

TA4000 SYSTEMS

- Up to 24 channels thermal array writing system
- 5 kHz frequency response
- 8 dots/mm resolution
- Variable trace expansion
- Overlapping traces or 8-channel mode
- Up to 200 mm/s chart speed
- 15 in. wide chart paper
- Fully compatible with 6600, 5700 and 4600 Series medical signal conditioners from Gould

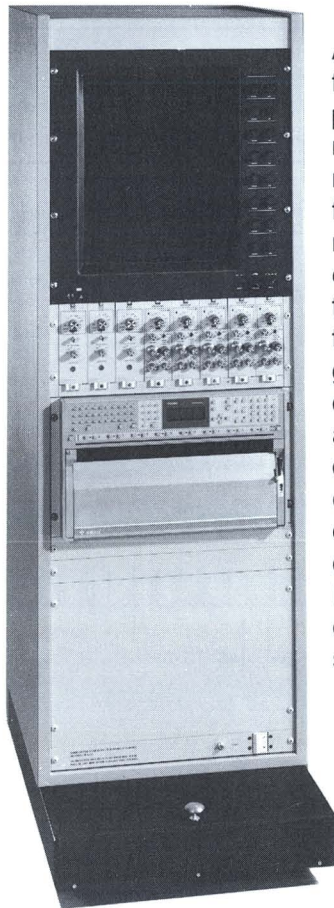

The TA4000 Thermal Array Recording System from Gould provides the performance and versatility required in a medical chart recorder. Whether it is high frequency response for recording intracardiac electrograms and nerve traffic, or overlapping traces to display pressure gradients, they do it all. Eight dot per mm linear thermal array writing assures dependable, trouble-free operation, and provides complete chart annotation capability. Thermal Array Recording Systems can be configured to suit your specific requirements.

CATH 2000

RECORDING/MONITORING SYSTEM FOR THE CARDIAC CATH LAB



- **Maximum versatility for hemodynamic, electrophysiology and angioplasty laboratories**
- **Portable, desk and vertical configurations to meet your lab's special needs**
- **High resolution, large format Color Monitor with digital display gives you complete information on your patient's status**
- **Inexpensive, high quality, easy-to-store 8.5 x 11 in. fanfold chart paper**
- **Chart speeds up to 500 mm/s**
- **Up to 40 simultaneous traces**

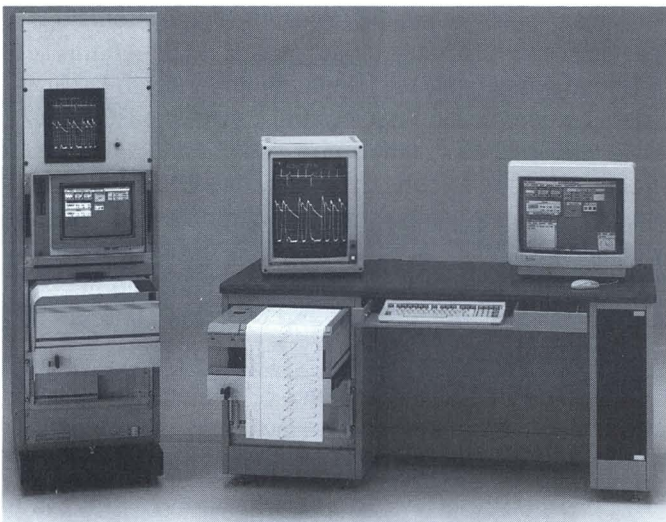

Gould's new Cath 2000 Cath Laboratory Recording/Monitoring system can be custom tailored to the needs of your cardiac cath or EP laboratory. Cath 2000 will help you visualize your waveforms, create high quality hardcopy traces, and produce detailed test results.

At the heart of Cath 2000 is a suite of digitally configured physiological amplifiers under the control of a

state-of-the-art Graphical User Interface. You may pre-specify and store system configurations for greater productivity and reduced operator intervention. Powerful Digital Signal Processors allow you to switch between EP and Hemodynamic configurations with a few clicks of a mouse, giving you unprecedented scheduling flexibility, reduced training and faster studies.

Gould has served the needs of the health care industry for over 50 years, with innovative products that have evolved into sophisticated computer-based systems that serve as a valuable tool and provide improved patient care. At Gould, we know that system reliability and service support are essential for your lab's maximum performance. That's why the heart of our customer support is a nationwide service organization dedicated to fast response and quality service. We offer in-depth training programs to help you achieve high operating efficiency right from the start.

For more information on the Cath 2000 from Gould, contact your local Medical Sales Specialist. Offices are listed on pages 130 and 131.

COMMUNICATIONS INTERFACES

Communication Interfaces between instruments and computers include serial interfaces and parallel interfaces. Both have advantages and limitations that will determine the choice of the integrator, depending on the overall system configuration and the application.

IEEE-488 Interface and SCPI

Enhanced by several revisions, the IEEE-488 Standard has become the most popular communication interface between multiple instruments and a computer. Issued initially in 1975, it is now known as "ANSI/IEEE Std.488.1-1987, IEEE Standard Digital Interface for Programmable Instrumentation." This standard defines electrical and mechanical specifications and transmission protocols for the interface.

In addition, "ANSI/IEEE Std.488.2-1987, IEEE Standard Codes, Formats, Protocols and Common Commands" has introduced common commands universally usable by 488.1 devices.

SCPI (Standard Commands for Programmable Instruments), created in 1990, defines a programming language for the control of test and measurement instruments. The same commands and responses address specific instrument functions, regardless of the manufacturer or the type of instrument. SCPI is not specific to communication hardware and its messages may be sent using other protocols, such as RS-232C, Ethernet or VXI.

The IEEE-488 interface is recommended when:

- more than one device must be connected to a computer;
- good communication speed is needed. Most IEEE-488 interfaces are designed to transfer data words at

rates up to 250 kbytes per second. If required, interface signal timing and cable length can be set so the interface can be run up to 1 Mbytes per second.

- total distance between devices is no more than 20 m;
- a structured environment (mechanical, electrical, protocol) is desired to facilitate integration of multiple instruments. SCPI has been developed to further facilitate this integration.

Serial Interfaces

A number of serial type communications interface standards are commonly used to link computers with instruments or peripherals (plotter, printers, etc.) They have been published by the Engineering Department of the Electronic Industries Association (EIA) to facilitate interchangeability and improvements of products.

Most common Recommended Electrical Standards (RS-) are RS-232C, RS-422A, RS-423A and RS-485.

RS-232C: The Most Popular

It was initially designed for connecting systems generating or processing data (called DTE — data terminal equipment) via telephone channels to DCE (data communication equipment) converting RS-232C data into voice-like signals and vice-versa. It is frequently used to connect directly two DTEs. Its major limitations are 20k bits/s maximum transmission rate, no definition for physical connectors (although 25-pin D subminiature connector is widely used) and the recommended configuration and 50 ft. (15 meters) maximum distance between DTE and DCE.

It is widely accepted because of its simplicity (3 wires are enough to transmit and receive) and its low cost.

	RS-232C	RS-422A	RS-423A	RS-485
Recommended max. distance between components	15 m (50 ft)	1200 m (4000 ft)	1200 m (4000 ft)	1200 ft
Max. signaling rate (bits/s)	19.2 k	10 M	100 k	10 M
Generator levels (Volts)				
Open circuit	<25	≤6	≤6	≤6
On, space, 0	+5 to +15	+2 to +6	+3.6 to 6	+1.5 to +5
Off, mark, 1	-5 to -15	-2 to -6	-3.6 to -6	-1.5 to -5
Maximum receiver levels (Volt)	±3 to ±25	±12	±12	-7 to +12
Balanced/Unbalanced circuit	U	B	U	B
Connector (NS: not specified)	25-pin D	NS	NS	NS

Comparison of EIA serial communications standards

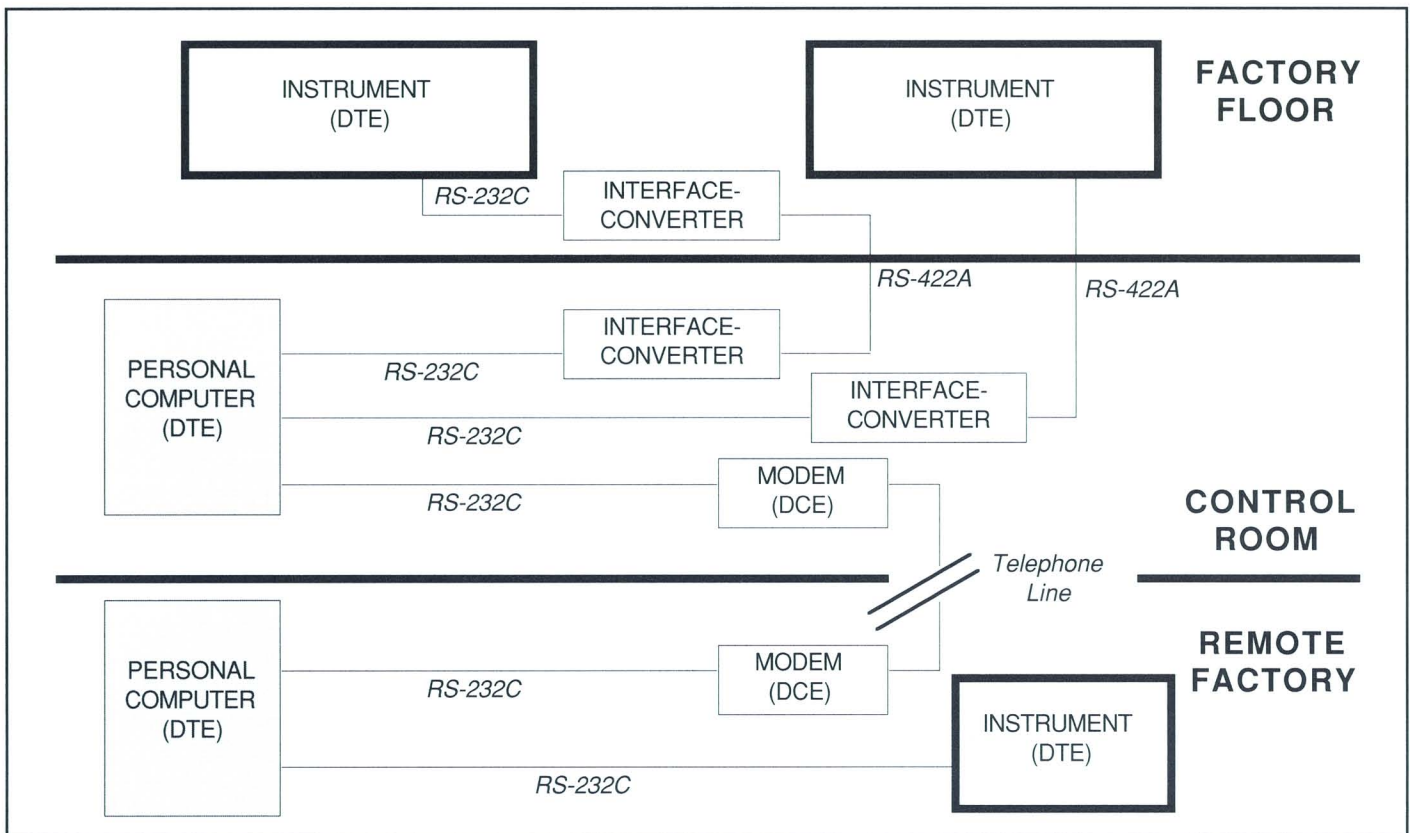

This example shows several Communication Standards in use within a network of instruments being controlled by Personal Computers. RS-422A is the choice for medium

distance; telephone lines connect the two PCs over long distance via Modems.

RS-422A: For Long Distance and Noisy Environment

The major difference between RS-422A and RS-232C is that RS-422A features balanced generators and receivers while RS-232C signaling voltage appear between an output terminal and a common ground. When exposed to electrical noise, balanced circuits suffer much less than single ended circuits. Both balanced wires are equally affected and the voltage difference between them is not.

RS-422A is frequently combined with RS-232C using conversion devices (see figure above). This design results in improved specifications: transmission rates up to 10 megabytes/s, cable lengths to 4,000 feet (1,200 meters) and trouble-free use in industrial environments.

RS-423A: For Long Distance

RS-423A works with the same design parameters as RS-422A except for balanced lines. Unbalanced lines limit data rates to 100k bits/s and reduce noise immunity considerably. It is lower cost than RS-422A.

RS-485: Balanced Multi Device System

RS-485 defines the electrical characteristics of a system that employs up to 32 generators or receivers all connected to the same cable. It does not deal with management of the communication when several generators try to transmit at the same time.

Gould's goal is to produce the most accurate permanent records of measured signals. This means that all of the high performance characteristics and quality features built into every recording system from Gould focus at the point where the pen or stylus meets the chart paper. And you, the user, can expect consistent performance to meet your most exacting requirements.

Gould is the one source that provides you with finely engineered chart papers and supplies that accurately and permanently document the true data record generated by your test and measurement application. Chart papers from Gould support your investment in a quality recording system from Gould. You invested wisely in capturing data — invest just as wisely in recording that same data.

Chart Papers

Accuchart chart papers are printed in the Gould factory for tight quality control on a high-accuracy gravure press, designed and constructed to our specifications.

Our chart paper stocks insure high tensile strength and dimensional stability. Writing surfaces are exceptionally smooth and specially processed for instant acceptance of the trace with minimum pen or

styli friction. All cores are precision fitted to prevent slippage. Each roll is wound under constant tension to assure tightness and perfect alignment.

Chart papers are handled under constant tension and kept at uniform temperature and humidity year-round in specially built press and spooling rooms.

Gould exercises total quality management in its own printing facility. Any technical charts, manufactured elsewhere at our request, are not accepted without assuring that each individual roll meets Gould's high standards. Compare our specifications.

Attention to such details makes the difference. Only chart papers from Gould fulfill the stringent requirements of recording equipment from Gould.

Supplies

Pens and styli from Gould are simple and rugged, engineered to give hundreds of hours of accurate recordings. Our oscillograph pens and styli combine light weight with exceptional rigidity.

All inks are specially formulated to insure proper flow and trace from within the engineered pen by Gould. All inks are packaged in specially prepared containers that meet all of Gould's rigid inspection and operation requirements.



- Immediate shipment of stocked items on selected supplies
- Quantity discounts are available
- Wide product selection
- High quality chart papers
- Precision pens and styli

24 Hour delivery is available.
 In the United States, dial
1-800-359-3536
 to place your order.
 Or, fax your order to
216-328-7403.

General Chart Paper Specifications

- A Printing.** Overall accuracy of printed grid lines is better than 0.15% of any dimension.
 - B Grid-paper edge registration.** Paper is trimmed so that distance between the centerline of any channel and the edge of the paper does not vary more than ± 0.13 millimeters throughout the entire roll.
 - C Coiling accuracy.** In passing through the recorder, lateral drift of the paper due to coiling errors or to core misalignment is held to ± 0.008 inch.
 - D Width of paper.** Overall tolerance better than ± 0.015 inch.*
- Coiling tension.** Rolls are coiled with uniform tension sufficient to prevent "telescoping" during normal use in Gould recorders.
- Uniformity.** There are no printing errors or other discontinuities in a complete roll.
- Compatibility with Recorders from Gould.** We certify that our chart papers will not compromise the accuracy or reliability of the recorder for which it is designed.

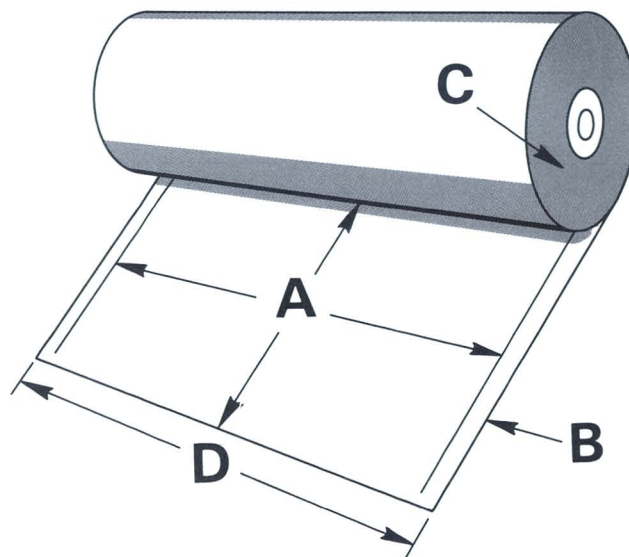

*All dimensional specifications based on a sustained condition of 50% relative humidity.
 "Accuchart" is a registered trademark of Gould Electronics.

Supplies and Probes for Oscilloscopes

Internal Plotter Consumables

Part No.	Description	Price
04101175	Pack of 4 pens (4 colors)	\$18.00
04101265	Pack of 4 black pens	\$18.00
04101165	Pack of 10 rolls of plain paper	\$51.50
04101251	Pack of 8 rolls of thermal paper (for DROs)	\$79.00

Probes

Probe Type	Bandwidth	Comments	Part No.	Price
PB49	DC to 5 MHz	x100 R gain adjustment	04101296	\$120.00
PB27	DC to 7 MHz	x1000 high voltage	04101154	\$235.00
PB59	DC to 15 MHz	x20, x200 differential	04101310	\$445.00
PB48	DC to 20 MHz	x100 Lemo connector (2608)	04101297	\$150.00
PB38	DC to 50 MHz	x1, x10 Lemo connector (2608)	04101259	\$110.00
PB12B	DC to 100 MHz	x1, x10	04101017	\$55.00
PB13	DC to 100 MHz	x10	04101030	\$38.00
PB39	DC to 100 MHz	x10 differential pair (1624)	04101260	\$220.00
PB45	DC to 150 MHz	x1, x10	04101280	\$55.00
PB20	DC to 250 MHz	x1, x10	04101128	\$75.00
PB19	DC to 250 MHz	x10	04101129	\$65.00
PB17	DC to 250 MHz	x100	04101074	\$95.00
PB17A	DC to 250 MHz	x100 autosense	04101201	\$150.00
PB36	DC to 300 MHz	x10 autosense	04101187	\$95.00
PB46	DC to 300 MHz	x10	04101278	\$90.00
PB50	DC to 500 MHz	x10 active	04101307	\$795.00
PB51	DC to 500 MHz	x1, x10 active	04101308	\$1395.00

Supplies for Thermal Array Recorder TA2000, TA4000

Thermal Array Recorder Paper

Chart Paper Model Number	Recorder Group	Recorder Model Number	Type of Chart	Chart Paper Width (in.)	Chart Paper Length (ft.)	Shipping Weight Per Roll/Pack (lb)	Rolls/Packs Per Ctn.	Price
CL-211097-	TA2000	3008-851X-4X	Thermal black trace fanfold pack, no grid, 11 in. folds	8.5	325	3.0	6	\$30.70
23-5215-10	TA4000	3008-X150X-1X	Thermal black trace roll, no grid	15.12	328	5.6	6	\$45.30
23-5215-11	TA4000	3008-X150X-1X	Thermal black trace fanfold pack, no grid, 8.5 in. folds	15.12	354	5.8	6	\$50.70
23-5215-13	TA4000	3008-X150X-1X	Thermal black trace roll perforated	15.12	328	5.3	6	\$50.70

TA4000 Starter Kits

TA4000 starter kits contain 12 rolls of paper and 1 pack of fanfold paper or 12 packs of fanfold paper and 1 roll.

For Chart Paper	Order Starter Kit Model No.	Chart Paper Width (in.)	Description of Chart Paper	Price
23-5215-10	11-46250-3	15.12	Thermal black trace roll, no grid	\$540.00
23-5215-11	11-46250-4	15.12	Thermal black trace fanfold pack, no grid	\$590.00

Supplies for EasyGraf and WindoGraf

Model Number	Description	Price
CL-213688-	Thermal black trace fanfold paper, 4 in. wide, 45 m long, 0.75 lb.	\$15.80
CL-213689-	3.5-in. floppy diskette, double sided, double density	\$5.00
11-66250-2	WindoGraf Starter Kit: 12 packs of paper and 10 diskettes	\$195.00

For quick direct-factory supplies orders, call 800-359-3536
Quantity discounts available; contact your nearest Gould sales office or representative.

Supplies for RS3000 Recorders

Pressurized Ink Pens

Recorder Group	Analog Pen Model No.	Price	Event Pen Model No.	Price
3000, with 40/50mm channels	11-2823-3A	\$37.00	11-2873-2A	\$22.00
3000, with 80/100mm channels	11-2823-4A	\$36.00	11-2873-2A	\$22.00

Thermal Pens

Recorder	Analog Pen Model No.	Price	Event Pen Model No.	Price
3000, with 40/50mm channels	11-2824-3A	\$80.00	11-2874-2A	\$87.00
3000, with 80/100mm channels	11-2824-4A	\$83.00	11-2874-2A	\$87.00

Ink for Pressurized Ink Pens

Recorder	Ink Model No.	Capacity	Container	Price
3000, all Ink Recorders	11-2731-1	1 oz.	Cartridge	\$25.00

Miscellaneous Supply Items

Recorder	Description of Item	Model Number	Price
3000, All Recorders	Gram Gage (for setting pen pressure)	-240601-910	\$69.00
	Ink Remover	-282920-	\$5.00
	Time Line Gage (for setting pen position)	CL-310999-	\$2.10
	Left Core Plug	-397737-	\$3.20
	Right Core Plug Assembly	CL-710359-	\$5.30

Supplies for RS3200 Recorders

Chart Paper (50 mm channels have 50 divisions; 100 mm channels have 100 divisions)

Chart Paper Model Number	Recorder Model Number	No. of Analog Channels	No. of Event Channels	No. of Annot. Channels	Type of Chart	Chart Paper Width (in.)	Chart Paper Length (ft.)	Shipping Weight Per Roll/Pack (lb.)	Rolls/Packs Per Ctn.	Price
11-2915-31	3X-V8210-1X 3X-V7210-1X	1-100 mm	1	1	Thermal black trace roll (can be used with ink recorder)	5.2	350	2.0	12	\$35.00
11-2917-30	3X-V7210-1X	1-100 mm	1	1	High contrast ink roll, annotation stripe	5.2	275	2.0	12	\$28.50
11-2925-35	3X-V8202-1X 3X-V7202-1X	2-50 mm	1	2	Thermal black trace roll (can be used with ink recorder)	5.2	350	2.0	12	\$34.00
11-2925-37	3X-8202-1X 3X-V7202-1X	2-50 mm	2	1	Thermal black trace roll (can be used with ink recorder)	5.2	350	2.0	12	\$34.00
11-2925-503	3X-V8202-1X	2-50 mm	2	1	Thermal black trace folded pack, 15 cm folds, 500 pgs.	5.2	246	1.4	8	\$29.50
11-2925-504	3X-V8202-1X	2-50 mm	1	2	Thermal black trace folded pack 15 cm folds, 500 pgs.	5.2	246	1.4	8	\$29.50
11-2927-31	3X-V7202-1X	2-50 mm	2	1	High contrast ink roll, annotation stripe	5.2	275	2.2	12	\$27.10

Starter Kits

Choose a starter kit based on the type of chart paper wanted. Each kit contains 12 rolls of paper or 8 packs of paper, 1 analog pen, and a time line gage. (Complete description of chart found in Chart Paper section above.) Roll paper kits also contain two each left and two each right core plugs.

For Chart Paper	Order: Starter Kit Model No.	Channel Config.	No. of Event Ch's	No. of Annot. Ch's	Description of Chart Paper	Price
11-2925-35	11-36250-3	2-50 mm	1	2	Thermal black trace roll	\$425.00
11-2925-37	11-36250-4	2-50 mm	2	1	Thermal black trace roll	\$425.00
11-2925-503	11-36250-5	2-50 mm	2	1	Thermal black trace folded pack	\$295.00
11-2925-504	11-36250-6	2-50 mm	1	2	Thermal black trace folded pack	\$295.00
11-2927-31	11-36250-7	2-50 mm	2	1	High contrast ink roll	\$350.00

For quick direct-factory supplies orders, call 800-359-3536

Quantity discounts available; contact your nearest Gould sales office or representative.

Supplies for RS3400 Recorders

Chart Paper (50 mm channels have 50 divisions; 100 mm channels have 100 divisions)

Chart Paper Model Number	Recorder Model Number	No. of Analog Channels	No. of Event Channels	No. of Annot. Channels	Type of Chart	Chart Paper Width (in.)	Chart Paper Length (ft.)	Shipping Weight Per Roll/Pack (lb.)	Rolls/Packs Per Ctn.	Price
11-2925-36	3X-V8420-1X 3X-V7420-1X	2-100 mm	2	1	Thermal black trace roll (can be used with ink recorder)	9.84	350	3.9	12	\$44.20
11-2927-300	3X-V7412-1X	2-100 mm	2	1	High contrast ink semi-perf roll, 30 cm between perfs, with annotation stripe	9.84	275	4.1	12	\$56.30
11-2935-30	3X-V8412-1X 3X-V7412-1X	1-100 mm 2-50 mm	3	1	Thermal black trace roll (can be used with ink recorder)	9.84	350	3.9	12	\$43.10
11-2937-300	3X-V7412-1X	1-100 mm 2-50 mm	3	1	High contrast ink semi-perf roll, 30 cm between perfs, with annotation stripe	9.84	275	4.1	12	\$56.60
11-2945-32	3X-V8404-1X 3X-V7404-1X	4-50 mm	1	4	Thermal black trace roll (can be used with ink recorder)	9.84	350	3.9	12	\$40.00
11-2945-33	3X-V8404-1X 3X-V7404-1X	4-50 mm	4	1	Thermal black trace roll (can be used with ink recorder)	9.84	350	3.9	12	\$40.00
11-2945-503	3X-V8404-1X	4-50 mm	4	1	Thermal black trace folded pack, 15 cm folds, 500	9.84	246	2.7	4	\$34.60
11-2945-504	3X-V8404-1X	4-50 mm	1	4	Thermal black trace folded pack, 15 cm folds, 500 pgs.	9.84	246	2.7	4	\$34.60
11-2947-31	3X-V7404-1X	4-50 mm	4	1	High contrast ink roll, with annotation stripe	9.84	275	4.1	12	\$46.20
11-2947-300	30-V7404-1X	4-50 mm	4	1	High contrast ink semi-perf roll, 30 cm between perfs, with annotation stripe	9.84	275	4.1	12	\$54.40

Starter Kits

Choose a starter kit based on the type of chart paper wanted. Each kit contains 12 rolls of paper or 8 packs of paper, 1 analog pen, and a time line gage. (Complete description of chart found in Chart Paper section above.) Roll paper kits also contain two each each left and two each right core plugs.

For Chart Paper	Order: Starter Kit Model No.	Channel Config.	No. of Event Ch's	No. of Annot. Ch's	Description of Chart Paper	Price
11-2945-32	11-36250-12	4-50mm	1	4	Thermal black trace roll	\$520.00
11-2945-33	11-36250-13	4-50mm	4	1	Thermal black trace roll	\$520.00
11-2945-503	11-36250-14	4-50mm	4	1	Thermal black trace folded pack	\$330.00
11-2945-504	11-36250-15	4-50mm	1	4	Thermal black trace folded pack	\$330.00
11-2947-31	11-36250-16	4-50mm	4	1	High contrast ink roll	\$550.00
11-2947-300	11-36250-17	4-50mm	4	1	High contrast ink semi-perf roll	\$625.00

Supplies for RS3600 Recorders

Chart Paper (50 mm channels have 50 divisions; 100 mm channels have 100 divisions)

Chart Paper Model Number	Recorder Model Number	No. of Analog Channels	No. of Event Channels	No. of Annot. Channels	Type of Chart	Chart Paper Width (in.)	Chart Paper Length (ft.)	Shipping Weight Per Roll/Pack (lb.)	Rolls/Packs Per Ctn.	Price
11-2965-33	3X-V8606-1X 3X-V7606-1X	6-50 mm	1	6	Thermal black trace (can be used with ink recorder)	15.0	350	5.8	6	\$55.00
11-2965-34	3X-V8606-1X 3X-V7606-1X	6-50 mm	6	1	Thermal black trace roll (can be used with ink recorder)	15.0	350	5.8	6	\$53.30
11-2965-503	3X-V8606-1X	6-50 mm	6	1	Thermal black trace folded pack, 15 cm folds, 500 pgs.	15.0	246	4.1	6	\$46.30
11-2965-504	3X-V8606-1X	6-50 mm	1	6	Thermal black trace folded pack, 15 cm folds, 500 pgs.	15.0	246	4.1	6	\$46.30
11-2967-301	3X-V7606-1X	6-50 mm	6	1	High contrast ink semi-perf roll, 30 cm between perfs with annotation stripe	15.0	275	6.3	6	\$60.20

For quick direct-factory supplies orders, call 800-359-3536

Quantity discounts available; contact your nearest Gould sales office or representative.

Supplies for RS3800 Recorders

Chart Paper (40mm channels have 50 divisions)

Chart Paper Model Number	Recorder Model Number	No. of Analog Channels	No. of Event Channels	No. of Annot. Channels	Type of Chart	Chart Paper Width (in.)	Chart Paper Length (ft.)	Shipping Weight Per Roll/Pack (lb.)	Rolls/Packs Per Ctn.	Price
11-2985-37	3X-V8808-1X 3X-V7808-1X	8-40 mm	1	8	Thermal black trace roll (can be used with ink recorder)	15.0	350	5.8	6	\$53.20
11-2985-38	3X-V8808-1X 3X-V7808-1X	8-40 mm	8	1	Thermal black trace roll (can be used with ink recorder)	15.0	350	5.8	6	\$53.20
11-2985-503	3X-V8808-1X	8-40 mm	8	1	Thermal black trace folded pack, 15 cm folds, 500 pgs.	15.0	246	4.1	6	\$45.00
11-2985-504	3X-V8808-1X	8-40 mm	1	8	Thermal black trace folded pack, 15 cm folds, 500 pgs.	15.0	246	4.1	6	\$48.00
11-2987-302	3X-V7808-1X	8-40 mm	8	1	High contrast ink semi-perf roll, 30 cm between perms, with annotation stripe	15.0	275	6.3	6	\$60.20
11-2985-302	3X-V8808-1X	8-40 mm	1	8	Thermal blk trace semi-perf roll	15.0	275	5.8	6	\$55.00
11-2985-305	3X-V8808-1X	8-40 mm	8	1	Thermal blk trace semi-perf roll	15.0	275	5.8	6	\$62.50

Starter Kits

Choose a starter kit based on the type of chart paper wanted. Each kit contains 12 rolls of paper or 8 packs of paper, 1 analog pen, and a time line gage. (Complete description of chart found in Chart Paper section above.) Roll paper kits also contain 2 each left and 2 each right core plugs.

For Chart Paper	Order: Starter Kit Model No.	Channel Config.	No. of Event Ch's	No. of Annot. Ch's	Description of Chart Paper	Price
11-2985-37	11-36250-23	8-40 mm	1	8	Thermal black trace roll	\$660.00
11-2985-38	11-36250-24	8-40 mm	8	1	Thermal black trace roll	\$660.00
11-2985-503	11-36250-25	8-40 mm	8	1	Thermal black trace folded pack	\$405.00
11-2985-504	11-36250-26	8-40 mm	1	8	Thermal black trace folded pack	\$425.00
11-2987-302	11-36250-27	8-40 mm	8	1	High contrast ink semi-perf roll	\$710.00

Supplies for Electrostatic Recorders

Electrostatic Recorder Paper

Chart Paper Model Number	Recorder Group	Recorder Model Number	Paper Description	Chart Paper Width (in./mm)	Chart Paper Length (ft./m)	Shipping Weight Per Roll/Pack (lb./kg.)	Rolls/Packs Per Ctn	Price
23-5101-10			Electrostatic standard roll, no grid	11/276	400/122	6.5/2.9	6	\$42.00
23-5101-11	ES1000, ES2000	30X9-115X-XX 30X9-X114X-X7	Electrostatic folded pack, no grid	11 x 8-1/2 in. 276 x 217	1000 pgs. 708/216	11.8/5.3	5 pks	\$85.30
23-5101-13			Electrostatic perforated roll, no grid	11/276	400/122	6.5/2.9	6	\$61.30

Electrostatic Toner and Supplies

Recorder Group	Recorder Model Number	Supply Model Number	Description	Price
ES1000	30X9-115X-XX	23-5101-1	Toner, box of four 1 qt. bottles	\$61.00
	30X9-11XX-XX	-490735-	Cleaner for Electrostatic recorders, 1 qt.	\$10.00
ES2000	3009-X114X-XX	23-5111-5	Toner, 2 liter bottle	\$47.00
		23-5111-6	Cleaner, 2 liter bottle	\$29.30
		PA-U29817-A	Core Plug	\$3.20
		X52305	Box of 10 diskettes for ES2000CP	\$65.00

For quick direct-factory supplies orders, call 800-359-3536

Quantity discounts available; contact your nearest Gould sales office or representative.

ES2000 Starter Kits

Each starter kit contains the right high quality Gould manufactured supplies needed to achieve maximum recorder performance. ES2000 Starter Kits contain 12 rolls or 5 packs of paper, 4 bottles toner, one bottle cleaner, one roll or pack of another type of paper, and two core plugs.

Order Starter Kit Model No.	Chart Paper Included	Configuration Width (mm)	Paper Description	Price
11-26250-1	23-5101-10†	276	Electrostatic standard roll, no grid	\$705.00
11-26250-2	23-5101-13††	276	Electrostatic perforated roll, no grid	\$945.00
11-26250-3	23-5101-11†	276	Electrostatic folded pack, no grid	\$645.00

†Also includes 1 roll p/n 23-5101-13

††Also includes 1 pack p/n 23-5101-11

Supplies for Mark 200, Mark 200A Recorders

Mark 200 Oscillographic Rectilinear Chart Paper

Chart Paper Model Number	Recorder Model Number	No. of Analog Ch's	Analog Channel Width	Div. Per Ch	No. of Event Ch'	Type of Chart	Chart Paper Width (in.)	Chart Paper Length (ft.)	Shipping Weight Per Roll (lb.)	Rolls Per Ctn.	Price
11-2933-50	8888-1707 Series	—	—	—	32	High contrast ink roll	15	500	12.0	4	\$71.00
11-2983-504	2222-17XX Series RF 1783 Series 15-1787 Series	8	40mm	50	9	High contrast ink semi-perf roll	15	500	12.0	4	\$72.70
RA-2983-503164	2222-17XX Series RF-1783 (8 Ch.) 15-1787 Series	8	40mm	50	9	High contrast ink roll	15	500	12.0	4	\$69.70

Mark 200A Oscillographic Rectilinear Chart Paper (40 mm channels have 50 divisions)

Chart Paper Model Number	Recorder Model Number	No. of Analog Channels	No. of Event Channels	No. of Annot. Channels	Type of Chart	Chart Paper Width (in.)	Chart Paper Length (ft.)	Shipping Weight Per Roll (lb.)	Rolls Per Ctn.	Price
11-2987-601	30-XX808-2X	8-40mm	8	1	High contrast ink, with annotation stripe.	15.0	575	12.4	4	\$110.30

Pressurized Ink Pens

Recorder/Group	Analog Pen Model No.	Price	Event Pen Model No.	Price
200 (RF 1783 Series)	RA 2823-30	\$83.50	RA 2821-20	\$34.20
200 (1707 and 15-1787 Series)	11-2823-31	\$57.80	RA 2821-20	\$34.20
200 (1704 Series)	11-2823-35	\$48.00	11-2821-22	\$36.80
200A	11-2823-3A	\$37.00	11-2873-2A	\$22.00

Thermal Pens

Recorder	Analog Pen Model No.	Price	Event Pen Model No.	Price
3000, Mark 200A	11-2824-3A	\$80.00	11-2874-2A	\$87.00

Ink for Pressurized Pens

Recorder	Blue Ink Model No.	Capacity (Oz)	Container	Price
200: RF 1783, 15-1787, 1704 and 1707 Series	11-2734-2	2	Plastic Syringe	\$42.00
Mark 200A	11-2731-1	1 oz.	Cartridge	\$25.00

Miscellaneous Supply Items

Recorder	Description of Item	Model Number	Price
Mark 200, Mark 200A	Ink Remover	-282920-	\$5.00
Mark 200A	Gram Gage (for setting pen pressure)	-240601-910	\$69.00
Mark 200A	Time Line Gage (for setting pen position)	CL-310999-	\$2.10

For quick direct-factory supplies orders, call 800-359-3536

Quantity discounts available; contact your nearest Gould sales office or representative.

Supplies for 220, 222, and 260 Recorders

Oscillographic Rectilinear Chart Paper

Chart Paper Model Number	Recorder Group	Recorder Model Number	No. of Analog Ch's	Analog Channel Width	Div. Per Ch	No. of Event Ch's	Type of Chart	Chart Paper Width (in.)	Chart Paper Length (ft.)	Shipping Weight Per Roll (lb.)	Rolls Per Ctn.	Price
11-2923-32	220/222	15-6327 Series	2	40 mm	50	3	High contrast ink roll	4.285	275	1.8	12	\$12.40
11-2923-38	220/222	15-632X Series	—	—	—	—	High contrast ink roll, no grid	4.285	275	1.8	12	\$14.00
11-2923-45	220/222	15-632X Series	2	40 mm	50	3	Reproducible ink roll	4.285	400	1.8	12	\$19.30
11-2925-30	220	15-6327 Series	2	40 mm	50	3	Thermal blue trace roll	4.285	275	1.7	12	\$18.00
11-2925-32	220/222	15-6327 Series	2	40 mm	50	3	Thermal black trace roll	4.285	275	1.5	12	\$20.70
11-2963-21	260	15-6367 Series	6	40 mm	50	4	High contrast ink roll	12.52	225	4.9	12	\$33.20
11-2963-200	260	15-6327 Series	6	40 mm	50	4	High contrast ink semi-perf roll	12.52	225	4.9	12	\$44.40

Pressurized Ink Pens

Recorder Group	Analog Pen Model No.	Price	Event Pen Model No.	Price
220, 222, 260, 440 & 480 Series	11-2823-33	\$51.30	11-2873-20	\$33.30

Longer-Life Pressurized Ink Pens

Recorder Group	Pen Number	Description	Price
220, 240, 260, 440, & 480 Series	11-2823-34	Longer-Life, tungsten-carbide pressurized ink pen	\$81.30

Thermal Oscillographic Styli

Recorder	Analog Styli Model No.	Price	Event Styli Model No.	Price
220 (15-6327 Series)	11-2824-35	\$89.00	11-2874-21	\$82.50

Ink for Pressurized Ink Pens

Recorder	Blue Ink Model No.	Capacity (Oz)	Container	Price
220, 222, 250, 260, 440 and 480 Series 2000, 2000S, 2000W	11-2730-1	1	Cartridge	\$27.50
For use in same Recorders as 11-2730-1	11-2730-12908 (Red)	1	Replaces 11-2730-1	\$46.50
	11-2730-15902 (Black)	1	Replaces 11-2730-1	\$46.50
	-282920-		Ink Remover	\$5.00

Supplies for 2000 Recorders

Pressurized Ink Pens

Recorder Group	Analog Pen Model No.	Price	Event Pen Model No.	Price
2200, 2400 and 2600 Series	11-2823-42	\$34.70	267884-5	\$15.50

Longer-Life Pressurized Ink Pens

Recorder Group	Pen Number	Price	Description	Price
2200, 2400, and 2600 Series	11-2823-422608	\$86.00	Longer-life pen	\$86.00

Thermal Oscillographic Styli

Recorder	Analog Styli Model No.	Price	Event Styli Model No.	Price
2000 Series - 2200, 2400, and 2600	11-2824-39	\$85.00	11-2874-34	\$97.00

For quick direct-factory supplies orders, call 800-359-3536

Quantity discounts available; contact your nearest Gould sales office or representative.

Ink for Pressurized Ink Pens

Recorder	Blue Ink Model No.	Capacity (Oz)	Container	Price
2000, 2000S, 2000W, 2200, 2400, 2600, 2800	11-2730-1	1	Cartridge	\$27.50
For use in same Recorders as 11-2730-1	11-2730-12908 (Red)	1	Replaces 11-2730-1	\$46.50
	11-2730-15902 (Black)	1	Replaces 11-2730-1	\$46.50
	-282920-		Ink Remover	\$5.00

Supplies for 2200 Recorders

Chart Paper (50 mm channels have 50 divisions; 100 mm channels have 100 divisions)

Chart Paper Model Number	Recorder Model Number	No. of Analog Channels	No. of Event Channels	No. of Annot. Channels	Type of Chart	Chart Paper Width (in.)	Chart Paper Length (ft.)	Shipping Weight Per Roll (lb.)	Rolls Per Ctn.	Price
11-2913-30	2X07-21XX-XX	1-100mm	2	—	High contrast ink roll	5.2	275	2.2	12	\$20.90
11-2923-35	2X07-22XX-XX	2-50mm	3	—	High contrast ink roll	5.2	275	2.2	12	\$18.50
11-2923-39	2X07-22XX-XX	—	—	—	High contrast ink roll, no grid	5.2	275	2.2	12	\$22.80
11-2923-46	2X07-22XX-XX	2-50mm	3	—	Reproducible ink roll	5.2	400	2.0	12	\$30.40
11-2925-31	2X08-22XX-XX	2-50mm	3	1	Thermal blue trace roll	5.2	275	1.9	12	\$19.50
11-2925-33	2X08-22XX-XX	2-50mm	3	1	Thermal black trace roll	5.2	275	1.5	12	\$25.60
11-2927-31	2X07-22XX-XX	2-50mm	2	1	High contrast ink roll, with thermal annotation stripe	5.2	275	2.2	12	\$27.10

Supplies for 2400 Recorders

Chart Paper (50 mm channels have 50 divisions; 100 mm channels have 100 divisions)

Chart Paper Model Number	Recorder Model Number	No. of Analog Channels	No. of Event Channels	No. of Annot. Channels	Type of Chart	Chart Paper Width (in.)	Chart Paper Length (ft.)	Shipping Weight Per Roll (lb.)	Rolls Per Ctn.	Price
11-2923-34	2X07-42XX-XX	2-100 mm	3	—	High contrast ink roll,	9.84	275	4.0	12	\$34.20
11-2923-301	2X07-42XX-XX	2-100 mm	3	—	High contrast ink semi-perf roll	9.84	275	4.0	12	\$43.50
11-2933-30	2X07-43XX-XX	1-100 mm 2-50 mm	4	—	High contrast ink roll	9.84	275	4.0	12	\$34.50
11-2933-300	2X07-43XX-XX	1-100 mm 2-50 mm	4	—	High contrast ink semi-perf roll	9.84	275	4.0	12	\$45.00
11-2943-30	2X07-44XX-XX	4-50 mm	5	—	High contrast ink roll	9.84	275	4.0	12	\$31.70
11-2943-300	2X07-44XX-XX	4-50 mm	5	—	High contrast ink semi-perf roll	9.84	275	4.0	12	\$38.00
11-2945-30	2X08-44XX-XX	4-50 mm	5	1	Thermal blue trace roll	9.84	275	3.8	12	\$37.40
11-2945-31	2X08-44XX-XX	4-50 mm	5	1	Thermal black trace roll	9.84	275	3.0	12	\$37.10
11-2947-31	2X07-44XX-XX	4-50 mm	4	1	High contrast ink roll, with thermal annotation stripe	9.84	275	4.1	12	\$46.20
11-2947-300	2X07-44XX-XX	4-50 mm	4	1	High contrast ink semi-perf roll with thermal annotation stripe	9.84	275	4.1	12	\$54.40

Supplies for 2600 Recorders

Chart Paper (50 mm channels have 50 divisions; 100 mm channels have 100 divisions)

Chart Paper Model Number	Recorder Model Number	No. of Analog Channels	No. of Event Channels	No. of Annot. Channels	Type of Chart	Chart Paper Width (in.)	Chart Paper Length (ft.)	Shipping Weight Per Roll (lb.)	Rolls Per Ctn.	Price
11-2933-31	2X07-63XX-XX	3-100 mm	4	—	High contrast ink roll,	15	275	6.3	6	\$44.00
11-2933-3130542	2X07-63XX-XX	3-100 mm	4	—	High contrast ink semi-perf roll	15	275	6.3	6	\$43.70
11-2963-30	2X07-66XX-XX	6-50 mm	7	—	High contrast ink roll	15	275	6.3	6	\$40.20
11-2963-300	2X07-66XX-XX	6-50 mm	7	—	High contrast ink semi-perf roll	15	275	6.3	6	\$43.60
11-2965-30	2X08-66XX-XX	6-50 mm	7	1	Thermal black trace roll	15	275	4.5	6	\$50.00
11-2965-300	2X08-66XX-XX	6-50 mm	6	1	Thermal blue trace semi-perf roll	15	275	5.8	6	\$46.00
11-2965-301	2X08-66XX-XX	6-50 mm	7	1	Thermal blk trace semi-perf roll	15	275	5.8	6	\$53.20
11-2967-301	2X07-66XX-XX	6-50 mm	6	1	High contrast ink semi-perf roll with thermal annotation stripe	15	275	6.3	6	\$60.20

For quick direct-factory supplies orders, call 800-359-3536

Quantity discounts available; contact your nearest Gould sales office or representative.

Supplies for 2800 Recorders

Chart Paper (40 mm channels have 50 divisions)

Chart Paper Model Number	Recorder Model Number	No. of Analog Channels	No. of Event Channels	No. of Annot. Channels	Type of Chart	Chart Paper Width (in.)	Chart Paper Length (ft.)	Shipping Weight Per Roll/Pack (lb.)	Rolls/Packs Per Ctn.	Price
11-2983-31	2X07-88XX-XX	8-40 mm	9	—	High contrast ink roll,	15	275	6.3	6	\$41.00
11-2983-301	2X07-88XX-XX	8-40 mm	9	—	High contrast ink semi-perf roll	15	275	6.3	6	\$43.60
11-2985-32	2X08-88XX-XX	8-40 mm	9	—	Thermal black trace roll	15	275	4.5	6	\$46.80
11-2985-36	2X08-88XX-XX	8-40 mm	8	1	Thermal black trace roll	15	275	4.5	6	\$47.70
11-2985-300	2X08-88XX-XX	8-40 mm	8	1	Thermal blue trace semi-perf roll	15	275	5.8	6	\$47.30
11-2985-301	2X08-88XX-XX	8-40 mm	9	—	Thermal blk trace semi-perf roll	15	275	5.8	6	\$53.00
11-2985-304	2X08-88XX-XX	8-40 mm	8	1	Thermal blk trace semi-perf roll	15	275	5.8	6	\$57.80
11-2985-500	2X08-88XX-XX	8-40 mm	8	1	Thermal blue trace fanfold pack 30 cm folds, 500 pages	15	492	9.4	4pk	\$74.00
11-2987-302	2X07-88XX-XX	8-40 mm	8	1	High contrast ink semi-perf roll with thermal annotation stripe	15	275	6.3	6	\$60.20

Pressurized Ink Pens

Recorder Group	Analog Pen Model No.	Price	Event Pen Model No.	Price
2800 (2007-88XX-XX)	11-2823-35	\$48.00	11-2873-20	\$33.30

Longer-Life Pressurized Ink Pens

Recorder Group	Pen Number	Description	Price
2800 Series	11-2823-352608	Longer-life pen	\$85.90

Thermal Oscillographic Styli

Recorder	Analog Styli Model No.	Price	Event Styli Model No.	Price
2800 Series	11-2824-38	\$81.60	11-2874-35	\$76.30

Supplies for 8000S Recorders

Oscillographic Rectilinear Chart Paper

Chart Paper Model Number	Recorder Group	Recorder Model Number	No. of Analog Ch's	Channel Width	Div. Per Ch	No. of Event Ch's	Type of Chart	Chart Width (mm)	Chart Length (m)	Shipping Weight Per Roll (kg)	Rolls Per Ctn.	Price
X72411	8100	8188-110X-XX	1	50	50	2	Thermal blue trace roll	66	60	0.2	24	\$10.50
X72421	8200	8188-220X-XX	2	50	50	2	Thermal blue trace roll	126	60	0.5	12	\$20.80
X72431	8300	8188-330X-XX	3	50	50	2	Thermal blue trace roll	196	60	0.8	12	\$29.30
X72441	8400	8188-4400-XX	4	50	50	2	Thermal blue trace roll	249	60	1.1	12	\$33.70
X73441			4	50	50	2	Perforated thermal blue trace	249	60	1.1	12	\$28.10
X72461	8600	8188-66XX-XX	6	50	50	2	Thermal blue trace roll	377	60	1.5	12	\$46.00
X72481	8800	8188-88XX-XX	8	40	50	2	Thermal blue trace roll	377	60	1.5	12	\$46.00

Thermal Oscillographic Styli

Recorder	Analog Styli Model No.	Price	Event Styli Model No.	Price
8000S Series (All)	X50521	\$65.80	X50744	\$53.00

Supplies for Thermal Array Recorders TA550, TA600

Thermal Array Recorder Paper

Chart Paper Model Number	Recorder Group	Recorder Model Number	Type of Chart	Chart Paper Width (in.)	Chart Paper Length (ft.)	Shipping Weight Per Roll (lb)	Rolls Per Ctn.	Price
CL-211007-	TA550	253-X22111-1	Thermal black trace roll, no grid	4.49	114.9	0.7	6	\$11.00
11-6905-31	TA600	3008-06XX-XX	Thermal blue trace roll, no grid	6.0	300	1.8	12	\$32.00

For quick direct-factory supplies orders, call 800-359-3536

Quantity discounts available; contact your nearest Gould sales office or representative.

Supplies for Strip Chart Recorders SC270, SC280, 2130, 2132

Strip Chart Recorder Paper

Chart Paper Model Number	Recorder Group	Recorder Model Number	No. of Analog Ch's	Analog Channel Width	No. of Event Ch's	Type of Chart	Chart Paper Width (in.)	Chart Paper Length (ft.)	Shipping Weight Per Roll/Pack (lb.)	Rolls/Packs Per Ctn.	Price
-297701-	SC270 SC280	27X-111122-1 28X-111111-1	4-6 4-8	250 mm	4-6 4-8	Capillary ink roll, metric grid	11.1	66	0.9	10	\$13.30
-297702-	SC270	27X-11122-1	4-6	250 mm	4-6	Capillary ink folded pack, metric grid	11.1x 150 mm	133 pgs.	0.8	10	\$12.30
-297711-	SC280	28X-111111-1	4-8	250 mm	4-8	Capillary ink folded pack, metric grid	11.1x 60 mm	333 pgs.	0.7	10	\$13.30
CL-211212-	SC2130	LR-XXX00-XX	30	250 mm	—	Box of 6 rolls ink jet paper	10.6	108.3	8/carton	6	\$144.00
CL-213083-1	SC2132	DL-XXX0-1	32	250 mm	—	Ink jet, std paper, folded pk	10.6	108.3	0.9	10	\$30.00
CL-213083-2	SC2132	DL-XXX0-1	32	250 mm	—	Ink jet brilliant paper roll	10.6	108.3	0.9	10	\$52.00
CL-213083-3	SC2132	DL-XXX0-1	32	250 mm	—	Ink jet std paper roll	10.6	108.3	0.9	10	\$30.00

Ink Strip Recorder Pens

Recorder/Description	Analog Pen Model No.	Price	Event Pen Model No.	Price
270/280 Series Strip Chart Recorder (Unit quantity is one pen per part number)				
Color: Red	-297703-1	\$24.00	-297704-1	\$16.10
Green	-297703-2	\$24.00	(Red for SC270)	
Brown	-297703-3	\$22.40	-297705-1	\$18.10
Light Green	-297703-4	\$22.40	(Red for SC280)	
Blue	-297703-5	\$22.40	-297705-2	\$18.10
Orange	-297703-6	\$22.40	(Green for SC280)	
Light Blue	-297703-7	\$22.40		
Violet	-297703-8	\$22.40		

Ink Jet Recorder Tanks/Supplies

Recorder	Description	Model No.	Price	Model No. for "A" Type Tank	Price
2130 Series Logging Recorder	Set of 4 basic color ink jet tanks (magenta, cyan, yellow, black)	CL-211210-	\$109.00	CL-212800-	\$105.00
	Individual black ink jet tank	CL-211211-	\$37.00	CL-212801-	\$37.00
	Rubber squeeze bulb	CL-211213-	\$28.00		
2132 Series Logging Recorder	Magenta ink jet tank, 1 ea.	CL-213084-1	\$31.00		
	Cyan ink jet tank, 1 ea.	CL-213084-2	\$31.00		
	Yellow ink jet tank, 1 ea.	CL-213084-3	\$31.00		
	Black ink jet tank, 1 ea.	CL-213084-4	\$31.00		
	Head cleaning set	CL-213085-	\$31.00		
	Cleaning fluid tray	CL-213086-	\$7.90		

For quick direct-factory supplies orders, call 800-359-3536

Quantity discounts available; contact your nearest Gould sales office or representative.

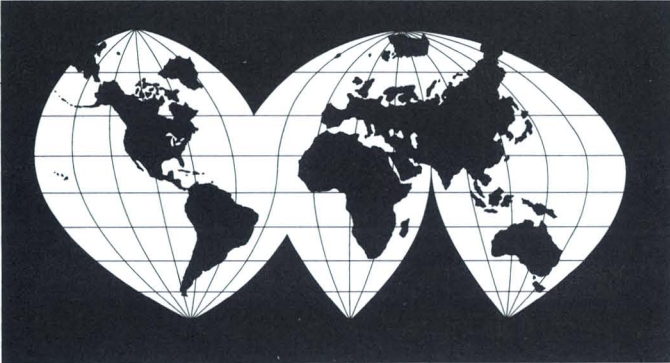

- **Reliable equipment installation and performance verification**
- **High quality factory product training**
- **Extended warranty agreements to save budget and time**
- **Professional expert service in a courteous, responsive manner**
- **Safety testing, equipment repair and calibration**
- **12 U. S. Service Centers**
- **More than 50 Service Centers world wide**

Gould designs and manufactures products and systems recognized as industry standards because of their high quality and reliability. This equipment is complemented by Gould's commitment to properly match products and systems to applications and to provide proper installation, operator education, servicing and maintenance.

To optimize the usefulness of these products and systems, Gould provides extensive customer services.

Installation

With this option, Gould Field Service Engineers will unpack, set up and verify the performance of all Gould equipment at your location.

Customer education

Gould Field Service Engineers can conduct short, informal training courses, covering basic product operation and routine maintenance.

Formal classroom training is available at the factory. Classes include Familiarization and Basic Instrument Operation, Modular Theory of Operation, Repair and Maintenance Procedures, and Testing.

Application consulting

Gould Product Specialists and Sales Engineers are available for pre-sale support and product selection. They are experts with Gould products and can help you match the proper Gould product or configure the proper Gould system to meet your application requirements. Through strategically located service centers, Gould provides customer service on all Gould products worldwide.

Field service engineers

Gould Field Service Engineers can provide on-the-spot assistance whenever and wherever required. All Field Service Engineers receive intensive and thorough factory training, but their greatest strength comes from their field experience. They are familiar with your requirements and are experienced with your product. Further, they are backed by one of the world's most experienced test and measurement organizations.

Factory service centers

Gould Factory Service Centers support your Gould instruments, Gould-supplied computers and peripherals, and Gould-supplied accessories. Therefore, you can be confident of prompt, effective results when you turn to one of our service centers for assistance.

Our prompt repair service is especially valuable to those companies without their own service facilities. By using the nearest Gould Service Center as its maintenance depot, a Gould instrument user can be confident that his instruments and systems will continue to provide uninterrupted performance.

Even organizations with their own repair facilities find it economical to be protected by a Gould Extended Warranty Agreement. This provides them with fast turn-around and eliminates the additional expense of carrying an inventory of instrument parts, accessories, and supplies.

To help you keep your Gould equipment performing properly, Gould provides the following services.

Extended warranty agreements

In addition to standard product warranties, Gould provides Extended Warranty Agreements on all Gould manufactured products to best fit your needs. You benefit in many ways:

- **Everything is covered.** All parts and labor, no hidden costs and the Gould rate is constant through the life of the agreement.
- **Known budget expense.** You know from the start what your maintenance budget will be for the year. You will be able to accurately forecast this cost on your budget.
- **Personal contact.** You get the benefit of the one-on-one relationship with the Gould Service Engineer. He or she becomes more familiar with what your application requires.
- **Priority treatment.** As an Extended Warranty customer, you receive preferred status should your equipment require service.

Board exchange program

Gould Service provides additional savings to its customers via a Board Exchange Program on selected products that supplies repaired boards for units no longer under warranty.

To qualify, customers must return a board to a Gould Service Center to make sure it can be repaired. Exchange rates are based on a percentage of the current list price. For further details, contact your nearest Gould Service Center.

Software support

All Software from Gould includes a free 12-month Software Maintenance/Upgrade Agreement. After the first year, this Agreement can be extended at minimal charge.

For availability of these services in your area, contact your local Gould Sales and Service Office listed on the back cover.

Telephone support

A Gould Service Engineer is available to answer your operating, repair and application questions. Call any of the Gould facilities listed on the back cover and ask for the Service Department.

YOU BENEFIT FROM THE GOULD RENT-TO-BUY PROGRAM

You can rent any of our state-of-the-art instruments

Renting oscilloscopes and recorders can be smart — when you have a short-term need; when you want to try the product before you buy; or if you just prefer to use your expense budget. Gould will help you with your recorder and oscilloscope rentals. And, if you want, you can apply the rental towards the purchase of the equipment.

What are the advantages of renting under the Gould Rent-to-Buy Program?

■ **Save money**

If you use recorders and oscilloscopes only occasionally, it's cheaper to rent the instrument, use it for just the time you need it, and return it when you're finished. Otherwise, if you purchase the instrument, you pay for it year round — regardless of how often you use it.

■ **Avoid obsolescence**

Because your testing requirements can change rapidly, the equipment you buy today may be inadequate tomorrow. Renting may be your only

affordable way to always have the necessary test equipment.

■ **You can meet emergencies**

If your own equipment breaks down, relax. Gould has a replacement for you.

■ **Avoid overleveraging**

Companies and institutions have a multitude of needs that all require money, yet capital is a limited resource. Renting your recorders and oscilloscopes helps you conserve your capital, reduce your overhead and control your budget.

■ **Eliminate maintenance hassles**

When you rent equipment from Gould, we take care of maintenance — maintenance from the company that knows oscilloscopes and recorders the best. You're free of all ownership burdens, repairs and maintenance expenses.

■ **Enjoy tax advantages**

You may be able to save money under the current tax laws. Rentals are typically 100% tax deductible as an operating expense. Also, depreciation deductions have

changed for equipment purchases, making equipment rental more attractive than ever.

■ **Get expert technical assistance**

When you rent from Gould, you get much more than just a recorder or an oscilloscope — you get a total equipment solution. Our team of experienced application specialists will assist you with the toughest testing requirements, offer reliable advice, and make sure you get the right equipment or system for your specific job.

■ **Receive Gould's commitment**

For more than 60 years, we've delivered the highest level of quality service and customer satisfaction to industry, science and medical research. Today, more than ever, your business needs a reliable partner. Choose the industry's best: Gould. We deliver total instrument solutions.

And a part of your cost of rental can be applied to purchase the recorder or oscilloscope. Under the Gould Rent-to-Buy program, you can use the rental fees to purchase the instrument. Call your nearest Gould sales office or division headquarters on the back cover to find out the details to fit your particular requirements.

RECONDITIONED INSTRUMENTS

Another solution to your budget restrictions is buying reconditioned Gould oscilloscopes and recorders. These units have a full one year warranty and may be just the way for you to stretch your test equipment budget.

Gould reconditioned test and measurement products are field sales and marketing demonstration units. They meet the Gould standard for performance and quality, both in performance and appearance. And the inventory may include the out-of-production recorder or oscilloscope that you would like to continue using.

All instruments have been reconditioned and tested to meet electrical and mechanical specifications at the time of manufacture. Reconditioned recorders and oscilloscopes meet current safety requirements. They are equipped with all standard accessories and manuals. Some may contain slight appearance blemishes, but performance or reliability is not affected. All reconditioned oscilloscopes and recorders include a full one year Gould warranty.

Gould reconditioned oscilloscopes and recorders are sold at reduced prices — below the new instrument price. All standard and contract discounts normally apply.

Contact your local Gould sales engineer to learn what instruments are available and ask for a quote of the current price. See for yourself how much you can save.

Most instruments are in stock and are available for quick delivery, helping you to meet tight deadlines.

Systems can also be configured to meet your specific application. Delivery of these units is within a minimum of days.

Gould is proud and confident of this reconditioning program. The warranty on these recorders and oscilloscopes is a full one year. The variety of service options detailed on page 125 is also available on most instruments.

And, as with our new instruments, you receive the support you require before the purchase and it continues long after you begin using it. The support is available from both our applications and service departments.

Call your nearest Gould Sales office or the main offices listed on the back cover. Find out another way Gould helps you with your test and measurement solutions.

SHIPPING, PRICES AND TERMS AND CONDITIONS

PLACING YOUR ORDER

United States. Gould Sales Engineers are available at the nearest Gould Sales Office to help you with equipment selection, pricing, availability and custom system definition.

Refer to the list of Gould Sales and Service offices listed on the back cover.

Orders for all products should be placed at:
Gould Inc., Test and Measurement Group
8333 Rockside Road
Valley View, OH 44125-6104
Telephone: 216-328-7000
Fax: 216-328-7400

Orders for chart papers and supplies should be placed through:

Telephone: 800-359-3536

GSA Contracts. Many Gould oscilloscopes, recorders and supplies are sold under GSA contracts. Contact either your local Gould Sales Office or Gould Inc., 8333 Rockside Road, Valley View, OH 44125-6104 (216-328-7000) for more information

Belcore Agreement. Selected Gould instruments are listed under an agreement with Bell Communications Research (Bellcore). These products have been assigned a CLEI number. Contact either your local Gould Sales Office or Gould Inc., 8333 Rockside Road, Valley View, OH 44125-6104 (216-328-7000) for more information.

Canada. For ordering, pricing and delivery information, contact your local Interfax Systems Inc. office listed on the back cover.

Outside of North America. For ordering, pricing and delivery information, contact your local Gould Sales Office, Gould Representative or Distributor. Refer to the back cover for listings.

TERMS OF SALES

United States. All products shipped from within the United States are F.O.B. factory, Cleveland, OH. Transportation is collect via best method in Gould's opinion unless shipping method is stipulated. Prices do not include shipping and handling charges.

Payment terms are net 30 days from date of invoice. Invoices paid late are subject to a 1.5% interest charge per month on the unpaid balance.

Outside of the United States. Contact your local Gould Sales Office, Representative or Distributor regarding terms for orders placed with them.

LEASE AND RENTAL AGREEMENTS

Gould Electronics offers leasing and Rent-to-Buy terms to meet most requirements. Contact your local Gould Sales Office for terms and rates.

MINIMUM ORDERS

The minimum order amount is \$100.00 for United States orders. Outside the United States, contact your local Gould Sales Office, Representative or Distributor.

DELIVERY SCHEDULE

Shipment of most equipment orders will be made in 15 to 90 days after receipt of order. Actual shipping schedule will be acknowledged after receipt of purchase order.

Orders for chart papers, supplies and replacement parts in stock will ship within 72 hours.

CERTIFICATION

Gould's Quality Assurance program certifies that products manufactured by Gould's Cleveland Operation have been inspected under U. S. Government Inspection System Requirements of MIL-I-45208A. The standards used in calibrating and testing the products are directly traceable to the National Institute of Standards and Test (NIST, formerly NBS) as required by the Calibration System Requirements of Mil-STD-45662.

PACKAGING

All items will be packaged and packed in accordance with best commercial practices. Consult factory for extra charges when compliance with MIL specifications covering packing, packaging, waterproof containers, or marking is required. An extra charge will be made for packing and packaging for ocean freight shipments.

REPLACEMENT PARTS AND SUPPLIES

Call 800-359-3536 to order parts and supplies.

PRICE AND PRODUCT CHANGE

This catalog is based on information in effect at the time of its publication. Due to Gould's continuing product improvement program, Gould reserves the right to make changes to prices, specifications and models without notice.

WARRANTY

All Gould products are warranted to meet high standards of quality and workmanship. For specific warranty provisions, refer to the Warranty Statements on the following page.

HARDWARE WARRANTY

All products manufactured and sold by Gould Inc., Test and Measurement Group, are warranted to the original purchaser from date of shipment for the applicable periods set forth in the table below. Gould's products are warranted to conform to the applicable published specifications in effect at the time of shipment, and to be free from any defects in material or manufacture when used with recommended Gould associated equipment and/or supplies. Except for products including on-site warranty, as noted below, all products are to be returned for warranty service, transportation prepaid by the buyer,

to Gould's designated service center. For products not including on-site warranty coverage, Gould may provide such service subject to an additional charge upon buyer's request. Gould reserves the right to determine the cause and existence of a defect under this warranty and this warranty shall not apply to normal wear and tear of the products or to any products which have been subjected to misuse, improper installation, repair, alteration, neglect, accident, inundation, fire, or operation outside their published maximum ratings.

Product Category

Oscillographic Recorders
Signal Conditioners
Array Recorders
Waveform Recording Products
DASA Data Acquisition Products
Oscilloscopes*
Monitor Scopes and Digital Displays
Cath Lab Systems**
Chart Paper

* For sales in the U.S. only, DSO model 465 and series 4060 and 4090 are warranted for as long as they are manufactured by Gould, or five years, whichever is longer. Plotters and printers in these models are limited to two years.

** Includes on-site warranty coverage during normal business hours.

Warranty Period

1 Year from date of shipment.
1 Year from date of shipment.
1 Year from date of shipment.
1 Year from date of shipment.
1 Year from date of shipment.
2 Years from date of shipment.
1 Year from date of shipment.
1 Year from date of installation.
1 Year from date of shipment.

GOULD'S LIABILITY UNDER SUCH WARRANTY IS LIMITED TO SERVICING OR REPLACING DEFECTIVE PARTS EXCEPT PENS, STYLI, FUSES, BATTERIES AND CATHODE RAY TUBES USED IN OTHER THAN GOULD OSCILLOSCOPES, AND DOES NOT INCLUDE CALIBRATION AND MINOR MAINTENANCE AS OUTLINED IN GOULD OPERATING AND SERVICE MANUALS. IN NO EVENT SHALL GOULD BE LIABLE FOR ANY LOSS OF PROFITS OR OTHER

CONTINGENT, CONSEQUENTIAL OR SPECIAL DAMAGES. THE FOREGOING WARRANTY IS EXCLUSIVE AND EXPRESSLY IN LIEU OF ALL OTHER WARRANTIES WHETHER EXPRESSED OR IMPLIED, INCLUDING ANY IMPLIED WARRANTIES OF MERCHANTABILITY OR FITNESS AND OF ANY OTHER OBLIGATION AND SHALL CONSTITUTE THE SOLE REMEDY OF THE BUYER AND SOLE LIABILITY OF GOULD.

SOFTWARE WARRANTY

All software products which are licensed by Gould and listed in Gould's current Products Price List are furnished "AS IS" without warranty of any kind, either expressed or implied; except that Gould warrants the media upon which such software is delivered to the licensee will be free from any defects in material and workmanship for a period of 90 days from the time of shipment. If any such medium proves defective during this warranty period, Gould will provide a replacement in exchange for the defective medium. Gould does not warrant that the functions contained in the software product will meet customer's requirement or that operation of the programs will be uninterrupted or error-free or that errors will be corrected. Gould will correct all reported substantial nonconformities in unaltered media for 90 days from time of shipment, provided such reports are made in accordance with Gould's standard reporting procedure, and such nonconformities are confirmed Gould. GOULD'S LIABILITY UNDER SUCH WARRANTY

IS LIMITED TO THE REPAIR OR REPLACEMENT OF THE MEDIA, AT GOULD'S OPTION. IN NO EVENT SHALL GOULD BE LIABLE UNDER ANY CIRCUMSTANCES, FOR ANY LOSS OF PROFITS OR OTHER CONTINGENT, CONSEQUENTIAL OR SPECIAL DAMAGES ARISING OUT OF ANY DEFECT IN OR FAILURE OR INADEQUACY OF PERFORMANCE OF ANY SOFTWARE PRODUCT FURNISHED BY GOULD. THE FOREGOING WARRANTY IS EXCLUSIVE AND EXPRESSLY IN LIEU OF ALL OTHER WARRANTIES WHETHER EXPRESSED OR IMPLIED, INCLUDING ANY IMPLIED WARRANTIES OF MERCHANTABILITY OR FITNESS AND OF ANY OTHER OBLIGATION AND SHALL CONSTITUTE THE SOLE REMEDY OF THE BUYER AND SOLE LIABILITY OF GOULD.

For further details regarding specific product extended warranty arrangements, please consult your local Gould Sales or Service office.

Gould Inc., Test and Measurement Group

AUSTRIA

Gould Electronics
Handelsges.m.b.H.
Mauerbachstrasse 24
A-1140 Wien
Telephone: 43-1/972506-0
Telefax 43-1/972506 38
Telex 1-31380

CANADA

BRITISH COLUMBIA

Vancouver

Interfax Systems Inc.
108-10334 152 A Street
Surrey, BC V3R 7P6
Telephone: (604) 582-2151
Fax: (604) 582-2161

ONTARIO

Ottawa

Interfax Systems Inc.
235 Stafford Road
Bay 104
Nepean, ON K2H 9C1
Telephone: (613) 726-8888
Fax: (613) 820-3213

Toronto

Interfax Systems Inc.
45 Voyager Court N.
Rexdale, ON M9W 4Y2
Telephone: (416) 674-8970
Fax: (416) 674-8986

QUEBEC

Montreal

Interfax Systems Inc.
5575 St. Francois
St. Laurent, PQ H4S 1W6
Telephone: (514) 336-0392
Fax: (514) 336-9607

FRANCE

Gould Electronique
57, rue Saint-Sauveur
Ballainvilliers
91160 Longjumeau
Telephone: (1) 69.34.10.67
Telex: 600 824
Fax: (1) 69.34.20.73

GERMANY

Gould Electronics GmbH
Waldstrasse 66
D-6057 Dietzenbach
Telephone: 06074 4908-0
Telex: 4 197 644 gould
Fax: 06074 4908-48

HONG KONG

JADA Development Ltd.
Block B, 4th Floor
Hop Hing Industrial Building
No. 702 Castle Peak Road
Kowloon
Telephone: 852-742-1771
Fax: 852-744-0401

ITALY

Gould Italia
Via Torino 25
20063 Cernusco S/N (MI)
Telephone: (02) 92.10.74.61
Fax: (02) 92.10.74.56

JAPAN

Nippon Mining Co., Ltd.
Copper Foil & Circuits Materials
Group
10-1, Toranomom 2-Chome
Minato-Ku, Toyko 105
Telephone: 81-3-3505-8746
Fax: 81-3-3505-8692

UNITED KINGDOM

Gould Electronics Ltd.
Roebuck Road
Hainault, Ilford
Essex IG6 3UE
Telephone: (081) 500 1000
Telex: 263785
Fax: (081) 501 0116

UNITED STATES

ARIZONA

Phoenix

Gould Inc.
8777 E. Via de Ventura, #100
Scottsdale, AZ 85258-3344
Telephone: (602) 990-8212
Fax: (602) 443-8286

CALIFORNIA

Los Angeles

Gould Inc.
11060 Artesia Blvd., Suite G
Cerritos, CA 90701
Telephone: (213) 404-1919
Fax: (213) 404-1635
TWX: (910) 583-1365

San Francisco

Gould Inc.
3777 Depot Road, Suite 418
Hayward, CA 94545
Sales Telephone: (415) 346-1349
Service Telephone: (510) 293-1402
Fax: (510) 293-1408

COLORADO

Denver

Gould Inc.
Telephone: (303) 347-9622
Fax: (303) 347-9632

DISTRICT OF COLUMBIA

Gould Inc.
5411 Berwyn Rd., Suite 104B
College Park, MD 20740
Sales Telephone: (301) 345-0050
or (800) 631-0985
Service Telephone: (301) 345-0052
Fax: (301) 345-2850

FLORIDA

Orlando

7648 Southland Blvd., Suite 103
Orlando, FL 32809
Telephone: (407) 438-5161 or
(800) 831-8373
Fax: (407) 438-5167

GEORGIA

Atlanta

Gould Inc.
5555 Oakbrook Parkway
Suite 605
Norcross, GA 30093
Sales Telephone: (404) 368-2170
or (800) 831-8373
Service Telephone: (404) 368-2175
Fax: (404) 368-2184

Gould Inc., Test and Measurement Group

ILLINOIS

Chicago

Gould Inc.
2800 West Golf Road
Rolling Meadows, IL 60008
Sales Telephone: (708) 640-4377
Service Telephone: (708) 640-4380
Fax: (708) 640-4584

INDIANA

Indianapolis

Gould Inc.
Telephone: (800) 326-4135
Fax: (708) 640-4584

IOWA

Davenport

Gould Inc.
Telephone: (319) 355-2171
Fax: (319) 355-2276

MASSACHUSETTS

Boston

Gould Inc.
Telephone: (617) 389-8652 or
(800) 631-0985
Fax: (617) 389-1651

MISSOURI

St Louis

Gould Inc.
Telephone: (314) 458-4429
Fax: (314) 458-4430

MICHIGAN

Detroit

Gould Inc.
11700 Metro Airport Center Dr.,
#101
Romulus, MI 48174
Sales Telephone: (313) 955-7880
Service Telephone: (313) 955-7883
Fax: (313) 955-7873

NEW YORK

Metropolitan New York

Gould Inc.
405 Murray Hill Parkway
East Rutherford, NJ 07073
Telephone: (201) 935-1717 or
(800) 631-0985
Fax: (201) 935-6945

NORTH CAROLINA

Greensboro

Gould Inc.
P. O. Box 16212
Greensboro, NC 27406
Telephone: (919) 275-1978

OHIO

Cleveland

Gould Inc.
8333 Rockside Road
Valley View, OH 44125-6104
Sales Telephone: (216) 328-7256
Service Telephone: (216) 328-7175
Fax: (216) 328-7404

Dayton

Gould Inc.
8401 Claude Thomas Road
Suite 46
Franklin, OH 45005
Sales Telephone: (513) 743-7965
Service Telephone: (513) 743-7967
Fax: (513) 743-7969

PENNSYLVANIA

Pittsburgh

Gould Inc.
3245 Old Frankstown Road
Pittsburgh, PA 15239
Sales Telephone: (412) 831-7074
Sales Fax: (412) 831-7832
Service Telephone: (412) 327-7451
Service Fax: (412) 327-7434

Philadelphia

Gould Inc.
Telephone: (215) 346-8025 or
(800) 631-0985
Fax: (215) 346-6084

TEXAS

Dallas

Gould Inc.
8214 Westchester, #500
Dallas, TX 75225
Telephone: (214) 691-8048
Fax: (214) 691-4176

Houston

Gould Inc.
10500 Northwest Freeway
Suite 209
Houston, TX 77092
Sales Telephone: (713) 680-1121
Service Telephone: (713) 680-3995
Fax: (713) 680-9653

WASHINGTON

Seattle

Gould Inc.
Telephone: (206) 861-4767
Fax: (206) 861-4769

USA

GOULD INC., TEST &
MEASUREMENT GROUP,
8333 Rockside Road,
Valley View, OH 44125-6104
Telephone (216) 328 7000
Fax (216) 328 7400

UNITED KINGDOM

GOULD ELECTRONICS LTD.
Roebuck Road,
Hainault, Ilford,
Essex IG6 3UE
Telephone (081) 500 1000
Telex 263785
Fax (081) 501 0116

AUSTRIA

GOULD ELECTRONICS
Handelsges. m.b.H.,
Mauerbachstrasse 24,
A-1140 Wien
Telephone (1) 972506-0
Telex 1-31380
Fax (1) 9725 0638

FRANCE

GOULD ELECTRONIQUE,
57, Rue Saint-Sauveur,
Ballainvilliers,
91165 Longjumeau Cédex.
Telephone (1) 6934 1067
Telex 600824 GOULD
Fax (1) 6934 2073

GERMANY

GOULD ELECTRONICS GmbH,
Waldstrasse 66,
D-6057 Dietzenbach.
Telephone (06074) 4908-0
Telex 4 197 644 GOULD
Fax (06074) 4908-48

ITALY

GOULD ITALIA,
Via Torino 25,
20063 Cernusco S/N (MI)
Telephone (02) 9210 7461
Fax (02) 9210 7456

JAPAN

NIPPON MINING CO., LTD.
Copper Foil & Circuits
Materials Group,
10-1, Toranomon 2-Chome,
Minato-Ku, Tokyo 105.
Telephone 81-3-3505-8746
Fax 81-3-3505-8692

AND OTHER GOULD
REPRESENTATIVES AND
DISTRIBUTORS WORLDWIDE.

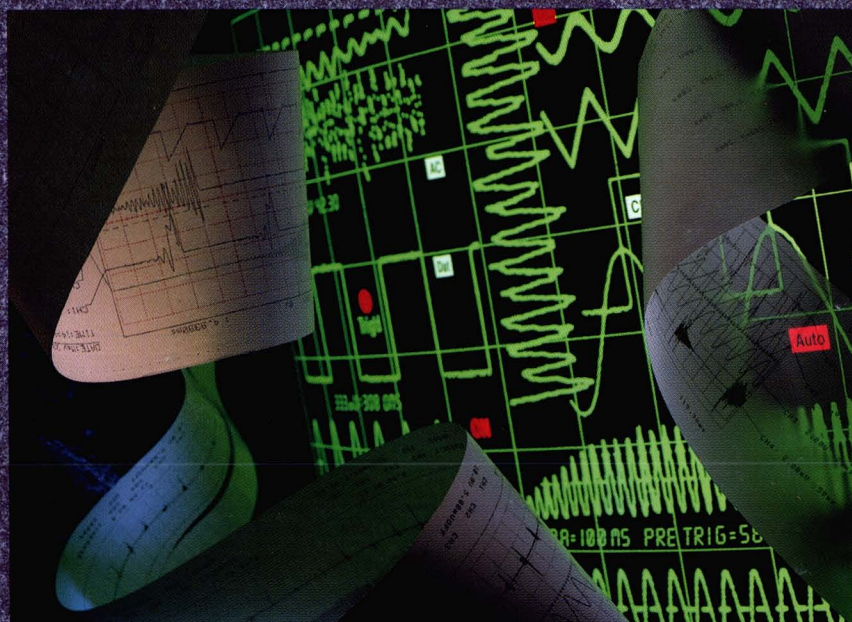

Gould Electronics manufactures and markets a family of sophisticated instrumentation which includes oscillographic, array, waveform and strip chart recorders; digital storage and recording oscilloscopes; and data acquisition systems. With Gould, you

use products that set the standard for comprehensive, yet easy-to-use instrumentation. You benefit from our experience and our determination to make every Gould instrument the best in its class.

