

1989 GOULD TEST AND MEASUREMENT INSTRUMENTS AND SYSTEMS

A SPECTRUM OF SOLUTIONSSM

INDEX

NEW
PRODUCTS

LOGIC
ANALYZERS

OSCILLOSCOPES

GRAPHIC
RECORDERS

SIGNAL
CONDITIONERS

WAVEFORM
RECORDERS

COMPUTER
BASED
INSTRUMENTATION

MEDICAL
PRODUCTS

CUSTOM
SYSTEMS

SUPPLIES



GOULD
Electronics

A SPECTRUM OF SOLUTIONSSM

Experience. Only Gould brings you more than 60 years of test and measurement know-how. With practical applications knowledge in electronics, aerospace, automotive, power and utilities, general industrial testing and health care. With the right hardware, the right software, and blue ribbon customer support. Experienced people, dedicated to helping you solve your toughest test and measurement problems with a spectrum of product solutions.

Today, with over 1,000 employees, and offices in the America's, Europe and Asia, Gould is one of the largest International producers of general and special purpose test instrumentation in the world. Our instruments and test systems combine innovative, user-oriented design with superior accuracy and rugged quality. A broad range of products that provide a full spectrum of electronic and physical-based test and measurement solutions.

Multi-national in scope, the Test and Measurement Group includes four divisions located in England, France and the United States.

□ Array Recorders Division. Located in Ballainvilliers (Paris), France, the Array Recorders Division is the world's most innovative designer of array recording systems. This Division's new powerful ES2000 Real-Time Electrostatic Recording System provides sophisticated, computer-based, real-time solutions for a host of aerospace, medical and industrial measurement problems.

□ Recording Systems Division. Located in Cleveland, Ohio, the Recording Systems Division, originally Brush Instruments, has set the standards for direct writing recording systems since the 1930's. Major new product introductions include a clinical recording system for hospitals equipped for cardiac cath studies. This Division has also introduced PC Instruments, a new category of computer-based instruments that provides a highly automated solution for controlling IEEE-488 instruments, making measurements, analyzing results and developing reports.

□ Instruments System Division. Located in Hainault, England, the Instrument System Division (Advance Instruments) produces a broad range of Digital Storage Oscilloscopes that provide solutions with outstanding price/performance and value. An example is the new OS400 DSO, a truly portable scope that runs from AC or DC power, offers 20MHz storage bandwidth, pre- and post-trigger delay, and much more.

□ Design and Test Systems Division. Located in Cupertino, California, the Design and Test Systems Division (Biomation) is

a world leader in the development of logic analyzers, and offers a full line of instruments that provide a broad range of solutions. This year the Design and Test Systems Division has introduced the CLAS 4000, a configurable multi-analyzer system controlled by a standard, workstation-class computer. Its intuitive operating environment has met Gould's objective to provide a powerful instrument with "no manual" operation.

Gould. The Right Choice for Your Test and Measurement Needs.

Gould is dedicated to helping you solve your electronic and physical-based test and measurement problems. With our broad range of innovative instrument technology and our vast experience in test and measurement applications, Gould is the right choice for you. The Right Choice for Now and the Future.



General Information	2	Computer Based Instrumentation	116
Gould Test and Measurement	2	Waveform Recorders	118
Alphabetical Index	4	DASA Technology	128
Model Number Index	7	DASA Software	131
New Products	13	PC Instruments	136
		PC Instrument Modules	138
Logic Analyzers	18	PCI Computers	152
Selection Chart	20	PCI Software	155
Applications Information	21		
CLAS 4000	22	Medical Products and Systems	162
Logic Analyzers	32	Medical Instrumentation Charts	164
Logic Analyzer Accessories	41	Signal Conditioners	166
Microprocessor Analysis Packages	46	Monitors	177
VLSI Analysis and Test Systems	48	Medical Accessories and Transducers	178
		Medical Instrumentation Systems	182
Oscilloscopes	54	Clinical EP/Cath Lab Systems	186
Selection Chart	54	Medical Motility Systems	187
Digital Storage Oscilloscopes	56		
Oscilloscope Software	66	Special Systems	188
Waveform Processors	68	Telemetry and Simulation Systems	189
Accessories and Consumables	71		
		Supplies	190
Graphic Recorders	74	Strip Chart and Thermal Array Recorders	192
Selection Chart	77	200 Series	194
Oscillographic Recorders	78	Electrostatic Recorders	196
Thermal Recorders	84	2000 Series	197
Electrostatic Recorders	88	3000 Series	202
Data Logger	96	8000 Series	207
		Colorwriter Plotters	207
Signal Conditioners	97	XY Recorders	210
Selection Chart	98	Obsolete Recorders	211
Programmable Amplifiers	100		
4600 Amplifiers	107	Shipping, Prices, Terms and Conditions	214
Isolation Amplifiers	114	Service	215
Amplifier Cases	114	Customer Services and Information	217
Accessories	115	Warranties	218
		United States Sales and Service	220
		International Facilities	221

© 1989
 Gould Inc.
 Test and Measurement Group
 All Rights Reserved

NEW
PRODUCTSLOGIC
ANALYZERS

OSCILLOSCOPES

GRAPHIC
RECORDERSSIGNAL
CONDITIONERSWAVEFORM
RECORDERSCOMPUTER BASED
INSTRUMENTATIONMEDICAL
PRODUCTSCUSTOM
SYSTEMS

SUPPLIES

Description	Page	Description	Page
8-Channel DC Amplifier	106	DASA Systems	128-130
A/D Converter	146	Data Acquisition Systems	128-130
Accessories	41-45, 52-53, 71-73, 115, 178-181	Data Logger	96
Amplifier	115	DC Amplifier	92, 100
Logic Analyzers	41-45, 52-53	DC Bridge Amplifier	109
Medical	178-181	DC Signal Conditioners	170
Oscilloscopes	71-73	Differentiator Signal Conditioner	175
Advance Oscilloscopes	56-65	Digital Input	91, 94
Alphanumeric Character Board	95	Digital Input/Output	149
Amplifiers	90-92, 100-114	Digital Multimeter	138-139
Accessories	115	Digital Storage Oscilloscopes	56-65, 144
Bridge	101, 109	Display Monitors	95
Carrier	107	Dual Channel DC Amplifier	104
Case	114	ECG Amplifier	172-173, 178
DC	100, 104-106, 108-109	ECG/Biotach Signal Conditioner	172-173
Envelope	113	Electrostatic Recorders	88-95
Frequency	111	Envelope/Pulse Amplifier	113
High Gain DC	108	EP/Cath Lab Recording Systems	186
High Voltage	108	ES1000 Modules	94
Log-Linear	112	ES2000 Modules	90-92
Pulse	113	Event Marker Input	94
RMS	102, 109	FFT/Analyzer	143
Temperature	103, 110	Frequency Deviation Amplifier	111
Thermocouple	103, 110	Frequency to Voltage Amplifier	111
Transducer	101	Function/Pulse Generator	145
Transmitter	112	Grid Generator	94
Universal	107	High Frequency Waveform Storage Amplifier	113
Waveform	113	High Gain Analog Input	94
Amplifier Case	114	High Gain DC Amplifier	108
Analog Input	92, 94	High Resolution Hard Copy Board	90
ASIC/VLSI Analysis Systems	48-51	High Voltage Amplifier	108
Biomation Logic Analyzers	41-45, 52-53	IEEE-488 Digital Input	91, 94
Biotach Signal Conditioner	171	Ink	192-213
Bridge Amplifier	101, 109	Ink Recorders	78-83
Brush Recorders	78-83		
Calibrator	148		
Carrier Signal Conditioner	168		
Cath Lab Recording Systems	168, 186		
Chart Paper	192-213		
Computer Based Instrumentation	116-161		
Computers	152-154		
Counters	142		

Description	Page	Description	Page
Integrator Signal Conditioner	174	Portable Recorders	83
Isolator	114	Power Supply	147
Log-Linear Amplifier	112	Pressure Processor Signal Conditioner	169
Logic Analysis System	22-31, 34	Programmable Bridge Amplifier	101
Logic Analyzers	18-53	Programmable DC Amplifier	100, 101
Accessories	41-45, 52-53	Programmable Power Supply	147
Analysis System	22-31, 34	Programmable RMS Amplifier	102
ASIC/VLSI Analysis Systems	48-51	Programmable Thermocouple Amplifier	103
Microprocessor Analysis Packages	46-47	Programmable Transducer Amplifier	101
Software	53	Pulse Amplifier	113
Medical Products	166-187	Recorders	74-96
Medical Signal Conditioners	166-176	Chart	78-83
Medical Systems	182-187	Direct Writing	78-83
Medical Transducers	178-181	Electrostatic	88-95
Microprocessor Analysis Packages	46-47	Ink	78-83
Monitor	95, 177	Oscillographic	78-83
Motility Systems	187	Portable	83
Multiple Writing Unit Interface	90	Thermal	78-82, 84-85
Oscillographic Recorders	78-83	Thermal Array	86-87
Electrostatic	88-95	Waveform	120-127
Ink	78-83	Relay Scanner	150-151
Portable	83	RMS Amplifier	109
Thermal	78-82	Signal Conditioners	90-92, 100-114
Thermal Array	86-87	Signal Conditioner Case	114
Oscilloscope Software	66-67	Simulation Data Display System	189
Oscilloscopes	56-65	Software	53, 66-67, 131-134, 155-161
Paper	192-213	Data Acquisition	131-134
PC Instruments	136-161	Logic Analysis	53
A/D Converter	146	Oscilloscopes	66-67
Computers	152-154	PC Instruments	155-161
Digital Input/Output	149	Special Systems	188-189
Digital Multimeter	138-139	Speed Expander Module	94
Digital Storage Oscilloscope	144	Starter Kits	192-213
FFT/Analyzer	143	Supplies	190-213
Function/Pulse Generator	145	Telemetry Systems	189
Power Supply	147	Temperature Signal Conditioner	110, 176
Relay Scanner	150-151	Thermal Array Recorders	86-87
Software	155-161	Thermal Recorders	78-82, 84-85
Transient Recorders	140-141	Thermocouple Amplifier	110
Universal Counter	142		
Voltage/Current Calibrator	148		
Pens	192-213		
Personal Computer Instruments	136-161		

Description	Page
Time Code Interface	91
Transducer Signal Conditioner	101, 167
Transient Recorders	140-141
Transmitter Amplifier	112
True RMS Amplifier	109
Universal Amplifier	107
Universal Counter	142
Universal Signal Conditioner	166
Voltage/Current Calibrator	148
Waveform Processors	68-70
Waveform Recorders	120-127
Waveform Storage Amplifier	113

Model Number	Description	Page	Model Number	Description	Page
A11007	T-12A Communicator	43	A14576	K450B Probe Kit	41
A11014	K100-D/10 Probe Pods	43	A14577	K450B Probe Kit	41
A11016	K100-D Probe Set	43	A14578	K450B Probe Kit	41
A11019	K100-D Probe Set	43	A14582	K450B PCLA with Telediagnosis	41
A11501	K115 Probe Kit	42	A14588	MAP for TMS-32010	41
A11502	K115 Probe Kit	42	A14590	MAP for 68030	41
A11503	K115 Probe Kit	42	A14592	MAP for 68HC11	41
A11510	MAP for 68000/10	42	A14593	MAP for 8096/196	41
A11511	MAP for 8086/88	42	A14595	MAP for 80515/535	41
A11512	MAP for 8085/8085A	42	A15002	Digital Probe Kit	45
A11513	MAP for 8080/8080A	42	A19502	S10 Probe	41, 42
A11514	MAP for Z80, Z80A, Z80B	42	A19511	K115 PCLA	42
A11515	MAP for 6800/02	42	A50004	Analog Probe	45
A11516	MAP for 6809	42	A50009	Instrument Cart	41 to 45
A11521	K115 Probe Kit	42	A60011	Z80/A/B/H Disassembler	44
A11522	K115 Probe Kit	42	A60012	8085/A/80C85 Disassembler	44
A11523	Flying Lead Kit	42	A60013	8048/49/35/39/40/50/8748/8749 Disassembler	44
A11524	MAP for 8031/51	42	A60014	8031/51/8344/8751 Disassembler	44
A11531	MAP for 68020	42	A60015	6502/65C02 Disassembler	44
A11532	MAP for 8048/49	42	A60017	6809/E Disassembler	44
A11533	MAP for 68008	42	A60021	8086/88 Disassembler	44
A11535	MAP for 80186/80188	42	A60022	68000/L/P/R Disassembler	44
A12523	K450B Flying Lead Kit	41	A60023	64180 Disassembler	44
A14550	MAP for 8031/8051	41	A60043	6301/03/63701/6801/6803/68701 Disassembler	44
A14551	MAP for 80286	41	A60044	6800/012/02NS/08 Disassembler	44
A14552	MAP for 80186/80188	41	A60045	80186/188 Disassembler	44
A14553	MAP for 8080/8080A	41	A60050	8086/88 Disassembler	44
A14554	MAP for Z80, Z80A, Z80B	41	A60051	68000/L/P/R Disassembler	44
A14555	MAP for 8086/88	41	A60052	64180 Disassembler	44
A14556	MAP for 68000/10	41	A60054	80186/188 Disassembler	44
A14557	MAP for 68008	41	A70001	68020 MAP for CLAS 4000	31
A14558	MAP for 68020	41	A70002	80386 MAP for CLAS 4000	31
A14559	MAP for 8085/8085A	41	A70003	68030 MAP for CLAS 4000	31
A14560	MAP for 80386	41	A70004	88000 MAP for CLAS 4000	31
A14563	Telediagnosis	41	A70005	80960 MAP for CLAS 4000	31
A14568	K450B Probe Kit	41	A70006	80486 MAP for CLAS 4000	31
A14569	K450B Probe Kit	41	A70024	SPARC MAP for CLAS 4000	31
A14573	MAP for 6809	41	A70025	R3000 MAP for CLAS 4000	31
A14574	K450B Probe Kit	41			
A14575	K450B Probe Kit	41			

Model Number	Description	Page	Model Number	Description	Page
A70026	T 800 MAP for CLAS 4000	31	K450B-180	80 Channel Logic Analyzer	33
A70027	Pyramid Module with Probe Set for CLAS 4000	31	K450M	Logic Analyzer System	34
A70031	CLAS 4000 Installation	31	K450M-132	32 Channel/2.5 Mbits Logic Analyzer System	34
ACQ5300	5300 Software	131	K450M-164	64 Channel/2.5 Mbits Logic Analyzer System	34
CL-712724	PCI-WINDOWS Software	155	K450M-232	32 Channel/10 Mbits Logic Analyzer System	34
CL-712725	PCI-GENESYS Program Generator Software	159	K450M-264	64 Channel/10 Mbits Logic Analyzer System	34
CL-712726	PCI-PANEL KIT Software	156	K500	Logic Analyzer	35
CL-712727	PCI-SNAP Software	157	K500-D	Logic Analyzer	35
CL-712728	PCI-BASIC Software	161	M200	Alphanumeric Character Board	95
CL-810413	Isolated High Voltage Connector	100	MW2000	Multiple Writing Unit Interface	90
CL-810414	High Voltage Connector	100	PB12	100 MHz Probe	71
CLAS 4000	Configurable Logic Analysis System	22	PB13	100 MHz Probe	71
DA1000	Differential Amplifier	73	PB17	250 MHz Probe	71
DASA 4600	Acquisition System	130	PB19	250 MHz Probe	71
ES2000	Electrostatic Recorders	88, 124	PB20	250 MHz Probe	71
HR2000	High Resolution Hard Copy Board	90	PB27	7 MHz Probe	71
IT160A	Single Channel Digital Input	94	PB36	300 MHz Probe	71
IT164	4-Channel Digital Input	94	PB150	Time Code Interface	91
IT190	Grid Generator	94	PB200	2-Channel DC Amplifier	92
IT200	20-Event Marker Input	94	PB400	4-Channel Analog Input	92
IT300	Time Code Interface	94	PB860	8-Channel Digital Input	91
IT488	IEEE-488 Interface	94	PC1360	PCI Digital Storage Oscilloscope Module	144
K25	Logic Analyzer	38	PC3000	PCI Function/Pulse Generator Module	145
K25-032	32 Channel Logic Analyzer	38	PC3050	PCI Voltage/Current Calibrator Module	148
K50	Logic Analyzer	39	PC3080	PCI Programmable Power Supply Module	147
K50-032	32 Channel Logic Analyzer	39	PC3100	PCI Digital Input/Output Module	149
K100-000	16 Channel Logic Analyzer	40	PC3101	PCI A/D Converter Module	146
K100-200	16 Channel Logic Analyzer	40	PC3120	PCI FFT/Analyzer Module	143
K100-950	16 Channel Logic Analyzer	40	PC3141	PCI Transient Recorder Module	140
K100-952	16 Channel Logic Analyzer	40	PC3143	PCI Transient Recorder Module	140
K100-D	Logic Analyzer	40	PC3180	PCI Relay Scanner Module	150
K115	Logic Analyzer	36	PC3200	PCI Universal Counter Module	142
K115-148	32 Channel Logic Analyzer	37	PC3220	PCI Digital Multimeter Module	138
K115-172	64 Channel Logic Analyzer	37	PC31490	PCI Transient Recorder Module	140
K450B	Logic Analyzer	32	RS 3200	Oscillographic Recorders	79
K450B-132	32 Channel Logic Analyzer	33			
K450B-148	48 Channel Logic Analyzer	33			
K450B-164	64 Channel Logic Analyzer	33			

Model Number	Description	Page	Model Number	Description	Page
RS 3400	Oscillographic Recorders	79	13-G4615-43	Thermocouple Amplifier	110
RS 3600	Oscillographic Recorders	79	13-G4615-44	Thermocouple Amplifier	110
RS 3800	Oscillographic Recorders	79	13-G4615-45	Thermocouple Amplifier	110
S10	Logic Analyzer Probe	41, 42	13-G4615-47	Temperature Amplifier	110
SC 2132	Data Logger	96	13-G4615-50	Transducer Signal Conditioner	167
SC1012	12-Channel ECG Amplifier	178	13-G4615-52	Pressure Processor Signal Conditioner	169
SET 5600	DASA Software	134	13-G4615-58	Universal Signal Conditioner	107, 166
SP100A	Single Channel Analog Input	94	13-G4615-64A	ECG Signal Conditioner	172
SP110A	Single Channel High Gain Analog Input	94	13-G4615-65A	ECG/Biotach Signal Conditioner	172
SP400A	4-Channel Analog Input	94	13-G4615-66	Biotach Signal Conditioner	171
SPX100	2-Channel Speed Expander Module	94	13-G4615-70	Integrator Signal Conditioner	174
STM4100	Digital VLSI Test System	50	13-G4615-71	Differentiator Signal Conditioner	175
STM4100-64	64 Channel Tester	51	13-G4615-90	High Voltage Amplifier	108
STM4100-128	128 Channel Tester	51	13-G4615-474029	Temperature Signal Conditioner	176
STM4100-192	192 Channel Tester	51	13-G4616-20A	High Frequency Waveform Storage Amplifier	113
STM4100-256	256 Channel Tester	51	13-G4616-30	Envelope/Pulse Amplifier	113
SYS6000	ASIC/VLSI Analysis System	48	13-G4616-31	Envelope/Pulse Amplifier	113
SYS6000-64	64 Channel Logic Analysis System	49	13-G4618-00	Frequency Deviation Signal Conditioner	111
SYS6000-128	128 Channel Logic Analysis System	49	13-G4618-10	True RMS Amplifier	109
SYS6000-256	256 Channel Logic Analysis System	49	13-G4618-20	Frequency/Voltage Signal Conditioner	111
SYS6000-352	352 Channel Logic Analysis System	49	13-G4618-40	Transmitter Amplifier	112
T-12A	K100-D Communicator	43	13-G4681-00	8-Channel Isolator Amplifier	114
TA 550	Thermal Recorders	85	015-1223-02	64 Channel Upgrade	53
TA 2000	Thermal Array Recorders	86	015-2620-00	16 Channel Upgrade	53
TA 2000/4300	Waveform Recording System	126	23-20121-01	ES2000 Controller	93
TR7	Oscilloscope Cart	73	23-21101-01	PB400 Analog Input	93
V1000	Display Monitor	95	23-21101-03	PB200 DC Amplifier	93
VIEW II	Graphics and Analysis Software	132	23-22101-01	PB860 Digital Input	93
11-4220-00	Status Report Board	105	23-22101-03	PB150 Time Code Interface	93
13-G4614-01	Log-Linear Amplifier	112	23-22101-08	PB861 Digital Input	93
13-G4615-20	High Gain DC Amplifier	108	23-26121-01	ES2000 Writing Unit	93
13-G4615-30	DC Bridge Amplifier	109	23-27121-01	ES2000 9-in. Monitor	93
13-G4615-35	Carrier Signal Conditioner	107, 168	23-27121-02	ES2000 12-in. Monitor	93
13-G4615-40	Thermocouple Amplifier	110	23-27121-03	ES2000 20-in. Monitor	93
13-G4615-41	Thermocouple Amplifier	110	23-28101-03	MW2000 Multiple Writing Unit Interface	93
13-G4615-42	Thermocouple Amplifier	110	23-28101-04	HR2000 High Resolution Hard Copy Board	93

Model Number	Description	Page	Model Number	Description	Page
23-28101-05	CRT2000 Video Controller Board	93	040-0006-01	Computer Aided Simulation Translation Software	53
23-29121-01	ES2000 Portable Keyboard	93	040-0107-00	Parametric Measurement Unit	53
23-29121-02	ES2000 Remote Control Keypad	93	040-0109-00	Voltage Level Sensitivity Measurement Software	53
35-V7202-10	2-Channel Ink Recorder	82	040-0113-00	Executive Command Language Software	53
35-V7202-11	2-Channel Ink Recorder	82	48-8400-01	8-Channel DC Amplifier	106
35-V7210-10	1-Channel Ink Recorder	82	51-3183-10	8-Channel Monitor	177
35-V7210-11	1-Channel Ink Recorder	82	51-3283-10	8-Channel Monitor	177
35-V7404-10	4-Channel Ink Recorder	82	51-4142-00	Medical Monitor	177
35-V7404-11	4-Channel Ink Recorder	82	51-4142-20	Medical Monitor	177
35-V7412-10	3-Channel Ink Recorder	82	53-90007-1	Waveform Recorder	122
35-V7412-11	3-Channel Ink Recorder	82	53-90008-1	Waveform Recorder	122
35-V7420-10	2-Channel Ink Recorder	82	53-90009-1	Waveform Recorder	122
35-V7420-11	2-Channel Ink Recorder	82	53-90010-1	Waveform Recorder	122
35-V7606-10	6-Channel Ink Recorder	82	56-1300-00	Programmable DC Amplifier	100
35-V7606-11	6-Channel Ink Recorder	82	56-1301-00	Programmable DC/Bridge/Transducer Amplifier	101
35-V7606-12	6-Channel Ink Recorder	82	56-1302-00	Programmable RMS Amplifier	102
35-V7606-13	6-Channel Ink Recorder	82	56-1303-00	Programmable Thermocouple Amplifier	103
35-V7808-10	8-Channel Ink Recorder	82	56-1340-00	DC Amplifier	105
35-V7808-11	8-Channel Ink Recorder	82	56-1340-6158	DC Signal Conditioner	170
35-V7808-12	8-Channel Ink Recorder	82	56-1440-00	DC Amplifier	105
35-V7808-13	8-Channel Ink Recorder	82	56-1440-6158	DC Signal Conditioner	170
35-V8202-10	2-Channel Thermal Recorder	82	56-2400-00	Dual Channel DC Amplifier	104
35-V8202-11	2-Channel Thermal Recorder	82	160A	Waveform Processor	68
35-V8210-10	1-Channel Thermal Recorder	82	170A	Waveform Processor	68
35-V8210-11	1-Channel Thermal Recorder	82	220	Portable Recorder	83
35-V8404-10	4-Channel Thermal Recorder	82	222	Battery-Operated Recorder	83
35-V8404-11	4-Channel Thermal Recorder	82	253-222111-1	Thermal Recorder	85
35-V8412-10	3-Channel Thermal Recorder	82	253-322111-1	Thermal Recorder	85
35-V8412-11	3-Channel Thermal Recorder	82	260	Waveform Processor	68
35-V8420-10	2-Channel Thermal Recorder	82	270	Waveform Processor	68
35-V8420-11	2-Channel Thermal Recorder	82	400	Digital Storage Oscilloscope	56
35-V8606-10	6-Channel Thermal Recorder	82	0409-0400	400 Digital Storage Oscilloscope	57
35-V8606-11	6-Channel Thermal Recorder	82	0409-0430	400 Digital Storage Oscilloscope with battery pack	57
35-V8606-12	6-Channel Thermal Recorder	82	0409-1425	1425 Digital Storage Oscilloscope with cursors and interface	65
35-V8606-13	6-Channel Thermal Recorder	82	0409-1429	1425 with Waveform Processor and Memory	65
35-V8808-10	8-Channel Thermal Recorder	82			
35-V8808-11	8-Channel Thermal Recorder	82			
35-V8808-12	8-Channel Thermal Recorder	82			
35-V8808-13	8-Channel Thermal Recorder	82			
040-0005-01	Computer Aided Simulation Translation Software	53			

Model Number	Description	Page	Model Number	Description	Page
0409-1430	Non-volatile Memory Option Kit	65	1410-1030	100 MHz Probe	71
0409-1431	1421 Digital Storage Oscilloscope	65	1421	2 Channel Digital Storage Oscilloscope	64
0409-1465	125 Waveform Processor	65	1425	2 Channel Digital Storage Oscilloscope	64
0409-1620	1602/104 Digital Storage Oscilloscope with Plotter	63	1602	2 Channel Digital Storage Oscilloscope	61
0409-1630	1602 2 Channel Digital Storage Oscilloscope	63	1604	4 Channel Digital Storage Oscilloscope	61
0409-1640	1604/104 Digital Storage Oscilloscope with Plotter	63	3000/4300	Waveform Recording System	127
0409-1650	1604 4 Channel Digital Storage Oscilloscope	63	3000	Ink and Thermal Oscillographic Recorders	78
0409-1662	RS423 (RS-232C) Serial Interfaces	63	3008-8510-43	Thermal Array Recorder	87
0409-1663	IEEE-488 Interface	63	3008-8510-44	Thermal Array Recorder	87
0409-1664	Internal Color Plotter	63	3008-8511-43	Thermal Array Recorder	87
0409-1666	160A Waveform Processor	63	3008-8511-44	Thermal Array Recorder	87
0409-1667	105A Waveform Storage Module	63	3008-8512-43	Thermal Array Recorder	87
0409-1670	260 Waveform Processor	63	3008-8512-44	Thermal Array Recorder	87
0409-1671	205 Waveform Storage Module	63	3008-8513-43	Thermal Array Recorder	87
0409-4720	4072 2 Channel Digital Storage Oscilloscope	60	3008-8513-44	Thermal Array Recorder	87
0409-4740	4074 4 Channel Digital Storage Oscilloscope	60	3009-A1140-17	Electrostatic Recorder	93
0409-4773	170A Waveform Processor	60	3009-A1141-17	Electrostatic Recorder	93
0409-4775	270 Waveform Processor	60	3009-A1143-17	Electrostatic Recorder	93
0409-9690	1425 Starter Software	67	3009-A1144-17	Electrostatic Recorder	93
0409-9696	1600 Starter Software	67	3009-A1145-17	Electrostatic Recorder	93
0409-9698	4070 Starter Software	67	3009-A1148-17	Electrostatic Recorder	93
0410-1017	100 MHz Probe	71	3009-D1140-17	Electrostatic Recorder	93
0410-1053	Oscilloscope Cart	73	4016	Color Timing Logic Analyzer	30
0410-1074	250 MHz Probe	71	4032	Color Dual Timing Logic Analyzer	30
0410-1128	250 MHz Probe	71	4048	Color Dual Timing Logic Analyzer	30
0410-1129	250 MHz Probe	71	4064	Color Dual Timing Logic Analyzer	30
0410-1152	Differential Amplifier	73	4072	2 Channel Digital Storage Oscilloscope	58
0410-1154	7 MHz Probe	71	4074	4 Channel Digital Storage Oscilloscope	58
0410-1187	300 MHz Probe	71	4100	Color General Purpose Logic Analyzer	29
0410-1225	DADiSP Worksheet Software	67	4100SE	General Purpose Single Logic Analyzer	29
0410-1226	DADiSP488 Software	67	4116	Color Timing/State Logic Analyzer	30
0410-1233	LabWindows Control Software	66	4132	Color Timing/State Logic Analyzer	30
0410-1234	Instrument Driver Modules	66	4148	Color Timing/State Logic Analyzer	30
0410-1235	Advanced Analysis Library for LabWindows	66	4200	Color Dual Logic Analyzer	30
0410-1238	Macros and Menus for 1600/4070	67			

Model Number	Description	Page
4216	Color Timing/Dual State Logic Analyzer	31
4232	Color Timing/State Logic Analyzer	31
4300	Color Triple Logic Analyzer	30
4300	Waveform Recorder	123
4316	Color Timing/State Logic Analyzer	31
4400	Color Quad Logic Analyzer	30
4600	4600 Signal Conditioners	107-113, 166-176
5300	Waveform Recorder	120
5600	5600 Signal Conditioners	100-105
5900	Signal Conditioner Case	114
8000S	Thermal Recorders	84
9012-1072-00	Compaq Deskpro Computer	153
9014-4072-00	Compaq Deskpro Computer	152
9015-3072-00	Compaq Portable Computer	153
9017-2072-00	Zenith Computer	152
9100-3000-01	Function/Pulse Generator	145
9100-3050-01	Voltage/Current Calibrator	148
9100-3080-01	Power Supply	147
9100-3100-01	Digital Input/output	148
9100-3101-01	A/D Converter	146
9100-3120-01	FFT/Analyzer	143
9100-3140-01	Transient Recorder	141
9100-3141-01	Transient Recorder	141
9100-3143-01	Transient Recorder	141
9100-3180-01	Relay Scanner	151
9100-3200-01	Universal Counter	142
9100-3220-01	Digital Multimeter	139

CLAS 4000 Logic Analyzer

Gould's new CLAS 4000 is the most powerful logic analyzer available today, and thanks to its hardware modularity, it will not become obsolete as your measurement needs change. It is easily configured from the man-machine interface to make your measurements; no jumpers to set, no modules to move, no special probes or interfaces to purchase. And it features an operating system that makes it easy to learn and simple to operate.

Pull down menu boxes let you point at a word and select commands from a number of choices. Icons replace words because they are easy to remember. Command and syntax memorization (and mistakes) are eliminated. Graphic presentations make channel selections, clocking schemes and trace control intuitive.

The basic operating level of the CLAS 4000 provides a broad range of fixed triggering scenarios for quick results. And an advanced operating level unleashes the full power of the CLAS 4000 as a multi-analyzer. Up to four interactive analyzers, with cross triggering and time correlation create a powerful analysis system.

For more information on the CLAS 4000 Logic Analyzer, see page 22.



ASIC/VLSI Analysis System

The new System 6000 is a cost effective, high speed, high performance digital ASIC/VLSI Analysis System. Designed by ASIC designers, it makes the task of IC testing easier and more accurate.

The System 6000 fits on a bench top and tests ASIC components at all levels from simple functional verification to full device troubleshooting and characterization. In the functional test mode, the System 6000 ensures that the logic in the chip is functional. As a characterization analyzer or troubleshooter, it measures and records device parameters in terms of both level and timing.

SoftWire[®] fixturing eliminates the time and expense of building personality cards. All connections are software assigned. Devices are simply plugged into an adapter board for testing. And SoftWire-created configurations can be stored as disk files, ready to be called up instantly for quick changes to other device types or fast modification of test parameters.

See page 48 for more information on the SYS 6000 Analysis System.



400 OSCILLOSCOPE

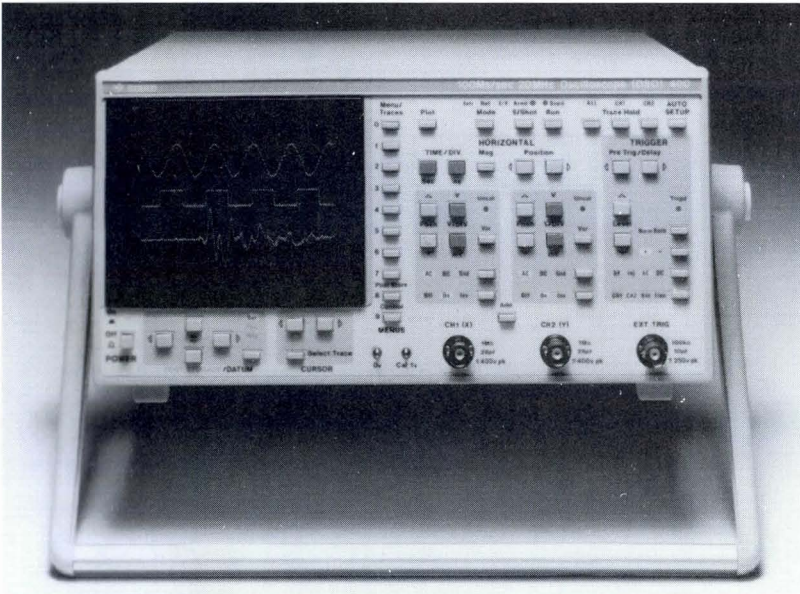

Truly a portable scope, the new 400 Series from Gould runs from 12 to 33VDC and weighs only 5.5 kg. In addition, a host of special features will help you solve difficult measurement problems. The 400 oscilloscope lets you capture only data of interest with pre- and post-trigger delay. Traces can be stored in 3 non-volatile backup memories and stored traces can be re-positioned in both X and Y, and scaled in Y. A separate reference trace can be displayed as well as the two normal channels to aid signal comparison. "Auto Setup" has been included to make operation easy. See page 56 for more details.

WAVEFORM PROCESSORS

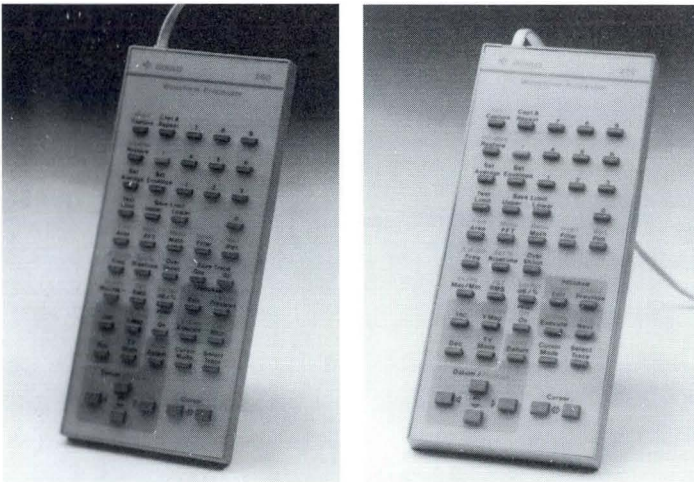

A family of 4 Waveform Processors designed for use with Gould's 1600 and 4070 Series Digital Storage Oscilloscopes will transform your DSO into a powerful signal capture, measurement and analysis system. See page 68 for more information.

OSCILLOSCOPE SOFTWARE

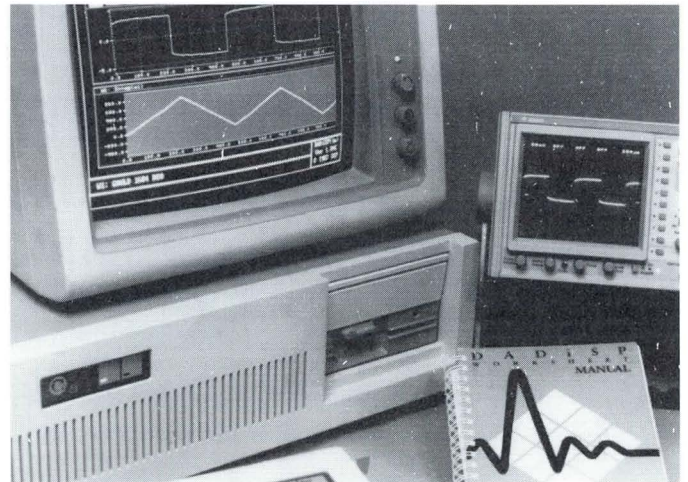

Three types of software are now available that let you increase productivity by integrating your oscilloscope with a personal computer. For more information on our control, analysis and starter software packs, see page 66.

THE ES2000 REAL TIME DISPLAY AND RECORDING SYSTEM

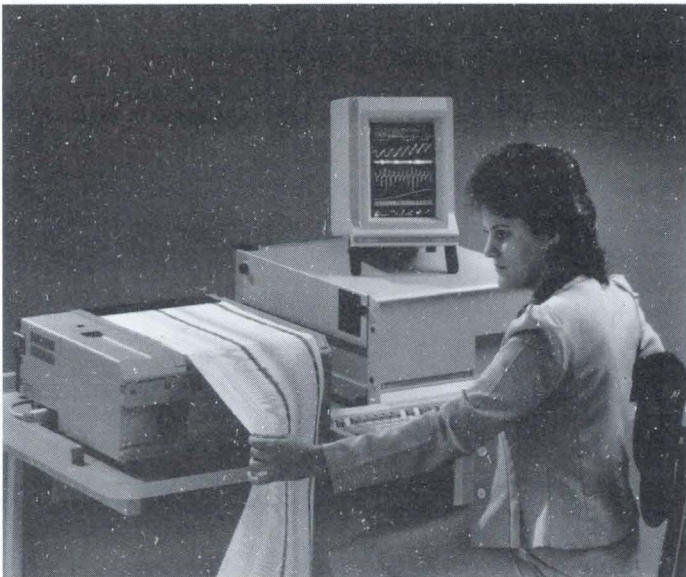

Gould's new ES2000 recording system uses a modular design based on a decentralized architecture to accommodate present and future applications. It is a powerful system comprised of an acquisition and control unit linked to a unique, high-speed electrostatic recorder, real-time video monitor, and keyboard.

Designed to meet the need of demanding aerospace, medical and industrial applications, the ES2000 offers capabilities no other recording system can match. Like real-time display and scrolling of digital and analog traces, grids and text on the monitor screen. And the ability to store setup configurations on a built-in 3-1/2 inch diskette. It offers programmed recording sequences to facilitate unattended operations, and a digitized data stream of up to 40,000 samples/s to download for storage and analysis. And you can achieve full remote programmability with a standard IEEE-488 or RS-422A interfaces.

For more information on the ES2000 recording system, see page 88.

5300 WAVEFORM RECORDER

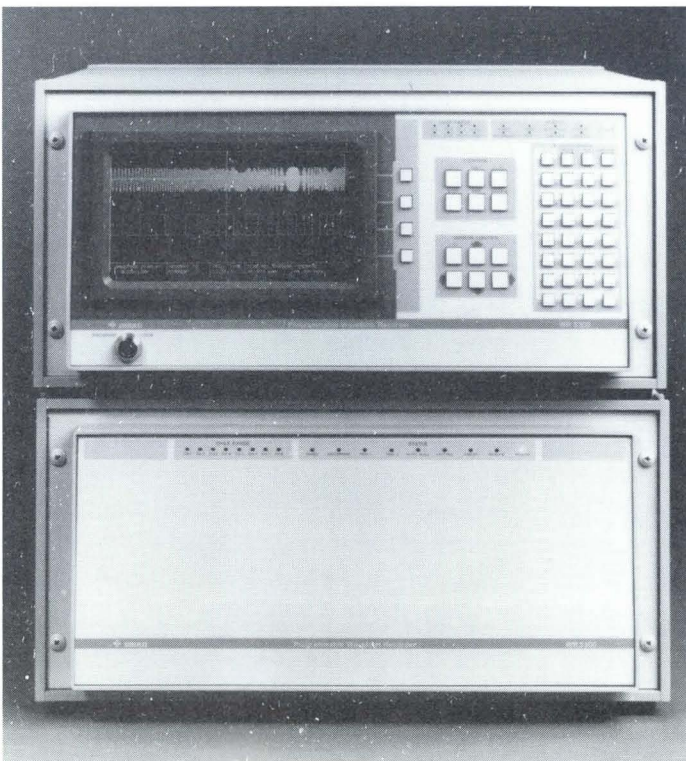

The new 5300 Waveform System provides unparalleled trigger and memory management capability. A fully programmable, 68000-based system, the 5300 combines the speed of analog signal comparators with the precision of digital logic for the most comprehensive trigger/event detection available. Handling up to 21 different trigger inputs, our exclusive Event Manager™ can discriminate more than 500,000 unique event criteria, reducing false triggers.

Each mainframe captures up to 16 channels of analog and digital data with true master/slave expansion capability to eight systems. The 5300 provides simultaneous sampling from one megasample/s to days at 12-bit resolution. The wide bandwidth is achieved through a fine resolution, 100-ns increment, dual-time base design. The 5300 is a perfect digital front end for PC, mini-computer or mainframe data acquisition. An Intelligent Front Panel with post acquisition soft display is available for stand-alone applications.

You'll find detailed information on the 5300 Waveform Recording System on page 120.

PC INSTRUMENTS



To meet the growing needs for greater automation and efficiency, Gould has introduced a family of PC Instruments (PCI) that are controlled by any IBM or compatible PC. With 13 IEEE-488 instruments and 5 software modules, this new family of instruments offers a unique and affordable way to automate test setup, analysis and documentation.

PCI from Gould is a complete system that includes acquire/measure, stimulus/source and control/switch functions. The lab quality, IEEE-488 instruments include a 5 1/2 digit multimeter, three transient recorders, universal counter, 16-bit A/D converter, FFT signal analyzer, digital storage oscilloscope, voltage/current calibrator, function-pulse generator, DC power supply, relay scanner and digital input/output. All modules are stackable to save space. Resident connectors automatically establish IEEE-488 bus connections for fast and easy configuration and reconfiguration.

The five software modules are simple to use, yet meet the most demanding application requirements. Gould's icon-based environment and uniform soft front panel displays immediately put you in complete control of setup and operation. A state-of-the-art Automatic Test Program generator, complete with analysis and convenient instrument control software put the solutions you need at your fingertips.

Whether your test application is physical, electromechanical or electronic, Gould PCI opens the door to a wide range of solutions. Its open system architecture lets you easily integrate any non-Gould IEEE-488 device. And you can add your favorite application-specific software to create a total system tailored to your precise needs.

You'll be surprised at how little it costs to maximize productivity. Gould's graphic-based software can dramatically reduce your software development for computer-based instrumentation by as much as 75%. The total solution is yours for a fraction the cost of conventional IEEE-488 systems you're using now.

For more information on the family of Gould PCI products, see page 136.

These products are available only in North America.

CLINICAL EP/CATH LAB RECORDING SYSTEMS



Gould has introduced a new line of research-quality clinical recording systems that can be custom tailored to the needs of hospital cardiac cath labs. These systems provide a complete solution for routine cardiac hemodynamic and EP testing as well as for clinical investigations. They deliver accurate records, maximum uptime and unparalleled clinical efficiency. Gould cath lab systems will help you visualize your EP or hemodynamic data, create high quality hard copy traces, produce detailed test reports, and using advanced LAN technology, quickly transmit data and reports to other areas within the hospital.

At the heart of each system is a totally programmable ES2000 Electrostatic RRecorder. This recorder features the most comprehensive annotation available, providing clear, easy-to-analyze charts. The exclusive electrostatic writing system requires no special expensive thermal or light-sensitive paper and produces a chart that won't fade or deteriorate in any way and is easy to read and reproduce. Chart speeds of up to 500 mm/s provides more accurate timing analysis, and a high resolution monitor provides the smoothest, easiest to read waveforms available.

For more information on EP/Cath Lab Systems, see page 186.

5600 PROGRAMMABLE SIGNAL CONDITIONERS

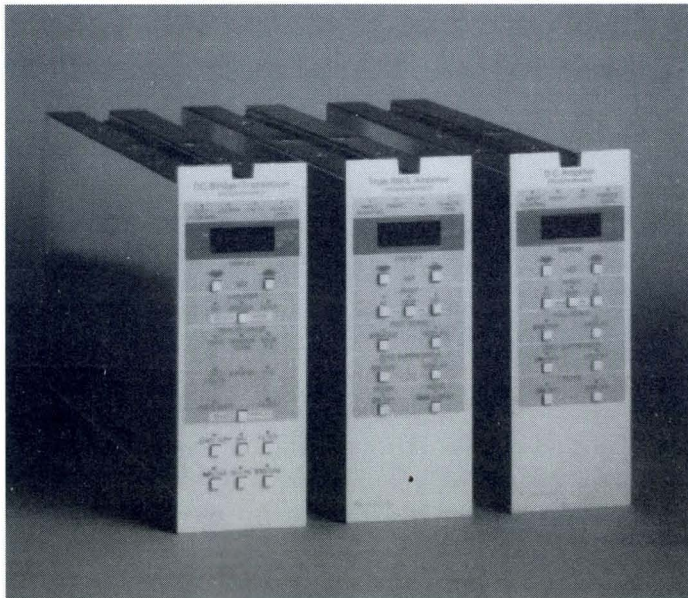

The Gould line of 5600 Series Programmable Signal Conditioners has been expanded and now includes 7 amplifiers for use with Gould Oscillographic Recorders or as stand-alone units. These amplifiers can be controlled from a computer through an IEEE-488 or RS-232C interface, or operated manually from the front panel. They provide full remote programmability and interchannel annotation of amplifier settings. The seven amplifiers currently being offered include an RMS amplifier, DC/Bridge/Transducer amplifiers, a dual channel DC amplifier, and a thermocouple amplifier. Additional programmable signal conditioners are under development.

For more information on programmable signal conditioners, turn to page 100.

Gould's Leading Edge Group of Logic Analyzers

Successful completion of any technical project depends upon having the right tools. Gould has a broad line of Logic Analyzers with performance tailored to your special application. Whether it is high speed computer design, microprocessor hardware and software integration, general logic hardware debug, or remote field service, look to Gould for logic analysis solutions.

CLAS 4000

Sophisticated designs require the power of a logic analysis system. The CLAS 4000 provides this power in a configurable multi-analyzer system. The system is configurable as 1 to 4 independent analyzers with a choice of measurement modules. Whether your need is for high channel count, to 384 channels, or high sampling speed, to 1 GHz, a CLAS 4000 system can be configured for your measurement needs.

Measurement power is only part of the CLAS story. Controlled by a standard, workstation class computer, the CLAS 4000 provides an ICON based human interface with high resolution color display. The intuitive operating environment has met Gould's objective to provide a powerful instrument with "no manual required" operation.

Whether you are designing with high speed RISC or CISC processors, ASIC components or general logic, a CLAS 4000 system can be configured to meet your most demanding measurement needs.

SYSTEM 6000

Verifying the operation of ASIC or other custom components can be a challenge. The Gould System 6000 brings this capability to the design engineer's bench. No longer do you have to configure a logic analyzer and pattern generator or learn the intricacies of an ATE system to make these measurements.

The System 6000 is configurable with up to 352 bi-directional pins operating at clock speeds to 50 MHz. Pattern generation edges and logic analysis sampling points can be positioned with a resolution of 1 ns. Softwire™ eliminates the need to produce custom component fixtures. Long pattern generation and data capture depths, to 64K vectors per pin, make it easy to exercise the most complex components.

The System 6000 is controlled by a PC compatible, 80386 based computer. Mating the system to CAE-generated test vector files and verification program development is made easy with a menu-driven human interface. Potential component faults are clearly identified. Be in control of your component design with the System 6000.

K500

Leading edge high speed logic designs require the 2 ns resolution (500 MHz sampling rate) performance of the K500 Logic Analyzer. Frequency bandwidth well beyond the 500 MHz sampling rate guarantees your signal gets into the analyzer undistorted. Search and compare functions then locate the failure. An analog measurement mode (100 MHz bandwidth), triggered from the logic analysis portion of the K500, aids in correlating analog signal problems (i.e. power supply failures) to digital faults.

K450B Analyzer

Up to 80 channels at 100 MHz, or 20 channels at 400 MHz sampling rate makes the K450B an ideal choice for designing hardware and integrating hardware/software. Sixteen levels of Trace Control™ aid in locating critical problems that fall beyond the typical logic analyzer performance capabilities.

Additionally, the versatile waveform display capabilities

- **Manufacturer of Biomation Logic Analyzers**
- **A history of technical leadership for over 20 years**
- **Extensive selection of Logic Analyzer configurations to meet your application needs**

make signal analysis fast and simple. To aid in quick setup, an Auto Setup function has been added to the K450B, to configure, capture and display data with the touch of a key. Other features such as the Autosave function, indispensable for locating intermittent faults, and extensive post-analysis compare features, complete the uncompromising analysis performance available to you in the K450B.

K115 Analyzer

The numerous types of microprocessors available today place a demand on you to select a flexible yet powerful Logic Analyzer. Gould's K115 Logic Analyzer solves the selection problems by offering two logic analyzers in one. The K115 can be configured with up to 64 channels at 20 MHz and an additional 8/4 channels at 100/200 MHz, or 32 channels at 20 MHz and 16/8 channels at 100/200 MHz. You can track hardware events at 100/200 MHz, software events at 20 MHz, and critical hardware/software interactions. Powerful triggering with eight levels of Trace Control then focuses the K115's measurement features on specific system activities.

K100-D/T12 Analyzer

Remote diagnosis of logic failures is easy with the Gould K100-D Logic Analyzer and T12 Communication option. Sixteen channels of data can be captured at 100 MHz sampling rates and transferred error free over standard telephone lines. The T12 Communicator performs extensive error checking to guarantee data transmission and receiving integrity. Communication can be established between two K100/T12 analyzers with one analyzer being a base installation and the other being a field installation.

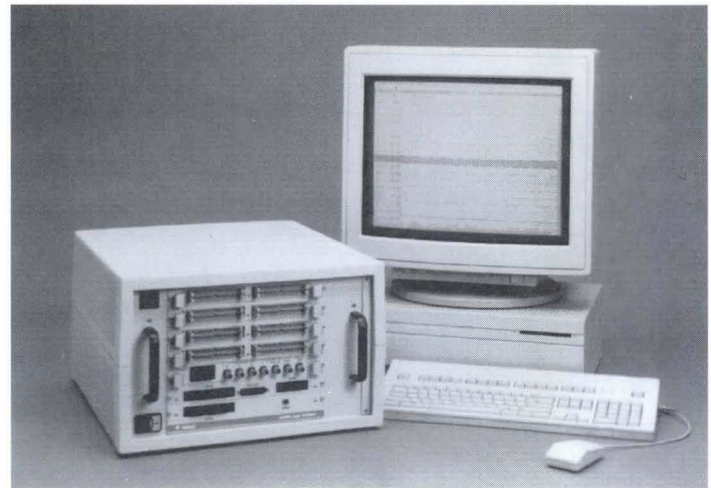

K50/K25 Analyzer

The Gould K50 Logic Analyzer is a low cost, lightweight (23 lb.), high performance, portable instrument. Used in engineering, education, service and manufacturing, the K50 offers features usually found only in logic analyzers costing much more. The K50 is a true general purpose Logic Analyzer. It provides the ability to capture state information to 25 MHz and to resolve timing problems on eight channels at 10 ns (100 MHz).

The Gould K25 Logic Analyzer provides timing and state measurement to 25 MHz (40 ns).

Both units support the widest range of 8- and 16-bit microprocessors available on any Logic Analyzer.

Microprocessor Analysis Packages

Analysis of program execution displayed in HEX or BINARY format is extremely time consuming for even the simplest program. Microprocessor Analysis Package disassembler software translates the data captured from a CLAS 4000, K450B, K115, K50 or K25 Logic Analyzer into easily understood assembly language mnemonics. Instruction fetches, memory reads and writes, and interrupts are clearly displayed to help understand a microprocessor's operation. Illegal and non-executed instructions are also prominently marked to eliminate interpretation errors. Gould supports a wide variety of disassemblers that range from the Motorola 68000/10/20/30 to the Intel 80186/188/286/386. Also supported are 8-bit microprocessors like the Z80, 6800 and 8080. If you need a disassembler that isn't available, Gould offers a User-Definable Microprocessor Analysis Package.

Logic Analyzer Features	CLAS 4000	K450B	K115	K100-D	K50 / K25
Applications	General purpose single & multiple microprocessors; Wide buses	High speed simultaneous hardware/software analysis	Microprocessor hardware/software debug	General purpose timing analysis	Multi purpose; Low cost
Timing Mode (internal clock) Maximum no. of channels at MHz Memory depth in channels	96 to 384 @ 50; 48 to 192 @ 100; 24 to 96 @ 200; (1-4 analyzers) 16 to 64 @ 1GHz 4K @ 50 MHz; 8K @ 100 MHz; 16K @ 100 MHz; 8K @ 1GHz	32,48,64,80 @ 100; 16,24,32,40 @ 200; 20 @ 400 2K @ 80 channels; 4K @ 40 channels	32,64 @ 20 (LS); 8,16 @ 100 (HS); 4,8 @ 200 (HS) <i>See Note</i> 1K @ all channels	16 @ 100 1K @ all channels	32 @ 25; 16 @ 50; 8 @ 100 1K @ all channels; 2K @ 16 channels; 4K @ 8 channels
State Mode (external clock) Maximum no. of channels at MHz Memory depth in channels Maximum no. of clocks	96 to 384 @ 50; 48 to 192 @ 100 (1-4 analyzers) 4 to 8 K 8 per 96 channels	32,48,64,80 @ 50 2K @ 80 channels; 4K @ 40 channels 12	32,64 @ 20 (Low speed); 8,16 @ 70 (High speed) 1K @ all channels 10	16 @ 70 1K @ all channels 4	32 @ 25; 16 @ 50 1K @ all channels; 2K @ 16 channels 3
Glitch Capture Minimum pulse width	Yes w/ glitch trigger 1 ns	Yes 5 ns	Yes 5 ns	Yes 5 ns	Yes w/ glitch trigger 5 ns
Trace Control No. of levels	16	16	8	2	4
Interfaces RS-232-C IEEE-488 Print timing and state analysis Video out	Standard Standard Standard Multiple color monitors	Standard Standard Standard Standard	Standard Standard Standard Standard	No Yes Yes* Standard	Standard Standard Standard Standard
Auxillary Storage Media Capacity Auto save	3-1/2" floppy 20 Mbyte hard disk Yes	1, 5-1/4" disk 360K bytes Yes	1, 5-1/4" disk 312K bytes Yes	No	Yes Battery backed internal memory
Microprocessor Analysis Package	CISC, RISC, Full speed	17 choices	19 choices	No	15 choices
Other	Multiple Independent Analyzers	Auto Setup; Telediagnosis; PCLA Software	Performance Analysis; PCLA Software	Telediagnosis	
Refer to Page	22	32	36	40	38 and 39
			Note: K115 has 3 card slots. Max 2 cards of one kind	*Video print of screen	

Digital Instrumentation to Solve Your Problems

Gould provides a wide range of digital instruments tailored for your environment. They include both systems and portable instruments. Under each of these major categories, there are several configurations to support specific measurement needs.

Systems

CLAS 4000 Configurable Logic Analysis System

The CLAS 4000 is the first in a new generation of logic analysis tools. Configurable with several measurement modules, the CLAS 4000 supports all of the measurement requirements in a sophisticated hardware and software design. Hardware timing, microprocessor analysis, software performance and design verification can all be performed with the unit. The need for multiple specific function logic analyzers, microprocessor emulators and special purpose instruments is eliminated with this integrated approach.

If your measurement requirements change, you have expansion capabilities with the CLAS 4000. Reconfigure the measurement capabilities from the screen. There are no jumpers or switches to set or modules to move. Need more channels, more speed? Add additional measurement modules to the system or add an additional instrument chassis for even greater capability.

Controlled by a workstation class computer, the CLAS 4000 broadens the usefulness of traditional instruments. Make your measurements, cut the results from the screen, paste them into documentation, the CLAS 4000 supports these activities. Network your logic analysis system to other computing resources and move information to others on your team.

System 6000 ASIC Analysis System

An instrument that verifies the operation of sophisticated ASIC, custom or commercial components has, until now, not been available to the design engineer or engineering team. The choices have been to configure a logic analyzer and pattern generator with custom software to make these measurements or rely on complex and expensive ATE systems. The Gould System 6000 satisfies this need with an inexpensive and fully configured component analyzer. Now you, the design engineer, can be under complete control of your design verification task.

Move your test vectors from your CAE system, modify them to reflect your current analysis goals, exercise your components to find logic and subtle timing faults. All of these functions are easily performed from the system's menu driven interface.

Portable Instruments

The need for portable instruments has not diminished. Bringing measurement power to the problem is the goal of the K series of Gould portable logic analyzers. Outline your measurement needs; high speed timing, microprocessor debugging, hardware/software integration, all of these in one general purpose unit; Gould has the instrument to match them.

Hardware Timing

If your job is examining hardware related problems in detail, you either need a few channels at high speed with easy-to-use triggering, or a lot of channels and sophisticated triggering.

If you are in the first group, consider the Gould K500 with 8 channels at 500 MHz. Its analog input channel allows you to look at specific signals in detail. If you need more channels, consider the Gould K450B with 80 channels at 100 MHz, configurable to 20 channels at 400 MHz.

Software Debugging, Software/Hardware Integration

Software development and integration engineers need logic analyzers to provide the transparent view of program execution which can not be obtained by using in-circuit emulators or operating system debuggers. Because a logic analyzer snapshots data nonintrusively in real time, you never have to be concerned about the interactions between the instrument and the debugging process.

Gould provides a range of capabilities, ordered by external clock speed measurement capability, for this task. The K450B (80 channels, 50 MHz), the K115 (64 channels, 20 MHz) with 8/4 channels at 100/200 MHz, the K50 or K25 (32 channels, 25 MHz) are each tailored for specific classes of measurement capability.

The Gould K450M is specifically tailored for software performance analysis. This unit removes the memory depth restrictions normally imposed by logic analyzers by allowing 2.5 or 10 million measurement samples to be made contiguously in one recording. Perform software analysis, software optimization, time in subroutine calculations, instruction mix determinations and cache memory measurements, even in environments where the software flow is not repeatable.

General Use

All Gould logic analyzers provide general purpose features. The instruments are configurable from the user interface for the correct channel count and measurement speed to meet your needs. All have reference memory which allows you to compare a new measurement with previously captured data. All have data and set-up storage, either on diskette or in nonvolatile RAM. There are a wide range of accessories, special probes, special connectors, bus interfaces, carts and carrying cases to match the instrument to your needs.

CLAS 4000 Configurable Logic Analysis System

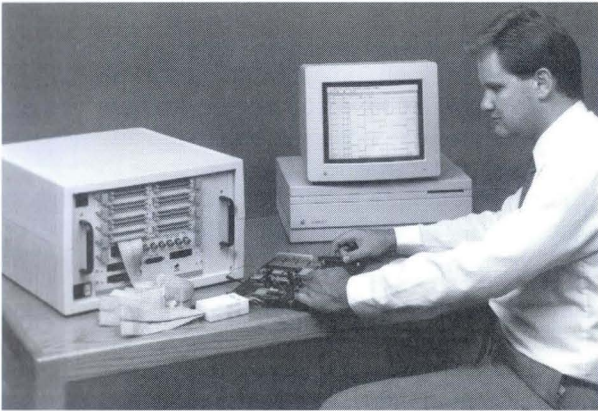

- Intuitive Operation
- Configurability
- Measurement Power

The CLAS 4000 is the best logic analysis system in the world. There are three major reasons that substantiate this claim:

- Intuitive Operation
- Configurability
- High Performance Measurement Power

Intuitive Operation

The CLAS 4000 delivers high-powered measurement capability and a man-machine interface that make operation enjoyable:

Point and choose vs. remember and type

Selections are made with pull down menu boxes, just point the arrow (under mouse control) and click to make selections. Point at a menu word, a list of choices appears on the screen.

Icons vs. words

Pictures replace text. They are easy to remember.

Graphic vs. textual

Eliminate command and syntax memorization and mistakes. Graphic presentations make channel selections, clocking schemes and Trace Control intuitive.

User labels vs. fixed formats

Define information with symbols and labels. Name signals, buses, trigger levels, and patterns in the state lists.

Two Levels of Operation

The CLAS 4000 is simple to learn and easy to operate. The basic operating level provides a broad range of fixed triggering scenarios, for quick results. You select the trigger word definitions and the CLAS 4000 does the rest.

The advanced level of operation unleashes the full power of the CLAS 4000 as a multi-analyzer. Up to four interactive analyzers, with cross triggering and time correlation, create a powerful analysis system. Trigger on either fixed scenarios or ones that you create. Save these scenarios and use them as components in larger triggering schemes.

Windows

Scroll horizontally and vertically through the data to quickly see all the information in the window. Use scroll boxes for jumping from one segment of the window to

any other. Window cutters slice the state window vertically for positioning any data column next to any other. Cut horizontally for seeing any two segments of the state listing next to each other. The window cutters create additional scroll bars that maximize display control.

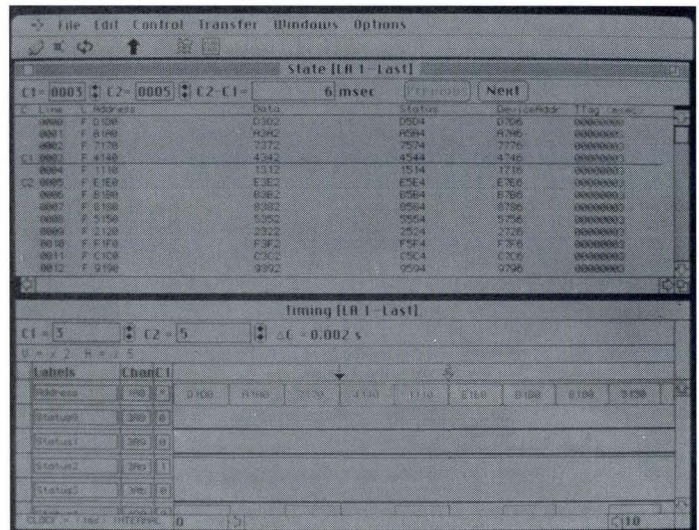

Time cursors move through the data, drawing a line that correlates samples taken across several analyzers.

Never Move Probes

One of the most painful tasks associated with using a logic analyzer is placing hundreds of probes in the target system. Once they are successfully attached, the last thing you want to do is move or even touch them. In the past, logic analyzers had separate timing and state probes. You had to change the probes, based on the type of measurement required. Logic analyzers had separate clock probes for state analysis. They had to be replaced with other probes for timing analysis.

The CLAS 4000 takes the pain out of probing. With timing and state capability on all channels, you never change the probes. Any channel picked from the probe window may be sampled with 5 ns timing resolution. Put high resolution measurements where you need them.

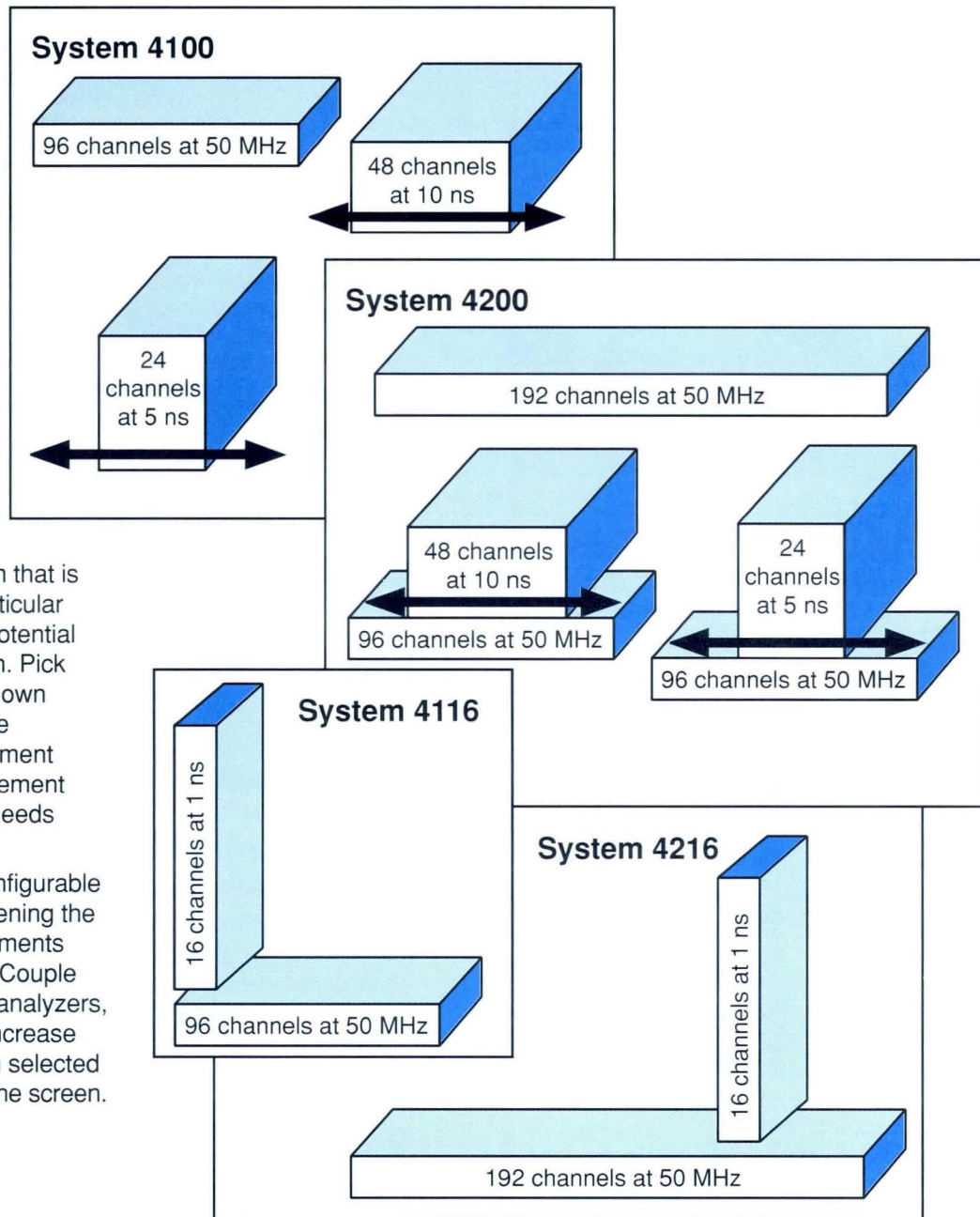

Configure a system that is optimized for a particular application. Four potential systems are shown. Pick one or create your own which best suits the particular measurement need. Add measurement modules later, as needs change and grow.

Each system is configurable on the screen, widening the variety of measurements that can be made. Couple modules for wider analyzers, reassign probes, increase sampling speed on selected channels; all from the screen.

The Pyramid module includes a CROSS POINT SWITCH to resequence the channels for:

- Changing the order of significance of the bits on a bus.
- Ordering or assigning up to 32 channels for Address Range Detection.
- Assigning any channel for high resolution measurements.
- Assigning any channels as a clock input.

The SWITCH also routes input signals to independently clocked latches for :

- Alignment of asynchronous buses.
- Demultiplexing of multiplexed buses.

Configurability

The CLAS 4000 is the most powerful logic analyzer available today and will not become obsolete as your measurement needs change. Unlike fixed function analyzers, the CLAS 4000 is configurable to address the toughest tasks. The system purchased today is configured from the man-machine interface to perform your measurements; no jumpers to set, no modules to move, no special probes or interfaces to purchase.

System 4400

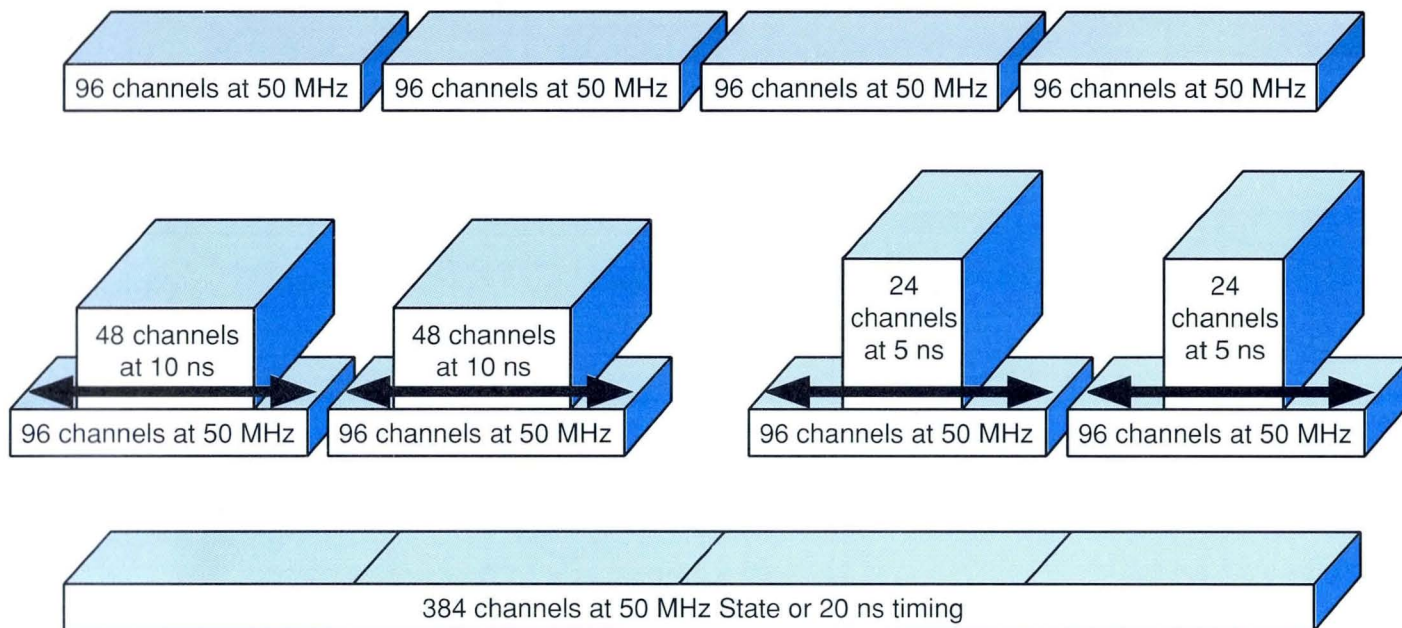

Measurement hardware modularity guarantees that as your needs change with time, the CLAS 4000 will meet the imagineering challenges. It is Gould's commitment, based on 15 years of designing and manufacturing high performance logic analyzers, that the CLAS 4000 will continue to set the standard for performance in the future.

The instrument of choice for the Imagineer is the CLAS 4000, configurability is the reason.

The CLAS 4000 Chassis holds up to 4 measurement modules. These modules, if they are of a similar type, can be configured as up to four independent logic analyzers or as wide multiple module analyzers. Several measurement modules are available.

Measurement Modules: Performance for the task

Pyramid Module - General purpose logic analyzer.

Channels:

- 96 @ 50 MHz X 4K samples
- 48 @ 100 MHz X 8K
- 96 @ 20 ns X 4K
- 48 @ 10 ns X 8K
- 24 @ 5 ns X 16K

Sampling : Synchronous
Asynchronous
Transitional
Mixed (synchronous and transitional)

Triggering: 16 level Trace Control
Up to 4 modules may be grouped for up to 384 channel analysis.

Magnifying Glass Module - High resolution timing logic analyzer. Channels: 16 @ 1ns X 2K (8K optional)

Hyper State™ Module - High speed state logic analyzer. State recording at greater than 200 MHz.

Memory Booster Module - Long memory enhances the Pyramid Module.

Digital Oscilloscope Interface - Connects the Gould 4070 Digital Oscilloscope to the CLAS 4000 for simultaneous operation.

Microprocessor support:

Intel - 80386, 80960
Motorola - 88000, 68020, 68030
AMD - 29000
Sun - SPARC
Inmos- T-800 Transputer
MIPS- R-3000

A wide range of 8- and 16-bit microprocessors, co-processors and peripherals.

Accessories: Building on a standard computer.

Printers - dot matrix and laser
Display monitors - high resolution color to 19" and multiple monitor configurations.
Engineering software
Storage - 3 1/2" floppy disk (standard) and hard drives (20 MB standard) to the gigabyte range.
Networking and many other enhancements.

Measurement Power

Single or Multiple module operation.

Synchronous (External) Clocking**Synchronous to 50 MHz**

Clock Inputs: Any 8 of the 96 inputs. Eight clock inputs may be ANDed (4), ORed (4), and NOTed (all 8).

Latches: 4 per Pyramid module, edge sensitive. Latches hold selected channel signals until they are sampled by the Master clock. Latches demultiplex and align asynchronous data.

Setup Time: 7 ns, 4 ns when a signal with twice the clock frequency is applied to the external (ECL) clock connector on the front panel.

Hold Time: 0 ns

Synchronous 50 to 100 MHz

Up to any 8 of the 48 inputs are used as clocks. One of the clock inputs must be the half frequency of the target system clock.

Setup Time: 7 ns, 4 ns when a signal with twice the clock frequency is applied to the external (ECL) clock connector on the front panel.

Hold Time: 0 ns.

Asynchronous (Internal) Clocking

Sample Rates: Selectable from 5 ns to 500 ms in a 1,2,5 sequence.

Time Stamp: 16 bits x 4096

Selectable Resolution: From 50 ns to 500 ms in a 1,2,5 sequence.

Data Memories

Last and Reference are displayed. Each is 4096 samples deep and 96 channels wide plus 16 bits for time stamp and 4 bits for Trace Control level for a total of 116 bits.

Setups: Next, Last and Reference. Either Last or Reference may be copied to Next.

Transitional Sampling

Samples are taken only when a user selected channel has toggled since the last sample. Each stored transition is time tagged. A time proportional timing diagram is displayed. The maximum resolution varies with the number of channels monitored:

96 channels @ 20 ns resolution

48 channels @ 10 ns resolution

24 channels @ 5 ns resolution

4K transitions are stored at all resolutions with up to 16K transitions stored with 5 ns resolution.

Mixed Sampling

During a recording the clocking mode may be changed from External to Transitional. By invoking "STORE IF TRANSITION", the sample mode is changed from External to Transitional on that Trace Control level. Trace Control has a reserve word called TRANSITION, where the user selects the channels where toggles are to be detected. Time stamp allows data reconstruction.

PYRAMID MODULE TRACE CONTROL**DC to 50 MHz all sample modes operation:**

16 decision levels with 20 ns decision time. On each level there is a selection of ACTIONS and CONDITIONS.

ACTIONS per level:

STORE (record samples)

GO TO LEVEL ____ (2 per level)

STOP (in lieu of one Go to level)

LINK enabled (each analyzer generates its own unique link signal)

GLOBAL LINK enabled

Increment EVENT counter (based on clocks, patterns or time)

Increment LOOP counter (determines if a software loop has been executed the nth time).

TRIGGER (each analyzer generates its own unique trigger signal to a front panel BNC).

CONDITIONS:

For any instruction, conditions may be logically either ANDed or ORed.

ALWAYS (if Master Clock)

NEVER

IF TIME = ____ns (20 ns resolution min.)

IF SAMPLE = PATTERN (choice of 16)

IF SAMPLE ≠PATTERN

IF IN ADDRESS RANGE (32 bit range)

IF COUNTER VALUE <,>,>=,<=,=N (max. count 64,535)

IF LINK (1 of 3) ENABLED

IF GLOBAL LINK ENABLED

IF TRANSITION ON ANY SELECTED CHANNELS

IF GLITCH ON ANY SELECTED CHANNELS

Patterns are defined across all channels. Each pattern is identified with a designated label. Two labels are reserved: GLITCH and TRANSITION. For those labels selected, input signals are checked for glitches or transitions.

Address Range Timers

Measures total time in range. 8 timers, one per address range. 16 bits with resolution to 20 ns (min.) or 1 clock period.

5 ns Asynchronous or Transitional operation

Word recognizers: 4

Min. time word present: 5 ns

Levels: 16

Min. time on level: 20 ns

10 ns asynchronous or transitional operation

Word recognizers: 8

Min. time word present: 10 ns

Levels: 16

Min. time on level: 20 ns

50 to 100 MHz synchronous operation

Word recognizers: 8

Min. time on level: 20 ns

Up to 15 consecutive words as close as 10 ns are recognized and triggered on.

Min. time word present: 10 ns

Levels: 16

Minimum time on level: 20 ns

Time Stamp: 50 to 500 ns resolution

MAGNIFYING GLASS MODULE

Channels: 16

Sample rates: 1 ms to 1 ns in a 1-2-5 sequence.

Data Memories: Last and Reference, each 2048 (8192 optional) samples x 16 channels.

Triggering

Word Recognizers: 2. Word TRUE, word FALSE, words in sequence or words ORed.

Min. recognition time: 2 ns single module, 4 ns minimum for multiple modules.

Filter: 0 to 128 ns with 2 ns setting resolution.

Trigger on violation: Setup time/hold time defined with 1 ns resolution.

Trigger on a glitch: User defines maximum pulse width, from 2 ns to 128 ns in 2 ns increments.

Delayed trigger: 1 to 65,535 events/recurrences of the trigger word (nth edge). When delay by events is selected the nth event is positioned in the memory by the delay after trigger counter.

Delay after trigger: 4 to 131,070 sample clocks with setting resolution of 2 sample clocks.

Linking to Pyramid module

Link from Pyramid: Trigger if link or wait for trigger if link.

Link time: 100 ns \pm one Pyramid Module Master clock.

Link to Pyramid module: Trigger sends link signal.

Link time: 100 ns \pm one Pyramid Module Master clock.

Data Alignment: To time stamp resolution, ± 20 ns minimum.

MAGNIFYING GLASS INPUTS

Probes: 16 single ended pods.

Glitch detection

Min. detectable pulse: 2 ns, with 25% overdrive or 250 mV, whichever is greater.

Impedance: 250 k Ω in parallel with 3 pF when measured at the probe tip, 6 pF when measured at the flying lead end.

Maximum voltage: 50 V continuous, 100 V transient.

Thresholds: TTL (+1.4V), ECL (-1.3V). Variable ± 10 V in 10 mV setting resolution.

Channel to channel skew: ≤ 3 ns.

SYSTEM CONTROLLER

CLAS 4000 is controlled by a Macintosh II or Macintosh SE with 2M internal RAM.

Floppy Drive: 3-1/2", 800K

HardDisk: Internal 20 Mbyte hard disk drive standard. External hard drives optional.

Speaker: 8 Ω standard jack.

Keyboard: Synchronous serial, Apple Desktop Bus (ADB).

Mouse: Apple Desktop Bus (ADB) interface Trackball.

Clock: A time of year clock is backed up by a 4.5 V battery.

Back up memory: Saves the setup of recording parameters if power is interrupted or when the unit is turned off.

Power Requirements

Input Frequency: 50 or 60 Hz

Input Volts: 90 to 135 VAC or 180 to 270 VAC, switch selectable.

Input Power: 800 Watts with full complement of Pyramid boards.

Fuses/Rated Voltage: 90 VAC to 135 VAC 3AG, 8 A; 180 VAC to 270 VAC 3AG, 4A.

Auxillary Power: +5V and -5.2V @ 300 mA for accessory devices via front panel connector.

Environmental Limits

Temperature

Operating: 39° to 115° F (4° to 46° C).

Storage: -8° to 117° F (-20° to 50° C).

Relative Humidity

Operating: 20% to 80%

Storage: 1% to 95%

Weight: 36.5 lbs. (16.5 kg), plus 2.5 lbs. (1.1 kg) per measurement module.

Size: 17.5"W x 10.5"H x 19.75"D (44.4 cm x 26.7 cm x 50.2 cm)

Interfaces

RS-232C: Serial interface, 19.2K baud maximum. Connects to modems for remote operation.

IEEE-488: Listener/Talker all set up and results accessible.

MONITORS

Macintosh SE: 9" monochrome built-in - 512 x 342 pixels. 4.5" x 7" standard.

Optional second monitor: 19" monochrome -1600 x 1200 pixels. 14.25" x 10.5".

Macintosh II: 13" color - 640 x 480 pixels. 9.25" x 7" standard.

Optional second monitor: 19" monochrome -1600 x 1200 pixels. 14.24" x 10.5". OR 9" color - 1024 x 768 pixels. 14.25" x 10.5".

CONTROL SPECIFICATIONS

Arm Modes: STOP after a single recording. ARM automatically until stop is requested. STOP IF Last =, or ≠ Reference. SAVE to disk (hard or floppy) if Last = or ≠ Reference. COMPARE all samples or those selected, based on channels and memory locations.

Reference memories may be edited to create perfect references, using 1, 0, X on a bit-by-bit basis.

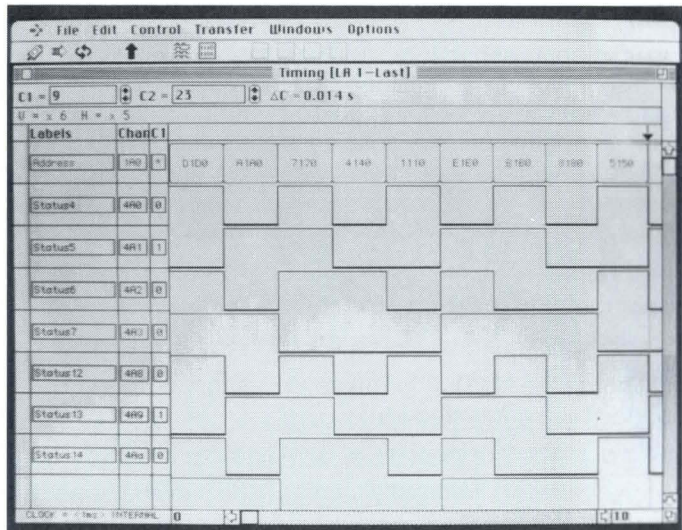

Timing: Displays timing waveforms for individual signals or buses. Two cursors measure time or cycles. Cursors also move through the State listing simultaneously.

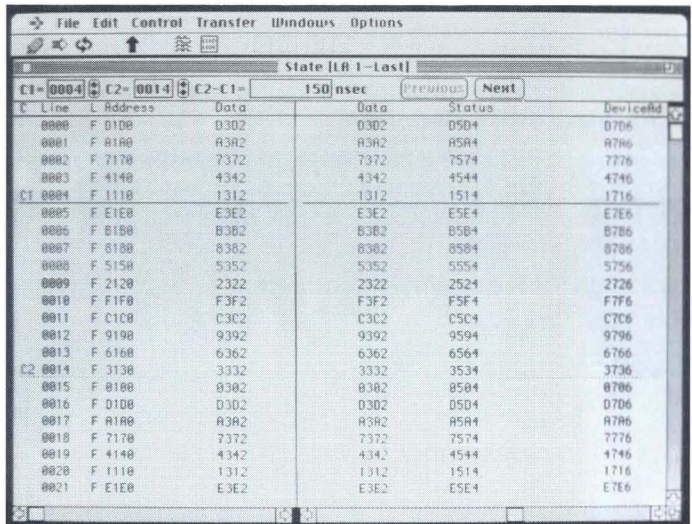

State: Displays recorded samples, time tag and level information. Samples are displayed in binary, octal, hexidecimal, ASCII or symbolics. Up to 14,000 user-defined symbols, each equated to a pattern, may be used.

Status (mini window): Indicates what each analyzer is presently doing, including display of Trace Control level.

Disassembled State: Transforms numerical state listing in mnemonics of microprocessor instructions.

Histograms: Four types for use with Pyramid modules:

- Time in each of 8 address ranges (continuous measurement method)
- Time between two distinct samples, cumulative and average
- Cumulative occurrences of a distinct sample over a period of time
- Count of the number of calls between modules to specific devices or memory locations

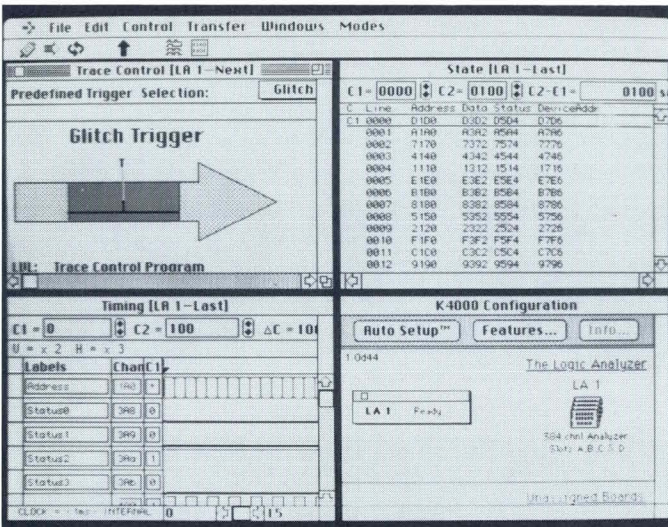

Display windows

Configuration: Allocated boards to analyzers, and names analyzers.

Channel Setup: Select sample mode and rate, column names, channel sequences or state displays, radices, polarities, thresholds, external clocks, and clock expressions.

Trace Control: Determines triggering sequence.

Arm Modes: Determines when to stop making recordings.

Support Products

A systems approach to logic analysis means the CLAS 4000 may include a wide range of optional capabilities that enhance the value of the entire system. Additional items will certainly be available, so please check with the local sales engineer about new system enhancing accessories.

Several types of support items are available now:

MAPs - Microprocessor Applications Packages - to probe and disassemble programs.

Bus Probes - to connect the CLAS 4000 to popular buses

User Configured MAPs - for microprocessors not supported by a dedicated MAP.

Probing devices - for popular IC packages

Additional monitors to greatly increase the viewing space.

MAPs - Microprocessor Analysis Packages

There are two reasons MAPs are used:

The MAP includes a probing device that allows non-intrusive probing of the target system. The device makes it possible to probe high pin count parts without a lot of trouble. The probing devices are passive. Both state (synchronous) and timing (asynchronous) measurements are made through the same pod. There is never a need to reprobe.

The MAP also includes a program that interprets the recorded samples and displays them as easier to understand mnemonics. This process is referred to as disassembly.

CLAS 4000 MAP support extends to:

Intel 80386, 80486, 80960

Motorola 68020, 68030, 88000

AMD 29000

SUN SPARC

MIPS R3000

INMOS T800

The list will grow, so check with the sales engineer in your area for the most recent offerings.

Bus Analysis

Support is available for VME bus architectures.

It includes convenient probing devices that are passive and therefore allow timing and state measurements without moving any probes.

The VME bus analyzer package includes a VBAT trigger board that finds 28 different kinds of faults and is used to trigger the CLAS 4000. This tool is ideal for finding bus design rule violations and isolating them for further inspection by the logic analyzer.

User Configured MAPs

It is desirable to observe the operation of parts not supported by dedicated MAPs. In those cases, the user can configure a unique MAP that is optimized for a particular application.

Both hardware and software support are included. For hardware support a scrambler case is supplied. The probes plug into the scrambler case. The case contains a passive board with connectors on the side opposite the probes. The probes are electrically connected to the connector. A cable plugs onto the connector. The other end of the cable attaches to a probing device. Those probing devices include:

40 lead DIP on probe

40 lead DIP on board

64 lead DIP on probe

64 lead DIP on board

14 X 14 PGA for 132 lead packages - Intel type A

17 X 17 PGA for 181 lead packages - Motorola case 823-01

13 X 13 PGA for 114 lead packages - Motorola case 791-01

13 X 13 PGA for 128 lead packages - Motorola case

The second support issue is disassembly. The basic CLAS 4000 includes a limited type of disassembly. Observe symbols in lieu of the numerical display in the state listing. The operator enters a list of symbols and the definition of the corresponding patterns. This is a single byte instruction disassembler. It is ideal for bit slice designs and RISC architectures, with single byte instructions. The same facility can be used for address interpretation as well as instructions and status. The user may choose to download the symbol table from a development system or word processor.

In cases when the symbol substitution table described above is inadequate, then a true user defined disassembler is available for examining multi-byte instructions.

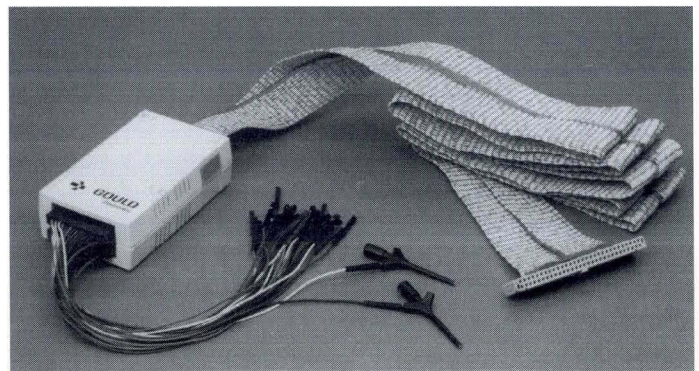

Each probe pod has an identification button. When pushed, the current individual probe connections, including the channel assignments by user-defined names, are displayed on the monitor screen.

MONITORS

CLAS 4000 is offered with a variety of monitors. The Macintosh SE has a high resolution screen and is suited for single analyzer applications. When more viewing space is desirable a 19" monochrome monitor is added to the system. In this configuration both screens are active, windows are dragged between screens.

When the Macintosh II is used as the system controller a 13" color monitor is standard. If more viewing space is

required, choose a 19" color or monochrome monitor in lieu of the standard display.

For the most viewing space use two monitors. Multiple monitor systems are ideal for observing multiple microprocessors or when it is desirable to see timing, state, histograms and set up information simultaneously.

The size of characters and waveforms on all the screens is about the same, the larger screens and multiple monitors show more information, not just the same information enlarged.

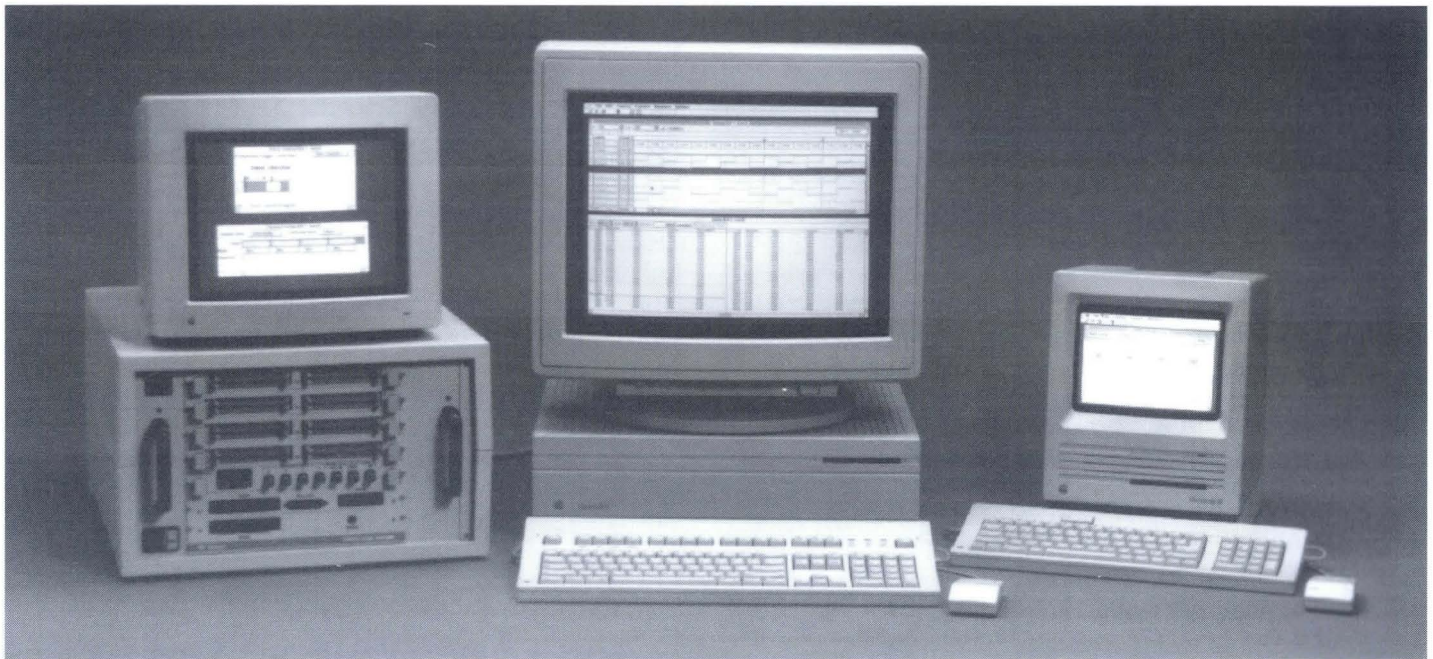

Ordering Information

Model	Pyramid Modules	Magnifying Glass Modules
4100	1	
4200	2	
4300	3	
4400	4	
4016		1
4032		2
4048		3
4064		4
4116	1	1
4132	1	2
4148	1	3
4216	2	1
4232	2	2
4316	3	1

MODEL NO. DESCRIPTION

4100SE CLAS 4100SE General Purpose Single Logic Analyzer

A 96 channel x 4K system with asynchronous and synchronous sampling to 50 MHz, 48 channels x 8K to 100 MHz asynchronous and synchronous, and 24 channels x 16K to 200 MHz asynchronous. Including: Four 24-channel probes, operating manual, and low cost System Controller configured with 9" monochrome monitor.

4100 CLAS 4100 Color General Purpose Logic Analyzer

A 96 channel x 4K system with asynchronous and synchronous sampling to 50 MHz, 48 channels x 8K to 100 MHz asynchronous and synchronous, and 24 channels x 16K to 200 MHz asynchronous. Including: Four 24-channel probes, operating manual, and high performance System Controller configured with 13" color monitor.

4100A CLAS 4100A

The above system without a system controller.

MODEL NO. DESCRIPTION

4200 CLAS 4200 Color Dual Logic Analyzer

A 192 channel x 4K system with asynchronous and synchronous sampling to 50 MHz, 96 channels x 8K to 100 MHz asynchronous and synchronous, and 48 channels x 16K to 200 MHz asynchronous. The analyzer can be used as two analyzers, each with half the number of channels. Including: Eight 24-channel probes, operating manual, and high performance System Controller configured with 13" color monitor.

4200A CLAS 4200A

The above system without a system controller.

4300 CLAS 4300 Color Triple Logic Analyzer

A 288 channel x 4K system with asynchronous and synchronous sampling to 50 MHz, 144 channels x 8K to 100 MHz asynchronous and synchronous, and 72 channels x 16K to 200 MHz asynchronous. The analyzer can be used as three analyzers, each with one third the number of channels. Including: Twelve 24-channel probes, operating manual, and high performance System Controller configured with a 13" color monitor.

4300A CLAS 4300A

The above system without a system controller.

4400 CLAS 4400 Color Quad Logic Analyzer

A 384 channel x 4K system with asynchronous and synchronous sampling to 50 MHz, 192 channels x 8K to 100 MHz asynchronous and synchronous, and 96 channels x 16K to 200 MHz asynchronous. The analyzer can be used as four analyzers, each with quarter the number of channels. Including: Sixteen 24-channel probes, operating manual, and high performance System Controller configured with 13" color monitor.

4400A CLAS 4400A

The above system without a system controller.

4016 CLAS 4016 Color Timing Logic Analyzer

A 16 channels x 4K to 1 GHz asynchronous logic analyzer. Including: One set of 16 High Resolution probes, and high performance System Controller configured with 13" color monitor.

4016A CLAS 4016A

The above system without a system controller.

4032 CLAS 4032 Color Dual Timing Logic Analyzer

A 32 channels x 4K to 1 GHz asynchronous logic analyzer. Including: Two sets of 16 High Resolution probes, and high performance System Controller configured with 13" color monitor.

4032A CLAS 4032A

The above system without a system controller.

MODEL NO. DESCRIPTION

4048 CLAS 4048 Color Dual Timing Logic Analyzer

A 48 channels x 4K to 1 GHz asynchronous logic analyzer. Including: Three sets of 16 High Resolution probes, and high performance System Controller configured with 13" color monitor.

4048A CLAS 4048A

The above system without a system controller.

4064 CLAS 4064 Color Dual Timing Logic Analyzer

A 64 channels x 4K to 1 GHz asynchronous logic analyzer. Including: Four sets of 16 High Resolution probes, and high performance System Controller configured with 13" color monitor.

4064A CLAS 4064A

The above system without a system controller.

4116 CLAS 4116 Color Timing / State Logic Analyzer

A 96 channel x 4K system with asynchronous and synchronous sampling to 50 MHz, 48 channels X 8K to 100 MHz asynchronous and 47 channels x 8K to 100 MHz synchronous, and 24 channels x 16K to 200 MHz asynchronous. A second analyzer with 16 channels x 4K to 1 GHz is included. Including: four 24-channel probes, operating manual, one set of 16 High Resolution probes, and high performance System Controller configured with 13" color monitor.

4116A CLAS 4116A

The above system without a system controller.

4132 CLAS 4132 Color Timing / State Logic Analyzer

A 96 channel x 4K system with asynchronous and synchronous sampling to 50 MHz, 48 channels X 8K to 100 MHz asynchronous and synchronous, and 24 channels x 16K to 200 MHz asynchronous. A second analyzer with 32 channels x 4K to 1 GHz is included. Including: four 24-channel probes, operating manual, two sets of 16 High Resolution probes, and high performance System Controller configured with 13" color monitor.

4132A CLAS 4132A

The above system without a system controller.

4148 CLAS 4148 Color Timing / State Logic Analyzer

A 96 channel x 4K system with asynchronous and synchronous sampling to 50 MHz, 48 channels X 8K to 100 MHz asynchronous and synchronous, and 24 channels x 16K to 200 MHz asynchronous. A second analyzer with 48 channels x 4K to 1 GHz is included. Including: four 24-channel probes, operating manual, three sets of 16 High Resolution probes, and high performance System Controller configured with 13" color monitor.

MODEL NO. DESCRIPTION

4148A CLAS 4148A

The above system without a system controller.

4216 CLAS 4216 Color Timing / Dual State Logic Analyzer

A 192 channel x 4K system with asynchronous and synchronous sampling to 50 MHz, 96 channels x 8K to 100 MHz asynchronous and synchronous, and 24 channels x 16K to 200 MHz asynchronous. The analyzer can be used as two analyzers, each with half the number of channels. A third analyzer with 16 channels x 4K to 1 GHz is included. Including: Eight 24-channel probes, Operating manual, one set of 16 High Resolution probes, and high performance System Controller configured with and 13" color monitor.

4216A CLAS 4216A

The above system without a system controller.

4232 CLAS 4232 Color Timing / State Logic Analyzer

A 192 channel x 4K system with asynchronous and synchronous sampling to 50 MHz, 96 channels X 8K to 100 MHz asynchronous and synchronous, and 48 channels x 16K to 200 MHz asynchronous. A second analyzer with 32 channels x 4K to 1 GHz is included. Including: Eight 24-channel probes, operating manual, two sets of 16 High Resolution probes, and high performance System Controller configured with 13" color monitor.

4232A CLAS 4232A

The above system without a system controller.

4316 CLAS 4316 Color Timing / State Logic Analyzer

A 288 channel x 4K system with asynchronous and synchronous sampling to 50 MHz, 144 channels X 8K to 100 MHz asynchronous and synchronous, and 72 channels x 16K to 200 MHz asynchronous. A second analyzer with 16 channels x 4K to 1 GHz is included. Including: Twelve 24-channel probes, operating manual, one set of 16 High Resolution probes, and high performance System Controller configured with 13" color monitor.

4316A CLAS 4316A

The above system without a system controller.

A70031 CLAS 4000 Installation

A field application Engineer will install the Logic Analyzer and provide 1/2 day of operational training.

DESCRIPTION

CLAS 4000 Extended Warranty

Chassis

Pyramid Module with Probe set

Magnifying Glass Module with Probe set

Pyramid Module without probe set

Design Ruler™

Pyramid Module Probes

Set of flying leads

Magnifying Glass Module Probe

Probe Pouch

Microprocessor Analysis Packages (MAPs)

68020 MAP

68030 MAP

88000 MAP (one required per 88100 or 88200)

80386 MAP

80960 MAP

80486 MAP

SPARC MAP

R3000 MAP

T 800 MAP

Bus Probes

VME Interface

VBAT Triggering module

Second Monitor

With the high performance System Controller:
19" monochrome monitor

With the low cost System Controller:
19" monochrome monitor

Printers

ImageWriter II with cable

LaserWriter II NT printer with cable

Storage

40 MB internal hard drive

80 MB internal hard drive

Rack Mount kit (for chassis only)

Shipping Container (for chassis only)

Users Manual

System controller

Cart

MODEL NO.

A70035

A70015

A70027

A70025

A70024

A70019

A70020

A70021

A70022

A70038

A70001

A70003

A70004

A70002

A70005

A70006

A70024

A70025

A70026

A70007

A14591

A70011

A70010

A70012

A70013

A70032

A70034

A70036

A70037

A70039

A70028

A70045

LOGIC ANALYZER

GOULD K450B The exceptional logic analyzer for digital design engineers

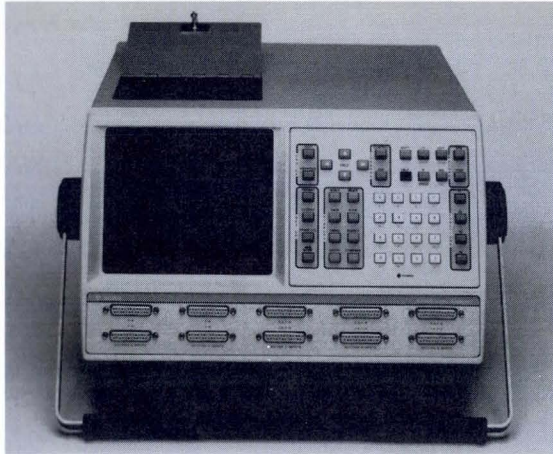

- Perform state and timing on the same channels
- 80/40 channels at 100/200 MHz
- Decisions within 20 ns on all 16 levels of Trace Control
- Popular microprocessor disassemblers including the Motorola 68000/10/20/30 and Intel 8086/186/286/386
- PCLA software interface

The K450B was designed to provide capabilities for today's and tomorrow's demanding digital designs. You require ease of use. We provide that with **AUTO SETUP**. You require powerful measurement capabilities. We provide that with Trace Control, Advanced clocking modes, and Arm Modes with Auto Compare and Auto Save features to uncover highly intermittent problems.

80 high-speed channels for optimizing your productivity. Your customers continually demand that you design faster and more complex products. Gould/Biomation is committed to meet your needs. Our K100 logic analyzer, introduced in 1978, created the timing analyzer market. It remains one of the most widely used analyzers today. We are continuing our heritage of innovation with the K450B. The K450B with either 80 channels at 100 MHz, or 40 channels at 200 MHz, or 20 channels at 400 MHz; and glitch capture across all channels, provides top performance.

With 80 channels of state and timing, you never have to make a tough decision common to many other logic analyzers: deciding which signals will have the benefits of high-timing resolution and which must be regulated on low-speed measurements - before you know what your

problem is. With the K450B you can choose asynchronous clocking for timing analysis or synchronous clocking for state analysis on any set of channels.

Once you have captured the data, the K450B gives you the power to display data in a variety of formats. Look at data in a timing waveform, state display (1's and 0's, HEX, ASCII, etc.) graph mode or disassembled data in familiar mnemonic form.

Application specific accessories make the job easier.

To keep in the tradition of pioneering solutions for its customers, Gould/Biomation has developed a host of accessories to meet a variety of application needs. These include a complete line of Microprocessor Analysis Packages (MAP's) for today's popular 8-, 16- and 32-bit microprocessors, and K450B PCLA (IBM control software) with Telediagnosics.

PCLA with Telediagnosics allows a K450B logic analyzer to be operated from an IBM PC over the phone lines. This option allows you to leave a K450B at a remote site while you debug problems from your office. Be productive! Let the logic analyzer trap and save intermittent faults while you go on about your business.

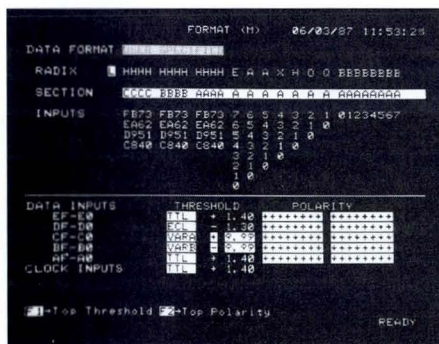

Format Screen (User Specified)

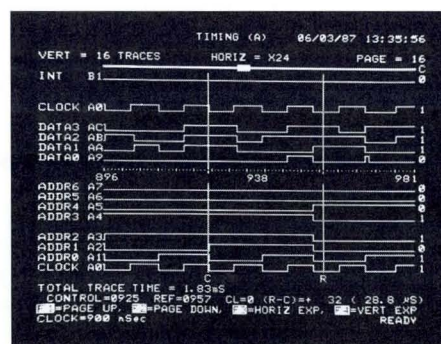

Timing Screen (Reference Display)

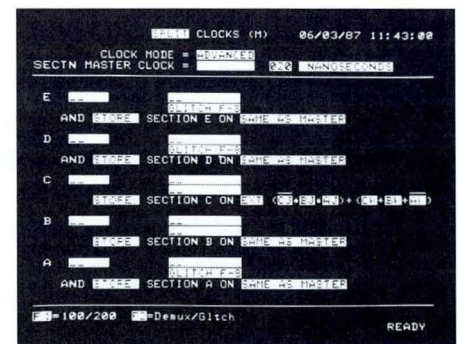

Clock Screen (Advanced Mode)

Help Screens

Help Messages: On-screen messages explain individual fields in setup screens by pressing the HELP key.

Self Test

During power-up, self tests check internal circuitry, including ROM, RAM, power supply, and keyboard.

Data Channels

Configurations: 32/16 Ch data at 100/200 MHz
64/32 Ch data at 100/200 MHz
80/40 Ch data at 100/200 MHz

Maximum Sample Rate: 50 MHz (external clock)
200 MHz (internal clock)
400 MHz (optional, internal)

Clocks

Sample Clock: The SAMPLE clock samples data from the probe tips and moves it into the sample registers. This can be an internal or external clock.

Internal Clock: The edge-sensitive internal SAMPLE clock period is selectable from 20 ns to 100 ms in a sequence of 10, 20, 30...100, 200, 300...etc. Also available is a 10 ns or 5 ns clock in the SAMPLE STORE section.

External Clock: DC to 50 MHz (20 ns). Provides 6 Sample (edge sensitive) and 6 Latch Enable (level-sensitive for demultiplexing) clocks for a total of 12 external clocks.

Clock Frequency Measurement: The K450B automatically measures the external clock's frequency from 100 Hz to 50 MHz with 0.1% accuracy.

Input Modes

Standard: Clocks all K450B sections with one master clock.

Advanced Modes: Sample store, Demultiplex, Latch, Glitch.

Sample Store: All three K450B sections (16 channels per section) can store sampled data at different rates.

Demultiplex: The K450B demultiplexes data collected via one set of probes from a multiplexed bus. There is no need to double-probe signals.

Latch: Data held by the LATCH clock is sampled by the SAMPLE clock, then moved into memory by the MASTER clock.

Glitch: A short HIGH or LOW pulse that occurs between SAMPLE clocks is stored as a state change at the next clock. Glitches can have a duration as short as 5 ns with 25% or 250 mV overdrive, whichever is greater.

Trace Control

The K450B can be programmed in 16 independent but interactive levels to follow the activities of the system under test. Trace Control runs at rates as high as 50 MHz and employs TRACE, WAIT, ADVANCE, GO TO and STOP commands and three conditions: FOR, UNTIL and IF.

Patterns: User definable labels for up to 50 patterns.

Delay: Up to 65,535 clocks or events per level.

Total Trace Time: Measures the time between any two events from 00.00 μ s to 1,638.35 s (27.3 min) at a 0.5 μ s resolution.

Interfaces

RS-232C: For communications between the K450B and other devices, you can set baud rate (up to 9600 bps), stop bits, parity, protocol, etc.

IEEE-488: A complete Talker/Listener interface.

GET: The Group Execute Trigger signal works with the IEEE-488 interface.

Composite Video: Video output (1 VP-P into 75 Ω).

Horizontal Freq: 19.23 kHz

Trace Output: This port outputs a TTL HIGH when the K450B is armed and trace is enabled.

Clock Output: An ECL active-LOW signal corresponds to the K450B's internal clock.

Probe Characteristics

Input Resistance: 1 M Ω , \pm 2%.

Input Capacitance: \leq 6 pF normally; \leq 15 pF with flying leads.

Probe Test

The K450B provides two sockets, either of which can test a probe's two clocks and eight data channels. Also use these sockets to explore the K450B's operation.

Battery Back-up CMOS Memory: Holds last setup in memory at power down.

Time Of Day Clock: The K450B displays a 24-hour time of day clock that is battery backed.

Physical Characteristics

Operating Temp: 4° to 46°C

Height: 8.6 inches (21.8 cm)

Width: 17.5 inches (44.5 cm)

Depth: 24.7 inches (62.7 cm) with bail.

Weight: 49 pounds (22 kg)

Input Voltages: 50 or 60 Hz. 90 to 135 VAC or 180 to 270 VAC.

Accessories Supplied: Probes, probe connectors with flying leads, grabbers, power cord, training kit, operating manual and pouch.

Ordering Information

32 Ch data	0 probes (32/16 at 100/200 MHz) K450B-132NP
	4 probes (32/16 at 100/200 MHz) K450B-132
48 Ch data	6 probes (48/24 at 100/200 MHz) K450B-148
64 Ch data	0 probes (64/32 at 100/200 MHz) K450B-164NP
	8 probes (64/32 at 100/200 MHz) K450B-164
80 Ch data	0 probes (80/40 at 100/200 MHz) K450B-180NP
	10 probes (80/40 at 100/200 MHz) K450B-180

See Accessories section for availability of accessories and probe kits.

LOGIC ANALYSIS SYSTEM

GOULD K450M MegaSamples of real time data capture



- 64 channels at 50 MHz with 2.5 Mbits/channel
- 16 channels at 200 MHz with 40 Mbits/channel
- Complete set up and operation from attached PC via IEEE-488 interface

Memory depth, on the order of 2-4Kbits per channel has been assumed to be sufficient for most data capture needs, especially when making hardware related measurements. The increasing complexity of today's designs has created a need for extremely long data captures. Gould has responded to this need with the K450M logic analysis system with MEGA-MEMORY. With MEGA-MEMORY, millions of events or data transactions may be captured with the analyzer, nonintrusively at full speed, providing a complete picture of the performance of a circuit.

The K450M system supports the full operation of the high performance GOULD K450B-164 logic analyzer in both timing (internal sampling clock) and state (external

sampling clock) modes. In timing mode, the system can capture data at a 5 nsec sampling rate (200 MHz) with 10 Mbits/channel (opt. 40 Mbits/ch.) captured. In state mode, the system can capture data at a 20 nsec sampling rate (50 MHz) with 2.5 Mbits/channel (opt. 10 Mbits/ch.) captured.

Using the K450M Trace Control features, the measurement process can be controlled by a 16 level decision tree allowing the user to specify the condition of interest. The recording process may be continuous, filling the full memory with information around an event, or segmented, using Trace Control to gate specific data streams into memory.

MODEL K450M SPECIFICATIONS

Full System

Inputs: 64 channels

Capture Speed

Internal or external clock

≤ 25 MHz segmented recording with Trace Control.

≤ 50 MHz continuous recording.

Internal clock:

100 MHz across 1/2 channels, 2x memory depth.

200 MHz across 1/4 channels, 4x memory depth.

Memory Depth: 2.5 Mbits/channel across 64 channels.

Options: 10 or 40 Mbits/channel.

Starter System

Inputs: 32 channels

Capture Speed, Memory Depth: Same as full system.

Data Capture Capability

as provided by Gould K450B analyzer, see previous page for details.

Data Analysis Software: View, Search, Scroll, Read/Write disk files, Move to host (via user supplied LAN connection).

Additional Software Modules

"C" subroutines linkable to user supplied analysis software which presents data in channel/sample format from MEGA-MEMORY module or disk file.

Typical Data Analysis Performance

16 bit DMA, MEGA-MEMORY to PC; 12.0 Mbits/s

16 bit PIO, MEGA-MEMORY to PC; 6.4 Mbits/s

Count 64 channel pattern matches in 2.5 MSamples; 20.0 s.

Archive 64 channels x 2.5 MSamples to disk; 3.2 min

Options

Memory Depth: 10 or 40 Mbit/channel memory cards (across 64 channels).

Host Interfaces: Replacing the PC-AT compatible computer, these interfaces allow MEGA-MEMORY to be interfaced to other host environments. Interfaces are available for DEC or VME bus based computers under a wide range of operating systems.

Ordering Information

Product No.	Description
K450M-132	32 channel logic analyzer with 2.5 Mbits/channel memory capacity.
K450M-232	32 channel logic analyzer with 10 Mbits/channel memory capacity.
K450M-164	64 channel logic analyzer with 2.5 Mbits/channel memory capacity.
K450M-264	64 channel logic analyzer with 10 Mbits/channel memory capacity.

LOGIC ANALYZER

GOULD K500 Ultra high speed sampling and glitch detection

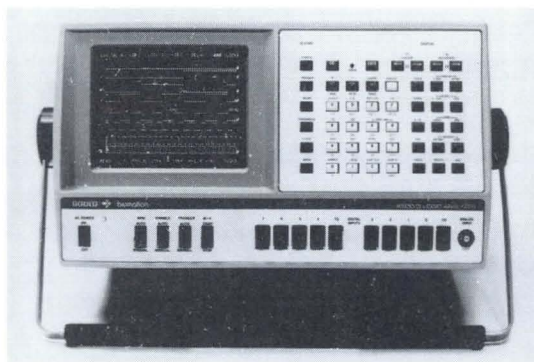

- 500 MHz sample rate
- 8 data channels
- 2 ns resolution
- 2k deep memory
- External clock plus trigger qualifier
- Analog channel at 500 MHz sample

The model K500 Logic Analyzer is a significant tool for design and development of high speed digital circuits. A set of features has been integrated into a single system and optimized to solve the problems encountered when working with ultra high-speed circuits.

The K500 is not only capable of sampling data at rates up to 500 MHz but of detecting glitches as short as 2 ns regardless of clock rate. Ten digital and one analog inputs are provided. The digital inputs include 8 data channels, one trigger and one qualifier. Each data

channel may be independently used in the sample or glitch mode while any of four different threshold levels may be selected for any of the ten digital inputs. The analog input has a resolution of 4 bits at a sample rate of 500 MHz and may be used simultaneously with four digital inputs.

In addition to being able to trigger on a defined word or an external pulse input, the K500 may also be triggered from an external analog event. The K500 combines precision and flexibility in an easy to use package.

MODEL K500 SPECIFICATIONS

Digital Inputs

10 , including 8 data, ext. clock, and 1 trigger qualifier.

Impedance: 25 k Ω /3.0pF at active probe tip.

Threshold: Each input may be assigned one of four references: TTL (1.4V), ECL (-1.3V), VAR A, VAR B (selectable between -6.35V and +6.30 V, in 50 mV increments).

Modes: Selected for each channel as sample or latch.

Minimum Detectable Pulse: 2 ns with threshold overdrive of 25 % of total voltage swing or 250 mV, whichever is greater.

Analog Inputs

Single input via front panel BNC

Impedance: 10 M Ω , 13 pF at tip of 10:1 probe; 1 M Ω , 40 pF at instrument.

Range: 2 V (0.5 V/D), 4 V (1.0V/D), and 8 V (2.0V/D)

Offset: +5 V to -5 V in 1 V increments.

Bandwidth: 100 MHz.

Max. Input: \pm 20 V continuous, \pm 50 V transient (at probe tip).

Resolution: 4 bits, (1 part in 16).

Coupling: DC only.

Clock

Internal: Selectable from 2 ns to 50 ms in a 1-2-5 sequence.

Skew: <1 ns, channel to channel.

External: DC - 130 MHz single edge. DC - 65 MHz both edges.

Setup Time. <2.5 ns

Hold Time: 0

Trigger

Three events control data and recording: Arm, Enable , and Trigger.

Arm: Selectable Manual, Auto, or via panel BNC input (ECL or TTL)

Delay: Trigger delay by clock or trigger occurrences up to 65,500.

Filter: When on, three trigger occurrences are required to trigger.

Output: BNC output, TTL active low when trigger is detected.

Memory

High speed, reference and display memory are each 8 bits wide and 2K words deep.

Output

RS-170, IEEE-488

General

Dimensions: 21.75" D x 8.5" H x 15.5" W (55.2 cm x 21.6 cm x 39.4 cm); 45 lbs.(20.5 kg)

Temperature: 0° to 55° C - operating

Power: 100, 120 VAC \pm 10%
220, 240 VAC \pm 10% 400 watts

Ordering Information

K500-D Includes digital probes, analog probe, power cord, signal wires, grabbers and users manual.

See accessories section for availability of accessories.

Help Screens

On-screen messages explain individual fields in setup screens by pressing the HELP key.

Self Test

During power-up, self tests check internal circuitry, including ROM, RAM, power supply, and keyboard.

Input Modules

Main Channels

Inputs: 32 or 64 main inputs at 20MHz. Recorded data controlled by Trace Control.

Internal Clocks: Selectable from 50ns to 50ms clock rate.

External Clocks: Eight external inputs are available to form a combinational (and/or) master clock signal (maximum 20MHz/minimum 25ns pulse width).

External Multiphased: The same capability as external mode with the addition of individual sample clock combinations for each section (up to four maximum).

Setup time: 25ns maximum, 10ns typical.

Hold Time: 0ns

Input Modes

Sample: Inputs are sampled only at active clock edge.

Demultiplex: Signal inputs to Section A are clocked into section A memory using the sample clock, then into section B memory using the demux clock on each clock cycle. Sections C and D operate in the same manner so that 32-channel demultiplexing may take place.

High Speed Channels

Inputs: Eight or sixteen channels at 100MHz or four or eight channels at 200MHz. Triggered by selected trigger word after link from Trace Control.

Internal Clocks: Selectable from 5ns to 50ms in a 1-2-5 sequence.

External Clocks: Two external inputs are available as an ORed clock signal up to 70MHz minimum, 90MHz typical (minimum 10ns pulse width).

Setup time: 4ns maximum.

Hold time: 0ns

Input Modes

Sample: Inputs are sampled only at active clock edge.

Glitch: A short positive or negative pulse that occurs between sample clocks is stored as a state change at the next clock. Glitches can have a duration as short as 5ns with 25% or 250mV overdrive, whichever is greater. (Not applicable on 5ns clock).

Data Channels

Maximum Number

K115-148: 32 main, 16 high speed

K115-172: 64 main, 8 high speed

Memory

1024 bits per channel of both acquisition and reference/compare memory.

Format

Timing Display: Four, eight, or sixteen channels, in any order, in groups of four.

Data Display: Binary, Hex, Octal, EBDIC, ASCII, or mixed.

Thresholds

Selectable for TTL (+1.40V), ECL (-1.30V), or one of two variable thresholds over a +9.9V to -9.9V range in 0.1V steps (50mV accuracy) for clock channels and groups of eight data channels.

Polarity

Selectable either + or - on a per-channel basis.

Trace Controls (Triggering)

8 levels @ 20 MHz decision rate. 4 recognizers per level: Trace, Advance, Go to___, and Stop.

Patterns: User definable for 50 patterns.

Delay: Up to 65,535 clocks or events per level.

Probe Inputs

Input Resistance: 1 M Ω , 2%

Input capacitance: ≤ 6 pF normally, ≤ 15 pF with flying leads.

Maximum input: ± 50 V peak

Interfaces

RS-232C

For communications between the K115 and other devices, you can set baud rate (up to 9600 bps), stop bits, parity, protocol, etc.

IEEE-488 (1978 STD)

A complete Talker/Listener interface

Composite Video (RS-170)

Video output (1VP-P into 75 Ω).

Link Output

This port outputs a TTL HIGH when the link from Trace Control to high speed trigger occurs.

Clock Output

An ECL active-LOW signal corresponds to the K115's internal clock.

Time of Day Clock and Date

The K115 displays a 24-hour time of day clock and the date. They are battery backed up.

Physical Characteristics

Operating Temperature: 10 $^{\circ}$ C to 40 $^{\circ}$ C.

Size: 8.6"H x 17.5"W x 24.7"D
(21.8 cm x 44.5 cm x 62.7 cm).

Maximum weight: 43 pounds (19.5 kg).

Input Voltages: 50 or 60 Hz. 90 to 135 VAC or 180 to 270 VAC.

Accessories Supplied: Probes, probe connectors with flying leads, grabbers, power cord, operating manual, and pouch.

Input power: 275 Watts, typical.

Ordering Information

Model Number	Main Channels	High Speed Channels	Mass Storage
K115-148	32	16	Single Disk Storage
K115-172	64	8	Single Disk Storage

LOGIC ANALYZER

GOULD K25

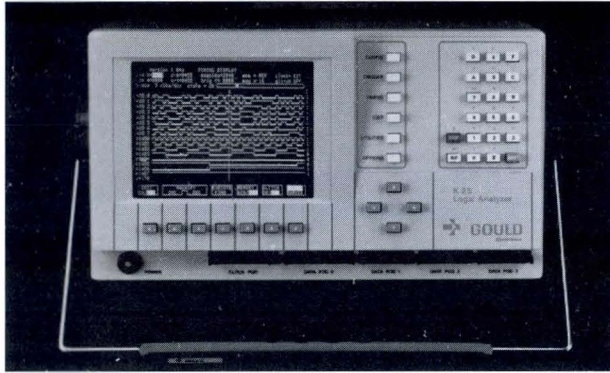

- 32 State or Timing channels
- 25 MHz data capture
- 4 levels of triggering
- Nonvolatile memory
- IEEE-488, RS-232C & Centronics interfaces standard

Hardware and Software Engineers

From Triggering on a hardware fault to conducting "what if" tests to untangle a software bug, the K25 provides the measurement capability to get the task done. High impedance probes minimize the possibility of the K25 changing the measurement you are making by loading the circuit.

Service and Manufacturing Technicians

You can quickly set up the K25 using the sixteen non-

volatile set up memories, sample data and compare the results with one of the reference memories. Then by using the channel and memory length compare options, you can quickly analyze the data for good and bad signals.

Educational Institutions

You can provide training on STATE, TIMING, and DISASSEMBLY of microprocessor code with an industrial quality instrument that gives your students the edge they will need to acquire a job upon graduation.

MODEL K25 SPECIFICATIONS

Inputs

Channels: 32 inputs to 25 MHz, 8 per pod

Clocks: Internal; 10 Hz to 25 MHz in 1-2-4 sequence. External; DC to 25 MHz, 3 clocks independently qualified and ORed together, 15 ns set up, 0 ns hold.

Impedance: 1 M Ω /5 pF

Threshold: Fixed TTL level (+1.4V), maximum input voltage +10/-5 continuous.

Skew: Typical <2 ns between input channels of the same pod; <4 ns across all channels.

Memory

Acquisition: 1K with pattern search.

Reference: 1K with pattern search and area compare.

Nonvolatile: Store reference, 4 acquisitions and 16 set ups.

Trigger

Words: 4 words of up to 32 bits. Each word can be used in any number of trigger sequencer terms.

Term: Up to 4 trigger sequencer words ORed together.

Steps: Up to 4 steps consisting of a search for the trigger and restart terms specified in that step. Each step has an event count of 1 to 256 occurrences of the trigger term.

Position: Selectable to be anywhere within the memory, or using the trigger delay, up to 60K clocks before the start of store.

Timing

17 channels simultaneously with X2, X4, X8, X16 expansion. Two cursors and trigger marker with read-out, channel labels.

State

To 16 groups of up to 32 channels with user-defined names, two cursors and trigger marker with read-out.

Disassemblers

See Accessories Section for selection.

Physical Characteristics

Dimensions: 13.8"W x 7.5"H x 17" D
(350cm x 190cm x 430cm)

Weight: 23 lbs (10.5 kg).

Environment: Operating temperature; 5° C to 40°C.

Power: 95-135 VAC or 180-265 VAC 47-440Hz; 100 VA maximum.

Interface (standard)

Full IEEE-488 Centronics and RS-232C port, composite video output (75 Ω , 1VP-P), TTI trigger and restart output.

Display

7" non-glare, green CRT; 25 lines x 64 characters; 17 timing traces max.

Ordering Information

Product Number	Description
K25-032	32 channel logic analyzer with probes, test leads and user's manual.

See Accessories Section for availability of accessories.

LOGIC ANALYZER

GOULD K50 The general purpose Logic Analyzer



- 32 state or timing channels
- 10 ns resolution on up to 8 channels
- Glitch triggering w/5 ns glitch capture
- Variable thresholds
- Popular disassemblers for 8-bit and 16-bit microprocessors
- Channel labeling

The Gould K50 Logic Analyzer is a low cost, light weight (23lb), high performance, portable instrument. Used in engineering, education, service, and manufacturing, the K50 offers features usually found only in logic analyzers costing much more. The K50 is a true general purpose Logic Analyzer. It provides the ability to resolve timing problems on eight channels at 10 ns (100 MHz) and disassemble most of today's popular 8-bit and 16-bit microprocessors. In addition, the K50 can capture data both synchronously and asynchronously without reprobng.

To pinpoint and capture data, four levels of trigger sequence steps can be programmed with one of four trigger words. Word one can be ANDed with the glitch word when glitch mode is selected. Each word can be used in any of the trigger sequencer terms. Once data has been captured, the K50's crisp timing and state displays include a trigger marker plus two reference cursors with direct readout of their absolute and relative positions and the data value of the selected cursor.

MODEL K50 SPECIFICATIONS

Data Channels, 32-Channels State/Timing

Probes: Four probes, 8 channels each

Formats(async.)

32 Channels up to 25 MHz
 16 Channels up to 50 MHz
 8 Channels up to 100 MHz
 4 Channels are used if in glitch capture mode.

Formats (sync)

32 Channels DC to 25 MHz
 16 Channels DC to 50 MHz

Memory

Reference: Equal in size and configuration to data memory. Can be loaded from data memory or via RS-232C/ IEEE-488 interfaces.

Non-volatile: Non-volatile storage of current Data and Reference memories, 2 further acquisitions and 16 set-ups. Data retention by Lithium cell; typical life 10 years.

Clocks

Internal: 10 Hz to 100 MHz in a 1-2-4 sequence.

External: DC to 50 MHz

Setup: 10 ns

Hold Time: 0 ns

Inputs: 3 clocks which are independently qualified and ORed together.

Triggering

Sequence Words: 4 words of up to the maximum number of bits of the selected channel configuration.

SequenceTerms: The actual trigger and restart terms searched for in a sequencer step each consist of up to 4 trigger sequencer words ORed together.

Sequencer Steps: Each of up to 4 steps consists of a search for the trigger and restart terms specified in that step.

Filter Trigger: OFF or 2 to 32 clocks

Restart Trigger: OFF or 1 to 16 clocks

Trigger Position: Selectable position on the screen or by using the delay up to 60K clocks before the display memory.

Glitch

Capture and trigger: 5ns.

Probe Inputs

Impedance: 1 M Ω , 5 pF shunt

Threshold: TTL (+1.4V) or Variable.

Max. Input Voltage: \pm 50 V continuous.

Data Skew: Typically better than 2 ns between input channels of the same pod; typically better than 4 ns between all channels.

Interfaces (standard)

Full IEEE-488, Centronics and RS-232C port. Composite video output (75 Ω , 1 VP-P).

Other: BNC TTL level trigger

Disassemblers

See Accessories Section for selection.

Ordering Information

Product No.	Description
K50-032	32-channel state or timing logic analyzer. Includes 4 probes, 1 clock probe, user's manual and power cord.

See Accessories Section for availability of accessories.

LOGIC ANALYZER

GOULD K100-D The most popular logic analyzer in the world



- 16 Timing channels to 100 MHz
- 32 State channels (Option)
- 1K samples per channel
- 10 ns trigger recognition
- Data and glitch modes
- Menu driven

The Gould K100-D Logic Analyzer is the most popular logic analyzer ever introduced. With over 8000 units installed, it sets the standard to which all logic analyzers are compared. The K100-D has proven itself to be an invaluable tool in hardware development, microprocessor hardware/software debugging, production testing and service. The wide range of options make it a complete problem solver. Timing, state, GPIB, RS-232C; wherever the problem exists, the K100-D can identify it.

The GPIB interface (standard) allows the K100-D to be fully programmed by an external controller.

The T-12 communicator option allows the K100-D units to operate in a master/slave configuration over a telephone line connection. This capability allows your top technical expert to diagnose problems in a remote location without having to travel.

K100-D SPECIFICATIONS

Standard

Channels: 16 data channels with 1K words of memory/channel.

Clock

Internal: 10 ns to 50 ms in 1-2-5 sequence

External: Selectable positive or negative edge, DC-70 MHz

Qualities: External clock, trigger (2 channels)

Threshold: TTL, ECL, 2 valuable (-6.4V to +6.4V) set at each input.

With D/32 External Option

Channels: 16 address, 16 data with 512 bits of memory/channel

Clock

External: DC-12MHz

Qualifiers: 3 external lines

Threshold: TTL

Modes

Sample: Unit stores the detected logic level present at active clock transition simultaneously on all inputs. Minimum pulse always detected and stored is one clock period plus 4 ns.

Latch: Whenever an even number of threshold transitions occur between two successive clock intervals, an input latch stores the state opposite that stored at the previous clock interval, on the next clock. The glitch may be stored in one or two memory cells.

Minimum Detectable Pluse: 4 ns typical, 5 ns with threshold overdrive of 25% of total voltage swing, or 250 mV, whichever is greater

Trigger

Function: Arm, Enable, Trigger, Delay, Filter

Event: Single level with 2 external qualifiers. May be defined in binary or hexadecimal as True, False, Don't Care.

Memory: Three segments each 1K words deep

M: High Speed data capture

A: Display

B: Reference compare, with conditions

A=B or A≠B over entire memory or segments

Probes

Standard: 6 foot length, flying leads accommodate test points to 18 inch separation; 1 MΩ, 5 pF.

With D/3 Option: Qualifier 0.2 mA Clock: 0.8 mA (TTL)

Interface: IEEE -488 standard

Physical Characteristics

Dimensions: 8.6"x17.5"x18.9" (21.8 cm x 44.6 cm x 48.0 cm)

Weight: 43lbs (19.5kg) including probes

Temp Range: 0 - 50°C, operating

Power: 100, 120, 220, or 240V ±10% 400W

UL Listing: Complies with Underwriters Laboratories Safety Standards UL1244, listing #342Z

Ordering Information

Product No.	Description
K100-000	16-channel logic analyzer with probes, flying leads
K100-200	Same as above with T12A communicator, phone
K100-950	Same as K100-000 with 50 Hz to 400 Hz power supply
K100-952	K100-000 with Portability package

See Accessories Section for availability of accessories.

K450B ACCESSORIES

Description	Product Number	Description	Product Number
Probe Kit (upper 8-F) Includes 1 - 10 input high impedance active (8 ch data, 2 ch. clocks, 1gnd.) data probe, 1 probe connector with 11 flying leads for upper (8-F) inputs, 1 set of 11 grabbers each, and a set of labels.	A14568	Qbus Interface Card Includes 1/2 height Q-Bus card and probe interface box.	A14581
Probe Kit (lower 0-7) Includes 1 - 10 input high impedance active (8 ch data, 2 ch. clocks, 1gnd.) data probe, 1 probe connector with 11 flying leads for lower (0-7) inputs, 1 set of 11 grabbers each, and a set of labels.	A14569	Serial Data Analyzer For monitoring RS-232C interface. Includes "piggy-back" connector.	A11505
K450B Probe Set One upper and one lower probe kit.	A14574	 GPIB Analyzer Provides transparent connector to IEEE-488 bus. Monitors all data and control lines.	A11506
K450B Probe Set 2 upper and 2 lower probe kits.	A14575	User-Definable Disassembler	A14589
K450B Probe Set 3 upper and 3 lower probe kits.	A14576	User-Definable Interface	A19509
K450B Probe set 4 upper and 4 lower probe kits.	A14577	SunLA Software:	A14599
K450B Probe Set 5 upper and 5 lower probe kits.	A14578	Software to control the Logic Analyzer from a Sun workstation.	
100 MHz State Clock Probe	A14604	K450B PCLA w/Telediagnosis:	A14582
400 MHz High Speed Probe 4 channels, 400 MHz sampling. (Requires Firmware 1.10 Rev. C or higher)	A14585	K450B PCLA w/Telediagnostics is software that allows you to run the K450B remotely from your desk or over the telephone from your IBM PC via RS-232C or GPIB*. Includes K450B PCLA diskette with users manual, and Telediagnosis diskette (A14563) with users manual.	
Firmware 1.10 Rev. E Update Includes 14 PROMS and installation instructions.	A14610	TeleDiagnosis	A14563
Microprocessor Analysis Packages		Remote communication over RS-232C, RS-232C modem or GPIB to a second Logic Analyzer. Includes diskette and users manual.	
INTEL		Histogram Software	A14606
MAP for 8031/8051	A14550	3 types of histograms on diskette.	
MAP for 8080/8080A	A14553	Modem	A19503
MAP for 8085/8085A	A14559	Hayes compatible, includes user manual.	
MAP for 8086/88	A14555	GPIB Interface	A19512
MAP for 8096/196	A14593	National IEEE-488 interface hardware for IBM PC supported by PCLA software (A19511, A14546 or A14562).	
MAP for 80186/80188	A14552	Dual Disk Storage System	A14548
MAP for 80286	A14551	Includes dual disk drives, DOS diskette and users manual, (field installable).	
MAP for 80386	A14560	S10 Probe	A19502
MOTOROLA		8 data and 2 clock inputs with each active probe on a 6' cable providing up to 12' of probe separation. Includes 10 sets of flying leads and grabbers.	
MAP for 6809	A14573	Graphics Printer Kit	A19510
MAP for 68008	A14557	Prints state and timing displays. Kit includes cable and printer compatible with Epson FX series graphic printers.	
MAP for 68000/10	A14556	K450B Service Kit	A14564
MAP for 68020	A14558	Includes two 4-layer extender cards, maintenance manual and diagnostic diskette.	
MAP for 68030	A14590	K450B Training Kit	A14527
MAP for 68HC11	A14592	Self teaching guide. Includes "Know Your K450B Quickly" work-book and data generator board. One kit already included with each K450B.	
ZILOG		K450B Flying lead kit:	A12523
MAP for Z80, Z80A, Z80B	A14554	Includes 3 lower section probe connectors with 11 flying leads each, and 3 upper section probe connectors with 11 flying leads each. Also includes 66 grabbers.	
MISC.		K450 User's Manual	A14502
MAP for 80515/535	A14595		
MAP for TMS-32010	A14588		
VBAT VMEbus Anomaly Trigger	A14591		
Triggers Logic Analyzer on any of 104 Bus errors. Uses one VME slot.			
VIC VMEbus Interface Card	A14605		
Provides quick and easy Logic Analyzer connection to any signal on VME P1 and P2 connectors. Uses one VME slot.			

*Supports National IEEE-488 command set only, see A19512.

K115 ACCESSORIES

Microprocessor Analysis Package

Microprocessor Analysis Packages translate the data captured from a K115 logic analyzer into easily understood assembly language mnemonics. Instruction fetches, memory reads and writes, and interrupts are clearly displayed to help understand a microprocessor's operation. Illegal and non-executed instructions are also prominently marked to eliminate interpretation errors.

Description	Product Number
-------------	----------------

INTEL

MAP for 8080/8080A	A11513
MAP for 8031/51	A11524
MAP for 8048/49	A11532
MAP for 8085/8085A	A11512
MAP for 8086/88	A11511
MAP for 80186/80188	A11535
MAP for 80286	A11537

MOTOROLA

MAP for 6800/02	A11515
MAP for 6809	A11516
MAP for 68008	A11533
MAP for 68000/10	A11510
MAP for 68020	A11531

ZILOG

MAP FOR Z80, Z80A, Z80B	A11514
-------------------------	--------

User-Definable Disassembler	A11508
------------------------------------	--------

User-Definable Interface	A19509
---------------------------------	--------

Serial Data Analyzer	A11505
-----------------------------	--------

For monitoring RS-232C interface. Includes "piggy-back" connector.

 GPIB Analyzer	A11506
-----------------------	--------

Provides transparent connector to IEEE-488 bus. Monitors all data and control lines.

K115 PCLA	A19511
------------------	--------

K115 PCLA is software that allows you to run the K115 from your IBM PC via RS-232C or GPIB*. Includes K115 PCLA diskette with user's manual.

GPIB Interface	A19512
-----------------------	--------

National IEEE-488 interface hardware for IBM PC supported by PCLA software (A19511).

Modem: Hayes compatible. Includes user's manual.	A19503
---	--------

S10 Probe	A19502
------------------	--------

8 data and 2 clock inputs each with an active probe on a 6' cable providing up to 12' of probe separation. Includes 10 sets of flying leads and grabbers.

Rack Mount Kit Includes drawer slides	A50001
--	--------

Instrument Cart	A50009
------------------------	--------

Transit Case	A50006
---------------------	--------

Reusable polyethylene shipping container. Measures 31" (L) x 21" (W) x 16 1/2" (H).

Graphics Printer Kit	A19510
-----------------------------	--------

Prints state and timing displays. Kit includes cable and printer compatible with Epson FX series graphic printers.

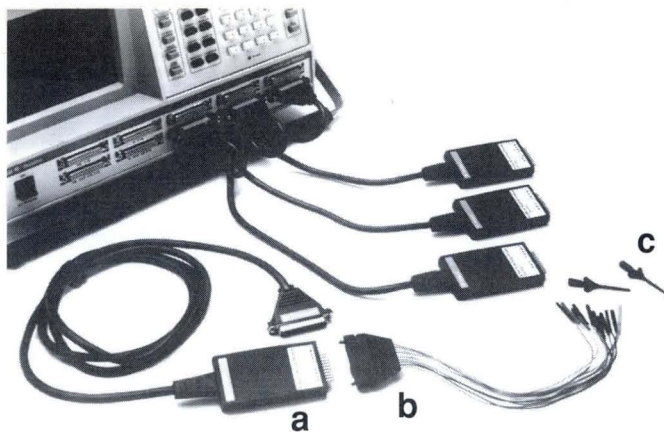

The K115/K450B probing system is designed to support a wide variety of interconnection techniques. Probe set components include: (a) compact 10 channel probes, (b) flying lead input cables, and (c) grabbers.

Description	Product Number
-------------	----------------

K115 Training Kit	A11553
--------------------------	--------

Self teaching guide. Includes "Know Your K115 Quickly" workbook and data generator board. One kit already included with K115.

K115 Service Kit	A11554
-------------------------	--------

Includes 2 extender cards, maintenance manual and diagnostics diskette.

Flying Lead Kit	A11523
------------------------	--------

Includes 3 lower section probe connector with 11 flying leads each, and 3 upper section probe connector with 9 flying leads each. Also includes 66 grabbers.

K115 User's Manual	A11551
---------------------------	--------

K115 Disk Storage System Operating Diskette	A11552
--	--------

Pouch	A50007
--------------	--------

32 Channels	A11501
--------------------	--------

For K115-132 and K115-140. Includes 4 probes, 4 probe connectors with flying leads, 4 sets of 9 grabbers each and installation instructions. (Field installable)

First 8 Channels at 100 MHz or 4 at 200 MHz	A11502
--	--------

For K115-132 and K115-164. Includes 1 probe, 1 probe connector with 11 flying leads, a set of 11 grabbers and installation instructions. (Field installable)

Second 8 Channels at 100 MHz or 4 at 200 MHz	A11503
---	--------

For conversion to K115-148. Includes 1 probe, 1 probe connector with 9 flying leads, a set of 9 grabbers and installation instructions. (Field installable)

Upper Probe Kit	A11521
------------------------	--------

Includes 1 probe, 1 probe connector with 9 flying leads, 9 grabbers and a set of labels.

Lower Probe Kit	A11522
------------------------	--------

Includes 1 probe, 1 probe connector with 11 flying leads, 11 grabbers and a set of labels.

*Supports National IEEE-488 command set only, see A19512.

K100-D ACCESSORIES

A full range of accessories is offered to further enhance your digital design productivity.

Description	Product Number
K100-D/10 Probe Pods Provide 16 channel operation. Each pod is supplied with a 9" signal cable, hook-type grabbers, and accepts 10 inputs	A11014
K100-D/32 Input Adapter Provides K100-D with 32 channel, 12MHz data domain capability with 512 bits per channel	A11003
K100-D/40 Input Adapter Provides convenient one-step connection between a microprocessor and K-100-D/32	A11004
6' Probe Set Includes two 6' probes, flying leads, and grabbers	A11016
9' Probe Set Includes two 9' probes, flying leads, and grabbers	A11019
10 TC-02 High Performance Probe Pod Includes two K100-D "Probe to BNC" adapters	A11011
10-XR High Performance Probe Set 10 M Ohm, x10 compensated probes, 6' lengths, packaged nine to a set with removable tips	A11010
Probe Tip Adapters (20 plus polarizer)	A11018
K100-D/RS-232 Serial Data Analyzer For monitoring RS-232-C interface. Includes "piggy-back" connector	A11005
K100-D/488 GPIB Analyzer Provides transparent connector to IEEE-488 bus. Monitors all data and control lines	A11006
Portability Package Includes hardware to cover front panel. Pouch to fit on top of K100-D (Field installable). PORTABILITY PACKAGE NOT AVAILABLE WITH T-12A	A50003
T-12A Communicator Allows the K100-D to communicate via telephone. For domestic (USA) use only. A flip-phone and pouch are included. The K100-D must have IEEE interface. PORTABILITY PACKAGE NOT AVAILABLE WITH T-12. (Field installable)	A11007

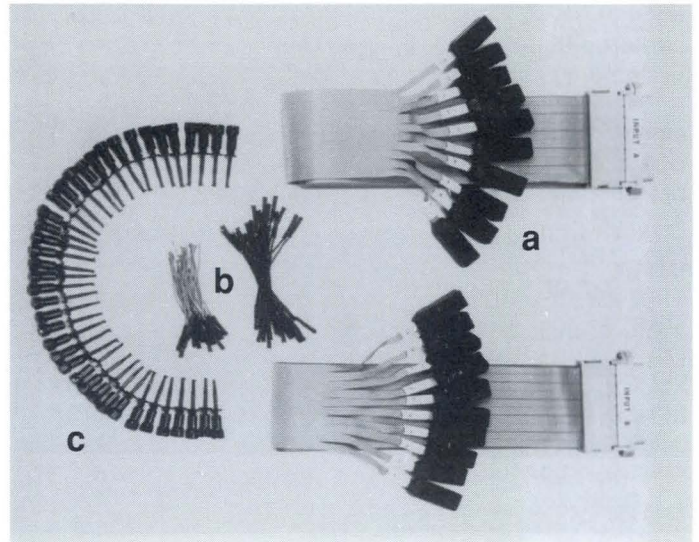

Separate active probe podlets attached to 6' or 9' splittable ribbon cables accommodate diverse system test points up to 18' apart. Probe set components include: (a) probe cables, (b) red and black signal wires, and (c) grabbers.

Description	Product Number
K100 User's Manual	A11013
T-12A User's Manual	A11020
Camera Adapter Designed for use with Tektronix C-5B or C-5C option 01 cameras	A50008
Pouch For probes, etc.	A50007
Rack Mount Kit Includes drawer slides	A50001
Instrument Cart	A50009
Transit Case Reusable polyethylene shipping container. Measures 31" (L) x 21" (W) x 16 1/2" (H).	A50006

K50 ACCESSORIES

A full range of accessories is offered to further enhance your digital design productivity.

Description	Product Number
DISASSEMBLERS:	
ZILOG	
Z80/A/B/H*	A60011
MOTOROLA	
6800/02/02NS/08	A60044
6809/E	A60017
68000/L/P/R	A60022
68HC11 (call factory for availability)	A60018
INTEL	
8085/A/80C85	A60012
8031/51/8344/8751	A60014
8086/88	A60021
8048/49/35/39/40/50/8748/8749	A60013
80186/188	A60045
OTHER	
6502/65C02*	A60015
64180	A60023
RS-232C	A60024
IEEE-488	A60046
6301/03/63701/6801/6803/68701	A60043
K50 User's Manual	A60025
8 Channel High Speed Probe (Pod 0):	A60026
8 Channel Probe (Pod 1,2 or 3):	A60027
Clock Probe	A60028
K50 Service Manual	A60035
1 Probe Connector: with 10 flying leads	A60029
Soft Carrying Case	A60030

* These microprocessors comprised of software and test-clip assembly only.

K25 ACCESSORIES

Description	Product Number
DISASSEMBLERS:	
ZILOG	
Z80/A/B/H *	A60011
MOTOROLA	
6800/02/02NS/08	A60044
6809/E	A60017
68000/L/P/R	A60051
INTEL	
8085/A/80C85	A60012
8031/51/8344/8751	A60014
8086/88	A60050
8048/49/35/39/40/50/8748/8749	A60013
80186/188	A60054
OTHER	
6502/65C02*	A60015
64180	A60052
RS-232C	A60055
IEEE-488	A60046
6301/03/63701/6801/6803/68701	A60043
K25 User's Manual	A60049
1 Probe Connector: with 10 flying leads	A60029
Soft Carrying Case	A60030

K500 ACCESSORIES

A full range of accessories is offered to further enhance your digital design productivity.

Description	Product Number
Digital Probe Set (new style) including: 1 each probe, 2 each signal wires, 2 each grabbers, 1 set of labels	A15002
Analog Probe 10 Megohm, 13 pF, 10x attenuation.	A50004
Portability Package Includes hardware to cover front panel, Pouch to fit on top of K500-D. (field installable)	A50003
K500 User's Manual	A15000
Pouch: for probes, etc.	A50007
K500 Service Kit Includes 2 extender cards and a maintenance manual.	A15005
Rack Mount Kit: Includes drawer slides.	A50001
Instrument Cart	A50009
Transit Case Reusable polyethylene shipping container. Measures 31" (length) x 21" (width) x 16 1/2" (height).	A50006
Camera Adapter Designed for use with Tektronix C-5B or C-5C option 091 cameras.	A50008

* Contact Factory for availability.

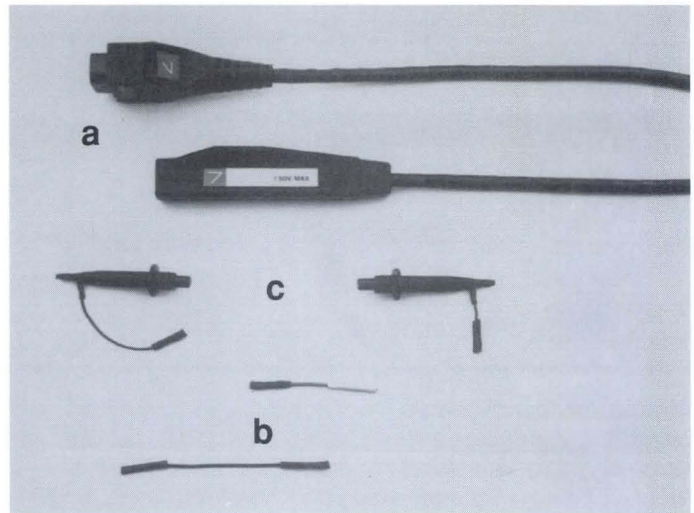

These individual high performance probes proved digital sampling at clock rates up to 500 MHz. Probe set components include: (a) probes, (b) red and black signal wires, and (c) red and black grabbers.

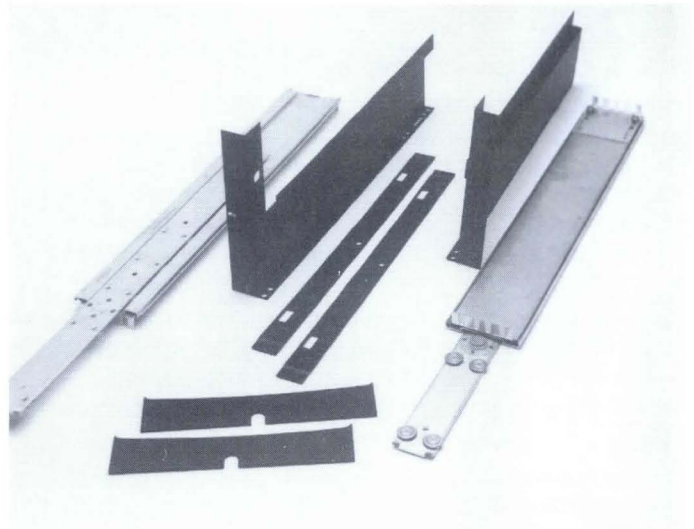

Each rack mount kit comes complete with drawer slides and moulding for neatly mounting Gould Logic Analyzers into a standard 19-in. rack.

MICROPROCESSOR ANALYSIS PACKAGES



- Non-invasive program execution monitoring
- Support for all popular 8, 16, and 32-bit μ Ps
- Display in manufacturers' mnemonics
- Easy connection to prototype with chip clip or probe
- Disassembly software provided on diskette (K450/K115) or in ROM pack (K50)

Microprocessor Analysis Packages (MAPs) provide complete interfacing and disassembly for most of the popular microprocessors in use today. In addition, a User-Definable Disassembler and Interface Adapter will support any additional standard or custom processors.

Analysis of program execution displayed in Hex or Binary format is extremely time consuming for even the simplest of programs. The Gould Microprocessor Analysis Package (MAP) quickly converts executed object code into assembly language instructions and data.

Multi-byte instructions are grouped together on one line. Each line lists address, hex object code, and source mnemonics of the executed code. Memory reads and writes are also displayed, including any special type of memory space addressed (user, supervisor, etc.). Interrupts and other exception processing are flagged so they can be quickly located and analyzed. Illegal and nonexecuted queue instructions also prominently marked to eliminate errors.

Each MAP is delivered with complete interface hardware (a convenient dip clip for snap-on simplicity and a processor probe board for high integrity termination). Each connection type is supported by a custom molded interface pod and cable.

A MAP transforms your logic analyzer into a complete microprocessor system debug station. Along with data formatting (for disassembly displays), a complete parametric set-up is made including Automatic Status

decoding. This decoding can be used in trace selections (READ, I/O, FETCH, etc.) without determining the individual status bits. Additionally, all monitored bus and control signals are labeled on the timing display for convenient analysis.

Logic analyzers with MAP support assist you in debugging and tuning your software. Disassembly allows you to pinpoint problems and determine how the software got to a code segment and what happened during its execution. Unlike an in-circuit emulator which may change program execution, the logic analyzer monitors circuit activity transparently.

The development of functional software is only half of the task. Optimizing it to meet performance and system requirements can be as time consuming as the development itself. The Gould K115 in a stand-alone configuration, or either the K115 or K450B used in conjunction with a PC for remote control, provide histogram overview displays. These graphical representations of program flow let you evaluate the time spent in program segments. This view of program execution allows you to quickly determine where to focus your code optimization efforts.

Disassemblers automatically display address, object data, mnemonics and operands. Histogram displays show time in code segments to aid in optimization. Non-microprocessor buses, including Q-Bus and IEEE-488 and RS-232C are also supported.

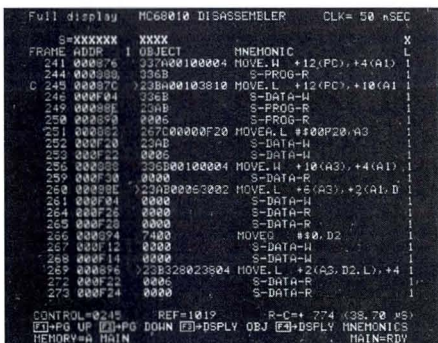

Disassemblers automatically display address, object data, mnemonics and operands.

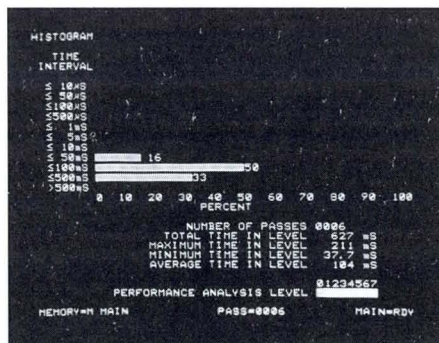

Histogram displays show time in code segments to aid in optimization.

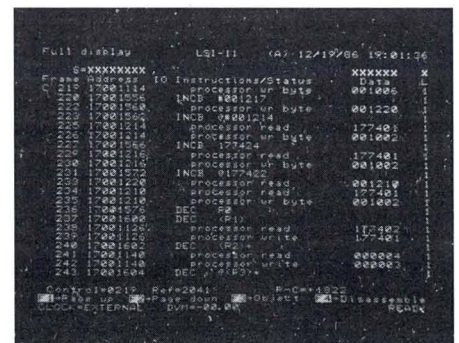

Non-microprocessor buses, including Q-Bus and IEEE-488 and RS-232C are also supported.

	-132	K450B -164	-180	-148	K115 -172	K50	K25
Intel							
8031/51	✓	✓	✓	✓	✓	✓	✓
8048/51	✓	✓		✓	✓	✓	✓
8080/A	✓	✓	✓	✓	✓		
8085/A	✓	✓	✓	✓	✓	✓	✓
8086/8		✓	✓		✓	✓	✓
8096/196	✓	✓					
80186/8		✓	✓		✓	✓	✓
80286		✓	✓		✓		
80386			✓				
Motorola							
6800/02				✓	✓	✓	✓
6809	✓	✓	✓	✓	✓	✓	✓
68008		✓	✓		✓		
68000/10		✓	✓		✓	✓	✓
68020			✓		✓		
68030			✓				
68HC11							
Zilog							
Z80A/B		✓	✓	✓	✓	✓	✓
Other							
6502						✓	✓
80515/535		✓	✓				
TMS-32010		✓	✓				✓
64180						✓	✓
RS-232-C						✓	✓
IEEE-488						✓	✓
6301/03/63701/6801/6803/68701						✓	✓
Universal (UDD)	✓	✓	✓	✓	✓	✓	

General Features

All MAP packages provide the following basic capabilities

- Capture of address, data and control signals related to program execution.

- Trigger on combinations of bus cycle types; Input, Output, Memory read/write, Instruction fetch, Interrupts. MAP packages configure Trace Control so that trace parameters can be defined in terms of the microprocessors' software architecture.

- Display in prime vendor execution mnemonics.

- Cycle by cycle or summary by instruction displays.

- Data capture speed is typically governed by the basic logic analyzer specification. Certain MAP packages contain external interface hardware to demultiplex bus signals and generate clock signals. This hardware is designed to support the fastest processor of its type. For details contact your local sales office.

Special Considerations

Microprocessor MAP support views the chip activity at the component pins. Certain microprocessors (eg: 68020, 8051) contain internal cache and program memory. These features must be disabled to obtain a complete picture of the components activity.

User-Definable Disassembler and Interface

Using a standard RS-232C terminal and the K115/K450B (with disk) as its own host computer, Gould's model User-Definable Disassembler (UDD) can be used to create your own symbolic translator. A flexible command structure allows you to design simple look-up tables of complex disassemblers for virtually any microprocessor. Unsupported or custom processors can receive the same productivity enhancements gained through standard disassemblers. The UDD is supplied with software diskette and user's manual.

The User-Definable Interface (UDI) can be easily configured into a custom interface adapter. Once configured, this adapter permits one-step connection to target systems. Circuit board area, IC pads, and power buses permit user-added circuitry. Each unit includes pod casing, motherboard with mounted connectors for 6 probes (K115/K450B type), internal PC board for cross-connections or circuitry, (clips and cables available as MAP accessory parts), and a user's manual.

Protocol Analyzers

Gould's K450B/K115 logic analyzers have the option which allows either RS-232C or IEEE-488 protocols to be examined at the transaction level. Each option includes mating connectors.

ASIC/VLSI ANALYSIS SYSTEM

GOULD SYS 6000 The exceptional ASIC/VLSI analysis for system hardware engineers

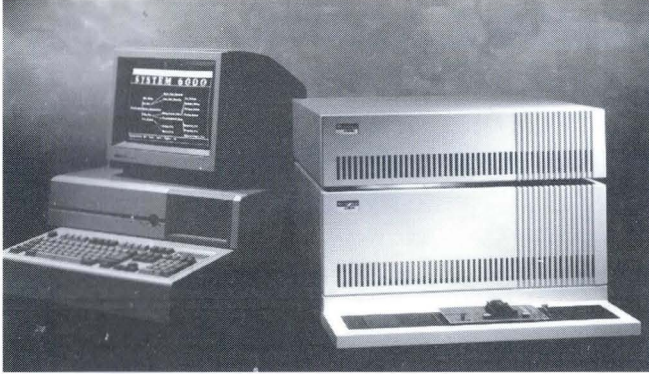

- SoftWire fixturing
- Per-pin architecture
- Configurable up to 352 bidirectional pins
- Variable up to 50 MHz clock rate and 25 MHz data rate.
- User definable stimulus with 1ns edge placement and timing measurements with 1ns resolution

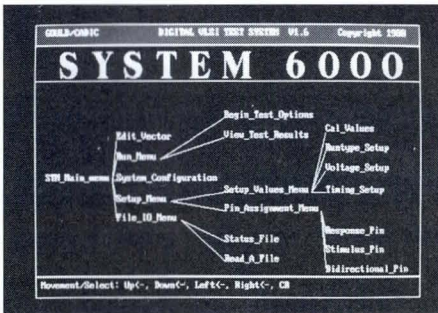

System 6000 Main Menu

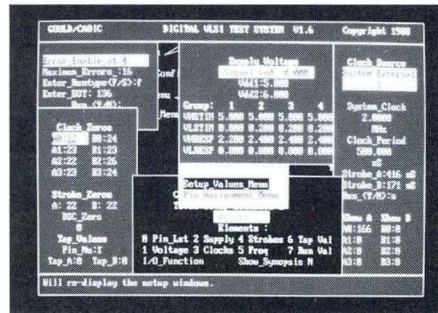

Setup SynopsiS

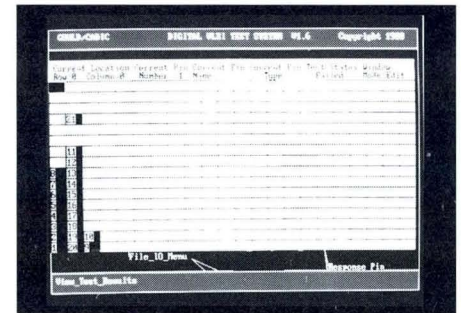

View Test Results

The System 6000 is a cost effective, high speed high-performance digital ASIC/VLSI Analysis System. It was designed by ASIC designers like yourself to make the task of IC testing easier and more accurate. Features such as SoftWire, which provides a menu driven user interface, contribute to its ease of use.

You will especially like the features provided with the System 6000 when faced with challenges of ASIC prototype analysis.

Test Flexibility

The System 6000 ASIC Analysis System tests ASIC components at all levels from simple functional verification to full device troubleshooting and characterization. In functional test mode, the System 6000 ensures that the logic in the chip is functional. As a characterization analyzer or troubleshooter, it measures and records device parameters in terms of both level and timing.

Test where you want, when you want.

The System 6000 Analysis System fits on a bench top. It is easily placed where it's needed: at the ASIC designer's bench, the incoming test station, or the failure analysis lab. Because the System 6000 is menu driven, it can be used when needed, without weeks of front-end program development and debug. All you need to get started is your device and a vector file.

Test Vector conversion made simple.

The System 6000 accepts simulator outputs directly as vector files which are ready to run with little translation required. You can also create vectors with the automatic pattern generator. There are no esoteric programming languages to learn! These features allow device verification tests to be setup and run quickly.

Eliminate fixture building with SoftWire.

You no longer have to spend weeks building expensive personality cards. With SoftWire, all connections are software assigned. Devices are simply plugged into an adapter board for testing.

SoftWire-created configurations can be stored as disk files, ready to be called up instantly for quick changes to other device types or fast modification of test parameters.

Per-Pin Architecture

Pins are assigned as entities allowing each pin, up to 352 pins maximum, to be individually assigned as an input, output or bi-directional.

Test Pins

Configuration: Available in 16 pin increments to 352 I/O pins.

Programmability: Each individually assigned as either stimulus, response, or bidirectional.

Memory Depth: 64K standard vectors behind each pin.

Tristate Control: 8 bidirectional controls. Pins are individually assignable to any control.

Test Speed

Clock Rate: 50 MHz maximum (Double Return Format).

Data Rate: 25 MHz maximum.

Acquisition Rate: 25 MHz maximum.

Cycle Rate

Programmable from 200 kHz to 25 MHz continuously variable within $\pm 0.5\%$. Can be driven by an external clock.

Pattern Placement

Edges: 8 programmable timing edges available on a per-pin basis to set stimulus edges and formats.

Edge Resolution: 1-ns increments.

Edge Range: 0 to 950 ns.

Pattern Generation

5 timing formats assignable on per-pin basis and 3 return formats (for bi-directional pins):

NR (non-return, delayed or non-delayed)

DRO (double return to 1)

DRZ (double return to 0)

RTZ (return to 0)

RTO (return to 1)

NRT (non-return to tri-state)

RTT (return to tri-state)

RTD (return to drive)

Programmable Drivers

Signal Levels: 4 independent pairs (Stimulus High and Stimulus Low) 0-6.2 V. Pins are individually assignable to any pair.

Resolution: 25 mV

Slew Rate: 1.5 V/ns

Output Drive Current: 50 mA (Source or Sink).

Output Impedance: 50 Ohms (nominal).

Programmable Receivers

Compare Levels: 4 independent pairs (Response High and Response Low) 0-6.2 V. Pins are individually assignable to any pair.

Resolution: 25 mV

Compare Strobe

Range: 0 to 1000 ns in 1-ns steps.

Strobes: 2 assignable at each pin.

DUT Power Supply

Programmable Voltages: 0 to 6.2 V in 25 mV increments at 2A. -6.2 to +6.2 V in 25 mV increments at 0.5A.

External Instrumentation

Sync-out: Synchronize out (e.g. scope).

Instrument Control: GPIB control (optional). General interface adapter control.

Autocalibration

Operation: Deskews system taking DUT board load into consideration. No additional hardware required.

Typical System Skew: ± 3.0 ns (channel to channel, 25 MHz, 64 pins, each clock).

Device Fixturing

DUT plugs directly into a device adapter board.

DUT-to-system connection made by mapping device pins through software assignment.

Operating Temperature

13 to 32°C (55-80°F).

Physical Dimensions

21"W (53.3 cm) x 16"H (40.6cm) x 24"L(60.9cm).

Weight is 95lbs. (43.1 kg) with 64 channels.

Power Requirements

110 VAC $\pm 10\%$ at 47-63 Hz, or 220 VAC $\pm 10\%$ at 47-63 Hz.

Ordering Information

Product No.	Description
SYS6000-64	64 channel logic analysis system.
SYS6000-128	128 channel logic analysis system.
SYS6000-256	256 channel logic analysis system.
SYS6000-352	352 channel logic analysis system.

See Accessories section for availability of accessories.

DIGITAL VLSI TEST SYSTEM

STM 4100

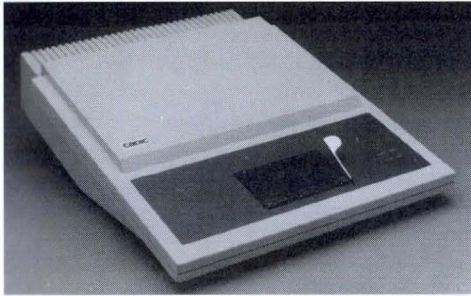

- SoftWire fixturing
- Per-pin architecture
- Up to 256 bidirectional pins
- Unlimited test vector depth
- Learn mode
- Menu-driven software
- Automatic self test
- Automatic pattern generation

The STM4100 is a low-cost, flexible tool for quick and efficient functional verification and failure analysis of devices at the engineer's bench. A simplified per-pin architecture and Cadic's exclusive SoftWire fixturing eliminate fixture building and I/O pin rewiring. Agonizing over test programming is also eliminated with the STM's easy-to-use, menu-driven operation.

As a result, complete functional test setup time is reduced to less than an hour. And, the STM4100's powerful per-pin architecture provides fast and complete state testing. The payoff is faster device turnaround, from prototypes to production, and a quicker time to market.

Efficient SoftWire Fixturing

Fixture building and wiring are things of the past with Cadic's exclusive SoftWire fixturing. Devices are simply plugged into a Device Adapter Card. There's no cabling or wiring to do. ALL test vectors and I/O assignments are done by software through menu-driven creation of a pin assignment file.

Since there's no wiring involved with SoftWire, the usual fixture loading and signal fidelity problems are avoided. And since pin assignments are table-driven, testing can be quickly changed from one device type to another simply by reading in new pin assignment files.

Per-Pin Architecture

Much of the STM4100's capabilities stem from its simple and powerful per-pin architecture. This architecture provides full state testing along with extensive error analysis.

The per-pin approach also allows the STM4100's pin channels to be individually programmed as input, output, or bidirectional. Moreover, the per-pin approach and SoftWire fixturing allow pin assignments - including I/O direction - to be made "on the fly" during testing. The test program trickery and fixture changes common with other test systems are eliminated. The result is a clean and simple method of full bidirectional verification in a single test run.

Up to 256 Bidirectional Pins

The STM4100 can be ordered with up to 256 bidirectional pins, making it possible to test a wide range of device types.

Unlimited Test Vectors

Along with clean and simple 256-pin testing, the STM4100 also is unrestrained by vector depth. It has unlimited capability for handling any number of test vectors supplied by its host computer. As a result, host computer storage is the only limit to test vector depth.

Automatic Test Vector Generation

With the STM4100, logic simulation can be directly downloaded with any workstation simulator. Only minor modifications to the simulation data are needed, allowing actual device testing to begin almost immediately.

Automatic Pattern Generation software is also provided with the STM4100. It provides a simple, concise method of creating large test pattern files quickly. Pattern entry is made through a simple description file, and actual patterns are generated algorithmically from this file. The Automatic Pattern Generator is also a useful tool for creating test vectors from a "known good" device. This is done with the Pattern Generator's "Learn Mode." Once the good device's responses are "learned" by the Pattern Generator, the resulting test file can be used to evaluate other devices of the same type.

Convenient Learn Mode.

The STM4100 also provides a convenient and familiar learn mode of operation. But the STM4100 goes beyond just comparing device responses to expected results. It also captures and stores device responses for use in other tests or for test comparisons.

Automatic Self Test

Throughout testing, the STM4100's Automatic Self Test feature provides continuous assurance of test validity. At program initialization, the STM4100 immediately tests itself for functionality. This initial test verifies the number of pins available for testing, including both stimulus and response pins. And during operation, the STM4100 also tests system validity and provides warnings. This eliminates invalid conditions that might not be apparent during device testing, such as stimulus errors.

SYS6000 AND STM 4100 ACCESSORIES

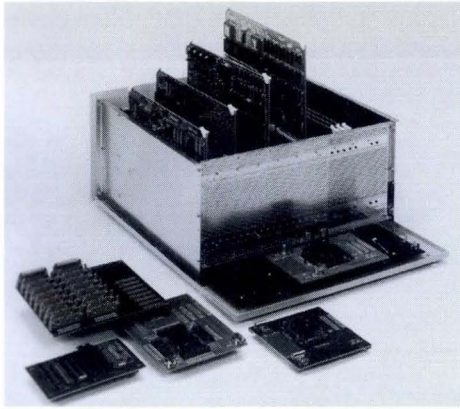

- Standard interface adapter cards
- DC parametric measuring unit
- Vector conversion software
- XCL system programmable language
- Voltage level sensitivity measurement

Interface Adapter Boards

The SYS6000 and STM 4100 Interface adapter boards will save you weeks in building custom personality cards. Through SoftWire, a user can assign each tester pin via software to the Device Under Test (DUT). Devices are simply plugged into one of the standard adapter interfaces for analysis.

Adapter Board Key Features

- 50 Ω controlled impedance traces.
- Multi-layer (PCB) ground or power planes between each layer.
- Crosstalk reduced by spacing traces at 3x dielectric thickness.
- 15 x 30 prototype grid area; .060 "pads"; holes.
- VDD1/VDD2; GND. (selected boards, consult factory) Ability to substitute external supplies for VDD1, VDD2. External supplies easily substituted for internal VDD1 and VDD2.
- Connect any DUT pins to VDD1 using shorting block type jumper.
- Connect any DUT pins to VDD2 using short wire jumper.
- Connect any DUT pins to GND using shorting block type jumper.
- VDD2 bypass capacitor located near VDD2 across pins.
- Boards available for most package types.
- Custom boards available.
- BNC connectors for scope probing; connection provided for any device pin on most boards.

Ordering Information

Order No.	Description	Available for	
		STM 4100	SYS6000
015-0005-00	Universal 64 Pin Dip	X	
015-2570-00	48 Pin DIP Adapter Card		X
015-1012-00	256 Pin PGA 17 x 17		X
015-1021-00	208 Pin PGA 17 x 17		X
015-1002-00	120 Pin PGA 15 x 15	X	
015-1020-00	181 Pin PGA 15 x 15		X
015-1002-00A	184 Pin PGA 15 x 15	X	
015-1005-00	160 Pin PGA 14 x 14		X
015-1010-00	144 Pin PGA 13 x 13		X
015-1008-00	84 Pin PGA 10 x 10	X	X
015-1011-00	124 Pad PLCC/LCC	X	X
015-1004-00A	84 Pad PLCC/LCC	X	X
015-1004-00	68 Pad PLCC/LCC	X	X
015-1009-00A	44 Pad PLCC/LCC	X	X
015-1009-00	28 Pad PLCC/LCC	X	X
015-1007-00	132 Pin Flat Pack	X	
015-1006-00	100 Pin Flat Pack	X	X
015-1003-00	256 Pin Signal Cable	X	
015-0501-00	32 Pin Flat Cable For Signal Cable Adapter	X	
015-1026-00	300 Pin Signal Cable		X
015-0500-00	50 Pin Cable for Cable Adapter Boards		X

16 Channel Upgrade (SYS6000 16K)

Upgrades the System 6000 16 channels at a time. Maximum upgrade channel count is 352. Call factory for installation information.

Order No. Description

015-2620-00 16 channel upgrade (SYS6000 only)

64 Channel Upgrade (STM 4100)

Upgrades the STM 4100 64 channels at a time. Maximum upgrade channel count is 256. Call factory for installation information.

Order No. Description

015-1223-02 64 channel upgrade (STM 4100 only)

DC Parametric Measuring Unit

The Parametric Measuring Unit (PMU) is a hardware option for the SYS6000 ASIC/VLSI Analysis System. With a PMU installed in the SYS6000, complete DC parametrics can be measured at any available SYS6000 pin, or group of pins. And, using the Executive Command Language (XCL) with the PMU, automates testing of multiple pin sequences. Parametric measurements can be included as part of functional verification because the PMU is fully integrated into the SYS6000 system.

PMU Modes of Operation

Force voltage/measure current

Force current/measure voltage

PMU Uses

Impedance measurements
Output driver measurements
Continuity testing

PMU Key Features

- Individual pin or group (gang) testing of DUT stimulus pins
- Value measurement or pass/fail testing
- * Auto-increment of forcing function
- Graphing (X/Y plots)
- Sequential measurement of selected pin group
- 12-bit ADC (measure)
- 12-bit DAC (force)

Order No. Description

040-0107-00 Parametric Measurement Unit (SYS6000 only)

Instrument Cart

Cart to hold the SYS6000 Analysis System.

Order No. Description

095-0001-00 Instrument Cart

Software Packages**Voltage Level Sensitivity Measurement**

The Voltage Level Sensitivity Measurement is easily setup, through menu driven windows, to determine input threshold levels, output voltage levels, and I/O voltage sensitivity versus VDD variations. Other features are: automatic variation of parameters, transfer function measurement, and 25 millivolt resolution. Results are collected, stored and are available in graphic form.

Order No. Description

040-0109-00 Voltage Level Sensitivity Measurement S/W
(Software available for SYS6000 only)

Executive Command Language

The Executive Command Language (XCL) is a software package which provides you with an easy method of accessing and controlling functions of the SYS6000 hardware by using simple commands which are contained in a high-level program environment. XCL allows you to write a test sequence for your device and have it automatically executed and recorded.

Order No. Description

040-0113-00 Executive Command Language S/W
(Software available for SYS6000 only)

Computer Aided Engineering Simulation Translation (CAEST)

The CAEST program converts user supplied simulator files to vector files consistent with the System 6000 requirements. The software can accept both synchronous and asynchronous simulator data formats. The program then determines the timing formats, the value of the clock, and pin requirements of the Device Under Test (DUT).

Order No. Description

040-0006-01 Computer Aided Simulation Translation S/W
(Software available for SYS6000 and STM 4100)

Sentry Translation

The Sentry translation program provides two way translation: to and from most Sentry files.

Order No. Description

040-0005-01 Computer Aided Simulation Translation S/W
(Software available for SYS6000 and STM 4100)

Digital Storage Oscilloscopes Selection Chart

Our full line of DSOs can meet your specific application requirement. Programmable models can be interfaced to computers via either RS-232C or GPIB (IEEE-488) for

mass storage, customized signal processing and automatic test applications.

Model No.	Bandwidth MHz	No. of Channels	Memory Size Per Channel K Words	Vertical Resolution Bits	Max. Sample Rate Ms/s	Reference Memories (Non Volatile)	RS-232C	IEEE -488	Special Features	Page No.
1421	20	2	1	8	2	—	No	No	Storage of Repetitive Signals to 20 MHz	64
1425	20	2	1	8	2	5	Yes	No	Cursor Measurements, Waveform Processing	64
1602	20	2	10	8	20	50	Yes	Yes	Fully Programmable, Built-in Color Plotter, Waveform Processing, External Clocking	61
1604	20	4	10	8	20	50	Yes	Yes	Fully Programmable, Built-in Color Plotter, Waveform Processing, External Clocking	61
400	20	2	0.5	8	100	3	Yes	No	Cursor Measurements, Data Transfer	56
4072	100	2	1	8	400	8	Yes	Yes	Fully Programmable, Built-in Color Plotter, Waveform Processing	58
4074	100	4	1	8	400	8	Yes	Yes	Fully Programmable, Built-in Color Plotter, Waveform Processing	58

Digital Storage Oscilloscope

Gould's full line of Digital Storage Oscilloscopes (DSO) offers you the advantages of digital storage without giving up the ruggedness, versatility, and convenience of a general-purpose, real time scope.

Gould brings you a complete selection of applications-oriented scopes that function as real time scopes, digital storage scopes, transient recorders and electronic chart recorders.

If your needs go beyond that offered by most oscilloscopes available today, a Gould DSO is for you. No other scopes — real time, storage tube or digital — offer comparable advanced systems capabilities for so little. Using the optional Waveform Processors, you can do filtering, signal averaging, waveform comparison, TV line capture, FFT's, programmable sequences, and inter-channel mathematical operations.



- DSOs with 400 Ms/s 8-bit converters
- 2 and 4 channel versions
- Automatic cursor measurements
- Extensive waveform processing
- Built-in color plotters

Gould's Test and Measurement equipment provides:

- Unmatched application flexibility.** Choose from the widest range of portable, dual-trace DSOs tailored to meet the needs of technicians, engineers and scientists in industries and professions with measurement needs in the DC to 100 MHz applications range.
- Unequaled system functionality.** Capture, store, measure, compare and process data. These comprehensive measurement systems also allow observation of events in real time, the study of transient phenomena, and the convenient documentation of test results on a wide variety of analog and digital systems.
- Unbeatable values.** Gould DSOs solve your problems for less money.

These DSOs are ideal for a multitude of exacting applications, such as:

Mechanical: Stress, vibration, and shock testing and analysis.

Electrical: Contact bounce, voltage breakdown, life/destructive testing, and transient analysis.

Electronic: Testing and development of microprocessor-based systems and communications products, power supplies, consumer electronics, part characterizations, etc.

Medical: Nerve studies, cardiac response, lung function, retina research, and speech pattern analysis.

Scientific: Tensile/compression, acceleration and displacement temperature and ultrasonic testing.

Gould Waveform Processors: To convert the Gould Digital Storage Oscilloscope into an even more powerful analysis system, see page 68 for more details.

Oscilloscope Accessories: See page 71 for details.

Software Packages

To simplify the interfacing of the Gould DSO to a computer we offer three types of software package:

Starter Packages — Simple procedures that can be used in your own program.

Analysis Package — A sophisticated software package that can take your captured signal and perform advanced signal processing.

Control Package — For the user who is building a test system we offer a high level package which greatly accelerates the integration of the DSO into the system.

See Page 66 for details.

NEW

OSCILLOSCOPES

GOULD 400

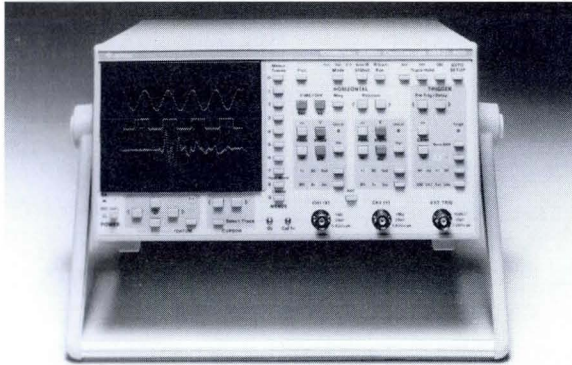

- 100 Ms/s Transient, 500 Ms/s Repetitive Sampling
- Low Cost, Small Size
- 20 MHz Storage Bandwidth
- Cursor Measurements
- RS-423C Interface
- DC or AC Powered

High Speed and Portable

The Gould 400 is truly portable, running from 12 to 33 VDC and weighing only 5.5 kg, yet its large feature set allows even very difficult measurement problems to be solved. Pre- and post-trigger delay allows acquisition of only that data which is of interest. Stored traces may be re-positioned in both X and Y, and scaled in Y. Traces can be stored in 3 non-volatile backup memories for recall later. A separate reference trace can be displayed as well as the normal two channels to aid comparison of signals.

Accurate on Screen Measurements

Whether stored or "live" traces are being displayed, the 400 cursor system performs Δt and ΔV measurements on the selected trace with respect to user-positioned datum lines.

Periodic auto-calibration ensures measurement accuracy.

Easy to Use

Controls are logically grouped and to ensure easy operation, "Auto Setup" has been included. Simply press the blue button. The 400 will choose the timebase and vertical sensitivities which best suit the input signal.

Unique, patented variable pressure push buttons are used to control vertical trace shift, trigger level and delay, and cursor and datum position. To shift a trace faster, push the button harder.

Additional features such as max-min, dot joining, display trace/alpha graticule intensities and averaging are controlled via an easy to use two level menu system.

Archive Data

The HPGL plot output is configured through the "Plot Options" menu and a full screen copy made on a digital plotter.

Trace data can be transferred to a computer for analysis via the RS-423 interface, and from the computer to the 400 for display of results.

MODEL 400 SPECIFICATIONS

Vertical Deflection

Two identical input channels CH1, CH2 (Invert provided for both channels).

Bandwidth: DC: 0 - 20 MHz. AC: 4 Hz - 20 MHz.

Sensitivity: 2 mV/div to 5 V/div.

Input Impedance: 1 M Ω /28 pF.

Input Protection: 400 VDC or pk AC.

Vertical Position Range: ± 12 div.

Expansion: Post Storage X0.062 to X4.0.

Display

CRT: 8x10 divisions rectangular with electronically generated graticule.

Intensity: Separate trace, graticule and alpha controls.

Display Modes

Alpha numeric display of channel sensitivity, coupling, timebase, status.

Roll: Stored data and display updated continuously.

Refreshed: Stored data and display updated by triggered sweep.

X-Y: CH1 for X, CH2 for Y. 8x8 div.

Interpolation: Linear.

Display Resolution: 8 bits x 501 words per channel (256 x 501)

Hold: "ALL" freezes both channels. "CH1", "CH2" freeze appropriate channel.

Single Trace: CH1 or CH2.

Dual Trace: CH1 and CH2.

Add: CH1 and CH2 added after digitization.

Cursor Measurement Display: ΔV and ΔT displayed on screen.

Trigger Indication: Separate trigger level and position indicators on screen.

Acquisition System

Acquisition Memory: 501 words per channel.

Maximum Sample Rate: 100 M samples/s.

ETS Sample Rate: Equivalent to 500 M samples/s for repetitive signals only.

Vertical Resolution: 8 bits (1 in 256).

Peak Detection (Glitch Capture): Capture of positive and negative glitches to 2- μ s pulse width.

Waveforms: A reference trace can be stored and displayed in addition to input channel displays.

Back-Up Stores: 3 non-volatile stores are available for waveform storage.

Averaging: From 2 to 256 acquisitions can be averaged to reduce noise.

Set-Up: The current set-up is restored on power-up.

Horizontal Deflection

Sweep Rate: 500 nS to 50 S/div.

ETS Sweep Rate: 100 nS and 200 nS/div.

Expansion: X10 in either ETS or normal acquisition.

Trigger

Variable level control with Auto/Normal facility.

Source: CH1, CH2, External, Line.

Slope: $+V_e$ or $-V_e$.

Coupling: DC, DC HF rej, AC, AC HF rej.

Post-Trigger Delay

Time: 0 to 5000 S, 20 nS resolution.

Pre-Trigger: 1-100% in 0.4% stops.

Digital Plotter Output

The instrument can directly output to HPGL format plotters via the RS-423 interface port.

Plot Mode: Manual or Automatic after acquisition.

Colors: Color pens automatically selected when available.

Labels: Range scaling, measurements, labels and graticule information selected by menu.

Power Requirements

AC Voltage: 90-130 V and 190-265 V.

Frequency: 45-400 Hz.

DC Voltage: 12-33 V.

Power: 85 VA approx.

Interface (RS423)

Serial interface port for bi-directional waveform data transfer and associated range parameters.

Baud Rate: Selectable via menu 75 to 9600.

Ordering Information

Model No.	Description
0409-0400	400 2 Channel Digital Storage Oscilloscope
0409-0440	106 400Hz Operation (must be ordered with the 400)
0409-0430	400 DSO with 107 Battery Pack
0409-0492	107 Battery Pack alone

GOULD 4072 AND 4074 HIGH SPEED DIGITAL STORAGE OSCILLOSCOPE

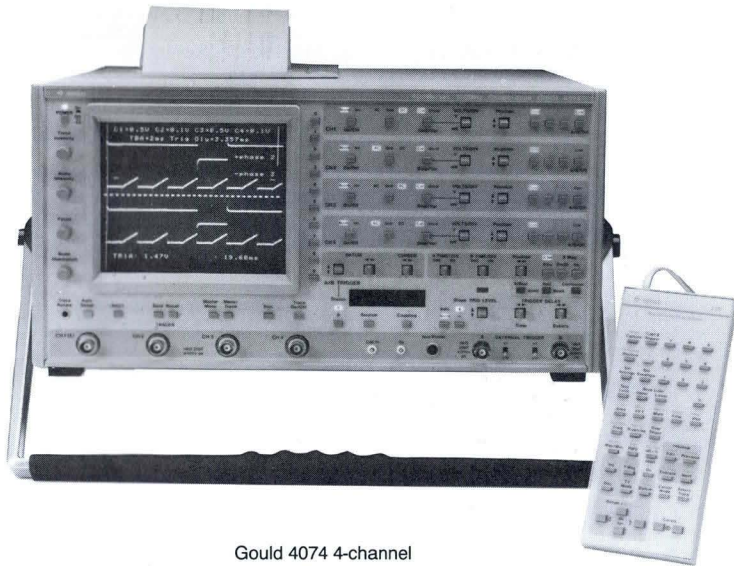

Gould 4074 4-channel
Digital Storage Oscilloscope with 270 Waveform Processor

- 400 M samples/s 8-bit converters on every channel
- 2 or 4 channel versions
- 100 MHz transient bandwidth
- Low jitter and 2 ns/div time resolution
- Waveform processing
- Fully programmable

The Gould 4070 Series provides application flexibility to meet a wide range of needs, including high speed and processing capabilities for design and test applications. These scopes also provide full programmability for laboratory automation or ATE, the portability needed for field service, and the ruggedness and easy operation required for manufacturing applications.

Best performance around

Gould's 4070 Digital Storage Oscilloscope Series delivers the best performance available. It features exclusive 400 M samples/s digitizers on every channel, enabling true 100 MHz bandwidth and accuracy for both transient and continuous signals in real time. To ensure the best results from fast signals there are sine and linear interpolators; less than 200 ps jitter to give high accuracy equivalent time sampling to 2-ns/div resolution, 5-ns glitch capture, and much more.

Exceptional triggering capability

To complement the signal capture performance, the 4070 offers one of the most sophisticated triggering systems available on any oscilloscope today. Two timebases with separate trigger inputs are available, which can run synchronously or asynchronously and offer full delay facilities, such as delay by time, delay by events and gating. When delay by events is selected, the Gould 4070 will either trigger after the Nth event, so that individual pulses can be stored from logic trains, or it will trigger every Nth event for the display of individual lines of TV signals.

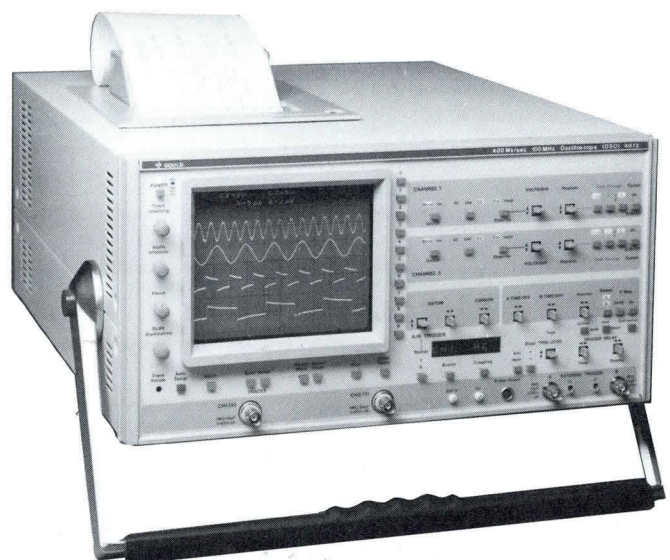

Gould 4072 2-channel
Digital Storage Oscilloscope

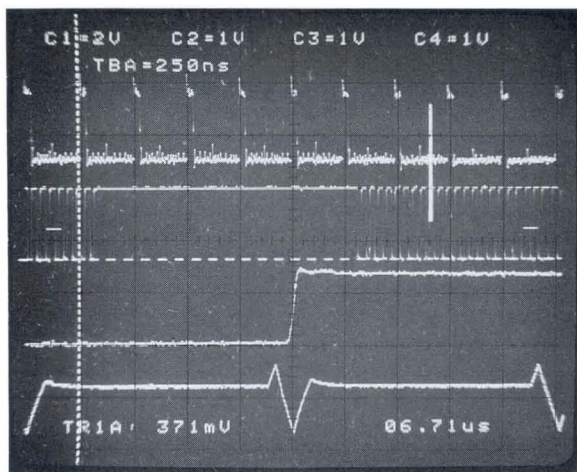

Four channels makes digital development easier.

Four channels can give accurate timing information because there are four full channels of operation.

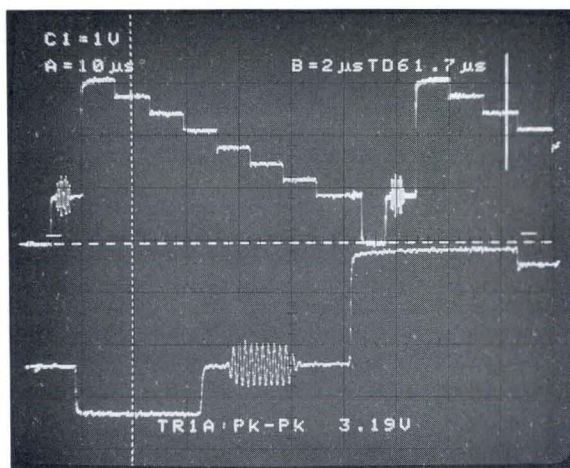

Advantage of dual timebase used with trigger delay system.

Use the optional Waveform Processor to trigger the 4070 on any preselected TV or video line. The fine detail of the color burst on the lower trace was achieved using the dual timebase facility in combination with the flexible trigger delay system.

MODELS 4072 AND 4074 SPECIFICATIONS

(Unless otherwise stated, the specifications of the 4072 and 4074 are identical.)

Vertical Input

Input: 4072: 2 Channels
4074: 4 Channels

Bandwidth: DC: 0 - 100 MHz (-3 dB).
AC: 4 Hz - 100 MHz (-3 dB).

Sensitivity: 2 mV/div to 5 V/div.

Input Impedance: 1 M Ω /20 pF.

Input Protection: 400 VDC or pk AC.

Vertical Position Range: ± 8 div.

Display

CRT: 10 x 12 cm rectangular. Internal illuminated graticule.

Display Modes:

4072: CH1, CH2, CH1 invert, CH2 invert, CH1 + CH2, CH1 vs CH2, Reference Traces 1 through 8.

4074: CH1, CH2, CH3, CH4, CH1 invert, CH2 invert, CH3 invert, CH4 invert, CH1 vs CH2, CH1 vs CH3, CH1 vs CH4, Reference Traces 1 through 8.

Interpolation: Selectable either sine, linear or no interpolation.

Trigger Reference: There is an on-screen indicator which shows the location of the trigger level and the trigger point.

Readout: Readout characters indicate the current setting of the instrument: vertical sensitivity, timebase and cursor measurements.

Acquisition System

Maximum Sample Rate: 400 M samples/s.

Vertical Resolution: 8 bits (0.4%).

Record Length: 1K word per input channel.

Acquisition Modes

Refresh Mode: For stored data and display updated by trigger event.

Roll Mode: Stored data and display updated continually prior to being frozen by trigger.

Pre-trigger Roll Mode: Stored data is updated continually as per roll mode in pre-trigger part of the display. Then entire display is frozen as in refresh mode upon receipt of trigger.

Glitch Capture: Capture of either positive, negative or alternate positive and negative glitches. Typically a 5-ns pulse can be captured with 80% confidence. There is a 100% confidence of capture to 95% of amplitude for a 30-ns pulse.

Averaging: From 2 to 256 sweeps.

Non-Volatile Memory

Waveforms: Up to 8 waveforms can be stored and recalled.

Set-Ups: Total of 4 set-ups can be stored.

Specifications continued on next page.

Horizontal Deflection

Horizontal Display Modes: A, A intensified by B, A alt B, B only, X-Y, Refresh, Roll, Pre-Trigger Roll.

Horizontal Display Accuracy: $\pm 3\%$.

A and B Delayed Sweep Range: 20 ns/div to 20 s/div. Sweep speeds faster than 250 ns/div use equivalent time sampling (ETS).

Horizontal Expansion: Expansion from x2 to x20 times to a maximum of 2 ns/div.

Trigger Delay: A or B sweep start can be delayed from either Trigger A or Trigger B, respectively. Delay can be either negative (pre-trigger), or positive (post-trigger).

Trigger Range:

Pre-Trigger: 0 to 100% with 0.1% resolution.

Post-Trigger:

Timebase Range	Max. Delay
20 s to 0.1 ms/div	99.9 s
50 μ s to 50 ns/div	0.99 s
20 ns/div	0.4 s

Delay by Events: This will allow the B sweep to be delayed from A sweep by up to 999,999 events with maximum trigger frequency of 100 MHz.

Trigger:

There are two trigger systems A and B. Each system has similar specifications.

Trigger A:

Source: 4072: CH1, CH2, EXT A, LINE.
4074: CH1, CH3, EXT A, LINE.

Couplings: AC, DC, ACHP, ACLP, DCLP.
TV Line, TV Field 1.
DCLP, ACLP — (< 15 kHz).
ACHP — (> 15 kHz).

Trigger B:

Source: As Trigger A except use EXT B.
Couplings: As Trigger A. TV Line taken from A Source.

Slope: Selectable +ve, -ve.

Trigger Level: Variable. Level indicated on screen with marker.

External Input Impedance: 1 M Ω /20 pF.

External Input Protection: 200 VDC or pk AC.

Trigger Combinations: A and B Timebase can be triggered independently or in any combination of the following:

- 'A' Trigger only.
- 'A' Triggered then after Nth event.
- 'A' Triggered then after Nth event plus 'B' trigger delay.
- 'B' Trigger only.
- 'A' Triggered then after N x 'B' trigger events.

Trigger Output: Rear panel TTL compatible pulse corresponding to the trigger point on the display.

Cursor Measurements

Voltage and time differences between the measurement and datum cursors are automatically displayed.

IEEE-488 Interface

Read and Write Functions: All front panel controls are fully programmable.

Data can be read from and written to all of the memories.

All on-screen alpha-numerics can be read remotely.

The computer can display messages on the display in 14 lines of 32 characters each.

RS-423 (RS-232C) Interface

Specification: All of the functions available via the IEEE-488 Interface are available via the RS-423 Interface.

Baud Rate: 50, 110, 300, 600, 1200, 2400, 4800, 9600 selectable via menu.

Digital Plotter Interface

The instrument can directly address HPGL format plotters via either the IEEE-488 or RS-423 Interface. This plots out either menus or traces. The trace plots will include cursor information, range settings, date and time.

Color: Different colors selected for traces and the grid when multicolor plotters are used.

Internal Plotter

Direct digital plots to the internal multicolor plotter can be selected by the menu to be in the same format as above.

Analog Plotter Output

Analog Dual

4072: Simultaneous output of X with Y1 and Y2 outputs.

4074: As 4072 followed by output of X with Y3 and Y4 outputs.

Analog Single

4072: Individual plot of single Y channel plus X output (allowing 2 channels to be plotted sequentially from the socket).

4074: As 4072, but all 4 channels plotted sequentially.

Auto Plot

Initiates a plot at end of acquisition, then re-arms instrument at end of plot.

Power Requirements

Voltage: 90 V - 260 VAC. No switching required between voltage ranges.

Frequency: 45 - 440 Hz.

Power: 200 W max.

Ordering Information

Part Number	Description
0409-4720	4072 2-Channel Digital Oscilloscope
0409-4740	4074 4-Channel Digital Oscilloscope
0409-4773	170A Waveform Processor
0409-4775	270 Waveform Processor

Waveform Processor

See types 170A and 270 on page 68.

GOULD 1600 DIGITAL STORAGE OSCILLOSCOPE



Gould 1604 4-channel Digital Storage Oscilloscope
with 260 Waveform Processor

- Advanced analysis capability
- 10 k word memories on every channel
- Available in 2 and 4 channel versions (1602 and 1604)
- Exceptional trigger flexibility
- Fully programmable
- Integral color plotter

Others display data — The 1600 displays information

This Digital Storage Oscilloscope improves efficiency by providing answers, not just data. For looking at signals in either low frequency electronics or from a transducer, the 1600 gives you a powerful combination of signal capture coupled with extensive data analysis and archiving capabilities.

Massive memories for more resolution

With massive 10 k word memories on each of its 4 channels, it allows examination of detail with expansion factors up to x200 and resolution down to 0.05 μ s. A glitch detector ensures that the 1600 can capture high speed pulses even at the slowest time base speeds.

Acquire only the data needed

Run the data acquisition system continuously and tell it when to freeze. The 1600 can use a trigger to acquire all the data that occurs before it (pre-trigger) or to show data that occurs up to 1000 s after it. It can even simultaneously show data that occurs both before and after the trigger and count triggers to show the data that occurs up to 16383 trigger events later. There is no need to waste chart paper or spend time scanning data that is not required.

The 1600 can also store up to 50 traces in the backup memories of the Waveform Processor with the date of occurrence, or plot them out automatically to a strip chart recorder, before rearming itself for the next trigger. It can, therefore, make available full details of signal activity without the need to have an operator present.

External clocking

Tailor the 1600 to the application using the external clock input to generate your own timebase. Clock pulses synchronized to the revolutions of a machine can give answers related to degrees of rotation. Compress data by clocking the 1600 only during the points of interest.

And it's easy to use

Press the blue button and the 1600 will automatically evaluate the incoming signal and position the fully programmable controls to give the optimum setting for that particular input, while also displaying the set up characteristics on the front panel.

It makes measurements automatically

Cursors can be positioned anywhere on the display to show the difference in voltage and time between them. When fitted with the Type 160A or 260 Waveform Processor, they can also show rise times, fall times, peak-to-peak measurements, overshoot, pulse widths, frequencies, area under curve and RMS values.

It provides more information with its Waveform Processor

The hand-held keypad also allows the ability to average up to 1024 traces, so that signals buried deep in noise can be analyzed in detail. Also, for transient events a built-in algorithm enables signals to be filtered in a number of selectable steps even after storage.

Individual lines of TV transmission can also be selected and stored in the large memories.

And the 1600 is fully programmable for use with personal computers

Optional IEEE-488 or dual RS-232C Interfaces enable the 1600 to communicate its data and fully programmable control functions with virtually all computers used in scientific areas. The 1600 can therefore be used for customized data analysis, mass storage or for integration as an acquisition component in an automatic test system.

(continued on next page)

The 1600 makes it easy to keep records of the data

When fitted with the Waveform Processor, the 1600 can store up to 50 traces (even when the power is switched off, the information is still retained). This optional plug-in waveform memory can be easily removed from the 1600 and sent from a remote site to base and the waveforms recalled to another 1600 — ideal in remote monitoring applications. For visual records a multi-color plotter is built into the instrument and enables each trace to be

plotted in different colors, along with full information as to time and date and the range settings at the time of acquisition of each trace — a grid is also printed in another color so that any printing or paper registration problems are eliminated.

Alternatively the 1600 contains the intelligence to drive an HPGL plotter automatically, and can output information in the same form as above. The 1600 can even output information direct to analog strip chart or XY recorders, along with full control of the pen so that plotting or fly back corruption are eliminated.

MODEL 1600 SPECIFICATIONS

Vertical Deflection

Identical input channels, CH1, CH2 - 1602; CH1, CH2, CH3, CH4 - 1604 (invert provided for all channels).

Bandwidth: DC: 0-20 MHz.
AC: 2 Hz-20 MHz.

Sensitivity: 2 mV/div to 10 V/div.

Input Impedance: 1 M Ω /30 pF.

Input Protection: 400 VDC or pk AC.

Vertical Position Range: ± 8 div.

Accuracy: $\pm 2\%$.

Display

CRT: 8 x 10 cm rectangular with internally illuminated graticule.

Non-Storage Display Modes

Single Trace: CH1 or CH2, or CH3 or CH4.

Multi-Trace: Any combination of the four available channels in Normal, Chopped or Alternate Modes, are automatically selected by the Timebase.

Add: CH1 + CH2 and/or CH3 + CH4.

Invert: Any channel may be inverted. When used in conjunction with ADD Mode, it gives the algebraic difference of the two channels.

X-Y: CH1 gives X, CH2, CH3 and CH4 give Y deflections. Alphanumeric display of input voltage range and timebase range.

Storage Display Modes

Roll: Stored data and display updated continually.

Refreshed: Stored data and display updated by triggered sweep.

X-Y Display: As Non-Storage. 8 bit x 8 bit (256 x 256).

Interpolation: Linear.

Display Resolution: 8 bits x 1 k per channel (256 x 1024).

Display Hold: Freezes total store.

Channel Hold: Freezes individual selected channel.

Datum Cursors: Independent vertical and horizontal cursor lines.

Measurement Cursor: Assigned to trace.

Cursor Measurement Display: ΔV and ΔT displayed on screen.

Trigger Indication: Trigger level indication on-screen. On-trace trigger point bright-up indication.

Storage Facilities

Acquisition System

Acquisition Memory: 10 k words per channel.

Maximum Sample Rate: 20 M samples/s.

Vertical Resolution: 8 bits (1 in 256).

Peak Detection (Glitch Capture): Capture of positive and/or negative glitches to 50-ns pulse width.

Waveforms: Two reference traces can be stored and displayed in addition to input channel displays.

Set-Ups: A total of 4 set-ups can be stored in non-volatile memory.

External Clock

Provides an input for Ext. clock signals to control the acquisition sample speed.

Selected by time base control.

Clock rate, DC to 2 MHz re-clocked internally at 20 MHz rate.

Input +5V amplitude CMOS.

Horizontal Deflection

Non-Storage

Sweep Rate: 0.2 μ s/div to 10 ms/div.

Expansion: x5 gives fastest range sweep speed of 40 ns/div.

Storage

Sweep Rate: 50 μ s/div - 200 s/div.

Horizontal Expansion: x1, x2, x5, x10, x20, x50, x100, x200.

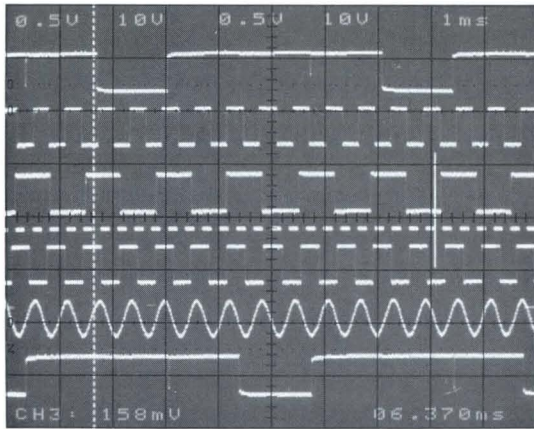

Display of 6 traces.



1602 2-channel Digital Storage Oscilloscope.

MODEL 1600 SPECIFICATIONS

Trigger

Variable level control with Auto/Normal facility.

Source: Internal CH1, CH2, CH3, CH4, Ext, Line.

Slope: +ve or -ve.

Band Trigger: 0 to ± 4 div.

Coupling: DC, DCLP, AC, ACLP, TV Frame, TV Line.

Post-Trigger Delay

Time: 0 to 1000 s.

Events: 1-16383 trigger events.

Trigger: Divide by N (N = 2 to 16383).

Pre-Trigger: 0-100% in 0.1% steps.

Internal Screen Plotter

Direct digital screen copy of waveforms with annotation of range scales, labels and graticule selected by menu.

Plotter Buffer: Permits oscilloscope to be used while plotting a screen.

Plot Size: 89 mm wide by 102 mm long (approx.).

No. of Pens: 4 colors automatically selected.

Analog Output

Analog output of the stored displays for plotters and recorders.

Y Output: Parallel output of up to 4 channels. Serial output CH1 through CH4.

X Output: X ramp output.

Digital Plotter Output

(Available with an Interface Option): The instrument can directly output to HPGL format plotters via the IEEE or RS423 Interface Ports.

Plot Mode: Manual or Automatic after acquisition.

Colors: Color pens automatically selected when available.

Labels: Range scaling, measurements, labels and graticule information selected by menu.

Auto Plot: Initiates a plot at the end of acquisition and re-arms the instruments at the end of the plot cycle.

Power Requirements

Voltage: 100 V, 120 V, 220 V and 240 V.

Frequency: 45-400 Hz.

Power: 70 VA approx.

Option 103A – IEEE-488 Interface

Read and Write Functions

All front panel controls with the exception of:

Variable Timebase Non-Storage

Variable Input Attenuation

Power On/Off

Trace Intensity

Scale Illumination

Trace Rotation

Alpha-Numeric Intensity.

All menu selections are programmable. Memory data is programmable. On-screen alpha-numeric can be read. Alpha-numeric 16 line x 32 characters are programmable for display messages.

Option 102 – RS423 (RS-232C) Serial Interface

Two Ports are provided:

1. Output only, e.g., for plotter or printer.
2. Input/Output for control as IEEE specification.

Baud Rate: Selectable via menu. 300 to 9600.

Ordering Information

Part Number	Description
0409-1630	1602 2 channel digital storage oscilloscope
0409-1620	1602/104 2 channel digital storage oscilloscope with integral plotter.
0409-1650	1604 4 channel digital storage oscilloscope
0409-1640	1604/104 4 channel digital storage oscilloscope with integral plotter.
0409-1662	102 RS423 (RS232) Serial Interface
0409-1663	103A IEEE-488 Interface
0409-1664	104 Internal Color Plotter
0409-1666	160A Waveform Processor type 160A
0409-1667	105A Waveform Storage Module type 105A/160A
0409-1670	260 Waveform Processor type 260
0409-1671	205 Waveform Storage Module type 205/260

Waveform Processors

See types 160A and 260 on page 68.

GOULD 1421 AND 1425 DIGITAL STORAGE OSCILLOSCOPES

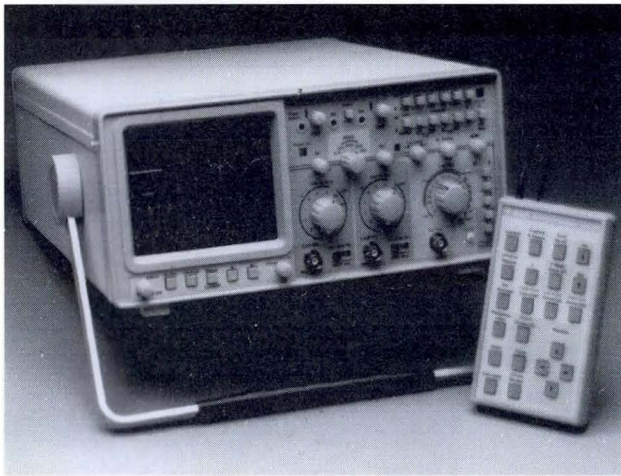

- Low cost
- 20MHz real time operation
- 20MHz storage bandwidth
- Cursor measurements
- Waveform processing
- Computer and plotter interface

The 1421 and 1425 provide two instruments in one for both electronics and transducer applications. Both will operate as comprehensive dual-channel conventional 20 MHz oscilloscopes or, at the touch of a button, as digital storage oscilloscopes.

To capture single shot events, the 1421 and 1425 sample at up to 2MS/s and save the acquired trace in memory. Pretrigger of 25%, 75% or 100% can be used to see the waveform before the trigger event, and so determine the baseline or cause of the trigger. Once a trace has been captured it can be expanded by x10 so that the full detail can be seen.

Fast low repetition rate signals can give a very dim display on a conventional scope. The 1421 and 1425 can sample over many trigger events, down to an effective interval of 5 ns between samples. This gives a crisp bright display, which can be magnified, plotted or measured like any other trace.

ROLL mode makes it possible to easily view slow signals. New data is written on the right hand side of the screen and the display rolls to the left, in a way that is very similar to a chart recorder.

Making time and voltage measurements on the 1425 is very simple using the cursors. For more complex waveform manipulation the 125 waveform processor provides the capability to add, subtract and multiply traces, and to filter a stored trace. Averaging can be used to reduce random noise in a signal over a number of sweeps.

The 1425 also features an RS423 (compatible with RS232) interface. This can be used to transfer captured traces to a computer for analysis, or to plot the traces directly to a digital plotter in different colors, together with the scaling information and graticule.

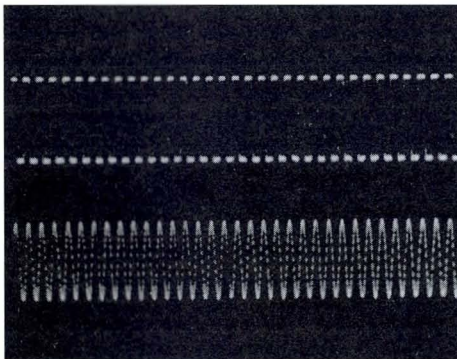

Stored signal before expansion.

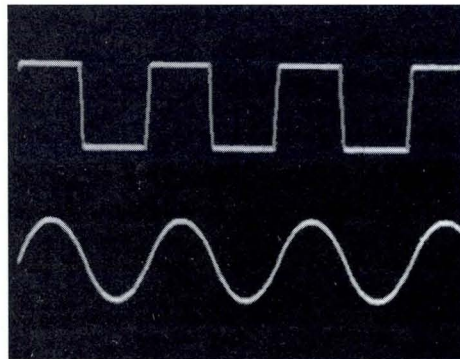

Stored signal after expansion

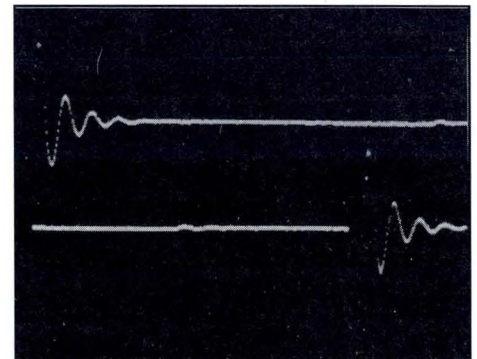

Top trace: No pre-trigger, bottom trace: 75% pre-trigger.

Features common to 1421 and 1425

Display

CRT: 8x10 cm rectangular with internal graticule.

Vertical Deflection

Two identical channels CH1 and CH2.

Bandwidth (-3 dB):DC to 20 MHz (2 Hz to 20 MHz on AC).

Sensitivity: 2 mV/div to 10V/div

Input Impedance: 1 MΩ/28 pF.

Input Protected: To 400 VDC or peak AC.

Horizontal Deflection

Normal Mode Sweep Rate: 0.5 μs/div to 0.2 s/div.

Storage Mode Sweep Rate: 0.5 μs/div to 50 s/div.

Expansion: x10 gives fastest sweep rate of 50 ns/div.

Accuracy: ±3%. (50 ns/div ±5%)

Trigger

Variable level control with Auto or Normal trigger.

Source: Internal CH1 or CH2, or External.

Slope: +/-.

Coupling: DC, AC or TV.

Note: TV is active sync separator with line/frame selected by timebase.

Display Modes

Single Trace: CH1 or CH2.

Dual Trace: In normal mode, chopped or alternate modes are automatically selected by timebase. In storage mode the dual-trace capture is simultaneous at all speeds.

Add: CH1 and CH2 added to give the algebraic sum of the two input channels. (Normal mode only.)

Invert: CH2 may be inverted. When used in conjunction with Add mode it gives the algebraic difference of the two channels.

X-Y: CH1 input gives X deflection and CH2 input gives Y deflection. (Normal mode only.)

Roll: Stored data and display updated continuously.

Refresh: Stored data and display updated by triggered sweep.

Digital Facilities

Two channels of digital storage

Memory Length: 1024 storage words per channel.

Vertical Resolution: 8 bits (1 in 256).

Expansion: x10 post storage trace magnification.

Equivalent Time Sampling: This mode enables repetitive waveforms to be stored with full horizontal resolution.

Single Shot: Freezes memory at end of triggered sweep.

Display Hold: Freezes memory immediately.

Channel 2 Hold: Freezes CH2 memory immediately.

Pre-Trigger Storage: Available in Roll mode only, switchable for 0%, 25%, 75% or 100% of full memory pre-trigger.

Plot Output

Analog output of the stored display.

Y Output: CH1 or CH2 at 100 mV/div (±10%).

X Ramp: X ramp at 100 mV/div (±10%).

Output Sweep Rate: 50 s/div to 50 ms/div.

Power Requirements

Voltage: 100V, 120V, 220V and 240 V

Frequency: 40-400 Hz

Power: 70 VA approx.

Extra Features on the 1425

Automatic Cursor Measurements

Measurement of voltage and time between a datum and cursor which may be assigned to either trace. (Storage mode only.)

RS423 Interface

Baud Rate: 300, 1200 or 9600.

Handshake: RTS/CTS.

Data Format: Binary, decimal, hexadecimal or octal.

Command Format: Commands and responses are ASCII strings.

Digital Plotter Interface

Output of stored traces and range settings via RS423 interface to a digital plotter in HPGL format.

Extra features on the 125 Waveform Processor (Available only on the 1425)

Frequency: Calculates frequency of trace between datum and cursor.

Signal Averaging: Calculates mean of between 2 and 256 acquisitions.

Trace Arithmetic: Add, subtract or multiply two traces.

Copy: Copies CH1 to CH2, or CH2 to CH1.

Trace Magnification/Attenuation: Multiplies trace from x3.98 to x0.06 in 250 steps.

Filter: 6 selectable steps of low pass filtering per timebase range.

Invert: Inverts trace about center line.

Position: Reposition a stored trace in both X and Y.

Reference Memories: 5 traces can be saved and recalled for comparison.

Non-Volatile Memory Option - Type 126

Provides non-volatile memory for the 5 reference memories available with the Waveform Processor type 125. Retains data for up to 10 years.

Ordering Information

Part Number	Description
0409-1431	1421 2 channel digital storage oscilloscope
0409-1425	1425 2 channel DSO with cursors and RS423 interface
0409-1465	125 Waveform Processor for use with 1425
0409-1430	126 non-volatile memory option kit for use with 1425/125
0409-1429	1425 with 125 and 126 non-volatile memory option

OSCILLOSCOPE SOFTWARE

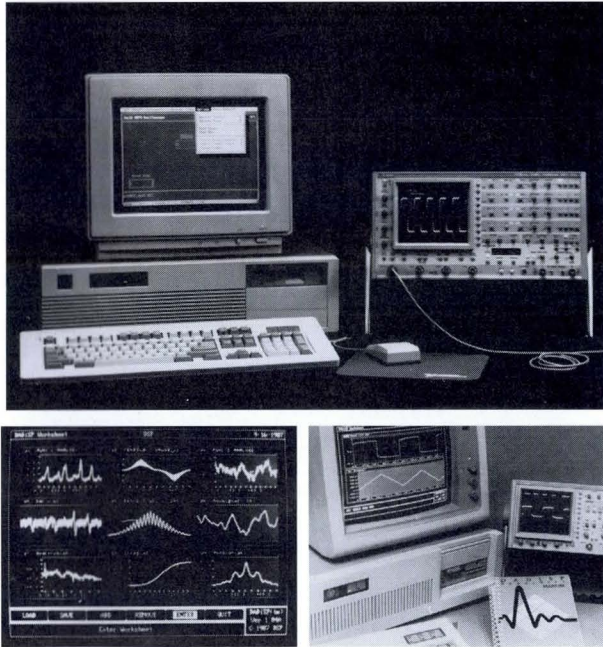

- Extend post-acquisition capabilities
- Reduce software development time
- Save waveforms on computer disc
- Comprehensive analysis capabilities

Gould offers three types of software package to meet the needs of scope users who want to increase their productivity by using personal computers;

- **Control Software** – For users who wish to incorporate a scope into a test system without writing the low level scope driver software himself.
- **Analysis Software** – A software package for the user who needs sophisticated post-storage processing capabilities.
- **Starter Software** – A package of several routines to enable the first time user to write his own programs incorporating Gould's BASIC procedures.

Control Software

For the user who is building an IEEE-488 test system, we offer the National Instruments LabWindows™ program. This is a high level control software package which makes the development of test systems easy by using virtual instruments. The user can quickly model the test system and develop the software with little concern for the driving of the scope. When he then starts to fully prove his system, he uses an instrument driver module to control the scope installed in the system.

The advantage is that the user can concentrate upon the operation of the system and not concern himself with communications between the scope and computer.

There are instrument drivers available for the 1600 and 4070 series of scopes which make the communication between the scope and computer easier for the user.

Specifications

LabWindows™ comprises five components:

1. Interactive development environment.
A test program can be written in either QuickBASIC or C.
2. Instrument library.
There is a library of instruments available for a wide range of test equipment.
3. Data Analysis library.
There are two analysis libraries. The standard (supplied with LabWindows™) and the Advanced Analysis Library available as a separate package.

4. Graphics library.
A range of plotting functions are available.
5. GPIB library.
A complete range of IEEE-488 functions.

Computer Requirement

The minimum Hardware requirements are:

1. IBM-PC/XT/AT or compatible.
2. 512 Kbytes memory
3. Graphics Adapter - supports CGA, EGA, MCGA, VGA and Hercules.
4. MS-DOS™ operating system.
5. GPIB Interface Card -- preferably National Instruments PCII/IIA.

Ordering Information

Part Number	Description
0410-1233	LabWindows™ Control software
0410-1234	Instrument driver Modules for 4070 and 1600
0410-1235	Advanced Analysis Library for LabWindows™

Analysis Software

For the user who wants sophisticated post-storage signal analysis, we offer the DSP Corporation DADiSP™ Worksheet. This is a unique software package in that it offers a large range of post-storage functions in an easy-to-use format.

The operation of the software emulates that of the spreadsheets which have been developed over the last few years. The user can set up to 64 windows in his worksheet. For each of these windows, he can display either simply a captured trace or the result of some mathematical manipulation. If a change is made to one window of the worksheet, the effect is calculated in all dependent windows.

There are over 200 functions supplied with DADiSP™. These can be used to produce macros which can, in turn, produce any function required. If a user has a processing program that he wishes to use as part of the worksheet, it can be incorporated using the Pipeline capability and the data can be sent to this program – processed and returned for further processing.

DADiSP488™ is a separate program which adds a range of high level commands to facilitate communications via the IEEE-488 interface.

Also available is the Gould menu disc. This is a set of menu windows that enable the user to perform simple control and data transfer between the computer and a 1600 or 4070 series scope.

Specifications

The DADiSP Worksheet™ has over 200 functions of the following type:

- Signal and Scalar Math
- Fourier Transform and Related Functions
- Trigonometric Functions
- Statistical Functions
- Peak Analysis
- Generated Signals
- Signal Display and Manipulation
- Data Type Conversion and Extraction
- Window Control
- Process Signal
- DSP Pipeline Functions

Computer Requirement

The minimum Hardware/Software Configuration is:

1. IBM-PC/XT/AT or compatible with at least 640 K of RAM. One 360K floppy drive with second floppy drive or hard disk.
2. Operating system IBM PC-DOS™ 2.0 or higher.
3. Graphics Card. For basic resolution a CGA card is sufficient. An EGA, Hercules or compatible will provide better resolution. Either color or monochrome monitor may be used.
4. A Maths co-processor is recommended to enhance performance.

Ordering Information

Part Number	Description
0410-1225	DADiSP™ Worksheet Software
0410-1226	DADiSP488™ IEEE-488 Software
0410-1238	Gould Macros and Menus for 1600 and 4070

Starter Software

These packages are designed for the user who wants to write his own software to control the scope and wants some help with the routine tasks of transferring the traces between the scope and computer.

Our software packages provide a set of BASIC language procedures that can either be used by themselves via the top level menu, or within a user's own program.

Specifications

The procedures supplied include:

- Reading the scope status
- Setting a scope control
- Bi-directional trace transfer between the scope and computer
- Saving the trace to disc
- Reading a trace from disc

- Displaying the trace on the display
- Outputting the trace to a plotter

Computer Requirement

All software is compatible with the IBM-PC/AT/XT or compatibles, and for IEEE-488 transfer the National Instruments PCII or compatible IEEE interface board is required. For further compatibility details, please contact your local Gould sales office.

Ordering Information

Instrument	Computer	Interface	Part No.
1425	IBM-PC/AT/XT	RS-423(RS-232C)	0409-9690
1602/1604	IBM-PC/AT/XT	IEEE or RS-423	0409-9696
4072/4074	IBM-PC/AT/XT	IEEE or RS-423	0409-9698

WAVEFORM PROCESSORS

GOULD 160A, 170A, 260, AND 270

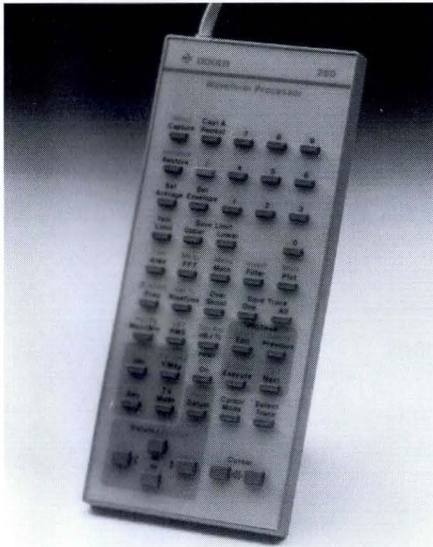

- Fast Fourier Transform
- Programmable Sequence
- Automatic Pulse Parameter Measurements
- Waveform Arithmetic
- Digital Filtering
- Signal Averaging
- Envelope Mode
- Automatic Test Limits Capability
- Video Waveform Analysis

4 Waveform Processors

The Gould family of Waveform Processors, designed for use with the 1600 and 4070 series of Digital Storage Oscilloscopes, will transform your DSO from a signal acquisition device into a powerful signal capture, measurement and analysis system.

A sequence of up to 24 keypad functions can easily be learned and executed to provide advanced test and signal analysis capabilities. The measurement functions eliminate the need for a wide range of test equipment, from voltmeters to spectrum analyzers, and they'll enable you to make measurements on even the most complex waveforms.

MODELS 160A, 170A, 260 AND 270 SPECIFICATIONS

Compatibility. The Waveform Processors are compatible with the following DSO's.

Initialize. Resets averaging, filtering, envelope and magnification. Also returns to the captured signal in 160A and 260.

Signal Acquisition

Averaging. Steps Selectable from 1, 2, 4, 8, 16, 32, 64, 128, 256. Also 512 and 1024 in 160A and 260.

Capture. Arms the DSO for a single capture of the signal.

Capture & Repeat. Arms the scope for a capture and automatically applies the last selected function to the trace.

TV Setup TV Line. Configures the instrument to acquire a selected TV Line (dependent on Transmission system). Selectable to PAL, SECAM and NTSC from the instrument.

Limits Testing. The scope will either hold, or display, a "TEST FAILED" message if the acquired signal goes outside a pre-defined test band.

	160A	170A	260	270
1602	✓	✓	✓	✓
1604	✓	✓	✓	✓
4072	✓	✓	✓	✓
4074	✓	✓	✓	✓
1602	✓	✓	✓	✓
4072	✓	✓	✓	✓
1604	✓	✓	✓	✓
4074	✓	✓	✓	✓
1602	✓	✓	✓	✓
4072	✓	✓	✓	✓
1604	✓	✓	✓	✓
4074	✓	✓	✓	✓

Peak-Peak. Calculates peak-to-peak voltage of the waveform bracketed between the time datum and cursor.

RMS. Calculates the root mean square (RMS) voltage of a waveform bracketed between the cursor and datum. The values are calculated with respect to both the voltage datum (DCRMS) and the mean of the waveform (ACRMS).

Area. Calculates the area of a waveform bracketed between the cursor and datum.

Measurement in dB or %. The instrument will calculate voltages as a percentage of a set 100% reference. It will also display voltages in dB relative to a set voltage difference or dB relative to 1V (dBV).

Cursor Modes. The cursor will measure voltages and times relative to the voltage and time datum which can be positioned to any point on the display.

Voltage at Time Datum. The cursor will measure voltages and times relative to the point at which the time datum crosses the trace.

Delta Time Mode. This will give the time from where the time datum crosses the trace to the first point of the trace with the same value of voltage as the time datum, measuring from the cursor towards the time datum.

Programmable Sequence.

This enables a sequence of up to 24 keystrokes to be entered and executed. The only functions that cannot be incorporated in the sequence are Capture & Repeat, numeric keypad/soft keys and any of the keys associated with the entry and execution of a programmable sequence.

Entry of a sequence is through the Learn command. A sequence can be subsequently edited.

There is a print command which enables the internal plotter (needs option 104 installed) to print the results. Measurement results can also be scrolled on the display during execution of the sequence.

Archiving

Plot. This function is the same as the PLOT function in the instrument.

Print. This will print the measurement results together with date and time to the internal plotter (needs option 104 installed).

Reference Memory. Additional reference memories are available within the waveform processor module. Up to 50 X 1Kword or 5 X 10K word memories configured from the menu. The Waveform Processor Module can be detached without losing the waveform data for at least 3 months.

Save Trace. There are two modes of operation. In the first mode all displayed traces will be stored in the reference memories. In the second mode only the trace with the cursor attached will be stored in the reference memory.

Realtime Clock. 24 hour and date set via menu, and plotted out with traces. Time is retained for at least 3 months with the power disconnected. For the 160A and 260 the date is stored with the reference traces.

Programmability. All functions can be accessed via the IEEE-488 or RS-423 interface.

	160A	170A	260	270
Peak-Peak	✓	✓	✓	✓
RMS	✓	✓	✓	✓
Area	✓	✓	✓	✓
Measurement in dB or %			✓	✓
Cursor Modes	✓	✓	✓	✓
Voltage at Time Datum			✓	✓
Delta Time Mode			✓	✓
Programmable Sequence			✓	✓
Plot			✓	✓
Print			✓	✓
Reference Memory	✓		✓	
Save Trace			✓	
Realtime Clock	✓		✓	✓
Programmability	✓	✓	✓	✓

ACCESSORIES AND CONSUMMABLES

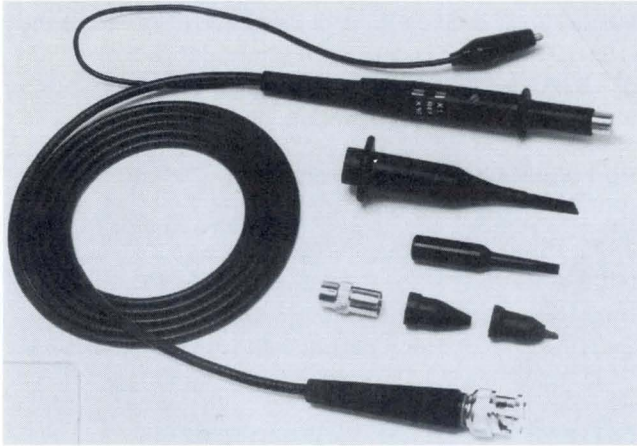

- Probes, Leads and Terminations
- Viewing Hoods and Camera
- Rack Mount Kits
- Panel Covers and Carrying Cases
- Instrument Cart
- Differential Amplifier
- Battery Pack

A comprehensive range of accessories are available to ensure that you get the best from your Gould oscilloscope.

Passive Probes

Probe Type	PB12		PB13	PB20		PB19	PB36	PB17	PB27
Switched	'x10' position	'x1' position	N/A	'x10' position	'x1' position	N/A	N/A	N/A	N/A
Attenuation Ratio	10:1	1:1	10:1	10:1	1:1	10:1	10:1	100:1	1000:1
Bandwidth	DC - 100 MHz	DC - 10 MHz	DC - 100 MHz	DC - 250 MHz	DC - 10 MHz	DC - 250 MHz	DC - 300 MHz	DC - 250 MHz	DC - 7 MHz typical
Rise Time	3.5 ns	35 ns	3.5 ns	1.4 ns	35 ns	1.4 ns	1.2 ns	1.4 ns	50 ns
Input Capacitance	Nominal 16 pF	55 pF + scope input capacitance	Nominal 15 pF	Nominal 18 pF	40 pF + scope input capacitance	Nominal 16 pF	Nominal 16 pF	Nominal 6.5 pF	Nominal 3 pF
Compensating Range	10-60 pF	--	10-60 pF	10-60 pF	--	10-60 pF	10-60 pF	15-50 pF	15-50 pF
Input Resistance	10MΩ when used with scopes which have 1 MΩ input. (Probe resistance 9 MΩ±1%)	1MΩ (scope input)	10 MΩ when used with scopes which have 1 MΩ input. (Probe resistance 9 MΩ±1%)	10 MΩ when used with scopes which have 1 MΩ input. (Probe resistance 9 MΩ±1%)	1 MΩ (scope input)	10 MΩ when used with scopes which have 1 MΩ input. (Probe resistance 9 MΩ±1%)	10 MΩ when used with scopes which have 1 MΩ input. (Probe resistance 9 MΩ±1%)	100 MΩ when used with scopes which have 1 MΩ input. (Probe resistance 99 MΩ±1%)	500 MΩ approx
Max Input Voltage	600 VDC including peak AC, derating with frequency							1200 V including peak AC, derating with frequency	15 kV including peak AC, derating above 55 kHz
Working Temp Range	-25 to 70°C								
Cable Length	1.5 meters		1.5 meters	1.2 meters		1.2 meters	1.5 meters	1.5 meters	1.5 meters
Notes	'REF' POSITION: Probe tip is grounded via 9 MΩ resistor, oscilloscope input grounded			Modular		Modular	Automatically indicates x10 selection with 4070 Series	PB17A automatically indicates x100 with 4070 Series 0410-1201	Switched for impedances of 1 MΩ or 100 MΩ
Part No.	0410-1017		1410-1030	0410-1128		0410-1129	0410-1187	0410-1074	0410-1154

Protective Carrying Cases (soft padded)

These are very strong and enclose the instrument with three thicknesses of padded material covering the front panel.

Part Number. Description

0410-1118	1421, 1425 Protective Carrying Case
0410-1221	400 Protective Carrying Case
0410-1172	4072, 4074 Protective Carrying Case
0410-1176	1604 Protective Carrying Case

Protective Transit Cases (Hard)

These are strong metal cases suitable for shipping products.

Part Number. Description

0410-1195	Protective Case for 1600
0410-1196	Protective Case for 4070

Protective Carrying Case (Hard)

This is a suitcase style carrying case with hard outer cover.

Part Number. Description

0410-1222	Protective Case for 400
-----------	-------------------------

Accessory Pouch.

A soft accessory pouch to fit products where plotter is not included.

Part Number. Description

0410-1223	Accessory Pouch
-----------	-----------------

Front Panel Covers

A hard plastic cover which clips over the oscilloscope control panel and display to protect it during transportation.

Part Number. Description

0410-1119	1421, 1425 Front Panel Cover
0410-1177	1604 Front Panel Cover
0410-1220	400 Front Panel Cover

Rack Mount Support (fixed)

Flanges to enable the Gould Oscilloscopes to be fitted into a 19-in. rack.

Part Number. Description

0409-1436	1421, 1425 Rack Mount Adaptor Kit
0409-0490	400 Rack Mount Kit

Rack Mount Support (with slides)

The one unit high support has slides and filler panels included. The Slide Kit provides ready access to the internal shelf areas and is designed for racks with 24-in. or 18-in. depth vertical support rails. Brackets and mounting screws are included.

Part Number. Description

(For 24 in. depth. 5 units total height.)

0409-1632	Rack Mount with slides for 1604
0409-4732	Rack mount with slides for 4072, 4074
(For 18 in. depth. 4 units total height)	
0409-1437	Rack mount with sides for 1421, 1425

Internal Plotter Consumable

For use on 1600 and 4070 DSO's.

Part Number. Description

0410-1175	Pack of 4 replacement pens One of each color
0410-1165	Pack of 8 rolls of paper

Service Manuals

Part Number. Description

0410-1224	Service Manual for 400
0410-1198	Service Manual for 1600
0410-1184	Service Manual for 4070

Viewing Hood

Fit to the bezel surround reducing glare in high ambient light.

Part Number. Description

0410-1073	Viewing Hood for 1421, 1425
-----------	-----------------------------

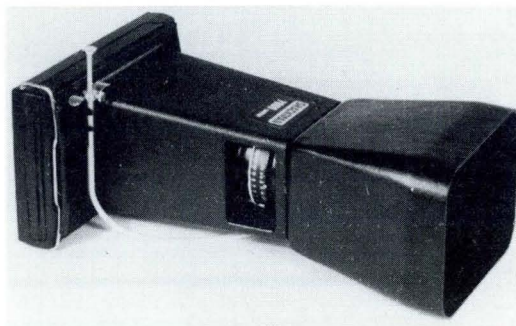

Type 7000 Camera

Oscilloscope Camera Model 7000

Fast and simple to operate. Can be fitted with a spacer/adaptor or hood and can be used with all Gould Oscilloscopes.

Hood for Hand Held Operation.

Oscilloscope Type	Hood Type
1421, 1425, 1600, 4070	504 516

Leads and Terminations

Type: PL43 lead
BNC-BNC 50- Ω lead with full cable strain reliefs. 1 m length.

Part Number
0410-1090

Type: PL44 lead
BNC-Crocodile Clips. 50- Ω lead with cable strain relief. 1 m length

Part Number
0410-1091

Cables

Cables	Part Number
RS-423 (400/6120) cable 2 m length.	0410-1232
RS-423 (1425/6120) cable 2 m length.	0410-1133
RS-423 (1600/6120) cable 2 m length.	0410-1197
RS-423 (4070/6120) cable 2 m length.	0410-1193
IEEE-IEEE cable 2 m length	0410-8105

Type: TP24 50- Ω termination
A 50- Ω through-termination for connecting a high impedance input in a transmission system.

Part Number
0410-1126

Type TR7 Cart **Part Number** 0410-1053

A purpose designed instrument cart incorporating a unique mechanism for adjusting the viewing angle without reducing the intrinsic stability of the cart or the safety of an instrument.

Specifications

Size of Instrument Tray: 45 cm (wide) x 50 cm (17-1/2 x 19-1/2 in.).

Height of Tray: 74 cm (29 in.).

Rear Wheels: Rubber tired, 20-cm diameter.

Front Wheels: Rubber tired castors with brake. 10-cm diameter.

Bottom Tray: Removable with non-slip rubber mat.

Top Tray: Fully adjustable angle (-5° to -65°) by unique "lead-screw" mechanism. Fitted with non-slip rubber mat.

Safety: 2-in. wide nylon safety belt. 2 adjustable rear stop handles.

Finish: Epoxy powder stove enamel.

Color: Grey.



Type TR7 Cart

Differential Amplifier DA1000.

Part Number 0410-1152

Specifications:

Input Impedance: 3 M Ω to ground - 6 M Ω differential

Input Sensitivity: 500V/Div. - 1 V/Div.

Input Protection: 800 Vpk to ground - 1500 Vpk differential

Input Load: In all ranges up to the maximum input voltage at U/Batt = 9V

Input Coupling: AC/DC, GND = ON/OFF switch in the OFF- position

Common Mode Rejection: Type 80dB

Bandwidth (-3dB): DC:0-50kHz, AC:5-50kHz

Output Impedance: 1k Ω 1/nF

Calibration of the Input Divider at: 50mV/Div.

Miscellaneous Information:

Power Supply: 2 x 9 V batteries (rechargeable)

Life Span of Battery: depending on the operating conditions about 50 hours per charge.

Operating Temperature: -10° to 70° C

Size: 165mm x 130mm x 42mm

Weight: 370 grams including batteries

Battery Pack for 400, Option 107

(available Mid 89)

The 107 option battery pack for the 400 is built into the bottom of the case making an integral unit. The battery pack contains Nickel Cadmium cells and a charger unit. This provides uninterrupted operation in the event of an AC supply failure. Battery life is protected by an automatic cut-out against excessive discharge.

Operating time of 400 from a fully charged battery: nominally 1.5 hours.

Recharge time from a full discharge: 5 hours.

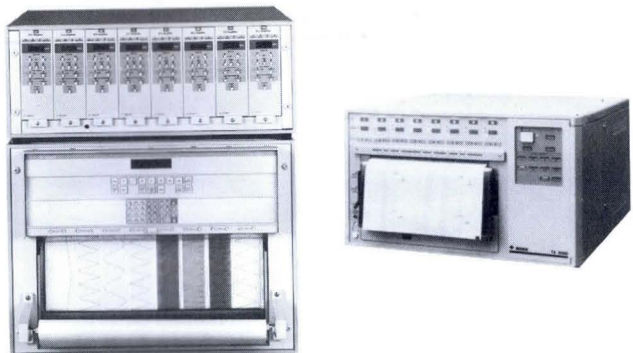

- **Broad range of recording technologies**
 - Direct writing ink and thermal
 - Thermal and electrostatic array
- **Input frequency ranges from DC to 17 kHz**
- **Channel widths up to 256 mm**
- **Discrete and overlapping traces**
- **Wide range of options**
- **Fully compatible with Gould 4600 and 5600 Signal Conditioners**
- **Leader in high performance recording technology since 1937**

A tradition of making the best better.

For more than 50 years, Gould's Recording Systems Division — and Brush Instruments before it — have carried on a tradition of quality and innovation. We've supplied the recording instruments you've relied on for accurate test and measurement performance. We've developed advanced technology to create instruments that provide you with meaningful information . . . not mere data.

We've built a heritage of technical leadership proven by a series of industry firsts:

- developing in 1937 the first portable electrocardiograph, forerunner of today's high performance direct writing recording instruments;
- being the prime recording system supplier for NASA's Mercury, Gemini and Apollo programs, with continued involvement in our country's on-going space program;
- supplying recording equipment to the University of Utah for the historic odyssey of Dr. Barney Clark, the world's first artificial heart recipient, and
- creating a patented pressurized ink writing system that produces accurate, clear, smudge-free rectilinear traces of uniform width at all pen velocities.

Direct Writing Recorders (Pressurized Ink and Thermal)

The fully programmable 3000 Series Direct Writing Oscillograph is the industry standard. It is designed with a unique pressurized ink system for clear uniform traces, high gain servo system for high response speed, and Metrisite position transducers for infinite resolution. Together these technologies provide a true rectilinear trace with 99.65% linearity and less than 1% overshoot on square waves and transients.

Thermal and Electrostatic Array Recorders

The TA 2000 and ES2000 Linear Array Recorders use digital technology to provide high performance and unique features. A stationary imaging head with an array of closely spaced writing elements (styli) generate permanent chart records of multiple analog signals. In the thermal TA 2000 the styli are heating elements and the recording medium is heat-sensitive paper. In the electrostatic ES2000 the styli are electrodes that place charges on a dielectric-coated paper medium that attract toner. Unique features include high frequency response (independent of the number of channels), high peak capture capability, overlapping traces, simultaneous generation of grids, timing marks, and traces and comprehensive annotation.

Our broad range of graphic recording technologies and our 50 years of applications experience combine to provide you with systems to meet your growing application requirements. When you need quality graphic recording systems, think Gould Recording Systems Division.

Technologies that Make Gould the Leader

Graphic recorders are divided into two basic writing technologies: direct and indirect. Direct writing technology is subdivided into pressurized ink, direct thermal and edge thermal; indirect into thermal array and electrostatic array. Each technology provides unique performance characteristics to meet your application requirements. The following information outlines the unique benefits of various writing technologies and provides specifications for representative Gould products.

Pressurized Ink and Thermal Writing

- True "real-time" trace representation
- Pressurized ink provides uniform traces independent of chart speed or pen excursion
- Closed loop control of thermal pen heat insures high quality trace at all chart speeds
- Discrete channels
- High quality permanent records

3000 Series Recorders

- 2, 4, 6 and 8 channel configurations
- 40, 50, 80, 100 mm channel widths
- 60 Hz at 40 mm frequency response
- Pressurized ink and thermal units
- Improved pressure ink system
- Four ink colors (red, black, green and blue)
- Remote control via RS-232C or IEEE-488
- Fully programmable
- Interchannel annotation and event marks
- Modular design

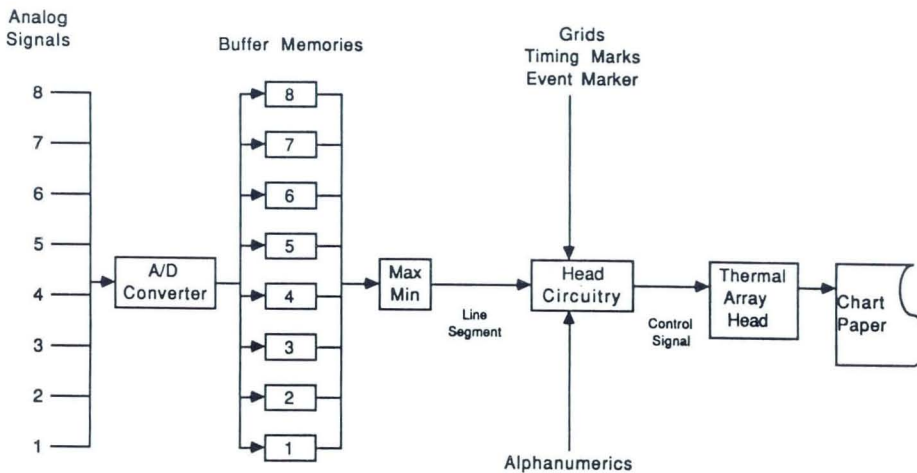
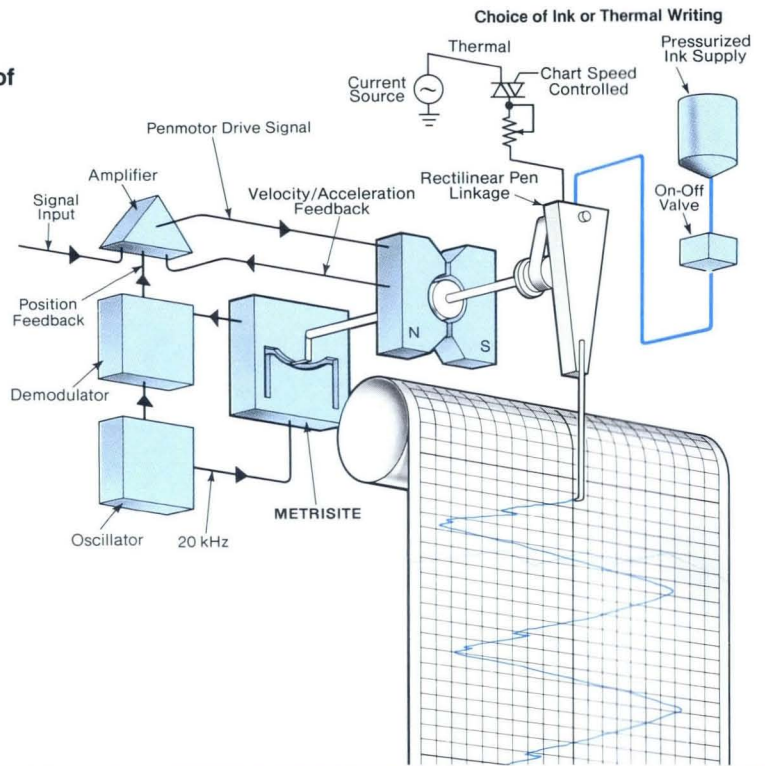

TA 2000 Writing System Block Diagram

Linear Thermal Array Writing

- No moving parts for increased performance and reliability
- High frequency response
- Transient capture capability
- Overlapping traces
- Full page annotation
- High resolution trace
- Self-generating grids

TA 2000 Thermal Array Recorder

- 1 to 8 traces
- 2.5 kHz frequency response
- Peak capture of events 150 μs or longer
- 200 dots/in amplitude resolution
- 200 mm maximum channel width
- Comprehensive annotation
 - Full page (48 lines x 80 columns)
 - Parameter ID (8 character)
- 5 grid patterns

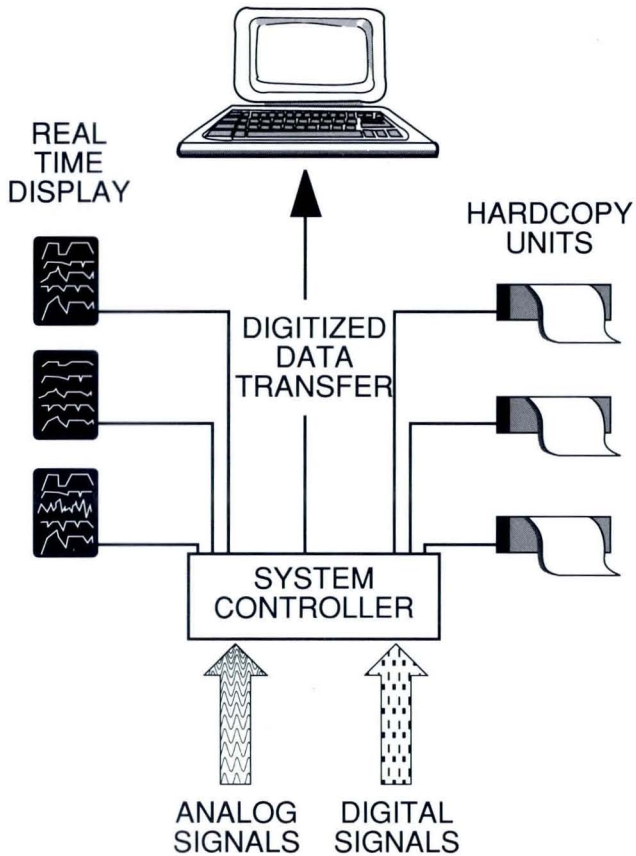

Linear Electrostatic Array Writing

- No moving parts for increased performance and reliability
- High frequency response
- Transient capture capability
- Overlapping or separate traces
- High contrast permanent records

ES2000 Real Time Display and Electrostatic Recording System

- System set-ups stored on built-in diskette
- Modular architecture:
 - Up to 4 Real time video monitors
 - Up to 3 Electrostatic hardcopy units
 - Up to 40 analog or 80 digital channels
- Up to 35 kHz frequency response
- Peak capture of events 25 μ s or longer
- Customized hardcopy outputs
 - User-programmable grids
 - User text
 - Line printing
- Waveform recording
- Digitized data output via IEEE-488

Writing Technologies

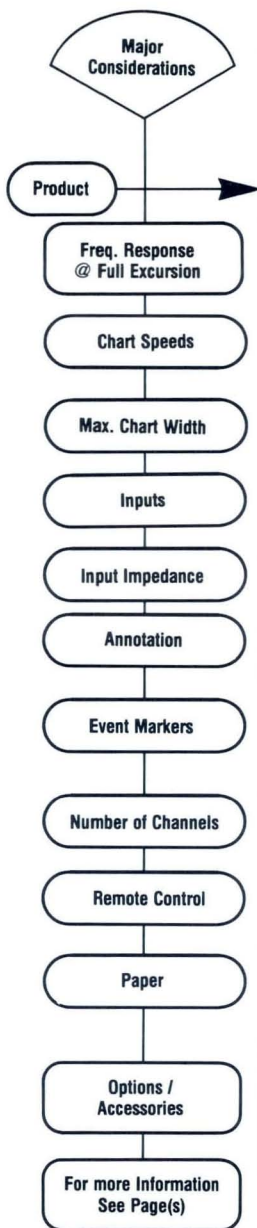

	Direct Writing		Indirect Writing		
	Pressurized Ink & Thermal	Edge Writer (Thermal)	Electrostatic Array	Thermal Array	Thermal Array
Product	3000 Series Recorders	8000 Series Recorders	ES2000 Recorder	TA 2000 Recorder	TA 550 Recorder
Freq. Response @ Full Excursion	Flat to 60 Hz, @ 40 mm	Down 2 mm, peak, at 50 Hz	Down 2% at 17 kHz	Less than 2% down at 2.5 kHz	Flat to 50 Hz
Chart Speeds	5, 10, 25, 100, 250, 500 mm/s, with divide by 60, 100, 1000, variable, external	1, 5, 10, 25, 50, 100, 200 mm/s, mm/min., mm/h	0.25 to 500 mm/s	1, 2.5, 5, 10, 25, 50, 100, 200 mm/s and mm/min	1 mm/min to 100 mm/s
Max. Chart Width	100 mm	50 mm	256 mm	200 mm	100 mm
Inputs	3 direct settings, all Gould Signal Conditioners	Direct, all Gould Signal Conditioners	Gould ES2000 Input Modules	3 direct settings, all Gould Signal Conditioners	Strip chart and high speed Signal Conditioners
Input Impedance	100 kΩ	100 kΩ	100 k/2 MΩ	100 kΩ	—
Annotation	Standard: Left Edge Optimal: Interchannel	No	Up to 44 pages Line and page printing	Left Edge	Left Edge
Event Markers	Standard: Right Edge Optimal: Interchannel, Bi-directional	Standard: Left Edge Time marker on Right Edge	Up to 80 markers	Left Edge	Right Edge
Number of Channels	2, 4, 6, 8 standard 1, 3, 5 by request only	1, 2, 3, 4, 6, 8	1 to 40 analog 1 to 80 digital	1 to 8	1 to 3
Remote Control	RS-232C, IEEE-488, TTL (HC)	TTL	IEEE-488, RS-422, RS-232C, TTL low/high	RS-232C Contact closure	RS-232C, IEEE-488
Paper	Ink - Rolls and semi-perf rolls, Thermal - rolls, Z-fold,	Thermal - Rolls	Rolls, semi-perf rolls, Z-fold, Translucent rolls	Z-fold	Roll
Options / Accessories	Chart take-up, Z-fold basket, IRIG time decoder, isolated power, cabinets, etc.	Chart take-up	Chart take-up; Z-fold basket; Time Code Interface; 12 and 20-in. Monitors; Medical and Aerospace Systems	5600IS, 4600 Signal Conditioners, 5900 Signal Conditioner Case	N/A
For more Information See Page(s)	78	84	88	86	85

Ink and Thermal Recorders

Gould 3000 Series

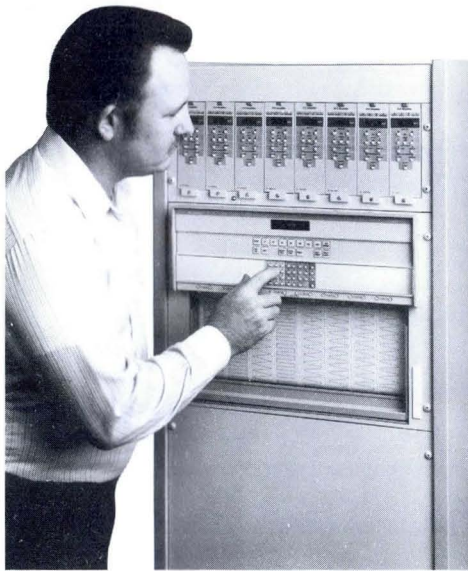

- Fully programmable
- 8-channel rack or portable models
- Permanent pressurized ink or convenient thermal writing
- Inter-channel alphanumeric annotation optional
- Total remote control via IEEE-488 or RS-232 interfaces
- Programmable amplitude triggering
- IRIG time code capability
- Compatible with 40 Gould 4600 and 5600 Signal Conditioners

Intelligent

Gould's 3000 Series Recorder with the 5600 Programmable Amplifiers sets new standards for intelligent direct writing recorders. Microprocessor controlled, it features both programmable amplitude triggering so you record only the data of interest. In addition your chart record can be completely annotated with chart speed, date, time, test number and a user message up to 256 characters long. With the new Gould 5600 Amplifiers and optional interchannel annotation feature amplifier gain and other settings can also be recorded alphanumerically. User text messages are added through the convenient front-panel keypad, or via RS-232C or IEEE-488 interfaces. A recorder self test can be performed at the push of a button. All front panel settings are retained by non-volatile RAM.

Performance

Gould is the only recorder manufacturer to provide users a choice between permanent pressurized ink or thermal writing. Either writing method gives you easy-to-read uniform traces that Gould has been providing users for over 30 years. The 3000's linearity and accuracy specifications are the best available! And we guarantee to meet them! Our patented Metrisite™ non-contact position sensor provides precise feedback control. Gould's rugged construction means you'll continue getting the same response after your 3000's been on the job for years.

Our patented stepper motor drive offers 14 front-panel selectable chart speeds with 4 adjustable chart speed modes. In addition, the 3000's exclusive variable chart speed allows selection between fixed speeds! And that speed is printed on the chart automatically. Maximum chart speed is 500 mm/s so you can measure 2 ms timing differences between channels. For long-term, unattended monitoring, the 3000 Recorder can run continuously for more than 6000 hours on a single roll of chart paper.

A complete selection of readily available Gould manufactured Accuchart recording paper and supplies means maximum performance and reliability day in and day out.

Direct Writing Systems Recorder

The 3000 is an ideal system output device. Completely programmable, it can supply permanent hard copy test data on demand under standard IEEE-488 or RS-232C computer control. IRIG time code signals can be continuously decoded and printed in alphanumeric format.

When used with an external pulse train, Gould 3000 Recorders can function in an XY mode, with chart movement controlled by the unit under test. This is ideal for well logging, measurements on rotating equipment, and process monitoring in metal rolling, paper coating and similar applications.

Easy to Use

Pen positions are easily set with the paired right/left push-buttons. If inputs are accidentally reversed it's no problem with the 3000's polarity reversal feature.

You can quickly and easily load either roll or fanfold chart paper. All recorders have a built-in pen guard that prevents accidental pen damage when loading paper.

Depending upon the recorder, up to seven bi-directional event markers or eight interchannel annotation heads can be added. A built-in timer allows synchronization with time signals and has seven switch-set time periods.

Cost of Ownership

Each unit is fully tested, burned in and calibrated on automated test stations by trained technicians who are proud to put their name on their recorders. The latest solid state technology, including microprocessor and application specific integrated circuits, lowers parts count and increases reliability.

Power supplies are in parallel for continuous operation at lowered specifications in event of a failure. The 3000's modular design makes it easy to repair, and lowers spare parts depot requirements.

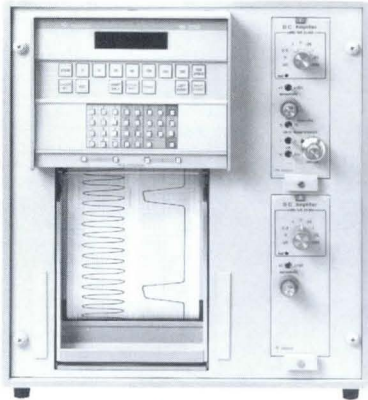

RS 3200

Two Channel Recorder RS 3200

- Channel configurations available:
 - two, 50-mm channels
 - one, 100-mm channel
- Unit pictured:
 - Two channel, portable ink unit with 2 resident signal conditioners; Model 30-V7202-10
- Dimensions:
 - 15 in. (38.1 cm) H x 14 in. (35.6 cm) W
 - x 17.25 in. (43.8 cm) D
- Weight:
 - Recorder only, 41 lbs. (18.6 kg)

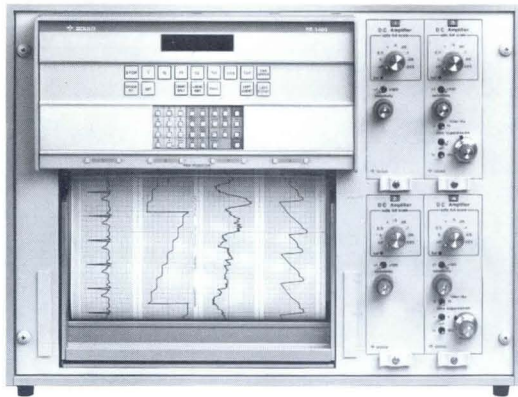

RS 3400

Four Channel Recorder RS 3400

- Channel configurations available:
 - four, 50-mm channels
 - two, 100-mm channels
 - two, 50-mm channels; one, 100-mm channel
- Unit pictured:
 - Four channel, portable ink unit with 4 resident signal conditioners; Model 30-V7404-10
- Dimensions:
 - 15 in. (38.1 cm) H x 19.75 in. (50.1 cm) W
 - x 17.25 in. (43.8 cm) D
- Weight:
 - Recorder only, 62 lbs. (28.2 kg)

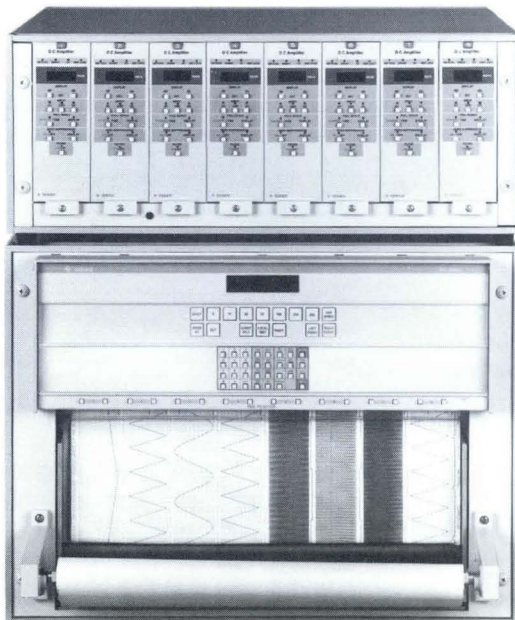

RS 3800

Eight Channel Recorder RS 3800

- Channel configurations available:
 - eight, 40-mm channels
- Unit pictured:
 - Eight channel, portable ink unit with 5900 signal conditioner cage; Model 30-V7808-12
- Dimensions:
 - Recorder — 15 in. (38.1 cm) H x 19.75 in. (50.1 cm) W x 17.25 in. (43.8 cm) D
 - Cage — 8.25 in. (20.9 cm) H x 19.75 in. (50.2 cm) W x 19 in. (48.3 cm) D
- Weight:
 - Recorder only, 80 lbs. (36.0 kg)

Six Channel Recorder RS 3600

- Channel configurations available:
 - six, 50-mm channels
- Unit: not pictured
- Dimensions: Same as RS 3800
- Weight: Recorder only, 66 lbs. (30.0 kg)

Contact your local Gould Sales Office (see pages 220 and 221) for other available configurations.

Common Recorder Options Include:

- Pressurized ink or thermal writing models
- Portable or rack mount configurations
- Roll or Z-fold paper
- Interchannel annotation and event marks
- RS-232C or IEEE-488 interfaces

3000 SERIES RECORDER SPECIFICATIONS

Note: Specifications are for Recorders without Signal Conditioners.

Standard Analog Channel Configurations:

RS 3800: Eight 40-mm channels.

RS 3600: Six 50-mm channels.

RS 3400: Four 50-mm channels or two 100-mm channels.

RS 3200: Two 50-mm channels or one 100-mm channel.

Number of Event Marker Channels: Standard: one bi-directional on right side of chart. Optional: up to seven interchannel event markers on 8-channel recorder.

Frequency Response:

At 100-mm full scale: Flat to 30 Hz.

At 50-mm full scale: Flat to 50 Hz.

At 40-mm full scale: Flat to 60 Hz.

At 10-mm amplitude: -3 dB at 140 Hz.

Linearity: >99.65% of full scale.

Direct Recorder Input Signal: Internally selected 2, 5, and 10-V span for 50 or 40-mm channels.

Direct Input Impedance: 100 k Ω .

Zero Stability (recorder only):

With Time: $\pm 0.1\%$ per 24 hrs.

With Temperature: $\pm 0.025\%$ per $^{\circ}\text{C}$.

With Line Voltage: $\pm 0.1\%$ per 10% change in line.

Gain Stability (recorder only):

With Time: $\pm 0.1\%$ per 24 hrs.

With Temperature: $\pm 0.05\%$ per $^{\circ}\text{C}$.

With Line Voltage: $\pm 0.05\%$ per 10% change in line.

Annotation: Left chart edge. 5x7 dot matrix. Date, time, chart speed plus comments, up to 256 characters total.

Maximum Annotation Speed: 500 mm/s less than 0.1-mm delay.

Interchannel Annotation: Optional; up to eight additional on 8-channel recorder.

Marking Method: Pressurized ink or thermal.

Ink Colors: Standard: blue. Optional: red and black.

Thermal Trace: Standard: black. Optional: blue in some configurations.

Trace Presentation: Rectilinear.

Trace Width (ink): 0.01 mm nominal.

Chart Speeds: Push button selected, from 0.005 mm/s to 500 mm/s. 1000 mm/s also available.

Chart Speeds (mm/s):

Panel	$\div 1$	$\div 60$	$\div 100$	$\div 1000$
5	5	0.083	0.05	0.005
10	10	0.167	0.1	0.01
25	25	0.417	0.25	0.025
50	50	0.833	0.5	0.05
100	100	1.667	1.0	0.1
250	250	4.167	2.5	0.25
500	500	8.333	5.0	0.5

Chart Speed Inaccuracy: $\pm 0.25\%$ at 25°C , $\pm 10^{\circ}\text{C}$.

Chart Wander: ± 0.25 mm roll, ± 0.5 mm fanfold, maximum.

Paper:

Pressurized Ink: 275 ft. (84 m) cast coated rolls, non-perforated or semi-perforated.

Thermal Roll: 350 ft. (107 m) high performance blue trace; 350 ft. high performance black trace.

Thermal Z-fold: 250 ft. (76 m) internal supply.

Time Lines: 1 mm accentuated every 5 mm and 100 mm.

IRIG Time Code Interface Decoder (optional): Accepts IRIG A, B, E and NASA 36, modulated or unmodulated on one board, automatically.

Triggering: Adjustable amplitude trigger with programmable chart speed and run time. Maximum input voltage, 15 VDC. Minimum cycle time, 100 ms. High or contact open (edge triggered) to start chart active in local or remote.

Variable Speed Control: 5 mm/s to 500 mm/s in 5 mm/s increments. Enabled by front-panel "Var Speed" push button. Speed entered via front-panel keypad.

Stop: TTL low, or contact closure to stop chart. Active in both local and remote modes.

External Chart Drive: One microstep per pulse. TTL signal level. 80 microsteps per millimeter of chart. Chart speed of 0 to 500 mm/s. Microstep occurs on negative transition of input pulse.

Remote Synchronization: Positive going TTL pulses with a minimum duration of 10 μs , indicates a motor step is initiated.

Environmental:

Operating Temperature: 0° to $+50^{\circ}\text{C}$.

Storage Temperature: -40° to $+70^{\circ}\text{C}$.

Humidity: 10% to 90% relative humidity, at 65°F non-condensing.

Signal Input Connectors: 37-pin D type (accepts Signal Conditioner output) and 2-wire sub-miniature phone plug (supplied) directly to pen drive amplifiers.

Input Connector (Supplied): Two wire sub-miniature phone plugs or signal conditioner output (Manufacturer model no. 290144).

Front Panel Settings Backup: Non-volatile RAM.

Clock Backup: Battery (10 years).

Power Requirement (Recorder only): 3600: 350 W; 3800: 400 W.

Hardware Configurations: Portable, rack mount or cabinet.

Dimensions:

RS 3600 and RS 3800 Recorders:

Portable: 15 in. (38.1 cm) H x 19.75 in. (50.2 cm) W x 17.25 in. (43.8 cm) D.

Rack Mounted: 14 in. (35.6 cm) H x 19 in. (48.3 cm) W x 15.5 in. (39.4 cm) D.

Chassis Only: 14 in. (35.6 cm) H x 19 in. (48.3 cm) W x 14.5 in. (36.8 cm) D.

RS 3400 Recorder:

Portable: 15 in. (38.1 cm) x 19.75 in. (50.2 cm) W x 17.25 in. (43.8 cm) D.

Chassis Only: 14 in. (35.6 cm) H x 17.5 in. (44.4 cm) W x 14.5 in. (36.8 cm) D.

RS 3200 Recorder:

Portable: 15 in. (38.1 cm) H x 14 in. (35.6 cm) W x 17.25 in. (43.8 cm) D.

Chassis Only: 14 in. (35.6 cm) H x 12 in. (30.5 cm) W x 14.5 in. (36.8 cm) D.

5900 Signal Conditioner Cage:

Portable: 8.25 in. (20.9 cm) H x 19.75 in. (50.2 cm) W x 19 in. (48.3 cm) D.

Rack Mounted: 7 in. (17.8 cm) H x 19 in. (48.3 cm) W x 18 in. (45.7 cm) D.

Weight:

RS 3600 Recorder Only: 66 lbs. (30.0 kg).

RS 3800 Recorder Only: 80 lbs. (36.0 kg).

RS 3400 Recorder Only: 62 lbs. (28.2 kg).

RS 3200 Recorder Only: 41 lbs. (18.6 kg).

5900 Cage: 27 lbs. (12.3 kg).

Ordering Information

Standard Recorder Models

Model Number Description

**RS 3800 Recorder
8 Channels (40 mm)**

35-V7808-10	Ink, Portable, Stand Alone
35-V8808-10	Thermal, Portable, Stand Alone
35-V7808-11	Ink, Rack Mount, Stand Alone
35-V8808-11	Thermal, Rack Mount, Stand Alone
35-V7808-12	Ink, Portable, with 5900 Signal Conditioner Case
35-V8808-12	Thermal, Portable, with 5900 Signal Conditioner Case
35-V7808-13	Ink, Rack Mount, with 5900 Signal Conditioner Case
35-V8808-13	Thermal, Rack Mount, with 5900 Signal Conditioner Case

**RS 3600 Recorder
6 Channels (50 mm)**

Signal Conditioner Case includes two blank panels

35-V7606-10	Ink, Portable, Stand Alone
35-V8606-10	Thermal, Portable, Stand Alone
35-V7606-11	Ink, Rack Mount, Stand Alone
35-V8606-11	Thermal, Rack Mount, Stand Alone
35-V7606-12	Ink, Portable, with 5900 Signal Conditioner Case
35-V8606-12	Thermal, Portable, with 5900 Signal Conditioner Case
35-V7606-13	Ink, Rack Mount, with 5900 Signal Conditioner Case
35-V8606-13	Thermal, Rack Mount, with 5900 Signal Conditioner Case

RS 3400 Recorder

Signal Conditioner Case built into Recorder

35-V7404-10	Ink, Portable, four 50-mm Channels
35-V8404-10	Thermal, Portable, four 50-mm Channels
35-V7404-11	Ink, Rack Mount, four 50-mm Channels
35-V8404-11	Thermal, Rack Mount, four 50-mm Channels
35-V7412-10	Ink, Portable, two 50-mm, one 100-mm Channels
35-V8412-10	Thermal, Portable, two 50-mm, one 100-mm Channels

Model Number	Description	RS 3000 Recorder Options and Accessories (con't.)	
		Model Number	Description
35-V7412-11	Ink, Rack Mount, two 50-mm, one 100-mm Channels	11-6293-02	Interchannel Annotation Head, Ink
35-V8412-11	Thermal, Rack Mount, two 50-mm, one 100-mm Channels	11-6293-03	Interchannel (Annotation) Drive Kit, Thermal
35-V7420-10	Ink, Portable, two 100-mm Channels	11-6293-04	Interchannel (Annotation) Driver Kit, Ink
35-V8420-10	Thermal, Portable, two 100-mm Channels	CL-811055	Portable Enclosure for 3400, 3600 and 3800 Recorders
35-V7420-11	Ink, Rack Mount, two 100-mm Channels	CL-811054	Portable Enclosure for 3200 Recorder
35-V8420-11	Thermal, Rack Mount, two 100-mm Channels	11-1202-38	Rack Mount Kit (3600 and 3800 Recorders)
RS 3200 Recorder		11-1202-39	Rack Mount Kit (3400 Recorder)
Signal Conditioner Case built into Recorder		11-1202-40	Rack Mount Kit (3200 Recorder)
35-V7202-10	Ink, Portable, two 50-mm Channels	11-1605-32	Input/Output Panel, front mount
35-V8202-10	Thermal, Portable, two 50-mm Channels	11-1605-33	Input/Output Panel, rear mount
35-V7202-11	Ink, Rack Mount, two 50-mm Channels	11-2273-01	Z-fold Basket for 3200 Recorder
35-V8202-11	Thermal, Rack Mount, two 50-mm Channels	11-2273-02	Z-fold Basket for 3400 Recorder
35-V7210-10	Ink, Portable, one 100-mm Channel	11-2273-03	Z-fold Basket for 3600 and 3800 Recorders
35-V8210-10	Thermal, Portable, one 100-mm Channel	11-6402-16	Chart Take-up for 3200 Recorder
35-V7210-11	Ink, Rack Mount, one 100-mm Channel	11-6402-17	Chart Take-up for 3400 Recorder
35-V8210-11	Thermal, Rack Mount, one 100-mm Channel	11-6402-18	Chart Take-up for 3600 and 3800 Recorders
RS 3000 Recorder Options and Accessories		11-6405-05	Mobile Cart
11-6283-01	Interface Kit, IEEE-488	CL-412045-1	Shipping Case for 3200
11-6283-02	Interface Kit, RS-232C	CL-412045-2	Shipping Case for 3400
11-6283-03	Interface Kit, IRIG Time Decoder	CL-412045-3	Shipping Case for 3600/3800
11-4221-00	3000 Interpreter/Controller Board Kit (for 3200 and 3400 Recorders)	CL-412045-4	Shipping Case for 5900
11-4221-01	5900 Interpreter/Controller Board Kit (for 3600 and 3800 Recorders)	CL-412341	Vinyl dust cover for 3600/3800 with 5900
11-4221-02	Auxiliary Analog Board Kit (for 5900 Case, medical applications)	CL-412346-1	Vinyl dust cover for 3200
11-6223-01	Interchannel Event Marker Kit, Thermal, 50 mm	CL-412346-3	Vinyl dust cover for 3400 and 3600/3800 without 5900
11-6223-02	Interchannel Event Marker Kit, Ink, 50 mm	CL-812620	Isolated Power Kit, rack mount, 115 VAC, 1500 W
11-6223-03	Interchannel Event Marker Kit, Thermal, 40 mm	CL-812621	Isolated Power Kit, portable, 115 VAC, 1500 W
11-6223-04	Interchannel Event Marker Kit, Ink, 40 mm	11-G1154-61	Vertical Cabinet
11-6293-01	Interchannel Annotation Head, Thermal	11-G1170-62	Tall Vertical Cabinet
		290144	Phone Jack
		882895-5	110 VAC Portable Isolation Transformer, gray, 500 W
		884208-7	110 VAC Power Supply Kit
		369500-9501	Mobile Utility Cart/Table

GOULD 220 AND 222 PORTABLE RECORDERS

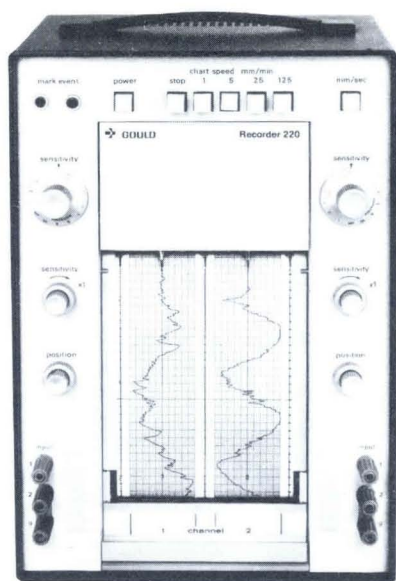

Gould 220 Recorder

- Pressure ink writing for trace crispness, clarity and uniformity
- Battery powered (Gould 222)
- Built-in preamplifiers
- Wide sensitivity range (1 millivolt to 500 VAC built-in preamps)
- Operates in any position

The solid-state Gould 220 is a completely self-contained portable recorder, weighing only 25 pounds. It has two 40 mm channels and measures 9 inches x 13½ inches x 7¾ inches. Built-in preamplifiers give you a measurement range of 1 mV per chart division to 500 V full scale without recalibration.

A pen-position servo system, based on a non-contact transducer, guarantees 99.5% linearity.

Pressure ink is still the standard of writing quality and the Gould fine-line thermal recorder approaches that standard closer than any other thermal writing unit. The thermal model is

especially suited for applications calling for slow speed or unattended operation.

Gould 222 Recorder

You get famous Gould quality and performance in a 2-channel general purpose recorder that operates anywhere. The Gould 222 has an internal battery supply and charger, permitting it to be used away from external power sources as well as from them. Imagine the many additional measurements you can record with this unit — quickly, conveniently, cordlessly.

MODELS 220 AND 222 SPECIFICATIONS

Gould 220 Recorder

Number of Channels: 2 analog, 2 event located on left and right margins.

Channel Span: 40 mm (50 divisions).

Frequency Response

At 50 divisions: Flat within $\pm 2\%$ of full scale from DC to 40 Hz.

Nonlinearity: Less than $\pm 0.5\%$ FS.

Marking Method: Pressurized Fluid, or Thermal.

Measurement Range: 1 mV per chart division to 500 VDC FS.

Maximum Allowable Input Voltage to Avoid Damage: 500 VDC or peak AC either terminal to ground.

Maximum Common-mode Voltage both terminals (No. 1 and No. 2) off ground: Up to 500 VDC or peak to peak AC.

Input Circuit: Differential, balanced-to-ground.

Input Impedance: 10 M Ω balanced, 5 M Ω each terminal to ground.

Chart Speeds: 1 to 125 mm/s and mm/min.

Chart Capacity: High-contrast — 275 ft. (84 m).

Power Input: 120 watts, 175 VA.

Weight: 25 pounds (11.3 kg).

Gould 222 Recorder**Frequency Response**

At 50 div.: Flat within $\pm 2\%$ of full scale from DC to 30 Hz.

Nonlinearity: $\pm 0.5\%$ FS DC.

Measurement Range: 1 mV/chart division to 500 VDC FS.

Maximum Safe Differential Input Voltage: 500 VDC or peak AC either terminal to guard or ground.

Maximum Common Mode Voltage: 500 VDC or peak AC at any attenuator setting between input terminals and chassis ground.

Input Circuit: Three terminal. Differential floating, balanced to guard. Chassis terminal at rear for connection to ground (if desired).

Input Impedance: 10 M Ω balanced; 5 M Ω each terminal to guard.

Ordering Information

Model Number	Description
Gould 220	
15-6327-57	Ink, portable
15-6327-572601	Thermal, portable
Gould 222	
15-6325-00	Ink, portable, 115 VAC operation, 50-400 Hz, 45 VA
15-6325-02	Ink, portable, 12-33 VDC operation, 1A

Gould 8000S THERMAL WRITING RECORDERS



- 1 to 8 channel models
- Lightweight and compact
- 1 mm/h to 200 mm/s chart speeds
- 100 Hz frequency response
- Compatible with Gould 4600 series signal conditioners

The Gould 8000S Series is a line of portable, compact and modular oscillographic recorders. Rugged design and compact size makes them especially suitable for field use and for applications where there is limited available space.

The 8000S is available in one to six 50-mm channel and eight 40-mm channel configurations. Frequency response is 50 Hz at 40 mm amplitude and 100 Hz at 10 mm amplitude. The stepping motor drive provides 21 accurate chart speeds from 1 mm/h to 200 mm/s in 1, 5, 10, 25, 50, 100, and 200 steps.

The 8000S' thermal writing system is simple, reliable and inkless. It provides excellent trace quality and accuracy, and is especially suited for unattended operation.

Signals with ± 2.5 V fixed sensitivity can be input directly or any Gould 4600 Series Signal Conditioners can be used. Signal conditioners are mounted in the one, two and three channel models; they are mounted in separate cages for the four, six and eight channel models. An external short run chart takeup is available.

MODEL 8000S SPECIFICATIONS

Number of Analog Channels and Channel Span: One, two, three, four and six 50-mm channels or eight 40-mm channels.

Marker Channels: Right time marker and left event marker.

Frequency Response: At 40-mm amplitude: DC to 50 Hz ± 2 mm. At 10 mm amplitude: DC to 100 Hz ± 3 mm.

Rise Time: Less than 10 ms.

Non-linearity: $\pm 0.5\%$ of full scale; rectilinear trace.

Marking Method: Heated stylus on heat-sensitive paper.

Input Sensitivity: ± 2.5 V full scale (without preamplifiers).

Pen Position: Adjustable over 120% of channel width.

Input: Single ended, floating (isolated from ground); 100 k Ω .

Pen Limiting: Mechanical and electronic adjustable.

Chart Speeds: 1, 5, 10, 25, 50, 100, 200 mm/s, mm/mn, mm/h.

Dimensions and Weight (350 mm depth)	Height mm	Width mm	Weight* kg	Power VA**
1 ch. with housing	203	250	5.5	95
2 ch. with housing	203	360	8.5	130
3 ch. with housing	203	480	11.5	165
4 ch. - recorder only	203	360	11	200
4 ch. with housing	403	360	11.5	200
6 ch. - recorder only	203	480	13	270
6 ch. with housing	403	480	18.5	270
8 ch. - recorder only	203	480	15	340
8 ch. with housing	403	480	21.5	340

*Without signal conditioner.

**50/60 Hz.

Accessories for all models

Model Number*	Description
XG51659	Chart take-up, 1 ch
XG51398	Chart take-up, 2 ch
XG51702	Chart take-up, 3 ch
XG51661	Chart take-up, 4 ch
XG51513	Chart take-up, 6/8 ch
X51377	Additional event marker for 3, 4 and 6-ch factory mounted
X51920	Additional event marker for 2-ch, factory mounted

**ALX- instead of "X" in North America.

Recorder Ordering Information

Model Number	Description
8188-G1102-0X*	1 ch. with signal conditioner case
8188-G2202-0X*	2 ch. with signal conditioner case**
8188-G3302-0X*	3 ch. with signal conditioner case**
8188-G4400-0X*	4 ch. without signal conditioner case**
8188-G6600-0X*	6 ch. without signal conditioner case**
8188-G8800-0X*	8 ch. without signal conditioner case**

*X: 0 = 115 V 50/60 Hz; 6 = 220 V 50/60 Hz; 9 = 240 V 50/60 Hz

**Also available in rack mount version (-GXX1X- instead of -GXX0X-).

8188-G402	Portable Case for 4 signal conditioners
8188-G602	Portable Case for 6 signal conditioners
8188-G802	Portable Case for 8 signal conditioners

All cases are also available in rack mount version (-GX1X instead of -GX0X).

GOULD TA 550 THERMAL RECORDERS

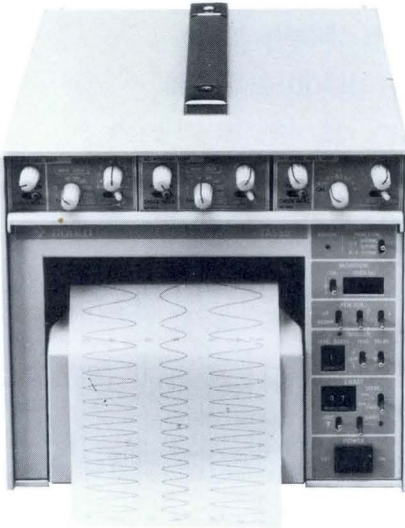

- Up to 3 channels
- Chart annotation for identification, scale, time, event
- 50 Hz frequency response
- 1 ms sampling rate
- 2 ms peak capture
- Pre- and post-event triggering

Using an innovative fixed array of thermal writing styli, the Gould TA 550 Recorder offers Y/t and XY recording for applications in industrial, laboratory and biophysical areas.

The writing system has no moving parts. It is highly reliable, and all analog channels can go full scale and overlap in any desired relationship. You can choose to display signal traces in non-overlapping channels.

Plain thermal paper can be used because grids are selected and printed with the signal traces. This ensures accuracy between the grid and the signal, despite possible paper expansion or contraction due to the environment. Pre- and post-event triggering also are provided to assure recording of only signals of interest, saving chart paper.

MODEL TA 550 SPECIFICATIONS

- Number of Channels:** 1, 2 or 3, selectable.
- Chart Width:** 101.2 mm.
- Resolution:** 6 dots/mm.
- Frequency Response:** Up to 50 Hz, peak capture for pulse signal over 2 ms.
- Grid Format:** Printed during operation; single 98-mm wide; dual, 48-mm wide, or triple, 30-mm wide.
- Event Marker:** Right hand.
- Chart Speeds:** 1 mm/min to 100 mm/s in 199 ranges, front panel or remote. Synchronized to external pulse.
- Trigger:** Level with 10% full-scale increments \pm slope, \pm 200-ms delay.
- Memory:** 2 kbytes, optional 64 kbytes.
- Interface:** Optional IEEE-488 or RS-232C.
- Operating Line Voltage:** Selectable plug — 110, 115, 200, 220, 240 VAC \pm 10%, 50-60 Hz.
- Weight:** 25 pounds (11.3 kg).
- Dimensions:** 8.7 in. (218 mm) W x 8.0 in. (199 mm) H x 14.0 in. (350 mm) D.

Multi-Range Pre-amplifiers

Select one per channel.

Model Number	Description
DC Voltage	
210-110001-1	1 V and 10 V full scale (non-isolated)
210-110002-1	100 mV to 500 mV, 1 to 10 V full scale (non-isolated), 7 ranges
210-110003-1	1 mV to 500 mV, 1 V to 200 V full scale, 17 ranges (isolated 200 V max input)
DC Voltage with \pm 400% Bias	
210-120003-1	1 mV to 500 mV, 1 V to 200 V full scale, 17 ranges (isolated 200 V max input)
Hi-Speed DC Voltage	
210-410004-1	50 mV to 500 mV, 1 V to 200 V full scale, 12 ranges (isolated); frequency response to 50 Hz
DC Current	
210-210006-1	1 μ A to 50 μ A, 6 ranges
210-210007-1	0.1 mA to 5 mA, 6 ranges
210-210008-1	10 mA to 500 mA, 6 ranges
Thermocouples	
210-310031-1	Type E, 3 ranges, 0° to 800°C
210-310032-1	Type J, 3 ranges, 0° to 800°C
210-310033-1	Type K, 3 ranges, 0° to 1200°C
210-310034-1	Type R, 3 ranges, 0° to 1600°C
210-310035-1	Type S, 3 ranges, 0° to 1600°C
210-310036-1	Type T, 3 ranges, -100° to +400°C
210-510000-1	Blank Module

Ordering Information

Model Number	Description
Standard Models	
253-222111-1	TA 550 recorder, 1 to 3 channels selectable, IEEE-488 interface, limit switch, and 64k memory
253-322111-1	TA 550 recorder, 1 to 3 channels selectable, RS-232C interface, limit switch, and 64k memory

TA 2000 THERMAL ARRAY RECORDER

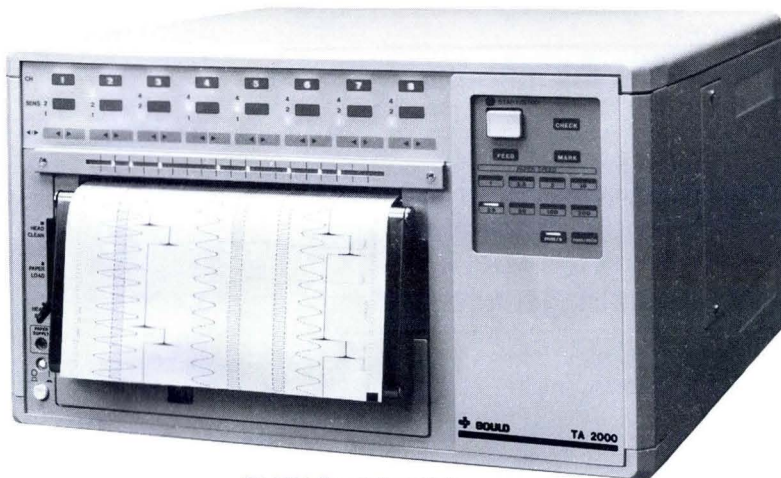

TA 2000 Stand Alone Unit

- 1 to 8 analog channels
- Frequency response 5 kHz
- Peak capture of events 150 μ s or longer
- 200 dots/in. amplitude resolution (8 dots/mm)
- 200 mm/s maximum chart speed
- Overlapping traces
- Compatible with Gould 4600 and 5600 Signal Conditioners

The penless digital writing system of the TA 2000 features a high resolution (8 dots/mm) linear thermal array head. This head is composed of closely spaced stationary heating elements which allow simultaneous printing of traces, grid lines and alphanumeric annotation. Because the writing system has no moving parts, there are no mechanical or inertial limits usually associated with pens or galvanometers. The result is high frequency response, no trace overshoot, and the ability to overlap traces. Also, traces may be written across the full 200 mm chart width.

The TA 2000 was designed with the user in mind. The front panel is composed of instantly recognizable keys that provide positive audible, tactile and visual feedback. Position keys allow movement of the trace in precise 10-mm increments across the chart making formatting a simple task. A row of LEDs just above the paper exit follows all signals in real time eliminating the need to run the chart during setup.

Frequency response is less than 3 dB down on a continuous 5 kHz sine wave. Peak capture of events as short as 150 μ s with no trace degradation is another benefit of TA 2000 array technology.

Three modes of chart operation allow continuous recording, or paper conservation when ongoing recording is not needed. The user simply programs the chart to run and stop or change speeds at specific time intervals. New *Chart* mode emulates a 4-channel pen recorder with separate 40-mm channel grids.

Real time, day/date and chart speed annotation are printed once per page. Channel identification can be enabled from the front panel. Full page of user text and 8-character parameter identification can be entered via the RS-232C interface a host computer. Also, all front panel functions can be remotely controlled via the RS-232C interface.

When combined with Gould's more than 40 general and special purpose signal conditioners, the TA 2000 provides unparalleled application flexibility to meet your specific recording requirements.

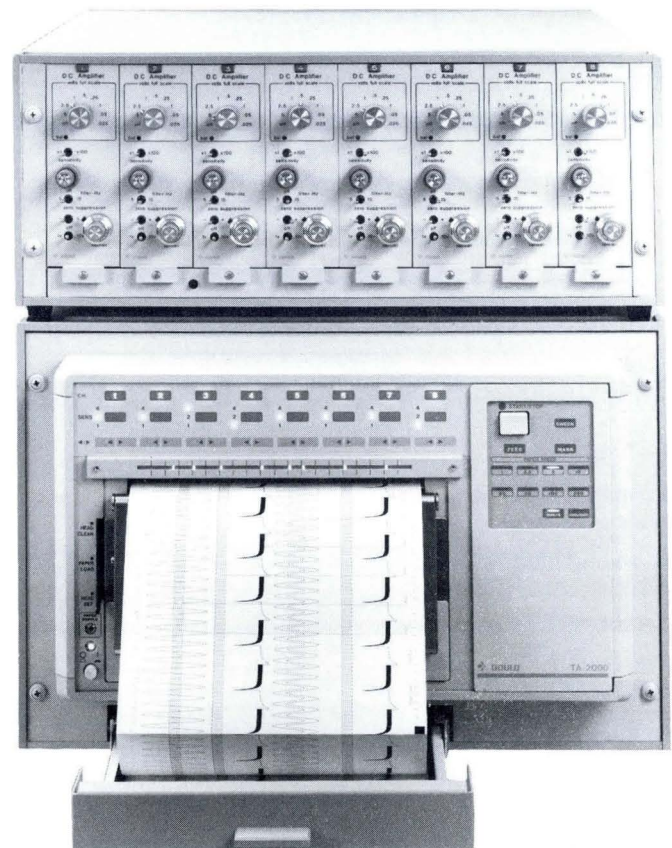

TA 2000 Bench Top Unit

Number of Analog Channels: 1 to 8 channels real time recording.

Event Marker: 2 mm wide mark at left chart edge when MARK key is depressed or activated via remote control connector.

Marking Method: Single fixed thermal array head.

Recording Width: 200 mm FS (recording is possible across full 8½ inches of chart paper).

Amplitude Resolution: 200 dots/in. (8 dots/mm).

Time Axis Resolution: 8 lines/mm (at 200 mm/s).
16 lines/mm (at 100 mm/s). 32 lines/mm (at 50 mm/s).
48 lines/mm (at 25 mm/s).

Frequency Response: 5 kHz (<3 dB down). Peak capture of events 150 µs or longer. Both specs independent of number of channels recorded or trace amplitude.

Analog Inputs: Single ended, grounded ±5 V FS (10 V span). In Chart mode, ±2.5 V FS.

Input Impedance: 100 kΩ ±10%.

Sensitivity: x1, 1 V/cm; x2, 0.5 V/cm; x4, 0.25 V/cm.

Chart Speeds: 1, 2.5, 5, 10, 25, 50, 100, 200 mm/s and mm/min.

Timing Marks: Recorded in three lengths along both edges of chart paper.

Range	Long	Print Interval		Speed	Long	Normal	Short
		Normal	Short				
mm/s	10 s	1 s	0.1 s	1	x	x	-
mm/min.	10 min.	1 min.	0.1 min.	2.5	x	x	-
				5	x	x	-
				10	x	x	-
				25	x	x	x
				50	-	x	x
x Printed				100	-	x	x
- Not Printed				200	-	x	x

Chart Speed Accuracy: ±3%.

Motor: Servo-controlled DC motor, quiet continuous drive.

Recording Modes: Continuous — Manual chart drive start/stop from front panel. Periodic — Chart drive starts and stops automatically at time intervals selected from front panel. Alternate — Chart drive switches between two chart speeds at time intervals selected from front panel. Chart — emulates pen recorder with four 40-mm channels.

Grid Line Printing: Selectable from front panel; Grids OFF, 10x10 mm and 5x10 mm grids each with selectable 1x1 mm fine grid.

Annotation: Date, Time and Chart Speed are printed once per page. User defined full page (48 lines x 80 columns) and 8 character parameter identification possible via RS-232C interface.

Channel Identification: Channels successively identified once per page by a thin line from the corresponding trace to a three character field (CH1, CH2, etc.). Turned on or off from IDENT Key.

Chart Paper Description: High Sensitivity Thermal Paper, 8½ x 11 inch, Z-fold, 11-inch fold length, 350 sheets.

Chart Paper Capacity: 325 ft. (107 m).

Chart Paper Take-up Drawer: Collects full paper capacity. (Standard with rack mount and portable systems.)

Remote Control: Chart Start/Stop and Event Mark can be controlled from rear panel remote connector via contact closure.

RS-232C Interface: The following functions are possible via the interface; control of all front panel functions, full page (48 lines x 80 columns) of annotation, 8 character parameter identification.

Operating Input Voltage: 100-125 VAC, 50/60/400 Hz. 200-240 VAC, 50/60 Hz.

Input Power: Typical — 100 VA. Maximum 500 VA.

Battery Back-Up: Maintains front panel settings and time/date for 30 days.

Weight: Stand Alone — 53 lbs. (24 kg). Portable System — Recorder 65 lbs. (29.5 kg). Cage 34 lbs. (15.4 kg).

Dimensions: Stand Alone — 17 in. (430 mm) W x 10 in. (248 mm) H x 17 in. (430 mm) D. Bench Top: Recorder — 20 in. (506 mm) W x 13.5 in. (341 mm) H x 17 in. (430 mm) D. Cage — 20 in. (506 mm) W x 8.25 in. (209 mm) H x 19 in. (480 mm) D. Rack mount — 19 in. (480 mm) W x 12.25 in. (310 mm) H x 17 in. (430 mm) D.

Operating Temperature: 5° to 40° C.

Standard Models

Model Number	Description
3008-8510-43	Stand Alone Unit, 115 V 50/60/400 Hz
3008-8510-44	Stand Alone Unit, 230 V 50/60 Hz
3008-8511-43	Bench Top Unit with 5900 Signal Conditioner Cage, 115 V 50/60/400 Hz
3008-8511-44	Bench Top Unit with 5900 Signal Conditioners, 230 V 50/60 Hz
3008-8512-43	Rack Mount System (less Signal Conditioners), 115 V 50/60/400 Hz
3008-8512-44	Rack Mount System (less Signal Conditioners), 230 V 50/60 Hz
3008-8513-43	Bench Top Unit without Signal Conditioner Cage, 115 V 50/60/400 Hz
3008-8513-44	Bench Top Unit without Signal Conditioner Cage, 230 V 50/60 Hz

Accessories

Model Number	Description
11-1202-37	Rack Mount Kit for Stand Alone Unit
CL-810971	Input Cable ("Blue Ribbon" to 8 Molex)
11-4310-25	Molex-BNC adapter
11-4310-23	Molex-Spade Lug adapter
11-4310-24	Molex-Bantam Plug adapter
369500-21509	RS-232C Cable (TA 2000 - IBM PC/XT)
369500-21508	RS-232C Cable (TA 2000 - IBM AT)
249334-14	Input Connector, mating
245537-9	Remote Control Connector (order with 284428-9 shell)
284428-9	Remote Connector Shell
11-6405-05	Mobile Cart for Portable System
A50009	Mobile Cart for Stand Alone TA 2000

GOULD ES2000 REAL TIME DISPLAY AND RECORDING SYSTEM

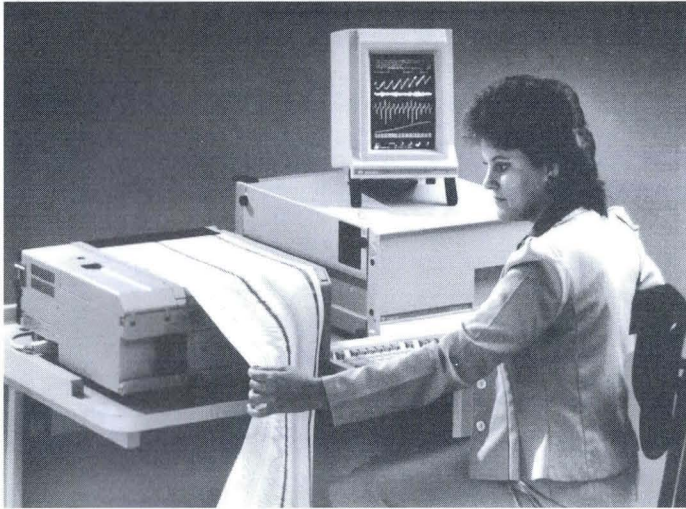

- Preconfigured settings stored on built-in diskette
- Full remote and local programmability
- High frequency, real time monitor
- Customized hard copy outputs
- Up to 40 analog or 80 digital channels
- 25 μ s full-scale peak capture
- 12-bit digitized data output
- High-speed data bus

Gould's new ES2000 is a modular real time display and recording system based on a very decentralized architecture to accommodate present and future applications. Its totally programmable design allows setup configurations combining trace positioning, texts, grids and trigger conditions to be stored on a built-in 3.5-in. diskette. Full remote programmability is achieved via the standard IEEE-488 or RS-422A interfaces.

An integrated non-fade, high-frequency video monitor displays real-time data, including all traces, text and grids. The monitor is simultaneously used as a terminal to program all system functions.

The system hard copy output consists of a Gould patented high-performance electrostatic writing unit. Gould electrostatic technology has a high reliability proven by more than ten years of use of thousands of recorders. The high-contrast records over the full 264-mm (10-3/8-in.) usable chart width are truly permanent and easily reproducible by office copiers. Its 8.5x11 in. (208x279 mm) page format is especially suitable for filing and publication. Paper cost is only a fraction of photosensitive papers used in light beam oscillographs. Powerful text capability and user programmable grid patterns allow to produce custom records.

The system Controller can house up to 11 plug-in modules in any combination to match input configuration with every application. Current module selection includes:

- CRT2000, Video Controller Board
- MW2000, Multiple Writing Unit Interface
- HR2000, High Resolution Hard-Copy Board
- PB400, 4-channel Analog Input
- PB200, 2-channel DC Amplifier
- PB860, 8-channel Digital Input
- PB150, Time Code Interface

- PB240, 2-channel High-Frequency Analog Input*
- SX2000, Sequencer, High-Speed Data Bus*
- SM2000, Waveform Memory Board*

The ES2000 Basic System is composed of a Controller, Writing Unit, Monitor and Keyboard. Available physical system configurations include benchtop, console and vertical cabinet. Every system component may be located up to 20 meters away.

The ES2000 is fully compatible with the Gould range of 4600 and 5600 Series Signal Conditioners. This combination allows to configure systems to meet specific requirements for the Industrial, Medical and Aerospace markets.

Local Programmability

The system's 3.5-in. diskette is used to store an unlimited number of "set-ups" including all trace parameters settings, text, grids and trigger conditions. These pre-configured settings reduce set-up time and potential for operator error.

Amplitude, event (on/off) and time based triggers - supported by AND/OR logic - can either initiate or dynamically alter recorder and display functions. In addition to reducing operator intervention, this conserves chart paper and simplifies analysis by recording only pertinent data.

Real Time Display

The Gould (either 9, 12 or 20 in.) high resolution, non fade monitors display signals, event markers, grids, alphanumeric in real time, with chart running or not. These are displayed exactly where they are on the chart. The monitors are also being used to program all system functions. For instance, text can be entered and accurately positioned with respect to overlaying scrolling traces.

*See page 125 for more information.

Using more than one CRT2000 (Video Controller Board), different subsets of recorded channels can be displayed on the monitors connected to each CRT Board. The display sweep speed may be independent from each other and from the chart speed.

Customized Hard Copy Outputs

The ES2000 gives the most flexibility in annotating and customizing chart records. User may program his own grid patterns, store them on 3.5-in. diskette and retrieve them when needed. Chart records are complete with chart speed, real time and date, channel number, input sensitivity and parameter identification of up to 5 lines of 25 characters per channel.

Up to 12 pages of user text can be entered and printed once as a header or repeated periodically. Up to 32 "on-the-fly" messages each containing up to 51 lines of 52 characters can be printed at reception of a command

(keystroke, contact closure, ..). All text is part of the set-up and, as such is saved on 3.5-in. diskette.

In addition, the ES2000 can be used as a page printer with text sent via the IEEE-488/RS-422A interface or entered via the keyboard. Text can also be printed in real time on a single line, along the chart with characters entered via keystrokes or one of the interfaces.

Digitized Data Output

Digitized analog data from the PB400 or PB200 Input Modules can be transferred to a computer for storage and analysis via the IEEE-488 interface at rates up to 2,000 samples/channel/s with 12-bit resolution. Maximum aggregate rate is 40,000 samples/second.

Waveform Recording

Modules PB240, SM2000 and SX2000 enable to expand the ES2000 into a high-performance waveform recording system. See page 124 for details.

MODEL ES2000 SPECIFICATIONS

Chart Paper Width: 279.4 mm (11 in.)

Usable Chart Width: 264 mm (10 3/8 in.)

Resolution: 8 dots/mm along the Y axis - 2000 dots/s max. along the time axis

Number of Electrodes: 2112

Writing Method: Electrostatic.

Type of Paper: Fan-fold (1000 sheets 216x279 mm; 8-1/2x11 in - total length: 216 m or 707 ft). Roll (122 m; 400 ft), plain, perforated or translucent.

Motor: Microstep drive.

Chart Speeds: 0.25, 0.5, 1, 2.5, 5, 10, 25, 50, 100, 250, 500 mm/s; accuracy: $\pm 0.25\%$; external variable speed control with analog voltage (0-10 V) or pulse train (TTL).

Number of Slots for optional plug-ins: 11.

Channel Identification: by two characters (channel number), sensitivity and up to 5 lines of text 1) along lower edge of the chart and joining the corresponding trace by a thin line; or 2) table printed on demand.

Time Markers: 4, 2, 1-mm marks every 10 s, 1 s, 0.1 s (upper edge of the chart) or 1 s, 0.1 s, 0.01 s (both edges).

Event Marker: System marker actuated by push-button; other markers are added with every plug-in input.

Grid Lines: Standard pattern: 5x5 mm; an infinite number of other patterns may be programmed and stored 4 per configuration; vertical lines spacing range: 1 to 99 mm; horizontal lines programming step: 1/8 mm.

Annotations: Chart speed, time and date (or elapsed time), up to 12 pages of user text, up to 32 "on-the-fly" messages, parameter identification.

Characters: Set of 256 characters in 20x28 matrix.

Single Line Printer: Provides for continuous printing of

one line of text along the chart at a preset location.

Page Printer: Printing of pages of text in comic mode simultaneously with chart recording (input via RS-422A/IEEE-488 interface).

Data Acquisition: Transfer of digitized data from PB200/PB400 via IEEE-488 interface; maximum throughput: 40k samples/s; 2k S/s/ch maximum; data resolution: 12 bits.

Configurations: Unlimited number of System configurations can be stored on System 3.5-in. disk drive (5 per diskette); each configuration includes complete set-up with annotations, grid patterns and input settings.

Remote Programming: All system functions and settings (except printing contrast) may be controlled via standard IEEE-488/RS-422A interface.

Toner Capacity: 2 liters.

Line Voltage: 100 to 240 V; 50/60/400 Hz.

Power: Controller : 100 VA min, 375 VA max.; Writing Unit : 160 VA; V12/V9 Monitors: 18 VA; V20 : 60 VA.

Dimensions

Controller: 453Wx535Dx240 mm H (17.9x21.1x9.5 in.)
Writing Unit: 450Wx450Dx195 mm H (17.5x17.7x7.6 in.)
Keyboard: 453Wx216Dx30 mm H (17.9x8.5x1.2 in.)
V9 Monitor: 220Wx330Dx300 mm H (8.6x12.7x12 in.)
V12: 262Wx354Dx360 mm H (10.3x14x14.2 in.)
V20: 400Wx475Dx520 mm H (15.8x18.7x20.5 in.)

Weight

Controller: 15 to 21 kg (33 to 45 lbs).
Writing Unit: 16 kg (35 lbs) without toner and paper.
V12: 12 kg (25 lbs).
V20: 26 kg (56 lbs).

See Page 93 for ordering information.

GOULD HR2000 HIGH RESOLUTION HARD COPY BOARD

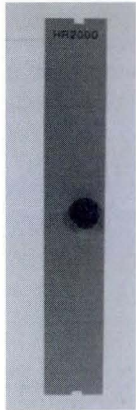

- Full resolution two-screen memory
- Hard Copy and Deferred Recording modes
- Minimizes use of chart
- Operation controlled by keyboard, computer or user defined program

The Gould HR2000 stores up to two full screens of ES2000 information, including all traces, grids and text for hard copy of frozen data in memory or deferred recording. In *hardcopy* mode, the screen display is frozen and 1 or 2-page hard copy is obtained on paper. In *deferred recording* mode, the chart is started and receives data flowing through the HR2000 memory (instead of real time). Data is continuously printed with 1 or 2-screen delay. This process provides a "pretrigger" feature of up to two pages of complete ES2000 data, including traces, grids and text.

Operation of the HR2000 is best performed by observing the ES2000 Monitor screen. Continuous stream of data is monitored without running the chart. If an event occurs or if an important pattern is recognized, the chart may be started in deferred recording mode and run continuously as long as data is considered as important. Up to two pages of critical data (with full resolution) occurring before the chart is started will be recorded on paper for further analysis and correlation with post event data.

SPECIFICATIONS

Memory: Bit map, 16 Mbits.

Amplitude Resolution: 1/8 mm.

Time Resolution: 1/16 mm for 2-page memory; 1/8 mm for 4-page memory; 1/4 mm for 8-page memory.

Operating modes: Hard copy of frozen screen(s) (1 or 2) or Deferred recording (1 or 2 screens delay).

Ordering Information

Model Number	Description
23-28101-04	HR2000 Hard Copy Board

GOULD MW2000 MULTIPLE WRITING UNIT INTERFACE

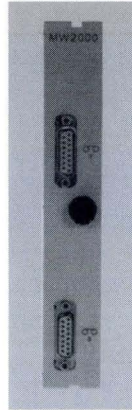

- Expands ES2000 up to 3 Writing Units
- Fully independent operation
- Synchronized recording
- One screen per Writing Unit
- Lower per-channel system cost

The Gould MW2000 allows you to add up to two ES2000 EW Electrostatic Writing Units to a basic ES2000 system. All three Writing Units are fully independent: different grids, texts and traces can be printed; they can be run at different chart speeds or, if desired, slaved to the first Unit. Use of a common system clock insures an accurately synchronized recording on all 3 Writing Units.

The addition of CRT2000 Video Controllers gives the possibility to associate one Monitor to each Writing Unit. The MW2000 is ideal for multiple recorder applications and enables control of the system by a single operator. It lowers per-channel system cost too.

SPECIFICATIONS

Character Generators: 2 (1 per EW) with sets of 256 characters.

Grid Generators: 2 (1 per EW).

Connectors: 2x 15-pin sub D for EW #2 and EW #3.

Ordering Information

Model Number	Description
23-28101-03	MW2000 Multiple Writing Unit Interface

GOULD PB860 8-CHANNEL DIGITAL INPUT

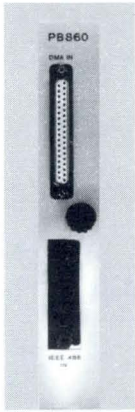

- Up to 12-bit resolution
- High acquisition speed: 2 μ s per data word
- Continuous traces, peak capturing at high speed.
- 16-bit parallel and IEEE-488
- Adjustable scale and position
- Compatibility with DR11/HSDRX

Digitized analog data stored and processed by computers are often required to be displayed in a chart format for analysis. The PB860 offers input capability for up to 8 independent channels via a GPIB interface (IEEE-488) or a 16-bit parallel interface. Eight continuous traces are generated with peak capturing. Minimum channel update rate is 2 μ s. Traces format can be programmed via the input interface or regular ES2000 system controls.

Gould PB861 version is compatible with Digital Equipment Corporation® DR11 and Gould HSDRX interfaces.

SPECIFICATIONS

Number of Channels: 8 digital with 12-bit resolution and 8 discrete. Up to 88 channels per ES2000.

Input Interfaces: Standard IEEE-488 and 16-bit parallel TTL level with 2-line handshake (STROBE and BUSY).

Input Connectors: Std. IEEE-488 and 37-pin sub-D female.

Data Acquisition Rate: 2 μ s per word (parallel input).

Channel Address Identification:

- 1) By 3 bits or
- 2) Automatic scanning of all 8 channels.

Module Address Identification: By 4 bits.

ES2000 CP Address Identification:

- 1) By 5 bits
- 2) By IEEE-488 device address (IEEE-488 interface only).

Trace Position: From 0 to 248 mm in 8-mm steps. Selection by ES2000 system controls or remote control.

Trace Scale: From 4 to 256 mm in binary steps. Selection by ES2000 system controls or remote control.

Trace Authorization: Every trace may be individually authorized or cancelled via ES2000 system controls or remote control

Channel Set-up Selection: By remote control

Discrete Channel (Event marker): Marker position and height are programmable using ES2000 controls.

GOULD PB150 TIME CODE INTERFACE

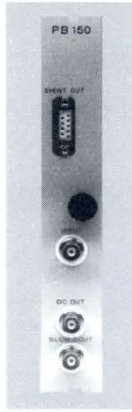

- Reads IRIG A, B, E, H and NASA 36
- x8 to \div 32 speed range
- Time and date display
- Synchronized time lines
- DC and Slow Code outputs
- Slow Code trace
- Tape search and control

This Time Code Interface is a versatile time code reading unit. Time information from a variety of codes is printed on the ES2000 chart and displayed on the ES2000 Monitor. Alphanumeric printed data is supplemented by synchronized time lines and slow code trace. A time triggering feature enables to control ES2000 functions, such as chart drive and a tape recorder.

SPECIFICATIONS

Supported Time Code Formats: Modulated and demodulated IRIG A,B,E,H and NASA 36.

Time Code Frequency: x8 to \div 32 basic code frequency (IRIG A: x1 to \div 32).

Modulated Input Level: 200 mV p-p minimum (logic level=0), 50 V p-p maxi (logic level=1).

Modulation Ratio: 1 \div 2 to 1 \div 6.

Demodulated Code Input Level: TTL.

Time Reference Accuracy: 500 μ s.

Annotation Positioning: Anyone of 52 lines.

Time Lines: Synchronized with time code. Spacing adjusts automatically with chart speed.

Time Display: Line, Table or Large Table format on ES2000 Monitor screen. Programmable position.

Demodulated Code Output: TTL level, BNC connector.

Slow Code Recording: Amplitude: up to 256 mm. Positioning: anywhere on the chart (1/8-mm steps).

Formats : 1 s to 3600 s.

Slow Code Output: Levels: \pm 10 V, 0 V, BNC connector.

Time Triggering: 2 independent settings for control

- 1) of ES2000 sequence programming and
- 2) of external device (e. g., tape recorder) via Sub-D connector.

Time Code Input: 100 k Ω , BNC connector.

Ordering Information

Model Number	Description
23-22101-03	PB150 Time Code Interface

GOULD PB200 2-CHANNEL DC AMPLIFIER

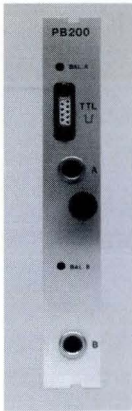

- Fully programmable
- Operates off ground to 750 V
- 35 kHz bandwidth, 25 μ s peak capture
- 5 mV/cm to 625 V f.s.
- Amplitude triggering
- Calibrated zero suppression
- Digitized data output
- Two event channels

This two-channel DC Amplifier with 2 event-channels is an ideal front-end for general purpose voltage measurements. Each amplifier is fully isolated input-to-output and operates up to 750 V off ground. Outstanding features of the Gould PB200 include: full programmability and complete set-up storage on ES2000 system disk; true calibrated zero suppression and operation up to 750 V off-ground; 5 mV/cm to 25 V/cm sensitivity (up to 625 V full scale); signal triggering on positive and negative slope; digitized analog data available for continuous transfer to a micro or minicomputer for storage and further analysis.

SPECIFICATIONS

- Number of Channels:** 2 analog and 2 event.
Input Circuit: Balanced to floating common and guarded.
Input Impedance: 2 M Ω differential.
Channel Position: 0 to 255.9 mm with 0.1-mm steps.
Channel Width: 0 to 256 mm with switchable limiters.
Measurement Range: 5 mV/cm to 25 V/cm or 625 V f.s. in 5-10-25 steps. Vernier with 1% resolution.
Maximum Input Voltage: 700 V DC or pk differential.
Zero Suppression: \pm 1,000 V.
Gain Accuracy: \pm 0.5%.
Output Noise: \leq 3 styli with inputs shorted.
Frequency Response: 35 kHz at -3 dB.
Sampling Frequency: 100 ks/s with peak capturing; peak capture: 25 μ s minimum.
Filter: Switchable, lowpass, 50 Hz at -10 dB, 12 dB/oct.
Common Mode Rejection: >90 dB at 50Hz.
Crosstalk: <-90 dB.
Amplitude Triggering: On positive slope and negative slope; from -50% to +50% of f.s. width.
Digitized Analog Signal: Up to 2,000 S/s with 12-bit resolution via IEEE-488 interface.
Channel Identification: Status and 125 char. user text.
Event Marker Input: TTL low/high level active.
Marker Position and Height: From 0 to 255 mm.
Input Connectors: 3-pin LEMO and 9-pin sub-D

See Page 93 for Ordering Information.

GOULD PB400 4-CHANNEL ANALOG INPUT

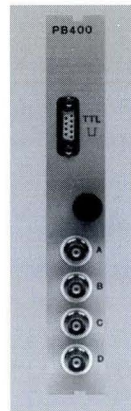

- Fully programmable
- 10 kHz bandwidth, 70 μ s peak capture
- 40 mV/cm to 250 V f.s.
- Amplifier and Coupler mode
- Amplitude triggering
- Digitized analog data output
- Four event channels

This versatile four-channel Analog Input with 4 event-channels is designed to receive signals from Gould Signal Conditioners or other preconditioned signals (Coupler Mode). In Amplifier Mode the PB400 can be used for direct DC voltage measurements. Gould PB400 features include: full programmability and complete set-up storage on ES2000 system disk; 40 mV/cm to 10 V/cm sensitivity (up to 250 V full scale); signal triggering on positive and negative slope; digitized analog data available for continuous transfer to a micro or mini computer for storage and further analysis.

SPECIFICATIONS

- Number of Channels:** 4 analog and 4 event.
Input Circuit: Single-ended.
Input Impedance: 100 k Ω .
Channel Position: 0 to 255.9 mm with 0.1-mm steps.
Channel Width: 0 to 256 mm with switchable limiters.
Measurement Range: 40 mV/cm to 10 V/cm or 250 V f.s. 1 V, 5 V and 10 V range settings for coupler mode.
Maximum Input Voltage: 260 VDC or pk (10 V range); 130 V (5 V range); 26 V (1 V range).
Gain Accuracy: \pm 0.5% f.s.
Output Noise: \leq 3 styli with inputs shorted.
Frequency Response: 10 kHz at -3 dB.
Sampling Frequency: 30 ks/s with peak capturing.
Peak Capture: 70 μ s minimum.
Amplitude Triggering: On positive slope and negative slope; from -50% to +50% of f.s. width with 0.1% resolution.
Transmission of Digitized Analog Signals: Up to 2,000 S/s with 12-bit resolution via IEEE-488 interface.
Channel Identification: Status and 125 char. user text.
Event Marker Input Circuit: TTL low or high level active.
Marker Position and Height: From 0 to 255 mm.
Input Connectors: BNC and 9 pin sub-D

See Page 93 for Ordering Information.

Ordering Information

ES2000 Basic Systems

Model Number	Description
3009-A1140-17*	Basic ES2000, portable, includes Controller, Writing Unit, 12-in. Monitor, Keyboard and Video Controller Board
3009-A1141-17**	Above integrated in Vertical Console.
3009-A1143-17**	Above integrated in Short Vertical Cabinet
3009-A1144-17**	Above integrated in Tall Vertical Cabinet
3009-A1145-17**	Above integrated in European rack.
3009-A1148-17*	Above with mobile cart.
3009-D1140-17*	Basic ES2000, portable, includes Controller, Writing Unit and Remote Control Keypad.

Consult your local Gould Sales Office for other systems and configurations.

* -16 instead of -17 : 220 V line supply

** -27/-26 instead of -17/-16: with Medical Line isolation and fanfold paper basket.

26/-16 instead of -27/-17, 220 V line supply.

ES2000 System Components

23-20121-01*	ES2000 CP, Controller, 100-240 V, 50/60 Hz, portable.
23-24131-04**	4600 signal conditioner cage, European rack mount, without power supply.
23-26121-01*	ES2000 EW, Writing Unit, 100-240 V, 50/60 Hz, portable.
23-27121-01	ES2000 V9, 9" Monitor, 100-240 V, 50/60 Hz, portable.
23-27121-02*	ES2000 V12, 12-in. Monitor, 100-240 V, 50/60 Hz, portable.
23-27121-03*	ES2000 V20, 20-in. Monitor, 100-240 V, 50/60 Hz, portable.
23-29121-02	ES2000 RC, Remote Control Keypad.
23-29121-01*	ES2000 KB, Keyboard, portable.
X52465***	Power supply, 100-240 V, 50/60 Hz, for 2 cages 23-24131-04.

EW, V9, V12, V20 and KB subsystems are supplied with 2 m cable to CP.

* -2x131- instead of -2x121-: European rack-mount, -2x141- instead of -2x121- : Retma rack-mount.

** -2x141- instead of -2x131-: Retma rack-mount.

*** PA-X52465 in North America.

Plug-in Modules

23-21101-01	PB400, 4-channel Analog Input with 4 event channels; for interfacing signal conditioners; with input cables.
-------------	--

Model Number	Description
23-21101-03	PB200, 2-channel DC Amplifier with 2 event channels; with input cables.
23-22101-01	PB860, 8-channel Digital Input with 8 event channels, IEEE-488 and 16-bit parallel interfaces
23-22101-03	PB150, Time Code Interface.
23-22101-08	PB861, 8-channel Digital Input with 8 event channels, DR11/HSDRX compatible.
23-28101-03	MW2000, Multiple Writing Unit Interface
23-28101-04	HR2000, High Resolution Hard Copy Board
23-28101-05	CRT2000, black and white Video Controller Board

Accessories

23-22101-07	RS422/RS232-C Interface Converter
23-23101-01	RE2000, full roll Chart Take-up
23-23101-02	FB2000, folding Fan-fold Paper Basket (compact)
23-23101-03	Fan fold Paper Basket, full-pack
23-24131-04	Mobile cart for ES2000 portable system.
23-29121-02	ES2000 RC, Remote Control Keypad.
297007-1	IEEE-488 Cable, 2 m (7 ft)
M16905**	IEEE-488 Cable, 4 m (13 ft)
X51792*	Video Cable, 20 m (66 ft)
X51905*	Video Cable, 5 m (16 ft)
X52298**	EW Extender Card
X52299**	CP Extender Card
X52267**	EW-to-CP Cable, 20 m (66 ft)
X52300**	KB-to-CP Cable, 20 m (66 ft)
X52301**	KB-to-CP Cable, 5 m (16 ft)
X52303**	EW-to-CP Cable, 5 m (16 ft)
X52305**	Box of ten 3.5 in. diskettes
X52472**	RC-to-CP Cable, 20 m (66 ft)
X52474**	RC-to-CP Cable, 50 m (164 ft)
X80066-D, E, F	User's manual (D = German, E = English, F = French)
X80067-E**	Service manual
Z00084**	Reusable shipping container for EW
Z00085**	Reusable shipping container for CP
Z00086**	Reusable shipping container for V12
Z00087**	Protective carrying case for EW
Z00088**	Protective carrying case for CP
Z00089**	Protective carrying case for V12
Z00090**	Protective carrying case for V9

* ALX- xxxxx instead of xxxxxx in North America .

** PA-xxxxxx instead of xxxxxx in North America

GOULD ES1000 PLUG-IN MODULES

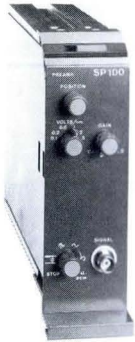
**SP100A: Single-channel Analog Input.**

Medium Gain DC Amplifier, single ended, non-floating 100 k Ω input.

Sensitivities: 0.1, 0.2, 0.5, 1, 2 and 5 V/cm; 2.5 V to 125 VFS. Continuous gain control from x1 to x2.5. Input protection: 500 VDC or peak. Full-scale positioning by 10-turn potentiometer. Transient capture of 40 μ s FS. Frequency response: DC to 25 kHz (-3 dB). Digital switchable filter (50 Hz). Sampling frequency: 84 kHz.

**SP110A: Single channel High Gain Analog Input.**

Differential DC Amplifier, balanced to floating common guarded 2 x 1 M Ω input.

Sensitivities: 5, 10, 20, 50, 100 and 200 mV/cm with x1 and x100 multipliers; 125 mV to 500 VFS. Full scale positioning by 10-turn potentiometer. Continuous gain control from x1 to x2.5. Input protection: 500 VDC or peak. Calibrated zero suppression ± 1 V to ± 500 V. Transient capture of 50 μ s FS. Frequency response: DC to 8 kHz (-3 dB). Digital switchable filter (50 Hz). Sampling frequency: 84 kHz.

**SP400A: Four-channel Analog Input.**

Single ended, non-floating 100 k Ω inputs.

Sensitivities: 0.1, 0.2, 0.5, 1, 2 V/cm; 2.5 V to 50 VFS. When used with 4600/5600 Signal Conditioner interface, channel widths: 25, 50, 100 and 250 mm. Full scale positioning by 10-turn potentiometer per channel. Frequency response: DC to 6 kHz (-3 dB) per channel. Input protection: 210 VDC or peak. Individual channel identification with M200. Sampling frequency: 32 kHz per channel.

**IT160A: Single-channel Digital Input.**

Accepts digitized signals directly from computers or digital storage media; 6 to 10-bit parallel word input for data (TTL levels). 42,000 words/s max. transfer rate. 4-bit address for up to 16 IT160A modules. 3-bit transfer control. Position and amplitude controlled by front panel thumbwheels or by digital remote control. 3-bit amplitude for 1/1, 1/2, 1/4, 1/8 and 1/16 of full scale - 4 bit for position. Overload indication by front panel LED and/or trace modification.

**IT164: Four-channel Digital Input, IEEE-488 compatible*.**

Accepts digitized signals directly from computers or controller via the standard IEEE-488 interface. Acceptor Handshake and Listener protocols. Addressable with MLA procedure and front panel miniswitches or by Listen Only procedure or by software. Full-scale 10 bit-resolution. 2-byte data format. Up to 32 channels with 8 modules in the same ES1000. Individual channel identification with M200. Each channel may be addressed every 2 μ s up to 32 μ s.

*Not available in North America

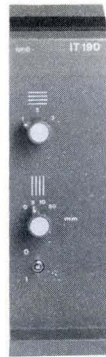
**IT190 Grid Generator.**

Provides 3 grid-line patterns in addition to standard pattern provided by ES1000 mainframe. Patterns stored on interchangeable EPROMS. Other patterns can be custom programmed by special request. The time lines can be printed every 5, 10 and 50 mm or not at all.

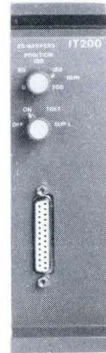
**IT200: 20-Event Marker Input.**

Marks up to 20 events. TTL and switch closure compatible. Position of each marker at rest shown by a thin line. When actuated, the marker line becomes 1.5 mm wide. Response time better than 1 ms. The group of 20 markers covers a 50 mm-wide band. This band can be placed at 5 successive locations over the full paper width. Five IT200 modules in the same ES1000 mainframe provide 100 event channels.

**IT300: Time Code Interface.**

Provides accurate synchronization of time with traces from telemetry station, tape recorder, or other source. Prints time in alphanumeric characters from modulated or demodulated IRIG A, B, E or H or NASA 36 time codes. Time data can be positioned anywhere on the chart.

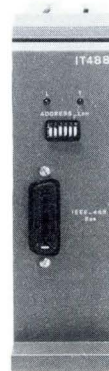
**IT488: IEEE-488 Interface.**

Allows for full remote control of the ES1000 Recorder via the IEEE-488 bus: time and amplitude lines ON/OFF. Four standard event markers, chart drive ON/OFF and chart speed selection. Protocols implemented are AH, SH, MLA, MTA. Listener and talker modes. Direct access to M200 character generator board and all its functions.

**SPX100: Two channel Speed Expander Module*.**

Two standard module slots wide. Expands the chart speed range from 10⁻⁴ mm/s to 25 m/s. Two differential non-floating 2x1 M Ω Inputs. Sensitivity: from 50 mV to 20 V/cm; 1.25 V to 500 VFS. 10-bit resolution. Acquisition time from 0.3 s to 91 hrs. Manual control via keyboard and 16-digit display in conversational mode. 64k word memory per channel (expandable to 128k) which can be divided into 2 to 5 blocks. Sampling frequency: 100 kHz.

*Not available in North America

GOULD ES1000

M200 Alphanumeric Character Board

The ES1000's comprehensive annotation provides a complete chart record, using the optional M200 Alphanumeric Character Module. Chart speed, channel number and input sensitivity are automatically printed. In addition, the following information may be printed: real time, date, text of 24 lines by 50 characters, 10 "on-the-fly" 50 character messages, and 2, 15 character parameter identification lines per channel. The text can be printed once or repeated every page. Further, "on-the-fly"

messages can be printed on demand by simply entering a message reference number.

All programmable annotation is easily entered using a dumb terminal, such as Lear Siegler ADM3A. This may also be done from a computer via the M200 RS-232C port or from the IEEE-488 bus with the optional Gould IT 488 Interface Module. All data entered is retained in the M200's memory up to 30 days with the recorder turned off.

V1000 Display Monitor

The Gould V1000 high-resolution, non-fade monitor clearly displays signals, event markers, grids and alphanumerics in real time. This data may be continuously monitored on the V1000 screen without running the chart.

On the high-frequency V1000, you can view signals up to 15 kHz on the screen. Four display modes are available: roll, refresh, page and stop.

A hard copy of the display can be obtained on the chart paper on demand.

The optional Remote Control Box (Gould RC 1000) and up to two Slave Monitors are available to remotely monitor and control the system. The Gould RC 1000 provides for simultaneous control for both the ES1000 and V1000. The Slave Monitors (12" or 24" screens) duplicate the V1000 display for up to 100 meters.



V1000 Real Time Monitor

Ordering Information:

IMPORTANT: In North America, use Model Numbers in Column B. In rest of the World, use Model Numbers in Column A. For availability of ES1000 Recorders, consult your local Gould Sales Office or Representative.

ES1000 Options and Accessories

Column A	Column B	Description
23-2111-19	23-2101-19	M200 Character Generator Board with menu in English (-29, French; -39, German)
23-2111-21	23-2101-21	CRT keyboard terminal for M200
23-1111-00	23-1101-00	IT100 Blank plug-in module
23-3111-01	23-3101-01	Chart Take-up for roll paper (25 m; 82 ft. capacity)
23-3103-03A	23-3103-03A	Paper Folding Basket (ES1000 lowboy and vertical racks)
23-3111-07	23-3101-02	Paper Folding Basket (1000 sheets capacity)
23-4111-01P/R*	P/R* 23-4101-01	PA 1000 8-Module Expansion Housing
23-3111-04P/R*	P23-3111-04	V1000 High Resolution Non-fade Monitor Scope
23-3111-06	23-3111-08	V100 12" Slave Monitor Scope
23-3111-12	23-3101-12	V200 24" Slave Monitor Scope
N/A	11-1202-34	Rack mount kit, vertical for V1000
23-3111-09	23-3111-09	RC1000 Remote Control Box for ES1000 and V1000
X51792	ALX-51792	20 m Cable for V1000/V100 or V200
X51905	ALX-51905	5 m Cable for V1000/V100 or V200
23-5111-04	23-5101-04	Extender Boards, kit of five
X51011	294950-5	Shipping Anti-spill Kit

*P: Portable - R: Rackmountable

Plug-In Modules

Column A	Column B	Description
23-1111-11	23-1101-11	SP100A Analog Input, single-channel DC Amplifier
23-1111-12	23-1101-12	SP110A Analog Input, single-channel DC Amplifier, isolated zero suppression
23-1111-14	23-1101-14	SP400A 4-channel, Analog Input
23-2111-20	23-2101-20	IT160A Digital Input, Single channel
23-2111-14	N/A	IT164 Digital Input, Four-channel IEEE-488 compatible
23-2111-16	23-2101-16	IT488 IEEE-488 Interface (programming and M200)
23-2111-06	23-2101-06	IT190 Grid Line Generator
23-1111-03	23-1101-03	IT200 20 Event Marker
23-2111-17	23-2101-25	IT300 Time Code Interface
23-2111-15	N/A	SPX100 Speed Expander, 2-channel
23-2111-35	N/A	SPX100 Speed Expander, 2-channel with memory extension

GOULD SC 2132 DATA LOGGER

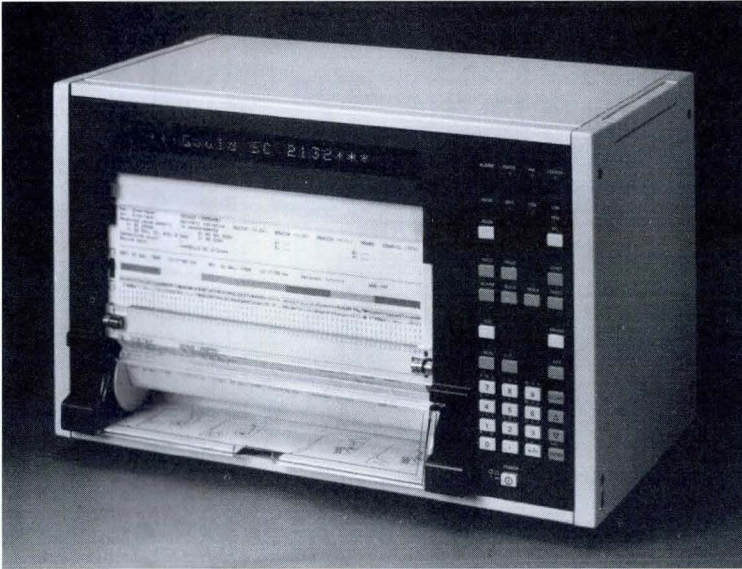

- 32 Channels without time offset
- Measuring cycle 1.5 seconds for all channels
- Measures
 - DC Voltage and current
 - AC Voltage and current
 - Temperature via thermocouples and RTDs
 - Resistance
- Easily programmable
- Stores up to seven user programs
- Seven colors for recording
- Mathematical operations
- 64 Alarm outputs
- Remote control
- Serial and parallel

The Gould SC 2132 can be used whenever monitoring, documentation, trend recording, signaling and further processing functions are required. Applications include research laboratories, heat treatment plants, motor and metal industries, power plants, environmental monitoring, and in process industries.

The Gould Data Logger is a versatile 32-channel data logger with the ability to acquire inputs from all standard thermocouples, Pt 100 RTDs, voltages, currents and resistances. It is microprocessor-controlled with all key

functions remotely controllable via computer, using either the IEEE-488 or RS-232C interfaces.

The SC 2132 is easily programmed by entering channel parameters, using the front-panel keypad and 3-1/2 digit LED display. Signals may be recorded in seven different colors, showing continuous overlapping waveshapes, or as an alphanumeric table. The Data Logger provides very clear documentation as a result of the modern ink-jet recording method.

SPECIFICATIONS

Measurement Ranges

DC Voltage: 20 millivolts to 50 Volts.

DC Current: 0 to 200 milliamperes.

AC Voltage: 0 to 500 Volts.

AC Current: 0 to 6 Amperes.

Resistance: 0 to 5000 Ohms.

Temperature: RTD type Pt 100, Ni 100, Pt 50, Pt 500, Pt 1000, Ni 50.

Thermocouple types J, T, K, N, E, S, R, B, L and U.

Limit Monitoring: 2 alarms per channel, minimum or maximum; programmable.

Limit Output: On violation of upper or lower limit or with defined change in signal.

Mathematical Functions: 32 freely programmable functions.

Recording System: Piezoelectric ink-jet system and colors plus black.

Chart Paper: 33 m roll or fanfold.

Recording Width: 250 mm, divided up to eight times.

Power: AC: 46 to 66 Hz, 903 to 264 V, approximately 80 VA. DC: 18 to 33 V, approximately 60 W.

Dimensions (Bench top configuration): 30.4 cm H x 46.6 cm W x 25.5 cm D.

Weight: Approximately 16 kg.

Options:

Alarm Output: 32 or 64 outputs with semiconductor drivers, short-circuit proof and overload proof.

Parallel Interface: IEEE-488.

Serial Interface: 20-mA (TTY), RS-232C, RS-422A, RS-423A, and RS-485.

Transmission Rate: 110-300-600-1200-2400-4800-9600 bits/s.

Ordering Information

Model Number	Description
DL-P0000-01	Portable SC 2132 Recorder, 46-66 Hz, 93-264



- Fully programmable 5600 Series
- 45 specialty and general purpose models
- Completely modular and interchangeable
- Excellent stability and linearity
- High input impedance

Gould is the established leader in signal conditioning. Its broad line of 45 general and special purpose 4600 Series Signal Conditioners is recognized as the industry standard for applications in industrial, medical and aerospace environments.

Gould now establishes a new standard of excellence with the 5600 Series Signal Conditioners which are fully programmable and can be operated remotely via computer.

Significant benefits of the 5600 Series include consistent and repeatable setup; reduction of setup time; and the elimination of "useless" data caused by improper front-panel settings.

Data Acquisition and Signal Recording starts with a "real world" (analog) signal that must be accurately reproduced.

Gould's broad range of signal conditioners are engineered to insure low level signal integrity. Features include floating and guarded input, high common mode rejection, excellent linearity, low noise output, and insensitivity to environmental changes.

Additional features of some Gould signal conditioners include:

- Attenuation
- Filtering
- Isolation
- Zero Suppression
- Digital Storage
- Calibrated Output
- High Off Ground Measurement

Further, the versatile Gould 4600 and 5600 Series are compatible with all Gould recording technologies. Whether it's the direct writing 3000, thermal array TA 2000, the electrostatic ES2000, or the computer-based instrumentation.

From DC and AC voltage/current to phase modulation and integration, Gould has a signal conditioner to meet your measurement requirements.

Use the Selection Chart on the following pages to choose the appropriate signal conditioner for your general and special purpose applications. Use the Selection Chart on pages 98 and 99 to choose the appropriate signal conditioner for your medical applications.

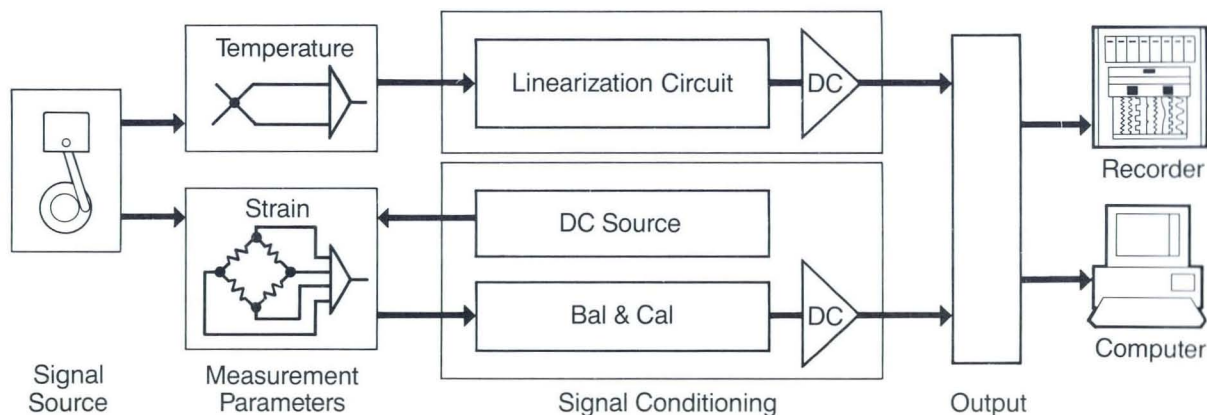

Gould Signal Conditioners

Note: All signal conditioners have identical dimensions 6.1 in. (15.5 cm) H x 2.18 in. (5.5 cm) W x 13.0 in (33.0 cm) D, weigh 3 to 4 lbs., and are totally interchangeable between recorders and portable cages.

Measurement Parameters

- Programmable DC (p. 100)
- Programmable RMS (p. 102)
- Programmable Transducer (p. 101)
- 8 Channel DC (p. 106)
- High Gain DC (p. 108)
- High Voltage DC (p. 108)
- Universal (p. 166)
- Carrier (p. 168)
- Thermocouple (p. 110)
- Temperature (p. 110)
- Bridge (p. 109)
- True RMS (p. 109)
- Log-Linear (p. 112)
- Transmitter (p. 112)
- Waveform Storage (p. 113)
- Envelope/Pulse (p. 113)
- Frequency Deviation (p. 111)
- Frequency to Voltage (p. 111)
- Integrator (p. 174)
- Differentiator (p. 175)
- Transducer (p. 167)

	Power	AC Voltage	AC Current	DC Voltage	DC Current	Strain	Torque	Pressure	Force	Flow
Programmable DC (p. 100)		■	■	■	■		■	■		■
Programmable RMS (p. 102)	■	■	■	■	■					
Programmable Transducer (p. 101)						■	■	■	■	■
8 Channel DC (p. 106)		■	■	■	■		■	■		■
High Gain DC (p. 108)		■	■	■	■		■	■		■
High Voltage DC (p. 108)		■	■	■	■		■	■		■
Universal (p. 166)		■	■	■	■	■	■		■	■
Carrier (p. 168)							■	■	■	■
Thermocouple (p. 110)										
Temperature (p. 110)										
Bridge (p. 109)						■	■	■	■	■
True RMS (p. 109)	■	■	■	■	■					
Log-Linear (p. 112)		■	■	■	■					
Transmitter (p. 112)										
Waveform Storage (p. 113)		■	■							
Envelope/Pulse (p. 113)		■	■							
Frequency Deviation (p. 111)										
Frequency to Voltage (p. 111)										
Integrator (p. 174)										
Differentiator (p. 175)										
Transducer (p. 167)							■	■	■	■

■ ■	Temperature
■ ■	Frequency
■ ■ ■ ■ ■ ■	Linear Acceleration
■ ■ ■ ■ ■ ■ ■	Linear Velocity
■ ■ ■ ■ ■ ■ ■	Linear Displacement
■	Humidity
■ ■ ■ ■ ■ ■ ■ ■	Viscosity
■ ■	Phase
■	Sound
■ ■ ■ ■ ■ ■ ■	Angular Acceleration
■ ■ ■ ■ ■ ■ ■	Angular Velocity
■ ■ ■ ■ ■ ■ ■	Angular Displacement
■ ■	Transients

PROGRAMMABLE DC AMPLIFIER

GOULD 56-1300-00

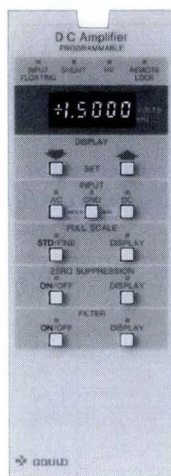

- Controllable from computer or front panel
- Memory retention
- Measurement range 10 mV to 750 V
- AC/DC coupling
- Input to output isolation
- 250 kHz bandwidth (non-isolated)
- Q position low-pass filter

The Amplifier can be operated manually from the front panel, or it is fully programmable via RS-232C or IEEE-488 interfaces. Used with a Gould 3000 Series Recorder, it provides full remote programmability and interchannel annotation of Amplifier settings. Moreover, its 250 kHz frequency response makes it an ideal front end for stand-alone use with other equipment.

Outstanding features of the Gould 5600 include: microprocessor control of gain and operating modes; integral LED indicators and

4-1/2 digit display; true zero suppression; selectable low pass filter; input-to-output isolation; high impedance differential or single-ended inputs; 10 mV to 750 VRMS full-scale sensitivity (up to 1500 V with high voltage options); and AC or DC coupling.

MODEL 56-1300-00 SPECIFICATIONS

Measurement Ranges

Isolated: 10mV to 750 V full scale.

Unisolated: 10 mV to 100 V full scale.

Standard Ranges: 10, 25, 50, 100, 250 and 500 mV; 1, 2.5, 5, 10, 25, 50, 100, 250, 500 and 1000 V.

Fine Adjustments (calibrated)

1-mV steps between 10 mV and 1 V full scale.
10-mV steps between 1 V and 10 V full scale.
100-mV steps between 10 V and 100 V full scale.
1-V steps between 100 V and 1000 V full scale.

Zero Suppression: ± 1000 V.

Frequency Response (filter switch off)

DC Coupled: flat DC to ≥ 10 kHz (isolated).

AC Coupled: -3 dB at ≤ 2.5 Hz to -3 dB at ≥ 10 kHz (isolated).

Input Circuit: Differential and balanced-to-common.

Input Coupling: AC, DC, and GND.

Input Impedance

Differential: 2 M Ω shunted by 11 pF.

Single Ended: 1 M Ω shunted by 22 pF.

Common Mode Rejection: 100 dB, inputs to output, 1k Ω unbalance, 60 Hz sine wave.

Input-to-Output Isolation: 1400 V peak AC.

Maximum Allowable Input Voltage: 100 VRMS or ± 100 VDC ≤ 1 V Full scale; 1000 VRMS or ± 1000 VDC ≥ 1 (differential input).

Output Voltage: ± 2.5 V into 2 k Ω or greater.

Filter: 2-pole Bessel; -12 dB/octave roll-off.

Non-linearity: $\pm 0.03\%$ of full-scale output.

Output Noise: Less than 10 μ V PP, 0.1 Hz to 100 Hz.
Less than 30 μ V PP, 0.1 Hz to 10 kHz.

Ordering Information

Model No.	Description
56-1300-00	Programmable DC Amplifier
CL-810413	Isolated High Voltage Connector Allows shunt measurements from 50 mV to 500 mV to be made in presence of high common mode voltages up to 1500 V peak. It has voltage gain of 10.
CL-810414	High Voltage Connector (non-isolated): Allows safe high voltage measurements up to 1500 V peak AC. It is a passive system with an attenuation of 1000:1.

PROGRAMMABLE DC/BRIDGE/TRANSDUCER AMPLIFIER

GOULD 56-1301-00



- Controlled from computer or front panel
- Measurement range from 100 μV to 1 V
- Direct front-panel calibration in gage factor or mV/volt
- Output scaled in engineering units
- Selectable bridge excitation: from 1 V to 10 VDC
- Auto zero balance
- Input-to-output isolation: ± 500 VDC

The new Gould DC/Bridge/Transducer Amplifier is used with a wide variety of resistive strain gages, strain-gage based transducers, resistance temperature devices (RTDs), and low-level signals. The user can operate it manually from the front panel, or it is fully programmable via RS-232C or IEEE-488 interfaces.

A plug-in board provides the internal connections for the bridge completion and shunt calibration resistors. The Amplifier is usable with 1/4, 1/2 or full bridge.

The new Gould Amplifier is equipped with auto-balance with a range of $\pm 50\%$ of normalized full-scale. To greatly simplify data reduction, you can scale the output in engineering units. Input-to-output isolation is standard. A fully programmable filter permits the user to eliminate all unwanted high-frequency signals.

In addition, the user has the option of using this Signal Conditioner as a stable, high-gain DC amplifier with sensitivities from 100 microvolts to 1 volt full scale.

MODEL 56-1301-00 SPECIFICATIONS

Inputs to Amplifier

Strain Gages: 1/4, 1/2 or full bridge.

Transducer: Foil or piezoresistive strain gage type.

Resistive Temperature Devices (RTD).

Low-level DC signals.

Amplifier Input

Measurement Range: 100 microvolts to 1 volt full scale.

Input Circuit: Differential and balanced to circuit common.

Input Impedance: Greater than 100 M Ω shunted by 45 pF differential.

Maximum Safe Input Voltage

Normal mode signal: 50 VDC or peak AC.

Common Mode Signal: 500 VDC or peak-to-peak (isolated).

Bias Current: Less than 15 nanoamperes.

Amplifier Output

Circuit: Single ended to common (short circuit proof to output common).

Voltage: ± 2.5 VDC or 5 V peak-to-peak.

Frequency Response: -3dB at 50 kHz without isolation; -3 dB at 10 kHz with isolation.

Noise: $\pm 0.4\%$ peak to peak from DC to 10 kHz.

Filter: 2 pole Bessel; -12 dB/octave roll-off.

Common Mode Rejection: + and - to common: Greater than 110 dB from DC to 60 Hz with 100 ohms balanced inputs to common.

Zero Suppression

Range: $\pm 1000\%$ of normalized full-scale value.

Inaccuracy: $\pm 0.3\%$ of normalized full-scale value.

Non-linearity: $\pm 0.025\%$ of normalized full-scale value.

Bridge Excitation

Voltage Range: ± 1 VDC to ± 10 VDC in 0.1 V increments at 100 milliamperes.

Voltage Sensing

Internal: Automatic.

Remote: \pm sense lines are available via the input connector.

Ordering Information

Model No.	Description
56-1301-00	DC/Bridge/Transducer Amplifier
11-5407-68	Input Connector

PROGRAMMABLE RMS AMPLIFIER

GOULD 56-1302-00

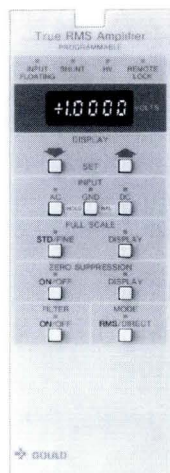

- Controlled from computer or front panel
- Wide measurement range: 10 mV to 750 VRMS full scale
- Fast response: less than 15 ms rise time
- Input-to-output isolation: 1400 VAC peak
- Calibrated zero suppression
- Wide frequency response: to 250 kHz

The Gould Programmable RMS Amplifier expands functions and performance in signal conditioning. It can be either computer controlled via IEEE-488 or RS-232C interfaces, or operated manually from the front panel. Used with a Gould 3000 Series Recorder, it provides full remote programmability and interchannel annotation of amplifier settings.

Its DC-to-250 kHz frequency response makes it an ideal front end for data acquisition systems. Input-to-output isolation permits off-ground measurements up to 750 Volts – or 1500 Volts with an optional high voltage connector. Calibrated zero suppression to 1000 Volts, AC or DC coupling, and a 15-millisecond rise time are some of the outstanding features that make the Gould

Programmable True RMS Amplifier the new industry standard.

This wide-band RMS Amplifier permits precise amplitude measurements of dynamic signals with crest factors as high as 10:1. It calculates the true RMS value of any input signal from 10 mV to 750 VRMS by continually squaring the input signal, averaging the result, and then extracting the square root. The resultant DC voltage level is the true RMS value of the incoming waveform.

In addition, this True RMS Amplifier also directly measures the RMS value of signals containing both AC and DC components. A push of a switch turns the Amplifier into a fully programmable, isolated DC Amplifier.

MODEL 56-1302-00 SPECIFICATIONS

Measurement Ranges: 10 mV to 750 V RMS.

Standard Ranges: 10, 25, 50, 100, 250 and 500 mV;
1, 2.5, 5, 10, 25, 50, 100, 250, 500 and 1000 V.

Fine Adjustments:

- 1-mV steps between 10 mV and 1 V full scale.
- 10-mV steps between 1 V and 10 V full scale.
- 100-mV steps between 10 V and 100 V full scale.
- 1-V steps between 100 V and 1000 V full scale.

Zero Suppression: ± 1000 V.

Frequency Response:

RMS Mode: 30 Hz to 250 kHz for full scale up to 100 V
30 Hz to 100 kHz for full scale over 100 V.

Direct Mode: DC to 10 kHz.

Input Circuit: Differential and balanced-to-common.

Input Coupling: AC, DC, and GND.

Input Impedance:

- Differential:** 2 M Ω shunted by 11 pF.
- Single Ended:** 1 M Ω shunted by 22 pF.

Common Mode Rejection: 100 dB at 60 Hz with 1 k Ω unbalance.

Input to Output Isolation: 1400 V peak AC.

Maximum Allowable Input Voltage:

- For full scale ≤ 1 V FS: 100 VRMS.
- For full scale > 1 V FS: 750 VRMS each input to common or 1000 VRMS between inputs.

Output Voltage: ± 5 V into 2 k Ω or greater.

Output Impedance: Less than 1 Ω DC to 10 kHz.

Non-linearity: $\pm 0.15\%$ of full-scale output.

Output Noise: Less than 20 μ V PP, 0.1 Hz to 100 Hz.
Less than 50 Ω μ V PP, 0.1 Hz to 10 kHz.

Ordering Information

Model Number	Description
56-1302-00	Programmable RMS Amplifier
CL-810413	Isolated High Voltage Connector
CL-810414	High Voltage Connector (non-isolated)

PROGRAMMABLE THERMOCOUPLE AMPLIFIER

GOULD 56-1303-00

- Controllable from computer or front panel
- Direct read-out in °F or °C
- Measurement range from -200°C to +1000°C

This multiplexed, 2-channel Programmable Thermocouple Amplifier will accept inputs from type J, K and T thermocouples with temperature ranges from -200°C to +1000°C.

Open collector alarm outputs are standard. It may be operated remotely from a bus or locally with front panel controls. Isolation from input to output common or chassis is 500 Volts DC or peak AC. Temperature measurements may be in degrees Celsius or Fahrenheit.

MODEL 56-1303-00 SPECIFICATIONS

Measurement Range:

Type J: -150°C to +1000°C.

Type K: -200°C to +1000°C.

Type T: -200°C to +400°C.

Input Circuit: Single ended, floating.

Common Mode Rejection: 100 dB at 60 Hz.

Amplifier Output:

Inaccuracy: Within 0.5°C.

Voltage: ±2.5 Volts into 2-kΩ load.

Frequency Response: -3 dB at >500 Hz.

Noise: ±0.5% of full scale.

Alarm Output: Light coupler isolated open collector NPN transistor, CMOS and TTL compatible. Separate outputs for each channel high and low limits.

Ordering Information

Model Number	Description
56-1303-00	Programmable Thermocouple Amplifier

Available Second Quarter 1989.

DUAL CHANNEL DC AMPLIFIER

GOULD 56-2400-00

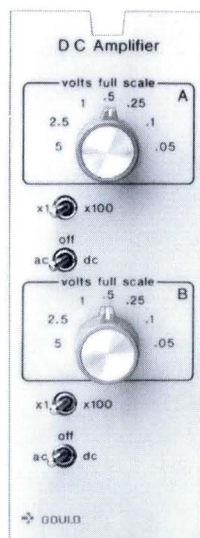

- Space saving, dual channel configuration
- Floating input: operates up to 1000 V peak off-ground
- 14 full-scale ranges from 50 mV to 500 V
- Maintenance free factory set calibration
- AC ODD DC input coupling
- Broad bandwidth: 5 kHz (-3 dB)
- Isolated input/output channel/channel: use as input isolator to oscilloscopes and other instrumentation

The Gould Dual Channel Signal Conditioner saves instrument panel space. Two channels occupy the same space previously used by only one. Full electrical isolation allows operation of two totally independent DC channels. Each channel has its own gain selector and an independent coupling switch.

The Dual Channel Signal Conditioner is designed to work with all Gould Recorders and Digital Data Acquisition Systems or as a stand-alone Amplifier.

Each amplifier input is single ended and can be grounded or floated up to 1000 volts peak above ground.

MODEL 56-2400-00 SPECIFICATIONS

Amplifier Input

Measurement Range: 50 millivolts full scale to 500 volts full scale.

Standard Ranges: 50, 100, 250 and 500 mV, 1, 2.5 and 5 V plus x 100 range.

Circuit: Floating, single-ended referenced to Amplifier isolated common. Isolated common connected to chassis by 1000 pF, 1 kV capacitor.

Floating: Input is floating from the output and chassis.

Coupling: AC/OFF/DC front panel selective. (-3 dB at approximately 2.5 Hz in AC).

Range-to-Range Inaccuracy: $\pm 0.5\%$ of full scale.

Maximum Input Voltage: 600 Volts peak for one minute at x1 setting.

Dielectric Withstand: 750 Volts RMS input to other input or to output/chassis.

Bias Current: Less than 75 pA at 25°C.

Amplifier Output

Both amplifiers (channels) share the same output and power common.

Voltage: ± 5 V with 2 k Ω load.

Frequency Response: DC to 5 kHz minimum at -3 dB.

DC Non-linearity: 0.4% of full scale.

Noise: 0.2% full scale, 0.1 to 10 Hz referred to input.

DC Inaccuracy: 1% of full scale reading, exclusive of drift.

Common Mode Rejection: 90 dB at 60 Hz with 1-k Ω unbalance in DC mode. (Common mode voltage applied between isolated common and chassis, at most sensitive range.) 140 dB at DC with 1-k Ω unbalance. (Common mode voltage to have less than 100- μ s rise time.)

Ordering Information

Model No.	Description
56-2400-00	Dual Channel DC Signal Conditioner.

GOULD MODELS 56-1340-00 AND 56-1440-00 IS SERIES DC AMPLIFIERS



Gould 56-1440-00
Basic DC Amplifier

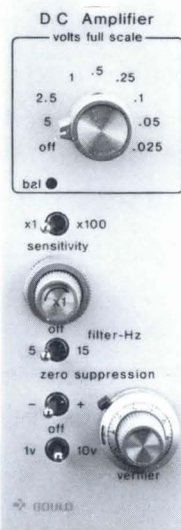

Gould 56-1340-00 General
Purpose DC Amplifier

- Wide input range: 25 mV to 500 V
- Calibrated zero suppression
- Input-to-output isolation
- Status reporting: front panel status for recorder annotation
- Wide frequency range: 10 kHz isolated

These general-purpose, direct-coupled Amplifiers are designed to be used with Gould direct writing recorders or as stand-alone units. Each is isolated from input to output and operates at up to 500 V off ground. A low-pass filter is provided to eliminate objectionable high frequency signal components.

The optional, user-installable, Status Reporting Board supplies all status information to the inter-channel annotation of the Gould 3000 Series Recorder.

For the Gould 56-1340-00, true input signal Calibrated Zero Suppression is provided with 8 full-scale ranges. A calibrated reading, with a resolution of one part per thousand, is provided on each full-scale range. This allows the static portion of a complex signal to be suppressed a *known* amount and the dynamic portion to be amplified for a more detailed evaluation.

MODELS 56-1340-00 AND 56-1440-00 SPECIFICATIONS

For 56-1440-00 Basic DC Amplifier and 56-1340-00 General Purpose DC Amplifier

Measurement Range: 25 mV FS to 500 V FS.

Attenuator Steps: 0.025, 0.05, 0.1, 0.25, 0.5, 1.0, 2.5 and 5.0 V FS, OFF plus x100 multiplier.

Sensitivity Vernier: Provides up to 2.5 times calibrated setting.

Input Impedance

X1 Multiplier: 2 M Ω differential; 1 M Ω each terminal to common.

X100 Multiplier: 100 M Ω differential; 56 M Ω each terminal to common.

Common Mode Rejection

DC at 1-k Ω unbalance: Greater than 120 dB.

60 Hz at 1-k Ω unbalance: Greater than 100 dB.

Maximum Allowable Input Voltage: 500 VDC or peak AC; inputs to input common.

Frequency Response

With Isolator Module: 10 kHz.

Without Isolator Module: 35 kHz.

For 56-1340-00 Amplifier Only

Frequency Response

Filter Switch Off: Less than 3 dB down at 10 kHz, 35 kHz without isolation module.

Zero Suppression Ranges: ± 10 , ± 1 VDC and OFF. Can be multiplied x100 (usable only to ± 500 maximum).

Resolution: $\pm 0.1\%$ of full suppression range.

Status Reporting Board, 11-4220-00

Front Panel Settings Indicated: Volts full scale (the numerical value), sensitivity, input divider, model type and zero suppression (on/off).

Status Connector Cable: 6 in., 20-pin DIN cable.

Rear Connector: 48-pin DIN connector.

Weight: 0.35 lbs.

Dimensions: 5 in. (12.7 cm) H x 9.1 in. (23.1 cm) L.

Power Requirements: Less than 50 mA at +5 V.

8-CHANNEL DC AMPLIFIER

GOULD 48-8400-01

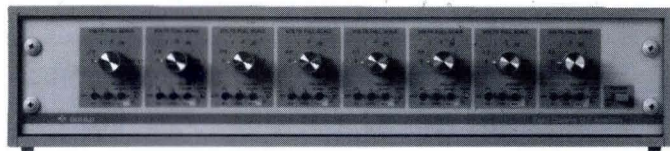

- AC-OFF-DC Coupling
- Input to output and channel to channel isolation
- Polarity reversal
- 5 kHz frequency response
- 5 V peak standard output – selectable to 10 V peak
- Low profile configuration

The Gould 48-8400-01 Amplifier is a low profile, 3-1/2 inch high, 8-channel amplifier with sensitivity from 50 millivolts to 500 volts. Frequency response is 5 kHz. The input is isolated from the output, chassis and adjacent channels. Additional features include AC/DC

coupling and polarity reversal. Excitation voltage of 12 volts at 1 ampere is optional.

Sensitivity control is provided, allowing full-scale adjustment from 20 millivolts to 500 volts.

MODEL 48-8400-01 SPECIFICATIONS

Amplifier Input

Measurement Range: 50 mV to 500 V.

Circuit: Single ended; Floating; referenced to individual amplifier isolated common.

Impedance: 1 M Ω shunted by less than 150 pF.

Coupling: AC/OFF/DC (-3dB at 2 Hz in AC).

Range-to-Range Inaccuracy: + or - 0.5% of full scale.

Amplifier Output

Circuit: Single ended referenced to amplifier(s) common. Each isolated common is connected to chassis through 2 kV, 1000 pF capacitor.

Stability: Stable with 2 k Ω load in parallel with 1000 pF.

Voltage: 5 V peak standard. (Up to 10 V peak with plug-in resistor.

DC Non-Linearity: 0.4% of full scale.

DC Inaccuracy: 0.5% of full scale exclusive of drift.

Frequency Response: DC to 5 kHz minimum at -3 dB.

Stability:

Zero vs Temperature: 50 μ V/ $^{\circ}$ C, RTI, measured at maximum gain.

Zero vs Line: 0.1% F.S. for 10% line change.

Zero vs Time: Less than 50 μ V/24 hours.

Gain vs Temperature: \pm 0.02%/ $^{\circ}$ C.

Gain vs Line: \pm 0.01 % for 10% line change.

Gain vs Time: \pm 0.05%/1000 hours.

Noise: 0.2 % F.S. 0.1 to 10 Hz. (RTI)

Common-Mode-Rejection: 90 dB at 60 Hz with 1 k Ω unbalance. 140 dB at DC with 1 k Ω unbalance.

Channel-to-Channel Crosstalk

Input switch at X 1: 110 dB down at 5 kHz Sine.

Input switch at X 100: 75 dB down at 5 kHz Sine.

Power Requirements: 110/220 V, 50/60/400 Hz consumption less than 30 watts.

Input Connector: 8 each, CL-211126-12.

Mating Connector: 8 each, CL 211125-12.

Output Connector: 37 π Pin " D " connector, 296509-37.

Dimensions: 3.5 in. H x 19 in. W x 16 in. D (8.9 cm x 48.3 cm x 40.6 cm).

Weight: 10 lbs. (4.5 kg).

Ordering Information

Model Number	Description
48-8400-01	8-Channel DC Amplifier
CL-211126-12	Input connector
CL-211125-12	Mating connector
297707-37	Output connector, 37 π pin D

GOULD 13-G4615-35 Carrier Amplifier



- Measures pressure, force, position
- Provides AC excitation for LVDT, variable reluctance and strain gage transducers
- Push-button auto balance
- Calibrated zero suppression
- Easy synchronization of multiple units

The Gould Carrier Amplifier measures pressures, forces, and displacement with unprecedented ease. By replacing separate, interactive R and C balance controls with electronic auto balance, as well as auto phase lock of excitation and signal, it provides features never before available to users of AC excited transducers. In multiple transducer applications, two features are important — Carrier oscillators can be synchronized to eliminate interference, and all Carrier Amplifiers can be balanced with a single command.

See page 168 for more details.

MODEL 13-G4615-35 SPECIFICATIONS

Measurement Range: 50 μV to 10.5 VRMS FS.

Input Configuration: Differential balanced to guard, and isolated from ground. Impedance: 1 M Ω at 2.5 kHz each input.

Sink Risk Leakage Current: < 10 μA at 120 VRMS, 60 Hz between any input (including excitation terminals) and chassis.

Noise (350- Ω unbalance): 10 μV p-p referred to input, residual carrier at output < 0.25% of FS.

Common Mode Rejection: > 120 dB at 60 Hz with 350- Ω unbalance measured at 100 μVRMS FS, input to chassis.

Step Sensitivity: 10 - 1000 units plus x100 input attenuator.

Zero Suppression: 0 to ± 100 or 0 to ± 1000 units.

Auto Balance

Range: 0 to ± 10 mVRMS referred to input (R and C balance), variable via plug-in balance resistor.

Resolution: 1 : 2048.

Remote Balance Command: TTL compatible or momentary short to common will initiate action.

Frequency Response: Direct DC to 200 Hz plus mean.

Transducer Excitation

Voltage: Adjustable from 2 to 10 VRMS, isolated from chassis; maximum load 0.285 W.

Frequency: 2500 Hz $\pm 5\%$ sine wave.

Synchronization: Jumper selectable master or slave.

GOULD 13-G4615-58 Universal™ Amplifier



- General purpose AC or DC signals from 25 μV to 10 V FS.
- Pressures, forces and displacements from strain gage transducers directly in units of measure.
- Combines high input impedance, wide bandwidth, low noise and low drift into one amplifier.

This 10-kHz Amplifier combines high impedance input, high gain, and low noise required for precise recordings. One-mV or 50- μV cal signals and a full range of high-pass and low-pass filters permit the Amplifier to easily reproduce the most demanding signal.

The Universal Amplifier's stable DC excitation makes precise measurements of pressure, force, and position. The optional Isolated Preamp provides isolation and true AC coupling, while putting the first gain stage close to the signal source to reduce signal loss and noise.

See page 166 for more details.

MODEL 13-G4615-58 SPECIFICATIONS

Input Configuration: Differential and balanced to chassis ground.

Sink Risk Leakage Current (with preamp): < 10 μA at 230 VRMS, 60 Hz, inputs to chassis.

Input Impedance: > 100 M Ω each input to chassis.

Measurement Range (full scale): 25 μV to 10 V FS.

Frequency Response (Adjustable): DC-10 kHz (-3 dB).

Maximum Safe Input Voltage: 120 VRMS input to chassis.

Internal Calibration Signal: Selectable between 50 μV and 1 mV within $\pm 1\%$ to 25°C.

Bridge Excitation (mV and mV x100 only): 5 VDC ± 5 mV (adjustable via plug-in resistor), polarity reversible.

GOULD 13-G4615-20 High Gain DC Amplifier



- High gain – 50 μ V full scale
- Solid state input chopper
- Calibrated zero suppression
- Input-output isolation
- Common mode rejection > 160 dB
- Low-pass output filter – 5 positions from 5 Hz to 120 Hz

This versatile high gain DC amplifier has a measurement range from 50 μ V to 250 V full scale. The solid-state input chopper does not wear out, become noisy or require periodic replacement. In addition, the calibrated zero suppression resolves one part per thousand on each of the 12 ranges.

MODEL 13-G4615-20 SPECIFICATIONS

Measurement Range: 50 μ V to 250 V FS.

Attenuator Steps: 0.05, 0.1, 0.25, 0.5, 1, 2.5, 5, 10, 25, 50, 100, 250 mV FS and OFF plus millivolts-volts multiplier switch.

Attenuator Inaccuracy: \pm 0.5% of calibrated step.

Sensitivity Vernier: Provides up to 2.5 times calibrated setting.

Input Circuit: Differential, floating, isolated and guarded.

Input Impedance: 1 M Ω on all ranges.

Common Mode Rejection

DC at 1 k Ω unbalance: > 160 dB on most sensitive range.

60 Hz at 1 k Ω unbalance: > 140 dB on most sensitive range.

120 VRMS on millivolts ranges.

250 VRMS on volts ranges.

250 VDC or peak AC.

Output Noise: Less than 3% of full scale, peak-to-peak at max. sensitivity DC to 50 Hz.

Frequency Response: DC to 120 Hz, down 3 dB. Flat within 0.5 dB DC to 50 Hz.

Filter Selector Switch: 3 dB down at 120 Hz, 50 Hz, 25 Hz, 10 Hz or 5 Hz.

Filter Roll-off: 12 dB/octave or 40 dB/decade.

Calibrated Zero Suppression Ranges: +100, +10, +1, OFF, -1, -10, -100 V or mV.

GOULD 13-G4615-90 High Voltage Amplifier



- Calibrated zero suppression
- Broad range – 2.5 mV to 1500 VDC
- Five low-pass output filters
- Operates off ground to 1500 V
- High input impedance
- “High-Pot” tested at 4000 VDC

The High Voltage DC Amplifier is a medium bandwidth, differential DC amplifier with an isolated output and fully floating, guarded input, capable of rejecting common mode voltages up to \pm 1500 V full scale. This special purpose DC amplifier has a common mode rejection greater than 140 dB and is designed to provide clean, crisp output signals in hostile industrial environments or in areas where high inrush currents, high voltages or other electrical noise is expected.

MODEL 13-G4615-90 SPECIFICATIONS

Measurement Range: 2.5 mV FS to 1500 V FS.

Attenuator Steps: 0.025, 0.05, 0.1, 0.25, 0.5, 1, 2.5, 5, 10, 25 V FS, OFF, plus x100 multiplier \pm 0.4% of calibrated step.

Attenuator Inaccuracy: \pm 0.4% of calibrated step.

Sensitivity Vernier: Provides up to 2.5 times calibrated setting.

Input Circuit: Fully floating, isolated, guarded and fused.

Input Impedance: 1.0 M Ω in x1 and 10.00 M Ω in x100 Sensitivity multiplier position.

Common Mode Rejection:

DC at 1 k Ω unbalance: Greater than 140 dB.

60 Hz at 1 k Ω unbalance: Greater than 120 dB.

Rated Input Voltage: \pm 1500 VDC or peak AC.

Rated Common Mode Voltage: \pm 1500 VDC or peak AC.

High Pot. Test (all inputs to chassis): 4000 VDC for 10 s.

Frequency Response:

With filter at 1 kHz: Flat 0 to 100 Hz \pm 1.0%; 6 dB down at 1.0 kHz \pm 10%.

With filter at 100 Hz: 6 dB down at 100 Hz \pm 10%.

With filter at 25 Hz: 6 dB down at 25 Hz \pm 10%.

Filter Roll-off: 12 dB/octave or 40 dB/decade.

Calibrated Zero Suppression

Span: 0 to 100% of each input attenuator position.

Ranges: 40 ranges from \pm 2500 V to 25 mV.

Resolution: \pm 0.1% of suppression range.

Nonlinearity: \pm 0.25% of suppression range.

Inaccuracy (At 25°C and nominal line): \pm 0.5% of suppression range.

GOULD 13-G4615-30 DC Bridge Amplifier



- 25 to 10,000 microinches/in. full scale
- Direct front panel calibration
- Selectable bridge excitation
- Low-pass output filtering
- Adjustable shunt calibration
- Calibrated zero suppression

This high-gain DC Bridge Amplifier is designed for operation with strain gages, passive transducers, resistance temperature devices and low-level DC input signals. This amplifier has internal switching for selection of 5 or 10 VDC excitation, positive or negative shunt calibration and bridge polarity reversal. Internal binding posts are provided for mounting bridge completion resistors assuring compatibility with virtually all transducers including half bridge and quarter bridge.

MODEL 13-G4615-30 SPECIFICATIONS

Measurement Range (Using a four-active-arm bridge with a gage factor of 1): 250 μ V FS to 100 mV FS. 25 microinches per inch FS to 10,000 microinches per inch FS.

Sensitivity or Gage Factor: Direct front panel calibration for transducers of 1 mV/V to 10 mV/V sensitivity. (100 Ω to 1000 Ω strain gage based transducers)

Attenuator Steps: 5, 10, 20, 50, 100 and 200% of load FS and OFF.

Attenuator Inaccuracy: $\pm 0.5\%$ of calibrated step.

Calibrate Vernier: Provides calibrated sensitivity adjustment from 1 mV/V to 10 mV/V.

Input Circuit: Differential and floating.

Input Impedance: 50 k Ω .

Common Mode Rejection

DC at 350 Ω unbalance: Greater than 130 dB on most sensitive range.

60 Hz at 350 Ω unbalance: Greater than 100 dB on most sensitive range.

Max. Allowable Input Voltage: 50 VDC or peak AC across input terminals. 500 VDC or peak AC from common to chassis.

Frequency Response

Without Filter: DC to 100 Hz $\pm 0.5\%$ (Less than 3 dB down at 5 kHz).

With Internal 5 Hz Filter: 3 dB down at 5 Hz $\pm 10\%$.

Filter Rolloff: 12 dB/octave or 40 dB/decade.

Calibrated Zero Suppression

Ranges: ± 100 , ± 10 mVDC and OFF.

Resolution: $\pm 0.1\%$ of full suppression range.

GOULD 13-G4618-10 True RMS Amplifier



- Bandwidth down 0.3 dB at 10 kHz
- Input protected to 1000 VRMS
- Full floating 1500 V off ground
- Calibrated zero suppression
- Crest factor up to 10:1
- Wide measurement range – 5 mV to 1000 VRMS, 50 mA to 10 A RMS

This wide-band True RMS Level Amplifier permits precise amplitude measurement of AC voltage and current waveforms with crest factors as high as 10:1. It calculates the true RMS value of any incoming AC waveform by continuously squaring the input signal, averaging the result and extracting the square root. This becomes a DC voltage level that is the true RMS value of the incoming waveform. Fast response (less than 25 ms) to a step input allows the True RMS Amplifier to detect power line surge or sag anomalies.

MODEL 13-G4618-10 SPECIFICATIONS

Measurement Range: 5 mV RMS FS to 1000 VRMS FS. 50 mA RMS FS to 10 A RMS FS.

Attenuator Steps: .05, .1, .25, .5, 1, 2.5, 5, 10 V FS, OFF plus x100 multiplier and .5, 1, 2.5, 5, 10 A FS and OFF.

Range Steps: x1, x.5, x.2, x.1.

Attenuator Inaccuracy: x1 V Mode: $\pm 0.2\%$ reading; x100 V Mode: $\pm 1.5\%$ reading; x10 A Mode: $\pm 1.5\%$ reading.

Sensitivity Vernier: Provides up to 2.5 times calibrated setting.

Input Circuit: Differential, floating and shielded.

Input Impedance

x100 V Mode: 1 M Ω .

x1 V Mode: 100 k Ω .

Current Mode: 0.1 Ω .

Crest Factor: 10 to 1.

Common Mode Rejection Voltage (60 Hz with 100 Ω unbalance): 80 dB on most sensitive range.

Maximum Allowable Input Voltage: 1000 VRMS on any range.

Input Voltage Isolation: 1500 V peak AC, from input to output.

Output Noise (at 50 Hz)

Filter Switch Off: Less than 25 mV FS on x1 range.

Filter Switch On: Less than 2.5 mV FS on x1 range.

Frequency Response: 50 Hz to 5,000 Hz, less than -2% or .175 dB. 5 kHz to 10 kHz, $< 4\%$ down or 0.35 dB.

Rise Time (10% to 90% full scale)

Filter Switch Off: Less than 25 ms.

Filter Switch On: Less than 60 ms.

Thermocouple



13-G4615-40 Type J
 13-G4615-41 Type K
 13-G4615-42 Type T
 13-G4615-43 Type E
 13-G4615-44 Type R
 13-G4615-45 Type S

- Cold junction compensation
- Electronic linearization
- Direct read-out in °F or °C
- Open thermocouple indication

This high gain Thermocouple Amplifier permits precise temperature recording directly in degree Fahrenheit or degree Celsius over a wide range from -250 to +2500 full scale. A 15-point electronic thermocouple linearizer provides automatic correction for the nonlinearity of each standard thermocouple type. Calibrated Zero Suppression is provided to suppress the static portion of any complex temperature signal, allowing the dynamic portion to be expanded for more detailed evaluation.

THERMOCOUPLE SPECIFICATIONS

Measurement Range: -250 to +2500 °C or °F, dependent on thermocouple type.

Attenuator Steps: 50, 100, 250, 500, 1000 and 2500° FS, plus OFF.

Attenuator Inaccuracy: ±0.25% of calibrated step.

Sensitivity Vernier: Multiplies calibrated setting up to 2.5 times.

Input Circuit: Single-ended to floating common.

Input Impedance: 1.0 MΩ.

Maximum Source Resistance: 100 Ω.

Common Mode Rejection

DC at 100 Ω unbalance: Greater than 120 dB.

60 Hz at 100 Ω unbalance: Greater than 80 dB.

Maximum Allowable Input Voltage: 500 VDC or peak AC from common to chassis.

Nonlinearity (Over linearized range)

Thermocouple types "J", "K", "T", and "E": Within 0.55°C or 1.0°F.

Thermocouple types "R" and "S": Within 1.5°C or 3.0°F.

Frequency Response

Internal Filter Off: 3 dB down at 200 Hz.

Internal Filter On: 3 dB down at 5 Hz ±10%.

Filter Rolloff: 6 dB/octave or 20 dB/decade.

Calibrated Zero Suppression

Ranges: -250°, OFF, +250°, +1000° and +2500°.

Resolution: ±0.1% of suppression range.

GOULD 13-G4615-47 Temperature Amplifier



- High sensitivity – up to 2° full scale
- Digital zero suppression
- Wide range – 2 to 1000°F/°C
- Supports copper or nickel RTDs
- Input floats 500 V off ground

The Gould Temperature Amplifier is an excellent choice in applications where maximum temperature resolution is required. At full sensitivity of 2°, temperature resolution of 1/100 of a degree is attained in normal operation without any special calibration. Gould's innovation in the art of continuous analog temperature measurement, gives digital zero suppression with a range from ±1° to ±999° and precise electronic linearization, up to 0.2% of full scale for platinum RTDs.

MODEL 13-G4615-47 SPECIFICATIONS

Measurement Range (Directly in °F or °C): ±2° to ±1000°.

Attenuator Steps: 2, 5, 10, 25, 50, 100, 250, 500, 1000° FS, plus OFF.

Attenuator Inaccuracy: ±0.25% of calibrated step.

Standard Input Sensors (No recalibration required): 100, 200, 500 or 1000 Ω, 4-wire, Platinum (385) RTDs or Yellow Springs Instrument (YSI), 400 Series Thermistor Probes.

Sensitivity Vernier: Multiplies calibrated setting up to 2.5 times.

Input Circuit: 4-wire, differential to floating common.

Input Impedance: 1.0 MΩ.

Maximum Allowable Input Voltage: 260 VRMS across input terminals. 500 VDC or peak AC from common to chassis.

Output Noise (on most sensitive range): Less than ±0.2% of full scale.

Frequency Response: 3 dB down at 10 Hz ±20%.

Calibrated Zero Suppression: 0 to ±999° in 1-degree steps.

Resolution: 1°F or 1°C.

Inaccuracy (at 25°C and nominal line): ±0.2% of suppression reading ±0.05°.

Platinum RTD Excitation Current: 2 mA at 100 Ω 1 mA at 200 Ω; 0.4 mA at 500 Ω; 0.2 mA at 1 kΩ.

Display Output Voltage: 100 mV/°F or °C, 0 to 100° max.; 10 mV/°F or °C, 0 to 1000° max.

Thermistor Probe Operation: Use YSI 400 Series Thermistor Probes.

Range: 0-42°C.

Linearity: Within ±0.5°C from 4°C to 40°C. Within ±1°C from 0°C to 42°C.

Excitation: Approx. 765 mVDC, internally supplied.

GOULD 13-G4618-00 Frequency Deviation

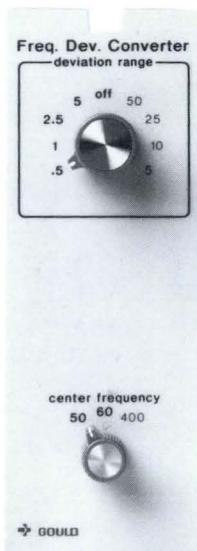

- Excellent frequency resolution
- Three center frequencies
- Input voltage 10 to 500 VRMS
- Isolation — 1500 V input to output isolation
- Response time < 100 ms

The Gould Frequency Deviation Converter detects the zero crossing of any AC waveform and outputs a DC voltage which is directly proportional to the frequency above or below the standard center frequencies of 50, 60 or 400 Hz. Applications cover a wide variety, from monitoring the speed regulating governors and electronic synchronizing equipment to detecting fluctuations in frequency due to system instability, step changes in load and transmission line switching anomalies.

MODEL 13-G4618-00 SPECIFICATIONS

Center Frequency: (factory preset): 50 Hz, 60 Hz, or 400 Hz $\pm 0.025\%$.

Measurement Ranges (full scale): 49.5-50.5, 49-51, 47.5-52.5 or 45-55 Hz; 59.5-60.5, 59-61, 57.5-62.5 or 55-65 Hz; 395-405, 390-410, 375-425 or 350-450 Hz.

Range Switch Inaccuracy: $\pm 0.2\%$ of reading.

Input Circuit: Fully floating and isolated from output.

Input Impedance: 100 k Ω (20 W).

Common Mode Rejection

DC at 1000 Ω unbalance: 120 dB at 100-V input.

60 Hz at 1000 Ω unbalance: 80 dB at 100-V input.

Input Voltage (nominal rating): 10 to 500 VRMS.

Maximum Safe Input Voltage: 700 VRMS

Input Voltage Isolation: 1500 V-P, from input to output or input to chassis.

Zero Line Instability (After 30-minute warm-up): $\pm 0.02\%$ of center frequency for 24 hours; $\pm 0.02\%$ of center frequency per $^{\circ}\text{C}$.

Gain Instability (After 30-minute warm-up): $\pm 0.02\%$ of reading for 24 hours; $\pm 0.08\%$ of reading per $^{\circ}\text{C}$.

Output Noise (peak-to-peak): > 10 mV.

Rise Time: > 100 ms (10%-90%).

Overshoot: > 0.5% of selected range.

Operating Temperature: 0°C to $+50^{\circ}\text{C}$ ($+32^{\circ}\text{F}$ to $+122^{\circ}\text{F}$).

Storage Temperature: -40°C to $+75^{\circ}\text{C}$ (-40°F to $+167^{\circ}\text{F}$).

Humidity: 95% to $+35^{\circ}\text{C}$ ($+95^{\circ}\text{F}$) non-condensing.

GOULD 13-G4618-20 Frequency-to-Voltage

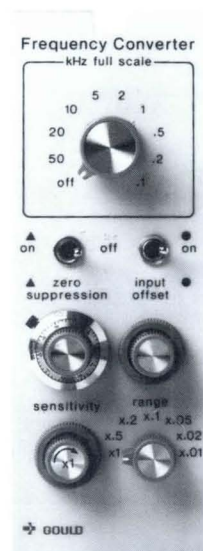

- Wide frequency measurement range 10 Hz to 50 kHz
- Wide voltage range 10 mV to 500 V
- Calibrated zero suppression
- Floating input — 1500 V isolation from input to output

This wide-band Frequency-to-Voltage Converter permits direct measurement of frequency or signal repetition rate over a range from 10 Hz to 50 kHz. It detects the zero crossing of any AC waveform, converting it to a DC voltage directly proportional to input frequency. The Converter input is virtually insensitive to voltage, converting AC waveforms between 10 mVRMS and 500 VRMS. The dynamic portion of the signal is easily expanded using the zero suppression to suppress up to 90% of the original signal.

MODEL 13-G4618-20 SPECIFICATIONS

Measurement Range: 10 Hz FS to 50 kHz FS.

Attenuator Steps: 0.1, 0.2, 0.5, 1, 2, 5, 10, 50 kHz FS.

Range Steps: x1, x0.5, x0.2, x0.1.

Attenuator Inaccuracy: $\pm 0.01\%$.

Sensitivity Vernier: Provides up to 2.5 times calibrated setting.

Input Circuit: Input No. 1 — Single ended floating.

Input No. 2 — For use with optical couplers.

Available LED current — 50 mA maximum at 12 V (with 220 Ω in series). Current Sink Requirement — 120 μA $\pm 10\%$.

Input Impedance: 100 k Ω .

Common Mode Rejection: (60 Hz at 1 k Ω unbalance): 80 dB.

Input Voltage: 10 mV RMS to 500 V RMS.

Maximum Allowable Input Voltage: 700 V DC or peak AC.

Input Voltage Isolation: 1500 V peak from input to output or input to chassis.

Output Noise: Less than 5 mV peak-to-peak.

Rise Time (10% to 90% full scale with less than 2% overshoot. Rise time is not affected by range switch):

0.1, 0.2, 0.5 kHz FS: < 200 ms.

1, 2, 5 kHz FS: < 20 ms.

10, 20, 50 kHz FS: < 2 ms.

Calibrated Zero Suppression

Ranges: 0 to 100% of selected attenuator setting.

Resolution: 0.1% of full scale.

Signal Input Connector: Guarded multi-pin mating connector supplied with each Converter (Model No. 11-5407-03).

GOULD MODEL 13-G4614-01 Log-Linear

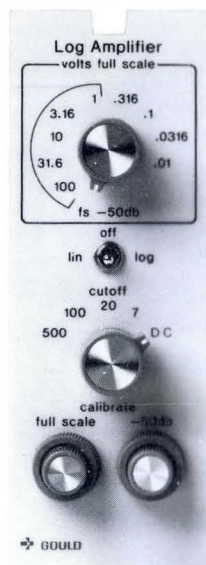

- AC Log-Linear Operation from 10 to 100 kHz
- DC Log-Linear Operation from DC to 400 Hz
- 130 dB measurement range
- Internal AC calibration
- 10 M Ω input impedance

The Log-Linear Amplifier is a specialized wide-band direct-coupled AC or DC Amplifier whose logarithmic output is calibrated in decibels below a preset full-scale value. When operated as a Log Amplifier, the preset full-scale amplitude appears on the left chart edge, and right chart edge is an amplitude which is exactly 50 dB down from the full-scales value. In the AC mode it senses the average value of incoming signals and is calibrated in terms of the RMS values of a sinusoidal waveform.

MODEL 13-G4614-01 SPECIFICATIONS

Measurement Range:

AC: 10 mVRMS FS to 100 VRMS FS.

DC: 1 V FS to 100 V FS.

Attenuator Steps: 0.01, 0.0316, 0.1, 0.316, 1, 3.16, 10, 31.6, 100 VRMS FS plus FS, and -50 dB.

Attenuator Inaccuracy: ± 0.2 dB.

Maximum Sensitivity: Log: 50 dB FS. AC: 10 mV FS. DC: 1 V FS.

Input Circuit: Single ended to common.

Input Impedance: 10 M Ω , constant, shunted by less than 80 pF (on all attenuator positions).

Maximum Allowable Input Voltage: 10x input attenuator setting - up to 300 V maximum.

Maximum Safe Input: 100 VDC or peak AC on .01 to 1 V ranges; 300 V on 3.16 to 100 V ranges.

Maximum Off-Ground Voltage: 500 V to chassis.

Frequency Response

AC Mode: Less than 1 dB down at 100 kHz.
Less than 3 dB down at 150 kHz.

DC Mode: Less than 1 dB down at 200 Hz.
Less than 3 dB down at 400 Hz.

Rise Time (10-90%) for 50 dB Change.

Filter Position in 7 Hz Cut-off: Less than 400 ms.

Filter Position in 20 Hz Cut-off: Less than 100 ms.

Filter Position in 100 Hz Cut-off: Less than 20 ms.

Filter Position in 500 Hz Cut-off: Less than 4 ms.

Filter Position in DC Cut-off: Less than 2 ms.

Internal Calibration (FS): 1.000 VRMS at 1000 Hz/1 VDC.

GOULD MODEL 13-G4618-40 Transmitter

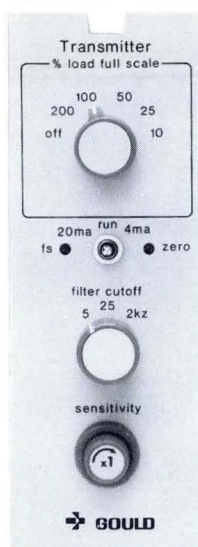

- Accommodates all standard current output transmitters
- Internal voltage source
- Adjustable zero suppression
- Low pass output filter: 5 Hz, 25 Hz and 2 kHz
- Low-gain DC amplifier

The Gould Transmitter Amplifier is ideal for accurately and dependably measuring process data from industrial transmitters and high signal output transducers. Its output can drive a digital indicator for numeric display and/or Gould recorder for permanent chart records. Exceptional measurement resolution is provided by a five-step front panel sensitivity control which has a range of 10 to 200% of rated full scale input. An adjustable voltage source provides up to 50 mA at 28 VDC for 2- and 4-wire transmitters.

MODEL 13-G4618-40 SPECIFICATIONS

Measurement Range: 1-5 mA, 4-20 mA, 10-50 mA and 0-5 VDC (Internally Selectable).

Attenuator Steps: 10, 25, 50, 100 and 200% of load FS plus OFF.

Sensitivity Vernier: Provides up to 2.5 times calibrated setting with a maximum of 200% of percent load full scale.

Input Circuit

Current Mode: Single ended, floating common.

Voltage Mode: Differential, floating.

Input Impedance

1-5 mA Range: 1000 Ω .

4-20 mA Range: 250 Ω .

10-50 mA Range: 100 Ω .

0-5 VDC: 1 M Ω .

Common Mode Rejection (350 Ω unbalance):

DC unbalance to common: 65 dB on most sensitive range.

60 Hz unbalance to common: 65 dB on most sensitive range.

60 Hz unbalance to chassis: 80 dB on most sensitive range.

Maximum Input Voltage

Current Mode: 28 VDC or peak AC normal mode or 500 V-PC common mode (input signal leads to case).

Voltage Mode: 200 VDC or peak AC normal mode.

Over Current Protection: 0.025 A fast blow fuse.

Frequency Response: Flat DC to 100 Hz $\pm 0.5\%$.

Transmitter/Transducer Voltages: (provided by amp):
+ 28 VDC ± 2 V at 50 mA (internally variable). ± 15 VDC $\pm 5\%$ at 50 mA.

GOULD 13-G4616-20A High Frequency Waveform Storage



- Wide bandwidth – DC to 100 kHz
- Transient response to 3 μ s
- Automatic or manual arm
- Master/slave of up to 8 units
- Pretrigger up to 100% or delay up to 300%
- Low frequency trigger rejection

The High Frequency Waveform Module is ideal for analyzing waveforms up to 100 kHz and capturing transients as fast as 3 μ s at full amplitude. Random transients are recorded in the order of their occurrence, with no wasted chart paper between events. Upon capture, a transient can be replotted repeatedly, at different chart speeds for the best presentation or resolution. Triggering is accomplished using ABOVE, BELOW or in WINDOW criteria, while pretrigger gives the signal history prior to a trigger event.

MODEL 13-G4616-20A SPECIFICATIONS

- Amplitude Input Range:** 50 mV to 500 V FS.
- Attenuator Steps:** .05, .1, .25, .5, 1, 2.5, 5 V FS plus OFF and x100 multiplier.
- Input Coupling:** DC or AC (low frequency cutoff – 3 dB at 2.5 Hz).
- Input Circuit:** Single ended with floating common.
- Input Impedance:** 1 M Ω to common, shunted by \leq 40 pF.
- Common Mode Rejection:** DC to 60 Hz w/1 k Ω unbalance, 90 dB on most sensitive range.
- Maximum Input Voltage:** 500 V peak.
- Time Base:** 4 MHz \pm 0.005% crystal controlled clock.
- Capture Bandwidth:** Based on 10 samp./cycle: DC to 100 kHz.
- External Trigger:** Contact closure or 13-mA current sink.
- Trigger Levels:** \pm 2% to \pm 100% of full scale for Above, Below or Window.
- Trigger Filter:** DC, AC or AC-HF reject. AC-HF uses a 2 pole high pass filter down 3 dB at 1200 Hz.
- Trigger Modes:** Automatic, manual or off.
- Recording Modes:** 100%, 75%, 50%, 25% of pretrigger or 100%, 200% or 300% of trigger delay.
- Sampling Rate:** 400 Hz to 1 MHz in 1-2-4 sequence.
- Record Time:** 4 ms to 10 s in a 1-2-4 sequence.
- Output Data Rate:** 200 data points per second.

GOULD 13-G4616-30/31 Envelope/Pulse Amplifier



- Outputs peak envelopes up to 100 kHz
- True amplitude 50- μ s pulse
- Wide bandwidth DC amplifier
- Full range zero suppression
- Accepts external sync.
- 50 mV to 500 V full scale range

The Gould Envelope/Pulse Amplifier is a cost effective solution for recording the peak envelopes of analog signals up to 100 kHz and detecting pulses as short as 50 μ s. As such, it presents an economical alternative to expensive high-frequency recording devices such as light beam recorders and waveform digitizers. The ability of this amplifier to output peak envelope of a signal and/or the occurrence of fast pulses and transients makes it ideal for numerous industrial and medical applications.

MODEL 13-G4616-30/31 SPECIFICATIONS

- Measurement Range:** 50 mV to 500 V in 1, 2.5, 5 steps.
- Maximum Input Voltage:** 500 V peak between inputs or input to ground.
- Input Circuit:** Single ended to floating common.
- Common Mode Rejection:** 80 dB at 60 kHz, 1 k Ω unbalance (most ranges).
- Zero Suppression:** \pm 100% full scale.
- Envelope Mode**
- DC to 40 Hz:** Displays true input signal.
 - 40 Hz to 100 kHz:** Displays positive or negative envelope.
- Pulse Response**
- Minimum Detectable Pulse Width:** 50 μ s for true amplitude.
 - Minimum Detectable Amplitude:**
 - No carrier: 5% of full scale.
 - Carrier present: 5% of full scale outside of envelope.
 - Minimum dV/dt for Detection:** 40% of full scale per ms.
 - Maximum Repetition Rate for Unipolar Pulses:** 30 pulses/s.
 - Maximum Repetition Rate for Bipolar Pulses (13-G4616-31 only):** 20 pulses/s.
 - Pulse Hold Time:** 15 ms.
 - Event Marker Output (13-G4616-31 only):** 30 ms pulse per input pulse. Isolated and capable of driving standard event marker.

GOULD 13-G4681-00 8-Channel Isolator

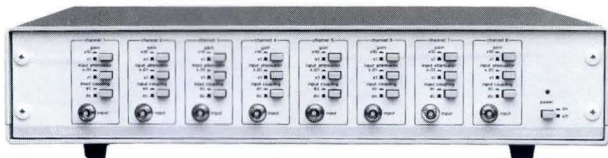

- Input/output and channel to channel isolation
- Selectable gain or attenuation
- AC or DC coupling
- Operates off ground
- High input impedance — 1 M Ω

The 8-Channel Isolator is designed to allow safe accurate measurement of multiple off ground signals up to ± 500 VDC or peak AC on instruments whose input circuits are single ended with respect to common or chassis ground. Multichannel instruments that frequently have single ended input circuits include magnetic tape recorders, waveform recorders, data acquisition systems and strip chart recorders. Each channel has a bandwidth up to 50 kHz and features front panel selection of AC or DC coupling.

MODEL 13-G4681-00 SPECIFICATIONS

Input Isolation

- ± 500 VDC or peak AC max. safe isolation from chassis ground.
- ± 500 VDC or peak AC channel to channel isolation from chassis ground.
- ± 500 VDC or peak AC max. linear input from + input to common.

Input Circuit

- Input Connector:** Triaxial (front panel).
- Configuration:** Single ended floating.
- Impedance:** 1 M Ω shunted by 40 pF.
- Coupling:** DC or AC (AC input coupling low frequency cut-in -3 dB at ≤ 2.5 Hz).

Frequency Response

- 50 kHz -3 dB at $\leq \pm 100$ VDC or peak AC with full x0.01 attenuation.
- 12 kHz at ± 500 VDC or peak AC with full x0.01 attenuation (slew rate limited to 0.3 V/ μ s worst case).

Common Mode Rejection (Atten. = x1, Gain = x10)

- AC:** > 84 dB with 1 k Ω source unbalance at 60 Hz, decreasing on other ranges.
- DC:** > 90 dB with 1 k Ω source unbalance, decreasing on other ranges.

Cross Talk to Adjacent Channels: > 120 dB from DC to 1 kHz; > 100 dB above 1 kHz to 50 kHz.

Inaccuracy (at 24°C $\pm 10^\circ$ C)

- Nonlinearity:** $\pm .2\%$ of 5 V full scale output.
- Zero Error:** $\pm .03$ VDC referenced to output.

GOULD 5900 Signal Conditioner Case

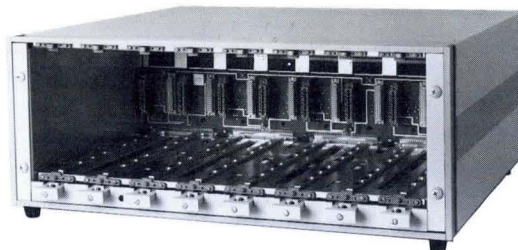

- Portable and rack mount
- Supports 5600 and 4600 Signal Conditioners
- Stand-alone, RS 3000 and TA 2000 configurations
- Convenient insertion and removal of signal conditioners via front panel

The 5900 Signal Conditioner case is totally interactive with Gould's new 5600 Programmable and 5600IS Status Reporting Signal Conditioners. It functions as a state-of-the-art "front end" for stand-alone applications or for use with 3000 or TA 2000 recorders. It allows either direct operation of these signal conditioners or total remote control via RS-232C or IEEE-488 digital interfaces. The 5900 also supports the comprehensive 4600 signal conditioner line.

MODEL 5900 SPECIFICATIONS

Dimensions

- Portable:** 8.13 in. (20.6 cm) H x 20 in. (50.8 cm) W x 19 in. (48.2 cm) D.
- Rack Mount:** 7 in (17.8 cm) H x 18 in. (45.7 cm) W x 17.8 in. (45.2 cm) D.

Number of Signal Conditioner Slots: 8.

Power Requirements, Voltage and Frequency: 90 to 130 VAC and 200 to 260 VAC, 45 to 445 Hz.

Weight: 27 lbs. (est.).

Ordering Information

Model Number Description

5900 Signal Conditioner Case

11-4183-03	Portable with 3000 interface board and cable
11-4781-01	Rack mount with 3000 interface board and cable
11-4183-04	Stand-alone portable
11-4783-02	Stand-alone rack mount

5900 Options and Accessories

CL-211222-1	3 Ft. 3000 interface cable
CL-211222-2	6 Ft. 3000 interface cable
11-4221-01	Interpreter board
11-4221-03	RS-232C interface board kit
11-4221-04	IEEE-488 interface board kit
11-4221-06	3000 interface board kit

Accessories for Gould 4600 and 5600 Series Signal Conditioners

DC and True RMS Accessories

Model No.	Description
11-5407-02	Connector (2-pin and guard), mates with 13-4615-00, 13-4615-10, 13-4615-20, and 13-4615-90 Amplifier input connectors
11-5407-03	Connector (6-pin and guard), mates with 13-4618-10 and 13-4618-30 Amplifier input connectors
11-5407-09	Connector Adapter, 3 binding posts to Gould connector 11-5407-02
11-5407-50	Connector (12-pin Deutsch), mates with 13-4615-58, 13-4615-70, 13-4615-71 Amplifier input connectors
11-5407-55	Connector Adapter, 3-pin binding posts to 12-pin Deutsch connector.
11-5407-67	Connector for 5600 Amplifiers

High Voltage DC Input Cables for 13-4615-90 Amplifier

892684-1	Complete Assembly, 25-ft. long
892684-2	Complete Assembly, 50-ft. long
892684-3	Complete Assembly, 100-ft. long
CL-810414	High Voltage Connector Cable

High Voltage AC Input Cables for 13-4618-10 Amplifier

888973-1	Complete Assembly, 10 ft. long
888973-2	Complete Assembly, 20 ft. long
369500-17013	Clamp-on Ammeter
369500-17015	Dual Range Clamp-on Ammeter
369500-17016	Dual Range Clamp-on Ammeter

Transducer Signal Conditioner Accessories

Model No.	Description
11-5407-03	Connector (6-pin and guard), mates with 13-4615-30, 13-4618-40 Amplifier input connectors
11-5407-50	Connector (12-pin Deutsch), mates with 13-4615-35, 13-4615-50 Amplifier input connectors
11-5407-10	Connector (14-pin), mates with 13-4616-00 Amplifier input connector
11-5407-06	Connector Adapter, adapts input connector (11-5407-03) to 6-pin Cannon connector receptacle
242879-351	Bridge Completion Resistor
369500-104	Adapter Cable, WK-6 Cannon to 12-pin Deutsch (Transducer Amplifier)

Frequency Signal Conditioner Accessories

Model No.	Description
11-5407-01	Connector (4-pin and guard), mates with 13-4618-00 Amplifier input connector
291955	Connector (5-pin Cannon), mates with 13-4618-30 Amplifier input connector

Temperature Signal Conditioner Accessories

Model No.	Thermocouple Input Connector (male)
288063-3	Iron-Constantan (Type "J")
288063-1	Chromel-Alumel (Type "K")
288063-2	Copper-Constantan (Type "T")
288063-4	Chromel-Constantan (Type "E")
288063-5	Platinum-Platinum 13% Rhodium (Type "R")

Conversion Kit Assembly

11-4308-40	Iron-Constantan (Type "J")
11-4308-41	Chromel-Alumel (Type "K")
11-4308-42	Copper-Constantan (Type "T")
11-4308-43	Chromel-Constantan (Type "E")
11-4308-45	Platinum-Platinum 10% Rhodium (Type "S")
11-4308-44	Platinum-Platinum 13% Rhodium (Type "R")
11-5407-03	Connector (6-pin and guard), mates with 13-4615-47 Amplifier input connector
11-5407-47	Connector Adapter, for YSI 400 Series Temperature Probes

High Voltage Connector for 5600 Programmable Amps

Model No.	Description
CL 810413	Isolated for shunt measurements, common mode voltage from 750 to 1500 V
CL 810414	High voltage connector, common mode voltage from 750 to 1500 V

Specialty Signal Conditioner Accessories

Model No.	Description
Waveform Recorder	
896413	Cable Harness Assembly
896412	Speed Control Cable Assembly
296661	Triax to BNC Adapter
11-4310-03	Cable Assembly, Triax to Alligator Clips (10')
895990	Auxiliary power supply assembly, external rack mounted 28 V supply
11-4310-15	Power supply adapter assembly for 4600 Series carrying cases

Computer Based Instrumentation

A spectrum of programmable devices that meet your test and measurement system requirements.

Gould's Computer-Based Instrument (CBI) System modules are designed to function as components of a totally integrated, flexible system that may easily be expanded. You may use this architecture to support a wide range of configuration options to integrate modules both from Gould's three product families and from non-Gould instruments. It also provides a logical and economical growth path within and between product families. Configure a system with minimum required functionality, then add modules as needed.

Gould's CBI is an "open" hardware and software system that's designed to incorporate virtually any IEEE-488 instrument and commercially available application-specific software package.

Computer-Based Data Acquisition

Gould's CBI System consists of hardware and software modules drawn from Gould's three product families and other non-Gould hardware and software modules.

	Analog Instrumentation	DASA Technology	PCI
Hardware	4600 Signal Conditioners 5600 Programmable Signal Conditioners 3000 Series Oscillographic Recorders	4300 Waveform Recorders 5300 Waveform Recorders 12 Bit, 16 Channel A/D Real Time Scroller	Transient Recorders Digital Storage Oscilloscope FFT-Analyzer Digital Multimeter Power Supply Scanner Function/Pulse Generator Digital Input-Output Calibrator 16 bit A/D Converter
Software	SET 5600	ACQ 4300 ACQ 5300 ACQ 4600 VIEW II	PCI-WINDOWS™ PCI-PANEL KIT™ PCI-SNAP™ PCI-GENESYS™ PCI-BASIC™

Other Hardware Any IEEE-488 instrument.

Other Software Commercial packages and user-written code.

PCI-WINDOWS, PCI-PANEL KIT, PCI-SNAP, PCI-GENESYS, and PCI-BASIC are trademarks of Gould Inc.

Computer-Based Instrument System: A Functional Overview.

Signal Conditioning

Gould knows signal conditioning. Our diverse line of more than 35 general and special purpose **4600 Series** and programmable **5600 Series** Amplifiers measure physical, life-science, electro-mechanical and electronic parameters. Typical parameters include temperature, pressure and flow; blood pressure, EKG and heart rate; torque, strain and linear acceleration; and AC and DC current and voltage.

- CBI hardware architecture is centered on the IEEE-488 standard to eliminate hardware incompatibility issues.

- CBI software architecture is centered on a common DASA Standard Format (DSF) database that eliminates data file compatibility issues associated with interfacing software between Gould CBI modules and non-Gould modules from multiple vendors.

With these standards, you may easily integrate Gould hardware and software with other hardware and software to provide complete system solutions.

More than 50 years of test and measurement experience is designed into Gould's Computer-Based Instrument family of programmable hardware devices and software modules. Analog Instrumentation, Data Acquisition and Signal Analysis (DASA) Technology, and Personal Computer Instrument (PCI) product families combine to meet a broad functional range of test and measurement requirements - from signal conditioning and device set-up to program and report generation.

Acquire/Measure

Gould understands low- and high-speed signal acquisition. Our DASA Technology and Personal Computer Instruments cover input frequencies from DC to 100 MHz. Gould's **DASA 4600 System** provides continuous long-term acquisition and real-time strip chart emulation, and Gould's new **5300 Waveform Recorder**, along with three PCI modules, provides a broad range of high-speed transient capture capabilities. Additional PCI acquisition modules include a 2-channel 100 MHz **Digital Storage Oscilloscope**; an 8-channel 40 kHz/16-bit **A/D Converter**, and a 2-channel **Fast Fourier Transform (FFT)-Analyzer** with 20 kHz real-time analysis.

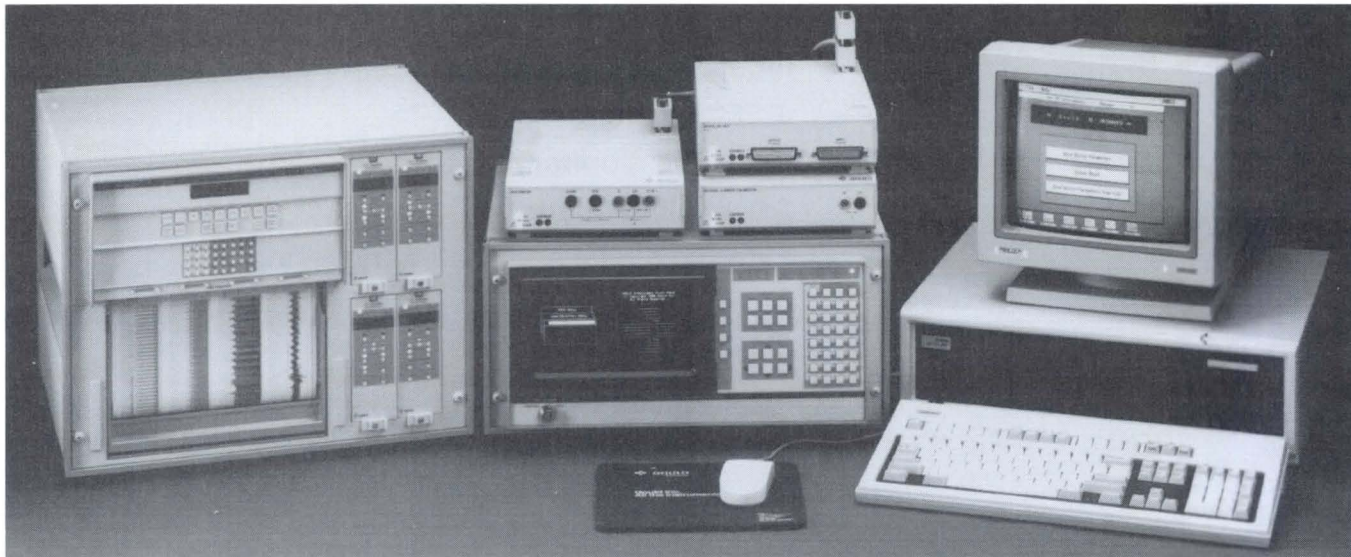

Stimulus/Source

Gould provides a complete range of basic stimulus functions. Our **Function/Pulse Generator** provides sinusoidal, rectangular, triangular, and pulse waveforms from 0.5 Hz to 5 MHz and a ramp output from 50 mHz to 500 kHz; the **Voltage/Current Calibrator** provides output voltages in the range of -30 to +30 volts with 1-mV resolution or currents from -30 to +30 mA with resolution of 1 μ A and the modular **Power Supply** provides four ranges of voltage and current output and can function as a programmable load.

Recording/Hard Copy

Gould is the world leader in recording technology with a wide range of devices that offer unique performance characteristics and recording methods to meet specific applications. Our **3000 Series Oscillographic Recorders** utilize ink and thermal direct writing for critical real-time applications, and the **TA2000** and **ES2000** provide thermal and electrostatic digital array writing for high-speed applications.

From basic instrument set-up to fully automated acquisition, analysis and reporting systems, Gould has the software that makes both inexperienced and advanced users more productive.

Set-up/Program. The fast, convenient, and exact operation of computer-based instrument configuration and control is achieved via "soft front panels" using a mouse and keyboard. This standard user-interface replaces the complex and confusing front panels of conventional instruments and provides the operator with a simple and easy way to interpret interface.

PCI-Windows™ provides for simultaneous operation and monitoring of multiple PC Instruments, and **PCI-PANEL KIT™** provides for swift creation of soft front panels for any IEEE-488 instrument for integration into the Gould CBI system.

Graphic Display and Manipulation. Based on its extensive experience in acquiring and displaying large amounts of data, Gould has developed a special graphics-oriented software package supporting virtual amounts of data. **VIEW II** provides extensive graphic display and manipulation functions for the quick-and-easy selection of critical acquired or generated waveforms for visual interpretation and basic analysis.

Analysis/Report. **PCI-SNAP™** is a special signal analysis package designed for instrumentation applications. It provides more than 100 math and statistics functions for both time and frequency analysis. File conversion routines provide compatibility with common spreadsheet, report generation, and other application-specific packages.

Program Generation/Automation. **PCI-GENESYS™** is an easy-to-use, graphics-based program generator used to create and document programs to automate IEEE-488-based instrument systems. The operator simply uses a mouse in a graphic environment to specify a particular test sequence including display, measure, storage and documentation parameters. **PCI-BASIC™*** source code is then automatically generated and executed. Extensive programming experience, knowledge of IEEE-488 communications, or knowledge of complex device-specific commands is not required. Generated source code can be extended and optimized with graphics commands, math functions, and structuring elements and decisions.

*A superset of TRUE BASIC™, TRUE BASIC is a trademark of True Basic, Inc.

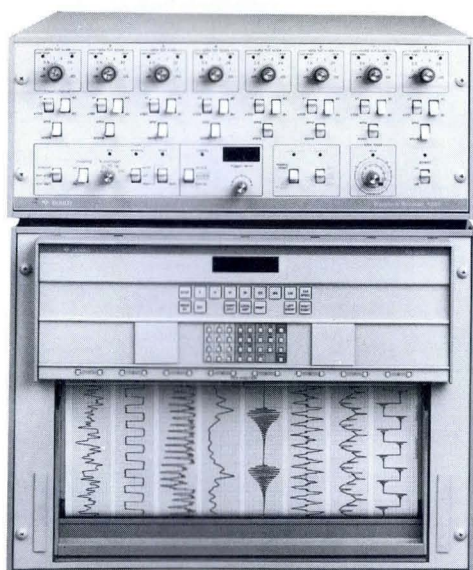

- Independent acquisition
- IEEE-488 addressable
- Real time monitor output
- DC amplifier mode
- External digital and analog triggering
- Analog outputs for hard copy
- Easy setup
- Pre-trigger capture
- Serial or parallel communications

Whatever your requirements for transient and waveform studies, there is a Gould high frequency multichannel recording system to do the job. These systems include analog recorders with a wide range of capabilities and writing methods. Gould covers the entire performance spectrum from the programmable 3000W to high performance array recorders like the thermal TA 2000W and the electrostatic ES2000.

The powerful 3000 and TA 2000 measurement systems are configured around the economical Gould 4300 and the high performance 5300 Waveform Recorders. The 4300 acquires up to 8 channels of analog data simultaneously sampled at rates up to .333 MHz. Data is stored in up to 32 k samples/channel. The 5300 Waveform acquires up to 8 channels of analog data simultaneously sampled at rates up to 1 MHz. Data can be stored in up to 256 k samples/channel. Memory can be cascaded to provide over 2 M samples memory for a single channel. The data is then reconstructed and output to Gould recorders for hard copy.

Comprehensive analog and digital triggering capabilities allow you to capture select test signal segments, one-time events, or responses to test stimuli. This eliminates the acquisition of nonessential data and provides for automatic, unattended data acquisition. Further a 0 to 100% pre-trigger feature allows for the study of cause-and-effect relationships between captured signals.

With Gould's DASA menu driven software, an IEEE interface and an IBM PC/AT or compatible, these waveform recording systems become turnkey data acquisition and analysis systems that acquire, display, analyze and output data.

Use the selection chart at right to choose the appropriate Gould Waveform Recording System. Refer to the appropriate catalog pages for more detailed product data.

Gould Waveform Recorders

Waveform Features	3000/4300	ES2000	TA 2000/4300
No. of Channels	4, 6, or 8	2 to 16	1 to 8
Channel Span	40 mm or 50 mm per channel	Up to 256 mm overlapped	Up to 200 mm Overlapped
Writing Method	Thermal or Pressurized Ink	Electrostatic Array	Thermal Array
Chart Speeds Actual	1 to 500 mm/s, mm/min or mm/hr; ÷ 60, ÷ 100, and ÷ 1000 and variable speed	.25 to 500 mm/s	1 to 200 mm/s or mm/min
Digital Equivalent	2.5 to 1667 times actual (up to 833 m/s)	up to 25 m/s	2.5 to 1667 times actual (up to 333.3 m/s)
Annotation	Left edge - standard; interchannel - optional	Anywhere on chart	Anywhere on chart (48 lines x 80 characters)
Overlapping Traces	No	Yes	Yes
Ext. Chart Drive	TTL, (HC)	TTL or analog	NA
Remote Start/Stop	Contact Closure	Contact Closure/ TTL low/high	TTL/Contact Closure
Frequency Response Amplifier Mode	@ 40 mm, DC-60 Hz ± 2% @ 10 mm, DC-180 Hz ± 3 dB	DC-35 kHz - 3 dB (sine wave)	DC-2.5 kHz < 2% down on continuous sine wave
Store Mode	50 kHz @ full scale	35 kHz @ full scale	50 kHz @ full scale
Rise Time Amplifier Mode	4 ms @ 40 mm, 5 ms @ 50 mm	500 µs	NA
Store Mode	10 µs	25 µs	10 µs
Trigger Clock	Yes	Yes	Yes
IRIG Input	Yes	Yes	No

Application	Description	Gould 5300	
		Features	Your Benefit
Material Tests	Destructive testing to measure stress and/or strain, tensile malleability, or quality of material.	100% pretrigger on all channels with the time base toggled to "high speed" just prior to the stress point.	All data acquired is pertinent with minimum over sampling. You can select a slow sample rate initially for trend logging, then toggle to higher rates when stress, or strain, exceeds a certain level.
Seismology/ Vibration/Sound	The primary event induces a secondary event, such as an echo or reverberation, which occurs several seconds later. Difficulty arises in triggering on the secondary event.	Trigger delay by real time or samples.	You obtain hard-to-acquire cause/effect correlations. Because acquisition does not occur until after a fixed time delay, you minimize false triggering on the primary event.
Periodic Mechanical Cycling	Devices, such as spark plugs, fuel injectors, diaphragm pumps, and relays, initially require logging of data at a slow rate for history. Then, the transient event must be recorded at a higher sample rate for maximum resolution.	Dual time base, toggled on a set criteria.	Gould's time base toggle enables logging pertinent, low frequency events which occur prior to a transient event. Then the 5300 "bursts" to a higher rate for the occurrence. You need less memory per event, reducing post-analysis time.
Power Line Anomalies	Multiple, non-periodic transients occur randomly on any one of the three phases. Anomalies can be either voltage or current.	Memory segmentation down to 256 samples. Any channel triggers.	You can segment channel memory to provide multiple event acquisition without your intervention. Each segment has its own pre-and/or post-trigger information.
Power Line Disturbances	Capture of three phase disturbances affecting all phases simultaneously in power lines.	Combination trigger logic.	The Event Manager allows triggering when the level is met on all channels, not just one. This conserves memory and assures the capture of only data you need.
Long Duration Testing	Tests requiring long recording times on one or two channels.	Memory cascading.	By cascading channel memory, you obtain extra deep memory which increases any acquisition period 2 to 8 times. And, with cascaded memory, you still have full access to all the pre/post and delay features of the Gould 5300.
Ballistic Tests	Measuring muzzle velocity, acceleration, temperature, pressure, and recoil shock. Radar lock determines ballistic velocity and range.	Multi-channel analog or event trigger. Two time bases with slow and fast sample rates assigned to the appropriate channel plus acquisition delay.	The 5300's powerful Event Manager allows you to trigger on any input from a simple contact closure to combinations of inputs. By using the dual time base, you conserve memory by setting slower sample rates for temperature and flight time. Simultaneously, using fast sample rates for pressure, shock, and other parameters. For mechanical phenomena acquisition delay, you can wait a pre-determined time after the event before beginning acquisition.
Nerve Traffic	Long record times on few channels with high resolution.	Memory cascading.	Memory can be combined to record times exceeding eight minutes on four-channel systems.

GOULD 5300

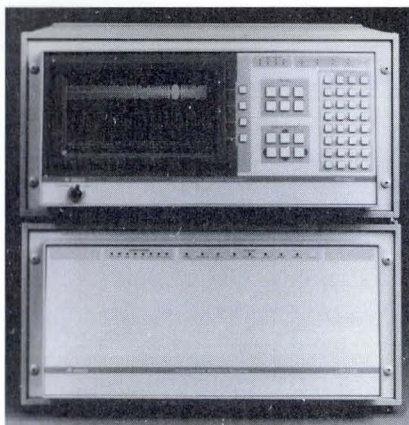

- Fully programmable
- Two independent time bases with toggle
- Comprehensive trigger event management
- RS-232C and IEEE-488 interfaces
- Eight analog and eight discrete inputs
- 1 MS/s, 250 KS/s and 100 KS/s, 12 bit A/D's
- Multi-Master or Master/Slave with one master clock

Gould's new 5300 Waveform is a fully programmable, 68000 based system. Each mainframe captures up to 16 channels of analog and digital data with true master/slave expansion capability to eight systems. The 5300 provides simultaneous sampling from one megasample/s to days at 12-bit resolution. The wide bandwidth is achieved through a fine resolution, 100-ns increment, dual-time base design.

The 5300's Event Manager™ will discriminate over a half million unique transient events. This high performance results from a 21-input, dual trigger-tree system, which uses logical OR and logical AND functions. User-defined memory allocation enables channel depth ranging from 256 to more than 2 million samples per acquisition.

Analog To Digital Conversion

System architecture for the 5300 input is maximized for speed and accuracy. Each of the 100 KS/s, 250 KS/s and 1 MS/s, 12-bit digitizer options has its own A/D converter, analog trigger level setting, discrete event marking input, memory storage capacity and over-voltage protection.

For the input signal, each channel has a digital waveform data bus connected directly to the memory and a separate analog path to the Event Manager. This allows the Event Manager to continuously compare the analog waveform to the user's programmed trigger parameters, insuring a precise, accurate event detection independent of the sample rate and A/D resolution.

Event Management

Successful acquisition requires gathering useful information. To do this, you must trigger only on significant events, and sample at the required rate and duration to achieve complete results. Inflexible acquisition hardware with its limited triggering, sample rates and memory depth compromises test efficiency and utility.

The Gould 5300's versatile, high performance Event Management System optimizes overall acquisition efficiency. It provides comprehensive trigger definition, precise time base selection, and variable memory length.

Trigger Criteria

The 5300's Event Management System handles up to 21 different trigger inputs, providing more than 500,000 unique event definitions. This defines virtually any trigger event – from single contact closure to complex Boolean definitions, including all acquisition parameters.

Channel Level Selection

You can establish individual channel trigger conditions using the functions of "above" or "below" a desired level, or "inside" or "outside" a defined asymmetrical window. This flexibility allows triggering when the signal (1) exceeds a threshold; (2) crosses through zero, or (3) breaks a boundary condition.

Real Time Clock and Interval Timer

The 5300 features two independent clock functions to correlate input signals to time. Just program the real time clock to begin acquisition at a specific date (dd:mm:yy) and time (hh:mm:ss), while the interval timer initiates periodic event "sampling" from one second to 24 hours.

Group Trigger

Under software control, the IEEE-488 group trigger function begins acquisition on a simple event, such as a keystroke or an automated software algorithm.

Boolean Logic

The Event Manager has two identical trigger trees. Thus, it provides thousands of unique trigger definitions through logical OR and logical AND combinations of the four independent channel level trigger criteria: real time clock, interval timer, I/O interface trigger, and external event.

Dual Time Base

For applications with a variety of low and high speed signals, you can selectively group channels and use two independent time bases. This conserves memory without compromising sample rates and, therefore, the accuracy required for high-speed channels.

Acquisition Delay

A programmable acquisition delay means you can capture secondary and tertiary events. By delaying acquisition through either a specified time or sample number, hard-to-isolate events (like echoes and reverberations) can be captured without sacrificing pre-trigger data or record duration.

Time Base Toggle

In applications with transients riding on slower signals, a "data logging" function provides information on both components. You can toggle a slow rate to a higher rate based on signal level, time or number of samples. Thus, you can efficiently monitor, capture and analyze long-term trends with high-speed events.

Time Base

Dual time bases, programmable in 100-ns increments, are derived from a 10-MHz master clock. This fine resolution eliminates oversampling, resulting in more efficient memory use and longer continuous acquisition times.

Memory Utilization

Waveform memory ranges from 256 to 2 million samples per acquisition. Assigning waveform memory in 256-sample increments to each of the two memory groups optimizes record time for the time base selected.

When several short duration transients occur in rapid succession, memory segmentation down to 256 samples/channel per event provides back-to-back capture without data transfer. For events longer than 256k samples, just cascade channel memory to form a deep channel. Both memory groups are totally independent of one another, each with its own sample rate, percent pre-trigger and recording time.

5300 SPECIFICATIONS

Analog Signal Inputs

Analog Inputs: Up to eight channels, BNC input, single ended to ground.

Active Channels: Up to eight analog and eight event simultaneously.

Converter: 12 bit, monotonic.

Number of Analog/Digital Converters: 1 A/D per analog channel.

Linearity: ± 1 LSB.

Input Voltage: ± 5 Volts.

Maximum Input Voltage: ± 20 Volts.

Input Impedance: 100 k Ω min.

Over Range Detection: YES.

Under Range Detection: YES.

Coupling: DC, AC (-3 dB at 2 Hz).

Sample Rate and Mode

Master Clock: 10 MHz.

Sample Increment: 100 nanoseconds.

Frequency Inaccuracy: $\pm 0.01\%$.

Maximum Sample Rate: Up to 100% of selected A/D.

Minimum Sample Rate: 69.4 days/sample.

External Clock Input: Two, independently selectable.

Time Base Toggle: Two TTL inputs with over-sampling detection.

External Disable: Independent of clock.

Time Base Stamp: YES, TTL low active.

Toggle Scheme: Yes. At time of trigger, A or B, A to B, B to A, successive A to B or B to A sequence per segment.

Real Time Clock: Battery backed, hh:mm:ss with mm-dd-yy.

Memory Utilization

Sample Memory: Two megasamples/mainframe, 12-bit/sample minimum.

Default Allocation: 256 k samples/channel.

Smallest Segment: 256 samples/channel.

Longest Depth: One channel, two megasamples deep.

Overwrite Protection: Yes, on a per-channel basis.

Access Time: Independent of A/D option

Setup Storage: Five user-defined setups stored in battery-backed RAM.

Sample Structure: A/D converter resolution plus:

- 1 bit - event marker
- 1 bit - time base stamp
- 1 bit - trigger indication
- 1 bit - reserved

Continued on next page.

Event Management

Arming

- **Auto Rearm:** YES.
- **Interval Rearm:** YES, at user-specified intervals.
- **External Input:** TTL, diode protected.
- **External Arm Output:** TTL low signal when armed.
- **Arm on Real Time:** User-specified real time/date.

Trigger Sources

- **Analog:** Any one or all eight inputs plus external.
- **Digital:** Any one or all eight inputs plus external.
- **Time:** Real Time Clock with date.
- **Software:** IEEE-488 group trigger.

Trigger Criteria

- **Pretrigger:** 0 to 100 % in 1% increments of memory or record time.
- **Trigger Resolution:** 256 steps/range.
- **Trigger Levels:** ABOVE or BELOW.
- **Trigger Boundary:** INSIDE/OUTSIDE Window with upper and lower boundary set independently.
- **Zero Cross Trigger:** Programmable to 0 volts.
- **Trigger Filter:** DC, 60 Hz (-17 dB at 60 Hz); 400 Hz (-16 dB at 400 Hz).
- **Trigger Delay:** YES, by samples or time.
- **Time Stamp:** YES, trigger date and time per channel, one per segment.
- **Logical Trigger:** Any input can be logically grouped for Logical OR and Logical AND combinations.

Master/Slave

Number of Units: Eight mainframes, 128 channels.

Time Base: Single clock operation for all systems.

Trigger: Simultaneous or independent.

Communications Interface: Both IEEE-488 and RS-232C standard.

Physical

Dimensions: 8.75" H x 17.8" W x 15" D.

Weight: Approximately 35 lbs.

Mounting: Portable or 19-in. RETMA rack.

Operating Temperature: +5° to 45°C; 10% to 90% relative humidity at 35°C, non-condensing.

Power: 100 to 130 VAC, 50/60 Hz; 200 to 265 VAC, 50/60 Hz.

Power Detect: System automatically saves setup to battery-backed RAM on power loss.

Ordering Information

Model No. **Description**

Waveform Products

5300 Base Units

53-90007-1	5300 Base Portable System Includes mainframe with enclosure, IEEE-488 Interface, and Status Front Panel.
53-90008-1	5300 Base Portable System Includes mainframe with enclosure, IEEE-488 Interface, and Intelligent Front Panel.
53-90009-1	5300 Base Rack Mount System Includes mainframe with enclosure, IEEE-488 Interface, and Status Front Panel.
53-90010-1	5300 Base Rack Mount System Includes mainframe with enclosure, IEEE-488 Interface, and Intelligent Front Panel.

5300 System Components

53-11001-1	A/D Board; 100Ks/s, 8 channel, 12 bit
53-11002-1	A/D Board; 250Ks/s, 2 channel, 12 bit
53-11003-1	A/D Board; 1Ms/s, 2 channel, 12 bit
53-12001-1	Single Channel Event Manager
53-12002-1	Multiple Channel Event Manager
53-13001-1	Memory Board; 64k samples/channel, 12 bit
53-13002-1	Memory Board; 256k samples/channel, 12 bit
53-13004-1	Memory Board; 64k samples/channel, 16 bit
53-13005-1	Memory Board; 256k samples/channel, 16 bit
53-16001-1	Universal Recorder Interface (URI)

5300 Cabling

53-99001-1	URI/ES2000 Interface Cable, 6'
53-99001-2	URI/ES2000 Interface Cable, 10'
53-99001-3	URI/ES2000 Interface Cable, 25'
53-99002-1	URI/3000 Interface Cable, 6'
53-99002-2	URI/3000 Interface Cable, 10'
53-99002-3	URI/3000 Interface Cable, 25'
53-99003-1	URI/TA2000 Interface Cable, 6'
53-99003-2	URI/TA2000 Interface Cable, 10'
53-99003-3	URI/TA2000 Interface Cable, 25'
CL-211712-1	RS-232C, 5300 to DB25 for PC/XT class
CL-211713-1	RS-232C, 5300 to DE9 for PC/AT class
CL-212174-1	Master/Slave Cable, 4'
CL-212174-2	Master/Slave Cable, 6'
CL-212174-3	Master/Slave Cable, 10'
CL-212175-1	Cable for Remote Front Panel, 4'
CL-212175-2	Cable for Remote Front Panel, 6'
CL-212175-3	Cable for Remote Front Panel, 10'

5300 Accessories

53-18000-1	Status Front Panel
53-18001-2	Intelligent Front Panel
CL-412045-6	Shipping Case

GOULD 4300 WAVEFORM RECORDER

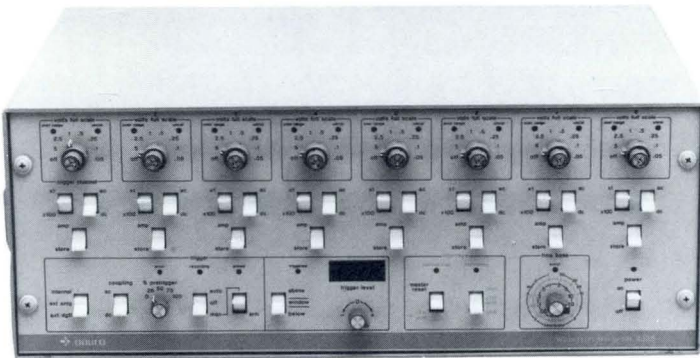

- 8 channels
- Each channel usable as wideband DC amplifier or high-speed digitizer
- Channels sampled simultaneously at 500 Hz to 1/3 MHz
- Large 32 k word/channel memory
- Flexible triggering, up to 100% pretrigger data capture
- Captures 50-kHz signals, 10- μ s transients
- Analog and digital outputs; IEEE-488 standard, RS-232C optional

These are the vital front ends for all Gould high frequency multichannel Waveform Recording Systems and DASA Systems. Setting up a 4300 for the measurements you want to make is extremely flexible and easy. With 13 calibrated input ranges from 50 mV to 500 V full scale plus variable gain, you can record each channel at maximum resolution. LEDs indicate any over-range or uncal conditions, and you can select AC or DC signal coupling. You can also set each channel for real time (amplifier) or store mode.

All channels in store mode are sampled simultaneously to avoid time skew between channels. Simply set the time base for the highest frequency you want to record. Sample interval and chart scale factor are also shown. Flexible triggering lets you precisely capture the waveform or transient you want, with up to 100% pretrigger data for cause-effect analysis. Stored data can be output repeatedly for analog plotting at various speeds or in digital form at high speed via standard interfaces.

MODEL 4300 SPECIFICATIONS

Number of Channels: 8.

Input Voltage Range: ± 50 mV to ± 500 V in 1-2-5 sequence, continuously variable >2.5 to 1 between steps.

Amplifier Characteristics: Bandwidth (-3 dB) 85 kHz; input impedance 1 M Ω shunted by ≤ 55 pF; AC or DC coupling.

Store Mode Characteristics

Bandwidth: (-3 dB) 50 kHz.

Sampling Rate: 500 samples/s to 1/3 megasamples/s in 1-2-5 sequence. All channels sampled simultaneously.

A/D Resolution: 8-bit (1 part in 256).

Memory: 32 k/channel.

Recording Time: 100 ms at 50-kHz bandwidth; 65.5 s at 50-Hz bandwidth using full 32 k word/channel memory.

Triggering

Internal: true level above, below or window; 0 to $\pm 100\%$ of range continuously selectable; AC or DC coupled.

External Analog: true level above, below or window; 0 to ± 50 V continuously selectable; AC or DC coupled.

External Digital: TTL or contact closure.

Trigger Position: 5 selectable positions at -100% , -75% , -50% , -25% and 0% of memory.

Recording/Arm Modes: MAN switch arms unit for a single recording after a trigger; AUTO switch arms unit for babysitting.

Analog Outputs: Data stored in each channel is reconstructed to analog form and output simultaneously at 200 sample/s rate.

Digital Outputs: Via standard IEEE-488 interface or optional RS-232C.

Ordering Information

Model Number	Description
13-G4186-02	8-Channel Waveform Recorder, 32 k/channel, IEEE-488 interface, rack mounting kit
13-G4348-02	8-Channel Waveform Recorder, 32 k/channel, IEEE-488 interface, portable case

Accessories

Model Number	Description
11-1202-33	Rack Mount kit
11-1508-10	3800/4300 Cable
11-1508-11	TA 2000/4300 Cable
11-1508-12	3600/4300 Cable
11-1508-13	3400/4300 Cable
11-1508-14	Cable Assembly (13-G4616-21/3000)
11-1508-15	Cable Assembly (TA 2000/13-G4616-21)
11-4313-00	RS-232C interface
11-4313-01	IEEE-488 interface (includes cable)
11-4313-05	8 ch. memory expansion board, 24k/ch (13-4X86-01/02)
896578	Extender card for RS-232C and IEEE-488 interface boards
896642	Remote playback speed control box w/interconnect cables for use with 2000 series recorders

WAVEFORM RECORDING SYSTEM

GOULD ES2000

- Up to 16 channels, 100 kS/s or higher
- Multiple anti-aliasing filters
- Simultaneous data storage and display
- Up to 4 Mega words of shared memory
- Two channel groups with two time bases each
- Flexible post-storage display
- High-speed post-storage data transfer
- Can be integrated with ES2000 real time display and recording system

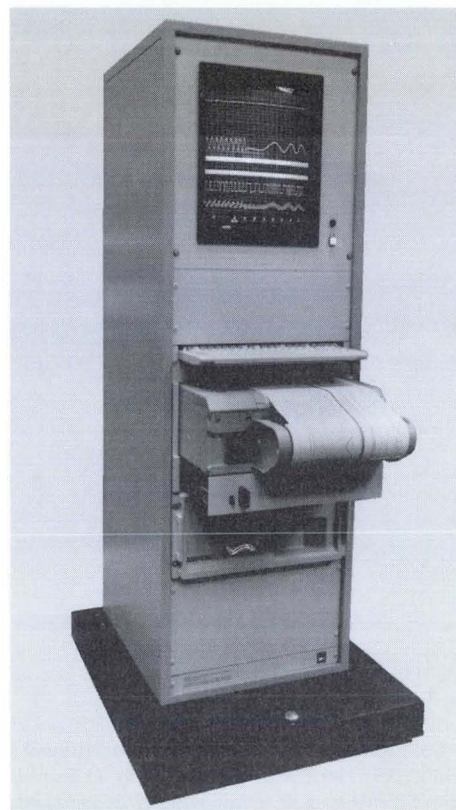

Gould new ES2000 can be configured to offer a high performance, fully programmable Waveform Recording System. The following new modules are required:

- the SX2000, Sequencer for controlling data via the ES2000 internal high speed data bus.
- the SM2000, Waveform Memory board,
- the PB240, 2-channel analog input, up to at least 100 kS/s per channel sampling rate, with anti-aliasing filters. Up to 8 PB240's can be used, providing the ES2000 with 16-analog channels and 16-event recording capability.

Analog inputs have the flexibility required for a wide range of applications: sensitivity range from 40 mV/cm to 250 V f.s., polarity reversal, simultaneous sampling, and triggering filters. Anti-aliasing filters insure the integrity of data being sampled at each time base. Each module can be allocated to 2 groups with independent time bases.

While digitized signals are being recorded in memory, they can simultaneously be displayed on the ES2000 screen or/and paper. This exclusive feature provides a quick-look of high-speed signals before performing the more detailed analysis allowed by the play-back of data in memory.

The SX2000 Sequencer handles the management of events and the channelling of data from the PB240 input modules to the Memory. A sophisticated trigger tree

combined with up to 100% pretrigger, trigger delay and 2 time bases per group of channel provides outstanding flexibility for a wide range of testing conditions.

Memory partitioning and a total capacity of up to 4 Megawords allow you to optimize memory utilization for the test being performed. Quick review of the data in memory is made easy by a zoom feature. Hard copy of data in memory is fully documented with all acquisition conditions. Stored data can be transferred to a computer for further analysis via the IEEE-488 system interface at high rate.

The Waveform Recording options can be combined with any of the other ES2000 options to configure systems to match specific requirements. See pages 88 to 93 for more information on ES2000 system, accessories and options.

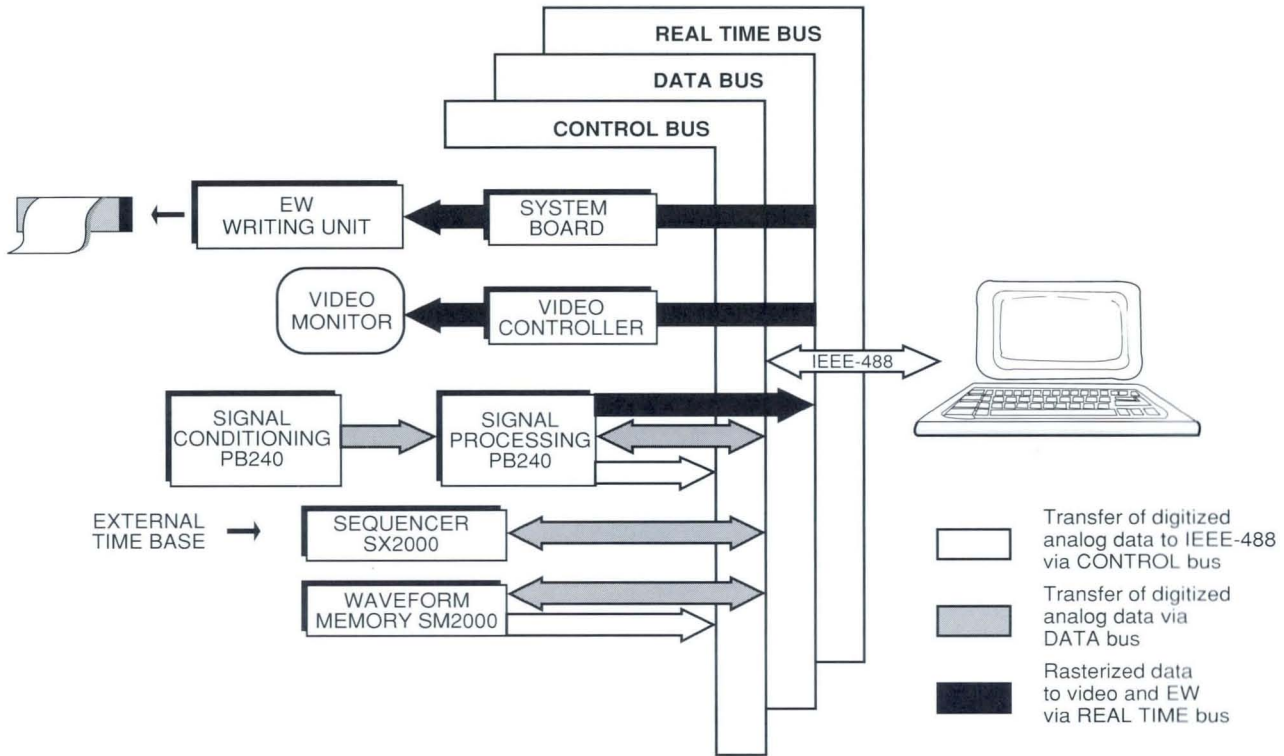

ES2000 Waveform Recording and Real Time Display System diagram

MODEL ES2000 SPECIFICATIONS

Number of Channels: 2 to 16 analog and 2 to 16 event.

Analog Input Circuit: Single-ended to ground. With polarity reversal.

Input Impedance: 100 kΩ.

Channel Position: 0 to 255.9 mm with 0.1-mm steps.

Channel Width: 0 to 256 mm with switchable limiters.

Measurement Range: 40 mV/cm to 10 V/cm or 250 V f.s. in amplifier mode. 1 V, 5 V and 10 V settings in coupler mode with 10, 20, 25, 40, 50, 100, 200 and 250 mm channel widths.

Sampling Rate: Programmable, up to at least 100 kHz.

Resolution: 12 bits.

Anti-aliasing filters: Switchable and programmable up to 30 kHz.

Memory: 2 or 4 Megawords shared by input channels. Partitioning in 1 kwords segments.

Triggering Filter: High pass 50 Hz, 60 Hz, 400 Hz and 1 kHz.

Internal Triggering: Per channel, true level above, below, outside or inside window.

Acquisition Modes: A, A-B, A-B-A, TOGGLE, TRIGGER DELAY (Groups with independent time bases but simultaneous triggers), GROUP#2 DELAYED.

Trigger Tree: Combination of up to 4 conditions using logical OR and AND operators.

Trigger Position: Pretrigger from -100% to 0% in 1% steps.

Post-storage Data Display: ES2000 Monitor and Writing Unit. Zooming and selection of memory section.

Digitized Data Output: Via ES2000 system IEEE-488 interface.

Event Marker Input Circuit: TTL low level active.

Marker Position and Height: From 0 to 255 mm.

PB240 Input Connectors: BNC and 15 pin sub-D

Ordering Information

Contact your nearest Gould Sales Office, Representative or Distributor for information on the new ES2000 plug-in modules:

- SX2000, Sequencer, High-Speed Data Bus
- SM2000, Waveform Memory Board
- PB240, 2-channel High Frequency Analog Input with 2 event channels and anti-aliasing filters.

GOULD TA 2000/4300 WAVEFORM RECORDING SYSTEM

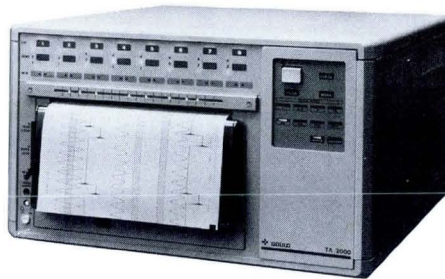
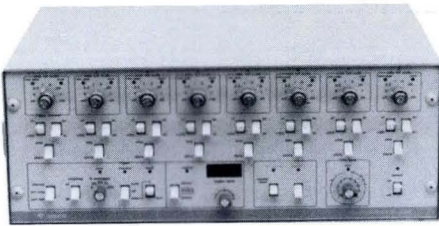

- Up to 8 channels
- Chart playback speeds up to 333.3 m/s
- Thermal array writing
- 200 mm maximum chart width
- Overlapping traces
- Full-page annotation
- x1, x2 and x3 trace expansion

The TA 2000/4300 Waveform Recording System is based on the 4300 Waveform Recorder and the fastest thermal array recorder in the industry. Signals with frequencies up to 50 kHz can be captured and stored and signals up to 2.5 kHz can be recorded in real time.

Data captured on the TA 2000/4300 System can be automatically output to the high-performance TA 2000 Thermal Array Recorder. Actual chart speeds range from 1 to 200 mm/s

or mm/min; equivalent digital playback chart speeds reach 333.3 m/s.

The TA 2000/4300 provides several unique features: When data is played back from storage, a chart edge event marker identifies the exact position of the trigger point and a front-panel gain feature expands traces up to 0.25 V/cm.

MODEL TA 2000 / 4300 SPECIFICATIONS

Number of Channels: 1 to 8.

Event Marker: 2 mm wide mark at left chart edge when MARK key is depressed.

Writing Method: Single fixed thermal array head.

Recording Width: 200 mm FS.

Amplitude Resolution: 200 dots/in. (8 dots/mm).

Time Axis Resolution: 8 lines/mm (at 200 mm/s); 16 lines/mm (at 100 mm/s); 32 lines/mm (at 50 mm/s); 48 lines/mm (at 25 mm/s).

Sensitivity: x1, 1 V/cm; x2, 0.5 V/cm; x4, 0.25 V/cm.

Chart Speeds: 1, 2.5, 5, 10, 25, 50, 100, 200 mm/s and mm/min.

Timing Marks: Recorded in three lengths along both edges of chart paper.

Annotation: Date, Time, and Chart Speed are printed once per page. User defined full page (48 lines x 80 columns) and 8 character parameter identification possible via RS-232C interface.

Remote Control: Chart Start/Stop and Event Mark can be controlled from the rear panel remote connector via contact closure.

RS-232C Interface: Controls all TA 2000 front panel functions, full page (48 lines x 80 columns) of annotation, 8 character parameter identification.

Ordering Information

Model No.	Description
3008-8513-43	Benchtop TA 2000, 115 V 50/60 Hz
3008-8513-44	Benchtop TA 2000, 230 V 50/60 Hz
11-1508-11	Interface Cable Kit (Analog input and remote start/stop cables)
13-G43X6-02	8 channel Waveform Recorder

GOULD 3000/4300 WAVEFORM RECORDING SYSTEM

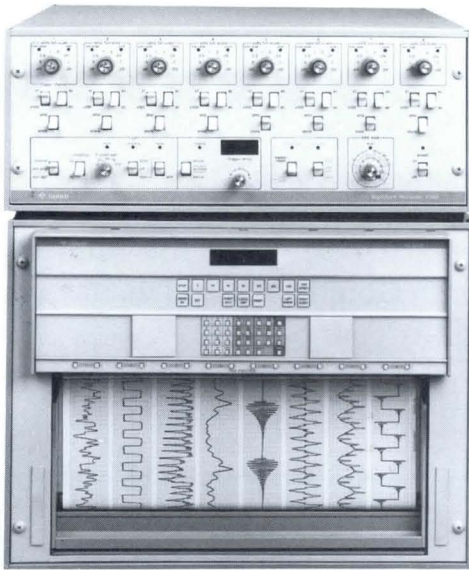

- 4, 6 or 8 channels
- Chart playback speeds up to 833 m/s
- Thermal or pressurized ink writing
- Chart edge annotation
- Accurate triggering with pretrigger viewing
- Low-cost hard copy
- IBM PC Series compatible

Rugged, stand alone and rack-mounted Gould 3000/4300 Systems are the undisputed performance standards of the industry. By merging digital storage technology with a superb direct writing oscillograph, these systems combine powerful data capture capabilities with accurate, clean hard copy of multiple analog signals. In fact, you can slave several 3000/4300 Systems to process up to 112 analog input signals simultaneously.

With DC to 50 kHz response, equivalent chart speeds to 833 m/s and 10 μ s transient response, the 3000/4300

outperforms all other recorders. It's faster, uses low-cost pressurized ink or thermal paper, provides the best trace quality, and is easy to use.

Significant features include: chart edge annotation of time, date, chart speed and user message; IRIG B input; trigger mark; remote start/stop and speed control; and a computer interface for detailed analysis of stored data.

MODEL 3000 / 4300 SPECIFICATIONS

Number of Channels: 4 at 50 mm, 6 at 50 mm or 8 at 40 mm.

Input Voltage Range: ± 50 mV to ± 500 V in 1-2-5 sequence, continuously variable > 2.5 to 1 between steps.

Amplifier Characteristics: Bandwidth (-3 dB) 85 kHz; input impedance 1 M Ω shunted by ≤ 55 pF; AC or DC coupling.

Store Mode Characteristics:

Bandwidth: (-3 dB): 50 kHz.

Sampling Rate: 500 samples/s to 1/3 megasamples/s in 1-2-5 sequence. All channels sampled simultaneously.

A/D Resolution: 8-bit (1 part in 256).

Memory: 32 k/channel.

Recording Time: 100 ms to 65.5 s.

Triggering:

Internal: True level above, below or window; 0 to $\pm 100\%$ of range continuously selectable; AC or DC coupled.

External Analog: True level above, below or window; 0 to ± 50 V continuously selectable; AC or DC coupled.

External Digital: TTL or contact closure.

Trigger Position: 5 selectable positions at -100% , -75% , -50% , -25% and 0% of memory.

Recording/Arm Modes: MAN switch arms unit for a single recording after a trigger; AUTO switch arms unit for babysitting.

Analog Outputs: Data stored in each channel is reconstructed to analog form and output simultaneously at 200 sample/s rate.

Digital Outputs: Via optional RS-232C or IEEE-488 interface.

DASA TECHNOLOGY

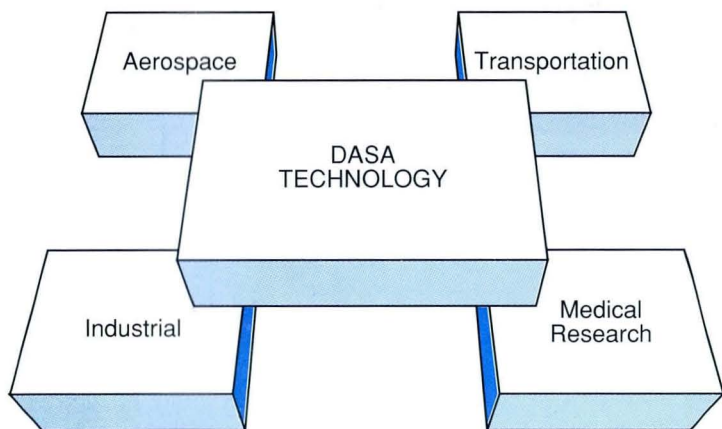

- IBM PC/AT class machines
- Sample rates to 1 MS/s
- User interactive
- Recorder Control
- More than 50 hard copy devices supported
- Compatible with Gould 4600 and 5600 Series Conditioners

Gould's DASA Technology is a group of hardware and software products which can be configured into integrated systems for industrial, medical research, aerospace and transportation applications. DASA technology enhances traditional analog signal conditioning and recording with PC-based data acquisition and analysis.

Currently, DASA technology includes three data acquisition systems. The first is composed of PC-bus plug-in boards, providing up to 40 kHz continuous data throughput to disk for up to 16 channels and real-time display of up to 8 waveforms. The other two are IEEE-488 computer front ends with simultaneous sampling and systems up to 128 channels.

DASA software is composed of interactive acquisition, display and analysis software modules. Each module is designed for the computer user with minimum knowledge of DOS or Gould DSF data base. Common functions to list, copy and delete acquisitions are provided in DASA Utilities. ACQ4600, ACQ4300 and ACQ5300 are used to set-up acquisition parameters, control data acquisition and storage; SET 5600 compliments the acquisition modules with set-up of Gould's programmable signal conditioners; View II is the common graphics and analysis package utilized by all modules using the DSF data base structure.

All data acquired with DASA technology is stored in a standard database. This DASA Standard Format (DSF) insures that data acquired with current Gould hardware and software will be compatible with future Gould hardware and software. DSF also facilitates the integration of third party software packages and custom, user-written programs with DASA technology. Gould's DASA technology provides hardware and software products that meet your application requirements from data acquisition and display to analysis and hard-copy output.

Software Modules

DASA Utilities

This Windows module provides simple utilities to access the Gould DSF data base. Prior understanding of DOS or the data base structure is not required to:

- Remove entire tests or parts of tests from the data base
- Copy tests between specified drives for backup or transport;
- List all tests and runs.

ACQ4600

This module provides simple menus for the entry of all acquisition, storage, and real time display parameters for the DASA 4600. Features include:

- 40 kHz maximum throughput direct to disk;
- Real time scrolling waveform display (of up to eight non-overlapping waveforms) in monitor only, and monitor and acquire modes;
- Keystroke, time, external digital (high/low, positive/negative, and change of state), internal (above, below, outside window, inside window), trigger modes;
- Halt and re-start acquisitions (without exiting the test);
- Digital marks to identify significant events;
- A Recall Test function that loads stored test parameters for execution;
- A Command Line function that allows a sequence of tests to be automatically loaded and executed.

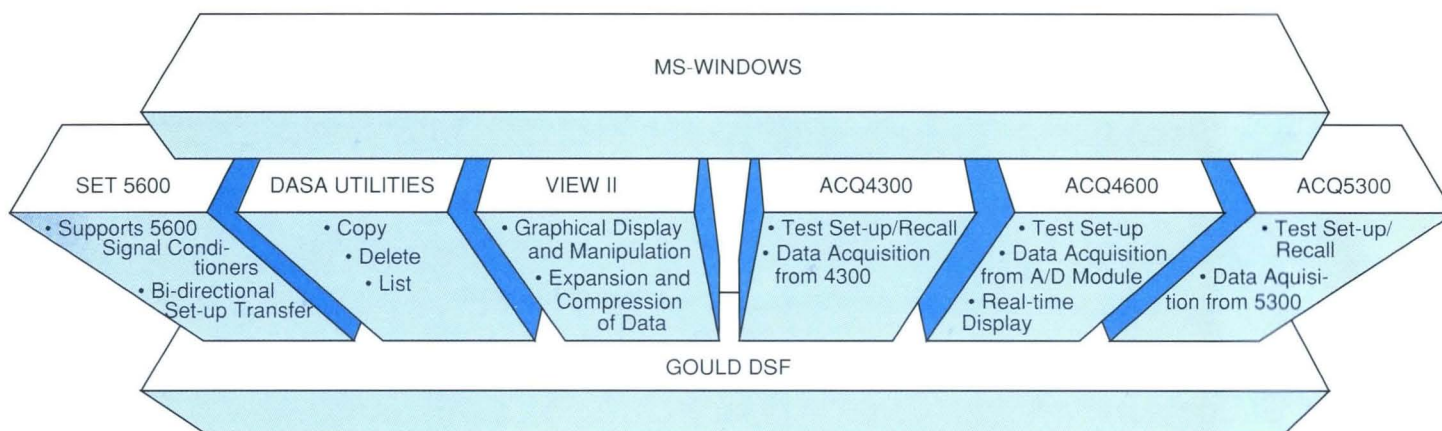

Software Architecture

Gould's unique software architecture utilizes several separate, yet interactive, menu-driven modules for acquisition/storage and for display/manipulation/analysis.

ACQ4300

This module provides simple menus for acquisition, display, storage, and analysis of data for the DASA 9000. Features include:

- Display of front-panel settings of the Gould 4300 Waveform Recorder;
- Transmission of 1 to 32 k (max.) samples acquired by the 4300 Waveform Recorder, with or without offset to any position in the 4300 buffer;
- Transmit, arm, and trigger acquisition modes with delay by time or event;
- Automatic time-based acquisition of up to 99 events;
- Easy recall of test data, parameters and 4300 front-panel settings;
- On-line help for all commands.

VIEW II

This graphically oriented Windows module provides all data display, manipulation, editing, annotation and hard copy functions. Features include:

- Handles megasamples of data in each of 16 channels;
- Individual recall, display and positioning of waveforms;
- Full expansion and compression of individual waveform data;
- Individual Y-axis scale in user units;
- X-Y display and calculation of area bounded by the curves;
- 1 to 20 character marks for tagging data points;
- More than 50 devices supported for hard copy output;
- CALC Functions: 16 basic functions including Mean, standard deviation, RMS, min/max., area, etc;
- Math Functions: -, +, *, /, integration and differentiation in a user-defined equation; no limit to parentheses levels.

ACQ5300

This module provides a series of simple pop-up panels for set-up and acquisition of the 5300 Waveform Recorder.

- Functions logically grouped for acquisition, display, edit and macro execution;
- Macro language reduces keystrokes;
- Graphical trigger display makes complex Boolean trigger logic set-up simple;
- 24 channel Quick-Look feature displays signals prior to storage on disk;
- Unique flexibility allows all text, help screens and error messages to be changed by user;
- On-line or off-line editing;
- Extensive on-line help.

SET 5600

This Windows application module speeds up programming, storage and recall of error-free set-ups for the Gould 5600 Programmable Signal Conditioner.

- Supports any combination of 5600 Series Signal Conditioner;
- Reads hardware front panel changes;
- Individual conditioner front panel "lock out";
- Bi-directional set-up transfer to on-line systems;
- All 5600 Series functions supported;
- Hard copy listing: over 50 output devices supported.

GOULD DASA 4600

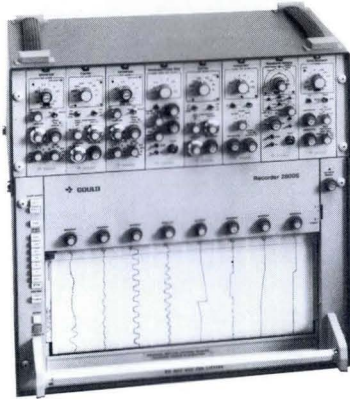

- 16 analog inputs
- 40 kHz continuous throughput direct to disk
- Real-time scrolling CRT display
- Extensive triggering
- Halt mode

The Gould DASA 4600 is a low-cost data acquisition system designed for industrial and life-science research applications. Gould's 4600 Series signal conditioners and direct writing recorders have been meeting the needs of research professionals for over 50 years and are recognized as industry standards.

Traditional research-oriented data acquisition is analog-trace oriented, requiring visual interpretation by an experienced operator who manually annotates, analyzes and documents test results. The procedure is tedious,

time consuming, and prone to computational errors. But now, with the DASA 4600, all data acquisition, storage, analysis, and reporting can be accomplished with computer speed and accuracy.

The DASA 4600 works with Gould and other signal conditioners and direct writing recorders, and it complements the performance of these traditional analog devices with special features like: continuous throughput to disk; real-time scrolling CRT display; sophisticated triggering; test sequence automation; and recorder support.

MODEL DASA 4600 SPECIFICATIONS

DASA 4600

Analog Inputs:

Channels: 16 single ended (Hi/GND); switch selectable (will be set to 16 single ended).

Accuracy: ± 1 bit.

Input Range: ± 10 V, ± 5 V, ± 1 V, ± 0.5 V or 0-10 V, 0-5 V, 0-2 V, 0-1 V; switch selected (will be set to ± 5 V).

Coding: Offset binary: True binary: unipolar 0 \pm inputs (will be set to bipolar).

Overvoltage: Continuous single channel to ± 35 V.

Input Current: 10 nA max 25°C.

Input Impedance: 1 M Ω .

Temperature Co-efficient: Gain or full seek, ± 25 ppm/°C max. Zero, ± 12 ppm/°C max.

A/D Type: Successive approximation.

Conversion Rate: 50,000 samples/s maximum.

Interchannel Skew: Constant at 20 μ s.

Linearity: $\pm 1/2$ bit.

Zero Drift: ± 10 ppm/°C max.

Gain Drift: ± 30 ppm/°C max.

Trigger Modes:

Software Selectable:

Keystroke.

Time.

External digital (high/low, positive/negative, and change of state).

Internal (above, below, outside window, inside window).

Digital Outputs: 4 TTL Status Outputs (high/low)

Bit 1: Start test/End test.

Bit 2: Start pre-trigger/Pre-trigger filled.

Bit 3: Trigger enabled/Trigger occurred.

Bit 4: Start post-trigger/Post-trigger filled.

Ordering Information

Model Number Description

DASA 4600 Configuration

9900-1000-2	DASA 4600 Base Kit includes: A/D Board (897655), Timer Board (897731), DASA Utilities (CL-712467), View II (CL-712468), ACQ4600 (797799), and MS-Windows (CL-212407)
9012-1072-2	DASA 4600 System includes: Compaq 286 Deskpro with coprocessor, 40 Mbyte drive, DOS, and 640 K memory, high-resolution EGA/VGA monitor, mouse plus Gould 9900-1000-2 DASA 4600 Base Kit
CL-710342-1	Real-Time Scroller. Displays real-time waveforms for signal monitoring

ACQ5300 SOFTWARE PACKAGE

- Pop up panels easy programming
- Macro's
- Quick look
- Configurable
- Full 5300 access
- Off line editing.

Use the ACQ5300 menu-driven software package to enter acquisition parameters, define waveform display formats and enter/edit text documentations. With its pop-up panels, 5300 setup is easy since all functions are logically grouped for acquisition, display, edit and macro execution.

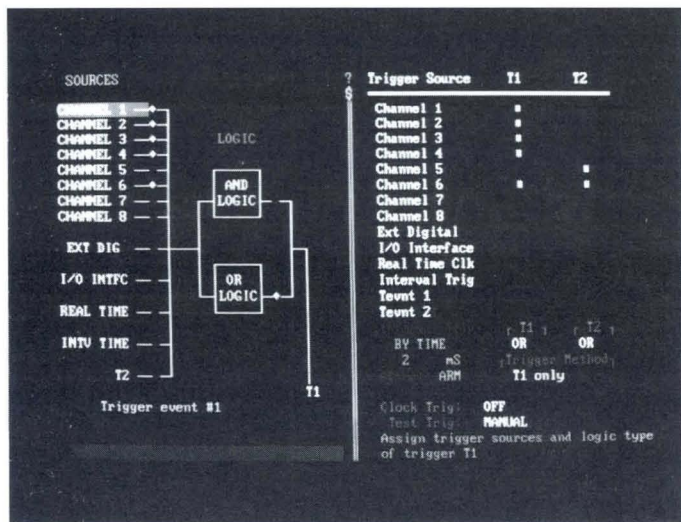

Event Manager

- Simple trigger free setup
- Combination logic

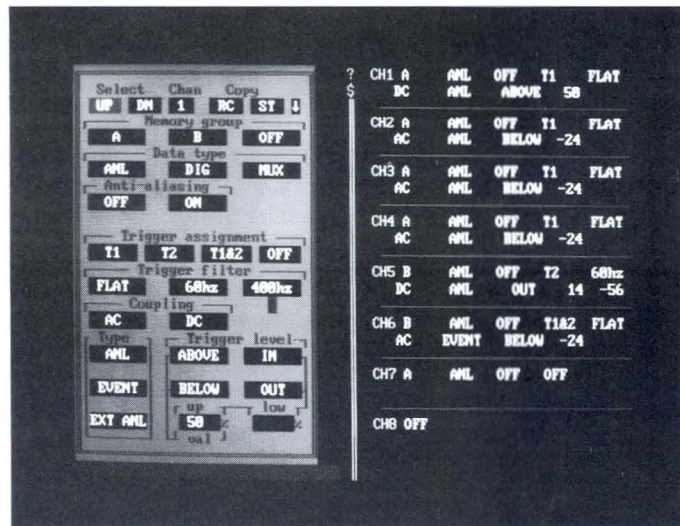

5300 Setup

- 5300 functions easily accessed
- Individually changed

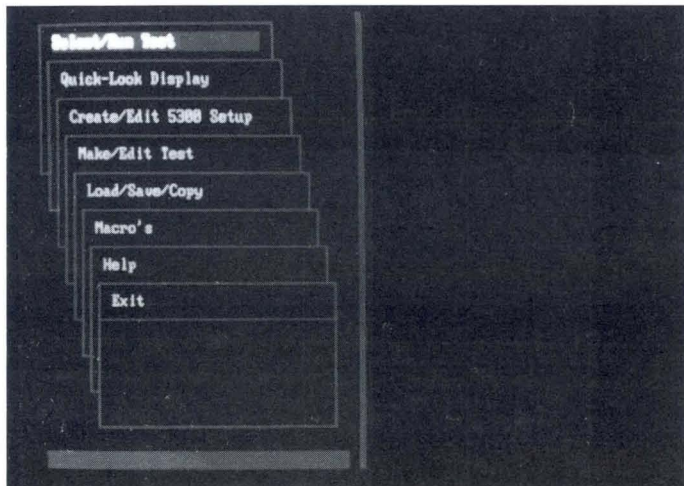

Main Screen

- Easy-to-use menus
- Requires no programming knowledge
- All test and colors configurable

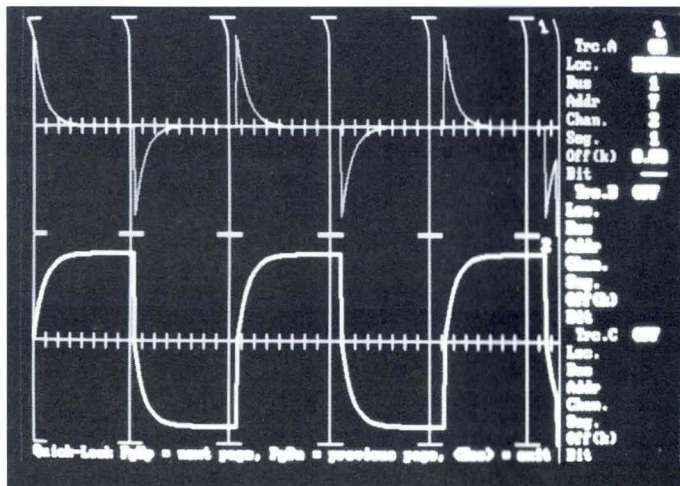

Waveforms

- Quick-Look display
- Displays all analog, digital and time base data

VIEW II GRAPHICS AND ANALYSIS SOFTWARE

- Comprehensive graphical display/functions
- Basic MATH and CALC functions
- Supports virtual amounts of data
- Report output up to the maximum resolution of the display device
- Manipulates Megabytes of data

VIEW II is a post-acquisition waveform display, manipulation, and analysis package. It provides extensive graphical manipulation functions to enhance the organization of waveforms for visual interpretation. Virtual memory management techniques support Mbytes of data, providing

for the support of long-term events. Basic MATH, CALC, and ANNOTATION functions are available to enhance data evaluation. All functions are accessible through task-oriented pull-down menus and pop-up dialog boxes within the consistent MS-Windows user interface.

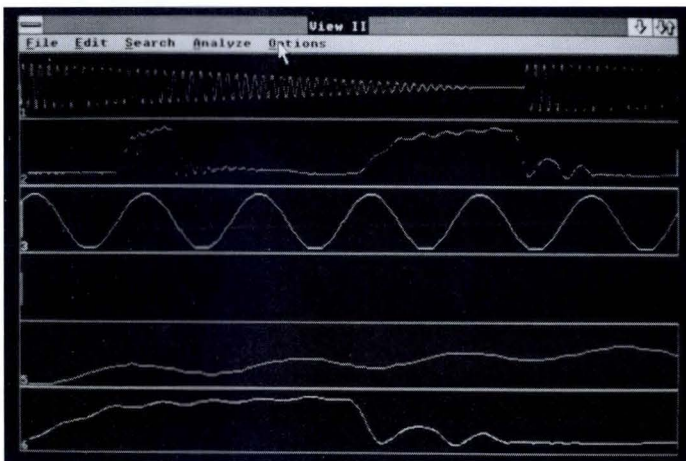

Graphical Display and Manipulation

Signal data is recalled from the Gould DSF (DASA Standard Format) data base. VIEW II can recall up to the maximum amount of data contained in the data-base. Recall specified data segments—down to an individual sample—from different devices, tests, channels, etc. for convenient comparison and analysis.

Display up to 16 Waveforms

Vertical cursor displays X and Y axis information

1 to 20 character marks for tagging data points

XY display

X-axis and Y-axis expansion/compression

Each waveform is displayed within its own "window". These windows can be sized to cover either the entire display area or some sub-set of it; windows can be either tiled adjacently or overlapped. Each window contains a definable amount of data and can be configured using several display attribute functions. The display can be output to any hardcopy device supported by MS-Windows.

User-defined size and position of signal windows

Comprehensive display attribute functions:

Signal ID

Tick marks

Limit lines

Horizontal and vertical graticules

Horizontal reference lines

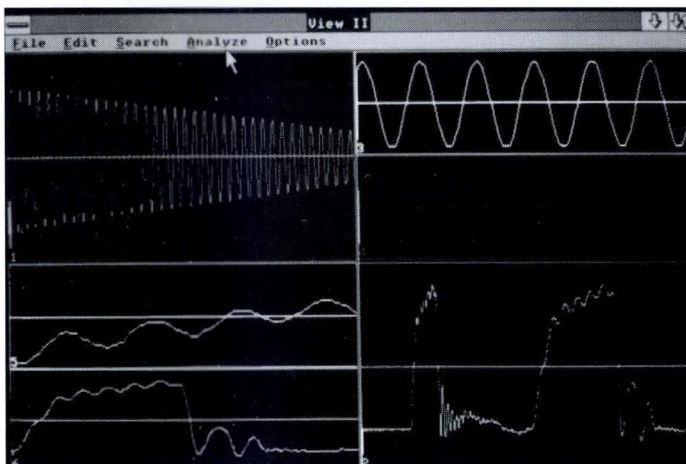

Data Search Functions

Points of interest in the data can be searched for by several functions. Search can be performed simultaneously across multiple channels. All searches are executed relative to the vertical cursor position.

Search Functions:

- N samples
- X-axis units
- Marks
- Y-axis level crossing

Analysis Functions

VIEW II provides two sets of analysis functions: CALC and MATH. CALCulations are those functions performed over a user-defined segment of a signal and result in a single value answer. MATH features those operations that are performed over one or more signals and result in a new signal. MATH functions are performed either between channels or between a channel and a constant value.

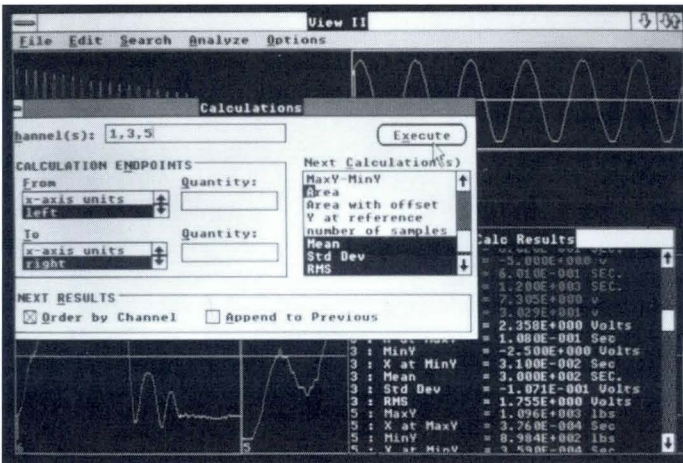

CALC Functions:

- 16 basic calculations
- Mean, standard deviation, RMS, etc.
- Max Y, min Y, area, Y at reference, etc.

MATH functions:

- +, -, *, /, integration and differentiation functions
- Math operations specified as a formula
- No limit to the level of parentheses in equation.

Defaults

Complete configurations can be saved as startup defaults. These can be modified at any time.

Configurations include:

- All display attributes
- Size and position of display windows
- Waveform data to be recalled
- Calculations to be performed.

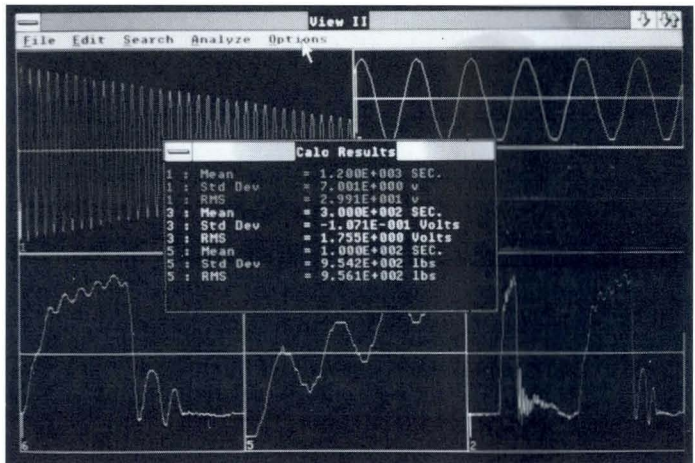

NEW

SET 5600 SOFTWARE

- Saves test setups in DASA Standard Format (DSF) database
- Downloads test setups to on-line systems
- Uploads setups from on-line systems
- Specifies all programmable parameters as part of a setup
- Prints test setups
- Communicates over IEEE-488 bus

SET 5600/DASA Software

SET 5600 is part of Gould's DASA Software. DASA Software is composed of separate, interactive menu-driven modules that run on an IBM PC/AT or true compatible. The DASA modules perform data acquisition, DSF utility functions, data display and analysis, as well as instrument setup. The data acquisition modules acquire data and either directly or, in conjunction with a data convert utility, put data into DASA Standard Format (DSF)

The DSF utility functions copy, delete, rename, etc. DSF data. The instrument setup modules are used to setup Gould's programmable instruments such as waveform recorders (5300), signal conditioner (5600 Series) and oscillographs (3000). The data display and analysis modules (VIEW) are used for displaying and analyzing data. The DSF data formats are published to facilitate third-party software packages and custom user-written software.

SET 5600 Files

SET 5600 Software consists of the following files:

SET5600.EXE: the executable file for the SET 5600 program.

CFG5300.EXE: the configuration function for SET 5600. This function is used to change help, message and screen text in the SET 5600 program. It can also be used to change screen colors. The screen text and color information will be stored in a file called SET 5600.CNF. Changes to message text and help text are stored in the

Gould SET 5600 Software programs any Gould 5600 Programmable Signal Conditioners for computer based instrumentation. It provides the capability for setting up any of the 5600 Programmable Signal Conditioners, copying the setups and transferring them to the computer or the signal conditioner via the IEEE bus.

SET 5600 is a menu-driven software package providing full access to the signal conditioners and featuring pop-up panels for easy programming and off-line editing. Signal Conditioner functions are easily accessed and can be changed individually.

file SET 5600.HLP and will overwrite the original text in this file.

INST5600.EXE: the SET 5600 installation program. This function is used to create the DSF directory structure, if necessary, and copy the Set 5600 software onto a hard drive.

Menus

Top level menus contain intermediate and submenus, organized as follows:

File

New
Open
Save
Save As
Print
Exit

Edit

Reset Sig. Cond.
New Device
Delete Device
Redefine Device
Redefine Channel
Copy Channel

Comm

Connect
Send
Lock
Poll IEEE-488 Bus

Setup file: Test.000

AD	<DEVICE>	CH	<TYPE>	<LABEL>
3	5900	1	RMS	
3	5900	2	Bridge	
3	5900	3	DC	
3	5900	4	<empty>	
3	5900	5	RMS	
3	5900	6	<empty>	
3	5900	7	DC	
3	5900	8	Bridge	

Display Values

Sensitivity GF: 2.00

Number of element: 2

Excitation voltage: 5.0

Expansion: 1000

Full Scale: 10000

Zero Suppression: 0.00

Filter: 200 Hz

Sensor Type: S/N

Range: UNITS:

Input: uSTRAIN UNITS Remote Lock

Amplifier Mode: DC Bridge XDCR

ZERO SUPP: A ZERO SUPP AMP BAL INP/GND

SH CAL: FILTER: INP/CLR: INP/BAL:

Setup file: Test.000

AD	<DEVICE>	CH	<TYPE>	<LABEL>
3	5900	1	RMS	
3	5900	2	Bridge	
3	5900	3	DC	
3	5900	4	<empty>	
3	5900	5	RMS	
3	5900	6	<empty>	
3	5900	7	DC	
3	5900	8	Bridge	

Display Values

Sensitivity mV: 1.00

Excitation voltage: 0.0

Expansion: 0.0

Zero Suppression: 0.00

Filter: 10 Hz

Sensor Type: S/N

Range: UNITS:

Input: uSTRAIN UNITS Remote Lock

Amplifier Mode: DC Bridge XDCR

ZERO SUPP: A ZERO SUPP AMP BAL INP/GND

SH CAL: FILTER: INP/CLR: INP/BAL:

CBI SYSTEM SERVICES

Training Services are available to assist customers as may be required in the technical understanding and operation of the individual products and complete systems. TRAINING SERVICE will normally be included as a separate line item in the quotation for complete system installations, but may be modified whenever required by the customer.

Training Service charges are based on pre-determined rates and the number of units required for specific products or systems. All training charges are subject to required minimums. Consult with your Gould Test and Measurement Sales Engineer.

Engineering Services are available for the complete or partial development of your requirements. These services will be quoted from Recording Systems Division Marketing with the assistance of the Systems Operations group.

Integration Services are available from Gould Inc., Recording Systems Division, for the custom assembly of hardware and software to meet the customer's requirements.

Installation Services are also available from Service. Each case will be evaluated based upon its particular needs. Contact the local service office or the factory for a quotation on service needs.

Software Contracts are available to maintain the most recent version of the software products as well as update contracts to maintain the most recent version of the firmware based products.

- **Broad selection instruments for acquire / measure, stimulus / source, and control/switch functions.**
- **Open system architecture integrating non-Gould IEEE-488 hardware and application software.**
- **Interactive and fully automated operating modes.**
- **Graphics-based software reduces development time.**
- **Rapid test system configuration and reconfiguration increases productivity.**
- **Complete test system parameters can be recalled providing consistent test parameters.**
- **Documentation of test results on a wide variety of printers and plotters.**

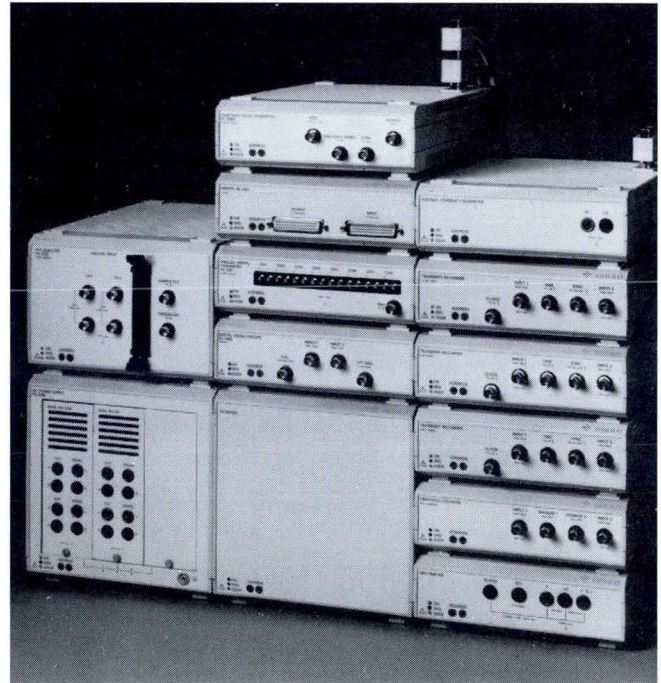

Gould's new generation of measuring instruments makes testing faster and simpler. The modular instruments provide all acquisition, stimulus, and control functions; the personal computer operates as the instrument controller and provides all analysis, display and output functions.

Data acquisition and testing with traditional IEEE-488 instruments involves adjusting parameters, re-setting measurements, and selecting new functions by twisting and flicking knobs and keys. This time-consuming process is eliminated with Gould PC-Instruments which are controlled by a computer using uniform soft front panels on a centralized display. All redundant displays and controls and their inherent confusion are eliminated, and the PC automates all analysis and documentation tasks.

Hardware

- 13 laboratory-quality IEEE-488 modules.
- Compact modular design.
- Resident IEEE-488 for convenient system configuration.
- Electrical isolation between modules.
- Easy to access connections/terminations.
- Serial 20-mA current loop communication.

The 13 modular PC-instruments have uniform dimensions and are designed to be stacked on each other to conserve space. The IEEE-488 bus connections are automatically established via resident connectors; only a single cable is required for the PC interface. The instruments conform to the IEEE-488.2 standard and are self-configuring. Non-Gould IEEE-488 instruments can be easily integrated into the system.

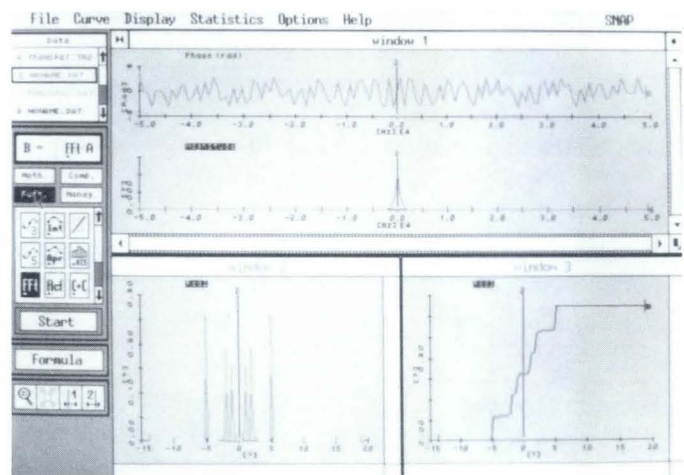
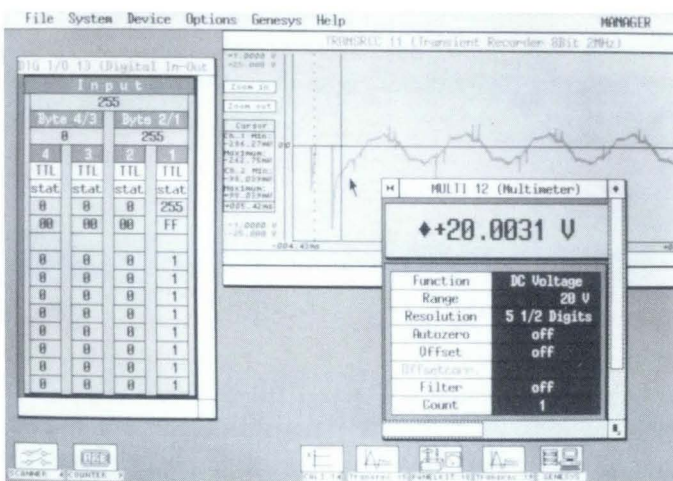

Software

GoULD PC-Instrument software is composed of five packages in a fully integrated environment.

PCI-WINDOWS is the primary user-interface providing soft front panels for the interactive control of all PC-instrument modules. Up to seven instrument panels can be displayed on a centralized display for convenient status review and data comparison.

PCI-PANEL KIT provides for the creation of soft front panels for non-GoULD IEEE-488 instruments. Five basic commands are used to quickly create soft front panels for simple and complex instruments.

PCI-SNAP provides over 150 graphics, analysis,

statistics, and file management functions. Functions appear as icons and are simply "clicked on" for execution.

PCI-GENESYS is a graphics-based program generator utilizing a powerful set of icons for the creation of automated test sequences. No experience with any programming language is required, not a single line of code needs to be written.

PCI-BASIC is a form of BASIC expanded for the support of IEEE-488 instruments. It is automatically compiled based on the program sequence defined in PCI-GENESYS, but it can be used to directly program IEEE-488 instruments.

DIGITAL MULTIMETER

GOULD PC3220

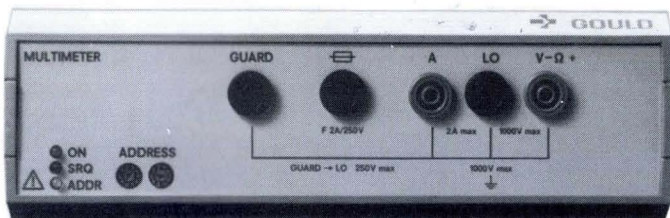

- 5-1/2 digit accuracy
- 26 measuring ranges for DC and AC Voltage and Current plus resistance
- Autoranging or fixed range selection
- Up to 530 measurements/second
- Overload protection with feedback signal

The Gould PC3220 Multimeter with autoranging or manual range selection will measure DC and AC voltages, direct and alternating currents, and resistances. The Multimeter has a selectable resolution of 5-1/2, 4-1/2 or 3-1/2 digits. Temperature in °C or °F is directly measured using a Pt 100 temperature sensor. The offset function enables relative measurements in all modes.

The internal data memory can store up to 500 values which can subsequently be outputted sequentially and evaluated. You can record values continuously, or you can measure a defined number of values following a start command.

MODEL PC3220 SPECIFICATIONS

DC Voltage

Measuring range	Resolution with			Input resistance
	5-1/2 digits	4-1/2 digits	3-1/2 digits	
± 200 mV	1 μV	10 μV	100 μV	≥ 1 GΩ
± 2 V	10 μV	100 μV	1 mV	≥ 1 GΩ
± 20 V	100 μV	1 mV	10 mV	10 MΩ
± 200 V	1 mV	10 mV	100 mV	10 MΩ

Accuracy (% of measured value + digits)				
Range	Number of digits			
	5-1/2	4-1/2	3-1/2	
200mV	0.02+4	0.02+1	0.02+2	
2V to 200V	0.01+4	0.01+1	0.01+2	
1000V	0.02+4	0.02+1	0.02+1	

Temperature coefficient: <.001%/°C (0 to 40°C).

Maximum input voltage: 1000 VDC in all ranges.

Maximum voltage: Low to ground: 1000 V RMS.

Input protection: Metal-oxide varistors for brief voltage peaks (2000 V for 30 ms or max.0.6Ws).

Response time: <100, 20, 2 ms with 5-1/2, 4-1/2, 3-1/2 digit display.

Common-mode rejection: >120 dB with DC and 1 kΩ in High or Low; >120 dB with AC to 63 Hz and 1kΩ in High or Low

DC Current

Measuring range	Resolution with digits			Shunt	Volt. Drop
	5-1/2	4-1/2	3-1/2		
200 μA	1 nA	10 nA	100 μA	500 Ω	100 mV
2 mA	10 nA	100 nA	1 μA	50 Ω	100 mV
20 mA	100 μA	1 μA	10 μA	5 Ω	100 mV
200 mA	1 μA	10 μA	100 μA	0.5 Ω	100 mV
2 A	10 μA	100 μA	1 mA	.05 Ω	100 mV

Accuracy (% of measured value + digits)				
Range	Number of digits			
	5-1/2	4-1/2	3-1/2	
200μA to 200mA	0.05 + 20	0.05 + 4	0.05 + 2	
2A	0.1 + 20	0.1 + 4	0.1 + 2	

Voltage drop across input terminals: <1V at rated current 2 A

Temperature coefficient: 0.005%/°C (0 to 40°C)

Overload protection: Fast-blow fuse 2 A/250 V (max=1500A)

AC Voltage (true RMS value)

Measuring range 0 to.	Resolution with		
	5-1/2 digits	4-1/2 digits	3-1/2 digits
200 mV	1 μV	10 μV	100 μV
2 V	10 μV	100 μV	1 mV
20 V	100 μV	1 mV	10 mV
200 V	1 mV	10 mV	100 mV
1000 V	10 mV	100 mV	1 V

Accuracy (% of measured value + digits)			
Range	Number of digits		
	5-1/2	4-1/2	3-1/2
0.2/2/20V (30 to 60 Hz)	1 + 200	1 + 20	1 + 4
(50 Hz to 40 kHz)	0.15 + 200	0.15 + 20	0.15 + 4
(40 to 100 kHz)	1 + 200	1 + 20	1 + 4
(100 to 160 kHz)	1 + 200	2 + 20	2 + 4
200/1000V (50 Hz to 30 kHz)	0.15 + 200	0.15 + 200	0.15 + 4

Input impedance in all ranges: 1MΩ at 50 pF

Voltage-frequency product: 3 . 107 VHz

Max. crest factor: 3 at full-scale value

Max. input voltag: 1000 V RMS (sinusoidal)

Max. voltage Low to ground: 1000 V RMS

Input protection: Overvoltage arrester for brief voltage peaks (2000V for 30 ms or max.0.6Ws)

Common-mode rejection (CMR): >120 dB with 63 Hz and 1kΩ in high; >60 dB with 63 Hz and 1 kΩ in Low

Response time: Approx. 600/500/200 ms 5-1/2,4-1/2, 3-1/2 digits

AC Current (true RMS value)

Range 0 to	Resolution with			Shunt
	5-1/2 digits	4-1/2 digits	3-1/2 digits	
200 μA	1 nA	10 nA	100 nA	500 Ω
2 mA	10 nA	100 nA	1 μA	50 Ω
20 mA	100 nA	1 μA	10 μA	5 Ω
200 mA	1 μA	10 μA	100 μA	0.5 Ω
2 A	10 μA	100 μA	1 mA	0.05 Ω

Accuracy (% of measured value + digits)			
Range	5-1/2	4-1/2	3-1/2
200μA to 200 mA (40 to 400 Hz)	0.2 + 200	0.2 + 20	0.2 + 4
2A	0.25 + 200	0.25 + 20	0.25 + 4

Frequency range: Up to 1 kHz

Crest factor: 2

Input protection: Fast-blow fuse 2 A/250V

Resistance

2-terminal measurements in all ranges

Range 0 to	Resolution with digits			Current	Voltage
	5-1/2	4-1/2	3-1/2		
200 Ω	1 mΩ	10 mΩ	100 mΩ	1 mA	200 mV
2 kΩ	10 mΩ	100 mΩ	1 Ω	1 mA	2 V
20 kΩ	100 mΩ	1 Ω	10 Ω	10 μA	200 mV
200 kΩ	1 Ω	10 Ω	100 Ω	10 μA	2 V
2 MΩ	10 Ω	100 Ω	1 kΩ	500 nA	1 V
20 MΩ	100 Ω	1 kΩ	10 kΩ	500 nA	10 V

Accuracy: % of measured value + digits			
Range	5-1/2	4-1/2	3-1/2
200 Ω to 2 MΩ	0.02 + 10	0.02 + 4	0.02 + 2
20 mΩ	0.05 + 10	.05 + 4	0.05 + 2

Input protection: 1000 V RMS interference

No-load voltage: Approx. 11 V

General Data

Display range (digits): 240000/24000/2400

Measurement Method: Integrating charge compensation

Measurement sequence (without autozero and filter, with internal triggering.			
Function/Range	Measurements/s with digits		
	5-1/2	4-1/2	3-1/2
VDC, VAC, R	10	50	530
IDC, IAC, R(2MΩ,20MΩ)	5	25	280
(with auto zero, a zero measurement is made every 100th measurement with the following delay)			
	Measurement time delay in ms		
	5-1/2	4-1/2	3-1/2
Filter on	340	140	26
Filter off	580	260	50
In addition with 20 MΩ	+100	+20	+2

Operating temperature: 0 to 40°C

Storage temperature range: -40 to + 70°C

Rated temperature range: 18 to 28°C

Power supply: 115/230V; -15 to + 10%, 48 to 63 Hz, approx. 15VA

Dimensions (w x h x d): 8.66in X 3.43 in. X 15.63 in. (220mm x 87mm x 397mm)

Weight: 7.5 lbs. (3.4 kg)

Ordering Information

Model Number	Description
9100-3220-01	Gould PC3220 Digital Multimeter with IEEE-488 interface and front panel driver software (for use with Gould PCI WINDOWS)
CL-712741	19 inch rack mount kit (accomodates up to 6 PC-instruments)
CL-212641	Pt 100 Temperature Sensor

Only available for sale in North America.

TRANSIENT RECORDERS

GOULD PC3140, PC3141, PC3143



- Two channels
- 8 or 12 bit A/D Converters
- 1, 2 and 10MHz Sampling Rates
- Memory 2 x 16k samples

The Gould PC3140 series transient recorders are used for capturing single-shot events over a wide frequency range. By offering various digitizing rates and A/D converter resolutions, the three transient modules extend the application possibilities of your PC test system: PC3140 for signals up to 660 kHz, PC3141 for signals up to 3.3 MHz and PC3143 for signals up to 330 kHz with the added advantage of 12-bit signal resolution (4096 steps). This high resolution is ideal if signal amplitude is unknown before it is recorded. For example, a signal as small as 1% of the full-scale range can be displayed in 40 steps.

First, the acquired signal is converted into 8-bit or 12-bit words. These digital signals are stored in the 2 x 16k sample memory and transferred to the PC for graphic display, signal analysis, hard copy output and filing on disk.

The trigger point can be positioned at any location in the memory for analysis of data prior to, or well after the trigger event. A dual time base mode allows the digitizing rate to automatically change during acquisition. The transient recorders can be extended into a multi-channel system via a simple BNC connection. A similar connection allows the memory of several units to be cascaded to greater depth.

MODELS PC3140, PC3141 & PC3143 SPECIFICATIONS

Input Amplifier:

Number of Channels: 2 (BNC connectors)

Input Coupling: AC, DC, GND

Measuring Ranges:

PC3140: 0 to 0.1/0.2/0.5/1/2/5/10/ 20/50 V

PC3141: 0 to 0.1/0.2/0.5/1/2/5/10/20/50 V

PC3143: 0 to 0.5/1/2/5/10/20/50 V

Offset Adjustment: Selectable in 0.5% steps from 0 - 100% of full scale.

Bandwidth (-3 dB):

DC Coupling:

PC3140: DC to 660 kHz

PC3141: DC to 3.3 MHz

PC3143: DC to 330 kHzS

AC Coupling:

PC3140: 7 Hz to 660 kHz

PC3141: 7 Hz to 3.3 MHz

PC3143: 7 Hz to 330 kHz

Gain Deviation: 0.55% of full-scale max.

Gain Drift: 0.033%/°C max.

Maximum Input Voltage: 400 VDC, 250 VAC ($f < 60\text{Hz}$)

Input Circuit: Single ended, grounded

Trigger Circuit:

Trigger Sources: Channel 1, channel 2, external, internal, SYNC in

Trigger Logic: Channel 1 AND channel 2, channel 1 OR channel 2

Internal Triggering:

Trigger Threshold: Selectable in 0.5% steps from 0 - 100% of full scale

Edge: Positive or negative

Deviation: Max. 2% of full-scale

Sensitivity: Typically 2% full-scale

Coupling: DC

Delay: Max. 100 ns, typical 70 ns (amplifier output \rightarrow TRG)

External Triggering, Synchronous:

Input Voltage Range: TTL (Schmitt trigger), negative edge

Pulse Width: ≥ 30 ns

Input Voltage: Max. ± 30 VDC + AC peak

Input Current: External: max, 1.1 mA; SYNC IN Max. 1.6 mA

Delay: TRG external \rightarrow TRG: typically 70 ns; SYNC in \rightarrow TRG: typically 35 ns

Signal Memory: 16384 measured values

Trigger Position Adjustment: Numerically, +65535 to 0 (0 is last memory location to be filled)

Sync. Output:

Output Level: TTL, Low-active

Output Current: IOL = 13 mA max; IOH = 0.4 mA max.

Single/Dual Time Base:

Sampling Frequency Range

PC3140: 1 Hz to 2 MHz

PC3141: 1 Hz to 10 MHz

PC3143: 1 Hz to 1 MHz

Frequency Ratio: $f_1:f_2$: 255:1....2:1, 1:1, 1:2....1:255

Clock Input:

Pulse Width: ≥ 30 ns

Frequency:

PC3140: Max. 1 MHz

PC3141: Max. 5 MHzS

PC3143: Max. 0.5 MHz

Multi-channel Operation: Several modules record signals in parallel; synchronization via external SYNC signal

Memory Cascading: Several modules record data serially and offset in time; synchronized via TRIG/SYNC connectors

General Data

Operating Temperature: 0 to 40°C, 70% relative humidity

Storage Temperature: -40 to + 70°C, 65% relative humidity

Overload Protection: IEC 348; Protection class 1 to DIN VDE 0411

Power: 115/230 V (-15 to +10%) 48 to 63 Hz; 40 VA typical

Dimensions (w x h x d): 8.66 in. x 3.43 in. x 15.63 in. (220 mm x 87 mm x 397 mm)

Weight: 7.5 lbs.(3.4 kg)

Ordering Information

Model Number	Description
9100-3140-01	Gould PC3140: 8-bit A/D resolution; 2 MHz sample rate 2x16k memory
9100-3141-01	Gould PC3141: 8-bit A/D resolution; 10 MHz sample rate; 2x16k memory
9100-3143-01	Gould PC3143: 12-bit A/D resolution; 1 MHz sample rate; 2x16k memory

Above models include IEEE-488 interface and front panel driver software for use with Gould PCI-WINDOWS Manager.

CL-712741	19-inch rack mount kit (accommodates up to 6 PC-instruments)
CL-212644	Probe/Attenuator 1:1,10:1
CL-712724	Gould PCI-WINDOWS Manager Software

Only available for sale in North America.

UNIVERSAL COUNTER

GOULD PC3200



- Frequency Range: DC to 100 MHz
- Two identical channels
- Marker outputs for each channel
- Reciprocal counting method
- High resolution: up to 9 digits
- Automatic triggering

The Gould PC3200 Universal Counter with frequency range from DC to 100 MHz is suitable for use in test departments, development and manufacturing. The standard operating modes (frequency, frequency ratio,

period, pulse width, rise time, time interval, peak value, event counting and timer) can be extended by user software for specific applications requirements such as measurement of RPM, phase angle, or duty cycle.

MODEL PC3200 SPECIFICATIONS

Operating modes: Frequency, frequency ratio, period, multiple period, pulse width, multiple pulse width, rise time, time interval, multiple time interval, peak value, event counting, clock, timer, wake-up functions.

Input: Channel 1 (CH1) and Channel 2 (CH2).

Frequency range: DC: 0 to 100 MHz. AC: 50 Hz to 100 MHz.

Input impedance: 1 M Ω , 20 pF (0.5 M Ω , 40 pF on rise time measurements)

Input sensitivity: 20 mV RMS min. sine wave (up to 10 MHz). 35 mV RMS min. sine wave (10 MHz to 100 MHz). 95 mVp-p min. with pulse width > 5 ns.

Input voltage range: 25 V RMS max. with attenuation x 10.

Signal coupling: DC, AC.

Attenuation: 1, 10

Input filter: Selectable, cut-off frequency: 60 kHz.

Trigger level: $\pm 100\%$ input range.

Autotrigger: For frequency ≥ 50 Hz.

Trigger edge: Positive/negative.

Delay: 200 μ s to 500 ms; resolution 10 μ s.

Marker outputs: CH1, CH2. Square-wave marker, short circuit proof.

General Data:

Operating temperature: 0 to 40 $^{\circ}$ C, 75% relative humidity.

Storage temperature: -40 to 70 $^{\circ}$ C 65% relative humidity

Power: 115/230 V (-15 to 10 %) 48 to 63 Hz

Dimensions: 3.43 in. x 8.66 in. x 15.63 in. (87 mm x 220 mm x 397)

Weight: 7.5 lbs (3.4 kg)

Mode	Channel	Range	Gate Time	Resolution
Frequency	CH1, CH2	DC to 100 MHz	10ms to 50s or 1 period	± 1 LSD
Frequency ratio	CH1, CH2	DC to 100 MHz	10ms to 50s or 1 period	± 1 LSD
Period	CH1	10 ns to 3 h	1 period	10 ns
Multiple period	CH1, CH2	10 ns to 3 h	10ms to 50s or 1 period	10 ns to 10 ps
Pulse Width	CH1	10 ns to 3 h	—	10 ns
Multi. pulse width	CH1	10 ns to 3 h	—	1 ns to 100 ps
Rise time	CH1	10 ns to 3 h	—	10 ns
Multiple Rise Time	CH1	10 ns to 3 h	—	1 ns to 100 ps
Time interval	CH1 - CH2	10 ns to 3 h	—	10 ns
Multi. time interval	CH1 - CH2	5 ns to 3 h	—	1 ns to 100 ps
Event counting	CH1, CH1 \pm CH2, CH2 with period on CH1, CH2 with pulse width on CH1	2^{40} events	—	1 event
Peak value	CH1, CH2	-25 to +25V (attenuation 10)	—	10 mV (attenuation 1)
Clock/Timer Wake-up	—	10 ms to 99999 s	—	10 ms

Ordering Information

Model Number	Description
9100-3200-01	Gould PC3200 Universal Counter with IEEE-488 interface and front panel driver software for use with Gould PCI-WINDOWS Manager
CL-712741	19 inch rack mount kit (accommodates up to 6 PC Instruments)
CL-712724	Gould PCI-WINDOWS Manager Software

Only available for sale in North America.

FFT / ANALYZER

GOULD PC3120

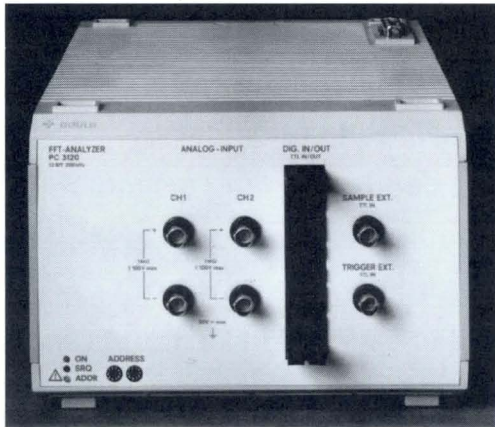

- 2 analog input channels with 72 dB dynamic range
- 2 sixteen bit digital I/O channels
- 200 kHz maximum frequency range with anti-aliasing filter
- 156 μ Hz maximum frequency resolution
- 20 kHz real-time analysis
- Input voltage range- 50 dBV to 30 dBV in 2 dB steps
- 1024 point FFT performed in 8 ms
- Time, frequency, and rotation domain analysis
- Digital filter (graphics based)

The Gould PC3120 is used in a wide variety of applications including: structural analysis, rotating machinery monitoring, acoustics and noise monitoring, control system monitoring and electronic parameter measuring.

The PC3120 has 2 analog inputs with 12-bit amplitude resolution and two 16-bit wide digital inputs for the analysis of pre-digitized signals. Time domain functions

include signal averaging, auto-correlation, cross-correlation, and impulse response determination. Frequency domain functions include linear, power, and cross-power spectrum analysis. Coherence and transfer functions are also available.

The PC3120 can also be utilized as a digital filter. The desired filter is simply graphically defined and stored; filter characteristics unachievable by conventional analog techniques are thus possible.

MODEL PC 3120 SPECIFICATIONS

Digital Inputs: Two 16-bit wide inputs.

Level: TTL, active low.

Analog Inputs: Two channels.

Input Impedance: 1 M Ω , <50 pF.

Coupling: DC or AC, <3 dB at 1 Hz.

Differential Voltage: +50 V maximum.

Digital Outputs: Two 16-bit wide outputs.

Level: CMOS, active low.

Analog Outputs (optional): Two channels (10-bit resolution).

Output Impedance: 50 Ω , +1 V.

Internal Triggering:

Source: Channel 1, channel 2.

Mode: Auto armed, single shot, free running.

Level: 0 to 100% in 0.5% steps (referred to full-scale input voltage range).

Slope: Positive or negative.

External Triggering:

Level: TTL, negative edge, 30-ns min. pulse width.

Trigger Location: -128 k to +128 k samples after triggering event.

Frequency Measuring Ranges: 0 to 200 kHz.

Number of Ranges: 17.

Resolution: 0.25% of Frequency Range (400 lines).

External Sampling: 200 kHz max. with anti-aliasing filter and rectangular window.

Voltage Ranges: -50 dBV to 30 dBV.

Number of Ranges: 12.

Steps: 1, 2, 5.

Dynamic Range: >72 dB per voltage range (12-bit resolution).

Window Function: Rectangular, Hanning, flat top, user defined.

Analyzer Functions:

Time Domain: Time signal channel 1, channel 2; autocorrelation; cross-correlation; impulse response.

Frequency Domain: Spectrum channel 1, channel 2; power spectrum channel 1, channel 2; cross cepstrum; transfer function; coherence; power spectrum.

Averaging Mode: Linear, exponential, peak hold.

Ordering Information

Model Number	Description
9100-3120-1	Gould PC3120 FFT Analyzer

Only available for sale in North America.

DIGITAL STORAGE OSCILLOSCOPE

GOULD PC3160



- 100-MHz analog bandwidth
- 1-GHz sampling rate
- 20-MHz bandwidth limit selectable
- 8-bit resolution
- 1,000 words/channel memory
- 200 mV to 50 V full scale input range
- 0 to 100% pre-trigger

The Gould PC3160 is ideally suited as a general purpose instrument for measuring electrical and electronic signals. Typical applications include digital design and testing, amplifier design and testing, and component testing.

The PC3160 has two input channels with an analog bandwidth of 100 MHz (3dB) and a voltage range from 20 mV to 50 V. The timebase has two modes:

Low frequency signals are measured using real time sampling; high frequency periodic signals are measured using random sampling.

There are three modes for displaying waveforms: refresh, min/max, and average. A tolerance band can be defined which when exceeded will either trigger acquisition or issue a status message.

MODEL PC3160 SPECIFICATIONS

Channels: Two.

Bandwidth:

DC Coupling: DC to 100 MHz.

AC Coupling: 5 Hz to 100 MHz.

Coupling: AC, DC, ground.

Range: 20 mV to 50 V (2 mV/div to 5 V/div) in 11 ranges, 1-2-5 steps.

Max. Input Voltage: 400 VDC; 400 VAC peak-peak.

Input Impedance: 1 M Ω , 22 pF.

Rise Time: 3 ns, 10% to 90%.

A/D Converter Resolution: 8 bit.

Input Offset: $\pm 100\%$ full scale in 1% steps.

Memory: 1000 measurements per channel.

Time Base

Real Sample Rate: 50 μ s to 50 ms.

Sequential Random Sampling: 100 ns to 20 μ s.

Random Sampling: 1 ns to 50 ns.

Resolution (Time window 1000 samples): 1 μ s to 50 s (100 ns/div to 5 s/div) in 24 ranges, 1-2-5 steps.

Trigger Source: internal, channel 1, channel 2, AND, OR, external, manual, line (50 or 60 Hz).

Trigger Delay

Pre-trigger: 1 μ s to 50 s.

Post-trigger: 0 to 70 minutes.

Internal Trigger

Trigger Level: $\pm 100\%$ full scale, in 1% steps.

Slope: Positive, negative.

External Trigger

Bandwidth: 150 MHz.

Level: $> \pm 1$ V peak (max. ± 30 VAC).

Slope: Negative, positive.

Calibration Trigger

Signal: Square.

Frequency: 1 kHz.

Amplitude: ± 4 V peak.

Ordering Information

Model Number	Description
PC3160	Digital Storage Oscilloscope

Only available for sale in North America.

FUNCTION/PULSE GENERATOR

GOULD PC3000



- Signal waveforms: sine, triangle, ramp, square wave, DC
- Frequency range 0.05 Hz to 5 MHz
- Normal and inverted signal polarity
- Trigger, gate and burst functions
- VCO input

The Gould PC3000 Function/Pulse Generator is a versatile waveform source, capable of generating highly accurate sine, triangular, ramp, square wave and pulse signals. Well suited for use in development, manufacturing and education, the function/pulse generator creates AC variables from 0.5 Hz to 5 MHz. The frequency is generated either crystal-stabilized or free-running.

Frequency can be swept over a wide range by applying a voltage to the VCO input. Triggering is possible via the interface (internal) or the TRIG/GATE(BURST) socket (external).

External control can be activated with either a positive or negative signal edge. The external trigger functions are described below:

MODEL PC3000 SPECIFICATIONS

Frequency:

Range: 0.5 Hz to 5 MHz

Accuracy: 3% of set value with free-running generator
0.01% with crystal control

Output Amplitude:

attenuation =1	No load		50 Ω load	
Voltage (p-p)	0.02 to 20 V		0.01 to 10 V	
DC offset	-10 to +10 V		-5 to +5 V	
Resolution	20 mV		10 mV	

Amplitude Accuracy: 2/3/5% with attenuation 1/10/100 and f = 1 kHz

Frequency Response: to 100 kHz < -0.2 dB
100 kHz to 5 MHz < -1.5 dB referred to 1 kHz, 5 V p-p, 50 Ω load

Temperature Drift: <0.1%/°C

Attenuation: 1/10/10

Waveforms

Sine	Adjustment Range Distortion (THD) Symmetry error	0.5 Hz to 5 MHz (free) 45 Hz to 5 MHz (stab.) <1% up to 100 kHz <2%
Triangle	Adjustment Range Linearity error Symmetry error	0.5 Hz to 5 MHz (free) 45 Hz to 5 MHz (stab.) <1% up to 100 kHz <3% 100 kHz to 1 MHz <2%
Ramp	Adjustment Range Fall time Linearity error	0.05 Hz - 500 kHz (free) 45 Hz - 500 kHz (stab.) 19:1 <1% up to 50 kHz <3% 50 to 500 kHz

Square wave	Adjustment Range Rise time Duty factor Overshoot	0.5 Hz to 5 MHz (free) 0.5 Hz to 5 MHz (stab.) <45 ns 50 %, 1 to 99% <5% of set amplitude
Pulse	Adjustment Range 0.5 Hz to 5 MHz (stab.) Pulse width Overshoot	0.5 Hz to 5 MHz (free) 200 ns to 2 s <5% of set amplitude

DC Source:

No-load Operation: -10 V to +10 V

50 Ω Load: -5 V to +5 V

Resolution: 20 mV (attenuation 1) 10 mV (50 Ω load, attenuation 1)

VCO Input:

Voltage Range: 0.5 to +5 V

Sweep Ratio: 1:10

Input Resistance: 200 kΩ

Maximum Input: ±250 V

TRG/GATE/BURST Input:

Input Voltage: TTL

Trigger Edge: positive, negative

Maximum Input: ±25 V

Ordering Information

Model Number	Description
9100-3000-01	Gould PC3000 Function/Pulse Generator with IEEE-488 interface and front panel driver software (for use with Gould PCI-WINDOWS Manager)

Only available for sale in North America.

16-BIT A/D CONVERTER

GOULD PC3101

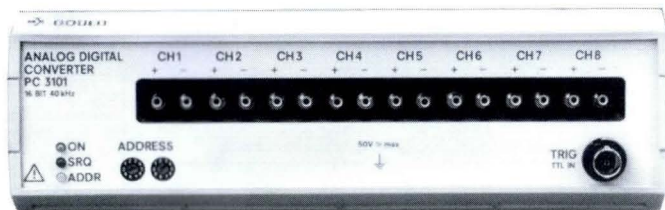

- 8 differential or single-ended channels
- 40 kHz sample rate, multiplexed
- ± 10 V, ± 1 V, ± 100 mV input ranges
- Input/output isolation
- Programmable channel sequencing
- Variable time sequence intervals (25 μ s to 400 s)
- TTL, slope, and window triggers
- Data reduction (min/max/mean)
- 64 k word memory

The Gould PC3101 is used to measure a wide variety of physical and electro-mechanical parameters, such as temperature, pressure, voltage, current, strain, and vibration.

All eight channels are isolated, have three input ranges, and can operate in either single-ended or differential

mode. The multiplexed sample rate is 40 kHz with 16 bit resolution.

The channel sequence is user-selectable and can be initiated by command or either external (TTL, slope) or internal (window) triggers. The sample time can be defined by either the sample interval (25 μ s to 400 s) or the channel sequence interval.

MODEL PC3101 SPECIFICATIONS

Input:

Channels: 8 differential inputs.

Ranges: ± 10 V, ± 1 V, ± 100 mV.

Resolution: 350 μ V, 35 μ V, 3.5 μ V.

Coupling: Single ended, differential, ground.

Sample Interval: 25 μ s to 400 s in 25- μ s steps.

Resistance: 1 M Ω .

Max. Input Voltage: Protected up to 50 V.

Memory: 65,535 words.

Trigger:

Internal Trigger: Window trigger.

Positive Level: $\pm 100\%$ full scale, 0.01% steps.

Negative Level: $\pm 100\%$ full scale, 0.01% steps.

External Trigger:

Voltage: TTL.

Slope: Positive, negative.

Ordering Information

Model Number	Description
9100-3101-1	PC3101 16-bit A/D Converter

Only available for sale in North America.

PROGRAMMABLE POWER SUPPLY

GOULD PC3080

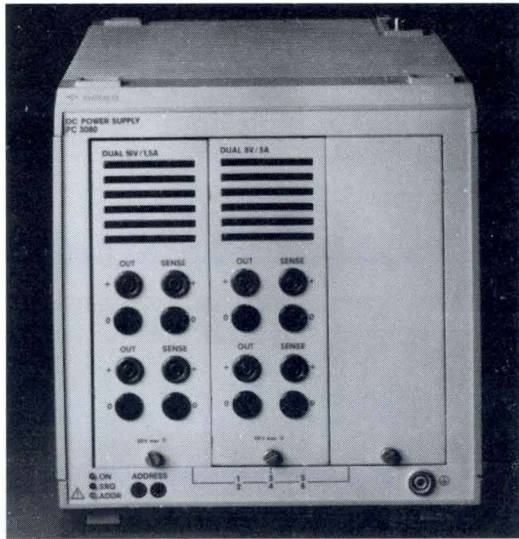

- 3 available slots
- 4 card types
- 12-bit resolution for voltage and current setup
- 12-bit resolution for voltage and current measurement
- Independent SRQ's for voltage and current overload
- $50\text{-}\mu\text{s}$ settling time (10-90% load change)
- Functions as a programmable load
- Programmable overvoltage and overcurrent protection
- Modes for constant voltage and current

The Gould PC3080 Power Supply provides the most commonly used voltages and currents in laboratory applications. It is designed to work within a system with other Gould PC modules.

MODEL PC3080 SPECIFICATIONS

Scanner cage with three slots at the front. User can select up to four modules.

Ranges:

Module 1: 0 to 7 V \pm 7 A, one channel.

Module 2: 0 to \pm 16 V \pm 1.5 A, channels 1 and 2.

Module 3: 0 to \pm 40 V \pm 0.6 A, channels 1 and 2.

Module 4: 0 to \pm 8 V \pm 3 A, channels 1 and 2.

Channels are independently isolated from ground.

Output range can be used as either source or sink.

The Sink function is guaranteed at the moment in the range $2\text{ V} \leq U_{\text{act}} \leq U_{\text{nom}}$.

Output coupling: parallel, serial and bridge circuit for BOP function.

Resolution for Voltage and Current Settings:

Module 1: 2 mV; 2 mA.

Module 2: 4 mV; 0.5 mA.

Module 3: 10 mV; 0.2 mA.

Module 4: 2 mV; 1 mA.

Accuracy:

Voltage: 0.1% of nominal value + 2 LSD.

Current: 0.1% of nominal value + 2 LSD.

Settling Time: 3 ms from 0 to 100% for constant voltage source with nominal value changing.

Temperature Coefficient (Voltage): 90 ppm for set value + 10 ppm for the nom. value.

Maximum Ripple:

Voltage: 1 mV RMS, 3 mV P-P.

Current: 5 mA RMS, 3 mA P-P.

Measuring Functions	Voltage	Current
Resolution	12 bits	12 bits
Accuracy	0.1% from upper range limit	
Rate	>10 values/s	>10 values/s

Additional Functions: Sense operating with autosensing; over temperature protection; output protection.

Nominal value definition and soft limit definition (limiting of nominal value settings).

Standby On/Off.

Definition of channel groups possible: Current and Voltage limits, regulation and switching.

Regulation: When the set limit is reached, the following changes can occur:

Constant current operation switches to pre-programmed constant voltage operation, or constant voltage operation switches to pre-programmed constant current operation.

Ordering Information

Model Number	Description
9100-3080-1	PC3080 Programmable Power Supply
Only available for sale in North America.	

VOLTAGE/CURRENT CALIBRATOR

GOULD PC3050



- Short-circuit and no-load protection
- Limiting of output current and voltage
- Standby function
- Programmable functions
 - Stabilized voltage source
 - Stabilized current source
 - Current/voltage ramp

The Gould PC3050 Voltage/Current Calibrator is a precision voltage and current source used to calibrate and test analog and digital circuits or devices. It can also be used as a reference voltage source when examining

components. The output is always off when the instrument is powered-up. The programmed voltage level is only present at the output connector when the standby function is cancelled.

MODEL PC3050 SPECIFICATIONS

DC Voltage Source:

Range 30: 30 V to +30 V; 1-mV resolution

Range 15: -15 V to +15 V; 500 μ V-resolution

Internal impedance: $\leq 50 \Omega$

Output current: 30 mA max.

Residual ripple: $\leq 150 \mu$ V RMS, 1 Hz to 80 kHz at 30 V and 1 k Ω

Accuracy: $\leq 0.033\%$ of full scale at 23°C $\pm 1^\circ$ C, 90 days

Temperature coefficient: $\leq 0.0033\%$ of full scale/ $^\circ$ C

Linearity: $\leq 0.0066\%$ of full scale

Response time: $\leq 400 \mu$ s

Long-term stability: $\leq 0.0033\%$ of full scale per month

DC Current Source:

Range 30: -30 mA to +30 mA; 1- μ A resolution

Range 15: -15 mA to +15 mA, 500-nA resolution

Output voltage: 10 V max.

Residual ripple: ≤ 150 nA RMS, 1 Hz to 80 kHz

Accuracy: $\leq 0.043\%$ of full scale, 23°C $\pm 1^\circ$ C, 90 days

Temperature coefficient: 0.005% of full scale/ $^\circ$ C

Linearity: $\leq 0.01\%$ of full scale

Response time: $\leq 400 \mu$ s

Long-term stability: $\leq 0.0033\%$ of full scale per month

Voltage ramp	Range 30	Range 15
Initial value	-30 V to +30 V	-15 V to +15 V
Final value	-30 V to +30 V	-15 V to +15 V
Step size	1 mV to 30 V	500 μ V to 15 V
Step duration	50 ms to 100 s	50 ms to 100 s
Resolution	10 ms	10 ms

Current ramp	Range 30	Range 15
Initial value	-30 mA to +30 mA	15 mA to +15 mA
Final value	-30 mA to +30 mA	15 mA to +15 mA
Step size	1 μ A to 30 mA	500 nA to 15 mA
Step duration	50 ms to 100 s	50 ms to 100 s
Resolution	10 ms	10 ms

General Data:

Operating temperature: 0 to 40°C, 75% relative humidity

Storage temperature: -40 to +70°C, 65% relative humidity

Power: 115/230 V (-15 to +10%), 48 to 63 Hz

Dimensions (h \times w \times d): 3.43 in. x 8.66 in. x 15.63 in. (87 mm x 220 mm x 397 mm)

Weight: 6.38 lbs. (2.9 kg)

Ordering Information

Model Number	Description
9100-3050-01	Gould PC3050 Voltage/Current Calibrator with IEEE-488 interface and front panel driver software for use with Gould PCI-WINDOWS Manager
CL-712741	19-inch rack mount kit (accommodates up to 6 PC instruments)
CL-712724	Gould PCI-WINDOWS Manager software

Only available for sale in North America.

DIGITAL INPUT/OUTPUT

GOULD PC3100

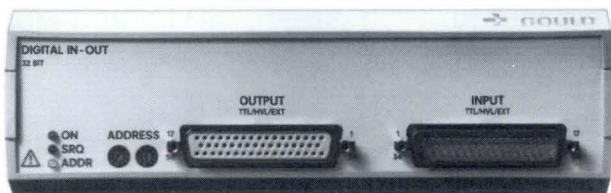

- 32-bit Digital Input
- 32-bit Digital Output
- Different voltage levels selectable:
 - TTL
 - HVL
 - external 1 to 25 Volts

The Gould PC3100 Digital Input/Output is a process interface for digital data. It can be used for many I/O applications such as the acquisition, monitoring and triggering of switching states with automatic test routines or relays.

The instrument has 32 inputs and 32 outputs combined into four groups of 8 bits. The input and output levels can be programmed for TTL or HVL. Additionally, the output voltage level can be preset from +1 to +25 V by an external circuit.

MODEL PC3100 SPECIFICATIONS

Input:

Number of inputs: 32 floating

Configuration: 4 groups with 8 inputs each. One common ground per group. One common trigger level (TTL, HVL, EXT) per group

Input voltage range: -3 V to +30 V

Trigger level: 1.5 V (TTL), 9 V (HVL), 0 to 25 V (EXT)

Input impedance: ≥ 10 k Ω

Sampling rate: 2.5 kHz (32 bit)

Output:

Number of outputs: 32 floating

Configuration: Four groups with 8 outputs each. One common ground per group. One common voltage level

Output voltage range: Programmable : TTL: 5 V, HVL: 25 V, EXT: High level + 1 to + 25 V, Low level 0 to +0.3 V

General Data:

Operating temperature: 0 to 40°C, 75% relative humidity

Storage temperature: -40 to +70°C, 65% relative humidity

Power supply: 115/230 V (-15 to +10%) 48 to 63 Hz

Dimensions (h \times w \times d): 3.43in. x 8.66in. x 15.63in. (87mm x220mm x397mm)

Ordering Information

Model Number	Description
9100-3100-01	Gould PC3100 Digital Input/Output with IEEE-488 interface and front panel driver software for use with Gould PCI-WINDOWS Manager
CL-712741	19 inch rack mount kit (accommodates up to 6 PC-instruments)
CL-712724	Gould PCI-WINDOWS Manager Software

Only available for sale in North America.

RELAY SCANNER

GOULD PC3180

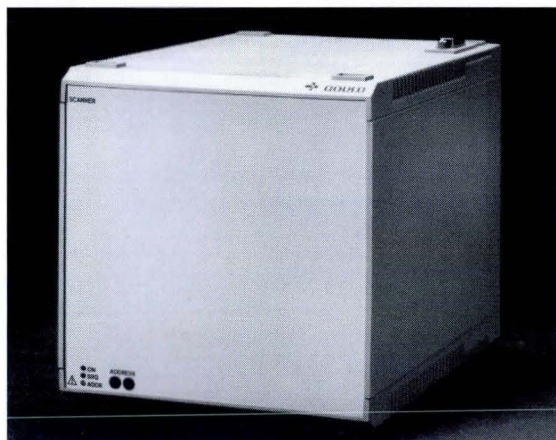

- **Relay matrix with plug-in cards for many applications:**
 - Universal relays
 - Power relays
 - High-frequency relays
 - Thermoelectric relays
- **Configurations stored on disk**
- **Programmable sequence control for automatic test setups**
- **Up to 120 relays**

The PC3180 Scanner is a relay multiplexer with many possible applications. Used primarily for selecting measuring points in automatic testing, the PC3180 can switch analog and digital signals from the mV range up to 380 V and currents from the mA range up to 5 A with frequencies from DC to 500 MHz.

The scanner has five plug-in locations which can be fitted with four different types of relay cards thus providing up to 120 matrix points. The relays can be switched individually or in any sequence or combination.

The universal relay card contains 24 single-pole relays for general purpose applications.

The power relay card is equipped with 20 power relays capable of switching 380 V (RMS) or 5 A.

The high-frequency relay card is used for connecting high speed signals as used in communication and digital engineering.

The thermoelectric relay card contains 20 two-pole relays particularly suitable for connecting temperature measurement points via the isothermal block.

SPECIFICATIONS

Scanner Mainframe

Number of Relay Cards: Maximum 5.

Number of Matrix Points: Maximum 120 depending on configuration.

Switching Delay: 7 ms to 16 min.

Operating Modes:

Direct Operation: User selects and switches relays via the PC. Up to 40 relays may be "blocked" for simultaneous switching. 60 different blocks may be defined.

Indirect Operation: Scanner controlled by PC program. 256 switching commands can be stored for sequential execution.

Operating Temperature: 0 to 40°C, 75% relative humidity.

Storage Temperature: -40 to +70°C, 65% relative humidity

Power Supply: 115/230V; -15 to +10%, 48 to 63 Hz.

Dimensions (w x h x d): 8.66 in. x 9.45 in. x 12.76 in.
(220 mm x 240 mm x 324 mm).

Weight: 9.2 lbs. (4.2 kgs).

Universal Relay Card

Number of Relays: 24, single-pole NO contacts, all relay contacts brought out

Switching Voltage: ≤50 VRMS.

Switching Current: 0.5 A maximum.

Switching Power: 10 VA maximum.

Service Life: > 10⁹ operations (mechanical); > 10⁶ operations (full load).

Bounce Time: 0.7 ms.

Contact Resistance: 170 mΩ ± 60 mΩ.

Input Capacitance: ≤140 pF (1 input against all other inputs/outputs).

Crosstalk Attenuation: > 57 dB with closed relay 100 kHz and 50 Ω load.

Dielectric Strength: 50 Hz; 250 VRMS. 1 min (contact/contact) 50 Hz; 500 VRMS. 1 min (contact/coil).

Insulation Resistance: ≥10⁹ Ω at 500 V.

Dimensions (w x h x d): 1.30 in. x 6.93 in. x 9.65 in.
(33 mm x 176 mm x 245 mm).

Weight: 1.71 lbs. (1.75 kg).

Power Relay Card

Number of Relays: 20, two-pole NO contacts.

Switching Voltage: ≤ 380 VRMS.

Switching Current: Maximum 5 A.

Switching Power: Max. 1000 VA with $\cos \phi = 1$ Max. 50 W with direct current.

Total Current for 5 Relays: Maximum 20 A.

Relay Configuration: 4 x 5 matrix.

Service Life: 2.5×10^7 operations (mechanical); 2.5×10^5 operations (full load).

Bounce Time: ≤ 10 ms.

Contact Resistance: ≤ 40 m Ω .

Dielectric Strength: 50 Hz, 1.5 kVRMS. 1 min (contact/contact) 50 Hz, 3 kVRMS. 1 min (contact/coil).

Insulation Resistance: $\geq 10^9 \Omega$ at 500 V.

Dimensions (w x h x d): 1.30 in. x 6.93 in. x 13.19 in. (33 x 176 x 335 mm).

Weight: 1.5 lbs (0.7 kg).

High-frequency Relay Card

Number of Relays: 16, single-pole NO contacts.

Switching Voltage: Maximum 42 V.

Switching Current: Maximum 0.5 A.

Switching Power: Maximum 10 VA.

Relay Configuration: 4 x 4, 4 relay multiplexers.

Frequency Range: 0 to 500 MHz.

Contact Resistance: $\leq 0.6 \Omega$.

Service Life: 2×10^8 operations (mechanical); 10^6 operations at full load.

Transmission Loss: 0.75 dB at 100 MHz; 1 dB at 250 MHz; 1.25 dB at 500 MHz.

Crosstalk Attenuation (insulation) with 50 Ω Load: 40 dB at 100 MHz; 35 dB at 250 MHz; 32 dB at 500 MHz.

Reflection Coefficient: ≥ 25 dB at 100 MHz; ≥ 20 dB at 250 MHz; ≥ 15 dB at 500 MHz.

Dielectric Strength: 500 VRMS (inputs/outputs-signal ground).

Insulation Resistance: $\geq 10^9 \Omega$.

Dimensions (w x h x d): 1.30 in. x 6.93 in. x 9.56 in. (33 mm x 176 mm x 245 mm).

Thermoelectric Relay Card

Number of Relays: 20, two-pole changeover contacts.

Switching Voltage: ≤ 60 VRMS.

Switching Current: Maximum 1 A.

Switching Power: Maximum 30 W/60 VA.

Relay Design: 4 x 5 matrix (20 relays).

Thermoelectric Voltage: $\leq 1 \mu\text{V}$ (relay only).

Dielectric Strength: 50 Hz, 500 VRMS, 1 min (contact/contact); 50 Hz, 1000 VRMS, 1 min (contact/coil).

Insulation Resistance: $\geq 10^9 \Omega$ at 500 V.

Bounce Time: ≤ 4 ms.

Service Life: 2×10^8 operations (mechanical) 10^6 operations (full load).

Contact Resistance: $80 \text{ m}\Omega \pm 40 \text{ m}\Omega$.

Input Capacitance: ≤ 20 pF (1 input against all other inputs/outputs).

Dimensions (w x h x d): 1.30 in. x 6.93 in. x 9.65 in. (33 mm x 176 mm x 245 mm).

Weight: 1.7 lbs (.75 kg).

Isothermal Block

(used with Thermoelectric card)

Number of Connections: Max. 19 thermocouples.

Relative Error: ≤ 0.1 °C between any terminals after 30 min.

Reference Element Accuracy: Pt 100 ± 0.35 °C at 25°C.

Operating Voltage: ≤ 60 VRMS.

Operating Temperature: 0 to 50°C.

Storage Temperature: -25 to +70°C.

Dimensions (w x h x d): 4.72 in. x 4.92 in. x 0.91 in. (120 mm x 125 mm x 23 mm).

Weight: .5 lbs (2 kg).

Ordering Information

Model Number	Description
9100-3180-01	Gould PC3180 Relay Scanner main frame with IEEE-488 interface and front panel driver software for use with Gould PCI-WINDOWS
CL-212792-1	Universal relay card
CL-212792-2	Power relay card
CL-212792-4	High-frequency relay card
CL-212792-3	Thermoelectric relay card
CL-212645-1	Isothermal block
CL-212645-2	Adapter for 20GA conductors
CL-212645-3	Adapter for 16GA conductors
CL-612643-1	Cable for high frequency card
CL-212642	Plug for high frequency card
CL-712741	19-inch rack mount kit (accommodates 2 scanners)
CL-712724	Gould PCI-WINDOWS Manager

Only available for sale in North America.

COMPAQ DESKPRO 386/20e

GOULD 9014-4072-00

- 32-bit, 20 MHz 80386 microprocessor
- 80387 math coprocessor
- 60 MB hard disk drive
- 1 MB of high speed 32-bit RAM
- Color monitor capable of displaying - 800 x 600 max. resolution
- Fully compatible with industry-standard software and 8/16-bit hardware
- Fully DOS compatible
- Small footprint

MODEL 9014-4072-00 SPECIFICATIONS

Processor: 20 MHz, 32 bit 80386. Real-time clock with battery. 80387 math coprocessor.

Expansion Slots: 4 (four 8/16-bit slots).

Memory: 1 MB RAM, 32-bit memory bus (expandable to 16 MB). Disk Cache software. Compaq Expanded Memory Manger (CEMM).

Storage Devices: 1.2 MB, 5-1/4 in. disk drive. Half-height 110 MB hard disk drive.

Interfaces: Parallel and asynchronous (serial) communication interfaces. Auxiliary input (for mouse and other pointing device).

Graphics Adaptor: Video Seven, VEGA Deluxe EGA graphics board, VGA compatible.

Operating System: MS-DOS.

Ordering Information

Model Number	Description
9014-4072-00	Compaq Deskpro 386/20e configured with the above components.
CL-212419	Monitor: 12-in. diagonal color monitor. Non-glare etched screen. 800 x 600 maximum resolution. 8, 16, 64 colors in TTL mode.

Note: Contact Gould Inc., Recording Systems Division, for non-standard configurations.

Only available for sale in North America.

ZENITH Z-386, MODEL 80

GOULD 9017-2072-00

- 32-bit, 16 MHz 80386 microprocessor
- 80387 math coprocessor
- 80 MB hard disk drive
- 1 MB dynamic RAM with EMS 3.2 support

MODEL 9017-2072-00 SPECIFICATIONS

Processor: 16 MHz, 32-bit 80386. with 80387 math coprocessor.

Expansion Slots: 10 (5 available). 3 (8/16/32-bit SuperSet). 1 (8/16-bit). 1 (8-bit).

Memory: 1 MB dynamic RAM with EMS 3.2 support.

Storage Devices: 1.2 MB, 5-1/4 in. disk drive. 80 MB hard disk drive.

Interfaces: Male DB 9 EIA RS-232C connector; (asynchronous RS-232C compatible). 25-pin female D-connector. (Centronics bidirectional parallel printer port).

Graphics Adaptor: Video Seven, VEGA Deluxe EGA graphics board, VGA compatible.

Operating System: MS-DOS.

Ordering Information

Model Number	Description
9017-2072-00	Zenith Z-386, Model 80 configured with the above components (less monitor)
CL-212419	Monitor: 12-in. diagonal color monitor. Non-glare etched screen. 800 x 600 maximum resolution.

Note: Contact Gould Inc., Recording Systems Division, for non-standard configurations

Only available for sale in North America.

COMPAQ PORTABLE 386

GOULD 9015-3072-00

- 32-bit, 20 MHz Intel microprocessor
- 80387 math coprocessor
- 1 MB of high speed 32-bit RAM
- Compaq dual-mode plasma display
- Compaq portable enhanced keyboard

MODEL 9015-3072-00 SPECIFICATIONS

Processor: 20 MHz, 32 bit 80386. 20 MHz, 80387 math coprocessor.

Expansion Slots: 2 (8/16-bit slots).

Memory: 1 MB RAM.

Storage Devices: 1.2 MB, 5-1/4 in. disk drive. 100 MB hard disk drive.

Interfaces: Asynchronous communication. Parallel interface.

Monitor: Compaq dual mode plasma display.

Graphics Adaptor: RGBI interface.

Ordering Information

Model Number	Description
9015-3072-00	Compaq 386 portable computer configured with the above components

Note: Contact Gould Inc., Recording Systems Division, for non-standard configurations

Only available for sale in North America.

COMPAQ DESKPRO 286

GOULD 9012-1072-00

- 16 bit, 12 MHz 80286 microprocessor
- 8-MHz 80287 math coprocessor
- 640 Kbytes of RAM
- 40 MB hard disk drive
- Color monitor capable of displaying - 800 x 600 max. resolution
- Fully compatible with industry-standard software and 8/16-bit hardware
- Fully DOS compatible

MODEL 9012-1072-00 SPECIFICATIONS

Processor: 12 MHz, 16-bit 80286. Real-time clock with battery. 80387 math coprocessor.

Expansion Slots: 6 (8-/16-bit slots). 1 (8-bit slot). 1 half-sized (8-bit slot).

Memory: 640 Kbytes RAM (expandable to 2.1 Mbytes of 12-MHz RAM on system board).

Storage Devices: 1.2 MB, 5-1/4 in. disk drive. Half-height 40 Mb hard disk drive.

Interfaces: Parallel and asynchronous (serial) communication interfaces.

Graphics Adaptor: Video Seven, VEGA Deluxe EGA graphics board, VGA compatible.

Operating System: MS-DOS

Ordering Information

Model Number	Description
9012-1072-00	Compaq Deskpro 286, Model 40 configured with the above components
CL-212419	Monitor: 12-in. diagonal color monitor. Non-glare etched screen. 800 x 600 maximum resolution. 8., 16, 64 colors in TTL mode.

Note: Contact Gould Inc., Recording Systems Division, for non-standard configurations.

Only available for sale in North America.

IBM 7532 INDUSTRIAL RACK MOUNT COMPUTER

- Ruggedized IBM DOS compatible
- 16-bit, 16 MHz 80286 microprocessor
- 3 MB RAM
- 20 MB hard disk drive
- 1.2 MB high capacity diskette drive
- Rack mount kit

SPECIFICATIONS

Processor: 8 MHz, 16-bit 80286 with 80286 math coprocessor. Real-time clock with battery.

Expansion Slots: 8 (six 8/16-bit slots and two 8-bit slots).

Memory: 640 KB RAM.

Storage Devices: 1.2 MB diskette drive. 20 MB ruggedized hard disk drive.

Interfaces: Parallel and asynchronous (serial) communication interfaces.

Monitor: 13-in. diagonal color EGA monitor. 640 x 350 pixel resolution, 64 color palette.

Graphics Adaptor: Enhanced graphics adaptor.

Environmental:

Air temperature (system on): 0 to 50°C.

Shock: 0.5 G at 10 ms duration.

Vibration: 5 to 10 Hz at 0.030 in. double amplitude displacement

Ordering Information

Model Number	Description
*	IBM 7532 Industrial Rack Mount Computer configured with the above components

* Contact Gould Inc., Recording Systems Division, for ordering and non-standard configuration information.

Only available for sale in North America.

PCI ACCESSORIES

DASA Accessories

Model Number	Description
897655	Analog/Digital Interface Assembly
897731	Timer Board
CL-710342-1	Real Time Scroller Card
CL-712450	National IEEE-488 Card

Computer Accessories

Model Number	Description
CL-212407	MS-Windows
CL-212419	Enhanced Color Monitor
CL-212872	Microsoft Bus Mouse
CL-712160-3	1 MB Memory Expansion LIM/EMS
CL-712160-1	3 MB Memory Expansion LIM/EMS
CL-712408	EGA Card

Only available for sale in North America.

PCI-WINDOWS SOFTWARE

GOULD CL-712724*

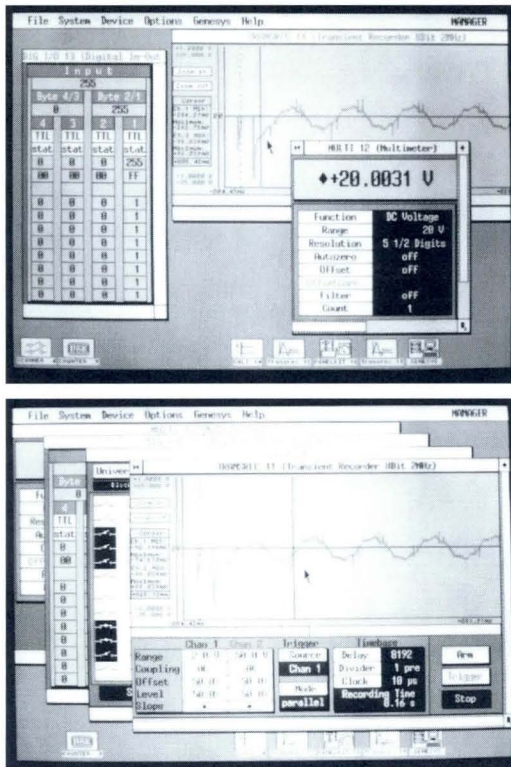

Convenient system monitoring and control with a centralized display of all instrument front panels.

- Convenient control of PC instruments via soft front panels via mouse and keyboard
- Simultaneous display of up to 7 PC instruments
- Complete setups are stored, recalled, and documented to insure consistent test results
- Transient recorder test curves can be stored as GEM Metafiles for output on a wide range of printers and plotters
- Measured data files can be transferred to PCI-SNAP for analysis
- Supports soft front panels for non-Gould devices created by PCI-PANEL KIT
- Fault-tolerant operation: incorrect parameters are prevented

PCI-WINDOWS is a graphics-oriented software package for the interactive control of all PC-instruments. Soft front panels provide access to all display and set-up functions. The configuration and control of the instrument system is achieved via a mouse and keyboard.

Up to 7 front panels can be simultaneously displayed in a

consistent format on a centralized display. The status and results for each instrument can be immediately compared.

Complete instrument configurations can be stored, recalled and documented to insure consistent test results.

* Includes GEM graphics software.

Only available in North America.

PCI-PANEL KIT SOFTWARE

GOULD CL-712726

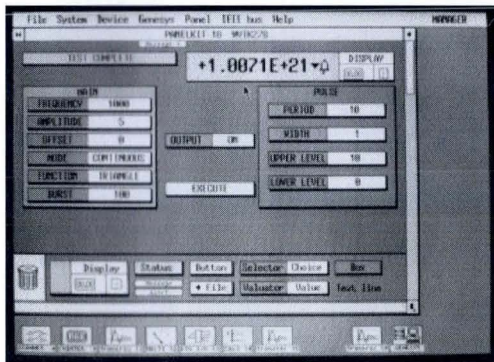
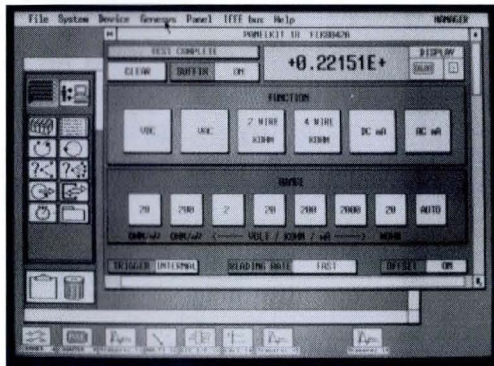

Custom build your test system incorporating any IEEE-488 device.

- Graphics-based creation of custom soft front panels for non-Gould IEEE-488 devices
- Create front panels of average complexity in less than an hour
- Created soft front panels are integrated into PCI-WINDOWS and PCI-GENESYS
- Expanding library of non-Gould instrument soft front-panels

PCI-PANEL KIT provides for the creation of soft front panels for non-Gould IEEE-488 devices. Panel creation is achieved via a set of powerful commands and the use of the mouse and keyboard. Only simple device-specific IEEE-488 commands are entered; all complex mnemonics and cryptic commands are avoided eliminating the opportunity for syntax-related errors.

PCI-PANEL KIT supports both simple and complex devices; creation of a panel with average complexity requires about an hour. Now your existing IEEE-488 instruments can be configured with Gould PC-Instruments to form a fully integrated test system.

PCI-PANEL KIT panels are supported by PCI-WINDOWS for interactive instrument control and PCI-GENESYS as part of fully automated test sequences.

Only available in North America.

PCI SNAP SOFTWARE

GOULD CL-712727*

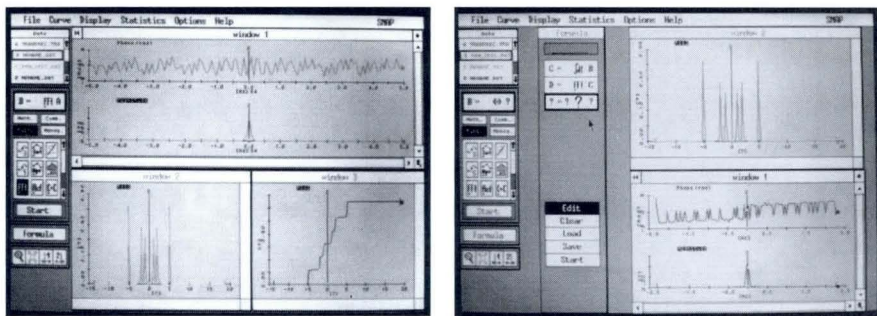

- Over 150 graphics, analysis, statistics, and file management functions
- Graphics interface for easy access to all functions
- Simultaneous display of up to 8 waveforms per window
- Zoom and cursor functions for display of curve details

Over 150 graphics, analysis, statistics, and file management functions.

PCI-SNAP is an easy to use signal analysis package. Simply recall the required data files and select the required function from the function toolbox. Complex

user-defined formulas (using existing PCI-SNAP functions) can be stored and automatically executed.

PCI SNAP SOFTWARE FEATURES

Analysis Functions

- Addition
- Subtraction
- x^y
- Multiplication
- Division
- Modulus
- Addition with a reference (constant) value
- Subtraction with a reference (constant) value
- Cross-correlation function
- Multiplication with a reference (constant) value
- Division with a reference (constant) value
- Convolution integral
- Complex real + real
- Cross power spectrum
- Absolute value
- Square
- Reciprocal
- Sign(-1, 0, +1)
- Root function
- Integer
- Natural logarithm
- Naperian logarithm
- Differentiation
- e^x
- 10^x
- Integral
- Sine rad
- Cosine rad
- Tangent rad
- Arc sine
- Arc cosine
- Arc tangent

- Smoothing of 3 points
- Smoothing of 5 points
- Spline interpolation
- Spline approximation
- Linear regression
- Histogram processing
- Fast Fourier transformation
- Inverse Fourier transformation
- Liftering and FFT
- Auto-correlation
- Cepstrum
- Power spectrum
- Seperation complex to real
- Complex transformation

Statistical Functions

k-th order moments

- Arithmetic mean
- Geometric mean
- Harmonic mean
- Skewness
- Kurtosis

Central k-th order moments

- Variance
- Standard deviation
- Variation coefficient

Distributions

- Distribution evaluation
- Distribution generator
- Binomal
- Poisson
- Normal
- CHI-square
- Student t

*Includes GEM graphics software.

Continued on next page

Estimations

- Mean value
- Variance

Uniformity tests

- Comparison of frequency distributions

Graphics Functions**Curve representation**

- F(t)
- Locus diagram
- Characteristic curve
- Real and imaginary parts
- Modulus (value without phase)
- Grid
- Datum line
- Axes scaling (logarithmic, automatic or manual)
- Maximum of 6 different windows
- Maximum of 6 different curves per window

Curve shapes

- Points
- Lines
- Bars
- Steps
- Color settings for curves, windows, axes and graduations

Labeling

- Diagram names
- Axes identification
- Graduations

Curve management

- Copying
- Moving
- Swap
- Deleting

File management

- Measured value files
- Formula files
- Reference value files
- Files for cursor values
- Statistical moment files
- Meta files—for outputs to printers/plotters or defining window configurations for GEM applications

PCI-SNAP Processing Data Formats**Data input format**

- ASCII 8, 16, 32, 64 bit/byte

Data output format

- DIF
- PCI

Additional Features

- Measured value editor
- Reference value (constant) editor
- Graphical formula editor
- Zooming in x and y directions
- 2 cursors
- Measured value display in text field
- Text field: t1, t2, y1, y2, t2-t1, 1/(t2-t1), y2-y1, (y2-y1)/(t2-t1)
- Data reduction (5 different types)

Only available in North America.

PCI-GENESYS PROGRAM GENERATOR

GOULD CL-712725*

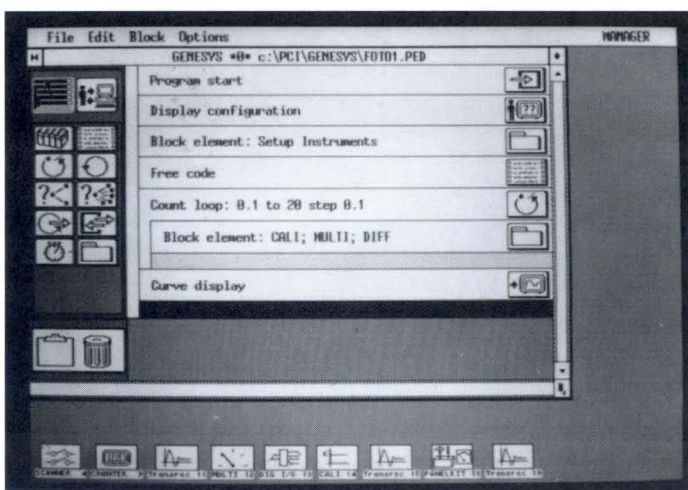

An icon-based program generator for IEEE-488 instrument control

- Automatic generation of PCI-BASIC code for IEEE-488 instrument control
- Icon-based program definition requires no programming experience
- Requires no knowledge of device-specific commands
- Import instrument parameters and values from their front panels
- Interactive control of instruments during program development for on-line performance verification

PCI-GENESYS provides for the rapid development of automated test sequences through the interactive use of instrument front panels and powerful programming functions.

Simply select programming and input/output icons to create a program sequence that is automatically converted into a PCI-BASIC program. No experience with programming language is required; not a single line of code needs to be written.

* Includes PCI-BASIC Software.

Only available in North America.

PCI-GENESYS. An icon-based program generator for IEEE-488 instrument control.

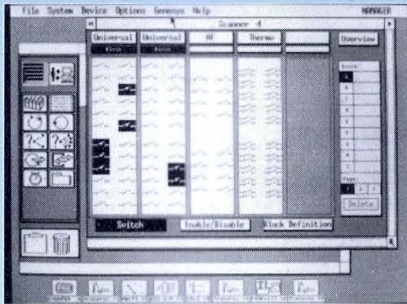

Instrument parameters are easily verified.

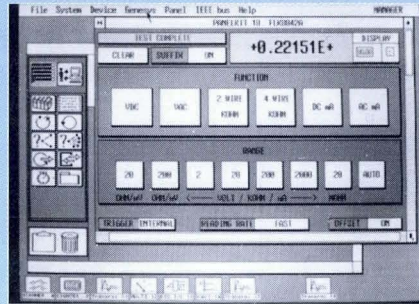

Easily integrate non-Gould instruments.

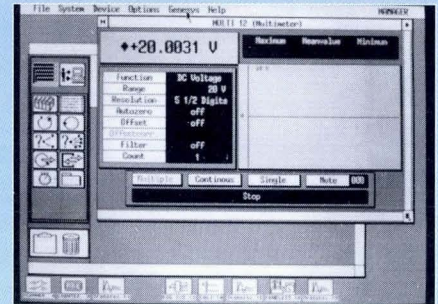

Data values are easily imported.

Powerful icon-based program control and I/O functions replace writing code.

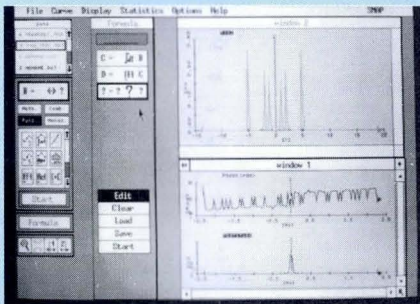

Utilize any PCI-SNAP analysis function.

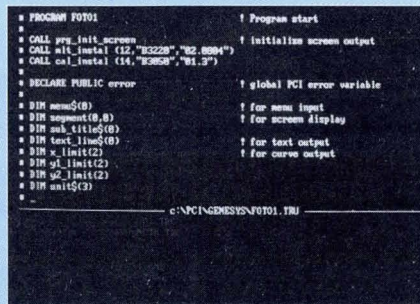

PCI-BASIC source code is generated with a single keystroke.

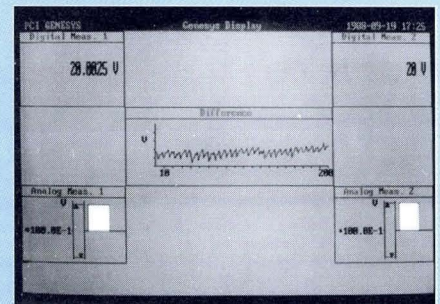

Sophisticated output with graphics, numeric values and text can be directed to the CRT, printer or plotter.

GOULD PCI-BASIC

CL-712728 INSTRUMENT PROGRAMMING LANGUAGE

```

PROGRAM FOTO1                      ! Program start
CALL prg_init_screen                ! initialize screen output
CALL mlt_instal (12,"B322B","B2.8884")
CALL cal_instal (14,"B385B","B1.3")
DECLARE PUBLIC error                ! global PCI error variable
DIM menu$(8)                        ! for menu input
DIM aspect(8,8)                      ! for screen display
DIM mh_title$(8)                    ! for screen display
DIM text_line$(8)                   ! for text output
DIM x_limit(2)                       ! for curve output
DIM y1_limit(2)
DIM y2_limit(2)
DIM unit$(3)

```

c:\PC\GENESYS\FOTO1.TRU

- Language and compiler for programming PC-based test systems
- Extremely fast program execution
- Integrated IEEE-488 bus control commands
- Mouse operation possible
- Integrated screen editor

Gould PCI-BASIC is a high-level programming language for PC based test systems or individual PC instruments via the IEEE-488 bus. Control is achieved through IEEE-488 commands such as SEND, RECEIVE, REN, and RPOL. The integral screen editor allows structured programming with function key operations such as scrolling, substitutions, search functions, etc.

Other PCI-BASIC Features:

- Extremely fast program execution.
- DEBUG functions
- Integrated commands for IEEE-488 bus control.

- Graphics statements, e.g., for window definition, window scaling, curve display from arrays, etc.
- Block structure programming.
- Definition of functions and subroutines possible.
- Libraries can be produced with external functions/subroutines
- Utilization of complete main memory area up to 640 kbyte.
- Support of arithmetic functions possible using additional arithmetic or numeric processor

PCI-BASIC SPECIFICATIONS

Language Elements

Variables: Local or global up to 31 characters

Structure elements: FOR... TO... STEP... NEXT EXIT FOR...; IF... THEN... ELSEIF... ELSE... ENDIF; DO... WHILE... LOOP; DO... LOOP... UNTIL...; DO WHILE... LOOP WHILE... EXIT DO; SELECT CASE... CASE n... CASE ELSE...END; GOTO.

Subroutine Structures: SUB... ENDSUB; DEF FUNC... END DEF; MODULE...END MODULE.

Language Extensions: External functions and subroutines can be called from libraries.

Arithmetic Functions:

Number Representations: Up to 16 digits (exponent +/- 308).

Array Size: up to 10 dimensions.

Operators: +, -, *, /, ^, MOD, DIVIDE, REMAINDER, ROUND, TRUNCATE.

Comparison Operations: +, >, <, <=, >=, <>

Logic Operations: AND, OR, NOT

Arithmetic, Trigonometric and Matrix Functions: ABS, SIGN, INT, IP, FP, SIN, COS, TAN, ATN, PI, DEG, RAD, ANGLE, SQR, EXP, LOG, LOG2, LOG10, RND, MAX, MIN, MAT, INV, TRN, DET... Higher functions from supplied libraries.

String Functions: Insert, replace, delete substrings, LEN, LCASE\$, UCASE\$, TRIM\$, LTRIM\$, RTRIM\$, POS(R), CPOS(R), NCPOS(R), REPEAT\$, using\$.

Conversion Functions: CHR\$, STR\$, NUM\$, ORD, VAL, NUM.

Arithmetic/Numeric Processor (option): Supported.

Time and Interrupt Control: DATE\$, TIME, PAUSE, WAIT SQR, WAIT UNTIL, WAIT INT, WAIT PORT, TIMEOUT BUS, TIMEOUT INPUT, TIMEOUT WAIT, ON SQR/ON KEY/ON TIME\$/ON INT.

IEEE-488 Bus Control: SEND, RECEIVE, REN, GTL, LLO, IFC, DCL, SDC, TRG, STA, RPOLL, SQR, SET DMA, SET EOS.

Graphics

Colors: 16 colors for background, 2 groups with 3 colors each for foreground.

Scale: As required on X and Y axis, referred to as defined window.

Coordinate System: Stored in graphics memory.

Display Formats: Measured curves in XY diagram, bar diagram, magnification, shifting display storage.

Development Aids: Screen-oriented program editor, command editor, scrolling, error messages in plain text with marking of error in source program, error trapping, setting of breakpoints, trace mode, correction aids, cross-reference list, program segmenting, help function.

Only available in North America.



Gould's involvement in high-quality medical instrumentation dates back to the 1930's, when we introduced the first practical, portable electrocardiograph. Since then, we have developed a full line of medical systems for measuring, displaying, and recording a wide range of variables in medical research, clinical, and teaching environments.

Quality, accuracy, and reliability are hallmarks of all Gould Recording Systems Division products — one reason why our medical instrumentation is used in leading research centers, hospitals, and medical schools throughout the world.

Our commitment to the highest quality, state-of-the-art equipment, plus a worldwide sales and service network, offer a total solution for your medical instrumentation requirements. This complete product-plus-support approach assists you from system specification and selection through startup and post-sale service.

Medical instrumentation described on these pages represents our current products. Major systems, recorders, amplifiers, displays, and accessories provide the broadest selection of medical instrumentation products to meet your exacting measurement requirements.

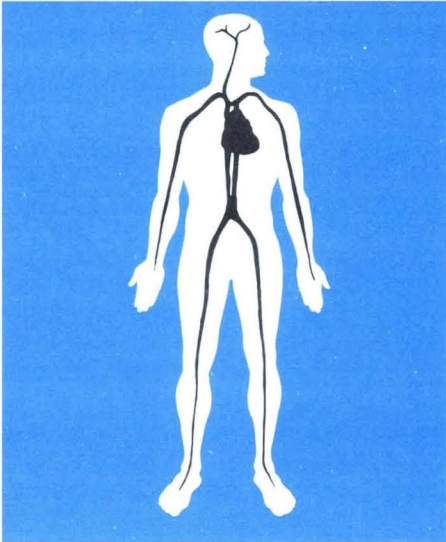

- 50 years experience in medical instrumentation and systems
- Complete systems for research and clinical applications
- Broadest range of high performance recorders
- Comprehensive selection of medical signal conditioners
- Worldwide service support

All Gould 4600 Series Medical Instrumentation Signal Conditioners are plug-in compatible with our RS 3000 Series, TA 2000, and ES 2000 Series Recorders. They also operate independently in portable and rackmounted cases. Units described on the following pages are designed specifically for life sciences research and clinical applications.

Gould Medical Systems and Medical Instrumentation products meet your exact investigative, diagnostic or student teaching needs.

We welcome your comments and suggestions concerning our Medical Instrumentation products. If you need more information or help, please contact your local Gould Medical Sales Specialist.

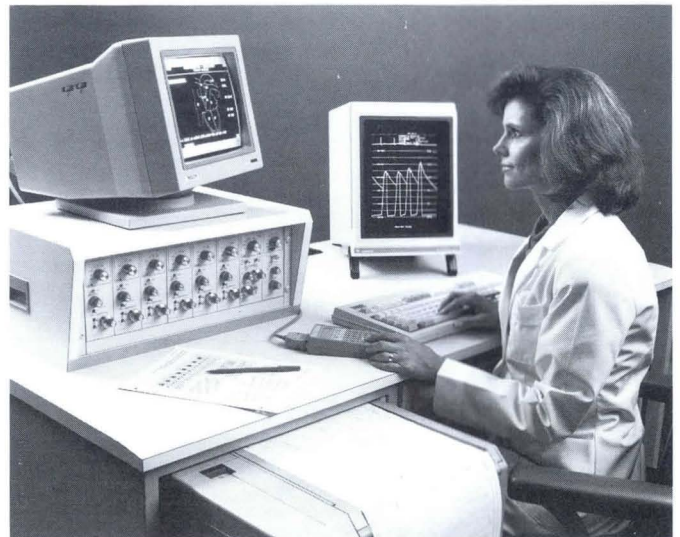
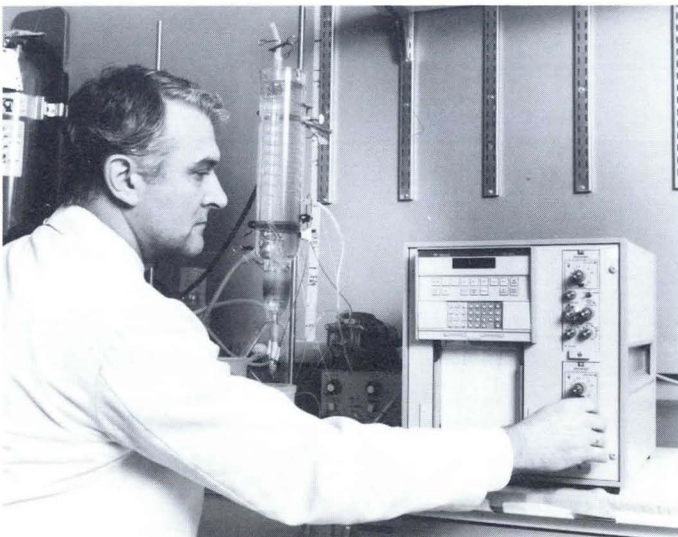

Gould Instrumentation Chart for Monitoring Physiological Variables

Use these definitive charts to determine which of the wide variety of Gould Signal Conditioners you can combine with an appropriate transducer and Gould recorder to meet your specific physiological recording needs. For assistance in

methodology and in all phases of system design, specifications and pricing, call on your nearest Gould medical instrumentation specialist.

Bioelectric Measurements

Application/Description	Frequency Range	Transducer/Accessory	Applicable Gould Signal Conditioner
Electrocardiogram (ECG or EKG) — A record of the electrical activity of the heart usually recorded from body surface electrodes.	0.05-500 Hz	Patient Cable Kit	13-G4615-64A ECG 13-G4615-65A ECG/Biotach
Electrophysiology (E.P.) — Invasive study of the electrical activity of the heart. Electrode tipped catheters are placed inside the heart to record local potentials. Electrodes may be surgically placed on or in the heart muscle (myocardium).	0.05-1000 Hz	Multipolar catheter, custom electrodes	13-G4615-58 Universal with 11-G5407-58 Isolated preamp
Electroencephalogram (EEG) — Record of the electrical activity of the brain. Recorded from surface electrodes on the scalp.	1-100 Hz	Surface electrodes	13-G4615-58 Universal with 11-G5407-58 Isolated preamp
Electromyogram (EMG) — Record of the electrical activity of a muscle. An index of total activity can be obtained by integrating the primary signal.	5-2000 Hz	Surface electrodes, needle electrodes, or custom electrodes	13-G4615-58 Universal with 11-G5407-58 Isolated preamp 13-G4615-70 Integrator
Electronystagmogram (ENG) — A record of changes in eye position using electrodes placed near the eyes. Rate of movement is calculated by differentiating the primary signal.	DC-100 Hz	Ag/AgCl surface electrodes	13-G4615-58 Universal with 11-G5407-58 Isolated preamp 13-G4615-71 Differentiator
Electroretinogram (ERG) — A record of the electrical activity of the retina.	0.01-200 Hz	Custom "contact lens" electrodes	13-G4615-58 Universal with 11-G5407-58 Isolated preamp
Direct Nerve Recordings — Record of the electrical activity of a single nerve or nerve bundle made by placing electrodes directly on (in) the nerve or bundle. An index of activity can be obtained by integrating the primary signal.	DC-10,000 Hz	Custom electrodes	13-G4615-58 Universal with 11-G5407-58 Isolated preamp 13-G4615-70 Integrator

Computed Measurements (Primary signal usually obtained from other medical amplifier.)

Application/Description	Primary Signal	Applicable Gould Signal Conditioners
Heart Rate — Beats per minute (beat-by-beat or average).	ECG waveform, Pulsatile pressure waveform or Pulsatile blood flow waveform	13-G4615-65A ECG/Biotach 13-G4615-66 Biotach
Respiratory Rate — Breaths per minute.	Respiratory flow waveform, Chest movement or Respiratory activity waveform	13-G4615-66 Biotach
Respiratory Volume — Volume of air expired in a single breath or per minute.	Respiratory flow (pneumotach)	13-G4615-70 Integrator
LV dP/dt — An index of myocardial contractility computed using the first derivative of the left ventricular blood pressure.	Left ventricular blood pressure	13-G4615-71 Differentiator
Rate of Muscle Contraction — An index of isotonic muscle contraction computed using the first derivative of the muscle length signal.	Muscle length (Isotonic signal)	13-G4615-71 Differentiator
d force/dt — The rate at which a muscle develops force while length is held constant.	Force of contraction (Isometric signal)	13-G4615-71 Differentiator
Nerve Activity — An index is developed by measuring the area under the curve (integral) representing the sum of nerve action potentials.	Direct nerve recording	13-G4615-70 Integrator
Muscle Activity — An index is developed by measuring the area under the curve (integral) representing the sum of muscle action potentials.	Electromyogram	13-G4615-70 Integrator

Gould 4600 Series Medical Instrumentation Signal Conditioners

All Gould 4600 Series Medical Instrumentation Signal Conditioners are plug-in compatible with Gould RS 3000 Series and TA 2000 Series Recorders, as well as Gould ES 2000 Electrostatic Recorders. They may be operated independently in portable and rack-mounted cases.

Units described on the following pages are designed specifically for life sciences research and clinical applications. We are con-

tinually developing new Signal Conditioners and welcome your inquiries.

All 4600 Series Medical Signal Conditioners are of rugged, solid state design and their direct-reading front panel controls are clearly labeled by function. These interchangeable units are 15.5 cm (6.1 in.) high x 5.5 cm (2.18 in.) wide x 33 cm (13.0 in.) deep, including attenuator knob and chassis-mounted connector.

Transduced Measurements

Application/Description	Primary Signal	Frequency Range	Applicable Gould Signal Conditioner
Blood Pressure — Hydrostatic pressure of blood in any vessel of the body.	Pressure transducers	DC-200 Hz	13-G4615-35 Carrier 13-G4615-58 Universal 13-G4615-50 Transducer 13-G4615-52 Pressure Processor
Phonocardiogram — Record of heart sounds. May be taken from the chest surface using a microphone or invasively using a transducer-tipped catheter.	Heart sound microphone Transducer-tipped catheter	16-2000 Hz	13-G4615-58 Universal
Carotid Pulse/Apex Pulse — Indirect recording of the blood pressure pulse waveform in the carotid artery, or mechanical movement of the heart.	Apex/carotid pulse sensor	0.1-60 Hz	13-G4615-58 Universal 13-G4615-64A ECG 13-G4615-65A ECG/Biotach 13-G4615-66 Biotach
Photoplethysmograph — A qualitative recording of arterial pulse waveform made by sensing changes in the volume of blood in a finger, ear lobe, etc.	Photoelectric finger, radial, or ear pulse sensors	0.05-30 Hz	13-G4615-64A ECG 13-G4615-65A ECG/Biotach 13-G4615-66 Biotach
Respiratory Flows and Volumes — Primary signal is the rate of flow of air into or out of the lungs in liters/second. Integrating this signal gives volumes of air expired (inspired) in liters.	Pneumotach with differential pressure transducer	DC-40 Hz	13-G4615-35 Carrier with 13-G4615-70 Integrator
Respiratory Activity — Motion of the chest associated with respiration — qualitative only.	Pneumotrace respiratory belt	DC-2 Hz	56-1340-6158 or 56-1440-6158 DC
Temperature — Body temperature, or temperature of an organ, region, water bath, or chemical reaction.	YSI thermistor RTD	DC-10 Hz	13-G4615-474029 Temperature
Isotonic Muscle Contraction — Change in muscle length while holding force constant.	Gould Metripak®	DC-200 Hz	56-1340-6158 DC 56-1440-6158 DC 13-G4615-58 Universal 13-G4615-50 Transducer
Isometric Muscle Contraction — Force of contraction of muscle held at constant length.	Gould Metrigram®	DC-200 Hz	13-G4615-58 Universal 13-G4615-50 Transducer 13-G4615-35 Carrier
Esophageal Pressure — Force exerted by the esophagus when moving food from the mouth to the stomach.	Multi-lumen catheter, infusion system and pressure transducers or multi-transducer catheter.	DC-20 Hz	13-G4615-50 Transducer 13-G4615-35 Carrier 13-G4615-58 Universal

Preconditioned Measurements

Transcutaneous blood gases; Respiratory O₂, CO₂; pH; organ blood flows are quantities that are preconditioned using specialized external amplifiers with DC outputs. Examples of specific applications are:

Application/Description	Specialized Signal Conditioner	Applicable Gould Signal Conditioner
Stroke Volume — Volume of blood ejected by the heart in one beat.	Blood flow signal from electromagnetic flow meter around ascending aorta.	13-G4615-70 Integrator
Cardiac Output — Volume of blood pumped by the heart per minute.	Blood flow signal from electromagnetic flow meter around ascending aorta.	13-G4615-70 Integrator
Cardiac Output (indicator dilution) — Volume of blood pumped by the heart per minute.	Dye or thermal dilution signal from cuvette densitometer or cardiac output computer.	56-1340-6158 DC 56-1440-6158 DC 13-G4615-58 Universal

GOULD MODEL 13-G4615-58 UNIVERSAL™ SIGNAL CONDITIONER

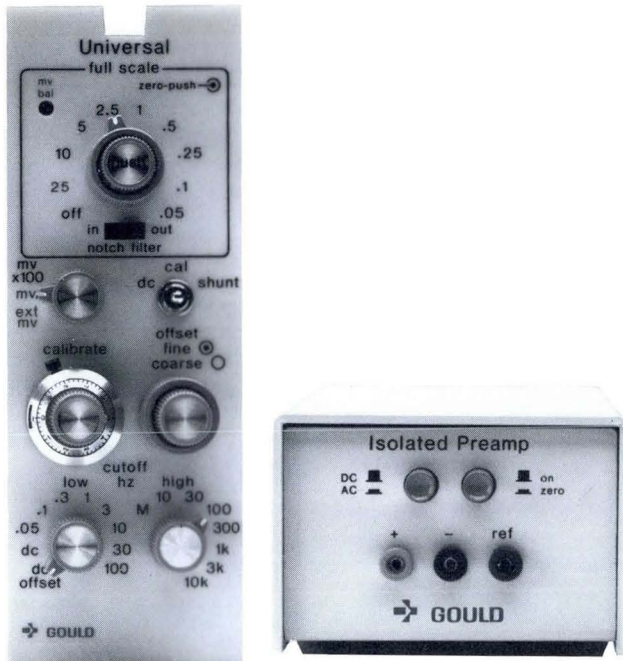

- This Signal Conditioner permits excellent measurements of
 - General purpose AC or DC signals from 25 μV to 10 V FS
 - Pressures, forces and displacements from strain gage transducers directly in units of measure
 - Bioelectric potentials when used with Isolated Preamp from high frequency nerve potentials to DC coupled eye potentials
- Combines high input impedance, wide bandwidth, low noise and low drift into one amplifier

This 10-kHz Signal Conditioner provides the high impedance inputs, high gain, and low noise characteristics required for recording bioelectric potentials including HIS Bundle, EMG, EOG, EEG, ENG, and ECG. One-mV or 50- μV cal signals and a full range of high-pass and low-pass filters permit the Amplifier to easily reproduce the most demanding bioelectric signal.

The Universal Signal Conditioner's stable DC excitation provides precise measurements of pressure, force, and position. Calibration is simple and precise in physiological units of measure.

As a general purpose AC or DC signal conditioner, it is also compatible with piezoelectric heart sound, and apex/carotid pulse microphones.

The optional Gould Isolated Preamplifier provides patient isolation* and true AC coupling, while putting the first gain stage close to the signal source. This reduces signal loss and noise associated with long signal cables, high impedance electrodes and non-isolated amplifiers.

*For bioelectric recordings only. For pressure measurements, patient isolation is provided by the transducer.

MODEL 13-G4615-58 SPECIFICATIONS

	Universal Signal Conditioner Alone	Universal Signal Conditioner with Isolated Preamp 11-G5407-58
Input Configuration	Differential and balanced to chassis ground	Isolated and guarded, differential and balanced to isolated reference
Sink Risk Leakage Current	Not applicable	< 10 μA at 230 VRMS, 60 Hz, inputs to chassis
Input Impedance	> 100 M Ω each input to chassis	DC coupled: > 1000 M Ω shunted by < 30 pF AC coupled: \approx 100 M Ω shunted by < 30 pF
Measurement Range (full scale)	25 μV to 10 V FS	25 μV to 260 mV FS
Frequency Response (Adjustable) . . .	DC to 10 kHz (– 3 dB)	DC to 10 kHz (– 6 dB)
Maximum Safe Input Voltage	120 VRMS input to chassis	50 V peak input to reference 500 V peak input to chassis
Internal Calibration Signal	Selectable between 50 μV and 1 mV within $\pm 1\%$	
Shunt	Connects shunt calibration resistor across one arm of bridge transducer circuit	
Bridge Excitation (mV and mV x100 only)	5 VDC \pm 5 mV (adjustable via plug-in resistor), polarity reversible.	Not applicable
Recorder and Monitor Outputs	5 V into 50 k Ω , single ended to ground	
Digital Display Output Voltage	(Unaffected by step sensitivity. Mean or direct signal via jumper wire) 10 mV per unit input	

GOULD MODEL 13-G4615-50 TRANSDUCER SIGNAL CONDITIONER

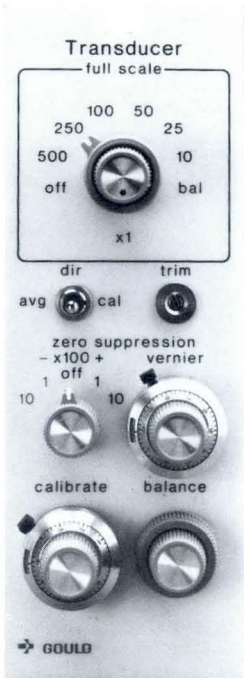

- **Pressure, force, and position measurement**
- **Simple, precise calibration directly in mmHg, grams, cm, etc.**
- **Front panel selection of direct or average (mean)**
- **Calibrated zero suppression in units of measure**
- **Low pass plug-in output filter**
- **Multiple simultaneous outputs for recorder, digital display, monitor, and computer**

The Gould Transducer Signal Conditioner is a precision module for measuring pressure, force, or position. It provides ultra-stable excitation for DC strain gage transducers while providing for plug-in bridge completion resistors.

Precision calibration directly in mmHg, grams, or cm is provided by the front-panel controls. Calibrated zero suppression permits adding or subtracting a constant from the input signal, which is

especially useful for moving the baseline without interrupting a procedure or recalibrating.

Multiple simultaneous outputs are available for recorder, digital display, monitor, and computer. An internally selectable low-pass filter permits you to further tailor this Signal Conditioner to your specific measurement requirements.

MODEL 13-G4615-50 SPECIFICATIONS

Measurement Range: 50 μ V to 5 V FS (10 mmHg to 500 mmHg FS with Gould blood pressure transducers).

Bridge Excitation: \pm 2.5 VDC standard (variable to \pm 5.0 VDC with plug-in resistor) regulated to \pm 0.05%.

Frequency Response

Direct Mode: DC to 1 kHz ($-$ 3 dB) internally selected filter.

Average Mode: Mean pressure (3.2 second time constant).

Input Circuit: Differential balanced to ground.

Input Impedance: 50 k Ω .

Recorder and Monitor Outputs: 5 V single-ended to ground into 2 k Ω or greater.

Display Output: 10 mV/unit or 100 mV/unit into 2 k Ω or greater (internally selected).

Calibrated Zero Suppression: Add or subtract zero to 100 or zero to 1000 units (i.e., mmHg) with resolution of 0.1%.

Accessories

Model Number	Description
11-5407-50	Input Connector, 12-pin Deutsch (supplied)
369500-18501	P23XL Isolated Blood Pressure Transducer
369500-18502	P10EZ Miniature Isolated Blood Pressure Transducer
793341-04042	Isotonic Muscle Transducer, Gould Metripak [®] for use only with Universal Signal Conditioner 13-G4615-58 and Transducer Signal Conditioner 13-G4615-50
	Isometric Force Transducer, Gould Metrigram [®]
797159-1	\pm 10 gm
797159-2	\pm 25 gm
797159-3	\pm 50 gm
797159-4	\pm 100 gm

GOULD MODEL 13-G4615-35 CARRIER SIGNAL CONDITIONER



- Measures pressure, force, position
- Provides AC excitation for LVDT, variable reluctance and strain gage transducers
- Push-button auto balance
- Simple calibration in physiological units such as mmHg, grams, cm
- Calibrated zero suppression
- Easy synchronization of multiple units

The Gould Carrier Signal Conditioner measures pressures, forces, and displacement with unprecedented ease. By replacing separate, interactive R and C balance controls with electronic auto balance, as well as auto phase lock of excitation and signal, it provides features never before available to users of AC excited transducers. Eliminates time-consuming setup or phase errors. Just flip a switch and it's balanced. It works equally well with LVDT, variable reluctance, and strain gage transducers.

Calibration in physiological units is a simple, one-step process. In multiple transducer applications, two features are important — Carrier oscillators can be synchronized to eliminate interference, and all Carrier Signal Conditioners can be balanced with a single command. Isolating inputs and excitation permits operation with non-isolated transducers by limiting leakage current to less than 10 μ A.

MODEL 13-G4615-35 SPECIFICATIONS

Amplifier Input Configuration: Differential balanced to guard, and isolated from ground. Impedance: 1 M Ω at 2.5 kHz each input.

Sink Risk Leakage Current: < 10 μ A at 120 VRMS, 60 Hz between any input (including excitation terminals) and chassis.

Measurement Range: 50 μ V to 10.5 VRMS FS, includes internally selectable x1-x100 input divider.

Noise (350- Ω unbalance): 10 μ V p-p referred to input, residual carrier at output < 0.25% of FS.

Common Mode Rejection: > 120 dB at 60 Hz with 350- Ω unbalance at 100 μ VRMS FS and from input to chassis.

Step Sensitivity: 10 - 1000 units plus x100 input attenuator.

Zero Suppression: 0 to \pm 100 or 0 to \pm 1000 units plus "OFF".

Auto Balance

Range: 0 to \pm 10 mVRMS referred to input (R and C balance), variable via plug-in balance resistor.

Resolution: 1:2048.

Remote Balance Command: TTL compatible or momentary short to common will initiate action.

Recorder and Monitor Outputs: 5 V into 2 k Ω or greater, single ended to ground.

Digital Display Output: 10 mV per unit or 100 mV per unit, internally selected.

Frequency Response: Direct DC to 200 Hz plus mean (3.2-s time constant).

Transducer Excitation

Voltage: Adjustable from 2 to 10 VRMS, isolated from chassis; maximum load 0.285 W.

Frequency: 2500 Hz \pm 5% sine wave.

Synchronization: Jumper selectable master or slave.

Accessories

Model Number	Description
11-5407-50	Input Connector, 12-pin Deutsch (supplied)
242879-351	350- Ω Bridge Completion Resistor
369500-18501	P23XL Isolated Blood Pressure Transducer
369500-18502	P10EZ Miniature Isolated Blood Pressure Transducer
369500-57035	Differential Pressure Transducer, Validyne 0 to \pm 20 mm H ₂ O
369500-57036	Differential Pressure Transducer, Validyne 0 to \pm 9 mm H ₂ O

GOULD MODEL 13-G4615-52 PRESSURE PROCESSOR SIGNAL CONDITIONER



- Connects directly to blood pressure transducers
- Calibrated directly in millimeters of mercury
- Computes parameters of blood pressure waveform
- Systolic, diastolic, mean, and pulse pressures
- Calculates and displays parameters beat-by-beat or on 2-, 4-, or 8-beat average
- Unaffected by electrosurgical noise
- Simultaneous multiple outputs
- Push-button autobalance

The Gould Pressure Processor extracts the discrete parameters of the dynamic arterial blood pressure waveform from strain gage blood pressure transducers. In addition to conditioning the signal and displaying the waveform in the direct mode, the following outputs are available for graphic display on a recorder, or independently, for numeric readout on a digital display: systolic pressure, diastolic pressure, mean pressure, pulse pressure, and

pulse rate. All outputs are simultaneously available for use with remote digital displays.

The discrete values of systolic, diastolic and pulse pressures are available per cardiac cycle or the average values may be obtained every 2, 4 or 8 cardiac cycles.

MODEL 13-G4615-52 SPECIFICATIONS

Measurement Range: 125 μ V to 7.5 V FS.

Attenuator Steps: 25 to 500 mmHg or bpm FS plus x1 to x2.5 vernier.

Input Circuit (EMI suppressed): Differential and balanced to ground.

Input Impedance: 1 M Ω shunted by 200 pF to ground.

Recorder Output: 5 V into 50 k Ω or greater, single-ended to ground.

Display Output: 6 V into 50 k Ω or greater. Scaled at either 10 or 100 mV/mmHg or bpm (internally selected).

Frequency Response (-6 dB): DC to 1000 Hz selectable internally; 100-Hz filter installed.

Bridge Excitation: \pm 2.5 VDC standard, polarity reversible, regulated to \pm 0.05%.

Trigger Requirements (dP/dt): Minimum signal for reliable trigger: a pulse pressure greater than 25 mmHg and changing at greater than 100 mmHg/second.

Display Update Pulse: TTL compatible positive pulse, \approx 10 ms in duration initiated by dP/dt pulse.

Accessories

Model Number	Description
11-5407-50	Input Connector, 12-pin Deutsch (supplied)
369500-18501	P23XL Isolated Blood Pressure Transducer
369500-18502	P10EZ Miniature Isolated Blood Pressure Transducer

GOULD MODELS 56-1440-6158 AND 56-1340-6158 DC SIGNAL CONDITIONERS

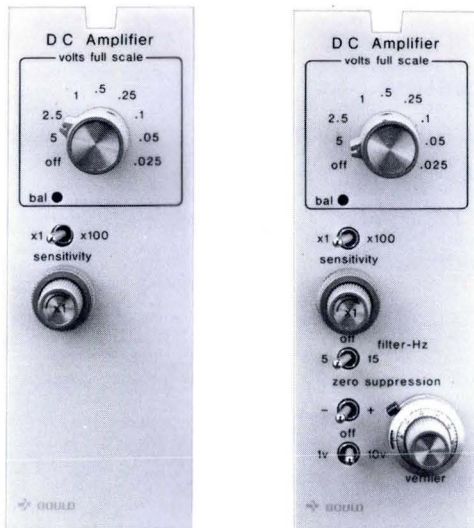

- Wide measurement range
- Calibrated zero suppression
- Low pass output filter

These economical, direct-coupled signal conditioners are useful for general purpose monitoring and recording of DC voltages in laboratory and research applications. They expand the measurement range of Gould Recorders for any signal from 25 mV full scale to 500 V full scale. Up to 16 factory-set, fixed-

gain measurement ranges are provided, plus a variable sensitivity control that permits operation at any point between the fixed-gain ranges. Low-pass output filtering is selectable to eliminate objectionable high-frequency signal components.

MODELS 56-1440-6158 AND 56-1340-6158 SPECIFICATIONS

Model Number	Basic DC 56-1440-6158	General Purpose DC 56-1340-6158
Measurement Range	25 mV FS to 500 V FS	
Frequency Response	Filter out: DC to 35 kHz Filter in: plug-in user selectable	Filter out: DC to 35 kHz Filter in: - 3 dB at 15 kHz; - 3 dB at 5 Hz; 12 dB/octave
Calibrated Zero Suppression Range	Not applicable	Add or subtract 0 to 1 or 10 VDC with resolution of 0.1%
Input Circuit	Differential, balanced to ground	
Output Voltage	5 V FS into 2 k Ω or greater, single ended to ground	

Accessories

Model Number	Description
11-5407-50	Input Connector (supplied)
793341-14042	Isotonic Muscle Transducer, Gould Metripak [®] for use only with DC Signal Conditioners 56-1340-6158 and 56-1440-6158

GOULD MODEL 13-G4615-66 BIOTACH™ SIGNAL CONDITIONER



- Computes biological rates beat-by-beat or time averaged from hummingbirds to whales
- Extremely reliable triggering
- ECG, pulse and respiration modes
- Peripheral pulse sensor input
- 20 bpm to more than 2000 bpm full scale
- Five separate simultaneous outputs
- TTL compatible sync pulse for system control
- Alarm mode
- Separate 10 mV/bpm output for digital rate display

The Biotach Signal Conditioner computes and outputs the beat-by-beat or average rate of repetitive biological events, including cardiac and respiratory. Inputs include signals originating from ECG, pulse, and respiratory events, and can come from other signal conditioners or directly from photoelectric pulse sensors. For accurate rate computation, special circuitry, of which the ECG, Pulse, and Respiration mode switch is a part, ensures that only a legitimate input event triggers the Signal Conditioner.

The Biotach Signal Conditioner is capable of multiple simultaneous outputs: 1) the direct reproduction of the input signal; 2) the computed rate for recorder or monitor; and 3) 10 mV/bpm rate signal for digital display. In addition, it provides a TTL compatible sync pulse coincident with the R-wave of the ECG signal or the rise of a blood pressure, flow, or respiratory waveform. This pulse is useful for resetting integrators, updating digital displays, or controlling computers.

MODEL 13-G4615-66 SPECIFICATIONS

Photoelectric Pulse Sensor Excitation Current: 25 mA DC \pm 5 mA.

Signal Input Sensitivity: 2.5 mV FS to 5 V FS plus x1 (detent) to x2.5 vernier (single ended to ground).

Rate Sensitivity: 20 to 1000 bpm FS plus x1 (detent) to x2.5 vernier.

Recorder and Direct Monitor Outputs: 5.0 V FS; single ended to ground.

Rate Display Output: Single ended to ground. 0 to + 10 V. Rate signal only for digital display, 10 mV = 1 bpm. Either beat-by-beat or average.

Rate Monitor Output: 5.0 V FS; single ended to ground. Either beat-by-beat or average selected by same internal jumper as Rate Display output.

Sync Output: TTL compatible, 20 ms (\pm 20%) positive pulse remains high in alarm mode.

Function	ECG*	Pulse	Respiration
Frequency Response (-3 dB)	0.05 Hz to 200 Hz \pm 20%	0.5 Hz to 20 Hz \pm 20%	0.05 Hz to 10 Hz \pm 20%
Rate Trigger Requirement (Minimum signal)	15% of full scale changing at 30 mV/s	20% of full scale, changing at 3 mV/s	20% of full scale, changing at 1 mV/s

*ECG signals must be preconditioned by either a Gould ECG Signal Conditioner (Model 13-G4615-64A) or a Gould Universal Signal Conditioner (Model 13-G4615-58).

Accessories

Model Number	Description	Model Number	Description
287169	Apex/Carotid Piezoelectric Pulse Sensor, with phone plug	288305	Finger Pulse Sensor, with 4-pin Winchester connector
287165	Ear Pulse Sensor, with 4-pin Winchester connector	11-5407-50	Input connector
287163	Radial Pulse Sensor, with 4-pin Winchester connector		

Gould Model 13-G4615-64A ECG Signal Conditioner

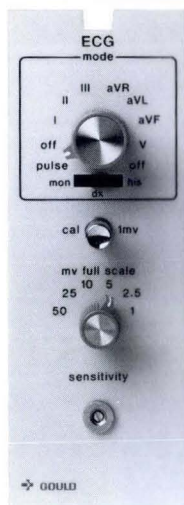

- Full 7-lead ECG selection
- Peripheral arterial pulse sensor input
- Patient isolated and defibrillator protected
- Monitor/Diagnostic/HIS bandwidth selector
- Automatic reset on overload, lead change or 1 mV calibration
- TTL compatible QRS sync pulse
- High level inputs to 1 V
- High common mode rejection, low noise amplifier
- Specialized circuitry for exceptionally reliable triggering
- Unipolar HIS electrogram

Model 13-G4615-64A

Combining three signal conditioners in one, the Gould 13-G4615-64A conditions signals from ECG and peripheral pulse sensors and accepts signals from tape recorders or other signal conditioners. A built-in pulse circuit receives inputs from finger, ear, radial, or carotid pulse sensors to provide blood pressure waveforms as a second method for monitoring the heart during electrocautery or stress-producing procedures. The sync pulse, when triggered by the R-wave or the rising portion

of the pulse waveform, is useful for resetting integrators, synchronizing defibrillators, or for computer control.

Specifications of the Gould ECG Signal Conditioner exceed the American Heart Association's recommendation for electrocardiography. Full isolation per ANSI/AAMI* safe current limits for electromedical apparatus is standard, as is defibrillator protection.

*American National Standards Institute/Association for Advancement of Medical Instrumentation Specification Number SCL 12/78.

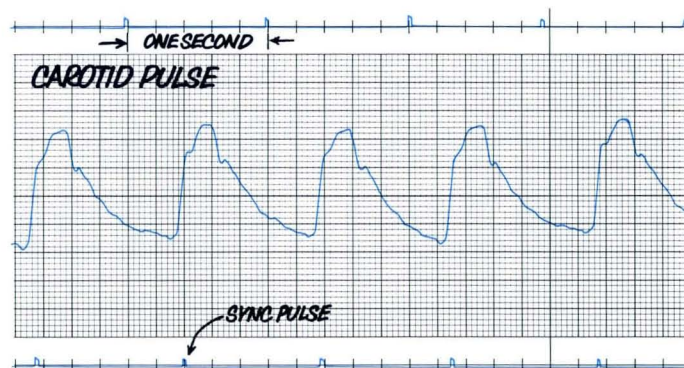
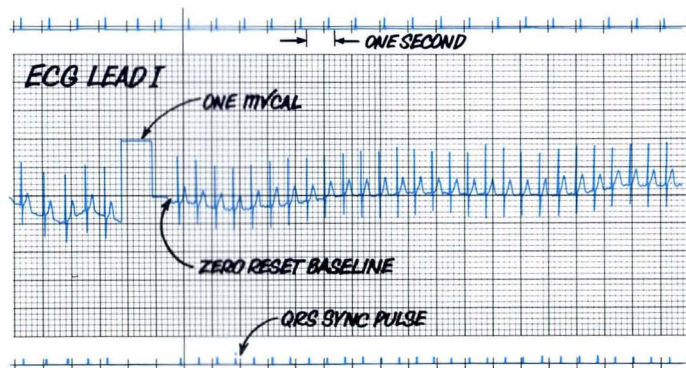

Full-size ECG (left) and Pulse (right) waveforms shown above are reproduced directly from the Gould 13-G4615-64A ECG Signal Conditioner. The sync pulse was applied to an event marker. Special circuitry prevents double triggering.

These same traces can be produced by the Gould 13-G4615-65A ECG/Biotach™ Signal Conditioner.

Note the clarity of the traces from the pressurized fluid writing Gould Recorder, which produces uniform trace density under all conditions.

Model 13-G4615-65A

- Two signal conditioners in one with independent outputs of waveforms and rate
- Physiologic rate determination from ECG, arterial pulse or high level signals from other signal conditioners, such as pressure or flow
- Computes biological rates beat-by-beat or time-averaged
- Simultaneous multiple outputs

Isolated ECG and biological rate measurement capabilities make the Gould 13-G4615-65A a versatile, multifunction signal conditioner. It has two separate outputs for simultaneous

recording and monitoring of waveform and rate. In addition, it outputs rate in two forms: an analog rate signal for recording, and a 10 mV/bpm signal for digital rate display by Gould Digital Display Units.

Additional available outputs include blood pressure waveforms from finger, ear, radial, or carotid pulse sensors (instead of ECG signals); a sync pulse coincident with the R-wave or the rising portion of a blood pressure waveform to control other equipment per cardiac cycle; and a 10 mV/bpm signal for digital display of computed beat-by-beat or average rate.

Models 13-G4615-64A and -65A Signal Conditioners	ECG (Normal)	ECG (Fetal)	Pulse	External Input
Step Sensitivity FS	1, 2.5, 5, 10, 25, 50 mV	500 μ V, 1.25, 2.5, 5.0, 12.5, 25 mV	2, 5, 10, 20, 50, 100 mV	20, 50, 100, 200, 500 mV, 1 V
Input Circuit Configuration	Five ECG leads electrically isolated from chassis and power		Single ended to chassis	
Frequency Response (-3 dB) Diagnostic ($\pm 20\%$) Monitor ($\pm 20\%$) HIS ($\pm 20\%$)	0.05 Hz to 500 Hz 0.5 Hz to 30 Hz 30 Hz to 500 Hz		0.5 Hz to 20 Hz 0.75 Hz to 20 Hz	0.05 Hz to 100 Hz 0.5 Hz to 100 Hz
Common Mode Rejection	Isolated inputs to chassis: 140 dB at DC; 100 dB at 60 Hz Isolated inputs to reference leads: 85 dB with 5-k Ω unbalance		Not applicable	
Sync Pulse Trigger*	15% of full scale, changing at 30 mV/s		20% of full scale, changing at 3 mV/s	
Amplifier Output Configuration	5 V, single ended to chassis, 50 Ω			
Overload Recovery	Automatic reset restores baseline in less than 1 s. Manual reset via the CAL pushbutton or lead selector change.			

*Rate Trigger on -65A, Minimum Requirement.

(Model 13-G4615-65A ECG/Biotach™ Signal Conditioner only)

Rate Measurement Range: 20, 50, 100, 200, 500, 1000 bpm FS plus x1 to x2.5 vernier between steps.

Time to Alarm: 5 s $\pm 20\%$. Variable by changing internal plug-in resistor.

Accessories (Models 13-G4615-64A and -65A Signal Conditioners)

Model Number	Description
369500-28000	Five-Lead ECG Cable Kit; includes 10-ft, low-noise patient cable, five color-coded shielded lead wires with snap adapters, five color-coded shielded lead wires with banana-plug type needle adapters, and a sample of disposable electrodes
369500-28003	Five-Lead ECG Cable Kit; same as above with input connectors to drive three -64A or -65A signal conditioners simultaneously

Model Number	Description
369500-28010	Ten-Lead Patient Cable Kit with V ₁ through V ₆ selector; includes 10-ft., low-noise patient cable, 10 color-coded shielded lead wires with snap adapters, and a sample of disposable electrodes
287163	Radial Pulse Sensor, with 4-pin Winchester connector
288305	Finger Pulse Sensor, with 4-pin Winchester connector
287169	Apex/Carotid Piezoelectric Pulse Sensor, with phone plug
11-5407-50	Input Connector, 12-pin Deutsch (supplied)
11-5407-66	Input Adapter, photoelectric pulse sensor, 4-pin Winchester to 12-pin Deutsch

GOULD MODEL 13-G4615-70 INTEGRATOR SIGNAL CONDITIONER

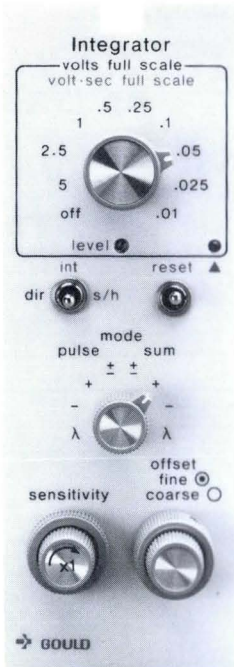

- Single-step calibration
- Flip-of-switch integration
- Programmable reset timer
- Full-wave rectified (λ) mode
- Preview of signal to be integrated (DIRECT)
- Peak integral recording (SAMPLE/HOLD)
- 10 mV • s to 50 V • s full scale integrate range
- An excellent 10 mV full scale DC amplifier
- Can be reset externally from other Gould signal conditioners

The Gould Medical Integrator Signal Conditioner determines the area under an input function waveform per unit of time. Whether the input signal is positive, negative, or bipolar, the signal may be offset, half-wave rectified, or full-wave (λ) rectified before integration. The integral can be reset externally via switch closure or TTL pulse, or internally via amplitude level, zero crossing, or internal timer. In addition, the value of the integral may be sampled and held prior to any reset function, thus allowing for use with digital displays.

Some applications include: determination of stroke volume from aortic blood flow; expiratory or inspiratory volume from respiratory air flow; or even the relative index of activity from electro-myograms or neurograms. A unique feature of the Gould Integrator Signal Conditioner is the ease with which it may be calibrated to any input function commonly coming from the outputs of other Gould Signal Conditioners. This eliminates tedious calibrations using external test equipment. In the direct mode, the Integrator is an excellent 10-mV FS amplifier.

MODEL 13-G4615-70 SPECIFICATIONS

Measurement Range (plus x1 to x2.5 vernier)

Direct Function: 10 mV to 50 V FS.

Integrate Function: 10 mV • s to 50 V • s FS.

Amplifier Input Circuit: Single ended to ground.
Impedance: 1 M Ω .

Amplifier Outputs (single ended to ground)

Recorder or Monitor: ± 5 V into 50 k Ω or greater.

Digital Voltmeter Display: 10 V into 50 k Ω or greater;
10 mV per unit input (adjustable).

Noise (DC to 1 kHz): Less than 50 μ V P-P referred to input with 50- Ω source.

Offset

Range: ± 6 V (± 60 V with internal attenuator in x10 position)
 $\pm 20\%$ RTI.

Resolution: 1 part in 50,000 with dual concentric 10-turn
Coarse-Fine controls.

Frequency Response: DC to 8 kHz (-3 dB with 6 dB/octave rolloff) to integrator. DC to 300 Hz (-3 dB with 12 dB/octave rolloff) in DIRECT at amplifier output.

Mode Selector (Direct or Integrate Functions): Selects both the Direct waveform to be integrated and the Integrate reset method employed. Adjusts for signals greater than reference zero (+), less than reference zero (-) or bipolar about reference zero (\pm). Also permits full wave rectification of a bipolar signal to determine its absolute value (λ).

Pulse: Reset of integrator with zero crossing — may be offset.

Sum: Reset of integrator on time, external TTL pulse, or integral amplitude (level).

Level: 10% to 100% of full scale.

Time: In either 1-s increments to 63 s, or 1/60 s increments to 1 s (1/50 for 50 Hz operation).

Accessories

Model Number	Description
11-5407-50	Input Connector (supplied)
369500-153	Adapter — Male BNC to 12-pin Deutsch. 24 in. long; allows signal from input/output panel or high level signals from drive amplifier monitor output to drive integrator input

GOULD MODEL 13-G4615-71 DIFFERENTIATOR SIGNAL CONDITIONER



- **Single-step calibration**
- **Flip-of-switch differentiation**
- **100 mV/s to 500 V/s fs differentiate range**
- **100 mV to 5 V fs direct measurement range**
- **Selectable low pass filter**

The Gould Medical Differentiator Signal Conditioner determines the rate of change of an input function . . . to determine acceleration from velocity or velocity from position. Some common applications include the determination of blood acceleration from blood flow, the determination of eye velocity from eye position while recording the electronystagmogram or as an index of contractility by taking the first derivative of pressure from the left

ventricle of the heart. The most unique feature of the Gould Differentiator Signal Conditioner is the ease with which it may be calibrated when used with other Gould amplifiers. This eliminates the need for auxiliary test equipment and tedious calibrations. In the direct mode, the Differentiator Signal Conditioner is an excellent 100-mV full-scale DC amplifier.

MODEL 13-G4615-71 SPECIFICATIONS

Measurement Range (plus x1 to x2.5 vernier)

Direct Mode: 100 mV FS to 5 V FS.

Differentiate Mode: 100 mV/s FS to 500 V/s FS.

Amplifier Input Circuit: Single ended to ground.
Impedance: 1 M Ω .

Amplifier Outputs (all single ended to ground)

Recorder: 5 V FS into 50 k Ω .

Monitor: 5 V FS into 50 k Ω .

Noise (100 mV or 100 mV/s FS, input shorted)

Direct Mode: 50 μ V P-P RTI

Differentiate Mode: 50 μ V/s P-P at 1 Hz increasing to 6 mV/s P-P at 100 Hz RTI.

Frequency Response (high cutoff): -3 dB at 1, 3, 5, 10, 15, 30, 100, 300 Hz, \pm 20% with -18 dB/octave nominal rolloff.

Accessories

Model Number	Description
11-5407-50	Input Connector (supplied)
369500-153	Adapter - Male BNC to 12-pin Deutsch. 24 in. long; allows signals from input/output panel or high level signals from drive amplifier monitor output to drive differentiator input

GOULD MODEL 13-G4615-474029 TEMPERATURE SIGNAL CONDITIONER

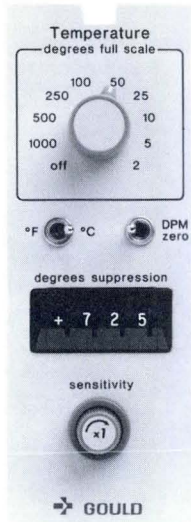

- Measures temperature directly from YSI 400 Series Thermistor Probes or selected 500 Series Probes
- High sensitivity and wide measurement range — from 2° to 1000°C or °F full scale
- Digital zero suppression — up to ± 999°C or °F
- Direct readout in degrees Celsius or Fahrenheit
- No special calibration required

The Gould Medical Temperature Signal Conditioner is a precision instrument designed for accurate, long-term monitoring and wide ranging, dynamic temperature recording. Low drift allows the measurement of small temperature changes over time, even at the most sensitive range setting. And, its broad measurement range accommodates widely fluctuating temperatures.

Front-panel controls simplify calibration, which is accomplished

directly in degrees Celsius or Fahrenheit as desired. The combination selector/indicator permits easy zero suppression setting and verification in one-degree steps.

The Temperature Signal Conditioner uses YSI 400 Series Thermistor Probes and selected YSI 500 Series Thermistors. For applications outside the range of YSI probes and thermistors, the signal conditioner uses platinum RTDs.

MODEL 13-G4615-474029 SPECIFICATIONS

Measurement Range: ± 2° to ± 1000°C or °F.

Standard Input Sensors: 100, 200, 500, or 1000 Ω, 4-wire Platinum (385) RTDs or Yellow Springs Instrument (YSI) 400 or selected 500 Series Thermistor Probes.

Input Circuit: 4-wire, differential to floating common. Impedance: 1 MΩ.

Output Voltage: 5 V into 2 kΩ.

Frequency Response: DC to 10 Hz ± 20% (– 3 dB).

Calibrated Zero Suppression: 0° to ± 999° in 1-degree steps (°F or °C).





Display Output (internally selected): 100 mV/°F or °C, or 10 mV/°F or °C, 10 V max.

Thermistor Probe Operation: Use YSI 400 Series Thermistor Probes.

Range: 0° to 42°C.

Linearity: Within ± 0.5°C from 4°C to 40°C; within ± 1°C from 0°C to 42°C.

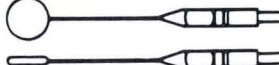
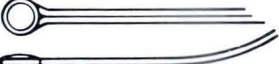
Temperature Probes

Probe	Description	Probe	Description
 YSI 401	General Purpose, Vinyl, most rugged probe. Esophageal or rectal temperatures in humans and animals. TC, 7.0 s. Gould 369500-18010	 YSI 427	Small Surface Temperature. Cuvette, water bath, leaf, and other surfaces. 24-in. Teflon® covered flexible wire. Stainless steel disc with epoxy back. Non-detachable lead, non-autoclavable. TC, 0.3 s. Gould 369500-18016
 YSI 423	Small Semiflexible Nylon. Esophageal and rectal readings. Nylon with epoxy tip. TC, 1.4 s. Gould 369500-18012	 YSI 408	Banjo Surface Temperature. Skin, oral, axillary, water bath, and flat surface temperatures. Stainless steel. TC, 0.6 s. Gould 369500-18013
 YSI 409	Attachable Surface Temperature. Tape on skin or flat surfaces. Stainless steel cup, epoxy backed. TC, 1.1 s. Gould 369500-18014	 YSI 402	Small Flexible Vinyl. Rectal temperatures of small animals. Esophageal temperatures of infants. Vinyl sheath and tip. TC, 3.2 s. Gould 369500-18011

GOULD MODELS 51-4142-00
Without Numerics,
51-4142-20 With Numerics
Four Channel Monitors

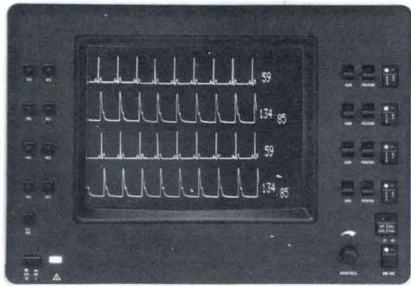

- **Nonfade 9-in. display with 12-bit resolution per channel**
- **Numeric option for S/D pressure and rate**
- **Trace freeze in place**
- **Overlapping traces**
- **Trace cascade function**

Gould 4-channel monitors feature non-glare, bright phosphor displays for excellent trace clarity. Their light weight and compact design are perfect for laboratories where space is at a premium. Digital display of heart rate or systolic/diastolic pressure on each channel can be selected as an option, and features simple one button calibration.

FOUR CHANNEL MONITORS SPECIFICATIONS

Viewing Dimensions: 13.3 cm x 17.8 cm.
Deflection Method: Electromagnetic.
Focus Method: Electrostatic.
Phosphor Type: C 124.
Input Impedance: 100 kΩ, single ended.
Maximum Useable Input: ± 15 V.
Absolute Max. Input: ± 30 V.
Frequency Response at Sweep: 25 mm/s > 45 Hz;
 50 mm/s > 90 Hz.
QRS Range: 20-240 bpm.
QRS Accuracy: 20 bpm, 20 ± 1 bpm; 80 bpm, 80 ± 1 bpm;
 240 bpm, 240 ± 2 bpm.
Digital Field Update Rate: 1/s.
Dimensions: 9.5 in. (24.1 cm) H x 13.0 in. (33.0 cm) W x
 14.5 in. (36.8 cm) D.
Weight: 31 lbs. (14 kg).
Cables (must be ordered separately)
 All cables are 20 m long.

Part Number	Terminating Connector	Recorder Type(s)
CL-711182-2	Miniature Spade Lug	2000S, 8000S
CL-711182-3	Quick Disconnect	2000S, 8000S Rackmount
CL-711183-2	BNC	RS3000, Medical I/O Panel, 5900 Cage
CL-711182-1	Bare Wire	RS3000, 5900 Cage
CL-711183-1	Bantam Phone Plug	2000S

GOULD MODELS 51-3183-10 Portable,
51-3283-10 Rackmount
Eight Channel Monitors

- **20-in. Oscilloscope monitor**
- **High resolution CRT display**
- **Front panel position and gain control**
- **300-Hz frequency response**
- **Sweep speeds 25, 50 and 100 mm/s**
- **Overlapping traces**

The Gould 8-channel monitor features a 300-Hz frequency response for monitoring intracardiac electrograms and other high frequency recordings in the medical research laboratory. Front panel mounted position and gain controls permit maximum versatility for setting up the display. The high resolution CRT display provides excellent viewability from a distance. The 8-channel monitor complements any of Gould's Medical Instrumentation Recording Systems for the research laboratory.

EIGHT CHANNEL MONITORS SPECIFICATIONS

Viewing Dimensions: 20.0 cm x 25.0 cm.
Input Impedance: 1 MΩ, single ended.
Maximum Input: 100 V.
Frequency Response: DC to 300 Hz (-3 dB).
Dimensions: 19.5 in. (49.5 cm) H x 17.8 in. (45.2 cm) W
 x 17.6 in. (44.7 cm) D.
Weight: 60.0 lbs. (27.2 kg).
Cables (must be ordered separately)
 All cables are 20 m long.

Part Number	Terminating Connector	Recorder Type(s)
CL-711184-2	Miniature Spade Lug	2000S, 8000S
CL-711184-3	Quick Disconnect	2000S, 8000S Rackmount
CL-711184-2	BNC	RS3000, Medical I/O Panel, 5900 Cage
CL-711184-1	Bare Wire	RS3000, 5900 Cage
CL-711185-1	Bantam Phone Plug	2000S

GOULD SC1012 12-CHANNEL ECG AMPLIFIER



Rear Panel affords convenient access.

This 12-channel ECG Amplifier offers simultaneous output of the 12 ECG leads. It is designed for Cardiology Laboratories and may be integrated with Gould Medical Lab Recording

- Simultaneous 12-lead ECG output
- Patient isolated
- Defibrillator protected
- Monitor or diagnostic mode
- ± 1 V output to recorder

Systems. Full isolation per ANSI/AAMI safe current limits for electromedical apparatus and defibrillator protection are standard.

MODEL SC1012 SPECIFICATIONS

Number of Channels: 12.

Input Circuit: 10 ECG leads isolated from chassis and power source.

Input Impedance: 100 M Ω to isolated common.

Gain: 1000.

Maximum Continuous Input Voltage: 230 VRMS any lead to chassis.

Defibrillator Protection: 2.5 kV for 20 ms.

Frequency Response:

Monitor: 0.5 to 30 Hz.

Diagnostic: 0.05 to 500 Hz.

Common Mode Rejection: > 85 dB at DC to 50 Hz (inputs to reference leads); 140 dB at DC (inputs to chassis).

Output Configuration: ± 1 V; single ended to chassis.

Overload recovery: Less than 1 second.

Dimensions: 89 mm H x 364 mm W x 283 mm D (3.5 in. x 15 in. x 11 in.). Mounting: Portable or 19-in rack.

Ordering Information*

Model Number	Description
23-24121-05	SC1012, Portable, 100-240 V, 50/60 Hz
23-24131-05	SC1012, Euro rack-mount, 100-240 V, 50/60 Hz
23-24141-05	SC1012, Retma rack-mount, 100-240 V, 50/60 Hz

*Available only in Europe.

MEDICAL INSTRUMENTATION ACCESSORIES

In order to ensure system compatibility, ease of operation, and accurate measurement, Gould provides a complete line of Medical Instrumentation accessories. Consult Signal Conditioner

pages to determine which accessories are compatible with a specific Signal Conditioner.

Reuseable Silver/Silver Chloride Biopotential Electrodes

Reuseable Ag/AgCl electrode with snap fastener built into back of unit. Ideal for EMG, EEG, EOG, and other measurements of bioelectric activity. **369500-31502**

Piezoelectric Pulse Transducer



Self-generating, high output transducer senses pulses from fingers, rat's tails, etc. Can also be used as a swallow microphone. Output 10 to 100 mV. Comes with 6-ft., low-noise cable terminating in a Deutsch connector. For 13-4615-58 Universal Signal Conditioner. **369500-31512**

Pneumotrace Respiratory Belt

This light weight belt is made of Spandex and has a Velcro closure to provide a comfortable fit for the chest or abdomen of both adults and children. Its solid-state circuitry produces a linear output to changes in thoracic or abdominal circumference due to respiration. This change can be displayed on a Gould 56-1340-6158 or 56-1440-6158 DC Signal Conditioner. **369500-31514**

Low-Cost Student-Grade Force Transducer

A semi-isometric, strain gauge transducer incorporating a stack of five stainless steel leaf springs. Full-scale measurement range is increased by adding more leaves to increase the stiffness of the spring. Sensitivity range is 10 mg to 10 kg. Comes with 10-ft. cable terminating in a Deutsch connector. Used with any Gould Medical Instrumentation Signal Conditioner with transducer input. **369500-31506**



Low-Cost Student-Grade Displacement Transducer

A semi-isotonic strain-gage cantilever-beam device to measure motion in physiological preparations. The 12-in. stainless steel lever may be placed in any position, affording the user a broad spectrum of experimental design. Comes with a 10-ft. cable terminating in a Deutsch connector. Used with any Gould Medical Instrumentation Signal Conditioners with transducer input. **369500-31507**

Checktrode Mk II Electrode Tester

Assures clean bioelectric data without artifacts. Instant digital readout indicates the quality of electrode/skin contact using a safe 10- μ A constant current source. **369500-31501**

MEDICAL INSTRUMENTATION ACCESSORIES



Apex/Carotid Piezoelectric Pulse Sensor, with phone plug. **287169**



Five-Lead ECG Cable Kit. Includes 10-ft. low-noise patient cable; five color-coded shielded lead wires with snap adapters; five color-coded shielded lead wires with banana-plug type needle adapters, and a sample of disposable electrodes. **369500-28003**



New infra-red, photoelectric plethysmograph records changes in pulsatile blood flow from fingers, toes, ear, forehead, etc. Miniature transducer attaches with velcro strap (supplied) or electrode type adhesive collars. Matched optics together with a unique two-stage IR-filter reduce the effects of ambient light and patient motion. **369500-31519**



Ten-Lead Patient Cable Kit with V_1 through V_6 selector. Includes 10-ft. low-noise patient cable; 10 color-coded shielded lead wires with snap adapters, and a sample of disposable electrodes. **369500-28010**



Ear Pulse Sensor, with 4-pin Winchester connector. **287165**



Three-Lead Universal Signal Conditioner Bioelectric Input Cable Kit, non-isolated and not for use on human subjects. Includes three color-coded shielded lead wires with banana-plug type needle adapters. **369500-28058**



Heart Sound Sensor, piezo-electric (non-isolated) with phone plug. **286700**



Finger Pulse Sensor, with 4-pin Winchester connector. **288305**



Radial Pulse Sensor, with 4-pin Winchester connector. **287163**

Transducers



P23XL Gould isolated physiological pressure transducer with 12-pin Deutsch Connector. - 50 to + 300 mm Hg. Patient safety assured by isolated plastic case and isolated sensing mechanism. Defibrillator protected.

369500-18501



P10EZ Gould miniature isolated physiological pressure transducer with 12-pin Deutsch connector. - 50 to + 300 mm Hg. Patient safety assured by isolated plastic case and isolated sensing mechanism. Defibrillator protected.

369500-18502



Differential pressure transducer (Validyne) with 12-pin Deutsch connector for pneumotachography and plethysmography. Extremely accurate and stable ± 20 mm H₂O. Only for use with 13-4615-35 Carrier Signal Conditioner.

369500-57035



Low range Differential pressure transducer (Validyne) with 12-pin Deutsch connector. For pneumotachography and plethysmography requiring a more sensitive transducer. ± 9 mm H₂O. Only for use with 13-4615-35 Carrier Signal Conditioner.

369500-57036

Metripak® Isotonic Muscle Transducer

This completely self contained DC-DC type position transducer incorporates the non-contact, frictionless Metrisite® position sensor proven in hundreds of thousands of applications. It provides infinite stepless resolution in a rugged low inertia design that includes a $\frac{3}{8}$ " stainless steel rod for clamping to laboratory stands.



Metripak with 12-pin Deutsch connector wired for use ONLY with:

13-4615-50 Transducer
13-4615-58 Universal.

793341-04042

13-4616-004029 DC Amp
13-4615-104029 DC Amp

793341-14042

Metrigram Isometric Force Transducer

A truly isometric force transducer, the beam travel for a full-scale deflection is less than 0.003 mm. The seamless, stainless steel body is 6 in. long and $\frac{3}{8}$ in. in diameter. The measuring beam is recessed to prevent accidental damage, and has a countersunk hole to attach the preparation. The Metrigram's extremely high output of 125 mV for a full-scale deflection makes it one of the most sensitive isometric transducers available.



797159-1 ± 10 gm

797159-2 ± 25 gm

797159-3 ± 50 gm

797159-4 ± 100 gm

797159-5 ± 150 gm

797159-6 ± 300 gm

Adapters

Input Adapter. YSI temperature probes to 12-pin Deutsch.

11-5407-54



Input Adapter, photoelectric pulse sensor, 4-pin Winchester to 12-pin Deutsch.

11-5407-66



Input Adapter, phone jack to 12-pin Deutsch.

11-5407-57



Male BNC to 12-pin Deutsch Adapter. 24 in. long; allows high-level signals from Input/Output Panel to drive high-level input of Signal Conditioners.

369500-153



Input Connector kit, 12-pin Deutsch Male.

11-5407-50



Connector kit, 12-pin Deutsch Female. For panel mount or line.

11-5407-51

Pneumotachs

Fleisch and Hans Rudolph Pneumotachs measure respiratory air flow and are calibrated to give accurate readings regardless of direction of air movement. Fleisch models can be used for deliveries exceeding those listed by 50% with only slight discrepancy. Heaters prevent condensation of water vapor.



Fleisch



Hans Rudolph

Fleisch Model	Delivery	Inside Diameter	Length	Dead Space	Gould Model Number
0000	1.2 l/min	6 mm	60 mm	1.7 ml	369500-45001
000	3 l/min	6 mm	60 mm	1.7 ml	369500-45002
00	6 l/min	6 mm	60 mm	1.7 ml	369500-45003
0	18 l/min	10 mm	60 mm	4.7 ml	369500-45004
1	60 l/min	18 mm	60 mm	15 ml	369500-45005
2	180 l/min	29 mm	60 mm	40 ml	369500-45006
3	360 l/min	44 mm	60 mm	92 ml	369500-45007
4	840 l/min	61 mm	70 mm	200 ml	369500-45008

6-volt heater supply for all Fleisch pneumotachs 369500-45009

NOTE: Use Transducer Model No. 369500-57035 with all the above Fleisch models. Full scale differential pressure (typical) for all the above models is 10 mm H₂O.

Application	Fleisch Model
Rats	0000
Cats, small dogs	00 to 000
Babies, neonates	00
Infants (1 - 4 years)	0 to 1
Children (over 4 years), rest breathing	1 or 2
Adults, rest breathing	2
Children (over 4 years), forced respirations, exercise	3 or 4
Adults, forced respirations, exercise	4

Hans Rudolph Heated Pneumotachs

Application	Flow Range	Full Scale Differential Pressure (typical)	Dead Space	Part/Model Numbers		
				Hans Rudolph	Gould	Transducer
Pediatric	0-0.2 l/sec 0-12 l/min	2.5 mm H ₂ O	10 cc	3600	369500-32501	369500-57036
Clinical	0-1.7 l/sec 0-12 l/min	9.0 mm H ₂ O	15 cc	3700	369500-32503	369500-57035
Pulmonary	0-17 l/sec 0-1200 l/min	9.0 mm H ₂ O	80 cc	3800	369500-32505	369500-57035

GOULD RS3000 MEDICAL INSTRUMENTATION RECORDING SYSTEMS FOR RESEARCH

- Pressurized ink or thermal writing system
- Push-button pen position
- 1 to 8 channels, 40, 50 or 100 mm wide
- Unmatched frequency response
- Chart annotation standard
- Programmable system parameters
- Remote controllability

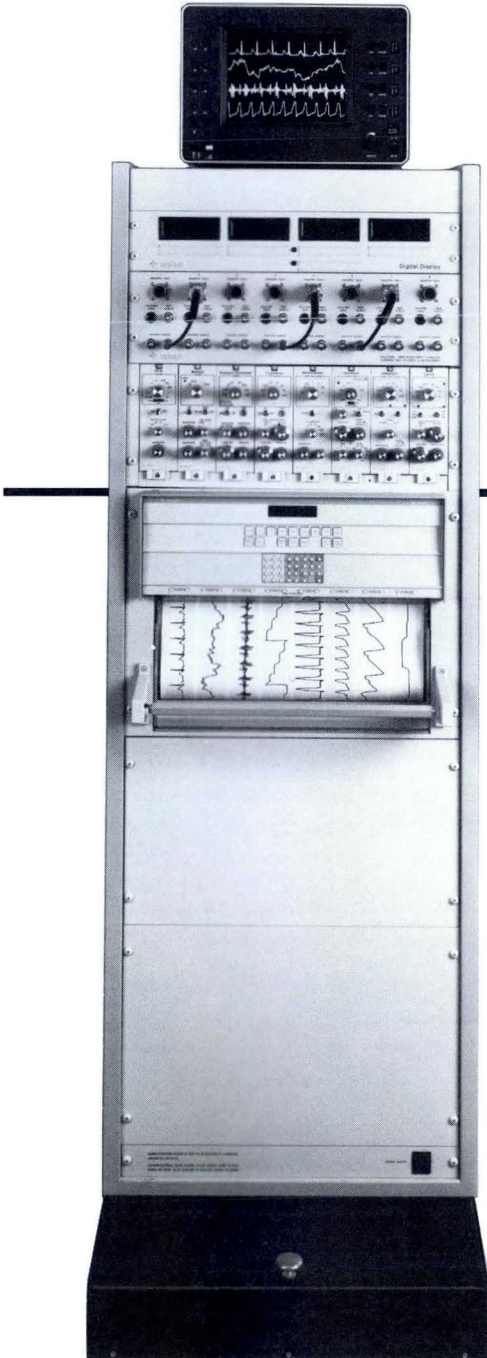

For 50 years Gould has been providing the standard in direct writing oscillographic recorders for the medical research community. Gould's exclusive pressurized ink writing method produces the crisp, uniform traces required for publication, and Gould's 4600 Series of Medical Instrumentation Signal Conditioners have long been accepted as the state-of-the-art choice for the exacting requirements of the medical researcher.

Gould now proudly introduces the RS3000 Recorder for the medical research laboratory. Whether you choose the rugged bench top recorder or customize a system for a complete solution to your recording needs, you can be assured of the highest quality from the leader in medical research instrumentation.

Gould RS3800 Cardiovascular Research Recording System

**GOULD RS3000 MEDICAL INSTRUMENTATION
BENCHTOP RECORDERS FOR RESEARCH**

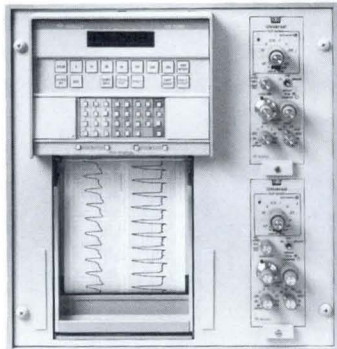

Gould Portable Two-Channel RS3200 Recorder (Model 30-V7202-10)

Gould RS3200 One- and Two-Channel Recorders

Description	No. Powered Amp. Positions ¹	Model Number ²	Starter Kit ³
Two 50-mm channels, pressurized ink writing	2	30-V7202-10	11-36250-07
One 100-mm channel, pressurized ink writing	1	30-V7210-10	11-36250-02
Two 50-mm channels, thermal writing	2	30-V8202-10	11-36250-04
Chart takeup		11-6402-16	

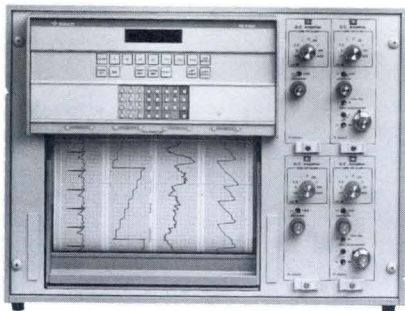

Gould Portable Four-Channel RS3400 Recorder (Model 30-V7404-10)

Gould RS3400 Two-, Three- and Four-Channel Recorders

Description	No. Powered Amp. Positions ¹	Model Number ²	Starter Kit ³
Four 50-mm channels, pressurized ink writing	4	30-V7404-10	11-36250-17
Two 100-mm channels, pressurized ink writing	2	30-V7420-10	11-36250-09
One 100-mm and two 50-mm channels, pressurized ink writing	3	30-V7412-10	11-36250-11
Four 50-mm channels, thermal writing	4	30-V8404-10	11-36250-12
Chart takeup		11-6402-17	

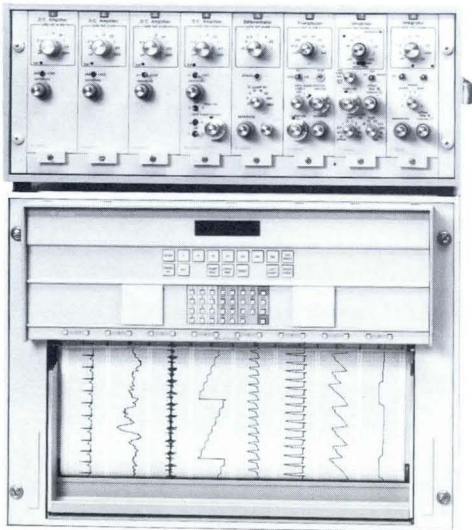

Gould Benchtop Eight-Channel RS3800 Recorder (Model 30-V7808-12). Configuration for benchtop six-channel RS3600 Recorder is the same, with amplifiers on top.

Gould RS3600 and RS3800 Six- and Eight-Channel Recorders

Description	No. Powered Amp. Positions ¹	Model Number ²	Starter Kit ³
Six 50-mm channel, pressurized ink writing	6	30-V7606-12	11-36250-22
Six 50-mm channel, thermal writing	6	30-V8606-12	11-36250-19
Eight 40-mm channel, pressurized ink writing	8	30-V7808-12	11-36250-27
Eight 40-mm channel, thermal writing	8	30-V8808-12	11-36250-24
Chart takeup		11-6402-18	

¹Powers one signal conditioner per recorder channel.

²Model Numbers for 115 VAC, 50-400 Hz operation. Replace 00 with 01 for 100 VAC; 06 for 230 VAC; or 07 for 200 VAC operation.

³Starter Kit includes 12 rolls of chart paper, analog pen and time line gauge.

GOULD TA 2000 MEDICAL INSTRUMENTATION RECORDING SYSTEMS FOR RESEARCH

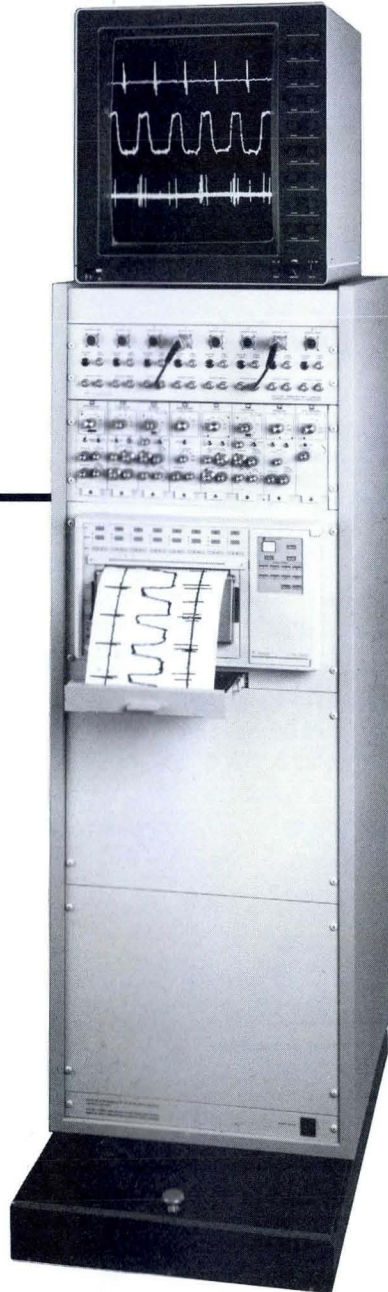

Gould TA 2000 Electrophysiology Research Recording System

- Eight-channel thermal array writing system
- 2.5 kHz frequency response
- 8 dots/mm resolution
- x1, x2, x4 trace expansion
- Overlapping traces
- 200 mm/s chart speed
- Fully compatible with Gould 4600 Series Medical Signal Conditioner

The Gould TA 2000 Thermal Array Recording System provides the performance and versatility required in a medical instrumentation recorder. Whether it is high frequency response for recording intracardiac electrograms and nerve traffic, or overlapping traces to display pressure gradients, the TA 2000 does it all. Eight dot per mm linear thermal array writing assures dependable, trouble-free operation, and provides complete chart annotation capability. The TA 2000 can be configured to suit your specific requirements such as the Electrophysiology Research Recording System shown below.

Gould Medical Instrumentation Isolated Power Supplies

Gould RS3000 and TA 2000 Recorders are frequently used in applications where the recorder must be electrically isolated from the power line for patient safety. Gould Medical Instrumentation Power Supplies limit the maximum current leakage to chassis to 30 μ A. Both sides of the AC line are switched, and circuit breakers open on both sides of the AC line. A hospital-grade low-leakage cord and plug are included.

Model Number	Description
CL-812620	Rackmount Isolated AC Power Supply
CL-812621	Portable Isolated AC Power Supply

GOULD ES2000 MEDICAL INSTRUMENTATION RECORDING SYSTEMS FOR RESEARCH

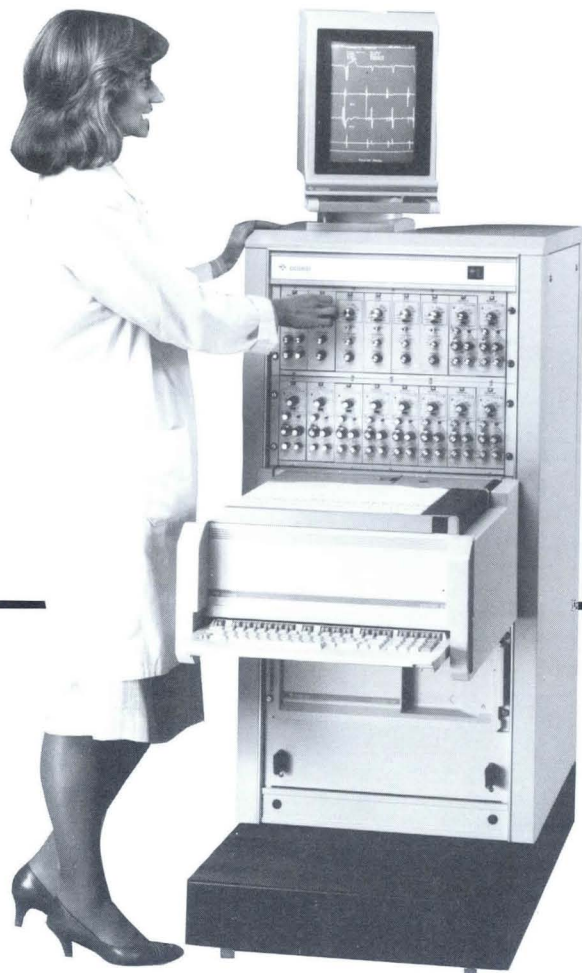

- Programmable set-ups saved on disk
- Up to 40 channels
- Digitized data output
- 10 kHz frequency response
- Real time, non-fade monitor
- High-contrast, hard copy
- Full annotation capability
- User-programmable grids

When multiple custom set-ups are frequently used, if eight channels aren't enough and if high frequency response is needed, then Gould's ES2000 Medical Instrumentation Systems are the ideal choice. Proven in medical research and clinical laboratories for the last 10 years, Gould's Electrostatic Recording Systems have been at the forefront in the fields of electro-physiology and nerve traffic recording.

High-contrast electrostatic hard-copy, full compatibility with Gould 4600 Series Medical Instrumentation Signal Conditioners, and the exclusive Non-fade Digital Monitor make this system ideal for any medical research application. Choose from the benchtop model or other system configuration to suit your specific requirements.

Gould ES2000 Medical Research Recording System

GOULD MEDICAL INSTRUMENTATION INPUT/OUTPUT PANELS

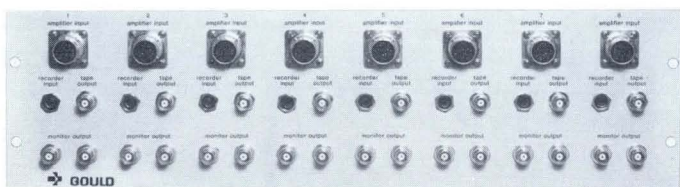

The Gould Medical Instrumentation Input/Output Panel simplifies input and output connections to and from the signal conditioners and the recorder. Front or rear mounting of the panel provides safe, convenient access to the signal connectors. Direct access to the recorder drive amplifier is as easy as inserting a standard phone plug, while outputs are available on three BNC connectors for connection to tape recorders, computers, monitors or other signal conditioners. All connections are labeled for easy identification.

Model Number	Description
11-1605-32	Input/Output Panel for RS 3000, front mount
11-1605-33	Input/Output Panel for RS 3000, rear mount
11-1605-34	Input/Output Panel for TA 2000, front mount
11-1605-35	Input/Output Panel for TA 2000, rear mount
11-1605-36	Input/Output Panel for ES2000, front mount
11-1605-37	Input/Output Panel for ES2000, rear mount

CLINICAL EP/CATH LAB RECORDING SYSTEMS



- High quality, high resolution traces
- Inexpensive, 256-mm wide paper
- Comprehensive annotation
- Up to 40-channel capability
- Chart speeds up to 500 mm/s
- Modular design accommodates future changes
- Wide selection of medical signal conditioners
- Maximum versatility for hemodynamic, angioplasty and electrophysiology laboratories

Gould offers a full line of research-quality clinical recording systems that can be custom tailored to your needs. Gould cath lab systems provide a complete solution for routine cardiac hemodynamic and EP testing as well as clinical investigations. They deliver accurate records, maximum uptime and unparalleled clinical efficiency. Gould cath lab systems will help you visualize your EP or hemodynamic data, create high quality hard copy traces, produce detailed test reports, and using advanced LAN technology, quickly transmit data and reports to other areas within the hospital.

With a compact workstation approach, Gould systems are easy to use featuring menu-driven screens and full-color graphics for fast access to patient data. At the heart of the system is a totally programmable ES2000 electrostatic recorder. This recorder lets you pre-configure settings for greater productivity and repeatability, and reduced operator interventions. Its advanced non-fade video monitor speeds setup. It also features the most comprehensive annotation available providing clear, easy-to-analyze charts. The exclusive electrostatic writing system requires no special expensive thermal or light-sensitive paper and produces a chart that

won't fade or deteriorate in any way and is easy to read and reproduce. Chart speeds of up to 500 mm/s will help you achieve more accurate timing analysis, and our high resolution monitor provides the smoothest, easiest to read waveforms available.

Gould has served the needs of the health care industry for over 50 years. With innovative products that have evolved into sophisticated computer-based systems capable of providing diagnostic value and improved patient care. At Gould, we know that system reliability and service support are essential. The hidden costs of downtime can severely affect your department's performance, the quality of health care, and your budget. That's why the heart of our customer support is a nationwide service organization dedicated to fast response and quality service. And why we offer in-depth training programs to familiarize your staff with equipment operation and help you achieve high operating efficiency right from the start.

For more information on Gould EP/Cath lab recording systems, contact your local Gould Medical Sales Specialist.

GOULD MEDICAL MOTILITY SYSTEMS

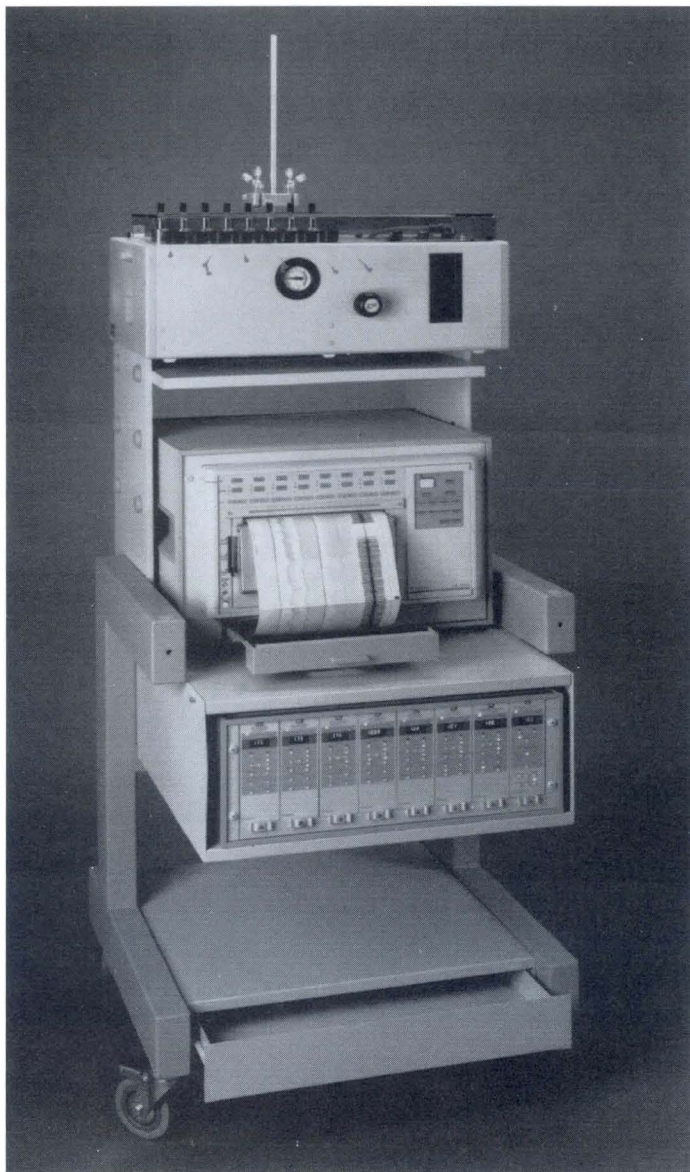

System shown is only representative. Actual configuration may differ.

Gould has long been a leading supplier of solutions for the research and clinical laboratory. These solutions have consistently set standards for physiology recording. Based on this experience, Gould now offers a complete solution for the Gastro-Intestinal Motility Laboratory. Applications include clinical and research, esophageal, anorectal biliary and intestinal studies.

Gould GI Motility Recording System

The new Gould GI Motility Recording System is the ideal combination of state-of-the-art instruments to perform accurate and reliable acquisition of up to eight channels of physiologic data. Its hydraulic capillary infusion system allows up to eight simultaneous pressure measurements. It is very simple to operate and does not generate patient discomfort. The system's Thermal Array Recorder is a versatile 8-channel unit, which features overlapping traces, alphanumeric annotation and high frequency response. This enables the capture of the most fugitive electromyograms. Systems can be configured for esophageal, intestinal biliary and anorectal studies.

Specifications and Ordering Information

Consult your local Gould Sales Office listed on pages 220 and 221 for more information.

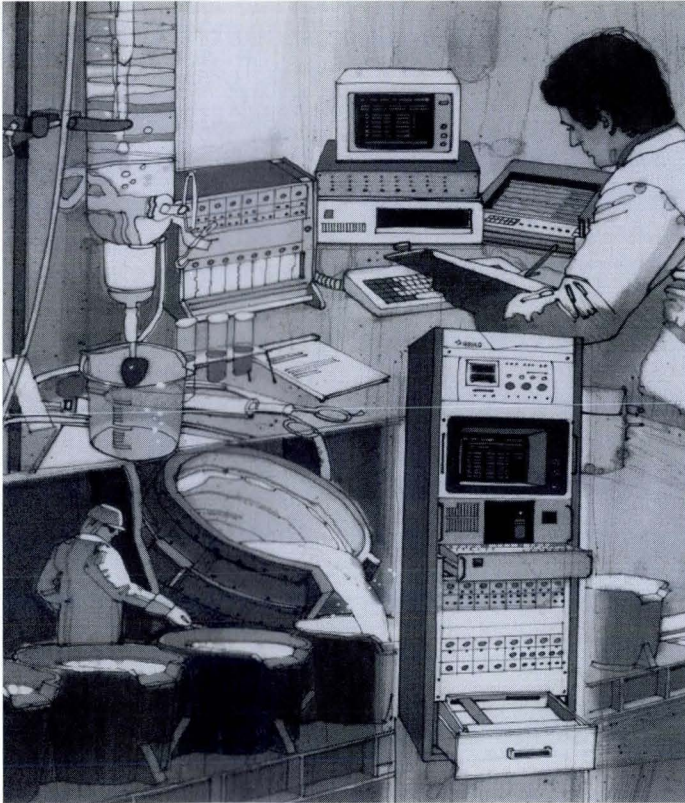

- Standard products and systems
- Application specific products and systems
- Custom products and systems

Gould Test and Measurement offers you application specific systems and solutions for a wide variety of manufacturing and research settings. Gould has more than 50 years of experience in providing its customers with proven products and solutions, designed to increase productivity and improve quality. Working with customers in medical, industrial and aerospace applications, Gould has developed the products, the people and the expertise necessary to meet your specific system application requirements.

Your experienced Gould Systems Engineer has a wide array of proven products and services designed to make your operation more efficient and effective.

System Services: These services represent the critical resources required to meet special system applications. They include:

- Consulting and Application Engineering for *Problem Solving*.
- Application Specific Software and Hardware
- System Documentation and Testing
- Third Party Product Integration, Documentation and Testing
- Systemization and Assembly
- Applications Engineering
- Application and Product Training
- On-site Installation
- On-Site Service

Complete Product Offering: These high quality, proven performers offer the reliability which only come from 50 years of supplying test and measurement equipment to a broad customer base.

- IEEE Controlled, Personal Computer Instrumentation
- Multi-Channel, Transient, Waveform Capture Instruments
- Wide Range of Signal Conditioning
- High Speed, Computer Based, Data Acquisition Products
- Software for Data Acquisition and Signal Analysis
- Hard Copy Recording Output
- Data Loggers

These Critical Services, combined with Gould's comprehensive line of measurement and monitoring instruments, provide our customers with proven performance and solutions. Call your local Gould Systems Engineer and let Gould's 50 years of experience and product development benefit your operation.

TELEMETRY AND SIMULATION DATA DISPLAY SYSTEM

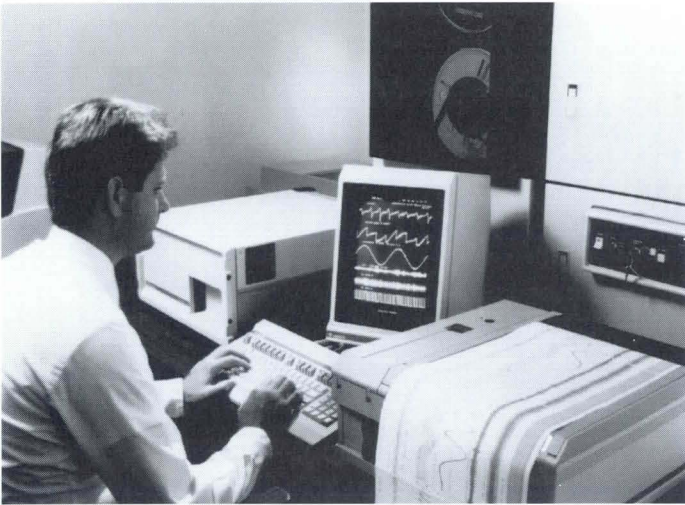

- State-of-the science system to monitor and record simulated or telemetered signals
- Displays up to 40 analog or 80 digitized and 80 discrete channels plus alphanumeric time code
- Provides customized hard-copy output with programmable channel widths, grid patterns and extensive annotation
- Advanced Real Time Monitor provides flexible "quick-look" capability
- Transient capture capability
- Full local and remote programmability

The Gould Telemetry and Simulation Data Systems are the most advanced recording and display systems available for the aerospace and aviation industries. These systems are designed to provide the utmost in flexibility for your tests and data processing needs.

The systems accept signals from analog tape, data reduction computer, or directly from your front-end equipment. They provide basic DC signal conditioning for analog signals and formatting for digital signals. Time codes are read, displayed on the system monitor(s) and translated into alphanumeric print by our special interface. A time-controlled output provides for tape search capability.

Extensive annotation capability enables you to document your hard-copy outputs with all the information you need. You may select from pre-entered messages and data identification to be printed periodically or on-the-fly (upon

a keystroke or reception of a word from a computer) . Or text can be entered on-line via the system keyboard or received from a computer.

The high resolution video Monitor provides "quick-look" display of simulated/telemetered signals that are identical to those on the moving chart. A special hard copy feature allows to start the chart only when recording is required without losing any data. Optional slave monitors can be remotely located.

Our exclusive transient capture feature allows simultaneous real time monitoring and storage of data . Stored data can be later retrieved for more detailed analysis

Specifications and Ordering Information

Consult your local Gould Sales Office or Representative (page 220) for more information.

In-Plant Control Assures Uniform Quality.

Gould Accuchart chart papers are printed in the Gould factory on a high-accuracy gravure press, designed and constructed to the company's specifications.

Chart papers are handled under constant tension and kept at uniform temperature and humidity year-round in their specially built press and spooling rooms.

Gould exercises complete quality control in its own printing facility. Any technical charts, manufactured elsewhere at our request, are not accepted without assuring that each individual roll meets Gould's high standards. Compare our specifications.

**The Printed Record —
Accurate, Crisp, Clean, Permanent.**

The ultimate purpose of Gould Recording Systems is to produce accurate, permanent records of the signals being measured. This means that all of the high-performance characteristics and quality features built into every Gould recorder focus at the point where the recording pen or styli meet the chart paper. Therefore, Gould has engineered chart papers that are expressly designed for use on Gould recorders. Substitute papers from other sources are merely adapted and do not measure up to Gould's standards to give the fine line resolution and trace fidelity for which Gould recorders are renowned.

Gould chart paper stocks insure high tensile strength and dimensional stability.

Writing surfaces are exceptionally smooth and specially processed for instant acceptance of the trace with minimum pen or styli friction. All cores are precision fitted to prevent slippage. Each roll is wound under constant tension to assure tightness and perfect alignment.

Attention to such details makes the difference. Only Gould chart papers fulfill the stringent requirements of Gould recording equipment.

Pens and Styli are Lightweight, Yet Rigid.

Gould pens and styli are simple and rugged, engineered to give hundreds of hours of accurate recordings. Gould oscillograph pens and styli combine light weight with exceptional rigidity.

A critical factor is that Gould pens and styli are dynamically matched with Gould penmotors to insure proper operation; there are no substitutes.

Gould Inks a "Must" for Gould Pens.

All Gould Ink is specially formulated to insure proper flow and trace from within the Gould engineered pen. All inks are packaged in specially prepared containers that meet all of Gould's rigid inspection and operation requirements.



- In plant production facilities
- More than 25 years experience in printing chart paper
- Accurate gravure printing
- Precision pens and styli
- Wide variety of writing media
- Supplies customized for Gould Recorders
- Emergency deliveries available from Gould supplies bank

General Chart Paper Specifications

- (A) **Printing.** Overall accuracy of printed grid lines is better than 0.15% of any dimension.
- (B) **Grid-paper Edge Registration.** Paper is trimmed so that distance between the centerline of any channel and the edge of the paper does not vary more than ± 0.13 millimeters throughout entire length of roll.
- (C) **Coiling Accuracy.** In passing through the recorder, lateral drift of the paper due to coiling errors or to core misalignment is held to ± 0.008 inch.
- (D) **Width of Paper.** Overall tolerance better than ± 0.015 inch.*

Coiling Tension. Rolls are coiled with uniform tension sufficient to prevent "telescoping" during normal use in Gould recorders.

Uniformity. There are no printing errors or other discontinuities in a complete roll.

Compatibility with Gould Recorders. We certify that Gould chart paper will not compromise the accuracy or reliability of the recorder for which it is designed.

*All dimensional specifications based on a sustained condition of 50% relative humidity.

"Accuchart" is a registered trademark of Gould Inc., Instruments Division.

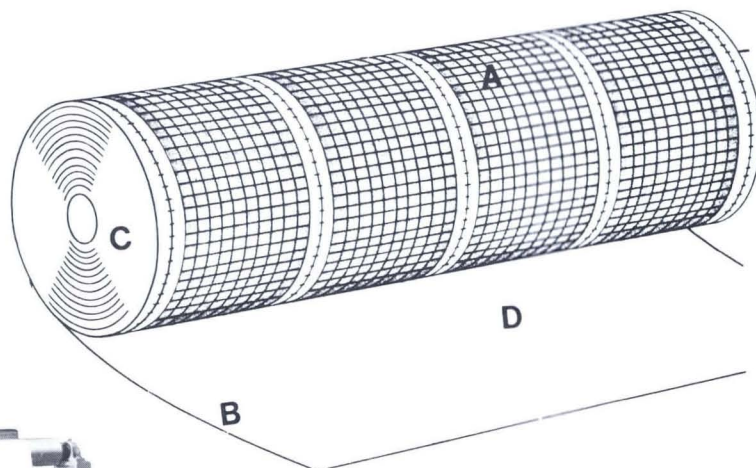
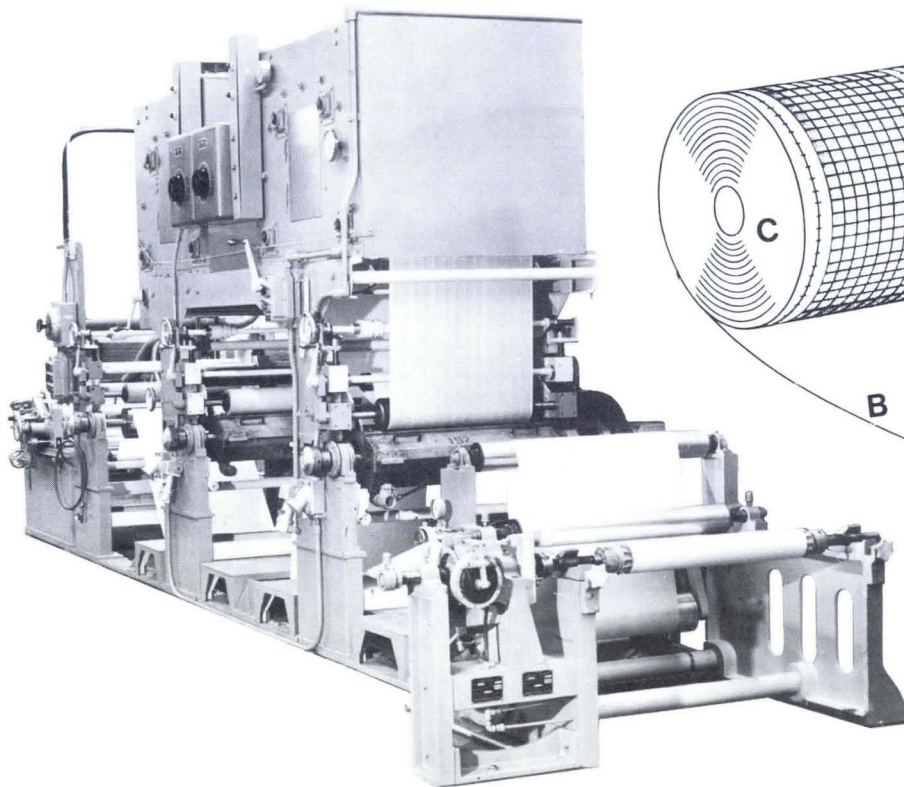

Supplies for:

Strip Chart Recorder 105, Model Series 15-42X8-XX
 110, Model Series 15-4XX8-XX
 270, Model Series 27X-111122-1
 280, Model Series 28X-111111-1
 2130, Model Series LR-XXX00-0X

Thermal Array Recorder TA550, Model Series 253-X22111-1
 TA600, Model Series 3008-06XX-XX
 TA2000, Model Series 3008-851X-4X

Strip Chart Recorder Paper

Chart Paper Model Number	Recorder Group	Recorder Model Number	No. of Analog Channels	Analog Channel Width	Div. Per Channel	No. of Event Channels	Type of Chart	Chart Paper Width (in.)	Chart Paper Length (ft.)	Shipping Weight Per Roll/Pack (lb.)	Rolls/Packs Per Ctn.
11-2913-19	105	15-42X8-00	2	10 in.	100	1	Capillary ink roll, English grid	11	120	1.25	12
11-2913-23	105	15-42X8-10	2	25 cm	250	1	Capillary ink roll, metric grid	11.5	120	1.25	12
11-2913-100	105	15-42X8-10	2	25 cm	250	1	Capillary ink folded pack, metric grid	11.5	100	1.5	1 pkg.
11-2913-101	105	15-42X8-00	2	10 in.	100	1	Capillary ink folded pack, English grid	11	100	1.5	1 pkg.
11-2915-10	110	15-4XX8-00	1-2	9.75 in.	100	—	Thermal black trace roll, English grid	11	120	1.25	12
11-2915-11	110	15-4XX8-10	1-2	24.8 cm	100	—	Thermal black trace roll, metric grid	11	120	1.25	12
11-2915-12	110	15-4XX8-00	1-2	7.67 in.	100	—	Thermal black trace roll, English grid, with integrator channel	11	120	1.25	12
11-2915-13	110	15-4XX8-10	1-2	19.5 cm	100	—	Thermal black trace roll, metric grid, with integrator channel	11	120	1.25	12
297701	SC270 SC280	27X-111122-1 28X-111111-1	4-6 4-8	250mm	—	4-6 4-8	Capillary ink roll, metric grid	11.1	66	.9	10
297702	SC270	27X-111122-1	4-6	250mm	—	4-6	Capillary ink folded pack, metric grid	11.1x 150mm	133 pgs.	.8	10
297711	SC280	28X-111111-1	4-8	250mm	—	4-8	Capillary ink folded pack, metric grid	11.1x 60mm	333 pgs.	.7	10
CL-211212	SC2130	LR-XXX00-XX	30	250mm	—	—	Box of 6 rolls ink jet paper	10.6	108.3	8/carton	6

Thermal Array Recorder Paper

Chart Paper Model Number	Recorder Group	Recorder Model Number	Type of Chart	Chart Paper Width (in.)	Chart Paper Length (ft.)	Shipping Weight Per Roll/Pack (lb.)	Rolls/Packs Per Ctn.
CL-211007	TA550	253-X22111-1	Thermal black trace roll, no grid	4.49	114.9	.7	6
11-6905-31	TA600	3008-06XX-XX	Thermal blue trace roll, no grid	6.0	300	1.8	12
11-6905-301	TA600	3008-06XX-XX	Thermal blue trace fanfold pack, no grid, 4 in. folds	6.0	250	1.5	1
CL-211097	TA2000	3008-851X-4X	Thermal black trace fanfold pack, no grid, 11 in. folds	8.5	325	3.0	6

Ink Strip Chart Recorder Pens

Recorder/Description	Analog Pen Model Number	Event Pen Model Number
105 Series Strip Chart Recorder		
Upper Red, Pkg. of 4	290863-1	
Lower Blue, Pkg. of 4	290862-2	
Left Black, Pkg. of 4		290863-2
270/280 Series Strip Chart Recorder		
(Unit quantity is one pen per part number.)		
Color: Red	297703-1	297704-1
Green	297703-2	(Red for SC270)
Brown	297703-3	297705-1
Light Green	297703-4	(Red for SC280)
Blue	297703-5	297705-2
Orange	297703-6	(Green for SC280)
Light Blue	297703-7	
Violet	297703-8	

Continued on next page.

Supplies for:

Strip Chart Recorders and Thermal Array Recorders (continued)

Ink Jet Tanks

Recorder	Description	Model Number
2130 Series Logging Recorder	Set of 4 basic color ink jet tanks (magenta, cyan, yellow, black)	CL-211210
	Individual black ink jet tank	CL-211211
	Rubber squeeze bulb	CL-211213

Thermal Strip Chart Styli

Recorder	Analog Styli Model Number	Event Styli Model Number
110	Upper Channel	11-2824-36
	Lower Channel	11-2824-37
	Left Event	11-2874-11
	Right Event	11-2874-12

Supplies for:

Mark 200 Recorder, Model Series 1704, 1707, RF 1783, 15-1787

Oscillographic Rectilinear Chart Paper

Chart Paper Model Number	Recorder Group	Recorder Model Number	No. of Analog Channels	Analog Channel Width	Div. Per Channel	No. of Event Channels	Type of Chart	Chart Paper Width (in.)	Chart Paper Length (ft.)	Shipping Weight Per Roll/Pack (lb.)	Rolls/Packs Per Ctn.
11-2933-50	200	8888-1707 Series	—	—	—	32	High contrast ink roll	15	500	12.0	4
11-2943-51	200	1111-17XX Series	4	80mm	50	5	High contrast ink roll	15	500	12.0	4
1222-2943-502	200	1222-17XX Series	7	(1) 80mm (6) 40mm	50	8	High contrast ink semi-perf roll	15	500	12.0	4
11-2963-502	200	1122-17XX Series	6	(2) 80mm (4) 40mm	50	7	High contrast ink semi-perf roll	15	500	12.0	4
11-2983-504	200	2222-17XX Series RF 1783 Series 15-1787 Series	8	40mm	50	9	High contrast ink semi-perf roll	15	500	12.0	4
RA-2983-503164	200	2222-17XX Series RF 1783 (8 Chan.) 15-1787 Series	8	40mm	50	9	High contrast ink roll	15	500	12.0	4
11-2983-903164	200	2222-1707 Series RF 1788 (8 Chan.) 15-1787 Series	8	40mm	50	9	Reproducible ink roll	15	850	14.5	4

For chart papers not listed consult factory.

Pressurized Ink Pens

Recorder Group	Analog Pen Model Number	Event Pen Model Number
200 (RF 1783 Series)	RA 2823-30	RA 2821-20
200 (1707 Series)	11-2823-31	RA 2821-20
200 (15-1787 Series)	11-2823-31	RA 2821-20
200 (1704 Series)	11-2823-35	11-2821-22

Ink for Pressurized Ink Pens

Recorder	Blue Ink Model Number	Capacity (Ounces)	Container
200, RF 1783 Series 15-1787 Series, 1704 Series 1707 Series	11-2734-02	2	Plastic Syringe
Ink remover	282920		

Continued on next page.

Supplies for:

Mark 200 Recorders (continued)

Starter Kits

Choose a starter kit based on the type of chart paper wanted. Each kit contains 12 rolls of paper, 1 analog pen, and a gram gage. (Complete description of chart found in "CHART PAPER" section.)

Recorder Group	For Chart Paper	Order: Starter Kit Model No.	Channel Config.	No. of Event Ch's	Description of Chart Paper
200	11-2983-504	11-6250-37	8-40mm	9	High contrast ink semi-perf roll

Supplies for:

Mark 200A Recorder

Chart Paper (40mm channels have 50 divisions)

Chart Paper Model Number	Recorder Group	Recorder Model Number	No. of Analog Channels	No. of Event Channels	No. of Annot. Channels	Type of Chart	Chart Paper Width (in.)	Chart Paper Length (ft.)	Shipping Weight Per Roll/Pack (lb.)	Rolls/Packs Per Ctn.
11-2987-601	Mk200A	30-XX808-2X	8-40mm	8	1	High contrast ink, with annotation stripe	15.0	575	12.4	4
11-2985-81	Mk200A	30-XX808-2X	8-40mm	1	8	Thermal black trace roll (can be used with ink recorder)	15.0	850	12.5	4
11-2985-82	Mk200A	30-XX808-2X	8-40mm	8	1	Thermal black trace roll (can be used with ink recorder)	15.0	850	12.5	4
11-2985-601	Mk200A	30-XX808-2X	8-40mm	1	8	Thermal black trace semi-perf roll	15.0	650	12.9	4
11-2985-602	Mk200A	30-XX808-2X	8-40mm	8	1	Thermal black trace semi-perf roll	15.0	650	12.9	4

Pressurized Ink Pens

Recorder Group	Analog Pen Model Number	Event Pen Model Number
3000, Mark 200A	11-2823-3A	11-2873-2A

Thermal Pens

Recorder	Analog Pen Model Number	Event Pen Model Number
3000, Mark 200A	11-2824-3A	11-2874-2A

Ink for Pressurized Ink Pens

Recorder	Ink Model Number	Capacity	Container
3000, Mark 200A	11-2731-01	1 oz.	Cartridge

Miscellaneous Supply Items

Recorder	Description of Item	Model Number
3000, Mark 200A	Gram Gage (for setting pen pressure)	240601-910
	Ink Remover	282920
	Time Line Gage (for setting pen position)	CL-310999

Supplies for:

220 Recorder, Model Series 15-6327-XX, 15-6327-572601

222 Recorder, Model Series 15-6325-XX

Oscillographic Rectilinear Chart Paper

Chart Paper Model Number	Recorder Group	Recorder Model Number	No. of Analog Channels	Analog Channel Width	Div. Per Channel	No. of Event Channels	Type of Chart	Chart Paper Width (in.)	Chart Paper Length (ft.)	Shipping Weight Per Roll/Pack (lb.)	Rolls/Packs Per Ctn.
11-2923-32	220/222	15-6327 Series	2	40mm	50	3	High contrast ink roll	4.285	275	1.8	12
11-2923-38	220/222	15-632X Series	—	—	—	—	High contrast ink roll, no grid	4.285	275	1.8	12
11-2923-45	220/222	15-632X Series	2	40mm	50	3	Reproducible ink roll	4.285	400	1.8	12
11-2925-30	220	15-6327 Series	2	40mm	50	3	Thermal blue trace roll	4.285	275	1.7	12
11-2925-32	220/222	15-6327 Series	2	40mm	50	3	Thermal black trace roll	4.285	275	1.5	12

Pressurized Ink Pens

Recorder Group	Analog Pen Model Number	Event Pen Model Number
220, 222, 260, 440, and 480 Series	11-2823-33	11-2873-20

Longer-Life Pressurized Ink Pens

Recorder Group	Pen Number	Description
220, 240, 260, 440, and 480 Series	11-2823-34	Longer-Life, tungsten-carbide pressurized ink pen (Replaces 11-2823-33)

Thermal Oscillographic Styli

Recorder	Analog Styli Model Number	Event Styli Model Number
220 (15-6327 Series)	11-2824-35	11-2874-21

Ink for Pressurized Ink Pens

Recorder	Blue Ink Model Number	Capacity (Ounces)	Container
220, 222, 250, 260, 440, and 480 Series 2000, 2000S, 2000W	11-2730-01	1	Cartridge
For use in same Recorders as 11-2730-01	11-2730-012908 (Red)	1	Replaces 11-2730-01
	11-2730-015902 (Black)	1	Replaces 11-2730-01
Ink remover	282920		

Starter Kits

Choose a starter kit based on the type of chart paper wanted. Each kit contains 12 rolls of paper, 1 analog pen, and a gram gage. (Complete description of chart found in "CHART PAPER" section.)

Recorder Group	For Chart Paper	Order: Starter Kit Model No.	Channel Config.	No. of Event Ch's	Description of Chart Paper
220/222	11-2923-32	11-6250-00	2	3	High contrast ink roll
	11-2925-32	11-6250-002601	2	3	Thermal black trace roll
	11-2923-32	11-6251-00 (This is 220 Replacement Supplies Kit)	2	3	High contrast ink roll

Supplies for:

260 Recorder, Model Series 15-6367-XX

Oscillographic Rectilinear Chart Paper

Chart Paper Model Number	Recorder Group	Recorder Model Number	No. of Analog Channels	Analog Channel Width	Div. Per Channel	No. of Event Channels	Type of Chart	Chart Paper Width (in.)	Chart Paper Length (ft.)	Shipping Weight Per Roll/Pack (lb.)	Rolls/Packs Per Ctn.
11-2963-21	260	15-6367 Series	6	40mm	50	4	High contrast ink roll	12.52	225	4.9	12
11-2963-31	260	15-6327 Series	6	40mm	50	4	Reproducible ink roll	12.52	325	4.2	12
11-2963-200	260	15-6327 Series	6	40mm	50	4	High contrast ink semi-perf roll	12.52	225	4.9	12

Pressurized Ink Pens

Recorder Group	Analog Pen Model Number	Event Pen Model Number
220, 222, 260, 440, and 480 Series	11-2823-33	11-2873-20

Longer-Life Pressurized Ink Pens

Recorder Group	Pen Number	Description
220, 240, 260, 440, and 480 Series	11-2823-34	Longer-Life, tungsten-carbide pressurized ink pen (Replaces 11-2823-33)

Ink for Pressurized Ink Pens

Recorder	Blue Ink Model Number	Capacity (Ounces)	Container
220, 222, 250, 260, 440, and 480 Series 2000, 2000S, 2000W	11-2730-01	1	Cartridge
For use in same Recorders as 11-2730-01	11-2730-012908 (Red)	1	Replaces 11-2730-01
	11-2730-015902 (Black)	1	Replaces 11-2730-01
Ink remover	282920		

Starter Kits

Choose a starter kit based on the type of chart paper wanted. Each kit contains 12 rolls of paper, 1 analog pen, and a gram gage. (Complete description of chart found in "CHART PAPER" section.)

Recorder Group	For Chart Paper	Order: Starter Kit Model No.	Channel Config.	No. of Event Ch's	Description of Chart Paper
260	11-2963-21	11-6250-02	6	4	High contrast ink roll

Supplies for:

Electrostatic Recorders

Electrostatic Recorder Paper

Chart Paper Model Number	Recorder Group	Recorder Model Number	Paper Description	Chart Paper Width (in./mm)	Chart Paper Length (ft./m)	Shipping Weight Per Roll/Pack (lb./kg)	Rolls/Packs Per Ctn.
23-5101-10	ES1000, ES2000	30X9-115X-XX	Electrostatic standard roll, no grid	11/276	400/122	6.5/2.9	6
23-5101-11		30X9-X114X-X7	Electrostatic folded pack, no grid	11 x 8½" 276x217	1000 pgs. 708/216	11.8/5.3	5 packs
23-5101-12			Electrostatic translucent roll, no grid (requires modification of "Paper Out" sensor on ES1000A)	11/276	400/122	6.8/3.1	6
23-5101-13			Electrostatic perforated roll, no grid	11/276	400/122	6.5/2.9	6

Continued on next page.

Supplies for:

Electrostatic Recorder (continued)

Electrostatic Toner and Supplies

Recorder Group	Recorder Model Number	Supply Model Number	Description
ES1000	30X9-115X-XX	23-5101-01	Toner, box of 4 – 1 qt. bottles
	30X9-113X-X7	23-5111-01	Toner, 1 liter bottle*
	30X9-11XX-XX	490735	Cleaner for Electrostatic Recorders, 1 qt.
ES2000	3009-X114X-XX 23-261X1-01	23-5111-05	Toner, 2 liter bottle**
		23-5111-06	Cleaner, 2 liter bottle
	PA-U29817-A	Core Plug	
	PA-X52305	Box of 10 diskettes for ES2000CP	

*Order in multiples of six.

**Order in multiples of four.

Starter Kits

Each starter kit contains the right high quality Gould manufactured supplies needed to achieve maximum recorder performance. ES1000 Starter Kits contain 12 rolls of paper or 10 packs of paper, 1 box toner, 1 bottle cleaner, and 1 roll or pack of another type of paper.

Recorder Group	Order: Starter Kit Model No.*	Order: Starter Kit Model No.**	Chart Paper Included	Chart Paper Width (mm)	Paper Description
ES1000	X52083	11-6250-57	23-5101-11†	276	Electrostatic folded pack, no grid
	X52084	11-6250-58	23-5101-10††	276	Electrostatic standard roll, no grid
	X52085	11-6250-59	23-5101-13††	276	Electrostatic perforated roll, no grid

†Also includes 1 roll p/n 23-5101-13
††Also includes 1 pack p/n 23-5101-11

*For rest of world
**For North America

Each starter kit contains the right high quality Gould manufactured supplies needed to achieve maximum recorder performance. ES2000 Starter Kits contain 12 rolls of paper or 5 packs of paper, 4 bottles toner, 1 bottle cleaner, 1 roll or pack of another type of paper, and two core plugs.

Recorder Group	Order: Starter Kit Model No.	Chart Paper Included	Chart Paper Width (mm)	Paper Description
ES2000	11-26250-01	23-5101-10†	276	Electrostatic standard roll, no grid
	11-26250-02	23-5101-13††	276	Electrostatic perforated roll, no grid
	11-26250-03	23-5101-11†	276	Electrostatic folded pack, no grid

†Also includes 1 roll p/n 23-5101-13
††Also includes 1 pack p/n 23-5101-11

Supplies for:

2200 Recorders, Model Series 2X07-2XXX-XX, 2X08-2XXX-XX

Chart Paper (50mm channels have 50 divisions; 100mm channels have 100 divisions)

Chart Paper Model Number	Recorder Group	Recorder Model Number	No. of Analog Channels	No. of Event Channels	No. of Annot. Channels	Type of Chart	Chart Paper Width (in.)	Chart Paper Length (ft.)	Shipping Weight Per Roll/Pack (lb.)	Rolls/Packs Per Ctn.
11-2913-30	2200	2X07-21XX-XX	1-100mm	2	—	High contrast ink roll	5.2	275	2.2	12
11-2923-35	2200	2X07-22XX-XX	2-50mm	3	—	High contrast ink roll	5.2	275	2.2	12
11-2923-39	2200	2X07-22XX-XX	—	—	—	High contrast ink roll, no grid	5.2	275	2.2	12
11-2923-46	2200	2X07-22XX-XX	2-50mm	3	—	Reproducible ink roll	5.2	400	2.0	12
11-2925-31	2200	2X08-22XX-XX	2-50mm	3	1	Thermal blue trace roll	5.2	275	1.9	12
11-2925-33	2200	2X08-22XX-XX	2-50mm	3	1	Thermal black trace roll	5.2	275	1.5	12
11-2927-31	2200	2X07-22XX-XX	2-50mm	2	1	High contrast ink roll, with thermal annotation stripe	5.2	275	2.2	12

Pressurized Ink Pens

Recorder Group	Analog Pen Model Number	Event Pen Model Number
2200, 2400 and 2600 Series	11-2823-42	267884-5

Continued on next page.

Supplies for:

2200 Recorders (continued)

Longer-Life Pressurized Ink Pens

Recorder Group	Pen Number	Description
2200, 2400 and 2600 Series	11-2823-422608	Longer-life pen, replaces 11-2823-42

Thermal Oscillographic Styli

Recorder	Analog Styli Model Number	Event Styli Model Number
2000 Series — 2200, 2400 and 2600	11-2824-39	11-2874-34

Ink for Pressurized Ink Pens

Recorder	Blue Ink Model Number	Capacity (Ounces)	Container
2000, 2000S, 2000W 2200, 2400, 2600, 2800	11-2730-01	1	Cartridge
For use in same Recorders as 11-2730-01	11-2730-012908 (Red)	1	Replaces 11-2730-01
	11-2730-015902 (Black)	1	Replaces 11-2730-01
Ink remover	282920		

Starter Kits

Choose a starter kit based on the type of chart paper wanted. Each kit contains 12 rolls of paper, 1 analog pen, and a gram gage. (Complete description of chart found in "CHART PAPER" section.)

Recorder Group	For Chart Paper	Order: Starter Kit Model No.	Channel Config.	No. of Event Ch's	No. of Annot. Ch's	Description of Chart Paper
2200/2200S	11-2913-30	11-6250-14	1-100mm	2	—	High contrast ink roll
	11-2923-35	11-6250-13	2-50mm	3	—	High contrast ink roll
	11-2925-31	11-6250-56	2-50mm	3	1	Thermal blue trace roll
	11-2925-33	11-6250-35	2-50mm	3	1	Thermal black trace roll
	11-2927-31	11-6250-48	2-50mm	2	1	High contrast ink roll

Supplies for:

2400 Recorders, Model Series 2X07-4XXX-XX, 2X08-4XXX-XX

Chart Paper (50mm channels have 50 divisions; 100mm channels have 100 divisions)

Chart Paper Model Number	Recorder Group	Recorder Model Number	No. of Analog Channels	No. of Event Channels	No. of Annot. Channels	Type of Chart	Chart Paper Width (in.)	Chart Paper Length (ft.)	Shipping Weight Per Roll/Pack (lb.)	Rolls/Packs Per Ctn.
11-2923-34	2400	2X07-42XX-XX	2-100mm	3	—	High contrast ink roll	9.84	275	4.0	12
11-2923-301	2400	2X07-42XX-XX	2-100mm	3	—	High contrast ink semi-perf roll	9.84	275	4.0	12
11-2933-30	2400	2X07-43XX-XX	1-100mm 2-50mm	4	—	High contrast ink roll	9.84	275	4.0	12
11-2933-300	2400	2X07-43XX-XX	1-100mm 2-50mm	4	—	High contrast ink semi-perf roll	9.84	275	4.0	12
11-2943-30	2400	2X07-44XX-XX	4-50mm	5	—	High contrast ink roll	9.84	275	4.0	12
11-2943-41	2400	2X07-44XX-XX	4-50mm	5	—	Reproducible ink roll	9.84	400	4.0	12
11-2943-300	2400	2X07-44XX-XX	4-50mm	5	—	High contrast ink semi-perf roll	9.84	275	4.0	12
11-2943-304011	2400	2X07-44XX-XX	—	—	—	High contrast ink roll, no grid	9.84	275	4.0	12
11-2945-30	2400	2X08-44XX-XX	4-50mm	5	1	Thermal blue trace roll	9.84	275	3.8	12
11-2945-31	2400	2X08-44XX-XX	4-50mm	5	1	Thermal black trace roll	9.84	275	3.0	12
11-2945-305160	2400	2X08-44XX-XX	4-50mm	5	1	Thermal black trace semi-perf roll	9.84	275	3.8	12
11-2947-31	2400	2X07-44XX-XX	4-50mm	4	1	High contrast ink roll, with thermal annotation stripe	9.84	275	4.1	12
11-2947-300	2400	2X07-44XX-XX	4-50mm	4	1	High contrast ink semi-perf roll with thermal annotation stripe	9.84	275	4.1	12

Continued on next page.

Supplies for:
2400 Recorders (continued)

Pressurized Ink Pens

Recorder Group	Analog Pen Model Number	Event Pen Model Number
2200, 2400, and 2600 Series	11-2823-42	267884-5

Longer-Life Pressurized Ink Pens

Recorder Group	Pen Number	Description
2200, 2400, and 2600 Series	11-2823-422608	Longer-life pen, replaces 11-2823-42

Thermal Oscillographic Styli

Recorder	Analog Styli Model Number	Event Styli Model Number
2000 Series — 2200, 2400, and 2600	11-2824-39	11-2874-34

Ink for Pressurized Ink Pens

Recorder	Blue Ink Model Number	Capacity (Ounces)	Container
2000, 2000S, 2000W 2200, 2400, 2600, 2800	11-2730-01	1	Cartridge
For use in same Recorders as 11-2730-01	11-2730-012908 (Red)	1	Replaces 11-2730-01
	11-2730-015902 (Black)	1	Replaces 11-2730-01
Ink remover	282920		

Starter Kits

Choose a starter kit based on the type of chart paper wanted. Each kit contains 12 rolls of paper, 1 analog pen, and a gram gage. (Complete description of chart found in "CHART PAPER" section.)

Recorder Group	For Chart Paper	Order: Starter Kit Model No.	Channel Config.	No. of Event Ch's	No. of Annot. Ch's	Description of Chart Paper
2400/2400S/ 2400W	11-2923-34	11-6250-05	2-100mm	3	—	High contrast ink roll
	11-2923-301	11-6250-18	2-100mm	3	—	High contrast ink semi-perf roll
	11-2933-30	11-6250-03	1-100mm 2-50mm	4	—	High contrast ink roll
	11-2933-300	11-6250-16	1-100mm 2-50mm	4	—	High contrast ink semi-perf roll
	11-2943-30	11-6250-04	4-50mm	5	—	High contrast ink roll
	11-2943-300	11-6250-17	4-50mm	5	—	High contrast ink semi-perf roll
	11-2945-30	11-6250-55	4-50mm	5	1	Thermal blue trace roll
	11-2945-31	11-6250-34	4-50mm	5	1	Thermal black trace roll
11-2947-31	11-6250-47	4-50mm	4	1	High contrast ink roll	

Supplies for:

2600 Recorders, Model Series 2X07-6XXX-XX, 2X08-6XXX-XX

Chart Paper (50mm channels have 50 divisions; 100mm channels have 100 divisions)

Chart Paper Model Number	Recorder Group	Recorder Model Number	No. of Analog Channels	No. of Event Channels	No. of Annot. Channels	Type of Chart	Chart Paper Width (in.)	Chart Paper Length (ft.)	Shipping Weight Per Roll/Pack (lb.)	Rolls/Packs Per Ctn.
11-2933-31	2600	2X07-63XX-XX	3-100mm	4	—	High contrast ink roll	15	275	6.3	6
11-2933-313054	2600	2X07-63XX-XX	3-100mm	4	—	High contrast ink semi-perf roll	15	275	6.3	6
11-2953-30	2600	2X07-65XX-XX	1-100mm 4-50mm	6	—	High contrast ink roll	15	275	6.3	6
11-2963-30	2600	2X07-66XX-XX	6-50mm	7	—	High contrast ink roll	15	275	6.3	6
11-2963-300	2600	2X07-66XX-XX	6-50mm	7	—	High contrast ink semi-perf roll	15	275	6.3	6

Continued on next page.

Supplies for:

2600 Recorders (continued)

Chart Paper (50mm channels have 50 divisions; 100mm channels have 100 divisions) - (continued)

Chart Paper Model Number	Recorder Group	Recorder Model Number	No. of Analog Channels	No. of Event Channels	No. of Annot. Channels	Type of Chart	Chart Paper Width (in.)	Chart Paper Length (ft.)	Shipping Weight Per Roll/Pack (lb.)	Rolls/Packs Per Ctn.
11-2965-30	2600	2X08-66XX-XX	6-50mm	7	1	Thermal black trace roll	15	275	4.5	6
11-2965-300	2600	2X08-66XX-XX	6-50mm	6	1	Thermal blue trace semi-perf roll	15	275	5.8	6
11-2965-301	2600	2X08-66XX-XX	6-50mm	7	1	Thermal black trace semi-perf roll	15	275	5.8	6
11-2965-500	2600	2X08-66XX-XX	6-50mm	6	1	Thermal blue trace fanfold pack 30cm folds, 500 pages	15	492	9.4	4 pk.
11-2965-501	2600	2X08-66XX-XX	6-50mm	6	1	Thermal black trace fanfold pack 30cm folds, 500 pages	15	492	9.4	4 pk.
11-2967-301	2600	2X07-66XX-XX	6-50mm	6	1	High contrast ink semi-perf roll with thermal annotation stripe	15	275	6.3	6
11-2983-32	2600 2800	2X07-66XX-XX 2X07-88XX-XX	—	—	—	High contrast ink roll, no grid	15	275	6.3	6

Pressurized Ink Pens

Recorder Group	Analog Pen Model Number	Event Pen Model Number
2200, 2400, and 2600 Series	11-2823-42	267884-5

Longer-Life Pressurized Ink Pens

Recorder Group	Pen Number	Description
2200, 2400, and 2600 Series	11-2823-422608	Longer-life pen, replaces 11-2823-42

Thermal Oscillographic Styli

Recorder	Analog Styli Model Number	Event Styli Model Number
2000 Series — 2200, 2400, and 2600	11-2824-39	11-2874-34

Ink for Pressurized Ink Pens

Recorder	Blue Ink Model Number	Capacity (Ounces)	Container
2000, 2000S, 2000W 2200, 2400, 2600, 2800	11-2730-01	1	Cartridge
For use in same Recorders as 11-2730-01	11-2730-012908 (Red)	1	Replaces 11-2730-01
	11-2730-015902 (Black)	1	Replaces 11-2730-01

Ink remover

282920

Starter Kits

Choose a starter kit based on the type of chart paper wanted. Each kit contains 12 rolls of paper or 12 packs of paper, 1 analog pen, and a gram gage. (Complete description of chart found in "CHART PAPER" section.)

Recorder Group	For Chart Paper	Order: Starter Kit Model No.	Channel Config.	No. of Event Ch's	No. of Annot. Ch's	Description of Chart Paper
2600/2600S/ 2600W	11-2963-30	11-6250-41	6-50mm	7	—	High contrast ink roll
	11-2963-300	11-6250-10	6-50mm	7	—	High contrast ink semi-perf roll
	11-2965-30	11-6250-43	6-50mm	7	1	Thermal black trace roll
	11-2965-300	11-6250-54	6-50mm	6	1	Thermal blue trace semi-perf roll
	11-2965-301	11-6250-33	6-50mm	7	1	Thermal black trace semi-perf roll
	11-2965-500	11-6250-52	6-50mm	6	1	Thermal blue trace fanfolded pack
	11-2965-501	11-6250-53	6-50mm	6	1	Thermal black trace fanfolded pack
	11-2967-301	11-6250-46	6-50mm	6	1	High contrast ink semi-perf roll

Supplies for:
2800 Recorders, Model Series 2X07-88XX, 2X08-88XX-XX

Chart Paper (40mm channels have 50 divisions)

Chart Paper Model Number	Recorder Group	Recorder Model Number	No. of Analog Channels	No. of Event Channels	No. of Annot. Channels	Type of Chart	Chart Paper Width (in.)	Chart Paper Length (ft.)	Shipping Weight Per Roll/Pack (lb.)	Rolls/Packs Per Ctn.
11-2983-31	2800	2X07-88XX-XX	8-40mm	9	—	High contrast ink roll	15	275	6.3	6
11-2983-32	2600 2800	2X07-66XX-XX 2X07-88XX-XX	—	—	—	High contrast ink roll, no grid	15	275	6.3	6
11-2983-301	2800	2X07-88XX-XX	8-40mm	9	—	High contrast ink semi-perf roll	15	275	6.3	6
11-2985-32	2800	2X08-88XX-XX	8-40mm	9	—	Thermal black trace roll	15	275	4.5	6
11-2985-36	2800	2X08-88XX-XX	8-40mm	8	1	Thermal black trace roll	15	275	4.5	6
11-2985-300	2800	2X08-88XX-XX	8-40mm	8	1	Thermal blue trace semi-perf roll	15	275	5.8	6
11-2985-301	2800	2X08-88XX-XX	8-40mm	9	—	Thermal black trace semi-perf roll	15	275	5.8	6
11-2985-304	2800	2X08-88XX-XX	8-40mm	8	1	Thermal black trace semi-perf roll	15	275	5.8	6
11-2985-500	2800	2X08-88XX-XX	8-40mm	8	1	Thermal blue trace fanfold pack 30cm folds, 500 pages	15	492	9.4	4 pk.
11-2985-501	2800	2X08-88XX-XX	8-40mm	8	1	Thermal black trace fanfold pack 30cm folds, 500 pages	15	492	9.4	4 pk.
11-2987-302	2800	2X07-88XX-XX	8-40mm	8	1	High contrast ink semi-perf roll with thermal annotation stripes	15	275	6.3	6

Pressurized Ink Pens

Recorder Group	Analog Pen Model Number	Event Pen Model Number
2800 (2007-88XX-XX)	11-2823-35	11-2873-20

Longer-Life Pressurized Ink Pens

Recorder Group	Pen Number	Description
2800 Series	11-2823-352608	Longer-life pen, replaces 11-2823-35

Thermal Oscillographic Styli

Recorder	Analog Styli Model Number	Event Styli Model Number
2800	11-2824-38	11-2874-35

Ink for Pressurized Ink Pens

Recorder	Blue Ink Model Number	Capacity (Ounces)	Container
2000, 2000S, 2000W 2200, 2400, 2600, 2800	11-2730-01	1	Cartridge
For use in same Recorders as 11-2730-01	11-2730-012908 (Red)	1	Replaces 11-2730-01
	11-2730-015902 (Black)	1	Replaces 11-2730-01
Ink remover	282920		

Continued on next page.

Supplies for:

2800 Recorders (continued)

Starter Kits

Choose a starter kit based on the type of chart paper wanted. Each kit contains 12 rolls of paper or 12 packs of paper, 1 analog pen, and a gram gage. (Complete description of chart found in "CHART PAPER" section.)

Recorder Group	For Chart Paper	Order: Starter Kit Model No.	Channel Config.	No. of Event Ch's	No. of Annot. Ch's	Description of Chart Paper
2800/2800S/ 2800W	11-2983-31	11-6250-42	8-40mm	9	—	High contrast ink roll
	11-2983-301	11-6250-15	8-40mm	9	—	High contrast ink semi-perf roll
	11-2985-32	11-6250-32	8-40mm	9	—	Thermal black trace roll
	11-2985-36	11-6250-60	8-40mm	8	1	Thermal black trace roll
	11-2985-300	11-6250-51	8-40mm	8	1	Thermal blue trace semi-perf roll
	11-2985-301	11-6250-36	8-40mm	9	—	Thermal black trace semi-perf roll
	11-2985-304	11-6250-61	8-40mm	8	1	Thermal black trace semi-perf roll
	11-2985-500	11-6250-49	8-40mm	8	1	Thermal blue trace fanfold pack
	11-2985-501	11-6250-50	8-40mm	8	1	Thermal black trace fanfold pack
	11-2987-302	11-6250-45	8-40mm	8	1	High contrast ink semi-perf roll

Supplies for:

3200 Recorders, Model Series 30-V72XX-1X, 30-V82XX-1X

Chart Paper (50mm channels have 50 divisions; 100mm channels have 100 divisions)

Chart Paper Model Number	Recorder Group	Recorder Model Number	No. of Analog Channels	No. of Event Channels	No. of Annot. Channels	Type of Chart	Chart Paper Width (in.)	Chart Paper Length (ft.)	Shipping Weight Per Roll/Pack (lb.)	Rolls/Packs Per Ctn.
11-2915-31	3200	30-V8210-1X 30-V7210-1X	1-100mm	1	1	Thermal black trace roll (can be used with ink recorder)	5.2	350	2.0	12
11-2917-30	3200	30-V7210-1X	1-100mm	1	1	High contrast ink roll, with annotation stripe	5.2	275	2.0	12
11-2925-35	3200	30-V8202-1X 30-V7202-1X	2-50mm	1	2	Thermal black trace roll (can be used with ink recorder)	5.2	350	2.0	12
11-2925-37	2200	30-V8202-1X 30-V7202-1X 2X08-22XX-XX with Annot.	2-50mm	2	1	Thermal black trace roll (can be used with ink recorder)	5.2	350	2.0	12
11-2925-503	3200	30-V8202-1X	2-50mm	2	1	Thermal black trace folded pack 15cm folds, 500 pgs.	5.2	246	1.4	8
11-2925-504	3200	30-V8202-1X	2-50mm	1	2	Thermal black trace folded pack 15cm folds, 500 pgs.	5.2	246	1.4	8
11-2927-31	2200	30-V7202-1X 2X07-22XX-XX with Annot.	2-50mm	2	1	High contrast ink roll, with annotation stripe	5.2	275	2.2	12

Pressurized Ink Pens

Recorder Group	Analog Pen Model Number	Event Pen Model Number
3000, with 40/50mm CH	11-2823-3A	11-2873-2A
3000, with 80/100mm CH	11-2823-4A	11-2873-2A

Thermal Pens

Recorder	Analog Pen Model Number	Event Pen Model Number
3000, with 40/50mm CH	11-2824-3A	11-2874-2A
3000, with 80/100mm CH	11-2824-4A	11-2874-2A

Ink for Pressurized Ink Pens

Recorder	Ink Model Number	Capacity	Container
3000, all Ink Recorders	11-2731-01	1 oz.	Cartridge

Continued on next page.

Supplies for:
3200 Recorders (continued)

Miscellaneous Supply Items

Recorder	Description of Item	Model Number
3000, all Recorders	Gram Gage (for setting pen pressure)	240601-910
	Ink Remover	282920
	Time Line Gage (for setting pen position)	CL-310999
	Left Core Plug	397737
	Right Core Plug Assembly	CL-710359

Starter Kits

Choose a starter kit based on the type of chart paper wanted. Each kit contains 12 rolls of paper or 8 packs of paper, 1 analog pen, and a time line gage. (Complete description of chart found in "CHART PAPER" section.) Roll paper kits also contain two each left and two each right core plugs.

Recorder Group	For Chart Paper	Order: Starter Kit Model No.	Channel Config.	No. of Event Ch's	No. of Annot. Ch's	Description of Chart Paper
3200	11-2915-31	11-36250-01	1-100mm	1	1	Thermal black trace roll
	11-2917-30	11-36250-02	1-100mm	1	1	High contrast ink roll
	11-2925-35	11-36250-03	2-50mm	1	2	Thermal black trace roll
	11-2925-37	11-36250-04	2-50mm	2	1	Thermal black trace roll
	11-2925-503	11-36250-05	2-50mm	2	1	Thermal black trace folded pack
	11-2925-504	11-36250-06	2-50mm	1	2	Thermal black trace folded pack
	11-2927-31	11-36250-07	2-50mm	2	1	High contrast ink roll

Supplies for:
3400 Recorders, Model Series 30-V74XX-1X, 30-V84XX-1X

Chart Paper (50mm channels have 50 divisions; 100mm channels have 100 divisions)

Chart Paper Model Number	Recorder Group	Recorder Model Number	No. of Analog Channels	No. of Event Channels	No. of Annot. Channels	Type of Chart	Chart Paper Width (in.)	Chart Paper Length (ft.)	Shipping Weight Per Roll/Pack (lb.)	Rolls/Packs Per Ctn.
11-2925-36	3400	30-V8420-1X 30-V7420-1X	2-100mm	2	1	Thermal black trace roll (can be used with ink recorder)	9.84	350	3.9	12
11-2927-300	3400	30-V7412-1X	2-100mm	2	1	High contrast ink semi-perf roll, 30cm between perfs, with annotation stripe	9.84	275	4.1	12
11-2935-30	3400	30-V8412-1X 30-V7412-1X	1-100mm 2-50mm	3	1	Thermal black trace roll (can be used with ink recorder)	9.84	350	3.9	12
11-2937-300	3400	30-V7412-1X	1-100mm 2-50mm	3	1	High contrast ink semi-perf roll, 30cm between perfs, with annotation stripe	9.84	275	4.1	12
11-2945-32	3400	30-V8404-1X 30-V7404-1X	4-50mm	1	4	Thermal black trace roll (can be used with ink recorder)	9.84	350	3.9	12
11-2945-33	2400	30-V8404-1X 30-V7404-1X 2X08-44XX-XX with Annot.	4-50mm	4	1	Thermal black trace roll (can be used with ink recorder)	9.84	350	3.9	12
11-2945-503	3400	30-V8404-1X	4-50mm	4	1	Thermal black trace folded pack 15cm folds, 500 pgs.	9.84	246	2.7	4
11-2945-504	3400	30-V8404-1X	4-50mm	1	4	Thermal black trace folded pack 15cm folds, 500 pgs.	9.84	246	2.7	4
11-2947-31	3400 2400	30-V7404-1X 2X07-44XX-XX with Annot.	4-50mm	4	1	High contrast ink roll, with annotation stripe	9.84	275	4.1	12
11-2947-300	3400 2400	30-V7404-1X 2X07-44XX-XX with Annot.	4-50mm	4	1	High contrast ink semi-perf roll, 30cm between perfs, with annotation stripe	9.84	275	4.1	12

Continued on next page.

Supplies for:

3400 Recorders (continued)

Pressurized Ink Pens

Recorder Group	Analog Pen Model Number	Event Pen Model Number
3000, with 40/50mm CH	11-2823-3A	11-2873-2A
3000, with 80/100mm CH	11-2823-4A	11-2873-2A

Thermal Pens

Recorder	Analog Pen Model Number	Event Pen Model Number
3000, with 40/50mm CH	11-2824-3A	11-2874-2A
3000, with 80/100mm CH	11-2824-4A	11-2874-2A

Ink for Pressurized Ink Pens

Recorder	Ink Model Number	Capacity	Container
3000, all Ink Recorders	11-2731-01	1 oz.	Cartridge

Miscellaneous Supply Items

Recorder	Description of Item	Model Number
3000, all Recorders	Gram Gage (for setting pen pressure)	240601-910
	Ink Remover	282920
	Time Line Gage (for setting pen position)	CL-310999
	Left Core Plug	397737
	Right Core Plug Assembly	CL-710359

Starter Kits

Choose a starter kit based on the type of chart paper wanted. Each kit contains 12 rolls of paper or 8 packs of paper, 1 analog pen, and a time line gage. (Complete description of chart found in "CHART PAPER" section.) Roll paper kits also contain two each left and two each right core plugs.

Recorder Group	For Chart Paper	Order: Starter Kit Model No.	Channel Config.	No. of Event Ch's	No. of Annot. Ch's	Description of Chart Paper
3400	11-2925-36	11-36250-08	2-100mm	2	1	Thermal black trace roll
	11-2927-300	11-36250-09	2-100mm	2	1	High contrast ink semi-perf roll
	11-2935-30	11-36250-10	1-100mm 2-50mm	3	1	Thermal black trace roll
	11-2937-300	11-36250-11	1-100mm 2-50mm	3	1	High contrast ink semi-perf roll
	11-2945-32	11-36250-12	4-50mm	1	4	Thermal black trace roll
	11-2945-33	11-36250-13	4-50mm	4	1	Thermal black trace roll
	11-2945-503	11-36250-14	4-50mm	4	1	Thermal black trace folded pack
	11-2945-504	11-36250-15	4-50mm	1	4	Thermal black trace folded pack
	11-2947-31	11-36250-16	4-50mm	4	1	High contrast ink roll
	11-2947-300	11-36250-17	4-50mm	4	1	High contrast ink semi-perf roll

Supplies for:

3600 Recorders, Model Series 30-V76XX-1X, 30-V86XX-1X

Chart Paper (50mm channels have 50 divisions; 100mm channels have 100 divisions)

Chart Paper Model Number	Recorder Group	Recorder Model Number	No. of Analog Channels	No. of Event Channels	No. of Annot. Channels	Type of Chart	Chart Paper Width (in.)	Chart Paper Length (ft.)	Shipping Weight Per Roll/Pack (lb.)	Rolls/Packs Per Ctn.
11-2965-33	3600	30-V8606-1X 30-V7606-1X	6-50mm	1	6	Thermal black trace roll (can be used with ink recorder)	15.0	350	5.8	6
11-2965-34	3600 2600	30-V8606-1X 30-V7606-1X 2X08-66XX-XX with Annot.	6-50mm	6	1	Thermal black trace roll (can be used with ink recorder)	15.0	350	5.8	6
11-2965-503	3600	30-V8606-1X	6-50mm	6	1	Thermal black trace folded pack 15cm folds, 500 pgs.	15.0	246	4.1	4
11-2965-504	3600	30-V8606-1X	6-50mm	1	6	Thermal black trace folded pack 15cm folds, 500 pgs.	15.0	246	4.1	4
11-2967-301	3600 2600	30-V7606-1X 2X07-66XX-XX with Annot.	6-50mm	6	1	High contrast ink semi-perf roll, 30cm between perfs with annotation stripe	15.0	275	6.3	6

Pressurized Ink Pens

Recorder Group	Analog Pen Model Number	Event Pen Model Number
3000, with 40/50mm CH	11-2823-3A	11-2873-2A

Thermal Pens

Recorder	Analog Pen Model Number	Event Pen Model Number
3000, with 40/50mm CH	11-2824-3A	11-2874-2A

Ink for Pressurized Ink Pens

Recorder	Ink Model Number	Capacity	Container
3000, all Ink Recorders	11-2731-01	1 oz.	Cartridge

Miscellaneous Supply Items

Recorder	Description of Item	Model Number
3000, all Recorders	Gram Gage (for setting pen pressure)	240601-910
	Ink Remover	282920
	Time Line Gage (for setting pen position)	CL-310999
	Left Core Plug	397737
	Right Core Plug Assembly	CL-710359

Starter Kits

Choose a starter kit based on the type of chart paper wanted. Each kit contains 12 rolls of paper or 8 packs of paper, 1 analog pen, and a time line gage. (Complete description of chart found in "CHART PAPER" section.) Roll paper kits also contain two each left and two each right core plugs.

Recorder Group	For Chart Paper	Order: Starter Kit Model No.	Channel Config.	No. of Event Ch's	No. of Annot. Ch's	Description of Chart Paper
3600	11-2965-33	11-36250-18	6-50mm	1	6	Thermal black trace roll
	11-2965-34	11-36250-19	6-50mm	6	1	Thermal black trace roll
	11-2965-503	11-36250-20	6-50mm	6	1	Thermal black trace folded pack
	11-2965-504	11-36250-21	6-50mm	1	6	Thermal black trace folded pack
	11-2967-301	11-36250-22	6-50mm	6	1	High contrast ink semi-perf roll

Supplies for:

3800 Recorders, Model Series 30-V78XX-1X, 30-V88XX-1X

Chart Paper (40mm channels have 50 divisions)

Chart Paper Model Number	Recorder Group	Recorder Model Number	No. of Analog Channels	No. of Event Channels	No. of Annot. Channels	Type of Chart	Chart Paper Width (in.)	Chart Paper Length (ft.)	Shipping Weight Per Roll/Pack (lb.)	Rolls/Packs Per Ctn.
11-2985-37	3800	30-V8808-1X 30-V7808-1X	8-40mm	1	8	Thermal black trace roll (can be used with ink recorder)	15.0	350	5.8	6
11-2985-38	3800 2800	30-V8808-1X 30-V7808-1X 2X08-88XX-XX with Annot.	8-40mm	8	1	Thermal black trace roll (can be used with ink recorder)	15.0	350	5.8	6
11-2985-503	3800	30-V8808-1X	8-40mm	8	1	Thermal black trace folded pack 15cm folds, 500 pgs.	15.0	246	4.1	4
11-2985-504	3800	30-V8808-1X	8-40mm	1	8	Thermal black trace folded pack 15cm folds, 500 pgs.	15.0	246	4.1	4
11-2987-302	3800 2800	30-V7808-1X 2X07-88XX-XX with Annot.	8-40mm	8	1	High contrast ink semi-perf roll, 30cm between perfs, with annotation stripe	15.0	275	6.3	6

Pressurized Ink Pens

Recorder Group	Analog Pen Model Number	Event Pen Model Number
3000, with 40/50mm CH	11-2823-3A	11-2873-2A

Thermal Pens

Recorder	Analog Pen Model Number	Event Pen Model Number
3000, with 40/50mm CH	11-2824-3A	11-2874-2A

Ink for Pressurized Ink Pens

Recorder	Ink Model Number	Capacity	Container
3000, all Ink Recorders	11-2731-01	1 oz.	Cartridge

Miscellaneous Supply Items

Recorder	Description of Item	Model Number
3000, all Recorders	Gram Gage (for setting pen pressure)	240601-910
	Ink Remover	282920
	Time Line Gage (for setting pen position)	CL-310999
	Left Core Plug	397737
	Right Core Plug Assembly	CL-710359

Starter Kits

Choose a starter kit based on the type of chart paper wanted. Each kit contains 12 rolls of paper or 8 packs of paper, 1 analog pen, and a time line gage. (Complete description of chart found in "CHART PAPER" section.) Roll paper kits also contain two each left and two each right core plugs.

Recorder Group	For Chart Paper	Order: Starter Kit Model No.	Channel Config.	No. of Event Ch's	No. of Annot. Ch's	Description of Chart Paper
3800	11-2985-37	11-36250-23	8-40mm	1	8	Thermal black trace roll
	11-2985-38	11-36250-24	8-40mm	8	1	Thermal black trace roll
	11-2985-503	11-36250-25	8-40mm	8	1	Thermal black trace folded pack
	11-2985-504	11-36250-26	8-40mm	1	8	Thermal black trace folded pack
	11-2987-302	11-36250-27	8-40mm	8	1	High contrast ink semi-perf roll

Supplies for:
8000S Recorders, Model Series 8188-XXXX-XX

Oscillographic Rectilinear Chart Paper

Chart Paper Model Number*	Recorder Group	Recorder Model Number	No. of Analog Channels	Analog Channel Width (mm)	Div. Per Channel	No. of Event Channels	Type of Chart	Chart Paper Width (mm)	Chart Paper Length (m)	Shipping Weight Per Roll (kg)	Rolls/Packs Per Ctn.
X-72411	8100	8188-110X-XX	1	50	50	2	Thermal blue trace roll	66	60	0.2	24
X-72511			1	50	50	2	Thermal black trace roll	66	60	0.2	24
X-72421	8200	8188-220X-XX	2	50	50	2	Thermal blue trace roll	126	60	0.5	12
X72521			2	50	50	2	Thermal black trace roll	126	60	0.5	12
X-72431	8300	8188-330X-XX	3	50	50	2	Thermal blue trace roll	196	60	0.8	12
X-72531			3	50	50	2	Thermal black trace roll	196	60	0.8	12
X-72441	8400	8188-4400-XX	4	50	50	2	Thermal blue trace roll	249	60	1.1	12
X-72541			4	50	50	2	Thermal black trace roll	249	60	1.1	12
X-73441			4	50	50	2	Perforated thermal blue trace	249	60	1.1	12
X-72461	8600	8188-66XX-XX	6	50	50	2	Thermal blue trace roll	377	60	1.5	12
X-72561			6	50	50	2	Thermal black trace roll	377	60	1.5	12
X-73461			6	50	50	2	Perforated thermal blue trace	377	60	1.5	12
X-72481	8800	8188-88XX-XX	8	40	50	2	Thermal blue trace roll	377	60	1.5	12
X-72581			8	40	50	2	Thermal black trace roll	377	60	1.5	12
X-73481			8	40	50	2	Perforated thermal blue trace	377	60	1.5	12

*Replace "X" with "ALX-" for North American orders.

Thermal Oscillographic Styli

Recorder	Analog Styli Model Number*	Event Styli Model Number*
8000S Series (All)	X50521	X50744

*Replace "X" with "ALX-" for North American orders.

Starter Kits

Choose a starter kit based on the type of chart paper wanted. Each kit contains 12 rolls of paper (except for 1 ch kit which contains 24 rolls). One, two, and three channel kits contain 1 analog pen, 1 event marker pen, and 1 fuse. Four, six, and eight channel kits contain 2 analog pens, 2 event pens, and 2 fuses.

Recorder Group	For Chart Paper	Order: Starter Kit Model No.*	Channel Config.	No. of Event Ch's	Description of Chart Paper
8100	X72411	X51743	1-50mm	2	Thermal blue trace roll
8200	X72421	X51744	2-50mm	2	Thermal blue trace roll
8300	X72431	X51745	3-50mm	2	Thermal blue trace roll
8400	X72441	X51746	4-50mm	2	Thermal blue trace roll
8600	X72461	X51747	6-50mm	2	Thermal blue trace roll
8800	X72481	X51748	8-40mm	2	Thermal blue trace roll

*Replace "X" with "ALX-" for North American orders.

Supplies for:

Colorwriter Digital Plotters: 6120-3111-00 Series, 63X0-X615-00 Series, 15-7XXX-00 Series

XY Chart Paper

Chart Paper Model Number	Recorder Group	Recorder Model Number	Description	Grid Description	Size	Unit Shipping Wt. Lbs.
11-2913-40				**** USE 63010-630 ****		
BR-62010-500				**** USE 63010-622 ****		
BR-62020-500				**** USE 63020-622 ****		
BR-62030-500				**** USE 63011-611 ****		
BR-62040-500				**** USE 63021-611 ****		
63010-622			Unruled Pack of 100 sheets, high contrast	—	8.5 x 11 inches	1.5
63020-622	Colorwriter	15-7XXX-00 6120-3111-00 63X0-X615-00	Unruled Pack of 100 sheets, high contrast	—	11 x 17 inches	3.2
63010-620			Unruled Pack of 100 sheets, standard paper	—	8.5 x 11 inches	1.2
63020-620			Unruled Pack of 100 sheets, standard paper	—	11 x 17 inches	2.3

Continued on next page.

Supplies for:
Colorwriter Digital Plotters (continued)

XY Chart Paper - (continued)

Chart Paper Model Number	Recorder Group	Recorder Model Number	Description	Grid Description	Size	Unit Shipping Wt. Lbs.
63010-630	Colorwriter	15-7XXX-00 6120-3111-00 63X0-X615-00	Unruled Pack of 50 sheets, clear film	—	8.5 x 11 inches	1.2
63020-623			Unruled Pack of 50 sheets, vellum (for use with drafting pens)	—	11 x 17 inches	1.2
63011-611			Unruled roll, 30 meters length Standard paper (for Model 6310)	—	8.5 x 11 inches	1.2
63021-611			Unruled roll, 30 meters length Standard paper (for Model 6320)	—	11 x 17 inches	1.7

Pens for Colorwriter Plotters

Pens for 6120 Series

	General Purpose	Long Life	Transparency/ General Purpose	
	Fine line, 0.3mm ceramic tip, pack of 7	Fine line, 0.3mm roller ball tip, pack of 7	High impact, 0.5mm felt tip, pack of 7	
Item	Model Number	Model Number	Model Number	
Multi-color	61000-210 (black, brown, red, orange, green, blue, violet)	61000-751 (black, brown, red, orange, green, blue, violet)	61000-211 (black, brown, red, orange, green, blue, violet)	
Single Color				
black	61000-200	61000-240	61000-250	
brown	61000-201	61000-241	61000-251	
red	61000-202	61000-242	61000-252	
orange	61000-203	61000-243	61000-253	
green	61000-205	61000-245	61000-255	
blue	61000-206	61000-246	61000-256	
violet	61000-207	61000-247	61000-257	

Pens for 6300 Series

	General Purpose/ Transparency	General Purpose/ Transparency	Long Life	Drafting*
	Fine line, 0.3mm plastic tip, pack of 5	Wide, 0.7mm plastic tip, pack of 5	Fine line, 0.3mm roller ball tip, pack of 5	Liquid ink, 0.3mm steel tip, disposable, pack of 4 (for Vellum Media only)
Item	Model Number	Model Number	Model Number	Model Number
Multi-color	63000-210 (black, red, cyan, green, blue)	None	63000-711 (black, red, green, blue, violet)	63000-752 (black, red, green, blue)
Single Color				
black	63000-200	63000-220	63000-240	63000-760
brown	63000-201	63000-221	63000-241	—
red	63000-202	63000-222	63000-242	63000-762
orange	63000-203	63000-223	63000-243	—
yellow	63000-204	63000-224	63000-244	—
green	63000-205	63000-225	63000-245	63000-765
blue	63000-206	63000-226	63000-246	63000-766
violet	63000-207	63000-227	63000-247	—
magenta	63000-208	63000-228	63000-248	—
cyan	63000-209	63000-229	63000-249	—

*Requires adapter 63000-28. Unit also accepts standard Koh-i-noor Rapid-o-graph drafting and Pentel Ceramicon pens with adapter 62000-27.

Supplies for:**Colorwriter Digital Plotters (continued)****Plot-Pak™ Supply Sampler Kits for Colorwriter Plotters**

Plot-Paks provide a useful sampling of the major supply items available for your Colorwriter, packaged to meet the typical needs of your specific model. Higher quantities of specific items of interest can then be purchased separately.

Kit	Description	Model Number	
Gould 6310 Basic Kit	Media — 8½ in. x 11 in., <ul style="list-style-type: none"> •paper, high contrast, 100 sheets •paper, standard, 100 sheets •transparency, 50 sheets Pens — pack of 5 each <ul style="list-style-type: none"> •general purpose/transparency, 0.3mm plastic tip, multi-color •general purpose/transparency, 0.7mm, plastic tip, black •long life, 0.3mm roller ball, multi-color 	63010-601	
Gould 6310 Kit for Lotus 1-2-3, Symphony and the IBM PC, PC/XT	Media — 8½ in. x 11 in., <ul style="list-style-type: none"> •paper, high contrast, 100 sheets •paper, standard, 100 sheets •transparency, 50 sheets Pens — pack of 5 each <ul style="list-style-type: none"> •general purpose/transparency, 0.3mm plastic tip, multi-color •general purpose/transparency, 0.7mm, plastic tip, black •long life, 0.3mm roller ball, multi-color Cable — IBM PC/Colorwriter RS-232C Application Notes — <ul style="list-style-type: none"> •Using Lotus Symphony with the Gould Colorwriter •Using Lotus 1-2-3 with the Gould Colorwriter 	63010-602	
Gould 6320 Basic Kit	Media — 11 in. x 17 in., <ul style="list-style-type: none"> •paper, high contrast, 100 sheets •paper, standard, 100 sheets •vellum, 50 sheets — 8½ in. x 11 in., •transparency, 50 sheets Pens — pack of 5 each <ul style="list-style-type: none"> •general purpose/transparency, 0.3mm plastic tip, multi-color •general purpose/transparency, 0.7mm plastic tip, black •long life, 0.3mm roller ball •disposable liquid ink drafting pens and adapters, pack of 4, multi-color 	63020-601	
Gould 6120 Basic Kit	Media — 8½ in. x 11 in., <ul style="list-style-type: none"> •paper, high contrast, 100 sheets •paper, standard, 100 sheets •transparency, 50 sheets Pens — multi-color, pack of 7 each <ul style="list-style-type: none"> •transparency/general purpose, 0.5mm, felt tip •long life, 0.3mm roller ball 	61020-601	
Gould 6120 Kit for Lotus 1-2-3, Symphony and the IBM PC, PC/XT	Media — 8½ in. x 11 in., <ul style="list-style-type: none"> •paper, high contrast, 100 sheets •paper, standard, 100 sheets •transparency, 50 sheets Pens — multi-color, pack of 7 each <ul style="list-style-type: none"> •transparency/general purpose, 0.5mm felt tip •long life, 0.3mm roller ball Cable — IBM PC/Colorwriter RS-232C Application Notes — <ul style="list-style-type: none"> •Using Lotus Symphony with the Gould Colorwriter •Using Lotus 1-2-3 with the Gould Colorwriter 	61020-602	
Gould 6120 Kit for Lotus 1-2-3, Symphony and the IBM PC/AT	Media — 8½ in. x 11 in., <ul style="list-style-type: none"> •paper, high contrast, 100 sheets •paper, standard, 100 sheets •transparency, 50 sheets Pens — multi-color, pack of 7 each <ul style="list-style-type: none"> •transparency/general purpose, 0.5mm felt tip •long life, 0.3mm roller ball Cable — IBM PC/AT to Colorwriter RS-232C Application Notes — <ul style="list-style-type: none"> •Using Lotus Symphony with the Gould Colorwriter •Using Lotus 1-2-3 with the Gould Colorwriter 	61020-603	

Supplies for:

Analog XY Recorders: 500, Model Series 15-3327-10
 305X, Model Series 15-3307-XX
 50000, Model Series 13-9XXX-XX
 50000, Model Series 15-9XXX-XX
 60000, Model Series BR-60XXX-X0

XY Chart Paper

Chart Paper Model Number	Recorder Group	Recorder Model Number	Description	Grid Description	Size	Unit Shipping Wt. Lbs.
11-2913-34			English grid, three-hole punched Pack of 100 sheets, standard paper	15 x 10 inches 150 x 100 divs	11 x 16.5 inches	2.8
11-2913-35			Metric grid, three-hole punched Pack of 100 sheets, standard paper	38 x 25 cm 380 x 250 divs	11 x 16.5 inches	2.8
11-2913-37	500, 3052, 3054, 3056 XY	15-3327-10 15-3307-XX	English grid, three-hole punched Pack of 100 sheets, high contrast	15 x 10 inches 150 x 100 divs	11 x 16.5 inches	3.0
11-2913-38			Metric grid, three-hole punched Pack of 100 sheets, high contrast	38 x 25 cm 380 x 250 divs	11 x 16.5 inches	3.0
11-2913-39			Unruled, three-hole punched Pack of 100 sheets, high contrast	—	11 x 16.5 inches	3.0
11-2913-35			Metric grid, three-hole punched Pack of 100 sheets, standard paper	38 x 25 cm 380 x 250 divs	11 x 16.5 inches	2.8
11-2913-38	50000 XY	15-9XXX-XX 13-9XXX-XX	Metric grid, three-hole punched Pack of 100 sheets, high contrast	38 x 25 cm 380 x 250 divs	11 x 16.5 inches	3.0
11-2913-39			Unruled, three-hole punched Pack of 100 sheets, high contrast	—	11 x 16.5 inches	3.0
BR-50840-500			Metric grid roll, 30 m. length One roll standard paper	28 cm wide 280 divs	32 cm wide	1.4
11-2913-34			English grid, three-hole punched Pack of 100 sheets, standard paper	15 x 10 inches 150 x 100 divs	11 x 16.5 inches	2.8
11-2913-35			Metric grid, three-hole punched Pack of 100 sheets, standard paper	38 x 25 cm 380 x 250 divs	11 x 16.5 inches	2.8
11-2913-37			English grid, three-hole punched Pack of 100 sheets, high contrast	15 x 10 inches 150 x 100 divs	11 x 16.5 inches	3.0
11-2913-38	60000 XY	BR-60XXX-X0	Metric grid, three-hole punched Pack of 100 sheets, high contrast	38 x 25 cm 380 x 250 divs	11 x 16.5 inches	3.0
11-2913-39			Unruled, three-hole punched Pack of 100 sheets, high contrast	—	11 x 16.5 inches	3.0
11-2913-41			English grid Pack of 100 sheets, high contrast	10 x 7 inches 100 x 70 divs	8.5 x 11 inches	1.5
11-2913-42			Metric grid Pack of 100 sheets, high contrast	25 x 18 cm 250 x 180 divs	8.5 x 11 inches	1.5
396220-12				**** USE 11-2913-42 ****		

Continued on next page.

Supplies for:

Analog XY Recorders (continued)

Felt Tip Pens for Analog XY Recorders

<p>3052, 3054, 3056 XY Series</p> <p>Color: Black 295220-1 Blue 295220-2 Red 295220-3 Green 295220-4</p> <p>Note: Pack of Five</p>	<p>Model Number</p>	<p>Multi-color Turret</p> <p>Six Color Mix: red, green, blue, black, violet, brown 396220-25</p> <p>Package of five 396220-25 396220-26</p> <p>Two Color Mix: three each of red and black 396220-27</p> <p>Package of five 396220-27 396220-28</p>	<p>Model Number</p>
<p>50000S XY Series</p> <p>Single Pen</p> <p>Color: Red, 1Y BR-50000-87 Black, 1Y BR-50000-89 Green, 1Y BR-50000-90 Red, 2Y BR-50000-526 Black, 2Y BR-50000-527</p>	<p>Model Number</p>	<p>60000 Series XY</p> <p>Color: Red 396220-1 Black 396220-2</p>	<p>Model Number</p>

Supplies for Obsolete Recorders:

<p>BL-201, BL-202</p> <p>ESR 200 Model Series 3009-1110-00</p> <p>Mark II Model Series 2521, 2522</p> <p>OEM Modules, Vert. Model Series XXXX-69XX-00</p> <p>OEM Modules, Horiz. Model Series XXXX-68XX-00</p> <p>Operations Monitor Model Series 15-6327-XX1018, RE-3X03-1X</p>	<p>280 Model Series 1100-6607-XX, 15-6327-XX</p> <p>440 Model Series 15-6347-XX</p> <p>480, 481 Model Series 15-668X-XX</p> <p>816 Model Series 15-6X17-4X, 15-6X18-2X</p> <p>842 Model Series 13-6624-00</p> <p>2100 Model Series 15-631X-6X</p> <p>4800 Printer Plotter All Model Series</p> <p>6500 Tape Recorder All Model Series</p>
<p>RD-2322</p> <p>RD-2631</p> <p>240 Model Series 2200-6607-XX</p> <p>250 Model Series 15-6X17-0X</p>	

Oscillographic Rectilinear Chart Paper

Chart Paper Model Number	Recorder Group	Recorder Model Number	No. of Analog Channels	Analog Channel Width	Div. Per Channel	No. of Event Channels	Type of Chart	Chart Paper Width (in.)	Chart Paper Length (ft.)	Shipping Weight Per Roll/Pack (lb.)	Rolls/Packs Per Ctn.
1 Channel Paper											
11-2913-10	250	15-6X17-0X	1	4.5 in.	50	2	High contrast ink roll	6.0	100	1.0	12
11-2913-22	OEM Modules 2100	XXXX-6917-00 or XXXX-6817-00 15-6317-60 15-6317-66	1	50mm	50	—	High contrast ink roll	2.47	150	0.5	100
11-2915-20	OEM Modules 2100	XXXX-6918-00 or XXXX-6818-00 15-6318-60 15-6318-66	1	50mm	50	—	Thermal black trace roll	2.47	150	0.6	100
2 Channel Paper											
RA-2921-32	Mark II	2521 Series	2	40mm	40	—	Capillary ink roll, curvilinear grid	3.72	300	1.0	12
11-2923-20	280	1100-6607 Series 15-6327 Series	2	80mm	50	3	High contrast ink roll	7.9	275	3.4	12
11-2923-23	OEM Module	XXXX-6927-00 or XXXX-6827-00	2	50mm	50	—	High contrast ink roll	5.0	150	1.0	50
3 and 4 Channel Paper											
2200-2923-30	240 440	2200-6607 Series 15-6347 Series	4	40mm	50	5	High contrast ink roll	7.9	275	3.4	12

Continued on next page.

Supplies for:
Obsolete Recorders (continued)

Oscillographic Rectilinear Chart Paper - (continued)

Chart Paper Model Number	Recorder Group	Recorder Model Number	No. of Analog Channels	Analog Channel Width	Div. Per Channel	No. of Event Channels	Type of Chart	Chart Paper Width (in.)	Chart Paper Length (ft.)	Shipping Weight Per Roll/Pack (lb.)	Rolls/Packs Per Ctn.
7 and 8 Channel Paper											
11-2983-30	480	15-6687 Series	8	40mm	50	9	High contrast ink roll	15	300	6.8	6
11-2983-300	480	15-6687 Series	8	40mm	50	9	High contrast ink semi-perf roll	15	300	6.8	6
11-2985-33	480	15-6688 Series	8	40mm	50	9	Thermal black trace roll	15	300	5.0	12

Strip Chart Recorder Paper

11-2913-120	816	15-6X17-4X 15-6X18-2X	1-8	4.5 in.	50	—	Capillary ink fanfold pack	5.97	75	8.0	6
11-2915-120	816	15-6318-20	1-8	4.5 in.	50	—	Thermal black trace roll	5.97	75	8.0	6

Magnetic Recording Tape and Take-up Reels (for 6500 Tape Recorder)

Model Number	Description	Model Number	Description
295912-1	Wideband 1/4" x 2300', 7" reel	295913-1	Take-up reel, 7" dia. for 1/4" tape
295912-2	Wideband 1/2" x 2300', 8" reel	295913-2	Take-up reel, 8" dia. for 1/2" tape
295912-3	Wideband 1/4" x 3300', 8 1/4" reel	295913-3	Take-up reel, 8" dia. for 1/4" tape

Pressurized Ink Pens

Recorder Group	Analog Pen Model Number	Event Pen Model Number
280 (15-6327 Series)	11-2823-31	RA2821-20
220, 222, 260, 440, and 480 Series	11-2823-33	11-2873-20
240 (6607 Series)	11-2823-33	RA2821-20
1 & 2 Channel Modules Low Profile Design (XXXX-68X7-00)	11-2823-33	11-2873-20
250 (15-6X17-0X)	11-2823-40	RA 2821-20
1 & 2 Channel Modules Vertical Design (XXXX-69X7-00)	11-2823-40	11-2873-30
2100 (15-631X-6X)	11-2823-43	11-2873-30

Longer-Life Pressurized Ink Pens

Recorder Group	Pen Number	Description
220, 240, 260, 440, and 480 Series	11-2823-34	Longer-Life, tungsten-carbide pressurized ink pen (Replaces 11-2823-33)

Continued on next page.

Supplies for:

Obsolete Recorders (continued)

Thermal Oscillographic Styli

Recorder	Analog Styli Model Number	Event Styli Model Number
Mark 842 (13-6624-00)	11-2824-33	
480 (15-6688-00)	11-2824-35	11-2874-23
481 (15-6688-10)	11-2824-35	11-2874-23
1 & 2 Channel Low Profile Design (XXXX-68X8-00)	11-2824-35	11-2874-21
1 & 2 Channel Modules Vertical Design (XXXX-69x8-00)	11-2824-41	11-2874-32
816 (15-6X18-2X)	11-2824-42	
2100 (15-631X-6X)	11-2824-43	11-2874-32

Electric Styli

Mark II-RD 2522 Series	RA-2822-31	RA-2822-31
RD 2322-00	RA-2822-31	
RD 2631-00	RA-2822-31	

Ink for Pressurized Ink Pens

Recorder	Blue Ink Model Number	Capacity (Ounces)	Container
220, 222, 250, 260, 440, and 480 Series			
2000, 2000S, 2000W 2200, 2400, 2600, 2800	11-2730-01	1	Cartridge
Dual Channel Modules			
For use in same Recorders as 11-2730-01	11-2730-012908 (Red)	1	Replaces 11-2730-01
	11-2730-015902 (Black)	1	Replaces 11-2730-01
200, RF1783 Series 15-1787 Series, 1704 Series 1707 Series 280, 6327 Series, 240, 6607 Series	11-2734-02	2	Plastic Syringe
Single Channel Modules	11-2735-04	4cc	Cartridge

SHIPPING, PRICES AND TERMS AND CONDITIONS

Placing Your Order

U.S.A.: Gould Test and Measurement Sales Engineers are available at the nearest Gould Sales Office to help you with equipment selection, pricing, availability and custom system definition.

Refer to the list of Gould Sales and Service offices listed on page 220.

Orders for all products except Logic Analyzers and ASIC Analysis Systems should be placed at:

Gould Inc.
Recording Systems Division
3631 Perkins Avenue
Cleveland, OH 44114
Telephone: 216-361-3315

Orders for Logic Analyzers and ASIC Analysis Systems should be placed at:

Gould Inc.
Design and Test Systems Division
19050 Pruneridge Avenue
Cupertino, CA 95014-0718
Telephone: 408-988-6800

Supplies Orders

Supplies Bank Rush Service: Small quantity emergency orders can be filled from the Gould Supplies Bank by calling the local sales office or the toll free or Ohio telephone numbers. From 5 p.m. to 8 p.m. Eastern Time, Supplies Bank orders may be placed at the Gould Los Angeles branch office at 213-404-1919.

There is a service charge of \$25.00 for Supplies Bank service. (This charge is largely offset by special reduced-rate freight charges when Supplies Bank orders are shipped via Federal Express.) Supplies Bank orders via Federal Express have delivery guaranteed by noon the next day in most areas.

GSA Contracts

For Gould products sold under GSA contracts, contact either your local Gould Sales Office or Gould Inc., Recording Systems Division, 3631 Perkins Avenue, Cleveland, OH 44114 (216-361-3315) for more information.

Canada: For ordering, pricing and delivery information contact your local Allan Crawford Associates, Ltd. office listed on page 220.

Outside of North America: For ordering, pricing and delivery information contact your local Gould Sales Office, Gould Representative or Distributor. Refer to page 220 for more information.

Terms of Sale

U.S.A.: All products are F.O.B. factory, Cleveland, OH. Logic Analyzers are F.O.B. Cupertino, CA. ASIC Analysis Systems are F.O.B. Beaverton, OR. Transportation is collect via best method in Gould's opinion unless shipping method is stipulated. Prices do not include shipping and handling charges.

Transportation for ASIC Analysis Systems is prepaid via best method, unless shipping method is stipulated.

Payment terms are net 30 days from date of invoice. Invoices paid late are subject to a 1.5% interest charge per month on the unpaid balance.

Outside of U.S.A.: Contact your local Gould Sales Office, Representative or Distributor regarding terms for orders placed with them.

Lease Agreements

Gould Inc., Test and Measurement Group offers leasing terms to meet most requirements. Contact your local Gould Sales Office for terms and rates.

Minimum Orders

The minimum order amount is \$50.00 for U.S.A. orders. Outside U.S.A., contact your local Gould Sales Office, Representative or Distributor.

Delivery Schedule

Shipment of most orders will be made in 15 to 60 days after receipt of order. Actual shipping schedule will be acknowledged after receipt of purchase order.

Certification

Gould's Quality Assurance program certifies that products manufactured by Gould Recording Systems Division have been inspected under U.S. Government Inspection System Requirements of MIL-1-45208A. The standards used in calibrating and testing the products are directly traceable to the National Bureau of Standards as required by the Calibration System Requirements of MIL-STD-45662.

Packaging

All items will be packaged and packed in accordance with best commercial practices. Consult factory for extra charges when compliance with MIL specifications covering packing, packaging, waterproof containers, or marking is required. An extra charge will be made for packing and packaging for ocean freight shipments.

Replacement Parts

Prices for Product Replacement Parts are available from your local Gould Test and Measurement Sales and Service Office or Gould Representative.

Product Changes

This catalog reflects information in effect at the time of its publication. Due to Gould's continuing product improvement program, Gould Inc. reserves the right to make changes to prices, specifications, and models without notice.

Warranty

All Gould Test and Measurement Group products are warranted to meet high standards of quality and workmanship. For specific warranty provisions, refer to the warranty statements on pages 218 and 219.

Through strategically located service centers, Gould provides customer service on all Gould products from each of the four divisions: Recording Systems Division (RSD), Instrument Systems Division (ISD), Design and Test Division (DTD), and Array Recording Division (ARD).

Field Engineers

Gould Field Service Engineers can provide on-the-spot assistance whenever and wherever required. Every field service engineer has received intensive and thorough factory training, but his greatest strength comes from his field experience. He is familiar with your requirements and is an expert with your product. Further, he is backed by one of the world's most experienced in test and measurement organizations.

Factory Service Centers

Gould factory Service Centers support Gould instruments, Gould-supplied computers and peripherals, and Gould-supplied accessories. Therefore, you can be confident of prompt,



effective results when you turn to one of our service centers for assistance.

Our prompt repair service is especially valuable to those companies that do not have their own service facilities. By using the nearest Gould Service Center as its maintenance depot, a Gould instrument user can be confident that his instruments will continue to provide uninterrupted performance.

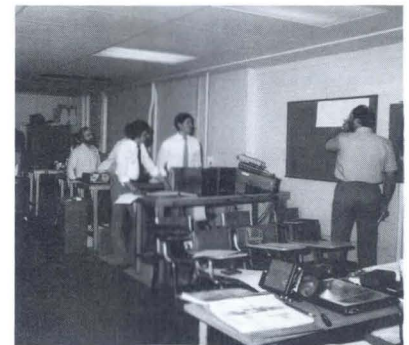

Even companies with their own repair facilities find it economical to be protected by a Gould service contract. This provides them with fast turn-around and eliminates the additional expense of carrying an inventory of instrument parts, accessories, and supplies.

Available Services

Gould provides extensive post sale support services, including:

Equipment installation — The Gould Field Service Engineer can be contracted to unpack, set-up, and check out all Gould equipment at your location.

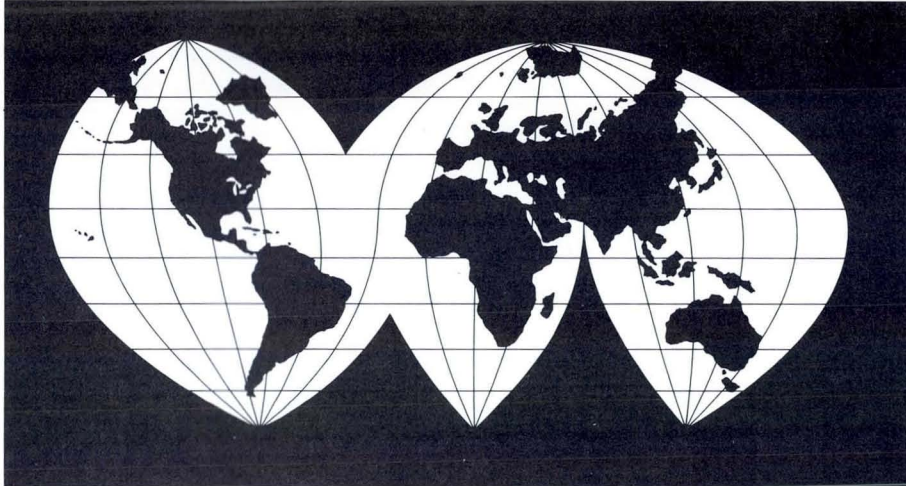

- Equipment installation
- Factory product training
- Extended warranty
- Parts and supplies
- 15 U.S. Service Centers
- More than 50 Service Centers outside the U.S.

Factory product training — Formal training classes at Gould cover detailed theory, repair, and maintenance procedures. Also, informal classes are available at your location to cover basic operation and maintenance issues.

Extended warranty — An optional extended warranty is available for selected new and used equipment. Both reduce overall operating cost by minimizing major breakdowns.

Parts and supplies — To meet emergency customer needs, each service center is fully stocked with factory approved parts and supplies for all Gould Test and Measurement instruments and systems.

Call your nearest Gould Service Center for more details on these programs.



Board Exchange Program

Gould T&M Service provides additional savings to its customers via a Board Exchange Program on selected products that supplies repaired boards for units *no longer under warranty*.

To qualify, customers must return a board to a Gould Service Center to make sure it can be repaired. Exchange rates are based on a percentage of the current list price. For further details, contact your nearest Gould Service Center.

Gould Technical Support

Gould Technical Support Specialists are as close as your telephone to answer any questions you have on the operation, repair, or implementation of Gould instruments. Save time and expense by calling 800-538-9320 for logic analyzers and oscilloscopes or 216-361-3315 for recorders, to talk directly to a specialist who can provide immediate product and system information. Outside the U.S., contact your local Gould Service Center, Representative or Distributor. (See page 220.)

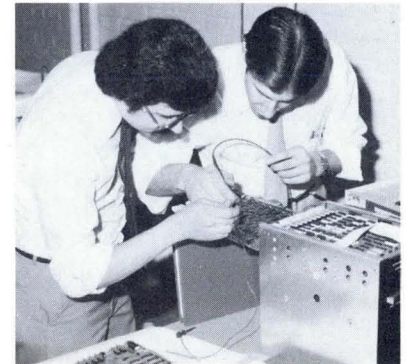

24-Hour Information System

A 24-hour Customer Information Systems is accessible via modem. It provides sales and service locations, parts/pricing information, warranty policy, sales training programs, and contract/installation options. In addition, it provides you with the ability to leave special requests. Either refer to page 217 or request the booklet *Customer Information Systems* for details.

Introduction

Gould Inc., Test and Measurement designs and manufactures products and systems recognized as industry standards because of their high quality and reliability. This equipment is complemented by Gould's commitment to properly match products and systems to applications and to provide proper installation, operator education, servicing and maintenance.

To optimize the usefulness of these products and systems, Gould provides extensive customer services.

Installation: With this option the Gould Technical Support Specialist will unpack, set up and check out all Gould equipment.

Training: Gould Technical Support Specialists can conduct short, informal training courses — either on-site or at his facility — covering basic product operation and routine maintenance.

Customer Education

Formal classroom training is available at factory and major Gould Sales and Service Offices consisting of Familiarization and Basic Instrument Operation, Modular Theory of Operation, Repair and Maintenance Procedures, and Testing.

Application Consulting

Gould Product Specialists are available for pre-sale support. They are experts with Gould products and can help you match the proper Gould product or configure the proper Gould system to meet your application requirements.

Hardware Support

A Trained Technical support specialist can quickly identify and resolve any hardware related problem. To help you keep your Gould equipment performing properly Gould provides the below services.

Maintenance Contracts: In addition to standard product warranties Gould provides Extended Warranty agreements on selected products to best fit your needs.

Board Exchange Program: Under this program defective boards are replaced with working boards in equipment that is no longer under warranty, on selected products.

Software Support: The Software Upgrade Agreement provides you with all software upgrades, at no charge, for DASA software for a period of one year.

For availability of these services in your area: Contact your local Gould Sales and Service Office listed on page 220, use the 24-hour Bulletin Board (see below), or refer to the Service Section on page 215.

Telephone Support: A Gould Service Engineer is available to answer your operation, repair and application questions. Call any of the Gould facilities listed on pages 220 and 221 and ask for the Technical Support Department.

24-Hour Bulletin Board: A 24-hour, on-line computer bulletin board is available in the U.S.A. and Canada to record your service requests and to provide current information on all service programs. This service may be accessed by any computer/modem configured at: 1200 baud, 8 data bits, no parity and 1-stop bit. The telephone number is (216) 431-1752.

Ordering Support

Gould Sales Engineers are available to help you with pre-sale product selection and system configuration.

Telephone Service

For information on the location of your nearest Gould Sales and Service Office, the name of your Gould Sales Engineer or information on any Gould product or service, call:

North America:

Cleveland, OH	1-216-361-3315
Cupertino, CA	1-408-988-6800

Europe:

Austria	43-222-972-506
Belgium	32-2-366-1752
France	33-16-934-1067
Switzerland	41-1-463-2766
United Kingdom	44-1-500-1000
West Germany	49-6074-49080

Hardware Warranty

All products manufactured and sold by Gould Test and Measurement in the United States are warranted to the original purchaser from date of shipment for the applicable periods set forth in the table below. Gould's products are warranted to conform to the applicable published specifications in effect at the time of the shipment, and to be free from any defects in material or manufacture when used with recommended Gould associated equipment and/or supplies. All products are

to be returned transportation prepaid by the buyer to Gould's designated service center. Upon buyer's request, on-site warranty service will be provided at additional charge. Gould reserves the right to determine the cause and existence of a defect under this warranty and this warranty shall not apply to any products which have been subjected to misuse, improper installation, repair, alteration, neglect, accident, inundation, fire, or operation outside their published maximum ratings.

Product Category	Warranty Period
Logic Analyzers	1 YEAR from date of shipment
3000 Series Oscillographic Recorders	25 MONTHS from date of shipment
Other Oscillographic Recorders	1 YEAR from date of shipment*
Strip Chart Recorders	1 YEAR from date of shipment
Signal Conditioners	1 YEAR from date of shipment
ASIC Analysis Systems	90 DAYS from date of shipment
Array Recorders	1 YEAR from date of shipment
5300 Series Waveform Recorders	25 MONTHS from date of shipment
Other Waveform Recording Products	1 YEAR from date of shipment
DASA Data Acquisition	1 YEAR from date of shipment
DASA Data Acquisition (Accessories)	1 YEAR from date of shipment
Analog & Digital Oscilloscopes	2 YEARS from date of shipment
Monitor Scopes & Digital Displays	1 YEAR from date of shipment
Chart Paper	1 YEAR from date of shipment

* Original penmotors in Oscillographic Recorders manufactured after July 1, 1986 are warranted for 5 years from date of shipment.

GOULD'S LIABILITY UNDER SUCH WARRANTY IS LIMITED TO SERVICING OR REPLACING DEFECTIVE PARTS EXCEPT PENS, STYLI, FUSES, BATTERIES AND CATHODE RAY TUBES, AND DOES NOT INCLUDE CALIBRATION AND MINOR MAINTENANCE AS OUTLINED IN GOULD OPERATING MANUALS. IN NO EVENT SHALL GOULD BE LIABLE FOR ANY LOSS OF PROFITS OR OTHER CONTINGENT, CONSEQUENTIAL OR SPECIAL DAMAGES.

THE FOREGOING WARRANTY IS EXCLUSIVE AND EXPRESSLY IN LIEU OF ALL OTHER WARRANTIES WHETHER EXPRESSED OR IMPLIED, INCLUDING ANY IMPLIED WARRANTIES OF MERCHANTABILITY OR FITNESS AND OF ANY OTHER OBLIGATION AND SHALL CONSTITUTE THE SOLE REMEDY OF THE BUYER AND SOLE LIABILITY OF GOULD.

Software Warranty

All software products which are licensed by Gould and listed in Gould's current Products Price List are furnished "as is" without warranty of any kind, either express or implied; except that Gould warrants media upon which such software is delivered to the licensee will be free from any defects in material and workmanship for a period of 90 days from the time of shipment. If any such medium proves defective during this warranty period, Gould will provide a replacement in exchange for the defective medium. Gould does not warrant that the functions contained in the software product will meet customer's requirements or that operation of the programs will be uninterrupted or error-free or that errors will be corrected. Gould will correct all reported substantial non-conformities in unaltered media for 90 days from time of shipment, provided such reports are made in accordance with Gould's standard reporting procedure, and such non-conformities are confirmed by Gould.

GOULD'S LIABILITY UNDER SUCH WARRANTY IS LIMITED TO THE REPAIR OR REPLACEMENT OF THE MEDIA, AT GOULD'S OPTION. IN NO EVENT SHALL GOULD BE LIABLE UNDER ANY CIRCUMSTANCES, FOR ANY LOSS OF PROFITS OR OTHER CONTINGENT, CONSEQUENTIAL OR SPECIAL DAMAGES ARISING OUT OF ANY DEFECT IN OR FAILURE OR INADEQUACY OF PERFORMANCE OF ANY SOFTWARE PRODUCT FURNISHED BY GOULD. THE FOREGOING WARRANTY IS EXCLUSIVE AND EXPRESSLY IN LIEU OF ALL OTHER WARRANTIES WHETHER EXPRESSED OR IMPLIED, INCLUDING ANY IMPLIED WARRANTIES OF MERCHANTABILITY OR FITNESS AND OF ANY OTHER OBLIGATION AND SHALL CONSTITUTE THE SOLE REMEDY OF THE BUYER AND SOLE LIABILITY OF GOULD.

Gould Test and Measurement Sales and Service Offices and Representatives.

ARIZONA

Phoenix

1525 North Hayden, #4
Scottsdale, AZ 85257
Phone: (602) 990-8212
Fax: (602) 941-4730

CALIFORNIA

•Los Angeles

16310 Arthur Street
Cerritos, CA 90701
Phone: (213) 404-1919
Fax: (213) 404-1635
TWX: (910) 583-1365

•San Francisco

19050 Pruneridge Avenue
Cupertino, CA 95014
Sales Phone: (408) 864-7733
Service Phone: (408) 864-7732
Fax: (408) 988-1647
TWX: (910) 338-0509

COLORADO

••Denver

8480 East Orchard Road
Suite 2000
Englewood, CO 80111
Phone: (303) 741-4600

•DISTRICT OF COLUMBIA

6301 Ivy Lane
Suite 106
Greenbelt, MD 20770
Phone: (301) 345-0050
Fax: (301) 345-2850

FLORIDA

•Orlando

774 North Lake Blvd., #1000
Altamonte Springs, FL 32701
Phone: (407) 830-0695

GEORGIA

•Atlanta

5300 Oakbrook Parkway
Suite 330
Norcross, GA 30093
Sales Phone: (404) 279-1652
Service Phone: (404) 279-2043
Fax: (404) 925-8202

HAWAII

Honolulu

Hawaiian Industrial Instrument
1154 Fort St. Mall, Suite 200
Honolulu, HI 96813
Phone: (808) 533-4232

ILLINOIS

•Chicago

30 Gould Center
Rolling Meadows, IL 60008
Sales Phone: (312) 640-4135
Service Phone: (312) 640-4378
Fax: (312) 640-4229

MASSACHUSETTS

•Boston

216 West Cummings Park
Woburn, MA 01801
Phone: (617) 938-0133

MICHIGAN

•Detroit

32307 Mally Road
Madison Heights, MI 48071
Phone: (313) 588-4020
Fax: (313) 588-4461

MINNESOTA

Minneapolis

Westview Business Center
620 Mendelssohn, Suite 199
Minneapolis, MN 55427
Phone: (612) 544-5253

NEW MEXICO

Albuquerque

P. O. Box 13494
Albuquerque, NM 87192
Phone: (505) 292-4063

NEW YORK

•Metropolitan New York

405 Murray Hill Parkway
East Rutherford, NJ 07073
Phone: (201) 935-1717
Fax: (201) 935-6945

NORTH CAROLINA

Greensboro

P. O. Box 16212
Greensboro, NC 27406
Phone: (919) 275-1078

OHIO

•Cleveland

3631 Perkins Avenue
Cleveland, OH 44114
Phone: (216) 361-3315
Fax: (216) 881-4256
Telex: 196113

•Dayton

432 Windsor Park Drive
Centerville, OH 45459
Phone: (513) 433-9586
Fax: (513) 433-2764

PENNSYLVANIA

•Pittsburgh

585 Rugh Street, Suite A
Greensburg, PA 15601
Phone: (412) 838-7700

TEXAS

Dallas

4230 LBJ Freeway
Suite 122
Dallas, TX 75244
Phone: (214) 991-8229
Fax: (214) 661-0229

•Houston

10500 Northwest Freeway
Suite 185
Houston, TX 77092
Sales Phone: (713) 680-1121
Service Phone: (713) 680-3995
Fax: (713) 680-9353

WASHINGTON

Seattle

P. O. Box 3068
Redmond, WA 98073-3068
Phone: (206) 882-7525

•Sales and Service Office.
••Service Office Only.

Gould Test and Measurement Division Offices

UNITED STATES

Gould Inc.
Design and Test Systems Division
 19050 Pruneridge Avenue
 Cupertino, California 95014
 Telephone: (408) 988-6800
 TWX: 910-338-0509
 Facsimile: (408) 988-1647

Gould Inc.
Recording Systems Division
 3631 Perkins Avenue
 Cleveland, Ohio 44114
 Telephone: (216) 361-3315
 Telex: 196113 GLD RS UT
 Facsimile: (216) 881-4256

EUROPE

AUSTRIA

Gould Electronics GmbH
Instrument Systems
 Niederlassung Wien
 Mauerbachstrasse 24
 A-1140 Vienna
 Telephone: 43-222-97-2506
 Telex: 1-31380 GOULD A
 Teletype: 43-222-97-250638

BELGIUM

Gould Instruments Systems Belgium
 Avenue Reine Astrid, 1
 B1430 Wauthier-Braine
 Telephone: 32-2-366-1752
 Telex: 20425 GOULD B
 Teletype: 32-2-366-1879

FRANCE

Gould Electronique
 57 Rue Saint Sauveur
 Ballainvilliers, 91160 Longjumeau
 Adresse postale: B.P. 115,
 91162 Longjumeau Cedex
 Telephone: (1) 69.34.10.67
 Telex: 600824
 Facsimile: 33-1-6934-2073

WEST GERMANY

Gould Instruments
 Dieselstrasse 5-7, D-6453 Seligenstadt
 Telephone: (6182) 8010
 Telex: 4184556
 Facsimile: 49-6182-80148

SWITZERLAND

Gould Electronics AG
Instrument Systems
 Grubenstrasse 56
 CH-8045 Zurich
 Telephone: 41-1-4632766
 Telex: 813607
 Teletype: 41-1-4632735

UNITED KINGDOM

Gould Electronics Ltd.
Instrument Systems
 7 Roebuck Road
 Hainault, Ilford, Essex
 England IG6 3UE
 Telephone: 44-1-500-1000
 Telex: 851-263785
 Teletype: 44-1-501-0116

INTERNATIONAL

For the names of representative in countries not listed above, please contact Gould Offices as follows:

For Scandinavia, Middle East, Turkey, Egypt, and South Africa, contact:

International Sales Department
 Gould Electronics Ltd.
 Instrument Systems
 7 Roebuck Road
 Hainault, Ilford, Essex
 England IG6 3UE
 Telephone: 44-1-500-1000
 Telex: 851-263785
 Teletype: 44-1-501-0116

For Italy, Spain, Portugal, Greece and Northern Africa, contact:

International Sales Department
 Gould Electronique
 57 Rue Saint Sauveur
 Ballainvilliers, 91160 Longjumeau, France
 Adresse postale: B.P. 115,
 91162 Longjumeau Cedex
 Telephone: (1) 69.34.10.67
 Telex: 600824
 Facsimile: 33-1-6934-2073

For Canada, Latin America, Far East, and Israel, contact:

Gould Inc.
 International Sales Department
 3631 Perkins Avenue
 Cleveland, Ohio 44114, United States
 Telephone: (216) 361-3315
 Telex: 196113 GLD RS UT
 Facsimile: (216) 881-4256

ALL GOULD PRODUCTS

For information on the full range of Gould products and services, contact:

UNITED STATES

Gould Inc.
 35129 Curtis Boulevard
 Eastlake, OH 44094
 Telephone: (216) 953-5000
 Telex: 687-3157
 Teletype: (216) 953-5001

Catalog 498-G1A
Printed in USA. Price \$1.00

