

XEROX

XEROX

Graphics

Xerox ViewPoint

Graphics Reference

6

Volume 6

XEROX

Xerox ViewPoint

Graphics Reference

VP Document Editor: Basic Graphics

VP Data-Driven Graphics

VP Free-Hand Drawing

Xerox Corporation
Product Education
701 S. Aviation Boulevard
ESCN-215
El Segundo, CA 90245

This publication was printed in May 1988 and is based on the VP Series 2.0 software.

©1988, Xerox Corporation. All rights reserved.

Copyright protection claimed includes all forms and matters of copyrightable material and information now allowed by statutory or judicial law or hereinafter granted, including without limitation, material generated from the software programs which are displayed on the screen such as icons, screen displays, looks, and so forth.

Publication number: 610E12280

Printed in the United States of America

Xerox®, 6085, 8010, ViewPoint, and VP are trademarks of Xerox Corporation.

Changes are made periodically to this document. Changes, technical inaccuracies, and typographic errors will be corrected in subsequent versions.

This book was created on the Xerox 6085 Professional Computer System.

Table of contents

Introduction	xv
Before you use this volume	xv
About this volume	xvi
Hardware and software requirements	xvii
Related documentation	xviii
Information for VP CUSP Button programmers	xviii
1. Overview of Graphics	1-1
Basic Graphics	1-1
VP Data-Driven Graphics	1-3
VP Free-Hand Drawing	1-5
2. Basic Graphics	2-1
Key concepts of Basic Graphics	2-2
Graphics frames	2-2
Graphic objects	2-4
Layered objects	2-5
Graphics alternate function keys	2-6
Control points of graphic objects	2-7
The Graphics Special keyboard	2-10
The Basic Graphics Transfer Document	2-12
Properties of graphic objects	2-13
The Graphics Frame properties sheet	2-16
The Graphics Frame property sheet	2-16
The Grid property sheet	2-20

TABLE OF CONTENTS

The Point properties sheet	2-21
The Line properties sheet	2-22
The Shape properties sheet	2-24
The Bitmap Frame properties sheet	2-25
The Bitmap property sheet	2-25
The Bitmap Frame property sheet	2-31
The Image Frame properties sheet	2-31
The Image Frame property sheet	2-32
The File Name property sheet	2-32
Working with graphics frames	2-34
Inserting an anchored graphics frame in a document	2-34
Moving or copying a frame	2-35
Modifying a frame	2-36
Deleting a frame	2-38
Verifying that a frame and anchor are linked	2-39
Placing graphic objects and embedded frames in a frame	2-39
Using the Graphics Special keyboard	2-40
Using the Basic Graphics Transfer Document	2-40
Drawing lines and curves	2-41
Drawing a straight line	2-41
Drawing a curve	2-43
Drawing lines and curves in succession	2-44
Selecting graphic objects	2-45
Selecting a single object	2-45
Selecting multiple graphic objects	2-46
Joining objects into a cluster	2-48
Splitting a cluster	2-48

Clustering objects in an embedded frame	2-49
Manipulating graphic objects	2-49
Moving or copying a graphic object	2-49
Moving or copying a small or layered object	2-50
Deleting a graphic object	2-50
Repositioning objects in a stack	2-50
Modifying the appearance of graphic objects	2-51
Changing the property sheet for one or more objects	2-51
Resizing an object using <Stretch> and <Magnify>	2-52
Copying properties using the <SAME> key	2-54
Changing default properties in the User Profile	2-55
Adding text labels to illustrations	2-55
Using the grid	2-56
Using the <Grid> key	2-56
Using the Grid property sheet	2-56
Printing a remote image file	2-57
3. VP Data-Driven Graphics	3-1
Key concepts of Data-Driven Graphics	3-2
Types of charts	3-2
Chart properties	3-5
Chart elements	3-6
Graphics alternate function keys for charts	3-8
Methods of inserting charts	3-8
Chart control points	3-9
Chart data table	3-10
Chart commands	3-11
Overview of constructing a chart	3-12

TABLE OF CONTENTS

The Bar Chart properties sheet	3-13
The Spatial property sheet	3-13
The Appearance property sheet	3-16
The All Data property sheet	3-17
The Pie Chart properties sheet	3-20
The Spatial property sheet	3-20
The Appearance property sheet	3-21
The All Data property sheet	3-22
The Line Chart properties sheet	3-24
The Spatial property sheet	3-25
The Appearance property sheet	3-27
The All Data property sheet	3-29
Inserting a chart in a document	3-32
Building a chart	3-32
Displaying the chart property sheet	3-33
Specifying the chart data	3-33
Constructing a table in the chart property sheet	3-33
Linking a chart with a table in the document	3-34
Updating charts	3-35
Treating numerical labels as text	3-35
Changing the appearance of charts	3-36
Changing individual chart elements	3-37
Creating a data-point chart	3-38
Creating a straight-line best-fit chart	3-38
4. VP Free-Hand Drawing	4-1
Key concepts of VP Free-Hand Drawing	4-2
The canvas icon	4-2
Canvas pointers	4-3

Operations using a canvas	4-4
Reminders in the message area	4-4
The free-hand drawing menu	4-5
The canvas auxiliary menu	4-6
Bitmap frames	4-7
The Canvas properties sheet	4-8
The canvas window	4-9
Canvas window commands	4-10
Canvas auxiliary menu commands	4-11
Free-hand drawing menu selections	4-12
The Size Canvas option sheet	4-24
The Add Text option sheet	4-25
Add Text commands	4-26
Add Text option	4-26
The Set Symmetry option sheet	4-27
Set Symmetry commands	4-27
Set Symmetry options	4-28
The Set Grid option sheet	4-29
Preparing to edit a canvas	4-31
Using cycling keys	4-32
Drawing points and free-hand lines	4-32
Drawing points	4-33
Drawing free-hand lines	4-33
Drawing straight lines, curves, and arcs	4-33
Drawing a straight line	4-34
Drawing a curve	4-34
Drawing an arc	4-35
Drawing shapes	4-36

TABLE OF CONTENTS

Using brushes	4-37
Creating a brush	4-38
Copying with a brush	4-39
Modifying a brush and changing its effect	4-40
Masking a brush	4-42
Layering shades and textures	4-42
Adding shading, texture, or ruling to a drawing	4-43
Placing a grid on your canvas	4-44
Creating a mirrored image	4-45
Using symmetry	4-46
Setting symmetry options	4-46
Removing symmetry options	4-48
Getting a close-up view of a canvas	4-49
Copying an area from the desktop into a canvas	4-50
Adding text to an illustration	4-51
Adding a single line of text—one font	4-52
Adding several lines of text—multiple fonts	4-52
Erasing a canvas	4-53
Erasing the entire canvas	4-53
Erasing part of the canvas	4-53
Sizing your canvas	4-56
Positioning the contents of the canvas	4-56
Adjusting the size of a canvas	4-57
Removing and replacing the cross-hair pattern	4-58
Placing a canvas in a document	4-58
Recreating a canvas from a bitmap frame	4-59

Appendices

A. Commands	A-1
----------------	-----

	B.	Anchored and embedded frames	B-1
Index			INDEX-1
List of figures			
1-1		A document with a Basic Graphics illustration	1-2
1-2		A document with a Data-Driven Graphics bar chart	1-4
1-3		A document with a Free-Hand Drawing illustration	1-5
2-1		An illustration created with Basic Graphics	2-1
2-2		A document with an anchored graphics frame and an embedded frame	2-4
2-3		Layered objects	2-5
2-4		Opaque and transparent objects	2-6
2-5		Graphics alternate function keys	2-6
2-6		Control points and guiding points	2-8
2-7		Pinned points and guiding points	2-9
2-8		Coincident control points	2-9
2-9		The Graphics Special keyboard	2-10
2-10		Graphics Special keyboard objects	2-11
2-11		The Basic Graphics Transfer Document	2-12
2-12		Graphic object properties	2-14
2-13		Shadings and textures used in an illustration	2-15
2-14		The Graphics Frame property sheet	2-16
2-15		The Grid property sheet with the Grid property set to [On]	2-20
2-16		The Point properties sheet	2-21
2-17		The Line properties sheet	2-22
2-18		The Shape properties sheet	2-24
2-19		Automatic scaling	2-26
2-20		Fixed scaling	2-26

TABLE OF CONTENTS

2-21	Print resolution scaling	2-26
2-22	The Bitmap Frame property sheet	2-31
2-23	The Image Frame property sheet	2-32
2-24	The File Name property sheet	2-33
2-25	Placing a graphics frame in a document	2-34
2-26	Rectangle and selected rectangle	2-41
2-27	Lines and curves created with Basic Graphics	2-42
2-28	A completed curve	2-43
2-29	The draw-through method of multiple selection	2-47
2-30	Stretching a triangle	2-53
2-31	Magnifying a triangle	2-54
3-1	A bar chart	3-2
3-2	A pie chart	3-3
3-3	A straight-line pieced chart	3-4
3-4	A data-point chart	3-4
3-5	A straight-line best-fit chart	3-5
3-6	Graphics alternate function keys	3-8
3-7	Basic Graphics Transfer Document	3-9
3-8	Chart control points	3-10
3-9	The Spatial property sheet for bar charts	3-13
3-10	The Appearance property sheet for bar charts	3-16
3-11	The All Data property sheet for bar charts	3-17
3-12	Bar chart for Table 3-3 with Data Set Is set to [Column]	3-18
3-13	Bar chart for Table 3-3 with Data Set Is set to [Row]	3-19
3-14	The Spatial property sheet for pie charts	3-21
3-15	The Appearance property sheet for pie charts	3-21
3-16	The All Data property sheet for pie charts	3-23

3-17	A pie chart for Table 3-3 with Data Set Is set to [Column]	3-23
3-18	A pie chart for Table 3-3 with Data Set Is set to [Row]	3-24
3-19	Spatial property sheet for line charts	3-25
3-20	The Appearance property sheet for line charts	3-28
3-21	The All Data property sheet for line charts	3-29
3-22	A line chart for Table 3-3 with Data Set Is set to [Column]	3-30
3-23	A line chart for Table 3-3 with Data Set Is set to [Row]	3-31
4-1	A Free-Hand Drawing example	4-1
4-2	Blank Canvas icon	4-2
4-3	Pointer shapes	4-3
4-4	The free-hand drawing menu	4-5
4-5	The canvas auxiliary menu	4-7
4-6	The Canvas properties sheet	4-8
4-7	A Blank Canvas window in read-only mode	4-9
4-8	A Blank Canvas window in edit mode	4-9
4-9	The Marker column of the free-hand drawing menu	4-12
4-10	The Stroke column of the free-hand drawing menu	4-13
4-11	The [Point] stroke	4-14
4-12	The [Paint] stroke	4-14
4-13	The [Draw] stroke	4-15
4-14	The Line column of the free-hand drawing menu	4-15
4-15	The Shape column of the free-hand drawing menu	4-16
4-16	The Shade column of the free-hand drawing menu	4-17

4-17	The Texture column of the free-hand drawing menu	4-17
4-18	The Ruling column of the free-hand drawing menu	4-17
4-19	The Effect column of the free-hand drawing menu	4-18
4-20	A gray ellipse drawn with [Opaque] and [Clear] selected	4-19
4-21	A brush with [Reverse] and [Replace] selected	4-20
4-22	The Edit column of the free-hand drawing menu	4-21
4-23	Methods for editing brushes	4-22
4-24	The Support column of the free-hand drawing menu	4-23
4-25	Illustration created with [Fill]	4-23
4-26	Bottle created with [Zoom]	4-23
4-27	Overlapping brushes with and without masking	4-24
4-28	The Size Canvas option sheet	4-24
4-29	The Add Text option sheet	4-26
4-30	The Set Symmetry option sheet with [Mirror] selected	4-27
4-31	Daisy—cyclic symmetry	4-28
4-32	Butterfly—mirrored symmetry	4-29
4-33	The Set Grid option sheet with [XY] selected	4-30
4-34	The cycling keys	4-32
4-35	Drawing a curved line	4-34
4-36	Drawing an arc	4-35
4-37	Creating a brush	4-38
4-38	Rotating a brush	4-41
4-39	Portrait filled with shading	4-43

4-40	Using a grid on your canvas	4-45
4-41	Mirrored image	4-45
4-42	Cyclic symmetry drawing using eight markers	4-47
4-43	Mirrored symmetry drawing with one mirrored marker	4-48
4-44	Magnify window showing part of a canvas	4-49

List of tables

3-1	Property sheets associated with chart elements	3-7
3-2	Ways to modify charts	3-12
3-3	Sample data table	3-18

Introduction

This volume is part of the *VP Series Reference Library*, which is the encyclopedia for ViewPoint software. This library provides the most complete source of information on ViewPoint and VP Series applications for your 6085 Professional Computer System or 8010 Information System.

Before you use this volume

Several separate volumes make up the *VP Series Reference Library*. Each volume provides information about a general category of applications, such as graphics, terminal emulation, or file conversion.

Before you refer to any VP Series reference application volume, you should become familiar with the following “core” documentation:

- *ViewPoint QuickStart Training*. Provides training and exercises for basic workstation operations as well as for creating, editing, printing, mailing, and filing documents.
- *General User Reference*. Describes the basic operations common to all ViewPoint and VP Series application software.
- *Document Editor Reference* volume 3. Provides complete information on creating and editing a document.

By mastering the ViewPoint and Document Editor basics, you will soon be able to use other VP Series applications to perform important tasks quickly and confidently.

About this volume

The *Graphics Reference* volume describes three graphics software applications available for your workstation. These applications include the Basic Graphics capability of the *VP Document Editor*; *VP Data-Driven Graphics*; and *VP Free-Hand Drawing*.

How chapters are organized

Reference material is rarely read through from cover to cover. Instead, you use it to look up specific information from time to time, much as you would use an encyclopedia.

To help you locate information, the major topics of most chapters are organized as follows:



- A key concepts section describes the principal elements of the application or feature. The key graphic illustrated at the left marks the beginning of such sections.
- A description of property sheets, option sheets, and windows provides detailed information about the properties and options related to the application.

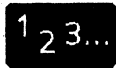

- A procedures section provides step-by-step information on how to use the application. The 1-2-3 graphic illustrated at the left marks the beginning of such sections.

Documentation conventions

The *VP Series Reference Library* uses the following conventions:

- Square brackets. Names of commands and property and option choices that you select with the mouse appear enclosed within brackets; for example, the [Close] command.

- Angle brackets. The names of workstation keys and alternate function keys are enclosed within angle brackets; for example, the <OPEN> key and the <PROP'S> key. This convention applies to alphabetic and numeric keys. It does not apply to words used to describe keys marked with arrow symbols, such as the tab key.
- Italics. Glossary words, VP application names, volume names, and the library name appear in *italics*.
- Bold. Names of properties, options, selections in the User Profile, information you must type, notes, and warnings appear in **bold**.

As often as possible, graphic images (such as pointer arrows) are printed in the text as they appear on the screen or on the keyboard.

Hardware and software requirements

The applications described in this volume run on the 6085 Professional Computer System and the 8010 Information System.

The following 2.0 software must be installed, enabled, and running on the workstation:

- *Xerox ViewPoint*
- *VP NetCom*, *VP RemoteCom*, or *VP Standalone*
- *VP Document Editor*, which includes Basic Graphics

Note: You do not need to run *VP Document Editor* to create *VP Free-Hand Drawing* canvases; however, the Document Editor must be running for you to include canvases in your documents.

- *VP Data-Driven Graphics*, if you intend to use that application
- *VP Free-Hand Drawing*, if you intend to use that application

Related documentation

The following training materials are recommended reading. You should be familiar with their contents before using the graphics software they describe.

- *VP Document Editor: Basic Graphics Training*
- *VP Data-Driven Graphics Training*
- *VP Free-Hand Drawing Training*

Information for VP CUSP Button programmers

Basic Graphics and Data-Driven Graphics objects can appear only in a Document Editor icon. If you are writing a CUSP program and want the program to refer to a Document Editor icon, use the following as the icon type (case does not matter):

- Document

If you are writing a CUSP program and want the program to refer to a Free-Hand Drawing canvas icon, use the following as the icon type (case does not matter):

- Canvas

1. Overview of Graphics

The graphics applications available for use with the *VP Document Editor* help you include a wide range of illustrations, charts, and drawings in your documents.

- *Basic Graphics*, a part of the *VP Document Editor*, lets you create illustrations based on geometric shapes.
- *VP Data-Driven Graphics*, an optional application, lets you build charts based on tables of numerical data in your document.
- *VP Free-Hand Drawing*, an optional application you can use independently of the *VP Document Editor*, lets you create free-form illustrations. You can include these illustrations in your documents.

Basic Graphics

Basic Graphics, an integral part of the *Document Editor*, lets you enhance documents with illustrations based on simple graphic objects such as points, lines, and geometric shapes. Figure 1-1 shows a *Basic Graphics* illustration in a document.

Figure 1-1 A document with a Basic Graphics illustration

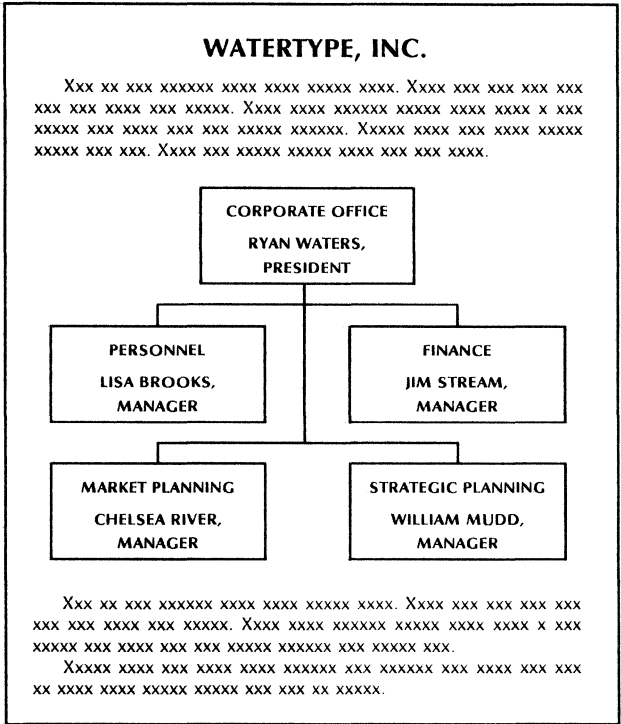

In Basic Graphics, you use the Graphics Special keyboard and the Basic Graphics Transfer Document to insert graphic objects and frames into your documents.

Each object has a property sheet that you can use to change the appearance of the object. You can:

- Modify the structure of a point, a line, or the outline of a graphic object.
- Smooth out line endings.

- Add an arrowhead to a line ending.
- Fill graphic objects with shadings and textures.

In addition to the alternate function keys used by the Document Editor, special graphics alternate function keys perform tasks specific to Basic Graphics. These keys:

- Stretch the dimensions of an object.
- Magnify an object.
- Display an alignment grid.
- Draw a line or a curve.
- Join objects into a single unit, or split them apart.
- Place an object on top of others in an overlapping stack.

Basic Graphics concepts, tools, and procedures are described in the chapter in this volume titled “Basic Graphics.”

VP Data-Driven Graphics

VP Data-Driven Graphics automatically builds charts based on the data in tables (Figure 1-2). A chart depicts numerical information in visual form and can be one of three types:

- A bar chart, which depicts information as a series of bars
- A pie chart, which represents proportions of a whole as sections of a circle that look like pie slices
- A line chart, which shows data plotted on a grid with or without connecting lines

Figure 1-2 A document with a Data-Driven Graphics bar chart

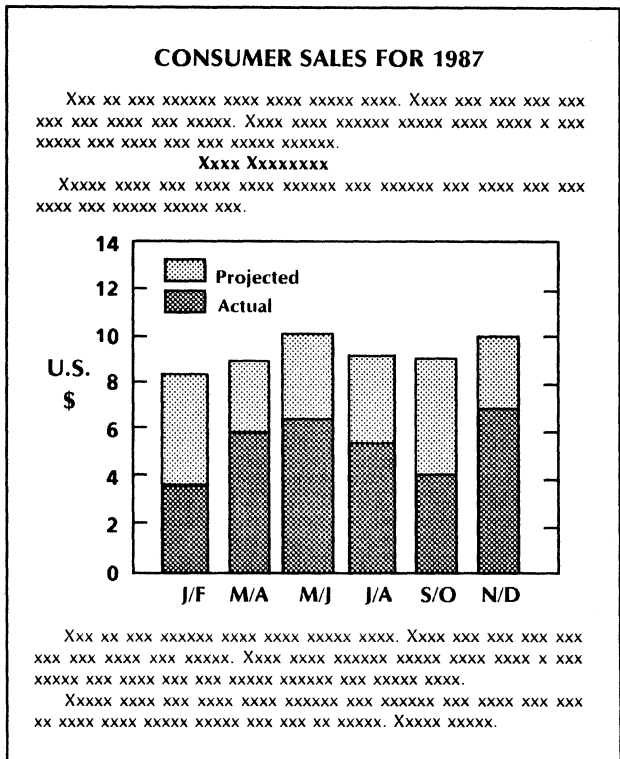

VP Data-Driven Graphics has the same features and functions as Basic Graphics. You use the Graphics Special keyboard and the Basic Graphics Transfer Document to insert charts into your documents.

You can base a chart on a table in the same document or on a table in the chart property sheet. You can automatically update a chart when you change the table on which it is based.

VP Data-Driven Graphics concepts, tools, and procedures are described in the chapter in this volume titled "VP Data-Driven Graphics."

VP Free-Hand Drawing

In *VP Free-Hand Drawing*, you work on a canvas instead of in a document. You use the mouse as a pen or a brush to draw shapes. You include a canvas in a document by copying the canvas icon into a special frame in the document (Figure 1-3).

Figure 1-3 A document with a Free-Hand Drawing illustration

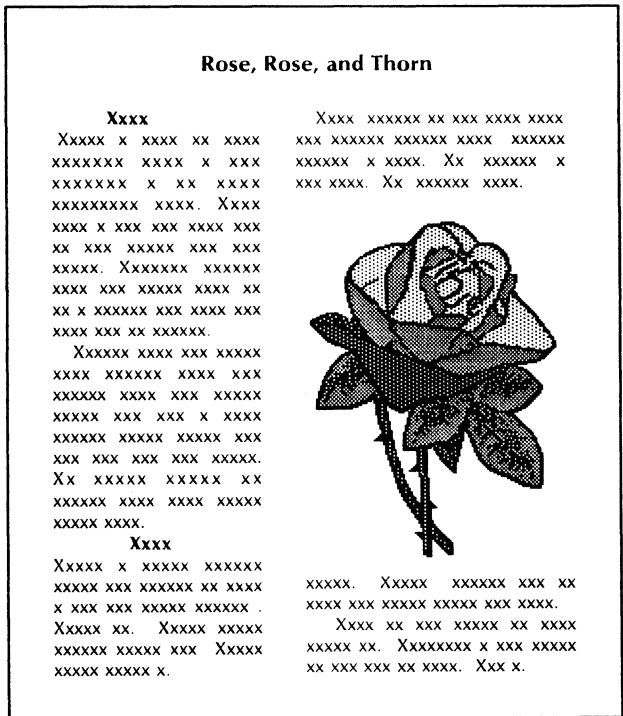

The free-hand drawing menu and the canvas auxiliary menu let you control what you want to include in a canvas and how it will appear.

From the free-hand drawing menu, you:

- Choose the type of marker to draw with and the type of stroke to use.
- Use a geometric shape, curve, or line if you do not want to draw free-hand.
- Select the shading, texture, or ruling pattern.
- Choose the effect your drawing will have on the existing canvas; for example, you can draw with a gray marker “over” or “under” a black shape.
- Use editing functions, such as filling in or erasing parts of the canvas.

From the canvas auxiliary menu, you:

- Control the size of your canvas.
- Add text to your illustration.
- Draw with symmetric cursors.
- Set an invisible grid that you use to align objects.

VP Free-Hand Drawing concepts, tools, and procedures are described in the chapter in this volume titled “VP Free-Hand Drawing.”

2.

Basic Graphics

Basic Graphics is part of the *VP Document Editor* software. With Basic Graphics, you can create illustrations within a document using points, lines, simple curves, and geometric shapes. Figure 2-1 shows an example of an illustration created with Basic Graphics.

Figure 2-1 **An illustration created with Basic Graphics**

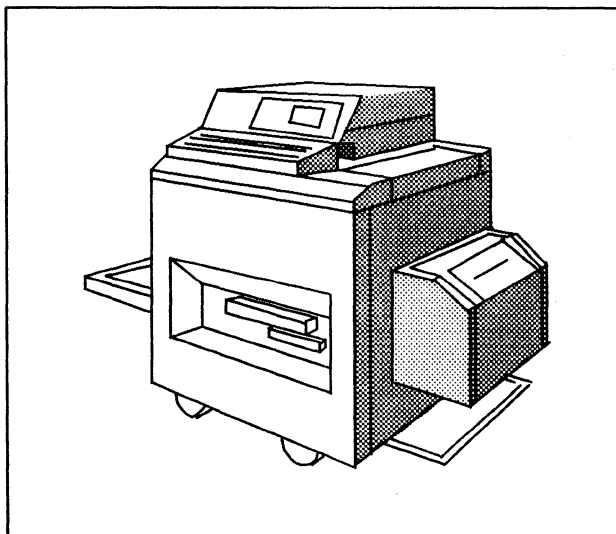

Key concepts of Basic Graphics



Basic Graphics has several features for creating illustrations and inserting them into your documents. These features include frames, graphic objects and their properties, graphics function keys, the Graphics Special keyboard, and the Basic Graphics Transfer Document.

Graphics frames

Graphics frames separate graphics from text. The two types of graphics frames are anchored frames and embedded frames. Refer to *Document Editor Reference* volume 3 in this library for general information about frames.

The location of an *anchored frame* is tied to a frame anchor inserted in document text. An anchored graphics frame is like the other anchored frames you use in *VP Document Editor*. You create all Basic Graphics illustrations inside an anchored graphics frame.

You insert an *embedded frame* into an anchored frame; an embedded frame has no anchor associated with it. You can insert the following types of embedded frames within an anchored graphics frame:

- Bitmap
- CUSP button
- Graphics
- Graphics field
- Image
- Table
- Text

You can use embedded frames for these purposes:

- **Labels:** Use an embedded text frame to label individual graphic objects in the anchored graphics frame.
- **Clusters:** Use an embedded graphics frame to hold a group of graphic objects.
- **Layers:** Use an embedded graphics frame for special layering effects.
- **Bitmaps:** Use an embedded bitmap frame to hold a *VP Free-Hand Drawing* illustration.
- **Tables:** Use an embedded table frame for tabular data within an illustration.

Figure 2-2 shows a document that contains an anchored graphics frame and an embedded text frame.

Generally, the property sheets of embedded frames display the same frame properties as the property sheets of anchored frames.

The difference is that the page **Alignment** and **Span** properties appear only on the property sheets of anchored frames. (Because embedded frames reside inside anchored frames you cannot adjust their position on the page separately from the anchored frame position.)

Refer to “The Graphics Frame properties sheet” section later in this chapter to see descriptions of frame property sheet properties.

Figure 2-2 **A document with an anchored graphics frame and an embedded frame**

Anchored and embedded frame example

■ The first character is the Page Format character. [Show Structure] has been selected in the document auxiliary menu so the Page Format character and the anchor are displayed. The last character in this paragraph is the anchor. ↓

The location of anchored frames is tied to a frame anchor inserted into document text.



Create all of your Basic Graphics illustrations inside the anchored graphics frames.

You insert an embedded frame into an anchored frame; a frame anchor associated with it. refer to "Anchored graphics frames," "Embedded text frame," or "copying a Frame," later in this chapter. An anchored graphics frame is like the other anchored frames you use in the Document Editor.

Anchored graphics frame

Embedded text frame

Graphic objects

A graphic object is a point, line, or shape you use to create illustrations in Basic Graphics. Graphic objects include:

- Point
- Horizontal line
- Vertical line
- Diagonal line (the line can assume any angle)
- Triangle
- Rectangle
- Curve
- Ellipse
- Circle

Layered objects

Your illustrations can depict stacks or layers of objects (Figure 2-3). The first object you enter into the frame is on the bottom (underneath); the last is on the top (covering the other objects). You can also change which object is on the top of a stack.

Figure 2-3 Layered objects

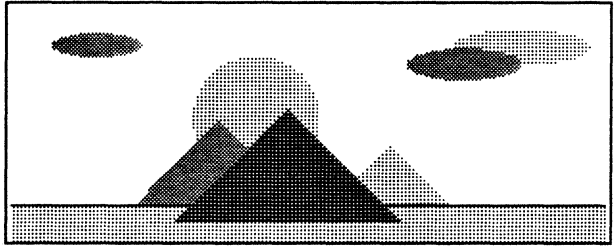

You can copy, move, or stretch any object in the frame to overlap other objects. The overlapping area combines the shadings and textures of the objects in the stack. “Shading” refers to a shade of gray; “texture” refers to a pattern.

Frames and other layered objects can be opaque or transparent (Figure 2-4).

- Objects can be opaque; they cover other objects.
- Objects can be transparent; objects beneath show through if the shading and texture of the objects on the bottom is darker than those on top.

Figure 2-4 Opaque and transparent objects

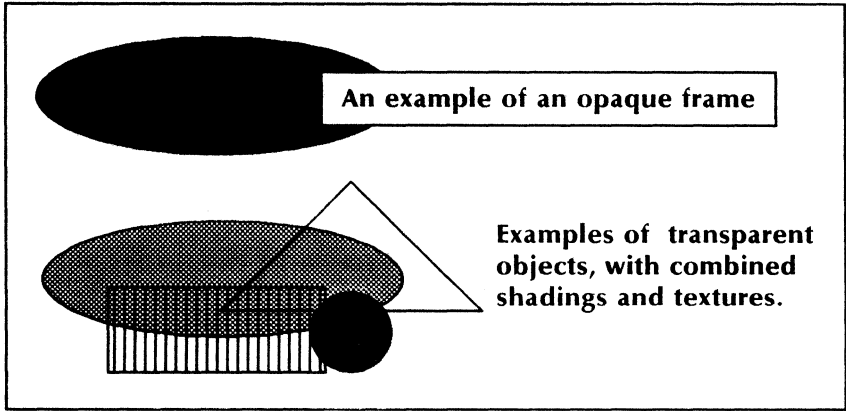

Graphics alternate function keys

Whenever you make a graphics selection, the top-row function keys on the keyboard provide graphics-related functions. The Document Editor displays the graphics alternate function keys (Figure 2-5).

Figure 2-5 Graphics alternate function keys

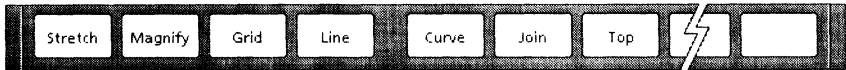

The *graphics alternate function keys* perform these operations:

< Stretch >

Stretches an object from the selected control point.

< Magnify >

Magnifies an entire object while maintaining its proportions.

< Grid >

Displays or removes a *grid* inside a graphics frame to assist you in aligning the objects you insert.

< Line >

Draws a line.

< Curve >

Draws a curve.

< Join >

Joins several objects into one unit, or *cluster*, or splits the cluster.

< Top >

Repositions an object from the bottom of the stack to the top or from the top of the stack to the bottom.

Control points of graphic objects

When you select an object or a group of objects, one or more *control points* become visible. Control points appear as tiny black boxes. Use them to stretch, magnify, copy, and move graphic objects.

Guiding points

The control point closest to the pointer is the *guiding point*. It appears slightly larger than the others and follows the movement of the pointer. Use the guiding point as a “handle” when manipulating the object (Figure 2-6).

Figure 2-6 Control points and guiding points

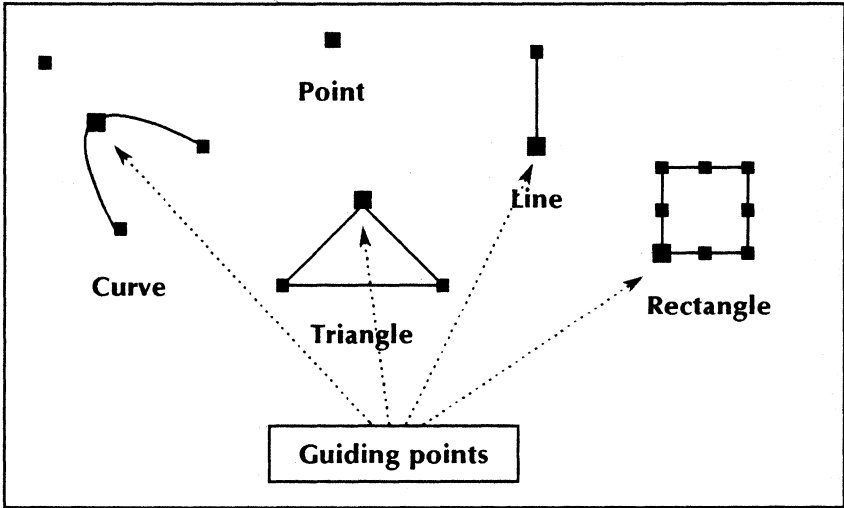

Pinned points

When you stretch or magnify an object or a group of objects, the control point or points farthest from the guiding point become stationary or pinned. Each *pinned point* appears as an "X." Figure 2-7 shows examples of pinned points and guiding points as you stretch or magnify objects.

Coincident control points

When you select two objects that touch, some of their control points may be coincident (Figure 2-8) or may be covered. Also, if an object is partially covered by an embedded frame or by a shape with black shading, some of its control points may be covered.

Position the pointer carefully to select the object you want and the guiding point you want.

Figure 2-7 Pinned points and guiding points

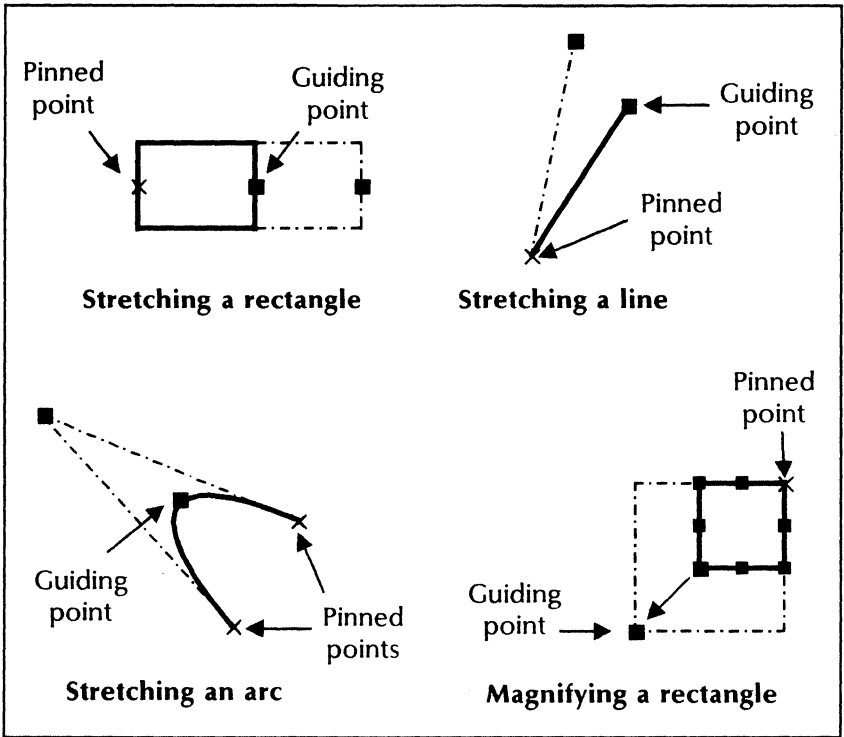
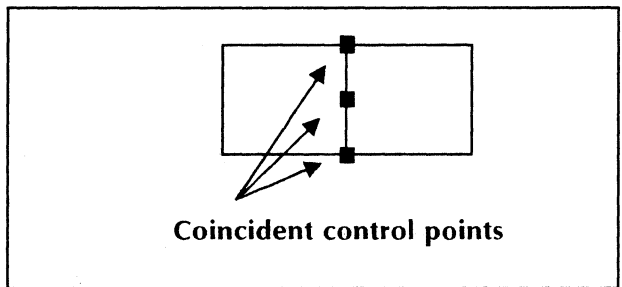

Figure 2-8 Coincident control points



The Graphics Special keyboard

The Graphics Special keyboard (Figure 2-9) is one of the primary tools for creating illustrations. It contains graphic objects as well as embedded frames.

Figure 2-9 The Graphics Special keyboard

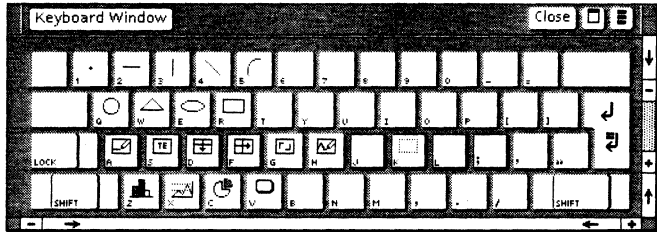





















You can access the Graphics Special keyboard after you select anywhere inside a graphics frame. To display the keyboard after accessing it or to set it permanently, you use the <Show> and <Set> alternate function keys as described in the *General User Reference* volume in this library.

Note: Some of the objects included in the Graphics Special keyboard (Figure 2-10) are elements of optional VP Series applications. These optional elements include: the bitmap frame for *VP Free-Hand Drawing*; the bar, line, and pie charts for *VP Data-Driven Graphics*; and the CUSP button for *VP CUSP Buttons*.

These objects are always shown on the keyboard display, but the keys have no effect unless its associated application is loaded and running. (You must log off and then log back on to make the key take effect after loading the application.)

Figure 2-10 Graphics Special keyboard objects

	Point		Text frame
	Horizontal line		Table—fill in by column
	Vertical line		Table—fill in by row
	Diagonal line		Graphics field frame
	Curve		Bitmap frame
	Circle		Image frame
	Triangle		Bar chart
	Ellipse		Line chart
	Rectangle		Pie chart
	Graphics frame		CUSP button

The Basic Graphics Transfer Document

You can place objects in a frame using the *Basic Graphics Transfer Document* (Figure 2-11) instead of the Graphics Special keyboard. The Basic Graphics Transfer Document is in the Basic Icons divider, which is in the Workstation divider of the directory.

Figure 2-11 **The Basic Graphics Transfer Document**

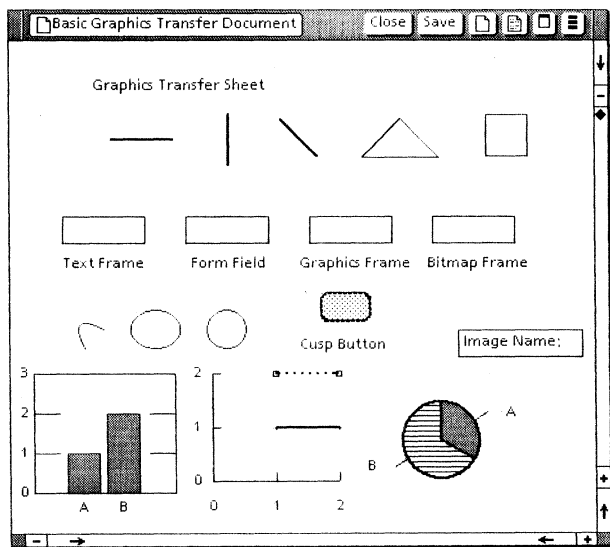

After copying the Basic Graphics Transfer Document to your desktop, you can insert or delete objects from the Basic Graphics Transfer Document to customize it to your own needs. You can also create additional transfer documents.

Note: Your Basic Graphics Transfer Document may not contain all the objects shown in Figure 2-11. For example, the bar, line, and pie charts appear only if you have *VP Data-Driven Graphics* installed and running. You must log off and then log back on to see the updated Basic Graphics Transfer Document after you have loaded an optional graphics application.

Properties of graphic objects

Each graphic object has an associated property sheet you use to modify the appearance of the object. These property sheets include:

- The Point properties sheet
- The Line properties sheet, which applies to straight and curved lines
- The Shape properties sheet, which applies to triangles, rectangles, circles, and ellipses

Using these property sheets, you can:

- Modify the structure of a point, a line, a curve, or the outline of a shape.
- Change line endings to create a smooth junction between two connected lines.
- Add an arrowhead to a line ending.
- Fill shapes with shadings and textures.

When you insert graphics frames and objects in your document from the keyboard or from the Basic Graphics Transfer Document, the property settings displayed for that object are not necessarily the default settings. The property sheets shown in this volume reflect the settings for the objects when you first insert them from the keyboard or transfer document.

When you select the [Defaults] command in the property sheet header for the graphic object, the properties of the object are changed to the predetermined default values. You can change default property settings in your User Profile. Refer to the *General User Reference* volume in this library for more information.

Figure 2-12 shows examples of graphic object properties.

Figure 2-12 **Graphic object properties**

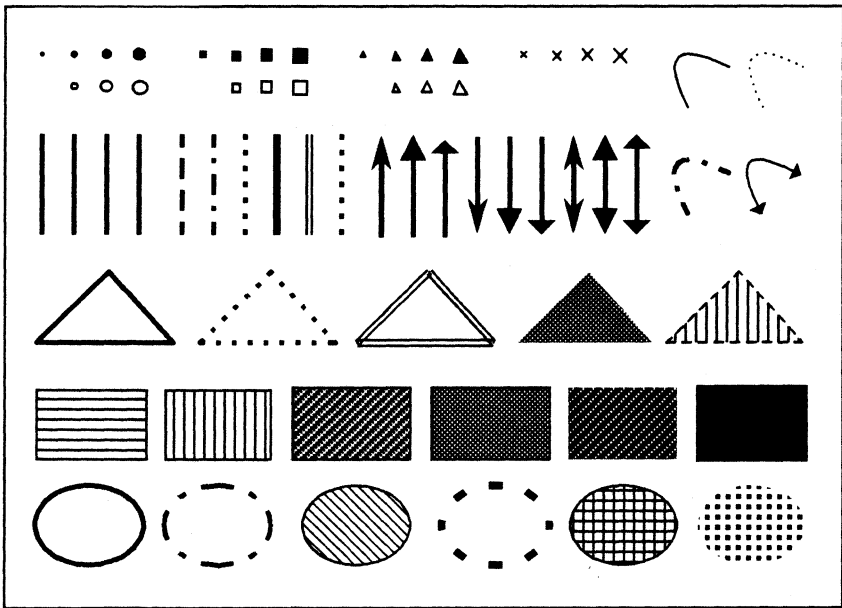
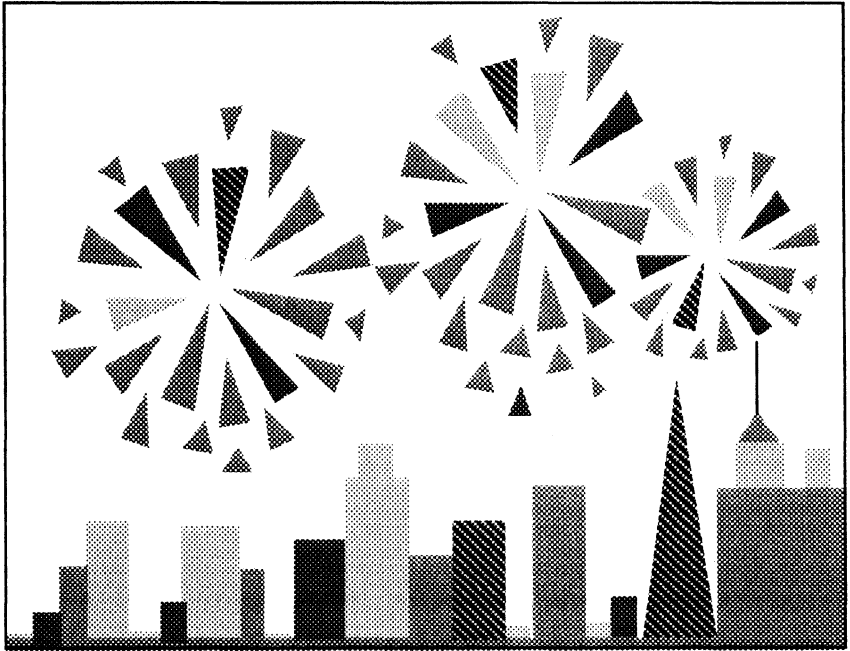

Figure 2-13 shows how you can combine shadings and textures in an illustration. For example, you can select diagonal lines in both directions to create cross-hatching.

Figure 2-13 **Shadings and textures used in an illustration**



The Graphics Frame properties sheet

The Graphics Frame properties sheet controls the appearance of a graphics frame. When you select a graphics frame and press <PROP'S>, you see the Graphics Frame properties sheet. The **Display** setting enables you to select one of two associated property sheets: the Frame property sheet and the Grid property sheet.

The Graphics Frame property sheet

Use the Graphics Frame property sheet (Figure 2-14) to modify the appearance of an anchored or embedded graphics frame.

Figure 2-14 The Graphics Frame property sheet

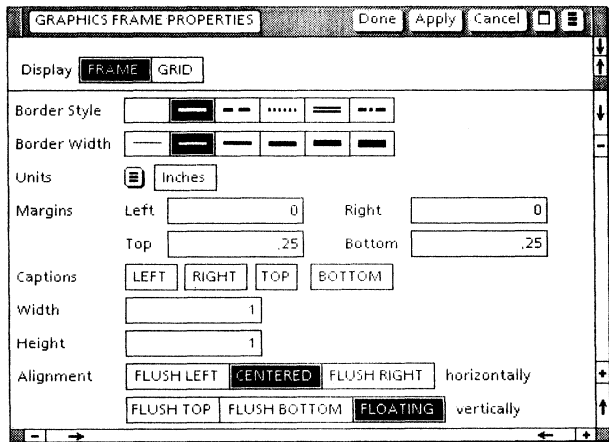

Border Style

Specifies the style of the frame border. If you select the first choice (blank box), the frame has no border.

The default is the second choice, a solid line.

Border Width

Specifies the width of the frame border. The default is the second choice.

Units

Displays the unit of measurement used to set the **Margins**, **Captions**, **Width**, and **Height** properties. An auxiliary menu lists the available choices: [Inches], [Millimeters], [Centimeters], [Points], and [Spaces]. (One inch equals 25.4 millimeters, 2.54 centimeters, 72 points, or 12 spaces.)

The default is the current value. (Selecting [Defaults] in the property sheet header does not change the **Units** value.)

Margins

Defines the size of the rectangular area which separates the frame from the surrounding text or objects, and in which you can place captions. This property consists of four settings:

[Left]

Specifies the amount of margin space to be reserved at the left edge of the frame. The default is 0.

[Right]

Specifies the amount of margin space to be reserved at the right edge of the frame. The default is 0.

[Top]

Specifies the amount of margin space to be reserved at the top edge of the frame. The default is 0.25.

[Bottom]

Specifies the amount of margin space to be reserved at the bottom edge of the frame. The default is 0.25.

The Document Editor adds the margin area as an invisible rectangular area adjacent to the corresponding frame border.

Note: For anchored graphics frames, if the resulting total frame width exceeds page limitations, the Document Editor reduces the margin settings so that the frame fits on the page. If the resulting total frame height exceeds page limitations, the Document Editor places the frame on the next page after pagination. Only the part of the frame that fits on the page appears in the printed document.

Captions

Specifies where captions are to appear around the frame. You can select any combination of [Left], [Right], [Top], and [Bottom]. When you select a setting, the Document Editor inserts a new-paragraph character in the margin on the corresponding side of the frame, enabling you to enter text for the caption.

The default is no caption location selected.

Note: You must specify a margin before entering text in the caption.

Width

Specifies the frame width, excluding the margin area. The default is 1.

Height

Specifies the frame height, excluding the margin area. The default is 1.

Note: When you adjust the size of the frame using the <Stretch> or <Magnify> graphics alternate function key, the Document Editor changes the value of **Width** and **Height**. You can further adjust the frame size by using <Stretch> or <Magnify> again, or by entering new values in the property sheet.

Alignment

Controls the horizontal and vertical position of the frame on the page. The choices for horizontal alignment are:

[Flush Left]

Aligns the frame at the left margin of the page or column.

[Centered]

Centers the frame between the page or column margins.

[Flush Right]

Aligns the frame at the right margin of the page or column.

The choices for vertical alignment are:

[Flush Top]

Aligns the frame at the top page margin.

Note: The frame anchor for a flush-top frame must be the first character on the page, immediately following any existing page format character and, on the first page, the first new-paragraph character in the document. Otherwise, the frame appears at the top of the next page or column.

[Flush Bottom]

Aligns the frame at the bottom page margin. If the frame does not fit below the anchor on the same page, it appears on the bottom of the next page.

[Floating]

Positions the frame immediately after the frame anchor. If you reposition the anchor, the frame moves with the anchor.

The default for horizontal alignment is [Centered]. The default for vertical alignment is [Floating].

Note: The **Alignment** property does not appear in the property sheets of embedded frames.

Span

Specifies whether the frame spans the page or column. **Span** appears when you select [Flush Top] or [Flush Bottom] for the vertical alignment property. The choices are [Page] and [Column]. The default is [Column].

Note: The **Span** property does not appear for embedded frames.

The Grid property sheet

The Grid property sheet (Figure 2-15) enables you to display a grid in the graphics frame. The grid is displayed on the screen only; it is not printed.

Figure 2-15 **The Grid property sheet with the Grid property set to [On]**

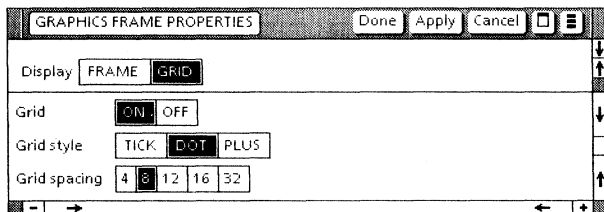

Grid

Turns the grid on and off. When you set the **Grid** property to [On], any graphic object you create, move, or copy in that frame aligns its guiding point on a grid mark. Turning on the grid does not reposition objects already inside the frame.

The default is [Off].

When you set the **Grid** property to [On], the following properties appear:

Grid Style

Specifies whether the grid marks are displayed as tick marks around the border of the frame, dots inside the frame, or plus signs inside the frame.

Grid Spacing

Specifies the density of grid points. The choices are a grid point for every 4, 8, 12, 16, or 32 screen dots. (There are 72 screen dots per inch.)

The Point properties sheet

When you select a graphic point and press <PROP'S>, the Point properties sheet (Figure 2-16) appears. Use the Point properties sheet to modify the structure of a point or dot.

Figure 2-16 The Point properties sheet

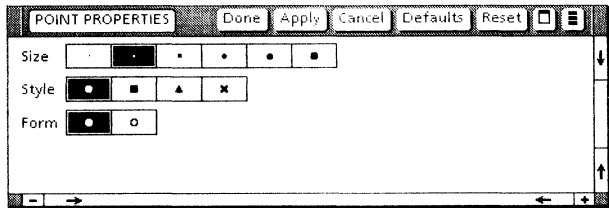

Size

Specifies one of six point sizes. The default is the second choice.

Style

Specifies one of four point shapes: round, square, triangular, or x-shaped. The default is round.

Form

Specifies either a hollow or a solid point. The default is solid.

The Line properties sheet

When you select a line and press <PROP'S>, the Line properties sheet (Figure 2-17) appears. Use the Line properties sheet to modify the width, structure, and end style of a straight or curved line.

Figure 2-17 The Line properties sheet

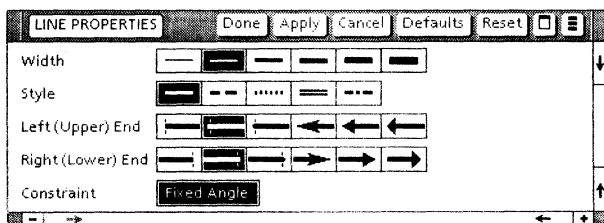

Width





Specifies one of six line widths. The default is the second choice.

Style

Specifies one of five types of solid, dashed, or dotted lines. The default is solid.

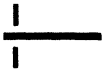
Left (Upper) End

Specifies the style of the left end of a horizontal line or the upper end of a vertical line. The choices are three styles of blunt ends and three styles of arrowheads, as illustrated in the following list.

Line ending	Description
	Flush, blunt-end: The left or upper end of the line is flush with its control point. (The control point location is indicated by the dotted line.)
	Square: The left or upper end of the line extends beyond its control point.
	Round: The left or upper end of the line is rounded and extends beyond its control point.
	Arrow one: This style of arrowhead is attached to the left or upper end of the line.
	Arrow two: This style of arrowhead is attached to the left or upper end of the line.
	Arrow three: This style of arrowhead is attached to the left or upper end of the line.
	Note: Arrowheads are not available for double lines.

The default is square.

Right (Lower) End

Specifies the style of the right end of a horizontal line or the lower end of a vertical line. The choices are the same as for the **Left (Upper) End** property. The default is square.

Constraint

If [Fixed Angle] is selected, the angle of the line remains the same, even when you stretch or magnify it. The default is no fixed angle.

The Shape properties sheet

When you select a graphic shape and press <PROP'S>, the Shape properties sheet appears (Figure 2-18). Use the Shape properties sheet to modify the appearance of a shape such as a rectangle or triangle.

Figure 2-18 The Shape properties sheet

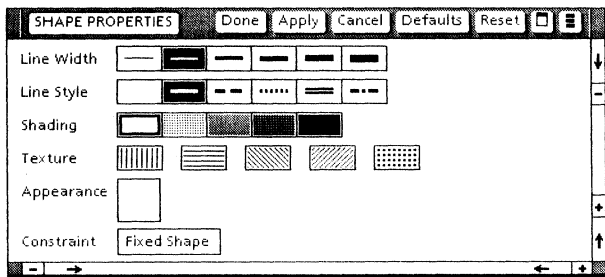

Line Width

Specifies one of six line widths for the outline of the shape. The default is the second choice.

Line Style

Specifies one of four solid, dashed, or dotted line styles for the outline of the shape. You can also select the first choice (blank box) to make the outline invisible. The default is the second choice, a solid line.

Shading

Specifies the shading for a shape as one of five tones. The default is white.

Note: You cannot select the first choice for the **Line Style** property and white for the **Shading** because the object would be invisible.

Texture

Specifies any combination of five textures as the interior pattern for a shape. The default is no texture.

Appearance

Shows the combination of **Shading** and **Texture**.

Constraint

If [Fixed Shape] is selected, the proportions of the shape are maintained when you stretch it. The default is no fixed shape.

The Bitmap Frame properties sheet

You can insert a bitmap frame into an anchored graphics frame by entering it from the Graphics Special keyboard or copying it from the Basic Graphics Transfer Document. Bitmap frames contain *VP Free-Hand Drawing* canvases. (All bitmap frames are embedded frames.)

The **Display** setting on the Bitmap Frame properties sheet enables you to select one of two associated property sheets: the Bitmap property sheet and the Bitmap Frame property sheet.

The Bitmap property sheet

The Bitmap property sheet enables you to determine the appearance of the frame contents.

Figures 2-19, 2-20, and 2-21 show the Bitmap property sheet appearance for each of the three **Scaling** choices: Automatic scaling, Fixed scaling, and Print Resolution scaling.

Figure 2-19 Automatic scaling

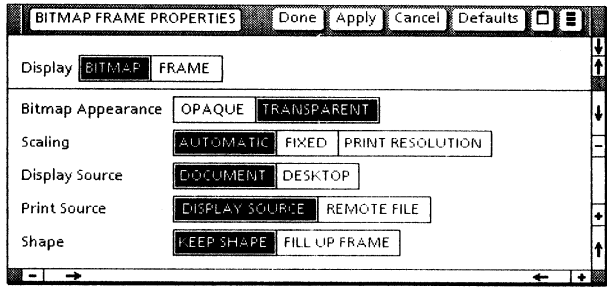

Figure 2-20 Fixed scaling

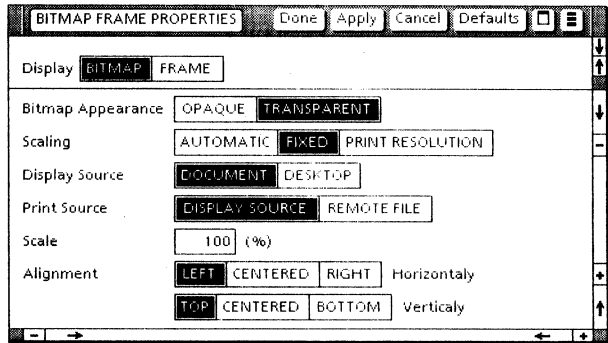
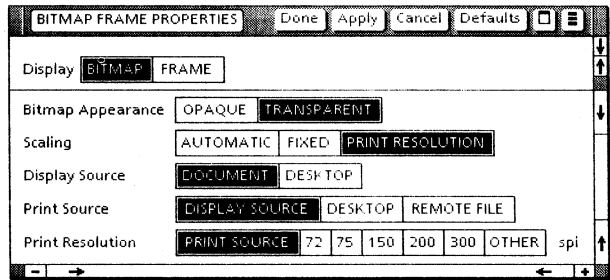

Figure 2-21 Print resolution scaling



Bitmap Appearance

Specifies whether the contents of the frame are opaque or transparent. This property applies when you have overlapping frames in your document. If the value is [Opaque], the bitmap frame will cover any frame underneath it. If the value is [Transparent], the items in the bottom frame will show through.

The default is [Transparent].

Scaling

Indicates the current mode of scaling. The three modes are:

[Automatic]

Causes the contents of the bitmap frame to shrink or expand automatically to fit the frame size (Figure 2-19). The **Shape** property that appears when you select [Automatic] controls whether the proportions are maintained during scaling.

[Fixed]

Modifies the contents of the bitmap frame according to the **Scale** and **Alignment** properties that appear (Figure 2-20).

[Print Resolution]

Scales the contents of the bitmap frame according to the **Print Resolution** property that appears (Figure 2-21).

Display Source

Indicates whether the contents of the bitmap frame displayed on the screen are from the document or the desktop. If the value is [Document], the contents of the bitmap frame are in the document itself. If the value is [Desktop], the contents of the bitmap frame come from a canvas on the desktop, and the **Name** property appears so that you can specify the name of the canvas.

The default is [Document].

Name

Appears if you select [Desktop] for the **Display Source** property. Enter the name of the canvas that is the source of the bitmap frame contents.

Print Source

Specifies the origin of the canvas that appears in the frame when it is printed. The choices are:

[Display Source]

Indicates the same origin as the canvas you selected for the **Display Source** property.

[Desktop]

Indicates the system is to print a canvas from your desktop. You enter the name of the canvas in the **Name** property that appears.

[Remote File]

Indicates an image (IMG) file stored on one of the Xerox 9700 or 3700 Printing Systems. You enter the name of the image file in the **Name** property that appears.

To merge your document with an image stored at a printer, you can either use a bitmap frame with the [Remote File] setting for the **Print Source** property option, or use an image frame.

The default is [Display Source].

Name

Appears if you select [Desktop] or [Remote File] for the **Print Source** property. Enter the name of the canvas or the image file. The image file name has a special format. Refer to "Printing a remote image file."

If the canvas is inside a folder on the desktop, you specify the name of the folder, followed by a slash, followed by the name of the document:

foldername/canvasname

Shape

Specifies how the contents of the bitmap frame are to be scaled during automatic scaling. If you select [Keep Shape], the contents of the bitmap frame maintain their relative proportions during scaling. If you select [Fill Up Frame], the contents of the bitmap frame shrink or expand both horizontally and vertically to meet the edges of the frame.

The default is [Keep Shape].

Scale

Appears if you select [Fixed] for the **Scaling** property. **Scale** determines the percentage by which the contents of the bitmap frame shrink or expand. You enter a number between 1 and 1000 to indicate the percentage of scaling. If you enter 100, the contents keep their current size. If you enter 50, the contents of the bitmap frame shrink by half, both horizontally and vertically.

Alignment

Appears if you select [Fixed] for the **Scaling** property. **Alignment** controls the horizontal and vertical position of the bitmap image within the bitmap frame.

The choices for horizontal alignment are:

[Left]

Aligns the bitmap at the left bitmap frame border.

[Centered]

Centers the bitmap between the bitmap frame borders.

[Right]

Aligns the bitmap at the right bitmap frame border.

The choices for vertical alignment are:

[Top]

Aligns the bitmap at the top bitmap frame border.

[Centered]

Centers the bitmap between the bitmap frame borders.

[Bottom]

Aligns the bitmap at the bottom bitmap frame border.

Print Resolution

Enables you to specify the number of spots per inch (spi) used to print the bitmap. The choices are:

[Print Source]

[72 spi]

[75 spi]

[150 spi]

[200 spi]

[300 spi]

[Other]

If you select [Other], you can specify the number of spots per inch. You may use this property to print a smaller, sharper image, eliminating jagged edges and angled lines.

Note: You get the best results by using a factor of your printer resolution. (For example, for a printer with 300 spi resolution, choose numbers such as 75, 100, 150, and 300.) You should not use a resolution higher than the resolution of your printer.

The Bitmap Frame property sheet

The Bitmap Frame property sheet (Figure 2-22) enables you to define the properties of the bitmap frame itself. Refer to “The Graphics Frame property sheet” earlier in this chapter for a description of the frame properties.

Figure 2-22 The Bitmap Frame property sheet

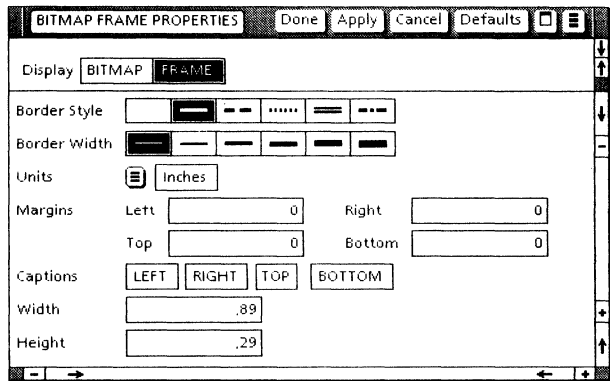

The default property settings are shown in Figure 2-22.

The Image Frame properties sheet

Image frames let you merge your ViewPoint document with an image stored at a remote printer and then print them together. The image must have been scanned in and stored at the printer before you send your document to the printer.

You enter an image frame into an anchored graphics frame from the Graphics Special keyboard. (All image frames are embedded frames.)

The **Display** setting on the Image Frame properties sheet enables you to select one of two associated property sheets: the Image Frame property sheet and the File Name property sheet.

The Image Frame property sheet

The Image Frame property sheet (Figure 2-23) enables you to define the properties of the frame itself. Refer to “The Graphics Frame property sheet” earlier in this chapter for a description of the frame properties.

Figure 2-23 The Image Frame property sheet

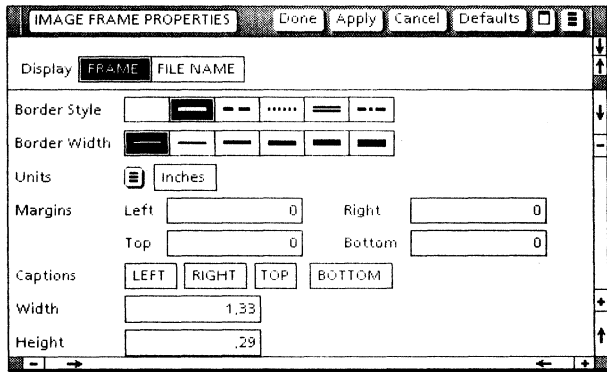

The File Name property sheet

The File Name property sheet (Figure 2-24) enables you to enter the name of the image file. The image contained in that file is inserted into the image frame when the document is printed. The image appears in the printed copy only.

Figure 2-24 The File Name property sheet

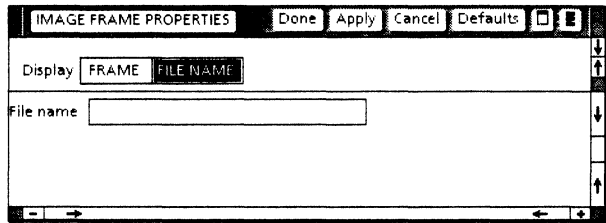

File Name

Specifies the name of the image file. The image file name has a special format. Refer to "Printing a remote image file."

Note: The Bitmap frame can also be used to print image files. Set the **Print Source** property to [Remote File] on the Bitmap property sheet.

Working with graphics frames

1 2 3...

Working with graphics frames is the same as working with other frames. For your convenience, this section repeats the most common procedures. See *Document Editor Reference* volume 3 in this library for complete procedures.

Inserting an anchored graphics frame in a document

1. In an open document in edit mode, select the character you want the frame anchor to follow. If you want to see the frame anchor, select [Show Structure] from the document auxiliary menu.
2. Hold down <KEYBOARD> and press <Special> to access the Document Special keyboard.
3. Press <A> to insert a frame anchor and its accompanying graphics frame (Figure 2-25).

Figure 2-25 **Placing a graphics frame in a document**

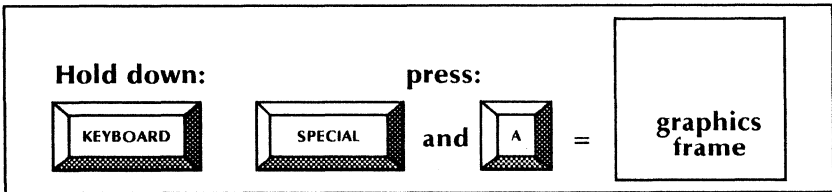

When you insert the frame, it appears in the first available space below the frame anchor. When you paginate the document, the alignment properties you specified in the Graphics Frame property sheet help determine the frame placement.

Moving or copying a frame

Refer to the “Anchored and embedded frames” appendix for a summary of which frames can be anchored, embedded, copied into a graphics frame, and copied out of a graphics frame.

When moving or copying anchored frames:

- You can move or copy an anchored frame to another position in the main body of the text; the resulting frame is an anchored frame.
- If your frame is an anchored text, table, graphics, or CUSP button frame, you can also move or copy it to a position inside a graphics frame. The resulting frame is an embedded frame.

When moving or copying embedded frames:

- You can move or copy an embedded frame to another position in the same graphics frame or into another graphics frame; the resulting frame is an embedded frame.
- If your frame is an embedded text, table, graphics, or CUSP frame, you can also move or copy it to a position in the main body of text. The resulting frame is an anchored frame.

Follow this procedure:

1. Select [Show Structure] from the document auxiliary menu, if you cannot see the frame anchor or border that you want to select.
2. Select the anchor or border of the frame you want to move or copy.
3. Press <MOVE> or <COPY>.

4. Select the destination for the frame.
 - For anchored frames: The destination may be in the main body of the text, in a graphics frame (for certain frames), or in another document.
 - For embedded frames: The destination may be in the same graphics frame, another graphics frame, or (for certain frames) in the main body of the text.
5. If the resulting frame is an anchored frame, paginate the document to place the frame in the new location.

Modifying a frame

You can modify the appearance of a graphics frame several ways:

- Changing its properties using the Graphics Frame property sheet
- Changing the frame size and shape using the <Stretch> and <Magnify> graphics alternate function keys
- Copying frame properties using the <SAME> key
- Changing default frame properties in the User Profile; refer to the chapter titled "The User Profile" in the *General User Reference* volume in this library for more information

Changing the property sheet for the frame

1. Select [Show Structure] from the document auxiliary menu, if you cannot see the frame border that you want to select.
2. Select the border of the graphics frame whose appearance you want to change.

3. Display the Graphics Frame property sheet.
4. Select the properties you want. If you select flush-top or flush-bottom vertical alignment, specify whether the frame should span the column or page.
5. Select [Apply] or [Done].
6. Although you should always paginate your document when you are finished making all your modifications, you may want to paginate immediately if you changed frame size or specified new **Alignment** properties.

Modifying a frame using <Stretch> and <Magnify>

You can use the <Stretch> or the <Magnify> graphics alternate function key to adjust the size of a graphics frame:

- <Stretch> changes the width, the height, or both, depending on the control point you select. Frame proportions can change.
- <Magnify> changes the width and height of the frame in one operation, while maintaining frame proportions.

Use this procedure:

1. Select the graphics frame whose size you want to change.

Note: For using <Stretch> to change only one dimension, select in the middle of any one of the four sides; to stretch in both dimensions, select a corner.

2. Press the alternate function key corresponding to <Stretch> or <Magnify>.
3. Hold down the left mouse button and move the pointer—away from the pinned point to expand the frame, toward the pinned point to shrink it—until the frame is the size you want.

4. Release the mouse button.
5. Be sure to paginate the document when you are finished editing.

You can also adjust the size by changing **Height** and **Width** values in the Graphics Frame property sheet.

Copying frame properties using <Same>

Note: This procedure does not copy the **Height** and **Width** properties.

1. Select either the border or the anchor of the graphics frame to receive the copied properties.
2. Press <SAME>.
3. Select either the border or the anchor of the graphics frame that has the properties you want to copy.

Deleting a frame

1. If you cannot see the frame border, select [Show Structure] from the document auxiliary menu.
2. Select the frame anchor or the border of the frame you want to delete.
3. If you selected an anchor, and its frame is on another page, scroll to view the frame.
4. Press . The Document Editor highlights the frame and its anchor and asks for confirmation in the message area.
5. After you verify that the correct frame is highlighted, select [Yes] to delete the frame.
6. Paginate the document.

Verifying that a frame and anchor are linked

1. Select the frame.
2. If necessary, scroll to the page that contains the anchor you think is linked to the frame.
3. Press . If the anchor is linked, it is highlighted.
4. Select [No] in the confirmation message so the frame will not be deleted.

Placing graphic objects and embedded frames in a frame

1 2 3...

You can place graphic objects and embedded frames in a graphics frame by using the Graphics Special keyboard or by copying the objects from the Basic Graphics Transfer Document. You can copy some types of anchored frames into a graphics frame, making them embedded frames.

You can also move or copy objects from one frame to another. After you have placed objects in a frame, you can move them around within the frame and adjust their size and shape. See "Manipulating graphic objects" later in this chapter.

If you select a location inside a graphics frame and begin typing, the Document Editor automatically inserts an embedded text frame and places your text inside it.

Using the Graphics Special keyboard

1. Select the location inside the frame where you want the object to appear.
2. Hold down <KEYBOARD> and press the top-row function key corresponding to <Special> to access the Graphics Special keyboard.
3. Still holding down <KEYBOARD>, press the key corresponding to the object you want to place in the frame. If you insert another object without selecting another location, the objects are layered.

If you select outside a graphics frame, the Graphics Special keyboard is no longer displayed. You must access the Graphics Special keyboard again to enter more graphic objects.

Using the Basic Graphics Transfer Document

1. If the Basic Graphics Transfer Document is not on your desktop, copy it from the Basic Icons divider. This divider is in the Workstation divider in the directory.
2. Open the Basic Graphics Transfer Document.
3. Select a transfer object or frame, such as a rectangle, by positioning the pointer along one edge of the object and clicking the left mouse button.

When you select an object or frame, its control points appear. Figure 2-26 shows the difference between a rectangle and a selected rectangle.

4. Place the selected object in the frame by pressing <COPY> and selecting a destination inside the frame for the object.

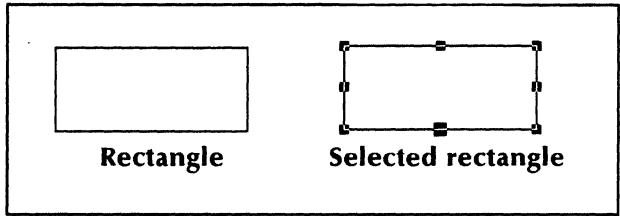
Figure 2-26 **Rectangle and selected rectangle**

After you press <COPY>, if you hold down the left mouse button inside the graphics frame, an outline or “ghost” of the object moves on the screen. This outline will help you determine where to place the new rectangle.

If part of the object extends beyond the frame, Basic Graphics displays a warning message. If you move the guiding point of the object outside the frame, Basic Graphics displays a question mark (?).

Drawing lines and curves

1 2 3...

You can draw lines and curves (Figure 2-27) using the <Line> and <Curve> graphics function keys. You can also insert them using the Graphics Special keyboard, or copy them from the Basic Graphics Transfer Document.

Drawing a straight line

The <Line> graphics alternate function key controls the drawing of any straight line—horizontal, vertical, or angled.

1. Select a location inside the frame as the starting point for the line. A blinking caret appears.

Figure 2-27 **Lines and curves created with Basic Graphics**

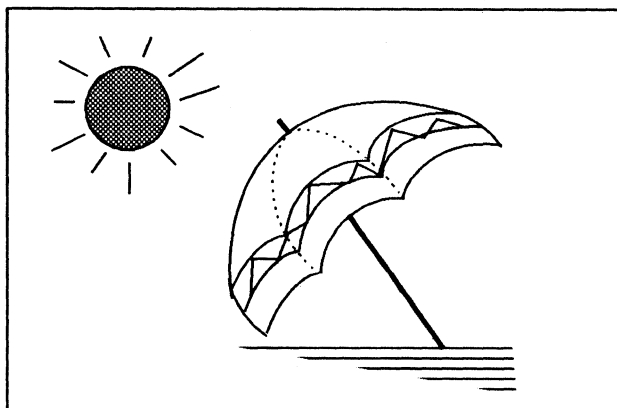

2. Press the alternate function key corresponding to <Line>. The blinking caret becomes an "X," marking the beginning of the line.
3. Hold down the left mouse button and position the pointer where you want the line to end.
4. Release the mouse button.
5. If you do not move the pointer immediately, the blinking caret changes again into an "X," marking the beginning of another line. Repeat steps 3 and 4 for each contiguous line you want to draw, or press <STOP> to stop drawing lines.
6. When you finish drawing contiguous lines, move the pointer immediately after selecting the end of a line or press <STOP>.

The end of the line is both a blinking caret and a guiding point. The caret indicates that you can attach another line or curve to the line. For more information, see "Drawing lines and curves in succession" later in this chapter.

Drawing a curve

The <Curve> graphics alternate function key controls the drawing of a curve. Drawing a curve is similar to drawing a line, except that you select an additional, intermediate point that is the apex of the curve. The apex is located just above the actual peak of the curve.

Figure 2-28 illustrates a completed curve. The dotted line represents the path the pointer took to create the curve.

Figure 2-28 A completed curve

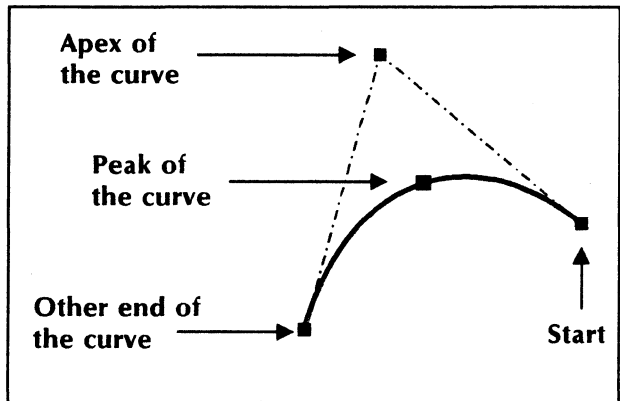

1. Select a location inside the frame as the starting point for the curve. A blinking caret appears.
2. Press the alternate function key corresponding to <Curve>. The blinking caret becomes an "X," marking the beginning of the curve.
3. Hold down the left mouse button and position the pointer at the apex of the curve.

4. Release the mouse button. Another "X" appears at the apex; it becomes the pinned point of the curve.
5. Hold down the left mouse button again and position the pointer where you want the curve to end.
6. Release the mouse button.
7. If you do not move the pointer immediately, the blinking caret changes again into an "X," marking the beginning of another curve. Repeat steps 3 through 6 for each contiguous curve you want to draw, or press <STOP> to stop drawing curves.
8. When you finish drawing contiguous curves move the pointer immediately after selecting the end of a curve, or press <STOP>.

The caret is now positioned at the end of the curve, ready for you to attach another line or curve to the curve you just drew.

Note: You can press the button (push down and release) rather than hold it down in steps 3 and 5 above. However, if you do so, you will not be able to adjust the curve as you draw it.

Drawing lines and curves in succession

The end of one line or curve can be the beginning of another. You can draw angles and polygons by drawing lines in succession.

1. Draw a line or curve using the procedures in "Drawing lines and curves."
2. Do not move the pointer if you want to draw the same object again. Otherwise, move the pointer to cancel the automatic drawing of the same object again.
3. Draw another line or curve, using the ending point of the first line or curve as the starting

point of the second. Use the procedures in "Drawing lines and curves."

Continue to draw line segments and curves until you have created the shape you want.

Note: You can smooth the junctions between adjacent lines and curves by selecting different line endings on the Line properties sheet.

Selecting graphic objects

1 2 3...

When you move, copy, or change the appearance of graphic objects, you first select a single object or a group of objects.

Selecting a single object

1. Point to the object.
2. Click the left mouse button.

Note: When two objects are very close or touching, make sure you position the pointer carefully to select the object and guiding point you want.

When you select a graphic object, control points appear (see Figure 2-26 for an example of a selected rectangle). The control point you choose as the guiding point determines which points become pinned:

- If you select a rectangle or graphics frame, the control point in the opposite corner or edge is the pinned point.
- If you select a triangle or curve, the control point farthest from the guiding point is the pinned point. (Triangles have two pinned points and curves have two or three, depending on the guiding point position.)

- If you select an ellipse, the control point opposite the guiding point is the pinned point. If the guiding point is the center of the ellipse, the pinned point is the control point in the upper left corner.
- If you select a group of objects, the control point farthest from the guiding point is the pinned point.

Selecting multiple graphic objects

You can select several objects at one time and then manipulate them in the same way. The group of objects stays intact for subsequent operations. You can enlarge or shrink each object by the same amount at the same time. You can also apply the same properties to each object in one operation.

You can use two techniques for multiple selection: the select-adjust method and the draw-through method.

The select-adjust method

Use the *select-adjust method* to select a few dispersed objects.

1. Select the first object with the left mouse button.
2. Select each successive object with the right mouse button.

The guiding point for the group is the guiding point of the last object you select.

The draw-through method

Use the *draw-through method* to select several close, small objects. This method creates a boxed selection area as you draw a diagonal line through the vicinity of the objects you want to select (Figure 2-29).

Figure 2-29 The draw-through method of multiple selection

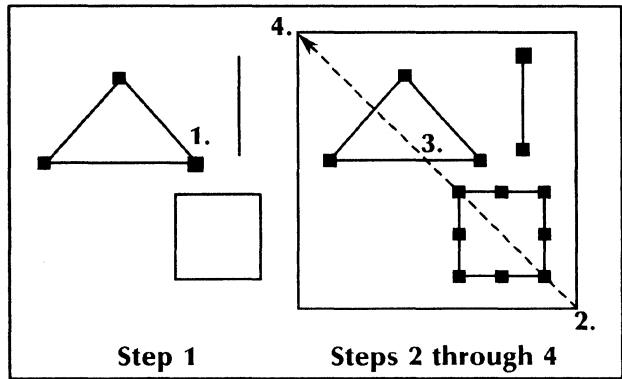

1. Select any one of the objects with the left mouse button.
 2. Position the pointer at a corner of a rectangular area that will include all of your objects.
 3. Hold down the right mouse button and move the pointer to the diagonally opposite corner (the dotted line in Figure 2-29). As you move the pointer, a box appears around the objects.
- Note:** All control points of each object, including the curve apex, must be included in the box.
4. When all the objects you want to select are included in the box, release the right mouse button.
 5. Add more objects to the selection by making more draw-through selections or by using the right mouse button to select objects.

The guiding point for the group is the guiding point of the last object you select.

Canceling selections

- Cancel the selection of one of the objects in the multiple-object selection by positioning the cursor on that object and clicking the right mouse button.
- Cancel the entire selection of all the objects by clicking the left mouse button in a blank area of the frame or outside the document.

Joining objects into a cluster

You can join several objects in a frame into a cluster. Then you can treat the cluster as a single object as you copy, move, stretch, or modify its properties. Make your multiple selection permanent by using this procedure:

1. Select the objects you want to join into a cluster, using the draw-through or the select-adjust method.
2. Press the alternate function key corresponding to <Join>. Basic Graphics displays the message, "The extended selection is now joined into a cluster."

Any time you select one object in the cluster, you select them all.

Splitting a cluster

You can also split a cluster into its component objects. When you want to disassemble a cluster, or alter some objects but not others, split the cluster by reversing the join operation. Use this procedure:

1. Select the cluster.
2. Press the alternate function key corresponding to <Join>. Basic Graphics displays the message, "The cluster is now split."

You can now select an individual object from the former cluster.

Clustering objects in an embedded frame

If you have several objects that are to be used as one cluster, you may prefer to place them all in one embedded graphics frame rather than simply join them. You can then select and move the graphics frame to move the cluster. Use this method when:

- You frequently have to edit a cluster, and you want to avoid splitting and joining the cluster for every edit.
- You have multiple clusters that you want to keep as individual clusters but you want to manipulate them as a whole. Place multiple clusters in one embedded graphics frame. Using this “multi-level cluster” method, you can split one of the clusters and edit it without disturbing the other clusters or the major grouping.

Manipulating graphic objects

1 2 3...

You can manipulate a graphic object in some familiar ways and some new ways.

Moving or copying a graphic object

1. Select the border of the object you want to move or copy.
2. Press <MOVE> or <COPY>.
3. Select the destination for the object. If you hold the mouse button down after you press <MOVE> or <COPY>, you can see the object as you position it. Release the mouse button when the object is at the destination.

Moving or copying a small or layered object

If you are having difficulty moving or copying an object to another position (for example, moving a graphic circle over a text frame), follow this procedure:

1. Draw a long line that touches the object you wish to move or copy. This line becomes your "handle".
2. Select the object with the left mouse button.
3. Select the far end of the line with the right mouse button.
4. Press <MOVE> or <COPY>.
5. Hold down the left mouse button and position the object in the desired location; then release the mouse button.
6. Select the line and press to delete it.

Deleting a graphic object

1. Select the object you want to delete.
2. Press .

Note: Basic Graphics does not prompt you for a confirmation when you delete an object within a frame.

Repositioning objects in a stack

When transparent objects overlap, the bottom object shows through and the shading of the objects is combined. Opaque objects, such as embedded frames or objects with black shading, cover any objects they overlap.

You can create a stack of objects by moving or stretching them so they overlap. You can move an object from within a stack to the top of the stack. Use this procedure:

1. Select the object you want to place on top.
2. Press the alternate function key corresponding to <Top>. Basic Graphics displays the message, "Selection is now on the top."

If you press <Top> again, Basic Graphics displays the message, "Selection is now on the bottom."

Modifying the appearance of graphic objects

1 2 3...

You can change the appearance of graphic objects in four ways:

- Using a property sheet to modify individual properties
- Using the <Stretch> and <Magnify> graphics alternate function keys to change the size and shape of an object
- Using the <SAME> key to copy properties from one object to another
- Changing the User Profile defaults for graphic object properties

Changing the property sheet for one or more objects

1. Select a graphic object or objects in the frame.
2. Press <PROP'S> to display the property sheet for the object or objects.

Note: When you select multiple objects or a cluster, you can change or copy the properties that all the selected objects have in

common. The property sheet for the multiple selection, called the Graphics Properties sheet, combines the properties the objects have in common and also displays associated property sheets for Line, Point, Shape, and Frame as appropriate.

3. Change the settings for one or more properties to change the line structure, shading, or texture of the object or objects.
4. Select [Apply] or [Done].

Resizing an object using <Stretch> and <Magnify>

You can reduce or enlarge one or more graphic objects using the <Stretch> or <Magnify> graphics alternate function key. The point you choose as the guiding point determines the direction in which the stretch or magnify operation will take place.

Note: The **Constraint** property on the Line properties and Shape properties sheets protects an object from accidentally having its angle or proportion changed.

As you move the guiding point while holding down the mouse button during stretch and magnify operations, you see a “ghost” of the object showing its new size and orientation.

If you are stretching or magnifying a large group of objects, the “ghost” of the group may lag behind the guiding point. Hold the mouse stationary to allow the outline to catch up.

Stretching an object

Stretching an object changes its size. Stretching can also change the shape of the object, because only the dimensions being stretched change in size (Figure 2-30).

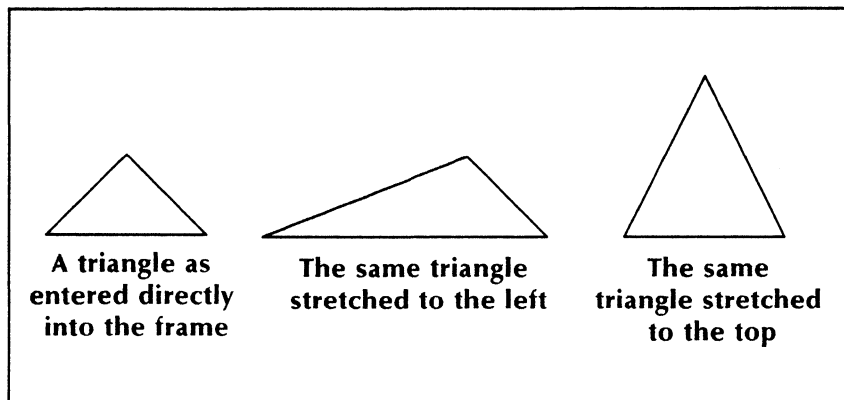
Figure 2-30 **Stretching a triangle**

1. Select the object you want to stretch.
2. Press the alternate function key corresponding to <Stretch>. The guiding point and the pinned point appear.
3. Hold down the left mouse button and move the pointer—away from the pinned point to expand the object, toward the pinned point to shrink it—until the object is the size and shape you want.
4. Release the mouse button.

Magnifying an object

Magnifying an object changes its size, but retains its overall proportions (Figure 2-31).

1. Select the object you want to magnify.
2. Press the alternate function key corresponding to <Magnify>. The guiding point and the pinned point appear.

Figure 2-31 Magnifying a triangle

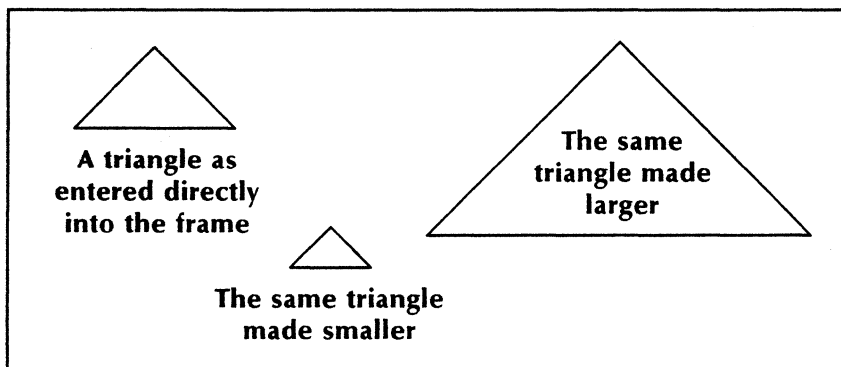

3. Hold down the left mouse button and move the pointer—away from the pinned point to expand the object, toward the pinned point to shrink it—until the object is the size you want.
4. Release the mouse button.

Copying properties using the <SAME> key

The <SAME> key copies the properties of one object to another in the same way it copies text properties in a document. It does not alter the type or size of an object (for example, it does not turn a square into a circle); it changes only the properties both objects have in common.

1. Select the object for which you want to set properties.
2. Press <SAME>.
3. Select the object that has the properties you want to copy.

Changing default properties in the User Profile

You can override the default values for many of the graphic objects by changing settings in your User Profile. In this way, you can tailor the appearance of a newly created graphic object to suit your needs. Refer to the chapter titled "The User Profile" in the *General User Reference* volume in this library for further information on setting up your User Profile.

You can change the default graphics properties for points, lines, curves, ellipses, pie slices, rectangles, and triangles in your User Profile.

Here is a sample User Profile entry for graphic objects:

Arrowheads: To create lines with arrowheads, your User Profile entry is:

[Structure Graphics Line Defaults]

Left (Upper) Line End: Arrow 1

Right (Lower) Line End: Arrow 2

Note: You must log off and log back on for the User Profile changes to take effect.

Adding text labels to illustrations

1 2 3...

Use an embedded text frame when you want to add text labels to an illustration.

1. Select a location inside either an anchored or an embedded graphics frame where you want to place a text label, and begin typing. The Document Editor automatically inserts a text frame for you, and places your text in the embedded text frame.
2. If necessary, select the text frame and move it to the exact desired location.

3. Repeat steps 1 and 2 for each label.

You may also adjust the dimensions of the frame to force your label into fewer or more lines, and you can change the frame border as desired.

Using the grid

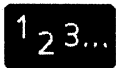

Displaying a grid in a graphics frame helps you align objects you insert in the frame. The grid does not affect objects already in the frame until you move or copy them.

When the grid is displayed, any object you copy or move into the frame automatically lines up with the grid. The control point of each object aligns on the nearest grid point.

You can turn the grid on and off using the <Grid> graphics alternate function key or the Grid property sheet. The <Grid> graphics alternate function key turns on a grid with the default style and spacing. If you want to modify the grid, use the Grid property sheet.

Using the <Grid> key

1. Select a location inside the graphics frame.
2. Press the alternate function key corresponding to <Grid>. A grid appears inside the frame.

To remove the grid, press the alternate function key corresponding to <Grid> again.

Using the Grid property sheet

1. Select the frame border.
2. Press <PROP'S>. The Graphics Frame properties sheet appears.

3. Select [Grid] as the **Display** setting.
4. Select [On] for the **Grid** property. The **Grid Style** and **Grid Spacing** properties appear.
5. Modify the grid style and grid spacing as desired.
6. Select [Done].

To remove the grid, redisplay the Grid property sheet and select [Off] for the **Grid** property. Then select [Done] to remove the property sheet.

You can also remove the grid by selecting a location inside the frame and pressing the alternate function key corresponding to <Grid>.

Printing a remote image file

1 2 3...

Before copying an image file into a frame, make sure the image file resides on one of the Xerox 9700 or 3700 Printing Systems and has an assigned name. (See "The Image Frame properties sheet" earlier in this chapter.) Then follow this procedure:

1. Insert a graphics frame in your document.
2. Insert an image frame in the graphics frame.
3. Display the Image Frame properties sheet.
4. Select [Frame] for the **Display** property.
5. Enter settings for the **Width** and **Height** properties of the image frame. The dimensions should be the same as the dimensions of the image stored at the printer. Normally the dimensions are the ones used for sizing (cropping) when the image was scanned in.

The width and height must be correct because the printed picture is scaled

according to the size you specify. If you specify a size too large or small, the image will be distorted when it is printed.

6. Select [File Name] for the **Display** property.
7. Enter the assigned name of the image file for the **File Name** property. For example, if the assigned name at the printer is in the form "IMG>filename.img," then the name you enter in the property sheet is "IMG>filename"; you do not enter the file name extension ".img."
8. Close the property sheet. The name you entered for **File Name** appears on the face of the image frame.
9. Adjust the size of the surrounding graphics frame.

When you print the document, the image is merged into the document at the location of the image frame.

3. VP Data-Driven Graphics

VP Data-Driven Graphics is a separate application that you load after the *VP Document Editor* is running. Data-Driven Graphics transforms numerical data into charts.

Using Data-Driven Graphics, you can create bar charts, pie charts, and line charts (or graphs), using a table to specify the data that drives the chart. You can also customize the layout and appearance of the chart and set up an explanatory key.

Data-Driven Graphics has features similar to those of Basic Graphics:

- A chart is a graphic object.
- You insert a chart inside an anchored or embedded graphics frame. (The “Basic Graphics” chapter in this volume describes anchored and embedded frames.)
- You can perform standard graphic operations on charts.
- Each chart has associated property sheets. Many of the properties are identical to the properties of Basic Graphics objects.
- You can combine charts with other illustrations.

To use Data-Driven Graphics effectively, you should be familiar with Basic Graphics.

Key concepts of Data-Driven Graphics



Like Basic Graphics, Data-Driven Graphics has several features for creating charts and inserting them into your document.

Types of charts

A *bar chart* represents data as a series of bar sets (Figure 3-1). A bar set, or *data set*, is one type (shade) of bar in the bar chart; it represents a column or row of data from the table driving the chart. In Figure 3-1, each day of the week is one bar set.

Figure 3-1 A bar chart

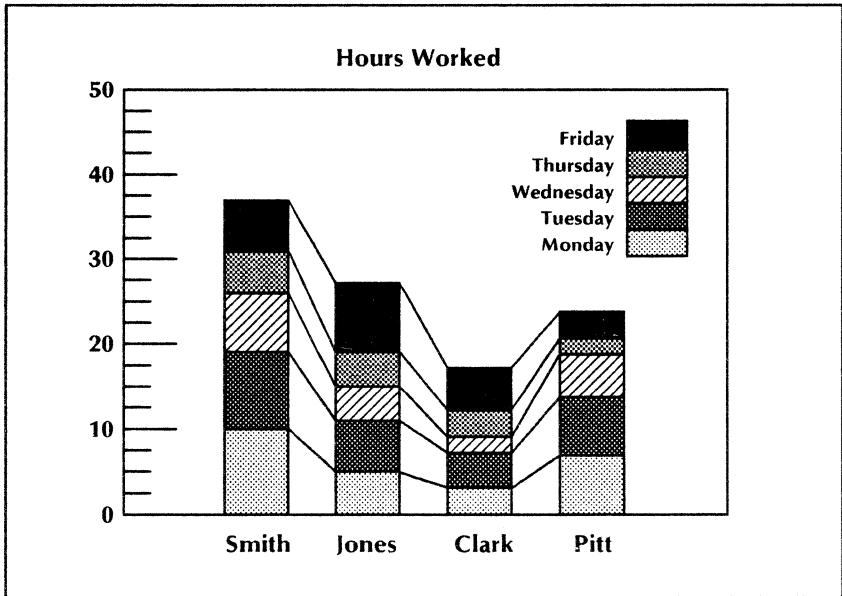

A *pie chart* represents a set of values as percentages of a whole (Figure 3-2). Each value represents a *pie slice* in the chart.

Figure 3-2 A pie chart

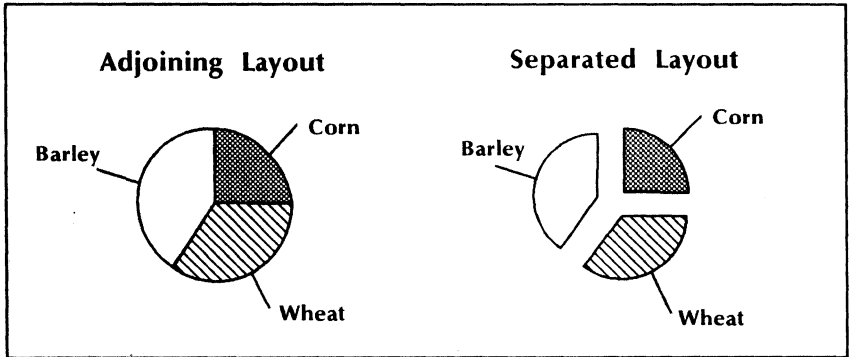

A *line chart* represents data as a series of line sets or point sets. A line set or a point set, also called a data set, is one style of line or point representing a column or row of data from the source table. In Figure 3-3, each city is one line set; in Figure 3-4, each test is one point set. The three types of line charts are:

- A *straight-line pieced chart*, where lines connect the points (Figure 3-3). Use this type of chart to indicate trends.
- A *data-point chart* (Figure 3-4), which is a special kind of straight-line pieced chart. Use this type of chart when the points occur in clusters. Refer to "Creating a data-point chart" under "Changing the appearance of charts," later in this chapter, for more information.

Figure 3-3 A straight-line pieced chart

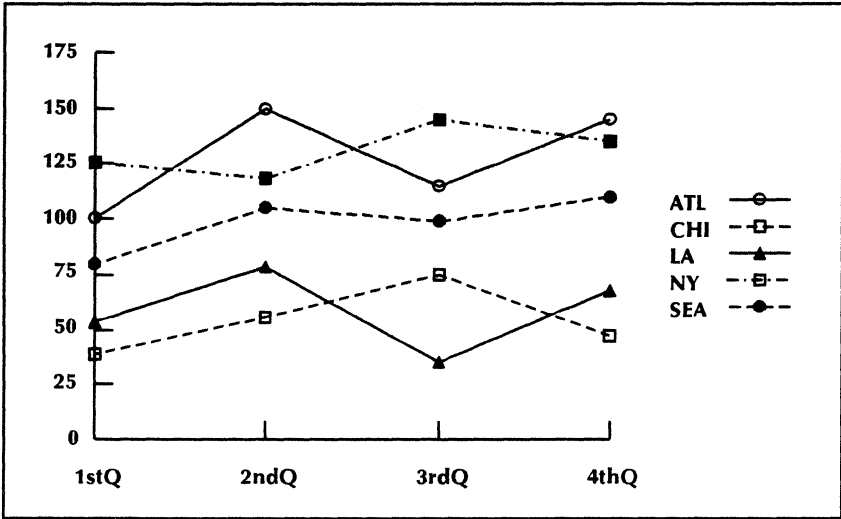
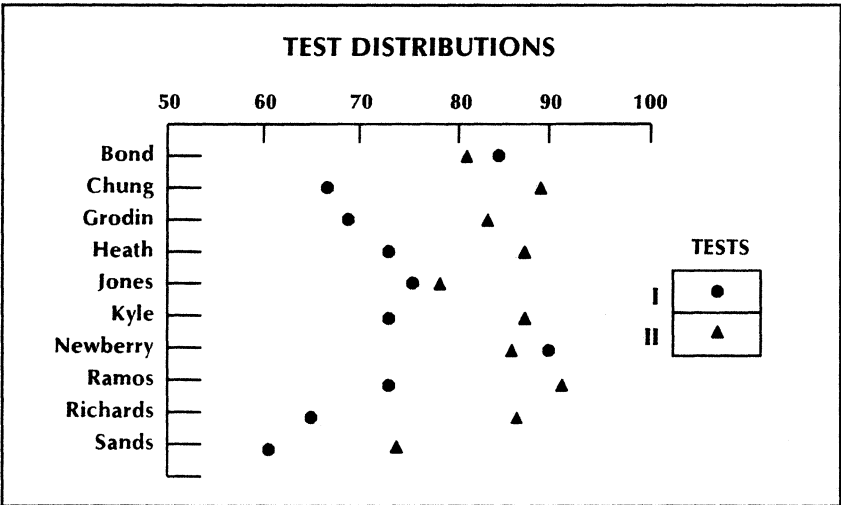

Figure 3-4 A data-point chart



- A *straight-line best-fit chart*, which is a special kind of straight-line pieced chart. It contains a single straight line drawn as close as possible to all the points (Figure 3-5). Use this type of chart to show the general trend of clusters of data points.

Figure 3-5 A straight-line best-fit chart

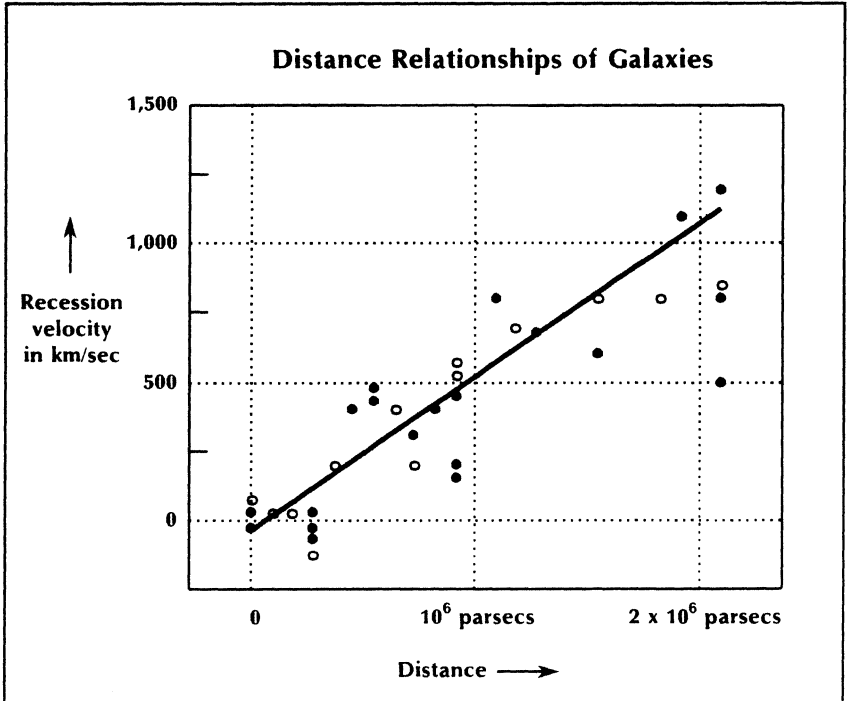

Chart properties

Each type of chart has three associated property sheets:

- The All Data property sheet contains properties that specify the data driving the chart. These properties are similar for all charts.

- The Spatial property sheet contains properties for positioning chart elements. The Spatial property sheet for line and bar charts has an option for selecting a key.
- The Appearance property sheet contains properties that determine how the chart elements appear. For bar and pie charts, the Appearance property sheet contains shading and texture properties. For a line chart, it contains point and line properties and specifies the line chart type (such as straight-line best-fit).

You can set the text properties of chart data by linking the chart to a table in the same document and setting the text properties of the table data.

Chart elements

A chart is a special type of graphics *cluster*, or collection of joined graphic objects. Each chart element—bar set, pie slice, point set, line set, or label—is a graphic object.

When you create a chart, Data-Driven Graphics automatically positions and shades each element.

When you split a chart into its component elements, each element becomes a distinct graphic object. Then you can select and modify each element individually.

When you split a chart into its elements using the <Join> graphics alternate function key, each element has a property sheet (Table 3-1).

When you finish modifying the individual elements, you can join them into a chart again.

Table 3-1 **Property sheets associated with chart elements**

Chart Element	Property Sheet
Bar	Shape
Pie slice	Shape
Point	Point
Line	Line
Label	Text Frame

The “Basic Graphics” chapter in this volume discusses the Shape, Point, and Line properties sheets.

You can make the following modifications to chart elements:

- Change the properties of bar sets, pie slices, point sets, line sets, or labels.
- Move the explanatory key within the chart.
- Move the labels.
- Adjust the spacing between bars on a bar chart.
- Delete bars, pie slices, or lines.
- Enlarge a text frame for a chart label so all the text is visible.

You can also adjust the default appearance of pie slices in your User Profile; refer to the *General User Reference* volume in this library for more information.

Graphics alternate function keys for charts

The graphics alternate function keys in *VP Data-Driven Graphics* are the same as those in *Basic Graphics* (Figure 3-6). Use them to modify a chart or alter individual elements of a chart. Refer to the “Basic Graphics” chapter in this volume for more information on graphics alternate function keys.

Figure 3-6 Graphics alternate function keys



Methods of inserting charts

Like *Basic Graphics*, you can use two methods to insert charts into frames in your documents: the Graphics Special keyboard and the Basic Graphics Transfer Document.

The Graphics Special keyboard

You can place charts in a frame using the Graphics Special keyboard. See the “Basic Graphics” chapter in this volume for information on the Graphics Special keyboard. After you access the keyboard, the following keys insert the different types of charts:

Key	Type of chart
<Z>	Bar chart
<X>	Line chart
<C>	Pie chart

The Basic Graphics Transfer Document

The Basic Graphics Transfer Document (Figure 3-7) also contains bar, pie, and line chart objects, provided Data-Driven Graphics is running. If you retrieve the Basic Graphics Transfer Document

from the Basic Icons divider before loading Data-Driven Graphics, you must log off, log back on, and retrieve the document again to obtain the chart objects.

Figure 3-7 Basic Graphics Transfer Document

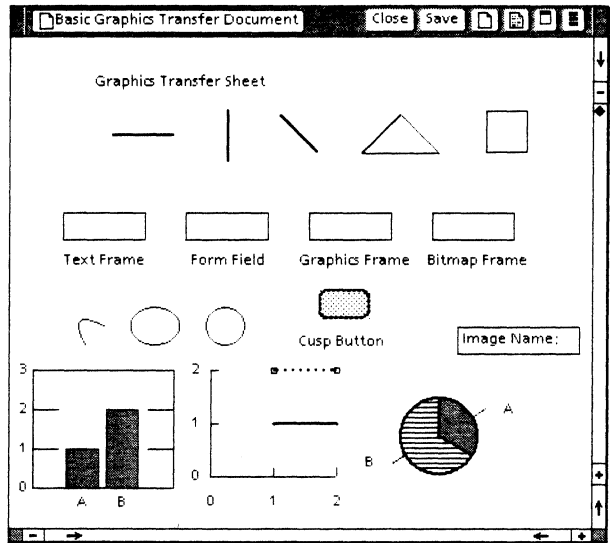

Copy chart objects from the Basic Graphics Transfer Document, or keep a customized set of chart templates in your own transfer document to recreate special charts.

Chart control points

The *control points* for a chart are on an invisible rectangle surrounding the chart. They become visible when you select the chart.

Each chart has eight control points (Figure 3-8). The *guiding point* is larger than the other points.

When you split a chart into its component elements, the control points are no longer visible.

Figure 3-8 **Chart control points**

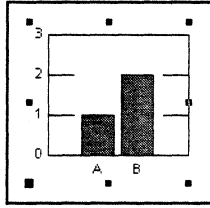

When you rejoin the chart, the control points become visible again.

When you select a chart, be sure the control points are visible.

For more information on control points, see the “Basic Graphics” chapter in this volume.

Chart data table

Every chart in Data-Driven Graphics is driven by a table. For general information about tables, see *Document Editor Reference* volume 4 in this library.

Sources of data

The source data can be in the table in the All Data property sheet or in any table that is in the same document as the chart.

Advantages of using a table in the document, rather than a table in the property sheet, are:

- You can use different text properties in the document table. They will appear in the chart.
- A document table can be automatically converted into a property sheet table; however, the reverse is not true.

You can create your own data table, or you can use a table derived from *VP Spreadsheet*, *VP List Manager*, or *VP Data Capture*.

Note: A data table for a chart cannot have subdivided columns or rows.

Data table labels

The column headers and the first column of a data table are reserved for chart labels. Chart labels can be numbers or text. If you leave a label entry empty, your chart will have labels for all entries except that one.

Data table entries

The entries in the body of a data table must be numbers. The numbers can be positive, negative (except for pie charts), decimal, or in scientific notation.

Note: Entries in a data table for a pie chart must be positive numbers. To create a pie chart, you must fill the first row (the row following the column header) or second column of the table, depending on how you have set the **Data Set Is** property. (Refer to "The All Data property sheet" under "The Pie Chart properties sheet.") The chart does not reflect any other table entries.

If you leave an entry empty in a data table for a bar chart, no bar appears on the chart for that entry. If you leave an entry empty in a data table for a line chart, no point appears on the chart for that entry.

Chart commands

One command specific to Data-Driven Graphics appears in the document auxiliary menu: [Update Charts]. [Update Charts] redraws all charts in the document to reflect changed data in their associated document tables.

Overview of constructing a chart

To construct a basic chart, insert the chart in a graphics frame in your document using the Graphics Special keyboard (or copy a chart from another document). Then complete the All Data property sheet for the chart.

You can construct the table that drives the chart in one of these locations:

- The All Data property sheet
- The document, linking it to the chart

After you build a basic chart, you can modify it in several ways.

Table 3-2 **Ways to modify charts**

To modify:	Use:
The style of the chart, or to add an explanatory key	The Spatial property sheet for the chart
The appearance of chart elements	The Appearance property sheet for the chart
The size, proportions, or position of the chart	The graphics function keys
A single chart element	The <Join> graphics function key to split the chart into individual elements that you can modify
The chart data	The All Data property sheet for the chart, or update the document table and select [Update Charts] from the document auxiliary menu

The Bar Chart properties sheet

The Bar Chart properties sheet controls the content and appearance of bar charts. The **Display** setting enables you to select one of three associated property sheets: the Spatial property sheet, the Appearance property sheet, and the All Data property sheet.

The Spatial property sheet

Use the Spatial property sheet (Figure 3-9) to change the style of a bar chart. The Spatial properties determine the style of the chart axes, the orientation of the bars, and the spacing between groups of bars.

Figure 3-9 The Spatial property sheet for bar charts

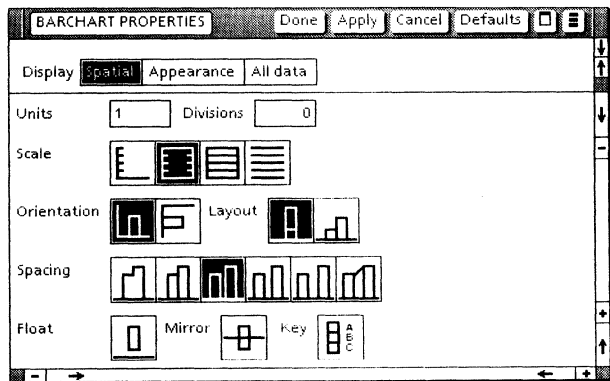

Units

Specifies the increment between major tick marks on the vertical axis. For example, if you enter 5, each successive major tick mark represents a change of five units (5, 10, 15, and so forth).

If you specify an increment so small that it places too many numbers along the vertical axis, Data-Driven Graphics automatically chooses a larger increment.

The default is 1.

Divisions

Specifies the number of divisions between major tick marks on the vertical axis. The divisions are indicated by minor tick marks.

The number of divisions is one more than the number of minor tick marks. To display no minor tick marks, enter 0 or 1. Enter 2 to display one tick mark and two divisions. Enter 3 to display two tick marks and three divisions.

The default is 0.

Scale

Specifies one of four selections as the style of vertical axis for the chart. The default **Scale** setting is the first choice.

Orientation

Specifies vertical or horizontal bars. The default is vertical.

Layout

Appears on the property sheet when the chart contains more than one bar set.

The Layout property specifies whether bar sets are stacked on top of each other or placed side by side. The default is stacked.

For best results, use the stacked layout under the following conditions:

- The bar sets contain labels and you do not use a key. The side-by-side layout causes the labels to overlap.

- You choose the last **Spacing** setting, in which the bars are connected by a line.
- The values are all positive or all negative.

If the table driving the bar chart contains both positive and negative numbers, use the side-by-side layout.

Spacing

Sets the spacing between bars. The first **Spacing** choice, which places the bar sets flush, is not yet available. The other five choices specify increasing amounts of space between the bar sets. As the amount of space increases, the bars become narrower.

Use the last choice only when the chart has a single bar set or when you select a stacked layout. In the last **Spacing** choice, the bars are spaced apart and line “ramps” connect the corresponding sections of each bar.

The default is the fourth choice.

Float

Positions the bars a distance above the horizontal axis. This property is not yet available.

Mirror

Positions the bars across the horizontal axis. This property is not yet available.

Key

Provides an explanatory key that shows the labels and shadings of each bar set. The key appears in the upper right corner of the chart. If you do not fill in the labels in the data table, the key does not have any labels. The default is no key.

The Appearance property sheet

Use the Appearance property sheet (Figure 3-10) to set the shading and texture for a bar set.

Figure 3-10 The Appearance property sheet for bar charts

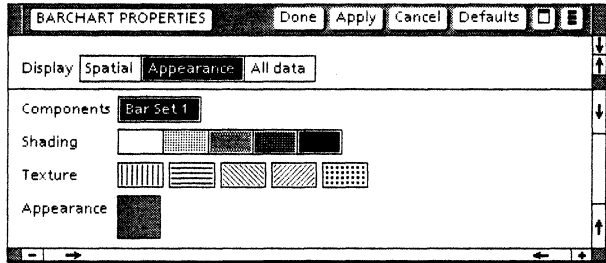

Components

Lists the names of the bar sets so you can select a bar set whose appearance you want to change. If the bar sets do not have labels, the system supplies the names [Bar Set 1], [Bar Set 2], and so on.

Shading

Specifies the shading for a bar set as one of five tones. The default for all bar sets is the second choice.

Texture

Specifies any combination of five textures as the interior pattern for a bar set. The default for all bar sets is no texture.

Appearance

Shows how the combination of **Shading** and **Texture** properties will appear, without applying the newly set properties. Select [Apply] in the property sheet header to view the effects within the chart.

The All Data property sheet

Use the All Data property sheet (Figure 3-11) to specify the table data that is to drive the bar chart. You can enter data in the All Data property sheet, or you can use the All Data property sheet to link the bar chart to a table already in the document.

Figure 3-11 The All Data property sheet for bar charts

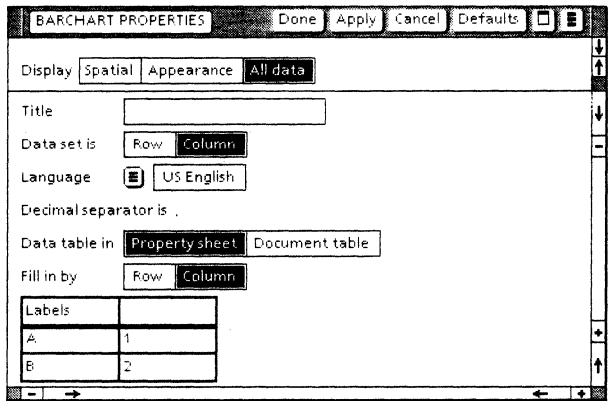

Title

Specifies the title above the chart. The default is no title.

Data Set Is

Specifies whether the labels are determined by the rows or columns of the data table.

When you select [Column], the bottom axis labels are based on the entries in the first column of the table. Each bar set derives its name from the entries in the column headers.

Figure 3-12 shows the resulting bar chart for the table shown in Table 3-3 when [Column] is selected.

When you select [Row], the bottom axis labels are based on the entries in the column headers. Each bar set derives its name from the entries in the first column.

Figure 3-13 shows how the bar chart appears for the sample data table in Table 3-3 when [Row] is selected.

The default is [Column].

Table 3-3 Sample data table

	Brand A	Brand B	Brand C	Brand D
Jan '82	9	3	2	11
Mar '82	10	4	6	6
Jun '82	12	2	9	2
Sep '82	16	3	13	10
Jan '83	8	2	11	7

Figure 3-12 Bar chart for Table 3-3 with Data Set Is set to [Column]

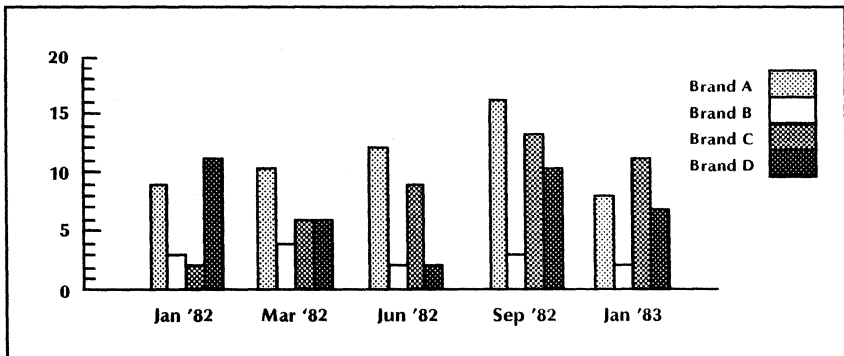
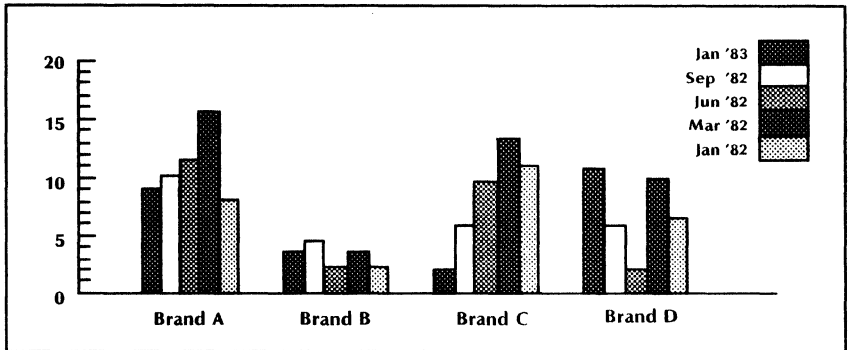

Figure 3-13 Bar chart for Table 3-3 with Data Set Is set to [Row]



Language

Specifies a language that determines the proper decimal and thousands separators. The decimal separator can be either a period or a comma. You select the language from an auxiliary menu.

The default is [US English].

Decimal Separator Is

Displays in read-only mode the type of decimal separator, either a period or a comma, used in the language specified for the **Language** property. The default is a period.

Data Table In

Determines the source of the data table that drives the chart. If you select [Property Sheet], the data comes from the data table in the property sheet. If you select [Document Table], the data comes from a table in the document. The default is [Property Sheet].

Fill In By

Appears when you select [Property Sheet] for the **Data Table In** property so you can specify the effect of pressing <NEXT> when entering data in the data table. If you select [Row], <NEXT> moves the caret to the next cell in the row. If you select [Column], <NEXT> moves the caret to the next cell in the column. The default is [Column].

Table Name

Appears when you select [Document Table] for the **Data Table In** property. The **Table Name** property specifies the name of the table to be used to drive the chart. Enter the name as it appears in the Table property sheet. The table must be in the same document as the chart.

The Pie Chart properties sheet

The Pie Chart properties sheet controls the content and appearance of pie charts. The **Display** setting enables you to select one of three associated property sheets: the Spatial property sheet, the Appearance property sheet, and the All Data property sheet.

The Spatial property sheet

Use the Spatial property sheet (Figure 3-14) to change the style of a pie chart.

Line Width

Specifies one of six line widths for the border of the pie slices. The default is the second choice.

Figure 3-14 The Spatial property sheet for pie charts

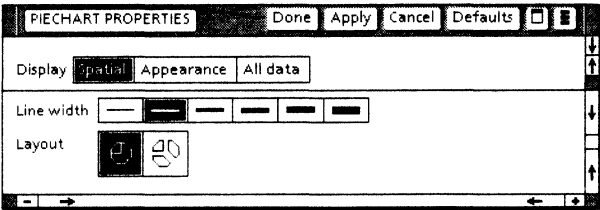

Layout

Specifies either an adjoining or a separated layout for the pie chart. In an adjoining layout, the pie slices are set flush and form a continuous circle. In a separated layout, the pie slices are spaced apart from the center of the circle. The default is adjoining.

The Appearance property sheet

Use the Appearance property sheet (Figure 3-15) to set the shading and texture for a pie slice.

Figure 3-15 The Appearance property sheet for pie charts

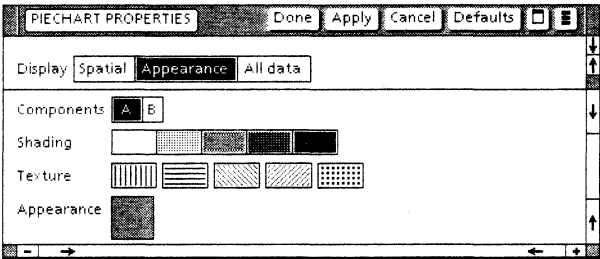

Components

Lists the names of the pie slices so you can select the pie slice whose appearance you want to change. If the pie slices do not have

labels, the system applies the names A, B, and so on.

Shading

Specifies the shading for a pie slice as one of five tones. The default for all pie slices is white.

Texture

Specifies any combination of five textures as the interior pattern for a pie slice. The default is no texture.

Appearance

Shows how the combination of **Shading** and **Texture** properties will appear, without applying the newly set properties. Select [Apply] in the property sheet header to view the effects within the chart.

The All Data property sheet

Use the All Data property sheet (Figure 3-16) to create a table. You can enter data in the All Data property sheet, or you can use the All Data property sheet to link the pie chart to a table already in the same document.

The All Data property sheet is the same for bar, pie, and line charts. Refer to “The All Data property sheet” under “The Bar Chart properties sheet” for a description of the All Data properties. The **Data Set Is** property is different for pie charts.

Data Set Is

Specifies whether the slices are determined by row or column in the data table.

When you select [Column], Data-Driven Graphics generates the pie chart labels from the column headers and builds the pie slices from the values in the first row following the column headers.

Figure 3-16 The All Data property sheet for pie charts

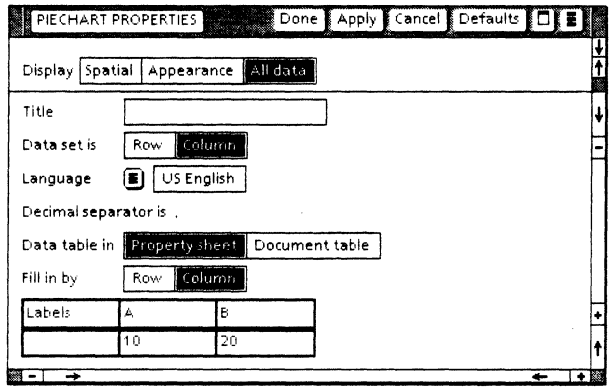
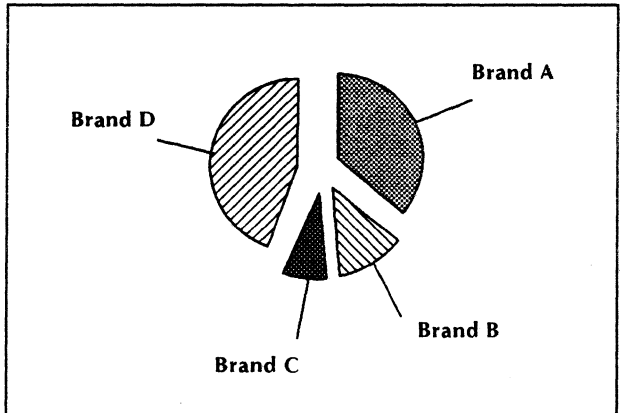

Figure 3-17 shows how the pie chart appears for the sample data table in Table 3-3 when [Column] is selected.

Figure 3-17 A pie chart for Table 3-3 with Data Set Is set to [Column]



When you select [Row], Data-Driven Graphics generates the pie chart labels from the first column and builds the pie slices from the values in the second column.

Figure 3-18 shows how the pie chart appears for the sample data table in Table 3-3 when [Row] is selected.

Figure 3-18 **A pie chart for Table 3-3 with Data Set Is set to [Row]**

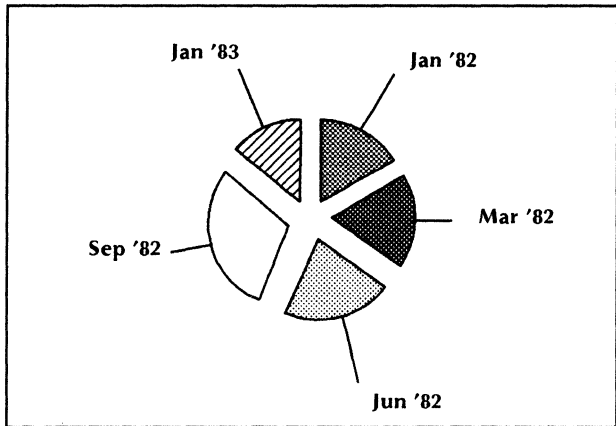

The Line Chart properties sheet

The Line Chart properties sheet controls the content and appearance of line charts. The **Display** setting enables you to select one of three associated property sheets: the Spatial property sheet, the Appearance property sheet, and the All Data property sheet.

The Spatial property sheet

Use the Spatial property sheet (Figure 3-19) to change the style of a line chart. The Spatial properties determine the style of the chart axes, the orientation of the chart, the style of each line or set of points, and whether the chart includes a key.

Figure 3-19 Spatial property sheet for line charts

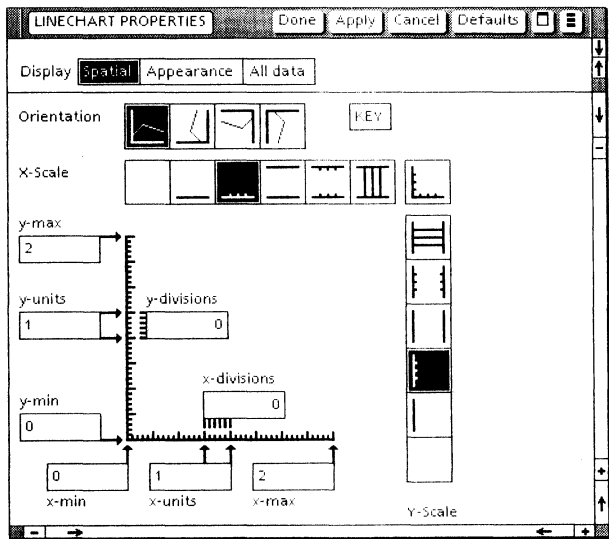

Orientation

Specifies one of four possible rotations for the chart. Every part of the chart except the key is displayed using the selected orientation. The default is the first choice.

Key

Provides an explanatory key that shows the labels and appearance of the line sets or point sets. The key appears in the upper right corner of the chart. If you do not fill in the labels in the data table, the key appears but does not contain labels. The default is no key.

X-Scale, Y-Scale

Specifies the style of the x-axis and y-axis for the chart. The default **X-Scale** setting is the third horizontal choice. The default **Y-Scale** setting is the third choice from the bottom.

Appearance

An unlabeled box at the intersection of the **X-Scale** and **Y-Scale** boxes. It shows you how the combination of **X-Scale** and **Y-Scale** affect the chart axes, without applying the newly set properties. Select [Apply] in the property sheet header to view the effects within the chart.

X-Max, Y-Max

Specifies the maximum values on the x-axis and y-axis. If the largest value in the data table is greater than the **X-Max** or **Y-Max** value, it overrides the **X-Max** or **Y-Max** value on the property sheet and automatically becomes the maximum value on the axis.

If the x-axis labels are text instead of numbers, the **X-Max** property has no effect.

The default value of **X-Max** and **Y-Max** is 0.

X-Min, Y-Min

Specifies the minimum values on the x-axis and y-axis. If the smallest value in the data table is smaller than the **X-Min** or **Y-Min** value, it overrides the **X-Min** or **Y-Min** value on the property sheet and automatically becomes the minimum value on the axis.

If the x-axis labels are text instead of numbers, the **X-Min** property has no effect.

The default value of **X-Min** and **Y-Min** is 0.

X-Units, Y-Units

Specifies the increment between major tick marks on the x-axis and y-axis. For example, if you enter 5 for **X-Units**, each successive major tick mark on the x-axis represents a change of five units (5, 10, 15, and so forth).

If you specify an increment so small that it places too many numbers along the axis, Data-Driven Graphics automatically chooses a larger increment. If the x-axis labels are text instead of numbers, the **X-Units** property has no effect.

The default value of **X-Units** and **Y-Units** is 1.

X-Divisions, Y-Divisions

Specifies the number of divisions between major tick marks on the x-axis and y-axis. The divisions are indicated by minor tick marks.

The number of divisions is one more than the number of tick marks. To display no tick marks, enter 0 or 1. Enter 2 to display one tick mark and two divisions. Enter 3 to display two tick marks and three divisions.

If the x-axis labels are text instead of numbers, the **X-Divisions** property has no effect.

The default value of **X-Divisions** and **Y-Divisions** is 0.

The Appearance property sheet

Use the Appearance property sheet (Figure 3-20) to set the style of the data points and the style of the connecting lines for a chart. You can set a different style for each line set or point set.

Figure 3-20 The Appearance property sheet for line charts

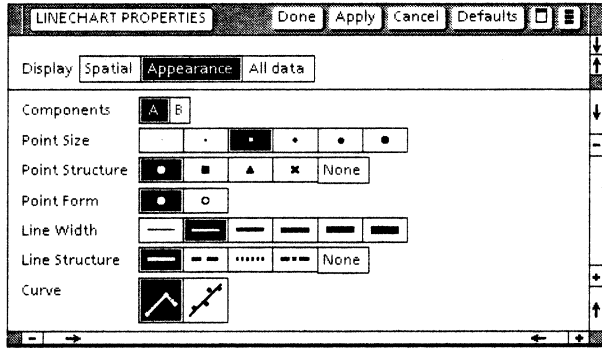

Components

Lists the names of the line sets or point sets so you can select one whose appearance you want to change. If the line sets or point sets do not have labels, the system applies the names A, B, and so on.

Point Size

Specifies one of six point sizes. The default is the third choice.

Point Structure

Specifies one of four point shapes: round, square, triangular, or x-shaped. You can also select [None]. **Point Structure** and **Line Structure** cannot both be [None]. The default is round.

Point Form

Specifies either a hollow or a solid point. The default is solid.

Line Width

Provides a choice of six line widths. The default is the second choice.

Line Structure

Specifies one of four solid, dotted, or dashed lines. Select [None] to create a data-point chart. **Point Structure** and **Line Structure** cannot both be [None]. The default line structure is solid.

Curve

Either connects points by straight lines or draws a single straight line as close as possible to all points. The second method is called a “least-squares best-fit” or “straight-line best-fit.” It provides an average of the point locations.

The default is connecting points by straight lines.

The All Data property sheet

Use the All Data property sheet (Figure 3-21) to specify the table data that is to drive the line chart. You can enter data in the All Data property sheet, or you can use the All Data property sheet to link the line chart to a table already in the same document. Each entry in the data table determines a data point on the graph.

Figure 3-21 The All Data property sheet for line charts

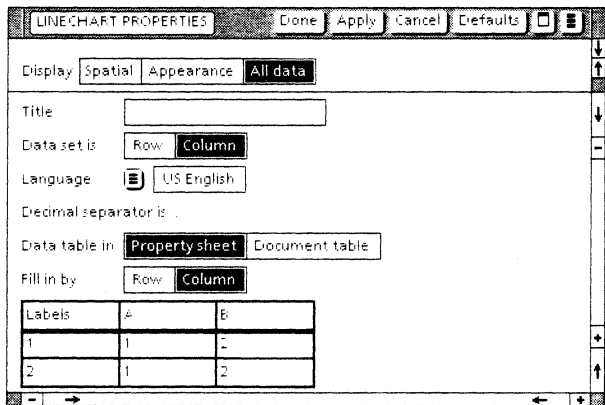

The All Data property sheet is the same for bar, pie and line charts. Refer to "The All Data property sheet" under "The Bar Chart properties sheet" for a description of the All Data properties. The **Data Set Is** property is different for line charts.

Data Set Is

Specifies whether the line sets or point sets are determined by the rows or columns of the data table.

When you select [Column], the x-axis labels are based on the entries in the first column of the table. Each line set or point set derives its name from the labels in the column headers. Figure 3-22 shows how the line chart appears for the sample data table in Table 3-3 when [Column] is selected.

Figure 3-22 **A line chart for Table 3-3 with Data Set Is set to [Column]**

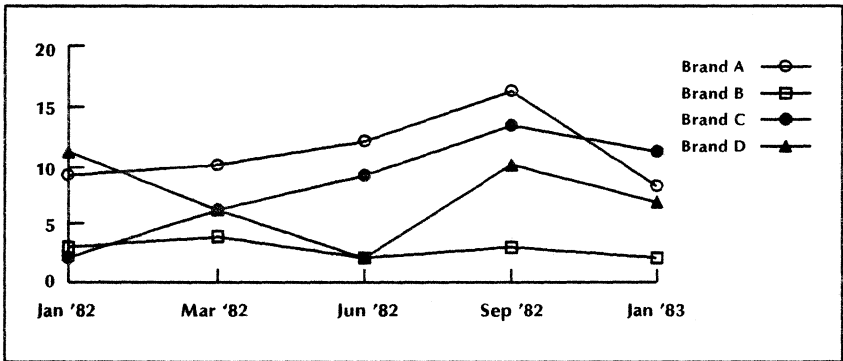

When you select [Row], the x-axis labels are based on the column headers. Each line or set of points derives its name from the entries in the first column. Figure 3-23 shows how the line chart appears for the sample data table in Table 3-3 when [Row] is selected.

Figure 3-23 A line chart for Table 3-3 with Data Set Is set to [Row]

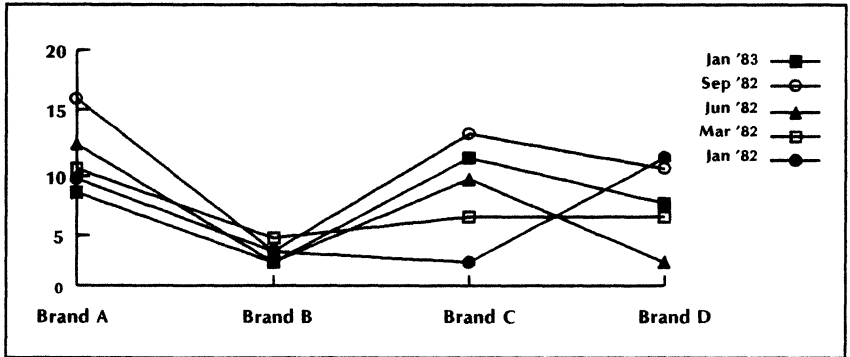

Inserting a chart in a document

1 2 3...

You insert charts into a document the same way you insert other graphic objects into a document. Use this procedure:

1. Insert an anchored graphics frame into the document and enlarge the frame to the desired size.
2. Insert a chart into the frame by using the Graphics Special keyboard or by copying a chart from another document such as the Basic Graphics Transfer Document.
3. Select the chart and enlarge it to the frame size, using either the <Stretch> or <Magnify> key. If you hold down the left mouse button during the stretch or magnify operation, you can watch a "ghost" image of the chart as it enlarges.

Note: Changes made to the chart property sheet may further modify the chart size.

You can also copy charts from one location to another, either from within a document or between two documents. You can copy just the chart or you can copy the entire graphics frame that contains the chart.

Building a chart

1 2 3...

To build a basic chart, display its property sheet and select the All Data, Spatial, and Appearance properties desired for the chart.

Displaying the chart property sheet

1. Select the chart by pointing at one of the chart components and clicking the left mouse button. The chart control points appear.
2. Press <PROP'S>.

Specifying the chart data

1. Display the chart property sheet and select [All Data] as the **Display** setting.
2. To name the chart, type the name in the **Title** box. The title appears at the top of the chart after you select [Apply] or [Done].
3. To specify a different language, use the **Language** property auxiliary menu.
4. To specify whether the chart labels are in the column headers or in the first column of the table, select either [Row] or [Column] as the **Data Set Is** property.

Constructing a table in the chart property sheet

Construct a table in the All Data property sheet for the chart if you do not want the table to appear in your document.

1. Select [Property Sheet] as the **Data Table In** property, if it is not already selected.
2. Select [Row] or [Column] as the **Fill In By** property.
3. Enter the table data.
4. Add table rows or columns by copying them, or add them as you fill in the table using the <NEXT> key.
5. Select [Apply] or [Done].

The procedures for entering data and adding rows and columns are the same as for a table in a document. For more information on tables, see *Document Editor Reference* volume 4 in this library.

Linking a chart with a table in the document

1. Build a table in your document, using the procedures in *Document Editor Reference* volume 4 in this library. Only the table column headers and the first column can contain text. All other columns must contain numerical data.
2. If desired, adjust the text properties of the table information the way you want it to appear in the chart.
3. Select [Document Table] as the **Data Table In** property on the All Data property sheet for the chart.
4. In the **Table Name** box, type the name of the table as it is displayed in the **Name** property on the Table property sheet for the table. The table must be in the same document as the chart.
5. Select [Apply] or [Done].

Note: If you later set **Data Table In** to [Property sheet], the table will appear in the property sheet, without any of the text property settings you set. The original text properties remain in the chart until you edit the property sheet table.

Updating charts

After changing the table data, you can update a chart in two ways:

- Change the property sheet data and select [Done] or [Apply] in the property sheet header. The chart reflects the new changes.
- Edit the table upon which the chart is based and then select [Update Charts] from the document auxiliary menu. The Document Editor updates all charts in the document.

Note: When you edit chart data while in redlining mode, either on the property sheet or by selecting [Update Charts], all the original text in the chart is deleted, no matter how it was previously marked for redlining. All chart text, including labels, key names, and title are marked as being revised. Refer to *Document Editor Reference* volume 4 in this library for redlining information.

Treating numerical labels as text

Sometimes you want numerical labels for a line chart to be treated as text instead of numbers. For example, you want labels representing a series of dates treated as text.

If you want numeric labels treated as text, insert a non-breaking space before one or more of the numbers. Data-Driven Graphics then treats all of the labels as text.

Note: When at least one of the labels in the line chart data table is text or is left empty, Data-Driven Graphics treats all the labels as text.

Changing the appearance of charts

1 2 3...

There are three ways to modify the appearance of an existing chart:

- Specify the properties in the Spatial and Appearance property sheets for the chart. You can do this as you create the chart, or afterwards. For more information on specific chart properties, refer to “The Bar Chart properties sheet,” “The Pie Chart properties sheet,” and “The Line Chart properties sheet” sections earlier in this chapter.

Note: Use the **Appearance** box for a chart to view the result of your changes without having to select [Apply] or [Done]. The **Appearance** box for bar and pie charts is in the Appearance property sheet. The **Appearance** box for line charts is in the Spatial property sheet at the intersection of the **X-Scale** and **Y-Scale** boxes.

- Select the chart and use the graphics alternate function keys, such as <Stretch> or <Magnify>. You can perform the same operations on a chart that you can on any other graphic object. For more information, see the “Basic Graphics” chapter in this volume.
- Split the chart and modify its appearance by modifying the individual elements. Use this method to modify chart labels and to create data-point and straight-line best-fit charts.

Note: Although you can modify the appearance of the chart and its individual elements at any point, it is best to make these types of changes after you have made all your property sheet changes. Applying changes to chart property sheet values causes the chart to be reconstructed; your other modifications are usually reversed when this happens.

Changing individual chart elements

You can split a chart and then modify individual elements. For example, sometimes a text frame is too small for a label. In this case, use the following procedure to split the chart, select the text frame, and enlarge it:

1. Select the chart.
2. Press the alternate function key corresponding to <Join>. The control points disappear. The following message appears in the message area: "The chart has been split."
3. Select a chart element.

Now you can modify the element by changing its properties or copying, moving, deleting, stretching, magnifying, or layering it.

4. Repeat step 3 to modify another element.
5. When you finish modifying the chart, rejoin it by selecting a single chart element and pressing the alternate function key corresponding to <Join>. (If you select more than one element and press <Join>, you create a graphics cluster rather than a chart.)

The control points reappear. The following message appears in the message area: "The chart has been joined."

Creating a data-point chart

Data-Driven Graphics automatically creates a straight-line pieced chart. To change it to a data-point chart, use this procedure:

1. Display the Line Chart properties sheet, and select [Appearance] as the **Display** setting.
2. Select a line for the **Components** property.
3. Select [None] as the **Line Structure** property.
4. Repeat steps 2 and 3 for each line.
5. Select [Apply] or [Done].

Creating a straight-line best-fit chart

Data-Driven Graphics automatically creates a straight-line pieced chart. To create a straight-line best-fit chart:

1. Create a data-point chart as described in "Creating a data-point chart."
2. Select the second choice for the **Curve** property.
3. Select [Apply] or [Done].

4. VP Free-Hand Drawing

VP Free-Hand Drawing is an optional application that supplements the Basic Graphics capabilities of the *VP Document Editor*. *VP Free-Hand Drawing* operates independently of *VP Document Editor*. It provides additional capabilities that let you create free-form lines, add shadings and textures, and create symmetric shapes.

You can include in your documents any illustrations you produce using *VP Free-Hand Drawing* (Figure 4-1).

Figure 4-1 A Free-Hand Drawing example

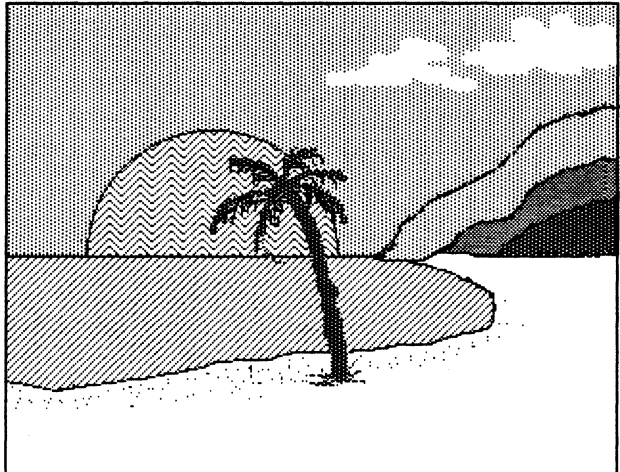

Key concepts of VP Free-Hand Drawing



VP Free-Hand Drawing enables you to draw using the mouse. You can also place and size shapes such as lines, curves, circles, ellipses, and rectangles. You can specify a variety of line thicknesses, rulings, shadings, and textures.

In Basic Graphics your drawings contain objects you can select; in Free-Hand Drawing, your drawings consist only of black or white pixels on your canvas. A *pixel* is a “picture element” and is the term used to refer to a single spot in the image.

You cannot directly select an image on the canvas; to modify your drawings, you use the free-hand drawing menu that appears when you view a canvas in edit mode.

The canvas icon

The *canvas* icon represents the electronic canvas on which you create drawings. It initially appears labeled “Blank Canvas” (Figure 4-2).

Figure 4-2 **Blank Canvas icon**







When you open a canvas, a window displays the contents of the canvas.

Canvas pointers

Free-Hand Drawing uses several pointer shapes that have special meaning inside a canvas (Figure 4-3).

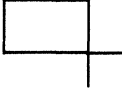
Figure 4-3 **Pointer shapes**

Pointer	Operation
	Moving outside the canvas; for example, to make a menu selection.
	Moving inside the canvas to draw lines and shapes. This shape is called a cross-hair pattern.
	Placing text in a canvas.
	Editing a brush.
	Copying areas of the screen to a canvas using the [Copy Screen] canvas window command.

You can use the *brush* feature to capture images from inside a canvas, or you can use the [Copy Screen] command to capture images from any displayed area of the screen. You cannot use the <COPY> and <MOVE> keys as you would with the Document Editor or Basic Graphics.

Operations using a canvas

A canvas has many characteristics in common with a document. You can:

- Copy a Blank Canvas icon from the Basic Icons divider to your desktop.
- Name your canvas.
- View the canvas in read-only mode.
- Edit the canvas in edit mode.
- Open, close, resize, and reposition the canvas window.
- Scroll across the canvas.
- Store your canvas in a folder, book, or file drawer.
- Copy, mail, or store the canvas on a file service in a networked system. Before storing or mailing the canvas, refer to “Sizing your canvas” later in this chapter.
- Print a canvas either separately or as part of a document.

Reminders in the message area

When you select a line, shape, or support command from the free-hand drawing menu, a prompt appears in the message area indicating the action you need to perform.

For example, suppose you want to draw a straight line:

1. You select the straight line image in the **Line** column of the free-hand drawing menu. In the message area, you see:

“Button down for beginning of line.”

2. You position the pointer where you want to begin the line, and hold down the left mouse button. In the message area, you see:

"Button up for end of line."

3. You move the pointer to the end point of the line you want to draw. You see a "ghost" image of the line as you move the pointer across the canvas.
4. You release the button to draw the line.

The messages displayed help you remember the key steps of the operation.

The free-hand drawing menu

The free-hand drawing menu (Figure 4-4) appears beneath the canvas window when you place the canvas in edit mode. Its columns correspond to the top-row function keys.

Figure 4-4 The free-hand drawing menu

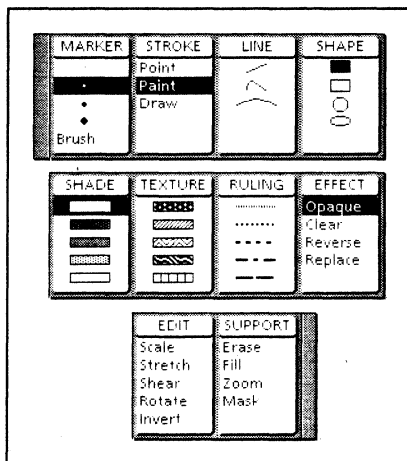

During some operations, the menu disappears. To make it reappear, click the left mouse button inside the canvas. The menu can be moved or

placed on the top or bottom of other windows, independently of the canvas window.

The menu selections you make determine the characteristics you want to use when drawing or painting on the canvas.

You make these four choices each time you edit your canvas:

- Select a marker to draw with.
- Select the type of free-hand **Stroke** to use, or select a predetermined **Line** or **Shape**.
- Select the type of **Shade**, **Texture**, or **Ruling** pattern to use.
- Select the type of **Effect** to use with the selected marker.

Other columns on the free-hand drawing menu enable you to modify a brush or canvas with special support commands.

Note: To avoid unexpected results when you finish any operation, always reselect the default choices for the **Stroke**, **Shade**, and **Effect** columns, as shown in Figure 4-4; namely, [Paint], black, and [Opaque], respectively.

The canvas auxiliary menu

The canvas auxiliary menu (Figure 4-5) appears as a small canvas icon in the Canvas window header. This menu contains additional canvas commands that enable you to perform operations such as sizing the canvas and setting symmetric cursors.

When you select most canvas auxiliary menu commands, an option sheet appears. You fill in the option sheet to execute the command.

Figure 4-5 The canvas auxiliary menu

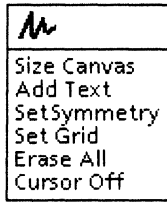

Bitmap frames

A *bitmap frame* is an embedded frame that enables you to include free-hand drawings in your documents. Bitmap frames exist inside graphics frames in documents.

To include a canvas in a document, copy or move the canvas icon into a bitmap frame, or specify the name of the canvas in the Bitmap Frame properties sheet. Refer to the "Bitmap Frame properties sheet" in the "Basic Graphics" chapter in this volume. For general information on frames, see *Document Editor Reference* volume 3 in this library.

The Canvas properties sheet

Associated with each canvas icon is a Canvas properties sheet (Figure 4-6). The Canvas properties sheet defines the canvas name and provides other information about the canvas.

Figure 4-6 The Canvas properties sheet

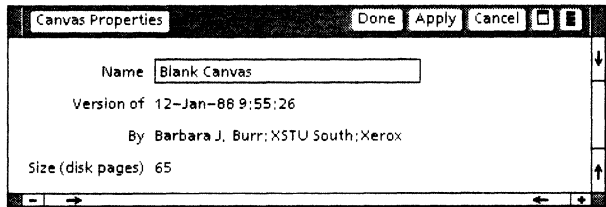

Name

Specifies the name of the canvas. This name appears on the canvas icon and as the title of the canvas window.

Version of

Displays the date and time of either the canvas creation or the last time the canvas was viewed in edit mode.

By

Displays the fully qualified user name of the person who created or last edited the canvas.

Size (disk pages)

Shows the canvas size in disk pages.

The canvas window

Open the window associated with a canvas icon to create free-hand drawing illustrations. Figure 4-7 shows a Blank Canvas window in read-only mode.

Figure 4-7 A Blank Canvas window in read-only mode

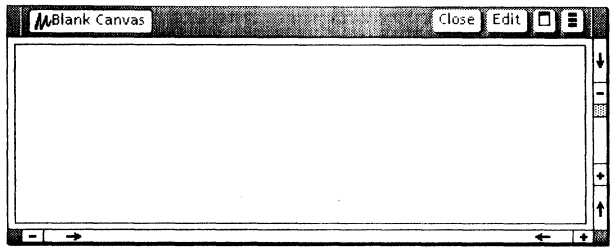

The window commands available depend on whether a canvas is in read-only or edit mode. In read-only mode, you can view the canvas, but you cannot modify it. To draw on the canvas, select [Edit] to place the canvas in edit mode. Figure 4-8 shows a Blank Canvas window in edit mode.

Figure 4-8 A Blank Canvas window in edit mode

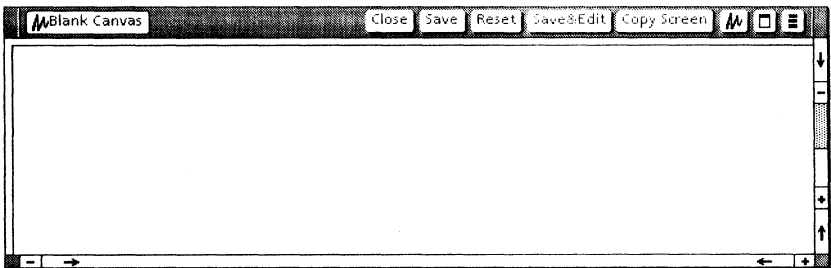

Note: You can open as many canvases as space will allow. You can edit only one canvas at a time.

Canvas window commands

In read-only mode, the commands are:

[Close]

Closes the canvas window.

[Edit]

Enables you to modify the contents of the canvas window.

When you select [Edit], the commands are:

[Close]

Saves all changes made to the canvas since you last selected [Edit], [Save], or [Save & Edit], and closes the canvas window.

[Save]

Saves all changes made to the canvas since you last selected [Edit], [Save], or [Save & Edit], and changes the canvas from edit mode to read-only mode.

[Reset]

Cancels all changes made to the canvas since you last selected [Edit], [Save], or [Save & Edit], and leaves the canvas open in edit mode.

[Save & Edit]

Saves all changes made to the canvas since you last selected [Edit], [Save], or [Save & Edit], and leaves the canvas open in edit mode.

[Copy Screen]

Enables you to create a brush from any rectangular portion of the screen, including any portion outside the canvas.

Canvas auxiliary menu commands

The commands in the canvas auxiliary menu (Figure 4-5) are:

[Size Canvas]

Displays the Size Canvas option sheet for specifying the size of the canvas.

[Add Text]

Displays the Add Text option sheet for placing text in a canvas.

[Set Symmetry]

Displays the Set Symmetry option sheet for creating multiple symmetric images of a marker simultaneously.

[Set Grid]

Displays the Set Grid option sheet for placing an invisible grid on the canvas to aid in aligning marks on the canvas.

[Erase All]

Erases the entire canvas. You must confirm the command in the message area when prompted.

[Cursor Off]

Removes the cross-hair pattern from the screen pointer and changes the command to [Cursor On].

[Cursor On]

Appears in the menu after you select [Cursor Off]. Places the cross-hair pattern on the screen pointer.

Later sections of this chapter describe the option sheets displayed by these commands.

Free-hand drawing menu selections

The free-hand drawing menu appears in a rectangular area beneath the canvas window when you open a canvas and place it in edit mode. The menu contains selections organized into the 10 columns: **Marker**, **Stroke**, **Line**, **Shape**, **Shade**, **Texture**, **Ruling**, **Effect**, **Edit**, and **Support**.

The top-row function keys correspond to the menu. The first eight keys act as *cycling keys* for the first eight columns of the menu. You can cycle through a column of menu selections by repeatedly pressing the function key corresponding to the column. Refer to “Using cycling keys” later in this chapter.

The Marker column

On your electronic canvas, you draw or paint using a *marker* that is either a pen point or a brush selected from the **Marker** column (Figure 4-9). You use the mouse to manipulate the marker.

Figure 4-9 **The Marker column of the free-hand drawing menu**

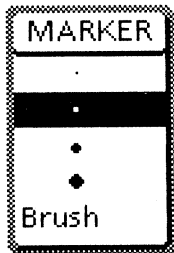

The default selection is the second marker, a small pen point, shown highlighted in Figure 4-9. If you select the [Brush] option, you must then capture a rectangular area of the canvas to use as your brush.

The pen-point markers offer four degrees of thickness. You might think of the thinnest point as the tip of a mechanical pencil and the thickest point as the tip of a large grade-school pencil. Choose the thickness you desire for the shape you want to create.

In addition to the pen points, you can also capture any rectangular area of the canvas to use as a brush. For example, you can draw a star and then “pick it up” in your brush.

With the brush, you can copy the image to another location on the canvas. You can use the star brush to fill the sky with stars. You can create more complex effects by drawing with your brush.

The Stroke column

Selections from the *stroke* column (Figure 4-10) determine the type of “wrist action” you use with your pen point or brush. The default selection is [Paint], shown highlighted.

Figure 4-10 **The Stroke column of the free-hand drawing menu**

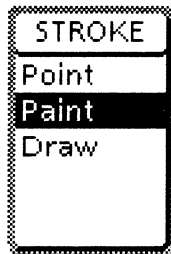

[Point]

Places a single marker image on the canvas when you click the left mouse button. You can use [Point] to copy or “stamp” an image on your canvas. Figure 4-11 shows the [Point] stroke.

Figure 4-11 The [Point] stroke

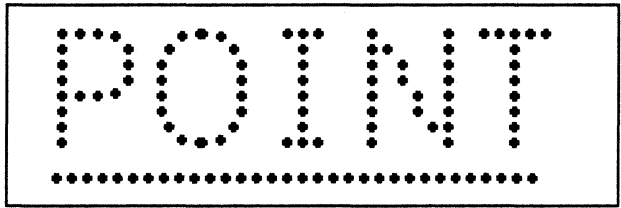

[Paint]

Repeatedly places points as you move the mouse while holding down the left mouse button. When you move the mouse quickly, the points are spaced farther apart, resulting in a dotted line. [Paint] is similar to the effect you create using a dripping paint brush. Figure 4-12 shows the [Paint] stroke.

Figure 4-12 The [Paint] stroke

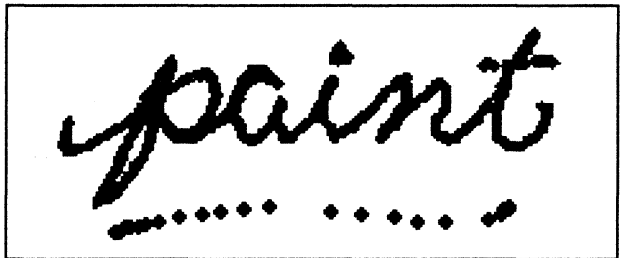

[Draw]

Works like [Paint] except the space between the points is filled in when you release the mouse button. [Draw] produces a solid line, regardless of the speed with which you move the mouse. [Draw] produces lines as you would using a pen or pencil without lifting it off the paper. Figure 4-13 shows the [Draw] stroke.

Figure 4-13 The [Draw] stroke

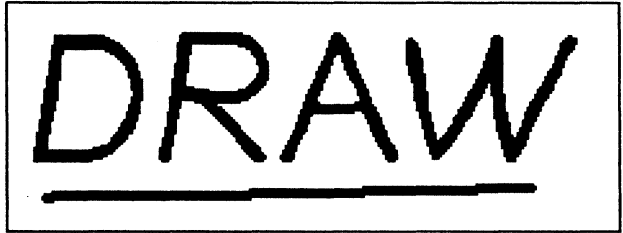

The Line column

The **Line** column contains three different choices (Figure 4-14), enabling you to select defining points. Free-Hand Drawing creates the line or curve you define.

Figure 4-14 The Line column of the free-hand drawing menu

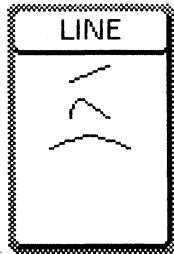

The first choice is a straight line; the second choice is a curve; and the third choice is an arc. A *curve* is a line with a smooth bend, not necessarily symmetrical. An *arc* is symmetrical; every point on an arc is an equal distance from an invisible center.

The Shape column

The **Shape** column contains four choices (Figure 4-15), enabling you to define geometric shapes. Free-Hand Drawing creates the shape you define.

Figure 4-15 **The Shape column of the free-hand drawing menu**

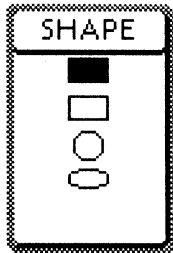

The first choice is a block or filled-in rectangle. The remaining shapes are outlines of a rectangle, circle, and ellipse.

The Shade, Texture, and Ruling columns

The choices in the **Shade**, **Texture**, and **Ruling** columns determine the pattern used for the images you draw or the images you "color in" or fill. You make one choice from these three columns. The default pattern is black in the **Shade** column.

The **Shade** column contains five different shadings: black, three shades of gray, and white (Figure 4-16).

The **Texture** column contains five different patterns or textures (Figure 4-17).

The **Ruling** column contains five different ruling patterns (Figure 4-18).

Figure 4-16 The Shade column of the free-hand drawing menu

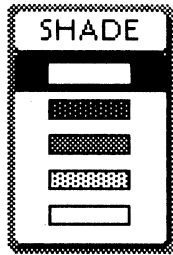

Figure 4-17 The Texture column of the free-hand drawing menu

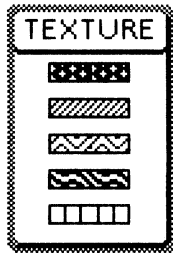
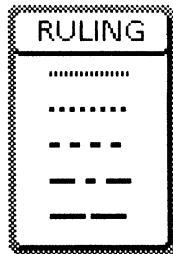

Figure 4-18 The Ruling column of the free-hand drawing menu



The Effect column

The **Effect** column choices determine how your marker is placed on the canvas (Figure 4-19).

Figure 4-19 **The Effect column of the free-hand drawing menu**

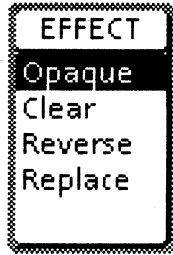

[Opaque]

Enables you to draw any shade or texture over a previously drawn image. For instance, with [Opaque] selected, you can draw white on top of black.

[Clear]

Enables you to layer shades and textures.

[Reverse]

Enables you to overlay shades and textures in reverse video.

[Replace]

Enables you to overlay lines, shapes, or the brush image on other marks on the canvas.

The default value is [Opaque], shown highlighted in Figure 4-19. [Opaque] draws **over** images; [Clear] draws **under** images. You use [Opaque] for most drawing. Figure 4-20 shows the difference between [Opaque] and [Clear].

Figure 4-20 A gray ellipse drawn with [Opaque] and [Clear] selected

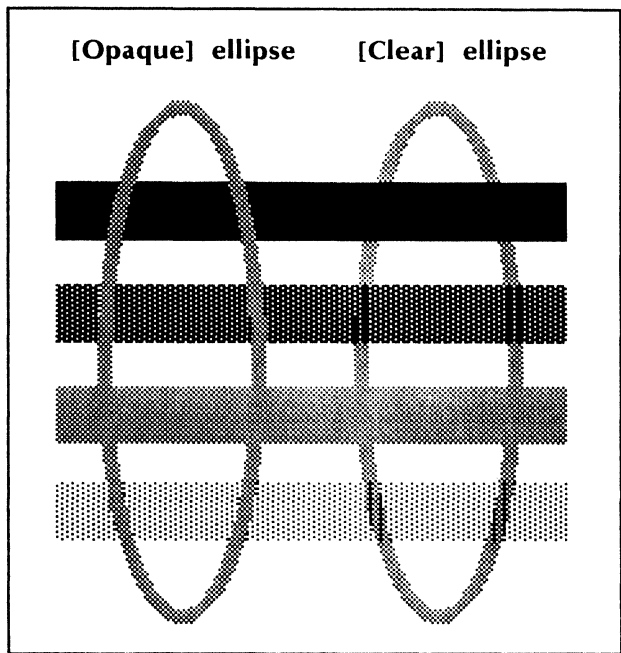

[Reverse] changes black to white and white to black; gray "shows through." [Replace] is the only **Effect** choice that uses the entire rectangular marker. The contents of the entire marker are placed on the canvas; in a sense, nothing underneath it shows through. Figure 4-21 illustrates [Reverse] and [Replace].

The Edit column

The **Edit** column provides five different ways to modify or edit your brush (Figure 4-22). You cannot modify a pen-point marker.

[Scale]

Increases or decreases the size of the brush while maintaining its proportions.

Figure 4-21 A brush with [Reverse] and [Replace] selected

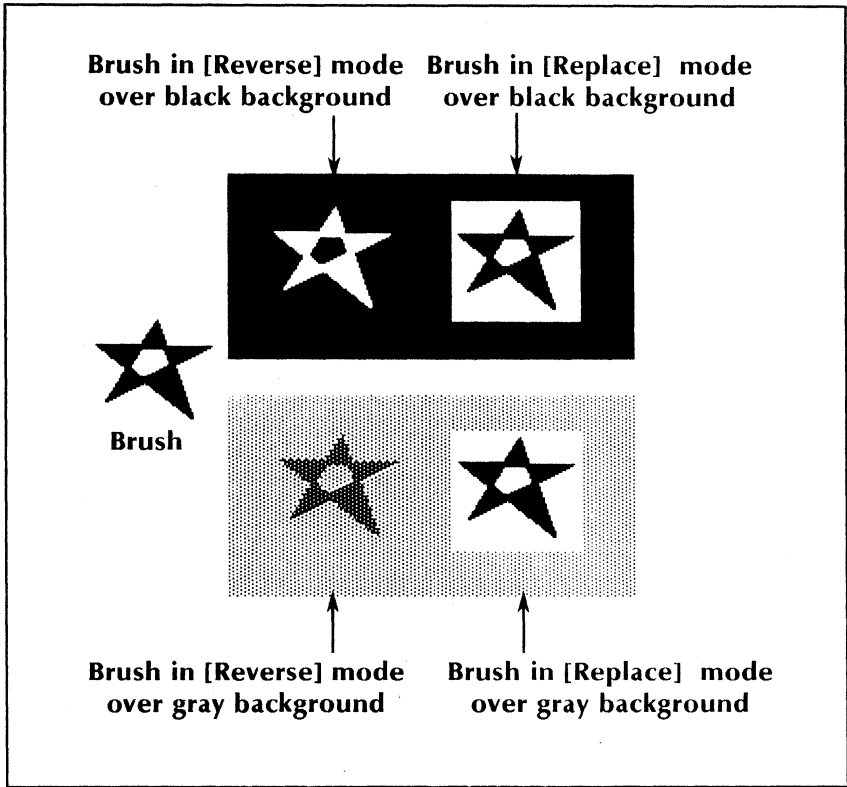

[Stretch]

Stretches the brush. (Proportions can change.)

[Shear]

Causes the brush to lean to the side.

[Rotate]

Changes the orientation of the brush. Rotating a brush in 90-degree increments produces the clearest image.

Figure 4-22 **The Edit column of the free-hand drawing menu**

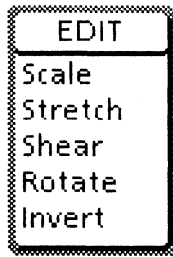

[Invert]

Reverses the black and white pixels in the brush, so that darker shadings become lighter and lighter shadings become darker.

Figure 4-23 illustrates these methods for editing brushes. Refer also to "Modifying a brush and changing its effects under "Using brush" later in this chapter.

The Support column

The **Support** column contains four choices that supplement your Free-Hand Drawing capabilities (Figure 4-24).

[Erase]

Outlines any rectangular region of the canvas and erases the contents of the rectangle.

[Fill]

Adds a shade or texture to any area of the canvas enclosed by a solid line. Pressing <STOP> halts the fill and removes any shade or texture that was added by the fill action. Figure 4-25 shows the use of [Fill].

Figure 4-23 Methods for editing brushes

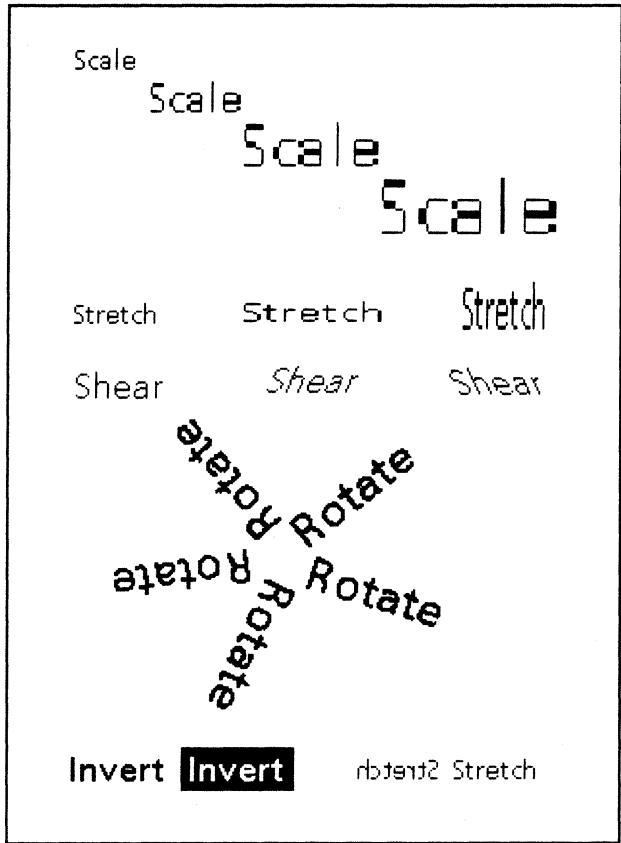

[Zoom]

Magnifies an area of the canvas by a factor of four. The area you select appears in the Magnify window. Use [Zoom] to perform detailed work on an illustration. Figure 4-26 shows the use of [Zoom].

[Mask]

Enables only the areas of the brush that are enclosed by a solid black line to overlay marks on the canvas (Figure 4-27).

Figure 4-24 **The Support column of the free-hand drawing menu**

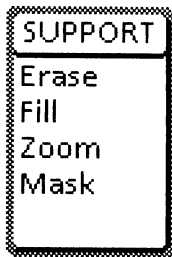

Figure 4-25 **Illustration created with [Fill]**

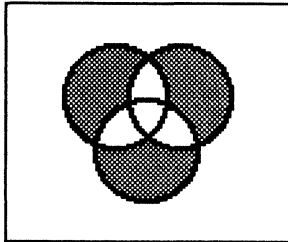
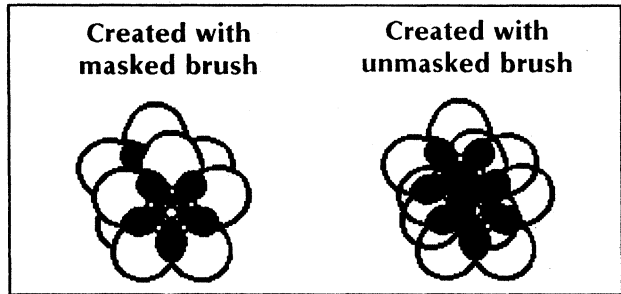

Figure 4-26 **Bottle created with [Zoom]**



The **Support** column choices [Erase], [Fill], and [Zoom] operate on a portion of the canvas. [Mask] operates on the brush. Support commands that affect the entire canvas are in the canvas auxiliary menu.

Figure 4-27 **Overlapping brushes with and without masking**



The Size Canvas option sheet

When you select the [Size Canvas] command from the canvas auxiliary menu, the Size Canvas option sheet appears (Figure 4-28). Use this option sheet to specify the size of a canvas.

Figure 4-28 **The Size Canvas option sheet**

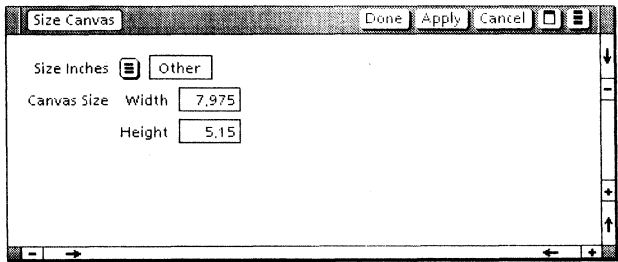

The size of your canvas affects the number of disk pages required to store the canvas, regardless of the amount of black or white in the canvas.

Note: Always make your canvas as small as possible (but not so small that you cut off part of the picture) before copying it into a document,

mailing it, or storing it. Refer to "Sizing your canvas" later in this chapter.

Size Inches

Provides an auxiliary menu from which you select the size of the canvas in inches. Choices are:

[8-1/2 x 11]
[11 x 8-1/2]
[8-1/2 x 14]
[14 x 8-1/2]
[Other]

If you select [Other], Width and Height options appear.

Width

Appears when you select [Other] for the Size option. Enter the width in inches.

Height

Appears when you select [Other] for the Size option. Enter the height in inches.

Note: Width and Height limits depend upon workstation disk space.

The Add Text option sheet

When you select the [Add Text] command from the canvas auxiliary menu, the Add Text option sheet appears (Figure 4-29). Use this option sheet for a quick way to place text images in a canvas. You can add one line at a time. The text is in Modern 12 font and may be up to 80 characters long.

Also refer to the [Copy Screen] command in the canvas window. It provides a way to copy text from documents into your canvas.

Figure 4-29 The Add Text option sheet

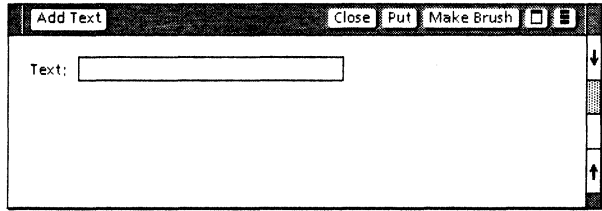

Add Text commands

[Close]

Removes the option sheet.

[Put]

Copies the text from the option sheet to the canvas. The pointer changes to a bull's-eye shape for the operation. You click the left mouse button inside the canvas to place the text at the pointer location. The original contents of the marker are preserved.

[Make Brush]

Copies the text from the option sheet into the brush. You then use the brush to copy the text onto the canvas. The copied text replaces the original contents of the marker.

Add Text option

Text

Provides a field into which you type the text you want to insert into the canvas.

The Set Symmetry option sheet

When you select the [Set Symmetry] command in the canvas auxiliary menu, the Set Symmetry option sheet appears (Figure 4-30). Use the option sheet to draw symmetrical images.

Figure 4-30 The Set Symmetry option sheet with [Mirror] selected

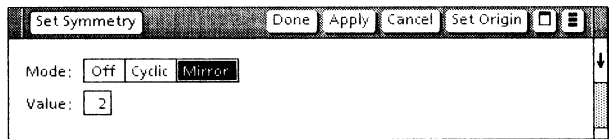

Set Symmetry commands

[Done]

Applies the options you set and removes the option sheet.

[Apply]

Applies the options you set, but keeps the option sheet displayed.

[Cancel]

Removes the option sheet from the desktop without applying any of the options you set since you last selected [Apply].

[Set Origin]

Enables you to select the point of symmetry.

For cyclic symmetry, the point you select is the point around which your markers revolve. For mirrored symmetry, the point you select is the intersection of the lines which act as the mirrors for the pairs of markers.

If you do not select [Set Origin], the default point of symmetry is the center of the canvas.

Set Symmetry options

Mode

Enables you to cancel symmetry or set the type of symmetry to use. The choices are:

[Off]

Indicates no symmetry.

[Cyclic]

Indicates symmetry for each marker about a control point. You may specify the control point with [Set Origin].

[Mirror]

Indicates mirrored symmetry for pairs of markers about lines intersecting a point. You may specify the point with [Set Origin].

The default symmetry is [Off].

Value

Specifies the number of markers or the number of mirrors you want to use for drawing.

For cyclic symmetry, you enter the number of markers. The markers are equally spaced and revolve around a central point. You might use cyclic symmetry to draw the petals of a flower such as a daisy. Figure 4-31 shows a daisy drawn with eight cyclic cursors.

Figure 4-31 Daisy—cyclic symmetry

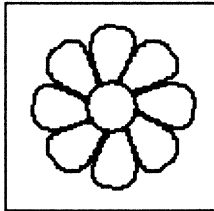

For mirrored symmetry, you enter the number of mirrors that intersect at the point of origin; the number of markers is then twice the number you enter. You may enter a number from 1 to 50. You might use mirrored symmetry to draw the wings of a butterfly. Figure 4-32 shows a butterfly drawn with one mirrored cursor.

Figure 4-32 **Butterfly—mirrored symmetry**

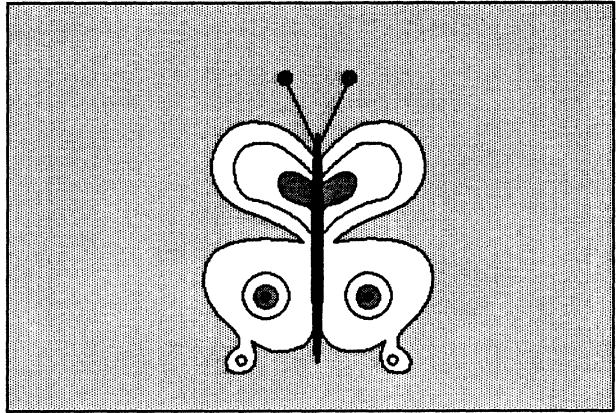

The Set Grid option sheet

When you select the [Set Grid] command from the canvas auxiliary menu, the Set Grid option sheet appears (Figure 4-33). Use this option sheet to activate an invisible *grid* in the canvas. You can use the grid to align images.

Unlike Basic Graphics, the grid is not displayed. The grid option is useful for aligning images, such as the boxes and lines of a flowchart diagram. Refer to “Placing a grid on your canvas” later in this chapter.

Figure 4-33 The Set Grid option sheet with [XY] selected

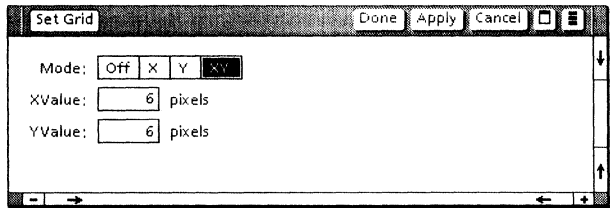

Mode

Enables you to specify the direction of the grid. The choices are:

[Off]

Indicates no grid.

[X]

Places grid points horizontally.

[Y]

Places grid points vertically.

[XY]

Places grid points both horizontally and vertically.

The default grid value is [Off].

XValue

Appears when you select [X] or [XY] for the **Mode** option. This value controls the horizontal distance between grid points. Enter the number of pixels you want between grid points.

YValue

Appears when you select [Y] or [XY] for the **Mode** option. This value controls the vertical distance between grid points. Enter the number of pixels you want between grid points.

Preparing to edit a canvas

1 2 3...

To create a free-hand drawing, you start with an open canvas in edit mode. The procedures to copy a blank canvas to the desktop, name the canvas, open the canvas, and place it in edit mode are the same as those for documents; use the canvas icon instead of a document icon.

Each time you add something to a canvas, you choose your tools from the free-hand drawing menu. If your canvas is open and in edit mode but the free-hand drawing menu is not displayed, you select within the canvas to display the menu. You make four choices from the menu:

- The type of pen point or brush from the **Marker** column
- One stroke, line, or shape (usually [Paint] or [Draw])
- One shade, texture, or ruling pattern (usually black)
- The effect you want your pen point or brush to have on the canvas (usually [Opaque])

For any choice you do not make, Free-Hand Drawing uses the previously selected value or the default value. To avoid unexpected results, you will probably want to reselect the default menu choices after you edit the canvas.

Note: You cannot modify the width, shade, texture, or ruling of marks on the canvas as you do in Basic Graphics. You can erase parts of the canvas and redraw, or you can select [Reset] from the Canvas window header to return to the previously saved version of the canvas.

When experimenting with new features, you should select [Save & Edit] first so you can restore your canvas if necessary.

Using cycling keys

1 2 3...

The first eight top-row function keys act as cycling keys for the first eight columns of the free-hand drawing menu.

Figure 4-34 The cycling keys

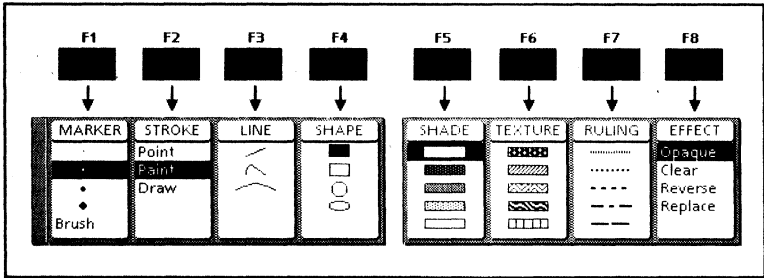

You may find it convenient to use one hand to change menu selections using the alternate function keys, while the other hand is using the mouse to guide the marker across the canvas. The advantage is that you do not need to move the marker away from your drawing to make menu selections.

Drawing points and free-hand lines

1 2 3...

You can draw points and lines using any marker and the [Point], [Paint], or [Draw] selection from the **Stroke** column of the free-hand drawing menu.

Note: Drawing with the left mouse button makes black marks. Drawing with the right mouse button makes white marks (erases). Refer to “Erasing a canvas” later in this chapter.

Drawing points

To draw points, use this procedure:

1. Select [Point] from the **Stroke** column.
2. Position the pointer on the canvas.
3. Click the left mouse button.
4. Repeat steps 2 and 3 wherever you want a point to appear in the canvas.

Drawing free-hand lines

To draw free-hand lines, use this procedure:

1. Select either [Paint] or [Draw] from the **Stroke** column.
2. Position the pointer on the canvas.
3. Hold down the left mouse button, and move the pointer around the canvas to draw the line you want.
4. When finished, release the mouse button.

A dotted line appears as you move the pointer around the canvas. If you selected [Draw] for your stroke, the dotted line is connected when you release the mouse button. You can produce a drawing that resembles a pencil sketch by using short overlapping movements of the mouse.

Drawing straight lines, curves, and arcs

1 2 3...

You can draw straight lines, curves, and arcs by making the appropriate selection from the **Line** column of the free-hand drawing menu.

Drawing a straight line

1. Select the straight line (the first choice) from the **Line** column.
2. Position the pointer where you want the line to start on the canvas.
3. Hold down the left mouse button and move the pointer to define the length and orientation of the line.
4. Release the button.

Drawing a curve

When drawing a curve, you use the pointer to specify the starting point, the peak, and the ending point of the curve (Figure 4-35).

Figure 4-35 **Drawing a curved line**

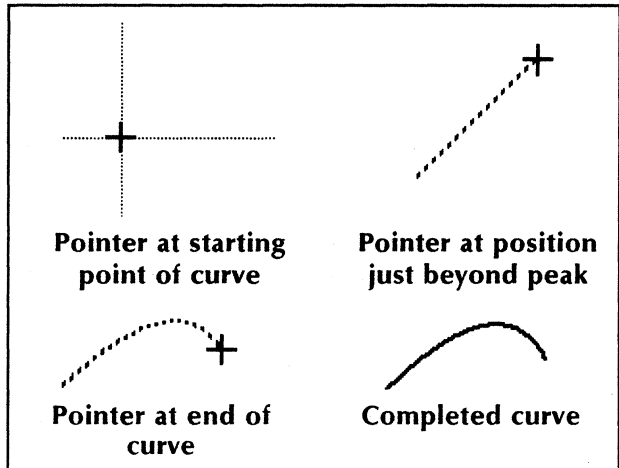

1. Select the curved line (the second choice) from the **Line** column.

2. Move the pointer on the canvas to the starting point of your curve.
3. Hold down the left mouse button, and move the pointer slightly beyond the position where you want the peak of the curve.
4. Release the button.
5. Position the pointer where you want the curve to end.
6. Click the left mouse button to specify the end of the curve.

Drawing an arc

When drawing an arc, you use the pointer to specify the radius, the starting point, and the ending point of the arc (Figure 4-36).

Figure 4-36 Drawing an arc

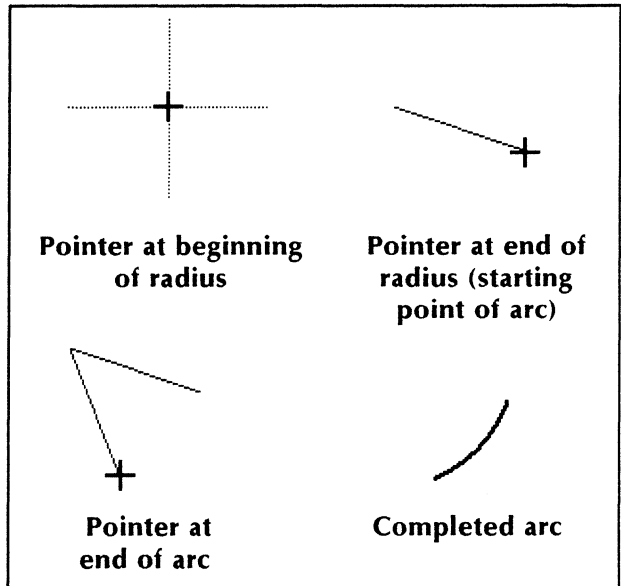

1. Select the arc (the third choice) from the **Line** column.
2. Move the pointer on the canvas to the position that you want to be the center of the circle that defines the arc. This position marks the beginning of the radius.
3. Hold down the left mouse button, and move the pointer to define the end of the radius, where the arc is to begin.
4. Release the button.
5. Hold down the left mouse button again, and move the pointer to define the length of the arc. An image of the arc appears on the screen as you move the pointer.
6. Release the button to draw the arc.

The system always draws the arc clockwise from the point that defines the radius to the ending point of the arc.

Drawing shapes

1 2 3...

You can draw a block, circle, rectangle, or ellipse by selecting the appropriate shape from the **Shape** column of the free-hand drawing menu.

1. Select the shape you want from the **Shape** column.
2. Specify the defining points of the shape by positioning the pointer at the first defining point, holding down the left mouse button, and then moving the pointer to the second defining point and releasing the mouse button.

Defining points for each shape are:

Shape	Defining Points
Block	Diagonally opposite corners of the block.
Circle	Center of the circle and a point along the edge of the circle, defining the radius.
Rectangle	Diagonally opposite corners of the rectangle.
Ellipse	Center of the ellipse and a corner of the rectangle that contains the ellipse.

You see a ghost image of the shape, or the containing shape for the ellipse, as you hold down the button and move the pointer. After you select the second defining point, the system draws the shape.

Using brushes

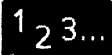

In VP Free-Hand Drawing, you can capture any rectangular portion of the canvas to use as a brush. The area or portion you select becomes the marker which you can use to copy or draw. You can also modify the brush or the effect it creates.

Also refer to “Copying an area from the desktop into a canvas,” later in this chapter, for information on copying areas outside the canvas into a brush.

Creating a brush

To create a brush, you select the diagonally opposite corners of the rectangle enclosing the brush image; then you select the guiding point of the brush (Figure 4-37).

Figure 4-37 Creating a brush

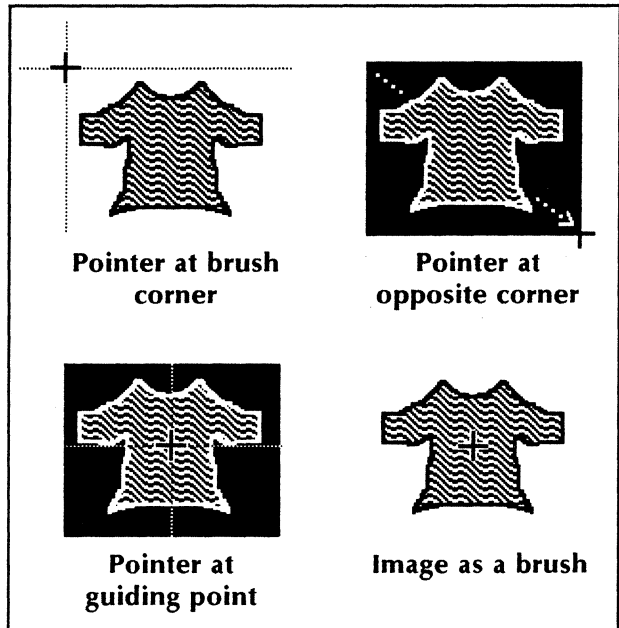

1. Unless you want to use a special shade or effect, make sure [Black] is selected in the **Shade** column and [Opaque] is selected in the **Effect** column.
2. Select [Brush] from the **Marker** column.
3. Position the pointer at a corner of the canvas area that you want to become your brush.
4. Hold down the left mouse button.

5. Move the pointer to the diagonally opposite corner of the canvas area you want to select.
6. Release the mouse button.
7. Position the pointer to select the guiding point of the brush. The *guiding point* is the point on the canvas at the center of the cross-hair shape. You often use the lower right corner or the center of the brush as your guiding point.
8. Click the left mouse button to select the guiding point.

The brush is now your pointer in the canvas, containing a copy of the image you selected. You can place that image on the canvas by clicking the left mouse button anywhere within the canvas, or you can paint or draw with the image.

Note: If your brush appears fuzzy or different from the area of the canvas you selected, check that the **Shade** column selection is black. If you select a different shade, texture, or ruling, your brush appears in that pattern.

9. When you are finished using the brush, select another pen point or brush.

Copying with a brush

You can use the brush to pick up any rectangular area and copy it somewhere else on the canvas.

1. Create a brush or use the currently selected brush.
2. Select [Point] in the **Stroke** column.

Note: Although you can also select [Paint] or [Draw], the image will smudge if you move the mouse as you place the marker on the canvas.

3. Position the brush at the location where you want to copy it.
4. Click the left mouse button.

Modifying a brush and changing its effect

After creating your brush, you can modify its shape or shade, using choices in the **Edit** and **Shade** columns. You can also use the [Mask] choice in the **Support** column to make only the portions of the brush enclosed by solid black lines overlay marks on the canvas.

You can alter the way the brush image makes marks on the canvas with the options in the **Effect** column; see "Layering shades and textures" later in this chapter.

Editing a brush

The five choices in the **Edit** column of the free-hand drawing menu enable you to modify the size, shape, and angle of your brush.

1. Create a brush or use the currently selected brush.
2. Select the editing option you want from the **Edit** column. (Selecting [Invert] changes black to white and white to black in the brush. To return the brush to its previous state, select [Invert] again.) If you did not select [Invert], continue with the next step.
3. Position the pointer on the canvas. The pointer changes to the shape of a brush outline; the brush image itself is invisible.
4. Hold down the left mouse button.

5. Move the mouse until the brush frame takes on the characteristics you want your brush to have, as described below:

Edit Choice	Result
[Scale]	Brush frame achieves the desired size (proportions maintained).
[Stretch]	Brush frame achieves the desired size.
[Shear]	Brush frame achieves the desired tilt.
[Rotate]	Brush frame achieves the desired orientation.

6. Release the left mouse button.

Figure 4-38 shows an example of using this procedure to rotate a brush.

Figure 4-38 **Rotating a brush**

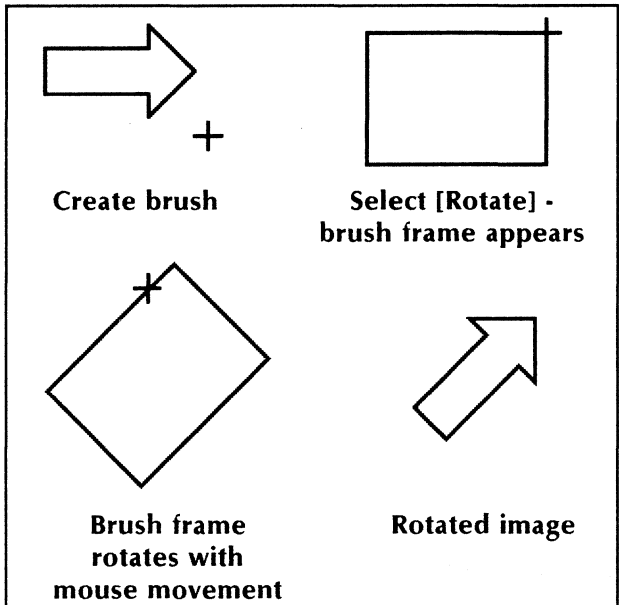

Changing the shade, texture, or ruling pattern of a brush

1. Create a brush or use the currently selected brush.
2. Select a choice from the **Shade, Texture, or Ruling** column.

The dark portions of the brush become the selected shade, texture, or ruling pattern.

Masking a brush

A *mask* enables you to replace or overlay with the enclosed areas of the brush, rather than the entire brush. An enclosed area is an area bounded by a solid black line.

1. Select a brush or use the currently selected brush.
2. Select [Mask] from the **Support** column.
3. Edit the canvas with your brush.

Note: Use Mask only with [Opaque] as the effect.

Layering shades and textures



The choices in the **Effect** column of the free-hand drawing menu change the way a marker places its image. Figures 4-20 and 4-21 earlier in this chapter show the differences between the different **Effect** column choices.

To use an effect, follow this procedure:

1. Select a pen point or [Brush] from the **Marker** column.

2. Select the effect you desire from the **Effect** column:
 - [Opaque] to draw over marks on the canvas.
 - [Clear] to draw under marks on the canvas.
 - [Reverse] to change black to white and white to black.
 - [Replace] to overlay an entire brush image over marks on the canvas.
3. Edit the canvas with your marker.

You can produce an endless array of effects and overlays by using different markers with different effects. Use Figures 4-20 and 4-21 to get started.

Adding shading, texture, or ruling to a drawing

1 2 3...

Use [Fill] in the **Support** column of the free-hand drawing menu to edit your drawing by adding shading, texture, or ruling to an enclosed space on the canvas. Figure 4-39 shows an illustration filled with shading.

Figure 4-39 **Portrait filled with shading**



1. Select the shade, texture, or ruling with which you want to fill the enclosed space.
2. Select [Fill] from the **Support** column.
3. Position the pointer inside the space you want to fill.
4. Click the left mouse button.

Note: If the space is not entirely enclosed with a black line, the shade, texture, or ruling will “spill” into the surrounding area. If you press <STOP> before the fill operation is complete, the canvas returns to the state it was in before you selected [Fill].

Placing a grid on your canvas

1 2 3...

You can place an invisible grid on your canvas to guide the pointer only to points in the grid. Using a grid makes it easy to align objects in your canvas, such as the shapes in a flowchart drawing.

1. Select [Set Grid] from the canvas auxiliary menu. The Set Grid option sheet appears.
2. For the **Mode** option, select the direction you want for the grid.
3. Enter values for the **XValue** and **YValue** options. The number you enter indicates the number of pixels between grid points. The larger the number, the farther apart the grid points will be.
4. Select [Done].

Figure 4-40 shows how you can evenly space the marks made with a brush containing a horizontal line. The **XValue** and **YValue** on the Set Grid option sheet are set to 6.

Figure 4-40 Using a grid on your canvas

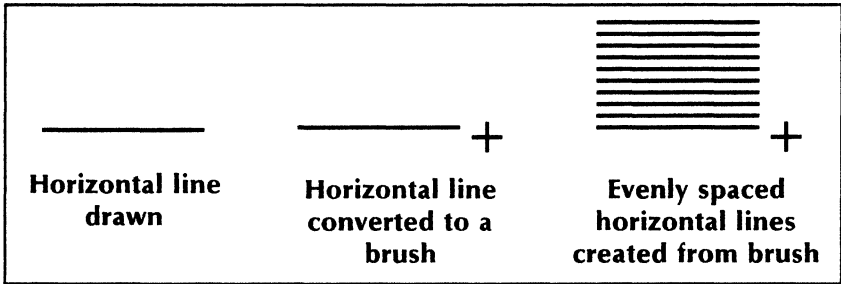

To remove the grid pattern, select [Off] for the **Mode** option.

Creating a mirrored image

1 2 3...

To create a mirrored image, you flip the brush over. First, you make it as small as you can, using [Stretch]; then you stretch it in the opposite direction a distance equal to its original size. Figure 4-41 shows an example of creating a mirrored image.

Figure 4-41 Mirrored image

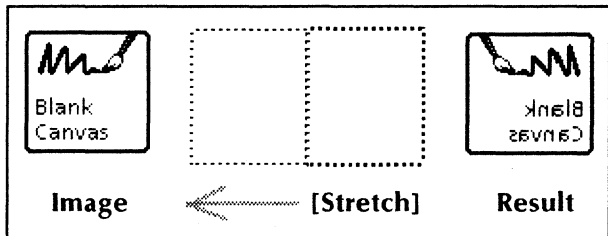

Use this procedure:

1. Create a brush containing the image you wish to mirror.

2. Set the grid, using the Set Grid option sheet. In the example, the grid is set to 10 pixels for both x and y units. Refer to the preceding procedure, "Placing a grid on your canvas," for more information.
3. Select [Stretch] in the **Edit** column of the free-hand drawing menu.
4. Hold down the left mouse button and stretch the brush to make it as small as possible.

Stretch in a horizontal direction to make a horizontal mirrored image, and vertically to make a vertical mirrored image.

5. Continue stretching in the same direction until the brush outline is equal in size to the original brush. (The grid makes sizing the brush easier.)
6. Release the mouse button.

You now have a mirror image of the original brush.

Using symmetry

1 2 3...

Symmetry enables you to draw with up to 100 symmetric images at the same time. You can use either cyclic or mirrored symmetry as you draw. You make selections on the Set Symmetry option sheet before drawing in symmetry mode.

Setting symmetry options

1. Select [Set Symmetry] from the canvas auxiliary menu. The Set Symmetry option sheet appears.
2. Select [Cyclic] or [Mirror] for the **Mode** option, depending on the type of symmetry you want.

3. In the **Value** option, enter the number of cyclic markers you want to use or the number of mirrors. In mirrored symmetry, the number of markers is twice the number of mirrors.
4. To use the default origin (the center of the canvas), skip to step 7. Otherwise, select [Set Origin] from the option sheet header.
5. Position the pointer on the canvas at the point you want to use as the center for symmetry.
6. Click the left mouse button to select the origin.
7. Select [Done].
8. Use the pointer to draw the line, curve, geometric shape, or free-hand shape you want.

Figure 4-42 and 4-43 show different stages of drawings created with cyclic and mirrored symmetry.

Figure 4-42 **Cyclic symmetry drawing using eight markers**

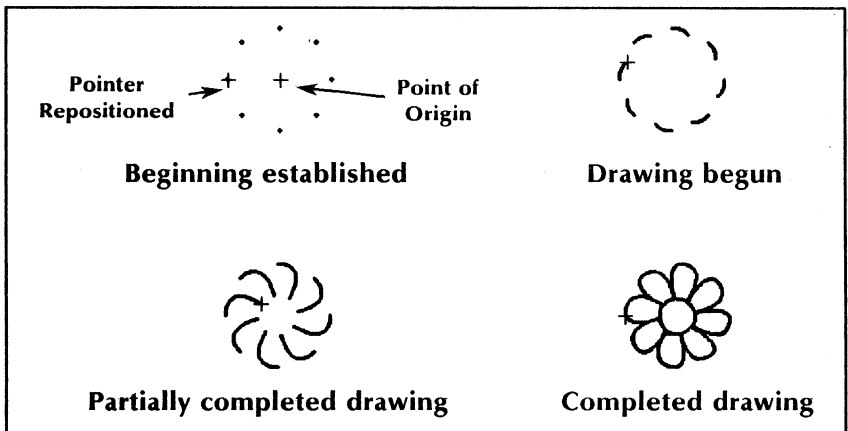
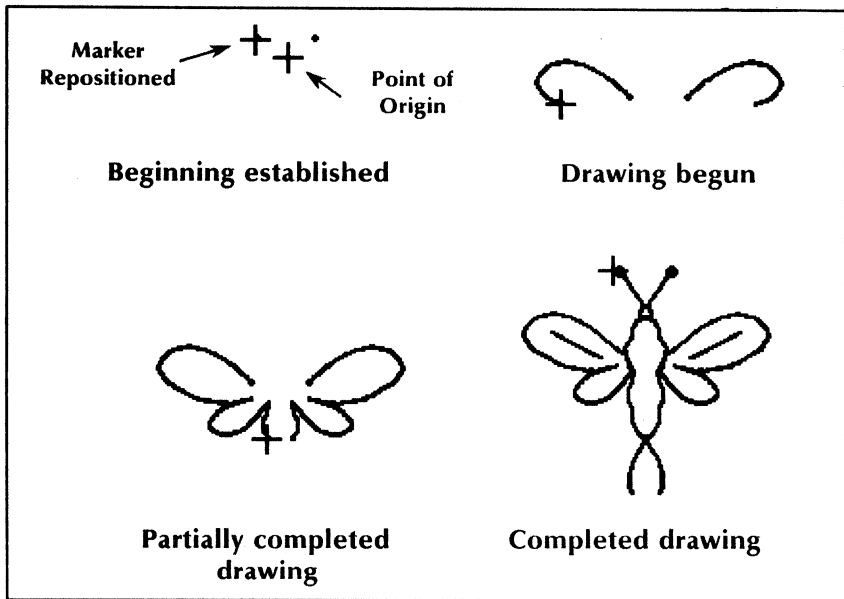

Figure 4-43 **Mirrored symmetry drawing with one mirrored marker**



When you finish, remove the symmetry options as described in the next section.

Removing symmetry options

1. Select [Set Symmetry] from the canvas auxiliary menu. The Set Symmetry option sheet appears.
2. Select [Off] for the **Mode** option.
3. Select [Done].

Getting a close-up view of a canvas

1 2 3...

The [Zoom] choice in the **Support** column of the free-hand drawing menu displays the selected canvas area at four times its actual size. Use [Zoom] to edit the fine details of a drawing by selectively erasing and adding pixels to the canvas.

When you select [Zoom], a separate Magnify window appears containing the enlarged area of the canvas (Figure 4-44). You can resize the window up to the limits of the original window size. You can scroll the window within the boundaries of the original selection.

Figure 4-44 **Magnify window showing part of a canvas**

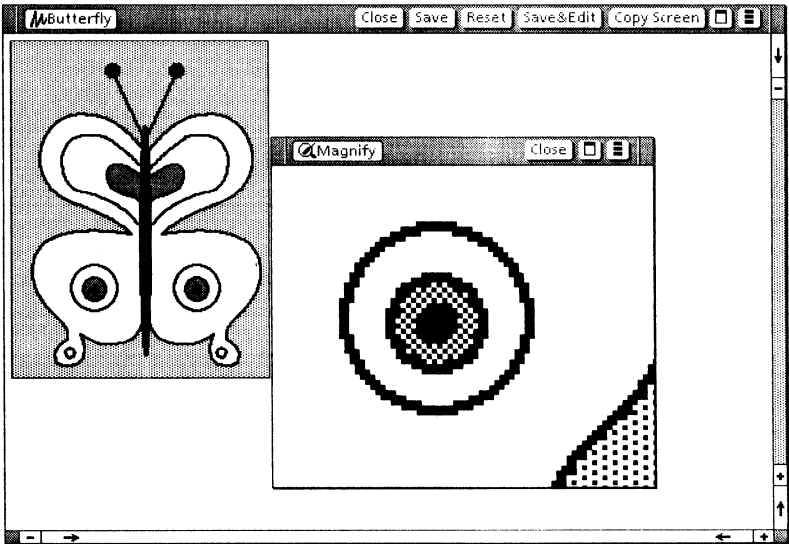

To magnify part of the canvas, use the procedure described below.

1. Select [Zoom] from the **Support** column.
2. Position the pointer at a corner of the rectangular area you want to magnify.
3. Hold down the left mouse button.
4. Move the pointer to the diagonally opposite corner until the area you want to magnify is contained within the displayed rectangle.
5. Release the mouse button.
6. Edit the contents of the Magnify window that appears. When you edit in the Magnify window, you can draw or erase one dot, or pixel, of the canvas at a time. Click the left mouse button to insert a black dot. Click the right button to erase a black dot (insert a white dot).
7. When finished, select [Close] from the Magnify window header.

You can move your canvas and Magnify windows so that the magnified area of the canvas is in view. That way, you can see the effects on the canvas of your editing in the Magnify window.

Copying an area from the desktop into a canvas

1 2 3...

You can copy any section of the desktop, including any open window, into a canvas using the [Copy Screen] command. Use this procedure:

1. Select [Copy Screen] from the window header of the destination canvas. The pointer changes to an upper-left-corner angle bracket.
2. Position the angle bracket at the upper left corner of the area you want to copy.

3. Click either mouse button. A lower-right-corner angle bracket appears.
4. Position the angle bracket at the lower right corner of the area you want to copy.
5. Click either mouse button.
6. Move the screen pointer into the canvas to see the image. (If the free-hand drawing menu is not displayed, you need to click the left mouse button to see the image.) You may have to wait a few seconds before the image appears.
7. The image is now a brush. Position the brush where you want it to appear.
8. Click the left mouse button to place the image on the canvas.

Adding text to an illustration

1 2 3...

You can add text to your illustration, using the [Add Text] command in the canvas auxiliary menu or the [Copy Screen] command in the canvas window. The [Add Text] command lets you add a single line of text in the Modern font. The [Copy Screen] command lets you copy several lines of text in any font from any open document.

Note: Whether you use [Add Text] or [Copy Screen], once the characters are placed in the canvas, they are no longer the fine-tuned fonts of the Document Editor, nor can they be edited. They are simply marks on a canvas.

To achieve the look of fine-tuned fonts in text that is editable, place your canvas in a document bitmap frame and overlay embedded text frames on the bitmap frame. Refer to “Placing a canvas in a document,” later in this chapter, and, for embedded frames, the “Basic Graphics” chapter of this volume.

Adding a single line of text—one font

Use the [Add Text] command as a quick method to place one line of text in a canvas.

1. Select [Add Text] from the canvas auxiliary menu. The Add Text option sheet appears.
2. Type the text into the box for the **Text** option.
3. If you need to preserve your marker, select [Put] from the option sheet header. The pointer changes to a bull’s-eye pattern. Position the bull’s-eye above where you want to add the text, and click the left mouse button. The text appears at the bottom right of the bull’s-eye.
4. If you do not need to preserve your marker, select [Make Brush] from the option sheet header. The pointer changes to a brush consisting of the text you entered. Position the brush where you want to add the text, and click the left mouse button. The text appears on the canvas.
5. Select [Close] from the option sheet header.

Adding several lines of text—multiple fonts

Another method of adding text to an illustration is to copy the text from a document to a canvas.

1. Create a document with the text you want to add to your illustration. Be sure to specify the **Font**, **Size**, **Face**, and other properties.

2. Leave the document open on your desktop.
3. Use the procedure described in “Copying an area from the desktop into a canvas,” earlier in this chapter, to copy the text from the document into your canvas.

Erasing a canvas

1 2 3...

You can erase the entire canvas with one command, or you can erase various portions of the canvas.

Erasing the entire canvas

1. Select [Erase All] from the canvas auxiliary menu.
2. Select [Yes] when the message “Erase all?” appears in the message area.

Erasing part of the canvas

You can erase (make white marks on) parts of a canvas by using one of three methods:

- **Right mouse button:** Use a marker and the right mouse button to erase small, irregular areas of the canvas.
- **[Erase]:** Use the [Erase] choice in the **Support** column of the free-hand drawing menu to perform a single rectangular erase. This method preserves the image you had in your marker before you erased; however, you must select [Erase] before each [Erase] operation.

- **Block choice:** Use the block choice in the **Shape** column, combined with the white shading in the **Shade** column of the free-hand drawing menu, to repeatedly erase rectangular areas. Although this method does not preserve your marker image, you do not have to reselect the block choice before each erase.

Erasing irregular areas of the canvas

You can erase (make white marks on the canvas) by holding down the right mouse button and using the marker as an eraser. Use this technique with the pen-point markers when you want to erase small, irregular areas. You also use this technique with [Zoom].

To erase an irregular area of the canvas, use this procedure:

1. Select your marker.
2. Select [Paint] in the **Stroke** column.
3. Position the pointer in the area you want to erase.
4. Hold down the right mouse button.
5. Move the pointer over the area you want to erase. That area of the canvas becomes blank as you move the pointer.
6. When finished, release the button.

Note: Instead of [Paint], you can select any item in the **Stroke**, **Line**, or **Shape** column (except the block choice), and draw with the right mouse button. For example, if you select the second pen-point marker and the line choice and draw with the right mouse button, you will erase (or draw) a thin white line.

Alternatively, you can use the white shading from the **Shade** column, along with the left mouse button. In this case, remember to return the **Shade** selection to black when you are finished.

Erasing a rectangular area while retaining the marker

You can erase any rectangular area of the canvas using the [Erase] choice in the **Support** column of the free-hand drawing menu. Use this procedure:

1. Select [Erase] in the **Support** column.
2. Position the pointer at one corner of the area you want to erase.
3. Hold down the left mouse button.
4. Move the pointer to the diagonally opposite corner, so that the area you want to erase is contained in the rectangle that appears.
5. Release the mouse button.

The contents of the rectangular area are white, and the image you had in your marker before beginning the erase reappears in the marker. Choose this method when you are erasing only a few areas and you wish to retain your marker.

If you want to erase another rectangular area, either repeat the entire procedure or use the method described in the next section.

Erasing several rectangular areas

You can erase several rectangular areas sequentially. Using the method described in the previous section retains your marker. Using the block choice in the **Shape** column and white shading in the **Shade** column of the free-hand drawing menu requires repeating fewer selections, but does not retain your marker.

1. Select the block choice in the **Shape** column.
2. Select the white shading in the **Shade** column.
3. Position the pointer at one corner of the area you want to erase.
4. Hold down the left mouse button.
5. Move the pointer to the diagonally opposite corner, so that the area you want to erase is contained in the rectangle that appears.
6. Release the mouse button.
7. Continue steps 3 through 6 until you finish erasing rectangular areas of your canvas.
8. If desired, reselect the black shading and desired marker when you are finished.

Sizing your canvas

1 2 3...

To save disk space, you should make your canvas as small as possible, without cutting off part of the image. A canvas takes up the same amount of space whether the canvas appears empty or full (that is, whether it has white pixels or black pixels). Unreduced canvases can add thousands of extra disk pages to the size of your document.

You can also adjust the size of your canvas to improve the presentation of your illustration.

Positioning the contents of the canvas

1. Put the contents of your canvas in a brush. Select the brush so that it contains all of the image but little or no extra "white space."
2. Select [Opaque] in the **Effect** column and [Point] in the **Stroke** column.

3. Select [Erase All] from the canvas auxiliary menu. Confirm the command by selecting [Yes] in the message area. The canvas is erased, but the entire canvas image is still in your brush.
4. Position your brush on the canvas at the desired location. To save disk space, position it so that the brush image is as close as possible to the top left corner of the canvas.
5. Click the left mouse button.
6. Adjust the size of the canvas, as explained in the next section, so that it is slightly larger than your brush image.

Adjusting the size of a canvas

1. Select [Size Canvas] from the canvas auxiliary menu. The Size Canvas option sheet appears.
2. Select the size you want from the auxiliary menu for the **Size Inches** option.
3. If you selected [Other], enter values for the **Width** and **Height** options.
4. Select [Done].

Note: If you make the canvas too small, and the image appears to be cut off, increase the value of **Width** or **Height**. Your entire image still appears unless you saved the canvas after applying the **Width** and **Height** values. (If you close or save the canvas, only the image that appears within the new canvas boundaries is saved.)

Removing and replacing the cross-hair pattern

1 2 3...

1. If the cross-hair pattern appears in the canvas, select [Cursor Off] from the canvas auxiliary menu so that the cross-hair is not displayed.
2. If the cross-hair pattern does not appear in the canvas, select [Cursor On] from the canvas auxiliary menu to display it.

Placing a canvas in a document

1 2 3...

To incorporate a free-hand drawing canvas into a document, you insert a bitmap frame into an anchored graphics frame in the document. You can insert the bitmap frame from the Document Special keyboard, or you can copy it from the Basic Graphics Transfer Document.

1. Size the canvas as small as possible. See "Sizing the canvas" for more information.
2. Close the canvas.
3. Make sure the document in which to insert the canvas is open and in edit mode.
4. Insert a graphics frame into the document.
5. Insert a bitmap frame into the graphics frame.
6. Adjust the size of the frames to accommodate the incoming canvas. You can perform this step before or after you copy the canvas into the document.
7. Select the canvas icon.
8. Press <COPY>.
9. Position the pointer inside the bitmap frame and click the left mouse button.

Note: If an image already exists in the bitmap frame, a message asks you to confirm replacing it with your new canvas image.

The image appears inside the bitmap frame.

See the "Basic Graphics" chapter and *Document Editor Reference* volume 3 in this library for information on inserting and adjusting frames.

A canvas inside a bitmap frame is in read-only mode and cannot be modified. However, you can combine the image with other embedded frames and graphic objects within the anchored graphics frame. You can also return the contents of the bitmap frame to a canvas for editing, as described in the next section.

Recreating a canvas from a bitmap frame

1 2 3...

Although you cannot edit the contents of a bitmap frame, you can recreate the canvas that was originally copied into the bitmap frame. Follow this procedure:

1. Select the bitmap frame.
2. Press <COPY>.
3. Select an empty place on the desktop.

A canvas icon named "Anonymous," containing the image in the bitmap frame, appears on the desktop. You can open the canvas and edit it as needed.

This appendix contains an alphabetical list of the commands discussed in this volume. For definitions of commands specific to other applications, see the *General User Reference* volume, *Document Editor Reference* volume 3, or other reference volumes in this library.

[Add Text]

Displays the Add Text option sheet for placing text in a canvas. (Canvas auxiliary menu command for *VP Free-Hand Drawing*)

[Apply]

Causes the changes made in a property or option sheet to take effect, and keeps the property or option sheet displayed.

[Cancel]

Cancels all changes made to the property or option sheet since you displayed it or selected [Apply], [Done], or [Start]. Also, [Cancel] closes the property or option sheet.

[Close]

Closes a window.

[Copy Screen]

Enables you to create a brush from any rectangular portion of the screen, including any portion outside the canvas. (Canvas window command for *VP Free-Hand Drawing*)

[Cursor Off]

Removes the cross-hair pattern from the screen pointer and changes the command to [Cursor On]. (Canvas auxiliary menu command for *VP Free-Hand Drawing*)

[Cursor On]

Appears in the menu after you select [Cursor Off]. Places the cross-hair pattern on the screen pointer.

[Defaults]

Sets all properties to their ViewPoint default settings, and keeps the property sheet displayed.

[Done]

Applies the properties or options currently selected and removes the property or option sheet.

[Edit]

Enables you to modify the contents of a document or canvas window.

[Erase All]

Erases the entire canvas. (Canvas auxiliary menu command for *VP Free-Hand Drawing*)

[Make Brush]

Copies text from the Add Text option sheet into the brush. You then use the brush to copy the text onto the canvas. The copied text replaces the original contents of the marker. (Add Text option sheet for *VP Free-Hand Drawing*)

[Put]

Copies text from the Add Text option sheet to the canvas. You click the left mouse button inside the canvas to place the text at the pointer position. The original contents of the marker are preserved. (Add Text option sheet for *VP Free-Hand Drawing*)

[Redisplay]

Updates the display of the contents of a window, reflecting any changes to those contents made since you opened the window.

[Reset]

Restores all properties to the settings in effect when you displayed the property sheet or selected [Apply]. The property sheet remains displayed. In a document or canvas window, cancels all changes made to the document or canvas since you last selected [Edit], [Save], [Save & Edit], or any pagination command except [Paginate Displayed Pages], and leaves the document or canvas open in edit mode.

[Save]

Saves the contents of a document or canvas to the hard disk, and returns the document or canvas to read-only mode.

[Save & Edit]

Saves the contents of a document or canvas to the hard disk, and leaves the document or canvas open in edit mode.

[Set Grid]

Displays the Set Grid option sheet for placing an invisible grid on the canvas to aid in aligning objects. (Canvas auxiliary menu command for *VP Free-Hand Drawing*)

[Set Origin]

Enables you to select the point of origin for symmetric cursors. (Set Symmetry option sheet for *VP Free-Hand Drawing*)

[Set Symmetry]

Displays the Set Symmetry option sheet for creating multiple symmetric images of a marker simultaneously. (Canvas auxiliary menu command for *VP Free-Hand Drawing*)

[Size Canvas]

Displays the Size Canvas option sheet for specifying the size of the canvas. (Canvas auxiliary menu command for *VP Free-Hand Drawing*)

[Update Charts]

Modifies charts in the document to reflect changed data in their associated document tables. The data table must be located in a document, not in a chart property sheet. (Document auxiliary menu command for *VP Data-Driven Graphics*)

B. Anchored and embedded frames

Table B-1 in this appendix tells which types of frames can be:

- Entered from the Document Special keyboard
- Entered from the Graphics Special keyboard
- Anchored
- Embedded

It also tells whether or not you can:

- Copy or move the anchor into a graphics frame to create an embedded frame.
- Copy or move the embedded frame into the main body of text to create an anchored frame.

Note: For CUSP button, equation, footnote, and Pro Illustrator frames, the *VP CUSP Buttons*, *VP Equations*, footnotes (*VP Long Documents*), and *Xerox Pro Illustrator* software, respectively, must be loaded and running.

Table B-1. Anchored and embedded frames

Frame	Entered from Document Special keyboard	Entered from Graphics Special keyboard	Can be anchored frame	Can be embedded in graphics frame	Can be moved or copied as anchored frame into graphics frame	Can be moved or copied as embedded frame from graphics frame into text
Bitmap	N	Y	N	Y	N/A	N
CUSP Button	Y	Y	Y	Y	Y	Y
Equation	Y	N	Y	N	N	N/A
Footnote	Y	N	Y	N	N	N/A
Graphics	Y	Y	Y	Y	Y	Y
Graphics field	N	Y	N	Y	N/A	N
Image	N	Y	N	Y	N/A	N
Pro Illustrator	Y	N	Y	N	N	N/A
Table	Y	Y	Y	Y	Y	Y
Text	Y	Y	Y	Y	Y	Y

A

- Add Text option sheet, 4-25
 - displaying, 4-25
 - illustration, 4-26
- All Data property sheet, see specific chart property sheet
- alternate function keys, see *graphics alternate function keys*
- anchor, 2-2
 - see also *graphics frames*
 - verifying that a frame and anchor are linked, 2-39
- anchored frames, see *graphics frames*
- Appearance property sheet, see specific chart property sheet
- arc, 2-9, 4-15, 4-35—4-36
 - see also *drawing*
- arrowheads, 2-23

B

- bar chart, see *charts*
- Bar Chart properties sheet, 3-13
 - All Data property sheet, 3-17
 - Appearance property sheet, 3-16
 - Spatial property sheet, 3-13
- bar set, 3-2, 3-14—3-18
- Basic Graphics capabilities, 2-1
- Basic Graphics Transfer
 - Document, 3-8
 - illustration, 2-12
 - using the Basic Graphics Transfer Document, 2-40
- Bitmap Frame properties sheet, 2-25, 4-7

Bitmap Frame property sheet, 2-25, 2-31

illustration, 2-31

Bitmap property sheet, 2-25, 2-33

bitmap frames, see *graphics frames*

border, 2-16—2-17, 2-35, 2-38

brush, 4-3, 4-19, 4-37

changing the effect of a brush, 4-42

copying with a brush, 4-39

creating a brush, 4-38

creating a mirrored image, 4-45

editing a brush, 4-40

masking a brush, 4-42

using brushes, 4-37

C

- canvas, 4-2
 - adding shading, texture, or ruling, 4-43
- canvas window, 4-9
 - illustration, 4-9
- copying an area from the desktop into a canvas, 4-50
- effect of canvas size on number of disk pages, 4-24
- erasing a canvas, 4-53
- placing a canvas in a document, 4-58
- positioning the contents of the canvas, 4-56
- preparing to edit a canvas, 4-31

- recreating a canvas from a
 bitmap frame, 4-59
- sizing a canvas, 4-56
- using brushes, *see brush*
- zooming in (getting a
 close-up view), 4-49
- canvas auxiliary menu, 4-6, 4-11
- canvas icon, 4-2
- Canvas properties sheet, 4-8
 illustration, 4-8
- captions, 2-18
- chart control points, *see*
 control points
- charts
 - axis, 3-13—3-15, 3-17—
 3-18, 3-25—3-27
 - bar chart, 3-2
 illustration, 3-2
 - building a chart, 3-32
 - changing chart appearance,
 3-36
 - chart elements, 3-6, 3-12
 changing individual
 chart elements, 3-37
 modifications to chart
 elements, 3-7
 - chart labels, 3-11, 3-22,
 3-24, 3-33, 3-36
 treating numerical
 labels as text, 3-35
 - constructing a table in the
 chart property sheet,
 3-33
 - copying a chart, 3-32
 - data-driven charts, 3-1
 - data-point chart, 3-3—3-4,
 3-29, 3-38
 creating, 3-38
 illustration, 3-4
 - data table, 3-10
 data table entries, 3-11
 data table labels, 3-11
 sample data table, 3-18
 tables, 3-10—3-11, 3-34
 subdivided, 3-11
 - displaying a chart property
 sheet, 3-33
 - divisions, 3-14, 3-27
 - inserting a chart, 3-32
 - key, 3-7, 3-12, 3-15, 3-26
 - layout, 3-3, 3-14, 3-21
 side-by-side layout,
 3-14—3-15
 stacked layout, 3-14—
 3-15
 - line charts, 3-3
 types of line charts, 3-3
 - linking a chart with a table
 in the document, 3-34
 - methods of inserting charts,
 3-8
 - pie charts, 3-3
 illustration, 3-3
 - redlining effects on charts,
 3-35
 - source table, 3-10
 - specifying chart data, 3-33
 - straight-line best-fit chart,
 3-5, 3-38
 creating, 3-38
 illustration, 3-5
 - straight-line pieced chart,
 3-3—3-5, 3-38
 illustration, 3-4
 - updating charts, 3-35
- charts alternate function keys,
 see graphics alternate
 function keys
- clusters, 2-7, 2-48—2-49, 2-51,
 3-6, 3-37
 see also chart elements
 under *charts*
 joining objects into a
 cluster, 2-48
 splitting a cluster, 2-48
- coincident control points, *see*
 control points
- commands
 - [Add Text], 4-11
 - [Copy Screen], 4-10
 - [Cursor Off], 4-11
 - [Cursor On], 4-11
 - [Defaults], 2-14, 2-17
 - [Erase All], 4-11

[Make Brush], 4-26
 [Put], 4-26
 [Set Grid], 4-11
 [Set Origin], 4-27
 [Set Symmetry], 4-11
 [Size Canvas], 4-11
 [Update Charts], 3-11—
 3-12, 3-35

control points, 2-7, 3-9
 chart control points, 3-9
 illustration, 3-10
 coincident control points,
 2-8—2-9
 examples of pinned points
 and guiding points, 2-9
 guiding points, 2-7, 3-9
 handle, 2-7
 pinned points, 2-8, 2-45

copying
 copying graphic objects,
 2-49
 copying properties using
 <SAME>, 2-54
 copying small or layered
 objects, 2-50
 using brushes, see *brush*
 <Curve>, see *graphics*
 alternate function keys
 curves, see *graphic objects*
 cyclic symmetry, see *symmetry*
 cycling keys, 4-12, 4-32
 using cycling keys, 4-32

D

data-driven charts, see *charts*
 data-point chart, see *charts*
 data set, 3-2
 data table, see *charts*
 deleting
 deleting a graphic object,
 2-50
 deleting a graphics frame,
 2-38

draw-through method, see
 selecting graphic objects
 under *graphic objects*

drawing
 arcs with Free-Hand
 Drawing, 4-35
 curves with Free-Hand
 Drawing, 2-41, 4-34
 lines with Basic Graphics,
 2-41
 lines with Free-Hand
 Drawing, 4-33
 objects with Basic Graphics,
 2-41
 points with Free-Hand
 Drawing, 4-33
 shapes with Free-Hand
 Drawing, 4-36
 straight lines with Free-
 Hand Drawing, 4-34
 using brushes, see *brush*

E
 embedded frames, see *graphics*
 frames

F
 File Name property sheet, see
 Image Frame properties
 sheet
 frame anchor, see *anchor*
 frame properties, see specific
 frame properties sheet
 frames, see *graphics frames*
 free-hand drawing menu, 4-5
 Edit column, 4-19
 Effect column, 4-18
 illustration, 4-5
 Line column, 4-15
 Marker column, 4-12
 Ruling column, 4-16
 selections, 4-12
 Shade column, 4-16
 Shape column, 4-16
 Stroke column, 4-13
 Support column, 4-21
 Texture column, 4-16
 function keys, see *graphics*
 alternate function keys

G

- graphic objects, 2-4
 - adding text labels to Basic Graphics illustrations, 2-55
 - appearance
 - opaque and transparent objects, 2-6
 - shadings and textures, 2-15
 - border, 2-16—2-17, 2-35, 2-38
 - changing the property sheet for one or more graphic objects, 2-51
 - chart elements, see *charts*
 - charts as objects, 3-1
 - copying a graphic object, 2-49
 - copying properties using the <SAME> key, 2-54
 - cross-hatching, 2-15
 - curves, 2-43, 2-15
 - apex, 2-43—2-44, 2-47
 - ending point, 2-44, 4-34—4-36
 - peak, 2-43, 4-34—4-35
 - starting point, 2-43—2-44, 4-34—4-35
 - deleting a graphic object, 2-50
 - initial properties vs. default properties, 2-13
 - inserting a graphic object in a frame, 2-39
 - joining objects, see *clusters*
 - layered objects, 2-5
 - manipulating, 2-49
 - modifying appearance, 2-51
 - moving or copying a graphic object, 2-49
 - moving or copying a small or layered object, 2-50
 - opaque, 2-5
 - overlapping, 2-5
 - position
 - bottom, 2-5, 2-50
 - top, 2-5, 2-51
 - properties, 2-14, 2-21—2-22, 2-24
 - property sheet summary, 2-13
 - repositioning objects in a stack, 2-50
 - resizing an object using <Stretch> and <Magnify>, 2-52
 - selecting graphic objects, 2-45
 - canceling selections, 2-48
 - draw-through method, 2-46—2-47
 - select-adjust method, 2-46, 2-48
 - when two objects are very close or touching, 2-45
 - shading, 2-5, 2-15, 3-6, 4-16
 - stacked objects, 2-5, 2-7, 2-51
 - texture, 2-5, 2-15, 3-6, 4-16
 - transparent, 2-5
 - types of graphic objects, 2-4
- graphics alternate function keys, 2-6
 - <Curve>, 2-7, 2-41, 2-43
 - <Grid>, 2-7, 2-56—2-57
 - illustration, 2-6
 - <Join>, 2-7, 2-48, 3-6, 3-12, 3-37
 - <Line>, 2-7, 2-41—2-42
 - <Magnify>, 2-6, 2-18, 2-36—2-37, 2-51—2-53, 3-32, 3-36
 - for resizing an object, 2-53
 - <Stretch>, 2-6, 2-18, 2-36—2-37, 2-51—2-53, 3-32, 3-36
 - for resizing an object, 2-52

- <Top>, 2-7, 2-51
 - Graphics Frame properties
 - sheet, 2-16
 - displaying, 2-16
 - Graphics Frame property sheet, 2-16
 - illustration, 2-16
 - Grid property sheet, 2-20
 - illustration, 2-20
 - using the Grid property sheet, 2-56
 - graphics frames
 - alignment, 2-19
 - anchored frames, 2-2
 - bitmap frames, 4-7
 - entering, 2-25
 - recreating a canvas from a bitmap frame, 4-59
 - spots per inch (spi), 2-30
 - border, 2-16—2-17, 2-35, 2-38
 - copying a frame, 2-35
 - deleting a frame, 2-38
 - embedded frames, 2-2
 - inserting an embedded frame, 2-39
 - purposes of embedded frames, 2-3
 - types of embedded frames, 2-2
 - image frame, 2-11, 2-28, 2-32, 2-57—2-58
 - inserting, 2-31
 - inserting a frame, 2-34
 - modifying a frame, 2-36
 - types of graphics frames, 2-2
 - verifying that a frame and anchor are linked, 2-39
 - Graphics Special keyboard, 2-10, 3-8
 - displaying, 2-10
 - elements of optional applications, 2-10
 - illustration, 2-10
 - illustration of keyboard objects, 2-11
 - using the Graphics Special keyboard, 2-40
 - grid, 2-7, 2-20, 2-56, 4-29
 - alignment of guiding point, 2-20
 - <Grid>, see *graphics alternate function keys*
 - grid points, 2-21, 4-30, 4-44
 - placing a grid on your canvas, 4-44
 - using the grid, 2-56
 - Grid property sheet, see *Graphics Frame properties sheet*
 - guiding point, see *control points*
- H**
- handle, see *control points*
 - hardware requirements, xvii
- I**
- image (IMG) file, 2-28, 2-32—2-33, 2-57—2-58
 - Image Frame properties sheet, 2-31
 - File Name property sheet, 2-32—2-33
 - illustration, 2-33
 - Image Frame property sheet, 2-32
 - illustration, 2-32
 - IMG file, see *image (IMG) file*
- J**
- <Join>, see *graphics alternate function keys*
 - joining objects, see *clusters*
- K**
- key, see *key* under *charts keyboards*, see *Graphics Special keyboard*
 - keys, see *cycling keys*; *graphics alternate function keys*

L

- labels, see *chart labels* under *charts*
- <Line>, see *graphics alternate function keys*
- line chart, see *charts*
- Line Chart properties sheet, 3-24
 - All Data property sheet, 3-29
 - Appearance property sheet, 3-27
 - Spatial property sheet, 3-25
- Line properties sheet, 2-22
 - displaying, 2-22
 - illustration, 2-22
- line set, 3-3
- lines
 - drawing lines, see *drawing*
 - line ends (illustration), 2-23

M

- <Magnify>, see *graphics alternate function keys*
- magnifying objects, see *resizing an object using <Stretch> and <Magnify>* under *graphic objects*
- markers, 4-12
 - see also *brush*
 - changing the effect of a marker by layering shades and textures, 4-42
 - pen-point, 4-12—4-13, 4-31
- mask, see *masking a brush* under *brush*
- menus, see *canvas auxiliary menu; free-hand drawing menu*
- mirrored, see *symmetry*
- moving
 - moving a graphics frame, 2-35
 - moving graphic objects, 2-49

O

- objects, see *graphic objects*
- option sheets, see *specific option sheet*

P

- pie chart, see *charts*
- Pie Chart properties sheet, 3-20
 - All Data property sheet, 3-22
 - Appearance property sheet, 3-21
 - Spatial property sheet, 3-20
- pie slice, 3-3
- pinned point, see *control points*
- pixels, 4-2, 4-49
- Point properties sheet, 2-21
 - displaying, 2-21
 - illustration, 2-21
- point set, 3-3
- pointer shapes
 - bull's eye, 4-26, 4-52
 - cross-hair, 4-3, 4-11, 4-39, 4-58
 - removing and replacing, 4-58
 - illustration of Free-Hand Drawing pointer shapes, 4-3
- points, 2-4
 - see also *drawing*
- print resolution, see *scaling*
- properties of graphic objects, 2-13
 - see also *specific property sheet*
- property sheet header, 2-14
- property sheets, see *specific property sheet*

R

- remote image files, 2-28, 2-33
 - merging a document with a remote image file, 2-28, 2-31

printing a remote image
file, 2-57
scanned, 2-31, 2-57
resolution, see *print resolution*
scaling under *scaling*
reverse video, 4-18

S

scaling, 2-25, 2-27, 2-29, 2-57
automatic scaling, 2-25—
2-26, 2-29
 illustration of
 properties, 2-26
fixed scaling, 2-25—2-26
 illustration of
 properties, 2-26
print resolution scaling,
2-26
 illustration of
 properties, 2-26
Set Grid option sheet, 4-29
 displaying, 4-29
 illustration, 4-30
Set Symmetry option sheet,
4-27
 displaying, 4-27
 illustration, 4-27
shading (inside a graphic
object), 2-14—2-15, 2-24
Shape properties sheet, 2-24
 displaying, 2-24
 illustration, 2-24
Size Canvas option sheet, 4-24
 displaying, 4-24
 illustration, 4-24
slice, see *pie slice*
software requirements, xvii
source table, see *data table*
under *charts*
Spatial property sheet, see
 specific chart property sheet
splitting a chart, see *chart*
 elements under *charts*
splitting a cluster, see *clusters*
straight-line best-fit chart, see
charts

straight-line pieced chart, see
charts
<Stretch>, see *graphics*
 alternate function keys
stretching an object, see
resizing an object using
 <Stretch> and <Magnify>
 under *graphic objects*
symmetry, 4-27
 cyclic symmetry, 4-46
 illustration, 4-47
 mirrored symmetry, 4-27—
 4-29, 4-46—4-48
 illustration, 4-48
 point of symmetry, 4-27
 using symmetry, 4-46

T

table-driven charts, see *data-*
driven charts under *charts*
tables, see *data table* under
charts
text
 adding text to an
 illustration, 2-55, 4-51
 properties in a canvas, 4-51
<Top>, see *graphics alternate*
function keys
training, xvi

U

User Profile, 2-14, 2-36, 2-51,
2-55, 3-7
 changing default properties
 in the User Profile, 2-55

V

VP Data-Driven Graphics
 capabilities, 3-1
 prerequisites, 3-1
VP Document Editor Basic
 Graphics capabilities, 2-1
VP Free-Hand Drawing
 capabilities, 4-1

Z

zoom, see *zooming in* under
 canvas

NOTES

NOTES

Reader's Comments

XEROX®

VP Series Reference Library
Graphics Reference volume

Your feedback will help us tailor our manuals to your needs.

Name: _____ Company: _____

City: _____ State/Zip: _____

1. Is the organization suitable for your needs?
- | | | | |
|--------------------------|--------------------------|--------------------------|--------------------------|
| Excellent | Good | Adequate | Poor |
| <input type="checkbox"/> | <input type="checkbox"/> | <input type="checkbox"/> | <input type="checkbox"/> |

Comments _____

2. Is the documentation written at an appropriate level?
- | | | | |
|--------------------------|--------------------------|--------------------------|--------------------------|
| <input type="checkbox"/> | <input type="checkbox"/> | <input type="checkbox"/> | <input type="checkbox"/> |
|--------------------------|--------------------------|--------------------------|--------------------------|

Comments _____

3. Are you able to find the information you need easily?
- | | | | |
|--------------------------|--------------------------|--------------------------|--------------------------|
| <input type="checkbox"/> | <input type="checkbox"/> | <input type="checkbox"/> | <input type="checkbox"/> |
|--------------------------|--------------------------|--------------------------|--------------------------|

Comments _____

4. Overall, how would you rate the documentation?
- | | | | |
|--------------------------|--------------------------|--------------------------|--------------------------|
| <input type="checkbox"/> | <input type="checkbox"/> | <input type="checkbox"/> | <input type="checkbox"/> |
|--------------------------|--------------------------|--------------------------|--------------------------|

5. How can we improve the documentation?
-
-

6. Did you find any errors?

Page No.	Error
_____	_____
_____	_____
_____	_____

7. How would you describe your position?

Technical support Professional/managerial
 Document developer Other (explain) _____

We appreciate your comments regarding our documentation.

Staple or tape

..... Fold here



No Postage
Necessary
If Mailed
In the
United States

BUSINESS REPLY MAIL

First Class Permit No. 229 El Segundo, CA

Postage will be paid by Addressee

Xerox Corporation
Attn: Product Education, N2-15
701 South Aviation Boulevard
El Segundo, California 90245

