

VISUAL

Visual 220 User's Guide

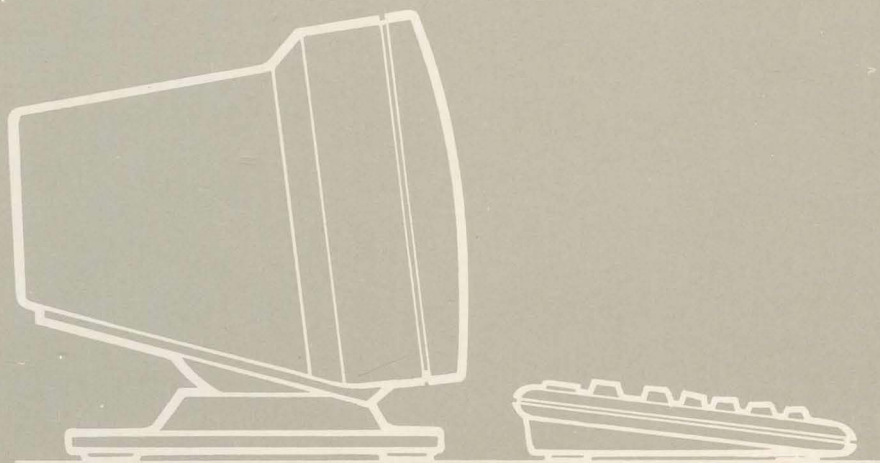

**Visual 220
User's Guide**

Visual Technology Incorporated
540 Main Street
Tewksbury, MA 01876

Disclaimer:

The information contained in this manual is believed to be accurate and reliable. However, Visual Technology Incorporated assumes no responsibility for any errors, omissions or inaccuracies whatsoever. Without limiting the foregoing, VISUAL TECHNOLOGY INCORPORATED DISCLAIMS ANY AND ALL WARRANTIES, EXPRESS OR IMPLIED, INCLUDING THE WARRANTY OF MERCHANTABILITY AND FITNESS FOR A PARTICULAR PURPOSE, WITH RESPECT TO THE INFORMATION CONTAINED IN THIS MANUAL AND THE HARDWARE AND FIRMWARE DESCRIBED HEREIN. The entire risk as to the quality and performance of such information and equipment is upon the buyer or user. Visual Technology Incorporated shall not be liable for any damages, including special or consequential damages arising out of the use of such information or equipment even if Visual Technology Incorporated has been advised in advance of such damages. The use of the information contained in this manual and the equipment described herein is subject to Visual Technology Incorporated's standard license agreement which must be executed by the buyer or user before the use of such information or firmware.

This warranty gives you specific legal rights and you may also have other rights which vary from state to state.

Some states do not allow the exclusion or limitation of incidental or consequential damages or limitations on how long an implied warranty lasts, so the above limitations or exclusion may not apply to you.

Part Number: UM220-001-00A

Copyright © 1985; Visual Technology Incorporated

FCC Notice:

This equipment generates, uses and can radiate radio frequency energy and if not installed and used in accordance with the instruction manual may cause interference to radio communications. The Visual 220 terminal has been tested and found to comply with the FCC limits set for a Class A computing device, pursuant to Subpart J of Part 15 of FCC Rules which are designed to provide reasonable protection against such interference when operated in a commercial environment. Operation of this equipment in a residential area is likely to cause interference in which case the user at his own expense will be required to take whatever measures may be appropriate to correct the interference.

The following are trademarks of Digital Equipment Corporation:

- DEC
- Digital Equipment Corporation
- VT52
- VT100
- VT200
- VT220
- DEC Multinational Character Set
- DEC Supplemental Graphics
- DEC Special Graphics

Contents

PART ONE: USING THE VISUAL 220 TERMINAL

Chapter 1: Introduction

1.1	General Description	1-1
1.2	Physical Description	1-2
1.3	Functional Description	1-2
1.4	Operating States	1-4
1.4.1	On Line	1-4
1.4.2	Local	1-4
1.4.3	Set-Up	1-4
1.5	Operating Modes	1-5
1.5.1	VT200 Compatible Mode with 7-bit Controls ...	1-5
1.5.2	VT200 Compatible Mode with 8-bit Controls ...	1-5
1.5.3	VT100 Compatible Mode	1-5
1.5.4	VT52 Compatible Mode	1-6
1.6	Operating Mode Differences	1-6
1.7	Terminal Enhancements	1-7
1.8	Options	1-7

Chapter 2: Operating the Visual 220 Terminal

2.1	Overview	2-1
2.2	Controls and Indicators	2-1
2.2.1	The Power Switch	2-2
2.2.2	Keyboard Controls	2-3
2.2.2.1	Main Keypad	2-3
2.2.2.2	Editing Keypad	2-5
2.2.2.3	Numeric/Application Keypad	2-5
2.2.2.4	Top-Row Function Keys	2-5
2.2.3	Keyboard Indicators	2-8
2.2.3.1	Visible Status Indicators	2-8
2.2.3.2	Audible Indicators	2-9
2.3	Selecting the Visual 220 User-Preference Features ..	2-10
2.3.1	Overview of User-Preference Features	2-10
2.3.2	Descriptions of User-Preference Features	2-12

Contents Contd.

2.3.2.1	Auto Repeat	2-13
2.3.2.2	Keyclick	2-13
2.3.2.3	Light/Dark Screen	2-13
2.3.2.4	Margin Bell	2-13
2.3.2.5	On Line/Local	2-13
2.3.2.6	Screen Intensity	2-14
2.3.2.7	Screen Saver	2-14
2.3.2.8	Shift/Caps Lock	2-14
2.3.2.9	Smooth/Jump Scroll	2-15
2.3.2.10	Time-of-Day Clock	2-16
2.3.2.11	User Features Lock/Unlock	2-16
2.3.2.12	Warning Bell	2-16
2.3.2.13	80/132 Column	2-16
2.4	Composing Characters	2-16
2.4.1	Three-Keystroke Compose Sequences	2-17
2.4.2	Two-Keystroke Compose Sequences	2-17
2.5	Printing	2-23
2.5.1	Printer Interface	2-24
2.5.2	Printing Modes	2-24
2.5.2.1	Normal Print Mode	2-24
2.5.2.2	Auto Print Mode	2-24
2.5.2.3	Controller Mode	2-24
2.5.2.4	Copy Mode	2-24

Chapter 3: Using Terminal Set-Up Mode

3.1	Introduction	3-1
3.2	Set-Up Mode Overview	3-1
3.2.1	Set-Up Directory and Sub-Menus	3-2
3.2.2	Set-Up Menu Format	3-3
3.2.2.1	Menu Identifier Line	3-3
3.2.2.2	Fields	3-3
3.2.2.3	Set-Up Status Line	3-5
3.3	Using Set-Up Mode	3-7

Contents Contd.

5.3.2	Using Fill (Null) Characters	5-6
5.3.3	Modem Connect/Disconnect	5-6
5.4	Host Interface	5-7
5.4.1	Configuring for Communication With a Local Host	5-10
5.4.1.1	EIA RS-232-C/CCITT Interface	5-10
5.4.1.2	20 MA Current Loop Option	5-11
5.4.2	Configuring for Communication With a Remote Host	5-11
5.5	Printer Interface	5-12
5.5.1	Printer Port Signal Descriptions	5-12
5.5.2	Printer Port Configuration	5-14

Chapter 6: Solving Difficulties

6.1	Overview	6-1
6.2	Problem Solving Procedure	6-1
6.2.1	Identifying Problems	6-1
6.2.2	Power-Up Difficulties	6-3
6.2.3	Host Communication Difficulties	6-5
6.2.4	Printing Difficulties	6-7

Chapter 7: Code Tables and Character Sets

7.1	Overview	7-1
7.2	Code Tables	7-1
7.3	Character Sets	7-5
7.3.1	ASCII Character Set	7-5
7.3.2	United Kingdom National Set	7-6
7.3.3	DEC Special Graphics	7-7
7.3.4	DEC Multinational Character Set	7-8
7.3.5	Display Controls Character Set	7-10
7.4	Character Sets and National Alphabets	7-12
7.5	Character Set Selection	7-14
7.5.1	Default Character Set	7-14
7.5.2	Changing Character Sets	7-14
7.5.2.1	Designating Hard Character Sets	7-14

Contents Contd.

8.4.2	Control Sequences Recognized in ANSI (X3.64)	
	Mode	8-19
8.4.2.1	Mode Set and Reset Control	
	Sequences	8-19
8.4.2.2	Define Scrolling Region	8-25
8.4.2.3	Cursor Control Commands	8-25
8.4.2.4	Erasement Commands	8-27
8.4.2.5	Tabbing Commands	8-30
8.4.2.6	Screen Alignment	8-30
8.4.2.7	Character Set Selection (private)	8-30
8.4.2.8	Report Commands and Responses	8-33
8.4.2.9	Video Attributes	8-35
8.4.2.10	Logical Attributes	8-36
8.4.2.11	Character Size Commands (Private)	8-37
8.4.2.12	Reset Commands	8-38
8.4.2.13	Numeric/Application Keypad	
	Commands	8-40
8.4.2.14	Editing Commands	8-41
8.4.2.15	Terminal Testing	8-42
8.4.2.16	Select Compatibility Levels	8-42
8.4.2.17	Selecting 7/8 Bit Control Code	
	Transmission	8-43
8.4.2.18	Programming Top-Row Function Keys ...	8-44
8.4.2.19	Down-line Loading Characters	8-46
8.4.2.20	Clearing a Down-Line Loaded Character	
	Set	8-49
8.4.2.21	Printer Control Sequences	8-50
8.4.2.22	Printer Set and Reset Modes	8-53
8.4.2.23	Programming the Time-of-Day Clock	8-54
8.4.3	Control Sequences Recognized in	
	VT52 Mode	8-55
8.4.3.1	Terminal Control Sequences	8-55
8.4.3.2	Printer Control Sequences	8-57

Contents Contd.

Appendix A: Terminal Specifications

A.1	Visual 220 Terminal Specifications	A-1
A.1.1	Physical	A-1
A.1.2	Environmental	A-1
A.1.3	Electrical	A-2
A.1.4	Data Communications	A-2
A.1.5	Screen Presentation	A-2
A.1.6	Keyboard	A-3
A.1.7	Miscellaneous	A-3

Appendix B: National Language Keyboards

B.1	Overview	B-1
-----	----------------	-----

Appendix C: Character Sets

C.1	Overview	C-1
-----	----------------	-----

Appendix D: Programming Code Summary

D.1	Overview	D-1
D.2	ANSI Control Sequences	D-1
D.3	VT52 Mode Control Sequences	D-10

Appendix E: Printed Translations for Supplemental Characters

E.1	Translations	E-1
-----	--------------------	-----

Appendix F: Test Connectors

F.1	Test Connector Diagrams	F-1
-----	-------------------------------	-----

List of Illustrations

Figure 1-1.	Visual 220 Terminal	1-1
Figure 2-1.	The Visual 220 Terminal Power Switch	2-1
Figure 2-2.	Terminal Power-Up Indications	2-2
Figure 2-3.	Visual 220 (North American) Keyboard	2-3
Figure 3-1.	Using Terminal Set-Up Mode	3-2
Figure 3-2.	Typical Set-Up Menu	3-3
Figure 3-3.	Set-Up Directory Menu (with Default Values Displayed)	3-9
Figure 3-4.	Display Set-Up Menu (with Default Values Displayed)	3-13
Figure 3-5.	General Set-Up Menu (with Default Values Displayed)	3-16
Figure 3-6.	Communications Set-Up Menu (with Default Values Displayed)	3-20
Figure 3-7.	Printer Set-Up Menu (with Default Values Displayed)	3-25
Figure 3-8.	Keyboard Set-Up Menu (with Default Values Displayed)	3-29
Figure 3-9.	Tab Set-Up Menu (with Default Values Displayed)	3-33
Figure 3-10.	Enhancement Set-Up Menu (with Default Values Displayed)	3-35
Figure 4-1.	Unpacking the Keyboard Shipping Carton	4-2
Figure 4-2.	Unpacking the Monitor Shipping Carton ...	4-3
Figure 4-3.	Checking the Contents	4-4
Figure 4-4.	Location of the Power Switch	4-7

List of Illustrations Contd.

Figure 8-1.	Visual 220 (North American) Keyboard	8-3
Figure B-1.	British Keyboard	B-2
Figure B-2.	Canadian (French) Keyboard	B-3
Figure B-3.	Danish Keyboard	B-4
Figure B-4.	Dutch Keyboard	B-5
Figure B-5.	Finnish Keyboard	B-6
Figure B-6.	Belgian (Flemish) Keyboard	B-7
Figure B-7.	French/Belgian Keyboard	B-8
Figure B-8.	German Keyboard	B-9
Figure B-9.	Italian Keyboard	B-10
Figure B-10.	North American Keyboard	B-11
Figure B-11.	Norwegian Keyboard	B-12
Figure B-12.	Spanish Keyboard	B-13
Figure B-13.	Swedish Keyboard	B-14
Figure B-14.	Swiss (French) Keyboard	B-15
Figure B-15.	Swiss (German) Keyboard	B-16
Figure C-1.	ASCII Character Set	C-1
Figure C-2.	DEC Multinational Character Set (Sheet 1 OF 2)	C-2
Figure C-2.	DEC Multinational Character Set (Sheet 2 OF 2)	C-3
Figure C-3.	DEC Special Graphics Character Set	C-4
Figure F-1.	Comm Port Loopback Test Connector	F-1
Figure F-2.	Printer Port Loopback Test Connector	F-1

List of Tables

Table 1-1.	Terminal Mode Comparison	1-6
Table 1-2.	Visual 220 Terminal Enhancements	1-7
Table 2-1.	Main Keypad Special Action Key Functions	2-4
Table 2-2.	Local Function Key (F1 - F5) Functions	2-6
Table 2-3.	Visible Status Indicators	2-8
Table 2-4.	Audible Indicators	2-9
Table 2-5.	User-Preference Feature Overview	2-11
Table 2-6.	Effects of the Lock Key When Shift Lock is Selected	2-15
Table 2-7.	Effects of the Lock Key When Caps Lock is Selected	2-15
Table 2-8.	Compose Sequences	2-19
Table 3-1.	Status Line Messages	3-6
Table 3-2.	Set-Up Menu Contents	3-8
Table 3-3.	Set-Up Directory Menu Field Descriptions	3-9
Table 3-4.	Display Menu Descriptions	3-13
Table 3-5.	General Set-Up Menu Field Descriptions ...	3-16
Table 3-6.	Communications Set-Up Menu Field Descriptions	3-20
Table 3-7.	Printer Set-Up Menu Field Descriptions	3-25
Table 3-8.	Keyboard Set-Up Menu Field Descriptions	3-29
Table 3-9.	Tab Set-Up Menu Field Descriptions	3-33

List of Tables Contd.

Table 3-10.	Enhancement Set-Up Menu Field Descriptions	3-35
Table 5-1.	Host Interface (Comm Port) Pin Usage	5-7
Table 5-2.	Host Interface Connector Pin Descriptions	5-8
Table 5-3.	Printer Port Pin-Signal Descriptions	5-13
Table 6-1.	Finding the Problem	6-2
Table 6-2.	Difficulties with Turning the Terminal On	6-3
Table 6-3.	Difficulties with Host Communication	6-6
Table 6-4.	Difficulties with Printing	6-8
Table 7-1.	ASCII Character Set Code Table	7-6
Table 7-2.	DEC™ Special Graphics Set	7-7
Table 7-3.	DEC™ Multinational Character Set	7-8
Table 7-4.	Display Controls Character Set	7-10
Table 7-5.	Designating Hard Character Sets	7-17
Table 7-6.	Designating Soft Character Sets	7-18
Table 7-7.	Invoking Character Sets Using Locking Shifts	7-20
Table 7-8.	Invoking Character Sets Using Single Shifts	7-21
Table 7-9.	Down-Line Load DCS Description	7-27
Table 7-10.	Down-Line Load Sequence Parameter Values	7-28
Table 7-11.	Down-Line Load Example Description	7-31

List of Tables Contd.

Table 8-1.	VT100 and VT200 Mode Differences	8-2
Table 8-2.	Main Keypad Special Action Key Functions	8-4
Table 8-3.	Editing Key Codes	8-6
Table 8-4.	Cursor Key Codes (ANSI Mode)	8-7
Table 8-5.	Cursor Key Codes (VT52 Mode)	8-7
Table 8-6.	Numeric/Application Keypad Codes	8-8
Table 8-7.	Local Function Key (F1 - F5) Functions	8-9
Table 8-8.	Programmable Function Key (F6 - F20) Descriptions	8-11
Table 8-9.	Keystroke Sequences for Generating C0 Control Codes	8-12
Table 8-10.	C0 Control Code Functions	8-16
Table 8-11.	C1 Control Code Functions	8-18
Table 8-12.	Set/Reset Mode Ps Values and Definitions	8-21
Table 8-13.	Designating Hard Character Sets	8-31
Table 8-14.	Video Attribute Control Sequences	8-36
Table 8-15.	Soft Terminal Reset Status	8-39
Table 8-16.	Parameter Value Definitions	8-43
Table 8-17.	Function Key Control String Parameter Effects	8-44
Table 8-18.	Top-Row Function Key Numbers	8-45
Table 8-19.	Soft Character Down-Line Load DCS Description	8-47

List of Tables Contd.

Table 8-20.	Parameter Values for a Down-Line Load Sequence	8-48
Table 8-21.	Printer Set/Reset Mode Parameter Value Definitions	8-54

PREFACE

The Visual 220 User's Guide provides information required to install, operate and program the Visual 220 terminal.

Part One, Using the Visual 220 Terminal

Part One, addresses the terminal user. A typical user may be a secretary or any person using the Visual 220 terminal for data entry or retrieval. Special technical knowledge not required to perform any of the operations in this part of the document.

Chapter 1, Introduction — Chapter 1 provides a product overview that sets operational and functional expectations for the Visual 220 terminal.

Chapter 2, Operating the Visual 220 Terminal — Chapter 2 describes how to use each of the controls and indicators on the terminal to get work done.

Since many application software packages control terminal operation, documentation supporting such packages may need to be consulted for operating instructions.

Chapter 3, Using Terminal Set-Up Mode — Chapter 3 describes Set-Up mode and how to use it to select terminal operating characteristics.

Part Two, Installation and Configuration

Part two addresses the installer. A typical installer may be a technician or secretary who is already familiar with simple cabling and setup procedures. Some technical knowledge may be required to perform certain operations in this part of the document.

Chapter 4, Terminal Installation — Chapter 4 provides information needed to unpack and install the Visual 220 terminal. Simple procedures for testing the installation are also provided.

Chapter 5, Communications — Chapter 5 provides information needed to configure the host and printer ports.

Chapter 6, Solving Difficulties — Chapter 6 provides simple corrective procedures to be used in the event that difficulties are encountered during installation or operation of the terminal.

Part Three, Programming the V220

Part three addresses the programmer. A typical programmer may use this part of the document as an aid in writing programs that can control the terminal. Knowledge of programming techniques is required to perform the operations in this part of the guide.

Chapter 7, Code Tables and Character Sets — Chapter 7 describes how different character sets may be mapped into code tables.

Chapter 8, Terminal Control Codes — Chapter 8 describes the codes that may be transmitted by the terminal. Received codes and their effects on terminal operation are also discussed.

Appendices

The appendices include miscellaneous information and summaries of other topics discussed in the document. The appendices include:

- Appendix A, Terminal Specifications
- Appendix B, National Language Keyboards
- Appendix C, Character Sets
- Appendix D, Programming Code Summary
- Appendix E, Printed Translations for Supplemental Characters
- Appendix F, Test Connectors

VISUAL

**Part One:
Using the
Visual 220 Terminal**



1.2 PHYSICAL DESCRIPTION

The Visual 220 terminal is made up of the following parts:

- CRT Cabinet (contains the monitor, system unit and power cable).
- Low-profile detachable keyboard and keyboard cable.

The CRT cabinet is permanently attached to a pedestal. This configuration allows a wide range of tilt and swivel positions providing a maximum of operator comfort.

The low-profile keyboard attaches to the CRT cabinet via a short coiled cable.

1.3 FUNCTIONAL DESCRIPTION

This section describes functions and features of the Visual 220 terminal. The terminal includes:

- Four firmware-based character sets including:
 - ASCII characters
 - DEC Supplemental characters
 - United Kingdom
 - Special Graphics
- A writable character generator allows creation of user-defined characters and character sets.
- The keyboard is compatible with the DEC VT220 keyboard and provides the following:
 - 106 keys provide a high degree of functional control over the terminal and application software.
 - 2-key rollover helps prevent loss of characters when two keys are pressed simultaneously.
 - Four LEDs indicate terminal status at a glance.

- Twenty-four function keys allow maximum control of application software as well as local terminal functions. There are three groups of function keys.
 - The first five top-row function keys (F1 through F5) provide single functions such as printing the screen or controlling entry and exit of Set-Up mode.
 - 15 host-programmable function keys (F6 through F20) accept up to 30 host-programmable values.

When pressed alone, each host-programmable function key transmits a permanently programmed value to the host system (the values are identified in Section 8.3.4).

When pressed in combination with the Ctrl or the Shift key, each key can transmit either of two host-programmed values to the host system. Procedures for programming these keys are provided in Section 8.4.2.18.

- Four non-volatile function keys (PF1 through PF4) retain their messages even when the power is turned off. These keys cannot be programmed by a host computer.
- A status line indicates the current operating state of the terminal and utilizes the 25th line of the display. This leaves 24 display lines that may be used by application software.
- Configurable functions such as communications parameters or terminal modes may be selected from the keyboard via Set-Up Mode.
- Visual character attributes include bold, blink, reverse, blank and underscore. Logical character attribute is “erasable/non-erasable.”
- A Screen Saver feature preserves the life of the display. When the display has not been updated for 10 minutes (no data has been entered by the keyboard or the host computer), the display goes blank. No data is lost, however, and the display can be restored by pressing the Shift key (any key may be used, but the Shift key is recommended because it does not perform any action).

1.4 OPERATING STATES

The Visual 220 terminal can be in one of three operating states at a given time. The operating states are:

- On-line
- Local
- Set-Up

1.4.1 On Line

When the terminal is On Line, data is routed to the host system. A Local Echo feature (if enabled in Set-Up) also routes data from the keyboard to the monitor screen.

This is the normal operating state used when running applications with the terminal. The On Line state is entered from the Set-Up Directory menu.

1.4.2 Local

When the terminal is in the Local state, transmission and reception of data is suspended. Data from the keyboard is routed to the monitor screen. The Local state is entered from the Set-Up Directory menu.

1.4.3 Set-Up

Set-Up is similar to the Local state in that transmission and reception of data is suspended. This state is used to select or change the terminal's operating parameters and is entered (and exited) by pressing the Set-Up key (F3) on the keyboard.

1.5 OPERATING MODES

The Visual 220 has four operating modes to ensure compatibility with DEC VT220 operating modes:

- VT200 compatible mode with 7-bit controls
- VT200 compatible mode with 8-bit controls
- VT100 compatible mode
- VT52 compatible mode

1.5.1 VT200 Compatible Mode with 7-bit Controls

This mode is used to execute standard ANSI functions. In addition, this mode utilizes the full range of terminal features except that 8-bit control codes cannot be sent to the host system. These codes can only be interpreted and acted on by the terminal if they are received from a host system.

This mode is used with application programs that expect 7-bit control characters and DEC multinational characters.

NOTE

Many applications that require VT100 compatibility can use VT200 compatible mode with 7-bit controls.

1.5.2 VT200 Compatible Mode with 8-bit Controls

This mode is used to execute standard ANSI functions and utilizes the full range of V220 features.

This mode is used with application programs that expect 8-bit control characters and DEC multinational characters.

1.5.3 VT100 Compatible Mode

This mode executes standard ANSI functions and should be used with application programs that require strict compatibility with VT100 terminals.

1.5.4 VT52 Compatible Mode

This is a text mode that executes DEC private functions (ANSI functions do not execute in VT52 compatible mode). This mode should be used for compatibility with existing application programs designed for DEC VT52 terminals.

1.6 OPERATING MODE DIFFERENCES

Table 1-1 lists the available operating modes and highlights some differences among them.

Table 1-1. Terminal Mode Comparison

Mode	Control Codes Executed	Received Codes Executed	Transmitted Codes
VT200 compatible (7-bit controls)	ANSI	7- and 8-bit	7-bit
VT200 compatible (8-bit controls)	ANSI	7- and 8-bit	7- and 8-bit
VT100 compatible	ANSI	7-bit	7-bit
VT52 compatible	DEC private	7-bit	7-bit

CHAPTER 2 OPERATING THE VISUAL 220 TERMINAL

2.1 OVERVIEW

This chapter describes Visual 220 controls and indicators and provides instructions for turning the Visual 220 terminal on and off. Information for using some of the user-preference features is also provided.

Since application software often controls terminal operation, documentation supporting such software should also be consulted.

2.2 CONTROLS AND INDICATORS

The terminal power switch is located on the rear of the CRT cabinet as shown in Figure 2-1. All of the remaining controls and indicators are located on the terminal keyboard.

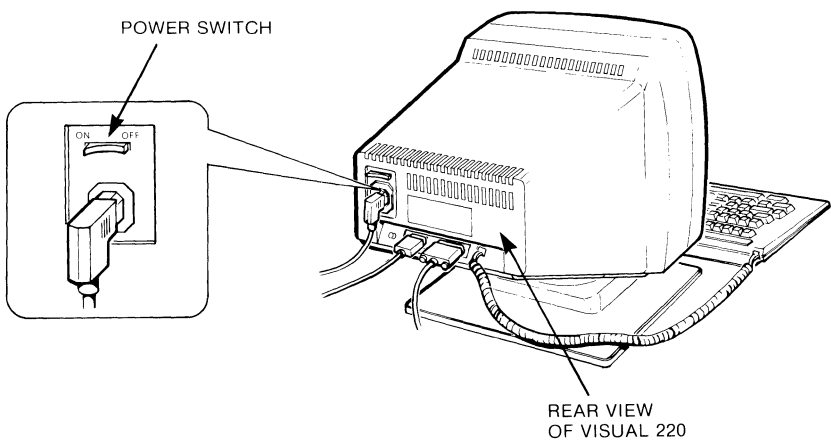
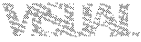

Figure 2-1. The Visual 220 Terminal Power Switch



2.2.1 The Power Switch

To turn the terminal on (or off), use the power switch located at the rear of the terminal (see Figure 2-1).

NOTE

When the switch is pushed to ON, a terminal self-test is performed that lasts for about 10 seconds. During this time, the four keyboard indicator lights blink on and off in a pattern. A ready tone (short beep) is produced after the self-test successfully completes.

After the ready tone is sounded, the terminal should be ready for normal operation. Figure 2-2 illustrates the power-up process.

If difficulties are encountered during start-up, turn to Chapter 6 for information that may help correct the apparent problem.

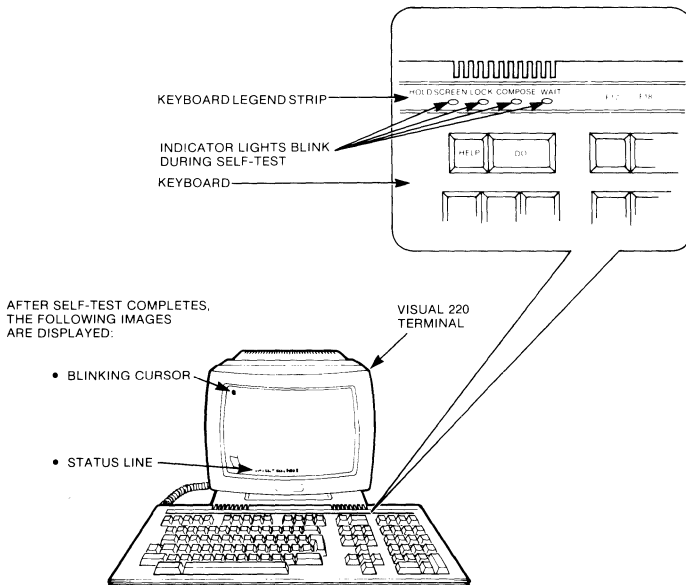

Figure 2-2. Terminal Power-Up Indications

2.2.2 Keyboard Controls

The Visual 220 keyboard shown in Figure 2-3 includes 106 keys that are divided into four distinct groups of keys. The groups are:

- Main keypad
- Editing/Cursor keypad
- Numeric/Application keypad
- Top-row function keys

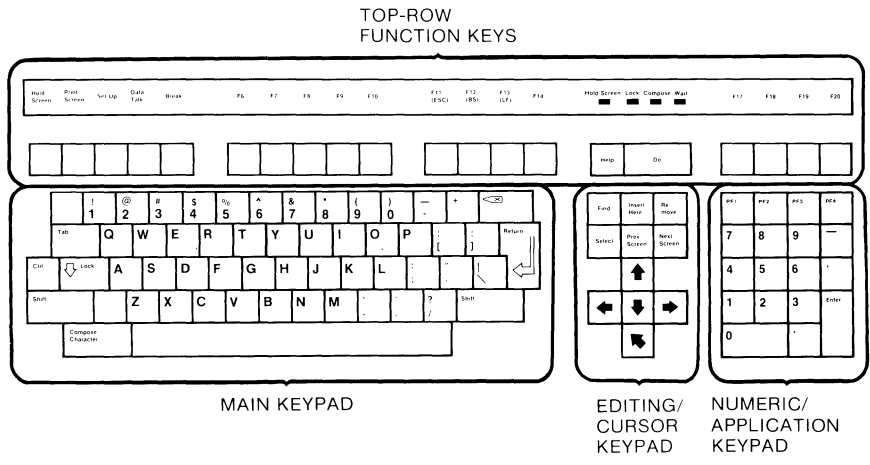

Figure 2-3. Visual 220 (North American) Keyboard

2.2.2.1 Main Keypad — The main keypad includes standard keys and special action keys.

The standard keys generate letters, numbers, punctuation marks and other text symbols (such as % [percent sign]) when they are pressed. Special action keys perform functions when used alone or in combination with other keys. The special action keys are described in Table 2-1.

Table 2-1. Main Keypad Special Action Key Functions

Key	Function
Ctrl	This key does not transmit a code. If pressed in combination with another key it transmits control codes to the system. Control codes direct the system to perform special operations such as transmitting an XOFF code to the host system.
Shift	This key does not transmit a code. However, when pressed with another alpha-numeric key it causes the generation of the upper case of that letter or the alternate character (if any) printed on that keycap. There are two of these keys for operator convenience.
Lock	This key alternately locks or unlocks the alpha characters. When locked, the codes are upper case letters. If Caps Lock is selected, only the alphabetic keys are affected. If Shift Lock is selected, the alpha keys generate only uppercase codes and the numeric/symbol keys generate codes for the alternate (upper) character printed on the keycap.
Tab	This key transmits a horizontal tab code (HT) that moves the cursor to the next tab stop.
Return	This key transmits a Carriage Return code. If New Line is enabled this key a Carriage Return and a Linefeed code.
⌫ (delete)	Pressing the ⌫ key generates a DEL character.
Space	Pressing Space causes a space code to be transmitted.
Compose Character	The Compose Character key is used to create characters that do not exist as standard keys on the selected keyboard. (Section 2.4 provides information on the uses of this key.)

2.2.2.2 Editing Keypad — The Editing Keypad contains editing keys and cursor control keys.

Editing keys produce codes that are used by the application program to edit data already entered on the display.

Cursor control keys move the cursor in the direction of the arrow on the keycap. The **home cursor** key (↖) moves the cursor to line 1, column 1 on the display.

2.2.2.3 Numeric/Application Keypad — The function of the numeric/application keypad depends on how it is programmed by the application software in use. This keypad has numeric and programmable function (PF1 through PF4) keys. The programmable function keys generate special codes that may be used by the application to perform specialized actions.

When programmed as a numeric keypad, the keys generate the numbers or symbols printed on the keycaps.

When programmed as an application keypad, the keys generate codes with meanings understood by the application software.

2.2.2.4 Top-Row Function Keys — The twenty top-row function keys include local function keys (F1 through F5) and programmable function keys (F6 through F20).

Local function keys F1 through F5 of the top-row function keys have local functions and do not transmit codes to a host computer. The functions of these keys are described in Table 2-2.



Table 2-2. Local Function Key (F1 - F5) Functions

Key	Function(s)
F1 — Hold Screen	Pressing this key freezes the screen and prevents any new characters from being displayed (the Hold Screen LED illuminates). Pressing the key again returns the screen to normal operation.
F2 — Print Screen	If the printer is available, pressing the Print Screen key sends the screen data to the printer. The amount of data sent depends on the print extent selected (Print Full Page/Scroll Region) from the printer Set-Up menu. Pressing Control-Print Screen toggles Normal/Auto-Print mode from the printer Set-Up menu.
F3 — Set-up	Pressing the Set-up Key causes the terminal to enter or exit Set-up mode (see Chapter 3).
F4 — Data/Talk	<p>This key is active only if EIA modem controls have been selected and jumpers W3, W4, W5 and W6 are installed on the system board.</p> <p>When pressed alone or in combination with the Shift key, the signal on pin 14 of the Comm port connector is reset to 0 volts.</p> <p>When pressed in combination with the Ctrl key, the signal on pin 14 of the Comm port connector is set to 5 volts.</p>

Table 2-2. Local Function Key (F1 - F5) Functions (Contd.)

Key	Function(s)
F5 — Break	<p>Depressing the Break key alone causes the terminal to transmit a break signal if break is enabled from the Keyboard Set-up menu (the transmit data line [TXD] is held low.)</p> <p>Depressing Shift and Break simultaneously causes the terminal to turn off Data Terminal Ready (DTR) and Request To Send (RTS). The Transmit Data Line (TXD) is held low. After 0.22 seconds, the terminal tests the condition of Data Set Ready (DSR). When DSR turns off (or after 1.8 seconds), the disconnect is complete.</p> <p>Depressing Ctrl and Break simultaneously causes the answerback message to be transmitted (the answerback message is controlled from the Keyboard Set-Up menu).</p>

Each of the top-row programmable function keys (F6 through F20) may have up to three separate functions depending on whether the key is pressed alone or in combination with the **Shift** or **Ctrl** keys. Details on programming these keys are provided in Chapter 8.

When pressed alone, function keys F6 through F20 (including **HELP** and **DO**) have functions that are determined by the application software. When the terminal is in VT100 mode, keys **F11**, **F12** and **F13** transmit escape (ESC), backspace (BS) and linefeed (LF) codes respectively.

When pressed in combination with the **Shift** key, the function keys F6 through F20 may generate host-programmed messages.

When pressed in combination with the **Ctrl** key, the function keys may generate alternate host-programmed messages.

2.2.3 Keyboard Indicators

The keyboard provides four visible status indicators and three audible indicators.

2.2.3.1 Visible Status Indicators — Four visible light emitting diodes (LEDs) indicate the current terminal status. These indicators are located on the keyboard function strip shown in Figure 2-2 and are described in Table 2-3.

Table 2-3. Visible Status Indicators

Indicator	
Hold Screen	The Hold Screen indicator is on when the screen is frozen. (See Hold Screen key description in Table 2-2.)
Lock	The Lock indicator is on when the <code>Lock</code> key is pressed (see the Lock key description in Table 2-1). It indicates that only upper-case codes are generated by the keyboard. The LED turns off when the <code>Lock</code> key is struck again. If Shift-Lock is selected, the LED also turns off when a shift key is struck.
Compose	The Compose indicator is on when a Compose Character sequence is in progress (see Section 2.4). The LED turns off when the sequence is completed.
Wait	The Wait indicator comes on to show when the keyboard is locked and cannot transmit data. If this condition does not correct itself, the Wait LED can be cleared by invoking the Clear Comm feature in Set-up Mode. This feature is described in Chapter 3, Table 3-3.

2.2.3.2 Audible Indicators — The keyboard can generate the following three sounds: keyclick, a margin bell and a warning bell. Table 2-4 describes each of the audible indicators.

The audible indicators may be enabled or disabled from the keyboard Set-Up menu (detailed information on using Set-Up mode and Set-Up menus is provided in Chapter 3).

Table 2-4. Audible Indicators

Indicator	Description
Keyclick	The keyclick is sounded each time a key is pressed (if Keyclick is enabled). The Shift and Ctrl keys do not click.
Margin Bell	The Margin bell sounds whenever a key is struck and the cursor is 8 columns from the end of the current line.
Warning Bell	The Warning bell sounds under the following conditions: <ul style="list-style-type: none">• upon power-up,• when the terminal receives a BEL code (\hat{G}) from the host,• when a compose error is made,• when an invalid key is pressed in setup mode.

2.3 SELECTING THE VISUAL 220 USER-PREFERENCE FEATURES

This section describes setting or selecting user-preference features. These features, such as keyclick or screen intensity, may be set to the preference of the individual user. Virtually all of the Visual 220 features may be selected from menus in Set-Up mode using the keyboard.

NOTE

Detailed instructions for Entering and exiting Set-Up mode are provided in Section 3.3 (Using Set-Up Mode).

Each of the Set-Up menus is fully described in Section 3.4 (Using Set-Up Menus).

Note, however, that many terminal features are designed to be controlled by the currently running application software. Thus some features that may be selected by individual users could be temporarily reset or reconfigured by the application software.

2.3.1 Overview of User-Preference Features

User-preference features are briefly described (in alphabetical order) in Table 2-5. The table also identifies the Set-Up menu used to control each feature.

NOTE

The features noted in Table 2-5 are more fully described in Section 2.3.2.

Table 2-5. User-Preference Feature Overview (Cont.)

Feature	Set-Up Menu	Description/Comment
Shift/Caps Lock	Keyboard	Controls whether Lock key (on the main keypad) functions as a shift lock or caps lock key.
Smooth/Jump Scroll	Display	Controls whether the display scrolls up smoothly or in steps to accommodate each newly displayed line.
Time-of-Day Clock	Enhancement	Enter the (military or civilian) time as prompted on the display.
User Features Lock/Unlock*	General	When locked, prevents the following user-preference features from being changed: <ul style="list-style-type: none"> • Auto-Repeat • Smooth/Jump Scroll • Light/Dark Screen • Tab Stops • Keyboard Lock
Warning Bell	Keyboard	When enabled, a tone sounds in response to certain keystroke and data entry errors and upon power-up.
80/132 Column	Display	Controls number of columns displayed.

*The lock/unlock feature should normally be unlocked, allowing software applications to control the necessary terminal features.

2.3.2 Descriptions of User-Preference Features

This section describes user-preference features. The features are presented in alphabetical order.

2.3.2.1 Auto Repeat — When enabled (from the Keyboard Set-Up menu), keys held down for more than 0.5 seconds begin repeating. This feature may aid in tasks requiring character repetition such as dotted or dashed lines.

2.3.2.2 Keyclick — When enabled (from the Keyboard Set-Up menu), an audible tone accompanies each keystroke. When disabled, keystrokes are virtually silent.

2.3.2.3 Light/Dark Screen — This feature (selected from the Display Set-Up menu) provides two options for the user:

- Light Text, Dark Screen displays light characters on a dark background.
- Dark Text, Light Screen displays dark characters on a light background.

2.3.2.4 Margin Bell — When enabled (from the Keyboard Set-Up menu), an audible tone is produced when a key is struck and the cursor is at column 72. This feature may be useful when, for example, the terminal is being used in local mode as a typewriter.

2.3.2.5 On Line/Local — This feature (selected from the Set-Up Directory menu) provides two options for the user:

- On Line mode is used for Communicating with a host system. Host system communication is essential for running typical applications. This is the normal operating mode for the Visual 220 terminal.
- Local mode is used to send characters to the display (or a printer if one is connected). This mode is typically used for local testing purposes and has limited applications.

2.3.2.6 Screen Intensity — Screen intensity may be adjusted up or down from any Set-Up menu. There are 16 levels of intensity.

- To increase (brighten) the intensity, hold down the **Shift** key and press the **Up Arrow**.
- To decrease (dim) the intensity, hold down the **Shift** key and press the **Dn Arrow**

2.3.2.7 Screen Saver — When enabled (from the Display Set-Up menu), the display goes blank when it has not been used for 10 minutes. This helps increase the life of the terminal by preventing characters from “burning” into the phosphor of the display.

The data that was on the display is restored when a character is received from the host, Aux port or the terminal keyboard. To manually restore the display, press the **Shift** key.

2.3.2.8 Shift/Caps Lock — This feature (selected from the Keyboard Set-Up menu) provides two options for the user:

- Selecting **Shift Lock** causes the **Lock** key (on the main keypad) to function as a **Shift-Lock Key**.
- Selecting **Caps Lock** causes the **Lock** key (on the main keypad) to function as a **Caps-Lock Key**.

The following tables show the effects of each option on alphabetic keys and numeric/symbol keys. Typical keyboard keys (**A** and **3/#**) are used to illustrate the effects.

Table 2-6 illustrates the effects of the **Lock** key states (unlocked and locked) when **Shift Lock** is selected and the **Shift** key state is unshifted and shifted.

Table 2-6. Effects of the Lock Key when Shift Lock is Selected

Lock Key State	Alphabetic Key		Numeric/Symbol Key	
	Unshifted	Shifted	Unshifted	Shifted
Unlocked	a	A	3	#
Locked	A	A	#	#

Table 2-7 illustrates the effects of the Lock key states (unlocked and locked) when Caps Lock is selected and the Shift key state is unshifted and shifted.

Table 2-7. Effects of the Lock Key when Caps Lock is Selected

Lock Key State	Alphabetic Key		Numeric/Symbol Key	
	Unshifted	Shifted	Unshifted	Shifted
Unlocked	a	A	3	#
Locked	A	A	3	#

2.3.2.9 Smooth/Jump Scroll — This feature (selected from the Display Set-Up menu) provides two options for the user:

- Smooth scroll causes the screen data to move at a smooth and steady rate to accommodate new lines of data.
- Jump scroll causes the screen data to step up or down (one full line at a time) to accommodate new lines of data.

2.3.2.10 Time-of-Day Clock — A time-of-day clock (enabled from the Enhancement Set-Up menu) can be displayed on the status line when not in Set-Up mode. When setting the time, the status line is temporarily replaced with the “Enter Time”: message. When this message is displayed, the time can be entered in the format hh:mm:ss. Standard (12 hour) or military (24 hour) time may be selected independently (using another field in the Enhancement menu). This feature may also be programmed by the host.

2.3.2.11 User Features Lock/Unlock — When locked (from the General Set-Up menu), this feature prevents the following features from being modified by application software.

- Auto-Repeat
- Smooth/Jump Scroll
- Light/Dark Screen
- Tab Stops
- Keyboard Lock

This feature should normally be left unlocked since some software applications expect to control these features.

2.3.2.12 Warning Bell — When enabled (from the keyboard Set-Up menu) the Warning bell is sounded under the following conditions:

- Upon power-up.
- When a compose error is made,
- When an illegal key is struck in setup mode and
- When the terminal receives a bell code (BEL) from the host.

2.3.2.13 80/132 Column — This feature (selected from the Display Set-Up menu) causes the terminal to display data using a screen width of 80 columns (80 characters) or 132 columns (132 characters).

2.4 COMPOSING CHARACTERS

Certain characters that do not exist as single characters may be “composed” (created) using three-keystroke or two-keystroke compose sequences.



Table 2-8 provides a list of composed characters and the corresponding three-keystroke and two-keystroke sequences. Note that a desired character can be selected using the **Shift** and **Lock** keys.

If a diacritical mark is used within a three-keystroke sequence, it is treated as though it were its equivalent character. Diacritical marks and their equivalent characters are as follows:

Diacritical Mark	Equivalent Character
Diaresis (umlaut) mark	Double quote (“)
Grave accent	Single quote (‘)
Acute accent	Apostrophe (’)
Circumflex accent	Circumflex character (^)
Tilde mark	Tilde (~)
Ring mark	Asterisk (*) or degree (°)

NOTE

In three-keystroke compose sequences, the characters may be entered in any order (unless otherwise stated). All two-keystroke sequences must be entered in the order shown.

Table 2-8. Compose Sequences

Composed Character	Three-Keystroke Sequence	Two-Keystroke Sequence
“ (quotation mark)	” (sp)	.. (sp)
# (number sign)	++	
' (apostrophe)	' (sp)	' (sp)
@ (commercial at)	a a or A A	
[(opening bracket)	((
\ (backslash)	// or /<	
] (closing bracket)))	
^ (circumflex)	^ (sp)	^ (sp)
' (single quote)	' (sp)	' (sp)
{ (opening brace)	(-	
(vertical line)	/^	^/
} (closing brace))-	
~ (tilde)	~ (sp)	~ (sp)
¡ (inverted !)	!!	
¿ (inverted ?)	??	
¢ (cent sign)	c/ or C/ or c or C	
£ (pound sign)	l- or L- or l= or L=	
¥ (yen sign)	y- or Y- or y= or Y=	
§ (section sign)	so or SO or S! or s! or s0 or S0	



Table 2-8. Compose Sequences (Contd.)

Composed Character	Three-Keystroke Sequence	Two-Keystroke Sequence
⌘ (currency sign)	xo or XO or x0 or X0	Xo OX
© (copyright sign)	co or CO or c0 or C0	
¶ (paragraph sign)	p! or P!	
α (feminine ordinal indicator)	a_ or A_	
♂ (masculine ordinal indicator)	o_ or O_	
<< (angle quotation mark left)	<<	
>> (angle quotation mark right)	>>	
° (degree sign)	0^ or (sp)* or (sp)°	^ 0
± (plus/minus sign)	+_	
¹ (superscript 1)	1^	^ 1
² (superscript 2)	2^	^ 2
³ (superscript 3)	3^	^ 3
μ (micro sign) *	/u or /U	
· (middle dot)	.^	^ .
1/4 (fraction one-quarter) *	1 4	
1/2 (fraction one-half) *	1 2	
À (A grave)	A'	'A
Á (A acute)	A'	'A
Â (A circumflex)	A^	^ A

* Must be entered in the order shown

Table 2-8. Compose Sequences (Contd.)

Composed Character	Three-Keystroke Sequence	Two-Keystroke Sequence
Ã (A tilde)	A~	~A
Ä (A umlaut)	A" or A"	"A
Å (A ring)	A* or A° (degree sign)	°A
Æ (A E ligature) *	AE	
Ç (C cedilla)	C, (comma)	
È (E grave)	E'	'E
É (E acute)	E'	'E
Ê (E circumflex)	E^	^E
Ë (E umlaut)	E" or E"	"E
Ì (I grave)	I'	'I
Í (I acute)	I'	'I
Î (I circumflex)	I^	^I
Ï (I umlaut)	I" or I"	"I
Ñ (N tilde)	N~	~N
Ò (O grave)	O'	'O
Ó (O acute)	O'	'O
Ô (O circumflex)	O^	^O
Õ (O tilde)	O~	~O
Ö (O umlaut)	O" or O"	"O

* Must be entered in the order shown

Table 2-8. Compose Sequences (Contd.)

Composed Character	Three-Keystroke Sequence	Two-Keystroke Sequence
Œ (O E ligature) *	O E	
Ù (U grave)	U'	'U
Ú (U acute)	U'	'U
Û (U circumflex)	U^	^U
Ü (U umlaut)	U" or U"	"U
ÿ (Y umlaut)	Y" or Y"	"Y
ß (German small sharp s)	ss	
à (a grave)	a'	'a
á (a acute)	a'	'a
â (a circumflex)	a^	^a
ã (a tilde)	a~	~a
ä (a umlaut)	a" or a"	"a
å (a ring)	a* or a° (degree sign)	°a
æ (a e ligature) *	ae	
ç (c cedilla)	c, (comma)	
è (e grave)	e'	'e
é (e acute)	e'	'e
ê (e circumflex)	e^	^e
ë (e umlaut)	e" or e"	"e
ì (i grave)	i'	'i

* Must be entered in the order shown

Table 2-8. Compose Sequences (Contd.)

Composed Character	Three-Keystroke Sequence	Two-Keystroke Sequence
í (i acute)	i'	'i
î (i circumflex)	i^	^i
ï (i umlaut)	i" or i"	"i
ñ (n tilde)	n~	~n
ò (o grave)	o'	'o
ó (o acute)	o'	'o
ô (o circumflex)	o^	^o
õ (o tilde)	o~	~o
ö (o umlaut)	o" or o"	"o
œ (o e ligature) *	o e	
ø (slash)	o/	
ù (u grave)	u'	'u
ú (u acute)	u'	'u
û (u circumflex)	u^	^u
ü (u umlaut)	u" or u"	"u
ÿ (y umlaut)	y" or y"	"y

* Must be entered in the order shown

2.5 PRINTING

This section provides an overview of the printer interface and descriptions of various printing modes. Since many printing functions are designed to be controlled by application software, additional information may be found within the application software documentation.

2.5.1 Printer Interface

The Visual 220 terminal has a 9-pin male D-type connector which provides a serial interface for printer connection. The terminal can support a wide variety of serial printers. The necessary interface and data format can be selected from the Communications Set-Up menu.

Chapter 5, Communications, contains the necessary information for making the appropriate connections.

2.5.2 Printing Modes

The Visual 220 terminal has four possible printing modes that determine how data is treated by the terminal/printer configuration.

Application software may control the entering and exiting of the various printer modes.

2.5.2.1 Normal Print Mode — The normal print mode allows print functions (such as print screen) to be invoked from the terminal keyboard or the host system.

2.5.2.2 Auto Print Mode — This mode causes the current line (the line containing the cursor) to be printed on receipt of a linefeed (LF), formfeed (FF) or vertical tab (VT). Any code (LF, FF or VT) that causes a line to be printed is appended to the end of that line.

2.5.2.3 Controller Mode — The controller mode allows the printer to be controlled solely from the host system. Data is routed from the host, through the terminal and to the printer. Data is not displayed on the terminal screen. Data flow control signals such as XOFF/XON, are expected to be managed by the printer (if such control is enabled).

To use the printer without involving the host system, place the terminal simultaneously in local mode and controller mode.

2.5.2.4 Copy Mode — This mode is similar to the Controller mode except that the data is also routed to the terminal screen.

CHAPTER 3 USING TERMINAL SET-UP MODE

3.1 INTRODUCTION

This chapter describes the Visual 220 terminal Set-Up mode, and how to use it to examine and/or modify the terminal's operating characteristics.

Any of the Set-Up features can be modified using the keyboard and then "saved" in NVR (non-volatile RAM). Saved parameters are remembered by the terminal even when the power is turned off. In addition, factory default settings are maintained by the terminal. These settings are typical for many applications and can be recalled at any time in Set-Up mode.

Certain features can be selected or modified by the host system. The control sequences for making these changes are described in Chapter 8 of this guide.

3.2 SET-UP MODE OVERVIEW

Set-up mode is made up of eight selectable displays called "menus." The main Set-Up menu is called the Set-Up Directory. The Set-Up Directory is used to invoke any one of seven available submenus.

Each menu displays information relative to its function and allows you to modify or retain that data. Only one menu can be displayed at a time.

NOTE

In Set-Up mode, screen data is suppressed and is not lost. However, incoming data may be lost unless the host supports XON/XOFF flow control and that feature is enabled on the terminal.

3.2.1 Set-Up Directory and Sub-Menus

The Set-Up Directory menu is displayed when you first enter Set-up mode (by pressing the **Set-Up** key). All of the sub-menus may be accessed from the Directory menu. Conversely, the Directory menu can be reached from any of the Set-up menus.

The sub-menus are ordered on a one-direction, continuous path. Once a sub-menu is displayed, pressing **Enter** causes the next sequential sub-menu to be displayed (if the "To Next Set-up" field is selected)

Figure 3-1 shows the relationship among the Set-Up menus.

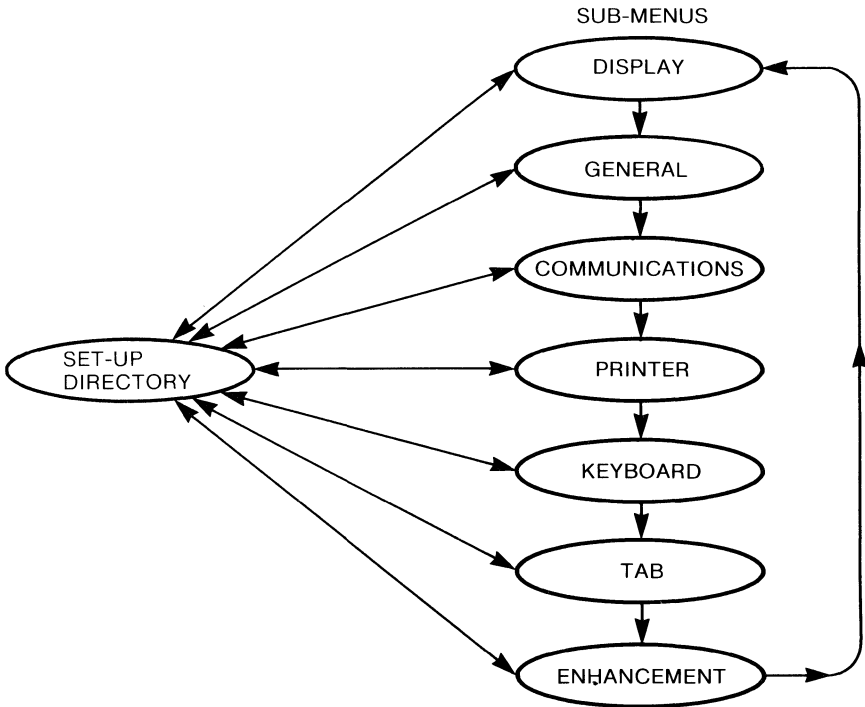

Figure 3-1. Paths to Set-Up Menus

3-2 Using Terminal Set-Up Mode

3.2.2 Set-Up Menu Format

Each set-up menu occupies the bottom eight lines of the screen. The rest of the screen is blank. Figure 3-2 shows a typical Set-Up menu.

As shown in Figure 3-2, each menu contains an identifier line, various fields (action fields, parameter fields and text fields), and a status line.

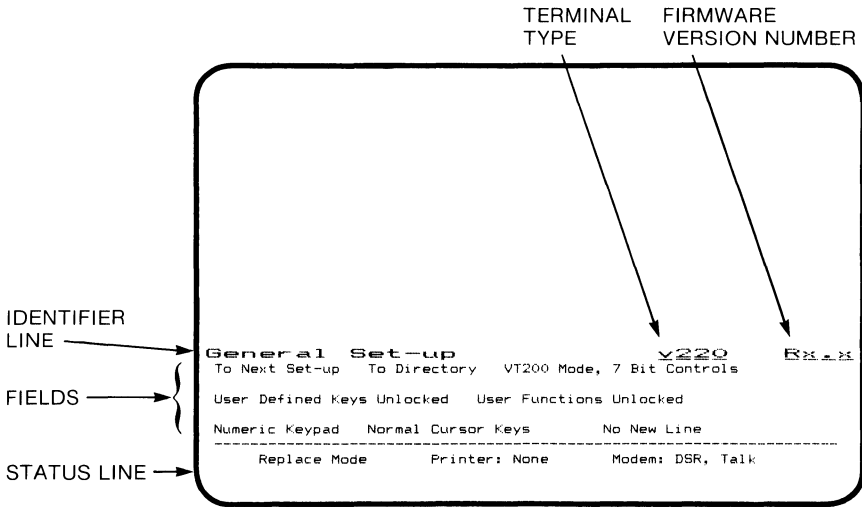

Figure 3-2. Typical Set-Up Menu

3.2.2.1 Menu Identifier Line — The menu identifier line identifies the current Set-Up menu, the type of terminal (v220), and the firmware revision number (refer to Figure 3-2).

3.2.2.2 Fields — The fields on each menu are blocks of text describing the current function or parameter. There are three types of fields: Action fields, Parameter fields, and Text fields.

- Action fields always read the same since, by definition, they have only one value. When an Action Field is selected and the **Enter** key is pressed, that action is performed.

For example, when the cursor is positioned on the “To Next Menu” action field in the General Set-Up pressing **Enter** causes the Communications Set-Up menu to be displayed.

- Parameter fields consist of self-describing text that has two or more values. When a parameter field is selected and the **Enter** key is pressed, the current value of the field is replaced with the next sequential value.

For example, pressing **Enter** when the cursor is positioned on the “Transmit=9600” parameter field in the Communications Set-Up menu, causes that field to read “Transmit=19200.”

- Text fields allow direct entry of text by typing the value from the keyboard. When a text field is selected and the **Enter** key is pressed, the terminal prompts for text entry, temporarily overwriting the status line.

Type in the desired text. The new data is displayed to the right of the prompt. Press the **Enter** key to enter the new value.

For example, when the cursor is positioned on the “Answerback=” text field in the Keyboard Set-Up menu, pressing **Enter** causes the status line to be temporarily overwritten with “Enter Answerback:_____”.

Additional Information for Text Fields:

- Mistakes can be erased by pressing the  (delete) key.
- To abort the text entry without changing the original value, press a cursor key to move the cursor to another field (or press **Set-Up** to exit).
- If any key which transmits a multi-character sequence (such as a function key) is struck, the entire sequence is included in the new value.
- Data entered beyond the length of the text field is ignored. A warning bell is also sounded (if enabled).

3.2.2.3 Set-Up Status Line — The Set-Up status line appears at the bottom of each menu. It displays the current status of the EIA modem (when modem controls is selected), the printer, and the terminal insert/replace mode.

The status line is for reporting only and can only be modified indirectly. For example, turning off the printer may change a “Printer: Ready” message to “Printer: Not ready.” The status line messages are described in Table 3-1.

Table 3-1 identifies the various Set-Up status line messages that may appear at the bottom of each menu. The status line displays three messages that define the current status of the terminal mode, the printer and the EIA modem.

Table 3-1. Status Line Messages

Message	Status	Meaning
Mode	Replace	The terminal is in Replace mode. New display characters replace old characters at the cursor position. Replace is the normal mode of operation.
	Insert	The terminal is in Insert mode. All incoming characters move the old characters to the right. Characters moved past the right margin are lost.
Printer:	Ready	The printer is ready.
	Not ready	The printer is not ready.
	None	There is no printer connected.
	Auto-Print	The terminal is in Auto-Print mode and is ready to print.
	Controller	The terminal is in Printer Controller mode and is ready to print.
	Copy	The terminal is in Printer-Copy mode and is ready to print.
Modem:	DSR, Data DSR, Talk	The modem is ready to send or receive data.
	No DSR, Data No DSR,Talk	The modem is not ready to send or receive data.

3.3 USING SET-UP MODE

This section describes the general procedures for entering and exiting Set-Up Mode and for selecting and using various fields.

3.3.1 Entering and Exiting Set-Up Mode

Enter Set-Up mode by pressing the **Set-Up** key (F3 of the top-row function keys). Exit Set-Up mode by again pressing the **Set-Up** key.

3.3.2 Selecting Set-Up Fields

Select a field by positioning the field cursor on the desired field. The field cursor is a highlighted bar that may be moved by pressing the cursor keys. The cursor moves in the direction of the arrow on the cursor keycap. The **home arrow** key moves the field cursor to the first Set-Up field in the menu.

3.3.3 Using a Selected Set-Up Field

Use a selected field by pressing the **Enter** key (on the Numeric/Application keypad).

If an action field is selected, that action is performed when the **Enter** key is pressed. If a parameter field is selected, pressing the **Enter** key cycles through the range of values for that field. The value displayed at any given time is the current value.

3.4 USING SET-UP MENUS

This section describes each of the Set-Up menus. Each field is named and identified as an action field, parameter field or text field (refer to Section 3.2.2.2). The default settings and functions of each field are also indicated.

Table 3-2 may be used as a guide for finding various fields in any of the eight Set-Up menus. The table numbers in parenthesis with each menu title identifies the corresponding table number where that menu is fully described.

Table 3-2. Set-Up Menu Contents

Set-Up Directory (Table 3-3)	Display Set-Up (Table 3-4)	General Set-Up (Table 3-5)
Display Set-Up	To Next Set-Up	To Next Set-Up
General Set-Up	To Directory	To Directory
Communications Set-Up	80/132 Columns	Terminal Mode
Printer Set-Up	Display Controls	User Defined Keys Lock
Keyboard Set-Up	Auto-Wrap	User Functions Lock
Tab Set-Up	Scrolling	Keypad Mode
On-line/Local	Light/Dark Screen	Cursor Key Mode
Clear Display	Cursor	New Line
Clear Comm	Cursor Style	
Reset Terminal	Status Line	
Recall Parameters	Screen Saver	
Save Parameters		
Set-Up Language		
Keyboard Language		
Default Parameters		
Exit Set-Up Mode		
Communications Set-Up (Table 3-6)	Printer Set-Up (Table 3-7)	Keyboard Set-Up (Table 3-8)
To Next Set-Up	To Next Set-Up	To Next Set-Up
To Directory	To Directory	To Directory
Transmit Speed	Transmit Speed	Typewriter or D.P. Keys
Receive Speed	Print Mode	Caps/Shift Lock
XOFF Value	Data Bits, Parity	Auto Repeat
Data Bits, Parity	Stop Bit(s)	Keyclick
Stop Bit(s)	Print Extent	Margin Bell
Local Echo	Print Data Type	Warning Bell
Comm Port Interface	Terminator	Break
Disconnect Delay		Auto Answerback
Transmit Limitations		Answerback Message
		Conceal Answerback
Tab Set-Up (Table 3-9)	Enhancement Set-Up (Table 3-10)	
To Next Set-Up	To Next Set-Up	
To Directory	To Directory	
Clear All Tabs	Time-Of-Day	
Set 8-Column Tabs	Standard/Military	
Individual Tabs and Ruler	PF1/PF2/PF3/PF4	

3-8 Using Terminal Set-Up Mode

3.4.1 Set-Up Directory Menu

The Set-Up Directory Menu is used to access sub-menus in Set-Up mode. Parameter values can be recalled or saved using this menu. This menu is displayed when Set-Up is first entered. Figure 3-3 shows a Set-Up Directory menu. Table 3-3 describes each of the fields in the Set-Up Directory menu.

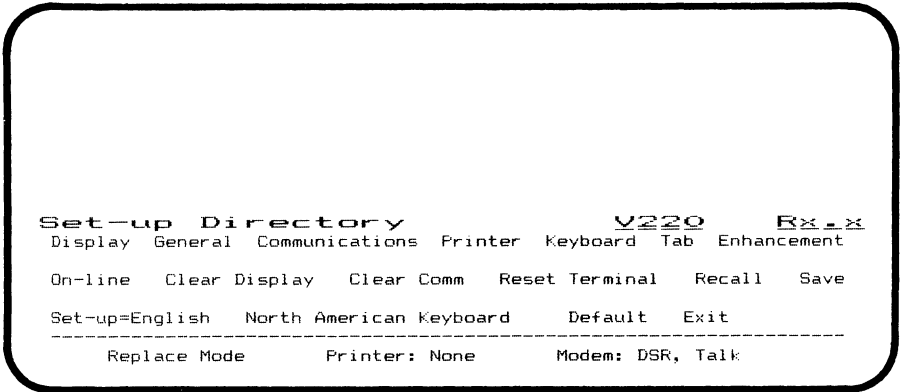

Figure 3-3. Set-Up Directory Menu (with Default Values Displayed)

Table 3-3. Set-Up Directory Menu Field Descriptions

Field Name	(Field Type) Function
Display	(Action Field) Pressing Enter replaces the Directory menu with the Display menu (see Table 3-4).
General	(Action Field) Pressing Enter replaces the Directory menu with the General menu (see Table 3-5).
Communications	(Action Field) Pressing Enter replaces the Directory menu with the Communications menu (see Table 3-6).

Table 3-3. Set-Up Directory Menu Field Descriptions (Contd.)

Field Name	(Field Type) Function
Printer	(Action Field) Pressing Enter replaces the Directory menu with the Printer menu (see Table 3-7).
Keyboard	(Action Field) Pressing Enter replaces the Directory menu with the Keyboard menu (see Table 3-8).
Tab	(Action Field) Pressing Enter replaces the Directory menu with the Tab menu (see Table 3-9).
Enhancement	(Action Field) Pressing Enter replaces the Directory menu with the Enhancement menu (see Table 3-10).
On-Line/Local	<p>(Parameter Field) Pressing Enter causes the terminal to alternate between on-line and local operation when the Enter key is pressed.</p> <ul style="list-style-type: none"> • On-line (default) allows the terminal to communicate with a host computer. • Local essentially puts the terminal on “hold”. Data entered at the keyboard is sent only to the screen.
Clear Display	(Action Field) Pressing Enter clears the text display when Set-Up mode is exited.

Table 3-3. Set-Up Directory Menu Field Descriptions (Contd.)

Field Name	(Field Type) Function
Clear Comm	<p>(Action Field) Pressing Enter clears communication functions in the following manner:</p> <ol style="list-style-type: none">1. Aborts any print operation in progress and takes the terminal out of printer controller or printer copy mode.2. Aborts any escape or control sequence or DCS processing.3. Erases the keyboard, transmitter and receiver buffers.4. Sends an XON to the host computer and resets XOFF received flags on the host and printer ports (if XON/XOFF is enabled).
Reset Terminal	<p>(Action Field) Pressing Enter resets the terminal to a known (default) state that is used by many application programs. The screen, communication and user-defined keys are not affected.</p>
Recall	<p>(Action Field) Pressing Enter replaces all current characteristics with saved values. (See "Save" in this table). The text display is cleared and the cursor returns to the home position.</p>
<p>NOTE</p> <p>Performing a "Recall" causes the terminal to disconnect from a modem.</p>	
Save	<p>(Action Field) Pressing Enter causes the current Set-up characteristics to be saved in non-volatile memory. The Answerback message is also saved.</p>

Table 3-3. Set-Up Directory Menu Field Descriptions (Contd.)

Field Name	(Field Type) Function
Set-up= English/French/ German	(Parameter Field) Pressing Enter changes the language in which the Set-Up menus are displayed.
Keyboard=	<p>(Parameter Field) Pressing Enter selects the correct terminal operation for the National keyboard in use. National keyboards are:</p> <ul style="list-style-type: none"> • British • Canadian (French) • Danish • Dutch • Finnish • Belgian/Flemish • French/Belgian • German • Italian • North American (Default) • Norwegian • Spanish • Swedish • Swiss (French) • Swiss (German)
Default	(Action Field) Pressing Enter replaces the current Set-up features with factory default settings. The text display is cleared and the cursor is returned to the Home position.
NOTE	
Performing a “Default” action causes the terminal to disconnect from a modem.	
Exit	(Action Field) Pressing Enter returns the terminal to normal operation.

```

    100  101  102  103  104  105  106  107  108  109  110  111  112  113  114  115  116  117  118  119  120
    121  122  123  124  125  126  127  128  129  130  131  132  133  134  135  136  137  138  139  140
    141  142  143  144  145  146  147  148  149  150  151  152  153  154  155  156  157  158  159  160
    161  162  163  164  165  166  167  168  169  170  171  172  173  174  175  176  177  178  179  180
    181  182  183  184  185  186  187  188  189  190  191  192  193  194  195  196  197  198  199  200
  
```

3.4.2 Display Set-Up Menu

The Display Set-Up menu is used to control various parameters that affect the display of information. Figure 3-4 shows a Display Set-Up menu. Table 3-4 describes each of the fields in the Display Set-Up menu.

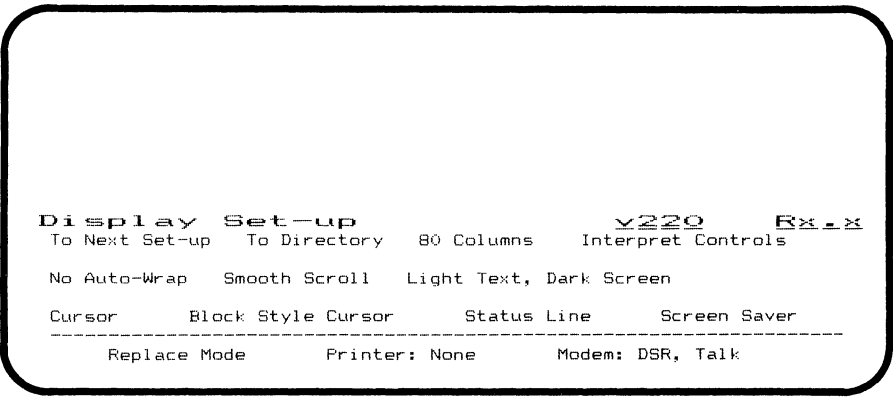

Figure 3-4. Display Set-Up Menu (with Default Values Displayed)

Table 3-4. Display Menu Descriptions

Field Name	(Field Type) Function
To Next Set-up	(Action Field) Pressing Enter causes the Display menu to be replaced with the General Set-up menu. (see Table 3-5).
To Directory	(Action Field) Pressing Enter causes the display menu to be replaced with the Set-Up Directory. (see Table 3-3).
80/132 Columns	(Parameter Field) The terminal alternates between an 80 column (default) and a 132 column text display. This change takes effect immediately and clears the text screen.

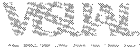

Table 3-4. Display Menu Field Descriptions (Contd.)

Field Name	(Field Type) Function
Interpret/Display Controls	<p>(Parameter Field) Pressing Enter causes the terminal to alternate between interpreting and displaying control codes received from the host.</p> <ul style="list-style-type: none">• When Interpret Controls (default) is selected the control codes are not displayed• When display Controls is selected, the control codes are displayed only and are not interpreted (except for linefeed [LF], formfeed [FF] or vertical tab [VT] which are performed after the code is displayed).
Auto-Wrap	<p>(Parameter Field) Pressing Enter causes the display to alternate between Auto-Wrap and No Auto-Wrap.</p> <ul style="list-style-type: none">• Auto-Wrap causes a character received beyond the right margin to be displayed in the left-most column of the following line.• No Auto-Wrap (default) causes characters received beyond the right margin to over write the last column of the current line.

Table 3-4. Display Menu Field Descriptions (Contd.)

Field Name	(Field Type) Function
Smooth/Jump Scroll	<p>(Parameter Field) Pressing Enter causes the display to alternate between Smooth Scroll and Jump Scroll.</p> <ul style="list-style-type: none">• Smooth Scroll (default) gives the impression of a smooth, steady scroll by limiting the speed at which new lines enter the screen.• Jump Scroll gives the impression that the screen jumps up to accept each new line that is displayed. Jump scroll displays new lines as fast as they are received.
Light Text, Dark Screen/ Dark Text, Light Screen	<p>(Parameter Field) Pressing Enter causes the display to alternate between light text on dark background (Default) and dark text on a light background.</p>
Cursor/No Cursor	<p>(Parameter Field) Pressing Enter selects whether the text cursor is displayed (default) or not displayed.</p>
Block/Underline Cursor Style	<p>(Parameter Field) Pressing Enter selects whether the type of cursor displayed is a “Block” (<input type="checkbox"/>) cursor (default) or an “Underline” (<u> </u>) cursor.</p>
Status Line/ No Status Line	<p>(Parameter Field) Controls whether the status line is displayed (default) or not displayed. The time-of-day clock is always displayed on the status line (if the clock is programmed).</p>
Screen Saver/ No Screen Saver	<p>(Parameter Field) Pressing Enter enables (default) or disables the screen saver feature.</p>

3.4.3 General Set-Up Menu

The General Set-Up menu is used to select various terminal modes and to lock and unlock the keyboard. Figure 3-5 shows a General Set-Up menu. Table 3-5 describes each of the fields in the General Set-Up menu.

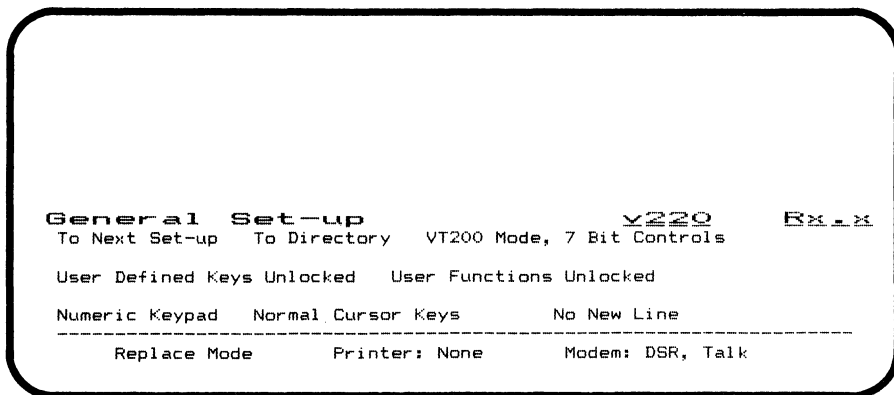

Figure 3-5. General Set-Up Menu (with Default Values Displayed)

Table 3-5. General Set-Up Menu Field Descriptions

Field Name	(Field Type) Function
To Next Set-up	(Action Field) Pressing Enter causes the General Set-Up menu to be replaced with the Communications Set-up menu (see Table 3-6).
To Directory	(Action Field) Pressing Enter causes the General Set-Up menu to be replaced with the Set-up Directory (see Table 3-3).

VT200 Mode: 8 Bit Controls
VT200 Mode: 7 Bit Controls (Default)
VT100 Mode

Table 3-5. General Set-Up Menu Field Descriptions (Contd.)

Field Name	(Field Type) Function
Mode/Controls	(Parameter Field) Pressing Enter causes this field to display each of the four operating modes.

NOTE

Changing this field causes the Application keypad and Application cursor keys to be reset to their default values.

The four operating modes are:

- VT200 Mode: 8 Bit Controls

This mode causes the terminal to operate with a full range of capabilities in an 8-bit environment with 8-bit controls and graphic characters.

- VT200 Mode: 7 Bit Controls (Default).

This mode causes the terminal to operate with a full range of capabilities transmitting 7-bit controls and 8-bit graphic characters. (in any VT200 mode the terminal can receive and interpret 8-bit control codes). This is the recommended mode for most applications.

- VT100 Mode

This mode causes the terminal to behave as a VT100. This mode is for use with application programs that require strict VT100 compatibility.

Table 3-5. General Set-Up Menu Field Descriptions (Contd.)

Field Name	(Field Type) Function
	<ul style="list-style-type: none"> • VT52 Mode This mode causes the terminal to behave as a VT52 for use with application programs designed for that terminal.
VT100 ASCII/U.K.	<p>(Parameter Field) Pressing Enter selects whether the default character set for use in VT52 or VT100 mode is ASCII (default) or U.K. When VT100 U.K. is selected, the ASCII number sign (#) is replaced with the U.K. Pound symbol (£).</p>
<p>NOTE</p> <p>This field is unique. It only appears when the terminal is in VT100 or VT52 mode.</p>	
User Defined Keys Locked/Unlocked	<p>(Parameter Field) Pressing Enter causes the terminal to alternately lock and unlock (default) the user defined function keys. When locked, the function keys cannot be programmed by the host computer.</p>
User Features Locked/Unlocked	<p>(Parameter Field) Pressing Enter causes the terminal to alternately lock and unlock (default) the User Preference Features. User preference features include Auto-Repeat, Smooth/Jump Scroll, Light/Dark Screen, Tab Stops, and Keyboard Lock.</p> <p>Some software applications expect to control these features. To ensure predictable behavior with these programs, this field should be set to "User Features Unlocked".</p>

Table 3-5. General Set-Up Menu Field Descriptions (Contd.)

Field Name	(Field Type) Function
Numeric/ Application Keypad	<p>(Parameter Field) Pressing Enter causes the terminal to alternately select whether numeric or application codes are generated by the numeric/application keypad.</p> <p>When the numeric keypad (Default) is selected, the auxiliary keypad transmits ASCII characters that correspond to the numeric characters on the keys.</p> <p>When the application keypad is selected, the auxiliary keypad transmits escape sequences used by application programs. The sequences transmitted are identified in Chapter 8.</p>
Normal/ Application Cursor Keys	<p>(Parameter Field) Pressing Enter causes the terminal to alternately select whether the cursor keys transmit "Normal" ANSI cursor control sequences (default) or application control sequences. Control sequences transmitted are identified in Chapter 8.</p>
New Line/No New Line	<p>(Parameter Field) Pressing Enter causes the terminal to alternately select the function of the keyboard Return key.</p> <ul style="list-style-type: none">• "New Line" (default) causes the Return key to transmit a carriage return (CR) and a line feed (LF).• "No New Line" causes the Return key to transmit a carriage return (CR) only.

NOTE:
When the Numeric Keypad is selected, this feature affects the Enter key in the same way as it affects the Return key.

3.4.4 Communications Set-Up Menu

The Communications Set-Up menu is used to select various communication parameters. Figure 3-6 shows a Communications Set-Up menu. Table 3-6 describes each of the fields in the Communications Set-Up menu.

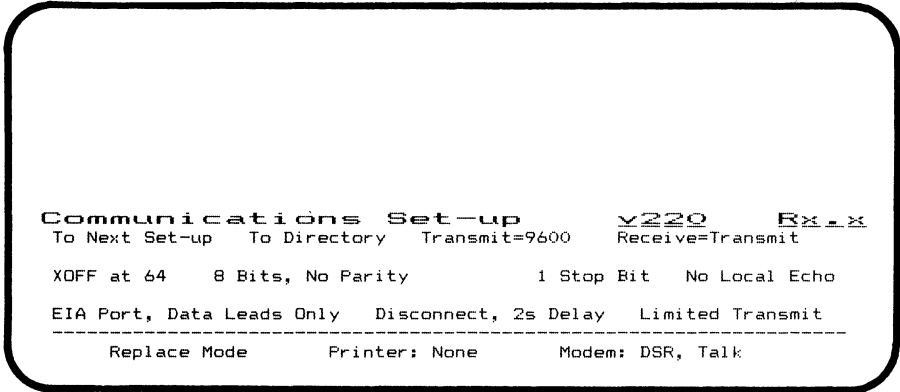

Figure 3-6. Communications Set-Up Menu (with Default Values Displayed)

Table 3-6. Communications Set-Up Menu Field Descriptions

Field Name	(Field Type) Function
To Next Set-up	(Action Field) Pressing Enter causes the Communications menu to be replaced with the Printer Set-up menu. (see Table 3-7).
To Directory	(Action Field) Pressing Enter causes the Communications menu to be replaced with the Set-up Directory. (see Table 3-3).

Table 3-6. Communications Set-Up Menu Field Descriptions (Contd.)

Field Name	(Field Type) Function
Receiver=	<p>(Parameter Field) Pressing Enter causes the terminal to cycle through the sixteen possible baud rates for the receiver. The terminal receive speed must be set to match the host transmit speed. However, the terminal can receive at one speed and transmit at another.</p> <p>The possible baud rates are:</p> <ul style="list-style-type: none"> • 50 baud • 75 baud • 110 baud • 134.5 baud • 150 baud • 200 baud • 300 baud • 600 baud • 1200 baud • 1800 baud • 2000 baud • 2400 baud • 3600 baud • 4800 baud • 9600 baud • 19200 baud • Receive=Transmit (Default)
XOFF at 64/128/256/No XOFF	<p>(Parameter Field) Pressing Enter selects the XOFF point or disables the XON/XOFF flow control. XOFF at 64 characters (12.5% of the input buffer capacity) is the default value for this field.</p>

Table 3-6. Communications Set-Up Menu Field Descriptions (Contd.)

Field Name	(Field Type) Function
Bits/Parity	<p>(Parameter Field) Pressing Enter causes the terminal to cycle through various selections of parity and data bits per character when the Enter key is struck.</p> <p>Available selections are:</p> <ul style="list-style-type: none">• 8 Bits, No Parity (Default)• 8 Bits, Even Parity• 8 Bits, Odd Parity• 7 Bits, No Parity• 7 Bits, Even Parity• 7 Bits, Odd Parity• 7 Bits, Mark Parity• 7 Bits, Space Parity• 7 Bits, Even Parity, No Check• 7 Bits, Odd Parity, No Check• 8 Bits, Even Parity, No Check• 8 Bits, Odd Parity, No Check
1/2 Stop Bits	<p>(Parameter Field) Pressing Enter causes the terminal to alternately select one (default) or two stop bits for the host data format. 2 stop bits are generally used only at baud rates below 200 baud.</p>
Local Echo	<p>(Parameter Field) Pressing Enter causes the terminal to alternately enable or disable (default) Local Echo Mode. The Local Echo feature automatically echoes characters to the terminal. If the host echoes data, this feature should be disabled.</p>

Table 3-6. Communications Set-Up Menu Field Descriptions (Contd.)

Field Name	(Field Type) Function
20 mA/EIA Port	<p>(Parameter Field) Pressing Enter causes the terminal to cycle through the available interfaces for the host Comm Port</p> <ul style="list-style-type: none"> • 20 mA Port should be selected if the terminal is connected to the host via the 20 mA port. • EIA Port, Data Leads Only (default) should be selected if the terminal is connected directly to the host via the EIA port. • EIA Port, Modem Controls should be selected if the terminal is connected to the host via an external modem requiring modem controls.
Disconnect, 2sec/60ms Delay	<p>(Parameter Field) Pressing Enter causes the terminal to alternate between the two available disconnect delay times. Delay time is the time between the loss of DCD (Data Carrier Detect) and terminal disconnection. 60 ms should be used in the U.K. 2 seconds (default) should be used for all other countries.</p>
Limited/Unlimited Transmit	<p>(Parameter Field) Pressing Enter causes the terminal to alternate between limited (default) and unlimited transmit. Limited Transmit limits the transmit rate to 150-180 characters per second, regardless of the baud rate, placing a minimum burden on the host operating system.</p>



Table 3-7. Printer Set-Up Menu Field Descriptions (Contd.)

Field Name	(Field Type) Function
Speed=	<p>(Parameter Field) Pressing <code>Enter</code> causes the terminal to cycle through the sixteen available baud rates for the printer port.</p> <p>The possible baud rates are:</p> <ul style="list-style-type: none">• 50 baud• 75 baud• 110 baud• 134.5 baud• 150 baud• 200 baud• 300 baud• 600 baud• 1200 baud• 1800 baud• 2000 baud• 2400 baud• 3600 baud• 4800 baud• 9600 baud (Default)• 19200 baud
Print Mode	<p>(Parameter Field) Pressing <code>Enter</code> selects the operating mode for the printer. The available modes are:</p> <ul style="list-style-type: none">• Normal Print Mode (Default) enables print functions to be invoked from either the host or the keyboard.• Auto Print Mode allows a variable number of lines to be sent to the printer. A received linefeed, formfeed or vertical tab causes the line containing the cursor to be transmitted. The control code that initiated printing is appended to the end of the printed data.

Table 3-7. Printer Set-Up Menu Field Descriptions (Contd.)

Field Name	(Field Type) Function
Bits/Parity	<ul style="list-style-type: none"> • Controller Mode, routes all data from the host directly to the printer instead of the screen. This means that the printer speed controls the host in terms of XOFF/XON protocol. The host XON/XOFF feature must be enabled. • Copy Mode is similar to Controller mode except that data is also routed to the terminal display. <p>(Parameter Field) Pressing <code>Enter</code> causes the terminal to cycle through various selections of parity and data bits per character.</p> <p>Available selections are:</p> <ul style="list-style-type: none"> • 8 Bits, No Parity (default) • 8 Bits, Even Parity • 8 Bits, Odd Parity • 7 Bits, No Parity • 7 Bits, Even Parity • 7 Bits, Odd Parity • 7 Bits, Mark Parity • 7 Bits, Space Parity
1/2 Stop Bits	<p>(Parameter Field) Pressing <code>Enter</code> causes the terminal to select one (default) or two stop bits for the printer interface.</p>
Print Full Page/ Scroll Region	<p>(Parameter Field) Pressing <code>Enter</code> causes the terminal to alternate between Full Page (default) and Scroll Region for the print extent. If Scroll Region is chosen, only the scrolling region area is printed when a Print Screen command is issued. Otherwise, the full screen is printed.</p>



Table 3-7. Printer Set-Up Menu Field Descriptions (Contd.)

Field Name	(Field Type) Function
Printed Data Type	<p>(Parameter Field) Pressing Enter causes the terminal to select the type of characters to be sent to the printer. The printer must be able to support the types of characters sent.</p> <ul style="list-style-type: none">• If ASCII or U.K. Only (default) is selected, only ASCII or U.K. data is printed. Line drawing and down-line loadable characters are replaced with underbars. Supplemental characters are replaced with appropriate translations (see Appendix E).• If Line Drawing, ASCII/U.K. is selected, only Line Drawing, ASCII and U.K. data is printed. Down-line loadable characters are replaced with underbars. Supplemental characters are replaced with appropriate translations (see Appendix E).• If All Characters is selected, all characters are printed.
Print Terminator	<p>(Parameter Field) Pressing Enter switches the print termination between formfeed (FF) and none.</p> <ul style="list-style-type: none">• When Terminator=FF is selected, the terminal transmits a FF code at the end of a print operation.• When No Terminator (default) is selected, no code is transmitted at the end of a print operation.

Table 3-8. Keyboard Set-Up Menu Field Descriptions (Contd.)

Field Name	(Field Type) Function
Typewriter/Data Processing Keys	<p>(Parameter Field) Pressing Enter causes the keyboard to switch between Typewriter and Data Processing keys.</p> <ul style="list-style-type: none"> • Selecting Typewriter Keys (default) causes the keyboard keys to generate the characters shown on left half of foreign national keycaps. • Selecting Data Processing causes the keys to generate the characters on the right half of foreign national keycaps.
Caps/Shift Lock	<p>(Parameter Field) Pressing Enter selects the operation of the Lock key.</p> <ul style="list-style-type: none"> • Caps Lock (default) causes the alphabetic keys to generate only uppercase characters when the Lock indicator is on. The numeric/symbol keys generate codes for the bottom character printed on the keycaps. • Shift Lock causes the alphabetic keys to generate only uppercase characters and the numeric/symbol keys to generate the top code only when the Lock indicator is on. <p>The lock indicator is set by pressing the Lock key. Caps Lock can be reset by pressing the Lock key again. Shift Lock can be cleared by pressing the Lock key or the Shift key.</p>
Autorepeat/ No Autorepeat	<p>(Parameter Field) Pressing Enter alternately enables (default) and disables the autorepeat feature. When enabled, keystrokes are automatically repeated when a key is held down for more than .5 seconds. When disabled, only single keystroke operation is allowed.</p>

Table 3-8. Keyboard Set-Up Menu Field Descriptions (Contd.)

Field Name	(Field Type) Function
Keyclick No Keyclick	(Parameter Field) Pressing Enter switches the keyboard between Keyclick (audible) and No Keyclick (silent) operation. Keyclick is the default value for this field.
Margin Bell/ No Margin Bell	(Parameter Field) Pressing Enter alternately enables (default) and disables the terminal from sounding a bell tone when the cursor is eight characters from the end of the current line.
Warning Bell/ No Warning Bell	(Parameter Field) Pressing Enter alternately enables (default) and disables the terminal from generating a bell tone for operating errors and receipt of Control-G.
Break/No Break	(Parameter Field) Pressing Enter alternately enables (default) and disables the Break key. This only affects break, not shift-break (long disconnect) or control-break (answerback). For more information on the Break key, refer to Table 2-2.
Auto Answerback/ No Auto Answerback	(Parameter Field) Pressing Enter alternately enables (default) and disables the ability of the terminal to automatically transmit the answerback message after a communication line connection.
Answerback=	(Text Field) Pressing Enter allows input of a new Answerback message. The status line is temporarily overwritten with the message, "Enter Answerback." Up to thirty-two (32) characters can be entered. Any ASCII or supplemental code can be programmed. Control codes are represented by their Display Controls characters. Pressing the Enter key terminates entry of the answerback message.

Table 3-8. Keyboard Set-Up Menu Field Descriptions (Contd.)

Field Name	(Field Type) Function
Concealed/Visible	<p>(Parameter Field) Pressing Enter conceals the answerback message, preventing it from being displayed on the screen during Set-Up.</p> <p>To reset to “Visible” (default), a new answerback message must be entered.</p>

Table 3-9. Tab Set-Up Menu Field Descriptions (Contd.)

Field Name	(Field Type) Function
Tab Stops	(Parameter Fields) Pressing <code>Enter</code> alternately sets and removes individual tab stops at the current cursor position. Change the cursor position using <code>Tab</code> , <code>Cursor Left</code> , <code>Cursor Right</code> and <code>Return</code> .

NOTE

The tab field and ruler can be either 80 or 132 columns, depending on which mode is selected (see Table 3-4).

3.4.8 Enhancement Set-Up Menu

The Enhancement Set-Up menu is used to enter time and to enter data for the four PF keys (on the Numeric/Application keypad). Figure 3-10 shows an Enhancement Set-Up menu. Table 3-10 describes each of the fields in the Tab Set-Up menu.

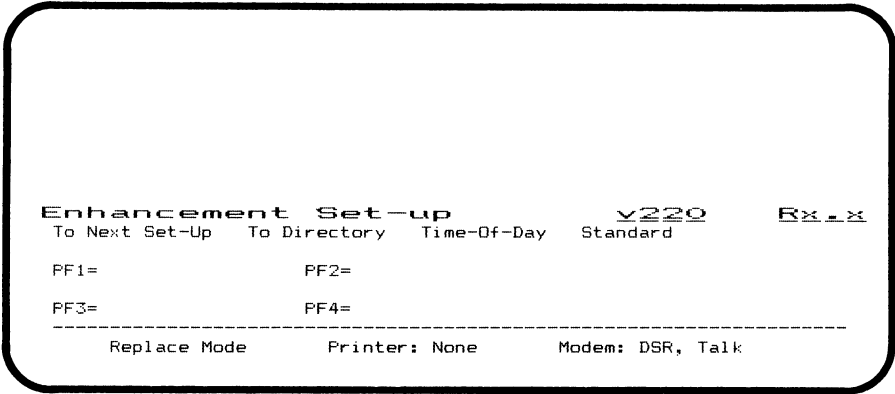

Figure 3-10. Enhancement Set-Up Menu (with Default Values Displayed)

Table 3-10. Enhancement Set-Up Menu Field Descriptions

Field Name	(Field Type) Function
To Next Set-Up	(Action Field) Pressing <u>Enter</u> causes the Enhancement menu to be replaced with the Display Set-up menu (see Table 3-4).
To Directory	(Action Field) Pressing <u>Enter</u> causes the Enhancement menu to be replaced with the Set-up Directory. (see Table 3-3).
Time-Of-Day	(Action/Text Field) Pressing <u>Enter</u> allows input of the time-of-day. The status line is temporarily overwritten with the message "Enter time (hh:mm:ss):". Time can be entered in standard or military format and is translated to the selected format.

**Table 3-10. Enhancement Set-Up Menu Field Descriptions
(Contd.)**

Field Name	(Field Type) Function
Standard/Military	(Parameter Field) Pressing Enter alternately selects the Standard or Military format to display the time. The Standard format is a 12 hour clock with AM and PM indicators. The Military format is a 24 hour clock.
PF1/PF2/PF3/PF4	(Text Fields) Pressing Enter allows input of data for the selected PF key. The status line is temporarily overwritten with the message "Enter PF key data:". Up to 15 characters can be entered for each key. Data entered is stored in non-volatile memory.

VSI/A

**Part Two:
Installation
and Configuration**

CHAPTER 4

TERMINAL INSTALLATION

4.1 OVERVIEW

This Chapter provides information required for installing the Visual 220 terminal. In addition, the self-test indications are also described. The self-test aids in assuring that the Visual 220 terminal is correctly installed and is functioning properly. The following information is provided:

- Site requirements
- Unpacking and inspection
- Installation and testing
- Printer port connection

4.2 SITE REQUIREMENTS

The location where the Visual 220 terminal is to be installed must meet the following requirements:

- The terminal operating area is located where the terminal is not likely to be damaged by bumps, spills, excessive heat and so on.
- All necessary cables reach the appropriate terminal connectors without being strained. Typical cables include:
 - Power cord
 - Keyboard cable
 - Printer cable (if required)
 - Host communications cable (or modem cable).
- The operating conditions (such as temperature, humidity, voltage levels and so on) are within the ranges prescribed for normal terminal operation. The terminal parameters are listed in Appendix A.

4.3 UNPACKING AND INSPECTION

This section provides instructions for unpacking the keyboard and monitor shipping cartons and verifying the presence and condition of the contents. These instructions may also be used for repacking the terminal in the event that it is to be shipped or moved to another location.

1. Unpack the keyboard and monitor shipping cartons as shown in Figures 4-1 and 4-2.

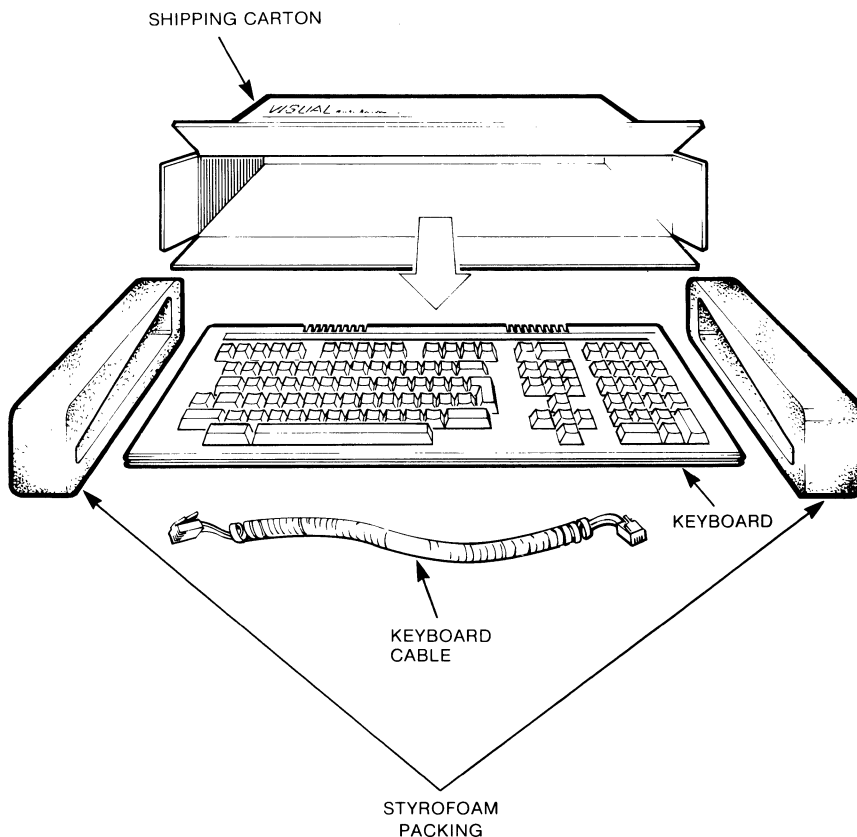

Figure 4-1. Unpacking the Keyboard Shipping Carton

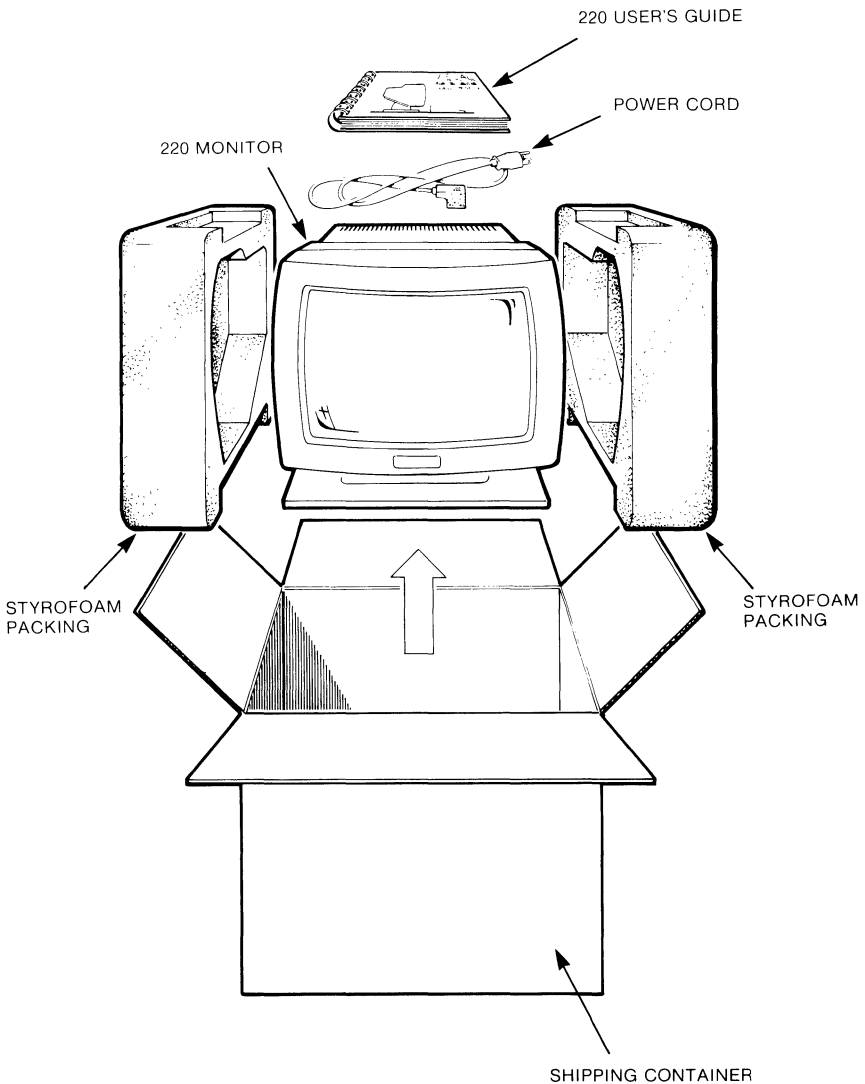

Figure 4-2. Unpacking the Monitor Shipping Carton

2. Verify that all of the items have been received and are not damaged. The items are shown in Figure 4-3.

NOTE

If any items are missing or damaged, contact the Visual sales representative and/or the shipping agent.

THE KEYBOARD CARTON CONTAINS:

KEYBOARD
CABLE



KEYBOARD

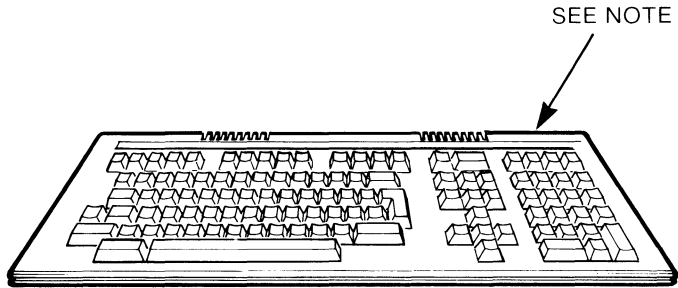

Figure 4-3. Checking the Contents (Sheet 1 of 2)

NOTE

Each keyboard has two function key legend strips. A generic strip is permanently bonded to the keyboard. A removable national language strip slides over the generic strip.

THE MONITOR CARTON CONTAINS:

- 220 MONITOR UNIT

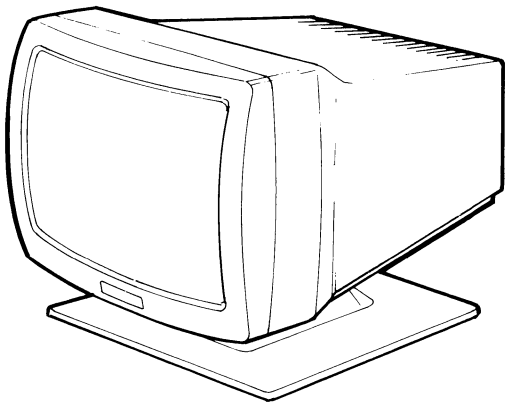

- 220 USER'S GUIDE

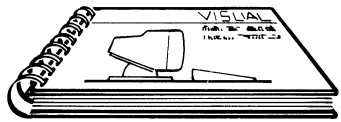

- POWER CORD

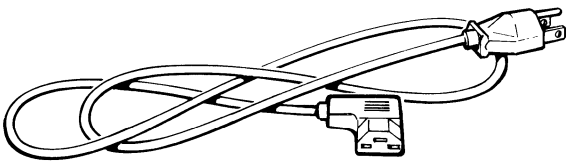

Figure 4-3. Checking the Contents (Sheet 2 of 2)

4.4 INSTALLATION AND TESTING

This section describes when and where to connect the necessary cables and when to perform various tests. The tests include:

- Terminal power-on self-test
- Host communication test
- Printer test

Information on configuring the host Comm port (selecting baud rates and so on) is provided in Chapter 5, Communication. Information on connecting a printer is provided in the subsequent section entitled "Printer Port Connection."

CAUTION

To avoid damage to any equipment, follow the installation instructions carefully. Make sure the terminal is turned off when any cables are being connected.

1. Locate the terminal (monitor and keyboard) where it is to be installed.
2. Make sure the terminal power switch is pushed to OFF as shown in Figure 4-4.

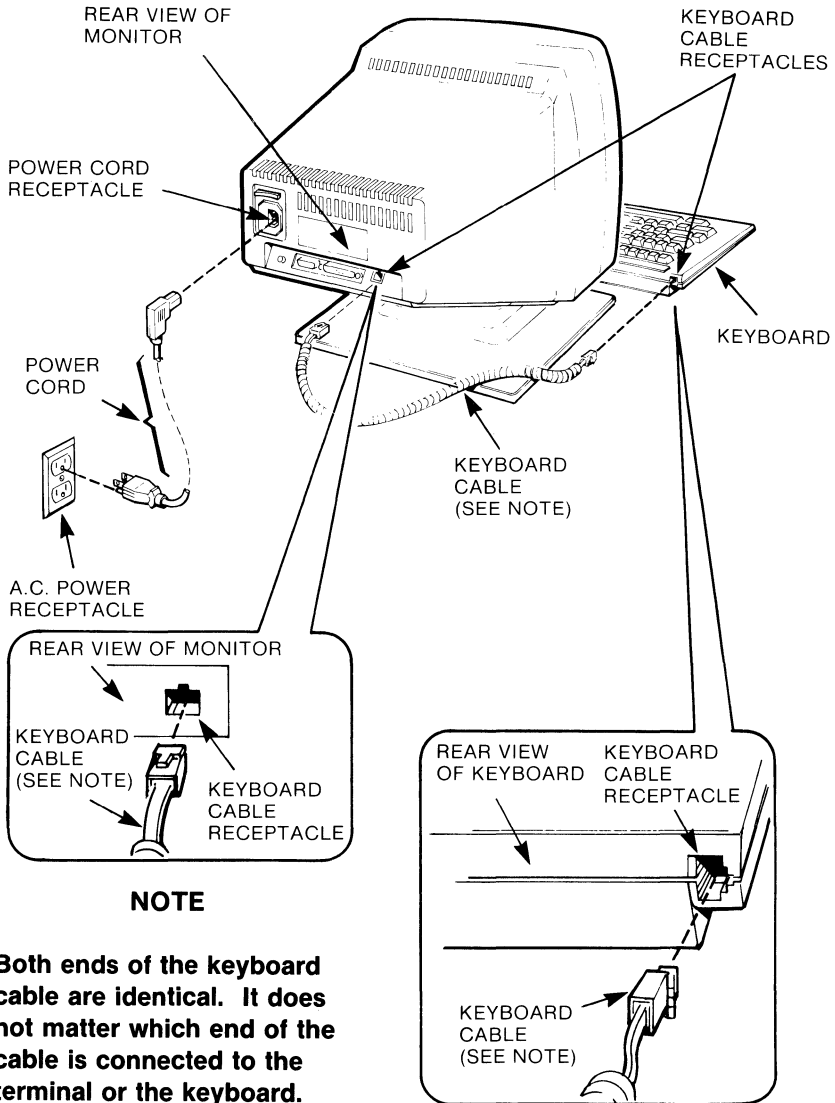

Figure 4-5 Keyboard Cable and Power Cord Connections

4. Push the power switch to ON and note the results of the self-test (see Figure 4-6).

NOTE

A self-test that lasts for about 10 seconds executes each time the terminal is turned ON or reset. Keyboard indicator lights (above top-row function keys F15 and F16) blink on and off while the test is executing.

When the self-test completes, the following indications should occur:

- a) A short tone (beep) sounds, signalling that the self-test has passed.
- b) A blinking cursor and status line are displayed (see Figure 4-6).

If the terminal does not power-up as expected, go to Chapter 6, Problem Solving, and try the suggested corrective procedures.

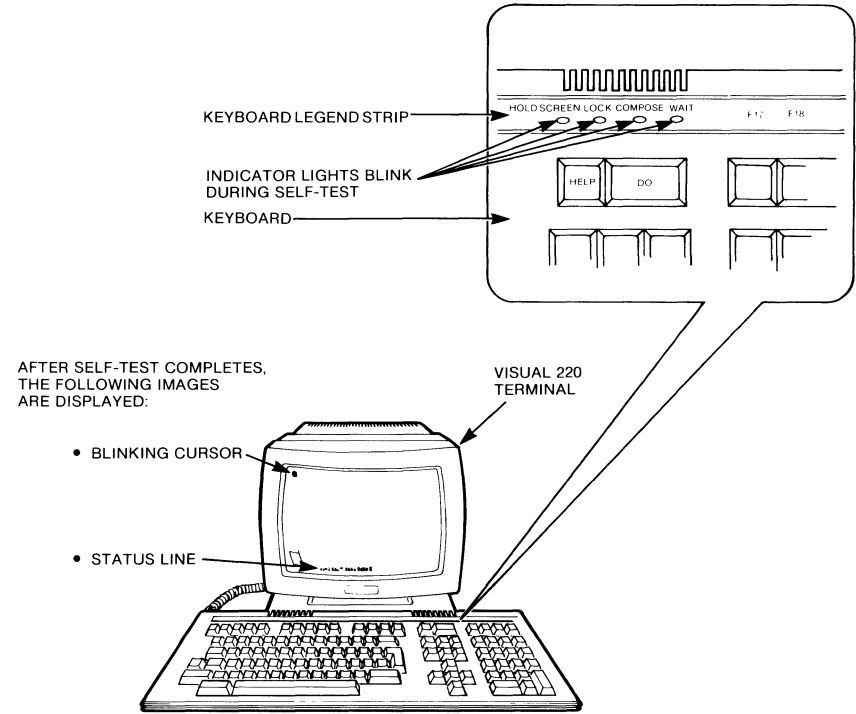

Figure 4-6. Self-Test Indications

4.5 PRINTER PORT CONNECTION

This section describes the procedure for connecting a printer to the printer port. Instructions for testing the printer interface are also included.

To connect a printer to the printer port, perform the following steps:

1. Log off of the host system (if necessary) and turn off the terminal (refer to Figure 4-4).
2. Connect the cable from the printer to the printer port on the rear of the terminal (refer to Figure 4-7).
3. Turn on the terminal. After self-test completes, use the Printer Set-Up menu to configure the printer port so that the terminal can communicate with the printer.

Information on configuring the printer port is provided in Chapter 5, Communications. The Printer Set-Up menu is fully described in Chapter 3, Terminal Set-Up.

4. Test the printer interface by performing the following steps:
 - a. Type a few lines of characters onto the terminal display (if a host system is not available, first place the terminal in local mode using the Set-Up Directory menu).
 - b. Print the displayed characters on the printer by pressing the **Print Screen** key (top-row function key F2).

If the printer does not respond by printing the displayed characters, go to Chapter 6, Problem Solving, and try the suggested corrective procedures.

5. Save the new configuration in non-volatile RAM (NVR) using the "Save" feature from the Set-Up Directory menu.

CHAPTER 5 COMMUNICATION

5.1 OVERVIEW

This Chapter provides information to aid in configuring the Visual 220 terminal so that it can communicate with a host system and a printer (if one is connected).

The following sections are included in this Chapter:

- Communications Protocols
- Data Flow Control
- Host Interface
 - Local Host
 - Remote Host
- Printer Interface

5.2 COMMUNICATION PROTOCOLS

The Visual 220 terminal must be able to communicate properly with a host computer in order to function. This section describes various standards and protocols supported by the Visual 220 terminal.

Selection of a desired protocol typically requires changing settings in the Communications Set-up menu. All of the Set-up menus are fully described in Chapter 3.

5.2.1 Communications Standards Supported

The Visual 220 terminal supports the following data communication standards:

- EIA Standard RS-232-C
- CCITT V.24
- (Optional) 20 mA current loop interface

The desired interface may be selected from the Communications Set-Up menu.

5.2.2 Communication Modes

The Visual 220 terminal supports full-duplex, asynchronous serial data communications only. The following additional features may be selected or modified from the Communications menu:

- Split data rates on transmit and receive lines.
- Local echo.
- Data Format:
 - Number of data bits.
 - Number of stop bits.
 - Even, odd or no parity.

5.2.2.1 Split Data Rates — The Visual 220 terminal may transmit at one speed and receive at another. However, for compatibility with the host system, the terminal's transmit speed must be set to match the host's receive speed and the terminal's receive speed must be set to match the host's transmit speed. The possible baud rates are: 50, 75, 110, 134.5, 150, 200, 300, 600, 1200, 1800, 2000, 2400, 3600, 4800, 9600, and 19200.

5.2.2.2 Local Echo — Data from the keyboard can be directed to the display as well as to the host computer. If the host computer is set to echo data back to the terminal, local echo should be disabled.

5.2.2.3 Data Format — The Visual 220 terminal uses a data format that consists of a 9- to 12-bit word. The word is made up of the following:

- One start bit (always a spacing [0] bit).
- Seven or eight data bits.
- An optional parity bit.
- One or two stop bits (a stop bit is always a mark [1] bit).



5.3 TERMINAL/HOST DATA FLOW CONTROL

The Visual 220 terminal supports XON/XOFF data flow control and hardware data flow control. This section describes both types of data flow control.

Data flow control helps to minimize lost data by signalling the host to stop sending data. The conditions under which the flow control signals are generated may be selected by the operator from the Communications Set-Up menu.

5.3.1 XON/XOFF Data Flow Control

The Visual 220 terminal supports the use of XOFF and XON characters to suspend and resume data transmission from the host computer. This feature helps prevent loss of data due to overflow of the terminal's receive data buffer.

5.3.1.1 Conditions Causing XOFF Character Transmission — An XOFF character (DC3 [Ctrl-S]) is transmitted by the terminal when XON/XOFF is enabled and any of the following occurs:

- The receive buffer reaches the selected threshold level of its capacity of 512 characters. The threshold may be set at 64, 128, or 256 characters (12.5%, 25% and 50% respectively) using the Communications Set-Up menu.
- The receive buffer reaches 75% (384 characters) of its capacity of 512 characters.
- A character is received when the receive buffer is full (512 characters). Any character that causes an XOFF transmission due to a full buffer is lost.

If the host system does not respond to XOFF, and the receive buffer continues to fill with characters, the buffer may overflow. When this happens, data is lost. The Visual 220 terminal replaces any lost characters with reverse question marks (¿). The question mark characters are sent to the screen and may be used as a signal that characters are being lost.

5.3.1.2 Conditions Causing XON Character Transmission — An XON character (DC1 [Ctrl-Q]) is transmitted by the terminal when XON/XOFF is enabled and any of the following occurs:

- The receive data buffer is emptied to a fixed level (16 characters) and XOFF was the last flow control signal sent.
- The Clear Communications (Clear Comm from the Set-Up Directory) function is performed.
- The Recall or Default function (from the Set-Up Directory) is performed.
- The self-test is completed.

5.3.1.3 Host XOFF Response Time — The following formula is used to determine how fast the host must respond to the XOFF character (DC3) to prevent any data from being lost.

Host response time formula:

$$\text{Host Response time (in seconds)} = \text{Overflow} \times \frac{\text{Word Size}}{\text{RxDR}}$$

Overflow = Calculated from the Overflow formula below.

RxDR = The receiver baud rate (receive data rate).

Word Size = 1 (Start Bit)
7 or 8 (Number of data bits per character)
1 or 2 (Number of stop bits per character)
+ 0 or 1 (Number of parity bits per character)

Overflow formula:

$$\text{Overflow} = (\text{RxBUF} - \text{XOFF}) - 3 \times \frac{\text{RxDR}}{\text{TxDR}} - \frac{\text{RxDR}}{600}$$

Overflow = The number of characters until overflow occurs.

RxBUF = Size of the receive buffer (512).

XOFF = The selected XOFF point (64, 128 or 256).

RxDR = The receiver baud rate (receive data rate).

TxDR = The transmitter baud rate (transmit data rate).

5.3.2 Using Fill (Null) Characters

With certain situations, data may be lost because the host system does not support (respond to) XON/XOFF characters. In these cases, fill characters (C0 control code "NUL") may be transmitted by the host in place of any real data characters that are being lost.

The terminal can also be used without XON/XOFF characters or fill characters if the following conditions are met:

- The baud rate does not exceed 9600 and
- The software does not send escape (ESC) sequences or use slow scrolling or the printer port.

5.3.3 Modem Connect/Disconnect

When DSR (Data Set Ready) and DCD (Data Carrier Detect) are received from a modem, the Visual 220 terminal performs the following operations to ensure that it is prepared to send and receive data:

- Unlocks the keyboard (if it is locked).
- Clears any transmission in progress.
- Clears the keyboard buffer and all message buffers.
- Clears the receive buffer.
- Clears XOFF sent and XOFF received.
- Asserts the RTS (Request to Send) signal to the modem.

A modem disconnects (hangs up) under the following conditions:

- Holding down the **Shift** and **Break** keys.
- Invoking "Saved" or "Default" values from Set-up.
- DSR is lost.
- DCD is lost for time defined by the user in Set-Up.
- DCD is not detected within 30 seconds after DSR.
- Receipt of a self-test command from the host.

5.4 HOST INTERFACE

Communication with a host computer is via the Comm Port on the rear of the terminal. The Comm Port may be configured (with the Communications menu) to support communications with local or remote host systems.

Table 5-1 identifies the Comm port pins that may be used for various local and remote host configurations

Table 5-1. Host Interface (Comm Port) Pin Usage

Interface Type	Connector Pins Used
RS-232-C / CCITT V.24 (connected to host)	1, 2, 3, 6, 7, 8, 12
RS-232-C / CCITT V.24 (connected to modem)	1, 2, 3, 4, 5, 6, 7, 8, 12, 20
20 mA current loop	17, 18, 21, 25

Table 5-2 Provides a pin signal description for the Comm port connector.

Table 5-2. Host Interface Connector Pin Descriptions

Pin	Mnemonic EIA (CCITT)	Signal Name / Definition
1	AA (101)	Protective Ground (GND) — This signal is connected to the chassis of the terminal. The terminal chassis is connected to the earth-ground pin on the power cord.
2	AB (103)	Transmit Data (TXD) — This line is used to transmit data from the terminal to the modem/host. When modem control is enabled, data can be transmitted only when DTR, DSR, RTS and CTS are on.
3	BB (104)	Receive Data (RXD) — This line is used to receive data from the host/modem. When modem controls are enabled, DCD must be on for this line to be monitored.
4	CA (105)	† Request to Send (RTS) — This signal is from the terminal to the host/modem indicating that the terminal is ready to transmit data. This signal is always asserted.
5	CB (106)	† Clear to Send (CTS) — This is a signal from the host/modem to the terminal indicating that transmission of data is allowed. This signal is monitored by the terminal only if modem controls are enabled. If not connected, it defaults to the OFF condition.

†These signals needed for modem control.

Table 5-2. Host Interface Connector Pin Descriptions (Contd.)

Pin	Mnemonic EIA (CCITT)	Signal Name / Definition
6	CC (107)	Data Set Ready (DSR) — This is a signal from the host/modem to the terminal indicating that the host/modem is ready for handshaking (exchanging RTS, CTS and DCD).
7	AB (102)	Signal Ground (GND) — This signal establishes a ground reference between the terminal and the host.
8	CF (109)	Data Carrier Detect (DCD) — This signal from the modem indicates that the quality of incoming data is sufficient for proper demodulation. If not connected it defaults to the ON condition.
12	CI (112)	Speed Indicator (SPDI) — This signal is from a modem. The ON condition causes the terminal transmit and receive rates to be 1200 baud regardless of the selection in Set-Up. This allows a modem to set the data rate.
17	N/A (N/A)	* 20 mA Current Loop Receive (-) — Refer to Figure 5-2.
18	N/A (N/A)	* 20 mA Current Loop Receive (+) — Refer to Figure 5-2.
20	CD (108.2)	† Data Terminal Ready (DTR) — This signal is ON whenever the terminal is ready to transmit or receive data. It is OFF when the terminal is not ready.

† These signals needed for modem control.

* These signals used only for 20 mA current loop interface.

Table 5-2. Host Interface Connector Pin Descriptions (Contd.)

Pin	Mnemonic EIA (CCITT)	Signal Name/Definition
21	N/A (N/A)	* 20 mA Current Loop Transmit (+) — Refer to Figure 5-2.
23	CH (111)	Data Signal Rate Selector — This signal is from the terminal. This signal is ON when the receive baud rate is greater than 600. This line is used to control a dual rate synchronous data set (if one is used).
25	N/A (N/A)	* 20 mA Current Loop Transmit (-) — Refer to Figure 5-2.

* These signals used only for 20 mA current loop interface.

5.4.1 Configuring for Communication With a Local Host

Communication with a local host can use the EIA RS-232-C/CCITT interface or the optional 20 mA current loop interface if it is installed. Use the Communications menu to select one of the following:

- For RS-232-C/CCITT communications, select “EIA Port, Data Leads Only.”
- For current loop communications, select “20 mA Port.”

5.4.1.1 EIA RS-232-C/CCITT Interface — To communicate with a local host using EIA standard RS-232-C or CCITT V.24, a minimum of three signal lines from the Communication port is required (Transmit Data, Receive Data and Signal Ground). Additional signal lines provide data flow control signals that may help to minimize lost data (refer to Table 5-2).

5.4.1.2 20 MA Current Loop Option — If the optional 20 mA current loop interface is being used, only the four current loop signal lines on the comm port (pins 17, 18, 21 and 25) are required.

The transmitter and/or receiver may be independently active (utilizing an internal current source) or passive (requiring an external current source).

The transmitter is active if jumper W5 on the main PCB is installed. The receiver is active if jumper W7 on the main PCB is installed. If a jumper is not installed, its associated device is passive and an external current source is required.

Figure 5-2 illustrates a full-duplex, current loop configuration. A marking condition (logical 1) is 20 mA flowing in the circuit. A spacing condition (logical 0) is no current flowing.

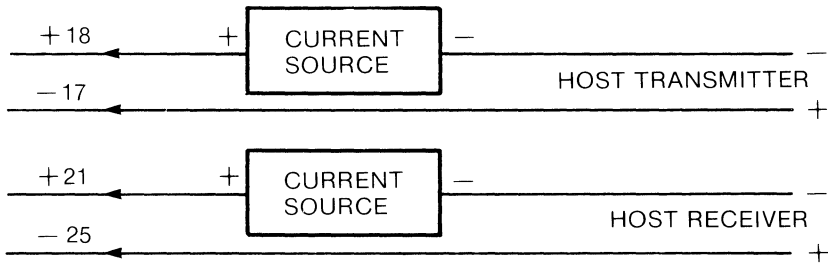

Figure 5-2. Full Duplex 20 mA Current Loop Diagram

5.4.2 Configuring for Communication With a Remote Host

Communication with a remote host requires using the EIA RS-232-C interface and a modem.

To communicate via a modem, select “EIA Port, Modem Control” from the Communications menu. Refer to Table 5-1 for signal line usage and to Table 5-2 for signal line descriptions.



5.5 PRINTER INTERFACE

The printer port uses a 9-pin, male, D-type connector on the rear of the Visual 220 terminal.

The interface includes the following features:

- 256 character FIFO.
- Independent parity from the Comm port. Parity may be selected from the Printer Set-Up menu.
- 16 baud rates (independent from the Comm port). The possible baud rates are: 50, 75, 110, 134.5, 150, 200, 300, 600, 1200, 1800, 2000, 2400, 3600, 4800, 9600, and 19200. The baud rate is selected from the Printer Set-Up menu.
- XON/XOFF protocol or Printer Busy control line. Control is selected automatically by the printer handler.
- Auto print mode allows individual lines to be sent to a printer. A received linefeed, formfeed or vertical tab causes the line containing the cursor to be transmitted to the printer. This mode may be selected from the Printer Set-Up menu.
- Print Line/Page/Region controlled remotely or by the keyboard.
- Print modes include ASCII/U.K. only, line drawing and ASCII/U.K., all characters.

5.5.1 Printer Port Signal Descriptions

Pin signal descriptions are provided in Table 5-3. The information may be helpful in making sure the proper connection is made.

Table 5-3. Printer Port Pin-Signal Descriptions

Pin	Signal Name	Description
1	Protective Ground	This signal is connected to the chassis of the terminal. The terminal chassis is connected to the earth-ground pin on the power cord.
2	Transmit Data to Printer	This is the data signal line from the terminal to the printer.
3	Receive Data from Printer	This is the data signal line from the printer to the terminal.
4	Request to Send	This signal is ON whenever the terminal is turned on.
5	Data Terminal Ready	This signal is ON whenever the terminal is turned on.
6	Data Set Ready	This is a signal from the printer to the terminal indicating a ready condition. If DSR is not present when the terminal is turned on, the terminal checks for DSR before each character is transmitted to the printer. If DSR is present when the terminal is turned on, the printer is allowed to control printing functions.
7	Signal Ground	This signal establishes a ground reference between the printer and the terminal.
8-9	Not Used	

5.5.2 Printer Port Configuration

The printer port is normally configured for Normal Print mode or Auto Print mode. In Normal Print mode, print functions may be invoked from the host or the terminal keyboard. In Auto Print mode, the current line (the line containing the cursor) is transmitted only when a linefeed, form feed or vertical tab is received from the host.

Two other modes, Controller Mode and Copy Mode, route data from the host directly to the printer or other device connected to the printer port. In this case, the device connected to the printer port manages the device/host XON/XOFF data flow control. Data is not displayed on the terminal screen in Controller Mode. Data is, however, displayed on the screen in Copy Mode.

NOTES

- 1. If an 8-bit format is used for terminal/printer communications, C1 control codes are also used. If a 7-bit format is used, the C0 control code extensions (such as ESC [for CSI) are used.**
- 2. If the printer cannot accept 8-bit control codes or 8-bit characters but is configured to accept 8-bit wide data with no parity, select "7-bits, space parity" from the Printer Set-Up menu.**

Table 6-1. Finding the Problem

Action	Expected Results
Turn the system on	
<ul style="list-style-type: none"> • Push the power switch to ON 	<ol style="list-style-type: none"> 1. Keyboard indicator lights blink on and off in a pattern. 2. A short beep is sounded. 3. A blinking cursor and status line are displayed on the monitor. <p>If the terminal does not respond as described, turn to Section 6.2.2</p>
Communicate with the host computer.	
<ul style="list-style-type: none"> • Log onto the host system. 	<p>The host system (computer) should respond with the appropriate log-on prompts (such as "Name:" and/or "Password:").</p> <p>If the host system does not respond as expected, turn to Section 6.2.3.</p>
Print on the local printer.	
<ol style="list-style-type: none"> 1. Place the terminal in Local mode. <ul style="list-style-type: none"> — Select Local Mode from Set-Up Directory menu (in Set-Up mode). 	<p>After leaving Set-Up mode, the status line (displayed on the bottom line) on the monitor should read "Local".</p>
<ol style="list-style-type: none"> 2. Type characters from the keyboard. 	<p>The display echoes keys pressed.</p>
<ol style="list-style-type: none"> 3. Print displayed characters by pressing Print Screen (F2 in top row function keys). 	<p>The printer prints displayed characters.</p> <p>If the printer does not respond as expected, turn to Section 6.2.4.</p>

6.2.2 Power-Up Difficulties

Table 6-2 suggests corrective actions to perform if difficulties are encountered when turning the terminal on.

If the suggested corrective action does not solve the problem, then the problem should be referred to qualified service personnel.

Table 6-2. Difficulties with Turning the Terminal On

Symptom	Suggested Corrective Action
No Response from the terminal:	
— No Indicator Lights	Make sure the terminal is turned ON.
— No Beep	Turn the terminal OFF, wait five seconds and turn the terminal ON.
— No display	Make sure both ends of the power cord are plugged in. Check for power at the outlet by plugging a lamp into it. Check the fuse and replace if necessary (see Figure 6-1). Make sure that both ends of the keyboard cable are connected and that the display intensity is set to maximum. To increase intensity, enter Set-Up mode (press Set-Up) then hold Shift and press up arrow . If the symptom persists, refer the problem to qualified service personnel.

Table 6-2. Difficulties with Turning the Terminal On (Contd.)

Symptom	Suggested Corrective Action
<p>The keyboard indicator lights remain ON (they do not blink). No other response from the terminal.</p> <ul style="list-style-type: none"> — No Beep — No display 	<p>Turn the terminal OFF, wait five seconds and turn the terminal ON. If the symptom persists, refer the problem to qualified service personnel.</p>
<p>Multiple beeps or a steady beep is sounded.</p>	<p>A hardware malfunction exists. Refer problem to qualified service personnel.</p>
<p>Display problems (other indications are normal)</p> <ul style="list-style-type: none"> — No display after warm up period. — No display. — A vertical or horizontal line is displayed. — The display is tilted or rotated or jittery. 	<p>Screen Saver feature enabled. Press the Shift key to restore display.</p> <p>Make sure that the display intensity is set to maximum. To increase intensity, enter Set-Up mode (press Set-Up) then hold Shift and press up arrow.</p> <p>A hardware malfunction exists. Refer problem to qualified service personnel.</p> <p>A hardware malfunction exists. Refer problem to qualified service personnel.</p>

Figure 6-1 shows the location of the terminal fuse. A screwdriver can be used to release the fuse holder from the power cord receptacle.

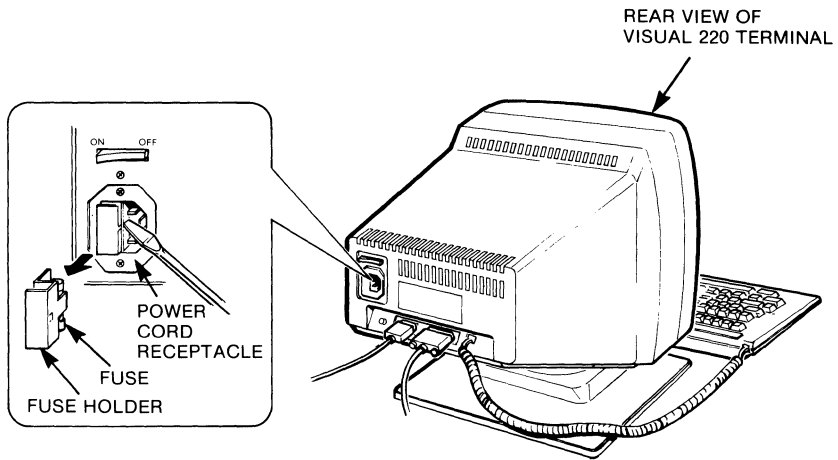

Figure 6-1. Checking the Terminal Fuse

6.2.3 Host Communication Difficulties

Table 6-3 suggests corrective actions to perform if difficulties are encountered when attempting to communicate with a host system.

NOTE

The corrective procedures in this section assume that the terminal has powered-up normally.

If the suggested corrective action does not solve the problem, then the problem should be referred to qualified service personnel.

Table 6-3. Difficulties with Host Communication

Symptom	Suggested Corrective Action
<p>Keyboard keys have no effect.</p>	<p>Free any keys that are stuck in the down position. Then turn the terminal OFF, wait five seconds and turn the terminal ON.</p> <p>If the symptom persists, refer the problem to qualified service personnel.</p>
<p>No response from the host.</p>	<p>Make sure terminal is "On Line" (noted in the status line).</p> <p>Make sure all of the communication cables are properly connected.</p> <p>If a modem is used, make sure it is turned on and properly set.</p> <p>Make sure all of the communication parameters are properly set (check the Communication Set-Up menu).</p> <p>If the symptom persists, a problem may exist with the communication cables or the host system. Refer problem to qualified service personnel.</p>

Table 6-3. Difficulties with Host Communication (Contd.)

Symptom	Suggested Corrective Action
Some Response but the data is garbled, and/or intermittent.	<p>Make sure the terminal mode (such as VT200 Mode: 8-Bit Controls or VT52 Mode) is properly selected from the General Set-Up menu.</p> <p>Make sure all of the communication cables are properly connected.</p> <p>Make sure all of the communication parameters are properly set (check the Communication Set-Up menu).</p> <p>If the symptom persists, a problem may exist with the communication cables or the host system. Refer problem to qualified service personnel.</p>

6.2.4 Printing Difficulties

Table 6-4 suggests corrective actions to perform if difficulties are encountered when attempting to print on a printer connected to the printer port.

NOTE

The corrective procedures in this section assume that the terminal has powered-up normally.

If the suggested corrective action does not solve the problem, then the problem should be referred to qualified service personnel.

Table 6-4. Difficulties with Printing

Symptom	Suggested Corrective Action
No response on the printer.	<p>Make sure that the printer is turned on and plugged in. Also check for proper power at the outlet by plugging a lamp into it.</p> <p>Verify printer operation by running the printer self-test (if applicable).</p> <p>Make sure the printer cable is the correct type and that it is properly connected.</p> <p>Make sure all of the terminal's printer port communication parameters are properly set (check the Printer Set-Up menu).</p> <p>If the symptom persists, a problem may exist with the printer cable or the printer. Refer problem to qualified service personnel.</p>
Printing is garbled and/or intermittent.	<p>Make sure the printer cable is properly connected.</p> <p>Make sure all of the printer communication parameters are properly set (check the Printer Set-Up menu).</p> <p>If the symptom persists, a problem may exist with the printer cable or the printer. Refer problem to qualified service personnel.</p>

VISUAL

**Part Three:
Programming the
Visual 220 Terminal**

CHAPTER 7

CODE TABLES AND CHARACTER SETS

7.1 OVERVIEW

This chapter describes how code tables are organized to accommodate the various character sets available for the Visual 220. Other information includes:

- Procedures for mapping hard (ROM-based) and soft (down-line loadable) character sets into code tables.
- Procedures for designing, down-line loading and clearing soft character sets.

7.2 CODE TABLES

The Visual 220 terminal can generate and interpret seven- and eight-bit characters. A code table provides a “picture” of how seven- and eight-bit codes are organized for use by the Visual 220 terminal. Since the terminal supports several character sets, it is essential to know which groups of characters in the code table are replaced when character sets are interchanged.

Up to 128 character codes can be represented using seven bits (the eighth bit is not set and is assumed to be 0). These codes and their character equivalents occupy the left half of the table. In seven-bit environments, only the codes in the left half of the table are used. The codes in the right half cannot be used.

Up to 256 character codes can be represented using eight bits. These codes and their character equivalents occupy the right half of the table. In eight-bit environments, the codes in the entire table may be used.

Figure 7-1 illustrates the Multinational Character set which is a typical code table for seven-bit and eight-bit characters.

					BIT 8	0	0	0	0	0	0	0	0	0
					BIT 7	0	0	0	0	1	1	1	1	1
					BIT 6	0	0	1	1	0	0	1	1	1
					BIT 5	0	1	0	1	0	1	0	1	1
BIT 4	BIT 3	BIT 2	BIT 1	COL										
				ROW	0	1	2	3	4	5	6	7		
0	0	0	0	0	NUL ⁰	DLE ¹⁶	SP ³²	0	48	@ ⁶⁴	P ⁸⁰	. ⁹⁶	p ¹¹²	
0	0	0	1	1	SOH ¹	DC1 ¹⁷	! ³³	1	49	A ⁶⁵	Q ⁸¹	a ⁹⁷	q ¹¹³	
0	0	1	0	2	STX ²	DC2 ¹⁸	" ³⁴	2	50	B ⁶⁶	R ⁸²	b ⁹⁸	r ¹¹⁴	
0	0	1	1	3	ETX ³	DC3 ¹⁹	# ³⁵	3	51	C ⁶⁷	S ⁸³	c ⁹⁹	s ¹¹⁵	
0	1	0	0	4	EOT ⁴	DC4 ²⁰	\$ ³⁶	4	52	D ⁶⁸	T ⁸⁴	d ¹⁰⁰	t ¹¹⁶	
0	1	0	1	5	ENQ ⁵	NAK ²¹	% ³⁷	5	53	E ⁶⁹	U ⁸⁵	e ¹⁰¹	u ¹¹⁷	
0	1	1	0	6	ACK ⁶	SYN ²²	& ³⁸	6	54	F ⁷⁰	V ⁸⁶	f ¹⁰²	v ¹¹⁸	
0	1	1	1	7	BEL ⁷	ETB ²³	' ³⁹	7	55	G ⁷¹	W ⁸⁷	g ¹⁰³	w ¹¹⁹	
1	0	0	0	8	BS ⁸	CAN ²⁴	(⁴⁰	8	56	H ⁷²	X ⁸⁸	h ¹⁰⁴	x ¹²⁰	
1	0	0	1	9	HT ⁹	EM ²⁵) ⁴¹	9	57	I ⁷³	Y ⁸⁹	i ¹⁰⁵	y ¹²¹	
1	0	1	0	A	LF ¹⁰	SUB ²⁶	* ⁴²	: ⁵⁸	J ⁷⁴	Z ⁹⁰	j ¹⁰⁶	z ¹²²		
1	0	1	1	B	VT ¹¹	ESC ²⁷	+ ⁴³	; ⁵⁹	K ⁷⁵	[⁹¹	k ¹⁰⁷	{ ¹²³		
1	1	0	0	C	FF ¹²	FS ²⁸	, ⁴⁴	< ⁶⁰	L ⁷⁶	\ ⁹²	l ¹⁰⁸	¹²⁴		
1	1	0	1	D	CR ¹³	GS ²⁹	- ⁴⁵	= ⁶¹	M ⁷⁷] ⁹³	m ¹⁰⁹	~ ¹²⁵		
1	1	1	0	E	SO ¹⁴	RS ³⁰	. ⁴⁶	> ⁶²	N ⁷⁸	^ ⁹⁴	n ¹¹⁰	¯ ¹²⁶		
1	1	1	1	F	SI ¹⁵	US ³¹	/ ⁴⁷	? ⁶³	O ⁷⁹	_ ⁹⁵	o ¹¹¹	DEL ¹²⁷		

C0 CODES ASCII GRAPHIC CHARACTERS

LEGEND

CHARACTER → **DC1**¹⁷ — POSITION (DECIMAL) IN CODE TABLE

Figure 7-1. Typical Code Table for Seven-Bit and Eight-Bit Characters (Sheet 1 of 2)



A code table is divided into four regions as shown in Figure 7-2. The regions have the following functions:

- The C0 (control 0) region contains 7-bit ASCII (American Standard Code for Information Interchange) control characters. These characters are not usually displayed but they do perform special functions in data communications and text processing.
- The C1 (control 1) region contains 8-bit ASCII control characters that provide additional data communication and text processing functions.
- The GL (graphics left) region may contain up to 94 seven-bit characters that can be displayed on a terminal. The graphic characters may include alphanumeric characters as well as punctuation marks and other symbols. SP (space) is considered to be apart from all character sets. DEL (delete) is always ignored by the terminal.

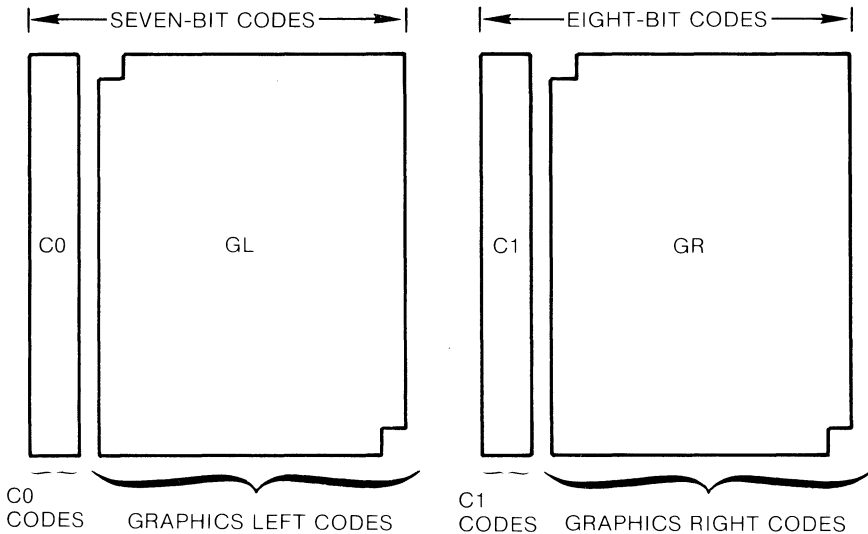

Figure 7-2. Four Regions of the 8-Bit Code Table

- The GR (graphics right) region may contain up to 94 eight-bit characters that can be displayed on a terminal. The graphic characters may include alphanumeric characters as well as punctuation marks and other symbols.

7.3 CHARACTER SETS

The Visual 220 supports a variety of “hard” and “soft” character sets. The hard character sets are permanently stored in read-only memory (ROM) and cannot be changed by users. Hard character sets include:

- ASCII Graphics Set
- United Kingdom National Set
- DEC™ Special Graphics
- DEC™ Multinational Character Set (ASCII Graphics Set and DEC™ Supplemental Graphics Set).
- Display Controls Set

Soft character sets may be designed by a programmer and then downline loaded to the terminal from a host computer. Soft character sets may include up to 94 characters.

Hard and soft character sets may be “mapped” into the GL and/or GR regions of the code table. The C0 and C1 regions of the Table always contain the ASCII control codes with their predefined functions.

NOTE

Each character set can be displayed in 80- and 132-column mode.

7.3.1 ASCII Character Set

The ASCII Character Set is shown in Table 7-1. This character set contains control and graphic characters defined by ANSI X3.4



7.3.2 United Kingdom National Set

The United Kingdom National Set differs from the ASCII Character Set only in that the # sign is replaced by the £ sign. This set is available for use only in the VT100 or VT52 compatible modes.

Table 7-1. ASCII Character Set Code Table

					BIT 8	0	0	0	0	0	0	0	0	0
					BIT 7	0	0	0	0	1	1	1	1	
					BIT 6	0	0	1	1	0	0	1	1	
					BIT 5	0	1	0	1	0	1	0	1	
BIT 4	BIT 3	BIT 2	BIT 1	COL ROW	0	1	2	3	4	5	6	7		
0	0	0	0	0	NUL ⁰	DLE ¹⁶	SP ³²	0 ⁴⁸	@ ⁵⁴	P ⁸⁰	. ⁹⁶	p ¹¹²		
0	0	0	1	1	SOH ¹	DC1 ¹⁷	! ³³	1 ⁴⁹	A ⁶⁵	Q ⁸¹	a ⁹⁷	q ¹¹³		
0	0	1	0	2	STX ²	DC2 ¹⁸	" ³⁴	2 ⁵⁰	B ⁶⁶	R ⁸²	b ⁹⁸	r ¹¹⁴		
0	0	1	1	3	ETX ³	DC3 ¹⁹	# ³⁵	3 ⁵¹	C ⁶⁷	S ⁸³	c ⁹⁹	s ¹¹⁵		
0	1	0	0	4	EOT ⁴	DC4 ²⁰	\$ ³⁶	4 ⁵²	D ⁶⁸	T ⁸⁴	d ¹⁰⁰	t ¹¹⁶		
0	1	0	1	5	ENQ ⁵	NAK ²¹	% ³⁷	5 ⁵³	E ⁶⁹	U ⁸⁵	e ¹⁰¹	u ¹¹⁷		
0	1	1	0	6	ACK ⁶	SYN ²²	& ³⁸	6 ⁵⁴	F ⁷⁰	V ⁸⁶	f ¹⁰²	v ¹¹⁸		
0	1	1	1	7	BEL ⁷	ETB ²³	' ³⁹	7 ⁵⁵	G ⁷¹	W ⁸⁷	g ¹⁰³	w ¹¹⁹		
1	0	0	0	8	BS ⁸	CAN ²⁴	(⁴⁰	8 ⁵⁶	H ⁷²	X ⁸⁸	\ ¹⁰⁴	x ¹²⁰		
1	0	0	1	9	HT ⁹	EM ²⁵) ⁴¹	9 ⁵⁷	I ⁷³	Y ⁸⁹	i ¹⁰⁵	y ¹²¹		
1	0	1	0	A	LF ¹⁰	SUB ²⁶	* ⁴²	: ⁵⁸	J ⁷⁴	Z ⁹⁰	j ¹⁰⁶	z ¹²²		
1	0	1	1	B	VT ¹¹	ESC ²⁷	+ ⁴³	; ⁵⁹	K ⁷⁵	[⁹¹	k ¹⁰⁷	¹²³		
1	1	0	0	C	FF ¹²	FS ²⁸	, ⁴⁴	< ⁶⁰	L ⁷⁶	\ ⁹²	l ¹⁰⁸	¹²⁴		
1	1	0	1	D	CR ¹³	GS ²⁹	- ⁴⁵	= ⁶¹	M ⁷⁷] ⁹³	m ¹⁰⁹	¹²⁵		
1	1	1	0	E	SO ¹⁴	RS ³⁰	. ⁴⁶	> ⁶²	N ⁷⁸	^ ⁹⁴	n ¹¹⁰	~ ¹²⁶		
1	1	1	1	F	SI ¹⁵	US ³¹	/ ⁴⁷	? ⁶³	O ⁷⁹	_ ⁹⁵	o ¹¹¹	DEL ¹²⁷		

C0 CODES ASCII GRAPHIC CHARACTERS

LEGEND

CHARACTER →

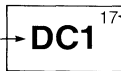

POSITION (DECIMAL)
IN CODE TABLE

7.3.3 DEC Special Graphics

The DEC Special Graphics Set includes ASCII C0 control codes, some alphanumeric graphic characters and a set of special symbols and line segments. The symbols and line segments can be used for drawing simple figures while in text mode. This set is shown in Table 7-2.

Table 7-2. DEC™ Special Graphics Set

					BIT 8	0	0	0	0	0	0	0	0	0
					BIT 7	0	0	0	0	1	1	1	1	1
					BIT 6	0	0	1	1	0	0	1	1	1
					BIT 5	0	1	0	1	0	1	0	1	1
BIT 4	BIT 3	BIT 2	BIT 1	COL ROW	0	1	2	3	4	5	6	7		
0	0	0	0	0	NUL ⁰	DLE ¹⁶	SP ³²	0 ⁴⁸	@ ⁶⁴	P ⁸⁰	◆ ⁹⁶	—	—	SCAN 3
0	0	0	1	1	SOH ¹	DC1 ¹⁷	!	1 ³³	A ⁶⁵	Q ⁸¹	⊠ ⁹⁷	—	—	SCAN 6
0	0	1	0	2	STX ²	DC2 ¹⁸	"	2 ⁵⁰	B ⁶⁶	R ⁸²	H ⁹⁸	—	—	SCAN 9
0	0	1	1	3	ETX ³	DC3 ¹⁹	#	3 ⁵¹	C ⁶⁷	S ⁸³	F ⁹⁹	—	—	SCAN 11
0	1	0	0	4	EOT ⁴	DC4 ²⁰	\$	4 ⁵²	D ⁶⁸	T ⁸⁴	Ⓒ ¹⁰⁰	†	†	116
0	1	0	1	5	ENQ ⁵	NAK ²¹	%	5 ⁵³	E ⁶⁹	U ⁸⁵	Ⓕ ¹⁰¹	‡	‡	117
0	1	1	0	6	ACK ⁶	SYN ²²	&	6 ⁵⁴	F ⁷⁰	V ⁸⁶	Ⓖ ¹⁰²	⊥	⊥	118
0	1	1	1	7	BEL ⁷	ETB ²³	'	7 ⁵⁵	G ⁷¹	W ⁸⁷	Ⓗ ¹⁰³	⊥	⊥	119
1	0	0	0	8	BS ⁸	CAN ²⁴	(8 ⁵⁶	H ⁷²	X ⁸⁸	Ⓘ ¹⁰⁴			120
1	0	0	1	9	HT ⁹	EM ²⁵)	9 ⁵⁷	I ⁷³	Y ⁸⁹	Ⓚ ¹⁰⁵	≤	≤	121
1	0	1	0	A	LF ¹⁰	SUB ²⁶	*	10 ⁵⁸	J ⁷⁴	Z ⁹⁰	Ⓛ ¹⁰⁶	≥	≥	122
1	0	1	1	B	VT ¹¹	ESC ²⁷	+	11 ⁵⁹	K ⁷⁵	[⁹¹	Ⓜ ¹⁰⁷	π	π	123
1	1	0	0	C	FF ¹²	FS ²⁸	,	12 ⁶⁰	L ⁷⁶	\	Ⓨ ¹⁰⁸	≠	≠	124
1	1	0	1	D	CR ¹³	GS ²⁹	-	13 ⁶¹	M ⁷⁷] ⁹³	Ⓟ ¹⁰⁹	£	£	125
1	1	1	0	E	SO ¹⁴	RS ³⁰	.	14 ⁶²	N ⁷⁸	^	Ⓡ ¹¹⁰	•	•	126
1	1	1	1	F	SI ¹⁵	US ³¹	/	15 ⁶³	O ⁷⁹	_	Ⓢ ¹¹¹	DEL	DEL	127

C0 CODES DEC™ SPECIAL GRAPHICS SET

LEGEND

CHARACTER →

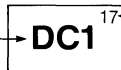

17 → POSITION (DECIMAL)
IN CODE TABLE

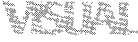

7.3.4 DEC Multinational Character Set

The DEC Multinational Character Set (see Table 7-3) is made up of the ASCII Character Set, the C1 control codes and the DEC Supplemental Graphics Set (the DEC Supplemental Graphics Set occupies the GR region of the code table).

Table 7-3. DEC™ Multinational Character Set (Sheet 1 of 2)

					BIT 8	0	0	0	0	0	0	0	0	0
					BIT 7	0	0	0	0	1	1	1	1	1
					BIT 6	0	0	1	1	0	0	1	1	1
					BIT 5	0	1	0	1	0	1	0	1	1
BIT 4	BIT 3	BIT 2	BIT 1	COL ROW	0	1	2	3	4	5	6	7		
0	0	0	0	0	NUL ⁰	DLE ¹⁶	SP ³²	0	@ ⁶⁴	P ⁸⁰			p ¹¹²	
0	0	0	1	1	SOH ¹	DC1 ¹⁷	!	1 ⁴⁹	A ⁶⁵	Q ⁸¹	a ⁹⁷		q ¹¹³	
0	0	1	0	2	STX ²	DC2 ¹⁸	.. ³⁴	2 ⁵⁰	B ⁶⁶	R ⁸²	b ⁹⁸		r ¹¹⁴	
0	0	1	1	3	ETX ³	DC3 ¹⁹	# ³⁵	3 ⁵¹	C ⁶⁷	S ⁸³	c ⁹⁹		s ¹¹⁵	
0	1	0	0	4	EOT ⁴	DC4 ²⁰	\$ ³⁶	4 ⁵²	D ⁶⁸	T ⁸⁴	d ¹⁰⁰		t ¹¹⁶	
0	1	0	1	5	ENQ ⁵	NAK ²¹	% ³⁷	5 ⁵³	E ⁶⁹	U ⁸⁵	e ¹⁰¹		u ¹¹⁷	
0	1	1	0	6	ACK ⁶	SYN ²²	& ³⁸	6 ⁵⁴	F ⁷⁰	V ⁸⁶	f ¹⁰²		v ¹¹⁸	
0	1	1	1	7	BEL ⁷	ETB ²³	· ³⁹	7 ⁵⁵	G ⁷¹	W ⁸⁷	g ¹⁰³		w ¹¹⁹	
1	0	0	0	8	BS ⁸	CAN ²⁴	(⁴⁰	8 ⁵⁶	H ⁷²	X ⁸⁸	h ¹⁰⁴		x ¹²⁰	
1	0	0	1	9	HT ⁹	EM ²⁵) ⁴¹	9 ⁵⁷	I ⁷³	Y ⁸⁹	i ¹⁰⁵		y ¹²¹	
1	0	1	0	A	LF ¹⁰	SUB ²⁶	· ⁴²	:	J ⁷⁴	Z ⁹⁰	j ¹⁰⁶		z ¹²²	
1	0	1	1	B	VT ¹¹	ESC ²⁷	+ ⁴³	;	K ⁷⁵	[⁹¹	k ¹⁰⁷		l ¹²³	
1	1	0	0	C	FF ¹²	FS ²⁸	, ⁴⁴	<	L ⁷⁶	\ ⁹²	l ¹⁰⁸		¹²⁴	
1	1	0	1	D	CR ¹³	GS ²⁹	- ⁴⁵	=	M ⁷⁷] ⁹³	m ¹⁰⁹		¹²⁵	
1	1	1	0	E	SO ¹⁴	RS ³⁰	· ⁴⁶	>	N ⁷⁸	^ ⁹⁴	n ¹¹⁰		~ ¹²⁶	
1	1	1	1	F	SI ¹⁵	US ³¹	/ ⁴⁷	?	O ⁷⁹	_ ⁹⁵	o ¹¹¹		DEL ¹²⁷	

C0 CODES ASCII GRAPHIC CHARACTERS

LEGEND

CHARACTER → **DC1**¹⁷ → POSITION (DECIMAL)
IN CODE TABLE

7-8 Code Tables and Character Sets

The DEC Supplemental Graphics Set includes alphabetic characters with diacritical marks that appear in major Western European alphabets. The DEC Supplemental Graphics Set is not available in the VT100 and VT52 modes.

The DEC Multinational Character Set is the (factory programmed) default character set that is mapped into the code table.

Table 7-3. DEC™ Multinational Character Set (Sheet 2 of 2)

1	1	1	1	1	1	1	1	BIT 8						
0	0	0	0	1	1	1	1	BIT 7						
0	0	1	1	0	0	1	1	BIT 6						
0	1	0	1	0	1	0	1	BIT 5						
8	9	A	B	C	D	E	F	COL ROW	BIT 4	BIT 3	BIT 2	BIT 1		
128	DCS	144	160	176	A	192	208	224	240	0	0	0	0	
129	PU1	145	161	177	A	193	N	209	225	1	0	0	0	1
130	PU2	146	162	178	A	194	O	210	226	2	0	0	1	0
131	STS	147	163	179	A	195	O	211	227	3	0	0	1	1
132	IND	148	164	180	A	196	O	212	228	4	0	1	0	0
133	NEL	149	165	181	A	197	O	213	229	5	0	1	0	1
134	SSA	150	166	182	A	198	O	214	230	6	0	1	1	0
135	ESA	151	167	183	C	199	OE	215	231	7	0	1	1	1
136	HTS	152	168	184	E	200	O	216	232	8	1	0	0	0
137	HTJ	153	169	185	E	201	U	217	233	9	1	0	0	1
138	VTS	154	170	186	E	202	U	218	234	A	1	0	1	0
139	PLD	155	171	187	E	203	U	219	235	B	1	0	1	1
140	PLU	156	172	188	i	204	U	220	236	C	1	1	0	0
141	RI	157	173	189	i	205	Y	221	237	D	1	1	0	1
142	SS2	158	174	190	i	206		222	238	E	1	1	1	0
143	SS3	159	175	191	i	207	B	223	239	F	1	1	1	1

C1 CODES

DEC™ SUPPLEMENTAL CHARACTER SET



7.3.5 Display Controls Character Set

The Display Controls character set is mapped into the code table when the “display controls” mode is selected from the display Set-Up menu. When this mode is selected, the control codes are displayed on the terminal screen. The controls are not executed (except for VT, LF, and FF which perform a new line function after the code is displayed). The Display Controls character set is shown in Table 7-4.

Table 7-4. Display Controls Character Set (Sheet 1 of 2)

					BIT 8	0	0	0	0	0	0	0	0	0
					BIT 7	0	0	0	0	1	1	1	1	1
					BIT 6	0	0	1	1	0	0	1	1	1
					BIT 5	0	1	0	1	0	1	0	1	1
BIT 4	BIT 3	BIT 2	BIT 1	COL ROW	0	1	2	3	4	5	6	7		
0	0	0	0	0	N _U ⁰	D _L ¹⁶		0	@ ⁶⁴	P ⁹⁰		P ⁹⁶		
0	0	0	1	1	S _H ¹	D ₁ ¹⁷	!	1	A ⁶⁵	Q ⁸¹	a	q		
0	0	1	0	2	S _X ²	D ₂ ¹⁸	"	2	B ⁶⁶	R ⁸²	b	r		
0	0	1	1	3	E _X ³	D ₃ ¹⁹	#	3	C ⁶⁷	S ⁸³	c	s		
0	1	0	0	4	E _T ⁴	D ₄ ²⁰	\$	4	D ⁶⁸	T ⁸⁴	d	t		
0	1	0	1	5	E _O ⁵	N _K ²¹	%	5	E ⁶⁹	U ⁸⁵	e	u		
0	1	1	0	6	A _K ⁶	S _Y ²²	&	6	F ⁷⁰	V ⁸⁶	f	v		
0	1	1	1	7	B _L ⁷	E _B ²³	'	7	G ⁷¹	W ⁸⁷	g	w		
1	0	0	0	8	B _S ⁸	C _N ²⁴	(8	H ⁷²	X ⁸⁸	h	x		
1	0	0	1	9	H _T ⁹	E _M ²⁵)	9	I ⁷³	Y ⁸⁹	i	y		
1	0	1	0	A	L _F ¹⁰	Ç ²⁶	•	:	J ⁷⁴	Z ⁹⁰	j	z		
1	0	1	1	B	V _T ¹¹	E _C ²⁷	+	;	K ⁷⁵	[⁹¹	k	{		
1	1	0	0	C	F _F ¹²	F _S ²⁸	,	<	L ⁷⁶	\ ⁹²	l			
1	1	0	1	D	C _R ¹³	G _S ²⁹	.	=	M ⁷⁷] ⁹³	m	}		
1	1	1	0	E	S _O ¹⁴	R _S ³⁰	•	>	N ⁷⁸	^ ⁹⁴	n	~		
1	1	1	1	F	S _I ¹⁵	U _S ³¹	/	?	O ⁷⁹	_ ⁹⁵	o	DEL		

C0 CODES

DISPLAY CONTROLS CHARACTERS

Table 7-4. Display Controls Character Set (Sheet 2 of 2)

1	1	1	1	1	1	1	1	BIT 8				
0	0	0	0	1	1	1	1	BIT 7				
0	0	1	1	0	0	1	1	BIT 6				
0	1	0	1	0	1	0	1	BIT 5				
8	9	A	B	C	D	E	F	COL ROW	BIT 4	BIT 3	BIT 2	BIT 1
8 ₀ ¹²⁸	9 ₀ ¹⁴⁴	A ₀ ¹⁶⁰	o ¹⁷⁶	À ¹⁹²	Ð _O ²⁰⁸	à ²²⁴	ƒ _O ²⁴⁰	0	0	0	0	0
8 ₁ ¹²⁹	9 ₁ ¹⁴⁵	i ¹⁶¹	± ¹⁷⁷	Á ¹⁹³	Ñ ²⁰⁹	á ²²⁵	ñ ²⁴¹	1	0	0	0	1
8 ₂ ¹³⁰	9 ₂ ¹⁴⁶	ç ¹⁶²	² ¹⁷⁸	Â ¹⁹⁴	Ò ²¹⁰	â ²²⁶	ó ²⁴²	2	0	0	1	0
8 ₃ ¹³¹	9 ₃ ¹⁴⁷	£ ¹⁶³	³ ¹⁷⁹	Ã ¹⁹⁵	Ó ²¹¹	ã ²²⁷	ô ²⁴³	3	0	0	1	1
8 ₄ ¹³²	9 ₄ ¹⁴⁸	Ä ¹⁶⁴	ß ₄ ¹⁸⁰	Ä ¹⁹⁶	Ö ²¹²	ä ²²⁸	ö ²⁴⁴	4	0	1	0	0
8 ₅ ¹³³	9 ₅ ¹⁴⁹	Ÿ ¹⁶⁵	µ ¹⁸¹	Å ¹⁹⁷	Ö ²¹³	å ²²⁹	ø ²⁴⁵	5	0	1	0	1
8 ₆ ¹³⁴	9 ₆ ¹⁵⁰	À ₆ ¹⁶⁶	¶ ¹⁸²	Æ ¹⁹⁸	Ö ²¹⁴	æ ²³⁰	ø ²⁴⁶	6	0	1	1	0
8 ₇ ¹³⁵	9 ₇ ¹⁵¹	Š ¹⁶⁷	· ¹⁸³	Ç ¹⁹⁹	œ ²¹⁵	ç ²³¹	œ ²⁴⁷	7	0	1	1	1
8 ₈ ¹³⁶	9 ₈ ¹⁵²	Ɔ ¹⁶⁸	ß ₈ ¹⁸⁴	È ²⁰⁰	ø ²¹⁶	è ²³²	ø ²⁴⁸	8	1	0	0	0
8 ₉ ¹³⁷	9 ₉ ¹⁵³	® ¹⁶⁹	ı ¹⁸⁵	É ²⁰¹	Û ²¹⁷	é ²³³	ü ²⁴⁹	9	1	0	0	1
8 _A ¹³⁸	9 _A ¹⁵⁴	ã ¹⁷⁰	© ¹⁸⁶	Ê ²⁰²	Ü ²¹⁸	ê ²³⁴	ü ²⁵⁰	A	1	0	1	0
8 _B ¹³⁹	9 _B ¹⁵⁵	« ¹⁷¹	» ¹⁸⁷	Ë ²⁰³	Û ²¹⁹	ë ²³⁵	û ²⁵¹	B	1	0	1	1
8 _C ¹⁴⁰	9 _C ¹⁵⁶	À _C ¹⁷²	¼ ¹⁸⁸	Ì ²⁰⁴	Ü ²²⁰	ì ²³⁶	ü ²⁵²	C	1	1	0	0
8 _D ¹⁴¹	9 _D ¹⁵⁷	À _D ¹⁷³	½ ¹⁸⁹	Í ²⁰⁵	ÿ ²²¹	í ²³⁷	ÿ ²⁵³	D	1	1	0	1
8 _E ¹⁴²	9 _E ¹⁵⁸	À _E ¹⁷⁴	¾ ¹⁹⁰	Î ²⁰⁶	ƒ _E ²²²	î ²³⁸	ƒ _E ²⁵⁴	E	1	1	1	0
8 _F ¹⁴³	9 _F ¹⁵⁹	À _F ¹⁷⁵	¹ ¹⁹¹	Ï ²⁰⁷	ƒ ²²³	ï ²³⁹	□ ²⁵⁵	F	1	1	1	1

C1 CODES
 DISPLAY CONTROLS CHARACTERS

7.4 CHARACTER SETS AND NATIONAL ALPHABETS

The following example describes what happens when a key is pressed on a national keyboard (such as German) and that keyboard has been selected from the keyboard Set-Up menu.

The annotated illustration (Figure 7-3) aids in describing the process that takes place. The circled numbers in the illustration correspond with the numbered steps below.

1. The β key (unshifted) on the German keyboard sends a 2B (hex) scan code to the Visual 220 terminal (the 2B [hex] scan code corresponds to the key's position on the keyboard).
2. The terminal reads the keyboard scan code and interprets it as 0DF (hex).
3. The hex code (0DF) is sent to the host system which processes the code according to the current application.
4. If echo is enabled, the 0DF code is sent (returned) to the Visual 220 terminal.
5. The terminal sees the 0DF code from the host and fetches the character from the corresponding position in the 8-bit code table.
6. If the Multinational Character set is invoked (as shown in Table 7-3), the β character is sent to the monitor screen.

NOTE

The character that is sent to the monitor screen depends on the character set invoked into that region of the code table.

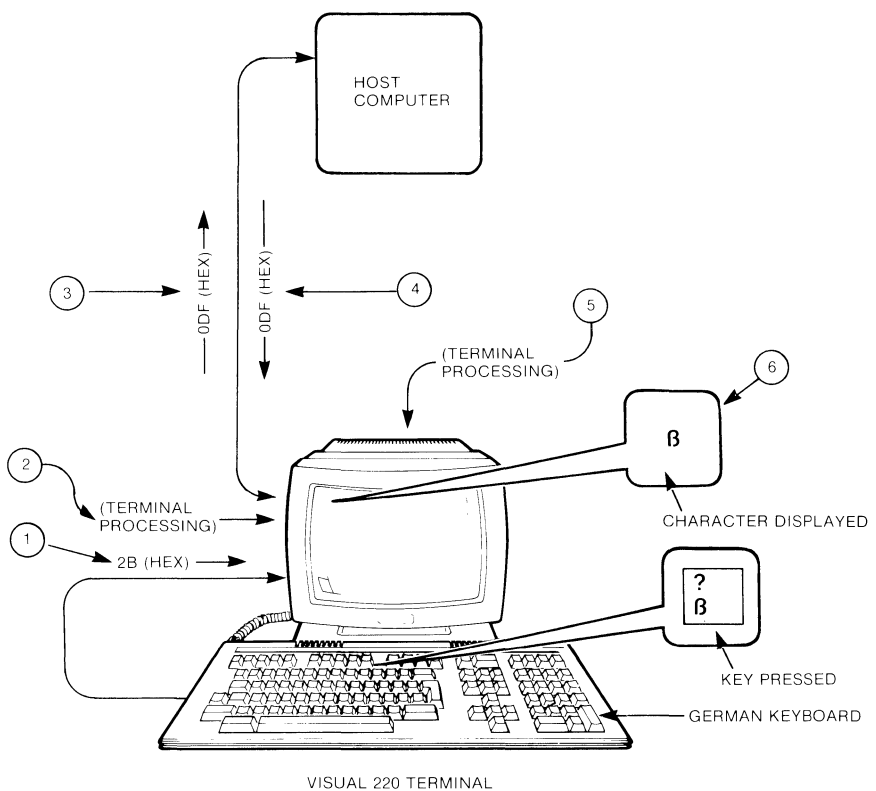

Figure 7-3. Keyboards and Character Sets

7.5 CHARACTER SET SELECTION

This section describes the procedures for designating hard and soft character sets. The procedures for mapping designated sets into the code table are also described.

7.5.1 Default Character Set

Each time the Visual 220 is powered-up or reset, the DEC Multi-national Character Set is mapped into the code table.

7.5.2 Changing Character Sets

Once the Visual 220 is powered-up or reset, hard character sets can be “designated” and then mapped into specified regions of the code table.

In VT200 compatible mode a soft character set defined by a programmer can be down-line loaded to a font-buffer (soft character sets may contain up to 94 characters each). The soft character set may be designated and then mapped into the code table.

NOTE

Soft character sets are not supported in the VT100 compatible mode.

Figures 7-4 and 7-5 illustrate the concept of designating and mapping character sets in VT100 and VT200 modes respectively.

7.5.2.1 Designating Hard Character Sets — Before any other character set can be mapped into the code table, it must first be designated as G0, G1, G2, or G3. Once designated, a character set is “on call” for use by the program.

Hard (ROM-based) character sets (ASCII, U.K. National, DEC Supplemental, and DEC Special Graphics Set) can be designated using the escape sequences shown in Table 7-5.

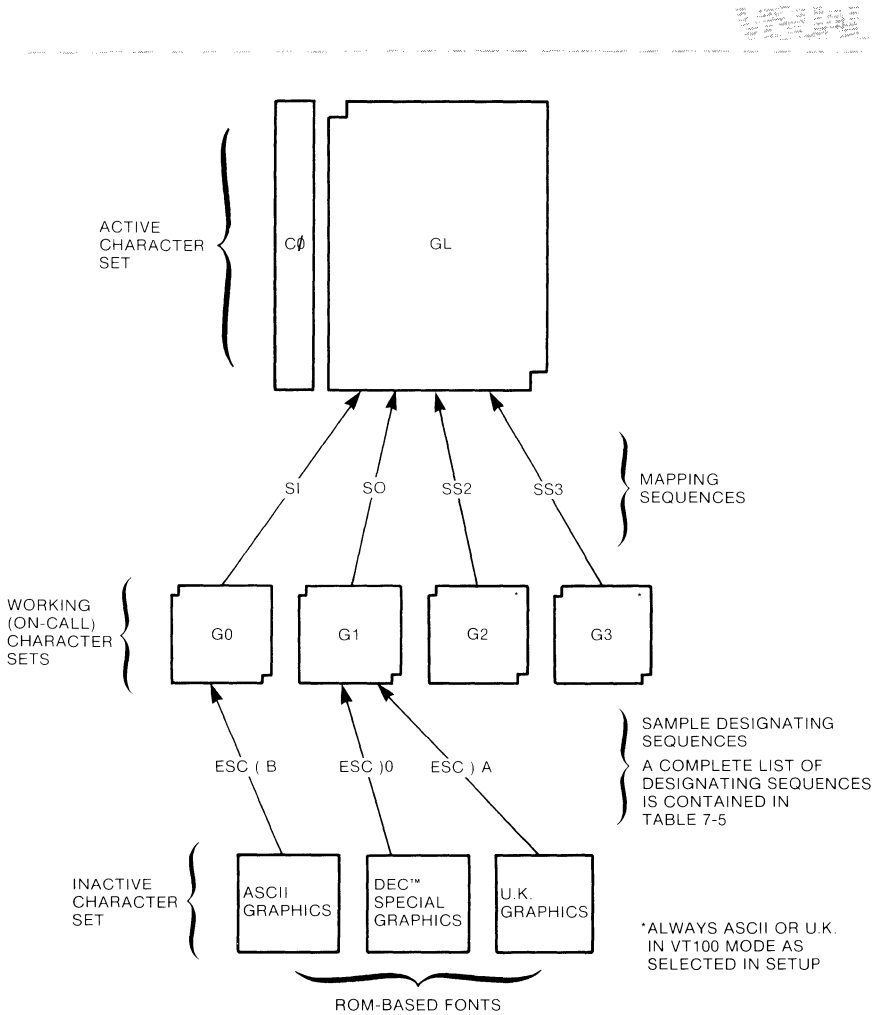

Figure 7-4. Designating and Mapping Character Sets (VT100 Mode)

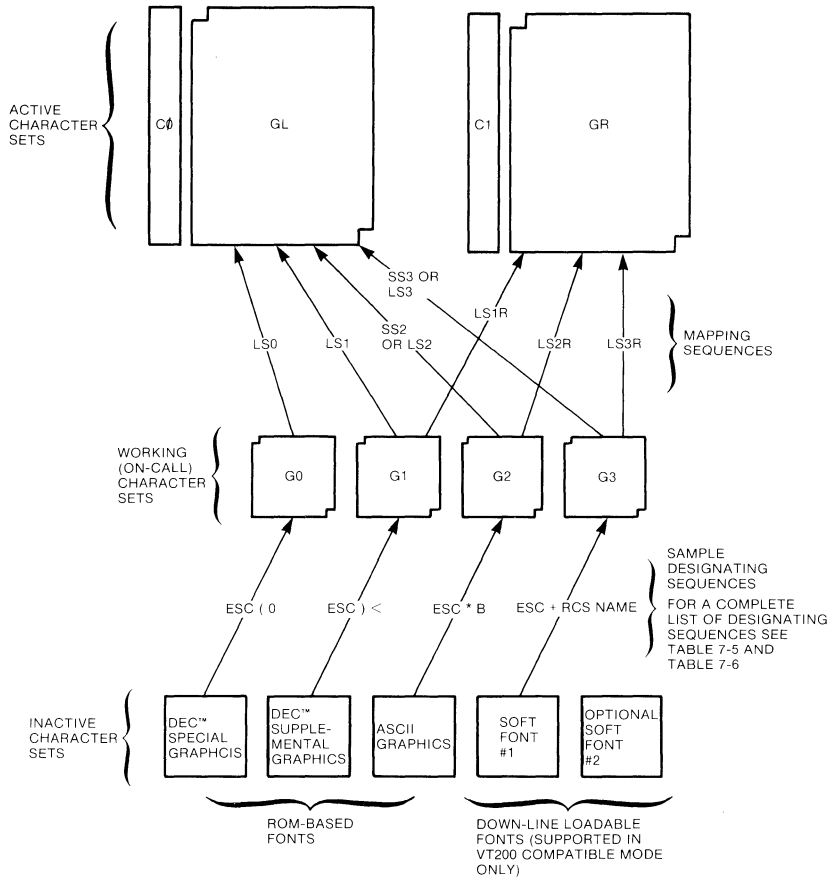
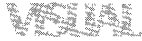

Figure 7-5. Designating and Mapping Character Sets (VT200 Mode)

Table 7-5. Designating Hard Character Sets

Character Set	Designate As:	Use Coding Sequence
ASCII	G0 (Default)	ESC (B
	G1	ESC) B
	G2 (VT200 Mode only)	ESC * B
	G3 (VT200 Mode only)	ESC + B
DEC Special Graphics	G0	ESC (0
	G1 (Default)	ESC) 0
	G2 (VT200 Mode only)	ESC * 0
	G3 (VT200 Mode only)	ESC + 0
DEC Supplemental (VT200 Mode only)	G0	ESC (<
	G1	ESC) <
	G2 (Default)	ESC * <
	G3 (Default)	ESC + <
U.K. National (VT100 Mode only)	G0	ESC (A
	G1	ESC) A

7.5.2.2 Designating Soft Character Sets — A soft character set may be designated when the Visual 220 is in the VT200 compatible mode.

NOTES

- **Soft character sets are not supported in VT100 or VT52 modes.**
- **Before a soft character set can be designated, it must be down-line loaded into the Visual 220 font buffer (see Down-Line Loading Characters).**
- **A second soft character set may be designated when a second soft character set option has been installed.**

The soft set(s) may be designated to replace or be used in addition to hard character sets.

Soft character sets may be designated using the escape sequences in Table 7-6.

Table 7-6. Designating Soft Character Sets

Escape Sequence*	Designate As:
ESC (RCS name	G0
ESC) RCS name	G1
ESC * RCS name	G2
ESC + RCS name	G3

*An RCS name is a variable that specifies the soft character set. An RCS name must be previously assigned to any soft character set that is to be down-line loaded.

The RCS name specifies the desired soft character set and has the following syntax:

RCS name Description

I I F RCS name syntax

An RCS name can contain from zero to two intermediate values (I) and one final value (F). The intermediate values are in the range of SP to / (column 2 in the code table). Final values are in the range of 0 to ~ (column 3 through column 7 excluding DEL in the code table).

21,567 RCS names can be generated according to the above scheme.

Examples of RCS names are as follows:

- SP @ Defines the character set as an unregistered soft set. This value is the recommended default value for user-defined sets.
- B Defines the character set to be ASCII.
- 0 Defines the character set to be DEC special graphics.
- % \$ V Defines the character set to be % \$ V. This is currently an unregistered set.

NOTE

If the RCS name is that of an existing character set (ASCII [B], Special Graphics [0] or Supplemental [<]), the existing character set is replaced only until the terminal is reset or the soft character set is renamed.

7.5.3 Invoking Character Sets

Once a character set has been designated, it is placed in the working set of character sets. It can then be mapped into the desired GL or GR region of the code table. Character sets can be “lock shifted” or “single shifted” into the code table.

7.5.3.1 Using Locking Shifts to Invoke Character Sets — Locking shifts imply that the character set is shifted into the code table and locked there. A lock-shifted set remains active until it is temporarily displaced by a single shift or permanently replaced by another lock-shift. Other conditions that may result in replacement of lock-shifted sets include:

- Hard reset or soft reset (see Section 8.4.2.12)
- Changing terminal emulation (see Section 8.4.2.16)

Character sets may be lock-shifted into the code table by using the coding sequences shown in Table 7-7.

Table 7-7. Invoking Character Sets Using Locking Shifts

Control Name			
Mnemonic	Meaning	Coding	Function
LS0	Lock Shift G0	SI	Map set G0 into GL (Default setting)
LS1	Lock Shift G1	SO	Map set G1 into GL.
LS2*	Lock Shift G2	ESC n	Map set G2 into GL. This sequence may cause software compatibility problems.
LS3*	Lock Shift G3	ESC o	Map set G3 into GL. This sequence may cause software compatibility problems.
LS1R*	Lock Shift G1, Right	ESC ~	Map set G1 into GR. This sequence may cause software compatibility problems.
LS2R*	Lock Shift G2, Right	ESC }	Map set G0 into GR.
LS3R*	Lock Shift G3, Right	ESC	Map set G0 into GR.

*Used in VT200 compatible modes only.

7.5.3.2 Using Single Shifts to Invoke Character Sets — Single shifts imply that the desired character set is temporarily shifted into the code table. A single shifted set remains active only for the next single graphic character. After the single shifted character has been processed, the previous character set is returned to its original region in the code table.

Character sets may be single-shifted into the code table using eight-bit control codes (SS2 and SS3). These codes can be expressed as escape sequences when coding for a seven-bit environment. Table 7-8 shows the coding sequences for both environments.

Table 7-8. Invoking Character Sets Using Single Shifts

Coding Sequence		
8-Bit	7-Bit	Function
SS2	ESC N	Map G2 into GL for the next graphic character.
SS3	ESC O	Map G3 into GL for the next graphic character.

7.6 DESIGNING A CHARACTER SET

A VT200 compatible mode allows users to design a Redefinable Character Set (RCS) containing up to 94 characters. Once created, these characters can be down-line loaded into the terminal's font buffer using a device control string (DCS).

NOTE

These characters are not loaded into the terminal's non-volatile RAM and are lost when the terminal power is shut off.

RCS characters must be designed to fit within an RCS cell. An RCS cell is larger than a normal character cell as shown in Figure 7-6. Additionally, RCS characters can be designed for either of two RCS cell sizes. They are:

- 10 scan-lines (10-scan) high RCS cell that is DEC-compatible. This is the default value for the RCS cell size.
- 12-scan RCS cell (Visual enhancement).

Both RCS cell sizes (and the corresponding 'normal character' cell sizes) are shown in Figure 7-6. Notice that 10-scan RCS cells are created from 12-scan RCS cells by blanking (turning off) the top two scan lines.

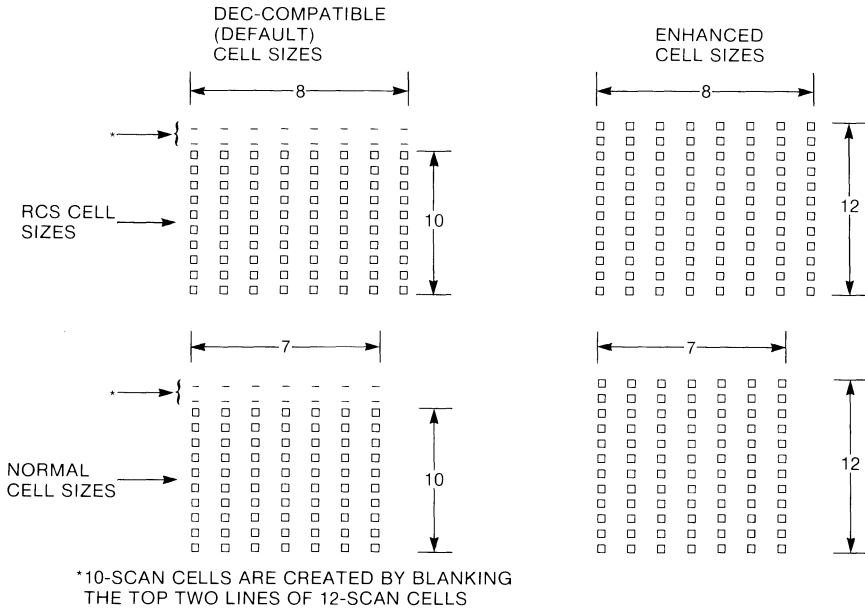

Figure 7-6. RCS Cell Sizes and Normal Cell Sizes

NOTE

The cell height to width ratio shown in Figure 7-6 is reduced for clarity. The vertical distance between pixels is actually about twice the horizontal distance.

7.6.1 Character Design Examples

Two examples illustrate how to design a typical character for 10-scan and 12-scan RCS cells. The examples (for a typical letter 'W') are shown side-by-side to highlight any differences.

Characters are created by designating certain picture elements (pixels) in the RCS cell to be on or off. Pixels that are defined outside the RCS cell are ignored. If pixels in column 8 are designated as on, the next two pixels to the right become active (on) also. This effect (called **"dot extension"**) is used primarily for line drawing.

1. Design the character as it would appear in the RCS cell. Figure 7-7 shows a typical design for the letter 'W.'

NOTE

Any pixel that is on is “stretched” to the right until it overlaps the adjacent pixel. This effect (shown below) produces characters that appear more solid and unified.

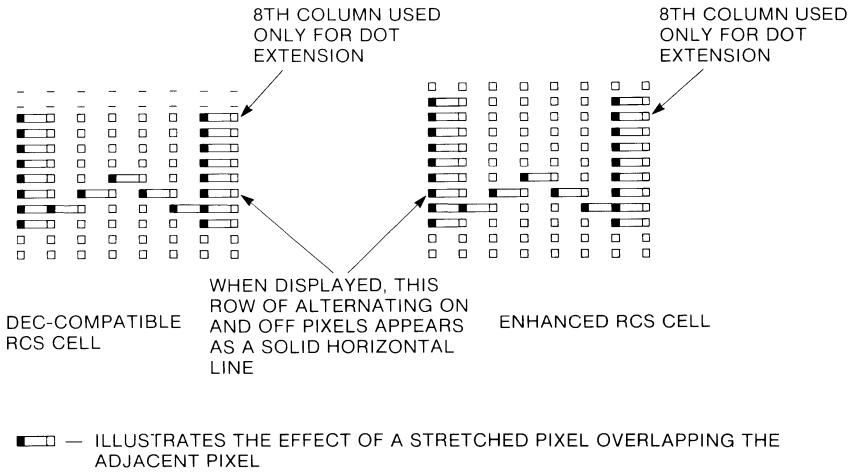

Figure 7-7. Typical RCS Character in RCS Cells

2. Divide and annotate the cell as shown in Figure 7-8. This scheme provides the basis for naming individual pixels in the RCS cell.

The upper columns are made up of eight, six-pixel columns. Each pixel has an assigned bit position with the top pixel corresponding with the least significant bit. The bottom pixel corresponds with the most significant bit.

The lower columns are made up of eight, four-pixel columns (six-pixel columns for 12-scan characters). The top pixel corresponds with the least significant bit. The bottom pixel corresponds with the most significant bit.

Note that the rightmost column (column 8) is used for dot extension and need not be programmed if dot extension is not desired.

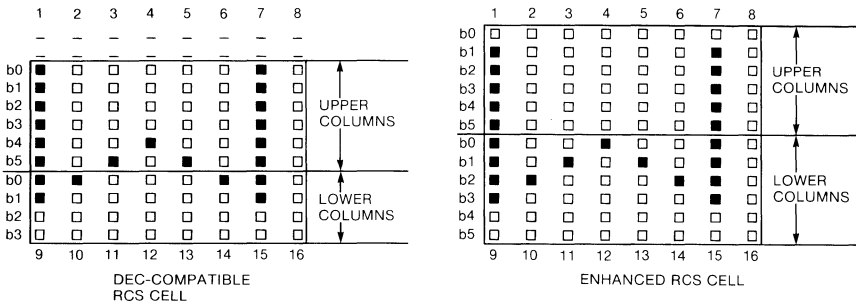

Figure 7-8. RCS Cells Divided Into Annotated Pixel Columns

3. Represent each column value by a character from the ASCII code table. Use Figure 7-9 for 10-pixel high cells and Figure 7-10 for 12-pixel high cells. The characters must be between ? and ~ (position 63 and 126 in the ASCII code table).
 - a. Convert each binary column code to its decimal value.
 - b. Add the offset (63) to the decimal value to determine each corresponding character position in the ASCII code table.

For example, column 1 of Figure 7-9 is decoded as follows:

- All pixels on = $111111_2 = 63_{10}$ (decimal column value)
- $63_{10} + 63_{10}$ (offset) = 126_{10} (position in code table)
- Position 126 contains a ~ character

Thus the example letter 'W' is represented by the following:

- `~?_O_?~/A@???`@A (for 10-scan RCS cells). The slash (/) advances pixel interpretation from the upper RCS columns to the lower RCS columns.
- `}?????}/NCA@ACN` (for 12-scan RCS cells)

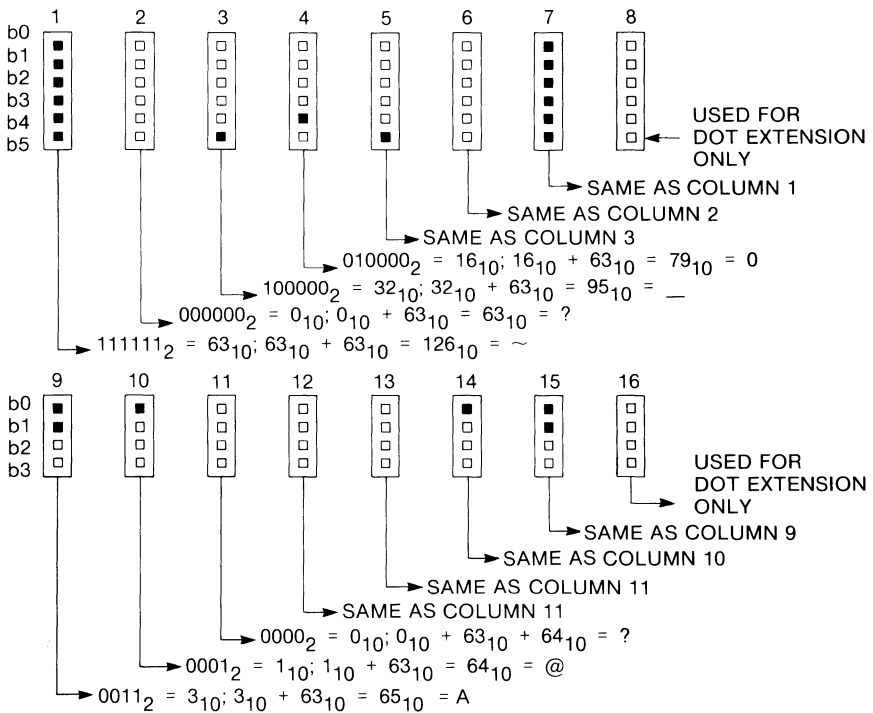

Figure 7-9. Converting 10-Scan Pixel-Bit Patterns to ASCII Code

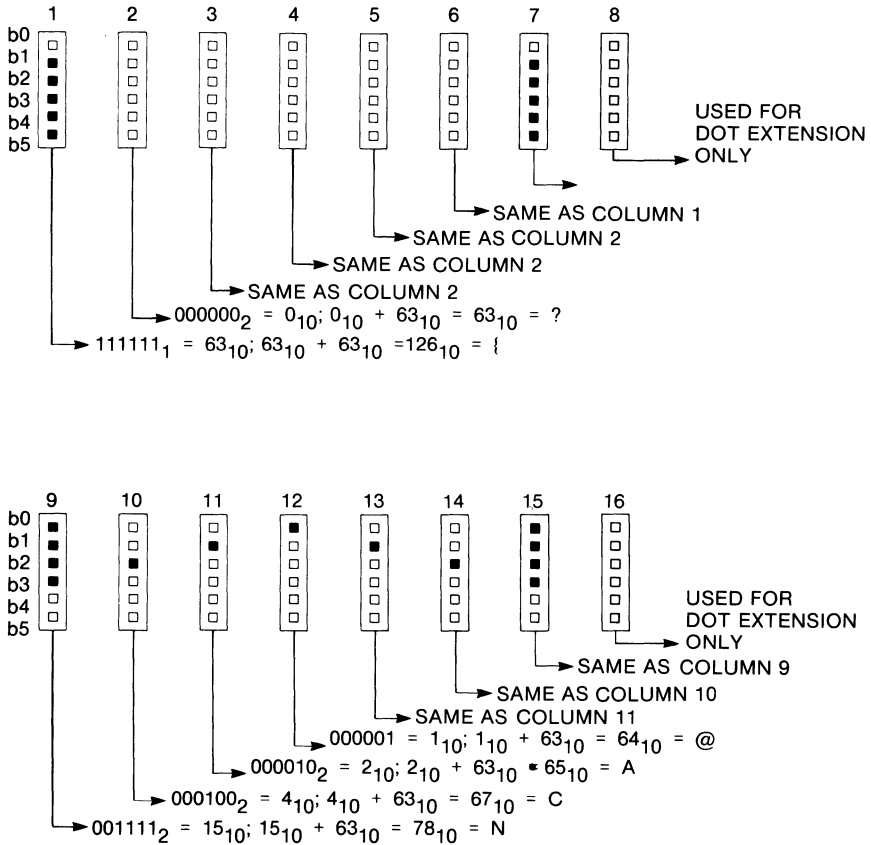

Figure 7-10. Converting 12-Scan Pixel-Bit Patterns to ASCII Code

7.6.2 Compensating for DEC-Compatible RCS Characters

The DEC VT220 terminal has Redefinable Character Set (RCS) cells that are 10 scan lines (scans) high. The Visual 220 RCS cell size is 12-scans high (refer to Figures 7-6 and 7-7).

The Visual 220 terminal compensates for this difference by shifting DEC-compatible characters down two scan lines within the RCS cell and blanking the top two scan lines.



Table 7-9. Down-Line Load DCS Description (Contd.)

DCS Characters	Description
RCS name	Defines the name for the soft character set. The RCS name is also used in the escape sequence for designating a soft character set (see Section 7.5.2.2).
Bp1;Bp2;Bp3; . . . Bpn	Character bit patterns for individual RCS characters. Each character bit pattern is separated by a semicolon (;). Up to 94 bit patterns may be included in the DCS.
ST	String Terminator. ST is an eight-bit control character that can be expressed as ESC \ when coding for seven-bit environments.

Table 7-10 names and describes the parameters for an RCS down-line load sequence.

Table 7-10. Down-Line Load Sequence Parameter Values

Parameters	Name	Description
Pfn	Buffer Number	Specifies the RCs font buffer to be used. Legal values and their definitions are: 0 or 1 = Use standard font buffer. 2 = Use optional font buffer.

Table 7-10. Down-Line Load Sequence Parameter Values (Contd.)

Parameters	Name	Description
Pw*	Width	Specifies the display width attribute as follows: 0 = Device default (80 columns) 1 = 80 column 2 = 132 column
Pt*	Text/ Full Cell	Specifies whether software treats the font as a text font or a full cell font. Legal values and their definitions are as follows: 0 = Device default (text) 1 = Text 2 = Full cell (not used) Text fonts typically cannot address all pixels individually within a cell. Full cell fonts can individually address all pixels in a cell.

*These parameters are defined for future use. Currently they have no effect.

7.7.1 Down-Line Load Example

The following example describes how to down-line load a typical RCS (Redefinable Character Set). The first letter of this RCS is the letter W that is used in the previous example for designing a character set.

DCS 1;1;1 {0%\$V }?????}/NCA@ACN;(next character); ST

Table 7-11 describes various parts of the down-line load sequence used in the above example.



Control String:

DCS 1;1;0 { SP @ ST
DCS 2;1;0 { SP @ ST
DCS 1;1;2 { SP @ ST

Effect:

Clear font buffer #1
Clear optional font buffer #2
Clear all font buffers

Other ways to clear a down-line loaded character set include:

- Turning off or resetting the terminal.
- Performing Set-Up Recall or Default functions.
- Performing a hard terminal reset (using ESC c sequences).

CHAPTER 8

TERMINAL CONTROL CODES

8.1 OVERVIEW

This chapter provides information required for programming the Visual 220 terminal. Information in this section is divided into the following three topics

- Operating mode differences. This information helps the programmer to optimize the terminal's capabilities.
- Codes transmitted by the various keys. These descriptions help the programmer to access the necessary codes for programming.
- Effects of received codes. These descriptions help the programmer to fully control all of the terminal's resources.

8.2 OPERATING MODE DESCRIPTIONS

This section describes the four operating modes of the Visual 220 terminal. The mode descriptions assume a compatible communications and host application environment.

There are differences among the operating modes of the Visual 220 that place certain restrictions on some coding sequences. That is, some coding sequences are not supported in every terminal operating mode. These differences are noted within the code descriptions for those coding sequences that are affected.

8.2.1 VT200 Mode (7-bit Controls)

This mode converts 8-bit control codes to the equivalent 7-bit escape sequences before they are sent to the host. Received codes are treated as 8-bit codes. This mode is intended for use in a 7-bit environment. Many VT100-compatible applications operate correctly in this mode.

8.2.2 VT200 Mode (8-bit Controls)

This mode sends and receives 8-bit ANSI codes and utilizes the full range of Visual 220 features. This mode is intended for use in an 8-bit environment.

8.2.3 VT100 Mode

This mode is selected for compatibility with applications and environments intended for use with VT100 terminals. In this mode, the terminal expects and processes 7-bit ANSI codes and certain private functions. The 8th bit of 8-bit codes is ignored.

8.2.4 VT52 Mode

VT52 mode is selected to execute private (non-ANSI) functions only. This mode is used for VT52-compatible applications.

8.2.5 Mode Differences

Some differences between the VT100 and VT200 modes of operation are described in Table 8-1.

Table 8-1. VT100 and VT200 Mode Differences

Area Affected	VT200 Mode	VT100 Mode
Keyboard	Full keyboard capabilities.	VT100 keys only. Function keys F11, F12 and F13 send ESC, BS and LF respectively. Other keys do nothing.
Received Codes	The 8th bit is significant.	The 8th bit is ignored (set to zero).
Character Sets	All Visual 220 character sets (except U.K.) are available.	ASCII, Special Graphics and U.K. only.
C1 Control Codes	Transmitted as 8-bit codes if 8-bit mode is selected.	Transmitted as 7-bit escape sequences.

```

101 00000000 00000000 00000000 00000000 00000000 00000000 00000000
102 00000000 00000000 00000000 00000000 00000000 00000000 00000000
103 00000000 00000000 00000000 00000000 00000000 00000000 00000000
104 00000000 00000000 00000000 00000000 00000000 00000000 00000000
105 00000000 00000000 00000000 00000000 00000000 00000000 00000000
106 00000000 00000000 00000000 00000000 00000000 00000000 00000000
107 00000000 00000000 00000000 00000000 00000000 00000000 00000000
108 00000000 00000000 00000000 00000000 00000000 00000000 00000000
109 00000000 00000000 00000000 00000000 00000000 00000000 00000000
110 00000000 00000000 00000000 00000000 00000000 00000000 00000000
111 00000000 00000000 00000000 00000000 00000000 00000000 00000000
112 00000000 00000000 00000000 00000000 00000000 00000000 00000000
113 00000000 00000000 00000000 00000000 00000000 00000000 00000000
114 00000000 00000000 00000000 00000000 00000000 00000000 00000000
115 00000000 00000000 00000000 00000000 00000000 00000000 00000000
116 00000000 00000000 00000000 00000000 00000000 00000000 00000000
117 00000000 00000000 00000000 00000000 00000000 00000000 00000000
118 00000000 00000000 00000000 00000000 00000000 00000000 00000000
119 00000000 00000000 00000000 00000000 00000000 00000000 00000000
120 00000000 00000000 00000000 00000000 00000000 00000000 00000000
121 00000000 00000000 00000000 00000000 00000000 00000000 00000000
122 00000000 00000000 00000000 00000000 00000000 00000000 00000000
123 00000000 00000000 00000000 00000000 00000000 00000000 00000000
124 00000000 00000000 00000000 00000000 00000000 00000000 00000000
125 00000000 00000000 00000000 00000000 00000000 00000000 00000000
126 00000000 00000000 00000000 00000000 00000000 00000000 00000000
127 00000000 00000000 00000000 00000000 00000000 00000000 00000000
128 00000000 00000000 00000000 00000000 00000000 00000000 00000000
129 00000000 00000000 00000000 00000000 00000000 00000000 00000000
130 00000000 00000000 00000000 00000000 00000000 00000000 00000000
131 00000000 00000000 00000000 00000000 00000000 00000000 00000000
132 00000000 00000000 00000000 00000000 00000000 00000000 00000000
133 00000000 00000000 00000000 00000000 00000000 00000000 00000000
134 00000000 00000000 00000000 00000000 00000000 00000000 00000000
135 00000000 00000000 00000000 00000000 00000000 00000000 00000000
136 00000000 00000000 00000000 00000000 00000000 00000000 00000000
137 00000000 00000000 00000000 00000000 00000000 00000000 00000000
138 00000000 00000000 00000000 00000000 00000000 00000000 00000000
139 00000000 00000000 00000000 00000000 00000000 00000000 00000000
140 00000000 00000000 00000000 00000000 00000000 00000000 00000000
141 00000000 00000000 00000000 00000000 00000000 00000000 00000000
142 00000000 00000000 00000000 00000000 00000000 00000000 00000000
143 00000000 00000000 00000000 00000000 00000000 00000000 00000000
144 00000000 00000000 00000000 00000000 00000000 00000000 00000000
145 00000000 00000000 00000000 00000000 00000000 00000000 00000000
146 00000000 00000000 00000000 00000000 00000000 00000000 00000000
147 00000000 00000000 00000000 00000000 00000000 00000000 00000000
148 00000000 00000000 00000000 00000000 00000000 00000000 00000000
149 00000000 00000000 00000000 00000000 00000000 00000000 00000000
150 00000000 00000000 00000000 00000000 00000000 00000000 00000000
151 00000000 00000000 00000000 00000000 00000000 00000000 00000000
152 00000000 00000000 00000000 00000000 00000000 00000000 00000000
153 00000000 00000000 00000000 00000000 00000000 00000000 00000000
154 00000000 00000000 00000000 00000000 00000000 00000000 00000000
155 00000000 00000000 00000000 00000000 00000000 00000000 00000000
156 00000000 00000000 00000000 00000000 00000000 00000000 00000000
157 00000000 00000000 00000000 00000000 00000000 00000000 00000000
158 00000000 00000000 00000000 00000000 00000000 00000000 00000000
159 00000000 00000000 00000000 00000000 00000000 00000000 00000000
160 00000000 00000000 00000000 00000000 00000000 00000000 00000000
161 00000000 00000000 00000000 00000000 00000000 00000000 00000000
162 00000000 00000000 00000000 00000000 00000000 00000000 00000000
163 00000000 00000000 00000000 00000000 00000000 00000000 00000000
164 00000000 00000000 00000000 00000000 00000000 00000000 00000000
165 00000000 00000000 00000000 00000000 00000000 00000000 00000000
166 00000000 00000000 00000000 00000000 00000000 00000000 00000000
167 00000000 00000000 00000000 00000000 00000000 00000000 00000000
168 00000000 00000000 00000000 00000000 00000000 00000000 00000000
169 00000000 00000000 00000000 00000000 00000000 00000000 00000000
170 00000000 00000000 00000000 00000000 00000000 00000000 00000000
171 00000000 00000000 00000000 00000000 00000000 00000000 00000000
172 00000000 00000000 00000000 00000000 00000000 00000000 00000000
173 00000000 00000000 00000000 00000000 00000000 00000000 00000000
174 00000000 00000000 00000000 00000000 00000000 00000000 00000000
175 00000000 00000000 00000000 00000000 00000000 00000000 00000000
176 00000000 00000000 00000000 00000000 00000000 00000000 00000000
177 00000000 00000000 00000000 00000000 00000000 00000000 00000000
178 00000000 00000000 00000000 00000000 00000000 00000000 00000000
179 00000000 00000000 00000000 00000000 00000000 00000000 00000000
180 00000000 00000000 00000000 00000000 00000000 00000000 00000000
181 00000000 00000000 00000000 00000000 00000000 00000000 00000000
182 00000000 00000000 00000000 00000000 00000000 00000000 00000000
183 00000000 00000000 00000000 00000000 00000000 00000000 00000000
184 00000000 00000000 00000000 00000000 00000000 00000000 00000000
185 00000000 00000000 00000000 00000000 00000000 00000000 00000000
186 00000000 00000000 00000000 00000000 00000000 00000000 00000000
187 00000000 00000000 00000000 00000000 00000000 00000000 00000000
188 00000000 00000000 00000000 00000000 00000000 00000000 00000000
189 00000000 00000000 00000000 00000000 00000000 00000000 00000000
190 00000000 00000000 00000000 00000000 00000000 00000000 00000000
191 00000000 00000000 00000000 00000000 00000000 00000000 00000000
192 00000000 00000000 00000000 00000000 00000000 00000000 00000000
193 00000000 00000000 00000000 00000000 00000000 00000000 00000000
194 00000000 00000000 00000000 00000000 00000000 00000000 00000000
195 00000000 00000000 00000000 00000000 00000000 00000000 00000000
196 00000000 00000000 00000000 00000000 00000000 00000000 00000000
197 00000000 00000000 00000000 00000000 00000000 00000000 00000000
198 00000000 00000000 00000000 00000000 00000000 00000000 00000000
199 00000000 00000000 00000000 00000000 00000000 00000000 00000000
200 00000000 00000000 00000000 00000000 00000000 00000000 00000000

```

8.3 TRANSMITTED CODES

This section describes the codes generated by the Visual 220 keyboard. The code descriptions assume that The DEC™ Multinational Character Set is mapped into the 8-bit code table as described in Chapter 7.

NOTE

Some codes may be generated internally as a response to codes received from a host system. These codes are described in Section 8.4.

The Visual 220 keyboard shown in Figure 8-1 includes 106 keys that are divided into four groups of keys. The groups are:

- Main keypad
- Editing/Cursor keypad
- Numeric/Application keypad
- Top-row function keys

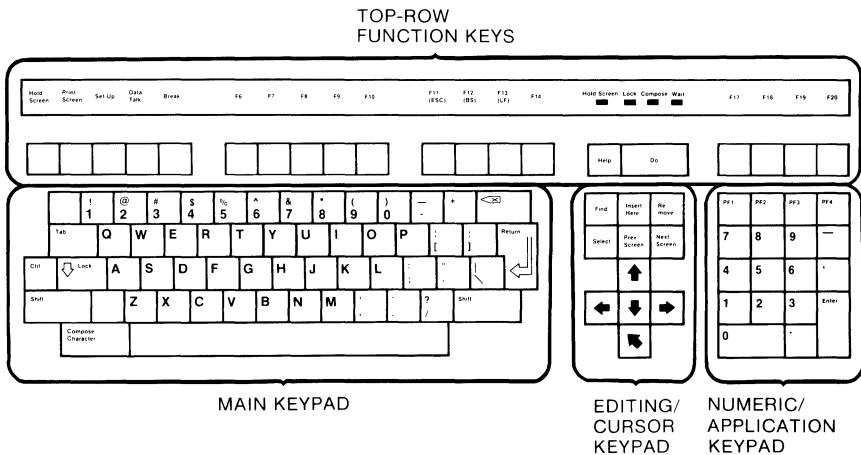

Figure 8-1. Visual 220 (North American) Keyboard

8.3.1 Main Keypad

The main keypad includes standard keys and special action keys. Both types of keys are described below.

8.3.1.1 Standard Keys — Standard keys generate codes for alpha-numeric characters, punctuation marks and other symbols. These keys may be used alone or in combination with special action keys (such as `Shift` or `Ctrl`). The character generated depends on several variables including:

- The character set currently in use,
- Whether Typewriter or Data Processing mode is selected is Set-Up.

8.3.1.2 Special Action Keys — The main keypad special action keys generate control codes that perform special functions when used alone or in combination with other keys. Table 8-2 describes the function of these keys.

Table 8-2. Main Keypad Special Action Key Functions

Key	Function
<code>Ctrl</code>	This key does not transmit a code. If depressed in combination with another key it transmits control codes to the system. Control codes direct the system to perform pre-defined operations (see Section 8.3.5).
<code>Shift</code>	This key does not transmit a code. However, when depressed with another alpha-numeric key it causes the generation of the upper case of that letter or the alternate character (if any) printed on that keycap. There are two of these keys for operator convenience.

8.3.2 Editing Keypad

The Editing Keypad contains editing keys and cursor control keys. Editing keys are used by the application program to edit data already entered on the display. The codes generated by the editing keys are shown in Table 8-3.

Table 8-3. Editing Key Codes *

Key	Code Generated
Find	CSI 1 ~
Insert Here	CSI 2 ~
Remove	CSI 3 ~
Select	CSI 4 ~
Prev. Screen	CSI 5 ~
Next Screen	CSI 6 ~

* The editing keys do not generate codes in VT100 or VT52 modes.

Cursor control keys move the cursor. When they are pressed, different codes are generated depending on whether the terminal is in ANSI or VT52 mode. Additionally, codes may differ depending on whether the cursor key mode is set for “normal” (ANSI) cursor control sequences or “application” control sequences.

Cursor key codes generated when the terminal is in ANSI mode are listed in Table 8-4. Cursor key codes generated when the terminal is in VT52 mode are listed in Table 8-5.



Table 8-6. Numeric/Application Keypad Codes

Key	ANSI MODE*		VT52 MODE	
	Numeric/Application Mode		Numeric/Application Mode	
	Numeric	Application	Numeric	Application
0	0	SS3 p	0	ESC ? p
1	1	SS3 q	1	ESC ? q
2	2	SS3 r	2	ESC ? r
3	3	SS3 s	3	ESC ? s
4	4	SS3 t	4	ESC ? t
5	5	SS3 u	5	ESC ? u
6	6	SS3 v	6	ESC ? v
7	7	SS3 w	7	ESC ? w
8	8	SS3 x	8	ESC ? x
9	9	SS3 y	9	ESC ? y
,	,	SS3 ℓ	,	ESC ? ℓ
—	—	SS3 m	—	ESC ? m
.	.	SS3 n	.	ESC ? n
† ENTER	CR or CR LF	SS3 M	CR or CR LF	ESC ? M
†† PF1	SS3 P	SS3 P	ESC P	ESC P
†† PF2	SS3 Q	SS3 Q	ESC Q	ESC Q
†† PF3	SS3 R	SS3 R	ESC R	ESC R
†† PF4	SS3 S	SS3 S	ESC S	ESC S

* ANSI mode applies to VT100 and VT200 modes only.

† The Enter key transmits a carriage return (CR) or a carriage return and linefeed (CR LF), depending on the New Line setting.

†† PF1 through PF4 can have functions assigned to them by the application program.

8.3.4 Top-Row Function Keys

The twenty top-row function keys include local function keys (F1 through F5) and programmable function keys (F6 through F20).

8.3.4.1 Local Function Keys — Local function keys F1 to F5 of the top-row function keys have local functions and do not transmit codes to a host computer. These keys are described in Table 8-7.

Table 8-7. Local Function Key (F1 – F5) Functions

Key	Function(s)
F1 — Hold Screen	Pressing this key freezes the screen and prevents any new characters from being displayed (the Hold Screen LED illuminates). Pressing the key again returns the screen to normal operation. Pressing Hold Screen does not send an XOFF code to the host system. However, if the host is sending data, the terminal transmits an XOFF code when the selected XOFF point is reached.
F2 — Print Screen	If the printer is available, pressing the Print Screen key sends the screen data to the printer. The amount of data sent depends on the print extent selected (Print Full Page/Scroll Region) from the printer Set-Up menu. Pressing Control-Print Screen toggles Normal/Auto-Print mode from the printer Set-Up menu.
F3 — Set-up	Pressing the Set-up Key causes the terminal to enter or exit Set-up mode.
F4 — Data/Talk	This key is active only if EIA modem controls have been selected and jumpers W2, W3, W4 and W6 are installed on the system board (see Table 2-2).

Table 8-7. Local Function Key (F1 - F5) Functions (Contd.)

Key	Function(s)
F5 — Break	<p>Depressing the Break key alone causes the terminal to transmit a break signal if break is enabled from the Keyboard Set-up menu (the transmit data line [TXD] is held low.)</p> <p>Depressing Shift and Break simultaneously causes the terminal to turn off Data Terminal Ready (DTR) and Request To Send (RTS). The Transmit Data Line (TXD) is held low. After 0.22 seconds, the terminal tests the condition of Data Set Ready (DSR). When DSR turns off (or after 1.8 seconds), the disconnect is complete.</p> <p>Depressing Ctrl and Break simultaneously causes the answerback message to be transmitted (the answerback message is controlled from the Keyboard Set-Up menu).</p>

8.3.4.2 Programmable Function Keys — Each of the top-row programmable function keys (F6 through F20) may have up to three separate functions depending on the condition of the **Shift** and **Ctrl** keys.

When the **Shift** key is shifted (held down), the function keys F6 through F20 are assigned host-programmable messages for application purposes. When the **Ctrl** key is held down, alternate host-programmable messages are assigned. Details of how to program these keys are provided in Section 8.4.2.18.

When the **Shift** key is unshifted, the top-row function keys F6 through F20 (including **F*ELP** and **DO**) of the top-row function keys have functions that are described in Table 8-8.

8.3.6 Generating C1 Control Codes

C1 (8-bit) control codes can be generated using 7-bit code extension techniques. In general, any C1 code can be expressed by sending the C0 code ESC followed by a second ASCII character that is 64 (decimal) less than that of the C1 character. For example, the C1 characters IND, CSI and SS2 can be expressed as follows:

C1 Character	Code Extension Equivalent
IND	ESC D
CSI	ESC [
SS3	ESC O

Table 8-9. Keystroke Sequences for Generating C0 Control Codes

C0 Control Code Mnemonic	Key pressed with Ctrl (All Modes)	Dedicated Function Key or Special Action Key
NUL	2 or space	
SOH	A	
STX	B	
ETX	C	
EOT	D	
INQ	E	
ACK	F	
BEL	G	
BS	H	F12 (BS) *
HT	I	Tab
LF	J	F13 (LF) *
VT	K	
FF	L	
CR	M	Return
SO	N	

**Table 8-9. Keystroke Sequences
for Generating C0 Control Codes (Contd.)**

C0 Control Code Mnemonic	Key pressed with Ctrl (All Modes)	Dedicated Function Key or Special Action Key
SI	O	
DLE	P	
DC1 (XOFF)	Q †	
DC2	R	
DC3 (XON)	S †	
DC4	T	
NAK	U	
SYN	V	
ETB	W	
CAN	X	
EM	Y	
SUB	Z	
ESC	3 or [F11 (ESC) *
FS	4 or /	
GS	5 or]	
RS	6 or ~	
US	7 or ?	
DEL	8	

* Pertains to VT100- and VT52-compatible modes only.

† If XON/OFF flow control is enabled, these keys (pressed in combination with the **Ctrl** key) do not generate codes. Instead, these keystroke combinations toggle the Hold Screen state.

8.4 RECEIVED CODES

This section describes how the Visual 220 responds to the various control codes received from an application or a host system.

NOTE

The code descriptions assume that The DEC™ Multi-national character set is mapped into the 8-bit code table as described in Chapter 7.

Control codes are used in programs to determine how the terminal handles data from an application or a host system. Control codes can determine such things as:

- setting the operating mode of the terminal.
- setting specified tab stops.
- moving the cursor to predefined points on the display.
- changing character sets.

All control codes can be expressed as single-byte or multi-byte codes. Single-byte codes (C0 and C1 codes) generate a limited number of control functions. Multi-byte codes, however, can perform many more functions due to the variety of combinations possible. The multi-byte codes are divided into three categories:

- Escape Sequences
- Control Sequences
- Device Control Strings

Escape sequences are made up of one or more 7-bit codes (represented by ASCII characters) that are preceded by the code for the C0 character "ESC."

An example of an escape sequence is **ESC [2 J**. This sequence causes the entire display to be erased (the cursor does not move).

Control sequences are made up of one or more 7-bit codes (represented by ASCII characters) that are preceded by the code for the C1 character “CSI.” Note that CSI can also be expressed as the escape sequence ESC [(refer to Section 8.3.6).

NOTE

CSI may be used whenever possible to gain processing speed.

An example of a control sequence is CSI K. This sequence causes the line to the right of the cursor to be erased (including the character in the cursor position). The cursor does not move. The equivalent escape sequence for this control sequence is ESC [K.

Device control strings are used to down-line load character set, program function keys F6 through F20 and to program the time-of-day clock.

A device control string is made up of an opening delimiter a data stream and a closing delimiter and has the following format:

DCS Control String Data ST

DCS (C1 code 90 hex) is the opening delimiter that can also be described as the escape sequence ESC P. ST (string terminator) is the closing delimiter. ST can also be expressed as the escape sequence ESC \.

8.4.1 C0 and C1 Control Characters

This section describes how the Visual 220 responds to C0 and C1 Control Characters that are received from the application or host system. Not all control characters have an effect on the Visual 220. Table 8-10 describes the allowable C0 Control Codes.

Table 8-10. C0 Control Code Functions

Code	Hex Value	Terminal's Response
NUL	00	Ignored when received.
ENQ	05	Initiates Answerback message.
BEL	07	Rings bell if Warning Bell is enabled.
BS	08	Moves cursor one position to the left. No action occurs if cursor is at left margin.
HT	09	Moves cursor to next tab stop, or to end of line if no more tab stops.
LF	0A	Moves cursor down one line or to the left margin depending on the setting of new line mode. Causes a scroll if the cursor is at the bottom line of the scroll region. Also causes printing of current line if auto print is enabled.
VT	0B	Same as LF.
FF	0C	Same as LF.
CR	0D	Moves cursor to first column of current line (this action is not affected by the setting of the New Line mode).
SO	0E	Invokes G1 character set into GL.
SI	0F	Invokes G0 character set into GL.
DC1	11	XON code.
DC3	13	XOFF code.
CAN	18	If received during an escape or control sequence, cancels the sequence. No error character is displayed.

Table 8-10. C0 Control Code Functions (Contd.)

Code	Hex Value	Terminal's Response
SUB	1A	Same as CAN, except causes a reverse question mark (‡) to be displayed.
ESC	1B	Initiates control sequence.
DEL	7F	Ignored. Should not be used as a filler.

The C1 control characters require 8-bit codes and are recognized only when the terminal is in 8-bit compatible mode. Table 8-11 describes the terminal's response to C1 control characters. Equivalent 7-bit escape sequences are provided for coding in a 7-bit environment.

Table 8-11. C1 Control Code Functions

Code Name	Hex Value	7-Bit Code Equivalent	Terminal's Response
IND	84	ESC D	Moves cursor down one line in the same column. If cursor is at bottom margin, initiates scroll up.
NEL	85	ESC E	Moves cursor to first column of next line. Initiates scroll up if cursor is at bottom margin.
HTS	88	ESC H	Sets a horizontal tab at the cursor position.
RI	8D	ESC M	Moves cursor up one line in the same column. If cursor is at top margin, initiates scroll down.
SS2	8E	ESC N	Invokes G2 character set into GL for next character only.
SS3	8F	ESC O	Invokes G3 character set into GL for next character only.
DCS	90	ESC P	Recognizes opening delimiter of Device Control String.
CSI	9B	ESC [Recognizes opening delimiter of extended escape sequences.
ST	9C	ESC \	Recognizes closing delimiter of Device Control String.

8.4.2 Control Sequences Recognized in ANSI (X3.64) Mode

This section describes those control sequences recognized by the Visual 220 that conform to the basic format specified by ANSI X3.64. Example (spaces are for clarity only):

ESC [Ps/Pn X or CSI Ps/Pn X

Certain control sequences that are not actually specified in the X3.64 standard are noted. The following conventions are used to identify non-ANSI (X3.64) control sequences:

- Non-ANSI DEC sequences are marked “(private).”
- Sequences that are not present in the DEC VT220 are marked “[VISUAL].” These sequences are enhancements to the DEC VT220.

8.4.2.1 Mode Set and Reset Control Sequences — Control sequences allow the host to set (and reset) terminal parameters. The parameters that are menu-selectable (in Set-Up) can be saved in non-volatile memory.

NOTE

Certain parameters can be “locked” by using Set-Up mode. Features that are locked cannot be changed by the host.

This section identifies control sequences and parameter values required to set and reset various Visual 220 operating modes. The following sequences are only valid in ANSI mode.

SET MODE COMMAND**CSI Ps ; Ps ; ... Ps h**

The Set Mode command is the control sequence used to change Visual 220 operating modes or parameters.

Ps represents a single mode value. A Set Mode control sequence can contain up to 16 different mode values. The modes and values are provided in Table 8-12.

An example of a Set Mode sequence is **CSI 12 ; 7 ; 8 h**. This sequence configures the terminal for local echo.

RESET MODE COMMAND**CSI Ps ; Ps ; ... Ps ℓ**

The Reset Mode command is the control sequence used to reset ANSI and non-ANSI modes. The various modes are described in Table 8-12.

Table 8-12 describes the set/reset modes available in the Visual 220. The modes that include the question mark (?) as part of the selected parameters are private modes that enhance the operation of the Visual 220.

NOTE

If a question mark (?) is used, it must be the first character in the parameter string. All subsequent parameters in the sequence are affected by the question mark.



Table 8-12. Set/Reset Mode Ps Values and Definitions (Contd.)

Mode Name	Ps Value	Function																		
Send/Receive Mode	12	<p>When set, no local echo of transmitted data occurs.</p> <p>When reset, this mode causes the transmitted data to be echoed back to the terminal display.</p>																		
Linefeed / New Line Mode	20	<p>When set, this mode causes the Return key to generate the CR (carriage return) and LF (line feed) codes.</p> <p>When reset, the return key generates a CR code only. LF is generated by the Line Feed key.</p>																		
Cursor Key Mode (private)	? 1	<p>When set, this mode causes the cursor positioning keys to generate special escape sequences.</p> <p>When reset, the cursor position keys transmit their normal ANSI mode sequences.</p> <table border="1"><thead><tr><th>Cursor Key</th><th>Set</th><th>Reset</th></tr></thead><tbody><tr><td>UP</td><td>SS3 A</td><td>CSI A</td></tr><tr><td>DOWN</td><td>SS3 B</td><td>CSI B</td></tr><tr><td>LEFT</td><td>SS3 C</td><td>CSI C</td></tr><tr><td>RIGHT</td><td>SS3 D</td><td>CSI D</td></tr><tr><td>HOME</td><td>SS3 H</td><td>CSI H</td></tr></tbody></table>	Cursor Key	Set	Reset	UP	SS3 A	CSI A	DOWN	SS3 B	CSI B	LEFT	SS3 C	CSI C	RIGHT	SS3 D	CSI D	HOME	SS3 H	CSI H
Cursor Key	Set	Reset																		
UP	SS3 A	CSI A																		
DOWN	SS3 B	CSI B																		
LEFT	SS3 C	CSI C																		
RIGHT	SS3 D	CSI D																		
HOME	SS3 H	CSI H																		

Table 8-12. Set/Reset Mode Ps Values and Definitions (Contd.)

Mode Name	PS Value	Function
Origin Mode (private)	? 6	<p>When set, this mode causes line and column numbers to be dependent on the selected scrolling region and home in the scrolling region. The cursor moves to the new home position after the mode changes.</p> <p>When reset, line and column numbers are independent of the selected scrolling region.</p>
Autowrap Mode (private)	? 7	<p>When set, this mode causes the cursor to automatically advance to the first position of the next line when characters are entered after the last column position is reached.</p> <p>When reset, the cursor does not move (wrap) to the next line. This function does not affect Tab, however. Tab never moves the cursor to the next line.</p>
Autorepeat Mode (private)	? 8	<p>When set, this mode causes most keys to be autorepeating.</p> <p>When reset, no keys autorepeat.</p>
Text Cursor Enable (private)	? 25	<p>When set, this mode causes the text cursor to be visible.</p> <p>When reset, the text cursor is not displayed.</p>

CURSOR UP**CSI Pn A**

This command moves the cursor up Pn lines. Pn can be 1 to 255. The cursor cannot move past the top margin.

CURSOR DOWN**CSI Pn B**

This command moves the cursor down Pn lines. Pn can be 1 to 255. The cursor cannot move past the bottom margin.

CURSOR RIGHT**CSI Pn C**

This command moves the cursor right Pn characters. Pn can be 1 to 255. The cursor cannot move past right margin.

CURSOR LEFT**CSI Pn D**

This command moves the cursor left Pn characters. Pn can be 1 to 255. The cursor cannot move past the left margin.

ABSOLUTE CURSOR POSITIONING**CSI r ; c H
CSI r ; c f**

Either of the absolute cursor positioning commands may be used to position the cursor anywhere on the terminal screen between lines (rows) 1 and 24 for the line count and between columns 1 and 80 (or 1 and 132) for the character count. The default values are 1. The line (row) count is specified by r and the column count by c.

If an attempt is made to position the cursor past the screen boundaries, the cursor moves to the screen boundary. If r or c are not selected or selected as 0, the cursor moves to the first line or column, respectively.

CURSOR INDEX**ESC D**

This command causes the cursor to move down one line in the scrolling region. If the cursor moves to the maximum boundary of the scrolling region the terminal scrolls up one line.

CURSOR REVERSE INDEX

ESC M

This command causes the cursor to move up one line in the scrolling region. If the cursor moves to the minimum boundary of the scrolling region the terminal scrolls down one line.

NEXT LINE

ESC E

This sequence causes the cursor to move to the beginning of the next line. If the cursor is positioned on the bottom line of the screen or the bottom of the screen scrolling region, the contents of the scrolling screen or scrolling region scrolls up one line.

SAVE CURSOR

ESC 7 (private)

This (private) sequence causes the cursor position, character set, origin mode selection and graphic rendition to be saved in memory. If the terminal power is shut off or a reset occurs, these values are lost.

RESTORE CURSOR

ESC 8 (private)

This sequence causes restoration of the previously saved cursor position, character set, origin mode selection and graphic rendition.

8.4.2.4 Erasure Commands — A wide variety of erasing commands permits characters to be removed from the screen without affecting other characters. Characters are lost when they are erased.



ERASE IN PAGE

CSI Ps J

This command erases some or all the data on a page depending on the value of Ps (Ps values are described below).

Ps Value	Action
0 (default)	Erase from cursor to end of page, including cursor position.
1	Erase from beginning of screen to cursor, including cursor position.
2	Erase page, all lines changed to single width. Cursor does not move.

ERASE IN LINE

CSI Ps K

This command erases some or all the data on a line according to the Ps value (Ps values are described below).

Ps Value	Action
0 (default)	Erase from cursor to end of line, including cursor position
1	Erase from start of line to cursor, including cursor position.
2	Erase line

SELECTIVE ERASE IN PAGE

CSI ? Ps J

This (VT200 mode only) command erases some or all erasable data on a page, depending on the value of Ps (Ps values are described below). Erasable characters are those whose logical attribute is set to “erasable” (see Section 8.4.2.10).

Ps Value	Action
0 or none	Erase all “erasable” characters from and including the cursor to the end of the screen
1	Erases all “erasable” characters from the beginning of the screen to and including the cursor.
2	Erases all “erasable” characters in the entire display.

SELECTIVE ERASE IN LINE

CSI ? Ps K

This (VT200 mode only) command erases some or all erasable data on a line, depending on the value of Ps (Ps values are described below). Erasable characters are those whose logical attribute is set to “erasable” (see Section 8.4.2.10).

PS Value	Action
0 or none	Erases all “erasable” characters from the cursor to the end of the line.
1	Erases all “erasable” characters from the beginning of the line up to and including the cursor position.
2	Erases all “erasable” characters on the line.

ERASE CHARACTER

CSI Pn X

This (VT200 mode only) command erases characters at the cursor position and the next Pn-1 characters.

8.4.2.5 Tabbing Commands — Tabbing commands permit setting and clearing of tab stops.

TABS CLEAR

CSI Ps g

This command clears one or more tabs stops depending on the value of Ps (Ps values are described below).

Ps Value	Action
0 (default)	Clears tab at current column
3	Clears all tab stops

SET TAB

ESC H

This command sets a Tab Stop at the current cursor position.

8.4.2.6 Screen Alignment — The screen alignment command is typically used by field maintenance personnel.

SCREEN ALIGNMENT COMMAND

ESC # 8

The screen alignment command fills the screen with upper case E's and may be used to focus and align the terminal display.

8.4.2.7 Character Set Selection (private) — The character set selection commands allow for remote selection of various hard (ROM-based) or soft (down-line loadable) character sets.

To use any character set, it first must be designated as G0, G1, G2 or G3. Once designated, the set can be invoked into GL (graphics left) or GR (graphics right) at any time. A detailed discussion of this procedure is provided in Chapter 7.

A soft character set may be designated using the following escape sequences:

To Designate as:	Use Sequence:
G0	ESC (RCS name
G1	ESC) RCS name
G2	ESC * RCS name
G3	ESC + RCS name

- Invoking Character Sets Using Lock Shifts

Once a character set has been designated, it can be invoked onto GL or GR using “lock shifts.” These sequences cause a character set to remain active until:

- a) it is replaced by another lock-shifted character set, or
- b) it is temporarily displaced by a single-shifted character set,
or
- c) the terminal is powered off.

Function:	Use Sequence:
Invoke G0 into GL	SI
Invoke G1 into GL	SO
Invoke G1 into GR	ESC ~
Invoke G2 into GL	ESC n
Invoke G2 into GR	ESC }
Invoke G3 into GL	ESC o
Invoke G3 into GR	ESC :

- Invoke Character Sets Using Single Shifts

Once a character set has been designated, it can be invoked into GL or GR using “single shifts.” These sequences cause a character set to remain active for the next single graphics character only. After that character has been processed, the set that was displaced is returned to its previous position.

Function	Use Sequence
Invoke G2 into GL for the next graphic character.	ESC N
Invoke G3 into GL for the next graphic character.	ESC O

8.4.2.8 Report Commands and Responses — The commands in this section allows the host to ask the terminal various questions about its status. The terminal typically responds by returning a specified sequence.

PRIMARY TERMINAL

CSI c
CSI 0 c
ESC Z

This command allows the host to ask the terminal to identify itself. A terminal’s typical response is shown below.

Terminal’s Response	Meaning
CSI ? 62; 1; 2; 6; 7; 8c	I am a service class 2 (VT200 family) terminal (62) with 132 columns (1), printer port (2), selective erase (6), RCS characters (7) and programmed function keys (8).

TERMINAL CONDITION**CSI 5 n**

This command allows the host to ask the terminal's condition. The terminal's response is shown below.

Terminal's Response**Meaning**

CSI 0 n

I have no malfunction.

CSI 3 n

I have a malfunction.

READ CURSOR LOCATION**CSI 6 n**

This command allows the host to find out where the terminal's cursor is located. The terminal's response is shown below.

Terminal's Response**Meaning**

CSI r ; c R,

"r" is the row (line) number and "c" is the column number. No parameters or parameters of 0 indicate the cursor is at the home position.

SECONDARY TERMINAL ID**CSI > c****CSI > 0 c**

This command asks what type of terminal it is, what the firmware version is, and what hardware options you have installed.

Terminal's Response**Meaning**

CSI > Pt; Pv; Po c

I am a Visual . . . terminal (Pt), my firmware rev is (Pv) and I have (Po) options installed.

```
CSI ? 25 n
CSI ? 20 n
CSI ? 21 n
```

Parameters	Values	Definitions
Pt	1 2	Visual 220 terminal Visual 240/241 terminal
Pv		Decimal version number (X10). Example; Version 3.2 = 32
Po	0	No options

USER DEFINED KEY LOCK

CSI ? 25n

This sequence asks the terminal whether the user defined function keys are locked or unlocked. The terminal response may be either of the following:

- CSI ? 20 n User defined keys are unlocked
- CSI ? 21 n User defined keys are locked

8.4.2.9 Video Attributes — Characters may be displayed on the terminal in any combination of the following attributes: Bold, Underline, Blank, Blink and Reverse Video.

VIDEO ATTRIBUTE COMMAND

CSI Ps ; ... Ps m

This command turns on any or all video attributes. The video attributes are cumulative. When an attribute or combination of attributes is turned on, all subsequently displayed characters remain affected until the attribute (or attributes) is turned off.

Table 8-14 provides the sequences for setting individual attributes.

Table 8-14. Video Attribute Control Sequences

Attribute	Ps Code	Control Sequence
Normal	0 (default)	CSI m
Bold	1	CSI 1 m
Blank	2	CSI 2 m [VISUAL]
Underline	4	CSI 4 m
Blink	5	CSI 5 m
Reverse	7	CSI 7 m
Display Normal Intensity	22	ESC [22m
Display Not Underlined	24	ESC [24 m
Display not Blinking	25	ESC [25 m
Display Positive Image	27	ESC [27 m

8.4.2.10 Logical Attributes — Characters may be assigned an “erasable” or “non-erasable” logical attribute.

SELECT LOGICAL ATTRIBUTES

CSI Ps " q

Characters entered on the display may be selected as "erasable" or "non-erasable" using this command. Characters selected as "non-erasable" cannot be erased using selective erase control sequences. Once the logical attribute is set, all subsequent characters entered on the display are affected. The video attributes are not affected by this command.

Selectable parameter (Ps) values are shown below.

Ps	Effect
0	All logical attributes off
1	Designate characters as non-erasable
2	Designate characters as erasable

8.4.2.11 Character Size Commands (Private) — Characters may be formed on the screen in three different sizes: single height-single width, double height-double width, or single height-double width. When using double size characters, the number of characters per line is halved.

This section describes the various character size commands.

SINGLE HEIGHT - SINGLE WIDTH LINE

ESC # 5

This command causes the characters in the line marked by the cursor to be single height-single width.

SINGLE HEIGHT - DOUBLE WIDTH LINE

ESC # 6

This command causes the characters in the line marked by the cursor to be single height-double width.

If the line was previously single height-single width, any characters in the right half of the display are lost. The cursor remains under the same character position, unless its character (column) position is lost, in which case the cursor is moved to the right margin.

DOUBLE HEIGHT - DOUBLE WIDTH LINE (TOP HALF) ESC # 3
DOUBLE HEIGHT - DOUBLE WIDTH LINE
(BOTTOM HALF) ESC # 4

These two commands are used as a pair, on adjacent lines to form double height-double width characters. The same character must be sent to the same column of both lines to form each character. If the line was previously single-height single-width, all characters from the middle of the line to the end of the line are lost. The cursor remains in the same character position unless the character position is lost, in which case the cursor is moved to the right margin.

8.4.2.12 Reset Commands — This section describes hard and soft reset commands. Data not stored in NVR (non-volatile RAM) is lost when these commands are used.

HARD RESET ESC c

This command causes the terminal to reset, and has the same effect as powering-down then powering-up the terminal. All set-up parameters are replaced by their NVR values, or power-up default values if NVR values do not exist.

In addition, this command:

- performs a communications line disconnect.
- clears user-defined keys (except non-volatile keys).
- clears all down-line loaded character sets.
- clears the display.
- returns the cursor to the home position.
- sets the video attributes to normal.
- resets the selective erase attribute.
- sets all character sets to the default.

SOFT RESET CSI ! p

The Soft Terminal reset sequence sets the terminal to the power-up default status listed in Table 8-15.

Ver. 2.00 (1998/01/15) 1000-1000
 Copyright (c) 1998, 1999, 2000, 2001, 2002, 2003, 2004, 2005, 2006, 2007, 2008, 2009, 2010, 2011, 2012, 2013, 2014, 2015, 2016, 2017, 2018, 2019, 2020, 2021, 2022, 2023, 2024, 2025
 All rights reserved.

Table 8-15. Soft Terminal Reset Status

Terminal Parameter	Status
Text Cursor	On*
Insert/Replace	Replace
Origin Mode	Absolute
Autowrap	Off*
Keyboard Action	Unlocked
Keypad Mode	Numeric
Cursor Key Mode	Normal
Top Margin	1
Bottom Margin	24
Character Sets:	
G0, G1, GL	ASCII
G2, G3, GR	DEC Supplemental Character Set
Video Character Attributes	Normal
Selective Erase Attributes	Normal (erasable)
Restore Cursor State	
Cursor Position	Home
Character Sets	VT200 defaults
Selective Erase Attribute	Off
Video Attributes	Normal
Origin Mode	Absolute
Character Shift	Power Up Defaults
(G0 to GL, G2 to GR, no shifts)	

* Ignores the "saved" value in the terminal's non-volatile memory.

8.4.2.13 Numeric/Application Keypad Commands — The commands in this section invoke a special set of codes for the Numeric/Application Keypad. These codes may be used by an application to perform specialized functions.

ENTER APPLICATION KEYPAD MODE

ESC =

This sequence causes the terminal to enter Application Keypad mode. When entered, this mode causes keys on the numeric keypad to transmit special escape sequences as opposed to their regular codes. These codes are as follows:

Key	Application Keypad Code
0	SS3 p
1	SS3 q
2	SS3 r
3	SS3 s
4	SS3 t
5	SS3 u
6	SS3 v
7	SS3 w
8	SS3 x
9	SS3 y
- (minus)	SS3 m
, (comma)	SS3 ℓ
. (period)	SS3 n
ENTER	SS3 M
PF1	SS3 P
PF2	SS3 Q
PF3	SS3 R
PF4	SS3 S

EXIT APPLICATION KEYPAD MODE

ESC >

This sequence causes the terminal to exit Application Keypad mode. The Numeric/Application keypad keys resume their numeric code functions.

8.4.2.14 Editing Commands — The following commands allow the host to delete characters or lines and insert lines.

INSERT LINE

CSI Pn L

This command insert Pn lines (where Pn can vary from 1 to 255) starting at the line with the cursor. Lines displayed below the cursor move down. Lines moved past the bottom margin are lost. This sequence is ignored when the cursor is outside the scrolling region.

DELETE LINE

CSI Pn M

This command deletes Pn lines (where Pn can vary between 1 and 255) starting at the line with the cursor. As lines are deleted, lines below the cursor move up. Lines added to bottom of screen have spaces with same character attributes as last line moved up. This sequence is ignored when the cursor is outside the scrolling region.

INSERT CHARACTER

CSI Pn @

This (VT200 mode only) command inserts Pn blank characters at the cursor position, with the character attributes set to normal.

DELETE CHARACTER

CSI Pn P

Deletes Pn characters starting with the character at the cursor position. When a character is deleted , all characters to the right of the cursor move left. This creates a space character at the right margin with the character attributes set to normal.

8.4.2.15 Terminal Testing — The terminal or host can invoke various tests or combinations of tests. These tests are typically performed by field maintenance personnel. The following control sequence causes the test(s) to be run (Ps values are described below):

RUN TEST(S) CSI 4; Ps; Ps; ...; Ps y

Ps Value	Effect
0	Test 1, 2, 3, and 6.
1	Power-up self test.
2	EIA port data loopback test. *
3	Printer loopback test. *
4	Not used.
5	Not used.
6	EIA port modem control line loopback test. *
7	20 MA loopback test. *
8	Not used.
9	Repeat selected tests until failure or power off.

* Loopback tests require loopback connectors (see Appendix F).

8.4.2.16 Select Compatibility Levels — The terminal may be set to a particular emulation mode for compatibility with host software. There are two emulation modes: VT200 and VT100 (VT52 is a subset of VT100 mode).

SELECT EMULATION MODE CSI Ps1 ; Ps2 ; " p

This command selects the emulation mode (Ps1) and the control codes for the terminal. The parameter values (Ps1 and Ps2) are defined in Table 8-16.

SELECT 8-BIT CONTROLS

ESC sp G

Causes the terminal to return C1 codes to the application without converting them to their equivalent 7-bit extensions.

8.4.2.18 Programming Top-Row Function Keys — Each top-row function key (F6 through F20) can be programmed with two different values. Programmed values are assigned to key numbers that correspond to function keys pressed in combination with special action keys *Shift* or *Ctrl*.

The function keys can be programmed using the following device control string:

DCS Pc; PI | ky1/st1; ky2/st2;...kyn/stn ST

String parameters (Pc and PI) and their effects are described in Table 8-17. Key numbers (kyn) are identified in Table 8-18.

String data (stn) is made up of hexadecimal numbers that correspond to the code table position (hex) of the desired character. Stn data cannot exceed 256 bytes for any single key number. A maximum of 1024 bytes may be shared among all function keys.

Table 8-17. Function Key Control String Parameter Effects

Parameter	Value	Effect
Pc (Clear)	0 or none	Clear all keys before loading new values.
	1	Load new values, clear old only where defined.
PI (Lock)	0 or none	Lock the keys against future redefinition
	1	Do not lock the keys against future redefinition *

* A PI value of 1 does not “unlock” locked keys.

Table 8-18 identifies the key numbers for Function keys that are pressed in combination with the **Shift** or **Ctrl** keys.

Table 8-18. Top-Row Function Key Numbers

Function Key	Key Number When Pressed in Combination With:	
	Shift	Ctrl
F6	17	37
F7	18	38
F8	19	39
F9	20	40
F10	21	41
F11	23	43
F12	24	44
F13	25	45
F14	26	46
HELP	28	48
DO	29	49
F17	31	51
F18	32	52
F19	33	53
F20	34	54

The following example illustrates a device control string that programs function key **F12** (pressed with **Ctrl**) with the escape sequence **ESC [2 J**.

DCS 1; 1 | 44 / 1B 5B 32 4A

8.4.2.19 Down-line Loading Characters — RCS (Redefinable Character Set) characters and other soft characters can be down-line loaded into the Visual 220 font buffer. The font buffer has a capacity of 94 characters.

NOTE

Soft character set selection is described in detail in Chapter 7 of this manual.

The following device control string (DCS) may be used for down-line loading soft characters:

DCS Pfn;Pcn;Pe;Pccs;Pw;Pt { RCS name Bp1;Bp2;Bp3;...Bpn ST

String variables are described in Table 8-19. The parameter substring (Pfn;Pcn;Pe;Pccs;Pw;Pt) is further defined in Table 8-20.

Table 8-19. Soft Character Down-Line Load DCS Description

DCS Characters	Description
DCS	Introduces a device control string. DCS is an eight-bit control character that can also be expressed as ESC P when coding for a seven-bit environment.
Pfn;Pcn;Pe;Pccs;Pw;Pt	A parameter substring. The parameter values are discussed in Table 8-20.
{	Identifies the end of the parameter substring and specifies a down-line load sequence.
RCS name	Defines the name for the soft character set. The RCS name is also used in the escape sequence for designating a soft character set.
Bp1;Bp2;Bp3;...Bpn	Character bit patterns for individual RCS characters. Each character bit pattern is separated by a semicolon (;). Up to 94 bit patterns may be included in the DCS. Bit patterns are fully described in Chapter 7.
ST	String Terminator. ST is an eight-bit control character that can be expressed as ESC \ when coding for seven-bit environments.

Table 8-20 names and describes the parameters in the parameter substring for the RCS down-line load DCS.

Table 8-20. Parameter Values for a Down-Line Load Sequence

Parameters	Name	Description
Pfn	Font Number	Specifies the RCS font buffer to be used. The Visual 220 has only one RCS font buffer. Legal values are 0 and 1.
Pcn	Starting Character Number	Specifies the position in the ASCII code table (and the font buffer) where the first character is to be loaded. 1 specifies position 33 (! in the ASCII table). 94 specifies position 126 (~ in the ASCII table).
Pe	Erase Control	Specifies which characters in the font buffer are erased before new characters are loaded. Legal values and their definitions are as follows: 0 = erase all characters in the font buffer. 1 = erase the characters that are being reloaded. 2 = erase all characters in all font buffers.
Pccs	Character Cell Size	Defines the expected limit of the RCS cell size. Legal values and their definitions are as follows: 0 = Device default (7x10) 1 = (not used) 5 = (not used) 2 = 5x10 6 = 5x12 3 = 6x10 7 = 6x12 4 = 7x10 8 = 7x12

Table 8-20. Parameter Values for a Down-Line Load Sequence (Contd.)

Parameters	Name	Description
Pw	Width	Specifies the display width attribute as follows: 0 = Device default (80 columns) 1 = 80 column 2 = 132 column
Pt	Text/ Full Cell	Specifies whether software treats the font as a text font or a full cell font. Legal values and their definitions are as follows: 0 = Device default (text) 1 = Text 2 = Full cell (not used) Text fonts typically cannot address all pixels individually within a cell. Full cell fonts can individually address all pixels in a cell.

8.4.2.20 Clearing a Down-Line Loaded Character Set — Down-line loaded character sets may be cleared by the following down-line load device control strings:

Control String:	Effect:
DCS 1;1;0 { SP @ ST	Clear font buffer #1
DCS 2;1;0 { SP @ ST	Clear optional font buffer #2
DCS 1;1;2 { SP @ ST	Clear all font buffers

8.4.2.21 Printer Control Sequences — The Visual 220 terminal provides a variety of commands to enhance terminal/printer performance.

PRINT PAGE**CSI i or CSI 0 i**

XOFF code is sent to host to suspend transmission. Contents of screen or scrolling region are transmitted to printer with CR/LF codes or only CR (depending on New Line selection from the General Set-Up menu) after each line. XON code sent to host to resume transmission once the Print Page function is complete.

If print extent is reset, only the scrolling region is sent to the printer. If print extent is set, the entire screen is transmitted.

If print termination character is set to FF (from the Printer Set-Up menu), a FF character is appended to the end of the transmission.

PRINT CURSOR LINE**CSI ? 1 i**

XOFF code is sent to the host to suspend transmission. Contents of cursor line are transmitted to printer with CR/LF codes or only CR (depending on New Line/No New Line Mode selection) after line. XON code sent to host to resume transmission once the Print Line function is complete.

PRINT LINE "P"**CSI ? 1 ; P i [VISUAL]**

XOFF code is sent to the host to suspend transmission. Contents of line "P" transmitted to printer with CR/LF codes or only CR (depending on New Line/No New Line Mode selection) after line. XON code is sent to the host to resume transmission once the Print Line function complete.

Line P is in decimal notation between the limits of 1 and 24.

ENTER AUTO PRINT MODE**CSI ? 5 i**

On receipt of LF code, XOFF code is sent to the host. Contents of line are transmitted to printer with CR/LF or only CR (depending on New Line/No New Line Mode selection) after the line. XON code sent to the host after the line is transmitted.

EXIT AUTO PRINT MODE**CSI ? 4 i**

The terminal exits Auto Print mode.

PRINTER STATUS REPORT**CSI ? 15 n**

This command allows the host to initiate a test of the printer status. When the terminal receives this command it checks the status of the printer's DTR line and responds in the following manner:

**Terminal
Response****Meaning**

CSI ? 13 n	The printer is not connected. This is detected by verifying that printer DTR has not been on since the terminal was turned on.
CSI ? 11 n	The printer is connected but not ready to print. This is detected by verifying that printer DTR has been on at some time since the terminal was turned on but is not on at present.
CSI ? 10 n	The printer is connected and ready to print.

8.4.2.2 Printer Set and Reset Modes —This section defines modes that may be used to control a printer that is connected to the Visual 220 terminal. The parameters that are menu selectable (in Set-Up) can be saved in non-volatile memory.

NOTE

More information on Set and Reset Mode Commands may be found in Section 8.4.2.1.

SET MODE

CSI Ps ; Ps ; ... Ps h

This command is used to set certain terminal operating parameters. The Ps (selectable parameter) values are described in Table 8-21. Additional Ps values may be found in Table 8-12.

RESET MODE

CSI Ps ; Ps ; ... Ps l

This command is used to reset certain terminal operating parameters. The Ps (selectable parameter) values are described in Table 8-21. Additional Ps values may be found in Table 8-12.

Table 8-21. Printer Set/Reset Mode Parameter Value Definitions

Mode Name	Ps Value	Set/Reset Definitions
Printer Form Feed	? 18 (private)	When set, this mode selects form feed (FF) as the print termination character. The terminal transmits this character to the printer after each print screen. When reset, no print termination character is selected.
Printer Extent	? 19 (private)	When set, the terminal prints the full screen after receiving a print screen command. When reset, the terminal only prints the scrolling region after receiving a print screen command.

8.4.2.23 Programming the Time-of-Day Clock — A device control string (DCS) may be used to program the time of day clock in the Visual 220 terminal. The DCS has the following form:

DCS 1; Ps ~ hh : mm : ss ST

Selectable parameter (Ps) values are described as follows:

Ps Value	Effect
0	Use value selected in Set-Up
1	Set to a.m. (Standard)
2	Set to p.m. (Standard)
3	Use Military (24 hour) time

The following examples illustrate the effects of typical device control strings used to set the time-of-day clock:

DCS	Effect
DCS 1; 1 ~ 10: 23: 00 ST	10:23 am
DCS 1; 3 ~ 23: 10 ST	23:10

8.4.3 Control Sequences Recognized in VT52 Mode

This section describes those control sequences that are recognized in VT52 mode.

NOTE

These codes may have an unpredictable effect if used when the terminal is in ANSI mode.

8.4.3.1 Terminal Control Sequences — The following control sequences are used to control the terminal when it is in VT52 mode.

MOVE CURSOR UP **ESC A**

This sequence causes the cursor to move up one line. If the cursor is positioned on the top line no action occurs.

MOVE CURSOR DOWN **ESC B**

This sequence causes the cursor to move down one line. If the cursor is positioned on the bottom line no action occurs.

MOVE CURSOR RIGHT **ESC C**

This sequence causes the cursor to move right one position. If the cursor is positioned on the last column of a line no action occurs.

MOVE CURSOR LEFT **ESC D**

This sequence causes the cursor to move left one position. If the cursor is positioned in the first column of a line no action occurs.

ENTER GRAPHICS MODE **ESC F**

This sequence causes the terminal to enter Graphics mode. When graphics mode is entered, all received lower-case ASCII codes (octal 137-172) and the ASCII codes for {,|,} and ~ (octal 173-176) are displayed as graphic characters.

EXIT GRAPHICS MODE**ESC G**

This sequence causes the terminal to exit graphics mode.

CURSOR HOME**ESC H**

This sequence causes the cursor to move to the home position (upper left-hand corner of the screen).

REVERSE LINE FEED**ESC I**

This sequence causes the cursor to move up one line. If the cursor is positioned on the top line, the contents of the screen scroll down one line.

ERASE TO END OF SCREEN**ESC J**

This sequence causes erasure of all data from the cursor position to the end of the screen, including cursor position.

ERASE TO END OF LINE**ESC K**

This sequence causes erasure of all data from the cursor position to the end of the line.

CURSOR ADDRESSING**ESC Y r c**

This sequence is used for positioning the cursor on an absolute basis. The next two codes following this sequence are to be interpreted as the new line and column positions respectively. Line and column numbers are ASCII characters whose codes are their octal value plus octal 37.

IDENTIFY**ESC Z**

This sequence requests the terminal to verify that it is a VT52 and is switched on and ready for communication. If this is the case, the terminal responds with the VT200 identification sequence (see Section 8.4.2.8).

ENTER APPLICATION KEYPAD MODE

ESC =

This sequence causes the terminal to enter Application Keypad mode. When entered, this mode causes keys on the numeric keypad to transmit special escape sequences as opposed to their regular codes. These codes are as follows:

Key	Application Keypad Codes
0	ESC ? p
1	ESC ? q
2	ESC ? r
3	ESC ? s
4	ESC ? t
5	ESC ? u
6	ESC ? v
7	ESC ? w
8	ESC ? x
9	ESC ? y
- (minus)	ESC ? m
, (comma)	ESC ? l
. (period)	ESC ? n
ENTER	ESC ? M
PF1	ESC P
PF2	ESC Q
PF3	ESC R
PF4	ESC S

EXIT APPLICATION KEYPAD MODE

ESC >

This sequence causes the terminal to exit Application Keypad mode.

ENTER ANSI MODE

ESC <

This sequence causes the terminal to enter ANSI mode.

8.4.3.2 Printer Control Sequences — The Visual 220 terminal provides commands to control terminal/printer performance when it is in VT52 mode.

PRINT PAGE**ESC]**

XOFF code is sent to the host to suspend transmission. Contents of the screen are transmitted to the printer with CR/LF codes or only CR (depending on the New Line/No New Line Mode selection) after each line. XON code is sent to the host to resume transmission once the Print Page function is complete.

PRINT LINE**Esc V**

XOFF code is sent to the host to suspend transmission. Contents of the cursor line are transmitted to the printer with CR/LF codes or only CR (depending on the New Line/No New Line Mode selection) after line. XON code is sent to the host to resume transmission once the Print Line function is complete.

ENTER PRINTER CONTROLLER MODE**Esc W**

Data sent from the host is passed through terminal to the printer. XOFF code is sent to the host in response to printer busy. XON code is sent to the host in response to printer not busy.

EXIT PRINTER CONTROLLER MODE**Esc X**

The terminal exits printer controller mode, and automatically appends the CAN or DEL code (as dictated by the CANCEL SELECT feature). If the PRINTER TYPE feature is on, no code is appended.

ENTER AUTO PRINT MODE**Esc ^**

On receipt of LF code, XOFF code is sent to the host. Contents of the current line are transmitted to the printer with CR/LF or only CR (depending on the New Line/No New Line Mode selection) after the line. XON code is sent to host after the line is transmitted.

EXIT AUTO PRINT MODE**Esc _**

The terminal exits Auto Print mode.

VISUAL

Appendices

A.1.3 Electrical

- Input voltage: 95 Vac to 130 Vac (115 Vac nominal)
190 Vac to 260 Vac (230 Vac nominal)
(Voltages are configurable internally)
- Input frequency: 50/60 Hz
- Power dissipation: Power Consumption: 50 watts maximum
- Line fuse rating: 2A, 250 V, fast blow, U.L. and C.S.A. approved

A.1.4 Data Communications

- Hardware interfaces: RS-232-C/CCITT V.24 (Comm port)
RS-232-C/CCITT V.24 (Printer port)
20 ma current loop option (Comm port)
RS-422 option (Comm port)
- Protocols: Start-stop asynchronous, 7- or 8-bit, with
or without parity, 1 or 2 stop bits
- Parity: Even, odd or none
- Baud rates: 50, 75, 110, 134.5, 150, 200, 300, 600,
1200, 1800, 2000, 2400, 3600, 4800, 9600,
19200
- Flow control: XON/XOFF
- Duplex: Full duplex

A.1.5 Screen Presentation

- Display type: 14 in. diagonal (across monitor, not display bezel) non-glare P31 phosphor.
- Display format: 24 line by 80 (or 132) columns, plus a 25th status line
- Refresh rate: 60 Hz

A-2 Terminal Specifications

- Display memory: 1920 characters @ 24 lines x 80 columns
3168 characters @ 24 lines x 132 columns
- Screen attributes: Normal and reverse
- Character attributes: Normal, reverse, bold, blink, blank, underline, combinations of the above
- Logical character attribute: Erasable/non-erasable
- Character sets: ASCII graphics, U.K. National, Supplemental graphics, Special graphics
- Scrolling: Jump or smooth (user selectable)
- Tabbing: 80 programmable stops at 80 columns
132 programmable stops at 132 columns
- Cursor: Block, underline or none (user selectable)
- Screen Saver: The screen is blanked after 10 minutes of host or keyboard inactivity

A.1.6 Keyboard

- General: Detached, low-profile (DIN standard); solid state capacitive scan; auto repeating keys; 2-key rollover; sculptured, nonglare keycaps; coiled cable with modular jack; selectable, audible feedback (keyclick)
- Number of keys: 106
- Cursor movement keys: Up, down, right, left, home. CR, LF, Tab
- Editing keys: Find, Insert Here, Remove, Select, Prev Scrn, Next Scrn

- **Function keys:** 20 keys. Of these, 15 are programmable and share 1024 bytes of memory. Four additional keys share 64 bytes of non-volatile memory.

A.1.7 Miscellaneous

- **Power-on Diagnostic:** Automatic upon power-on or reset.
- **Mechanical controls:** Power on switch
- **Indicators:** Four LEDs (light emitting diodes) under the legend strip of the keyboard, an audible tone generator (located in the keyboard)

APPENDIX B NATIONAL LANGUAGE KEYBOARDS

B.1 OVERVIEW

This appendix illustrates each of the national language keyboards that are available for the Visual 220 terminal.

The following keyboards are illustrated in alphabetical order:

- British
- Canadian (French)
- Danish
- Dutch
- Finnish
- Belgian (Flemish)
- French/Belgian
- German
- Italian
- North American
- Norwegian
- Spanish
- Swedish
- Swiss (French)
- Swiss (German)

B-2 National Language Keyboards

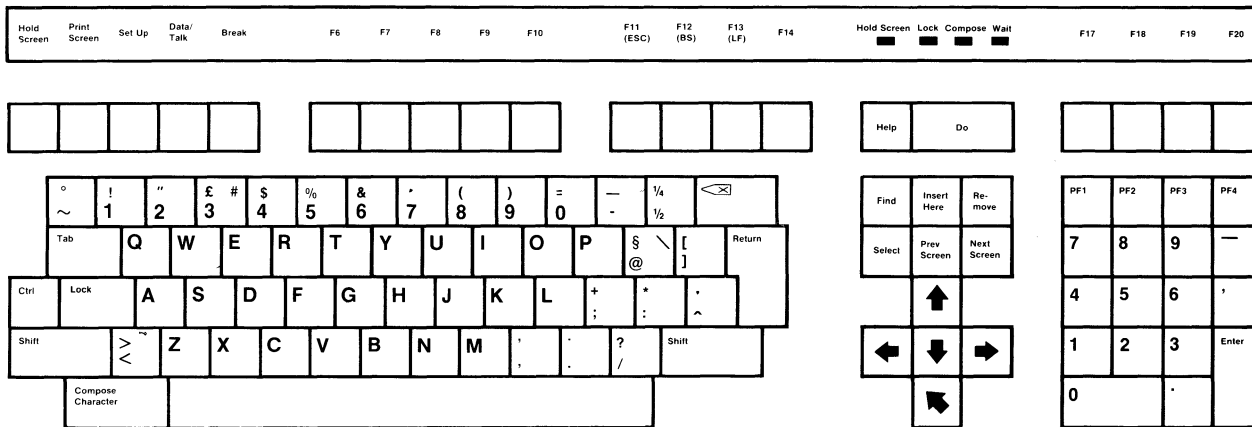

Figure B-1. British Keyboard

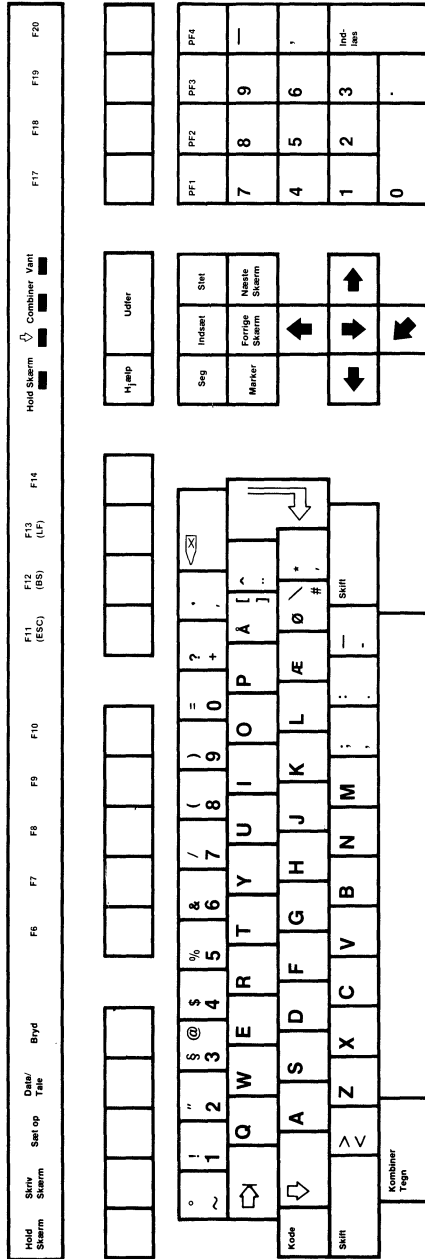

Figure B-3. Danish Keyboard

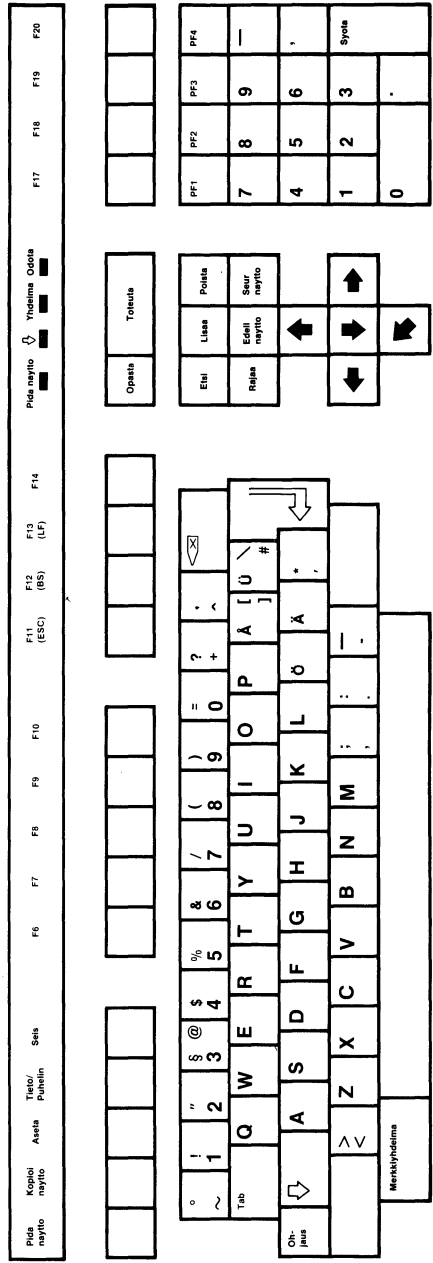

Figure B-5. Finnish Keyboard

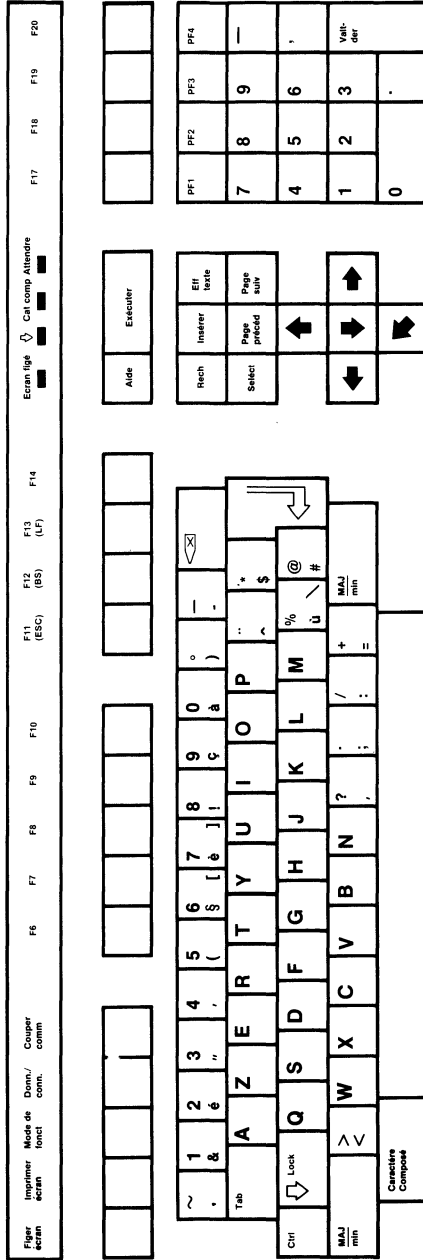

Figure B-7. French/Belgian Keyboard

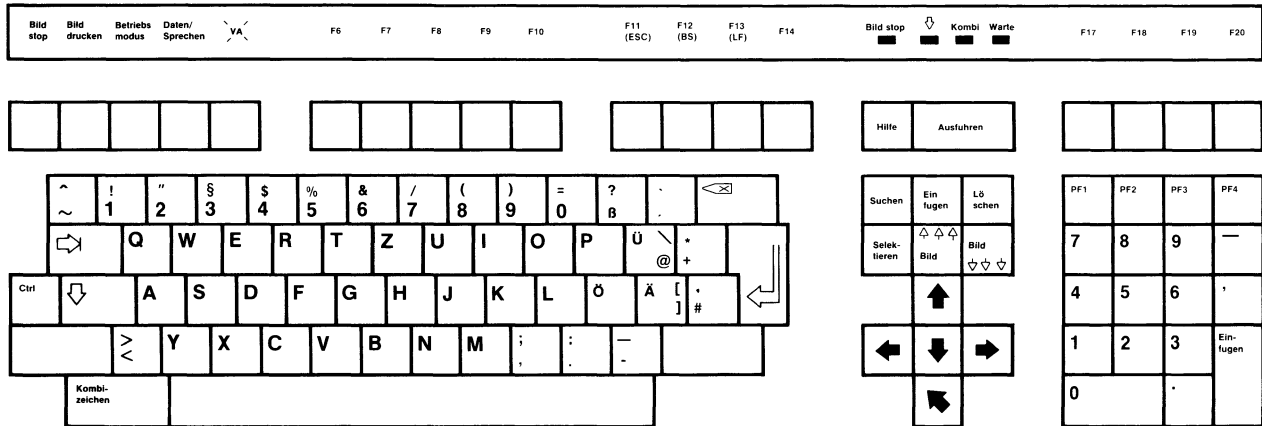

Figure B-8. German Keyboard

This document is a technical drawing of a German keyboard layout. It shows the main keyboard with its keys and various function and auxiliary keys. The function keys are labeled F6 through F20. The auxiliary keys include 'Hilfe', 'Ausführen', 'Suchen', 'Einfügen', 'Löschen', 'Selektieren', 'Bild', 'Bild', 'PF1', 'PF2', 'PF3', 'PF4', '7', '8', '9', '-', '4', '5', '6', "'", '1', '2', '3', 'Einfügen', '0', '.', '<left>', '<down>', '<right>', and '<down>'. The main keyboard keys are labeled with their respective characters and symbols.

B-10 National Language Keyboards

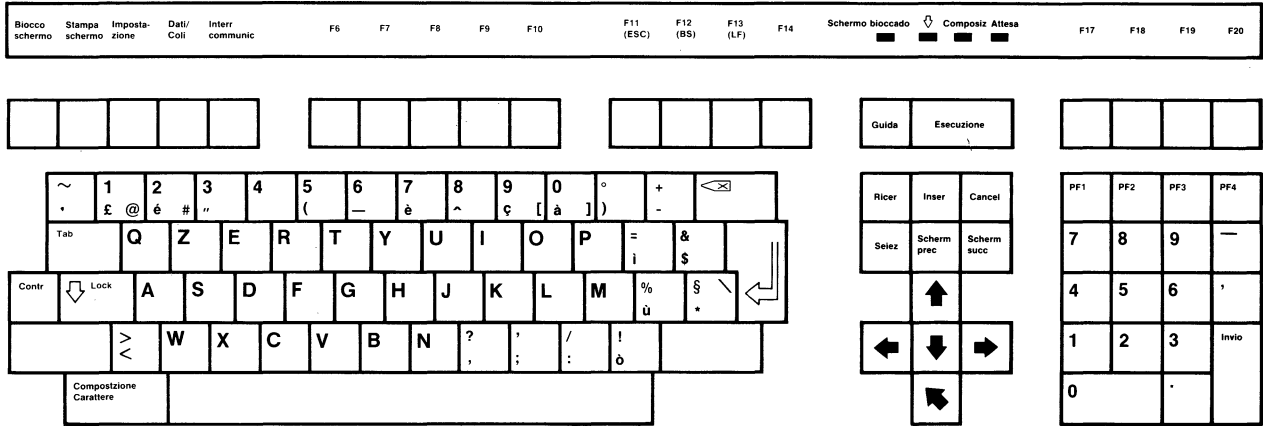

Figure B-9. Italian Keyboard

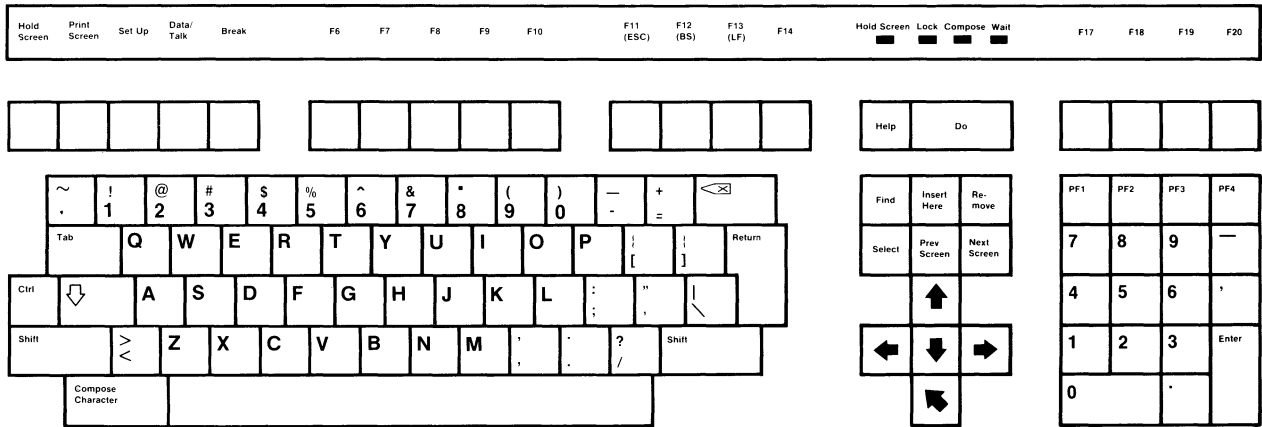

Figure B-10. North American Keyboard

This document is a technical drawing of a keyboard layout. It is not a photograph of a physical keyboard. The drawing shows the arrangement of keys and their labels. The labels include function keys (F1-F20), navigation keys (arrow keys, Home, End, etc.), and alphanumeric keys. The drawing is intended to provide a clear visual representation of the keyboard's layout for documentation purposes.



B-12 National Language Keyboards

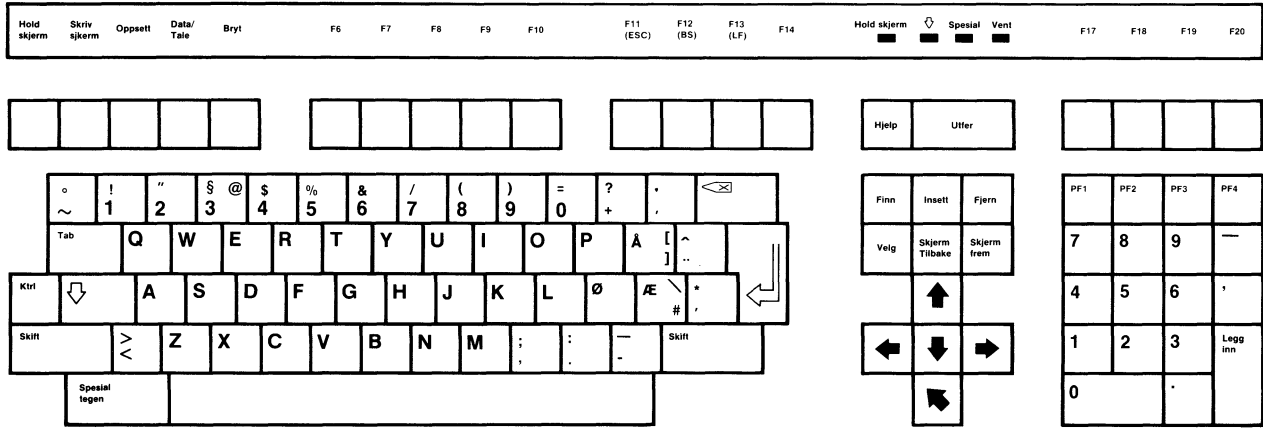

Figure B-11. Norwegian Keyboard

This document is a reproduction of the original document. It is not intended to be used as a substitute for the original document.

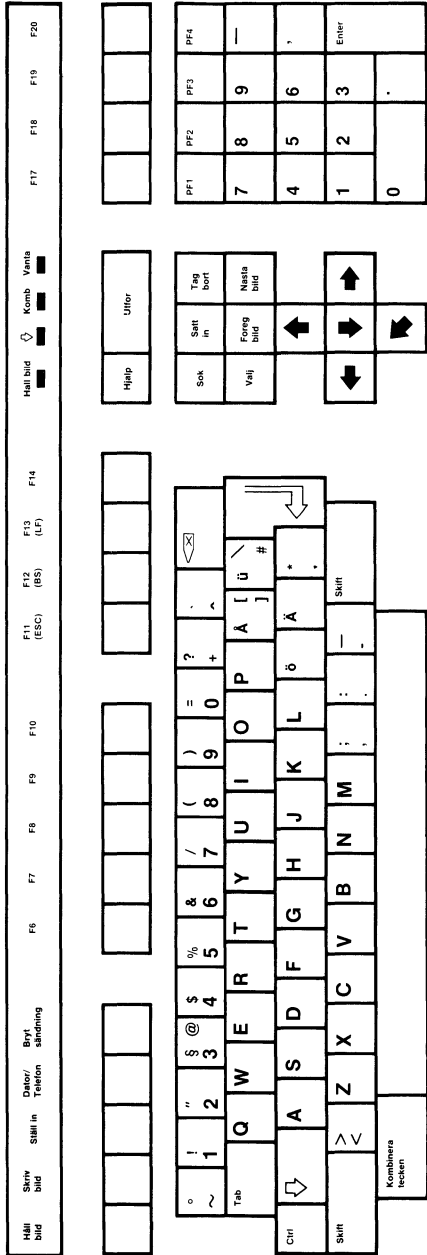

Figure B-13. Swedish Keyboard

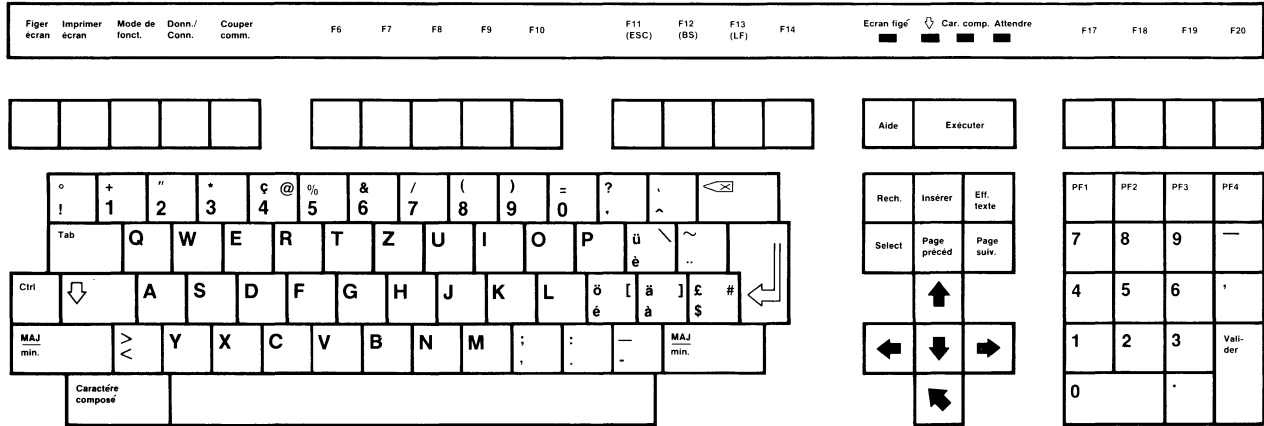

Figure B-14. Swiss (French) Keyboard

1. 2. 3. 4. 5. 6. 7. 8. 9. 10. 11. 12. 13. 14. 15. 16. 17. 18. 19. 20. 21. 22. 23. 24. 25. 26. 27. 28. 29. 30. 31. 32. 33. 34. 35. 36. 37. 38. 39. 40. 41. 42. 43. 44. 45. 46. 47. 48. 49. 50. 51. 52. 53. 54. 55. 56. 57. 58. 59. 60. 61. 62. 63. 64. 65. 66. 67. 68. 69. 70. 71. 72. 73. 74. 75. 76. 77. 78. 79. 80. 81. 82. 83. 84. 85. 86. 87. 88. 89. 90. 91. 92. 93. 94. 95. 96. 97. 98. 99. 100.

| | | | | | | | | | | | | | | | |
|-------|-------|-------|-------|------------|------------------|-------------------|------------------|-----------------|-----------------|-----------------|------------------|--------------------|---|---|---|
| | | | | | BIT 8 | 0 | 0 | 0 | 0 | 0 | 0 | 0 | 0 | 0 | 0 |
| | | | | | BIT 7 | 0 | 0 | 0 | 0 | 1 | 1 | 1 | 1 | 1 | 1 |
| | | | | | BIT 6 | 0 | 0 | 1 | 1 | 0 | 0 | 1 | 1 | 1 | 1 |
| | | | | | BIT 5 | 0 | 1 | 0 | 1 | 0 | 1 | 0 | 1 | 0 | 1 |
| BIT 4 | BIT 3 | BIT 2 | BIT 1 | COL
ROW | 0 | 1 | 2 | 3 | 4 | 5 | 6 | 7 | | | |
| 0 | 0 | 0 | 0 | 0 | NUL ⁰ | DLE ¹⁶ | SP ³² | 0 ⁴⁸ | @ ⁶⁴ | P ⁸⁰ | . ⁹⁶ | p ¹¹² | | | |
| 0 | 0 | 0 | 1 | 1 | SOH ¹ | DC1 ¹⁷ | ! ³³ | 1 ⁴⁹ | A ⁶⁵ | Q ⁸¹ | a ⁹⁷ | q ¹¹³ | | | |
| 0 | 0 | 1 | 0 | 2 | STX ² | DC2 ¹⁸ | " ³⁴ | 2 ⁵⁰ | B ⁶⁶ | R ⁸² | b ⁹⁸ | r ¹¹⁴ | | | |
| 0 | 0 | 1 | 1 | 3 | ETX ³ | DC3 ¹⁹ | # ³⁵ | 3 ⁵¹ | C ⁶⁷ | S ⁸³ | c ⁹⁹ | s ¹¹⁵ | | | |
| 0 | 1 | 0 | 0 | 4 | EOT ⁴ | DC4 ²⁰ | \$ ³⁶ | 4 ⁵² | D ⁶⁸ | T ⁸⁴ | d ¹⁰⁰ | t ¹¹⁶ | | | |
| 0 | 1 | 0 | 1 | 5 | ENQ ⁵ | NAK ²¹ | % ³⁷ | 5 ⁵³ | E ⁶⁹ | U ⁸⁵ | e ¹⁰¹ | u ¹¹⁷ | | | |
| 0 | 1 | 1 | 0 | 6 | ACK ⁶ | SYN ²² | & ³⁸ | 6 ⁵⁴ | F ⁷⁰ | V ⁸⁶ | f ¹⁰² | v ¹¹⁸ | | | |
| 0 | 1 | 1 | 1 | 7 | BEL ⁷ | ETB ²³ | ' ³⁹ | 7 ⁵⁵ | G ⁷¹ | W ⁸⁷ | g ¹⁰³ | w ¹¹⁹ | | | |
| 1 | 0 | 0 | 0 | 8 | BS ⁸ | CAN ²⁴ | (⁴⁰ | 8 ⁵⁶ | H ⁷² | X ⁸⁸ | h ¹⁰⁴ | x ¹²⁰ | | | |
| 1 | 0 | 0 | 1 | 9 | HT ⁹ | EM ²⁵ |) ⁴¹ | 9 ⁵⁷ | I ⁷³ | Y ⁸⁹ | i ¹⁰⁵ | y ¹²¹ | | | |
| 1 | 0 | 1 | 0 | A | LF ¹⁰ | SUB ²⁶ | * ⁴² | : ⁵⁸ | J ⁷⁴ | Z ⁹⁰ | j ¹⁰⁶ | z ¹²² | | | |
| 1 | 0 | 1 | 1 | B | VT ¹¹ | ESC ²⁷ | + ⁴³ | ; ⁵⁹ | K ⁷⁵ | [⁹¹ | k ¹⁰⁷ | { ¹²³ | | | |
| 1 | 1 | 0 | 0 | C | FF ¹² | FS ²⁸ | , ⁴⁴ | < ⁶⁰ | L ⁷⁶ | \ ⁹² | l ¹⁰⁸ | ¹²⁴ | | | |
| 1 | 1 | 0 | 1 | D | CR ¹³ | GS ²⁹ | - ⁴⁵ | = ⁶¹ | M ⁷⁷ |] ⁹³ | m ¹⁰⁹ | } ¹²⁵ | | | |
| 1 | 1 | 1 | 0 | E | SO ¹⁴ | RS ³⁰ | · ⁴⁶ | > ⁶² | N ⁷⁸ | ^ ⁹⁴ | n ¹¹⁰ | ~ ¹²⁶ | | | |
| 1 | 1 | 1 | 1 | F | SI ¹⁵ | US ³¹ | / ⁴⁷ | ? ⁶³ | O ⁷⁹ | _ ⁹⁵ | o ¹¹¹ | DEL ¹²⁷ | | | |

Figure C-2. DEC Multinational Character Set (Sheet 1 of 2)

| | | | | | | | | | | | | | | |
|----------|----------|----------|----------|----------|----------|----------|----------|------------|------------|--------------|--------------|--------------|--------------|--|
| 1 | 1 | 1 | 1 | 1 | 1 | 1 | 1 | 1 | BIT 8 | | | | | |
| 0 | 0 | 0 | 0 | 1 | 1 | 1 | 1 | 1 | BIT 7 | | | | | |
| 0 | 0 | 1 | 1 | 0 | 0 | 1 | 1 | 1 | BIT 6 | | | | | |
| 0 | 1 | 0 | 1 | 0 | 1 | 0 | 1 | 1 | BIT 5 | | | | | |
| 8 | 9 | A | B | C | D | E | F | COL | ROW | BIT 4 | BIT 3 | BIT 2 | BIT 1 | |
| 128 | DCS | 144 | 150 | 176 | 192 | 208 | 224 | 240 | 0 | 0 | 0 | 0 | 0 | |
| 129 | PU1 | 145 | 161 | 177 | 193 | 209 | 225 | 241 | 1 | 0 | 0 | 0 | 1 | |
| 130 | PU2 | 146 | 162 | 178 | 194 | 210 | 226 | 242 | 2 | 0 | 0 | 1 | 0 | |
| 131 | STS | 147 | 163 | 179 | 195 | 211 | 227 | 243 | 3 | 0 | 0 | 1 | 1 | |
| 132 | IND | 148 | 164 | 180 | 196 | 212 | 228 | 244 | 4 | 0 | 1 | 0 | 0 | |
| 133 | NEL | 149 | 165 | 181 | 197 | 213 | 229 | 245 | 5 | 0 | 1 | 0 | 1 | |
| 134 | SSA | 150 | 166 | 182 | 198 | 214 | 230 | 246 | 6 | 0 | 1 | 1 | 0 | |
| 135 | ESA | 151 | 167 | 183 | 199 | 215 | 231 | 247 | 7 | 0 | 1 | 1 | 1 | |
| 136 | HTS | 152 | 168 | 184 | 200 | 216 | 232 | 248 | 8 | 1 | 0 | 0 | 0 | |
| 137 | HTJ | 153 | 169 | 185 | 201 | 217 | 233 | 249 | 9 | 1 | 0 | 0 | 1 | |
| 138 | VTS | 154 | 170 | 186 | 202 | 218 | 234 | 250 | A | 1 | 0 | 1 | 0 | |
| 139 | PLD | 155 | 171 | 187 | 203 | 219 | 235 | 251 | B | 1 | 0 | 1 | 1 | |
| 140 | PLU | 156 | 172 | 188 | 204 | 220 | 236 | 252 | C | 1 | 1 | 0 | 0 | |
| 141 | RI | 157 | 173 | 189 | 205 | 221 | 237 | 253 | D | 1 | 1 | 0 | 1 | |
| 142 | SS2 | 158 | 174 | 190 | 206 | 222 | 238 | 254 | E | 1 | 1 | 1 | 0 | |
| 143 | SS3 | 159 | 175 | 191 | 207 | 223 | 239 | 255 | F | 1 | 1 | 1 | 1 | |

Figure C-2. DEC Multinational Character Set (Sheet 2 of 2)

| | | | | | | | | | | | | | | |
|-------|-------|-------|-------|-----|------------------|-------------------|------------------|-----------------|-----------------|------------------|-------------------|------------------|--------------------|-----------------|
| | | | | | BIT 8 | 0 | 0 | 0 | 0 | 0 | 0 | 0 | 0 | 0 |
| | | | | | BIT 7 | 0 | 0 | 0 | 0 | 1 | 1 | 1 | 1 | 1 |
| | | | | | BIT 6 | 0 | 0 | 1 | 1 | 0 | 0 | 1 | 1 | 1 |
| | | | | | BIT 5 | 0 | 1 | 0 | 1 | 0 | 1 | 0 | 1 | 1 |
| BIT 4 | BIT 3 | BIT 2 | BIT 1 | COL | ROW | 0 | 1 | 2 | 3 | 4 | 5 | 6 | 7 | |
| | | | | 0 | | 0 | 0 | 0 | 0 | NUL ⁰ | DLE ¹⁶ | SP ³² | 0 ⁴⁸ | @ ⁶⁴ |
| 0 | 0 | 0 | 1 | 1 | SOH ¹ | DC1 ¹⁷ | ! ³³ | 1 ⁴⁹ | A ⁶⁵ | Q ⁸¹ | ⊠ ⁹⁷ | — ¹¹³ | SCAN 6 | |
| 0 | 0 | 1 | 0 | 2 | STX ² | DC2 ¹⁸ | " ³⁴ | 2 ⁵⁰ | B ⁶⁶ | R ⁸² | ⌘ ⁹⁸ | — ¹¹⁴ | SCAN 9 | |
| 0 | 0 | 1 | 1 | 3 | ETX ³ | DC3 ¹⁹ | # ³⁵ | 3 ⁵¹ | C ⁶⁷ | S ⁸³ | ⌡ ⁹⁹ | — ¹¹⁵ | SCAN 11 | |
| 0 | 1 | 0 | 0 | 4 | EOT ⁴ | DC4 ²⁰ | \$ ³⁶ | 4 ⁵² | D ⁶⁸ | T ⁸⁴ | ⌢ ¹⁰⁰ | — ¹¹⁶ | | |
| 0 | 1 | 0 | 1 | 5 | ENQ ⁵ | NAK ²¹ | % ³⁷ | 5 ⁵³ | E ⁶⁹ | U ⁸⁵ | ⌣ ¹⁰¹ | — ¹¹⁷ | | |
| 0 | 1 | 1 | 0 | 6 | ACK ⁶ | SYN ²² | & ³⁸ | 6 ⁵⁴ | F ⁷⁰ | V ⁸⁶ | ⌤ ¹⁰² | — ¹¹⁸ | | |
| 0 | 1 | 1 | 1 | 7 | BEL ⁷ | ETB ²³ | ' ³⁹ | 7 ⁵⁵ | G ⁷¹ | W ⁸⁷ | ± ¹⁰³ | — ¹¹⁹ | | |
| 1 | 0 | 0 | 0 | 8 | BS ⁸ | CAN ²⁴ | (⁴⁰ | 8 ⁵⁶ | H ⁷² | X ⁸⁸ | ⌥ ¹⁰⁴ | — ¹²⁰ | | |
| 1 | 0 | 0 | 1 | 9 | HT ⁹ | EM ²⁵ |) ⁴¹ | 9 ⁵⁷ | I ⁷³ | Y ⁸⁹ | ⌦ ¹⁰⁵ | — ¹²¹ | | |
| 1 | 0 | 1 | 0 | A | LF ¹⁰ | SUB ²⁶ | * ⁴² | : ⁵⁸ | J ⁷⁴ | Z ⁹⁰ | ⌧ ¹⁰⁶ | — ¹²² | | |
| 1 | 0 | 1 | 1 | B | VT ¹¹ | ESC ²⁷ | + ⁴³ | ; ⁵⁹ | K ⁷⁵ | [⁹¹ | ⌨ ¹⁰⁷ | — ¹²³ | | |
| 1 | 1 | 0 | 0 | C | FF ¹² | FS ²⁸ | , ⁴⁴ | < ⁶⁰ | L ⁷⁶ | \ ⁹² | 〈 ¹⁰⁸ | — ¹²⁴ | | |
| 1 | 1 | 0 | 1 | D | CR ¹³ | GS ²⁹ | - ⁴⁵ | = ⁶¹ | M ⁷⁷ |] ⁹³ | 〉 ¹⁰⁹ | — ¹²⁵ | | |
| 1 | 1 | 1 | 0 | E | SO ¹⁴ | RS ³⁰ | · ⁴⁶ | > ⁶² | N ⁷⁸ | ^ ⁹⁴ | ⌫ ¹¹⁰ | — ¹²⁶ | | |
| 1 | 1 | 1 | 1 | F | SI ¹⁵ | US ³¹ | / ⁴⁷ | ? ⁶³ | O ⁷⁹ | _ ⁹⁵ | — ¹¹¹ | SCAN 1 | DEL ¹²⁷ | |

Figure C-3. DEC Special Graphics Character Set

C-4 Character Sets

Cursor Control Commands (see Section 8.4.2.3)

| | |
|--------------------------|-------------------------------|
| Cursor Up | CSI Pn A |
| Cursor Down | CSI Pn B |
| Cursor Right | CSI Pn C |
| Cursor Left | CSI Pn D |
| Absolute cursor position | CSI r ; c H or
CSI r ; c f |
| Cursor index | ESC D |
| Cursor reverse index | ESC M |
| Next line | ESC E |
| Save cursor | ESC 7 |
| Restore Cursor | ESC 8 |

Sequences for Erasing (see Section 8.4.2.4)

| | |
|-------------------------|--|
| Erase in page | CSI Ps J |
| Parameters: | 0 = Erase to end of page (default).
1 = Erase screen to cursor.
2 = Erase page. |
| Erase in line | CSI Ps K |
| Parameters: | 0 = Erase from cursor to end of line (default).
1 = Erase from start of line to cursor.
2 = Erase line. |
| Selective erase in page | CSI ? Ps J |
| Parameters: | 0 = Erase all "erasable" characters from and including the cursor to the end of the screen.
1 = Erases all "erasable" characters from the beginning of the screen to and including the cursor.
2 = Erases all "erasable" characters in the entire display. |
| Selective erase in page | CSI ? Ps K |
| Parameters: | 0 = Erases all "erasable" characters from the cursor to the end of the line.
1 = Erases all "erasable" characters from the beginning of the line up to and including the cursor position.
2 = Erases all "erasable" characters on the line. |
| Erase character | CSI Pn X |

Invoking Character Sets Using Lock Shifts

| | |
|-------------------|-------|
| Invoke G0 into GL | SI |
| Invoke G1 into GL | SO |
| Invoke G1 into GR | ESC ~ |
| Invoke G2 into GL | ESC n |
| Invoke G2 into GR | ESC } |
| Invoke G3 into GL | ESC o |
| Invoke G3 into GR | ESC |

Invoke Character Sets Using Single Shifts

| | |
|-------------------|-------|
| Invoke G2 into GL | ESC N |
| Invoke G3 into GL | ESC O |

Report Commands and Responses (see Section 8.4.2.8)

| | |
|-----------------------|--|
| Primary terminal ID | CSI c
CSI 0 c
ESC Z |
| Terminal condition? | CSI 5 n |
| Terminal's response: | CSI 0 n = I have no malfunction.
CSI 3 n = I have a malfunction. |
| Read cursor location | CSI 6 n |
| Terminal's response: | CSI r ; c R, ("r" = row (line) number
"c" is the column number) |
| Secondary terminal ID | CSI > c
CSI > 0 c |
| Terminal's response: | CSI > 1; Pv; Po c
I am a VT220 (identification code of
1), my firmware rev is ___ (Pv) and I
have (Po) options installed. |
| Function keys locked? | CSI ? 25n |
| Terminal's response: | CSI ? 20 n = User Defined Keys are
unlocked.
CSI ? 21 n = User Defined Keys are
locked. |

Terminal Testing (see Section 8.4.2.15)

Run test(s) CSI 4; Ps; Ps; ...; Ps Y

- Parameters:
- 0 = Test 1, 2, 3, and 6.
 - 1 = Power-up self test.
 - 2 = EIA port data loopback test. *
 - 3 = Printer loopback test. *
 - 4 = Not used.
 - 5 = Not used.
 - 6 = EIA port modem control line loopback test. *
 - 7 = 20 MA loopback test. *
 - 8 = Not used.
 - 9 = Repeat tests until failure or power off.

* Loopback tests require loopback connectors (see Appendix F)

Select Compatibility Levels (see Section 8.4.2.16)

Select emulation mode CSI Ps1 ; Ps2 ; " p

- Parameters:
- Ps1 = 61 VT100 mode.
 - Ps1 = 62 VT200 mode.

 - Ps2 = 0 Selects 8 bit controls (VT200 mode only)
 - Ps2 = 1 Selects 7 bit controls (VT200 mode only)
 - Ps2 = 2 Selects 8 bit controls (VT200 mode only)

Selecting 7/8 Bit Control Code Transmission (see Section 8.4.2.17)

Select 7-bit controls ESC sp F

Select 8-bit controls ESC sp G

Programming Function Keys (F6 through F20) (see Section 8.4.2.18)

DCS Pc; PI | ky1/st1; ky2/st2;...kyn/stn ST

- Parameters:
- Pc = 0 Clear all keys before loading values.
 - Pc = 1 Clear keys that are to be reloaded.
 - PI = 0 Lock keys against redefinition
 - PI = 1 Do not lock keys against redefinition.

100
101
102
103
104
105
106
107
108
109
110
111
112
113
114
115
116
117
118
119
120
121
122
123
124
125
126
127
128
129
130
131
132
133
134
135
136
137
138
139
140
141
142
143
144
145
146
147
148
149
150
151
152
153
154
155
156
157
158
159
160
161
162
163
164
165
166
167
168
169
170
171
172
173
174
175
176
177
178
179
180
181
182
183
184
185
186
187
188
189
190
191
192
193
194
195
196
197
198
199
200
201
202
203
204
205
206
207
208
209
210
211
212
213
214
215
216
217
218
219
220
221
222
223
224
225
226
227
228
229
230
231
232
233
234
235
236
237
238
239
240
241
242
243
244
245
246
247
248
249
250
251
252
253
254
255
256
257
258
259
260
261
262
263
264
265
266
267
268
269
270
271
272
273
274
275
276
277
278
279
280
281
282
283
284
285
286
287
288
289
290
291
292
293
294
295
296
297
298
299
300
301
302
303
304
305
306
307
308
309
310
311
312
313
314
315
316
317
318
319
320
321
322
323
324
325
326
327
328
329
330
331
332
333
334
335
336
337
338
339
340
341
342
343
344
345
346
347
348
349
350
351
352
353
354
355
356
357
358
359
360
361
362
363
364
365
366
367
368
369
370
371
372
373
374
375
376
377
378
379
380
381
382
383
384
385
386
387
388
389
390
391
392
393
394
395
396
397
398
399
400
401
402
403
404
405
406
407
408
409
410
411
412
413
414
415
416
417
418
419
420
421
422
423
424
425
426
427
428
429
430
431
432
433
434
435
436
437
438
439
440
441
442
443
444
445
446
447
448
449
450
451
452
453
454
455
456
457
458
459
460
461
462
463
464
465
466
467
468
469
470
471
472
473
474
475
476
477
478
479
480
481
482
483
484
485
486
487
488
489
490
491
492
493
494
495
496
497
498
499
500
501
502
503
504
505
506
507
508
509
510
511
512
513
514
515
516
517
518
519
520
521
522
523
524
525
526
527
528
529
530
531
532
533
534
535
536
537
538
539
540
541
542
543
544
545
546
547
548
549
550
551
552
553
554
555
556
557
558
559
560
561
562
563
564
565
566
567
568
569
570
571
572
573
574
575
576
577
578
579
580
581
582
583
584
585
586
587
588
589
590
591
592
593
594
595
596
597
598
599
600
601
602
603
604
605
606
607
608
609
610
611
612
613
614
615
616
617
618
619
620
621
622
623
624
625
626
627
628
629
630
631
632
633
634
635
636
637
638
639
640
641
642
643
644
645
646
647
648
649
650
651
652
653
654
655
656
657
658
659
660
661
662
663
664
665
666
667
668
669
670
671
672
673
674
675
676
677
678
679
680
681
682
683
684
685
686
687
688
689
690
691
692
693
694
695
696
697
698
699
700
701
702
703
704
705
706
707
708
709
710
711
712
713
714
715
716
717
718
719
720
721
722
723
724
725
726
727
728
729
730
731
732
733
734
735
736
737
738
739
740
741
742
743
744
745
746
747
748
749
750
751
752
753
754
755
756
757
758
759
760
761
762
763
764
765
766
767
768
769
770
771
772
773
774
775
776
777
778
779
780
781
782
783
784
785
786
787
788
789
790
791
792
793
794
795
796
797
798
799
800
801
802
803
804
805
806
807
808
809
810
811
812
813
814
815
816
817
818
819
820
821
822
823
824
825
826
827
828
829
830
831
832
833
834
835
836
837
838
839
840
841
842
843
844
845
846
847
848
849
850
851
852
853
854
855
856
857
858
859
860
861
862
863
864
865
866
867
868
869
870
871
872
873
874
875
876
877
878
879
880
881
882
883
884
885
886
887
888
889
890
891
892
893
894
895
896
897
898
899
900
901
902
903
904
905
906
907
908
909
910
911
912
913
914
915
916
917
918
919
920
921
922
923
924
925
926
927
928
929
930
931
932
933
934
935
936
937
938
939
940
941
942
943
944
945
946
947
948
949
950
951
952
953
954
955
956
957
958
959
960
961
962
963
964
965
966
967
968
969
970
971
972
973
974
975
976
977
978
979
980
981
982
983
984
985
986
987
988
989
990
991
992
993
994
995
996
997
998
999
1000

Function Key Numbers

| Function Key | Key Number When Pressed in Combination With: | |
|--------------|--|------|
| | Shift | Ctrl |
| F6 | 17 | 37 |
| F7 | 18 | 38 |
| F8 | 19 | 39 |
| F9 | 20 | 40 |
| F10 | 21 | 41 |
| F11 | 23 | 43 |
| F12 | 24 | 44 |
| F13 | 25 | 45 |
| F14 | 26 | 46 |
| HELP | 28 | 48 |
| DO | 29 | 49 |
| F17 | 31 | 51 |
| F18 | 32 | 52 |
| F19 | 33 | 53 |
| F20 | 34 | 54 |

Stn = String data. maximum 256 bytes per key;
max 1024 bytes is shared by all keys.

Down-line Loading Characters (see Section 8.4.2.19)

DCS Pfn;Pcn;Pe;Pccs;Pw;Pt {RCS name Bp1;Bp2;Bp3;...Bpn ST

Parameters: Pfn = Font buffer number

Pcn = Starting character number

Pe = Erase control:

0 = erase all characters in the font buffer.

1 = erase the characters that are being reloaded.

2 = erase all characters in all font buffers.

Pccs = Character cell size:

- 0 = Device default (7x10)
- 1 = (not used) 5 = (not used)
- 2 = 5x10 6 = 5x12
- 3 = 6x10 7 = 6x12
- 4 = 7x10 8 = 7x12

Pw = Width:

- 0 = Device default (80 columns)
- 1 = 80 column
- 2 = 132 column

Pt = Text / Full cell:

- 0 = Device default (text)
- 1 = Text
- 2 = Full cell

Clearing a Down-Line Loaded Character Set (see Section 8.4.2.20)

| Control String: | Effect: |
|------------------------|-------------------------------|
| DCS 1;1;0 { SP @ ST | Clear font buffer #1 |
| DCS 2;1;0 { SP @ ST | Clear optional font buffer #2 |
| DCS 1;1;2 { SP @ ST | Clear all font buffers |

Printer Control Sequences — (see Section 8.4.2.21)

| | |
|-------------------------------|----------------------------|
| Print page | CSI i |
| | CSI 0 i |
| Print cursor line | CSI ? 1 i |
| Print line "P" | CSI ? 1 ; P i |
| Print lines "P" through "Q" | CSI ? 1 ; P ; Q i [VISUAL] |
| Enter printer controller mode | CSI 5 i |
| Exit printer controller mode | CSI 4 i |
| Enter copy mode | CSI ? 7 i |
| Exit copy mode | CSI ? 6 i |
| Enter auto print mode | CSI ? 5 i |
| Exit auto print mode | CSI ? 4 i |
| Printer status report | CSI ? 15 n |

... 234 235 236 ...
... 237 238 239 ...
... 240 241 242 ...
... 243 244 245 ...
... 246 247 248 ...
... 249 250 251 ...
... 252 253 254 ...
... 255 256 257 ...
... 258 259 260 ...
... 261 262 263 ...
... 264 265 266 ...
... 267 268 269 ...
... 270 271 272 ...
... 273 274 275 ...
... 276 277 278 ...
... 279 280 281 ...
... 282 283 284 ...
... 285 286 287 ...
... 288 289 290 ...
... 291 292 293 ...
... 294 295 296 ...
... 297 298 299 ...
... 300 301 302 ...
... 303 304 305 ...
... 306 307 308 ...
... 309 310 311 ...
... 312 313 314 ...
... 315 316 317 ...
... 318 319 320 ...
... 321 322 323 ...
... 324 325 326 ...
... 327 328 329 ...
... 330 331 332 ...
... 333 334 335 ...
... 336 337 338 ...
... 339 340 341 ...
... 342 343 344 ...
... 345 346 347 ...
... 348 349 350 ...
... 351 352 353 ...
... 354 355 356 ...
... 357 358 359 ...
... 360 361 362 ...
... 363 364 365 ...
... 366 367 368 ...
... 369 370 371 ...
... 372 373 374 ...
... 375 376 377 ...
... 378 379 380 ...
... 381 382 383 ...
... 384 385 386 ...
... 387 388 389 ...
... 390 391 392 ...
... 393 394 395 ...
... 396 397 398 ...
... 399 400 401 ...
... 402 403 404 ...
... 405 406 407 ...
... 408 409 410 ...
... 411 412 413 ...
... 414 415 416 ...
... 417 418 419 ...
... 420 421 422 ...
... 423 424 425 ...
... 426 427 428 ...
... 429 430 431 ...
... 432 433 434 ...
... 435 436 437 ...
... 438 439 440 ...
... 441 442 443 ...
... 444 445 446 ...
... 447 448 449 ...
... 450 451 452 ...
... 453 454 455 ...
... 456 457 458 ...
... 459 460 461 ...
... 462 463 464 ...
... 465 466 467 ...
... 468 469 470 ...
... 471 472 473 ...
... 474 475 476 ...
... 477 478 479 ...
... 480 481 482 ...
... 483 484 485 ...
... 486 487 488 ...
... 489 490 491 ...
... 492 493 494 ...
... 495 496 497 ...
... 498 499 500 ...
... 501 502 503 ...
... 504 505 506 ...
... 507 508 509 ...
... 510 511 512 ...
... 513 514 515 ...
... 516 517 518 ...
... 519 520 521 ...
... 522 523 524 ...
... 525 526 527 ...
... 528 529 530 ...
... 531 532 533 ...
... 534 535 536 ...
... 537 538 539 ...
... 540 541 542 ...
... 543 544 545 ...
... 546 547 548 ...
... 549 550 551 ...
... 552 553 554 ...
... 555 556 557 ...
... 558 559 560 ...
... 561 562 563 ...
... 564 565 566 ...
... 567 568 569 ...
... 570 571 572 ...
... 573 574 575 ...
... 576 577 578 ...
... 579 580 581 ...
... 582 583 584 ...
... 585 586 587 ...
... 588 589 590 ...
... 591 592 593 ...
... 594 595 596 ...
... 597 598 599 ...
... 600 601 602 ...
... 603 604 605 ...
... 606 607 608 ...
... 609 610 611 ...
... 612 613 614 ...
... 615 616 617 ...
... 618 619 620 ...
... 621 622 623 ...
... 624 625 626 ...
... 627 628 629 ...
... 630 631 632 ...
... 633 634 635 ...
... 636 637 638 ...
... 639 640 641 ...
... 642 643 644 ...
... 645 646 647 ...
... 648 649 650 ...
... 651 652 653 ...
... 654 655 656 ...
... 657 658 659 ...
... 660 661 662 ...
... 663 664 665 ...
... 666 667 668 ...
... 669 670 671 ...
... 672 673 674 ...
... 675 676 677 ...
... 678 679 680 ...
... 681 682 683 ...
... 684 685 686 ...
... 687 688 689 ...
... 690 691 692 ...
... 693 694 695 ...
... 696 697 698 ...
... 699 700 701 ...
... 702 703 704 ...
... 705 706 707 ...
... 708 709 710 ...
... 711 712 713 ...
... 714 715 716 ...
... 717 718 719 ...
... 720 721 722 ...
... 723 724 725 ...
... 726 727 728 ...
... 729 730 731 ...
... 732 733 734 ...
... 735 736 737 ...
... 738 739 740 ...
... 741 742 743 ...
... 744 745 746 ...
... 747 748 749 ...
... 750 751 752 ...
... 753 754 755 ...
... 756 757 758 ...
... 759 760 761 ...
... 762 763 764 ...
... 765 766 767 ...
... 768 769 770 ...
... 771 772 773 ...
... 774 775 776 ...
... 777 778 779 ...
... 780 781 782 ...
... 783 784 785 ...
... 786 787 788 ...
... 789 790 791 ...
... 792 793 794 ...
... 795 796 797 ...
... 798 799 800 ...
... 801 802 803 ...
... 804 805 806 ...
... 807 808 809 ...
... 810 811 812 ...
... 813 814 815 ...
... 816 817 818 ...
... 819 820 821 ...
... 822 823 824 ...
... 825 826 827 ...
... 828 829 830 ...
... 831 832 833 ...
... 834 835 836 ...
... 837 838 839 ...
... 840 841 842 ...
... 843 844 845 ...
... 846 847 848 ...
... 849 850 851 ...
... 852 853 854 ...
... 855 856 857 ...
... 858 859 860 ...
... 861 862 863 ...
... 864 865 866 ...
... 867 868 869 ...
... 870 871 872 ...
... 873 874 875 ...
... 876 877 878 ...
... 879 880 881 ...
... 882 883 884 ...
... 885 886 887 ...
... 888 889 890 ...
... 891 892 893 ...
... 894 895 896 ...
... 897 898 899 ...
... 900 901 902 ...
... 903 904 905 ...
... 906 907 908 ...
... 909 910 911 ...
... 912 913 914 ...
... 915 916 917 ...
... 918 919 920 ...
... 921 922 923 ...
... 924 925 926 ...
... 927 928 929 ...
... 930 931 932 ...
... 933 934 935 ...
... 936 937 938 ...
... 939 940 941 ...
... 942 943 944 ...
... 945 946 947 ...
... 948 949 950 ...
... 951 952 953 ...
... 954 955 956 ...
... 957 958 959 ...
... 960 961 962 ...
... 963 964 965 ...
... 966 967 968 ...
... 969 970 971 ...
... 972 973 974 ...
... 975 976 977 ...
... 978 979 980 ...
... 981 982 983 ...
... 984 985 986 ...
... 987 988 989 ...
... 990 991 992 ...
... 993 994 995 ...
... 996 997 998 ...
... 999 1000 1001 ...
... 1002 1003 1004 ...
... 1005 1006 1007 ...
... 1008 1009 1010 ...
... 1011 1012 1013 ...
... 1014 1015 1016 ...
... 1017 1018 1019 ...
... 1020 1021 1022 ...
... 1023 1024 1025 ...
... 1026 1027 1028 ...
... 1029 1030 1031 ...
... 1032 1033 1034 ...
... 1035 1036 1037 ...
... 1038 1039 1040 ...
... 1041 1042 1043 ...
... 1044 1045 1046 ...
... 1047 1048 1049 ...
... 1050 1051 1052 ...
... 1053 1054 1055 ...
... 1056 1057 1058 ...
... 1059 1060 1061 ...
... 1062 1063 1064 ...
... 1065 1066 1067 ...
... 1068 1069 1070 ...
... 1071 1072 1073 ...
... 1074 1075 1076 ...
... 1077 1078 1079 ...
... 1080 1081 1082 ...
... 1083 1084 1085 ...
... 1086 1087 1088 ...
... 1089 1090 1091 ...
... 1092 1093 1094 ...
... 1095 1096 1097 ...
... 1098 1099 1100 ...
... 1101 1102 1103 ...
... 1104 1105 1106 ...
... 1107 1108 1109 ...
... 1110 1111 1112 ...
... 1113 1114 1115 ...
... 1116 1117 1118 ...
... 1119 1120 1121 ...
... 1122 1123 1124 ...
... 1125 1126 1127 ...
... 1128 1129 1130 ...
... 1131 1132 1133 ...
... 1134 1135 1136 ...
... 1137 1138 1139 ...
... 1140 1141 1142 ...
... 1143 1144 1145 ...
... 1146 1147 1148 ...
... 1149 1150 1151 ...
... 1152 1153 1154 ...
... 1155 1156 1157 ...
... 1158 1159 1160 ...
... 1161 1162 1163 ...
... 1164 1165 1166 ...
... 1167 1168 1169 ...
... 1170 1171 1172 ...
... 1173 1174 1175 ...
... 1176 1177 1178 ...
... 1179 1180 1181 ...
... 1182 1183 1184 ...
... 1185 1186 1187 ...
... 1188 1189 1190 ...
... 1191 1192 1193 ...
... 1194 1195 1196 ...
... 1197 1198 1199 ...
... 1200 1201 1202 ...
... 1203 1204 1205 ...
... 1206 1207 1208 ...
... 1209 1210 1211 ...
... 1212 1213 1214 ...
... 1215 1216 1217 ...
... 1218 1219 1220 ...
... 1221 1222 1223 ...
... 1224 1225 1226 ...
... 1227 1228 1229 ...
... 1230 1231 1232 ...
... 1233 1234 1235 ...
... 1236 1237 1238 ...
... 1239 1240 1241 ...
... 1242 1243 1244 ...
... 1245 1246 1247 ...
... 1248 1249 1250 ...
... 1251 1252 1253 ...
... 1254 1255 1256 ...
... 1257 1258 1259 ...
... 1260 1261 1262 ...
... 1263 1264 1265 ...
... 1266 1267 1268 ...
... 1269 1270 1271 ...
... 1272 1273 1274 ...
... 1275 1276 1277 ...
... 1278 1279 1280 ...
... 1281 1282 1283 ...
... 1284 1285 1286 ...
... 1287 1288 1289 ...
... 1290 1291 1292 ...
... 1293 1294 1295 ...
... 1296 1297 1298 ...
... 1299 1300 1301 ...
... 1302 1303 1304 ...
... 1305 1306 1307 ...
... 1308 1309 1310 ...
... 1311 1312 1313 ...
... 1314 1315 1316 ...
... 1317 1318 1319 ...
... 1320 1321 1322 ...
... 1323 1324 1325 ...
... 1326 1327 1328 ...
... 1329 1330 1331 ...
... 1332 1333 1334 ...
... 1335 1336 1337 ...
... 1338 1339 1340 ...
... 1341 1342 1343 ...
... 1344 1345 1346 ...
... 1347 1348 1349 ...
... 1350 1351 1352 ...
... 1353 1354 1355 ...
... 1356 1357 1358 ...
... 1359 1360 1361 ...
... 1362 1363 1364 ...
... 1365 1366 1367 ...
... 1368 1369 1370 ...
... 1371 1372 1373 ...
... 1374 1375 1376 ...
... 1377 1378 1379 ...
... 1380 1381 1382 ...
... 1383 1384 1385 ...
... 1386 1387 1388 ...
... 1389 1390 1391 ...
... 1392 1393 1394 ...
... 1395 1396 1397 ...
... 1398 1399 1400 ...
... 1401 1402 1403 ...
... 1404 1405 1406 ...
... 1407 1408 1409 ...
... 1410 1411 1412 ...
... 1413 1414 1415 ...
... 1416 1417 1418 ...
... 1419 1420 1421 ...
... 1422 1423 1424 ...
... 1425 1426 1427 ...
... 1428 1429 1430 ...
... 1431 1432 1433 ...
... 1434 1435 1436 ...
... 1437 1438 1439 ...
... 1440 1441 1442 ...
... 1443 1444 1445 ...
... 1446 1447 1448 ...
... 1449 1450 1451 ...
... 1452 1453 1454 ...
... 1455 1456 1457 ...
... 1458 1459 1460 ...
... 1461 1462 1463 ...
... 1464 1465 1466 ...
... 1467 1468 1469 ...
... 1470 1471 1472 ...
... 1473 1474 1475 ...
... 1476 1477 1478 ...
... 1479 1480 1481 ...
... 1482 1483 1484 ...
... 1485 1486 1487 ...
... 1488 1489 1490 ...
... 1491 1492 1493 ...
... 1494 1495 1496 ...
... 1497 1498 1499 ...
... 1500 1501 1502 ...
... 1503 1504 1505 ...
... 1506 1507 1508 ...
... 1509 1510 1511 ...
... 1512 1513 1514 ...
... 1515 1516 1517 ...
... 1518 1519 1520 ...
... 1521 1522 1523 ...
... 1524 1525 1526 ...
... 1527 1528 1529 ...
... 1530 1531 1532 ...
... 1533 1534 1535 ...
... 1536 1537 1538 ...
... 1539 1540 1541 ...
... 1542 1543 1544 ...
... 1545 1546 1547 ...
... 1548 1549 1550 ...
... 1551 1552 1553 ...
... 1554 1555 1556 ...
... 1557 1558 1559 ...
... 1560 1561 1562 ...
... 1563 1564 1565 ...
... 1566 1567 1568 ...
... 1569 1570 1571 ...
... 1572 1573 1574 ...
... 1575 1576 1577 ...
... 1578 1579 1580 ...
... 1581 1582 1583 ...
... 1584 1585 1586 ...
... 1587 1588 1589 ...
... 1590 1591 1592 ...
... 1593 1594 1595 ...
... 1596 1597 1598 ...
... 1599 1600 1601 ...
... 1602 1603 1604 ...
... 1605 1606 1607 ...
... 1608 1609 1610 ...
... 1611 1612 1613 ...
... 1614 1615 1616 ...
... 1617 1618 1619 ...
... 1620 1621 1622 ...
... 1623 1624 1625 ...
... 1626 1627 1628 ...
... 1629 1630 1631 ...
... 1632 1633 1634 ...
... 1635 1636 1637 ...
... 1638 1639 1640 ...
... 1641 1642 1643 ...
... 1644 1645 1646 ...
... 1647 1648 1649 ...
... 1650 1651 1652 ...
... 1653 1654 1655 ...
... 1656 1657 1658 ...
... 1659 1660 1661 ...
... 1662 1663 1664 ...
... 1665 1666 1667 ...
... 1668 1669 1670 ...
... 1671 1672 1673 ...
... 1674 1675 1676 ...
... 1677 1678 1679 ...
... 1680 1681 1682 ...
... 1683 1684 1685 ...
... 1686 1687 1688 ...
... 1689 1690 1691 ...
... 1692 1693 1694 ...
... 1695 1696 1697 ...
... 1698 1699 1700 ...
... 1701 1702 1703 ...
... 1704 1705 1706 ...
... 1707 1708 1709 ...
... 1710 1711 1712 ...
... 1713 1714 1715 ...
... 1716 1717 1718 ...
... 1719 1720 1721 ...
... 1722 1723 1724 ...
... 1725 1726 1727 ...
... 1728 1729 1730 ...
... 1731 1732 1733 ...
... 1734 1735 1736 ...
... 1737 1738 1739 ...
... 1740 1741 1742 ...
... 1743 1744 1745 ...
... 1746 1747 1748 ...
... 1749 1750 1751 ...
... 1752 1753 1754 ...
... 1755 1756 1757 ...
... 1758 1759 1760 ...
... 1761 1762 1763 ...
... 1764 1765 1766 ...
... 1767 1768 1769 ...
... 1770 1771 1772 ...
... 1773 1774 1775 ...
... 1776 1777 1778 ...
... 1779 1780 1781 ...
... 1782 1783 1784 ...
... 1785 1786 1787 ...
... 1788 1789 1790 ...
... 1791 1792 1793 ...
... 1794 1795 1796 ...
... 1797 1798 1799 ...
... 1800 1801 1802 ...
... 1803 1804 1805 ...
... 1806 1807 1808 ...
... 1809 1810 1811 ...
... 1812 1813 1814 ...
... 1815 1816 1817 ...
... 1818 1819 1820 ...
... 1821 1822 1823 ...
... 1824 1825 1826 ...
... 1827 1828 1829 ...
... 1830 1831 1832 ...
... 1833 1834 1835 ...
... 1836 1837 1838 ...
... 1839 1840 1841 ...
... 1842 1843 1844 ...
... 1845 1846 1847 ...
... 1848 1849 1850 ...
... 1851 1852 1853 ...
... 1854 1855 1856 ...
... 1857 1858 1859 ...
... 1860 1861 1862 ...
... 1863 1864 1865 ...
... 1866 1867 1868 ...
... 1869 1870 1871 ...
... 1872 1873 1874 ...
... 1875 1876 1877 ...
... 1878 1879 1880 ...
... 1881 1882 1883 ...
... 1884 1885 1886 ...
... 1887 1888 1889 ...
... 1890 1891 1892 ...
... 1893 1894 1895 ...
... 1896 1897 1898 ...
... 1899 1900 1901 ...
... 1902 1903 1904 ...
... 1905 1906 1907 ...
... 1908 1909 1910 ...
... 1911 1912 1913 ...
... 1914 1915 1916 ...
... 1917 1918 1919 ...
... 1920 1921 1922 ...
... 1923 1924 1925 ...
... 1926 1927 1928 ...
... 1929 1930 1931 ...
... 1932 1933 1934 ...
... 1935 1936 1937 ...
... 1938 1939 1940 ...
... 1941 1942 1943 ...
... 1944 1945 1946 ...
... 1947 1948 1949 ...
... 1950 1951 1952 ...
... 1953 1954 1955 ...
... 1956 1957 1958 ...
... 1959 1960 1961 ...
... 1962 1963 1964 ...
... 1965 1966 1967 ...
... 1968 1969 1970 ...
... 1971 1972 1973 ...
... 1974 1975 1976 ...
... 1977 1978 1979 ...
... 1980 1981 1982 ...
... 1983 1984 1985 ...
... 1986 1987 1988 ...
... 1989 1990 1991 ...
... 1992 1993 1994 ...
... 1995 1996 1997 ...
... 1998 1999 2000 ...
... 2001 2002 2003 ...
... 2004 2005 2006 ...
... 2007 2008 2009 ...
... 2010 2011 2012 ...
... 2013 2014 2015 ...
... 2016 2017 2018 ...
... 2019 2020 2021 ...
... 2022 2023 2024 ...
... 2025 2026 2027 ...
... 2028 2029 2030 ...
... 2031 2032 2033 ...
... 2034 2035 2036 ...
... 2037 2038 2039 ...
... 2040 2041 2042 ...
... 2043 2044 2045 ...
... 2046 2047 2048 ...
... 2049 2050 2051 ...
... 2052 2053 2054 ...
... 2055 2056 2057 ...
... 2058 2059 2060 ...
... 2061 2062 2063 ...
... 2064 2065 2066 ...
... 2067 2068 2069 ...
... 2070 2071 2072 ...
... 2073 2074 2075 ...
... 2076 2077 2078 ...
... 2079 2080 2081 ...
... 2082 2083 2084 ...
... 2085 2086 2087 ...
... 2088 2089 2090 ...
... 2091 2092 2093 ...
... 2094 2095 2096 ...
... 2097 2098 2099 ...
... 2100 2101 2102 ...
... 2103 2104 2105 ...
... 2106 2107 2108 ...
... 2109 2110 2111 ...
... 2112 2113 2114 ...
... 2115 2116 2117 ...
... 2118 2119 2120 ...
... 2121 2122 2123 ...
... 2124 2125 2126 ...
... 2127 2128 2129 ...
... 2130 2131 2132 ...
... 2133 2134 2135 ...
... 2136 2137 2138 ...
... 2139 2140 2141 ...
... 2142 2143 2144 ...
... 2145 2146 2147 ...
... 2148 2149 2150 ...
... 2151 2152 2153 ...
... 2154 2155 2156 ...
... 2157 2158 2159 ...
... 2160 2161 2162 ...
... 2163 2164 2165 ...
... 2166 2167 2168 ...
... 2169 2170 2171 ...
... 2172 2173 2174 ...
... 2175 2176 2177 ...
... 2178 2179 2180 ...
... 2181 2182 2183 ...
... 2184 2185 2186 ...
... 2187 2188 2189 ...
... 2190 2191 2192 ...
... 2193 2194 2195 ...
... 2196 2197 2198 ...
... 2199 2200 2201 ...

D.3 VT52 MODE CONTROL SEQUENCES

Control Sequences Recognized in VT52 Mode (see Section 8.4.3.1)

| | |
|-------------------------------|-----------|
| Move cursor up | ESC A |
| Move cursor down | ESC B |
| Move cursor right | ESC C |
| Move cursor left | ESC D |
| Enter graphics mode | ESC F |
| Exit graphics mode | ESC G |
| Cursor home | ESC H |
| Reverse line feed | ESC I |
| Erase to end of screen | ESC J |
| Erase to end of line | ESC K |
| Cursor addressing | ESC Y r c |
| Identify | ESC Z |
| Enter application keypad mode | ESC = |
| Exit application keypad mode | ESC > |
| Enter ANSI mode | ESC < |

Printer Control Sequences (VT52 Mode) (see Section 8.4.3.2)

| | |
|-------------------------------|-------|
| Print page | ESC J |
| Print line | Esc V |
| Enter printer controller mode | Esc W |
| Exit printer controller mode | Esc X |
| Enter auto print mode | Esc ^ |

Reader Response Card

Visual 220 User's Guide

Your comments and suggestions are a welcome contribution to our efforts in improving the quality of our technical publications. Please take a few moments to complete and mail this postage free card. Thank you.

What is your reaction to this document?

| | Excl | Good | Fair | Poor |
|--------------------|------|------|------|------|
| Organization | [] | [] | [] | [] |
| Accuracy | [] | [] | [] | [] |
| Readability | [] | [] | [] | [] |
| Overall usefulness | [] | [] | [] | [] |

What features do you find most useful (text, tables, illustrations etc.)?

Additional Comments _____

Please check the box next to the description below that most closely describes your experience level.

[] Little or none. [] Some experience. [] Much experience.

Please check the box next to the description below that most closely characterizes you in relation to the Visual 220 terminal.

[] Operator or user. [] Programmer.

[] Installer or technician. [] Other _____

Name _____

Organization _____

Serial number (located at the rear of the monitor):

Street _____

City _____ State _____

Zip Code/Country _____

102659119



NO POSTAGE
NECESSARY
IF MAILED
IN THE
UNITED STATES

BUSINESS REPLY CARD

FIRST CLASS PERMIT NO. 6 TEWKSBURY, MA 01876

POSTAGE WILL BE PAID BY ADDRESSEE

Visual Technology Incorporated
540 Main St.
Tewksbury, MA 01876

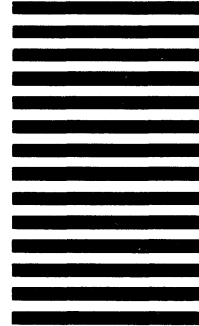

Attn: Technical Publications Manager

Visual Technology Incorporated

540 Main Street, Tewksbury, MA 01876
~~(617) 851-5000~~, Telex 951-539

~~508~~
~~617-538-7900~~
~~508-~~

508-459-4903 Lowell
836-4400

Visual Technology Incorporated

540 Main Street, Tewksbury, MA 01876
~~(617) 851-5000~~, Telex 951-539

~~508~~
~~617~~ 338-7900
~~508~~

508-459-4903 Lowell
836-4400

102659119

Visual 220 User's Guide

UM220-001-00A
March 1985