

**PUBLICATIONS
REVISION**

90/30 B Data Processing Systems

Operations Handbook
for Operators

UP-8072 Rev. 2

This SPERRY UNIVAC® 90/30, 90/30 B Data Processing Systems Library Memo announces the release and availability of "SPERRY UNIVAC 90/30, 90/30 B Data Processing Systems Operations Handbook for Operators", UP-8072 Rev. 2. This is a Standard Library Item (SLI).

This revision primarily includes:

- The operating instructions needed to operate a SPERRY UNIVAC 90/30 B System under the control of the Operating System/3 (OS/3).
- New peripheral device information for the SPERRY UNIVAC 8413 Diskette Subsystem, the 8415 Disc Subsystem, and the 0719 Card Reader Subsystem, in support of the 90/30 B system.
- The operating procedures for running a SPERRY UNIVAC 9200/9300 Series System as a peripheral device for either a 90/30 or 90/30 B system via a 9000 Series channel adapter.
- Changes and additions to the system spooling commands.
- The information contained in changes Notices 7, 8, and 9 for OS/3 (UP-8235.7, 8235.8, and 8235.9) that pertains to this document.

In addition, the online diagnostic information previously described in Part 4 of this manual, has been published as a separate document, OS/3 Online Diagnostics Operator Reference, UP-8512.

Destruction Notice: This revision supersedes and replaces "SPERRY UNIVAC Operating System/3 (OS/3) Operations Handbook for Operators", UP-8072 Rev. 1 released on Library Memo dated November, 1975. Also destroyed is Updating Package A, UP-8072 Rev. 1-A released on Library Memo dated April, 1976 and Updating Package B UP-8072 Rev. 1-B released on Library Memo dated September 1976. Please destroy all copies of UP-8072 Rev. 1, UP-8072 Rev. 1-A and UP-8072 Rev. 1-B and or their Library Memos.

Additional copies may be ordered by your local Sperry Univac Representative.

LIBRARY MEMO ONLY	LIBRARY MEMO AND ATTACHMENTS	THIS SHEET IS
Mailing Lists 217, 630, and 692	Mailing Lists 75 and 76 (Cover and 644 pages)	Library Memo
		RELEASE DATE: August, 1977



**PUBLICATIONS
UPDATE**

90/30, 90/30B Data Processing Systems

**Operations Handbook
for Operators**

UP-8072 Rev. 2-A

This Library Memo announces the release and availability of Updating Package A to "SPERRY UNIVAC 90/30, 90/30B Data Processing Systems Operations Handbook for Operators", UP-8072 Rev. 2-A.

This update includes changes in the IPL Procedure, enhancements to some Spool File commands, new command formats that enable the operator to process 8413 diskette files, and instructions on the use of the 0778 Printer Subsystem. In addition, other minor technical changes are included throughout the manual.

Copies of Updating Package A are now available for requisitioning. Either the updating package alone, or the complete manual with the updating package may be requisitioned by your local Sperry Univac Representative. To receive the updating package alone, order UP-8072 Rev. 2-A. To receive the complete manual, order UP-8072 Rev. 2-A.

LIBRARY MEMO ONLY	LIBRARY MEMO AND ATTACHMENTS	THIS SHEET
Mailing Lists 217,630 and 692	Mailing Lists 75 and 76 (Package A to UP-8072 Rev. 2-A, 113 pages plus Memo)	Library Memo
		RELEASE DATE: November, 1977



SPERRY UNIVAC
90/30, 90/30 B

Data Processing Systems

Operations Handbook
for Operators



SPERRY UNIVAC

90/30, 90/30 B

Data Processing Systems

Operations Handbook for Operators

This document contains the latest information available at the time of preparation. Therefore, it may contain descriptions of functions not implemented at manual distribution time. To ensure that you have the latest information regarding levels of implementation and functional availability, please contact your local Sperry Univac representative.

Sperry Univac reserves the right to modify or revise the content of this document. No contractual obligation by Sperry Univac regarding level, scope, or timing of functional implementation is either expressed or implied in this document. It is further understood that in consideration of the receipt or purchase of this document, the recipient or purchaser agrees not to reproduce or copy it by any means whatsoever, nor to permit such action by others, for any purpose without prior written permission from Sperry Univac.

Sperry Univac is a division of the Sperry Rand Corporation.

AccuScan, ESCORT, FASTRAND, PAGEWRITER, PIXIE, SPERRY UNIVAC, UNISCOPE, UNISERVO, and UNIVAC are trademarks of the Sperry Rand Corporation.

This document was prepared by Systems Publications using the SPERRY UNIVAC UTS 400 Text Editor. It was printed and distributed by the Customer Information Distribution Center (CIDC), 555 Henderson Rd., King of Prussia, Pa., 19406.



PAGE STATUS SUMMARY

ISSUE: Update A – UP-8072 Rev. 2

Part/Section	Page Number	Update Level	Part/Section	Page Number	Update Level	Part/Section	Page Number	Update Level
Cover		Orig.	8	1 thru 24	Orig.			
Title Page		Orig.	9	1 thru 17	Orig.			
PSS	1	A	PART 3					
Preface	1, 2	Orig.	Title Page		Orig.			
Contents	1, 2	Orig.	10	1	Orig.			
	3, 4	A	11	1 thru 3	Orig.			
	5	Orig.		4 thru 8	A			
	6	A		9	A*			
	6a	A*	12	1, 2	A			
	7, 8	Orig.		3 thru 5	Orig.			
	9, 10	A		6, 7	A			
	11 thru 13	Orig.		8 thru 17	Orig.			
	14	A		18 thru 26	A			
	14a	A*		27, 28	Orig.			
15	A	29 thru 50		A				
16	Orig.	51, 52		A*				
17	A							
PART 1			PART 4					
Title Page		Orig.	Title Page		Orig.			
1	1 thru 15	Orig.	Appendix A	1, 2	Orig.			
PART 2			Appendix B	1 thru 7	Orig.			
Title Page		Orig.	Index	1	A			
2	1 thru 79	Orig.		2	Orig.			
3	1, 2	A		3 thru 10	A			
	3 thru 54	Orig.		11	Orig.			
	55	A		12 thru 15	A			
3	56 thru 58	Orig.	16	Orig.				
	59	A	User Comment Sheet					
3	60 thru 68	Orig.						
	4	1, 2						
4	2a	A*						
	3 thru 40	Orig.						
	41	A						
	42 thru 91	Orig.						
5	1 thru 132	Orig.						
	133	A						
	134 thru 153	A*						
6	1	A						
	2 thru 59	Orig.						
7	1 thru 47	Orig.						

*New pages

All the technical changes are denoted by an arrow (→) in the margin. A downward pointing arrow (↓) next to a line indicates that technical changes begin at this line and continue until an upward pointing arrow (↑) is found. A horizontal arrow (→) pointing to a line indicates a technical change in only that line. A horizontal arrow located between two consecutive lines indicates technical changes in both lines or deletions.



Preface

This manual is designed to instruct and guide the operator in the procedures required to operate the SPERRY UNIVAC 90/30 and 90/30 B Systems under control of the SPERRY UNIVAC Operating System/3 (OS/3). Its intended audience is the operator with a basic knowledge of data processing operations but whose experience is limited to non SPERRY UNIVAC systems.

One other document relating to the operation of the 90/30 and 90/30 B systems under control of OS/3 is the system messages programmer/operator reference manual, UP-8076 (current version). This manual describes all the system messages you could encounter while operating the 90/30 or 90/30 B data processing system and the appropriate responses, when necessary.

This operations handbook is divided into the following parts:

- PART 1. SYSTEM DEFINITION

Briefly describes the minimum and maximum hardware configurations of the SPERRY UNIVAC 90/30 and 90/30 B Systems and the components comprising OS/3.

- PART 2. HARDWARE CHARACTERISTICS

Describes the function and use of all the operating controls and indicators in the system, the turn-on and turn-off procedures for each device in the system, the operating procedures peculiar to each device, and the recovery procedures applicable to each device. This information is organized and presented under individual device headings to allow you to remove information that does not pertain to your installation.

We recommend that you go through this part of the manual and remove the information that does not pertain to you, and then flag, or in some way identify, the entries in the table of contents that pertain to the information that was removed. In some cases, entire sections are designed to be removed (e.g., Sections 8 and 9); in others, only a portion of a section is to be removed (e.g., subsections 2.4.1 and 2.4.2).

For example, if your system uses only SPERRY UNIVAC 8416 Disc Subsystems, you would remove those sections pertaining to all other disc subsystems discussed in Section 3 and flag these entries in the table of contents.

Extraneous entries in the table of contents should not be obliterated nor should any removed sections be discarded as this would preclude their future use in the event your installation should obtain a new device.

- PART 3. STANDARD OPERATING PROCEDURES

Contains the procedures required to power up, initialize, and run jobs on the 90/30 system under the control of OS/3.

■ PART 4. APPENDIXES

Describes the conventions used to illustrate the message and command formats presented in this manual and other aids deemed necessary to help you perform your job.

Each of the foregoing parts, excluding Part 4, consists of one or more sections that cover the different aspects of the subject matter contained in each part.

Online diagnostic procedures for the operator are provided in the current version of OS/3 online diagnostic procedures, operator reference, UP-8512. These procedures allow the operator to perform confidence tests on the system and peripheral subsystem operations.

Contents

PAGE STATUS SUMMARY

PREFACE

CONTENTS

PART 1. SYSTEM DEFINITION

1. SYSTEM ORIENTATION

1.1.	GENERAL	1-1
1.2.	SYSTEM CONFIGURATION	1-1
1.3.	CENTRAL HARDWARE	1-6
1.3.1.	Processor	1-6
1.3.1.1.	Main Storage	1-6
1.3.1.2.	Input/Output Control Section	1-7
1.3.1.3.	Integrated Peripheral Channel	1-7
1.3.1.4.	Integrated Disc Adapter	1-7
1.3.1.5.	Micrologic Expansion Feature	1-7
1.3.1.6.	Storage Protection Feature	1-7
1.3.1.7.	Storage Expansion Feature	1-7
1.3.1.8.	Integrated Communication Adapter Feature	1-7
1.3.1.9.	Internal Multiplexer Channel Feature	1-8
1.3.2.	System Console	1-8
1.3.3.	Communications Output Printer (COP)	1-8
1.3.4.	External Storage Cabinet	1-8
1.3.5.	I/O Expansion Cabinet	1-8
1.3.5.1.	Selector Channels	1-9
1.3.5.2.	Multiplexer Channel	1-9
1.4.	INPUT/OUTPUT SUBSYSTEMS	1-9

1.5.	OPERATING SYSTEM	1—12
1.5.1.	Supervisor	1—13
1.5.2.	Job Control	1—13
1.5.3.	Data Management	1—14
1.5.4.	Integrated Communication Access Method	1—14
1.5.5.	Emulators	1—14
1.5.6.	Service Programs	1—14
1.5.7.	Language Processors	1—14
1.5.8.	Diagnostic Programs	1—15
1.5.9.	Application Programs	1—15
1.5.10.	Information Management System	1—15

PART 2. HARDWARE CHARACTERISTICS

2. CENTRAL HARDWARE

2.1.	PROCESSOR CABINET	2—1
2.1.1.	Operating Controls and Indicators	2—2
2.1.2.	Turn-On and Turn-Off Procedures	2—19
2.1.3.	Operating Procedures	2—20
2.1.4.	Recovery Procedures	2—20
2.2.	SYSTEM CONSOLE	2—23
2.2.1.	Operating Controls and Indicators	2—25
2.2.2.	Turn-On and Turn-Off Procedures	2—29
2.2.3.	Operating Procedures	2—29
2.2.4.	Recovery Procedures	2—30
2.3.	COMMUNICATIONS OUTPUT PRINTER	2—31
2.3.1.	Operating Controls and Indicators	2—31
2.3.2.	Turn-On and Turn-Off Procedures	2—33
2.3.3.	Operating Procedures	2—34
2.3.3.1.	Loading Forms	2—34
2.3.3.2.	Aligning Forms	2—36
2.3.3.3.	Replacing Inking Roll	2—44
2.3.4.	Recovery Procedures	2—46
2.4.	EXTERNAL STORAGE CABINETS	2—47
2.4.1.	7024—00/01 External Storage Cabinet	2—49
2.4.1.1.	Operating Controls and Indicators	2—49
2.4.1.2.	Turn-On and Turn-Off Procedures	2—58
2.4.1.3.	Recovery Procedures	2—59
2.4.2.	7024—02/03 External Storage Cabinet	2—62
2.4.2.1.	Operating Controls and Indicators	2—62
2.4.2.2.	Turn-On and Turn-Off Procedures	2—68
2.4.2.3.	Recovery Procedures	2—68
2.5.	I/O EXPANSION CABINET	2—71
2.5.1.	Operating Controls and Indicators	2—71
2.5.2.	Turn-On and Turn-Off Procedures	2—75
2.5.3.	Operating Procedures	2—76
2.5.4.	Recovery Procedures	2—76

3. DISC SUBSYSTEMS

3.1.	GENERAL	3-1
3.2.	DISC PACK HANDLING PRECAUTIONS	3-3
3.3.	8411/8414 DISC SUBSYSTEMS	3-5
3.3.1.	Operating Controls and Indicators	3-5
3.3.2.	Turn-On and Turn-Off Procedures	3-13
3.3.2.1.	Independent Power Turn-On Procedure	3-14
3.3.2.2.	Independent Power Turn-Off Procedure	3-14
3.3.3.	Operating Procedures	3-15
3.3.3.1.	Mounting Disc Pack and Starting Disc Drive Unit	3-15
3.3.3.2.	Stopping Disc Drive Unit and Unloading Disc Drive Pack	3-16
3.3.4.	Recovery Procedures	3-16
3.4.	8416 DISC SUBSYSTEM	3-19
3.4.1.	Operating Controls and Indicators	3-20
3.4.2.	Turn-On and Turn-Off Procedures	3-22
3.4.3.	Operating Procedures	3-22
3.4.3.1.	Mounting Disc Pack and Starting Disc Drive Unit	3-22
3.4.3.2.	Stopping Disc Drive Unit and Unloading Disc Pack	3-23
3.4.4.	Recovery Procedures	3-24
3.5.	8418 DISC SUBSYSTEM	3-25
3.5.1.	Operating Controls and Indicators	3-26
3.5.2.	Turn-On and Turn-Off Procedures	3-30
3.5.3.	Operating Procedures	3-30
3.5.3.1.	Mounting Disc Pack and Starting Disc Drive Unit	3-30
3.5.3.2.	Stopping Disc Drive Unit and Unloading Disc Pack	3-34
3.5.4.	Recovery Procedures	3-34
3.6.	8416/8418 AUXILIARY AC POWER SUPPLY	3-37
3.6.1.	Operating Controls and Indicators	3-37
3.6.2.	Operating Procedures	3-38
3.7.	8430 DISC SUBSYSTEM	3-39
3.7.1.	Operating Controls and Indicators	3-40
3.7.2.	Turn-On and Turn-Off Procedures	3-46
3.7.2.1.	Independent Power Turn-On Procedure	3-47
3.7.2.2.	Independent Power Turn-Off Procedure	3-47
3.7.3.	Operating Procedures	3-47
3.7.3.1.	Mounting Disc Pack and Starting Disc Drive Unit	3-48
3.7.3.2.	Stopping Disc Drive Unit and Removing Disc Pack	3-48
3.7.4.	Recovery Procedures	3-49
3.8.	8415 DISC SUBSYSTEM	3-51
3.8.1.	Operating Controls and Indicators	3-52
3.8.2.	Turn-On and Turn-Off Procedures	3-55
3.8.3.	Operating Procedures	3-55
3.8.3.1.	Mounting Disc Cartridge and Starting Disc Drive Unit	3-55
3.8.3.2.	Stopping Disc Drive Unit and Unloading Disc Cartridge	3-59
3.8.4.	Recovery Procedures	3-60

3.9.	8413 Diskette Subsystem	3—63
3.9.1.	Operating Controls and Indicators	3—63
3.9.2.	Turn-On and Turn-Off Procedures	3—64
3.9.3.	Operating Procedures	3—64
3.9.3.1.	Loading the Diskette	3—65
3.9.3.2.	Unloading the Diskette	3—65
3.9.4.	Recovery Procedures	3—68
4.	MAGNETIC TAPE SUBSYSTEMS	
4.1.	GENERAL	4—1
4.1.1.	Tape Terminology	4—2a
4.1.2.	Tape Specifications	4—2a
4.1.2.1.	Tape Dressing	4—3
4.1.2.2.	Tape Markers	4—3
4.2.	UNISERVO VI-C MAGNETIC TAPE SUBSYSTEM	4—5
4.2.1.	Operating Controls and Indicators	4—5
4.2.2.	Turn-On and Turn-Off Procedures	4—12
4.2.2.1.	Independent Power Turn-On Procedure	4—13
4.2.2.2.	Independent Power Turn-Off Procedure	4—13
4.2.3.	Operating Procedures	4—14
4.2.3.1.	Tape Loading	4—14
4.2.3.2.	Tape Rewinding	4—18
4.2.3.3.	Tape Unloading	4—18
4.2.4.	Recovery Procedures	4—18
4.3.	UNISERVO 10 AND UNISERVO 14 MAGNETIC TAPE SUBSYSTEMS	4—21
4.3.1.	Operating Controls and Indicators	4—21
4.3.2.	Turn-On and Turn-Off Procedures	4—31
4.3.2.1.	Independent Power Turn-On Procedure	4—32
4.3.2.2.	Independent Power Turn-Off Procedure	4—33
4.3.3.	Operating Procedures	4—33
4.3.3.1.	Tape Loading With Reel Cartridge	4—33
4.3.3.2.	Tape Loading Without Reel Cartridge	4—36
4.3.3.3.	Tape Unloading With Program Control	4—37
4.3.3.4.	Tape Unloading Without Program Control	4—38
4.3.4.	Recovery Procedures	4—38
4.4.	UNISERVO 12/16 MAGNETIC TAPE SUBSYSTEM	4—43
4.4.1.	Operating Controls and Indicators	4—44
4.4.2.	Turn-On and Turn-Off Procedures	4—56
4.4.2.1.	Independent Power Turn-On Procedure	4—57
4.4.2.2.	Independent Power Turn-Off Procedure	4—58
4.4.3.	Operating Procedures	4—58
4.4.3.1.	UNISERVO 12 Magnetic Tape Unit Reel Mounting	4—58
4.4.3.2.	UNISERVO 12 Magnetic Tape Unit Reel Unloading	4—63
4.4.3.3.	UNISERVO 16 Magnetic Tape Unit Reel Mounting	4—64
4.4.3.4.	UNISERVO 16 Magnetic Tape Unit Reel Unloading	4—67
4.4.4.	Recovery Procedures	4—67

4.5.	UNISERVO 20 MAGNETIC TAPE SUBSYSTEM	4-71
4.5.1.	Operating Controls and Indicators	4-71
4.5.2.	Turn-On and Turn-Off Procedures	4-83
4.5.2.1.	Independent Power Turn-On Procedure	4-84
4.5.2.2.	Independent Power Turn-Off Procedure	4-85
4.5.3.	Operating Procedures	4-85
4.5.3.1.	Tape Loading With Reel Cartridge	4-85
4.5.3.2.	Tape Loading Without Reel Cartridge	4-88
4.5.3.3.	Tape Unloading With Program Control	4-89
4.5.3.4.	Tape Unloading Without Program Control	4-89
4.5.4.	Recovery Procedures	4-90
5.	PRINTER SUBSYSTEMS	
5.1.	GENERAL	5-1
5.2.	0768 PRINTER SUBSYSTEM	5-3
5.2.1.	Operating Controls and Indicators	5-3
5.2.2.	Turn-On and Turn-Off Procedures	5-11
5.2.2.1.	Independent Power Turn-On Procedure	5-12
5.2.2.2.	Independent Power Turn-Off Procedure	5-12
5.2.3.	Operating Procedures	5-13
5.2.3.1.	Forms Control Tape Preparation	5-13
5.2.3.2.	Forms Control Tape Replacement	5-15
5.2.3.3.	Forms Loading	5-19
5.2.3.4.	Character Phasing Adjustment	5-21
5.2.3.5.	Print Drum Motor Speed Selection	5-23
5.2.4.	Recovery Procedures	5-23
5.3.	0770 PRINTER SUBSYSTEM	5-27
5.3.1.	Operating Controls and Indicators	5-27
5.3.2.	Turn-On and Turn-Off Procedures	5-39
5.3.2.1.	Independent Power Turn-On Procedure	5-41
5.3.2.2.	Independent Power Turn-Off Procedure	5-41
5.3.3.	Operating Procedures	5-41
5.3.3.1.	Forms Loading	5-42
5.3.3.1.1.	Forms Loading, General Method	5-42
5.3.3.1.2.	Forms Loading, Alternate Method	5-52
5.3.3.2.	Forms Unloading	5-55
5.3.3.3.	Stacker Adjustments	5-56
5.3.3.4.	Ribbon Replacement	5-59
5.3.3.5.	Ribbon Shield Replacement	5-65
5.3.3.6.	Print Band Replacement	5-68
5.3.3.7.	Print Gap Adjustment	5-73
5.3.3.8.	Print Phasing Adjustment	5-75
5.3.3.9.	Print Speed Selection	5-75
5.3.4.	Recovery Procedures	5-76
5.4.	0773 PRINTER SUBSYSTEM	5-79
5.4.1.	Operating Controls and Indicators	5-79
5.4.2.	Turn-On and Turn-Off Procedures	5-84
5.4.2.1.	Independent Power Turn-On Procedures	5-85
5.4.2.2.	Independent Power Turn-Off Procedures	5-85

5.4.3.	Operating Procedures	5-86
5.4.3.1.	Forms Loading	5-86
5.4.3.2.	Ribbon Replacement	5-94
5.4.3.3.	Print Cartridge Replacement	5-99
5.4.3.4.	Print Phasing Adjustment	5-102
5.4.3.5.	Print Speed Selection	5-103
5.4.3.6.	Print Gap Adjustment	5-104
5.4.4.	Recovery Procedures	5-104
5.5.	0776 PRINTER SUBSYSTEM	5-107
5.5.1.	Operating Controls and Indicators	5-107
5.5.2.	Turn-On and Turn-Off Procedures	5-112
5.5.2.1.	Independent Power Turn-On Procedure	5-112
5.5.2.2.	Independent Power Turn-Off Procedure	5-113
5.5.3.	Operator Procedures	5-113
5.5.3.1.	Forms Loading	5-114
5.5.3.2.	Ribbon Replacement	5-122
5.5.3.3.	Print Band Cartridge Replacement	5-126
5.5.3.4.	Print Phasing Adjustment	5-128
5.5.3.5.	Print Gap Adjustment	5-129
5.5.4.	Recovery Procedures	5-129
5.6.	0778 PRINTER SUBSYSTEM	5-133
5.6.1.	Operating Controls and Indicators	5-133
5.6.2.	Turn-On and Turn-Off Procedures	5-135
5.6.2.1.	Independent Power Turn-Off Procedure	5-135
5.6.2.2.	Emergency Power Turn-Off Procedure	5-136
5.6.3.	Operating Procedures	5-136
5.6.3.1.	Forms Loading	5-137
5.6.3.1.1.	Initial Loading of Print Form	5-138
5.6.3.1.2.	Adding Print Form to Current Run	5-143
5.6.3.1.3.	Loading New Type of Print Form	5-143
5.6.3.2.	Ribbon Replacement	5-145
5.6.3.3.	Print Band Cartridge Replacement	5-148
5.6.3.4.	Print Phasing Adjustment	5-150
5.6.3.5.	Forms Thickness Adjustment	5-151
5.6.4.	Recovery Procedures	5-151

6. CARD READER SUBSYSTEMS

6.1.	GENERAL	6-1
6.2.	0716 CARD READER SUBSYSTEM	6-3
6.2.1.	Operating Controls and Indicators	6-3
6.2.2.	Turn-On and Turn-Off Procedures	6-8
6.2.2.1.	Independent Power Turn-On Procedure	6-9
6.2.2.2.	Independent Power Turn-Off Procedure	6-10
6.2.3.	Operating Procedures	6-10
6.2.3.1.	Card Feed Guide Setting	6-10
6.2.3.2.	Loading Cards in Hopper When Stopped	6-11
6.2.3.3.	Loading Cards in Hopper When Running	6-14
6.2.3.4.	Unloading Cards From Stackers	6-14
6.2.3.5.	Clearing Card Jams	6-15
6.2.4.	Recovery Procedures	6-19

6.3.	0717 CARD READER SUBSYSTEM	6-23
6.3.1.	Operating Controls and Indicators	6-23
6.3.2.	Turn-On and Turn-Off Procedures	6-28
6.3.3.	Operating Procedures	6-29
6.3.3.1.	Card Feed Guide Setting	6-29
6.3.3.2.	Loading Cards in Hopper When Stopped	6-29
6.3.3.3.	Loading Cards in Hopper When Running	6-33
6.3.3.4.	Unloading Cards From Stacker	6-33
6.3.3.5.	Clearing Card Jams	6-34
6.3.3.6.	Cleaning Vacuum Filters	6-37
6.3.4.	Recovery Procedures	6-38



6.4.	0719 CARD READER SUBSYSTEM	6-45
6.4.1.	Operating Controls and Indicators	6-45
6.4.2.	Turn-On and Turn-Off Procedures	6-51
6.4.3.	Operating Procedures	6-51
6.4.3.1.	Card Loading	6-51
6.4.3.2.	Card Unloading	6-52
6.4.3.3.	Placing Card Reader Online	6-52
6.4.3.4.	Clearing Card Jams	6-53
6.4.3.5.	Cleaning	6-54
6.4.3.6.	Indicator Lamp Replacement	6-54
6.4.4.	Recovery Procedure	6-55
7.	CARD PUNCH SUBSYSTEMS	
7.1.	GENERAL	7-1
7.2.	0604 CARD PUNCH SUBSYSTEM	7-3
7.2.1.	Operating Controls and Indicators	7-3
7.2.2.	Turn-On and Turn-Off Procedures	7-7
7.2.3.	Operating Procedures	7-7
7.2.3.1.	Loading Cards in Hopper and Placing Unit Online	7-7
7.2.3.2.	Emptying the Chad Container	7-10
7.2.3.3.	Clearing Card Jams in Card Track	7-12
7.2.3.4.	Clearing Card Jams in Stacker Mechanism	7-18
7.2.4.	Recovery Procedure	7-20
7.3.	0605 CARD PUNCH SUBSYSTEM	7-21
7.3.1.	Operating Controls and Indicators	7-21
7.3.2.	Turn-On and Turn-Off Procedures	7-24
7.3.3.	Operating Procedures	7-25
7.3.3.1.	Loading Cards in Hopper	7-25
7.3.3.2.	Unloading Cards From Stacker	7-28
7.3.3.3.	Unloading Cards From Error Stacker	7-30
7.3.3.4.	Emptying the Chad Container	7-31
7.3.3.5.	Clearing Card Jam in Read Station	7-31
7.3.3.6.	Clearing Card Jam Behind Card Guide Plate	7-34
7.3.3.7.	Clearing Card Jam in Advance Station	7-36
7.3.3.8.	Clearing Card Jam in Punch Station	7-39
7.3.4.	Recovery Procedures	7-41
8.	2703 OPTICAL DOCUMENT READER SUBSYSTEM	
8.1.	GENERAL	8-1
8.2.	OPERATING CONTROLS AND INDICATORS	8-2
8.3.	TURN-ON AND TURN-OFF PROCEDURES	8-7
8.3.1.	Independent Power Turn On	8-7
8.3.2.	Independent Power Turn Off	8-7

8.4.	OPERATING PROCEDURES	8—8
8.4.1.	Loading Documents in Hopper	8—9
8.4.2.	Camera Positioning	8—12
8.4.3.	Document Aligner Adjustment	8—15
8.4.4.	Unloading Documents	8—17
8.4.5.	Clearing Document Jams	8—18
8.5.	RECOVERY PROCEDURES	8—21
9.	0920 PAPER TAPE SUBSYSTEM	
9.1.	GENERAL	9—1
9.2.	OPERATING CONTROLS AND INDICATORS	9—2
9.3.	TURN-ON AND TURN-OFF PROCEDURES	9—6
9.3.1.	Independent Power Turn On	9—7
9.3.2.	Independent Power Turn Off	9—7
9.4.	OPERATING PROCEDURES	9—8
9.4.1.	Tape Reading	9—8
9.4.2.	Tape Reader Rewinding	9—11
9.4.3.	Reloading Tape Punch	9—11
9.4.4.	Tape Punching	9—16
9.5.	RECOVERY PROCEDURES	9—17

PART 3. STANDARD OPERATING PROCEDURES

10. SYSTEM TURN-ON AND TURN-OFF PROCEDURES

10.1.	SYSTEM TURN ON	10—1
10.2.	SYSTEM TURN OFF	10—1

11. SYSTEM INITIALIZATION PROCEDURES

11.1.	GENERAL	11—1
11.2.	CONTROL STORAGE LOAD PROCEDURE	11—1
11.3.	INITIAL PROGRAM LOAD PROCEDURE	11—2

12. JOB PROCESSING PROCEDURES

12.1.	GENERAL	12—1
12.2.	KEYIN PROCEDURE	12—1
12.2.1.	System Command Characteristics	12—2
12.2.2.	System Message Characteristics	12—3
12.2.2.1.	Solicited Messages	12—4
12.2.2.2.	Unsolicited Messages	12—4

12.3.	JOB PROCESSING COMMANDS	12-6
12.3.1.	Job Initialization	12-6
12.3.1.1.	Filing Job Control Streams (FILE)	12-6
12.3.1.2.	Running Job Control Streams (RUN/RV)	12-6
12.3.2.	Job Rescheduling	12-8
12.3.2.1.	Deferring Job Scheduling (HOLD)	12-8
12.3.2.2.	Rescheduling Deferred Jobs (BEGIN)	12-9
12.3.2.3.	Suspending a Job in Progress (PAUSE)	12-9
12.3.2.4.	Activating a Suspended Job (GO)	12-10
12.3.2.5.	Changing a Job Scheduling Priority (CHANGE)	12-10
12.3.2.6.	Changing a Job Switching Priority (SWITCH)	12-11
12.3.3.	Job Termination	12-11
12.3.3.1.	Cancelling a Job in Progress (CANCEL)	12-12
12.3.3.2.	Deleting Jobs From Job Queue (DELETE)	12-13
12.3.3.3.	Stopping Execution of Symbiont or Transient (END)	12-13
12.3.3.4.	Terminating a Job (STOP)	12-14
12.4.	SELECTED-OCCASION OPERATOR COMMANDS	12-14
12.4.1.	Displaying Portions of Main Storage (DISPLAY)	12-14
12.4.2.	Initiating a Main Storage Dump (DUMP)	12-17
12.4.3.	Displaying System Information (MIX)	12-17
12.4.4.	Reconstructing Console Display (REBUILD)	12-19
12.4.5.	Setting Simulated Day Clock (SET CLOCK)	12-19
12.4.6.	Setting Date Field (SET DATE)	12-20
12.4.7.	Setting Error Log (SET ELOG)	12-20
12.4.8.	Setting Up Physical Unit Block (SET IO)	12-26
12.4.9.	Reading a Mounted Volume Serial Number (AVR)	12-28
12.4.10.	Running IBM System/3 Operation Command Language (OCL) Jobs	12-28
12.5.	SPOOLING COMMANDS	12-29
12.5.1.	Spool File Commands	12-30
12.5.1.1.	Displaying the Status of Spool Subfiles (DISPLAY)	12-31
12.5.1.2.	Deleting Closed Spool Subfiles (DELETE)	12-34
12.5.1.3.	Placing Spool Subfiles on Hold (HOLD)	12-35
12.5.1.4.	Releasing Spool Subfiles (BEGIN)	12-36
12.5.1.5.	Breakpointing Active Spool Subfiles (BRKPT)	12-37
12.5.1.6.	Changing the System Spooling Criteria (SET SPL, BURST/NBURST)	12-38
12.5.1.7.	Changing the System Accumulation of Log Files (SET SPL, DUMP/ENDDUMP)	12-39
12.5.1.8.	Changing the Spool File Printout Format (SET SPL, HEADER/NOHDR)	12-40
12.5.1.9.	Changing the Job Log File Print Specifications (SET SPL, NOACT/NOLOG/NOPRINT/PRINT)	12-40
12.5.1.10.	Changing the Console Log File Specifications (SET SPL, CNSLG)	12-41
12.5.1.11.	Suppress or Display Forms Change Message (SET SPL, TEST/NOTEST)	12-42 ←
12.5.2.	Input Reader Commands	12-42
12.5.2.1.	Loading an Input Reader	12-42
12.5.3.	Output Writer Commands	12-43
12.5.3.1.	Loading an Output Writer	12-43
12.5.3.2.	Directing the Operation of an Output Writer	12-46
12.5.4.	Spool File Processing Aids	12-47
12.5.4.1.	Using Tape for the SYSLOG File	12-49
12.5.4.2.	Using Disc for the SYSLOG File	12-49
12.5.4.2.1.	Establishing the SYSLOG File on Disc	12-49
12.5.4.2.2.	Accumulating Job Log Subfiles on Disc	12-50
12.5.4.2.3.	Reinitializing the SYSLOG File on Disc	12-50

12.6.	SYSTEM UTILITY COMMANDS	12—50
12.7.	INTEGRATED COMMUNICATIONS ACCESS METHOD (ICAM) COMMANDS	12—51
12.7.1.	Loading ICAM Message Control Program (MCP) Modules	12—51
12.7.2.	ICAM Operator Communications	12—52

PART 4. APPENDIXES

A. MESSAGE AND COMMAND FORMAT CONVENTIONS

B. OPERATING PROCEDURES FOR THE 9200/9300 SERIES SUBSYSTEM

B.1.	GENERAL	B—1
B.2.	OPERATING CONTROLS AND INDICATORS	B—2
B.3.	INITIAL PROGRAM LOAD PROCEDURE	B—3
B.4.	INITIALIZATION AND RESET PROCEDURES	B—3
B.4.1.	Initializing the Printer	B—3
B.4.2.	Initializing the Card Reader	B—3
B.4.3.	Initializing the Channel Adapter	B—4
B.4.4.	Obtaining a Storage Dump and Reinitializing the System	B—4
B.5.	RECOVERY PROCEDURES	B—4
B.5.1.	90/30 and 90/30 B Console Messages	B—4
B.5.2.	9200/9300 Halt Displays	B—6

INDEX

USER COMMENT SHEET

FIGURES

1—1.	90/30 Data Processing System	1—1
1—2.	Basic 90/30 System Configuration	1—2
1—3.	90/30 System With All Hardware Options Shown	1—3
1—4.	Basic 90/30 B System Configuration	1—4
1—5.	90/30 B System Configuration With All Hardware Options Shown	1—5
1—6.	Operating System/3 Components	1—12
2—1.	90/30 System Processor Cabinet (Front View)	2—1
2—2.	90/30 System Processor Cabinet, Operator/Maintenance Panel	2—3
2—3.	90/30 System Processor Cabinet, Right Side (Doors Open)	2—4
2—4.	90/30 System Processor Cabinet, Power Supplies	2—5
2—5.	90/30 System Processor Cabinet, Power Control Panel	2—5
2—6.	90/30 B System Processor Cabinet, Right Side (Door Open)	2—6
2—7.	90/30 B System Processor Cabinet, Power Supplies	2—7

2-8.	90/30 B System Processor Cabinet, Power Control Panel	2-8
2-9.	90/30 B System Processor Cabinet, Power Distribution Panel	2-8
2-10.	Location of Integrated Communication Adapter Circuit Breaker and Indicator	2-9
2-11.	90/30 B System, System Console	2-23
2-12.	System Console, Control/Indicator Panel	2-24
2-13.	System Console Keyboard	2-24
2-14.	8541-06 Communications Output Printer	2-31
2-15.	8541-06 Communications Output Printer, Operator Control Panel	2-32
2-16.	8541-06 Communications Output Printer, Power Control Panel	2-32
2-17.	Loading Forms in COP	2-36
2-18.	Replacing Inking Roll in COP	2-45
2-19.	90/30 System, External Storage Cabinets	2-48
2-20.	7024-00/01 External Storage Cabinet, Power Control Panel	2-49
2-21.	7024-00/01 External Storage Cabinet, AC Power Distribution Panel	2-50
2-22.	7024-00/01 External Storage Cabinet, DC Power Distribution Panel	2-51
2-23.	7024-00/01 External Storage Cabinet, Rear View	2-52
2-24.	7024-00/01 External Storage Cabinet, 5 Volt Regulator Panel	2-53
2-25.	7024-00/01 External Storage Cabinet, Module Power Supply Panel	2-54
2-26.	7024-00/01 External Storage Cabinet, Air Filter	2-61
2-27.	7024-02/03 External Storage Cabinet, Power Control Panel	2-63
2-28.	7024-02/03 External Storage Cabinet, AC Power Distribution Panel	2-64
2-29.	7024-02/03 External Storage Cabinet, +5 Volt Power Supply Panel	2-64
2-30.	7024-02/03 External Storage Cabinet, Rear View	2-65
2-31.	7024-02/03 External Storage Cabinet, 18.5 and 22.5 Volt Power Supply	2-66
2-32.	1921-00/01 I/O Expansion Cabinet, Front View	2-71
2-33.	1921-00/01 I/O Expansion Cabinet, Power Control Panel	2-72
2-34.	1921-00/01 I/O Expansion Cabinet, +5 Volt Power Supply	2-72
2-35.	1921-00/01 I/O Expansion Cabinet, +6, -12, +24 Volt Power Supply	2-73
2-36.	Air Filter Location on Rear of I/O Expansion Cabinet	2-79
3-1.	5024 Control Unit for the 8411/8414 Disc Subsystem	3-5
3-2.	8411/8414 Disc Drive Unit	3-6
3-3.	5024 Control Unit, Maintenance Panel	3-6
3-4.	5024 Control Unit, Power Control Panel	3-7
3-5.	5024 Control Unit, Power Distribution Panel	3-7
3-6.	8411/8414 Disc Drive Unit, Power Control Panel	3-10
3-7.	8411/8414 Disc Drive Unit, Operator Control Panel	3-11
3-8.	8411/8414 Disc Drive Unit, Disc Pack Well	3-11
3-9.	Disc Drive Unit With Plexiglass Cover Open	3-15
3-10.	8416 Disc Drive Unit	3-19
3-11.	8416 Disc Drive Unit, Power Panels	3-20
3-12.	8416 Disc Drive Unit, Operator Control Panel	3-21
3-13.	8418 Disc Drive Unit	3-25
3-14.	8418 Disc Drive Unit, Power Panels	3-26
3-15.	8418 Disc Drive Unit, Operator Control Panel	3-27
3-16.	Disc Drive Well Cover Opened	3-31
3-17.	Disc Well Showing Drive Spindle	3-31
3-18.	8418 Disc Pack	3-33
3-19.	8416/8418 Auxiliary AC Power Supply (T2408)	3-38
3-20.	5039 Control Unit For the 8430 Disc Subsystem (Interior View)	3-39
3-21.	8430 Disc Drive Unit	3-40
3-22.	5039 Control Unit, Power Panel	3-41
3-23.	5039 Control Unit, Operator and Maintenance Panels	3-41
3-24.	8430 Disc Drive Unit, Power Panels	3-44
3-25.	8430 Disc Drive Unit, Operator Control Panel	3-44

3-26.	8415 Disc Drive Unit	3-51
3-27.	8415 Disc Drive Unit, Operator Control Panel	3-52
3-28.	8415 Disc Drive Unit, Power Panels	3-52
3-29.	8415 Disc Drive Unit, Disc Drive Well	3-56
3-30.	8415 Disc Cartridge (F1215-00)	3-57
3-31.	8415 Disc Cartridge Mounted on Drive Spindle	3-57
3-32.	8415 Disc Cartridge and Cover Assembly Fully Mounted on Drive Spindle	3-58
3-33.	8413 Diskette Subsystem (Optional Four-Drive Unit Shown)	3-63
3-34.	8413 Diskette Subsystem, Input Power Circuit Breaker and LED Indicators	3-64
3-35.	Loading and Unloading the 8413 Diskette Subsystem	3-66
4-1.	Tape Dressing Tool	4-3
4-2.	Tape Marker Locations on Tape Surface	4-4
4-3.	UNISERVO VI-C Magnetic Tape Subsystem	4-5
4-4.	UNISERVO VI-C Magnetic Tape Subsystem, Operator Control Panel	4-5
4-5.	UNISERVO VI-C Magnetic Tape Subsystem, Master Main Power Panel	4-6
4-6.	UNISERVO VI-C Magnetic Tape Subsystem, Master DC Power Panel	4-6
4-7.	UNISERVO VI-C Magnetic Tape Subsystem, Slave Power Panel	4-6
4-8.	Write-Enable Ring and Rear of Tape Reel	4-14
4-9.	Loading Tape Reel on Tape Unit	4-15
4-10.	UNISERVO 10 or UNISERVO 14 Magnetic Tape Subsystem	4-22
4-11.	UNISERVO 10 or UNISERVO 14 Control Unit, Front and Rear Views With Covers Removed	4-23
4-12.	UNISERVO 10 or UNISERVO 14 Control Unit, Power Control Panel	4-24
4-13.	UNISERVO 10 or UNISERVO 14 Control Unit, Power Distribution Panel	4-24
4-14.	UNISERVO 10 or UNISERVO 14 Control Unit, Power Supply Panel	4-25
4-15.	UNISERVO 10 or UNISERVO 14 Tape Unit, Operator Control Panel	4-27
4-16.	UNISERVO 10 or UNISERVO 14 Tape Unit, Power Control Panel	4-28
4-17.	Tape Reel and Write-Enable Ring	4-34
4-18.	Tape Reel Cartridge	4-35
4-19.	Tape Reel Cartridge Mounted on Supply Hub	4-36
4-20.	Tape Reel Without Cartridge, in Position for Automatic Threading	4-37
4-21.	Tape Transport Items and Method for Cleaning	4-41
4-22.	UNISERVO 12/16 Magnetic Tape Subsystem	4-43
4-23.	5017 Control Unit, Rear View With Door Open	4-44
4-24.	5017 Control Unit, Power Control Panel	4-45
4-25.	5017 Control Unit, Power Distribution Panel	4-45
4-26.	UNISERVO 12 Magnetic Tape Unit, Operator Control Panel	4-48
4-27.	UNISERVO 12 Magnetic Tape Unit, Rear View With Door Open	4-48
4-28.	UNISERVO 12 Magnetic Tape Unit, Master Power Control Panel	4-48
4-29.	UNISERVO 12 Magnetic Tape Unit, Master Power Supply Panel	4-49
4-30.	UNISERVO 16 Magnetic Tape Unit, Operator Control Panel	4-51
4-31.	UNISERVO 16 Magnetic Tape Unit, Rear View With Door Open	4-52
4-32.	UNISERVO 16 Magnetic Tape Unit, Power Supply Panel	4-52
4-33.	UNISERVO 16 Magnetic Tape Unit, Power Control Panel	4-53
4-34.	Tape Reel and Write-Enable Ring	4-59
4-35.	Loading Tape Reel on UNISERVO 12 Magnetic Tape Unit	4-60
4-36.	Loading Tape Reel on UNISERVO 16 Magnetic Tape Unit	4-65
4-37.	UNISERVO 20 Magnetic Tape Subsystem	4-71
4-38.	5034 Control Unit, Rear View	4-72
4-39.	5034 Control Unit, Power Control Panel	4-72
4-40.	5034 Control Unit, Power Distribution Panel	4-73
4-41.	UNISERVO 20 Magnetic Tape Unit, Operator Panels	4-75
4-42.	UNISERVO 20 Magnetic Tape Unit, Indicator Panel	4-75
4-43.	UNISERVO 20 Magnetic Tape Unit, Operator Control Panel	4-76
4-44.	UNISERVO 20 Magnetic Tape Unit, Rear View	4-76

4-45. UNISERVO 20 Magnetic Tape Unit, Power Supply Panel	4-77
4-46. UNISERVO 20 Magnetic Tape Unit, Power Control Panel	4-77
4-47. Tape Reel and Write-Enable Ring	4-86
4-48. Tape Reel Cartridge	4-87
4-49. Tape Reel Mounted on Supply Hub With Cartridge	4-88
4-50. Tape End Positioned for Automatic Loading Without Tape Reel Cartridge	4-89
5-1. 0768 Printer Subsystem	5-3
5-2. Rear View of 0768 Printer Subsystem	5-4
5-3. 0768 Printer Subsystem, Left Control Panel	5-4
5-4. 0768 Printer Subsystem, Right Control Panel	5-5
5-5. 0768 Printer Subsystem, Rear Control Panel	5-5
5-6. 0768 Printer Subsystem, Power Control Panel	5-6
5-7. 0768 Printer Subsystem, Forms Control Tape	5-13
5-8. 0768 Printer Subsystem, Forms Control Tape Preparation (Sample)	5-16
5-9. 0768 Printer Subsystem, Left View	5-17
5-10. 0768 Printer Subsystem, Forms Control Mechanism	5-18
5-11. Form Access Cover Open and Carriage Out	5-20
5-12. Ribbon Access Panel Raised and Form Loading Door Open	5-21
5-13. Character Phasing Examples	5-22
5-14. Character Phasing Thumbwheel	5-22
5-15. Print Drum Motor Speed Selection Switch	5-23
5-16. 0770 Printer Subsystem	5-27
5-17. Rear View of 0770 Printer Subsystem	5-28
5-18. 0770 Printer Subsystem, Control Panel	5-28
5-19. 0770 Printer Subsystem, Indicator Panel	5-29
5-20. 0770 Printer Subsystem, Stacker Control Panel	5-29
5-21. 0770 Printer Subsystem, Power Distribution Panel	5-30
5-22. 0770 Printer Subsystem, Low Voltage Power Supply Panel	5-30
5-23. 0770 Printer Subsystem, Paper Feed Power Supply Panel	5-31
5-24. 0770 Printer Subsystem, High Voltage Power Supply Panel	5-31
5-25. 0770 Printer Subsystem, POWER ON/POWER OFF Switch	5-32
5-26. 0770 Printer Subsystem, Print Carriage Assembly Closed	5-43
5-27. Printer Open to Receive Forms	5-44
5-28. Recommended Cut of Forms Container	5-45
5-29. Forms Loaded in Printer	5-46
5-30. HORIZONTAL TRACTOR ADJUSTMENT Controls	5-47
5-31. Forms Alignment Guide Retracted in Housing	5-48
5-32. Forms Alignment Guide and Tractors	5-49
5-33. Vertical Position Control and Vertical Forms Tension Control	5-50
5-34. Forms Compression Control and Print Band Speed Selector Switch	5-51
5-35. PRINT DENSITY Switch and Print Phasing Control	5-52
5-36. Stacker Gate Closed	5-55
5-37. Stacker Gate Open	5-56
5-38. Rear Photocell Covered	5-59
5-39. Dimension Between Ribbon Mandrel and Ribbon	5-60
5-40. Changing Ribbon	5-62
5-41. Ribbon Shield Types	5-65
5-42. Changing Ribbon Shield	5-67
5-43. Replacing Print Band	5-70
5-44. Print Gap Adjustment	5-74
5-45. Print Phasing Adjustment Examples	5-75
5-46. 0773 Printer Subsystem	5-79
5-47. 0773 Printer Subsystem, Control Panel	5-80
5-48. 0773 Printer Subsystem, Indicator Panel Located on Processor Operator/Maintenance Panel	5-81

5-49. 0773 Printer Subsystem, Overload Protection Controls	5-82
5-50. 0773 Printer Subsystem, Internal Adjustments	5-86
5-51. Preliminary Adjustments for Forms Loading	5-87
5-52. Print Carriage Assembly Closed	5-88
5-53. Print Carriage Opened to Receive Form	5-89
5-54. Placement of Form Alignment Ticks at Column Indicator	5-90
5-55. Alignment Gauge Tape in Position for Form Alignment	5-91
5-56. Form Advance, Line Phasing, and Form Tension Controls	5-91
5-57. Alignment of Forms Without Alignment Ticks	5-92
5-58. FORM THICKNESS and HORIZONTAL FORM ADJUSTMENT Controls	5-93
5-59. Form Feed Path	5-94
5-60. Replacing Ribbon	5-95
5-61. Replacing Print Cartridge	5-100
5-62. Print Phasing Control on Print Cartridge	5-102
5-63. Examples of Print Phasing Adjustment Results	5-103
5-64. BAND SPEED Switch on Upper Right of Paper Handling Assembly	5-103
5-65. 0776 Printer Subsystem	5-107
5-66. 0776 Printer Subsystem, Operator Control Panel	5-107
5-67. 0776 Printer Subsystem, Front View With Paper Well Door Removed	5-108
5-68. 0776 Printer Subsystem, Power Control Panel	5-108
5-69. 0776 Printer Subsystem, Rear View With Rear Cover Removed	5-109
5-70. 0776 Printer Subsystem, Power Supply Control Panel	5-109
5-71. 0776 Printer Subsystem, Internal Adjustments	5-113
5-72. Horizontal Form Adjustment	5-114
5-73. Print Carriage Assembly, Closed	5-115
5-74. Printer, Opened to Receive Form	5-116
5-75. Placement of Alignment Ticks	5-117
5-76. Form Alignment, Form Advance, and Form Tension Controls	5-118
5-77. Form Alignment	5-119
5-78. Printer Forms Thickness (Gap Adjust) Lever	5-120
5-79. Form Feed Configuration	5-121
5-80. Changing Ribbon	5-122
5-81. Replacing Print Band Cartridge	5-126
5-82. Examples of Print Phasing	5-128
5-83. Print Phasing Control on Print Cartridge	5-129
5-84. Operator Control Panel	5-133
5-85. Printer Indicator Panel on Processor Operator/Maintenance Panel	5-134
5-86. Printer With Print Carriage Open	5-136
5-87. Printer With Print Carriage Closed	5-137
5-88. Recommended Cut for Forms Container	5-138
5-89. Print Carriage Open to Set Tractors	5-139
5-90. Tractors Open to Receive Form	5-139
5-91. Print Forms Secured on Printer	5-140
5-92. Print Carriage Fully Open	5-141
5-93. Form Alignment Guide Set to Adjust Form	5-142
5-94. Aligning Form According to Tick Marks	5-142
5-95. Form Path at Front of Printer	5-144
5-96. Form Path at Rear of Printer	5-144
5-97. Carriage Release Lever in Lock Position	5-145
5-98. Forms Alignment Guide Latched to Print Carriage	5-146
5-99. Removing the Print Roller	5-146
5-100. Removing the Upper and Lower Ribbon Spools	5-147
5-101. Ribbon Threading Path	5-147
5-102. Removing the Upper Print Spool	5-148
5-103. Print Ribbon in Reverse Thread Position	5-149

5—104. Print Cartridge Mounted in the Print Carriage	5—149
5—105. Print Cartridge Removed From Print Carriage	5—150
5—106. Examples of Print Phasing Adjustments	5—151
6—1. 0716 Card Reader Subsystem	6—3
6—2. 0716 Card Reader, Operator Control Panel	6—3
6—3. Operator Control Panel with Cover Raised	6—4
6—4. 0716 Card Reader, Power Control Panel	6—4
6—5. Card Feed Guide Settings in Hopper	6—10
6—6. Loading Cards in Hopper	6—12
6—7. Removing Cards from Stacker	6—14
6—8. Clearing Card Jams	6—16
6—9. 0717 Card Reader Subsystem	6—23
6—10. 0717 Card Reader, Operator Control Panel	6—23
6—11. 0717 Card Reader, Indicator Panel Located on Processor Operator/Maintenance Panel	6—24
6—12. 0717 Card Reader Subsystem, AC POWER Circuit Breaker	6—25
6—13. Card Feed Guide Settings in Hopper	6—30
6—14. Loading Cards in Hopper	6—31
6—15. Removing Cards From Stacker	6—33
6—16. Clearing Card Jam	6—35
6—17. Vacuum Pump Filter Covers	6—38
6—18. 0719 Card Reader Subsystem	6—45



6—19.	0719 Card Reader, Operator Control Panel	6—45
6—20.	0719 Card Reader, Indicator Panel Located on Processor Operator/Maintenance Panel	6—46
6—21.	0719 Card Reader, Power Circuit Breaker	6—47
6—22.	0719 Card Reader, Input Hopper and Output Stacker	6—52
6—23.	0719 Card Reader, Read Station and Transport Mechanism	6—53
7—1.	0604 Card Punch Subsystem	7—3
7—2.	0604 Card Punch Subsystem, Operator Control Panel	7—4
7—3.	0604 Card Punch Subsystem, Rear View	7—4
7—4.	0604 Card Punch Subsystem, Power Control Panel	7—5
7—5.	Loading Cards in Hopper	7—8
7—6.	Removing Cards From Hopper	7—10
7—7.	Emptying Chad Container	7—11
7—8.	Clearing Card Jams in Card Track	7—14
7—9.	Clearing Card Jams in Stacker Mechanism	7—19
7—10.	0605 Card Punch Subsystem	7—21
7—11.	0605 Card Punch Subsystem, Operator Control Panel	7—22
7—12.	0605 Card Punch Subsystem, Indicator Panel Located on Processor Operator/Maintenance Panel	7—22
7—13.	0605 Card Punch Subsystem, Front View With Door Open	7—23
7—14.	Loading Cards in Hopper	7—26
7—15.	Unloading Cards From Stacker	7—28
7—16.	0605 Card Punch Subsystem with Top Cover Raised to Show Error Stacker	7—30
7—17.	Clearing Card Jam in Read Station	7—32
7—18.	Clearing Card Jam Behind Card Guide Plate	7—34
7—19.	Clearing Card Jam in Advance Station	7—36
7—20.	Clearing Card Jam in Punch Station	7—39
7—21.	Air Filter Location and Card Feed Path (Cover Raised)	7—47
8—1.	2703 Optical Document Reader Subsystem	8—1
8—2.	2703 Optical Document Reader Subsystem, Operator Control Panel	8—2
8—3.	2703 Optical Document Reader Subsystem, Power Control Panel	8—3
8—4.	2703 Optical Document Reader Subsystem, Power Distribution Panel	8—3
8—5.	Loading Documents in Hopper	8—9
8—6.	Camera Positioning	8—13
8—7.	Document Aligner Adjustment	8—16
8—8.	Removing Documents from Stacker	8—18
8—9.	Clearing Document Jams	8—19
8—10.	Air Filter Locations on Front of Cabinet	8—24
9—1.	0920—02 Paper Tape Subsystem	9—1
9—2.	0920—02 Paper Tape Subsystem, Operator Control Panel	9—2
9—3.	0920—02 Paper Tape Subsystem, Rear View	9—3
9—4.	0920—02 Paper Tape Subsystem, Power Control Panel	9—3
9—5.	Tape Reading	9—9
9—6.	Loading Tape on Punch	9—13
12—1.	Typical System Console Messages	12—5
12—2.	Sample Error Log Summary Report	12—23
12—3.	Typical Job Log Subfile Printout	12—48
B—1.	9200/9300 Series Subsystem	B—1
B—2.	Control Console, Controls and Indicators	B—2

TABLES

1—1.	90/30 and 90/30 B Systems Input/Output Subsystems	1—9
2—1.	Processor Cabinet, Operating Controls and Indicators	2—10
2—2.	Processor Cabinet, Power Switch Settings	2—19
2—3.	Processor Cabinet, Recovery Procedures	2—20
2—4.	System Console, Operating Controls and Indicators	2—25
2—5.	System Console, Recovery Procedures	2—30
2—6.	8541—06 Communications Output Printer, Controls and Indicators	2—33
2—7.	Inking Roll Types Used on COP	2—45
2—8.	8541—06 Communications Output Printer, Recovery Procedures	2—46
2—9.	7024—00/01 External Storage Cabinet, Controls and Indicators	2—55
2—10.	7024—00/01 External Storage Cabinet, Power Switch Settings	2—58
2—11.	7024—00/01 External Storage Cabinet, Power-On Indicators	2—59
2—12.	7024—00/01 External Storage Cabinet, Recovery Procedures	2—59
2—13.	7024—02/03 External Storage Cabinet, Controls and Indicators	2—66
2—14.	7024—02/03 External Storage Cabinet, Power Switch Settings	2—68
2—15.	7024—02/03 External Storage Cabinet, Power-On Indicators	2—68
2—16.	7024—02/03 External Storage Cabinet, Recovery Procedures	2—69
2—17.	1921—00/01 I/O Expansion Cabinet, Controls and Indicators	2—73
2—18.	1921—00/01 I/O Expansion Cabinet, Power Switch Settings	2—75
2—19.	1921—00/01 I/O Expansion Cabinet, Recovery Procedures	2—76
3—1.	5024 Control Unit, Controls and Indicators	3—8
3—2.	8411/8414 Disc Drive Unit, Controls and Indicators	3—12
3—3.	8411/8414 Disc Subsystem, Power Switch Settings	3—13
3—4.	8411/8414 Disc Subsystem, Recovery Procedures	3—17
3—5.	8416 Disc Drive Unit Controls and Indicators	3—21
3—6.	8416 Disc Subsystem, Recovery Procedures	3—24
3—7.	8418 Disc Drive Unit, Controls and Indicators	3—28
3—8.	8418 Disc Subsystem, Recovery Procedures	3—34
3—9.	8416/8418 Auxiliary AC Power Supply, Controls and Indicators	3—37
3—10.	8430 Disc Subsystem Control Unit, Controls and Indicators	3—42
3—11.	8430 Disc Drive Unit, Controls and Indicators	3—45
3—12.	8430 Disc Subsystem, Power Switch Settings	3—46
3—13.	8430 Disc Subsystem, Recovery Procedures	3—49
3—14.	8415 Disc Drive Unit, Controls and Indicators	3—53
3—15.	8415 Disc Subsystem, Recovery Procedures	3—60
3—16.	8413 Diskette Subsystem, Recovery Procedures	3—68
4—1.	UNISERVO VI-C Magnetic Tape Subsystem, Controls and Indicators	4—7
4—2.	UNISERVO VI-C Magnetic Tape Subsystem, Power Switch Settings	4—13
4—3.	UNISERVO VI-C Magnetic Tape Subsystem, Recovery Procedures	4—19
4—4.	UNISERVO 10 or UNISERVO 14 Control Unit, Controls and Indicators	4—25
4—5.	UNISERVO 10 or UNISERVO 14 Tape Unit, Controls and Indicators	4—28
4—6.	UNISERVO 10 or UNISERVO 14 Magnetic Tape Subsystem, Power Switch Settings	4—32
4—7.	UNISERVO 10 or UNISERVO 14 Magnetic Tape Subsystem, Recovery Procedures	4—38
4—8.	5017 Control Unit, Controls and Indicators	4—46
4—9.	UNISERVO 12 Magnetic Tape Unit, Controls and Indicators	4—49
4—10.	UNISERVO 16 Magnetic Tape Unit, Controls and Indicators	4—53
4—11.	UNISERVO 12/16 Magnetic Tape Subsystem, Power Switch Settings	4—56
4—12.	UNISERVO 12/16 Magnetic Tape Subsystem, Recovery Procedures	4—68
4—13.	5034 Control Unit, Controls and Indicators	4—73
4—14.	UNISERVO 20 Tape Unit, Controls and Indicators	4—78

4—15.	UNISERVO 20 Magnetic Tape Subsystem, Power Switch Settings	4—84
4—16.	UNISERVO 20 Magnetic Tape Subsystem, Recovery Procedures	4—90
5—1.	0768 Printer Subsystem, Controls and Indicators	5—6
5—2.	0768 Printer Subsystem, Power Switch Settings	5—12
5—3.	0768 Printer Subsystem, Forms Control Tape Code Designations	5—14
5—4.	0768 Printer Subsystem, Recovery Procedures	5—24
5—5.	0770 Printer Subsystem, Controls and Indicators	5—32
5—6.	0770 Printer Subsystem, Power Switch Settings	5—40
5—7.	Stacker Settings for Standard Forms	5—58
5—8.	Ribbon Types	5—64
5—9.	0770 Printer Subsystem, Recovery Procedures	5—76
5—10.	0773 Printer Subsystem, Controls and Indicators	5—83
5—11.	0773 Printer Subsystem, Power Switch Settings	5—85
5—12.	Ribbon Types	5—98
5—13.	0773 Printer Subsystem, Recovery Procedures	5—104
5—14.	0776 Printer Subsystem, Controls and Indicators	5—110
5—15.	0776 Printer Subsystem, Power Switch Settings	5—112
5—16.	Ribbon Types	5—125
5—17.	0776 Printer Subsystem, Recovery Procedures	5—130
5—18.	0778 Printer Subsystem, Controls and Indicators	5—135
5—19.	0778 Printer Subsystem, Recovery Procedures	5—152
6—1.	0716 Card Reader Subsystem, Controls and Indicators	6—5
6—2.	0716 Card Reader Subsystem, Power Switch Settings	6—9
6—3.	0716 Card Reader Subsystem, Recovery Procedures	6—19
6—4.	0717 Card Reader Subsystem, Controls and Indicators	6—25
6—5.	0717 Card Reader Subsystem, Recovery Procedures	6—39
6—6.	0719 Card Reader Subsystem, Controls and Indicators	6—48
6—7.	0719 Card Reader Subsystem, Recovery Procedures	6—55
7—1.	0604 Card Punch Subsystem, Controls and Indicators	7—5
7—2.	0604 Card Punch Subsystem, Recovery Procedures	7—20
7—3.	0605 Card Punch Subsystem, Controls and Indicators	7—23
7—4.	0605 Card Punch Subsystem, Recovery Procedures	7—41
8—1.	2703 Optical Document Reader Subsystem, Controls and Indicators	8—4
8—2.	2703 Optical Document Reader Subsystem, Power Switch Settings	8—8
8—3.	General Document Characteristics	8—12
8—4.	2703 Optical Document Reader Subsystem, Recovery Procedures	8—21
9—1.	0920—02 Paper Tape Subsystem, Controls and Indicators	9—4
9—2.	0920—02 Paper Tape Subsystem, Power Switch Settings	9—7
9—3.	0920—02 Paper Tape Subsystem, Recovery Procedures	9—17
12—1.	Spool File Directories	12—30
12—2.	Spool File Command Modifiers	12—31
12—3.	Output Writer Function Codes	12—44
B—1.	90/30 and 90/30 B Console Messages for the 9200/9300 Series Subsystem	B—5
B—2.	9200/9300 Control Panel Halt Displays	B—6



PART 1. SYSTEM DEFINITION



1. System Orientation

1.1. GENERAL

The SPERRY UNIVAC 90/30 and 90/30 B Data Processing Systems are general-purpose, disc-oriented computers designed to function in many different data processing environments with equal operating efficiency. This efficiency is achieved through the use of the SPERRY UNIVAC Operating System/3 (OS/3), a multiprogramming software system specifically designed to operate with either computer to make maximum use of the capabilities of the system hardware. The 90/30 system and 90/30 B system have a similar outward appearance. Figure 1-1 illustrates one version of the 90/30 system. Different versions of both systems are assembled from system configurations (1.2).

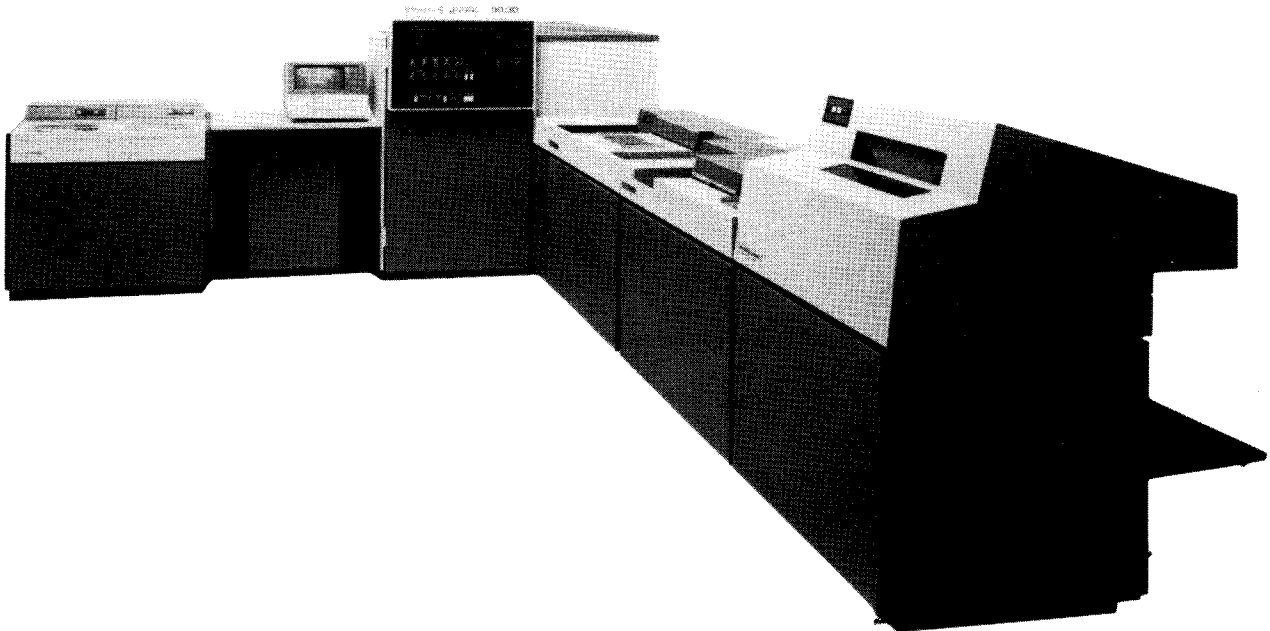

Figure 1-1. 90/30 System

1.2. SYSTEM CONFIGURATION

Diagrams of the basic 90/30 system and its expanded hardware options are presented in Figures 1-2 and 1-3, respectively. The basic and expanded hardware configurations for the 90/30 B system are presented in Figures 1-4 and 1-5, respectively.

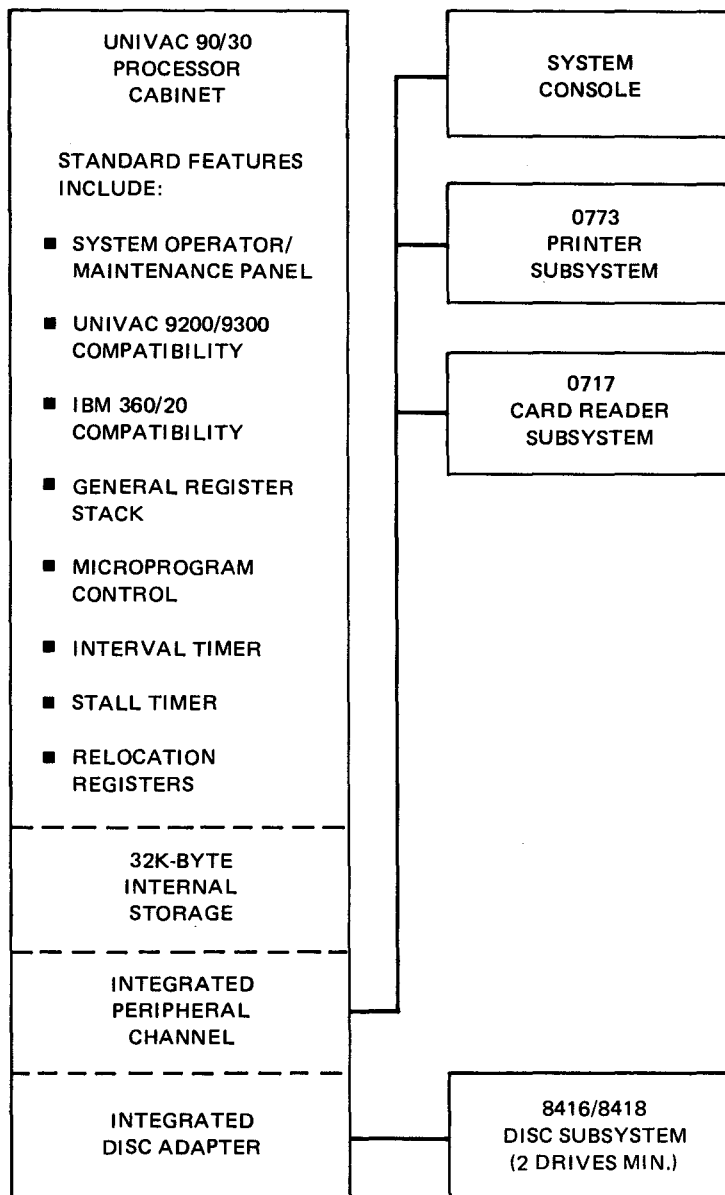

Figure 1-2. Basic 90/30 System Configuration

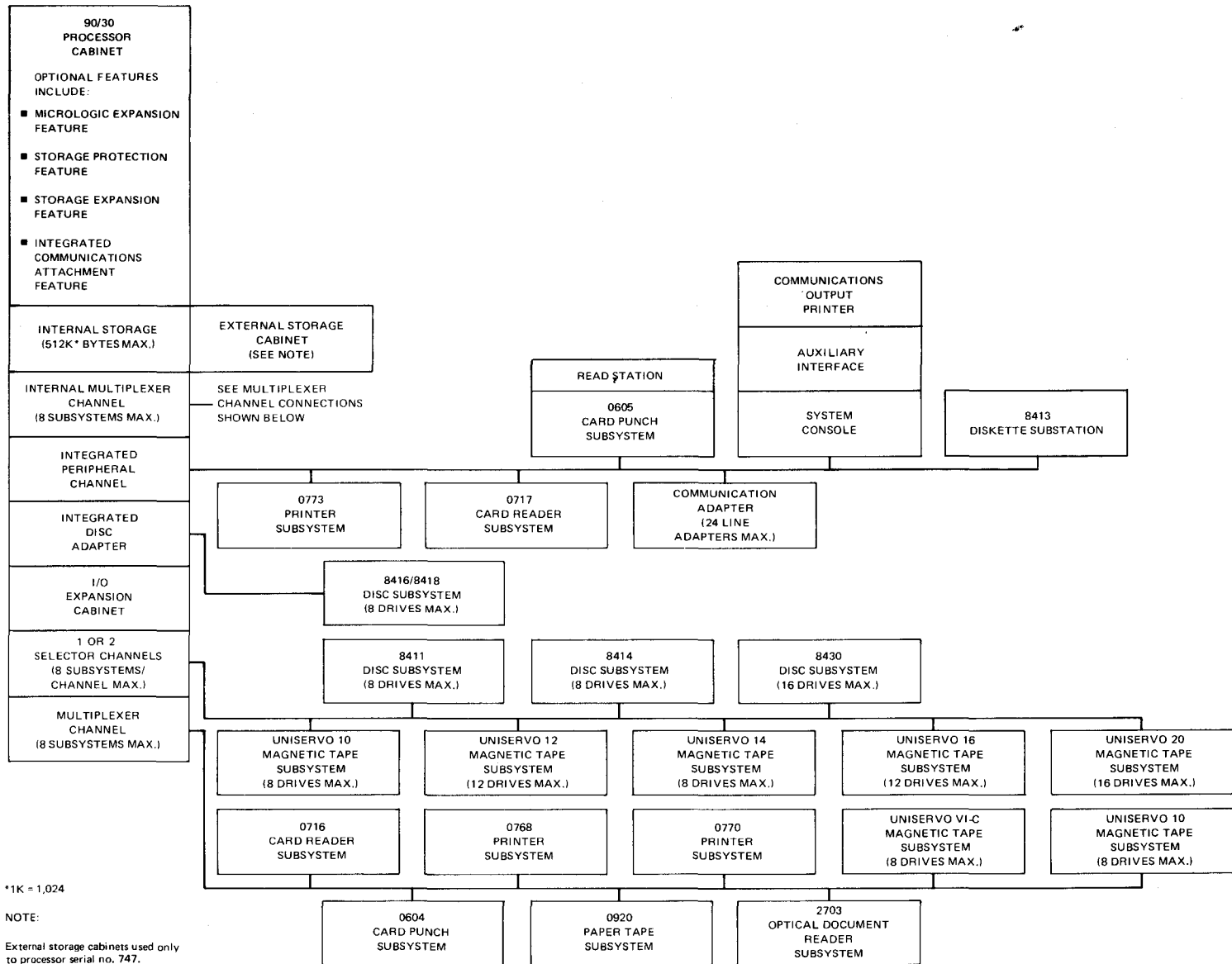

Figure 1-3. 90/30 System With All Hardware Options Shown

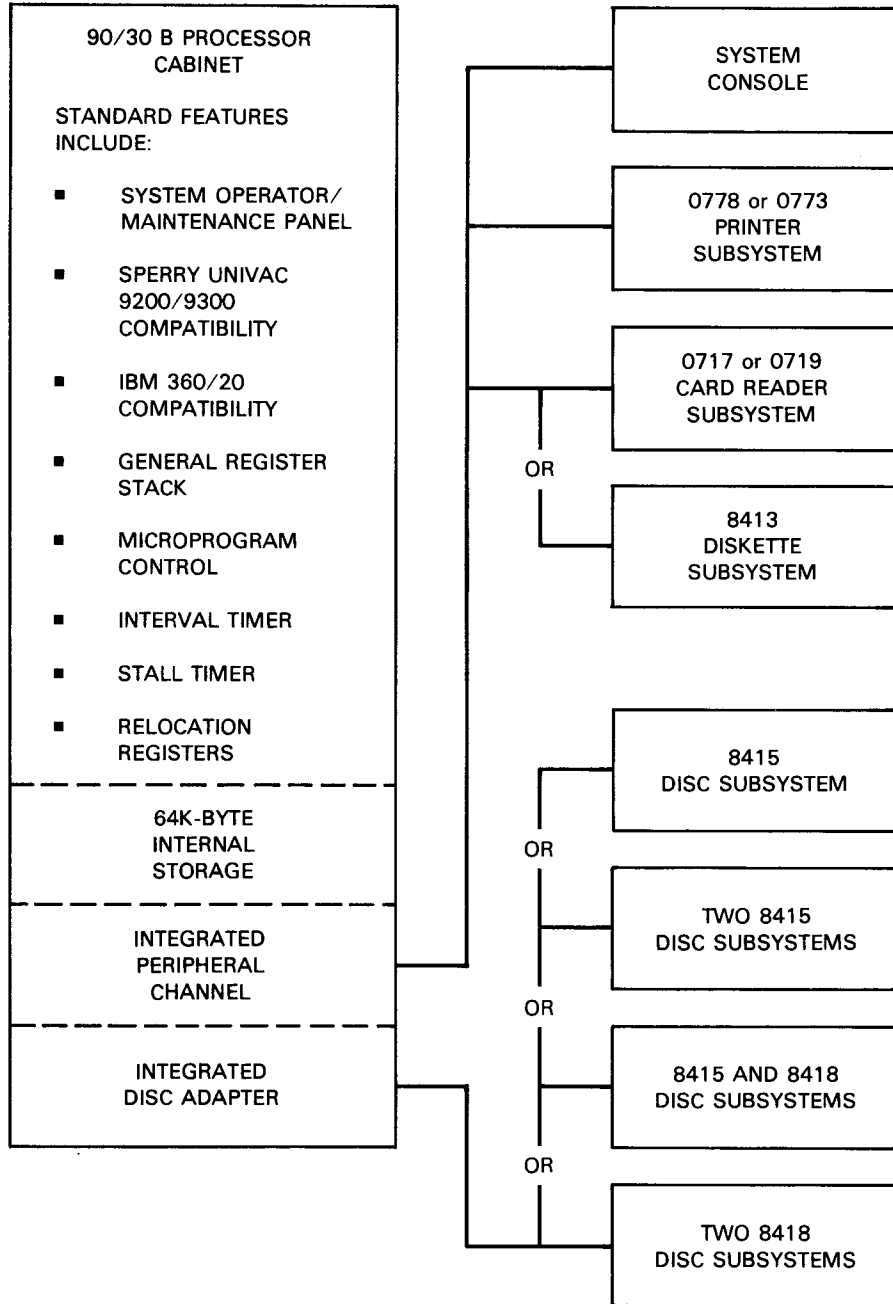
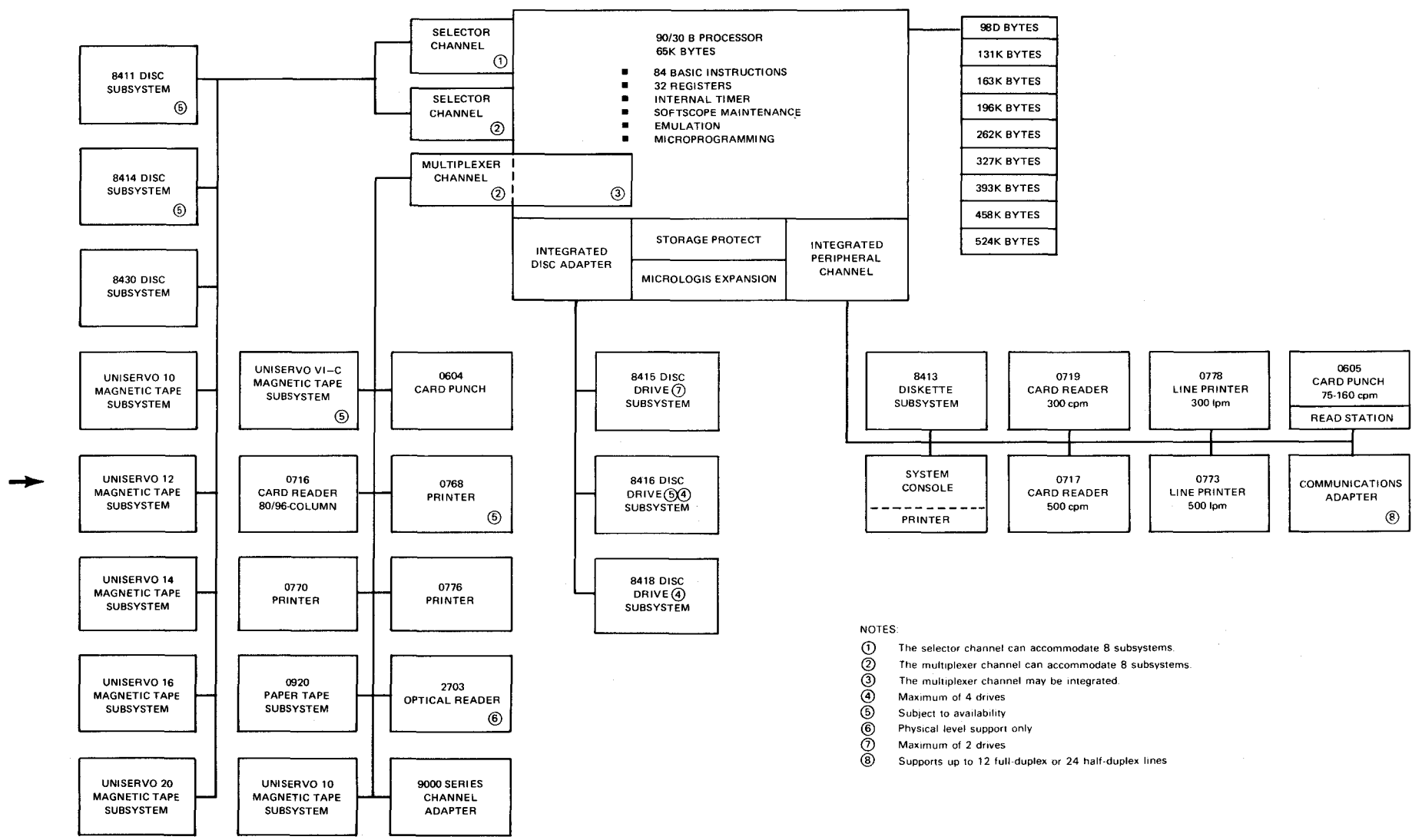

Figure 1-4. Basic 90/30 B System Configuration





- NOTES:
- ① The selector channel can accommodate 8 subsystems.
 - ② The multiplexer channel can accommodate 8 subsystems.
 - ③ The multiplexer channel may be integrated.
 - ④ Maximum of 4 drives
 - ⑤ Subject to availability
 - ⑥ Physical level support only
 - ⑦ Maximum of 2 drives
 - ⑧ Supports up to 12 full-duplex or 24 half-duplex lines

Figure 1-5. 90/30 B System Configuration With All Hardware Options Shown

1.3. CENTRAL HARDWARE

The central hardware of a basic 90/30 or 90/30 B system consists of the processor cabinet and a system console, which is a modified UNISCOPE 100 Display Terminal. The central hardware for a fully expanded 90/30 or 90/30 B system also includes an external storage cabinet, an I/O expansion cabinet, a communications output printer (COP), and the processor cabinet optional features shown in Figures 1—3 and 1—5, respectively. All of the controls and input/output (I/O) channels required to process a job in the system are built into the basic central hardware components. Enhanced system performance is obtained with the addition of the optional features mentioned.

The characteristics of all the central hardware components are briefly described in Table 1—1, and are described in detail in Part 2.

A brief description of each of the functional components comprising the central hardware is provided in 1.3.1 through 1.3.5.2. More detailed descriptions are presented in Section 2.

1.3.1. Processor

The processor is a general-purpose, microprogram-controlled processor that includes the following:

- Basic instruction set
- 32 general registers, 8 working registers, and 8 floating-point registers (optional)
- Interval timer
- Stall timer
- Integrated peripheral channel
- Relocation registers
- Integrated disc adapter
- Operator/maintenance panel
- 32K* bytes main storage (expandable to 512K bytes) on the 90/30 system, or 64K bytes main storage (expandable to 524K bytes) on the 90/30 B system.
- Input/output control section

1.3.1.1. Main Storage

Main storage is of the semiconductor type with a 600-nanosecond half-word read/write cycle time. Main storage is constructed in modular form and is packaged as an internal part of the processor. Periodic refreshing of main storage is required to ensure data integrity. This refreshing of storage occurs automatically within the system. Power losses experienced by the system result in loss of all data in main storage.

*1K = 1,024

1.3.1.2. Input/Output Control Section

The input/output control section initiates, directs, and monitors the transfer of data between main storage and the peripheral subsystems. After an I/O instruction is initiated, the data is transferred autonomously of other processor functions; i.e., the I/O and the processor operate concurrently. The I/O control section is the processor interface to the integrated peripheral channel, the integrated disc adapter, and the selector and multiplexer channels.

1.3.1.3. Integrated Peripheral Channel

The integrated peripheral channel (IPC) coordinates all information transfers between main storage and the integrated peripheral devices: system console, card reader, card punch, printer, diskette subsystem, and communications adapter. The IPC is a half-duplex channel that transfers commands, data, status, and sense information. Input/output activity is initiated by the processor upon issuance of a start I/O instruction to IPC. This instruction results in the transfer of a command to the control logic of a specific peripheral device. The command specifies the type of operation to be performed and is executed on an individual basis. The high transfer rate of the IPC permits simultaneous operation of all integrated peripherals.

1.3.1.4. Integrated Disc Adapter

The integrated disc adapter (IDA) acts as a combination channel and control unit for the integrated disc subsystems. The integrated disc subsystems on the 90/30 system consist of one to eight 8416 or 8418 disc drive units, with any combination of 8416's and 8418's. The integrated disc subsystems on the 90/30 B system consist of at least two 8415 disc drive units and up to four 8416 and four 8418 disc drive units. The IDA is an optional feature because other disc subsystems are available to supply the two minimum disc drive units required.

1.3.1.5. Micrologic Expansion Feature

The micrologic expansion feature provides a repertoire of 64 additional instructions, four registers (each 64 bits long), and expanded control storage. It provides micrologic for execution of 44 floating-point instructions in both long and short, normalized and unnormalized formats, and micrologic for the execution of 20 additional nonprivileged instructions.

1.3.1.6. Storage Protection Feature

The storage protection feature provides read/write protection on access to main storage and two additional privileged instructions (SSK, ISK). It protects up to 524,288 bytes of main storage.

1.3.1.7. Storage Expansion Feature

The storage expansion feature in the 90/30 system provides for increasing the size of internal main storage up to 512K* bytes. Storage expansions can be in either 16K- or 32K-byte increments. In the 90/30 B, the storage expansion feature allows internal main storage to be increased up to 524K bytes, and storage expansion can be in either 32K- or 64K-byte increments.

1.3.1.8. Integrated Communication Adapter Feature

The integrated communication adapter feature provides for interfacing the IPC with a communication adapter.

*1K = 1,024

↓
1.3.1.9. Internal Multiplexer Channel Feature

The internal multiplexer channel feature on the 90/30 system provides I/O capability between the processor and up to eight subsystems with a throughput rate of 83K bytes per second. If the system configuration for the 90/30 system includes an I/O expansion cabinet, this feature cannot be used. The 90/30 B system uses a single multiplexer channel that may or may not be integrated, depending on the system configuration.

↑
1.3.2. System Console

The system console provides the main interface for operator interaction with the processor. The system console is a modified UNISCOPE 100 Display Terminal, which accepts data from the keyboard of the console control unit, displays the data, and transfers the data to the integrated peripheral channel.

Data entered into the keyboard is displayed on the screen in a 64-character-per-line by 16-line format, providing a total display of 1024 characters. Displayable characters consist of the 64-character (including space) ASCII set plus control characters.

↓
1.3.3. Communications Output Printer (COP)

The COP is a freestanding auxiliary output device for the system console. Capable of printing at a maximum rate of 30 characters per second, the COP can produce from one to six printed copies on edge-sprocketed forms 11 inches (27.9 cm) long and 3-5/8 inches (9.19 cm) wide to 14-7/8 inches (37.76 cm) wide. Operation is asynchronous. The COP requires only ac power connection and an interface connection to the system console.

1.3.4. External Storage Cabinet

External storage cabinets are used in early production models of the 90/30 system to extend the main storage capacity of their processor cabinets to 256K bytes. Processor cabinets up to and including serial number 746 can only house up to 128K bytes of main storage. When one of these early processors uses more than 128K bytes of main storage, the first 64K bytes are installed in the processor cabinet, and the remainder, up to 192K, is placed in an external storage cabinet.

All 90/30 systems using more than 256K bytes of main storage have serial number 747 or above. These newer processor cabinets can house up to 512K bytes of main storage, and thus eliminate the need for an external storage cabinet.

The 90/30 B system can house up to 524K bytes without an external storage cabinet.

↑
1.3.5. I/O Expansion Cabinet

The I/O expansion cabinet for either system provides increased processor I/O capability by providing up to two selector channels and one multiplexer channel. Addition of these channels allows standard peripheral subsystems to operate with the system, in addition to the integrated peripheral subsystems.

1.3.5.1. Selector Channels

Each selector channel controls the exchange of information between up to eight subsystems and processor main storage. The selector channels operate in the burst mode. (For example, one of eight possible subsystems retains control of the interface for duration of its I/O operation. Simultaneously, other subsystems can be executing previously initiated operations that do not involve data transfer over the I/O interface.) The processor initiates all I/O operations to the selector channel and the specific subsystem connected to the channel. When the operation is successfully initiated, the channel maintains control of the data transfers between main storage and the subsystem independently of the processor. Upon completion of the I/O operation, the status of the channel and the subsystem is presented to the processor.

1.3.5.2. Multiplexer Channel

The multiplexer channel is similar in operation to the selector channel except that it operates in multiplexed mode. That is, the channel services several concurrently operating subsystems by assigning the input/output interface to a subsystem only long enough to transfer one or a few bytes of information. The multiplexer channel controls up to eight subsystems and initiates all input/output operations by issuing input/output instructions to a selected subchannel and subsystem. When the operation is successfully initiated, the multiplexer channel controls the flow of data between the main storage and the subsystem, independent of the processor. At the completion of the input/output operation, the status of the multiplexer channel is presented to the processor.

1.4. INPUT/OUTPUT SUBSYSTEMS

The I/O subsystems available for use with the 90/30 and 90/30 B systems include disc subsystems, magnetic and paper tape subsystems, high-speed printer subsystem, card reader and punch subsystems, an optical document reader subsystem, and a communications adapter. The specific subsystems and their characteristics are briefly described in Table 1-1. More detailed descriptions of these subsystems, excluding the communications adapter, are presented in appropriate sections throughout the manual. The communications adapter is described in Section 2, along with the processor cabinet in which it is housed.

Table 1-1. 90/30 and 90/30 B Systems Input/Output Subsystems (Part 1 of 4)

Subsystem	Description
Disc Subsystems	
8411 disc subsystem	7.25 million bytes/pack, maximum 58 million bytes/subsystem, maximum 156k bytes/second transfer rate 75 milliseconds average access time
8413 diskette subsystem	242, 944 bytes/diskette 971,776 bytes/subsystem, maximum 83.33 milliseconds average access time
8414 disc subsystem	29.17 million bytes/pack, maximum 233.36 million bytes/subsystem, maximum 312k bytes/second transfer rate 60 milliseconds average access time
8415 disc subsystem	33.1 million bytes/pack, maximum 66.2 million bytes/subsystem, maximum 625k bytes/second transfer rate 33 milliseconds average access time

Table 1-1. 90/30 and 90/30 B Systems Input/Output Subsystems (Part 2 of 4)

Subsystem	Description
Disc Subsystems (cont)	
8416 disc subsystem	28.9 million bytes/pack, maximum 231.7 million bytes/subsystem, maximum 625k bytes/second transfer time 40 milliseconds average access time
8418 disc subsystem	28.95 million bytes/pack, maximum on types 8418-92/93 57.9 million bytes/pack, maximum on types 8418-94/95 231.6 million bytes/system, maximum on types 8418-92/93 463.2 million bytes/system, maximum on types 8418-94/95 625K bytes/second transfer time 38 milliseconds average access time on types 8418-92/93 44 milliseconds average access time on types 8418-94/95
8430 disc subsystem	100 million bytes/pack, maximum 800 million bytes/subsystem, maximum 806k bytes/second transfer rate 27 milliseconds average access time
Magnetic Tapes 7- and 9-Track, Phase and NRZI (cont)	
UNISERVO VI-C Magnetic Tape Subsystem UNISERVO 10 Magnetic Tape Subsystem UNISERVO 12 Magnetic Tape Subsystem UNISERVO 14 Magnetic Tape Subsystem UNISERVO 16 Magnetic Tape Subsystem UNISERVO 20 Magnetic Tape Subsystem	34k bytes/second transfer rate 40k bytes/second transfer rate 68k bytes/second transfer rate 96k bytes/second transfer rate 192k bytes/second transfer rate 320k bytes/second transfer rate
0768 printer subsystem	2000 lines/minute, 14-character set 1600 lines/minute, 46-character set 1200 lines/minute, 64-character set 1000 lines/minute, 87-character set 840 lines/minute, 94-character set
0770 printer subsystem	1435 lines/minute, 24-character set 800 lines/minute, 48-character set Forms advance rate, 50 inches (127 cm)/second 2300 lines/minute, 24-character set 1400 lines/minute, 48-character set Forms advance rate, 75 inches (196.5 cm)/second 3000 lines/minute, 24-character set 2000 lines/minute, 48-character set Forms advance rate, 100 inches (254 cm)/second
0773 printer subsystem	500 lines/minute, 48-character set 400 lines/minute for the 48-character set of a 48-16 combination character set 670 lines/minute for the 16-character set of a 48-16 combination character set 400 lines/minute, 64-character set 310 lines/minute, 85-character set 217 lines/minute for the 96-character set of a 96-16-16 combination character set

Table 1—1. 90/30 and 90/30 B Systems Input/Output Subsystems (Part 3 of 4)

Subsystem	Description
Magnetic Tapes 7- and 9-Track, Phase and NRZI (cont)	
0773 printer subsystem (cont)	500 lines/minute for the 16-16 character set of a 96-16-16 combination character set 217 lines/minute, 128-character set 114 lines/minute, 256-character set
0776 printer subsystem 0776-00/01	115 lines/minute, 384-character set 225 lines/minute, 192-character set 325 lines/minute, 128-character set 420 lines/minute, 96-character set 600 lines/minute, 64-character set 760 lines/minute, 48-character set 1030 lines/minute, 32-character set 1090 lines/minute, 24-character set
0776-02	150 lines/minute, 384-character set 290 lines/minute, 192-character set 420 lines/minute, 128-character set 540 lines/minute, 96-character set 750 lines/minute, 64-character set 940 lines/minute, 48-character set 1250 lines/minute, 32-character set 1250 lines/minute, 24-character set
0776-03	145 lines/minute, 384-character set 280 lines/minute, 192-character set 400 lines/minute, 128-character set 520 lines/minute, 96-character set 730 lines/minute, 64-character set 900 lines/minute, 48-character set 1220 lines/minute, 32-character set 1250 lines/minute, 24-character set
Card Punches	
0604 card punch subsystem	80 columns, 250 cards/minute
0605 card punch subsystem	80 columns, 75 cards/minute 28 columns, 160 cards/minute
Card Readers	
0716 card reader subsystem	51/66/80 columns, 600 or 100 cards/minute
0717 card reader subsystem	51/66/80 columns, 500 cards/minute
Optical Document Reader	
2703 optical document reader	330 documents/minute, documents 4 inches in length 380 documents/minute, documents 3 inches in length
Paper Tape Subsystem	
0920 paper tape subsystem	Reading, 5-, 6-, 7, or 8-track perforated paper tape, 300 characters/second. Punching, 110 characters/second

Table 1—1. 90/30 and 90/30 B Systems Input/Output Subsystems (Part 4 of 4)

Subsystem	Description
Communication Interfaces	
F1625 communication adapter	Supports up to 12 half-duplex or 6 full-duplex communication lines at speeds up to 56k bits/second
F2121 dual communication attachment	With this dual communication attachment, the communication adapter supports up to 24 half-duplex and 12 full-duplex communication lines.

1.5. OPERATING SYSTEM

- Operating System/3 (OS/3) is used with the 90/30 and 90/30 B systems. OS/3 (Figure 1—6) is composed of a group of major programs: supervisor, job control, data management, data communications, language processors, service programs, emulators, and diagnostics.

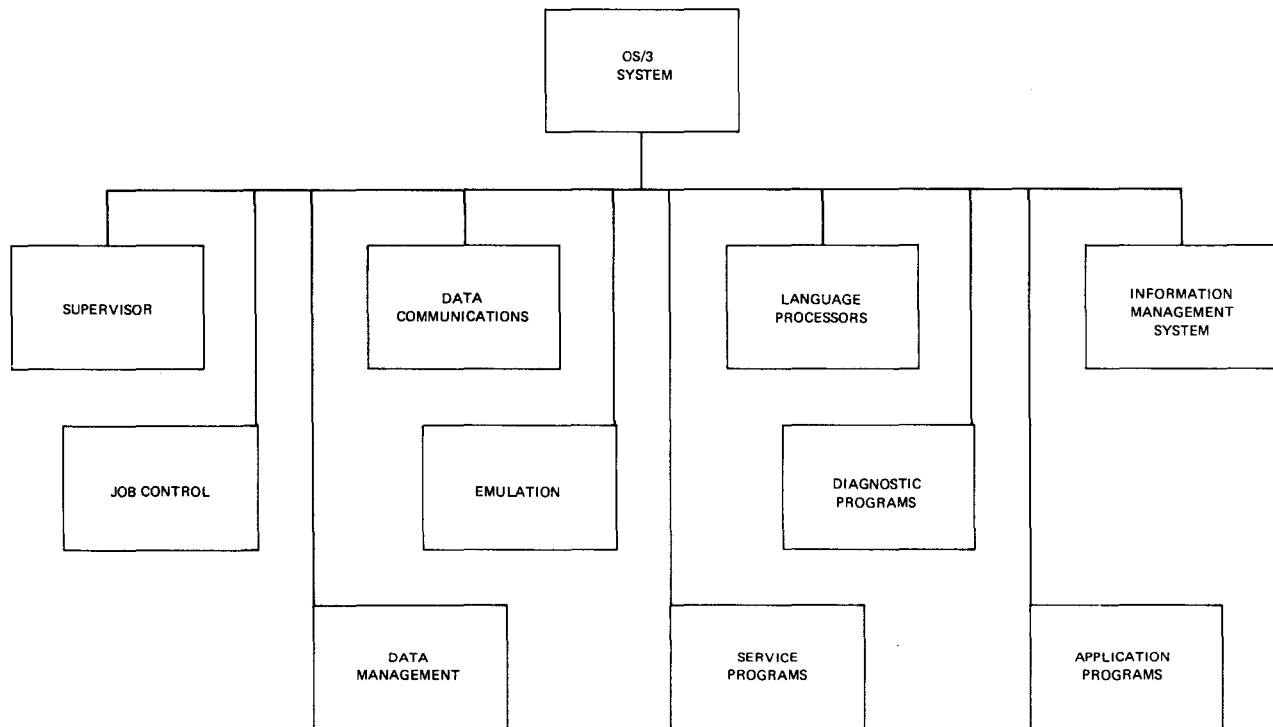

Figure 1—6. Operating System/3 Components

1.5.1. Supervisor

The supervisor is the part of the operating system that interfaces with the user programs to provide the necessary control for the optimum utilization of the system hardware and software. It controls the physical I/O operations, system resource allocation on a dynamic basis, task switching to achieve multitasking, hardware interrupt servicing, communications with the system operator, and interface to user programs with the system hardware. To accomplish this, the supervisor is composed of the following program elements:

- Interrupt control
- Priority control
- Transient control
- Physical I/O controls
- Resource allocation
- Task control
- Interrupt timer and day clock services
- Program management
- System console management
- File services
- Program error handling
- Cooperative/symbiont operations
- Physical input/output control system (PIOCS)
- Debugging aids

1.5.2. Job Control

Job control is a nonresident program of the operating system responsible for controlling the orderly initiation and termination of jobs within a multiprogrammed environment. The job control services are performed prior to execution of the initial job step of a job, during the transition between job steps, and at the conclusion of a job. Some of the services of job control are:

- Volume label and file label storage
- Job control stream file maintenance
- Job scheduling by priority
- Main storage allocation and reallocation
- Peripheral device assignment
- Program restart

The functions of job control are implemented by the programmer through the job control language or by the operator through the system console commands. These sequenced control statements form the control stream that defines a job's facility requirements and directs the execution of the job. The job control statements, through the job control stream, function as an interface between the programmer and OS/3.

1.5.3. Data Management

Data management provides the interface between the hardware-oriented I/O facility and the user program. The data management facilities consist of logical input/output control stream (IOCS) modules, transient routines, declarative macro instructions, and imperative macro instructions.

1.5.4. Integrated Communication Access Method

The communication software necessary to support remote terminals or processors is controlled by two logical levels of software. These levels are:

- the communications physical input/output control system (CPIOCS) and the communication symbionts; and
- the message control program (MCP).

There are four user levels (interfaces) which communicate with the logical control levels via declarative and imperative macro instructions. These are:

- CPI — communications physical interface
- DDI — direct data interface
- STDMCP — standard GET/PUT interface
- TCI — transaction control interface

1.5.5. Emulators

There are two emulation programs that adapt the instruction repertoire and peripheral characteristics of existing systems to OS/3. The IBM 360/20 emulator allows existing 360/20 programs to be executed on the 90/30 or 90/30 B system. The 9200/9300 emulator allows existing 9200/9300 programs to be executed on the 90/30 or 90/30 B system.

1.5.6. Service Programs

The OS/3 service programs make available to the system the means for sorting data into a specified order, merging data to facilitate processing, maintaining files on magnetic disc storage, and linking output modules of language processors into executable programs.

1.5.7. Language Processors

Four language processors are available with OS/3: assembler, COBOL, FORTRAN, and report program generator (RPG). All language processor input can be on punched cards, magnetic tape, or disc files; all output can be recorded on magnetic tape or disc files. All processor output is in a common system output format.

1.5.8. Diagnostic Programs

The diagnostic programs provided with OS/3 are hardware maintenance routines that can be executed concurrently with user programs. These programs are intended to be run as confidence tests by the system operator, and as diagnostic and maintenance tests by the customer engineer.

1.5.9. Application Programs

Application programs are those specialized programs that are available to a user but are not provided as part of the standard software package. These programs are directed towards handling problems distinctive to a particular user and include program evaluation and review techniques/critical path method analysis (PERT/CPM) and linear programming (LP).

1.5.10. Information Management System

The information management system (IMS/90) used with OS/3 is common to the 9000 series and facilitates access to information stored in data files. IMS/90 provides a terminal-oriented data retrieval and update capability for managerial and clerical personnel and, thereby, relieves them of needing to learn complex methods employed by programming personnel.



PART 2. HARDWARE CHARACTERISTICS



2. Central Hardware

2.1. PROCESSOR CABINET

The processor cabinet (Figure 2—1) for the SPERRY UNIVAC 90/30 and 90/30 B Systems is similar in appearance and function. The cabinet houses the arithmetic and control logic circuits of the central processor unit, 131K bytes of main storage, the integrated disc adapter (IDA), integrated peripheral channel (IPC), and optionally, the integrated communication adapter and internal multiplexer channel. It also contains the operator/maintenance panel, from which most of the system operations are controlled. The integrated communications adapter housing unit also doubles as a deck for the system console.

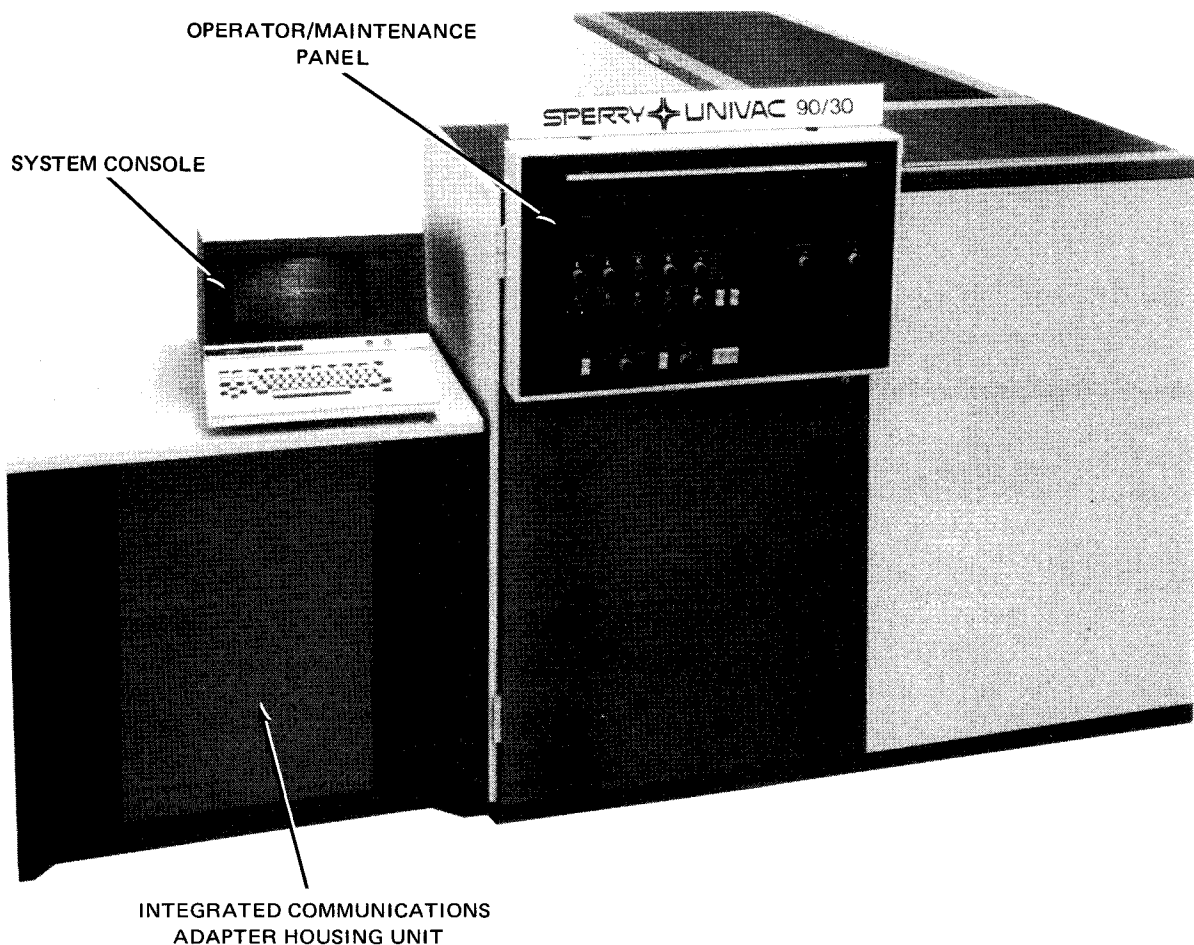

Figure 2—1. 90/30 System Processor Cabinet (Front View)



2.1.1. Operating Controls and Indicators

The operator/maintenance panel (Figure 2—2) on the 90/30 system is identical to that used on the 90/30 B system, except for the nameplate above the panel.

The 90/30 system processor power supplies and power control panel are located on the right side, behind the cabinet doors (Figure 2—3). The 90/30 system power supplies (Figure 2—4) and power control panel (Figure 2—5) provide operating power for the processor and main storage.

The 90/30 B system processor power supplies, power control panel, and power distribution panel are located on the right side, behind the cabinet doors (Figure 2—6). The 90/30 B system power supplies (Figure 2—7), power control panel (Figure 2—8), and power distribution panel (Figure 2—9) provide operating power for the 90/30 B processor and main storage.

The integrated communications adapter (ICA) for the 90/30 and 90/30 B systems is located adjacent to the processor cabinet, beneath the system console (Figure 2—1). A dc power indicator and circuit breaker for the ICA used on both systems are located behind the front and rear cabinet doors, respectively (Figure 2—10).

Operating controls and indicators of the processor cabinet are listed and described for the 90/30 system and 90/30 B system in Table 2—1.



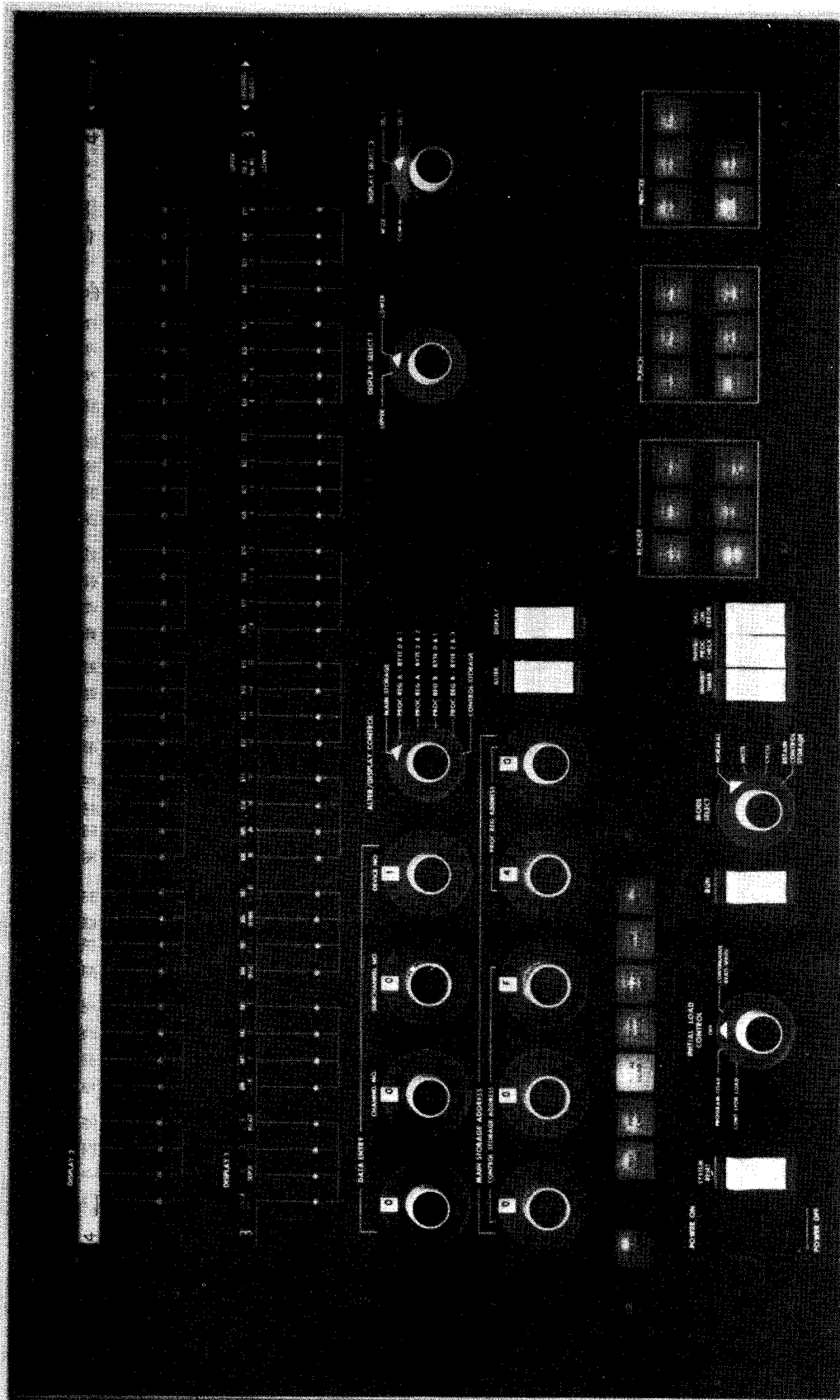

Figure 2-2. 90/30 System Processor Cabinet, Operator/Maintenance Panel



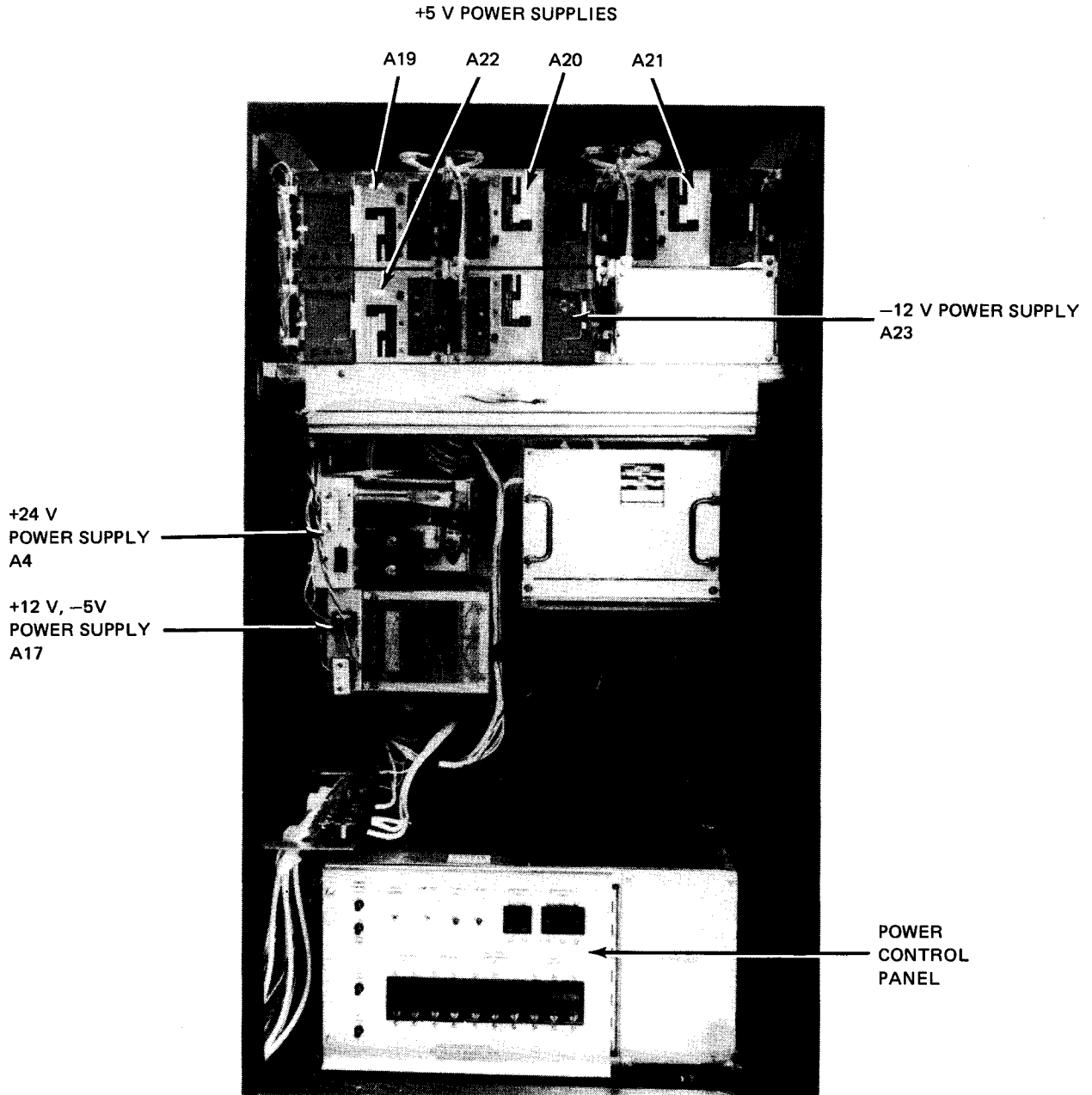

Figure 2-3. 90/30 System Processor Cabinet, Right Side View (Doors Open)



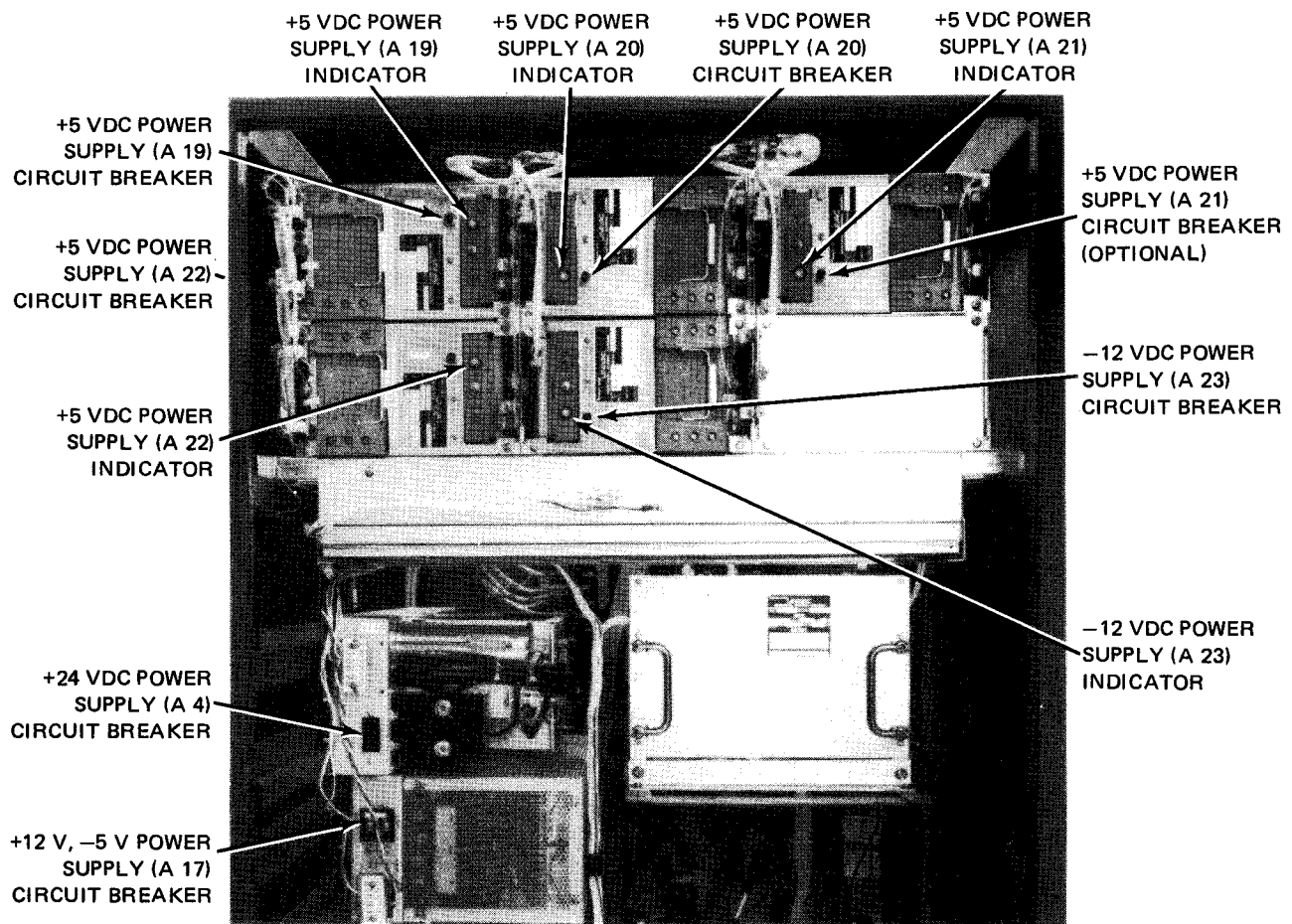

Figure 2-4. 90/30 System Processor Cabinet, Power Supplies

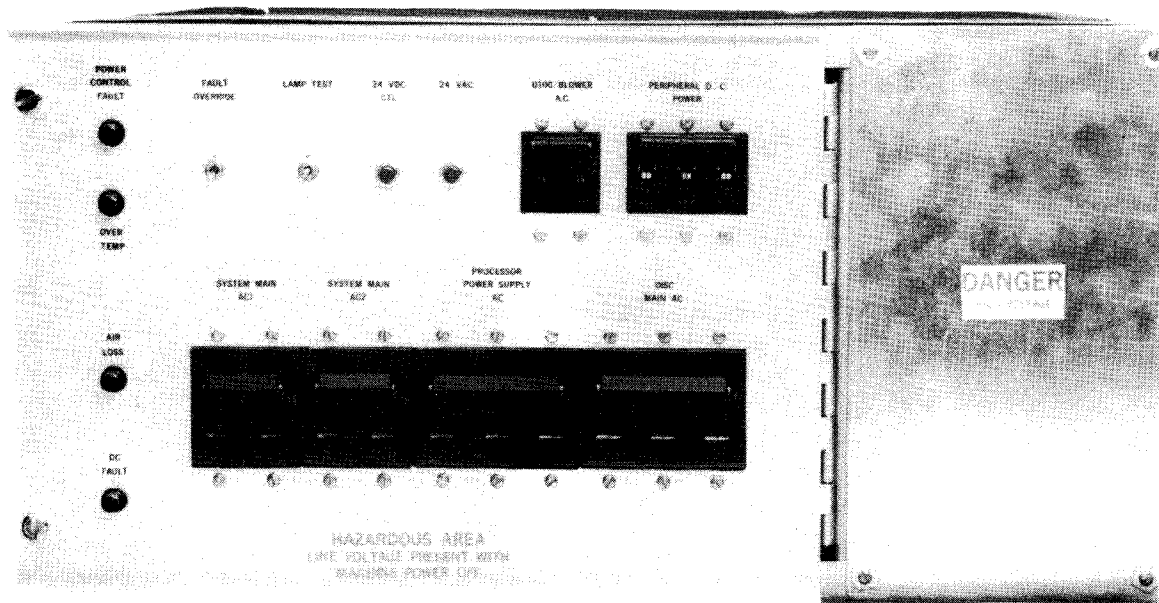

Figure 2-5. 90/30 System Processor Cabinet, Power Control Panel

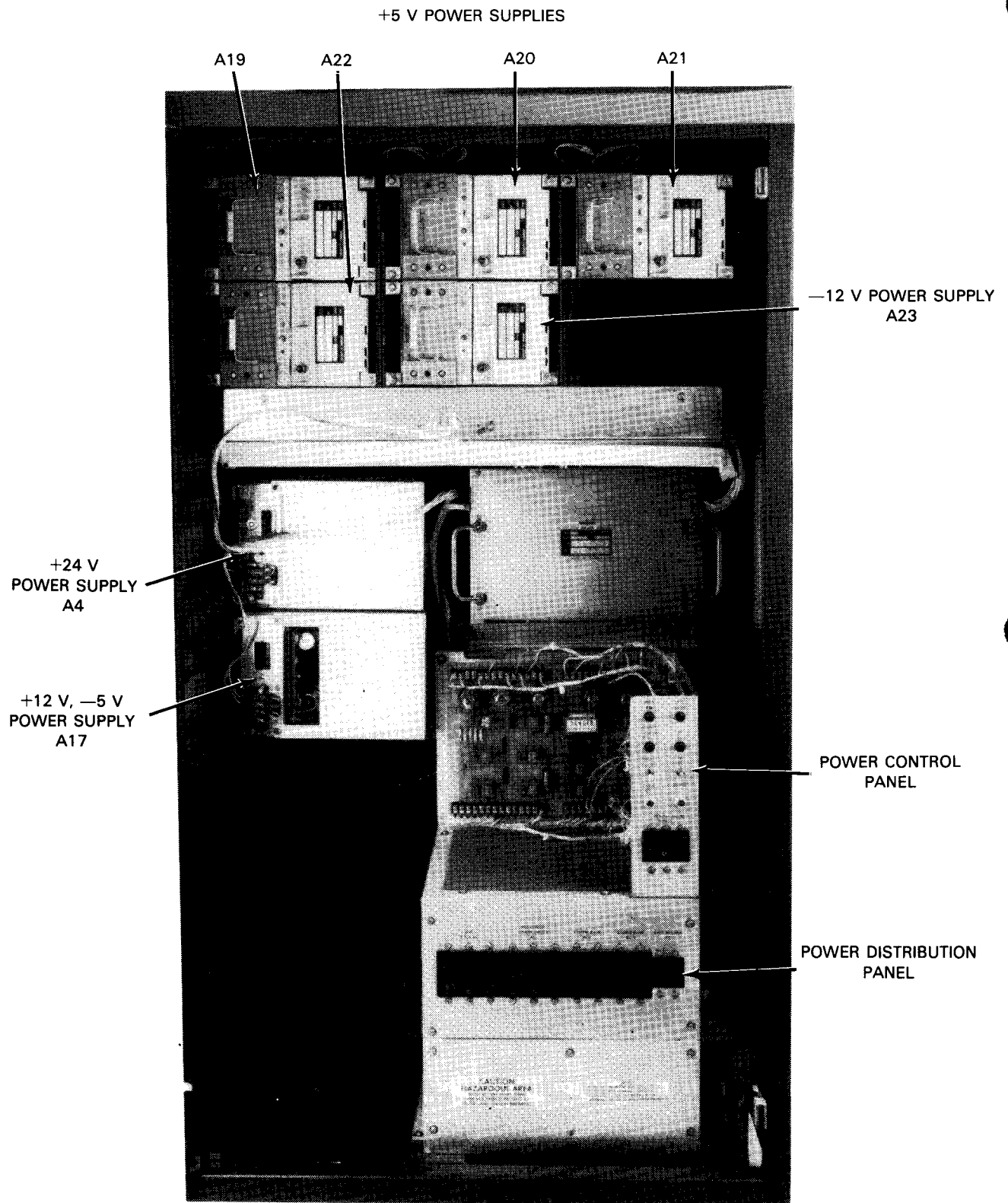

Figure 2-6. 90/30 B System Processor Cabinet, Right Side View (Doors Open)

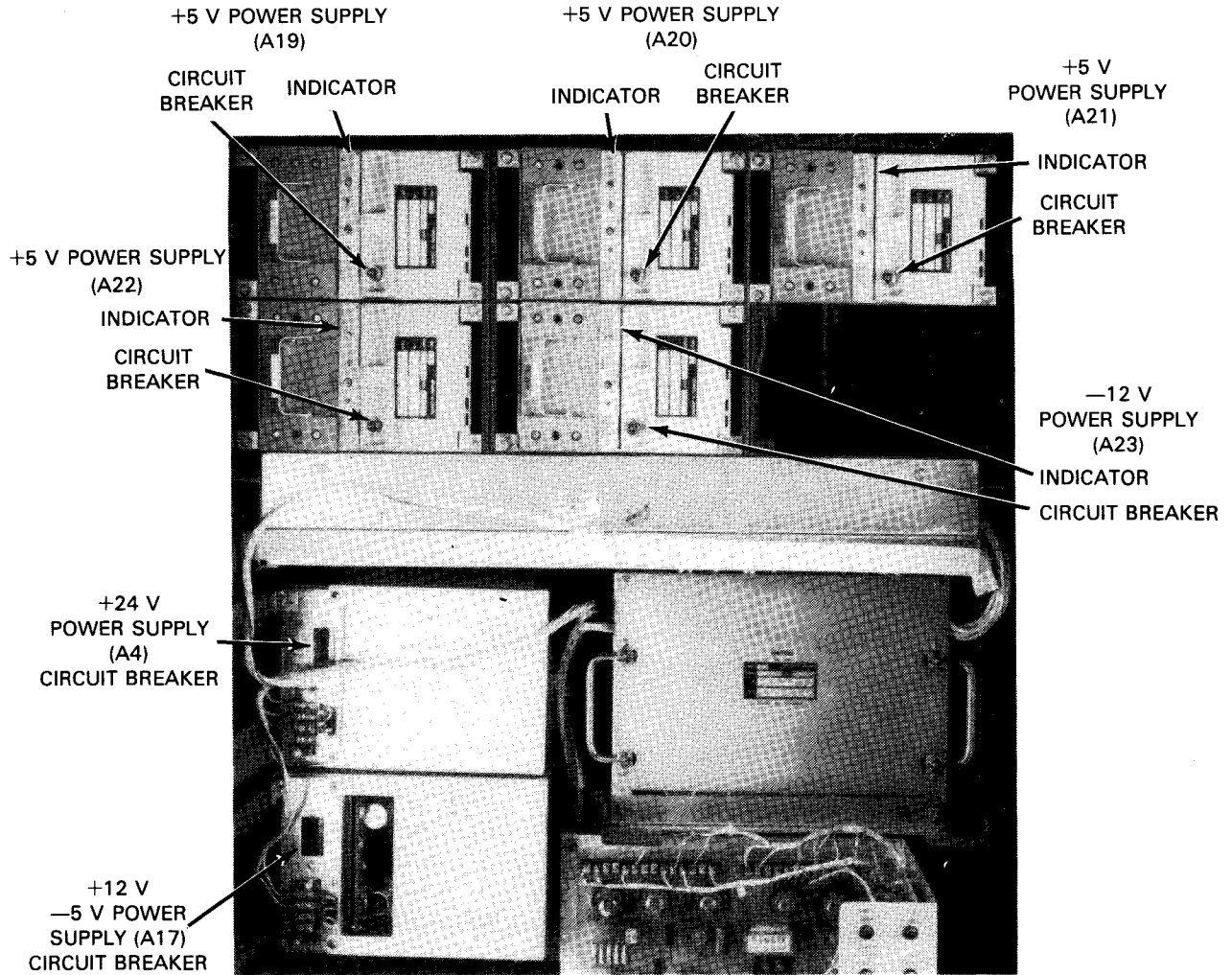

Figure 2-7. 90/30 B System Processor Cabinet, Power Supplies

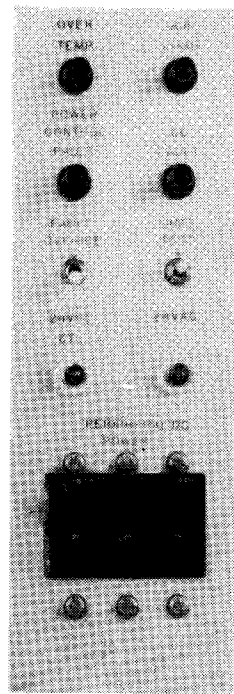

Figure 2-8. 90/30 B System Processor Cabinet, Power Control Panel

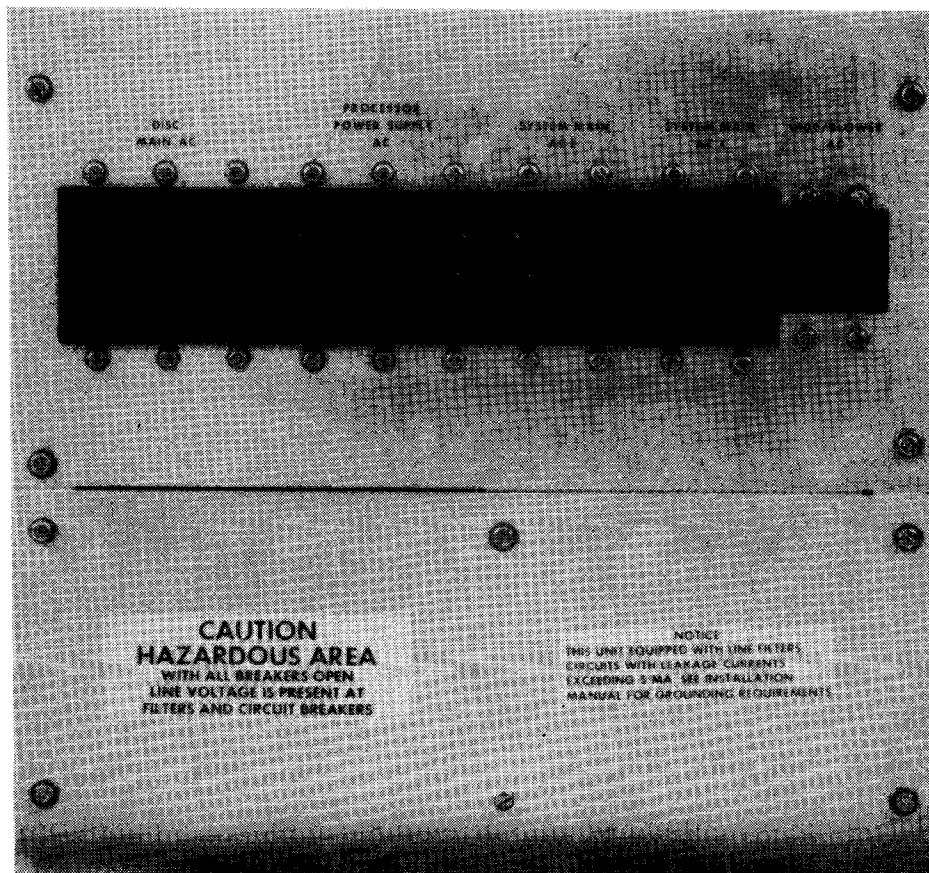
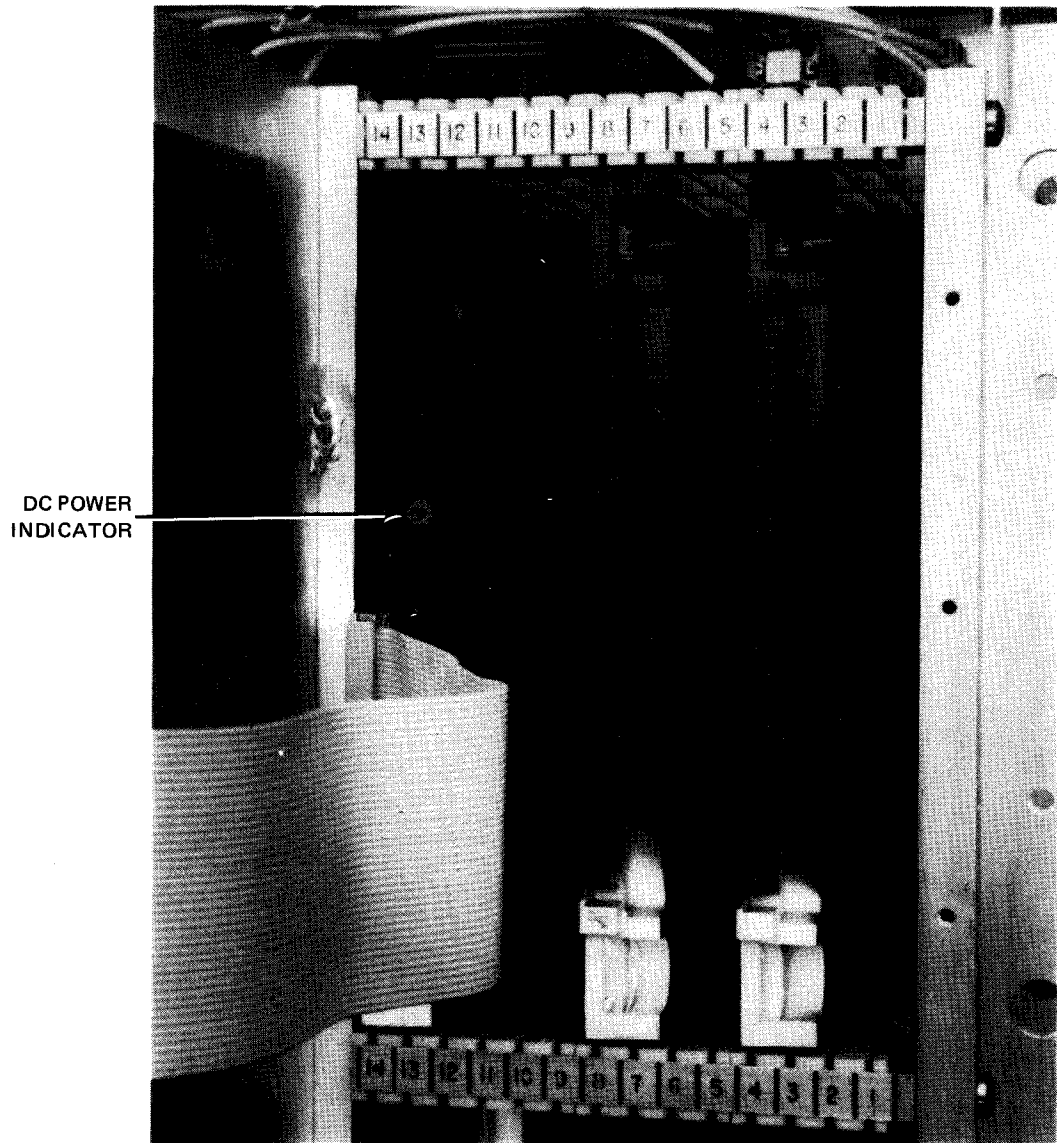
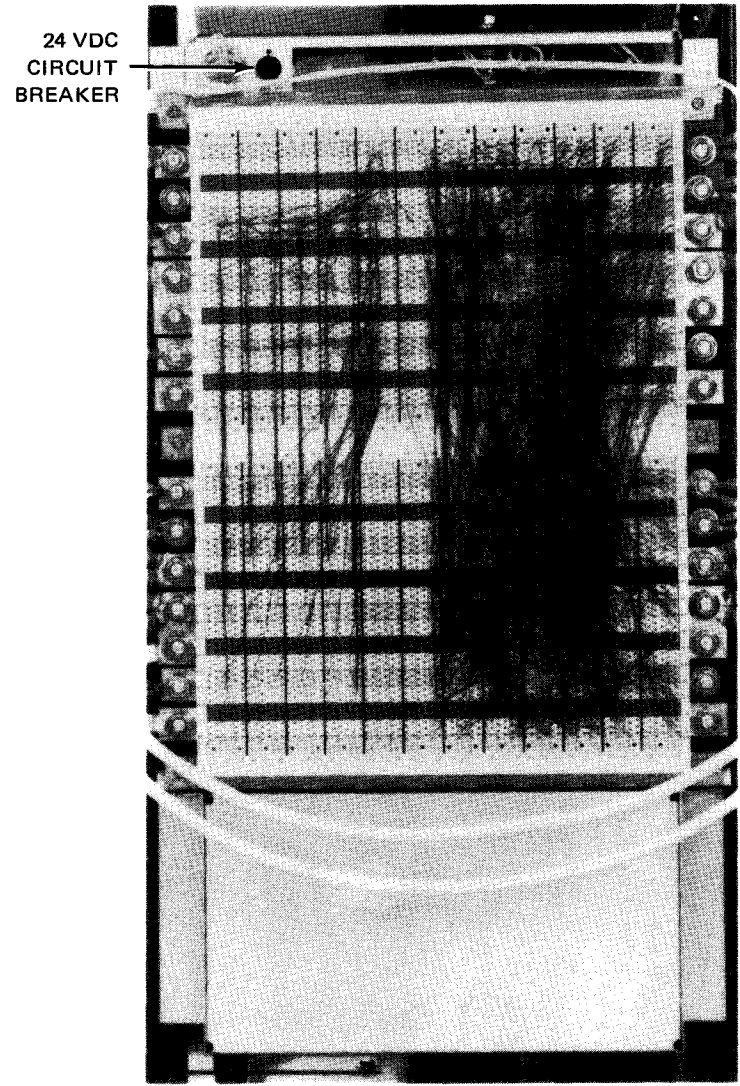

Figure 2-9. 90/30 B System Processor Cabinet, Power Distribution Panel



a. Front view of communications adapter
located under the system console portion of processor cabinet



b. Rear view of communications adapter
located under the system console portion of processor cabinet

Figure 2-10. Location of Integrated Communications Adapter Circuit Breaker and Indicator

Table 2—1. Processor Cabinet, Operating Controls and Indicators (Part 1 of 9)

Control/Indicator — Function
90/30 and 90/30 B Systems Operator/Maintenance Panel
DISPLAY 2 indicators Display the contents of a selected location in the multiplexer, selector, or communication intelligence channel (CIC). Each indicator represents one bit. Each position on the roll chart legend represents a specific logic signal. Selection of the location to be displayed is controlled by the LEGEND SELECT 2 and DISPLAY SELECT 2 switches. The upper legend positions display the contents of the selector channels, and the lower legend positions display the contents of the multiplexer channel. The display of the CIC has not been assigned. This display is only provided when one or more of the following items is configured in the system: I/O expansion cabinet, CIC cabinet, or internal multiplexer channel.
LEGEND SELECT 2 switch In conjunction with the DISPLAY SELECT 2 switch, selects the logic signals to be displayed by the DISPLAY 2 indicators . The DISPLAY 2 roll chart is connected directly to this switch.
DISPLAY 1 indicators Display the contents of a selected location in control storage or main storage, a processor register, or the state of selected logic signals in the integrated disc adapter or the integrated peripheral channel. Each indicator represents one bit. Each position on the roll chart legend represents a specific logic signal. Selection of the location to be displayed is controlled by the LEGEND SELECT 1 , DISPLAY SELECT 1 , and ALTER/DISPLAY CONTROL switches.
LEGEND SELECT 1 switch In conjunction with the DISPLAY SELECT 1 and ALTER/DISPLAY CONTROL switches, selects the logic signals to be displayed on DISPLAY 1 indicators. The DISPLAY 1 roll chart is connected directly to this switch.
DATA ENTRY switches A set of four 16-position, hexadecimal-encoded switches used to select the channel, subchannel, and device for the initial program load operation. Also used when performing a storage or processor register alter operation. They represent the two bytes of data that are to be transferred into the location identified by the setting of the ALTER/DISPLAY CONTROL and either MAIN STORAGE ADDRESS or PROC REG ADDRESS switches. The ALTER switch actuates the transfer of data.
ALTER/DISPLAY CONTROL switch Selects the processor register or storage location to be altered or displayed. Used in conjunction with the LEGEND SELECT 1 , and DISPLAY switches, and either MAIN STORAGE ADDRESS , CONTROL STORAGE ADDRESS , or PROC REG ADDRESS switches for the display function. The contents of the selected location are displayed on the DISPLAY 1 indicators. Used in conjunction with the DATA ENTRY and ALTER switches, and either the MAIN STORAGE ADDRESS or PROC REG ADDRESS switches for the alter function.
DISPLAY SELECT 1 switch Selects whether the upper or lower legend positions selected by the LEGEND SELECT 1 switch are to be displayed on the DISPLAY 1 indicators.
DISPLAY SELECT 2 switch Selects whether the upper (selector channels) or lower (multiplexer channel) legend positions selected by the LEGEND SELECT 2 switch are to be displayed on the DISPLAY 2 indicators.

Table 2-1. Processor Cabinet, Operating Controls and Indicators (Part 2 of 9)

Control/Indicator — Function
90/30 and 90/30 B Systems Operator/Maintenance Panel (cont)
MAIN STORAGE ADDRESS switches A set of five 16-position hexadecimal-encoded switches whose settings select a main storage location to be displayed or altered. Used in conjunction with the LEGEND SELECT 1 , ALTER/DISPLAY CONTROL , DISPLAY SELECT 1 , and DISPLAY switches for display of the selected main storage location. The contents of the selected main storage location are displayed on the DISPLAY 1 indicators. Used in conjunction with the DATA ENTRY , ALTER/DISPLAY CONTROL , and ALTER switches for altering a selected main storage location.
CONTROL STORAGE ADDRESS switches A set of three 16-position hexadecimal-encoded switches whose settings select a control storage location to be displayed. Used in conjunction with the LEGEND SELECT 1 , ALTER/DISPLAY CONTROL , DISPLAY SELECT 1 , and DISPLAY switches. The contents of the selected control storage location are displayed on the DISPLAY 1 indicators. Control storage cannot be altered.
PROC REG ADDRESS switches A set of two 16-position hexadecimal-encoded switches whose settings select a processor register to be displayed or altered. Used in conjunction with the LEGEND SELECT 1 , ALTER/DISPLAY CONTROL , DISPLAY SELECT 1 , and DISPLAY switches to display the selected processor register. The contents of the selected processor register are displayed on the DISPLAY 1 indicators. Used in conjunction with the DATA ENTRY , ALTER/DISPLAY CONTROL , and ALTER switches to alter a selected processor register.
ALTER switch Transfers the data specified by the setting of the DATA ENTRY switches into the storage location or processor register selected by the ALTER/DISPLAY CONTROL and either the MAIN STORAGE ADDRESS or PROC REG ADDRESS switches. Control storage cannot be altered.
DISPLAY switch Causes the contents of the main storage location, control storage location, or processor register selected by LEGEND SELECT 1 , ALTER/DISPLAY CONTROL , and either the MAIN STORAGE ADDRESS , CONTROL STORAGE ADDRESS , or PROC REG ADDRESS switches to be displayed on the DISPLAY 1 indicators.
POWER CYCLING indicator Lights when initializing power to the system. Goes out when the power-up sequence is complete.
POWER ON indicator Lights when power is applied to the system.



Table 2-1. Processor Cabinet, Operating Controls and Indicators (Part 3 of 9)

Control/Indicator — Function	
90/30 and 90/30 B Systems Operator/Maintenance Panel (cont)	
TEST MODE indicator	
Lights when the processor is in a nonrun mode of operation. Setting any of the following switches to any of the indicated positions lights this indicator.	
<u>Switch</u>	<u>Position</u>
1. INITIAL LOAD CONTROL	a. CONTROL STOR LOAD b. PROGRAM LOAD c. CONTINUOUS READ-WRITE
2. MODE SELECT	a. INSTR b. CYCLE c. RETAIN CONTROL STORAGE
3. INHIBIT TIMER	On
4. INHIBIT PROC CHECK	On
5. HALT ON ERROR	On
6. FAULT OVERRIDE (on power control panel)	On
PROC CHECK indicator	
Lights when a nonrecoverable error is detected or when an error is detected during processor operation in the halt-on-error mode	
INITIAL LOAD indicator	
Lights when the initial control storage load or initial program load is in progress. Goes out when loading is successfully completed.	
TEMP CHECK indicator	
Lights when excessive heat has been detected in the processor cabinet. A buzzer sounds. The buzzer also sounds when excessive heat has been detected in the printer, card punch, diskette subsystem, or card reader connected to the integrated peripheral channel. In this instance, however, the TEMP CHECK indicator does not light. The buzzer keeps sounding until the excessive heat condition is corrected.	
CONTROL STORAGE CHECK indicator	
Lights when a control storage addressing exception or a nonrecoverable error caused by a control storage parity check is detected	

Table 2-1. Processor Cabinet, Operating Controls and Indicators (Part 4 of 9)

Control/Indicator — Function
90/30 and 90/30 B Systems Operator/Maintenance Panel (cont)
HPR STOP indicator Lights when the processor stops: <ol style="list-style-type: none">1. under control of a halt and proceed instruction;2. at a display point; or3. under the following conditions:<ol style="list-style-type: none">a. The system was reset.b. The processor was set to operate in the halt-and-proceed instruction mode.c. Loading of control storage was completed.d. An unused location of control storage was addressed.
RUN indicator Lights during system processing, after system reset, during instruction mode operation, during initial control storage load, or during initial program load
POWER ON/POWER OFF switch Controls power application to and from the system
SYSTEM RESET switch Clears all current system functions; processor, integrated, and external input/output channels; and online subsystems
INITIAL LOAD CONTROL switch Selects whether control storage or main storage is to be loaded. During normal operation, this switch is set to OFF . The CONTINUOUS READ-WRITE position is for use by the Sperry Univac customer engineer only.
RUN switch Initiates processor in the selected mode
MODE SELECT switch Controls the processor mode of operation. Is set to NORMAL for standard operation. Processing is stopped by setting this switch to INSTR .
INHIBIT TIMER switch Disables the interval timer
INHIBIT PROC CHECK switch For use by the Sperry Univac customer engineer only
HALT ON ERROR switch Immediately halts processor operation when a machine check or channel error condition occurs. Causes the main storage to operate in the storage hold mode.

Table 2-1. Processor Cabinet, Operating Controls and Indicators (Part 5 of 9)

Control/Indicator — Function
90/30 and 90/30 B Systems Operator/Maintenance Panel (cont)
<p>READER indicators</p> <p>Indicate the status of the IPC card reader subsystem</p> <p>DEVICE CHECK Lights when an interlock opens, a reader lamp is overheating, or a high temperature condition in the card reader assembly is detected</p> <p>FEED CHECK Lights when a card jam occurs in the card path or in the stacker. The card reader immediately stops.</p> <p>READ CHECK Lights when a read or overrun error occurs. The card reader immediately stops.</p> <p>HOPPER Lights when a card fails to reach the read station or when the hopper is empty. The card reader immediately stops.</p> <p>TRANSFER CHECK Lights when a card is fed through the card reader without a feed signal issued. The misfed card is the last card in the stacker or card path. The card reader immediately stops.</p> <p>VALIDITY CHECK Lights when multiple punches in rows 1 through 7 are detected during operation in the translate mode. The card reader immediately stops.</p> <p>PUNCH indicators</p> <p>Indicate the status of the IPC card punch subsystem</p> <p>DEVICE CHECK Lights when an interlock opens, or when an actuator overheat failure or high temperature condition in the card punch is detected. The card punch stops immediately when an open interlock is detected.</p> <p>FEED CHECK Lights when a card jam occurs in the card path or in the stacker. The card punch immediately stops.</p> <p>PUNCH CHECK Lights during card punch operation under the read/punch or stop on error mode when a column has been punched incorrectly or an overrun error occurs. The card punch immediately stops.</p> <p>HOPPER Lights when a card fails to feed into the advance station or when the hopper is empty. The card punch immediately stops.</p> <p>READ CHECK Lights when a read or overrun error occurs. The card punch immediately stops.</p> <p>VALIDITY CHECK Lights when multiple punches in rows 1 through 7 are detected during operation in the translate mode. The card punch immediately stops.</p>

Table 2-1. Processor Cabinet, Operating Controls and Indicators (Part 6 of 9)

Control/Indicator — Function
90/30 and 90/30 B Systems Operator/Maintenance Panel (cont)
<p>PRINTER indicators</p> <p>Indicates the status of the IPC printer subsystem</p> <p>DEVICE CHECK Lights when an open type carriage interlock, a tripped circuit breaker, a lack of air flow, or a high temperature condition is detected in the printer. The printer immediately stops, except for the high temperature condition.</p> <p>FORMS CHECK Lights when paper either is feeding too fast or too slow or is jammed. The printer immediately stops.</p> <p>OUT OF FORMS Lights when the printer assembly detects only 6 inches (15.24 cm) of paper below the print line. The printer immediately stops.</p> <p>PARITY CHECK Lights when detection of a load code buffer parity error or print line buffer parity error occurs. The printer immediately stops.</p>
90/30 System Power Control Panel
<p>POWER CONTROL FAULT indicator</p> <p>Lights when the low voltage power that controls the power sequencing of the processor is inoperative or marginal</p> <p>FAULT OVERRIDE switch</p> <p>To be used by the Sperry Univac customer engineer only</p> <p>LAMP TEST switch</p> <p>Checks the operability of the four panel indicators (POWER CONTROL FAULT, OVERTEMP, AIR LOSS, and DC FAULT)</p> <p>24 VDC CTL circuit breaker</p> <p>Provides overload protection for the +24 volt power line to the power control assembly and processor maintenance panels</p> <p>24 VAC circuit breaker</p> <p>Provides overload protection for the 24 volt ac power line to the power control assembly</p> <p>U100/BLOWER AC circuit breaker</p> <p>Provides overload protection for the ac power line to the system console and the blower motors in the processor cabinet</p> <p>PERIPHERAL D.C. POWER circuit breaker</p> <p>Provides overload protection for the dc power (+5 volt, -12 volt, and +24 volt) lines for the 0773 printer subsystem, 0605 card punch subsystem diskette subsystem, and 0717 card reader subsystem, as well as the +5 volt dc power line to the disc drives connected to the processor</p> <p>OVER TEMP indicator</p> <p>Lights when an overtemperature condition occurs within the processor cabinet, 0773 printer, diskette subsystem, 0605 card punch, or 0717 card reader</p>

Table 2-1. Processor Cabinet, Operating Controls and Indicators (Part 7 of 9)

Control/Indicator — Function	
90/30 System Power Control Panel (cont)	
→	<p>AIR LOSS indicator</p> <p>Lights when a loss of air flow across the logic pages in the processor is detected</p> <p>SYSTEM MAIN AC1 circuit breaker</p> <p>Provides overload protection for the ac power line to the line voltage autotransformer for the 0773 printer, 0605 card punch, and the ac power line for the 24 volt transformer that provides power to the relays and indicators of the processor</p> <p>SYSTEM MAIN AC2 circuit breaker</p> <p>Provides overload protection for the ac power line to the 0717 card reader, the system console, diskette subsystem, and the processor blower motors</p> <p>PROCESSOR POWER SUPPLY AC circuit breaker</p> <p>Provides overload protection for the ac power line to all the power supplies within the processor</p> <p>DISC MAIN AC circuit breaker</p> <p>Provides overload protection for the ac power line to the integrated disc adapter</p> <p>DC FAULT indicator</p> <p>Lights when one of the dc power supplies in the processor becomes marginal or inoperative</p>
→	90/30 and 90/30 B Systems +5 V Power Supply (A19)
	<p>Circuit breaker</p> <p>Provides overload protection for the +5 volt power line to processor logic pages 1 and 2</p> <p>Indicator</p> <p>Lights when +5 volts is applied to the processor logic pages 1 and 2</p>
↓	90/30 and 90/30 B Systems +5 V Power Supply (A20)
	<p>Circuit breaker</p> <p>Provides overload protection for the +5 volt power line to processor logic pages 3 and 4, and the integrated card reader, card punch, and printer.</p> <p>Indicator</p> <p>Lights when +5 volts is applied to processor logic pages 3 and 4, and the integrated card reader, card punch, and printer.</p>
	90/30 and 90/30 B Systems +5 V Power Supply (A21) (Optional)
↑	<p>Circuit breaker</p> <p>Provides overload protection for the +5 volt power line to the integrated communication adapter and diskette subsystem if these are used with the processor.</p> <p>Indicator</p> <p>Lights when +5 volts is applied to the integrated communication adapter and diskette subsystem.</p>

Table 2-1. Processor Cabinet, Operating Controls and Indicators (Part 8 of 9)

Control/Indicator — Function
90/30 System +5 V Power Supply (A22)
<p>Circuit breaker</p> <p>Provides overload protection for the +5 volt power line to processor logic page 5, system operator/maintenance panel, main storage, and expansion storage in the processor.</p> <p>Indicator</p> <p>Lights when +5 volts is applied to processor logic page 5, system operator/maintenance panel, main storage, and expansion storage in the processor</p>
90/30 System -12 V Power Supply (A23)
<p>Circuit breaker</p> <p>Provides overload protection for the -12 volt power line to processor logic pages 1, 2, 3, 4 and 5.</p> <p>Indicator</p> <p>Lights when -12 volts is applied to processor logic pages 1, 2, 3, 4 and 5.</p>
90/30 System +24 V Power Supply (A4)
<p>Circuit breaker</p> <p>Provides overload protection for the +24 volt power line to the integrated printer, card punch, card reader, diskette subsystem, 8416 disc subsystem, processor power control, and the status indicators on the system operator/maintenance panel</p>
90/30 System +12 V, -5 V Power Supply (A17)
<p>Circuit breaker</p> <p>Provides overload protection for +12 volt and -5 volt power line to main storage and expansion storage in the processor.</p>
90/30 B System Power Control Panel
<p>OVER TEMP indicator</p> <p>Lights when an overtemperature condition occurs within the processor cabinet, or within the integrated printer, card punch, diskette subsystem, or card reader.</p> <p>AIR LOSS indicator</p> <p>Lights when loss of air flow across the logic pages is detected.</p> <p>POWER CONTROL FAULT indicator</p> <p>Lights when low voltage power that controls power sequencing of the processor is inoperative or marginal.</p> <p>DC FAULT indicator</p> <p>Lights when one of the dc power supplies in the processor has become marginal or inoperative.</p> <p>FAULT OVERRIDE switch</p> <p>Used by Sperry Univac customer engineer.</p>

Table 2-1. Processor Cabinet, Operating Controls and Indicators (Part 9 of 9)

Control/Indicator — Function
90/30 B System Power Control Panel (cont)
<p>LAMP TEST switch</p> <p>Used to check validity of four indicators: POWER CONTROL FAULT, OVER TEMP, AIR LOSS, and DC FAULT.</p> <p>24 VDC CTL circuit breaker</p> <p>Provides overload protection for the +24 volt power line to the power control assembly and operator/maintenance panel</p> <p>24 VAC circuit breaker</p> <p>Provides overload protection for the 24 volt ac power line to the power control assembly</p> <p>PERIPHERAL D.C. POWER circuit breaker</p> <p>Provides overload protection for dc power (+5 volt, -12 volt, and +24 volt) lines for the integrated printer subsystem and card punch subsystem, diskette subsystem, card reader subsystem, as well as the +5 volt power line to the disc drives connected to the processor</p>
90/30 B System Power Distribution Panel
<p>DISC MAIN AC circuit breaker</p> <p>Provides overload protection for the ac power line to the integrated disc adapter</p> <p>PROCESSOR POWER SUPPLY AC circuit breaker</p> <p>Provides overload protection for the ac power line to all power supplies within the processor</p> <p>SYSTEM MAIN AC2 circuit breaker</p> <p>Provides overload protection for the ac power line to the integrated card reader, system console, diskette subsystem, and processor blower motors</p> <p>SYSTEM MAIN AC1 circuit breaker</p> <p>Provides overload protection for the ac line to the line voltage autotransformer for the integrated printer, card punch, and the ac power line for the 24 volt transformer that provides power to the relays and indicators on the processor</p> <p>U100/BLOWER A.C. circuit breaker</p> <p>Provides overload protection for the power line to the system console and the blower motors in the processor cabinet</p>
90/30 and 90/30 B Systems Integrated Communication Adapter
<p>24 VDC CTL circuit breaker</p> <p>Provides overload protection for the +24 volt power line to the communication adapter</p> <p>Indicator</p> <p>Lights when +24 volts is applied to the communication adapter</p>



2.1.2. Turn-On and Turn-Off Procedures

Power for the processor and most peripheral subsystems is normally applied to and removed from the processor cabinet via the **POWER ON/POWER OFF** switch on the operator/maintenance panel. In order for power to be controlled from this panel, however, certain circuit breakers on the power supplies and power control panel within the processor cabinet must be set to specific positions. These circuit breaker settings are described in Table 2—2.

When the circuit breakers are set as specified in Table 2—2 and the **POWER ON/POWER OFF** switch on the operator/maintenance panel is set to the **POWER ON** position, the **POWER ON** indicator on the operator/maintenance panel and the indicators on all of the dc power supply assemblies should light. No other indicators on the processor cabinet should be lit. If any indicators are lit, or if any indicators that should be lit are not, refer the problem to the Sperry Univac customer engineer.

The circuit breakers and settings listed in Table 2—2 apply to the 90/30 system and 90/30 B system.

Table 2—2. Processor Cabinet, Power Switch Settings

Circuit Breaker	Normal Setting
Power Control Panel and Power Distribution Panel	
SYSTEM MAIN AC1	On (up)
SYSTEM MAIN AC2	On (up)
PROCESSOR POWER SUPPLY AC	On (up)
DISC MAIN AC	On (up)
24 VDC CTL	On (in)
24 VAC	On (in)
U100/BLOWER AC	On (up)
PERIPHERAL D.C. POWER	On (up)
Each +5 V Power Supply (A19, A20, A21, A22)	
Pushbutton	On (in)
-12 V Power Supply (A23)	
Pushbutton	On (in)
+24 V Power Supply (A4)	
Pushbutton	On (up)
+12 V, -5 V Power Supply (A17)	
Pushbutton	On (up)
Integrated Communication Adapter	
Pushbutton	On (in)

↓
2.1.3. Operating Procedures

The operator/maintenance panel on the processor cabinet is used during the operation of the system. Sections 10 and 11 of this handbook describe the system operating procedures that involve the use of this panel.

2.1.4. Recovery Procedures

↑
Table 2—3 lists the processor cabinet malfunctions for 90/30 and 90/30 B systems that may be corrected by the operator. If fault indications persist, contact your Sperry Univac customer engineer.

Table 2—3. Processor Cabinet, Recovery Procedures (Part 1 of 2)

Fault Indication	Probable Cause	Operator Action
<p>POWER CYCLING and POWER ON indicators on operator/maintenance panel light at the same time.</p>	<p>System power-up sequencing is in stall condition</p>	<ol style="list-style-type: none"> 1. Set POWER ON/POWER OFF switch on operator/maintenance panel to POWER OFF position. 2. Ensure that all circuit breakers and switches required for powering up the system are in the on position. (Refer to Table 2—2.) 3. Set POWER ON/POWER OFF switch to POWER ON position.
<p>TEMP CHECK indicator on the operator/maintenance panel lights. OVER TEMP and AIR LOSS indicators on the power control panel are lit. The audible alarm sounds continuously. Early temperature warning message is displayed on the system console screen.</p>	<p>Excessive heat in processor cabinet</p>	<ol style="list-style-type: none"> 1. Prepare for orderly termination of jobs in the system to prevent loss of data if power is removed from the system. 2. Ensure that the fans in the processor cabinet are working. Clean the air filters, if necessary. 3. Ensure the U100/BLOWER ac circuit breaker on the power control panel of the 90/30 system, or on the power distribution panel of the 90/30 B system, is in the on (up) position.
<p>DEVICE CHECK indicator under READER, PUNCH, or PRINTER on the operator/maintenance panel lights. OVER TEMP indicator on the power control panel lights. The audible alarm sounds continuously.</p>	<p>Excessive heat detected in an integrated subsystem (indicated by which DEVICE CHECK indicator lights)</p>	<ol style="list-style-type: none"> 1. Prepare for orderly termination of jobs in the system to prevent loss of data if power is removed from the system. 2. Ensure that the fans in the integrated subsystem are working. Clean the air filters, if necessary.

Table 2-3. Processor Cabinet, Recovery Procedures (Part 2 of 2)

Fault Indication	Probable Cause	Operator Action
System powers down. DC FAULT indicator on the power control panel lights.	A loss or marginal operation of one or more of the dc power supplies in the processor cabinet	<ol style="list-style-type: none"> 1. Ensure that the PROCESSOR POWER SUPPLY AC and 24 VDC CTL circuit breakers on the power control panel of the 90/30 system, or on the power distribution panel of the 90/30 B system, are in the on position. 2. Ensure that the circuit breaker on each power supply (A4, A17, A19, A20, A21, A22, and A23) in the processor cabinet is in the on position. 3. Set the POWER ON/POWER OFF circuit breaker on the operator/maintenance panel to the POWER ON position.
System powers down. POWER CONTROL FAULT indicator on the power control panel lights.	Loss of low voltage power that controls the power sequencing	Ensure that the 24 VDC CTL circuit breaker on the power control panel is in the on position.
System powers down. AIR LOSS and DC FAULT indicators on the power control panel light.	Air flow loss across the processor cabinet logic pages	Ensure that the fans in the processor cabinet are working. Clean the air filters, if necessary. Ensure the U100/BLOWER ac circuit breaker on the power control panel of the 90/30 system, or on the power distribution panel of the 90/30 B system, is in the on (up) position.
PROC CHECK indicator on the operator/maintenance panel lights.	Processor has detected a non-recoverable fault.	Reload the initial program load program. In the event the indicator lights during system initialization, reload the initial control storage load program.
CONTROL STORAGE CHECK on the operator/maintenance panel lights.	Processor has detected a non-recoverable error due to a control storage read bus check, a control storage write bus check, or a control storage address exception.	Reload the initial control storage load program.
HPR STOP indicator on the operator/maintenance panel lights.	<ol style="list-style-type: none"> 1. Processor has stopped at the display point during the halt-and-proceed instruction. 2. An unused location in control storage was detected. 3. Loading of the initial control storage load program is completed. 	Set the LEGEND SELECT 1 switch to position 7 and the DISPLAY SELECT 1 switch to position UPPER. DISPLAY 1 gives you the error code that caused the HPR STOP indicator to light.
An indicator under READER, PUNCH, or PRINTER on the operator/maintenance panel lights.	Refer to 6.3.4, 7.3.4, or 5.3.4, respectively.	Refer to 6.3.4, 7.3.4, or 5.3.4, respectively.

This page left blank intentionally.

2.2. SYSTEM CONSOLE

The system console (Figure 2—11) is the primary means available to the operator for communication with the system. It consists of a display screen, a control/indicator panel (Figure 2—12), and a keyboard (Figure 2—13) for entering information. ←

The system console operates in a protected and unprotected format; that is, messages transmitted to the system console from the processor cannot be overwritten by the operator and are thus said to be in protected format. Messages generated by the operator, however, can be overwritten (edited and changed) by the operator and are thus said to be in unprotected format.



Figure 2—11. 90/30 or 90/30 B System, System Console ←

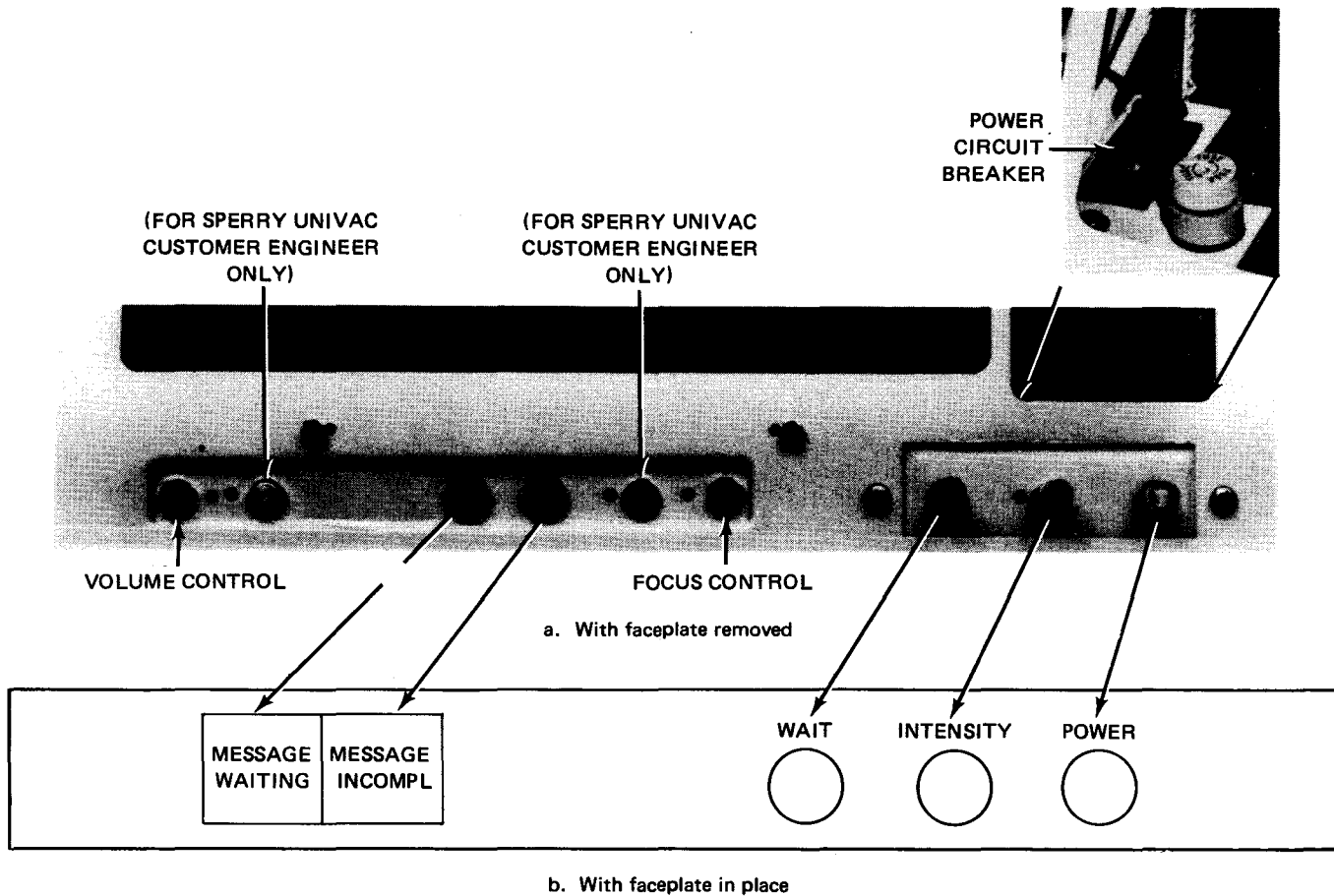

Figure 2-12. System Console, Control/Indicator Panel

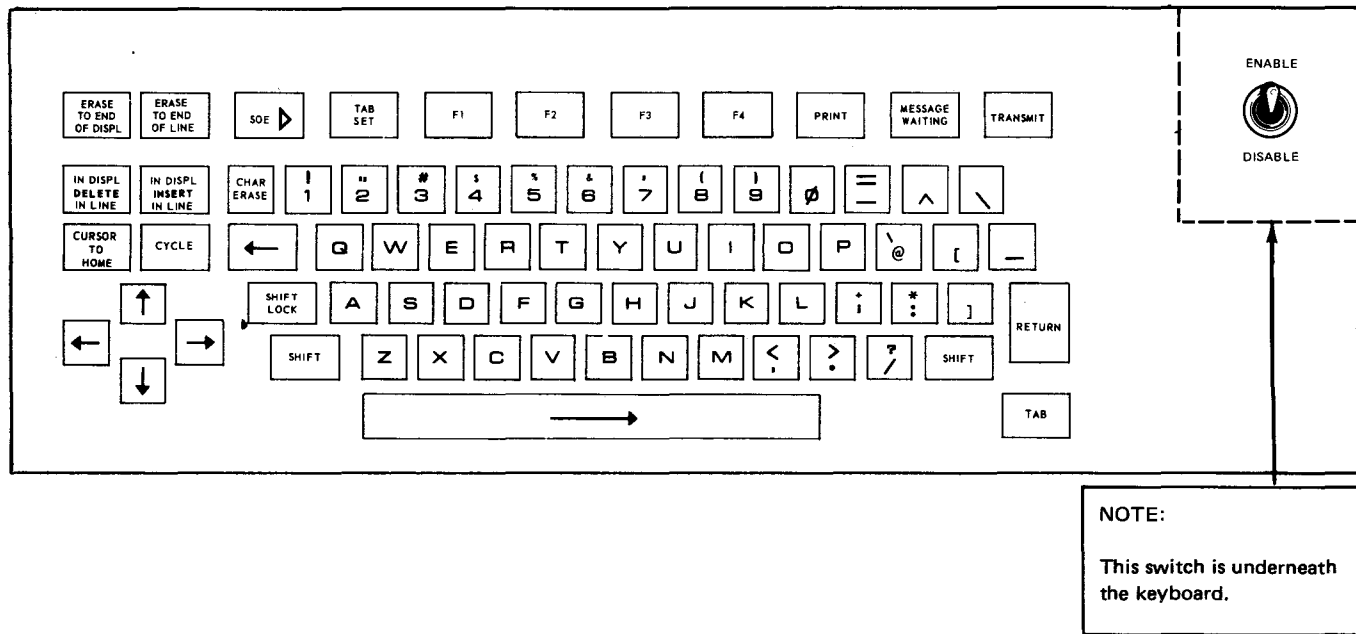

Figure 2-13. System Console Keyboard

2.2.1. Operating Controls and Indicators

The controls, indicators, and keyboard of the system console that are used by the operator are described in Table 2-4.

Table 2-4. System Console, Operating Controls and Indicators (Part 1 of 4)

Control/Indicator — Function
Control/Indicator Panel
<p>Volume control</p> <p>Adjusts the volume of the audible alarm. The audible alarm sounds:</p> <ul style="list-style-type: none"> ▪ Once when the cursor moves to the eighth character position from the right end of any line in the display ▪ Once when the cursor moves to the first character position of the last line of the display ▪ Intermittently while the MESSAGE WAITING indicator is lit <p>The alarm stops when the MESSAGE WAITING indicator goes out.</p> <p>MESSAGE WAITING indicator</p> <p>Lights when the processor has a conditional unsolicited message for display. It goes out when the operator presses the TRANSMIT key and the message is displayed.</p> <p>MESSAGE INCOMPL indicator</p> <p>Lights when a message is being received by the system console. Extinguishes when all checks for the message have been satisfied. If the indicator remains lit, the operator should not depend on the displayed data as it may contain an error. Normally, the processor program is aware of the error and will automatically resend the message.</p> <p>Focus control</p> <p>Adjusts the sharpness of the screen display</p> <p>WAIT switch/indicator</p> <p>Lights when a message is being transmitted to or from the system console. At the same time, it is indicating the keyboard is locked.</p> <p>Manually unlocks the keyboard and provides a master clear for the system console. It is advisable not to use this switch when online as it interferes with normal activity and can interrupt transmission or print activities, causing loss of data.</p> <p>INTENSITY control</p> <p>Adjusts the brightness of the displayed information on the screen</p> <p>POWER indicator</p> <p>Lights when power is on</p> <p>Power circuit breaker</p> <p>Provides overload protection for the power line to the system console</p>

Table 2-4. System Console, Operating Controls and Indicators (Part 2 of 4)







Control/Indicator — Function	
Keyboard	
Enable/disable switch	Applies or removes high voltage for the display screen and locks or unlocks the keyboard. When in the enable position, high voltage is applied and the keyboard is unlocked. When in the disable position, the screen is blanked out and the keyboard is logically disabled.
Cursor (T) Control Keys	
 Space bar	Moves the cursor to the right one space each time it is pressed. If the next location is protected, the cursor moves right to the first unprotected location on the line or subsequent lines.
 Scan-backward key	Moves the cursor to the left one space at a time; the cursor keeps moving as long as the key is pressed. If the cursor is positioned over a protected location when the key is released, the cursor automatically moves to the left to the first unprotected location on the line. If all locations to the beginning of the display are protected, the cursor stops at the home position.
 Scan-up key	Moves the cursor up one line at a time; the cursor keeps moving up as long as the key is pressed. If the cursor is positioned over a protected location when the key is released, the cursor automatically moves to the right to the first unprotected location on the line. If all locations to the beginning of the display are protected, the cursor stops at the home position.
 Scan-forward key	Moves the cursor to the right one space at a time; the cursor keeps moving as long as the key is pressed. If the cursor is positioned over a protected location where the key is released, the cursor automatically moves to the right to the first unprotected location on the line. If all locations to the end of the display are protected, the cursor stops at the home position.
 Scan-down key	Moves the cursor down one line at a time; the cursor keeps moving down as long as the key is pressed. If the cursor is positioned over a protected location when the key is released, the cursor automatically moves to the right to the first unprotected location on the line. If all locations to the end of the display are protected, the cursor stops at the home position.
CURSOR TO HOME key	
	Moves the cursor to the first character position on the display screen, unless the location is protected. In this event, the cursor moves to the right until the first unprotected location is found. If every location is protected on the display screen, the cursor returns to the home position and the keyboard locks.
 Backspace key	Moves the cursor to the left one space each time it is pressed; it does not repeat if the key is held down. If the next location is protected, the cursor moves to the left to the first unprotected location on the line. When the cursor reaches the left end of the line, this key moves the cursor to the last character to the right of the previous line.

Table 2-4. System Console, Operating Controls and Indicators (Part 3 of 4)

Control/Indicator — Function
Cursor (⌈) Control Keys (cont)
RETURN key Moves the cursor to the first character position of the next line. This key is similar to the carriage return key on a typewriter. Automatic cursor return is caused after the last character of each line without pressing the RETURN key. If the first character of the next line is protected, the cursor moves to the right until it locates the first unprotected character position.
TAB key Moves the cursor to the right until a tab-set character in display storage is detected. When the tab-set character is detected, the cursor stops one position past it. If no tab-set character is detected, the cursor returns to the home position. If the position next to the tab-set character is protected, the cursor does not stop on it, but moves on to the first unprotected character.
TAB SET key Inserts the tab-set character into display storage. The cursor indicates the position of the tab set. A tab set on one line does not have any effect on any other line. Tab sets are transmitted with the data and must be reset for each new screen format.
Editing Keys
ERASE TO END OF DISPL key Erases all the unprotected characters from and including the cursor position to the end of the display. Spaces are inserted in all the erased positions. The cursor does not move.
ERASE TO END OF LINE key Erases all the unprotected characters from and including the cursor position to the end of the unprotected field in which the cursor is positioned or to the end of the line on which the cursor is positioned, whichever comes first. Spaces are inserted in all the erased positions. The cursor does not move. If software places the cursor over a protected position, this key will not function. Before this key will operate, the cursor must be moved to an unprotected position, using the cursor control keys.
IN DISPL DELETE IN LINE key With the SHIFT key in the lowercase position, this key erases the unprotected character in the cursor position, leaving a space. It then shifts, one position to the left, all the characters in the unprotected field immediately to the right of the cursor up to the end of the line, with one space inserted at the end of the line. If a protected character is encountered before the end of the line, all unprotected characters up to the protected field are moved one space to the left, with one space inserted before the protected field. With the SHIFT key in the uppercase position, this key erases the unprotected character in the cursor position, leaving a space. It then shifts, one position to the left, all the characters in the unprotected field immediately to the right of the cursor up to the end of the display, inserting one space at the end of the display. If a protected character is encountered before the end of the display, all unprotected characters up to the protected field are moved one space to the left, inserting one space before the protected field. When moving of one unprotected field covering two lines or more takes place, the unprotected character in the first position of each subsequent line is moved to the last position of the line above.

Table 2-4. System Console, Operating Controls and Indicators (Part 4 of 4)

Control/Indicator — Function
<p style="text-align: center;">Editing Keys (cont)</p>
<p>IN DISPL INSERT IN LINE key</p> <p>With the SHIFT key in the lowercase position, this key moves, one space to the right, all the unprotected characters immediately to the right of the cursor and any character under the cursor to the end of the line. The character in the last position of the line is discarded. If a protected character is encountered before the end of the line, all unprotected characters up to the protected field are moved one space to the right, including the character under the cursor. The character right next to the beginning of the protected field is discarded.</p> <p>With the SHIFT key in the uppercase position, this key moves, one space to the right, all the unprotected characters immediately to the right of the cursor and any character under the cursor to the end of the display. The character in the last position of the display is discarded. If a protected character is encountered before the end of the display, all unprotected characters up to the protected field are moved one space to the right, including the character under the cursor. The character right next to the beginning of the protected field is discarded. When moving of one unprotected field covering two lines or more takes place, the unprotected character in the last position of the first line is moved to the first position of the line below.</p>
<p>CHAR ERASE key</p> <p>Erases and replaces with a space the unprotected character in the cursor position. The cursor then moves to the right to the first unprotected position.</p>
<p>CYCLE key</p> <p>Causes the next character or function chosen by the operator to be repeated as long as both the CYCLE key and the other key are pressed. This key operates all keys except: ERASE TO END OF DISPL, ERASE TO END OF LINE, SOE \triangleright, TAB SET, PRINT, MESSAGE WAITING, TRANSMIT, IN DISPL DELETE IN LINE, IN DISPL INSERT IN LINE, CHAR ERASE, CURSOR TO HOME, SHIFT LOCK, SHIFT, RETURN, TAB, backspace, and the four cursor scan keys.</p>
<p style="text-align: center;">Message Control Keys</p>
<p>SOE \triangleright key</p> <p>Places the start-of-entry symbol (\triangleright) on the display screen. The location of this symbol on the screen designates the starting point of the message to be transmitted to the processor. If the start-of-entry symbol is not inserted, all data on the screen from the beginning of the display to the cursor is transmitted.</p>
<p>PRINT key</p> <p>Routes, from the display screen to the COP, data normally not printed on the COP.</p>
<p>MESSAGE WAITING key</p> <p>The only key available to the operator when the keyboard is locked (WAIT indicator lit). Pressing this key alerts the operating system that control of the system console is requested for data entry.</p>
<p>TRANSMIT key</p> <p>Alerts the processor that an input message is waiting to be transmitted. Pressing this key locks the keyboard, except for the MESSAGE WAITING key, until a read command is received from the processor.</p>
<p>F1, F2, F3, F4 special function keys</p> <p>These special function keys are inhibited.</p>
<p>Alpha, numeric, symbol keys</p> <p>Arranged in standard typewriter layout, these keys are for message composition.</p>

2.2.2. Turn-On and Turn-Off Procedures

Power is normally applied to the system console via the **POWER ON/POWER OFF** switch on the operator/maintenance panel (Figure 2—2). In order for power to be controlled from this panel, however, the power circuit breaker located behind the control/indicator panel (Figure 2—12) must be set to the ON position. ←

When the circuit breaker is set to ON and the **POWER ON/POWER OFF** switch on the operator/maintenance panel is set to the **POWER ON** position, the **POWER** indicator on the control/indicator panel should light.

To completely turn off power to the system console, set the power circuit breaker behind the control/indicator to the **OFF** position.

2.2.3. Operating Procedures

The following procedures is to be performed just before starting to use the system console and after the system has been shut down for a period of time.

1. Set the enable/disable switch (located underneath the right side of the keyboard) to the enable (rear) position. This applies high voltage to the display screen and unlocks the keyboard.

NOTE:

Any time the operator leaves the processing area, the enable/disable switch should be set to the disable position. This action extends the life of the display screen and prevents accidental inputs into the system.

2. Adjust the **INTENSITY** control on the control/indicator panel until a clear, readable display of the cursor (⌈) is obtained with the intensity set at the lowest possible position.

CAUTION

Extended use of the display screen at too high an intensity can damage the screen.

3. Press the **WAIT** switch/indicator on the control/indicator panel. This provides a master clear of the system console and places it in the initial starting condition.

A message or command can now be instituted by the operator by proceeding as follows:

1. Press the **MESSAGE WAITING** key.
2. Beginning with the start-of-entry character (▷), type in your message or command in accordance with the requirements of Section 12.
3. Press the **TRANSMIT** key.

Any message from the processor to the system console for display cannot be received by the system console between the time the **MESSAGE WAITING** and **TRANSMIT** keys are pressed.

2.2.4. Recovery Procedures

Table 2-5 lists the system console malfunctions that may be corrected by the operator. If the fault indication persists, contact your Sperry Univac customer engineer.

Table 2-5. System Console, Recovery Procedures

Fault Indication	Probable Cause	Operator Action
System console completely in-operative, POWER indicator on control/indicator panel not lit.	Power circuit breaker tripped	Remove control/indicator panel faceplate and reset the power circuit breaker to ON position.
No images appear on the display screen. POWER indicator on the control/indicator panel lit.	Enable/disable switch underneath keyboard is in disable (forward) position. INTENSITY control on control/indicator panel set incorrectly.	Set the enable/disable switch to the enable (rear) position. Adjust the INTENSITY control clockwise until cursor appears. Do not adjust too brightly as the display screen life is shortened with too bright a display.
When TRANSMIT or PRINT key is pressed, WAIT indicator on the control/indicator panel remains off but keyboard is locked.	WAIT indicator lamp is burned out.	Lift up the control/indicator panel faceplate and replace the WAIT indicator lamp.
WAIT indicator on control/indicator panel lights when PRINT key is pressed but does not light when TRANSMIT key is pressed.	Internal system console problem	Call your Sperry Univac customer engineer.
Character entered from keyboard is incorrect or entered in wrong position.	Internal system console problem	Call your Sperry Univac customer engineer.
Characters entered from keyboard are distorted.	Internal system console problem	Call your Sperry Univac customer engineer.

2.3. COMMUNICATIONS OUTPUT PRINTER

The SPERRY UNIVAC 8541-06 Communications Output Printer (COP) is an incremental printer housed in a freestanding cabinet with its own power supply and control circuits (Figure 2—14). The COP provides an auxiliary printed output for the processor system console, using a rotating printwheel having a set of 63 characters. Character sets may be in ASCII, EBCDIC, FORTRAN, or ECMA/ISO. Translation between the selected character set and EBCDIC (used by the processor) is performed in the system console.

The COP can print on up to six copies of edge-sprocketed forms having a length of 11 inches (27.9 cm) and a width of from 3-5/8 inches (9.2 cm) to 14-7/8 inches (37.8 cm). There are up to 132 print positions per line, with 10 characters per inch and 6 lines per inch. The maximum print rate is 30 characters per second. Continuous lines are fed (without printing) at 30 lines per second. Although the standard printing color is black, inking rolls are also available in green, red, and violet to print in those colors.

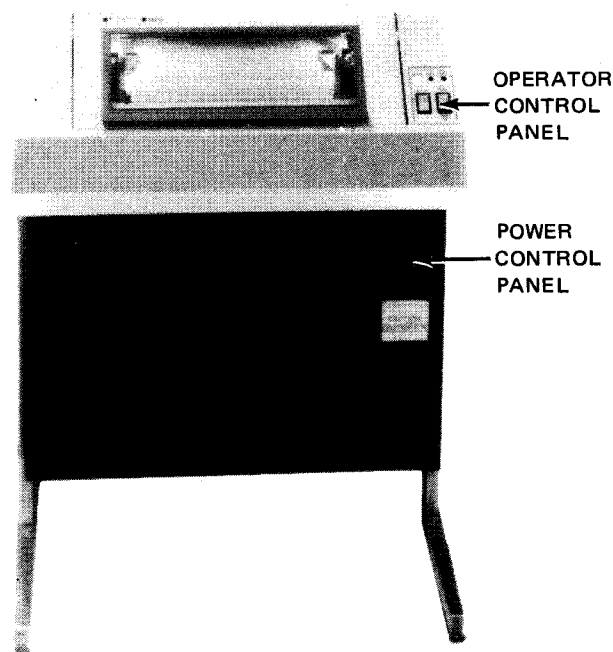

Figure 2—14. 8541-06 Communications Output Printer

The print carriage moves automatically. Paper feeding is also automatically controlled by two tractors, one on each end of the form. Tractor teeth fit into the sprocket holes on the form, which is held firmly against the tractors with spring-loaded tractor sprocket belts. A safety interlock removes power to the mechanical drive motors and blower motor when the cabinet top cover is opened.

2.3.1. Operating Controls and Indicators

The operator control panel (Figure 2—15) contains the controls and indicators used by the operator during normal operation of the COP. The power control panel (Figure 2—16) is mounted on front of the COP, on the right and just below the upper cabinet cover. The operator controls power for the COP from this panel. All controls and indicators are listed and described in Table 2—6.

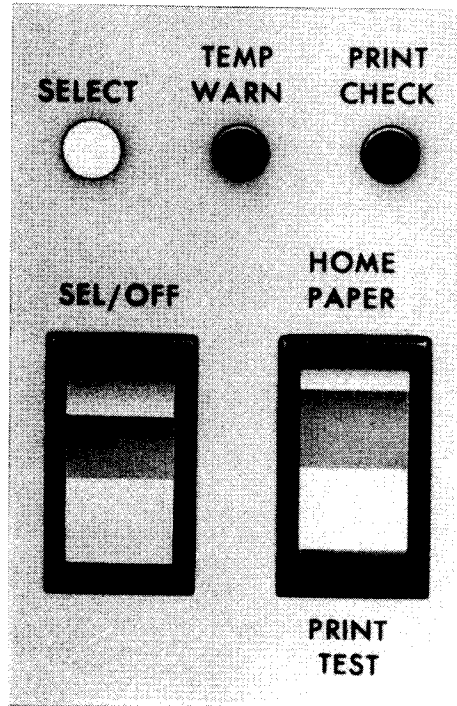

Figure 2-15. 8541-06 Communications Output Printer, Operator Control Panel

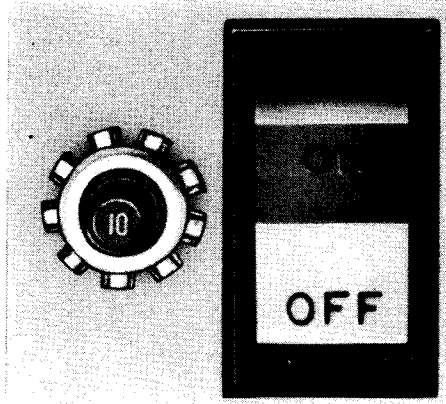

Figure 2-16. 8541-06 Communications Output Printer, Power Control Panel

Table 2-6. 8541-06 Communications Output Printer, Controls and Indicators

Control/Indicator — Function
<p style="text-align: center;">Operator Control Panel</p> <p>SELECT indicator</p> <p>Lights when COP is selected for output either by processor or manually. Extinguishes when selection terminates</p> <p>SEL/OFF switch</p> <p>When pressed, selects COP if SELECT indicator is extinguished and causes a carriage return and single-line forms advance. If SELECT indicator is lit when switch is pressed, COP selection is terminated.</p> <p>TEMP WARN indicator</p> <p>Lights when COP internal temperature reaches 140° F (60° C). COP continues to function, but operator should open cabinet doors and, if permissible, halt operation of the COP until it cools.</p> <p>HOME PAPER/PRINT TEST switch</p> <p>When held in HOME PAPER position, entire forms continue to advance until switch is released; then forms advance to fourth line of next form and stop.</p> <p>When held in PRINT TEST position, COP prints complete lines of the character E, advances forms, and returns carriage until switch is released; then the current line is completed, form advances one line, carriage returns, and COP stops. PRINT TEST function is inoperative if the SELECT indicator is lit.</p> <p>Switch automatically returns to midposition (off) when not in use.</p> <p>PRINT CHECK indicator</p> <p>Lights and printing stops if COP is out of forms or a fuse opens.</p>
<p style="text-align: center;">Power Control Panel</p> <p>10 pushbutton circuit breaker</p> <p>Pops out to interrupt ac power when an overload condition occurs in the COP. Circuit breaker is pushed in to reset.</p> <p>ON/OFF rocker switch</p> <p>ON position:</p> <p>Applies operating power to the COP.</p> <p>OFF position:</p> <p>Removes operating power from COP.</p>

2.3.2. Turn-On and Turn-Off Procedures

Power to the COP is applied independently of the processor. Placing the **ON/OFF** switch on the COP power control panel to the **ON** position applies operating power, which remains on until the **ON/OFF** switch is repositioned to the **OFF** position.

Normally, power to the COP is turned on at the beginning of an operating day, and remains on until operation is complete.

Once power is applied to the COP, operation may be selected either online through the processor by programming or selection control, or offline at the COP by pressing the **SEL/OFF** switch. By either method, the **SELECT** indicator lights and remains lit during the operation. Upon completing printing, operation is terminated again either at the processor or manually with the **SEL/OFF** switch, and the **SELECT** indicator extinguishes.

Successful operation of the COP always depends on whether the unit is in a ready state. If forms are to be loaded, or any condition is present that inhibits operation of the COP, printing cannot resume until the error condition is corrected. This requirement prevails whether operation is attempted online or offline.

2.3.3. Operating Procedures

Operation of the COP includes the loading of paper forms to be printed, aligning ruled or preprinted forms for proper position of additional print characters, and replacing the inking roll.

2.3.3.1. Loading Forms

To load forms in the COP, proceed as follows:

1. Set the **ON/OFF** switch on the power control panel to **OFF** position.
2. Raise the top cover of the COP cabinet (Figure 2—17a).
3. Open the pressure plate on the left paper-drive tractor (Figure 2—17b) and the pressure plate on the right paper-drive tractor to expose the tractor drive belt teeth (Figure 2—17c).
4. If the print actuator carriage is not spring-loaded on your COP, move the print actuator carriage to its extreme right setting on the print mechanism by pushing the actuator carriage frame (Figure 2—17d).

CAUTION

The print actuator carriage must be moved only by pushing the actuator carriage frame; damage will result if moved in any other manner.

5. If the width of the forms to be loaded is different from previously printed forms, loosen the knurled screw locking the right paper drive tractor (Figure 2—17e), and slide the tractor assembly either right or left to match the approximate width of the new forms (measure the width for the new form from the left tractor). Do not tighten the lock screw at this time. Do not attempt to move the tractor; this remains in a fixed position.
6. Pull outward on the paper positioning knob (Figure 2—17a) and turn the knob until the two colored teeth on the left and right tractor drive belts are positioned near the top of the tractors (Figure 2—17f).
7. Place a supply of forms in the feed tray behind the COP cabinet (Figure 2—17g).

NOTE:

Preprinted forms or forms having carbon sets must feed into the cabinet with the writing surface facing the COP.

8. Insert the leading edge of the form through the cabinet slot so that the form passes *over* the paper guide (Figure 2—17g). Forms must pass over the paper guide to feed into the print mechanism. If forms feed under the paper guide, they are accumulated in the electronics compartment of the cabinet.
9. Continue to feed forms through the cabinet slot until the leading edge emerges below the tractor drive belts.
10. Pull the forms leading edge up between the print wheel and print hammer (Figure 2—17h).
11. Center the forms leading edge between the two colored teeth on the left and right tractor drive belts (Figure 2—17i).
12. Slide the right tractor assembly to a position that allows the tractor drive belt teeth to engage with the form sprocket holes; fit the form sprocket holes on both sides with the left and right tractor drive belt teeth; then close the left and right pressure plates to secure the form to the drive belts (Figure 2—17j).
13. Move the right tractor assembly (Figure 2—17j) as required to provide a firm tension on the form, then tighten the knurled lock screw to secure the right tractor assembly (Figure 2—17e).
14. Close the cabinet top cover, set the **ON/OFF** switch to **ON**, then press the **PRINT TEST** switch to print a row of E test characters. (**SELECT** indicator should be lit; if it is extinguished, press **SELECT** switch once to light the indicator.)
15. Examine the test characters to determine if the top or bottom portion of the character is clipped (not printed). If multiple forms are printed, open the right pressure plate and peel away the upper sheets to examine the last sheet (Figure 2—17k). Characters may be printed properly on the upper sheets, but are often clipped on the last sheet.
16. If the characters are clipped, set the **ON/OFF** switch to **OFF**, raise the cabinet top cover and adjust the phasing control (Figure 2—17l). If the upper portion of the character is clipped, turn the phasing control up slightly, or turn the control down if the lower portion is clipped.
17. Repeat steps 14, 15, and 16 until the test characters are printed properly (Figure 2—17m).
18. Pull the paper positioning knob outward and turn it to feed the form leading edge under the guide fingers (Figure 2—17n).
19. Close the top cover, then press and release the **HOME PAPER** switch to allow one form to feed into the receiver basket (Figure 2—17o). Additional blank forms may be fed by again pressing the **HOME PAPER** switch.
20. Check that forms feeding into the receiver basket are folding in the same direction as their original fold (Figure 2—17o), or feeding problems may develop during operation. Be sure that printed forms are always fed into the receiver basket provided with the COP.

2.3.3.2. Aligning Forms

Preprinted forms are positioned to the required printing line as follows:

1. With forms loaded and ready for printing, pull the paper positioning knob (Figure 2—13n) outward and turn the knob to position the form as necessary.
2. Press and release the **PRINT TEST** switch to check the character alignment.
3. Repeat steps 1 and 2 to obtain satisfactory character alignment.

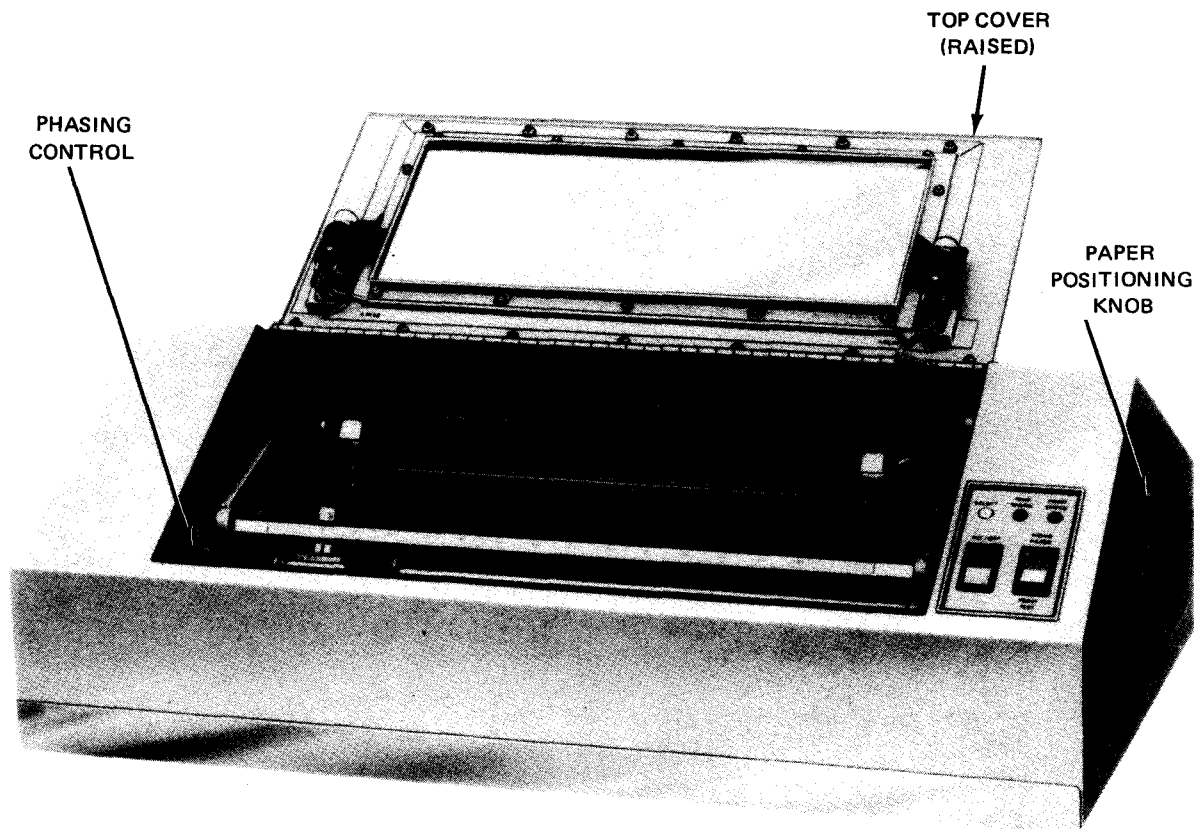

a. Top cover raised to access COP mechanism

Figure 2—17. Loading Forms in COP (Part 1 of 8)

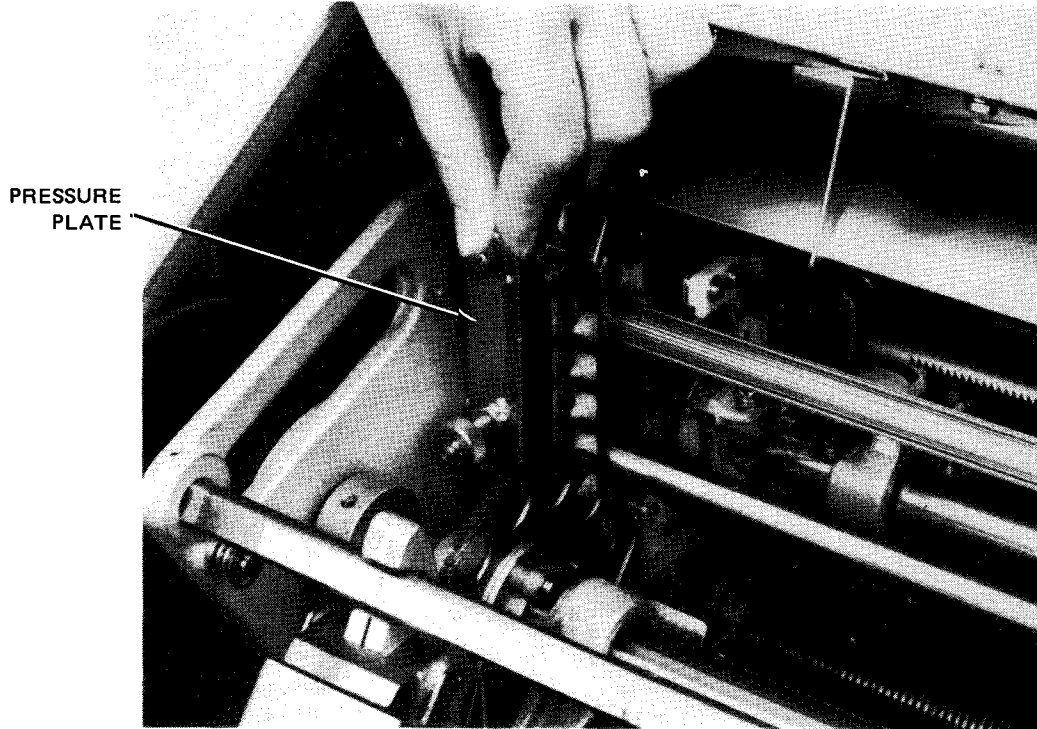

PRESSURE
PLATE

b. Opening pressure plate on left paper-drive tractor

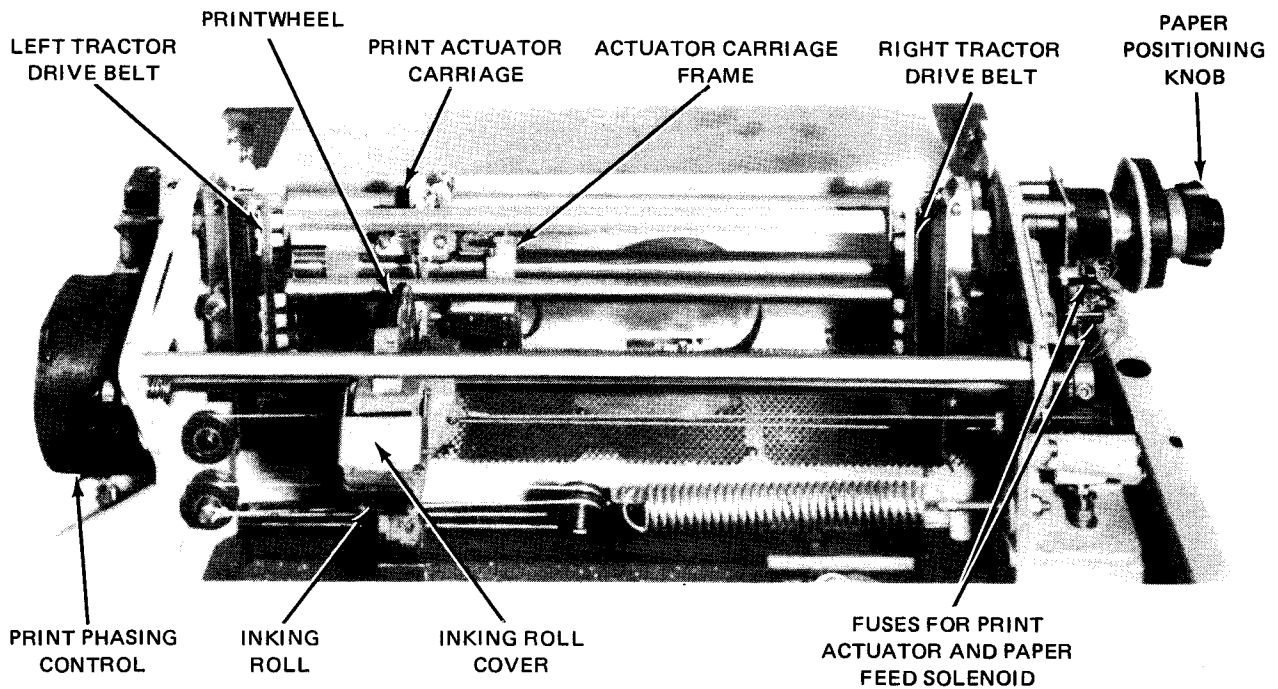

c. Printer mechanism removed to show operating assemblies

Figure 2-17. Loading Forms in COP (Part 2 of 8)

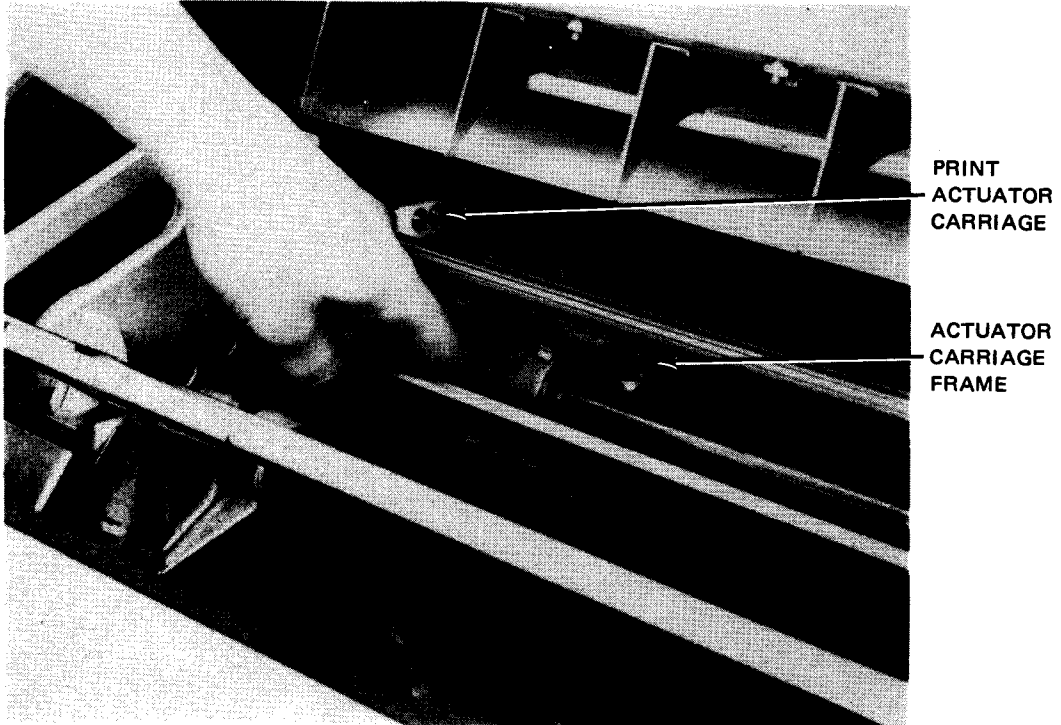

d. Moving the print actuator carriage to the right

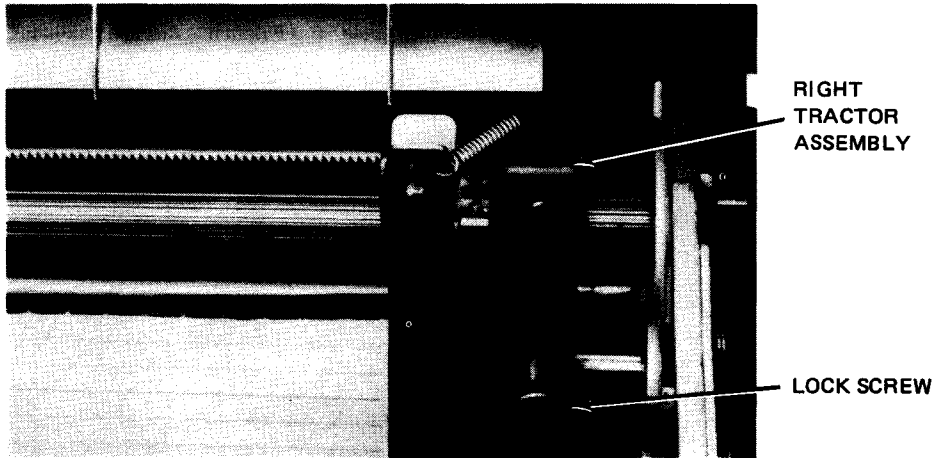

e. Lockscrew location for moving right tractor assembly

Figure 2-17. Loading Forms in COP (Part 3 of 8)

COLORED TEETH
ON LEFT TRACTOR
DRIVE BELT

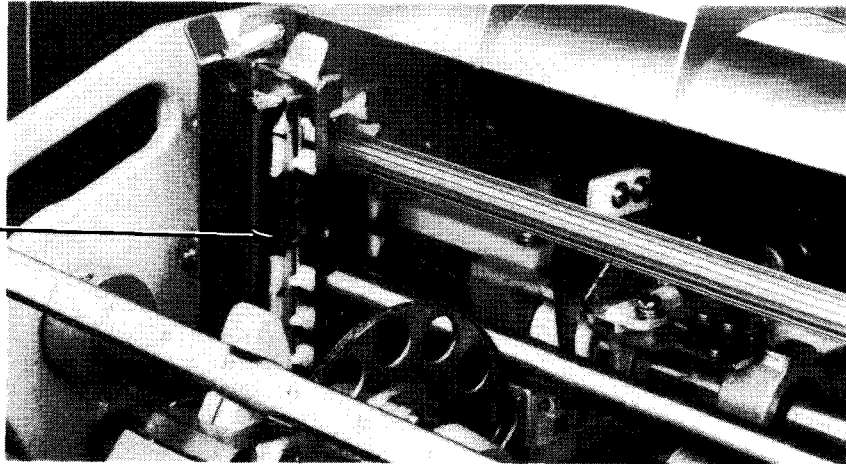

f. Colored teeth on tractor drive belt in proper position

PAPER
GUIDE

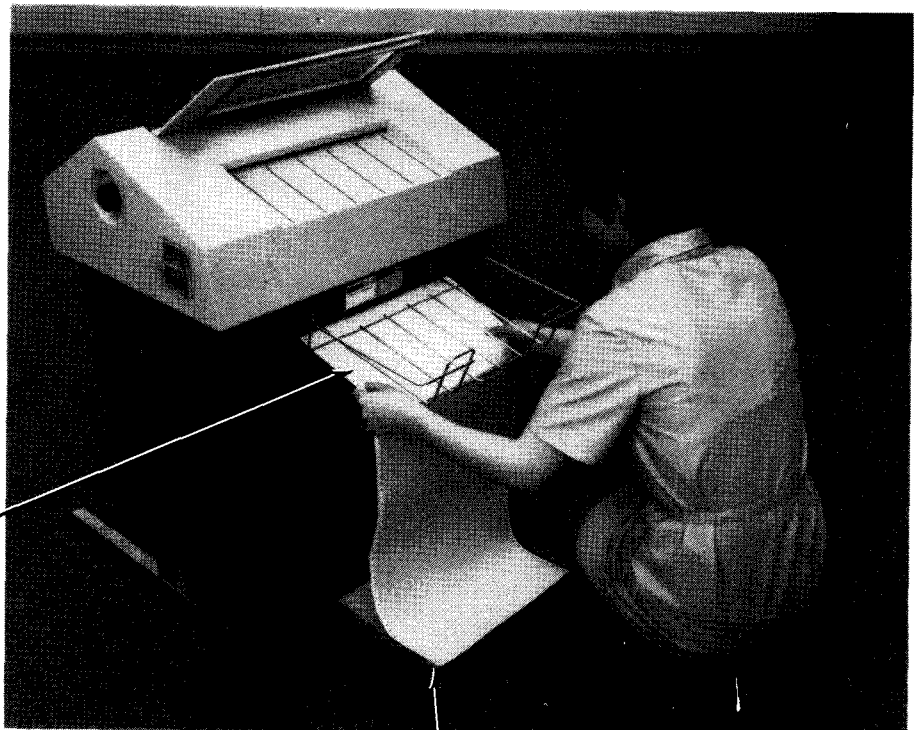
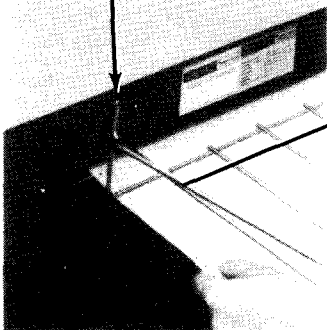

FEED TRAY

g. Inserting forms into the COP cabinet

Figure 2-17. Loading Forms in COP (Part 4 of 8)

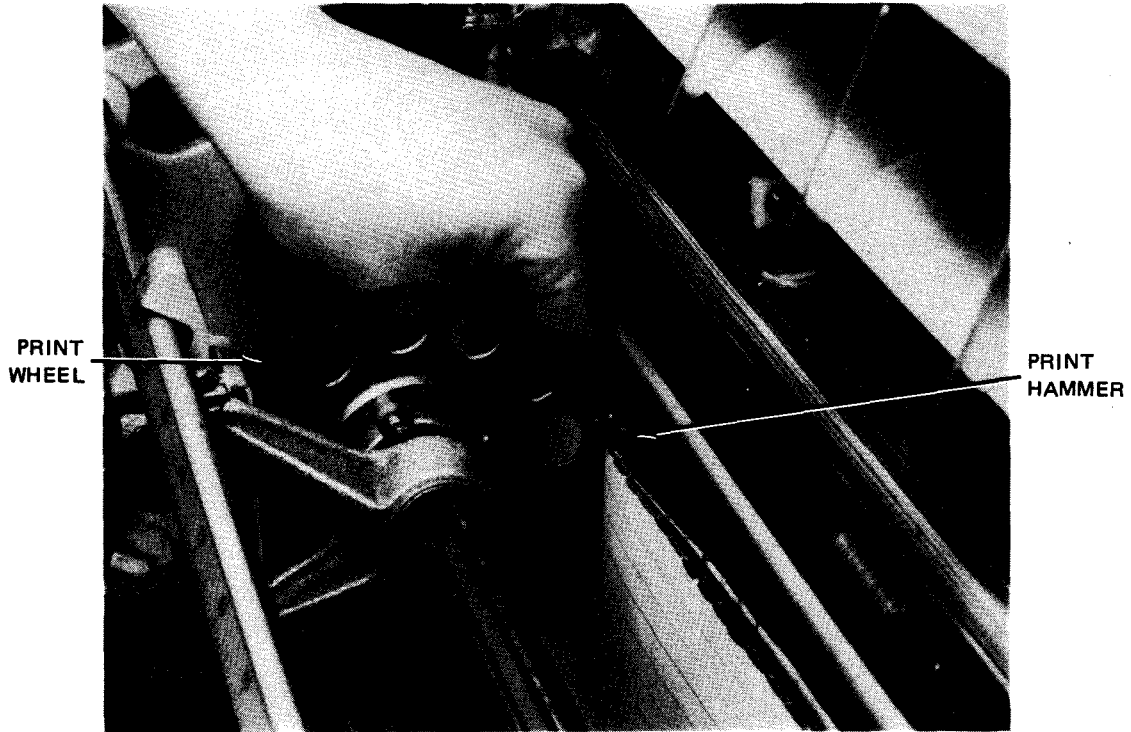

h. Pulling form leading edge between print wheel and print hammer

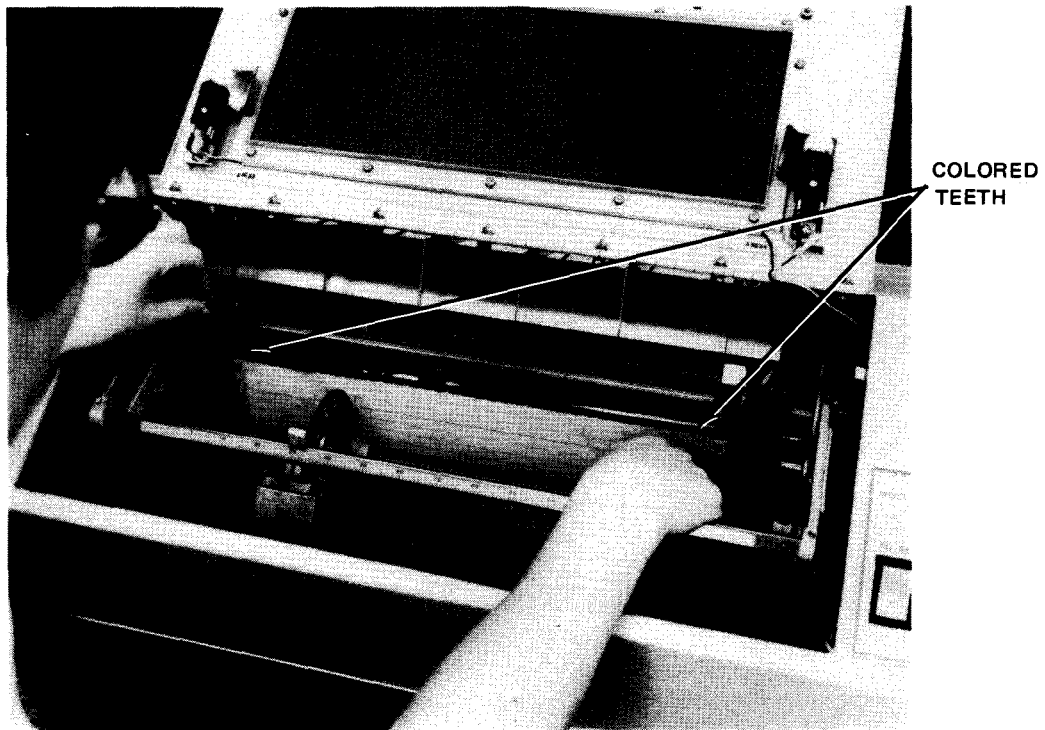

i. Form leading edge centered between colored teeth

Figure 2-17. Loading Forms in COP (Part 5 of 8)

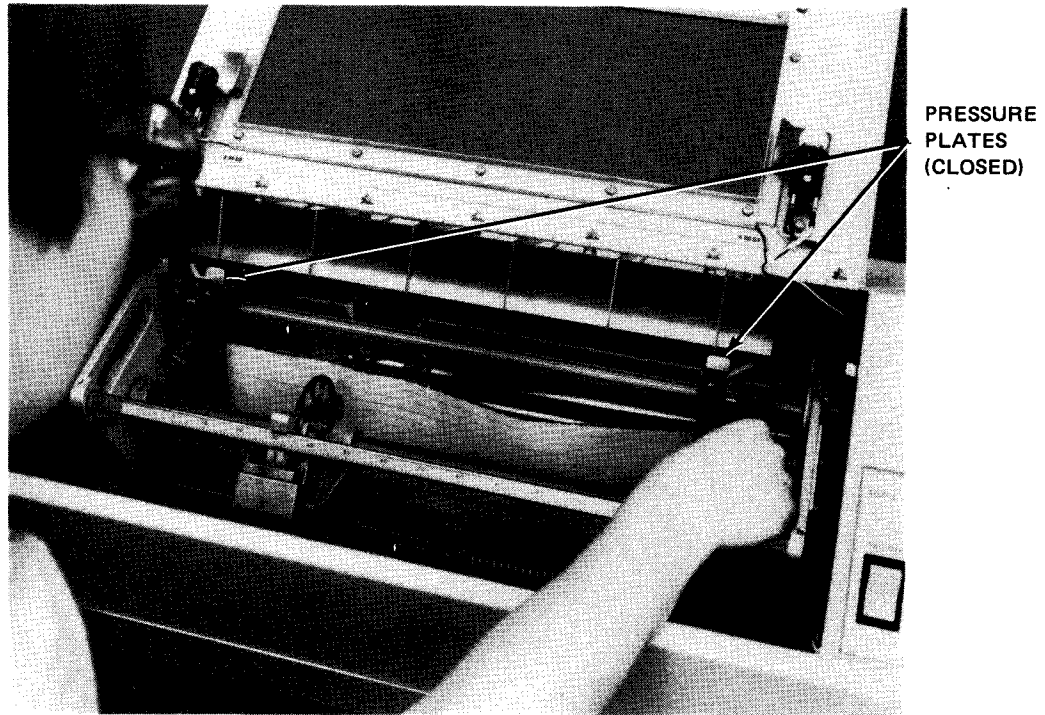

j. Adjusting right tractor assembly to tighten forms tension

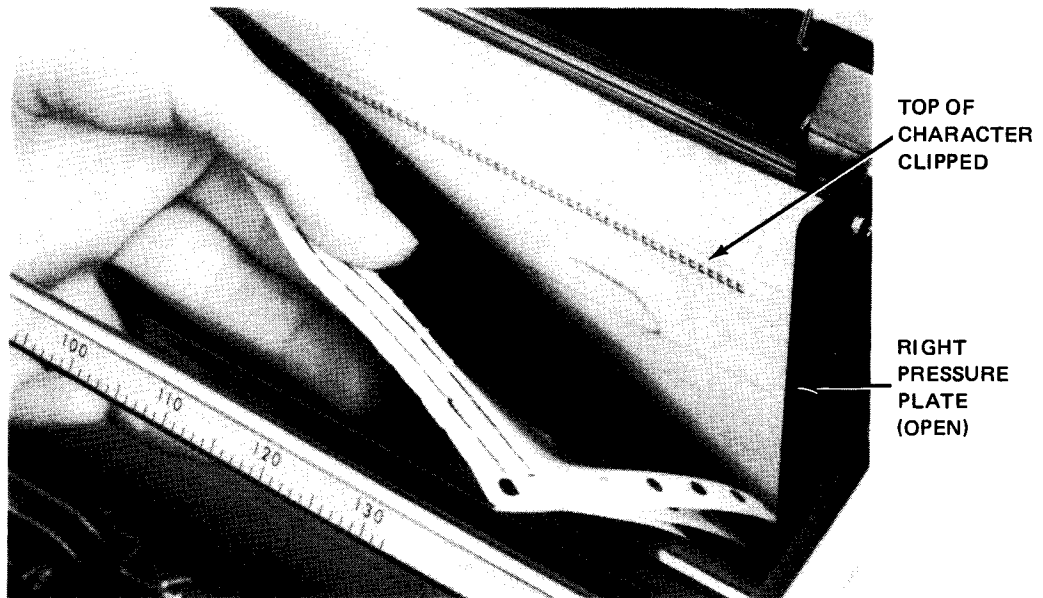

k. Checking printed test characters in carbon pack

Figure 2-17. Loading Forms in COP (Part 6 of 8)



PHASING
CONTROL

l. Adjusting phasing control to remove clipping

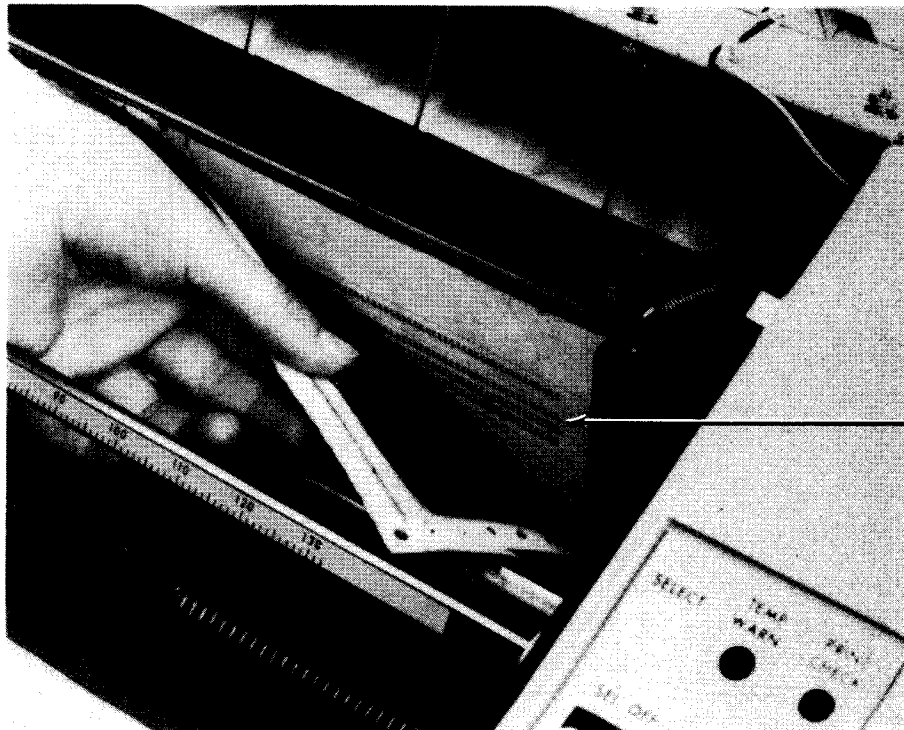

FULL
CHARACTER
PRINTED

m. Test characters printed with satisfactory quality

Figure 2-17. Loading Forms in COP (Part 7 of 8)

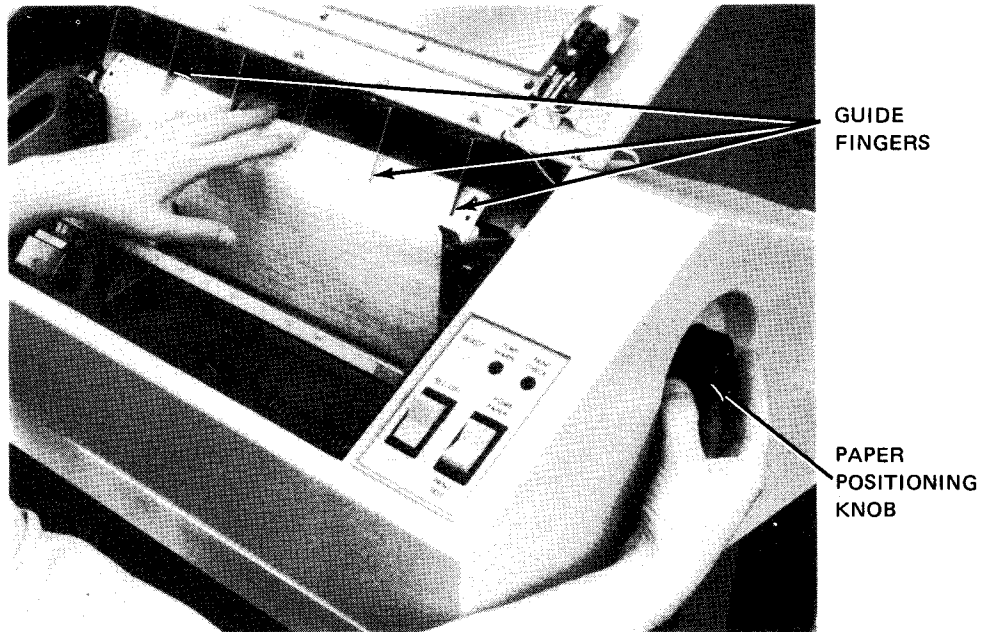

n. Feeding leading edge of form under guide fingers

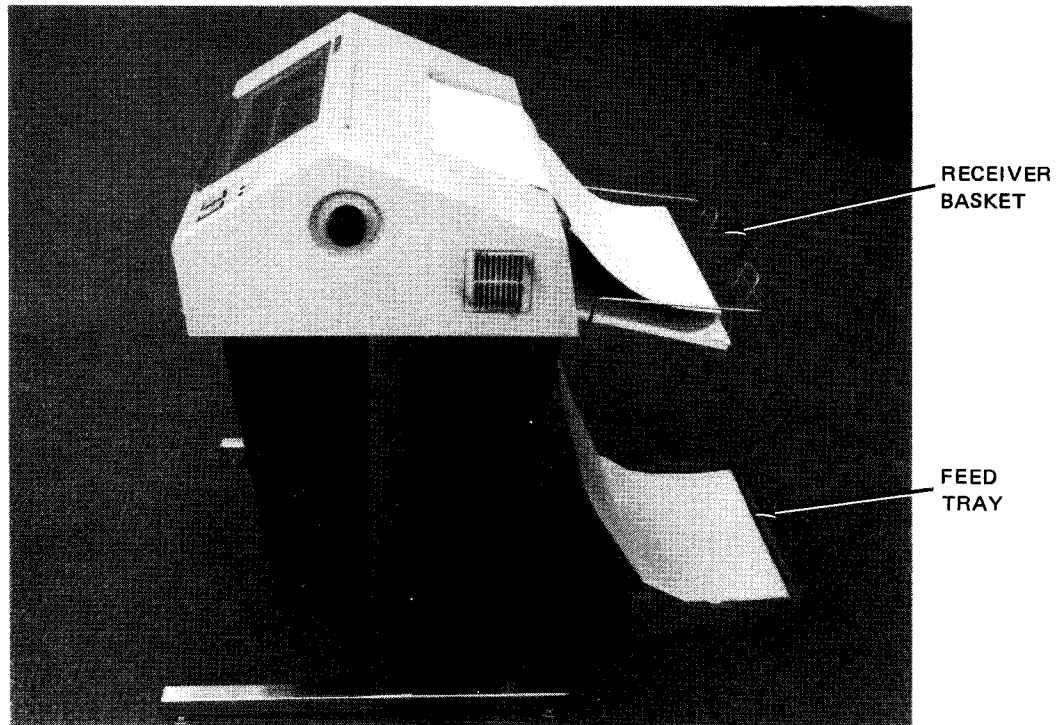

o. Printed forms folding correctly in receiver basket

Figure 2-17. Loading Forms in COP (Part 8 of 8)

4. Press and release the **FORM FEED** switch to feed a new form for printing in proper position.

NOTE:

*The first line printed is normally the fourth line below the form leading edge (perforation). If printing is to start below this line, press the **SEL/OFF** switch twice for each line the form is to be positioned below the normal first printing line.*

2.3.3.3. Replacing Inking Roll

To replace the inking roll because it is used up or if printing in a different color is required, proceed as follows:

1. Set **ON/OFF** switch on power control panel to **OFF** position.
2. Raise the cabinet top cover.
3. Grasp the inking roll shaft ends protruding from slots on each side of the housing (Figure 2—18) and lift the roll out of the housing. The housing cover will swing upward as the roll is lifted.
4. Push the shaft to remove it from the inking roll and insert the shaft into a new roll. Replace the inking roll with one listed in Table 2—7.

NOTE:

If only one side of the inking roll is used, it may be reversed in the housing to allow the print wheel to contact its opposite unused side.

5. Grip the inking roll shaft ends with one hand, and raise the housing cover with the other hand. Place the inking roll under the housing cover and slide the roll shaft into the housing slots (Figure 2—18). The housing cover will follow the inking roll down until both are in proper position.
6. Set **ON/OFF** switch on power control panel to **ON** position.

NOTE:

Internal temperature of the COP is approximately 11°F above ambient. Add 11 to ambient temperature to find total operating temperature for determining environmental requirements for inking roll.

Storage (shelf) life of inking roll is approximately 12 months.

Rolls are individually packaged in containers holding 12 rolls. Order from local Sperry Univac branch or established Sperry Univac dealer. Specify part number, quantity, and delivery date.

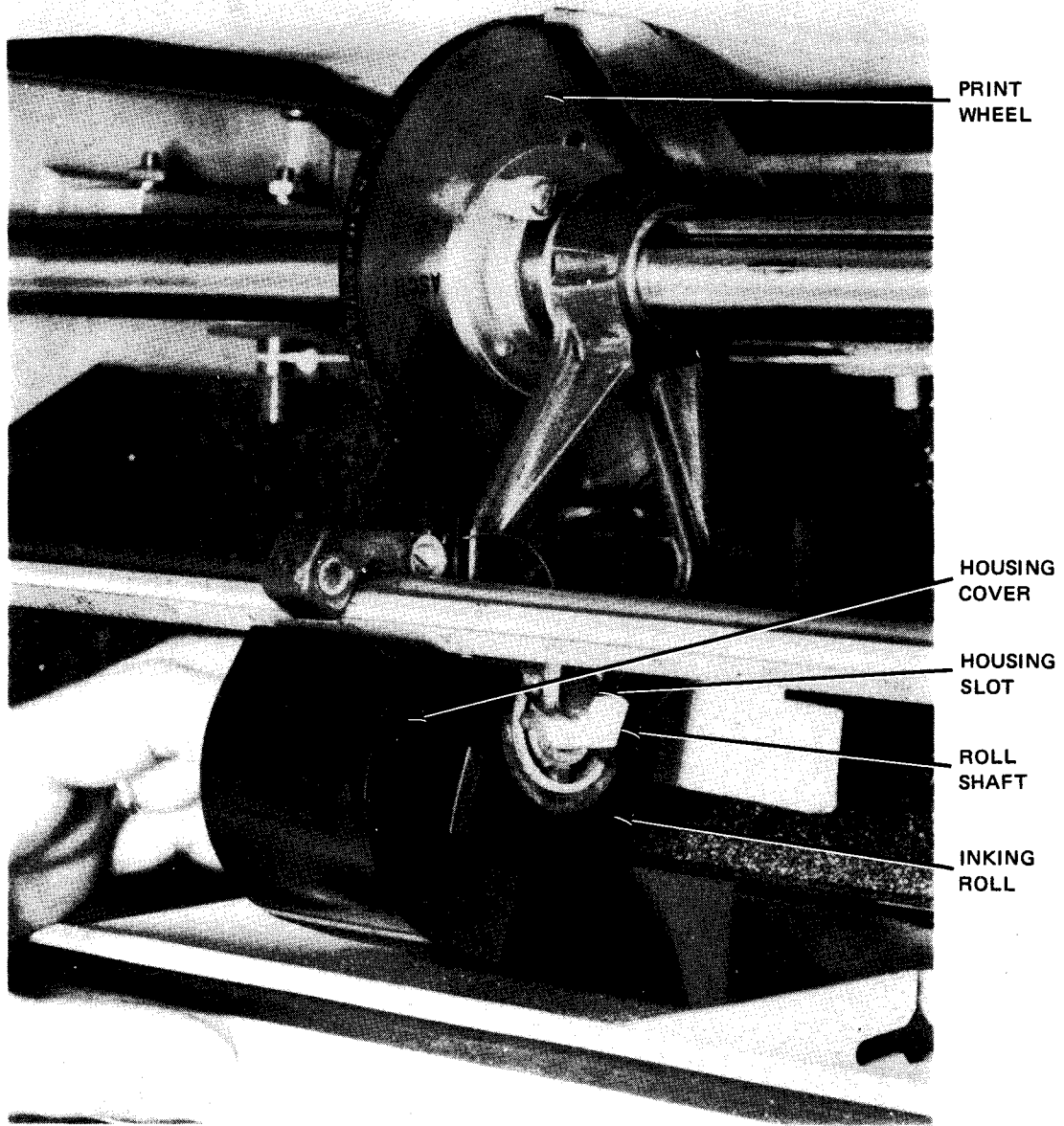

Figure 2-18. Replacing Inking Roll in COP

Table 2-7. Inking Roll Types Used on COP

Sperry Univac Part Number	Color	Environment (°F)
2551087-00	Black	65 to 115
2551087-01	Black	40 to 65
2551087-02	Red	65 to 115
2551087-03	Green	65 to 115
2551087-04	Violet	40 to 115

2.3.4. Recovery Procedures

Table 2—8 lists the COP malfunctions that may be corrected by the operator.

Table 2—8. 8541-06 Communications Output Printer, Recovery Procedures

Fault Indication	Probable Cause	Operator Action
PRINT CHECK indicator lit	<ol style="list-style-type: none"> 1. COP is out of forms. 2. Fuse blown 3. Paper feed signal too long 	<p>Load forms as directed in 2.3.3.1.</p> <p>Contact Sperry Univac customer engineer.</p> <p>Paper (forms) can be fed by program control or manually, but should not be attempted for longer than 18 seconds or the paper feed solenoid fuse will burn out. Contact Sperry Univac customer engineer.</p>
TEMP WARN indicator lit	COP is overheated.	<ol style="list-style-type: none"> 1. If permissible, set ON/OFF switch to OFF. 2. Open all cabinet doors and allow COP to cool. 3. Resume normal operation after TEMP WARN indicator extinguishes.
Forms tear as they are fed.	Out-of-paper microswitch is out of adjustment.	Contact Sperry Univac customer engineer.
SELECT indicator does not light.	Input power to COP is interrupted.	<ol style="list-style-type: none"> 1. Check pushbutton circuit breaker on power control panel. If it is extruding, push it in and release. If the circuit breaker pops out again, contact the Sperry Univac customer engineer. <div style="text-align: center; border: 1px solid black; padding: 2px; width: fit-content; margin: 10px auto;">CAUTION</div> <p>Do not hold the circuit breaker pressed in or damage will result to the COP.</p> <ol style="list-style-type: none"> 2. Ensure that power card is plugged into power outlet.

2.4. EXTERNAL STORAGE CABINETS

External storage cabinets are used only in early production models of the 90/30 system to extend the main storage capacity of their processor cabinets to 256K* bytes. Processor cabinets up to and including serial number 746 can only house up to 128K bytes of main storage. When a system containing one of these processors uses more than 128K bytes of main storage, the first 64K bytes are installed in the processor cabinet, and the remainder is placed in an external storage cabinet. External storage cabinets can house up to 192K bytes of main storage. Present 90/30 systems can house up to 512K bytes without an external storage cabinet. ←

External storage cabinets for the 90/30 System may be in either of two types: SPERRY UNIVAC 7024-00/01 or 7024-02/03 (Figure 2—19). Although their appearances are different, both types serve identical purposes. Only one external main storage cabinet (either type) is used in a system. Both types, therefore, are described separately in subsequent removable paragraphs.

The 90/30 B system is capable of expanding main storage up to 524K bytes without an external storage cabinet. ←

*K= 1,024

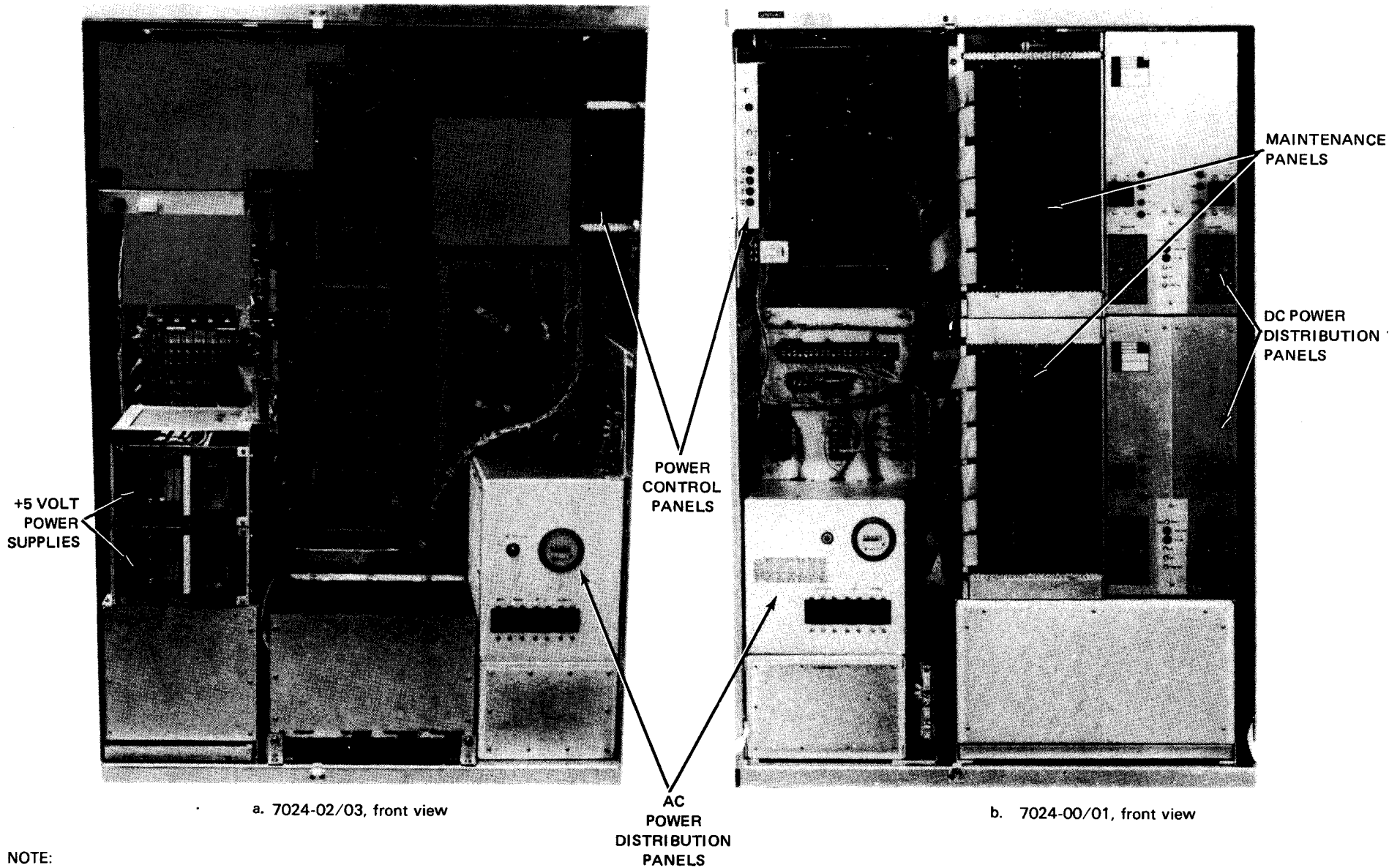

a. 7024-02/03, front view

b. 7024-00/01, front view

NOTE:

Only one cabinet is used in a system.

Figure 2-19. 90/30 System, External Storage Cabinets

2.4.1. 7024-00/01 External Storage Cabinet

The 7024-00/01 external storage cabinet (Figure 2—19b) is a freestanding unit using MOS storage chips and containing its own power supplies. The storage unit can transfer 2-byte words through a single access port with a random read access time of 350 nanoseconds. The random read or write cycle is 600 nanoseconds with any data pattern to any available address. The storage is volatile and is refreshed for 600 nanoseconds each 60 microseconds.

A maintenance panel is included on each storage module with type 7024-00/01 storage unit. The maintenance panel displays data, address, byte write enables, test mode, and data parity for online or offline modes. The state of the registers is displayed when an error occurs in storage hold mode.

2.4.1.1. Operating Controls and Indicators

The operator is concerned with controls and indicators on the front and rear of the external storage cabinet. The cabinet front (Figure 2—19b) contains the power control panel (Figure 2—20), ac power distribution panel (Figure 2—21) and dc power distribution panels (Figure 2—22). The maintenance panel is used by the Sperry Univac customer engineer, but the operator should check that all toggle switches are in the down position.

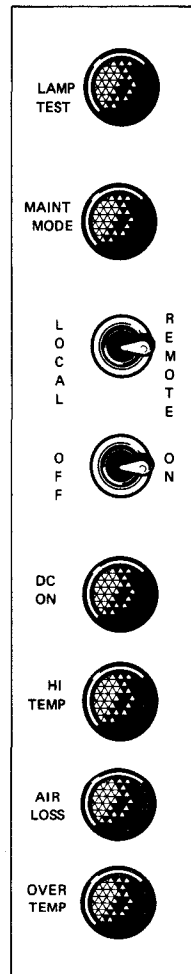

Figure 2—20. 7024-00/01 External Storage Cabinet, Power Control Panel

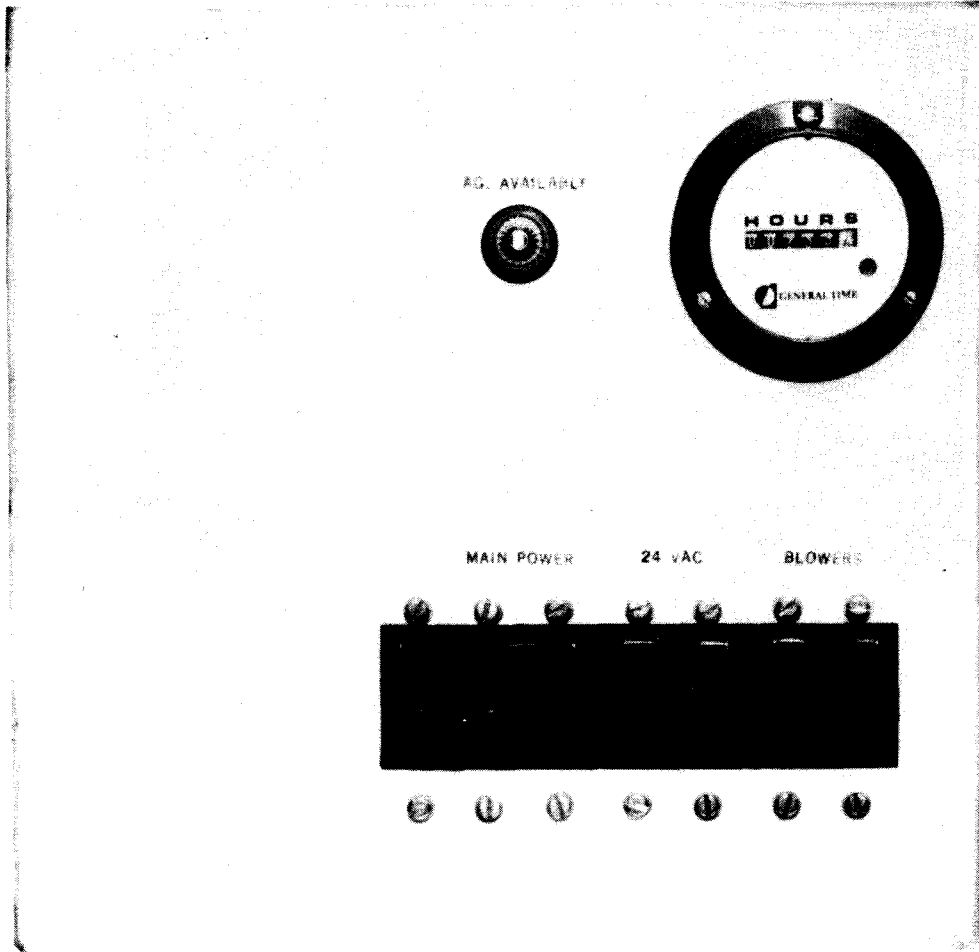

Figure 2-21. 7024-00/01 External Storage Cabinet, AC Power Distribution Panel

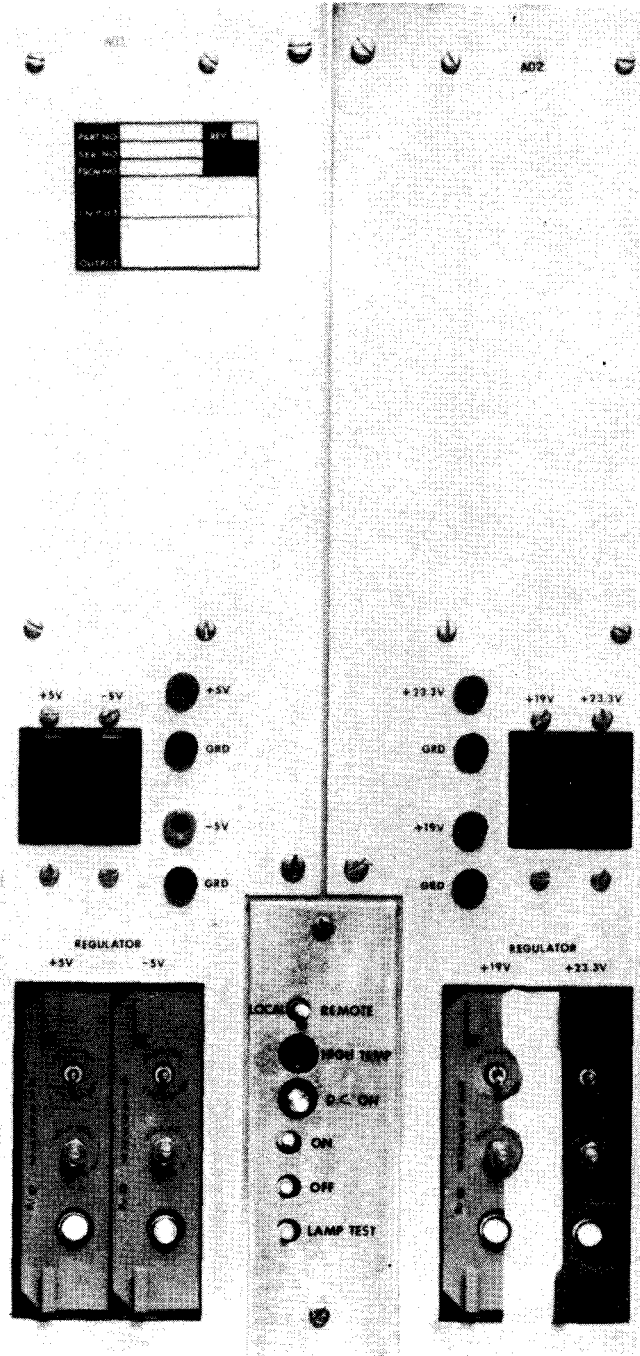

Figure 2-22. 7024-00/01 External Storage Cabinet, DC Power Distribution Panel

The rear of the external storage cabinet (Figure 2-23) contains the 5-volt regulator panel (Figure 2-24), module power supply panels (Figure 2-25), and additional dc power distribution panels, which are identical to the dc power distribution panels located on the front of the cabinet (Figure 2-22).

The number of dc power distribution panels and module power supply panels located in the cabinet depends upon the number of storage expansion features included with the system.

All controls and indicators for all panels of concern to the operator are listed and described in Table 2-9.

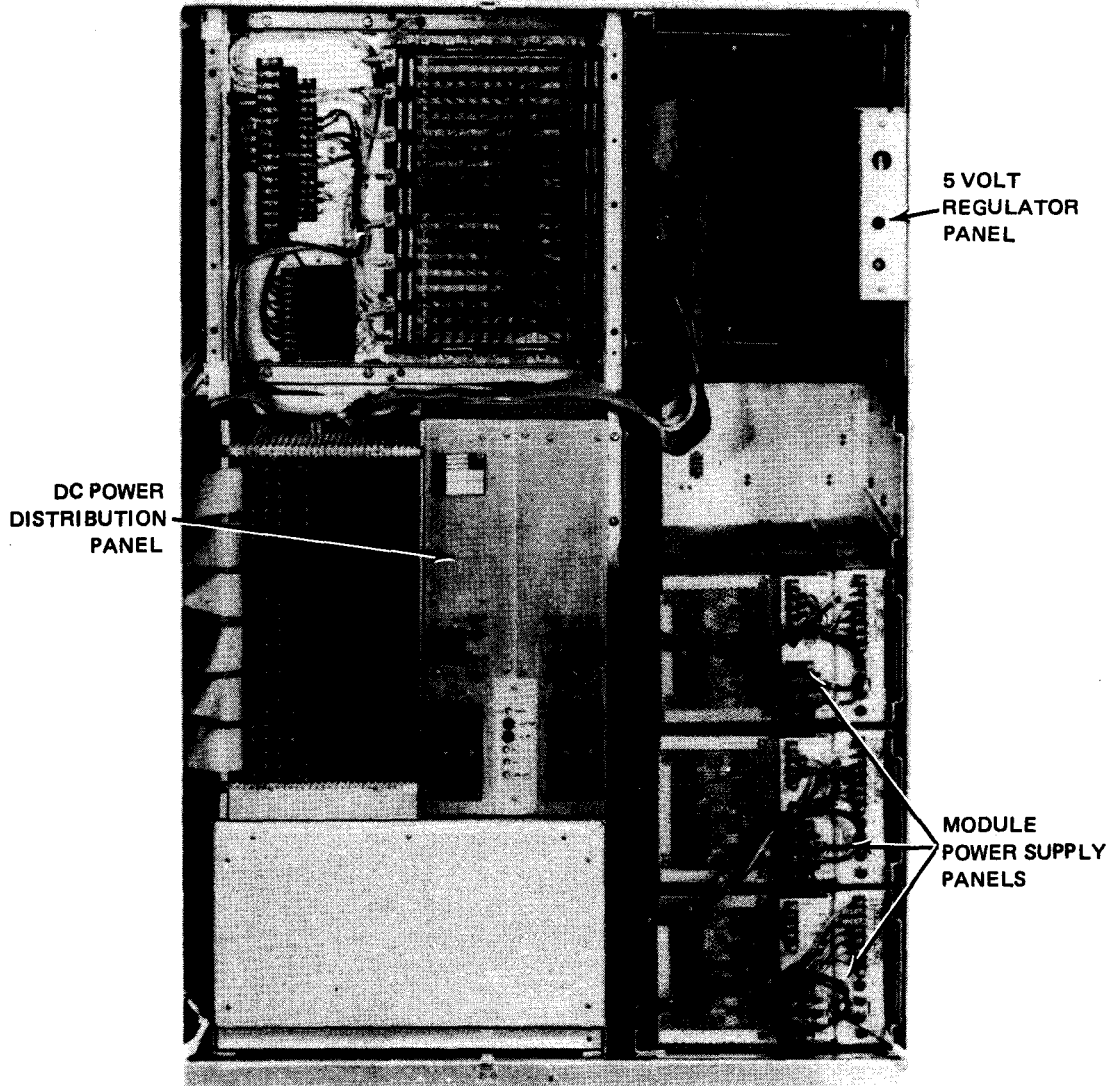

Figure 2-23. 7024-00/01 External Storage Cabinet, Rear View

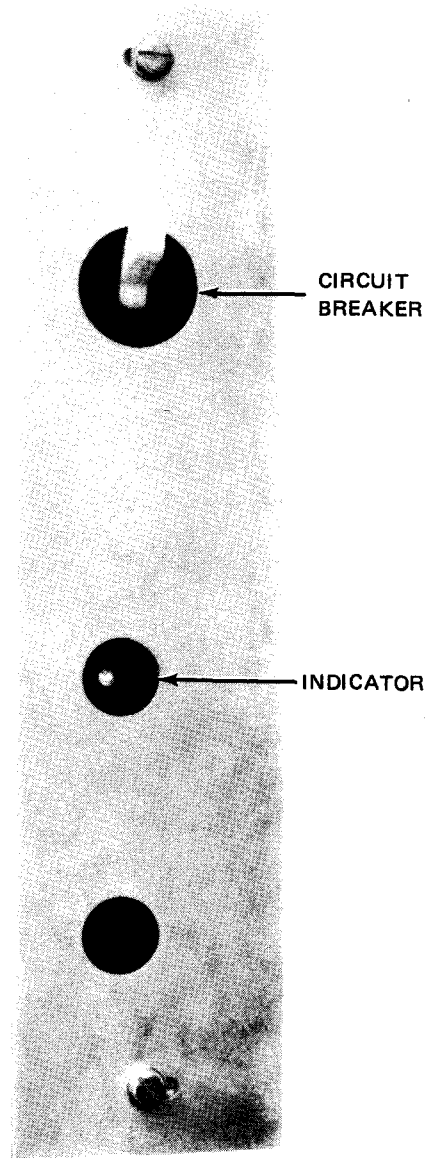

Figure 2-24. 7024-00/01 External Storage Cabinet, 5 Volt Regulator Panel

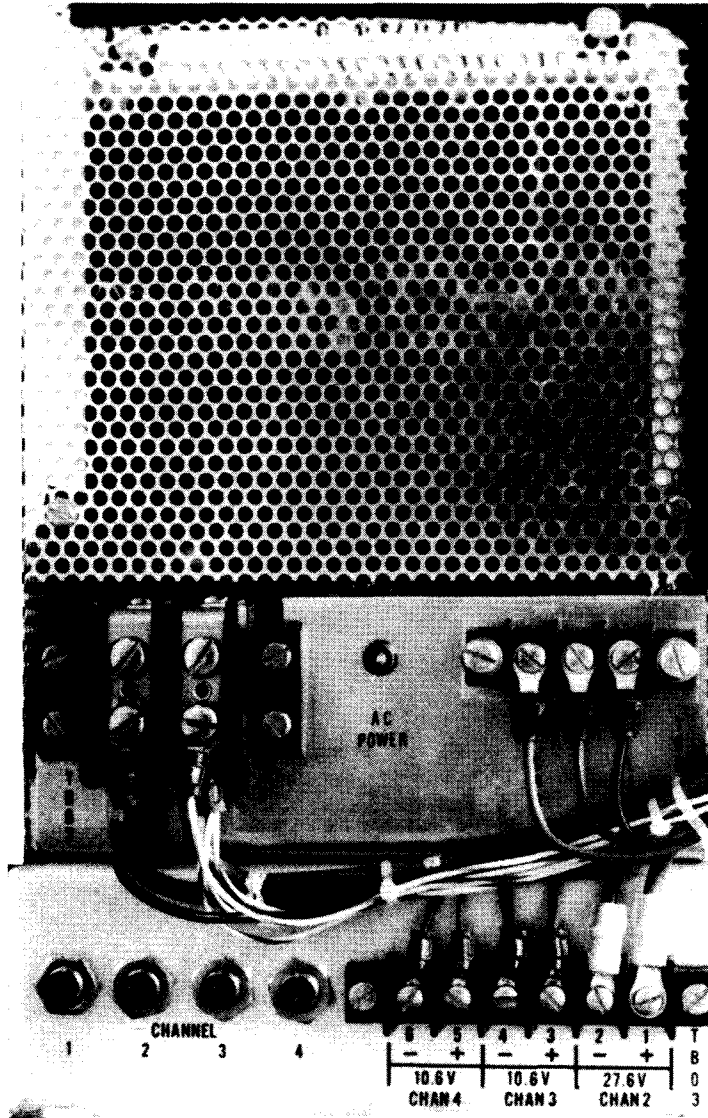

Figure 2-25. 7024-00/01 External Storage Cabinet, Module Power Supply Panel

Table 2-9. 7024-00/01 External Storage Cabinet, Controls and Indicators (Part 1 of 3)

Control/Indicator — Function
Power Control Panel
LAMP TEST switch When pressed, lights all indicators on power control panel for a lamp test
MAINT MODE indicator Indicates one or more storage modules are operating offline
LOCAL/REMOTE switch Selects dc control power: LOCAL position: Power from external storage cabinet REMOTE position: Power from processor maintenance panel
ON/OFF switch Applies dc power to external storage cabinet if LOCAL/REMOTE switch is set to LOCAL
DC ON indicator Lights when dc power is applied to each storage module
HI TEMP indicator Lights when a higher than normal temperature condition is detected (above 132° F) in one or more storage modules
AIR LOSS indicator Lights when air flow is blocked or fan is off inside the cabinet
OVER TEMP indicator Lights when an overheated condition (above 153° F) exists in one or more storage modules
AC Power Distribution Panel
AC AVAILABLE indicator Lights when ac operating power is applied to external storage cabinet
Elapsed time meter Indicates, in hours, the total time ac power has been applied to module power supplies
MAIN POWER circuit breaker Protects external storage cabinet primary power circuits from current overload

Table 2-9. 7024-00/01 External Storage Cabinet, Controls and Indicators (Part 2 of 3)

Control/Indicator — Function
AC Power Distribution Panel (cont)
24 VAC circuit breaker Protects 24 volt ac power circuits from current overload
BLOWERS circuit breaker Protects blower motors from current overload
DC Power Distribution Panel
+5V circuit breaker Protects +5 volt power supply from current overload
-5V circuit breaker Protects -5 volt power supply from current overload
+19V circuit breaker Protects 19 volt power supply from current overload
+23.3V circuit breaker Protects 23.3 volt power supply from current overload
REGULATOR +5V HI MARGIN/LOW MARGIN switch Used by Sperry Univac customer engineer for testing and adjusting +5 volt regulator; switch normal position is at center.
REGULATOR -5V HI MARGIN/LO MARGIN switch Used by Sperry Univac customer engineer for testing and adjusting -5 volt regulator; switch normal position is at center.
LOCAL/REMOTE switch LOCAL position: Power control is from external storage cabinet. REMOTE position: Power control is from processor operator/maintenance panel (normal setting).
HIGH TEMP indicator Lights when internal temperature is excessive (above 132° F); extinguishes when temperature drops
D.C. ON indicator Lights when power sequence is complete

Table 2-9. 7024-00/01 External Storage Cabinet, Controls and Indicators (Part 3 of 3)

Control/Indicator — Function
DC Power Distribution Panel (cont)
ON switch When pressed, applies regulated dc power to storage modules
OFF switch When pressed, removes regulated dc power from storage modules
LAMP TEST switch When pressed, tests D.C. ON and HIGH TEMP indicators on same panel
REGULATOR +19V HI MARGIN/LOW MARGIN switch Used by Sperry Univac customer engineer for testing and adjusting +19 volt regulator; switch normal position is at center
REGULATOR +23.3V HI MARGIN/LOW MARGIN switch Used by Sperry Univac customer engineer for testing and adjusting +23.3 volt regulator; switch normal position is at center
+5 Volt Regulator
+5V circuit breaker Protects +5 volt regulator from current overload
Power-on indicator Indicates +5 volts is supplied from the regulator
Module Power Supply
AC POWER indicator Lights when power is applied to module power supply
CHANNEL 1/2/3/4 circuit breakers <ol style="list-style-type: none">1 Protects +10.6 volt supply circuit for +5 volt regulator2 Protects +27.6 volt supply circuit for +19 volt regulator3 Protects -10.6 volt supply circuit for -5 volt regulator4 Protects +10.6 volt supply circuit for part of +23.3 volt regulator

2.4.1.2. Turn-On and Turn-Off Procedures

Power to the external storage cabinet is normally applied with the **POWER ON/POWER OFF** switch on the processor operator/maintenance panel (Figure 2-2). However, to control power from this panel, certain switches and circuit breakers on the external storage cabinet must first be set to specific positions. The switches and circuit breakers and their required settings are listed in Table 2-10.

When the switches and circuit breakers are set as listed in Table 2-10, and the **POWER ON/POWER OFF** switch on the processor is set to **POWER ON**, the indicators listed in Table 2-11 should be lit.

Table 2-10. 7024-00/01 External Storage Cabinet, Power Switch Settings

Switch/Circuit Breaker	Normal Setting
Power Control Panel	
LOCAL/REMOTE switch	REMOTE
AC Power Distribution Panel	
MAIN POWER circuit breaker	On (up)
24 VAC circuit breaker	On (up)
BLOWERS circuit breaker	On (up)
DC Power Distribution Panel	
+5V circuit breaker	On (up)
-5V circuit breaker	On (up)
+19V circuit breaker	On (up)
+23.3V circuit breaker	On (up)
REGULATOR +5V HI/LOW switch	Center position
REGULATOR -5V HI/LOW switch	Center position
LOCAL/REMOTE toggle switch	REMOTE
ON pushbutton switch	Press
REGULATOR +19V HI/LOW switch	Center position
REGULATOR +23.3V HI/LOW switch	Center position
5 Volt Regulator Panel	
+5V circuit breaker	On (up)
Maintenance Panel	
All toggle switches	Down for online operation

Table 2-11. 7024-00/01 External Storage Cabinet, Power-On Indicators

Equipment Panel	Indicator Lit
Power Control	DC ON
AC Power Distribution	AC AVAILABLE
DC Power Distribution	DC ON
5 Volt Regulator	Power indicator

2.4.1.3. Recovery Procedures

Table 2-12 lists the external storage cabinet malfunctions that may be corrected by the operator.

Table 2-12. 7024-00/01 External Storage Cabinet, Recovery Procedures (Part 1 of 2)

Fault Indication	Probable Cause	Operator Action
Audible alarm sounds; HI TEMP indicator is lit on power control panel; HIGH TEMP indicator is lit on dc power distribution panel; operation continues.	Cooling air flow is restrained or some other condition is causing internal temperature to rise.	<ol style="list-style-type: none"> 1. Open all cabinet doors. 2. Check air filters (Figure 2-26) and clean, if necessary, as follows: <ol style="list-style-type: none"> a. Rinse filter under open faucet with warm water. b. Shake out excess water but do not strike filter on solid object to remove water. c. Spray filter on air intake side with filter coating adhesive (Univac part number 4956915-00). 3. If unit has not yet cooled (alarm silenced and TEMP indicators extinguished), prepare system for an orderly termination of operation to prevent possible loss of data. If temperature continues to rise, the OVER TEMP indicator on power control panel lights, and power sequences down. Contact Sperry Univac customer engineer.
Power is turned off; AIR LOSS indicator on power control panel is lit; audible alarm sounds.	Cooling air is obstructed.	<ol style="list-style-type: none"> 1. Check for air flow obstructions on outside of cabinet. 2. Open all cabinet doors and check for air flow obstruction. 3. Check whether BLOWERS circuit breaker is tripped on ac power distribution panel.

Table 2-12. 7024-00/01 External Storage Cabinet, Recovery Procedures (Part 2 of 2)

Fault Indication	Probable Cause	Operator Action
		<p>4. To reapply power, on power control panel:</p> <ul style="list-style-type: none"> a. Set LOCAL/REMOTE switch to LOCAL. b. Set ON/OFF switch to OFF, then back to ON. c. Set LOCAL/REMOTE switch to REMOTE. <p>5. If no obstruction to air flow is located but AIR LOSS indicator remains lit, or if BLOWERS circuit breaker trips again after resetting, contact Sperry Univac customer engineer.</p>
<p>Power is turned off; D.C. ON indicator on dc power distribution panel is extinguished.</p>	<p>Tripped circuit breaker on dc power distribution panel</p>	<p>Ensure that all circuit breakers on the dc power distribution panel are on (up), REGULATOR +5V/-5V/+19V/+23.3V toggle switches are in center position, and LOCAL/REMOTE toggle switch is in REMOTE position. If a circuit breaker trips again after resetting, contact Sperry Univac customer engineer.</p>
<p>Power is turned off; DC ON indicator on power control panel is extinguished; AC POWER indicator on any module power supply is extinguished; AC AVAILABLE indicator on ac power distribution panel is lit.</p>	<p>A pushbutton circuit breaker on any of the module power supplies may be tripped (button extruding).</p>	<p>Reset the tripped pushbutton circuit breaker by pressing the button in and releasing it.</p> <div style="border: 1px solid black; padding: 5px; text-align: center; margin: 10px 0;"> <p>CAUTION</p> </div> <p>Do not hold a pushbutton circuit breaker pressed in. If a current overload is present, damage may result to the equipment. If the pushbutton circuit breaker trips again after resetting, contact the Sperry Univac customer engineer.</p>

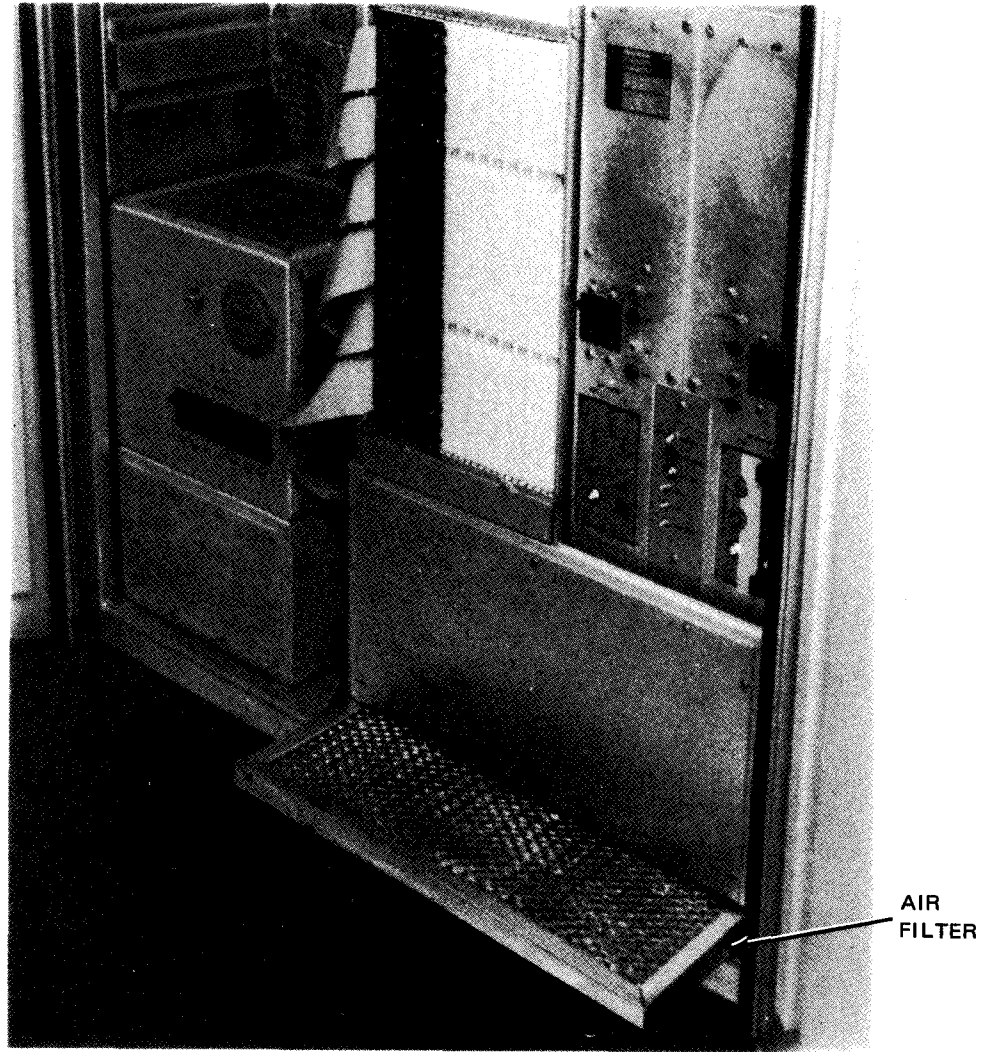

Figure 2-26. 7024-00/01 External Storage Cabinet, Air Filter

2.4.2. 7024-02/03 External Storage Cabinet

The 7024-02/03 external storage cabinet (Figure 2—19a) is a freestanding unit using MOS storage chips and containing its own power supplies. The storage unit can transfer 2-byte words through a single access port with a random read access time of 350 nanoseconds. The random read or write cycle is 600 nanoseconds with any data pattern to any available address. The storage is volatile and is refreshed for 600 nanoseconds each 60 microseconds.

The 7024-02/03 external storage cabinet is an improved version of the earlier 7024-00/01 type. The operations exerciser (used only by the Sperry Univac customer engineer) has been eliminated to reduce costs, and the power supplies and voltage regulators are separated from the storage modules. Both external storage cabinet types perform identical functions, and both are the same physical size.

↓
The 7024-02/03 is used only on the 90/30 system. No external storage cabinet is required to expand main storage up to 524K bytes on the 90/30 B system. Later versions of the 90/30 system are capable of expanding main storage up to 512K bytes without an external storage cabinet.
↑

2.4.2.1. Operating Controls and Indicators

The operator is concerned with controls and indicators on the front and rear of the external storage cabinet. The cabinet front (Figure 2—19a) contains the power control panel (Figure 2—27), the ac power distribution panel (Figure 2—28), and +5 volt power supply panels (Figure 2—29).

The rear of the external storage cabinet (Figure 2—30) contains the 18.5 and 22.5 volt power supply panels (Figure 2—31).

All controls and indicators for all panels of concern to the operator are listed and described in Table 2—13.

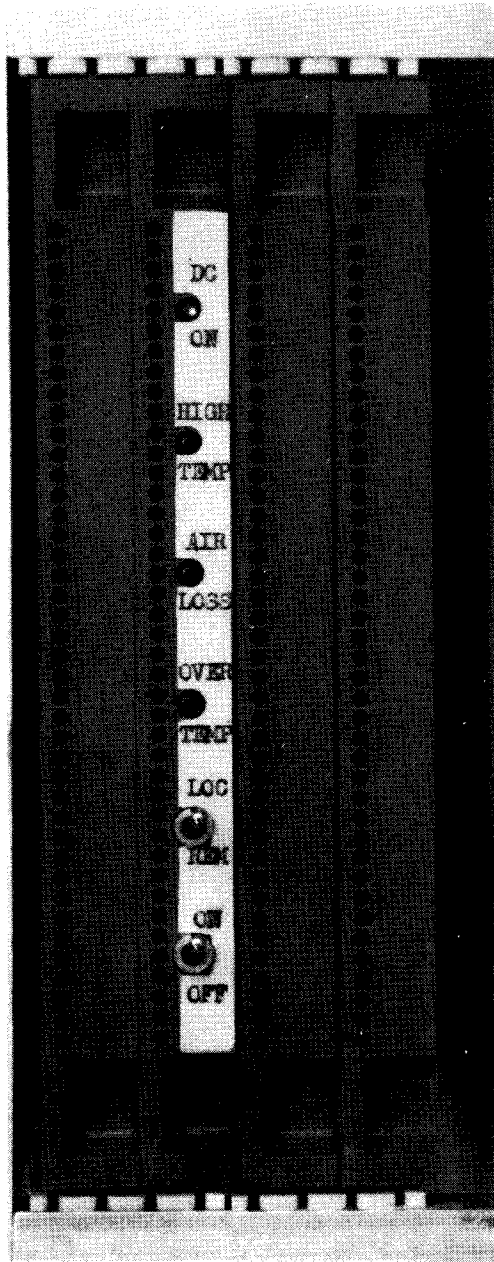

Figure 2-27. 7024-02/03 External Storage Cabinet, Power Control Panel

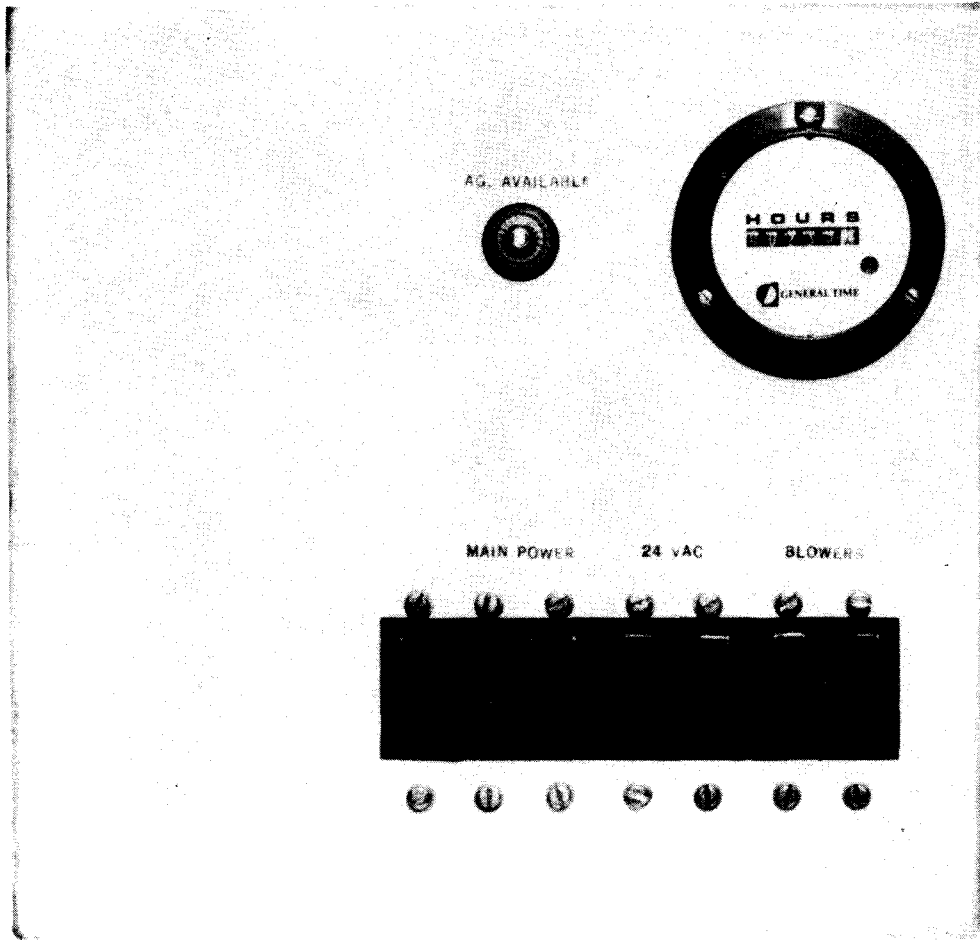

Figure 2-28. 7024-02/03 External Storage Cabinet, AC Power Distribution Panel

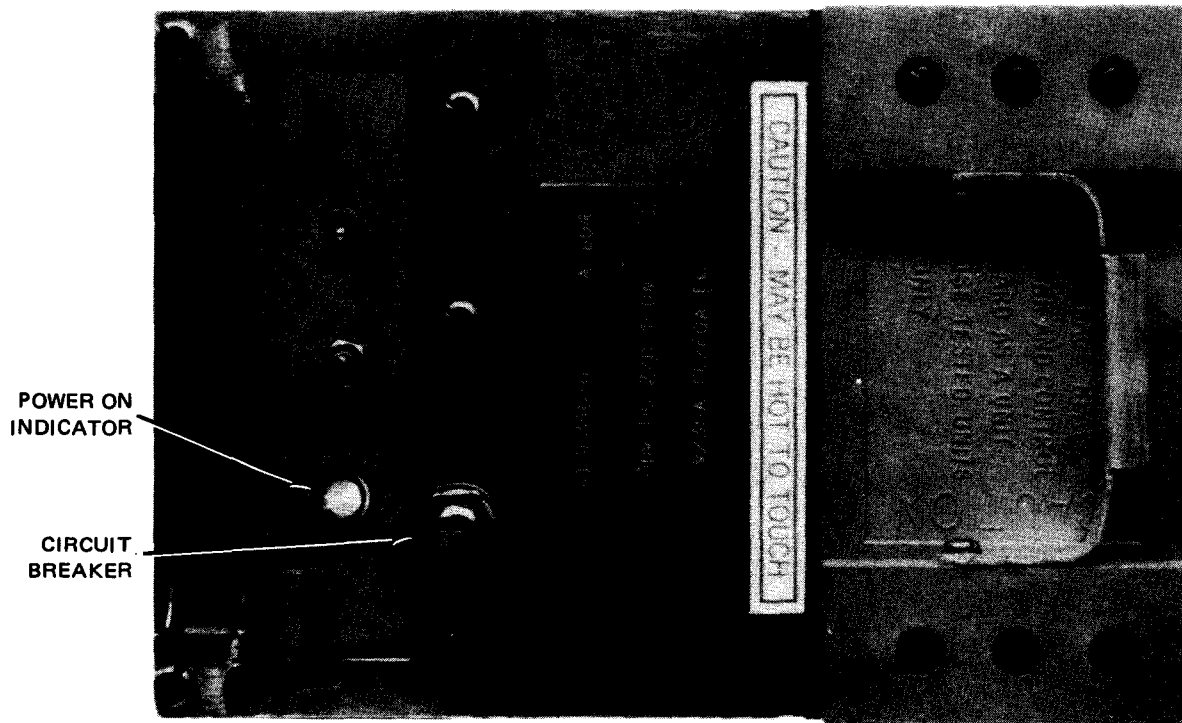

Figure 2-29. 7024-02/03 External Storage Cabinet, +5 Volt Power Supply Panel

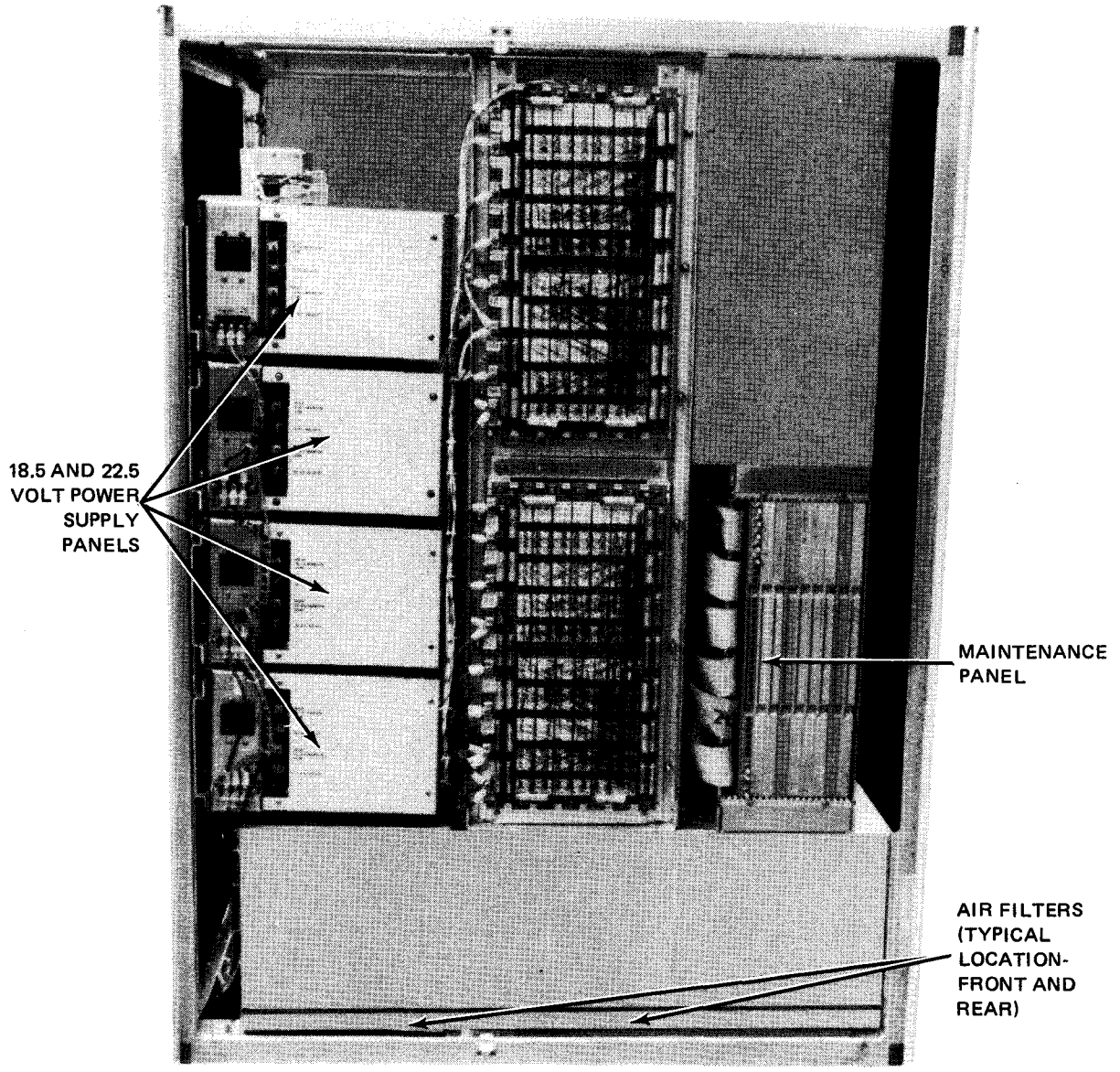

Figure 2-30. 7024-02/03 External Storage Cabinet, Rear View

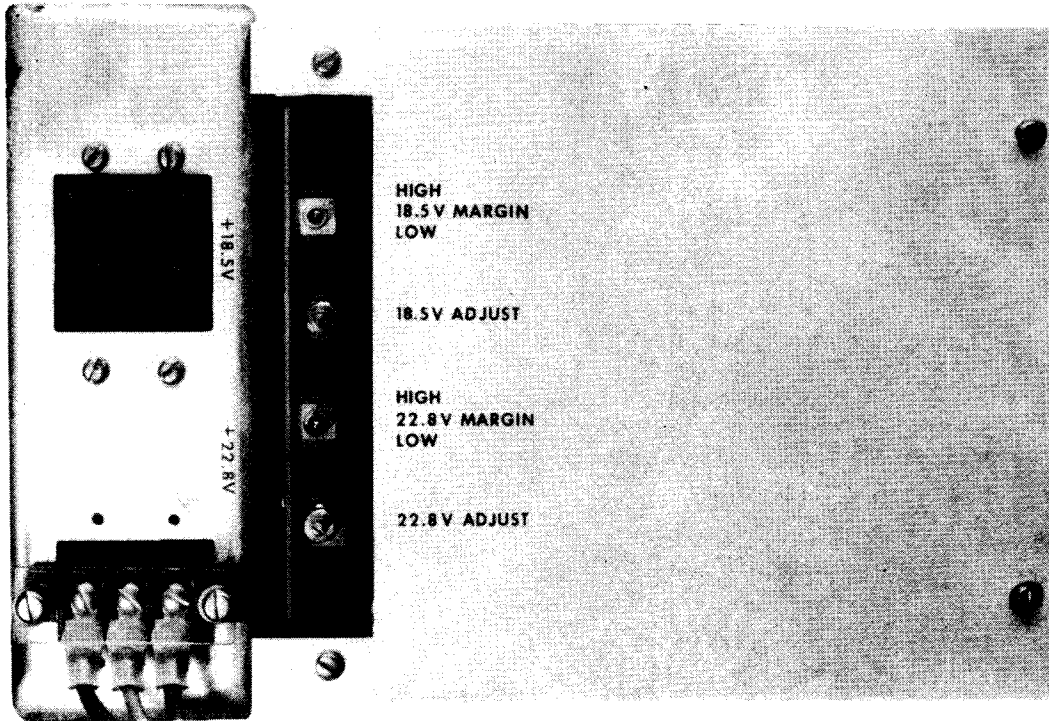

Figure 2-31. 7024-02/03 External Storage Cabinet, 18.5 and 22.5 Volt Power Supply Panel

Table 2-13. 7024-02/03 External Storage Cabinet, Controls and Indicators (Part 1 of 2)

Control/Indicator — Function	
Power Control Panel	
DC ON indicator	Lights when dc power is applied to storage modules
HIGH TEMP indicator	Lights when high temperature (132° F) is present inside the cabinet
AIR LOSS indicator	Lights when a blower is not providing cooling air through the cabinet; power is turned off.
OVER TEMP indicator	Lights when overheating (152° F) condition inside the cabinet; power is turned off.
LOC/REM switch	
LOC position:	Power is controlled locally at the external storage cabinet.
REM position:	Power is controlled remotely at processor.
ON/OFF switch	
	Controls dc power in cabinet when LOC/REM switch is set to LOC

Table 2-13. 7024-02/03 External Storage Cabinet, Controls and Indicators (Part 2 of 2)

Control/Indicator — Function
AC Power Distribution Panel
<p>AC AVAILABLE indicator</p> <p>Lights when ac operating power is applied to external storage cabinet</p> <p>Elapsed time meter</p> <p>Indicates, in hours, the total time ac power has been applied to module power supplies</p> <p>MAIN POWER circuit breaker</p> <p>Protects external storage cabinet primary power circuits from current overload</p> <p>24 VAC circuit breaker</p> <p>Protects 24 volt ac power circuits from current overload</p> <p>BLOWERS circuit breaker</p> <p>Protects blower motors from current overload</p>
+5 Volt Power Supply
<p>HI MARGIN/LOW MARGIN 3-position toggle switch</p> <p>Used by Sperry Univac customer engineer for testing and adjusting +5 volt regulator; switch normal position is at center.</p> <p>Power-on indicator</p> <p>Lights when +5 volts is supplied from the regulator</p> <p>Pushbutton circuit breaker</p> <p>Protects +5 volt regulator from current overload</p>
18.5 and 22.5 Volt Power Supply
<p>Circuit breaker</p> <p>Protects 18.5 and 22.5 volt power supply from current overload</p> <p>HIGH/18.5V MARGIN/LOW switch</p> <p>Used by Sperry Univac customer engineer for testing and adjusting +18.5 volt regulator; switch normal position is at center.</p> <p>HIGH/22.5V MARGIN/LOW switch</p> <p>Used by Sperry Univac customer engineer for testing and adjusting +22.5 volt regulator; switch normal position is at center.</p>

2.4.2.2. Turn-On and Turn-Off Procedures

Power to the external storage cabinet is normally applied with the **POWER ON/POWER OFF** switch on the processor operator/maintenance panel (Figure 2—2). However, to control power from this panel, certain switches and circuit breakers on the external storage cabinet must first be set to specific positions. The switches and circuit breakers and their required settings are listed in Table 2—14.

When the switches and circuit breakers are set as listed in Table 2—14, and the **POWER ON/POWER OFF** switch on the processor is set to **POWER ON**, the indicators listed in Table 2—15 should be lit.

Table 2—14. 7024-02/03 External Storage Cabinet, Power Switch Settings

Switch/Circuit Breaker	Normal Setting
Power Control Panel	
LOC/REM switch	REM
AC Power Distribution Panel	
MAIN POWER circuit breaker	On (up)
24 VAC circuit breaker	On (up)
BLOWERS circuit breaker	On (up)
18.5 and 22.5 Volt Power Supplies	
Circuit breaker	On (up)

Table 2—15. 7024-02/03 External Storage Cabinet, Power-On Indicators

Equipment Panel	Indicator Lit
Power Control	DC ON
AC Power Distribution	AC AVAILABLE
+5 Volt Power Supplies	Power-on

2.4.2.3. Recovery Procedures

Table 2—16 lists the external storage cabinet malfunctions that may be corrected by the operator. If the fault indication persists, contact your Sperry Univac customer engineer.

Table 2-16. 7024-02/03 External Storage Cabinet, Recovery Procedures (Part 1 of 2)

Fault Indication	Probable Cause	Operator Action
Audible alarm sounds; HIGH TEMP indicator on power control panel is lit; early temperature warning message is displayed on system console screen; operation does not terminate.	Cooling air flow is restrained or some other condition is causing internal temperature to rise.	<ol style="list-style-type: none"> 1. Open all cabinet doors. 2. Check air filters (Figure 2-26) and clean, if necessary, as follows: <ol style="list-style-type: none"> a. Rinse filter under open faucet with warm water. b. Shake out excess water, but do not strike filter on solid object to remove water. c. Spray filter on air intake side with filter coating adhesive (Univac part number 4956915-00). 3. If unit has not yet cooled (alarm silenced and HIGH TEMP indicator extinguished), prepare system for an orderly termination of operation to prevent possible loss of data. If temperature continues to rise, the OVER TEMP indicator on the power control panel lights, and power sequences down. Contact Sperry Univac customer engineer.
Power is turned off. AIR LOSS indicator on power control panel is lit.	Cooling air is obstructed.	<ol style="list-style-type: none"> 1. Check for air flow obstruction on outside of cabinet. 2. Open all cabinet doors and check for air flow obstruction. 3. Check whether BLOWERS circuit breaker is tripped on ac power distribution panel. 4. To reapply power, on power control panel: <ol style="list-style-type: none"> a. Set LOC/REM switch to LOC. b. Set ON/OFF switch to OFF, then back to ON. c. Set LOC/REM switch to REM. 5. If no obstruction to air flow is located, but AIR LOSS indicator remains lit, or if BLOWERS circuit breaker trips again, contact Sperry Univac customer engineer.

Table 2-16. 7024-02/03 External Storage Cabinet, Recovery Procedures (Part 2 of 2)

Fault Indication	Probable Cause	Operator Action
<p>Power is turned off; OVER TEMP indicator is lit, audible alarm sounds.</p>	<p>Internal cabinet temperature is overheated.</p>	<ol style="list-style-type: none"> 1. Open all cabinet doors. 2. Check for cooling air obstruction or tripped BLOWERS circuit breaker. 3. Allow unit to cool (OVER TEMP indicator extinguished and alarm silenced). 4. Reapply power from power control panel: <ol style="list-style-type: none"> a. Set LOC/REM switch to LOC. b. Set ON/OFF switch to OFF, then to ON. c. Set LOC/REM switch to REM. <p>If overheat condition recurs, contact Sperry Univac customer engineer.</p>
<p>Power is turned off; power-on indicator is on +5 volts; power supply is extinguished.</p>	<p>Power from +5 volt supply is interrupted.</p>	<ol style="list-style-type: none"> 1. Check for tripped circuit breaker (pops out) on +5 volt power supply panel. Push in the circuit breaker to reset. 2. Reapply power as directed for over-temperature condition (previously described). 3. If circuit breaker trips again (pops out), do not reset. Contact Sperry Univac customer engineer. <div style="border: 1px solid black; padding: 2px; text-align: center; width: fit-content; margin: 10px auto;"> <p>CAUTION</p> </div> <p>Do not hold a pushbutton circuit breaker pressed in. If a current overload is present, damage may result to the equipment.</p>

2.5. I/O EXPANSION CABINET

I/O expansion cabinet 1921-00/01 (Figure 2—32) provides for expanding the processor input/output capability with two additional selector channels and one additional multiplexer channel. This I/O expansion is required to allow standard peripheral subsystems to operate with the system, in addition to the integrated peripheral subsystems.

Selector channels are numbered 1 and 2 to permit proper I/O selections during operation. Up to eight subsystems can be accommodated on each selector channel. Operations are in burst mode so that only one subchannel is active at any given time. The normal transfer rate through the active subchannel is 825k bytes per second. ←

The single multiplexer channel permitted in the system (internal or external) can accommodate up to eight active subchannels. Several subsystems can be serviced concurrently because the devices attached to the multiplexer channel normally supply or accept data at a slower rate than the selector channels. The normal transfer rate for the multiplexer channel is 83k bytes per second. ←

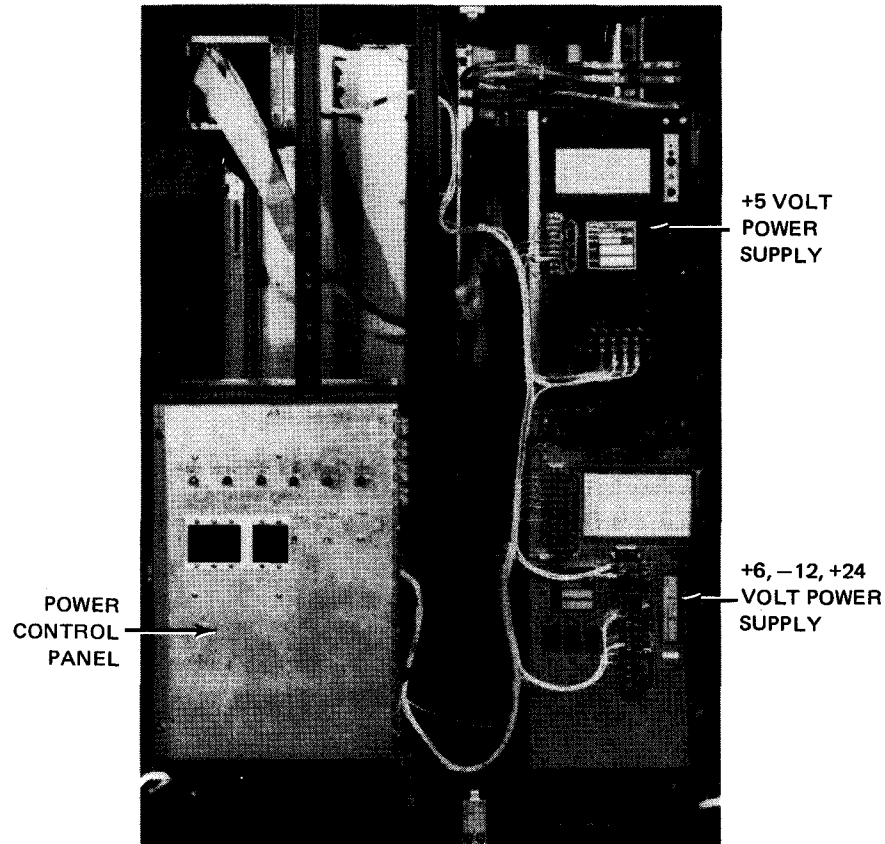

Figure 2—32. 1921-00/01 I/O Expansion Cabinet, Front View

2.5.1. Operating Controls and Indicators

All operating controls and indicators for the I/O expansion cabinet are located behind the cabinet front door on three panels (Figure 2—32). Main power for the cabinet is controlled from the power control panel (Figure 2—33). The +5 volt power supply panel (Figure 2—34) and +6, -12, +24 volt power supply panel (Figure 2—35) control dc power to logic circuits in the cabinet. All controls and indicators are listed and described in Table 2—17.

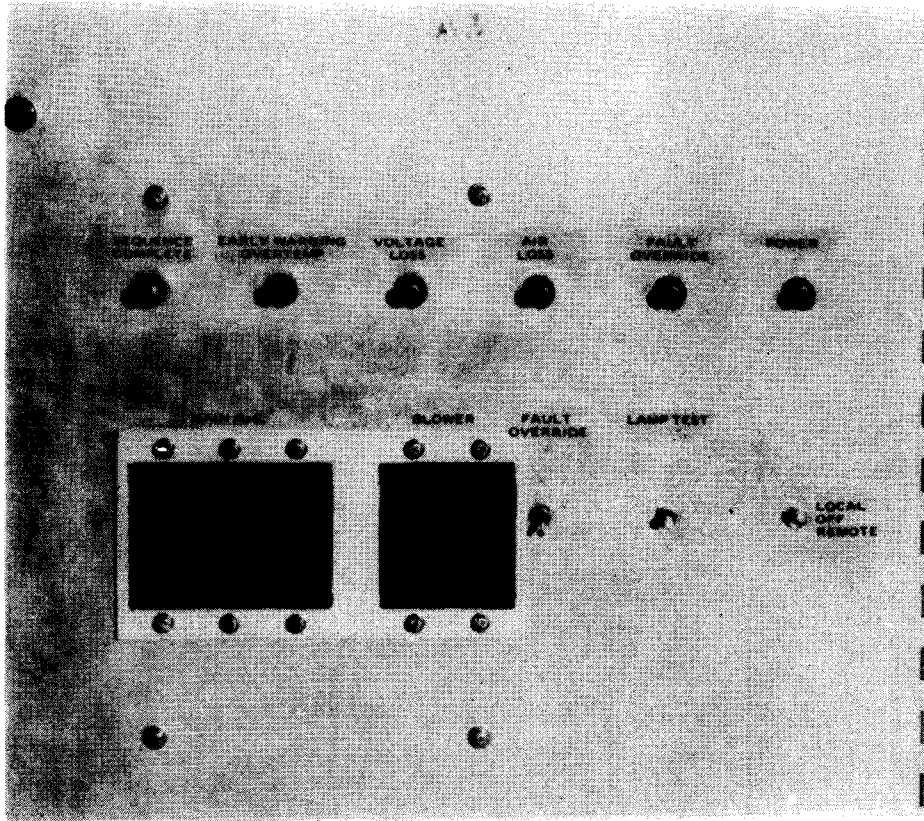

Figure 2-33. 1921-00/01 I/O Expansion Cabinet, Power Control Panel

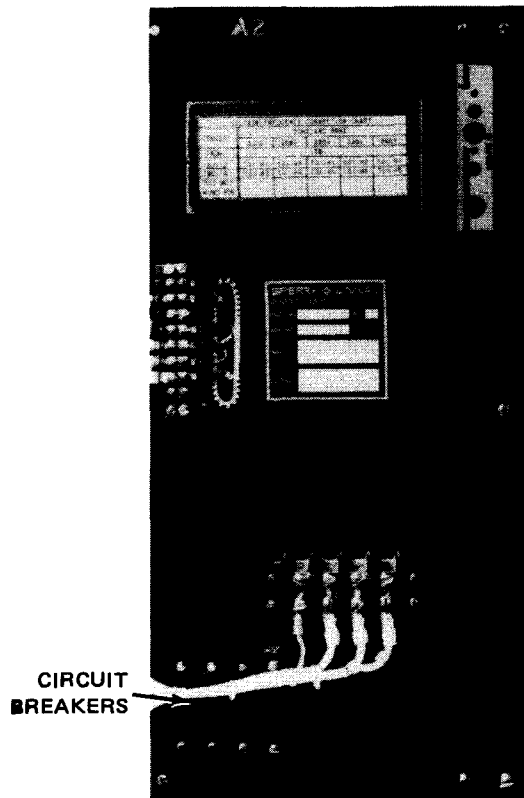

Figure 2-34. 1921-00/01 I/O Expansion Cabinet, +5 Volt Power Supply

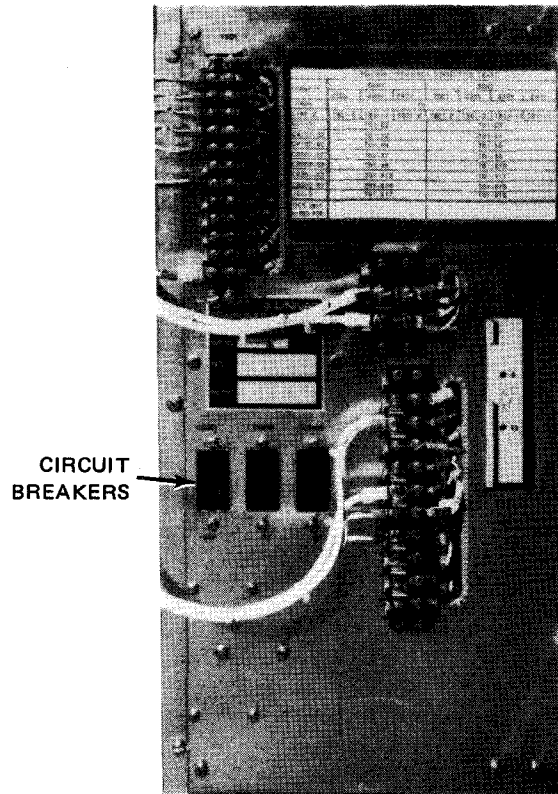

Figure 2-35. 1921-00/01 I/O Expansion Cabinet, +6, -12, +24 Volt Power Supply

Table 2-17. 1921-00/01 I/O Expansion Cabinet, Controls and Indicators (Part 1 of 3)

Control/Indicator — Function
Power Control Panel
<p>SEQUENCE COMPLETE indicator</p> <p>Lights after power is applied to cabinet and all subsystems connected to multiplexer and selector channels.</p>
<p>EARLY WARNING OVERTEMP indicator</p> <p>Indicates an overheated condition that caused power to be removed from cabinet and all subsystems connected to multiplexer and selector channels.</p> <p>When lit in conjunction with POWER indicator, indicates an early warning high temperature condition exists in the cabinet.</p>
<p>VOLTAGE LOSS indicator</p> <p>Indicates loss or marginal operation of dc power supplies; if marginal, temporary correction can be made by setting FAULT OVERRIDE switch in up position.</p>
<p>AIR LOSS indicator</p> <p>Indicates an air flow obstruction within the cabinet; temporary correction can be made by setting FAULT OVERRIDE switch in up position.</p>

Table 2-17. 1921-00/01 I/O Expansion Cabinet, Controls and Indicators (Part 2 of 3)

Control/Indicator — Function
Power Control Panel (cont)
<p>FAULT OVERRIDE switch</p> <p>Up position overrides air flow obstruction fault or marginal dc power fault.</p> <p>Down position is off.</p> <p>POWER indicator</p> <p>Lights when dc power is applied in cabinet</p> <p>MAIN AC circuit breaker</p> <p>Provides overload protection for ac power circuits in cabinet</p> <p>BLOWER circuit breaker</p> <p>Provides overload protection for blower motors in cabinet</p> <p>FAULT OVERRIDE indicator</p> <p>Lights when FAULT OVERRIDE switch is in up position to override air loss fault or marginal dc power fault</p> <p>LAMP TEST switch</p> <p>When held in up position, lights all indicators on power control panel for lamp test</p> <p>LOCAL/OFF/REMOTE switch</p> <p>LOCAL (up position):</p> <p>Operating power is controlled from I/O expansion cabinet.</p> <p>OFF (center position):</p> <p>Operating power is off.</p> <p>REMOTE (down position):</p> <p>Operating power for I/O expansion cabinet is controlled from processor operator/maintenance panel.</p>
+5 Volt Power Supply
<p>CB101/CB201/CB301/CB401 circuit breakers</p> <p>Provide overload protection for each of the +5 volt power circuits in cabinet.</p>

Table 2-17. 1921-00/01 I/O Expansion Cabinet, Controls and Indicators (Part 3 of 3)

Control/Indicator — Function
+6, -12, +24 Volt Power Supply
<p>CB101 circuit breaker</p> <p>Provides overload protection for -12 volt power circuit in cabinet.</p> <p>CB201 circuit breaker</p> <p>Provides overload protection for +6 volt power circuit in cabinet.</p> <p>CB301 circuit breaker</p> <p>Provides overload protection for +24 volt power circuit in cabinet.</p>

2.5.2. Turn-On and Turn-Off Procedures

Power to the I/O expansion cabinet is normally applied with the **POWER ON/POWER OFF** switch on the processor operator/maintenance panel (Figure 2-2). However, to control power from this panel, certain switches and circuit breakers on the I/O expansion cabinet must first be set to specific positions. The switches and circuit breakers, and their required settings, are listed in Table 2-18.

When the switches and circuit breakers are set as listed in Table 2-18, and the **POWER ON/POWER OFF** switch on the processor operator/maintenance panel is set to **POWER ON**, the following indicators should be lit on the I/O expansion cabinet power control panel:

- **SEQUENCE COMPLETE**
- **POWER**

Table 2-18. 1921-00/01 I/O Expansion Cabinet, Power Switch Settings (Part 1 of 2)

Switch/Circuit Breaker	Normal Setting
Power Control Panel	
FAULT OVERRIDE toggle switch	Off (down)
MAIN AC circuit breaker	On (up)
BLOWER circuit breaker	On (up)
LOCAL/OFF/REMOTE toggle switch	REMOTE (down)

Table 2—18. 1921-00/01 I/O Expansion Cabinet, Power Switch Settings (Part 2 of 2)

Switch/Circuit Breaker	Normal Setting
+5 Volt Power Supply Panel	
CB101 circuit breaker	On (up)
CB201 circuit breaker	On (up)
CB301 circuit breaker	On (up)
CB401 circuit breaker	On (up)
+6, -12, +24 Volt Power Supply Panel	
CB101 circuit breaker	On (up)
CB201 circuit breaker	On (up)
CB301 circuit breaker	On (up)

2.5.3. Operating Procedures

There are no operating procedures for the I/O expansion cabinet.

2.5.4. Recovery Procedures

Table 2—19 lists the I/O expansion cabinet malfunctions that may be corrected by the operator.

Table 2—19. 1921-00/01 I/O Expansion Cabinet, Recovery Procedures (Part 1 of 3)

Fault Indication	Probable Cause	Operator Action
Audible alarm sounds; early warning message is displayed on system console screen; EARLY WARNING OVERTEMP indicator is lit; and POWER indicator is lit.	Cooling air flow is restrained, or some other condition is causing internal temperature to rise.	<ol style="list-style-type: none"> 1. Open all cabinet doors. 2. Check air filter (Figure 2—36), and clean, if necessary, as follows: <ol style="list-style-type: none"> a. Rinse filter under open faucet with warm water. b. Shake out excess water, but do not strike filter on solid object to remove water. c. Reinstall filter in proper location, noting air flow orientation (no coating on filter is required).

Table 2-19. 1921-00/01 I/O Expansion Cabinet, Recovery Procedures (Part 2 of 3)

Fault Indication	Probable Cause	Operator Action
		<ol style="list-style-type: none"> 3. If unit has not yet cooled (alarm silenced and EARLY WARNING OVER-TEMP indicator extinguished), prepare all peripheral subsystems connected to the multiplexer and selector channels for an orderly termination of operation. Contact Sperry Univac customer engineer. 4. Set FAULT OVERRIDE switch to up position, and continue operation until terminated by an overheat condition that turns off power in the cabinet.
<p>Audible alarm sounds; EARLY WARNING OVER TEMP indicator is lit; POWER indicator is extinguished; power is turned off.</p>	<p>An overtemperature condition has caused power to turn off.</p>	<ol style="list-style-type: none"> 1. Open all cabinet doors. 2. Check air filters and clean, if necessary. (Refer to previous fault indication above.) 3. Allow internal cabinet temperature to drop. 4. Set LOCAL/OFF/REMOTE switch to OFF, then back to REMOTE position to recycle power. 5. Note that POWER indicator is lit. If it remains extinguished, contact Sperry Univac customer engineer.
<p>Power is turned off; POWER indicator is extinguished; VOLTAGE LOSS indicator is lit.</p>	<p>DC power has dropped or turned off on a power supply.</p>	<ol style="list-style-type: none"> 1. Set FAULT OVERRIDE switch to up position. 2. Check all circuit breakers on power control panel, +5 volt power supply, and +6, -12, +24 volt power supply. Reset any tripped circuit breaker. 3. Set LOCAL/OFF/REMOTE switch to OFF, then back to REMOTE position to recycle power. 4. Note VOLTAGE LOSS indicator; if extinguished, set FAULT OVERRIDE switch to down position; if lit, contact Sperry Univac customer engineer. <p>NOTE:</p> <p>If any circuit breaker trips again after it is reset, leave it in the off position and contact the Sperry Univac customer engineer.</p>

Table 2-19. 1921-00/01 I/O Expansion Cabinet, Recovery Procedures (Part 3 of 3)

Fault Indication	Probable Cause	Operator Action
Power is turned off; POWER indicator is extinguished; AIR LOSS indicator is lit.	Air flow through cabinet is obstructed.	<ol style="list-style-type: none">1. Set FAULT OVERRIDE switch to up position.2. Check front and back of cabinet for air flow obstruction.3. Check whether BLOWER circuit breaker on power control panel is tripped; reset, if necessary.4. Set LOCAL/OFF/REMOTE switch to OFF, then back to REMOTE position to recycle power.5. Check AIR LOSS indicator; if it remains lit or if BLOWER circuit breaker trips again, contact Sperry Univac customer engineer.
SEQUENCE COMPLETE indicator is extinguished.	Power is not applied to all peripheral subsystems.	<ol style="list-style-type: none">1. Hold LAMP TEST switch to up position to check bulb.2. Check whether all circuit breakers on +5 volt power supply are not tripped.3. Check each peripheral subsystem connected to the multiplexer and selector channels for a tripped main circuit breaker. Each online peripheral should be energized by power control from the I/O expansion cabinet.4. Reset any tripped circuit breaker, and set LOCAL/OFF/REMOTE switch to OFF, then REMOTE. Contact Sperry Univac customer engineer if the SEQUENCE COMPLETE indicator remains out, or if any circuit breaker trips again.

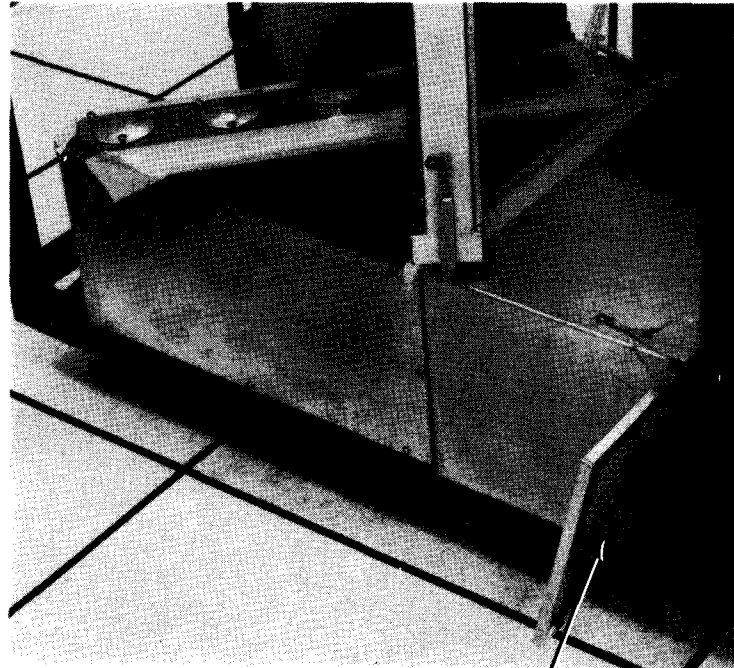

AIR FILTER
(PARTLY
REMOVED)

Figure 2-36. Air Filter Location on Rear of I/O Expansion Cabinet



3. Disc Subsystems

3.1. GENERAL

The disc subsystems that may be part of the SPERRY UNIVAC 90/30 or 90/30 B Systems are:

- SPERRY UNIVAC 8411 Disc Subsystem
- SPERRY UNIVAC 8414 Disc Subsystem
- SPERRY UNIVAC 8416 Disc Subsystem
- SPERRY UNIVAC 8418 Disc Subsystem
- SPERRY UNIVAC 8430 Disc Subsystem
- SPERRY UNIVAC 8415 Disc Subsystem
- SPERRY UNIVAC 8413 Diskette Subsystem

The 8411 disc subsystem uses interchangeable disc packs having a storage capacity of 7.25 million 8-bit bytes. Each disc pack includes 6 discs, and data is read or recorded on their 10 inside surfaces by 10 read/write heads mounted on a single accessor mechanism. The accessor mechanism can assume one of 203 positions across the disc surface. This simultaneous head movement on the disc surfaces accesses 200 addressable data recording cylinders (3 cylinders being reserved for replacement). Each cylinder contains 10 tracks numbered 0 through 9. The addressing of an individual track in a cylinder is by cylinder number (000 through 199) and by a read/write head number (00 through 09). ←

The 8414 disc subsystem uses interchangeable disc packs having a storage capacity of 29.17 million 8-bit bytes. Each disc pack includes 11 discs, and data is read or recorded on their 20 inside surfaces by 20 read/write heads mounted on a single accessor mechanism. The accessor mechanism can assume one of 203 positions across the disc surface. This simultaneous head movement on the 20 disc surfaces accesses 200 addressable data recording cylinders (3 cylinders being reserved for replacement). Each cylinder contains 20 tracks numbered 0 through 19. The addressing of an individual track in a cylinder is by cylinder number (000 through 199) and by read/write head number (00 through 19). ←

The 8416 disc subsystem uses interchangeable disc packs having a storage capacity of 28.9 million 8-bit bytes. Each disc pack includes five discs, and data is read or recorded on seven inside surfaces by seven read/write heads mounted on a single accessor mechanism. The accessor mechanism can assume one of 411 positions across the disc surface. This simultaneous head movement on the seven disc surfaces accesses 404 addressable data recording cylinders (7 cylinders being reserved for replacement). Each cylinder contains seven tracks numbered 0 through 6. The addressing of an individual track in a cylinder is by cylinder number (000 through 403) and by read/write head number (00 through 06). ←

- ➔ The 8418 disc subsystem uses interchangeable disc packs having a storage capacity of 57.9 million 8-bit bytes when used on disc subsystem types 8418—94/95, and 28.95 million 8-bit bytes when used on types 8418—92/93. Each disc pack includes four discs, and data is read or recorded on seven of the eight surfaces. The eighth surface is used for servo reference information required for head positioning. Eight heads are mounted on a single accessor mechanism; seven heads read and write data, and one head reads servo information. The accessor mechanism on types 8418—94 and 8418—95 can assume one of 815 cylinder positions across the disc surface (seven cylinders being reserved for spares or replacements). On types 8418—92 and 8418—93, the accessor mechanism can assume one of 411 cylinder positions across the disc surface (seven cylinders being reserved for spares or replacements). Addressing of an individual track is by cylinder number (000 through 807 on types 8418—94/95 or 000 through 403 on types 8418—92/93) and head number (00 through 06). A circular protective plate is mounted above the top disc, and another plate is under the bottom disc.
- ➔ The 8430 disc subsystem uses interchangeable disc packs having a storage capacity of 77.3 million 8-bit bytes. Each disc pack includes 11 discs, and data is read or recorded on their 19 inside surfaces by 19 read/write heads mounted on a single accessor mechanism (one head and one disc surface are used for servo information). The accessor mechanism can assume one of 411 positions across the disc surface. This simultaneous head movement on the 19 disc surfaces accesses 404 addressable data recording cylinders (7 cylinders being reserved for replacement). Each cylinder contains 19 tracks numbered 0 through 18. The addressing of an individual track in a cylinder is by cylinder number (000 through 403) and by read/write head number (00 through 18).
- ➔ The 8415 disc subsystem uses fixed and removable storage media having a combined storage capacity of 33.1 million 8-bit bytes. Both the fixed and removable media are driven by a common drive and share a common accessor mechanism having a read/write head for each recording surface. The fixed storage media consists of two 14-inch diameter discs (forming an integral part of the vertical drive) permanently mounted in the lower portion of the disc well. The removable storage media consists of a single interchangeable, 14-inch diameter disc hub mounted in a plastic cartridge. The cartridge mounts directly above the fixed storage media. The two fixed discs provide four recording surfaces, of which three are used for data and the other is used for servo referencing information required for head positioning. Each surface contains 815 tracks (808 data + 7 spares) providing a total storage capacity of 24 million 8-bit bytes. The removable disc contains two recording surfaces each having 408 tracks (404 data + 4 spares), providing a total storage capacity of over 8 million 8-bit bytes. Each 8415 disc drive accepts two device addresses: an even address for the fixed storage media and an odd address for the removable storage media. The accessor mechanism, however, moves the read/write heads for both storage media simultaneously. The design of the accessor mechanism is such that it can position the heads from one cylinder to another without returning to a home position. There are 815 attainable head positions for the fixed discs and 408 positions for the removable disc. (The tracks of the removable disc physically coincide with the even-numbered tracks of the fixed discs.) Addressing of an individual track is by cylinder number (000 through 807 for fixed discs and 000 through 403 for removable discs).
- ➔ The 8413 diskette subsystem uses an interchangeable diskette storage media having a storage capacity of 242,944 bytes per diskette. Each diskette consists of a flexible magnetic disc enclosed in an 8-inch square plastic jacket. It has one recording surface consisting of 77 tracks each having 26 evenly spaced sectors. A single read/write head can be positioned at any one of the 77 tracks. Tracks are addressable 00 through 76, with track 00 located at the outermost edge of the diskette. Track 00 is used as an index track; tracks 01 through 74 are the data tracks; and tracks 75 and 76 are spares. The basic subsystem has two drives; two additional drives can be added as an optional feature. Only one drive can be online at any one time. The subsystem reads at the rate of 4680 records per minute, and writes at the rate of 3120 records per minute. Concurrently operations with multiple diskette drives are not supported. The diskette subsystem interfaces with the 90/30 B system through the integrated peripheral channel (IPC).

3.2. DISC PACK HANDLING PRECAUTIONS

The following precautions must be observed while loading and unloading disc packs during operation of the disc storage unit.

Loading Precautions:

1. Do not drop the disc pack onto the disc drive spindle; the first threads of the spindle may be damaged.
2. Make certain that the protective cover is completely released from the disc pack before attempting its removal; an upward pull applied to the drive shaft lock can damage the threads.
3. Avoid excessive loading torque; extra clockwise twisting to ensure that the disc pack is locked on the shaft is not necessary and can damage the spindle threads.

Unloading Precautions:

1. To prevent damage to the threads, do not lift the disc pack from the disc drive spindle threads until the pack is completely disengaged.
2. A clicking sound can be heard when the spindle releases the disc pack (after the pack is turned counterclockwise for removal); do not permit more than one or two clicks before removing the pack or damage to the threads can result.

CAUTION

To prevent damage to the drive spindle lock, do not apply excess torque to the bottom cover of the disc pack.

3. Store the disc pack in the same environment as the disc storage unit.

This page left blank intentionally

3.3. 8411/8414 DISC SUBSYSTEMS

The 8411 and 8414 disc subsystems consist of a SPERRY UNIVAC 5024 Control unit and a disc drive unit. The 8411 subsystem uses an 8411 disc drive unit which is designed to be used with an F1211 disc pack. The 8414 disc subsystem uses an 8414 disc drive unit which is designed to be used with the higher capacity F1214 disc pack. The physical appearance of both disc drive units is virtually identical, including the control and indicator panels.

3.3.1. Operating Controls and Indicators

The controls and indicators on the 5024 control unit (Figure 3-1) are contained on the maintenance panel (Figure 3-3), power control panel (Figure 3-4), and power distribution panel (Figure 3-5). The operating controls and indicators on these panels are illustrated in Figures 3-2 through 3-4 and described in Table 3-1.

The controls and indicators on the disc drive unit (Figure 3-2) are contained on the power control panel (Figure 3-6), the operator control panel (Figure 3-7), and in the disc pack well (Figure 3-8). The operator controls and indicators on these panels are described in Table 3-2.

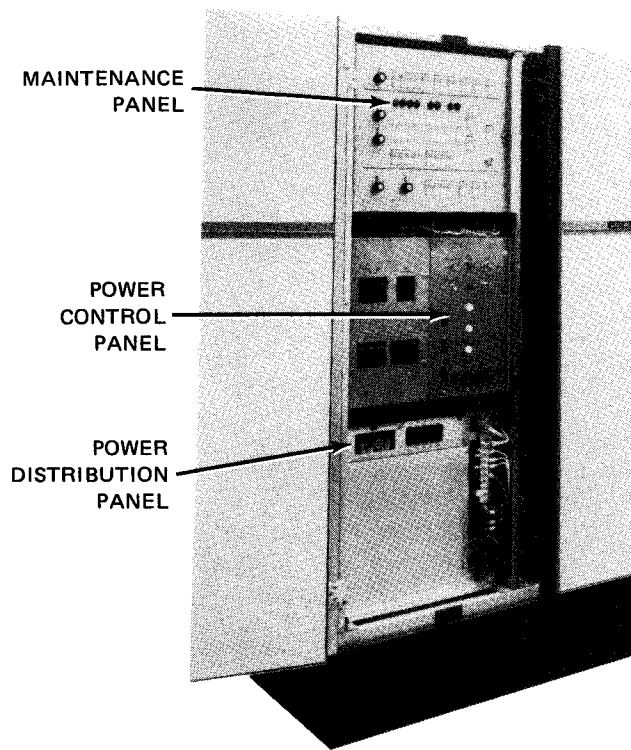

Figure 3-1. 5024 Control Unit for the 8411/8414 Disc Subsystem

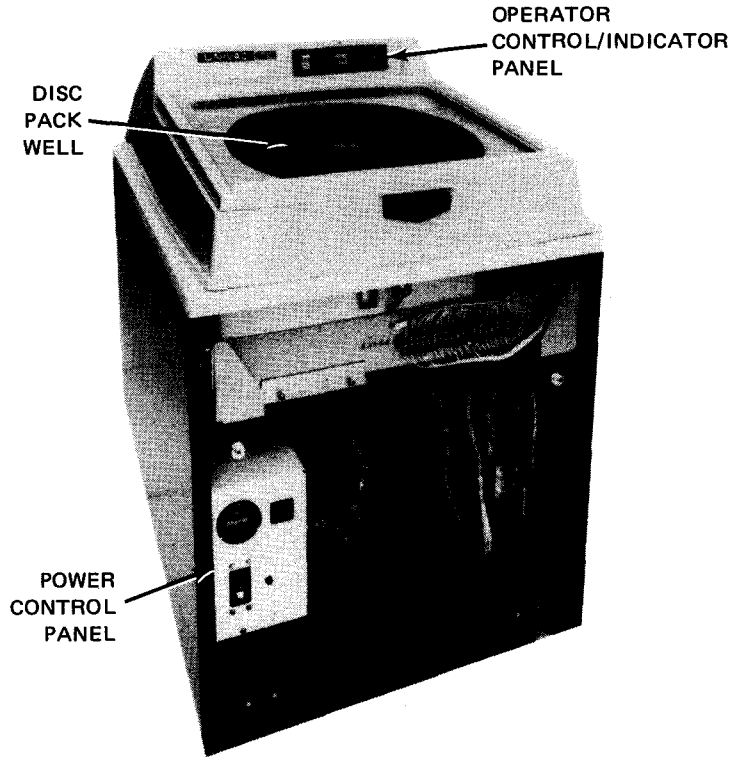

Figure 3-2. 8411/8414 Disc Drive Unit

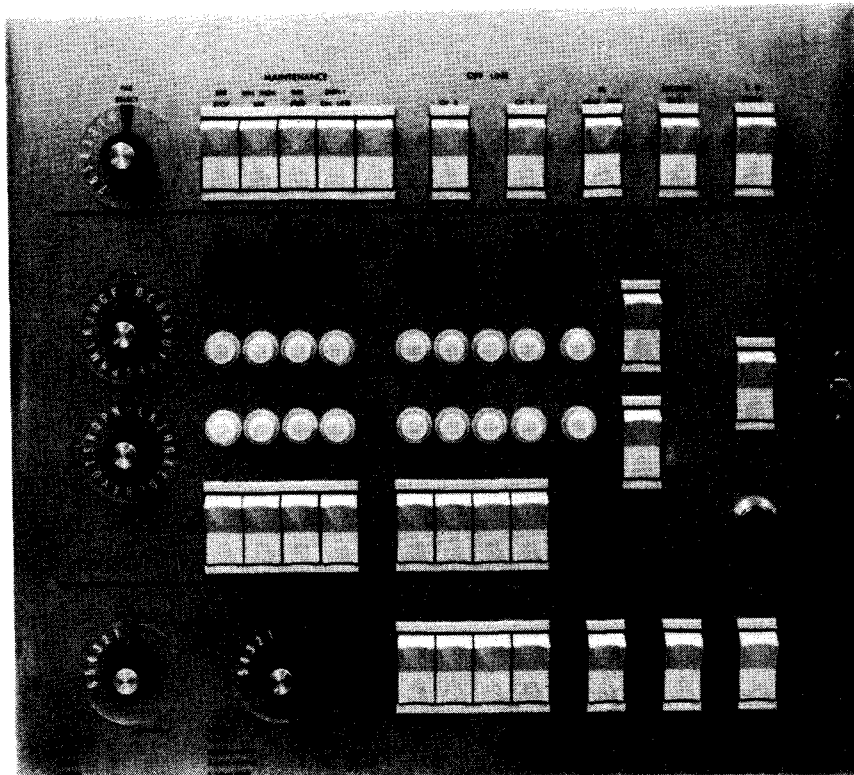

Figure 3-3. 5024 Control Unit, Maintenance Panel

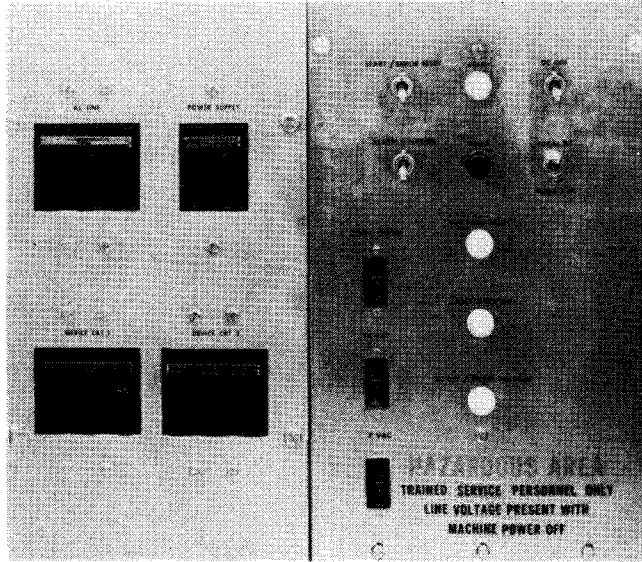

Figure 3-4. 5024 Control Unit, Power Control Panel

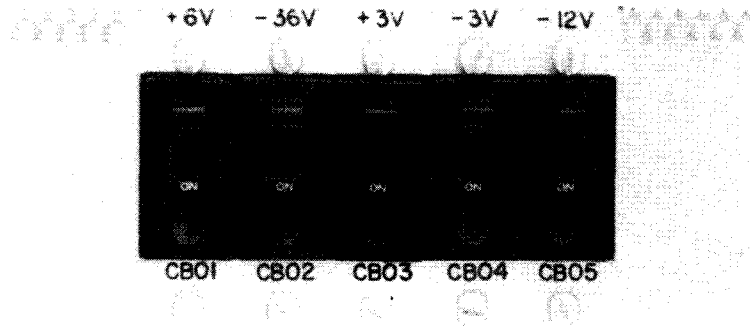

Figure 3-5. 5024 Control Unit, Power Distribution Panel

Table 3-1. 5024 Control Unit, Controls and Indicators (Part 1 of 3)

Control/Indicator — Function
Maintenance Panel
<p>OFF LINE CH X switch</p> <p>Locks out selector channel CH X when top of switch is pressed in (offline mode); permits access to selector channel CH X when bottom of switch is pressed in (online mode). The normal operating position is with the bottom of the switch pressed in.</p> <p>OFF LINE CH Y switch</p> <p>Locks out selector channel CH Y when top of switch is pressed in (offline mode); permits access to selector channel CH Y when bottom of switch is pressed in (remote mode). The normal operating position is with the bottom of the switch pressed in.</p> <p>NOTE:</p> <p>All other controls and indicators on the maintenance panel are to be used by the Sperry Univac customer engineer only.</p>
Power Control Panel
<p>AC LINE circuit breaker</p> <p>Provides overload protection for the main ac power line to the subsystem</p> <p>POWER SUPPLY circuit breaker</p> <p>Provides overload protection for the ac power line to the power supply</p> <p>DEVICE CKT 1 circuit breaker</p> <p>Provides overload protection for the ac power line to disc drive units 4 through 7</p> <p>DEVICE CKT 2 circuit breaker</p> <p>Provides overload protection for the ac power line to disc drive units 0 through 3</p> <p>START/ERROR RESET switch</p> <p>Initiates the power-on cycle in the control unit when held in the up position if the LOCAL DC/REMOTE DC switch is set to LOCAL DC</p> <p>READY indicator</p> <p>Lights when power is turned on in each of the modules in the control unit</p> <p>DC OFF switch</p> <p>Turns off the dc power in the control unit when held in the up position if the LOCAL DC/REMOTE DC switch is set to LOCAL DC</p>

Table 3-1. 5024 Control Unit, Controls and Indicators (Part 2 of 3)

Control/Indicator — Function
Power Control Panel (cont)
ALARM OVERRIDE switch Disconnects the audible (fault) alarm, when momentarily held in the up position
FAULT indicator Lights when a fault has been detected in the subsystem after the audible alarm is turned off
LOCAL DC/REMOTE DC switch Controls where the subsystem power is actuated: LOCAL DC position: Power is actuated by momentarily holding the START/ERROR RESET toggle switch in the up position. REMOTE DC position: Power is actuated from the processor operator/maintenance panel.
AIR FLOW FAULT indicator Lights when one or both blower assemblies are not providing sufficient cooling air within the control unit. This air loss causes loss of power within the cabinet.
CONV OUTLET pushbutton circuit breaker Provides overload protection for the ac power line to the convenience outlet. This circuit breaker is to be used by the Sperry Univac customer engineer only.
EARLY WARNING indicator Lights when temperature within the subsystem is 130° F. The subsystem automatically shuts down when the temperature reaches 160° F.
24 VAC pushbutton circuit breaker Provides overload protection for the 24 volt ac power line to the relay switches in the control unit
DC OFF/UNDER VOLTAGE indicator Lights when one or more of the circuit breakers (CB01 , CB02 , CB03 , CB04 , or CB05) on the power distribution panel open or if the control unit powers down automatically
7 VAC pushbutton circuit breaker Provides overload protection for the 7 volt ac power line to the control unit power lamps

Table 3-1. 5024 Control Unit, Controls and Indicators (Part 3 of 3)

Control/Indicator — Function	
Power Distribution Panel	
CB01 (+6v) circuit breaker	Provides overload protection for the +6 volt power line to the disc file control unit logic system
CB02 (-36V) circuit breaker	Provides overload protection for the -36 volt power line to the disc drive read/write heads
CB03 (+3V) circuit breaker	Provides overload protection for the +3 volt power line to the special logic circuits of the disc file control unit
CB04 (-3V) circuit breaker	Provides overload protection for the -3 volt power line to the special logic circuits of the disc file control unit
CB05 (-12V) circuit breaker	Provides overload protection for the -12 volt power line to the special logic circuits of the disc file control unit

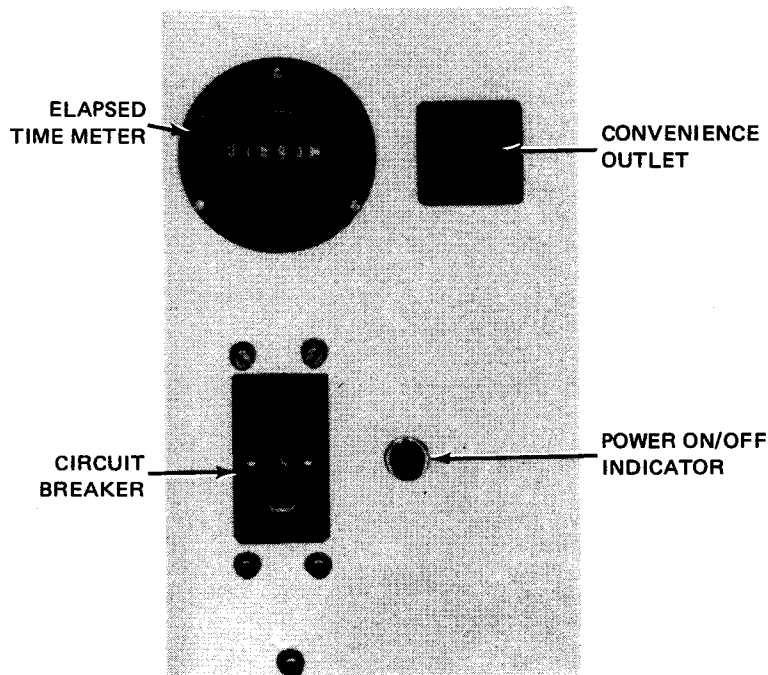

Figure 3-6. 8411/8414 Disc Drive Unit, Power Control Panel

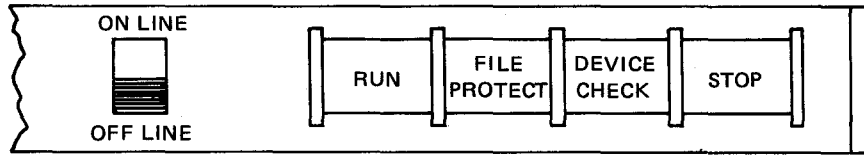

Figure 3-7. 8411/8414 Disc Drive Unit, Operator Control Panel

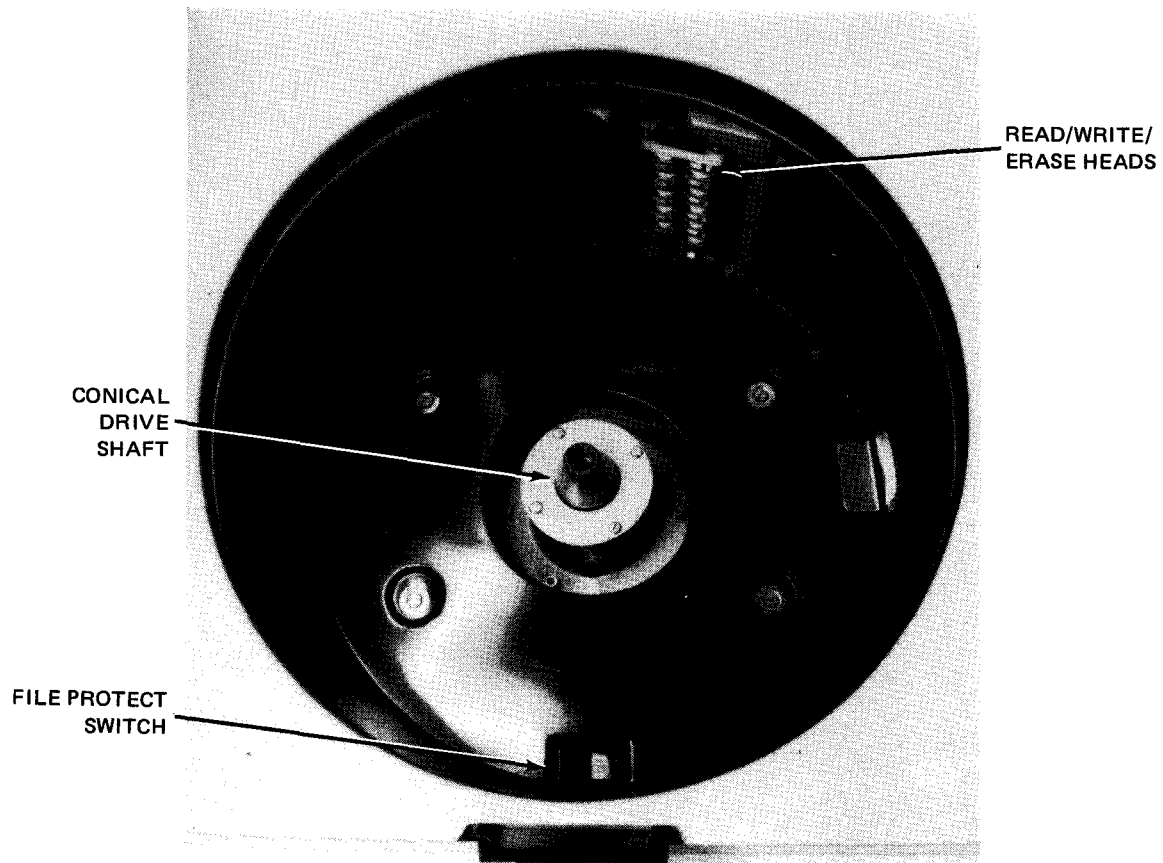

Figure 3-8. 8411/8414 Disc Drive Unit, Disc Pack Well

Table 3-2. 8411/8414 Disc Drive Unit, Control and Indicators

Control/Indicator — Function
Power Control Panel
Time meter For use by the Sperry Univac customer engineer only
Convenience outlet For use by the Sperry Univac customer engineer only
Circuit breaker Provides overload protection for the ac power line to the disc drive unit
Power on/off indicator Lights when power is present in the disc drive unit
Operator Control Panel
ONLINE/OFFLINE switch When set to the OFFLINE position, removes the disc drive unit from processor control. Access to the disc drive unit is blocked until this switch is set to the ONLINE position.
RUN switch/indicator When pressed after ac and dc power has been applied and the disc pack is in place, energizes the disc drive motor and moves the read/write heads to cylinder 0. Lights when this action is finished.
FILE PROTECT indicator Lights when write mode of the disc drive unit is inhibited. Setting the file protect switch in the disc pack well to the OFF position turns off the indicator and activates the disc drive read or read/write mode.
DEVICE CHECK indicator Lights when a fault has been detected during reading or writing to the disc pack.
STOP switch/indicator Removes power from the disc drive motor and the read/write heads. Lights when this action is finished. The RUN switch/indicator is extinguished.
Disc Pack Well
File protect ON/OFF switch ON position: Information can only be read from a disc pack. OFF position: Information may also be written to a disc pack.

3.3.2. Turn-On and Turn-Off Procedures

Power is normally applied to and removed from the 8411/8414 disc subsystem via the **POWER ON/POWER OFF** switch on the operator/maintenance panel (Figure 2—2). In order for power to be controlled from this panel, however, certain switches and circuit breakers on the disc subsystem components must first be set to specific positions. These switches and circuit breaker settings are listed in Table 3—3.

When the switches and circuit breakers are set as specified in Table 3—3 and the **POWER ON/POWER OFF** switch on the operator/maintenance panel is set to its **POWER ON** position, the following indicators should light:

- On the control unit, the **READY** indicator on the power control panel;
- On the disc drive unit:
 - the power on/off indicator on the power control panel; and
 - the **STOP** switch/indicator on the operator control/indicator panel.

No other indicators on the disc subsystem components should be lit. If any are, or if any of the indicators that should be lit are not, refer the problem to the Sperry Univac customer engineer.

Table 3—3. 8411/8414 Disc Subsystems, Power Switch Settings

Switch/Circuit Breaker	Normal Setting
Control Unit Maintenance Panel	
OFF LINE CH X switch	Online (lower half depressed)
OFF LINE CH Y switch	Online (lower half depressed)
Control Unit Power Control Panel	
AC LINE circuit breaker	On (up)
POWER SUPPLY circuit breaker	On (up)
DEVICE CKT 1 circuit breaker	On (up)
DEVICE CKT 2 circuit breaker	On (up)
24 VAC pushbutton circuit breaker	On (in)
7 VAC pushbutton circuit breaker	On (in)
DC OFF switch	On (down)
LOCAL DC/REMOTE DC switch	REMOTE DC
Power Distribution Panel	
CB01 through CB05 circuit breakers	On (up)
Disc Drive Unit Power Control Panel	
All circuit breakers	On (up)
Disc Drive Unit Operator Control Panel	
ONLINE/OFFLINE switch	ONLINE

3.3.2.1. Independent Power Turn-On Procedure

To apply power to the disc subsystem without applying power to the rest of the system, proceed as follows:

1. On control unit maintenance panel (Figure 3—3), set:
 - a. **OFF LINE CH X** switch to offline (upper half depressed); and
 - b. **OFF LINE CH Y** switch to offline (upper half depressed).
2. On control unit power control panel, set:
 - a. **LOCAL DC/REMOTE DC** switch to **LOCAL DC**;
 - b. **DC OFF** switch to on (down); and
 - c. all circuit breakers to on (up).
3. On control unit power distribution panel, set all circuit breakers to on (up).
4. On disc drive operator control panel, set **ON LINE/OFF LINE** switch to **OFF LINE**.
5. On disc drive unit power control panel, set all circuit breakers to on (up).
6. Using the *UP* function of the SET I/O command (Section 12), include the disc drive in the system's resources for job allocations.

CAUTION

Independent power turn on or turn off of the disc subsystem while the processor is operating requires that the disc subsystem be set to an offline condition before the subsystem is turned on or off. Failure to follow this procedure will cause power transients that may disturb processor operation.

3.3.2.2. Independent Power Turn-Off Procedure

To remove power from the disc subsystem without removing power from the rest of the system, use the *DOWN* function of the SET IO command (Section 12), then set **OFF LINE CH X** and **OFF LINE CH Y** switches on control unit maintenance panel (Figure 3—3) to offline (upper half depressed), set the **LOCAL DC/REMOTE DC** switch on the control unit power control panel (Figure 3—4) to **LOCAL DC**, and set the **DC OFF** switch to its on (up) position.

WARNING

This procedure does not remove dc power from either the control unit or disc drive unit.

3.3.3. Operating Procedures

The operating procedures for the disc subsystem include the procedures for loading and starting the disc drive unit, and stopping and unloading the disc drive unit.

3.3.3.1. Mounting Disc Pack and Starting Disc Drive Unit

To load and start a disc drive unit proceed as follows:

1. Ensure that the **ON LINE/OFF LINE** switch on the operator control panel is set to the **OFF LINE** position.
2. Open the spring-loaded plexiglass cover by pressing down the latch on the front of the shroud (Figure 3-9).

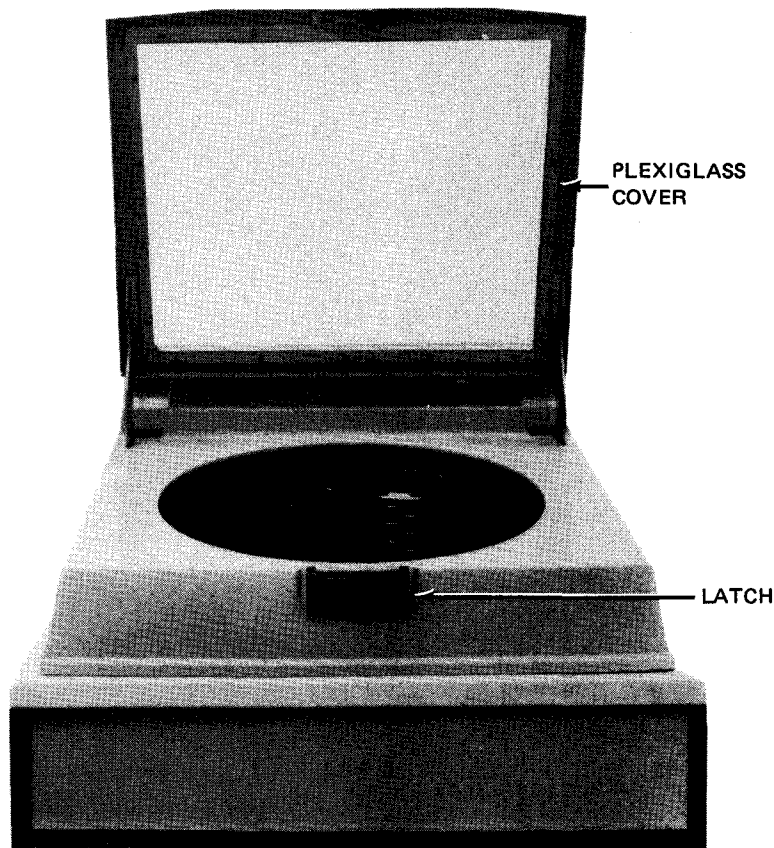

Figure 3-9. Disc Drive Unit With Plexiglass Cover Open

3. Set the file protect **ON/OFF** switch to the **ON** position if a read-only operation is required, or to the **OFF** position if writing to the disc pack is to be permitted.
4. Remove the bottom protective cover of the disc pack by rotating it counterclockwise. Place the bottom protective cover in its normal storage location, usually on the disc drive cabinet.

5. Grasping the handle of the disc pack top protective cover, carefully lower the disc pack onto the drive shaft in the center of the disc pack well (Figure 3—8).
6. When the disc pack is seated firmly on the drive shaft, using the top protective cover handle, firmly but gently rotate the disc pack clockwise until rotation stops. This action disconnects the disc pack from its protective cover.
7. Lift off the disc pack top protective cover and place it on the bottom protective cover stored in step 4. Close the plexiglass cover (press gently but firmly until a click is heard).
8. Press the **RUN** switch/indicator on the operator control/indicator panel; the top half of the indicator lights, the **STOP** switch/indicator extinguishes, and the rest of the indicators on the panel remain extinguished. When read/write heads are positioned at track 0 of the disc pack, the bottom half of the **RUN** switch/indicator lights. This indicates the disc pack is fully operational.
9. Press the **ON LINE/OFF LINE** rocker switch on the operator control/indicator panel to the **ON LINE** position. The disc drive unit is now ready for use with the system.

3.3.3.2. Stopping and Unloading Disc Drive Unit

To stop and unload a disc drive unit, proceed as follows:

1. Press the **STOP** switch/indicator on the operator control panel. The **STOP** indicator lights and the **RUN** indicator extinguishes.
2. Wait until the disc stops rotating, then lift the disc drive unit spring-loaded plexiglass cover by pressing down the latch on the front of the shroud.
3. Take a disc pack top protective cover and carefully set it over the disc pack in the well.
4. Grasping the handle of the disc pack top protective cover, carefully rotate it counterclockwise until you hear a click.
5. Carefully lift the disc pack off the drive shaft and out of the well.
6. Install the bottom cover of the disc pack by rotating the disc pack clockwise.

3.3.4. Recovery Procedures

Table 3—4 lists the disc subsystem malfunctions that may be corrected by the operator. If fault indications persist, contact your Sperry Univac customer engineer.

Table 3-4. 8411/8414 Disc Subsystem, Recovery Procedures

Fault Indication	Probable Cause	Operator Action
Control Unit		
Operating power is removed. READY indicator on the power control panel is extinguished.	There is a loss or marginal operation of one or more power supplies within the control unit.	Raise and release the START/ERROR RESET switch on the power control panel. Ensure that all power switches and circuit breakers on the control unit panels are in the up or in (on) position.
Audible alarm sounds; FAULT indicator on the power control panel is lit.	Fault in subsystem	Raise and release the ALARM OVERRIDE switch on the power control panel to silence the audible alarm, and then contact the Sperry Univac customer engineer.
Audible alarm sounds; EARLY WARNING indicator on the power control panel is lit.	Temperature within one or more of the modules within the cabinet has reached 130° F. The control unit shuts down automatically when the temperature reaches 160° F.	Ensure that the air filters are clean and the fans within the control unit are operational.
Disc Unit		
DEVICE CHECK indicator is lit.	AC power loss or disc unit electrical or mechanical malfunction	<p>Immediately contact the Sperry Univac customer engineer.</p> <div style="border: 1px solid black; padding: 5px; text-align: center; margin: 10px 0;">CAUTION</div> <p>If a suspected disc pack or disc drive malfunction requires substitution of the disc pack or disc drive due to a recurring check condition, do not continue to substitute disc packs or disc drives after the first replacement. A read/write head and/or disc pack crash during a previous operation may have caused damage to the heads and/or disc pack which will cause further damage and eventually disable the entire subsystem if substitutions continue. Contact the Sperry Univac customer engineer at once when the second disc pack or disc drive, known to be previously operative, presents a malfunction indication.</p>

This page left blank intentionally.

3.4. 8416 DISC SUBSYSTEM

The 8416 disc subsystem (Figure 3-10) is connected to a 90/30 or 90/30 B system processor via the integrated disc adapter (IDA). The IDA can support from one to eight 8416 or 8418 disc drive units. Any combination of 8416's and 8418's can be used. Subsystems containing from one to four disc drive units are powered by the processor; subsystems containing from five to eight disc drive units are powered by the auxiliary ac power supply type 2408 (3.6). The F1216-02 disc pack is designed for use with this subsystem.



Figure 3-10. 8416 Disc Drive Unit

3.4.1. Operating Controls and Indicators

The controls and indicators used for operating this disc drive unit are contained on the main ac distribution panel, the 208 Vac panel, the +48 Vdc panel located behind the rear cabinet panel (Figure 3—11), and the operator control panel located on the top front (Figure 3—12). The function of each of these controls and indicators is described in Table 3—5.

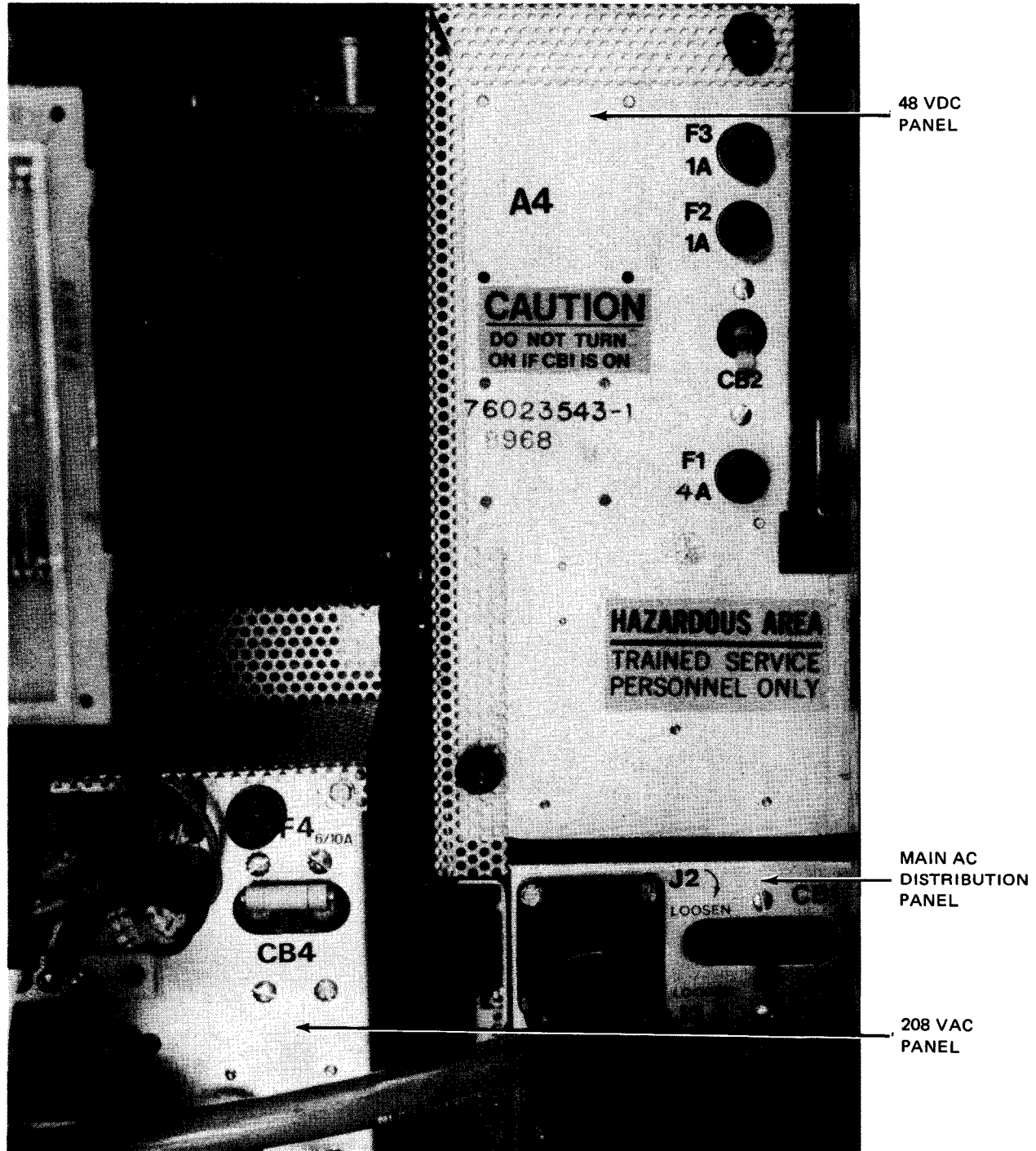

Figure 3—11. 8416 Disc Drive Unit, Power Panels

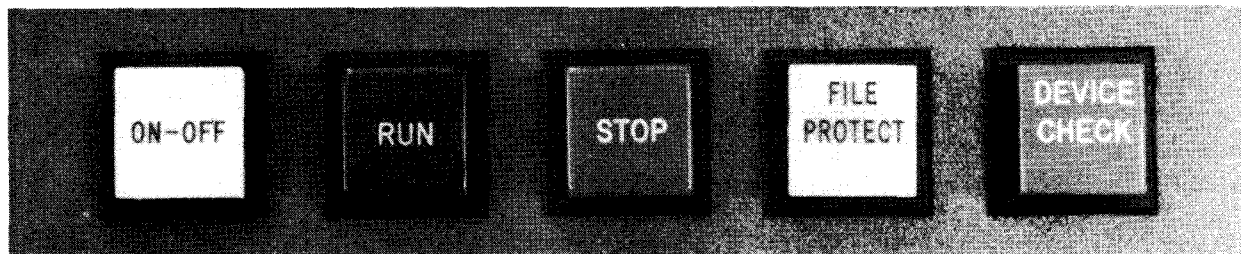

Figure 3-12. 8416 Disc Drive Unit, Operator Control Panel

Table 3-5. 8416 Disc Drive Unit, Controls and Indicators

Control/Indicator — Function
Main AC Distribution Panel
<p>CB1 circuit breaker</p> <p>Provides overload protection for the main ac power line to the disc drive unit</p>
208 VAC Panel
<p>CB4 circuit breaker</p> <p>Provides overload protection for the 208 Vac power line within the disc drive unit</p>
+48 VDC Panel
<p>CB2 circuit breaker</p> <p>Provides overload protection for the +48 Vdc power line within the disc drive unit</p>
Operator Control Panel
<p>ON-OFF switch/indicator</p> <p>Energizes and deenergizes the disc drive motor and sets the read/write heads in the operating or nonoperating position. The indicator lights in two steps; the upper half lights when power is applied to the drive motor, and the bottom half lights when the disc drive is up to speed and the read/write heads are positioned at cylinder 0.</p> <p>NOTE:</p> <p>For this switch/indicator to operate, a disc pack must be mounted in the disc well and the disc well cover closed securely.</p> <p>RUN switch/indicator</p> <p>Establishes the communications link between the integrated disc adapter and the subsystem. Lights when the communications link is established</p> <p>STOP switch/indicator</p> <p>Removes the communication link between the integrated disc adapter and the subsystem. Lights when the communication link is removed</p> <p>FILE PROTECT switch/indicator</p> <p>Selects whether the system can write data on the disc pack. When lit, writing to the disc pack is prevented.</p> <p>DEVICE CHECK indicator</p> <p>Lights whenever an electrical or mechanical malfunction of the subsystem is detected.</p>

3.4.2. Turn-On and Turn-Off Procedures

Power for the 8416 disc subsystem is supplied by the processor and is normally applied and removed from the disc subsystem by the **POWER ON/POWER OFF** switch on the processor operator/maintenance panel (Figure 2—2). For power to be controlled from this panel, however, the **DISC MAIN AC** circuit breaker on the processor power control panel (Figure 2—4), and circuit breakers **CB1**, **CB2**, and **CB4** on the power panels of the disc subsystem (Figure 3—11) must first be set to the on (up) positions. If more than four disc drive units are included in the subsystem, circuit breakers **CB1**, **CB2**, and **CB3** in auxiliary ac power supply (Figure 3—19) must be set to on (up) position. The **STOP** switch/indicator (Figure 3—12) lights when power is applied to the subsystem.

NOTE:

Before performing the following procedures, remove the device from the system's list of available resources by using the DOWN function of the SET IO command (Section 12). After the procedure is completed, restore the device's available status by using the UP function of the SET IO command.

To remove power from the subsystem without removing power from the rest of the system, press the **STOP** switch/indicator and then the **ON-OFF** switch/indicator, on the operator control panel. For subsystems with four or fewer disc drive units, the **DISC MAIN AC** circuit breaker on the processor power control panel then has to be set to the off (down) position. For subsystems with five to eight disc drive units, circuit breakers **CB1**, **CB2**, and **CB3** on the auxiliary ac power supply then have to be set to the off (down) position. All indicators on the operator control panel extinguish.

CAUTION

*When removing power from the subsystem, failure to press the **STOP** switch/indicator (Figure 3—12) before pressing the **ON-OFF** switch/indicator will cause power transients that will disturb processor operation.*

3.4.3. Operating Procedures

The operating procedures for the subsystem include procedures for mounting a disc pack and starting the disc drive unit, and stopping the disc drive unit and unloading a disc pack.

NOTE:

*If the **DEVICE CHECK** indicator on the operator control panel lights and remains lit during any operation, refer to 3.4.4 for corrective action.*

3.4.3.1. Mounting Disc Pack and Starting Disc Drive Unit

Before the disc drive unit can be started, a disc pack must be securely mounted in the disc well. To mount a disc pack and start the disc drive unit, proceed as follows:

1. Press the latch on the top front of the subsystem and push the well cover all the way to the rear of the well.
2. Hold the disc pack to be mounted by its top protective cover handle and remove its bottom cover by squeezing the bottom cover handle and pulling it off.
3. While still holding the top cover handle, carefully lower the disc pack onto the drive shaft in the well.

4. When the disc pack is firmly seated on the drive spindle in the well, carefully rotate the disc pack clockwise with its top cover handle until rotation stops.
5. Lift off the disc pack top cover and gently slide the well cover forward until it locks.
6. Set the mode of operation desired by pressing the **FILE PROTECT** switch/indicator to either light the **FILE PROTECT** indicator or extinguish it. The read-only mode is set when the indicator is lit.

NOTE:

The mode of operation can be changed at any time; however, the change does not take effect until the current operation is completed.

7. Press the **ON-OFF** switch/indicator on the operator control panel. The bottom portion of the **ON-OFF** switch/indicator lights. When the disc drive is up to operating speed and the read/write heads are at cylinder 000, the top portion of the **ON-OFF** switch/indicator lights.
8. Press the **RUN** switch/indicator on the operator control panel. The **RUN** switch/indicator lights and the **STOP** switch/indicator extinguishes. The disc drive unit is now ready for communication with the integrated disc adapter.

NOTE:

*It is not necessary to wait for the disc drive to power up completely before the **RUN** switch/indicator is pressed. If the **ON-OFF** switch/indicator and then the **RUN** switch/indicator are pressed in sequence, the disc drive immediately goes out of the stop state (the **STOP** indicator extinguishes). The disc drive status automatically changes to the run state after the normal power-up cycle is complete.*

9. When it is necessary to set the subsystem offline (integrated disc adapter prevented from communicating with the subsystem), press the **STOP** switch/indicator on the operator control panel. The **STOP** indicator lights and the **RUN** indicator extinguishes.

3.4.3.2. Stopping Disc Drive Unit and Unloading Disc Pack

To completely stop the disc drive unit operation and remove a disc pack from the disc well, proceed as follows:

1. Press the **STOP** switch/indicator and then the **ON-OFF** switch/indicator on the operator control panel. The **ON-OFF** and **RUN** switch/indicators extinguish, and the **STOP** switch/indicator lights.
2. When the disc drive stops rotating, press the latch on the top front of the disc drive unit and push the well cover all the way to the rear of the well.
3. Take a disc pack top protective cover and carefully lower it down over the disc pack in the well.
4. Grasping the handle of the top cover, carefully rotate the top cover counterclockwise until the handle rotates freely.
5. Using the handle of the top cover, carefully lift the disc pack off the drive shaft and out of the well.
6. Holding the disc pack by the handle of the top cover, put the disc pack bottom cover on by squeezing the bottom cover handle, pressing it onto the bottom of the disc pack, and release the handle.

3.4.4. Recovery Procedures

Table 3—6 describes the disc subsystem malfunctions that may be corrected by the operator. If the malfunction persists after the operator completes this corrective action, contact the Sperry Univac customer engineer.

Table 3—6. 8416 Subsystem Recovery Procedures

Fault Indication	Probable Cause	Operator Action
No indicator is lit on operator control panel.	Loss of power within the subsystem	<ol style="list-style-type: none"> 1. Ensure that circuit breakers CB1, CB2, and CB4 on the subsystem power panels are in the on (up) position. Reset if necessary. <div style="text-align: center; border: 1px solid black; padding: 2px; width: fit-content; margin: 10px auto;">CAUTION</div> <p>Do not reset circuit breakers CB2 or CB4 with circuit breaker CB1 in the on (up) position, as internal damage to the disc drive unit may result.</p> <ol style="list-style-type: none"> 2. Ensure that the DISC MAIN AC circuit breaker on the processor power control panel is in the on (up) position. Reset if necessary.
DEVICE CHECK indicator remains lit.	An electrical or mechanical subsystem malfunction was detected.	<p>Press the ON-OFF switch/indicator on the operator control panel. The ON-OFF and DEVICE CHECK indicators go off. Wait 2 seconds and then press the ON-OFF switch/indicator again. The ON-OFF indicator lights, and the DEVICE CHECK indicator remains off.</p> <div style="text-align: center; border: 1px solid black; padding: 2px; width: fit-content; margin: 10px auto;">CAUTION</div> <p>If a suspected disc pack or disc drive malfunction requires substitution of the disc pack or disc drive due to a recurring check condition, do not continue to substitute disc packs or disc drives after the first replacement. A read/write head and/or disc pack crash during a previous operation may have caused damage to the heads and/or disc pack which will cause further damage and eventually disable the entire subsystem if substitutions continue. Contact the Sperry Univac customer engineer at once when the second disc pack or disc drive, known to be previously operative, presents a malfunction indication.</p>
Power Loss	Circuit breaker is tripped.	<p>Follow proper sequence when resetting any circuit breaker:</p> <ol style="list-style-type: none"> 1. Set CB1 to off (down). 2. Set all other circuit breakers to off (down) to reset, then on (up). 3. Set CB1 to on (up). If circuit breaker trips again, contact Sperry Univac customer engineer.

3.5. 8418 DISC SUBSYSTEM

The 8418 disc subsystem (Figure 3—13) is connected to a 90/30 or 90/30 B system processor via the integrated disc adapter (IDA). The IDA can support from one to eight 8416 or 8418 disc drive units. Any combination of 8416's and 8418's can be used. Subsystems containing from one to four disc drive units are powered by the processor; subsystems containing from five to eight disc drive units are powered by the auxiliary ac power supply type 2408 (3.6). The F1216—02 disc pack is designed for use with this subsystem.

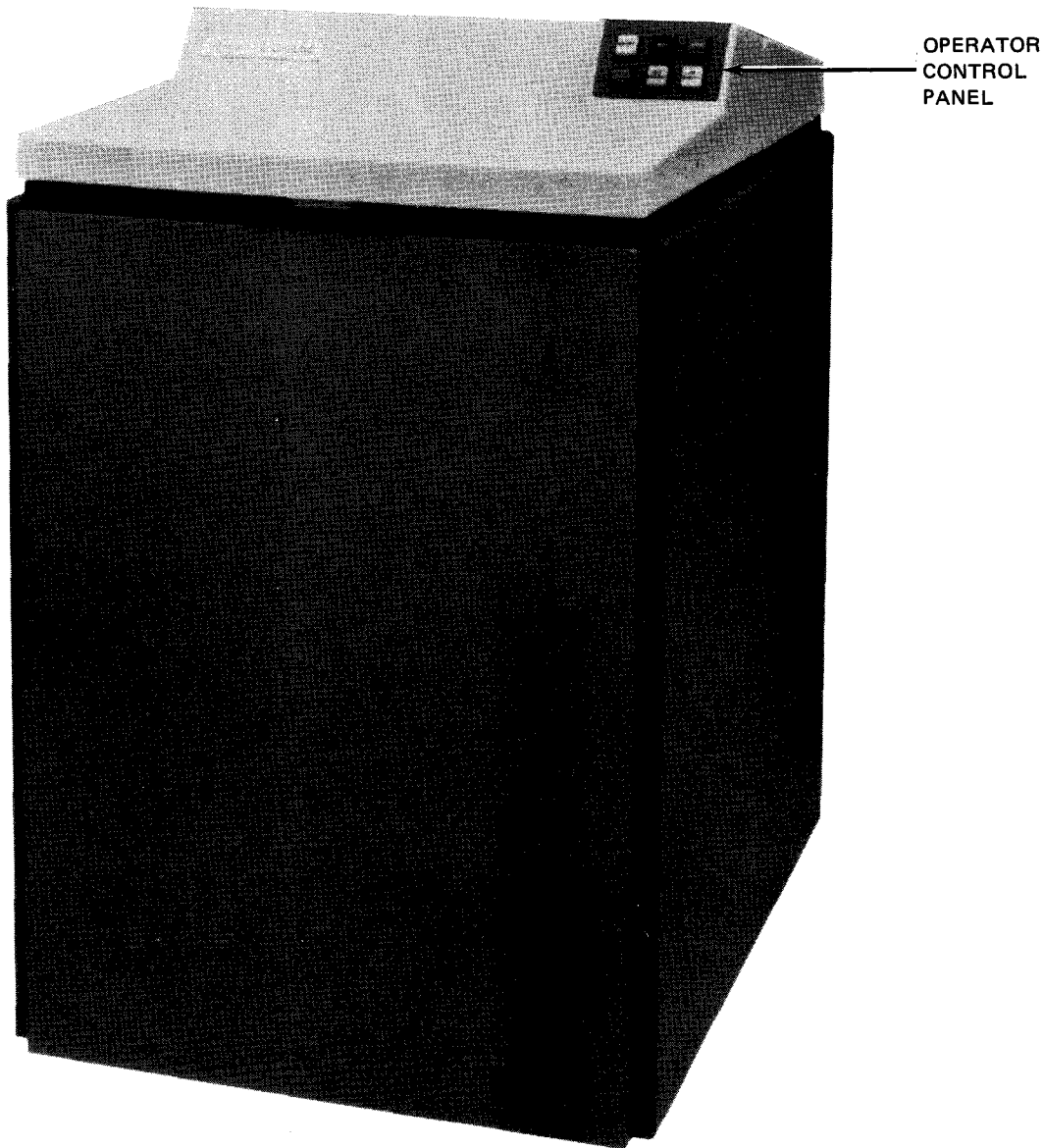

Figure 3—13. 8418 Disc Drive Unit

3.5.1. Operating Controls and Indicators

The controls and indicators used for operating the 8418 disc drive unit are contained on the main ac distribution panel, the 48 Vdc/208 Vac panel located behind the rear cabinet panel (Figure 3—14), and the operator control panel located on the top front (Figure 3—15). The function of each of these controls and indicators is described in Table 3—7.

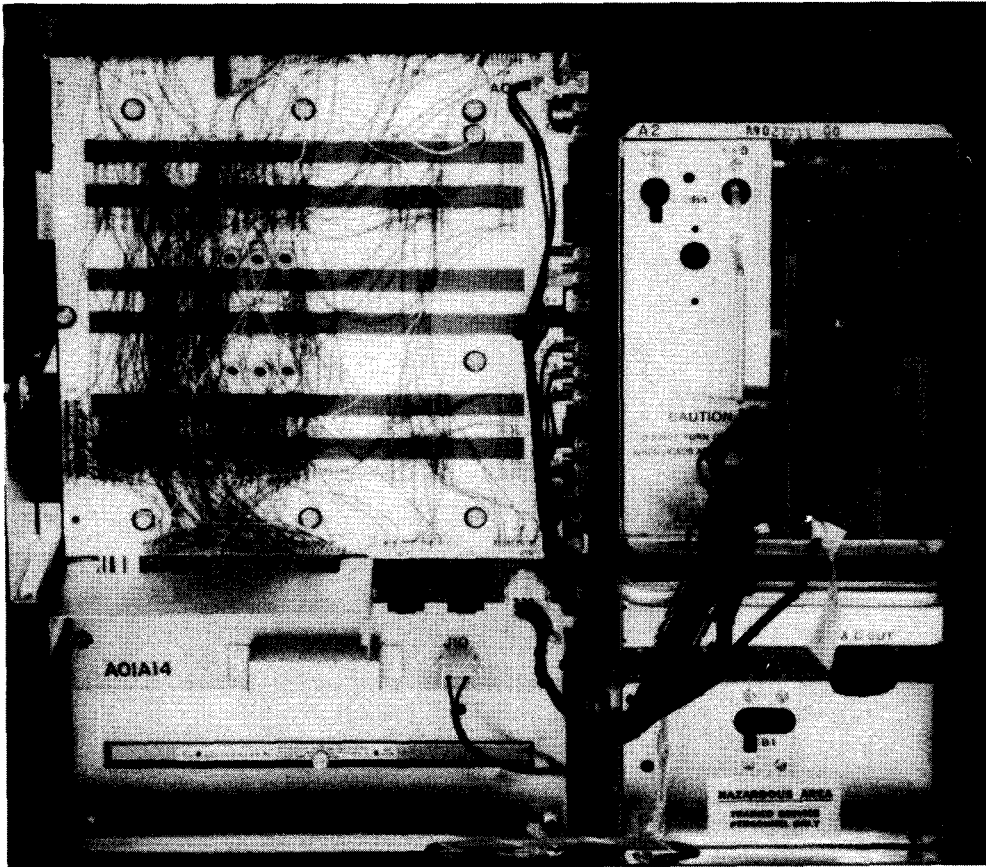

Figure 3—14. 8418 Disc Drive Unit, Power Panels

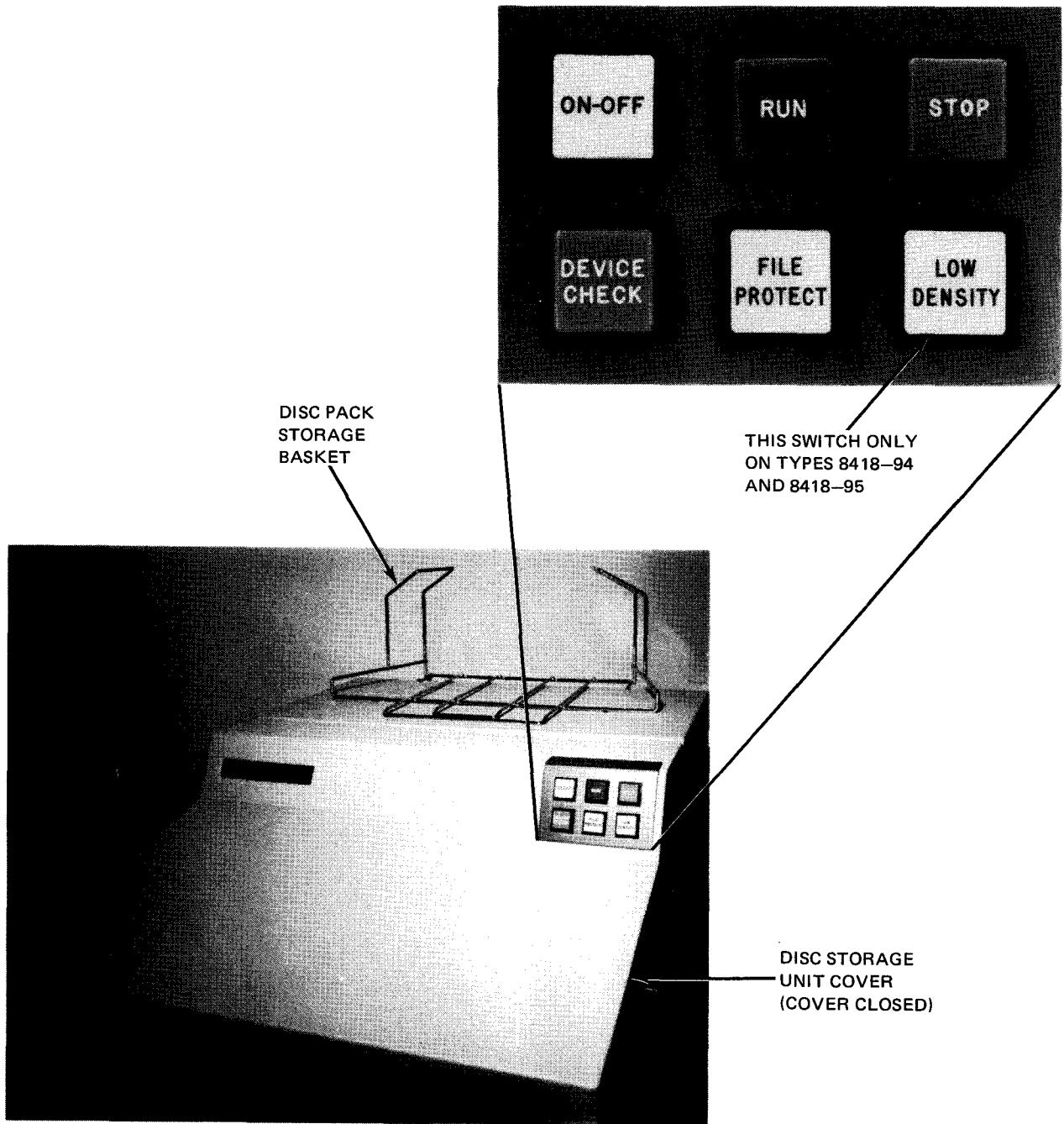

Figure 3-15. 8418 Disc Drive Unit, Operator Control Panel

Table 3-7. 8418 Disc Drive Unit, Controls and Indicators (Part 1 of 2)

Control/Indicator—Function
Main AC Distribution Panel
<p>CB1 circuit breaker</p> <p>Provides overload protection for the main ac power line to the subsystem</p>
+48 VDC/208 VAC Panel
<p>CB2 circuit breaker</p> <p>Provides overload protection for the 208 Vac power line within the disc drive unit</p> <p>CB3 circuit breaker</p> <p>Provides overload protection for the +48 Vdc power line within the disc drive unit</p>
Operator Control Panel
<p>ON-OFF switch/indicator</p> <p>Controls the application of power to the disc drive motor and sets the read/write heads in the operating or nonoperating position</p> <p>For this switch/indicator to be set to ON (indicator lit), a disc pack must be mounted on the spindle and the disc well cover closed securely. If either or both of these conditions are not met, the ON-OFF switch/indicator will not light and the STOP switch/indicator will blink.</p> <p>When this switch/indicator is set to OFF, the indicator flashes intermittently until the spindle stops rotating.</p> <p>If the drive motor temperature increases, a thermal switch turns off power to the motor until the drive motor has cooled to a safe level. While the thermal switch is open, the switch/indicator remains lit if in the ON position, or remains extinguished if in the OFF position, but power to the motor remains off until the motor has cooled.</p> <p>RUN switch/indicator</p> <p>Establishes the communications link between the integrated disc adapter and the subsystem</p> <p>When pressed, the RUN switch/indicator lights, the STOP switch/indicator extinguishes, and the communications link is established provided that the:</p> <ol style="list-style-type: none"> 1. ON-OFF switch/indicator is lit; 2. drive spindle is at operating speed; 3. read/write heads are positioned at cylinder 0; and 4. DEVICE CHECK indicator is extinguished. <p>NOTE:</p> <p>The RUN switch/indicator lights only when all of the above conditions are met. The STOP switch/indicator, however, extinguishes immediately after the RUN switch/indicator is pressed and released.</p>

Table 3-7. 8418 Disc Drive Unit, Controls and Indicators (Part 2 of 2)

Control/Indicator—Function
Operator Control Panel (cont)
STOP switch/indicator
Removes the communications link between the integrated disc adapter and the disc subsystem.
When pressed, the STOP switch/indicator lights, the RUN switch/indicator extinguishes, and the communications link is removed.
If an operation is in progress when the STOP switch/indicator is pressed, that operation continues to completion before the stop action takes place.
The STOP switch/indicator lights when ac power is initially applied to the disc drive unit. This indicates that, although power is applied to the unit, the communications link has not yet been established.
Flashes intermittently if a disc pack is not mounted or the disc well cover is not closed when the ON-OFF switch/indicator is pressed to ON .
When held depressed, provides a lamp test for all operator control panel indicators.
DEVICE CHECK indicator
Lights whenever an electrical or mechanical malfunction of the subsystem is detected. The condition must be cleared before normal operation can be resumed.
There are three general types of conditions that cause a DEVICE CHECK indicator to light: soft unsafes, hard unsafes, and an early warning temperature indication. Soft unsafes can usually be reset by the system. If the soft unsafe cannot be cleared by recovery procedures initiated by the system, the unsafe is considered to be hard. A hard unsafe requires operator intervention at the disc drive.
To reset a hard unsafe condition, the operator turns the disc drive off and then on again. If the DEVICE CHECK indicator lights again immediately, corrective maintenance is required. Contact the Sperry Univac customer engineer.
The DEVICE CHECK indicator is lighted for any early warning temperature indication or (soft or hard) unsafe. A hard unsafe causes the drive to go offline. When the drive goes offline, the RUN switch is extinguished and the STOP switch and DEVICE CHECK indicator are both lighted. A DEVICE CHECK condition cannot be cleared by pressing the RUN or STOP switches. While the DEVICE CHECK condition exists, the affected disc drive cannot be placed in the RUN state.
FILE PROTECT switch/indicator
Selects whether the system can write data on a disc pack. When the FILE PROTECT switch/indicator is lit, writing to the disc pack is prevented. If an operation is in progress when this switch/indicator is pressed, that operation continues to completion before the file protect function is activated.
LOW DENSITY switch/indicator
Allows F1216-02 disc packs to be interchanged between type 8418-92/93 and type 8418-94/95 disc drive units
This switch/indicator is only used on type 8418-94/95 disc drive units. When this switch/indicator is in the low density mode (switch/indicator illuminated), only cylinders 000 through 410 can be accessed for reading and writing. The type 8418-92/93 disc drive units operate only in this low density mode and do not require use of this switch/indicator.

3.5.2. Turn-On and Turn-Off Procedures

Power for the 8418 disc subsystem is supplied by the processor and is normally applied and removed from the disc subsystem by the **POWER ON/POWER OFF** switch on the processor operator/maintenance panel (Figure 2—2). For power to be controlled from this panel, however, the **DISC MAIN AC** circuit breaker on the processor power control panel (Figure 2—4) and circuit breakers **CB1**, **CB2** and **CB3** on the power panels of the disc drive unit (Figure 3—14) must be set to the on (up) position. If more than four disc drive units are included in the subsystem, circuit breakers **CB1**, **CB2**, and **CB3** in the auxiliary ac power supply (Figure 3—19) must be set to the on (up) position and the **LOCAL/REMOTE** switch set to **REMOTE**. The **STOP** switch/indicator on the operator control panel lights when power is applied to the subsystem.

NOTE:

Before performing the following procedures, remove the device from the system's list of available resources by using the DOWN function of the SET IO command (Section 12). After the procedure is completed, restore the device's available status by using the UP function of the SET IO command.

To remove power from the subsystem without removing power from the rest of the system, press the **STOP** switch/indicator and then the **ON-OFF** switch/indicator on the operator control panel. For subsystems with four or fewer disc drive units, the **DISC MAIN AC** circuit breaker on the processor power control panel then has to be set to the off (down) position. For subsystems with five to eight disc drive units, circuit breakers **CB1**, **CB2**, and **CB3** on the auxiliary ac power supply then have to be set to the off (down) position. All indicators on the operator control panel extinguish.

CAUTION

*When removing power from the subsystem, failure to press the **STOP** switch/indicator (Figure 3—15) before pressing the **ON-OFF** switch/indicator will cause power transients that may disturb processor operation.*

3.5.3. Operating Procedures

The operating procedures for the subsystem include procedures for mounting a disc pack, starting the disc drive unit, stopping the disc drive unit, and unloading a disc pack.

NOTE:

*If the **DEVICE CHECK** indicator on the operator control panel lights and remains lit during any operation, refer to 3.5.4 for corrective action.*

3.5.3.1. Mounting Disc Pack and Starting Disc Drive Unit

Before the disc drive unit can be started, a disc pack must be securely mounted in the disc well. To mount a disc pack and start the disc drive unit, proceed as follows:

1. Press the cover latch on the top of the disc drive unit. Allow the well cover to spring upward (Figure 3—16), then lift the cover fully to expose the disc well (Figure 3—17).

NOTE:

The well cover should be closed as soon as possible to reduce contamination of the well by airborne particles.

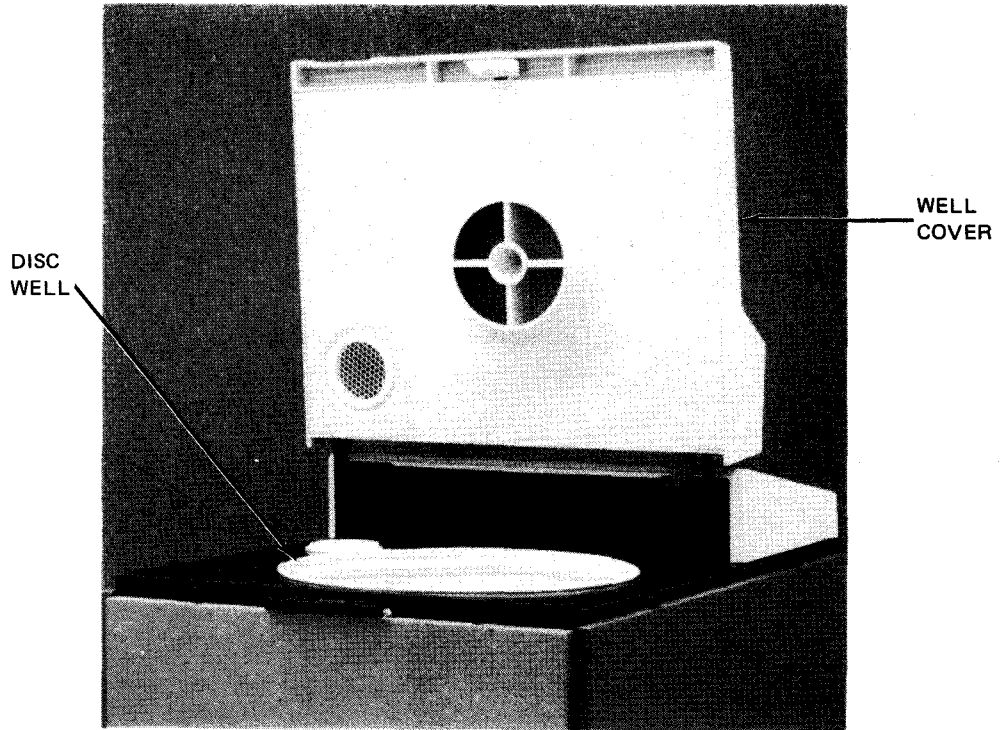

Figure 3-16. Disc Drive Well Cover Opened

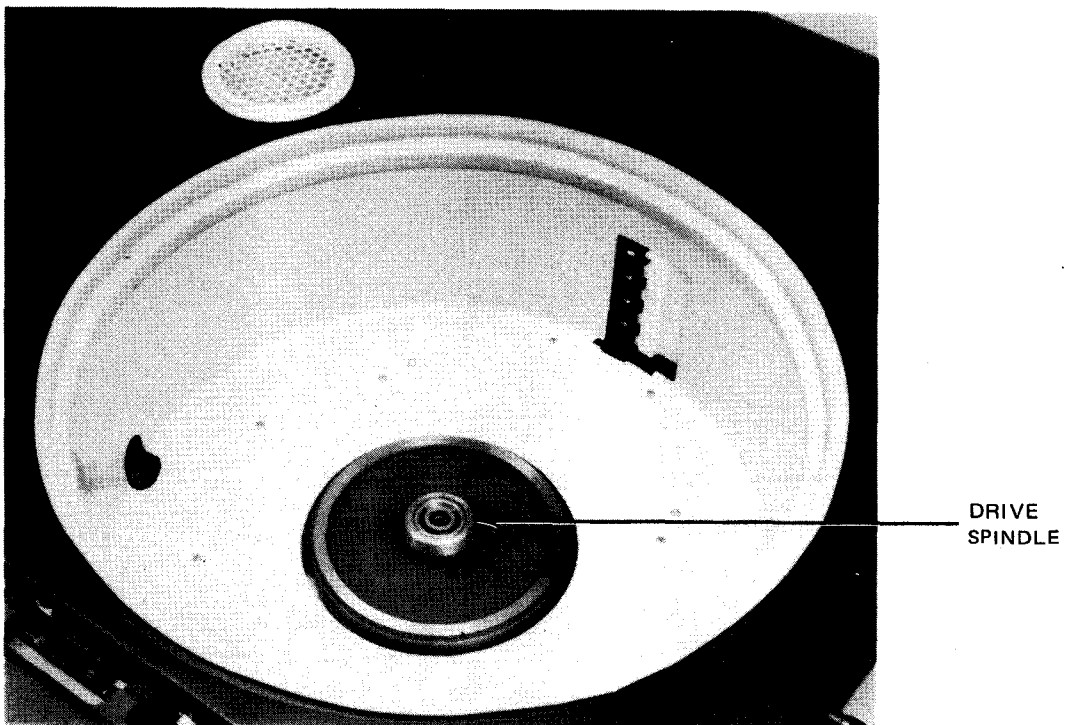

Figure 3-17. Disc Well Showing Drive Spindle

2. Hold the disc pack to be mounted by its top protective cover handle (Figure 3—18) and remove its bottom cover by squeezing the bottom cover handle and pulling it off.
3. While still holding the top cover handle, carefully lower the disc pack onto the drive shaft in the well.
4. When the disc pack is firmly seated on the drive spindle in the well, carefully rotate the disc pack clockwise with its top cover handle until rotation stops.
5. Lift off the disc pack top cover.
6. Close and latch the disc drive cover. Store the disc pack top and bottom covers in the disc pack storage basket on the disc drive or in a designated area.
7. Set the mode of operation desired by pressing the **FILE PROTECT** switch/indicator to either light the **FILE PROTECT** indicator or extinguish it. The read-only mode is set when the indicator is lit.

NOTE:

The mode of operation can be changed at any time; however, the change does not take effect until the current operation is completed.

8. On the operator control panel, press the **ON-OFF** switch/indicator and the **RUN** switch/indicator. The **ON-OFF** switch/indicator lights and the **STOP** switch/indicator extinguishes. The **RUN** switch/indicator extinguishes. The **RUN** switch/indicator lights when the disc drive is up to operating speed and the read/write heads are at cylinder 000. The disc drive unit is now ready for communications with the processor through the integrated disc adapter.

NOTE:

*It is not necessary to wait for the disc drive to completely attain operational speed before the **RUN** switch/indicator is pressed. If the **ON-OFF** switch/indicator and then the **RUN** switch/indicator are pressed in sequence, the disc drive immediately goes out of the stop state (the **STOP** switch/indicator extinguishes). The disc drive status automatically changes to the run state after the normal power-up cycle is complete.*

9. When it is necessary to set the subsystem offline (integrated disc adapter prevented from communicating with the subsystem), press the **STOP** switch/indicator on the operator control panel. The **STOP** switch/indicator lights and the **RUN** switch/indicator extinguishes.

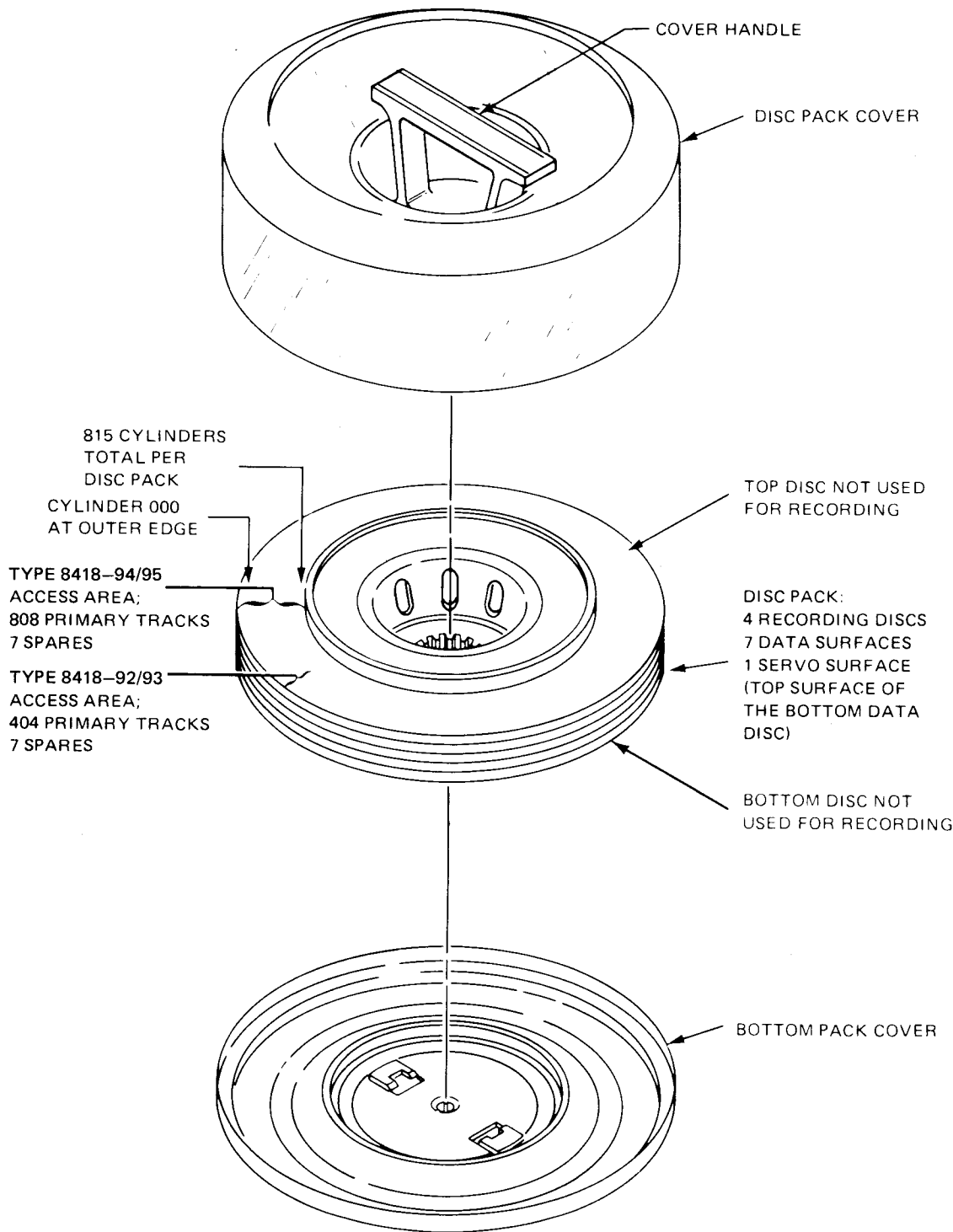

NOTE:

Each cylinder position intersects a disc data surface to establish a track location.

Figure 3-18. 8418 Disc Pack

3.5.3.2. Stopping Disc Drive Unit and Unloading Disc Pack

To completely stop disc drive unit operation and remove a disc pack from the disc well, proceed as follows:

1. Press the **STOP** switch/indicator and then the **ON-OFF** switch/indicator on the operator control panel. The **STOP** switch/indicator lights, the **RUN** switch/indicator extinguishes, and the **ON-OFF** switch/indicator flashes until the disc drive stops rotating.

NOTE:

A solenoid-operated latch locks the disc well cover until the disc drive stops.

2. When the disc drive stops rotating, press the latch on the top front of the disc drive unit and push the well cover all the way up.
3. Take a disc pack top protective cover and carefully lower it down over the disc pack in the well.
4. Grasping the handle of the top cover, carefully rotate the top cover counterclockwise until the handle rotates freely.
5. Using the handle of the top cover, carefully lift the disc pack off the drive shaft and out of the well.
6. Holding the disc pack by the handle of the top cover, put the disc pack bottom cover on by squeezing the bottom cover handle, pressing it onto the bottom of the disc pack, and releasing the handle.
7. Close the well cover securely.

3.5.4. Recovery Procedures

Table 3—8 describes the disc subsystem malfunctions that may be corrected by the operator. If the malfunction persists after the operator completes this corrective action, contact the Sperry Univac customer engineer.

Table 3—8. 8418 Disc Subsystem, Recovery Procedures (Part 1 of 2)

Fault Indication	Probable Cause	Operator Action
No indicators are lit on operator control panel.	Loss of power within the subsystem	<ol style="list-style-type: none"> 1. Ensure that circuit breakers CB1, CB2, and CB3 on the disc drive are in the on (up) position. Reset if necessary. <div style="text-align: center; border: 1px solid black; padding: 5px; width: fit-content; margin: 10px auto;"> CAUTION </div> <p>Do not reset circuit breakers CB2 or CB3 with circuit breaker CB1 in the on (up) position, because internal damage to the disc drive unit may result.</p> <ol style="list-style-type: none"> 2. On subsystems with four or fewer disc drive units, ensure that the DISC MAIN AC circuit breaker on the processor power control panel is in the on (up) position. Reset if necessary. 3. On subsystems with five to eight disc drive units, ensure that circuit breakers CB1, CB2, and CB3 are in the on (up) position. Reset if necessary.

Table 3-8. 8418 Disc Subsystem, Recovery Procedures (Part 2 of 2)

Fault Indication	Probable Cause	Operator Action
<p>DEVICE CHECK indicator remains lit.</p>	<p>An electrical or mechanical malfunction was detected.</p>	<p>The DEVICE CHECK indicator is lit when conditions are detected within the disc drive unit that might affect normal operation of the drive. A DEVICE CHECK (as indicated by the RUN switch/indicator going off and DEVICE CHECK and STOP indicators on) caused by a hard unsafe must be cleared before normal drive operation can be resumed. A DEVICE CHECK indicator on accompanied by an EARLY WARNING indication on the processor is a signal for operations to be terminated as soon as possible before the temperature problem in the drive results in a thermal trip condition.</p> <p>To reset a hard unsafe generated DEVICE CHECK condition, the operator turns the disc drive off and then back on. Note the occurrence in the system log. If the DEVICE CHECK recurs, corrective maintenance is required and the Sperry Univac customer engineer should be notified.</p> <div style="border: 1px solid black; padding: 5px; text-align: center; width: fit-content; margin: 10px auto;"> CAUTION </div> <p>If a suspected disc pack or disc drive malfunction requires substitution of the disc pack or disc drive unit due to a recurring check condition, do not continue to substitute disc packs or disc drive units after the first replacement. A read/write head or disc pack crash during a previous operation might have caused damage to the heads or disc pack, which will cause further damage and eventually disable the entire subsystem if substitutions continue. Contact the Sperry Univac customer engineer at once when the second disc pack or disc drive unit, known to be previously operative, presents a malfunction indication.</p>
<p>Power loss</p>	<p>Circuit breaker is tripped.</p>	<p>Follow proper sequence when resetting any circuit breaker:</p> <ol style="list-style-type: none"> 1. Set CB1 to off (down). 2. Set all other circuit breakers to off (down) to reset, then on (up). 3. Set CB1 to on (up). If circuit breaker trips again, contact Sperry Univac customer engineer.

This page left blank intentionally.

3.6. 8416/8418 AUXILIARY AC POWER SUPPLY

The 8416/8418 auxiliary ac power supply (Figure 3-19) is used to distribute primary ac power to an 8416 or 8418 disc subsystem, whenever the subsystem contains more than four disc drive units.

3.6.1. Operating Controls and Indicators

The function of each of the controls and indicators is described in Table 3-9.

Table 3-9. 8416/8418 Auxiliary AC Power Supply, Controls and Indicators

Control/Indicator — Function
LOCAL-REMOTE switch When set to the LOCAL position, the disc drive units can be sequenced up even though the POWER ON/POWER OFF switch on the processor operator/maintenance panel is in the POWER OFF position. When set to the REMOTE position, the disc drive units are sequenced up when the POWER ON/POWER OFF switch on the processor operator/maintenance panel is set to the POWER ON position.
POWER ON indicator Indicates power is on in the auxiliary ac power supply
CB1 circuit breaker Provides overload protection for the 208 Vac power lines within the auxiliary ac power supply
CB2 circuit breaker Provides overload protection for the 208 Vac power lines to disc drive units 0 through 3
CB3 circuit breaker Provides overload protection for the 208 Vac power lines to disc drive units 4 through 7

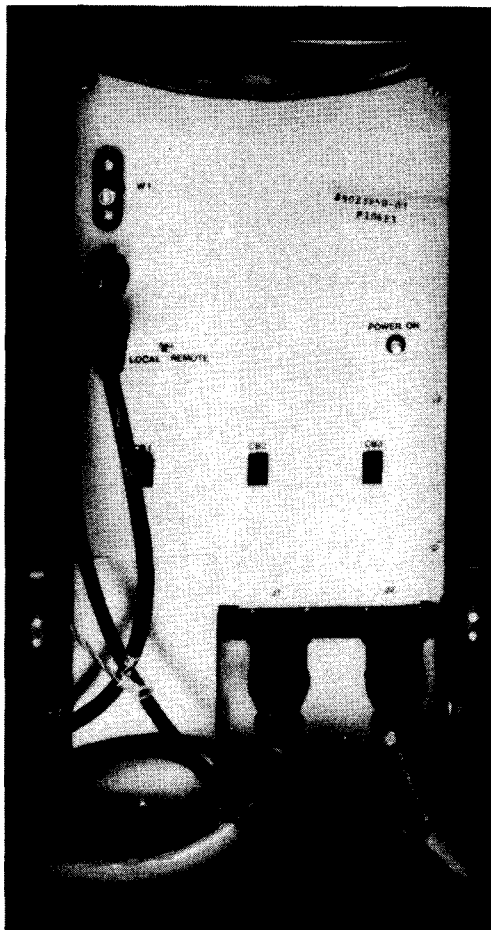

Figure 3—19. 8416/8418 Auxiliary AC Power Supply (T2408)

3.6.2. Operating Procedures

There are no operating procedures per se for the auxiliary ac power supply. Its three circuit breakers are normally left in the on (up) position and the **LOCAL/REMOTE** switch in the **REMOTE** position. These switch settings allow power to the disc units to be controlled by the **POWER ON/POWER OFF** switch on the processor/operator maintenance panel (Figure 2—2). Setting the **LOCAL REMOTE** switch to the **LOCAL** position will remove this interlock and allow power to the disc units to be completely controlled by the settings of circuit breakers **CB1**, **CB2**, and **CB3**. Setting **CB1** to its off (down) position causes power to be removed from all disc units connected to the auxiliary ac power supply.

3.7. 8430 DISC SUBSYSTEM

The 8430 disc subsystem consists of a 5039 control unit (Figure 3—20) and a 8430 disc drive unit (Figure 3—21). The disc drive unit is designed to be used with the F1230 disc pack.

The control unit controls from one to eight disc drive units. With F2047 installed, up to eight more disc drive units can be controlled by the 5039 control unit. Also, with F2046, each 8430 disc drive unit can communicate with two 5039 Control Units.

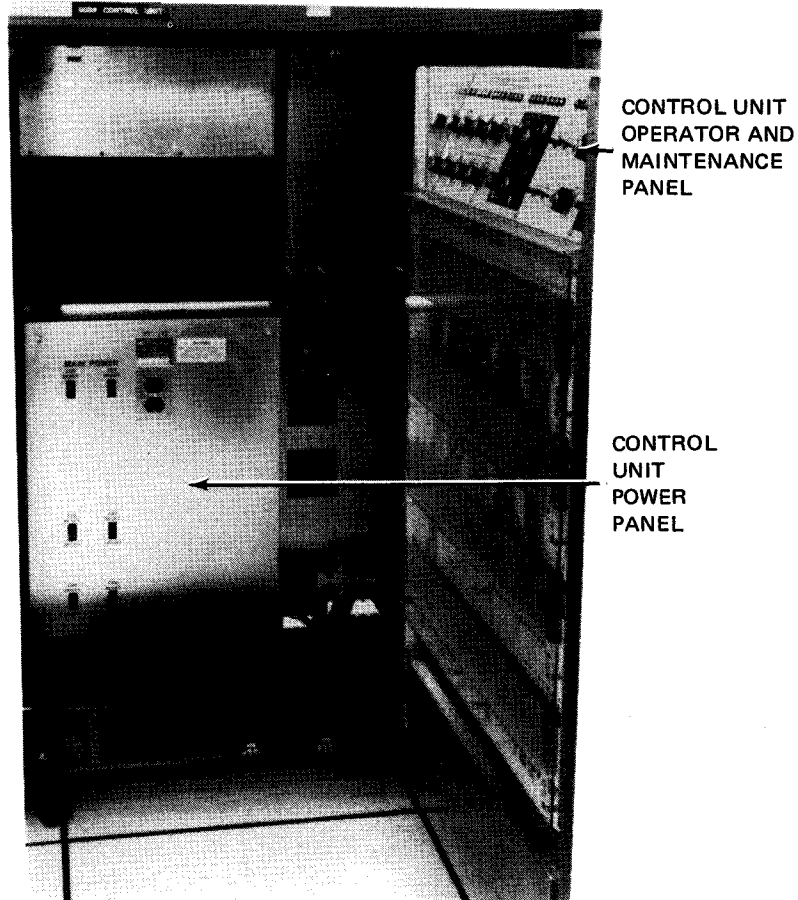

Figure 3—20. 5039 Control Unit for the 8430 Disc Subsystem (Interior View)

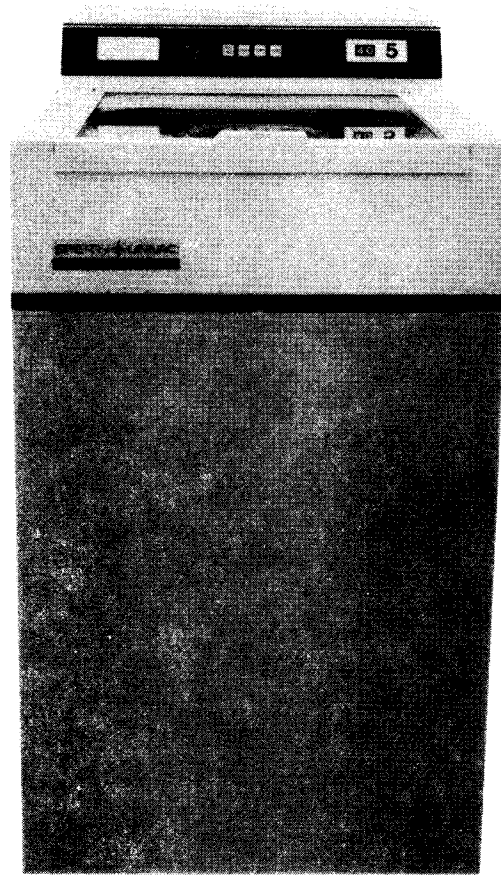

Figure 3—21. 8430 Disc Drive Unit

3.7.1. Operating Controls and Indicators

The control and indicators for the control unit are contained on the power panel and the operator and maintenance panels. The control unit module panel must be opened, by unlatching the catch on the upper left corner of the module panel and swinging the panel open, to reach these panels. The disc drive power panels are located on the rear of the unit behind the rear cabinet door. The operating controls and indicators on these panels are illustrated in Figure 3—22 and 3—23, and described in Table 3—10.



Figure 3-22. 5039 Control Unit, Power Panel

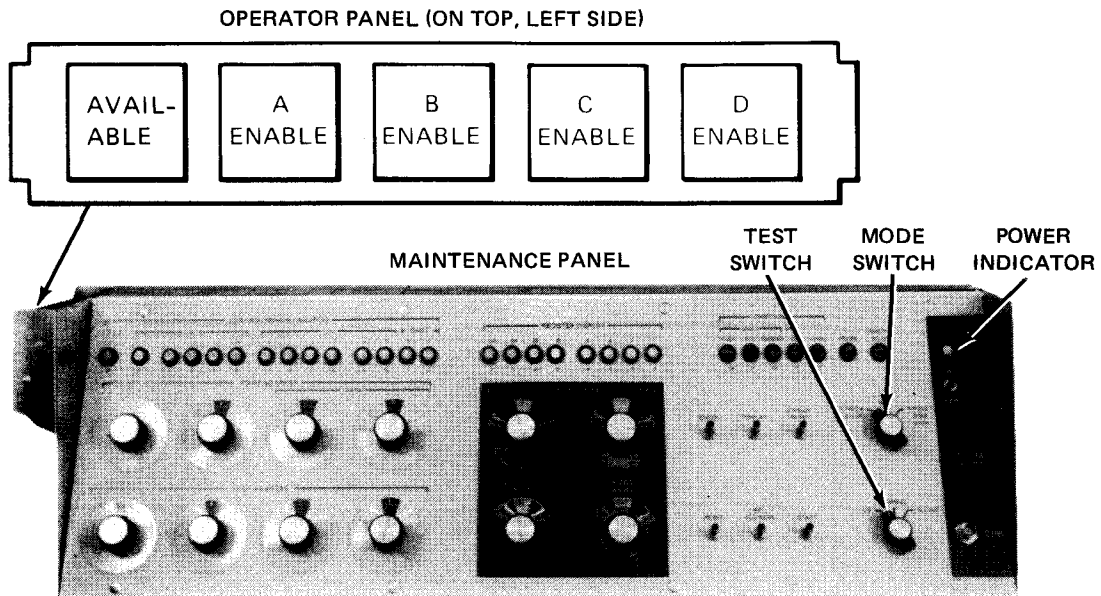

Figure 3-23. 5039 Control Unit, Operator and Maintenance Panels

Table 3-10. 8430 Disc Subsystem Control Unit, Controls and Indicators (Part 1 of 2)

Control/Indicator — Function
Power Panel
<p>MAIN POWER — CB1 circuit breaker</p> <p>Provides overload protection for the main ac power line to the control unit and the power lines to the blowers</p> <p>MAIN POWER — CB4 circuit breaker</p> <p>Provides overload protection for the power lines to the control unit internal power supplies</p> <p>CB2 circuit breaker</p> <p>Provides overload protection for the power distribution circuits supplying power to disc drive units 1 through 4</p> <p>CB5 circuit breaker</p> <p>Provides overload protection for the power distribution circuits supplying power to disc drive units 9 through 12</p> <p>CB3 circuit breaker</p> <p>Provides overload protection for the power distribution circuits supplying power to disc drive units 5 through 8</p> <p>CB6 circuit breaker</p> <p>Provides overload protection for the power distribution circuits supplying power to disc drive units 13 through 16</p>
Operator Panel
<p>AVAILABLE indicator</p> <p>Lights when control unit power is on and at least one ENABLE switch/indicator is lit</p> <p>A ENABLE switch/indicator</p> <p>Establishes the communication link between the system and disc drive units 1 through 4. Lights when the communication line is open</p> <p>B ENABLE switch/indicator</p> <p>Establishes the communication link between the system and disc drive units 5 through 8. Lights when the communication line is open</p> <p>C ENABLE switch/indicator</p> <p>Establishes the communication link between the system and disc drive units 9 through 12. Lights when the communication line is open</p> <p>D ENABLE switch/indicator</p> <p>Establishes the communication link between the system and disc drive units 13 through 16. Lights when the communication line is open</p>

Table 3-10. 8430 Disc Subsystem Control Unit, Controls and Indicators (Part 2 of 2)

Control/Indicator — Function
Maintenance Panel
<p>Power indicator</p> <p>Lights when dc voltage is applied to the logic circuits in the control unit</p> <p>POWER switch</p> <p>Applies and removes dc power to the logic circuits in the control unit</p> <p>LAMP TEST switch</p> <p>Tests all lamps on maintenance panel</p> <p>Mode switch</p> <p>Selects the mode of operation of the control unit. Under system operating conditions, this switch is to be in the RUN position. The CHECK STOP and SINGLE STEP STOP positions are for use by the Sperry Univac customer engineer only.</p> <p>CHECK RESET switch</p> <p>Clears all control unit registers</p> <p>START switch</p> <p>Sets the control unit microprogram to the idle state</p> <p>Test switch</p> <p>Selects the mode the control unit is to operate in. Under system operating conditions, this switch is to be in the NORMAL position. The CE position is used during power-up of the control unit and for use by the Sperry Univac customer engineer. The IN LINE position is for use by the Sperry Univac customer engineer only.</p> <p>NOTE:</p> <p>All other controls and indicators on the maintenance panel are for use of the Sperry Univac customer engineer.</p>

The controls and indicators for the 8430 disc unit are contained on the power panels and the operator control panel. The operating controls and indicators on these panels are illustrated in Figures 3-24 and 3-25, and described in Table 3-11.

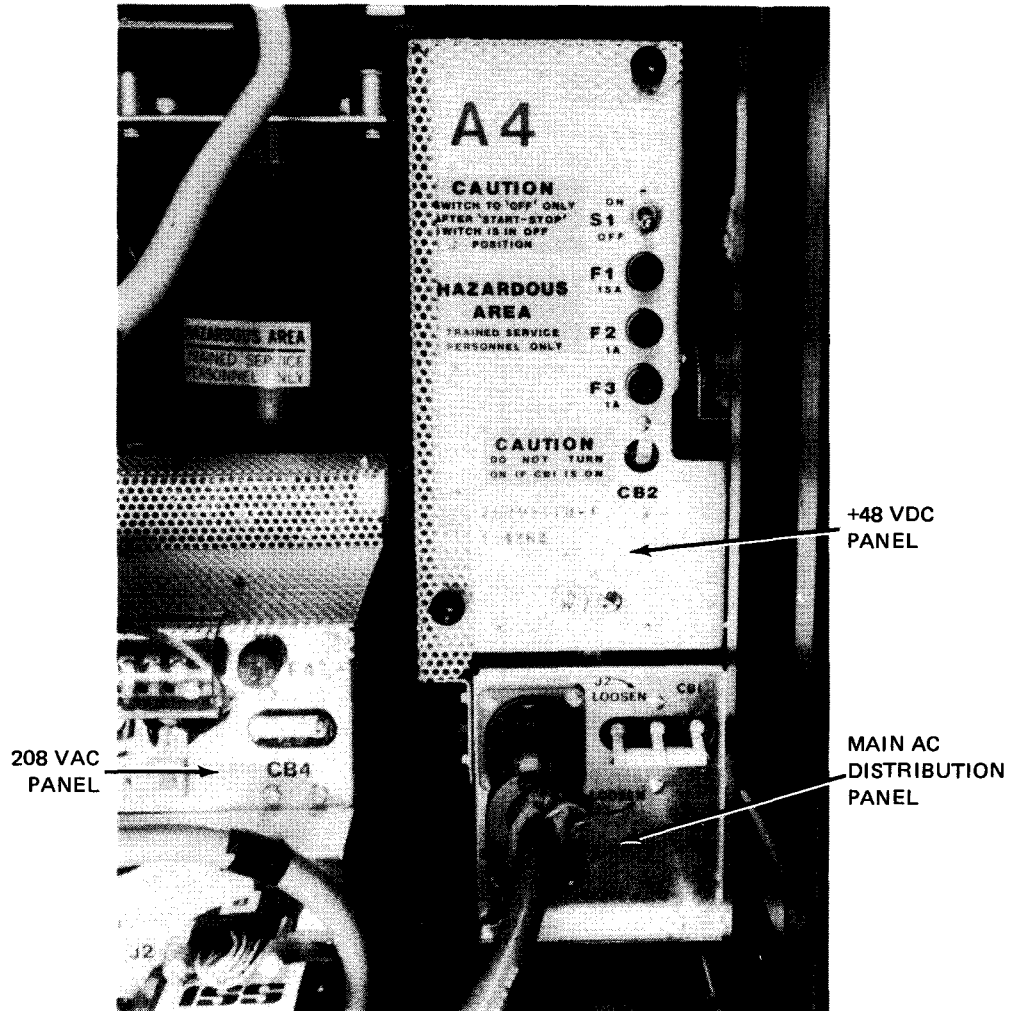

Figure 3-24. 8430 Disc Drive Unit, Power Panels

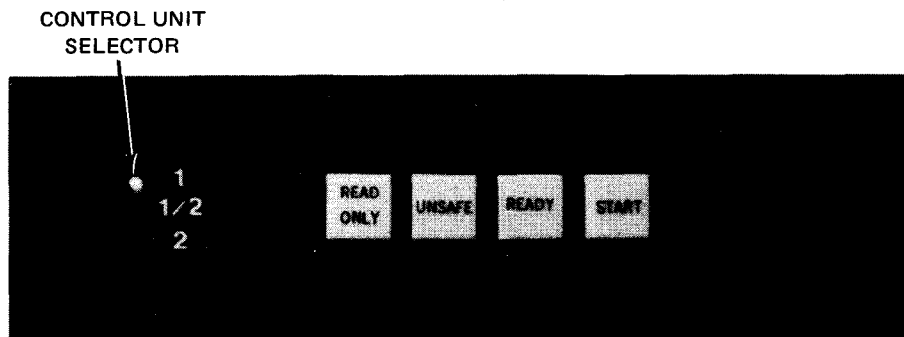

Figure 3-25. 8430 Disc Drive Unit, Operator Control Panel

Table 3-11. 8430 Disc Drive Unit, Controls and Indicators

Control/Indicator — Function
+48 Vdc Panel
<p>S1 switch</p> <p>Controls the applications of dc power within the disc drive unit</p> <p>CB2 circuit breaker</p> <p>Provides overload protection for the +48 volt power distribution circuits within the disc drive unit</p>
208 Vac Panel
<p>CB4 circuit breaker</p> <p>Provides overload protection for the 208 Vac power distribution circuits within the disc drive unit</p>
Main AC Distribution Panel
<p>CB1 circuit breaker</p> <p>Provides overload protection for the main ac power line to the disc drive unit</p>
Operator Control Panel
<p>Control Unit Selector switch</p> <p>Selects control unit (number 1 only, 1 or 2, or 2) the disc drive unit is to communicate with</p> <p>READ ONLY switch/indicator</p> <p>Selects whether the system can execute write commands to the disc pack. When lit, writing to the disc pack is prevented.</p> <p>UNSAFE indicator</p> <p>Lights whenever an electrical or mechanical malfunction of the disc drive unit is detected</p> <p>READY indicator</p> <p>Lights when the disc drive is up to speed and the read/write heads are positioned at cylinder 0</p> <p>START switch/indicator</p> <p>Energizes and deenergizes the disc drive motor and sets the read/write heads in the operating or nonoperating position. Lights when the disc drive unit is energized</p>

3.7.2. Turn-On and Turn-Off Procedures

Power is normally applied and removed from the 8430 disc subsystem by the **POWER ON/POWER OFF** switch on the processor operator/maintenance panel (Figure 2—2). For power to be controlled from this panel, however, certain switches and circuit breakers on the disc subsystem components must be set to specific positions. These switch and circuit breaker settings are specified in Table 3—12.

When the switches and circuit breakers are set as specified in Table 3—12 and the **POWER ON/POWER OFF** switch on the operator/maintenance panel is set to the **POWER ON** position, the following indicators on the control unit should light:

1. the power indicator on the maintenance panel; and
2. the **AVAILABLE** indicator on the operator panel and, depending on the disc subsystem configuration, the **A ENABLE** (for disc drive units 1 to 4), the **B ENABLE** (for disc drive units 5 to 8), the **C ENABLE** (for disc drive units 9 to 12), and the **D ENABLE** (for disc drive units 13 to 16) switch/indicators.

Table 3—12. 8430 Disc Subsystem, Power Switch Settings (Part 1 of 2)

Switch/Circuit Breaker	Normal Setting
Control Unit Power Panel	
MAIN POWER-CB1 circuit breaker	On (up)
MAIN POWER-CB4 circuit breaker	On (up)
CB2 circuit breaker	On (up) (for disc drive units 1 through 4)
CB3 circuit breaker	On (up) (for disc drive units 5 through 8)
CB5 circuit breaker	On (up) (for disc drive units 9 through 12)
CB6 circuit breaker	On (up) (for disc drive units 13 through 16)
Control Unit Maintenance Panel	
Mode switch	RUN
Test switch	NORMAL
POWER switch	ON
RESET switch	On (up)
START switch	On (up)
Control Unit Operator Panel	
A ENABLE switch/indicator	On (lit) (for disc drive units 1 through 4)
B ENABLE switch/indicator	On (lit) (for disc drive units 5 through 8)
C ENABLE switch/indicator	On (lit) (for disc drive units 9 through 12)
D ENABLE switch/indicator	On (lit) (for disc drive units 13 through 16)

Table 3-12. 8430 Disc Subsystem, Power Switch Settings (Part 2 of 2)

Switch/Circuit Breaker	Normal Setting
Disc Drive Unit Power Panels	
S1 switch	ON
CB2 circuit breaker	On (up)
CB4 circuit breaker	On (up)
CB1 circuit breaker	On (up)

3.7.2.1. Independent Power Turn-On Procedure

To apply power to the disc subsystem without applying power to the rest of the system, set the circuit breakers and switches on the control unit to the following positions:

1. set **MAIN POWER CB1** and **CB4** circuit breakers on the power panel to the on (up) position; and
2. set the test switch on the maintenance panel, to the **CE** position and the **POWER** switch to the **ON** position.

3.7.2.2. Independent Power Turn-Off Procedure

To remove power from the disc subsystem without removing power from the rest of the system, first use the *DOWN* function of the SET IO command (Section 12), then press the **START** switch/indicator on operator control panel (indicator extinguishes), then set the **MAIN POWER CB1** and **CB4** circuit breakers on the power panel of the control unit to the off (down) position.

CAUTION

*Failure to press the **START** switch/indicator before setting the circuit breakers to off may cause power transients and disrupt processor operation.*

3.7.3. Operating Procedures

The operating procedures for the disc subsystem include procedures for mounting a disc pack, starting the disc drive unit, stopping the disc drive unit, and unloading a disc pack.

NOTE:

*If the **UNSAFE** indicator on the operator control panel lights and remains lit during any operation, refer to 3.7.4 for corrective action.*

3.7.3.1. Mounting Disc Pack and Starting Disc Drive Unit

Before the disc drive unit can be started, a disc pack must be securely mounted in the disc well. To mount a disc pack and start the subsystem, proceed as follows:

1. Press the latch on the top front of the subsystem and push the well cover all the way to the rear of the well.
2. Hold the disc pack to be mounted by its top protective cover handle and remove its bottom cover by squeezing the bottom cover handle and pulling it off.
3. Still holding the top cover handle, carefully lower the disc pack onto the drive shaft in the well.
4. When the disc pack is firmly seated in the well, carefully rotate the disc pack clockwise using its top cover handle until rotation stops.
5. Lift off the top cover and gently slide the well cover forward until a click is heard.
6. Set the mode of operation desired by pressing the **READ ONLY** switch/indicator on the operator control panel to either light or extinguish the indicator portion. The read-only mode is set when the indicator is lit.

NOTE:

The mode of operation can be changed at any time; however, the change does not take effect until the current operation is completed.

7. Press the **START** switch/indicator on the operator control panel. The indicator portion lights. When the disc drive is up to speed and the read/write heads are at cylinder 0, the **READY** indicator on the operator control panel lights. The disc drive unit is now ready to receive commands.
8. Using the *UP* function of the SET IO command (Section 12), include the subsystem in the system's resources for job allocation.

3.7.3.2. Stopping Disc Drive Unit and Removing Disc Pack

To completely stop the disc drive unit operation and remove the disc pack from the disc well, proceed as follows:

1. Press the **START** switch/indicator on the operator control panel. The **START** and **READY** indicators extinguish.
2. When the disc drive stops rotating, press the latch on the top front of the disc drive unit and push the well cover all the way to the rear of the well.
3. Take a disc pack top protective cover and carefully lower it down over the disc pack in the well.
4. Grasp the handle of the top cover and carefully rotate the top cover counterclockwise until the handle rotates freely.
5. Using the handle of the top cover, carefully lift the disc pack off the drive shaft and out of the well.
6. While holding the disc pack by the handle of the top cover, put the disc pack bottom cover on by squeezing the bottom cover handle, pressing it onto the bottom of the disc pack, and releasing the handle.

3.7.4. Recovery Procedures

Table 3-13 describes the disc subsystem malfunctions that may be corrected by the operator. If a malfunction persists, contact your Sperry Univac customer engineer.

Table 3-13. 8430 Disc Subsystem, Recovery Procedures (Part 1 of 2)

Fault Indication	Probable Cause	Operator Action
Control Unit		
Power indicator on main-tenance panel is not lit.	No power in control unit logic	<ol style="list-style-type: none"> 1. Ensure the CB1 and CB4 circuit breakers on the power panel are in the on (up) position. 2. Ensure the POWER switch on the maintenance panel is in the ON position.
AVAILABLE indicator on the operator panel is not lit.	<ol style="list-style-type: none"> 1. One or more ENABLE switch/indicators on operator panel not pressed 2. No power at the operator panel 	<ol style="list-style-type: none"> 1. Ensure at least one ENABLE switch/indicator on the operator panel is pressed. 2. Ensure the CB1 and CB4 circuit breakers on the power panel are in the on (up) position. 3. Ensure the POWER switch on the maintenance panel is in the ON position.
Disc Drive Unit		
START switch/indicator on the operator control panel does not activate the disc drive, when pressed. Indicator portion does not light.	No power at the disc drive unit	<ol style="list-style-type: none"> 1. Ensure that switch S1 and circuit breaker CB2 on the +48 Vdc panel are in the on (up) position. 2. Ensure that circuit breaker CB4 on the 208 Vac panel is in the on (up) position. 3. Ensure that circuit breaker CB1 on the main ac distribution panel is in the on (up) position. 4. Ensure that MAIN POWER circuit breakers CB1 and CB4 on the control unit power panel are in the on (up) position. 5. Ensure that the applicable circuit breaker (CB2 for disc drive units 1 through 4, CB5 for disc drive units 5 through 8, CB3 for disc drive units 9 through 12, or CB6 for disc drive units 13 through 16) on the control unit power panel is in the on (up) position.

Table 3-13. 8430 Disc Subsystem, Recovery Procedures (Part 2 of 2)

Fault Indication	Probable Cause	Operator Action
Disc Drive Unit (cont)		
<p>UNSAFE indicator is lit.</p>	<p>Operational electrical or mechanical problem</p>	<p>Refer to 3.7.2.2 and contact Sperry Univac customer engineer.</p> <div style="border: 1px solid black; padding: 5px; width: fit-content; margin: 10px auto;"> <p>CAUTION</p> </div> <p>If a suspected disc pack or disc drive malfunction requires substitution of the disc pack or disc drive due to a recurring check condition, do not continue to substitute disc packs or disc drives after the first replacement. A read/write head and/or disc pack crash during a previous operation may have caused damage to the heads and/or disc pack which will cause further damage and eventually disable the entire subsystem if substitutions continue. Contact the Sperry Univac customer engineer at once when the second disc pack or disc drive, known to be previously operative, presents a malfunction indication.</p>



3.8. 8415 DISC SUBSYSTEM

The 8415 disc subsystem (Figure 3-26) is connected to a 90/30 B system processor via the integrated disc adapter (IDA). The 90/30 B system can support a maximum of two 8415 disc units in combination with a maximum of four 8416 disc units (3.4) and four 8418 disc units (3.5). Subsystems containing one to four disc drive units are powered by the processor. Subsystems containing more than four disc drives are powered by the 2408 auxiliary ac power supply (3.6). The F1215-00 removable disc cartridge is designed for use with the 8415 disc subsystem.

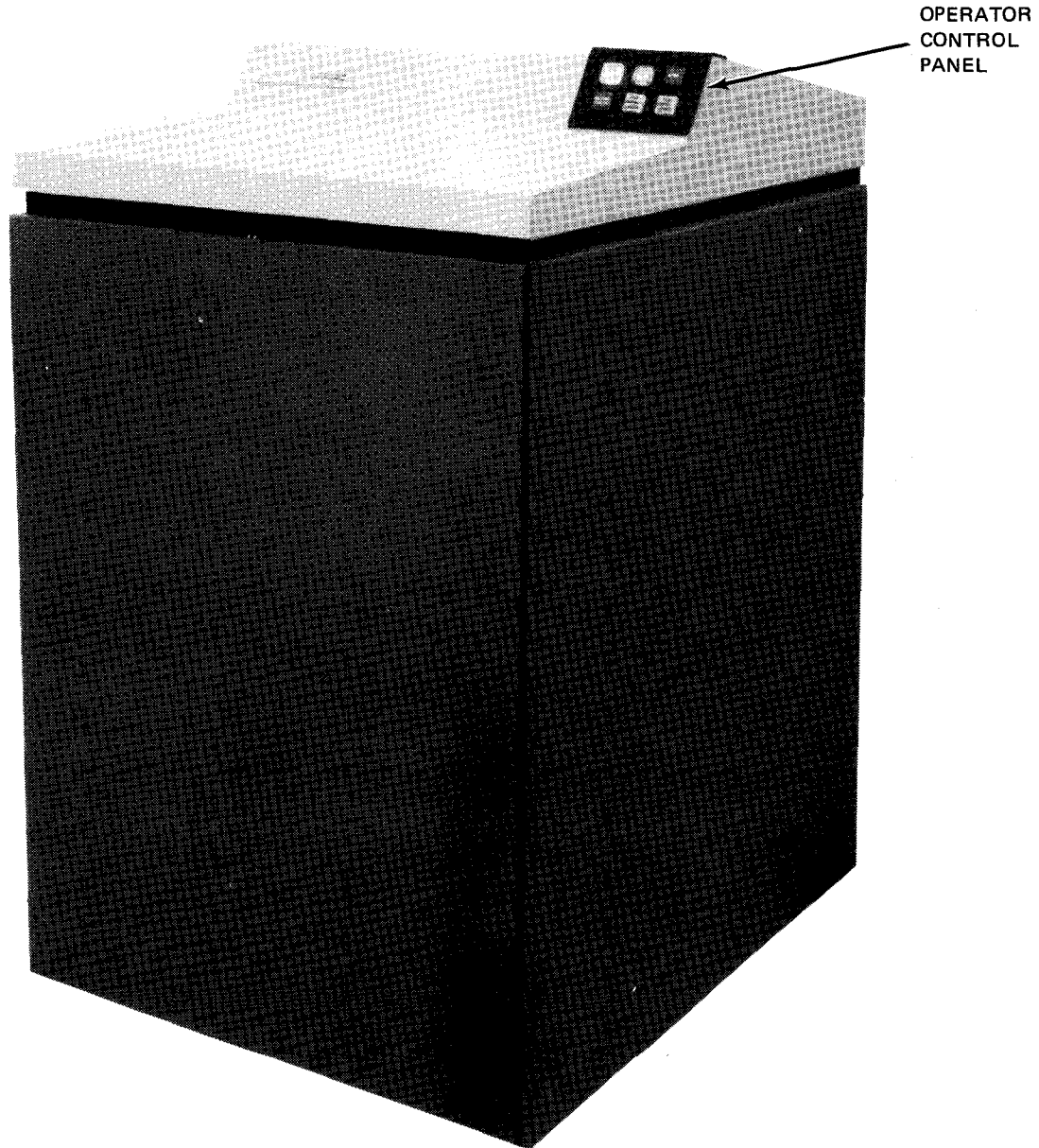

Figure 3-26. 8415 Disc Drive Unit





3.8.1. Operating Controls and Indicators

The operating controls and indicators used for operating the 8415 disc drive unit are located on the operator control panel (Figure 3-27) at the top of the cabinet. The controls for input power to the unit are located on the main ac distribution panel, the 208 Vac panel, and the +48 V panel (Figure 3-28) within the cabinet. Access to these controls is gained by removal of the rear cabinet panel. The function of each control and indicator for the 8415 disc unit is described in Table 3-14.

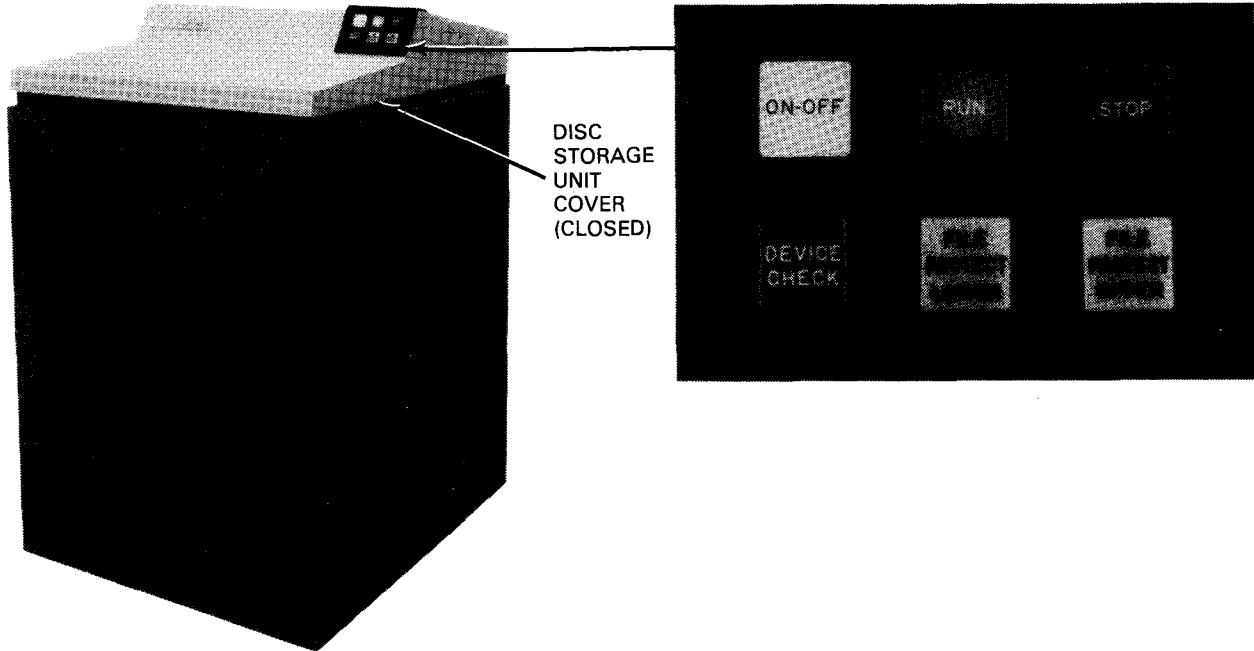

Figure 3-27. 8415 Disc Drive Unit, Operator Control Panel

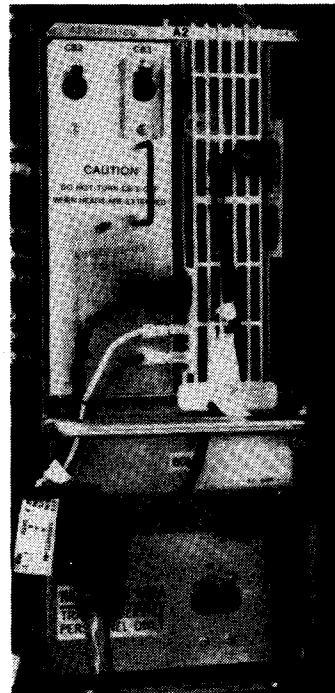

Figure 3-28. 8415 Disc Drive Unit, Power Panels



Table 3-14. 8415 Disc Drive Unit, Controls and Indicators (Part 1 of 2)

Control/Indicator—Function
Main AC Distribution Panel
<p>CB1 circuit breaker</p> <p>Provides overload protection for the main ac power line to the subsystem</p>
+48 VDC/208 VAC Panel
<p>CB2 circuit breaker</p> <p>Provides overload protection for the 208 Vac power line within the disc drive unit</p>
<p>CB3 circuit breaker</p> <p>Provides overload protection for the +48 Vdc power line within the disc drive unit</p>
Operator Control Panel
<p>ON-OFF switch/indicator</p> <p>Controls the application of power to the disc drive motor and sets the read/write heads in the operating or nonoperating position</p> <p>For this switch/indicator to be set to ON (indicator lit), the removable disc cartridge must be mounted on the spindle and the disc well cover closed securely. If either or both of these conditions are not met, the ON-OFF switch/indicator will not light and the STOP switch/indicator will blink.</p> <p>When this switch/indicator is set to OFF, the indicator flashes intermittently until the spindle stops rotating.</p> <p>If the drive motor temperature increases, a thermal switch turns off power to the motor until the drive motor has cooled to a safe level. While the thermal switch is open, the switch/indicator remains lit if in the ON position, or remains extinguished if in the OFF position, but power to the motor remains off until the motor has cooled.</p>
<p>RUN switch/indicator</p> <p>Establishes the communications link between the integrated disc adapter and the disc subsystem.</p> <p>When pressed, the RUN switch/indicator lights, the STOP switch/indicator extinguishes, and the communications link is established provided that the:</p> <ol style="list-style-type: none"> 1. ON-OFF switch/indicator is lit; 2. drive spindle is at operating speed; 3. read/write heads are positioned at cylinder 0; and 4. DEVICE CHECK indicator is extinguished. <p>NOTE:</p> <p>The RUN switch/indicator lights only when all of the above conditions are met. The STOP switch/indicator, however, extinguishes immediately after the RUN switch/indicator is pressed and released.</p>

Table 3-14. 8415 Disc Drive Unit, Controls and Indicators (Part 2 of 2)

Control/Indicator—Function
Operator Control Panel (cont)
STOP switch/indicator <p>Removes the communications link between the integrated disc adapter and the disc subsystem.</p> <p>When pressed, the STOP switch/indicator lights, the RUN switch/indicator extinguishes, and the communications link is removed.</p> <p>If an operation is in progress when the STOP switch/indicator is pressed, that operation continues to completion before the stop action takes place.</p> <p>The STOP switch/indicator lights when ac power is initially applied to the disc drive unit. This indicates that, although power is applied to the unit, the communications link has not yet been established.</p> <p>Flashes intermittently if the removable disc cartridge is not mounted or the disc well cover is not closed when the ON-OFF switch/indicator is pressed to ON.</p> <p>When held depressed, provides a lamp test for all operator control panel indicators.</p>
DEVICE CHECK indicator <p>Lights whenever an electrical or mechanical malfunction of the subsystem is detected. The condition must be cleared before normal operation can be resumed.</p> <p>There are three general types of conditions that cause a DEVICE CHECK indicator to light: soft unsafes, hard unsafes, and an early warning temperature indication. Soft unsafes can usually be reset by the system. If the soft unsafe cannot be cleared by recovery procedures initiated by the system, the unsafe is considered to be hard. A hard unsafe requires operator intervention at the disc drive.</p> <p>To reset a hard unsafe condition, the operator turns the disc drive off and then on again. If the DEVICE CHECK indicator lights again immediately, corrective maintenance is required. Contact the Sperry Univac customer engineer.</p> <p>The DEVICE CHECK indicator is lighted for any early warning temperature indication or (soft or hard) unsafe. A hard unsafe causes the drive to go offline. When the drive goes offline, the RUN switch is extinguished and the STOP switch and DEVICE CHECK indicator are both lighted. A DEVICE CHECK condition cannot be cleared by pressing the RUN or STOP switches. While the DEVICE CHECK condition exists, the affected disc drive cannot be placed in the RUN state.</p>
FILE PROTECT LOWER switch/indicator <p>Selects whether the system can write data on the fixed discs. When the FILE PROTECT LOWER switch/indicator is lit, writing to the fixed discs is prevented. If an operation is in progress when this switch/indicator is pressed, that operation continues before the file protect function is activated.</p>
FILE PROTECT UPPER switch/indicator <p>Selects whether the system can write data on the removable disk. When the FILE PROTECT UPPER switch/indicator is lit, writing to the removable disc is prevented. If an operation is in progress when this switch/indicator is pressed, that operation continues to completion before the file protect function is activated.</p>

3.8.2. Turn-On and Turn-Off Procedures

Power for the 8415 disc subsystem is supplied by the processor and is normally applied and removed from the disc subsystem by the **POWER ON/POWER OFF** switch on the processor operator/maintenance panel (Figure 2—2). For power to be controlled from this panel, however, the **DISC MAIN AC** circuit breaker on the processor power control panel (Figure 2—4) and circuit breakers **CB1**, **CB2**, and **CB3** on the power panels of the disc drive unit (Figure 3—28) must be set to the on (up) position. If more than four disc drive units are included in the subsystem, circuit breakers **CB1**, **CB2**, and **CB3** in the auxiliary ac power supply (Figure 3—19) must be set to the on (up) position and the **LOCAL/REMOTE** switch set to **REMOTE**. The **STOP** switch/indicator on the operator control panel lights when power is applied to the subsystem.

NOTE:

Before performing the following procedures, remove the device from the system's list of available resources by using the DOWN function of the SET IO command (Section 12). After the procedure is completed, restore the device's available status by using the UP function of the SET IO command.

To remove power from the subsystem without removing power from the rest of the system, press the **STOP** switch/indicator and then the **ON-OFF** switch/indicator on the operator control panel. For subsystems with four or fewer disc drive units, the **DISC MAIN AC** circuit breaker on the processor power control panel then has to be set to the off (down) position. For subsystems with five to eight drive units, circuit breakers **CB1**, **CB2**, and **CB3** on the auxiliary ac power supply then have to be set to the off (down) position. All indicators on the operator control panel extinguish.

CAUTION

*When power is removed from the subsystem, failure to press the **STOP** switch/indicator (Figure 3—27) before pressing the **ON-OFF** switch/indicator causes power transients that may disturb processor operation.*

3.8.3. Operating Procedures

The operating procedures for the subsystem include procedures for mounting the disc cartridge, starting the disc drive unit, stopping the disc drive unit, and unloading the disc cartridge.

NOTE:

*If the **DEVICE CHECK** indicator on the operator control panel lights and remains lit during any operation, refer to 3.8.4 for corrective action.*

3.8.3.1. Mounting Disc Cartridge and Starting Disc Drive Unit

Before the disc drive unit can be started, a disc cartridge must be securely mounted in the disc well. To mount the disc cartridge and start the drive unit, proceed as follows:



1. Press the cover latch on the front of the disc drive unit to release the well cover. Allow the well cover to spring upward; then lift cover to fully expose the disc well (Figure 3—29).

NOTE:

The well cover should be closed as soon as possible to reduce contamination of the well by airborne particles.

2. Place disc cartridge and cover assembly on flat surface.
3. Release the bottom cover of cartridge by sliding the locking latch (located in cartridge handle) fully to one side and lifting handle to an upright position (Figure 3—30).

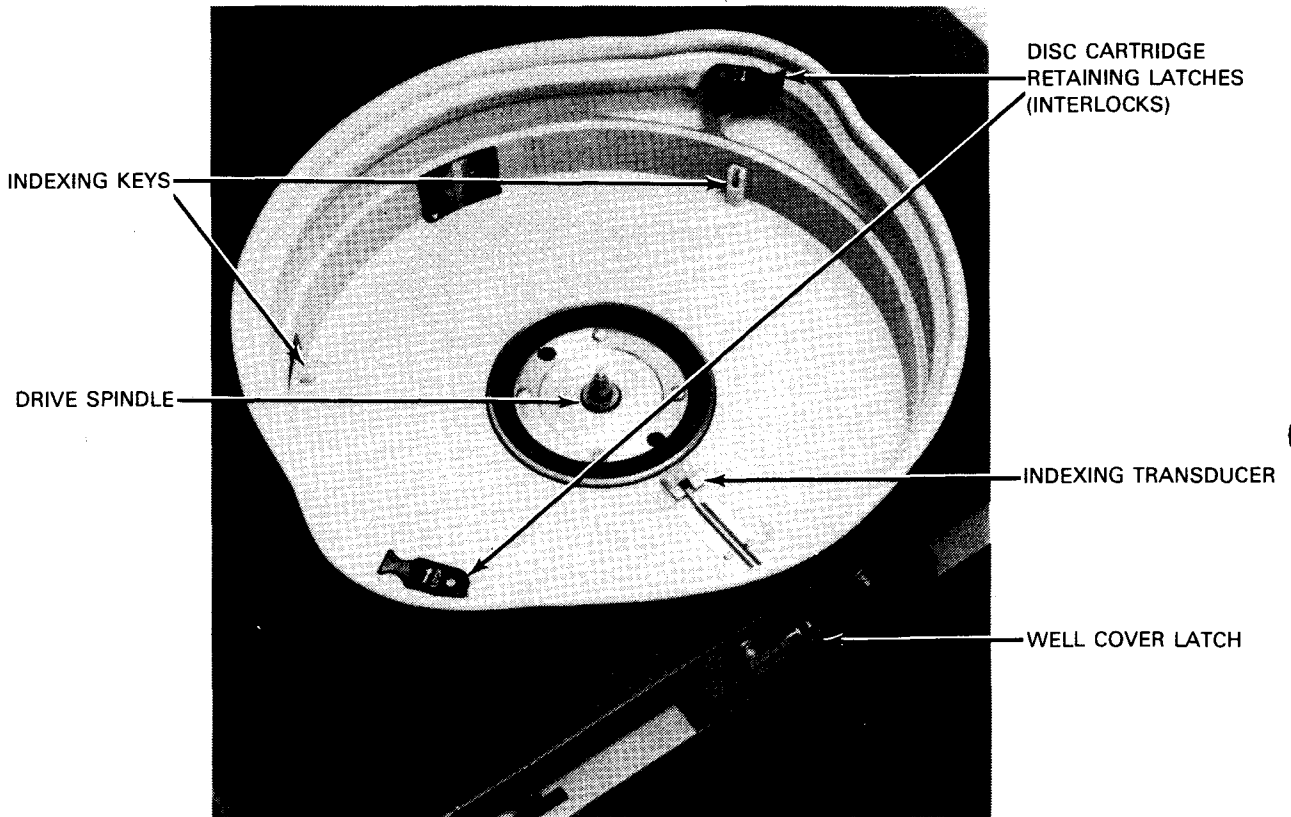

Figure 3—29. 8415 Disc Drive Unit, Disc Drive Well

4. Lift cartridge (Figure 3—30) out of bottom cover; then release locking latch.
5. While holding the cartridge handle, carefully align the indexing slots of the disc cartridge (Figure 3—30) to the indexing keys and indexing transducer in the well (Figure 3—29).
6. Carefully lower cartridge onto the drive spindle in the well; making certain that the cartridge fits securely onto the indexing keys (Figure 3—31).
7. Lower cartridge handle.



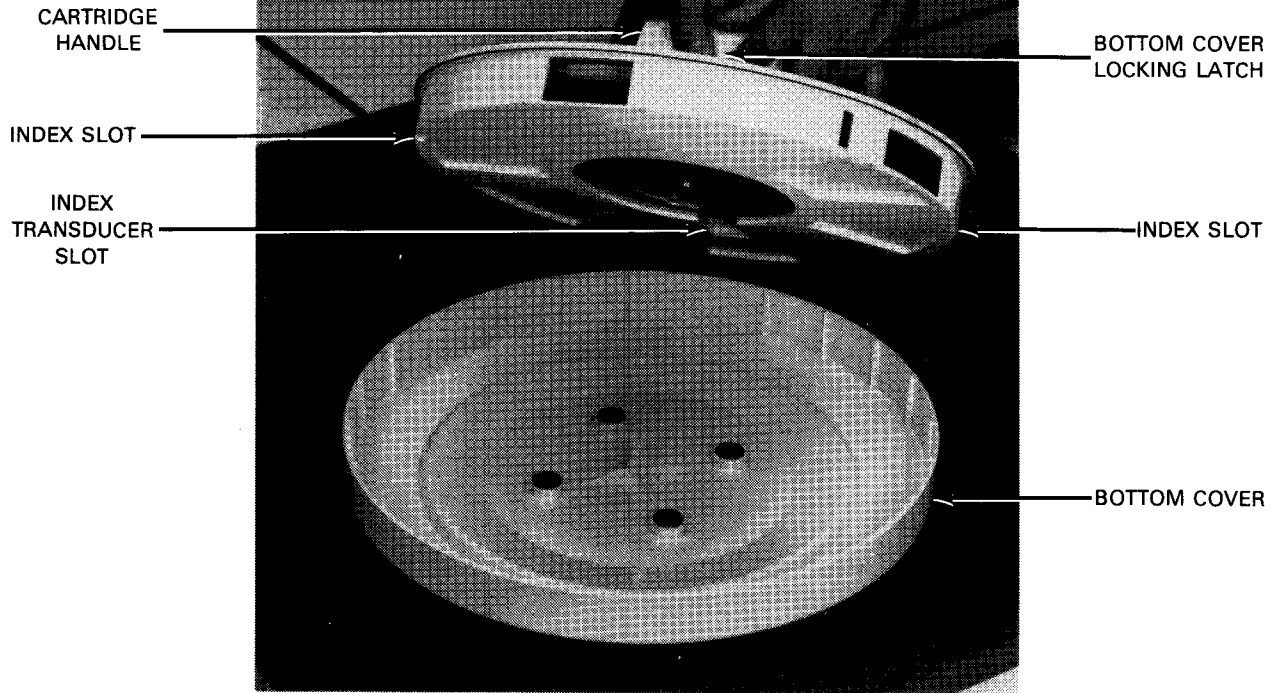

Figure 3-30. 8415 Disc Cartridge (F1215-00)

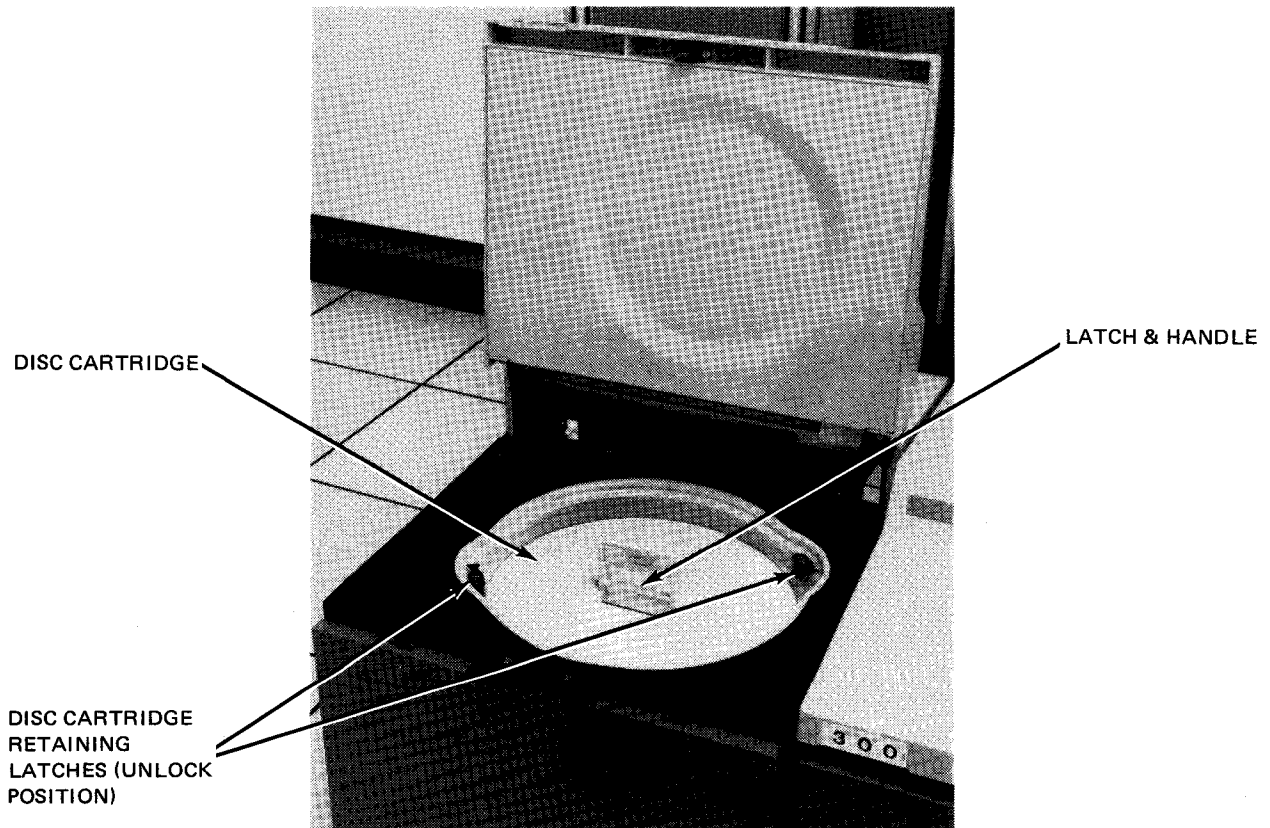

Figure 3-31. 8415 Disc Cartridge Mounted on Drive Spindle



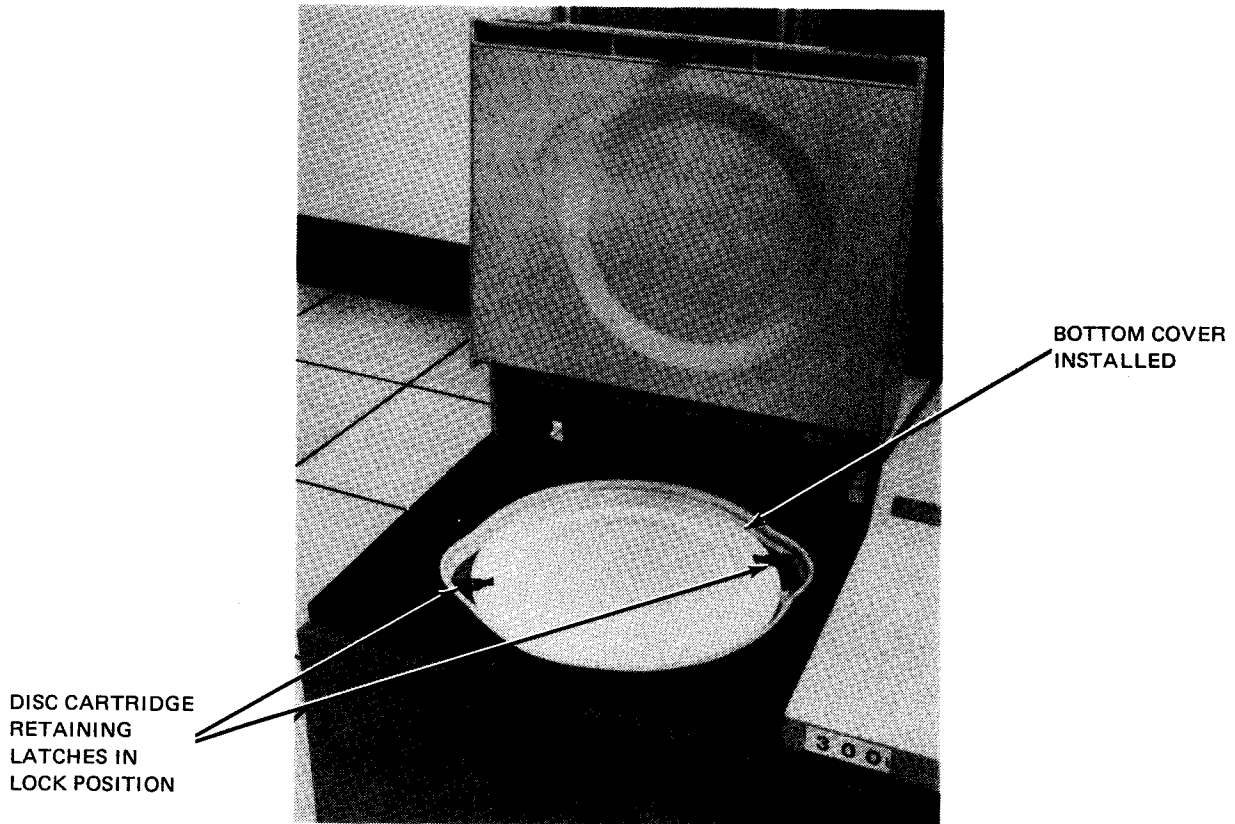

Figure 3-32. 8415 Disc Cartridge and Cover Fully Mounted on Drive Spindle

8. Invert the bottom cover (Figure 3-30) of the cartridge (bottom facing upward) and install it over the cartridge in the well (Figure 3-32).
9. Lock cover in place by rotating the disc cartridge retaining latches (Figure 3-32) to their lock position (clockwise direction).

NOTE:

The disc cartridge retaining latches serve as interlocks. The disc unit cannot be placed online unless the latches are in the lock position.

10. Close and latch the disc drive cover.
11. Set mode of operation for the fixed disc by pressing the **FILE PROTECT LOWER** switch/indicator either to light the **FILE PROTECT LOWER** indicator or to extinguish it. The read-only mode is set when the indicator is lit. The mode of operation for the removable disc cartridge is set by use of the **FILE PROTECT UPPER** switch/indicator.

NOTE:

The mode of operation for both the removable disc cartridge and the fixed discs can be changed at any time; however, the change does not take effect until the current operation is completed.



12. Press the **ON-OFF** switch/indicator, then the **RUN** switch/indicator on the operator control panel. The **ON-OFF** switch/indicator lights and the **STOP** switch/indicator extinguishes. The **RUN** switch/indicator extinguishes until the disc drive reaches operating speed and the read/write heads are at cylinder 000 (load complete). The **RUN** switch/indicator, at this point, flashes. The flashing indicator informs the operator that the fixed discs (lower discs) are online and the removable disc (upper disc) is offline. The removable disc is not placed online until it has reached thermal stability; this takes approximately 150 seconds. As soon as the removable disc reaches thermal stability, it is automatically placed online; the **RUN** switch/indicator stops flashing (lights steadily). The operator does not need to wait until the removable disc stabilizes before accessing the fixed discs. The fixed discs can be accessed as soon as they are placed online (ready state).

NOTE:

*It is not necessary to wait for the disc drive to completely attain operational speed before the **RUN** switch/indicator is pressed. If the **ON-OFF** switch/indicator and then the **RUN** switch/indicator are pressed in sequence, the disc drive immediately goes out of the stop state (the **STOP** switch/indicator extinguishes). The disc drive status automatically changes to the run state after the normal power-up cycle is complete.*

13. When it is necessary to set the subsystem offline (integrated disc adapter prevented from communicating with the subsystem), press the **STOP** switch/indicator on the operator control panel. The **STOP** switch/indicator lights and the **RUN** switch/indicator extinguishes.

3.8.3.2. Stopping Disc Drive Unit and Unloading Disc Cartridge ←

To completely stop disc drive unit operation and remove the disc cartridge from the disc well, proceed as follows:

1. Press the **STOP** switch/indicator and then the **ON-OFF** switch/indicator on the operator control panel. The **STOP** switch/indicator lights; the **RUN** switch/indicator extinguishes; the **ON-OFF** switch/indicator flashes until the disc drive stops rotating, then remains extinguished.

NOTE:

A solenoid-operated latch locks the disc well cover until the disc drive stops.

2. When the disc drive stops rotating, press the latch on the top front of the disc drive unit and lift the well access cover all the way up to fully expose the disc cartridge.
3. Rotate the disc cartridge retaining latches to the unlock position (counterclockwise direction).
4. Remove disc cartridge cover from disc well; invert cover and place on flat surface.
5. Raise handle of disc cartridge, grasp firmly, and lift cartridge carefully off the drive spindle and out of the well.
6. Holding the cartridge by its handle, insert cartridge into its cover; lower handle to lock cartridge into cover.
7. Close the well cover securely.

3.8.4. Recovery Procedures

Table 3—15 describes the 8415 disc subsystem malfunctions that may be corrected by the operator. If the malfunction persists after the operator completes this corrective action, contact the Sperry Univac customer engineer.

Table 3—15. 8415 Disc Subsystem, Recovery Procedures (Part 1 of 2)

Fault Indication	Probable Cause	Operator Action
No indicators are lit on operator control panel.	Loss of power within the subsystem	<ol style="list-style-type: none"> 1. Ensure that circuit breakers CB1, CB2, and CB3 on the disc drive are in the on (up) position. Reset if necessary. <div style="text-align: center; border: 1px solid black; padding: 5px; width: fit-content; margin: 10px auto;"> CAUTION </div> <p>Do not reset circuit breakers CB2 or CB3 with circuit breaker CB1 in the on (up) position, because internal damage to the disc drive unit may result.</p> <ol style="list-style-type: none"> 2. On subsystems with four or fewer disc drive units, ensure that the DISC MAIN AC circuit breaker on the processor power control panel is in the on (up) position. Reset if necessary. 3. On subsystems with five to eight disc drive units, ensure that circuit breakers CB1, CB2, and CB3 are in the on (up) position. Reset if necessary.
DEVICE CHECK indicator remains lit.	An electrical or mechanical malfunction was detected.	<p>The DEVICE CHECK indicator is lit when conditions are detected within the disc drive unit that might affect normal operation of the drive. A DEVICE CHECK (as indicated by the RUN switch/indicator going off and DEVICE CHECK and STOP indicators on) caused by a hard unsafe must be cleared before normal drive operation can be resumed. A DEVICE CHECK indicator on accompanied by an EARLY WARNING indication on the processor is a signal for operations to be terminated as soon as possible before the temperature problem in the drive results in a thermal trip condition.</p> <p>To reset a hard unsafe generated DEVICE CHECK condition, the operator turns the disc drive off and then back on. Note the occurrence in the system log. If the DEVICE CHECK recurs, corrective maintenance is required and the Sperry Univac customer engineer should be notified.</p>

Table 3-15. 8415 Disc Subsystem, Recovery Procedures (Part 2 of 2)

Fault Indication	Probable Cause	Operator Action
<p>DEVICE CHECK (cont)</p>		<div style="border: 1px solid black; padding: 5px; margin: 10px auto; width: fit-content;"> <p>CAUTION</p> </div> <p>If a suspected disc pack or disc drive malfunction requires substitution of the disc pack or disc drive unit due to a recurring check condition, do not continue to substitute disc packs or disc drive units after the first replacement. A read/write head or disc pack crash during a previous operation might have caused damage to the heads or disc pack, which will cause further damage and eventually disable the entire subsystem if substitutions continue. Contact the Sperry Univac customer engineer at once when the second disc pack or disc drive unit, known to be previously operative, presents a malfunction indication.</p>
<p>Power loss</p>	<p>Circuit breaker is tripped.</p>	<p>Follow proper sequence when resetting any circuit breaker:</p> <ol style="list-style-type: none"> 1. Set CB1 to off (down). 2. Set all other circuit breakers to off (down) to reset, then on (up). 3. Set CB1 to on (up). If circuit breaker trips again, contact Sperry Univac customer engineer.
<p>ON/OFF indicator does not light in ON position; STOP indicator flashing</p>	<p>Removable disc cartridge not mounted or mounted improperly</p> <p>Well cover not properly closed</p> <p>Power circuit breakers at rear of disc cabinet tripped.</p>	<p>Ensure removable disc cartridge is properly installed (3.8.3).</p> <p>Open and close well cover securely.</p> <p>Reset circuit breaker as described under power loss.</p>

This page left blank intentionally.

3.9. 8413 DISKETTE SUBSYSTEM

The 8413 diskette subsystem (Figure 3—33) is a freestanding, direct access storage device comprising two of four (optional feature) diskette drives, a microprocessor controller, and the device interface logic, all housed in a single cabinet. The device uses a removable flexible diskettes as the storage medium for online and offline operations. The diskettes are interchangeable between drive mechanisms. Interface between the diskette subsystem and the 90/30 B system processor is provided via the integrated peripheral channel (IPC).

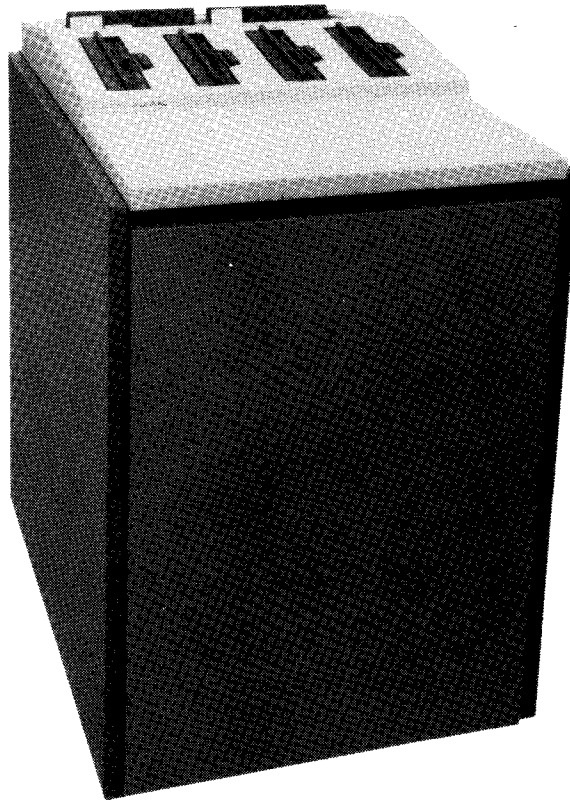

Figure 3—33. 8413 Diskette Subsystem (Optional Four-Drive Unit Shown)

3.9.1. Operating Controls and Indicators

The only controls and indicators located on the 8413 diskette subsystem are an input power circuit breaker and a light-emitting diode (LED) indicator in the latch push bar of each diskette drive. The input power circuit breaker (Figure 3—34) provides overload protection for the subsystem and can be used as a master power turnoff switch if it is necessary to remove input power to the subsystem. This circuit breaker is normally left in the on position, and power to the subsystem is controlled remotely from the operator/maintenance panel of the processor. Access to the circuit breaker is gained by removal of the front access panel of the cabinet. The circuit breaker is located in the lower left corner at the front of the cabinet.

The LED indicator in the latch push bar of each diskette drive (Figure 3—34) lights under system control whenever the diskette drive is being tested by the system. This indicator, when lit, informs the operator that the diskette is in use and not to attempt to remove it until the operation is completed.

Except for the circuit breaker and the LED indicator, all operations of the diskette subsystem are controlled by the system software and the device controller logic.

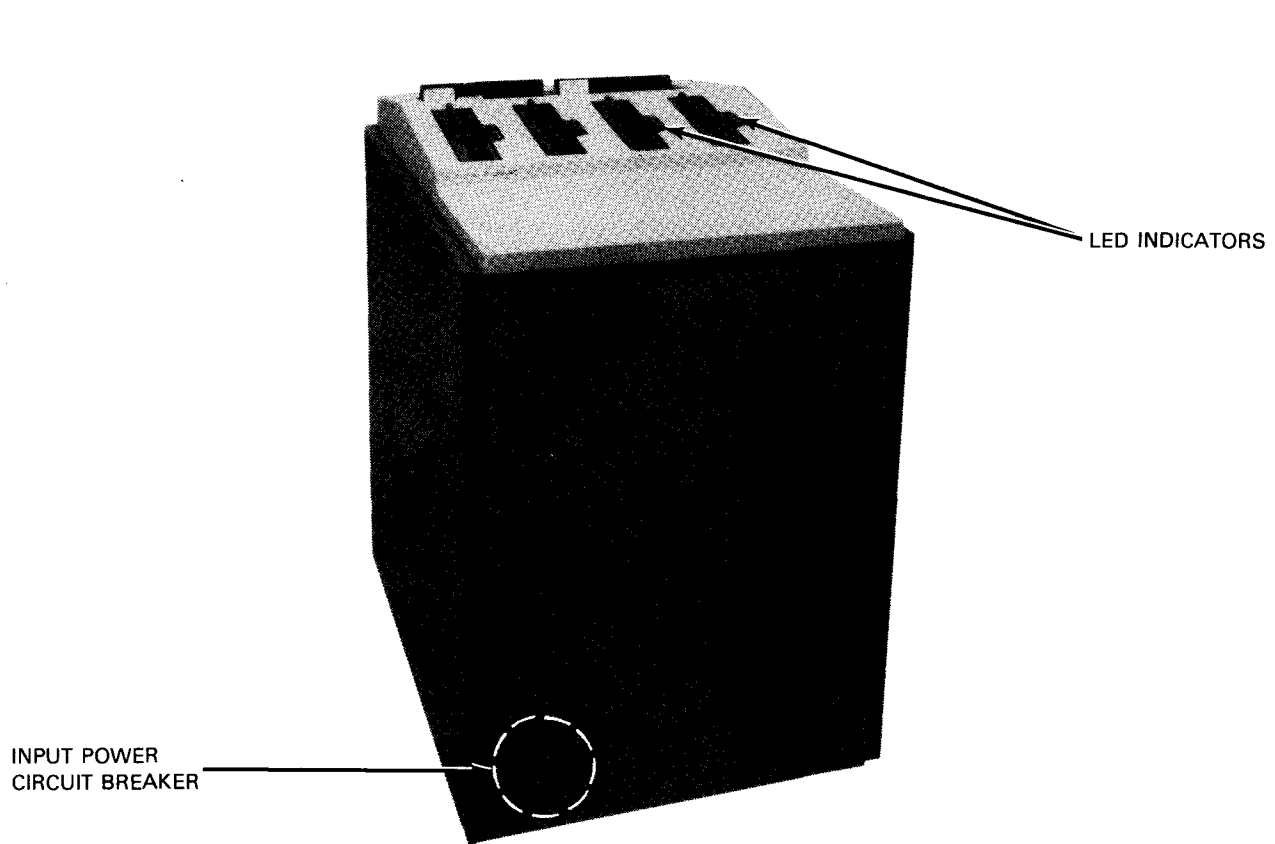

Figure 3—34. 8413 Diskette Subsystem, Input Power Circuit Breaker and LED Indicators

3.9.2. Turn-On and Turn-Off Procedures

Power for the 8413 diskette subsystem is supplied by the processor and is applied to and removed from the subsystem by the **POWER ON/POWER OFF** switch on the processor operator/maintenance panel (Figure 2—2). In order for power to be controlled from the processor, the ac power circuit breaker within the cabinet of the diskette subsystem must be set to the on (up) position. Access to the power circuit breaker is achieved by removal of the front access panel of the cabinet.

NOTE:

*If the diskette subsystem is to be turned off locally by use of the power circuit breaker, remove the device from the system's list of available resources by use of the **DOWN** function of the **SET IO** command (Section 12). After power is applied, restore the subsystem's available status by using the **UP** function of the **SET IO** command.*

3.9.3. Operating Procedures

The operating procedures for the 8413 diskette subsystem include procedures for loading and unloading the flexible diskette.

3.9.3.1. Loading the Diskette

Loading the diskette consists of inserting the diskette into a drive and closing the door. To load the diskette, proceed as follows:

1. Face diskette unit and insert diskette (label to left) into diskette drive (Figure 3—35a).
2. Press diskette down until it latches at bottom of drive unit (Figure 3—35b).
3. Move door to right (toward latch push bar) until it latches in a closed position (Figure 3—35c). The diskette subsystem is now ready for use by the system. When the system addresses a particular drive, the system-use indicator (LED) on the push bar associated with that drive will light.

3.9.3.2. Unloading the Diskette

Unloading the diskette consists of releasing the diskette from the drive. To unload the diskette, proceed as follows:

1. Press the push bar located to the right of the drive door (Figure 3—35b). The door opens and the diskette rises in the drive.
2. Remove the diskette and place it in the storage well provided at the top rear of the diskette subsystem.

NOTE:

Diskette removal while the drive is operational does not cause physical damage to the media or the drive; however, data integrity cannot be guaranteed if a write operation is in progress.

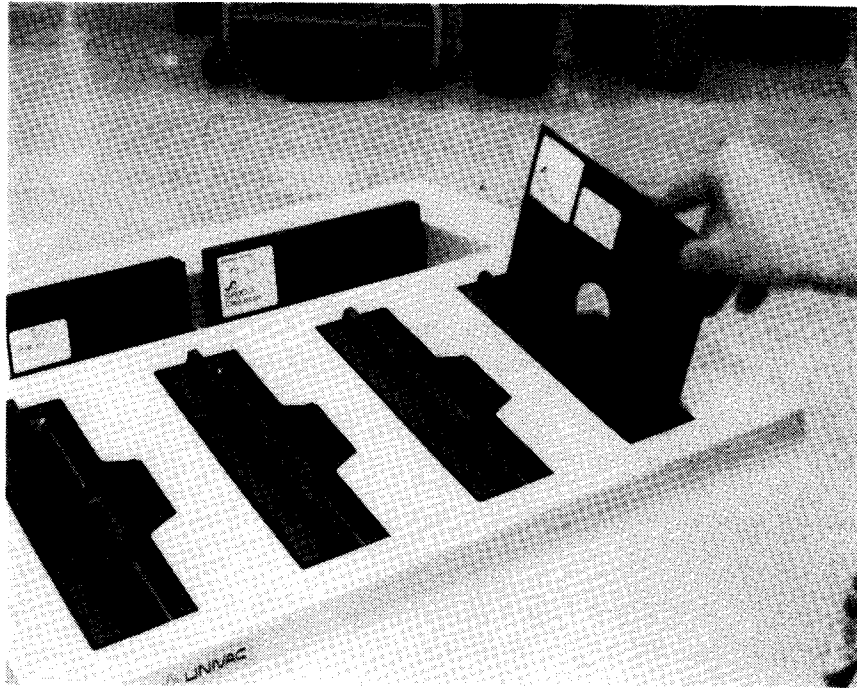

a. Inserting diskette into disk drive

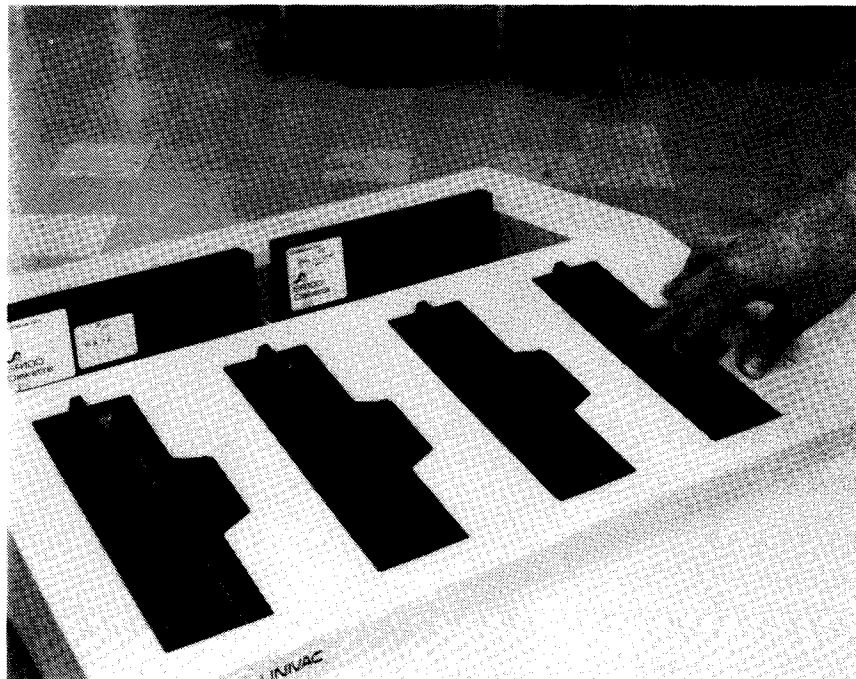

b. Pressing diskette into disk drive

Figure 3-35. Loading and Unloading the 8413 Diskette Subsystem (Part 1 of 2)



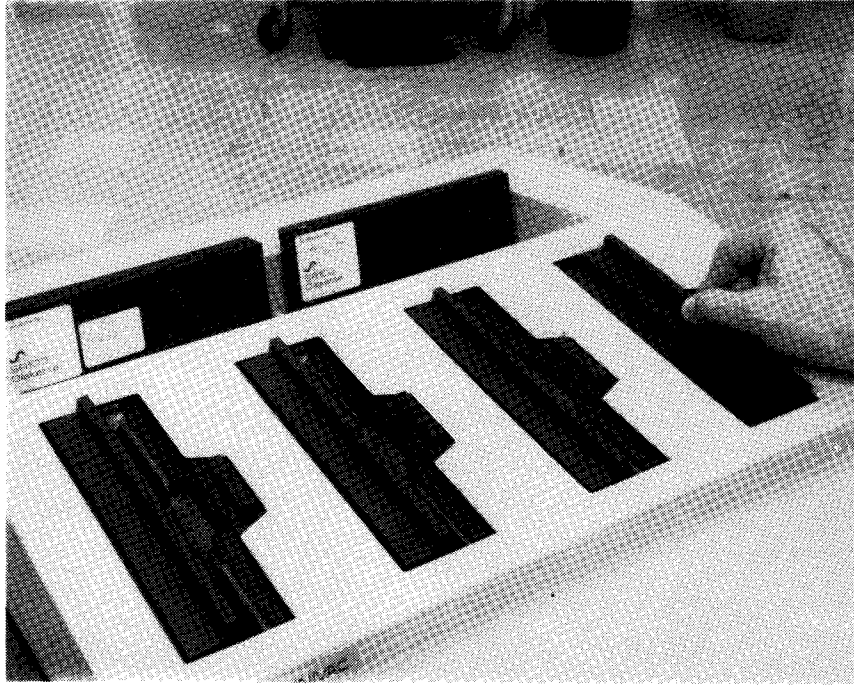

c. Closing door over diskette

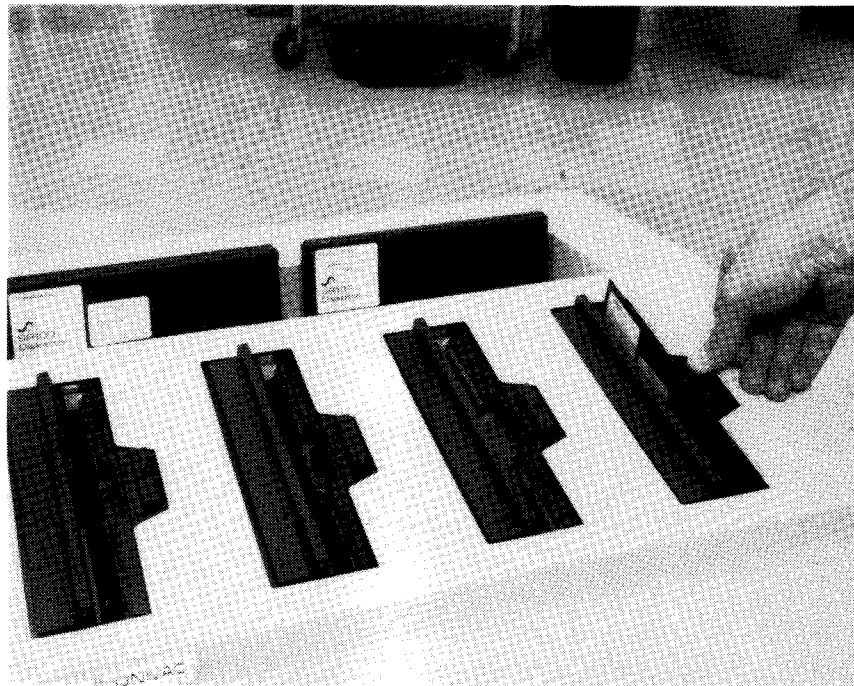

d. Unloading diskette

Figure 4-35. Loading and Unloading the 8413 Diskette Subsystem (Part 2 of 2)





3.9.4. Recovery Procedures

Table 3-16 describes the 8413 diskette subsystem malfunctions that may be corrected by the operator. If the malfunction persists after the operator completes this corrective action, contact the Sperry Univac customer engineer.

Table 3-16. 8413 Diskette Subsystem, Recovery Procedures

Fault Indication	Probable Cause	Operator Action
Processor cannot access diskette.	Loss of power within sub-system Diskette not loaded properly	Ensure that ac circuit breaker within subsystem cabinet is in the ON (up) position. Reset if necessary. Reload diskette according to load procedure (3.9.3.1); then attempt to repeat the halted operation.



4. Magnetic Tape Subsystems

4.1. GENERAL

Magnetic tape subsystems available for use with the SPERRY UNIVAC 90/30 or 90/30 B Systems are:

- UNISERVO VI-C Magnetic Tape Subsystem
- UNISERVO 10 and UNISERVO 14 Magnetic Tape Subsystems ←
- UNISERVO 12/16 Magnetic Tape Subsystem ←
- UNISERVO 20 Magnetic Tape Subsystem

The UNISERVO VI-C Magnetic Tape Subsystem, comprising a single control unit and up to eight tape units, operates from the processor multiplexer channel. This subsystem can operate with 7-track or 9-track configurations with selected byte densities of 200, 556, or 800 bytes per inch (bpi). At 800 bpi, a 2400-foot tape reel can store approximately 11,520,000 bytes. Transfer rates at the respective byte densities are 8540, 23,741, and 34,160 bytes per second (bps). Tape rewinding is at 160 inches per second (ips).

The UNISERVO 10 Magnetic Tape Subsystem and the UNISERVO 14 Magnetic Tape Subsystem are identical in outward appearance, in that each basic subsystem consists of a single cabinet housing a control unit and two tape units, all with identical control panels. Up to three auxiliary cabinets may be included with each subsystem, with each auxiliary cabinet having one or two tape units. The subsystems are separate; auxiliary cabinets from one subsystem type are not connected to or associated with any cabinets of the other subsystem type. Both subsystem types can operate with 9-track phase-encoded tape with density of 1600 bpi, or with extended operation using 7-track and 9-track non-return-to-zero (NRZI) tape with density of 800 bpi. These recording modes can be used in any combination. Tape can be read in a forward or backward direction on the UNISERVO 10 at the rate of 25 ips, and on the UNISERVO 14 at 60 ips. Tape writing is only in a forward direction on both subsystems at their normal speeds. ←

↓
The data transfer rates (in kilobytes per second) for the UNISERVO 10 and UNISERVO 14 subsystems are as follows:

<u>Tape</u>	<u>UNISERVO 10</u>	<u>UNISERVO 14</u>
9-track phase-encoded	40	96
9-track NRZI	20	48
7-track NRZI		
at 200 bpi	5	12
at 556 bpi	13.9	33.4
at 800 bpi	20	48

↑
→ The UNISERVO 12/16 Magnetic Tape Subsystem, which may comprise 1 or 2 5017 control units and up to 16 tape units, operates from the processor selector channel. This subsystem may use only UNISERVO 12 tape units or only UNISERVO 16 tape units, or any combination of both. The same control unit is used for either tape unit type or combination of both. The subsystem permits simultaneous read and write operations with any two tape units with appropriate features. Both UNISERVO types can operate with 9-track phase-encoded tape or 7-track NRZI tape, or 9- and 7-track NRZI tape, depending on the model and features selected. Tape recordings are only written in a forward direction, but may be read in a forward or backward direction. UNISERVO 12 magnetic tape units operate with densities of 1600 bpi on 9-track tape, or 200, 556, or 800 bpi on 7-track tape. Tape rewinding is at the rate of 160 ips on the UNISERVO 12, and at 240 ips on the UNISERVO 16.

↓
The data transfer rates (in bytes per second) for the UNISERVO 12 and UNISERVO 16 magnetic tape units are as follows:

<u>Tape</u>	<u>UNISERVO 12</u>	<u>UNISERVO 16</u>
9-track	68,320	192,000
7-track		
at 200 bpi	8,540	24,000
at 556 bpi	23,741	66,700
at 800 bpi	34,160	96,000

↑
The UNISERVO 20 Magnetic Tape Subsystem, consisting of a 5034 control unit and from 1 to 16 tape units, operates from the processor selector channel. The control unit and tape units are compatible with and can include combinations of UNISERVO 12 and UNISERVO 16 tape units, with at least one UNISERVO 20 tape unit in the subsystem. An additional control unit may also be included for simultaneous read and write operations with any two tape units. UNISERVO 20 tape units operate with densities of 1600 bpi phase-encoded on 9-track tape, and a transfer rate of 320,000 bps. With applicable features in the control unit, NRZI compatibility with 7- and 9-track tape is provided. Tape rewinding is at the rate of 500 ips for the UNISERVO 20 tape units. New tape reels are automatically threaded without need for a tape leader, after the new tape reel with cartridge is mounted on the tape transport.

4.1.1. Tape Terminology

Certain operating terms are used throughout the operating procedures and recovery procedures presented in this section. These terms are defined as follows:

- Normal position of tape

When the tape is in normal position in the vacuum columns, the loop extends approximately one quarter to three quarters of the column length.

- Rewind with interlock

Tape is rewound at high speed until approximately 60 feet of tape remain on the take-up reel, then at low speed to load point. Tape is then unloaded at low speed until all tape is transferred to the supply reel.

- Rewind to load point

Tape is rewound at high speed until approximately 60 feet of tape remain on the take-up reel, then at low speed to load point.

4.1.2. Tape Specifications

The magnetic tapes used with the tape units described in this section are required to be dressed and have tape markers on them.



4.1.2.1. Tape Dressing

The leading edge of the tape must be free of wrinkles, dirt, oil, or other foreign matter, and must have a smooth edge. If tape dressing is required:

1. Clean leading edge of tape.

NOTE:

If the leading edge of the tape is provided with a tape attachment loop for use with a tape leader on UNISERVO 12 or UNISERVO 16 Magnetic Tape Subsystems, the tape edge without the tape leader is satisfactory for use on the UNISERVO 10, UNISERVO 14, and UNISERVO 20 Magnetic Tape Subsystems. Do not perform steps 2 through 4 unless the tape edge is damaged.

2. Insert tape edge into tape slot on tape dressing tool (Sperry Univac part number 3093952) (Figure 4—1).
3. Squeeze tape dressing tool so that cutter plunger is fully inserted in tool.
4. Remove tape from tool, and note that tape edge is dimpled and cut to a smooth rounded end.

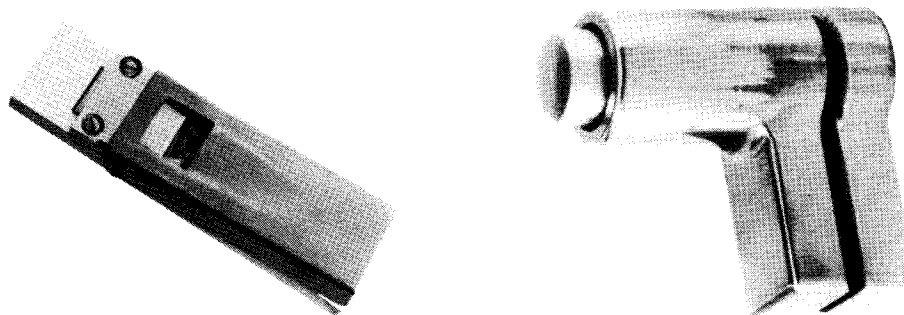

Figure 4—1. Tape Dressing Tool

4.1.2.2. Tape Markers

Tapes used on the tape unit must include the load point (also known as beginning-of-tape or BOT) marker and the end-of-tape warning marker, as illustrated in Figure 4—2.

The two markers are light reflective aluminum strips measuring 1 x 3/16 inch, with a pressure-sensitive adhesive on the reverse side (Sperry Univac part number 3011819—00). The strips are mounted on the shiny side of the tape (outside surface as the tape is wound on the reel). The inner surface of the tape contains the iron oxide coating.

The load point marker is placed 1/32 inch from the outside edge of the tape and at least 12 feet from the leading end. When the tape reel is mounted in the unit, the outside edge is the edge nearest the operator.

The end-of-tape warning marker is placed 1/32 inch from the inside edge of the tape and at least 14 feet from the trailing end.

Should the tape not contain the markers, or should either end of the tape become damaged, the markers must be applied or reapplied according to the preceding specifications.

The tape unit does not operate properly unless the tape contains both of these markers properly placed on the tape.

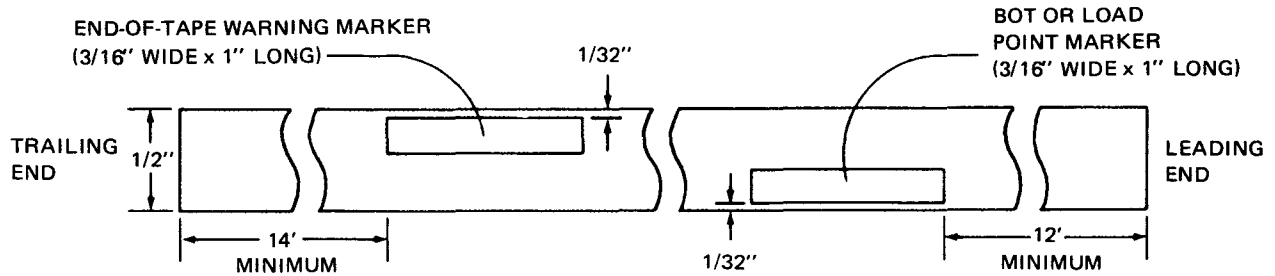

NOTE:

Tape shown shiny side up.

Figure 4—2. Tape Marker Locations on Tape Surface

4.2. UNISERVO VI-C MAGNETIC TAPE SUBSYSTEM

A basic UNISERVO VI-C Magnetic Tape Subsystem contains a master unit and one slave unit. Both are identical in outward appearances. Inwardly, the master unit contains two master power panels (accessible at the rear of the unit) that control operating power for the subsystem. The slave unit contains a slave power panel (also accessible at the rear) to control power for that unit only. Up to three slave units can be shared with a single master unit to form a quad. All units of a subsystem are bolted together.

4.2.1. Operating Controls and Indicators

The master unit and every slave unit (Figure 4—3) each contain an operator control panel (Figure 4—4). All operator control panels are identical. The master power panels consist of a master main power panel (Figure 4—5) and master dc power panel (Figure 4—6). The slave power panel (Figure 4—7) and master power panels are located behind the rear cabinet door in their respective units. Table 4—1 lists all operating controls and indicators for the three panels.

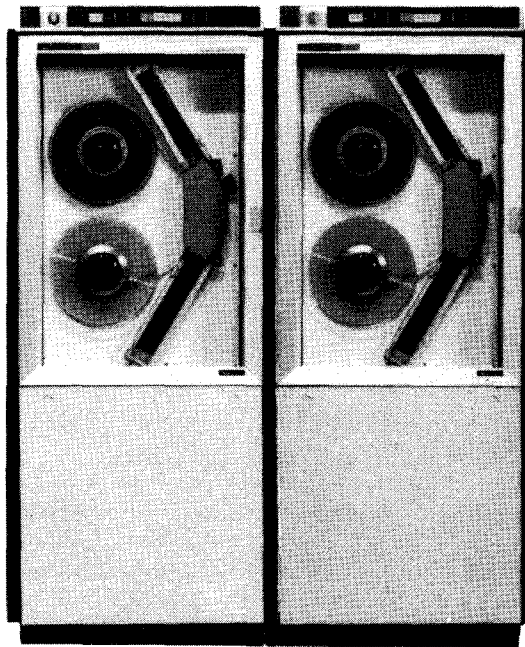

Figure 4—3. UNISERVO VI-C Magnetic Tape Subsystem

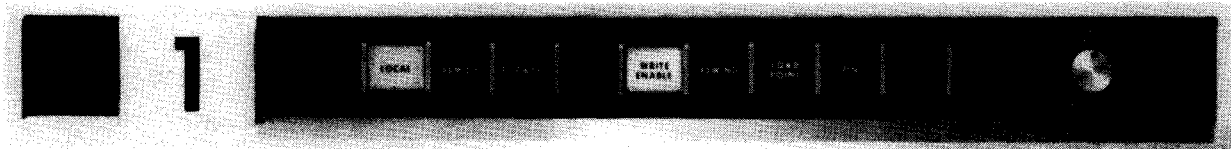

Figure 4—4. UNISERVO VI-C Magnetic Tape Subsystem, Operator Control Panel

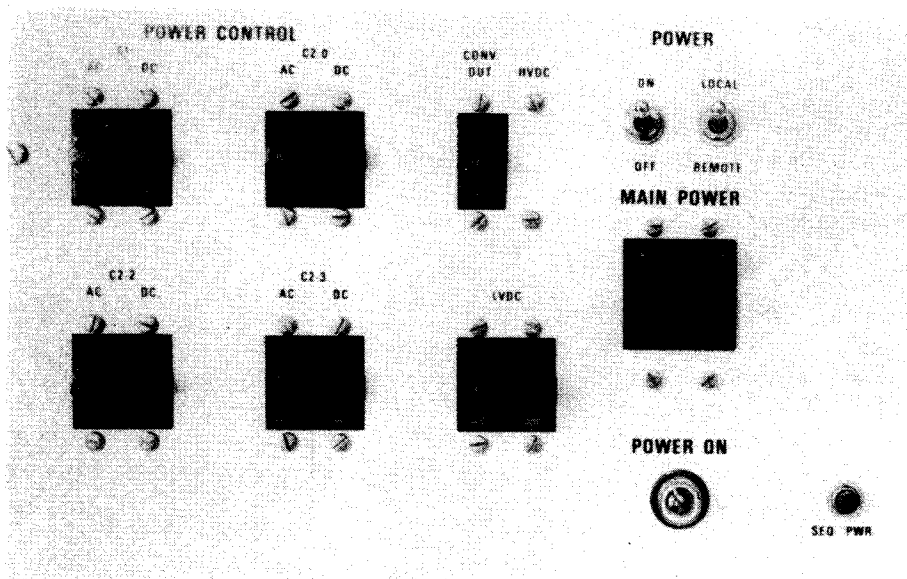

Figure 4-5. UNISERVO VI-C Magnetic Tape Subsystem, Master Main Power Panel

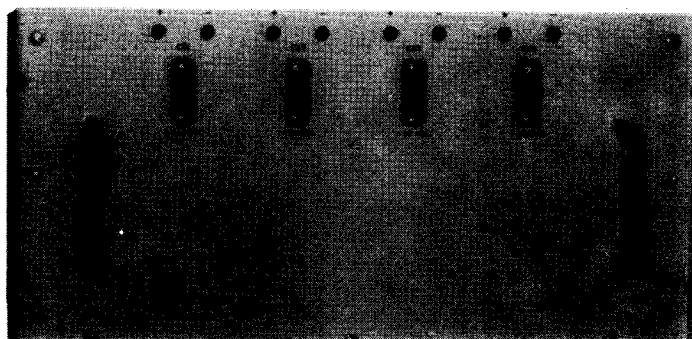

Figure 4-6. UNISERVO VI-C Magnetic Tape Subsystem, Master DC Power Panel

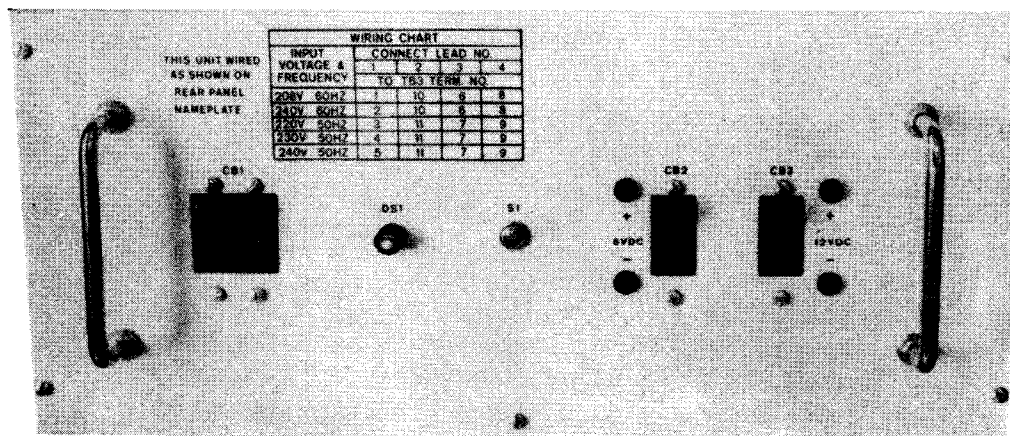

Figure 4-7. UNISERVO VI-C Magnetic Tape Subsystem, Slave Power Panel

Table 4-1. UNISERVO VI-C Magnetic Tape Subsystem, Controls and Indicators (Part 1 of 6)

Control/Indicator — Function
Operator Control Panel
Numerical indicators 0 through 15
Identify the physical number assigned to the magnetic tape unit. Numeral goes off when the OFF switch/indicator is pressed, when any rewinding process (either manual or program) is initiated, whenever excessive tape is pulled out of either of the two vacuum columns, or whenever tape enters either vacuum column.
LOCAL switch/indicator
Sets tape unit offline. Lights when tape unit will not accept external signals. Also lights when pressed and when:
<ul style="list-style-type: none">■ ac power is first applied to the quad;■ the ON or OFF switch/indicator is pressed;■ the tape unit receives a REWIND WITH INTERLOCK signal from a control unit; or■ tape is pulled out of either vacuum column or extends too far into either vacuum column as a result of a malfunction.
Goes off when:
<ul style="list-style-type: none">■ the load point marker reaches the marker detector after the LOAD POINT switch/indicator is pressed;■ the REMOTE switch/indicator is operational and pressed; or■ power is removed from the power supply for the quad.
When the LOCAL switch/indicator is pressed, the REMOTE switch/indicator, if lit, goes off. If the LOCAL switch/indicator is pressed while a rewind-to-load-point operation is active, the process is converted to a rewind-with-interlock operation.
REMOTE switch/indicator
Sets tape unit online. Lights when the tape unit is conditioned to accept external signals, provided the ON switch/indicator is also lit.
Also lights when:
<ul style="list-style-type: none">■ it is operational and pressed (LOCAL switch/indicator then goes off); or■ the load point marker reaches the marker detector after the LOAD POINT switch/indicator is pressed.
Goes off when:
<ul style="list-style-type: none">■ LOCAL, ON, or OFF switch indicator is pressed;■ a rewind-with-interlock operation is initiated; or■ tape is pulled out of the vacuum column or extends too far into either vacuum columns.

Table 4-1. UNISERVO VI-C Magnetic Tape Subsystem, Controls and Indicators (Part 2 of 6)

Control/Indicator — Function
Operator Control Panel (cont)
FORWARD switch/indicator
<p>Initiates forward tape motion. Releasing this switch/indicator halts tape motion. If the LOAD POINT switch/indicator is lit, pressing the FORWARD switch/indicator long enough to move the load point marker away from the marker detector extinguishes the LOAD POINT switch/indicator. The FORWARD switch/indicator is operational only when both the LOCAL and ON indicators are lit.</p> <p>Lights when pressed and when the tape unit is conditioned for forward motion. Also lights when:</p> <ul style="list-style-type: none">■ a FORWARD signal is supplied to the tape unit;■ forward tape motion is initiated as a result of pressing the LOAD POINT switch/indicator;■ tape halts and starts to move forward to load point near the end of a rewind-to-load point operation; or■ the ON switch/indicator is pressed. <p>Goes off when:</p> <ul style="list-style-type: none">■ a BACKWARD signal is sent to the tape unit;■ a rewind operation is initiated; or■ the UNLOAD or REWIND pushbutton or OFF switch/indicator is pressed.
UNLOAD pushbutton
<p>Moves tape backward following a rewind-with-interlock function so that all tape is removed from the take-up reel as part of the tape unloading procedure. The UNLOAD pushbutton is operational only when both the LOCAL and ON switch/indicators are lit.</p> <p>Pressing the UNLOAD pushbutton when it is operational extinguishes the FORWARD switch/indicator and initiates tape motion backward. Tape motion halts when the UNLOAD pushbutton is released or when tape extends too far into the lower vacuum column. If the LOAD POINT switch/indicator is lit, pressing the UNLOAD pushbutton long enough to move the load point marker away from the marker detector extinguishes the LOAD POINT switch/indicator. If the UNLOAD pushbutton is held down until motion is halted as a result of tape extending too far into the lower vacuum column, all indicators except the LOCAL switch/indicator go off.</p>
WRITE ENABLE indicator
<p>Lights only when the mounted reel of tape has a write-enable ring in place (writing and erasing can take place on that tape) and the ON switch/indicator is pressed or a rewind operation is completed.</p> <p>Goes off when:</p> <ul style="list-style-type: none">■ a rewind process is initiated;■ the OFF switch/indicator is pressed; or■ tape is pulled out of either vacuum column or extends too far into either vacuum column.

Table 4-1. UNISERVO VI-C Magnetic Tape Subsystem, Controls and Indicators (Part 3 of 6)

Control/Indicator — Function
Operator Control Panel (cont)
REWIND pushbutton
Initiates a rewind-with-interlock function. Tape is pulled from the vacuum columns and rewound at high speed.
The REWIND pushbutton is operational only when both the LOCAL and ON switch/indicators are lit. When the REWIND pushbutton is pressed, the FORWARD switch/indicator goes off. The tape moves backward until the load point marker is detected, at which time tape motion halts. If the LOAD POINT switch/indicator is pressed between the time the REWIND pushbutton is pressed and tape motion halts, the manually initiated rewind-with-interlock process is converted to a rewind-to-load-point process. In this case, the LOCAL switch/indicator goes off and the REMOTE switch/indicator goes on when tape comes to rest with the load point marker under the marker detector.
Pressing the REWIND pushbutton when the LOAD POINT switch/indicator is lit is not recommended. Repeatedly pressing the REWIND pushbutton when the tape is positioned at load point pulls the tape out of the upper vacuum column and has the same effect as pressing the OFF switch/indicator.
LOAD POINT switch/indicator
Sets tape to load point.
Pressing the LOAD POINT switch/indicator when both the LOCAL and ON switch/indicators are lit turns on the FORWARD switch/indicator and starts tape motion forward. When the load point marker is detected, tape motion halts, the LOCAL switch/indicator goes off, and the REMOTE switch/indicator lights. The tape motion, started by pressing the LOAD POINT switch/indicator, is also halted if either the ON or OFF switch/indicator is pressed, or if tape is pulled out of either vacuum column or extends too far into either vacuum column. Pressing the LOAD POINT switch/indicator when tape is positioned at load point does not start tape motion, but it does extinguish the LOCAL switch/indicator and light the REMOTE switch/indicator.
Pressing the LOAD POINT switch/indicator when the tape is moving backwards as a result of a rewind-with-interlock function initiated manually or by the program converts the rewind-with-interlock function to a rewind-to-load-point function.
The LOAD POINT switch/indicator lights when the tape is positioned at load point. It can be lit only if the ON switch/indicator is lit.
The LOAD POINT switch/indicator also lights when the load point marker is under the detector. This can be a result of:
<ul style="list-style-type: none">■ pressing the LOAD POINT switch/indicator;■ completing a rewind-to-load-point process; or■ attempting execution of a read-backward function when tape is positioned with the read head between the first block and the load point marker.
The LOAD POINT switch/indicator goes off when the load point marker moves out from under the detector. It also goes off if the OFF switch/indicator is pressed or if the tape is pulled out of either vacuum column or extends too far into either vacuum column.
The LOAD POINT switch/indicator blinks if the load point marker passes under the marker detector while the FORWARD switch/indicator or UNLOAD pushbutton is pressed.

Table 4-1. UNISERVO VI-C Magnetic Tape Subsystem, Controls and Indicators (Part 4 of 6)

Control/Indicator — Function
Operator Control Panel (cont)
ON switch/indicator <p>The effect of pressing the ON switch/indicator depends on existing conditions:</p> <ul style="list-style-type: none">■ If pressed when no indicators on the operator panel are lit, there is no effect, because power is not reaching the power supply for the quad.■ If pressed when the LOCAL switch/indicator is lit and tape has been threaded and wound onto the take-up reel as part of the tape loading procedure, the numerical indicator and FORWARD, WRITE ENABLE (if appropriate), and ON switch/indicators light; both reel motors and the vacuum motor turn on; tape is loaded into the proper position in both vacuum columns (provided the ON switch/indicator is pressed for about 2 seconds); and the tape unit is conditioned for further manual operation.■ If pressed when lit or when a rewind process is active, tape motion is halted, the tape unit is cleared, the REMOTE switch/indicator goes off if lit, the LOCAL and FORWARD switch/indicators light, and, if a rewind process is occurring, tape is loaded into the vacuum columns. <p>Whenever the ON switch/indicator is pressed, the recorded position of the end-of-tape warning marker with respect to the detector is cleared so that the tape unit will not report that the end-of-tape warning marker is on the take-up reel side of the marker detector. Pressing the ON switch/indicator during a run involving that tape unit should be avoided.</p> <p>The ON switch/indicator lights when both of the reel motors and the vacuum motor are on, tape is properly loaded in both vacuum columns, and the tape unit is conditioned for either manual or program control. This occurs when:</p> <ul style="list-style-type: none">■ the ON switch/indicator is pressed as part of the tape-loading procedure;■ backward motion stops near the end of a rewind-to-load-point process; or■ a rewind-with-interlock process is ended. <p>The ON switch/indicator goes off when:</p> <ul style="list-style-type: none">■ the OFF switch/indicator is pressed;■ tape extends too far into either vacuum column; or■ tape is pulled out of either vacuum column during a rewind process initiated manually or by a program.
OFF switch/indicator <p>Turns off power to the tape unit reel and vacuum motors and extinguishes all indicators except the LOCAL switch/indicator. The LOCAL switch/indicator lights if it is not lit when the OFF switch indicator is pressed.</p>
DENSITY switch <p>Selects the operating density (200, 556, or 800 bits per inch) for read-forward, read-backward, write, skip/write, and bootstrap functions</p>

Table 4-1. UNISERVO VI-C Magnetic Tape Subsystem, Controls and Indicators (Part 5 of 6)

Control/Indicator — Function
<p style="text-align: center;">Master Main Power Panel</p>
<p>Power Control pushbutton circuit breakers</p> <p>C1 AC/DC C2-0 AC/DC C2-2 AC/DC C2-3 AC/DC</p> <p>Provide overload protection for power control circuits in master tape unit. Button pops out if current is excessive.</p>
<p>CONV. OUT., HVDC, and LVDC pushbutton circuit breakers</p> <p>Provide overload protection for converter circuits in master tape unit. Buttons pop out if current is excessive.</p>
<p>POWER ON/OFF switch</p> <p>Controls power to slave tape unit.</p>
<p>POWER LOCAL/REMOTE switch</p> <p>LOCAL position: Power is controlled at master tape unit.</p> <p>REMOTE position: Power is controlled at processor.</p>
<p>MAIN POWER circuit breaker</p> <p>Provides overload protection for the master tape unit power supply.</p>
<p>POWER ON indicator</p> <p>Lights when power is available in the master tape unit.</p>
<p style="text-align: center;">MASTER DC Power Panel</p>
<p>CB1 +20 VOLT pushbutton circuit breaker</p> <p>Provides overload protection for +20 volt supply circuits.</p>
<p>CB2 -8 VOLT pushbutton circuit breaker</p> <p>Provides overload protection for -8 volt supply circuits.</p>

Table 4—1. UNISERVO VI-C Magnetic Tape Subsystem, Controls and Indicators (Part 6 of 6)

Control/Indicator — Function
Master DC Power Panel (cont)
CB3 —30 VOLT pushbutton circuit breaker Provides overload protection for —30 volt supply circuits.
CB4 —24 VOLT pushbutton circuit breaker Provides overload protection for —24 volt supply circuits.
Slave Power Panel
CB1 circuit breaker Provides overload protection for slave tape unit power supply.
DS1 indicator Lights when operating power is available in slave tape unit power supply.
S1 switch Turns on (up position) 6 volt supply for slave unit control circuits.
CB2 6VDC circuit breaker Provides overload protection for 6 volt supply of slave power supply.
CB3 12VDC circuit breaker Provides overload protection for 12 volt supply of slave power supply.

4.2.2. Turn-On and Turn-Off Procedures

Power to the subsystem is normally controlled from the **POWER ON/POWER OFF** switch on the processor operator/maintenance panel (Figure 2—2). However, before power can be applied from the processor, all switches and circuits breakers must be set as listed in Table 4—2. After checking that all settings are as listed, the **POWER ON/POWER OFF** switch on the processor may then be set to **POWER ON** (assuming that all other contingencies for the system have been met), and finally, the **ON** switch/indicator on the subsystem operator control panel (Figure 4—4) may be pressed on each master tape unit and slave tape unit of the subsystem.

To turn power off for the subsystem, the tape must first be rewound on all tape units to prevent tape stretch, which may be caused by very rapid removal of the tape loop from the tape well. Power may then be turned off either at the processor or independently at the master main power panel on each master tape unit (Figure 4—5).

Table 4-2. UNISERVO VI-C Magnetic Tape Subsystem, Power Switch Settings

Switch/Circuit Breaker	Normal Setting
Master Main Power Panel	
MAIN POWER circuit breaker	On (up)
POWER ON/OFF switch	ON
POWER LOCAL/REMOTE switch	REMOTE
All pushbutton circuit breakers	On (in)
Master DC Power Panel	
All pushbutton circuit breakers	On (in)
Slave Power Panel	
CB1 circuit breaker	On (up)
S1 switch	On (up)
CB2 circuit breaker	On (up)
CB3 circuit breaker	On (up)

4.2.2.1. Independent Power Turn-On Procedure

Power to the subsystem is turned on independently of the processor as follows:

1. Check that all circuit breakers on slave power panel are set to on (up) position.
2. Check that **MAIN POWER** circuit breaker on master main power panel is set to on (up) position.
3. Set **POWER LOCAL/REMOTE** switch on master main power panel to **LOCAL** position.
4. Set **POWER ON/OFF** switch on master main power panel to **ON** position.
5. Using the *UP* function of the SET IO command (Section 12), include the subsystem in the system's resources for job allocation.

4.2.2.2. Independent Power Turn-Off Procedure

Power to the subsystem is turned off independently of the processor as follows:

NOTE:

Before performing the following procedure, remove the device from the system's list of available resources by using the DOWN function of the SET IO command (Section 12). After the procedure is completed, restore the device's available status by using the UP function of the SET IO command.

1. Rewind tape completely onto supply reel to prevent tape stretch caused by rapid removal of tape loop from tape well (refer to 4.2.3.2).
2. Press **OFF** switch on operator control panel. Note that **LOCAL** indicator lights.

3. Set **POWER LOCAL/REMOTE** switch on master main power panel to **LOCAL** position.
4. Set **POWER ON/OFF** switch on master main power panel to **OFF** position.

CAUTION

When turning power off at the subsystem, the OFF switch on the operator control panel must first be pressed to place the subsystem in an offline condition. Failure to follow this procedure will cause power transients that may disturb processor operation.

4.2.3. Operating Procedures

Operating procedures for the UNISERVO VI-C Magnetic Tape Subsystem include tape loading and unloading and tape rewinding procedures.

4.2.3.1. Tape Loading

To load a reel of tape on the tape unit, proceed as follows:

1. Press **OFF** switch/indicator on operator control panel. Note that **LOCAL** indicator lights.
2. Determine if writing is to be done on the tape being installed. If writing is to occur, insert the write-enable ring (Figure 4—8) in the slot behind the tape reel. If no writing is to take place, be sure that the write-enable ring is removed or erasure of the present recording may occur. During tape rewinding, the write-enable ring is ineffective.

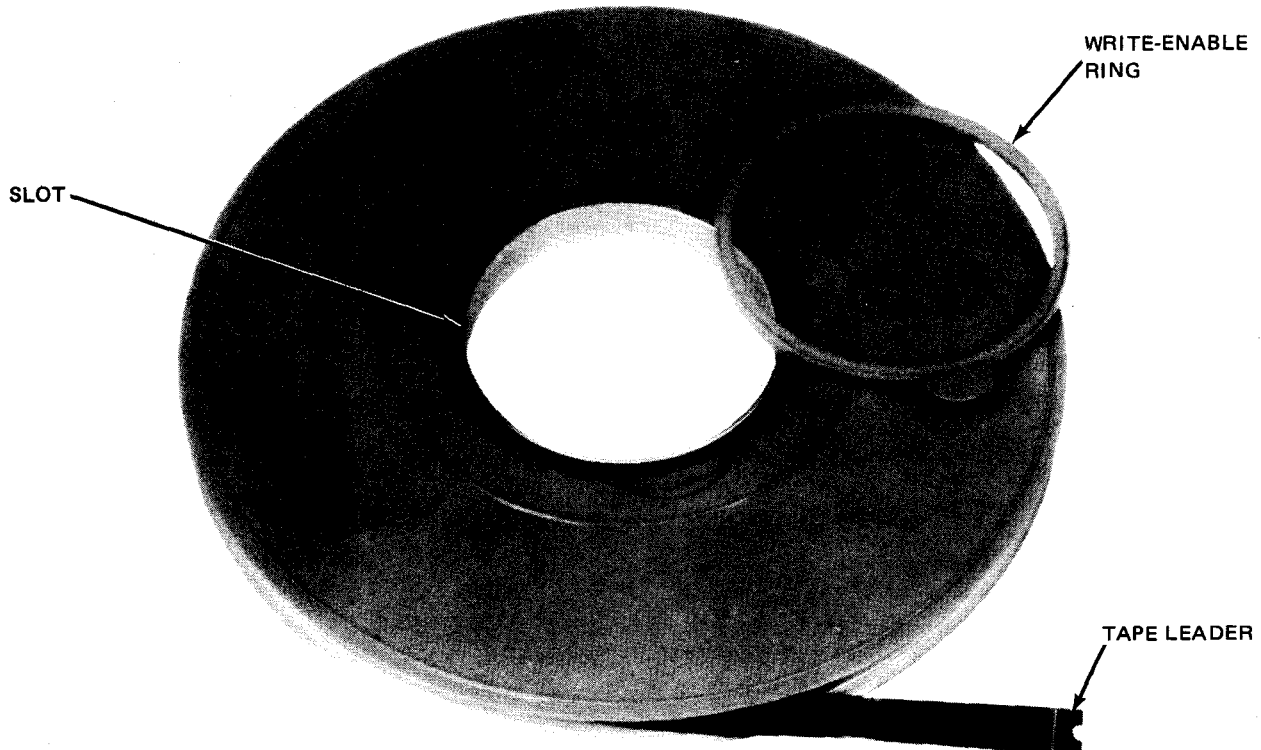
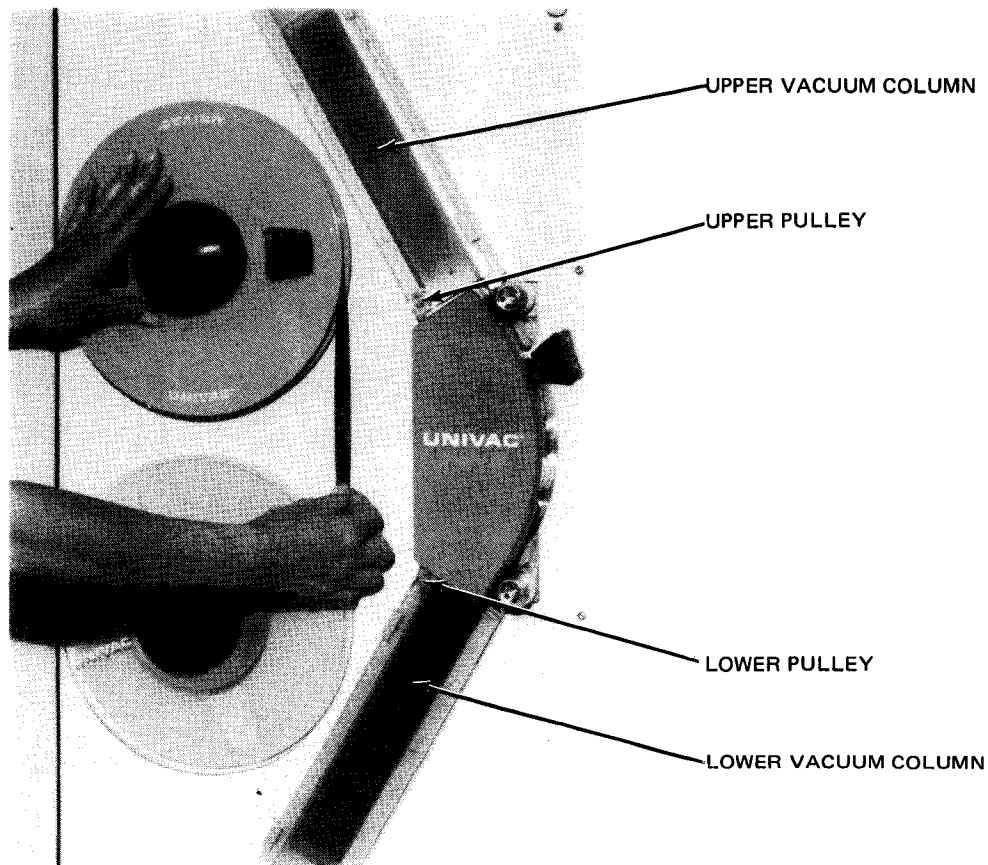

Figure 4—8. Write-Enable Ring and Rear of Tape Reel

3. Open glass door on upper front of tape unit.
4. Mount reel on supply reel hub and press core of reel to lock it on reel hub (Figure 4—9a).
5. Thread leading edge of tape below upper pulley (Figure 4—9a), over upper pressure roller (Figure 4—9b), between capstan and pressure roller, between erase head and load point detector, and over read/write head (Figure 4—9c). Pass leading edge of tape around lower pulley between the pulley and lower pressure roller on lower vacuum column (Figure 4—9d).
6. Pull leading edge of tape around bottom of take-up reel core and around core in a clockwise direction (Figure 4—9e). Pull sufficient tape through head unit to allow slack from end of tape to wrap around take-up reel core. Hold leading edge of tape by inserting a finger through reel opening. Turn take-up reel clockwise to wind tape on take-up reel an additional turn. Rotate take-up reel clockwise three or four turns to secure tape on take-up reel. Turn supply reel slightly clockwise to form a loop of tape (Figure 4—9e).
7. Close glass door.
8. Press and hold **ON** switch/indicator on operator control panel, until tape is loaded in upper and lower vacuum columns and both reels are at rest (3 or 4 seconds).
9. Press **LOAD POINT** switch/indicator on operator control panel. Note that tape moves from supply reel to take-up reel until load point marker is positioned under marker detector. The **LOCAL** indicator now extinguishes, and **LOAD POINT** and **REMOTE** indicators light. The tape unit is now ready for remote operation upon receiving commands from the processor.



a. Tape reel mounted on supply reel hub

Figure 4—9. Loading Tape Reel on Tape Unit (Part 1 of 3)

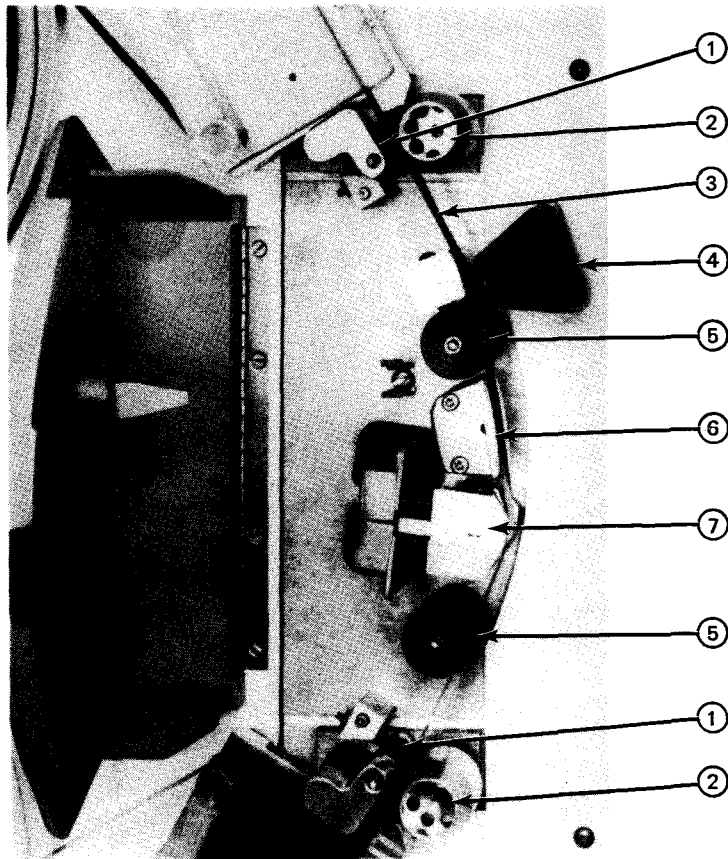

- ① PRESSURE ROLLERS
- ② CAPSTANS
- ③ ERASE HEADS
- ④ LOAD POINT WITH END-OF-TAPE WARNING MARKER DETECTOR
- ⑤ EDGE GUIDES
- ⑥ TAPE CLEANER
- ⑦ READ/WRITE HEAD

b. Head unit cover open to show tape path.

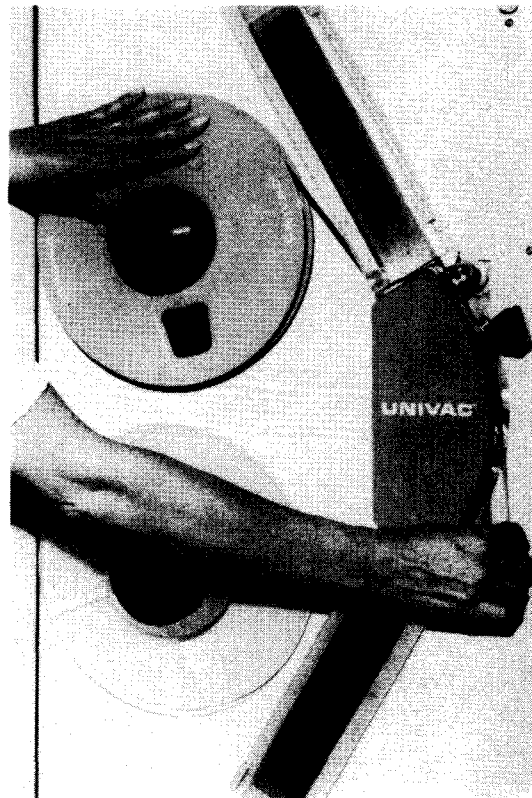

c. Tape threaded over read/write head

Figure 4-9. Loading Tape Reel on Tape Unit (Part 2 of 3)

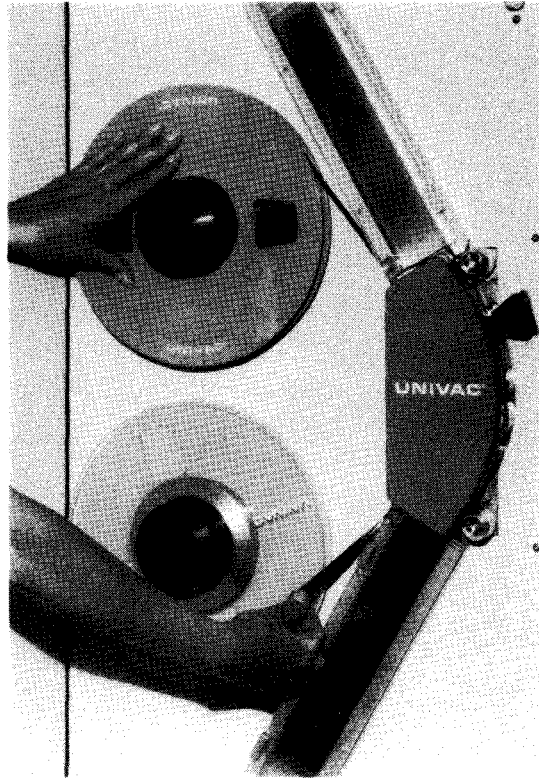

d. Tape threaded over lower vacuum column

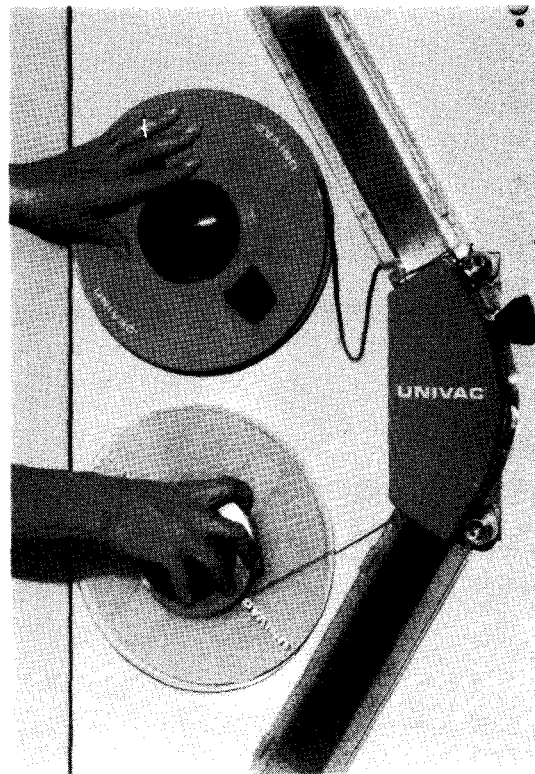

e. Loop formed for upper vacuum column

Figure 4-9. Loading Tape Reel on Tape Unit (Part 3 of 3)

4.2.3.2. Tape Rewinding

Normally a rewind-with-interlock operation is initiated by programming after operations with a tape have been completed. If a rewind-with-interlock operation is to be initiated manually, wait until the current operation is completed, then proceed as follows:

1. Press **LOCAL** switch/indicator on operator control panel.
2. After tape stops moving, press **REWIND** pushbutton switch and then **LOAD POINT** switch/indicator on operator control panel. The tape rewinds until load point marker is detected, then stops. The tape reel may now be removed (by following tape unloading procedure) or operation using the same tape may be repeated.

4.2.3.3. Tape Unloading

After an operation is complete and the tape stops moving, a tape rewind-with-interlock operation may be initiated to unload the tape as follows:

1. Press **LOCAL** switch/indicator on operator control panel.
2. Press **REWIND** pushbutton switch and allow tape to rewind to load point, then stop.
3. Press and release **UNLOAD** pushbutton switch.
4. Open glass door and manually rotate supply reel in counterclockwise direction until leading edge of tape is rewound on supply reel.
5. Press supply reel hub to unlock tape reel. Remove tape reel from hub. Close glass door.
6. Remove write-enable ring (Figure 4—8), and store reel in assigned location. The tape unit is now ready to receive a new reel of tape.

4.2.4. Recovery Procedures

Table 4—3 lists the tape unit malfunctions that may be corrected by the operator. An error condition causes the tape unit to stop and display the error condition on the operator control panel. If the operator is able to correct the error condition, a reply to the processor should be made with the **GO** command message after recovery is completed.

Table 4-3. UNISERVO VI-C Magnetic Tape Subsystem, Recovery Procedures

Fault Indication	Probable Cause	Operator Action
Subsystem is completely inoperative.	Main Power circuit breaker tripped.	Reset MAIN POWER circuit breaker on master main power panel. (Set to off, then to on.)
Subsystem is partially inoperative.	Circuit breaker tripped.	Reset any tripped circuit breaker. (Set to off, then to on.)
WRITE ENABLE indicator on operator control panel fails to light.	Write-enable ring is not installed.	Ensure that write-enable ring is properly installed and tape reel is correctly mounted.
ON switch/indicator is off, and OFF switch/indicator is on.	Tape is not looped within vacuum columns properly.	Ensure tape is normally looped in vacuum columns. If it is not, rewind and reload tape.
LOAD POINT switch/indicator is blinking.	Load point marker has passed marker detector. FORWARD switch/indicator or UNLOAD pushbutton was held pressed too long.	Rewind tape past load point and then press LOAD POINT switch/indicator to position tape at load point.
Power to quad cannot be controlled from processor.	Incorrect switch setting.	Set POWER LOCAL/REMOTE switch on master main power panel to REMOTE.

This page left blank intentionally.

4.3. UNISERVO 10 AND UNISERVO 14 MAGNETIC TAPE SUBSYSTEMS

The UNISERVO 10 and UNISERVO 14 Magnetic Tape Subsystems (Figure 4—10) are separate subsystem types, each having unique characteristics. They cannot be intermixed. For the operator, however, the subsystems appear identical and operating procedures are the same. A basic subsystem consists of a single cabinet having a control unit and two tape units. An expanded subsystem may have up to three additional auxiliary cabinets, each cabinet containing one or two tape units, for a maximum of eight tape units in a subsystem.

4.3.1. Operating Controls and Indicators

The control unit power panels are located on the front and rear of the cabinet behind closed doors (Figure 4—11). The power control panel (Figure 4—12) is located on the front. The power distribution panel (Figure 4—13) and power supply panel (Figure 4—14) are located in the rear. All controls and indicators for the control unit are listed and described in Table 4—4.

The tape unit contains an operator control panel (Figure 4—15) and power control panel (Figure 4—16). The tape unit power control panel (for use only by Sperry Univac customer engineer) is located at the left side of the tape unit, behind the tape drive door. The **ON/OFF** switch and fuses on the tape unit power supply panel are for use only by the Sperry Univac customer engineer, and should not be disturbed by the operator. The panel is presented in this manual only for information purposes. All controls and indicators for the tape unit are listed and described in Table 4—5.

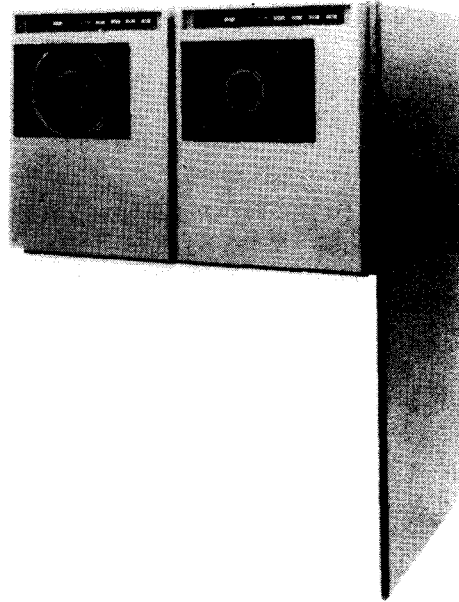

a. Basic subsystem

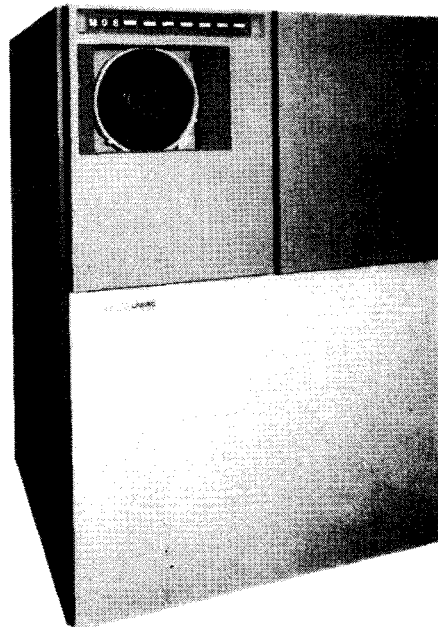

b. Auxiliary cabinet with single tape unit

Figure 4-10. UNISERVO 10 or UNISERVO 14 Magnetic Tape Subsystem

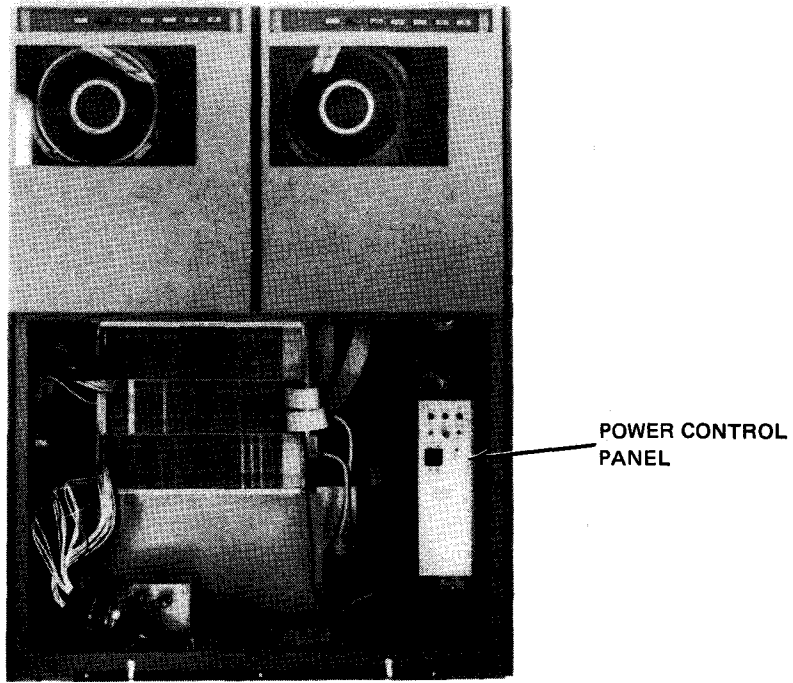

a. Front view

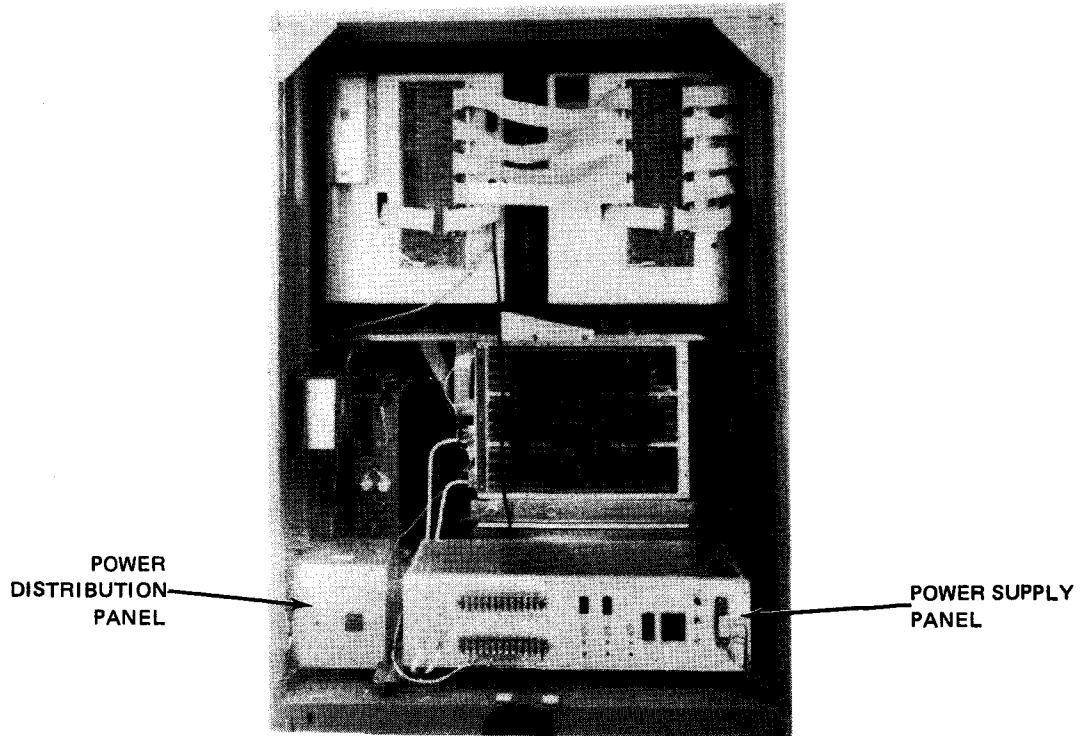

b. Rear view

Figure 4-11. UNISERVO 10 or UNISERVO 14 Control Unit, Front and Rear Views With Covers Removed



Figure 4-12. UNISERVO 10 or UNISERVO 14 Control Unit, Power Control Panel

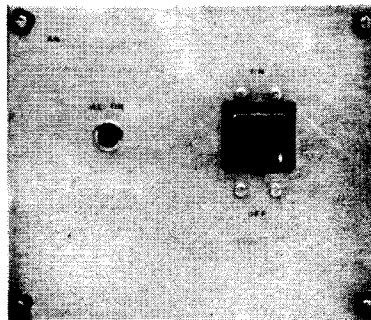

Figure 4-13. UNISERVO 10 or UNISERVO 14 Control Unit, Power Distribution Panel

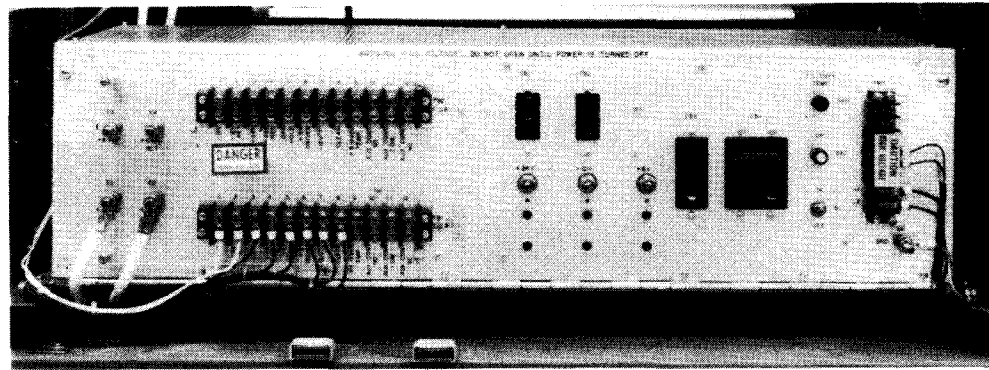

Figure 4-14. UNISERVO 10 or UNISERVO 14 Control Unit, Power Supply Panel

Table 4-4. UNISERVO 10 or UNISERVO 14 Control Unit, Controls and Indicators (Part 1 of 3)

Control/Indicator — Function	
Power Control Panel	
AIR FLOW indicator	Not used.
EARLY WARNING indicator	Lights when exhaust air temperature reaches 118° F (47.73° C). Audible alarm sounds.
OVERHEAT indicator	Lights when exhaust air temperature reaches 129° F (53.84° C). Control unit operation stops.
FAULT CLR/RESTART switch	Allows subsystem to operate after a fault is corrected and supplies restart pulse:
FAULT CLR position:	After a fault is corrected, resets fault indication to allow subsystem to be operational.
OFF (center position):	Normal setting.
RESTART position:	Supplies pulse to power up the control unit after momentary power interruption.
ALARM OVERRIDE switch	Silences audible alarm.

Table 4-4. UNISERVO 10 or UNISERVO 14 Control Unit, Controls and Indicators (Part 2 of 3)

Control/Indicator — Function
Power Control Panel (cont)
<p>PWR SEQ LOCAL-REMOTE switch</p> <p>Allows control unit power supplies to be turned on from either subsystem cabinet or processor:</p> <p>LOCAL position:</p> <p>Power supplies can be turned on only on subsystem cabinet.</p> <p>REMOTE position:</p> <p>Power supplies can be turned on only at processor.</p> <p>POWER MAINS circuit breaker</p> <p>Provides overload protection for entire subsystem cabinet.</p> <p>POWER CONTROL circuit breaker</p> <p>Provides overload protection for air flow, overheat, and early warning detection circuits.</p>
Power Distribution Panel
<p>AC ON indicator</p> <p>Lights when power is on for power distribution panel.</p> <p>ON-OFF circuit breaker</p> <p>Provides overload protection for power input to power control panel.</p>
Power Supply Panel
<p>+24VDC potentiometer</p> <p>Used by Sperry Univac customer engineer to set +24 volt supply.</p> <p>-12VDC potentiometer</p> <p>Used by Sperry Univac customer engineer to set -12 volt supply.</p> <p>+6VDC potentiometer</p> <p>Used by Sperry Univac customer engineer to set +6 volt supply.</p> <p>CB1 circuit breaker</p> <p>Provides power input overload protection for +6 volt power supply.</p>

Table 4-4. UNISERVO 10 or UNISERVO 14 Control Unit, Controls and Indicators (Part 3 of 3)

Control/Indicator — Function
Power Supply Panel (cont)
CB2 circuit breaker Provides power input overload protection for -12 volt power supply.
CB3 circuit breaker Provides power input overload protection for +24 volt power supply.
CB4 circuit breaker Provides power input overload protection for power supply panel.
ON DS1 indicator Lights when power for power supply panel is on.
PS OVER TEMP DS2 indicator Lights when power supply is overheated.
S1 ON-OFF switch Controls power input to power supply: ON position: Primary power is applied to input circuits. OFF position: Primary power is removed.

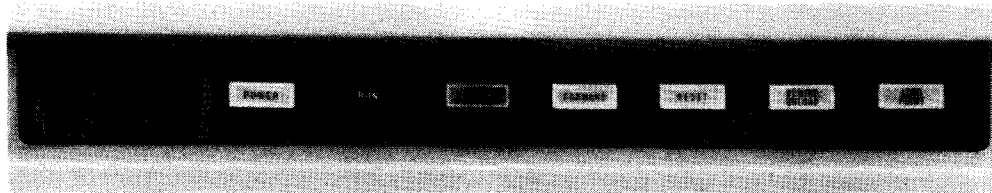

Figure 4-15. UNISERVO 10 or UNISERVO 14 Tape Unit, Operator Control Panel

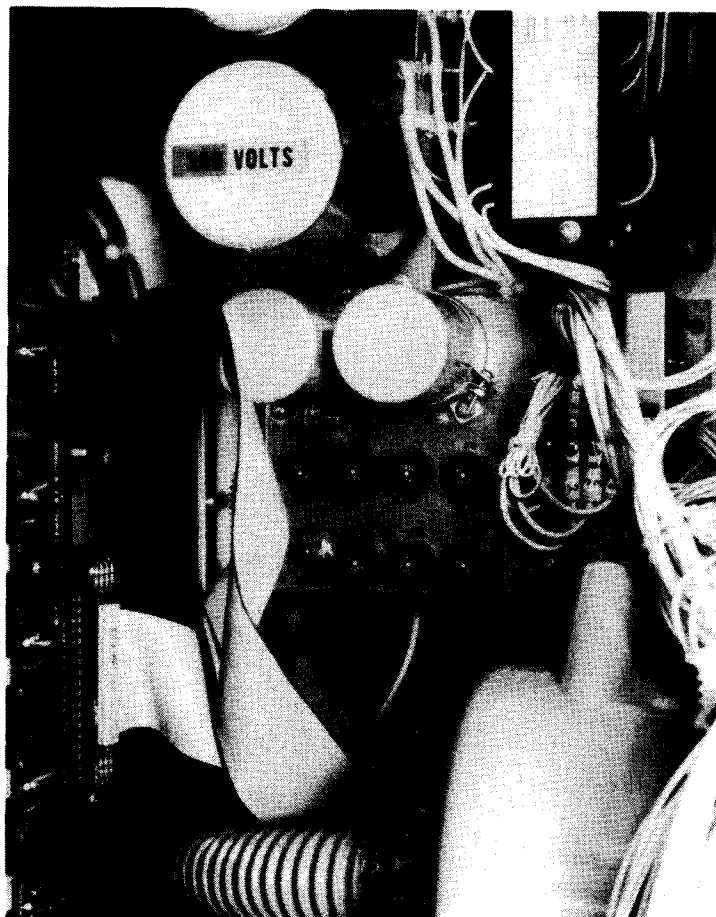

Figure 4-16. UNISERVO 10 or UNISERVO 14 Tape Unit, Power Control Panel

Table 4-5. UNISERVO 10 or UNISERVO 14 Tape Unit, Controls and Indicators (Part 1 of 4)

Control/Indicator — Function
Operator Control Panel
<p>POWER switch/indicator</p> <p>Applies operating power to tape unit; turns on blower motor and dc power supplies. Switch/indicator lights when power is on. Switch/indicator extinguishes when:</p> <ul style="list-style-type: none"> ▪ POWER switch/indicator is pressed after tape unit power was on; or ▪ any voltage failure occurs.

Table 4-5. UNISERVO 10 or UNISERVO 14 Tape Unit, Controls and Indicators (Part 2 of 4)

Control/Indicator — Function
Operator Control Panel (cont)
RUN switch/indicator Places tape unit online under control of processor, provided no interlocks are open, tape reel is loaded, tape is not rewinding, and tape is positioned on load point. Switch/indicator lights when: <ul style="list-style-type: none">■ tape unit is online;■ RUN switch/indicator is pressed and tape unit is in ready condition; or■ load point marker reaches marker detector after LOAD POINT switch/indicator is pressed. Switch/indicator extinguishes when: <ul style="list-style-type: none">■ tape unit is offline;■ RESET switch/indicator is pressed;■ a rewind operation is initiated; or■ the tape unit is not ready.
FILE PROTECT indicator Lights when write-enable ring is not installed on tape reel to indicate that data cannot be written or erased on the tape. When write-enable ring is locked in place at the back of tape reel, and reel is properly mounted on tape unit, FILE PROTECT indicator extinguishes and data may be written or erased.
FORWARD switch/indicator Moves tape forward at normal speed until RESET switch/indicator is pressed, or until beginning-of-tape (BOT) or end-of-tape (EOT) marker is encountered. RUN switch/indicator becomes extinguished. Switch/indicator lights when: <ul style="list-style-type: none">■ FORWARD switch/indicator is pressed and forward tape motion is initiated, provided the RESET switch/indicator was lit;■ control unit sends a forward signal to tape unit; or■ tape halts and starts to move forward to load point at end of a rewind operation. Switch/indicator extinguishes when: <ul style="list-style-type: none">■ control unit sends a backward signal to tape unit;■ rewind operation is initiated by control unit; or■ REWIND/UNLOAD switch/indicator is pressed. NOTE: FORWARD switch/indicator is operational only when RESET switch/indicator is lit, and pressing RESET halts the tape motion. If LOAD POINT switch/indicator is lit, pressing FORWARD switch/indicator will extinguish LOAD POINT switch/indicator if FORWARD is held pressed long enough to move load point marker from marker detector.

Table 4-5. UNISERVO 10 or UNISERVO 14 Tape Unit, Controls and Indicators (Part 3 of 4)

Control/Indicator — Function
Operator Control Panel (cont)
<p>RESET switch</p> <p>Stops tape movement except during unloading, and extinguishes RUN switch/indicator. When lit, RUN, FORWARD, LOAD POINT, and REWIND/UNLOAD switch/indicators are operational.</p> <p>A reset condition occurs when:</p> <ul style="list-style-type: none"> ■ tape unit is in offline condition; ■ ac power is first applied to tape unit; ■ tape unit receives a REWIND signal from control unit; or ■ RESET switch is pressed to terminate any command, except during an unloading operation. <p>A reset condition terminates when:</p> <ul style="list-style-type: none"> ■ load point marker reaches marker detector after LOAD POINT switch/indicator is pressed; ■ RUN switch/indicator is lit; or ■ power is removed at the tape unit power supply. <p>REWIND/UNLOAD switch/indicator</p> <p>Rewinds tape at high speed until BOT marker is detected, or until rewind is terminated by pressing RESET switch. Upon detecting BOT marker, tape automatically returns to load point. If REWIND/UNLOAD is pressed when tape is not at load point, tape rewinds completely onto reel or cartridge for unloading.</p> <p>NOTE:</p> <p>REWIND/UNLOAD switch/indicator is operational only when tape unit is in a reset condition. Pressing REWIND/UNLOAD extinguishes FORWARD switch/indicator, and causes tape to move backward and stop after load point marker passes load point detector. If RESET is pressed after REWIND/UNLOAD is pressed but before tape motion halts, the rewind operation is terminated.</p> <p>LOAD POINT switch/indicator</p> <p>Initiates load operation; tape is automatically threaded, positioned in vacuum chambers, and advanced to load point. When tape is positioned at load point, operation stops and LOAD POINT and RUN switch/indicators light. LOAD POINT switch/indicator does not light after a rewind, although tape is then positioned on load point.</p> <p>Switch/indicator lights when:</p> <ul style="list-style-type: none"> ■ load point marker is positioned on marker detector; ■ LOAD POINT switch/indicator is pressed to begin a tape loading operation; or ■ a read-backward function is attempted when tape is positioned so that the read head is located between the first block and load point marker. <p>Switch/indicator extinguishes when:</p> <ul style="list-style-type: none"> ■ load point marker is moved away from marker detector; ■ the control unit requests forward tape motion when tape is at load point at start of execution of a read-forward or write operation; or ■ the FORWARD or REWIND/UNLOAD switch/indicator is pressed when tape is at load point.

Table 4—5. UNISERVO 10 or UNISERVO 14 Tape Unit, Controls and Indicators (Part 4 of 4)

Control/Indicator — Function
Power Control Panel
ON/OFF switch Master power switch, applies or removes power to tape unit and operator control panel. This switch is a maintenance safety feature for use by Sperry Univac customer engineers, and should normally be left in the ON position. NOTE: Power source for tape unit is obtained when flexible cord is plugged into outlet on control unit power distribution box.
FUSE FI (8A) fuse Provides overload protection for primary power to tape unit.
FUSES F2 (5A), F3 (5A), F4 (10A), and F6 (10A) fuses Provide overload protection for control circuits of take-up and supply reel motors.
FUSE F5 (4A) fuse Provides overload protection for +5 volt power supply.
FUSE F6 (7.5A) fuse Provides overload protection for capstan motor.

4.3.2. Turn-On and Turn-Off Procedures

Power to the subsystem is normally applied and removed via the **POWER ON/POWER OFF** switch on the processor operator/maintenance panel (Figure 2—2). However, to control power from this panel, certain switches and circuit breakers on the control unit and tape units must first be set to specific positions. The switch and circuit breaker settings are listed in Table 4—6.

When the switches and circuit breakers on the control unit and tape units are set as specified in Table 4—6, and the **POWER ON/POWER OFF** switch on the processor is set to **POWER ON** the **POWER** switch/indicator on each tape unit operator control panel may be pressed to turn on power to the tape units. **POWER** switch/indicator lights when power is applied.

To turn power off for the subsystem, the **RESET** switch is pressed to place the subsystem offline, then tape must be fully rewound on all tape units to prevent tape stretch, which may be caused by very rapid removal of the tape loop from the vacuum columns. Power may then be turned off either at the processor or independently at the power panels of the control unit and each tape unit.

Table 4-6. UNISERVO 10 or UNISERVO 14 Magnetic Tape Subsystem, Power Switch Settings

Switch/Circuit Breaker	Normal Setting
Control Unit Power Control Panel	
PWR SEQ LOCAL-REMOTE switch	REMOTE
POWER MAINS circuit breaker	On (up)
Control Unit Power Distribution Panel	
ON-OFF circuit breaker	On (up)
Control Unit Power Supply Panel	
CB1 circuit breaker	On (up)
CB2 circuit breaker	On (up)
CB3 circuit breaker	On (up)
CB4 circuit breaker	On (up)
S1 ON-OFF switch	ON
Tape Unit Power Control Panel	
ON/OFF switch	This switch is always in the ON position and should not be disturbed.

4.3.2.1. Independent Power Turn-On Procedure

Power to the subsystem is turned on independently of the processor as follows:

1. Check that circuit breaker on control unit power distribution panel is set to on (up) position.
2. Set **PWR SEQ LOCAL-REMOTE** switch on control unit power control panel to LOCAL position.
3. Check that **POWER MAINS** circuit breaker on control unit power control panel is set to on (up) position.
4. Check that **CB1**, **CB2**, **CB3**, and **CB4** circuit breakers on control unit power supply panel are set to on (up) position.
5. Check that **S1** switch on control unit power supply panel is set to **ON** position.
6. Press **POWER** switch/indicator on operator control panel for each tape unit. Note that the switch/indicator lights.
7. Use the *UP* function of the SET IO command (Section 12) to include the subsystem in system's resources for job allocation.

4.3.2.2. Independent Power Turn-Off Procedure

Power to the subsystem is turned off independently of the processor as follows:

NOTE:

Before performing the following procedures, remove the device from the system's list of available resources by using the DOWN function of the SET IO command (Section 12). After the procedure is completed, restore the device's available status by using the UP function of the SET IO command.

1. Press **RESET** switch on operator control panel to place tape unit in an offline condition. Note that RUN switch/indicator extinguishes.
2. If tape is not fully rewound onto supply reel on the tape unit to be turned off, unload tape as directed in 4.3.3.3 and 4.3.3.4. Rewind or unload all reels if the entire subsystem is to be turned off.
3. Press **POWER** switch/indicator on operator control panel. Note that the switch/indicator extinguishes.
4. Set **PWR SEQ LOCAL-REMOTE** switch on control unit power control panel to **LOCAL** position.
5. Set **POWER MAINS** circuit breaker on control unit power control panel to off (down) position.

CAUTION

*Before turning power off at a tape unit be sure that the **RUN** switch/indicator is extinguished to indicate that the tape unit is offline. Failure to follow this procedure will result in power transients that may interfere with processor operation.*

4.3.3. Operating Procedures

Operating procedures for the subsystem include dressing the tape end for use with automatic loading, loading tape with the tape reel cartridge, loading tape without the tape reel cartridge, and tape unloading.

4.3.3.1. Tape Loading With Reel Cartridge

Mount a tape reel on the tape unit as follows:

1. Before mounting the reel, check to see if it contains a write-enable ring:
 - If writing is to be done on the tape, a write-enable ring must be used. Figure 4-17 illustrates the back of the reel of tape and the write-enable ring. The ring fits into a slot in the reel.
 - If no writing is to be done on the tape, the reel must not contain a write-enable ring.

- No writing or erasing can occur during tape rewinding.

CAUTION

Remove the write-enable ring when it is not required for writing, or inadvertent tape erasure or modification of data may occur.

2. Press **RESET** switch. Note that **RUN** switch/indicator is extinguished.
3. Attach the tape reel to the tape reel cartridge as follows:
 - Open the clasp to secure the reel in the cartridge (Figure 4—18).
 - Insert the tape reel in the cartridge so that the reel front is facing out. Be sure that the entire circumference of the reel edge fits evenly in the cartridge.
 - Close the clasp to secure the reel in the cartridge.

NOTE:

Use of the tape reel cartridge permits faster tape loading and unloading, and prevents tape from unwinding.

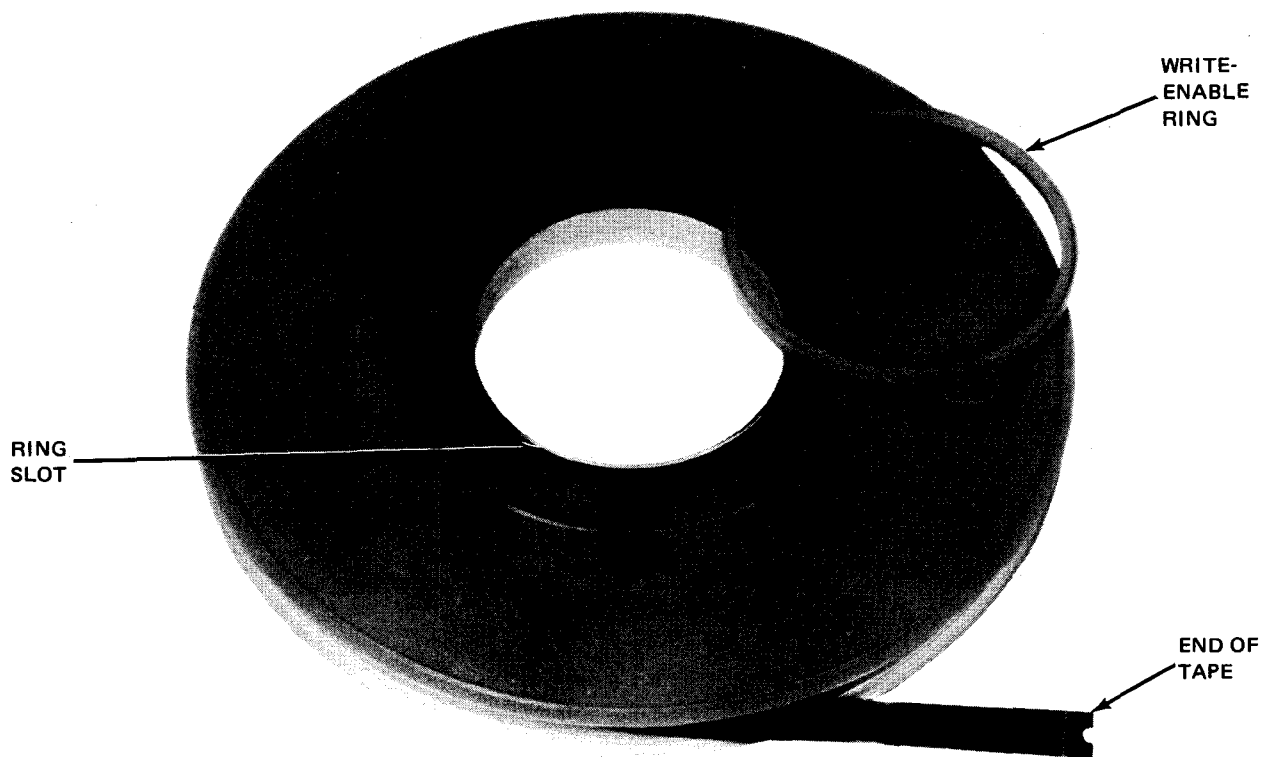

Figure 4—17. Tape Reel and Write-Enable Ring

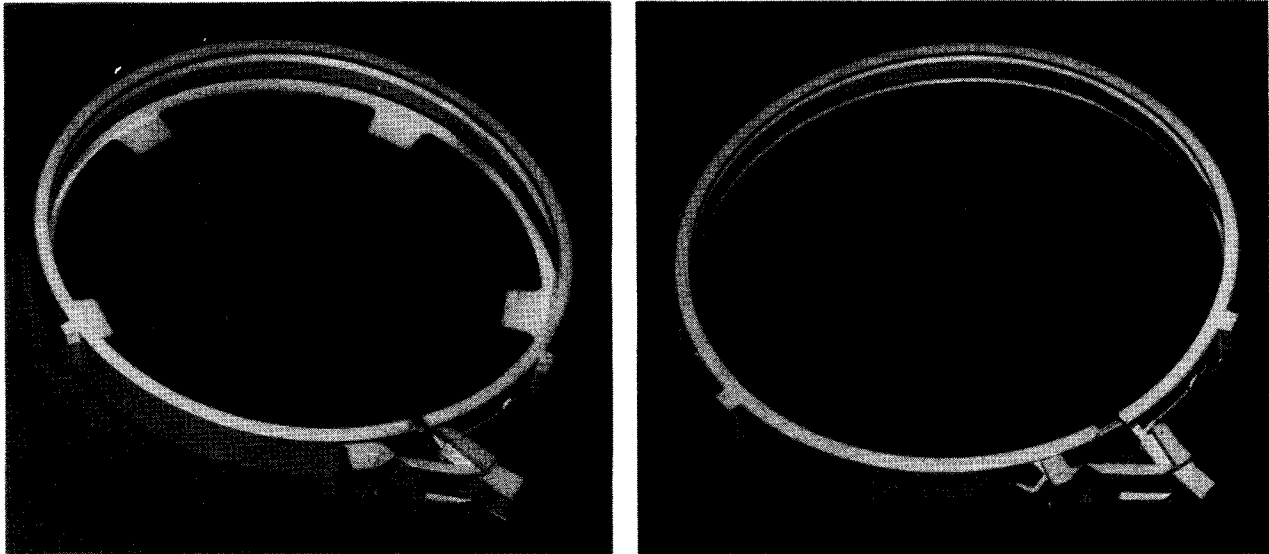

Figure 4—18. Tape Reel Cartridge

4. Open tape transport door at tape transport panel.
5. Carefully mount tape reel cartridge with tape on supply hub so that upper and lower keys on cartridge (Figure 4—18) fit into slots provided for them on tape transport panel (Figure 4—19).
6. Press reel to lock it in place on the supply reel hub.

NOTE:

*The cartridge clasp is automatically opened by the clasp opener pin (Figure 4—20) when the **LOAD POINT** switch/indicator is pressed.*

7. Close tape transport door.
8. With power turned on, press **LOAD POINT** switch/indicator on operator control panel to initiate tape loading; note that the switch/indicator lights. Power is now applied to reel motors, capstan motor, and vacuum pressure pumps, and tape is advanced to load point marker.
9. Note that **RUN** switch/indicator lights after tape is loaded to indicate the tape unit is online. The tape unit is now ready for remote operation under control of processor via the control unit.

NOTE:

The vacuum chamber cover on the tape unit must be closed and locked to permit vacuum pressure and thread tape automatically. The tape unit logic circuits will retry once to load tape in event of an aborted load operation.

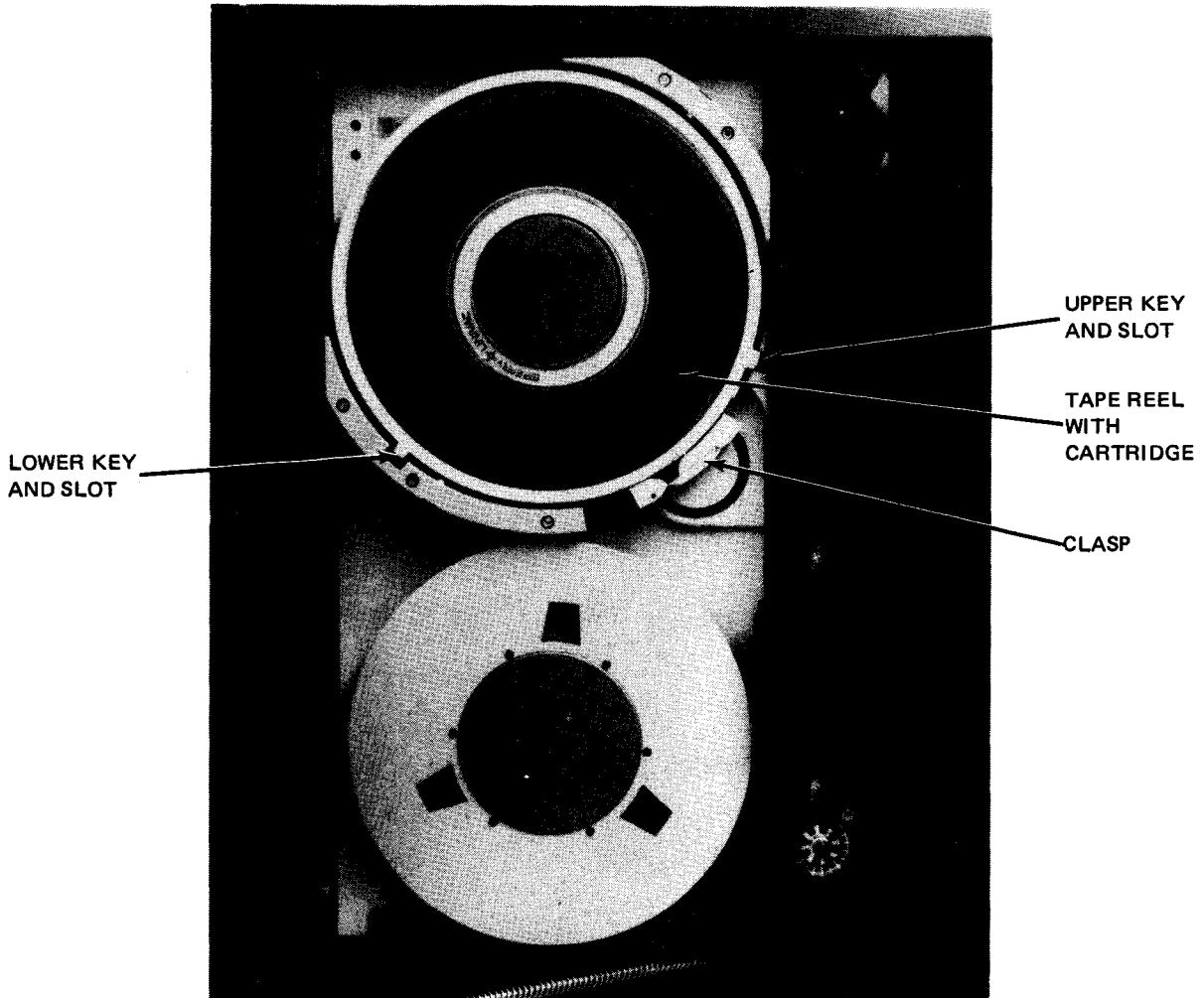

Figure 4—19. Tape Reel Cartridge Mounted on Supply Hub

4.3.3.2. Tape Loading Without Reel Cartridge

Tape is threaded automatically through the tape transport without a tape loader. Proceed as follows:

1. Check that the tape end has a smooth finished edge for proper threading. If necessary, dress the tape end (4.1.2.1).
2. Press **RESET** switch/indicator. Note that **RUN** switch/indicator is extinguished.
3. Mount reel on supply hub so that leading edge of tape can be inserted into tape loading slot (Figure 4—20).
4. Press reel to lock it on hub and insert leading edge of tape into tape loading slot.
5. Perform steps 7, 8, and 9 of 4.3.3.1.

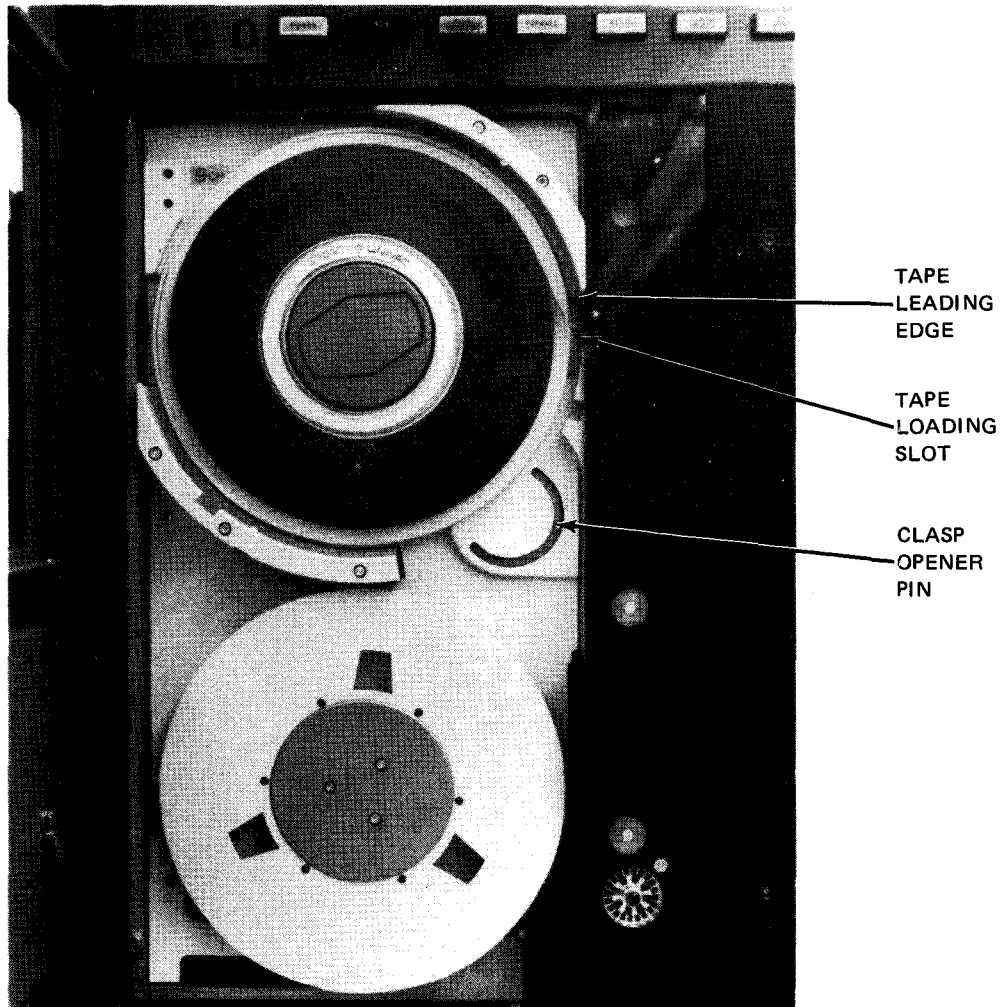

Figure 4-20. Tape Reel Without Cartridge, in Position for Automatic Threading

4.3.3.3. Tape Unloading With Program Control

If the program issues a rewind-with-interlock function, the tape rewinds completely and all tape is transferred to the supply reel. The reel motors, capstan motor, and vacuum pressure pump are turned off. To unload the tape reel, proceed as follows:

1. If clasp is not closed, close clasp (Figure 4-18) to secure reel in cartridge if a tape reel cartridge is used.
2. Press supply reel hub to unlock tape reel.
3. Remove tape reel from supply reel hub.

4.3.3.4. Tape Unloading Without Program Control

To unload tape when not fully rewound on the supply reel, proceed as follows:

1. Press **RESET** switch on operator control panel to place tape unit offline.
2. Press **REWIND/UNLOAD** switch/indicator on operator control panel to initiate a rewind operation. Reel motors, capstan motor, and vacuum pressure pump turn off automatically after all tape is transferred to the supply reel, and the reel cartridge (if used) is locked.
3. Perform steps 1, 2, and 3 of 4.3.3.3.

4.3.4. Recovery Procedures

Table 4—7 lists the control unit and tape unit malfunctions that may be corrected by the operator. An abnormal condition presents certain indications on the control unit and tape unit power panels, or on the tape unit operator control panel. If the operator is able to correct the condition, a reply to the processor should be made with the GO command message after recovery is complete.

Table 4—7. UNISERVO 10 or UNISERVO 14 Magnetic Tape Subsystem, Recovery Procedures (Part 1 of 3)

Fault Indication	Probable Cause	Operator Action
Control Unit		
EARLY WARNING indicator is lit and audible alarm is sounding.	Air intake is obstructed.	<ol style="list-style-type: none"> 1. Set POWER MAINS circuit breaker to off (down). 2. Check air intake for obstruction of air flow. 3. Remove obstruction and set POWER MAINS circuit breaker to on (up). 4. Press RESET switch. If fault indication persists, notify Sperry Univac customer engineer.
OVERHEAT indicator is lit.	Control unit is overheated.	Turn off subsystem immediately; notify Sperry Univac customer engineer.
Subsystem is completely inoperative.	Main circuit breaker is tripped.	<ol style="list-style-type: none"> 1. Set POWER MAINS circuit breaker to off (down) and then to on (up). 2. Press RESET switch on operator control panel. If power loss occurs again, notify Sperry Univac customer engineer.
Subsystem is partially inoperative.	A circuit breaker on power distribution panel is tripped.	<ol style="list-style-type: none"> 1. Reset any tripped circuit breaker; set to off (down) and then to on (up). 2. Press RESET switch on operator control panel. If power loss occurs again, notify Sperry Univac customer engineer.
PS OVER TEMP DS2 indicator is lit.	Control unit power supply is overheated.	Turn off subsystem immediately; notify Sperry Univac customer engineer.

Table 4-7. UNISERVO 10 or UNISERVO 14 Magnetic Tape Subsystem, Recovery Procedures (Part 2 of 3)

Fault Indication	Probable Cause	Operator Action
Tape Unit		
<p>POWER switch/indicator does not turn on power to tape unit when switch is pressed.</p>	<p>Power is off at the power distribution panel.</p>	<ol style="list-style-type: none"> 1. Check that power cord on tape unit power supply panel is plugged into outlet provided in the cabinet. 2. Set ON/OFF circuit breaker on control unit power distribution panel to OFF, then to ON. 3. If POWER switch/indicator remains extinguished when pressed, contact Sperry Univac customer engineer.
<p>FILE PROTECT indicator remains lit when attempting to write on tape.</p>	<p>Write-enable ring is not installed on tape reel.</p>	<ol style="list-style-type: none"> 1. Check that write-enable ring is properly installed on supply reel. 2. Check that supply reel is properly positioned.
<p>LOAD POINT and RUN switch/indicators do not light when pressed after loading a tape reel on transport panel.</p>	<p>Tape loading is aborted because of excessive oxide coating flakes on critical tape transport parts.</p>	<p>Clean tape unit after every 8 hours of operation, or more often if necessary, as follows:</p> <ol style="list-style-type: none"> 1. Unload tape as directed in 4.3.3.4. 2. Press POWER switch/indicator to turn off power to the tape unit. 3. Press in the two spring-loaded latches on the vacuum chamber cover and pull open the transparent vacuum chamber cover. 4. Remove head cover by gently pulling it straight off. 5. Moisten a soft lint-free cloth, or preferably a cotton tipped applicator, with FREON TF* solvent, and swab completely the following items (Figure 4-21): <div style="text-align: center; border: 1px solid black; padding: 5px; width: fit-content; margin: 10px auto;"> <p>CAUTION</p> </div> <p>Be sure that FREON TF solvent does not spill near the capstan or pneumatic brakes, or improper operation of the tape unit may result.</p> <ul style="list-style-type: none"> ■ read, write, and erase heads; ■ tape cleaner (remove any oxide residue from between the blades); and ■ tape guides (four deck mounting guides, one head guide, three guideposts, and two fixed guides).

*Trademark of E. I. du Pont de Nemours & Co., Inc.

Table 4-7. UNISERVO 10 or UNISERVO 14 Magnetic Tape Subsystem, Recovery Procedures (Part 3 of 3)

Fault Indication	Probable Cause	Operator Action
Tape Unit (cont)		
		<p>NOTE:</p> <p>A can of FREON TF solvent, swabs, and tissues are initially supplied with the subsystem. Additional supplies of FREON TF solvent are available from the Sperry Univac customer engineer; other materials are available commercially. The FREON TF solvent is the only cleaning solvent (besides alcohol) warranted for use on the read/write heads and erase head. The neutral fluid does not damage these elements, whereas residual traces of some other solvents can cause tape damage.</p> <ol style="list-style-type: none"> 6. Dry each item with a lint-free cloth after swabbing. 7. Moisten a lint-free cloth with water and wipe the following items (Figure 4-21): <ul style="list-style-type: none"> ■ vacuum chambers; ■ vacuum pockets; ■ vacuum chamber cover and reel cover; and ■ tape capstan. 8. Dry each item after wiping with a lint-free cloth. 9. Remount head cover by aligning two posts and gently pushing it in. 10. Close transparent vacuum chamber cover and engage the two spring-loaded latches by pressing them halfway in. The tape unit is now ready for tape loading.

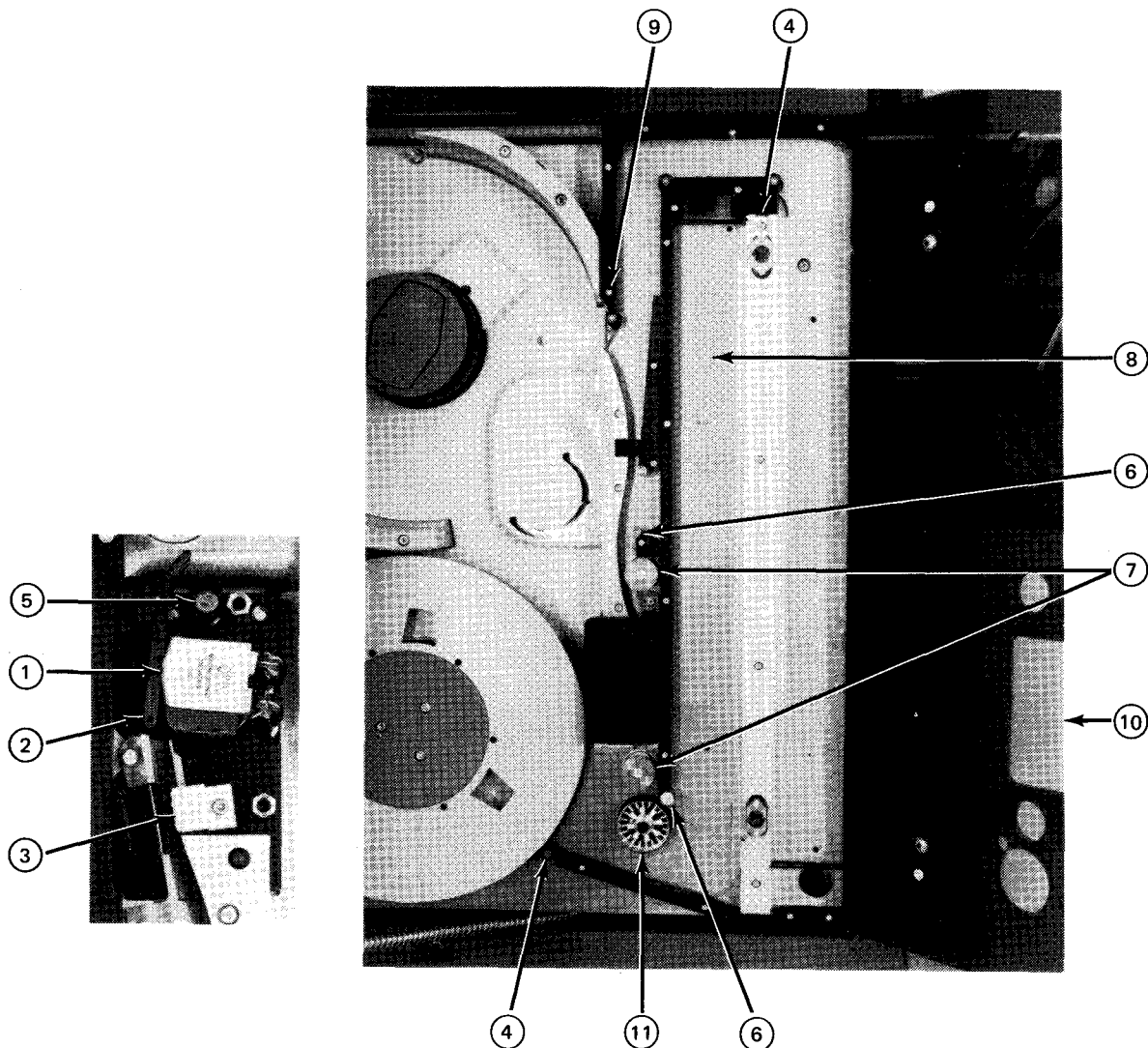

Clean with FREON TF solvent:

- ① Read/write heads
- ② Erase head
- ③ Tape cleaner
- ④ Deck mounting guides
- ⑤ Head guide
- ⑥ Guide posts
- ⑦ Fixed guides

Clean with damp cloth:

- ⑧ Vacuum chambers
- ⑨ Vacuum pockets
- ⑩ Chamber and reel covers
- ⑪ Tape capstan

Figure 4-21. Tape Transport Items and Method for Cleaning

This page left blank intentionally.

4.4. UNISERVO 12/16 MAGNETIC TAPE SUBSYSTEM

A basic UNISERVO 12/16 Magnetic Tape Subsystem contains, one 5017 control unit and one UNISERVO 12 or UNISERVO 16 magnetic tape unit (Figure 4—22). An expanded subsystem may include an additional control unit and up to 16 UNISERVO 12 or UNISERVO 16 tape units, or any combination of these for a total of 16 tape units. UNISERVO 12 magnetic tape units are grouped in banks of one master tape unit and up to three slave units; all units in a bank are bolted together. Each UNISERVO 16 magnetic tape unit or control unit is freestanding.

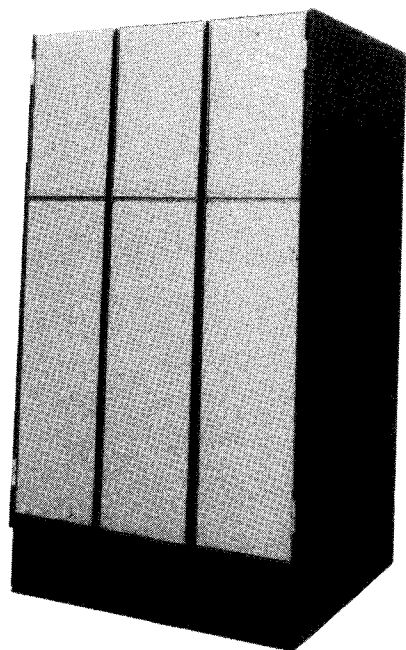

5017 CONTROL UNIT

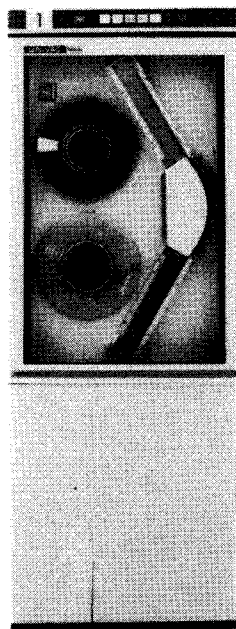

UNISERVO 12
MAGNETIC TAPE UNIT



UNISERVO 16
MAGNETIC TAPE UNIT

Figure 4—22. UNISERVO 12/16 Magnetic Tape Subsystem

4.4.1. Operating Controls and Indicators

The 5017 control unit power panels (Figure 4-23) are located behind the rear door of the control unit. The power control panel (Figure 4-24) and power distribution panel (Figure 4-25) contain indicators, circuit breakers, and switches that require occasional use by the operator. All controls and indicators for the control unit are listed and described in Table 4-8.

The UNISERVO 12 magnetic tape unit, master or slave, contains an operator control panel at the top front of the unit (Figure 4-26). The rear (behind the cabinet door) of the master tape unit (Figure 4-27) also contains a power control panel (Figure 4-28) and power supply panel (Figure 4-29) that control power to that master and its associated slaves in the bank. All controls and indicators for the UNISERVO 12 magnetic tape unit are listed and described in Table 4-9.

The UNISERVO 16 magnetic tape unit contains an operator control panel (Figure 4-30) at the top front of the unit. At the rear of the unit, behind the cabinet door (Figure 4-31), are located the power supply panel (Figure 4-32) and power control panel (Figure 4-33) for that unit. Each UNISERVO 16 magnetic tape unit is equipped with the same controls and indicators, both front and rear. All controls and indicators for the UNISERVO 16 magnetic tape unit are listed and described in Table 4-10.

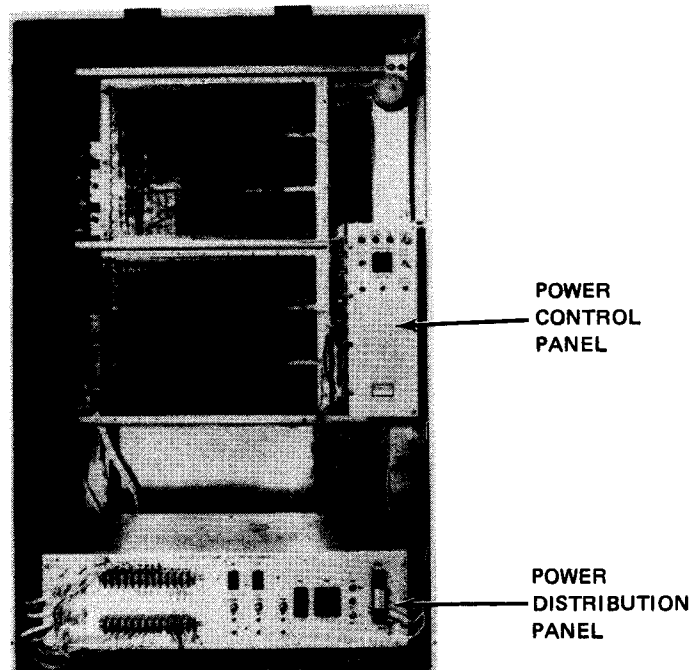

Figure 4-23. 5017 Control Unit, Rear View With Door Open

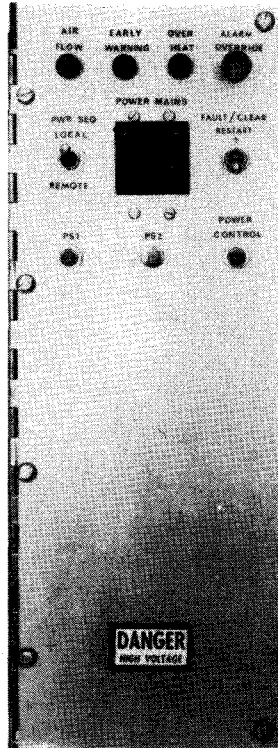

Figure 4-24. 5017 Control Unit, Power Control Panel

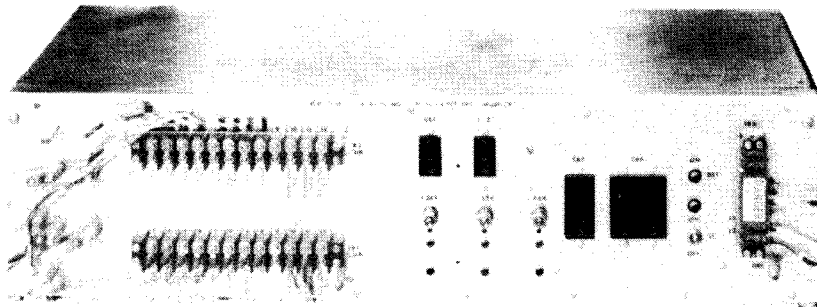

Figure 4-25. 5017 Control Unit, Power Distribution Panel

Table 4-8. 5017 Control Unit, Controls and Indicators (Part 1 of 2)

Control/Indicator — Function
Power Control Panel
AIR FLOW indicator Lights when air flow in control unit drops below a safe limit.
EARLY WARNING indicator Lights when exhaust air reaches 116°F. At the same time, the audible alarm sounds.
OVER HEAT indicator Lights when control unit cabinet exhaust air reaches 130°F.
PWR SEQ LOCAL-REMOTE switch Allows control unit power supplies to be turned on from either control unit cabinet or processor: LOCAL position: Power supplies can be turned on only at control unit cabinet. REMOTE position: Power supplies can be turned on only at processor.
POWER MAINS circuit breaker Provides overload protection for entire control unit cabinet.
FAULT CLEAR/RESTART switch Allows subsystem to operate after a fault is corrected and supplies restart pulse: FAULT CLEAR position: After a fault is corrected, resets fault indication to allow subsystem to be operational. Off (center) position: Normal position RESTART position: Supplies pulse to power up the control unit after momentary power interruption.
ALARM OVERRIDE switch Silences audible alarm.
PS1 circuit breaker Provides overload protection for power supply 1.

Table 4-8. 5017 Control Unit, Controls and Indicators (Part 2 of 2)

Control/Indicator — Function
Power Control Panel (cont)
<p>PS2 circuit breaker</p> <p>Provides overload protection for power supply 2 (if used).</p> <p>POWER CONTROL circuit breaker</p> <p>Provides overload protection for power control panel.</p>
Power Distribution Panel
<p>CB1 circuit breaker</p> <p>Provides overload protection for +24 volt power circuit in the control unit.</p> <p>CB2 circuit breaker</p> <p>Provides overload protection for -12 volt power circuit in the control unit.</p> <p>+24V indicator</p> <p>Lights when +24 volts is applied to control unit.</p> <p>-12V indicator</p> <p>Lights when -12 volts is applied to control unit.</p> <p>+6V indicator</p> <p>Lights when +6 volts is applied to control unit.</p> <p>CB3 circuit breaker</p> <p>Provides overload protection for +6 volt power circuit in the control unit.</p> <p>CB4 circuit breaker</p> <p>Provides overload protection for primary ac power line input to the low voltage dc power supplies in the control unit.</p> <p>ON indicator</p> <p>Lights when the low voltage dc power supplies are energized.</p> <p>ON/OFF switch</p> <p>Controls application of ac power to the low voltage dc power supplies in the control unit.</p> <p>PS OVER TEMP indicator</p> <p>Lights when an overtemperature condition occurs within the low voltage dc power supply.</p>

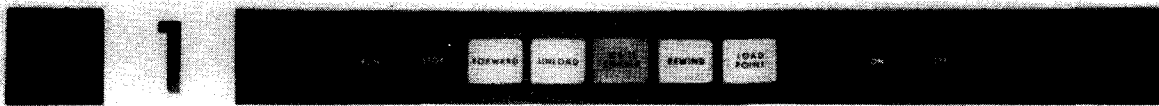
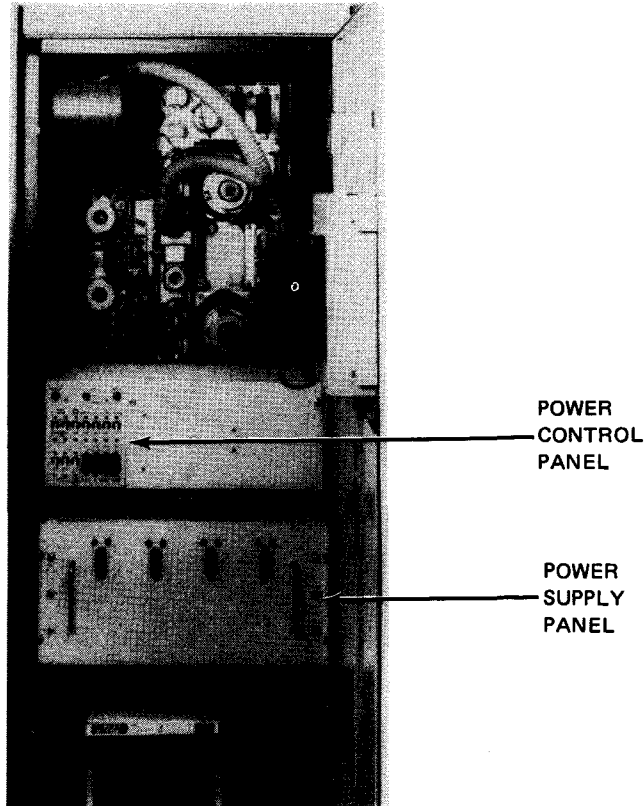

Figure 4-26. UNISERVO 12 Magnetic Tape Unit, Operator Control Panel



POWER
CONTROL
PANEL

POWER
SUPPLY
PANEL

Figure 4-27. UNISERVO 12 Magnetic Tape Unit, Rear View With Door Open

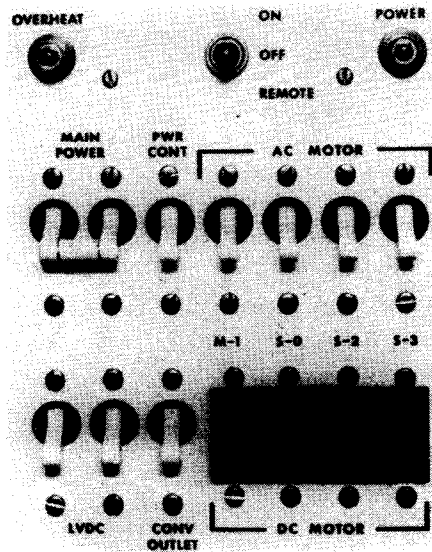

Figure 4-28. UNISERVO 12 Magnetic Tape Unit, Master Power Control Panel

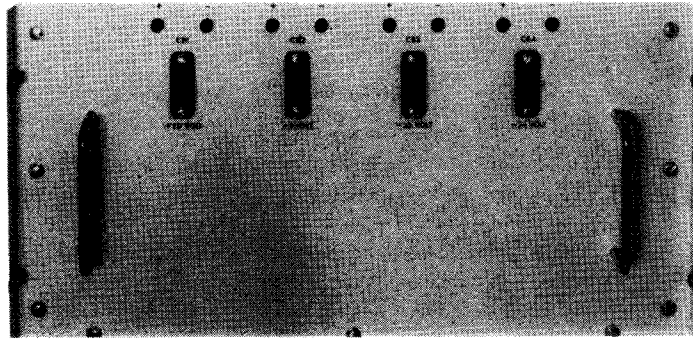

Figure 4-29. UNISERVO 12 Magnetic Tape Unit, Master Power Supply Panel

Table 4-9. UNISERVO 12 Magnetic Tape Unit, Controls and Indicators (Part 1 of 3)

Control/Indicator — Function	
Operator Control Panel	
Unit number (0 through 5) indicator	Shows number assigned to magnetic tape unit. Indicator is lit when unit power is on.
RUN switch/indicator	Places tape unit under control of processor, and all local motion controls are disabled. Indicator lights and STOP switch/indicator goes off.
STOP switch/indicator	Places tape unit in local status under control of operator control panel. Indicator lights and RUN switch/indicator goes off.
FORWARD* switch/indicator	Advances tape at normal speed (42.7 inches per second) until switch/indicator is released. Indicator lights if tape unit is conditioned for forward motion.
UNLOAD switch	Moves tape backward at normal speed (42.7 inches per second) until switch is released.
WRITE ENABLE indicator	Lights when write-enable ring is in proper position on tape reel and reel is properly mounted.
REWIND switch	Rewinds tape (with interlock) at high speed to unload position on tape.

*Inoperative unless STOP switch/indicator is lit.

Table 4-9. UNISERVO 12 Magnetic Tape Unit, Controls and Indicators (Part 2 of 3)

Control/Indicator — Function
Operator Control Panel (cont)
<p>LOAD POINT* switch/indicator</p> <p>Advances tape to load point. Indicator lights when load point marker is positioned at marker detector, and remains lit while tape is positioned at load point.</p> <p>ON switch/indicator</p> <p>Applies power to reel motors and vacuum motor to load tape into vacuum columns. Indicator lights, and OFF switch/indicator goes out. If pressed while lit, unit is cleared.</p> <p>OFF switch/indicator</p> <p>Turns off power to tape drive motors. Indicator lights to indicate that power is still available in power unit.</p>
Master Power Control Panel
<p>OVERHEAT indicator</p> <p>Lights when internal heat of cabinet exceeds 120° F.</p> <p>ON/OFF/REMOTE switch</p> <p>ON position:</p> <p>DC power application or removal for quad is under control of control unit.</p> <p>REMOTE position:</p> <p>Power application or removal for quad is under control of control unit.</p> <p>OFF position:</p> <p>Master tape unit power supplies (and therefore power to quad) is inoperative.</p> <p>POWER indicator</p> <p>Lights when ac power is applied to control circuits of master tape unit.</p> <p>MAIN POWER circuit breaker</p> <p>Provides overload protection for circuits of master tape unit.</p> <p>PWR CONT circuit breaker</p> <p>Provide overload protection for dc power supply.</p>

*Inoperative unless STOP switch/indicator is lit.

Table 4-9. UNISERVO 12 Magnetic Tape Unit, Controls and Indicators (Part 3 of 3)

Control/Indicator — Function
Master Power Control Panel (cont)
<p>AC MOTOR circuit breakers (4)</p> <p>Provide overload protection for ac power to center drive and vacuum motors of tape units of quad.</p>
<p>LVDC circuit breakers (2)</p> <p>Provide overload protection for low voltage power supplies in master tape unit.</p>
<p>CONV OUTLET circuit breaker</p> <p>Provides overload protection for convenience outlet in master tape unit.</p>
<p>DC MOTOR circuit protectors (4)</p> <p>Provide overload protection for 115 volt reel and brake motors of tape units of quad.</p>
Master Power Supply
<p>CB1 circuit breaker</p> <p>Provides overload protection for +20 volt dc power supply.</p>
<p>CB2 circuit breaker</p> <p>Provides overload protection for -8 volt dc power supply.</p>
<p>CB3 circuit breaker</p> <p>Provides overload protection for -30 volt dc power supply.</p>
<p>CB4 circuit breaker</p> <p>Provides overload protection for -24 volt dc power supply.</p>

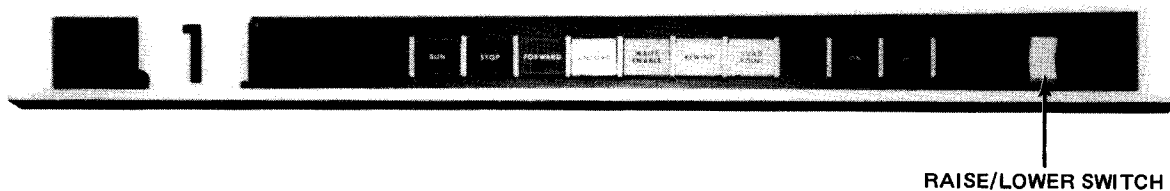

Figure 4-30. UNISERVO 16 Magnetic Tape Unit, Operator Control Panel

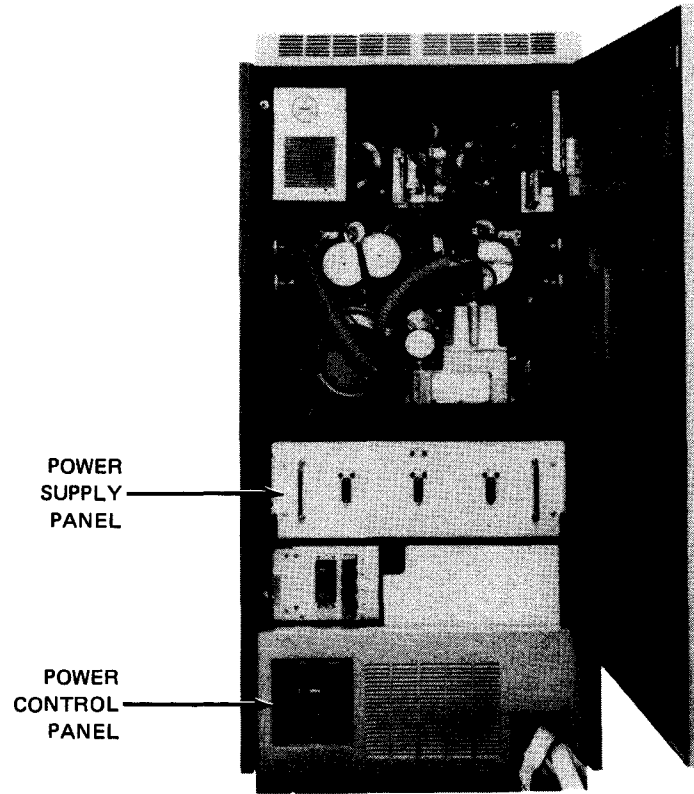

Figure 4-31. UNISERVO 16 Magnetic Tape Unit, Rear View With Door Open

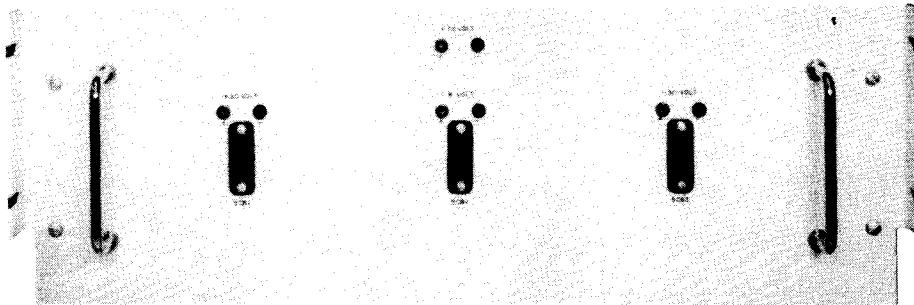

Figure 4-32. UNISERVO 16 Magnetic Tape Unit, Power Supply Panel

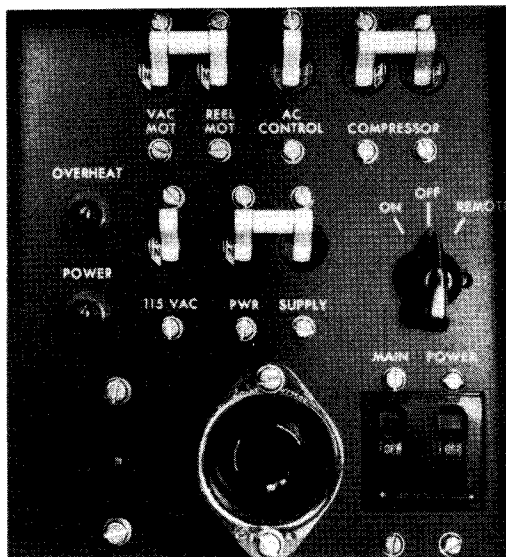

Figure 4—33. UNISERVO 16 Magnetic Tape Unit, Power Control Panel

Table 4—10. UNISERVO 16 Magnetic Tape Unit, Controls and Indicators (Part 1 of 3)

Control/Indicator — Function
Operator Control Panel
<p>Unit number (0 through 15) indicator</p> <p>Shows number assigned to magnetic tape unit.</p>
<p>RUN switch/indicator</p> <p>Places tape unit under control of processor and disables all local motion controls. When pressed, switch/indicator lights, and STOP switch/indicator goes off.</p>
<p>STOP switch/indicator</p> <p>Places tape unit in local status under control of operator control panel. When pressed, switch/indicator lights, and RUN switch/indicator goes off.</p>
<p>FORWARD switch/indicator</p> <p>Advances tape at normal speed (120 inches per second) until released. When pressed, switch/indicator lights if tape unit is conditioned for forward motion. FORWARD switch/indicator is inoperative unless STOP switch/indicator is lit.</p>
<p>UNLOAD switch/indicator</p> <p>Moves tape backward at normal speed (120 inches per second) until released. When pressed, switch/indicator lights if tape unit is conditioned for backward motion by rewinding under program control. UNLOAD switch/indicator is inoperative unless STOP switch/indicator is lit.</p>
<p>WRITE ENABLE indicator</p> <p>Lights when write-enable ring is in proper position on tape reel and reel is properly mounted.</p>

Table 4-10. UNISERVO 16 Magnetic Tape Unit, Controls and Indicators (Part 2 of 3)

Control/Indicator — Function
Operator Control Panel (cont)
REWIND switch/indicator Initiates rewind at high speed (240 inches per second) until tape reaches level on reel that allows reel to be removed from unit. Lights during rewind whether switch/indicator is actuated manually or by program control. REWIND switch/indicator is inoperative unless STOP switch/indicator is lit.
LOAD POINT switch/indicator Advances tape to load point. When pressed, lights when load point marker is under load point detector and remains lit while tape is positioned at load point. LOAD POINT switch/indicator is inoperative unless STOP switch/indicator is lit.
ON switch/indicator Applies power to reel motors and vacuum motor to load tape into vacuum columns. When pressed, switch/indicator lights, and OFF switch/indicator goes off.
OFF switch/indicator Turns off power to tape drive motor. When pressed, lights to indicate that power is still available in power unit.
RAISE/LOWER switch RAISE position: Raises glass door on front of tape unit. LOWER position: Lowers door; overrides window command control logic.
Power Control Panel
MAIN POWER circuit breaker Provides overload protection for primary power ac circuits in tape unit.
POWER indicator Lights when primary ac power is present in tape unit.
ON/OFF/REMOTE switch Selects point of control for the application of dc power to tape unit: OFF position: The dc power is not available. ON position: Off/on control of dc voltage in tape unit is at operator control panel. REMOTE position: Off/on control of dc voltage in tape unit is at processor.

Table 4-10. UNISERVO 16 Magnetic Tape Unit, Controls and Indicators (Part 3 of 3)

Control/Indicator — Function
Power Control Panel (cont)
AC CONTROL circuit breaker Provides overload protection for tape unit power control circuits.
VAC MOT — REEL MOT circuit breaker Provides overload protection for take-up and supply reel drive motors and vacuum loop motor.
115 AC circuit breaker Provides overload protection for cabinet blowers, pressure blower, and forward and backward capstan motors.
COMPRESSOR circuit breaker Provides overload protection for compressor motor.
PWR SUPPLY circuit breaker Provides overload protection for ac input circuits of low voltage dc power supplies.
Convenience outlet Provides power for external equipment (for use only by Sperry Univac customer engineer).
OVERHEAT indicator Lights when heat inside cabinet is excessive.
Power Supply
5CB1 circuit breaker Provides overload protection for +20 volt dc power supply.
5CB2 circuit breaker Provides overload protection for —8 volt dc power supply.
5CB3 circuit breaker Provides overload protection for —30 volt dc power supply.
NOTE: Circuit breaker handles are up for on and down for off.

4.4.2. Turn-On and Turn-Off Procedures

Power to the subsystem is normally applied and removed via the **POWER ON/POWER OFF** switch on the processor operator/maintenance panel (Figure 2—2). However, to control power from this panel, certain switches and circuit breakers on the control unit and tape units must first be set to specific positions. The switch and circuit breaker settings are listed in Table 4—11.

When the switches and circuit breakers on the control unit and tape units are set as specified in Table 4—11, and the **POWER ON/POWER OFF** switch on the processor is then set to **POWER ON**, the following indicators on the tape unit operator control panels should light:

- Unit number indicator
- **STOP** switch/indicator
- **OFF** switch/indicator

To turn power off for the subsystem, tape must first be fully rewound on all tape units to prevent tape stretch, which may be caused by very rapid removal of the tape loop from the vacuum columns. Power may then be turned off either at the processor or independently at the power panels on the control unit and each tape unit.

Table 4—11. UNISERVO 12/16 Magnetic Tape Subsystem, Power Switch Settings (Part 1 of 2)

Switch/Circuit Breaker	Normal Setting
Control Unit Power Control Panel	
PWR SEQ LOCAL-REMOTE switch	REMOTE
POWER MAINS circuit breaker	On (up)
Control Unit Power Distribution Panel	
CB1 circuit breaker	ON (up)
CB2 circuit breaker	ON (up)
CB3 circuit breaker	On (up)
CB4 circuit breaker	On (up)
ON/OFF switch	ON
UNISERVO 12 Master Power Control Panel	
ON/OFF/REMOTE switch	REMOTE
MAIN POWER circuit breaker	On (up)
PWR CONT circuit breaker	On (up)
AC MOTOR circuit breakers	On (up)
LVDC circuit breakers	On (up)

Table 4-11. UNISERVO 12/16 Magnetic Tape Subsystem, Power Switch Settings (Part 2 of 2)

Switch/Circuit Breaker	Normal Setting
UNISERVO 16 Power Control Panel	
MAIN POWER circuit breaker	On (up)
ON/OFF/REMOTE switch	REMOTE
AC CONTROL circuit breaker	On (up)
VAC MOT-REEL MOT circuit breaker	On (up)
115 AC circuit breaker	On (up)
COMPRESSOR circuit breaker	On (up)
PWR SUPPLY circuit breaker	On (up)

4.4.2.1: Independent Power Turn-On Procedure

Power to the subsystem is turned on independently of the processor as follows:

1. Check that all circuit breakers on the control unit power distribution panel are set to on (up) position and that **ON/OFF** switch on control unit power distribution panel is set to **ON** position.
2. Check that **POWER MAINS** circuit breaker on control unit power control panel is set to on (up) position.
3. Set **PWR SEQ LOCAL-REMOTE** switch on control unit power control panel to **LOCAL** position.
4. Check that all circuit breakers on UNISERVO 12 master power control panel are set to on (up), position.
5. Set **ON/OFF/REMOTE** switch on UNISERVO 12 master power control panel to **ON** position.
6. Check that all circuit breakers on UNISERVO 16 power control panel are set to on (up) position.
7. Set **ON/OFF/REMOTE** switch on UNISERVO 16 power control panel to **ON** position.
8. Using the *UP* function of the SET IO command (Section 12), place tape unit in the system's resource list for job allocation.

4.4.2.2. Independent Power Turn-Off Procedure

Power to the subsystem is turned off independently of the processor as follows:

NOTE:

Before performing the following procedures, remove the device from the system's list of available resources by using the DOWN function of the SET IO command (Section 12). After the procedure is completed, restore the device's available status by using the UP function of the SET IO command.

1. Rewind tape completely onto supply reel to prevent tape stretch caused by rapid removal of the tape from the vacuum columns (refer to 4.4.3.2 for UNISERVO 12 tape unit or to 4.4.3.4 for UNISERVO 16). Note that **STOP** switch/indicator on the operator control panel remains lit.
2. Press **OFF** switch/indicator on operator control panel.
3. Set **ON/OFF/REMOTE** switch on UNISERVO 12 power control panel and on UNISERVO 16 power control panel to **OFF** position.
4. Set **PWR SEQ LOCAL-REMOTE** switch on control unit power control panel to **LOCAL** position.
5. Set **ON/OFF** switch on control unit power distribution panel to **OFF** position.

CAUTION

*Before turning power off at the subsystem, be sure that the **STOP** switch/indicator on the operator control panel is lit. Failure to follow this procedure will result in power transients that may interfere with processor operation.*

4.4.3. Operating Procedures

Operating procedures for the tape subsystem include mounting the tape reel and unloading tape from the tape transport. Separate procedures are provided for the UNISERVO 12 and UNISERVO 16 tape units.

4.4.3.1. UNISERVO 12 Magnetic Tape Unit Reel Mounting

Mount a supply reel on the UNISERVO 12 tape unit as follows:

1. Before mounting the reel, check to see if it contains a write-enable ring.
 - If writing is to be done on the tape, a write-enable ring must be used. Figure 4-34 shows the back of the reel of tape and a write-enable ring. The ring fits into a slot in the reel.
 - If no writing is to be done on the tape, the reel must not contain a write-enable ring.

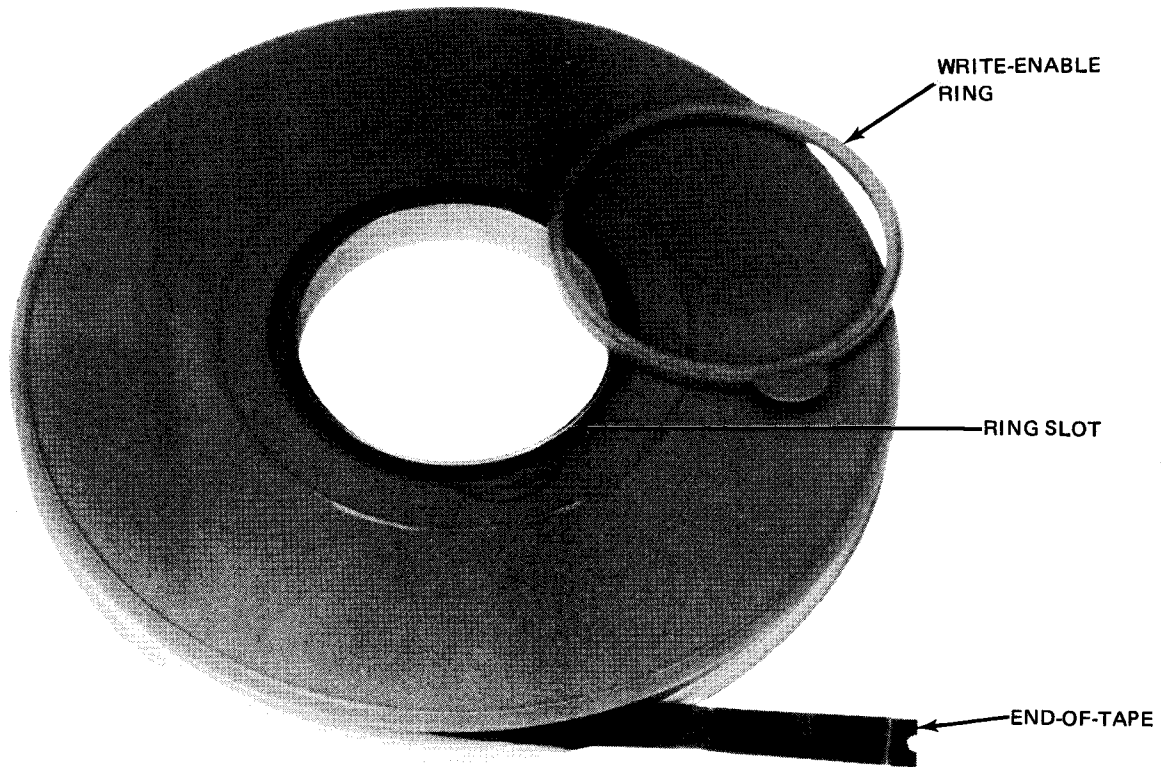

Figure 4—34. Tape Reel and Write-Enable Ring

- No writing or erasing can occur during a rewind operation.

CAUTION

Remove the write-enable ring when it is not required for writing, or inadvertent tape erasure or modification may occur.

2. Press **STOP** switch/indicator and open the glass door on the upper front of the tape unit.
3. Mount the reel on the supply-reel hub so that the leading end of tape is toward the right (Figure 4—35a). Press on core of reel to lock in place.

CAUTION

Never apply pressure to flanges of the reel or permanent damage can result to edges of the tape.

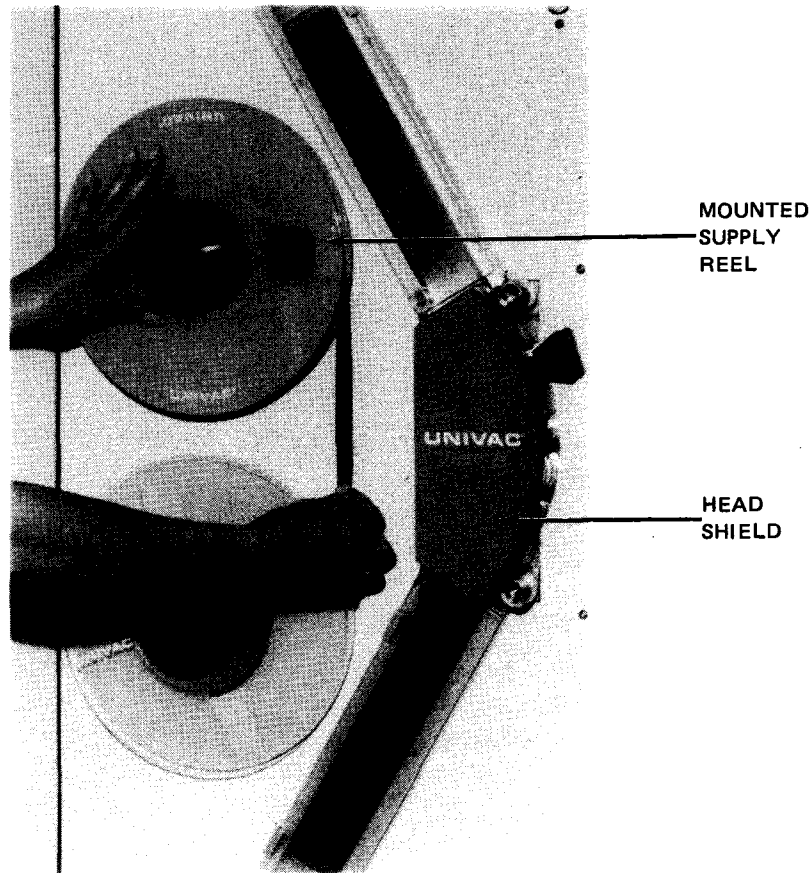

a. Tape reel mounted on supply reel hub

Figure 4-35. Loading Tape Reel on UNISERVO 12 Magnetic Tape Unit (Part 1 of 4)

4. Restrain the supply reel to prevent excessive tape from being unreeled; thread the leading end of the tape under the pulley at the lower left-hand corner of the upper vacuum column (Figure 4-35b), between the capstan and the pressure roller at the top of the head unit, then down between the erase head and the load point and end-of-tape warning marker detector, and over the read/write head (Figure 4-35c).

NOTE:

If the read/write head is equipped with a tape guide, snap the guide back, pass the tape along the read/write head, then close the tape guide.

5. Bring the tape end between the lower capstan and pressure roller (Figure 4-35b), around the pulley between the pressure roller and lower vacuum column; and over the lower vacuum column and the pulley near the upper left-hand corner of the lower vacuum column (Figure 4-35d).
6. Lock the head shield securely in place.
7. Draw the tape around the underside of the core of the take-up reel in a clockwise direction (Figure 4-35e) until there is enough slack for the end of the tape to fall against the top side of the core of the take-up reel. Wind three or four turns of tape onto the reel, holding the end of the tape against the core with one finger to aid in starting.

8. Close the glass door.
9. Press and hold the **ON** switch on operator control panel for 2 seconds or more until tape is loaded into both the upper and the lower vacuum columns and both reels are at rest; **STOP** indicator goes on.
10. Press **LOAD POINT** switch on operator control panel, to advance the tape from the supply reel to the take-up reel until the load point marker is under the marker detector. **STOP** indicator then goes off, and **LOAD POINT** and **RUN** indicators go on. The tape unit is now ready for remote operation under control of the processor via the control unit.

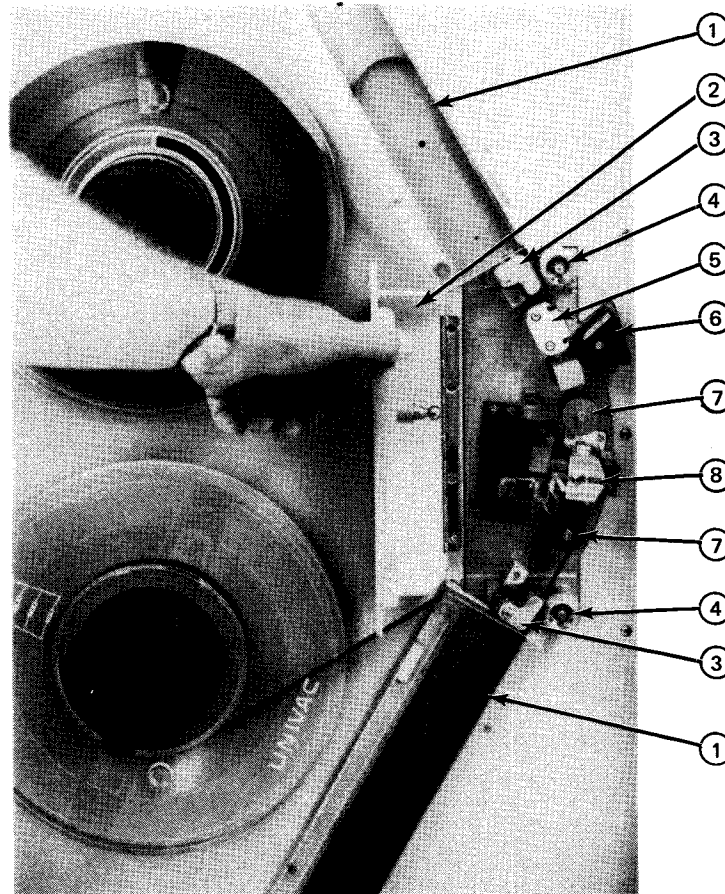

- | | |
|--------------------|--|
| ① VACUUM COLUMNS | ⑤ ERASE HEAD |
| ② HEAD SHIELD | ⑥ LOAD POINT AND END-OF-TAPE MARKER DETECTOR |
| ③ PRESSURE ROLLERS | ⑦ EDGE GUIDES |
| ④ CAPSTANS | ⑧ READ/WRITE HEAD |

b. Head shield open to show tape path

Figure 4-35. Loading Tape Reel on UNISERVO 12 Magnetic Tape Unit (Part 2 of 4)

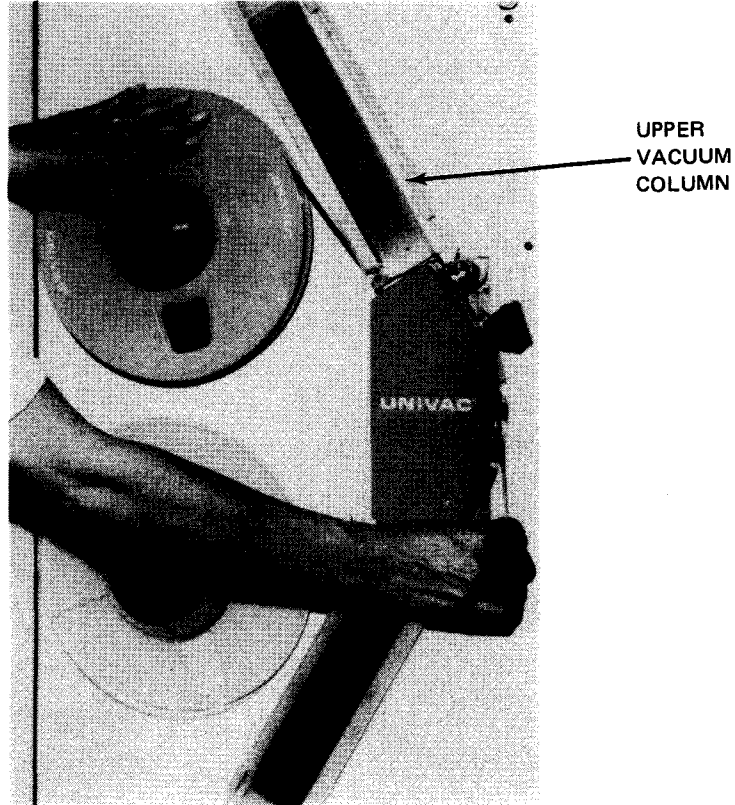

c. Threading tape down over read/write head

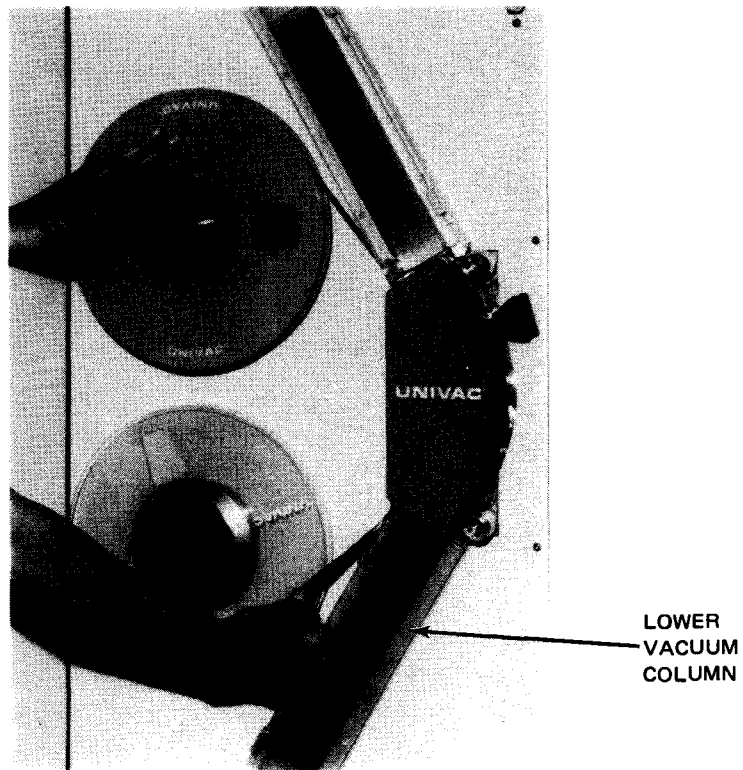

d. Threading tape over lower vacuum column

Figure 4-35. Loading Tape Reel on UNISERVO 12 Magnetic Tape Unit (Part 3 of 4)

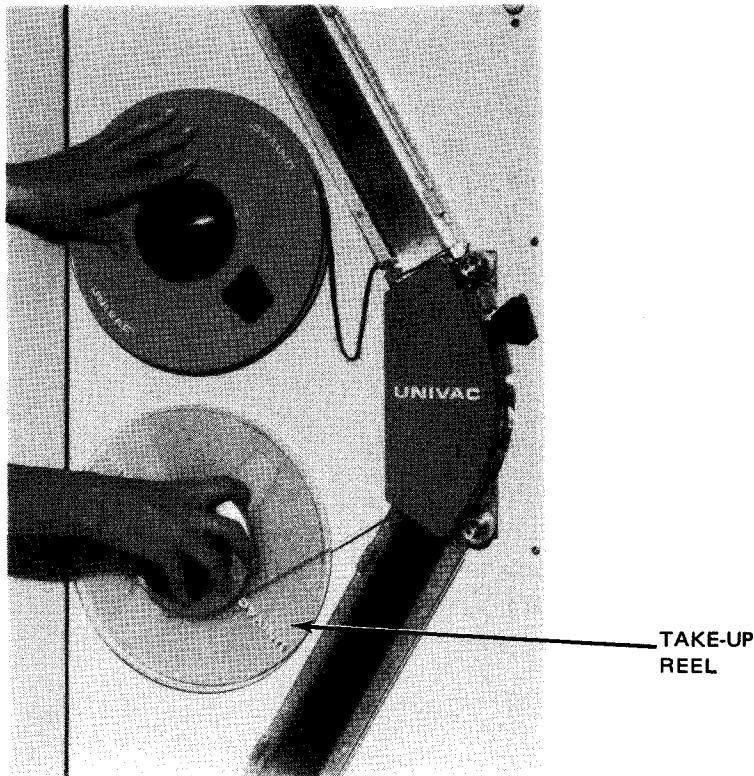

e. Securing tape on take-up reel

Figure 4-35. Loading Tape Reel on UNISERVO 12 Magnetic Tape Unit (Part 4 of 4)

4.4.3.2. UNISERVO 12 Magnetic Tape Unit Reel Unloading

When read or write operations on a reel of tape have been completed, the program ordinarily issues a rewind-with-interlock function in preparation for unloading tape; the operator must wait until the operation is completed. If it is desired to unload tape when the tape is not positioned at the load point, a rewind-with-interlock operation can be initiated at the operator control panel by pressing the **STOP** switch/indicator when tape is not moving, then pressing the **REWIND** switch.

CAUTION

REWIND switch must not be pressed when the load point marker is on the supply-reel side of the marker detector; the resulting high speed may damage the end of the tape when it is released from the take-up reel.

Unload a reel of tape as follows:

1. Ensure that **STOP** switch/indicator is lit (if not, press **STOP** switch/indicator) then press and hold **UNLOAD** switch/indicator until the tape is free of the take-up reel.

2. Open the glass door.
3. Release the head shield latch (Figure 4—35b).
4. Turn the supply reel counterclockwise to take up the remaining tape (Figure 4—35a).
5. Press the supply-reel hub to unlock the tape reel.
6. Remove the tape reel from its hub. The tape unit is now ready to receive a new reel of tape (4.4.3.1).

4.4.3.3. UNISERVO 16 Magnetic Tape Unit Reel Mounting

Mount a supply reel on the UNISERVO 16 tape unit as follows:

1. Before mounting the reel, check to see if it contains a write-enable ring:
 - If writing is to be done on the tape, a write-enable ring must be used. Figure 4—34 shows the back of a reel of tape and write-enable ring. The ring fits into a slot in the reel.
 - If no writing is to be done on the tape, the reel must not contain a write-enable ring.

No writing and erasing can occur during a rewind operation.

CAUTION

Remove the write-enable ring when it is not required-for writing, or inadvertent tape erasure may occur.

2. Press **STOP** switch/indicator and lower the glass door on the upper front of the unit by pressing the lower half of the **RAISE/LOWER** switch on the UNISERVO 16 operator control panel.
3. Mount the reel on the supply-reel hub so that the leading end of tape is toward the right (Figure 4—36a). Press on the core of the reel to lock it in place.

CAUTION

Never apply pressure to flanges of the reel, or permanent damage can result to edges of the tape.

4. Unreel a short length of tape from the supply reel.
5. Check that tape clamp (Figure 4—36b) is in clamped position (down), then insert the connection clip on the take-up reel leader (Figure 4—36c) through the tape attachment loop on the leading end of tape from the supply reel. Make certain that neither the tape or leader is twisted.

6. Turn the supply reel to take up slack in the tape.
7. Check that the leader is threaded in its proper path (Figure 4—36d).
8. Release the tape clamp (Figure 4—36e).
9. Press the **ON**, then **LOAD POINT** switch/indicators. Note that the glass door rises and closes, the **STOP** switch/indicator extinguishes, the **RUN** switch/indicator lights, and tape advances until the load point marker is positioned beneath the marker detector, as indicated by the lit **LOAD POINT** switch/indicator. The tape unit is now ready for remote operation under control of the processor via the control unit.

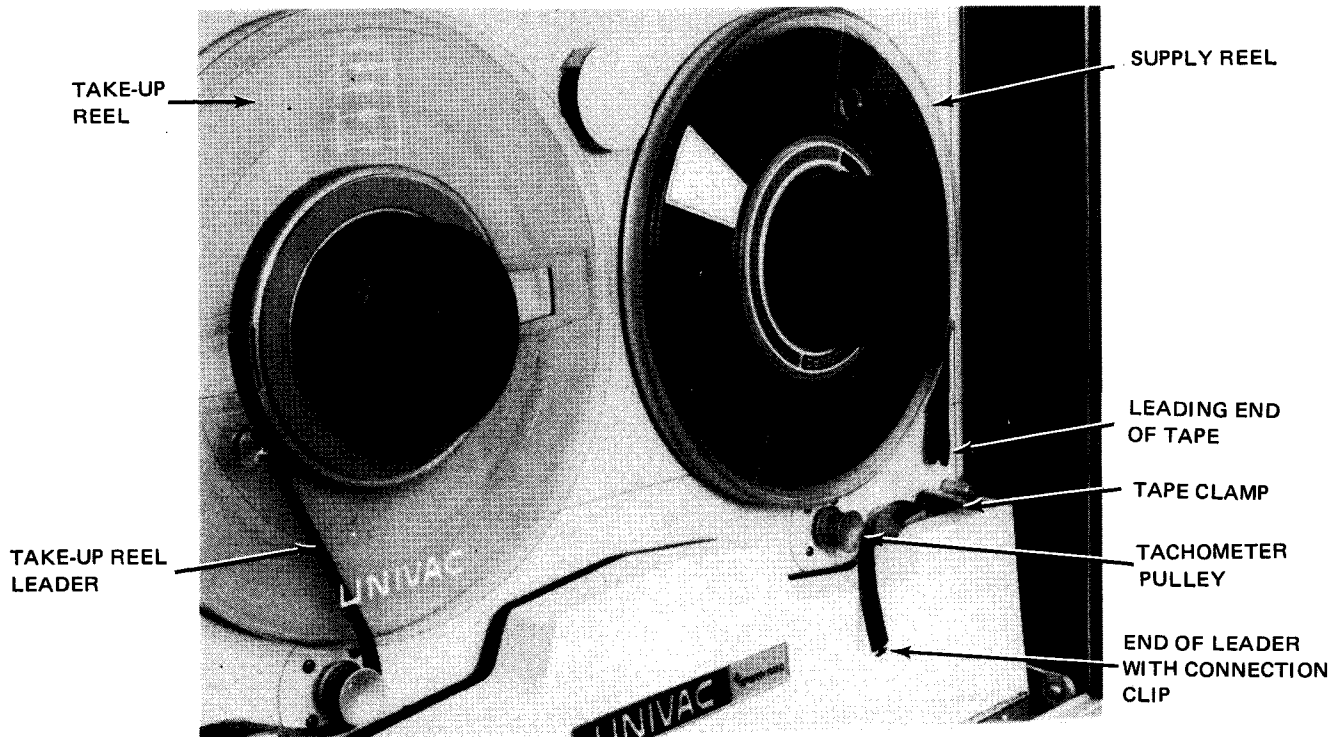

a. Supply reel mounted but not connected to leader

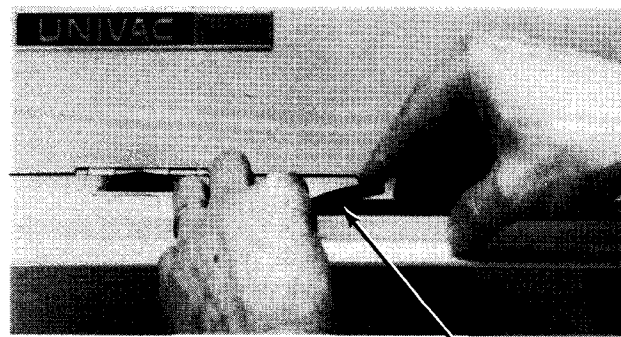

TAPE CLAMP

b. Closing tape clamp to secure tape leader

Figure 4—36. Loading Tape Reel on UNISERVO 16 Magnetic Tape Unit (Part 1 of 3)

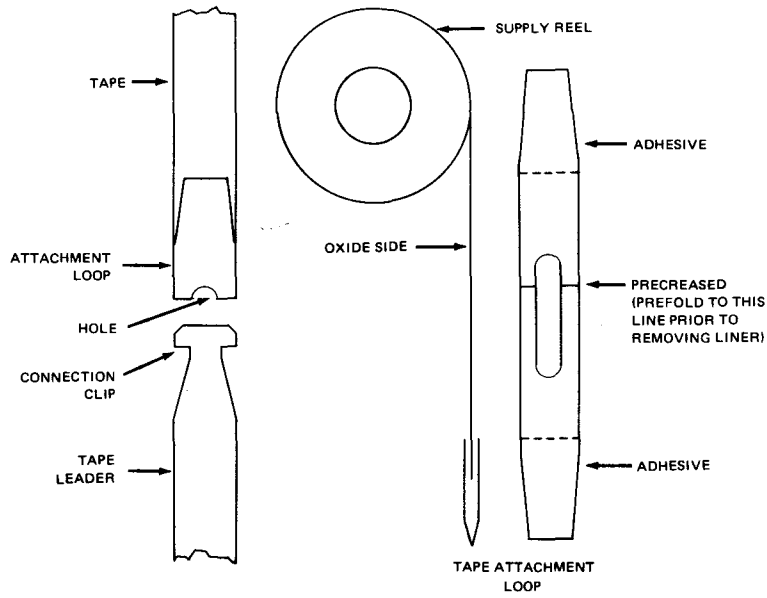

c. Tape attachment loop and tape leader connection clip

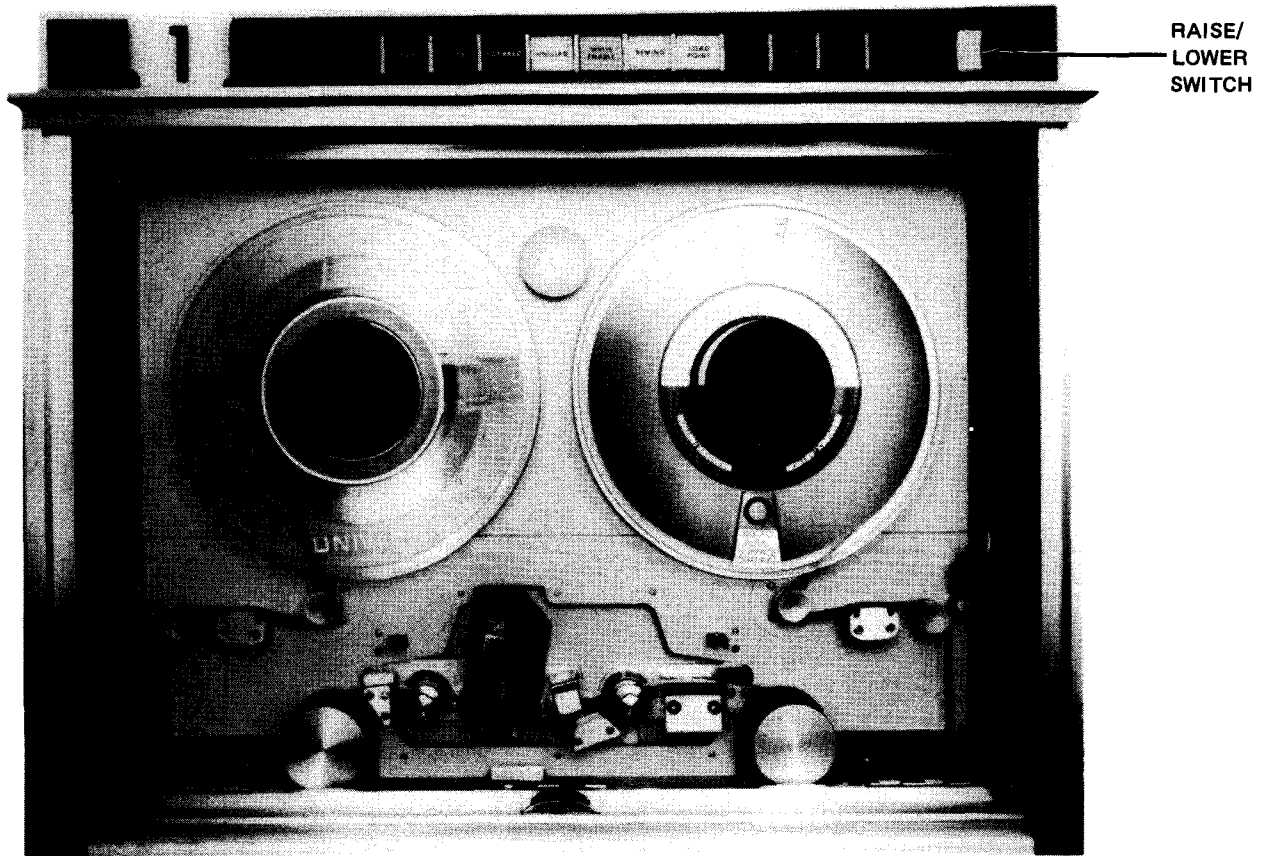

d. Head cover open to show tape leader path

Figure 4-36. Loading Tape Reel on UNISERVO 16 Magnetic Tape Unit (Part 2 of 3)

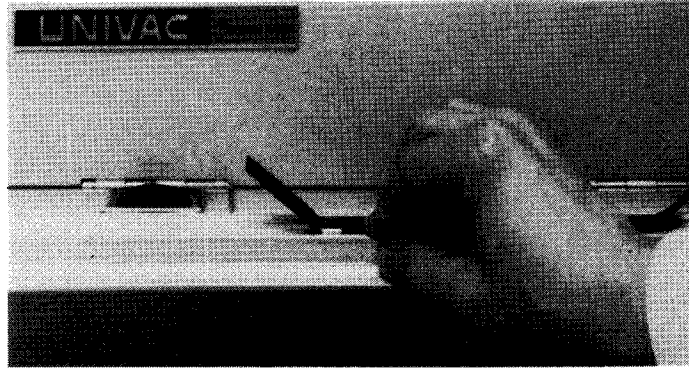

e. Releasing tape clamp to release tape leader

Figure 4—36. Loading Tape Reel on UNISERVO 16 Magnetic Tape Unit (Part 3 of 3)

4.4.3.4. UNISERVO 16 Magnetic Tape Unit Reel Unloading

When read or write operations on a reel of tape have been completed, the program ordinarily issues a rewind-with-interlock (a complete rewind to leading end of tape) function in preparation for unloading tape; the operator must wait until the operation is completed. If it is desired to unload tape when tape is not positioned at load point, a rewind-with-interlock operation is initiated at the operator control panel by pressing **STOP** when tape is not moving, then pressing **REWIND**. Unload the reel of tape as follows:

1. After tape motion stops, press **OFF** switch/indicator. Note that **STOP** switch/indicator lights.
2. Swing the tape clamp down toward the left (Figure 4—36b) to clamp the tape leader.
3. Turn the supply reel to provide slack in the tape.
4. Remove the leader clip from the tape end attachment loop on the supply reel (Figure 4—36b).
5. Turn the supply reel to wind up the remaining tape.
6. Press on the supply-reel hub to unlock the tape reel. Remove the tape reel from its hub; the tape unit is now ready to receive a new reel of tape.

4.4.4. Recovery Procedures

Table 4—12 lists the tape unit malfunctions that may be corrected by the operator. An error condition causes the tape unit to stop and display the error condition on the operator control panel. If the operator is able to correct the error condition, a reply to the processor should be made with the **GO** command message after recovery is completed.

Table 4-12. UNISERVO 12/16 Magnetic Tape Subsystem, Recovery Procedures (Part 1 of 2)

Fault Indication	Probable Cause	Operator Action
Control Unit		
AIR FLOW indicator is lit.	Cooling air input is obstructed.	Clear any air intake obstruction; if no obstruction is apparent or if indicator remains lit, notify Sperry Univac customer engineer.
EARLY WARNING indicator is lit and audible alarm sounds.	Cooling air input is obstructed.	Check AIR FLOW indicator and clear any obstructions to free air flow.
OVERHEAT indicator is lit.	Rising internal heat.	Turn off subsystem immediately; notify Sperry Univac customer engineer.
Loss of power to entire subsystem.	Circuit breaker tripped.	Reset POWER MAINS circuit breaker on power control panel. (Set to OFF , and then to ON .)
Loss of all dc power output.	Excessive internal heat.	Check OVER HEAT indicator; if lit, turn off subsystem and notify Sperry Univac customer engineer. When trouble is cleared, raise FAULT CLEAR/RESTART switch to RESTART and release.
UNISERVO 12 Magnetic Tape Unit		
Subsystem is completely inoperative.	MAIN POWER circuit breaker tripped.	Reset MAIN POWER circuit breaker on master power control panel. (Set to OFF , and then to ON .)
Subsystem is partially inoperative.	Pushbutton circuit breaker tripped (button out).	Reset (by pressing button in) any tripped circuit breaker (button out). <div style="border: 1px solid black; padding: 5px; text-align: center;">CAUTION</div> Do not hold the button in or damage to power supply may result.
WRITE ENABLE indicator fails to light.	Write-enable ring is not installed.	Ensure that write-enable ring is properly installed and tape reel is properly positioned.
Tape unit ON indicator is lit, and STOP indicator is off.	Tape is not loaded properly.	Ensure tape is pulled out of vacuum column or is extended too far into a column; if necessary, rewind and reload tape.
OVERHEAT indicator is lit.	Excessive internal heat.	Set MAIN POWER circuit breaker on master power control panel to OFF . Remove any obstructions from cooling vents; set MAIN POWER circuit breaker to ON . If trouble persists, notify Sperry Univac customer engineer.

Table 4-12. UNISERVO 12/16 Magnetic Tape Subsystem, Recovery Procedures (Part 2 of 2)

Fault Indication	Probable Cause	Operator Action
UNISERVO 16 Magnetic Tape Unit		
Subsystem is completely inoperative.	MAIN POWER circuit breaker tripped.	Reset MAIN POWER circuit breaker on power control panel. (Set to OFF and then to ON .)
Subsystem is partially inoperative.	Circuit breaker tripped.	Reset any tripped circuit breaker. (Set to off, and then to on.) Reset any pushbutton circuit breaker (button out) by pushing in. <div style="border: 1px solid black; padding: 5px; width: fit-content; margin: 10px auto;">CAUTION</div> Do not hold pushbutton in or damage will result to power supply.
WRITE ENABLE indicator on operator control panel fails to go on.	Write-enable ring is not installed.	Ensure that write-enable ring is properly installed and tape reel is correctly mounted.
ON and RUN switch/indicators are off, and OFF and STOP switch/indicators are lit.	Tape is not loaded properly.	Ensure tape is positioned correctly in vacuum columns. If it is not, rewind and reload the tape.
OVERHEAT indicator is lit.	Excessive internal heat.	Set MAIN POWER circuit breaker on power control panel to OFF ; reset circuit breaker to ON . If trouble persists, notify Sperry Univac customer engineer.

This page left blank intentionally.

4.5. UNISERVO 20 MAGNETIC TAPE SUBSYSTEM

A basic UNISERVO 20 Magnetic Tape Subsystem contains one UNISERVO 20 control unit and at least one UNISERVO 20 tape unit (Figure 4—37). An expanded subsystem may include up to 16 UNISERVO 20 tape units. The tape units and control unit are compatible with and can include combinations of UNISERVO 12 and UNISERVO 16 tape units, provided at least one UNISERVO 20 tape unit is included in the subsystem. The single UNISERVO 20 control unit cabinet can be equipped with circuitry for an additional control unit if simultaneous read and write operations are desired. All UNISERVO 20 tape units are freestanding.

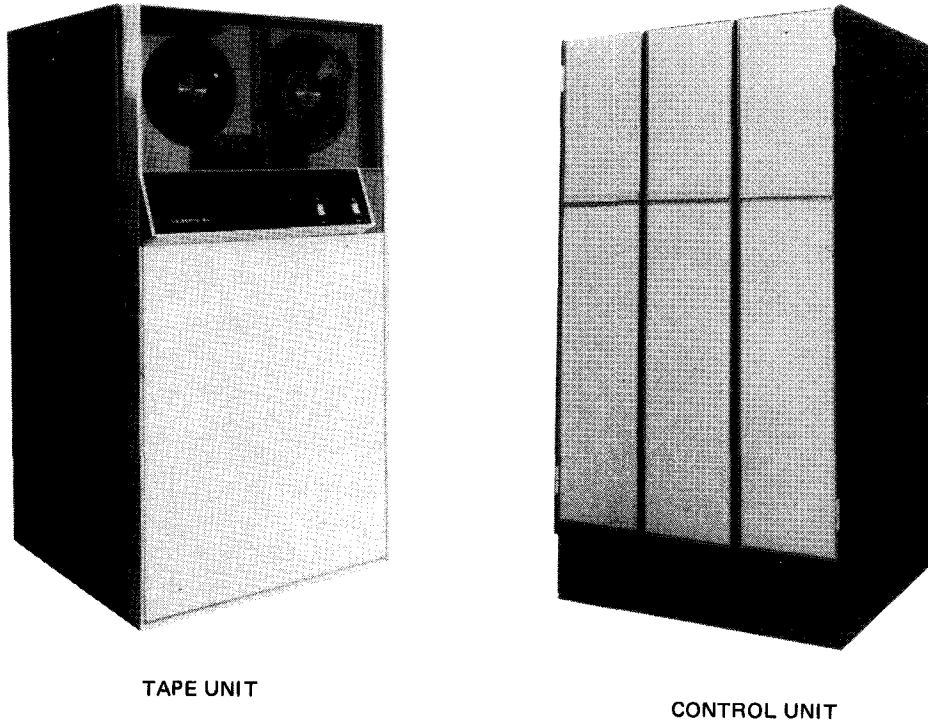

Figure 4—37. UNISERVO 20 Magnetic Tape Subsystem

4.5.1. Operating Controls and Indicators

The control unit power panels (Figure 4—38) are located behind the rear door of the control unit. The power control panel (Figure 4—39) and two identical power distribution panels (Figure 4—40) contain indicators, circuit breakers, and switches requiring occasional use by the operator. All controls and indicators for the control unit are listed and described in Table 4—13.

The front of the UNISERVO 20 tape unit contains two operator panels (Figure 4—41). The indicator panel (Figure 4—42) permits tape unit operating conditions to be monitored, and the operator control panel (Figure 4—43) permits the operator to control tape operations and monitor conditions pertinent to tape operations. Four indicators on the operator control panel are visible only when lit. Behind the rear cabinet door of the tape unit (Figure 4—44) are located the power supply panel (Figure 4—45), which is accessible behind the printed card library, and the power control panel (Figure 4—46) located at the bottom of the cabinet. All controls and indicators for the tape unit are listed and described in Table 4—14.

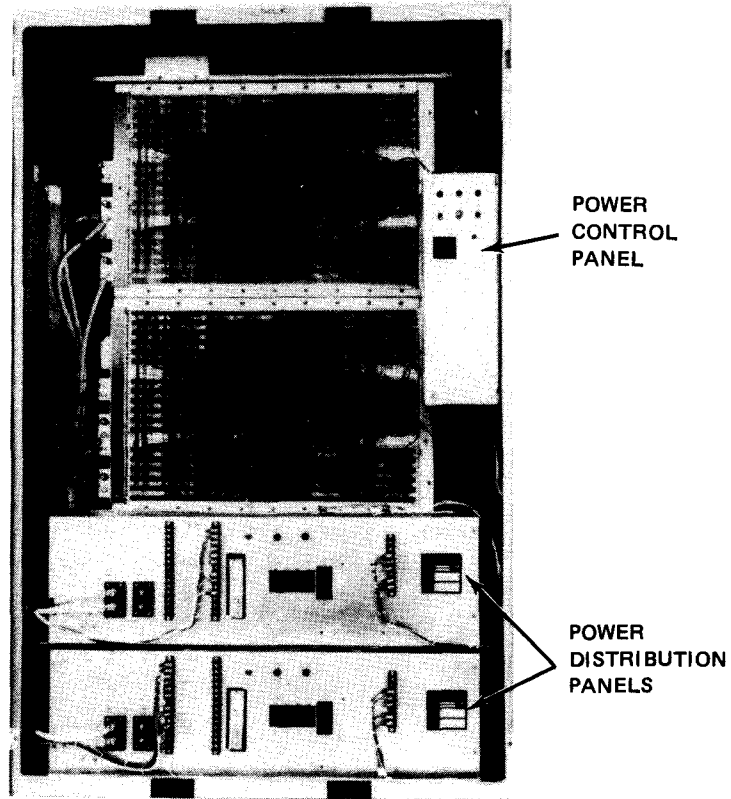

Figure 4-38. 5034 Control Unit, Rear View

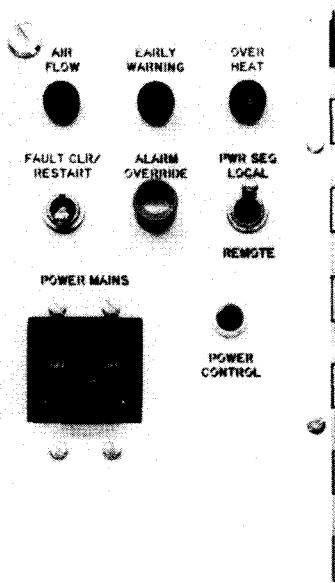

Figure 4-39. 5034 Control Unit, Power Control Panel

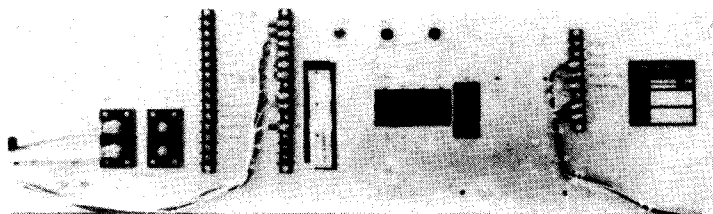

Figure 4-40. 5034 Control Unit, Power Distribution Panel

Table 4-13. 5034 Control Unit, Controls and Indicators (Part 1 of 2)

Control/Indicator — Function
Power Control Panel
<p>AIR FLOW indicator</p> <p>Lights when air flow in control unit is restricted.</p> <p>EARLY WARNING indicator</p> <p>Lights when exhaust air reaches 118°F. At the same time, audible alarm sounds.</p> <p>OVER HEAT indicator</p> <p>Lights when control unit cabinet exhaust air reaches 130°F.</p> <p>PWR SEQ LOCAL-REMOTE switch</p> <p>Allows control unit power supplies to be turned on from either control unit or processor:</p> <p>LOCAL position:</p> <p>Power supplies can be turned on only at control unit.</p> <p>REMOTE position:</p> <p>Power supplies can be turned on only at processor.</p> <p>POWER MAINS circuit breaker</p> <p>Provides overload protection for entire control unit.</p> <p>FAULT CLEAR/RESTART switch</p> <p>Allows system to operate after a fault is corrected, and supplies restart pulse:</p> <p>FAULT CLEAR position:</p> <p>After a fault is corrected, resets fault indication to allow system to be operational.</p> <p>Off (center) position:</p> <p>Normal position.</p> <p>RESTART position:</p> <p>Supplies pulse to power up the control unit.</p>

Table 4-13. 5034 Control Unit, Controls and Indicators (Part 2 of 2)

Control/Indicator — Function
Power Control Panel (cont)
ALARM OVERRIDE switch Silences audible alarm.
POWER CONTROL circuit breaker Provides overload protection for power control panel.
Power Distribution Panel
AC INPUT circuit breaker Provides overload protection for main ac power input circuits of low voltage dc power control unit.
AC POWER/OFF switch Controls ac power to low voltage dc power control unit.
+12V circuit breaker Provides overload protection for +12 volt dc power supply circuit.
-12V circuit breaker Provides overload protection for -12 volt dc power supply circuit.
+6V circuit breaker Provides overload protection for +6 volt dc power supply circuit.
DC ON indicator Lights when power supplies are energized and dc voltages are available to logic circuits.
PWR SUP OVER TEM indicator Lights when over temperature condition exists within low voltage dc power supply.

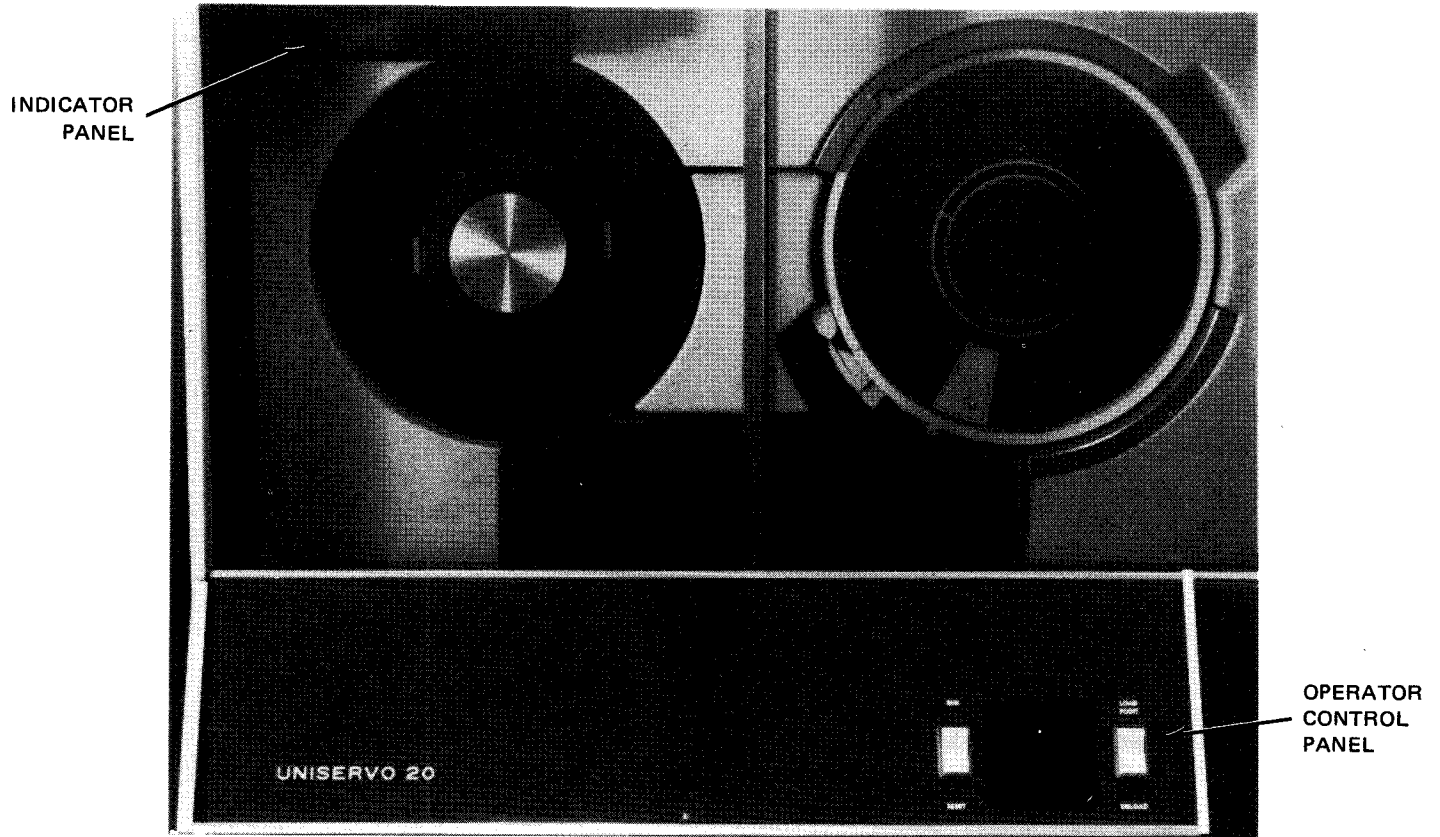

Figure 4-41. UNISERVO 20 Magnetic Tape Unit, Operator Panels

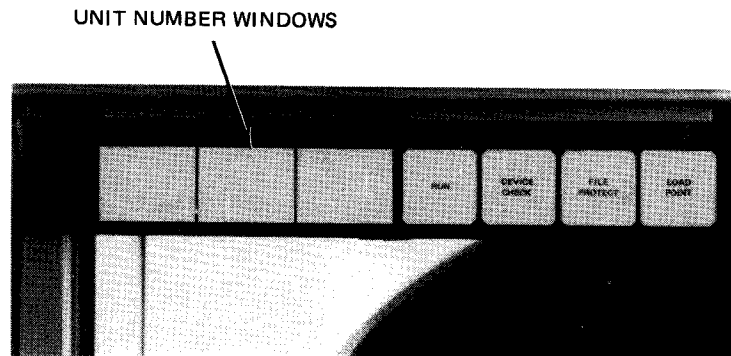

Figure 4-42. UNISERVO 20 Magnetic Tape Unit, Indicator Panel

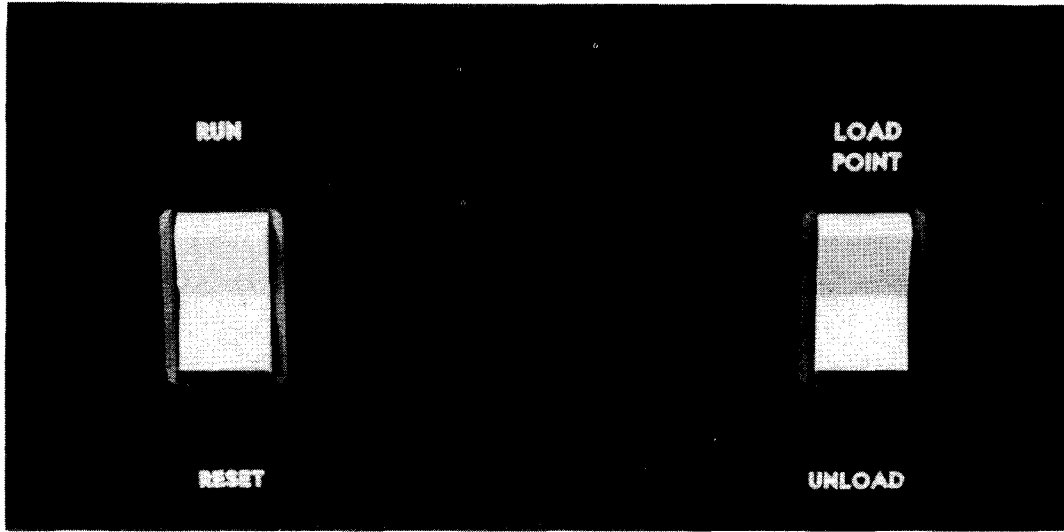

Figure 4-43. UNISERVO 20 Magnetic Tape Unit, Operator Control Panel

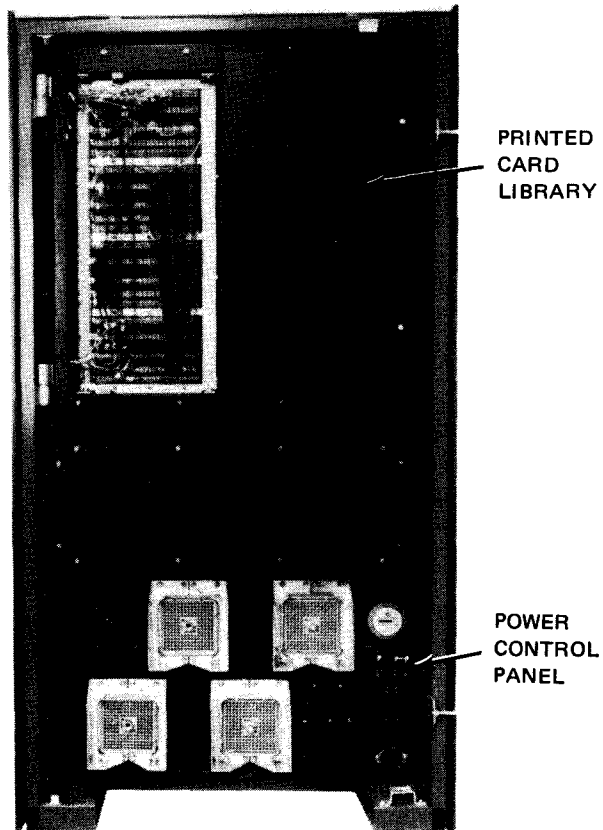

Figure 4-44. UNISERVO 20 Magnetic Tape Unit, Rear View

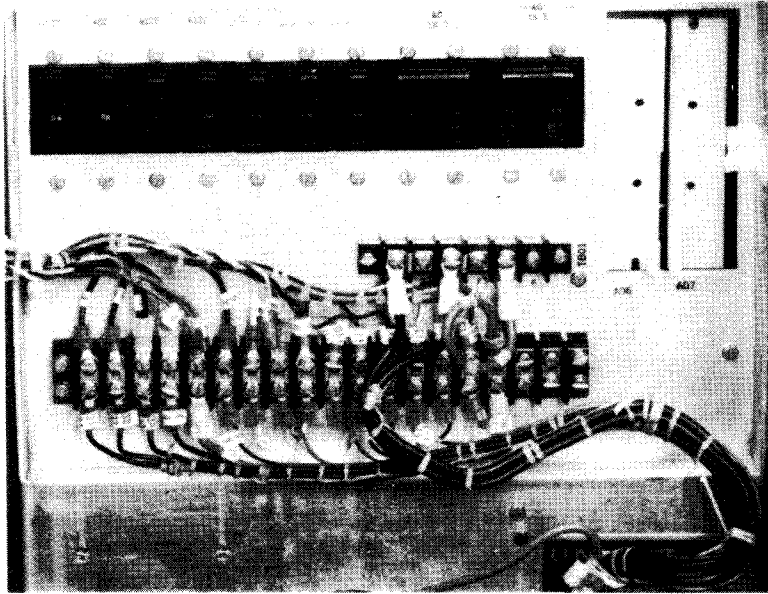

Figure 4-45. UNISERVO 20 Magnetic Tape Unit, Power Supply Panel

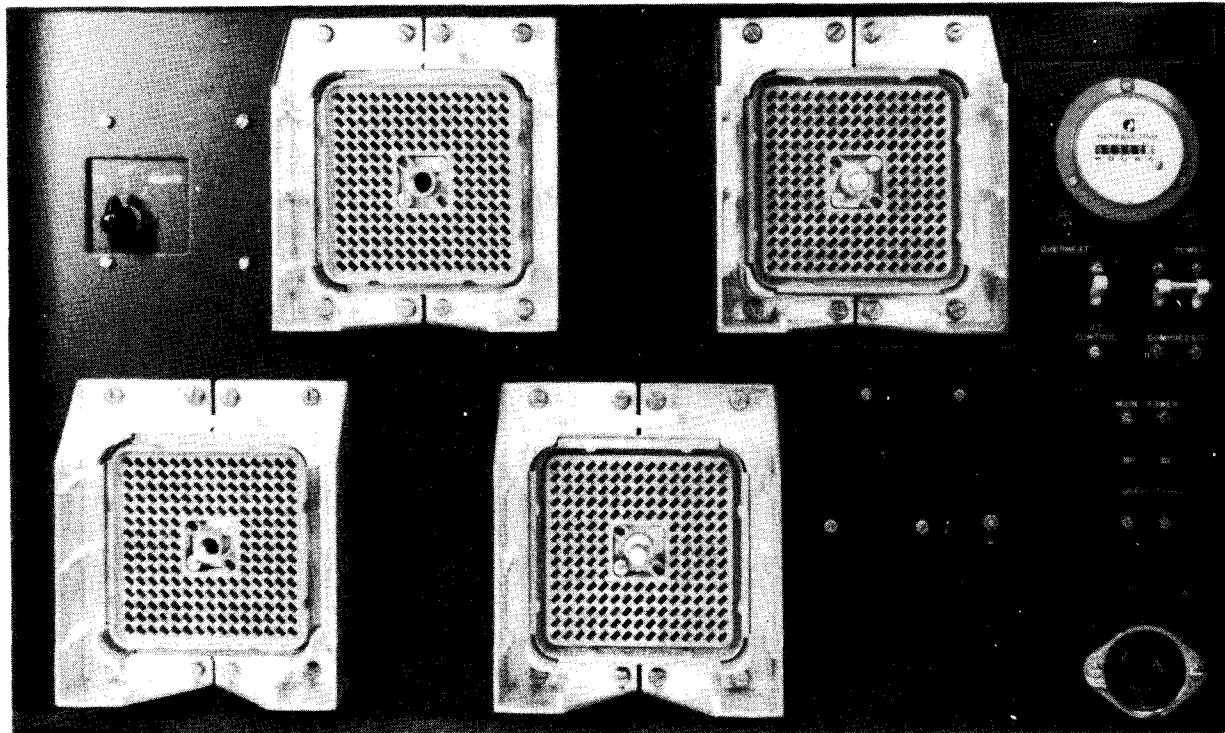

Figure 4-46. UNISERVO 20 Magnetic Tape Unit, Power Control Panel

Table 4-14. UNISERVO 20 Magnetic Tape Unit, Controls and Indicators (Part 1 of 6)

Control/Indicator — Function
Indicator Panel
Unit number indicator Displays number assigned to tape unit when power is turned on. Remains lit until power is turned off. Display numerals may be changed to correspond with address assigned to tape unit by the operating system.
RUN indicator Lights when tape unit can accept signals from control unit. A run condition can be initiated only when: <ul style="list-style-type: none">■ tape is in load condition, i.e., beginning of tape (BOT) marker is beneath BOT sensor;■ tape unit is in online mode;■ no interlock condition is present on tape unit (i.e., interlock switch is open, circuit breaker trips, or tape is not threaded properly); and■ no mechanical failure that requires attention by Sperry Univac customer engineer. RUN indicator goes off and run condition is cancelled when: <ul style="list-style-type: none">■ RUN/RESET switch is pressed;■ DEVICE CHECK indicator lights;■ tape unit is in local control;■ rewind-to-load point function is initiated (run is reset until completion of rewind);■ rewind-with-interlock function is initiated by control unit; or■ tape is not positioned properly in either vacuum column.
DEVICE CHECK indicator Lights when: <ul style="list-style-type: none">■ tape is not threaded properly;■ interlock condition has occurred and all operations stop; or■ tape is pulled out of either vacuum column or extends too far into either vacuum column because of malfunction. Goes off when abnormal condition is corrected and RUN/RESET switch is pressed. If pressing switch extinguishes indicator without corrective action, tape was probably not threaded properly.
FILE PROTECT indicator Lights: <ul style="list-style-type: none">■ when write-enable ring is not mounted on supply reel. No writing can take place unless write-enable ring is mounted on supply reel. Write-enable ring must be removed unless writing is to take place, or inadvertent tape erasure or modification of data may occur;■ during all rewind operations; and■ during a load sequence, and cleared by pressing RUN/RESET switch, regardless of whether write-enable ring is mounted on supply reel.

Table 4-14. UNISERVO 20 Magnetic Tape Unit, Controls and Indicators (Part 2 of 6)

Control/Indicator — Function
<p style="text-align: center;">Indicator Panel (cont)</p> <p>Goes off when write-enable ring is mounted on supply reel. A signal is indicated in status byte that ring is in proper position for writing.</p> <p>LOAD POINT indicator</p> <p>Lights when BOT marker is positioned beneath BOT sensor. Goes off when BOT marker moves away from BOT sensor and power to reel motors, capstan motor, and vacuum pressure pumps is off.</p>
<p style="text-align: center;">Operator Control Panel</p> <p>RUN/RESET switch</p> <p>RUN position:</p> <p>Places tape unit in run condition under control of control unit.</p> <p>RESET position:</p> <p>Causes:</p> <ul style="list-style-type: none">■ current run status to be cancelled;■ tape unit to be placed under local control;■ termination of an unload or load operation;■ rewinding rate to reduce to low speed if switch is tapped once, or rewind to terminate if switch is tapped again or held pressed;■ DEVICE CHECK indicator to go off if a tape threading operation has occurred;■ window to close if tape is loaded on tape transport panel; and■ OFF LINE indicator to light. <p>LOAD POINT/UNLOAD switch</p> <p>LOAD POINT position:</p> <p>Initiates rewind-to-load operation.</p> <p>Pressing switch when BOT marker is beneath BOT sensor does not initiate tape movement. LOAD POINT indicator goes off when tape BOT marker moves out from beneath BOT sensor.</p> <p>If tape reel is mounted but tape is not positioned in a load condition, tape advances to position BOT marker under BOT sensor.</p> <p>If tape reel is mounted and tape is in a loaded condition (i.e., beyond BOT marker), tape rewinds and REWIND indicator lights until BOT marker is positioned beneath BOT sensor.</p> <p>UNLOAD position:</p> <p>Initiates a rewind-and-unload operation.</p> <p>Pressing switch causes tape movement only if tape unit is in local control or if tape is not fully unloaded. Tape motion is halted when tape unloads.</p>

Table 4-14. UNISERVO 20 Magnetic Tape Unit, Controls and Indicators (Part 3 of 6)

Control/Indicator — Function
Operator Control Panel (Cont)
<p>Tape unit initiates an unload function when:</p> <ul style="list-style-type: none"> ■ tape unit is in local control (RUN/RESET switch pressed to RESET); and ■ tape BOT marker is positioned beneath BOT sensor. <p>Placing tape unit in an unload condition causes:</p> <ul style="list-style-type: none"> ■ tape to rewind at high speed to load point (i.e., BOT marker beneath sensor) and then continue at low speed; ■ REWIND and FILE PROTECT indicators to go on; ■ all tape to be transferred to supply reel; ■ window to open automatically at end of unload function; ■ power to be turned off for reel motors, capstan motor, and vacuum pressure pumps at completion of unload; and ■ OFF LINE indicator to light. <p>RUN indicator</p> <p>Lights when tape unit is available for control by control unit. If RUN/RESET switch is pressed while a load operation or rewind-to-load operation is in progress, tape unit does not enter run condition until operation is completed.</p> <p>Tape unit can accept run-condition signals from control unit when:</p> <ul style="list-style-type: none"> ■ tape is loaded on tape unit; ■ a rewind operation is not in progress; ■ no interlock function is in effect; and ■ RUN indicator is lit. <p>Tape unit cannot accept run-condition signals from control unit when:</p> <ul style="list-style-type: none"> ■ a load operation is in progress and tape is not yet loaded on tape unit; ■ a rewind-to-load point operation is in effect and load point has not been reached; ■ tape unit is not in local control and DEVICE CHECK indicator is lit. <p>LOAD POINT indicator</p> <p>Lights when BOT marker is beneath the marker sensor (tape reaches load point position).</p> <p>Tape unit initiates a load function that moves tape to load point when:</p> <ul style="list-style-type: none"> ■ tape unit is in local control; ■ tape reel is mounted but BOT marker is not positioned under BOT sensor; or ■ tape reel is mounted and BOT marker is positioned under BOT sensor. <p>NOTE:</p> <p>BOT marker is also referred to as load point marker when marker is approached from a rewind direction.</p>

Table 4-14. UNISERVO 20 Magnetic Tape Unit, Controls and Indicators (Part 4 of 6)

Control/Indicator — Function
Operator Control Panel (Cont)
Initiating a load function causes: <ul style="list-style-type: none">▪ power to be turned on for reel motors, capstan motor, and vacuum pressure pumps;▪ OFF LINE indicator to light;▪ LOAD POINT indicator to light after BOT marker is positioned under BOT sensor; and▪ REWIND and FILE PROTECT indicators to light when BOT marker is not positioned under sensor.
OFF LINE indicator
Lights when: <ul style="list-style-type: none">▪ power is applied to tape unit and no circuit breakers are tripped;▪ tape unit is in local control;▪ RUN/RESET switch is pressed to RESET;▪ rewind-to-load point operation is in progress; or▪ unload function is in progress.
Goes off when: <ul style="list-style-type: none">▪ power to tape unit is turned off;▪ control unit has control of tape unit; or▪ RUN indicator is lit.
REWIND indicator
Lights when: <ul style="list-style-type: none">▪ tape unit is in rewind mode;▪ unload operation is in progress (provided unload was not initiated at load point); or▪ a load function is initiated but BOT marker is not positioned beneath BOT sensor.
Goes off when: <ul style="list-style-type: none">▪ RUN/RESET switch is pressed to RESET for ½ second for fast rewind or tapped for slow rewind;▪ rewind function is completed;▪ LOAD POINT indicator lights;▪ DEVICE CHECK indicator lights; or▪ BOT marker is beneath BOT sensor during a load function.
A rewind function may be initiated manually by use of LOAD POINT/UNLOAD switch or by program control. Either method causes REWIND indicator to light and remain lit until function is completed or until tape is fully rewound on supply reel, unless a condition is detected which inhibits rewind function (circuit breaker trips, etc.) and causes indicator to go off.

Table 4-14. UNISERVO 20 Magnetic Tape Unit, Controls and Indicators (Part 5 of 6)

Control/Indicator — Function
Power Supply Panel
CB1 circuit breaker Provides overload protection for entire dc supply.
CB2 circuit breaker Provides overload protection for +24 volt supply.
CB3 circuit breaker Provides overload protection for +12 volt supply.
CB4 circuit breaker Provides overload protection for +5 volt supply
CB5 circuit breaker Provides overload protection for —12 volt supply
CB6 circuit breaker Provides overload protection for entire —62 volt supply
CB7 circuit breaker Provides overload protection for —62 volt line to capstan motor
CB8 circuit breaker Provides overload protection for —62 volt line to armature of left reel motor
CB9 circuit breaker Provides overload protection for —62 volt line to armature of right reel motor
CB10 circuit breaker Provides overload protection for —62 volt line to field windings of both reel motors
Power Control Panel
OVERHEAT indicator Lights when heat inside cabinet exceeds 135°F
POWER indicator Lights when power is present in tape unit

Table 4-14. UNISERVO 20 Magnetic Tape Unit, Controls and Indicators (Part 6 of 6)

Control/Indicator — Function
Power Control Panel (cont)
Time elapsed meter Indicates time, in hours, that tape is loaded on tape unit and a vacuum condition is maintained for tape motion control
AC CONTROL circuit breaker Provides overload protection for tape unit cooling fans and 24 Vac power control circuits.
COMPRESSOR circuit breaker Provides overload protection for compressor motor.
MAIN POWER circuit breaker Provides overload protection for all components and primary ac circuits in tape units.
ON/OFF/REMOTE switch Determines method of applying dc control power to tape unit logic circuits: ON position: Power is applied to one or more control circuits when they are activated. OFF position: Power is not available. REMOTE position: Power in tape unit is controlled at processor.

4.5.2. Turn-On and Turn-Off Procedures

Power to the subsystem is normally applied and removed via the **POWER ON/POWER OFF** switch on the processor operator/maintenance panel (Figure 2-2). However, to control power from this panel, certain switches and circuit breakers on the control unit and tape units must first be set to specified positions. The switch and circuit breaker settings are listed in Table 4-15.

When the switches and circuit breakers on the control unit and all tape units are set as specified (see Table 4-15) and the **POWER ON/POWER OFF** switch on the processor operator/maintenance panel is set to the **POWER ON** position, the following indicators should be lit on the indicator panel and operator control panel:

- Unit number and **OFF LINE** indicators on indicator panel
- **RUN** indicator on operator control panel if tape is loaded on the tape unit

Table 4-15. UNISERVO 20 Magnetic Tape Subsystem, Power Switch Settings

Switch/Circuit Breaker	Normal Setting
Control Unit Power Control Panel	
PWR SEQ LOCAL-REMOTE switch	REMOTE
POWER MAINS circuit breaker	On (up)
POWER CONTROL circuit breaker	On (up)
Control Unit Power Distribution Panel	
AC INPUT circuit breaker	On (up)
AC POWER/OFF switch	AC POWER
+12V circuit breaker	On (up)
-12V circuit breaker	On (up)
+6V circuit breaker	On (up)
Tape Unit Power Supply Panel	
All circuit breakers	On (up)
Tape Unit Power Control Panel	
AC CONTROL circuit breaker	On (up)
COMPRESSOR circuit breaker	On (up)
MAIN POWER circuit breaker	On (up)
ON/OFF/REMOTE switch	REMOTE

To turn power off for the subsystem, tape must first be fully rewound on all tape units to prevent tape stretch, which may be caused by very rapid removal of the tape loop from the vacuum columns. Power may then be turned off either at the processor or at the power panels on the control unit and on each tape unit (refer to 4.5.2.2).

4.5.2.1. Independent Power Turn-On Procedure

Power to the subsystem is turned on independently of the processor as follows:

1. Check that all circuit breakers on each tape unit power supply panel are set to on (up) position.
2. Check that **AC CONTROL**, **COMPRESSOR**, and **MAIN POWER** circuit breakers on each tape unit power control panel are set to an (up) position.
3. Set **ON/OFF/REMOTE** switch on each tape unit power control panel to **ON** position.
4. Check that all circuit breakers on control unit power distribution panel are set to on (up) position.
5. Set **AC POWER/OFF** switch on control unit power distribution panel to **AC POWER** position.
6. Check that **POWER MAINS** and **POWER CONTROL** circuit breakers on control unit power control panel are set to on (up) position.

7. Set **PWR SEQ LOCAL-REMOTE** switch on control unit power control panel to **LOCAL** position.
8. Note that **OFF LINE** indicator and unit number indicator on each tape unit indicator panel are lit.
9. Using the *UP* function of the SET IO command (Section 12), place the tape unit in system's resource list for job allocation.

4.5.2.2. Independent Power Turn-Off Procedure

Power to the subsystem is turned off independently of the processor as follows:

NOTE:

Before performing the following procedures, remove the device from the system's list of available resources by using the DOWN function of the SET IO command (Section 12). After the procedure is completed, restore the device's available status by using the UP function of the SET IO command.

1. If tape is not fully rewound onto supply reel on each tape unit, rewind it as directed in 4.5.3.3 or 4.5.3.4 to prevent tape stretch.
2. Place tape unit in an offline condition by pressing **RESET** half of **RUN/RESET** switch on each tape unit operator control panel. Note that **OFF LINE** indicator lights.
3. Set **ON/OFF/REMOTE** switch on each tape unit power control panel to **OFF** position.
4. Set **PWR SEQ LOCAL-REMOTE** switch on control unit power control panel to **LOCAL** position.
5. Set **POWER MAINS** circuit breaker on control unit power control panel to off (down).

CAUTION

*Before turning power off at the subsystem, be sure that the **OFF LINE** indicator is lit (by pressing **RESET** switch). Failure to follow this procedure will result in power transients that may interfere with processor operation.*

4.5.3. Operating Procedures

Operating procedures for the subsystem include dressing the tape end for use with automatic loading (4.1.2.1), loading tape with the tape reel cartridge, loading tape without the tape reel cartridge, and tape unloading.

4.5.3.1. Tape Loading With Reel Cartridge

Mount a supply reel on the tape unit as follows:

1. Before mounting the reel, check to see if it contains a write-enable ring.
 - If writing is to be done on the tape, a write-enable ring must be used. Figure 4-47 illustrates the back of the reel of tape and a write-enable ring. The ring fits into a slot in the reel.
 - If no writing is to be done on the tape, the reel must not contain a write-enable ring.
 - No writing or erasing can occur during tape rewinding.

CAUTION

Remove the write-enable ring when it is not required for writing, because inadvertent tape erasure or modification of data may occur.

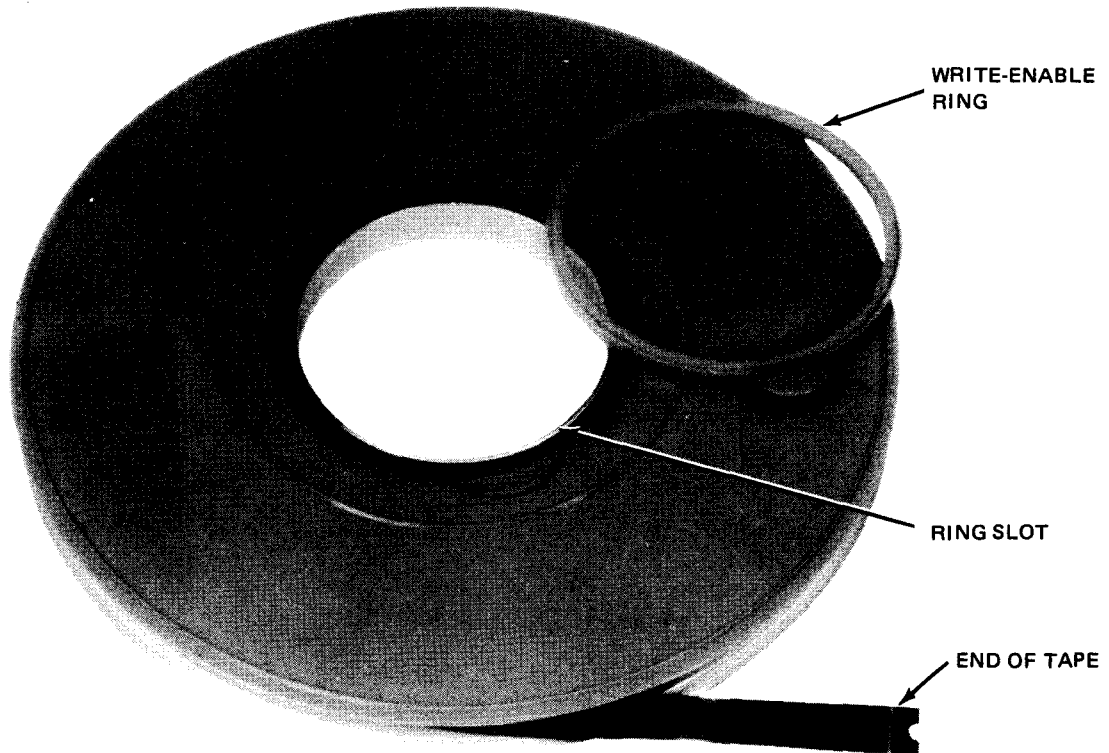

Figure 4-47. Tape Reel and Write-Enable Ring

2. Attach the tape reel to the tape reel cartridge as follows:
 - a. Open the clasp to secure the reel in the cartridge (Figure 4-48).
 - b. Insert the tape reel in the cartridge so that the reel front is facing out. Be sure that the entire circumference of the reel edge fits evenly in the cartridge.
 - c. Close the clasp to secure the reel in the cartridge.

NOTE:

Use of the tape reel cartridge permits faster tape loading and unloading, and prevents tape from unwinding.

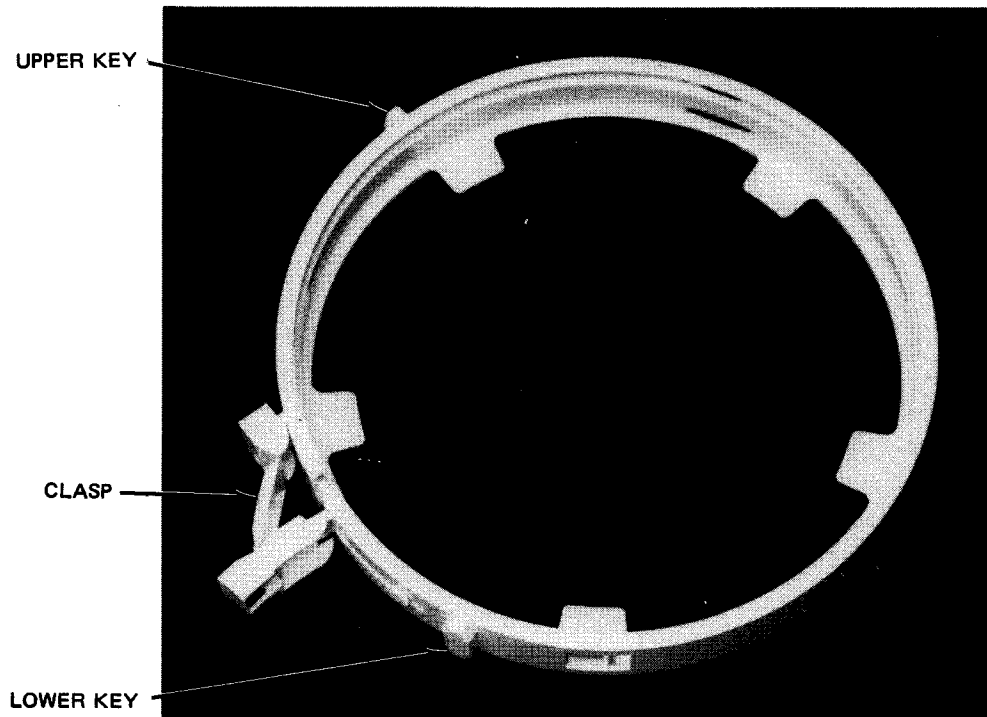

Figure 4-48. Tape Reel Cartridge

3. Press **RESET** switch, then set **LOAD/UNLOAD** switch on operator control panel to **UNLOAD** to open glass door at tape transport panel.
4. Mount tape reel cartridge with tape on supply hub so that upper and lower keys on cartridge (Figure 4-48) fit in slots provided for them on tape transport panel (Figure 4-49).
5. Press reel to lock it in place.

CAUTION

Be sure that reel is fully locked around the entire circumference of the hub or damage may result to the reel.

6. Press **LOAD POINT/UNLOAD** switch on operator control panel to **LOAD POINT** position. Power is now applied to reel motors, capstan motor, and vacuum pressure pumps, which causes the window to close and the tape to be advanced to the load point marker.

NOTE:

*The cartridge clasp is automatically opened by the clasp opener pin (Figure 4-50) when the **LOAD POINT** switch is pressed.*

7. Press **RUN** switch on operator control panel.

- Note that **LOAD POINT** and **RUN** indicators on operator control panel and indicator panel light. Tape unit is now ready for remote operation under control of processor via the control unit.

NOTE:

The front cabinet door on the tape unit must be closed to permit vacuum pressure and to thread tape automatically. The window also must be closed for remote operation.

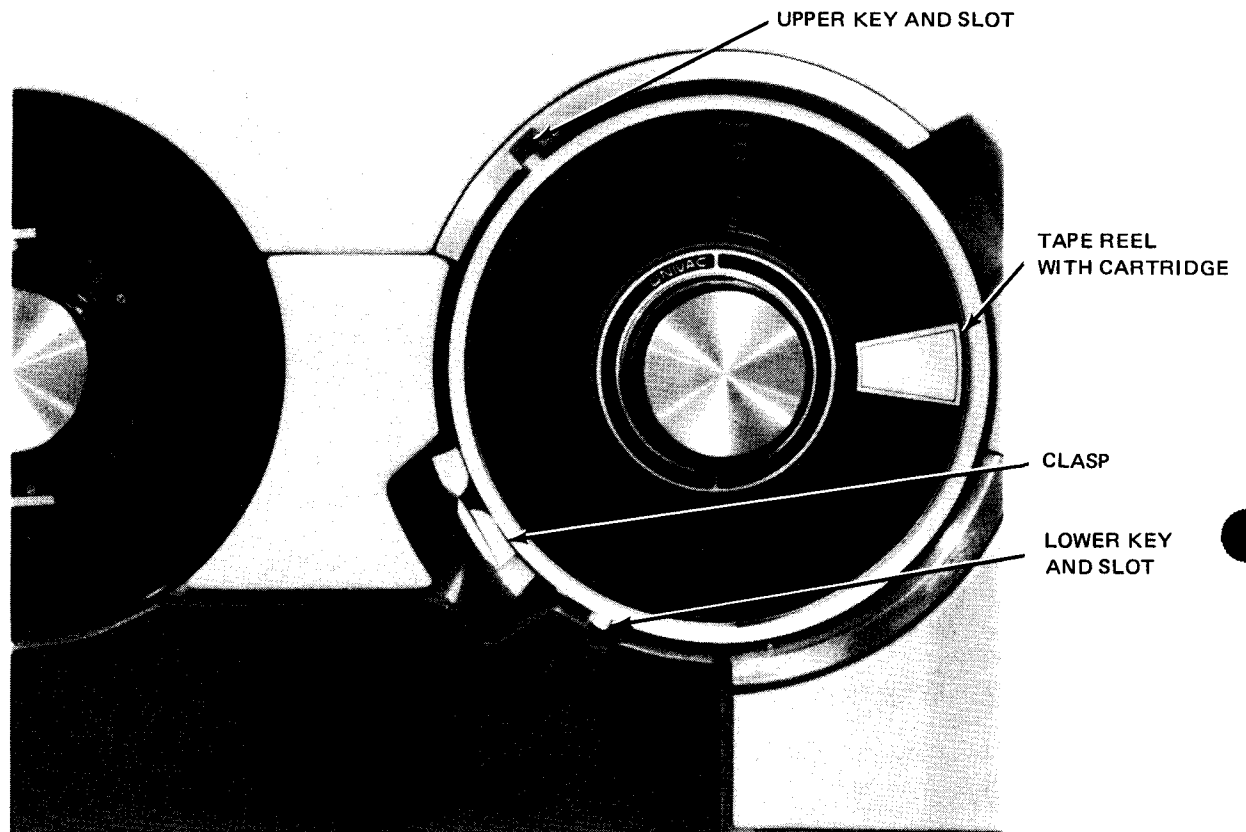

Figure 4-49. Tape Reel Mounted on Supply Hub With Cartridge

4.5.3.2. Tape Loading Without Reel Cartridge

Tape is threaded automatically, without a tape leader, through the tape transport. Proceed as follows:

- Check that the tape end has a smooth finished edge for proper threading. If necessary dress the tape end (4.1.2.1).
- Mount reel on supply hub so that leading edge of tape is approximately one inch from 180-degree point of reel socket (Figure 4-50).
- Press reel to lock it on hub.
- Perform steps 6, 7, and 8 of 4.5.3.1.

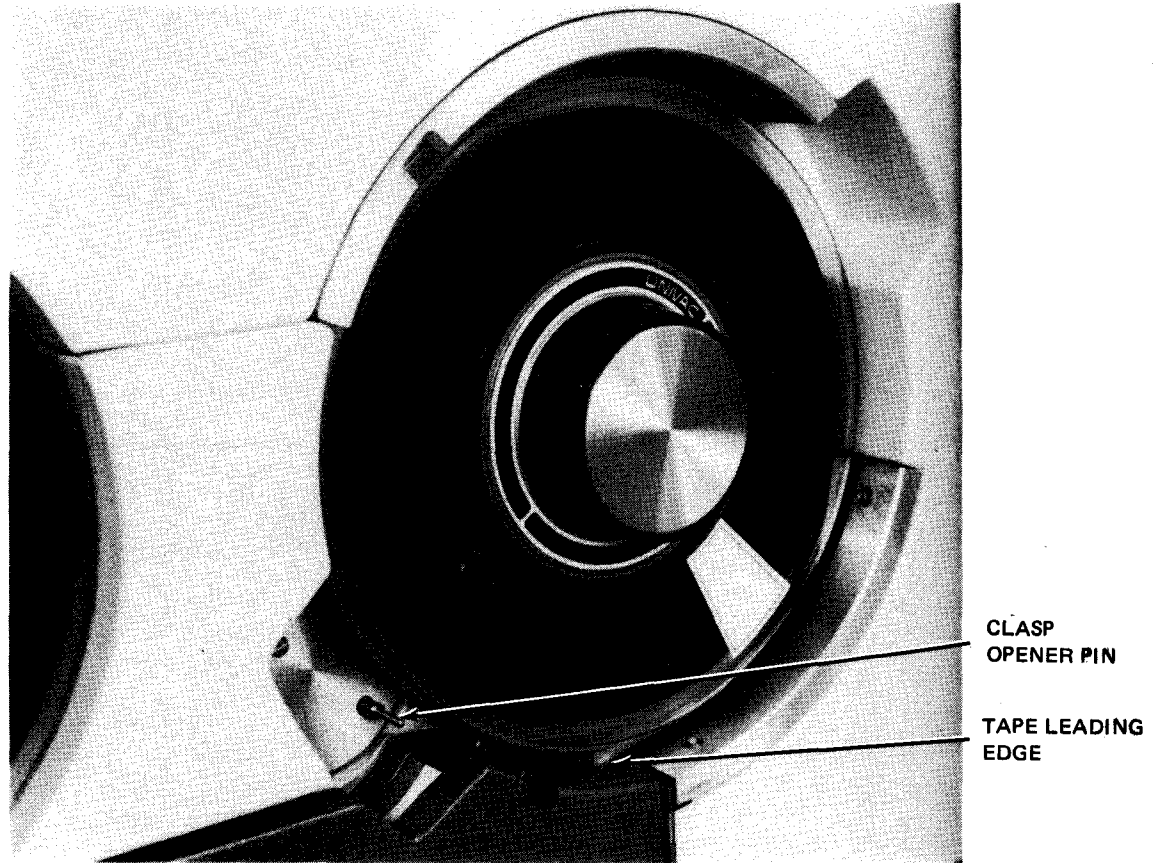

Figure 4-50. Tape End Positioned for Automatic Loading Without Tape Reel Cartridge

4.5.3.3. Tape Unloading With Program Control

If the program issues a rewind-with-interlock function, the tape rewinds completely and all tape is transferred to the supply reel. The window on the control unit opens automatically and the reel motors, capstan motor, and vacuum pressure pump are turned off. To unload the tape reel, proceed as follows:

1. Close clasp (Figure 4-49) to secure reel in cartridge if a tape reel cartridge is used.
2. Press supply reel hub to unlock tape reel.
3. Remove tape reel from its hub.

4.5.3.4. Tape Unloading Without Program Control

To unload tape when it is not fully rewound on the supply reel, proceed as follows:

1. Set **RUN/RESET** switch on operator control panel to **RESET** to place tape unit in local operating mode.
2. Press **LOAD POINT/UNLOAD** switch on operator control panel to **UNLOAD** position to allow all tape to be transferred to supply reel. Window on tape unit opens, and reel motors, capstan motor, and vacuum pressure pump turn off automatically after all tape is transferred.
3. Perform steps 1, 2, and 3 of 4.5.3.3.

4.5.4. Recovery Procedures

Table 4—16 lists the control unit and tape unit malfunctions that may be corrected by the operator. An abnormal condition presents certain indications on the control unit and tape unit power panels, or on the tape unit indicator panel. If the operator is able to correct the condition, a reply to the processor should be made with the GO command message after recovery is complete.

Table 4—16. UNISERVO 20 Magnetic Tape Subsystem, Recovery Procedures (Part 1 of 2)

Fault Indication	Probable Cause	Operator Action
Control Unit		
AIR FLOW indicator is lit.	Air intake is obstructed.	<ol style="list-style-type: none"> 1. Set POWER MAINS circuit breaker to off (down). 2. Check air intake for obstruction of air flow. 3. Remove obstruction and set POWER MAINS circuit breaker to on (up). 4. If no obstruction is apparent and AIR FLOW indicator remains lit, notify Sperry Univac customer engineer.
EARLY WARNING indicator is lit and audible alarm is sounding.	Air intake is obstructed.	<ol style="list-style-type: none"> 1. Set POWER MAINS circuit breaker to off (down). 2. Check air intake for obstruction of air flow. 3. Remove obstruction and set POWER MAINS circuit breaker to on (up). 4. Set FAULT CLR/RESTART switch to FAULT CLR and then to RESTART; if indication persists, notify Sperry Univac customer engineer.
OVER HEAT indicator is lit.	Control unit is overheated.	Turn off subsystem immediately; notify Sperry Univac customer engineer.
Subsystem is completely inoperative.	Main circuit breaker is tripped.	<ol style="list-style-type: none"> 1. Set POWER MAINS circuit breaker to off (down) and then to on (up). 2. Set FAULT CLR/RESTART switch to FAULT CLR and then to RESTART; if power loss occurs again, notify Sperry Univac customer engineer.
Subsystem is partially inoperative.	A circuit breaker on power distribution panel tripped.	<ol style="list-style-type: none"> 1. Reset any tripped circuit breaker; (set to off (down) and then to on (up)). 2. Set FAULT CLR/RESTART switch to FAULT CLR and then to RESTART. If power loss occurs again, notify Sperry Univac customer engineer.
PWR SUP OVER TEM indicator is lit.	Power supply is overheated.	Turn off subsystem immediately; notify Sperry Univac customer engineer.

Table 4-16. UNISERVO 20 Magnetic Tape Subsystem, Recovery Procedures (Part 2 of 2)

Fault Indication	Probable Cause	Operator Action
Tape Unit		
Subsystem is completely inoperative.	Main circuit breaker tripped.	<ol style="list-style-type: none"> 1. Reset MAIN POWER circuit breaker on power control panel (set to off (down) and then to on (up)). 2. If power loss occurs, notify Sperry Univac customer engineer.
Subsystem is partially inoperative.	A circuit breaker is tripped.	<ol style="list-style-type: none"> 1. Reset any tripped circuit breaker on power control panel and power supply panel by setting to off (down) and then to on (up). 2. If circuit breaker trips again, notify Sperry Univac customer engineer.
FILE PROTECT indicator remains lit when attempting to write on tape.	Write-enable ring is not installed on tape reel.	<ol style="list-style-type: none"> 1. Check that write-enable ring is properly installed on supply reel. 2. Check that supply reel is properly positioned.
RUN indicator is off and DEVICE CHECK indicator is lit.	Tape end was not positioned correctly during tape loading procedure.	<ol style="list-style-type: none"> 1. Check that tape is properly threaded and not pulled out of vacuum column or extended too far into columns. 2. Rewind tape if correction is required. 3. Press RUN/RESET switch to RESET. 4. Press LOAD POINT/UNLOAD switch to LOAD POINT.
OVERHEAT indicator is lit.	Cooling air for tape unit is obstructed.	<ol style="list-style-type: none"> 1. Set MAIN POWER circuit breaker on power control panel to off (down). 2. Remove any obstruction from cooling vents. 3. Notify Sperry Univac customer engineer to determine that overheat condition is corrected and to reset thermostat.



5. Printer Subsystems

5.1. GENERAL

Printer subsystems available for use with the SPERRY UNIVAC 90/30 or 90/30 B Systems are:

- SPERRY UNIVAC 0768 Printer Subsystem
- SPERRY UNIVAC 0770 Printer Subsystem
- SPERRY UNIVAC 0773 Printer Subsystem
- SPERRY UNIVAC 0776 Printer Subsystem
- SPERRY UNIVAC 0778 Printer Subsystem

The 0768 printer subsystem is a drum type printer capable of printing a full set of 63 characters at the rate of 900 lines per minute (lpm), or a subset of 49 contiguous characters at 1100 lpm. With an expanded character set, a full set of 94 characters is printed at a rate of 840 lpm; a subset of 87 contiguous characters at the rate of 1000 lpm; and a subset of 14 characters at the rate of 2000 lpm. Each character on the drum is represented by an 8-bit byte which must be preloaded into an assigned buffer location. Printing is on a 132-position (column) line. After a line is printed, the form advances one, two, or three lines as specified by the printing program. For movement of more than three lines, a prepunched forms control tape is used.

The 0770 printer subsystem is an impact type printer with an operator-replaceable print cartridge. This subsystem may be any one of a family of three printers capable of printing at rates of 800 lpm, using a 48-character set, to 3000 lpm using a 24-character set. A basic print line contains 132 columns which may be expanded to 160 columns with feature 1533. Forms are advanced by program control. Forms control information and character-code bytes are preloaded into appropriate buffers under program control.

The 0773 printer subsystem is an impact type printer with an operator-replaceable print cartridge. Printing rates are from 217 lpm, using a 128-character set, to 670 lpm using a 16-character set. A basic print line contains 120 columns which may be expanded to 132 columns with feature 1648-01, or to 144 columns with feature 1640-02. The basic print cartridge has 48 different characters on a 240-character print band. Expanded character sets have 63 different characters on 256-character print bands. As in the 0770 printer, forms are advanced by program control by preloading an associated buffer. Character codes are also preloaded in another associated buffer.



The 0776 printer subsystem is an impact type printer with an operator-replaceable print cartridge. Printing rates are from 325 lpm, using three arrays of 128 characters (nonrepeated) in each array, up to 1250 lpm, using 16 arrays with 24 characters (nonrepeated) in each array. A basic print line contains 136 columns and can accept forms up to 24 inches (60.96 cm) wide. Forms are advanced by program control. Up to 384 characters can be included on a print band. Character codes are preloaded in an associated buffer under program control.

The 0778 printer subsystem is an impact type printer with an operator-replaceable print cartridge. Printing rates are 120 lpm, using a 128-character set, to 360 lpm, using a 16-character set. A basic print line contains 120 columns but can be expanded to 136 columns with F2386-01. Expanded character sets have 63 different characters on 256-character print band. As in the 0770 and 0773 printers, forms are advanced by program control by preloading an associated buffer. Character codes also are preloaded in an associated buffer under program control.



5.2. 0768 PRINTER SUBSYSTEM

The 0768 printer subsystem is a single unit with self-contained control circuits and power supplies. Most operations for the printer are controlled from the front; however, basic run/stop operations can also be controlled from the rear to facilitate forms handling during an operation. Primary power control is also available at the rear of the unit.

5.2.1. Operating Controls and Indicators

Four operating control panels (Figures 5—1 and 5—2) contain all controls normally required to operate the printer. The left control panel (Figure 5—3) controls power on/off sequencing and other functions associated with operating modes. The right control panel (Figure 5—4) is used mostly for forms control, forms loading, and ribbon changing. The rear control panel (Figure 5—5) is used primarily to facilitate stop/run operations while forms are being fed to a rear platform. The power control panel (Figure 5—6) controls primary power and remote/local operation of the printer. Table 5—1 lists all of the operating controls for all four panels.

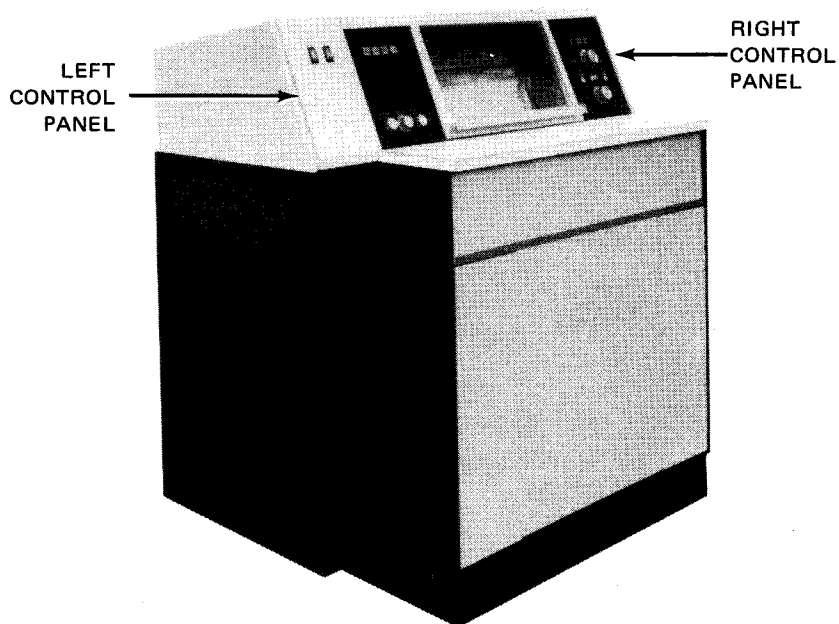

Figure 5—1. 0768 Printer Subsystem

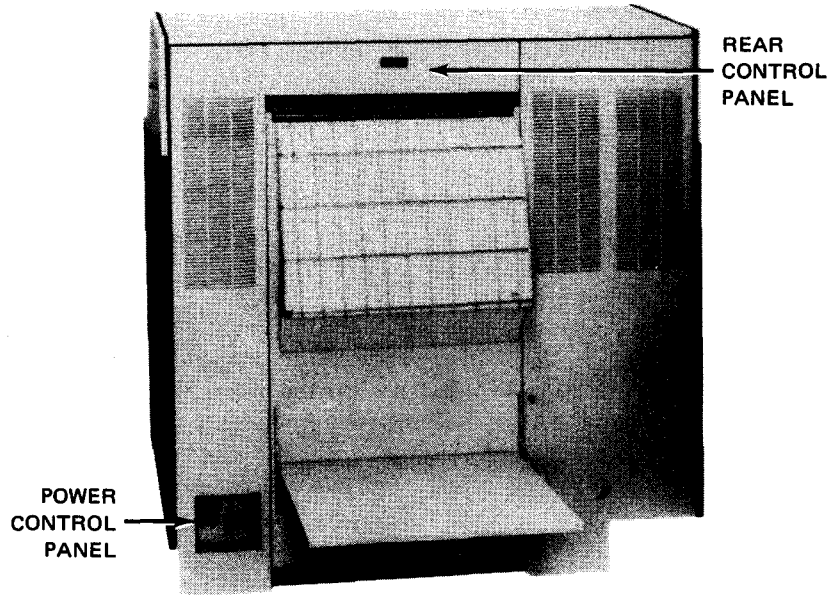

Figure 5-2. Rear View of 0768 Printer Subsystem

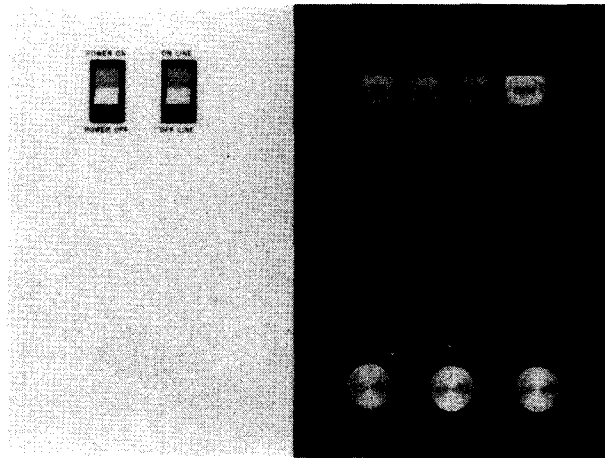

Figure 5-3. 0768 Printer Subsystem, Left Control Panel

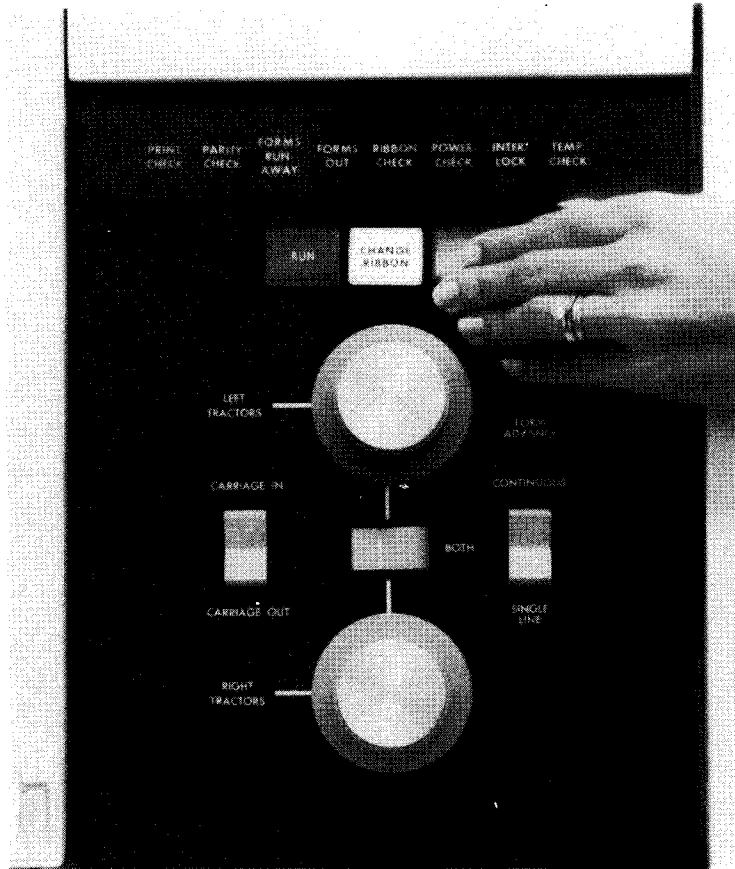

Figure 5-4. 0768 Printer Subsystem, Right Control Panel

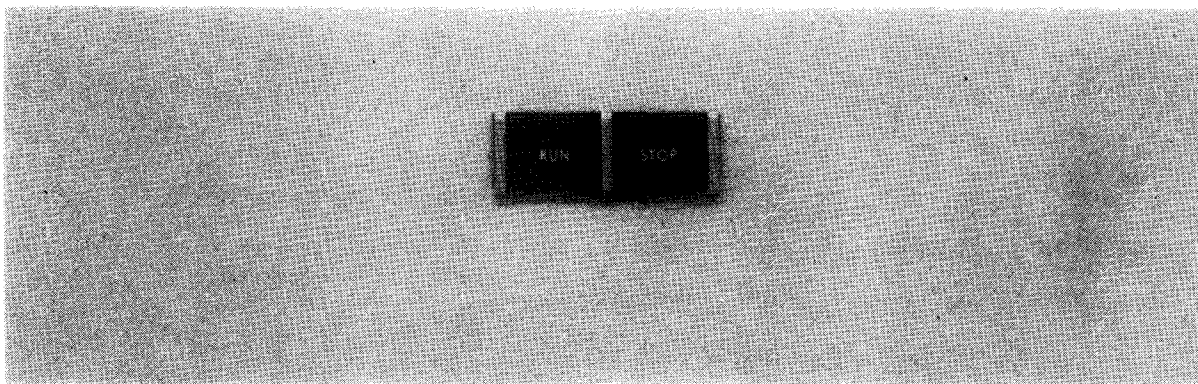

Figure 5-5. 0768 Printer Subsystem, Rear Control Panel

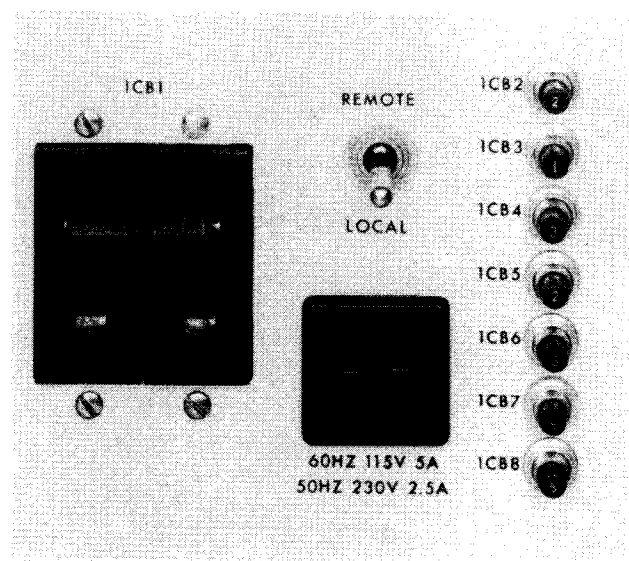

Figure 5-6. 0768 Printer Subsystem, Power Control Panel

Table 5-1. 0768 Printer Subsystem, Controls and Indicators (Part 1 of 6)

Control/Indicator — Function
Left Control Panel
POWER ON/POWER OFF switch Controls power to the printer NOTE: Before deactivating the power circuits, press the ON LINE/OFF LINE switch to OFF LINE to prevent interference with remaining system operations.
ON LINE/OFF LINE switch In ON LINE position, connects the printer control circuitry to the processor via the multiplexer channel In OFF LINE position, disconnects printer control circuitry from the processor; current instruction is completed; RUN switch/indicator goes off; and STOP switch/indicator lights. In OFF LINE position, power to the printer may be turned on or off without affecting the operation of the multiplexer channel.

Table 5—1. 0768 Printer Subsystem, Controls and Indicators (Part 2 of 6)

Control/Indicator — Function
Left Control Panel (cont)
OFF LINE indicator Lights when the printer is in offline mode and effectively disconnected from the processor
HOME switch/indicator Advances form until the home-form code, punched in the form control tape, is detected. Each time switch is pressed, this action is repeated. The printer must be in the offline or stop mode for this operation. The HOME indicator lights when the form control tape is in the home paper position.
MANUAL PRINT pushbutton Prints the contents of the print buffer. Each time pushbutton is pressed, this action is repeated. This pushbutton is operative only when the printer is in the offline mode.
CLEAR pushbutton Clears the fault circuits and extinguishes the following indicators (on the right control panel): <ul style="list-style-type: none">▪ PRINT CHECK▪ FORMS RUNAWAY▪ FORMS OUT▪ PARITY CHECK This pushbutton is operative only when the OFF LINE/ON LINE switch is in the OFF LINE position.
LINE POSITION control Adjusts the vertical position of a preprinted form with respect to the print line (printer hammer line). Clockwise rotation raises the preprinted form; this adjustment can be made while the printer is in operation.
FORM THICKNESS control Adjusts for form thickness. Counterclockwise rotation allows thicker forms to be used. Perform this adjustment with the carriage in the out position, and then return the carriage to its normal operating position.
FORM TENSION control Adjusts vertical position on the form. Clockwise rotation increases tension. Perform this adjustment with the carriage in the out position. Use this control when it is evident form tension is incorrect (that is, form sprocket holes are elongated or tearing as forms are moving past print head).

Table 5-1. 0768 Printer Subsystem, Controls and Indicators (Part 3 of 6)

Control/Indicator — Function
Right Control Panel
PRINT CHECK indicator Lights when any of the following conditions occur: <ul style="list-style-type: none">▪ Actuator driver circuit jammed▪ Open actuator coil or connector▪ High voltage circuit malfunction▪ Blown fuse on print actuator card
PARITY CHECK indicator Lights when a parity error is detected
FORMS RUNAWAY indicator Lights whenever a form has advanced for two seconds or more without intervention
FORMS OUT indicator Lights when the last 2.5 inches of paper is positioned below the print head and the home paper code (1111 or 1110), punched in the form control tape, is detected
RIBBON CHECK indicator Lights after the CHANGE RIBBON switch/indicator is pressed prior to a ribbon change; the ribbon is switching from the upper take-up mandrel and preparing to wind down onto the lower take-up mandrel.
POWER CHECK indicator Lights when a dc circuit breaker trips or a dc supply fails
INTERLOCK indicator Lights when interlock is open in the left panel, forms loop access panel, or ribbon access panel
TEMP CHECK indicator Lights if: <ul style="list-style-type: none">▪ air flow is deficient; or▪ an early warning occurs for excessive temperature (over 110° F)
RUN switch/indicator Initiates normal operation between the processor and printer. Press when the STOP switch/indicator is lit and the printer is in the online mode. The STOP indicator then goes out and the RUN indicator lights.

Table 5-1. 0768 Printer Subsystem, Controls and Indicators (Part 4 of 6)

Control/Indicator — Function
Right Control Panel (cont)
CARRIAGE CHECK indicator Lights when the carriage moves outward, away from the form
CHANGE RIBBON switch/indicator Lights when pressed or when the ribbon is fully wound on the upper mandrel
STOP switch/indicator Stops printing after completion of current operation. Lights if any of the following indicators light during an operation: <ul style="list-style-type: none">▪ FORMS OUT▪ PRINT CHECK▪ POWER CHECK▪ FORMS RUNAWAY▪ INTERLOCK▪ TEMP CHECK▪ RIBBON CHECK▪ CARRIAGE CHECK When held pressed, STOP switch/indicator also lights all panel indicators for a lamp check.
LEFT TRACTORS control Moves both upper and lower left tractors. Clockwise rotation moves the tractors to the right, and counterclockwise rotation moves the tractors to the left. Do not turn this control during printing. NOTE: Before using this control, release the upper left tractor lock and set the BOTH switch in the left position. To release the tractor lock, press the knob inward toward the tractor shaft before attempting to position the tractor.
RIGHT TRACTORS control Moves right tractors in the same way as LEFT TRACTORS control
BOTH switch When pressed to the right (toward BOTH), links the left and right tractors so they can be moved simultaneously with either tractor control. When pressed to the left, LEFT TRACTORS and RIGHT TRACTORS controls operate individually.

Table 5-1. 0768 Printer Subsystem, Controls and Indicators (Part 5 of 6)

Control/Indicator — Function
Right Control Panel (cont)
<p>CARRIAGE IN/CARRIAGE OUT switch</p> <p>When pressed to CARRIAGE IN position, moves the carriage in to the printing position. When pressed to CARRIAGE OUT position, moves the carriage outward away from the form.</p> <p>NOTE:</p> <p>This switch can operate only when the form access cover is in the up position.</p> <p>FORM ADVANCE switch</p> <p>Advances form manually when the STOP switch indicator lights</p> <ul style="list-style-type: none"> ■ When pressed and held in the CONTINUOUS position, advances form until the switch is released ■ When pressed to the SINGLE LINE position, advances form one line each time the switch is pressed
Power Control Panel
<p>1CB1 circuit breaker</p> <p>Controls power to the subsystem</p> <p>REMOTE/LOCAL switch</p> <p>Selects where ac power is to be controlled:</p> <p>LOCAL position:</p> <p>Power is controlled at the printer.</p> <p>REMOTE position:</p> <p>Power is controlled from the processor.</p> <p>1CB2 pushbutton circuit breaker</p> <p>Provides overload protection for main blower motor and the clutch/brake blower motor. If tripped, the POWER CHECK indicator lights.</p> <p>1CB3 pushbutton circuit breaker</p> <p>Provides overload protection for the print head blower motor and static eliminator. If tripped, the POWER CHECK indicator lights.</p> <p>1CB4 pushbutton circuit breaker</p> <p>Provides overload protection for the carriage motor. If tripped, the POWER CHECK indicator lights.</p>

Table 5-1. 0768 Printer Subsystem, Controls and Indicators (Part 6 of 6)

Control/Indicator — Function
Power Control Panel (cont)
1CB5 pushbutton circuit breaker Provides overload protection for the ribbon feed and print check relays and the ribbon motor
1CB6 pushbutton circuit breaker Provides overload protection for the print drum motors and the paper feed motor. If tripped, the POWER CHECK indicator lights.
1CB7 pushbutton circuit breaker Provides overload protection for the convenience outlet
1CB8 pushbutton circuit breaker Provides overload protection for the dc indicator light circuits. If tripped, the POWER CHECK indicator lights.

5.2.2. Turn-On and Turn-Off Procedures

Power for the printer is normally applied and removed by the **POWER ON/POWER OFF** switch on the processor operator/maintenance panel (Figure 5-2). However, to control power from this panel, certain switches and circuit breakers on the printer must first be set to specific positions. The switch and circuit breaker settings for the printer are listed in Table 5-2.

CAUTION

*Do not apply power to the printer as specified in Table 5-2 if the processor **POWER ON/POWER OFF** switch is presently in the **POWER ON** position, as power transients may disturb processor operation. Instead, follow the procedures provided in 5.2.2.1.*

When the switches and circuit breakers on the printer are set as specified in Table 5-2, and the **POWER ON/POWER OFF** switch on the processor is set to **POWER ON**, the **STOP** switch/indicator should be lit on the right control panel.

Table 5-2. 0768 Printer Subsystem, Power Switch Settings

Switch/Circuit Breaker	Normal Setting
Left Control Panel	
POWER ON/POWER OFF switch	POWER ON
ON LINE/OFF LINE switch	ON LINE
Power Control Panel	
1CB1 circuit breaker	On (up)
REMOTE/LOCAL switch	REMOTE
1CB2 through 1CB8 pushbutton circuit breakers	On (in)

If any other indicators on the printer are lit, or if the **STOP** switch/indicator does not light, contact the Sperry Univac customer engineer.

5.2.2.1. Independent Power Turn-On Procedure

To turn on power at the printer independently of the processor, proceed as follows:

1. Set **ON LINE/OFF LINE** switch on left control panel to **OFF LINE**.
2. Set **LOCAL/REMOTE** switch on power control panel to **LOCAL** position.
3. Ensure that all circuit breakers on the power control panel are in their on position.
4. Set **POWER ON/POWER OFF** switch on left control panel to **POWER ON** position. Allow 30 seconds for power-on clearing sequence. Check to see that the **OFF LINE** switch/indicator on the left control panel and the **STOP** switch/indicator on the right control panel both light.
5. Using the *UP* function of the SET IO command (Section 12), include the printer in the system's resources list for job allocation.

5.2.2.2. Independent Power Turn-Off Procedure

To turn off power at the printer independently of the processor, proceed as follows:

1. Using the *DOWN* function of the SET IO command (Section 12), remove the printer from the system's resources and prevent it from being allocated to a job while offline.
2. Set **ON LINE/OFF LINE** switch on left control panel to **OFF LINE** position.
3. Set **LOCAL/REMOTE** switch on power control panel to **LOCAL** position.
4. Set **POWER ON/POWER OFF** switch on left control panel to **POWER OFF** position.
5. Set **1CB1** circuit breaker on power control panel to off (down) position if complete power turn off is desired.

5.2.3. Operating Procedures

Operating procedures for the printer include: preparing a forms control tape, installing or replacing tape, loading forms, adjusting print character phasing, and selecting print drum motor speed.

5.2.3.1. Forms Control Tape Preparation

A punched paper forms control tape loop is used to control form advancement; the blank tape is selected as required for operating at 6 or 8 lines per inch (6-line-per-inch (lpi) tape — Sperry Univac Part No. 3168457-00; 8-lpi tape — Sperry Univac Part No. 3168457-01).

The length of the forms control tape is between 10 and 22 inches and is equal to the form length or to a multiple of form length. Figure 5-7 illustrates sections of a 6-lpi and an 8-lpi forms control tape loop. Channel 1 is on the left side of the tape and channel 4 is on the right side. The evenly spaced perforations running vertically in the center of the tape are sprocket holes that ensure proper tape feeding and alignment. The arrow printed on the tape indicates the direction the tape travels when it is installed. Also, four columns of small circles are printed on the tape as an aid to perforation. The cross in the center of each of these circles assists in centering the perforations. The numbers (1, 2, 4, and 8) to the right of each track designate the channel code position to which each is related. The codes are listed in Table 5-3.

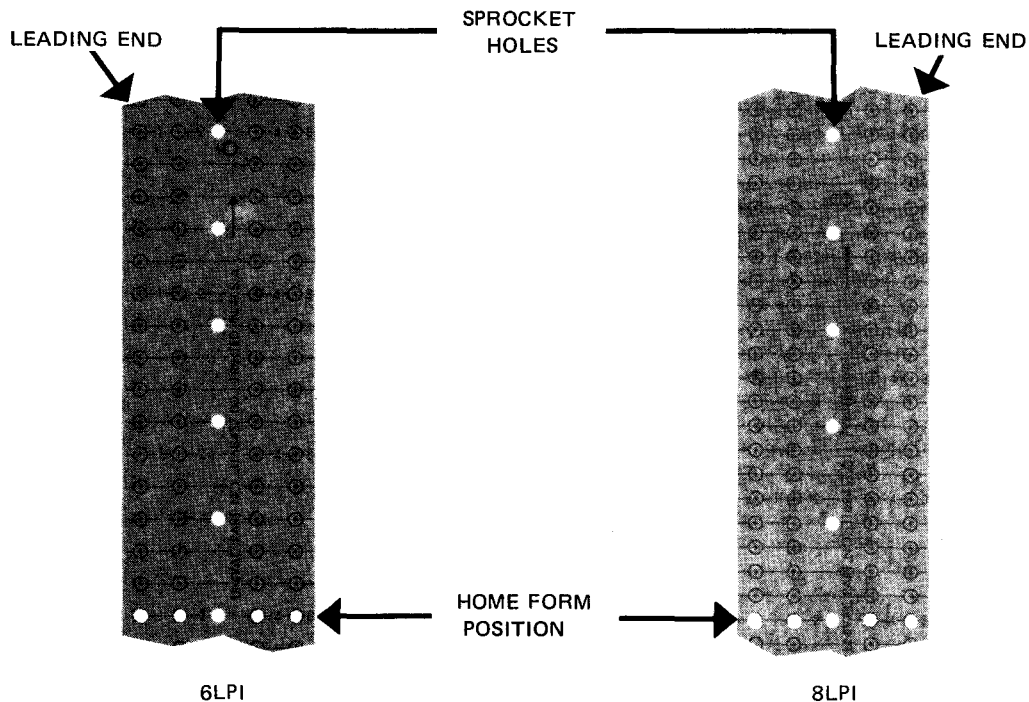

Figure 5-7. 0768 Printer Subsystem, Forms Control Tapes

Table 5-3. 0768 Printer Subsystem, Forms Control Tape Code Designations

Channel	Designation
4	—
1 and 4	—
2 and 4	—
1, 2, and 4	—
8	—
1 and 8	Form overflow
2 and 8	—
1, 2, and 8	—
4 and 8	—
1, 4, and 8	—
2, 4, and 8	Home position (6 lpi)
1, 2, 4, and 8	Home position (8 lpi)

To prepare either a 6-lpi or an 8-lpi tape:

1. Spread the form (or actual size facsimile) on a flat surface.
2. Cut the leading end of the tape (Figure 5-7) so that the end is about 1/4 inch above a sprocket hole:
 - a. For a 6-lpi tape, the leading end is cut two line spaces above a sprocket hole.
 - b. For an 8-lpi tape, the leading end is cut three line spaces above a sprocket hole.
3. Spread tape down full length of form; align first sprocket hole in leading end with top of form, and mark trailing end horizontally through a sprocket hole to indicate the tape length required.
4. Cut tape horizontally through first sprocket hole below mark made in step 3.
5. Mark tape with circles for desired skip codes. All codes must be punched on the line corresponding to pertinent print line of associated form. When one tape is to accommodate several form lengths, all codes are usually duplicated in each section (corresponding to each form length) of the tape (Figure 5-8).
6. Hold tape punch (supplied by Sperry Univac) with die side up so that circles to be punched are visible in punch opening; insert tape and punch out each marked circle.
7. Spread small quantity of cement between mark made in step 3 and trailing end of tape.
8. Bring leading end of tape over so that its underside overlaps the splicing end and forms a loop, and sprocket holes at top and bottom of splice are aligned.
9. Press entire splice and allow cement to dry.
10. Inspect splice to ensure that all punch codes and sprocket holes are through both layers. If they are not, punch through second layer by using holes in first layer as guide.

5.2.3.2. Forms Control Tape Replacement

The forms control mechanism (Figure 5—9) consists primarily of a sprocket wheel, a tape retainer, a read head, a lamp, and a tape guide. The pins around the sprocket wheel engage sprocket holes in the tape and, thereby, synchronize tape feeding with form feeding. The tape retainer holds the tape firmly against the sprocket wheel to ensure constant engagement. The lamp, located below the retainer, shines through the hole punch codes in the tape and onto photocells in the read heads. The tape guide holds long tape loops clear of the printer mechanism.

NOTE:

Before performing the following procedures, remove the device from the system's list of available resources by using the DOWN function of the SET IO command (Section 12). After the procedure is completed, restore the device's available status by using the UP function of the SET IO command.

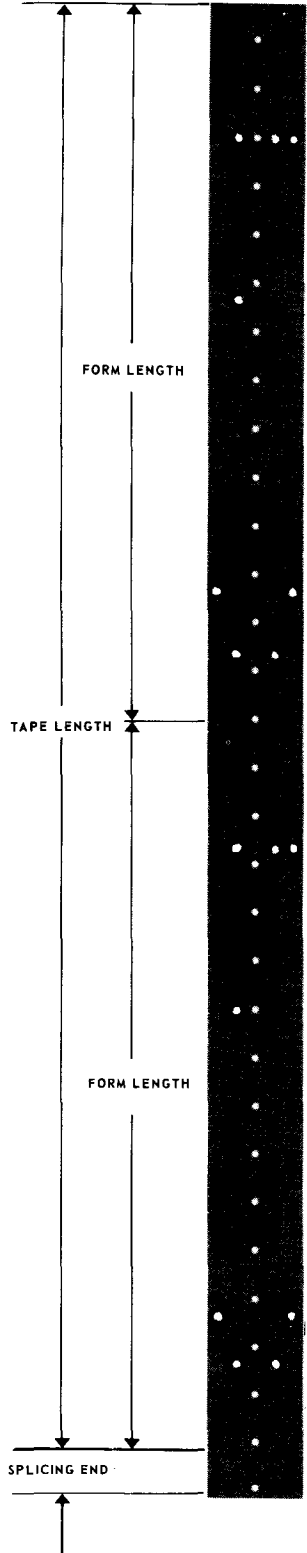

1

XYZ

Checks May Be Made Payable to "XYZ DIVISION"

COUNTY	BUSINESS	ORDER DATE	CUSTOMER'S ORDER NO.	REQUISITION NO.	CONTRACT NO.	INT. OFF. NO.	INVOICE NO.
FIRST HEADING LINE (HOME POSITION)							
LEASED TO					CUST. NO.		SHEET NO.
INSTALLED AT					MONTHLY SERVICE CHARGE FOR FULL CALENDAR MONTH STARTING FROM ABOVE DATE		
TERMS NET CASH							

DATE ON RENTAL	ST.	R.R. CODE	TYPE NUMBER	DESCRIPTION	SERIAL NUMBER	EXCISE TAX	AMOUNT
FIRST DETAIL LINE							
TOTAL							
ISOLATED TOTAL		<small>Seller represents that with respect to the production of the articles and/or the performance of the services covered by this invoice, they fully complied with the Fair Labor Standards Act of 1938, as amended.</small>					

PLEASE REMIT TO
 P.O. BOX San Francisco Calif 94128
 P.O. BOX Terminal Annex Bldg Los Angeles, Calif 90054
 P.O. BOX Dallas, Texas 75221
 P.O. BOX Atlanta Georgia 30302
 P.O. BOX Chicago Illinois 60600
 P.O. BOX Check 51 Station New York N.Y. 10008

RETURN DUPLICATE WITH REMITTANCE OR REFER TO INVOICE NO.

XYZ

1

XYZ

Checks May Be Made Payable to "XYZ DIVISION"

COUNTY	BUSINESS	ORDER DATE	CUSTOMER'S ORDER NO.	REQUISITION NO.	CONTRACT NO.	INT. OFF. NO.	INVOICE NO.
FIRST HEADING LINE (HOME POSITION)							
LEASED TO					CUST. NO.		SHEET NO.
INSTALLED AT					MONTHLY SERVICE CHARGE FOR FULL CALENDAR MONTH STARTING FROM ABOVE DATE		
TERMS NET CASH							

DATE ON RENTAL	ST.	R.R. CODE	TYPE NUMBER	DESCRIPTION	SERIAL NUMBER	EXCISE TAX	AMOUNT
FIRST DETAIL LINE							
TOTAL							
ISOLATED TOTAL		<small>Seller represents that with respect to the production of the articles and/or the performance of the services covered by this invoice, they fully complied with the Fair Labor Standards Act of 1938, as amended.</small>					

PLEASE REMIT TO
 P.O. BOX San Francisco Calif 94128
 P.O. BOX Terminal Annex Bldg Los Angeles, Calif 90054
 P.O. BOX Dallas, Texas 75221
 P.O. BOX Atlanta Georgia 30302
 P.O. BOX Chicago Illinois 60600
 P.O. BOX Check 51 Station New York N.Y. 10008

RETURN DUPLICATE WITH REMITTANCE OR REFER TO INVOICE NO.

XYZ

Figure 5-8. 0768 Printer Subsystem, Forms Control Tape Preparation (Sample)

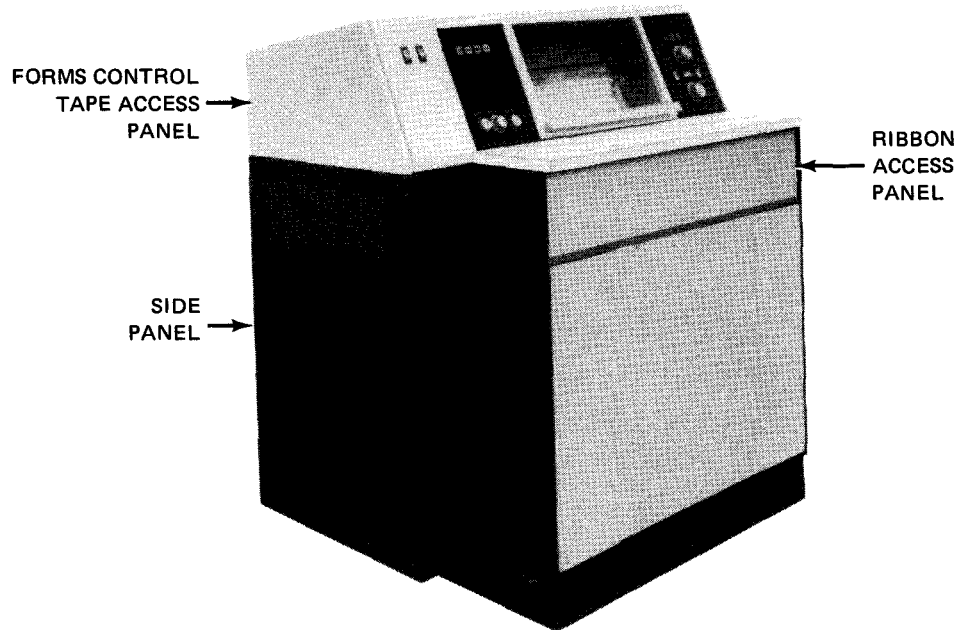

Figure 5—9. 0768 Printer Subsystem, Left View

To remove a forms control tape:

1. Press **STOP** switch/indicator, **STOP** switch/indicator lights and **RUN** switch/indicator extinguishes.
2. Set **POWER ON/POWER OFF** switch on left control panel to **POWER OFF**.
3. Open forms control tape loop access panel on left side of printer (Figure 5—9).
4. Swing down the left end-of-tape retainer (Figure 5—10).
5. Release tape from sprocket wheel pins (be careful not to damage tape sprocket holes).

NOTE:

If tape sprocket holes are damaged, prepare new tape.

6. Lift out tape.

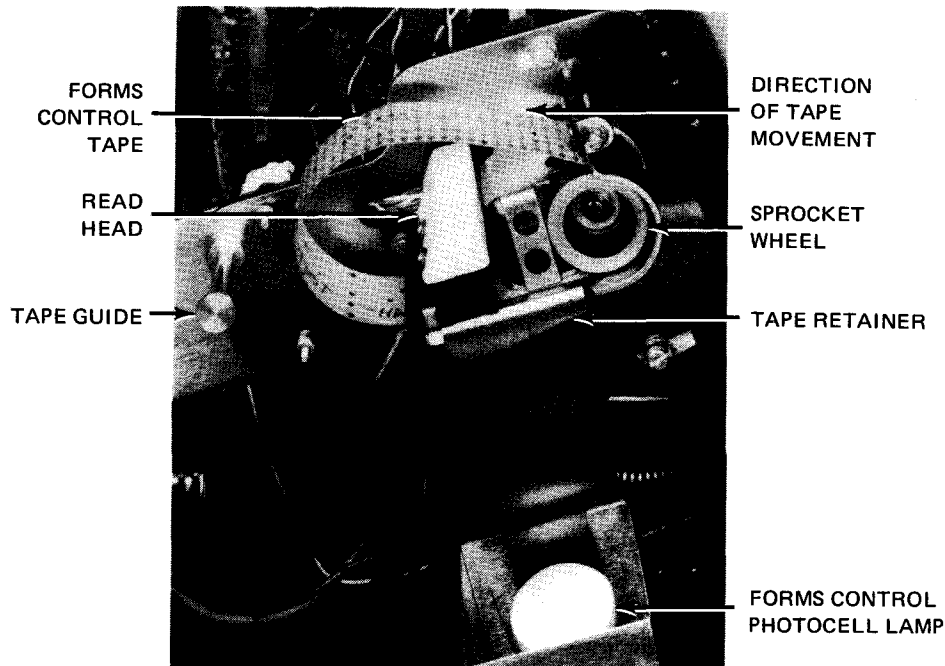

Figure 5—10. 0768 Printer Subsystem, Forms Control Mechanism

To change or install a forms control tape:

1. Press **STOP** switch/indicator on right control panel. **STOP** switch/indicator lights and **RUN** switch/indicator extinguishes.
2. Set **POWER ON/POWER OFF** switch on left control panel to **POWER OFF**.
3. With tape retainer swung down, hold appropriate tape loop with arrows at top pointing in the same direction as forms flow; edge of tape containing channel 8 is toward the printer. No particular part of tape loop circumference need be related to any reference point in the printer.
4. Insert lower portion of tape in opening above tape retainer around sprocket wheel.
5. Engage sprocket holes of tape with pins of sprocket wheel.
6. Hold tape by left end so that holes are fully and properly engaged with pins around right half of sprocket wheel and carefully raise tape retainer into its locked position. Place left side of tape around tape guide only if there is too much slack.
7. Close forms control tape access panel. Set **POWER ON/POWER OFF** switch on left control panel to **POWER ON**.
8. Press **HOME** switch (on left control panel) twice. This brings the tape and mechanism to top-of-form (home paper) position and sets LPI mode as determined by home paper code punched in the paper tape loop. The **HOME** indicator lights.
9. Using the SET IO command described in Section 12, synchronize the home paper position with the OS/3 operating system.
10. Raise form access cover (Figure 5—11) by releasing latch on lower front edge and open form loading door.

11. Lift retaining clamps on both upper and lower tractors (Figure 5—11 and 5—12).
12. Position the top edge or designated home position of the form just above the print actuators.
13. Close the retaining clamps on both upper and lower tractors and close the form access cover.

5.2.3.3. Forms Loading

The printer accepts continuous paper forms having edge perforations for sprocket feeding. Forms can range from one to six parts, with dimensions ranging from 4 to 22 inches wide, up to 14 inches long, and up to 15.5 mils thick. To load forms, proceed as follows:

NOTE:

Before performing the following procedure, remove the device from the system's list of available resources by using the DOWN function of the SET IO command (Section 12). After the procedure is completed, restore the device's available status by using the UP function of the SET IO command.

1. Press **STOP** switch/indicator. **STOP** switch/indicator lights and **RUN** switch/indicator extinguishes.
2. Press **ON LINE/OFF LINE** switch on left control panel to **OFF LINE**. **OFF LINE** indicator lights.
3. Press **HOME** switch/indicator. **HOME** indicator lights when form control tape reaches home position.
4. Using the SET IO command described in Section 12, synchronize the home paper position with the OS/3 operating system.
5. Raise form access cover (Figure 5—11) by lifting latch on the lower front edge. Open form loading door.
6. Press and hold **CARRIAGE IN/CARRIAGE OUT** switch, on the right control panel, to **CARRIAGE OUT** position until carriage is away from form. **CARRIAGE CHECK** indicator lights.
7. Lift retaining clamps on both upper tractors (Figure 5—11). Lift retaining clamps on both lower tractors (Figure 5—12).
8. Lift the old form off the sprockets; slide it through to the rear of the printer.
9. With a tissue dampened with FREON TF* solvent (supplied by Univac), clean print head and surrounding areas of all accumulated foreign material.
10. If forms of the same width are to be loaded and the print line is not to be shifted right or left, disregard steps 10, 11, 13, 14, and 15 for releasing and repositioning the tractors. If a form of a different width is to be loaded, release both upper tractor locks by pushing them back (Figure 5—11) and proceed to step 10.
11. Press left end of **BOTH** switch, located on the right control panel, to uncouple the tractor control knobs.
12. Position the tractors with the **LEFT TRACTORS** and **RIGHT TRACTORS** controls so that they are spaced approximately the width of the form to be loaded.
13. Place the box of forms in the recess in the front of the printer. Feed the form up between the carriage and the ribbon and place the sprocket holes of the form on the top and bottom sprockets. Position the upper edge of the form just above the print head.

* Trademark of E. I. du Pont de Nemours & Co., Inc.

14. Position the left tractor to align it with the left-hand sprocket holes of the form. Close the retaining clamps and carefully move the right tractor to the right to place the form under slight horizontal tension.
15. Press right end of **BOTH** switch and adjust the form horizontally to the position desired.
16. Pull the tractor locks forward (toward the operator) to lock the form into position.
17. Press and hold **CARRIAGE IN/CARRIAGE OUT** switch to **CARRIAGE IN** until carriage is positioned against form. (**CARRIAGE CHECK** indicator will extinguish.)
18. Close form access cover and form loading door.
19. Press **RUN** switch/indicator. **RUN** switch/indicator lights.
20. Press **ON LINE/OFF LINE** switch to **ON LINE**. **OFF LINE** indicator goes out. Printer is now ready to be used.

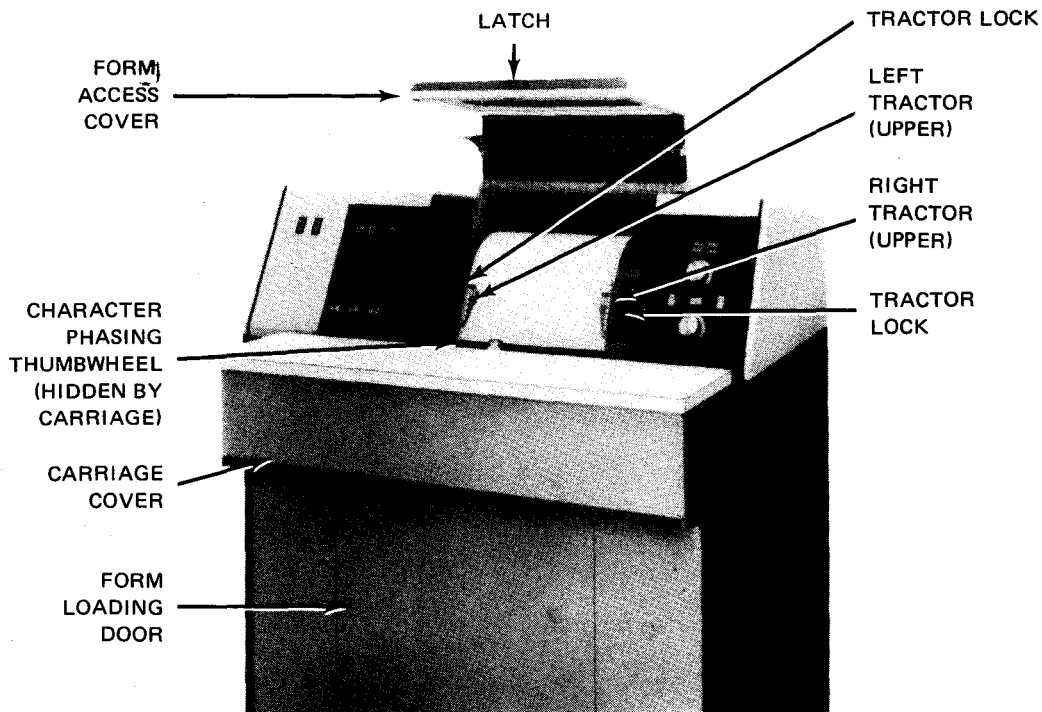

Figure 5-11. Form Access Cover Open and Carriage Out

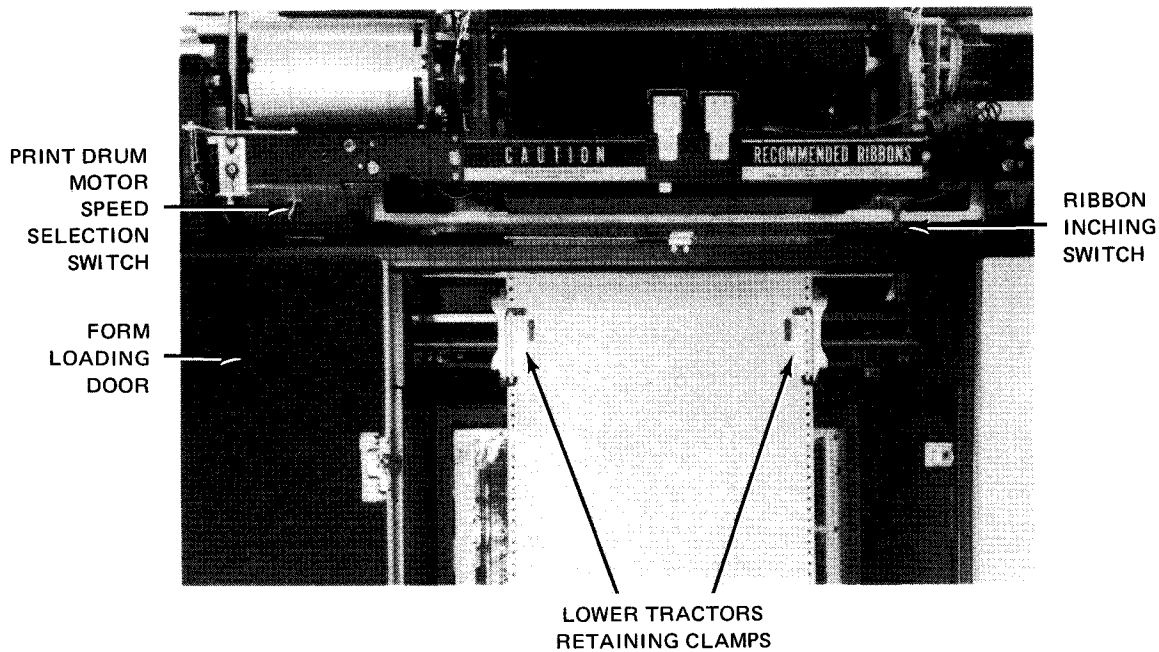

Figure 5-12. Ribbon Access Panel Raised and Form Loading Door Open

5.2.3.4. Character Phasing Adjustment

Character phasing is required when the printed character is not uniformly printed on the form (see Figure 5-13). To perform this adjustment proceed as follows:

NOTE:

Before performing the following procedure, remove the device from the system's list of available resources by using the DOWN function of the SET IO command (Section 12). After the procedure is completed, restore the device's available status by using the UP function of the SET IO command.

1. Press **STOP** switch/indicator. **STOP** switch/indicator lights and **RUN** switch/indicator goes out.
2. Press the **ON LINE/OFF LINE** switch on the left control panel to **OFF LINE**. **OFF LINE** indicator lights.
3. Release latch and raise form access cover (Figure 5-11).
4. Momentarily press **MANUAL PRINT** switch on the left control panel. One line of characters will be printed.
5. Turn character phasing thumbwheel (Figures 5-11 and 5-14) in direction required to correct character phasing:
 - Clockwise rotation, if bottom of character is light (Figure 5-13b).
 - Counterclockwise rotation, if top of character is light (Figure 5-13a).
6. After each adjustment of the thumbwheel, momentarily press **MANUAL PRINT** switch and inspect printed characters for uniform impression (Figure 5-13c).
7. Close form access cover.
8. Press **ON LINE/OFF LINE** switch to **ON LINE**. The **OFF LINE** indicator extinguishes.
9. Press **RUN** switch/indicator. **RUN** switch/indicator lights and **STOP** switch/indicator extinguishes. Printer is ready for use.

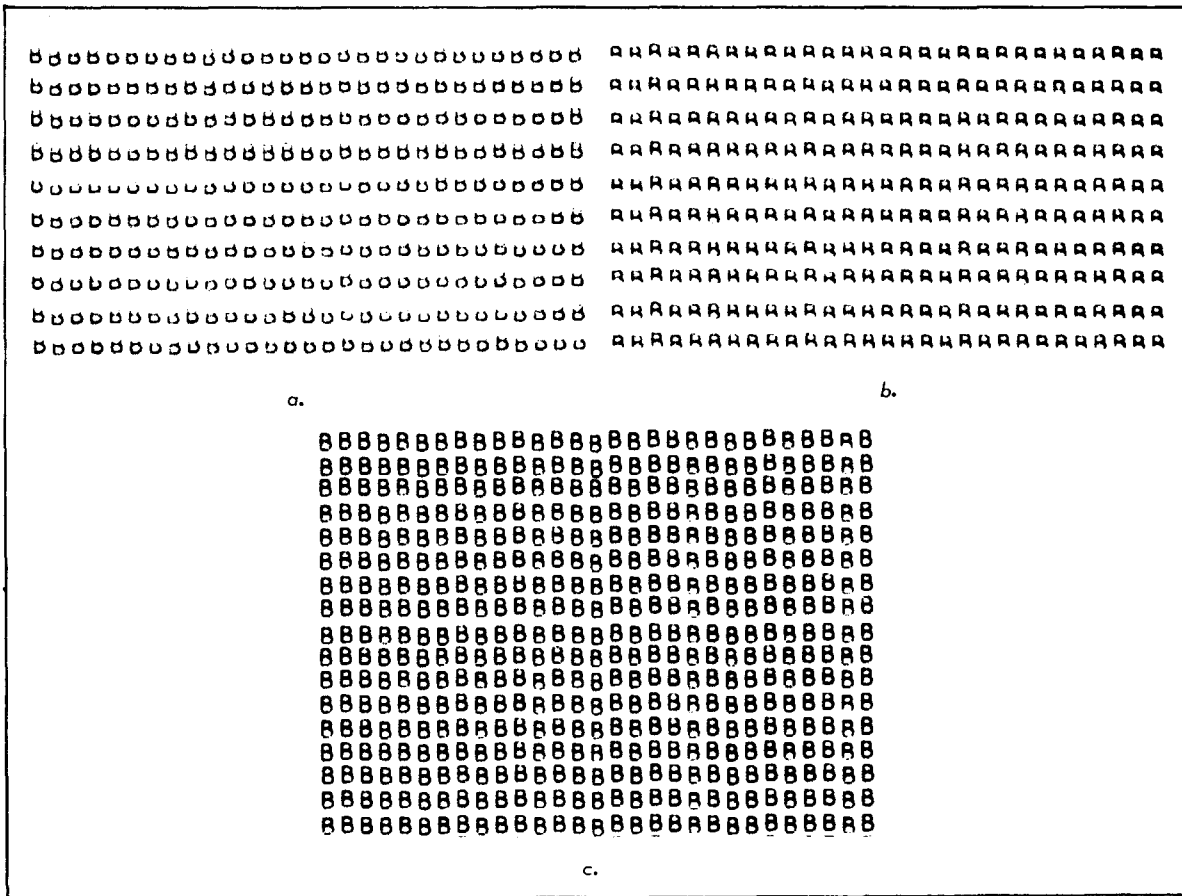

Figure 5-13. Character Phasing Examples

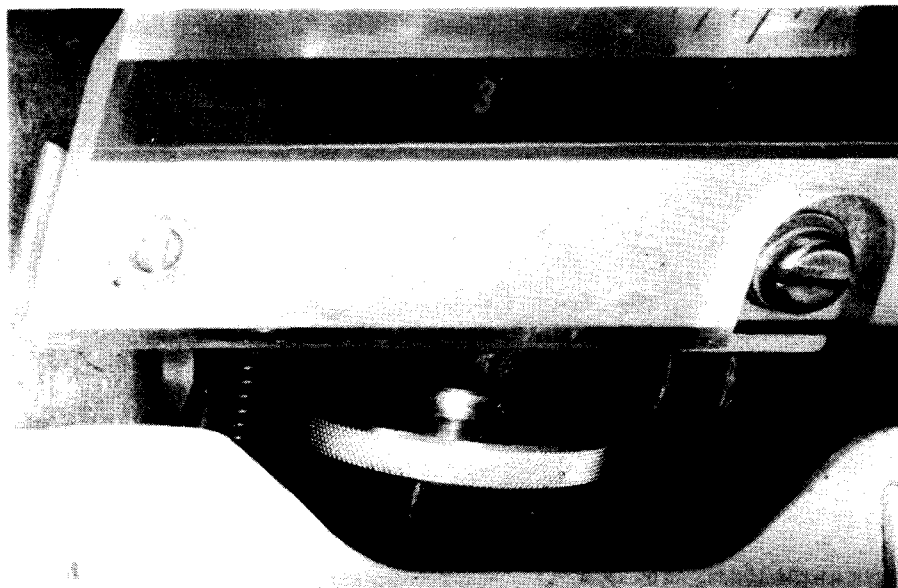

Figure 5-14. Character Phasing Thumbwheel

5.2.3.5. Print Drum Motor Speed Selection

The print drum motor may be run at half speed when it is required to optimize print definition on special form stocks. When it is desired to change the selection of motor speed, proceed as follows:

NOTE:

Before performing the following procedure, remove the device from the system's list of available resources by using the DOWN function of the SET IO command (Section 12). After the procedure is completed, restore the device's available status by using the UP function of the SET IO command.

1. Press **STOP** switch/indicator. **STOP** switch/indicator lights and **RUN** switch/indicator extinguishes.
2. Press the **ON LINE/OFF LINE** switch on the left control panel, to **OFF LINE**. **OFF LINE** indicator lights.
3. Release latch and raise form access cover (Figure 5—11).
4. Press **CARRIAGE IN/CARRIAGE OUT** switch on right control panel to **CARRIAGE OUT**. **CARRIAGE CHECK** indicator lights.
5. Operate print drum motor speed selection switch (Figure 5—12 and 5—15) to the left for half speed or to the right for maximum speed.
6. Press and hold **CARRIAGE IN/CARRIAGE OUT** switch to **CARRIAGE IN** position until carriage is positioned against form. **CARRIAGE CHECK** indicator extinguishes.
7. Rephase print drum as described in steps 3 through 5 of 5.2.3.3.4.
8. Close form access cover.
9. Press the **ON LINE/OFF LINE** switch to **ON LINE** position. **OFF LINE** indicator extinguishes.
10. Press **RUN** switch/indicator. **RUN** switch/indicator lights and **STOP** switch/indicator extinguishes.

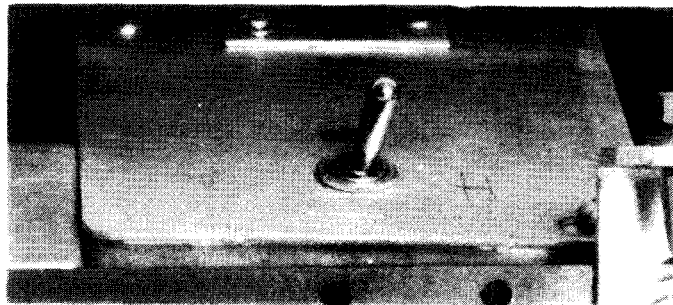

Figure 5—15. Print Drum Motor Speed Selection Switch

5.2.4. Recovery Procedures

Table 5—4 lists the printer subsystem malfunctions that may be corrected by the operator.

Table 5-4. 0768 Printer Subsystem, Recovery Procedures (Part 1 of 3)

Fault Indication	Probable Cause	Operator Action
PRINT CHECK indicator is lit.	<ul style="list-style-type: none"> ■ Actuator driver circuit jammed because of noise or circuit malfunction ■ Open actuator coil or connector ■ High voltage circuit malfunction ■ Blown fuse on print actuator card 	<ol style="list-style-type: none"> 1. Set ON LINE/OFF LINE switch to OFF LINE. 2. Press CLEAR pushbutton. If PRINT CHECK indicator goes off, set ON LINE/OFF LINE switch to ON LINE and then press RUN switch indicator. 3. If PRINT CHECK indicator remains lit, notify Sperry Univac customer engineer.
PARITY CHECK indicator lit, printer does not stop.	A parity error is detected in the code wheel signals.	Contact Sperry Univac customer engineer.
PARITY CHECK indicator lit, printer stops.	A parity error is detected in the command code.	Contact Sperry Univac customer engineer.
PARITY CHECK indicator blinking, printer does not stop.	A parity error is detected in either the code drum buffer or print line buffer.	Contact Sperry Univac customer engineer.
CARRIAGE CHECK indicator is lit.	Carriage movement is not correct. Carriage moves outward, away from the paper.	<ol style="list-style-type: none"> 1. Set ON LINE/OFF LINE switch to OFF LINE. 2. Set CARRIAGE IN/CARRIAGE OUT switch to CARRIAGE IN. Ensure that the carriage is fully engaged against form. 3. Press CLEAR pushbutton. If CARRIAGE CHECK indicator goes off, set ON LINE/OFF LINE switch to ON LINE and then press RUN switch/indicator. 4. If CARRIAGE CHECK indicator remains lit, notify Sperry Univac customer engineer.
FORMS RUNAWAY indicator is lit.	Form has advanced for 2 seconds or more without intervention.	<ol style="list-style-type: none"> 1. Set ON LINE/OFF LINE switch to OFF LINE. 2. Press CLEAR pushbutton. FORMS RUNAWAY indicator goes off. 3. Open forms control tape access panel and inspect forms control tape for correct and undamaged code punch. 4. Set ON LINE/OFF LINE switch to ON LINE. 5. Press RUN switch/indicator. 6. If FORMS RUNAWAY indicator remains lit, notify Sperry Univac customer engineer.

Table 5-4. 0768 Printer Subsystem, Recovery Procedures (Part 2 of 3)

Fault Indication	Probable Cause	Operator Action
FORMS OUT indicator is lit.	The last 2.5 inches of paper is positioned below the print head, and the home paper code (1111 ₂ or 1110 ₂) punched in the forms control tape is detected.	<ol style="list-style-type: none"> 1. Set ON LINE/OFF LINE switch to OFF LINE. 2. Replenish form supply. 3. Press CLEAR pushbutton. The FORMS OUT indicator goes off. 4. Set ON LINE/OFF LINE switch to ON LINE. 5. Press RUN switch/indicator.
RIBBON CHECK indicator is lit.	The CHANGE RIBBON switch/indicator has been pressed and the ribbon is in position to be changed.	<ol style="list-style-type: none"> 1. Press CLEAR pushbutton. 2. Set ON LINE/OFF LINE switch to ON LINE. 3. Press RUN switch/indicator.
POWER CHECK indicator is lit.	A dc circuit breaker tripped, or a dc power supply failed.	<ol style="list-style-type: none"> 1. Set ON LINE/OFF LINE switch to OFF LINE. 2. Reset any tripped circuit breakers on the power control panel and proceed as follows: <ol style="list-style-type: none"> a. Press CLEAR pushbutton. The POWER CHECK indicator goes off. b. Set ON LINE/OFF LINE switch to ON LINE. c. Press RUN switch/indicator. 3. If no indication of a tripped circuit breaker can be found, or if frequent tripping occurs, notify Sperry Univac customer engineer.
INTERLOCK indicator is lit.	The left panel, forms loop access panel, or ribbon panel is opened.	<ol style="list-style-type: none"> 1. Press the opened panel to close the associated interlock. 2. Press CLEAR pushbutton. The INTERLOCK indicator goes off. 3. Set ON LINE/OFF LINE switch to ON LINE. 4. Press RUN switch/indicator. 5. If the INTERLOCK indicator remains lit, notify the Sperry Univac customer engineer.

Table 5-4. 0768 Printer Subsystem, Recovery Procedures (Part 3 of 3)

Fault Indication	Probable Cause	Operator Action
<p>TEMP CHECK indicator is lit.</p>	<ul style="list-style-type: none"> ■ Thermostat open ■ Air flow deficient ■ Early warning; temperature over 110°F 	<p>Clean blocked ventilation openings or clean clogged air filter. After sufficient cooling time, open rear of cabinet and press red reset switch above card library location. Then press ON LINE/OFF LINE switch to OFF LINE and press POWER ON switch (OFF LINE and STOP indicators light). Proceed as follows:</p> <ol style="list-style-type: none"> 1. Press CLEAR pushbutton. 2. Set ON LINE/OFF LINE switch to ON LINE. 3. Press RUN switch/indicator. 4. If the TEMP CHECK indicator remains lit, turn off the printer and notify the Sperry Univac customer engineer.
<p>Printer stops. (No fault indicator lit.)</p>	<p>Power failure or printer offline</p>	<ol style="list-style-type: none"> 1. Set ON LINE/OFF LINE switch to OFF LINE. 2. Press any protruding red pushbuttons on the circuit protector devices on the power control panel. 3. Press HOME switch/indicator twice. 4. Key in SET IO command (Section 12) to synchronize the home paper position with the OS/3 operating system. 5. Set ON LINE/OFF LINE switch to ON LINE. OFF LINE indicator extinguishes. 6. If printer does not start or the circuit protection device again trips, notify the Sperry Univac customer engineer.

5.3. 0770 PRINTER SUBSYSTEM

The 0770 printer subsystem is a single unit containing its own control circuits and power supplies. Operations involving the front of the printer are controlled from a front control panel. Operations involving forms stacking are controlled by a rear stacker control panel. Power control panels are located behind closed doors on the front, side, and rear of the printer.

It is recommended that the cover and all casework panels be closed when the printer is in operation. The casework is designed for maximum noise reduction and operator protection. Failure to completely close the cover and casework panels exposes all personnel in the area to unnecessary hazards and discomfort.

The printer cover opens automatically when certain error conditions occur; therefore, objects should not be placed or stored on the top cover.

5.3.1. Operating Controls and Indicators

During normal operation, the operator is concerned with the front control and indicator panels (Figure 5-16), the rear stacker control panel and power distribution panels (Figure 5-17). The control panel (Figure 5-18) is used primarily for stop/run control and set up during forms loading. The indicator panel (Figure 5-19) provides the operator with check indicators, which become visible only when an indicator is lit. The stacker control panel (Figure 5-20) permits the operator to control major printer functions from the rear of the cabinet so that he may initiate runs as the stacker is set up.

The power distribution panel (Figure 5-21), located at the lower left-rear of the cabinet behind the rear door (Figure 5-17), controls power for the printer. The low voltage power supply panel (Figure 5-22) is located behind the closed door at the front of the cabinet, to the right of the paper feed compartment (Figure 5-16). The paper feed power supply panel (Figure 5-23) is located behind the door on the left side of the cabinet. The high voltage power supply panel (Figure 5-24) is located directly above the power distribution panel. The **POWER ON/POWER OFF** switch (Figure 5-25) is located in the paper feed compartment (Figure 5-16), near the top of the right frame. Controls and indicators for each panel are listed and described in Table 5-5.

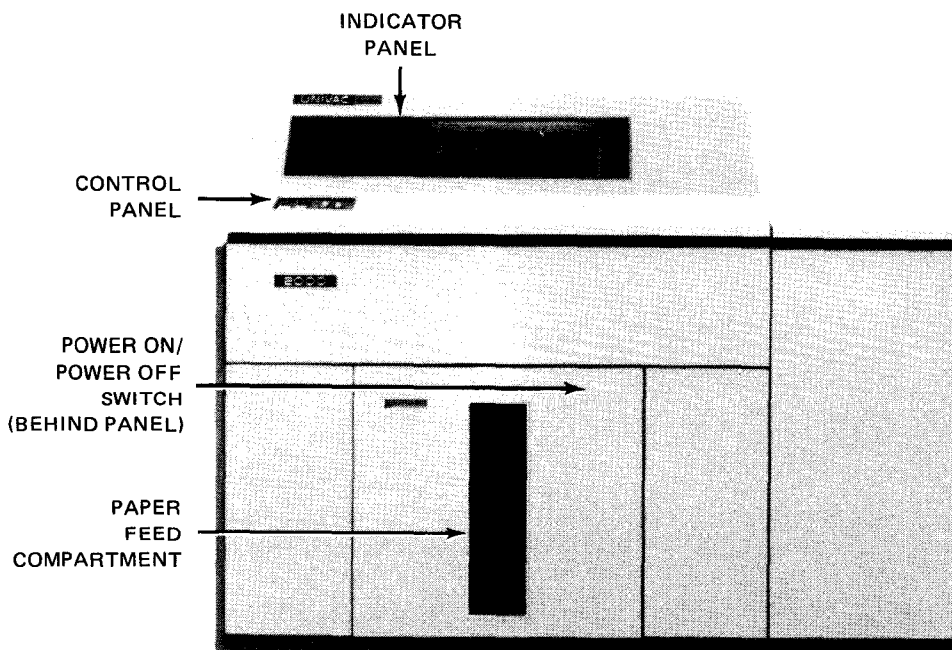

Figure 5-16. 0770 Printer Subsystem

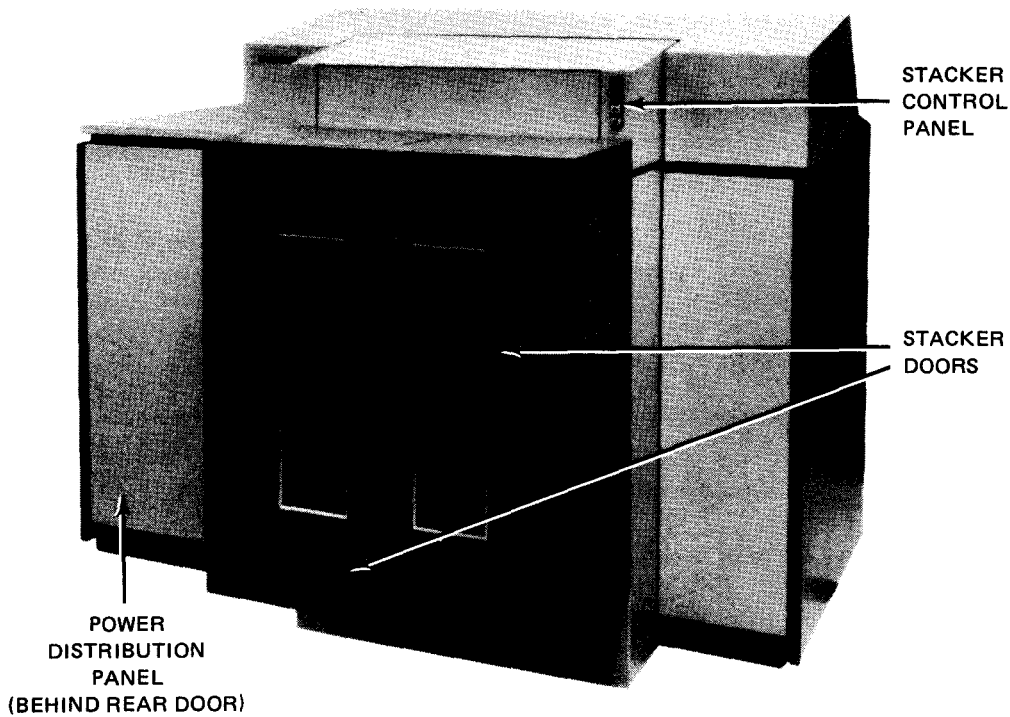

Figure 5-17. Rear View of 0770 Printer Subsystem

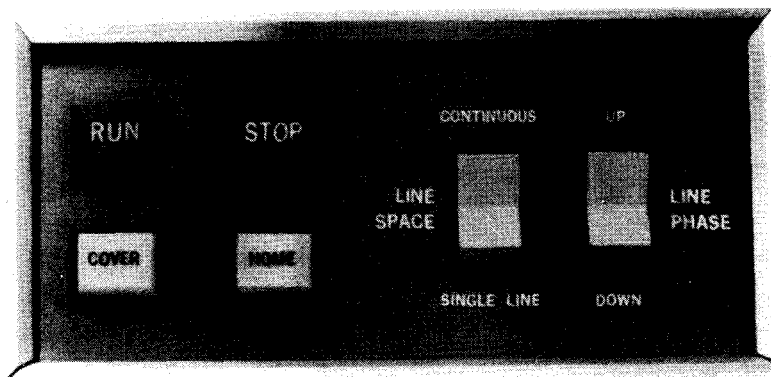

Figure 5-18. 0770 Printer Subsystem, Control Panel

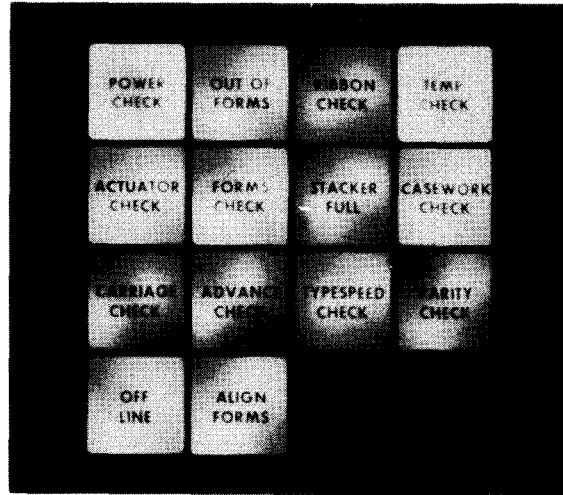

Figure 5-19. 0770 Printer Subsystem, Indicator Panel

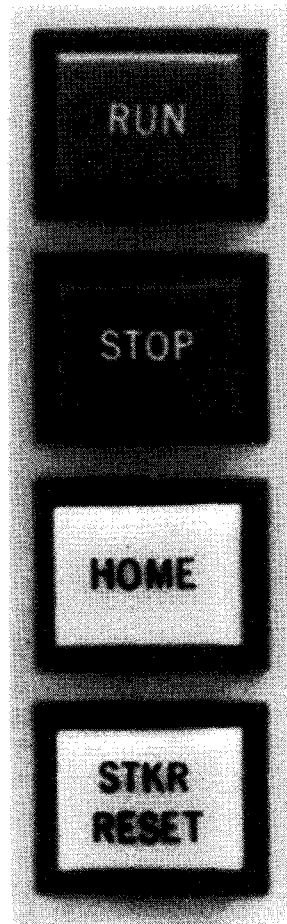

Figure 5-20. 0770 Printer Subsystem, Stacker Control Panel

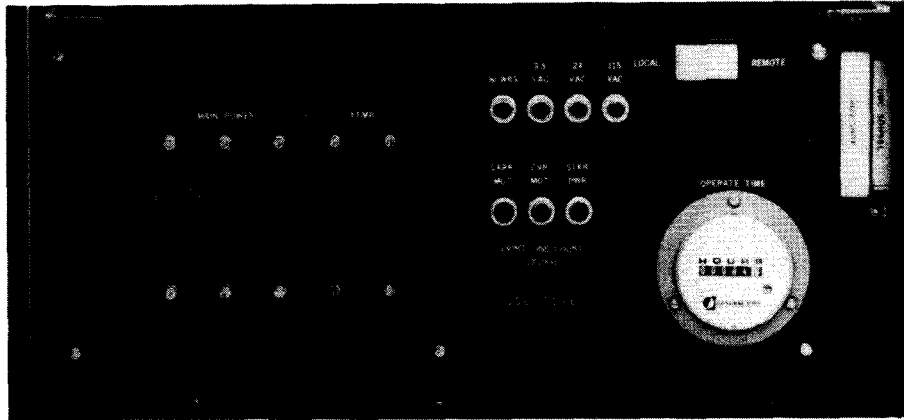

Figure 5-21. 0770 Printer Subsystem, Power Distribution Panel

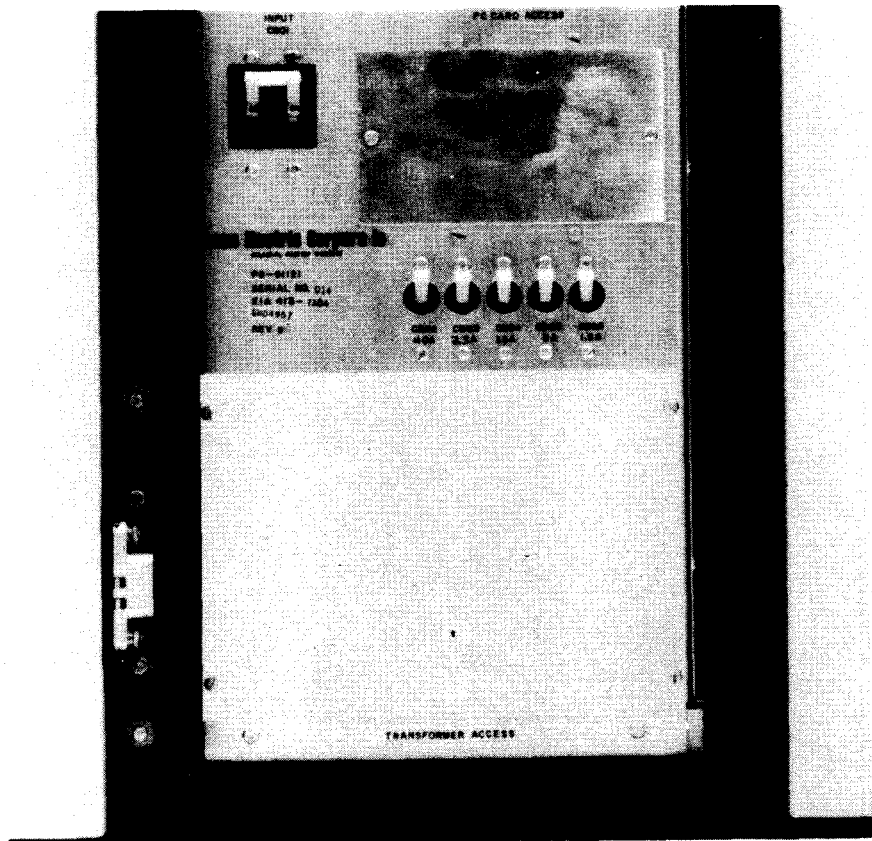

Figure 5-22. 0770 Printer Subsystem, Low Voltage Power Supply Panel

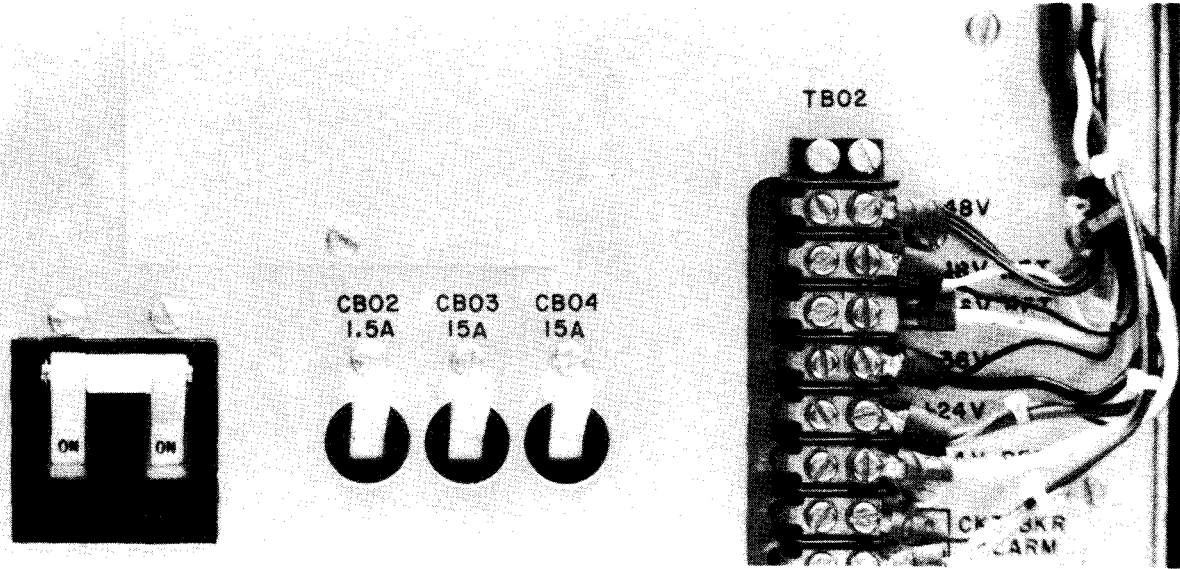

Figure 5-23. 0770 Printer Subsystem, Paper Feed Power Supply Panel

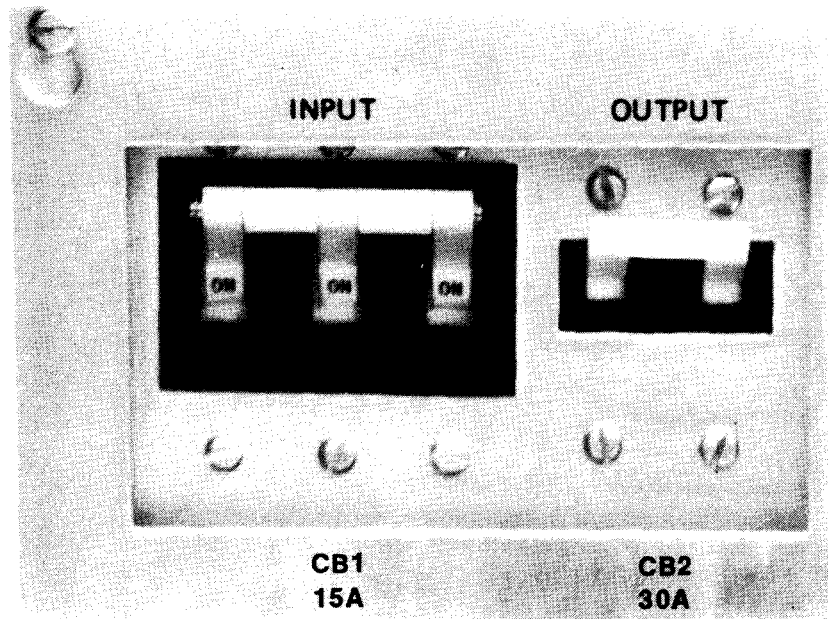

Figure 5-24. 0770 Printer Subsystem, High Voltage Power Supply Panel

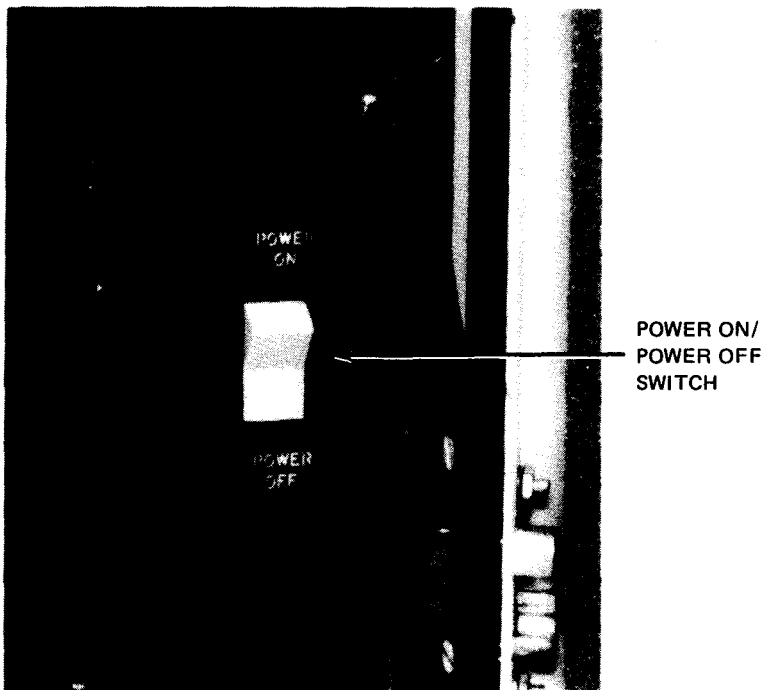

Figure 5-25. 0770 Printer Subsystem, POWER ON/POWER OFF Switch

Table 5-5. 0770 Printer Subsystem, Controls and Indicators (Part 1 of 8)

Control/Indicator — Function
Control Panel
<p>RUN switch/indicator</p> <p>Readies printer for operation if none of the following indicators are lit:</p> <ul style="list-style-type: none"> ▪ OUT OF FORMS ▪ FORMS CHECK ▪ RIBBON CHECK ▪ STACKER FULL ▪ CASEWORK CHECK ▪ TEMP CHECK ▪ CARRIAGE CHECK ▪ POWER CHECK <p>Enters printer in run mode, lights the indicator, and extinguishes STOP switch/indicator. Pressing the lighted switch has no effect on printer.</p>

Table 5-5. 0770 Printer Subsystem, Controls and Indicators (Part 2 of 8)

Control/Indicator — Function
Control Panel (cont)
STOP switch/indicator
Enters printer in stop mode after completion of current command; also causes all indicators on indicator panel to light for lamp test.
Stop mode is entered automatically when any of the following indicators light:
<ul style="list-style-type: none">▪ OUT OF FORMS▪ FORMS CHECK▪ ADVANCE CHECK▪ PARITY CHECK▪ RIBBON CHECK▪ STACKER FULL▪ CASEWORK CHECK▪ TYPE SPEED CHECK▪ CARRIAGE CHECK▪ POWER CHECK▪ TEMP CHECK
STOP switch/indicator also is used with HOME switch/indicator to home the vertical format buffer.
HOME switch/indicator
Pressed only when in stop mode to cause forms to advance to next home (or setup) position. Forms do not advance unless vertical format buffer is loaded. If switch is pressed while STOP switch/indicator is held pressed, the vertical format buffer homes without forms advancement. HOME indicator lights when vertical format is in home position.
COVER switch/indicator
When pressed and released, opens or closes cover. Lights when cover is in motion. Cover cannot be opened during run mode; however, run mode can be entered while cover is fully opened. (To reduce noise, the throughput is automatically reduced when the cover is raised.) Cover also is opened by raise-cover command in program or when any of the following indicators light:
<ul style="list-style-type: none">▪ OUT OF FORMS▪ FORMS CHECK▪ RIBBON CHECK▪ ADVANCE CHECK▪ TYPE SPEED CHECK

Table 5-5. 0770 Printer Subsystem, Controls and Indicators (Part 3 of 8)

Control/Indicator — Function
<p style="text-align: center;">Control Panel (cont)</p>
<p>LINE SPACE switch</p> <p>Operates only in stop mode. Advances forms at rate of six or eight lines per inch (lpi). If vertical format buffer is not loaded, forms advance in increments of six lpi.</p> <ul style="list-style-type: none">■ CONTINUOUS position: Advances forms one line at a time until switch is released■ Off (center) position: Normal position■ SINGLE LINE position: Advances forms one line
<p>LINE PHASE switch</p> <p>Performs a vernier adjustment of vertical position of print line and is normally used after initial vertical alignment of the form using the vertical position control. Each time LINE PHASE switch is pressed, the print line shifts an additional 4 percent of a line space at the next forms advance. This switch can be used during printing or stop mode.</p> <p>UP position: Shifts printing position up on form for next line of print</p> <p>Off (center) position: Normal position</p> <p>DOWN position: Shifts printing position down on form for next line of print</p>
<p style="text-align: center;">Indicator Panel</p>
<p>OFF LINE indicator</p> <p>Lights when printer is in offline mode and is not available for operation with the system. Maintenance panel switches are enabled.</p>
<p>OUT OF FORMS indicator</p> <p>Lights when additional forms are required. Printing may have continued to end of page. Indicator remains lit until more forms are loaded.</p>
<p>FORMS CHECK indicator</p> <p>Lights when form is torn or jammed. Indicator remains lit until condition is corrected.</p>
<p>RIBBON CHECK indicator</p> <p>Lights when ribbon has moved left or right beyond correction limits, ribbon is not moving at correct rate, or ribbon width has decreased sufficiently to prevent printing in column number 160. Indicator remains lit until ribbon movement is corrected and a stop-to-run mode transition occurs.</p>

Table 5-5. 0770 Printer Subsystem, Controls and Indicators (Part 4 of 8)

Control/Indicator — Function
Indicator Panel (cont)
STACKER FULL indicator Lights when stacker is filled to capacity. Indicator remains lit until forms are removed from stacker and STKR RESET switch is pressed.
CASEWORK CHECK indicator Lights when a cabinet door is open. Indicator remains lit until casework is closed or interlock is overridden by pulling out plunger of interlock switch.
TEMP CHECK indicator Lights when printer cabinet is overheated. Indicator remains lit until POWER ON/POWER OFF switch is recycled.
CARRIAGE CHECK indicator Lights when print carriage latch is open or print band is improperly installed. Indicator remains lit until condition is corrected. After carriage is closed, indicator remains lit until automatic gap adjustment function is complete.
POWER CHECK indicator Lights when a circuit breaker has tripped in one of the power supplies or TEMP CHECK indicator lights. Indicator remains lit until breaker is reset and POWER ON/POWER OFF switch is pressed to POWER ON which allows power to be sequenced.
PARITY CHECK indicator Lights when a parity error is detected in: <ul style="list-style-type: none">▪ load code buffer;▪ print line buffer; or▪ vertical format buffer. Indicator remains lit until stop-to-run mode transition occurs.
ACTUATOR CHECK indicator Lights when actuator circuitry malfunctions during last printing. Indicator also may be lit if a type speed check or a ribbon check occurs. Indicator remains lit until a stop-to-run mode transition occurs.
ADVANCE CHECK indicator Lights when forms advance function is not properly completed or forms are not in correct position. Indicator remains lit until forms are advanced by use of LINE SPACE switch or HOME switch/indicator.
TYPE SPEED CHECK indicator Lights when print band is not operating at proper speed during printing. Indicator remains lit until stop-to-run mode transition occurs.

Table 5-5. 0770 Printer Subsystem, Controls and Indicators (Part 5 of 8)

Control/Indicator — Function
Indicator Panel (cont)
ALIGN FORMS indicator Lights when vertical format buffer is loaded and followed by a raise-cover command. Signals operator to check forms alignment with new vertical format. Indicator remains lit until stop-to-run transition occurs.
Stacker Control Panel
RUN switch/indicator Same as that of RUN switch/indicator on control panel
STOP switch/indicator Same as that of STOP switch/indicator on control panel
HOME switch/indicator Same as that of HOME switch/indicator on control panel
STKR RESET switch/indicator Raises stacker tray to proper height for stacking after printed forms are removed from stacker
Power Distribution Panel
MAIN POWER circuit breaker Provides overload protection for power sequence circuits
XFMR circuit breaker Provides overload protection for step-down transformer for ac power circuits
BLWRS pushbutton circuit breaker Provides overload protection for blower motors
9.5 VAC pushbutton circuit breaker Provides overload protection for 9.5 Vac primary power circuit
24 VAC pushbutton circuit breaker Provides overload protection for 24 Vac primary power circuit
115 VAC pushbutton circuit breaker Provides overload protection for 115 Vac primary power circuits

Table 5—5. 0770 Printer Subsystem, Controls and Indicators (Part 6 of 8)

Control/Indicator — Function
Power Distribution Panel (cont)
<p>LOCAL/REMOTE switch</p> <p>Selects location for power control:</p> <p>LOCAL position:</p> <p>Power to subsystem is to be turned on at printer.</p> <p>REMOTE position:</p> <p>Power for subsystem is to be turned on at processor.</p> <p>CARR MOT pushbutton circuit breaker</p> <p>Provides overload protection for ribbon and band drive motors in carriage assembly</p> <p>CVR MOT pushbutton circuit breaker</p> <p>Provides overload protection for cover motor</p> <p>STKR MOT pushbutton circuit breaker</p> <p>Provides overload protection for form stacker motor</p> <p>OPERATE TIME time-elapsed meter</p> <p>Indicates number of hours that the type band drive motor has operated</p> <p>PRINT LINE COUNT (1x1024) counter indicator</p> <p>Indicates number of lines printed. Number indicated is to be multiplied by 1024.</p>
Low Voltage Power Supply
<p>INPUT CB01 — PRIMARY POWER circuit breaker</p> <p>Provides overload protection for primary power on low voltage power supply</p> <p>CB02 40A circuit breaker</p> <p>Provides overload protection for +5 Vdc on low voltage power supply</p> <p>CB03 2.5A circuit breaker</p> <p>Provides overload protection for +12 Vdc supply</p>

Table 5-5. 0770 Printer Subsystem, Controls and Indicators (Part 7 of 8)

Control/Indicator — Function
Low Voltage Power Supply (cont)
CB04 1.5A circuit breaker Provides overload protection for — 12 Vdc supply
CB05 2A circuit breaker Provides overload protection for +6 Vdc supply
CB06 1.5A circuit breaker Provides overload protection for —6 Vdc supply
Paper Feed Power Supply
CB01 — PRIMARY POWER circuit breaker Provides overload protection for primary power on paper feed power supply
CB02 1.5A circuit breaker Provides overload protection for +48 Vdc on paper feed power supply
CB03 15A circuit breaker Provides overload protection for —36 Vdc supply
CB04 15A circuit breaker Provides overload protection for +24 Vdc supply
High Voltage Power Supply
CB1 — 15A circuit breaker Provides overload protection for primary power on high voltage power supply
CB2 30A circuit breaker Provides overload protection for 100 Vdc power supply to output terminals

Table 5-5. 0770 Printer Subsystem, Controls and Indicators (Part 8 of 8)

Control/Indicator — Function
Paper Feed Compartment
POWER ON/POWER OFF switch
POWER ON position:
Turns on power to printer if LOCAL/REMOTE switch is in LOCAL position (In REMOTE position, power is turned on at the processor.)
Off (center) position:
Normal position
POWER OFF position:
Turns off power to printer, regardless of setting of LOCAL/REMOTE switch

5.3.2. Turn-On and Turn-Off Procedures

Power for the printer is normally applied and removed by the **POWER ON/POWER OFF** switch on the processor operator/maintenance panel (Figure 2-2). However, to control power from this panel, certain switches and circuit breakers on the printer must first be set to specific positions. The switch and circuit breaker and settings for the printer are listed in Table 5-6.

CAUTION

*Do not apply power to the printer as specified in Table 5-6 if the processor **POWER ON/POWER OFF** switch is presently in the **POWER ON** position, as power transients may disturb processor operation. Instead, follow the procedures provided in 5.3.2.1.*

When the switches and circuit breakers on the printer are set as specified in Table 5-6, and the **POWER ON/POWER OFF** switch on the processor is set to **POWER ON**, the following indicators should be lit on the indicator panel, control panel, and stacker control panel:

- **POWER CHECK** indicator (lights during power-up sequencing, then extinguishes); and
- **STOP** switch/indicator.

If the **POWER CHECK** indicator remains lit, check (and reset, if necessary) circuit breakers on the power panels (Figures 5-21 through 5-24). After a circuit breaker is reset, the **POWER ON/POWER OFF** switch in the paper feed compartment must be reset to allow power-up sequencing. If the **POWER CHECK** indicator or any other indicator still remains lit, or if the **STOP** switch/indicator fails to light, contact the Sperry Univac customer engineer.

Press the **RUN** switch/indicator to initiate operation. Note that the **RUN** switch/indicator lights and the **STOP** switch/indicator extinguishes.

Figure 5-6. 0770 Printer Subsystem, Power Switch Settings

Switch/Circuit Breaker	Normal Setting
Power Distribution Panel	
MAIN POWER circuit breaker	On (up)
XFMR circuit breaker	On (up)
LOCAL/REMOTE rocker switch	REMOTE
All pushbutton circuit breakers	On (in)
Low Voltage Power Supply	
INPUT CB01 – PRIMARY POWER circuit breaker	On (up)
CB02 40A circuit breaker	On (up)
CB03 2.5 A circuit breaker	On (up)
CB04 1.5A circuit breaker	On (up)
CB05 2A circuit breaker	On (up)
CB06 1.5A circuit breaker	On (up)
Paper Feed Power Supply	
CB01 – PRIMARY POWER circuit breaker	On (up)
CB02 1.5A circuit breaker	On (up)
CB03 15A circuit breaker	On (up)
CB04 15A circuit breaker	On (up)
High Voltage Power Supply	
CB1 – 15A circuit breaker	On (up)
CB2 30A circuit breaker	On (up)
Paper Feed Compartment	
POWER ON/POWER OFF switch	Press to POWER ON and then release.

5.3.2.1. Independent Power Turn-On Procedure

To turn on power at the printer independently of the processor, proceed as follows:

1. Set **LOCAL/REMOTE** switch on power distribution panel to **LOCAL** position.
2. Ensure that all circuit breakers on the power distribution panel, low voltage power supply, paper feed power supply, and high voltage power supply are in the on (up) position.
3. Set and release the **POWER ON/POWER OFF** switch in the paper feed compartment to the **POWER ON** position (switch moves to center position when released).

CAUTION

*Do not turn **POWER ON/POWER OFF** switch on and off rapidly, or damage may result to printer power sequencing circuits.*

4. Note that the **STOP** switch/indicator lights and the **POWER CHECK** indicator on the indicator panel lights during power-up sequencing, then extinguishes.
5. Press **RUN** switch/indicator on control panel. Note that the switch/indicator lights and the **STOP** switch/indicator extinguishes.
6. Use the *UP* function of the **SET IO** command (Section 12) to place the printer on the system's resource list for job allocation.

5.3.2.2. Independent Power Turn-Off Procedure

To turn off power to the printer independently of the processor, proceed as follows:

1. Use the *DOWN* function **SET IO** command (Section 12) to remove the printer from the system's resource list and to prevent it from being allocated to a job while offline.
2. Set **LOCAL/REMOTE** switch on power distribution panel to **LOCAL** position.
3. Set **POWER ON/POWER OFF** switch in paper feed compartment to **POWER OFF** position.
4. Set **MAIN POWER** circuit breaker on power distribution panel to off (down) if complete power turn off is desired.

5.3.3. Operating Procedures

Operating procedures for the 0770 printer subsystem include forms loading and unloading, stacker adjustments, ribbon and ribbon shield replacements, print band replacement, print gap adjustment, and print phasing adjustment.

5.3.3.1. Forms Loading

Forms can be loaded into the printer by two methods:

1. A general method (5.3.3.1.1.), which requires setting home position for the forms being loaded. This procedure must be used when the printer is being loaded for the first time and when new forms that require a different home position are being loaded.
2. An alternate method (5.3.3.1.2), which enables replacement of forms while home position is retained. This method should be used when loading forms of the same format, prior to reaching an out-of-forms condition (printer cover is open and only **STOP** indicator is lit).

5.3.3.1.1. Forms Loading, General Method

To load forms into the printer according to the general method, proceed as follows:

NOTE:

Before performing the following procedure, remove the device from the system's list of available resources by using the DOWN function of the SET IO command (Section 12). After the procedure is completed, restore the device's available status by using the UP function of the SET IO command. Note also that this procedure assumes that no forms are present in the printer. If forms are present, they must be unloaded as described in 5.3.3.2.

1. Press **STOP** switch/indicator on control panel.
2. Press **COVER** switch/indicator on control panel and allow cover to open fully. Note that **COVER** switch/indicator is extinguished when cover is fully opened.
3. Open the print carriage by lifting the latch lever and pressing in to release the latch (Figure 5—26). Swing the carriage assembly fully open.

CAUTION

Be very careful when opening the print carriage. Open it slowly and do not allow it to swing freely and slam against the frame because misalignment or physical damage to the carriage may result.

4. Check to determine that the correct ribbon shield for the type of form being loaded is installed in the print carriage. If necessary, remove the installed shield and replace it with the correct type (5.3.3.5).

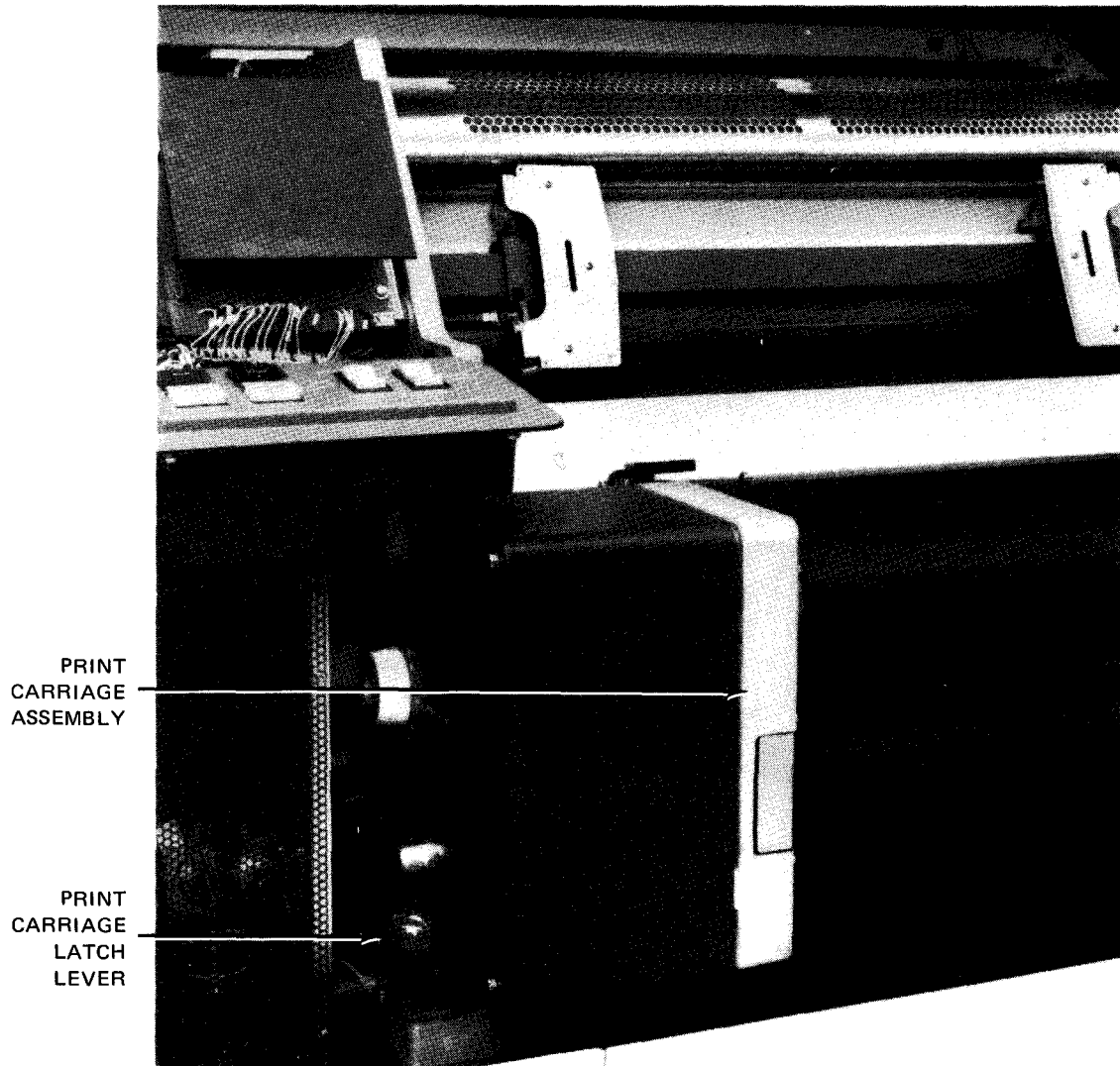

Figure 5-26. 0770 Printer Subsystem, Print Carriage Assembly Closed

5. Release the antistatic brush by pulling back the latch (Figure 5—27). Swing back the brush to permit access for loading forms.

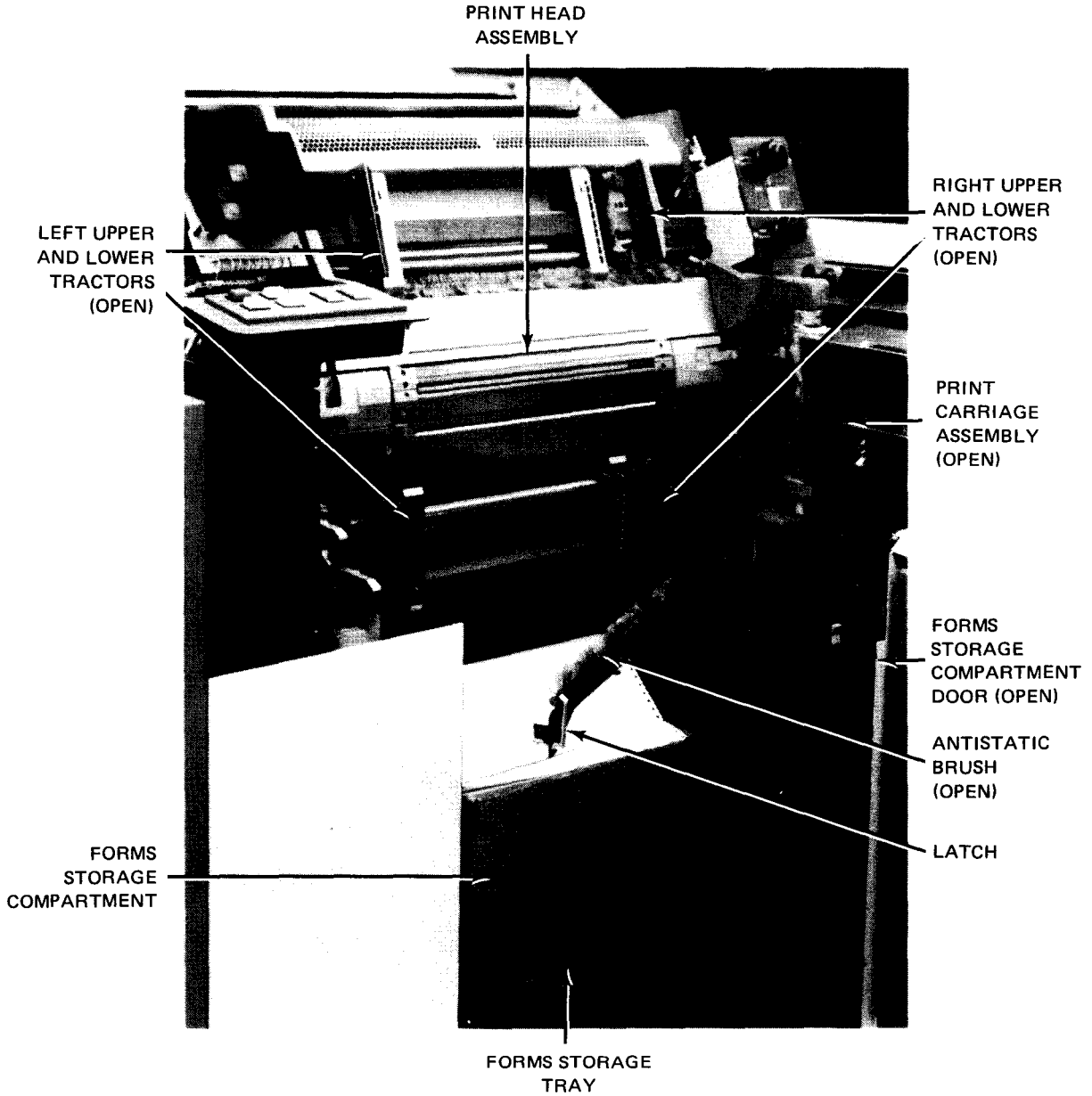

Figure 5—27. Printer Open to Receive Forms

9. While holding several sheets, obtain the starting edge of the first sheet and raise it above the tractors. Engage the form sprocket holes on the left tractors and close both the upper and lower left tractors.
10. Set the **SINGLE TRACTORS/BOTH TRACTORS** switch (Figure 5-30) to the **SINGLE TRACTORS** position to lock the tractors.

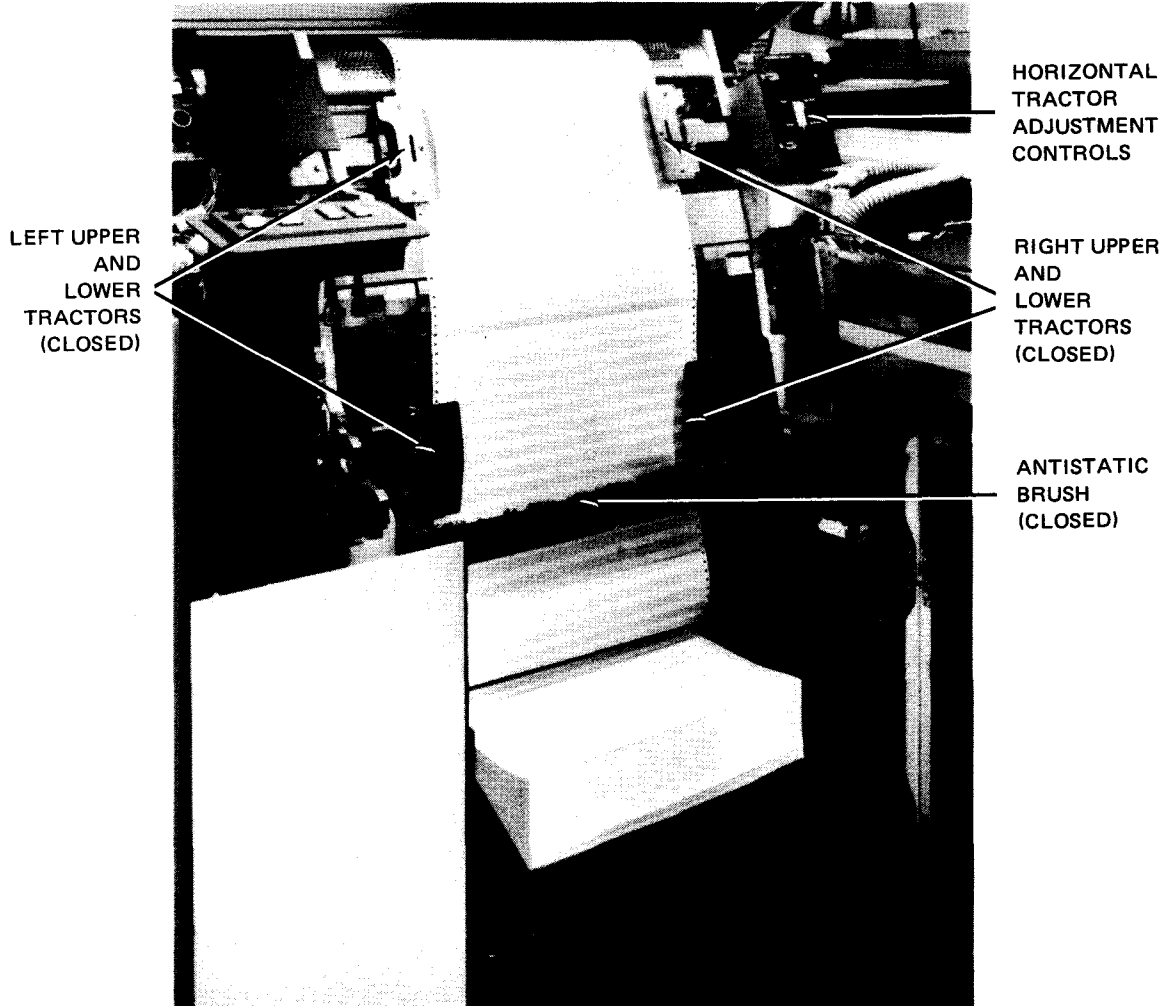

Figure 5-29. Forms Loaded in Printer

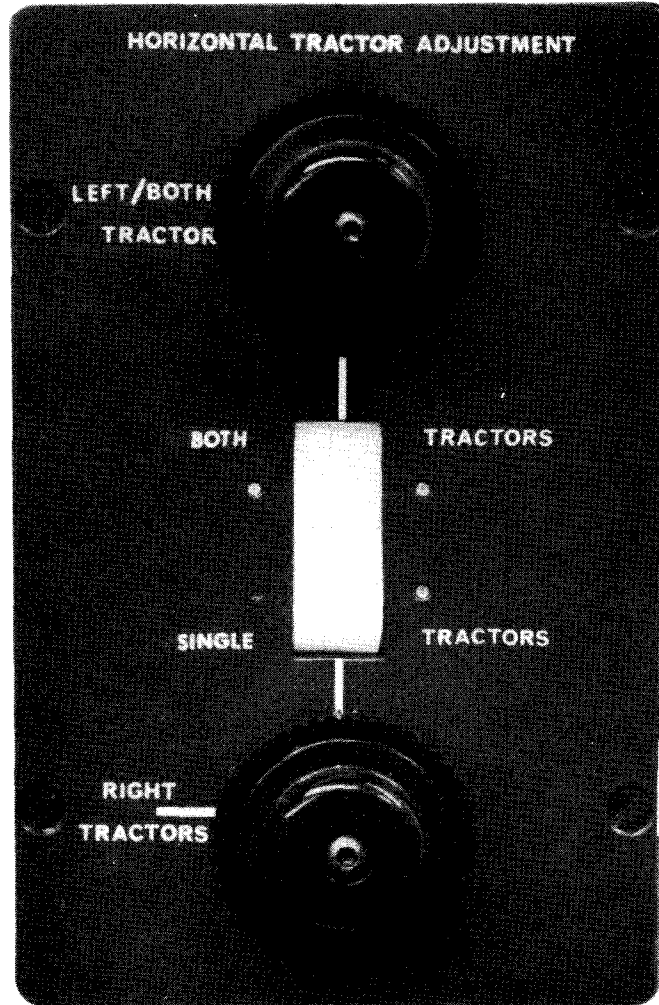

Figure 5-30. HORIZONTAL TRACTOR ADJUSTMENT Controls

11. Pull out the **RIGHT TRACTORS** knob (Figure 5-30) to release the lock, and turn the knob so that the tractors are aligned with sprocket holes on right edge of forms and engage the sprocket holes with the sprocket. Close upper and lower tractors. Carefully move the tractors with the **RIGHT TRACTORS** control to cause a slight, horizontal tension on the form.

NOTE:

*Adjustment of the **RIGHT TRACTORS** control determines the horizontal tension on the form. Excessive tension causes form sprocket holes to become elongated during a run; insufficient tension causes the form to be under loose control, which may affect form feeding and print quality.*

12. Pull out the forms alignment guide from its retracted position (Figure 5-31) and connect the catch to the pin on the left side of the print head assembly (Figure 5-32).
13. Set the **SINGLE TRACTORS/BOTH TRACTORS** switch to **BOTH TRACTORS** position (Figure 5-30).
14. Pull out **LEFT/BOTH TRACTORS** control (Figure 5-30) and turn it to position the form horizontally to the printing location required for that form.

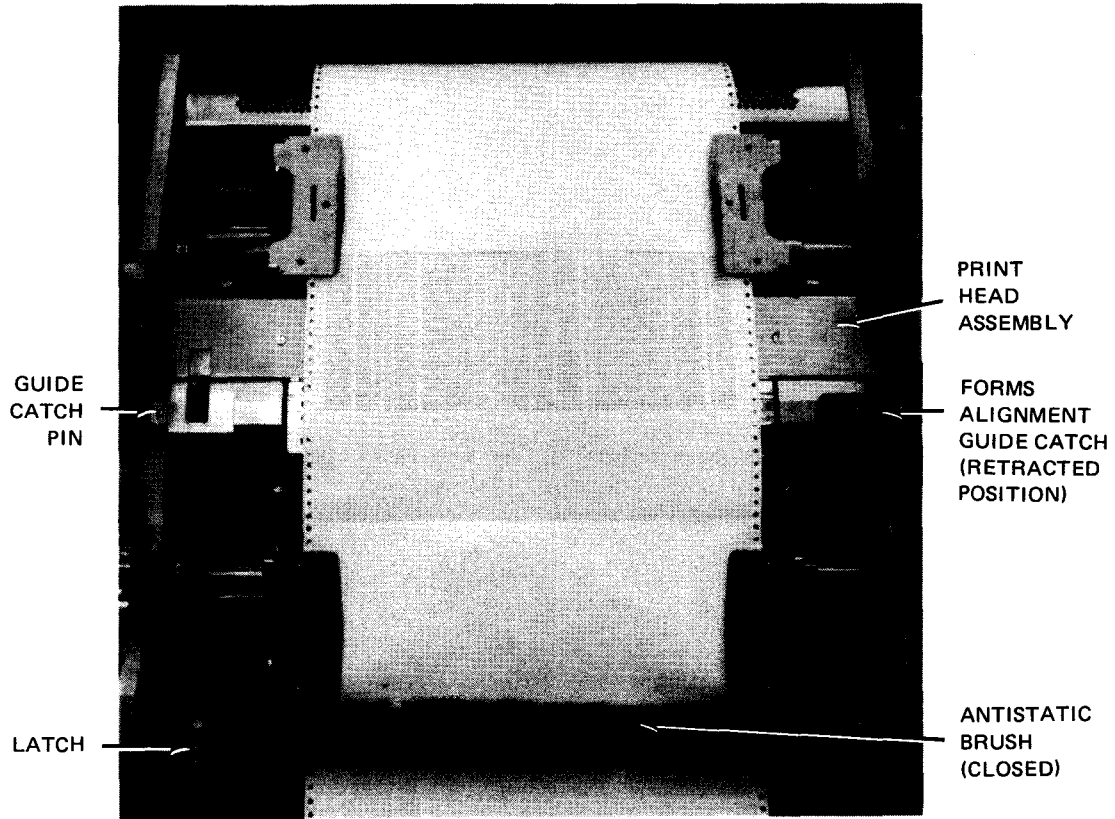

Figure 5-31. Forms Alignment Guide Retracted in Housing

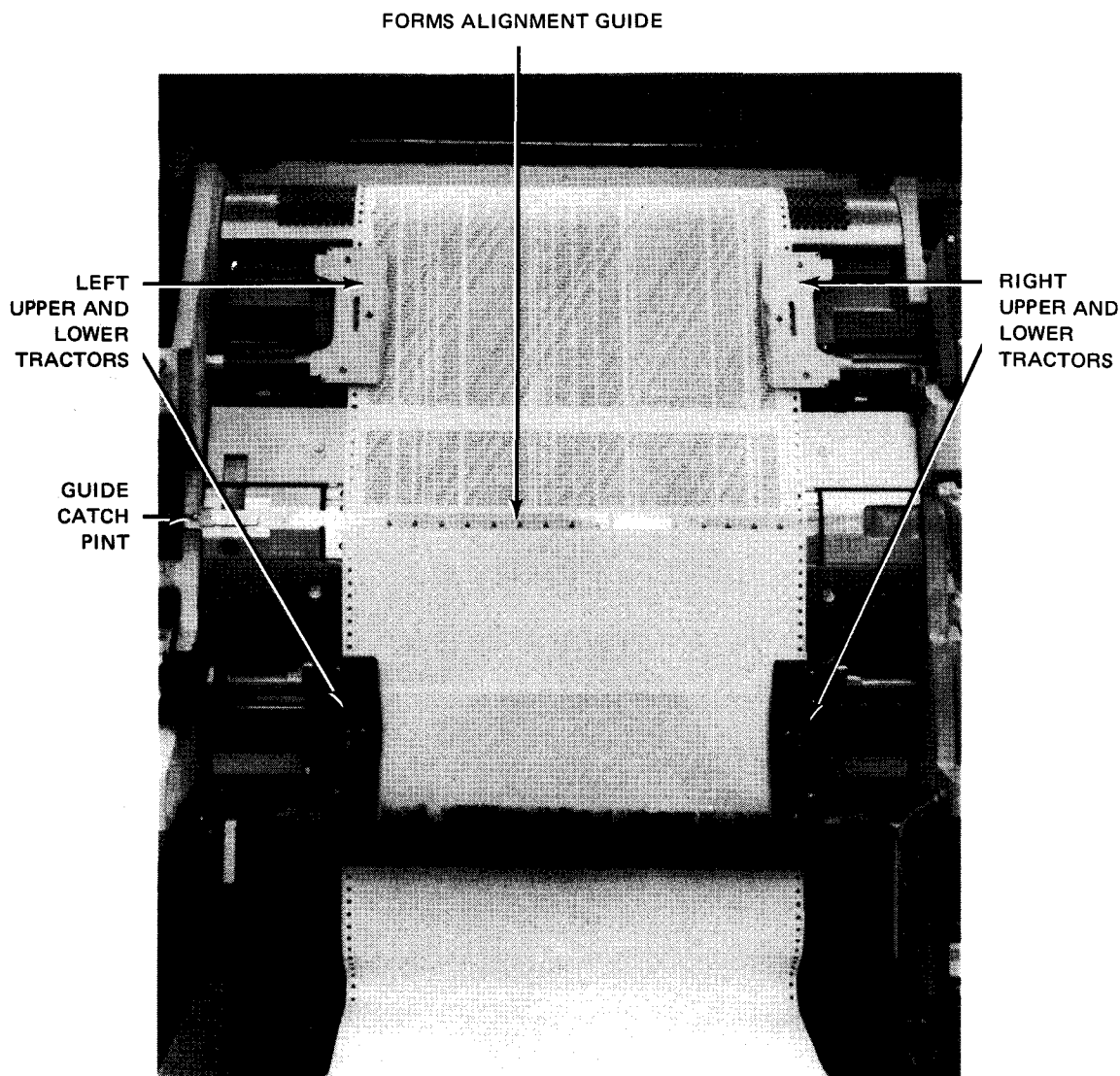

Figure 5-32. Forms Alignment Guide and Tractors

NOTE:

If forms of nonuniform thickness are used, the thickest portion of the form must be placed at column 20 of the forms alignment guide to ensure proper gapping.

15. Set the **SINGLE TRACTORS/BOTH TRACTORS** switch to the **SINGLE TRACTORS** position to ensure that the tractors lock.
16. Push in the vertical position control (Figure 5-33) to engage gears and turn the control to position the form vertically to the printing location required for the first printed line. The horizontal line on the alignment guide indicates the bottom of the print line.
17. If included on your printer, adjust the vertical tension by pulling the knurled plastic ring (Figure 5-33), located on the lower tractor drive shaft, to the right to release coupling. Turn the ring clockwise to decrease tension, or counterclockwise to increase tension.

NOTE:

Excessive vertical tension causes form sprocket holes to tear; insufficient tension causes forms to be too loose, which may affect form feeding, print quality, and forms stacking.

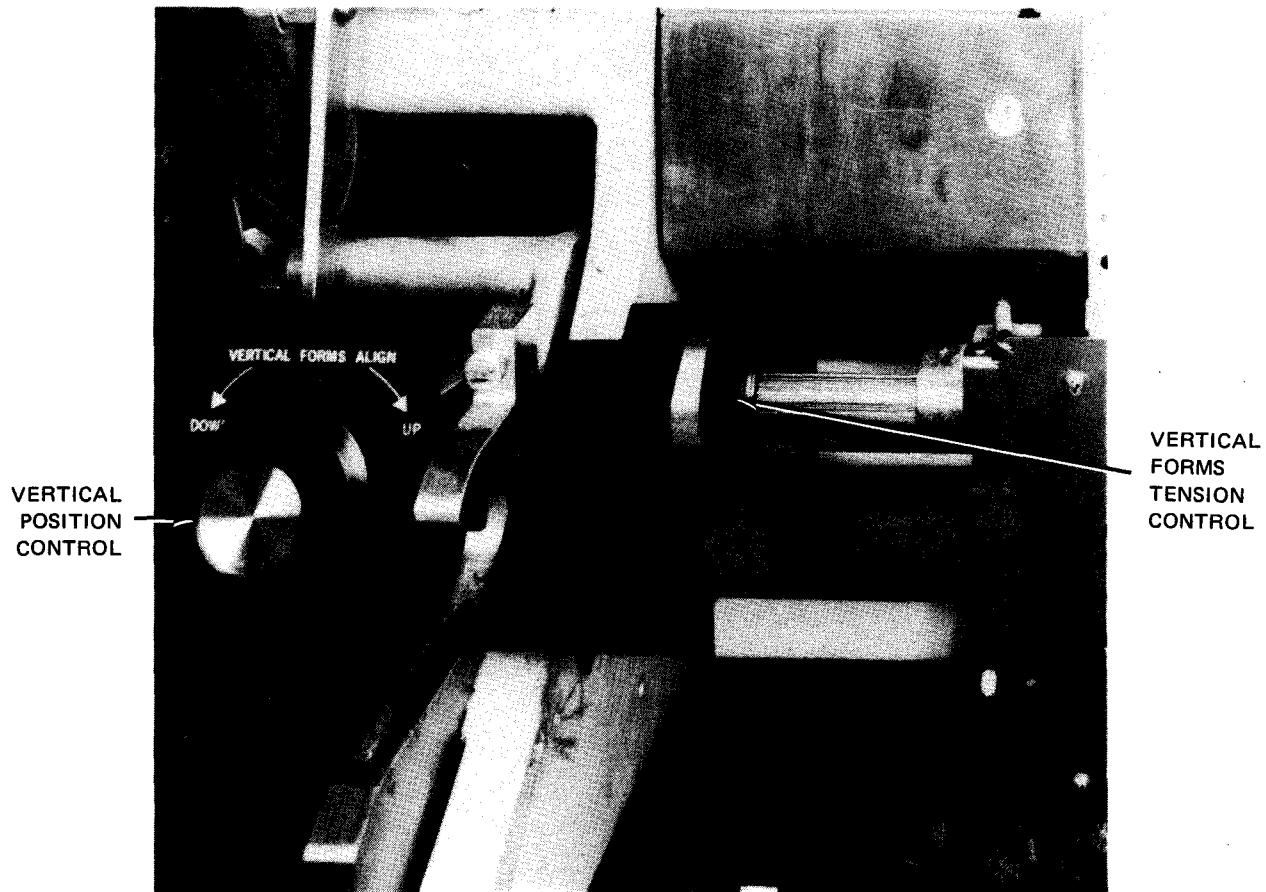

Figure 5—33. Vertical Position Control and Vertical Forms Tension Control

18. Disengage the forms alignment guide from the catch pin and retract it to its normal position (Figure 5—31).

NOTE:

*Failure to retract the forms alignment guide prevents the print carriage from locking and causes the **CARRIAGE CHECK** indicator to remain lit.*

19. Set the forms compression control on the print carriage assembly (Figure 5—34) by rotating the variable control knob to the number 1 dial setting; this setting is satisfactory for most operating conditions. If forms handling difficulties occur, use the lowest dial setting compatible with good forms registration.

CAUTION

The print carriage must be closed slowly and carefully to avoid damage or misalignment to the print carriage and print hammer assembly.



FORMS
COMPRESSION
CONTROL

PRINT BAND
SPEED SELECTOR
SWITCH

PRINT CARRIAGE
LATCH LEVER

Figure 5-34. Forms Compression Control and Print Band Speed Selector Switch

20. Close the antistatic brush (Figure 5-31) and engage the latch so that the brush is firmly positioned against the forms.
21. Close the print carriage assembly and lower the print carriage latch lever (Figure 5-34). The **CARRIAGE CHECK** indicator remains lit until the print gap is automatically adjusted. Occasionally, to eliminate ribbon smear on special forms (labels, mailing envelopes, etc), the print gap must be adjusted manually with the print gap manual vernier adjustment control (5.3.3.7). If manual adjustment of the print gap is required, the **HORIZONTAL CHARACTER PHASING** control may also require adjustment (5.3.3.8).
22. Set the **PRINT DENSITY** switch (Figure 5-35) to **NORM** for printing on single-part forms. When printing on multipart forms, set the switch to **HI** to print darker on the last form.
23. Press **HOME** switch/indicator on control panel to feed two forms into the stacker.
24. Close storage compartment door and press **COVER** switch/indicator on control panel to close the cover.

NOTE:

A run may be initiated with the cover open, but throughput is automatically reduced to avoid excessive noise.

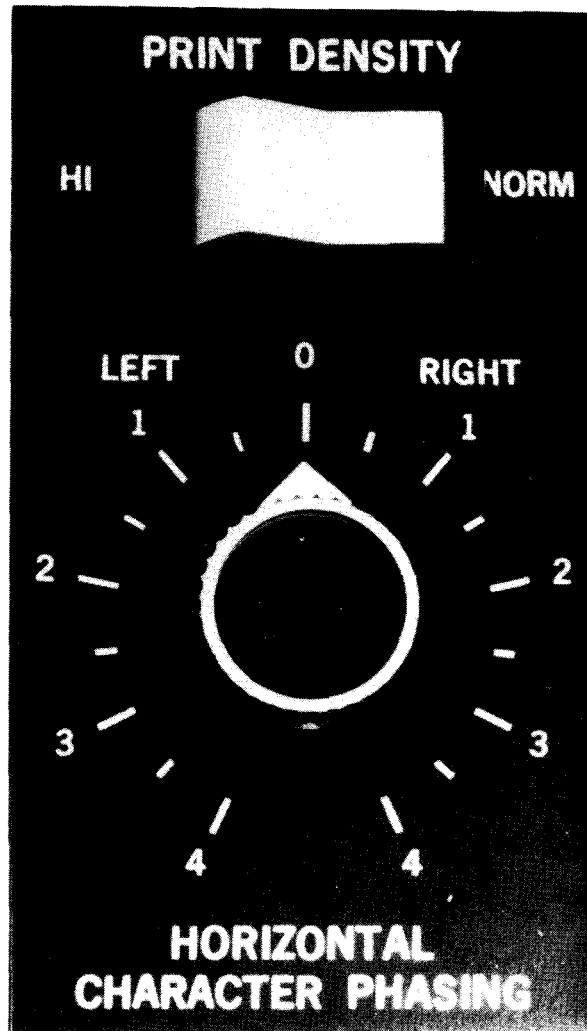

Figure 5—35. PRINT DENSITY Switch and Print Phasing Control

25. Press **RUN** switch/indicator on control panel. Printer is now ready to operate upon receiving a command from the processor.

5.3.3.1.2. Forms Loading, Alternate Method

To load forms into the printer according to the alternate method, proceed as follows:

NOTES:

- a. Before performing the following procedure, remove the device from the system's list of available resources by using the **DOWN** function of the **SET IO** command (Section 12). After the procedure is completed, restore the device's available status by using the **UP** function of the **SET IO** command.
- b. Be careful not to press the **HOME** switch/indicator while performing this procedure; otherwise home position will have to be reestablished as described in 5.3.3.1.1.

1. Open the print carriage by lifting the latch lever and pressing in to release the latch (Figure 5—26). Swing the carriage assembly fully open.

CAUTION

Be very careful when opening the print carriage. Open it slowly and do not allow it to swing freely and slam against the frame because misalignment or physical damage to the carriage may result.

2. Release the antistatic brush by pulling back the latch (Figure 5—27). Swing the brush back to permit access for loading forms.
3. Open and cut the container holding new forms as follows:
 - a. Cut off the top of the container approximately 2 inches (5.08 cm) below the top edge (Figure 5—28).
 - b. Remove the cardboard spacers from the top of the container and locate the outside edge of the top form.
 - c. To prevent cutting the edges of forms, insert one cardboard spacer vertically between the forms and the right side of the container.
 - d. Position the container and make a diagonal cut down the right side to the front of the container, with the outside edge of the top form facing the front.
 - e. Keeping the cardboard spacer between the forms and the container, cut across the front of the container and up the left side diagonally to the top.
4. With the forms compartment door open, place the supply of forms on the storage tray in the storage compartment so that the forms print surface faces the operator.

NOTES:

- a. *To reduce forms play between the unprinted forms and the engaging lower tractors, remove the forms storage tray and insert it in the position (any of three available) which allows approximately 2 inches (5.08 cm) between the lower tractor paper guide and the top of the forms when the supply is placed on the storage tray.*
 - b. *There are two procedures which can be followed at this point: taping the forms together or overlapping the forms. To tape the forms, proceed with step 5; to overlap the forms, proceed with step 6.*
5. Carefully tape the first form from the new container to the bottom of the last form of the previous container with transparent adhesive tape. Do not unlatch the tractors. Omit steps 6 through 12 and proceed with step 13.
 6. Leaving the upper tractors closed, open the lower tractors.
 7. Thread sufficient new forms over the closed upper tractors and over the stacker, so that a few new forms will extend beyond the stacker upper position.

8. Align the horizontal perforations of the new forms with the perforations of the old forms and place the new forms over the lower sprockets.
9. Close the lower tractors.
10. Open the upper tractors and remove the old forms from the upper sprockets and stacker.
11. Raise the stacker to the upper position and fold the leading new forms into the stacker.
12. Close the upper tractors.
13. If the sprocket holes in the forms are elongated, indicating need for adjustment, proceed with step 14; otherwise, continue with step 15.

NOTE:

*Adjustment of the **RIGHT TRACTORS** control determines the horizontal tension on the form. Excessive tension causes form sprocket holes to become elongated during a run; insufficient tension causes the form to be under loose control, which may affect form feeding and print quality.*

14. Pull out the **RIGHT TRACTORS** knob (Figure 5—30) to release the lock, and turn the knob so that the tractors are aligned with sprocket holes on right edge of forms and engage the sprocket holes with the sprocket. Close upper and lower tractors. Carefully move the tractors with the **RIGHT TRACTORS** control to cause a slight, horizontal tension on the form.

Set the **SINGLE TRACTORS/BOTH TRACTORS** switch to the **SINGLE TRACTORS** position to ensure that the tractors lock.

15. Close the antistatic brush (Figure 5—31) and engage the latch so that the brush is firmly positioned against the forms.

CAUTION

The print carriage must be closed slowly and carefully to avoid damage or misalignment to the print carriage and print hammer assembly.

16. Close the print carriage assembly and lower the print carriage latch lever (Figure 5—34). The **CARRIAGE CHECK** indicator remains lit until the print gap is automatically adjusted. Occasionally, to eliminate ribbon smear on special forms (labels, mailing envelopes, etc), the print gap must be adjusted manually with the print gap manual venier adjustment control (5.3.3.7). If manual adjustment of the print gap is required, the **HORIZONTAL CHARACTER PHASING** control may also require adjustment (5.3.3.8).
17. Set the **PRINT DENSITY** switch (Figure 5—35) to **NORM** for printing on single-part forms. When printing on multipart forms, set the switch to **HI** to print darker on the last form.
18. Close the cover.
19. Press the **RUN** switch to resume printing.
20. Anytime after the newly printed forms have entered the stacker, the forms can be torn at the perforation and removed.

5.3.3.2. Forms Unloading

Forms are unloaded after a program is complete or if the stacker is full. Unload forms as follows:

NOTE:

Before performing the following procedure, remove the device from the system's list of available resources by using the DOWN function of the SET IO command (Section 12). After the procedure is completed, restore the device's available status by using the UP function of the SET IO command.

1. Press **STOP** switch/indicator on stacker control panel and open stacker doors (Figure 5—17).
2. Press and hold **HOME** switch/indicator on stacker control panel until the last printed form arrives in the stacker.
3. Squeeze the gate release pinions on the forms gate (Figure 5—36) and raise the gate to its extreme open position (Figure 5—37). Release the pinions to lock the gate in its raised position.
4. Tear off the last printed form at the perforation.
5. Remove the printed forms from the stacker tray.
6. Press the **STKR RESET** switch/indicator on the stacker control panel to allow the stacker tray to rise.
7. Start the first fold from succeeding forms so that forms feed and fold in a natural direction.
8. Squeeze the gate release pinions on the forms gate and close the gate. Close the stacker doors.
9. Press the **RUN** switch/indicator on the stacker control panel.

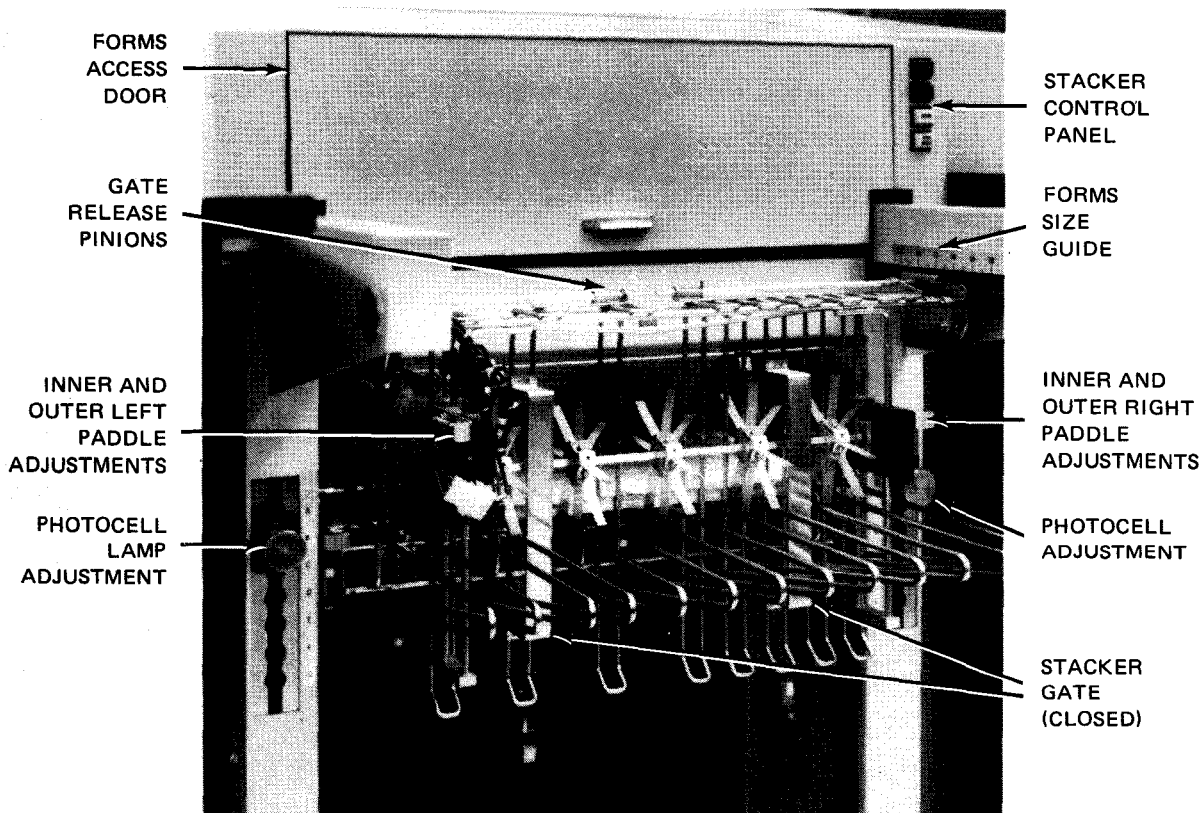

Figure 5—36. Stacker Gate Closed

5.3.3.3. Stacker Adjustments

Stacker adjustments are made to accommodate forms of a different size. To adjust the stacker, proceed as follows:

NOTE:

Before performing the following procedure, remove the device from the system's list of available resources by using the DOWN function of the SET IO command (Section 12). After the procedure is completed, restore the device's available status by using the UP function of the SET IO command.

1. Open the stacker doors (Figure 5-17) and the forms access door (Figure 5-36).
2. Open the stacker gate by squeezing the gate release pinions (Figure 5-36) and raising the stacker gate (Figure 5-37). Release the pinions to lock the gate in its open position.

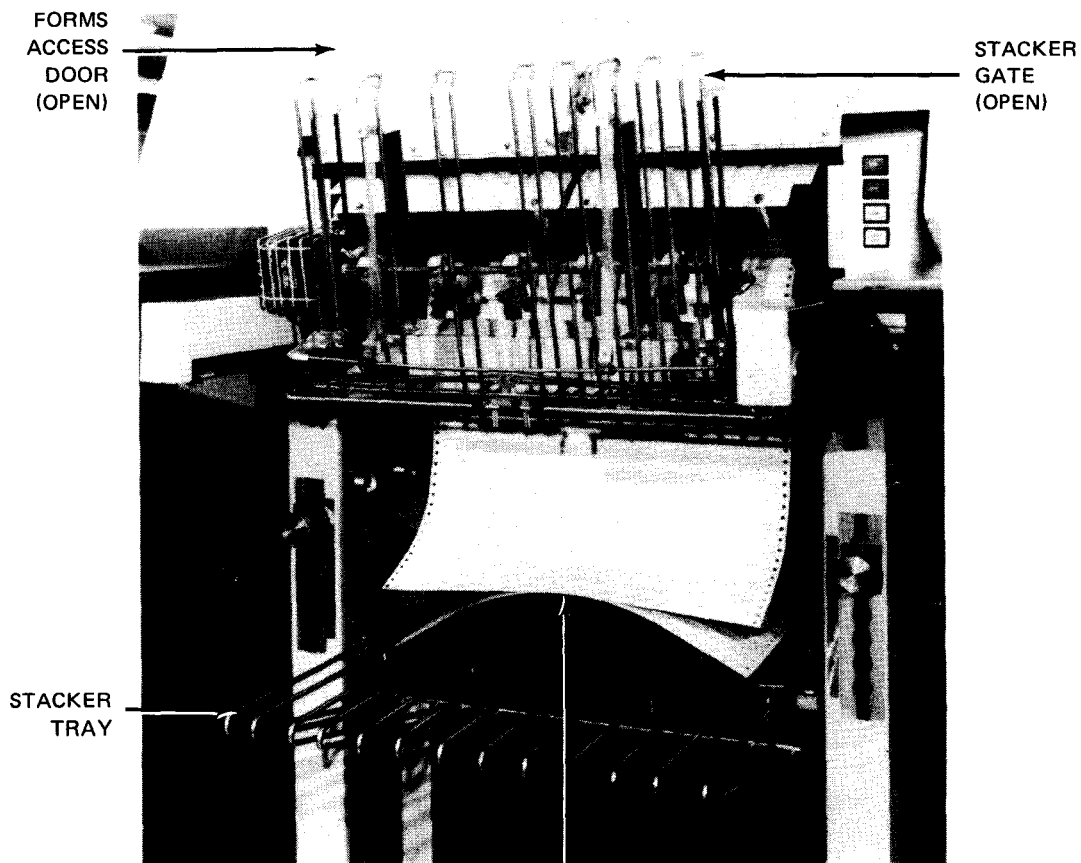

PAPER STACKER SUPPORT
(USED ONLY FOR FORMS WIDER
THAN 17-25/32 IN. (45,16 CM)
OR LARGER

Figure 5-37. Stacker Gate Open

3. Press the **HOME** switch/indicator on the stacker control panel to feed several sheets into the stacker.

CAUTION

If the vertical length of oversize forms are less than 11 inches (27,94 cm), the paper stacker support must not be used because damage to the stacker gate and tray may result when the tray is raised.

4. For forms with a horizontal dimension of 17-25/32 inches (45,16 cm) or greater and a vertical dimension of 11 inches (27,94 cm) or more, place the paper stacker support (Figure 5—37) on the stacker tray so that the forms are centered on the paper stacker support.
5. Press the **HOME** switch/indicator to feed two forms into the stacker. Manually, guide the two forms so that they fold in their natural direction and lie properly in the stacker. Do not tear off these forms.

NOTE:

On certain types of forms (e.g., card stock, check forms, etc) where the perforations are located at places other than at the folds, it may be necessary for the operator to assist the stacker in folding the forms properly.

6. Close the stacker gate by squeezing the gate release pinions.
7. Move the gate inward or outward by gate top so that front and back of the form gate are set to the form length, as indicated on forms size guide (Figure 5—36).

WARNING

Do not allow hands or clothes to engage or become entangled with rotating rollers/paddles to prevent personal injury.

8. To accommodate form size (positions are marked A through G on the stacker), set the following items (Figure 5—36) to the same position:
 - Photocell lamp
 - Photocell
 - Right inner paddle
 - Right outer paddle
 - Left inner paddle
 - Left outer paddle

NOTE:

If paddle settings require positions at opposite extremes (e.g., position A to position F), move the paddles in increments of two positions right, then left, until a new setting is reached for both sides.

9. If standard-size forms are used, set items (step 8) to positions indicated in Table 5—7.

Table 5-7. Stacker Settings for Standard Forms

Horizontal Form Length	Number of Parts (Form Thickness)	Forms Size Guide (Figure 5-36)	All Stacker Settings
3.5 in. (8,89 cm)	1-6	7	A
5.5 in. (13,97 cm)	1-6	11	B
7 in. (17,78 cm)	1-3	7	A
7 in. (17,78 cm)	4-6	7	B
8.5 in. (21,59 cm)	1-6	8.5	B
10 in. (25,4 cm)	1-6	10	B
11 in. (27,94 cm)	1-6	11	B
14 in. (35,56 cm)	1-3	14	C
14 in. (35,56 cm)	4-6	14	D
17 in. (43,18 cm)	1	17	D
17 in. (43,18 cm)	2-6	17	E

NOTES:

1. Stacker settings are based on form length and number of parts per form based on industry standard forms for normal modes of operation. Operator must modify settings as required to achieve optimum performance for particular applications.
2. Nonstandard forms up to 23 inches (58,42 cm) long also can be stacked.
3. Press **STKR RESET** switch/indicator on stacker control panel to allow tray to rise to new setting as sensed by photocell, after settings are complete.
10. If the vertical length of the forms is less than 7 inches (17,78 cm) perform the following:
 - a. Set all items (step 8) to position A.
 - b. Cover the rear photocell with a piece of masking tape (Figure 5-38).
 - c. Open the stacker gate and press the **HOME** switch/indicator to feed several forms into the stacker. Manually, guide the forms so that they fold naturally and lie flat in the stacker tray.
 - d. Position the forms in the stacker tray so that the feed rollers are centered over the form and neither side of the forms pile is touching either gate.
 - e. Allow the four MYLAR* tapes to hang directly over the sides of the forms pile, rather than through the front and rear gates.

NOTE:

The stacker operation should be monitored by the operator because the forms pile is not supported by gates and the pile may fall over if allowed to exceed 9 inches (22,86 cm) in height.

* MYLAR is a trademark of E. I. du Pont de Nemours & Co., Inc.

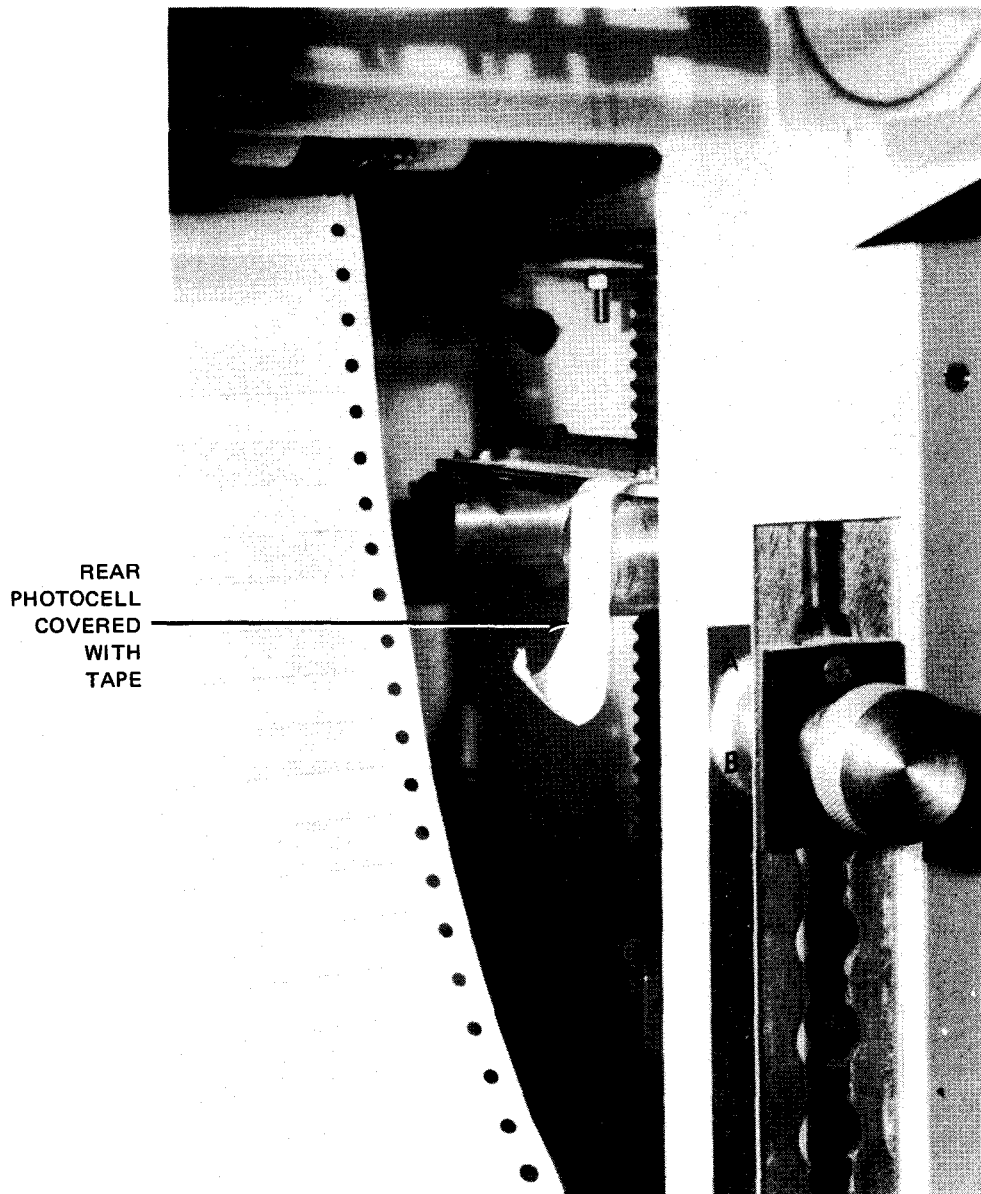

Figure 5-38. Rear Photocell Covered

5.3.3.4. Ribbon Replacement

The ribbon should be replaced when printing appears light or faded. Care should be exercised to avoid replacing the ribbon with one that is too wide. Before installing a new ribbon, the dimension between the end of the ribbon mandrel and the edge of the ribbon on the left side of the ribbon assembly (Figure 5-39) must be checked. If the dimension is less than 0.3 inch (7.62 cm), the ribbon should not be used because the ribbon may come in contact with the reversing arm, resulting in high frequency cycling of ribbon reversals that cause excess ribbon wear.

It is recommended that the print carriage assembly be cleaned each time the ribbon is changed.

CAUTION

Be very careful when opening the print carriage. Open it slowly and do not allow it to swing freely and slam against the frame or misalignment or damage to the carriage may result.

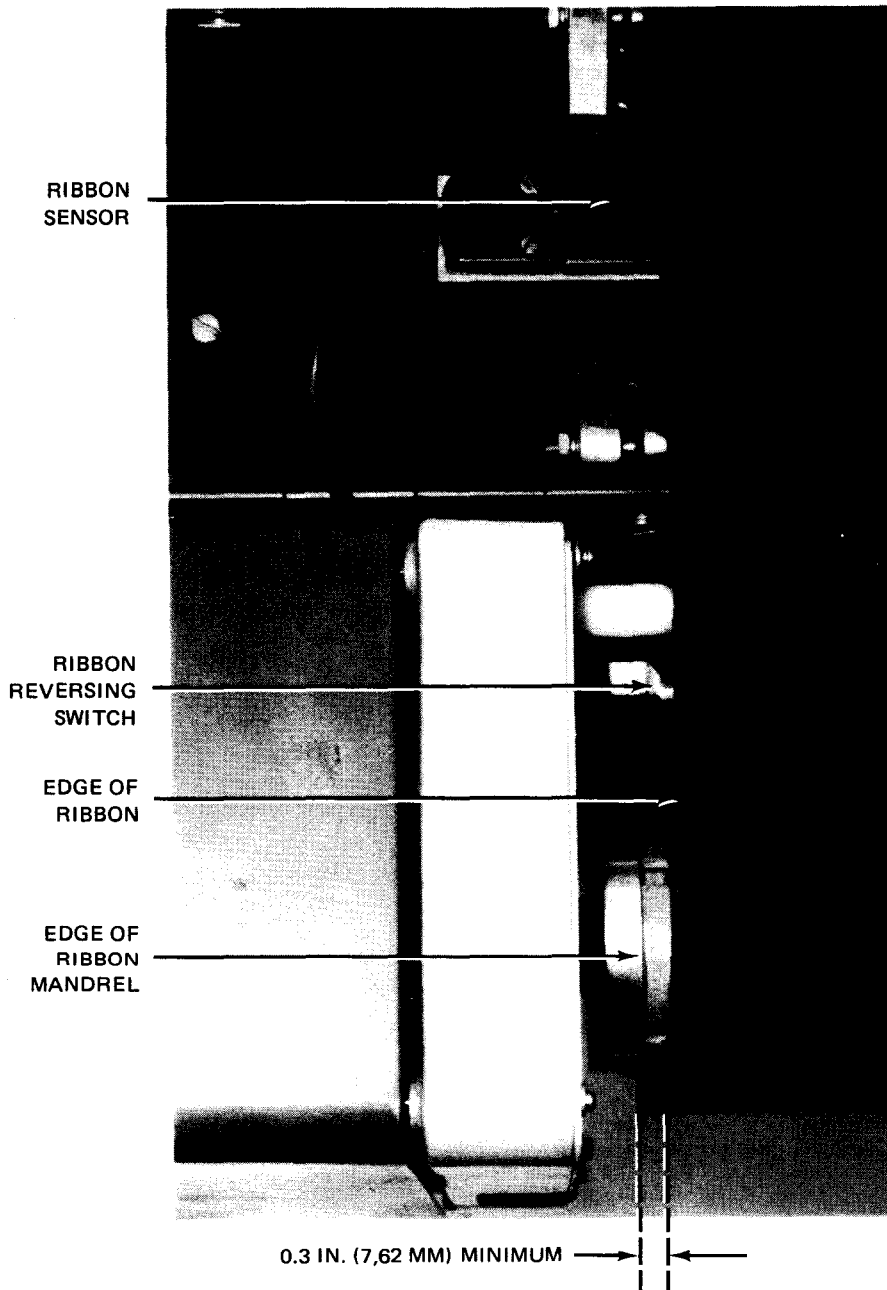

Figure 5-39. Dimension Between Ribbon Mandrel and Ribbon

To replace the ribbon, proceed as follows:

NOTE:

Before performing the following procedure, remove the device from the system's list of available resources by using the DOWN function of the SET IO command (Section 12). After the procedure is completed, restore the device's available status by using the UP function of the SET IO command.

1. Release the print carriage latch (Figure 5—40a) by lifting the latch lever; swing the print carriage assembly fully open.
2. Open the ribbon shield by releasing the shield latch and pulling the shield handle (Figure 5—40a) straight back; swing the shield back (Figure 5—40b).

NOTE:

The ribbon shield handle is not pivoted and must not be turned.

3. Wear plastic gloves and remove the upper takeup spool from the spool holder (Figure 5—40c) by pushing the spool toward the spring-loaded spool holder (pivot end of carriage).
4. Remove the lower takeup spool from the spool holder (Figure 5—40d) in same manner as upper spool (step 3); discard the ribbon and spool.
5. Obtain a new ribbon to meet present requirements (Table 5—8) and check the ribbon/mandrel dimension (Figure 5—39).
6. Install a new ribbon on the lower, then upper, spool holders in the reverse manner that the old ribbon was removed. Note that the ribbon threading path follows that illustrated in Figure 5—40e. Ensure that the ribbon edge passes inside of sensor (Figure 5—40b).

CAUTION

Before closing the ribbon shield (Figure 5—40a) make certain that ribbon edge shield is correctly positioned (Figure 5—44a).

7. Close the ribbon shield (Figure 5—40a).

CAUTION

Be very careful when closing the print carriage. Close it slowly or misalignment or damage to the carriage or print hammer assembly may result.

8. Close the print carriage and lock it firmly with print carriage latch lever (Figure 5—40a).

NOTE:

The ribbon reversing lever (Figure 5—40a) automatically reverses ribbon direction at the end of the spool.

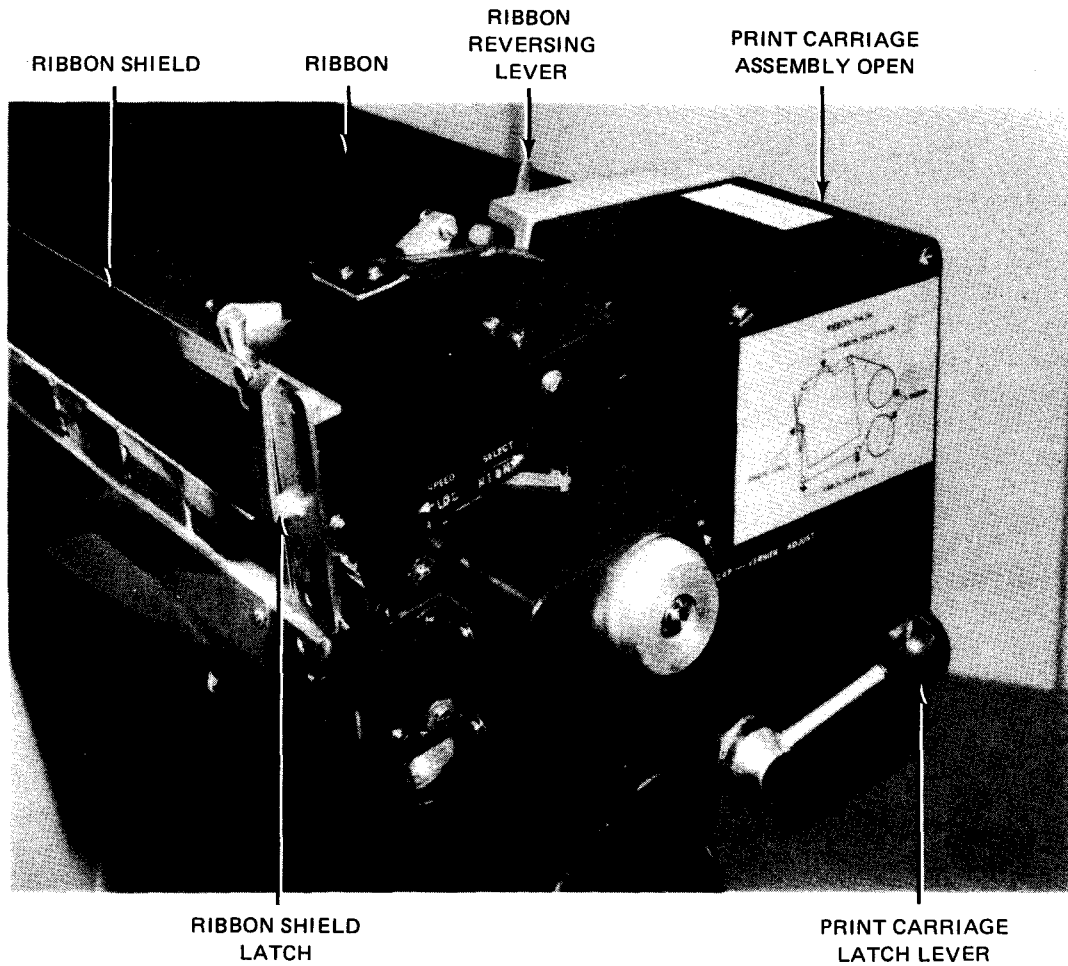

a. Ribbon shield closed

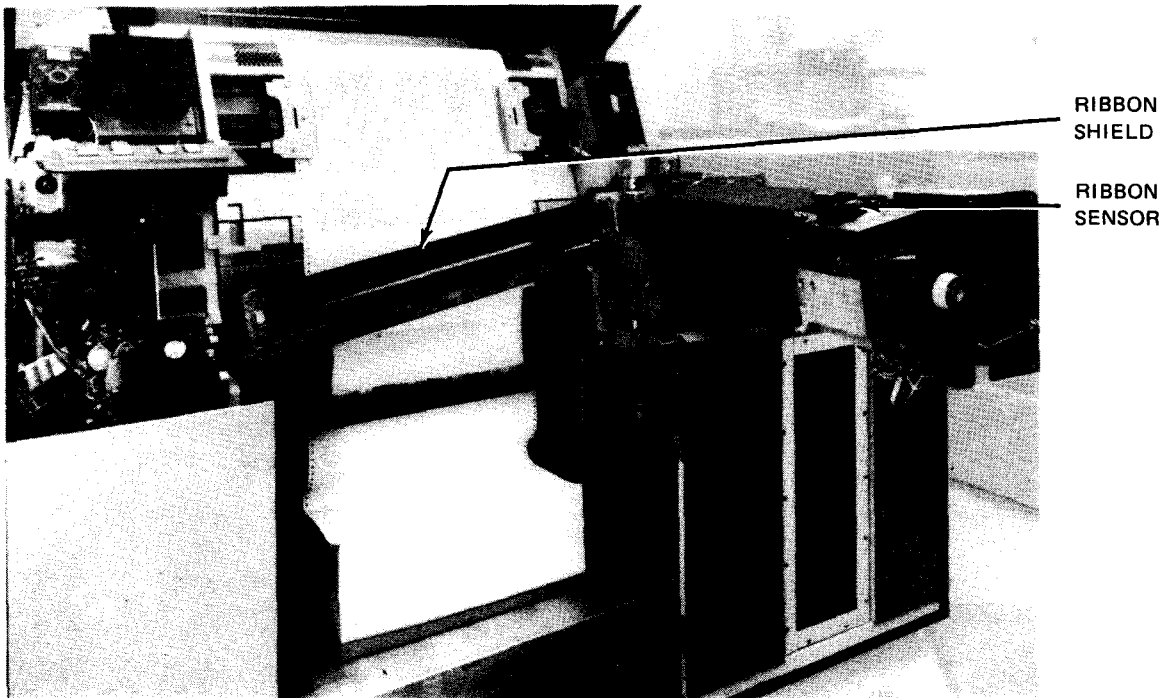

b. Ribbon shield open

Figure 5-40. Changing Ribbon (Part 1 of 3)

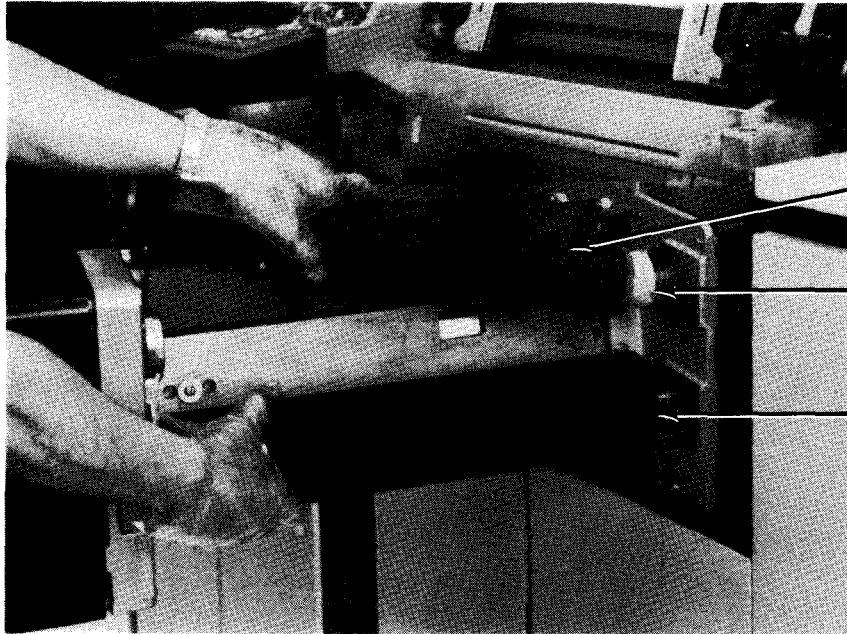

UPPER
TAKEUP
SPOOL

UPPER
SPOOL
HOLDER

LOWER
TAKEUP
SPOOL

c. Removing upper takeup spool

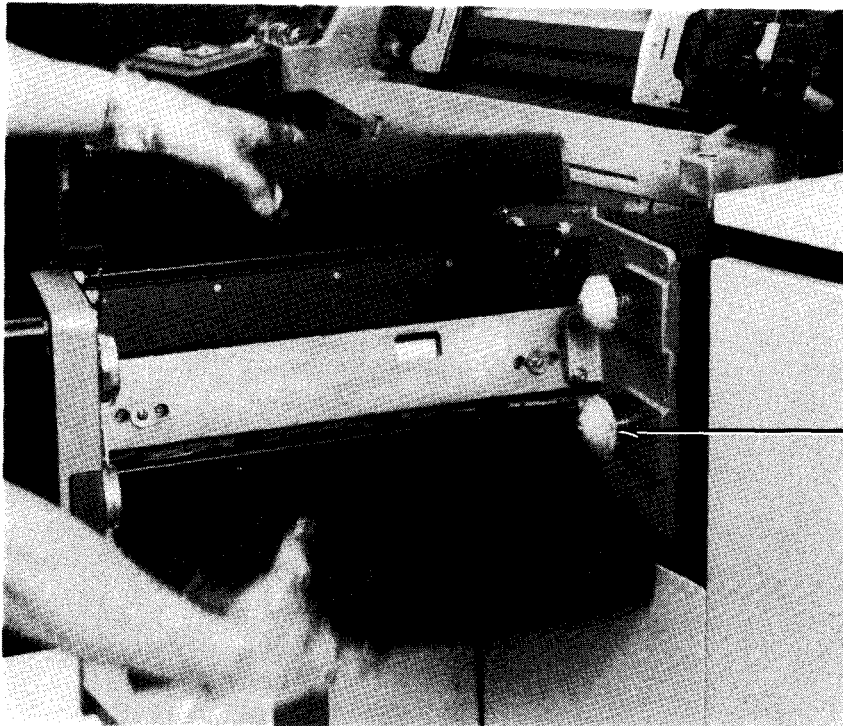

LOWER
SPOOL
HOLDER

d. Upper and lower takeup spools removed

Figure 5-40. Changing Ribbon (Part 2 of 3)

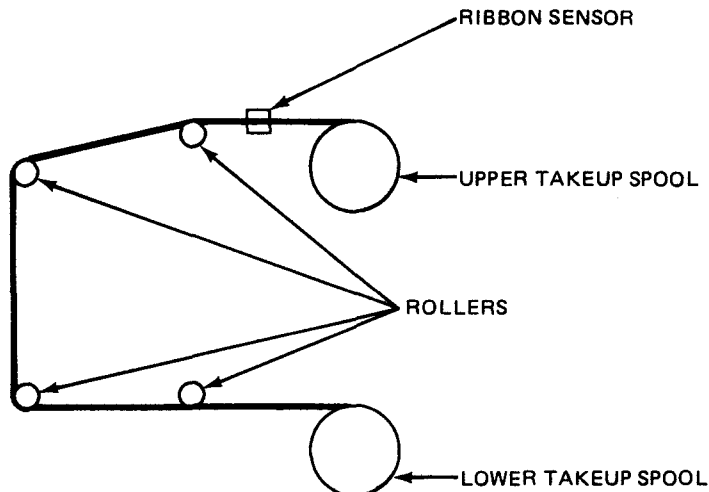

e. Ribbon threading path

Figure 5-40. Changing Ribbon (Part 3 of 3)

Table 5-8. Ribbon Types

Sperry Univac Part Number		Description	Sperry Remington Part Number	
132 Columns	160 Columns*		132 Columns	160 Columns
3534843-00	3534180-00	High resolution fabric for sharper character definition. Usually results in shorter life than general purpose fabric.	7470012	7471012
3534843-01	3534180-01	High resolution film for character definition and minimum ghosting.	7070154	7071154
3534843-02	3534180-02	General purpose fabric for long life; used especially with 1- or 2-part forms, where heavier inking does not cause extensive ghosting.	7670013	7671013
3534843-03	3534180-03	Optical scanning applications, where high resolution and dark printing are desired. Useful life is limited by the need for dark characters. This type of ribbon may be either fabric or film.	**	**
3534843-04	3534180-04	Offset master applications, containing specially formulated ink for use in preparation of offset masters.	7470092	7471092

*With F1533-00 installed on printer

**Contact Sperry Univac customer engineer for Sperry Remington part numbers.

5.3.3.5. Ribbon Shield Replacement

Two interchangeable ribbon shields (Figure 5—41) are included in some models of the printer. One type, with a narrow slot, is used with standard forms and the second type, with a wider slot, is used with card stock forms (Figure 5—42). The latter type has a wider slot which prevents the catching of the top edge of the card stock forms.

NOTE:

Before performing the following procedure, remove the device from the system's list of available resources by using the DOWN function of the SET IO command (Section 12). After the procedure is completed, restore the device's available status by using the UP function of the SET IO command.

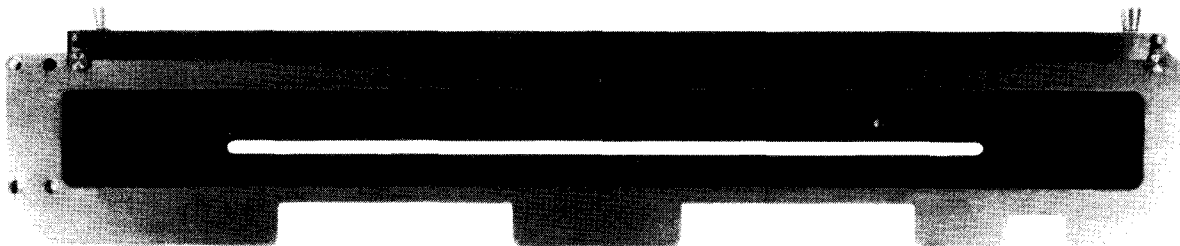

a. Narrow slot ribbon shield



b. Wide slot ribbon shield

Figure 5—41. Ribbon Shield Types

Replace one ribbon shield type with another type as follows:

CAUTION

Be very careful when opening the print carriage. Open it slowly and do not allow it to swing freely and slam against the frame or misalignment or damage to carriage may result.

1. Release the print carriage latch by lifting the latch lever (Figure 5—40a), and swing carriage assembly open.
2. Remove the ribbon shield as follows:
 - a. Pull up on the two knobs on the clip portion of the ribbon shield (Figure 5—42a).

NOTE:

It may be necessary to turn the forms compression control (Figure 5—42b) clockwise to release tension of forms pressure pads (Figure 5—42a) against the bottom of shield before removing shield.

- b. Tilt the shield slightly backwards to remove the two alignment pins from the holes in the frame (Figure 5—42b) then lift the shield upward.
3. Open the hinged, left side panel of the printer and remove the shield to be installed from the storage compartment on the panel. Place the removed shield in the storage compartment and close the panel.
4. Install the replacement shield by:
 - a. Placing the bottom edge of the shield in the slot at the bottom of the frame so that the shield is between each of the four forms pressure pads and the frame (Figure 5—42a).
 - b. Aligning the two alignment pins with the two holes in the frame (Figure 5—42b); and
 - c. Securing the shield to the frame by positioning the shield clip over the edge of the frame and pushing downward all along the clip (Figure 5—42a). Readjust forms compression control (Figure 5-42b) if control was turned clockwise to release the shield.

CAUTION

Be very careful when closing the print carriage. Close it slowly or misalignment or damage to the carriage or print hammer assembly may result.

5. Close the carriage and lock it firmly with the carriage latch (Figure 5—40a).

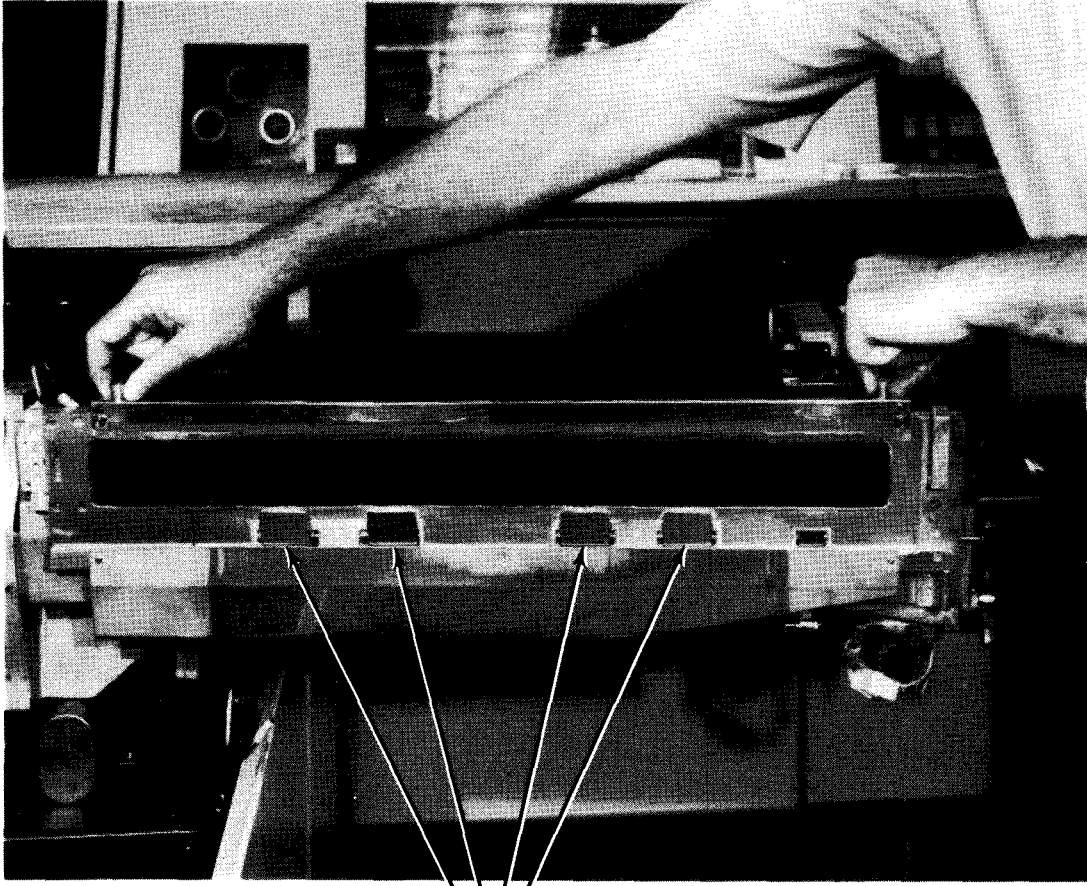

FORMS PRESSURE
PADS

a. Removing or installing ribbon shield clip

Figure 5-42. Changing Ribbon Shield (Part 1 of 2)

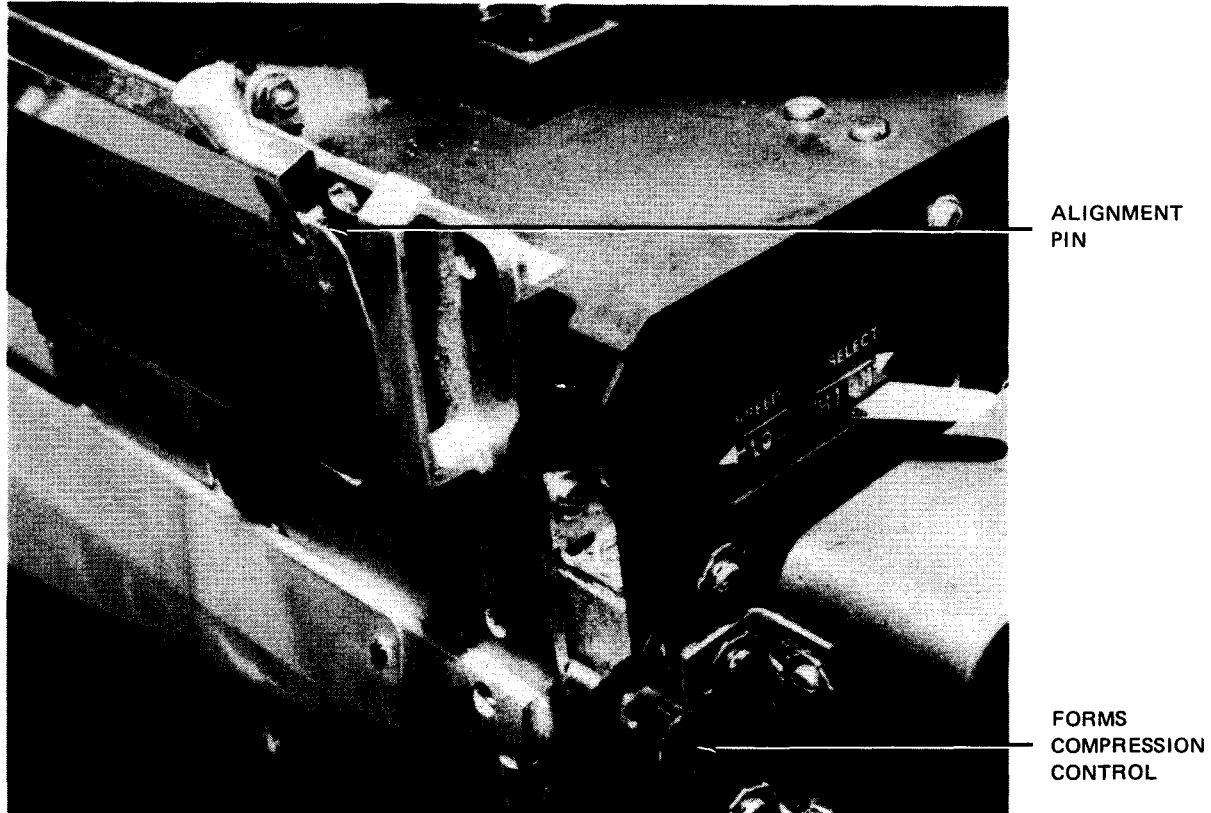

b. Positioning of alignment pin (typical, two places)

Figure 5-42. Changing Ribbon Shield (Part 2 of 2)

5.3.3.6. Print Band Replacement

A print cartridge contains a print band, which is supplied with its own carrier and cover. The print band always is replaced in the same carrier. Change the print band as follows:

NOTE:

Before performing the following procedure, remove the device from the system's list of available resources by using the DOWN function of the SET IO command (Section 12). After the procedure is completed, restore the device's available status by using the UP function of the SET IO command.

1. Remove the ribbon from the upper takeup spool holder as directed in steps 1 through 3 of 5.3.3.4.
2. Unthread the ribbon from its normal path around the carriage front and bring the upper takeup spool around the opposite side of the carriage assembly. Engage the upper takeup spool to the upper spool holder with the ribbon threaded on the rear of the carriage assembly so that the carriage front is accessible (Figure 5-43a).
3. Raise the print band cover on the print carriage (Figure 5-43b).
4. Release the ribbon shield (Figures 5-43a and c) and note that it swings freely.

5. Obtain the empty print band carrier from the carrier cover, in which the presently mounted print band was stored prior to installation, and remove the carrier from the carrier cover (Figure 5—43d) by raising it to release the two button latches on the carrier.
6. Hold the carrier by its two handles (Figure 5—43e) and carefully fit it over the print band. Note that the band release slot (Figure 5—43e) fits around the print band release lever and the print band sensors (Figures 5—43b and e) fit into openings provided on the carrier. Be sure that the carrier is seated fully over the print band.

CAUTION

Do not force the print band carrier over the print band. If the carrier does not seat fully, carefully examine its position over components near its perimeter. The carrier must clear all parts before it can be seated properly. Also ensure that the carriage area is clear of ribbon dust that could impede removal of print band.

7. Move the print band release lever from the tension position (Figure 5—43b) to release the print band (Figure 5—43e).
8. Lift off the print band carrier containing the print band (Figure 5—43f) and store it in the carrier cover in a suitable location. Press the button latches on the carrier to lock the carrier in the cover (Figure 5—43d).

NOTE:

Dropping the print band carrier may cause the print band to be released from holding magnets inside the carrier. If this occurs, the print band should be replaced carefully inside the carrier with the character timing marks on the bottom and font set identification marks on top (Figure 5—43b). Bending or creasing the print band may result in premature failure of the band.

9. Remove the replacement print band, with its carrier, from the carrier cover (Figure 5—43d).
10. Install the print band by:
 - a. Placing the left end of the print band carrier over the drive pulley and gently moving the carrier to the right so that the print band fits easily over the right-hand pulley of the print band mechanism.

NOTE:

If the curvature of the print band is not the same as the pulley, the print band must be repositioned in the carrier.

- b. Set the band release lever firmly in the tension position (Figure 5—43b).

CAUTION

Make certain that the print band is in position on the pulley before applying tension to the band by the hand release lever.

- c. Remove the print band carrier by its handles (Figure 5—43e). Gently lift the carrier free from the print band.

NOTE:

It may be necessary to jiggle the print band carrier slightly to free it from the print band.

- d. Manually rotate the idler pulley several turns to ensure proper tracking of the print band.
11. Remove the print band carrier (Figure 5—43e). Manually rotate the band pulleys to ensure proper tracking of the band. Close the print band cover (Figure 5—43a) and ribbon shield.
 12. Remove the upper takeup spool from the spool holder and rethread the ribbon as directed in steps 6, 7, and 8 of 5.3.3.4.

NOTE:

To provide product improvement, it is suggested that the operator record the operating time when the print cartridge is replaced by logging the time indicated on the OPERATE TIME meter on the power distribution panel.

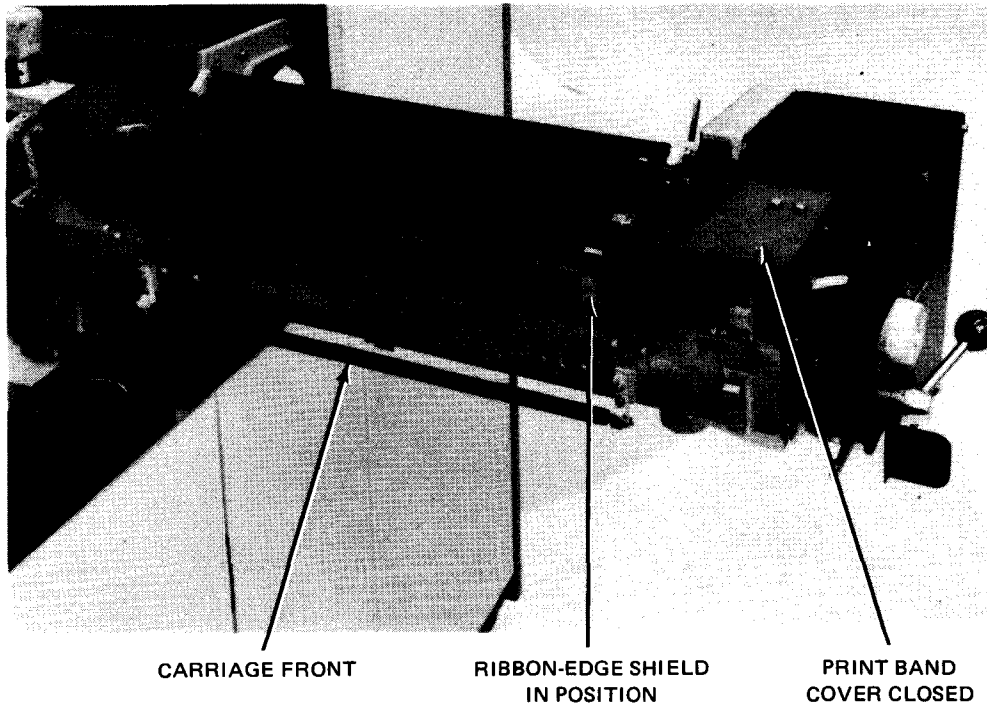

a. Ribbon removed and print band cover closed

Figure 5—43. Replacing Print Band (Part 1 of 4)

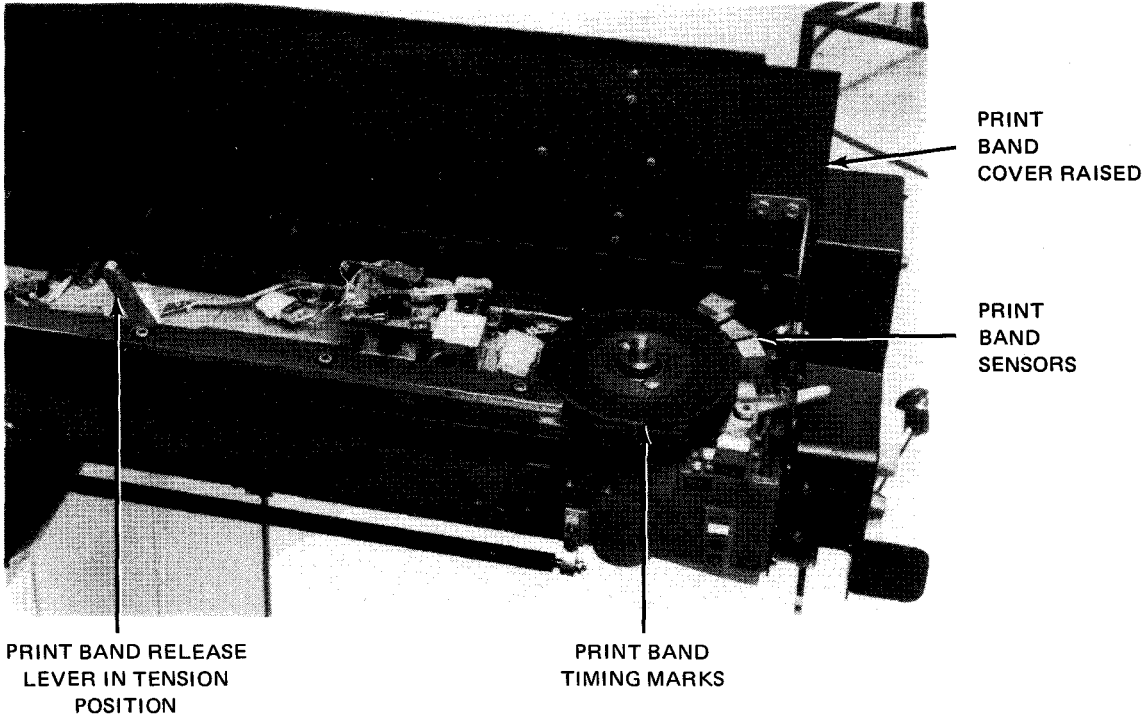

b. Print band cover open

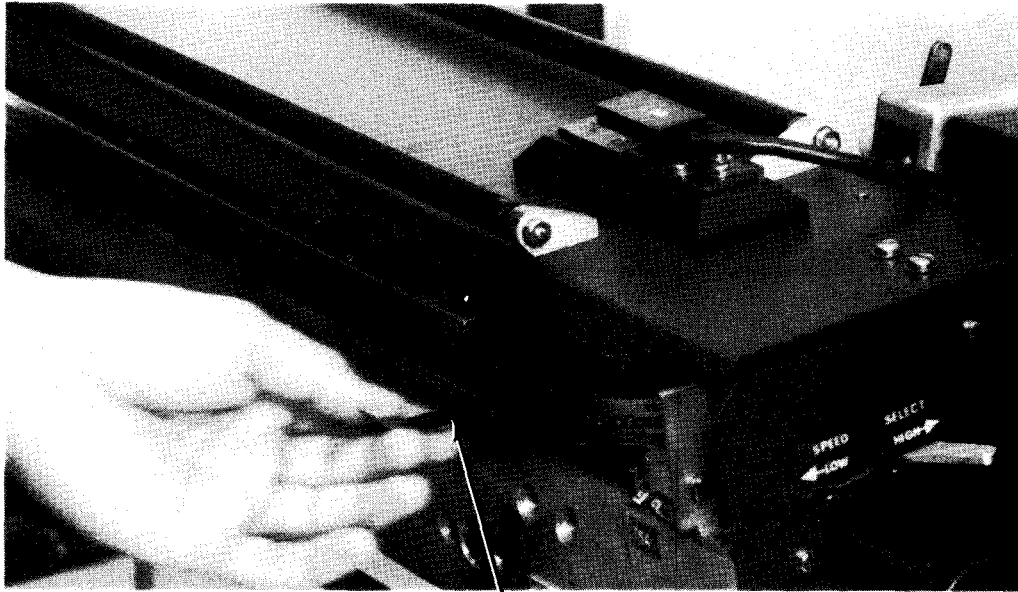

c. Releasing ribbon-edge shield

Figure 5-43. Replacing Print Band (Part 2 of 4)

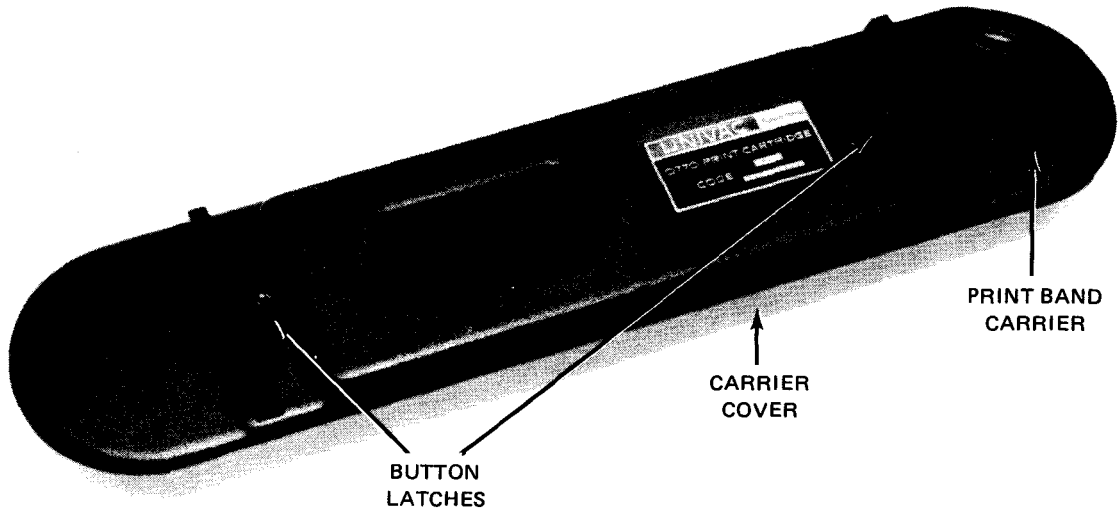

d. Print band carrier in carrier cover

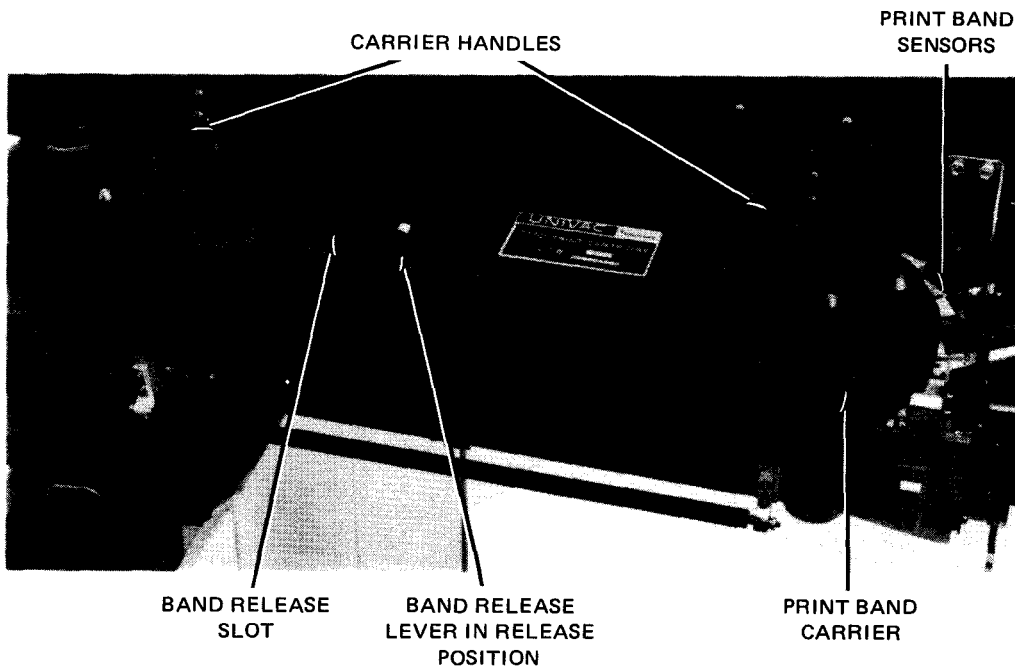

e. Print band carrier in position over print band

Figure 5-43. Replacing Print Band (Part 3 of 4)

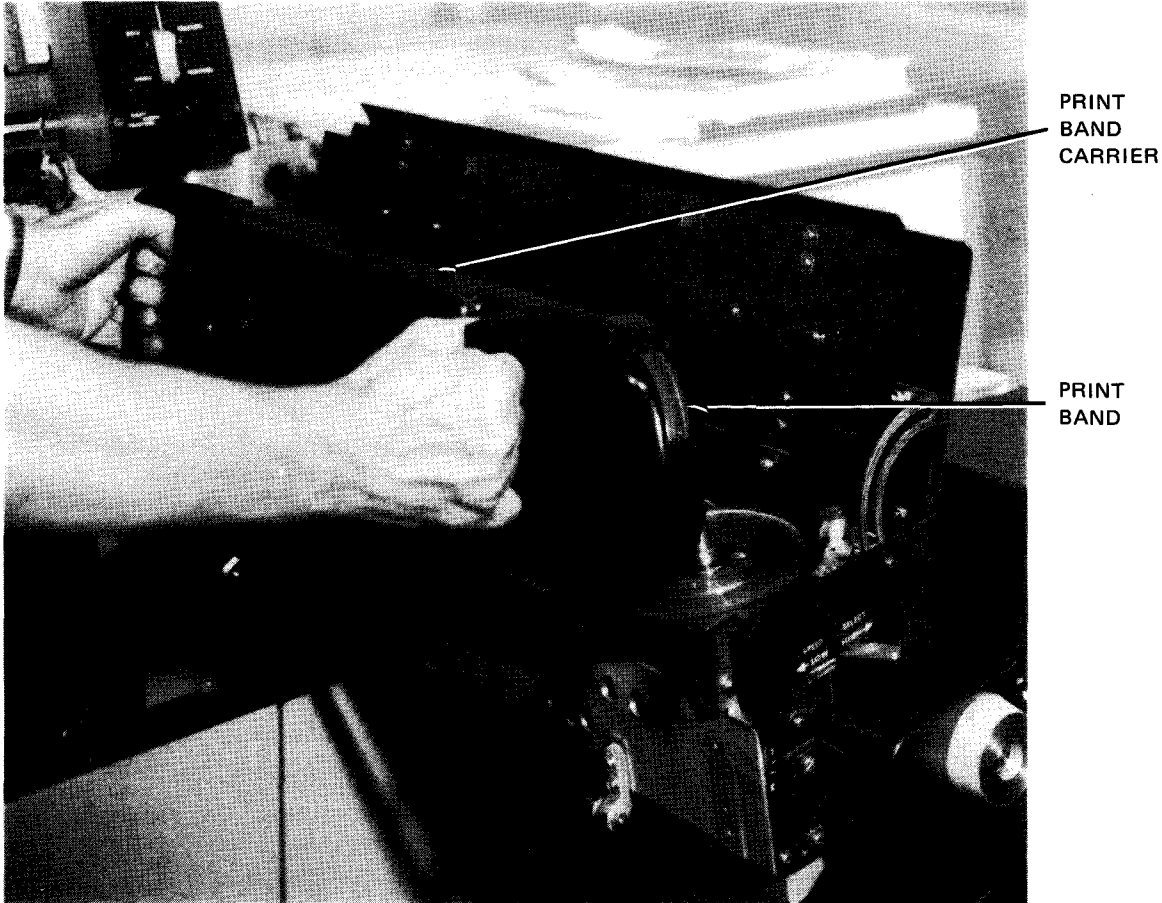

f. Print band removed

Figure 5—43. Replacing Print Band (Part 4 of 4)

5.3.3.7. Print Gap Adjustment

The print gap (i.e., the distance between hammer and type face) is normally adjusted automatically by a special sensor in the printer for forms of different thicknesses. Occasionally, however, special forms have thicknesses requiring a gap setting beyond the maximum automatic adjustment. The operator may compensate for these extreme circumstances by adjusting the print gap beyond its automatic setting by use of the print gap manual vernier adjustment control (Figure 5—44a). Manual adjustment is performed with the print carriage closed (Figure 5—44b), by pushing in the control knob and rotating it until reaching the limit stop. If further adjustment is required, the control knob must be released, pushed in and rotated an additional increment. Another method of making the adjustment is to insert a piece of paper or card stock at the probe area (column 20) and close the print carriage assembly. The operator must contact the Sperry Univac customer engineer for assistance in determining correct settings for special forms.

NOTE:

Manual print gap settings return to automatic control when the print carriage is opened and reclosed. If the print carriage is opened during a run with forms of abnormal thickness, the print gap manual vernier adjustment control must be reset after closing the print carriage.



PRINT GAP
MANUAL VERNIER
ADJUSTMENT
CONTROL

a. Print carriage open to show print gap manual vernier adjustment control

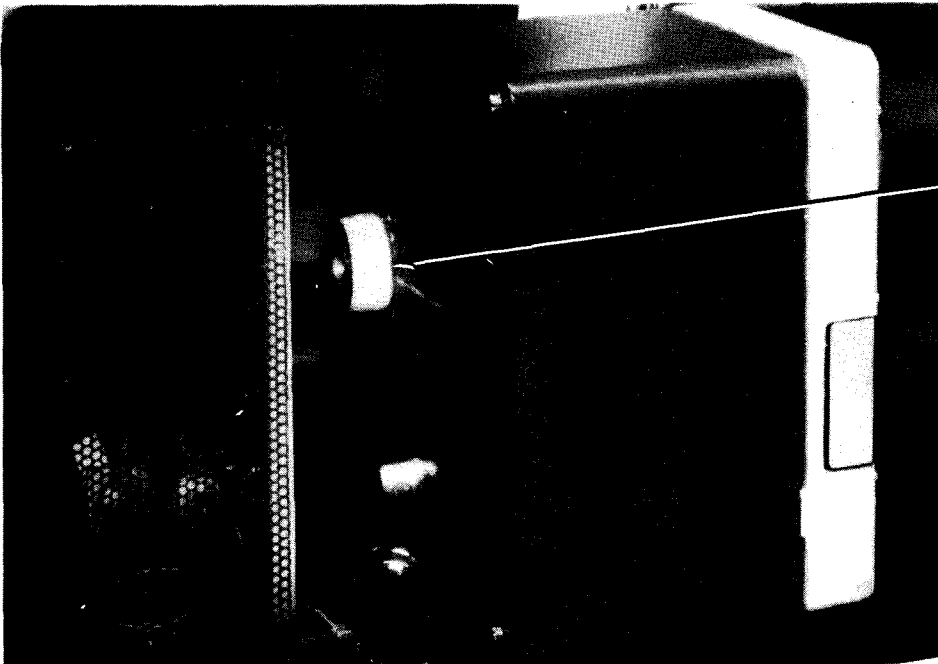

PRINT GAP
MANUAL
VERNIER
ADJUSTMENT
CONTROL
WITH PRINT
CARRIAGE
CLOSED

b. Print gap manual vernier adjustment control during operation

Figure 5-44. Print Gap Adjustment

5.3.3.8. Print Phasing Adjustment

The print phasing control (Figure 5—35), designated **HORIZONTAL CHARACTER PHASING** on the printer, permits the operator to eliminate clipping of printed characters. Clipping is indicated when either side of the printed character is faded or missing. Evidence of incorrect setting of the print phasing control is first indicated on the last part of a multipart form.

The **HORIZONTAL CHARACTER PHASING** control usually is set to position 0 on the dial. If clipping occurs, however, print phasing can be adjusted during printing by turning the control in either direction until the characters are printed uniformly. Figure 5—45 illustrates examples of clipping improper adjustment of the print phasing control. The example showing uniformly printed characters indicates a properly adjusted phasing control.

NOTE:

Adjustment of the print phasing control is seldom required; however, if a correct setting can be obtained only by setting the control near either limit of its rotation range, the operator must notify the Sperry Univac customer engineer.

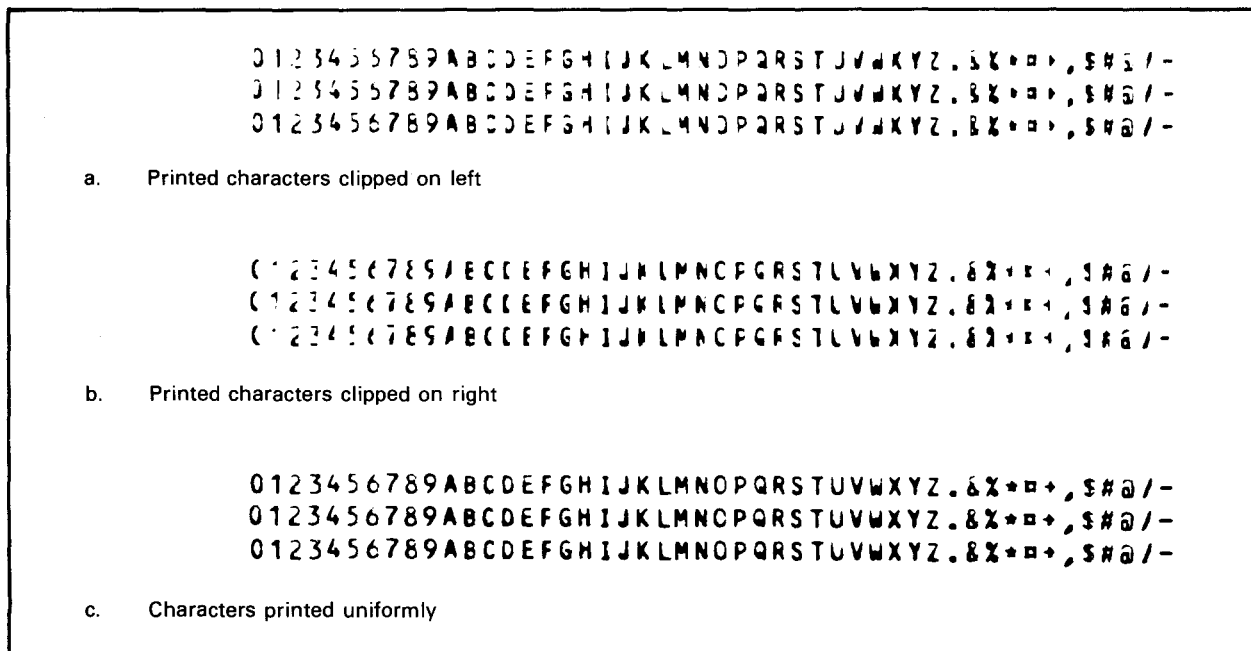

Figure 5—45. Print Phasing Adjustment Examples

5.3.3.9. Print Speed Selection

The print band may be operated at reduced speed for best print quality on special form stocks. Change the print band speed as follows:

1. Open the print carriage by lifting the print carriage latch lever (Figure 5—40a).
2. Set the print band **SPEED SELECT** switch (Figure 5—34) to the **LOW** position.
3. Close the print carriage and lock it in position by closing the print carriage latch lever firmly.

5.3.4. Recovery Procedures

Table 5—9 lists the printer subsystem check conditions that may be corrected by the operator.

Table 5—9. 0770 Printer Subsystem, Recovery Procedures (Part 1 of 3)

Fault Indication	Probable Cause	Operator Action
ALIGN FORMS indicator is lit; STOP switch/ indicator is lit; cover is open.	A program-initiated indication to remind the operator that new forms are required for the next run	If forms already are installed and properly aligned, press RUN switch/indicator to start the print run. If forms are not properly aligned, load forms as directed in 5.3.3.1.
STOP switch/ indicator is lit; cover is open.	Last page of form is being printed.	<ol style="list-style-type: none"> 1. If it is not necessary to complete printing on the remainder of the page, proceed to load the new forms as described in 5.3.3.1. 2. If it is necessary to complete printing on the remainder of the page, proceed as follows: <ol style="list-style-type: none"> a. Carefully open print carriage by lifting the carriage latching lever. b. Set the PRINT BAND SPEED SELECT switch to LOW position. c. Lower the FORMS COMPRESSION control for more acceptable printwork, if required. d. Press RUN to resume printing remainder of page. When OUT OF FORMS indicator lights, load new forms according to 5.3.3.1.
OUT OF FORMS indicator is lit; STOP switch/ indicator is lit; cover is open.	Forms are required.	<ol style="list-style-type: none"> 1. Unload stacker as directed in 5.3.3.2. 2. Reload forms, as directed by 5.3.3.1. 3. Reenter program at proper point.
FORMS CHECK indicator is lit; STOP switch/ indicator is lit; cover is open.	Forms are jammed and the printer must be cleared.	<ol style="list-style-type: none"> 1. Open print carriage by releasing print carriage latch. 2. Remove torn or jammed forms from printer; note location of torn or jammed forms with respect to printed data so that a convenient restart point may be established. 3. Reload forms, as directed in 5.3.3.1. 4. Press RUN switch/indicator. 5. Ensure that FORMS CHECK indicator is extinguished. 6. Reenter program at proper point. <p>NOTE:</p> <p>The vertical format buffer is set automatically to home condition when all four tractors are open.</p>

Table 5-9. 0770 Printer Subsystem, Recovery Procedures (Part 2 of 3)

Fault Indication	Probable Cause	Operator Action
RIBBON CHECK indicator is lit; STOP switch/ indicator is lit; cover is open.	Ribbon failed to move properly or shifted horizontally, probably due to excessive wear.	<ol style="list-style-type: none"> 1. Open print carriage by releasing print carriage latch. 2. Examine ribbon threading path to determine what has caused malfunction. 3. Replace ribbon with new ribbon as directed in 5.3.3.4. 4. Reenter program at proper point.
ADVANCE CHECK indicator is lit; STOP switch/ indicator is lit; cover is open.	The last forms advance movement did not stop at the proper line.	<ol style="list-style-type: none"> 1. Press LINE SPACE switch. 2. Determine proper location of line position. 3. If forms stopped at wrong location, realign forms to home position. 4. Press HOME switch while holding STOP switch/indicator pressed to home the vertical format buffer. 5. Reenter program at proper point.
TYPE SPEED CHECK indicator is lit; STOP switch/indicator is lit; cover is open.	The print band is not moving at proper speed.	<ol style="list-style-type: none"> 1. Open print carriage by releasing print carriage latch. 2. Examine ribbon for tears or defects that may be causing print band drag. Examine print band for damage or improper tracking on its pulleys. 3. Carefully examine printed characters on last line: <ul style="list-style-type: none"> ■ If printed characters are severely smudged or form is torn, contact Sperry Univac customer engineer. ■ If printed characters seem acceptable, close and lock print carriage. Restart printing at a convenient point. Press COVER switch/indicator and then RUN switch/indicator. If TYPE SPEED CHECK indicator lights, contact Sperry Univac customer engineer.
ACTUATOR CHECK indicator is lit; STOP switch/ indicator is lit; cover is open.	An actuator failed to cause printing in a column.	<ol style="list-style-type: none"> 1. Check last printed line for missing printed column or misalignment. 2. If no columns are misprinted, press RUN switch/indicator and continue operation. 3. If ACTUATOR CHECK indicator lights, contact Sperry Univac customer engineer.
STACKER FULL indicator is lit; STOP switch/ indicator is lit.	Stacker is full.	Unload forms from stacker as directed in 5.3.3.2.
CASEWORK CHECK indicator is lit; STOP switch/ indicator is lit.	Interlock switch is open.	<ol style="list-style-type: none"> 1. Firmly close all doors on printer casework. 2. Press RUN switch/indicator.
TEMP CHECK indicator is lit; POWER CHECK indicator is lit; STOP switch/ indicator is lit.	An overheat condition is present.	<ol style="list-style-type: none"> 1. Check air filters and clean them, if required. 2. Press POWER ON/POWER OFF switch to POWER ON. 3. Close all cabinet doors. Press RUN switch/indicator. If trouble persists, contact Sperry Univac customer engineer.

Table 5-9. 0770 Printer Subsystem, Recovery Procedures (Part 3 of 3)

Fault Indication	Probable Cause	Operator Action
CARRIAGE CHECK indicator is lit; STOP switch/ indicator is lit.	Print carriage latch is not completely engaged or print band is installed incorrectly.	<ol style="list-style-type: none"> 1. Open and close print carriage assembly and lower print carriage latch firmly to lock carriage in place. If CARRIAGE CHECK indicator is still lit, perform steps 2 through 5. <p>NOTE:</p> <p>CARRIAGE CHECK indicator normally remains lit for several seconds after closing print carriage.</p> <ol style="list-style-type: none"> 2. Remove ribbon as directed in steps 1, 2 and 3 of 5.3.3.4. Unthread ribbon from normal path and reconnect spool to upper spool holder with ribbon path around rear of carriage. 3. Print band may be improperly installed. Remove and reinstall print band as directed in 5.3.3.6. If CARRIAGE CHECK indicator is still lit, contact Sperry Univac customer engineer. 4. Replace ribbon in normal thread path as described in steps 6, 7, and 8 of 5.3.3.4. 5. Press COVER and RUN switch/indicators to resume operation.
POWER CHECK indicator is lit; STOP switch/ indicator is lit.	Interruption of power occurred, or a circuit breaker tripped.	<ol style="list-style-type: none"> 1. Reset any tripped circuit breaker on power distribution panel, low voltage power supply, paper feed power supply, and high voltage power supply. 2. Set POWER ON/POWER OFF switch to POWER OFF and then to POWER ON. The POWER CHECK indicator is extinguished. 3. Press RUN switch/indicator. 4. If POWER CHECK indicator remains lit, contact Sperry Univac customer engineer.
PARITY CHECK indicator is lit.	Incorrect parity was detected.	Inform processor console operator that a parity error was detected in: <ul style="list-style-type: none"> ■ print line buffer; ■ vertical format buffer; or ■ load code buffer. Extinguish PARITY CHECK indicator by pressing RUN switch/indicator. Reenter program at proper point.
OFF LINE indicator is lit.	Abnormal condition exists, because printer operates in online mode except during maintenance.	Contact Sperry Univac customer engineer.
Printer does not print after print band is changed, or a console message indicates wrong print band is installed.	Print band identification code does not agree with verification code in load code buffer. Either the wrong print band has been installed, or load code has not been changed.	Contact supervisor or programmer to determine correct print band for load code being used at processor.

5.4. 0773 PRINTER SUBSYSTEM

The 0773 printer subsystem is an integral part of the 90/30 or 90/30 B system. Although the printer is a freestanding unit that can be removed from the system, electronically, the printer is integrated with the processor by its control section contained inside the processor cabinet. In addition, the printer indicator panel is located on the processor operator/maintenance panel. Operating controls and overload protection controls are located on the printer.

5.4.1. Operating Controls and Indicators

A control panel on the front of the printer (Figure 5-46) allows the operator to perform normal operating procedures. The control panel (Figure 5-47) contains three switch/indicators and one pushbutton switch. The indicator panel (Figure 5-48), located on the processor operator/maintenance panel, alerts the operator to specific check conditions that may occur during normal operation. Overload protection controls, located behind the front door of the printer (Figure 5-46), comprise circuit breakers (Figure 5-49) that provide protection for the printer from current overloads. Controls and indicators for each panel are listed and described in Table 5-10.

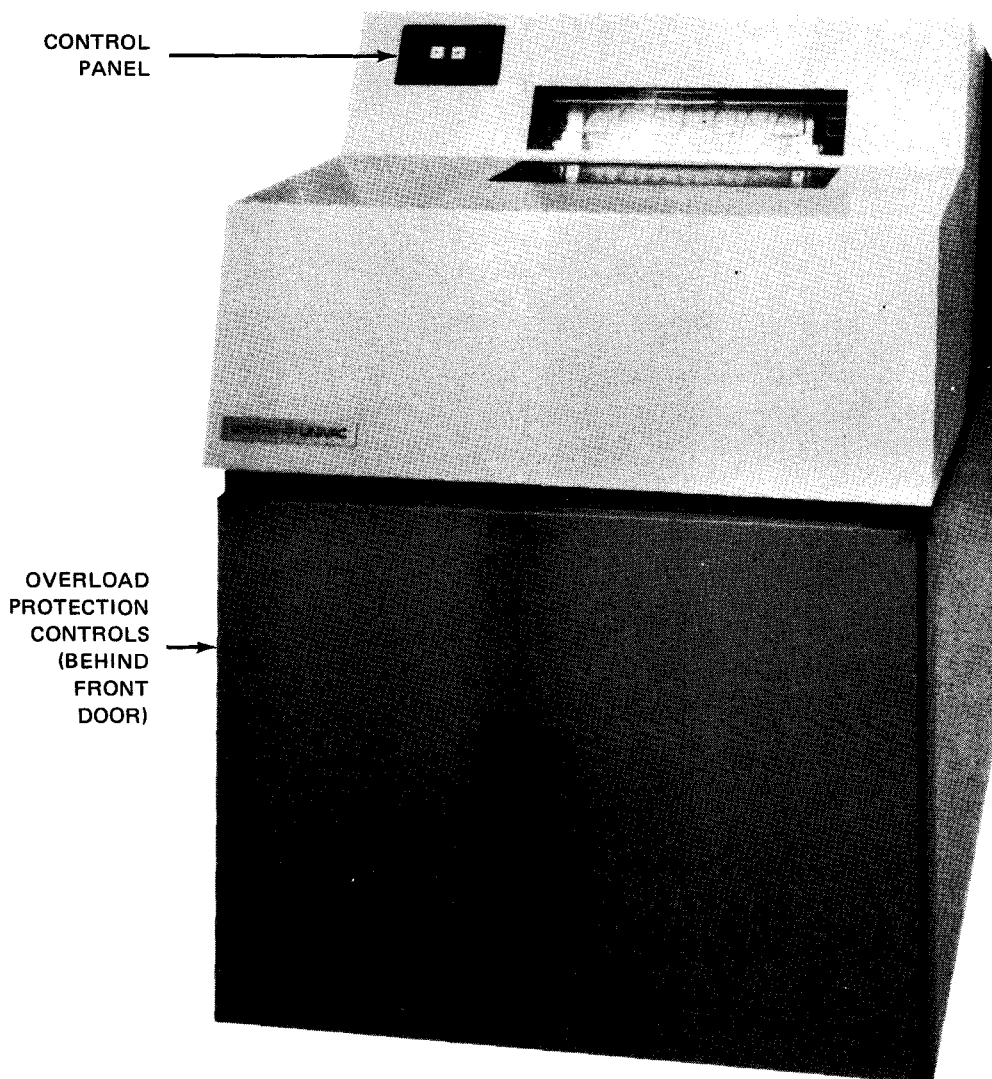

Figure 5-46. 0773 Printer Subsystem

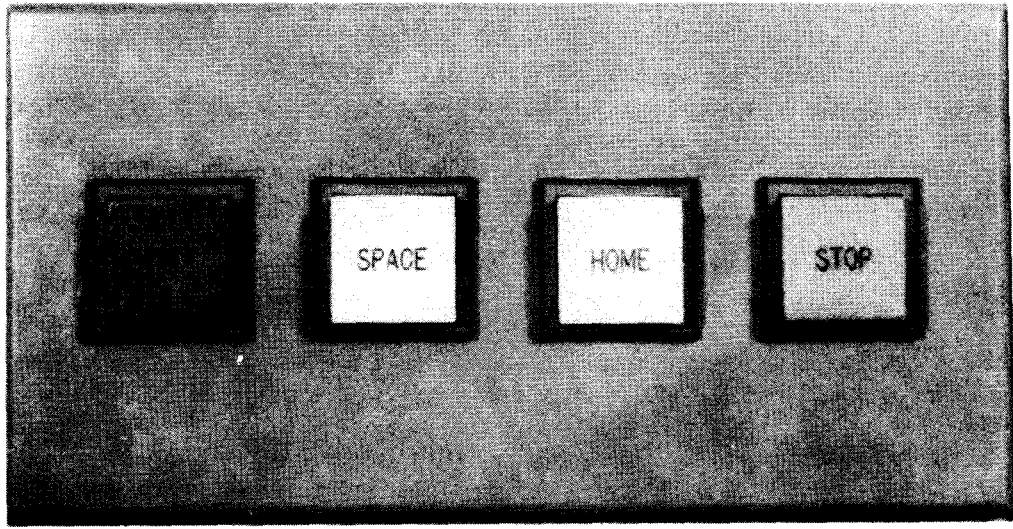

Figure 5-47. 0773 Printer Subsystem, Control Panel

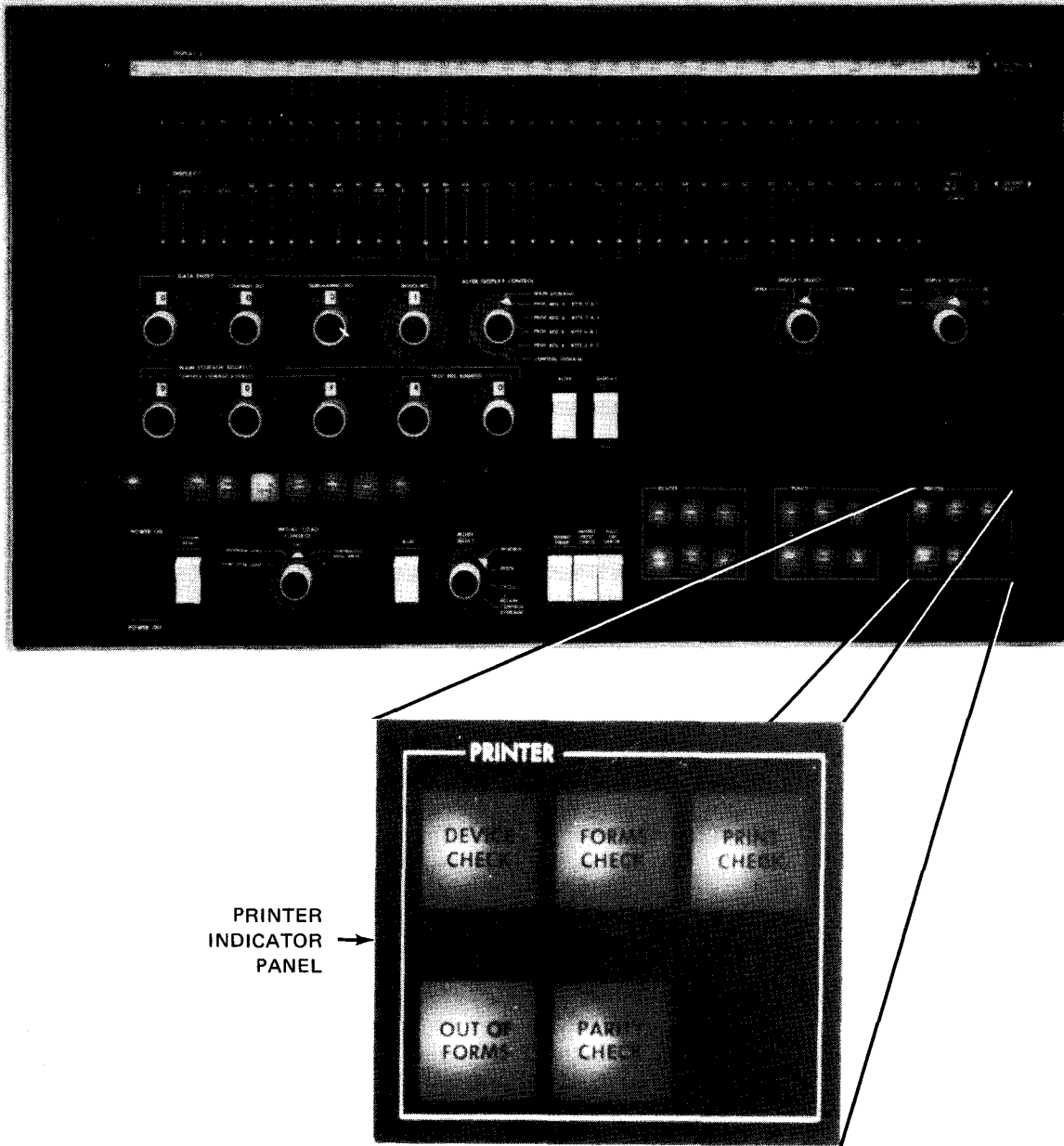

Figure 5-48. 0773 Printer Subsystem, Indicator Panel Located on Processor Operator/Maintenance Panel

220 VAC
CIRCUIT
BREAKER

AC LINE
CIRCUIT
BREAKER

+48V
CIRCUIT
BREAKER

AUX 25 VAC
CIRCUIT
BREAKER

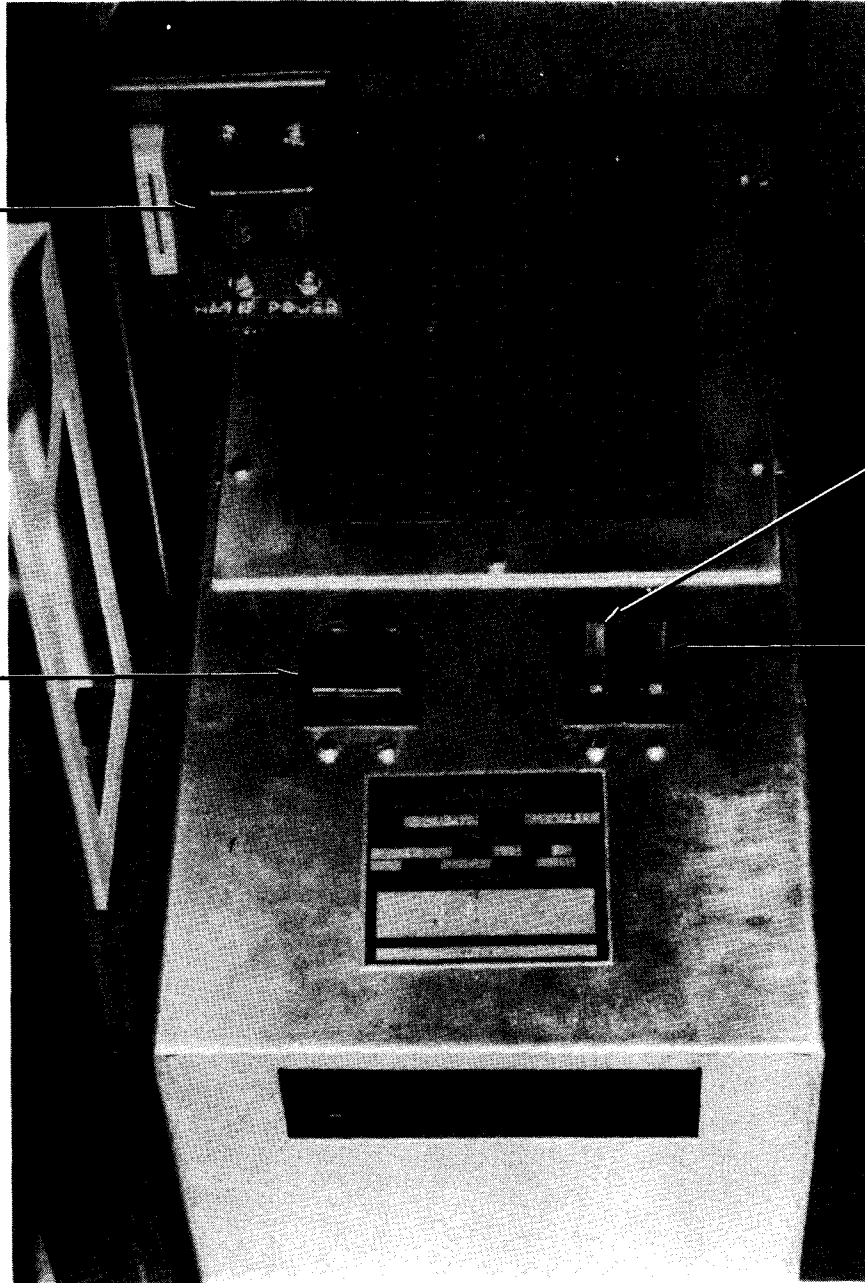

Figure 5-49. 0773 Printer Subsystem, Overload Protection Controls

Table 5-10. 0773 Printer Subsystem, Controls and Indicators (Part 1 of 2)

Control/Indicator — Function
Control Panel
RUN switch/indicator Selects the run mode (online mode), provided that none of the following printer status indicators on the processor operator/maintenance panel are lit: <ul style="list-style-type: none">▪ PRINT CHECK▪ OUT OF FORMS▪ FORMS CHECK▪ PARITY CHECK▪ DEVICE CHECK RUN switch/indicator is lit when printer is in run mode. Pressing the RUN switch/indicator while in this mode has no effect.
STOP switch/indicator Selects the stop mode (offline mode). In this mode, the STOP switch/indicator is lit. Can also be used for lamp test of all switch/indicators by being pressed and held.
HOME switch/indicator Pressed only in the stop mode to advance forms to the home position. The home position is selectable by advancing the form to a position where printing is to start and simultaneously pressing both the STOP switch/indicator and the HOME switch/indicator. When lit, indicates that paper system is stopped at the home paper position.
SPACE switch Allows single-line space or multiline space advancement of form when printer is in stop mode. Amount of the line spacing is determined by length of time the switch is pressed.
Indicator Panel
OUT OF FORMS indicator Lights when printer is out of forms. Indicator is initially lit when 6 inches of form is left below the print line. Indicator remains lit until forms are loaded.
FORMS CHECK indicator Lights when form is torn or jammed. Indicator remains lit until condition is corrected.
PRINT CHECK indicator Lights when a fault exists in printer actuator circuits or in print band.

Table 5—10. 0773 Printer Subsystem, Controls and Indicators (Part 2 of 2)

Control/Indicator — Function
Indicator Panel (cont)
PARITY CHECK indicator Lights when a parity error is detected in printer controller of processor.
DEVICE CHECK indicator Lights when one of the following conditions exists in the printer: <ul style="list-style-type: none">■ Lack of air flow from blower■ Failure of ac power to print band motor■ Print carriage assembly is not locked in operating position.■ Ambient temperature within printer cabinet exceeds 134.6° F (57° C).
Overload Protection Controls
Main power 220 VAC circuit breaker Provides overload protection for the printer
25 VAC circuit breaker Provides overload protection for ribbon drive motors
AC LINE circuit breaker Provides overload protection for the power supply assembly that provides 25 volt ac power and +48 volt dc power
+48V AUX circuit breaker Provides overload protection for the printer paper feed motor circuits

5.4.2. Turn-On and Turn-Off Procedures

Power to the printer is controlled by the **POWER ON/POWER OFF** switch on the processor (Figure 2—2). However, to initially turn on power for the printer, the overload protection controls listed in Table 5—11 must first be set to the on position. Setting the **POWER ON/POWER OFF** switch to **POWER ON** then applies power to the printer.

CAUTION

*Do not apply power to the printer if the processor **POWER ON/POWER OFF** switch is presently in **POWER ON** position, as power transients may disturb processor operation. Instead, follow the procedures provided in 5.4.2.1.*

Table 5-11. 0773 Printer Subsystem, Power Switch Settings

Switch/Circuit Breaker	Normal Setting
Overload Protection Controls	
220 VAC circuit breaker	On (up)
25 VAC circuit breaker	On (up)
AC LINE circuit breaker	On (up)
+48V AUX circuit breaker	On (up)

5.4.2.1. Independent Power Turn-On Procedure

To turn power on at the printer independently of the processor, proceed as follows:

CAUTION

The turn-on sequence must be followed as indicated or power fuses may open.

1. Press **STOP** switch/indicator on control panel.
2. Set all circuit breakers on overload protection panel to off (down) position.
3. Set **220 VAC** circuit breaker to on (up).
4. Set **AC LINE** circuit breaker to on (up).
5. Set **25 VAC** circuit breaker to on (up).
6. Set **+48V AUX** circuit breaker to on (up). Note that **STOP** switch/indicator lights.
7. Press **RUN** switch/indicator on control panel.
8. Use the *UP* function of the SET IO command (Section 12) to place the printer on the system's resources list for job allocation.

5.4.2.2. Independent Power Turn-Off Procedure

To turn power off at the printer independently of the processor, proceed as follows:

CAUTION

The turn-off sequence must be followed as indicated or power fuses may open.

1. Use the *DOWN* function of the SET IO command (Section 12) to remove the printer from the system's resources list and prevent it from being allocated to a job while offline.
2. Press **STOP** switch/indicator on control panel.
3. Set **+48V AUX** circuit breaker to off (down).
4. Set **25 VAC** circuit breaker to off (down).
5. Set **AC LINE** circuit breaker to off (down).
6. Set **220 VAC** circuit breaker to off (down).

5.4.3. Operating Procedures

Operating procedures for the 0773 printer subsystem include forms loading, ribbon replacement, print band cartridge replacement, print phasing adjustment, print speed selection, and print gap adjustment. Figure 5—50 illustrates the location of internal adjustments.

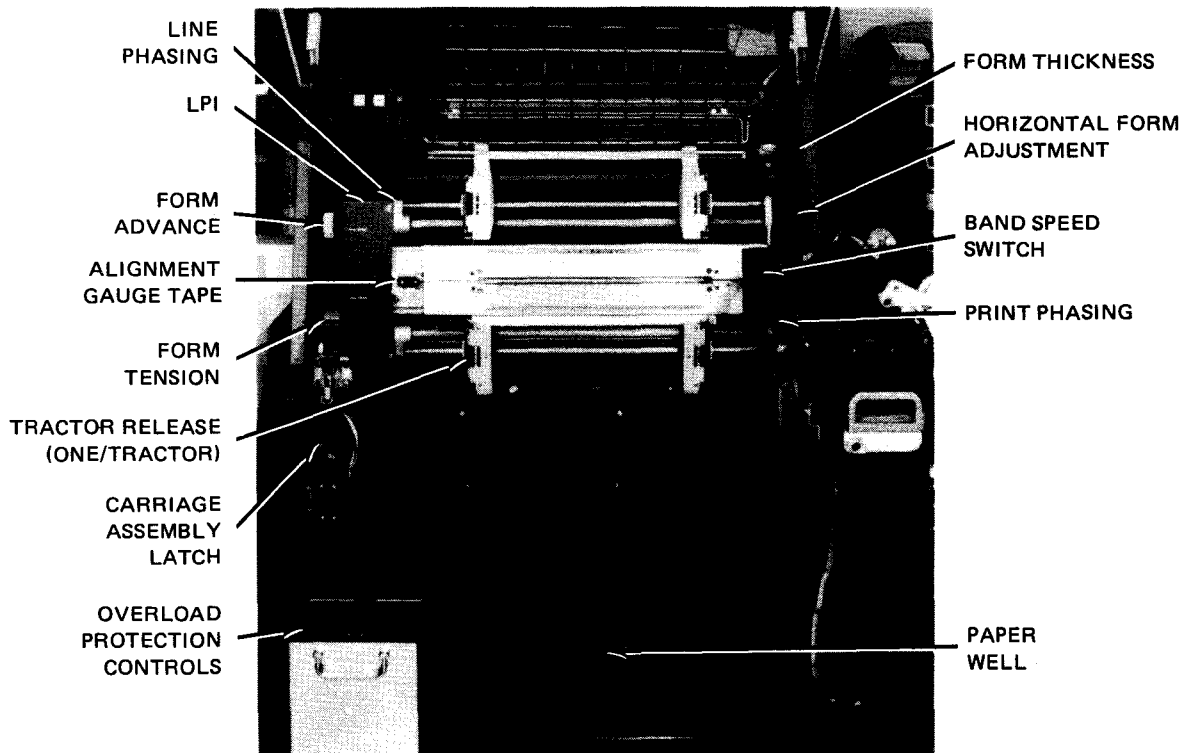

Figure 5—50. 0773 Printer Subsystem, Internal Adjustments

5.4.3.1. Forms Loading

To load forms on the printer, proceed as follows:

NOTE:

Before performing the following procedure, remove the device from the system's list of available resources by using the DOWN function of the SET IO command (Section 12). After the procedure is completed, restore the device's available status by using the UP function of the SET IO command.

1. Set printer in stop mode by pressing the **STOP** switch/indicator.
2. Raise front hood of printer to reach internal adjustments (Figure 5-50).
3. Open front door of printer cabinet.
4. Perform the following preliminary adjustments:
 - a. Adjust **HORIZ FORM ADJ** control so that retaining rings on tractor shafts are equally spaced with respect to the side castings (Figure 5-51a).
 - b. Adjust **LINE PHASING** control so that the white index mark is centered in the slot of the cover in which the control is housed (Figure 5-51b).

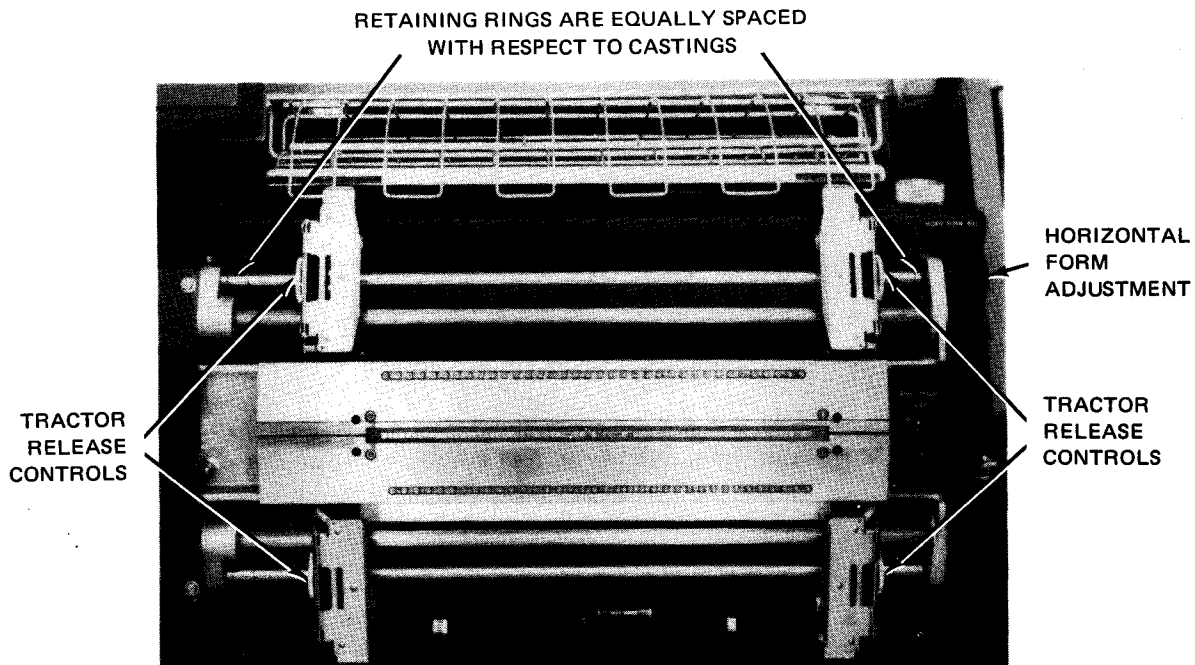

a. Horizontal form adjustment

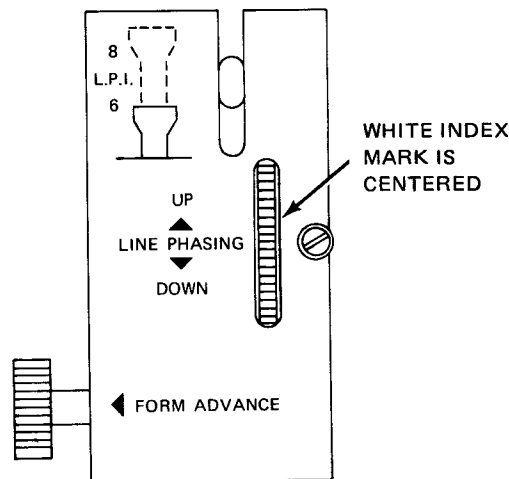

b. Line phasing adjustment

Figure 5-51. Preliminary Adjustments for Forms Loading

5. Release carriage assembly latch by pressing down on the latch lever (Figure 5—52). Swing the carriage assembly fully open; assembly is hinged on its right side.
6. Unclamp all four tractors by revolving each tractor knurled control counterclockwise (Figure 5—51a).
7. Open all four tractor pressure plates and swing up hinged portion of paper rack (Figure 5—53).
8. Place a supply of forms in paper well compartment (Figure 5—53) so that form print surface faces the operator.
9. Place the form on the upper left tractor pins with top edge of the form resting against the column indicator on the paper rack (Figure 5—52).
10. Close the pressure plate of the upper left tractor (Figure 5—53).

NOTE:

If the forms being loaded contain alignment ticks, perform instructions listed under step 11. Otherwise, proceed to step 12.

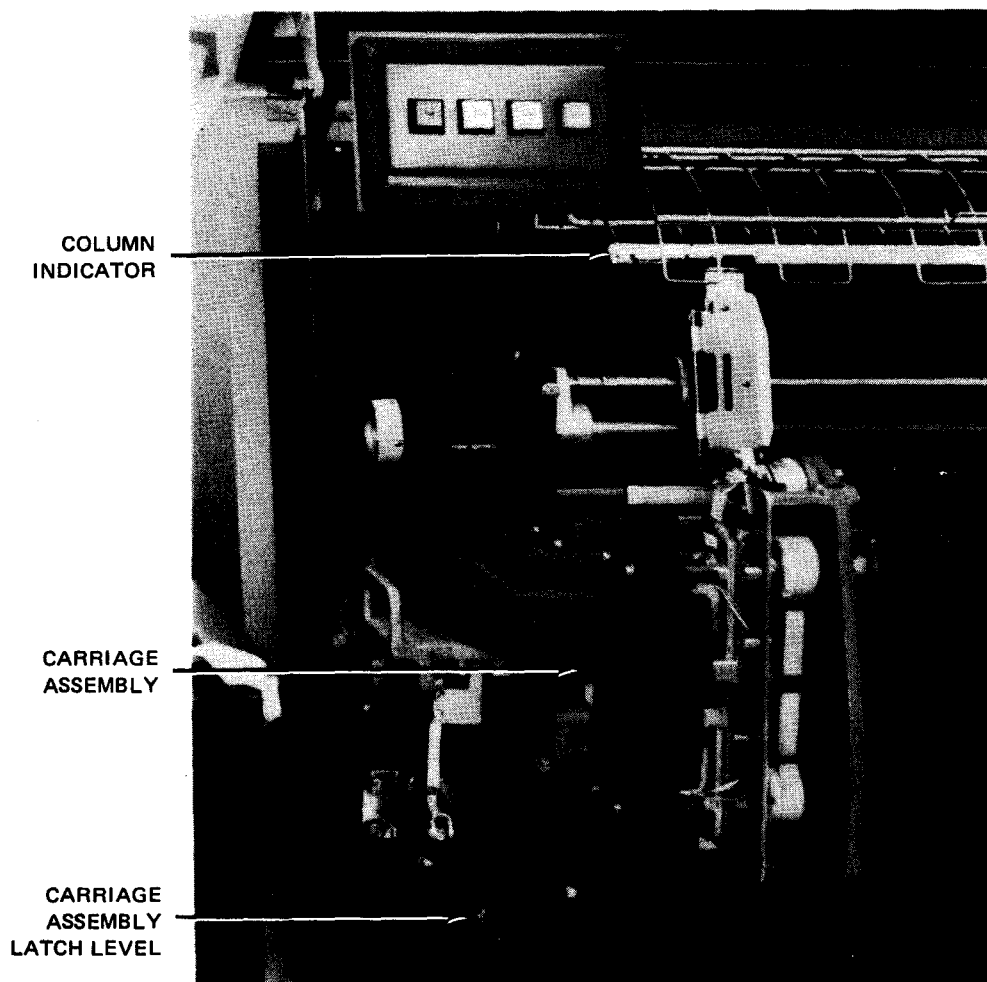

Figure 5—52. Print Carriage Assembly Closed

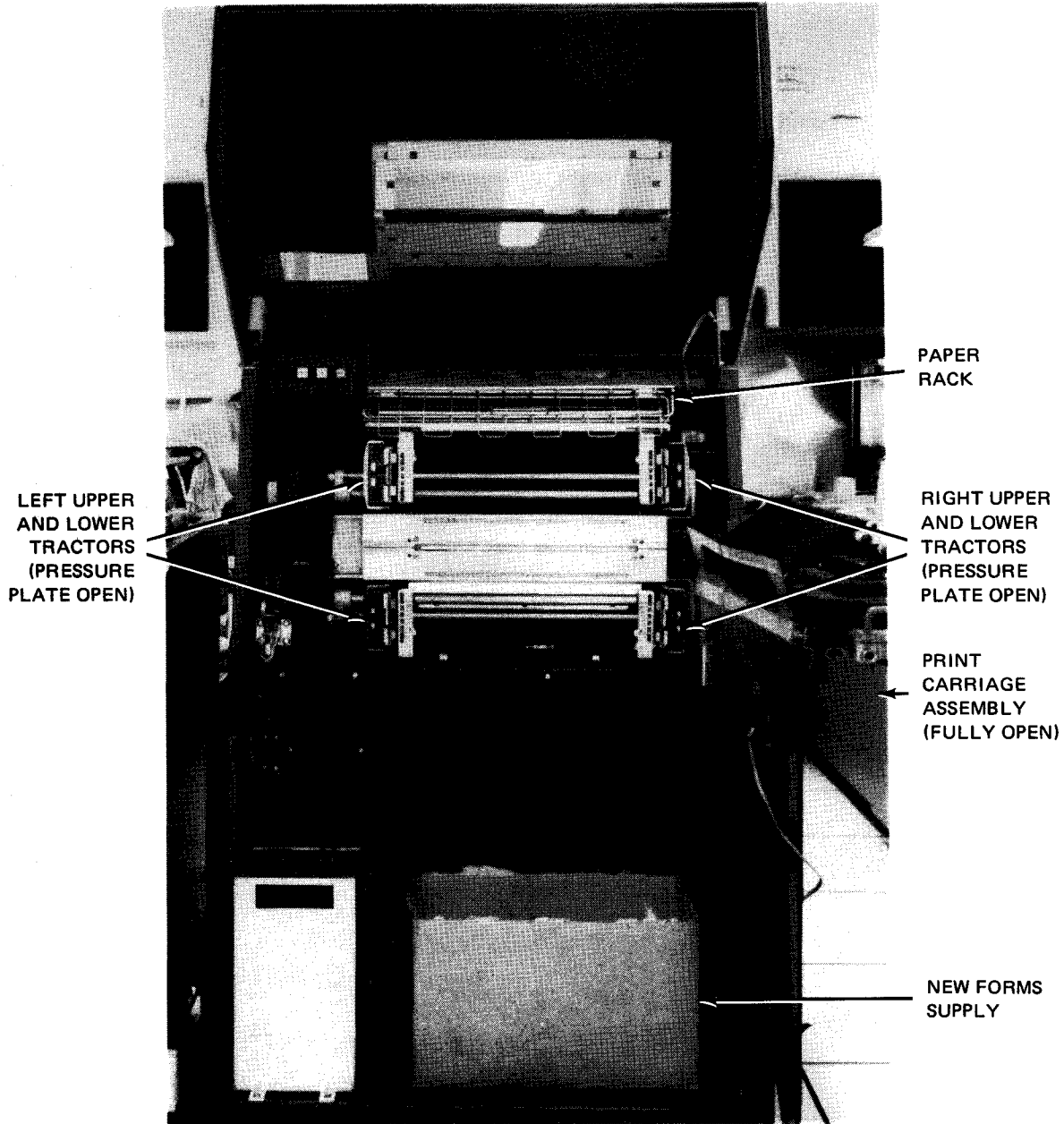

Figure 5-53. Print Carriage Opened to Receive Forms

11. Load forms provided with alignment ticks as follows:

- a. Adjust the upper left tractor on its shaft until the column indicator vertical tick mark on the form corresponds to the proper column on the column indicator (Figure 5-54).
- b. Secure upper left tractor by revolving tractor knurled wheel clockwise.
- c. Adjust upper right tractor until the form mates with the tractor pins.
- d. Close pressure plate of upper right tractor.
- e. Proceed to step 13.

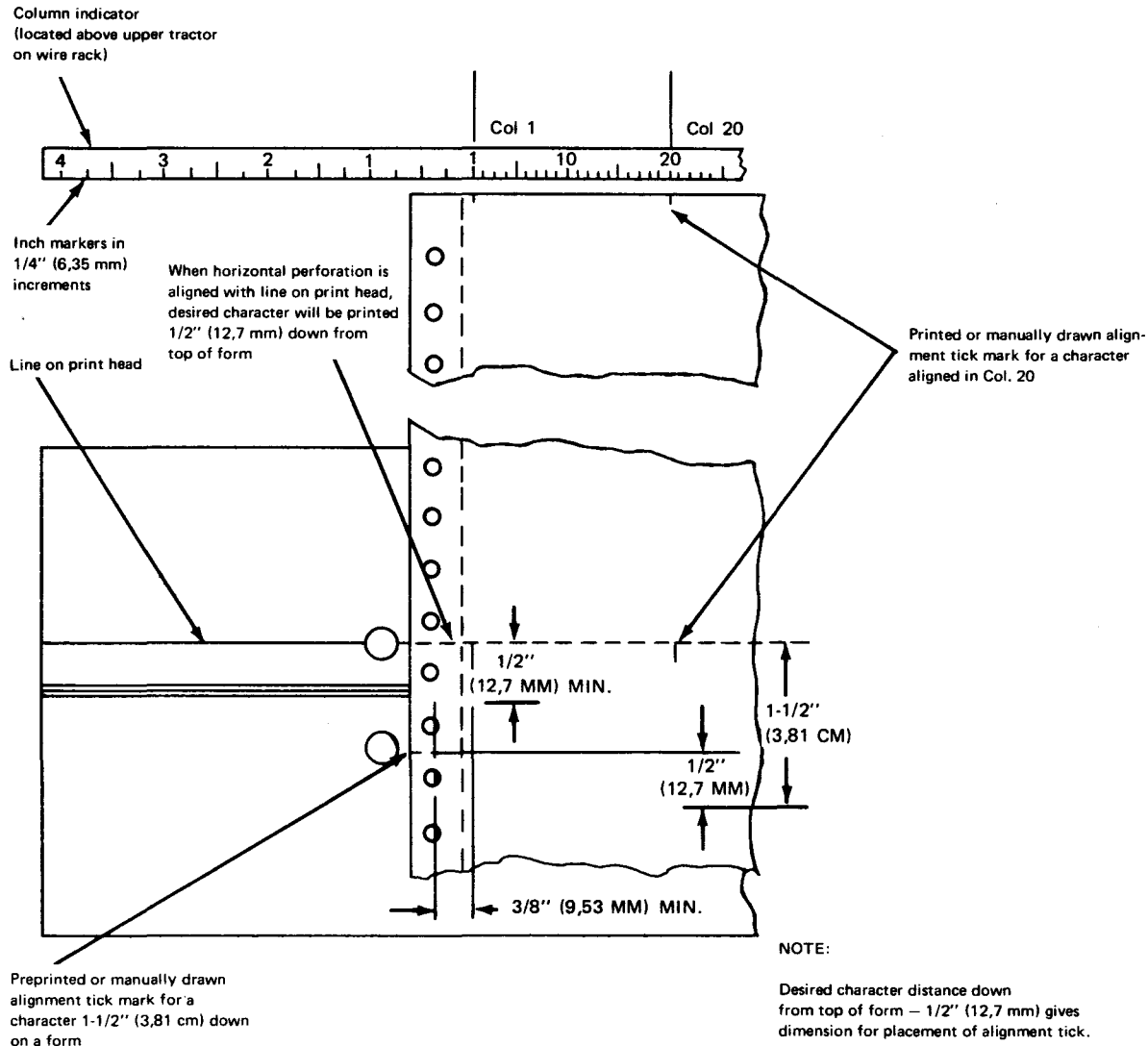

Figure 5-54. Placement of Form Alignment Ticks at Column Indicator

12. Load forms not provided with alignment ticks as follows:
 - a. Adjust upper right tractor until form mates with tractor pins and then close pressure plate to secure form in tractor.
 - b. Pull alignment gauge tape across the print head and latch it in place (Figure 5-55).
 - c. Press **FORM ADVANCE** knob (Figure 5-56) and turn knob until the bottom line on alignment gauge tape corresponds to bottom of line intended to be printed (Figure 5-57).
 - d. By moving the two upper tractors, horizontally shift form until correct column indication block is centered on intended position of first column.
 - e. Remove all horizontal slack from form by adjusting the two upper tractors, then secure both tractors by turning each tractor knurled wheel clockwise.
13. Adjust and secure the two lower tractors the same as for the upper tractors so that form is held in a correct vertical condition.

ALIGNMENT
GAUGE
TAPE

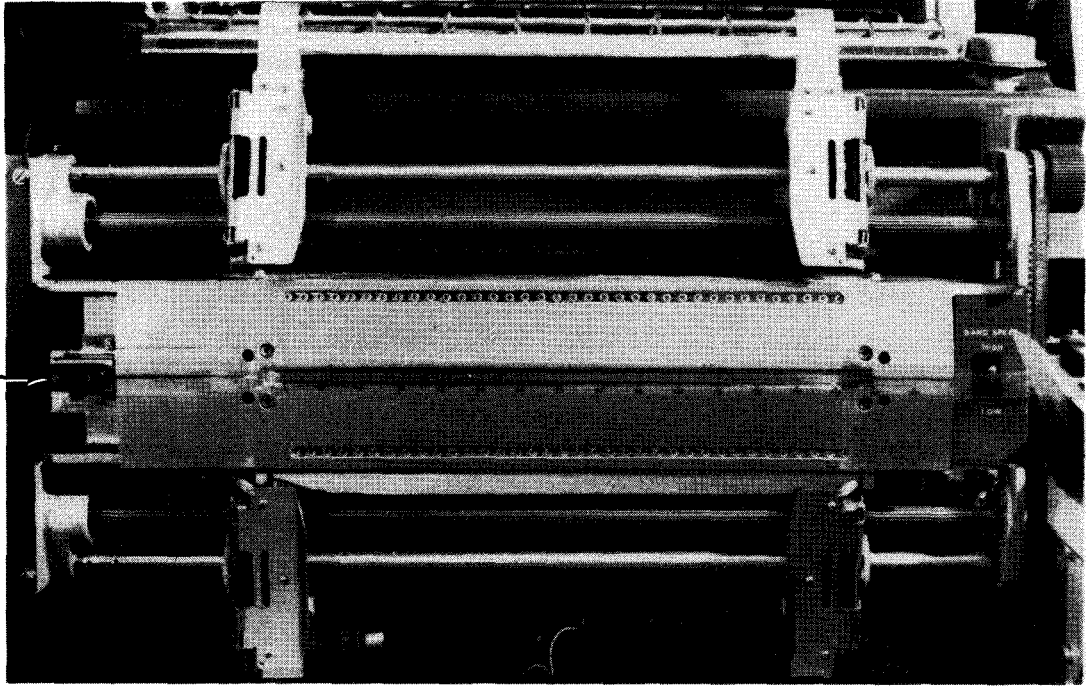

Figure 5-55. Alignment Gauge Tape in Position for Form Alignment

LP1
LINE
PHASING
FORM
ADVANCE
FORM
TENSION

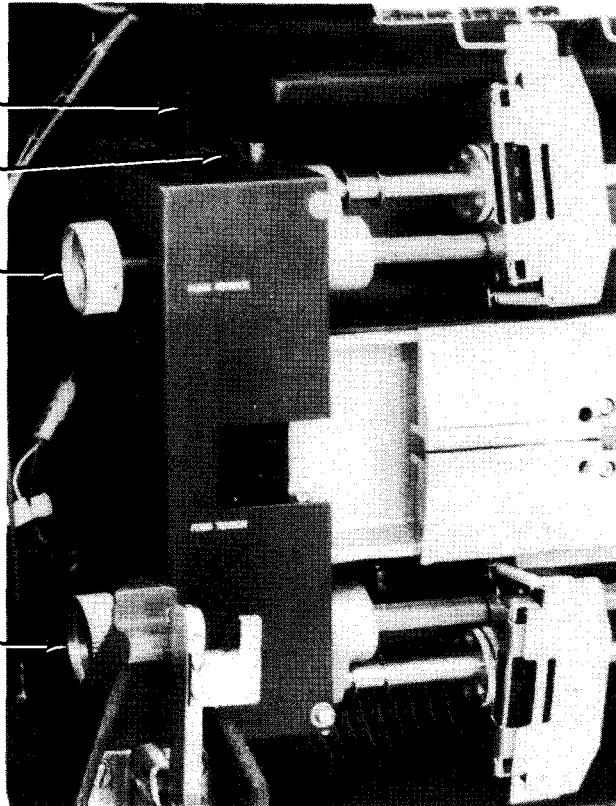
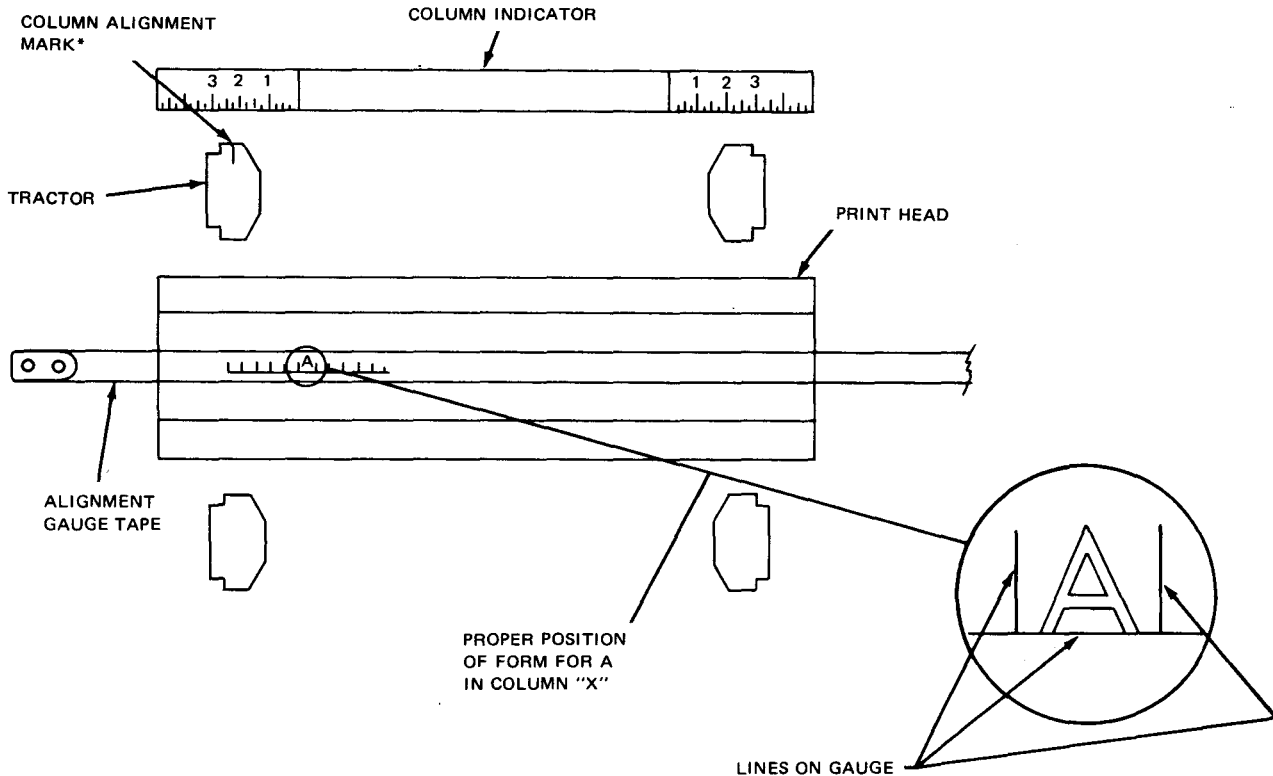

Figure 5-56. Form Advance, Line Phasing, and Form Tension Controls



*Repeatable tractor position — The upper left-hand tractor contains an indicator mark that points to the column indicator on the upper rack. This is used for prepositioning of the tractors to a known location for the same type of form. The first time a common form is used and set in its proper position a notation should be made of the upper left-hand tractor location so that in future usage of this form the tractors can be prepositioned.

Figure 5—57. Alignment of Forms Without Alignment Ticks

14. Adjust form vertical tension by pressing inward and turning **FORM TENSION** knob (Figure 5—56) until slight tension is felt over the curvature of the print head, and so that sprocket holes are not deformed.
15. If alignment gauge tape was used in alignment of the form, retract the alignment gauge tape.
16. On forms provided with horizontal alignment tick, turn **FORM ADVANCE** knob (Figure 5—56) until horizontal alignment tick at edge of form is aligned with the line on print head (Figure 5—54). Make certain that form is revolved beyond paper switch on upper tractor.
17. Rotate **FORM THICKNESS** control (Figure 5—58) to proper setting.
18. Turn **FORMS ADVANCE** control (Figure 5—56) to pass forms over the lower paper guide.
19. Feed form through internal guide assembly to rear of the printer so that form passes through slot in the sound hood (or paper pull-out assembly if feature 1661—00/01 is installed in printer) and folds between rear and front paper guides on paper shelf (Figure 5—59).
20. Lower the upper paper guide.
21. Raise or lower **LPI** control (Figure 5—56) for 8 or 6 lines per inch, respectively, according to printing requirements.

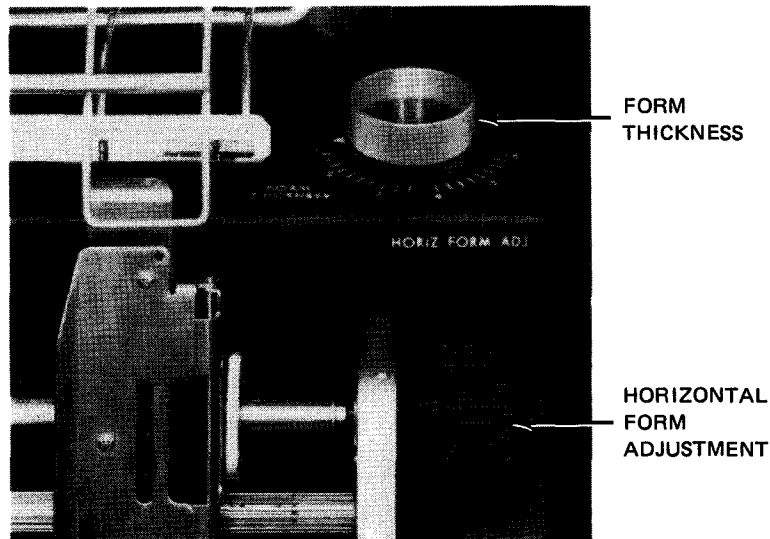

Figure 5-58. FORM THICKNESS and HORIZONTAL FORM ADJUSTMENT Controls

22. Close print carriage assembly and secure assembly with associated latch.
23. Press **HOME** switch/indicator to advance tape to home position.
24. Press and release **RUN** switch/indicator on printer control panel and start printing program.
25. If further minor adjustment is required, adjust **LINE PHASING** control (Figure 5-56) for up-down character placement or **HORIZ FORM ADJ** control (Figure 5-58) for side-to-side placement. (Turn **HORIZ FORM ADJ** control clockwise to move printed characters to left; counterclockwise to move characters to right.)

CAUTION

*Do not adjust the **FORM ADVANCE** or tension controls while form is in motion.
Otherwise, form may rip or tear.*

26. Close front hood.
27. Close the cabinet front door.

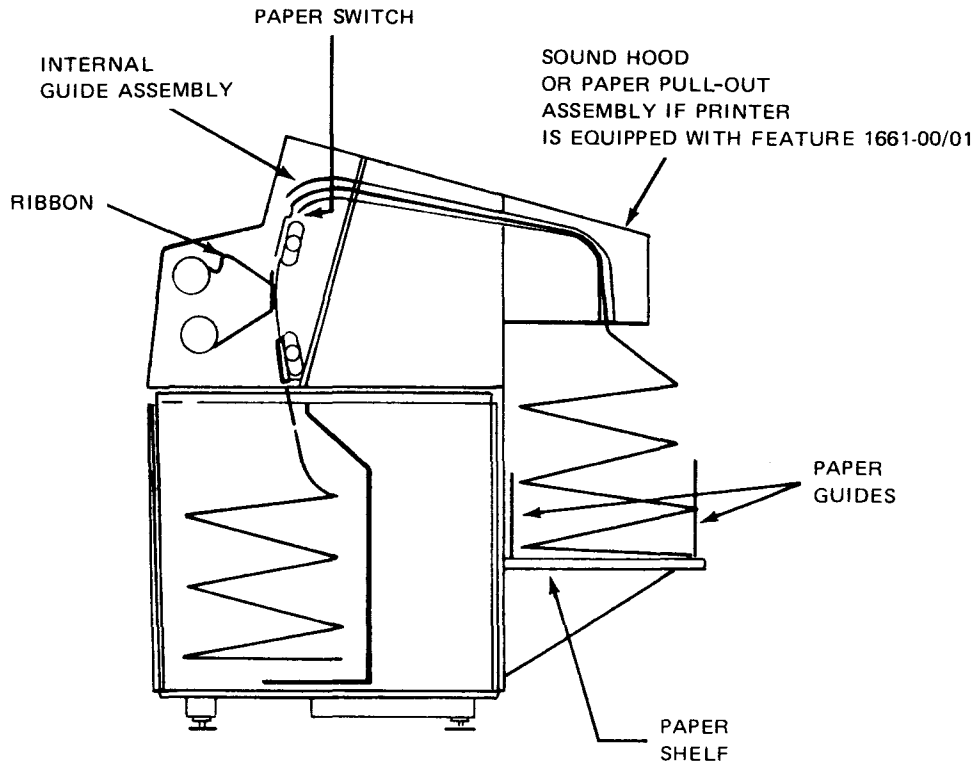

Figure 5-59. Forms Feed Path

5.4.3.2. Ribbon Replacement

Ribbon on the printer is replaced when printing appears light or faded. To replace the ribbon, proceed as follows:

NOTE:

Before performing the following procedure, remove the device from the system's list of available resources by using the DOWN function of the SET IO command (Section 12). After the procedure is completed, restore the device's available status by using the UP function of the SET IO command.

1. Release print carriage assembly latch (Figure 5-52) by lifting the latch lever. Swing print carriage assembly fully open to obtain full access to ribbon on both sides of carriage assembly (Figure 5-60a).
2. Open ribbon shield by pulling right side of shield from magnetic catch. Swing shield back (Figure 5-60b).
3. Open hinged roller by grasping and pulling knurled lever of roller (Figure 5-60b).
4. Wearing plastic gloves provided with new ribbon, remove upper takeup spool from upper spool holder (Figure 5-60c) by pushing spool toward spring-loaded spool holder.
5. Remove lower spool from lower takeup spool holder (Figure 5-60d) by pushing spool toward spring-loaded spool holder.
6. With both takeup spools disengaged, remove ribbon from around print carriage assembly (Figure 5-60d) and discard ribbon.
7. Obtain new ribbon as per Table 5-12.

8. Install new ribbon on lower takeup spool and upper takeup spool in reverse manner that old ribbon was removed. Note ribbon threading path which is illustrated in Figure 5—60e. Be sure that the ribbon guide is along the side and not underneath the ribbon (Figure 5—60a).
9. Close hinged roller over ribbon.
10. Take up slack in ribbon by turning ribbon rolls or by continuously pressing the **SPACE** key on the control panel. Make sure ribbon edge passes inside of ribbon sensing switch (Figure 5—60b).
11. Close ribbon shield.
12. Close print carriage assembly and lock firmly with print carriage assembly latch.

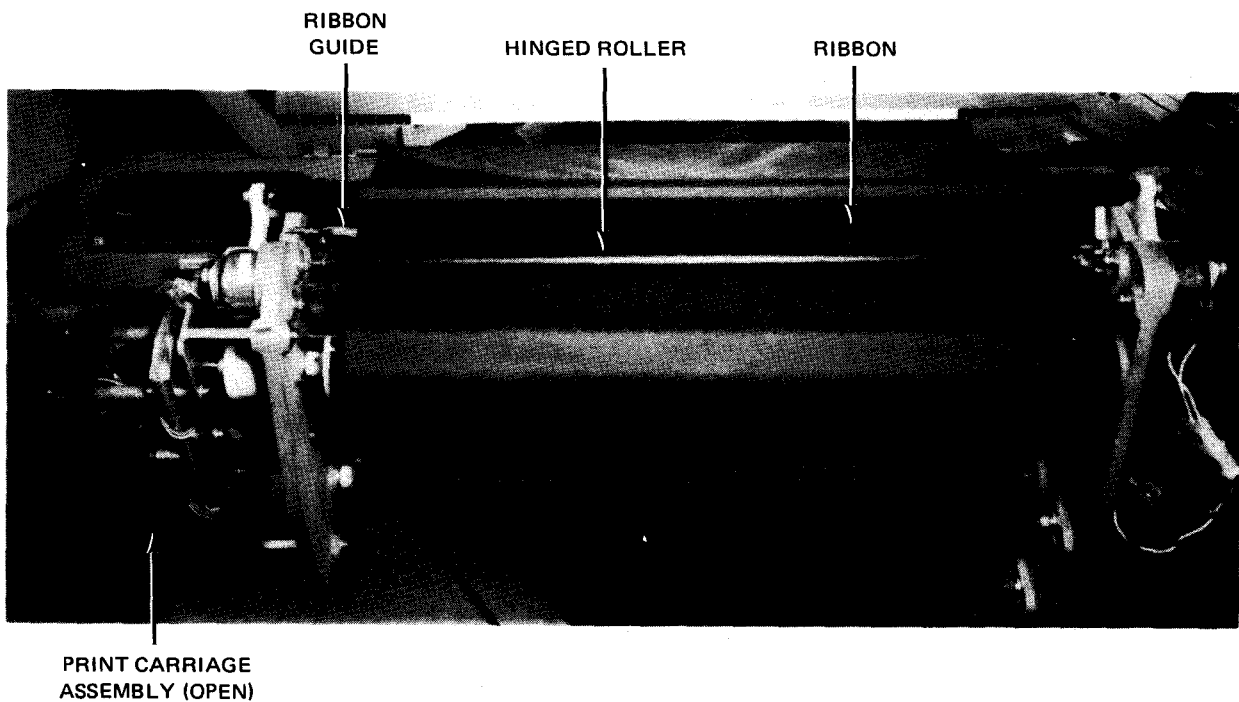

- a. Print carriage assembly open with hinged roller in place

Figure 5—60. Replacing Ribbon (Part 1 of 4)

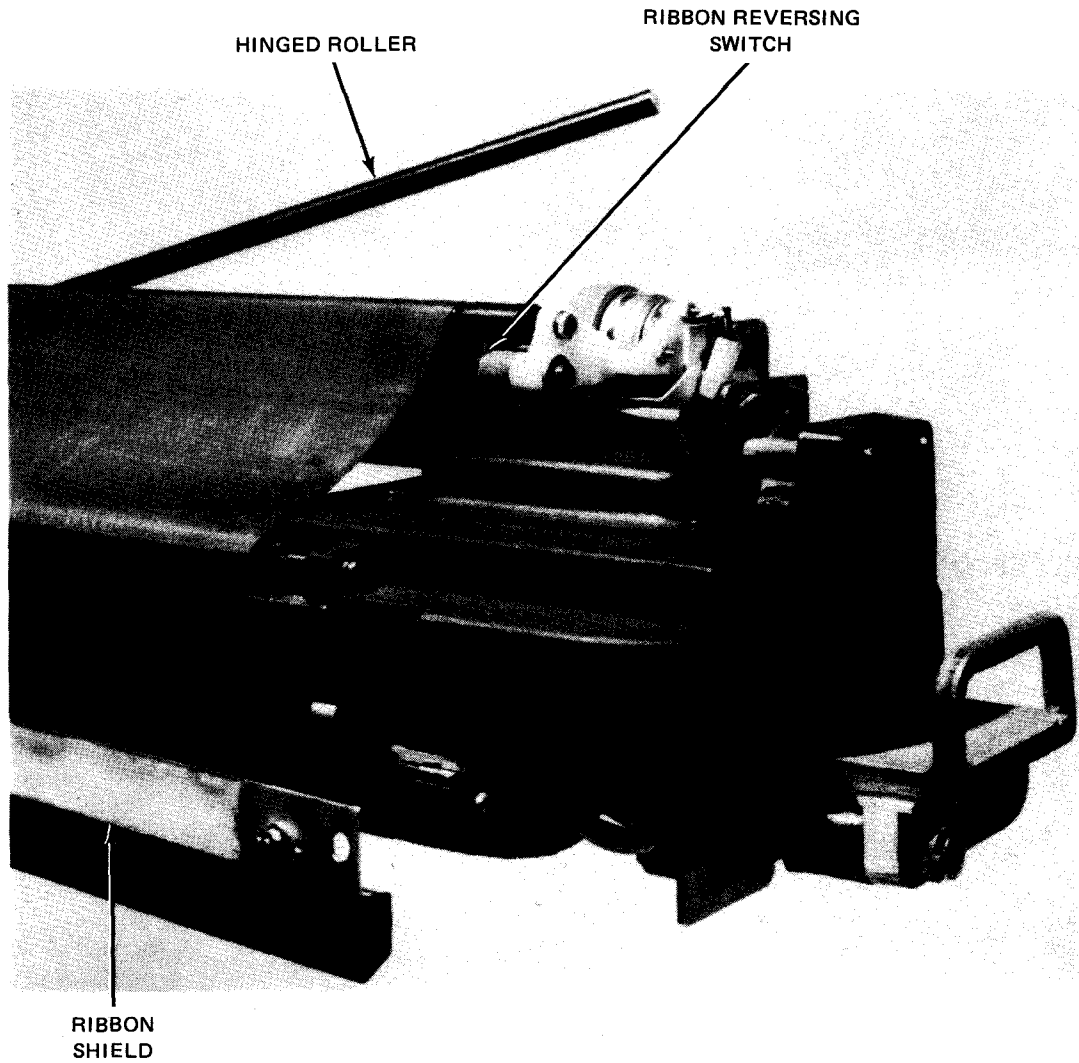

b. Ribbon shield and hinged roller open

Figure 5-60. Replacing Ribbon (Part 2 of 4)

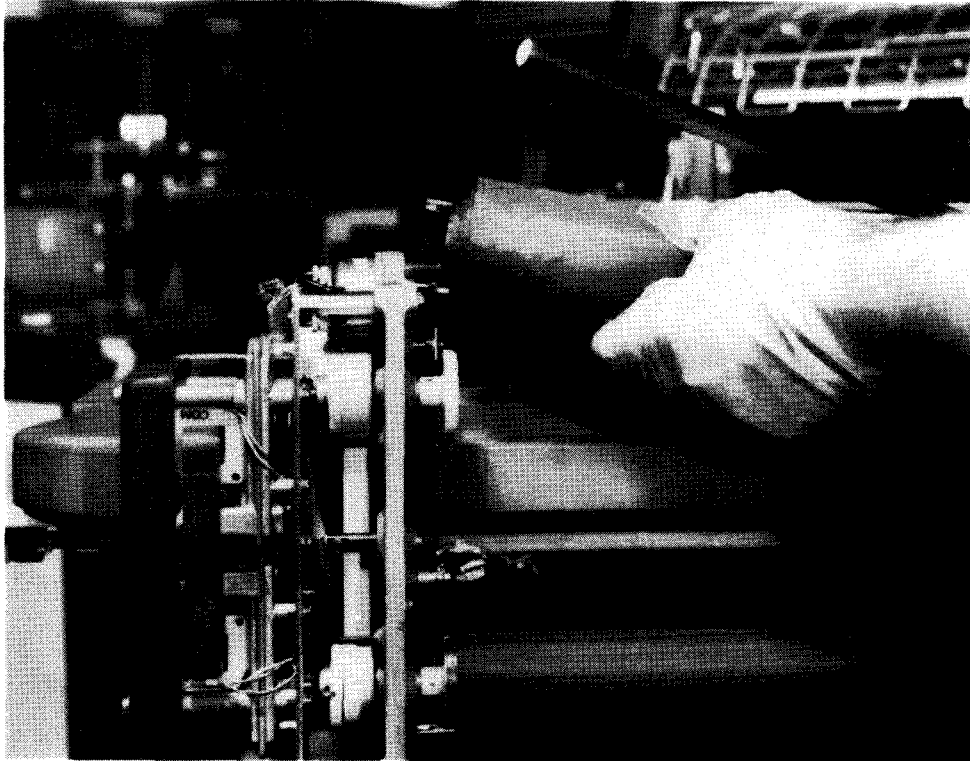

c. Removing upper takeup spool

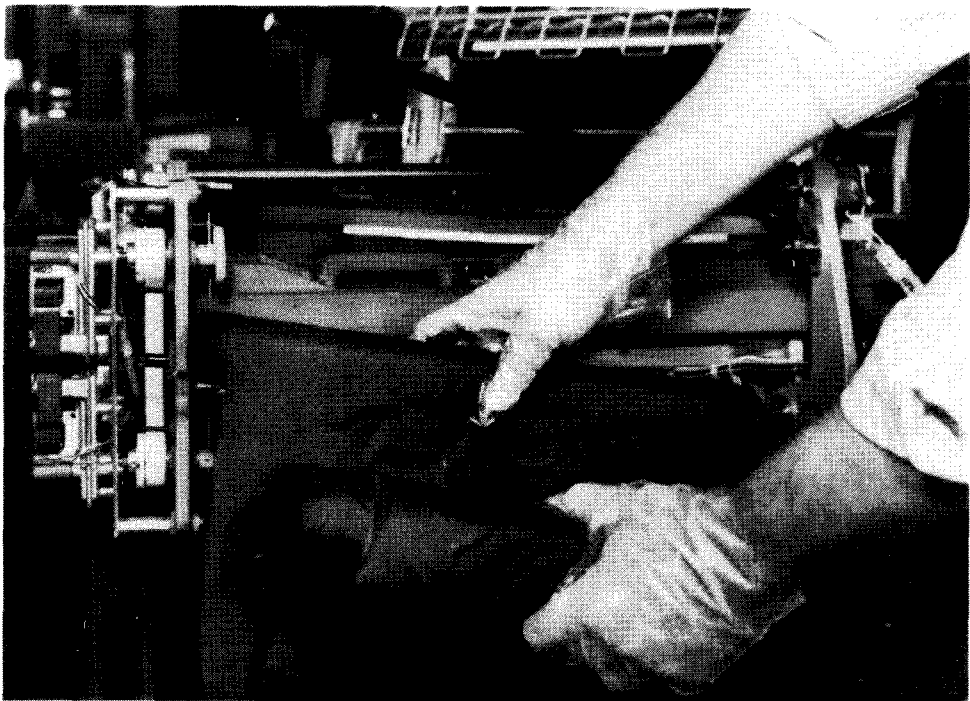

d. Removing upper and lower takeup spools

Figure 5-60. Replacing Ribbon (Part 3 of 4)

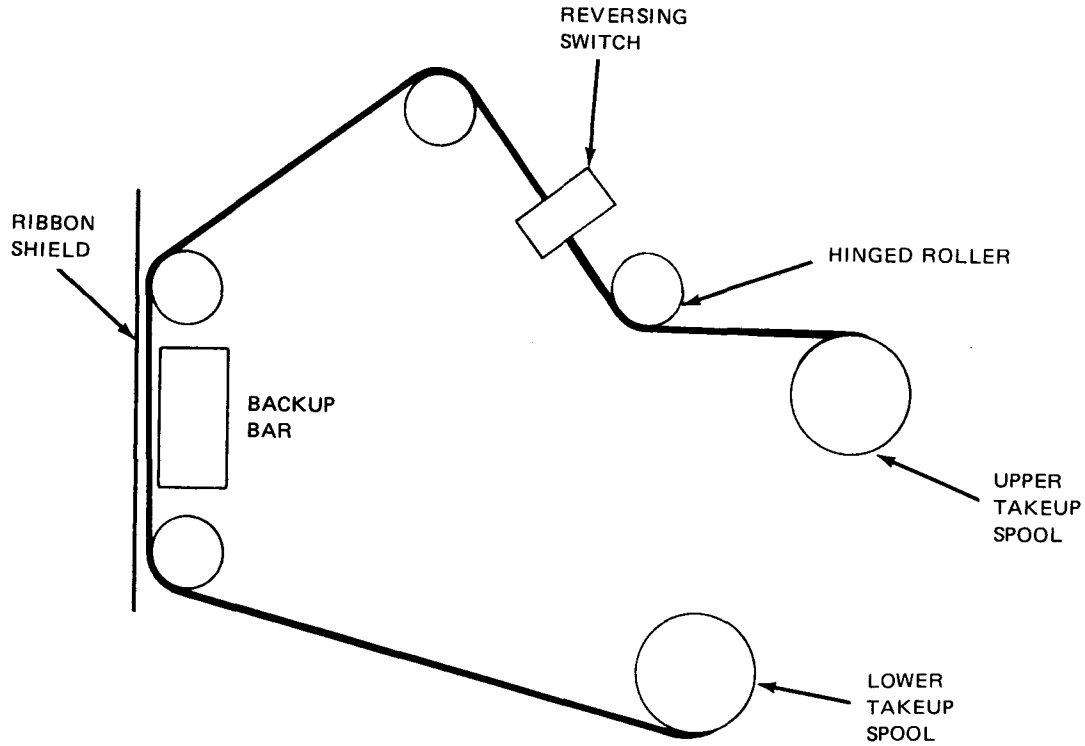

e. Ribbon threading path

Figure 5-60. Replacing Ribbon (Part 4 of 4)

Table 5-12. Ribbon Types

Type/Usage	Part Number					
	Sperry Univac			Sperry Remington		
	120 Column	132** Column	144** Column	120 Column	132* Column	144** Column
Woven nylon fabric ribbon for normal use	3012577-00	3012577-01	3012577-02	7473012	7474012	7475012
Woven nylon fabric containing specially formulated ink for use in preparation of offset masters	3012577-03	3012577-04	3012577-05	7473092	7474092	7475092
Plastic film (0.001-inch, or 0,254 mm MYLAR†) provides better character definition on single part forms	3012577-06	3012577-07	3012577-08	7073154	7074154	7075154

*Used if printer is equipped with 132 print positions (feature 1648-00).

**Used if printer is equipped with 144 print positions (feature 1648-02).

† Trademark of E.I. du Pont de Nemours & Co., Inc.

5.4.3.3. Print Cartridge Replacement

The print cartridge, which contains the print band, is changed as follows:

NOTE:

Before performing the following procedure, remove the device from the system's list of available resources by using the DOWN function of the SET IO command (Section 12). After the procedure is completed, restore the device's available status by using the UP function of the SET IO command.

1. Release print carriage assembly latch (Figure 5—52) by lifting the latch lever. Swing print carriage assembly fully open (Figure 5—60a).
2. Open ribbon shield by pulling right side of shield from magnetic catch (Figure 5—60b). Leave hinged roller in place.
3. Wearing plastic gloves, remove lower ribbon spool from lower take up spool holders (Figure 5—61a) by pushing ribbon spool toward spring-loaded spool holder. Swing released lower ribbon spool up and around print carriage assembly, and cradle spool between upper ribbon spool and hinged roller (Figure 5—61a).
4. Loosen two thumbscrews which secure print cartridge to print carriage assembly (Figure 5—61b).
5. Grasp the two handles on print cartridge (Figure 5—61b) and remove it from print carriage assembly by pulling it straight up.
6. To install print cartridge assembly, align two holes on print cartridge assembly with two alignment pins on casting of print carriage assembly (Figure 5—61b) and lower print cartridge assembly onto the print carriage assembly. Be sure that the cartridge assembly is fully seated by noting that the alignment pins are protruding through the cartridge holes.
7. Secure print cartridge assembly by tightening the two thumbscrews on print cartridge assembly (Figure 5—61b).
8. Visually check cartridge to ensure that it is fully seated.
9. Remove lower ribbon roll cradled in step 3 and replace it on bottom mandrel. Close ribbon shield. Close print carriage assembly and lower the latch to secure assembly.

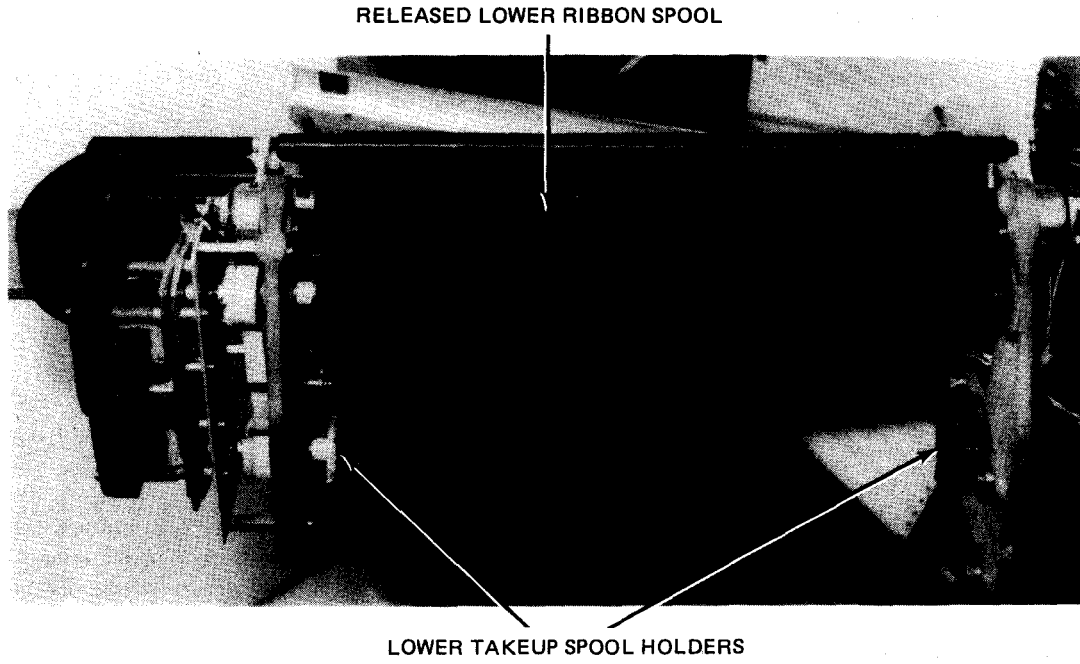

- a. Lower ribbon spool removed and cradled above upper spool

Figure 5-61. Replacing Print Cartridge (Part 1 of 2)

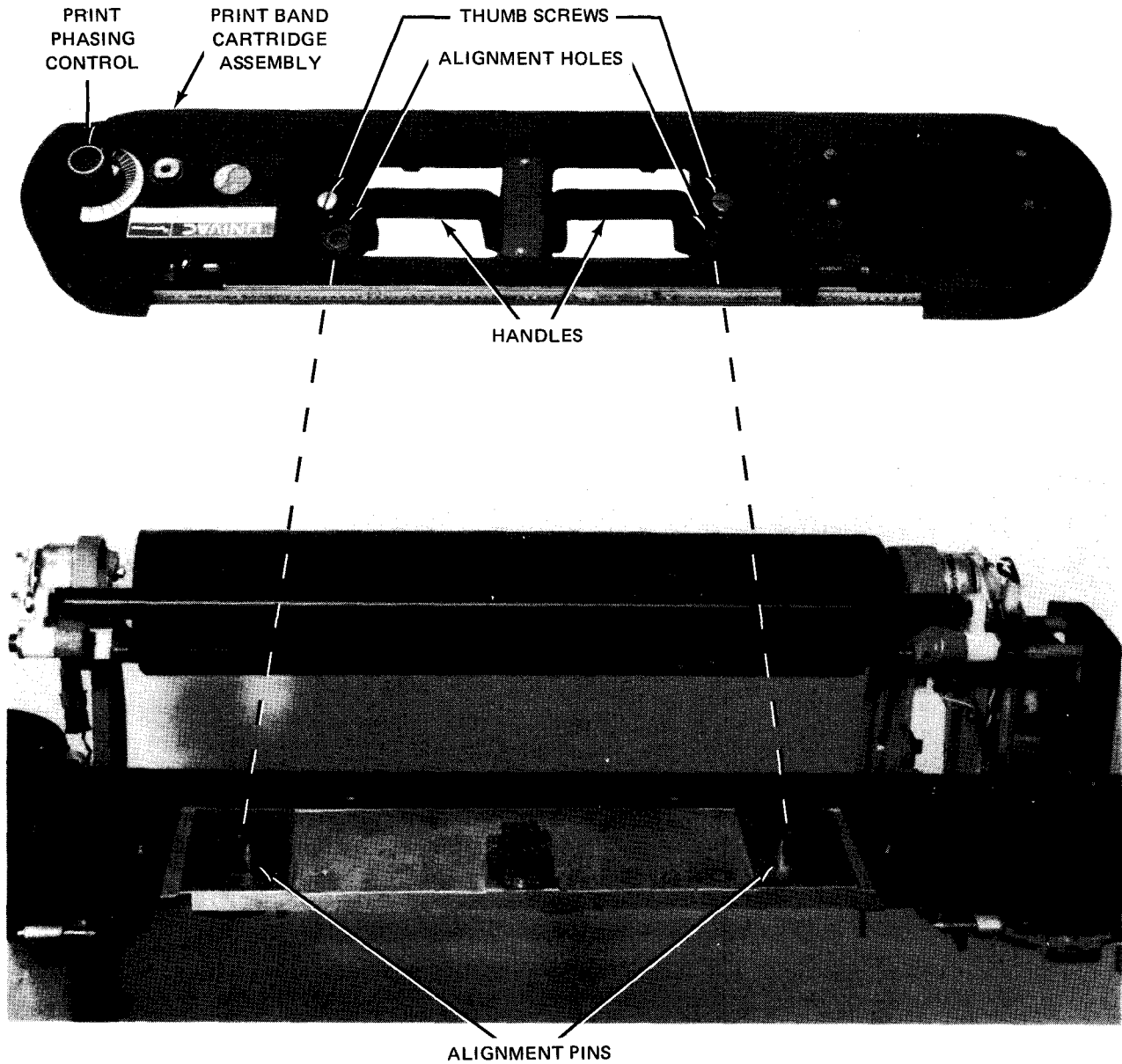

b. Alignment of print cartridge with alignment pins

Figure 5-61. Replacing Print Cartridge (Part 2 of 2)

5.4.3.4. Print Phasing Adjustment

The print phasing control (Figure 5—62) on the print cartridge eliminates clipping of printed characters. Clipping is indicated when either side of the printed character is faded or missing. Evidence of incorrect setting of the print phasing control can best be seen on the last part of a multipart form.

If clipping occurs, print phasing can be adjusted during printing by turning the control in either direction until characters are printed uniformly over their entire surface. Figure 5—63 illustrates examples of clipping on each side of the printed characters due to improper adjustment of the print phasing control. The example showing evenly printed characters (c) indicates a properly adjusted phasing control.

Changing the thickness of the forms or print speed (available only if printer is equipped with feature 1697—00/01) requires adjustment of the print phasing control. If correct phasing cannot be obtained by setting the control near either limit of its rotation range, notify the Sperry Univac customer engineer.

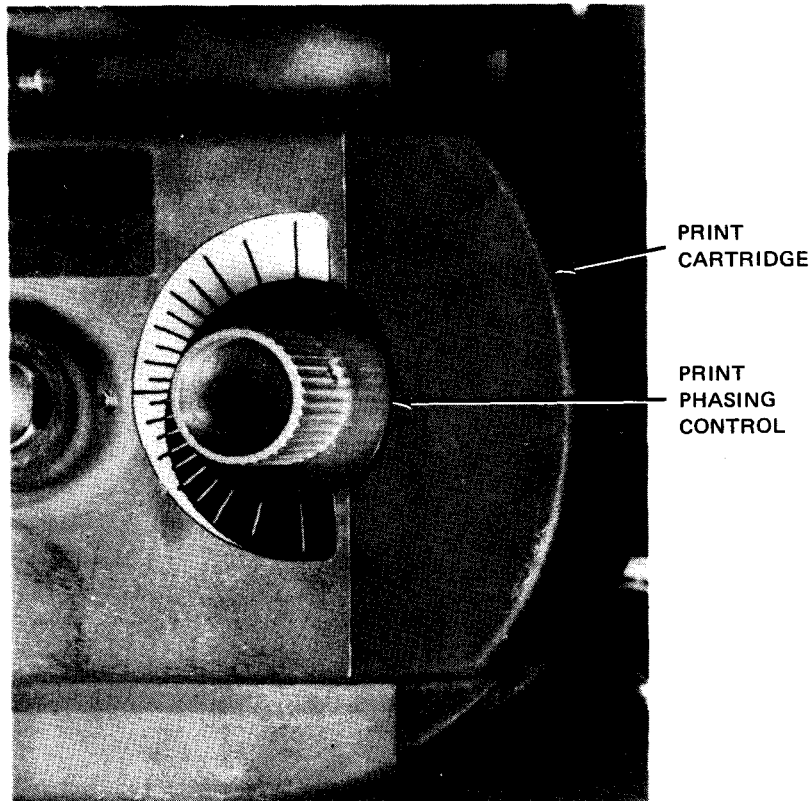

Figure 5—62. Print Phasing Control on Print Cartridge

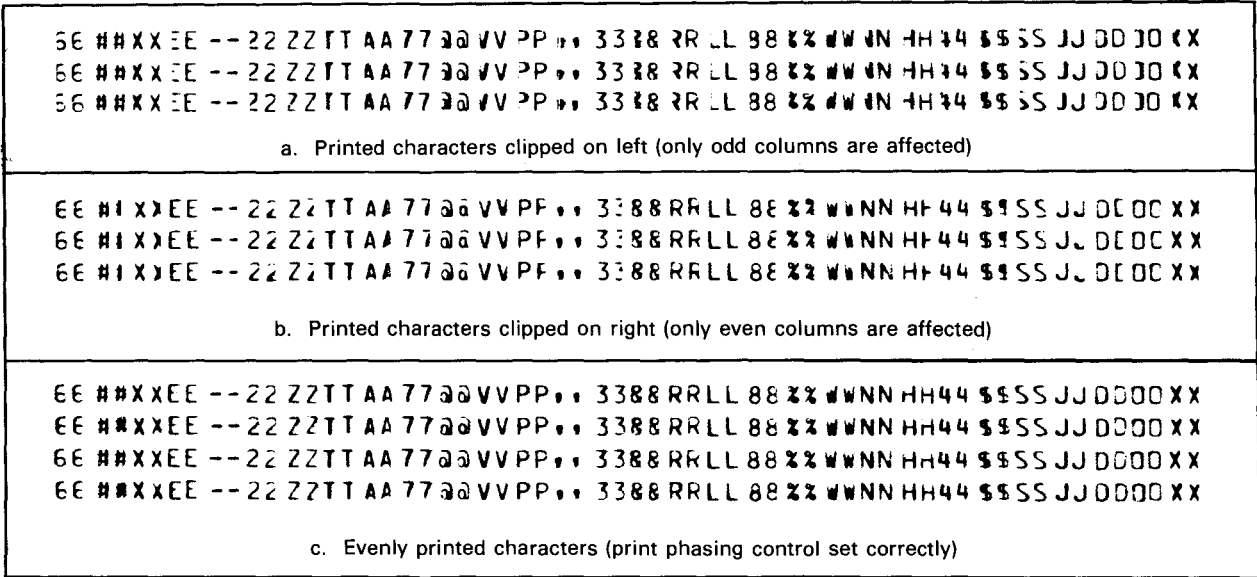

Figure 5-63. Examples of Print Phasing Adjustment Results

5.4.3.5. Print Speed Selection

On printers equipped with the dual print band speed feature 1697-00/01, the printing speed can be reduced for best print quality on special form stock. The speed selection is accomplished through the use of the **BAND SPEED** switch (Figures 5-50 and 5-64). Each time the band speed is changed, the characters must be rephased (5.4.3.4) by using the print phasing control.

To change the print speed, proceed as follows:

1. Open print carriage assembly.
2. Turn print phasing control (Figure 5-62) in proper direction (counterclockwise direction for low speed; clockwise direction for high speed operation).

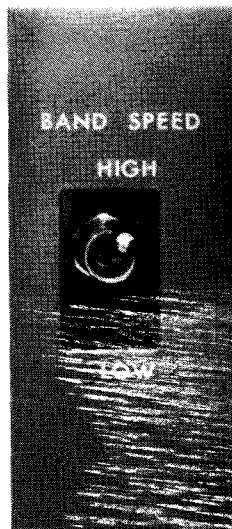

Figure 5-64. BAND SPEED Switch on Upper Right of Paper Handling Assembly

3. Set **BAND SPEED** switch to desired speed (**LOW** position for low speed operation; **HIGH** position for normal speed).
4. Adjust the print phasing control to eliminate any clipping (5.4.3.4).

5.4.3.6. Print Gap Adjustment

The print gap (i.e., distance between hammer face and type face) is adjusted with the **FORM THICKNESS** control (Figure 5—58) to compensate for forms with various thicknesses. The range of control is such that a 6-part form with a maximum pack thickness of 0.018 inch (0,457 mm) can be printed without any degradation in quality. At the operator's discretion, other forms which exceed the maximum pack thickness may be made workable by manipulation of the **FORM THICKNESS** control in conjunction with the print phasing control (Figure 5—62). However, this option is not recommended, because reduced print quality may result. For assistance in determining the correct settings for special forms, contact the Sperry Univac customer engineer.

5.4.4. Recovery Procedures

Table 5—13 lists the printer malfunctions that may be corrected by the operator. The printer must be in stop state (**STOP** switch/indicator lit) to initiate recovery. If fault indications persist, contact your Sperry Univac customer engineer.

Table 5—13. 0773 Printer Subsystem, Recovery Procedures (Part 1 of 2)

Fault Indication	Probable Cause	Operator Action
DEVICE CHECK indicator is lit; STOP switch/indicator is lit.	<ol style="list-style-type: none"> 1. Print carriage assembly is not closed properly. 2. Power is removed from ribbon drive motors. 3. Air flow within printer is restricted. 4. Temperature within printer exceeds 134.6°F (57°C). 	<p>Close print carriage assembly securely.</p> <p>Reset any tripped AC LINE and 25 VAC circuit breakers on power supply.</p> <p>Ensure blower is operating and air is circulating within the printer.</p> <p>Ensure that ambient temperature is not excessive and that printer floor-level fresh air intakes are not obstructed.</p> <p>Press and release RUN switch/indicator on printer control panel. DEVICE CHECK indicator and STOP switch/indicator are extinguished.</p> <p>Restart the program.</p>
PARITY CHECK indicator is lit; STOP switch/indicator is lit.	Incorrect parity was detected.	Press and release RUN switch/indicator and reenter program at proper point.
PRINT CHECK indicator is lit; STOP switch/indicator is lit.	Failure in print head actuator circuits or print band	<p>Reset any tripped AC LINE and 220 VAC circuit breakers on power supply.</p> <p>Restart program, or if it is desirable to continue printing from this line, press and release RUN switch/indicator; the line will be overprinted.</p>

Table 5-13. 0773 Printer Subsystem, Recovery Procedures (Part 2 of 2)

Fault Indication	Probable Cause	Operator Action
<p>FORMS CHECK indicator is lit; STOP switch/indicator is lit.</p>	<p>Forms are jammed or ripped.</p>	<p>Remove torn or jammed form from printer. Note location of torn or jammed form with respect to printed data so that a convenient restart point may be established.</p> <p>Reload forms as described in 5.4.3.1.</p> <p>Advance the form to the next applicable print line. This line would have been the one next printed had a forms check not occurred.</p> <p>Press and release RUN switch/indicator on printer control panel. FORMS CHECK indicator and STOP switch/indicator extinguishes.</p> <p>Reenter program at proper point.</p>
<p>OUT OF FORMS indicator is lit; STOP switch/indicator is lit.</p>	<p>Paper forms are required in printer.</p>	<p>Reload forms as described in 5.4.3.1.</p> <p>Press and release RUN switch/indicator on printer control panel. OUT OF FORMS indicator and STOP indicator go out.</p> <p>Reenter program at proper point.</p>



This page left blank intentionally.

5.5. 0776 PRINTER SUBSYSTEM

The 0776 printer subsystem is a freestanding, impact-type print cartridge (print band), line printer which can be connected directly to a 9000 type selector or multiplexer I/O channel. Most operations for the printer and forms control are controlled from a front panel. Operating controls and overload protection controls are located within the printer.

5.5.1. Operating Controls and Indicators

An operator control panel on the front of the printer (Figures 5-65 and 5-66) contains all controls normally required to operate the printer. A power control panel (Figures 5-67 and 5-68), located behind the paper well door, contains overload protection between the input line and power supply. A printer power supply control panel (Figures 5-69 and 5-70), located behind the rear cover, provides overload protection for power supply input. Controls and indicators for each panel are listed and described in Table 5-14.

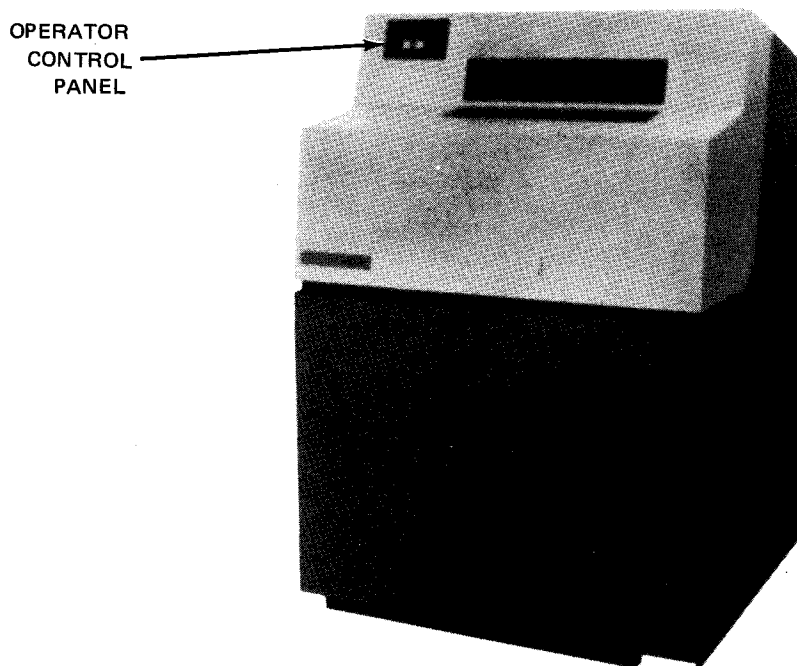

Figure 5-65. 0776 Printer Subsystem

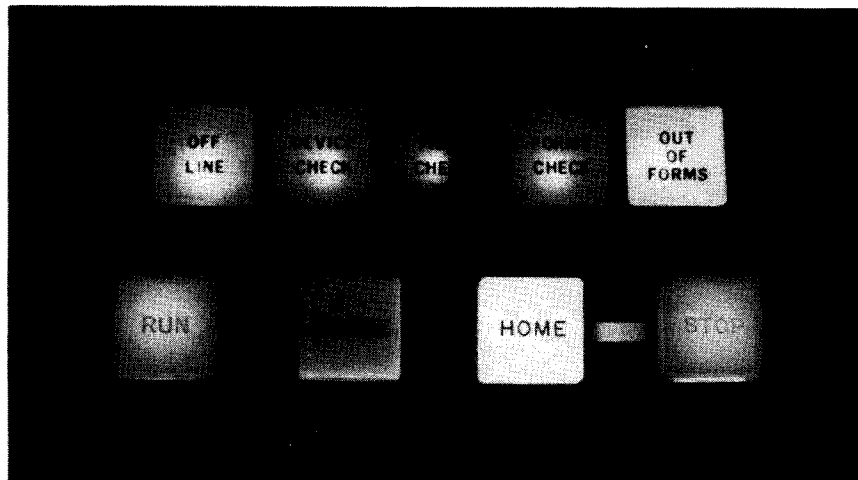

Figure 5-66. 0776 Printer Subsystem, Operator Control Panel

POWER CONTROL
PANEL

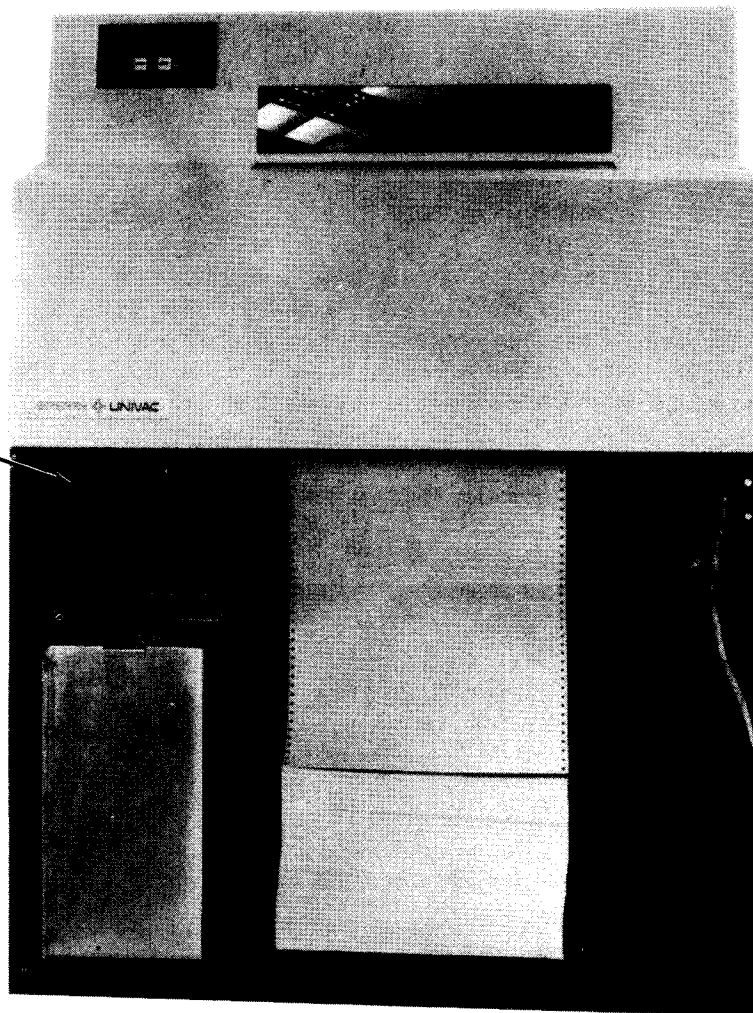

Figure 5-67. 0776 Printer Subsystem, Front View With Paper Well Door Removed

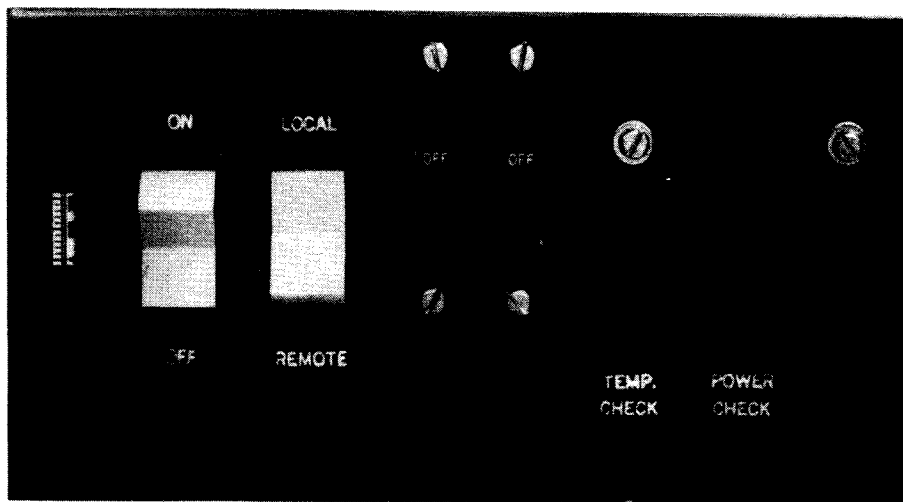
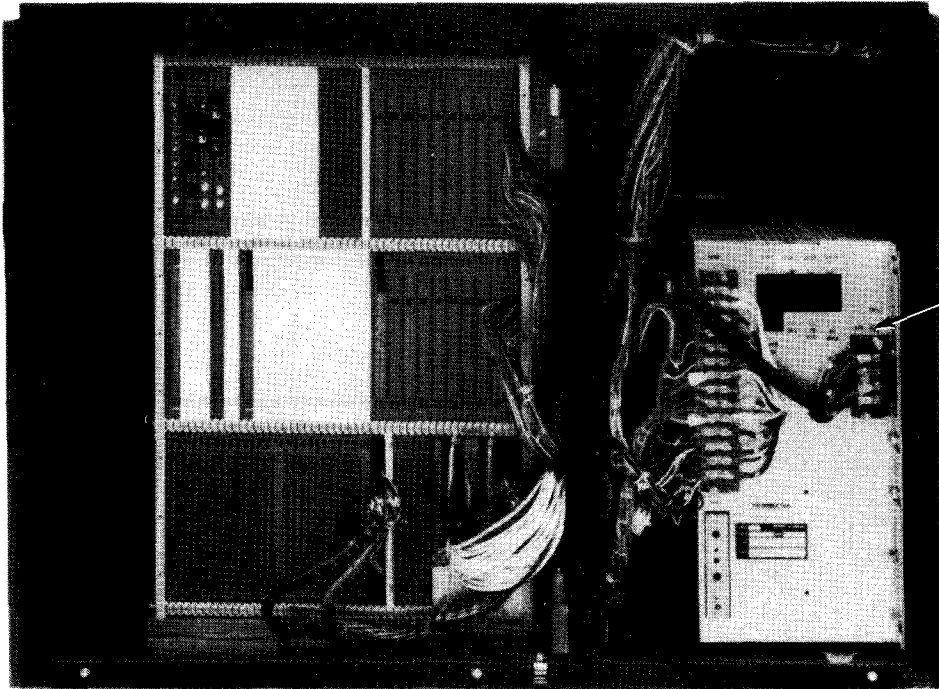

Figure 5-68. 0776 Printer Subsystem, Power Control Panel



POWER SUPPLY
CONTROL PANEL

Figure 5-69. 0776 Printer Subsystem, Rear View With
Rear Cover Removed

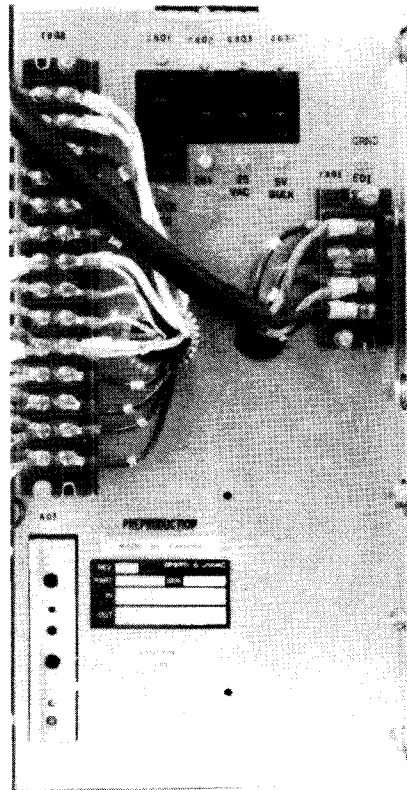

Figure 5-70. 0776 Printer Subsystem, Power Supply Control Panel

Table 5-14. 0776 Printer Subsystem, Controls and Indicators (Part 1 of 2)

Control/Indicator — Function
Operator Control Panel
RUN switch/indicator Prepares the printer for operation RUN indicator lights; STOP indicator extinguishes if all check conditions are cleared. If pressed during run mode, no action results.
STOP switch/indicator Stops the printer if it is in run mode. A command being executed will be completed before the printer enters the stop mode. The following conditions will also cause the printer to stop: <ul style="list-style-type: none">■ carriage open ■ forms out■ forms check ■ loss of cooling air■ forms low ■ actuator check Pressing the STOP switch when the printer is in stop mode will perform a lamp test, lighting all indicators on the panel.
HOME switch/indicator Pressed simultaneously with the STOP switch causes forms to advance to next home (or setup) position without advancing the forms. When lit, indicates the paper system is stopped at home position.
SPACE switch When pressed during stop mode, this switch advances the form by one line. Continuing to press the switch causes single, continued spacing of the form.
OFFLINE indicator Indicates the printer is not available, being in offline mode. Maintenance panel switches are enabled.
DEVICE CHECK indicator Indicates one or both of the following conditions: <ul style="list-style-type: none">■ Carriage is opened.■ Insufficient air flow to printer. The printer will go into the stop mode.
PRINT CHECK indicator Indicates one or more of the following conditions: <ul style="list-style-type: none">■ Actuator circuit malfunction■ Band broken or slowed■ Print line buffer parity error■ Print cycle not properly completed

Table 5-14. 0776 Printer Subsystem, Controls and Indicators (Part 2 of 2)

Control/Indicator — Function
Operator Control Panel (cont)
<p>FORMS CHECK indicator</p> <p>Indicates one or more of the following conditions:</p> <ul style="list-style-type: none"> ■ Forms were fed continuously (without an intervening stop) for over 1.2 seconds. ■ Forms feeding system required excessive time to accelerate to running speed (may indicate a jammed system). ■ Forms feeding system required excessive time to decelerate to stop. ■ Jammed forms ■ Vertical format buffer parity error
<p>OUT OF FORMS indicator</p> <p>Indicates approximately 8 inches of paper (or less) remain below the print line.</p>
Power Control Panel
<p>Elapsed time indicator</p> <p>Indicates time, in hours, that power has been applied to the printer.</p>
<p>ON/OFF switch</p> <p>Used in conjunction with the LOCAL/REMOTE switch to control the application of power to the printer. Setting this switch to the OFF position removes power from the printer regardless of the setting of the LOCAL/REMOTE switch.</p>
<p>LOCAL/REMOTE switch</p> <p>Selects the power source to the printer. When in the LOCAL position, the ON/OFF switch has control. When in the REMOTE position, the POWER ON/POWER OFF switch on the processor operator/maintenance panel has control.</p>
<p>Main circuit breaker</p> <p>Provides overload protection for the printer.</p>
<p>TEMP. CHECK indicator</p> <p>Lights when a high temperature condition is detected in the printer.</p>
<p>POWER CHECK indicator</p> <p>Lights when a dc power failure is detected in the printer.</p>
Power Supply Control Panel
<p>CB03 circuit breaker</p> <p>Provides overload protection for the ribbon drive motors. Initiates a signal to indicate 25 Vac power is removed from the ribbon drive motor.</p>
<p>CB01, CB02, and CB04 circuit breakers</p> <p>Provide overload protection for the printer and associated circuitry.</p>

5.5.2. Turn-On and Turn-Off Procedures

Power for the printer is normally applied and removed by the **POWER ON/POWER OFF** switch on the processor operator maintenance panel (Figure 2—2). However, to control power from this panel, certain switches and circuit breakers on the printer must first be set to specific positions. The switch and circuit breaker settings for the printer are listed in Table 5—15.

Table 5—15. 0776 Printer Subsystem, Power Switch Settings

Switch/Circuit Breaker	Normal Setting
Power Control Panel	
LOCAL/REMOTE switch	REMOTE
ON/OFF switch	Center (ON) position
Main circuit breaker	On (up)
Power Supply Control Panel	
CB01 circuit breaker	On (up)
CB02 circuit breaker	On (up)
CB03 circuit breaker	On (up)
CB04 circuit breaker	ON (up)

When the switches and circuit breakers on the printer are set as specified in Table 5—15, and the **POWER ON/POWER OFF** switch on the processor is set to **POWER ON**, either the **STOP** or **RUN** switch/indicator on the operator control panel should light. If any other indicators light or if the **STOP** or **RUN** switch/indicator fails to light, contact the Sperry Univac customer engineer.

5.5.2.1. Independent Power Turn-On Procedure

To turn power on at the printer independently of the processor, proceed as follows:

CAUTION

The turn-on sequence must be followed as indicated or power fuses may open.

1. Set **LOCAL/REMOTE** switch on operator control panel to **LOCAL**.
2. Ensure that all circuit breakers on power control panel and power supply control panel are set to their on position.
3. Momentarily set the **ON/OFF** switch on the operator control panel to its **ON** position and then allow it to return to its normal center position. Either the **STOP** or **RUN** switch/indicator should light to indicate the power-on condition.

5.5.2.2. Independent Power Turn-Off Procedure

To turn off power at the printer independently of the processor, proceed as follows:

1. Set **ON/OFF** switch on the operator control panel to **OFF**.
2. Set the main circuit breaker on the operator control panel to its off position if complete power turn off is desired.

NOTE:

Setting the ON/OFF switch to the OFF position will remove power from the printer regardless of the position of the LOCAL/REMOTE switch.

5.5.3. Operating Procedures

Operating procedures for the 0776 printer include forms loading, ribbon replacement, print band cartridge replacement, print phasing adjustment, print speed selection, and print gap adjustment. Access to these controls is obtained by raising the hinged front hood of the printer cabinet. The locations of these controls are shown in Figure 5-71.

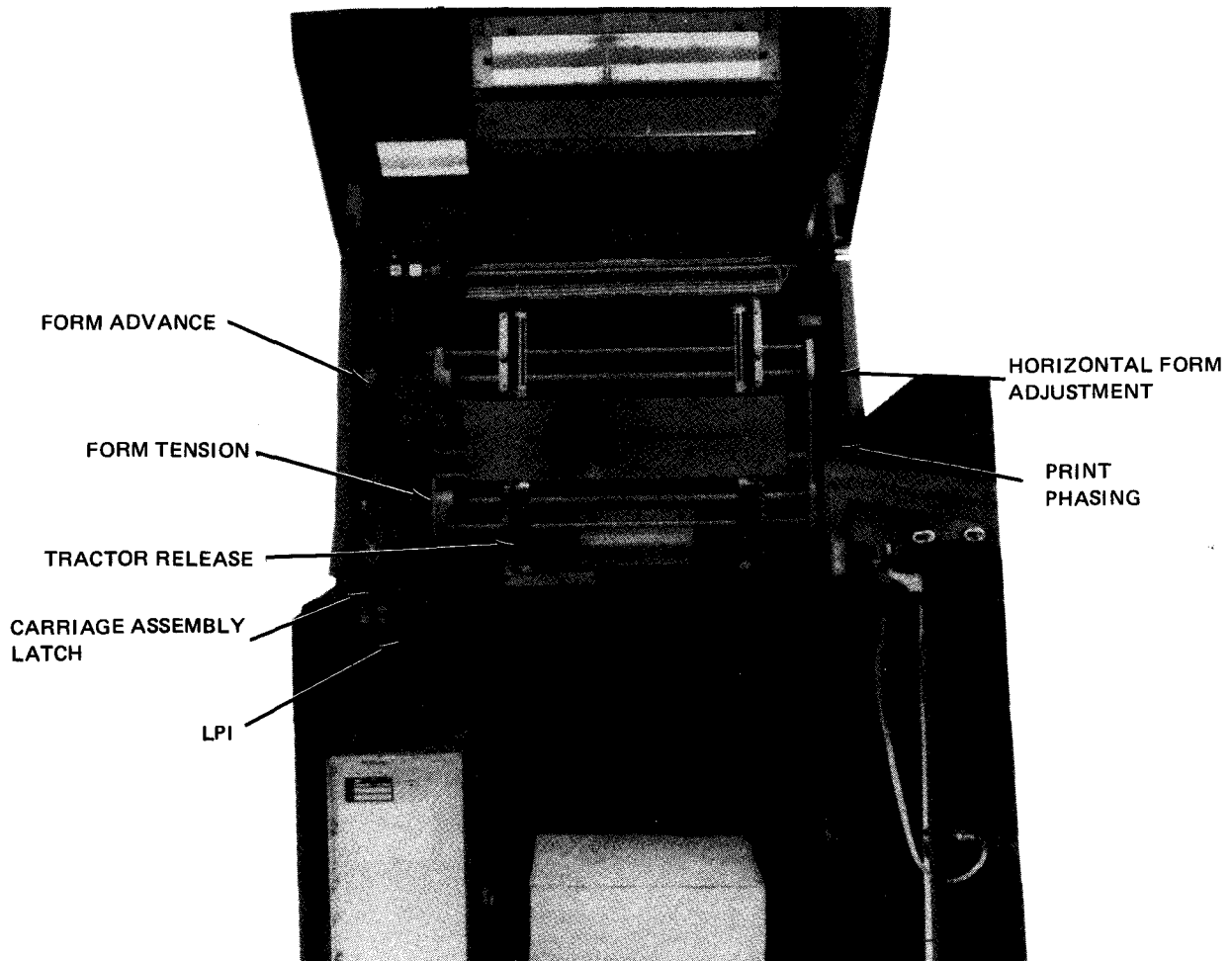

Figure 5-71. 0776 Printer Subsystem, Internal Adjustments

5.5.3.1. Forms Loading

To load forms on the printer, proceed as follows:

NOTE:

Before performing the following procedure, remove the device from the system's list of available resources by using the DOWN function of the SET IO command (Section 12). After the procedure is completed, restore the device's available status by using the UP function of the SET IO command.

1. Ensure that printer is in stop mode, which is indicated when the **STOP** switch/indicator is lit.
2. Raise front hood of printer.
3. Perform the following preliminary adjustment:

Adjust **HORIZ FORM ADJ** control so that retaining rings on tractor shafts are equally spaced with respect to the side castings (Figure 5-72).

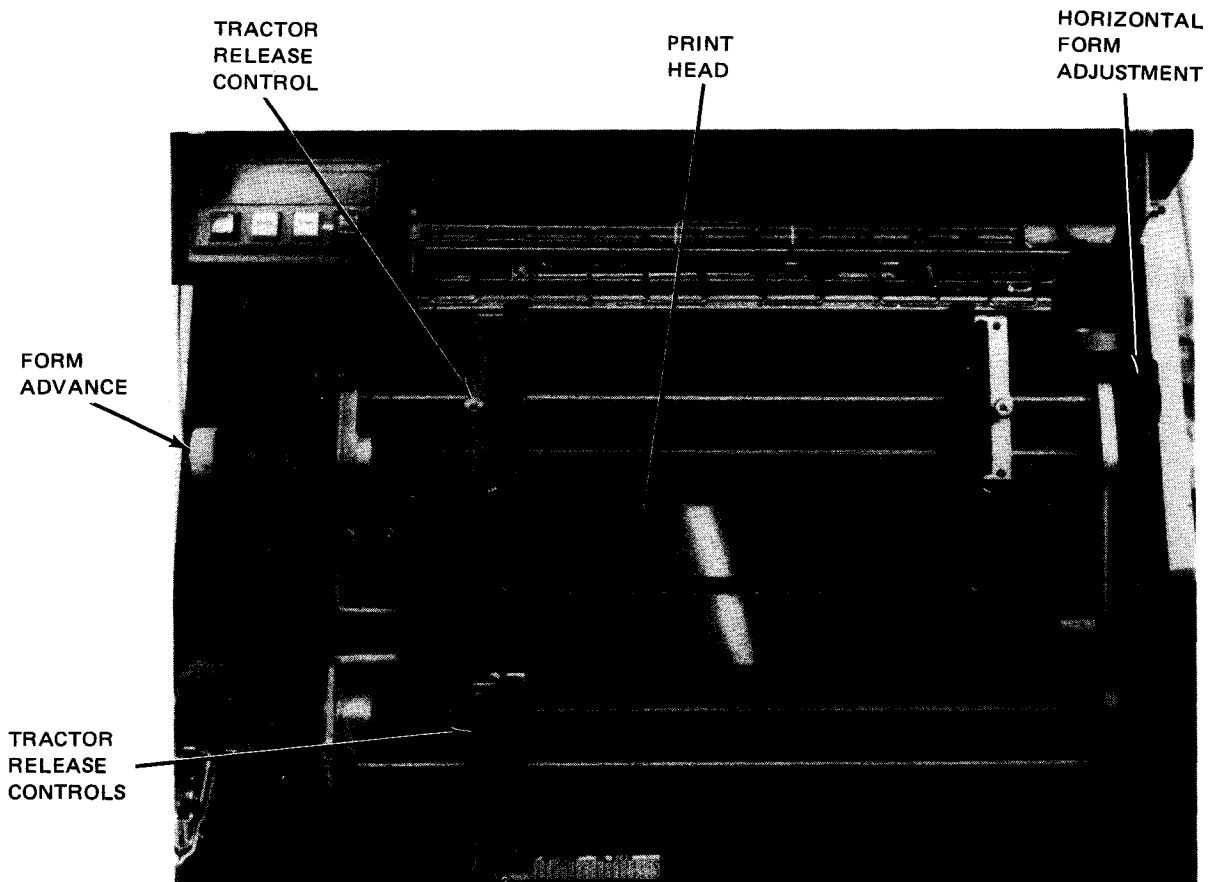

Figure 5-72. Horizontal Form Adjustment

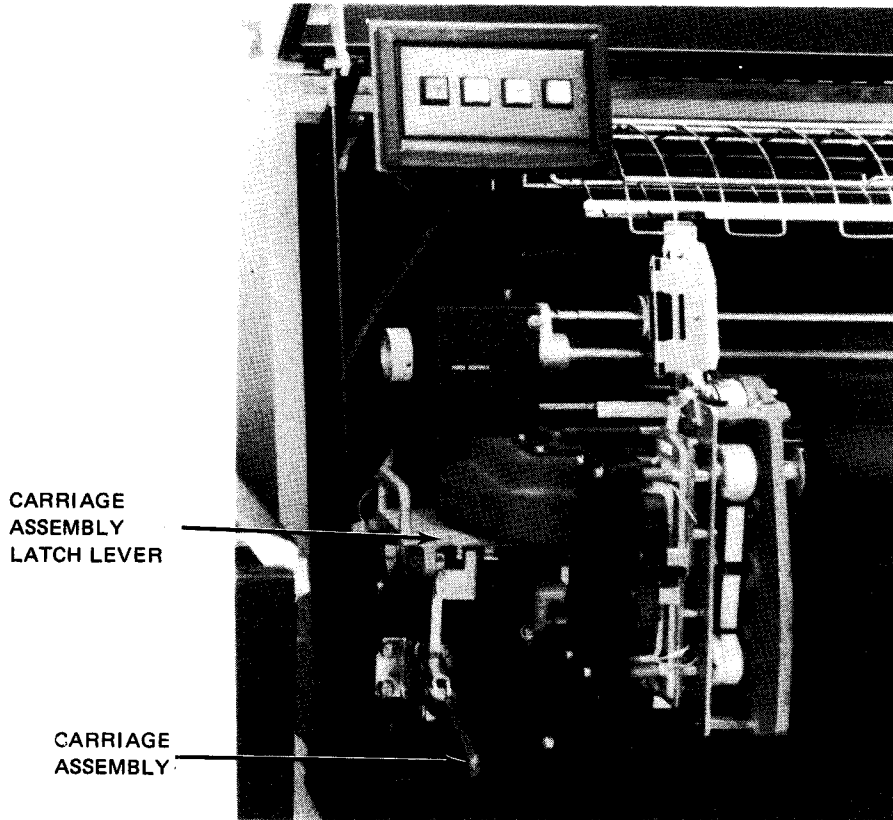

Figure 5-73. Print Carriage Assembly, Closed

4. Open paper well door of printer cabinet.
5. Release carriage assembly latch by pressing down on the latch lever (Figure 5-73). Swing the carriage assembly fully open; assembly is hinged on its right side (Figure 5-74).
6. Unclamp all four tractors by revolving each tractor knurled screw counterclockwise.
7. Open all four tractor pressure plates and swing up hinged portion of paper rack.
8. Place a supply of forms in paper well compartment (Figure 5-74) so that form print surface faces the operator.
9. Place the form on the upper left tractor pins with top edge of the form resting against the column indicator on the paper rack.
10. Close the pressure plate of the upper left tractor.

NOTE:

If the forms which are being loaded contain alignment ticks, perform those instructions listed under step 11. Otherwise, perform step 12.

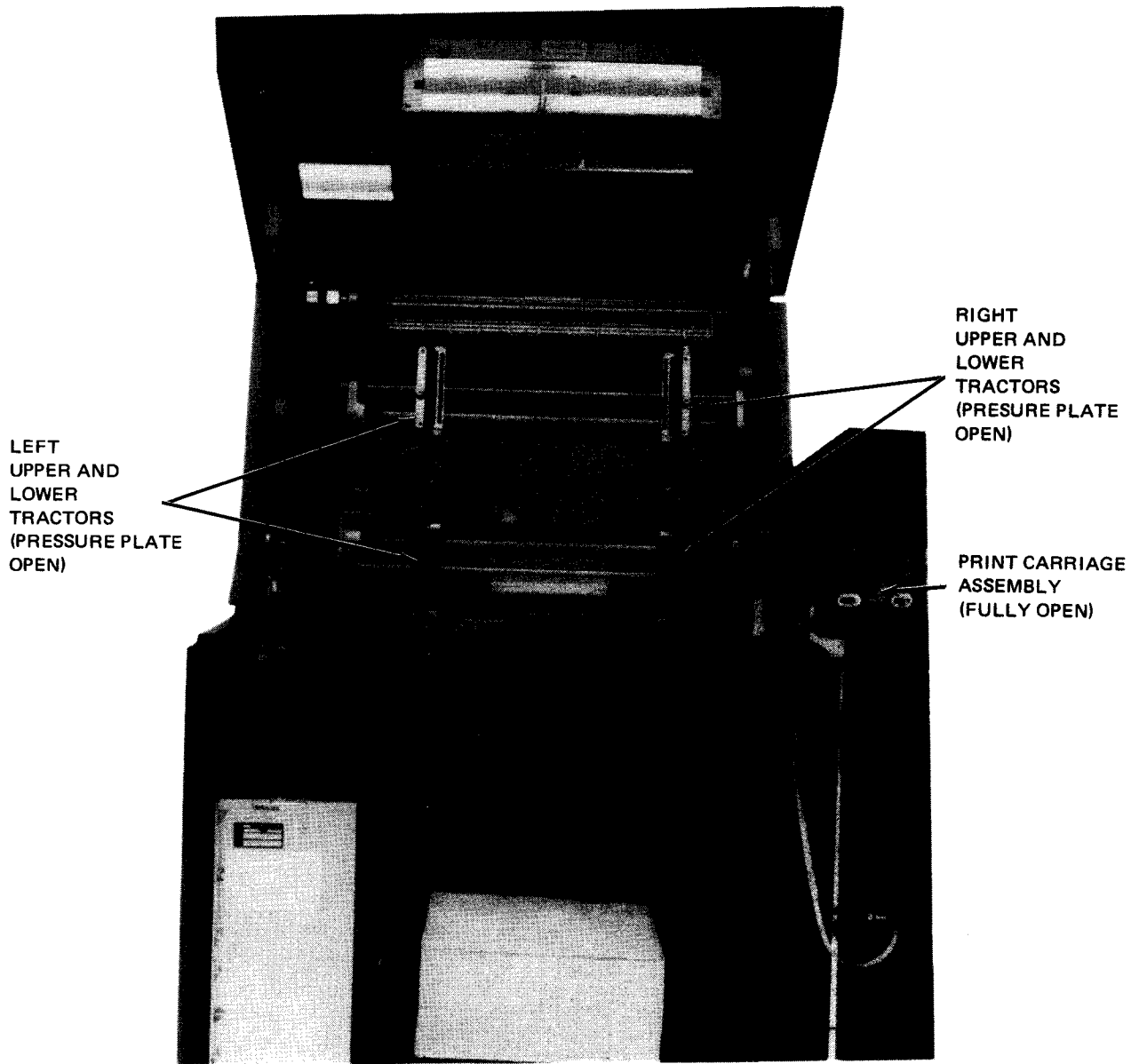

Figure 5-74. Printer, Opened to Receive Forms

11. To load forms provided with alignment ticks perform the following five steps.
 - a. Unlatch form alignment guide from print carriage assembly and place it across print head.
 - b. Adjust the upper left tractor on its shaft until the column indicator vertical tick mark on the form corresponds to the proper column on the column indicator (Figure 5—75).
 - c. Secure upper left tractor by revolving tractor knurled screw clockwise.
 - d. Adjust upper tractor until the form mates with the tractor pins.
 - e. Close pressure plate of upper right tractor.
 - f. Proceed to step 13.

When horizontal perforation is aligned with line on print head, desired character will be printed 1/2" (12.7 mm) down from top of form.

Printed or manually drawn alignment tick mark for a character aligned in Col. 20.

Line on print head

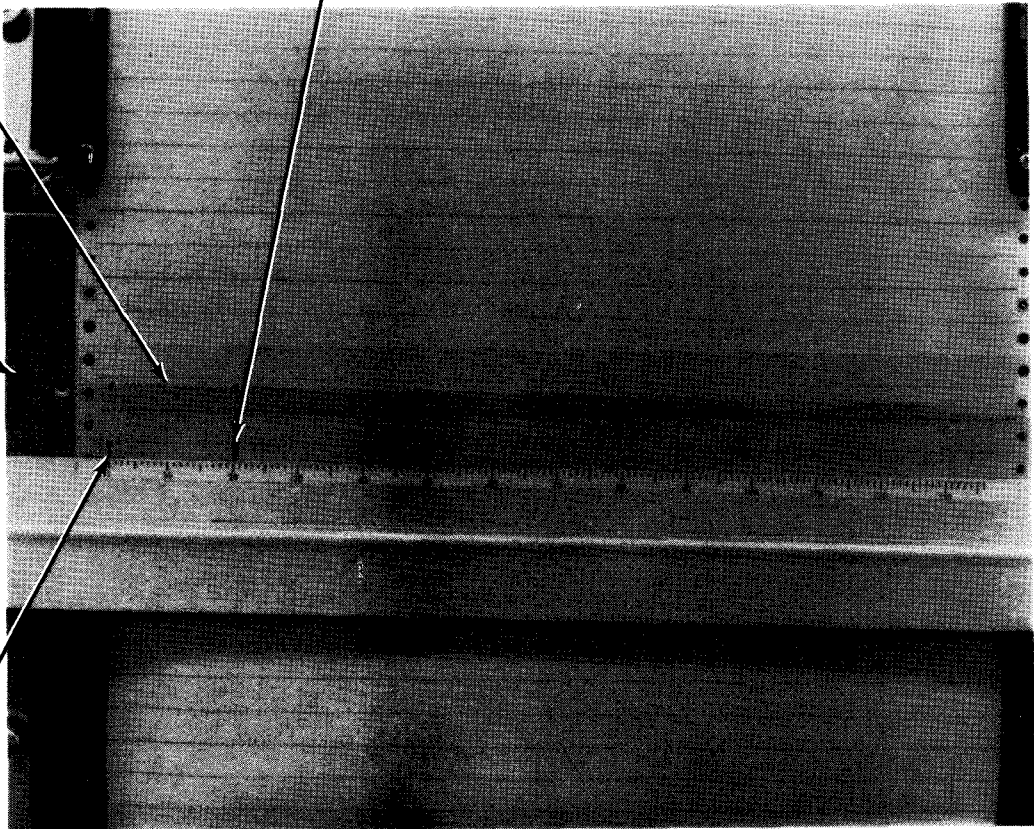

Preprinted or manually drawn alignment tick mark for a character in Col. 1 — 1-1/2" (3.81 cm) down on a form.

NOTE:

Desired character distance down from top of form—1/2" (12.7 mm) gives dimension for placement of alignment tick.

Figure 5—75. Placement of Alignment Ticks

12. To load forms that are not provided with alignment ticks, perform the following:
 - a. Adjust upper right tractor until form mates with tractor pins, and then close pressure plate to secure form in tractor.
 - b. Unlatch forms alignment guide from the print carriage assembly and place it across the print head.
 - c. Press **FORM ADVANCE** knob (Figure 5—76) and turn knob until the bottom edge on forms alignment guide corresponds to intended bottom of line to be printed.
 - d. By moving the two upper tractors, horizontally, shift form until correct column indication block is centered on intended position of first column.
 - e. Remove all horizontal slack from form by adjusting the two upper tractors, then secure both tractors by turning each tractor knurled knob clockwise.
 - f. Proceed to step 13.

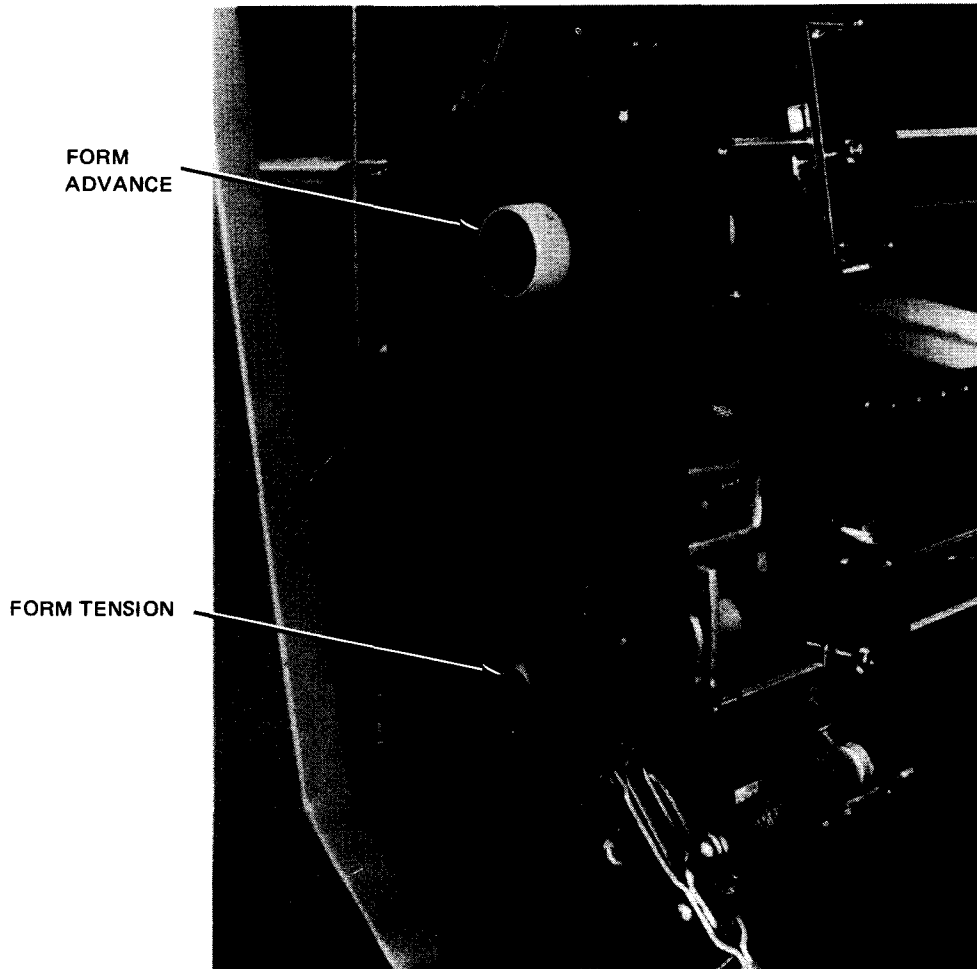
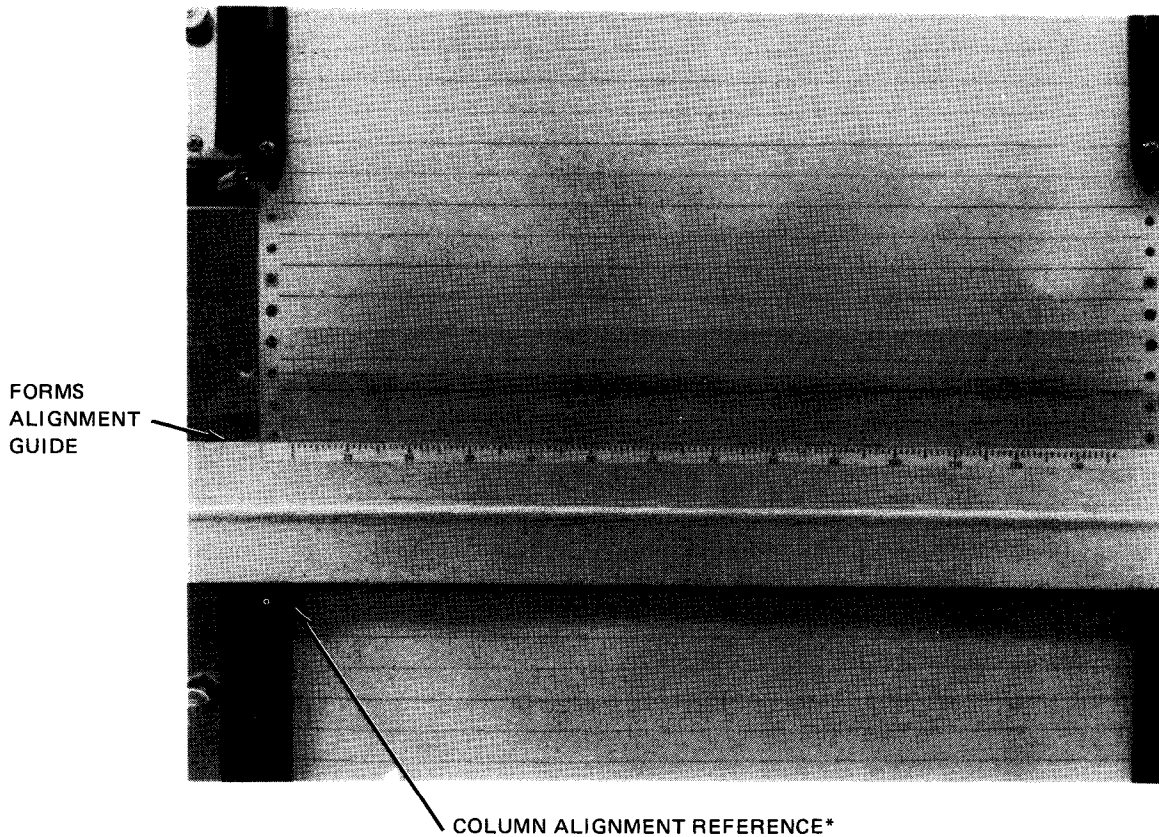

Figure 5—76. Form Alignment, Form Advance and Form Tension Controls



*Repeatable tractor position — The inner edge of the lower left-hand tractor can be used as a reference mark to point to column indicator on forms alignment guide. This is used for prepositioning of the tractors to a known location for the same type of form. The first time a common form is used and set in its proper position a notation should be made of the upper left-hand tractor location so that in future usage of this form the tractors can be prepositioned.

Figure 5-77. Form Alignment

13. Adjust and secure the two lower tractors so that form is held in a correct vertical condition.
14. Adjust form vertical tension by pressing and turning **FORM TENSION** knob (Figure 5-76) until slight tension is felt over the curvature of the print head and no sprocket holes are deformed.
15. If forms alignment guide was used in alignment of the form, retract and latch the forms alignment guide on the print carriage assembly.
16. On forms provided with horizontal alignment tick, turn **FORM ADVANCE** knob until horizontal alignment tick at edge of form is aligned with the line on print head (Figure 5-77). Make certain that form is revolved beyond paper switch on the upper tractor.

17. Rotate **FORM THICKNESS** control (Figure 5—78) to proper setting.
18. Close print carriage assembly and secure assembly with associated latch.
19. Close paper well door of printer cabinet.
20. Press **HOME** switch/indicator to advance paper to home position.

FORMS THICKNESS
(GAP ADJUST) LEVER

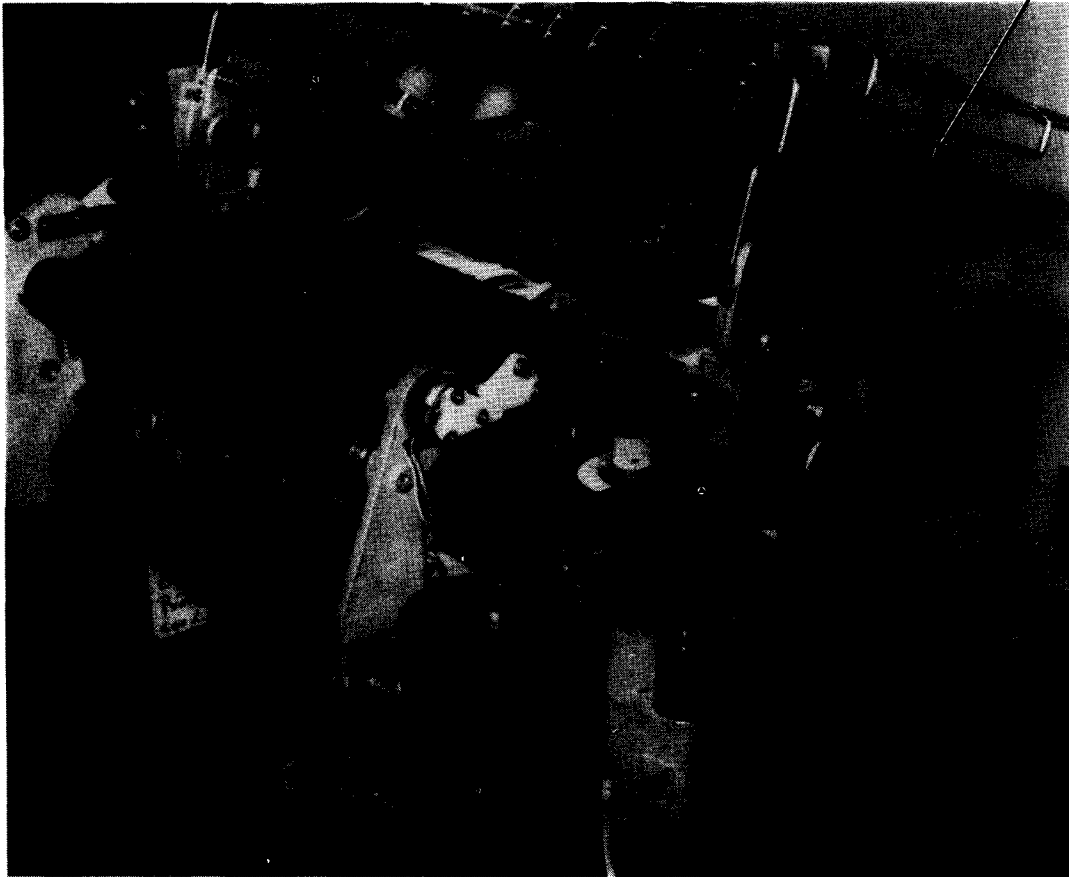

Figure 5—78. Printer Forms Thickness (Gap Adjust) Lever

21. Feed form through internal guide assembly to rear of printer so that form passes through slot in the sound hood and folds between rear and front paper guides on the paper shelf (Figure 5-79).
22. Press and release **RUN** switch/indicator on printer control panel and start printing program.
23. If further minor adjustment is required, adjust **HORIZ FORM ADJ** control for side-to-side placement. (Turn **HORIZ FORM ADJ** control clockwise to move printed characters to the left; turn the control counter-clockwise to move characters to the right.)

CAUTION

*Do not adjust the **FORM ADVANCE** or tension controls while form is in motion or a tear may result.*

24. Close front hood.

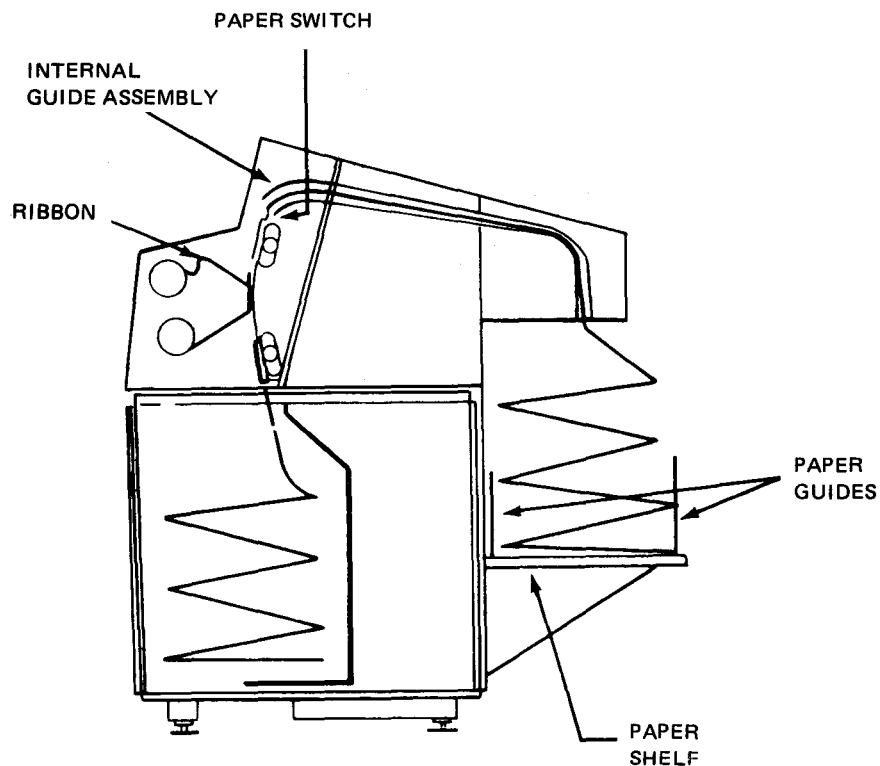

Figure 5-79. Form Feed Configuration

5.5.3.2. Ribbon Replacement

The ribbon must be replaced on the print carriage assembly when printing appears light or faded. To replace the ribbon proceed as follows:

NOTE:

Before performing the following procedure, remove the device from the system's list of available resources by using the DOWN function of the SET IO command (Section 12). After the procedure is completed, restore the device's availability status by using the UP function of the SET IO command.

1. Release print carriage assembly latch (Figure 5—73) by lifting latch lever. Swing print carriage assembly to fully open position (Figure 5—80a).

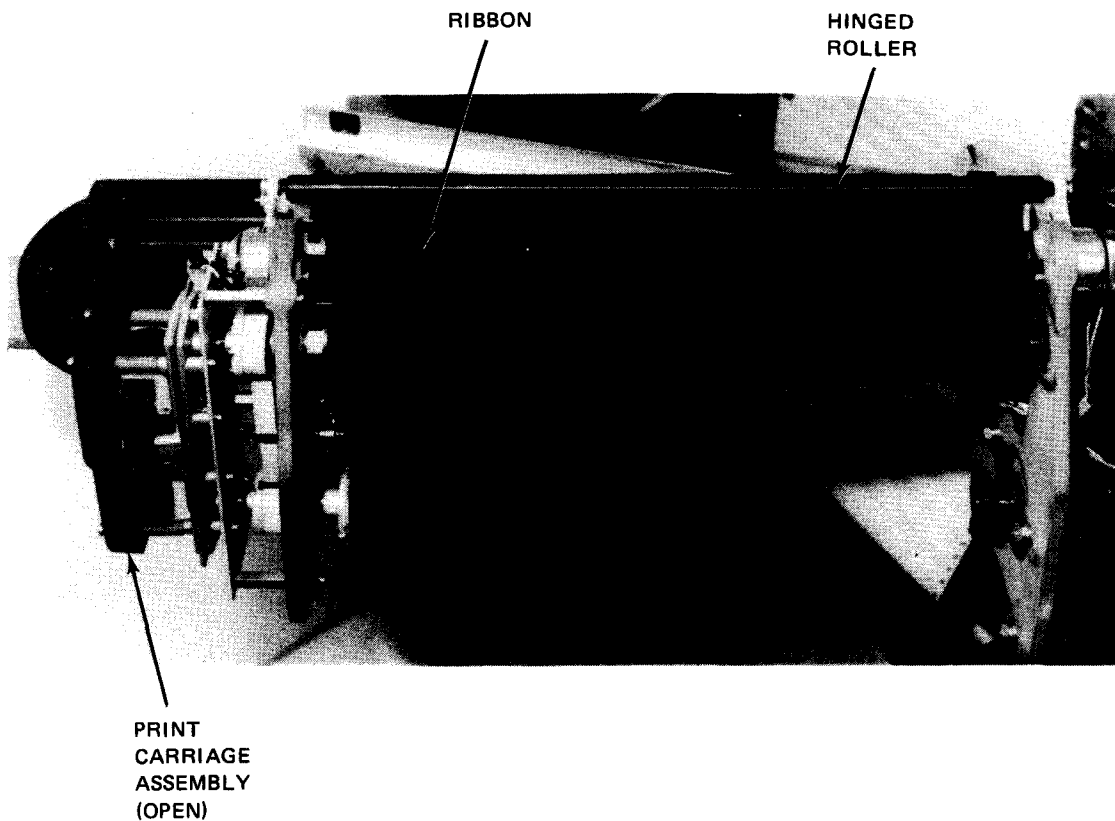

a. Ribbon shield and hinged roller closed

Figure 5—80. Changing Ribbon (Part 1 of 4)

2. Open ribbon shield by pulling right-hand side of shield from magnetic catch. Swing shield back (Figure 5-80a).
3. Open hinged roller by grasping and pulling knurled lever of roller (Figure 5-80b).

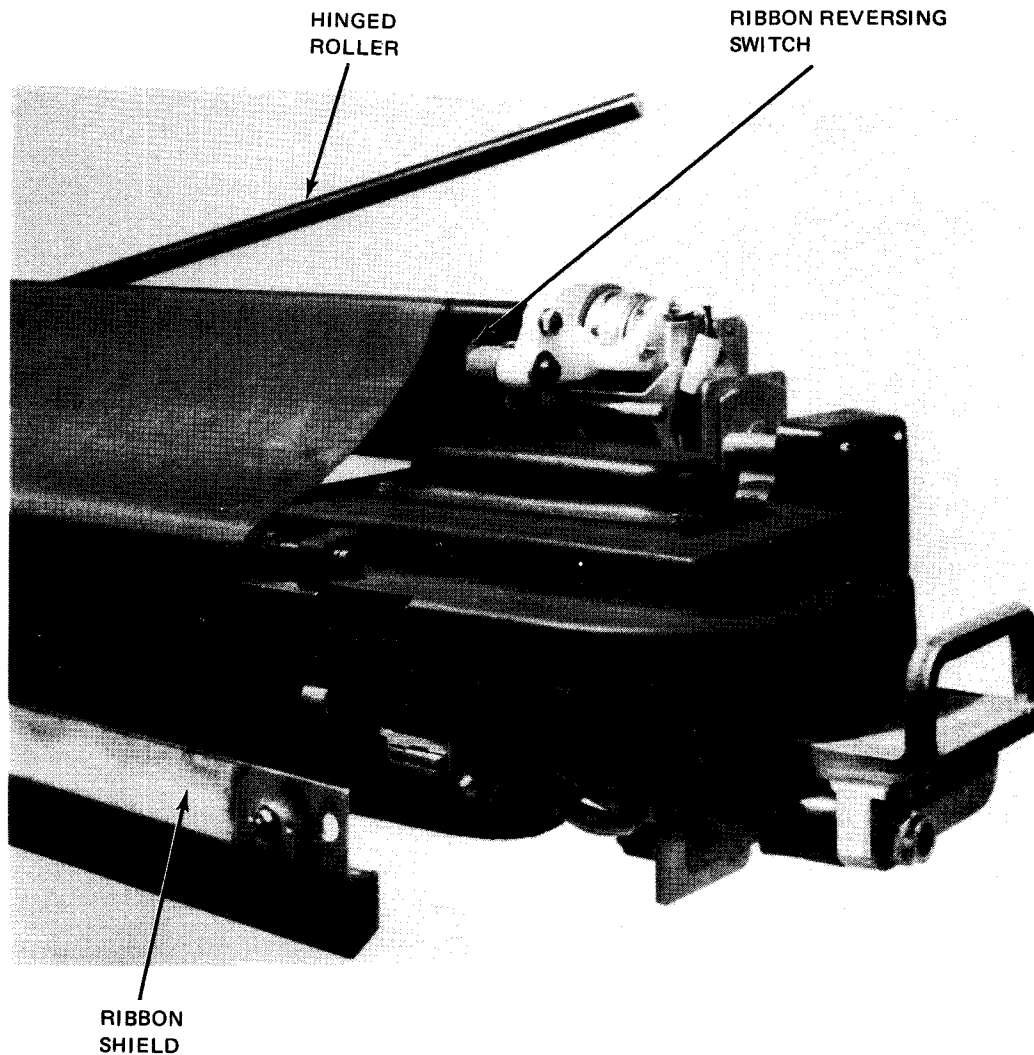

b. Ribbon shield and hinged roller open

Figure 5-80. Changing Ribbon (Part 2 of 4)

4. Wearing plastic gloves provided with new ribbon, remove upper takeup spool from upper spool holder (Figure 5-80c) by pushing spool toward spring-loaded spool holder.
5. Remove lower spool from lower takeup spool holder (Figure 5-80d) by pushing spool toward spring-loaded spool holder.
6. With both takeup spools disengaged, remove ribbon from around print carriage assembly and discard ribbon (Figure 4-80d).

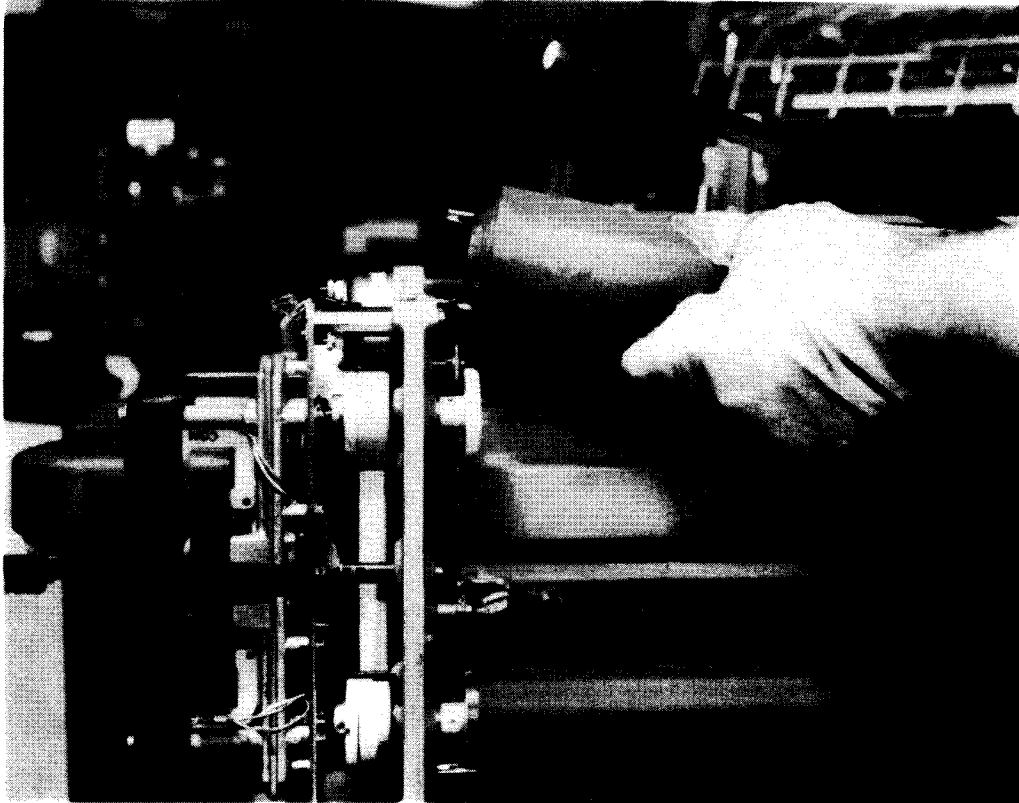

c. Removing upper takeup spool



d. Removing upper and lower takeup spools

Figure 5-80. Changing Ribbon (Part 3 of 4)

7. Obtain new ribbon as per Table 5-16.
8. Install new ribbon on lower takeup spool, and upper takeup spool in reverse manner that old ribbon was removed. Note ribbon threading which is illustrated in Figure 5-80e.

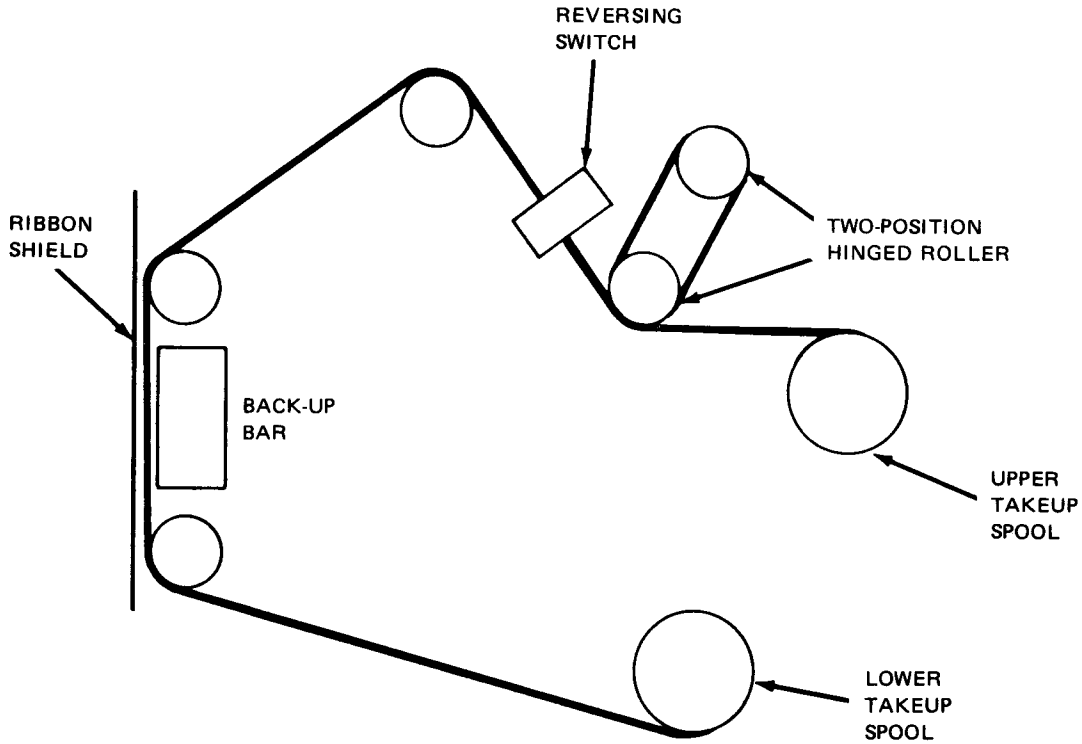

e. Ribbon threading path

Figure 5-80. Changing Ribbon (Part 4 of 4)

Table 5-16. Ribbon Types

Type	Part Number	
	Sperry Univac	Sperry Remington
Woven textured nylon	3012577-02 or 3012577-05	7475012 or 7475092
MYLAR* film	3012577-08	7075154
Heavy duty nylon	3012577-11	7675013
Nylon	3012577-14	7375013

*Trademark of E. I. duPont de Nemours & Co., Inc.

9. Close hinged roller over ribbon.
10. Take up slack in ribbon by turning ribbon rolls. Make sure ribbon edge passes inside of ribbon sensing switch (Figure 5—80b).
11. Close ribbon shield.
12. Close print carriage assembly and lock firmly with print carriage assembly latch.

5.5.3.3 Print Band Cartridge Replacement

To change the print band cartridge, which contains the print band, proceed as follows:

NOTE:

Before performing the following procedure, remove the device from the systems list of available resources by using the DOWN function of the SET IO command (Section 12). After the procedure is completed, restore the device's available status by using the UP function of the SET IO command.

1. Remove ribbon from upper takeup spool holder as described in steps 1 through 4 of 5.5.3.2.
2. Remove bottom ribbon roll and cradle it between the upper ribbon roll and hinged roller (Figure 5—81a).
3. Loosen two thumbscrews which secure print cartridge assembly to print carriage assembly.
4. Grasp the two handles on print cartridge assembly and remove it from print carriage assembly by pulling straight up.

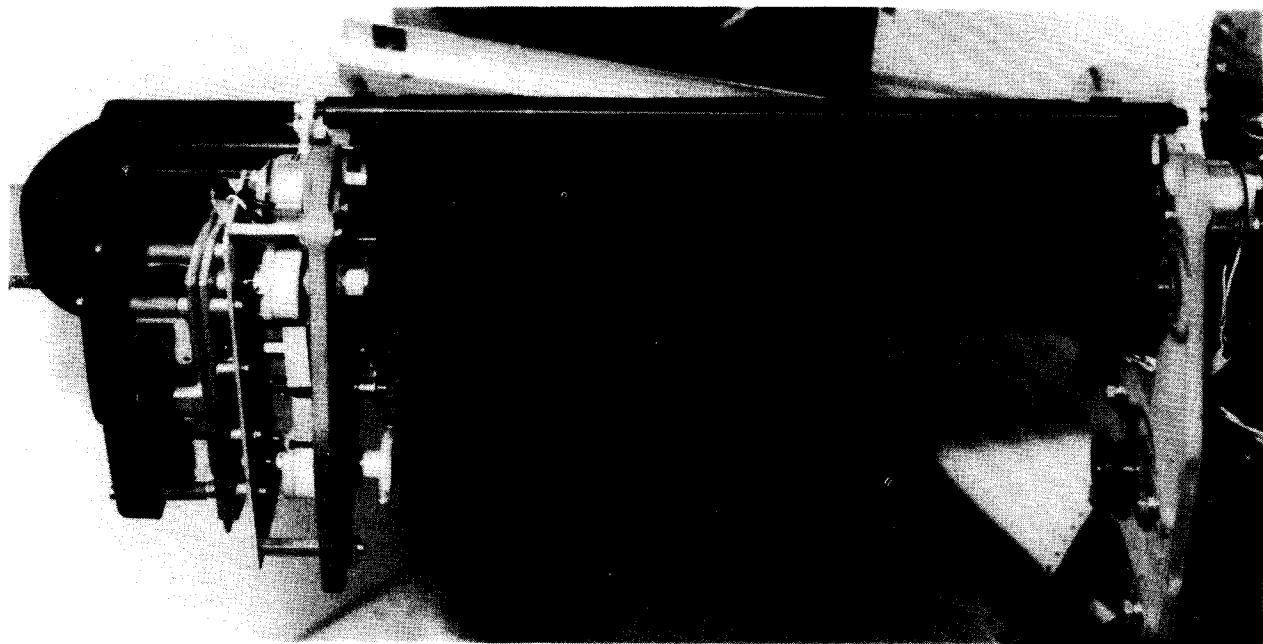

a. Ribbon removed and print band cartridge ready for removal

Figure 5—81. Replacing Print Band Cartridge (Part 1 of 2)

5. To install print cartridge assembly, align two holes on print cartridge assembly with two alignment pins on casting of print carriage assembly and lower print cartridge assembly onto the print carriage assembly (Figure 5-81b).
6. Secure print cartridge by hand tightening the two thumbscrews on print cartridge assembly.
7. Visually check cartridge to ensure that it is fully seated.
8. Remove ribbon roll cradled in step 2 and replace it on bottom mandrel.

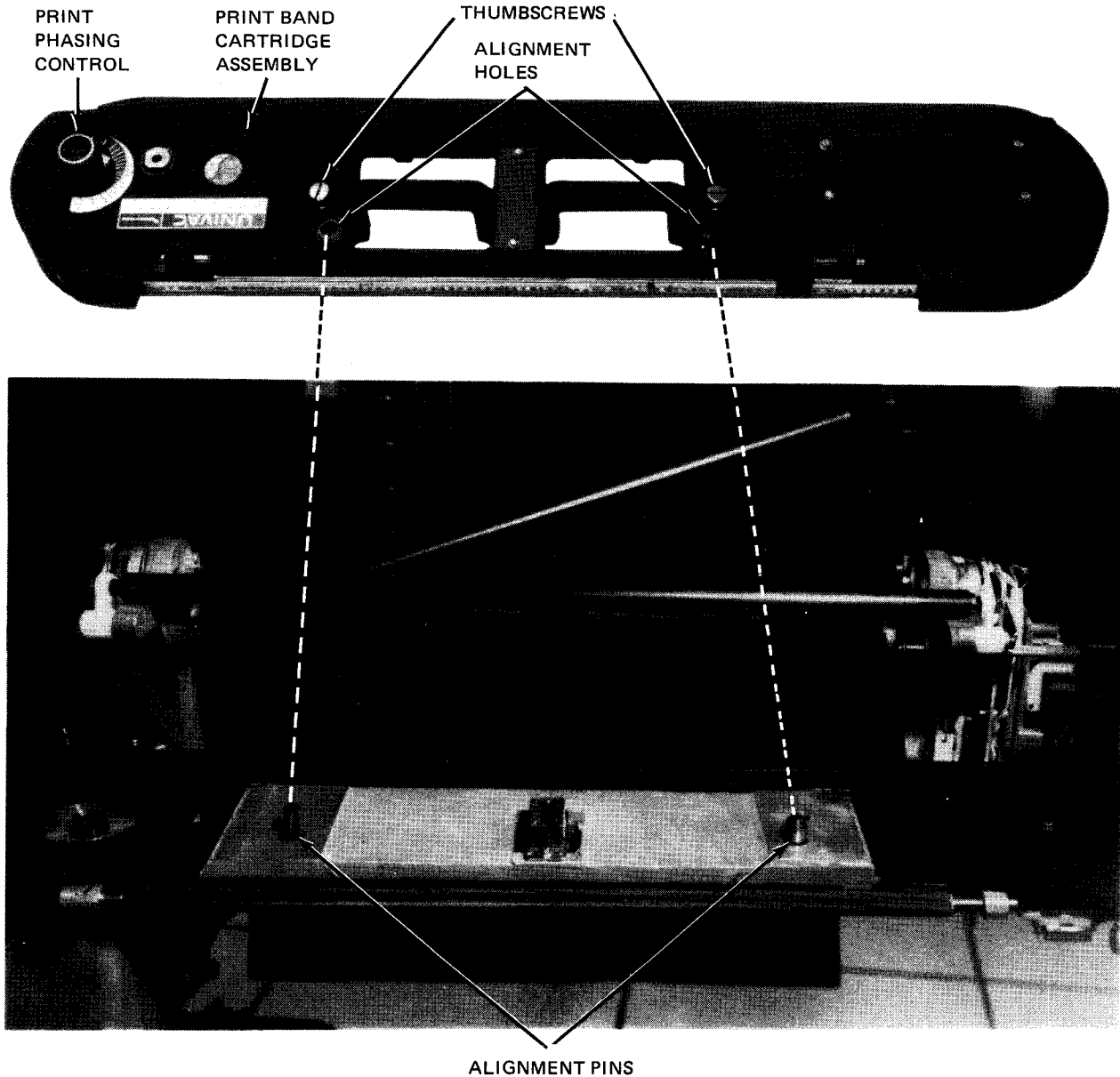

b. Alignment of print band cartridge

Figure 5-81. Replacing Print Band Cartridge (Part 2 of 2)

9. Close ribbon shield.
10. Close print carriage assembly and secure assembly by lowering print carriage assembly latch.

5.5.3.4. Print Phasing Adjustment

The print phasing control (Figure 5—83) on the print cartridge assembly of printer permits the operator to eliminate clipping of printed characters. Clipping is indicated when either side of the printed character is faded or missing. Evidence of incorrect setting of the print phasing control can best be seen on the last part of a multipart form.

If clipping occurs, print phasing can be adjusted during printing by turning the control in either direction until the characters are printed uniformly over their entire surface. Figure 5—82 illustrates examples of clipping on each side of the printed characters due to improper adjustment of the print phasing control. The example showing evenly printed characters indicates a properly adjusted control.

Changing the thickness of the forms and a print band speed (available only if printer is equipped with feature 1697—00/01) requires an adjustment of the print phasing control. If the correct phasing setting can not be obtained by setting the control near either limit of its rotation range, the operator should notify the Sperry Univac customer engineer.

```
5E #NXXEE --22 ZZTTAA 77 @ @ VV PP , 33 88 RR LL 88 XX WW NN HH 44 55 SS JJ DD OO XX  
6E #NXXEE --22 ZZTTAA 77 @ @ VV PP , 33 88 RR LL 88 XX WW NN HH 44 55 SS JJ DD OO XX  
56 #NXXEE --22 ZZTTAA 77 @ @ VV PP , 33 88 RR LL 88 XX WW NN HH 44 55 SS JJ DD OO XX
```

a. Printed characters clipped on left (only odd columns are affected)

```
EE #IXXEE --22 ZZTTAA 77 @ @ VV PP , 33 88 RR LL 88 XX WW NN HH 44 55 SS JJ DD OO XX  
6E #IXXEE --22 ZZTTAA 77 @ @ VV PP , 33 88 RR LL 88 XX WW NN HH 44 55 SS JJ DD OO XX  
6E #IXXEE --22 ZZTTAA 77 @ @ VV PP , 33 88 RR LL 88 XX WW NN HH 44 55 SS JJ DD OO XX
```

b. Printed characters clipped on right (only even columns are affected)

```
EE #NXXEE --22 ZZTTAA 77 @ @ VV PP , 33 88 RR LL 88 XX WW NN HH 44 55 SS JJ DD OO XX  
EE #NXXEE --22 ZZTTAA 77 @ @ VV PP , 33 88 RR LL 88 XX WW NN HH 44 55 SS JJ DD OO XX  
6E #NXXEE --22 ZZTTAA 77 @ @ VV PP , 33 88 RR LL 88 XX WW NN HH 44 55 SS JJ DD OO XX  
6E #NXXEE --22 ZZTTAA 77 @ @ VV PP , 33 88 RR LL 88 XX WW NN HH 44 55 SS JJ DD OO XX
```

c. Evenly printed characters

Figure 5—82. Examples of Print Phasing

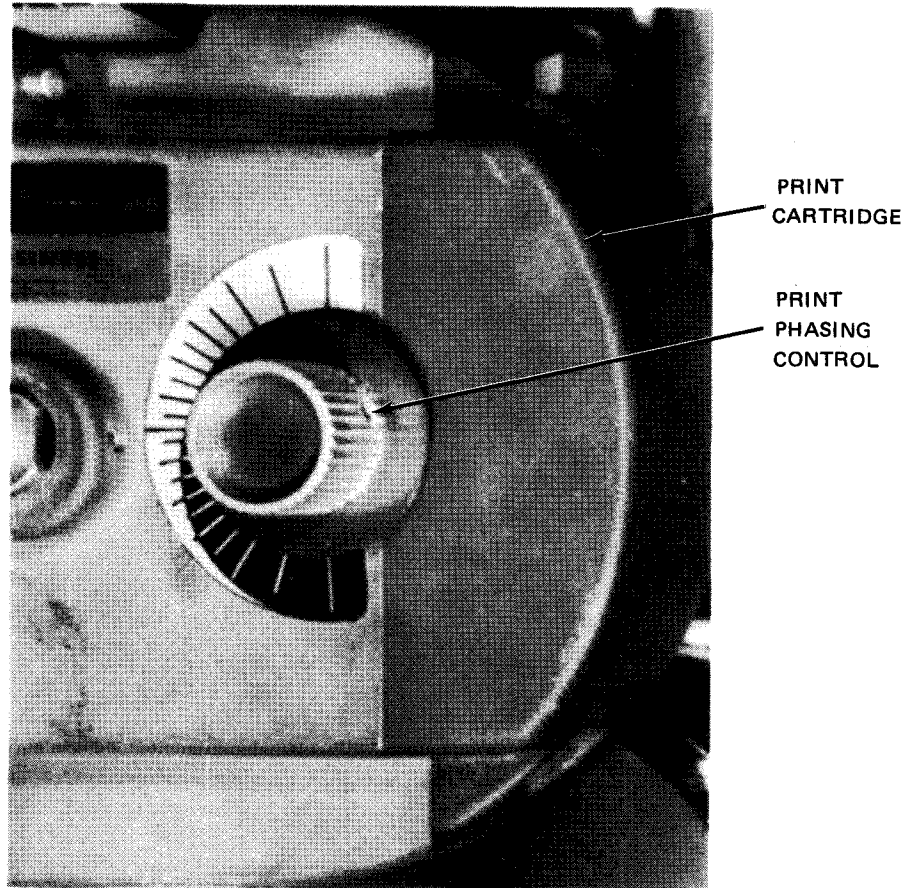

Figure 5-83. Print Phasing Control on Print Cartridge

5.5.3.5. Print Gap Adjustment

The print gap (i.e., distance between hammer face and type face) is adjusted through the use of the **GAP ADJUST** (Figure 5-78) control. To compensate for use of forms with various thicknesses, the operator adjusts this control. The range of the control is such that a 6-part form with a maximum pack thickness of 0.018 inch (.457 mm) can be printed without any degradation in quality. At the operator's discretion, other forms which exceed the maximum pack thickness may be made workable by manipulation of the **GAP ADJUST** control in conjunction with the print phasing control on the print cartridge assembly. However, this is not recommended, and if this option is taken by the operator, reduced print quality may result. For assistance in determining the correct settings for special forms, the operator should contact the Sperry Univac customer engineer.

5.5.4. Recovery Procedures

Table 5-17 lists the print malfunctions which may be corrected by the operator. The printer must be in stop mode (**STOP** switch/indicator lit) to initiate recovery. If fault indications persist, contact your Sperry Univac customer engineer.

Table 5-17. 0776 Printer Subsystem, Recovery Procedures (Part 1 of 2)

Indication	Probable Cause	Recovery Procedures
<p>DEVICE CHECK indicator lit; STOP switch/indicator lit</p>	<p>There are four possible faults which could result in the condition:</p> <ol style="list-style-type: none"> 1. Print carriage assembly not closed or installed properly. 2. Power is removed from ribbon drive motors. 3. Air flow within printer is restricted. 4. Temperature within printer exceeds 134.6°F (57°C). 	<p>Check installation of print carriage assembly.</p> <p>Open rear cover and paper well door of the printer cabinet, check 25 Vac (Figure 5-70) and the main power circuit breaker on the power supply panel 220 Vac circuit breaker on the power control panel (Figure 5-68) for tripped condition. Reset any tripped breakers.</p> <p>Determine if blower is operating or if air is circulating within the printer.</p> <p>Determine that ambient temperature is not excessive and that printer floor-level fresh air intakes are not obstructed.</p> <p>Press and release RUN switch/indicator on printer control panel. Observe that DEVICE CHECK indicator and STOP switch/indicator are extinguished.</p> <p>Restart the program.</p> <p>If error condition persists or reoccurs, notify Sperry Univac Customer engineer.</p>
<p>PRINT CHECK indicator lit, STOP switch/indicator lit</p>	<p>Failure in print band actuator circuits or print band.</p>	<p>Open paper well door of printer cabinet, check main power 220 Vac circuit breaker located on power control panel (Figure 5-68) for tripped condition. Reset circuit breaker if tripped.</p> <p>Restart program or if it is desirable to continue printing from this line, press and release RUN switch/indicator; the line will be overprinted.</p> <p>If error persists, notify Sperry Univac customer engineer.</p>

Table 5-17. 0776 Printer Subsystem, Recovery Procedures (Part 2 of 2)

Indication	Probable Cause	Recovery Procedures
<p>FORM CHECK indicator lit, STOP switch/indicator lit</p>	<p>Forms are jammed or ripped.</p>	<p>Remove torn or jammed form from printer. Note location of torn or jammed form with respect to printed data so that a convenient restart point may be established.</p> <p>Reload forms as described in 5.5.3.1.</p> <p>Press and release RUN switch/indicator on printer control panel. Observe that FORM CHECK indicator and STOP switch/indicator are extinguished.</p> <p>Reenter program at proper point.</p> <p>If error persists, notify Sperry Univac customer engineer.</p>
<p>OUT OF FORMS indicator lit, STOP switch/indicator lit</p>	<p>Paper forms are required in printer.</p>	<p>Reload forms as described in 5.5.3.1.</p> <p>Press and release RUN switch/indicator on printer control panel. Observe that OUT OF FORMS indicator and STOP indicator are extinguished.</p> <p>Reenter program at proper point.</p>

This page left blank intentionally.

5.6. 0778 PRINTER SUBSYSTEM

The 0768 printer subsystem is a freestanding, impact-type printer with an operator-replaceable print cartridge. The logic circuitry that controls the printer is located in the processor cabinet. The operator uses the operator control panel on the printer and the printer indicator panel on the processor operator/maintenance panel to operate the printer. In addition, the printer has a number of internal controls that are used during forms loading and set-up.

5.6.1. Operating Controls and Indicators

A control panel on the upper front of the printer cabinet (Figure 5—84) allows the operator to perform normal operating procedures. The printer indicator panel on the processor operator/maintenance panel (Figure 5—85) alerts the operator to specific check conditions that may occur during normal operation. Controls and indicators for each panel are listed and described in Table 5—18.

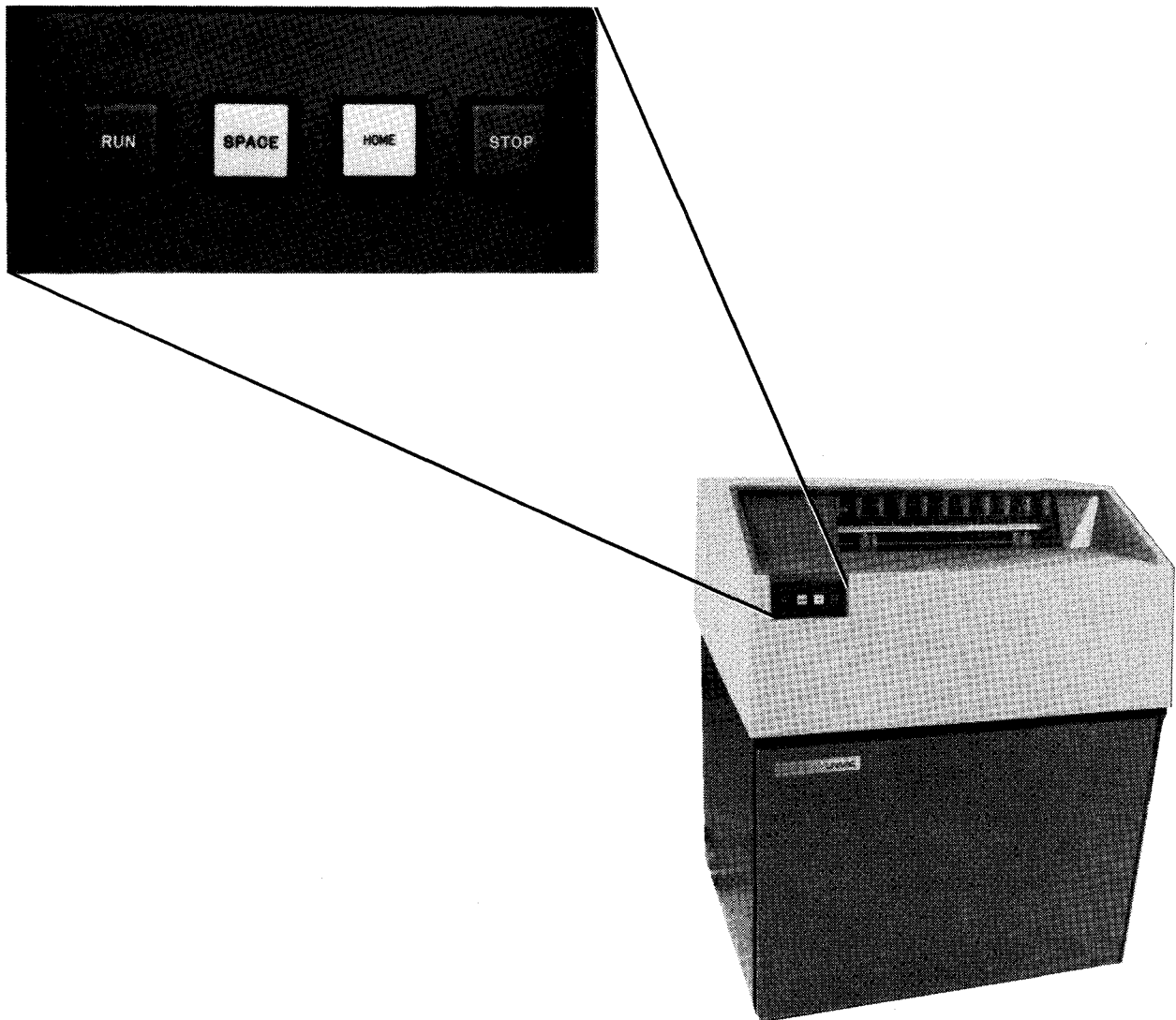

Figure 5—84. Operator Control Panel

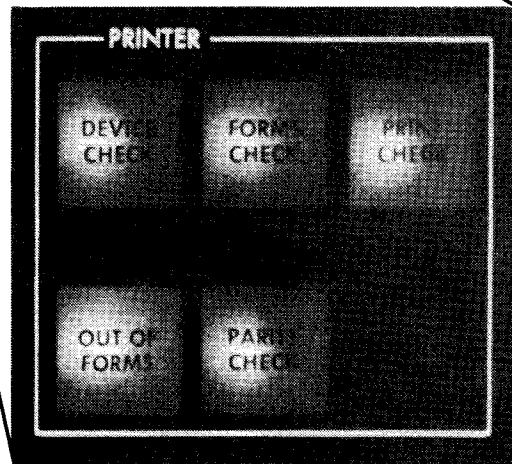
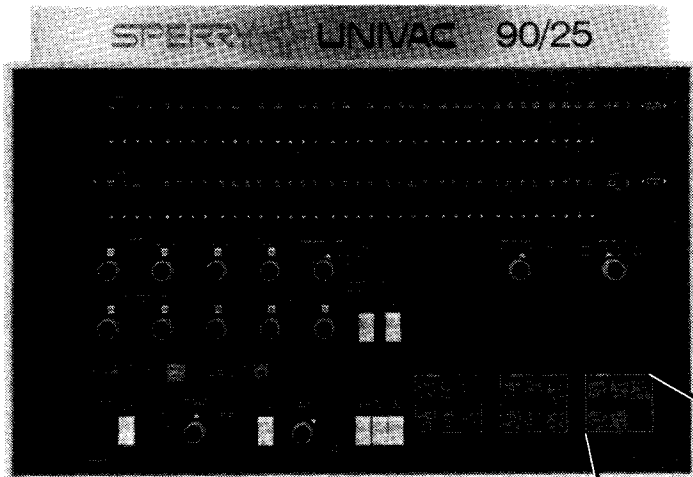

Figure 5—85. Printer Indicator Panel on Processor Operator/Maintenance Panel



Table 5-18. 0778 Printer Subsystem, Controls and Indicators

Control/Indicator	Function
RUN switch/indicator	When pressed while the printer is in stop state, all check conditions are cleared, the switch/indicator lights, and software is notified that the printer is ready to operate.
SPACE switch	When pressed and released, forms advance one line. When pressed and held, forms advance continuously. The STOP switch/indicator must be lit for space advances.
HOME switch/indicator	Used when in stop state to advance forms to the next home paper position indicated in the vertical format buffer (VFB). The switch/indicator lights when the form is stopped in the home paper position.
STOP switch/indicator	Halts printer operation and places it in stop (offline) state, as indicated by the lighted switch/indicator. If commands are in progress they are completed before the printer stops. The switch/indicator can be held pressed to check lamps in the RUN, STOP, and HOME switch/indicators.
DEVICE CHECK indicator	One of the following conditions exists in the printer: <ul style="list-style-type: none"> ■ Air flow from the blower is blocked ■ Power failure for the print band motor ■ The print carriage is unlocked ■ Ambient temperature inside the printer exceeds 57°C (134.6°F).
FORMS CHECK indicator	Print form is torn or jammed; indicator remains lighted until the condition is corrected.
PRINT CHECK indicator	A malfunction is detected in the print hammer actuator circuits or in movement of the print band.
OUT OF FORMS indicator	Less than 4.5 inches (11.43 centimeters) of print form below the print line is available for printing. The indicator remains lighted until new forms are loaded into the printer.
PARITY CHECK indicator	A parity error was detected on an input code by printer logic control circuits in the processor cabinet.

5.6.2. Turn-on and Turn-off Procedures

Power to the printer is controlled by the POWER ON/POWER OFF switch on the processor operator/maintenance panel. Power may not be turned on at the printer independently of the processor.

5.6.2.1. Independent Power Turn-Off Procedure

To turn off power at the printer independently of the processor, proceed as follows:

1. Use the DOWN function of the SET IO command (12.4.8) to remove the printer from the system's available resources.
2. Press the STOP switch/indicator on the operator control panel.
3. Open the front cabinet door and set the main circuit breaker to the OFF (down) position.

NOTE:

To make the printer available again, return the main circuit breaker to the ON (up) position, press the RUN switch/indicator on the operator control panel, and enter the UP function of the SET IO command.



5.6.2.2. Emergency Power Turn-Off Procedure

An emergency condition, such as an electrical or mechanical failure that appears to be causing damage, requires all power to be turned off immediately. Proceed as follows:

1. Open the front cabinet door and set the main circuit breaker to the OFF (down) position.
2. Remove the printer from the system's resources for job applications by using the DOWN function of the SET IO command (12.4.8).
3. Contact your Sperry Univac customer engineer and explain the emergency condition.

CAUTION

The main circuit breakers should not be used to turn off power to the printer in normal circumstances, because power transients may interfere with processor operations. Follow the procedures described in 5.6.2.2.

5.6.3. Operating Procedures

Operating procedures for the 0778 printer include forms loading, ribbon replacement, print band cartridge replacement, print phasing adjustment and print gap adjustment. Access to printer internal controls is made available when the top cover is raised and the hopper door is open. The internal controls are shown in Figures 5-86 and 5-87.

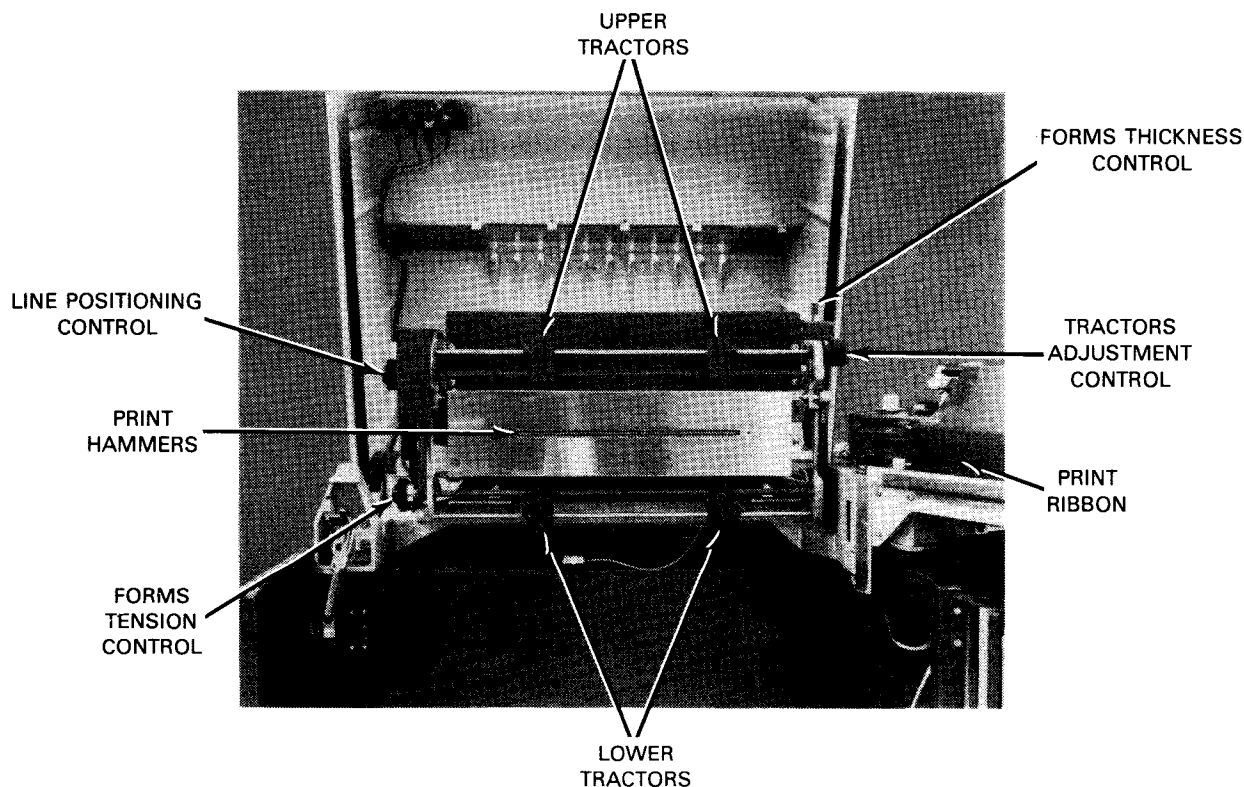

Figure 5-86. Printer With Print Carriage Open



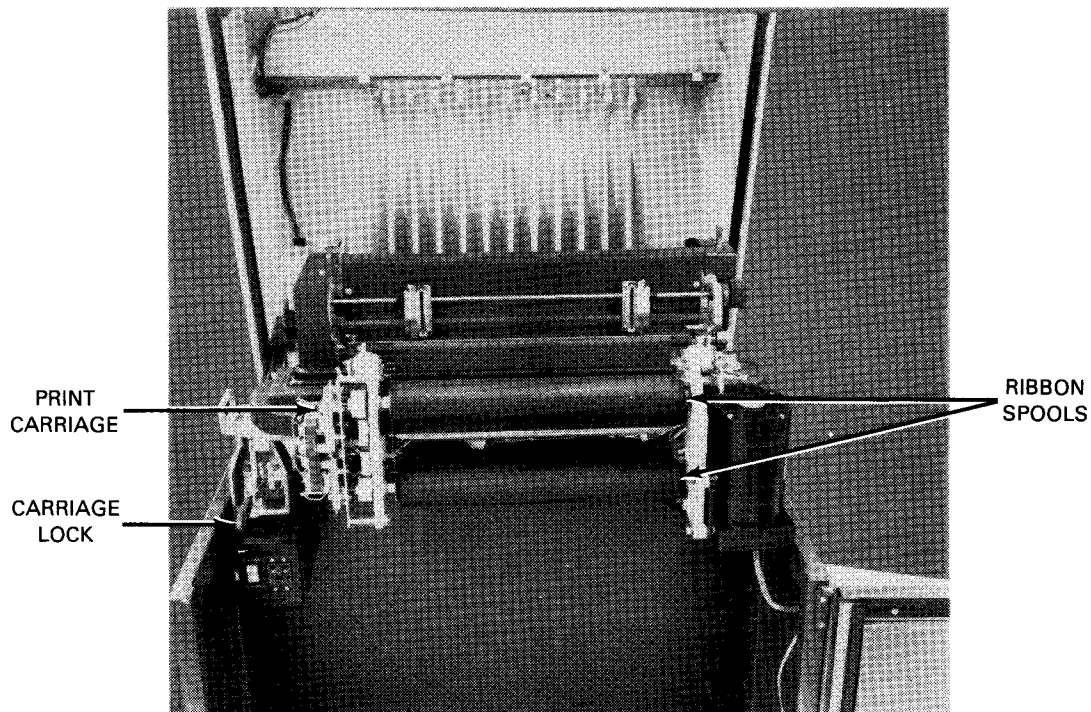

Figure 5—87. Printer With Print Carriage Closed

5.6.3.1. Forms Loading

Print forms may be loaded into the printer under three different circumstances. A separate procedure is required for each condition.

NOTE:

Before performing the following procedure, remove the device from the system's list of available resources by using the DOWN function of the SET IO command (12.4.8). After the procedure is completed, restore the device's available status by using the UP function of the SET IO command.





5.6.3.1.1. Initial Loading of Print Forms

To load print forms when no forms are contained in the printer, proceed as follows:

1. Open the top of the new forms container, find the leading edge of the top form, and cut the container as illustrated in Figure 5—88.
2. Open the printer top and front covers, and set the main circuit breaker to the OFF (down) position.
3. Insert the cut forms container on the shelf in the printer hopper so that the deep cut of the container faces the operator.

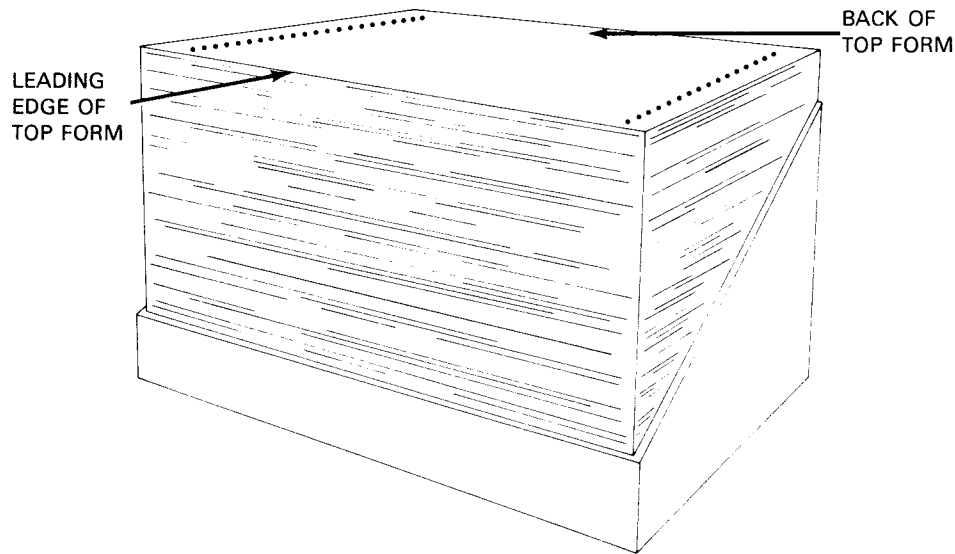

Figure 5—88. Recommended Cut for Forms Container

4. Press the carriage release latch (Figure 5—89) to unlock the print carriage. Swing the print carriage out to its fully open position.
5. Set the tractors adjustment control (Figure 5—89) for maximum adjustment capability by turning the control until the two retaining rings on the tractor supports are equally spaced from their respective side castings.
6. Unclamp the two upper tractors by lowering the release latch adjacent to each upper tractor. Unclamp the two lower tractors by raising the release latch adjacent to each lower tractor (Figure 5—89).
7. Flip open the four tractor plates to obtain access to the tractor teeth on the upper and lower tractors (Figure 5—90), and raise the leading edge of the print forms over the tractors and onto the paper guide screen. The print surface should face the operator.
8. Center the print forms and forms container so that the side edges of the print form are approximately equidistant from the small holes on the print hammer assembly (Figure 5—90).
9. Slide the upper and lower tractors along their guide bars so that the tractor teeth are aligned with the holes along the edges of the print forms. Fit the carriage teeth into the holes and close the tractors (Figure 5—91). Close the release latch on each tractor to secure each tractor on its guide bar (Figure 5—89).



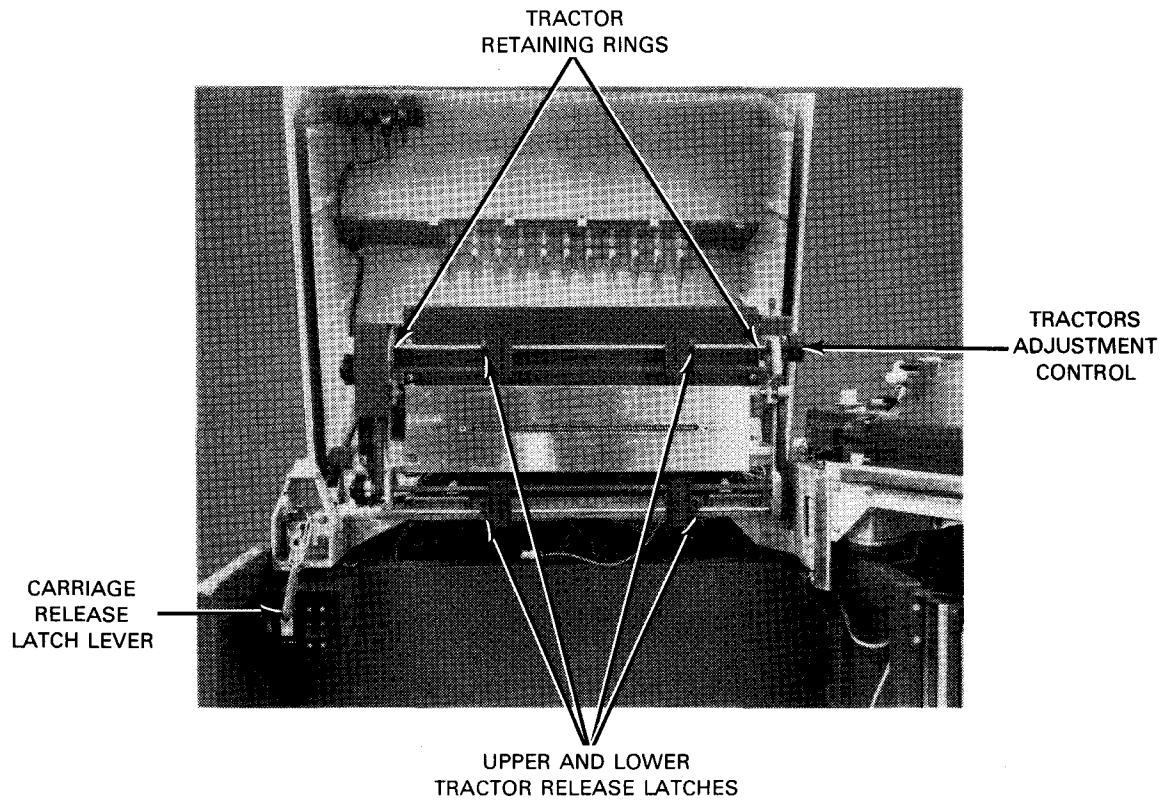

Figure 5-89. Print Carriage Open to Set Tractors

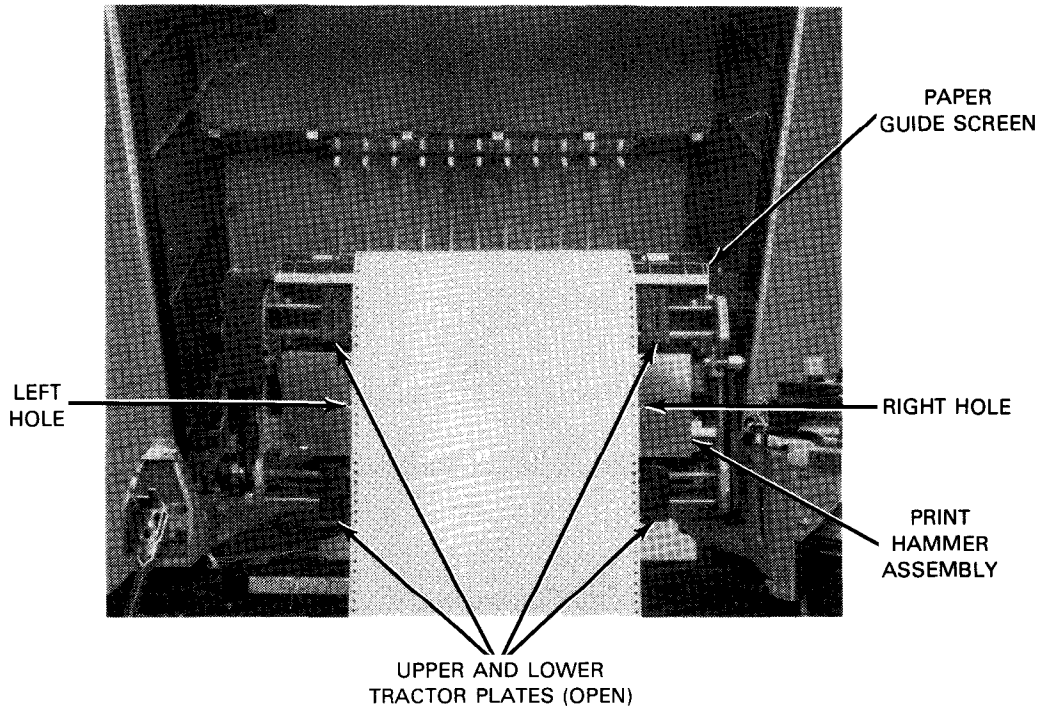
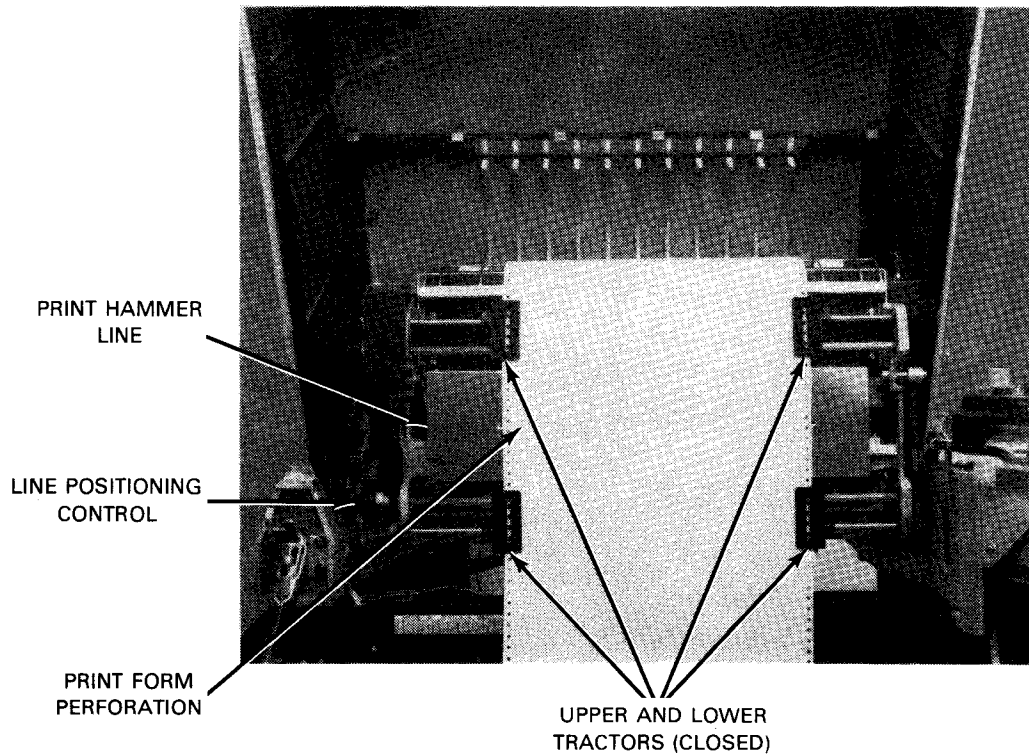

Figure 5-90. Tractors Open to Receive Form

- ↓
10. Gently pull out on the line positioning control (Figure 5—91) and turn the control (to move the print forms vertical) so that the print form perforation is aligned with the print hammer line.
 11. Release the form alignment guide (Figure 5—92) from the print carriage (the guide is held magnetically to the carriage), and swing the form alignment guide against the print form (Figure 5—91). If the print form is preprinted with alignment ticks, proceed to step 12; otherwise, proceed to step 13.



↑

Figure 5—91. Print Form Secured on Printer

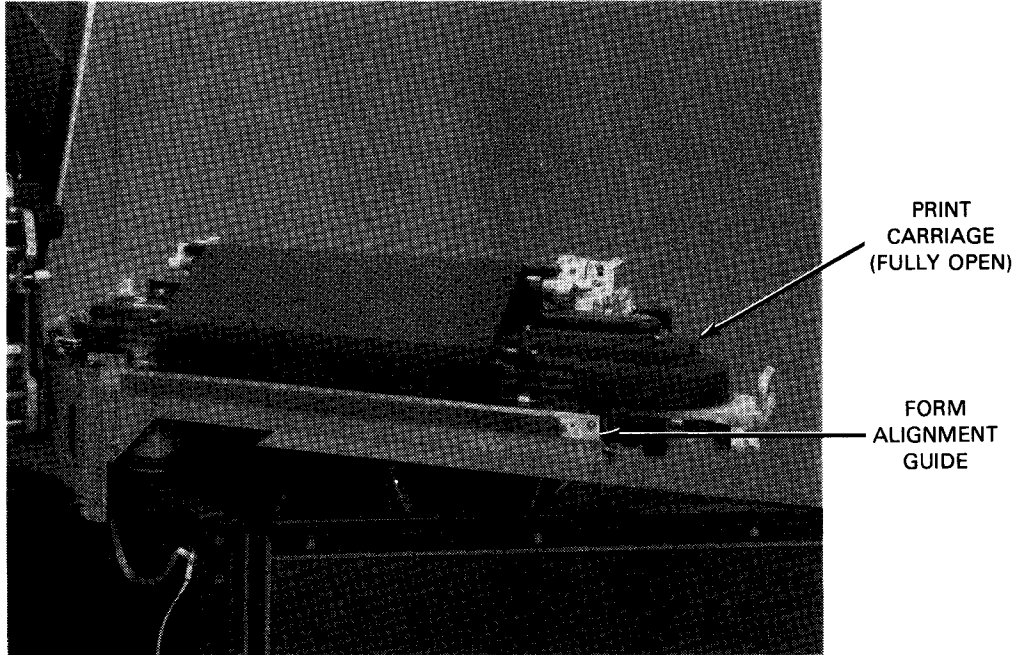

Figure 5—92. Print Carriage Fully Open

12. Turn the tractors adjustment control (Figure 5—93) until the column 1 or column 15 tick mark (Figure 5—94) is aligned with the required column, as designated by programming, and indicated on the form alignment guide scale.

NOTE:

The form alignment guide scale indicates the position of each print hammer. The scale is not intended to be used for measurements.

13. If no tick mark is used on the print form, adjust the tractors adjustment control (Figure 5—93) until the first column for printing is aligned with the column indication presented on the form alignment guide scale.

NOTE:

If the tractors adjustment control cannot be adjusted sufficiently to move the print forms to the required location on the form alignment guide scale due to unusual form size, further adjustments are required to the upper and lower tractors (steps 5 through 9).

14. Adjust the line positioning control (Figure 5—93) until the bottom edge of the form alignment guide is aligned with the bottom of the first line to be printed.
15. Push in the forms tension control (Figure 5—93) and gently turn the control until slight vertical tension appears on the print form. It may be necessary to hold the line positioning control while turning the forms tension control to prevent forms movement.

CAUTION

Do not tighten forms tension excessively because perforated holes on the print form will tear during operation.



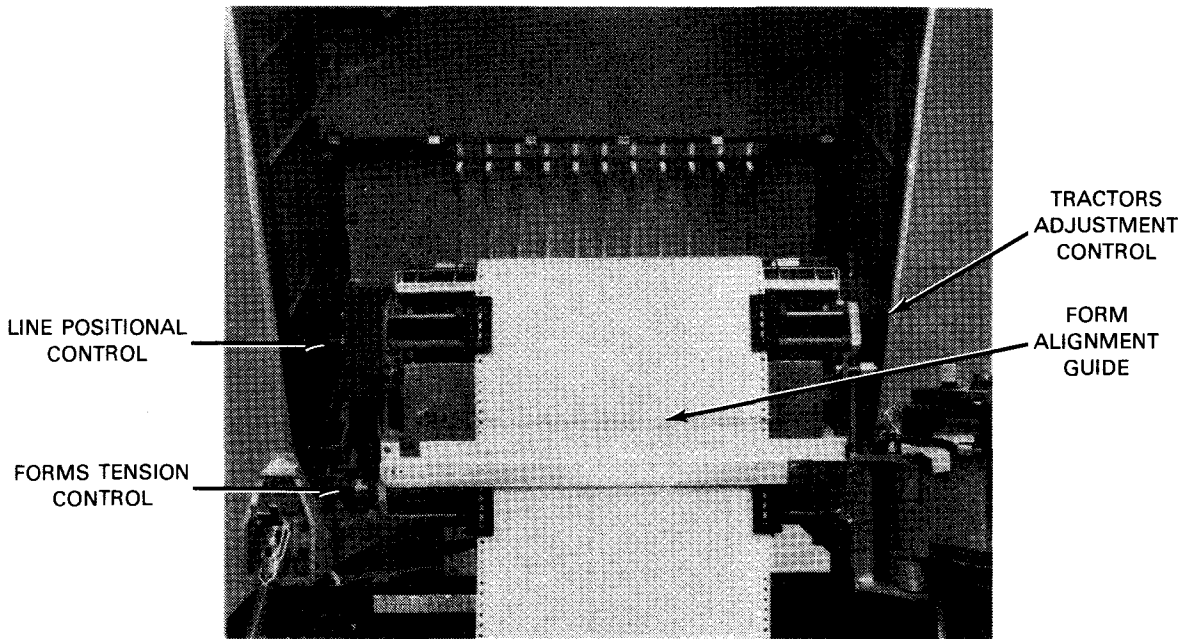

Figure 5-93. Form Alignment Guide Set to Adjust Form

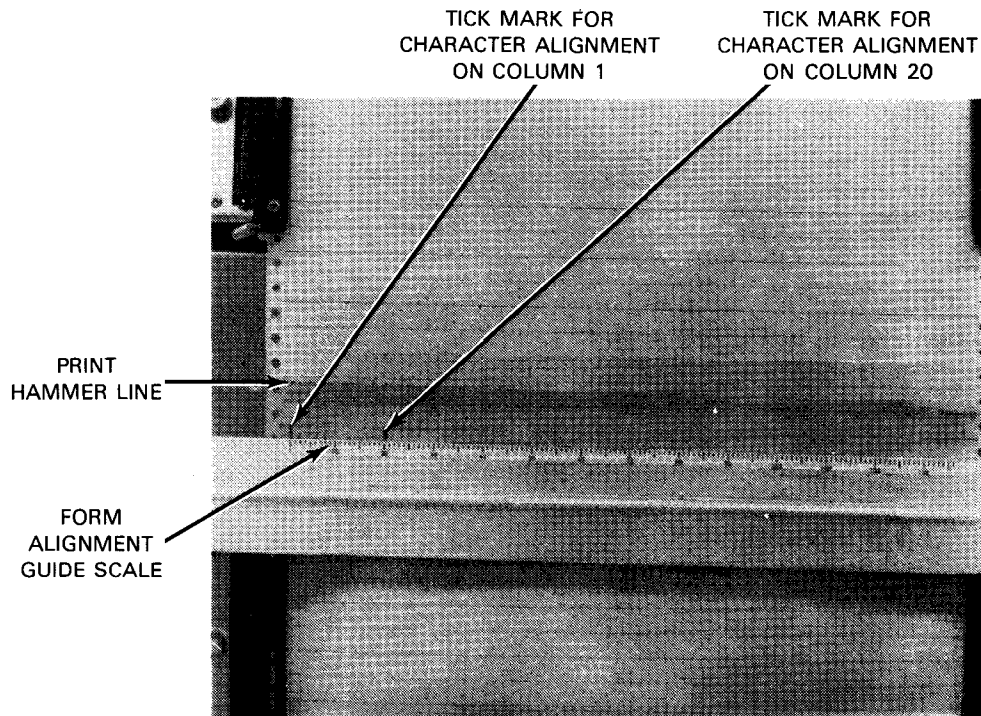

Figure 5-94. Aligning Form According to Tick Marks

16. Swing the form alignment guide back to the print carriage and latch it magnetically to the carriage (Figure 5-95).
17. Check that forms move unimpeded from the container in the forms hopper (Figure 5-95).
18. Adjust the forms thickness control (Figure 5-95) for proper thickness according to the print forms pack to be printed.





19. Close the print carriage and firmly raise the carriage release latch lever to lock the carriage.
20. Set the main circuit breaker to the ON (up) position.
21. Close the printer cabinet front and top covers.
22. Note that the STOP switch/indicator is lighted on the operator control panel (Figure 5—84), then press the SPACE switch to allow forms to feed through the printer.
23. Use an auxiliary forms container to stack printed forms (Figure 5—96), and position the printed forms so that they fold evenly as they are fed through the printer.
24. Press the HOME switch/indicator on the operator control panel (Figure 5—84) to align the print form to the programmed first printing line, then press the RUN switch/indicator to resume operation.

5.6.3.1.2. Adding Print Forms to Current Run

To add more print forms of the same type presently in use, proceed as follows:

1. Press the SPACE switch on the operator control panel (Figure 5—84) to clear remaining forms from the printer.
2. Perform steps 1 through 4 of the procedures in 5.6.3.1.1.
3. Perform steps 7 and 8 of 5.6.3.1.1, then fit the holes on the print form over the tractor teeth and close the tractor plates.
4. Perform steps 14 through 24 of 5.6.3.1.1.

5.6.3.1.3. Loading New Type of Print Forms

To change from one type of print form to another, proceed as follows:

1. Press the STOP switch/indicator on the operator control panel (Figure 5—84).
2. Open the printer top and front covers.
3. Press the carriage release latch (Figure 5—89) to unlock the print carriage. Swing the print carriage out to its fully open position.
4. Tear off the last printed form at the perforation below the form. Remove the remaining unprinted forms (with container) from the forms hopper.
5. Press and hold the SPACE switch (Figure 5—84) until all forms remaining in the printer are fed out through the back of the printer and stacked at the rear. Remove the stacked forms from the rear of the printer.
6. Open the top of the new forms container, find the leading edge of the top form, and cut the container as illustrated in Figure 5—88.
7. Perform step 3 and steps 5 through 24 of 5.6.3.1.1.



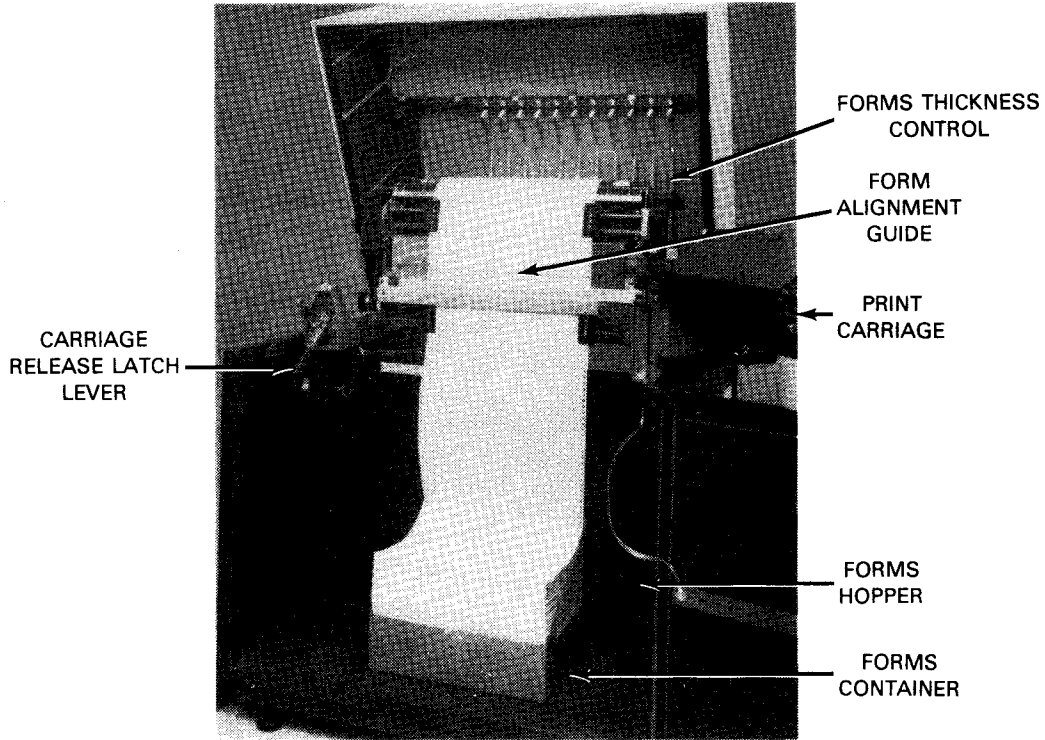

Figure 5-95. Form Path at Front of Printer

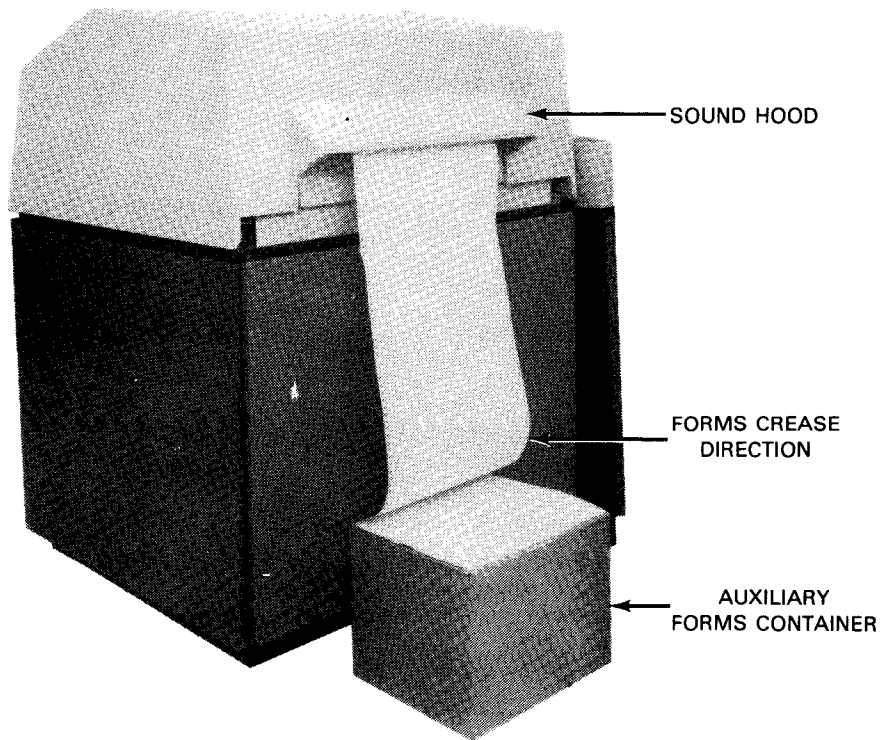

Figure 5-96. Form Path at Rear of Printer





5.6.3.2. Ribbon Replacement

The print ribbon should be replaced when printing appears light or faded. Proceed as follows to replace the ribbon:

NOTE:

Before performing the following procedure, remove the device from the system's list of available resources by using the DOWN function of the SET IO command (12.4.8). After the procedure is completed, restore the device's available status by using the UP function of the SET IO command.

1. Open the top and front covers of the printer cabinet. Set the main circuit breaker to the OFF (down) position.
2. Press down the carriage release lever (Figure 5-97) to release the print carriage and fully swing open the carriage.

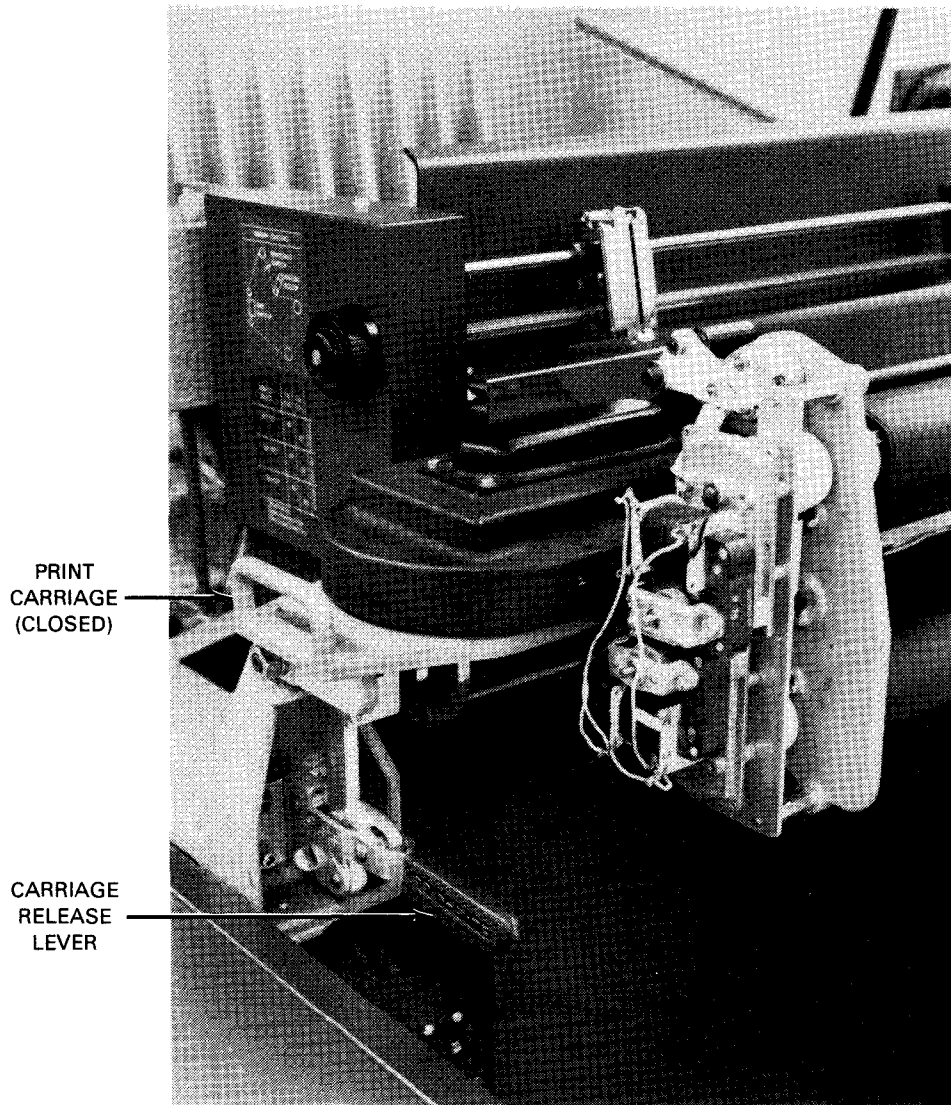

Figure 5-97. Carriage Release Lever in Lock Position





3. Swing the form alignment guide (Figure 5—98) back against the print hammers.

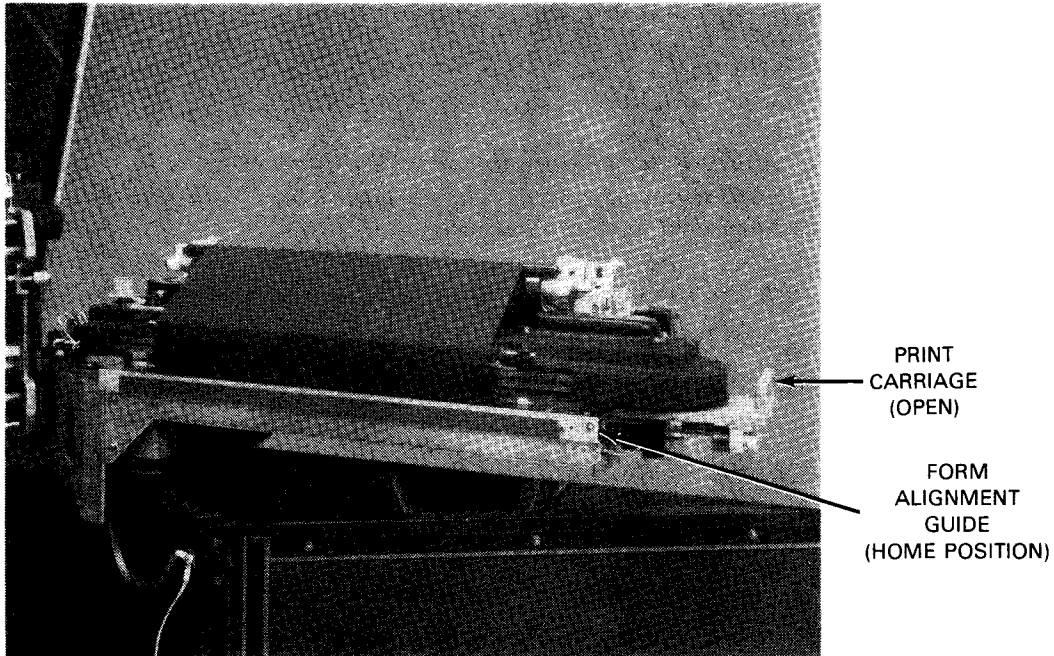

Figure 5—98. Form Alignment Guide Latched to Print Carriage

4. Wearing the plastic gloves provided with the new ribbon, press the ribbon roller (Figure 5—99) toward the carriage latch end to release and remove the ribbon roller.

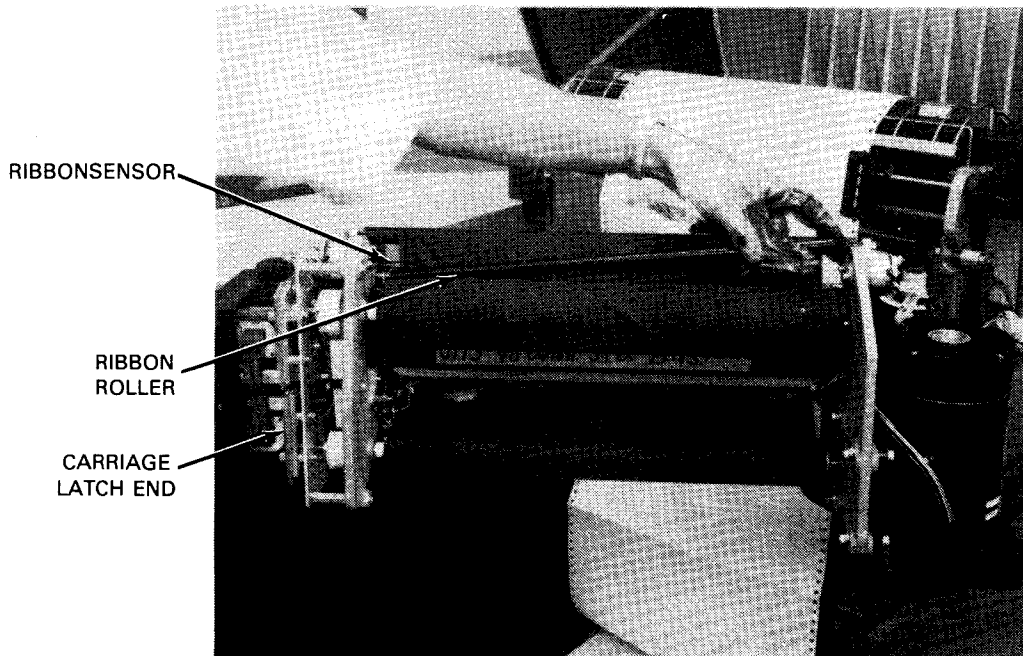

Figure 5—99. Removing the Print Roller

5. Hold the print ribbon spool with the left hand and push it toward the print carriage hinge end to release it. Repeat the procedure with the right hand for the lower ribbon spool (Figure 5—100). Swing the ribbon away from the print carriage and discard the ribbon and spools in a suitable container.



6. Obtain the new ribbon and unwind sufficiently to allow the ribbon to pass over the front of the print carriage. Fit the lower spool into the lower black spring-loaded spool holder, press the spool forward to compress the spring, and fit the opposite end of the spool on the white spool holder (Figure 5—100). Note that the notches on the edge of the white spool holder fit correctly with the flat extension on the spool so that the notch will turn the spool when operating.
7. Fit the upper spool into the upper black spring-loaded spool holder in the same manner (step 6) in which the lower spool was mounted (Figure 5—100).

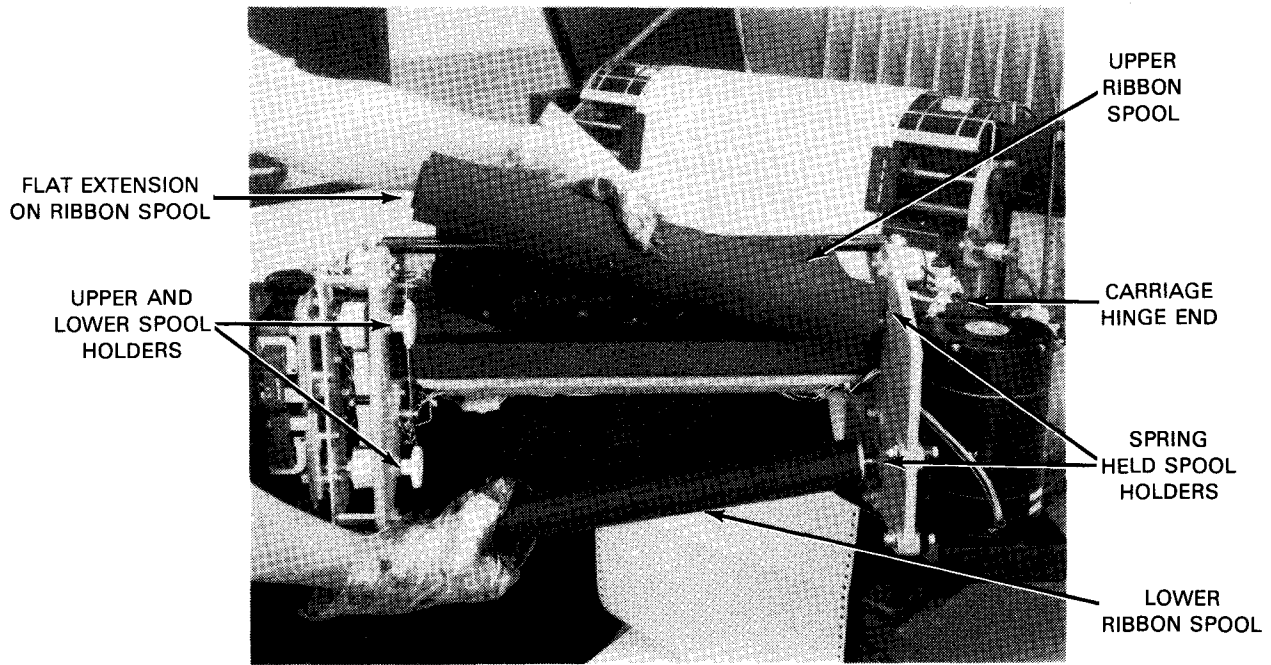

Figure 5—100. Removing the Upper and Lower Ribbon Spools

8. Turn the lower spool to take up slack and straighten the ribbon along its path (Figure 5—101). Note that the ribbon passes beneath the ribbon sensor (Figure 5—99).

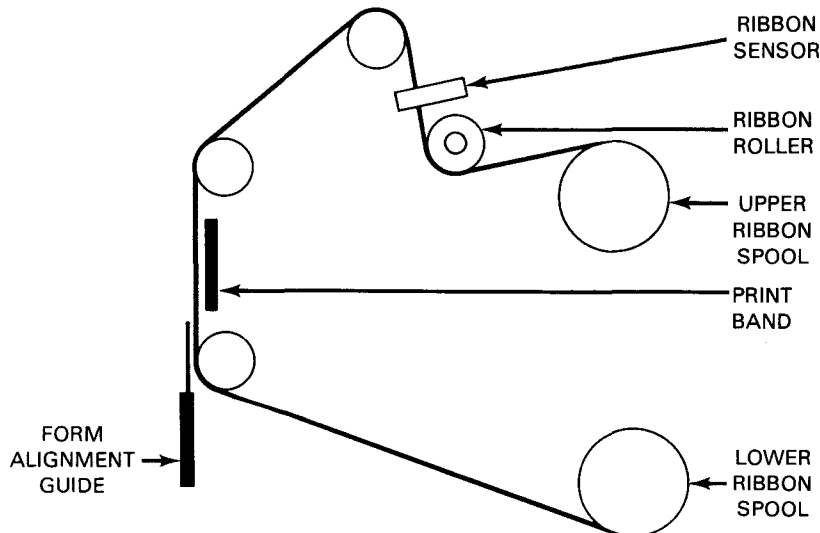

Figure 5—101. Ribbon Threading Path



9. Replace the ribbon roller by fitting one end of the roller to the spring-loaded pin on the carriage latch end of the print carriage (Figure 5—99), then push the ribbon roller to compress the spring, and insert the opposite end of the roller to the pin on the opposite end of the print carriage. The ribbon roller should maintain an even pressure on the print ribbon during operation.
10. Remove the plastic gloves and store them in a suitable location for use during print cartridge replacement procedures.
11. Swing the form alignment guide (Figure 5—98) back to its home position against the print carriage.
12. Set the main circuit breaker to the ON (up) position. Close the print carriage and firmly raise the carriage release lever to lock the carriage. Close the cabinet top and front covers.

5.6.3.3. Print Band Cartridge Replacement

The print cartridge is replaced when a different print band (type font) is required, or when the print band is damaged. Proceed as follows to replace the print band:

NOTE:

Before performing the following procedure, remove the device from the system's list of available resources by using the DOWN function of the SET IO command (12.4.8). After the procedure is completed, restore the device's available status by using the UP function of the SET IO command.

1. Perform steps 1 through 4 of the procedures in 5.6.3.2.
2. Hold the upper print ribbon and push it toward the print carriage hinge end (Figure 5—102) to release the ribbon spool.

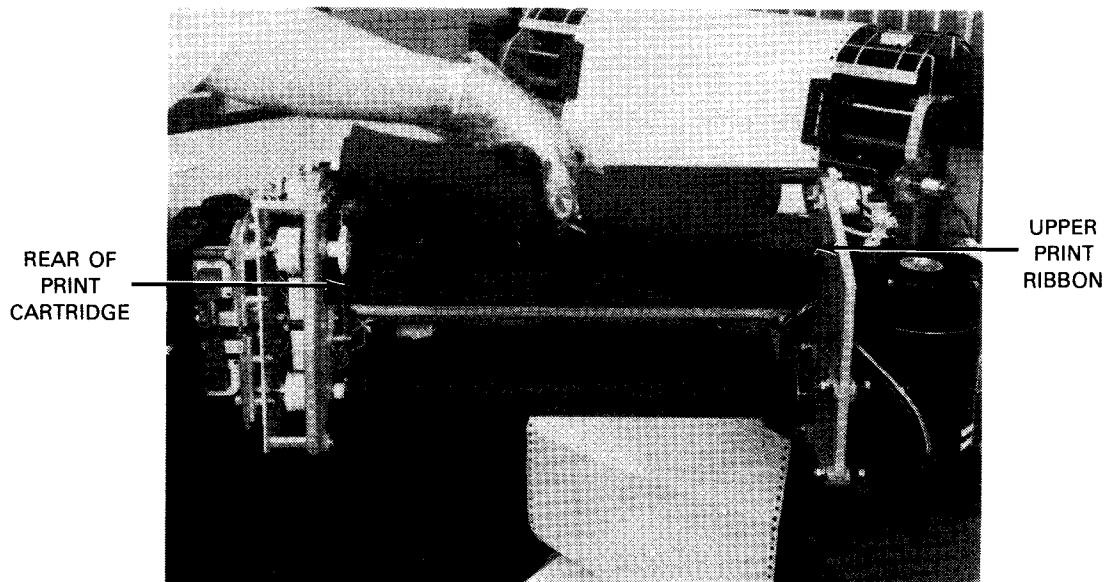

Figure 5—102. Removing the Upper Print Spool





3. Swing the upper ribbon spool away from the front of the print carriage and print band, and remount the upper ribbon spool on its holder from the rear of the print carriage (Figure 5—103). This is a temporary method of ribbon threading to allow access to the print carriage.

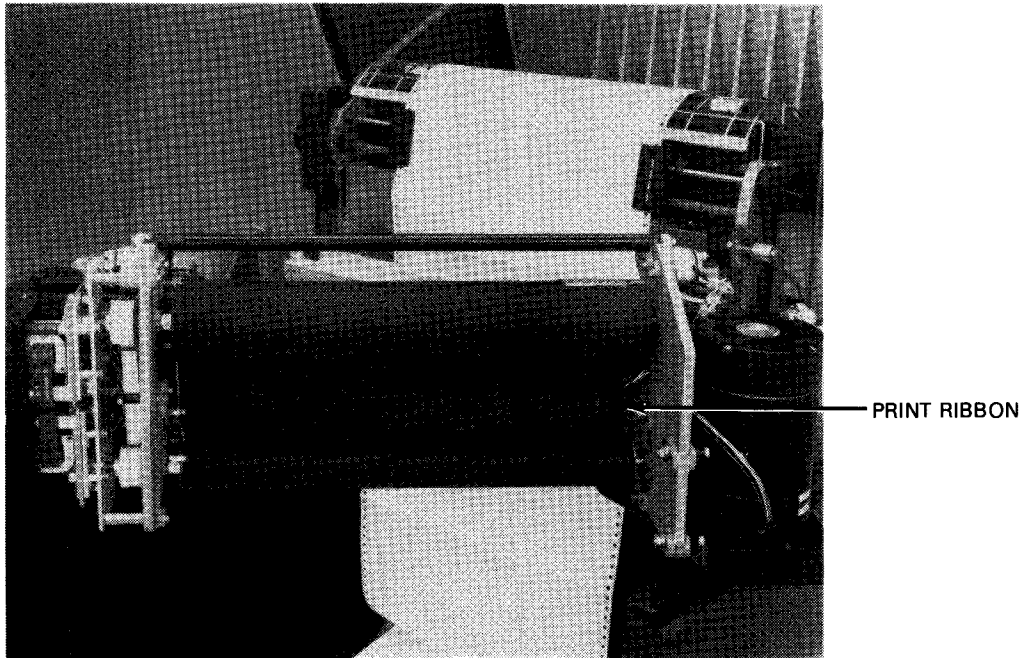

Figure 5—103. Print Ribbon in Reverse Thread Position

4. Turn the two captive thumbscrews on the print carriage (Figure 5—104) until they are disengaged from the print carriage.
5. Using the two handles on the print carriage, carefully lift out the print carriage in an upward direction and pass it under the fixed ribbon roller (Figure 5—104). Store the print carriage in its container in a suitable location.

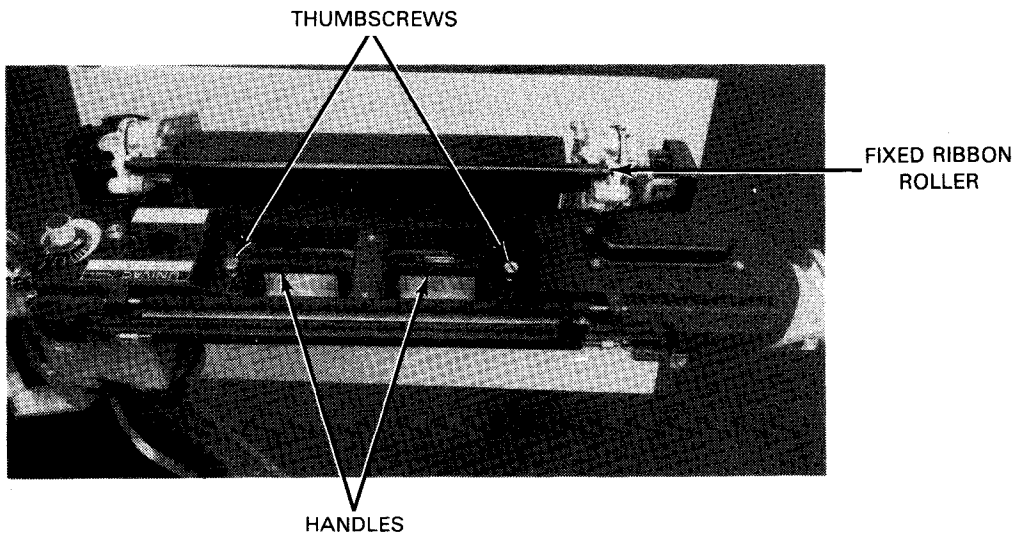

Figure 5—104. Print Carriage Mounted in the Print Carriage





6. Mount the replacement print cartridge so that the nameplate is to the left, and fit the two guide pins on the print carriage into the two guide holes on the print cartridge (Figure 5—105). Press the print cartridge down firmly, then tighten the two thumbscrews to secure it to the print carriage.

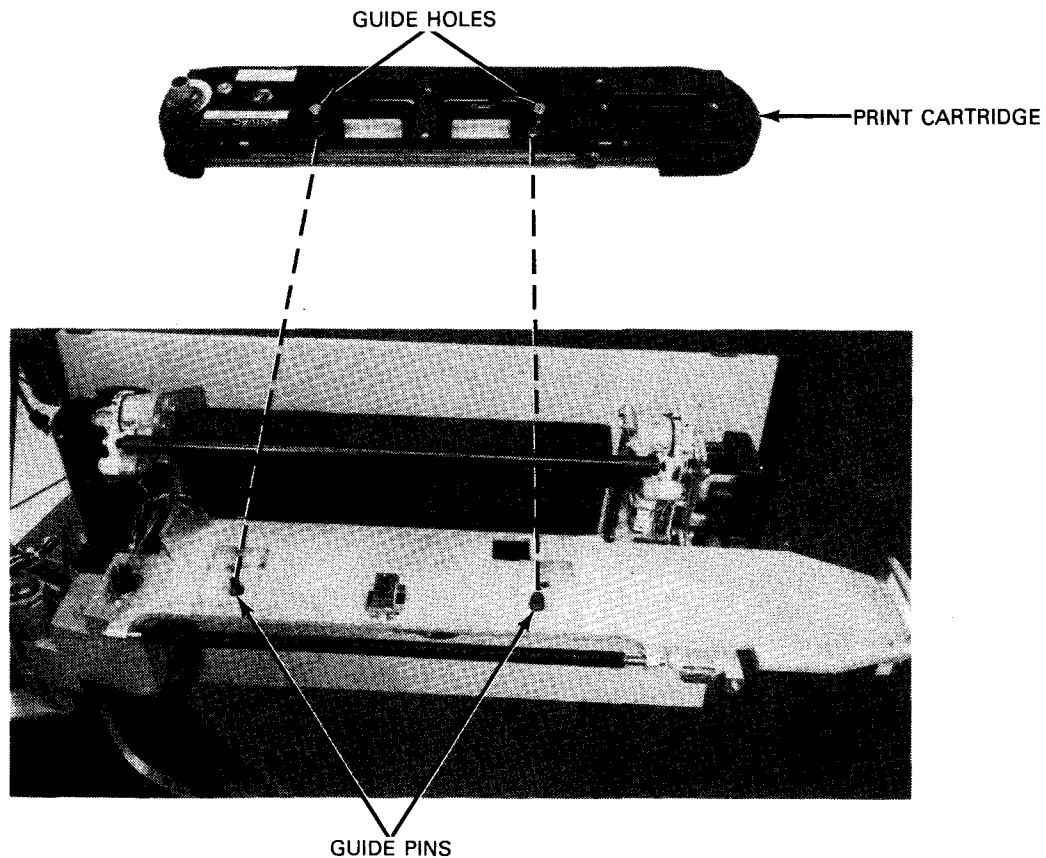

Figure 5—105. Print Cartridge Removed From Print Carriage

7. Using the plastic gloves, remove the upper ribbon spool from its upper spool holder and rethread the ribbon around the front of the print carriage, passing the print band, then remount the upper ribbon spool to the upper spool holder (Figure 5—102).
8. Perform steps 8 through 12 of 5.6.3.2.

5.6.3.4. Print Phasing Adjustment

The print phasing control on the print cartridge allows the operator to adjust timing of print hammer actuation so that the entire character is printed. When not adjusted correctly, print phasing causes clipping on the right or left of the characters.

If characters are being clipped, the print phasing control is adjusted during printing. The operator only needs to open the cabinet top cover and turn the print phasing control in either direction until clipping is removed. The last form of a multipart form should be examined for evidence of clipping. Figure 5—106 illustrates examples of print phasing adjustments.





0123456789ABCDEFGHIJKLMN OPQRSTUVWXYZ .&X*+,-\$#@/-
0123456789ABCDEFGHIJKLMN OPQRSTUVWXYZ .&X*+,-\$#@/-
0123456789ABCDEFGHIJKLMN OPQRSTUVWXYZ .&X*+,-\$#@/-

a. Printed characters clipped on left

(123456789ABCDEFGHIJKLMN OPQRSTUVWXYZ .&X*+,-\$#@/-
(123456789ABCDEFGHIJKLMN OPQRSTUVWXYZ .&X*+,-\$#@/-
(123456789ABCDEFGHIJKLMN OPQRSTUVWXYZ .&X*+,-\$#@/-

b. Printed characters clipped on right

0123456789ABCDEFGHIJKLMN OPQRSTUVWXYZ .&X*+,-\$#@/-
0123456789ABCDEFGHIJKLMN OPQRSTUVWXYZ .&X*+,-\$#@/-
0123456789ABCDEFGHIJKLMN OPQRSTUVWXYZ .&X*+,-\$#@/-

c. Characters printed uniformly

Figure 5-106. Examples of Print Phasing Adjustments

5.6.3.5. Forms Thickness Adjustment

The forms thickness control is used to adjust the distance between the print ribbon and print hammers (print gap) to accommodate forms packs of various thicknesses. The forms thickness control (Figure 5-86) should be adjusted for maximum print quality on all forms of the forms pack.

When the correct adjustment is found for a particular forms pack, the operator should note the forms thickness control setting so that the same adjustment can readily be made each time the same pack is printed. A scale is provided to facilitate returning to the same setting when required.

5.6.4. Recovery Procedures

Indicators on the operator control panel (Figure 5-84) and printer indicator panel on the processor operator/maintenance panel (Figure 5-85) inform the operator of abnormal conditions detected in the printer. Table 5-19 lists some faults that may cause error conditions and the recovery procedures for those faults.



Table 5-19. 0778 Printer Subsystem, Operator Recovery Procedures (Part 1 of 2)

Indication	Probable Cause	Recovery Procedures
<p>STOP indicator does not light when POWER ON/ POWER OFF switch on processor operator/ maintenance panel is set to POWER ON, and all motors and indicators are off.</p>	<p>Main power to the printer is turned off.</p>	<ol style="list-style-type: none"> 1. Raise the printer top cover and set the main circuit breaker to ON (up) position. 2. If main circuit breaker was turned on, check external power source for the printer and note that the power source is turned on. 3. If external power source is also turned on, but power to the printer remains off, contact your Sperry Univac customer engineer.
<p>DEVICE CHECK indicator on processor operator/maintenance printer indicator panel and STOP switch/indicator on printer operator control panel are both lit.</p>	<ol style="list-style-type: none"> 1. Print carriage is not locked properly. 2. One of printer drive motors is not operating. 	<p>Check that carriage release latch lever has engaged. The print carriage and the lever is raised to its maximum position. If print band, ribbon, or form feed motors are inoperative, contact Sperry Univac customer engineer.</p>
<p>PRINT CHECK indicator and STOP switch/indicator are lit.</p>	<p>A print actuator is defective, or print band timing is incorrect.</p>	<ol style="list-style-type: none"> 1. Press RUN switch/indicator if you wish to continue printing. 2. Restart the program if it is to be reprinted. 3. Contact Sperry Univac customer engineer if problem persists.
<p>FORMS CHECK indicator and STOP switch/indicator are lit.</p>	<p>Print form is jammed or torn.</p>	<ol style="list-style-type: none"> 1. Remove jammed or torn print form. 2. Note location of torn or jammed form with respect to printer data so that convenient restart point can be determined. 3. Reload print forms as directed in 5.6.3.1.2. 4. Press and release RUN switch/indicator. 5. Observe that FORM CHECK and STOP switch/indicators are extinguished. 6. Reenter program at proper point. 7. If error persists, contact Sperry Univac customer engineer.

Table 5-19. 0778 Printer Subsystem, Operator Recovery Procedures (Part 2 of 2)

Indication	Probable Cause	Recovery Procedures
OUT OF FORMS indicator and STOP switch/indicator are lit.	Less than 4.5 inches (11.43 centimeters) of print form remains below the print line.	<ol style="list-style-type: none">1. Reload forms as directed in 5.6.3.1.2.2. Press and release RUN switch/indicator.3. Observe that STOP switch/indicator and OUT OF FORMS indicator are extinguished.4. Reenter program at proper point.
PARITY CHECK indicator is lit.	An input error was detected on the input code for the printer.	<ol style="list-style-type: none">1. Correct the parity error.2. Press the RUN switch/indicator.3. Reenter the program at the proper point.



6. Card Reader Subsystems

6.1. GENERAL

Card reader subsystems that may be part of the SPERRY UNIVAC 90/30 B Systems are:

- SPERRY UNIVAC 0716 Card Reader Subsystem
- SPERRY UNIVAC 0717 Card Reader Subsystem
- SPERRY UNIVAC 0719 Card Reader Subsystem

The 0716 card reader subsystem contains its own control circuits which regulate data flow and control signals to and from the card reader via the system's multiplexer channel. Cards having 80, 66, or 51 columns are read at the rate of 1000 cards per minute (cpm). The short cards (66 and 51 columns) are read only if the applicable features are included in the card reader. The input hopper, having a capacity of 2400 cards, accepts all three card sizes but not if intermixed. Two stackers, each capable of holding 2000 cards, are accessible during operation. The output stacker accepts all error-free cards not supplied to the alternate stacker. An alternate-stacker-fill feature allows cards to be diverted automatically from a filled output stacker to the alternate stacker. ←

The 0717 card reader subsystem control circuits are located within the processor cabinet, and the subsystem operates online with the processor via the integrated peripheral channel. Cards having 80, 66, or 51 columns are read at the rate of 500 cpm. The 66- and 51-column cards are read only if the applicable features are installed in the card reader. The input hopper, having a capacity of 2400 cards, accepts all three card sizes but not intermixed. The stacker is capable of holding 2400 cards. ←

The 0719 card reader subsystem control circuits are located within the processor cabinet. The subsystem operates online with the processor via the integrated peripheral channel. Cards having 80, 66, or 51 columns are read at a rate of 300 cpm. The 66 and 51 column cards are read only if the applicable features are installed on the card reader. The input hopper is capable of holding a maximum of 1000 cards (standard thickness). The output stacker also is capable of holding 1000 cards. ←

This page left blank intentionally.

6.2. 0716 CARD READER SUBSYSTEM

The 0716 card reader is a freestanding unit (Figure 6—1) containing its own power supply and control circuits. Each card reader comprises a subsystem capable of operations independent of other card readers in the system.

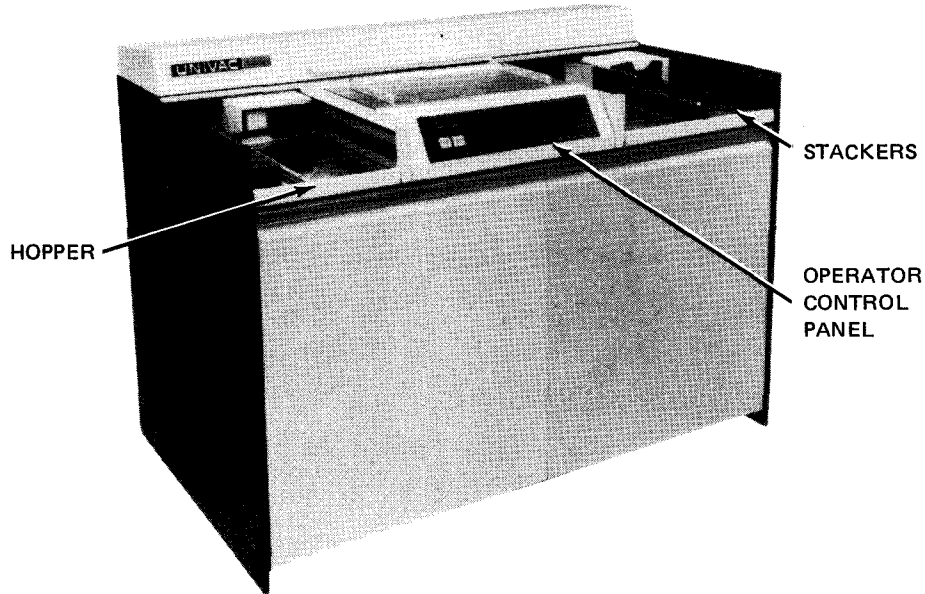

Figure 6—1. 0716 Card Reader Subsystem

6.2.1. Operating Controls and Indicators

The card reader contains a control panel (Figure 6—2) located on the front of the unit. The panel contains four switch/indicators used during normal operations, and two switches behind a flip-cover which are used only occasionally (Figure 6—3). Indicators are located on the center of the panel, and are visible only when lit. A power control panel (Figure 6—4) is located behind the left-front cabinet door. All controls and indicators for both panels are listed and described in Table 6—1.

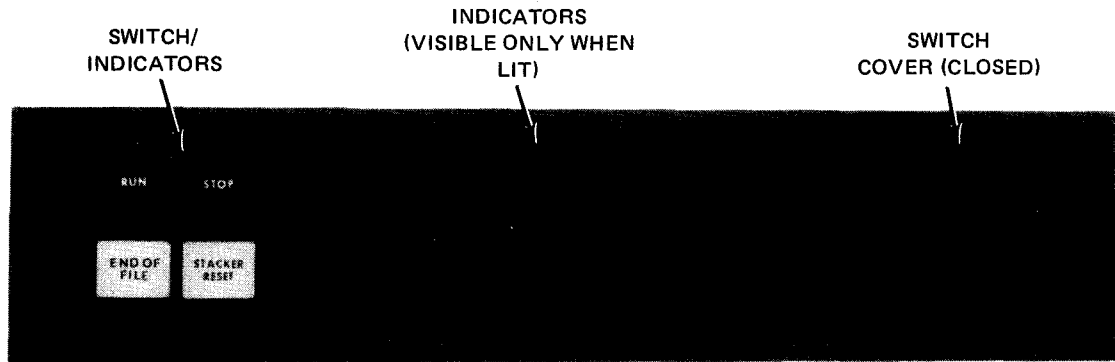

Figure 6—2. 0716 Card Reader, Operator Control Panel

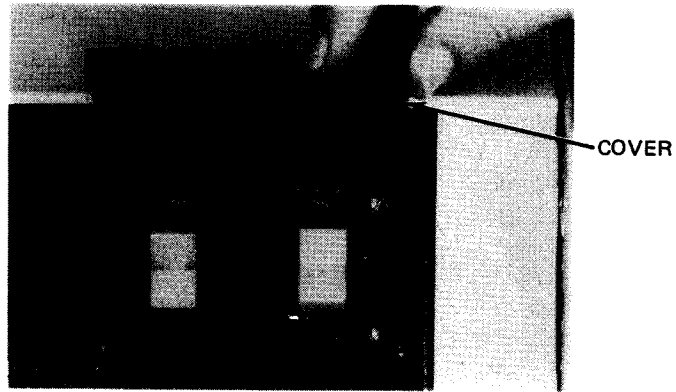

Figure 6—3. Operator Control Panel with Cover Raised

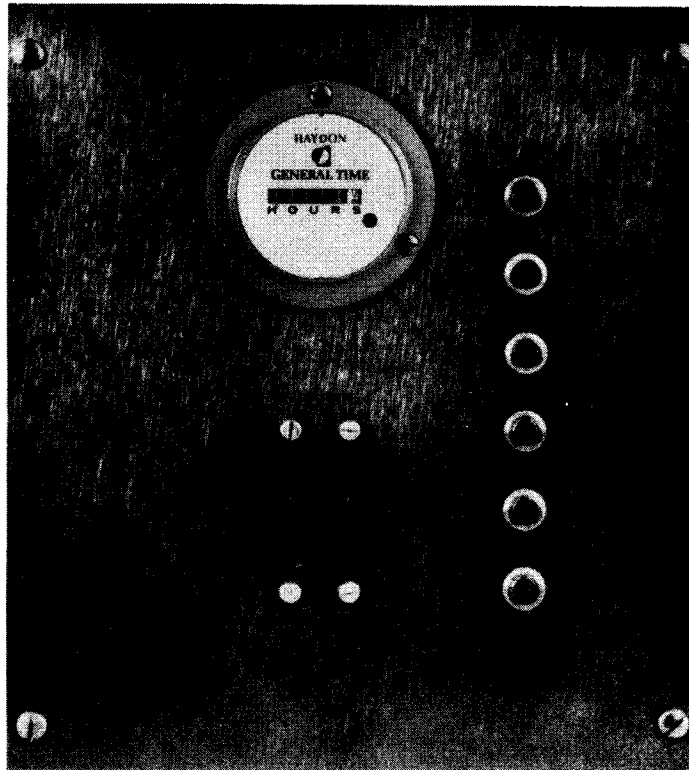

Figure 6—4. 0716 Card Reader, Power Control Panel

Table 6-1. 0716 Card Reader Subsystem, Controls and Indicators (Part 1 of 4)

Control/Indicator — Function
Operator Control Panel
RUN switch/indicator Clears previously stored data and prepares card reader for new data. Extinguishes STOP , TRANSFER CHECK , READ CHECK , and OPERATOR indicators
STACKER/RESET switch/indicator Used only with alternate-stacker fill feature, permits loading cards in alternate stacker. Lights when alternate stacker is full. Can be pressed before output stacker fills to prevent an operations stop
STOP switch/indicator The STOP switch/indicator: <ul style="list-style-type: none">▪ turns off motors on card transport panel after 3 seconds;▪ lights all indicators on operator control panel for a lamp test;▪ inhibits new read orders; and▪ clears END OF FILE indicator Lights when: <ul style="list-style-type: none">▪ power is applied to subsystem;▪ OPERATOR indicator is lit;▪ VALIDITY CHECK indicator is lit and reader is operating in stop-on-error mode;▪ FEED CHECK indicator is lit;▪ READ CHECK indicator is lit;▪ DEVICE CHECK indicator is lit; or▪ TRANSFER CHECK indicator is lit.
END OF FILE switch/indicator Used with end-of-file feature, permits end-of-file status when last card of file is fed
OPERATOR indicator Lights when: <ul style="list-style-type: none">▪ a cover with an interlock is open;▪ hopper is empty; or▪ either stacker is full. Condition causing indicator to light also causes:

Table 6—1. 0716 Card Reader Subsystem, Controls and Indicators (Part 2 of 4)

Control/Indicator — Function
Operator Control Panel (cont)
<ul style="list-style-type: none">■ card reader to stop;■ STOP switch/indicator to light; and■ read commands to be rejected.
FEED CHECK indicator
Lights when:
<ul style="list-style-type: none">■ card transport is jammed; or■ card does not feed after read command is given.
Condition causing indicator to light also causes:
<ul style="list-style-type: none">■ card reader to stop and STOP switch/indicator to light;■ RUN indicator to go off; and■ read commands to be rejected.
DEVICE CHECK indicator
Lights when:
<ul style="list-style-type: none">■ air flow is below level required for cooling;■ an overheat condition occurred in card reader; or■ circuit breaker tripped.
Condition causing indicator to light also causes card reader power to go off.
STACKER 1 indicator
Lights when last card read is directed to output stacker and card reader is operating in stop-on-error mode. Operates only if alternate-stacker-fill feature is included with subsystem
STACKER 2 indicator
Lights when last card read is directed to alternate stacker and card reader is operating in stop-on-error mode. Operates only if alternate-stacker-fill feature is included with subsystem
OFF LINE indicator
Lights when card reader is in offline mode
VALIDITY CHECK indicator
Lights when multiple punches are detected in rows 1 through 7 of one or more columns when reading in 80-column format translate mode. Condition causing indicator to light also causes:
<ul style="list-style-type: none">■ card reader to stop if operating in stop-on-error mode;

Table 6—1. 0716 Card Reader Subsystem, Controls and Indicators (Part 3 of 4)

Control/Indicator — Function
Operator Control Panel (cont)
<ul style="list-style-type: none">▪ card to be rejected if operating in sort-on-error mode;▪ STOP switch/indicator to light; and▪ RUN switch/indicator to extinguish.
READ CHECK indicator
Lights when:
<ul style="list-style-type: none">▪ a data overrun or read error caused by mispunched card is detected;▪ improper registration is detected; or▪ read head becomes inoperative.
Condition causing indicator to light also causes:
<ul style="list-style-type: none">▪ card reader to stop, if operating in stop-on-error mode;▪ card to be rejected if operating in sort-on-error mode;▪ STOP switch/indicator to light; and▪ RUN switch/indicator to extinguish.
TRANSFER CHECK indicator
Lights when a card was fed without a feed signal. Condition causing indicator to light also causes:
<ul style="list-style-type: none">▪ card reader to stop if operating in stop-on-error mode; and▪ if operating in sort-errors mode, error card to be sent to assigned alternate stacker and reader to accept next command or error card to be sent to normal stacker
ON LINE/OFF LINE switch
ON LINE position:
Connects card reader output to processor. Power to card reader is controlled remotely from processor. POWER ON/POWER OFF switch must be set to POWER ON for remote control of power to reader.
OFF LINE position:
Disconnects card reader output to processor. Power to card reader is controlled from card reader with POWER ON/POWER OFF switch. ON LINE/OFF LINE switch must be set to OFF LINE before setting POWER ON/POWER OFF switch to POWER OFF .
POWER ON/POWER OFF switch
POWER ON position:
Applies operating power to card reader. ON LINE/OFF LINE switch must be in ON LINE position if power is to be controlled remotely, and POWER ON/POWER OFF switch must be in midpositions. If in OFF LINE , POWER ON is obtained by pressing switch in extreme up position. Spring action causes switch to return to midposition.

Table 6—1. 0716 Card Reader Subsystem, Controls and Indicators (Part 4 of 4)

Control/Indicator — Function
Operator Control Panel (cont)
<p>POWER OFF position: Removes operating power from card reader. Power cannot be applied remotely.</p>
Power Control Panel
<p>XPORT TIME time-elapsed meter Indicates time, in hours, that card reader has operated</p> <p>MAIN PWR circuit breaker Provides overload protection for main power circuit in card reader</p> <p>PWR SUPPLY pushbutton circuit breaker (5 amperes) Provides overload protection for main power supply</p> <p>READ LAMP pushbutton circuit breaker (5 amperes) Provides overload protection for indicator circuits</p> <p>9.5 VAC pushbutton circuit breaker (5 amperes) Provides overload protection for 9.5 Vac power supply</p> <p>+24 VDC pushbutton circuit breaker (3 amperes) Provides overload protection for 24 Vdc power supply</p> <p>XPORT MOTOR pushbutton circuit breaker (7 amperes) Provides overload protection for transport drive motor</p> <p>VACUUM MOTOR pushbutton circuit breaker (10 amperes) Provides overload protection for vacuum motor</p>

6.2.2. Turn-On and Turn-Off Procedures

→ Power to the card reader is normally applied and removed via the **POWER ON/POWER OFF** switch on the processor operator/maintenance panel (Figure 2—2). However, to control power from this panel, certain switches and circuit breakers must first be set to specific positions. The switch and circuit breaker settings are listed in Table 6—2.

When switches and circuit breakers are set as listed in Table 6—2, and the processor **POWER ON/POWER OFF** switch is then set to **POWER ON**, the **STOP** switch/indicator on the card reader will light. All other indicators and switch/indicators will be extinguished. The **RUN** switch/indicator may be pressed to begin operation (**RUN** switch/indicator lights and **STOP** extinguishes).

CAUTION

If the card reader is to be turned on after the system has already been powered up (card reader is in offline mode) follow the independent power turn-on procedures in 6.2.2.1 to apply power to the unit. Power transients may interfere with proper operation of the processor if this procedure is not followed.

Table 6—2. 0716 Card Reader Subsystem, Power Switch Settings

Switch/Circuit Breaker	Normal Setting
Power Control Panel	
MAIN PWR circuit breaker	On (up)
All pushbutton circuit breakers	In (not protruding)
Operator Control Panel	
ON LINE/OFF LINE switch	ON LINE
POWER ON/POWER OFF switch	POWER ON
NOTE:	
The POWER ON/POWER OFF switch springs back to midposition when set to POWER ON and released.	

6.2.2.1. Independent Power Turn-On Procedure

To turn power on at the card reader independently of the processor, proceed as follows:

1. Raise switch cover on operator control panel, and set **ON LINE/OFF LINE** switch to **OFF LINE** position.
2. Check that all pushbutton circuit breakers on the power control panel are closed (not protruding).
3. Check that **MAIN PWR** circuit breaker on power control panel is set to **ON** (up) position. Close cabinet door securely to engage interlock switch.
4. Set **POWER ON/POWER OFF** switch on operator control panel (beneath switch cover) to **POWER ON** position (spring action returns it to midposition). Note that **OFF LINE** indicator and **STOP** switch/indicator are both lit but all other indicators are extinguished.
5. Press **RUN** switch/indicator on operator control panel to begin local operation. Note that **RUN** switch/indicator lights and **STOP** switch/indicator extinguishes.
6. Use the *UP* function of the SET IO command (Section 12) to place the card reader on the system's resources list for job allocation.

6.2.2.2. Independent Power Turn-Off Procedure

To turn power off at the card reader independently of the processor, proceed as follows:

1. Raise switch cover on operator control panel, and set **ON LINE/OFF LINE** switch to **OFF LINE** position. Note that **OFF LINE** indicator and **STOP** switch/indicator both light.
2. Set **POWER ON/POWER OFF** switch on operator control panel (beneath switch cover) to **POWER OFF** position. Note that all indicators extinguish.
3. Set **MAIN PWR** circuit breaker on power control panel to **OFF** (down) position if complete power turn-off is desired.
4. Use the *DOWN* function of the SET IO command (Section 12) to remove the card reader from the system's resources list and prevent it from being allocated to a job while offline.

6.2.3. Operating Procedures

Operating procedures for the card reader include setting the card feed guide for proper card size, loading cards when stopped and when running, and unloading cards. The operator is also required to clear card jams.

6.2.3.1. Card Feed Guide Setting

The card reader can accommodate 80-, 66-, or 51-column cards, provided the card feed guide in the hopper is set according to the card size to be read. Proceed as follows to set the card feed guide:

1. Determine the card size by the number of columns (Figure 6—5a).
2. Loosen the two thumbscrews holding the card feed guide plate to the feed tray and feeder backplate (Figure 6—5b).
3. Move the card feed guide to the appropriate setting to accommodate the card size to be used (Figure 6—5b), then tighten the thumbscrews.

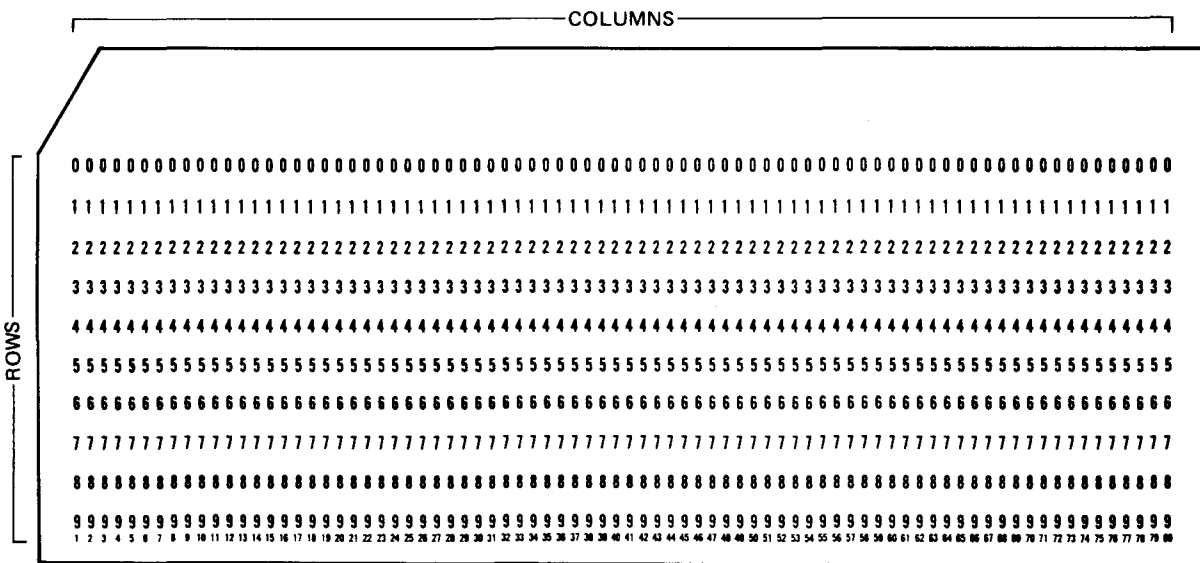

a. Example of an 80-column card

Figure 6—5. Card Feed Guide Settings in Hopper (Part 1 of 2)

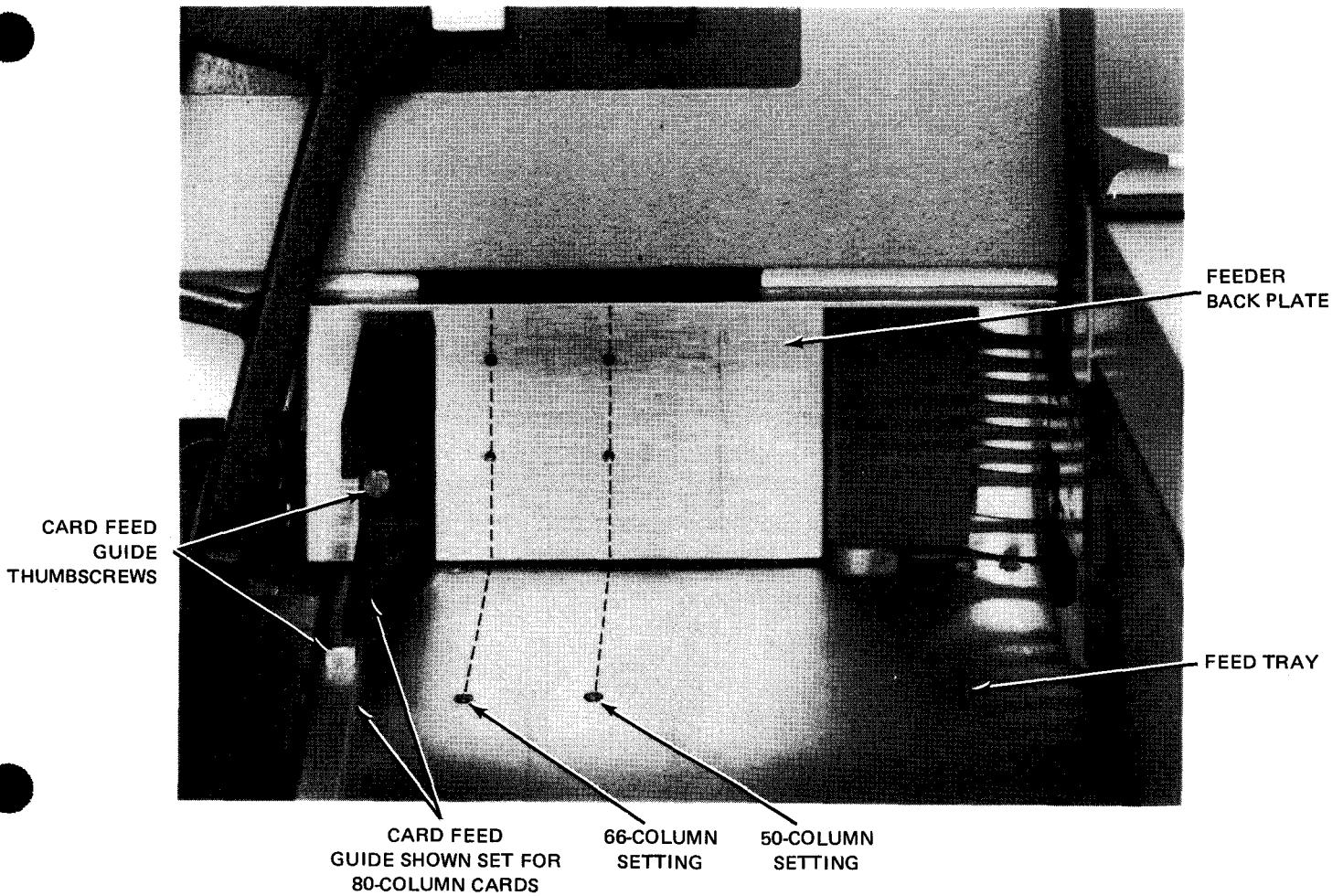

b. Select proper card size setting

Figure 6-5. Card Feed Guide Settings in Hopper (Part 2 of 2)

6.2.3.2. Loading Cards In Hopper When Stopped

To load cards when the card reader is not feeding cards, proceed as follows:

1. Select a handful of cards to be read. Fan the cards (Figure 6-6a) so that they will feed properly.
2. Retract card follower plate (Figure 6-6b).
3. Place cards on feed tray so that the card face is toward the feeder and row 9 is down.
4. Jog cards against left feed guide of hopper (Figure 6-6b). Place cards behind feeder backplate or behind cards previously loaded (Figure 6-6c).
5. Release card follower plate and allow it to press against last card (Figure 6-6d).
6. Repeat steps 1 through 5 until hopper is filled to desired capacity. Hopper capacity is 2400 cards.

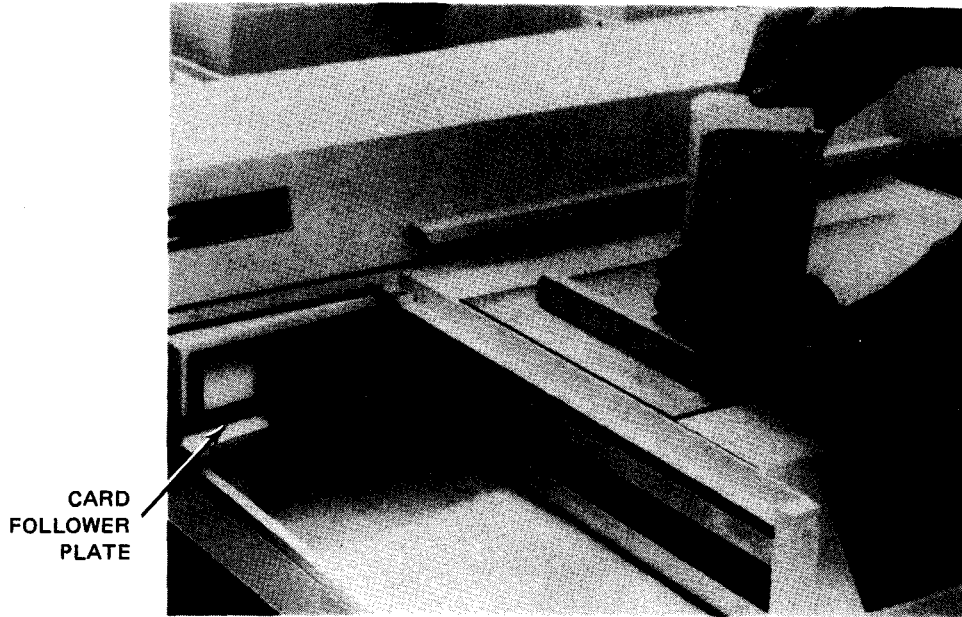

a. Fanning cards before loading

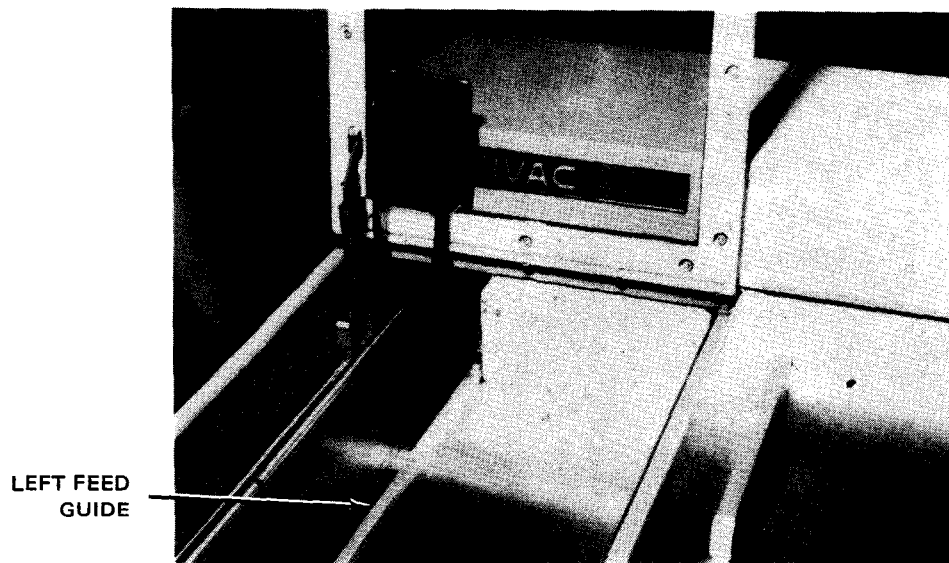

b. Card follower plate retracted

Figure 6-6. Loading Cards in Hopper (Part 1 of 2)

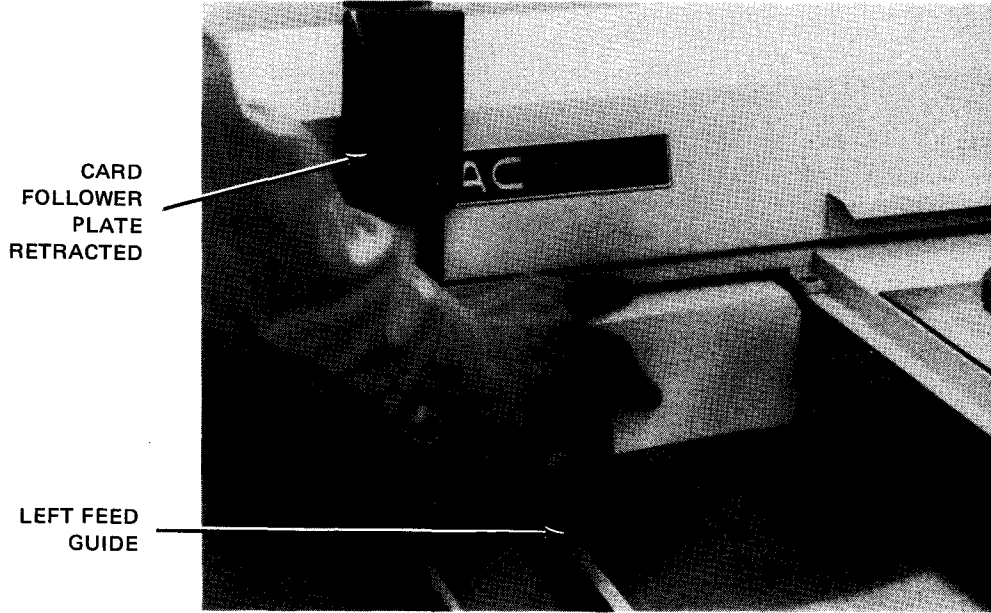

c. Placing cards in hopper

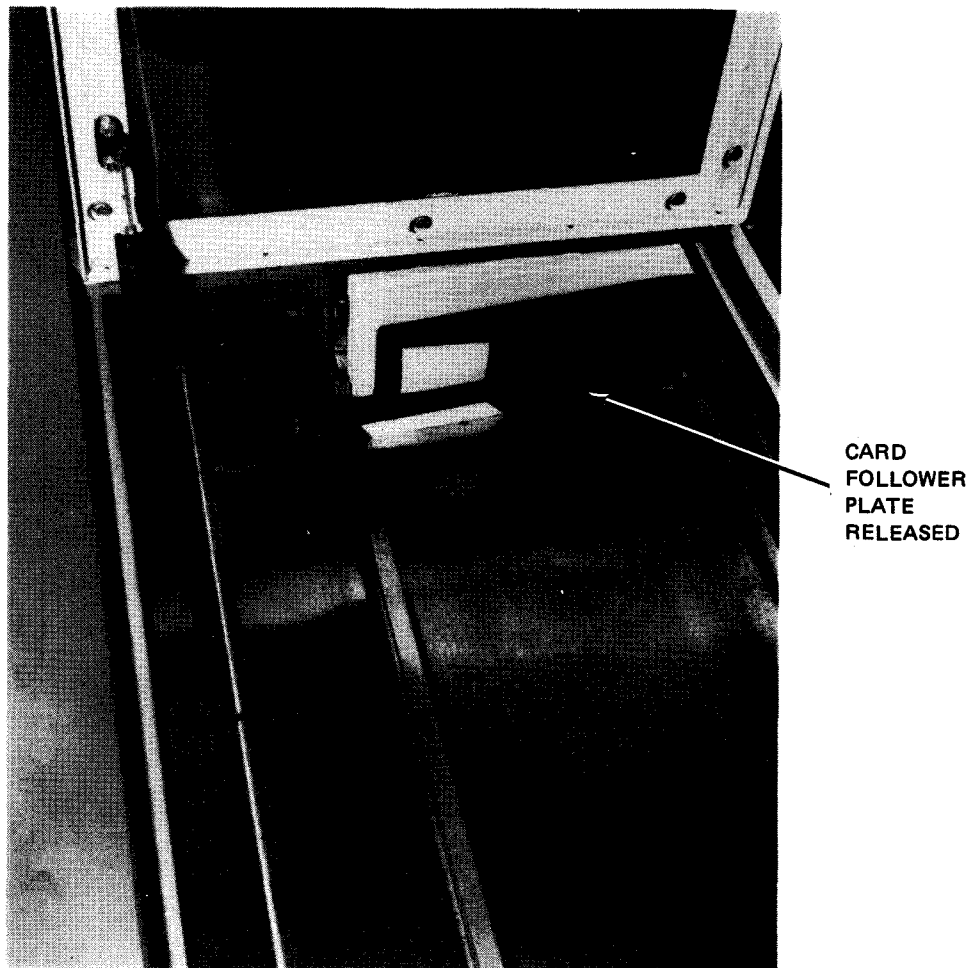

d. Card follower plate in position to feed cards

Figure 6-6. Loading Cards in Hopper (Part 2 of 2)

6.2.3.3. Loading Cards in Hopper When Running

To load cards while the card reader is feeding cards into the card transport, proceed as follows:

1. Select a handful of cards to be read. Fan cards (Figure 6—6a) so that they will feed properly.
2. Place cards on feed tray so that the face of the card is toward the feeder and row 9 is down. Jog cards against left feed guide of hopper (Figure 6—6b).
3. With card feed follower plate in position (Figure 6—6d), place cards against card feed follower plate. Maintain pressure at the bottom of cards.
4. Raise the card feed follower plate (Figure 6—6c), draw it backward then lower it so that it presses against the newly-loaded supply of cards.

6.2.3.4. Unloading Cards From Stackers

Cards may be removed from either stacker while the card reader is operating or stopped. To remove cards from either stacker, proceed as follows:

1. While maintaining a slight pressure on card backs, retract stacker holding plate and grasp a quantity of cards nearest to holding plate (Figure 6—7).
2. Allow stacker holding plate to release on remaining cards.
3. Repeat steps 1 and 2 until all cards are removed from stacker.

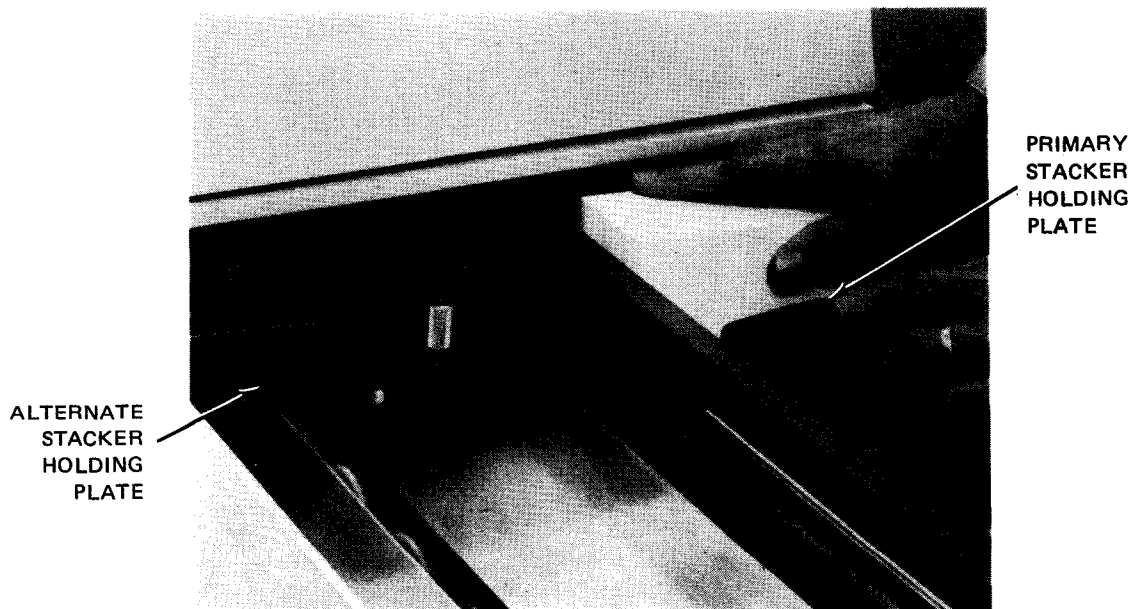

Figure 6—7. Removing Cards from Stacker

6.2.3.5. Clearing Card Jams

A card may occasionally become jammed at the timing diverter gate or stacking diverter gate. If a jam occurs, the card reader stops operation until the jam is cleared. After the jam is cleared, operation is resumed as directed in the recovery procedures for **FEED CHECK** in Table 6-3. Proceed as follows to clear a jammed card:

NOTE:

Before performing the following procedure, remove the device from the system's list of available resources by using the DOWN function of the SET IO command (Section 12). After the procedure is completed, restore the device's available status by using the UP function of the SET IO command.

1. Perform independent power turn-off procedure (6.2.2.2) then raise transport mechanism cover (Figure 6-8a) for access to the card transport panel.
2. Locate jammed card (Figure 6-8b). Depending on location of jammed card, release timing diverter gate lock (Figure 6-8c) or stacking diverter gate lock (Figure 6-8d) by raising knurled locking pin on gate that is jammed.
3. Swing diverter gate away from jammed card (Figure 6-8e) and lift card away from transport mechanism.
4. Rotate manual feed control (Figure 6-8e) to direct next card to proper path.
5. Close diverter gate and lock in proper operating position by allowing lock tip to enter the hole on the transport panel.

CAUTION

Be sure that diverter gate is returned to proper operating position before resuming operation or damage may result to transport mechanism.

6. Close transport mechanism cover, and perform steps 3 through 5 of error recovery procedure for **FEED CHECK** (Table 6-3).

NOTE:

If cards continue to jam or do not feed past the feed drum (Figure 6-8f) because the vacuum pump is inoperative, contact the Sperry Univac customer engineer.

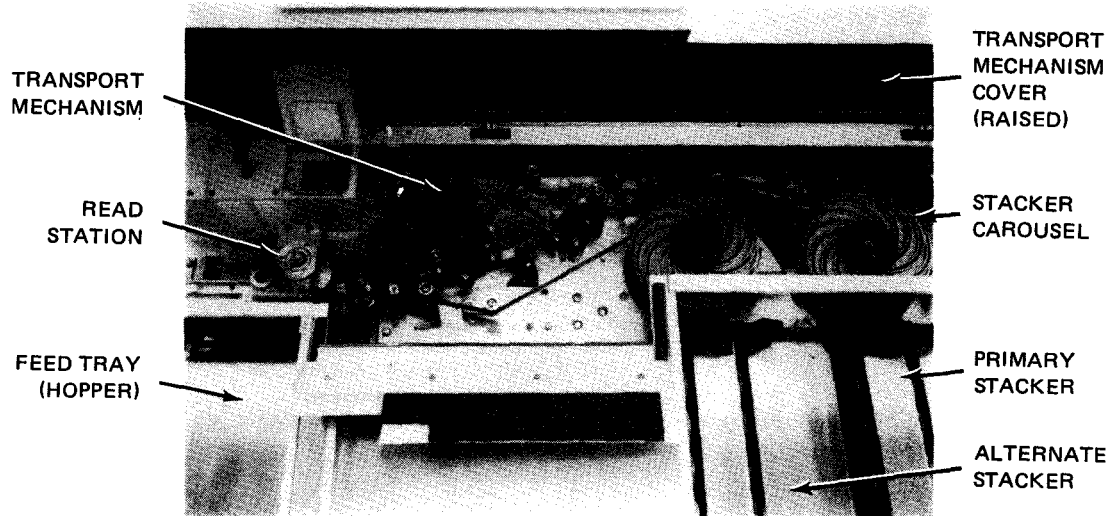

a. Top cover open to show card transport panel

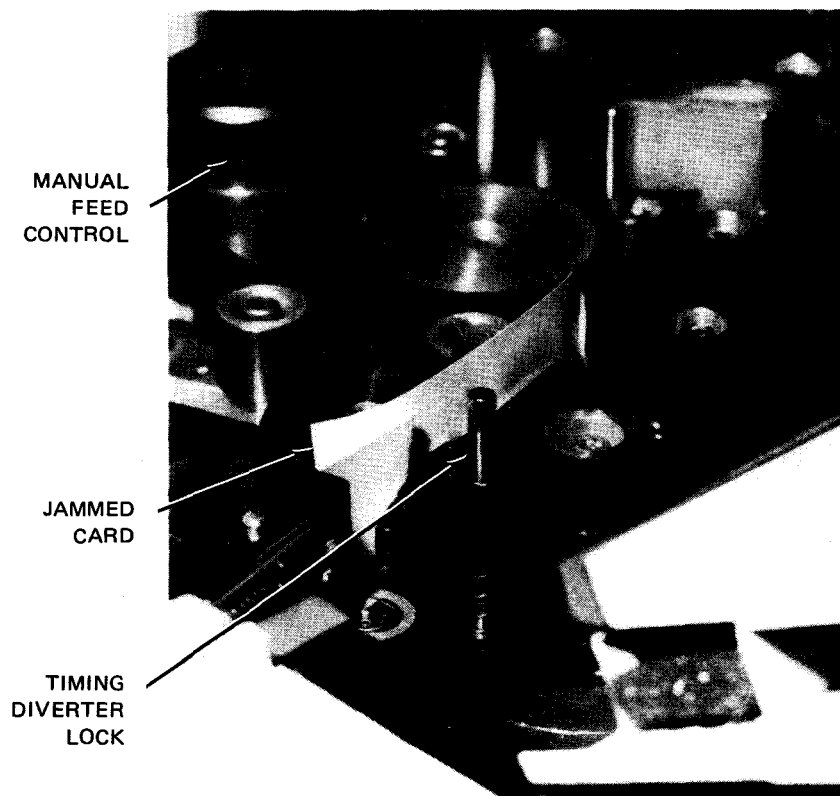

b. Card jammed at card timing diverter gate

Figure 6-8. Clearing Card Jams (Part 1 of 3)

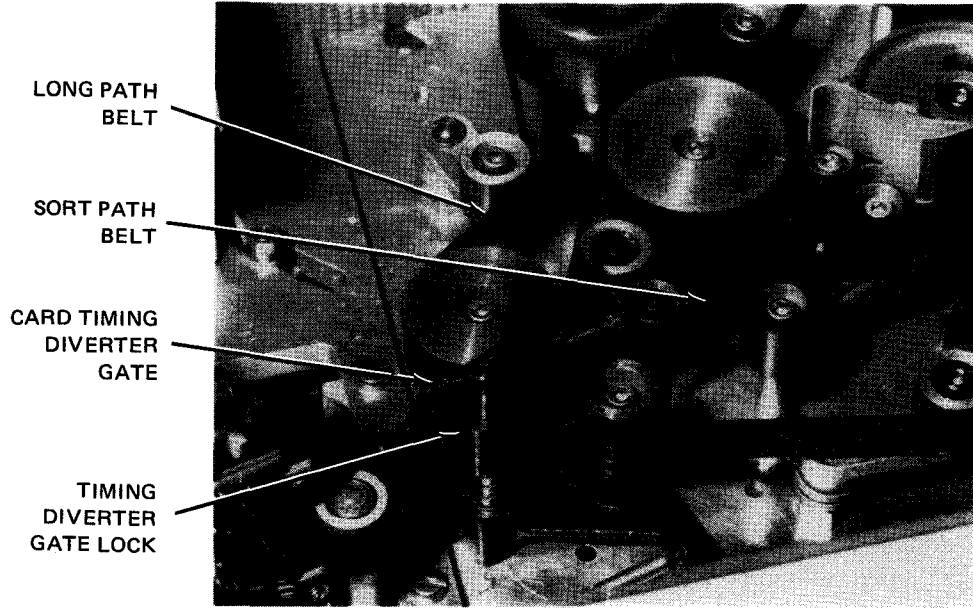

c. Timing diverter on card transport panel

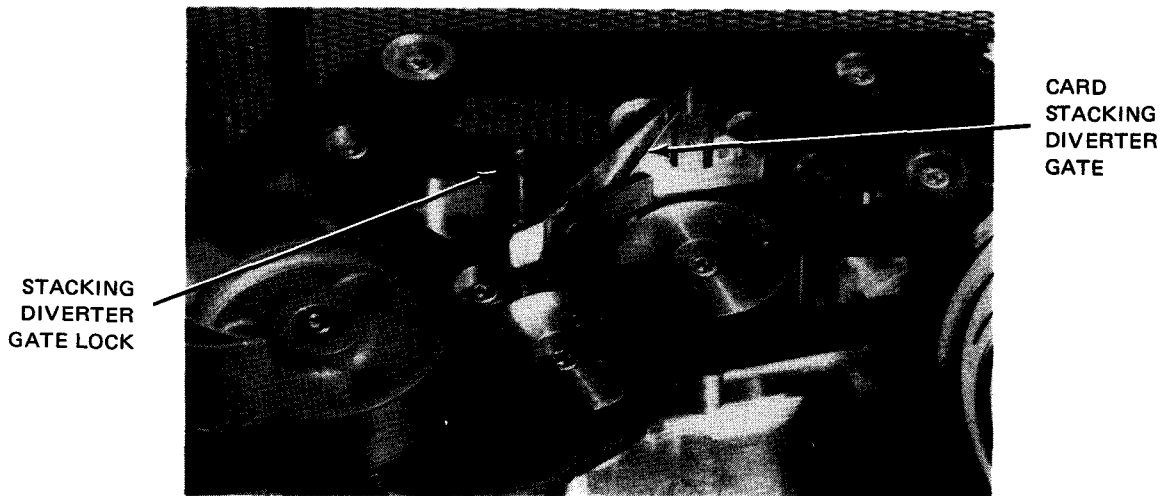

d. Stacking diverter on card transport panel

Figure 6-8. Clearing Card Jams (Part 2 of 3)

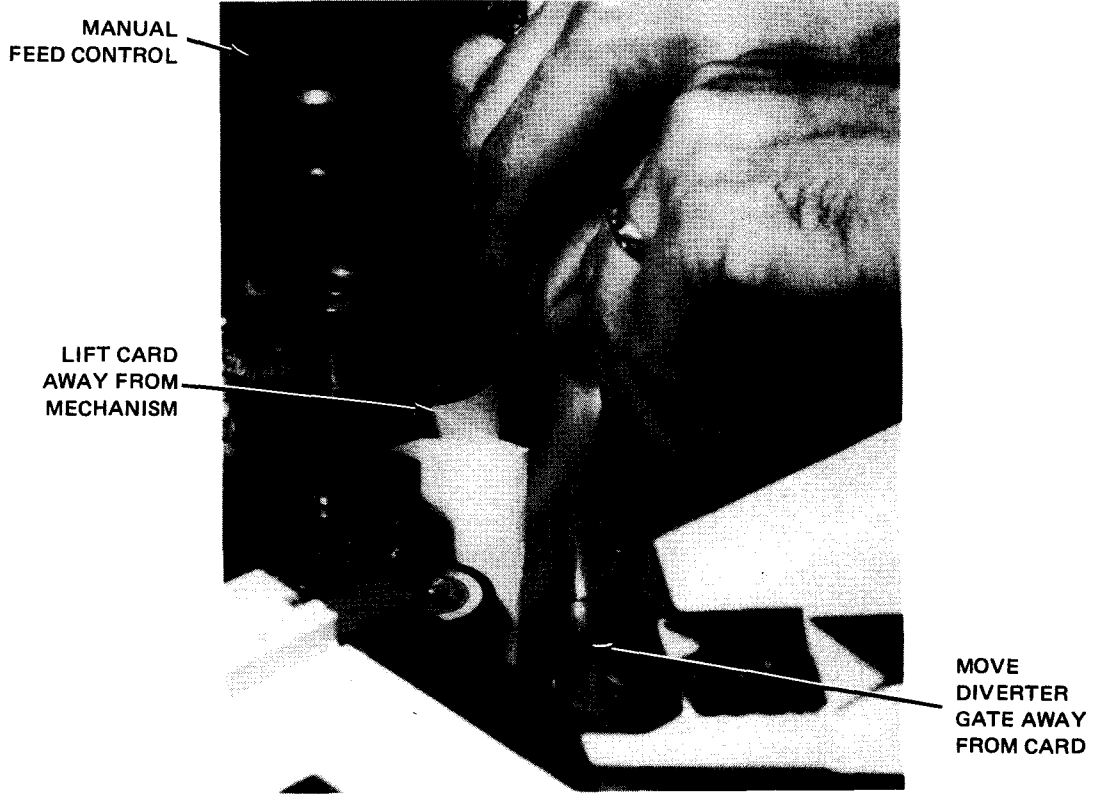

e. Removing jammed card from transport mechanism

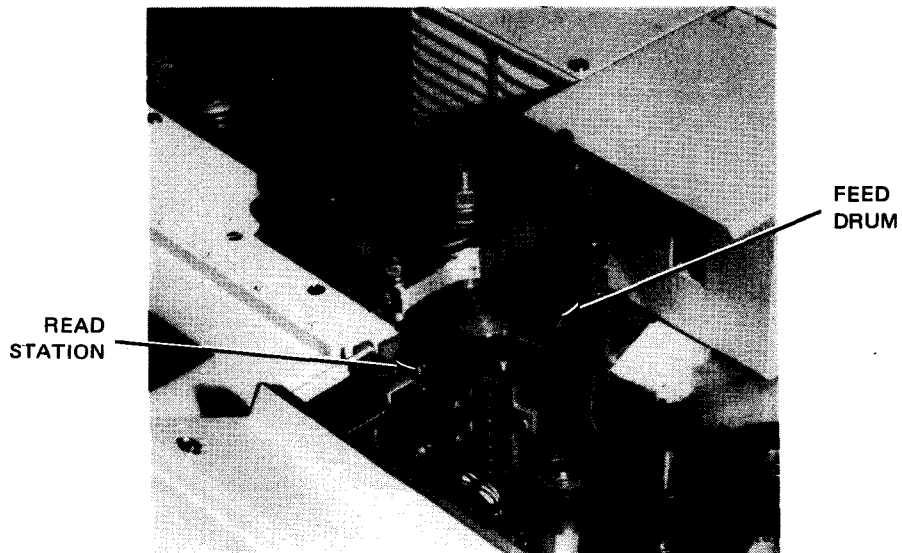

f. Feed drum location on transport mechanism

Figure 6-8. Clearing Card Jams (Part 3 of 3)

6.2.4. Recovery Procedures

Table 6—3 lists the malfunctions which may be correctable by the operator. If any error indicator remains lit after performing the recommended operator action, contact the Sperry Univac customer engineer.

Table 6—3. 0716 Card Reader Subsystem, Recovery Procedures (Part 1 of 4)

Fault Indication	Probable Cause	Operator Action
OPERATOR indicator is lit, and current read operation is completed	Hopper is empty.	<ol style="list-style-type: none"> 1. Set ON LINE/OFF LINE switch to OFF LINE. 2. Load cards into hopper. OPERATOR indicator extinguishes. 3. Set ON LINE/OFF LINE switch to ON LINE (if operating online). 4. Press RUN switch/indicator. RUN switch/indicator lights and STOP indicator extinguishes.
	Output stacker is full.	<ol style="list-style-type: none"> 1. Set ON LINE/OFF LINE switch to OFF LINE. 2. Unload stacker. OPERATOR indicator goes off after unloading is complete. 3. If the alternate-stacker feature is included with card reader, press STACKER RESET switch. 4. Set ON LINE/OFF LINE switch to ON LINE (if operating online). 5. Press RUN switch/indicator. RUN switch/indicator lights and STOP switch/indicator extinguishes.
	Top cover or cabinet door is open or not closed properly.	<ol style="list-style-type: none"> 1. Set ON LINE/OFF LINE switch to OFF LINE. 2. Close cabinet top door. OPERATOR indicator extinguishes. 3. Set ON LINE/OFF LINE switch to ON LINE. 4. Press RUN switch/indicator. RUN switch/indicator lights and STOP switch/indicator extinguishes.
FEED CHECK indicator lights after repeated attempts are made to feed a card. Preceding card continues through transport and is read.	Card is jammed in transport.	<ol style="list-style-type: none"> 1. Perform independent power turn-off procedure (6.2.2.2). 2. Open top cover on cabinet and remove jammed card from diverter gate as directed in 6.2.3.5. 3. Restore cards in correct order in hopper. 4. Examine first card in hopper for damage and examine hopper for any possible causes for jam.

Table 6-3. 0716 Card Reader Subsystem, Recovery Procedures (Part 2 of 4)

Fault Indication	Probable Cause	Operator Action
		<p>5. Perform independent power turn-on procedure (6.2.2.1). Set ON LINE/OFF LINE switch to ON LINE.</p> <p>NOTE:</p> <p>If FEED CHECK indicator lights and other conditions indicate a card jam but no card is jammed in card transport panel, data from last card may be questionable. Reread the card by restoring the card in correct order in the hopper and check for duplicate readings. If jam indications recur, notify Sperry Univac customer engineer.</p> <p>6. Press RUN switch/indicator. RUN switch/indicator lights, FEED CHECK indicator goes off, and STOP switch/indicator extinguishes.</p>
<p>READ CHECK indicator lights and:</p> <ul style="list-style-type: none"> ■ if operating in sort-errors mode (by program control), the erroneous card is sent to the alternate stacker, and reader accepts next read command; or ■ if operating in stop-on-errors mode (by program control), the erroneous card is the last card in the output stacker and the reader stops. 	<p>Read error caused by:</p> <ul style="list-style-type: none"> ■ data overrun (data sent to processor incorrectly); ■ read head failure; ■ mispunched cards; or ■ improper registration of the cards with read heads. 	<ol style="list-style-type: none"> 1. Set ON LINE/OFF LINE switch to OFF LINE. 2. Remove or mark erroneous card for programmer's reference. 3. Set ON LINE/OFF LINE switch to ON LINE. 4. Press RUN switch/indicator. RUN switch/indicator lights, STOP switch/indicator goes off, and READ CHECK indicator extinguishes.
<p>VALIDITY CHECK indicator lights and if operating in sort-errors mode (by program control), the mispunched card is the last one in the output stacker, and the reader stops.</p>	<p>Validity error caused by detection of multiple punches in rows 1 through 7 of one or more columns</p>	<ol style="list-style-type: none"> 1. Set ON LINE/OFF LINE switch to OFF LINE. 2. Remove or mark erroneous card for programmer's reference. 3. Set ON LINE/OFF LINE switch to ON LINE. 4. Press RUN switch/indicator. RUN switch/indicator lights, STOP switch/indicator goes off, and VALIDITY CHECK indicator extinguishes. <p>NOTE:</p> <p>A validity error is detected only if the validity-check feature is included with the card reader. A validity check is made in translate mode (program controlled) for 80-column cards.</p>

Table 6-3. 0716 Card Reader Subsystem, Recovery Procedures (Part 3 of 4)

Fault Indication	Probable Cause	Operator Action
<p>TRANSFER CHECK indicator lights and:</p> <ul style="list-style-type: none"> ■ if operating in sort-errors mode (by program control), the error card is sent to the alternate stacker, and the card reader accepts the read command; or ■ if operating in stop-on-errors mode (by program control), the error card is the last card in the output stacker, and the card reader stops. 	Transfer error	<ol style="list-style-type: none"> 1. Set ON LINE/OFF LINE switch to OFF LINE. 2. Remove error card from stacker and place in the hopper for the next card to be read. 3. Set ON LINE/OFF LINE switch to ON LINE. 4. Press RUN switch/indicator. RUN switch/indicator lights, STOP switch/indicator goes off, and TRANSFER CHECK indicator extinguishes.
<p>DEVICE CHECK indicator lights and card reader stops.</p>	Power loss	<ol style="list-style-type: none"> 1. Set ON LINE/OFF LINE switch to OFF LINE. Set MAIN PWR circuit breaker on power control panel to OFF. 2. Reset (push in) any tripped circuit breakers on the power control panel. 3. Examine cooling air intakes or output for obstructions blocking air flow. Remove obstructions. 4. Open card reader cabinet doors and look for any obstructions preventing cooling fans from operating properly. Remove obstructions. 5. If excessive heat appears to be present inside the reader, and if overheating of card reader is suspected, allow card reader to cool with all doors and panels open. 6. After all suspected causes have been checked and corrected, as described in steps 2 through 5, close all doors and panels securely to engage interlocks. 7. Set ON LINE/OFF LINE switch to OFF LINE. 8. Turn on power as directed in 6.2.2.1. 9. Set ON LINE/OFF LINE switch to ON LINE. <div style="border: 1px solid black; padding: 5px; text-align: center; margin: 10px 0;">CAUTION</div> <p>If a power loss recurs, or DEVICE CHECK indicator lights again, notify Sperry Univac customer engineer.</p>

Table 6-3. 0716 Card Reader Subsystem, Recovery Procedures (Part 4 of 4)

Fault Indication	Probable Cause	Operator Action
Transport mechanism stops automatically.	Card is jammed in transport mechanism.	Same as when FEED CHECK indicator lights.
	One or more cover interlocks are open.	Same when OPERATOR indicator lights.
	Card misfeeds.	Same as when FEED CHECK and when TRANSFER CHECK indicators light.
	Read error.	Same as when READ CHECK indicator lights.
	Circuit protector trips.	Same as when DEVICE CHECK indicator lights.

6.3. 0717 CARD READER SUBSYSTEM

The 0717 card reader subsystem is an integral part of the 90/30 or 90/30 B system. Although the card reader is a freestanding unit (Figure 6—9) that can be physically removed from the system, electronically the card reader is integrated with the processor by its control section and power supplies located inside the processor cabinet. The card reader indicator panel is located on the processor/operator maintenance panel, and the card reader operator control panel is located on the card reader.

6.3.1. Operating Controls and Indicators

An operator control panel (Figure 6—10) is located on the front of the card reader to provide the operator

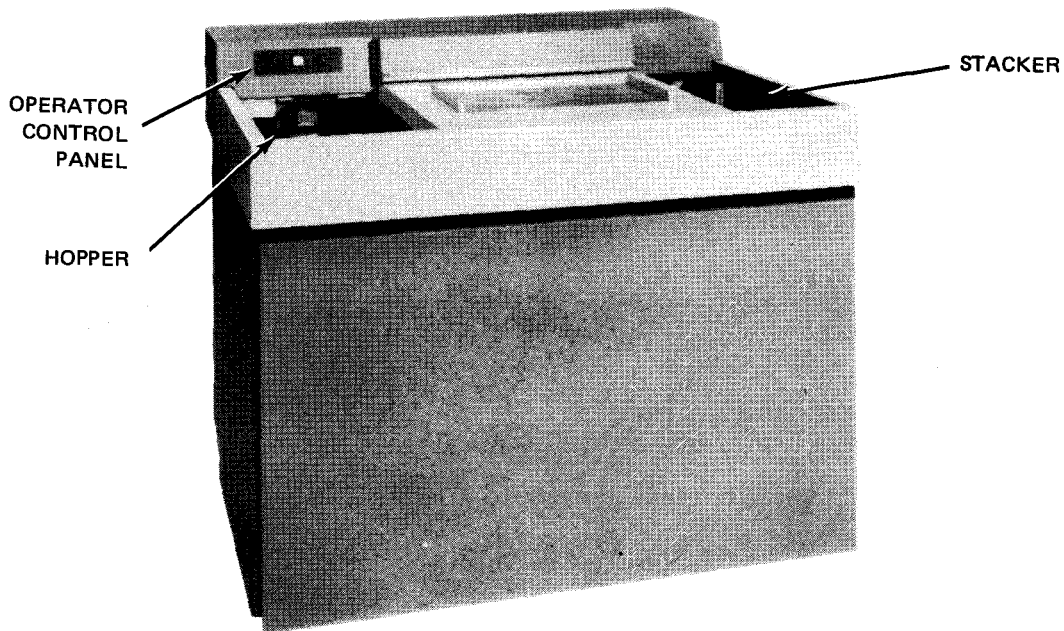

Figure 6—9. 0717 Card Reader Subsystem

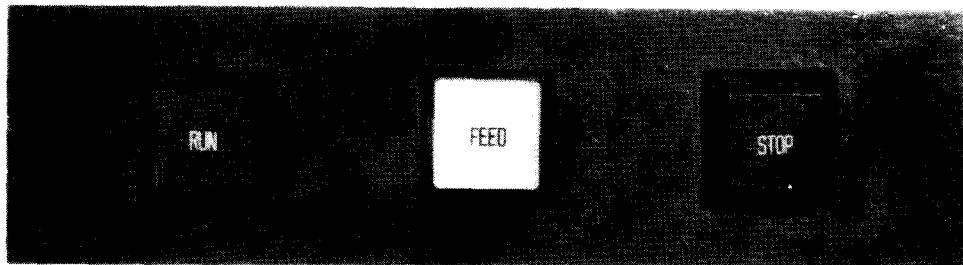

Figure 6—10. 0717 Card Reader, Operator Control Panel

with control during normal operation. The card reader indicator panel (Figure 6—11), located on the processor operator/maintenance panel, alerts the operator of specific check conditions occurring at the card reader. The indicators are visible only when lit.

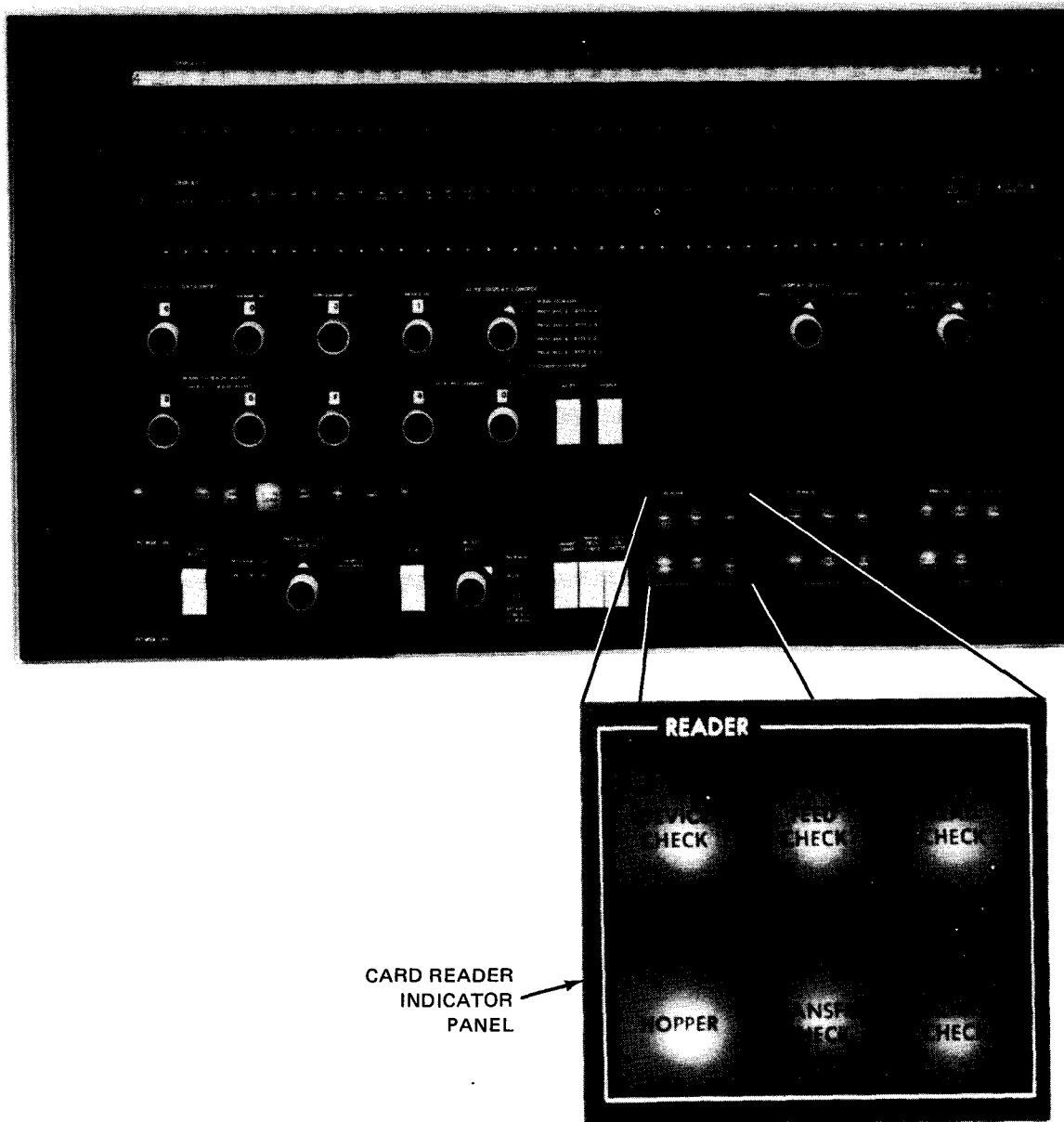

Figure 6—11. 0717 Card Reader, Indicator Panel Located on Processor Operator/Maintenance Panel

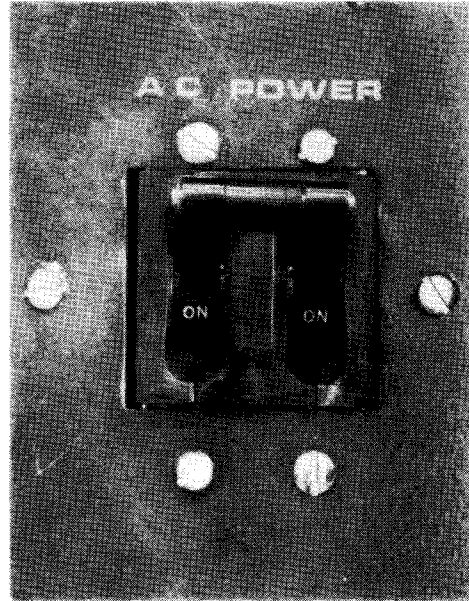

Figure 6-12. 0717 Card Reader Subsystem, AC POWER Circuit Breaker

An **AC POWER** circuit breaker, located behind the card reader front cabinet door, connects power to the drive circuits. The circuit breaker is normally left in the **ON** (up) position; power for the entire card reader is controlled from the processor. All controls and indicators for the card reader are listed and described in Table 6-4.

Table 6-4. 0717 Card Reader Subsystem, Controls and Indicators (Part 1 of 4)

Control/Indicator — Function
Operator Control Panel
<p>RUN switch/indicator</p> <p>When pressed:</p> <ul style="list-style-type: none"> ▪ lights RUN switch/indicator; ▪ extinguishes STOP indicator; and ▪ places card reader in run state (online). <p>Upon release of RUN switch/indicator, all error conditions are cleared, provided corrective action has been taken.</p> <p>An error condition or pressing STOP switch/indicator causes RUN switch/indicator to extinguish.</p> <p>FEED switch</p> <p>Checks the card feed path when a misfeed or card jam occurs. Switch operates only in the stop state (STOP switch/indicator lit) and is disabled when RUN switch/indicator is lit. Momentarily pressing FEED switch feeds one card through card transport mechanism and into output stacker; holding switch down feeds cards continuously, and no data is processed. A preclear is generated when this switch is initially pressed.</p>

Table 6-4. 0717 Card Reader Subsystem, Controls and Indicators (Part 2 of 4)

Control/Indicator — Function
Operator Control Panel (cont)
STOP switch/indicator When pressed: <ul style="list-style-type: none">■ lights STOP switch/indicator;■ extinguishes RUN indicator;■ stops motors in card transport mechanism in 3 seconds; and■ places card reader in stop state (offline). Pressing and holding STOP switch/indicator lights RUN and STOP indicators for a lamp test. An error condition places card reader in stop state and lights indicator. Pressing RUN switch/indicator or clearing an error condition extinguishes STOP switch/indicator. The STOP switch/indicator is lit with one or more of the following: <ul style="list-style-type: none">■ HOPPER indicator is lit.■ VALIDITY CHECK indicator is lit.■ FEED CHECK indicator is lit.■ READ CHECK indicator is lit.■ DEVICE CHECK indicator is lit.■ TRANSFER CHECK indicator is lit.■ Stacker is full (no other indicator lights for this condition).
Indicator Panel (on Operator/Maintenance Panel)
HOPPER indicator Lights when: <ul style="list-style-type: none">■ hopper is empty; or■ card does not feed. Condition causing indicator to light also causes: <ul style="list-style-type: none">■ card reader to stop;■ motors to stop immediately;■ STOP switch/indicator to light; and■ RUN switch/indicator to extinguish.

Table 6-4. 0717 Card Reader Subsystem, Controls and Indicators (Part 3 of 4)

Control/Indicator — Function
Indicator Panel (on Operator/Maintenance Panel) (cont)
FEED CHECK indicator
Lights when card is jammed:
<ul style="list-style-type: none">▪ in transport mechanism path;▪ in read station; or▪ in stacker.
Condition causing indicator to light also causes:
<ul style="list-style-type: none">▪ card reader to stop;▪ motors to stop immediately;▪ STOP switch/indicator to light; and▪ RUN switch/indicator to extinguish.
DEVICE CHECK indicator
Lights when:
<ul style="list-style-type: none">▪ a cover with an interlock is open; or▪ high temperature presents an early warning indication.
An open interlock or overheating condition causing indicator to light also causes:
<ul style="list-style-type: none">▪ card reader to stop;▪ motors to stop immediately;▪ RUN switch/indicator to extinguish; and▪ STOP switch/indicator to light.
High temperature early warning indication does not cause card reader to enter stop state. When this condition occurs, allow card reader to cool until DEVICE CHECK indicator goes off. System power drops if overheating occurs following an early warning indication.
Power loss extinguishes both RUN and STOP switch/indicators.
VALIDITY CHECK indicator
Lights if multiple punches are detected in rows 1 through 7 of one or more columns during reading in 80-column format translate mode. Condition causing indicator to light also causes:
<ul style="list-style-type: none">▪ card reader to stop;▪ motors to stop immediately;▪ STOP switch/indicator to light; and▪ RUN switch/indicator to extinguish.

Table 6-4. 0717 Card Reader Subsystem, Controls and Indicators (Part 4 of 4)

Control/Indicator — Function
Indicator Panel (on Operator/Maintenance Panel) (cont)
READ CHECK indicator Lights when: <ul style="list-style-type: none">▪ a data overrun or read error is detected;▪ improper registration is detected;▪ read head becomes inoperative; or▪ card jam occurs in read station. Condition causing indicator to light also causes: <ul style="list-style-type: none">▪ card reader to stop;▪ motors to stop immediately;▪ STOP switch/indicator to light; and▪ RUN switch/indicator to extinguish.
TRANSFER CHECK indicator Lights when a card was fed without a feed signal. Condition causing indicator to light also causes: <ul style="list-style-type: none">▪ card reader to stop;▪ motors to stop immediately;▪ STOP switch/indicator to light; and▪ RUN switch/indicator to extinguish.
Card Reader Cabinet
AC POWER circuit breaker Provides overload protection for primary ac power circuit in card reader.

6.3.2. Turn-On and Turn-Off Procedures

→ Power to the card reader is normally controlled from the **POWER ON/POWER OFF** switch on the processor operator/maintenance panel (Figure 2-2). However, to turn on from this switch, the **AC POWER** circuit breaker on the card reader (Figure 6-12) must first be set to the **ON** (up) position and all cabinet doors must be closed. This circuit breaker remains on unless independent power turn off is desired.

When the **AC POWER** circuit breaker is set to **ON**, and the processor **POWER ON/POWER OFF** switch is set to **POWER ON**, the **STOP** switch/indicator on the card reader should be lit and all other indicators should be extinguished.

A card jam or other error condition that causes the card reader to halt operation will also cause the processor to receive an error condition and stop the processing operation. If the card reader error requires that the **AC POWER** circuit breaker be turned off for operator safety (e.g., clearing a card jam), power can be reapplied after the error condition is corrected by setting the **AC POWER** circuit breaker to **ON** (up) without regard to power transients causing processor interference. However, if power is to be turned off without an error condition causing operations to halt, power should be turned off on the card reader independently of the processor as directed in the following procedure.

To turn power off at the card reader without disturbing processor operation, proceed as follows:

1. Press **STOP** switch/indicator to place the card reader in an offline condition.
2. Set **AC POWER** circuit breaker (Figure 6-12) to **OFF** (down).
3. Use the *DOWN* function of the SET IO command (Section 12) to remove the card reader from the system's resources list and prevent it from being allocated to a job while offline.

6.3.3. Operating Procedures

Operating procedures for the card reader include setting the card feed guide for proper card size, loading cards when stopped and when running, unloading cards, clearing card jams, and periodic cleaning of the vacuum pump filters.

6.3.3.1. Card Feed Guide Setting

The card reader can accommodate cards with 80-, 66-, or 51-columns, if the card feed guide in the hopper is set according to the card size to be read. Proceed as follows to set the card feed guide:

1. Determine the card size by the number of columns on the card (Figure 6-13a).
2. Loosen the two thumbscrews holding the card feed guide plate to the feed tray and feeder backplate (Figure 6-13b).
3. Move the card feed guide to the appropriate setting to accommodate the card size to be used (Figure 6-13b), then tighten the thumbscrews.

6.3.3.2. Loading Cards in Hopper When Stopped

Cards may be loaded into the hopper when no run is in progress in the following manner:

1. Select a handful of cards to be read. Fan the cards so they will feed properly (Figure 6-14a).
2. Retract the card follower plate by pulling the plate back and raising it (Figure 6-14b).
3. Place cards in the feed tray so that the card face (Figure 6-13a) is toward the feeder backplate (Figure 6-13b) and row 9 of the card is down.
4. Joggle cards against left card feed guide to align the cards evenly (Figure 6-14c). Cards are placed behind the feedback plate if the hopper is empty, or behind previously loaded cards.
5. Release card follower plate and allow it to press against the last card (Figure 6-14d).
6. Repeat steps 1 through 5 until the hopper is filled to desired capacity. Maximum hopper capacity is 2400 cards.

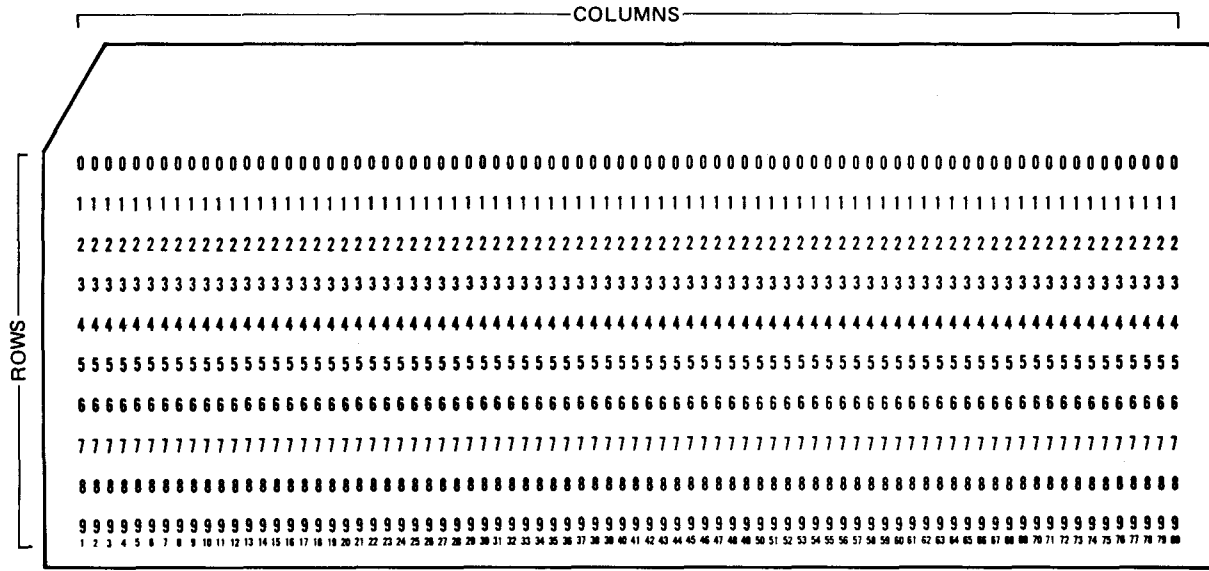

a. Example of 80-column card

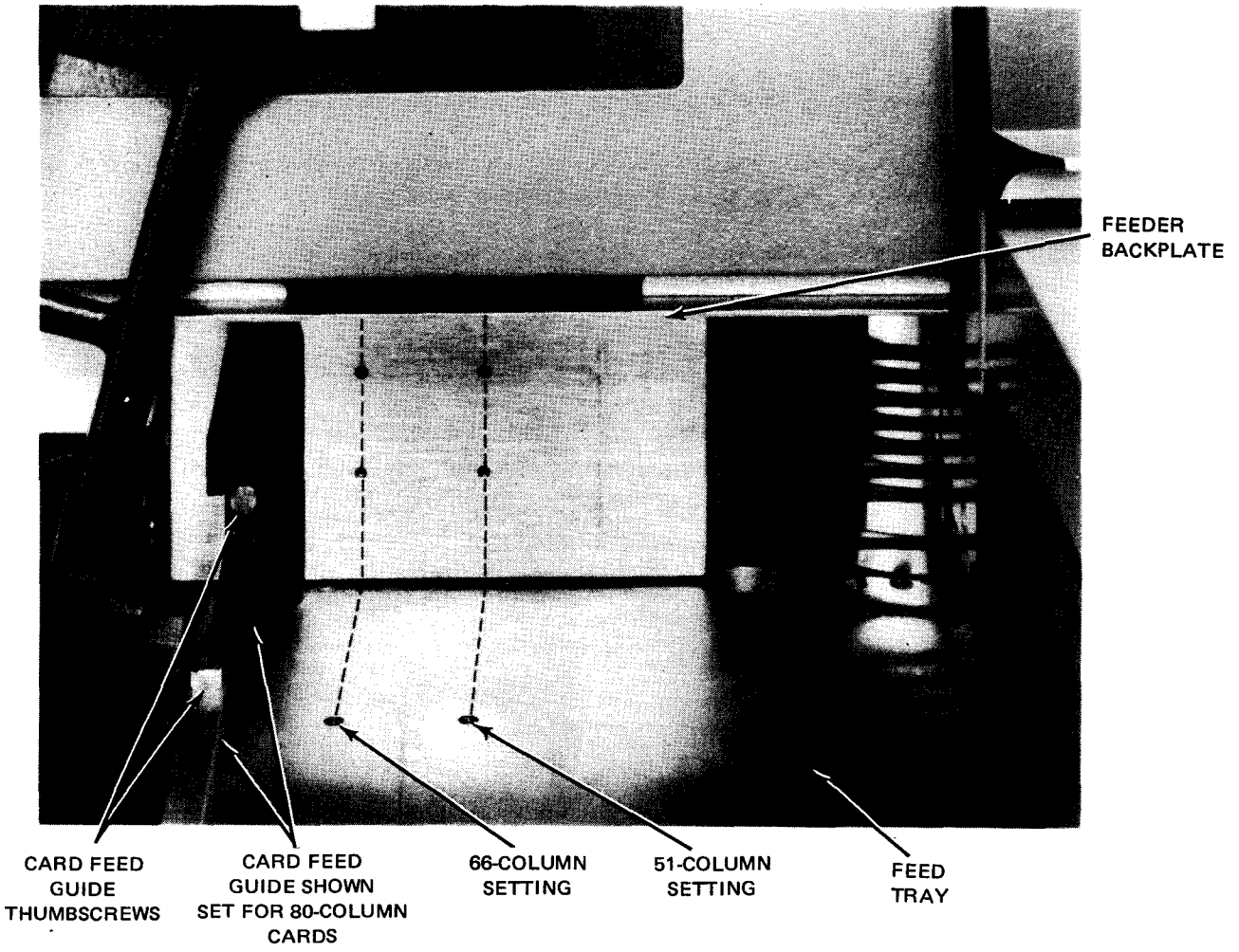

b. Card size settings

Figure 6-13. Card Feed Guide Settings in Hopper

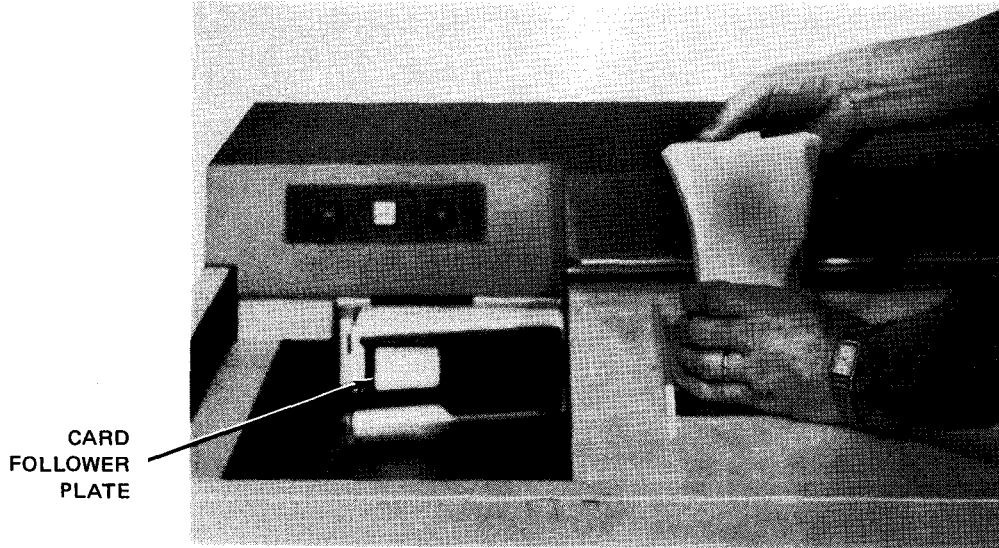

a. Fanning cards before loading

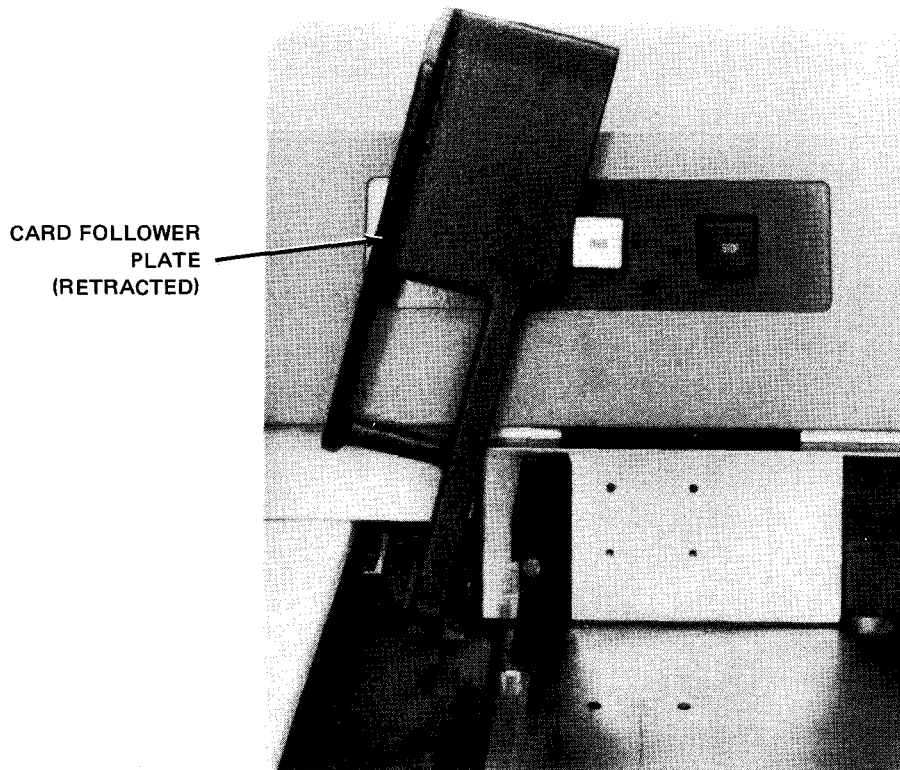

b. Hopper ready to receive cards

Figure 6-14. Loading Cards in Hopper (Part 1 of 2)

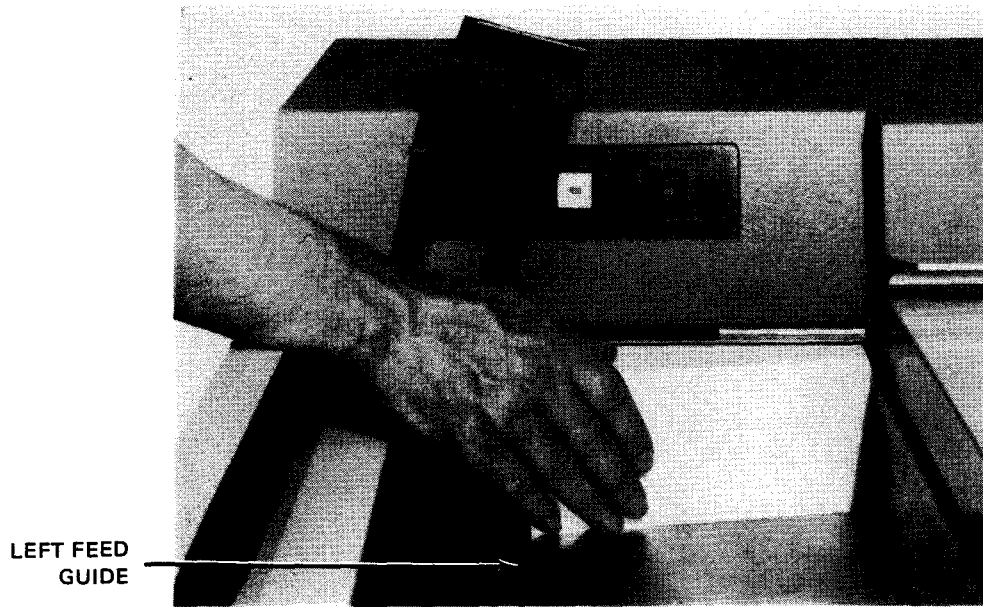

c. Joggling cards against feed guide

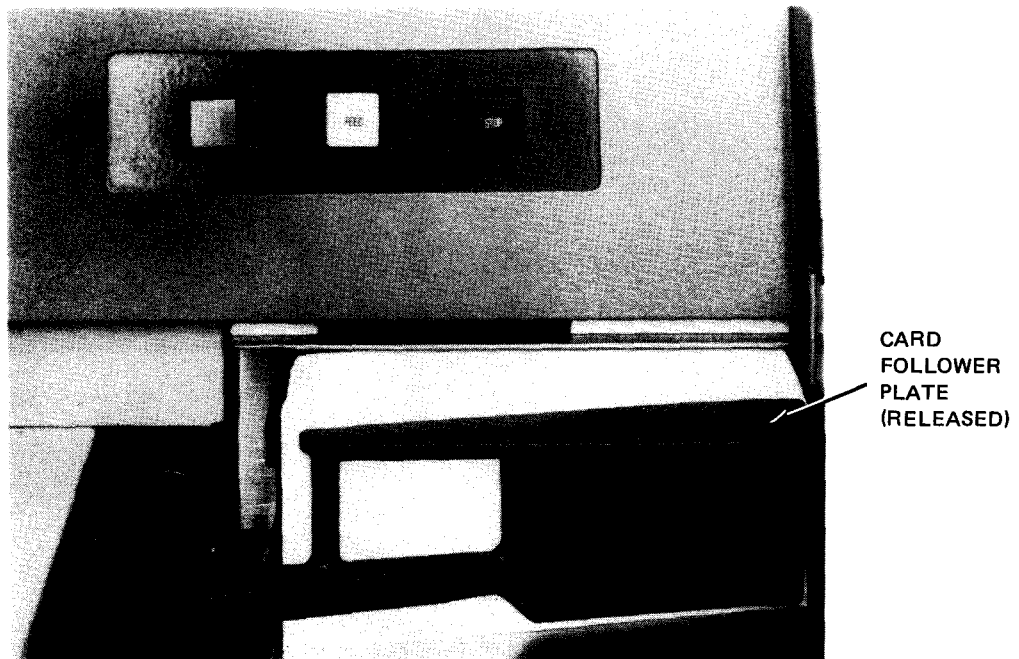

d. Card follower plate in position to feed cards

Figure 6-14. Loading Cards in Hopper (Part 2 of 2)

6.3.3.3. Loading Cards in Hopper When Running

To load cards while the card reader is feeding cards into the card transport, proceed as follows:

1. Select a handful of cards to be read. Fan cards (Figure 6—14a) so that they will feed properly.
2. Place cards on feed tray so that the face of the card is toward the feeder and row 9 is down (Figure 6—13a). Joggle cards against left feed guide of hopper (Figure 6—14c).
3. Place cards against card feed follower plate (Figure 6—14d). Maintain pressure at the bottom of cards.
4. Raise the card feed follower plate (Figure 6—14c), draw it backward and lower it, so that it will press against the newly loaded supply of cards.

6.3.3.4. Unloading Cards From Stacker

Cards may be removed from the card reader while the reader is stopped or while cards are feeding. To remove cards from stacker, proceed as follows:

1. While maintaining a slight pressure on card backs, retract stacker holding plate and grasp a quantity of cards nearest to holding plate (Figure 6—15).
2. Allow stacker holding plate to release against remaining cards.
3. Repeat steps 1 and 2 until all cards are removed from stacker.

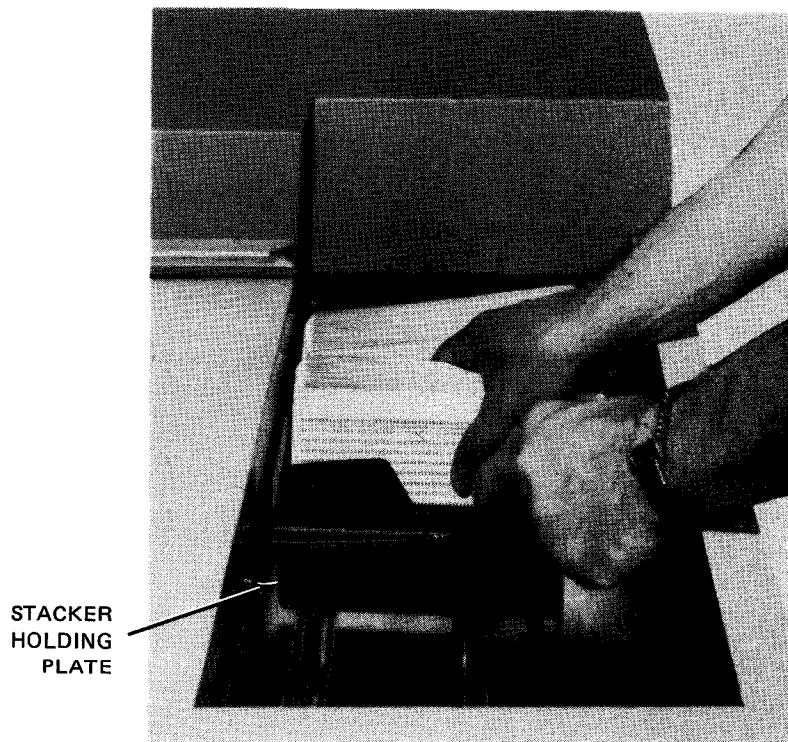

Figure 6—15. Removing Cards From Stacker

6.3.3.5. Clearing Card Jams

Card jams may occur at the card timing diverter gate, which cause the card reader to stop operation until the jam is cleared. After the jam is cleared, operation is resumed as directed in Table 6—5 for **FEED CHECK** fault.

NOTE:

Before performing the following procedure, remove the card reader from the system's list of available resources by using the DOWN function of the SET IO command (Section 12). After the procedure is completed, restore the card reader's available status by using the UP function of the SET IO command.

Proceed as follows to clear a card jam in the card transport panel.

1. If the card reader is not in stop mode, press **STOP** switch/indicator, then set **AC POWER** circuit breaker to **OFF** (down). (If in stop mode, do not press **STOP** switch/indicator.)
2. Raise card transport mechanism cover (Figure 6—16a) for access to the card transport panel.
3. Locate jammed card (Figure 6—16b).
4. Release timing diverter gate lock (Figure 6—16b) by raising knurled locking pin on gate.
5. Swing diverter gate away from jammed card (Figure 6—16c) and lift card away from card transport mechanism.
6. Rotate manual feed control (Figure 6—16c) to direct next card to proper path.
7. Close diverter gate and lock in proper operating position by allowing lock tip to enter the hole on the transport panel (Figure 6—16d).

CAUTION

Be sure that diverter gate is returned to proper operating position before resuming operation or damage may result to card transport mechanism.

8. Set **AC POWER** circuit breaker to **ON** (up) position. Follow steps 2 through 4 of recovery procedures as directed under **FEED CHECK** in Table 6—5.

NOTE:

If cards continue to jam, or are not fed past the feed drum (Figure 6—16e) because the vacuum pump is inoperative, contact Sperry Univac customer engineer.

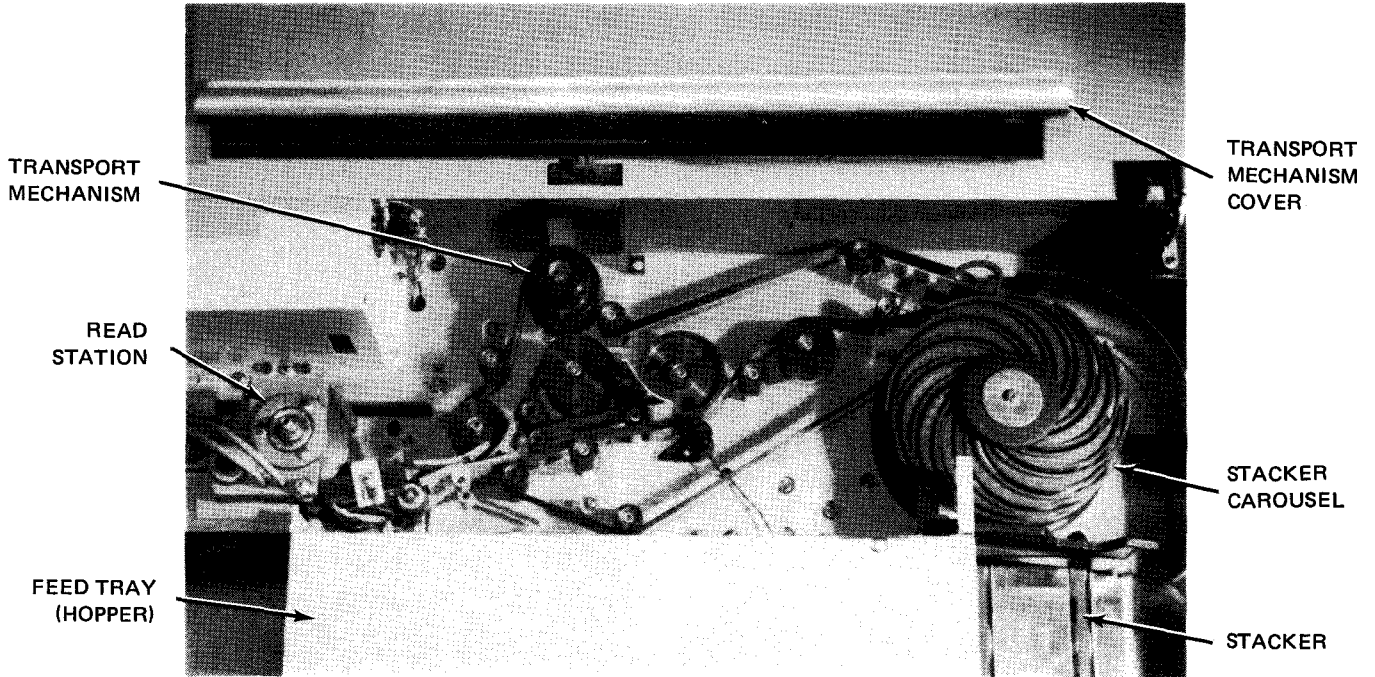

a. Top cover raised to show card transport panel

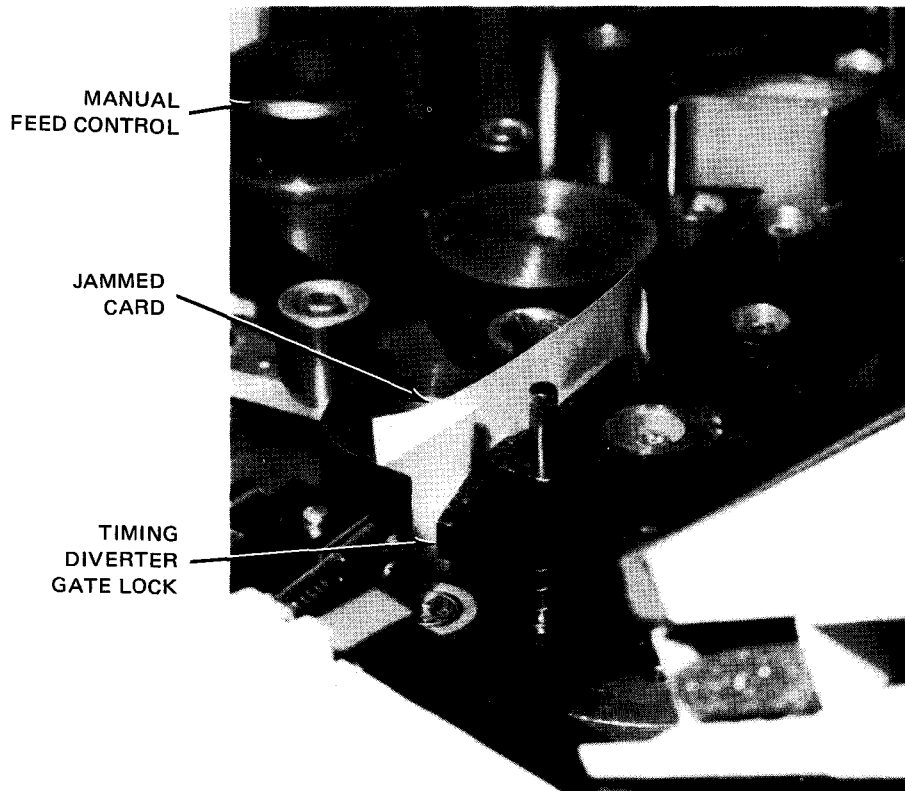

b. Card jammed at card timing diverter gate

Figure 6-16. Clearing Card Jam (Part 1 of 3)

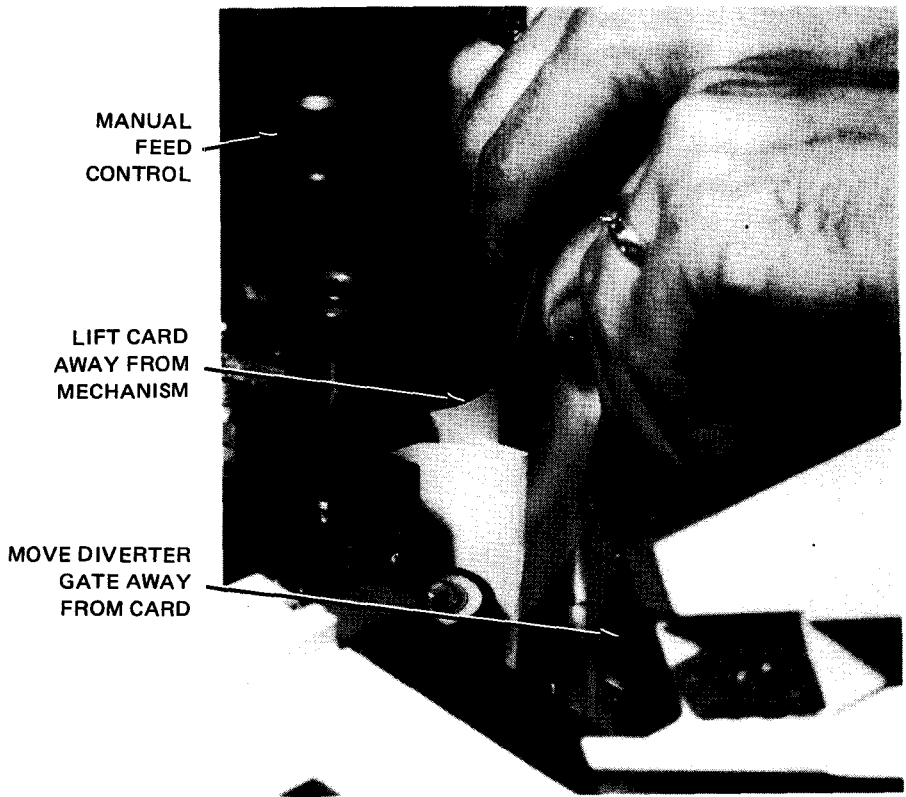

c. Removing jammed card from transport mechanism

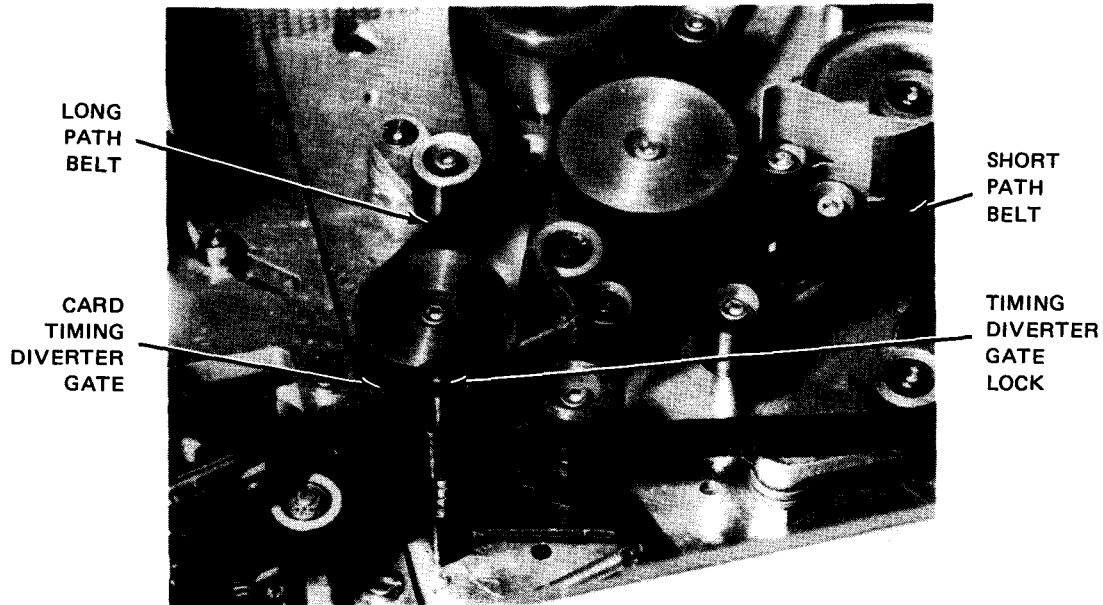

d. Timing diverter on card transport path

Figure 6-16. Clearing Card Jam (Part 2 of 3)

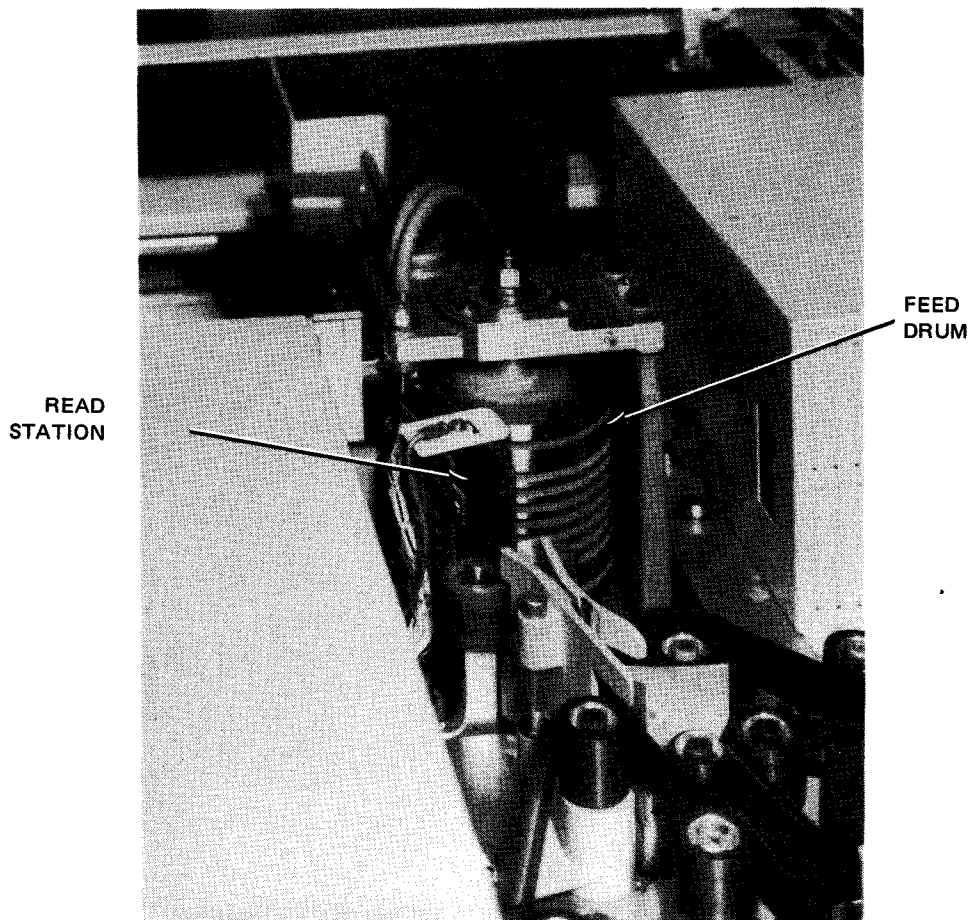

e. Feed drum location on transport mechanism

Figure 6-16. Clearing Card Jam (Part 3 of 3)

6.3.3.6. Cleaning Vacuum Filters

Two vacuum pump filters must be cleaned once per month (approximately), depending on environmental conditions. Proceed as follows to clean the vacuum pump filters:

NOTE:

Before performing the following procedure, remove the card reader from the system's list of available resources by using the DOWN function of the SET IO command (Section 12). After the procedure is completed, restore the card reader's available status by using the UP function of the SET IO command.

1. Press the **STOP** switch/indicator on the operator control panel, and note that the switch/indicator lights. Set **AC POWER** circuit breaker to **OFF** (down) position.
2. Lift the front cabinet door off.
3. Remove each filter cover (Figure 6-17) from the unit by turning the cover counterclockwise.
4. Empty the filter cover into a suitable container by gently tapping the cover to remove all dirt.

5. Reinstall each filter cover by turning it clockwise on its mounting holder.
6. Replace the front cabinet door and secure it firmly to engage the interlock, then set **AC POWER** circuit breaker to **ON** (up) position.

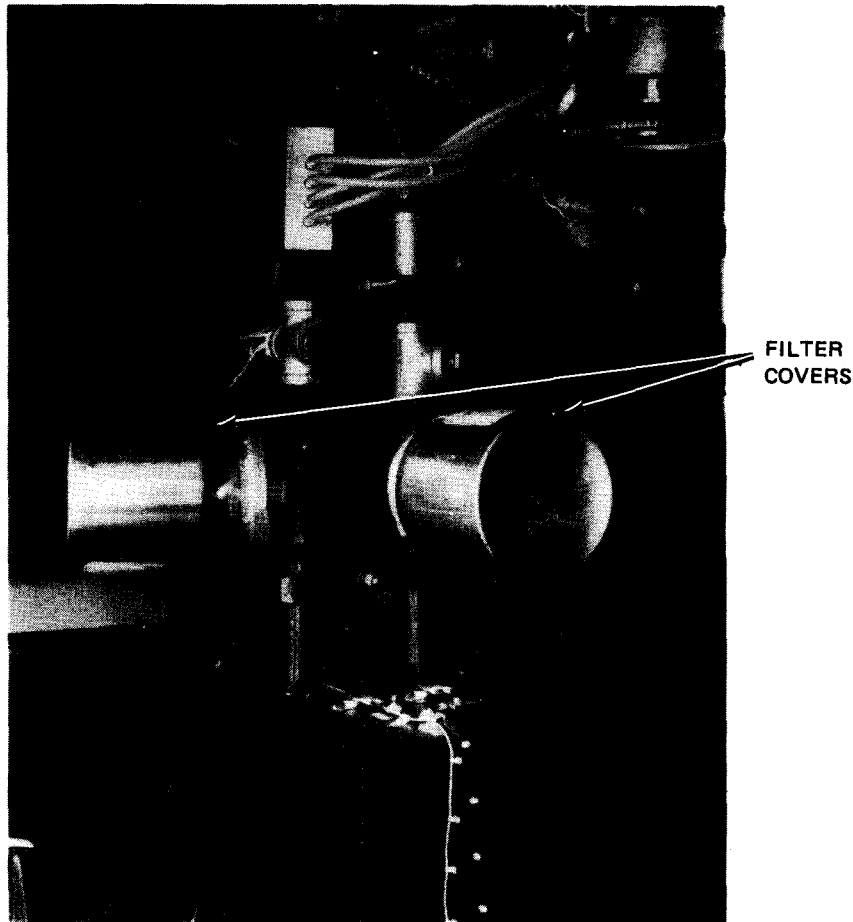

Figure 6-17. Vacuum Pump Filter Covers

6.3.4. Recovery Procedures

Table 6-5 lists the malfunctions or check indicators on the card reader indicator panel at the processor operator/maintenance panel. The card reader must be in the stop state prior to initiating recovery procedures.

Table 6-5. 0717 Card Reader Subsystem, Recovery Procedures (Part 1 of 5)

Fault Indication	Probable Cause	Operator Action
<p>HOPPER indicator is lit, and read operation is completed.</p> <p>NOTE:</p> <p>If FEED CHECK indicator is also lit, see recovery procedure for that indicator.</p>	<p>Hopper is empty, card failed to feed, or vacuum pump filter requires cleaning.</p>	<ol style="list-style-type: none"> 1. Check card path for: <ol style="list-style-type: none"> a. empty hopper; b. questionable type cards; and c. card jam in card path (see recovery procedure for FEED CHECK indicator). Take corrective action. 2. Load cards. HOPPER indicator extinguishes. 3. Press RUN switch/indicator. RUN switch/indicator lights and STOP switch/indicator extinguishes. 4. Check vacuum pump filters (6.3.3.6). 5. If error persists, call Sperry Univac customer engineer.
<p>TRANSFER CHECK indicator is lit; the error card could be in the card path, or it could be the last card in the stacker.</p>	<p>Transfer error occurred; card was fed when no command was issued.</p>	<ol style="list-style-type: none"> 1. Open top cover (DEVICE CHECK indicator lights) and check card path for cards. If cards are present, remove them and place the last card in the hopper as the next card to be read. 2. If no cards are found in the card path, error card is last card in stacker. Remove last card from stacker and place it in the hopper as next card to be read. 3. Press RUN switch/indicator. RUN switch/indicator lights, and STOP switch/indicator and TRANSFER CHECK indicator extinguishes. 4. If error persists, call Sperry Univac customer engineer.
<p>Transport mechanism stops automatically, and no error/fault indicators are lit.</p>	<p>Stacker is full.</p>	<ol style="list-style-type: none"> 1. Unload stacker. 2. Press RUN switch/indicator. RUN switch/indicator lights and STOP switch/indicator extinguishes.
<p>DEVICE CHECK indicator is lit, and card reader is operating.</p>	<p>High temperature early warning</p> <p>NOTE:</p> <p>The audible alarm on the processor sounds when high temperature early warning is sensed.</p>	<ol style="list-style-type: none"> 1. Press STOP switch/indicator and allow card reader to cool until DEVICE CHECK indicator goes off. High temperature early warning does not cause unit to enter stop state. 2. Press RUN switch/indicator. RUN switch/indicator lights and STOP switch/indicator extinguishes.
<p>DEVICE CHECK indicator lights, and card reader stops.</p>	<p>Interlock on panel or door is open.</p>	<ol style="list-style-type: none"> 1. Check all panels and doors to ensure that all interlocks are engaged.

Table 6-5. 0717 Card Reader Subsystem, Recovery Procedures (Part 2 of 5)

Fault Indication	Probable Cause	Operator Action
DEVICE CHECK (cont)		<ol style="list-style-type: none"> 2. Press RUN switch/indicator. RUN indicator lights, and STOP switch/indicator and DEVICE CHECK indicator extinguish. 3. Restart program and reload cards.
	Power loss	<ol style="list-style-type: none"> 1. Ensure AC POWER circuit breaker on power panel is in ON position. 2. If DEVICE CHECK indicator lit while unit was reading cards, proceed as follows: <ol style="list-style-type: none"> a. Raise top cover. If card path has one or more cards, remove cards in sequence and place card that was nearest to hopper ahead of the card(s) in hopper. Place other cards (if any) behind card(s) in stacker. Proceed with step 3. b. If no cards are in card path, remove last card in stacker and place it as the front card in hopper. Proceed with step 3. 3. Close top cover. DEVICE CHECK indicator extinguishes. 4. Press RUN switch/indicator. RUN switch/indicator lights and STOP switch/indicator extinguishes. 5. Restart program and reload cards.
	Lamp or motor overheat condition	<ol style="list-style-type: none"> 1. Remove any obstructions blocking air flow through grilles. 2. Open cover and doors and remove any obstructions blocking cooling fans. 3. Clean vacuum pump filters (6.3.3.6). 4. If overheating in card reader is suspected, allow card reader to cool with all doors and panels open. When card reader has cooled, DEVICE CHECK indicator extinguishes. 5. Proceed with steps 2 through 4 in block above (power loss). <div style="text-align: center; border: 1px solid black; padding: 5px; width: fit-content; margin: 10px auto;"> CAUTION </div> <p>If a power loss recurs, or DEVICE CHECK indicator lights again, notify Sperry Univac customer engineer.</p>

Table 6-5. 0717 Card Reader Subsystem, Recovery Procedures (Part 3 of 5)

Fault Indication	Probable Cause	Operator Action
<p>FEED CHECK and READ CHECK indicators light after repeated attempts to feed a card.</p>	<p>Card is jammed in card path or in stacker.</p>	<ol style="list-style-type: none"> 1. Open top cover on cabinet (DEVICE CHECK indicator lights) and remove jammed card from card timing diverter gate. 2. Under all of the following conditions, remove cards from hopper and stacker. <ol style="list-style-type: none"> a. If two or more cards are in card path, remove cards and retain sequence. The card nearest the hopper has not been read and must be placed ahead of the cards removed from hopper (reproduce card, if necessary). Return cards to hopper. <p>Place other cards that were removed from card path behind card deck that was removed from stacker and store cards. Proceed with step 3.</p> b. If only one card is in card path, remove and if necessary, reproduce it. Place the card ahead of those removed from hopper. Store cards from stacker and proceed with step 3. c. If no cards are in card path, take last card from card deck that was removed from stacker and place it ahead of cards removed from hopper. Return cards to hopper; store stacker cards. d. If HOPPER indicator is lit, load cards and store stacker cards. 3. Close top cover. DEVICE CHECK indicator extinguishes. 4. Press RUN switch/indicator. RUN switch/indicator lights and FEED CHECK indicator and STOP switch/indicator extinguish.
<p>READ CHECK indicator lights.</p> <p>NOTE:</p> <p>If FEED CHECK indicator is also lit, see recovery procedure for that indicator. If VALIDITY CHECK indicator is also lit, disregard it.</p>	<p>Read error caused by:</p> <ul style="list-style-type: none"> ■ Data overrun (data sent to processor incorrectly) ■ Read head failure ■ Improper registration of cards with read heads 	<ol style="list-style-type: none"> 1. Open top cover; DEVICE CHECK indicator lights. 2. Check card path for one of the following conditions: <ol style="list-style-type: none"> a. If more than one card is in card path, the card nearest the hopper is the error card. Remove or mark erroneous card for programmer's reference. Place remaining card(s) in correct sequence in stacker. Proceed with step 3. b. If only one card is in card path, this card is the error card. Remove or mark the erroneous card for programmer's reference and proceed with step 3.

Table 6-5. 0717 Card Reader Subsystem, Recovery Procedures (Part 4 of 5)

Fault Indication	Probable Cause	Operator Action
<p>READ CHECK (cont)</p>		<p>c. If no cards are in card path, remove cards from stacker and store cards, with the exception of the last card; the last card is the card on which the error occurred.</p> <ol style="list-style-type: none"> 3. Remove cards from hopper. 4. Place error card in front of the cards removed from hopper. 5. Return cards to hopper. 6. Close top cover; DEVICE CHECK indicator extinguishes. 7. Press RUN switch/indicator; RUN switch/indicator lights, and READ CHECK indicator and STOP switch/indicator extinguish. 8. If error persists, call Sperry Univac customer engineer. <p>NOTE:</p> <p>If entry to this recovery procedure is via a message on the processor console, press STOP switch/indicator. When STOP indicator extinguishes, proceed with step 2c.</p>
<p>VALIDITY CHECK indicator lights</p> <p>NOTE:</p> <p>If a READ CHECK or FEED CHECK indicator is also lit, disregard VALIDITY CHECK indicator and see recovery procedure for FEED CHECK indicator.</p>	<p>Validity error is caused by detection of multiple punches in rows 1 through 7 of one or more columns.</p>	<ol style="list-style-type: none"> 1. Open top cover; DEVICE CHECK indicator lights. 2. Check card path for one of the following conditions: <ol style="list-style-type: none"> a. If more than one card is in card path, the card nearest the hopper is the error card. Remove or mark erroneous card for programmer's reference. Place remaining card(s) in correct sequence in stacker. Proceed with step 3. b. If only one card is in card path, this card is the error card. Remove or mark the erroneous card for programmer's reference and proceed with step 3. c. If no cards are in card path, remove cards from stacker and store all cards except the last card; the last card is the card on which the error occurred. 3. Check error card for invalid punches as follows: <ol style="list-style-type: none"> a. Determine columns with invalid punches and make corrections. Proceed with step 4.

Table 6-5. 0717 Card Reader Subsystem, Recovery Procedures (Part 5 of 5)

Fault Indication	Probable Cause	Operator Action
<p>VALIDITY CHECK (cont)</p>		<ul style="list-style-type: none"> b. If the card is not to be corrected and removed from input data, mark card and note its position in card deck and proceed with step 7. c. If no invalid punches are found, proceed with step 4. 4. Remove cards from hopper. 5. Place error card in front of the cards removed from hopper. 6. Return cards to hopper. 7. Close top cover; DEVICE CHECK indicator extinguishes. 8. Press RUN switch/indicator. RUN switch/indicator lights, and VALIDITY CHECK indicator and STOP switch/indicator extinguish. 9. If error persists, call Sperry Univac customer engineer.

This page left blank intentionally.

6.4. 0719 CARD READER SUBSYSTEM

The 0719 card reader subsystem (Figure 6—18) is a freestanding, table-top device designed for integration into the 90/30 B system. Although this subsystem is freestanding by fact that it can be physically removed from the 90/30 B system, electronically it is considered an integral part of the 90/30 B system. The logical control section and the power supplies for the subsystem are located within the cabinet of the 90/30 B processor. An operator control panel located at the top of the subsystem contains the controls used during normal operation of the card reader. Indicators for the subsystem are located on the card reader indicator panel on the processor/operator maintenance panel.

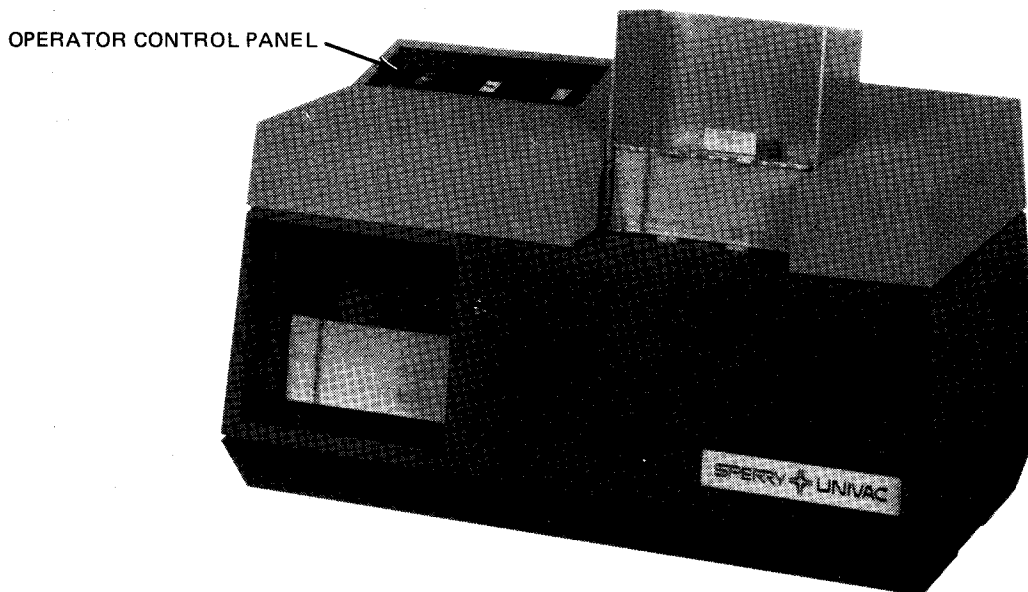

Figure 6—18. 0719 Card Reader Subsystem

6.4.1. Operating Controls and Indicators

The operating controls used by the operator during normal operation of the 0719 card reader subsystem are located on an operator control panel. This panel (Figure 6—19) is located at the top left corner of the subsystem. Indicators providing a visual display to alert the operator of specific check conditions that occur at the card reader are located on the card reader indicator panel (Figure 6—20) of the processor operator/maintenance panel. The indicators are visible only when lit.

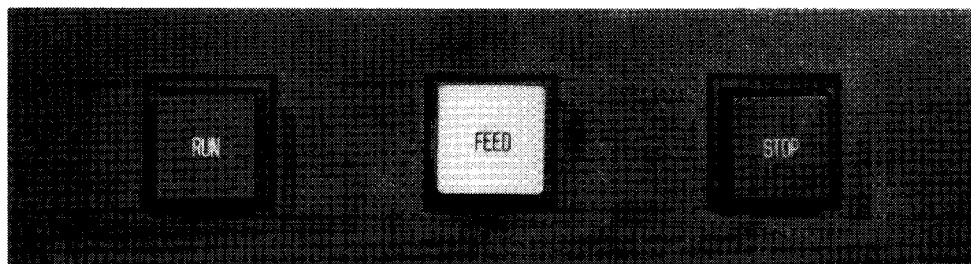

Figure 6—19. 0719 Card Reader, Operator Control Panel

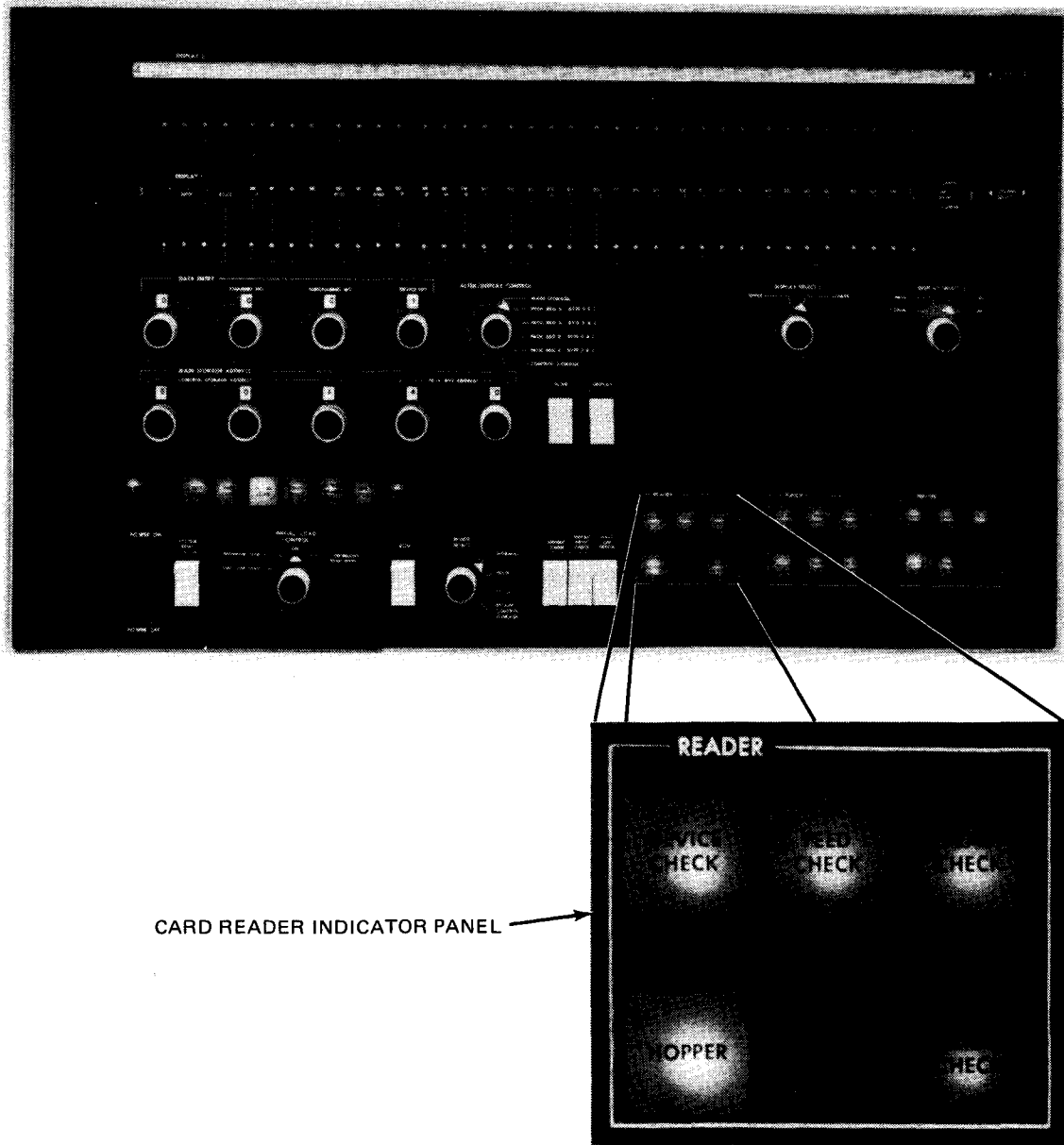
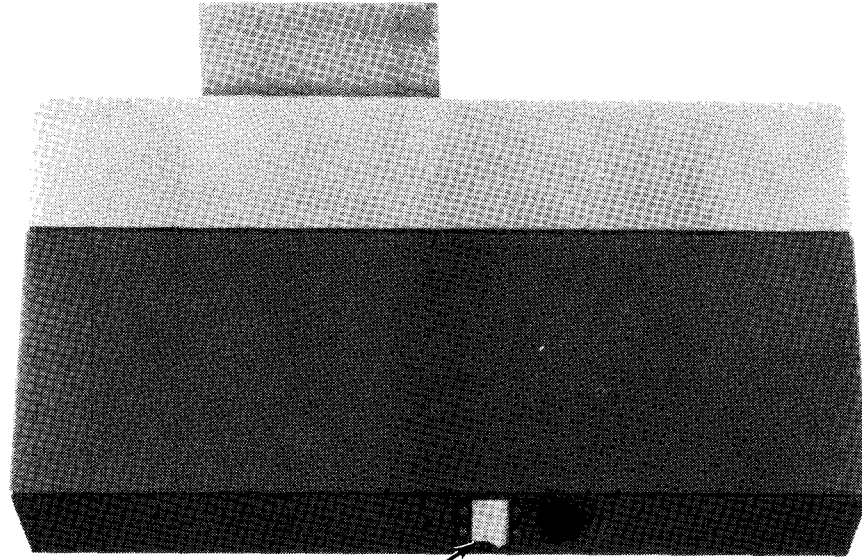

Figure 6—20. 0719 Card Reader, Indicator Panel Located on Processor Operator/Maintenance Panel

In addition to the controls on the operator panel, the card reader has an interlock switch and an input power circuit breaker that can affect normal operation.

The cover interlock switch is located under the top cover and directly behind the input hopper. It prevents reader operation if the top is raised or not closed properly.

A power circuit breaker located at the lower rear portion of the card reader cabinet (Figure 6—21) protects the power circuits of the subsystem. This circuit breaker is normally left in the on position because power to the card reader is controlled remotely from the operator/maintenance panel of the processor. The circuit breaker can be used, however, as a master power turn-off switch if it is necessary to remove input power to the card reader subsystem.



POWER CIRCUIT BREAKER

Figure 6—21. 0719 Card Reader, Power Circuit Breaker

All controls and indicators for the card reader are listed and described in Table 6—6.

Table 6-6. 0719 Card Reader Subsystem, Controls and Indicators (Part 1 of 3)

Control/Indicator — Function
Operator Control Panel
RUN switch/indicator When pressed: <ul style="list-style-type: none">■ lights RUN switch/indicator;■ extinguishes STOP indicator; and■ places card reader in run state (online). Upon release of RUN switch/indicator, all error conditions are cleared, provided corrective action has been taken. An error condition or pressing STOP switch/indicator causes RUN switch/indicator to extinguish.
FEED switch Checks the card feed path when a misfeed or card jam occurs. Switch operates only in the stop state (STOP switch/indicator lit) and is disabled when RUN switch/indicator is lit. Momentarily pressing FEED switch feeds one card through card transport mechanism and into output stacker; holding switch down feeds cards continuously, and no data is processed. A preclear is generated when this switch is initially pressed.
STOP switch/indicator When pressed: <ul style="list-style-type: none">■ lights STOP switch/indicator;■ extinguishes RUN switch/indicator;■ stops motors in card transport mechanism; and■ places card reader in stop state (offline). Pressing and holding STOP switch/indicator lights RUN and STOP indicators for a lamp test. An error condition places card reader in stop state and lights indicator. Pressing RUN switch/indicator or clearing an error condition extinguishes STOP switch/indicator. The STOP switch/indicator is lit with one or more of the following: <ul style="list-style-type: none">■ HOPPER indicator is lit.■ VALIDITY CHECK indicator is lit.■ FEED CHECK indicator is lit.■ READ CHECK indicator is lit.■ DEVICE CHECK indicator is lit.■ Stacker is full (no other indicator lights for this condition).

Table 6-6. 0719 Card Reader Subsystem, Controls and Indicators (Part 2 of 3)

Control/Indicator — Function
<p style="text-align: center;">Indicator Panel (on Operator/Maintenance Panel)</p>
<p>DEVICE CHECK indicator</p> <p>Lights when:</p> <ul style="list-style-type: none">▪ a cover with an interlock is open; or▪ high temperature presents an early warning indication. <p>An open interlock or overheating condition causing indicator to light also causes:</p> <ul style="list-style-type: none">▪ card reader to stop;▪ motors to stop immediately;▪ RUN switch/indicator to extinguish; and▪ STOP switch/indicator to light. <p>High temperature early warning indication does not cause card reader to enter stop state. When this condition occurs, allow card reader to cool until DEVICE CHECK indicator goes off. System power drops if overheating occurs following an early warning indication.</p> <p>Power loss extinguishes both RUN and STOP switch/indicators.</p>
<p>FEED CHECK indicator</p> <p>Lights when card is jammed.:</p> <ul style="list-style-type: none">▪ in transport mechanism path;▪ in read station; or▪ in stacker. <p>Condition causing indicator to light also causes:</p> <ul style="list-style-type: none">▪ card reader to stop;▪ motors to stop immediately;▪ STOP switch/indicator to light; and▪ RUN switch/indicator to extinguish.

Table 6-6. 0719 Card Reader Subsystem, Controls and Indicators (Part 3 of 3)

Control/Indicator — Function
Indicator Panel (on Operator/Maintenance Panel)
<p>READ CHECK indicator</p> <p>Lights when:</p> <ul style="list-style-type: none"> ■ a data overrun or read error is detected; ■ improper registration is detected; ■ read head becomes inoperative; or ■ card jam occurs in read station. <p>Condition causing indicator to light also causes:</p> <ul style="list-style-type: none"> ■ card reader to stop; ■ motors to stop immediately; ■ STOP switch/indicator to light; and ■ RUN switch/indicator to extinguish.
<p>HOPPER indicator</p> <p>Lights when:</p> <ul style="list-style-type: none"> ■ hopper is empty; or ■ card does not feed. <p>Condition causing indicator to light also causes:</p> <ul style="list-style-type: none"> ■ card reader to stop; ■ motors to stop immediately; ■ STOP switch/indicator to light; and ■ RUN switch/indicator to extinguish.
<p>VALIDITY CHECK indicator</p> <p>Lights if multiple punches are detected in rows 1 through 7 of one or more columns during reading in 80-column format translate mode. Condition causing indicator to light also causes:</p> <ul style="list-style-type: none"> ■ card reader to stop; ■ motors to stop immediately; ■ STOP switch/indicator to light; and ■ RUN switch/indicator to extinguish.
Card Reader Cabinet
<p>Power circuit breaker</p> <p>Provides overload protection for primary ac power circuit in card reader.</p>



6.4.2. Turn-On and Turn-Off Procedures

Power to the card reader is normally controlled from the **POWER ON/POWER OFF** switch on the processor operator/maintenance panel (Figure 2—2). However to turn power on from this switch, the power circuit breaker on the card reader (Figure 6—21) must first be set to the on position and the top cover must be closed and properly fastened. This circuit breaker remains on unless independent power turn off is desired.

When the power circuit breaker is set on and the processor **POWER ON/POWER OFF** switch is set to **POWER ON**, the **STOP** switch/indicator on the card reader should be lit and all other indicators should be extinguished.

A card jam or other error condition that causes the card reader to halt operation also causes the processor to receive an error condition and stops the processing operation. If the card reader error requires that the power circuit breaker be turned off for operator safety (e.g., clearing a card jam), power can be reapplied after the error condition is corrected by setting the power circuit breaker on without regard to power transients causing processor interference. However, if power is to be turned off without an error condition causing operations to halt, power should be turned off on the card reader independently of the processor as directed in the following procedure.

To turn power off at the card reader without disturbing processor operation, proceed as follows:

1. Press **STOP** switch/indicator to place the card reader in an offline condition.
2. Set power circuit breaker (Figure 6—21) off.
3. Use the *DOWN* function of the SET IO command (Section 12) to remove the card reader from the system's resources list and prevent it from being allocated to a job while offline.

6.4.3. Operating Procedures

Operating procedures for the card reader include loading cards, unloading cards, placing the card reader online, clearing card jams, periodic cleaning, and indicator lamp replacement.

6.4.3.1. Card Loading

Cards may be loaded into the input hopper while the card reader is operating (feeding) or stopped. The procedure for card loading is as follows:

1. Remove the card weight (Figure 6—22) from the input hopper.
2. Select a handful of cards. Fan and jog the cards for evenness and also to permit easier loading and feeding.
3. Place the cards into the input hopper, face-side down (row 9 to rear of hopper).
4. Place the card weight on top of the cards in the hopper.
5. Repeat steps 1 through 4 until all cards to be read are placed in the hopper or until the hopper is full. (Input hopper has a maximum card capacity of 1000 cards.) It is necessary to place the card weight on top of the last card that is loaded into the hopper.

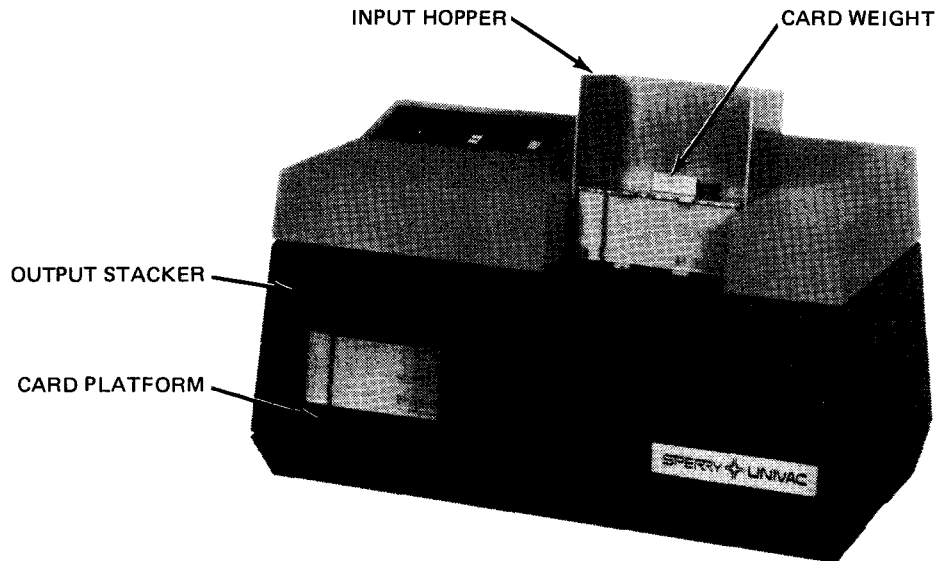

Figure 6—22. 0719 Card Reader, Input Hopper and Output Stacker

6.4.3.2. Card Unloading

Cards may be removed from the card reader anytime during operation or when stopped. To remove cards from either the output stacker or the input hopper, proceed as follows.

- Output stacker
 1. While maintaining slight pressure on card backs, hold spring-loaded card platform (Figure 6—22) down.
 2. Grasp a quantity of cards and lift them from the output stacker.
 3. Allow card platform to release against remaining cards.
 4. Repeat steps 1 through 3 until all cards are removed from output stacker.
- Input hopper
 1. Remove the card weight (Figure 6—22) from the top of the cards in the input hopper.
 2. Remove the cards by lifting them up and out of the input hopper.
 3. Replace the card weight into the input hopper.

6.4.3.3. Placing Card Reader Online

After the card reader is turned on (6.4.2) and the cards are loaded into the input hopper, press and release the **RUN** switch/indicator on the operator panel to place the card reader online. The card reader is now ready to start reading cards by command from the processor.

6.4.3.4. Clearing Card Jams

A card jammed in the transport mechanism causes the card reader to stop operation until the jam is cleared. After the jam is cleared, operation is resumed as directed in Table 6—5 for FEED CHECK fault.

NOTE:

Before performing the following procedure, remove the card reader from the system's list of available resources by using the DOWN function of the SET IO command (Section 12). After the procedure is completed, restore the card reader's available status by using the UP function of the SET IO command.

Proceed as follows to clear a card jam in the card transport panel.

1. If the card reader is not in stop mode, press **STOP** switch/indicator, then set power circuit breaker to off. (If in stop mode, do not press **STOP** switch/indicator.)
2. Raise card reader top cover (Figure 6—23) for access to the card transport mechanism.
3. Locate jammed card.
4. Remove card from transport mechanism by raising hinged read station (Figure 6—23) and gently turning transport rollers to free jammed card.
5. Return hinged read station to its normal operating position.
6. Set power circuit breaker on.
7. Follow steps 2 through 4 of recovery procedure as directed under **FEED CHECK** in Table 6—7.

NOTE:

If cards continue to jam or not feed properly, contact Sperry Univac customer engineer.

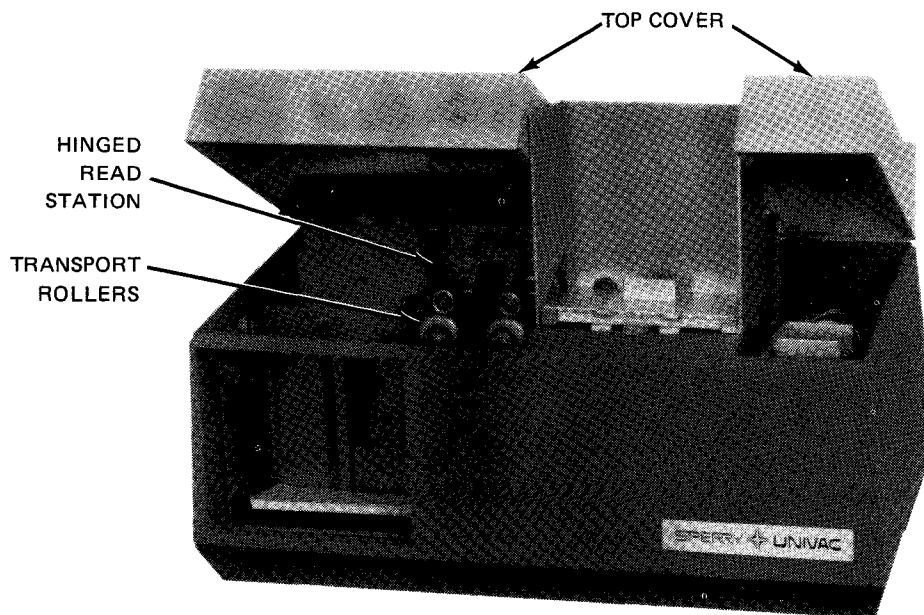

Figure 6—23. 0719 Card Reader, Read Station and Transport Mechanism



6.4.3.5. Cleaning

The card reader must be cleaned periodically. Failure to do so can result in faulty operation.

To clean the card reader, proceed as follows:

NOTE:

Before performing the following procedure, remove the card reader from the system's list of available resources by using the DOWN function of the SET IO command (Section 12). After the procedure is completed, restore the card reader's available status by using the UP function of the SET IO command.

1. Press and release the **STOP** switch/indicator on the operator control panel; note that the **STOP** switch/indicator lights and the **RUN** switch/indicator extinguishes.
2. Set power circuit breaker off.
3. Remove all cards from both input hopper and output stacker.
4. Raise card reader top cover.
5. Remove all paper, dust, and debris from the transport mechanism, input hopper, and output stacker using a soft brush and vacuum cleaner. Wipe hopper and stacker with clean dry cloth.
6. Inspect the picker knives and the pinch-and-scrub rollers for cleanliness.
7. Close top cover and turn on card reader as specified in the turn-on procedures (6.4.2).

6.4.3.6. Indicator Lamp Replacement

Defective indicator lamps in the operator control panel are replaced by the operator. The **RUN**, **FEED**, and **STOP** switch/indicators are the only indicators containing replaceable lamps. To replace a defective lamp in the switch/indicators, proceed as follows:

NOTE:

Before performing the following procedure, remove the card reader from the system's list of available resources by using the DOWN function of the SET IO command (Section 12). After the procedure is completed, restore the card reader's available status by using the UP function of the SET IO command.

1. Grasp switch lens and pull forward to remove.
2. Using a piece of 1/8-inch or 4-mm rubber tubing, slide tubing over bulb, push down, turn counterclockwise, and remove bulb.
3. Place new lamp into tubing with lamp base protruding from tubing.
4. Place lamp base into lamp socket using tubing, press in, and turn clockwise. Remove tubing from lamp.
5. Replace switch lens by pressing lens into place.



6.4.4. Recovery Procedures

Table 6—7 lists the malfunctions or check indicators on the card reader indicator panel at the processor operator/maintenance panel. The card reader must be in the stop state prior to initiating recovery procedures.

Table 6—7. 0719 Card Reader Subsystem, Recovery Procedures (Part 1 of 5)

Fault Indication	Probable Cause	Operation Action
<p>HOPPER indicator lit; card feeding stopped</p> <p>NOTE:</p> <p>If FEED CHECK indicator is also lit, see recovery procedure for that indicator.</p>	<p>Input hopper empty, card failed to feed, or output stacker full</p>	<ol style="list-style-type: none"> 1. Check card path for: <ol style="list-style-type: none"> a. empty input hopper b. full output stacker c. questionable card type d. card jam <p>If input hopper is empty card reading is complete, proceed to step 2.</p> <p>If output stacker is full and cards remain in input hopper, card read operation is not complete. Remove cards from stacker as specified in 6.4.3.2. Proceed to step 3.</p> <p>If card jam occurred, see recovery procedure for FEED CHECK indicator.</p> <ol style="list-style-type: none"> 2. Load cards as specified in 6.4.3.1. HOPPER indicator extinguishes. 3. Press RUN switch/indicator. RUN switch/indicator lights and STOP switch/indicator extinguishes. 4. If error persists, call Sperry Univac customer engineer.
<p>Transport mechanism stops automatically, and no error—fault indicators are lit.</p>	<p>Output stacker full.</p>	<ol style="list-style-type: none"> 1. Unload output stacker as specified in 6.4.3.2. 2. Press RUN switch/indicator. RUN switch/indicator lights and STOP switch/indicator extinguishes.
<p>DEVICE CHECK indicator is lit and card reader is operating.</p>	<p>High temperature early warning</p> <p>NOTE:</p> <p>The audible alarm on the processor sounds when high temperature early warning is sensed.</p>	<ol style="list-style-type: none"> 1. Press STOP switch/indicator and allow card reader to cool until DEVICE CHECK indicator goes off. High temperature early warning does not cause unit to enter stop state. 2. Press RUN switch/indicator. RUN switch/indicator lights and STOP switch/indicator extinguishes.

Table 6-7. 0719 Card Reader Subsystem, Recovery Procedures (Part 2 of 5)

Fault Indication	Probable Cause	Operator Action
<p>DEVICE CHECK indicator lights and card reader stops.</p>	<p>Interlock for top cover is open.</p>	<ol style="list-style-type: none"> 1. Check card reader top cover to ensure it is closed properly. If indicator remains lit, examine casework for proper fastening; check interlock switch to ensure switch plunger is in center position. 2. Press RUN switch/indicator. RUN indicator lights, and STOP switch/indicator and DEVICE CHECK indicator extinguish. 3. Restart program and reload cards.
	<p>Power loss</p>	<ol style="list-style-type: none"> 1. Ensure power circuit breaker on card reader is in on position. 2. If DEVICE CHECK indicator lit while unit was reading cards, proceed as follows: <ol style="list-style-type: none"> a. Raise top cover. If card path has one or more cards, remove cards in sequence and place card that was nearest to hopper ahead of the card(s) in hopper. Place other cards (if any) behind card(s) in stacker. Proceed with step 3. b. If no cards are in card path, remove last card in stacker and place it as the front card in hopper. Proceed with step 3. 3. Close top cover. DEVICE CHECK indicator extinguishes. 4. Press RUN switch/indicator. RUN switch/indicator lights and STOP switch/indicator extinguishes. 5. Restart program and reload cards.
	<p>Lamp or motor overheat condition</p>	<ol style="list-style-type: none"> 1. Remove any obstructions blocking air flow through grills. 2. Open top cover and remove any obstructions blocking cooling fan. 3. If overheating in card reader is suspected, allow card reader to cool with top cover open. When card reader has cooled, DEVICE CHECK indicator extinguishes. 4. Proceed with steps 2 through 4 in operator action for power loss. <div style="border: 1px solid black; padding: 5px; text-align: center; margin: 10px auto; width: fit-content;"> <p>CAUTION</p> </div> <p>If a power loss recurs, or DEVICE CHECK indicator lights again, notify Sperry Univac customer engineer.</p>

Table 6-7. 0719 Card Reader Subsystem, Recovery Procedures (Part 3 of 5)

Fault Indication	Probable Cause	Operator Action
<p>FEED CHECK and READ CHECK indicators light after repeated attempts to feed a card.</p>	<p>Card is jammed.</p>	<ol style="list-style-type: none"> 1. Open top cover (DEVICE CHECK indicator lights) and remove jammed card from card transport mechanism (6.4.3.4). 2. Under all of the following conditions, remove cards from hopper and stacker. <ol style="list-style-type: none"> a. If two or more cards are in card path, remove cards and retain sequence. The card nearest the hopper has not been read and must be placed ahead of the cards removed from hopper (reproduce card, if necessary). Return cards to hopper. <p>Place other cards that were removed from card path behind card deck that was removed from stacker and store cards. Proceed with step 3.</p> b. If only one card is in card path, remove and, if necessary, reproduce it. Place the card ahead of those removed from hopper. Store cards from stacker and proceed with step 3. c. If no cards are in card path, take last card from card deck that was removed from stacker and place it ahead of cards removed from hopper. Return cards to hopper; store stacker cards. d. If HOPPER indicator is lit, load cards and store stacker cards. 3. Close top cover. DEVICE CHECK indicator extinguishes. 4. Press RUN switch/indicator. RUN switch/indicator lights and FEED CHECK indicator and STOP switch/indicator extinguish.
<p>READ CHECK indicator lights.</p> <p>NOTE:</p> <p>If FEED CHECK indicator is also lit, see recovery procedure for that indicator. If VALIDITY CHECK indicator is also lit, disregard it.</p>	<p>Read error caused by:</p> <ul style="list-style-type: none"> ■ Data overrun (data sent to processor incorrectly) ■ Read head failure ■ Improper registration of cards with read heads 	<ol style="list-style-type: none"> 1. Open top cover; DEVICE CHECK indicator lights. 2. Check card path for one of the following conditions: <ol style="list-style-type: none"> a. If more than one card is in card path, the card nearest the hopper is the error card. Remove or mark erroneous card for programmer's reference. Place remaining card(s) in correct sequence in stacker. Proceed with step 3.

Table 6-7. 0719 Card Reader Subsystem, Recovery Procedures (Part 4 of 5)

Fault Indication	Probable Cause	Operator Action
<p>READ CHECK (cont)</p>		<p>b. If only one card is in card path, this card is the error card. Remove or mark the erroneous card for programmer's reference and proceed with step 3.</p> <p>c. If no cards are in card path, remove cards from stacker and store cards, with the exception of the last card; the last card is the card on which the error occurred.</p> <p>3. Remove cards from hopper.</p> <p>4. Place error card ahead of the cards removed from hopper.</p> <p>5. Return cards to hopper.</p> <p>6. Close top cover; DEVICE CHECK indicator extinguishes.</p> <p>7. Press RUN switch/indicator; RUN switch/indicator lights, and READ CHECK indicator and STOP switch/indicator extinguish.</p> <p>8. If error persists, call Sperry Univac customer engineer.</p> <p>NOTE:</p> <p>If entry to this recovery procedure is via a message on the processor console, press STOP switch/indicator. When STOP indicator extinguishes, proceed with step 2c.</p>
<p>VALIDITY CHECK indicator lights.</p> <p>NOTE:</p> <p>If a READ CHECK or FEED CHECK indicator is also lit, disregard VALIDITY CHECK indicator and see recovery procedure for FEED CHECK indicator.</p>	<p>Validity error is caused by detection of multiple punches in rows 1 through 7 of one or more columns.</p>	<p>1. Open top cover; DEVICE CHECK indicator lights.</p> <p>2. Check card path for one of the following conditions:</p> <p>a. If more than one card is in card path, the card nearest the hopper is the error card. Remove or mark erroneous card for programmer's reference. Place remaining card(s) in correct sequence in stacker. Proceed with step 3.</p> <p>b. If only one card is in card path, this card is the error card. Remove or mark the erroneous card for programmer's reference and proceed with step 3.</p> <p>c. If no cards are in card path, remove cards from stacker and store all cards except the last card; the last card is the card on which the error occurred.</p>

Table 6-7. 0719 Card Reader Subsystem, Recovery Procedures (Part 5 of 5)

Fault Indication	Probable Cause	Operator Action
<p>VALIDITY CHECK (cont)</p>		<ol style="list-style-type: none"> 3. Check error card for invalid punches as follows: <ol style="list-style-type: none"> a. Determine columns with invalid punches and make corrections. Proceed with step 4. b. If the card is not to be corrected and removed from input data, mark card and note its position in card deck and proceed with step 7. c. If no invalid punches are found, proceed with step 4. 4. Remove cards from hopper. 5. Place error card ahead of the cards removed from hopper. 6. Return cards to hopper. 7. Close top cover; DEVICE CHECK indicator extinguishes. 8. Press RUN switch/indicator. RUN switch/indicator lights, and VALIDITY CHECK indicator and STOP switch/indicator extinguish. 9. If error persists, call Sperry Univac customer engineer.

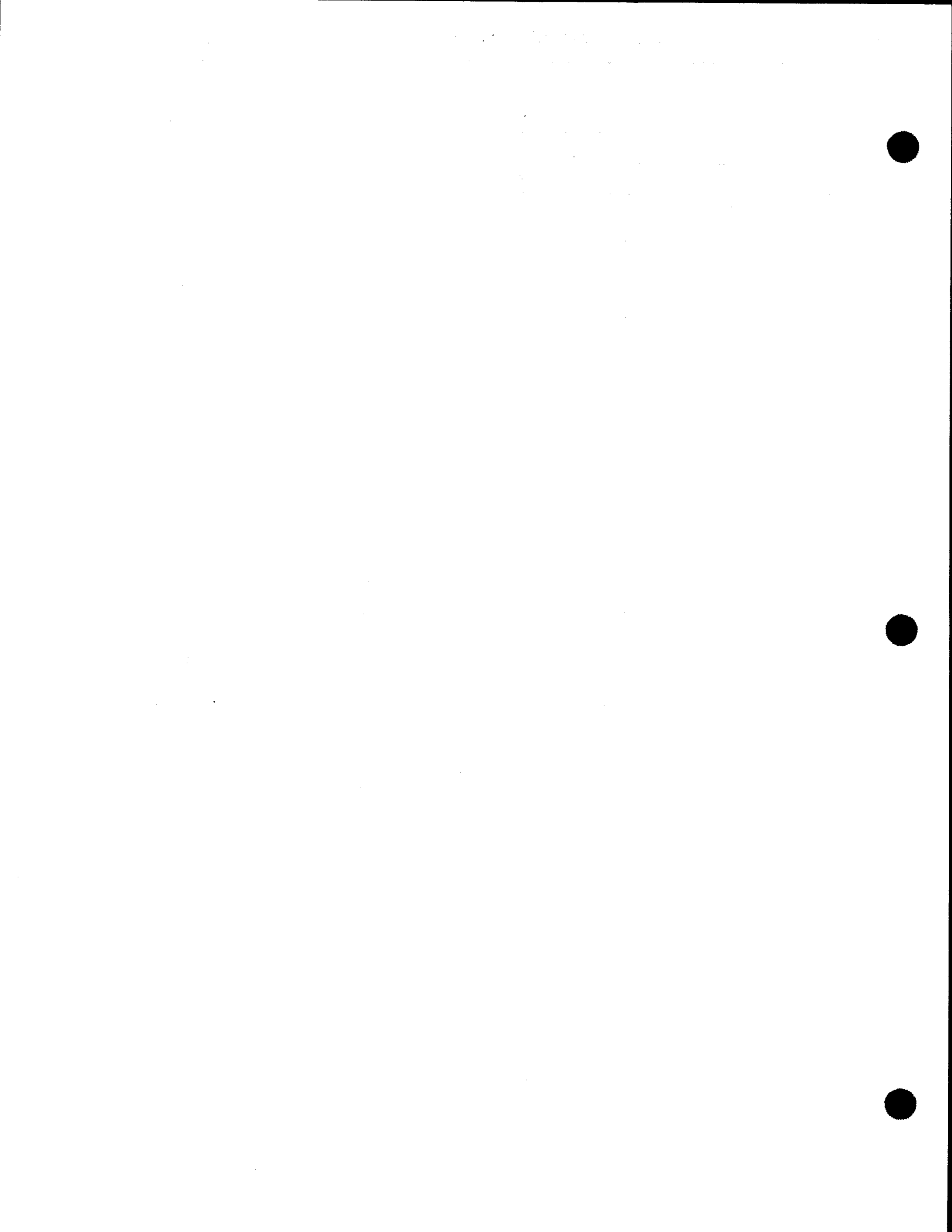

7. Card Punch Subsystems

7.1. GENERAL

Card punch subsystems available for use with the SPERRY UNIVAC 90/30 or 90/30 B Systems are:

- SPERRY UNIVAC 0604 Card Punch Subsystem
- SPERRY UNIVAC 0605 Card Punch Subsystem

The 0604 card punch subsystem is a row-type card punch that feeds and punches 80-column cards row-by-row at the rate of 250 cards per minute (cpm). Each card is checked after it is punched to ensure that it was correctly punched. Card punching is controlled by commands from the processor through the multiplexer channel. After punching and checking, the cards are directed by program control to either a normal stacker or a select stacker. The stackers are each capable of holding 1000 cards. The input hopper capacity is also 1000 cards.

The 0605 card punch subsystem is a column-type card punch that feeds and punches 80-column cards in 2-column increments at the rate of 75 cpm. If only the first 28 columns of the cards are to be punched, the feed and punch rate increases to 160 cpm. Each card is checked after being punched to ensure that it was punched correctly. An optional read station may also be included to permit read-only or read/punch operations. Functions of the card punch are controlled by an integrated punch control, located in the processor, through the integrated peripheral channel. Punched (or read) cards are supplied to either a primary stacker having a capacity of 700 cards, or to a reject stacker with a capacity of 100 cards. The input hopper capacity is 700 cards.

This page left blank intentionally.

7.2. 0604 CARD PUNCH SUBSYSTEM

The 0604 card punch subsystem is a freestanding unit (Figure 7—1) containing its own control circuits and power supply. Each card punch comprises a subsystem capable of independent operations from other card punches of the system.

7.2.1. Operating Controls and Indicators

The card punch contains an operator control panel (Figure 7—2) located on the front of the unit. The rear of the card punch (Figure 7—3) contains the power control panel (Figure 7—4) on the lower right corner. All operating controls and indicators are listed and described in Table 7—1.

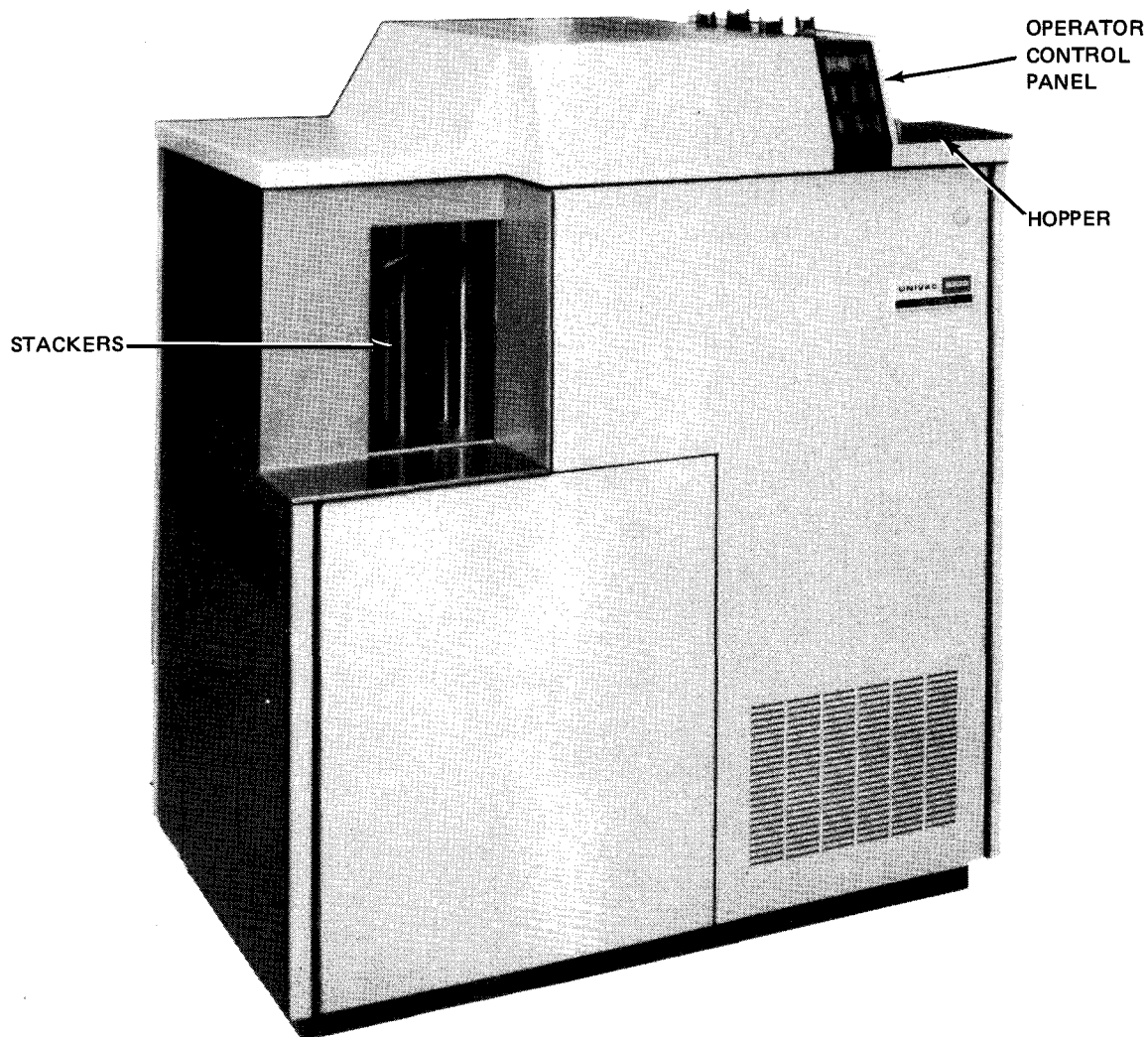

Figure 7—1. 0604 Card Punch Subsystem

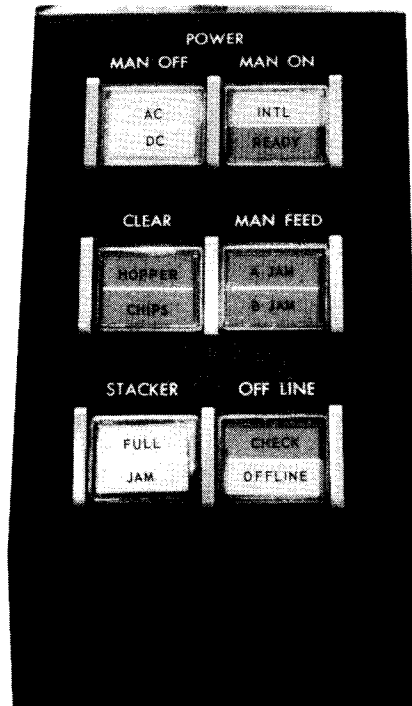

Figure 7-2. 0604 Card Punch Subsystem, Operator Control Panel

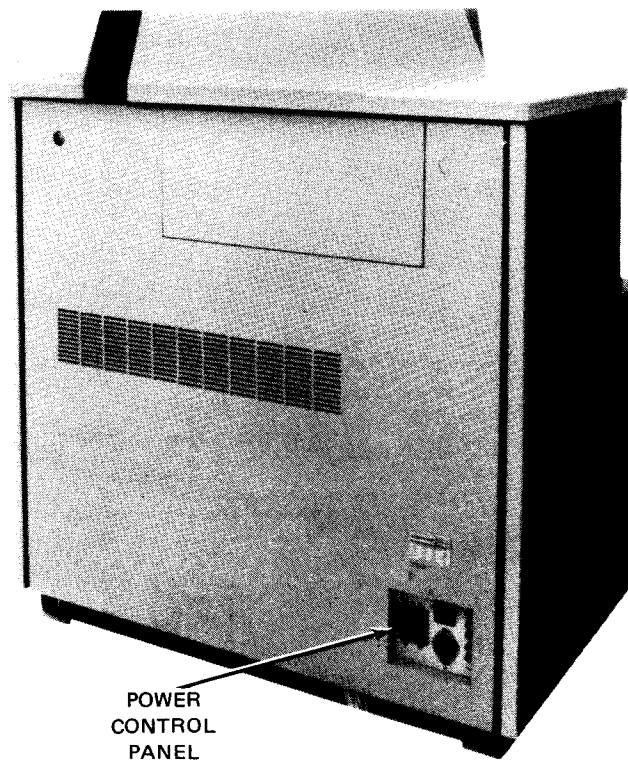

Figure 7-3. 0604 Card PUnch Subsystem, Rear View

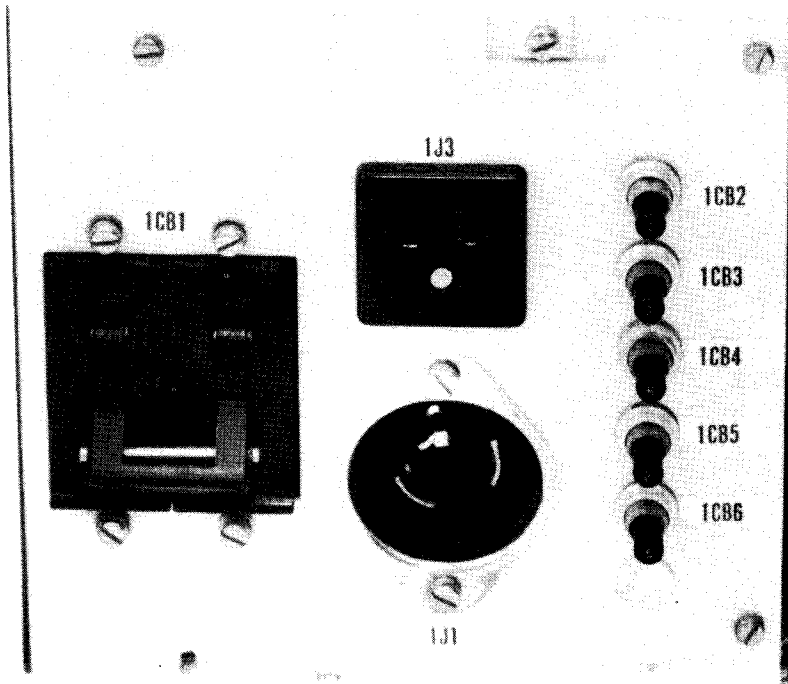

Figure 7-4. 0604 Card Punch Subsystem, Power Control Panel

Table 7-1. 0604 Card Punch Subsystem, Controls and Indicators (Part 1 of 2)

Control/Indicator — Function
Operator Control Panel
<p>POWER MAN ON INTL/READY switch/indicator</p> <p>Applies power to the punch unit</p> <p>INTL portion of indicator lights amber when card punch is in operating condition and:</p> <ul style="list-style-type: none"> ■ top cover is closed; ■ punch assembly and upper card feed assembly are locked down; and ■ read station brushes are in place. <p>READY portion lights green when either a punch operation is being performed or card punch is ready to receive a punch order from multiplexer channel.</p>
<p>POWER MAN OFF AC/DC switch/indicator</p> <p>Removes power from punch unit</p> <p>AC portion of indicator lights white when ac power is applied to the card punch.</p> <p>DC portion lights white when dc power is applied to the card punch. The OFF LINE indicator remains lit if unit was operating offline.</p>

Table 7-1. 0604 Card Punch Subsystem, Controls and Indicators (Part 2 of 2)

Control/Indicator — Function
Operator Control Panel (cont)
<p>CLEAR HOPPER/CHIPS switch/indicator</p> <p>Clears status and control circuits</p> <p>HOPPER portion of indicator lights red when hopper is empty and goes off when cards are placed in hopper.</p> <p>CHIPS portion lights red when chip box is full or not in place or cabinet door is open; it goes off when either condition is corrected.</p> <p>MAN FEED A JAM/B JAM switch/indicator</p> <p>Permits manual feeding of cards after clearing of an A or B jam</p> <p>A JAM portion of indicator lights red when card feed jam is in prepunch feed section.</p> <p>B JAM portion lights red when card feed jam is in postpunch feed section.</p> <p>STACKER FULL/JAM indicator</p> <p>STACKER FULL portion of indicator lights white when one of the card stackers is filled to capacity.</p> <p>STACKER JAM portion lights red when card feed jam is in stacker transport section.</p> <p>OFF LINE CHECK/OFF LINE switch/indicator</p> <p>Electrically disconnects card punch from multiplexer channel</p> <p>CHECK portion of indicator lights red when a card fails the hole count check, which is a comparison of the weighted counts of punch data and postpunch check data.</p> <p>OFF LINE portion lights amber and remains lit as long as card punch is independent of multiplexer channel.</p>
Power Control Panel
<p>ICB1 circuit breaker</p> <p>Provides overload protection for primary power circuit in card punch</p> <p>ICB2 pushbutton circuit breaker</p> <p>Provides overload protection for blower motor circuit</p> <p>ICB3 pushbutton circuit breaker</p> <p>Provides overload protection for low voltage power supply</p> <p>ICB4 pushbutton circuit breaker</p> <p>Provides overload protection for convenience outlet</p> <p>ICB5 pushbutton circuit breaker</p> <p>Provides overload protection for power control circuits and indicators</p> <p>ICB6 pushbutton circuit breaker</p> <p>Provides overload protection for punch drive motor</p>

7.2.2. Turn-On and Turn-Off Procedures

The card punch is turned on and off at the operator control panel on the card punch; no remote power control is possible. To power up the card punch, the **1CB1** circuit breaker on the power control panel must be set to its on (up) position, the **OFF LINE** switch/indicator is pressed (**OFFLINE** indicator lights), and the **POWER MAN ON INTL/READY** switch/indicator is pressed. The **OFF LINE** switch/indicator is now pressed again (**OFFLINE** indicator extinguishes) to place unit online with the multiplexer channel. Use the *UP* function of the SET IO command (Section 12) to place the card punch on the system's resources list for job allocation.

CAUTION

*The card punch must be placed offline to the multiplexer channel prior to applying power with the **POWER MAN ON INTL/READY** switch/indicator. After circuit breaker **1CB1** is turned on, press the **OFFLINE** switch/indicator if that switch/indicator is extinguished. Power transients may interfere with proper operation of the processor if this procedure is not followed.*

When power is applied to the unit, the following indicators on the operator control panel light:

- **POWER MAN ON INTL/READY** switch/indicator
- **POWER MAN OFF AC/DC** switch/indicator
- **CLEAR HOPPER** switch/indicator (remains lit until the operator loads cards into the hopper)

All other indicators should be extinguished.

Power is removed from the punch unit by first pressing the **OFF LINE** switch/indicator (**OFF LINE** portion of switch/indicator lights) and then pressing **POWER MAN OFF** switch/indicator on the operator control panel. The blowers are turned off by setting the **1CB1** circuit breaker to off (down). Use the *DOWN* function of the SET IO command (Section 12) to remove the card punch from the system's resources list and prevent it from being allocated to a job while off line.

7.2.3. Operating Procedures

Operating procedures for the card punch include loading cards in the hopper and placing the unit online, emptying the chip container, and clearing card jams. Punched cards are unloaded from either stacker by merely lifting the cards straight up and allowing the spring-loaded follower plate to rise and receive new cards.

7.2.3.1. Loading Cards in Hopper and Placing Unit Online

1. Load a deck of cards to be punched into the hopper as follows:
 - a. Fan cards to ensure that no cards are stuck together (Figure 7—5a).
 - b. Jog the cards on the joggle plate (Figure 7—5b) to align them for insertion into the hopper.
 - c. Raise the card weight in the hopper, and carefully insert the cards into the hopper face down, with column 9 edge leading (Figure 7—5c). Place the card weight over the inserted cards. If no cards are in the feed path, continue to step 2.

2. Ready the punch unit for online operation as follows:
 - a. If **OFF LINE** portion of **OFF LINE** switch/indicator on operator control panel is not lit, press **OFF LINE** switch/indicator; note that the indicator lights.
 - b. Press **MAN FEED** switch/indicator twice on operator control panel. Note that **A JAM** portion of the switch/indicator lights.
 - c. Press **CLEAR** switch/indicator. Note that **A JAM** portion of the switch/indicator extinguishes.
 - d. Press **MAN FEED** switch/indicator once. Note that **B JAM** portion of the switch/indicator lights.
 - e. Press **CLEAR** switch/indicator. Note that **B JAM** portion of the switch/indicator extinguishes.
 - f. Press **OFF LINE** switch/indicator to place card punch on online condition. Note that the switch/indicator extinguishes. The card punch is now ready for online operation, with an initial 3-card run completed.

NOTE:

If cards are to be removed from the hopper, raise the card weight, press the card lifter button, and remove the cards (Figure 7—6).



a. Fanning cards before loading

Figure 7—5. Loading Cards in Hopper (Part 1 of 2)

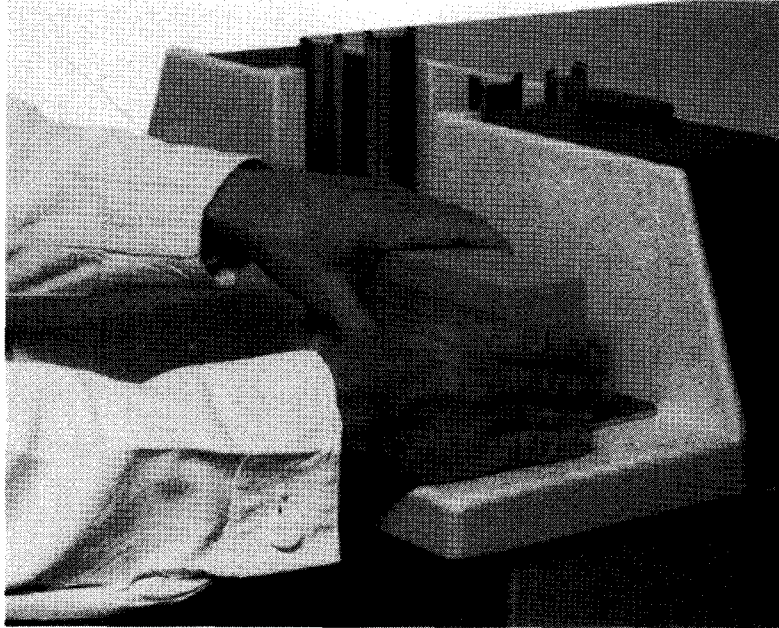

b. Jogging cards against joggle plate

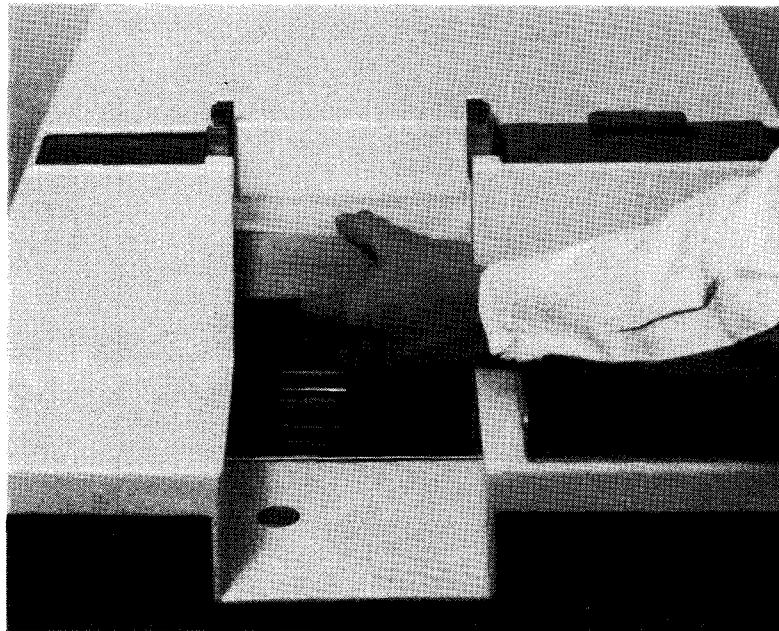

c. Placing the fanned and aligned cards into hopper

Figure 7-5. Loading Cards in Hopper (Part 2 of 2)

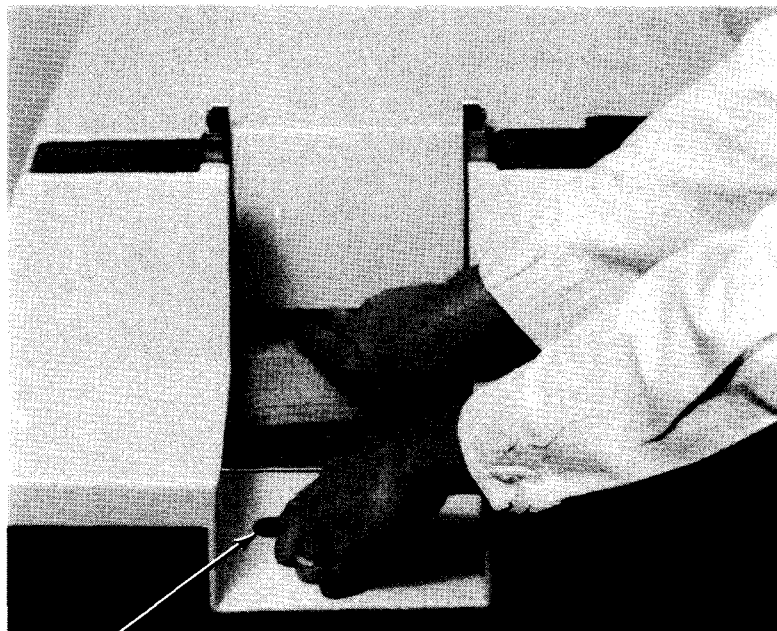

CARD
LIFTER
BUTTON
(RECESSED)

Figure 7-6. Removing Cards From Hopper

7.2.3.2. Emptying the Chad Container

When necessary to empty the chad container, proceed as follows:

1. Open the lower front cabinet door (Figure 7-7a).
2. Remove the chad container from the card punch (Figure 7-7b), and empty its contents into a suitable container.
3. Replace the chad container into the card punch (Figure 7-7c), and close the cabinet door securely to engage the interlock. Press the **CLEAR** switch/indicator.

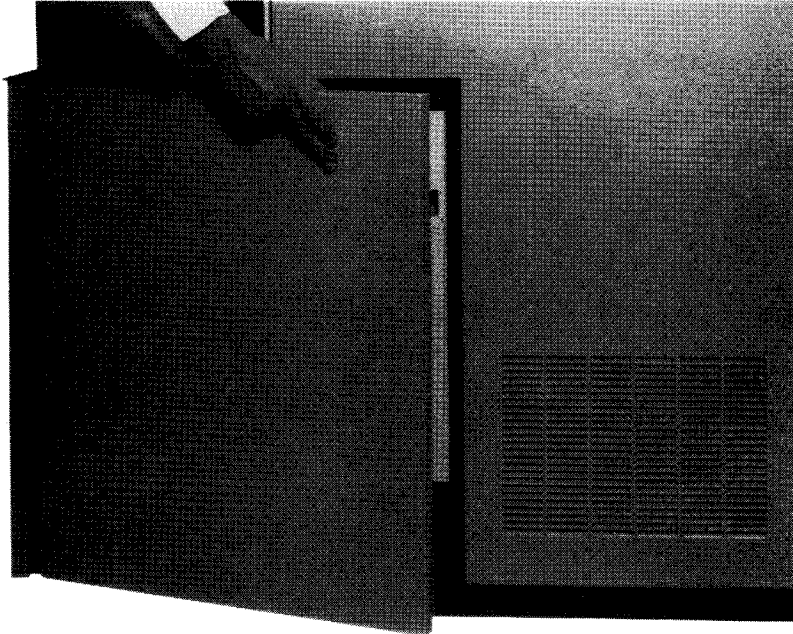

a. Cabinet door that allows access to chad container

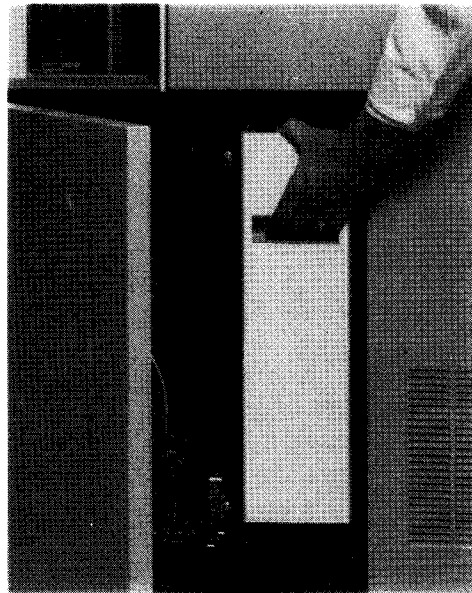

b. Chad container inside card punch

Figure 7-7. Emptying Chad Container (Part 1 of 2)

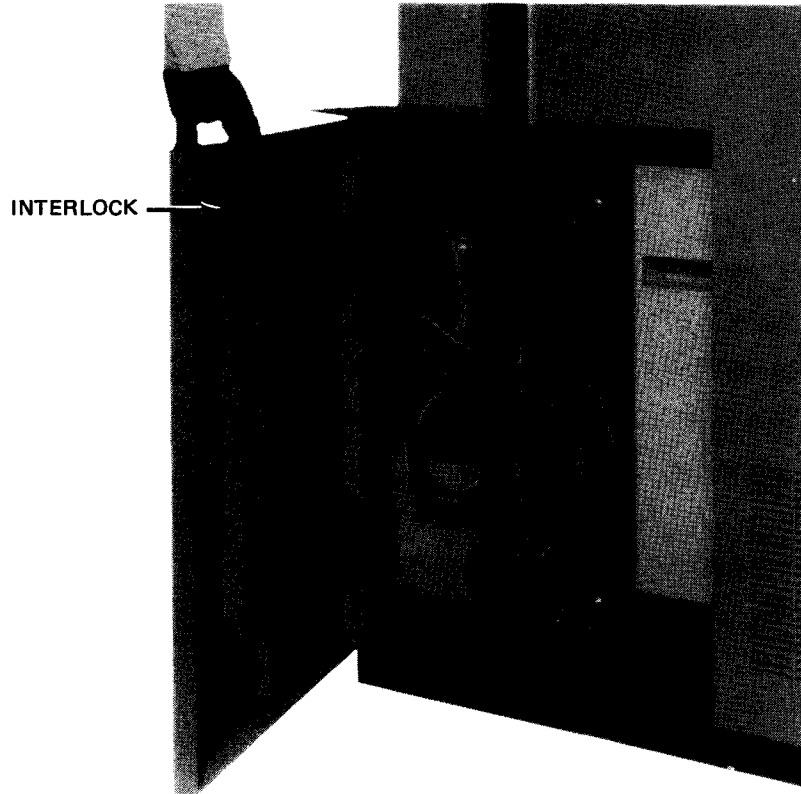

c. Chad container replaced after emptying

Figure 7-7. Emptying Chad Container (Part 2 of 2)

7.2.3.3. Clearing Card Jams in Card Track

Card jams occurring in the card track, which light the **A JAM** or **B JAM** indicator on the operator control panel, are corrected as follows:

NOTE:

Before performing the following procedure, use the DOWN function of the SET IO command (Section 12) to prevent the card punch from being allocated to a job while offline. After the procedure is completed, use the UP function of the SET IO command to restore the card punch's available status.

1. Press **OFF LINE CHECK/OFF LINE** switch/indicator and note that the **OFF LINE** indicator lights.
2. Press the **MAN OFF AC/DC** switch/indicator and note that the **MAN ON INTL** indicator extinguishes; set **1CB1** circuit breaker in power control panel to off (down).
3. Raise the card punch top cover and latch the top cover to lock it in its raised position (Figure 7-8a).
4. Unlock the upper punch block by releasing the punch block locking lever (Figure 7-8b).
5. Raise the block by the lifting block (Figure 7-8c) to its fully open position (Figure 7-8d).

CAUTION

When clearing card jams, be very careful to avoid damage to pusher fingers and read brushes. If locked, read brushes are released by releasing the brush block latch (Figure 7-8b).

6. Remove a jammed card from under the feed roll (Figure 7-8e) by raising the feed roll lifting lever (Figure 7-8d) to raise the feed roll.
7. Tear the jammed card along the rear edge of the punch die (Figure 7-8f) if a card is jammed there.
8. Pull out the remainder of the card from under the punch die in its normal direction of travel. Fit the two card pieces together to determine if any card pieces remain in the punch (Figure 7-8g).
9. Locate any missing card fragments (Figure 7-8h).
10. Remove card fragments by sliding another card through the punch and die assembly in the direction indicated by the arrow (Figure 7-8i).

NOTE:

A card will slide through the punch and die assembly even if no fragments are seen. If the card cannot slide through, contact the Sperry Univac customer engineer.

11. Remove all remaining cards in the card feed track (Figure 7-8d).
12. Carefully lower the upper punch block and lock it in place by firmly latching the punch block locking lever (Figure 7-8b). Close both brush block latches, if your card punch has two; otherwise, close the single latch.
13. Release top cover latch (Figure 7-8a) and close top cover and all cabinet doors.
14. Set **1CB1** circuit breaker on power control panel to on (up) position. Press the **MAN ON INTL** switch/indicator, then press the **CLEAR HOPPER/CHIPS** switch/indicator on the operator control panel. Note that the **B JAM** indicator of the **MAN FEED** switch/indicator extinguishes, and **MAN OFF AC/DC** and **MAN ON INTL/READY** switch/indicators light.
15. Perform step 2 of 7.2.3.1 to perform an initial 3-card run and condition the card punch for online use.

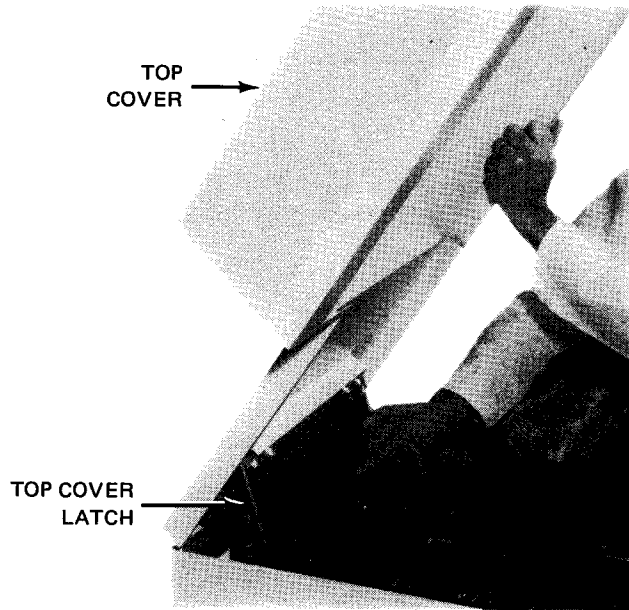

a. Raising and locking top cover open

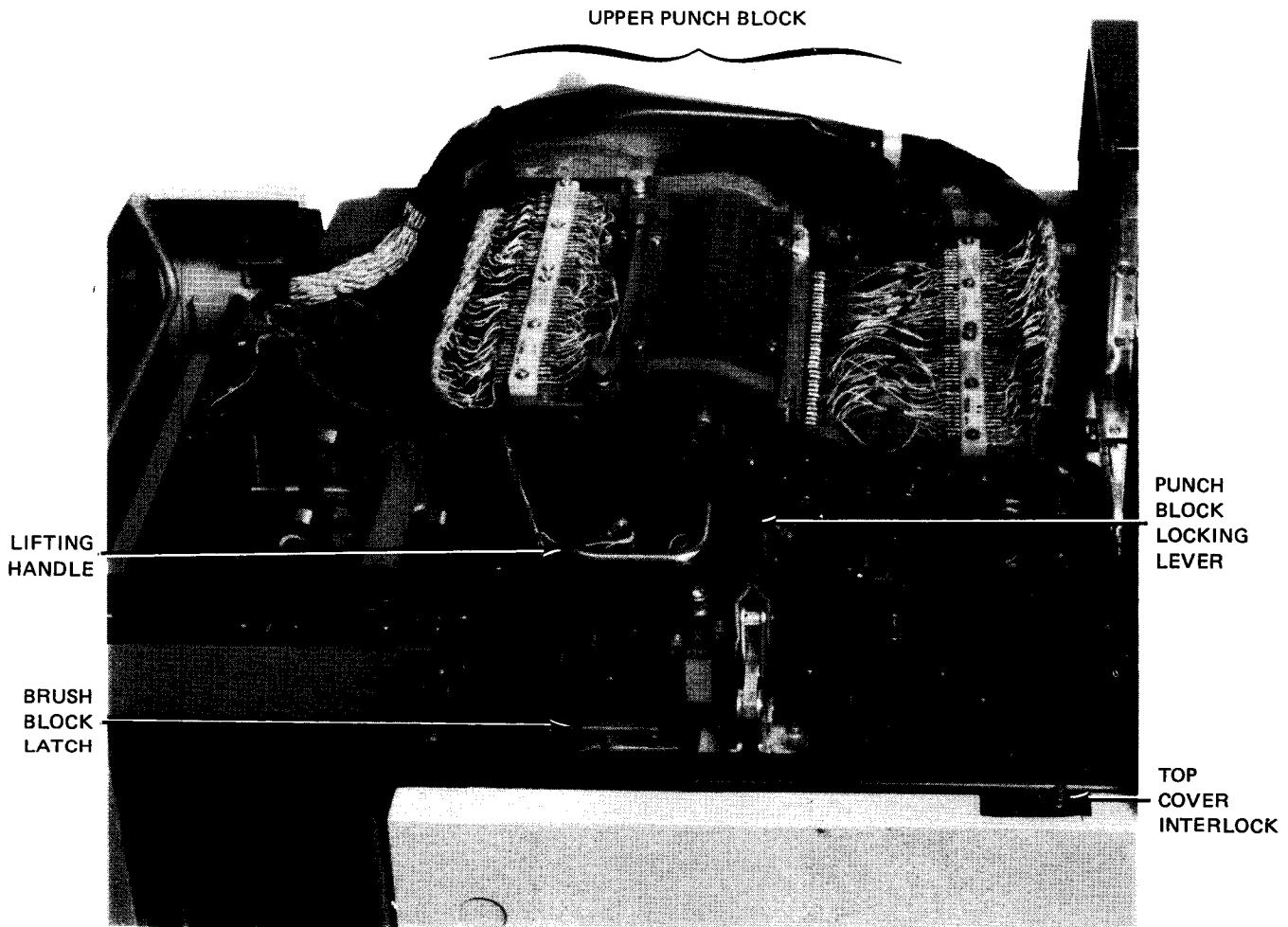

b. Upper punch block in closed position

Figure 7-8. Clearing Card Jams in Card Track (Part 1 of 5)

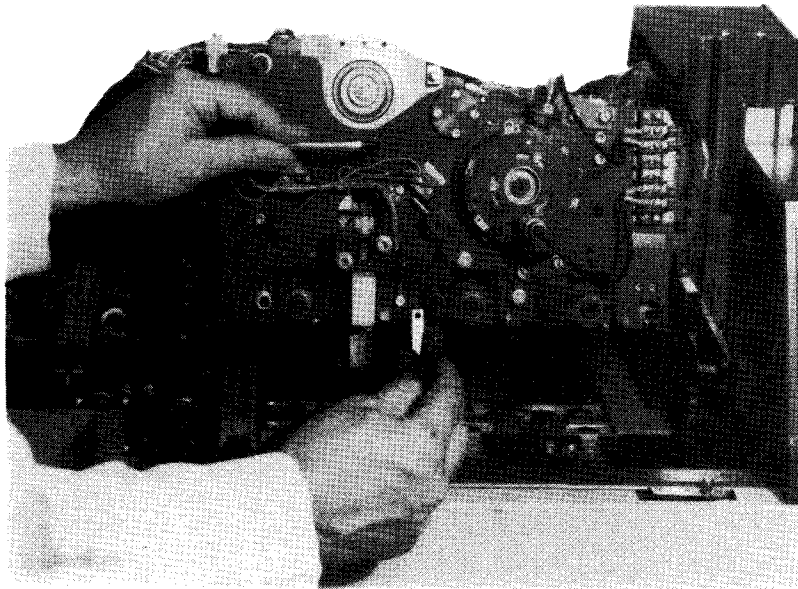

c. Raising upper punch block after being released

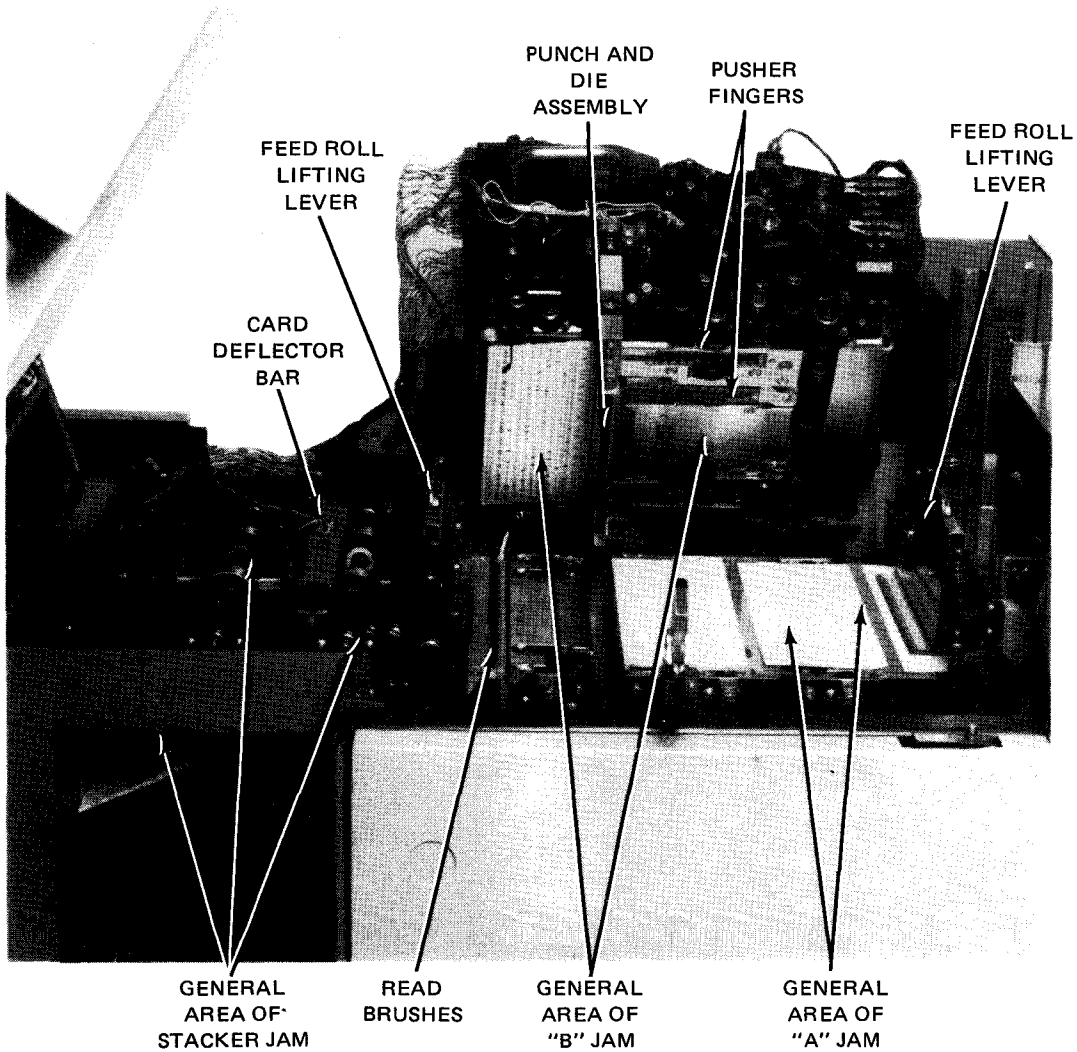

d. Upper punch block in open position without a card jam

Figure 7-8. Clearing Card Jams in Card Track (Part 2 of 5)

JAMMED CARD
IN PUNCH AND DIE
ASSEMBLY

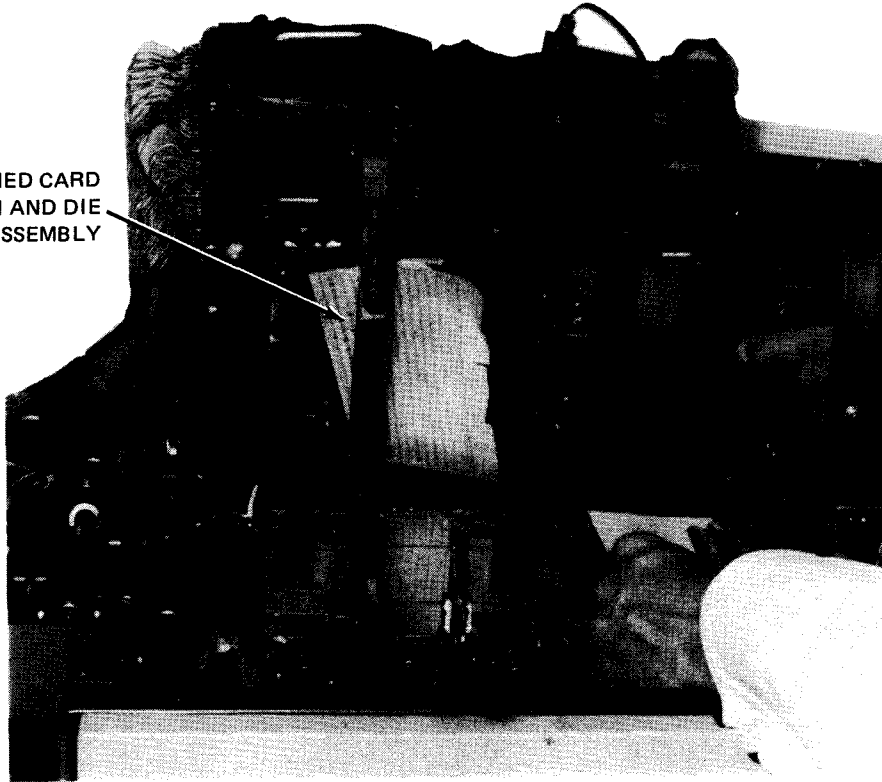

e. Removing card from under feed roll

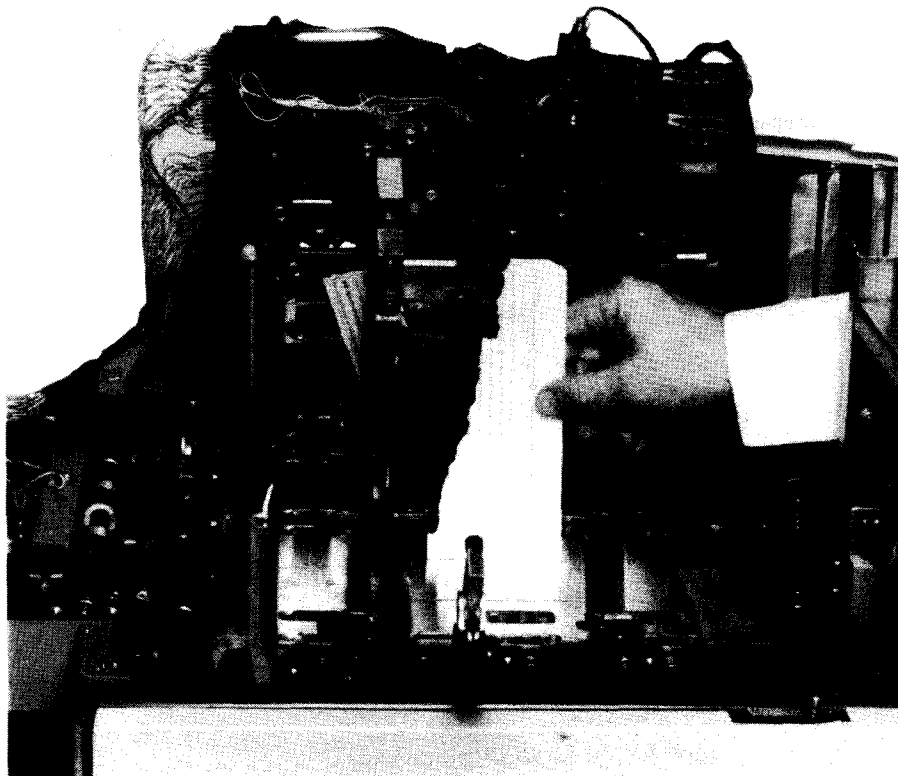

f. Tearing off card from punch and die assembly

Figure 7-8. Clearing Card Jams in Card Track (Part 3 of 5)

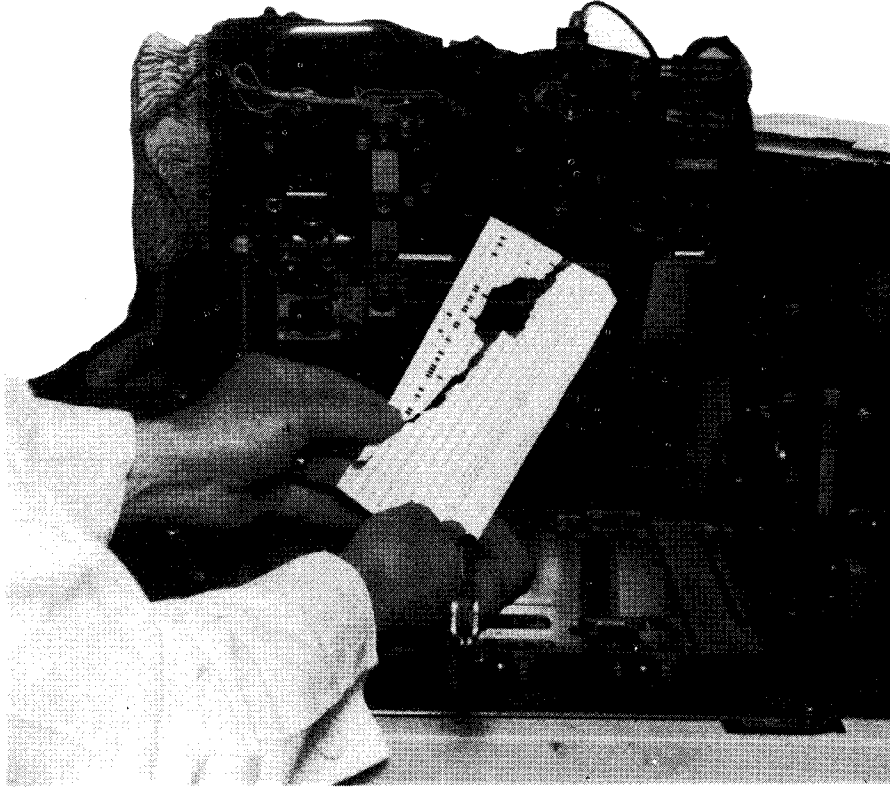

g. Matching torn card to determine if fragment is missing

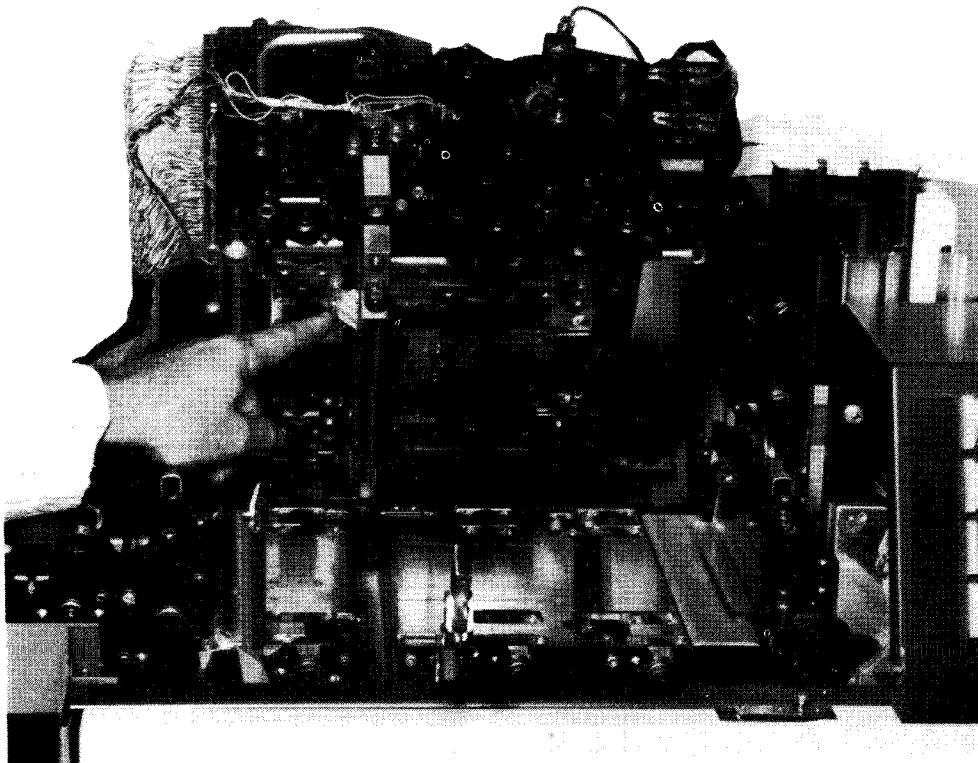

h. Missing fragment located

Figure 7-8. Clearing Card Jams in Card Track (Part 4 of 5)

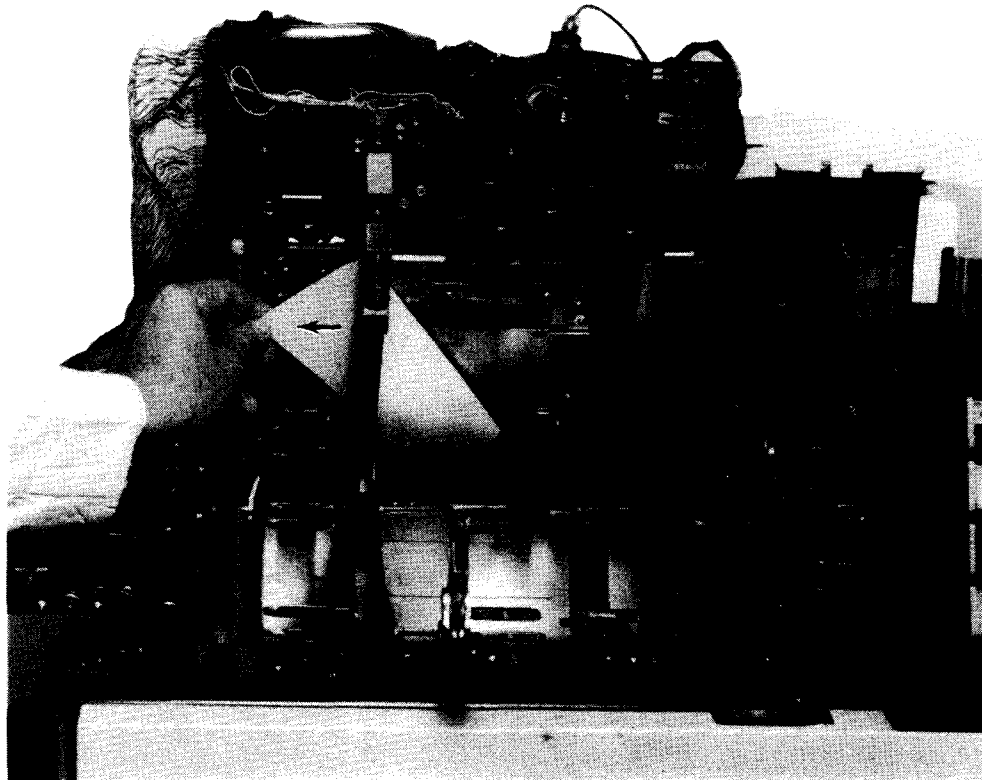

i. Sliding new card under punch and die assembly

Figure 7—8. Clearing Card Jams in Card Track (Part 5 of 5)

7.2.3.4. Clearing Card Jams in Stacker Mechanism

If a card jam occurs only in the stacker feed mechanism, it is not necessary to raise the upper punch block. Proceed to correct a card jam in the stacker mechanism as follows:

NOTE:

Before performing the following procedure, use the DOWN function of the SET IO command (Section 12) to prevent the card punch from being allocated to a job while offline. After the procedure is completed, use the UP function of the SET IO command to restore the card punch's available status.

1. Perform steps 1, 2, and 3 of 7.2.3.3.

NOTE:

Most card jams in the stacker feed mechanism are easily corrected by merely removing the card. However, if the card deflector bar (Figure 7—9a) is to be removed, proceed to subsequent steps.

2. Loosen and remove two knurled screws at each end of card deflector bar (Figure 7—9a).
3. Lift card deflector bar away from mounting location (Figure 7—9b), then remove jammed card by sliding it beneath stacker jam bar (Figure 7—9a).

4. Replace card deflector bar, being careful to fit the pins into holes provided on each end of the bar. Fasten bar with the two knurled screws removed in step 2.
5. Remove all remaining cards in the card feed path (Figure 7—8d).
6. Close the top cover and all cabinet doors securely, then perform step 2 of 7.2.3.1 to initiate a 3-card run and condition the card punch for online use.

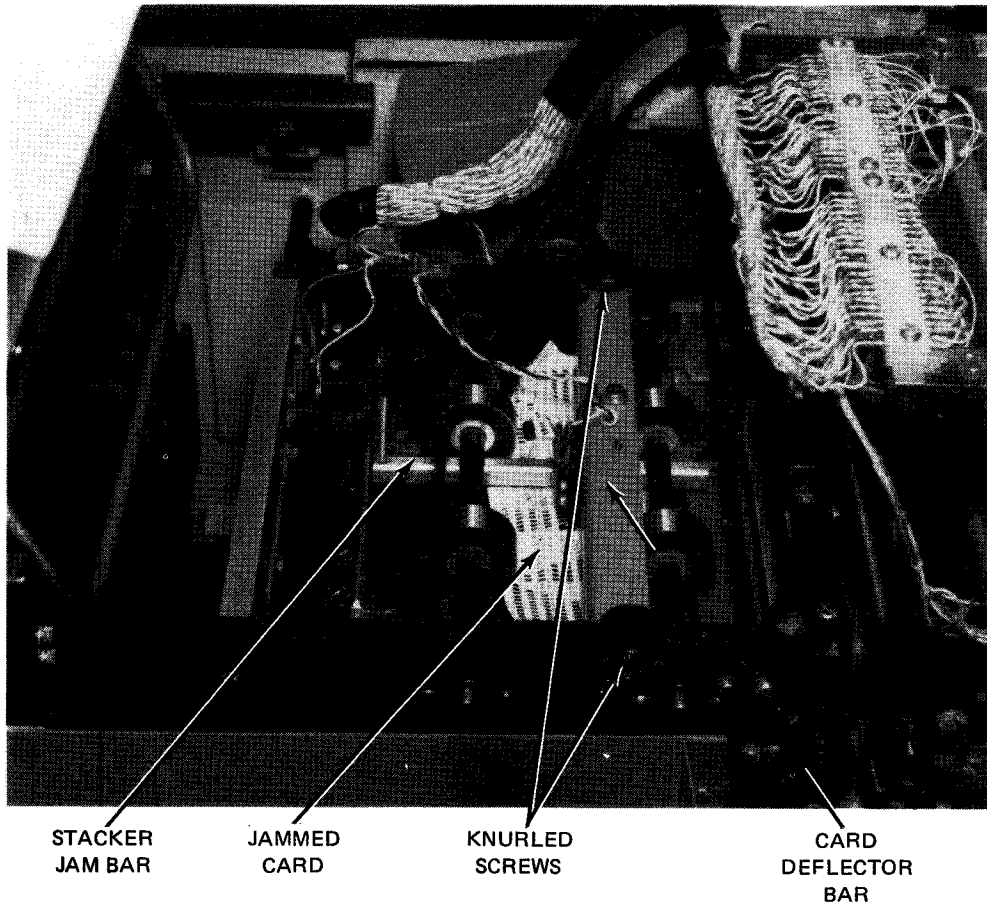

a. Jammed card beneath card deflector bar

Figure 7—9. Clearing Card Jam in Stacker Mechanism (Part 1 of 2)

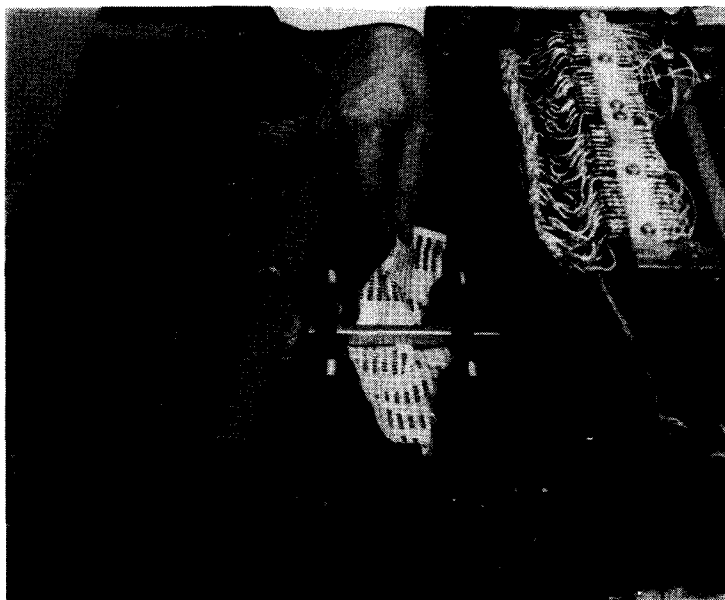

b. Sliding jammed card from beneath stacker jam bar

Figure 7-9. Clearing Card Jam in Stacker Mechanism (Part 2 of 2)

7.2.4. Recovery Procedures

Table 7-2 lists the malfunctions that may be corrected by the operator. An abnormal condition presents certain indicators on the operator control panel. If any of the error indicators persist after the recommended operator action is carefully performed, contact the Sperry Univac customer engineer.

Table 7-2. 0604 Card Punch Subsystem, Recovery Procedures

Fault Indication	Probable Cause	Operator Action
CLEAR HOPPER indicator is lit.	Input hopper is empty.	Load input hopper (7.2.3.1).
CLEAR CHIPS indicator is lit.	Chad container is filled.	Empty chad container (7.2.3.2).
MAN FEED A JAM or B JAM indicator is lit.	Card is jammed in card track.	Remove jammed card in card track mechanism (7.2.3.3).
STACKER FULL indicator is lit.	Either one or both stackers are full.	Empty the full stackers (7.2.3).
STACKER JAM indicator is lit.	Card is jammed in stacker mechanism.	Clear card jammed in stacker mechanism (7.2.3.4).
OFF LINE indicator is lit.	Card punch is set for offline operation.	Press OFF LINE switch/indicator.

7.3. 0605 CARD PUNCH SUBSYSTEM

The 0605 card punch subsystem is an integral part of the 90/30 and 90/30 B systems. Although the card punch is a freestanding unit (Figure 7-10) that can be physically removed from the system, electronically, the card punch is integrated with the processor by its control section, which is contained inside the processor cabinet. The card punch indicator panel is located on the processor operator/maintenance panel, and the card punch operator control panel is located on the card punch.

7.3.1. Operating Controls and Indicators

A control panel on front of the card punch (Figure 7-10) allows the operator to perform normal operating procedures. The control panel (Figure 7-11) contains three switch/indicators used during normal operation. The card punch indicator panel (Figure 7-12), located on the processor operator/maintenance panel, alerts the operator of specific check conditions. The AC circuit breaker, located behind the card punch front cabinet door (Figure 7-13), connects power to the drive circuits. The circuit breaker is normally left in the **ON** (up) position; power for the entire card punch is controlled from the processor. All controls and indicators for the card punch are listed and described in Table 7-3.

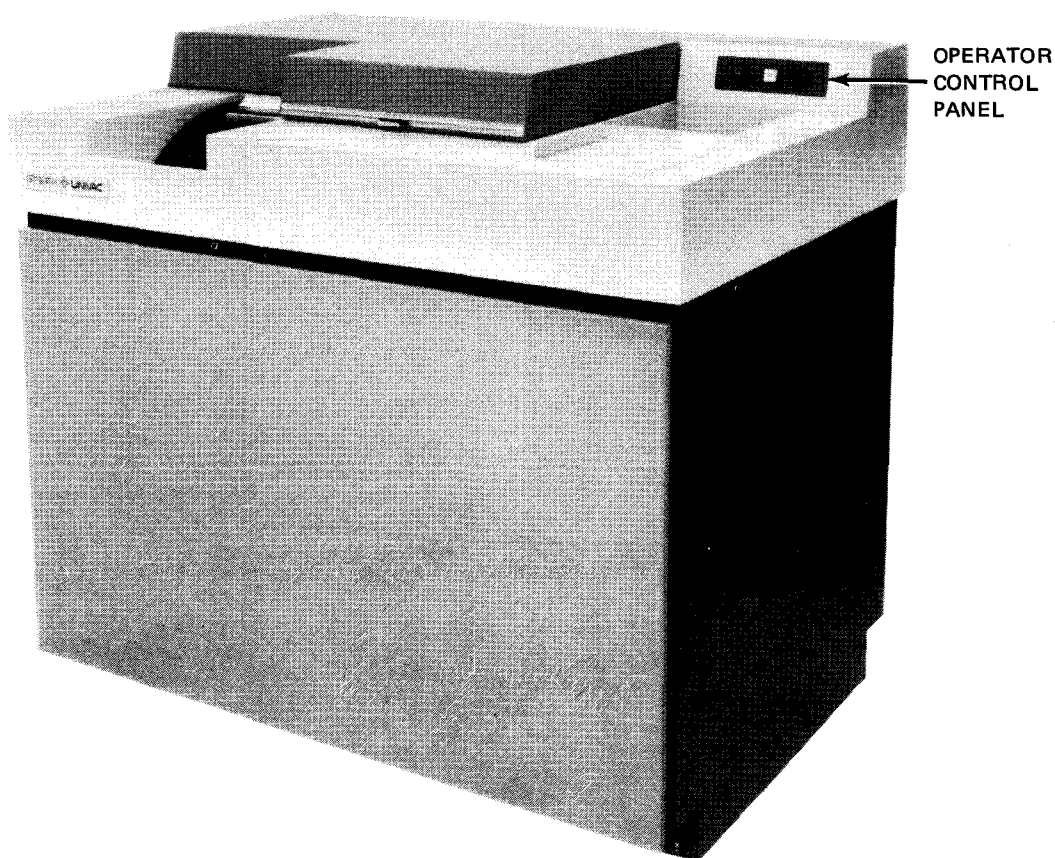

Figure 7-10. 0605 Card Punch Subsystem

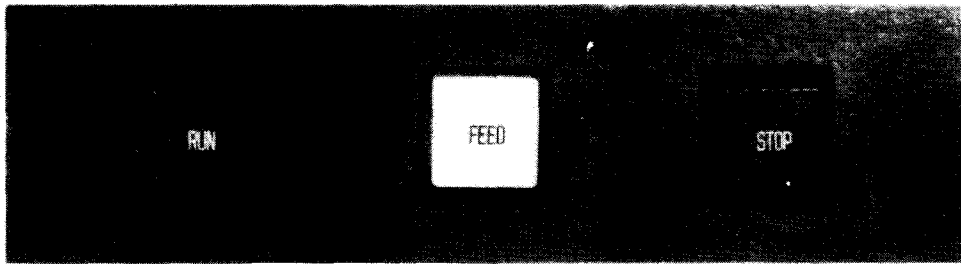
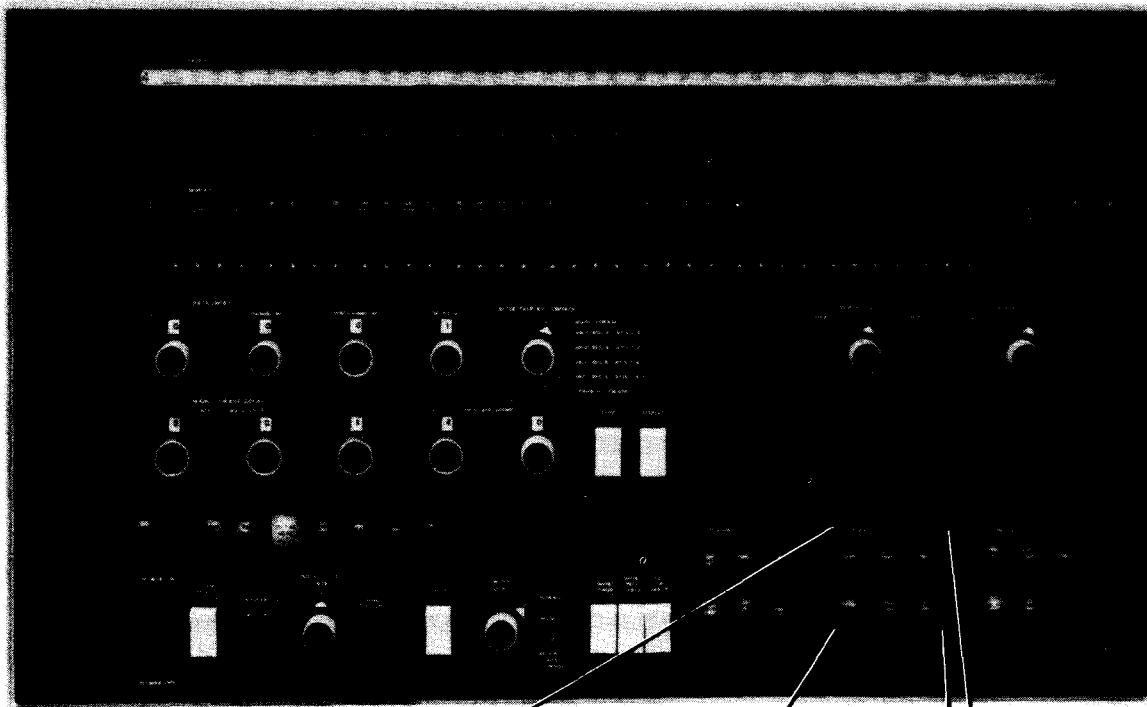

Figure 7-11. 0605 Card Punch Subsystem, Operator Control Panel



CARD PUNCH
INDICATOR
PANEL →

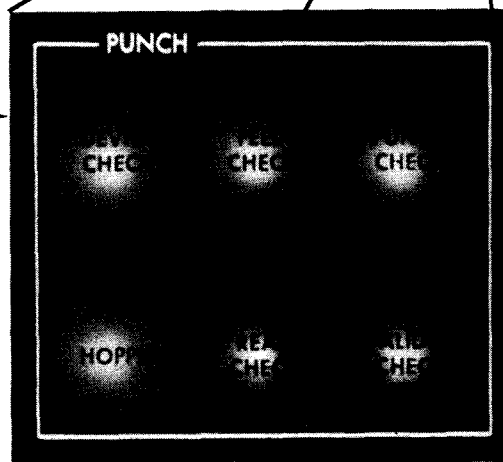

Figure 7-12. 0605 Card Punch Subsystem, Indicator Panel Located on Processor Operator/Maintenance Panel

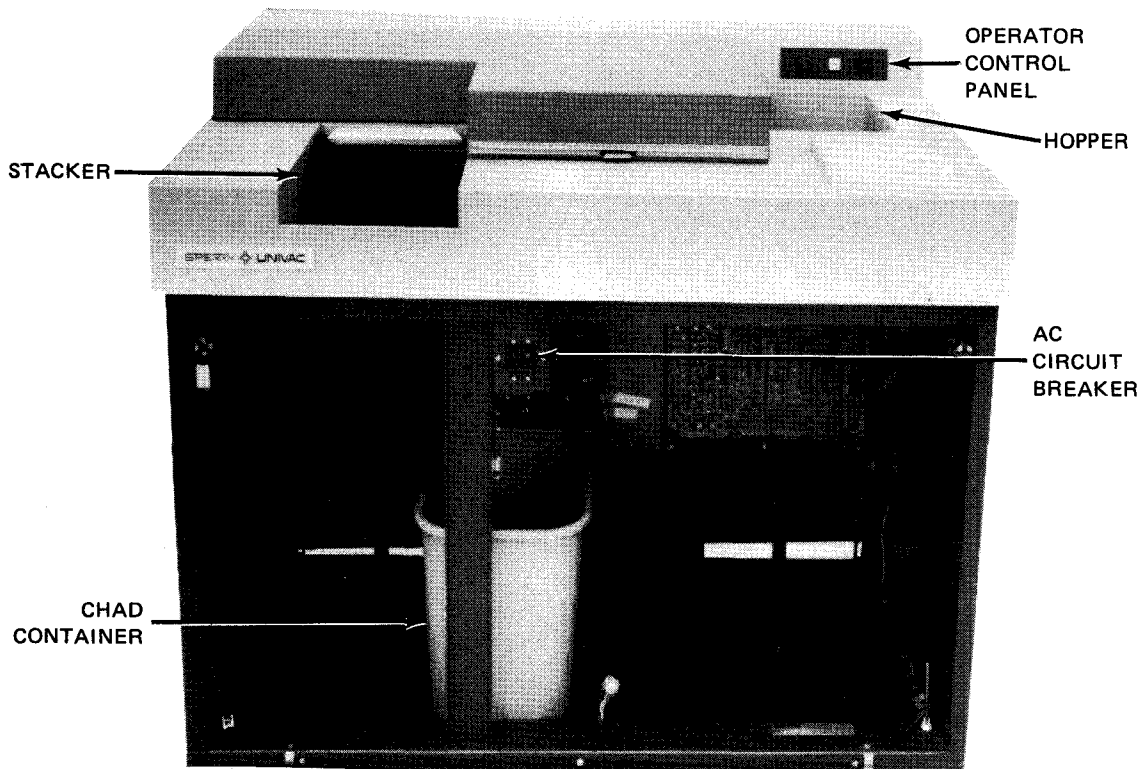

Figure 7-13. 0605 Card Punch Subsystem, Front View With Door Open

Table 7-3. 0605 Card Punch Subsystem, Controls and Indicators (Part 1 of 2)

Switch/Indicator — Function	
Operator Control Panel	
RUN switch/indicator	Readies card punch for immediate response to commands from punch control. Lights when punch enters run state. Releasing switch/indicator clears all error conditions (except device check) in punch, provided that all errors are corrected. STOP switch/indicator is extinguished when punch enters run state.
FEED switch	Feeds a single card through card path and enters it in advance station prior to normal running. Pressing switch a second time feeds the card from the advance station to the output stacker. This switch is also used to test integrity of the card path when misfeeds or feed check conditions are occurring and to clear card path in error recovery procedures. Releasing switch clears all error conditions (except device check) in punch, provided all errors are corrected.
STOP switch/indicator	Enters card punch in stop state. Lights when punch enters stop state and RUN switch/indicator extinguishes. Motor goes off after a nominal time delay. Pressing and holding switch/indicator provides a lamp test for STOP and RUN switch/indicators.

Table 7-3. 0605 Card Punch Subsystem, Controls and Indicators (Part 2 of 2)

Switch/Indicator — Function
Indicator Panel (on Operator/Maintenance Panel)
READ CHECK indicator (Feature 1617-00 must be included.) Lights if a data error or overrun error is detected in card punch. STOP switch/indicator on punch also lights to indicate unit is in stop state.
VALIDITY CHECK indicator Lights during operation in translate mode if more than one punch is detected in rows 1 through 7 of one or more columns
PUNCH CHECK indicator Lights if a column has been punched incorrectly or if an overrun error occurs
FEED CHECK indicator Lights if a card is jammed in card path or output stacker. STOP switch/indicator on card punch also lights to indicate unit is in stop state; drive motor stops to halt operation of punch.
DEVICE CHECK indicator Lights when a cabinet interlock switch is open, ac power is off, or a high temperature early warning condition exists in card punch. An open interlock switch or ac power turned off also causes STOP switch/indicator on punch to light and places unit in stop state, but a high temperature early warning condition does not.
HOPPER indicator Lights when start I/O instruction is complete on final card of input hopper. STOP switch/indicator on card punch also lights, and unit is placed in stop state. Indicators also light when misfeed occurs.
Card Punch Cabinet
AC circuit breaker Provides overload protection for the primary power circuits in the unit

7.3.2. Turn-On and Turn-Off Procedures

→ Power to the card punch is normally controlled from the **POWER ON/POWER OFF** switch on the processor operator/maintenance panel (Figure 2-2). However, to turn power on from this switch, the **AC** circuit breaker (Figure 7-13) must be set to the **ON** (up) position and all cabinet doors must be closed. This circuit breaker remains on unless independent power turn off is desired.

When the **AC** circuit breaker is set to **ON** and the **POWER ON/POWER OFF** is set to **POWER ON**, the **STOP** switch/indicator on the card punch lights and all other indicators are extinguished.

A card jam or other error conditions that cause the card punch to go into stop mode (**STOP** indicator lights) also cause the processor to receive an error condition and stop the processing operation. If the card punch error condition requires that the **AC** circuit breaker be turned **OFF** for operator safety (e.g., clearing card jams), power can be reapplied after the error condition is corrected by setting the **AC** circuit breaker to **ON** (up) without regard to power transients causing processor interference, because the card punch is automatically placed in stop mode (offline) by the error condition. However, if power is to be turned off without an error condition causing operations to halt, power should be turned off on the card punch independently of the processor as follows:

1. Press **STOP** switch/indicator to place card punch in an offline condition.
2. Set **AC** circuit breaker (Figure 7—13) to **OFF** (down) position.
3. Use the *DOWN* function of the SET IO command (Section 12) to remove the card punch from the system's resources list and prevent it from being allocated to a job while offline. After power is turned back on, use the *UP* function of the SET IO command to restore the card punch's available status.

7.3.3. Operating Procedures

Operating procedures for the card punch include loading cards in the hopper, unloading cards from the stackers, emptying the chad container, and clearing card jams.

7.3.3.1. Loading Cards in Hopper

Load a deck of cards to be punched into the hopper as follows:

1. Press the **STOP** switch/indicator on operator control panel to place the card punch in stop state.
2. Fan the cards so they will feed properly (Figure 7—14a).
3. Jog cards against the card aligner (Figure 7—14b) to align the cards.
4. Pull back and lock the card follower plate in its maximum retracted position; it is held fully retracted by a magnet. While holding cards currently in hopper, insert additional cards. Cards should feed horizontally, with faces directed toward operator (Figure 7—14c). If read/punch feature is to be used, data cards must be preceded by one blank card.
5. Release card follower plate and allow it to press against the cards (Figure 7—14d). The stacker holding plate (Figure 7—15a) must be in its uppermost position to ensure proper card stacking.
6. Press **FEED** switch on operator control panel to verify that cards feed through card transport. Observe that no check indicators are lit on card punch indicator panel after **FEED** switch is pressed.

NOTE:

Pressing the FEED switch places the first card in the advance station. Operation can continue by program control of the processor or by pressing the RUN switch/indicator on the card punch operator control panel.

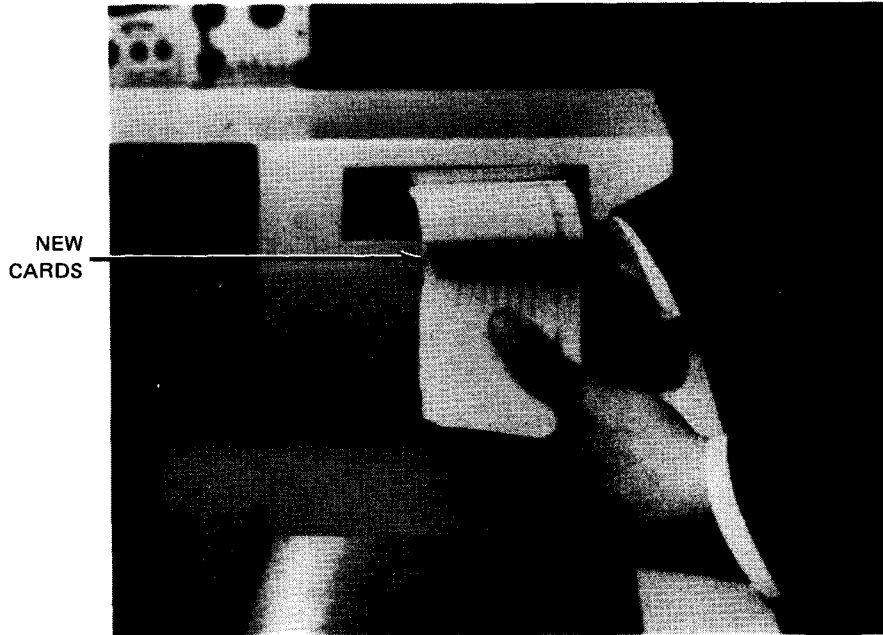

a. Fanning cards before loading

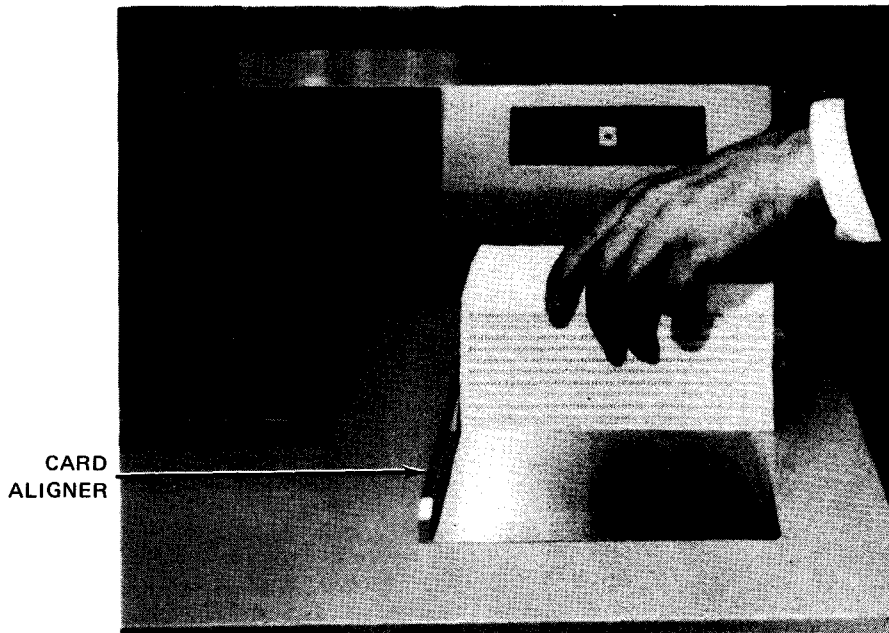

b. Jogging cards to align before loading

Figure 7-14. Loading Cards in Hopper (Part 1 of 2)

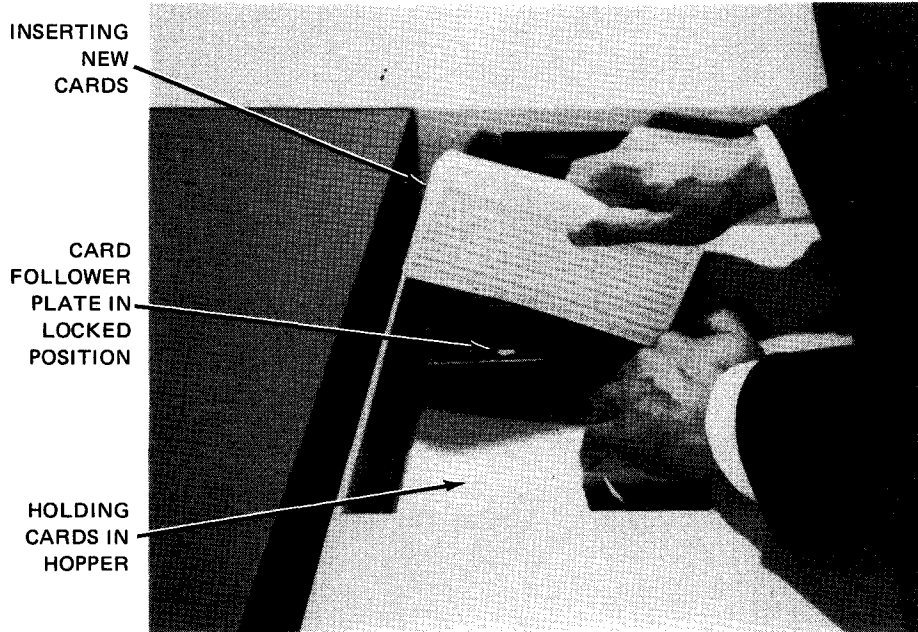

c. Inserting new cards in hopper

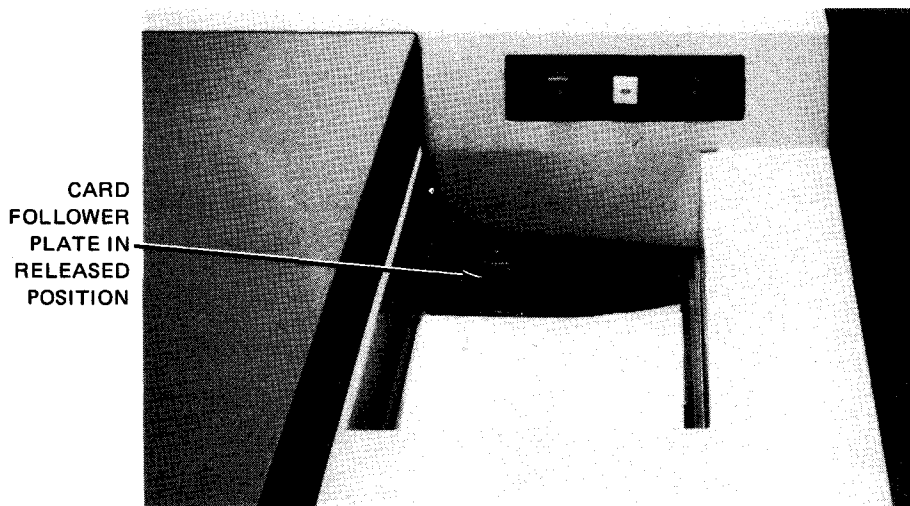

d. Hopper filled and card follower plate released

Figure 7-14. Loading Cards in Hopper (Part 2 of 2)

7.3.3.2. Unloading Cards From Stacker

Remove cards from the stacker, while a run is in progress, as follows:

1. Lower output stacker cover; cover handle is on top and cover slides downward in a circular motion (Figure 7—15a).
2. Release brake on stacker holding plate by pressing downward on brake (Figure 7—15a).
3. While holding brake released, grasp a quantity of cards from stacker while maintaining a slight pressure on remaining cards (Figure 7—15b).
4. Raise cards sufficiently to clear stacker holding plate, then slide plate against remaining cards (Figure 7—15b).
5. Place punched cards in correct storage container, then repeat steps 1 through 4 until all cards are removed from stacker and card holding plate is set in uppermost position (Figure 7—15c). Allow output stacker cover to close automatically after all cards are removed.

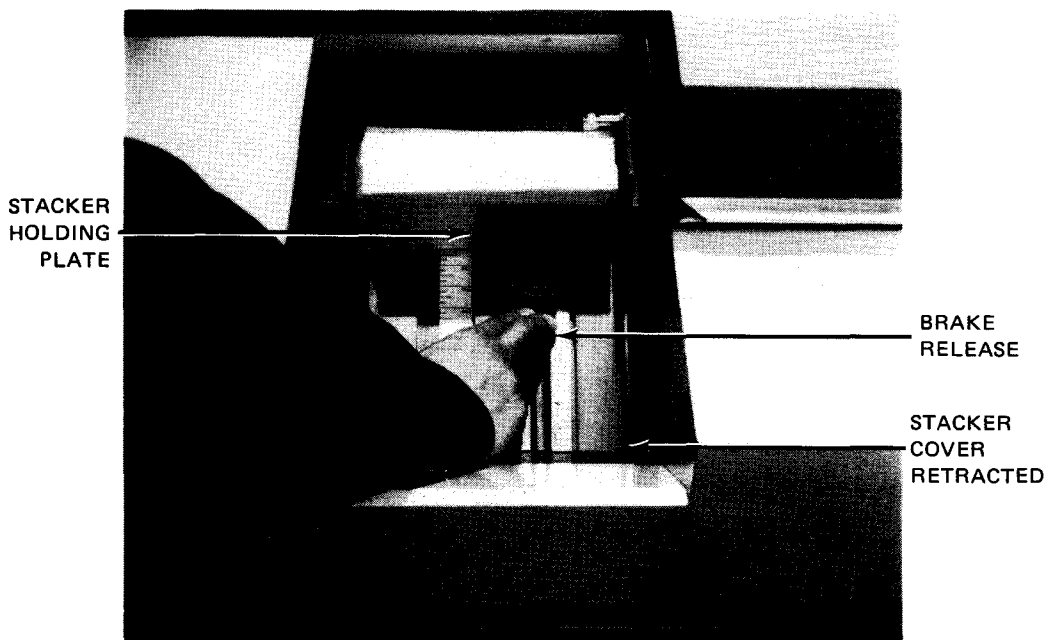

a. Holding stacker cover open while releasing brake

Figure 7—15. Unloading Cards From Stacker (Part 1 of 2)

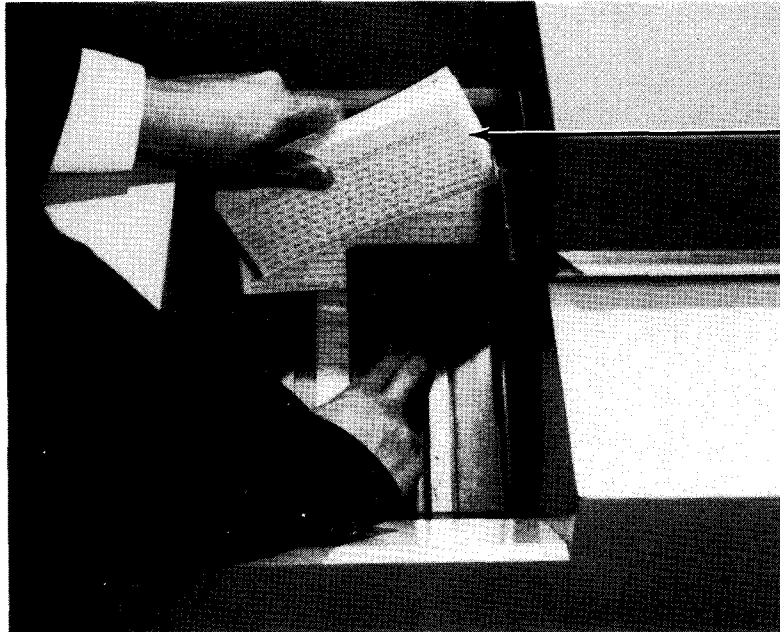

REMOVING
CARDS WHILE
MAINTAINING
PRESSURE ON
REMAINING
CARDS

b. Removing punched cards from stacker

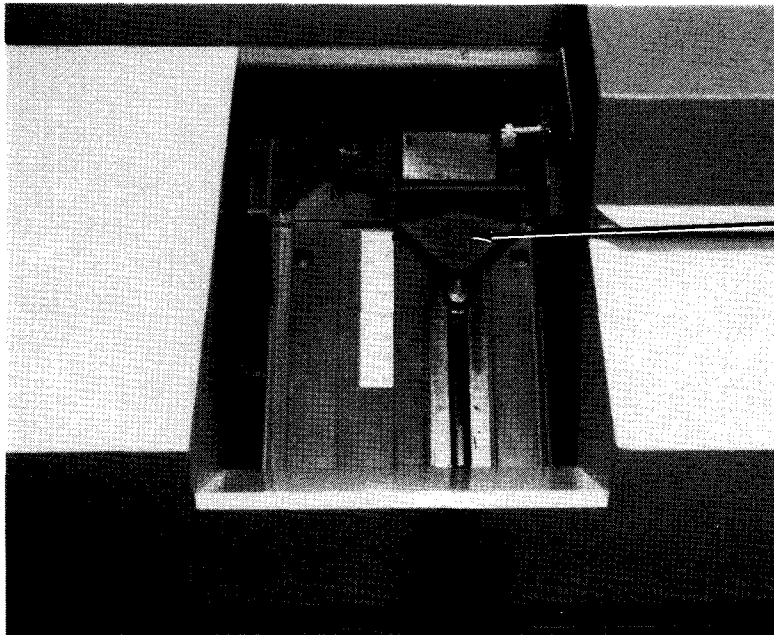

STACKER
HOLDING
PLATE

c. All cards removed and stacker holding plate in uppermost position

Figure 7-15. Unloading Cards From Stacker (Part 2 of 2)

7.3.3.3. Unloading Cards From Error Stacker

Cards are unloaded from the error stacker (Figure 7—16) as follows:

1. Raise the top cover of the card punch.
2. Remove cards from error stacker.
3. Close the top cover securely to engage the interlock switch.

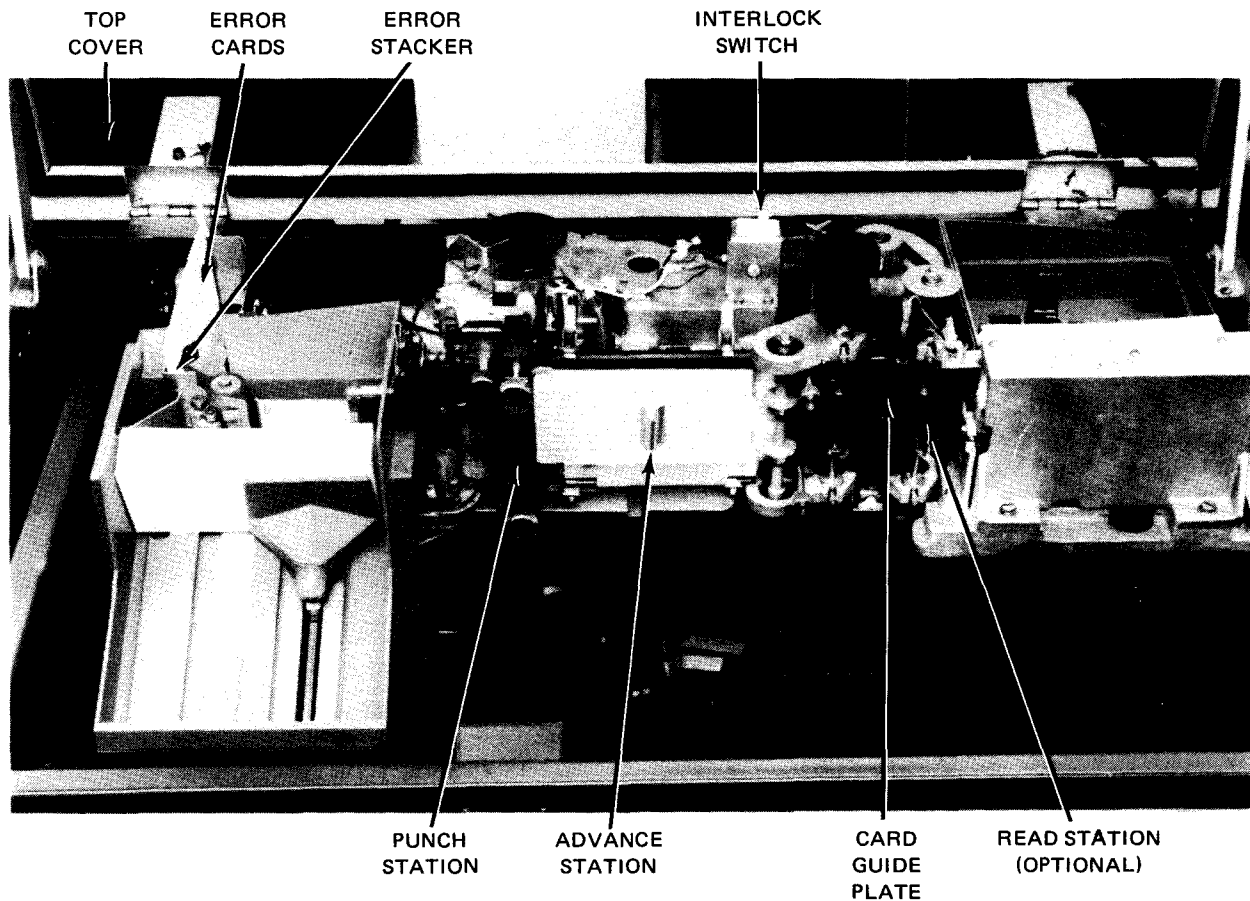

Figure 7—16. 0605 Card Punch Subsystem with Top Cover Raised to Show Error Stacker

7.3.3.4. Emptying the Chad Container

The chad container is located behind the front cabinet door (Figure 7—13), and should be kept clean to assure maximum operating capabilities. The chad container should be emptied every other day, or as often as necessary, depending on the operator requirements of the card punch. After emptying the chad container, be sure to close the front cabinet door securely to engage the interlock.

7.3.3.5. Clearing Card Jam in Read Station

NOTE:

A read station is included in the card punch only if feature 1617—00 is installed.

Proceed as follows to clear a card jam in the read station (Figure 7—16):

NOTE:

Before performing the following procedure, use the DOWN function of the SET IO command (Section 12) to prevent the card punch from being allocated to a job while offline. After the procedure is completed, use the UP function of the SET IO command to restore the card punch's available status.

1. If card punch is not in stop mode, press **STOP** switch/indicator, then set **AC** circuit breaker to **OFF** (down). (If in stop mode, do not press **STOP** switch/indicator).
2. Raise the top cover fully for access to the card feed path.
3. Loosen thumbscrew on fiber optic assembly at read station (Figure 7—17a).
4. Carefully lift out fiber optic assembly and place it in a convenient location.
5. Rotate manual feed control (Figure 7—17b) until jammed card passes through read station and becomes accessible.
6. Lift out jammed card (Figure 7—17c).
7. Carefully remount fiber optic assembly in its mounting position. Note mounting groove (Figure 7—17d).
8. Tighten thumbscrew on fiber optic assembly (Figure 7—17a).
9. Perform **FEED CHECK** recovery procedure for read/punch operation described in Table 7—4.

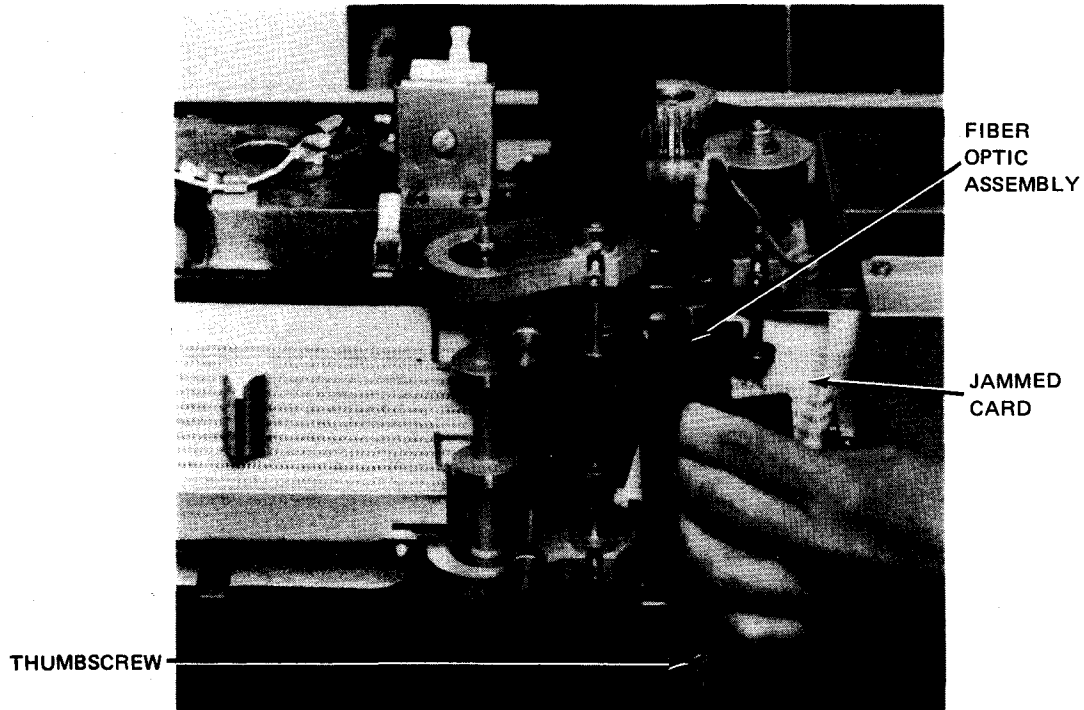

a. Removing fiber optic assembly

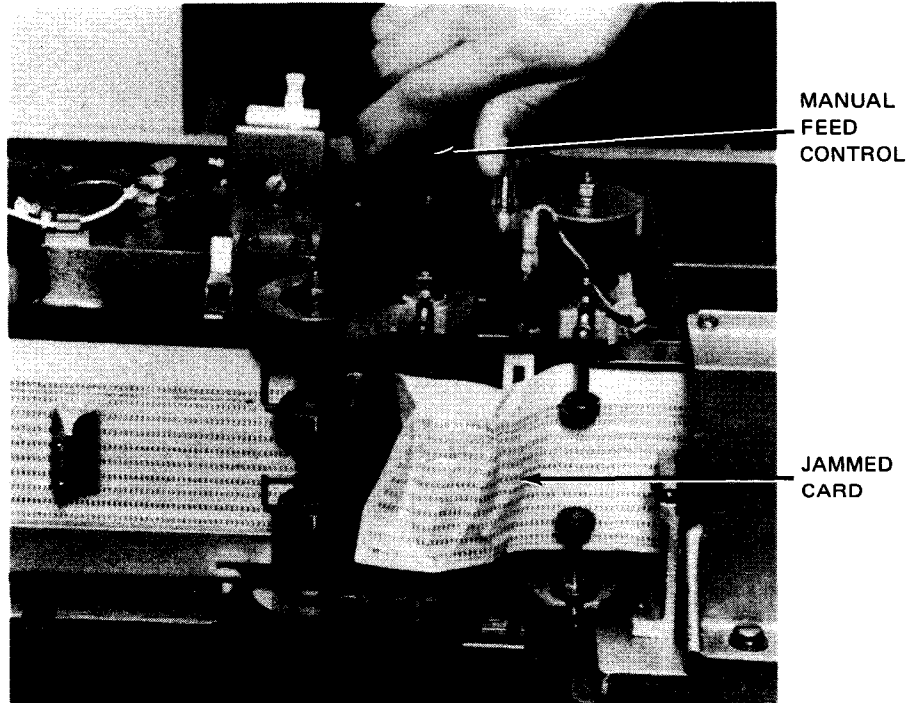

b. Rotating manual feed control

Figure 7-17. Clearing Card Jam in Read Station (Part 1 of 2)

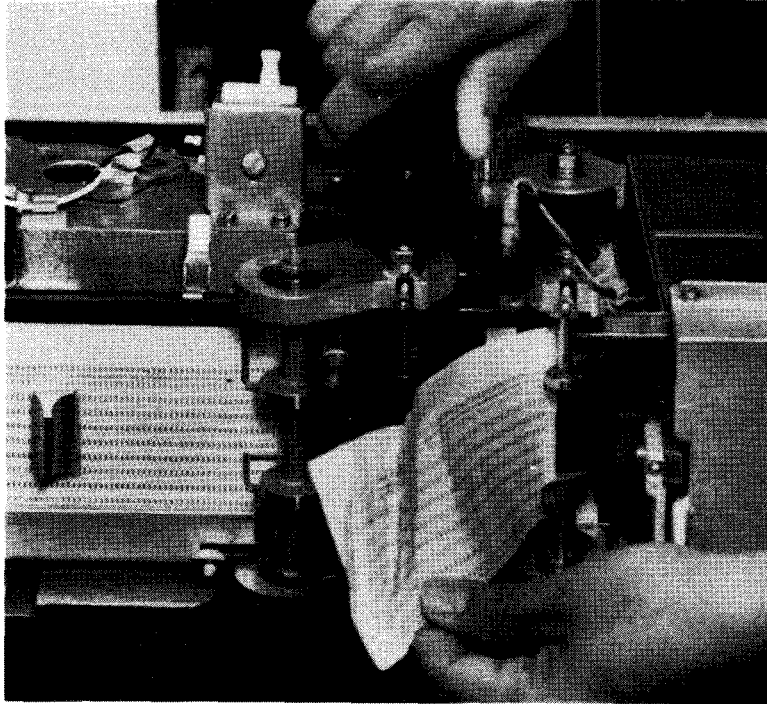

c. Removing jammed card

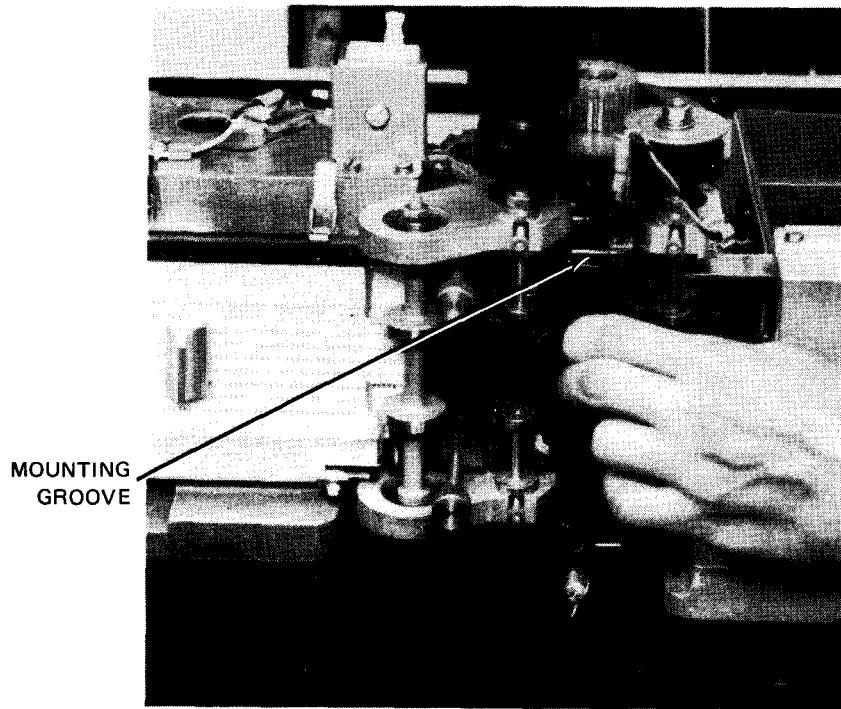

d. Replacing fiber optic assembly

Figure 7-17. Clearing Card Jam in Read Station (Part 2 of 2)

7.3.3.6. Clearing Card Jam Behind Card Guide Plate

Proceed as follows to clear a card jam from behind the card guide plate (Figure 7—16):

NOTE:

Before performing the following procedure, use the DOWN function of the SET IO command (Section 12) to prevent the card punch from being allocated to a job while offline. After the procedure is completed, use the UP function of the SET IO command to restore the card punch's available status.

1. If card punch is not in stop mode, press **STOP** switch/indicator and set **AC** circuit breaker to **OFF** (down). (If in stop mode, do not press **STOP** switch/indicator.)
2. Raise the top cover fully for access to the card feed path.
3. Loosen two thumbscrews holding card guide plate (Figure (7—18a)).
4. Remove card guide plate by lifting it straight out (Figure 7—18b).
5. Rotate manual feed control to remove jammed card (Figure 7—18c).
6. Replace card guide plate; note that it is oriented correctly to fit properly (Figure 7—18b).
7. Tighten both thumbscrews to secure card guide plate (Figure 7—18a).
8. Perform **FEED CHECK** recovery procedure for punch-only operation described in Table 7—4.

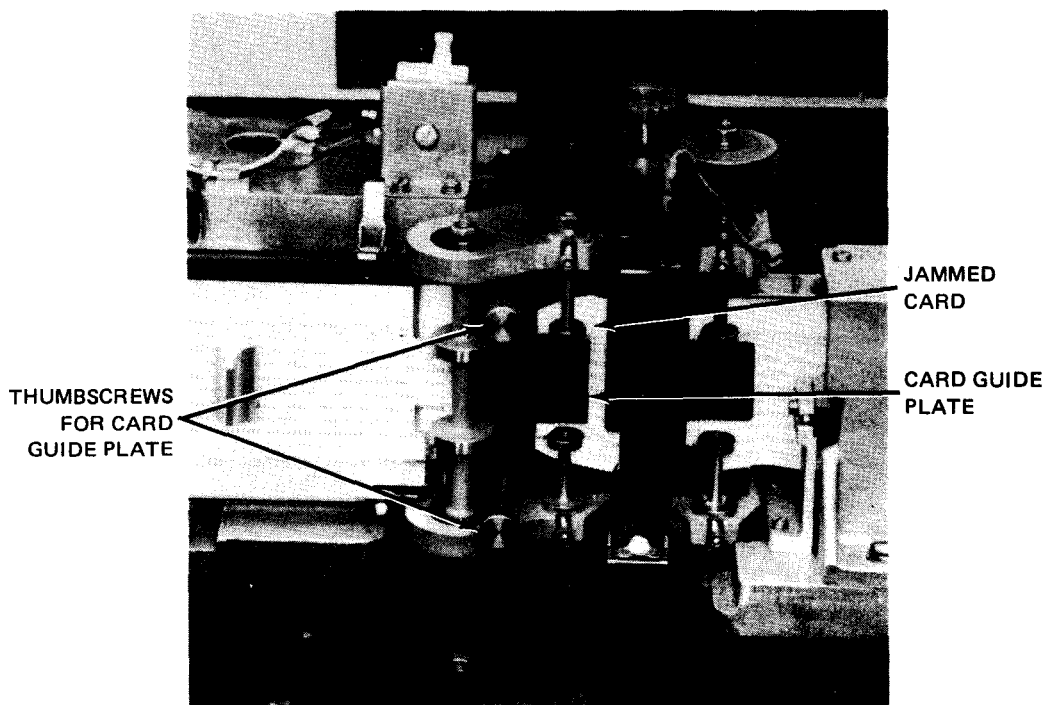

a. Jammed card behind card guide plate

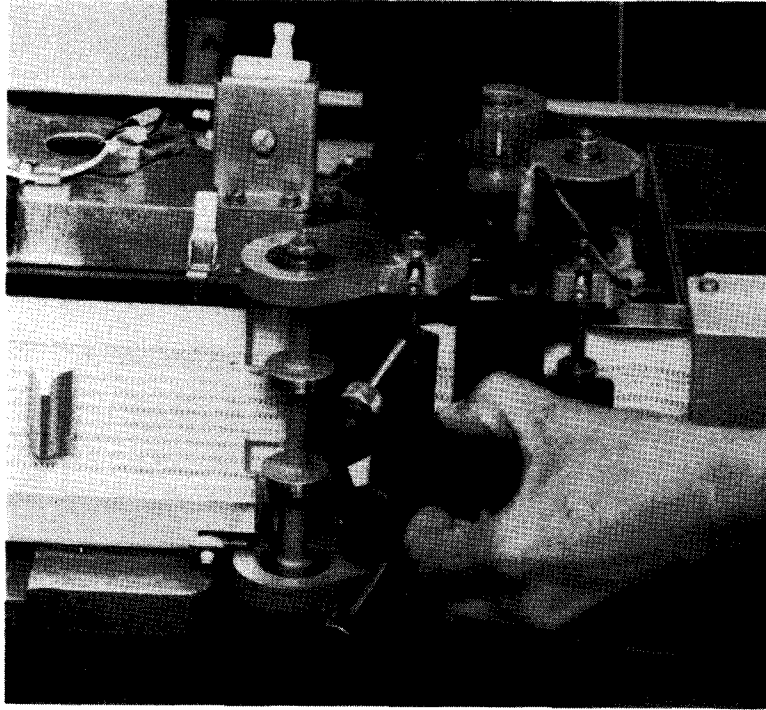

b. Removing card guide plate

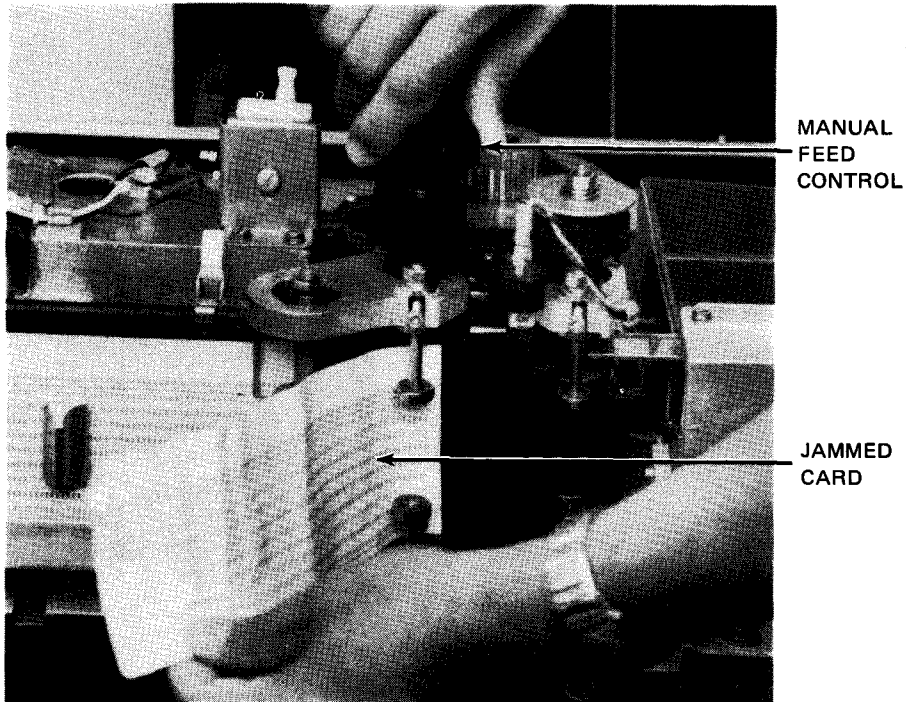

c. Removing jammed card

Figure 7-18. Clearing Card Jam Behind Card Guide Plate (Part 2 of 2)

7.3.3.7. Clearing Card Jam in Advance Station

Proceed as follows to clear a card jam in the advance station (Figure 7-16):

NOTE:

Before performing the following procedure, use the DOWN function of the SET IO command (Section 12) to prevent the card punch from being allocated to a job while offline. After the procedure is completed, use the UP function of the SET IO command to restore the card punch's available status.

1. If card punch is not in stop mode, press **STOP** switch/indicator and set **AC** circuit breaker to **OFF** (down). (If in stop mode, do not press **STOP** switch/indicator.)
2. Raise top cover fully for access to the card feed path.
3. Loosen two thumbscrews holding punch die in place (Figure 7-19a), and remove the punch die (Figure 7-19b).
4. Loosen two snap fasteners holding glass cover (by snapping them toward you) (Figure 7-19b).
5. Slide glass cover by its handle toward the left, then tilt back glass cover and remove jammed card (Figure 7-19c).
6. Raise glass cover and press in firmly toward card guide plate while closing (snapping) the two snap fasteners (Figure 7-19d).
7. Replace punch die, noting that the two thumbscrews are aligned with threaded holes (Figure 7-19b) on feed mechanism. Be sure that thumbscrews holding punch die are snug (Figure 7-19e).
8. Perform **FEED CHECK** recovery procedure for punch-only operation described in Table 7-4.

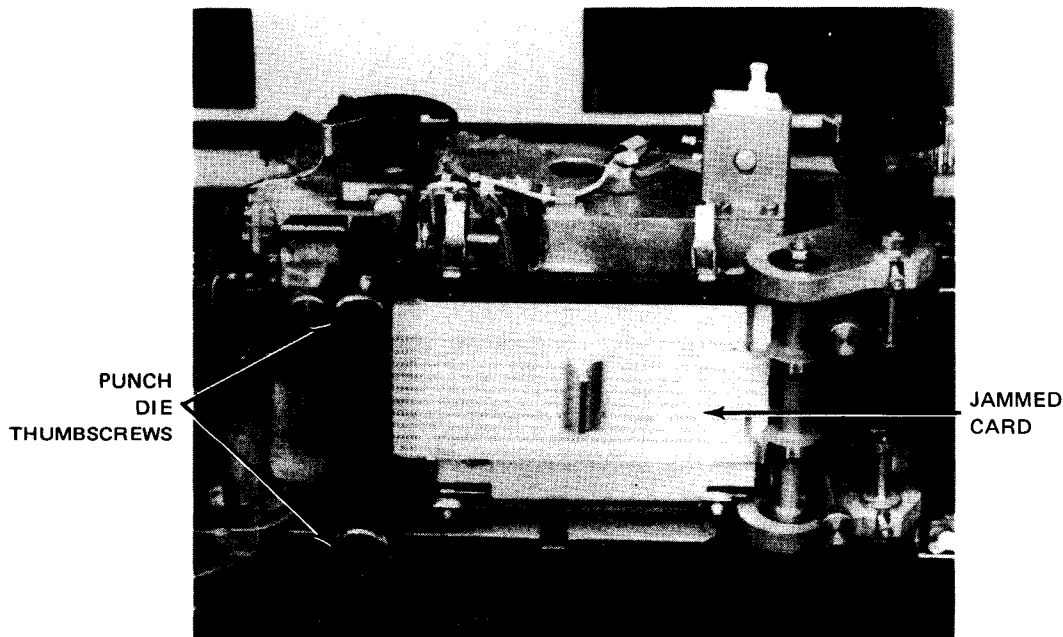

a. Jammed card in advance station

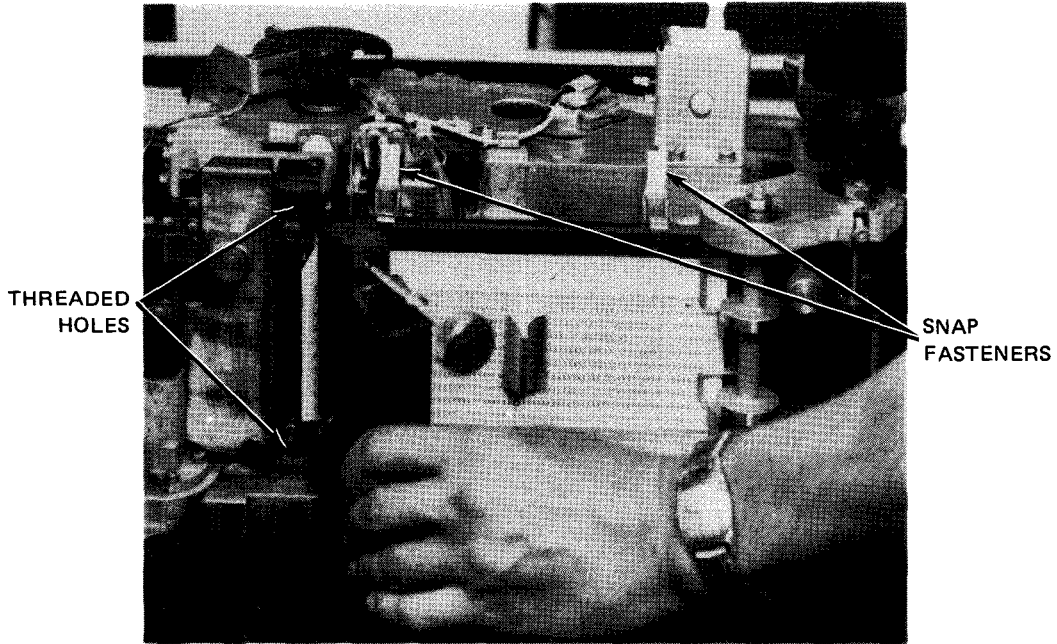

b. Removing punch die

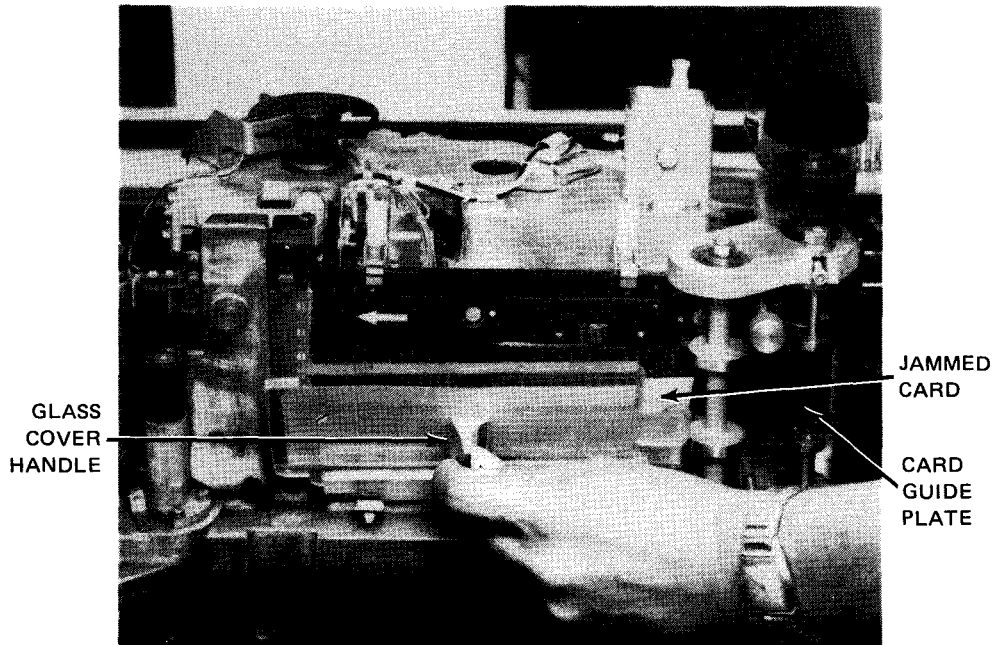

c. Opening glass cover to remove jammed card

Figure 7-19. Clearing Card Jam in Advance Station (Part 2 of 3)

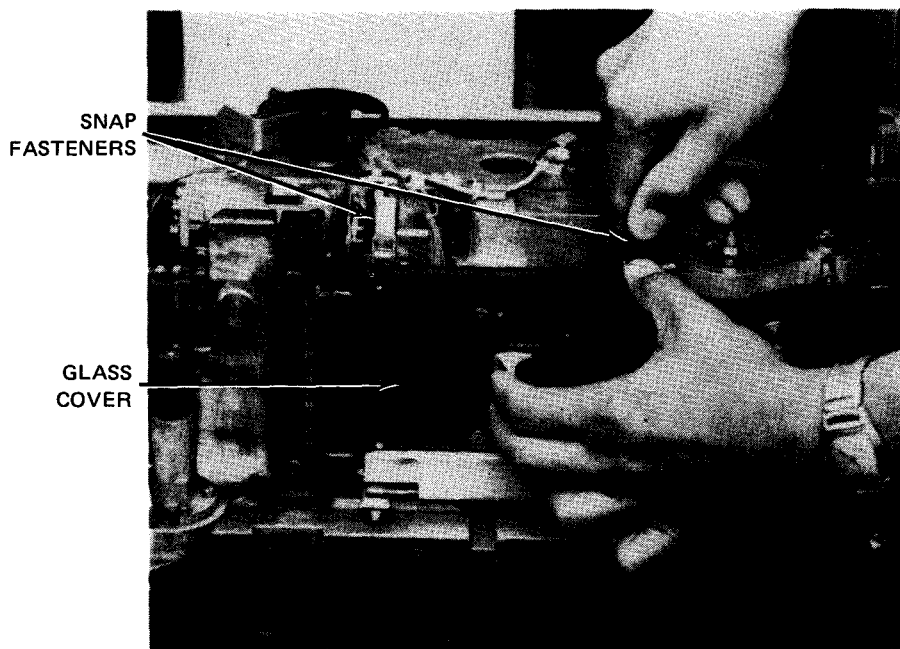

d. Closing glass cover

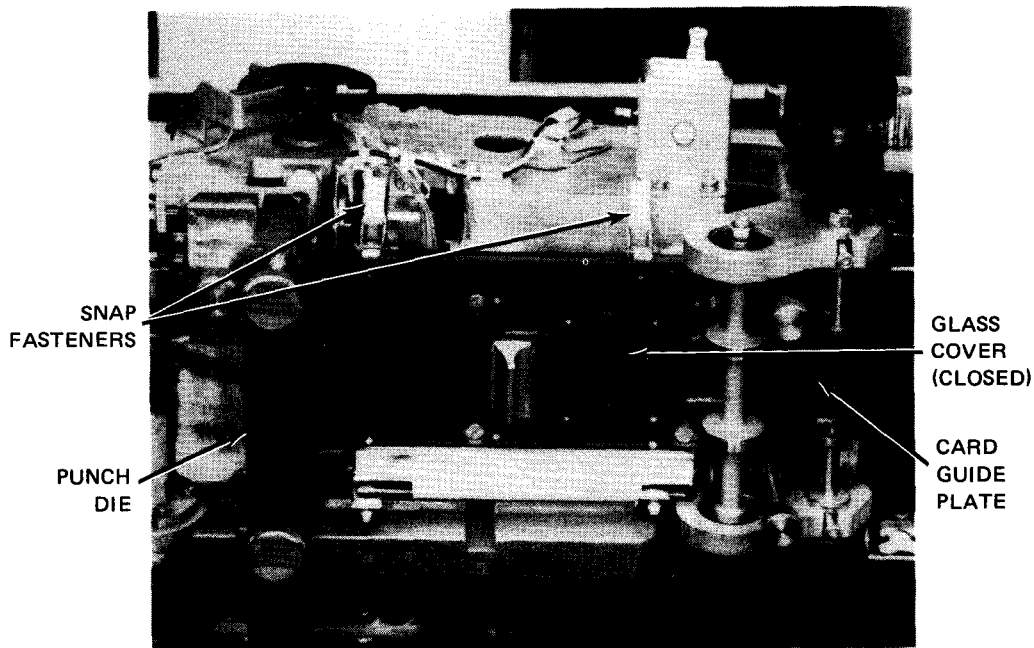

e. Advance station cleared of card jam

Figure 7-19. Clearing Card Jam in Advance Station (Part 3 of 3)

7.3.3.8. Clearing Card Jam in Punch Station

Proceed as follows to clear a card jam in the punch station (Figure 7—20):

NOTE:

Before performing the following procedure, use the DOWN function of the SET IO command (Section 12) to prevent the card punch from being allocated to a job while offline. After the procedure is completed, use the UP function of the SET IO command to restore the card punch's available status.

1. If card punch is not in stop mode, press **STOP** switch/indicator, and set **AC** circuit breaker to **OFF** (down). (If in stop mode, do not press **STOP** switch/indicator.)
2. Raise top cover fully for access to the card feed path.
3. Loosen single thumbscrew holding post-punch card guide (Figure 7—20a), and remove the card guide (Figure 7—20b).
4. Perform steps 3 through 7 of 7.3.3.7 to remove a jammed card from behind glass cover. (Also see Figure 7—20c.)
5. Replace post-punch card guide and tighten thumbscrew to secure card guide (Figure 7—20a).
6. Perform **FEED CHECK** recovery procedure for punch-only operation described in Table 7—4.

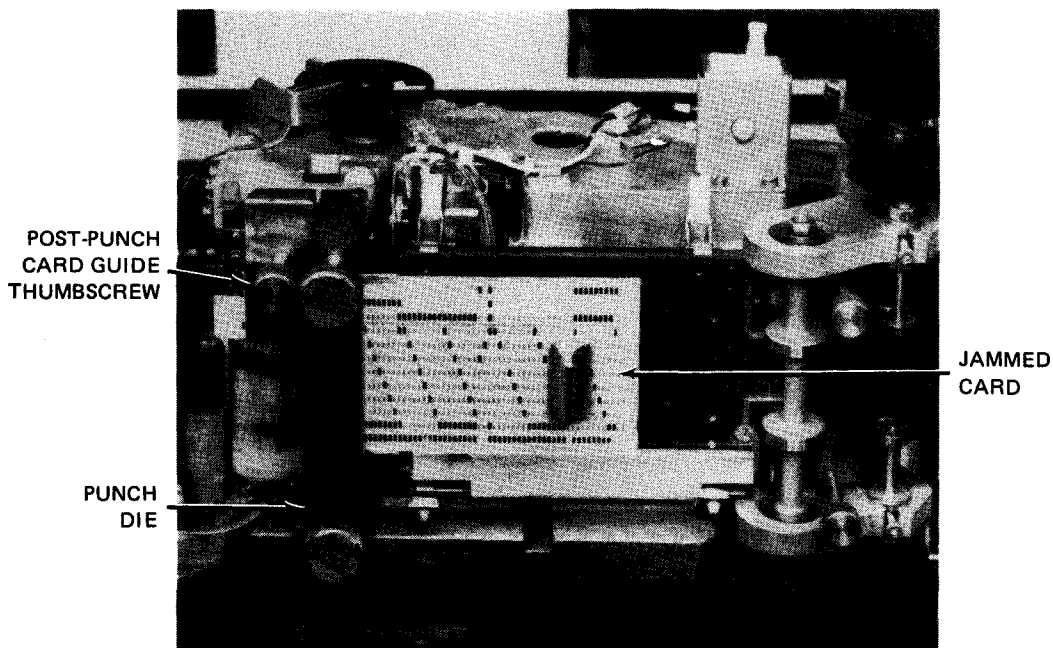

a. Jammed card in punch station

Figure 7—20. Clearing Card Jam in Punch Station (Part 1 of 2)

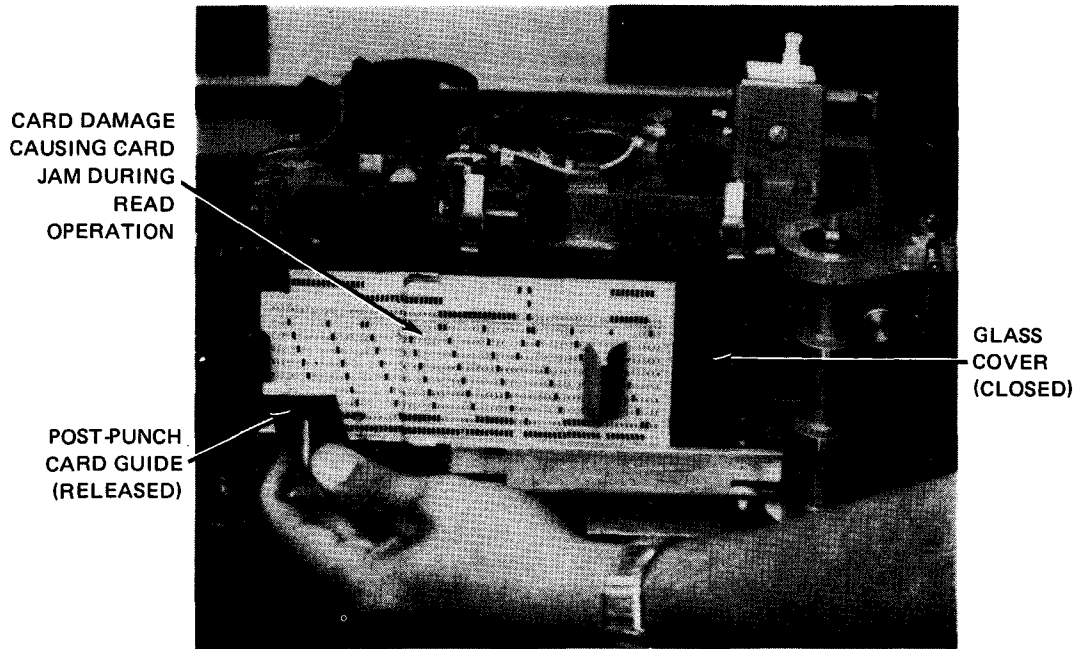

b. Removing post-punch card guide

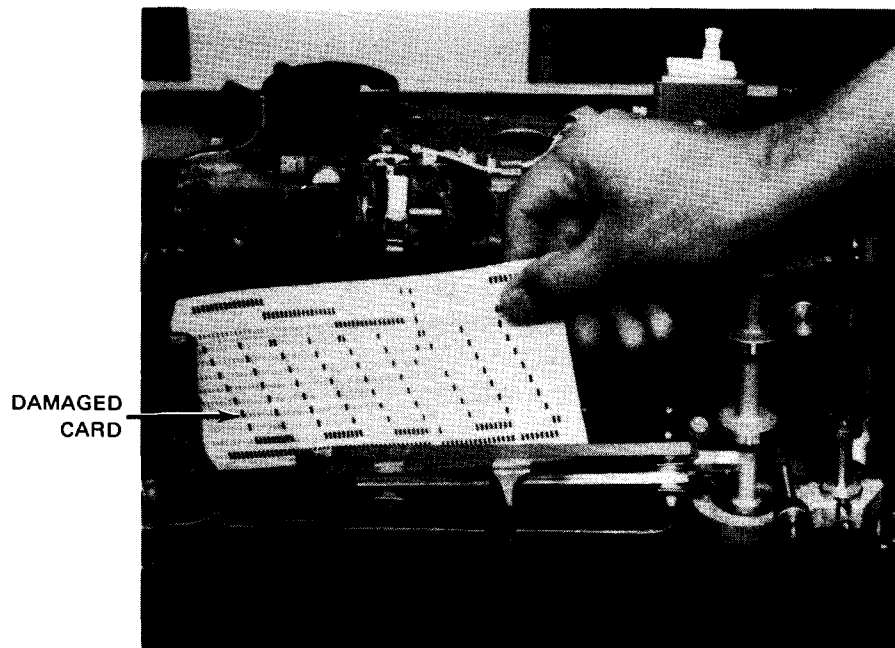

c. Removing jammed card from punch station

Figure 7-20. Clearing Card Jam in Punch Station (Part 2 of 2)

7.3.4. Recovery Procedures

Table 7-4 lists the malfunction indications on the indicator panel and operator control panel which may be corrected by the operator. An abnormal condition presents a certain combination of lit indicators on the indicator panel (at the processor) and operator control panel (at the card punch). If any of the error indications persist after the recommended operator action is carefully performed, contact the Sperry Univac customer engineer.

NOTE:

The card punch must be in the stop state (STOP switch/indicator is lit) before recovery procedures can be performed.

Table 7-4. 0605 Card Punch Subsystem, Recovery Procedures (Part 1 of 7)

Fault Indication	Probable Cause	Operator Action
<p>DEVICE CHECK indicator and STOP switch/indicator are lit, and operation stops.</p>	<p>Open cabinet interlock</p>	<ol style="list-style-type: none"> 1. Open top cover and remove cards from card path (keep cards in order). 2. Close all cabinet doors and top cover securely. 3. Remove cards from stacker. <p>If in punch-only operation:</p> <ol style="list-style-type: none"> 1. Discard cards punched by interrupted program. 2. Place blank cards in hopper. 3. Press FEED switch and then press RUN switch/indicator to continue the program. <p>If in read/punch operation:</p> <ol style="list-style-type: none"> 1. Remove cards from hopper. 2. Replace cards in hopper in following sequence: <ol style="list-style-type: none"> a. blank card; b. cards removed from stacker; c. cards removed from card path; and d. cards removed from hopper. 3. Press FEED switch and then press RUN switch/indicator to restart.

Table 7-4. 0605 Card Punch Subsystem, Recovery Procedures (Part 2 of 7)

Fault Indication	Probable Cause	Operator Action
DEVICE CHECK (cont)	AC power fault	<ol style="list-style-type: none"> 1. Open top cover and remove any cards in card path. 2. Open front door and reset (set to ON) AC circuit breaker if tripped. 3. Perform the punch-only or read/punch procedure required for an open cabinet interlock. 4. If DEVICE CHECK indicator is still lit and/or circuit breaker trips again, contact Sperry Univac customer engineer.
DEVICE CHECK indicator is lit; STOP switch/indicator is off.	High temperature early warning condition exists.	<p>Card punch does not enter stop state immediately (STOP switch/indicator is extinguished initially) when an early warning overheat condition exists. Proceed as follows:</p> <ol style="list-style-type: none"> 1. Attempt to continue run to completion. If card punch enters stop state before run is complete, or when run completes, proceed to step 2. 2. Press STOP switch/indicator. Set AC circuit breaker to OFF (down). 3. Raise card punch top cover. 4. Remove and clean air filter (Figure 7-21). Remove any obstructions that may prevent circulation of cooling air flow. 5. Allow card punch to cool for approximately 15 minutes. 6. Close top cover, set AC circuit breaker to ON (up), and perform either of following: <ul style="list-style-type: none"> ■ If DEVICE CHECK indicator remains lit after the cooling period or if the punch returns to a high temperature early warning condition after running, contact Sperry Univac customer engineer. ■ If DEVICE CHECK indicator goes off, press RUN switch/indicator to continue processing.

Table 7-4. 0605 Card Punch Subsystem, Recovery Procedures (Part 3 of 7)

Fault Indication	Probable Cause	Operator Action
<p>FEED CHECK indicator and STOP switch/indicator are lit, (READ CHECK and PUNCH CHECK indicator may also be lit); operation stops.</p>	<p>Card jam in card path or stacker</p>	<p>In punch-only operation:</p> <ol style="list-style-type: none"> 1. Clear jam as directed in 7.3.3.6 through 7.3.3.8. Duplicate any damaged prepunched cards and place at front of input deck. Discard all blank cards. <p>NOTE:</p> <p>Before punching is resumed, mark the last card in the stacker. Compare the first card repunched with the marked card. Discard the repunched card if it is a duplicate of the marked card in the stacker.</p> <ol style="list-style-type: none"> 2. Press FEED switch to load punch wait station. 3. Press RUN switch/indicator to continue program. 4. Close top cover and set AC circuit breaker to ON (up). <p>In read/punch operation:</p> <ol style="list-style-type: none"> 1. Perform steps 1 through 8 of 7.3.3.5. Remove any cards in card path, keeping cards in sequence. Remove jammed card and duplicate. Place duplicated card in proper sequence with other cards removed from card path. 2. Place cards in sequence in input card deck. 3. Restart program from beginning. 4. Close top cover and set AC circuit breaker to ON (up).
<p>READ CHECK indicator is lit, and STOP switch/indicator is out.</p>	<p>Read error detected</p>	<p>In read-only operation:</p> <ol style="list-style-type: none"> 1. Clear card path, remove cards from hopper, retain card sequence, and reconstruct any damaged cards. 2. Remove last card in sequence and with a blank card placed in front of this last card, place both cards in front of card deck removed from hopper. 3. Replace cards into hopper. 4. Press FEED switch to load wait station. 5. Press RUN switch/indicator to resume operation. 6. Remove first card from stacker and discard. (This card should be the blank one in step 2.)

Table 7-4. 0605 Card Punch Subsystem, Recovery Procedures (Part 4 of 7)

Fault Indication	Probable Cause	Operator Action
<p>READ CHECK indicator and STOP switch/indicator are lit; operation stops.</p>	<p>Read error or overrun error detected</p>	<ol style="list-style-type: none"> 1. Remove cards from stacker. Store cards in a convenient location. 2. Remove cards from hopper. 3. Press FEED switch. 4. Remove error card from stacker. 5. Place the following cards in hopper in sequence indicated: <ol style="list-style-type: none"> a. a blank card; b. error card removed in step 4; c. all cards removed from hopper in step 2. 6. Press FEED switch. 7. Press RUN switch/indicator. 8. Discard first card (facing operator) in stacker. 9. If read error recurs, contact Sperry Univac customer engineer.
<p>VALIDITY CHECK indicator and STOP switch/indicator are lit.</p>	<p>More than one punch detected in rows 1 through 7 in one or more columns while operating in translate mode (program controlled)</p>	<p>If VALIDITY CHECK, PUNCH CHECK, and FEED CHECK indicators are lit, or if only FEED CHECK indicator is lit, perform recovery procedures for FEED CHECK indicator.</p> <p>If VALIDITY CHECK and PUNCH CHECK indicators are lit, perform recovery procedures for PUNCH CHECK indicator.</p> <p>If only VALIDITY CHECK indicator is lit, proceed as follows:</p> <ol style="list-style-type: none"> 1. Remove cards from stacker and store in a convenient location. 2. Remove cards from hopper. 3. Press FEED switch. 4. Remove error card from stacker.

Table 7-4. 0605 Card Punch Subsystem, Recovery Procedures (Part 5 of 7)

Fault Indication	Probable Cause	Operator Action
<p>VALIDITY CHECK (cont)</p>		<ol style="list-style-type: none"> 5. Check error card for invalid punches; if invalid punches are found, perform step 5a or 5b. If no invalid punches are found, perform recovery procedure for READ CHECK indicator. <ol style="list-style-type: none"> a. Replace or repunch card with a card containing valid punches. Place a blank card, followed by the new card, into hopper then reload cards removed from hopper in step 2. b. Place a blank card in hopper first, then all cards removed in step 2. 6. Press FEED switch. 7. Press RUN switch/indicator. 8. Discard first card in stacker.
<p>Punch check condition exists, but PUNCH CHECK indicator is off; card punch operation is terminated.</p>	<p>Incorrectly punched column or overrun error</p>	<ol style="list-style-type: none"> 1. Press STOP switch/indicator. 2. Remove last card from output deck. 3. If card punch does not have read feature, perform step 4. If read feature is included, proceed to step 5. 4. Press RUN switch/indicator. Program now attempts to repunch last card in the deck. If punching is incorrect, punch enters stop state. Discard card removed in step 2. 5. Remove cards from hopper. 6. Press FEED switch. 7. Place following cards in hopper in sequence indicated: <ol style="list-style-type: none"> a. card removed from output deck in step 2; b. card fed out with FEED switch in step 6; c. all cards removed from hopper in step 5. 8. Press FEED switch. 9. Press RUN switch/indicator.

Table 7-4. 0605 Card Punch Subsystem, Recovery Procedures (Part 6 of 7)

Fault Indication	Probable Cause	Operator Action
<p>PUNCH CHECK indicator is lit during read/punch operation (read feature must be installed).</p>	<p>Column punched incorrectly, or overrun error</p>	<ol style="list-style-type: none"> 1. Remove cards from stacker. 2. Remove last card from output deck. 3. Store output deck. 4. Remove cards from hopper. 5. Press FEED switch. 6. Place the following cards in hopper in sequence indicated: <ol style="list-style-type: none"> a. a blank card; b. card fed manually after pressing FEED switch; c. all cards removed from hopper in step 4. 7. Press FEED switch. 8. Place card that was fed out manually in front of cards that were removed from hopper. 9. Place blank card in front of the input deck. 10. Replace all cards into hopper. 11. Press FEED switch. 12. Press RUN switch/indicator. 13. Remove first card (facing operator) from stacker; this card contains only newly punched information. <p>NOTE:</p> <p>Last card that was removed earlier from the stacker should be merged with new card on a keypunch. Overpunching, if required, should be performed with extra care.</p> <ol style="list-style-type: none"> 14. Insert merged card in correct location in output deck of cards removed in step 1. 15. Store output deck.

Table 7-4. 0605 Card Punch Subsystem, Recovery Procedures (Part 7 of 7)

Fault Indication	Probable Cause	Operator Action
HOPPER indicator and STOP switch/indicator are lit, and card punch operation is terminated.	Card failed to feed into advance station, or hopper is empty.	<ol style="list-style-type: none"> 1. Check cards in hopper. 2. Open top cover and check card path. Clear obstructions (Figure 7-21). Close cover. 3. Load hopper. 4. Remove cards from stacker. 5. Place blank card in front of input deck. 6. Press FEED switch. 7. Press RUN switch/indicator. 8. Remove first card fed to stacker. 9. Resume operation in normal manner.
STOP switch/indicator is lit, and card punch operation is terminated.	Output stacker is full.	<ol style="list-style-type: none"> 1. Unload cards from stacker. 2. Press RUN switch/indicator.
	System is in reset condition.	Operation resumed by processor operator

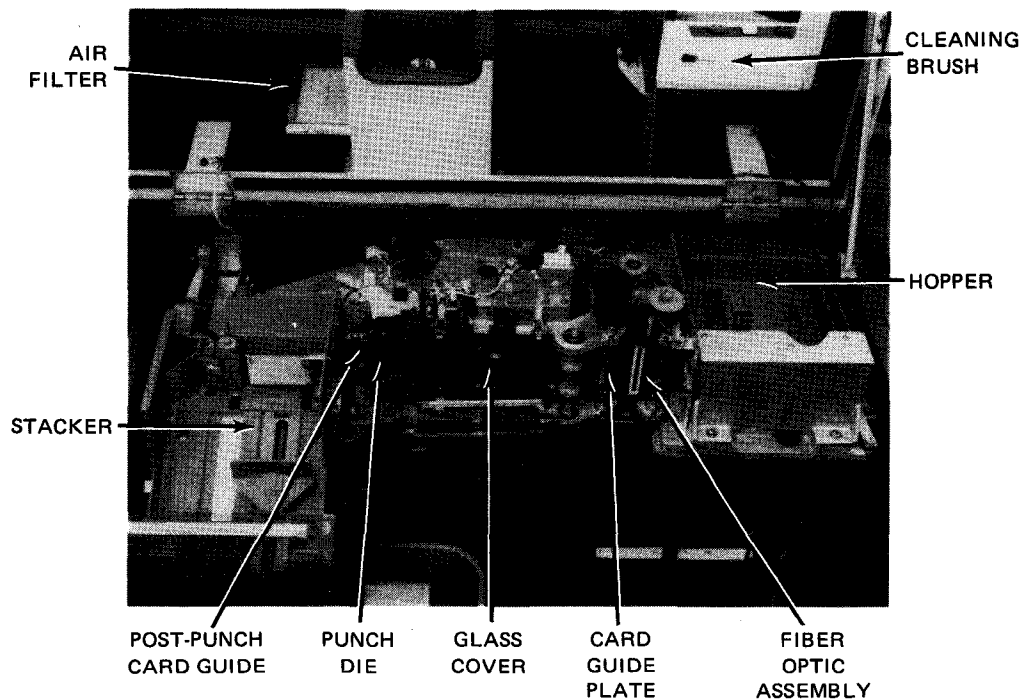

NOTE:

Carefully observe filter position before removing so that it can be replaced with the same side up. Filter is cleaned with a vacuum cleaner; do not strike the filter to loosen dirt. Alternate direction of vacuuming through filter so that dust is removed from both sides.

Figure 7-21. Air Filter Location and Card Feed Path (Cover Raised)



8. 2703 Optical Document Reader Subsystem

8.1. GENERAL

The SPERRY UNIVAC 2703 Optical Document Reader Subsystem (ODR) can be used with the SPERRY UNIVAC 90/30 or 90/30 B System. The ODR is a freestanding unit providing the processor with input by optical character recognition (Figure 8—1). Printed numeric- and mark-encoded documents are read in sizes from 2.75 inches (6,98 cm) by 3.00 inches (7,62 cm) to 4.25 inches (10,79 cm) by 8.75 inches (22,22 cm). The smaller documents are read at the approximate rate of 380 per minute, and the larger documents at the approximate rate of 300 per minute. Depending on selection made at installation, the subsystem recognizes the numeric size A font subset of the American National Standard Character Set for Optical Document Readers (ANSCSOR) or the Sperry Univac H-14 font. With optional features, the subsystem may provide speed upgrading, modulus 10 check digit verification, mark read, punch card read, and validity checks.

The subsystem is a single unit containing its own control circuits and power supplies. Operator controls are located on the front of the unit. The hopper can accommodate up to 2000 documents in the full range of sizes without requiring mechanical feed adjustments. Documents are fed from the hopper upon command of the processor. Recognition logic determines the character and translates it into an appropriate digital code acceptable to the processor. Three stackers, selected by the subsystem logic and by programming, accept the read documents. Each stacker can hold up to 1000 documents, or an equivalent of 7.5 inches (19 cm).

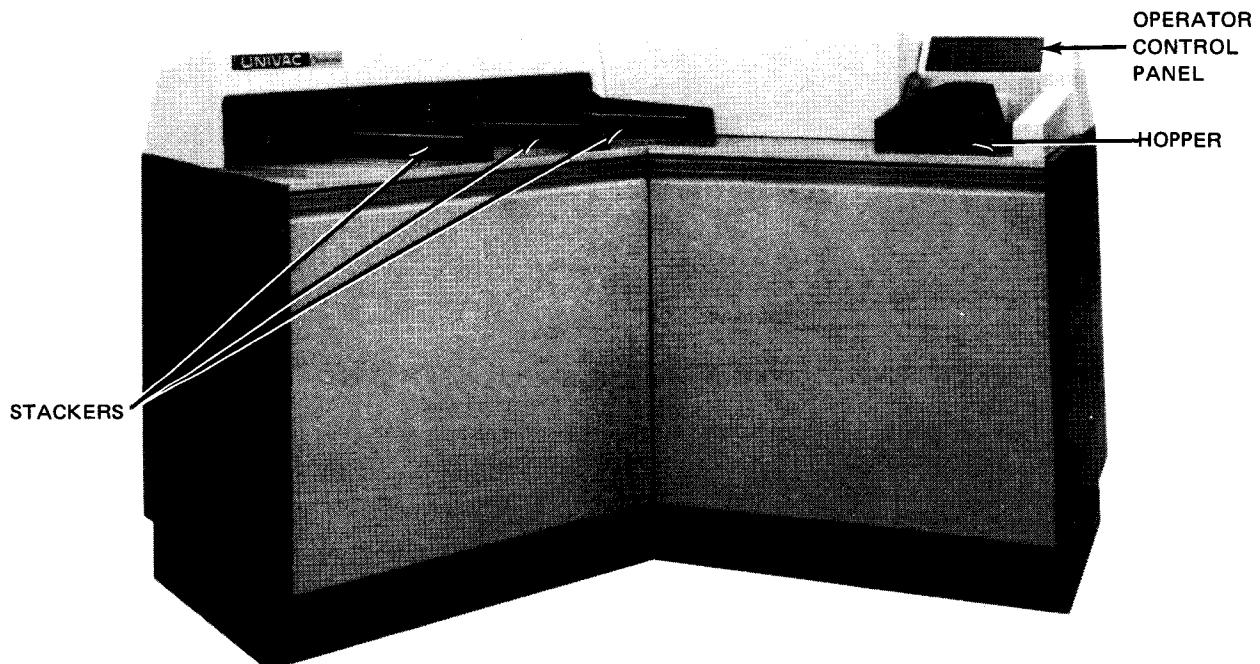

Figure 8—1. 2703 Optical Document Reader Subsystem

8.2. OPERATING CONTROLS AND INDICATORS

The operator control panel (Figure 8—2) contains two switch/indicators, two rocker switches beneath a a snap panel, and four indicators that are visible only when lit. Power is controlled from the rear of the unit, behind a single cabinet door, at the power control panel (Figure 8—3) and power distribution panel (Figure 8—4). All controls and indicators are listed and described in Table 8—1.

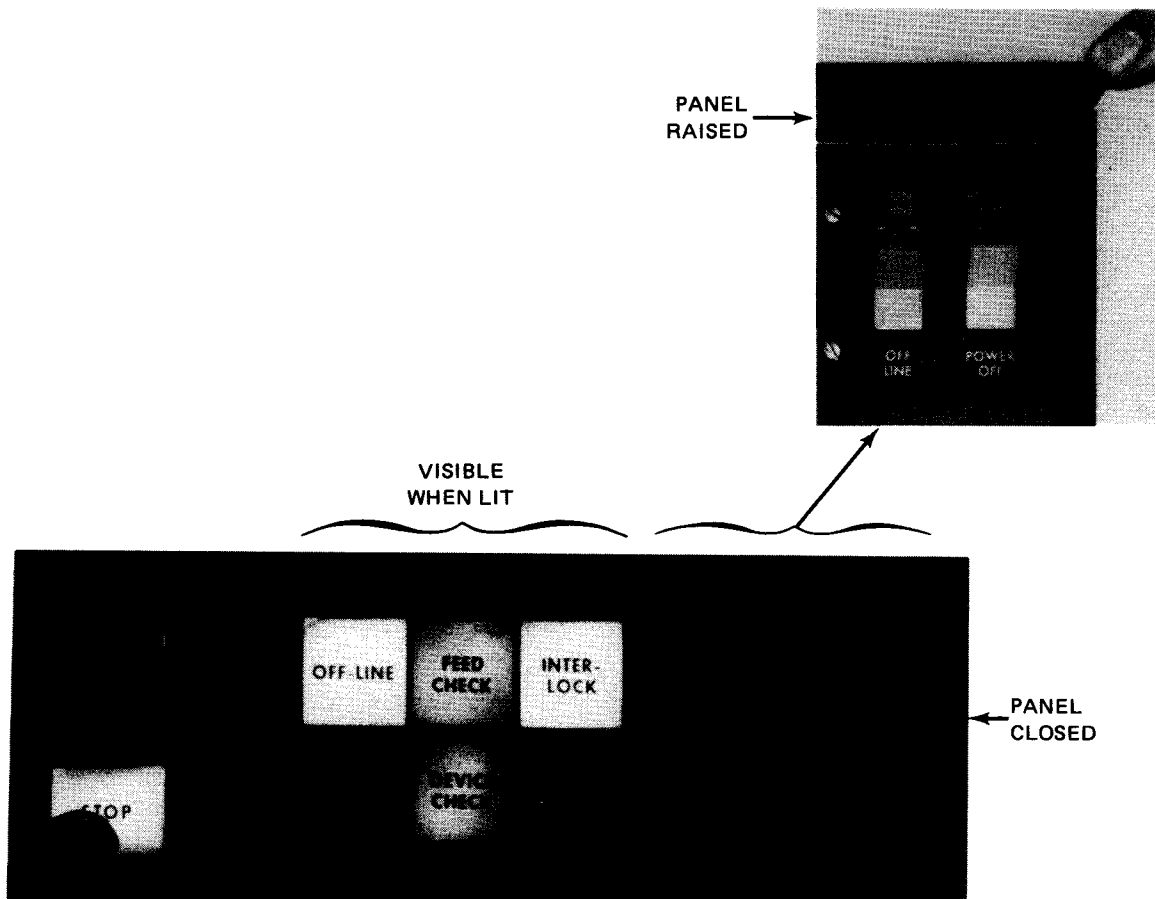

Figure 8—2. 2703 Optical Document Reader Subsystem, Operator Control Panel

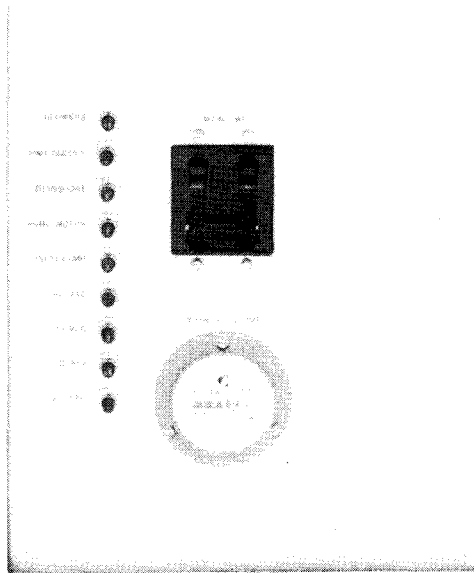

Figure 8-3. 2703 Optical Document Reader Subsystem, Power Control Panel

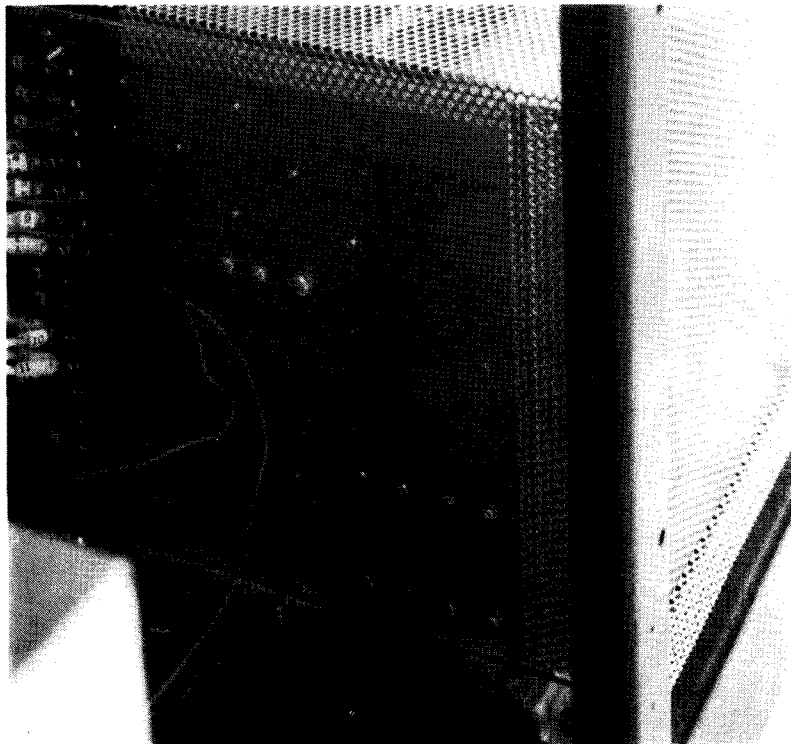

Figure 8-4. 2703 Optical Document Reader Subsystem, Power Distribution Panel

Table 8—1. 2703 Optical Document Reader Subsystem, Controls and Indicators (Part 1 of 3)

Control/Indicator — Function
Operator Control Panel
RUN switch/indicator Clears all sense bits (except bit 6) and status bits previously stored, and sets attention bit in status register to act immediately on read commands. Indicator lights when subsystem can act immediately on commands.
STOP switch/indicator When pressed: <ul style="list-style-type: none">▪ turns off transport, camera lamps, and motors after a delay of approximately 3 seconds;▪ sets operation intervention sense bit and unit check status bit; and▪ lights all panel indicators for lamp check. Indicator lights when any of the following indicators light: <ul style="list-style-type: none">▪ OFF-LINE▪ FEED CHECK▪ DEVICE CHECK▪ INTERLOCK
OFF-LINE indicator Lights when subsystem is offline to the processor
FEED CHECK indicator Lights when document jams
DEVICE CHECK indicator Lights when: <ul style="list-style-type: none">▪ Air flow in cabinet is reduced below required level due to blower failure or air intake obstruction.▪ Cabinet air temperature increases to 94°F.▪ Circuit breaker trips open (except MAIN PWR).
INTERLOCK indicator Lights when cabinet interlock is open. Document transport cannot operate with an open interlock.

Table 8-1. 2703 Optical Document Reader Subsystem, Controls and Indicators (Part 2 of 3)

Control/Indicator — Function
Operator Control Panel (cont)
<p>ON LINE/OFF LINE switch</p> <p>ON LINE position:</p> <p>Connects the processor multiplexer channel to the subsystem control unit</p> <p>OFF LINE position:</p> <p>Disconnects the processor multiplexer channel. OFF-LINE indicator lights.</p> <p>POWER ON/POWER OFF switch</p> <p>POWER ON position:</p> <p>Initiates power-on sequence and resets all logic circuitry. When power-on sequence is complete, the STOP switch/indicator lights, and the subsystem is ready for online operation if ON LINE/OFF LINE switch is set to ON LINE.</p> <p>POWER OFF position:</p> <p>Initiates power-off sequence and stops the cooling blowers. When power-off sequence is complete, the subsystem is set to offline condition, regardless of position of ON LINE/OFF LINE switch.</p> <p>Power-on or power-off sequencing occurs without introducing transients on the processor multiplexer channel.</p>
Power Control Panel
<p>BLOWERS pushbutton circuit breaker</p> <p>Provides overload protection for blower motors in the unit</p> <p>PWR SUPPLY pushbutton circuit breaker</p> <p>Provides overload protection for power supply input circuits</p> <p>TRANSPORT pushbutton circuit breaker</p> <p>Provides overload protection for document transport drive circuits</p> <p>PUMP MOTOR pushbutton circuit breaker</p> <p>Provides overload protection for vacuum pump motor</p> <p>PROJ LAMP pushbutton circuit breaker</p> <p>Provides overload protection for projection lamps</p> <p>110 VAC pushbutton circuit breaker</p> <p>Provides overload protection for power control circuits</p> <p>24 VAC pushbutton circuit breaker</p> <p>Provides overload protection for 24 volt power supply</p>

Table 8-1. 2703 Optical Document Reader Subsystem, Controls and Indicators (Part 3 of 3)

Control/Indicator — Function
Power Control Panel (cont)
CL/BR pushbutton circuit breaker Provides overload protection for clutch and brake circuits
9.5 VAC pushbutton circuit breaker Provides overload protection for 9.5 Vac power supply
TRANSP ON TIME elapsed time meter Records time that power is on for document transport panel
MAIN PWR dual circuit breaker Provides overload protection for main power input to subsystem
Power Distribution Panel
CB1 +6 circuit breaker Provides overload protection for +6 volt power supply
CB2 +12 circuit breaker Provides overload protection for +12 volt power supply
CB3 -12 circuit breaker Provides overload protection for -12 volt power supply
CB4 +48 circuit breaker Provides overload protection for +48 volt power supply

8.3. TURN-ON AND TURN-OFF PROCEDURES

Power for the subsystem is normally applied and removed via the **POWER ON/POWER OFF** switch on the processor operator/maintenance panel (Figure 2—2). To control power from this panel, however, certain switches and circuit breakers must first be set to specific positions. The switch and circuit breaker settings are listed in Table 8—2. ←

The switches and circuit breakers are first set as listed in Table 8—2; then the processor **POWER ON/POWER OFF** switch is set to **POWER ON** and the **RUN** switch/indicator on the operator control panel lights after the power-on sequence is complete. Power for the subsystem is turned off remotely at the processor when the entire system is turned off, provided operation of the subsystem had continued in an online mode.

8.3.1. Independent Power Turn On

To turn power on at the subsystem, independently of the processor, proceed as follows:

1. Raise switch cover panel on operator control panel and set **ON LINE/OFF LINE** switch to **OFF LINE**.
2. Check that all circuit breakers on power distribution panel are set to on (up) position.
3. Check that all pushbutton circuit breakers on power control panel are closed (not protruding).
4. Set **MAIN PWR** circuit breaker on power control panel to on (up) position.
5. Set **POWER ON/POWER OFF** switch on operator control panel (beneath panel cover) to **POWER ON**. Note that **OFF-LINE** indicator and **STOP** switch/indicator are lit.
6. Press **RUN** switch/indicator on operator control panel to begin local operation. Note that **RUN** switch/indicator lights and **STOP** switch/indicator extinguishes.
7. Use the *UP* function of the SET IO command (Section 12) to include the subsystem in the system's resources list for job allocation.

8.3.2. Independent Power Turn Off

To turn power off at the subsystem, independently of the processor, proceed as follows:

CAUTION

If the ODR is to be turned on after the system has already been powered up (ODR is in offline mode of operation), follow the independent power turn-on procedure in 8.3.1. Power transients may interfere with proper operation of the processor if this procedure is not followed.

1. Raise switch cover panel on operator control panel, and set **ON LINE/OFF LINE** switch to **OFF LINE** position. Note that **OFF-LINE** indicator and **STOP** switch/indicator light.
2. Set **POWER ON/POWER OFF** switch on operator control panel (beneath cover panel) to **POWER OFF** position. Note that all indicators extinguish.
3. Set **MAIN PWR** circuit breaker on power control panel to off (down) position.
4. Use the *DOWN* function of the SET IO command (Section 12) to remove the subsystem from the system's resources list and prevent it from being allocated to a job while offline.

Table 8-2. 2703 Optical Document Reader Subsystem, Power Switch Settings

Switch/Circuit Breaker	Normal Setting
Power Distribution Panel	
CB1 +6 circuit breaker	On (up)
CB2 +12 circuit breaker	On (up)
CB3 -12 circuit breaker	On (up)
CB4 +48 circuit breaker	On (up)
Power Control Panel	
MAIN PWR circuit breaker	On (up)
All pushbutton circuit breakers	On (in)
Operator Control Panel	
POWER ON/POWER OFF switch	POWER ON
ON LINE/OFF LINE switch	ON LINE

8.4. OPERATING PROCEDURES

Operating procedures for the subsystem include loading documents in the hopper, positioning the camera for center, adjusting the document aligner, unloading documents from the stackers, and clearing document jams in the transport panel.

8.4.1. Loading Documents in Hopper

Documents to be read must conform to the general characteristics listed in Table 8—3. To load documents in the hopper, proceed as follows:

1. Select a handful of documents to be read, and fan them (Figure 8—5a) so they will feed correctly.
2. Position the documents with the bottom edges down and the data sides facing rear of the subsystem; then jog the documents against the left guide of the hopper (Figure 8—5b) to align them.
3. Retract the document follower plate and insert the documents so they are positioned against the left guide edge (Figure 8—5c).
4. Release the document follower plate and allow it to press against the last document (Figure 8—5d).
5. Repeat steps 1 through 4 until the hopper is filled to desired capacity (Figure 8—5e). Maximum hopper capacity is 2000 documents.



a. Fanning documents

Figure 8—5. Loading Documents in Hopper (Part 1 of 3)



b. Jogging documents



c. Retracting document follower plate

Figure 8-5. Loading Documents in Hopper (Part 2 of 3)

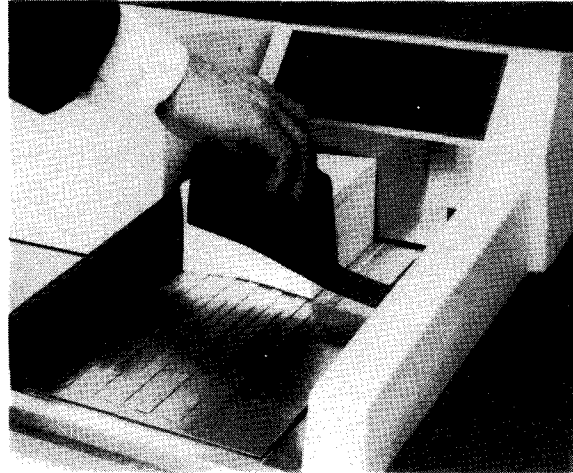

d. Releasing document follower plate

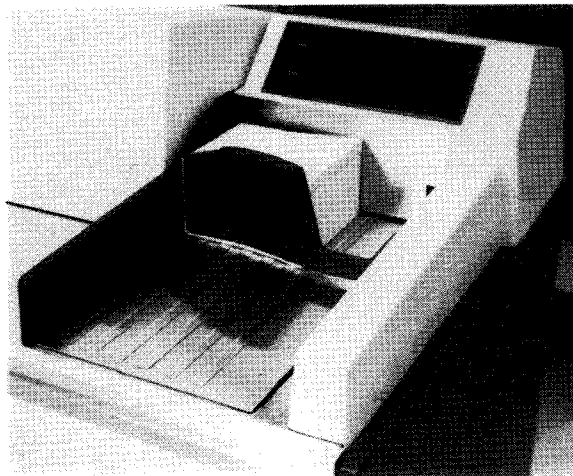

e. Correctly loaded documents

Figure 8-5. Loading Documents in Hopper (Part 3 of 3)

Table 8-3. General Document Characteristics

Parameter	Characteristic
Size	Length (parallel to direction of feed): 3.00 inches (7,62 cm) to 8.75 inches (22,23 cm) Height: 2.75 inches (6,99 cm) to 4.25 inches (10,80 cm)
Weight, based on a 500-sheet ream of 17-inch (43,18 cm) by 22-inch (55,88 cm) paper	Minimum: 20-pound (9,07 kg) bond paper Maximum: 62-pound (28,12 kg) paper
Thickness	0.003 inch (0,08 mm) to 0.010 inch (0,30 mm)
Color	White background in entire clear bond of reading and mark fields
Coatings	None
Parts	Single-part documents
Edges	<ul style="list-style-type: none">■ Parallel edges and square ends that align as single-ply after sealing, on laminated documents■ Perforations with irregularities not exceeding 0.03 inch (0,80 mm) when forms are burst apart■ Extruded edges may cause document jam and are not recommended; pin-feed tractor strips should be removed.
Thickness variations	Adhesive tapes or labels causing variations in thickness should be avoided.
Surface breaks	Clips, staples, or spindle punctures causing surface breaks should be avoided.

8.4.2. Camera Positioning

To align, or center, the camera lens on the ODR print line of a document, proceed as follows:

NOTE:

Before performing the following procedure, use the DOWN function of the SET IO command (Section 12) to prevent the subsystem from being allocated to a job while offline. After the procedure is completed, use the UP function of the SET IO command to restore the subsystem's available status.

1. Press **ON LINE/OFF LINE** switch to **OFF LINE** position.
2. Raise right document transport cover; cover swings upward and toward the rear (Figure 8-6a).
3. Open document aligner (Figure 8-6b) and insert a sample document with its bottom edge down and data side facing the rear of the subsystem. Engage the leading edge of the document with the drive belts.
4. Rotate manual transport drive (Figure 8-6c) in a clockwise direction and move document into read station.

5. In the alignment mirror, observe the projected image on the document (Figure 8—6d).
6. Raise or lower the camera by means of the camera positioning switch (Figure 8—6c) so that the reflected image is centered between the two spots of light (Figure 8—6d). Check full length of print line (may have inserted a skewed document or skewed printer sample).
7. Eject the sample document back into the document aligner by rotating the manual transport drive in a counterclockwise direction.
8. Remove document from document aligner, close the document aligner, and close document transport cover.

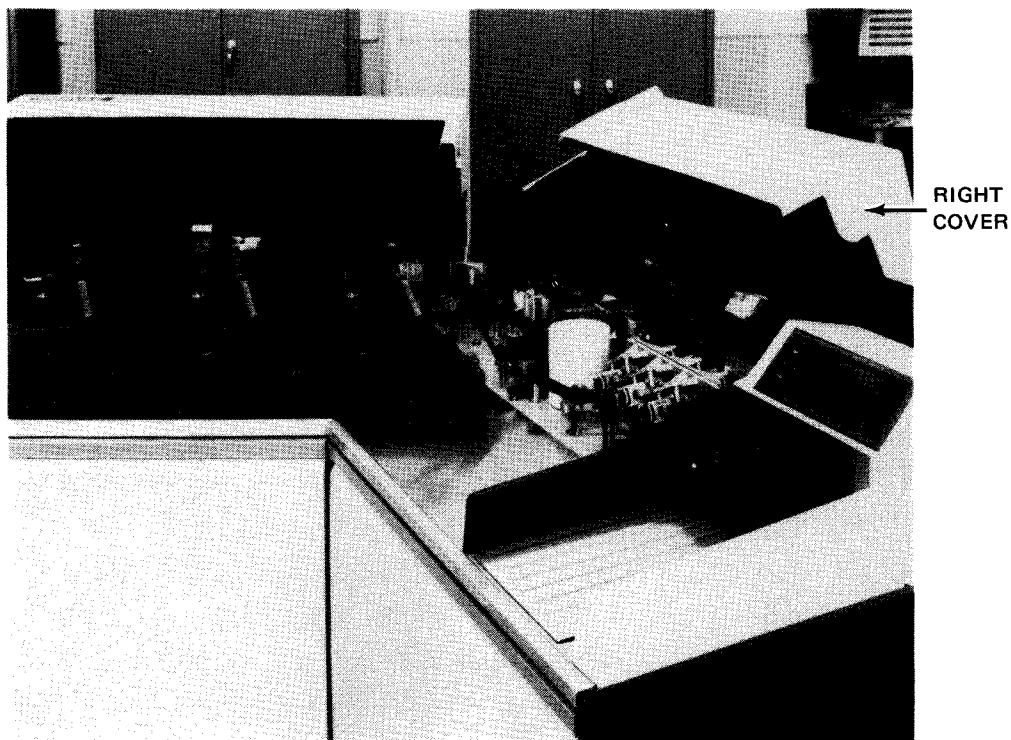

a. Document transport with covers raised

Figure 8—6. Camera Positioning (Part 1 of 3)

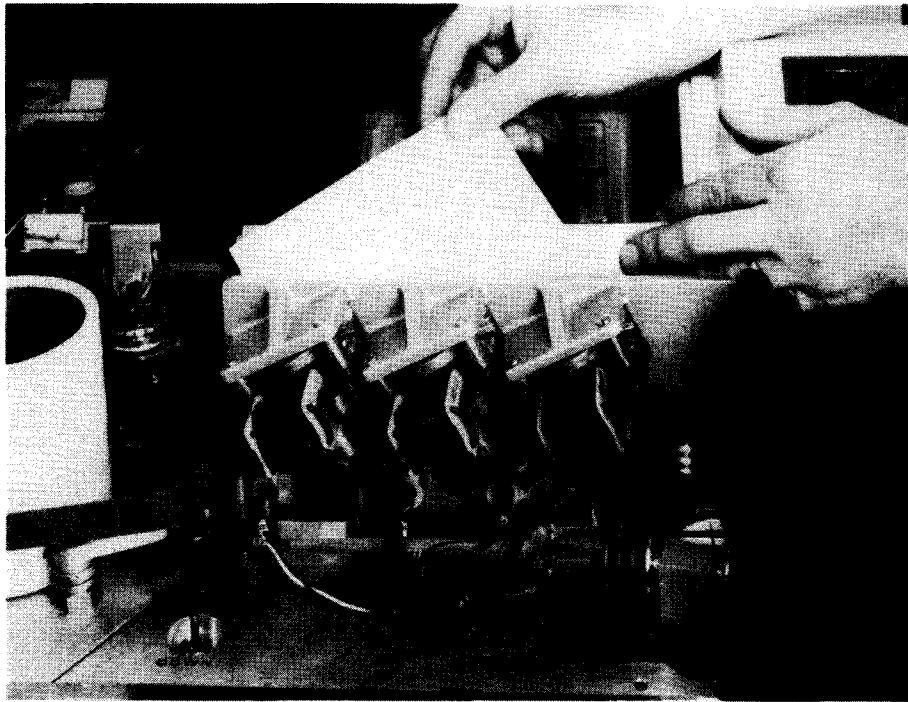

b. Inserting document in aligner throat

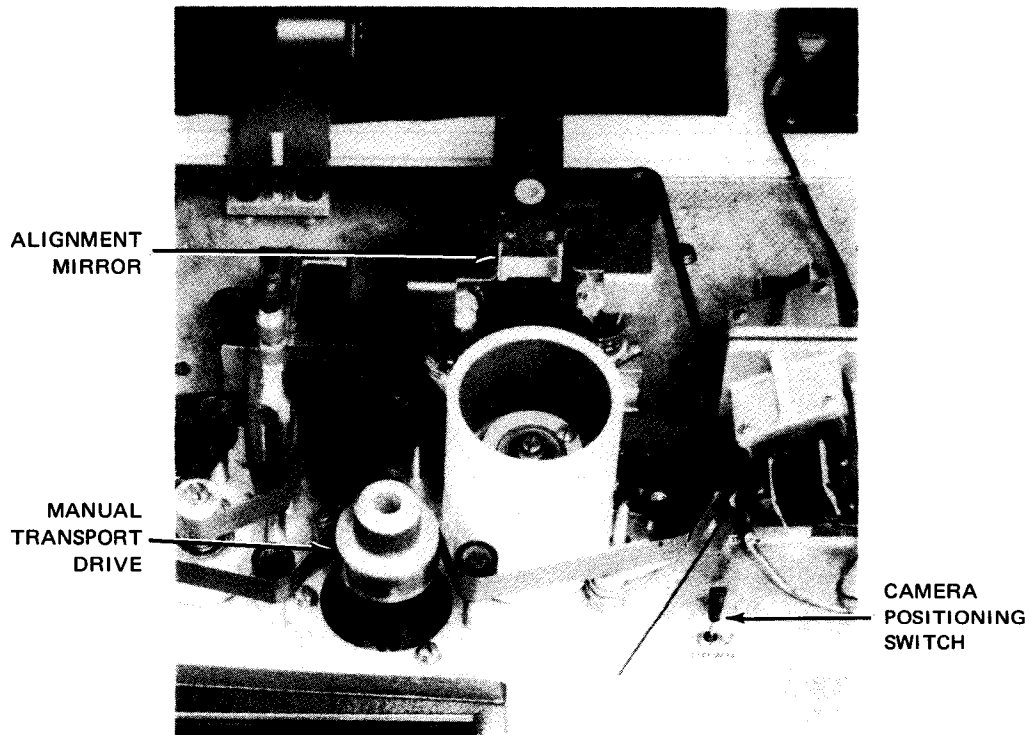

c. Camera positioning controls

Figure 8-6. Camera Positioning (Part 2 of 3)

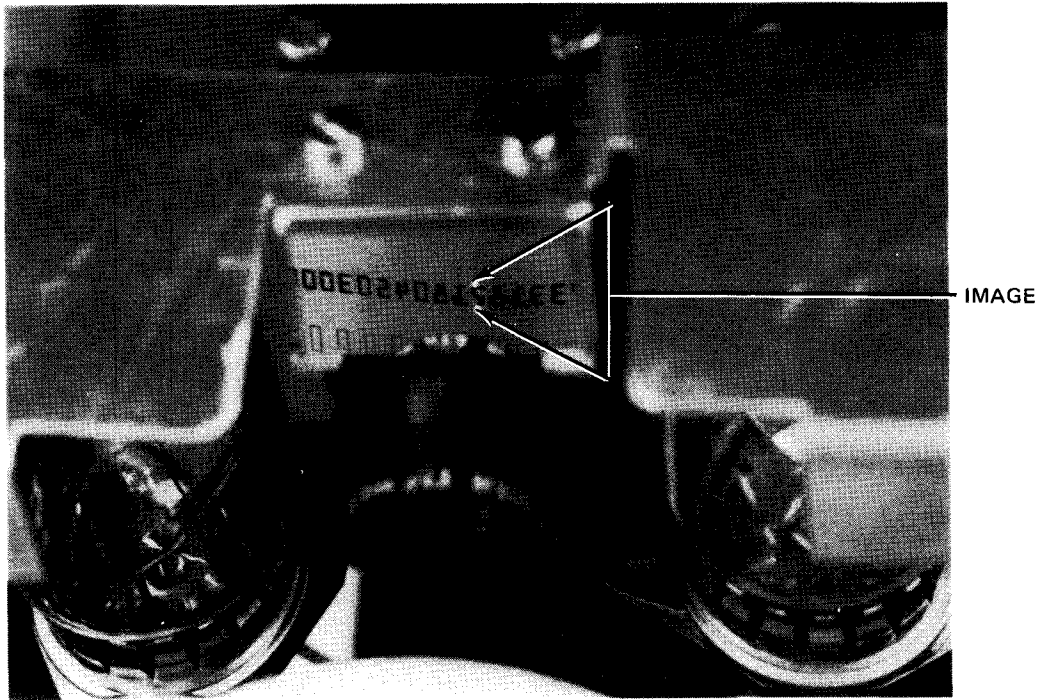

d. Reflected optical image centered between light spots

Figure 8-6: Camera Positioning (Part 3 of 3)

8.4.3. Document Aligner Adjustment

Make adjustments to accommodate documents of various thicknesses as follows:

1. Raise the right document transport cover (Figure 8-6a); cover swings upward and toward the rear.
2. On the left side of the exposed document transport, raise the interlock switch plunger so that it remains up (Figure 8-7a).

CAUTION

Safety devices are now disabled. Power can be applied to the document transport by the operator; however, do not apply power unless the document transport is cleared of extraneous objects or damage to the equipment may result.

3. Load samples of documents in hopper.
4. Press **ON LINE/OFF LINE** switch to **OFF LINE** position.
5. Press **RUN** switch/indicator to set document transport in operation.

6. Rotate aligner adjustment (Figure 8—7b) so that documents feed properly. Rotating the control clockwise (increasing scale) increases the document aligner dimension to accommodate thicker documents.

NOTE:

*If the documents being fed are thinner than previously fed documents, a multiple feed error may occur and the documents will be directed to the reject stacker. The **FEED CHECK** indicator lights. Adjust document aligner to reduce throat dimensions.*

7. When documents feed correctly, press the **STOP** switch/indicator.
8. Lower the document transport cover, which automatically resets the interlock switch.
9. Press the **ON LINE/OFF LINE** switch to **ON LINE** position. The subsystem is now ready to accept commands.

INTERLOCK
SWITCH

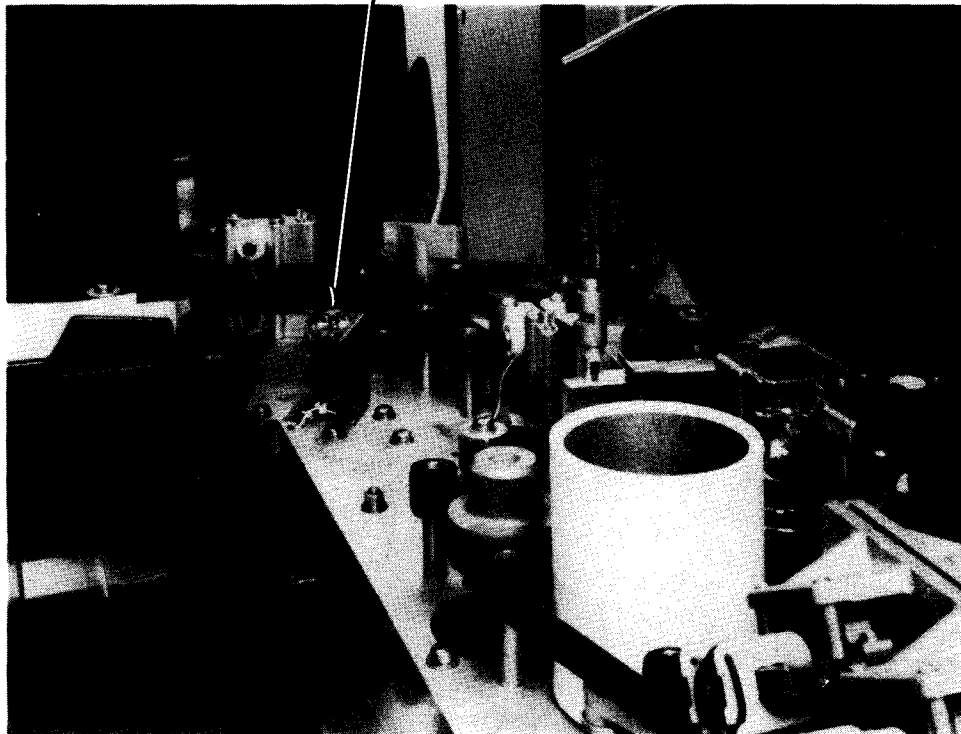

a. Interlock switch for document transport cover

Figure 8—7. Document Aligner Adjustment (Part 1 of 2)

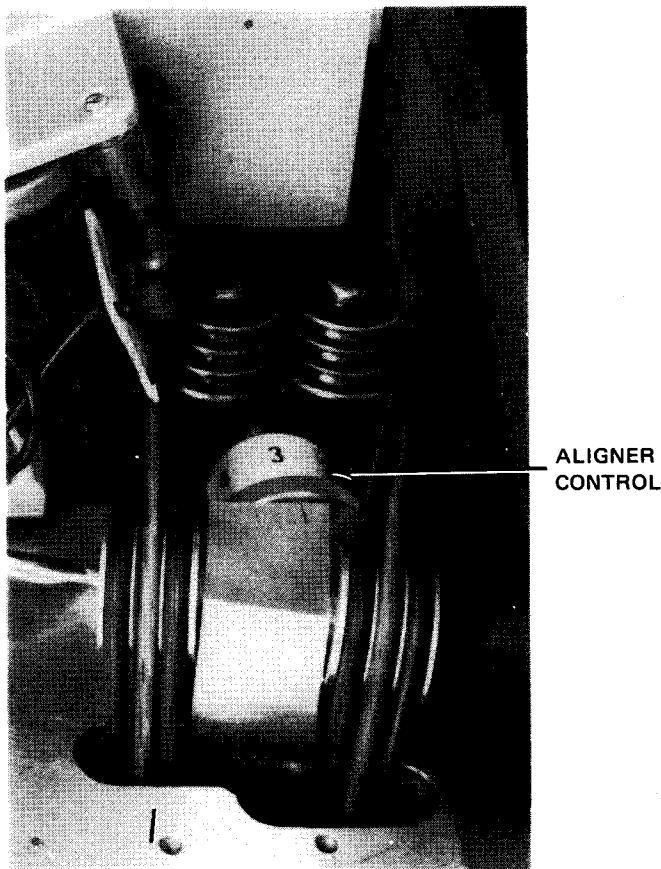

b. Document aligner control

Figure 8—7. Document Aligner Adjustment (Part 2 of 2)

8.4.4. Unloading Documents

Documents are removed from any of the three stackers as follows:

1. Grasp documents while slightly retracting the follower plate (Figure 8—8).
2. Remove documents and allow follower plate to return under tension to make contact with documents remaining in stacker.
3. Repeat steps 1 and 2, as required.

NOTE:

Processed (or rejected) documents may be safely removed from any stacker while the subsystem is in operation.

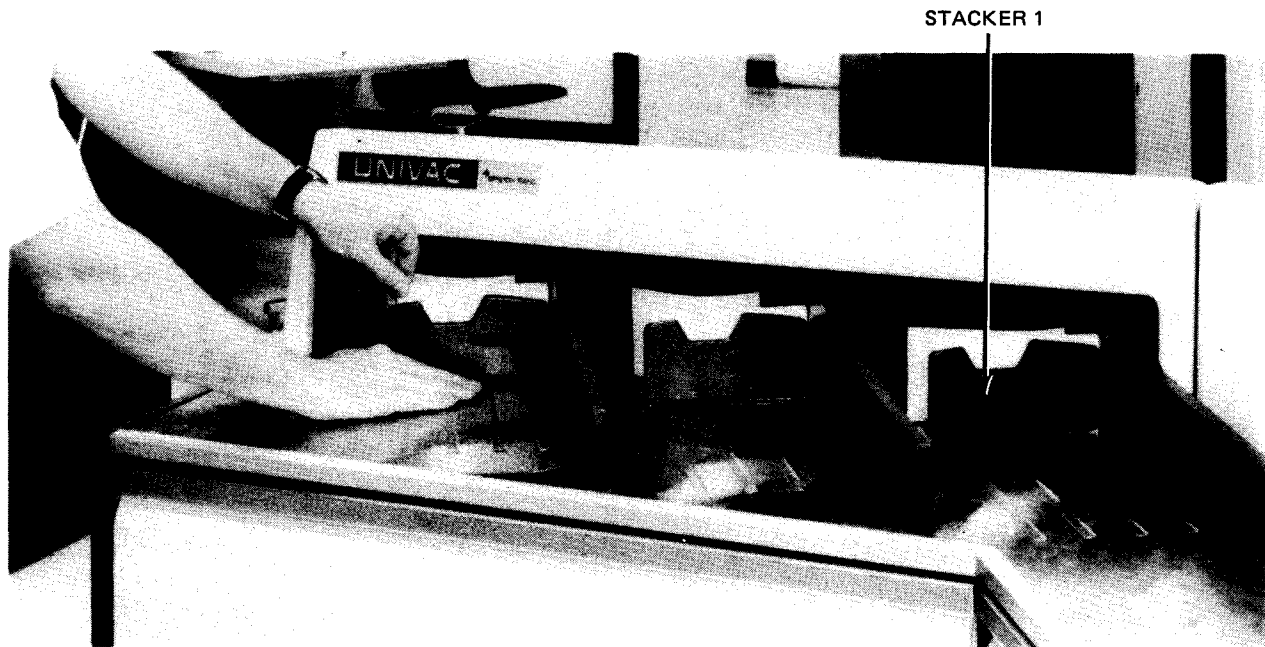

Figure 8—8. Removing Documents from Stacker

8.4.5. Clearing Document Jams

To clear a document jam in the document transport panel, proceed as follows:

NOTE:

Before performing the following procedure, use the DOWN function of the SET IO command (Section 12) to prevent the subsystem from being allocated to a job while offline. After the procedure is completed, use the UP function of the SET IO command to restore the subsystem's available status.

1. Set **ON LINE/OFF LINE** switch to **OFF LINE**, and set **MAIN PWR** circuit breaker on power control panel to off (down).
2. Raise both document transport covers; covers swing upward and toward the rear (Figure 8—9a).
3. Locate jam and remove all documents involved in the jam.
4. If documents are mutilated, use manual transport drive (Figure 8—9a) to move document transport back and forth to eject document pieces.
5. If jam occurred in either the document stacker select or diverter gate (Figure 8—9b) and cannot be cleared by methods stated in steps 3 and 4, it may be necessary to lift the knurled spring-loaded gate pin (Figure 8—9b) adjacent to the gate, and pivot the gate open to clear document pieces.

NOTE:

Return the spring-loaded gate to its original position after correcting the jammed condition.

6. If jam occurred in the mark/card read station (Figure 8—9c) and cannot be cleared by methods stated in steps 4 and 5, press the front section of the diverter gate to the rear to open the station.
7. Lower document transport covers.
8. Set **MAIN PWR** circuit breaker to on (up), and set **ON LINE/OFF LINE** switch to **ON LINE**.
9. Press **RUN** switch/indicator to restart document transport.

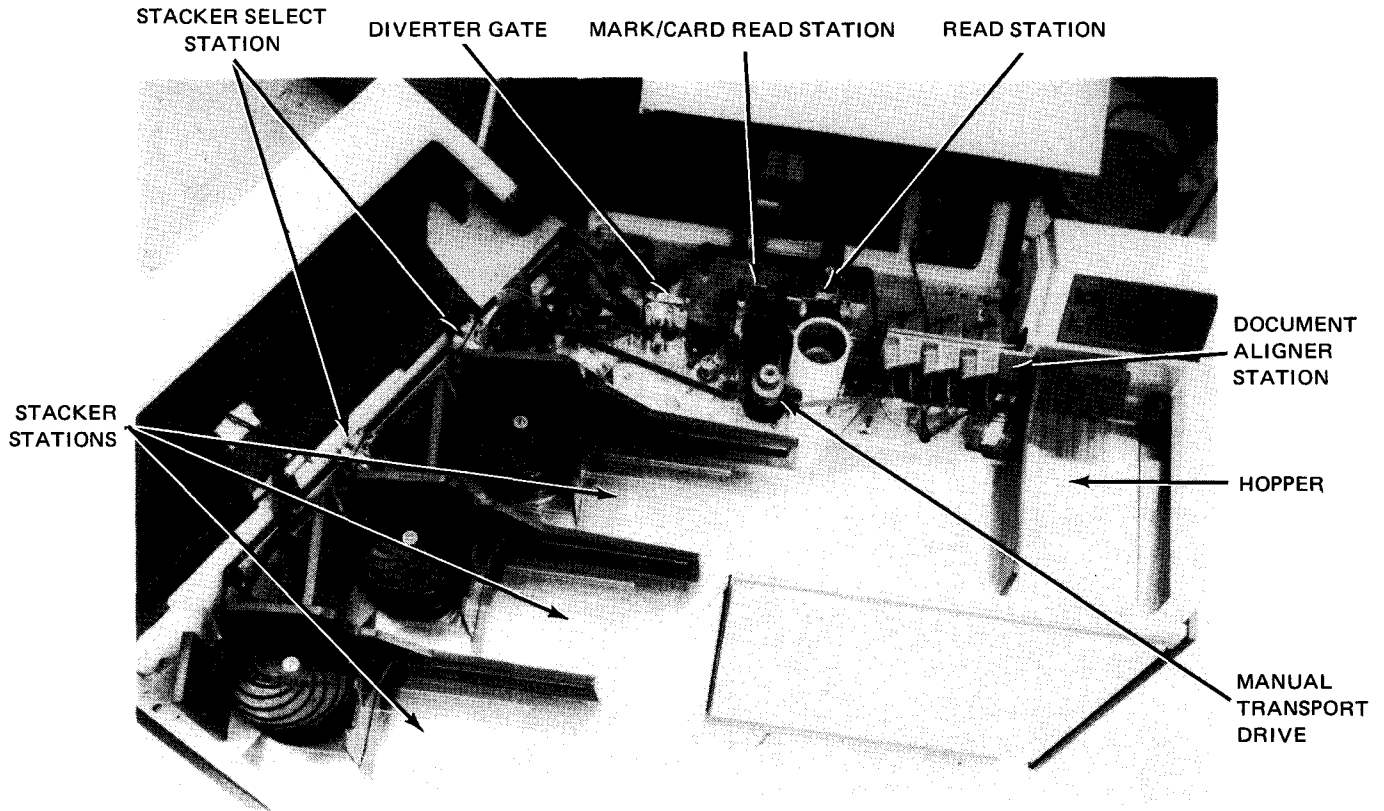

a. Document transport with covers raised

Figure 8—9. Clearing Document Jams (Part 1 of 2)

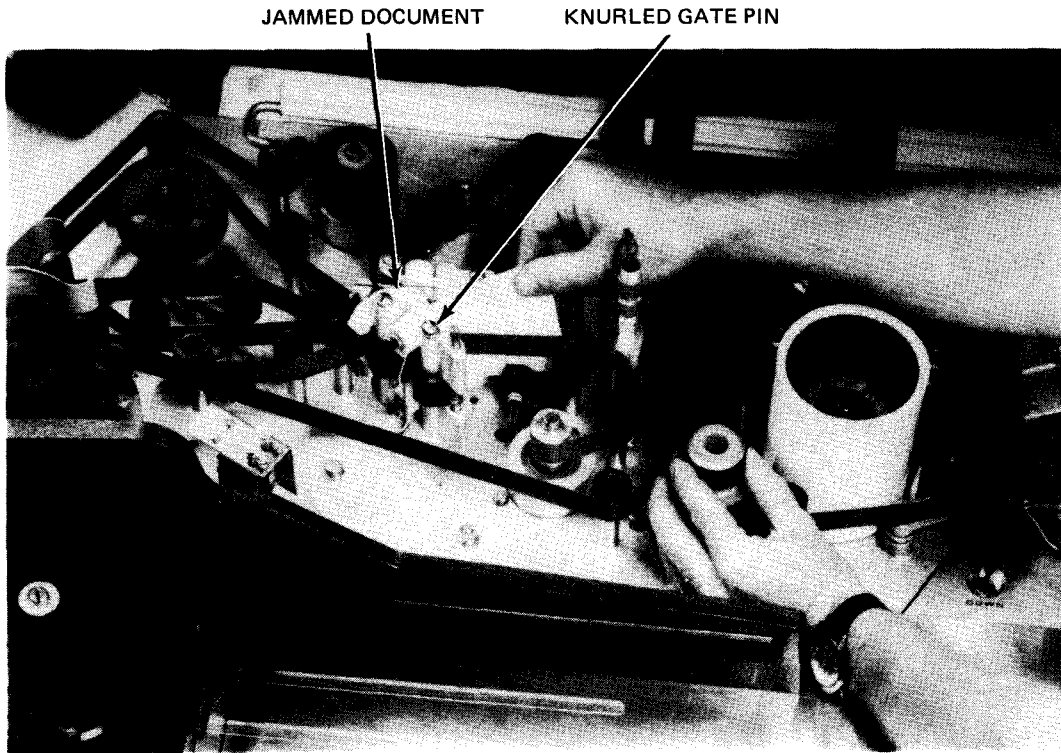

b. Removing jammed document at diverter gate

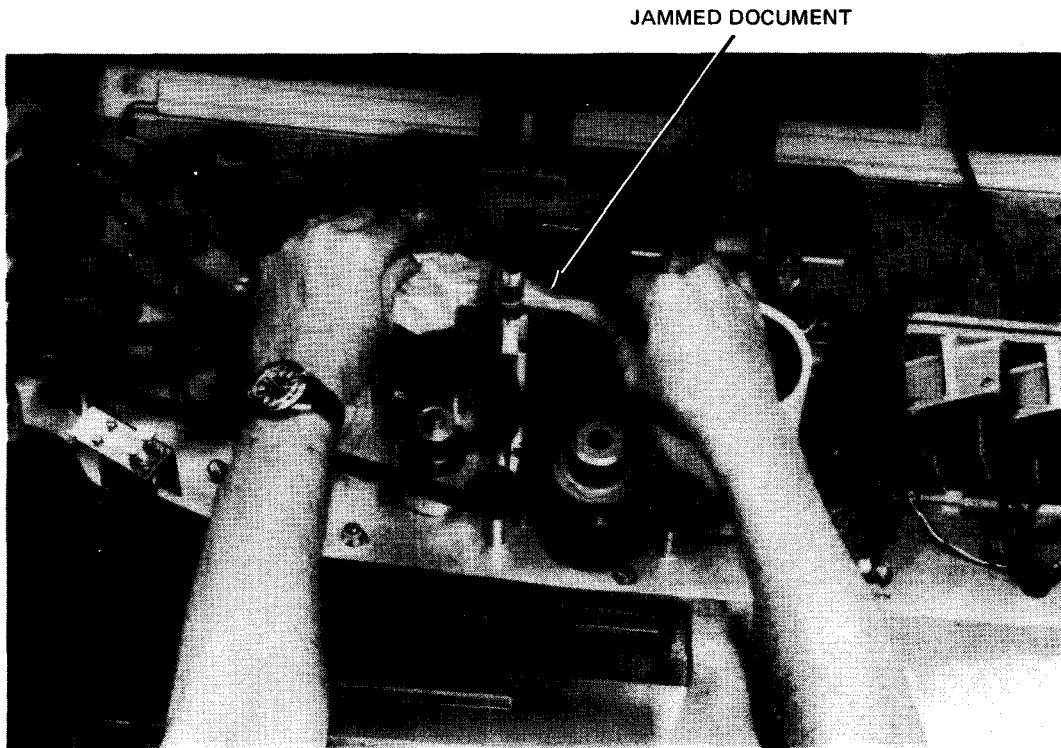

c. Removing jammed document at mark/card station

Figure 8—9. Clearing Document Jams (Part 2 of 2)

8.5. RECOVERY PROCEDURES

The subsystem malfunctions that may be correctable by the operator are listed in Table 8-4.

Table 8-4. 2703 Optical Document Reader Subsystem, Recovery Procedures (Part 1 of 3)

Fault Indication	Probable Cause	Operator Action
FEED CHECK and STOP indicators are lit.	A document is jammed.	Refer to 8.4.5 for recovery procedure.
INTERLOCK indicator is lit.	Cover is not closed securely.	<ol style="list-style-type: none">1. Check document transport covers and lower front and rear panels to ensure that the interlock switches are properly seated and closed.2. Press RUN switch/indicator to restart program.
DEVICE CHECK indicator and STOP switch/indicator are lit.	Overheat condition or tripped circuit breaker	<p>Check for one or both of the following conditions in the sequence listed:</p> <ol style="list-style-type: none">1. Loss of cooling air:<ol style="list-style-type: none">a. Open both front panels.b. Check air filters (Figure 8-10) at the bottom of each electronics rack by removing the bottom and examining for accumulated dirt.c. If dirty, remove the filter frame and tap it gently on a container to dislodge dirt.d. Replace filters and close casework panels.e. If DEVICE CHECK indicator is off, press RUN switch/indicator.f. If DEVICE CHECK indicator is still lit, allow the subsystem to cool and then press the RUN switch/indicator. If the DEVICE CHECK indicator is still lit, proceed to step 2.2. Tripped circuit breaker:<ol style="list-style-type: none">a. Open rear panel (second from right when facing rear of unit).b. Visually inspect circuit breakers on both the power control panel and power distribution panel.

Table 8-4. 2703 Optical Document Reader Subsystem, Recovery Procedures (Part 2 of 3)

Fault Indication	Probable Cause	Operator Action
DEVICE CHECK and STOP (cont)		<p>c. If any circuit breaker is in off position (pushbutton protruding or lever down), place MAIN PWR switch/circuit breaker in OFF position and then reset tripped circuit breaker.</p> <p>d. Place MAIN PWR switch/circuit breaker in ON position.</p> <p>e. If DEVICE CHECK indicator is off, press RUN switch/indicator.</p> <p>f. If DEVICE CHECK indicator is still lit and the circuit breaker trips again, notify Sperry Univac customer engineer.</p>
STOP switch/indicator is lit.	Improper operation	<p>Check to see if:</p> <ol style="list-style-type: none"> 1. stacker is full (8.4.4); 2. hopper is empty (8.4.1); or 3. documents are not being fed from hopper; this condition also occurs if commands from the processor are delayed for 30 seconds or more.
Documents rejected	Incorrect document spacing	Consecutive documents are closer than 6 inches. Increase spacing.
	Multiple documents are detected.	More than one document is fed from hopper. For adjustment, see 8.4.3.
	Stacker command is received too late for execution.	A stacker-select-2-or-3 command may be given after completion of a read command to assign the document just read to either stacker 2 or 3. The time available for this stacker command is between 20 and 60 milliseconds because documents are in motion. If command is late, the document proceeds into the reject stacker (stacker 1).
	Document is not read when speed upgrade feature is installed.	If the first document is read and second document is allowed to pass the reading station without occurrence of a read command, the second document proceeds to the reject stacker and operation is reduced to normal speed. No action is required.
Validity check (validity check or mark read feature only)	Indicates that more than one mark or hold per column is present on a mark read or punched card document. Remove error document and resume operation.	

Table 8-4. 2703 Optical Document Reader Subsystem, Recovery Procedures (Part 3 of 3)

Fault Indication	Probable Cause	Operator Action
Documents rejected (cont)	Overrun causes at least one character to be lost.	The processor multiplexer channel did not service the subsystem in time. Reinsert the document in the hopper and resume operation.
	Modulus 10 (modulus 10 check digit feature only) causes a reject.	<ol style="list-style-type: none"> 1. The numeric optical reading is incorrect; the document automatically goes to the reject stacker. 2. Either or both long vertical marks are absent from each end of the optical character reader (OCR) line. Correct document and resume operation.
	Multiple read	More than one character is identified in a single character space; for example, a 3 was identified as an 8 as well as a 3. Correct document and resume operation.
	Blank document	<p>The document contains no OCR characters. This situation also occurs if:</p> <ol style="list-style-type: none"> 1. the OCR camera is incorrectly positioned (8.4.2); 2. document is reversed; or 3. OCR projection lamps are not functioning; contact Sperry Univac customer engineer.

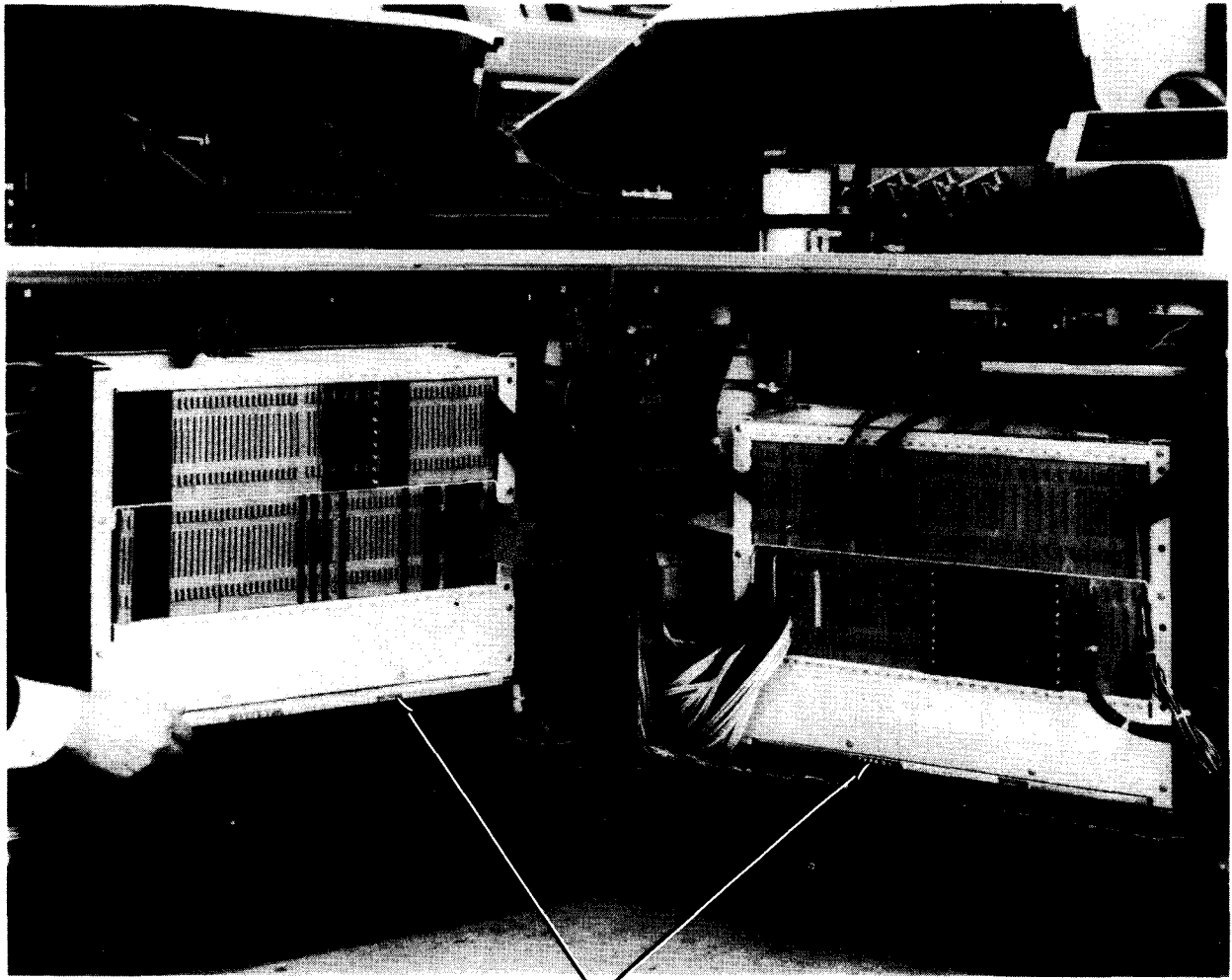

AIR FILTERS

Figure 8-10. Air Filter Locations on Front of Cabinet

9. 0920 Paper Tape Subsystem

9.1. GENERAL

The 0920-02 paper tape subsystem (Figure 9—1) is available with the 90/30 or 90/30 B system. The subsystem is a freestanding unit capable of punching data in paper tape and reading data into the processor from prepunched paper tape. The subsystem reads or punches tape in 5, 6, 7, or 8 tracks. Reading is at the rate of 300 characters per second, and punching at the rate of 110 characters per second.

The basic subsystem consists of a control unit with a tape reader and reader synchronizer, or a tape punch and punch synchronizer, or both, and power supplies. The control unit synchronizes and interfaces the reader and punch synchronizers with the processor multiplexer channel. Transfer of data characters between the reader or punch and the control unit is regulated by the synchronizers. Data transfer rate is determined by the read and punch rates.

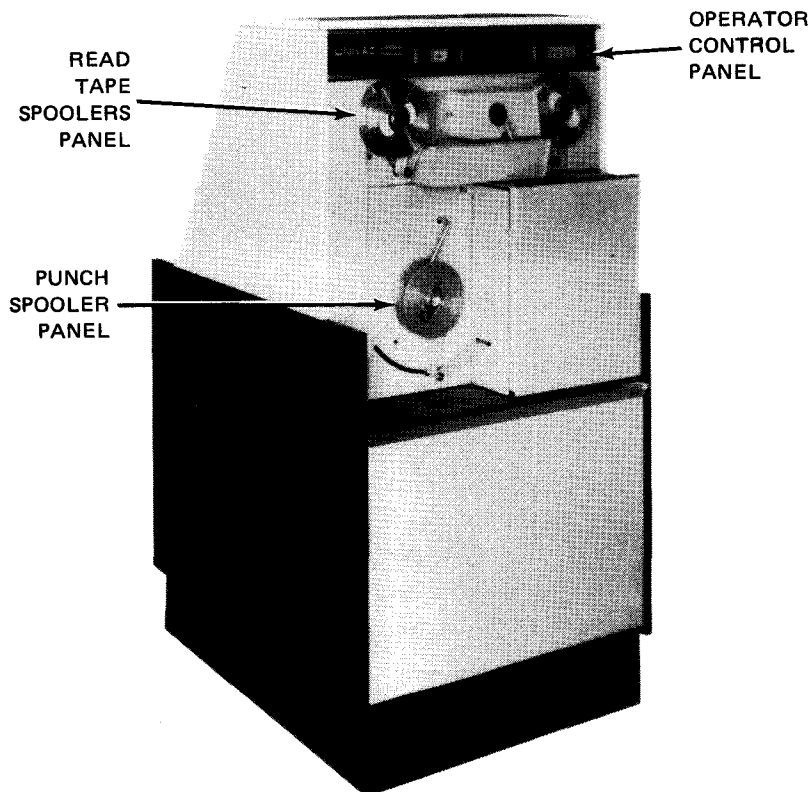

Figure 9—1. 0920-02 Paper Tape Subsystem

The basic tape reader mechanism can be optionally equipped with a tape spooler mechanism with associated control circuits. The spools can accommodate snap-on reels up to 5 inches (12,70 cm) in diameter. The basic punch mechanism can be optionally equipped with a punch take-up spooler having a servo-controlled drive motor for a reel hub and associated control circuits. The punch spooler is equipped with a small hub to accommodate snap-on reels of 5-inch (12,70 cm) diameter, or a large hub for snap-on reels of 8-inch (20,32 cm) diameter. The tape supply reel for punching is located behind a front cover on the right side of the cabinet.

9.2. OPERATING CONTROLS AND INDICATORS

The operator control panel (Figure 9—2) contains the controls and indicators used by the operator for tape reading and punching. Indicators that alert the operator for his intervention are visible only when lit. The power control panel, located at the rear of the subsystem (Figure 9—3) contains a main circuit breaker and pushbutton circuit breakers (Figure 9—4). All controls and indicators are listed and described in Table 9—1.

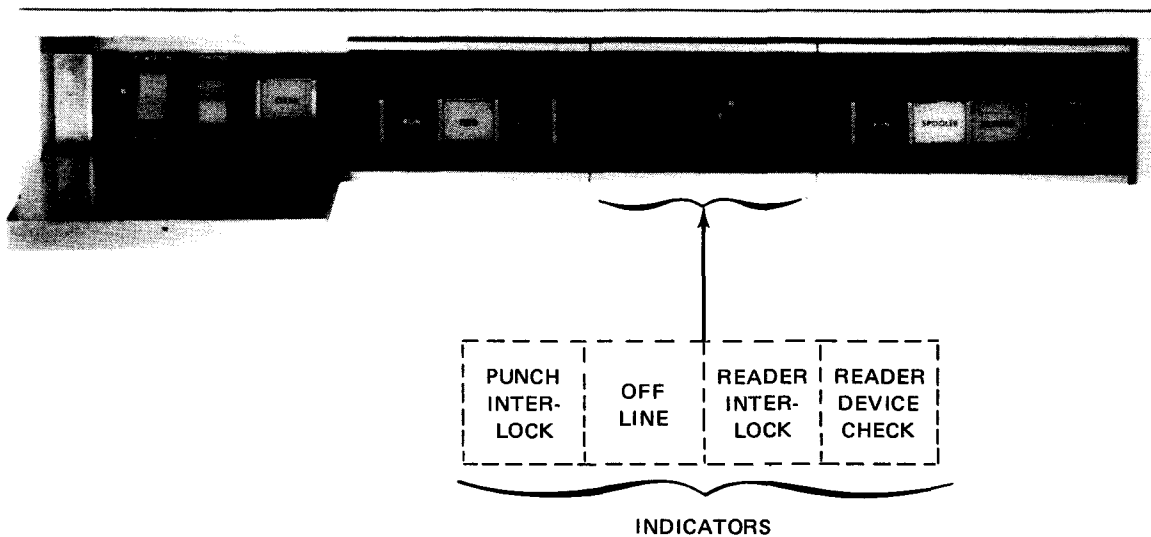

Figure 9—2. 0920-02 Paper Tape Subsystem, Operator Control Panel

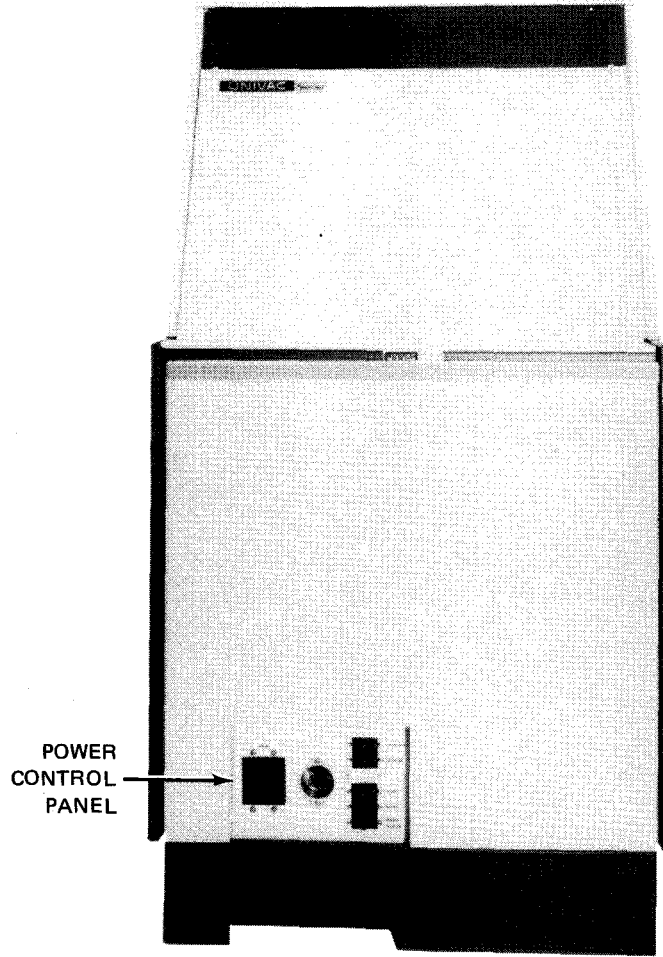

Figure 9-3. 0920-02 Paper Tape Subsystem, Rear View

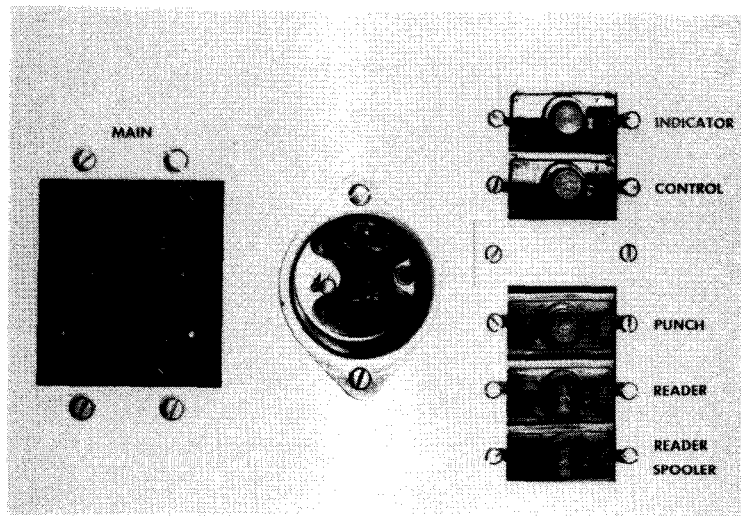

Figure 9-4. 0920-02 Paper Tape Subsystem, Power Control Panel

Table 9-1. 0920-02 Paper Tape Subsystem, Controls and Indicators (Part 1 of 3)

Control/Indicator — Function
Operator Control Panel
POWER ON/POWER OFF switch
POWER ON position:
Applies ac power to the read and punch motors and dc power to the control circuitry if the subsystem is offline or if control voltage is supplied from the processor in online mode
POWER OFF position:
Removes power when the subsystem is in offline mode. This switch should normally be in POWER ON position.
ON LINE/OFF LINE switch
ON LINE position:
Places the subsystem online to the processor
OFF LINE position:
Places the subsystem offline to the processor
CLEAR pushbutton
Causes a general clear of the subsystem when in offline mode. This pushbutton does not function when the ON LINE/OFF LINE switch is in ON LINE position.
PUNCH RUN switch/indicator
Clears the tape punch synchronizer and puts the tape punch in the ready-to-run condition after occurrence of an abnormal stop or after the PUNCH STOP switch/indicator has been pressed.
Run occurs only if:
<ul style="list-style-type: none">■ not out of tape;■ program connector is inserted; and■ ready/load lever on reader mechanism is in ready position.
Pressing the PUNCH RUN switch/indicator while the tape punch is stopped causes a status byte containing an attention bit to be presented to the processor.
PUNCH FEED pushbutton
When pressed, causes the tape to be fed and punched with sprocket holes. Punching continues until pushbutton is released.
This pushbutton is operative only when the PUNCH STOP switch/indicator is lit.
PUNCH STOP switch/indicator
Stops the operation of the tape punch after the block has been punched. Upon receipt of the next punch command, the tape punch generates a unit off-normal-interrupt signal, informing the program that the PUNCH STOP switch/indicator has been pressed. Pressing the PUNCH RUN switch/indicator clears the condition and restarts the operation of the unit by presenting a status byte containing an attention bit to the processor. Also provides a lamp test when held depressed.

Table 9-1. 0920-02 Paper Tape Subsystem, Controls and Indicators (Part 2 of 3)

Control/Indicator — Function
Operator Control Panel (cont)
PUNCH INTERLOCK indicator Lights when the program connector has been improperly inserted. This condition is correctable by the operator.
OFF LINE indicator Lights when the subsystem is offline to the processor. This indicator lights as a result of pressing ON LINE/OFF LINE switch to OFF LINE when the control unit is inactive.
READER INTERLOCK indicator Lights under at least one of the following conditions: <ul style="list-style-type: none">■ Ready/load lever is in load position.■ Broken tape■ Program connector is not inserted or, at the system console, the <i>DOWN</i> function of the SET IO command (Section 12) is used to prevent the subsystem from being allocated to a job while offline. These conditions are usually correctable by the operator.
READER DEVICE CHECK indicator Lights when overshoot and overrun condition (reader stopped and paper moved) has occurred within the tape reader
READER RUN switch/indicator Clears the tape reader synchronizer and puts the tape reader in operable condition if tape has been loaded properly, the program connector is inserted, and the ready/load lever is in load position. Pressing the READER RUN switch while the tape reader is stopped causes a status byte containing an attention bit to be presented to the processor. This switch is operative only when no interlock condition exists.
READER SPOOLER switch/indicator When pressed and lit, applies ac power to the tape spooler motors. When the switch is pressed again, ac power is removed and the indicator is extinguished. If the reader tape spooler option is not included in the subsystem, this switch/indicator is inactive.
READER REWIND switch/indicator When pressed and lit, applies ac power to the spooler rewind motor and rewinds the tape into the right-hand spooler reel. When the switch is pressed again, ac power is removed and the indicator is extinguished. This switch is operative only when the READER SPOOLER switch/indicator is lit. If the reader tape spooler option is not included in the subsystem, this switch/indicator is inactive.
READER STOP switch/indicator Stops the tape reader after the block has been read. Upon receipt of the next read command, the tape reader generates a unit off-normal-interrupt signal, informing the program that the READER STOP switch/indicator has been pressed. Pressing the READER RUN switch/indicator clears the interlock condition and causes a status byte containing an attention bit to be presented to the processor. The indicator lights when power is turned on for the subsystem.

Table 9-1. 0920-02 Paper Tape Subsystem, Controls and Indicators (Part 3 of 3)

Control/Indicator — Function
Power Control Panel
MAIN circuit breaker (15 amperes) Provides overload protection for the main power circuit in subsystem
Convenience outlet Provides ac power for external equipment. This outlet is for use of Sperry Univac customer engineer only.
INDICATOR pushbutton circuit breaker (4 amperes) Provides overload protection for the 7 Vac power circuit used for logic relay operation
CONTROL pushbutton circuit breaker (4 amperes) Provides overload protection for the 24 Vac power circuit used for logic relay operation
PUNCH pushbutton circuit breaker (3 amperes) Provides overload protection for the punch elapsed time meter, punch motor, and punch spooler motor
READER pushbutton circuit breaker (3 amperes) Provides overload protection for the reader elapsed time meter and the reader motor
READER SPOOLER pushbutton circuit breaker (3 amperes) Provides overload protection for the left, right, and rewind motors of the reader spooler

9.3. TURN-ON AND TURN-OFF PROCEDURES

→ Power for the subsystem is normally applied and removed via the **POWER ON/POWER OFF** switch on the processor operator/maintenance panel (Figure 2-2). However, to control power from this panel, certain switches and circuit breakers on the subsystem must first be set to specific positions. The switches and circuit breaker settings for the subsystem are listed in Table 9-2.

When switches and circuit breakers are first set as listed in Table 9-2, then the **POWER ON/POWER OFF** switch on the processor is set to **POWER ON** and the **READER INTERLOCK** indicator should light then extinguish as power sequences up. The **READER STOP** indicator remains lit after power is applied to the subsystem, but extinguishes when a run or rewind operation begins.

CAUTION

If the paper tape unit is to be turned on after the system has already been powered up, follow the independent power turn-on procedure in 9.3.1. Power transients may interfere with proper operation of the processor if this procedure is not followed.

9.3.1. Independent Power Turn On

To turn power on at the subsystem independently of the processors, proceed as follows:

1. Set **ON LINE/OFF LINE** switch on operator control panel to **OFF LINE** position.
2. Check that all pushbutton circuit breakers on power control panel are closed (not protruding).
3. Set **MAIN** circuit breaker on power control panel to on (up) position.
4. Set **POWER ON/POWER OFF** switch on operator control panel to **POWER ON** position.
5. Press **CLEAR** switch on operator control panel to extinguish the **READER INTERLOCK** indicator. Note that **READER STOP** and **OFF LINE** indicators are lit. Operation of the subsystem in offline mode may now begin.
6. Use the *UP* function of the SET IO command (Section 12) to include the subsystem in the system's resources list for job allocation.

9.3.2. Independent Power Turn Off

To turn power off at the subsystem independently of the processor, proceed as follows:

1. Set **ON LINE/OFF LINE** switch on operator control panel to **OFF LINE** position.
2. Set **POWER ON/POWER OFF** switch on operator control panel to **POWER OFF** position.
3. Set **MAIN** circuit breaker on power control panel to off (down) position.
4. Use the *DOWN* function of the SET IO command (Section 12) to remove the subsystem from the system's resources list and prevent it from being allocated to a job while offline.

Table 9-2. 0920-02 Paper Tape Subsystem, Power Switch Settings

Switch/Circuit Breaker	Normal Setting
Power Control Panel	
MAIN circuit breaker	On (up)
All pushbutton circuit breakers	On (in)
Operator Control Panel	
POWER ON/POWER OFF switch	POWER ON
ON LINE/OFF LINE switch	ON LINE

9.4. OPERATING PROCEDURES

Operating procedures for the subsystem include tape reading, rewinding the tape reel, tape punching, and reloading the tape punch.

9.4.1. Tape Reading

To read prepunched tape, proceed as follows:

1. Set **ON LINE/OFF LINE** switch on operator control panel to **OFF LINE** position.
2. Determine if 5-track tape (Figure 9—5a) or 6-, 7-, or 8-track tape (Figure 9—5b) is to be read by noting the tape width on the supply reel.
3. Insert the supply reel on the right spool holder (Figure 9—5c) so that when tape feeds from the spool the reel unwinds in a clockwise direction if 5-track tape is to be read, or in a counterclockwise direction if 6-, 7-, or 8-track tape is to be read. The tape must pass around the supply control arm.
4. Move the ready/load lever (Figure 9—5d) to the load (right) position.
5. Manually unwind sufficient tape from the supply reel to reach the take-up reel, and slide the tape sideways between the tape reader mechanism and drive mechanism (Figure 9—5c).
6. Thread the tape around the take-up control arm (Figure 9—5c) and insert the tape edge in the slot provided at the hub of the take-up reel; manually turn the reel to tighten the tape. The reel rotates in a counterclockwise direction.
7. While holding the tape edge back against the inner guide (Figure 9—5e), move the ready/load lever in or out and partly to the ready position to accommodate the tape width. Observe the position of the ready/load lever with respect to the outer edge of the tape through the viewing window (Figure 9—5d).

NOTE:

The ready/load lever in/out movement has three positions to accommodate the following tape widths:

<u>Tape Width</u>	<u>Ready/Load Lever Position</u>
11/16 inch (17,462 mm)	In
7/8 inch (22,225 mm)	Midpoint
1 inch (25,4 mm)	Out

CAUTION

The ready/load lever should not be moved to ready position prior to setting for proper width or the the tape may tear.

8. Move the ready/load lever to ready (left) position after determining the correct tape width.
9. Press the **READER SPOOLER** switch/indicator and note that it lights, then set the **ON LINE/OFF LINE** switch to **ON LINE** position and press the **RUN** switch/indicator. The **RUN** switch/indicator lights when a read command is supplied from the processor.

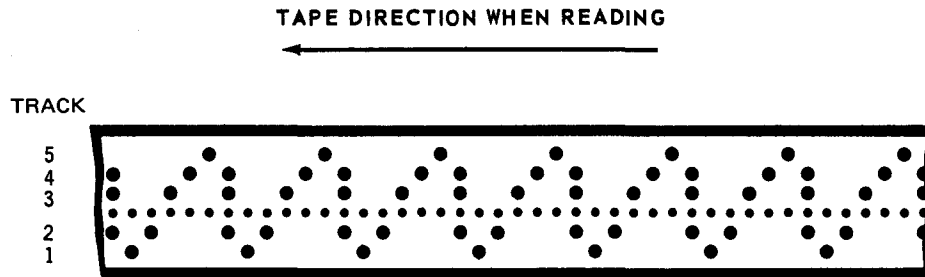

a. 5-track tape

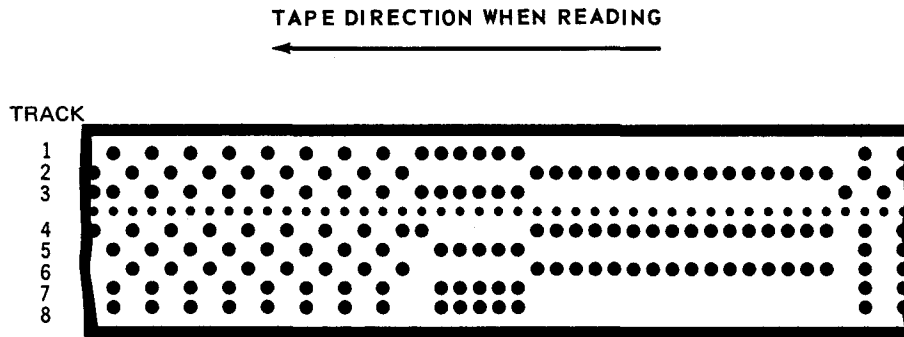

b. 8-track tape

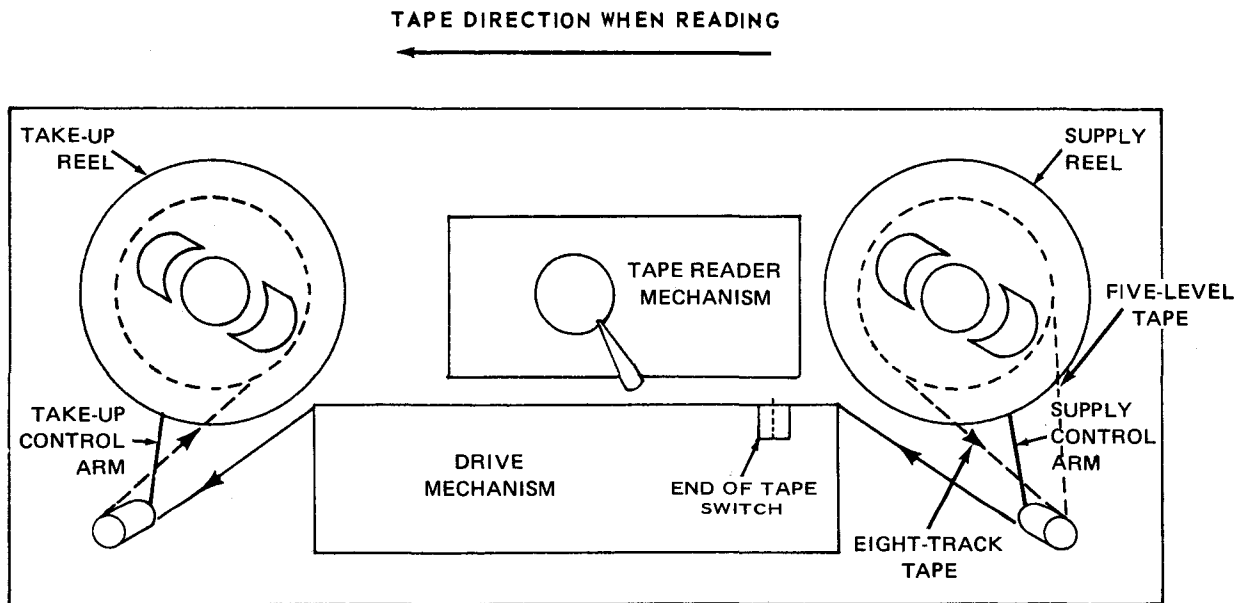

c. Tape threading path in tape reader

Figure 9-5. Tape Reading (Part 1 of 2)

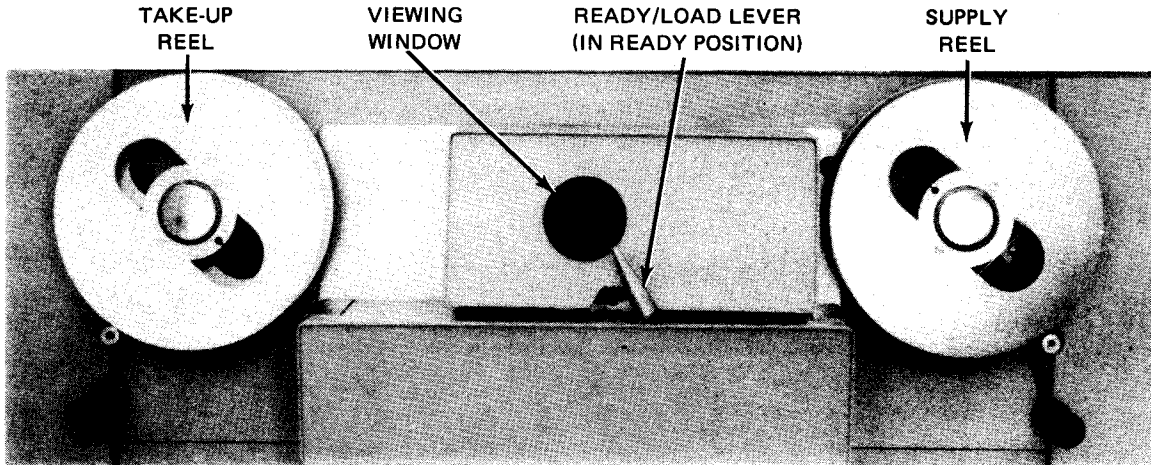

d. Ready/load lever in ready position

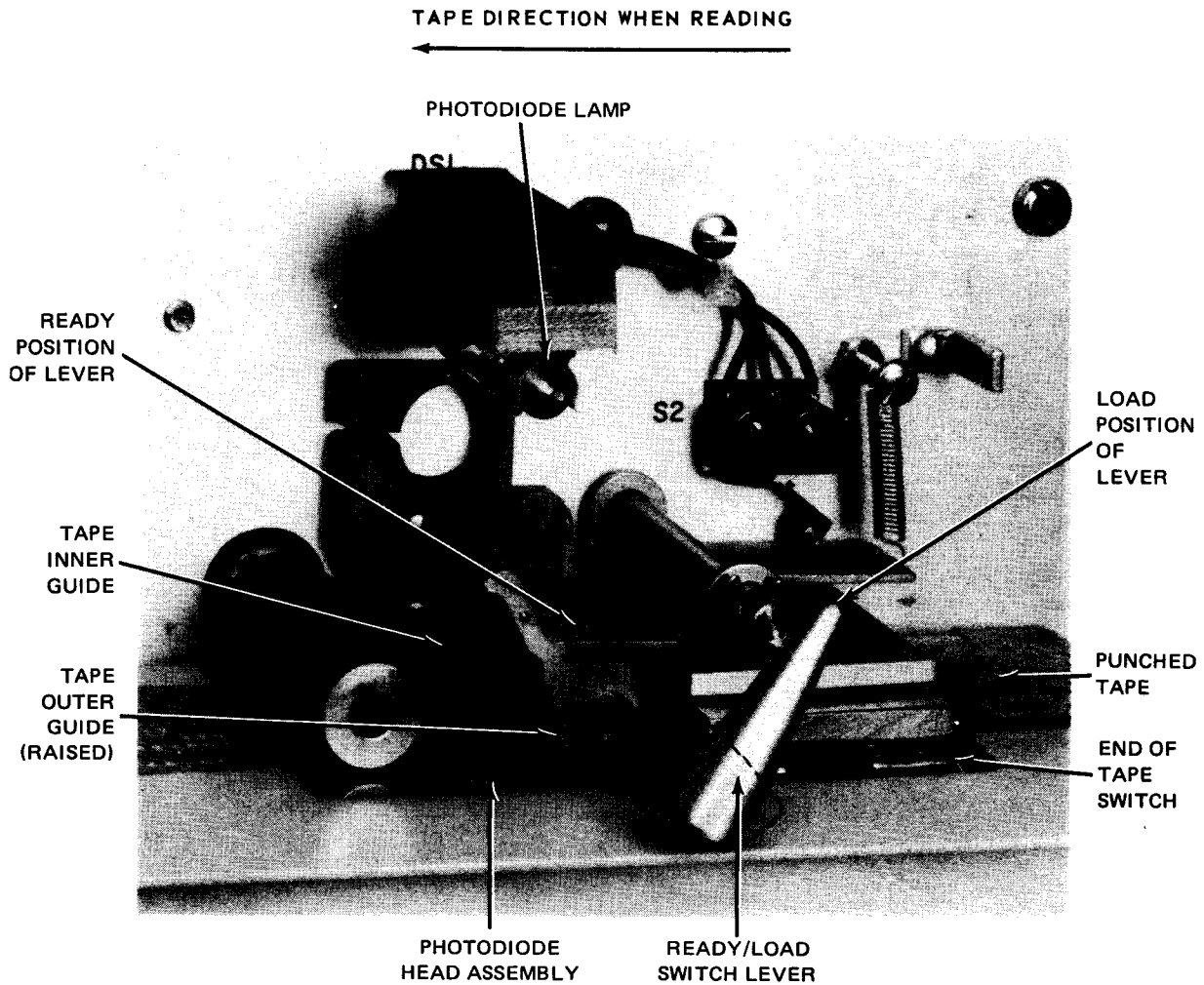

e. Cover removed from reader to show tape location

Figure 9-5. Tape Reading (Part 2 of 2)

9.4.2. Tape Reader Rewinding

To rewind the tape reel after a read operation is complete, proceed as follows:

1. Set **ON LINE/OFF LINE** switch on operator control panel to **OFF LINE** position.
2. Move ready/load lever (Figure 9—5d) to load (right) position.
3. Press **READER SPOOLER** switch/indicator on operator control panel (note that the switch/indicator lights).
4. Press **REWIND** switch/indicator on operator control panel (note that the switch/indicator lights).
5. Allow tape on the take-up reel to rewind onto the supply reel, then press **REWIND** switch/indicator after all tape is transferred to supply reel or until a desired length of tape is rewound (note that the switch/indicator is extinguished).
6. Press **READER SPOOLER** switch/indicator (note that switch/indicator is extinguished).

9.4.3. Reloading Tape Punch

A new supply reel of unpunched tape is loaded into the tape punch mechanism as follows:

1. Set **ON LINE/OFF LINE** switch on operator control panel to **OFF LINE**.
2. Open the cabinet door on the right of the tape punch spooler (the door is hinged on the left).
3. Release the punch carriage lock (Figure 9—6a) by pulling the lock open and turning it counterclockwise one-quarter turn.
4. Slide out the punch mechanism by pulling the release punch carriage lock. Stops are provided to prevent the mechanism from being completely removed from the cabinet.
5. Turn and hold the knurled locking knob (Figure 9—6b) to release the tape supply reel holder; slide holder out until it is fully extended.
6. Raise the tape supply switch sensing arm (Figure 9—6b), install a new supply reel with unpunched tape, and release the supply switch sensing arm. Note the reel hub slots (Figure 9—6b) provided for the reel hub. Tape should feed from the bottom rear of the tape supply reel holder (an arrow on the holder indicates reel direction) and through the tension arm.
7. Slide the tape supply reel holder back into its normal position (Figure 9—6c).

NOTE:

Cut the tape end with the knife blade (Figure 9—6a) to obtain a straight edge before attempting to thread tape between the punch head and punch die.

8. Thread tape in the following sequence (Figure 9-6c):
 - Thread tape
 - through the guide and around the feed roller;
 - down along the punch drive mechanism cover; and
 - beneath the lower roller.
 - Pull a length of tape and slide it sideways over tape width guide A; gently pull out guide A to accommodate the tape width (Figure 9-6d).
 - Thread tape between the punch head and punch die (Figure 9-6c), adjust tape width guide B to accommodate the tape width (Figure 9-6d).
 - Raise the pressure pad (Figure 9-6c), pass tape over the sprocket roll, and release pressure pad.
 - Thread tape beneath the knife blade.
9. Push in the punch mechanism and lock it in place by closing the punch carriage lock handle (Figure 9-6c) and turning it one-quarter turn clockwise.
10. Thread the tape under the knife blade and through the slot in the punch mechanism cabinet (Figure 9-6e).
11. Press **FEED** switch on operator control panel to start the punch drive motor.
12. Intermittently press the feed control lever (Figure 9-6a) to feed tape through the cabinet slot (Figure 9-6e). Allow sufficient tape to feed through to secure tape end to the tape punch take-up spooler.
13. Raise spooler arm (Figure 9-6e) from take-up spooler.
14. Wind tape around full-reel-control arm (Figure 9-6e) and on take-up spooler.
15. Insert tape in slot on take-up spooler reel, lower the spooler arm, then press the feed control lever until sufficient tape is wound on reel to hold tape on reel.
16. Empty the chad drawer (Figure 9-6b).

NOTE:

The chad drawer should be emptied each time a new supply reel is installed.

17. Set the **ON LINE/OFF LINE** switch to **ON LINE** position, and close the punch mechanism door.

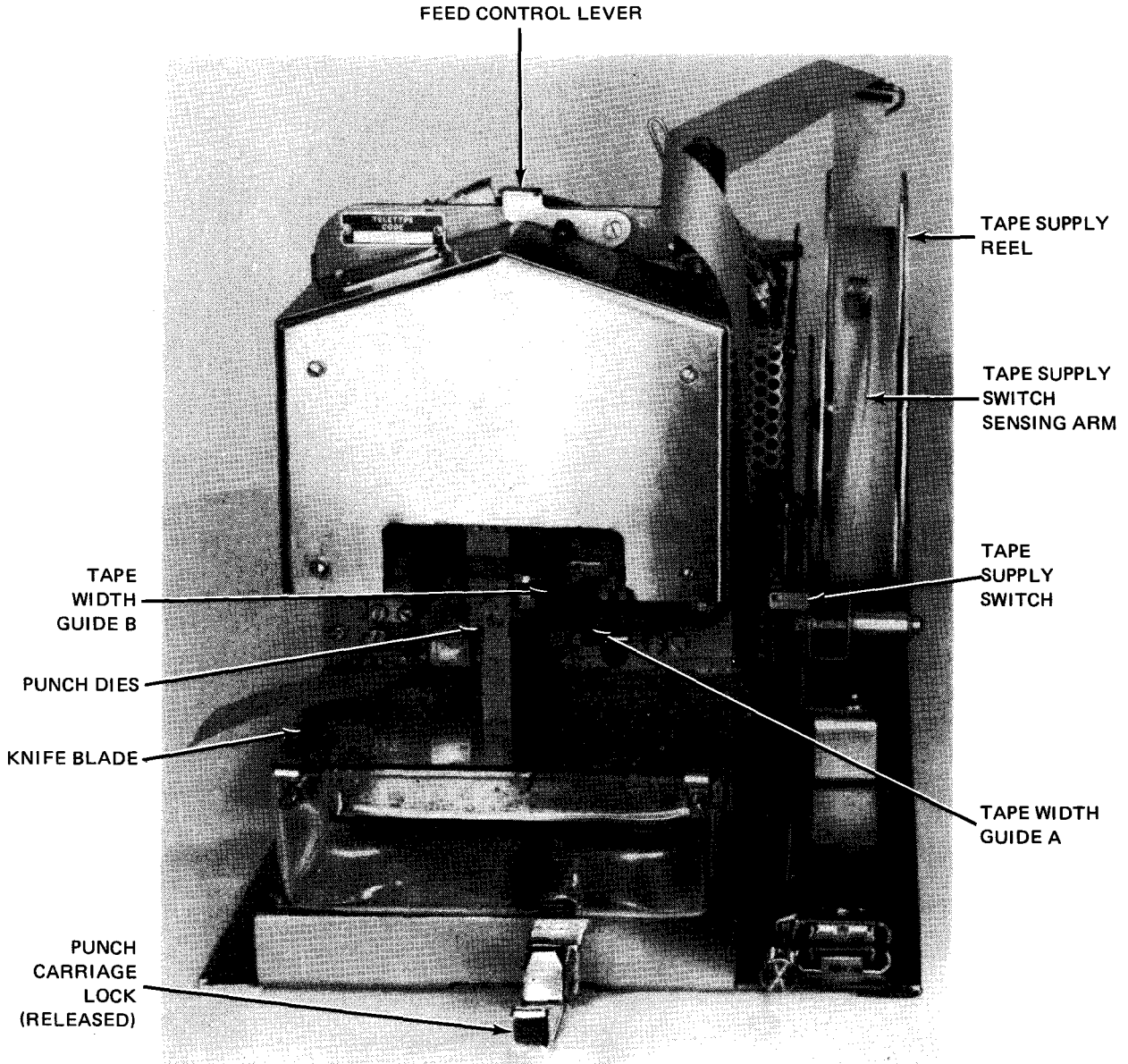

a. Punch mechanism front view

Figure 9-6. Loading Tape on Punch (Part 1 of 4)

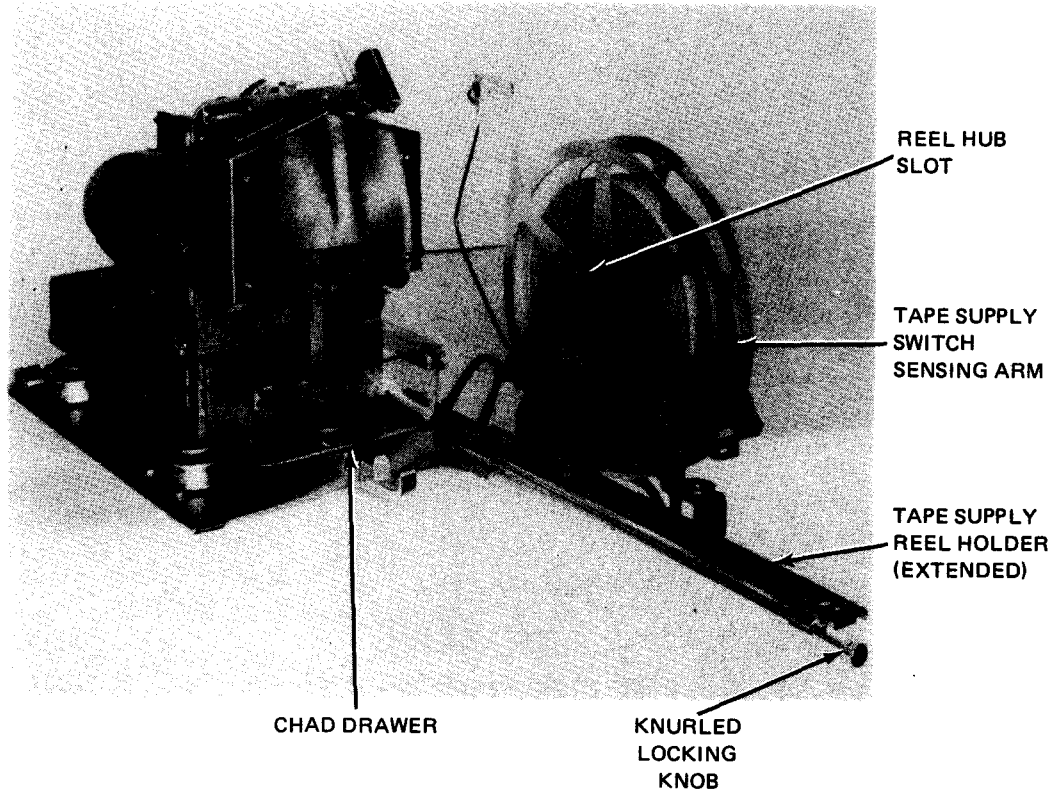

b. Tape supply reel holder in extended position

Figure 9-6. Loading Tape on Punch (Part 2 of 4)

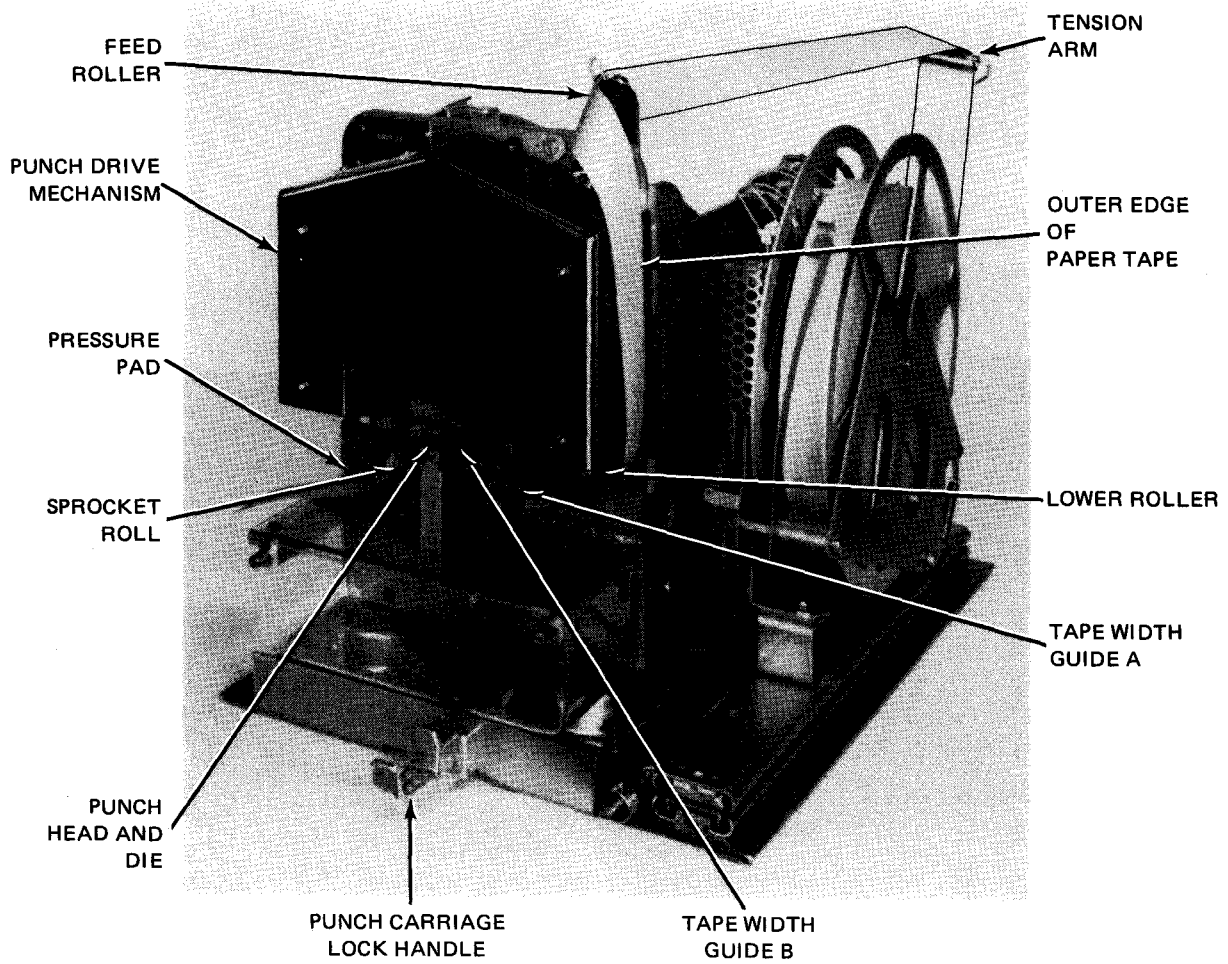

c. Tape punching path

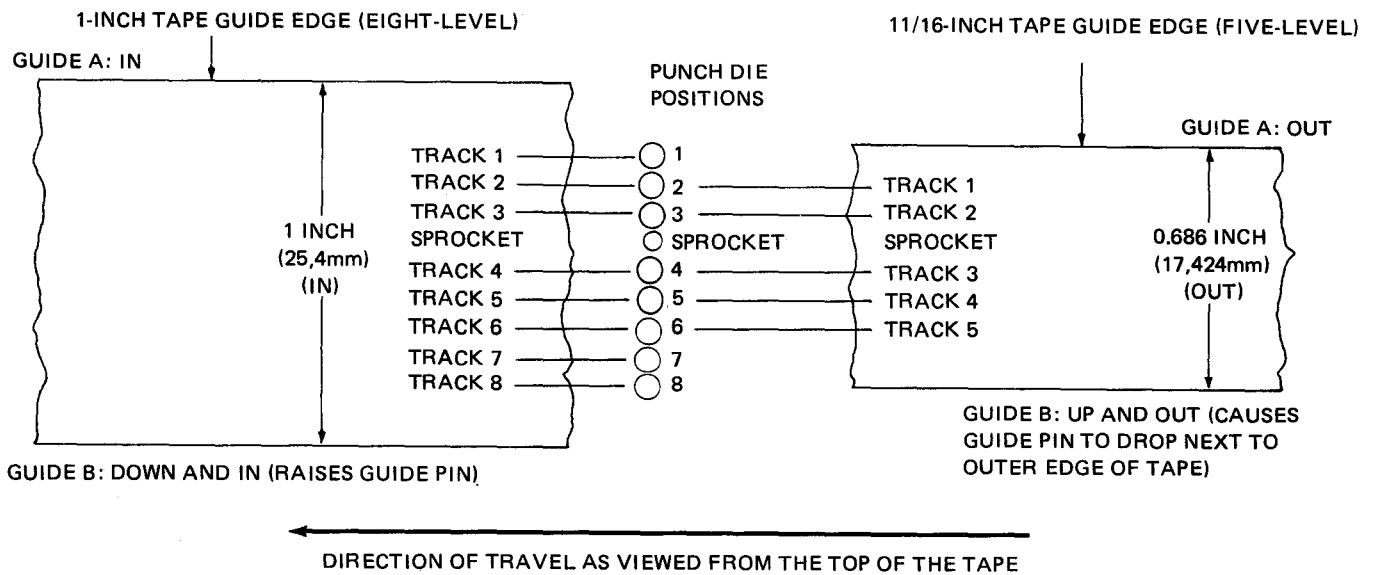

d. Tape width guide settings

Figure 9-6. Loading Tape on Punch (Part 3 of 4)

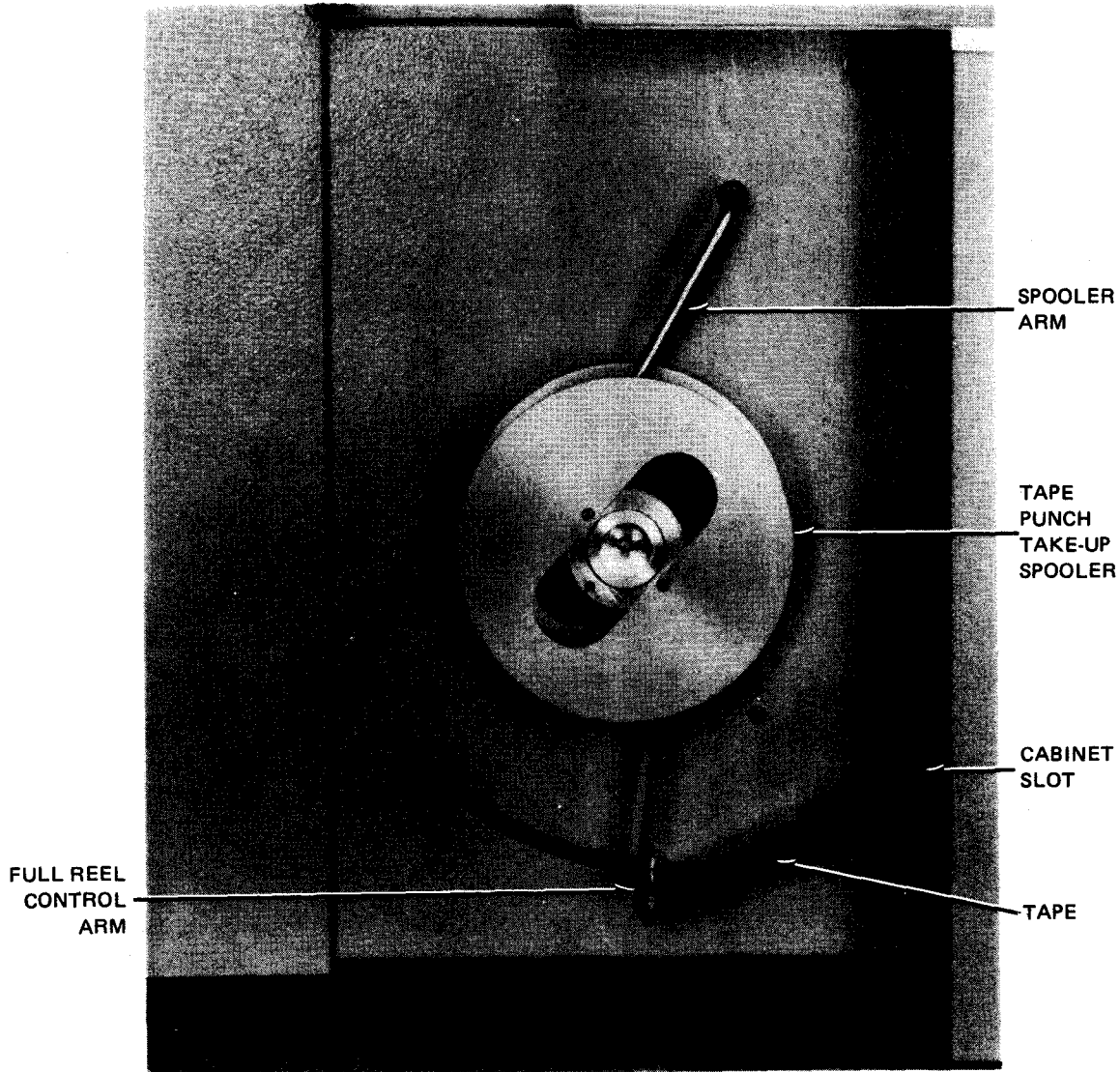

e. Take-up spooler with tape threaded

Figure 9-6. Loading Tape on Punch (Part 4 of 4)

9.4.4. Tape Punching

Proceed as follows to punch new tape:

1. Open the punch mechanism door and examine the tape supply reel to determine if it has sufficient tape for the operation.
2. Feed a length of tape from the supply reel by one of two methods:
 - If the subsystem is in stop mode (**STOP** switch/indicator is lit), press the **FEED** switch on the operator control panel to start the punch drive motor and feed a length of tape.
 - If tape is to be fed after a punch command is issued, but without going into stop mode, the punch drive motor is started and tape is fed automatically (by programming) upon receiving a signal from the processor.

3. Wrap the tape leader around the full-reel control arm (Figure 9—6e) and insert the tape end into the slot on the take-up reel. Secure the tape on the take-up reel with a few turns of tape.
4. Press the **CLEAR** switch on the operator control panel if operation is to be offline.
5. Set the **ON LINE/OFF LINE** switch to **ON LINE** if operation is to be online with the processor.
6. Press the **PUNCH RUN** switch/indicator to place the subsystem in a ready-to-run condition. The switch/indicator lights upon receiving a signal from the processor, the punch drive motor starts, and tape punching starts automatically. When the tape punch operation is complete, a length of tape automatically feeds through to bring all the punch codes onto the take-up reel. Cut the tape at the cabinet slot (a knife is mounted near the slot), and remove the take-up reel.

9.5. RECOVERY PROCEDURES

Subsystem malfunctions that may be correctable by the operator are listed in Table 9—3. If any of the indicated fault indications persist, contact your Sperry Univac customer engineer.

Table 9—3. 0920-02 Paper Tape Subsystem, Recovery Procedures

Fault Indication	Probable Cause	Operator Action
PUNCH INTERLOCK indicator is lit	An error occurred during punching.	Press CLEAR pushbutton and resume operation.
READER INTERLOCK indicator is lit.	Tape is binding during feed or tape is torn.	<ol style="list-style-type: none"> 1. Ensure that ready/load lever is in load position. 2. Check tape threading path to see if an obstruction occurred. 3. Rethread tape if tape is torn or broken. 4. Press CLEAR pushbutton and resume operation.
READER DEVICE CHECK indicator is lit.	Reader overshoot condition	<ol style="list-style-type: none"> 1. Rewind tape a short distance. 2. Press CLEAR pushbutton. 3. Resume normal operation.
	Interruption occurred in the communications line.	Press CLEAR pushbutton and resume normal operation.
	Circuit breaker on power control panel tripped.	<ol style="list-style-type: none"> 1. Reset tripped pushbutton circuit breaker. 2. Press CLEAR pushbutton and resume normal operation. <div style="border: 1px solid black; padding: 5px; text-align: center; margin: 10px 0;">CAUTION</div> <p>If circuit breaker continues to trip, do not hold the pushbutton in or damage to the subsystem will result. Contact the Sperry-Univac customer engineer.</p>



PART 3. STANDARD OPERATING PROCEDURES



10. System Turn-On and Turn-Off Procedures

10.1. SYSTEM TURN ON

To turn on your SPERRY UNIVAC 90/30 or 90/30 B System from a full power-off condition, proceed as follows: ←

1. Set the system circuit breakers (wall mounted) to the **ON** position.
2. Set the **POWER ON/POWER OFF** switch, on the processor operator/maintenance panel (Figure 2—2), to the **POWER ON** position. The **POWER CYCLING** indicator lights during the power-up sequence. All other indicators remain off. ←

When the power-up sequence is complete, the **POWER ON** indicator on the operator/maintenance panel lights and all other indicators are extinguished. This condition indicates that operating power is applied to all the central hardware and on-line peripheral devices, excluding 0604 card punch subsystems, in the system.

If the **POWER CYCLING** indicator, as well as the **POWER ON** indicator, on the operator/maintenance panel lights at the end of the power-up sequence, and all the other indicators remain extinguished, a stall condition in the power-up sequencing of the system has occurred. To remedy this condition, set the **POWER ON/POWER OFF** switch on the operator/maintenance panel to the **POWER OFF** position. Check the peripheral devices and central hardware circuit breakers and switches to ensure that they are set to their respective power-on positions. Then set the **POWER ON/POWER OFF** switch to the **POWER ON** position.

If, after this power-up sequence is completed, the **POWER CYCLING** indicator, as well as the **POWER ON** indicator lights, and all other system indicators remain extinguished, refer the situation to your Sperry Univac customer engineer.

3. Apply power to all the 0604 card punch subsystems in the system as described in 7.2.2.

10.2. SYSTEM TURN OFF

To turn off your 90/30 or 90/30 B system, proceed as follows: ←

1. Set the **POWER ON/POWER OFF** switch, on the processor operator/maintenance panel, to the **POWER OFF** position. All the indicators on the operator/maintenance panel light momentarily and then extinguish.
2. Turn off all the 0604 card punch subsystems in the system in accordance with the turn-off procedure in 7.2.2.
3. If the system is to remain unused for a period of time, set the system circuit breakers (wall mounted) to the **OFF** position.



11. System Initialization Procedures

11.1. GENERAL

Initialization of the SPERRY UNIVAC 90/30 or 90/30 B System is a 2-step operation: ←

1. Loading and initializing control storage (11.2)
2. Loading and initializing the resident portion of the supervisor (11.3).

Whenever power is removed from the system, both these operations must be performed to initialize the system after power is reapplied. Whenever a nonrecoverable error occurs, only the supervisor need be reloaded and initialized. The only time control storage needs to be reloaded and initialized after a nonrecoverable error occurs, is when you are unable to load and initialize the supervisor.

11.2. CONTROL STORAGE LOAD PROCEDURE

Whenever the 90/30 or 90/30 B system is turned on from a full power-off condition or the initial program load (IPL) operation cannot be completed successfully, control storage must be loaded and initialized. To load and initialize control storage, proceed as follows: ←

1. Place the system resident (SYSRES) disc pack containing the control storage code on a suitable disc drive unit and set the disc drive to the run state in accordance with the operating procedures presented in Section 3.
2. Perform the following operations at the operator/maintenance panel.
 - a. Set the **INHIBIT TIMER** switch to its off (down) position.
 - b. Set the **INHIBIT PROC CHECK** switch to its off (down) position.
 - c. Set the **HALT ON ERROR** switch to its off (down) position.

NOTE:

The INHIBIT TIMER, INHIBIT PROC CHECK, and HALT ON ERROR switches are never set to the on position during normal system operation.

- d. Set the **MODE SELECT** switch to **NORMAL**.
- e. Set the **INITIAL LOAD CONTROL** switch to **CONT STOR LOAD**.

- f. Set the **DATA ENTRY CHANNEL NO.** switch to the channel number on which the selected disc drive is connected. The numbers assigned to these channels are:

<u>Channel</u>	<u>Assigned Number</u>
Integrated disc adapter	3
Selector channel 1	4
Selector channel 2	6

- g. Set the **DATA ENTRY SUBCHANNEL NO.** switch to the subchannel number assigned to the selected disc drive unit. The possible subchannel assignments are:

<u>Subchannel</u>	<u>Assigned Number</u>
Integrated disc adapter	0
Selector channel 1	0—7
Selector channel 2	0—7

- h. Set the **DATA ENTRY DEVICE NO.** switch to the actual physical unit number assigned to the selected disc drive unit (0 through F).
- i. Press the top portion of the **SYSTEM RESET** switch twice. The **TEST MODE** indicator lights.
- j. Press the top portion of the **RUN** switch. The **INITIAL LOAD** indicator lights and remains lit until control storage has been successfully loaded (**HPR STOP** indicator lights).

If the **INITIAL LOAD** indicator fails to extinguish and the **PROC CHECK** or **CONTROL STORAGE** indicators light, control storage was not successfully loaded and steps 2i and 2j must be repeated.

NOTE:

Do not disturb any switch settings until control storage loading is complete.

If the proper indications cannot be obtained try loading control storage from another disc drive unit. If the abnormal indications persist, refer the problem to your Sperry Univac customer engineer.

11.3. INITIAL PROGRAM LOAD PROCEDURE

Before the system can be used to run productive jobs, the resident portion of OS/3 (the supervisor) must be loaded into main storage and initialized. This operation can only be performed after control storage is loaded and initialized, and must be performed whenever control storage is loaded or a nonrecoverable error occurs.

To load and initialize the supervisor (the IPL procedure), proceed as follows:

CAUTION

Make certain the system is in the idle condition (no jobs are active) before you perform the IPL procedure. Otherwise, the SYSRES volume table of contents (VTOC) may be left in a nonrecoverable state requiring that a new SYSRES volume be generated.

1. Place the system resident (SYSRES) disc pack containing the initial program load (IPL) routine on a suitable disc drive unit and set the disc drive to the run state in accordance with the operating procedures presented in Section 3.

NOTE:

The control storage code and initial program load routine are stored on the same disc pack.

2. Set the controls and switches on the operator/maintenance panel to the following positions:
 - a. Set the **INHIBIT TIMER** switch to its off (down) position.
 - b. Set the **INHIBIT PROC CHECK** switch to its off (down) position.
 - c. Set the **HALT ON ERROR** switch to its off (down) position.

NOTE:

*The **INHIBIT TIMER**, **INHIBIT PROC CHECK**, and **HALT ON ERROR** switches are never set to the on position during normal system operation.*

- d. Set the **MODE SELECT** switch to **NORMAL** position.
- e. Set the **INITIAL LOAD CONTROL** switch to **PROGRAM LOAD** position.
- f. Set the **DATA ENTRY CHANNEL NO.** switch to the channel number on which the selected disc drive is connected. The numbers assigned to these channels are:

<u>Channel</u>	<u>Assigned Number</u>
Integrated disc adapter	3
Selector channel 1	4
Selector channel 2	6

- g. Set the **DATA ENTRY SUBCHANNEL NO.** switch to the subchannel number assigned to the selected disc drive unit. The possible subchannel assignments are:

<u>Subchannel</u>	<u>Assigned Number</u>
Integrated disc adapter	0
Selector channel 1	0—7
Selector channel 2	0—7

- h. Set the **DATA ENTRY DEVICE NO.** switch to the actual physical unit number assigned to the selected disc drive unit (0 through F).
- i. Press the top portion of the **SYSTEM RESET** switch. The **TEST MODE** indicator lights.
- j. Press the top portion of the **RUN** switch. The **INITIAL LOAD** and **RUN** indicators light. After the initial program load routine is loaded into the system the **INITIAL LOAD** indicator goes out, and only the **POWER ON**, **TEST MODE**, and **RUN** indicators remain lit.

If either the **PROC CHECK** or **HPR STOP** indicators light, the IPL operation was unsuccessful and steps 2i and 2j must be repeated until the proper indications are obtained. If the **PROC CHECK** indicator continues to light, refer the problem to the Sperry Univac customer engineer. If the **HPR STOP** indicator continues to light, perform the following procedure to determine the cause of the error:

- (1) Set the **DISPLAY SELECT 1** switch to UPPER position.
- (2) Set the **LEGEND SELECT 1** switch to position 7.
- (3) Read the first four sets of the **DISPLAY 1** indicators (I0 through I15). HPR codes displayed by these indicators are listed and described in the OS/3 system messages programmer reference, UP-8076 (current version).

If possible, correct the cause of the **HPR STOP**, and then repeat steps 2i and 2j. If the HPR code identified a condition that cannot be corrected by the operator or if the **HPR STOP** persists, contact your Sperry Univac customer engineer.

After this phase of the IPL operation is successfully completed, proceed with step 2k.

NOTE:

The system automatically sets all devices or subsystems not online during IPL time to down. The operator must set any devices or subsystems placed online after IPL to up through use of the SET IO command.

- k. Set the **INITIAL LOAD CONTROL** switch to the **OFF** position. The **TEST MODE** indicator extinguishes and the following message appears on the system console screen:

IPL TO LOAD STANDARD SUPERVISOR UNLESS NEW NAME KEYED IN _ _ _ _ _ , $\left. \begin{matrix} L \\ C \\ D \end{matrix} \right\}$



NOTE: *At this point, the cursor () is at the point of entry for the type-in of the desired supervisor name (six characters). The final character after the comma is for special types of loading as follows:*

L = Special load for stand alone programs

C = Supervisor control storage card read

D = Supervisor debug option (For details, see supervisor user guide, UP-8075, current version).



- l. If the standard supervisor is to be loaded into the system, press the **TRANSMIT** key on the system console. No keyin is required. If a different supervisor is to be loaded in, key in the name of the new supervisor and then press the **TRANSMIT** key. The following statements are now displayed on the system console. Respond to each statement as directed. After all statements are answered, again press the **TRANSMIT** key.

NOTE:

*The cursor (\sqcap) is initially positioned at the point of entry for the date (second statement). Upon completion of a keyin, the cursor is automatically positioned on the following line at the point where keyin is to begin. Lines requiring answers may be bypassed by pressing the **RETURN** key on the system console, thus selecting the displayed default value.*

The **MESSAGE WAITING** key need not be pressed before initiating any keyin during this procedure.

OS/3 VERSION nn

Indicates the release version (nn) of the OS/3 system; no reply is required.

DATE? Δ (YY/MM/DD)— —/— —/— —

Requires the year, month, and day to be entered using 2-digit format.

TIME? Δ (HH/MM/SS)— —:— —:— —

Requires the time of day in hours, minutes, and seconds using 2-digit format.

RUN LIBS DEVICE ADDR? (DEFAULT=SYSRES)— — —

Questions whether the system job run library file \$Y\$RUN is to be located on a disc volume other than the \$Y\$RES volume. If \$Y\$RUN is to be located on a different disc volume, key in the new device number using the true physical unit number. If the run library is to be located on \$Y\$RES, no keyin is required; press the **RETURN** key on the system console to position the cursor on the next line.

RECOVER FILES?

Requests operator action on the following three statements:

JOB QUEUE (N, Y, H DEFAULT=N)

If the jobs previously filed in the job queue are to be retained, key in Y, or if the recovered jobs should be put into hold status, key in H; otherwise press the **RETURN** key to advance to the next statement.

ERROR LOG (N, Y DEFAULT=Y)

This message appears only if an error log option is configured in your system. Key in N to clear all accumulated errors in the error log and start a new error log file. Otherwise, if you wish to retain the present error log file and continue to list errors in the error log, press the **RETURN** key to advance to the next line.

SPOOL FILES (N, A, C, L, H DEFAULT =SYSGEN option)

This message appears only if the spooling option is configured in your system. It requests that you specify the level of recovery you may desire for the spool file in your system. You may specify a method of establishing the spool file by keying in one of the following responses:

N

Previously spooled input and output was processed before the system was turned off and the spool file is empty; therefore, no recovery is required.

A

↓

All spooled subfiles are to be recovered when the spool file is reinitialized because previously spooled or output files in the spool file are to be processed. With this response, all spooled subfiles, whether complete or incomplete, are to be saved. This response (or H) must be specified to recover the system console log file (if configured into the system). Console messages that were not copied from main storage buffer to spool file are not recovered; copying is done only when buffer has been filled.

↑

C

Only completed subfiles are to be recovered when the spool file is initialized.

L

↓

Only the user log directory is to be recovered when the spool file is initialized.

H

↑

May be selected if the operator has taken a system dump at the operator/maintenance panel by pressing the SYSTEM RESET switch, then the RUN switch. When the spool file is reinitialized, all spool subfiles (same as with A option), as well as system console messages that have been accumulated in main storage buffer, but not copied onto the spool file, are recovered; copying is done only when the buffer has been filled. The hot start should be used only if a system crash occurs. If there is a planned shutdown of the system and spool files are to be recovered at a later date, the operator should breakpoint the console log, then select the A, C or L spool recovery option when the system is rebooted.

If you wish to use the same method of establishing the spool file that was specified during SYSGEN, ignore the above keyins and default by pressing the **RETURN** key to advance to the next line.

SPOOLING DVC ADDR? (DEFAULT= { blank
vsn
SYSRES })

This message appears only if the spooling option is configured in your system. Further, if multivolume spooling was configured, it will appear once for each volume that the spool file can be on, as specified at SYSGEN time. Each of these messages requests that you identify the volume serial numbers of the disc volumes that are to contain the spool file. If the volume specified during SYSGEN, as identified in the message as the DEFAULT value, is to be used, press the space bar three times. If you wish to locate the spool volume being referenced on a different volume than that displayed in the message, key in the device address of the disc unit containing the desired disc volume. Repeat this procedure for each message displayed.

If no DEFAULT volume is identified (DEFAULT=blank) you have the option of identifying another volume for use by the spool file or limiting the spool file to those volumes already identified. To identify another volume, key in the device address of the disc unit containing the desired disc volume. To indicate that no more volumes are to be used, press the **TRANSMIT** key. This action will cause the message presented in step m to be displayed. Remember, all volumes identified as spool volumes at IPL time must be online for the system to be operational.

CAUTION

*Be sure to respond to all the above statements requiring keyin before pressing the **TRANSMIT** key. Once the **TRANSMIT** key is pressed, the questions and answers are lost and the entire procedure must be restarted if the procedure was not performed correctly.*

- m. After the requested information has been responded to as required, press the **TRANSMIT** key on the system console. When the selected supervisor has been loaded and initialized, the following message appears on the system console screen.

(1) - - - - - (2) - - - - - (3) - - - - - (4) - - - - - (5) - - - - - (6) - - - - - (7) - - - - -

OS/3 supnam VERSION nn yy/mm/dd hh:mm:ss ←

Message Description:

(1) through (7)

These seven numbers represent the numbers assigned to the seven jobs that can be concurrently run in the system. When a job is initiated, the number disappears and the job name takes its place. The position of the job name signifies its job number.

Example:

Three jobs are running in the system named A, B, and C.

Screen format:

A B C (4) (5) (6) (7)

NOTE:

The first IPL of a supervisor that is configured for spooling with the spool file being located on a selector channel disc subsystem (8411, 8414, or 8430) requires that the spool file be formatted. This formatting operation takes an appreciable amount of time (approximately 1 minute on a 8430 for the default specification of 50 cylinders), and is no cause for concern.

supnam

Signifies the name of the supervisor that has been loaded into the system. ↓

nn

Signifies the system software version that has been loaded into the system.

yy/mm/dd

Signifies the system year, month, and day.

hh:mm:ss

Signifies the system time in hours, minutes, and seconds. ↑

- ↓
- n. If Y or H was selected for the JOB QUEUE message (refer to step l), the following message appears on the system console screen:

JOB QUEUE RECOVERED — n JOBS QUEUED

Message Description:

n JOBS QUEUED

Specifies the number of jobs on the job queue.

- o. If N was selected for the ERROR LOG message (refer to step l), the following message appears on the system console screen:

ERROR LOG NOT RECOVERED

↑

When one job terminates, the next job to be run takes the place and job number of the terminated job on the system console screen heading.

→

If either the **PROC CHECK** or **HPR STOP** indicators (on the operator/maintenance panel) light during these phases (m, n, o) of the IPL operation, the preceding messages won't be displayed because the supervisor wasn't loaded or initialized properly, and you must repeat the IPL operation beginning with step 2e of this procedure.

If, after repeating this procedure, the **PROC CHECK** indicator remains lit, reload control storage and then repeat the IPL operation. If the **HPR STOP** indicator continues to light, perform the following procedure, at the operator/maintenance panel, to determine the cause of the error:

- (1) Set the **DISPLAY SELECT 1** switch to **UPPER**.
- (2) Set the **LEGEND SELECT 1** switch to position 7.
- (3) Read the first four sets of the **DISPLAY 1** indicators (I0 through I15). The possible HPR codes that can be displayed by these indicators during this phase of the IPL operation are listed and described in the OS/3 system messages programmer reference, UP-8076 (current version). If one of the special supervisor initialization HPR codes is displayed, set the **LEGEND SELECT 1** switch to position 6 and read the **DISPLAY 1** indicators representing registers Z00 through Z15 to further identify the cause of the HPR stop. The first two hexadecimal digits displayed (Z00 through Z07) identify the HPR stop code (O1 through OF). The last two hexadecimal digits further identify the cause of the HPR stop. The meaning of the last two digits is described in the OS/3 system messages programmer reference, UP-8076 (current version).

If possible, correct the cause of the HPR stop and then retry the IPL operation. If the IPL operation still cannot be completed successfully or if the HPR code identified a condition that cannot be corrected, reload control storage and then retry the IPL operation.

If either the **PROC CHECK** or **HPR STOP** error condition persists, contact your Sperry Univac customer engineer.

After the header is displayed on the system console, the system is ready to process user jobs. Note however, that any integrated disc units (8416's and 8418's) that were offline when the supervisor was initialized are not available for system use until they are identified as available by the operator via the SET IO command (12.4.8), or a disc pack is mounted on them and they are initialized. Note also, that the supervisor cannot distinguish between a low density 8418 disc unit and an 8416 disc unit. Thus, if a low density 8418 is placed online after system initialization, the following SET IO command must be keyed in to identify this fact to the supervisor:

SET IO, device-address, TYP, 2002

Jobs requiring more than the available devices will be terminated with an R277 message. The operator may review device status with the MIX command (12.4.3) and change the status with the SET IO command.

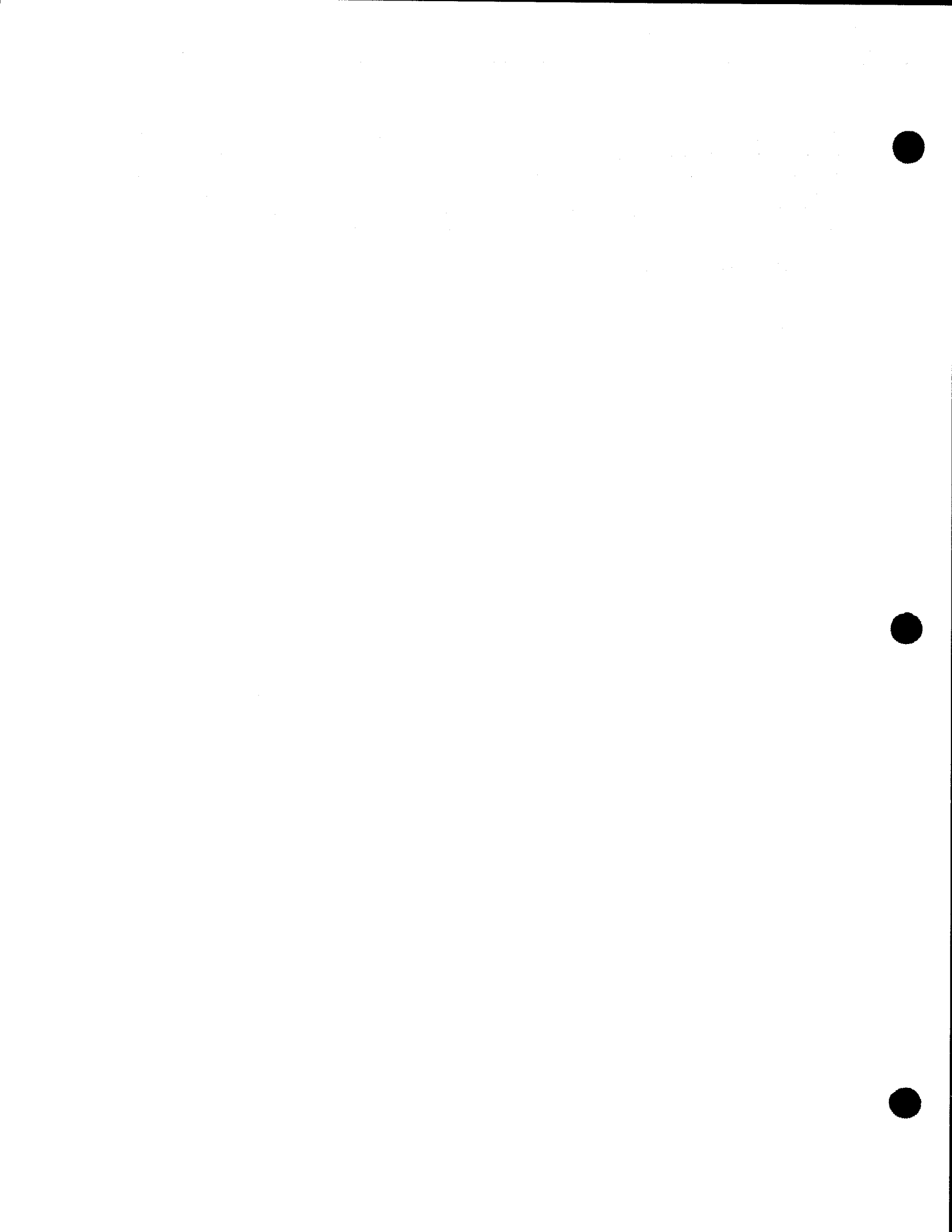

12. Job Processing Procedures

12.1. GENERAL

After the header is displayed on the system console screen, the system is ready to process user jobs. To begin processing, place the input media (cards or disc) containing the job control stream (JCS) to be processed on the input device and set the device to the run state in accordance with the procedure specified for that device in Part 2. Then proceed to the system console to initiate running the job, using the system commands described in this section.

To perform confidence tests on the system and peripheral subsystems, reference should be made to the current version of OS/3 online diagnostic procedures, operator reference, UP-8512.

NOTE:

Refer to Appendix A for the conventions used to illustrate the commands and messages appearing in this manual.

12.2. KEYIN PROCEDURE

Before keying in any message or command on the system console for transmittal to the system, the **MESSAGE WAITING** key on the system console must be pressed. Pressing this key notifies the system you want to send a message or command to it, automatically opens a line on the system console screen for display of the input command or message, gives the start of entry (▷) signal, and sets the cursor (␣) to the position where typing is to start.

After keying in the message or command, press the **TRANSMIT** key on the system console keyboard. This initiates transmittal of the message or command to the system. All commands are acted upon immediately or placed on a queue for future processing; they are never ignored or lost. Commands are placed on queue when insufficient memory exists or a required device is not available. Queued commands are activated as soon as all requirements for execution are met. Therefore, commands keyed in twice are eventually executed twice. If a message or command is unacceptable, the system responds with a negative acknowledgement (NAK) error message indicating why. This error message appears in the last 12 character positions of the line of the unacceptable message or command, and, if necessary, overwrites any message or command text that may be present in the last 12 character positions. A blinking delta (Δ) symbol appears at the beginning and end of each error message. The message or command must then be retyped in accordance with the information furnished by the error message, so that the job involved with the unacceptable message or command may be executed. The error messages that may be displayed are described in the system messages manual, UP-8076.

If console logging has been configured for the system, the console log messages are recorded in a spool file for later printing. Any console log messages not recorded will be identified by a single blinking character in the rightmost position of the console line containing the message. This may occur if, for example, the device containing the spool file is in error recovery and the operator does not want to halt processing.



12.2.1. System Command Characteristics

When a command is being typed in, there must be at least one space between the command and the first parameter, and commas between all parameters. The format for these commands is:

Format:

→ **command** $\left[\left\{ \begin{array}{l} \text{(did)} \\ \text{((did) label)} \end{array} \right\} \right] \Delta$ [command-parameters]

where:

▷

Is the start of entry symbol (SOE) that must precede all lines.

command

Is two to eight alphabetic characters that identify the system command to be processed. At least two characters must be supplied.

did

→ Is a 3-character device address that serves to further identify the software routine that is to receive the command or identify a device that is to be used when carrying out the command. A device address should be included in all commands that are being directed to a software routine that is controlling or using a peripheral device (such as an output writer symbiont), because more than one copy of the routine being referenced may be active in the system at the same time. The device address must be enclosed in parentheses.

↓

If this is not entered, the first appropriate software routine or device will be used.

did, label

When a diskette is used to serve the function of a card reader or card punch, a file identifier (label) is required to identify the specific file to be accessed on the diskette. The device address also must be included, unless SYSRDR is configured as a diskette. The label, which may be a maximum of 8 alphanumeric characters, is separated from the device address by a comma.

Examples:

RUN (010,DATANAM1) JOBNAM1

RUN (.DATANAM1) JOBNAM1 (Valid if SYSRDR is configured as a diskette)

↑

command-parameters

Are optional positional parameters used to influence the effect of the command being issued. Each specified parameter must appear in its own position. Commas are used to separate positions. For example, the following command format

→ **RUN** $\left[\left\{ \begin{array}{l} \text{(did)} \\ \text{((did),label)} \end{array} \right\} \right] \left[\left\{ \begin{array}{l} \text{jobname} \\ \text{jobname (new-name)} \\ \text{(new-name)} \end{array} \right\} \right] \left[\text{.priority} \right]$

indicates that two positional parameters are associated with the RUN command; the comma separates the first from the second. If only the second parameter is to be specified, the command must be keyed in as follows:

RU ,HIGH

As shown, the comma must be included to indicate the omission of the first parameter; otherwise, HIGH would be considered the name of the job to be run.

Also, if a parameter may take more than one form, as is the case with the first parameter in the RUN command, the punctuation marks, in this case parentheses, must be keyed in whenever shown in the format. For example, if a new-name is specified, the command could be keyed in as

RU MYJOB(JOBA),PRE

or

RU (TEMPNAME)

In either case, the parentheses must be included.

12.2.2. System Message Characteristics

Console messages in which information/questions are exchanged between the operator and the system have the message format shown below. The messages that may be output to the system console by the components of OS/3, are described in the system messages manual, UP-8076 (current version), together with their associated operator responses, when appropriate.

Format:

▷ ji $\left. \begin{matrix} ? \\ \Delta \\ * \end{matrix} \right\}$ message-text

where:

▷

Is the start of entry symbol (SOE); must precede all lines.

j

Is a 1-digit job number that is assigned to each active job in the system. The numbers 1 through 7 are assigned to user jobs as they become scheduled for execution. The number assignments for user jobs are shown in the header area on the system console screen (Figure 12—1). Each job name replaces its corresponding job number. These job numbers are used in output messages to identify the job that transmitted the message, and in input messages, to identify the job that is to receive the message. The supervisor is always assigned the job number zero.

i

Is a 1-digit hexadecimal message number. Message numbers are consecutively assigned to output messages that are generated by user jobs beginning with the number 1 and ending with the letter F. Likewise, message numbers are consecutively assigned to output messages generated by the supervisor. These numbers are used together with the job numbers to explicitly identify each message in the system. When an output message requires a reply, the reply message must be prefixed with the job and message number of the message requesting the reply. Unsolicited input messages are identified by the message number zero. Thus, an unsolicited message to the supervisor has the prefix 00; and an unsolicited message to job number 1 has the prefix 10; job 2 has the prefix 20, etc.

?

Identifies an output message that must be responded to before the job that issued the message can continue. Output messages requiring replies are not rolled off the system console screen until they are answered.

△

Identifies an output message that requires no reply or operator action; information only. Input messages, solicited and unsolicited, may optionally include a space between the message number and message text.

*

Identifies an output message that requires that some action be taken by the operator. The job that generated the message has placed itself in a "yield" state. A GO command is required from the operator to reactivate the job.

message-text

Comprises the actual message content and is a maximum of 60 characters.

12.2.2.1. Solicited Messages

Solicited messages are those messages input by the operator in direct response to an output message that requires a reply (question mark immediately follows message number). The format of all solicited input messages is:

▷ ji △ message-text

where:

ji

Identifies the job and message number of the message being replied to; Figure 12-1, line 3 is an example of a solicited message. The message soliciting the response is shown in line 2.

message-text

Is the actual reply message.

12.2.2.2. Unsolicited Messages

Unsolicited messages are those messages input by the operator that are not in direct response to an output message that requires a reply. The format of all unsolicited input messages is:

▷ j0△[symbiont-name][(did)]△message-text

where:

j

Is the job number of the job you want to receive the unsolicited message.

0

Is the message number that must be used to identify the message as an unsolicited message.

symbiont-name

Is the 2-character alphanumeric name of the supervisor symbiont that is to receive the unsolicited message (the job and message numbers are 00). If a symbiont is not the recipient of the message, no symbiont name is required.

did

Is the address of the device being used or controlled by a specific copy of a symbiont in memory. The symbiont having this device allocation receives the unsolicited message. If the specified device is not assigned to the symbiont, the unsolicited message is not acknowledged. The device-address must be enclosed in parentheses.

NOTE:

When you key in an unsolicited message to a symbiont, the system task control blocks (TCB) are searched to locate an active symbiont identified by the name specified in the message. When no address is specified, the unsolicited message is transferred to the buffer of the first symbiont encountered in the switch list that bears this name. If there is more than one copy of the same symbiont activity, only the first will get the message. Figure 12-1, line 11, is an example of an unsolicited type-in to a symbiont.

message-text

Is the actual text of the message.

```
PROGRAM1 __ (2) ___ (3) ___ PROGRAM4 PROGRAM5 __ (6) ___ PROGRAM7
1  ▷ 71 THIS IS A COMMENT FROM PROGRAM7
2  ▷ 12? ANSWER A QUESTION FROM PROGRAM1?
3  ▷ 12 THIS IS THE ANSWER TO PROGRAM1
4  ▷ 50 ACTIVATE USER ISLAND CODE FOR PROGRAM5
5  ▷ 43* MOUNT DEV=440 VSN=DSP614 LU=050 DEV=441 VSN=DSP633 LU=051
6  ▷ 44* MOUNT DEV=442 VSN=DSP554 LU=052 GO?
7  ▷ GO PROGRAM4,4
8  ▷ DISPLAY 140,7
9  ▷ 0A? THIS IS A QUESTION FROM THE 'DISPLAY' SYMBIONT
10 ▷ 0A THIS IS THE ANSWER TO THE 'DISPLAY' SYMBIONT'S QUESTION
11 ▷ 00 IO ACTIVATE IO SYMBIONT ISLAND CODE
12 ▷ CANCEL IO,S
13 ▷ DUMP PROGRAM5,5
14 ▷ 0B THIS IS A COMMENT FROM THE DUMP ROUTINE
15 ▷ END DUMP,PROGRAM5,5
```

Figure 12-1. Typical System Console Messages

Command Code:

RUN

Used to initiate the running of a prefiled job control stream that requires the use of a card reader or the running of a job control stream that is being input from the card reader. If no device is identified, the first available card reader as defined when the system was generated, will be used for the job. If a prefiled job control stream is to be run, positional parameter 1 must be specified.

If a diskette is functioning as the card reader, the did and label are required (12.2.1). ←

RV

Used to initiate the running of a prefiled job control stream that does not require the use of a card reader. The jobstream to be run must not contain a // CR (read card reader) statement.

Positional Parameter 1:

jobname

Identifies the name of the job to be read from \$Y\$JCS and stored in \$Y\$RUN to await execution. The job name consists of one to eight alphanumeric characters.

jobname (new-name)

Assigns a new 1- to 8-alphanumeric-character name to a job already stored in \$Y\$JCS. The job identified by the *jobname* subparameter is read from \$Y\$JCS and stored in \$Y\$RUN under the name identified by the *new-name* subparameter to await execution.

(new-name)

Assigns a new 1- to 8-alphanumeric-character name to a job input from the card reader. The job is read and stored in \$Y\$RUN under the new name to await execution.

If omitted, the jobs loaded in the system card reader are read into \$Y\$RUN to await execution.

Positional Parameter 2:

priority

Specifies the job priority status, as either PRE (preemptive), HIGH, or NORMAL for scheduling the job. This priority assignment overrides the priority assigned to the job via its JOB control statement. If the system is not generated with the rollout/rollin option specified, all PRE specifications are treated as HIGH.

If omitted, the job priority assigned to the job via the job control statement is in effect.

Positional Parameters 3 through n:

key-1=val-1...,key-n=val-n

Are keywords and their values that may be used by the job being run. The keywords and their values must be supplied by the person requesting the job.

NOTE:

The total length of all the parameters specified in this command, from the first character of positional parameter 1 to the last character of the last keyword value specified, is limited to 44 characters. ←

12.3.2. Job Rescheduling

When a job is placed in the run state through the RUN command, it is placed in a job queue to await execution. While in the run state, the operator may elect to hold temporarily, or suspend, the execution of a job, change its scheduling priority, or change its task switching priority. The following commands enable you to perform these functions. Note that only the underlined portions of these commands (HO, BE, etc.) and their parameters (H, N, P, etc.) should be used; otherwise a job-not-found error is issued.

12.3.2.1. Deferring Job Scheduling (HOLD)

Function:

The HOLD command defers scheduling of all jobs, a specific job, or jobs of a given priority. Scheduling remains deferred until the BEGIN command is issued. When the HOLD ALL command is issued, jobs entered on a job queue subsequent to that command are deferred until a BEGIN command is issued for the particular job queue.

Format:

HOLD { ALL
HIGH
jobname
NOR
PRE }

Positional Parameter 1:

ALL

Specifies that all jobs in \$Y\$RUN that are not already active, as well as jobs subsequently entered into the system, are to be placed in hold status and not scheduled for execution. The BEGIN command can then be used to release a particular job, or all the jobs, for scheduling.

HIGH

Specifies that every job with a high priority, including jobs subsequently entered into the HIGH queue, is to be placed in hold status and not scheduled for execution.

jobname

Identifies a specific job that is to be placed in hold status and not scheduled for execution.

NOR

Specifies that every job with a normal priority, including jobs subsequently entered into the NOR queue, is to be placed in hold status and not scheduled for execution.

PRE

Specifies that every job with a preemptive priority, including jobs subsequently entered into the PRE queue, is to be placed in hold status and not scheduled for execution.

12.3.2.2. Rescheduling Deferred Jobs (BEGIN)

Function:

The BEGIN command reinstitutes scheduling of jobs that are currently inactive as the result of a HOLD command being issued. Jobs entered in a job queue prior to issuance of the HOLD command are always held until specifically released with a particular BEGIN command.



Format:

BEGIN [ALL
HIGH
jobname
NOR
PRE]

Positional Parameter 1:

ALL

Specifies that all jobs being held inactive are to be scheduled for execution.

HIGH

Specifies that all high-priority jobs being held inactive are to be scheduled for execution.

jobname

Identifies a specific, currently inactive job that is to be scheduled for execution. The job name cannot be HIGH, NOR, or PRE because these are names of scheduling priorities. A job selected with this command will be analyzed for possible scheduling first, whether it was entered before or after issuance of any HOLD command.



NOR

Specifies that all normal-priority jobs being held inactive are to be scheduled for execution.

PRE

Specifies that all preemptive-priority jobs being held inactive are to be scheduled for execution.

12.3.2.3. Suspending a Job in Progress (PAUSE)

Function:

The PAUSE command suspends processing of a job. The command may be given at any time and job processing is suspended immediately. This permits mounting a new volume on a tape unit or disc drive, replacing paper on the printer, or placing more cards in the card reader. The suspended job is reactivated by the GO command.

Format:

PAUSE jobname

Positional Parameter:

jobname

Specifies the name of the job whose processing is to be suspended.

12.3.2.4. Activating a Suspended Job (GO)

Function:

The GO command reactivates a job suspended by the PAUSE command or by job control operations. Job control suspends processing of a job when it issues instructions to mount a new volume on a tape unit or disc drive. The GO command also is required as a response to a message from the system preceded by an asterisk (*).

Format:

GO jobname

Positional Parameter 1:

jobname

Specifies the job to be reactivated after execution had been temporarily suspended.

12.3.2.5. Changing a Job Scheduling Priority (CHANGE)

Function:

The CHANGE command changes the scheduling priority of a specific job.

Format:

CHANGE jobname, { HIGH
NOR
PRE }

Positional Parameter 1:

jobname

Identifies the job that is to have its priority schedule changed.

Positional Parameter 2:

HIGH

Specifies that the job is to be changed to high-priority status.

NOR

Specifies that the job is to be changed to normal-priority status.

PRE

Specifies that the job is to be changed to preemptive-priority status.

12.3.2.6. Changing a Job Switching Priority (SWITCH)

Function:

The SWITCH command changes a job task switching priority from one level to another.

Format:

SWITCH jobname, { +number-of-queue-positions }
 { -number-of-queue-positions }

Positional Parameter 1:

jobname

Specifies the name of the job whose task switching priority is to be changed.

Positional Parameter 2:

+number-of-queue-positions

Specifies the number of switching priority levels a job is to be raised.

-number-of-queue-positions

Specifies the number of switching priority levels a job is to be lowered.

The number of switching priority levels a job can be raised or lowered is governed by the number of switching priority levels established at system generation time. If the SWITCH command exceeds the upper or lower limit of these levels, the system automatically changes the number of levels the job can be raised or lowered, so that the job remains within the preset switching priority limits. When any job switching priority is changed, all tasks of that job retain switching priority relative to each other; therefore, if any task of a job exceeds the upper or lower switching priority limit, all the tasks of the job move only by the number of queue positions that the highest or lowest priority task can be moved within the switching priority limits.

12.3.3. Job Termination

The operator may elect to:

- terminate the execution of an active job;
- prevent the execution of one or more jobs waiting to be executed;
- terminate execution of a job-related symbiont; or
- request that a job be terminated after completion of the currently active job step.

The following commands enable you to perform these functions.

12.3.3.1. Cancelling a Job in Progress (CANCEL)

Function:

The CANCEL command immediately halts all processing of a job or symbiont. The CANCEL command may be issued at any time during processing of a job and results in the immediate termination of the job step being executed at the time the CANCEL command is given, plus any subsequent job steps scheduled for the job. The job run library file for this job also is deleted.

Format:

$$\underline{\text{CANCEL}} \left\{ \begin{array}{l} \text{jobname} \left[\left\{ \begin{array}{l} \text{D} \\ \text{N} \end{array} \right\} \right] \\ \text{symbiont,S} \end{array} \right\}$$

Positional Parameter 1:

jobname

Specifies the name of the job whose processing is to be immediately terminated and whose job run library file is to be deleted.

symbiont

Specifies the 2-character name of the symbiont to be terminated.

Positional Parameter 2:

D

Specifies that a dump is to be taken when the job is terminated, regardless of the dump option specified in the job control stream for the job.

N

Specifies that no dump is to be taken when the job is terminated, regardless of the dump option specified in the job control stream for the job.

S

Specifies that the name specified in positional parameter 1 is the name of a symbiont. A dump is always taken when a symbiont is terminated.

If omitted, the job control dump options remain in effect. Positional parameter 2 must be specified when a symbiont is being cancelled.

12.3.3.2. Deleting Jobs From Job Queue (DELETE)

Function:

The DELETE command deletes all jobs, a specific job, or jobs with specific scheduling priorities from the job run library file, and thus prevents their execution. Only jobs that have not been started can be deleted.

Format:

```
DELETE { ALL  
          HIGH  
          jobname  
          NOR  
          PRE }
```

Positional Parameter 1:

ALL

Specifies that all jobs in \$Y\$RUN waiting to be run are to be deleted.

HIGH

Specifies that all jobs with high priorities are to be deleted.

jobname

Specifies the name of a job in \$Y\$RUN that is to be deleted.

NOR

Specifies that all jobs with normal priorities are to be deleted.

PRE

Specifies that all jobs with preemptive priorities are to be deleted.

12.3.3.3. Stopping Execution of Symbiont or Transient (END)

Function:

The END command terminates execution of a system symbiont or transient routine.

Format:

```
END system-routine,jobname
```

Positional Parameter 1:

system-routine

Specifies the name of the symbiont or transient routine whose execution is to be stopped.

Positional Parameter 2:

jobname

Specifies the job that is using the system routine whose execution you want stopped (i.e., stopping the execution of a dump for a particular job).

12.3.3.4. Terminating a Job (STOP)

Function:

The STOP command terminates a specific job at the end of the currently executing job step. This command provides for orderly termination of the job.

Format:

STOP jobname

Positional Parameter 1:

jobname

Specifies the job whose processing is to be terminated in an orderly sequence.

12.4. SELECTED-OCCASION OPERATOR COMMANDS

During the course of processing a job, the operator may be required to:

- Display or dump an area of main storage
- Clear the system console screen of all but outstanding questions
- Obtain a listing of all current system I/O devices and identification of the volumes mounted on them
- Change the system time, date, or I/O configuration
- Change the error log status of recording the physical I/O control system errors
- Read the volume serial number of a mounted disc or tape volume
- Run an IBM System/3 job in an OS/3 environment.

The following commands enable you to perform these functions.

12.4.1. Displaying Portions of Main Storage (DISPLAY)

Function:

The DISPLAY command causes selected areas of main storage to be displayed at the system console.

Jobs in the scheduler queues are displayed according to the priority specified in positional parameter 2. If no inactive job is available at the specified priority, a message is displayed on the console screen indicating that condition.

Format:

$$\text{DISPLAY} \left\{ \begin{array}{l} \text{JBO} \left[\begin{array}{l} \{ \text{N} \} \\ \{ \text{P} \} \\ \{ \text{H} \} \\ \{ \text{jobnumber} \} \\ 0 \end{array} \right] \\ \text{address,} \end{array} \right\}$$

Positional Parameter 1:

JBO

Specifies that a job queue is to be displayed.

address

A hexadecimal number that identifies a job-relative address if a job number is specified in positional parameter 2 or an absolute address when 0 is specified in positional parameter 2.

Positional Parameter 2:

N

Specifies that the normal priority job queue is to be displayed. This is the default specification.

P

Specifies that the preemptive-priority job queue is to be displayed.

H

Specifies that the high-priority job queue is to be displayed.

jobnumber

Specifies the job identification number of the job in main storage whose relative address is to be displayed.

0

Specifies that the address entered in positional parameter 1 is an absolute address.

It should be noted that, after a DISPLAY command is issued and the display symbiont (DI) is loaded, the following message appears on the system console:

▷ ji? addr [JOB#n] contents-of-selected-addr Y, N, NXT?

where:

j

Is the job identification number (1 through 7) assigned to the display symbiont (DI).

i

Is a message number (1 through F).

addr

Is the address of the main storage location being displayed, in hexadecimal.

JOB#n

Identifies the address being displayed as a job-relative address and identifies the job region by its job number. If JOB#n is not displayed, the address being displayed is an absolute address.

contents-of-selected-addr

Is the hexadecimal representation of the contents of the selected main storage address.

Y

Is a message response code that causes the display symbiont to display the next sequential main storage location.

N

Is a message response code that causes the display symbiont to be terminated.

NXT

Is a reminder to the operator that another nonconsecutive main storage location may be displayed without recalling the display symbiont, simply by responding to this message in the following form:

▷ ji addr, { $\begin{matrix} \text{jobnumber} \\ 0 \end{matrix}$ }

where:

j

Is the job identification number (1 through 7) assigned to the display symbiont (DI).

i

Is a job-relative message number (1 through F).

addr

Is the main storage location to be displayed.

jobnumber

Is a decimal number from 1 to 7 that identifies the main storage address being keyed in as a new job-relative address.

0

Identifies the main storage address being keyed in as an absolute address.

If the new main storage address to be displayed is in the same job region as the previously displayed main storage location, or if the new main storage address to be displayed is an absolute address and the main storage address previously displayed was an absolute address, only the new address need be supplied.

When no more addresses are to be displayed, the operator should terminate the display symbiont by responding to the last display message as follows:

> ji N

Otherwise, the last message output generated by it will continue to be displayed on the system console.

12.4.2. Initiating a Main Storage Dump (DUMP)

Function:

The DUMP command causes a specific job step region in main storage, which is currently being executed, to be dumped to a printer for printing. At completion of the dump, the dumped job step is lost; however, the remaining job steps, of the specified job, if any, are returned to job control for execution.

If the DUMP command is keyed in while the files associated with a job are open, a dump is not performed on the job step, but instead a cancel function (12.3.3.1) is performed to terminate the job.

Format:

DUMP [(did)] { jobname
 { symbiont, S } }

If no device is identified, the first available printer, as defined when the system was generated, is used.

Positional Parameter 1:

jobname

Specifies the job whose job step region in main storage is to be dumped to the system printer.

symbiont

Specifies the 2-character symbiont name whose region in main storage is to be dumped to the system printer.

Positional Parameter 2:

S

Specifies that positional parameter 1 is the name of a symbiont, rather than a job name.

12.4.3. Displaying System Information (MIX)

Function:

The MIX command displays tables of different aspects of system information.

Format:

MIX { DA
 VI
 SQ
 SI
 DS [,device-address] }



Positional Parameter 1:

DA

Causes the following information to be displayed on the system console screen:

- Job names of all jobs being processed
- Job numbers of all jobs being processed
- Regions of main storage that are allocated to jobs
- Device numbers of devices allocated to jobs being processed
- Priorities of jobs being processed
- Any variance of the storage key from the job key or variance in protection mode within a user job (e.g., a user job should be read/write protect; if a region is write protect only, that region's start-end addresses will be displayed)

VI

Displays device identification of devices having a mounted volume and the volume serial number of each volume.

SQ

Displays a list of outstanding symbiont requests, including unprocessed queued operator commands. (These are console commands that could not be processed immediately.)

SI

Displays system information including: supervisor name, date, time, RES device address, RUN device address, SPOOL device addresses.

DS

Causes the following information to be displayed on the system console screen for each device in the system if no device is specified in positional parameter 2, or for only the device specified in positional parameter 2:

- The device address of each device
- Whether the device is up or down (UP or DO)
- Whether the device is available or not (Y or N)
- Whether the device is sharable or not (Y or N)
- The job numbers of all the jobs to which the device is allocated
- The job numbers of all the jobs for which the device is reserved
- If device is a diskette, will show 'IN USE' if currently being used



Positional Parameter 2:

device-address

This parameter is used in conjunction with the DS parameter to identify a particular device or group of devices for which status information is desired. One, two or three characters may be used. A 3-character key-in specifies the exact device to be displayed. If two characters are keyed in, the group of devices whose device addresses start with those two characters will be displayed. A 1-character key-in may be used to display information about all devices that have addresses beginning with the character keyed. If this parameter is omitted, the status of all the devices in the system is displayed.

Examples:

MI DS,4	displays any configured devices from 400 to 499
MI DS,40	displays any configured devices from 400 to 409
MI DS,400	displays device 400 only

12.4.4. Reconstructing Console Display (REBUILD)

Function:

The REBUILD command clears all information from the system console, then restores the first line on the console screen and rewrites all outstanding questions and action requests on the screen. All displays other than unanswered questions and action requests are lost.

Format:

REBUILD

Positional Parameters:

No positional parameters are required for the REBUILD command.

12.4.5. Setting Simulated Day Clock (SET CLOCK)

Function:

The SET CLOCK command resets the time of day in the system-simulated day clock. This should normally be done at midnight to change from 24:00:00 to 00:00:00.

Format:

SET CLOCK, hh:mm:ss

Positional Parameter 1:

CLOCK

Specifies that the simulated day clock is to be set to the time specified in positional parameter 2.

Positional Parameter 2:

hh:mm:ss

Specifies the time to which the simulated day clock is to be set, as follows:

hh	hours (00 through 99)
mm	minutes (00 through 59)
ss	seconds (00 through 59)

12.4.6. Setting Date Field (SET DATE)

Function:

The SET DATE command resets the calendar date in the system information block date field. This should normally be done at midnight, in conjunction with the SET CLOCK command (12.4.5) to advance the date.

Format:

SET DATE,yy/mm/dd[,yyddd]

Positional Parameter 1:

DATE

Specifies that the calendar date in the system information block date field is to be changed to the date specified in positional parameter 2.

Positional Parameter 2:

yy/mm/dd

Specifies the date to which the calendar date in the system information block date field is to be changed, as follows:

yy year (00 through 99)

mm month (01 through 12)

dd day (01 through 31)

Positional Parameter 3:

yyddd

→ Specifies the date, in EBCDIC, where yy is the year (00 through 99) and ddd is the ordinal day (001 through 366). This date is maintained in a separate part of the system information block and is used by data management routines that check the label fields.

→ If omitted, this field in the system information block is set to the ordinal date corresponding to the yy/mm/dd date specified in positional parameter 2.

12.4.7. Setting Error Log (SET ELOG)

Function:

The SET ELOG command starts or stops physical I/O control system (PIOCS) errors from being logged.

Format:

SET ELOG, { OFF
ON
RESUM
SUSPND }

Positional Parameter 1:

ELOG

Specifies that the PIOCS error logging processor is to be set to some condition.

Positional Parameter 2:

OFF

Specifies that PIOCS error logging is to cease.

ON

Specifies that PIOCS error logging is to begin; can be used only after a SET ELOG,OFF command has been issued.

RESUM

Specifies that PIOCS error logging is to be resumed.

SUSPND

Specifies that PIOCS error logging is to be suspended until a SET ELOG,RESUM command is issued.

When the ELOG file is nearly full (only 200 more I/O errors can be recorded), ELOG informs the operator of the near-full condition. When this message appears (ELOG), the operator should:

1. Suspend error logging using the SET ELOG,SUSPND command.
2. Initiate the running of the job ONUERL to print the contents of the ELOG file by using the RUN ONUERL command, or the following job control stream: ←

1	10	20	30	40	50	60	70
---	----	----	----	----	----	----	----

```
// JOB ERRLOG,,7000
// DVC 20 // LFD PRNTR
// WORK1
// EXEC ONUERL
// PARAM LOG-ID ← installation-name → ser-no
/ε
// FIN
```

NOTE:

The operand entries in the PARAM statement consist of LOG-ID, followed by the site installation name and the site serial number both of which are part of the heading line printed on each page of the summary report.

The first space occurring after column 9 terminates the PARAM statement; therefore, there can be no spaces within the operands portion of the statement.

- LOG-ID must be entered in columns 10 to 15.
- The installation name entry consists of 34 nonspace characters and must occupy columns 16 to 49. You can use any printable characters as connectors or fillers.
- The serial number can be from 1 to 4 characters and must start at column 50.

For example, a PARAM statement specifying the installation name CORPORATE DATA CENTER and serial number 14 could be entered as:

	LABEL	Δ	OPERATION	Δ	OPERAND
1		10		20	

```
// PARAM LOG-ID.....CORPORATE-DATA-CENTER.....14
```

3. Resume error logging using the SET ELOG,RESUM command.

When the ELOG file becomes full, ELOG asks the operator if he wants to suspend error logging or wraparound to the beginning of the log file. The reply message has the following format:

▷ Oi { S }
 { W }

where:

i

Identifies the console message being answered.

S

Informs the PIOCS error logging processor to suspend logging temporarily.

W

Informs the PIOCS error logging processor to wraparound the log file and continue logging.

If printing of the ELOG file has previously been initiated, the operator should respond with the letter W. Otherwise, he should respond with the letter S to suspend error logging, initiate the printing of the ELOG file as previously directed, and then resume error logging using the SET ELOG,RESUM command.

- ➔ The summary report obtained as a result of running the ONUERL job provides a concise comprehensive report of system performance for the period covered by the error log file. The main body of the report consists of a single line for each error log entry. The entries are sorted chronologically by device. The report also includes a summary of total I/O count and sense byte errors per device.
- ➔ A sample ONUERL summary report is illustrated in Figure 12-2.

ERROR LOG EVENT SUMMARY REPORT REV. 48/05XYZ COMPANY..... SERIAL NO. 1234 77/08/18 21.32 PAGE 4

DEVICE
TYPE ADR
0440 002

TIME	JOB NAME	VSN	RCVRY	VALID I/O'S	ERROR CCXX AAAA XXXXBBBB	BCW	DISK CCC HH RR	DV/SC	STATS	SENSE BYTES
DATE 08/18										
R06.56.36	SLSSQW00	-----	1L	4	BF 0117D6	000000C2	---	06	00 0802	0000 0000
06.57.06	SLSSQW00	-----	2U	2	BF 0117D6	000000C2	---	06	00 0802	0000 0000
06.57.25	SLSSQW00	-----	1L	1	BF 0117D6	000000C2	---	02	00 0802	0000 0000
06.57.59	SLSSQW00	-----	2U	2	BF 0117D6	000000C2	---	06	00 0802	0000 0000
R07.15.58	SLSSQW00	-----	1L	4	BF 0089D6	000000C2	---	06	00 0802	0000 0000
07.17.24	SLSSQW00	-----	2L	2	BF 0089D6	000000C2	---	06	00 0802	0000 0000

SENSE BYTE	X'80'	X'40'	X'20'	X'10'	X'08'	X'04'	X'02'	X'01'	DEVICE = 002
0	0	0	0	0	6	C	0	0	
1	0	0	0	0	0	C	6	0	
2	0	0	0	0	0	C	0	0	
3	0	0	0	0	0	C	0	0	
4	0	0	0	0	0	C	0	0	
5	0	0	0	0	0	C	0	0	

6 ERRORS OCCURRED FOR 15 VALID I/O'S

Figure 12-2. Sample Error Log Summary Report (Part 1 of 2)

↓

ERROR LOG EVENT SUMMARY REPORT REV. 48/05 XYZ .COMPANY..... SERIAL NO. 1234 77/08/18 21.32 PAGE 7

DEVICE	001	1	ERRORS	OCCLRRD	FOR	0	VALID	I/C'S
DEVICE	002	6	ERRORS	OCCLRRD	FOR	15	VALID	I/C'S
DEVICE	302	1	ERRORS	OCCLRRD	FOR	22446	VALID	I/C'S
DEVICE	400	1	ERRORS	OCCLRRD	FOR	17977	VALID	I/C'S

↑

KEY TO ERROR-ON-ENTRY LETTER CODE

- A = NON-EXISTENT DEVICE ENTRY
- C = BCW FIELD CONTAINS FAILING CCW
- D = DISK POSITIONING FAILURE ENTRY
- E = ERROR ON SENSE ENTRY
- I = IOST ERROR - CCW INCLUDES IOSTCW
- N = NON-OPERATIONAL DEVICE ENTRY
- O = OVERTIME ENTRY
- P = PROCESSOR MACHINE CHECK ENTRY
- R = SYSTEM RESTARTED
- S = INVALID DEVICE STATUS ENTRY
- T = BCW FIELD CONTAINS A CCW BUT NOT NECESSARILY THE FAILING CCW

Figure 12-2. Sample Error Log Summary (Part 2 of 2)

A description of each summary report heading follows:

- **DEVICE-TYPE** — A 4-character identification of device type assembled into the PUB at supervisor generation time.
- **DEVICE ADR** — A combination address consisting of the channel for this I/O (cochannel or primary) and the control unit device address from the PUB.
- **DATE, TIME** — The date and time the error log record was written to the error file.
- **JOB NAME** — The name of the job to which the device was allocated.
- **VSN** — The volume serial number of the volume mounted on the device.
- **RCVRY** — The number indicates the number of retries the supervisor initiated in trying to recover from the error. The letter following the retry number indicates the error's disposition.

R = recovered by supervisor

U = not recovered by supervisor; error passed to user program

- **VALID I/O's** — Report containing the number of valid I/O prior to the error; indicates frequency of errors for the device.

- **ERROR BCW** — The error or failing buffer control word

CCXXAAAA — command code, key and data address

XXXXBBBB — byte or record count

For selector channel devices, this field may contain a channel command word (CCW) instead of a BCW. This will be indicated by the letter 'C' immediately preceding the CCW field. For a full description of the BCW and CCW see the supervisor user guide, UP-8075 (current version).

- **DISK** — If the failing device was a disc and the first CCW was a seek, the cylinder (CCC) and the head (HH) identifications are recorded. If, in scanning the chain, a search equals command is recognized, the record number (RR) is recorded.
- **DV/SC STATS** — The device and subchannel status recognized when the first unit check of the error recovery sequence was initiated.
- **SENSE BYTES** — The sense bytes recognized when the first unit check of the error recovery sequence was initiated. Up to six sense bytes are displayed for all devices except the 8430 disc drives, which display 24 sense bytes.
- An error-on-entry letter code may be located in print positions 1 and 2 of the error log printout. The codes have the following significance:

A = nonexistent device entry. Device address field includes the device address which caused an interrupt; the fields following are not significant.

C = BCW field contains the failing CCW instead of a failing BCW. (Note that 'C' error-on-entry codes will appear immediately preceding the CCW, not in print position 1 or 2).

D = disc positioning failure entry. The disc surface address that resulted from the issuance of a seek command was not equal to the intentional address.

E = error on sense entry. The sense command issued for an error failed. The sense bytes field is not significant.

I = IOST entry. Error BCW field includes the contents of the IOSTCW.

N = nonoperational device entry. The condition code was 3 when an I/O command was issued.

O = overtime entry. No interrupt occurred by the device that had accepted an I/O command.

➔ P = processor machine check entry.

R = system restarted.

S = invalid device status entry. The contents of device/subchannel status field is equal to zero.

➔ T = BCW field contains a CCW, but it is not necessarily the failing CCW.

12.4.8. Setting Up Physical Unit Block (SET IO)

Function:

The SET IO command allows you to set specific bits in the physical unit blocks (PUB), which define operational characteristics and assignments of I/O devices. All devices or subsystems must be set *DOWN* before attempting operation on the device, such as forms loading, changing ribbon, etc. This is required if the processor is to continue operation with other peripheral devices while the subject device is undergoing isolated operations. Before a procedure is performed or when power is turned off for the device, key in SET IO pub-id, DOWN. After the offline procedure is completed or after turning on power independently of the processor, key in SET IO pub-id UP.

NOTE:

The system automatically sets all devices or subsystems not online during IPL time to not available. After IPL, any attention interrupt from a device causes that device to be set available.

Format:

SET IO, pub-id,	}	<u>AV</u> <u>DOWN</u> <u>EON</u> <u>EOF</u> FEA,type-code <u>HOME</u> <u>NA</u> <u>NOSHARE</u> <u>RDR</u> <u>SHARE</u> <u>TYPE,type-code</u> <u>UP</u>
-----------------	---	---

Positional Parameter 1:

IO

Specifies that the change is to be made in the PUB specified by positional parameter 2.

Positional Parameter 2:

pub-id

Specifies a 1- to 4-character numeric field identifying the PUB to be changed (device addresses are usually attached at a visible location on the device cabinet). The following are the PUB identifiers:

0000	integrated peripheral channel (console)
0001	integrated peripheral channel (card reader)
0002	integrated peripheral channel (printer)
0003	integrated peripheral channel (card punch)
0100 through 0177	multiplexer channel
0300 through 0307	integrated disc adapter
0400 through 0477	selector channel 4
0600 through 0677	selector channel 6

Positional Parameter 3:

AV

Specifies that the device identified by positional parameter 2 is available for assignment to user jobs.

DOWN

Specifies that the device identified in positional parameter 2 is not to be considered for assignment to user jobs.

EON

Specifies that error logging is to be turned on for the specified device.

EOF

Specifies that error logging is to be halted for the specified device.

FEA

Allows modification of the feature bytes of the device specified in positional parameter 2. The typecode in positional parameter 4 is the new feature bytes.

HOME

Synchronizes the operating system with the physical paper position of an 0768, 9200, or 9300 printer during a home operation.

NA

Specifies that the device identified by positional parameter 2 is not available for assignment to user jobs, although the device is physically up.

NOSHARE

Forbids allocation of the device specified in positional parameter 2 to more than one program simultaneously.

RDR

Assigns the new pub-id specified in positional parameter 2 as the system card reader.

SHARE

Permits the device specified in positional parameter 2 to be shared by more than one program simultaneously.

TYPE

Allows modification of the type bytes of the device specified in positional parameter 2. The type-code specified in positional parameter 4 describes the modification.

UP

Specifies that the device identified in positional parameter 2 is to be made available for assignment to user jobs.

Positional Parameter 4:

type-code

A 1- to 4-character field specifying the device, its options, and features desired.

12.4.9. Reading a Mounted Volume Serial Number (AVR)

The AVR command initiates the reading of the volume serial number of a premounted/prepped disc pack or magnetic tape volume and storing it in the device physical unit block. This command is required when a disc pack or magnetic tape is mounted on a unit that does not have an attention interrupt capability (i.e., UNISERVO VI-C Magnetic Tape Subsystems).

Format:

AVR device-addr[,device-addr][,device-addr]

Positional Parameters 1 through 3:

device-addr

Specifies the addresses of the devices on which the volumes to be recognized are mounted.

12.4.10. Running IBM System/3 Operation Command Language (OCL) Jobs

Function:

The OCL command enables the operator to run an IBM System/3 job control stream in an OS/3 environment.

The OCL statements, concluded with an OS/3 FIN job control statement, must be placed into the card reader. To initiate the job control stream, the OCL command must be keyed in and the entire OS/3 control stream will be read and interpreted by the OCL processor. Once the OCL processor has verified that no syntax or sequence errors exist, the job begins.

Several FIN job control statements may be inserted to logically divide each independent task (or program) to utilize the multiprocessing power of parallel execution.

If the job stream is on a diskette, the did and label are required (12.2.1).

Format:

$$\text{OCL} \left[\left\{ \begin{array}{l} (\text{did}) \\ ((\text{did}), \text{label}) \end{array} \right\} \right] \left[(\text{rename}) \right] \left[\left\{ \begin{array}{l} \text{N} \\ \text{P} \\ \text{H} \end{array} \right\} \right]$$

Positional Parameter 1:

(rename)

Enables the operator to rename the OS/3 job to be run; otherwise, the name given by the OCL processor will be OCLnnnn by default, where nnnn is a decimal number from 0001 to 9999. A name of eight alphanumeric characters, within parentheses, can be assigned.

Positional Parameter 2:

N

Specifies that the job is to be scheduled as a normal priority job. This is the default specification.

P

Specifies that the job is to be scheduled as a preemptive priority job.

H

Specifies that the job is to be scheduled as a high priority job.

12.5. SPOOLING COMMANDS

The commands available for controlling the spooling environment in OS/3 are divided into three categories:

1. Spool File Commands

These commands permit the operator to display and manipulate the various subfiles in the spool file, and change the operating mode of the spooling function.

2. Input Reader Commands

These commands permit the operator to direct the operation of the input reader symbionts that are active in the system, and to load an input reader symbiont when necessary.

3. Output Writer Commands

These commands permit the operator to direct the operation of the output writer symbionts that are active in the system, and to load an output writer symbiont when necessary.

NOTE:

The spooling function of OS/3 is described in detail in the supervisor user guide, UP-8075.

12.5.1. Spool File Commands

All the spool file commands described in this section have the following general format:

command queue [,directory][,modifier-1...,modifier-n]

NOTE:

Command keyins cannot exceed 28 characters in length, including commas.

where:

command

Is the name of the command being transmitted.

queue

Is SPL to indicate that only the completed subfiles in the specified directory (positional parameter 2) are being referenced, ACT to indicate that only the currently active subfiles in the specified directory are being referenced, SPQ to indicate that the completed and the currently active subfiles in the specified directory are being referenced, or CN to indicate that only the console log is being referenced.

directory

Identifies one of the various directories that make up the spool file. The spool file directories are listed in Table 12-1. If not specified, all of the directories accessible to the command are acted on.

modifier-1...,modifier-n

Are used optionally to further identify the subfiles within the specified directory that are being referenced. Any number of modifiers may be specified. The various modifiers and their meanings are listed in Table 12-2.

Table 12-1. Spool File Directories

Directory	Subfile Function
LOG	Subfile input or output is on designated log file.
<u>P</u> PRINT	Subfile output is to designated printer.
<u>P</u> PUNCH	Subfile output is to designated card punch or diskette.
RBPIN	Remote batch processing input is from card reader.
RBPPR	Remote batch processing output is to printer.
RBPPU	Remote batch processing output is to card punch.
RDR	Subfile input is from designated card reader or diskette.

Table 12-2. Spool File Command Modifiers

Modifier	Subfile Identification
<u>ACCT</u> =acctno	Account number of up to four characters
<u>CART</u> =cartridge-id	Print cartridge identification of up to eight characters
<u>DEV</u> = $\left. \begin{array}{l} 768 \\ 770 \\ 773 \\ 776 \\ 778 \\ 9300 \end{array} \right\}$	Any device of the type designated that is available. The designation 9300 refers to a SPERRY UNIVAC 9300 System that is being used as a 90/30 system peripheral device.
<u>FILE</u> =filename	File name of up to eight characters
<u>FORM</u> =formname	Form name of up to eight characters
<u>JOB</u> =jobname	Job name of up to eight characters
<u>STEP</u> =stepno	Job step number of 3 characters (left-justified with zeros)
<u>LBL</u> =labelname	Label name of up to 8 characters for diskette, up to 17 characters for card reader
<u>VOL</u> =volno	Volume number of up to 6 characters (for diskette only)

12.5.1.1. Displaying the Status of Spool Subfiles (DISPLAY)

Function:

The DISPLAY command (when either ACT or SPL is specified) causes all pertinent information concerning the specified subfiles to be displayed on the system console. If there are no spool subfiles in the specified directory, the message "DI03 SPOOL FILE EMPTY" appears on the system console. Otherwise, if DISPLAY SPL is used, the display function displays the number, if any, of subfiles queued (ready for processing), in hold, and in progress (being processed by the output writer). The operator then indicates the type of display desired by responding to the following message:

DI02 SPOOL FILE DETAILS? *Y,N,Q,H,I,S,SQ,SH,SI*****

The operator may reply as follows:

- Y = Display all spool details
- N = Do not continue display
- Q = Display all queued files
- H = Display all files in hold
- I = Display all files currently being processed by output writers



- S = Abbreviated display of all files
- SQ = Abbreviated display of all queued files
- SI = Abbreviated display of all files in progress
- SH = Abbreviated display of all files being held

If the response was Y, Q, H or I and a directory other than RDR was specified, the following display is produced:

```

DI04  JOB-NAME jobname FILE filename STATUS file-status
DI05  TOTAL- { PAGES }
           { CARDS }
           { LINES }
DI06  STEP-NUMBER nnn DEVICE-TYPE xxxxx BREAKPOINT {Y}
                                                {N}
DI07  BAND-NAME xxxxxxxx FORM-NAME xxxxxxxx ACCT xxxx
DI08  PROGRAM-NAME xxxxxxxx CONTINUE? ***Y,N***

```

If the response was Y, Q, H or I and the RDR directory was specified, the following appears on the console screen:

```

D109 DEVICE-TYPE RDR TOTAL-CARDS nnnnn [vol xxxxxx]
D110 LABEL XXXXXXXXXXXXXXXXXXXX CONTINUE ? ***Y, N***

```

NOTE:

The VOL display appears only when the RDR directory file was spooled in from a diskette.

If the response was S, SQ, SI or SH, abbreviated displays in the following format are produced for up to five files at a time:

```

DI11 JOB=jobname PROG=program name FORM=form name { PAGES } = nnnnn
                                                { CARDS }
                                                { LINES }

```

After five lines of DI11 messages have been produced, the following message appears on the console screen:

DI12 CONTINUE SUMMARY? *Y, N*****

A response of Y to DI08, DI10 or DI12 continues the display; a response of N terminates the display.

If DISPLAY ACT is used and no modifiers are entered, the number of subfiles currently being created for the specified directory is displayed and the operator is given the option (Y or N) of displaying information about those files similar to that produced with the DISPLAY SPL command (when the reply to SPOOL FILE DETAILS? is Y, Q, H or I). If modifiers are entered, the spool file details are displayed immediately.

When ACT is specified, the LOG, RDR and RBPIN directory options are not available; ALL is qualified to mean PRINT, PUNCH, RBPPR and RBPPU.



When CN is specified, the DISPLAY command causes a system console display of the number of lines that have accumulated in the current console log subfile.

Format:

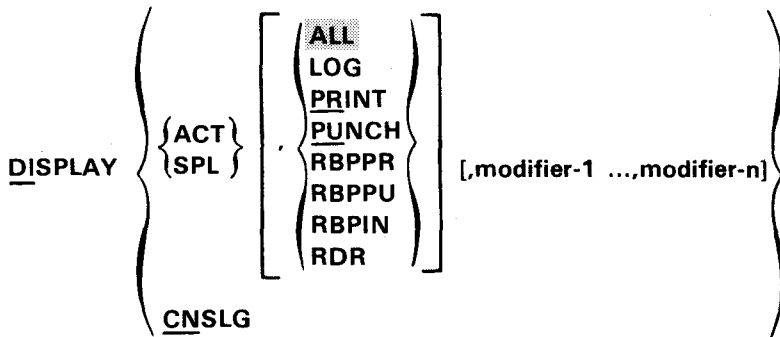

Positional Parameters:

Refer to 12.5.1.

Examples:

1. Operator keyin:

DI SPL,ALL

Function requested;

Display all closed subfiles in the spool file.

2. Operator keyin:

DI SPL,PRINT

Function requested;

Display all closed subfiles in the print directory.

3. Operator keyin:

DI SPL,PUNCH,JOB=XYZ

Function requested:

Display all closed subfiles associated with job XYZ that are in the punch directory.



4. Operator keyin:

DI SPL,PR,FO=ABC,CART=48-BUS

Function requested:

Display all closed files in the print directory that require use of a form named ABC and a 48-character business print cartridge.

5. Operator keyin:

DI ACT

Function requested:

Display the number of active files (those being created) and question if details on subfiles in the directory are desired. If so, respond with Y to display the subdirectory entry.

6. Operator keyin:

DI CN

Function requested:

Display the number of lines that have accumulated in the current console log subfile.

12.5.1.2. Deleting Closed Spool Subfiles (DELETE)

Function:

To delete closed spool subfiles from the spool file. Only closed subfiles will be deleted; subfiles that are currently being processed are not deleted.

Entering LOG does not affect logs destined for a remote device. If no parameter is specified, or ALL is entered, the RBPPR, RBPPU, and logs destined for a remote device are not affected.

Format:

$$\underline{\text{DELETE SPL}} \left[\left(\begin{array}{c} \text{ALL} \\ \text{LOG} \\ \text{PRINT} \\ \text{PUNCH} \\ \text{RBPPR} \\ \text{RBPPU} \\ \text{RDR} \end{array} \right) \right] [,\text{modifier-1} \dots, \text{modifier-n}]$$

Positional Parameters:

Refer to 12.5.1.

Examples:

- 1. Operator keyin:

DE SPL,ALL,JOB=ABC

Function requested:

Delete all closed subfiles associated with job ABC.

- 2. Operator keyin:

DE SPL,PRINT,JOB=XYZ

Function requested:

Delete all closed subfiles associated with job XYZ that are contained in the print directory.

12.5.1.3. Placing Spool Subfiles on Hold (HOLD)

Function:

To place active and closed spool subfiles in a hold condition. Subfiles in this condition are not available for processing by an output writer or job control symbiont until they are subsequently released by the operator using the BEGIN command (12.5.1.4).

Entering LOG does not affect logs destined for a remote device. If no parameter is specified, or ALL is entered, the RBPPR, RBPPU, and logs destined for a remote device are not affected.

If ACT is specified, all spool subfiles that are currently being created (active), or that will be created in the directory named, will be placed in the hold condition when closed.

The SPQ option has the effect of the HOLD SPL and the HOLD ACT commands combined. If specified, all closed spool subfiles in the directory named will be immediately placed in the hold condition and all of the directory's active and future spool subfiles will be placed in the hold condition when closed.

Modifiers should not be used with Format 2. If any are entered, the command is ignored.

Format 1:

HOLD SPL [(ALL
LOG
PRINT
PUNCH
RBPPR
RBPPU
RDR)] [,modifier-1...modifier-n]

Format 2:

HOLD {ACT
SPQ} [(LOG
PRINT
PUNCH
ALL)]

Positional Parameters:

Refer to 12.5.1.

Examples:

1. Operator keyin:

HO SPL,PRINT,CART=48-SCI

Function requested:

Hold all closed subfiles in the print directory that require the use of a 48-character scientific print cartridge.

2. Operator keyin:

HO SPL,READER,JOB=TEST

Function requested:

Hold all closed subfiles in the reader directory that are associated with the job named TEST.

➔ **12.5.1.4. Releasing Spool Subfiles (BEGIN)**

Function:

➔ Removes the hold status from active and closed subfiles previously placed in the hold condition by the HOLD command (12.5.1.3), and releases a file placed in hold condition by the //SPL card. This function causes the output writer to be loaded, if an output device is available.

Entering LOG does not affect logs destined for a remote device. If no parameter is specified or ALL is entered, the RBPPR, RBPPU, and logs destined for a remote device are not affected.

↓ If ACT is specified, spool subfiles that are currently being created (active), or that will be created in the directory named, will not be placed in the hold condition when closed.

The SPQ option has the effect of the HOLD SPL and the HOLD ACT commands combined. If specified, the hold status will be removed from all closed spool subfiles in the directory named, and the directory's active and future spool subfiles will not be placed in the hold condition when closed.

↑ Modifiers should not be used with Format 2. If any are entered, the command is ignored.

NOTE:

If the system is set in the nonburst mode, the print output writers will not be capable of accessing these released files. You should load an output writer in burst mode to process these files.

Format 1:

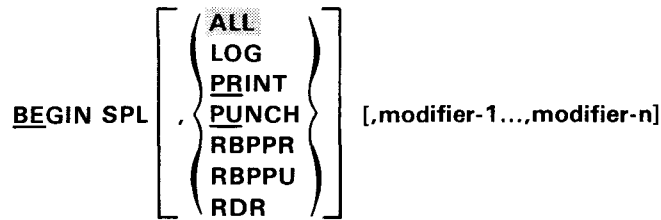

Format 2:

↓

BEGIN {ACT} {SPO} [(LOG
PRINT
PUNCH
ALL)]

↑

Positional Parameters:

Refer to 12.5.1.

Examples:

1. Operator keyin:

BE SPL,PRINT,CART=48-SCI

Function requested:

Release all the subfiles in the print directory that require the use of a 48-character scientific print cartridge and that are currently in the hold condition. This command countermands the HOLD command presented as example 1 in 12.5.1.3.

2. Operator keyin:BE SPL,READER,JOB=TEST

Function requested:

Release all the subfiles in the reader directory that are associated with the job named TEST and are currently in the hold condition. This command countermands the HOLD command presented as example 2 in 12.5.1.3.

12.5.1.5. Breakpointing Active Spool Subfiles (BRKPT)

Function:

To breakpoint subfiles currently being created by a spooling symbiont. It effectively closes a subfile or subfiles so that the information created in the subfile or subfiles is available for processing by an output writer. A new subfile or subfiles are created that will contain the remainder of the information being created by the spooling symbiont.

The operator should use this function when warning messages are displayed on the console indicating the spool file is nearly depleted.

NOTES:

1. *After the breakpoint has been taken for printer or punch subfiles, the operator should call in an output writer in burst mode.*
 2. *After the breakpoint has been taken for the console log subfile, the output writer is brought in automatically. The output writer recognizes the console log subfile and prints it.*
 3. *Diskette subfiles may not be breakpointed.*
 4. *After the BR command has been entered, a message will appear on the system console telling the operator whether the breakpoint was successful.*
- ↓
- ↑

Format:

$$\underline{\text{BRKPT}} \left\{ \begin{array}{l} \{ \text{P} \} \\ \{ \text{I} \} \\ \underline{\text{CNSLG}} \end{array} , \begin{array}{l} \{ \text{PR} \} \\ \{ \text{PU} \} \end{array} , \text{JOB}=\text{jobname}[\text{,modifier-1} \dots \text{,modifier-n}] \right\}$$

Positional Parameters:

P

Indicates breakpoint the subfile at the end of the page.

I

Indicates breakpoint the subfile immediately.

For punch subfile, either P or I may be entered.

Refer to 12.5.1 for other parameters.

Examples:

1. Operator keyin:

BR I,PU,JOB=ABC

Function requested:

Breakpoint the punch subfile that is currently being created for the job named ABC.

2. Operator keyin:

BR P,PR,FILE=INVCONT,JOB=MYOWN

Function requested:

At the end of the page, breakpoint the print subfile named INVCONT that is currently being created for the job named MYOWN.

3. Operator keyin:

BR CN

Function requested:

Breakpoint the console log subfile.

12.5.1.6. Changing the System Spooling Criteria (SET SPL,BURST/NBURST)

Function:

The SET SPL,BURST/NBURST command is used to change the spooling criterion or subcriterion established for processing the subfiles in the spool file. Basically, subfiles can be processed in either a burst or nonburst mode. Burst mode processing allows closed and breakpointed files within subfiles to be

processed by spooling symbionts before the job they are associated with has terminated. Nonburst mode processing requires that a job be terminated before any of the files associated with the job can be output by an output writer symbiont. Operating in the burst mode, therefore, permits the output printed and punched produced by a single job to be split between two or more like output devices, which tends to speed up throughput for a job, but also creates a confusion factor for the operator if more than one job is being run in the system. On the other hand, operating in the nonburst mode may slow down throughput, but ensures that all like output associated with one job is produced on one device (e.g., all print files are printed on the same printer).

When a SET SPL,BURST/NBURST command is issued, the system spooling criterion (or subcriterion) is changed immediately and all future output writers loaded by the system spooler will function accordingly. Previously loaded output writers, however, will continue to function using the criterion established for them either where they were loaded or via operator command (12.5.3). This SET command should not be confused with the BURST and NBURST functions of the output writer commands.

Format:

SET SPL, { BURST
NBURST } [,modifier]

Positional Parameter 1:

SPL

Indicates that the SET command is directed to the system spooler.

Positional Parameter 2:

BURST

Specifies that the spooler should operate in the burst mode.

NBURST

Specifies that the spooler should operate in the nonburst mode.

Positional Parameter 3:

Specifies additional subcriterion for the system spooler.

12.5.1.7. Changing the System Accumulation of Log Files (SET SPL,DUMP/ENDDUMP)

Function:

This command is used to change the method of processing the log subfiles produced in the system. The initial method of processing is specified at SYSGEN time.

As each job in the system is terminated, its associated spool log subfile is closed and automatically output to a high-speed printer as soon as an output writer becomes available in the system. The log subfile is then either deleted from the spool LOG subfile or saved for future processing, depending on the SYSGEN option selected. This command permits you to override the SYSGEN selected option.

Format:

SET SPL, { DUMP
ENDDUMP }

Positional Parameter 1:

SPL

Indicates the SET command is directed to the system spooler.

Positional Parameter 2:

DUMP

Specifies that log files are to be accumulated for later routing to a magnetic tape or disc file.

ENDDUMP

Specifies that log file accumulation is to end.

12.5.1.8. Changing the Spool File Printout Format (SET SPL, HEADER/NOHDR)

Function:

To enable or suppress the printing of a 3-page header that precedes each spool print file. The spool file printout format is initially established at SYSGEN time.

Format:

→ **SET SPL** { **HEADER** }
 { **NOHDR** }

Positional Parameter 1:

SPL

Indicates the SET command is directed to the system spooler.

Positional Parameter 2:

→ **HEADER**

Indicates that a 3-page header is to precede the printing of each spooled print file.

Positional Parameter 3:

→ **NOHDR**

Indicates that spooled output files are to be printed without headers.

12.5.1.9. Changing the Job Log File Print Specifications (SET SPL, NOACT/NOLOG/NOPRINT/PRINT)

Function:

To select what job log records, if any, are to be printed at the end of each job. The initial job log print specification is established at SYSGEN time.

Format:



SET SPL, { NOACT
NOLOG
NOPRINT
PRINT }

Positional Parameter 1:

SPL

Indicates the SE command is directed to the system spooler.

Positional Parameter 2:

NOACT

Indicates that job accounting records are not to be printed.

NOLOG

Indicates that job log records are not to be printed.

NOPRINT

Indicates that both job accounting and log records are not to be printed.

PRINT

Indicates that both job accounting and log records are to be printed.



NOTE:

User snap and cancel dumps are always printed at the end of each job.

12.5.1.10. Changing the Console Log File Specifications (SET SPL, CNSLG)

Function:

This command allows the operator to turn the console log function on or off and to delete or retain the console log for SYSLOG accumulation.

If the last parameter is omitted, the console log file remains in the same RETAIN or DELETE mode that it was in before the command. If the last parameter is specified without the ON or OFF parameter, the output mode of the file changes without changing the ON or OFF condition.

Format:

SET SPL, CNSLG [, { ON }] [, { RETAIN }]
[, { OFF }] [, { DELETE }]





12.5.1.11. Suppress or Display Forms Change Message (SET SPL, TEST/NOTEST)

Function:

This command is used to set the option directing the output writer to display or suppress the message that informs the operator of a forms change and asks whether test lines of the first page of output should be printed. On the test lines page, all numeric characters are replaced with 9s and all alphabetic characters are replaced with Zs.

This command may be used to override the forms change message setting that was established during systems generation (SPOOLTEST statement). If the forms change message setting was specified in the job control stream (// SPL statement), this command may be used to override the job control option that calls for the test lines message but may not be used to override the job control option that suppresses the forms change message.

Format:

SET SPL, { TEST
NOTEST }

Positional Parameter 1:

SPL

Indicates the SE command is directed to the system spooler.

Positional Parameter 2:

TEST

Indicates the test lines message should be displayed on the system console when applicable.

NOTEST

Indicates the test lines message should not be displayed on the system console.

12.5.2. Input Reader Commands

The only input reader command required to support the spooling function in OS/3 is the load input reader command described in 12.5.2.1.

12.5.2.1. Loading an Input Reader

Function:

To cause the operating system to load an input reader that will transfer a card or diskette file into the RDR spool directory.

Card data files to be spooled must be preceded by a //DATA job control statement (for details, see the job control user guide, UP-8065, current version). The cards are read into the spool file until a // FIN or another // DATA card is detected.

When diskette data files are to be spooled, the // DATA and // FIN job control statements should not be used. If any are entered, they are included as records in the data file.

A // RUN jobname job control statement may appear anywhere within the user card or diskette file to cause the input reader to schedule the specified job. This job is scheduled, however, only when and if the spooled subfile is successfully entered and closed in the system spool file.



Any number of input readers, up to the number of card readers and diskettes in the system, can be executing simultaneously. ↓

Format 1:

IN [(did)] [{51 }
 {66 }]

Format 2:

IN [(did) ,label]

Positional Parameter 1:

Input readers may accept data files from card readers equipped to read 51 or 66 column cards.

51

Indicates input reader is to accept a file that resides on 51-column cards.

66

Indicates input reader is to accept a file that resides on 66-column cards.

No parameters are required. If the data file is on a diskette, format 2 must be used (12.2.1). If the data file is on cards and no device (did) is identified, the first available card reader, as defined when the system was generated, is expected to contain the card file to be spooled. ↑

12.5.3. Output Writer Commands

Only two output writer commands are required to support the spooling function in OS/3: one to load an output writer symbiont, and one to direct its mode of operation and specify its processing criteria. Commands directed to output writers that are processing print directory subfiles are prefixed PR, commands for output writers processing punch directory subfiles are prefixed PU, and commands for output writers processing diskette directory subfiles are prefixed PD. ←

12.5.3.1. Loading an Output Writer

Function:

To cause the operating system to load an output writer symbiont. Output writers are normally loaded automatically by the system, as required, up to the number of output devices available for their use. Under certain conditions, such as the system set in nonburst mode, the operator must load an output writer into the system in burst mode in order to have files printed. Some of these conditions are:

1. Warm start (i.e., recovering files at IPL)
2. BE SPL function
3. BR ACT function
4. Terminating an output writer from the console through a STOP or HALT function

An output writer should be manually loaded so that the system log tape can be created (DUMP function of the output writer).

An output writer should be manually loaded so that tape input can be specified (IN function of the output writer).

Format:

→ $\left. \begin{matrix} \text{PR} \\ \text{PU} \\ \text{PD} \end{matrix} \right\} \text{[(did)] function-code}$

Command Code:

PR

Indicates that the request is for an output writer to process print files.

PU

Indicates that the request is for an output writer to process punch files.

→ **PD**

Indicates that the request is for an output writer to process diskette files.

Positional Parameter 1:

(did)

Designates the address of the output device to be used by the output writer.

→ If the address specified by *did* is that of a tape unit, all output files processed by the output writer being called are output to tape (not valid with PD).

If omitted, it is assumed that only one device is available for assignment in the system, or the system should select the first available device, and the output writer will, by default, use that device.

→ No *did* is needed if PD is used. Diskette files will be written to the location on the diskette defined in the job control device assignment set for the file.

Positional Parameter 2:

function-code

Identifies the mode of operation and processing criteria under which the output writer is to function. The various function codes that may be specified in this parameter location are listed and described in Table 12-3.

NOTE:

Function code keyins cannot exceed 28 characters in length, including commas.

Table 12-3. Output Writer Function Codes (Part 1 of 2)

Function Code	Meaning
<u>BURST</u> [,modifier-1...,modifier-n]	Output writer is to function in the burst mode, as optionally further qualified by modifiers 1 through n. The modifiers that may be specified are listed and described in Table 12-2. Burst mode processing is described in 12.5.1.6.
<u>BYPASS</u>	Output writer is to discontinue processing the current subfile and continue processing on the next subfile. The bypassed subfile can be restarted later.

Table 12-3. Output Writer Function Codes (Part 2 of 2)

Function Code	Meaning
<u>COPIES</u> ,nnn	Specifies the number of copies the output writer is to produce of each subfile it processes. The number of copies that may be specified is from 0 to 255. If zero is specified, the subfile is closed when the current processing of the file completed. This function may not be used with PD.
<u>DELETE</u>	Delete subfile currently being processed from spool file and proceed with the next subfile ready to be processed.
<u>DEVICE</u> [,did]	Indicates that the output writer is to change the device it is currently using to print (punch) its output. If a new device (did) is identified in the function code, that device is allocated to the output writer, and the current device is deallocated. If a new device is not identified, a device having the same characteristics as the current device will replace the current device. If the new device specified is a tape unit, all subsequent output files are written to tape, as long as the same copy of the output writer remains in main storage.
<u>DISPLAY</u>	Output writer is to display the status of subfile being processed on the system console.
<u>HALT</u>	Output writer is to terminate after current subfile is processed. If multiple copies of the current subfile were requested, the remaining copies will be produced when the output writer is reloaded.
<u>HOLD</u>	Output writer is to place the subfile it is processing in the hold state and process the next subfile. Subfiles in the hold state are not available for processing until they are released by a BEGIN command (12.5.1.4).
<u>INPUT</u> ,did	Directs the output writer to accept input from the tape unit (did) identified in the function code. This function may not be used with PD.
<u>NBURST</u>	Output writer is to function in the nonburst mode. If this function code is received while the output writer is processing a subfile, it does not take effect until the subfile is completed. Nonburst mode processing is described in 12.5.1.6.
<u>RESTART</u> [,nnn]	Restart processing of the currently active subfile from n number of pages or cards back from the current position of the file. If no number is specified, the output writer is to restart processing from the beginning of the subfile. This function may not be used with PD.
<u>SKIP</u> { nnnn <u>PAGE</u> ,nnnn <u>CARD</u> ,nnnn }	Directs the output writer to skip n number of pages or cards. If only nnnn is entered, the file will be positioned nnnn pages or cards from the current position. If PA or CA is entered with nnnn, the file will be positioned forward to the page or card identified by nnnn. After positioning, a request will be made for an additional function. This function may not be used with PD.
<u>STOP</u> [, <u>PAGE</u>]	Directs the output writer to stop processing. If STOP is entered without the PAGE operand, the output writer terminates immediately. If STOP is entered with the PAGE operand, the output writer terminates after printing the complete current page. If a subfile is being processed when this function code is received, the subfile is closed but not deleted. When the subfile is accessed by another output writer, it will be processed from the point at which it was closed by the previous output writer.

NOTE:

After you enter a function, another request is usually made to enter another function after the current request is complete. If no additional functions are required, respond with a null entry (i.e., press the **TRANSMIT** key).

12.5.3.2. Directing the Operation of an Output Writer

Function:

To change the operating mode or processing criteria under which an output writer is to function. Communication with an output writer by the operator is accomplished through solicited and unsolicited messages rather than commands per se. Unsolicited communications is not allowed if an output writer is waiting for a response to a solicited message.

Format:

■ Unsolicited Messages

→ 00 $\left. \begin{array}{l} \text{PR} \\ \text{PU} \\ \text{PD} \end{array} \right\} \text{[(did)] function-code}$

■ Solicited Messages

On function-code

where:

00

Is the job and message number used to communicate with an output writer through the supervisor in the unsolicited mode of transmission.

Oi

Is the job and message number used to reply directly to an output writer in the solicited mode of transmission. The number i corresponds to the number of the message that was transmitted by the output writer that requested the reply.

→ $\left. \begin{array}{l} \text{PR} \\ \text{PU} \\ \text{PD} \end{array} \right\} \text{[(did)] function-code}$

Is the message text that is used to communicate with and identify the desired output writer. As shown, it is similar to the command format used to load an output writer (12.5.3.1). The only difference between them is that the device identification and function-code parameters are optional in the command format, but the device identification is optional here and the function code is required here. The did parameter here is used to identify the output writer that is to receive the instructions being sent in the function-code portion of the message. A function-code is required because the output writer being communicated with is already loaded. The function-codes that can be specified here are the same as those that can be specified in the command format, and are described in Table 12-3.

function-code

Is the message text that is used to instruct the requesting output writer of the function to be performed. The function codes that may be specified here are the same as those described in Table 12-3.

Examples:

1. Operator keyin:

00 PR(002)STOP

Function requested:

The output writer that is using the printer whose did is 002 is to stop all processing immediately.

2. System console display:

05? ENTER OUTPUT WRITER FUNCTION

Operator keyin:

05 BURST

Function requested:

The output writer that requested a new function is to begin processing in the burst mode.

12.5.4. Spool File Processing Aids

A special system service program (SL\$LOG) and two canned job control streams allow you to dump the job log subfiles from the spool LOG file to a user disc tape or disc file. Once in a user file, they are available for processing by user programs.

SPERRY UNIVAC provides you with a job log report program (JOBLOG) which produces a job accounting report based on the contents of the LOG file. For more information about JOBLOG, see the system service programs (SSP) user guide, UP-8062, (current version).

All 90/30 systems that are generated with the spooling option specified (SPOOLING=INPUT,OUTPUT, or REMOTE) maintain a spool log subfile for each job processed in the system. Each log subfile contains a copy of:

- the system messages transmitted by the system on behalf of the job (log records);
- the job control statements processed for the job (log records);
- any user snap and cancel dumps processed for the job; and
- any accounting records maintained for the job (accounting records are only available if the system was generated with the accounting option specified (JOBACCT=YES)).

As each job is terminated, its associated spool log subfile is closed and normally output to a high-speed printer as soon as an output writer becomes available in the system. This copy of the job log subfile (Figure 12-3) is normally given to the person that submitted the job for his debugging and bookkeeping purposes. If the system is operating with the accumulate system log files option in effect (the system was generated with the SYSLOG=YES parameter specified, or the SET SPL, DUMP command was issued by the operator after the system was initialized), the job log subfile is marked as having been printed, and then saved to allow job accounting and other bookkeeping chores to be accomplished at the "installation level".

If the system is operating with the accumulate system log files option suppressed (the system was generated with the SYSLOG=NO parameter specified or the SET SPL,ENDDUMP command was issued by the operator after the system was initialized), the job log subfile is deleted from the spool log file immediately after it is processed by the output writer. The job log subfile is no longer available for any further processing.

```

// LOAD CASEY,F 2
//PRNTR1 SPL ,,,,P,NOHDR
// RUN
025 TEST CARD FOR OCL PROG
// LOAD CASEY,F 2
//PLNCH SPL ,5,,,MYFORMS
//PLNCH SPL HOLD
// RUN
055 TEST CARD FOR OCL PROG
// FIN
AC01 JOB OCL0002 ACCT. NO.          ASSIGNED MEMORY=0000819 2 B YTES (PLUS 003072 BYTE PROLOGUE)    00/00/00
JC07 LSING DEV=FFF TYPE=PRNTR      DEV=FFF TYPE=PRNTR
JC08 LSING DEV=FFF TYPE=PLNCH
JC01 JOB OCL0002 EXECUTING JOB STEP CASEY000 #001 DC:01:43
AC10 LFD - PRNTR , FORM NAME - STAND1 , COPIES - 001, PAGES - 00000000, STEP =001
AC11 STEP #001 (CASEY000) USED 00004866 BYTES ELAPSED WALL CLOCK TIME=00:00:04.494    TOTAL SVC CALLS=00000213
AC12 TERM CODE=000 SWITCH-PRIORITY=10 CPU TIME USED =00:00:00.610    TRANSIENT CALLS=00000010
AC19 DEVICE EXCP'S 303=00000080 PRT=00000002
JC07 LSING DEV=FFF TYPE=PRNTR      DEV=FFF TYPE=PRNTR
JC08 LSING DEV=FFF TYPE=PLNCH
JC01 JOB OCL0002 EXECUTING JOB STEP CASEY000 #002 DC:01:51
AC10 LFD - PRNTR , FORM NAME - STAND1 , COPIES - 001, PAGES - 00000000, STEP =002
AC11 STEP #002 (CASEY000) USED 00004866 BYTES ELAPSED WALL CLOCK TIME=00:00:04.655    TOTAL SVC CALLS=00000212
AC12 TERM CODE=000 SWITCH-PRIORITY=10 CPU TIME USED =00:00:00.593    TRANSIENT CALLS=00000010
AC19 DEVICE EXCP'S 303=00000080 PRT=00000002
JC07 LSING DEV=FFF TYPE=PRNTR      DEV=FFF TYPE=PRNTR
JC08 LSING DEV=FFF TYPE=PLNCH
AC21 JOB TOTALS USED 00004866 BYTES TOTAL ELAPSED WALL CLOCK TIME=00:00:20.605    TOTAL JOB SVC CALLS=00000425
AC22 WALL CLOCK TIME OF ALL STEPS =00:00:09.159    JOB TRANSIENT CALLS=00000020
AC23 TOTAL CPU TIME OF ALL STEPS =00:00:01.203    TOTAL JOB EXCP'S =00000164
JC02 JOB OCL0002 TERMINATED NORMALLY DC:02:01
    
```

```

L CO:01:29
L CO:01:32
L CO:01:33
L CO:01:33
L CO:01:34
L CO:01:35
L CO:01:35
L CO:01:35
L CO:01:35
L CO:01:35
L CO:01:35
A CO:01:40
L CO:01:43
L CO:01:43
L CO:01:43
A CO:01:48
A CO:01:48
A CO:01:48
A CO:01:48
L CO:01:50
L CO:01:51
L CO:01:51
A CO:01:56
A CO:01:56
A CO:01:56
A CO:01:56
L CO:01:58
L CO:01:59
A CO:02:01
A CO:02:01
A CO:02:01
L CO:02:01
    
```

Figure 12-3. Typical Job Log Subfile Printout

If log subfiles are being saved, the SL\$LOG utility can be used to transfer them to either a user tape or disc file to make them available for further processing by user programs. The SL\$LOG utility allows for dumping log records only, accounting records only, or both log and accounting records. Snap and cancel dump records are ignored as they can serve no purpose from a bookkeeping standpoint. After the transfer operation takes place, SL\$LOG effectively erases the closed log subfiles from the spool LOG file, returning the file space to the system spooler for its reuse.

If disc is being used for the output file, job log subfiles may be accumulated in a previously created file. If tape is being used, a new tape must be mounted each time the SL\$LOG utility is run in order to accumulate job log subfiles. If the same tape is used, the job log subfiles previously written on the tape will be overwritten by the job log subfiles currently being transferred to it.

The remainder of this section describes how the SL\$LOG utility is executed using the canned job control streams to transfer job log subfiles to either a tape or disc file. The name of the file created by SY\$LOG is SYSLOG.

12.5.4.1. Using Tape for the SYSLOG File

To establish a SYSLOG file or tape and transfer the contents of the system spool LOG file into this file, keyin the following RUN command.

```
RU DUMPLOGT [ [ ,D= { ACT } ] [ ,V= { vsn } ] [ ,C= { Y } ] ]
```

←

If both log and accounting records are to be transferred, omit the D parameter. Otherwise, specify the desired records by keying in ACT for accounting records only, or LOG for log records only. Identify the volume serial number for the tape you want to use using the V keyword and indicate whether checkpoint records are desired using the C keyword. The default specifications for these keywords are shaded.

After the transfer operation is completed, the output tape will be rewound to its load point.

12.5.4.2. Using Disc for the SYSLOG File

12.5.4.2.1. Establishing the SYSLOG File on Disc

To establish a SYSLOG file on disc and transfer the contents of the system spool LOG file into this file, key in the following RUN command.

```
RU DUMPLOG,,F=ALLOC [ ,D= { ACT } ]
```

If both log and accounting records are to be accumulated, omit the D parameter. Otherwise, specify the desired records by keying in ACT for accounting records only or LOG for log records only.

12.5.4.2.2. Accumulating Job Log Subfiles on Disc

To add additional job log subfiles to the SYSLOG file, key in the following RUN command.

```
RU DUMPLOG [ ,D= { ACT }  
             { LOG } ]
```

Here again, if both log and accounting records are desired, the D parameter should be omitted. Otherwise, specify the desired records by keying in ACT for accounting records only or LOG for log records only.

12.5.4.2.3. Reinitializing the SYSLOG File on Disc

To overwrite the current contents of the SYSLOG file with new spool LOG file records, key in the following RUN command.

```
RU DUMPLOG ,F=INIT [ ,D= { ACT }  
                    { LOG } ]
```

This command causes the SYSLOG file to be reinitialized (effectively erased) and the new job log subfiles in the spool LOG file to be transferred into the SYSLOG file. Here again, the type of records to be transferred should be indicated by either omitting the D parameter or equating it to the type of records desired.

12.6. SYSTEM UTILITY COMMANDS

→ Two system utility symbionts (SU and TU) are available in OS/3 to permit the following utility functions to be requested and controlled from the system console.

1. Card Utility Functions

- Duplicate a card file that is punched in standard or nonstandard card punch codes, including binary.
- Duplicate and resequence a BAL, COBOL, or RPG source program card file.
- Copy a card file onto an unlabeled magnetic tape volume in card image format (unblocked — one record per block; blocked — n number of records per block).
- Print a card file in either character or vertical-hexadecimal format.
- Punch cards using the system console as the input device and a card punch as the output device.

2. Tape Utility Functions

- Duplicate a tape file.
- Print tape records, blocks, or files in character or vertical-hexadecimal formats.
- Print selected records of a tape file.
- Reproduce a tape file with selected changes to its block size or content.
- Copy a tape file onto cards.

- Initialize a tape volume by writing a standard volume label on it.
- Forward space and backspace a tape volume to a specific file.
- Forward space and backspace a tape file to a specific block of records.
- Write tape marks on a tape volume.
- Rewind a tape volume to load point.
- Erase a portion of a tape.

3. Disc Utility Functions

- Print the volume table of contents of a disc volume.
- Print a selected portion or all of a disc file.

4. Diskette Utility Functions

- Print the diskette data set labels (similar to volume table of contents of a disc volume).
- Print a selected portion or all of a diskette file.

The SU and TU symbionts may be used interchangeably (both call in SL\$\$SU). When TU is used, the buffer size for all selector channel tape operations is increased from 8189 to 32,767 bytes. Because these commands are intended to be used primarily by a programmer, they are presented in the system service programs (SSP) user guide, UP-8062, (current version).

12.7. INTEGRATED COMMUNICATIONS ACCESS METHOD (ICAM) COMMANDS

The integrated communications access method (ICAM) is an extension of the supervisor that handles data communications tasks. The commands needed to load an ICAM load module and to mark up or down the lines, terminals, or ports with which the module is operating are presented in this section.

12.7.1. Loading ICAM Message Control Program (MCP) Modules

Function:

The Cn/Mn command brings in the load module specified to handle the communications task.

Format:

$\left. \begin{array}{l} \{ Cn \} \\ \{ Mn \} \end{array} \right\}$

where n = 1—9.

When the ICAM load modules are generated, they are named C1—C9 or M1—M9. The response will be:

ICAM READY

12.7.2. ICAM Operator Communications

On occasion, the operator is required to type in instructions to ICAM to facilitate processing. These type-ins have the following format:

$$00 \left\{ \begin{array}{c} Cn \\ Mn \end{array} \right\} cc f, \left\{ \begin{array}{c} xxxx \\ xx \end{array} \right\} ,jj$$

where:

$$\left\{ \begin{array}{c} Cn \\ Mn \end{array} \right\}$$

Is a 2-character name of an ICAM load module (C1—C9 or M1—M9).

cc

Is a 2-character command.

f

Is a 1-character facility type (L=line, P=port, T=terminal).

xxxx

Is a 1- to 4-character line/terminal type and is terminated by a comma. The xxxx field is associated with a user's network whose job number is jj. If f is a T, it is a terminal. If f is an L, it is a line. P indicates a 2-character value of a port on the CA.

xx

Is a 2-character port indication on the CA.

jj

Is a 2-digit job number. If terminated by a blank, the cc field must be two characters long.

The following unsolicited type-ins are the only ones that are valid:

$$00 \left\{ \begin{array}{c} Cn \\ Mn \end{array} \right\} UP L, xxxx, jj = \text{request (open) specified line}$$
$$00 \left\{ \begin{array}{c} Cn \\ Mn \end{array} \right\} DO L, xxxx, jj = \text{release (close) specified line}$$
$$00 \left\{ \begin{array}{c} Cn \\ Mn \end{array} \right\} UP T, xxxx, jj = \text{mark terminal specified available (up)}$$
$$00 \left\{ \begin{array}{c} Cn \\ Mn \end{array} \right\} DO T, xxxx, jj = \text{mark terminal specified unavailable (down)}$$
$$00 \left\{ \begin{array}{c} Cn \\ Mn \end{array} \right\} UP P, xx, jj = \text{mark port specified available (up)}$$
$$00 \left\{ \begin{array}{c} Cn \\ Mn \end{array} \right\} DO P, xx, jj = \text{mark port specified unavailable (down)}$$

A typical response to an unsolicited type-in is:

MC#90 LINE— — — —MARKED UP, USER— —

PART 4. APPENDIXES



Appendix A. Message and Command Format Conventions

The conventions used to illustrate the messages and commands presented in this manual are:

- Information that must be keyed in exactly as shown in information displayed by OS/3 is presented in uppercase letters. For example, a message output to the system console by the supervisor is illustrated as follows:

▷ 01 EARLY WARNING OVERTEMP. CONDITION EXISTS

- Lowercase letters represent variable information that is either displayed or keyed in. For example, the following command format implies that the command DELETE must be followed by the name of the job to be deleted.

DELETE jobname

- The first two letters of each command are underlined to remind you that they are the only letters required to be keyed in to initiate processing of the command and its associated symbiont. For example, only the letters DE need be keyed in to initiate processing of the DELETE command and subsequent running of the delete symbiont. Its format is thus presented as:

DELETE jobname

- Braces { } illustrates alternate choices. For example, the format of the change command

**CHANGE jobname, { HIGH
NOR
PRE }**

indicates that HIGH (H), NOR (N), or PRE (P), may be keyed in after the jobname.

- Brackets [] denote optional entries.

For example, the format of the RUN command

**RUN [{ jobname
jobname(new-name)
(new-name) }] [.priority]**

indicates that the RUN command can be keyed in by itself, or with one or two parameters, as desired.

- Default parameters are shaded. For example, the HOLD command format.

HOLD [ALL
HIGH
jobname
NOR
PRE]

indicates that if no parameter is specified with the HOLD command, the ALL option is assumed.

NOTE:

Not all optional parameters have a default specification.

Appendix B. Operating Procedures for the 9200/9300 Series Subsystem

B.1. GENERAL

This appendix outlines the procedures required for operating the SPERRY UNIVAC 9200/9300 Series Subsystem (Figure B—1) online with the SPERRY UNIVAC 90/30 or 90/30 B System under control of Operating System/3 (OS/3). For complete details about the 9200/9300 system, see the 9200/9300 series processor and storage operator reference, UP-7781 (current version).

The 9200/9300 subsystem is connected to the 90/30 system or 90/30 B system by means of a 9000 channel adapter attached to multiplexer channels on both units. When operated online with the 90/30 or 90/30 B system, the 9200/9300 acts as an I/O controller through which the integrated printer, card reader, and card punch are used as 90/30 or 90/30 B I/O devices. Other 9200/9300 devices and the read/punch feature on the integrated card punch are not supported. To perform the function of an I/O controller, the 9200/9300 uses a highly modified MOS supervisor, which is provided as a deck of punched cards.

OS/3 interfaces with the 9200/9300 I/O devices through a device handler that is configured at system generation time if the keyword parameter TYPE=9200 or TYPE=9300 is specified for any printer, reader, or punch category. OS/3 supports each I/O device independently, regardless of the status or condition of the other 9200/9300 devices.

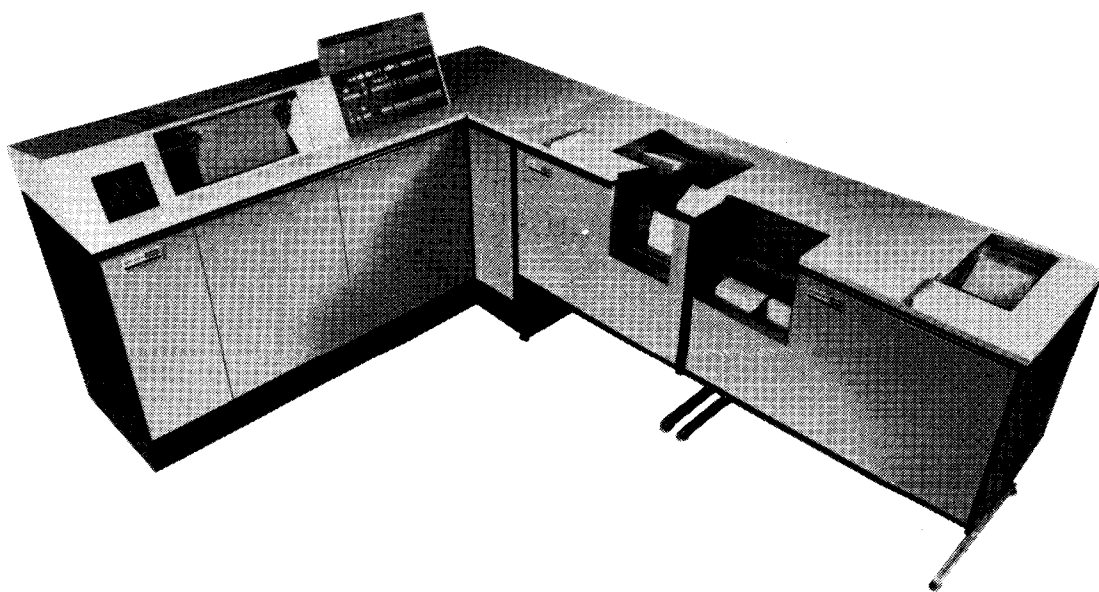

Figure B—1. 9200/9300 Series Subsystem

B.2. OPERATING CONTROLS AND INDICATORS

The control console (Figure B—2) contains the controls and indicators required to:

- perform an initial program load of the 9200/9300 subsystem;
- initialize and reset the printer, reader, and punch;
- produce a main storage dump; and
- receive and respond to error messages.

Controls on the control console are of two types: momentary and 2-position. Momentary controls may be buttons or switches. Momentary switches are pressed on the upper portion; when released, they return to the normal position. Two-position switches are set to either of two positions by pressing the upper or lower portion.

Data is entered by setting the **DATA ENTRY** switches to represent hexadecimal values. Storage locations are indicated by setting the **MEMORY ADDRESS** switches. In both cases the upper portion of each switch is depressed to designate a bit value of 1; the lower portion to designate a bit value of 0.

Error messages are displayed in hexadecimal code on the **NEXT INSTRUCTION/HALT DISPLAY** indicators. A lighted indicator designates a bit value of 1; an unlighted indicator, a bit value of 0. Error messages relating to the 9200/9300 devices are also received on the 90/30 or 90/30 B system console.

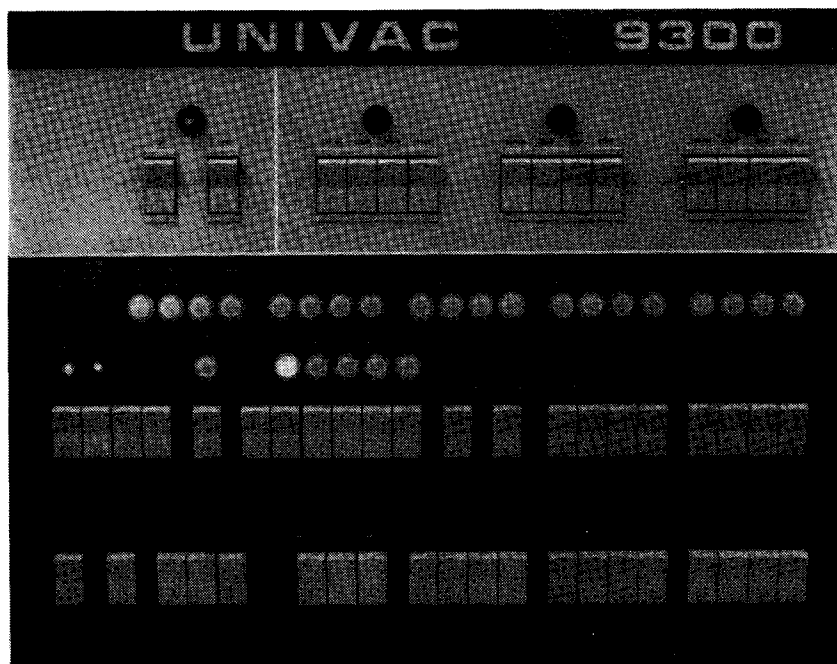

Figure B—2. Control Console, Controls and Indicators

B.3. INITIAL PROGRAM LOAD PROCEDURE

The initial program load for the 9200/9300 supervisor may be performed either before or after the IPL for the 90/30 or 90/30 B system (11.3). The procedure is as follows:

1. Place program deck in the reader input hopper.
2. Press **READER CLEAR** and **READER FEED** switches.
3. Set **DATA ENTRY** switches to X'01'.
4. Press **CLEAR** switch.
5. Press **LOAD** switch.
6. Press **START** switch.
7. Reset **LOAD** switch.
8. Reset **START** switch.

B.4. INITIALIZATION AND RESET PROCEDURES

Initialization and reset procedures are performed by means of the OPERATOR REQUEST function and the low-order (right position) **DATA ENTRY** switches. To perform each procedure, set the indicated hexadecimal value in the **DATA ENTRY** switches and depress the **OP REQ** button. The high-order **DATA ENTRY** switches have no significance.

B.4.1. Initializing the Printer

Before attempting to operate the printer, be certain that the printer form control tape meets the specifications of the vertical format buffer being used. Procedures for preparing the printer form control tape are detailed in the 9200/9300 series processor and storage operator reference, UP-7781 (current version).

To initialize the vertical format buffer, enter the value X'3' and press the **OP REQ** button. This sets the VFB to the home-paper position but does *not* move the forms.

To initialize the VFB and move the forms to the home paper position at the same time, enter the value X'B' and press the **OP REQ** button.

B.4.2. Initializing the Card Reader

To initialize the card reader, enter the value X'9' and press the **OP REQ** button. Two cards are read and any existing errors or images in the card reader buffers are discarded. Be sure to place at least two blank cards at the end of each job deck.

Although it is required only that a card be in the card reader wait station before attempting to read cards, it is advisable to reinitialize the card reader between jobs to ensure that residual information is not inadvertently carried over from job to job.

When this procedure is performed, the channel adapter is also initialized (B.4.3).



B.4.3. Initializing the Channel Adapter

To initialize the channel adapter, enter the value X'C' and press the **OP REQ** button. An "ack" message is transmitted to OS/3, containing the current status of all the 9200/9300 I/O devices. This can be helpful when misoperation has stalled the system.

B.4.4. Obtaining a Storage Dump and Reinitializing the System

When the 9200/9300 subsystem has failed as a result of stalling, power failure, or other reason, the following procedure may be performed to obtain a storage dump and/or restart the input/output operation.

1. Do either of the following:
 - a. Enter the value X'F' and press the **OP REQ** button; or
 - b. Depress the **CLEAR** and **RUN** controls.
2. The **NEXT INSTRUCTION/HALT DISPLAY** indicators display the value X'1FFF'.
3. Set the low-order **MEMORY ADDRESS** switches to location 4 (X'4').
4. Key in a value in the **DATA ENTRY** switches and depress the **RUN** button:
 - a. If 0 is entered, the system will proceed from where it was prior to the interruption.
 - b. If 1 is entered, a storage dump is printed. At the conclusion of the dump, the **HALT DISPLAY** of '1FFF' is repeated, and one of the three keyins must be made again.
 - c. If any value other than 0 or 1 is entered, the system is reinitialized. It goes an idle loop and is in the same condition as after a successful IPL.

B.5. RECOVERY PROCEDURES

Error conditions are communicated to the operator through messages on the 90/30 or 90/30 B console or halt displays on the 9200/9300 control panel.

B.5.1. 90/30 and 90/30 B Console Messages

All console messages pertaining to the 9200/9300 devices are in the standard device, status, sense format. There are three basic messages:

1. ji? DEVICE=14x STATUS=00FF SENSE=0000 9300-NAK RU*C
2. ji? DEVICE=14x STATUS=00FF SENSE=0000 9300-CLEAR RU*C
3. ji? DEVICE=14x STATUS=0200 SENSE=ss00 9300-6xss RU*C



where:

j

Is the job number.

i

Is the message number.

x

Is the device number:

1 = card reader

2 = card punch

3 = printer

ss

Is the device status.

*RU*C*

Indicates the allowable operator responses:

R = retry

U = unrecoverable — return control to issuing program

C = cancel user program

Message 1 (9300-NAK) indicates that an I/O order was accepted by the channel adapter but has not been executed within 20 seconds thereafter. Probably the 9200/9300 subsystem is stopped. If so, press RUN on the 9200/9300, and respond R on the console.

Message 2 (9300-CLEAR) indicates that a retry on message 1 has also timed out. If the 9200/9300 is running, but idle, try reinitializing (B.4.4) and respond R to this message.

Message 3 (9300-6xss) indicates that one of the 9200/9300 devices has developed an unrecoverable error. Correct the condition as described in Table B—1 and respond R, U, or C to the message.

Table B—1. 90/30 and 90/30 B Console Messages for the 9200/9300 Series Subsystem (Part 1 of 2)

Error Code	Module	Condition	Operator Action
6108	Reader	Multistrobe check error	Place the last card in the output stacker and the card in the wait station on the bottom of the input deck. Feed one card; then press READER CLEAR .
6140	Reader	Hopper is empty or stacker is full.	Correct the condition and press READER CLEAR .
6140	Reader	Misfeed	If there is a card in the wait station, place it on the bottom of the input deck; feed a card and press READER CLEAR .
6180	Reader	Card jam or photocell check	See operator action for 6108 error code.

Table B-1. 90/30 and 90/30 B Console Messages for the 9200/9300 Series Subsystem (Part 2 of 2)

Error Code	Module	Condition	Operator Action
6202	Punch	Hopper is empty or stacker is full.	Correct the condition and press PUNCH CLEAR .
6220	Punch	Punch check error	Press PUNCH CLEAR .
6280	Punch	Interlock check, misfeed, stacker jam, punch entry, or exit check	Correct the condition and press PUNCH CLEAR .
6301	Printer	Low paper supply	Correct the condition.
6308	Printer	Wrong print bar setting	Insert the correct bar or reset the bar switch.
6320	Printer	Storage overload	No action required.
6340	Printer	Skip code cannot be found on the paper loop.	Install the correct paper loop and press PRINTER CLEAR .
6340	Printer	Skip code cannot be found in the VFB.	NO recovery is possible. Either the VFB has been destroyed or an incorrect skip has been issued.
6380	Printer	Abnormal condition on the printer	Correct the condition and press PRINTER CLEAR . An extra line may print or a print line may be missing.

B.5.2. 9200/9300 Halt Displays

Error conditions may be indicated by hexadecimal displays on the **NEXT INSTRUCTION/HALT DISPLAY** indicators on the 9200/9300 control panel. Halt displays, their causes, and recovery procedures are listed in Table B-2.

Table B-2. 9200/9300 Control Panel Halt Displays (Part 1 of 2)

Hexadecimal Display	Module	Cause	Operator Action
03ss	Printer	Error during VFB initialization and "home paper" (OP REQ X'B')	Follow procedure in Table B-1 for comparable 63ss message.
12FF	Channel adapter	Illogical command sequence between 90/30 and 9200/9300	Depress CLEAR and RUN to dump storage.
12ss	Channel adapter	Error on I/O command to the channel adapter	Depress RUN to retry. Depress CLEAR and RUN to reinitialize or dump storage.
1FFF	Storage dump	See B.4.4.	See B.4.4.
4300	Loader	Card count discrepancy	Repeat IPL procedure.
6100	Loader	Hole-count check	Repeat IPL procedure.
6100	Reader	Illogical sequence	Depress CLEAR and RUN to dump storage.

Table B-2. 9200/9300 Control Panel Halt Displays (Part 2 of 2)



Hexadecimal Display	Module	Cause	Operator Action
61ss	Loader	Card reader error	Follow procedure in Table B-1 and depress RUN , or repeat IPL procedure.
6200	Punch	Illogical sequence	Depress CLEAR and RUN to dump storage.
6300	Printer	Illogical sequence	Depress CLEAR and RUN to dump storage.
63ss	Storage dump	Printer error during storage dump	Follow procedure in Table B-1.
7676	Switcher	Software switch list is full.	Depress CLEAR and RUN to dump storage.





Index

Term	Reference	Page	Term	Reference	Page
A			C		
Accumulating job log subfiles	12.5.4.2	12—49	Camera positioning, 2703	8.4.2 Fig. 8—6	8—12 8—13
Advance station, 0605	7.3.3.7 Fig. 7—19	7—36 7—36	CANCEL command	12.3.3.1	12—12
Air filters			Cancelling jobs in progress	12.3.3.1	12—12
I/O expansion cabinet	Fig. 2—36	2—79	Card feed guide		
0605 card punch	Fig. 7—21	7—47	0716	6.2.3.1 Fig. 6—5	6—10 6—10
7024-00/01 external storage cabinet	Fig. 2—26	2—61	0717	6.3.3.1 Fig. 6—13	6—29 6—30
Alignment gauge tape, 0773	Fig. 5—55	5—91	Card feed path, 0605	Fig. 7—21	7—47
Alignment ticks			Card punch subsystem	6.1	6—1
0773 printer	Fig. 5—54 Fig. 5—57	5—90 5—92	Card punch subsystems, 0604		
0776 printer	Fig. 5—75	5—117	clearing card jams in card track	7.2.3.3 Fig. 7—8	7—12 7—14
Application programs	1.5.9	1—15	clearing card jams in stacker	7.2.3.4 Fig. 7—9	7—18 7—19
Antistatic brush	Fig. 5—31	5—48	description	7.2 Fig. 7—1	7—3 7—3
AC power distribution panels			emptying chad container	7.2.3.2 Fig. 7—7	7—10 7—11
7024-00/01	Fig. 2—21	2—50	loading cards	7.2.3.1 Fig. 7—5	7—7 7—8
7024-02/03	Fig. 2—28	2—64	operating controls and indicators	7.2.1 Table 7—1	7—3 7—5
AVR command	12.4.9	12—28	operating procedures	7.2.3 Fig. 7—2	7—7 7—4
B			operator control panel	7.2.3.1 Fig. 7—4	7—7 7—5
BEGIN command	12.3.2.2 12.5.1.4	12—9 12—36	placing online	7.2.3.1 Fig. 7—4	7—7 7—5
Breakpointing active spool subfiles	12.5.1.5	12—37	power control panel	Fig. 7—3	7—4
BRKPT command	12.5.1.5	12—37	rear view	Fig. 7—3	7—4
			recovery procedures	7.2.4 Table 7—2	7—20 7—20
			turn-on and turn-off procedures	7.2.2	7—7
			unloading cards	Fig. 7—6	7—10

Term	Reference	Page	Term	Reference	Page
Card punch subsystem, 0605			Card reader subsystem, 0717		
air filter location and card feed			AC POWER circuit breaker	Fig. 6—12	6—25
path	Fig. 7—21	7—47	card feed guide setting	6.3.3.1	6—29
clearing card jam behind card guide	7.3.3.6	7—34		Fig. 6—13	6—30
Fig. 7—18	7—34		cleaning vacuum filters	6.3.3.6	6—37
clearing card jam in advance station	7.3.3.7	7—36	cleaning card jams	6.3.3.5	6—34
Fig. 7—19	7—36		description	Fig. 6—16	6—35
clearing card jam in punch station	7.3.3.8	7—39		6.3	6—23
Fig. 7—20	7—39		indicator panel on processor	Fig. 6—9	6—23
clearing card jam in read station	7.3.3.5	7—31	operator/maintenance panel	Fig. 6—11	6—24
Fig. 7—17	7—32		loading hopper, running	6.3.3.3	6—33
description	7.3	7—21	loading hopper, stopped	6.3.3.2	6—29
Fig. 7—10	7—21			Fig. 6—14	6—31
emptying chad container loading			operating controls and indicators	6.3.1	6—23
cards	7.3.3.1	7—25		Table 6—4	6—25
Fig. 7—14	7—26		operating procedures	6.3.3	6—29
front view	Fig. 7—13	7—23	operator control panel	Fig. 6—10	6—23
indicator panel on processor			recovery procedures	6.3.4	6—38
operator/maintenance panel	Fig. 7—12	7—22		Table 6—5	6—39
operating controls and indicators	7.3.1	7—21	turn-on and turn-off procedures	6.3.2	6—28
	Table 7—3	7—23	unloading stacker	6.3.3.4	6—33
operating procedures	7.3.3	7—25		Fig. 6—15	6—33
operator control panel	Fig. 7—11	7—22	vacuum pump filter covers	Fig. 6—17	6—38
recovery procedures	7.3.4	7—41			
	Table 7—4	7—41	Card reader subsystem, 0719		
turn-on and turn-off procedures	7.3.2	7—24	card jams	6.4.3.4	6—53
unloading cards, error stacker	7.3.3.3	7—30		Fig. 6—23	6—53
Fig. 7—16	7—30		card loading	6.4.3.1	6—51
unloading cards, stacker	7.3.3.2	7—28		Fig. 6—22	6—52
Fig. 7—15	7—28		card unloading	6.4	6—45
				Fig. 6—22	6—52
Card reader subsystem	6.1	6—1	cleaning	6.4.3.5	6—54
			clearing card jams	6.4.3.4	6—53
Card reader subsystem, 0716				Fig. 6—23	6—53
card feed guide setting	6.2.3.1	6—10	controls, operating	6.4	6—45
Fig. 6—5	6—10			Table 6—6	6—48
clearing card jams	6.2.3.5	6—15	description	6.1	6—1
Fig. 6—8	6—16			6.4	6—45
description	6.2	6—3	indicators	6.4	6—45
Fig. 6—1	6—3		loading card hopper	6.4.3.1	6—51
independent power turn-off			operating controls and indicators	6.4.1	6—45
procedure	6.2.2.2	6—10	operating procedures	6.4.3	6—51
independent power turn-on			placing reader online	6.4.3.3	6—52
procedure	6.2.2.1	6—9	power circuit breaker	6.4.1	6—45
loading hopper, running	6.2.3.3	6—14	recovery procedures	6.4.4	6—55
loading hopper, stopped	6.2.2.2	6—11		Table 6—7	6—55
	Fig. 6—6	6—12	removing cards from stacker	6.4.3.2	6—52
operating controls and indicators	6.2.1	6—3	turn-off procedure	6.4.2	6—51
	Table 6—1	6—5	turn-on procedure	6.4.2	6—51
operating procedures	6.2.3	6—10	unloading card stacker	6.4.3.2	6—52
operator control panel	Fig. 6—2	6—3	unloading cards	6.4	6—45
	Fig. 6—3	6—4			
power control panel	Fig. 6—4	6—4	Card utility functions	12.6	12—48
power switch settings	Table 6—2	6—9			
recovery procedures	6.2.4	6—19	Chad container, 0605	7.3.3.4	7—31
	Table 6—3	6—19			
turn-on and turn-off procedures	6.2.2	6—3	CHANGE command	12.3.2.5	12—10
unloading stacker	6.2.3.4	6—14			
Fig. 6—7	6—14				

Term	Reference	Page
Changing job scheduling priority	12.3.2.5	12—10
Changing log file accumulation	12.5.1.7	12—39
Changing spool criteria	12.5.1.6	12—39
Changing switching priority	12.3.2.6	12—11
Character phasing adjustment	5.2.3.4	5—21
examples	Fig. 5—13	5—22
thumbwheel	Fig. 5—14	5—22
Cleaning filters, 0717 card reader	6.3.3.6	6—37
Clearing card jams		
0604	7.2.3.3	7—12
	7.2.3.4	7—18
	Fig. 7—8	7—14
	Fig. 7—9	7—19
0604, advance station	7.3.3.7	7—36
	Fig. 7—19	7—36
0604, card guide	7.3.3.6	7—34
	Fig. 7—18	7—34
0604, punch station	7.3.3.8	7—39
	Fig. 7—20	7—39
0604, read station	7.3.3.5	7—31
	Fig. 7—17	7—32
0716	6.2.3.5	6—15
	Fig. 6—8	6—17
0717	6.3.3.5	6—34
	Fig. 6—16	6—35
0719	6.4.3.4	6—53
	Fig. 6—23	6—53
2703	8.4	8—18
	Fig. 8—9	8—19
Command characteristics	12.2.1	12—2
Command format conventions	Appendix A	
Commands		
ICAM	12.7	12—51
selected-occasion operator	See operator commands.	
spooling	See spooling commands.	
system utility	12.6	12—50
Communications output printer		
aligning forms	2.3.3.2	2—36
description	2.3	2—31
	1.3.3	1—8
	Fig. 2—14	2—31
inking roll types	Table 2—7	2—45
loading forms	2.3.3.1	2—34
	Fig. 2—17	2—36

Term	Reference	Page
operating controls and indicators	2.3.1	2—31
	Table 2—6	2—33
operating procedures	2.3.3	2—34
operator control panel	Fig. 2—15	2—32
power control panel	Fig. 2—16	2—32
recovery procedures	2.3.4	2—46
	Table 2—8	2—46
replacing ink rollers	2.3.3.3	2—44
	Fig. 2—18	2—45
turn-on and turn-off procedures	2.3.2	2—33
Console	See system console.	
Console display, reconstructing	12.4.4	12—19
Control units		
5024	See disc subsystem 8411/8414.	
5039	See disc subsystem 8430.	
UNISERVO VI-C	See UNISERVO VI-C.	
UNISERVO 12/16 (5017)	See UNISERVO 12/16.	
Controls and indicators	See operating controls and indicators.	
Cursor control keys	Table 2—4	2—25

D

Data management	1.5.3	1—14
Date field, setting	12.4.6	12—20
Deferring scheduling	12.3.2.1	12—8
DELETE command	12.3.3.2	12—13
	12.5.1.2	12—34
Deleting jobs in queues	12.3.3.2	12—13
Deleting spool subfiles	12.5.1.2	12—34
Diagnostic programs, description	1.5.8	1—15
Disc adapter	1.3.1.4	1—7
Disc pack handling precautions	3.2	3—3
Disc pack well, 8411/8414	Fig. 3—8	3—11
Disc subsystems		
description	3.1	3—1
disc pack precautions	3.2	3—3
power supply, 8416/8418	3.6	3—37
SYSLOG	12.5.4.2	12—49

Term	Reference	Page	Term	Reference	Page
Disc subsystem, 8411/8414			Disc subsystem, 8416		
control unit	Fig. 3—1	3—5	description	3.4	3—19
control unit controls and indicators	3.3.1	3—5	mounting disc packs	Fig. 3—10	3—19
control unit maintenance panel	Fig. 3—3	3—6	operating controls and indicators	3.4.3.1	3—22
control unit power control panel	Fig. 3—4	3—7		3.4.1	3—20
control unit power distribution panel	Fig. 3—5	3—7	operating procedure	Table 3—5	3—21
description	3.3	3—5	3.4.3	3.4.3	3—22
disc drive unit	Fig. 3—2	3—6	operator control panel	Fig. 3—12	3—21
	Fig. 3—9	3—15	power panels	Fig. 3—11	3—20
disc drive unit controls and indicators	Table 3—2	3—12	recovery procedures	3.4.4	3—24
disc drive unit power control panel	Fig. 3—6	3—10		Table 3—6	3—24
disc pack well	Fig. 3—8	3—11	starting disc drive unit	3.4.3.1	3—22
independent power turn-off procedure	3.3.2.2	3—14	stopping disc drive unit	3.4.3.2	3—23
independent power turn-on procedure	3.3.2.1	3—14	turn on and turn off procedures	3.4.2	3—22
mounting disc packs	3.3.3.1	3—15	unloading disc packs	3.4.3.2	3—23
operating procedures	3.3.3	3—15			
power switch settings	Table 3—3	3—13	Disc subsystem, 8418		
recovery procedures	3.3.4	3—16	description	3.5	3—25
	Table 3—4	3—17	mounting disc packs	3.5.3.1	3—30
starting disc drive unit	3.3.3.1	3—15	operating controls and indicators	3.5.1	3—26
stopping disc drive unit	3.3.3.2	3—16	operating procedures	3.5.3	3—30
turn-on and turn-off procedures	3.3.2	3—13	recovery procedures	3.5.4	3—34
unloading disc packs	3.3.3.2	3—16	starting disc drive unit	3.5.3.1	3—30
			stopping disc drive unit	3.5.3.2	3—34
			turn-on and turn-off procedures	3.5.2	3—30
			unloading disc packs	3.5.3.2	3—34
Disc subsystem, 8415			Disc subsystem, 8430		
description	3.1	3—1	controls and indicators, control unit	3.7.1	3—40
	3.8	3—51		Table 3—10	3—42
	Fig. 3—2	3—6	controls and indicators, disc drive unit	Table 3—11	3—45
disc cartridge	Fig. 3—30	3—57	description	3.7	3—29
disc drive spindle	Fig. 3—29	3—56		Fig. 3—13	3—25
disc well	Fig. 3—29	3—56	disc drive unit	Fig. 3—14	3—26
index keys and transducer for disc cartridge	Fig. 3—29	3—56	independent power turn-off procedure	3.7.2.2	3—47
mounting disc cartridge	3.8.3.1	3—55	independent power turn-on procedure	3.7.2.1	3—47
	Fig. 3—29	3—56	mounting disc packs	3.7.3.1	3—48
	Fig. 3—30	3—57	operating procedures	3.7.3	3—47
	Fig. 3—31	3—57	operator and maintenance panels, control unit	Fig. 3—16	3—31
	Fig. 3—32	3—58	operator control panel, disc drive	Fig. 3—18	3—33
operating procedures	3.8.3	3—55	power panel, control unit	Fig. 3—15	3—27
operator control panel	3.8.1	3—52	power panel, disc drive	Fig. 3—17	3—31
	Fig. 3—2	3—6	power switch settings	Table 3—12	3—46
	Fig. 3—26	3—51	recovery procedures	3.7.4	3—49
operator controls and indicators	3.8.1	3—52		Table 3—13	3—49
	Fig. 3—27	3—52	removing disc packs	3.7.3.2	3—48
	Table 3—14	3—53	starting disc drive unit	3.7.3.1	3—48
power panel	Fig. 3—28	3—52	stopping disc drive unit	3.7.3.2	3—48
procedures	3.8.1	3—52	turn-on and turn-off procedures	3.7.2	3—46
recovery procedures	3.8.4	3—58			
	Table 3—15	3—58	Disc utility functions	12.6	12—50
starting disc drive unit	3.8.3.1	3—55			
stopping disc drive unit	3.8.3.2	3—59			
turn-off procedures	3.8.2	3—55			
turn-on procedures	3.8.2	3—55			
unloading disc cartridge	3.8.3.2	3—59			

Term	Reference	Page
Diskette subsystem, 8413		
controls and indicators	3.9.1	3—63
description	Fig. 3—34	3—64
diskette loading	3.9	3—63
diskette unloading	Fig. 3—33	3—63
loading the diskette	3.9.3.1	3—65
operating controls and indicators	Fig. 3—34	3—64
operating procedures	3.9.3.2	3—65
power panel	Fig. 3—34	3—65
procedures	3.9.3.1	3—65
recovery procedures	3.9.3.1	3—65
turn-off procedure	Fig. 3—35	3—66
turn-on procedure	3.9.1	3—63
unloading the diskette	Fig. 3—34	3—64
	3.9.3	3—64
	3.9.1	3—63
	Fig. 3—34	3—64
	3.9.3	3—64
	3.9.4	3—68
	Table 3—16	3—68
	3.9.2	3—64
	3.9.2	3—64
	3.9.3.2	3—65
	Fig. 3—34	3—65

DISPLAY command	12.4.1	12—14
	12.5.1.1	12—31
Display spooling status	12.5.1.1	12—31
Displaying main storage	12.4.1	12—14
Displaying system information	12.4.3	12—17
Document adjust, 2703	8.4.3	8—15
	Fig. 8—7	8—16
Document characteristics, 2703	Table 8—3	8—12
DUMP command	12.4.2	12—17

E

Editing keys	Table 2—4	2—27
Emptying chad container		
0604	7.2.3.2	7—10
0605	7.3.3.4	7—31
Emulators	1.5.5	1—14
END command	12.3.3.3	12—13
Error log		
sample summary report	Fig. 12—2	12—23
setting	12.4.7	12—20

Term	Reference	Page
Expansion cabinet, I/O		See I/O expansion cabinet.
External storage cabinet, 7024-00/01		
AC power distribution panel	Fig. 2—21	2—50
air filters	Fig. 2—26	2—61
DC power distribution panel	Fig. 2—22	2—51
description	1.3.4	1—8
	2.4	2—47
	2.4.1	2—49
	Fig. 2—19	2—48
module power supply panel	Fig. 2—25	2—54
operating controls and indicators	2.4.1.1	2—49
	Table 2—9	2—55
power control panel	Fig. 2—20	2—49
power-on indicators	Table 2—11	2—59
rear view	Fig. 2—23	2—52
recovery procedures	2.4.1.3	2—59
	Table 2—12	2—59
5-volt regulator panel	Fig. 2—24	2—53

External storage cabinet, 7024-02/03		
AC power distribution panel	Fig. 2—28	2—64
description	1.3.4	1—8
	2.4	2—47
	2.4.2	2—62
	Fig. 2—19	2—48
operating controls and indicators	2.4.2.1	2—62
	Table 2—13	2—66
power control panel	Fig. 2—27	2—63
power-on indicators	Table 2—15	2—68
power supply panel, 5-volt	Fig. 2—29	2—64
power supply panel, 18.5- and 22.5-volt	Fig. 2—31	2—66
power switch settings	Table 2—14	2—68
rear view	Fig. 2—30	2—65
recovery procedures	2.4.2.3	2—68
	Table 2—16	2—69
turn-on and turn-off procedures	2.4.2.2	2—68

F

Filing job streams	12.3.1.1	12—6
Filter covers, vacuum pump, 0717	Fig. 6—17	6—38
Form alignment ticks, 0773	Fig. 5—54	5—90
Form feed configuration, 0776	Fig. 5—79	5—121
Forms alignment guide	Fig. 5—31	5—48
	Fig. 5—32	5—49
Forms change test lines	12.5.1.11	12—42
Forms compression control	Fig. 5—34	5—51
Forms control mechanism	Fig. 5—10	5—18

Term	Reference	Page	Term	Reference	Page
J			Keyin procedure		
Job control	1.5.2	1—13	description	12.2	12—1
Job initialization			system command characteristics	12.2.2.1	12—2
filing (FILE)	12.3.1.1	12—6	system message characteristics	12.2.2.2	12—3
running (RUN/RV)	12.3.1.2	12—6	L		
Job log file print specifications	12.5.1.9	12—40	Language programs	1.5.7	1—14
Job log processing aids			Loading cards		
accumulating job log subfiles			0604	7.2.3.1	7—7
on disc	12.5.4.2.2	12—50		Fig. 7—5	7—8
description	12.5.4	12—47	0605	7.3.3.1	7—25
establishing SYSLOG file on disc	12.5.4.2.1	12—49		Fig. 7—14	7—26
reinitializing SYSLOG file	12.5.4.2.3	12—50	0716	6.2.3.2	6—11
Job log subfile printout	Fig. 12—3	12—48		6.2.3.3	6—14
Job processing commands			0717	Fig. 6—6	6—12
initialization	12.3.1	12—6		6.3.3.2	6—29
rescheduling	12.3.2	12—8	0719	6.3.3.3	6—33
termination	12.3.3	12—11		Fig. 6—14	6—31
Job processing procedures				6.4.3.1	6—51
ICAM commands	12.7	12—51	Loading documents, 2703	8.4.1	8—9
keying in	12.2	12—1		Fig. 8—5	8—9
loading ICAM	12.7.1	12—51	Loading forms, COP	2.3.3.1	2—34
operator communications, ICAM	12.7.2	12—52		Fig. 2—13	2—36
operator commands, selected-			Loading ICAM	12.7.1	12—51
occasion	12.4	12—14	Loading input reader	12.5.2.1	12—42
processing commands	12.3	12—6	Loading output writer	12.5.3.1	12—43
spooling commands	12.5	12—29	M		
Job rescheduling			Magnetic tape subsystems		
activating suspended job (GO)	12.3.2.4	12—10	description	4.1	4—1
changing scheduling priority (CHANGE)	12.3.2.5	12—10	dressing	4.1.2.1	4—3
changing switching priority (SWITCH)	12.3.2.6	12—11		Fig. 4—1	4—3
deferring scheduling (HOLD)	12.3.2.1	12—8	markers	4.1.2.2	4—3
rescheduling deferred job (BEGIN)	12.3.2.2	12—9		Fig. 4—2	4—4
suspending job in progress (PAUSE)	12.3.2.3	12—9	specifications	4.1.2	4—2
Job termination			terminology	4.1.1	4—2
cancelling a job in progress			UNISERVO VI-C	See UNISERVO VI-C.	
(CANCEL)	12.3.3.1	12—12	UNISERVO 10/14	See UNISERVO 10/14.	
deleting a job on queue (DELETE)	12.3.3.2	12—13	UNISERVO 12/16	See UNISERVO 12/16.	
stopping a symbiont/transient			UNISERVO 20	See UNISERVO 20.	
(END)	12.3.3.3	12—13	Main storage	1.3.1.1	1—4
terminating a job (STOP)	12.3.3.4	12—14	Main storage dump	12.4.2	12—17
K			Message characteristics, system	12.2.2	12—3
Keyboard, system console	Fig. 2—13	2—24	Message control keys	Table 2—4	2—28
	Table 2—4	2—26			

Term	Reference	Page	Term	Reference	Page
Message format conventions	Appendix A		card reader, 0719	6.4.1	6-45
Messages, typical system console	Table 12-1	12-30	disc, power supply, 8416/8418	Table 6-6	6-48
Micrologic expansion feature	1.3.1.5	1-5	disc, 8411/8414	3.6.1	3-37
MIX command	12.4.3	12-17	disc, 8415	Table 3-1	3-8
Mounting disc packs			disc, 8416	3.3.1	3-5
8411/8414	3.3.3.1	3-15	disc, 8418	Table 3-2	3-12
8413	3.9.3.1	3-65	disc, 8430	3.8.1	3-52
8416	3.4.3.1	3-22	diskette, 8413	Table 3-14	3-53
8418	3.5.3.1	3-30	optical document reader, 2703	3.4.1	3-20
8430	3.7.3.1	3-48	paper tape, 0920	Table 3-5	3-21
Multiplexer channels	1.3.1.9	1-6	printer, communications output	3.5.1	3-26
	1.3.5.2	1-7	printer, 0768	Table 3-7	3-28
			printer, 0770	3.7.1	3-40
			printer, 0773	Table 3-10	3-42
			printer, 0776	3.9.1	3-63
			printer, 0778	8.2	8-2
			printer, 0779	Table 8-1	8-4
			printer, 0780	9.2	9-2
			printer, 0781	Table 9-1	9-4
			printer, 0782	2.3.1	2-27
			printer, 0783	Table 2-6	2-33
			printer, 0784	5.2.1	5-3
			printer, 0785	Table 5-1	5-6
			printer, 0786	5.3.1	5-27
			printer, 0787	Table 5-5	5-32
			printer, 0788	5.4.1	5-79
			printer, 0789	Table 5-10	5-83
			printer, 0790	5.5.1	5-107
			printer, 0791	Table 5-14	5-110
			printer, 0792	5.6.1	5-133
			printer, 0793	Table 5-18	5-135
			printer, 0794	2.2	2-23
			printer, 0795	Table 2-4	2-25
			printer, 0796	4.4.1	4-44
			printer, 0797	Table 4-8	4-46
			printer, 0798	4.5.1	4-71
			printer, 0799	Table 4-13	4-73
			printer, 0800	4.2.1	4-5
			printer, 0801	Table 4-1	4-7
			printer, 0802	4.3.1	4-29
			printer, 0803	Table 4-4	4-25
			printer, 0804	4.4.1	4-44
			printer, 0805	Table 4-9	4-49
			printer, 0806	Table 4-10	4-53
			printer, 0807	4.5.1	4-71
			printer, 0808	Table 4-14	4-78
			printer, 0809		
			printer, 0810		
			printer, 0811		
			printer, 0812		
			printer, 0813		
			printer, 0814		
			printer, 0815		
			printer, 0816		
			printer, 0817		
			printer, 0818		
			printer, 0819		
			printer, 0820		
			printer, 0821		
			printer, 0822		
			printer, 0823		
			printer, 0824		
			printer, 0825		
			printer, 0826		
			printer, 0827		
			printer, 0828		
			printer, 0829		
			printer, 0830		
			printer, 0831		
			printer, 0832		
			printer, 0833		
			printer, 0834		
			printer, 0835		
			printer, 0836		
			printer, 0837		
			printer, 0838		
			printer, 0839		
			printer, 0840		
			printer, 0841		
			printer, 0842		
			printer, 0843		
			printer, 0844		
			printer, 0845		
			printer, 0846		
			printer, 0847		
			printer, 0848		
			printer, 0849		
			printer, 0850		
			printer, 0851		
			printer, 0852		
			printer, 0853		
			printer, 0854		
			printer, 0855		
			printer, 0856		
			printer, 0857		
			printer, 0858		
			printer, 0859		
			printer, 0860		
			printer, 0861		
			printer, 0862		
			printer, 0863		
			printer, 0864		
			printer, 0865		
			printer, 0866		
			printer, 0867		
			printer, 0868		
			printer, 0869		
			printer, 0870		
			printer, 0871		
			printer, 0872		
			printer, 0873		
			printer, 0874		
			printer, 0875		
			printer, 0876		
			printer, 0877		
			printer, 0878		
			printer, 0879		
			printer, 0880		
			printer, 0881		
			printer, 0882		
			printer, 0883		
			printer, 0884		
			printer, 0885		
			printer, 0886		
			printer, 0887		
			printer, 0888		
			printer, 0889		
			printer, 0890		
			printer, 0891		
			printer, 0892		
			printer, 0893		
			printer, 0894		
			printer, 0895		
			printer, 0896		
			printer, 0897		
			printer, 0898		
			printer, 0899		
			printer, 0900		
			printer, 0901		
			printer, 0902		
			printer, 0903		
			printer, 0904		
			printer, 0905		
			printer, 0906		
			printer, 0907		
			printer, 0908		
			printer, 0909		
			printer, 0910		
			printer, 0911		
			printer, 0912		
			printer, 0913		
			printer, 0914		
			printer, 0915		
			printer, 0916		
			printer, 0917		
			printer, 0918		
			printer, 0919		
			printer, 0920		
			printer, 0921		
			printer, 0922		
			printer, 0923		
			printer, 0924		
			printer, 0925		
			printer, 0926		
			printer, 0927		
			printer, 0928		
			printer, 0929		
			printer, 0930		
			printer, 0931		
			printer, 0932		
			printer, 0933		
			printer, 0934		
			printer, 0935		
			printer, 0936		
			printer, 0937		
			printer, 0938		
			printer, 0939		
			printer, 0940		
			printer, 0941		
			printer, 0942		
			printer, 0943		
			printer, 0944		
			printer, 0945		
			printer, 0946		
			printer, 0947		
			printer, 0948		
			printer, 0949		
			printer, 0950		
			printer, 0951		
			printer, 0952		
			printer, 0953		
			printer, 0954		
			printer, 0955		
			printer, 0956		
			printer, 0957		
			printer, 0958		
			printer, 0959		
			printer, 0960		
			printer, 0961		
			printer, 0962		
			printer, 0963		
			printer, 0964		
			printer, 0965		
			printer, 0966		
			printer, 0967		
			printer, 0968		
			printer, 0969		
			printer, 0970		
			printer, 0971		
			printer, 0972		
			printer, 0973		
			printer, 0974		
			printer, 0975		
			printer, 0976		
			printer, 0977		
			printer, 0978		
			printer, 0979		
			printer, 0980		
			printer, 0981		
			printer, 0982		
			printer, 0983		
			printer, 0984		
			printer, 0985		
			printer, 0986		
			printer, 0987		
			printer, 0988		
			printer, 0989		
			printer, 0990		
			printer, 0991		
			printer, 0992		
			printer, 0993		
			printer, 0994		
			printer, 0995		
			printer, 0996		
			printer, 0997		
			printer, 0998		
			printer, 0999		
			printer, 1000		

Term	Reference	Page	Term	Reference	Page
Operating procedures (cont)					
disc, 8416	3.4.3	3—22	reading mounted volume serial number (AVR)	12.4.9	12—28
disc, 8418	3.5.3	3—30	reconstructing console display (REBUILD)	12.4.4	12—19
disc, 8430	3.7.3	3—47	releasing closed spool subfiles (BEGIN)	12.5.1.4	12—36
diskette, 8413	3.9.3	3—65	rescheduling deferred jobs (BEGIN)	12.3.2.2	12—9
optical document reader, 2703	8.4	8—8	running IBM System/3 jobs in an OS/3 environment	12.4.10	12—28
paper tape 0920	9.4	9—8	running job streams (RUN/RV)	12.3.1.2	12—6
printer, communications output	2.3.3	2—34	setting date (SET DATE)	12.4.6	12—20
printer, 0768	5.2.3	5—13	setting debug byte for error code 15	12.4.10	12—28
printer, 0770	5.3.3	5—41	setting error log (ELOG)	12.4.7	12—20
printer, 0773	5.4.3	5—86	setting physical unit block (SET IO)	12.4.8	12—26
printer, 0776	5.5.3	5—113	setting simulated clock (CLOCK)	12.4.5	12—19
printer, 0778	5.6.3	5—136	stopping symbiont/transient (END)	12.3.3.3	12—11
system console	2.2.3	2—29	suspending job in progress (PAUSE)	12.3.2.2	12—9
tape, UNISERVO VI-C	4.2.3	4—14	terminating (STOP)	12.3.3.4	12—14
tape, UNISERVO 10/14	4.3.3	4—33			
tape, UNISERVO 12/16	4.4.3	4—58	Operator communications, ICAM	12.7.2	12—52
tape, UNISERVO 20	4.5.3	4—85	Optical document reader subsystem, 2703		
Operating system			camera positioning	8.4.2	8—12
application programs	1.5.9	1—15	clearing document jams	8.4.5	8—18
components	Fig. 1—6	1—12	description	8.1	8—1
data management programs	1.5.3	1—14	document alignment	8.4.3	8—15
description	1.5	1—12	document characteristics	Table 8—3	8—12
diagnostic programs	1.5.8	1—15	independent power turn-off procedure	8.3.2	8—7
emulators	1.5.5	1—14	independent power turn-on procedure	8.3.1	8—7
information management system	1.5.10	1—15	loading documents	8.4.1	8—9
integrated communications access method	1.5.4	1—14	operating controls and indicators	8.2	8—2
job control	1.5.2	1—13	operating procedures	Table 8—1	8—4
language processors	1.5.7	1—14	operator control panel	8.4	8—2
service programs	1.5.6	1—14	power control panel	Fig. 8—2	8—2
supervisor	1.5.1	1—13	power distribution panel	Fig. 8—3	8—3
Operator commands, selected-occasion			power switch settings	Fig. 8—4	8—3
activating suspended job (GO)	12.3.2.4	12—10	recovery procedures.	Table 8—2	8—8
breakpointing active spool subfiles (BRKPT)	12.5.1.5	12—37		8.5	8—21
cancelling job in progress (CANCEL)	12.3.3.1	12—12	turn-on and turn-off procedures	Table 8—5	8—21
changing accumulation of log files (SET SPL, DUMP/ENDUMP)	12.5.1.7	12—39	unloading documents	8.3	8—7
changing scheduling priority (CHANGE)	12.3.2.5	12—10		8.4.4	8—17
changing spool criteria (SET SPL, BURST/NBURST)	12.5.1.6	12—38		Fig. 8—8	8—18
changing switching (SWITCH)	12.3.2.6	12—11	Output printer		See communications output printer.
deferring scheduling (HOLD)	12.3.2.1	12—8	Output writer commands		
deleting closed spool subfiles (DELETE)	12.5.1.2	12—34	directing operation	12.5.3.2	12—46
deleting jobs from queue (DELETE)	12.3.3.2	12—13	function codes	Table 12—3	12—44
displaying main storage (DISPLAY)	12.4.1	12—14	loading	12.5.3.1	12—43
displaying spool subfile status (DISPLAY)	12.5.1.1	12—31	Overload protection controls	Fig. 5—49	5—82
displaying system information (MIX)	12.4.3	12—17			
filing job streams (FILE)	12.3.1.1	12—6			
holding closed spool subfiles (HOLD)	12.5.1.3	12—35			
initiating main storage dump (DUMP)	12.4.2	12—17			
load ICAM module (Cn/Mn)	12.7.1	12—51			

Term	Reference	Page	Term	Reference	Page
P					
Paper tape subsystem, 0920 description	9.1	9-1	Print band replacement	5.3.3.6	5-68
	Fig. 9-1	9-1		Fig. 5-43	5-70
independent power turn-off procedure	9.3.2	9-7	Print cartridge replacement		
independent power turn-on procedure	9.3.1	9-7	0773	5.4.3.3	5-99
operating controls and indicators	9.2	9-2		Fig. 5-61	5-100
	Table 9-1	9-4	0776	5.5.3.3	5-126
operating procedures	9.4	9-8		Fig. 5-81	5-126
operator control panel	Fig. 9-2	9-2	0778	5.6.3.3	5-148
power control panel	Fig. 9-4	9-3	Print gap adjustment		
power switch settings	Table 9-2	9-7	0770	5.3.3.7	5-73
punching tape	9.4.4	9-16		Fig. 5-44	5-74
reading tape	9.4.1	9-8	0773	5.4.3.6	5-104
	Fig. 9-5	9-9	0776	5.5.3.5	5-129
rear view	Fig. 9-3	9-3	0778	5.6.3.5	5-151
recovery procedures	9.5	9-17	Print phasing adjustment		
	Table 9-3	9-17	0770	5.3.3.8	5-75
reloading tape punch	9.4.3	9-11	0773	Fig. 5-45	5-75
	Fig. 9-6	9-13	0778	5.4.3.4	5-102
rewinding tape	9.4.2	9-11		Fig. 5-62	5-102
turn-on and turn-off procedures	9.3	9-6	Print speed selection	5.6.3.4	5-150
PAUSE command	12.3.2.3	12-9	0768	5.2.3.5	5-23
Peripheral channel, integrated	1.3.1.3	1-7		Fig. 5-15	5-23
Physical unit block, setting up	12.4.8	12-26	0770	5.3.3.9	5-75
Power-on indicators, external storage cabinets			0773	5.4.3.5	5-103
7024-00/01	Table 2-11	2-55	Printer, communications output	See communications output printer.	
7024-02/03	Table 2-15	2-65	Printer subsystem	5.1	5-1
Power supplies			Printer subsystem, 0768		
I/O expansion cabinet	Fig. 2-34	2-72	character phasing adjustment	5.2.3.4	5-23
	Fig. 2-35	2-73	character phasing examples	Fig. 5-13	5-22
processor	Fig. 2-4	2-5	character phasing thumbwheel description	Fig. 5-14	5-22
	Fig. 2-7	2-7		5.2	5-3
Power switch settings				Fig. 5-1	5-3
cabinet I/O expansion	Table 2-18	2-75	forms access cover open and carriage out	Fig. 5-11	5-20
cabinet, processor	Table 2-2	2-19	forms control mechanism	Fig. 5-10	5-18
cabinet, 7024 00/01 storage	Table 2-10	2-58	forms control tape designations	Table 5-3	5-14
cabinet, 7024 02/03 storage	Table 2-14	2-68	forms control tape preparation	5.2.3.1	5-13
card reader, 0716	Table 6-2	6-9		Fig. 5-8	5-16
disc, 8411/8414	Table 3-3	3-13	forms control tape replacement	5.2.3.2	5-15
disc, 8430	Table 3-12	3-46	forms control tapes	Fig. 5-7	5-13
optical document reader, 2703	Table 8-2	8-8	forms loading	5.2.3.3	5-21
paper tape, 0920	Table 9-2	9-7	independent power turn-off procedure	5.2.2.2	5-12
printer, 0768	Table 15-2	5-12	independent power turn-on procedure	5.2.2.1	5-12
printer, 0770	Table 5-6	5-40	left control panel	Fig. 5-3	5-4
printer, 0773	Table 5-11	5-85	left view	Fig. 5-9	5-17
printer, 0776	Table 5-14	5-110	operating controls and indicators	5.2.1	5-3
printer, 0778	Table 5-18	5-135		Table 5-1	5-6
tape, UNISERVO VI-C	Table 4-2	4-13	operating procedures	5.2.3	5-13
tape, UNISERVO 10/14	Table 4-6	4-32	power control panel	Fig. 5-6	5-6
tape, UNISERVO 12/16	Table 4-11	4-56	power switch settings	Table 5-2	5-12
tape, UNISERVO 20	Table 4-15	4-84	print drum motor speed selection	5.2.3.5	5-23
				Fig. 5-15	5-23
			rear control panel	Fig. 5-5	5-5

Term	Reference	Page	Term	Reference	Page
Printer subsystem, 0768 (cont)			ribbon shield replacement	5.3.3.5	5-65
rear view	Fig. 5-2	5-4	Fig. 5-42	5-67	
recovery procedures	5.2.4	5-23	ribbon shield types	Fig. 5-41	5-65
ribbon access panel raised and form	Table 5-4	5-24	ribbon types	Table 5-8	5-64
loading door open	Fig. 5-12	5-21	stacker adjustments	5.3.3.3	5-56
right control panel	Fig. 5-4	5-5	stacker control panel	Fig. 5-20	5-29
turn-on and turn-off procedures	5.2.2	5-11	stacker gate closed	Fig. 5-36	5-55
Printer subsystem, 0770			stacker gate open	Fig. 5-37	5-56
control panel	Fig. 5-18	5-28	stacker settings for standard		
description	5.3	5-27	forms	Table 5-7	5-58
dimension between ribbon mandrel	Fig. 5-16	5-27	turn-on and turn-off procedures	5.3.2	5-39
and ribbon	Fig. 5-39	5-60	vertical position control and		
forms alignment guide and tractors	Fig. 5-32	5-49	vertical forms tension control	Fig. 5-33	5-50
forms alignment guide retracted			Printer subsystem, 0773		
in housing	Fig. 5-31	5-48	alignment gauge tape	Fig. 5-55	5-91
forms compression control and print			alignment of forms without		
band speed selector switch	Fig. 5-34	5-51	alignment ticks	Fig. 5-57	5-92
forms loading	5.3.3.1	5-42	BAND SPEED switch on upper		
forms unloading	5.3.3.1.1	5-42	right of paper handling assembly	Fig. 5-64	5-103
high voltage power supply panel	Fig. 5-29	5-46	control panel	Fig. 5-47	5-80
HORIZONTAL TRACTOR ADJUSTMENT	5.3.3.2	5-55	description	5.4	5-79
controls	Fig. 5-24	5-31	form advance, line phasing, and	Fig. 5-46	5-79
independent power turn-off procedure	Fig. 5-30	5-47	form tension control	Fig. 5-56	5-91
independent power turn-on procedure	5.3.2.2	5-41	form alignment ticks at column		
indicator panel	5.3.2.1	5-41	indicator	Fig. 5-54	5-90
low voltage power supply panel	Fig. 5-19	5-29	FORM THICKNESS and HORIZONTAL		
operating controls and indicators	Fig. 5-22	5-30	FORM ADJUSTMENT controls	Fig. 5-58	5-93
operating procedures	5.3.1	5-27	forms feed path	Fig. 5-59	5-94
paper feed power supply panel	Table 5-5	5-32	forms loading	5.4.3.1	5-86
power distribution panel	5.3.3	5-41	independent power turn-off procedure	Fig. 5-51	5-87
POWER ON/POWER OFF switch	Fig. 5-23	5-31	independent power turn-on procedure	5.4.2.2	5-85
power switch settings	Fig. 5-21	5-30	indicator panel on processor	5.4.2.1	5-85
power switch settings	Fig. 5-25	5-32	operator/maintenance panel	Fig. 5-48	5-81
print band replacement	Table 5-6	5-40	operator/maintenance panel	Fig. 5-50	5-86
print carriage assembly closed	5.3.3.6	5-68	internal adjustments	5.4.1	5-79
PRINT DENSITY switch and	Fig. 5-43	5-70	operating controls and indicators	Table 5-10	5-83
print phasing control	Fig. 5-26	5-43	operating procedures	5.4.3	5-86
print gap adjustment	Fig. 5-35	5-52	overload protection controls	Fig. 5-49	5-82
print phasing adjustment	5.3.3.7	5-73	power switch settings	Table 5-11	5-85
print speed selection	Fig. 5-44	5-74	print carriage assembly closed	Fig. 5-52	5-88
printer open to receive forms	5.3.3.8	5-75	print carriage open to receive		
rear photocell covered	Fig. 5-45	5-75	forms	Fig. 5-53	5-89
rear view	5.3.3.9	5-75	print cartridge replacement	5.4.3.3	5-99
recommended cut of forms	Fig. 5-27	5-44	print gap adjustment	Fig. 5-61	5-100
container	Fig. 5-38	5-59	print phasing adjustment	5.4.3.6	5-104
recovery procedures	Fig. 5-17	5-28	print speed selection	Fig. 5-62	5-102
ribbon replacement	Fig. 5-28	5-45	recovery procedures	Fig. 5-63	5-103
	5.3.4	5-76	turn-on and turn-off procedures	5.4.3.5	5-103
	Table 5-9	5-76		5.4.4	5-104
	5.3.3.4	5-59	ribbon replacement	Table 5-13	5-104
	Fig. 5-40	5-62	turn-on and turn-off procedures	5.4.3.2	5-94
				Fig. 5-60	5-95
				5.4.2	5-84

Term	Reference	Page
Printer subsystem, 0776		
alignment ticks	Fig. 5—75	5—117
description	5.5	5—107
	Fig. 5—65	5—107
form alignment, form advance, and form tension controls	Fig. 5—76	5—118
form alignment sketch	Fig. 5—77	5—119
form feed configuration	Fig. 5—79	5—121
forms loading	5.5.3.1	5—114
front view	Fig. 5—67	5—108
horizontal form adjustment	Fig. 5—72	5—114
independent power turn-off procedure	5.5.2.2	5—113
independent power turn-on procedure	5.5.2.1	5—112
internal adjustments	Fig. 5—71	5—113
opened to receive forms	Fig. 5—74	5—116
operating controls and indicators	5.5.1	5—107
	Table 5—14	5—110
operating procedures	5.5.3	5—113
operator control panel	Fig. 5—66	5—107
power control panel	Fig. 5—68	5—108
power supply control panel	Fig. 5—70	5—109
power switch settings	Table 5—15	5—112
print carriage assembly closed	Fig. 5—73	5—115
print cartridge replacement	5.5.3.3	5—126
	Fig. 5—81	5—126
print gap adjustment	5.5.3.5	5—129
print phasing adjustment	5.5.3.4	5—128
print phasing control	Fig. 5—83	5—129
print phasing example	Fig. 5—82	5—128
print mechanism, gap adjust lever	Fig. 5—78	5—120
rear view	Fig. 5—69	5—109
recovery procedures	5.5.4	5—129
	Table 5—17	5—130
ribbon replacement	5.5.3.2	5—122
	Fig. 5—80	5—122
ribbon types	Table 5—16	5—125
turn-on and turn-off procedures	5.5.2	5—112
Printer subsystem, 0778	5.6	5—133
Processor		
cabinet	See processor cabinet.	
description	1.3.1	1—6
input/output control section	1.3.1.2	1—6
integrated communications adapter feature	1.3.1.8	1—7
integrated disc adapter	1.3.1.4	1—7
integrated peripheral channel	1.3.1.3	1—7
internal multiplexer channel feature	1.3.1.9	1—8
main storage	1.3.1.1	1—6
micrologic expansion feature	1.3.1.5	1—7
storage expansion feature	1.3.1.7	1—7
storage protection feature	1.3.1.6	1—7

Term	Reference	Page
Processor cabinet		
communications adapter circuit breaker and indicator	Fig. 2—10	2—9
controls and indicators	2.1.1	2—2
	Fig. 2—2	2—3
	Table 2—1	2—10
description	2.1	2—1
front view	Fig. 2—1	2—1
operating procedures	2.1.3	2—20
operator/maintenance panel	Fig. 2—2	2—3
power control panel	Fig. 2—5	2—5
power supplies	Fig. 2—4	2—5
power switch settings	Table 2—2	2—19
recovery procedures	2.1.4	2—20
	Table 2—3	2—20
Program loading	11.3	11—2
Punching tape	9.4.4	9—16
R		
Read station, clearing jams, 0605 card punch	7.3.3.5	7—31
	Fig. 7—17	7—32
Reading tape	9.4.1	9—8
Reading volume serial numbers	12.4.9	12—28
REBUILD command	12.4.4	12—19
Reconstructing console display	12.4.4	12—19
Recovery procedures		
cabinet, expansion	2.5.4	2—76
	Table 2—19	2—76
cabinet, processor	2.1.4	2—20
	Table 2—3	2—20
cabinet, 7024 00/01 storage	2.4.1.3	2—59
	Table 2—12	2—59
cabinet, 7024 02/03 storage	2.4.2.3	2—68
	Table 2—16	2—69
card punch, 0604	7.2.4	7—20
	Table 7—2	7—20
card punch, 0605	7.3.4	7—41
	Table 7—4	7—41
card reader, 0716	6.2.4	6—19
	Table 6—3	6—19
card reader, 0717	6.3.4	6—38
	Table 6—5	6—39
card reader, 0719	6.4.4	6—55
	Table 6—7	6—55
disc, 8411/8414	3.3.4	3—16
	Table 3—4	3—17
disc, 8415	3.8.4	3—60
	Table 3—15	3—60

Term	Reference	Page	Term	Reference	Page
Recovery procedures ¹ (cont)					
disc, 8416	3.4.4	3-24	Ribbon sensor	Fig. 5-39	5-60
	Table 3-6	3-24	Ribbon shield types	Fig. 5-41	5-65
disc, 8418	3.5.4	3-34	Ribbon threading path	Fig. 5-40	5-62
	Table 3-8	3-34	Ribbon types, 0770	Table 5-8	5-64
disc 8430	3.6.4	3-49	Running job streams	12.3.1.2	12-6
	Table 3-13	3-49			
diskette, 8413	3.9.4	3-68			
	Table 3-16	3-68	S		
optical document reader, 2707	8.5	8-21	Selector channels	1.3.5.1	1-9
	Table 8-4	8-21	Service programs	1.5.6	1-14
paper tape, 0920	9.5	9-17	SET CLOCK command	12.4.5	12-19
	Table 9-3	9-17	SET DATE command	12.4.6	12-20
printer, communications output	2.3.4	2-46	SET ELOG command	12.4.7	12-20
	Table 2-8	2-46	SET I/O command	12.4.8	12-26
printer, 0768	5.2.4	5-23	SET SPL command		
	Table 5-4	5-24	BURST/NBURST	12.5.1.6	12-38
printer, 0770	5.3.4	5-76	DUMP/ENDUMP	12.5.1.7	12-39
	Table 5-9	5-76	HEADER/NOHDR	12.5.1.8	12-40
printer, 0773	5.4.4	5-104	NOACT/NOLOG/NOPRINT/PRINT	12.5.1.9	12-40
	Table 5-13	5-104	CNSLG	12.5.1.10	12-41
printer, 0776	5.5.4	5-129	TEST/NOTEST	12.5.1.11	12-42
	Table 5-16	5-125	Solicited messages	12.2.2.1	12-4
printer, 0778	5.6.4	5-151	Speed select, printer		
	Table 5-19	5-152	0768	5.2.3.5	5-23
system console	2.2.4	2-30	0770	5.3.3.9	5-75
	Table 2-5	2-30	0773	5.4.3.5	5-103
tape, UNISERVO VI-C	4.2.4	4-18	Spool file commands		
	Table 4-3	4-19	BEGIN	12.5.1.4	12-36
tape, UNISERVO 10/14	4.3.4	4-38	BRKPT	12.5.1.5	12-37
	Table 4-7	4-38	DELETE	12.5.1.2	12-34
tape, UNISERVO 12/16	4.4.4	4-67	directories	Table 12-1	12-30
	Table 4-12	4-68	DISPLAY	12.5.1.1	12-31
tape, UNISERVO 20	4.5.4	4-90	HOLD	12.5.1.3	12-35
	Table 4-16	4-90	modifiers	Table 12-2	12-31
Reinitializing SYSLOG file	12.5.4.2.3	12-50	Spool files		
Releasing spool files	12.5.1.4	12-36	printout format, changing	12.5.1.8	12-40
Reloading tape	9.4.3	9-11	processing aids	12.5.4	12-47
	Fig. 9-6	9-13			
Rescheduling deferred jobs	12.3.2.2	12-9			
Rewinding tape	9.4.2	9-11			
Ribbon mandrel	Fig. 5-39	5-60			
Ribbon replacement					
0770	5.3.3.4	5-59			
	Fig. 5-40	5-62			
0773	5.4.3.2	5-94			
	Fig. 5-60	5-95			
0776	5.5.3.2	5-122			
	Fig. 5-80	5-122			
0778	5.6.3.2	5-145			

Term	Reference	Page
Spool subfiles		
breakpointing	12.5.1.5	12-37
console log	12.5.1.1	12-31
	12.5.1.5	12-37
	12.5.1.10	12-41
deleting	12.5.1.2	12-34
displaying status	12.5.1.1	12-31
placing on hold	12.5.1.3	12-35
releasing	12.5.1.4	12-36
Spooling commands		
file	12.5.1	12-30
input reader	12.5.2	12-42
output writer	12.5.3	12-43
processing aids	12.5.4	12-47
Spooling criteria, changing	12.5.1.6	12-38
Stacker adjustment	5.3.3.3	5-56
Stacker gate		
closed	Fig. 5-36	5-55
open	Fig. 5-37	5-56
Stacker settings, standard forms	Table 5-7	5-58
STOP command	12.3.3.4	12-14
Storage cabinets, external	See external storage cabinets.	
Storage expansion	1.3.1.7	1-7
Storage protection	5.3.3.3	5-56
SU symbiont	12.6	12-50
Subsystem tests	See tests.	
Supervisor	1.5.1	1-13
Suspending a job	12.3.2.3	12-9
SWITCH command	12.3.2.6	12-11
SYSLOG		
accumulating file on disc	12.5.4.2.2	12-50
establishing file on disc	12.5.4.2.1	12-49
reinitializing file	12.5.4.2.3	12-50
System command characteristics	12.2.1	12-2
System configuration		
description	1.2	1-1
central hardware	1.3	1-6
I/O subsystem	1.4	1-9
operating system	1.5	1-12

Term	Reference	Page
System console		
description	2.2	2-23
	1.3.2	1-8
	Fig. 2-11	2-23
keyboard	Fig. 2-13	2-24
operating controls and indicators	2.2.1	2-25
	Fig. 2-12	2-24
	Table 2-4	2-25
operating procedures	2.2.3	2-29
reconstructing display (REBUILD)	12.4.4	12-19
recovery procedures	2.2.4	2-30
	Table 2-5	2-30
turn-on and turn-off procedures	2.2.2	2-29
System initialization		
control storage load	11.2	11-1
general	11.1	11-1
initial program load	11.3	11-2
System message characteristics	12.2.2	12-3
System orientation	Section 1.	
System turn-on and turn-off procedures	10.1	10-1
System utility commands	12.6	12-50

T

Term	Reference	Page
Tape		
dressing	4.1.2.1	4-1
	Fig. 4-1	4-3
loading	4.2.3.1	4-14
loading with reel cartridge	4.3.3.1	4-33
	4.5.3.1	4-85
loading without reel cartridge	4.3.3.2	4-36
	4.5.3.2	4-88
magnetic	See magnetic tape subsystems.	
markers	4.1.2.2	4-3
	Fig. 4-2	4-4
mounting	4.4.3.1	4-58
	4.4.3.3	4-64
punching	9.4.4	9-16
reading	9.4.1	9-8
	Fig. 9-5	9-9
specifications	4.1.2	4-2
SYSLOG	12.5.4.1	12-49
terminology	4.1.1	4-2
UNISERVO	See UNISERVO.	
unloading with program control	4.3.3.3	4-38
	4.5.3.3	4-89
unloading with reel cartridge	4.3.3.1	4-33
	4.5.3.1	4-85
unloading without program control	4.3.3.4	4-38
	4.5.3.4	4-90
unloading without reel cartridge	4.3.3.2	4-36
	4.5.3.2	4-88

Term	Reference	Page	Term	Reference	Page
Tape reel cartridge			operating controls and indicators	4.2.1	4-5
UNISERVO 10/14	Fig. 4-18	4-35		Table 4-1	4-7
	Fig. 4-19	4-36	operating procedures	4.2.3	4-14
UNISERVO 20	Fig. 4-48	4-87	operator control panel	Fig. 4-4	4-5
	Fig. 4-49	4-88		Table 4-1	4-7
Tape subsystems	See magnetic/paper tape subsystems.		power switch settings	Table 4-2	4-13
Terminating a job	12.3.3.4	12-14	recovery procedures	4.2.4	4-18
TU symbiont	12.6	12-50		Table 4-3	4-19
Turn-on and turn-off procedures			rewinding tape	4.2.3.2	4-18
cabinet, expansion	2.5.2	2-75	slave power panel	Fig. 4-7	4-6
cabinet, processor	2.1.2	2-19		Table 4-1	4-12
cabinet, 7024 00/01 storage	2.4.1.2	2-58	test procedures	15.2	15-1
cabinet, 7024 02/03 storage	2.4.2.2	2-68	turn-on and turn-off procedures	4.2.2	4-12
card punch, 0604	7.2.2	7-7	unloading tape	4.2.3.3	4-18
card punch, 0605	7.3.2	7-24	write-enable ring and rear of tape reel	Fig. 4-8	4-14
card reader, 0716	6.2.2	6-3	UNISERVO 10/14		
card reader, 0717	6.3.2	6-28	control unit controls and indicators	4.3.1	4-27
card reader, 0719	6.4.2	6-51		Table 4-4	4-25
disc, 8411/8414	3.3.2	3-13	control unit power control panel	Fig. 4-12	4-24
disc, 8415	3.8.2	3-55		Table 4-4	4-25
disc, 8416	3.4.2	3-22	control unit power distribution panel	Fig. 4-13	4-24
disc, 8418	3.5.2	3-30		Table 4-4	4-26
disc, 8430	3.7.2	3-46	control unit power supply panel	Fig. 4-14	4-25
diskette 8413	3.9.2	3-64		Table 4-4	4-26
optical document reader, 2703	8.3	8-7	description	4.3	4-21
paper tape 0920	9.3	9-6		Fig. 4-10	4-22
printer, communications output	2.3.2	2-33	front and rear views	Fig. 4-11	4-23
printer, 0768	5.2.2	5-11	independent power turn-off procedure	4.3.2.2	4-33
printer, 0770	5.3.2	5-39	independent power turn-on procedure	4.3.2.1	4-32
printer, 0773	5.4.2	5-84	loading tape with reel cartridges	4.3.3.1	4-33
printer, 0776	5.5.2	5-112	loading tape without reel cartridges	4.3.3.2	4-36
printer, 0778	5.6.2	5-135	operating procedures	4.3.3	4-33
system console	2.2.2	2-29	operator control panel	Fig. 4-15	4-27
tape, UNISERVO VI-C	4.2.2	4-12	power switch settings	Table 4-6	4-32
tape, UNISERVO 10/14	4.3.2	4-31	recovery procedures	4.3.4	4-38
tape, UNISERVO 12/16	4.4.2	4-56		Table 4-7	4-38
tape, UNISERVO 20	4.5.2	4-83	tape reel and write-enable ring	Fig. 4-17	4-34
			tape reel cartridge	Fig. 4-18	4-35
				Fig. 4-19	4-36
				Fig. 4-20	4-37
			tape reel without cartridge		
			tape transport items and method for cleaning	Fig. 4-21	4-41
			tape unit control and indicators	Table 4-5	4-28
			tape unit power control panel	Fig. 4-16	4-28
			turn-on and turn-off procedures	4.3.2	4-31
			unloading with program control	4.3.3.3	4-37
			unloading without program control	4.3.3.4	4-38
			UNISERVO 12/16		
			controls and indicators (control unit)	4.4.1	4-44
				Table 4-8	4-46
			controls and indicators (12)	Table 4-9	4-49
			controls and indicators (16)	Table 4-10	4-53

U

UNISERVO VI-C		
description	4.2	4-5
	Fig. 4-1	4-5
independent power turn-off procedure	4.2.2.2	4-13
independent power turn-on procedure	4.2.2.1	4-13
loading tape	4.2.3.1	4-14
	Fig. 4-9	4-15
master DC power panel	Fig. 4-6	4-6
	Table 4-1	4-11
master main power panel	Fig. 4-5	4-6
	Table 4-1	4-11

Term	Reference	Page	Term	Reference	Page
UNISERVO 12/16 (cont)					
rear view with door open (12)	Fig. 4-27	4-48	0719 card reader	6.4.3.2	6-52
rear view with door open (16)	Fig. 4-31	4-52		Fig. 6-22	6-52
recovery procedures	4.4.4	4-67	Unloading discs		
	Table 4-12	4-68	8411/14	3.3.3.2	3-16
reel mounting (12)	4.4.3.1	4-58	8415	3.8.3.2	3-59
	Fig. 4-35	4-60	8416	3.4.3.2	3-23
reel mounting (16)	4.4.3.3	4-64	8418	3.5.3.2	3-34
	Fig. 4-36	4-65	8430	3.7.3.2	3-48
tape reel and write-enable ring	Fig. 4-34	4-59	Unloading diskette, 8413	3.9.3.2	3-65
turn-on and turn-off procedures	4.4.2	4-56			
unloading (12)	4.4.3.2	4-63	Unloading documents, 2703	8.4.4	8-17
unloading (16)	4.4.3.4	4-67		Fig. 8-8	8-18
UNISERVO 20			Unsolicited messages	12.2.2.2	12-4
controls and indicators, control unit	Table 4-13	4-73			
controls and indicators, tape unit	Table 4-14	4-78			
description	4.5	4-71			
	Fig. 4-37	4-71			
independent power turn-off procedure	4.5.2.2	4-85			
independent power turn-on procedure	4.5.2.1	4-84			
indicator panel, tape unit	Fig. 4-42	4-75			
loading tape with reel cartridges	4.5.3.1	4-85			
loading tape without reel cartridges	4.5.3.2	4-88			
operating controls and indicators	4.5.1	4-71			
operating procedures	4.5.3	4-85			
operator control panel, tape unit	Fig. 4-43	4-76			
operator panel, tape unit	Fig. 4-41	4-75			
power control panel, control unit	Fig. 4-39	4-72			
power control panel, tape unit	Fig. 4-46	4-77			
power distribution panel, control unit	Fig. 4-40	4-73			
power supply panel, tape unit	Fig. 4-45	4-77			
power switch settings	Table 4-15	4-84			
rear view, control unit	Fig. 4-38	4-72			
rear view, tape unit	Fig. 4-44	4-76			
recovery procedures	4.5.4	4-90			
	Table 4-16	4-90			
tape end positioned for automatic loading	Fig. 4-50	4-89			
tape reel and write-enable ring	Fig. 4-47	4-86			
tape reel cartridge	Fig. 4-48	4-87			
tape reel mounted on supply hub with cartridge	Fig. 4-49	4-88			
turn-on and turn-off procedures	4.5.2	4-83			
unloading with program control	4.5.3.3	4-89			
unloading without program control	4.5.3.4	4-89			
Unloading cards					
0604 card punch	Fig. 7-6	7-10			
0605 card punch	7.3.3.2	7-28			
	7.3.3.3	7-30			
	Fig. 7-15	7-28			
	Fig. 7-16	7-30			
0716 card reader	6.2.3.4	6-14			
	Fig. 6-7	6-14			
0717 card reader	6.3.3.4	6-33			
	Fig. 6-15	6-33			

V

W

Comments concerning this manual may be made in the space provided below. Please fill in the requested information.

System: _____

Manual Title: _____

UP No: _____ Revision No: _____ Update: _____

Name of User: _____

Address of User: _____

Comments:

CUT

FOLD

FIRST CLASS
PERMIT NO. 21
BLUE BELL, PA.

BUSINESS REPLY MAIL

NO POSTAGE STAMP NECESSARY IF MAILED IN THE UNITED STATES

POSTAGE WILL BE PAID BY

SPERRY  **UNIVAC**

P.O. BOX 500
BLUE BELL, PA.
19424

ATTN: SYSTEMS PUBLICATIONS DEPT.



CUT

FOLD

Comments concerning this manual may be made in the space provided below. Please fill in the requested information.

System: _____

Manual Title: _____

UP No: _____ Revision No: _____ Update: _____

Name of User: _____

Address of User: _____

Comments:

CUT

NOTE: DO NOT USE THIS FORM TO ORDER MANUALS.

FOLD

FIRST CLASS
PERMIT NO. 21
BLUE BELL, PA.

BUSINESS REPLY MAIL

NO POSTAGE STAMP NECESSARY IF MAILED IN THE UNITED STATES

POSTAGE WILL BE PAID BY

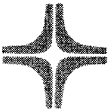
SPERRY  **UNIVAC**

P.O. BOX 500
BLUE BELL, PA.
19422

ATTN: SYSTEMS PUBLICATIONS DEPT.

CUT

FOLD