

SILENT 700[®]

Electronic Data Terminals

Model 733 ASR/KSR Operating Instructions

USASCII Code

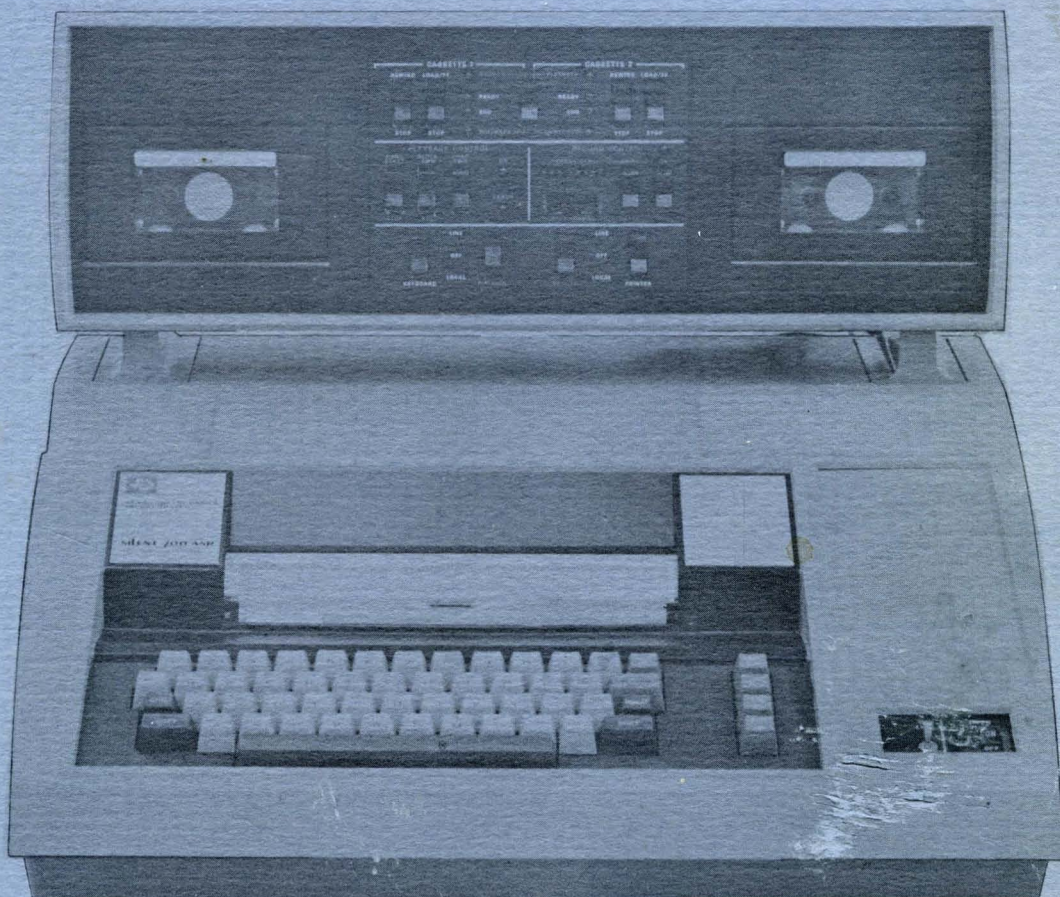

MANUAL NO. 959227-9701
ISSUED 1 MAY 1973
REVISED 1 NOVEMBER 1973



TEXAS INSTRUMENTS
INCORPORATED

Copyright 1973
By
Texas Instruments Incorporated

All Rights Reserved

PRINTED IN U.S.A.

The information and/or drawings set forth in this document and all rights in and to inventions disclosed herein and patents which might be granted thereon disclosing or employing the materials, methods, techniques or apparatus described herein are the exclusive property of Texas Instruments Incorporated.

No disclosure of the information or drawings shall be made to any other person or organization without the prior consent of Texas Instruments Incorporated.

ENGINEERING CHANGE NOTICE

DATE	ECN	LEVEL	DESCRIPTION
11-1-73	383371	C	Add Options to Appendix B

ATTENTION

Before attempting to operate your new Silent 700 Data Terminal, carefully review the following sections of this manual

Section		Page
6-4	Installing the ASR Upper Unit (ASR only)	6-4
2-1	Visual Check	2-1
2-2	Power Connections	2-1
2-3	Paper Loading	2-1
2-6	Tape Cassette Installation (ASR only)	2-2
2-7	Communication Interface Connections	2-3
Appendix B	Optional Equipment (as applicable)	B-1

TABLE OF CONTENTS

Section	Page	Section	Page
	vi	4-3 Controls and Indicators	4-2
		4-3.1 Upper Switch Panel	4-2
I		4-3.1.1 Top Row, Tape Cassette Control	4-3
1-1 Introduction	1-1	4-3.1.2 Middle Row, PLAYBACK and RECORD Controls	4-4
1-2 Description	1-1	4-3.1.3 Bottom Row, Device Controls	4-6
II		4-3.2 On-Line/Off Switch	4-7
INSTALLATION		4-3.3 Keyboard Controls	4-7
2-1 Visual Check	2-1	4-4 Cassette Tape Preparation (Tape Load) and Removal	4-8
2-2 Power Connections	2-1	4-4.1 Tape Write Tabs	4-8
2-3 Paper Loading	2-1	4-4.2 Tape Cassette Insertion	4-8
2-4 Printer and Keyboard	2-2	4-4.3 Tape Cassette Removal	4-8
2-5 Contrast Setting	2-2	4-4.4 Cassette "Load" and Transport Ready	4-8
2-6 Tape Cassette Installation (ASR Only)	2-2	4-5 Tape Recording Operations	4-9
2-7 Communication Interface Connections	2-3	4-5.1 Block Recording Technique	4-9
2-7.1 EIA (RS232C)	2-3	4-5.2 Recording Limitations	4-9
2-7.2 Current Loop	2-3	4-5.3 Character Display	4-9
2-7.3 Phone Line Connections	2-3	4-5.4 Recording the Buffer Data	4-10
III		4-5.5 Inspecting Contents of Record Buffer	4-10
OPERATING PROCEDURES FOR KSR		4-5.6 Erasing Entire Record Buffer	4-10
3-1 General	3-1	4-5.7 Terminal Setup	4-10
3-2 Controls and Indicators	3-1	4-5.8 Editing While Recording	4-11
3-3 Keyboard	3-1	4-6 Playback Operations	4-12
3-4 Printer Control Characters	3-1	4-6.1 Terminal Setup	4-12
3-5 Full and Half Duplex Operation	3-1	4-6.2 Continuous Playback	4-12
IV		4-6.3 Block Forward/Reverse	4-12
GENERAL INSTRUCTIONS FOR ASR OPERATION		4-6.4 Character Forward	4-12
4-1 General	4-1		
4-2 Definitions	4-1		

TABLE OF CONTENTS (Continued)

Section	Page	Section	Page
4-6.5 Locating a Block on Tape	4-12	5-2.6 Print Out From Line (No Recording)	5-17
4-7 Erasing a Tape Cassette	4-13	5-2.7 Play Back Tape to Line (No Printout)	5-18
4-8 Playback Error Procedure (Option)	4-14	5-2.8 Play Back Tape To Line and Print Out	5-19
4-8.1 Replay the Block	4-14	5-2.9 Play Back Tape To Line, Print Out From Line	5-20
4-8.2 Read (Transmit) the Block with an Error	4-14	5-2.10 Simultaneously Send and Receive From Tapes to Line	5-21
4-8.3 Skip the Block with an Error	4-14	5-3 Simultaneous Line/Local	5-22
4-8.4 Read up to Character Error	4-14	5-3.1 Keyboard to Line, Print Out From Line, and Duplicate Tape	5-22
4-8.5 Correct an Entire Line	4-14	5-3.2 Play Back Tape to Line and Record on Tape From Keyboard	5-23
4-9 Duplicating a Tape	4-15		
4-9.1 Duplication Process	4-15	VI CARE AND CLEANING	
4-9.2 Editing While Duplicating a Tape	4-15	6-1 General	6-1
4-9.2.1 Changing a Block on Duplicate Tape	4-15	6-2 Cleaning	6-1
4-9.2.2 Change a Character During Duplication	4-15	6-2.1 Paper Drive Roller Cleaning	6-1
4-10 Control Interlocks	4-16	6-2.2 Printhead Drive Mechanism Cleaning	6-1
4-10.1 Record Mode Interlocks	4-16	6-2.3 Cassette Transport Cleaning	6-1
4-10.2 Playback Mode Interlocks	4-16	6-2.4 Printhead Cleaning	6-1
4-10.3 Operating Mode Interlocks	4-16	6-3 Access to PC Cards	6-3
4-10.4 Transport Control Interlock	4-16	6-3.1 ASR Upper Unit Access	6-3
		6-3.2 KSR Lower Unit PC Card Access	6-3
V STEP-BY-STEP ASR OPERATING INSTRUCTIONS		6-4 Installing and Removing the ASR Upper Unit	6-4
5-1 Local Operations	5-2	6-4.1 Installing the Upper Unit	6-4
5-1.1 Record on Tape From Keyboard	5-2	6-4.2 Removing the Upper Unit	6-4
5-1.2 Editing Blocks of Data on Tape	5-4	6-5 Terminal Malfunction Checklist	6-5
5-1.3 Play Back and Print Out Tape	5-6		
5-1.4 Duplicate Tape and Print Out Original Tape	5-7	APPENDIX A	
5-1.5 Duplicate Tape at High Speed	5-8	MODEL 733 EQUIPMENT SPECIFICATIONS	
5-1.6 Erase Tape	5-9		
5-1.7 Duplicate Tape and Edit Copy Tape	5-10	APPENDIX B	
5-2 On-Line Operations	5-12	MODEL 733 OPTIONS	
5-2.1 Keyboard to Line (No Printout)	5-12		
5-2.2 Keyboard to Line and Print Out	5-13	APPENDIX C	
5-2.3 Keyboard to Line, Print Out, and Record on Tape	5-14	OPERATOR'S QUICK-REFERENCE CARD	
5-2.4 Record on Tape From Line (No Printout)	5-15		
5-2.5 Record on Tape From Line and Print Out	5-16		

LIST OF ILLUSTRATIONS

Figure No.	Page	Figure No.	Page
1-1	KSR/ASR Data Terminals 1-2	3-4	Shifted Characters, Standard ASCII 3-5
2-1	115V and 230V Connections at TB1 2-1	3-5	Control Characters, Limited ASCII 3-6
2-2	Paper Loading (Side View) 2-2	3-6	Shift and Control Characters, Limited ASCII 3-6
2-3	Tape Cassette Installation 2-3		
2-4	ASR/KSR Data Terminal External Connections 2-4		
2-5	TTY-Neutral Interface Wiring Diagram 2-6	4-1	Tape Data Format 4-1
2-6	TTY-Neutral Interface Wiring Diagram, Used for Receive Only 2-6	4-2	ASR Module Assembly (Upper Unit) Switch Panel 4-2
2-7	TTY-Polar Interface Wiring Diagram 2-7	4-3	Terminal On-Line/Off Switch and Power Switch 4-7
2-8	TTY-Polar Interface Wiring Diagram, Used for Receive Only 2-7	4-4	USASCII Keyboard Special Functions Keys 4-7
3-1	Internal Controls 3-2	4-5	Tape Tabs 4-8
3-2	Keyboard Layout and Symbolization, Standard ASCII 3-4	6-1	Model 733 Data Terminal, Internal Assemblies (Card Rack Cover Removed) 6-2
3-3	Unshifted Characters, Standard ASCII 3-5	6-2	Tape Transport Cleaning Areas 6-3

LIST OF TABLES

Table No.	Page	Table No.	Page
2-1	EIA Interface Cable Pin Functions 2-5	3-2	ASCII Code System and Character Set 3-4
2-2	Current Loop (TTY) Interface Cable Pin Functions 2-5	4-1	Tape Control Switches (Switch Panel Top Row) 4-3
2-3	Phone Line (Modem) Cable Pin Functions 2-5	4-2	Playback/Record Control Switches (Switch Panel Middle Row) 4-4
3-1	KSR and ASR Terminal Controls and Indicators 3-3	4-3	Device Function Switches (Switch Panel Bottom Row) 4-6

DEFINITIONS

The following words are defined to aid the reader who may be unfamiliar with ASR/KSR Data Terminal operation and data communication terminology. The list is certainly not a complete glossary, but simply an elementary guide to words common to this publication.

address — a specific location in a storage device.

baud — a unit of signalling speed equal to the number of signal events per second.

bit (binary digit) — the smallest unit of information in a binary system of notation.

block — a grouping of data (characters) to facilitate a particular operation; in the ASR a block consists of up to 86 characters stored in the buffer or on tape.

buffer — an intermediate storage device between magnetic tape and the electronics of the ASR Terminal; it groups data prior to recording on tape and provides speed conversions between the tape read/write and terminal electronics.

cassette, tape — a container facilitating operation, storage, and protection of magnetic recording tape.

character — symbols corresponding to alphabet letters, numerals, punctuation marks, spaces, and nonprinting control codes (e.g., line feed, carriage return).

code — a system of symbols representing data or instructions to ASR/KSR devices.

controller; record, playback — the electronics (logic) responsible for carrying out automatically and manually-initiated operating commands related to record and playback functions.

data — general term for any type of information.

duplex — describes two operations, such as sending and receiving, occurring on the same line or equipment; full duplex means simultaneous send and receive; half duplex means send or receive but not simultaneous.

line, on-line — describes cables, wires, telephone lines, etc. over which data is transmitted to and from the ASR/KSR; when connected to these lines, the terminal (or certain devices) is "on-line."

load — describes the operation of positioning a tape cassette at the "beginning of tape" marker for recording or playback operation.

local — operations within the data terminal itself, as opposed to on-line operations.

mark — a specific state of a binary bit on communication lines; equivalent to a logic ONE.

null — a specific character of the USASCII (00000000), code normally used as a time fill or media fill character.

playback (play back) — the act of transmitting data from magnetic tape through a buffer to the printer, line, recorder, or other device.

printer — mechanism which prints readable characters across a page; in the KSR, it includes the printhead, printhead carriage, paper-handling devices, and control electronics.

read — to sense information contained in some source such as tape or buffer.

read error — a playback malfunction caused by a missing flux reversal (bit dropout) which is in turn caused by dirty tape, defective tape, dirty head, equipment malfunction, etc.

read-only tape — a permanent tape recording used only for playback.

record — to put data into a storage device (tape, buffer, etc.)

serial — occurring sequentially with time; one after the other.

space — a code or character (nonprinting) to indicate an output space in which nothing is printed. Also with respect to communication lines a "space" is a specific state of a binary bit; it is equivalent to a logic ZERO.

transport, tape — a device which moves magnetic recording tape from one reel to another for playback, recording, erasure, rewinding, etc.

write — to record data in a storage device (tape, buffer, etc.)

SECTION I

GENERAL DESCRIPTION

1-1 INTRODUCTION.

This manual describes operation of the Silent 700 Electronic Data Terminal, Model 733, manufactured by the Digital Systems Division of Texas Instruments Incorporated. The manual contains information for installation, checkout, and operation of the basic unit. Optional equipment, terminal specifications, and a quick-reference terminal operation chart are presented in appendixes to this manual.

1-2 DESCRIPTION.

The Model 733 is designed to serve a wide variety of telecommunication applications requiring the USASCII code. The Model 733 KSR is a keyboard send-receive unit with selectable transmission speeds of 110, 150, and 300 baud (10, 15, or 30 characters per second). The Model 733 ASR is an automatic send-receive terminal utilizing the keyboard and printer of the KSR and two cassette magnetic tape units for automatic sending and receiving. Figure 1-1 shows photos of the ASR and KSR models.

The 733 is designed in several modular units: the keyboard, printer mechanism, and transmit/receive electronics of the KSR lower unit; and record and playback units and associated controls of the ASR upper unit.

- a. The standard 733 ASCII KEYBOARD permits manual typing operations and transmission of printable characters and operational codes in seven-level USASCII code. Full uppercase and lowercase capability is available as an option.
- b. The 733 PRINTER unit features a solid-state printhead with a 5 by 7 dot matrix of heating elements, paper-handling mechanism, and printhead movement devices.
- c. The transmit/receive electronics within the KSR control telecommunications with remote terminals or computers or local (no transmit/receive) operation.
- d. The RECORD section in the ASR upper unit controls recording of local (from the keyboard) or remote (from the telecommunication lines) messages on magnetic tape cassettes.
- e. The PLAYBACK section in the ASR upper unit controls playback of messages recorded on the magnetic tape cassettes for local use (printed out by the 733 printer unit) and/or transmission to remote terminals or other devices.

The Model 733 can be interfaced with Bell System data sets or other equipment having an EIA RS232C interface, or with acoustic couplers, Bell Data Access Arrangements, or Teletype current loops in an asynchronous serial by bit and character nature.

The basic features of the Model 733 ASR and KSR and their optional equipment (described in Appendix B) make them ideally suited for timesharing, point-to-point telecommunication, remote access, remote data entry, computer console, and similar applications.

A unique serial data bus provides switch-selectable simultaneous operation in local or on-line modes and the capability to accept optional features without changing the basic unit.

A self-contained power supply provides all power necessary to operate the terminal. The supply can be wired for either 115V or 230V operation, 50 to 60 hertz.

The Model 733 ASR includes a magnetic tape cassette system consisting of two cassette transports, a record controller, and a playback controller. Either of the two transports may be used with the record controller or the playback controller but must operate alone or in opposite modes; i.e., one in the record mode and the other in the playback mode.

The tape recording format is serial by bit and serial by character, 86 characters to a block. The recording system permits the operator to easily edit or correct any line of data being recorded. It also allows correction of previously recorded lines, and blocks may be added to, or deleted from, a tape using a tape duplicating process. In continuous tape format, maximum storage capacity of a cassette, using both sides, is 310,000 characters.

Data read from the tape is stored (one block at a time) in a buffer (memory) before being transmitted to a line or local device. The playback system allows data to be read from tape either continuously, a block at a time, or a character at a time. A block also can be reread any number of times;

this is particularly helpful when trying to recover data in which a read error is detected. If the playback operation stops because of a read error, the erroneous block just read can be either skipped, transmitted, or reread.



MODEL 733 ASR DATA TERMINAL

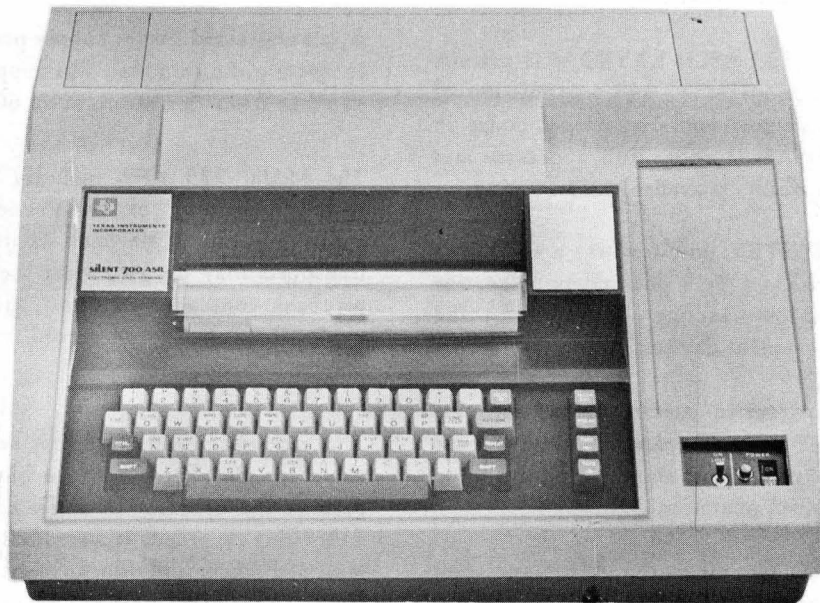

MODEL 733 KSR DATA TERMINAL

FIGURE 1-1. KSR/ASR DATA TERMINALS

SECTION II

INSTALLATION

2-1 VISUAL CHECK.

Visually check the data terminal before connecting the ac power cord. Check for any obvious shipping damage such as broken cassette windows, cracked or bent terminal cover, or packing material inside the case. Check to see that the terminal cover opens and closes freely. Remove the PC card rack covers of the ASR and KSR units as instructed in paragraph 6-3 and Figure 3-1, and visually check for foreign objects which could possibly short any of the circuits. Press down on the PC card ejectors of all cards to be sure they are plugged into their sockets tightly.

Before connecting the power cord, load paper in the terminal (see paragraph 2-3).

CAUTION

The printer should never be operated without paper on the platen (drive roller); damage to both platen and printhead could result.

Check that none of the connectors are loose. Also check that all keys on the keyboard operate smoothly without

binding. Lift the window and pinch roller (Figure 3-1) and manually move the printhead across its carriage to check that the printhead moves freely without interference.

2-2 POWER CONNECTIONS.

The normal power connection is 115 Vac, 50/60 Hz. Before plugging the power cord into a 230 volt outlet, be sure the terminal is wired for 230 volts. Figure 2-1 shows the connections at terminal block TB1 for 115 and 230V operation. TB1 is located under the card rack cover shown in Figure 6-1. For 230V operation replace fuse F1 at the terminal power cord exit (see Figure 2-4) with a Slo-Blo 1.5A, 250V fuse. Replace the power cord plug to match your 230V wall receptacle.

2-3 PAPER LOADING.

The terminal must be loaded with paper before applying power. Load the paper as follows (Figure 2-2):

- a. Open the terminal cover and lift the pinch roller. Do not turn the platen unless the pinch roller is lifted.
- b. Place a fresh roll of TI Silent 700® printing paper on the supply roll holders as shown in

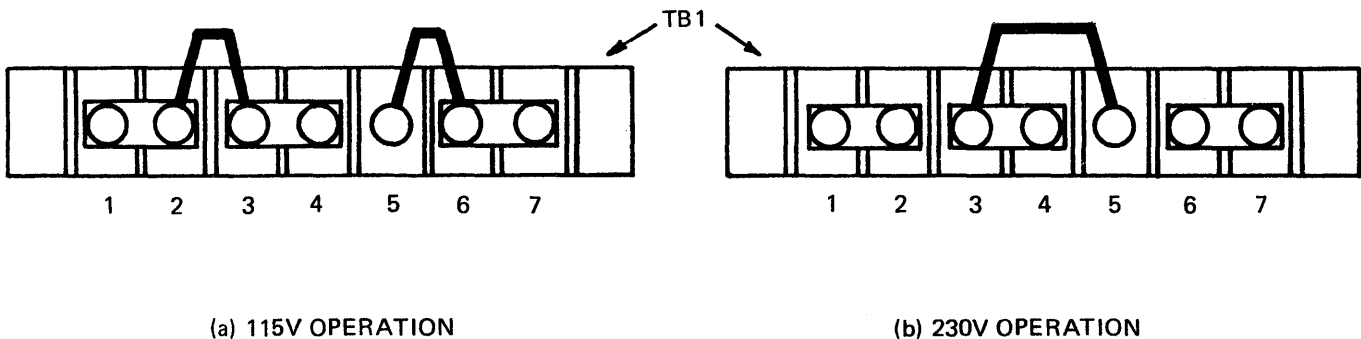

NOTE: TB1 is located under the Power Assembly Cover (shown in Figure 3-1). Fuse F1 at rear of terminal must be a 3A, 120V Slo-Blo or a 1.5A, 250V Slo-Blo, as appropriate.

FIGURE 2-1. 115V AND 230V CONNECTIONS AT POWER SUPPLY TERMINAL BLOCK TB1

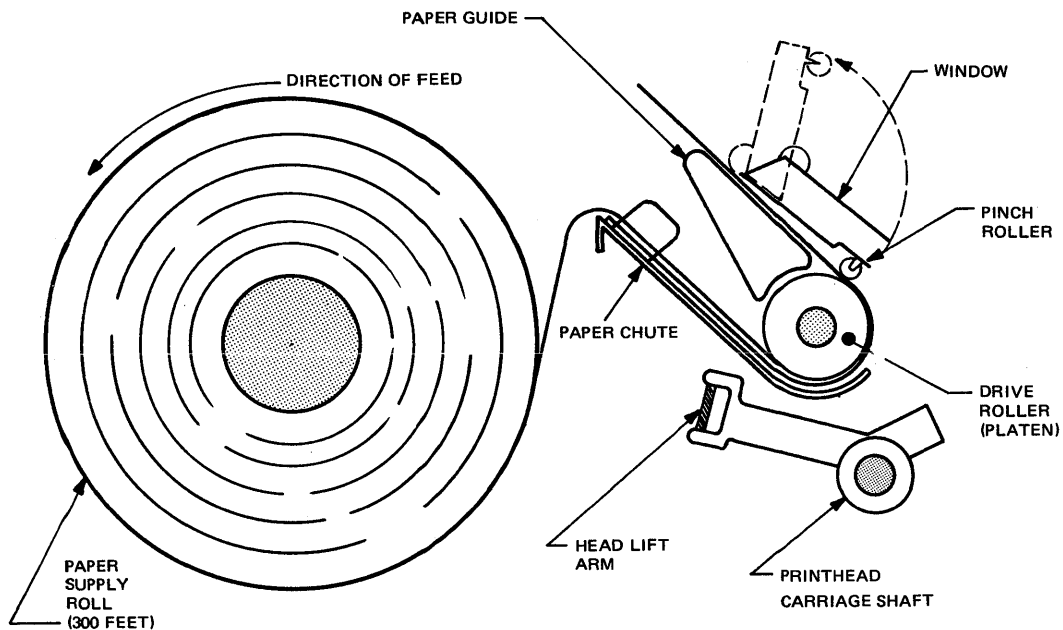

FIGURE 2-2. PAPER LOADING (SIDE VIEW)

Figure 2-2, checking that the roll can turn freely.

- c. Feed paper down the paper chute, then between the paper chute and drive roller as shown in Figure 2-2. Be sure the paper is centered in the paper chute.
- d. Lower the pinch roller, checking that the paper is between the pinch roller and the platen.
- e. Switch on power and depress the PAPER ADV key. Be sure paper is feeding smooth and straight. Tear off excess paper by pulling forward over the tear-off edge.
- f. Close the terminal cover, and check that the paper feeds through the slot in the cover and on to the rear of the terminal.

2-4 PRINTER AND KEYBOARD.

To check operation place the printer and keyboard in the LOCAL mode as follows: On the KSR, set the ON-LINE/OFF switch to OFF. On the ASR also set the

lower row of switches on the upper switch panel (Figure 4-2) to LOCAL. Check printer and keyboard operation by typing on the keyboard and checking that the correct characters are printed and that all keys operate.

2-5 CONTRAST SETTING.

To increase image contrast, rotate the contrast adjustment under the terminal cover (Figure 3-1) clockwise; to decrease, turn counterclockwise.

2-6 TAPE CASSETTE INSTALLATION (ASR ONLY).

Load cassettes as follows:

- a. Open the cassette transport door.
- b. Insert the tape cassette with the tape side up as shown in Figure 2-3.
- c. Press the tape cassette down and in, being sure that the capstan and reel rotors fit into the proper holes.
- d. Close the cassette transport door.

2-7 COMMUNICATION INTERFACE CONNECTIONS.

Connect interface cables at the rear of the terminal (lower right of Figure 2-4).

2-7.1 EIA (RS232C). A data set cable (TI Part No. 959372-0001) is used to connect the 733 ASR/KSR to an external data set. A standard RS232C-compatible 25-pin connector is provided at the end of the 6-foot cable. For pin assignments see Table 2-1.

2-7.2 CURRENT LOOP. A Teletype cable (TI Part No. 959384-0001) is used to connect the ASR/KSR to the

communication line. This cable consists of an edge connector for connection to the terminal with a 6-foot cable terminated with four spade lugs. For specific connections see Figures 2-5, 2-6, 2-7, and 2-8 and Table 2-2.

2-7.3 PHONE LINE CONNECTIONS. This connector (TI Part No. 959383-0001) is used to connect the 733 ASR/KSR with built-in modem option to a phone line. The 6-foot cable is terminated with two spade lugs for connection to the Bell System type-CDT Data Access Arrangement. For pin assignments see Table 2-3.

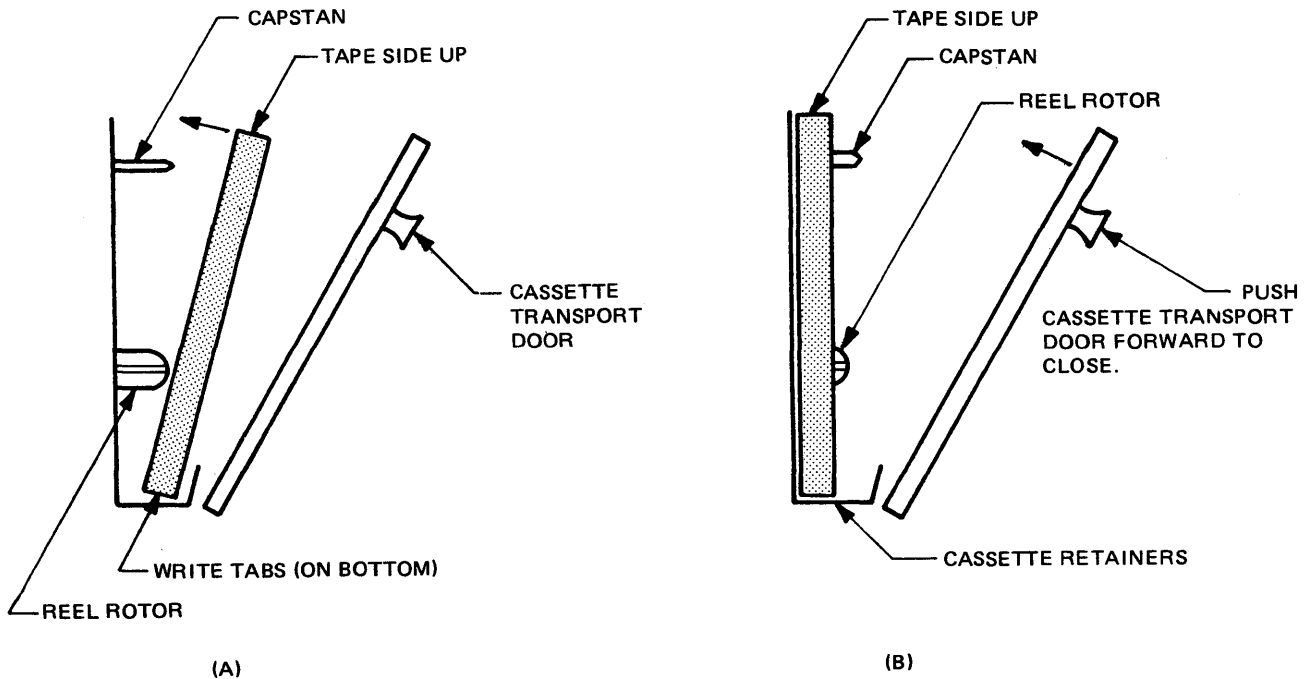
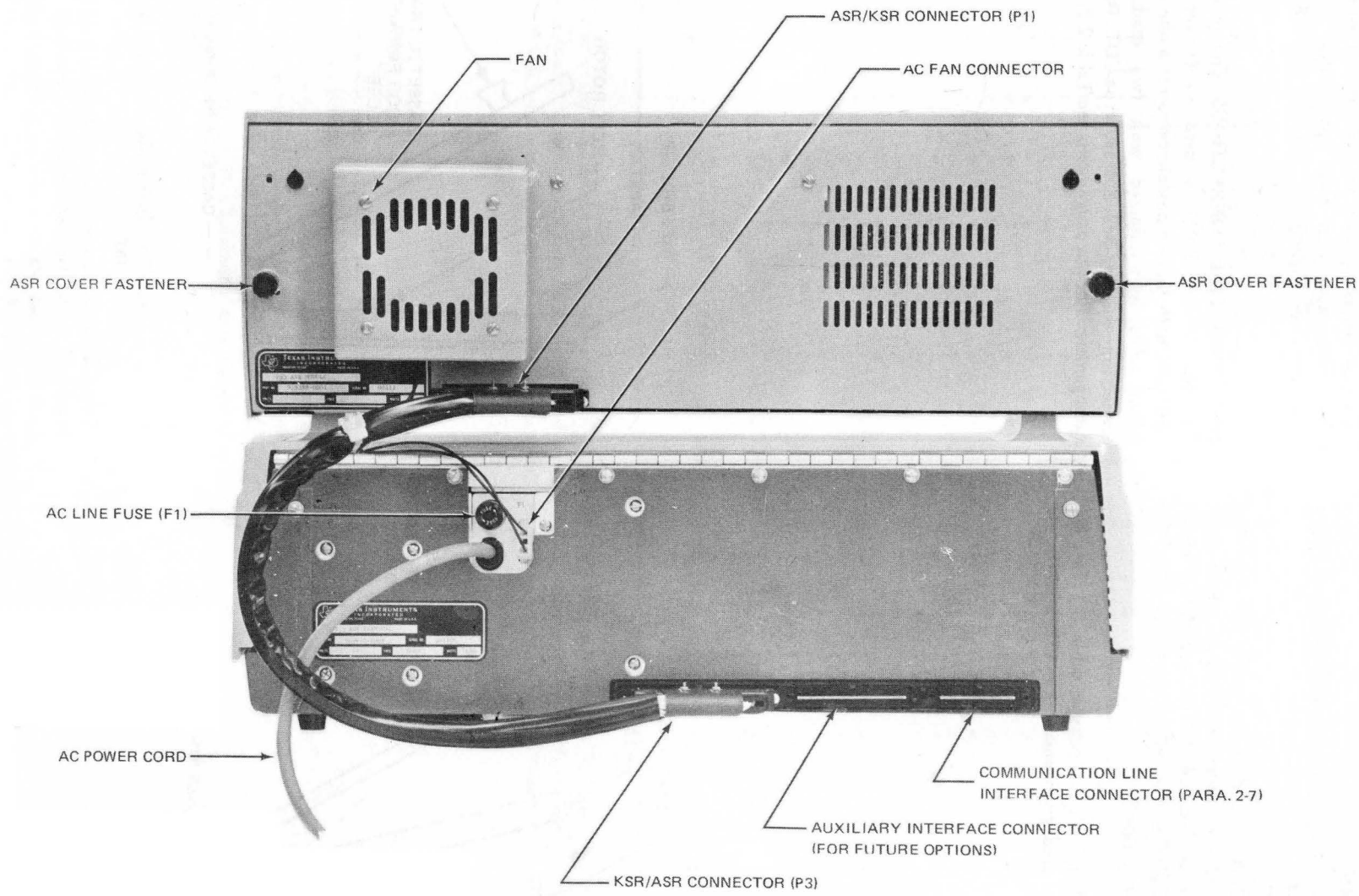

FIGURE 2-3. TAPE CASSETTE INSTALLATION



ASR/KSR REAR VIEW

FIGURE 2-4. ASR/KSR DATA TERMINAL EXTERNAL CONNECTIONS

TABLE 2-1. EIA INTERFACE CABLE PIN FUNCTIONS⁴
(CABLE 959372-0001)

Connector Pin Numbers		Pin Function
Terminal	Data Set	
6	20	Data Terminal Ready ¹
7	7	Signal Grounds
8	5	Clear to Send ²
9	6	Data Set Ready ³
10	3	Received Data
A	1	Protective Grounds
F	4	Request to Send ¹
H	2	Transmitted Data
K	8	Data Carrier Detects

NOTES:
¹Held to an ON condition by data terminal.
²Held to an ON condition by data set during transmission.
³Held to an ON condition when data set is operative.
⁴All are used only with external modem.

TABLE 2-2. CURRENT LOOP (TTY) INTERFACE CABLE PIN FUNCTIONS
(CABLE 959384-0001)

Terminal Pin No.	Wire Color at Spade Lug	Pin Function
4	White	Teletype positive receiver input loop
D	Green	Teletype receiver input loop
5	Black	Teletype transmitter output loop
E	Red	Teletype transmitter output loop

TABLE 2-3. PHONE LINE (MODEM) CABLE PIN FUNCTIONS*
(CABLE 959383-0001)

Terminal Pin No.	Wire Color at Spade Lug	Pin Function
C	Red	Communication line
3	Black	Communication line

*Used only with built-in internal modem option.

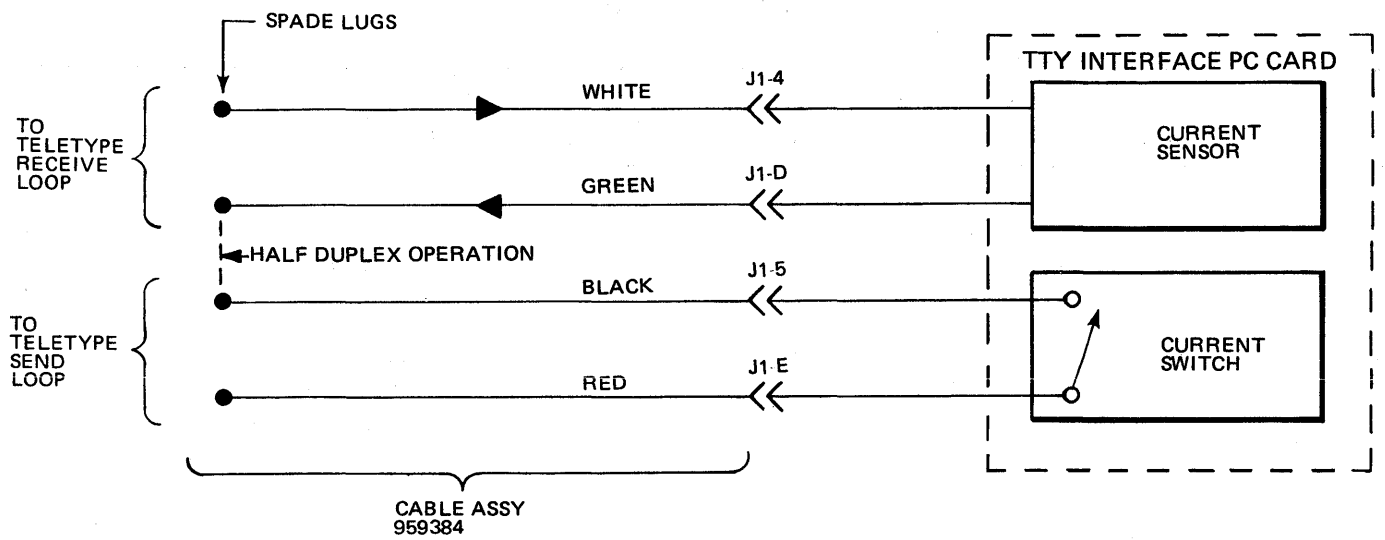

NOTE: SEE PARAGRAPH 2-7.2.

FIGURE 2-5. TTY-NEUTRAL INTERFACE WIRING DIAGRAM

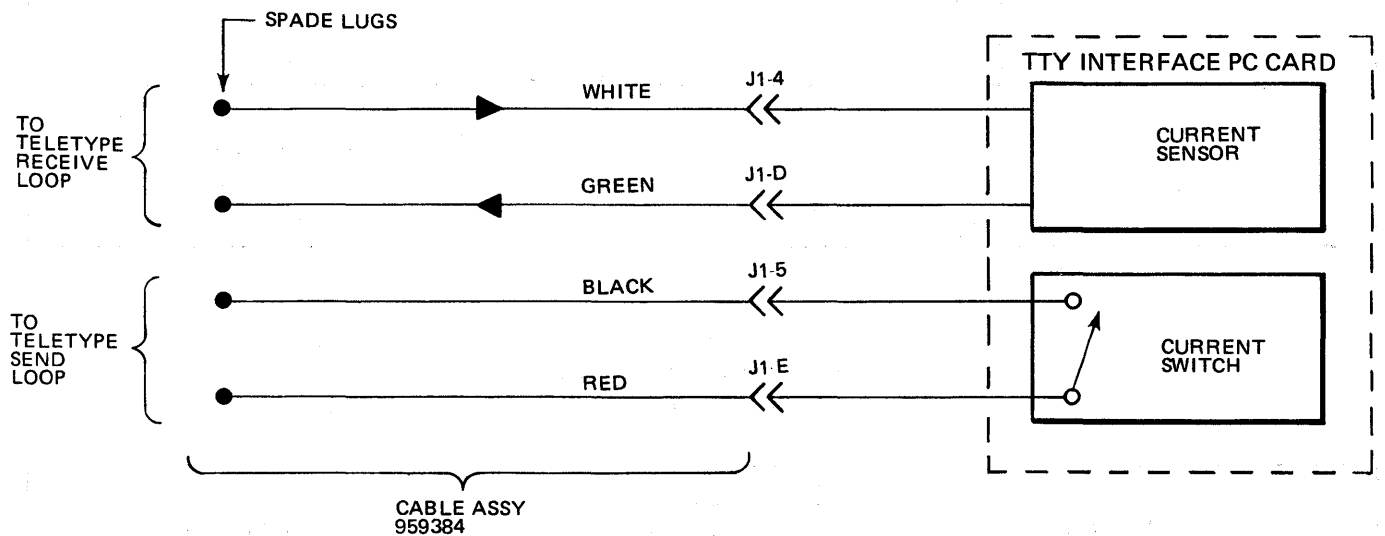

NOTE: SEE PARAGRAPH 2-7.2.

FIGURE 2-6. TTY-NEUTRAL INTERFACE WIRING DIAGRAM, USED FOR RECEIVE ONLY

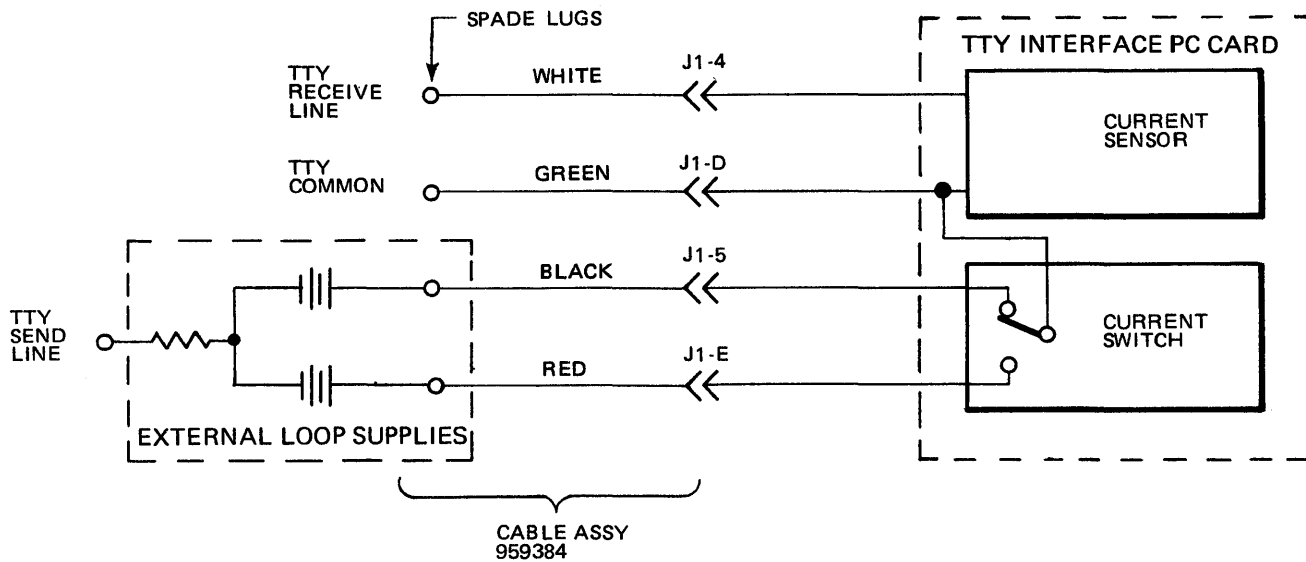

NOTE: SEE PARAGRAPH 2-7.2.

FIGURE 2-7. TTY-POLAR INTERFACE WIRING DIAGRAM

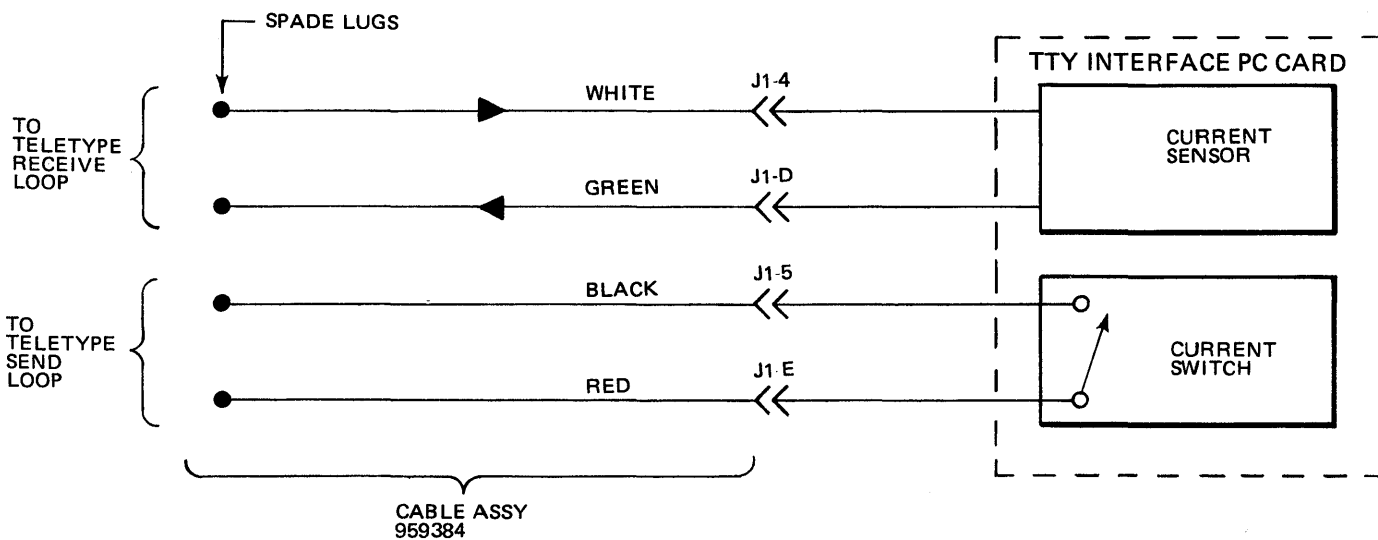

NOTE: SEE PARAGRAPH 2-7.2.

FIGURE 2-8. TTY-POLAR INTERFACE WIRING DIAGRAM, USED FOR RECEIVE ONLY

SECTION III
OPERATING PROCEDURES FOR KSR

3-1 GENERAL.

All operations described in this section apply to both the 733 KSR and ASR data terminals. Additional information needed to operate the ASR terminal is contained in Sections IV and V.

3-2 CONTROLS AND INDICATORS.

Controls and indicators are shown in Figure 3-1 and explained in Table 3-1. The keyboard is explained in paragraph 3-3 below.

3-3 KEYBOARD.

Standard USASCII keyboard codes (uppercase only) are shown in Table 3-2. Bits 1 through 7 are represented by b_1 through b_7 . Figure 3-2 shows keyboard arrangement; Figures 3-3 through 3-5 show characters and control codes generated using the SHIFT and CTRL keys.

The following special function keys are also on the keyboard:

REPEAT Used to repeat a character. Hold the REPEAT key down while the character to be repeated is momentarily depressed once. By depressing other characters in succession, these characters will be repeated in succession (REPEAT key held down).

SHIFT Depressed to type shifted characters shown in Figures 3-4 (lowercase is an option) and 3-6.

PAPER ADV Advances paper, returns the carriage to the left margin, and continuously feeds paper as long as depressed. No code is transmitted. LINE FEED and RETURN must both be used to obtain a conventional typewriter carriage return code to tape or line.

CTRL Depressed to generate control character codes shown in Figures 3-5 and 3-6.

HERE IS With the terminal set to ON-LINE, this key triggers the automatic Answer-Back Memory option. An answer-back message of up to 21 characters will be transmitted.

TAPE  Performs a local printer backspace; also used by the record controller in the ASR unit (no code is transmitted).

TAPE  Performs a local printer forward space; also used by the record controller in the ASR unit (no code is transmitted).

BREAK This key sends a continuous space as long as it is held depressed; used to interrupt a transmission to a remote on-line terminal.

3-4 PRINTER CONTROL CHARACTERS.

The following occur when the printer receives these printer control characters (Figure 3-2) from the line or the keyboard.

- a. BEL (bell) – the audible alarm is actuated.
- b. LF (line feed) – the printer advances one paper line without moving the printhead.
- c. CR (carriage return) – the printhead returns to the left margin. The paper is not advanced one line.
- d. BS (backspace) – the printhead is stepped one space to the left if not in column one.

Both LINE FEED and RETURN must be used to obtain a conventional typewriter carriage return code. Control characters are generated from the keyboard by pressing and holding the CTRL key, then the control character.

3-5 FULL AND HALF DUPLEX OPERATION.

In the half duplex mode with the terminal switch to ON LINE, only one operation, either transmit or receive, may occur during a given time. The terminal automatically locks out the transmitter as long as the receiver is receiving data continuously, or it automatically locks out the receiver as long as the transmitter is transmitting data continuously. In half duplex the printer prints both transmitted and received data from the external communication line.

In the full duplex mode with the terminal switch to ON LINE, the printer only prints data received from the external communications line and does not print data from the keyboard (or auxiliary devices). In other words, the transmitter and receiver operate independently and can be operated simultaneously. If the terminal is OFF line, the printer prints data transmitted by the keyboard.

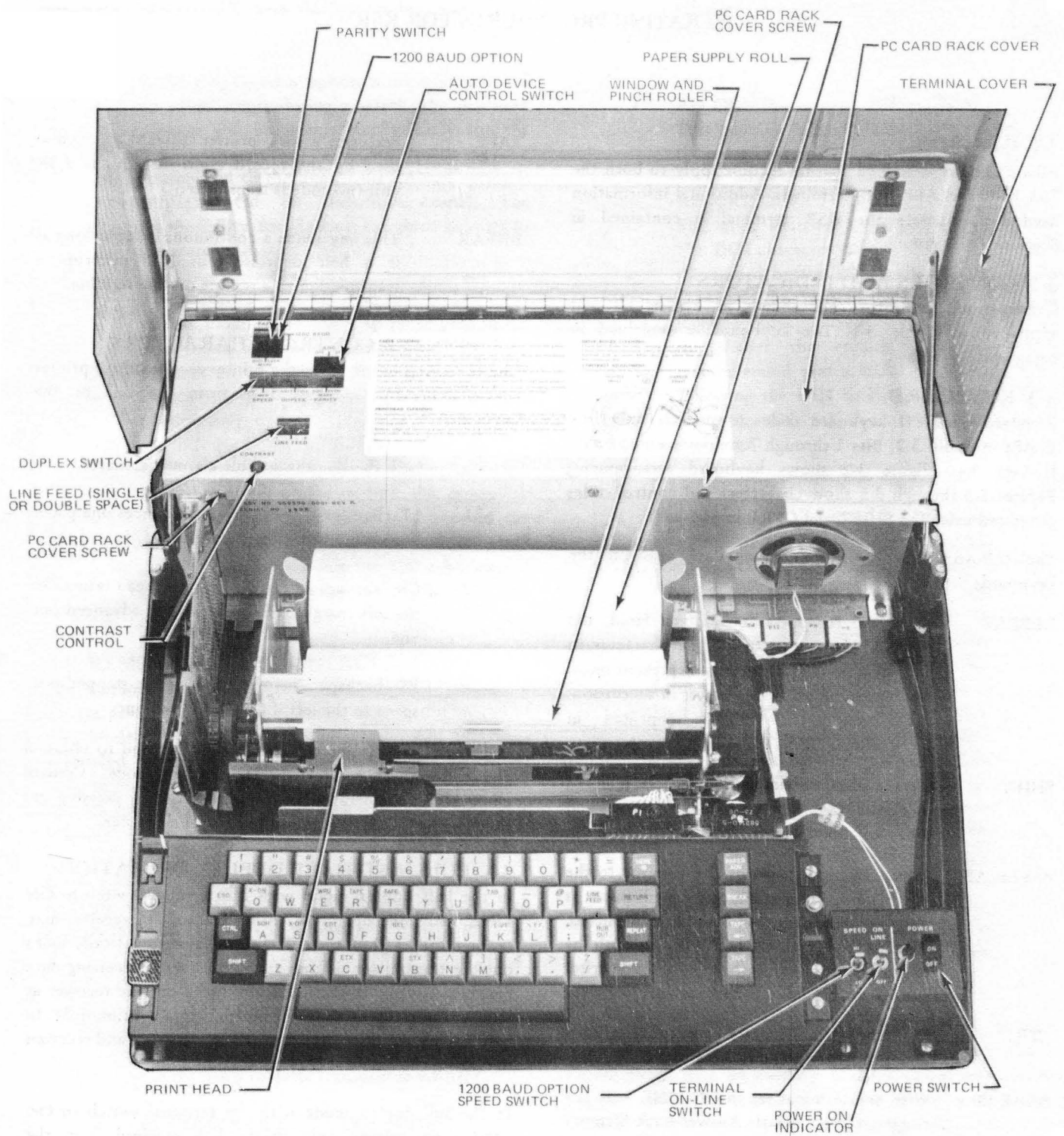





FIGURE 3-1. ASR/KSR CONTROLS AND INDICATORS

TABLE 3-1. KSR AND ASR TERMINAL CONTROLS AND INDICATORS

Control/Indicator	Function and Location (See Figure 3-1)
POWER Switch and Indicator Lamp	With the switch in the OFF (down) position, the high side of the power line is disconnected from all circuits in the terminal except the fuse. The adjacent "power on" lamp glows orange when the switch is in the ON (up) position. When initially applying power, or after a momentary power failure, a power-on reset circuit within the terminal resets and resynchronizes the terminal.
ON-LINE/OFF Switch	Located next to the POWER switch. Set to ON-LINE to connect the entire terminal to the external communications line. OFF disconnects the terminal from the line.
HALF/FULL DPX	Located under the terminal cover. Set to the left for half duplex and to the right for full duplex. See paragraph 3-5.
SPEED	Located under the terminal cover. Set to LO, MED, or HI for data transmission speeds of 110, 150, or 300 baud respectively. The speed selected must correspond to the input data line rate.
LINE FEED	Located under the terminal cover. Set to "1" for single space or "2" for double space paper feed.
CONTRAST	Located under the terminal cover. Rotate with a screwdriver clockwise to increase contrast and counterclockwise to decrease contrast.
PARITY	Located under terminal cover (Figure 3-1). Sets transmission parity to EVEN, ODD, or MARK (continuous marking).
SPEED HI/LO Switch	Located next to the POWER switch for use with the 1200 Baud Interface option. Set to HI for 1200-baud transmit/receive; set to LO for normal data terminal operation.
ADC OFF/ON	Located under the terminal cover. Set to ON to activate the Auto Device Control option and/or the Remote Device Control option.

TABLE 3-2. ASCII CODE SYSTEM AND CHARACTER SET

b ₄ b ₃ b ₂ b ₁	b ₇ → 0	0	0	0	1	1	1	1
	b ₆ → 0	0	1	1	0	0	1	1
	b ₅ → 0	1	0	1	0	1	0	1
0 0 0 0	NUL	DLE	SPACE	0	@	P	~	p
0 0 0 1	SOH	DC1	!	1	A	Q	a	q
0 0 1 0	STX	DC2	"	2	B	R	b	r
0 0 1 1	ETX	DC3	#	3	C	S	c	s
0 1 0 0	EOT	DC4	\$	4	D	T	d	t
0 1 0 1	ENO	NAK	%	5	E	U	e	u
0 1 1 0	ACK	SYN	&	6	F	V	f	v
0 1 1 1	BEL	ETB	'	7	G	W	g	w
1 0 0 0	BS	CAN	(8	H	X	h	x
1 0 0 1	HT	EM)	9	I	Y	i	y
1 0 1 0	LF	SUB	*	:	J	Z	j	z
1 0 1 1	VT	ESC	+	;	K	[k	{
1 1 0 0	FF	FS	,	<	L	\	l	
1 1 0 1	CR	GS	-	=	M]	m	}
1 1 1 0	SO	RS	.	>	N	^	n	~
1 1 1 1	SI	US	/	?	O	_	o	DEL

-  PRINTABLE CHARACTER
-  PRINTER CONTROL CHARACTER (See paragraph 3-4)
-  AUXILIARY DEVICE CONTROL CHARACTER (See paragraphs B-2 and B-4)
-  CODES GENERATED BY KEYBOARD, BUT NO ACTION TAKEN

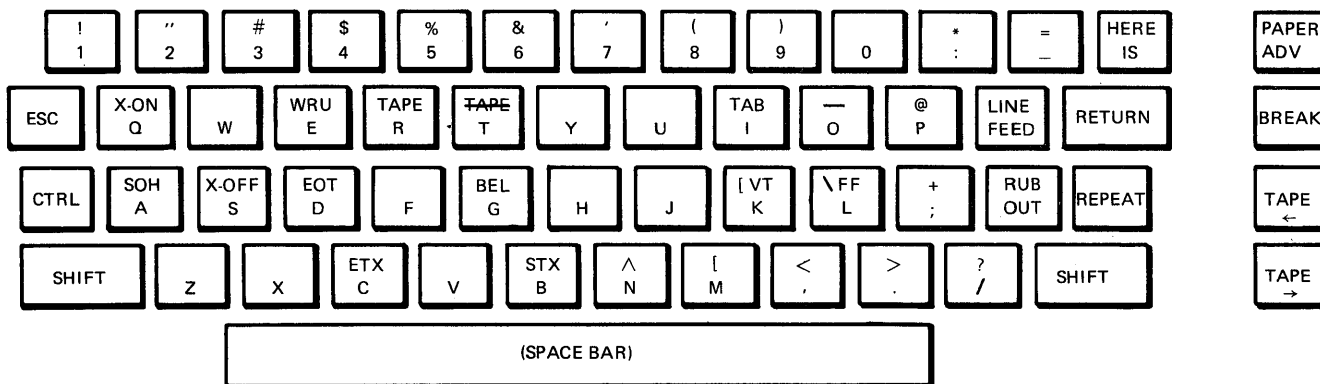
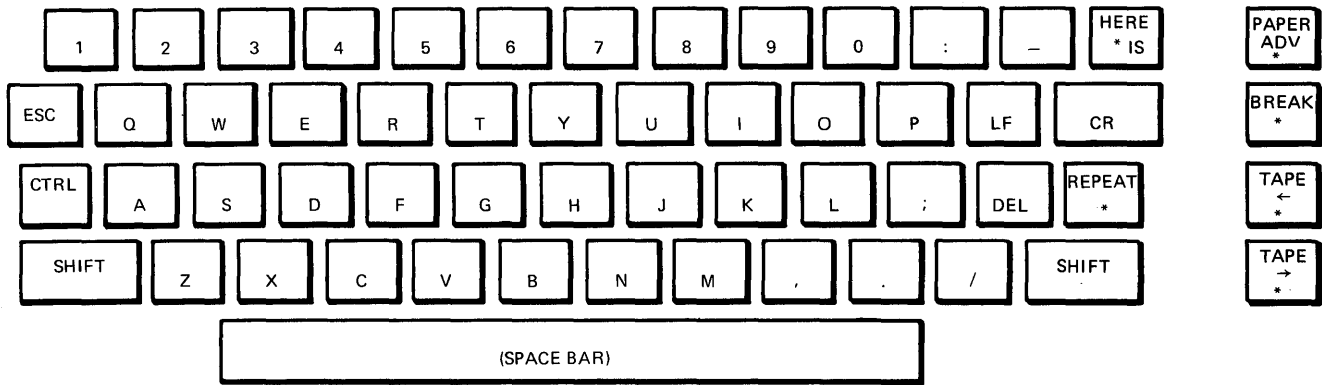

FIGURE 3-2. KEYBOARD LAYOUT AND SYMBOLIZATION, STANDARD ASCII



NOTES: The above codes are generated when the labeled key is depressed but neither the SHIFT nor the CTRL key is depressed.

* Indicates that it is not a code generating key.

FIGURE 3-3. UNSHIFTED CHARACTERS, STANDARD ASCII KEYBOARD

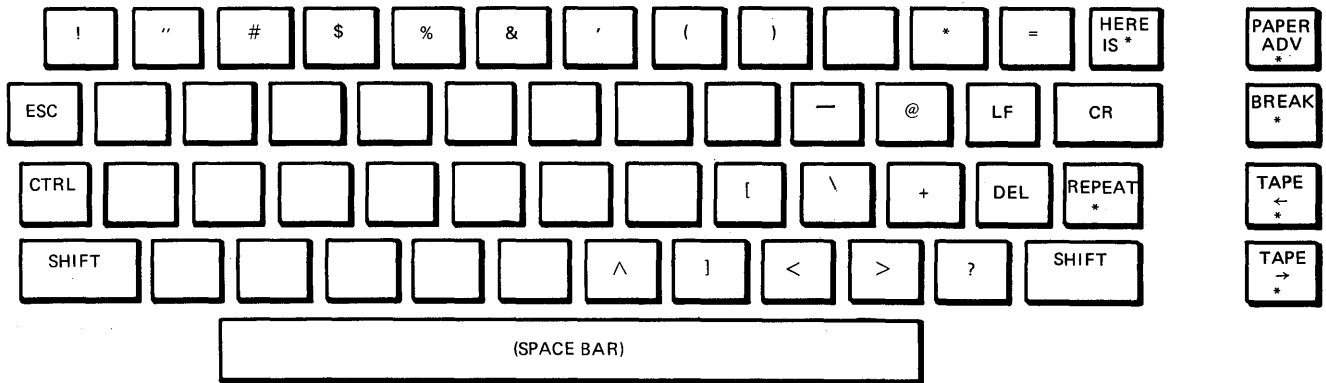

NOTES: The above codes are generated when the labeled key and the SHIFT key are depressed but the CTRL key is not depressed.

* Indicates that it is not a code generating key.

[] A blank key indicates a code is not generated when depressed.

FIGURE 3-4. SHIFTED CHARACTERS, STANDARD ASCII KEYBOARD

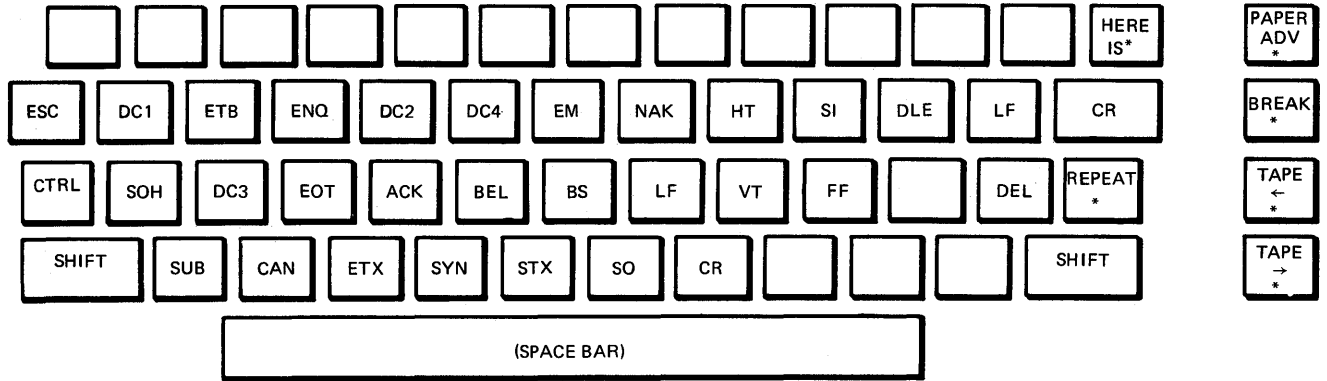

NOTES: The above codes are generated when the labeled key and the CTRL key are depressed but the SHIFT key is not depressed.

* Indicates that it is not a code generating key.

A blank key indicates strobe inhibit.

FIGURE 3-5. CONTROL CHARACTERS, STANDARD ASCII KEYBOARD

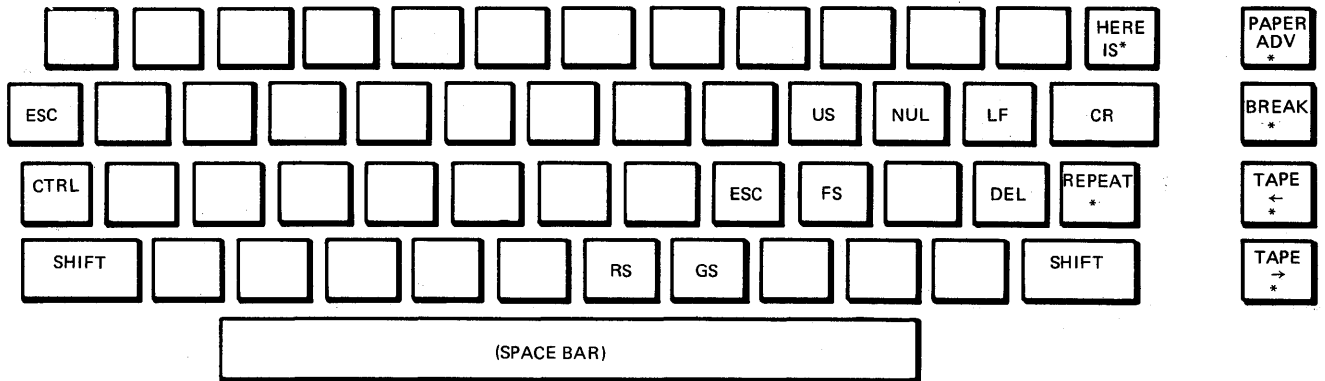

NOTES: The above codes are generated when the labeled key and the SHIFT key and the CTRL key are depressed.

** Indicates not a code generating key.

A blank key indicates strobe inhibit.

FIGURE 3-6. SHIFT AND CONTROL CHARACTERS, STANDARD ASCII KEYBOARD

SECTION IV

GENERAL INSTRUCTIONS FOR ASR OPERATION

4-1 GENERAL.

To completely understand 733 ASR Data Terminal operation, read Section III first. Operations applying to the KSR unit also apply to the ASR unit, and these common operations are covered in Section III. This section describes general operations and functions of the ASR Data Terminal. Specific step-by-step instructions for particular operations are contained in Section V.

4-2 DEFINITIONS.

The following terms are used throughout the instructions.

- a. **BLOCK** – In the LINE tape format a block generally corresponds to one printed line of up to 86 data and control characters, terminated by either a carriage return or the 86th character of the block. In the CONT (continuous) tape format, a block is always 86 characters long and may consist of several printed lines. Figure 4-1 shows the format of a block of tape recorded data.
- b. **RECORD AND PLAYBACK BUFFERS** – Recording and playback with tapes is done by blocks of characters, not by individual characters. In **PLAYBACK**, one block is transferred from tape to the playback buffer and then transmitted to the line, to tape (sent through the record buffer), and/or to the printer. In **RECORD**, one block is loaded in the record buffer (from the line, playback buffer, or keyboard) and then recorded on tape. The contents of the record buffer can be edited before recording. A buffer is an intermediary memory device in the ASR electronics.
- c. **PRINTED LINE** – One typed line consists of 80 or less characters; maximum length is 7.9 inches.
- d. **LINE, ON-LINE** – Data received from, or sent to, another terminal, computer, or other remote device is transmitted over a “line” or cable. When the data terminal is “on line,” it is sending or receiving data through a “line” or cable.
- e. **LOCAL** – When the data terminal or any of its separate functions (printer, keyboard, etc.) is not sending or receiving data over the “line,” it is operating “locally,” i.e., only within itself. Some functions can be on line while others are local at the same time.

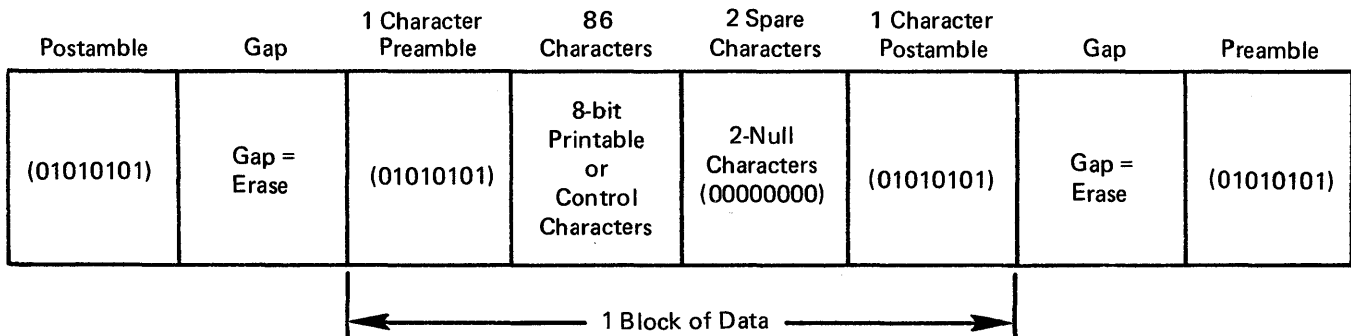

FIGURE 4-1. TAPE DATA FORMAT

4-3 CONTROLS AND INDICATORS.

The ASR has three primary control areas: (1) the ASR Module assembly display and control panel, (2) the ON-LINE/OFF and master power switches, and (3) the keyboard controls.

4-3.1 UPPER SWITCH PANEL. The ASR upper switch panel (Figure 4-2) controls the ASR major devices: keyboard, playback cassette, record cassette, and printer. The switch panel is divided into three rows, each corresponding to a major function:

- a. Top row: Tape mode and tape motion control
- b. Middle row: record and playback control and editing
- c. Bottom row: device functions (keyboard, record, playback, and printer) and their connections with an outside line or local loop.

A table in Appendix C summarizes typical ASR functions and the switch settings for each. The following paragraphs describe switch functions for each switch panel row.

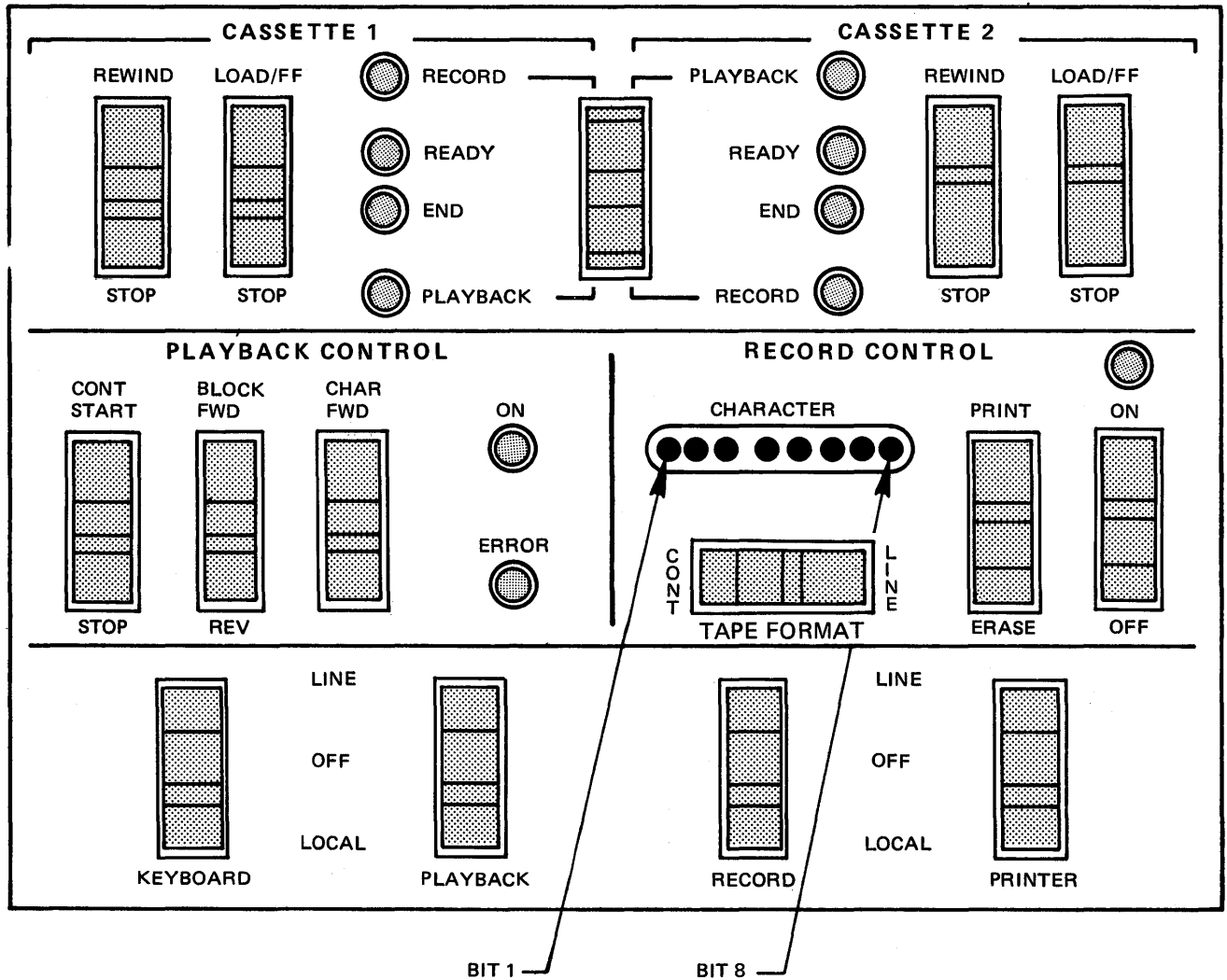

FIGURE 4-2. ASR MODULE ASSEMBLY (UPPER UNIT) SWITCH PANEL

4-3.1.1 Top Row, Tape Cassette Control. The cassette controls perform the following:

Select which tape cassette will be played back or recorded on

Rewind, fast forward, and load (ready) the cassettes

Describe tape position and readiness using indicators.

Table 4-1 lists functions of each top row switch.

- a. **Tape FAST FORWARD.**
Momentarily actuating the LOAD/FF switch after a load cycle has been performed (tape not on clear leader) causes the tape to move forward at high speed until STOP is actuated or the clear leader is sensed. The fast forward operation is useful in advancing the tape to the opposite end or for performing a tape search for editing purposes.

- b. **Tape REWIND.**
This switch is used to rewind a tape (with RECORD CONTROL to OFF). Actuating the REWIND switch of the desired transport causes the tape to slew at high speed toward the beginning of the tape until the STOP switch is actuated or clear leader is sensed.

Always rewind tape:

- a. After a tape is inserted in a transport
- b. After every initialization of power
- c. Before removing a tape from a transport
- d. Before switching off power to the terminal.

To rewind a tape which is on clear leader with the takeup reel (reel on the left) full and the END indicator illuminated, the REWIND switch must be depressed until the END indicator extinguishes. The tape is then past the clear leader.

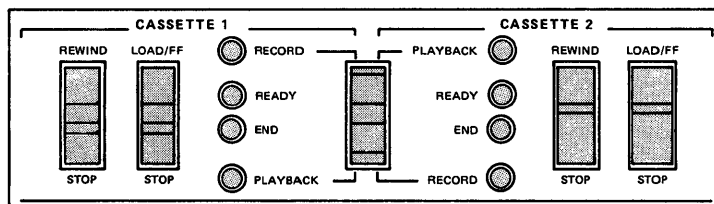

TABLE 4-1. TAPE CONTROL SWITCHES (SWITCH PANEL TOP ROW)

Switch/Indicator	Function
REWIND/STOP	REWIND causes the tape to slew toward the beginning-of-tape; continues until clear leader is sensed or STOP is pressed.
LOAD/FF/STOP	After rewinding to tape beginning, the cassette is "loaded" by pressing LOAD/FF. Tape moves forward to the beginning-of-tape marker, then stops. Pressing LOAD/FF again causes the tape to slew forward at high speed to the end-of-tape unless STOP is depressed.
NOTE	
REWIND and LOAD/FF are inoperative when RECORD CONTROL or PLAYBACK CONTROL (second row of switches) are ON (see paragraph 4-10).	
PLAYBACK/RECORD Switch	Selects which cassette is in playback mode or record mode (cassette 1 or 2); cassettes automatically switch to opposite modes.
PLAYBACK/RECORD Indicator Lamps	Indicate cassette is in playback or record mode.
END Indicator Lamps	Illuminate when clear leader is sensed at either end of tape.
READY Indicator Lamps	Illuminate when cassette is ready for applicable record or playback operation. Conditions are described in paragraph 4-4.4.c.

4-3.1.2 Middle Row, **PLAYBACK** and **RECORD** Controls.
Some of the functions performed by the **PLAYBACK** and **RECORD** controls are the following:

Allow print or erasure of blocks while recording

Start and stop tapes during recording or playback

Select whether recording will be in line or continuous tape format

Perform the edit functions. Editing is conducted in the **LOCAL** mode only (off-line).

Table 4-2 lists functions of each middle row switch.

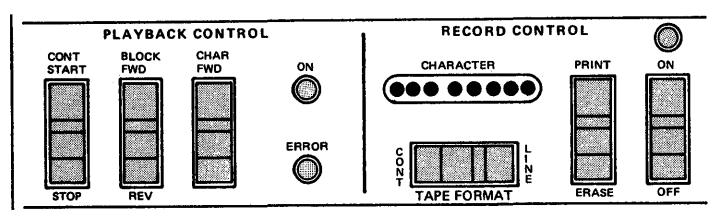

TABLE 4-2. **PLAYBACK/RECORD CONTROL SWITCHES (SWITCH PANEL MIDDLE ROW)**

Switch/Indicator	Mode	Function
CONT START/STOP		Momentarily pressing CONT START begins continuous playback of the cassette designated by the illuminated PLAYBACK light. Tape will stop when clear leader is sensed or STOP is momentarily pressed. This switch is further explained in para. 4-6.2.
BLOCK FWD/REV	P L A Y B	Momentarily pressing BLOCK FWD causes the next block on tape to be read and played back, or the remainder of a block should the playback of that block have been stopped in the middle. Momentarily pressing REV causes the tape to back up one block and stop (used in block locating).
CHAR FWD	A C K	Momentarily pressing CHAR FWD allows reading out the playback buffer one character at a time. If the buffer is empty, the next block will be entered in the buffer from tape, and the first character will be read. Character can be read on the CHARACTER display if duplicating a tape or on printer.
ON Indicator Lamp		Illuminates when PLAYBACK CONTROL is in use.
ERROR Indicator Lamp		Illuminates when a missing flux reversal on the tape is found during playback.

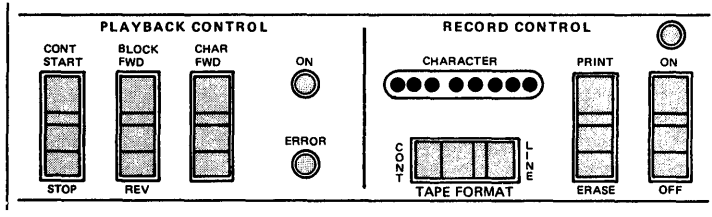

TABLE 4-2. PLAYBACK/RECORD CONTROL SWITCHES (SWITCH PANEL MIDDLE ROW) (Concluded)

Switch/Indicator	Mode	Function
CHARACTER Indicator Lamps		Shows 7-bit ASCII code (Table 3-2) of the character being addressed in the Record Buffer. Bits 1 to 8 read from left to right. Bit 8 is used internally by the terminal.
LINE/CONT (TAPE FORMAT switch)		This two-position switch controls the recording tape format. When the switch is in the LINE position, recording of data on tape is initiated by the ASCII carriage return character or the 86th character of each block. Therefore, each block of data normally corresponds to one line of printout on the printer. This format is especially helpful when preparing and/or editing a tape on the recorder. With the TAPE FORMAT switch in the continuous (CONT) position, recording of data on tape is initiated only by the 86th character of each block. Therefore, each block of data on tape may contain several lines of printout on the printer. This format is especially useful when maximum tape storage is desired. Tapes recorded in one format may be easily converted to the other format through the tape duplicating process (para. 4-9.1.c.).
PRINT/ERASE	R E C O R D	This switch is used to check record buffer contents during editing. The PRINTER and RECORD switches must be set to LOCAL. Contents of the record buffer will be printed out (but not recorded on tape) when PRINT is pressed (explained in para. 4-5.5); buffer contents will not be affected. Pressing ERASE will erase record buffer contents but not affect data recorded on tape (explained in para. 4-5.6). To erase an entire tape cassette, load tape in RECORD, press ERASE, press OFF, release OFF, release ERASE. Tape erasure will continue until OFF is again pressed. This is explained in para. 4-7.
ON/OFF		This switch turns on the recorder and RECORD CONTROL, allowing receipt of data, and turns off RECORD CONTROL, transferring contents of the record buffer (if any) to tape. If ERASE is pressed before or during actuation of OFF and OFF is released first, tape erasure will be initiated and continue until OFF is pressed again.
ON Indicator Lamp		Illuminates when RECORD CONTROL is in use.

4-3.1.3 Bottom Row, Device Controls. The functions of the major ASR devices are controlled by the bottom row of switches, as follows:

Select whether to connect the devices to the local loop or to the outside communication line (LINE, LOCAL)

Disconnect the devices from both the local loop and outside communication line (OFF).

Table 4-3 lists functions of each bottom row device mode switch.

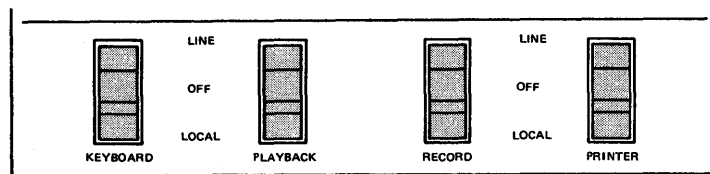

TABLE 4-3. DEVICE FUNCTION SWITCHES (SWITCH PANEL BOTTOM ROW)

Setting	Function
LINE/OFF/LOCAL	The LINE/OFF/LOCAL switches are used to connect the keyboard, playback, recorder, and printer to the local loop or to the line loop. Devices set to LOCAL are interconnected but not connected to the line loop. When the terminal ON-LINE/OFF switch adjacent to the keyboard is set to ON-LINE, devices set to LINE will be interconnected and also connected to the line loop if in half duplex. In full duplex, the keyboard and playback can be connected to the transmit line; and the recorder and printer can be connected to the receive line. Devices set to OFF are disconnected from both the line and local loops.

4-3.2 ON-LINE/OFF SWITCH (FIGURE 4-3). In ON-LINE, the terminal is set up to communicate with external devices through the line interface. The terminal transmits to the outside line from the keyboard or playback tape and receives data on the printer or recorder tape. In the ASR, local operation is normally controlled from the upper switch panel LINE/OFF/LOCAL switches (Figure 4-2) while the terminal ON-LINE/OFF switch remains set to ON-LINE. The ON-LINE/OFF switch is set to OFF when it is advisable to disconnect the entire terminal from the communications line. When set to OFF, the printer and keyboard are automatically set to the local mode if the upper switch panel PRINTER and KEYBOARD switches are set to either LINE or LOCAL. The playback and recorder, however, are held in the off state unless their bottom row LINE/OFF/LOCAL switches are set to LOCAL.

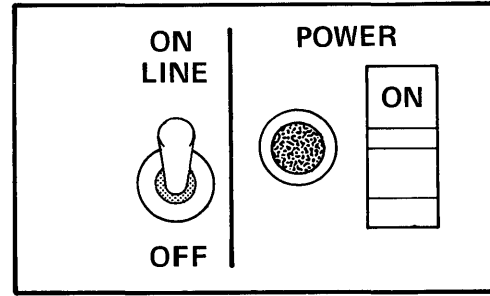

FIGURE 4-3. TERMINAL ON-LINE/OFF SWITCH AND POWER SWITCH

4-3.3 KEYBOARD CONTROLS. The standard USASCII keyboard special function keys are the following (see Figure 4-4). Other keys are described in Section III.

TAPE, TAPE

These two keys are used in the local mode to edit data in the record buffer. After placing characters in the record buffer, tape reverse (TAPE) backspaces to a character in error, then the character can be changed from the keyboard. To return to the point where the tape reverse was started, actuate tape forward (TAPE)

as many times as necessary. If the PRINTER switch is in LOCAL, the printhead will move with actuation of these switches to help locate the character. No code is transmitted.

HERE IS

Depressing this key with the terminal on-line and the KEYBOARD LINE/OFF/LOCAL switch to either LINE or LOCAL, activates the optional automatic Answer-back Memory, and the answer-back message (21 characters maximum) is transmitted to the line. The Answer-back Memory option is further explained in Appendix B.

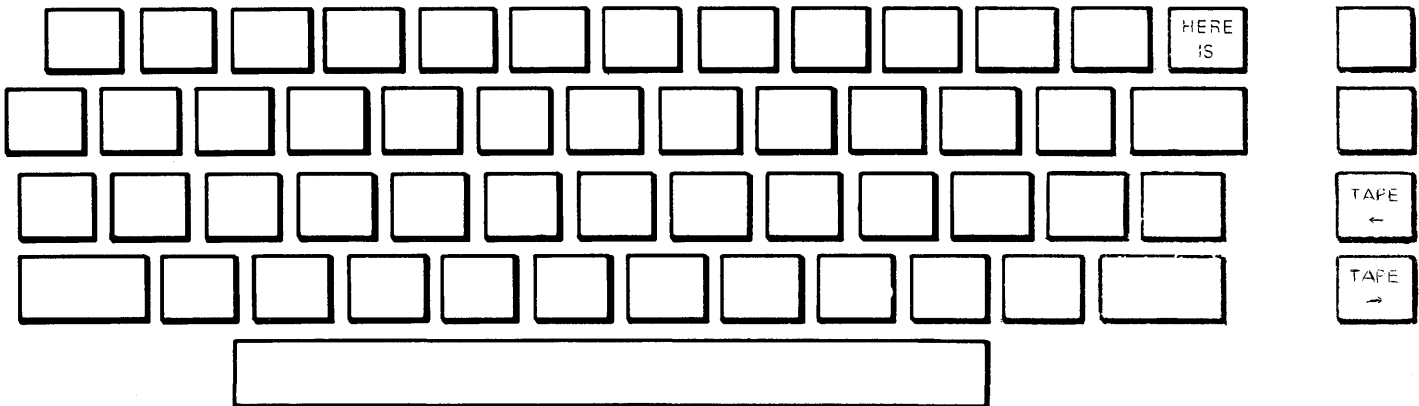

FIGURE 4-4. USASCII KEYBOARD SPECIAL FUNCTIONS KEYS

4-4 CASSETTE TAPE PREPARATION (TAPE LOAD) AND REMOVAL.

4-4.1 TAPE WRITE TABS. Before inserting a tape cassette into a transport, check the status of the write tabs on the bottom of the tape. If the tape is to be written on, the tab for the side of the tape to be written on should cover the hole in the cassette case; if it is a read-only tape, the tab should not cover the hole. Holding a tape cassette in front of you with the tape side up, the write tab for that side of the tape will be on the bottom right of the tape cassette. See Figure 4-5.

4-4.2 TAPE CASSETTE INSERTION. Insert the tape cassette into the selected transport as shown in Figure 2-3. The supply reel will be on the cassette right and the takeup reel on the left. If the tape is not rewound (END indicator illuminated and supply reel full), rewind after insertion.

CAUTION

Always rewind the tape before removing a tape or turning off power to ensure that no data "glitches" are written by accident, and that a minimum of dust and smudges will get on the tape. Following this precaution and keeping tapes in their cases when not in use will enhance tape cleanliness (and thereby data reliability).

4-4.3 TAPE CASSETTE REMOVAL. To remove a tape cassette from a transport, open the transport door outward to the first stop. A quick downward motion from that point should "pop" the tape out of the transport. Always rewind tape before removal or power turnoff.

4-4.4 CASSETTE "LOAD" AND TRANSPORT READY.

- a. After a tape has been properly inserted in a transport, momentarily press REWIND. The tape will rewind to the clear leader at tape beginning and the END light will illuminate.
- b. Perform a load operation to make the cassette ready for playback or record: momentarily press the LOAD/FF switch to load the tape. The tape will advance forward until the BOT marker is sensed, and the READY lamp will illuminate. A cassette in the record mode, without the write tabs in place, will not accept a load operation (see paragraph 4-4.1).

c. After a load operation, the transport is ready to record or playback data, provided the READY indicator for that transport is illuminated. Necessary conditions for the transport to be ready are as follows:

- (1) The cassette is in place.
- (2) The write enable tab is in place (record mode only). See paragraph 4-4.1)
- (3) The cassette transport door is closed.
- (4) The associated LINE/OFF/LOCAL control is set to LINE or LOCAL. If set to LINE, the ON-LINE switch at the power switch panel must be set to ON-LINE.
- (5) The end-of-tape clear leader is not sensed.
- (6) A fast-forward or rewind is not in progress.

If any of the first five of these conditions ceases to exist while an operation is in progress (condition 6 is locked out while operation is in progress), the operation is terminated, the record and/or playback buffers are cleared, and the control logic is reset (i.e., operation terminates).

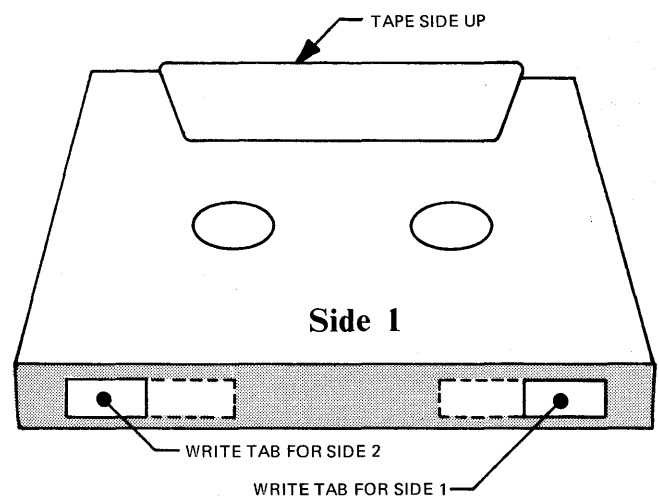

FIGURE 4-5. TAPE TABS

4-5 TAPE RECORDING OPERATIONS.

Before initiating a record or playback operation, check that the desired cassette is in the RECORD or PLAYBACK mode. If not, actuate the RECORD/PLAYBACK switch (top row of switch panel) as necessary (RECORD CONTROL and PLAYBACK CONTROL must be OFF, and there should be no tape motion). The state of each tape transport (playback or record) is indicated by the PLAYBACK and RECORD lamps and the READY and END (end of tape) lamps.

4-5.1 BLOCK RECORDING TECHNIQUE. The ASR records data on tape by blocks, with approximately six blocks per foot of tape, or 1800 blocks per 300-foot cassette. Each block of data is separated by an interblock gap (no data), with the following information included in each block:

- a. Preamble (8 bits)
- b. 86 eight-bit characters
- c. Two unused characters (8 bits each)
- d. Postamble (8 bits).

A block of data is terminated and recorded on tape from the record buffer after one of the following events:

- a. The 86th character in a block is entered into the record buffer (LINE or CONTInuous tape format).
- b. A carriage return is received by the record buffer (LINE tape format only).
- c. The RECORD CONTROL OFF switch (switch panel middle row) is actuated with data still in the record buffer (LINE or CONTInuous format). Unfilled character positions of that block are filled with null characters.

If fewer than 86 characters are entered into the record buffer prior to terminating a block, unused character positions in the block are filled with null (00000000) characters. If more than 86 characters are generated, the corresponding data is recorded in two or more blocks. If data is written on tape in line format (each block normally equals one printed line), editing of tapes is an extremely easy operation. Line and continuous formats are chosen by setting the TAPE FORMAT CONT/LINE switch (switch panel middle row).

4-5.2 RECORDING LIMITATIONS. In the LINE tape format, it is possible to receive data from the line at a faster rate than it can be recorded. For example, at 30 characters-per-second transmission rate, a carriage return can be sent (causing a block to be written) in ASCII code every 75 milliseconds. Record control takes 250 milliseconds to write each block initiated by a carriage return. Thus, if 3 or fewer characters are sent with carriage returns (in this example), data is being transmitted faster than it is being recorded (i.e., 3 characters times 75 msec = 225 msec or less time than it takes to record a block). Hence, data can be lost if some constraints are not placed on the maximum number of blocks (carriage returns) sent to the recorder in a given time.

A block counter within the cassette controller allows up to 16 blocks to be remembered, giving the recorder greater flexibility. If all blocks transmitted to the recorder require at least 250 milliseconds to transmit (250 milliseconds between carriage returns), the recorder will never lose data. If a string of blocks are to be transmitted which requires less than 250 milliseconds between them (less than 250 milliseconds between carriage returns), the following formula must be followed to prevent loss of data.

$$B < 4 T + 14.8$$

where,

- B = number of blocks (carriage returns) sent
 T = time in seconds to send B number of blocks or

$$\frac{\text{total characters}}{\text{characters per second rate}}$$

< = less than

4-5.3 CHARACTER DISPLAY. As data is entered into the record buffer, the USASCII code of the last character entered is displayed on the CHARACTER display. This display shows bit 1 (least significant bit) on the left and bit 8 on the right. USASCII codes are identified in Table 3-2.

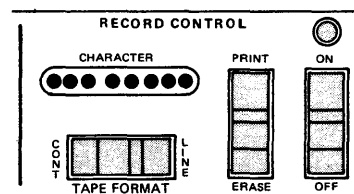

4-5.4 RECORDING THE BUFFER DATA. Data is recorded on tape from the record buffer by any of three actions:

- a. When a carriage return signal is received from the keyboard, line, or tape, the data in the buffer is recorded on tape. The TAPE FORMAT switch (switch panel middle row) must be set to LINE. In this manner, data is recorded in a line format, with the line terminated by a carriage return.
- b. If 86 characters are received in the record buffer (filling a data block), the data in the buffer will be written on tape when the 86th character is received in either line or continuous tape format. The 87th character will then become the first character in the next block. If set to LINE format (switch panel middle row), the contents of the record buffer will be recorded at carriage return, or will be recorded at the 86th character if no carriage return is received. If set to CONT format, the record buffer contents will be recorded on tape at the 86th character only.
- c. If the RECORD CONTROL ON/OFF switch is set to OFF, the data in the record buffer (if any) will be recorded on tape. In this way, short blocks (less than 86 characters) can be recorded without using the line format (with a carriage return) or recording a full 86-character block in continuous format.

In all cases, the block will be recorded on tape as 86 characters. The record control automatically fills out the block to 86 characters with null characters if there are less than 86 characters in the block.

4-5.5 INSPECTING CONTENTS OF RECORD BUFFER. If RECORD and PRINTER (switch panel lower row) are set to LOCAL, the contents of the record buffer can be printed out for inspection before recording on tape. By pressing PRINT (panel second row), the printer will print out the buffer contents. By using the keyboard and tape forward and reverse keys (TAPE, TAPE), the contents can be changed (explained in paragraph 4-5.8).

4-5.6 ERASING ENTIRE RECORD BUFFER. The contents of the entire record buffer (one block) can be erased by actuating the ERASE switch. This can be done only if RECORD is set to LOCAL. This operation clears the record buffer but does not affect data already on tape.

4-5.7 TERMINAL SETUP. Before initiating a record operation, check the following conditions:

- a. Set the terminal ON-LINE switch (adjacent to keyboard) and device mode switches (bottom row of switch panel) to the desired positions (LINE, OFF, or LOCAL). If a device is set to LINE, the terminal switch must be set to ON-LINE.
- b. The cassette tape is properly inserted and loaded (described in paragraph 4-4).

NOTE

If the cassette write tabs are removed, the tape will not load in the RECORD mode.

- c. Set the appropriate cassette RECORD/PLAYBACK switch (upper row, switch panel) to RECORD. The RECORD CONTROL switch must be OFF

To initiate recording, set the RECORD CONTROL to ON. If the ON indicator lamp does not glow, recheck the terminal setup.

4-5.8 EDITING WHILE RECORDING. When recording in the local mode from the keyboard to the tape or from tape to tape (duplication), changes can be made to the data in the record buffer (before recording on tape) using the **TAPE** and **TAPE** keys located on the keyboard.

- a. Set all four bottom row switch-panel switches to LOCAL.
- b. Load and ready tapes so that the READY lamps illuminate (paragraph 4-4.4). Set RECORD CONTROL to ON. Begin recording.
- c. To change a character, use the CHARACTER display to determine (in ASCII code) the character being "addressed." If recording from keyboard to tape with the printer, it will be the last character typed and will also be the character immediately to the left of the printhead. If a new character is entered, this character will be inserted immediately after the addressed character. For example, if you wish to change the "3" in the series "1234," use **TAPE** to read the "2" in the CHARACTER display (the left edge of the printhead will cover the 3 with the 2 showing immediately to the left). By pressing a new character, the 3 will

be changed. When a printable-character key is pressed, the printer first prints the character, then shifts one space to the new address.

- d. When at the correct address, type in the new character (or retype the remainder of the line). After changing one or several characters, use **TAPE** to return to the end of the line where typing can continue or the block can be entered on tape (use a technique in paragraph 4-5.1).
- e. New characters can replace old characters only on a character-for-character basis. If additional characters are to be inserted, retype the remainder of the line.
- f. If you wish to check the block before entering on tape, press PRINT (second row of switch panel). The buffer will be printed out, but buffer contents will not be affected. To print on a clean line with the printhead starting at the left margin, first press PAPER ADV (no code will be transmitted).
- g. To change an entire line, press ERASE (switch panel middle row), PAPER ADV (to return printhead to left margin), and retype new line.

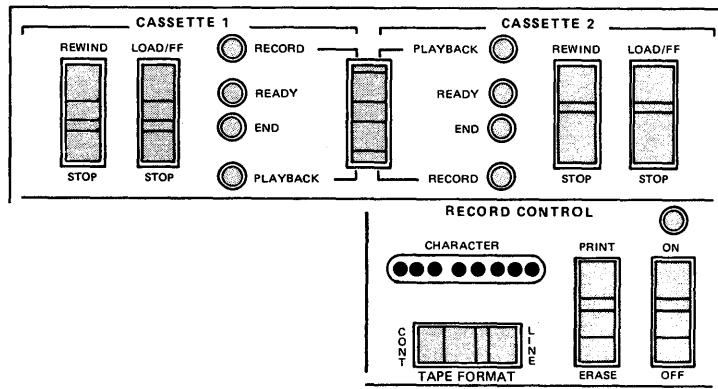

4-6 PLAYBACK OPERATIONS.

Before initiating a playback operation, check that the desired cassette is in the PLAYBACK mode. If not, actuate the RECORD/PLAYBACK switch (top row of switch panel) as necessary (RECORD CONTROL and PLAYBACK CONTROL must be OFF, and there can be no tape motion). The state of each tape transport (playback or record) is indicated by the PLAYBACK and RECORD lamps and the READY and END (end of tape) lamps.

4-6.1 TERMINAL SETUP. Check the following conditions:

- a. The POWER switch is ON.
- b. The terminal is functioning properly, with the terminal ON-LINE/OFF and device ON/OFF/LOCAL switches set as desired.
- c. The cassette tape is properly inserted and loaded (paragraph 4-4.4), and the desired cassette is in the PLAYBACK mode.

4-6.2 CONTINUOUS PLAYBACK. Momentarily actuate the CONT START switch and the tape will be read continuously until the (CONT) STOP switch is actuated, or the tape reaches the end (clear leader), or an error occurs. Procedures for errors are described in paragraph 4-8.

4-6.3 BLOCK FORWARD/REVERSE. To play back one block at a time, momentarily depress the BLOCK FWD switch. The next block on tape will be read and transmitted, and playback will stop. If an error is indicated, proceed as described in paragraph 4-8. The BLOCK FWD switch may be used to transmit the remaining contents of a block which has been terminated during playback by the CONT STOP switch. The block reverse operation is initiated by momentarily actuating the BLOCK REV switch. This will back up the tape one block and clear the contents of the playback buffer. No playback occurs.

4-6.4 CHARACTER FORWARD. Momentarily actuate CHAR FWD, and one character will be read out of the playback buffer. If the buffer is empty, the next block of

data will be transferred from tape to the playback buffer, and the first character will be read out of the buffer.

4-6.5 LOCATING A BLOCK ON TAPE. To locate a particular block of data recorded on a tape, proceed as follows:

- a. Set the PRINTER and PLAYBACK switches to LOCAL. Set the cassette to PLAYBACK.
- b. Momentarily press either the REWIND or LOAD/FF switch to advance or reverse the tape to the approximate location of the desired block.
- c. When the tape reaches the approximate location, stop the rewind or fast-forward operation by momentarily pressing the applicable STOP switch (REWIND or LOAD/FF).
- d. Press the BLOCK REV switch to set the tape to an interblock gap.
- e. Press the BLOCK FWD switch to print out the next block recorded on tape.
- f. If this printed block is still not near the desired block, repeat the above procedure starting with step b. If the printed block is near the desired block, use either BLOCK FWD or BLOCK REV to approach the desired block.

CAUTION

Always approach in the forward playback direction; i.e., use BLOCK REV to retreat past the desired block, then use BLOCK FWD to print out the block immediately before the desired block. Thus you will ensure being located at the beginning of the desired block.

4-7 ERASING A TAPE CASSETTE.

a. Set the cassette-to-be erased to RECORD (upper row of switch panel). Tape must not be at the beginning (clear leader); if so, perform a load operation (paragraph 4-4.4).

b. Hold the ERASE switch depressed and momentarily press the RECORD CONTROL/OFF switch. Release ERASE first then OFF.

c. To stop tape erase, momentarily press the RECORD CONTROL/OFF switch again.

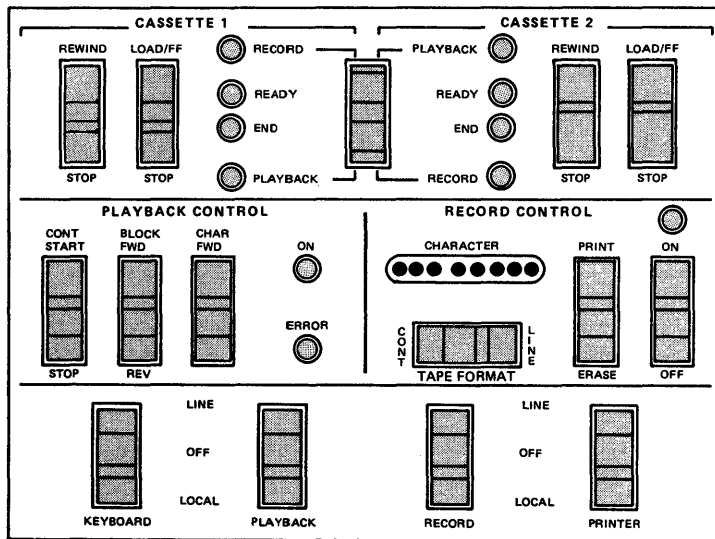

4-8 PLAYBACK ERROR PROCEDURE (OPTION).

If the stop-on-error option is incorporated, playback will stop and the ERROR lamp will light when a missing flux reversal is sensed. (This option is further discussed in Appendix B). When this occurs, use one of the following procedures.

4-8.1 REPLAY THE BLOCK.

- a. Press the BLOCK REV switch once. This backs up the tape to the start of the block and clears the playback buffer and ERROR indicator so that the block can be reread in any mode desired.
- b. Press CONT START to reread the block in question. Playback will continue if the error does not recur.
- c. Press BLOCK FWD to reread the entire block, and playback will stop prior to reading the next block. The block will not be transmitted, however, if the error recurs.

4-8.2 READ (TRANSMIT) THE BLOCK WITH AN ERROR. With the ERROR indicator illuminated, actuate the CONT START switch. The erroneous block will then be transmitted in the mode in effect before the error occurred. The data transmitted from an error block consists of true data to the point in the block at which the read error

occurred and null characters (00000000) from that point to the end of the block (total of 86 characters, true data and nulls).

4-8.3 SKIP THE BLOCK WITH AN ERROR. With the ERROR indicator illuminated, actuate the BLOCK FWD switch. Playback will bypass the erroneous block and continue in the mode in effect before the error occurred.

4-8.4 READ UP TO CHARACTER ERROR. To read data out of the playback buffer one character at a time up to the error, do the following:

- a. Use BLOCK REV to back up the tape to the start of the block in question.
- b. Press CHAR FWD (the ERROR indicator should illuminate).
- c. Press the CONT START switch to inhibit the ERROR indicator, and allow the playback controller to continue.
- d. Press CHAR FWD as many times as necessary to reach the error. The error point is that point in the block at which good data ends and only null characters (00000000) remain in the block.

4-8.5 CORRECT AN ENTIRE LINE. See paragraph 4-9.2.1.

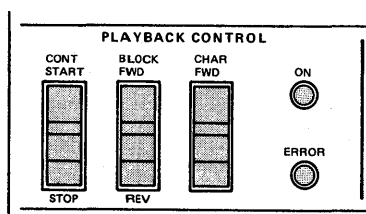

4-9 DUPLICATING A TAPE.

A tape may be duplicated in the local mode or in the line mode (ON-LINE/OFF switch to ON-LINE) in half duplex only. For discussion purposes, the tape being duplicated is called the "original tape," and the copy of that tape is called the "copy tape" herein.

4-9.1 DUPLICATION PROCESS. Load the cassettes into the tape transports, and proceed as follows:

- a. At the lower row of the switch panel, set the PLAYBACK and RECORD switches and the PRINTER switch (if hard copy is desired) to LOCAL unless desired to transmit while duplicating (then set to LINE).

NOTE

If set to LINE, make sure that the keyboard ON-LINE/OFF switch is set to ON-LINE and that the terminal is set to HALF DUPLEX (normally dictated by the communication line setup).

- b. Set the original tape (to be duplicated) to PLAYBACK (copy tape will be in RECORD).
- c. Set the TAPE FORMAT switch to the tape format desired for the copy tape. The copy tape can be recorded in either format using this switch.
- d. If high-speed duplication (LOCAL mode only) is desired, set the PRINTER switch to OFF or LINE. High-speed duplication is 250 characters per second maximum.
- e. Set RECORD CONTROL to ON.
- f. Press CONT START to begin tape duplication. Data will be transmitted from playback cassette (original tape) to record cassette (copy tape). Press (CONT) STOP to stop duplication.

4-9.2 EDITING WHILE DUPLICATING A TAPE. Information may be changed, added, or deleted while a tape is being duplicated. The KEYBOARD, PLAYBACK, RECORD, and PRINTER switches must be set to LOCAL during editing.

4-9.2.1 Changing a Block on Duplicate Tape.

- a. Start tape duplication (paragraph 4-9.1). Approach the block to be changed using the BLOCK FWD switch as in paragraph 4-6.5.
- b. Type in the new block. Terminate the block as in paragraph 4-5.4. Set RECORD CONTROL to

OFF, press BLOCK FWD, set RECORD CONTROL to ON. Press CONT START to continue duplicating. Thus, the new line is placed in the record buffer, then sent to tape at block termination. The old block which was substituted is moved out of the playback buffer (but not sent to record buffer); the next block for duplication is brought into the playback buffer; and the system continues duplication.

4-9.2.2 Change a Character During Duplication. To change one or several characters in a row during duplication, do the following. Changes will be made only on the copy tape, not on original tape.

- a. Start tape duplication (paragraph 4-9.1). Approach the block to be changed using BLOCK FWD as in paragraph 4-6.5.
- b. Press CHAR FWD to send characters to the record buffer. Characters will be shown in the CHARACTER display. When the character-to-be-changed is displayed, press tape reverse (TAPE), type in the new character. If no new character is entered, that character is deleted. Continue this correction process until all characters to be changed or deleted have been sent to the copy tape. To load the remainder of the playback buffer (if any) into the record buffer and record the corrected block, press BLOCK FWD.

NOTES

- (1) If too many characters in a block need changing, it is easier to retype the entire line. See paragraph 4-9.2.1.
- (2) At any time before the record buffer contents are recorded on tape, the contents can be printed out for checking to verify that the change was correctly made. Do this by pressing PRINT (the PRINTER switch must be on LOCAL).
- (3) If PRINTER is set to LOCAL, the printhead will move with each character sent by the playback control and with each actuation of the tape forward and reverse switches, one character at a time. The character immediately to the left of the printhead will be that displayed in the CHARACTER display.
- (4) In placing characters into the record buffer when a keyboard key is pressed, record control first moves to the next character address, then inserts the character. Thus, to change a character, the preceding character is addressed first (shown in the CHARACTER display), then the proper key is pressed.

4-10 CONTROL INTERLOCKS.

Numerous interlocks are incorporated into the system to protect both data and the tape cassettes.

4-10.1 RECORD MODE INTERLOCKS. A cassette transport in the RECORD mode is considered "busy" if it is performing load, rewind, or fast forward operation. It is also considered busy if RECORD CONTROL is ON or if the unit is erasing a tape. When one of the above functions is in progress, all others are inhibited. Further, a cassette-not-in-place or door-not-closed signal will inhibit all operations. If the cassette write enable tab is not present, all record operations on that cassette except rewind are inhibited. Fast forward (FF), RECORD CONTROL ON, and erase functions are inhibited if the END (end-of-tape) indicator is on.

4-10.2 PLAYBACK MODE INTERLOCKS. A cassette transport in the PLAYBACK mode is considered "busy" if it is loading or in fast forward, rewinding, reading data from the playback buffer, reading a block from tape, or backspacing (BLOCK REV) the tape. When one of the above functions is in progress, all others are inhibited. A cassette-not-in-place or door-not-closed signal within the electronics will inhibit all operations. Fast forward, reading from tape or reading from playback buffer, and tape backspace operations are inhibited if the END (end-of-tape) indicator is on.

4-10.3 OPERATING MODE INTERLOCKS. If RECORD CONTROL is ON or if the playback control is reading data or backspacing (BLOCK REV) tape, the cassette mode select switch (PLAYBACK/RECORD) is inhibited. In other words, a cassette transport cannot be switched from RECORD mode to PLAYBACK mode, or vice versa, if either the playback or record function is busy (ON).

4-10.4 TRANSPORT CONTROL INTERLOCK. When a cassette is in place, the reel on the right-hand side of the cassette is considered the supply reel, and the reel on the left is the takeup reel. Starting a load operation with the END indicator on and supply reel full, or starting a rewind operation with END indicator on and the takeup reel full, enables the motion control circuit to identify and remember the two different ends of the cassette. After this "tape orientation" occurs, a load operation with full takeup reel and a rewind operation with full supply reel are inhibited.

Inserting or removing a cassette tape which is not fully rewound is not recommended. However, when a partially rewound cassette is first inserted in a transport, a rewind or fast forward operation terminated automatically by sensing the clear end of the tape will enable the control logic to identify and remember the two ends of the cassette.

SECTION V

STEP-BY-STEP ASR OPERATING INSTRUCTION

INTRODUCTION

The instructions in this section of the manual are designed to provide simplified directions to accomplish specific ASR functions. The operator using these instructions must have some familiarity with the ASR Data Terminal; for example, the instructions assume that the operator knows how to insert the tape cassettes into the tape transports. The instructions also assume that the ASR Data Terminal is installed and connected to its on-line communications network; that the ON/OFF switch is ON; and that the SPEED, DUPLEX, PARITY, LINE FEED, and CONTRAST controls under the terminal cover are correctly adjusted.

GENERAL INSTRUCTIONS

1. PRESS means to depress the designated key or control momentarily and release. PRESS AND HOLD means to depress and hold the key or control until some stated action is completed.
2. Press the PAPER ADV key to return the printhead to the left margin and advance the paper. This action is not recorded or transmitted on the line.
3. Press both LINE FEED and RETURN at the end of a typed line to transmit on-line and/or record a conventional-typewriter line.
4. Press the T key for a backspace. This action is not recorded or transmitted on the line.
5. Press and hold the REPEAT key and then press the desired key to repeat a character; the character will then repeat as long as REPEAT is held depressed.
6. To generate a control character from the keyboard, press and hold the CTRL key; then press the control character key.

NOTE

White numbers appearing on the switch panel drawings in this section indicate the order and direction in which to activate the upper panel switches. The white numbers are the same as the numbers and order of the step-by-step instructions. An asterisk (*) indicates that the switch is used optionally or pressed more than once. Instructions not keyed to the drawings are numbered a., b., c., etc.

CONTENTS

FUNCTIONS		PAGE
5-1	LOCAL OPERATIONS.	
5-1.1	Record on Tape From Keyboard	5-2
5-1.2	Editing Blocks of Data on Tape	5-4
5-1.3	Play Back and Print Out Tape	5-6
5-1.4	Duplicate Tape and Print Out Original Tape	5-7
5-1.5	Duplicate Tape at High Speed	5-8
5-1.6	Erase Tape	5-9
5-1.7	Duplicate Tape and Edit Copy Tape	5-10
5-2	ON-LINE OPERATIONS.	
5-2.1	Keyboard to Line (No Printout)	5-12
5-2.2	Keyboard to Line and Print Out	5-13
5-2.3	Keyboard to Line, Print Out, and Record on Tape	5-14
5-2.4	Record on Tape From Line (No Printout)	5-15
5-2.5	Record on Tape From Line and Print Out	5-16
5-2.6	Print Out From Line (No Recording)	5-17
5-2.7	Play Back Tape To Line (No Printout)	5-18
5-2.8	Play Back Tape To Line and Print Out	5-19
5-2.9	Play Back Tape To Line, Print Out From Line	5-20
5-2.10	Simultaneously Send and Receive From Tapes to Line	5-21
5-3	SIMULTANEOUS LINE/LOCAL.	
5-3.1	Keyboard to Line, Print Out from Line, and Duplicate Tape	5-22
5-3.2	Play Back Tape to Line and Record on Tape From Keyboard	5-23

LOCAL OPERATIONS

5-1.1 RECORD ON TAPE AND PRINT OUT* FROM THE KEYBOARD. To record on tape from the keyboard of the ASR, complete the following steps.

On the ASR panel lower switch row, set

- (1) KEYBOARD to LOCAL
- (2) PLAYBACK to OFF
- (3) RECORD to LOCAL
- (4) PRINTER to LOCAL*

Insert a tape cassette into the CASSETTE 1 transport. Check that the write tabs are in place on the bottom of the cassette.

- (5) Set the RECORD CONTROL ON/OFF switch (middle row) to OFF.
- (6) Press the CASSETTE 1 RECORD switch.
- (7) Press the CASSETTE 1 REWIND switch.
- (8) When the END lamp lights, press LOAD/FF. The READY lamp should light after a few seconds.

- (9) Set the RECORD CONTROL ON/OFF switch to ON.
- (10) Set the TAPE FORMAT switch to CONT or LINE.

NOTE

The CONTInuous tape format conserves tape and permits recording the maximum number of characters per block of tape. The LINE tape format ends a block of characters and records it when carriage RETURN is pressed. LINE tape format requires more tape but permits easier editing.

Proceed to type from the keyboard. If you wish the tape to be recorded in conventional typewriter format with a carriage return and a line space at the end of every line, press both LINE FEED and RETURN at the point at which you want each typed line to end.

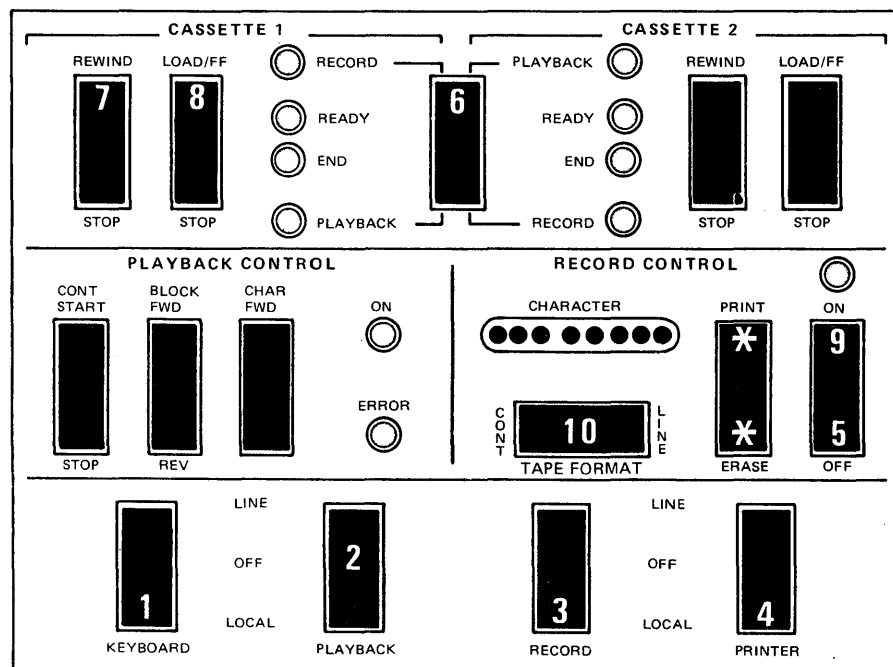

*If you do not wish a printout, set the PRINTER switch (lower row) to OFF.

LOCAL OPERATIONS

INSPECTING CONTENTS OF RECORD BUFFER.

Since a block of characters (up to 86 characters in CONT tape format, including spaces between words) is collected in the record buffer memory before it is recorded on tape, you may inspect the entire block before recording. Simply press PAPER ADVANCE to permit printing on a clean line of paper, and press the RECORD CONTROL/PRINT switch.

- a. To correct an error in the record buffer, use the TAPE key to back up the printhead over the incorrect character. "Strike over" the correct character and retype the remainder of the line.

—OR—

- b. Erase the entire record buffer by pressing the RECORD CONTROL/ERASE switch and retype the entire block.

REMOVING THE TAPE CASSETTE.

Upon completion of recording operations, it is advisable to remove and store the tape cassettes to prevent accidental erasure and to preserve cleanliness. Remove the tape cassettes as follows:

- a. Press the CASSETTE/REWIND switch.
- b. When the END lamp lights, pull open the cassette transport door. The cassette should pop out.
- c. Place the cassette in its container and store in a clean, dry location.

CORRECTING TYPING ERRORS.

If you discover a typographical error before a line is recorded on tape while typing in the LINE tape format, press TAPE until the left side of the printhead just covers the incorrect character. Then "strike over" the correct character and either retype from that point forward or press TAPE until the printhead just passes the last character typed before the error was discovered. This technique must be used *before* a carriage RETURN is used.

LOCAL OPERATIONS

5-1.2 EDITING BLOCKS OF DATA ON TAPE. If you wish to edit blocks or lines of data during the keyboard-to-tape recording process or after the tape is recorded, proceed as follows.

- (1) to (4) On the ASR panel lower switch row, set all four switches to LOCAL.

Insert the original cassette (the cassette to be edited) into CASSETTE 1 transport. Check that the write tabs are in place on the bottom of the cassette.

- (5) Set the RECORD CONTROL ON/OFF switch to OFF.
- (6) Press the CASSETTE 1 REWIND switch.
- (7) When the END lamp lights, press LOAD/FF. The READY lamp should light after a few seconds.
- (8) Press the CASSETTE 1 PLAYBACK switch. CASSETTE 2 will be in RECORD.

Insert a spare cassette (a "scratch" tape) into the CASSETTE 2 transport, and

- (9) Press the CASSETTE 2 REWIND switch.

- (10) When the END lamp lights, press LOAD/FF. The READY lamp should light after a few seconds.

Locate the block to be changed as follows.

- (11) Press CONT START to start tape playback and printout.

NOTE

You may use fast forward (LOAD/FF switch) to arrive at the tape recorded area of interest more quickly. To use fast forward, simply press LOAD/FF instead of CONT START in step (1) above. Press (LOAD/FF) STOP to stop the tape, and proceed with step (2) below.

- (12) When the printout nears the block to be edited, press (CONT) STOP.
- (13) Press BLOCK FWD to print out the remainder of the block. Press BLOCK FWD again as many times as necessary to arrive at the block to be changed. You may print out the block to be changed, then press (BLOCK) REV to retreat to the beginning of that block.

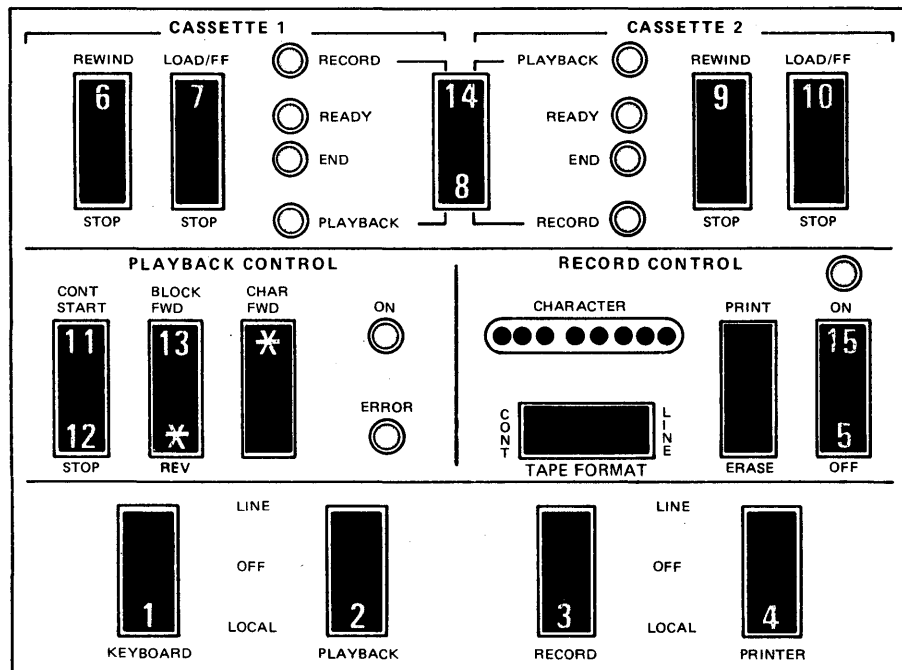

LOCAL OPERATIONS

When you are sure you are at the beginning of the block to be changed:

- (14) Set CASSETTE 1 to RECORD.
- (15) Set RECORD CONTROL ON/OFF (middle switch row) to ON. The ON lamp should light.

Type in a new block of data (up to 86 characters in CONT tape format, ended by pressing RECORD CONTROL OFF; or one line of type in the LINE format, ended by a LINE FEED and a carriage RETURN from the keyboard).

After the new block is typed, press RECORD CONTROL/OFF, press CASSETTE 1 PLAYBACK, and resume playback by pressing CONT START.

—OR—

(The following technique is possible only on a two-cassette ASR).

If you wish to change only one or a few characters on the recorded tape:

At the completion of step (13) above, proceed as follows:

- a. Set RECORD CONTROL to ON.
- b. Press CHAR FWD to print out one character at a time.
- c. When the character to be changed is printed, press TAPE and "strike over" the new character (and/or space).
- d. Press BLOCK FWD to print out the remainder of the line.
- e. Set RECORD CONTROL to OFF.
- f. Press BLOCK REV.
- g. Set CASSETTE 1 to RECORD.
- h. Press BLOCK REV.
- i. Set RECORD CONTROL to ON.
- j. Press BLOCK FWD.
- k. Set RECORD CONTROL to OFF.
- l. Set CASSETTE 1 to PLAYBACK and press CONT START (or BLOCK FWD) to resume playback.

NOTES

- a. If a typographical error is made while typing a line, backspace (TAPE) until the printhead moves back just over the character in error, then type in the correct character. Use TAPE to advance to end of line and continue typing: **DO NOT USE THE SPACE BAR TO ADVANCE!**
- b. If a string of blocks needs to be changed, change no more than five blocks at a time. After the fifth block set RECORD CONTROL to OFF, and set CASSETTE 1 to PLAYBACK. Verify correct location in the buffer by pressing BLOCK FWD to print out the sixth block, then BLOCK REV to relocate the tape at the start of block six. Then repeat step e. above.

CAUTION

Always approach in the forward playback direction; i.e., use BLOCK REV to retreat past the desired block, then use BLOCK FWD to print out the block immediately before the desired block. Thus you will ensure being located at the beginning of the desired block.

- c. If a new block is larger than 86 characters, it will require more than one block of space on tape and therefore will require duplicating the tape. Duplicating and adding a block or blocks is explained in paragraph 5-1.7.

LOCAL OPERATIONS

5-1.3 PLAY BACK AND PRINT OUT TAPE. You may play back a tape one block at a time (up to 86 characters including spaces and carriage returns) or continuously. To start the playback process, proceed as follows:

On the ASR panel lower switch row, set

- (1) KEYBOARD to OFF
- (2) PLAYBACK to LOCAL
- (3) RECORD to OFF
- (4) PRINTER to LOCAL.

Insert the tape cassette to be played back into the CASSETTE 1 transport. Be sure you load the side of the cassette you want played back toward you; each cassette has two sides.

- (5) Press the CASSETTE 1 PLAYBACK switch.
- (6) Press the CASSETTE 1 REWIND switch.
- (7) When the END lamp lights, press LOAD/FF. The READY lamp should light.

The ASR Data Terminal is now ready to start playback either continuously or one block at a time:

- (8) To play back and print out continuously, press the PLAYBACK CONTROL/CONT START

switch. The printer will print out all data on the tape until either the entire tape (one side) is played back, or until the (CONT START) STOP switch is pressed.

- (9) To play back and print out one block at a time, press the PLAYBACK CONTROL/BLOCK FWD switch. The printer will print out one block of data from the tape. Then press BLOCK FWD again for the next block. Continue pressing BLOCK FWD until all blocks you need are printed out.

Upon completion of playback operations, remove the tape cassette as follows:

- a. Press the CASSETTE 1/REWIND switch to rewind the tape to its beginning. This will protect and help preserve tape cleanliness.
- b. Pull open the cassette door. The cassette should pop out.
- c. Place the cassette in its container and store in a clean, dry location.

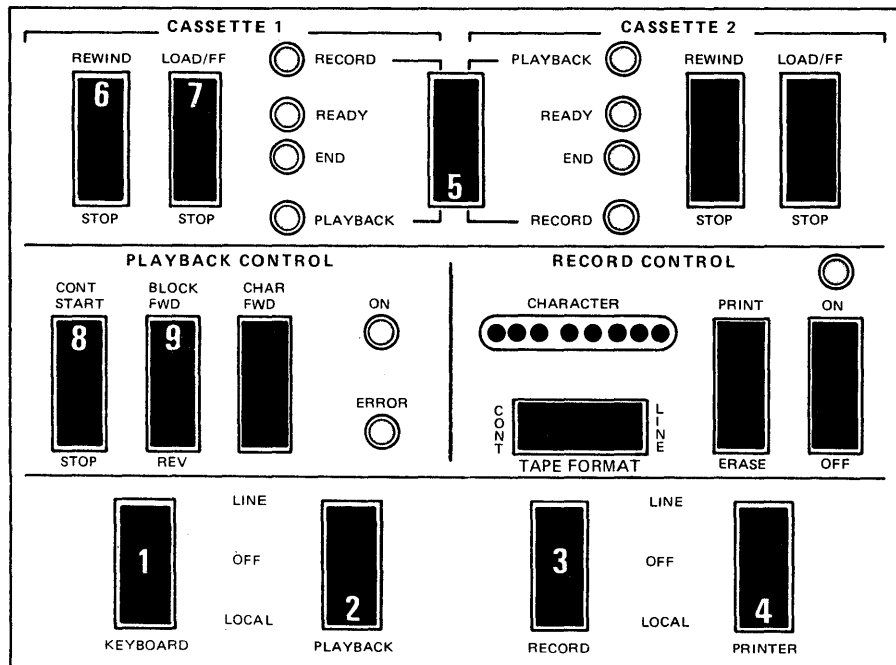

LOCAL OPERATIONS

5-1.4 DUPLICATE TAPE AND PRINT OUT ORIGINAL TAPE. To duplicate a tape and print it out at the same time (for editing purposes or for a hard copy), proceed as follows:

On the ASR panel lower switch row, set

- (1) KEYBOARD to OFF
- (2) PLAYBACK to LOCAL
- (3) RECORD to LOCAL
- (4) PRINTER to LOCAL

Insert the tape cassette to be duplicated (original tape) into the CASSETTE 1 transport.

- (5) Set RECORD CONTROL to OFF
- (6) Press CASSETTE 1 REWIND
- (7) When the END lamp lights, press LOAD/FF. The READY lamp should light after a few seconds.

Insert the copy tape cassette into the CASSETTE 2 transport, and:

- (8) Press CASSETTE 2 REWIND
- (9) When the END lamp lights, press LOAD/FF. The READY lamp should light after a few seconds.

- (10) Set CASSETTE 1 to PLAYBACK; CASSETTE 2 will be in RECORD.
- (11) Press the RECORD CONTROL/ON switch. The ON lamp should light.
- (12) Set the TAPE FORMAT switch to the tape format desired for the copy tape (LINE or CONTinuous).
- (13) Press the CONT START switch. Data will be transmitted from CASSETTE 1 to CASSETTE 2 and will be printed out on paper until the END lamps light.

NOTE

To stop the duplication process (for editing or other reason), press (CONT) STOP. To resume duplication and printout, press CONT START.

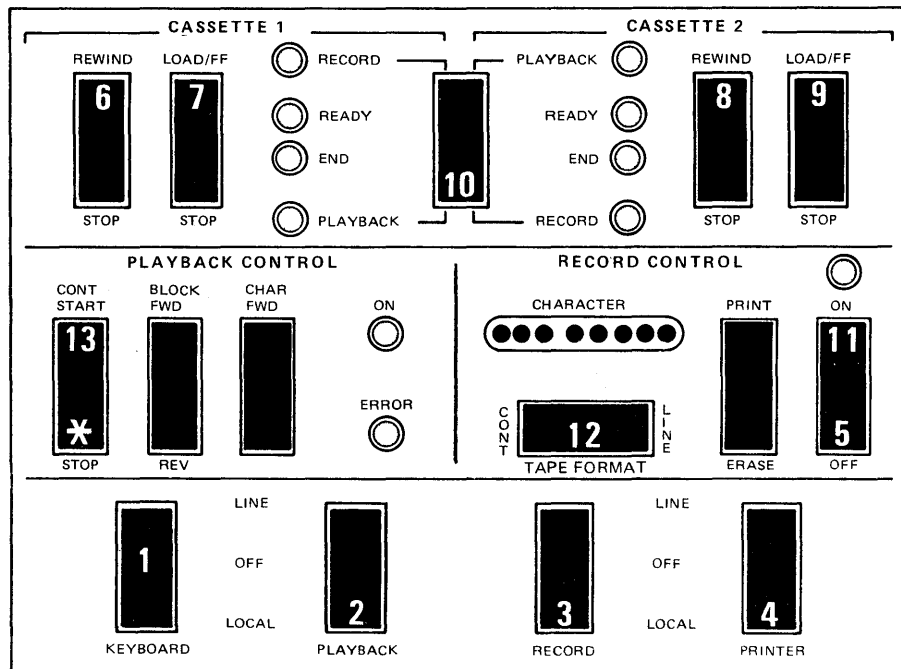

LOCAL OPERATIONS

5-1.5 HIGH-SPEED TAPE DUPLICATION (NO PRINTOUT). While duplicating a tape at high speed (250 characters per second, maximum), no other operations may be carried out. Proceed as follows for high-speed tape duplication.

On the lower row of the ASR panel, set

- (1) KEYBOARD to OFF
- (2) PLAYBACK to LOCAL
- (3) RECORD to LOCAL
- (4) PRINTER to OFF

Insert the tape cassette to be duplicated (original tape) into the CASSETTE 1 transport.

- (5) Set RECORD CONTROL to OFF
- (6) Press CASSETTE 1 REWIND
- (7) When the END lamp lights, press LOAD/FF. The READY lamp should light after a few seconds.

Insert the copy tape cassette into the CASSETTE 2 transport, and:

- (8) Press CASSETTE 2 REWIND

- (9) When the END lamp lights, press LOAD/FF. The READY lamp should light after a few seconds.
- (10) Set CASSETTE 1 to PLAYBACK; CASSETTE 2 will be in RECORD.
- (11) Press the RECORD CONTROL/ON switch. The ON lamp should light.
- (12) Set the TAPE FORMAT switch to the tape format desired for the copy tape (LINE or CONTinuous).
- (13) Press the CONT START switch to begin high-speed tape duplication. Data will be transmitted from CASSETTE 1 to CASSETTE 2 (original tape to copy tape) until the END lamps light.

NOTE
To stop the duplication process at any point, press (CONT) STOP.

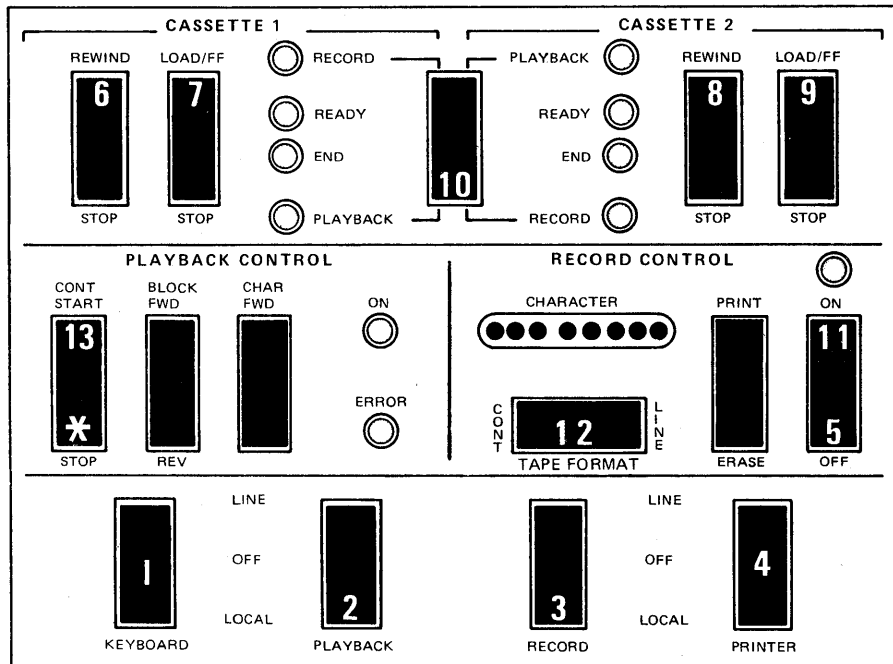

LOCAL OPERATIONS

5-1.6 ERASE A TAPE CASSETTE.

NOTE
The write tab must be in place on the bottom of the cassette to permit erasure.

To erase an entire side of a tape cassette, insert the tape cassette into either cassette transport.

- (1) Set RECORD CONTROL (middle row) to OFF.
- (2) Set the cassette to be erased to RECORD (upper switch row).
- (3) Press the REWIND switch of the tape to be erased.
- (4) When the END lamp lights, press LOAD/FF. The READY lamp should light after a few seconds.

- (5) Press-and-hold the RECORD CONTROL/ERASE switch and press the RECORD CONTROL/OFF switch. Release the ERASE switch. The tape side will be erased when the cassette END lamp lights.

NOTE
To stop tape erasure for any reason, press the RECORD CONTROL/OFF switch.

To erase the other side of the tape cassette, open the cassette transport door to pop out the cassette, and turn the cassette around so that the opposite side faces you. Reinsert into the cassette transport and repeat steps (1) through (5).

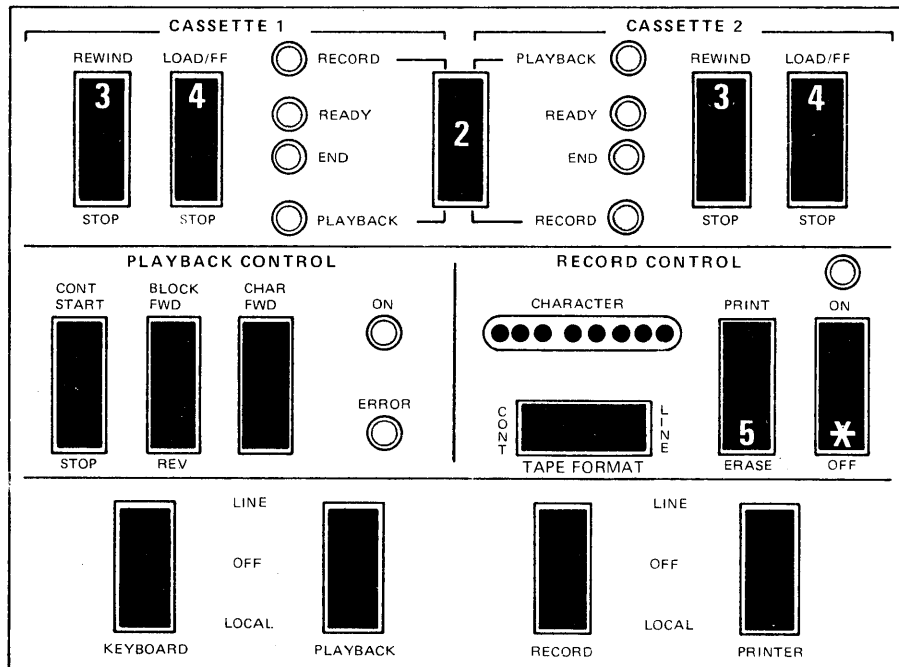

LOCAL OPERATIONS

5-1.7 DUPLICATE TAPE AND EDIT COPY TAPE.

Information on a tape cassette may be changed, added, or deleted while duplicating a tape. No other operations can be carried out while editing a tape, such as transmitting or receiving from the line.

Several degrees of editing are possible while duplicating a tape. One or several characters in a block may be changed, or an entire block or several blocks may be added or deleted. Load and ready the tape cassettes for duplication and editing as follows.

NOTE

All editing operations affect only the copy (duplicate) tape, not the original tape. The original tape will remain unchanged unless an operational mistake is made. If you wish to completely protect the original tape, remove the write tabs from the bottom of the cassette.

- (1) to (4) On the ASR panel lower switch row, set all four switches to LOCAL.

Insert the tape cassette to be duplicated (original tape) into the CASSETTE 1 transport, and

- (5) Set RECORD CONTROL to OFF
- (6) Press CASSETTE 1 REWIND
- (7) When the END lamp lights, press LOAD/FF. The READY lamp should light after a few seconds.

Insert the copy tape cassette into the CASSETTE 2 transport, and:

- (8) Press CASSETTE 2 REWIND
- (9) When the END lamp lights, press LOAD/FF. The READY lamp should light after a few seconds.
- (10) Set CASSETTE 1 to PLAYBACK; CASSETTE 2 will be in RECORD.
- (11) Press the RECORD CONTROL/ON switch. The ON lamp should light.
- (12) Set the TAPE FORMAT switch to the tape format desired for the copy tape (LINE or CONTInuous).

The data terminal is now ready to begin recording, printout, and editing functions. For the specific editing function required, see the following instructions.

ADDING BLOCK(S) OF DATA DURING DUPLICATION.

To add a block of data during tape duplication, you must stop the duplication process at the point on tape before the block to be added. *To do this, proceed from step (12) above as follows.*

- a. Press CONT START to start tape duplication and printout of the original tape.
- b. When the printout nears the block to be added, press (CONT) STOP.
- c. Press BLOCK FWD to print out and duplicate the remainder of the block.
- d. Press BLOCK FWD to duplicate and print out blocks one at a time until the tape reaches the block *before* the block to be added. When you are sure the tape is located at the beginning of the block to be added (the end of the previous block), type in the new block or blocks.
- e. Terminate each new block with a carriage RETURN, or press both LINE FEED and RETURN for a conventional typewriter carriage return (depending on tape format needed).
- f. When all new blocks are added, press CONT START to resume normal tape duplication and printout. To change later blocks in the tape, repeat steps b. through f. above.

NOTE

If a mistake is made while typing a new block, press TAPE (backspace) as many times as necessary until the printhead moves back just over the incorrect character. Then type in the correct character(s). Press TAPE (forward space) to return to the point where you stopped or retype the remainder of the block. Do NOT use the space bar to advance to the original point; press only the TAPE key!

LOCAL OPERATIONS

DELETING BLOCK(S) OF DATA WHILE DUPLICATING TAPE.

To delete a block or several blocks of data from the copy tape while duplicating a tape, proceed from step (12) above as follows:

- a. Press CONT START to begin tape duplication and printout of the original tape.
- b. When the printout nears the block to be deleted, press (CONT) STOP.
- c. Press BLOCK FWD to print out and duplicate the remainder of the block.
- d. Press BLOCK FWD as necessary to print out and duplicate blocks one at a time until the tape prints out the block *before* the block to be deleted. When you are sure the tape is located at the end of the block before the block(s) to be deleted, proceed as follows:
 - (1) Set RECORD CONTROL to OFF.
 - (2) Press BLOCK FWD once for each block(s) to be deleted. Set PRINTER to OFF if you do not want to print the deleted block(s).
 - (3) Set RECORD CONTROL to ON (and PRINTER to LOCAL if you wish to resume printout) and press CONT START to continue tape duplication.

Repeat steps (1) and (2) above for each block or group of consecutive blocks to be deleted.

CHANGING SINGLE CHARACTERS WHILE DUPLICATING TAPE.

To change one or more characters on the copy tape while duplicating (the original tape will not be changed), proceed from step (12) above as follows:

- a. Press CONT START to begin tape duplication and printout of the original tape.
- b. When the printout nears the block to be deleted, press (CONT) STOP.
- c. Press BLOCK FWD to print out and duplicate the remainder of the block.
- d. Press CHAR FWD until the character to be changed is printed out, then:
 - (1) Press TAPE and "strike over" the new character(s) or space.
 - (2) Press BLK FWD to print out and record the remainder of the line.
 - (3) Press CONT START to resume continuous duplication, or press BLK FWD to print out and duplicate one block at a time.

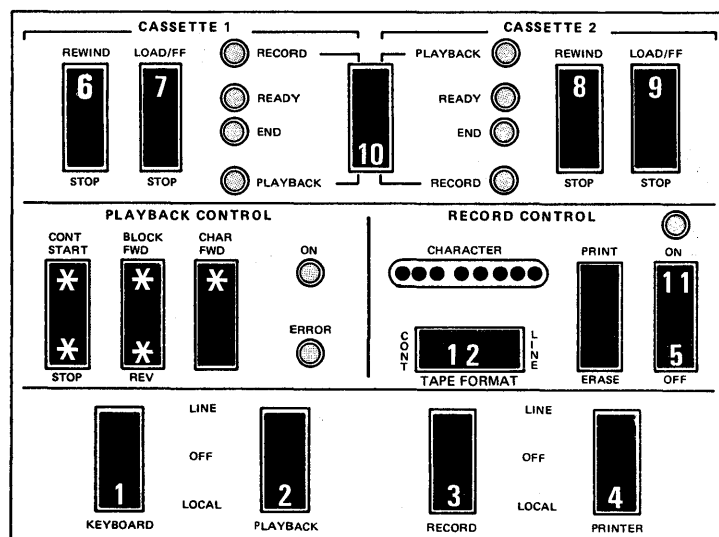

ON-LINE OPERATIONS

5-2.1 **KEYBOARD TO LINE (NO PRINTOUT)**. To transmit data over the line from the keyboard with no printout on the ASR printer, proceed as follows.

- (3) RECORD to OFF
- (4) PRINTER to OFF
- (5) Set the terminal ON-LINE/OFF switch (to right of keyboard) to ON LINE.

On the ASR switch panel lower row, set

- (1) KEYBOARD to LINE
- (2) PLAYBACK to OFF

Commence typing message.

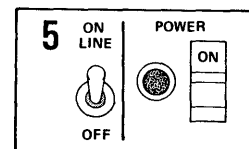
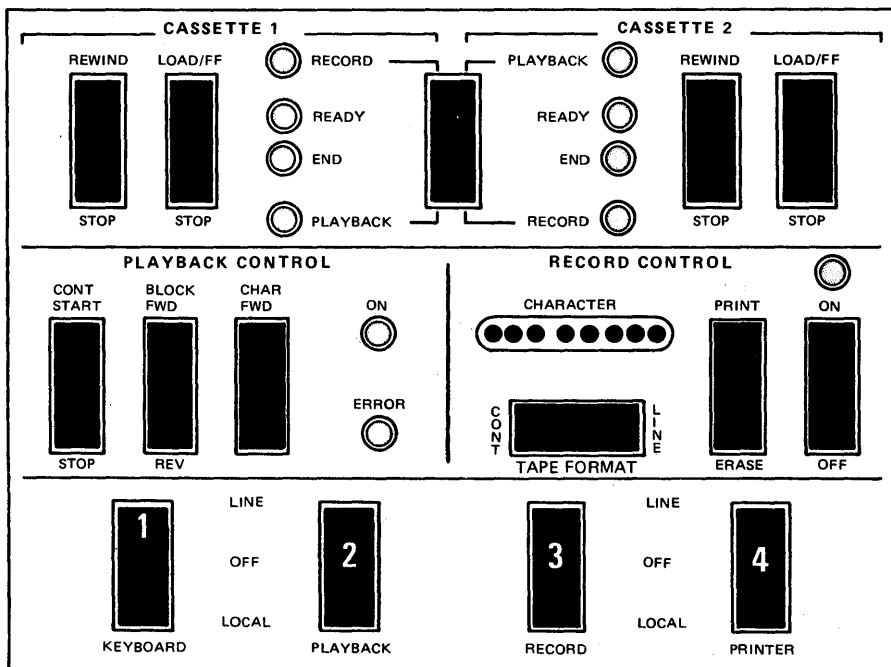

ON-LINE OPERATIONS

5-2.2 KEYBOARD TO LINE AND PRINT OUT*. To transmit data over the line from the keyboard and make a printout on the ASR printer, proceed as follows.

On the ASR switch panel lower row, set

- (1) KEYBOARD to LINE
- (2) PLAYBACK to OFF

- (3) RECORD to OFF
- (4) PRINTER to LINE
- (5) Set the terminal ON-LINE/OFF switch (to right of keyboard) to ON LINE.

Commence typing message. The keyboard will print out whatever is typed.*

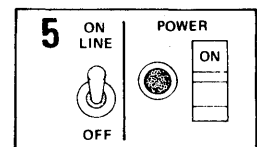
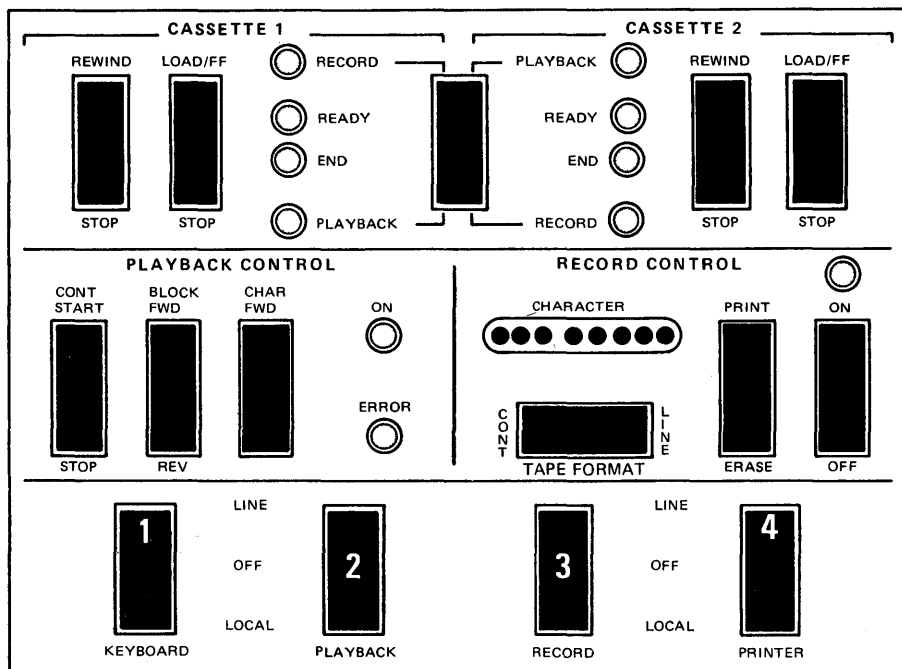

*Only if the data terminal is in HALF DUPLEX; if in FULL DUPLEX the printer will not print out from the keyboard.

ON-LINE OPERATIONS

5-2.3 RECORDING ON TAPE AND TRANSMITTING ON LINE FROM THE KEYBOARD.* The keyboard transmission over the line may be recorded on tape. To record and print out the keyboard messages, proceed as follows.

NOTE

The recorder and printer will act upon both keyboard and incoming on-line messages if the terminal is in HALF DUPLEX.

On the ASR switch panel lower row, set

- (1) KEYBOARD to LINE
- (2) PLAYBACK to OFF (switch position is immaterial)
- (3) RECORD to LINE
- (4) PRINTER to LINE.
- (5) Set the terminal ON-LINE/OFF switch to ON LINE.

Insert a tape cassette into the CASSETTE 1 transport (check that the write tab is in place on the bottom of the cassette). Then,

- (6) Set RECORD CONTROL to OFF (Middle row)
- (7) Press CASSETTE 1 REWIND
- (8) When the END lamp lights, press LOAD/FF. The READY lamp should light after a few seconds.
- (9) Press the CASSETTE 1 RECORD switch.
- (10) Set the TAPE FORMAT switch (middle row) to CONT or LINE. The LINE format most closely resembles conventional typewriting, but uses more tape. The CONTinuous tape format conserves tape. In either format, end a line of type with a carriage RETURN and a LINE FEED to produce conventional typewritten hard copy.
- (11) Set RECORD CONTROL to ON.

Commence typing. The message will be recorded on tape, printed out, and sent over the transmission line.

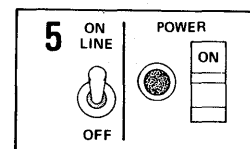
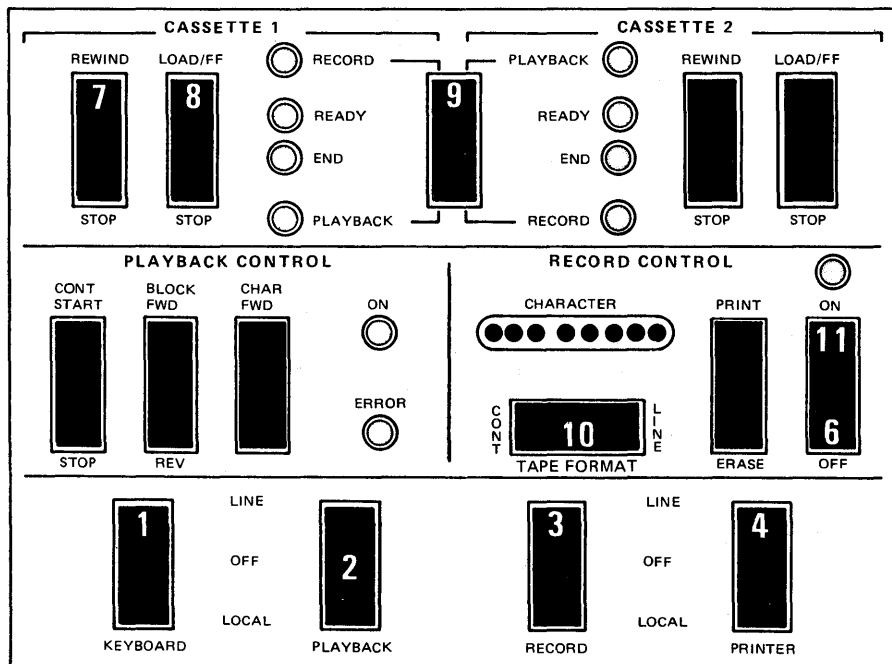

*Possible only if terminal is in HALF DUPLEX.

ON-LINE OPERATIONS

5-2.4 RECORD ON TAPE FROM THE LINE (NO PRINTOUT). To record incoming messages sent over the transmission line to the data terminal when no printout is desired, proceed as follows.

On the ASR switch panel lower row, set

- (1) KEYBOARD to OFF
- (2) PLAYBACK to OFF
- (3) RECORD to LINE
- (4) PRINTER to OFF
- (5) Set the terminal ON-LINE/OFF switch to ON-LINE.

Insert a tape cassette into the CASSETTE 1 transport (check that the write tabs are in place on the bottom of the cassette). Then,

- (6) Set RECORD CONTROL to OFF.
- (7) Set CASSETTE 1 to RECORD.
- (8) Press CASSETTE 1 REWIND.
- (9) When the END lamp lights, press LOAD/FF. The READY lamp should light after a few seconds.
- (10) Set the RECORD CONTROL switch to ON.

The terminal will now receive and record messages on tape.

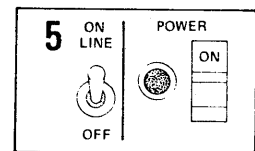
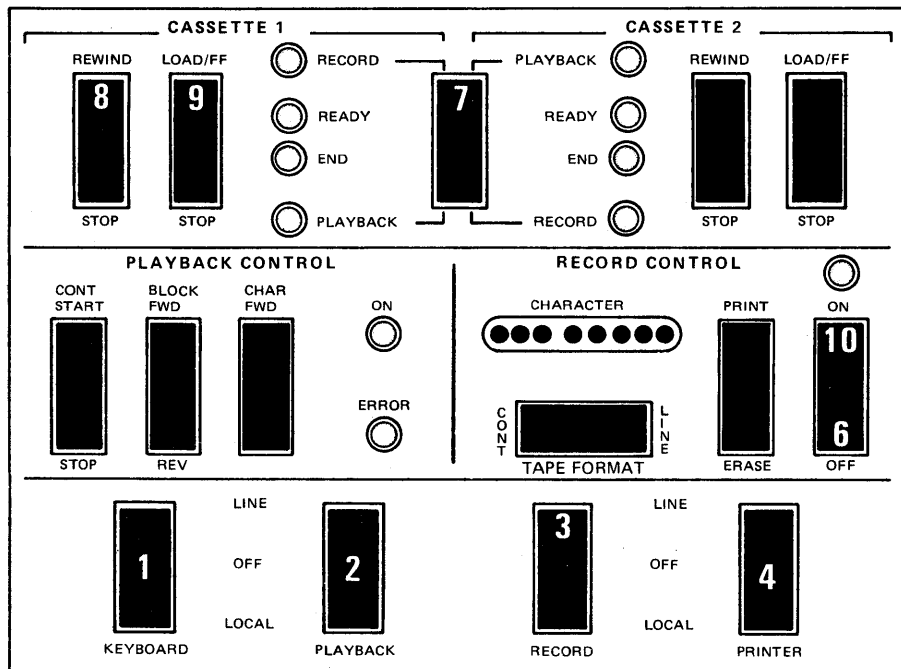

ON-LINE OPERATIONS

5-2.5 RECORD ON TAPE FROM LINE AND PRINT OUT.

To record incoming messages to the terminal on both tape and hard copy printout, proceed as follows.

On the ASR switch panel lower row, set

- (1) KEYBOARD to OFF (position immaterial)
- (2) PLAYBACK to OFF (position immaterial)
- (3) RECORD to LINE
- (4) PRINTER to LINE
- (5) Set the terminal ON-LINE/OFF switch to ON-LINE.

Insert a tape cassette into the CASSETTE 1 transport (check that the write tabs are in place on the bottom of the cassette). Then,

- (6) Set RECORD CONTROL to OFF
- (7) Set CASSETTE 1 to RECORD
- (8) Press CASSETTE 1 REWIND
- (9) When the END lamp lights, press LOAD/FF. The READY lamp should light after a few seconds.
- (10) Set RECORD CONTROL to ON.

The terminal is now ready to tape record and print out incoming messages.

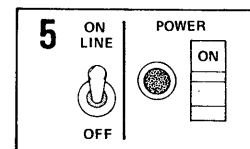
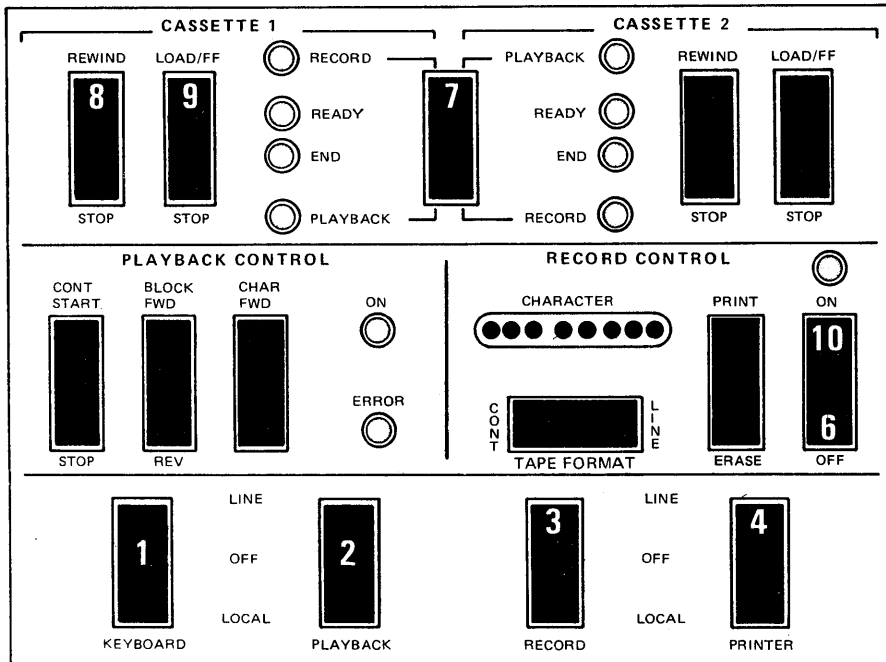

ON-LINE OPERATIONS

5-2.6 PRINT OUT FROM LINE ONLY (NO RECORD ON TAPE). To print out incoming messages to the terminal with no tape recording, proceed as follows.

- (3) RECORD to OFF
- (4) PRINTER to LINE
- (5) Set the terminal ON-LINE/OFF switch to ON-LINE.

On the ASR switch panel lower row, set

- (1) KEYBOARD to OFF (position immaterial)
- (2) PLAYBACK to OFF (position immaterial)

The data terminal is now ready to receive and print out incoming messages.

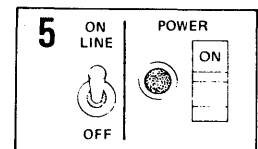
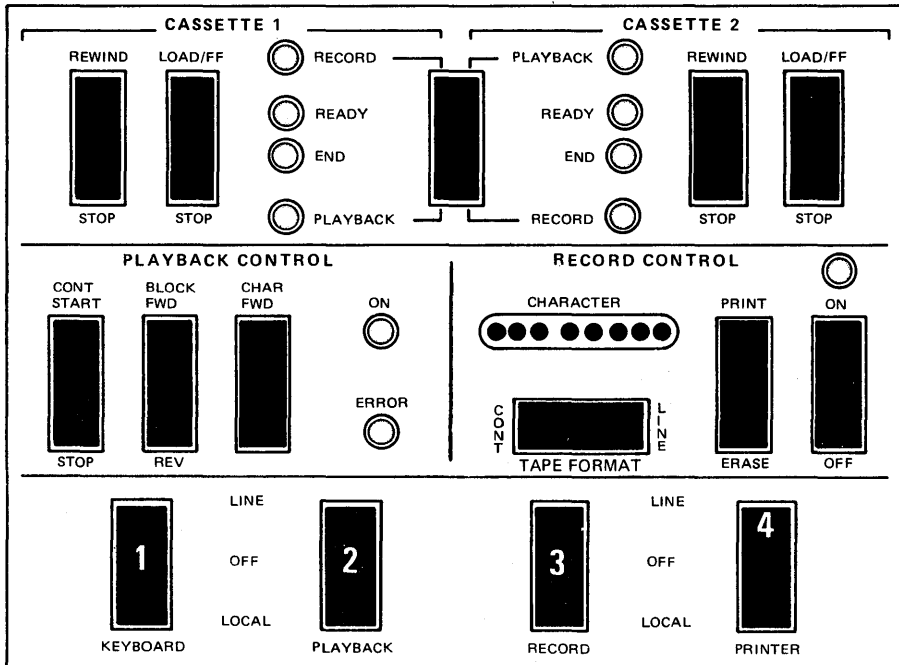

ON-LINE OPERATIONS

5-2.7 PLAY BACK TAPE TO LINE ONLY (NO PRINTOUT). To transmit a tape recording over the line with no printout, proceed as follows.

On the ASR switch panel lower row, set

- (1) KEYBOARD to OFF
- (2) PLAYBACK to LINE
- (3) RECORD to OFF
- (4) PRINTER to OFF.

Insert the tape cassette to be transmitted into the CASSETTE 1 transport. Then,

- (5) Set CASSETTE 1 to PLAYBACK

- (6) Press CASSETTE 1 REWIND
- (7) When the END lamp lights, press LOAD/FF. The READY lamp should light after a few seconds.
- (8) Set the terminal ON-LINE/OFF switch to ON-LINE.
- (9) Press the PLAYBACK CONTROL (middle row) CONT START switch; playback to line will commence.

To stop playback before the end-of-tape, press (CONT) STOP.

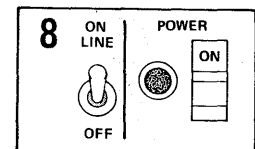
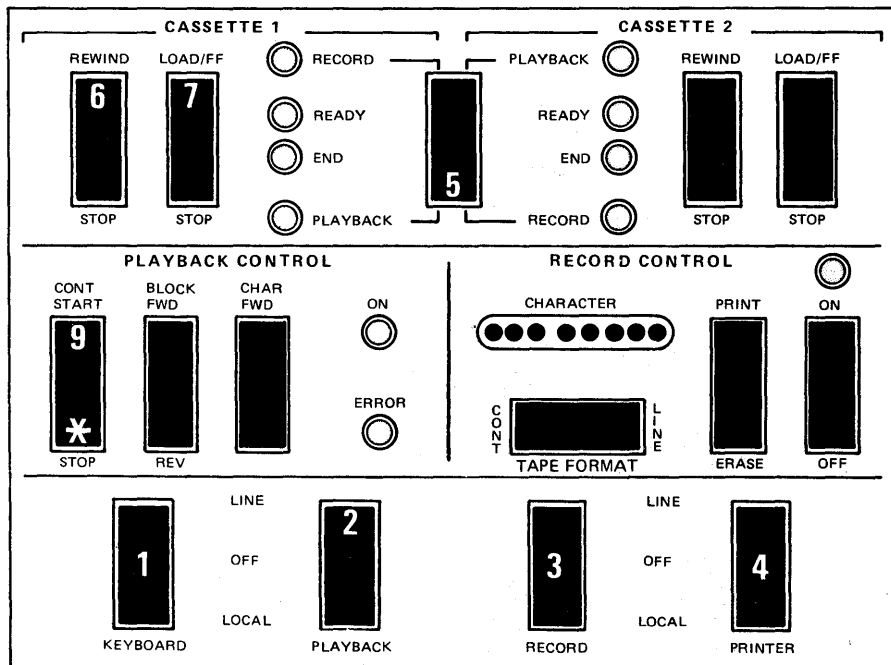

ON-LINE OPERATIONS

5-2.8 PLAY BACK TAPE TO LINE AND MAKE PRINTOUT.* To transmit a tape recording over the line and make a hard copy printout simultaneously, proceed as follows.

- On the ASR switch panel lower row, set
- (1) KEYBOARD to OFF (position immaterial)
 - (2) PLAYBACK to LINE
 - (3) RECORD to OFF
 - (4) PRINTER to LINE.

Insert the tape cassette to be transmitted into the cassette 1 transport. Then,

- (5) Set CASSETTE 1 to **PLAYBACK**
- (6) Press **CASSETTE 1 REWIND**
- (7) When the **END** lamp lights, press **LOAD/FF**. The **READY** lamp should light after a few seconds.
- (8) Set the terminal **ON-LINE/OFF** switch to **ON-LINE**, and press **PAPER ADV.**
- (9) Press the **PLAYBACK CONTROL** (middle row) **CONT START** switch; playback transmission and hard copy printout will commence.

To stop playback before the end-of-tape, press (CONT) **STOP**.

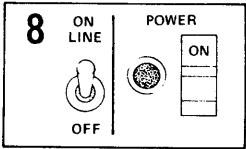
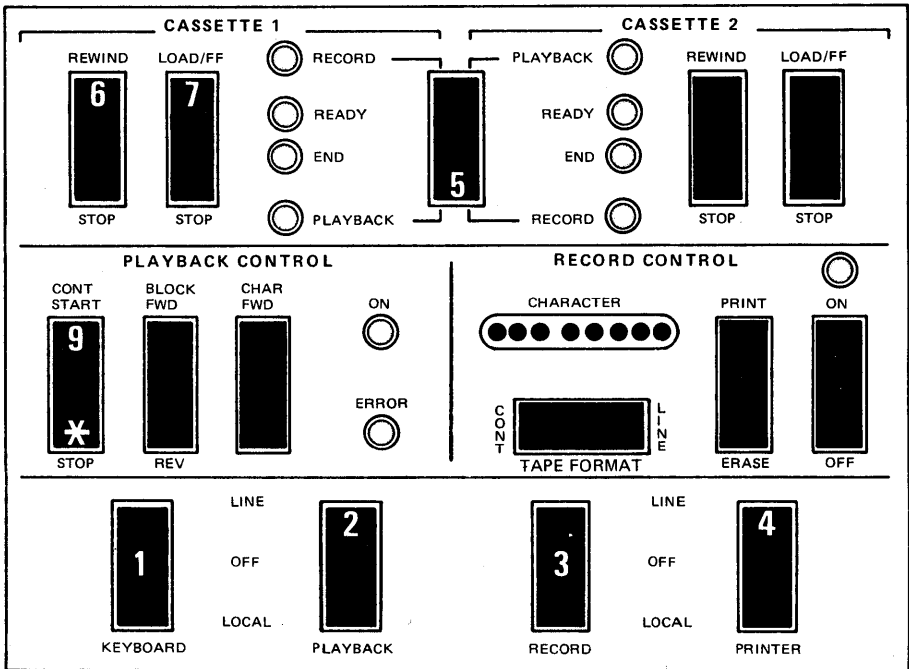

*A printout is possible only if the data terminal is in HALF DUPLEX.

ON-LINE OPERATIONS

5-2.9 PLAY BACK TAPE TO LINE AND MAKE PRINTOUT FROM LINE.* To transmit a tape recording from the terminal over the line and print out data received from the line, proceed as follows.

On the ASR switch panel lower row, set

- (1) KEYBOARD to OFF
- (2) PLAYBACK to LINE
- (3) RECORD to OFF
- (4) PRINTER to LINE.

Insert the tape cassette to be transmitted into the CASSETTE 1 transport. Then,

- (5) Set CASSETTE 1 to PLAYBACK
- (6) Press CASSETTE 1 REWIND
- (7) When the END lamp lights, press LOAD/FF. The READY lamp should light after a few seconds.
- (8) Set the terminal ON-LINE/OFF switch to ON-LINE, and press PAPER ADV.
- (9) Press the PLAYBACK CONTROL (middle row) CONT START switch; transmission of the tape cassette will commence. The ASR is also ready to print out incoming messages*.

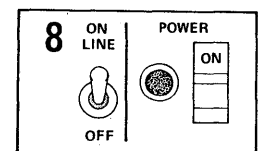
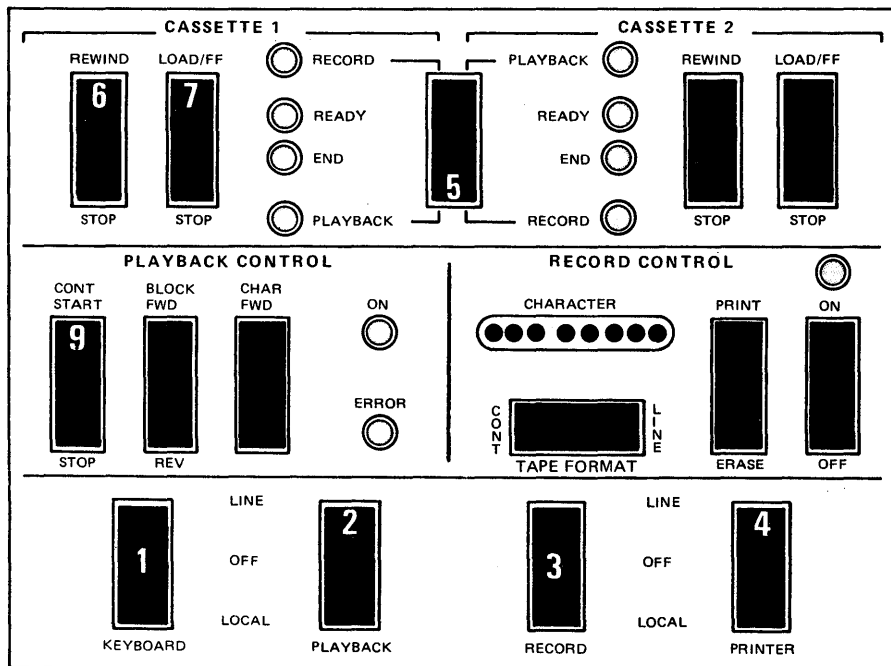

*A printout is possible only if the data terminal is in FULL DUPLEX.

ON-LINE OPERATIONS

5-2.10 TRANSMIT AND RECEIVE FROM TAPES TO LINE SIMULTANEOUSLY.* This function, possible only on the dual-cassette ASR model, permits transmission of one recorded tape cassette over the line and recording of incoming messages on the other tape cassette. To accomplish this process set up the ASR terminal as follows.

On the ASR switch panel lower row, set

- (1) KEYBOARD to OFF
- (2) PLAYBACK to LINE
- (3) RECORD to LINE
- (4) PRINTER to OFF
- (5) Set the terminal ON-LINE/OFF switch to ON-LINE.

Insert the tape cassette to be transmitted in cassette 1 transport. Then,

- (6) Set the RECORD CONTROL ON/OFF switch to OFF.
- (7) Set CASSETTE 1 to PLAYBACK; CASSETTE 2 will be in RECORD.

- (8) Press the CASSETTE 1 REWIND switch
- (9) When the END lamp lights, press LOAD/FF. The READY lamp should light after a few seconds.

Insert the tape cassette which will record incoming data into the CASSETTE 2 transport (check that write tabs are in place on the bottom of the cassette). Then,

- (10) Press the CASSETTE 2 REWIND switch
- (11) When the END lamp lights, press LOAD/FF. The READY lamp should light after a few seconds.
- (12) Set RECORD CONTROL to ON
- (13) Set TAPE FORMAT to LINE or CONT.
- (14) Press the PLAYBACK CONTROL (middle row) CONT START switch.

The data recorded on CASSETTE 1 will now be transmitted over the line; CASSETTE 2 will record incoming data from the line.

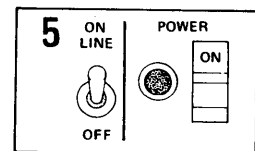
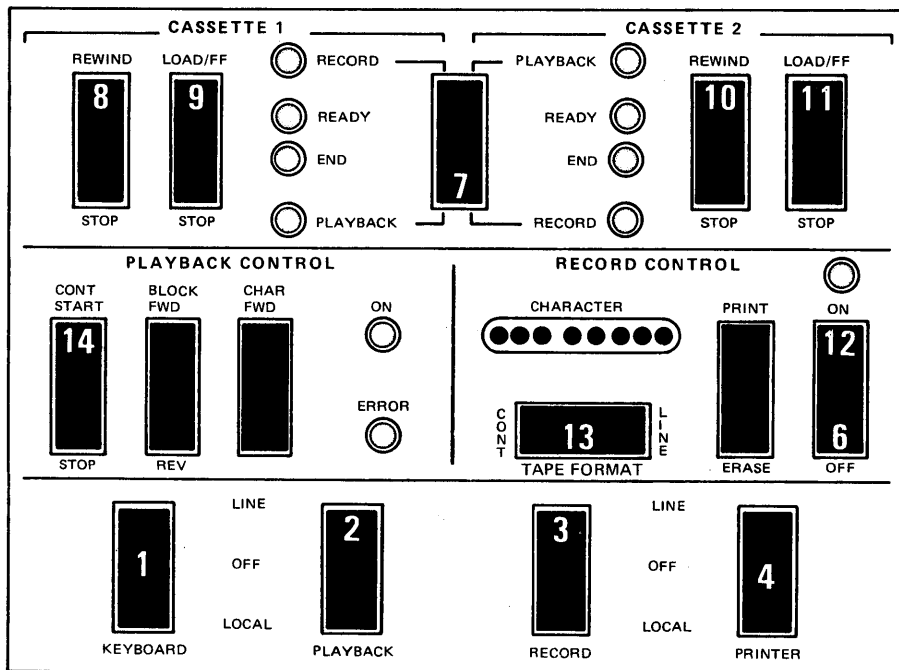

*Possible only if data terminal is in FULL DUPLEX.

SIMULTANEOUS LINE/LOCAL

5-3.1 KEYBOARD TO LINE, MAKE PRINTOUT FROM LINE, AND DUPLICATE A TAPE SIMULTANEOUSLY.

NOTE

This technique is possible only on dual-cassette ASR Data Terminals.

This technique permits tape duplication while keyboard send/receive operations are underway. To duplicate a tape while transmitting data from the keyboard to the line and simultaneously printing out data received from the line, proceed as follows.

On the ASR switch panel lower row, set

- (1) KEYBOARD to LINE
- (2) PLAYBACK to LOCAL
- (3) RECORD to LOCAL
- (4) PRINTER to LINE
- (5) Set the terminal ON-LINE/OFF switch to ON-LINE.

Insert the tape cassette to be duplicated (original tape) into the CASSETTE 1 transport. Then,

- (6) Set RECORD CONTROL to OFF
- (7) Set CASSETTE 1 to PLAYBACK. CASSETTE 2 will be in RECORD.
- (8) Press the CASSETTE 1 REWIND switch

- (9) When the END lamp lights, press LOAD/FF. The READY lamp should light after a few seconds.

Insert the copy tape cassette into the CASSETTE 2 transport (check that the write tabs are in place on the bottom of the cassette). Then,

- (10) Press the CASSETTE 2 REWIND switch
- (11) When the END lamp lights, press LOAD/FF. The READY lamp should light after a few seconds.
- (12) Set the RECORD CONTROL ON/OFF switch to ON. The ON lamp should light.
- (13) Set the TAPE FORMAT switch to the tape format desired for the copy tape (LINE or CONTINUOUS).
- (14) Press the CONT START switch to begin tape duplication. Data will be transmitted from CASSETTE 1 to CASSETTE 2 (original tape to copy tape) until the END lamps light.

Proceed with keyboard transmission over the line. (No printout will occur in HALF DUPLEX.) Data received from the line will be printed out by the terminal.

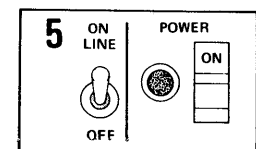
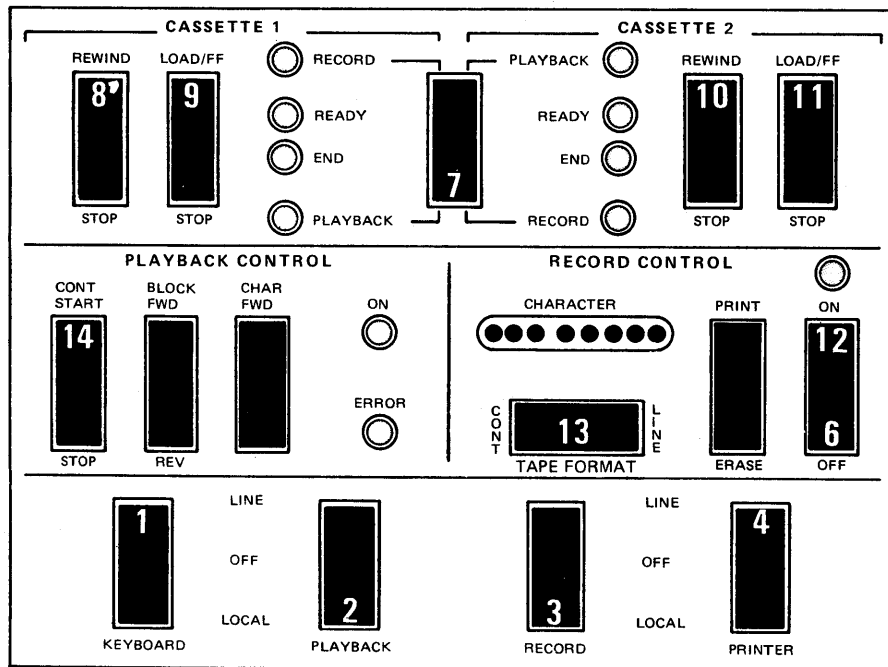

SIMULTANEOUS LINE/LOCAL

5-3.2 PLAY BACK TAPE TO THE LINE AND RECORD ON TAPE FROM THE KEYBOARD SIMULTANEOUSLY.

NOTE

This technique is possible only on dual-cassette ASR Data Terminals.

The ASR Data Terminal will transmit one recorded tape cassette over the line while data from the keyboard is recorded on the other tape cassette. To accomplish this technique, proceed as follows.

On the ASR switch panel lower row, set

- (1) KEYBOARD to LOCAL
- (2) PLAYBACK to LINE
- (3) RECORD to LOCAL
- (4) PRINTER to LOCAL
- (5) Set the terminal ON-LINE/OFF switch to ON-LINE.

Insert the recorded tape cassette to be sent over the line into the CASSETTE 1 transport. Then,

- (6) Set RECORD CONTROL to OFF
- (7) Set CASSETTE 1 to PLAYBACK
- (8) Press the CASSETTE 1 REWIND switch.

- (9) When the END lamp lights, press LOAD/FF. The READY lamp should light after a few seconds.

Insert a tape cassette into the CASSETTE 2 transport to record the terminal keyboard data. Then,

- (10) Press the CASSETTE 2 REWIND switch
- (11) When the END lamp lights, press the LOAD/FF switch. The READY lamp should light in a few seconds.
- (12) Set the RECORD CONTROL ON/OFF switch to ON. The ON lamp should light.
- (13) Set the TAPE FORMAT switch to the format desired for the keyboard copy tape. LINE format will terminate a block when carriage RETURN is pressed. CONTinuous tape format will record up to 86 characters per block and increase tape cassette storage capacity.
- (14) Press the CONT START switch (PLAYBACK CONTROL in middle row) to commence transmission of the recorded tape over the line.

You may now also begin typing data on the keyboard for recording on CASSETTE 2. The CASSETTE 1 END lamp will light when the entire cassette (one side) is transmitted over the line.

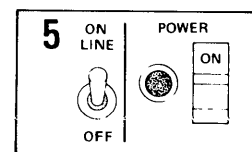
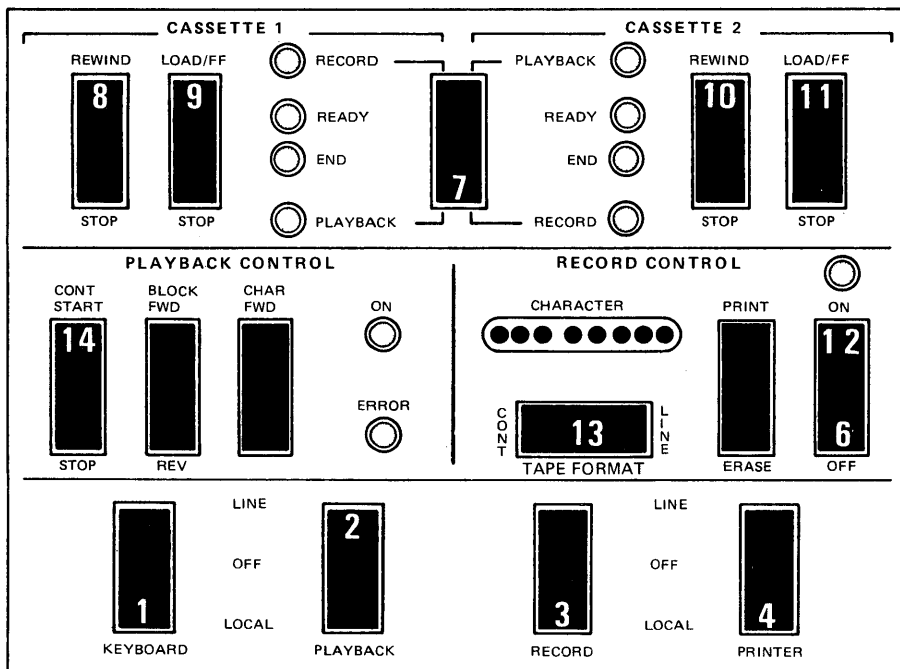

SECTION VI

CARE AND CLEANING

6-1 GENERAL.

This section outlines routine cleaning procedures which will promote trouble-free operation and maximum performance of 733 ASR/KSR data terminals. These simple procedures can be implemented by operating personnel.

6-2 CLEANING.

Model 733 ASR/KSR data terminals are designed to give months of trouble-free service under rigorous operating conditions. To ensure highest performance levels, the following minimal cleaning procedures should be performed at regular intervals. These consist primarily of keeping the thermal printer mechanism and cassette transports clean and free of foreign matter.

6-2.1 PAPER DRIVE ROLLER CLEANING. To maintain uniform line spacing, clean the paper drive roller every 3 months or when line spacing becomes uneven or too close. This is accomplished as follows:

- a. Switch off power to the data terminal.
- b. Remove the thermal paper supply roll from the printer, leaving the paper drive pinch roller up (Figure 6-1).
- c. Move the printhead to the far right side.
- d. Wipe the left side of the paper drive roller with a soft rag or paper towel moistened with alcohol. Rotate the drive roller manually and ensure that the entire roller is cleaned.
- e. Slide the printhead to the far left and clean the right side of the drive roller.
- f. Reload the supply roll into the printer and switch on power.

6-2.2 PRINTHEAD DRIVE MECHANISM CLEANING. To ensure continued smooth and quiet operation of the printer mechanism, clean the printhead carriage assembly every 3 months or whenever the carriage rod appears dirty. Failure to do this can result in increased audible noise and can reduce the lifetime of the printer mechanism. Clean the assembly as follows:

- a. Switch off power to the terminal and remove the supply roll of thermal paper.
- b. Gently clean the printhead carriage rod (Figure 6-1) with a clean soft rag to remove accumulated paper residue. Slide the printhead to the left and right as necessary.
- c. Reload the paper and switch on power.

6-2.3 CASSETTE TRANSPORT CLEANING. Follow the manufacturers' recommendations for proper handling and storage of magnetic tape. In addition, clean the tape read/write heads, capstans, and pinch rollers at regular intervals. To enhance the cassette system data reliability (minimize data error rate), this cleaning should be done once each day, or after 8 hours of operation.

- a. Remove the tape cassettes from the transports.
- b. Use a clean cotton swab (or lint-free cloth) saturated with denatured alcohol to clean the heads, forward and reverse capstans and associated pinch rollers shown in Figure 6-2.

6-2.4 PRINTHEAD CLEANING. To ensure that the thermal printer continues to print legibly, the printhead should be cleaned periodically, as follows:

- a. Remove the thermal paper supply roll from the printer.
- b. Insert a sheet of vellum or good quality bond paper into the printer.
- c. Print six to ten lines on the cleaning paper.

NOTE

The printhead will not print visibly on the cleaning paper.

- d. Remove the cleaning paper and reload the thermal paper supply roll.

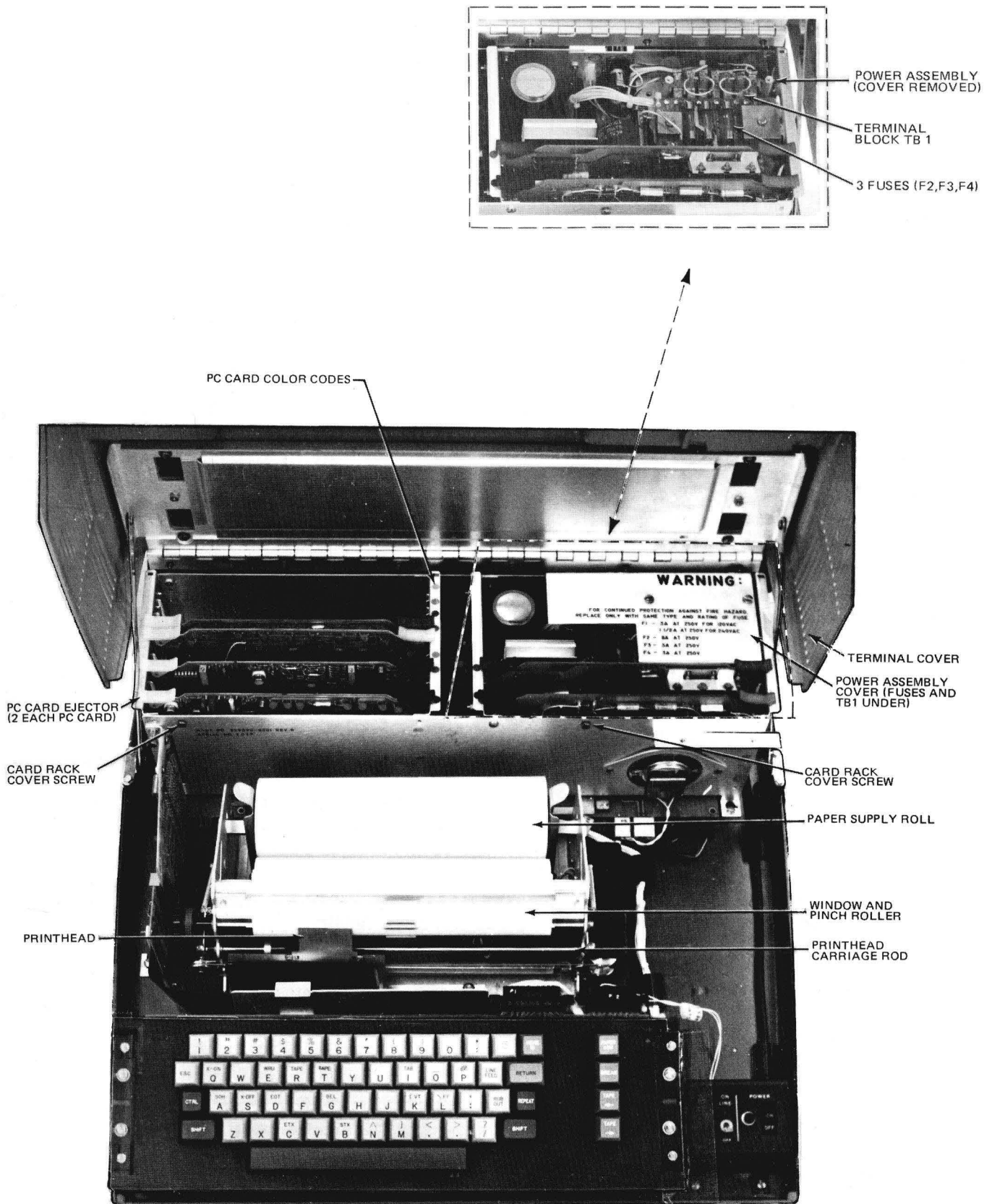

FIGURE 6-1. MODEL 733 DATA TERMINAL INTERNAL ASSEMBLIES (CARD RACK COVER REMOVED)

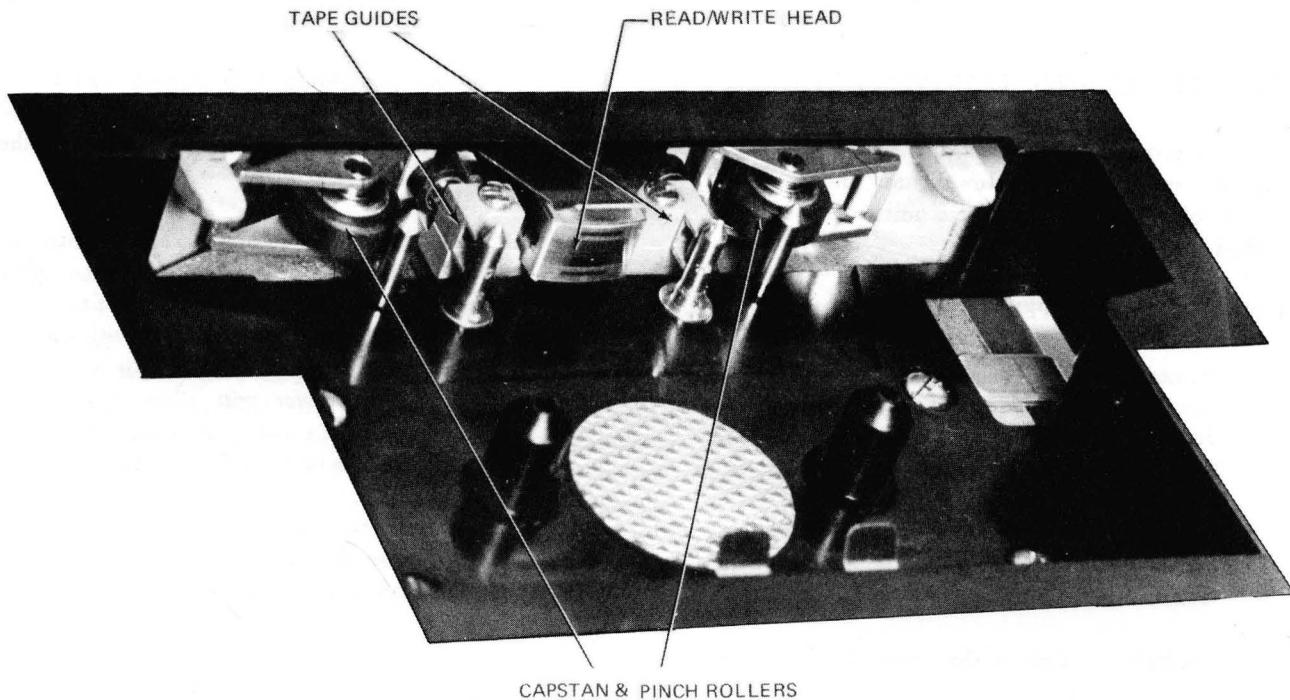

FIGURE 6-2. TAPE TRANSPORT CLEANING AREAS

This cleaning procedure should be repeated each time a new roll of paper is loaded into the printer or whenever the image starts to fade as a result of residue buildup on the printhead.

6-3 ACCESS TO PC CARDS.

PC cards are located in both the ASR (upper unit) and the KSR (lower unit). Occasionally check that the PC cards are securely plugged into their connectors, particularly after shipping or moving the terminal.

CAUTION

Consult the ASR/KSR Maintenance Manual before removing or replacing PC cards. Several cards require special instructions to remove (e.g., the Display PC card and the Code PC card). DISCONNECT POWER TO THE TERMINAL BEFORE PROCEEDING.

6-3.1 ASR UPPER UNIT ACCESS.

- a. Loosen two knurled knobs at the rear of the upper unit (see Figure 2-4) about 1/2 turn and slide the upper unit cover toward the keyboard.

- b. Loosen the screw in each corner of the PC card rack cover (top center of the upper unit); slide the cover toward the keyboard and lift off over the four screws.

6-3.2 KSR LOWER UNIT PC CARD ACCESS.

- a. Raise the terminal cover and loosen the two PC card rack cover screws (see Figure 6-1).
- b. Lift the card rack cover back and off.
- c. To gain access to the power assembly, terminal block, and fuses, remove two retaining screws and lock washers and lift off the power assembly cover.

CAUTION

Replace all covers before applying power to the terminal.

- d. To replace the card rack cover, engage the three tongues, along the back of the cover, with the three slots; then fold down the cover as if on a hinge.

6-4 INSTALLING AND REMOVING THE ASR UPPER UNIT.

For maximum protection in transit, the ASR is shipped in two separate units: the KSR lower unit and the ASR display and control upper unit. These units must be joined and checked before operating.

6-4.1 INSTALLING THE UPPER UNIT.

- a. Remove the KSR (lower unit) from its shipping container and place it on the accessory Silent 700 Terminal Stand or other flat surface. (Leave the terminal cover closed.)
- b. Remove the ASR upper unit from its shipping carton and carefully place it, display panel down, on a flat surface.
- c. Facing the bottom of the upper unit, loosen the four 10-32 screws about 4-1/2 turns (these are the screws with the largest heads). The four screws should protrude 1/8 to 3/16 inch.
- d. Note the two keyhole slots in both pedestals at the top rear of the KSR (lower) unit. Pick up the ASR upper unit and place it on the two pedestals so that the heads of the four screws loosened in step c. enter the large portion of the slots. Make sure the upper unit controls face the keyboard.
- e. Check that the base of the upper unit is resting squarely on the pedestals. Now slide the upper unit to the rear so the screws locate at the narrow part of the keyhole slots.



Before proceeding, check that the upper unit is in proper position by trying to lift it from the KSR unit. It will not lift from the lower unit if properly located.

- f. Slowly raise the KSR cover to its uppermost position. The four upper unit mounting screws are now accessible through the four rectangular shaped holes in the metal support plate (see Figure 6-1). Tighten the four mounting screws securely. Lower the cover.
- g. Remove the ASR/KSR interconnecting cable (959371-1) from the shipping box. A paper

envelope containing four screws should be taped inside the terminal base (two 4-40 X 3/8 and two 4-40 X 5/8 screws). Remove the envelope and the screws.

- h. Plug the ASR connector marked P1 onto the PC card tab at the lower left side of the upper unit through the opening in the rear of the unit. The key slot must be up to mate with the tab on the cover. Be sure the connector is inserted as far as the cover will allow. Secure the connector with the two shorter screws (4-40 X 3/8) through the holes in the connector ears.
- i. Check that the cable is dressed to the left (viewed from the rear), close to the unit, and in a "C" shaped configuration (refer to Figure 2-4).
- j. Plug the connector marked P3 onto the innermost PC card tab protruding through the slot in the black housing at the bottom of the KSR lower unit. The key slot must be up to mate with the key in the connector housing. Insert as far as possible. Secure this connector with the two longer screws (4-40 X 5/8) through the holes in the connector ears.
- k. Plug the small white connector (P13) on the cable extending from the upper unit fan into the connector next to the fuse and power cord outlet on the KSR unit. It is keyed and may be inserted only one way.
- l. The unit is now assembled and ready for initial checkout described in Section II of this manual.

6-4.2 REMOVING THE UPPER UNIT. Sometimes (for shipping purposes, etc.) it is necessary to remove the upper unit of the 733 ASR terminal. To remove it, do the following:

- a. Disconnect the fan wire (P13) and the ASR/KSR cable (P1/P3) shown in Figure 2-4.
- b. Lift the terminal cover. With a screwdriver loosen about 4-1/2 turns (do not remove) the four screws in the recessed area of the two pedestals on which the ASR switch panel rests (see Figure 6 1).
- c. Close the cover gently. Pull the upper switch panel forward, then lift it off.

6-5 TERMINAL MALFUNCTION CHECKLIST.

If the terminal fails to operate properly, perform the following checks before calling service personnel for assistance.

- a. Check all ac power connections.
- b. Check that the POWER switch is ON (Figure 3-1).
- c. Ensure that a fuse is not blown (Figures 2-4 and 6-1).
- d. Check the transmission SPEED switch for proper setting (Figure 3-1).
- e. Check that the external connectors are plugged in and tightened (Figure 2-4).
- f. Check that the thermal print paper roll is loaded properly (Figure 2-2).
- g. If the terminal has been in cold storage, allow sufficient time for warmup to operating temperature.
- h. Check settings of all operator controls.
- i. Check that the tape cassettes are in place and that both transport doors are closed.
- j. Check that a tape to be recorded on has the appropriate write tab in place (Section IV).
- k. Review control interlock status (Section IV).
- l. Ensure that all PC cards are securely plugged in (see paragraph 6-3).
- m. Check that all options are correctly installed.

APPENDIX A

MODEL 733 EQUIPMENT SPECIFICATIONS

APPENDIX A

MODEL 733 EQUIPMENT SPECIFICATIONS

A-1 TRANSMISSION CODE AND CHARACTER SET.

The transmission code is USASCII, seven-level, 11 bits per character; this includes 7 data bits, a parity bit, a start bit, and 2 stop bits at 10 characters per second speed. Only 1 stop bit is used at higher speeds, resulting in 10 bits per character (see Figure A-1). The KSR has 95 printable characters, plus four printer control characters and one terminal control character. The 733 ASR terminal recognizes four additional terminal control characters: DC-1 through DC-4 which are optional (see Appendix B, paragraph B-4).

A-2 DATA FORMAT AND TRANSMISSION.

Data is routed *within* the terminal via a single data bus. The data is sent serial by bit, 8 bits per character. The 8 bits include a 7 bit ASCII character code plus an eighth bit which is used as an end-of-block indicator in the ASR unit. Transmission speed is switch selectable by the operator to 10 characters per second (110 Baud), 15 characters per second (150 Baud), or 30 characters per second (300 Baud). An ON-LINE switch located on the power switch panel controls the status of the entire terminal.

A-3 PRINTER.

See Table A-1.

A-4 COMMUNICATION LINE INTERFACE.

The standard line interface conforms to EIA Standard RS232C. The terminal can receive, without error, signals with mark and space distortion of up to 45 percent. The minimum stop bit time for error-free reception at any speed is 0.6 of a normal bit time. The signals and connector pins involved are described in Table 2-1.

A-5 PHYSICAL.

- a. Terminal Dimensions See Figure A-2.
- b. Terminal Weight 38 pounds KSR, 55 pounds ASR, exclusive of all options.

A-6 POWER REQUIREMENTS.

- a. Frequency Normal operation with primary input power frequencies in the band of 48 to 62 Hz.
- b. Voltage 115 (+10%, -15%) volts RMS. It is possible to field-modify the terminal to operate on 230 (+10%, -15%) volts RMS.
- c. Power Required primary input power at maximum rated voltage is 200 VA maximum.

A-7 TAPE TRANSPORT.

See Table A-2.

A-8 RECORD.

Data can be recorded on the RECORD transport (selected by operator) from the keyboard, line interface, or PLAYBACK transport. The recording method is phase encoding at 800 bits per inch (1600 flux reversals per inch). single-track (a second track in the cassette is also available for recording by turning the cassette over).

A-9 PLAYBACK.

Data can be retrieved from the playback transport and transmitted to the printer, line interface, and/or record transport. Record and playback to the communication line are performed at a maximum rate of 10, 15, or 30 characters per second, as selected on the terminal SPEED selection switch. When transferring data from a transport to the page printer or line interface, playback is inhibited for 200 milliseconds following the carriage return character in the line tape format (carriage return character time is included in the 200 milliseconds), or at the end of each block in either format. High-speed playback is performed at a maximum rate of 250 characters per second when the playback is in local mode. If a printout is desired simultaneously with playback, however, the maximum speed is 30 characters per second.

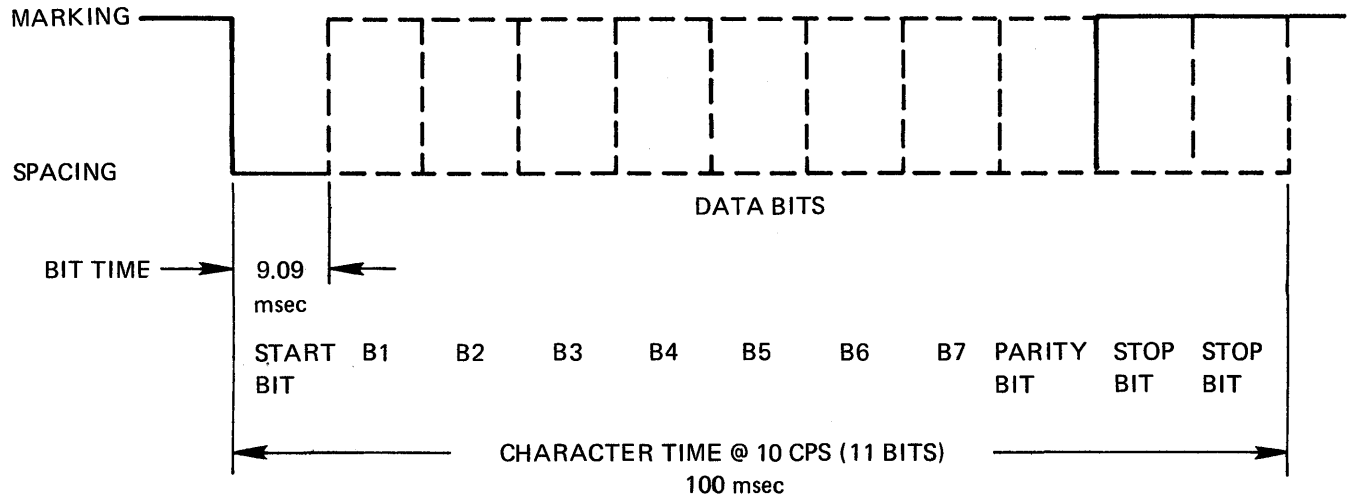

(a) 10 CPS TIMING

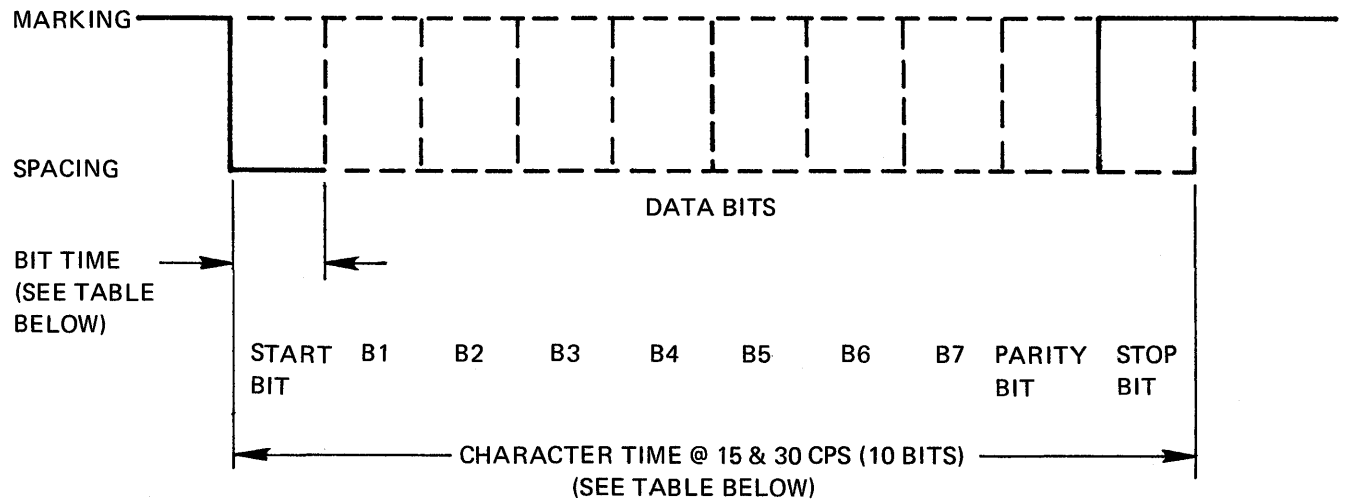

	15 CPS	30 CPS
BIT TIME (msec)	6.67	3.33
CHARACTER TIME (msec)	66.7	33.3

(b) 15 AND 30 CPS TIMING

NOTE: CPS = CHARACTERS PER SECOND

FIGURE A-1. SERIAL DATA TIMING

TABLE A-1. PRINTER SPECIFICATIONS

Specification	Value
Printing Method	5 X 7 dot matrix, electronically heated, on heat-sensitive paper
Line Length	7.9 inches, 80 characters
Character Spacing	0.1 inch, character center to center
Line Spacing	Six or three lines per inch (single or double spaced)
Paper (TI Part Number 213714-0001 or 953167-0001)	Roll, 8.5 inches wide by 3.625 inches maximum diameter (300 feet), heat-sensitive
Platen	Friction feed
Carriage Return Time	195 milliseconds maximum
Line Feed Time	33 milliseconds maximum (single space), 66 milliseconds maximum (double space)
Audible Alarm Time	250 (±50) milliseconds on receipt of the BEL character
Printable Characters	95
Carriage Return and Line Feed (CR/LF)	Automatic at column 81, no code is transmitted
Visibility of Printed Lines	At least 50 previous lines of print (including line and character being printed) are visible
Print Contrast	Operator adjustable (paragraph 2-4)

TABLE A-2. TAPE TRANSPORT SPECIFICATIONS

Specification	Value
Recording Speed	8 inches per second
Rewind Time	60 seconds maximum
Tape Drive	Capstan drive for recording or playing back
Error Rate	One in 10^6 maximum, using certified cassette tapes and proper head-cleaning procedures; one in 10^7 typical
Interchangeability	Any tape recorded on any 733 ASR transport operating within specifications may be read on any other 733 ASR transport of the same model operating within specifications
Sensors	EOT, BOT, cassette-in-place, write tab, transport-door-closed

A-10 HIGH-SPEED DUPLICATION.

Recording on the record cassette from the playback cassette can be accomplished at a maximum rate of 250 characters per second when both are operated in the local mode. If a printout is desired simultaneously with duplication, the speed is limited to 30 characters per second. Manual changes (deletion, addition, or substitution of whole line) can also be merged into the tape being recorded.

A-11 CASSETTE TAPE.

The storage medium is a cassette tape comparable to the improved Philips cassette, containing 275 to 300 feet of

digital-grade magnetic tape with approximately 20 inches of nonmagnetic transparent leader joined to each end. The magnetic tape has a beginning-of-tape and an end-of-tape marker (BOT and EOT), consisting of a hole or transparent spot in the tape. The magnetic and physical characteristics of the tape, leader, and markers are compatible with existing or proposed ECMA, BEMA, and ANSI standards. Storage capacity of the cassette is approximately six blocks per foot, or 1800 blocks per 300-foot cassette. Assuming 50 percent page-use efficiency, or an average of 43 characters per block (86 is maximum), typical storage capacity is 77,500 characters per track (side). Maximum tape capacity using both tape sides is 310,000 characters.

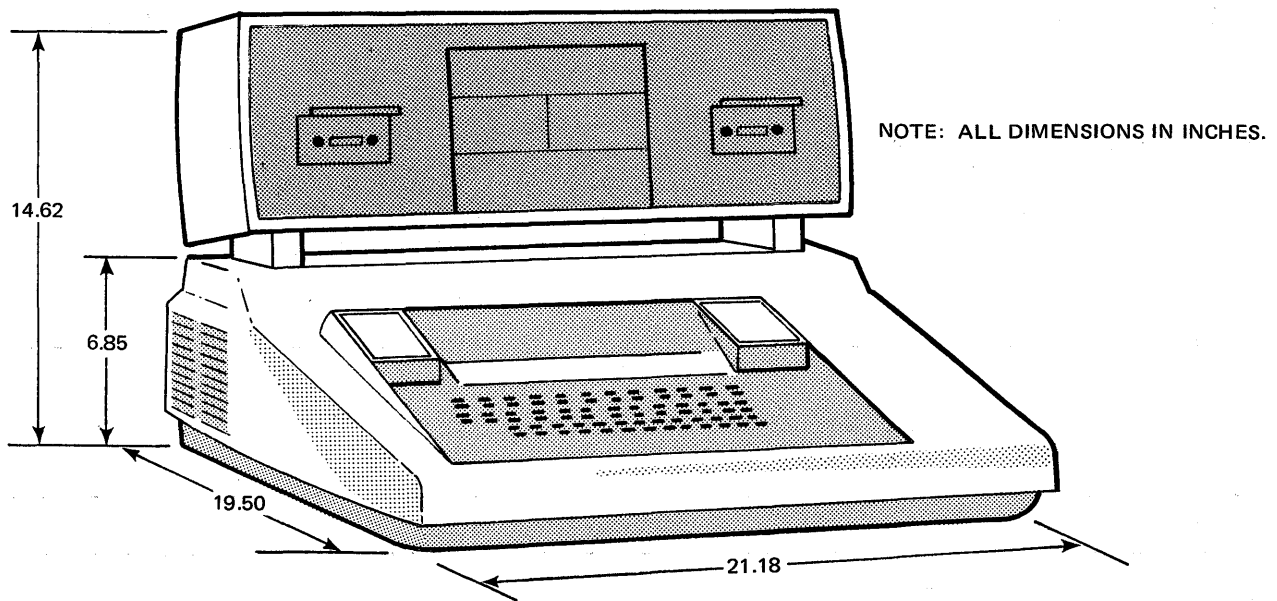

FIGURE A-2. DIMENSIONS (KSR/ASR)

APPENDIX B
MODEL 733 OPTIONS

TABLE OF CONTENTS

Section	Page
B-1	Uppercase and Lowercase Keyboard B-1
B-2	Answer-Back Memory B-1
B-3	Current Loop Line Interfaces B-1
B-3.1	Neutral B-1
B-3.2	Polar B-1
B-3.3	Modem Line Interface B-1
B-4	Auto Device Control (ASR Model Only) B-1
B-5	Single-Cassette System B-4
B-6	Strappable Options B-4
B-6.1	End-of-Line Alarm B-4
B-6.2	Playback Stop on Error B-4
B-6.3	Strappable ETX Character to Initiate Recording B-6
B-7	Auto Answer Control (300 Baud) B-6
B-8	Automatic Search Control B-8
B-8.1	Local ASC Operation B-8
B-8.2	Remote ASC Operation B-10
B-9	Remote Device Control B-12
B-9.1	Remote Device Control Commands B-12
B-9.2	Local Operation B-14
B-9.3	Initial Setup B-15
B-9.4	RDC Status Characters B-15
B-9.5	Error Detect B-17
B-10	Numeric Keyboard B-19
B-11	1200 Baud Interface B-19
B-11.1	1200 Baud Operation B-19
B-11.2	Continuous Versus Line Format B-20
B-11.3	Low Speed Operation B-20
B-11.4	Printing in 1200 Baud Mode B-21

APPENDIX B

MODEL 733 OPTIONS

B-1 UPPERCASE AND LOWERCASE KEYBOARD.

An optional full ASCII keyboard replaces the standard ASCII keyboard. The full ASCII keyboard arrangement is shown in Figure B-1.1, and Figures B-1.2 through B-1.4 show the characters generated in the various shift and control modes. It includes an UPPERCASE-only key. When depressed, this key causes unshifted alphabetic characters to generate uppercase codes.

B-2 ANSWER-BACK MEMORY.

The Answer-Back Memory option provides up to 21 characters, which are field-programmable and nonvolatile. It is activated by receiving the USASCII ENQ character or by depressing the HERE IS key on the keyboard when the terminal is on-line and the KEYBOARD LINE/OFF/LOCAL switch is not OFF (ASR only). The contents of the memory are not recorded or printed except when transmitting in half duplex and the printer and recorder inhibit switches on the Answer-Back card are open. Other Answer-Back Memory options include inhibiting of the auxiliary-1 (AUX1) during transmission of the memory contents, and disabling actuation of the Answer-Back Memory by the ENQ character. For information on all answer-back options and for instructions on programming the memory, see the Model 732/733 Maintenance Manual (TI Part No. 960129).

B-3 CURRENT LOOP LINE INTERFACES.

B-3.1 NEUTRAL. This optional interface replaces the standard EIA interface. Signaling is accomplished by opening and closing the circuit presented to the terminal I/O connector. Nominal operating current is field selectable to either 60 mA or 20 mA.

B-3.2 POLAR. The optional polar interface replaces the standard EIA interface. Signaling is accomplished by alternately opening one circuit and closing the other circuit presented to the terminal I/O connector. A positive current in the external circuit represents a "mark" and a negative current represents a "space." Nominal operating current is either 60 mA or 20 mA.

B-3.3 MODEM LINE INTERFACE. This optional interface replaces the standard EIA interface. It conforms to the

requirements of the Bell System Data Access Arrangement, and it operates asynchronously up to a maximum speed of 300 baud in full or half duplex over a two-wire voice-grade line. Signaling is accomplished by means of frequency shift keying (FSK). Both originate mode and answer mode units are available.

B-4 AUTO DEVICE CONTROL (ASR MODEL ONLY).

The Automatic Device Control (ADC) option (TI Part No. 971481) accommodates control characters DC1, DC2, DC3, DC4, and EOT. An earlier version of the ADC (TI Part No. 960891) accommodates control characters DC1, DC2, DC3, and DC4 only. When the DC1, DC2, DC3, or DC4 are received from the communication line or generated by the terminal keyboard, the record and playback tape transports respond as follows:

<u>Full ASCII Keyboard</u>	<u>Standard ASCII Keyboard</u>	<u>Action</u>
DC1	(X-ON)	Playback ON
DC2	(TAPE)	Record ON
DC3	(X-OFF)	Playback OFF
DC4	(TAPE)	Record OFF
*EOT		Disconnect

When the playback transport reads a DC3 (playback OFF) character, the next character after the DC3 is read and transmitted before the playback transport is stopped (unless the DC3 character is the last character within the block, in which case the transport stops reading and transmitting immediately after the DC3 character).

On terminals equipped with the Auto Device Control option, consult Section B-9.1 for recording precautions concerning data terminals which do not have the ETX option (Section B-6.3) implemented.

*The EOT function is operable on terminals equipped with both the Auto Answer Control option (TI Part No. 960885) and the latest version of the ADC option (TI Part No. 971481).

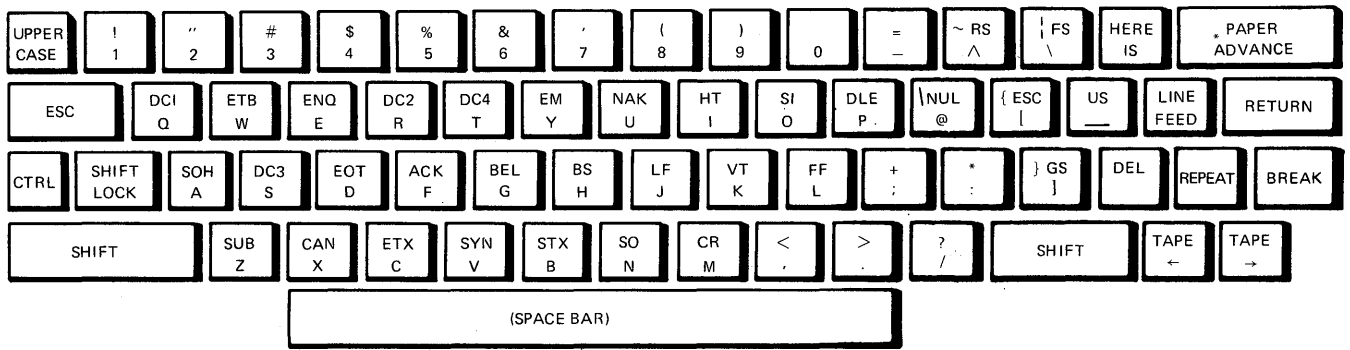

LEGEND:

- SOH** = Control Character
- A** = Alphabetic character (SHIFT for uppercase)
- !** = Shifted character
- 1** = Unshifted character
- ~.RS** = Shifted character, control character
- ^** = Graphic unshifted

FIGURE B-1.1. OPTIONAL FULL ASCII KEYBOARD LAYOUT AND SYMBOLIZATION

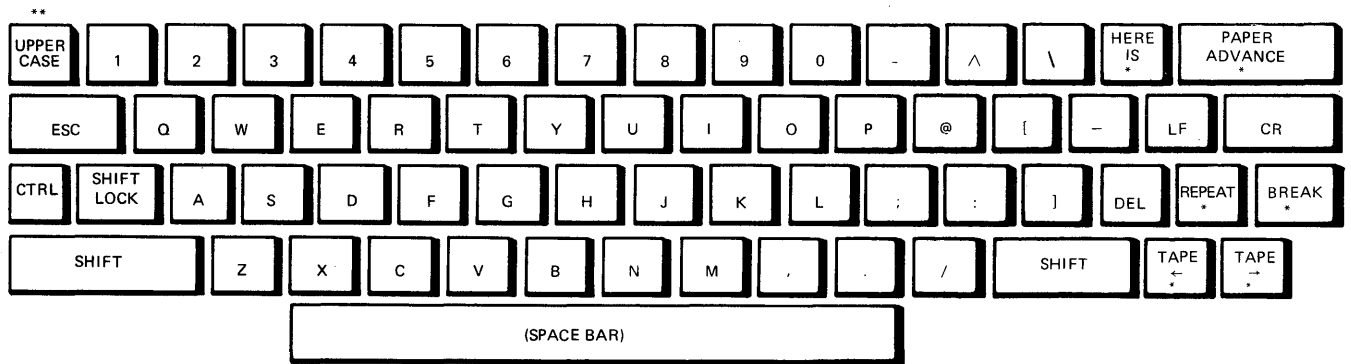

The above codes are generated when the labeled key is depressed but neither the SHIFT nor the CTRL key is depressed.

NOTES:

- * Not a code-generating key.
- ** If UPPER CASE is depressed, only uppercase codes are generated; otherwise, lowercase alphabetic codes are generated. (Press again to release.)

FIGURE B-1.2. LOWERCASE CHARACTERS, OPTIONAL FULL ASCII KEYBOARD

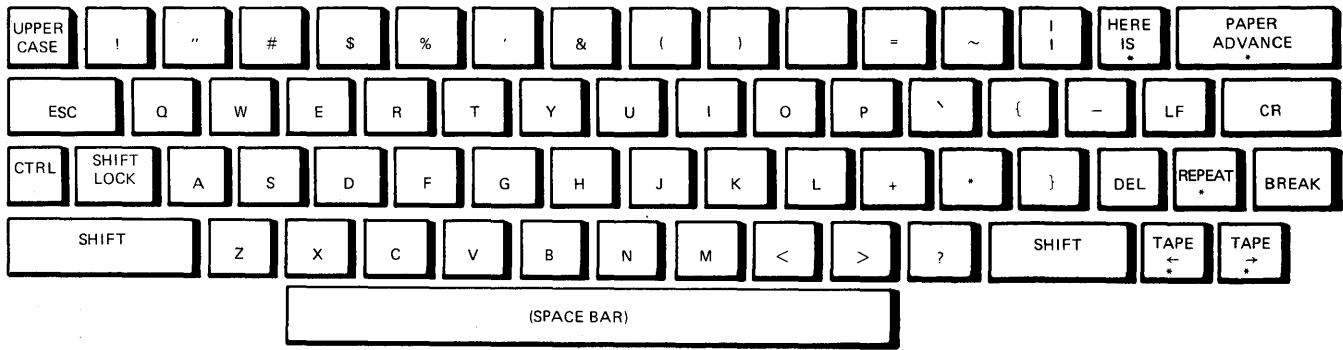

The above codes are generated when the SHIFT key and the labeled key are depressed. UPPERCASE key has no effect.

NOTES:

* Not a code-generating key.



A blank key indicates strobe inhibit. Depressing SHIFT and CTRL together inhibits strobe.

FIGURE B-1.3. SHIFTED CHARACTERS, OPTIONAL FULL ASCII KEYBOARD

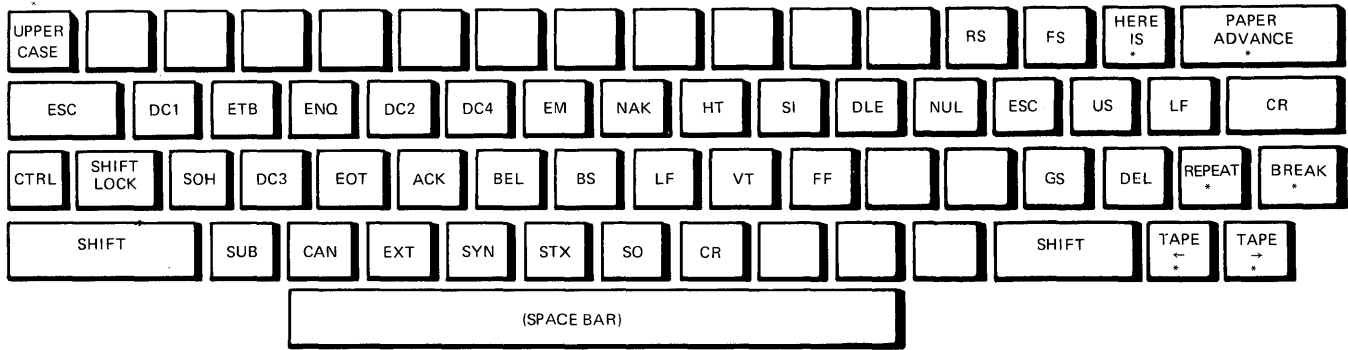

The above codes are generated when the CTRL key and the labeled key are depressed. UPPERCASE and SHIFT keys have no effect.

NOTES:

* Not a code-generating key.



A blank indicates strobe inhibit. Depressing SHIFT and CTRL keys together inhibits strobe.

FIGURE B-1.4. CONTROL CHARACTERS, OPTIONAL FULL ASCII KEYBOARD

NOTE

In local operation all keyboard data is ignored while the playback transport is ON. This means the DC3 control character cannot be generated from the keyboard to switch OFF the playback transport. The playback cassette will be stopped either by pressing the playback control (CONT) STOP or by reading a DC3 character on tape.

An ADC ON/OFF switch (on the new version only), accessible through the lower unit card cage cover, permits disabling of all functions (except EOT decode, for auto disconnect with Auto Answer Control option, Part No. 960885). This feature is particularly useful when recording tapes in which the DC1, DC2, DC3, and DC4 characters are to be recorded (i.e. format tapes, tape duplication).

It is possible for the Automatic Device Control to ignore or respond to the DC1, DC2, DC3, and DC4 characters coming from received, transmitted, or local data. These options are implemented by pencil switches on the new ADC PC card (971481) or by strappable resistors on the older version (960891). To implement these enabling options, see Table B-4.1 (new version) or Table B-4.2 (earlier version) as appropriate.

The Automatic Device Control is valuable for recording or playing back tapes from an unattended data terminal. Unattended operation is possible on terminals equipped with the Automatic Answer Control option. Before leaving the terminal unattended, set up the terminal as follows:

- a. REWIND and LOAD the cassette to be recorded (must have write tab installed).
- b. REWIND and LOAD the cassette to be played back.
- c. Select the desired TAPE FORMAT (CONT or LINE).
- d. On the ASR lower switch row the recommended settings are:
 - (1) KEYBOARD to OFF
 - (2) PLAYBACK to LINE
 - (3) RECORD to LINE
 - (4) PRINTER to LINE or OFF as desired.
- e. Set the terminal ON LINE/OFF switch to ON LINE.

On single-cassette ASR models, the tape may be only recorded or played back, depending upon the mode selected before leaving the terminal unattended.

It is recommended that the cassette being read (played back) be made a read only tape by removing the write tab for that side (see paragraph 4-4.1).

The terminal may be programmed to respond to the control character EOT only if the Automatic Answer Control option is installed in the data terminal. Upon receipt of the EOT control character, the terminal will be disconnected from the communications line.

For further information on the Automatic Device Control option, refer to the Silent 700 Models 732/733 Maintenance Manual (TI Manual No. 960129-9701).

B-5 SINGLE-CASSETTE SYSTEM.

The Model 733 ASR is available without the cassette-2 transport and its associated controls. This single-cassette system has the same controls, indicators, and capabilities as a dual-cassette system except for the following:

- a. Simultaneous playback and record operations cannot be performed.
- b. Tapes cannot be duplicated.
- c. Some editing functions are inhibited.

B-6 STRAPPABLE OPTIONS.

Several operating options may be implemented by adding, removing, or changing certain resistors on the appropriate PC cards as noted below. The PC cards may be removed for service as described in Section 6-3 of this manual.

B-6.1 END-OF-LINE ALARM. The end-of-line alarm may be inhibited from sounding automatically at column 72 by removing resistor R20 (10 ohms) from between J1 and J2 on the Printer Control PC card (red-tabbed card in slot A2 of the KSR PC card rack). This resistor is easily pulled out or inserted in its connector by hand. This will not inhibit the alarm from sounding upon receipt of the ASCII 'BEL' character. The card rack cover is shown in Figure 3-1.

B-6.2 PLAYBACK STOP ON ERROR. Upon detecting a read error when reading from the tape, the Playback Controller option will automatically stop if resistor R1 (10 ohms) is connected between J3 and J4 on the Playback Control PC card (Slot 4 in the upper ASR unit). If R1 is

connected between J1 and J2 on this same card, the controller will not stop upon detecting a read error; instead, it will transmit the erroneous block to the terminal and

continue reading tape (if in continuous playback mode). This resistor is easily pulled out of J3/J4 and inserted in J1/J2, or vice versa, by hand (no tools necessary)

TABLE B-4.1. AUTO DEVICE CONTROLLER ENABLING OPTIONS
(for Part No. 971481)

Control Function	Enabling Switch Section		
	To Enable When Transmitting	To Enable When Receiving	To Enable When in Local
DC1, DC3 (Playback ON/OFF)	S2-1 (DC3 only)	S2-2	S2-3
DC2, DC4 (Record ON/OFF)		S2-4	S2-5

NOTE

Control characters DC1 through DC4 function in the selected operating modes shown above. Close the appropriate switch section on S2 to enable the corresponding function. When the ADC ON/OFF switch is in the OFF position, all ADC functions are disabled except the automatic disconnect on receipt of the EOT character (if the Auto Answer Option is installed).

TABLE B-4.2. AUTO DEVICE CONTROLLER (EARLIER MODEL) ENABLING OPTIONS
(Part No. 960891)

Control Function	To Enable When Transmitting	To Enable When Receiving	To Enable In Local
DC1 (Playback ON) Resistor Between	R1 J1-J2	R2 J3-J4	R3 J5-J6
DC2 (Record ON) Resistor Between	R7 J13-J14	R8 J15-J16	R9 J17-J18
DC3 (Playback OFF) Resistor Between	R4 J7-J8	R5 J9-J10	R6 J11-J12
DC4 (Record OFF) Resistor Between	R10 J19-J20	R11 J21-J22	R12 J23-J24

NOTE: All resistors are 10 ohm, 0.25 watt, 5 %.

B-6.3 STRAPPABLE ETX CHARACTER TO INITIATE RECORDING. The optional Dual-Format Record Buffer PC card (962285-0001) may be strapped to permit use of the ASCII ETX control character to initiate tape recording of the contents of the record buffer when the TAPE FORMAT switch is set to CONT. The ETX control character then serves to initiate recording in CONT format the same as the carriage RETURN code does in LINE format.

When transmitting on-line in the CONTinuous tape format, it is important to send the ETX character last in the data stream, just before the DC4 character, to ensure that all transmitted data will be recorded on tape.

The ETX option may be enabled by removing R8 (10 ohms) between J3 and J4 on the Dual Format Record Buffer PC card (position XA-5, upper unit) and reinstalling R8 as R13 between J1 and J2. No tools are required to move R8.

B-7 AUTO ANSWER CONTROL (300 BAUD).

The Auto Answer Control option (TI Part No. 960984) permits a 300 baud terminal to automatically answer a call through the Bell System DDD network. Two versions of this option provide interface to either a Bell CBS Data Access Arrangement (or equivalent) with the Answer Mode Modem option or a Bell 103A Data Set (or equivalent) with Auto Answer Control. The two versions require different interface cables. This option offers the following features:

- * (1) Automatic triggering of the Answer-Back Memory (if installed) when the call is answered. The Answer-Back Memory is triggered after a standard delay of 1.28 seconds from the carrier detect, but the delay can be adjusted by installing a 10-ohm resistor jumper between the points listed in Table B-7.1.
- (2) The terminal is automatically disconnected from the line, and the data line is blinded from receiving or transmitting any further data if any of the following conditions occur.
 - (a) A carrier from the originating station is not received within 10 seconds after a call is answered.
 - (b) The carrier from the originating station is lost for at least 50 msec during a call.

*Requires either an RDC (971483 M/L, 973901 M/W) PC card or an ADC (971481) PC card.

- (c) The disconnect character (usually EOT) is received from the originatig station [if a Remote Device Control or an Automatic Device Control (971481) option is installed].
- (d) A continuous space of at least 1.28 seconds without a mark is received from the originating station.

- (3) Indicator lamps on the keyboard option panel display the following:

RING INDICATOR: blinks 2 seconds on and 4 seconds off with the ringing indicator of the 103A or DAA (or equivalent). The indicator glows steadily after the call is answered until the carrier is received from the originating station.

TERMINAL READY: illuminates when the terminal ON-LINE/OFF switch is set to ON-LINE, indicating that the terminal will answer an incoming call.

LINE-READY: illuminates when the terminal has answered the call, received the carrier from

TABLE B-7.1. ANSWER-BACK MEMORY TRIGGER DELAY ADJUSTMENTS

Delay	Install ¹ Resistor	Between
10.24 sec	R15	J10 & J16
5.12 sec	R16	J9 & J14
2.56 sec	R17	J8 & J1
1.28 sec	R18 ²	J7 & J15
640 msec	R19	J6 & J17
320 msec	R20	J5 & J15
160 msec	R21	J4 & J14
80 msec	R22	J3 & J1
0.6-1.9 msec	R23	J2 & J16

NOTES:

- ¹ Only one 10-ohm resistor is installed.
- ² R18 is standard setting for trigger delay.

the originating station, and is ready to transmit or receive.

or 103 series is selectable by removing or installing the following resistor on the Auto Answer Control PC card:

The interface signals for both versions of the Auto Answer Control option are compatible with EIA Standard RS232C. The interface cable pin assignments and functions are listed in Tables B-7.2 and B-7.3. Operation with either the DAA

	<u>Install</u>	<u>Remove</u>
To implement with the DAA	R2	R1
To implement with the 103	R1	R2

TABLE B-7.2. 300 BAUD AUTO ANSWER CONTROL PIN ASSIGNMENTS AND FUNCTIONS FOR THE 103A SERIES (OR EQUIVALENT) DATA SETS (CABLE, TI PART NO. 971555-0001)

Connector Pin Numbers		Pin Function
Data Terminal	Data Set	
A	1	Protective GND ¹
H	2	Transmitted Data ²
10	3	Received Data ³
8	5	Clear to Send ³
9	6	Data Set Ready ³
7	7	Signal GND ¹
K	8	Carrier Detect ³
E	20	Data Terminal Ready ²
D	22	Ring Indicator ³

NOTES

1. Common Signal From both Terminal and Data Set
2. Signal From Terminal
3. Signal From Data Set

TABLE B-7.3. 300 BAUD AUTO ANSWER CONTROL PIN ASSIGNMENTS AND FUNCTIONS FOR THE CBS-DAA SERIES (OR EQUIVALENT) DATA COUPLERS* (CABLE, TI PART NO. 971557-0001)

Terminal Pin No.	Wire Color at Spade Lug	DAA Terminal Lugs	Description
7	Black	SG	Signal Ground
E	Red	OH	Off Hook
D	Green	RI	Ring Indicator
5	White	CCT	Coupler Cut Through
6	Brown	DA	Data Transmission
C	Orange	DT	Data Tip
3	Yellow	DR	Data Ring
4	Blue	SH	Switch Hook

*Used only with built-in internal Answer Modem option.

B-8 AUTOMATIC SEARCH CONTROL.

The Automatic Search Control (ASC) option provides the capability to search a cassette tape for previously recorded data, using from 1 to 16 printable characters as an identity code. The search rate depends on which of various configurations and modes is used. The minimum rate* is 250 characters per second (CPS).

B-8.1 LOCAL ASC OPERATION.

B-8.1.1 Initiating a Search. To initiate automatic tape search in local standalone operation, prepare the data terminal as follows.

- a. On the ASR switch panel lower row, set
 - (1) KEYBOARD to LOCAL
 - (2) PLAYBACK to LOCAL
 - (3) *RECORD to OFF
 - (4) PRINTER to LOCAL.
- b. Insert the cassette to be searched into the cassette 1 transport, rewind and load, and set the RECORD/PLAYBACK switch to PLAYBACK for that cassette.
- c. Press the ESC key and then the \$ key. The data terminal will respond with a line feed and a carriage return.
- d. Type in the information to be located on the playback cassette. This information is stored in a memory on the ASC PC card and must be from 1 to 16 printable ASCII characters in length. This information becomes the search identity (ID); it will be retained in memory until a new ID is entered or POWER is switched OFF. If more than 16 printable characters are entered, the printer is automatically inhibited and the memory retains only the first 16 printable characters entered.

Control characters, including carriage return and line feed, are ignored if entered in the search ID or in the data on tape. The search ID must be information known to be recorded on the cassette tape (e.g., name, part number, account number, header, trailer, etc.) including

spaces and punctuation. When the tape cassettes are recorded, it is useful to give each file (record) a header which can later be used as the search ID. Be sure the header is from 1 to 16 printable characters in length and is unique from all other data on the tape.

- e. Start the search using one of the following methods:

- (1) Press CONT START; this causes the cassette to be searched continuously.

OR

- (2) Press BLOCK FWD; this causes the cassette to be searched one data block each time the switch is pressed.

OR

- (3) Terminals equipped with the Automatic Device Control (ADC) option or the Remote Device Control (RDC) option may use the DC1 (X-ON) control character entered from the keyboard to start the search. This produces the same action as pressing CONT START. Depending on the intended use of the data terminal, the ADC or RDC options may have been set to ignore the DC1 (X-ON) control character in the local mode of operation (a selectable option). This precludes starting a search from the keyboard; the search must be started by pressing CONT START.

The printer is inhibited and the DC1 through DC4 functions are ignored while the playback cassette is being searched. When the desired data is located on the tape, the terminal responds with a line feed and a carriage return, and the terminal enables the printer and stops the playback cassette.

- f. To play back the searched-for data:

- (1) If the search ID selected occurs just before the desired information, press CONT START (or BLK FWD or CHAR FWD). The search process halts when the last character of the search ID is located,

*In the local mode the search rate is contingent on the record status; i.e., if record is ON-LINE and READY, the search rate is maximum (326 CPS). For all others (i.e., record *not* ON-LINE and READY) the search rate is a maximum 250 CPS.

and in this case the desired information will be readily available from the tape.

- (2) If the search ID selected was part of the desired data, press BLOCK REV several times (this ensures that most of the data will be printed, since the data may be contained in more than one consecutive block). Then press CONT START, BLOCK FWD, or CHAR FWD as desired.

B-8.1.2 Reinitiating a Search. If the desired data is contained on the playback cassette more than once, it is not necessary to re-enter the search ID. The search may be restarted simply by entering the activate code (ESC and \$), and then press CONT START, BLOCK FWD, or CHAR FWD as desired.

B-8.1.3 Termination of a Search. To terminate a search, press the BREAK key*. The ASR will respond by causing a line feed and a carriage return. The cassette in the playback mode will stop, and the printer will be automatically activated. The contents of the ASC memory will not be altered.

B-8.1.4 Tape Editing and Duplication. The ASC is a very useful and time-saving aid in editing and duplicating tapes. Editing is faster with ASC since it is not necessary to stop the play back and approach the error using BLOCK FWD's and CHAR FWD's as in the conventional method of editing tapes (described in Section 5-1.7). Tape duplication at the full search speed is possible while a search is in progress. Tape editing is easier if the tape is recorded in LINE tape format and the duplicate (copy) tape also is recorded in LINE tape format. If desired, a CONTinuous format tape can be recorded after editing is complete. This procedure is described in Section 5-1.5.

To duplicate and edit proceed as follows:

- a. Complete steps B-8.1.1 a. and b.
- b. Insert a blank tape cassette (with write tabs in place) into the CASSETTE 2 transport. (CASSETTE 1 can be used, but CASSETTE 2 is described to simplify the explanation.)

- (1) Press CASSETTE 2 REWIND.

- (2) When the END lamp lights, press LOAD/FF. The READY lamp should light after a few seconds.

- c. Set the TAPE FORMAT switch to LINE.
- d. Enter the activate code: ESC and \$.
- e. Type in the search ID. For editing purposes the search ID can be the desired text identifier.
- f. Press the RECORD CONTROL/ON switch. The ON lamp should light.
- g. Press CONT START. CASSETTE 2 will duplicate CASSETTE 1 while the search is in progress. The DC1 (X-ON) character should not be used to start the search because the character will be recorded on the tape.
- h. When the search ID is located on the playback cassette (CASSETTE 1), the data terminal will respond with a line feed and a carriage return.
- i. Press the RECORD CONTROL/PRINT switch. This will cause display and printing of the contents of the record buffer. The search ID characters will be the last characters printed. For example, suppose the search ID was a misspelled word; therefore, the last word printed is misspelled. The TAPE (backspace) key can be pressed as many times as necessary until the printhead moves back just over the incorrect character. The correct character(s) can then be typed in. The TAPE (forward space) key is pressed to return to the point where the printing was stopped. Pressing BLOCK FWD will put the remainder of that line in the record buffer and on tape the same as the carriage return character. If more editing is necessary, press RECORD CONTROL/OFF. Repeat the above process, starting with entering the activate code (step d. above), until editing is complete. When the last error is corrected, normal duplication procedures, as described in section 4-9.1 may be used to complete the duplication process.

*More than one line feed may result from pressing the BREAK key because of key switch contact bounce; however, no other operations are affected.

For another example, suppose the search ID is a word to be eliminated from the text. The TAPE (backspace) key is repeatedly pressed until the printhead just covers the first letter of the word. Pressing BLOCK FWD will cause the remainder of the line to be printed and recorded after a carriage return on the duplicate tape (cassette 2). The resulting line on cassette 2 will have the word eliminated.

B-8.1.5 Tape Search Abort. A search in progress will be automatically and unconditionally terminated if any of the following conditions occur.

- a. The data cassette in the PLAYBACK mode reaches clear leader.
- b. The cassette door is opened.
- c. The status of the cassette in the PLAYBACK mode is changed; i.e., switched to OFF or LINE.

B-8.1.6 Playback Errors During a Search. The following indications and actions occur when the cassette under search encounters a playback error.

- a. If the stop-on-error option is implemented on the Playback Control PC card, when an error occurs the ERROR lamp on the upper panel will glow and the tape will stop on the error block until the error is cleared. The error can be cleared only from the ASR (upper unit) control panel. The error is cleared as follows:
 - (1) Press CONT START; this will cause the block in error to be fully read and searched with the possibility of missing the desired data which may be contained in the error block.
OR
 - (2) Press BLOCK FWD; this will cause the ASR to read and search the *next* sequential block, bypassing the error block. Again, the possibility of missing the desired data exists.
OR
 - (3) Press BLOCK REV, then press BLOCK FWD or CONT START; the block-in-error will be reread, and the data will be recovered if the error is not permanent.

- b. If the stop-on-error option is not implemented, the error block will be searched and the possibility of missing desired data exists if it is contained in the error block.

B-8.2 REMOTE ASC OPERATION. When the data terminal is equipped with both the ASC and the Remote Device Control (RDC) options, the ASC also may be activated by data received over the communications line. Usually, this data is transmitted to the terminal by a computer (CPU) or another data terminal.

B-8.2.1 Local Preparation. The RDC permits remote selection of cassette 1 or cassette 2 in the playback mode. It also will activate rewinding and loading of the cassettes. The conditions necessary at the *local* terminal to permit search by a remote controller are the following.

- a. On the ASR (upper unit) switch panel, set
 - (1) KEYBOARD to OFF
 - (2) PLAYBACK to LINE
 - (3) RECORD to LINE
 - (4) PRINTER to LINE
 - (5) Terminal ON LINE/OFF to ON LINE
- b. Place cassette(s) to be searched in the tape transport(s).
- c. Switch the RDC to ON (it must be enabled to respond to DC1 on received data).

The terminal will then permit a remote tape search.

B-8.2.2 Conducting a Search from a Remote Location. The controlling device may request status of the terminal if desired (see the Remote Device Control instructions in Section B-9 for the procedure to request status of a terminal and the interpretation of the status characters). The cassette tape to be searched must be loaded and ready before the search can begin. If the status is not correct for a search to be conducted, consult the Remote Device Control operation instructions (section B-9) and perform the steps necessary to load and ready the tape cassette to be searched.

- a. The search is activated upon receipt of the ESC and \$ signals by the terminal via the communication line.

CAUTION

To ensure that the status character does not become a part of the search ID, always request status either before transmitting ESC and \$ or after the search is initiated.

- b. The search ID is entered via the communication line. This may be from 1 to 16 printable characters in length. The search ID may be selected as described in Section B-8.1.

NOTE

Control characters (including carriage return and line feed) entered in the search ID field are ignored.

- c. The X-ON (DC1) character then is entered via the communication line. The search will then be conducted. During the search all control characters are ignored.

NOTE

A character-by-character or block-by-block search cannot be performed from a remote location.

- d. The controlling device may determine if the search is complete by requesting status as described in Section B-9.4. Bit 7 (playback ON) of the status character indicates the status of the search. When it is a logic ONE, the search is complete. When Bit 7 is a logic ZERO, the search is being conducted.

NOTE

The RDC is normally set up to force bit 7 to a logic ONE when status is requested. This switch-selectable option must be ON for the playback-ON feature of the status character to be enabled (see Section B-9.4).

No indication will be given at the searched terminal (i.e., no line feed and carriage return) when the search is completed.

- e. When it is determined that the search is completed, the two-character control code for block reverse (DLE and 8) is entered. The block

reverse should be performed several times to ensure that all desired data is transmitted.

NOTE

Data should normally be recorded on tape so that one BLOCK REV is sufficient, or the desired data may be recorded immediately after the search ID so that only a CONT START or BLOCK FWD is necessary.

- f. The desired data is now located, and it may be played back as desired (i.e., CONTinuously or a block at a time; see the RDC instructions, Section B-9, for command codes).

B-8.2.3 Reinitiation of Remote Search. The tape cassette may be searched again for the same data (using the same search ID) by receipt of ESC, then \$, and then DC1 (X-ON) via the communication line.

B-8.2.4 Termination of a Remote Search. The operator (or CPU) controlling the remote-search may cancel the search while it is being executed. This is accomplished by transmitting the DLE character and the ? character via the communication line. This action causes termination of the remote search. No indication of search cancel is given at the searched terminal (i.e., no line feed and carriage return).

A new search ID may be entered (following ESC, \$) if desired. Rewind and load the playback cassette if the desired data has passed during the previous search.

B-8.2.5 Tape Duplication. Remote control of the tape duplication process is not possible.

B-8.2.6 Tape Search Abort. The search in progress, regardless of mode or configuration, will be automatically and unconditionally terminated if any of the following conditions occur.

- a. The data cassette in the playback mode reaches clear leader.
- b. The data terminal is switched OFF-LINE while a remote search is in progress.
- c. The cassette door is opened.
- d. The status of the cassette in the playback mode is changed; i.e., switched to OFF or LOCAL.

B-8.2.7 Playback Error During Search. The error status and indications for the ASC with RDC in on-line mode are as follows:

- a. If the stop-on-error option is implemented and an error occurs during a search, the playback cassette will be stopped immediately and the CAN character will automatically be transmitted to the line (if the CANcel option is implemented on the RDC card). The responsibility for clearing the error belongs to the search initiator.

The methods used to clear the error in the remote mode are identical to those used in the local mode, but instructions to the terminal are transmitted by codes defined in the Remote Device Control operators instructions (see Section B-9).

- b. If the stop-on-error option is not implemented, the search will continue, and the possibility exists that the error block may contain the desired data. Again, the RDC will unconditionally transmit the CAN character if this option is implemented on the RDC PC card.

B-9 REMOTE DEVICE CONTROL.

The Remote Device Control (RDC) option permits a remote device to control the functional operating modes of the Model 733 ASR Data Terminal. All functions controlled by the Remote Device Control are performed upon receipt of specific ASCII characters. Five functions are controlled by single ASCII characters; the remaining functions require a sequence of two ASCII characters.

B-9.1 REMOTE DEVICE CONTROL COMMANDS. The single-character functions and the standard characters to activate these functions are as follows.

- | Function | Character |
|---|--------------|
| 1. PLAYBACK ON | -DC1 (X-ON) |
| This code switches ON the Playback Control if the playback cassette transport is READY. | |
| 2. PLAYBACK OFF | -DC3 (X-OFF) |
| This code switches OFF the Playback Control. When the playback transport reads a DC3 (X-OFF) character, the next character after the DC3 is read and transmitted before the | |

playback transport is stopped. If the DC3 character is the last character within the block, the transport stops reading and transmitting immediately after the DC3 character.

- 3. RECORD ON -DC2 (TAPE)
This code switches ON the Record Control if the record cassette transport is READY.
- 4. RECORD OFF -DC4 (TAPE)
This code switches OFF the Record Control. The DC4 character will be the last character in the record buffer. All characters following the DC4 will be written into the same buffer location (overpunched). Thus, it is impossible to predict the resulting character. It is recommended that a RUBOUT (DEL) be sent following the DC4 to ensure the overpunched character will not cause subsequent system problems.

NOTE

The contents of the record buffer are not recorded on the cassette tape when the RECORD OFF (DC4, TAPE) command is received. When recording in LINE tape format, a carriage return will ensure that the data is recorded on the cassette tape. When recording in CONTinuous tape format, it is recommended to send at least 86 filler characters, usually delete (DEL), to the terminal after the last data entry and before the RECORD OFF (DC4) command is transmitted. If the terminal is equipped with the ETX option (described in section B-6.3) and the terminal is recording in CONTinuous tape format, the following procedure is recommended. After the last data entry, the ETX character should be sent to initiate recording the final contents of the buffer on tape.

The playback ON/OFF and/or record ON/OFF functions can be enabled or disabled from local, received, or transmitted data by switches located on the RDC printed circuit card. The functions of these switches are listed in Table B-9.1. All other functions are enabled on received-data only.

NOTE

DC3 is the only control character acted upon during transmission.

TABLE B-9.1. RDC SWITCH OPTIONS

Switch S2	Description
1	Enable DC2 and DC4 in LOCAL
2	Enable DC2 and DC4 from received data
3	Enable DC1 and DC3 in LOCAL
4	Enable DC1 and DC3 from received data
5	Enable DC3 from transmitted data
6*	Enable playback OFF indicator to bit 7 of status character
7*	Enable automatic CAN character on playback error option

*These functions are normally disabled (switch in OFF position).

5. Auto Disconnect -EOT
 When used with the 300-baud Auto Answer Control option, this code disconnects the terminal from the communication line (i.e., 'hangs up the phone') when the EOT character is received from the line.

The remaining functions require a sequence of two ASCII characters. The first character of the sequence is the data link escape control character (DLE).

NOTE

The printer is automatically disabled from printing the first character following the DLE character. Data to the recorder is not affected.

All two-character functions are enabled from *received data only*. The two-character functions and the *second* character of the code sequence are the following:

- | Function | Characters (DLE plus . . .) |
|---|-----------------------------|
| 1. Rewind Cassette 1 | -1 |
| This code rewinds cassette 1 to the clear leader at the beginning of the tape when the character sequence DLE and 1 is received. If a rewind is issued for cassette 1 and it is already on clear leader, the RDC is automatically disabled (including EOT decode) for 1.5 seconds. The RDC is not disabled if cassette 1 was not on clear leader. | |
| 2. Rewind Cassette 2 | -2 |
| This code rewinds cassette 2 (dual-cassette models only) to the clear leader at the beginning of the tape when the character | |

sequence DLE and 2 is received. If a rewind command is issued for cassette 2 and it is already on clear leader, the RDC card is automatically disabled (including EOT decode) for 1.5 seconds. The RDC card is not disabled if cassette 2 was not on clear leader.

- | | |
|--|----|
| 3. Load Cassette 1 | -3 |
| When the character sequence DLE and 3 is received, cassette 1 is loaded if on BOT clear leader. If cassette 1 is not on clear leader when this command is received, a fast forward (F/F) will result. If the cassette is on EOT clear leader when the command is received, no action occurs. | |
| 4. Load Cassette 2 | -4 |
| When the character sequence DLE and 4 is received, cassette 2 is loaded if on clear leader (dual-cassette models only). If cassette 2 is not on clear leader when this command is received, a fast forward (F/F) will result. If the cassette is on EOT clear leader when the command is received, no action occurs. | |

NOTE

A fast forward CANNOT be stopped by a remote command. The fast forward will stop when clear leader is reached at the end of the tape.

- | | |
|--|----|
| 5. Cassette 1 in Record Mode | -5 |
| On all models the character sequence DLE and 5 places cassette 1 in the record mode. On dual-cassette models this command also | |

automatically places cassette 2 in the playback mode.

6. **Cassette 1 in Playback Mode -6**
On all models the character sequence DLE and 6 places cassette 1 in the playback mode. On dual-cassette models, this function also automatically places cassette 2 in the record mode.

CAUTION

To prevent either loss of data intended for recording or a resultant read error, allow at least 0.5 second for the first block following a load command and 0.25 second for all other blocks before issuing a RECORD/PLAYBACK mode change (i.e., DLE 5 or DLE 6). The RECORD/PLAYBACK mode change command (DLE 5 or DLE 6) is ignored if the RECORD and/or PLAYBACK is ON when the command is received. When recording in CONTINUOUS tape format, do not use these commands unless the ETX option is enabled, because any data in the record buffer will be lost.

7. **Block Forward (BLOCK FWD) -7**
This code causes the next block of data on the playback cassette to be read and played back (or the remainder of a block if the playback of that block has been stopped).
8. **Block Reverse (BLOCK REV) -8**
This code causes the playback tape transport to reverse one block of data and stop in the interrecord gap. This action consumes 0.4 second.
9. **Printer ON -9**
This code enables the printer to receive data from the communications line (if the printer is in the LINE mode) after having been disabled (number 10 below).
10. **Printer OFF -0 (zero)**
When the terminal receives the character sequence DLE and 0 (zero) from the communications line, the printer is disabled from printing (receiving) line data. If the character sequence is received when the printer

is in either the LINE or LOCAL modes the printer is disabled in the LINE mode only. This function is reset and reverts to the printer-ON condition when the terminal is switched OFF LINE, when the power is turned OFF, or when the RDC PC card is switched OFF.

11. **Auto Device Control ON -: (colon)**
This code enables the playback ON, playback OFF, record ON, and record OFF functions on received data after having been disabled by the Auto Device Control OFF function (number 12 below).
12. **Auto Device Control OFF -; (semicolon)**
This code disables the playback ON, playback OFF, record ON and record OFF functions (on received data only). This function is particularly useful when recording data from the line containing the playback ON/OFF or record ON/OFF characters (DC1, DC2, DC3, and DC4). This function is reset and reverts back to the ON condition when the terminal is switched OFF LINE, power is switched OFF and ON, or the RDC PC card is switched OFF.
13. **Request Status < (less-than symbol)**
This code enables the terminal to send a status character. It is particularly useful in determining when a rewind, load, etc. function has been completed. See paragraph B-9.4 below for an interpretation of status characters.
14. **ASC Remote Cancel -? (question mark)**
When used with the Automatic Search Control option, this code cancels a remote search once it has been started. This is the ON-LINE equivalent to the local search operation BREAK key. During an on-line search, the DC3 (playback OFF) control character is ignored if encountered. No data is transmitted during an on-line search except status (if it has been requested) or the CAN character if a playback error is made and the CAN character option is enabled.

B-9.2 LOCAL OPERATION. In the local (off-line) mode of operation, the only functions the RDC can execute are the following:

Playback ON	-DC1 (X-ON)
Playback OFF	-DC3 (X-OFF)
Record ON	-DC2 (TAPE)
Record OFF	-DC4 (TAPE)

The conditions recommended for using the Remote Device Control in the local mode are

- (1) *RDC switch to ON
- (2) KEYBOARD to LOCAL
- (3) PLAYBACK to LOCAL
- (4) RECORD to LOCAL
- (5) PRINTER to LOCAL (if desired).

NOTE

When the playback is ON (playback ON lamp illuminated) and the keyboard is in the same mode as the playback (i.e., LINE or LOCAL), the keyboard is "locked out" and all data from the keyboard is ignored.

B-9.3 INITIAL SETUP. All functions (except EOT) of the RDC may be either enabled or disabled via a switch accessible under the terminal cover. When this switch is in the ON position, all functions are enabled. When this switch is in the OFF position, the auto disconnect (EOT) is the only function enabled.

The conditions recommended to permit a 733 ASR Data Terminal to be controlled by a remote device are the following:

- (1) *RDC switch to ON
- (2) KEYBOARD to OFF
- (3) PLAYBACK to LINE
- (4) RECORD to LINE
- (5) PRINTER to LINE
- (6) Terminal ON LINE/OFF switch to ON LINE
- (7) Tape cassette(s) in the transport(s)
- (8) DC1 through DC4 functional pencil switches on the RDC PC card enabled to line data (received and/or transmitted data) as listed in Table B-9.1.

NOTE

Remote commands to the terminal must allow adequate time between commands to permit execution of each command. For example, a cassette-1 rewind command (DLE plus 1) cannot

immediately be followed with a load cassette-1 command (DLE plus 3). If cassette 1 has not completed the rewind, the load command is ignored. See Table B-9.2 for a list of command execution times.

Status may be requested at any time except for 1.5 seconds after a rewind command with the cassette on clear leader. This is useful if the remote controller is uncertain a command has been completely executed (e.g., rewind).

B-9.4 RDC STATUS CHARACTERS. The status character transmitted by the terminal as a result of a status request command is a single ASCII character, the data bits of which indicates the status of the playback, record, and printer functions.

B-9.4.1 Status Character Bits. The status information indicated by each bit of the status character is as follows:

Bit 1 – (Least significant bit) indicates that the playback function is ready when bit 1 is a logic ONE. If bit 1 is a logic ZERO, playback is not ready for one or more of the following reasons:

- (1) Cassette door open or cassette not in place.
- (2) Cassette on clear leader.
- (3) Playback not in LINE mode.
- (4) Other operations being performed (i.e., rewind and load).

Bit 2 – indicates a playback error has been made if bit 2 is a logic ONE. A logic ZERO indicates a playback error has not been made. If the playback is strapped to *not* stop on an error, bit 2 will indicate a ONE only while a block with an error is being (or waiting to be) transmitted.

NOTE

A playback error may be cleared either by using the remote control codes or locally by using the manual controls; i.e., playback ON, BLOCK REV, or BLOCK FWD (see Section 4-8).

*The RDC ON/OFF switch is labeled ADC ON/OFF on the PC card rack cover.

Bit 3 – indicates cassette 1 is on the clear leader at either end of tape if bit 3 is a logic ONE. A logic ZERO indicates cassette 1 is not on clear leader.

Bit 4 – same as bit 3 except applied to cassette 2.

Bit 5 – indicates that the record function is ready to be enabled with the record-ON function when bit 5 is a logic ONE. If bit 5 is a logic ZERO, record is not ready for one or more of the following reasons:

- (1) Cassette door open or cassette not in place.
- (2) Cassette on clear leader.
- (3) Record not in LINE mode.
- (4) Other operation being performed (i.e., rewind and load).

- (5) Write-enable tab removed from the tape cassette.

Bit 6 – indicates that the printer is ready when bit 6 is a logic ONE. If bit 6 is a logic ZERO, the printer is not ready for any of the following reasons:

- (1) Printer not in LINE mode.
- (2) Printer is OFF as a result of a printer-OFF command or while the ASC is searching.

Bit 7 – always a logic ONE to force the status character out of the control character subset. This bit may be optionally strapped to indicate playback-ON status. In this case a logic ZERO indicates the playback is ON (i.e., playback either

TABLE B-9.2. MODEL 733 ASR COMMAND EXECUTION TIMES

Command	Maximum Time
¹ REWIND	60 sec
² LOAD	3 sec
BLOCK REVERSE	400 msec
³ RECORD-OFF (When followed by a RECORD/PLAYBACK mode change)	$T = 0.4 + 0.25 (N-1)$ (for $N > 0$) $T = 0$ for $N = 0$

¹Time to rewind from the right end of the tape. A status request may be used to determine when a rewind is complete (the cassette will be on clear leader).

²Status may be requested to determine completion of this command. The cassette will become ready.

³T = time in seconds

N = In LINE tape format (or CONT tape format with ETX option) the number of carriage returns (or ETX's when in CONT tape format) received by the terminal within 250 msec immediately before receiving RECORD OFF. The very first block on the tape requires 0.250 sec additional time.

reading tape or transmitting data), and a logic ONE indicates playback is not ON. This option is particularly helpful in determining when the Automatic Search Control option has completed a search. If this option is used, the status character will *not* be excluded from the control character subset.

EXAMPLE: If the playback is ready, a playback error has not been made, cassette 1 is not on clear leader, cassette 2 is on clear leader, record is not ready, and printer is ready; the status character would be

b ₁ - ONE	}	= the USASCII character "i"
b ₂ - ZERO		
b ₃ - ZERO		
b ₄ - ONE		
b ₅ - ZERO		
b ₆ - ONE		
b ₇ - *ONE		

*strapped to logic ONE

A complete list of status characters is contained in Table B-9.3.

B-9.4.2 Use of Status Character Information. In addition to the specific status indicated by each bit of the status character, combining specific commands with the status information reveals certain facts. For example:

- (1) If both cassettes are on clear leader following a rewind, issuing a load command to either cassette and verifying whether PLAYBACK or RECORD comes ready provides "mode" status for each of the cassettes.
- (2) If a rewind command is issued when a cassette is on clear leader and the clear leader status does not change within 1.5 seconds, the cassette is at beginning-of-tape clear leader (not end of tape). Similarly, if a "load" command is issued and the PLAYBACK or RECORD (whichever is appropriate) does not come ready, the cassette is on end-of-tape clear leader.
- (3) After a rewind command is issued, the clear leader status will indicate when the rewind is complete.
- (4) After a load command, the PLAYBACK or RECORD ready status will indicate when the load operation is complete.

B-9.5 ERROR DETECT. The automatic error-detect feature causes transmission of the CAN (cancel) character when a playback error occurs. This option is strappable and allows the system to recover from playback error in minimal time in cases where the Model 733 ASR is strapped to stop-on-error. See Table B-9.1 for information to enable the error-detect option.

B-9.5.1 Non-Stop-On-Error Operation. If a playback error occurs and the stop-on-error option is not incorporated on the Playback Control PC card (see Section B-6.2 for further details), the CAN (cancel) control character will be transmitted before the erroneous block of data is transmitted. The erroneous block will consist of true data to the point in the block at which the read error occurred and the NUL (null) control character from that point to the end of the block (a total of 86 characters: true data and nulls).

B-9.5.2 Stop-On-Error Operation. If a playback error occurs and the stop-on-error option is incorporated on the Playback Control PC card (see Section B-6.2), the CAN control character will be transmitted after the last block of "good" (no playback error) data. The CAN character indicates that the next block of data on tape contains a playback error. No more taped data will be transmitted until the playback error is cleared.

The playback error may be cleared using one of the following methods.

- a. Replaying the Block
 - (1) Send a block reverse command (DLE and 8).
 - (2) After sufficient time for this command to be executed has elapsed (typically 400 milliseconds), send a block forward command (DLE and 7). This causes the block of data to be reread. If the error recurs, the CAN character will again be transmitted by the terminal.

If there was no playback error, the block of data will be transmitted and playback may be resumed.
- b. Reading (Transmitting) the Block With an Error

Send the playback ON command (DC1). The erroneous block will then be transmitted in the mode (playback ON or block forward) in effect

TABLE B-9.3. REMOTE DEVICE CONTROL STATUS CODES AND CHARACTERS

Status Character	Status Code								Status Code								
	Parity	High (ONE) or Playback OFF	Printer Ready (ONE)	Recorder Ready (ONE)	Clear Leader Cassette-2	Clear Leader Cassette-1	Playback Error (ONE)	Playback Ready (ONE)	Status Character	Parity	High (ONE) or Playback OFF	Printer Ready (ONE)	Recorder Ready (ONE)	Clear Leader Cassette-2	Clear Leader Cassette-1	Playback Error (ONE)	Playback Ready (ONE)
	b 8	b 7	b 6	b 5	b 4	b 3	b 2	b 1	b 8	b 7	b 6	b 5	b 4	b 3	b 2	b 1	
@	P	1	0	0	0	0	0	0	\	P	1	1	0	0	0	0	0
A	P	1	0	0	0	0	0	1	a	P	1	1	0	0	0	0	1
C	P	1	0	0	0	0	1	1	c	P	1	1	0	0	0	1	1
D	P	1	0	0	0	1	0	0	d	P	1	1	0	0	1	0	0
E	P	1	0	0	0	1	0	1	e	P	1	1	0	0	1	0	1
G	P	1	0	0	0	1	1	1	g	P	1	1	0	0	1	1	1
H	P	1	0	0	1	0	0	0	h	P	1	1	0	1	0	0	0
I	P	1	0	0	1	0	0	1	i	P	1	1	0	1	0	0	1
K	P	1	0	0	1	0	1	1	k	P	1	1	0	1	0	1	1
L	P	1	0	0	1	1	0	0	l	P	1	1	0	1	1	0	0
P	P	1	0	1	0	0	0	0	p	P	1	1	1	0	0	0	0
Q	P	1	0	1	0	0	0	1	q	P	1	1	1	0	0	0	1
S	P	1	0	1	0	0	1	1	s	P	1	1	1	0	0	1	1
T	P	1	0	1	0	1	0	0	t	P	1	1	1	0	1	0	0
X	P	1	0	1	1	0	0	0	x	P	1	1	1	1	0	0	0
SOH	P	0	0	0	0	0	0	1	!	P	0	1	0	0	0	0	1
ETX	P	0	0	0	0	0	1	1	#	P	0	1	0	0	0	1	1
ENQ	P	0	0	0	0	1	0	1	%	P	0	1	0	0	1	0	1
BEL	P	0	0	0	0	1	1	1	/	P	0	1	0	0	1	1	1
HT	P	0	0	0	1	0	0	1)	P	0	1	0	1	0	0	1
VT	P	0	0	0	1	0	1	1	+	P	0	1	0	1	0	1	1
DC1	P	0	0	1	0	0	0	1	1	P	0	1	1	0	0	0	1
DC3	P	0	0	1	0	0	1	1	3	P	0	1	1	0	0	1	1

*Bit 7 (b7) is normally held in the logic ONE state. If the playback-OFF indication option is used (S2-7 in ON position), a logic ONE indicates the playback function is OFF and a logic ZERO indicates the playback function is ON. When the playback OFF option is used, some of the status characters may be control characters as indicated by the shaded characters.

before the error occurred. The data transmitted from an erroneous block consists of true data to the point in the block at which the read error occurred and NUL (null) control characters from that point to the end of the block (total of 86 characters: true data and nulls).

c. Skipping the Block With an Error

Send a block forward command (DLE and 7). Playback will bypass the erroneous data block and continue playback in the mode (playback ON or block forward) in effect before the error occurred.

B-10 NUMERIC KEYBOARD.

The Numeric Keyboard shown in Figure B-10.1 is a separate keyboard which is attached by cable to a Model 733 KSR or ASR Data Terminal. It operates as an extension of the main keyboard and assumes the same mode (LOCAL/OFF/LINE) as the main keyboard. The Numeric Keyboard option provides basic numerals and appropriate graphic and control characters configured similar to an adding machine to facilitate rapid entry of numerical data. The following characters are provided on the numeric keyboard option:

Numerals zero through nine	(0-9)
Number sign	#
Slant	/
Comma	,
Period (decimal point)	.
Hyphen (minus)	-
Plus	+
Line feed	
Carriage return	

The characters on the numeric keyboard are generated regardless of the mode (SHIFT, CTRL) of the terminal keyboard. On 733 models, the cable to the terminal may be disconnected (terminal power OFF) at the numeric keyboard to permit storing the cable in the basic terminal.



FIGURE B-10.1. NUMERIC KEYBOARD

B-11 1200 BAUD INTERFACE.

The 1200 Baud Interface option permits a Model 733 ASR Data Terminal to transmit and receive data to and from the tape cassettes at the rate of 120 characters per second (1200 baud). There are several physical differences between a Model 733 ASR equipped with the 1200 Baud Interface option and a standard Model 733 ASR equipped for 300 baud (maximum) operation. The standard line interface with the 1200-Baud option is the EIA RS232C which is compatible with the Bell Systems' 202D, 202R, 202C, and 202S (or equivalents) data sets. Interface cable pin functions are listed in Table B-11.1. The 1200-Baud equipped terminal includes the following:

- (1) A HIGH/LOW speed switch is added to the left of the ON-LINE/OFF switch.
- (2) The PARITY switch is located on the Transmitter PC card, the rearmost PC card in the left row of the lower unit PC card rack.

The printer is normally disabled from printing line data, but the 1200 baud data terminal has a strappable option which enables the printer when the terminal is operating at 1200 baud with the PRINTER switch in the LINE position. Implementation of this strappable option is not recommended unless the terminal is also equipped with the Remote Device Control option (see Section B-11.4).

B-11.1 1200 BAUD OPERATION. To operate the data terminal in 1200-baud mode, the following steps are recommended.

- (1) Set the PARITY switch under the terminal cover as desired (even, odd, or continuous marking).
- (2) Select either HALF or FULL duplex operation as required by the communication line. HALF duplex must be selected unless four-wire transmission is used.
- (3) Set the Speed HI/LO Switch to HI.
- (4) Set the terminal ON-LINE/OFF switch to ON-LINE.
- (5) Set the KEYBOARD to OFF or LOCAL.
- (6) Set PLAYBACK to LINE.
- (7) Set RECORD to LINE.

TABLE B-11.1. 1200-BAUD, EIA INTERFACE CABLE, PIN FUNCTIONS⁴
(CABLE TI PART NO. 959372-0002)

Connector Pin Numbers		Pin Function
Terminal	Data Set	
6	20	Data Terminal Ready ¹
7	7	Signal Ground
8	5	Clear to Send ²
9	6	Data Set Ready ³
10	3	Received Data
A	1	Protective Ground
C	4	Request to Send ⁶
H	2	Transmitted Data
K	8	Data Carrier Detect ⁵

NOTES:

- ¹Held to an ON condition by the data terminal ON LINE switch.
- ²Turned ON in response to "request to send;" typical delay is approximately 220 msec.
- ³Held to an ON condition when data set is operative; required for terminal operation.
- ⁴All are used only with external modem.
- ⁵Held to an ON condition by modem when carrier is received; required by terminal for data reception.
- ⁶Turned ON when transmission begins; turned OFF 20 msec after transmission ends.

(8) Set PRINTER to OFF or LOCAL.

The terminal is now ready to transmit (play back) or receive (record) information at 120 characters per second (1200 baud). Information may be recorded on tape from the communication line at the 1200 Baud rate and later printed locally (OFF-LINE) at 30 characters per second.

B-11.2 CONTINUOUS VERSUS LINE FORMAT. The 1200-Baud transmitter section uses a 64-character first-in/first-out (FIFO) buffer (temporary storage) which stores data from the data bus before transmission to the communications line. This permits the transmitter to operate at virtually 100 percent line efficiency. To achieve such high line efficiency it is necessary for the data to be played back so the FIFO is never empty. Therefore, data to be transmitted should be recorded in CONTInuous tape format before it is transmitted at 1200 baud. This will ensure high communications line efficiency.

If the data transmitted to the line is recorded in LINE tape format, at least 33 characters must be recorded in each block of LINE-formatted tape data to achieve 100 percent communication line efficiency. A lower efficiency will result if fewer than 33 characters are in a block of LINE-formatted data.

If the 1200 Baud Interface option is used in conjunction with the Automatic Device Control (ADC) or Remote Device Control (RDC) options, the following situation may occur in FULL DUPLEX operation. When the DC3 (playback OFF) command is received from the line, the contents of the FIFO are transmitted before the transmission halts. Therefore, up to 64 characters may be transmitted before data transmission stops.

When recording in the LINE tape format, each data block must consist of at least 40 characters to prevent overflowing the record buffer. For this reason, recording in CONTInuous tape format is recommended. (See Section 4-5.2 for further information).

B-11.3 LOW SPEED OPERATION. The 1200-Baud option equipped data terminal may also operate on-line at a selected lower speed (110, 150, or 300 baud) as determined by the speed switch located under the terminal cover. The speed switch settings and baud rates correspond as follows:

<u>Speed</u>	<u>Baud</u>	<u>Characters per Second</u>
LOW	110	10
MED	150	15
HIGH	300	30

After the speed has been selected, set the HIGH/LOW speed switch to LOW. The terminal will operate as a standard 300-baud Model 733 Data Terminal. Low speed, full duplex operation requires a type 103 or 113 series data set (or equivalent) to operate on a communication line.

NOTE

The 1200 Baud option, when used in either the 300-baud or 1200-baud mode in HALF-DUPLEX, has a 20-millisecond request-to-send delay time. This means the terminal will not accept line data until 20 milliseconds have elapsed following transmission of the last character of data.

When using the 1200 Baud option in HALF-DUPLEX in either the 1200 or 300 baud modes, and using an EIA interface directly (such as to a computer), the user should be aware of the 20-msec delay time before the receiver is enabled to receive line data. In modem-type interfaces (e.g., the 202 series or equivalent) the modem turnaround time is concurrent with this delay and, hence, is transparent to the system.

B-11.4 PRINTING IN 1200 BAUD MODE. The printer normally is disabled when the terminal is in the 1200-baud mode and it is ON LINE. However, a strappable option permits the printer to be enabled in the 1200-baud mode. This is accomplished by removing R-10 from J1 and J2 (no tools required) of the 1200-Baud Receiver PC card (TI Part No. 962291, slot A5 in the lower ASR unit). It is recommended that this strappable option not be implemented unless the terminal is also equipped with the Remote Device Control (RDC) option. If the printer is enabled, the following procedure must be used to simulate 300 baud transmission for proper response of the terminal printer:

- a. Each character must be followed by three filler characters [usually delete (DEL)].

- b. Each carriage return and line feed (except from column 1; i.e., printhead at left margin) must be followed by 22 filler characters [usually delete (DEL)].
- c. If carriage return only is sent, 23 filler characters after the carriage return should be sent.

This compensates for

- (1) The 33 millisecond print cycle
- (2) The 195 millisecond carriage return delay time (a carriage return from column 1 only causes a 1-character time delay of 33 milliseconds).

The printer may be selectively turned ON or OFF if the terminal is equipped with the Remote Device Control (RDC) option and the 1200 baud print option is implemented (R10 removed).

NOTE

While recording in CONTInuous tape format, it is desirable to have the ETX control character initiate the recording of a block of data. This is possible only on terminals equipped with the Dual-Format Record Buffer (962285). See Section B-6.3 for further information

On Terminals equipped with either the Automatic Device Control or Remote Device Control options, see Section B-9.1 for recording precautions concerning data terminals which do not have the ETX option.

APPENDIX C
OPERATOR'S QUICK - REFERENCE CARD*

* This card laminated in plastic is available as TI Part No. 959230.



I. DEVICE FUNCTION SWITCH SETUP

Set the **KEYBOARD**, **PLAYBACK**, **RECORD**, and **PRINTER** switches to the desired positions according to the table on the reverse side of this card.

II. CASSETTE INSTALLATION

1. Pull open the cassette transport door and install cassette.
2. Make sure cassette has tape side up. To record on a cassette, the **WRITE** tab must cover hole for side to be recorded on.
3. Close the cassette transport door.

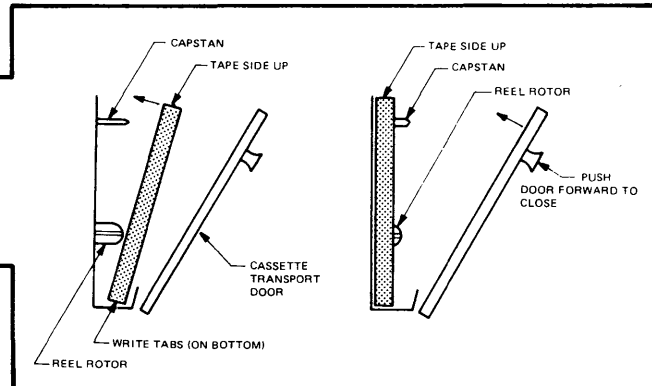

III. READYING THE CASSETTE

1. Press the **REWIND** switch for the appropriate cassette. The **END** lamp will come on.
2. Select **PLAYBACK** or **RECORD** mode with the center switch. The appropriate **RECORD** and **PLAYBACK** lamp will come on.
3. Press the **LOAD/FF** switch momentarily and release.
4. The cassette is ready when the **READY** lamp comes on.

IV. FAST FORWARD

1. After a cassette is installed and readied, pushing the **LOAD/FF** switch will cause the tape to advance at high speed.
2. To stop, push **STOP** switch for the appropriate cassette.

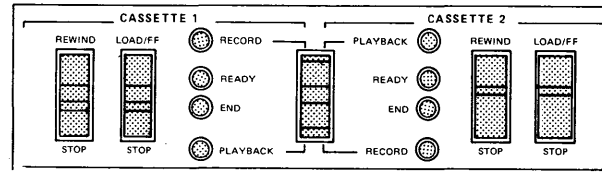

VII. REMOVING THE CASSETTE

1. If cassette is in **RECORD** mode, press the **(RECORD CONTROL) OFF** switch and then the **REWIND** switch for that cassette.
2. If the cassette is in the **PLAYBACK** mode, press **(CONT START) STOP** and then the **REWIND** switch for that cassette.
3. Pull open the transport door to pop out the cassette.

VIII. INITIATING A RECORD

1. Perform steps I, II, and III.
2. Select **LINE** or **CONTINUOUS** tape format with the **TAPE FORMAT** switch.
3. Push **(RECORD CONTROL) ON** switch. The **ON** lamp will come on.
4. Start recording from the keyboard, the line, or initiating on playback (perform step V.)
5. To stop, push the **(RECORD CONTROL) OFF** switch.

V. INITIATING A PLAYBACK

1. Perform steps I, II, and III.
2. Push the appropriate **PLAYBACK CONTROL** switch:
 - **CONT START**, or
 - **BLOCK FWD**, or
 - **CHAR FWD**
3. To stop, push the **(CONT START) STOP** switch.

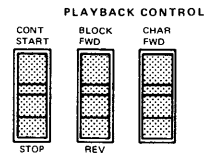

VI. CORRECTING A PLAYBACK ERROR

If the **ERROR** lamp comes on:

1. To transmit the error block press **CONT START**.
2. To skip the error block, press **BLOCK FWD**.
3. To reread the error block, press **(BLOCK) REV** and then **CONT START**

RECORD CONTROL

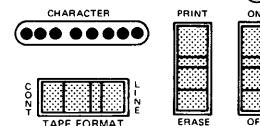

IX. ERASING THE TAPE

1. Perform steps I, II, and III.
2. Be sure cassette to be erased is set to **RECORD** mode.
3. While holding the **(RECORD CONTROL) ERASE** switch depressed, press **(RECORD CONTROL) OFF**. Release **OFF** first, then **ERASE**.
4. To stop, press **(RECORD CONTROL) OFF** switch.
5. Repeat step III to ready cassette.

X. EDITING

1. Set the terminal **ON-LINE** switch to **OFF**
2. If while typing a line to be recorded, a mistake is made:
 - A. Use Tape backspace key (**TAPE**) to back up to the erroneous character. "Strike over" with the correct character. Use the tape advance key (**TAPE**) to return to last character recorded and continue recording.
 - B. To replace the entire line, push **(RECORD CONTROL) ERASE** switch followed by **PAPER ADVANCE** key and retype the new line.
3. To proofread a line while recording, push **PAPER ADVANCE** key followed by **(RECORD CONTROL) PRINT** switch.
4. Additional editing techniques are described in the Operator's Manual.

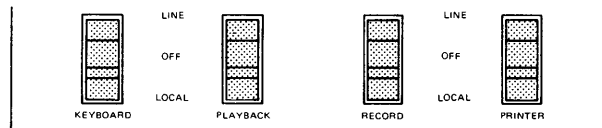

MODEL 733 KSR/ASR USASCII CODE SYSTEM

b ₇ b ₆ b ₅ b ₄ b ₃ b ₂ b ₁	0	0	0	1	1	1	1
	0	1	0	1	0	1	0
0 0 0 0	NUL	DLE	SPACE	0	@	P	^
0 0 0 1	SOH	DC1	!	1	A	Q	a
0 0 1 0	STX	DC2	"	2	B	R	b
0 0 1 1	ETX	DC3	#	3	C	S	c
0 1 0 0	EOT	DC4	\$	4	D	T	d
0 1 0 1	ENQ	NAK	%	5	E	U	e
0 1 1 0	ACK	SYN	&	6	F	V	f
0 1 1 1	BEL	ETB	'	7	G	W	g
1 0 0 0	BS	CAN	(8	H	X	h
1 0 0 1	HT	EM)	9	I	Y	i
1 0 1 0	LF	SUB	*	:	J	Z	j
1 0 1 1	VT	ESC	+	;	K	[k
1 1 0 0	FF	FS	<	<	L	\	l
1 1 0 1	CR	GS	=	=	M]	m
1 1 1 0	SO	RS	>	>	N	^	n
1 1 1 1	SI	US	/	?	O	_	o
							DEL

PRINTABLE CHARACTER
 AUXILIARY DEVICE CONTROL CHARACTER
 PRINTER CONTROL CHARACTER
 CODES GENERATED BY KEYBOARD, BUT NO ACTION TAKEN

MODEL 732 KSR/ASR BAUDOT CODE AND CHARACTER SET

Bits					Letters U. S. & U. K.	Figures	
b5	b4	b3	b2	b1		U. S.	U. K.
0	0	0	0	1	E	3	3
0	0	0	1	0	LINE FEED	LINE FEED	LINE FEED
0	0	0	1	1	A	-	-
0	0	1	0	0	SPACE	SPACE	SPACE
0	0	1	1	0	S	!	!
0	0	1	0	1	I	8	8
0	0	1	1	1	U	7	7
0	1	0	0	0	CAR RET	CAR RET	CAR RET
0	1	0	0	1	D	*	*
0	1	0	1	0	R	4	4
0	1	0	1	1	J	BELL	BELL
0	1	1	0	0	N	'	'
0	1	1	0	1	F	\$	%
0	1	1	1	0	C	:	:
0	1	1	1	1	K	((
1	0	0	0	0	T	5	5
1	0	0	0	1	Z	"	"
1	0	0	1	0	L))
1	0	0	1	1	W	2	2
1	0	1	0	0	R	#	#
1	0	1	0	1	Y	6	6
1	0	1	1	0	P	0	0
1	0	1	1	1	Q	1	1
1	1	0	0	0	O	9	9
1	1	0	0	1	B	?	?
1	1	0	1	0	G	&	@
1	1	0	1	1			
1	1	1	0	0	FIGS	FIGS	FIGS
1	1	1	0	1	M	.	.
1	1	1	1	0	X	/	/
1	1	1	1	1	V	:	:
1	1	1	1	1	LTRS	LTRS	LTRS

Nonprinting characters

ASR (UPPER UNIT) DEVICE SWITCH POSITIONS

FUNCTION	DEVICE FUNCTION SWITCHES ASR Switch Panel (Lower Row)				KEYBOARD ON-LINE/OFF SWITCH
	KEYBOARD	PLAYBACK	RECORD	PRINTER	
TYPICAL ON-LINE CONFIGURATIONS					
1. Record on tape from line only (no printout)		OFF/LOCAL	LINE ²	OFF/LOCAL	ON-LINE
2. Print from line only			OFF/LOCAL	LINE ²	ON-LINE
3. Print and record on tape from line			LINE ²	LINE ²	ON-LINE
4. Play back to line only	OFF/LOCAL	LINE	OFF/LOCAL		ON-LINE
5. Play back to line and print out ¹		LINE		LINE ²	ON-LINE
6. Keyboard to line (no printout)	LINE				ON-LINE
7. Keyboard to line, record on tape, and print ¹	LINE		LINE ²	LINE ²	ON-LINE
8. Transmit and receive from tapes to line simultaneously ³		LINE	LINE		ON-LINE
9. Play back to line; print from line		LINE		LINE ²	ON-LINE
TYPICAL LOCAL CONFIGURATION					
1. High-speed tape duplication		LOCAL	LOCAL	OFF	
2. Record on tape from keyboard	LOCAL		LOCAL		
3. Play back to printer only		LOCAL		LOCAL	
4. Duplicate tape and print		LOCAL	LOCAL	LOCAL	
5. Erase a tape			LOCAL		
TYPICAL SIMULTANEOUS LINE/LOCAL CONFIGURATIONS					
1. LINE: Keyboard to line line to printer LOCAL: duplicate a tape	LINE	LOCAL	LOCAL	LINE ²	ON-LINE
2. LINE: playback to line LOCAL: record on tape from keyboard	LOCAL	LINE	LOCAL	LOCAL	ON-LINE

NOTES

1. HALF DUPLEX only; in FULL DUPLEX, receive devices (recorder, printer) receive from line only.
2. In HALF DUPLEX, receive devices (recorder, printer) receive both transmitted and received data (if any).
3. FULL DUPLEX only.

WHERE A LINE/OFF/LOCAL POSITION IS LEFT BLANK IN ABOVE TABLE, THAT SWITCH MAY BE IN ANY POSITION.

silent 700
Electronic Data Terminals

MODELS 732 AND 733 ASR QUICK REFERENCE CARD



USER'S CRITIQUE

To make this manual more useful to you, our customer, we will appreciate your comments and recommendations on any improvements to this manual you feel are needed. After using this manual, please take the first opportunity to complete this questionnaire and return it, postpaid, to the factory where your comments will be given every consideration. Thank you.

MANUAL ORGANIZATION

Was the Table of Contents detailed enough and useful?

Yes, No, Comment _____

Were the manual sections well organized?

Yes, No, Comment _____

GRAPHICS

How would you rate the quality of the photos, diagrams, etc.?

Excellent, Adequate, Poor

Were there enough illustrations throughout the manual?

Yes, No, Comment _____

Were the tables clear and easy to follow?

Yes, No, Comment _____

TEXT

How would you rate the quality of the technical writing?

Excellent, Adequate, Poor

If there are particular paragraphs, instructions, etc., you feel need clarification or rewriting, please identify them and add your comments. _____

GENERAL COMMENTS

Respondent _____ Title _____

Company _____

Address _____

City/State/Zip _____

Manual Title 733 ASR/KSR OPERATING INSTRUCTIONS Manual No. 959227-9701

NO POSTAGE NECESSARY IF MAILED IN U.S.A.

Fold on the two lines on reverse side, staple or tape, and mail

CUT ALONG LINE

FOLD

FIRST CLASS
Permit No. 6189
Houston, Texas

BUSINESS REPLY MAIL
No postage necessary if mailed in the United States

Postage will be paid by
TEXAS INSTRUMENTS INCORPORATED
DIGITAL SYSTEMS DIVISION
P.O. BOX 1444 HOUSTON, TEXAS 77601

ATTENTION: TECHNICAL PUBLICATIONS
M/S 670

FOLD

Sales and Service Offices of Texas Instruments are located throughout the United States and in major countries overseas. Contact the Digital Systems Division, Texas Instruments Incorporated, P.O. Box 1444, Houston, Texas 77001, or call (713) 494-5115, for the location of the office nearest to you.



Texas Instruments reserves the right to make changes at any time to improve design and supply the best product possible.

TEXAS INSTRUMENTS
INCORPORATED