

DIAGNOSTICS USER'S GUIDE

System 1000 Series, System 1500

LIST OF EFFECTIVE PAGES

Insert latest changed pages and discard superseded pages.

Note: The changes in the text are indicated by a change number at the bottom of the page and a vertical bar in the outer margin of the changed pages, with the following exceptions:

- A change number at the bottom of the page but no change bar indicates either a deletion or a page layout change.
- An entire section with no change bars but with change numbers at the bottom of each page is an entirely new section.

Diagnostics User's Guide (2534850-0001)

Original Issue	June 1986
Revision A	August 1986
Revision B	September 1986
Revision C	November 1986
Revision D	December 1986
Revision E	June 1987
Revision F	December 1987
Revision G	September 1988
Revision H	March 1989
Revision J	October 1989
Revision K	April 1990
Change 1 (Revision L)	January 1991

Copyright © 1986, 1987, 1988, 1989, 1990, 1991, Texas Instruments Incorporated. All Rights Reserved.

No part of this publication may be reproduced, stored in a retrieval system, or transmitted, in any form or by any means, electronic, mechanical, photocopying, recording, or otherwise, without the prior written permission of Texas Instruments.

RESTRICTED RIGHTS LEGEND

Use, duplication, or disclosure by the Government is subject to restrictions as set forth in subdivision (c)(1)(ii) of the Rights in Technical Data and Computer Software clause at 252.227-7013.

Texas Instruments Incorporated
ATTN: Information Technology Group, M/S 2151
P.O. Box 149149
Austin, Texas 78714-9149

Produced by the Publishing Center
Texas Instruments Incorporated
Information Technology Group
Austin, Texas

SYSTEM 1000 SERIES, SYSTEM 1500 RELEVANT DOCUMENTATION

SOFTWARE MANUALS

System 1500 Environment	General Description	2534827-0001
	System 1500 Product Overview	DBND007A
	DX10/DNOS to TI System V: System 1500 Migration Guide	2534842-0001
<hr/>		
Operating System	TI System V Release Information	2549448-0001
	TI System V Administrator's Guide	2540539-0001
	TI System V Programmer's Guide	2540545-0001
	TI System V Programmer's Reference	2540543-0001
	TI System V Support Tools Guide	2540546-0001
	TI System V User's Guide	2540542-0001
	TI System V User's Reference	2540558-0001
	TI System V Error Messages	2549477-0001
	TI System V Performance Monitor User's Guide	2555397-0001
	TI System V Terminal Concentrator Software	2564122-0001
	TI System V 68020 Assembler	2540559-0001
	TI System V Streams Primer	2564861-0001
	TI System V Streams Programmer's Guide	2564870-0001
	TI System V Network Programmer's Guide	2564863-0001
	T-ISAM System V	2564854-0001
<hr/>		
Programming Languages	C System V	2540551-0001
	COBOL Forms System V Utility Manual	2540564-0001
	COBOL System V ANIMATOR™ Operating Guide	2540563-0001
	COBOL System V Programmer's Guide	2540552-0001
	COBOL System V Error Messages	2534838-0001
	COBOL System V Getting Started	2534836-0001
	COBOL System V Language Reference	2540565-0001
	COBOL System V Operating Guide	2540561-0001
	COBOL System V Source Conversion for RM/COBOL®	2540562-0001
	COBOL System V Source Conversion for TI-990 COBOL	2540566-0001
	FORTRAN System V	2540553-0001
	COBOL System V, COBOL Forms System V, and Sort/Merge System V Installation Guide	2544360-0001
	Pascal System V	2540554-0001
	Sort/Merge System V User's Guide	2540556-0001
	TI System V 68020 Assembler	2540559-0001
<hr/>		
Communications	3780/2780 System V User's Guide	2549931-0001
	3270 SNA System V	2549897-0001
	3770 SNA System V	2549948-0001
	DNIO/1500 System V	2549409-0001
	TCP/IP System V	2564120-0001
	NFS™ System V	2564121-0001

ANIMATOR is a trademark of Micro Focus Ltd.
 RM/COBOL is a registered trademark of Ryan-McFarland Corporation.
 NFS is a trademark of Sun Microsystems, Inc.

HARDWARE MANUALS

System 1500 Installation and Operation	System Operation	2557949-0001
	Computer System Site Preparation	2558023-0001
	System Maintenance Terminal Operating Parameters	2558022-0001
	Computer Enclosure Installation and Operation	2557942-0001
	Peripheral Enclosure Installation and Operation	2557943-0001
	System Board Installation and Operation	2557941-0001
	Mass Storage Unit (MSU IIA) Installation and Operation	2557935-0001
	WD1200 Disk Drive Installation and Operation	2557944-0001
	Terminal Concentrator Installation and Operation	2557938-0001
	Terminal/Printer Information	2557939-0001
	Installation and Operation Appendixes	2557946-0001
System 1505 Computer Installation and Operation	2564903-0001	

System 1500 Field Maintenance	System 1500 Field Maintenance	2534849-0001
	DB380 Disk Drive Field Maintenance Supplement	2557953-0001
	DB760 Disk Drive Field Maintenance Supplement	2555402-0001
	CT150 Tape Drive Field Maintenance Supplement	2558007-0001
	CT2000 Tape Drive Field Maintenance Supplement	2557951-0001
	WD1200 Disk Drive Field Maintenance Supplement	2557952-0001
	Computer Enclosure/Peripheral Enclosure Field Maintenance Supplement	2557961-0001
	68030 Symmetric Processor Field Maintenance Supplement	2558002-0001
	16/32-Megabyte Data Buffer Board Field Maintenance Supplement	2558003-0001
	NUPI-2 Board Field Maintenance Supplement	2564103-0001
	NuBus™ Systems System 1500 Field Maintenance Handbook	2549258-0001
	Diagnostics User's Guide	2534850-0001

CONTENTS

Paragraph	Title	Page
	About This Manual	xiii
1	Overview	
1.1	Highlights of This Section	1-1
1.2	About the Diagnostics	1-2
1.2.1	Power-Up Diagnostic Tests	1-2
1.2.2	Loadable Diagnostic Tests	1-3
1.2.3	Diagnostics Partitions	1-3
1.3	GDOS Diagnostics	1-4
1.3.1	Menu Windows	1-5
1.3.2	Dynamically Allocated Menu Entries	1-6
1.4	GDOS Online Help	1-6
1.5	GDOS Test Execution	1-7
1.6	Standalone S15A Diagnostic	1-7
1.7	S15A Online Help	1-8
1.8	S15A Test Execution	1-8
2	Starting the Diagnostics	
2.1	Highlights of This Section	2-1
2.2	Setting Terminal Parameters	2-2
2.3	Booting the System	2-3
2.3.1	Retesting With the Interface Diagnostic Tests	2-4
2.3.2	Running Interface Diagnostic Tests in Extended Mode	2-4
2.3.3	Looping on All Installed Boards	2-4
2.3.4	Looping on Selected Boards	2-5
2.4	Loading GDOS	2-5
2.5	Noninteractive and Interactive Diagnostic Tests	2-8
2.6	Extended-Interactive Diagnostic Mode	2-9
2.7	Loading the S15A Processor Board Diagnostic	2-10
2.8	Running the S15A Processor Board Diagnostic	2-11
2.8.1	Changing S15A Operational Parameters	2-12
2.9	Special Considerations	2-12
2.9.1	Connecting a Serial Printer to an AUX Port	2-12
2.9.2	Loading GDOS From Tape	2-12
3	Features	
3.1	Highlights of This Section	3-1
3.2	Function Keys and Cursor Keys	3-2
3.3	Changing GDOS Operational Parameters	3-4
3.4	Menu Structure	3-6
3.5	Error Reporting	3-12

Paragraph	Title	Page
4	Diagnostic Tests and Utilities	
4.1	Highlights of This Section	4-1
4.2	Running GDOS Diagnostic Tests and Utilities	4-2
4.3	Disk Diagnostic Tests	4-2
4.4	Tape Diagnostic Tests	4-3
4.5	CCB Diagnostic Program	4-3
4.6	CPO Board Diagnostic Program	4-3
4.7	LAN Option Board Diagnostic Program	4-3
4.8	Asynchronous Communications Board Diagnostic Program	4-4
4.9	Synchronous Communications Board Diagnostic Program	4-4
4.10	CK202 Communications Board Diagnostic Program	4-4
4.11	NuBus and Multiprocessor Diagnostic	4-4
4.12	S15A Processor Diagnostic Program	4-5
4.12.1	S15A Processor Board Tests	4-5
4.12.2	Single Board 68030 Tests	4-6
4.12.3	M68000 Family Tests	4-6
4.12.4	16/32 Megabyte Data Buffer Board Test	4-6
4.13	Disk Media Utility	4-7
4.14	GDOS Utilities—Backup/Restore and Edit Label	4-7
4.15	GDOS Utilities—Batch Menu	4-8
4.16	Print Online Manual Utility	4-8
4.17	Using the GDOS Utilities	4-9
4.17.1	Disk Format/Verify Utility	4-9
4.17.2	Make Bootable Tape Utility	4-15
4.17.3	Restore Bootable Tape Utility	4-17
4.17.4	Verify Tape Partition(s) Utility	4-21
4.17.5	Display/Edit Disk Label or Display Tape Label Utility	4-22
5	Boot Problems	
5.1	Highlights of This Section	5-1
5.2	System Testing During Power-Up	5-2
5.3	Reading Boot Error Codes	5-2
5.4	Reading Fault Indicator LEDs	5-3
5.5	Other Problems	5-8
A	NuBus Multiprocessor Tests	
A.1	Introduction	A-1
A.1.1	Loading NuBus and Multiprocessor Diagnostics	A-1

Glossary

Acronym and Abbreviation List

Index

	Figure	Title	Page
Figures	1-1	GDOS Menu Windows	1-5
	1-2	S15A Main Menu	1-8
	2-1	GDOS Top-Level Menu	2-8
	2-2	GDOS Extended-Interactive Diagnostic Mode Menu	2-9
	2-3	S15A Main Menu	2-11
	3-1	Change Operational Parameters Menu	3-5
	3-2	GDOS Menu Map for the Loadable Diagnostics and the Disk Media Utilities	3-8
	3-3	Standalone S15A Processor Board Diagnostic	3-9
	3-4	Sample Error Message	3-12
	4-1	GDOS Top-Level Menu	4-10
	4-2	GDOS Extended-Interactive Diagnostic Mode Menu	4-11
	4-3	GDOS Top-Level Menu	4-18
	4-4	GDOS Extended-Interactive Diagnostic Mode Menu	4-19
	5-1	Location of Fault Indicator LEDs — 7-Slot Chassis	5-4
	5-2	Location of Fault Indicator LEDs — 16-Slot Chassis	5-5
	5-3	Location of LEDs on the S1505 — Front	5-6
	5-4	Location of LEDs on the S1505 — Back	5-7
	A-1	GDOS Top-Level Menu	A-3
	A-2	GDOS Extended-Interactive Diagnostic Mode Menu	A-4
	A-3	NuBus and Multiprocessor Diagnostic Main Menu	A-5

	Table	Title	Page
Table	3-1	Function Keys and Control Keys	3-2
	3-2	Cursor-Movement Keys	3-4
	3-3	Error Code Prefixes	3-13
	4-1	Defined User Types	4-20
	5-1	Boot Error Codes	5-3
	5-2	Fault Indicator LED Error Listing	5-8

ABOUT THIS MANUAL

Introduction

This manual is intended as a guide to help you get started with the Texas Instruments System 1000 Series, System 1500 diagnostic package. The diagnostic package includes read-only memory (ROM)-based self-tests and interface diagnostic tests that run during system power-up, loadable diagnostic programs and utilities that run under the General Diagnostics Operating System (GDOS), and standalone processor board diagnostic tests that are loaded and executed outside of GDOS.

The material in this guide is of a general nature and is both descriptive and procedural. The descriptive material provides you with an overview of all the diagnostic and utility programs available for the System 1500. The procedural material instructs you in their use.

Detailed information about how to use each of the diagnostics and utilities is available online. To print all the menus and online information, use the GDOS Print Online Manual utility described in Section 4, Diagnostics and Utilities.

NOTE: An additional set of diagnostic tests is available in this package for testing the NuBus and the multiprocessor logic on units with multiple System 1500 processor boards. For information about running the NuBus and Multiprocessor Diagnostic tests, refer to Appendix A, NuBus Multiprocessor Tests.

Purpose

The comprehensive loadable diagnostic tests discussed in this user's guide are provided because many boards do not have sufficient ROM to store diagnostics capable of fully testing all boards and related hardware. Additionally, running diagnostics that test entire systems can be a lengthy process that is not desirable at system power-up. The loadable diagnostics can identify a larger percentage of hardware failures and provide more informative error messages than can the self-tests.

The loadable and standalone diagnostic tests verify device performance by exercising and testing all logic paths in the hardware components. If the tests find any defects, they display error messages.

Terminology

In this manual, the word diagnostic refers to a program or a group of programs that tests one hardware board or subsystem. The individual tests within each diagnostic are called diagnostic tests or simply tests. For example, the synchronous communications diagnostic is a group of diagnostic tests that checks the operation of the 3-channel multifunction communications board.

Contents of This Manual

This manual contains an index and a glossary and is divided into five sections as follows:

Section 1: Overview — Provides descriptive information about the diagnostics to help you understand other sections in this manual. You should read this section if you have no prior knowledge of System 1500 diagnostics.

Section 2: Starting the Diagnostics — Provides instructions for booting the system, rerunning the ROM-based diagnostic tests, and running the loadable diagnostic tests.

Section 3: Features — Provides descriptions of the keyboard functions and operational parameters and a map of the menu structure. This section provides information that applies primarily to GDOS and the loadable diagnostics.

Section 4: Diagnostic Tests and Utilities — Provides brief descriptions of the GDOS diagnostics and utilities. Procedures for formatting and verifying a disk, making a bootable tape, and restoring tape to disk partitions are also provided. For information more detailed than that provided in this user's guide, refer to the online help information.

Section 5: Boot Problems — Provides troubleshooting information you can use if you are unable to load GDOS.

Appendix A: NuBus Multiprocessor Diagnostics — Describes the procedure for running the NuBus and Multiprocessor Diagnostic tests in units containing multiple System 1500 processor boards.

OVERVIEW

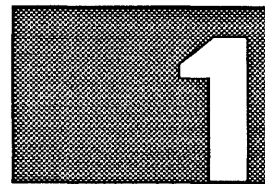

Highlights of This Section

1.1 This section provides a brief overview of the System 1000 Series, System 1500 power-up diagnostic tests, the General Diagnostics Operating System (GDOS) loadable diagnostics and the standalone S15A processor board diagnostic. The following topics are discussed:

- The four types of diagnostic programs
- GDOS partitions
- GDOS loadable diagnostics
- GDOS online help information
- Standalone S15A processor board diagnostic program
- S15A online help information
- General information about running the diagnostic tests

NOTE: If this is the first time you have used the GDOS loadable diagnostics and standalone S15A processor board diagnostic, or if you want some background information about them, read this section. If you have used these diagnostics before and do not need any background information, refer to Section 2 for information about starting the diagnostics.

About the Diagnostics

1.2 Four types of diagnostic programs are available to test the System 1500. The first two types—called power-up self-tests and interface diagnostic tests—are read-only memory (ROM)-based diagnostic programs that are associated with the system power-up procedure. After initial startup, two additional types of diagnostic programs—the set of GDOS loadable diagnostic programs and the standalone S15A processor board diagnostic program—can be loaded and executed separately to test each system hardware component further. Following are brief descriptions of the four types of diagnostics.

Power-Up Diagnostic Tests

1.2.1 The two types of ROM-based diagnostic tests that are associated with the system power-up procedure are:

- **Power-up self-tests.** These are ROM-based tests that are executed automatically by the communications carrier board (CCB), the NuBus peripheral interface (NUPI) board, and the system processor board when the system is powered up. Each power-up self-test is internal to a specific intelligent board and does not interact with other system components.
- **Interface diagnostic tests.** These are additional ROM-based tests. They reside on all boards under test, but they are executed from the system test boot master (STBM). Some of the interface diagnostic tests do interact with board self-tests on certain of the intelligent boards, such as the processor board, the NUPI board, the storage module drive (SMD)/small computer system interface (SCSI) Mass Storage Controller (MSC) board, the NuBus peripheral interface 2 (NUPI-2) board, the CCB, and the Communications Peripheral Option (CPO) board.

The interface diagnostic tests have two modes of operation — normal and extended.

- **Normal mode.** In this mode, the interface diagnostic tests are executed automatically during power up after the self-tests have run. When the system load menu appears, you can rerun the interface diagnostic portion of the power-up tests by selecting the `Retest` option. This procedure is described in paragraph 2.3.1, *Retesting With the Interface Diagnostic Tests*.
- **Extended mode.** In this mode, the interface diagnostic routines perform additional testing and provide status and error reports in greater detail than in the normal mode. When the system load menu appears, you can run the interface diagnostic tests in extended mode by selecting the `Extended` option in the system load menu. This procedure is described in paragraph 2.3.2, *Running Interface Diagnostic Tests in Extended Mode*.

Special looping options are also available for the extended interface diagnostic tests. These options enable you to loop the extended interface diagnostic tests on all boards or to loop the tests only on a selected board. The looping procedures are described in paragraphs 2.3.3, *Looping on All Installed Boards*, and 2.3.4, *Looping on Selected Boards*.

**Loadable
Diagnostic
Tests**

1.2.2 The two other types of diagnostic programs that are available for loading and execution after the power-up tests have run are:

- GDOS loadable diagnostic programs. These diagnostic programs execute under the control of GDOS. They are designed to diagnose problems in the system's peripheral devices such as its disk drives, tape drives, communications boards, and so forth.
- Standalone diagnostic program. The S15A Processor Board diagnostic program tests the NuBus interface and the multiprocessor arbitration logic of the system processor boards. GDOS, by itself, is unable to perform these tests. Therefore, the S15A processor board diagnostic tests *cannot* run under GDOS. Instead, they must be loaded and run separately.

The GDOS loadable diagnostic tests and the S15A standalone diagnostic tests enable you to test the following System 1500 hardware components:

- NUPI board, NUPI-2 board, MSC board, SCSI Peripheral Controller (SPC) board, and associated disk drives and tape drives
- CCB
- CPO board
- Local area network (LAN) option board
- Synchronous communications option board
- Asynchronous communications option board
- CK202 communications option board
- Multiple System 1500 processor boards and the NuBus*
- 16- and 32-Megabyte Data Buffer boards

**Diagnostics
Partitions**

1.2.3 The GDOS diagnostics contains the following partitions on each disk:

- GDOS — The GDOS partition is a diagnostic load partition containing object code that can be loaded into processor memory by the user. Even though more than one GDOS partitions are shown when the disk partitions are displayed, there is only one physical GDOS partition on the disk as indicated by the starting address and length of the partition.
- DIAG — The DIAG partition is a file system partition containing the files and directories used by GDOS and by the diagnostics. DIAG is of user type code FC02.

* The NuBus and Multiprocessor diagnostic, which tests NuBus arbitration logic between multiple processors, runs only on units in which multiple S1500 processor boards are installed. Refer to Appendix A for more information about this set of diagnostics.

- S15A — The S15A partition contains the System 1500 processor board standalone diagnostic, which is loaded and run separately from GDOS. Even though two S15A partitions are shown when the disk partitions are displayed, there is only one physical S15A partition on the disk as indicated by the starting address and length of the partition.
- GBUS — The GBUS partition is a configuration partition that allows GDOS to boot in multiprocessor mode.

The following are additional partitions located on the disk:

- TZON — The test zone partition consists of two 1K-byte blocks containing fixed data patterns and two 1K-byte blocks of ROM. The remaining blocks in the TZON partition are reserved for diagnostics testing.
- FMT — The format partition contains parameters for format and surface analysis and a map of defects on the disk.

If you modify the disk label, you must restore the modified partitions before running diagnostics. Editing the disk label modifies only the pointers; you must still restore the partitions so the pointers point to the new code.

For information about formatting a disk and installing the diagnostics on a disk that does not contain these partitions, refer to Section 4, Diagnostic Tests and Utilities.

GDOS Diagnostics

1.3 GDOS is a menu-driven operating system that controls the loading and execution of the GDOS diagnostics and provides additional system utilities.

Menu Windows 1.3.1 GDOS menus are organized into four nonoverlapping window areas as shown in Figure 1-1.

Figure 1-1 GDOS Menu Windows

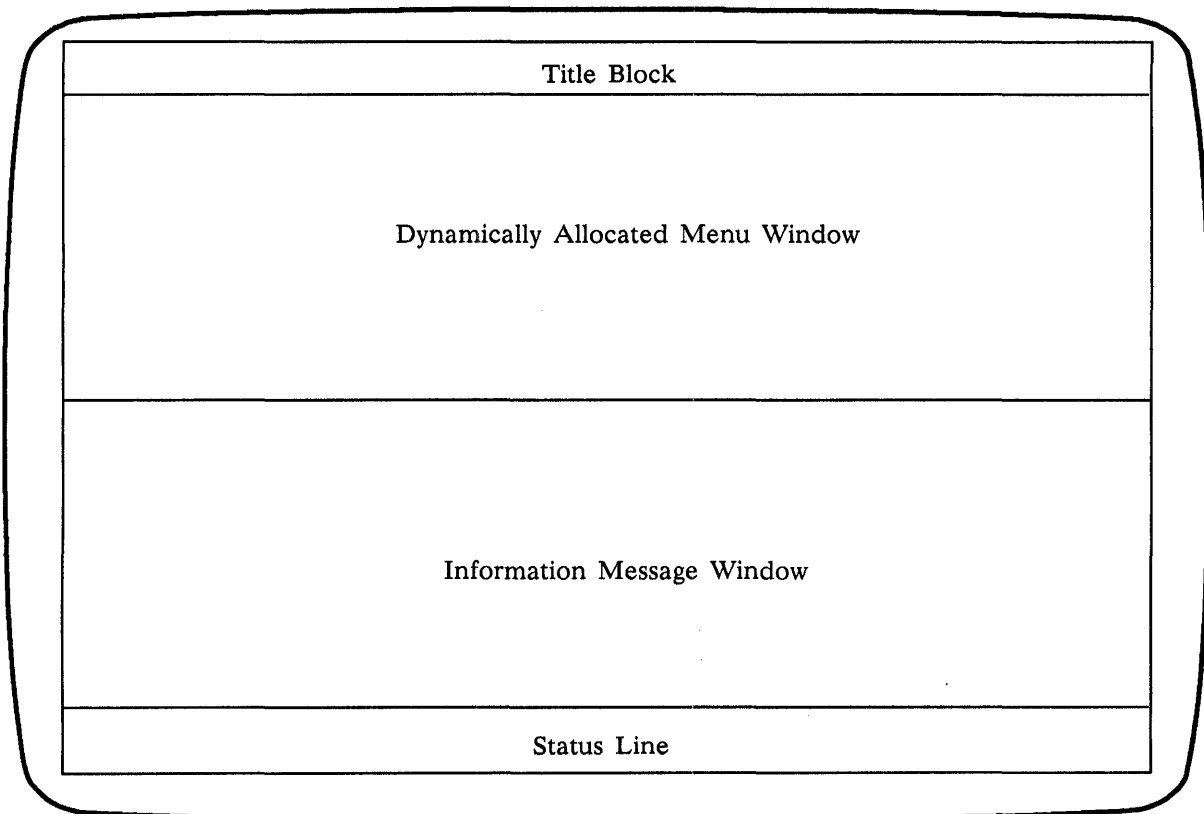

- The title block in the menu window contains information describing the function of the menu.
- The dynamically allocated menu window lists all available menu entries. It varies in size depending upon the number of diagnostic tests available for each system configuration.
- The information message window displays GDOS and diagnostic help information and error messages.
- The status line displays key functions, system prompts, and status messages.

User prompts and error messages are sent to the video display terminal (VDT). Options available in the Change Operational Parameters Menu enable you to route error messages only, or both error messages and information messages to a printer in addition to the VDT.

**Dynamically
Allocated
Menu Entries**

1.3.2 Before building the diagnostic menus, GDOS routines first check the specific hardware configuration. The diagnostic menus are then dynamically allocated for the current hardware configuration. The menus display only those diagnostic programs and utilities that are appropriate for the System 1500 under test.

Many of the menu entries in GDOS and in the loadable diagnostics can be expanded to show additional submenus or additional selection options. This feature provides more available screen space for displaying help messages, error messages, and information messages.

NOTE: You communicate with GDOS by way of the keyboard and VDT on the system maintenance terminal (SMT). You move the cursor to menu items using the Arrow keys or the HOME key, and you execute the diagnostic test(s) using the RETURN key or the ENTER key. Control key sequences (CTRL-K, CTRL-T, CTRL-B, and so forth) and function keys (F1, F2, F3, and F4) also perform operations in GDOS and in the loadable diagnostic programs. However, different keyboards that can be used with the system may require different keys for these operations.

For information about key functions on the TI 931, TI 924, and TI 928 VDTs, refer to Table 3-1, Function Keys and Control Keys, and Table 3-2, Cursor-Movement Keys. If you are using a non-TI workstation, refer to the specific manufacturer's documentation for differences.

**GDOS Online
Help**

1.4 Online help information is provided for each menu entry in the currently displayed menu. Online help messages provide more details and descriptions about the diagnostic package than are available in this user's guide. Help messages provide the following information:

- A summary of the menu entry's function
- Instructions on how to use the menu entry
- A detailed description of the test, utility, or function that the menu entry represents
- Other information necessary to run the test, utility, or function

The help screens, along with a listing of error messages, comprise the online manual. You can print all or part of the online manual with the Print Manual utility. For instructions on how to print the online manual, refer to paragraph 4.16, Print Online Manual Utility.

To display help information about a specific menu item, move the cursor to the appropriate item and type a question mark (?).

For a quick, online summary of key functions, press the CTRL-F key sequence. For detailed descriptions of the key functions, refer to Table 3-1, Function Keys and Control Keys, and Table 3-2, Cursor-Movement Keys.

GDOS Test Execution

1.5 You can run all of the noninteractive tests, that is, all of the tests that do not require user input during execution, from both the GDOS Top-Level Menu and the Extended-Interactive Diagnostic Mode Menu. However, the interactive tests, which require user input during execution, can *only* be run from Extended-Interactive Diagnostic Mode Menu.

To run a specific test within a particular diagnostic, you load a diagnostic using either the `Load a Diagnostic by Menu or Name and Show Its Main Menu` entry or the `Load a Diagnostic by Menu or Name` menu entry in the Extended-Interactive Diagnostic Mode Menu. Next, you select the specific test to run using the diagnostic's `Selected Test` menu.

For more information about loading the GDOS diagnostics and utilities, refer to Section 2, *Starting the Diagnostics*. For descriptions of the GDOS diagnostics and utilities, refer to Section 4, *Diagnostic Tests and Utilities*. For detailed information about the diagnostics and utilities, refer to the online help information.

Standalone S15A Diagnostic

1.6 The standalone S15A processor board diagnostic program verifies the correct operation of the NuBus interface and the associated multiprocessor arbitration logic for multiple processor boards. At least two processor boards must be installed to run the S15A diagnostic program, except when testing a Data Buffer board which requires only one processor board. Additionally, because S15A is not under GDOS control, it must be loaded separately. (For information about loading and running the S15A processor board diagnostic, refer to Section 2.)

When the standalone S15A diagnostic program is loaded, it determines which slots contain processor boards. If the program does not find at least two processor boards, it displays an error message and returns control to the STBM.

Like the GDOS diagnostic programs, the standalone S15A diagnostic is menu-driven. However, the S15A diagnostic menus contain no separate menu, command, and information windows as in GDOS. Instead, a single window displays a list of menu options. The menu scrolls upward to accommodate requested help information or error message listings. When scrolling occurs, you can redisplay the menu by typing the letter M, which selects the `Redisplay Current Menu` option. Figure 1-2 shows an example of the S15A Main Menu.

Figure 1-2 S15A Main Menu

```
MAIN MENU

0 Execute All Tests with Current Parameters
1 Execute All Selected Tests
2 Return to System Boot Master
3 Enter Test Operation Parameters Menu
4 Enter Menu to Select Round Robin Processor Tests
5 Enter Menu to Select Single Board 88030 Tests
6 Enter Memory Board Test Menu
M Redisplay Current Menu
? Help

SELECT OPTION :
```

S15A Online Help

1.7 Online help information is provided for menu entries in the currently displayed menu. Help messages provide information about the menu entry's function.

To display help information about a specific menu item, type a question mark (?) and the number of the menu item, then press RETURN.

An online manual that contains more detailed information about the S15A diagnostic tests can be printed using the GDOS Print Manual utility. You must return to GDOS to use this utility. The online manual presents the following information about each S15A menu entry:

- A summary of each menu entry's function
- Instructions on how to use the menu entry
- A detailed description of the test, utility, or function that the menu entry represents
- Other information necessary to run the test, utility, or function
- A list of error messages that can be returned by each of the tests

Instructions on how to print the S15A online manual are contained in paragraph 4.16, Print Online Manual Utility.

S15A Test Execution

1.8 You can run all of the S15A tests (with the exception of the Data Buffer board tests) using the current default parameters from the Top-Level Menu. You can also run specific tests using selected test parameters by choosing a sublevel menu. Note, however, that the Data Buffer board tests must be run from the Memory Board Test Menu.

For general information about the S15A diagnostic tests and utilities, refer to Section 4, Diagnostic Tests and Utilities. For detailed information about the diagnostic tests and utilities, refer to the online help information or print the online manual.

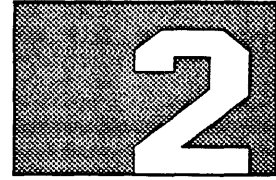

STARTING THE DIAGNOSTICS

Highlights of This Section

2.1 This section describes the following procedures:

- Setting terminal parameters
- Booting the system
- Rerunning system self-tests
- Executing the extended interface diagnostic tests
- Looping the extended interface diagnostic tests
- Loading the General Diagnostics Operating System (GDOS)
- Running noninteractive and interactive diagnostic tests
- Loading and running the S15A Processor Board diagnostic program

Setting Terminal Parameters

2.2 If you are using a TI 924, TI 928, or TI 931 terminal to run GDOS, be sure to set the terminal parameters before you boot GDOS. Press the ALT-SHIFT-BACKSPACE key combination to enter the Terminal Parameter Setup Menu for your terminal. Set the parameters as follows for the terminal you are using.

- TI 924 terminal — You can set the TI 924 terminal to run in TI 924 mode or TI 931 mode. Set the parameters for TI 924 mode as follows:

```

Display Setup . . . . . No Auto Wrap
Display Setup . . . . . Jump Scroll
General Setup . . . . . TI 924, 7 Bit Controls
Communications Setup . . . . . Transmit = 9600
Printer Setup (must match protocol of your
terminal) . . . . . Speed = 9600
Printer Setup . . . . . Normal Print Mode
Printer Setup (must match protocol of your
terminal) . . . . . 7 bits, Odd Parity
Printer Setup . . . . . 1 Stop Bit
Printer Setup . . . . . Print Full Page
Printer Setup . . . . . ASCII/U.K.
Printer Setup . . . . . No terminator
    
```

- Set the parameters for TI 931 mode as follows:

```

Display Setup . . . . . No Auto Wrap
Display Setup . . . . . Jump Scroll
General Setup . . . . . TI 931 Mode
Communications Setup . . . . . Transmit = 9600
Printer Setup (must match protocol of your
terminal) . . . . . Speed = 9600
Printer Setup . . . . . Normal Print Mode
Printer Setup (must match protocol of your
terminal) . . . . . 7 bits, Odd Parity
Printer Setup . . . . . 1 Stop Bit
Printer Setup . . . . . Print Full Page
Printer Setup . . . . . ASCII/U.K.
Printer Setup . . . . . No terminator
    
```

```

Comm Speed . . . . . 9600
Comm Parity . . . . . Odd
Comm Receive Parity Check . . . . . On
Comm Protocol Parity Check . . . . . FDPX
Comm Transmit Block Size . . . . . 01H
Comm Transmit Block Delay . . . . . 00H
Comm Port . . . . . EIA
Comm Receive DC1/DC3 . . . . . On
Aux Enable . . . . . Yes
Aux Speed (must match protocol of your printer) . . . . . 9600
Aux Parity (must match protocol of your printer) . . . . . Odd
Aux Protocol (must match protocol of your printer) . . . . . FDPX-RC
(Rdy=On)
Aux Offline Data Abort . . . . . Yes
    
```

- TI 928 terminal — If you are using the TI 928 terminal to run GDOS (as the system maintenance terminal), be sure to set the terminal parameters as shown in the following list before you boot GDOS. Press the SETUP key on the TI 928 terminal to enter the Terminal Parameter Setup Menu. Move to the following window in the menu:

```
GLOBAL  USER  EMULATOR  PORT 1  PORT 2  KEYBRD  PROGRAM
```

Select the following items in the window using the PgUp and PgDn keys, and set corresponding values using the Left and Right Arrow keys in the Choices window:

```
USER
Smooth Scroll ..... Jump
Local Echo ..... Off
Auto Wrap ..... Off

EMULATION
Emulation ..... VT320
Terminal ID ..... VT320
Control Code ..... 7-bit

PORT 1
Data Length ..... 7-bit
Parity ..... Odd
Xmit Baud ..... 9600
Xmit Pace ..... Xon/Xoff

PORT 2
Communication ..... Full Duplex
Data Length (must match the protocol of your
printer) ..... 7 bits
Parity (must match the protocol of your
printer) ..... Odd
Stop Bits ..... 1
Xmit Baud (must match the protocol of your
printer) ..... 9600
Recv Baud ..... =Xmit
Xmit Pace ..... DSR/Xon/Xoff
Xmit Pace ..... Xon/Xoff
```

Setting Printer Parameters

2.3 If you are using a serial printer (TI Model 810, 850, or 855), make sure that the following parameters are set.

- TI 810 printer:

```
9600 baud (must match protocol of your terminal)
Odd parity (must match protocol of your terminal)
Automatic line feed override
Override the automatic perforation skip
```

- TI 850 printer:

```
7 bit data (must match protocol of your terminal)
No line feed on carriage return
US
9600 (must match protocol of your terminal)
```

If a board fails its self-test, an error message is displayed. You may not be able to load GDOS until the board is repaired or replaced. If such a failure occurs, you can retest the system with the interface diagnostic tests to further define the source of the problem. Instructions for retesting the system are provided in paragraphs 2.3.1 through 2.3.4. If the board failure does not prevent you from loading GDOS, you can run the loadable diagnostics to exhaustively test specific hardware components. Procedures for loading GDOS and running the loadable diagnostics are presented in paragraphs 2.4 through 2.9.

Refer to Section 5, Boot Problems, for more information about board failures.

For detailed descriptions of the system self-tests and the interface diagnostic tests, refer to the *Field Maintenance* manual for the System 1500, TI part number 2534849-0001.

**Retesting With
the Interface
Diagnostic Tests**

2.3.1 To retest the system by rerunning the interface diagnostic portion of the power-up tests, press the R key to select the **Retest** option after the power-up self-tests have run and the system load menu appears:

D=Default load, M=Menu load, R=Retest, E=Extended tests :

NOTE: You have approximately 15 seconds to press the R key after the system load menu appears or the system performs its default system initialization procedure. To suspend default initialization before the 15-second timeout, press any key (such as the Space bar) or type any character (X, T, Z, and so forth) except a command character that specifies a load procedure. If default initialization occurs, reboot.

**Running Interface
Diagnostic Tests in
Extended Mode**

2.3.2 To test the system by running the interface diagnostic tests in the extended mode, press the E key to select the **Extended tests** option after the power-up self-tests have run and the system load menu appears:

D=Default load, M=Menu load, R=Retest, E=Extended tests :

The system is retested with the interface diagnostic tests in extended mode. Status messages—and if necessary, error messages—appear on the VDT while the tests are running.

**Looping on All
Installed Boards**

2.3.3 To test the system by looping the extended interface diagnostic tests on all installed boards, perform this procedure:

1. After the power-up tests have run, the system load menu is displayed:

D=Default load, M=Menu load, R=Retest, E=Extended tests :

Type an exclamation mark (!) to execute continuous looping on all installed boards. The extended interface diagnostic tests loop continuously on all boards until an error occurs or until you manually stop the looping.

2. To manually stop the looping, press any key. The current test completes before looping is halted.

Looping on Selected Boards

2.3.4 To test the system by looping the extended interface diagnostic tests on a selected board, perform this procedure:

1. After the power-up tests have run, the system load menu is displayed:
D=Default load, M=Menu load, R=Retest, E=Extended tests :
Type the at sign @. The following prompt appears:
Loop on slot number :
2. Type the hexadecimal number of the slot that contains the board you wish to test.
3. The extended interface diagnostic tests loop continuously on the selected board until an error occurs or until you manually stop the looping by pressing any key. When you press a key to manually stop looping, the current test completes before looping is halted.

For detailed descriptions of the system self-tests and the interface diagnostic tests, refer to the *Field Maintenance* manual for the System 1500, TI part number 2534849-0001.

Loading GDOS

2.4 You must boot GDOS to run any of the GDOS utilities and all of the GDOS loadable diagnostic programs for the System 1500. The only loadable diagnostic program that is not available under GDOS is the S15A processor board diagnostic program. Instructions for loading and running the S15A diagnostic program are provided in paragraphs 2.7 and 2.8.

To load GDOS, perform the following procedure:

1. Boot the system. Refer to paragraph 2.3, Booting the System, for the boot procedure. After the self-tests have run, the system load menu is displayed.
D=Default load, M=Menu load, R=Retest, E=Extended tests :
2. Press the G key to load GDOS. You have approximately 15 seconds to press the G key after the system load menu appears or the system performs its default system initialization procedure (in most cases, the default parameters specify loading the TI System V operating system). If default initialization occurs, reboot.

You can suspend default initialization before the 15-second time-out by pressing any key or by typing any character except a command character that specifies a load procedure. For example, you could suspend the system load menu by typing a number, by pressing the Space bar, or by typing a character such as X, T, Z, and so forth, but not by typing G (which would load GDOS) or by typing E (which would run the extended interface diagnostics tests).

The system displays a list of disk drives and tape drives that are available as load devices and a prompt requesting you to select a load device. The following example illustrates a display that might appear on your screen, depending upon the configuration of your system:

Available load devices

```
* A = Slot 2 disk 00
  B = Slot 2 disk 01
```

Select load device:

If one of the disk drives is not listed as an available load device, check the power switch on the drive, and check all cables and connections.

If one of the tape drives is not listed, ensure that a tape cartridge is installed in the drive and proceed. If you wish to load GDOS from a tape drive that is not listed, install the bootable tape cartridge in the drive, reboot, and proceed. (Booting from tape takes considerably longer than booting from a disk.)

NOTE: If you boot GDOS from tape, you must leave the tape in the drive when running the diagnostics or GDOS utilities.

3. To accept the default drive, simply press RETURN. (The drive denoted by an asterisk (*), Drive A in the example above, is the default drive.) The system attempts to find GDOS on the default drive. If GDOS is stored on a different drive, type the letter associated with that drive. If you do not know where GDOS is stored, try the default drive first.

If you select a drive that does not have the GDOS files on it, the following message is displayed:

```
Program not found
```

```
D=Default load, M=Menu load, R=Retest, E=Extended tests :
```

Press the G key again and enter an alternate load device by typing the letter associated with that device.

If the error message continues to appear with each listed load device you try, it is possible that GDOS and the loadable diagnostics are not installed. Refer to the *System 1500 Diagnostics Release Notes*, TI part number 2549447-0001, for instructions on how to install GDOS on your disk.

NOTE: To stop GDOS from loading after you choose a load device, press the ABORT key. On the TI 931 terminal, pressing the ESC key twice or pressing the CTRL-C key sequence performs the abort function when you are in GDOS. On the TI 924 and TI 928 terminals, pressing the CTRL-C key sequence performs the abort function.

4. After you select the drive on which GDOS is installed, the following GDOS prompt appears, which permits terminal-type selection when GDOS is booted:

Enter Terminal Type (0=TI-931, 1=TI-928, 2=TI-924, 3=TI-924
in 931 mode)

Enter the corresponding number:

A TI restricted rights notice appears; then, the GDOS Top-Level Menu appears. (See Figure 2-1.) At this time, you are asked to answer whether the time and date are correct.

If the time and date are correct, press Y and RETURN; to enter a new date and time, press N and RETURN.

The next two prompts ask you to enter the military time and the date. Then you are asked if you observe Daylight Saving Time (DST).

You are also prompted for the number of hours your time zone is from Greenwich Mean Time. If you are west of Greenwich, England, you should use a positive number. If you are east, use a negative number. For example, if you live in the Eastern Standard Time zone, enter 5. The default is 6 for Central Standard Time.

You can also change the time and date by entering the Operational Parameters Menu.

Figure 2-1 GDOS Top-Level Menu

```
General Diagnostics Operating System
GDOS Version: SYS ddd/yy
Top-Level Menu

1 Loop on All Noninteractive Diagnostics (0-Loop Until ABORT)-----> 1 dec
2 Loop on Selected Noninteractive Diagnostics . . . . . Expand
3 Enter Menu for Extended-Interactive Diagnostic Mode . . . . . Execute
4 Enter Menu to Change GDOS Operational Parameters . . . . . Execute

09:23:49 08/16/88
Is this time correct (Y/N)? N
Enter military time (hhmmss): 092500
Enter date (MMDDYY): 081688
Do you observe Daylight Saving Time (Y/N)? Y
Hours from Greenwich Mean Time (default=6;CST): 5
09:25:00 08/16/88
Is this time correct (Y/N)? Y

?=HELP, CTRL-F=Key Functions, CTRL-T/F2=Exit GDOS
```

Noninteractive and Interactive Diagnostic Tests

2.5 Menu entry one, Loop on all Noninteractive Diagnostics, enables you to execute all of the GDOS diagnostic tests that do not require operator intervention. Menu entry two, Loop on Selected Noninteractive Diagnostics, expands into a submenu that enables you to select and run specific noninteractive diagnostic tests.

Although the noninteractive diagnostics available in menu entries one and two enable you to test most of the system hardware, to thoroughly test the entire system you must run the interactive GDOS diagnostic tests as well, along with the standalone S15A processor board diagnostic program.

The interactive GDOS diagnostic tests are available in menu entry three, Enter Menu for Extended-Interactive Diagnostic Mode. This option enables you to run all of the diagnostic tests that are under GDOS control and are appropriate for your system.

Extended-Interactive Diagnostic Mode 2.6 The Extended-Interactive Diagnostic Mode provides you with a greater degree of flexibility in diagnosing possible hardware failures than is available to you in the noninteractive mode alone. From the Extended-Interactive Diagnostic Mode, you can:

- Specify devices or slots to test
- Choose various combinations of tests to run within a single diagnostic program
- Change the loop count for any combination of tests in a diagnostic program
- Perform GDOS utility operations

To run interactive mode tests, select the Enter Menu for Extended-Interactive Diagnostic Mode entry in the GDOS Top-Level Menu and press RETURN. The Extended-Interactive Diagnostic Mode Menu, Figure 2-2, appears.

Figure 2-2 GDOS Extended-Interactive Diagnostic Mode Menu

GDOS	
Extended-Interactive Diagnostic Mode Menu	
1	Load a Diagnostic by Menu or Name and Show Its Main Menu -----> Menu
2	Load a Diagnostic by Menu or Name Menu
3	Display Main Menu of Loaded Diagnostic Execute
4	Display GDOS and Diagnostic Memory Information Execute
5	Display System Information Execute
6	Display Slot Information 0 dec
7	Enter Debug Menu Execute
8	Enter Backup/Restore and Edit Label Utility Execute
9	Enter Batch Menu Execute
10	Enter Menu to Print the Online Manual Execute
<p>?=HELP, CTRL-F=Key Functions, CTRL-B/F1=Previous Menu, CTRL-T/F2=Top Menu</p>	

To execute a diagnostic program in the Extended-Interactive Diagnostic Mode Menu, follow these steps:

1. Place the cursor on the Load a Diagnostic by Menu or Name and Show Its Main Menu entry, and press RETURN. The Diagnostic Load Menu appears.
2. Place the cursor on the menu entry for the diagnostic program you want to run, and press RETURN. The Main Menu for the diagnostic program you selected appears. From this menu you can execute the interactive and/or noninteractive tests for that diagnostic program.

Loading the S15A Processor Board Diagnostic

2.7 The S15A Processor Board diagnostic program is a standalone program and does not run under GDOS; it must be loaded and run separately from the GDOS diagnostics.

The S15A Processor Board diagnostic program verifies the correct operation of the NuBus interface and associated multiprocessor arbitration logic. Therefore, your system must contain at least two processor boards in order for the Round Robin and NuBus Arbitration diagnostic programs to run. The Single Board 68030 diagnostic program tests a single 68030 processor board.

For general information on how to run the S15A diagnostic tests, refer to paragraph 2.8, Running the S15A Processor Board Diagnostic. For a description of the S15A Processor Board diagnostic program, refer to Section 4.

NOTE: Refer to Appendix A for information about loading and running the NuBus and Multiprocessor diagnostic tests on systems with multiple System 1500 processor boards.

To load the standalone S15A Processor Board diagnostic program, perform the following steps:

1. Boot the system. Refer to paragraph 2.3, Booting the System, for the system boot procedure. After the self-tests have run, the system load menu appears:

D=Default load, M=Menu load, R=Retest, E=Extended tests :

2. Press the N key, indicating that you wish to initiate a Name load from the system test boot master (STBM). The following prompt appears:

system load band name :

3. Type S15A and press RETURN. Note that S15A must be typed in uppercase letters only. The following prompt appears:

configuration band name :

4. Press RETURN to indicate none. A message showing the available load device(s) appears, and you are prompted to select the appropriate load device.
5. Press RETURN to accept the default load device. The S15A Main Menu (Figure 2-3) appears. From this menu you can execute all S15A Processor Board diagnostic tests, select specific tests to run, and change test parameters.

Figure 2-3 S15A Main Menu

```

MAIN MENU

0 Execute All Tests with Current Parameters
1 Execute All Selected Tests
2 Return to System Boot Master
3 Enter Test Operation Parameters Menu
4 Enter Menu to Select Round Robin Processor Tests
5 Enter Menu to Select Single Board 68030 Tests
6 Enter Memory Board Test Menu
M Redisplay Current Menu
? Help
SELECT OPTION :

```

Running the S15A Processor Board Diagnostic

2.8 To execute a menu entry in the S15A Processor Board diagnostic program, type the number or letter that corresponds to the desired entry. To display the help message for the Main Menu, type a question mark (?) and press RETURN. To display the help message for a specific entry, type a question mark and the number or letter that corresponds to the desired menu entry, and press RETURN.

Typing the number 0 executes all S15A processor board diagnostic tests using the current default parameters. Typing the number 1 executes either or both the NuBus Interface test and the Multiprocessor Arbitration test, depending on whether the Select Test parameter for each of these tests is set to YES or NO (found in the Round Robin Processor Test Menu). The Single Board 68030 Test Menu is displayed when you enter the number 5.

Typing the number 6 displays the Memory Board Test Menu, which may be used to test any 16- and 32-Megabyte Data Buffer board.

NOTE: To stop execution of the S15A diagnostic, press and hold the ALT key, then press the Break key. On the TI 931 terminal, the Break key is the blank key located in the upper right-hand corner; on the TI 924 and TI 928 terminals, press the CTRL-C key combination. A prompt is displayed requesting you to press the A key to abort the test, C to continue, or M to enter the Debug Menu.

**Changing S15A
Operational
Parameters**

2.8.1 The Change Operational Parameters Menu, which is displayed when you select Enter Test Operation Parameters Menu in the S15A Main Menu enables you to change parameters that affect all of the S15A diagnostic tests:

- Abort on Error, when enabled, aborts the diagnostic test when an error occurs and returns you to the S15A Main Menu.
- Pause on Error, when enabled, causes the diagnostic to stop running when an error occurs. To continue testing after you observe the error message, press any key.
- Loop allows you to specify the number of times that a selected test or all tests will run. A value of 0 causes the diagnostic utility to enter a continuous loop.

NOTE: Changes in S15A operational parameters do not affect the utilities or diagnostics that run under GDOS. For more information about changing GDOS operational parameters, refer to paragraph 3.3, Changing GDOS Operational Parameters.

**Special
Considerations**

2.9 The following paragraphs describe special considerations that you should note when connecting a printer or loading GDOS from tape.

**Connecting
a Serial Printer
to an AUX Port**

2.9.1 A serial printer (TI Model 810, 850, or 855) can be attached to the AUX port of the terminal. The switch setting on the printer should match the AUX port parameters. The printer cable used to connect a serial printer to a terminal varies depending on the printer/terminal combination, as follows:

- When connecting a Model 810, 850, or 855 printer to a Model 931 terminal, use printer cable part number 2230504-0001.
- When connecting a Model 810 or 850 printer to a Model 924 terminal, use printer cable part number 2308663-0001.
- When connecting a Model 855 printer to a Model 924 terminal, use printer cable part number 2230504-0001.
- When connecting a Model 810, 850, or 855 printer to a Model 928 terminal, use printer cable part number 2554927-0001 with adapter part number 2554900-0001.

**Loading GDOS
From Tape**

2.9.2 If you load GDOS from tape, self-tests of the system boards and disk drives must complete before the tape drive has finished retensioning the tape. As a result, when the prompt appears that requires you to press G (to load GDOS), the tape drive is not listed as an available load device. You should wait at this point until the tape has completed its initialization, then press the ESC key to exit to the point where you press G again. This time the tape will be listed as an available load device.

FEATURES

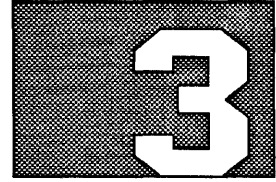

Highlights of This Section

3.1 This section provides descriptions of the keyboard functions, operational parameters, error messages, and other information applicable to the General Diagnostics Operating System (GDOS) and the loadable diagnostic programs. The following topics are discussed:

- Function keys and control keys
- Cursor-movement keys
- Changing GDOS operational parameters
- Overview of the menu structure
- Error reporting

Function Keys and Cursor Keys

3.2 The following tables describe the keys that perform special functions in the diagnostic programs that run under GDOS (differences in key mapping between the TI 931, TI 924, and TI 928 VDTs are noted). Table 3-1 lists keys that allow you to select options or control execution of the diagnostics. Table 3-2 lists keys that enable you to move around within menus and to respond to selection options within certain menu options. (Note that the standalone S15A processor board diagnostic does not support most of the key functions described in Table 3-1 and Table 3-2.)

NOTE: If you are using a TI 931, TI 924, or TI 928 VDT to run GDOS, be sure to set the terminal parameters before you boot GDOS. The correct parameters are listed in paragraph 2.2, Setting Terminal Parameters.

Table 3-1

Function Keys and Control Keys

Key	Function
ESC and CTRL-C (Abort)	Press the ESC key twice or press the CTRL-C key sequence to abort the current test. Control is returned to the menu from which the test was executed.

NOTE: To stop execution of the S15A diagnostic program, use the ALT-Break key combination on the TI 931 (the Break key is the blank gray key in the upper right hand corner of the keyboard), or the SHIFT-Break key combination on the TI 924 and TI 928. A prompt is displayed requesting you to type A to abort, C to continue, or M to execute the Debug monitor.

CTRL-R (Clears Screen)	Clears the information message window and redisplay the current menu.
------------------------	---

RETURN/ENTER	Executes the currently selected menu item. Also executes all the selected subentries that are indented under a Main Menu option.
--------------	--

For example, in the GDOS Top-Level Menu, move the cursor (use the Down Arrow key) to the second menu option. The cursor should highlight the word *Expand in the Loop on Selected Noninteractive Diagnostics* option. Now press RETURN or ENTER. An expanded version of the menu appears. It contains subentries that show the various noninteractive tests that can be executed. If you press RETURN or ENTER when the cursor is highlighting the *Execute command* in this menu, all subentries for which a *yes* response is selected will run.

Table 3-1

Function Keys and Control Keys (Continued)

Key	Function
CTRL-S/CTRL-Q (Pause/Resume)	The CTRL-S key temporarily halts (pauses) test execution and stops the scrolling of help messages and error messages. To resume execution, press the CTRL-Q key sequence.
CMD	Displays menu commands.
TAB	Alternates between Yes and No; On and Off; Interactive, Noninteractive, and All; Menu and Name; and radix notations — decimal, hexadecimal, and octal (when these options are available).
F1 * and CTRL-B	Moves operation to the previous menu.
F2 * and CTRL-T	Moves operation to the Main Menu as follows: <ul style="list-style-type: none"> ■ In GDOS — Displays the Top-Level Menu (Note that if you are already in the Top-Level Menu, F2 allows you to exit GDOS.) ■ In a diagnostic test — Displays the Main Menu ■ In the Change Operational Parameters Menu — Moves operation to the previous menu
F4	Allows you to access the Change Operational Parameters Menu from any other menu.
CTRL-F *	Provides a summary of all the available key functions listed in Table 3-1 and Table 3-2, and is available from any menu.
CTRL-U	Resets values to their initial state (to change Name back to Menu, and so forth).
Space bar	Expands the information message window so that it covers the current menu and provides more screen space for information messages and error messages. Pressing the Space bar a second time redisplayes the current menu.
? *	Provides online help information for the current menu option. The ? key is the designated HELP key in all GDOS and S15A diagnostic tests and utilities.

Note:

* The function of this key is displayed in the status line at all times (when applicable).

Table 3-2

Key	Function
Up Arrow and CTRL-K	Moves the cursor up; however, if the cursor is on the first menu option, this key moves the cursor to the last option.
Down Arrow and CTRL-J	Moves the cursor down; however, if the cursor is on the last menu option, this key moves the cursor to the first menu option.
Right Arrow and CTRL-L	Changes a No response to Yes and selects among Interactive, Noninteractive, and All, and between Menu and Name (where available).
Left Arrow and CTRL-H	Changes a Yes response to No and selects among Interactive, Noninteractive, and All, and between Menu and Name (where available.)
HOME or CTRL-O	Moves the cursor to the top menu option.

NOTE: To enter a numeric value when called for within a menu option, place the cursor (use the Left and Right Arrow keys) on any space other than the space immediately to the left of the existing value, and type the number. If you enter a number in the space immediately to the left of the existing value, the value you enter will be concatenated with the previous value. For example, if the existing value is 1 and you enter an 8 in the space to the left of the value, the diagnostic program will consider the new value to be 81. When you move the cursor off the option or press RETURN to execute the menu item, the new value replaces the previous value.

Changing GDOS Operational Parameters

3.3 The Change Operational Parameters Menu (shown in Figure 3-1) allows you to change parameters that affect the execution of all the diagnostic programs under GDOS. You can access the Change Operational Parameters Menu by selecting the Enter Menu to Change GDOS Operational Parameters option in the GDOS Top-Level Menu or by pressing the F4 key in any GDOS menu.

NOTE: Changes in GDOS operational parameters have no effect on the execution of tests within the standalone S15A Processor Board diagnostic program. For more information about changing the operational parameters in the S15A diagnostic program, refer to paragraph 2.8.1.

Figure 3-1 Change Operational Parameters Menu

GDOS	
Change Operational Parameters Menu	
1	Select Trace Level to Print -----> Off
2	Select Trace Level to Log File Off
3	Select Option for Log File Full Abort
4	Pause on Error On
5	Halt on Error Off
6	Stop When Error Window Is Full On
7	Stop When Information Window Is Full Off
8	Select Paging Mode of the Menu NoPaging
9	Display/Set Time & Date or Reset Elapsed Time Display
10	Show Log File Execute

The following options are in the Change Operational Parameters Menu:

- Select Trace Level to Print — The diagnostic programs send *only* error messages, or both error messages *and* information messages to the printer as well as to the video display terminal depending on which of three options you select. The selection options are *off*, *ErrorMsgs*, and *AllMsgs*.
- Select Trace Level to Log File — The diagnostic programs send *only* error messages, or both error messages *and* information messages to a file on disk as well as to the video display terminal depending on which of three options you select. The selection options are *off*, *ErrorMsgs*, and *AllMsgs*. The log file is */batch/errorfile*.
- Select Option for Log File Full — This option specifies what to do when the log file is full. *Abort* aborts the test or command, and the log file is closed. *Replace* deletes the log file and restarts the log; testing the command then continues. *Logoff* closes the log file and either continues to execute the command or continues testing; messages are not sent to the log file.
- Pause on Error — When an error occurs, an error message appears and test execution stops. To continue the test or to display the next error message, press any key except the *ABORT* key.
- Halt on Error — When an error occurs, the current process stops and the menu from which the process was executed is displayed.
- Stop When Error Window Is Full — Scrolling stops when the screen window is full. To scroll half the error window, press the space bar; to scroll one line, press any other key.
- Stop When Information Window is Full — Scrolling stops when the information window is full. To scroll half the information window, press the Space bar; to scroll one line, press any other key.

- **Select Paging Mode of the Menu** — The current menu window shrinks when a diagnostic test is executed, allowing more screen space for error messages and information to be displayed depending on which of three options you select. The selection options are `NoPaging`, `AutoPaging`, and `ManualPaging`.
- **Display/Set Time & Date or Reset Elapsed Time** — This option displays the time and date, sets the time and date, or resets the elapsed time. The selection options are `Display`, `Set`, and `Reset`.
- **Show Log File** — This option displays the log file if it exists. The path to the log file is `/batch/errorfile`. The Trace level to Log File must be set to `Off` to display the log file.

To execute any of these menu options, place the cursor on the parameter value you wish to change, then use the TAB key or the Left and Right Arrow keys to change the current value to a different value. After you have changed the desired parameters, press RETURN.

All options in the Change GDOS Operational Parameters Menu are under the control of GDOS. Therefore, when you change one of the parameters, you affect execution of all the diagnostic programs. However, in some cases you can change parameters that are specific to a diagnostic program by accessing those parameters through a Test Execution Parameters submenu within the particular diagnostic program. Parameter changes that are specific to a diagnostic program do not affect any of the other diagnostic programs.

Menu Structure

3.4 The typical menu structure of the loadable diagnostics (the diagnostics under GDOS control) consists of four menus:

- Main Menu
- Execute Selected Tests Menu
- Test Execution Parameters Menu
- Loop on Selected Tests Menu

All of the diagnostic programs under GDOS have at least one Main Menu and an Execute Selected Tests Menu. Other menus are included as appropriate for the diagnostic program.

The Main Menu for each diagnostic appears after the initial loading of the diagnostic. This menu allows you to execute tests or branch to other menus in the diagnostic.

The Execute Selected Tests Menu lists each test in the diagnostic program and allows you to select specific tests to run.

The Test Execution Parameters Menu is available in the diagnostic programs that contain parameters you can change. After you change the execution parameters in this menu, go to the Execute Selected Tests Menu or to the Main Menu of the diagnostic program to execute the tests with the new parameters.

The Loop on Selected Tests Menu is available in diagnostic programs that contain noninteractive tests. This menu allows you to change the loop count on any of the noninteractive tests. (You can also loop on all noninteractive tests by selecting the Loop on All Noninteractive Tests option in the Main Menu of the diagnostic program you are using.)

Figures 3-2 and 3-3 display the menus available in GDOS and in the stand-alone S15A Processor Option Board diagnostic program.

Figure 3-2 GDOS Menu Map for the Loadable Diagnostics and the Disk Media Utilities

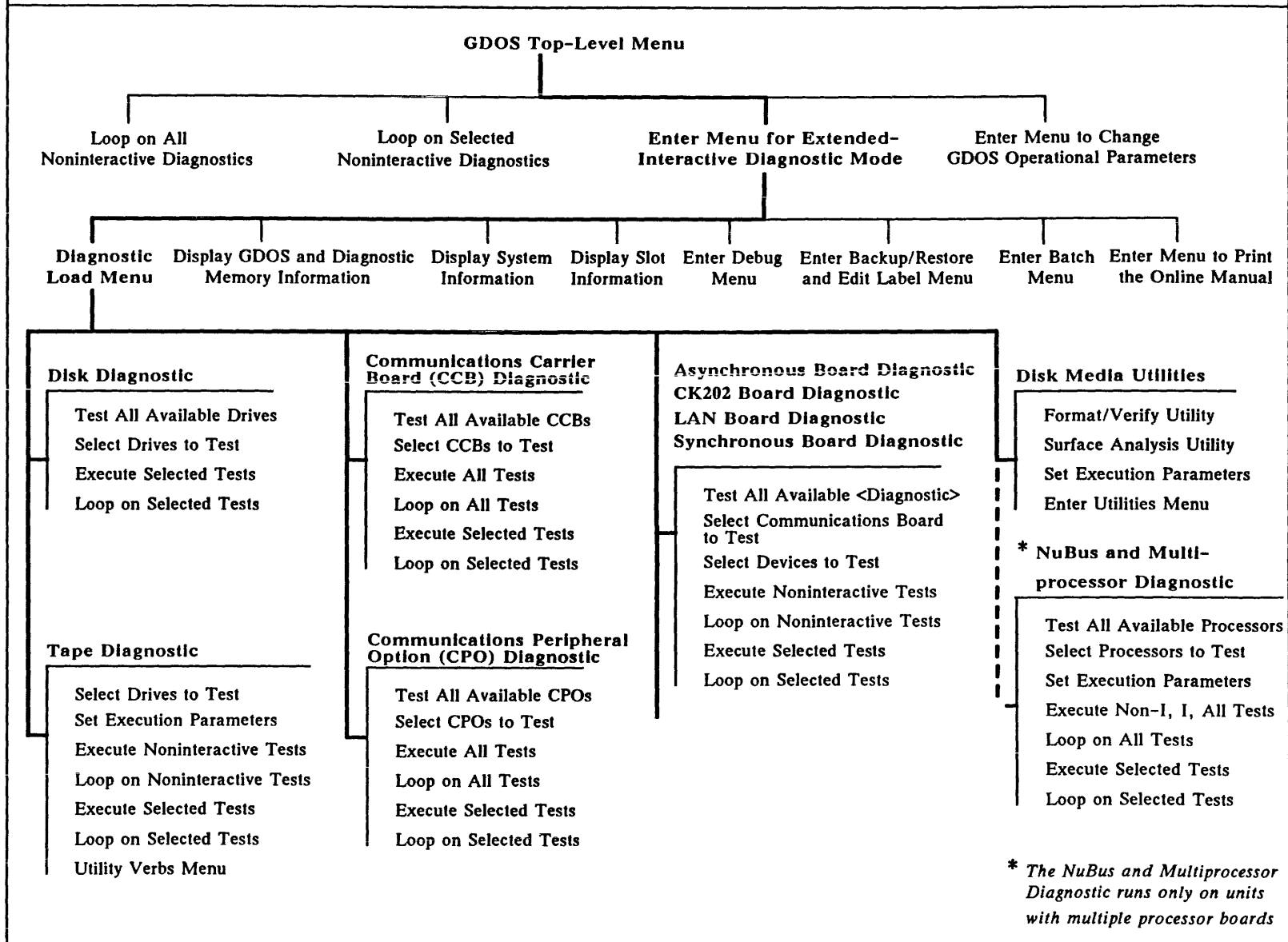

Figure 3-3 Standalone S15A Processor Board Diagnostic

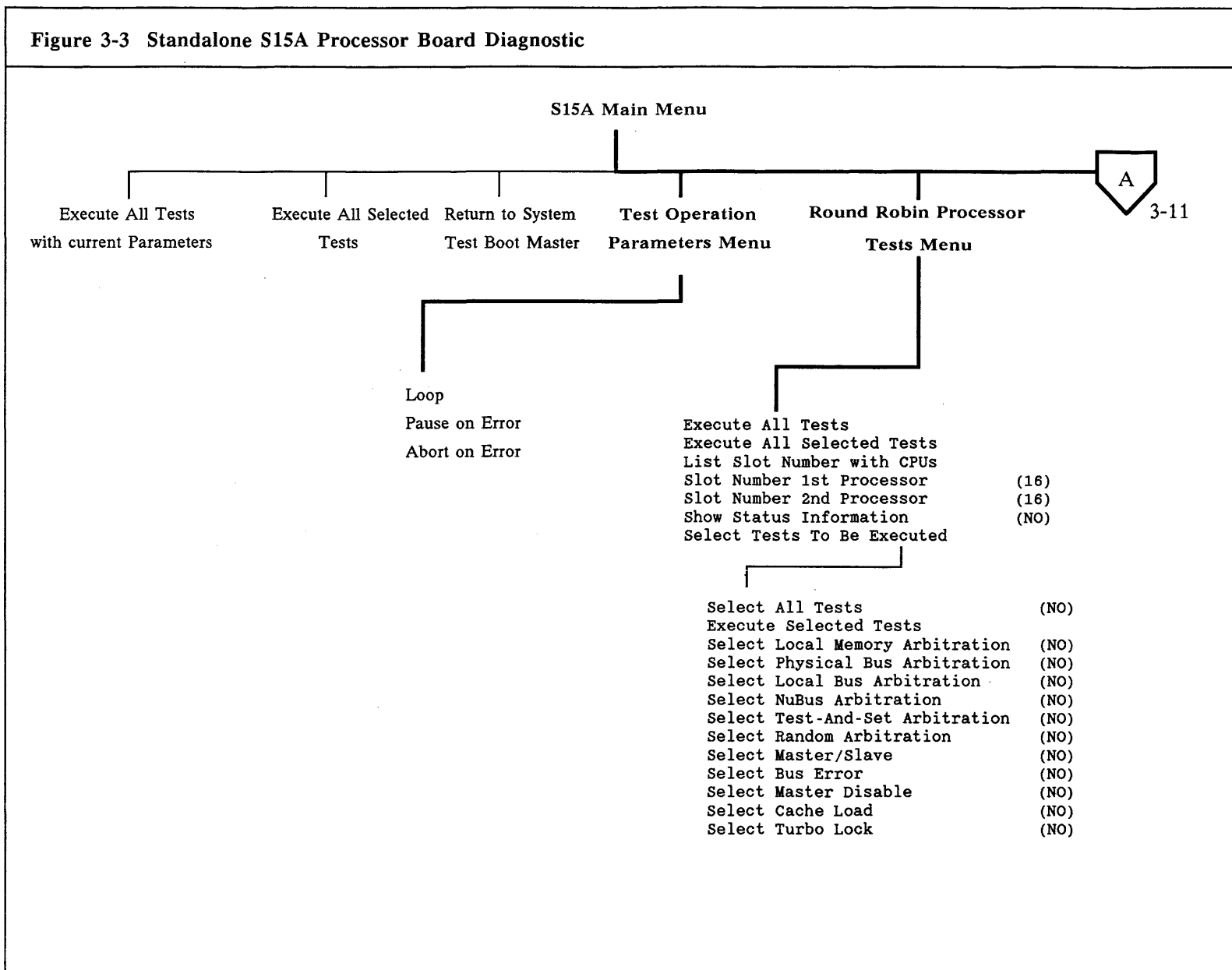
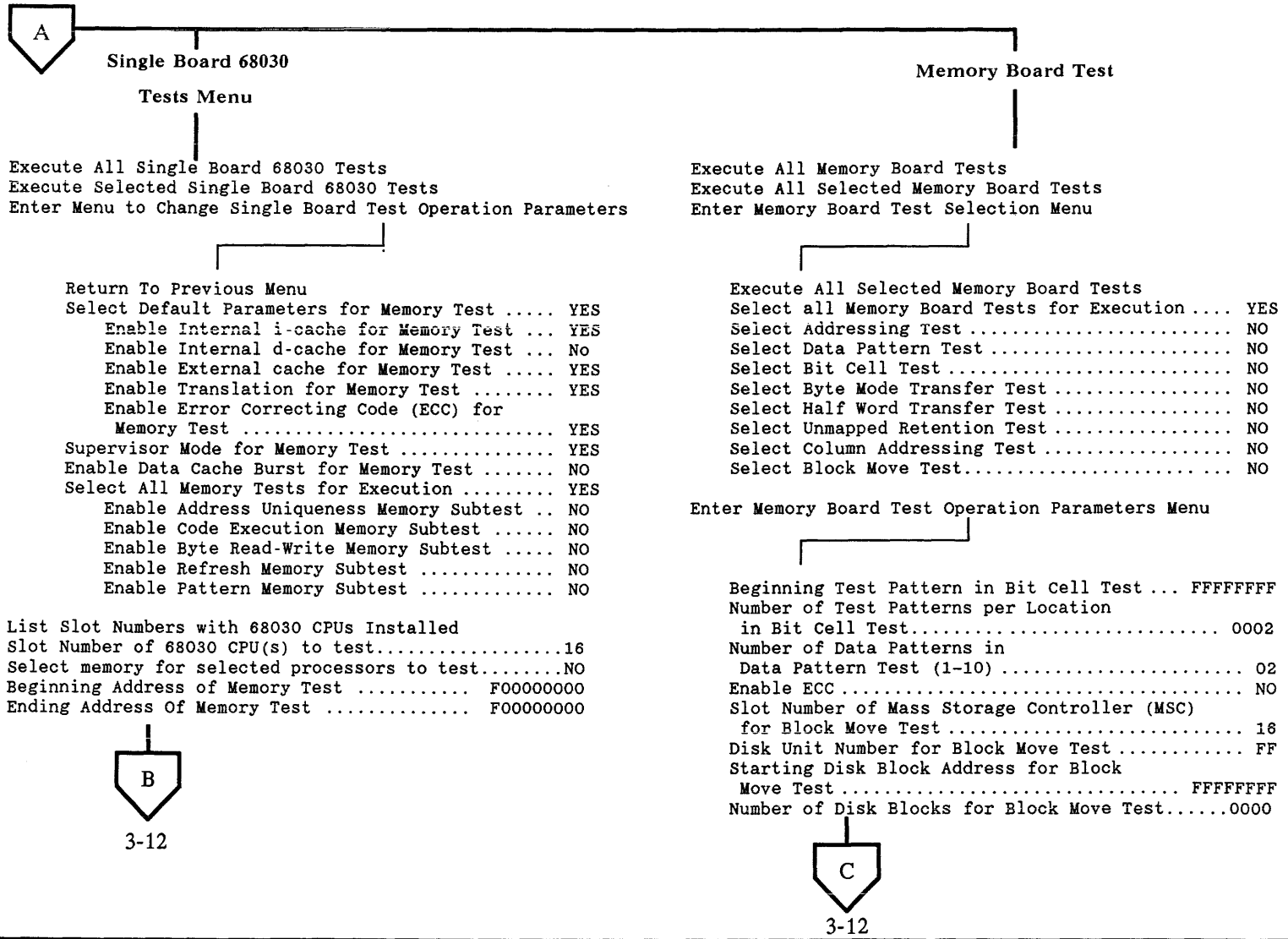

Figure 3-3 Standalone S15A Processor Board Diagnostic (continued)



3-12

3-12

Figure 3-3 Standalone S15A Processor Board Diagnostic (continued)

B

Enter Menu to select 68030 Self-tests

```

Return To Previous Menu
Execute All 68030 Self-tests ..... YES
Execute Selected 68030 Self-tests
Select Random Access Memory (RAM)
Self-test ..... NO
Select Interrupt Controller Chip (ICC)
Self-test ..... NO
Select Cache Self-test ..... NO
Select Floating Point Unit (FPU)
Self-test ..... NO
Select Timer Self-test ..... NO
Select Multifunction Peripheral
(MFP) Self-test ..... NO
Select Nonvolatile Random Access
Memory (NVRAM) Self-test ..... NO
Select NuBus Data Buffer (NDB)
Self-test ..... NO
Select Software Protection Adapter
(SPA) Self-test ..... NO
Select Configuration and Read-Only
Memory (CROM) Self-test ..... NO
    
```

Enter Menu to select M68000 Family Tests

```

Return To Previous Menu
Execute All M68030 Tests ..... YES
Execute Selected M68030 Tests
Select Central Processing Unit
(CPU) Test ..... NO
Select Memory Management Unit
(MMU) Test ..... NO
Select FPU Test ..... NO
    
```

C

List Slot Numbers with Memory Boards Installed

```

Slot Number of Memory Board to Test ..... 16
Select All Memory for Test ..... YES
Beginning Address of Memory Test ..... 00000000
Ending Address for Memory Test ..... 00000000
Enter Memory Utilities Menu
    
```

```

Beginning Memory Address ..... 00000000
Number of Words ..... 00000000
Data Pattern ..... 00000000
Execute Display Memory
Execute Write Memory
Execute Verify Memory
    
```

Error Reporting

3.5 Error messages are reported in the information message window located in the lower half of the video display terminal. The menu can be made to remain on screen when error messages for the GDOS diagnostics are displayed, or it can be optionally paged out.

To send error messages to a printer, perform these steps:

1. Make sure that the printer is turned on and is online. Do this *before* you run a diagnostic program. (If you specify `select Trace Level to Print` and the printer is not on, you may have to reboot.)
2. Press F4 to access the Change Operational Parameters Menu.
3. Use the TAB key or the Left and Right Arrow keys to change the `select Trace Level to Print` option to either `ErrorMsgs` or `AllMsgs`.

The error messages include all the information available for the error that occurred, including probable causes and corrective actions.

To send error messages to the log file on disk, do the following:

1. Press F4 to access the GDOS Change Operational Parameters Menu.
2. Use the TAB key or the Left and Right Arrow keys to change the `Select Trace Level to Log File` option to either `ErrorMsgs` or `AllMsgs`.

NOTE: Turn the Trace Level to Off before powering down the system. There is a possibility of corrupting the GDOS file system if the Trace Level is not returned to Off.

Figure 3-4 shows a sample diagnostic error message. The numbers at the left do not appear on the display; they are included here for reference.

Figure 3-4 Sample Error Message

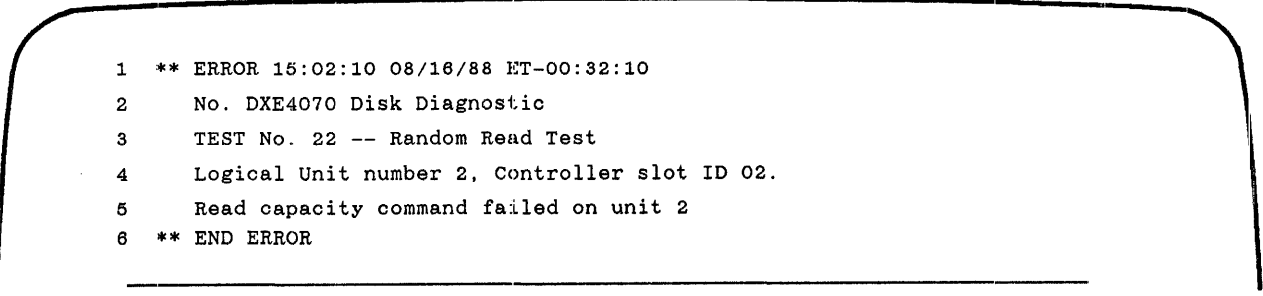

```
1  ** ERROR 15:02:10 08/16/88 ET-00:32:10
2  No. DXE4070 Disk Diagnostic
3  TEST No. 22 -- Random Read Test
4  Logical Unit number 2, Controller slot ID 02.
5  Read capacity command failed on unit 2
6  ** END ERROR
```

The ****ERROR** header shown in line 1 appears in every error message except some GDOS error messages. The next part of the line shows the time, the date, and the elapsed time from system boot or reset to the occurrence of the error.

Line 2, No. **DXE4070**, is the error code. The first three characters in the error code, always letters, are the error code prefix. They indicate which diagnostic produced the error message. The last four characters in the error code, always numbers, indicate the unique error number. Table 3-3 below lists the error code prefixes and the corresponding diagnostics.

Line 3 in the message indicates which subtest of the diagnostic produced the error.

Lines 4 and 5 contain the actual message. Error messages can be any length — some are only one line of text and others are longer than the one shown in this example.

Line 6, ****END ERROR**, signals the end of the error message. It is identical for all error messages.

Table 3-3

Error Code Prefixes

Prefix	Diagnostic/Utility
SYS	GDOS
DXE	Disk diagnostic
XTC	Tape diagnostic
CCB	Communications Carrier Board diagnostic
CPO	Communications Peripheral Option diagnostic
ASY	Asynchronous Communications Board diagnostic
SYN	Synchronous Communications Board diagnostic
LAN	Local Area Network diagnostic
DSA	Disk Surface Analysis, Format/Verify utility
CPU	Standalone Processor Board diagnostic
BUS	NuBus and Multiprocessor diagnostic*
CK2	CK202 Communications Board diagnostic

Note:

* The NuBus and Multiprocessor diagnostic runs only on systems with multiple S1500 processor boards.

DIAGNOSTIC TESTS AND UTILITIES

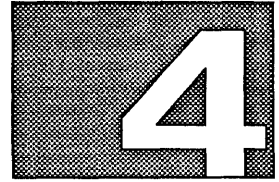

Highlights of This Section

4.1 This section contains brief descriptions of the diagnostics and the General Diagnostics Operating System (GDOS) utilities, including the various tests that can be run in Extended-Interactive Diagnostic Mode and the utilities available in the GDOS Utilities Menu. The standalone S15A Processor Board diagnostic program is also described. The following diagnostic programs and utilities are discussed:

Diagnostics

- Disk diagnostic tests
- Tape diagnostic tests
- Communications Carrier Board (CCB) diagnostic program
- Communications Peripheral Option (CPO) Board diagnostic program
- Local Area Network (LAN) Option Board diagnostic program
- Asynchronous Communications Board diagnostic program
- Synchronous Communications Board diagnostic program
- CK202 Communications Board diagnostic program
- NuBus and Multiprocessor Board diagnostic program

Standalone Diagnostics

- S15A Processor Board diagnostic program

GDOS Utilities

- **Disk Media Utility**
 - Disk surface analysis
 - Format/Verify
- **GDOS Backup/Restore and Edit Label Utilities**
 - Display or Edit Partition(s)
 - Restore Partition(s)
 - Verify Partition(s)
 - Make Bootable (Labelled) Tape
- Batch utility
- Print Online Manual utility

Running GDOS Diagnostic Tests and Utilities

4.2 You can run any of the noninteractive diagnostic tests from the GDOS Top-Level Menu. You can only run the interactive diagnostic tests, however, by entering the Extended-Interactive Diagnostic Mode and loading the diagnostic program. This process is described in paragraph 2.6, Extended-Interactive Diagnostic Mode. To run a GDOS utility, enter the Extended-Interactive Diagnostic Mode Menu, then select menu entry number 8 — Enter Backup/Restore and Edit Label Utility, or menu entry number 9 — Enter Menu to Print Online Manual.

Detailed descriptions of the GDOS diagnostic tests and utilities are available online. You can access the online help information in the following two ways:

- Type ? (question mark) after placing the cursor on the menu entry about which you want information.

For example, if you want information about the `Loop on Selected Noninteractive Diagnostics` menu entry, place the cursor on that item in the GDOS Top-Level Menu and type ?.

- Print the online manual. For instructions on how to print the online manual, refer to paragraph 4.15, Print Online Manual Utility.

Disk Diagnostic Tests

4.3 The tests in the Disk diagnostic program verify the integrity of each fixed disk and its controller board. The Device Integrity test, called Test 10, checks the overall integrity of the disk drives being tested. Any drives that do not pass Test 10 are not tested further.

CAUTION: The interactive tests in this diagnostic program can be data destructive if you direct the test to write on areas of the disk that store user data. To determine which tests can destroy existing data, refer to the help screens for individual tests.

The disk must already be formatted before testing can begin because disk drives with unformatted disks are not recognized by the diagnostic program as acceptable for testing. To format a disk, use the Format/Verify option in the Disk Media utility described in paragraph 4.16, Using the GDOS Utilities.

If you elect to run all noninteractive tests from the Disk Diagnostic Main Menu, Test 10 automatically executes. If you select specific controller boards or disk drives to test from the `select Controller to Test` menu entry in the Disk Diagnostic Main Menu, you must first run Test 10.

Most write operations performed during the Disk diagnostic operation are made to the test zone (TZON) partition on the disk. Therefore, you *should not* use TZON for storing other data.

Tape Diagnostic Tests

4.4 The tests in the Tape diagnostic program ensure that the tape drive can complete typical tape drive commands issued by the controller. Test 1, the Tape Device Integrity Test, checks the overall integrity of the selected tape drives and also checks for data on tape. If data is there, a prompt appears asking if you wish to destroy that data. The Tape diagnostic program will run only if you install a tape in the drive.

CAUTION: The Tape diagnostic program destroys all the data on the cartridge tape. When you run this diagnostic, use a blank tape or a tape containing unimportant data. Also, you cannot boot from the tape and then run tape diagnostics.

When you run any of the Tape diagnostic tests, the Tape diagnostic program first determines if the integrity of the tape drive has been tested. If the tape drive integrity has not been tested, the Tape diagnostic program automatically runs Test 1 before proceeding with any other tests. If the integrity of the tape drive has been tested, Test 1 is omitted.

When you first attempt to run a test in this diagnostic, a prompt appears asking if you wish to retension the tape cartridge. Retensioning ensures that tape tension is uniform throughout the reel.

CCB Diagnostic Program

4.5 The Communications Carrier Board (CCB) diagnostic program tests the NuBus interface logic. The program verifies that the interface master cycle and slave cycle logic execute correctly on the CCB; all possible error conditions are tested. A cyclic redundancy check (CRC) is performed on the self-test ROM. Tests are run on all dynamic and static random access memory (RAM). Nonmaskable interrupt and bus error exceptions are also tested and a check-sum test is performed on the local area network (LAN) ID read-only memory (ROM).

CPO Board Diagnostic Program

4.6 The Communications Peripheral Option (CPO) Board diagnostic program tests the NuBus interface logic. The program verifies that the interface master cycle and slave cycle logic execute correctly on the CPO board; all possible error conditions are tested. A CRC is performed on the self-test ROM. Tests are run on all dynamic and static RAM. Nonmaskable interrupt and bus error exceptions are also tested and a check-sum test is performed on the LAN ID ROM.

LAN Option Board Diagnostic Program

4.7 The LAN Option Board diagnostic program verifies the integrity of the LAN communications option board. After a self-test is performed on the local communication controller (LCC) chip, data packets are transmitted, received, and verified using internal loopback, and installation of the correct board is verified. A LAN multicast transmission is made and LCC chip acknowledgment is verified. CRC logic is tested during a transmission. If the LAN board has a loopback connector or is on an active net, then an off-board test can be executed.

Asynchronous Communications Board Diagnostic Program

4.8 The Asynchronous Communications Board diagnostic program verifies the integrity of either the four- or eight-channel asynchronous option board. Read and write tests are executed on the control registers of each dual universal asynchronous receiver/transmitter (DUART). Interrupts are verified for transmit, receive, and timer operations. Most baud rates are tested for each DUART. Character blocks are transmitted, received, and verified. Another test verifies installation of the correct board. If loopback connectors are available, an external loopback test can be run.

Synchronous Communications Board Diagnostic Program

4.9 The Synchronous Communications Board diagnostic program checks the integrity of the 3-channel multifunction synchronous communication option board. Read and write tests are performed on the multiprotocol controller chip (MPEC). The parallel interface/timer chip (PI/T) is checked and installation of the correct adapter board is verified. Asynchronous and synchronous tests are performed with and without the direct memory access (DMA) chip. Bit-oriented protocol (BOP), nonreturn to zero inverted (NRZI), and bisynchronous protocols are tested using internal loopback. If loopback connectors are installed, the external loopback test can be run.

CK202 Communications Board Diagnostic Program

4.10 The CK202 Communications Board diagnostic program verifies the integrity of the CK202 option board. A test is performed to ensure that the onboard address decodes are functional. The parallel interface/timer is checked, and the board's ability to perform memory and DMA cycles to/from CCB memory is verified. If an external loopback is installed, the external loopback test can be run.

NuBus and Multiprocessor Diagnostic

4.11 The NuBus and Multiprocessor diagnostic program tests the multiprocessor arbitration logic on systems with multiple S1500 processor boards. These multiple boards are tested both individually and in the interactive multiprocessing environment. The following diagnostic tests are performed:

- Test 10 — Interprocessor communications test
- Test 20 — Bus error test
- Test 30 — General arbitration test
- Test 40 — Locked accesses test
- Test 50 — Processor unique test
- Test 60 — System stress test

NOTE: Refer to Appendix A for information about running the NuBus and Multiprocessor diagnostic.

Refer to the online help information for additional descriptions and procedures for running these tests.

S15A Processor Diagnostic Program

4.12 The S15A processor diagnostic program tests both the 68020 and 68030 processor boards. This diagnostic program does not run under GDOS and must, therefore, be booted separately. The S15A processor board diagnostics program consists of the following:

- S15A processor board tests (68020 and 68030 processors)
- Single board 68030 tests (68030 processor only)
- M68000 family tests (68030 processor only)
- 16- and 32-Megabyte Data Buffer board tests

S15A Processor Board Tests

4.12.1 The S15A processor board diagnostic program verifies the correct operation of the NuBus interface and associated multiprocessor arbitration logic.

NOTE: The S15A Processor Board Round Robin diagnostic program tests cannot be run unless your system contains at least two processor boards.

The S15A Processor Board Round Robin diagnostic tests the following functions on the primary and the secondary processor boards:

- Master NuBus access and slave NuBus access
- Cache load from master NuBus accesses
- Turbo cycles
- Master disable function
- Memory bus arbitration
- Physical bus arbitration
- NuBus arbitration
- Locked cycles arbitration
- Random arbitration
- Test-And-Set Arbitration Test
- Slave block move access

**Single Board
68030 Tests**

4.12.2 The single board 68030 tests consists of the following options:

- RAM — Random access memory self-test
- ICC — Interrupt chip controller self-test
- Cache — Internal and external cache memory self-test
- FPU — Floating point unit self-test
- Timer — Processor timer self-test
- MFP — Multifunction peripheral self-test
- NVRAM — Nonvolatile random access memory self-test
- NDB — NuBus data buffer self-test
- SPA — Software protection adapter self-test
- CROM — Configuration and self-test read-only memory self-test

**M68000
Family Tests**

4.12.3 The M68000 family tests execute only on the 68030 processor and consist of the following options:

- CPU — Central processing unit test
- MMU — Memory management unit test
- FPU — Floating point unit test

For instructions on how to load and run the S15A standalone diagnostic program, refer to paragraphs 2.7 and 2.8 in Section 2, Starting the Diagnostics.

**16- and
32-Megabyte Data
Buffer Board Test**

4.12.4 The 16- and 32-Megabyte Data Buffer board is tested using the S15A Processor Board diagnostic program. The Memory Board Test consists of the following options:

- Addressing Test
- Data Pattern Test
- Bit Cell Test
- Byte Mode Transfer Test
- Half Word Transfer Test
- Unmapped Retention Test
- Column Addressing Test
- Block Move Tests

**Disk Media
Utility**

4.13 This utility, which is loaded and executed from the GDOS Diagnostic Load Menu, performs three major disk utility operations:

- **Disk Surface Analysis.** Writes, then reads worst-case data patterns as it scans an entire disk. Displays the addresses of disk logical blocks that are defective. Defects can be reallocated either by reformatting or by reassignment, depending on hardware type. This is a data-destructive operation.
- **Format/Verify.** Initializes the disk surface by writing the ID fields of each sector on the disk. The format operation is immediately followed by a verify procedure. If the verify procedure finds read errors, the utility provides the option of reformatting. This is a data-destructive operation.
- **Verify Only.** Searches for read errors on a disk. This operation is not data-destructive.

NOTE: The Format/Verify procedure is described in detail in paragraph 4.17.1, Disk Format/Verify Utility.

**GDOS Utilities—
Backup/Restore
and Edit Label**

4.14 These GDOS utilities enable you to perform the following tape and disk utility operations:

- Display or edit a selected disk label
- Display a selected tape label
- Create a bootable (labeled) tape
- Restore all or selected partitions
- Verify partitions
- Create or restore UNIX® tar tapes

NOTE: The procedures for using the GDOS utilities are described in detail in paragraphs 4.17.2 through 4.17.5. Information about all of the GDOS utilities is available online or by printing the GDOS section of the online manual.

UNIX is a registered trademark of AT&T.

**GDOS Utilities—
Batch Menu**

4.15 This GDOS utility enables you to perform the following operations:

- Load and/or run a batch file
- Create/Edit or delete a batch file
- List batches
- Show a file

Refer to the printed online manual for more details on this utility.

**Print Online
Manual Utility**

4.16 The Print Online Manual utility allows you to print all or selected sections of the diagnostics menus, the online help information, and the online error messages. Each of these is printed by the print manual utility to produce the online manual. One section is devoted to GDOS, and one section is devoted to each of the other diagnostic programs.

If you print the GDOS section, the following is printed:

- Preface
- Title page for the GDOS section
- Table of contents for the GDOS section
- Help information for all the menus in GDOS
- A listing of system error messages

If you print a section for a diagnostic, the following is printed:

- Title page for the section
- Table of contents for the section
- Help information for all the menus in the diagnostic
- A listing of error messages for the diagnostic

NOTE: Make sure that the printer is plugged in and turned on before you execute this utility. The Print Online Manual utility automatically puts the printer online.

To access the Print Online Manual utility, follow these steps:

1. Enter Extended-Interactive Diagnostic mode from the GDOS Top-Level Menu.
2. Enter the Print Online Manual Utility Menu from the Extended-Interactive Diagnostic Mode Menu.

3. Select the option to print the entire manual or select the specific section(s) you want to print.
4. For more instructions, press the ? (HELP) key.

Using the GDOS Utilities

4.17 Your System 1500 is shipped with formatted disks. GDOS and the TI System V software usually have already been installed. However, you may need to format or reformat a new disk or a damaged disk at some point and install the GDOS software on it. The following procedures describe how to use the Disk Media utility to format a disk; and how to use the Backup/Restore and Edit Label utility to make a bootable tape, restore a bootable tape to disk, verify a restore operation, display a tape or disk partition, and edit a disk partition.

Disk Format/ Verify Utility

4.17.1 The Disk Format/Verify utility allows you to format and verify a disk, or to verify only. The format/verify procedure below is described as if you were performing a system startup using the bootable GDOS tape. However, you may not need to perform all the steps presented.

An interactive feature of this utility displays the list of disk defects and allows you to edit the list before formatting. This defect list is stored on the format (FMT) partition or, if no FMT partition exists, on the maximum cylinder. After formatting is complete, the utility creates an FMT partition for future format operations. For Maxtor/Adaptec mass storage units (MSU1s), the order of preference for defect lists is the FMT partition, then the Vendor defect list on the maximum cylinder. For other disk devices, such as MSU2, MSU2A, mass storage controller (MSC) storage module drive (SMD) disks, the order of preference is the combination of Vendor and Grown defect lists (V+G), the Vendor defect list, the Grown defect list, or the FMT partition. After formatting is complete, the utility creates the FMT partition for future format operations. The FMT partition reflects the defect data with which the unit is currently formatted.

Use the following procedure to perform the Disk Format/Verify operation:

1. Insert the tape into a tape drive on the system.
2. Boot or reboot the system (refer to paragraph 2.4 for instructions on booting the system). The system self-tests execute automatically during the boot process. As the self-tests run, messages indicating the test results scroll onto the video display terminal (VDT). When the self-tests are complete, the system displays specific slot number and device information, depending upon system configuration, as in the following example:

```
Slot 0 CPU TESTING SYSTEM :
Slot 0 CPU Passed
Slot 2 NPI Passed
Slot 3 CPU Passed
D=Default load, M=Menu load, R=Retest, E=Extended tests :
```

Make a note of the slot number for the controller board (in the example above, it is slot number 2) so you can type it in at Step 8.

3. Type G to boot GDOS. The system displays a list of available load devices along with the slot number of the disk controller and each logical unit number, as in the following example. Make a note of this information so that you can type it in at Step 8. Each available load device is also identified by an associated letter. An asterisk indicates the default drive.

```
Available load devices

*A = Slot 2 disk 00
  B = Slot 2 tape 08
Select load device:
```

4. Select the disk with GDOS on it by pressing the corresponding letter. Otherwise, choose the tape drive the bootable tape is in by pressing its corresponding letter.

After GDOS is booted (from tape, booting takes approximately 3 minutes), the GDOS Top-Level Menu is displayed (Figure 4-1). The cursor will be on the first item in this menu, Loop on All Noninteractive Diagnostics.

CAUTION: Formatting a disk destroys all existing data on the disk. Therefore, before you format a disk containing such data, copy the contents of the disk to a cartridge tape or to another disk. In addition, editing or otherwise modifying the disk label/partition table can introduce unpredictable errors, possibly resulting in severe boot problems and other operational difficulties.

Figure 4-1 GDOS Top-Level Menu

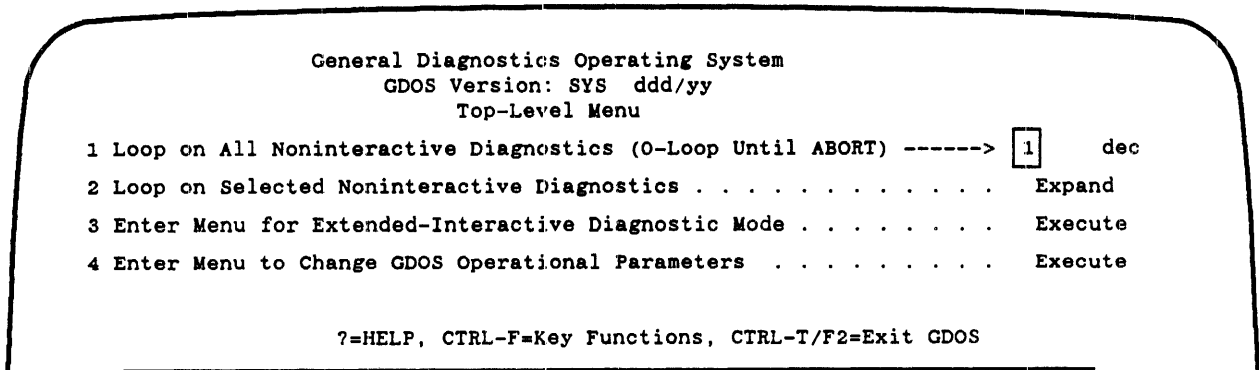

5. Place the cursor on item number three, Enter Menu for Extended-Interactive Diagnostic Mode, and press RETURN. The Extended-Interactive Diagnostic Mode Main Menu is displayed (Figure 4-2).

Figure 4-2 GDOS Extended-Interactive Diagnostic Mode Menu

```

                                GDOS
                        Extended-Interactive Diagnostic Mode Menu

1  Load a Diagnostic by Menu or Name and Show Its Main Menu ----->  Menu
2  Load a Diagnostic by Menu or Name . . . . .  Menu
3  Display Main Menu of Loaded Diagnostic . . . . .  Execute
4  Display GDOS and Diagnostic Memory Information . . . . .  Execute
5  Display System Information . . . . .  Execute
6  Display Slot Information . . . . .  0      dec
7  Enter Debug Menu . . . . .  Execute
8  Enter Backup/Restore and Edit Label Utility . . . . .  Execute
9  Enter Batch Menu . . . . .  Execute
10 Enter Menu to Print the Online Manual . . . . .  Execute

? = HELP, CTRL-F = Key Functions, CTRL-B/F1 = Previous Menu, CTRL-T/F2 = Top Menu
    
```

6. When this menu is displayed, the cursor will be on the first item, Load a Diagnostic by Menu or Name and Show Its Main Menu. Select this item by pressing the RETURN key. The GDOS Diagnostic Load Menu is displayed. It contains a list of the diagnostics that are available for your system as well as the Disk Media utility.

The sample list below may differ from what appears on your VDT, depending on your particular system configuration:

```

                                GDOS
                        Diagnostic Load Menu

1  Disk Diagnostic ----->  Execute
2  Tape Diagnostic . . . . .  Execute
3  . . . . .
. . . Disk Media Utility. . . . .  Execute
    
```

7. Move the cursor to the Disk Media utility option and press RETURN to load the utility. When the Disk Format/Verify utility has been loaded, the Disk Media Utilities Main Menu is displayed. It contains the following entries:

```

                        Disk Media Utilities Main Menu

1  Enter Format/Verify Utility ----->  Expand
2  Enter Surface Analysis Utility - DATA DESTRUCTIVE . .  Short
3  Enter Menu to Display and Set Test Execution Parameter  Execute
4  Enter Utilities Menu . . . . .  Execute
5  Return to GDOS . . . . .  Execute
    
```

The cursor is on the first entry, Enter Format/Verify Utility. Press RETURN to expand this menu entry. The expanded entry contains the following items:

```

1 Enter Format/Verify Utility ----->      Execute
  Slot id . . . . .                2      dec
  Logical Unit Number . . . . .      0      dec
    
```

8. Place the cursor on the appropriate subentries, and enter the correct slot ID number and logical unit number of the disk you wish to format. Press RETURN. Before the Format/Verify Utility Menu is entered, the utility performs routines designed to identify the controller type and the disk type and to acquire the correct disk defect data for the format operation.

9. The first routine checks the logical unit to identify the controller type:
- If identification of the controller type is successful, the utility then attempts to identify the disk type. (See Step 10.)
 - If identification of the controller type is unsuccessful, the utility displays the Select Disk Controller Type menu shown below:

Select Disk Controller Type

```

1 Select SCSI Formatter Type and Press RETURN ----->      MSU1
2 Select SMD Disk Type and Press RETURN . . . . .          WD900
    
```

In this menu, use the TAB key to select either the MSU1, MSU2, or MSU2A option from menu entry 1 and press RETURN, or move the cursor to menu entry 2, use the TAB key to select either the WD900 or WD1200 option, and press RETURN.

The disk controller type is determined by the disk header information as follows:

- MAX-0140 — MSU1
- CDC-0182 — MSU2
- MAX-0380 — MSU2A
- MAX-0760 — MSU2A

After successfully identifying the controller type, the utility performs the second identification routine.

10. The second identification routine checks the disk type:
- If identification of the disk type is successful, the utility loads the appropriate disk format parameters.

If the disk format parameters are loaded successfully, the utility displays a prompt asking if you wish to enter the Format Parameters Menu to edit existing disk parameters. The default for this option is no. Pressing RETURN accepts the default. If you wish to display the Format Parameters Menu, type y (yes) and press RETURN.

- If identification of the disk type is unsuccessful, the utility automatically displays the Format Parameters Menu, which enables you to modify existing disk parameters and to change the disk defect list source. Parameters that do not apply to the MSU2A are not displayed.

Format Parameters Menu

1	Defect List Source	FMT	
2	Number of Cylinders ----->	1864	dec
3	Number of Heads	16	dec
4	Sectors per Track	95	dec
5	Data Bytes Per Sector	512	dec
6	Alternate Sectors per Defect Handling Zone	13	dec
7	Interleave Factor	1	dec
8	Track Skew Factor	2	dec
9	Cylinder Skew Factor	28	dec
10	Drive Type Field	40	hex
11	Medium Type	0	hex
12	Density Code	0	hex
13	Read Clock Sync Delay	224	dec
14	Gap 1 Delay	227	dec
15	Gap 1 Count	16	dec
16	Preamble Count	12	dec
17	Enhanced SMD Flag Code	2	dec
18	Unformatted Bits per Sector	4734	dec
19	Number of Primary Map Tracks	3	dec
20	Beginning Head Address of Primary Track	1	dec

11. Modify the appropriate entries in the the Format Parameters Menu, and press RETURN to execute. (For more information about each item in the Format Parameters Menu, refer to the online help messages.)

The utility now attempts to fetch the disk defect data list.

- If the disk defect data is loaded without error, the Format/Verify Utility Menu is displayed (see Format/Verify Utility Menu below).
- If errors occur when the utility attempts to load the disk defect data list, an error message is displayed and you must enter the Format Parameters Menu to select an alternate disk defect data list source.

Press the ABORT key (or the abort key sequence) and reenter the utility. The utility returns you either to the prompt that asks if you wish to enter the Format Parameters Menu, or to the Format Parameters Menu if it was displayed in a previous step.

Select an alternate defect data list source and press RETURN. If the disk defect data is now loaded without error, the Format/Verify Utility Menu is displayed.

Format/Verify Utility Menu

1	Scroll Defect Window Up or Down ----->	Down	
2	Modify Defect List (Add, Delete, Read, Replace) . .	Add	
3	Entry Number	1	dec
4	Cylinder Address	63	dec
5	Head Address	3	dec
6	Bytes From Index	8496	dec
7	Format and Verify the Disk	Execute	
8	Verify the Disk	Execute	
9	Reassign Verify Defects	Execute	
10	Reassign Defective Block - Enter Address	0	dec
11	Display Disk Defect List	Execute	
12	Display Trace - Enter Number to Display	0	dec
13	Write Disk Label - DATA DESTRUCTIVE.	Execute	
14	Adaptive Surface Analysis - Head Limit Bias in 1/10.	20	dec
15	Adaptive Surface Analysis - Loop Count	50	dec

After you have selected a defect list source and the Format/Verify Utility Menu is displayed, you can manually enter printed defect data. Any manually entered defect data is written to the G and FMT defect lists during the format/verify process. All references to the G defect list do not apply to the MSU1 disk.

12. Place the cursor on entry number 7, Format and Verify the Disk, and press RETURN.

When the format operation executes, the following occurs:

- The entire disk is formatted then verified to ensure that all bad tracks are reallocated.
- If the verify operation passes, the utility displays a completion message and returns control to the Format/Verify Utility Menu.
- If the verify operation fails, the addresses of any read errors found by the verify operation are displayed along with a prompt that allows you to continue.
 - An affirmative response to the prompt causes the defect data to be added to the G defect list, and the format/verify process is repeated.
 - A negative response to the prompt halts the format/verify process and returns you to the Format/Verify Utility Menu.

If errors are detected on subsequent format/verify processes, you may need to repeat the process more than once to format out all the readily detected errors.

Due to practical limits, only 16 defects can be added to the G defect list for each repetition of the format/verify process. If a disk has more than 16 unknown defects or marginally repeatable defects, you may need to repeat the format/verify process several times.

If you are formatting a disk that has no vendor defect list (either electronic or printed), you may need to repeat the format/verify process until the verify operation passes without user intervention.

13. Surface analysis (SA) should be performed after a format operation. Two types of SA are available: regular SA and adaptive SA.

Note that both forms of SA are data destructive; all user data on the disk will be lost even though the partition table may still show that it is there.

- Regular SA makes several write and read passes of the entire disk starting at the end of the TZON partition using different data patterns. If medium or long regular SA is selected, head and data strobe offsets will be used (if the drive supports them). Regular SA is available from the Disk Media Utilities Main Menu. Select entry 2: Enter Surface Analysis Utility, and press the RETURN key.
- Adaptive SA uses the defect information in the defect list(s) selected in the Format Parameters Menu to statistically locate areas on the disk where new defects are most likely to appear. This allows the scan to spend more time in these areas trying to detect defects. Adaptive SA should be run as a supplement to regular SA. It is also available from the Format/Verify Utility Menu. Select entry 14: Adaptive Surface Analysis - Head Limit Bias in 1/10, and press the RETURN key.

When performing any SA, and prompted as to whether or not to reallocate any defects, always answer yes.

The same limit of 16 defects applies to SA as in format. If more than 16 defects are found in a run of SA, SA must be run again.

When finished running SA, and no more defects are found, you will need to run a final pass of Format/Verify. (For MSU1 disk drives, you must manually record, and enter any defects detected in SA before formatting.)

**Make Bootable
Tape Utility**

4.17.2 The Make Bootable (Labelled) Tape utility enables you to make a bootable tape and copy partitions from the disk to the tape. Use the following procedure to perform this operation (the procedure described below assumes that GDOS has already been booted and the GDOS Top-Level Menu is displayed):

1. Insert the tape into a tape drive on the system. In the GDOS Top-Level Menu, move the cursor to the third menu item, Enter Menu for Extended-Interactive Diagnostic Mode, and press the RETURN key.
2. When the Extended-Interactive Diagnostic Mode Menu appears, move the cursor to item number 8, Enter Backup/Restore and Edit Label Utility Menu, and press RETURN. The Backup/Restore and Edit Label Utility menu is displayed.

Backup/Restore and Edit Label Utility

1	Display/Edit Disk Label or Display Tape Label ----->	Expand
2	Make Bootable (Labelled) Tape	Expand
3	Verify Partition(s)	Expand
4	Restore Bootable (Labelled) Tape	Expand
5	File Backup/Restore - TAR Format	Expand

3. When this menu is displayed, the cursor is on the first menu entry, Display/Edit Disk Label or Display Tape Label. Place the cursor on the Expand option of the Make Bootable (Labelled) Tape menu. (For detailed information about any of the menu entries in the Backup/Restore and Edit Label utility, refer to the online help information.) Press the RETURN key. The following subentries appear under the expanded Make Bootable (Labelled) Tape menu:

```

2 Make Bootable (Labelled) Tape -----> Execute
   Tape Slot Number (0-F hexadecimal) . . . . . 2 hex
   Tape Logical Unit Number (0-F hexadecimal) . . . . 6 hex
   Disk Slot Number (0-F hexadecimal) . . . . . 2 hex
   Disk Logical Unit Number (0-F hexadecimal) . . . . 0 hex
    
```

4. Place the cursor on the appropriate subentries and enter the correct slot numbers and logical unit numbers, as appropriate, then press RETURN. The following menu is displayed:

```

                Make Bootable (Labelled) Tape
1 Select Entry Number of Partition to Include -----> 2 dec
2 Make Bootable (Labelled) Tape . . . . . Execute
    
```

5. Insert the tape and press the space bar when ready. After you press the space bar, the utility program displays a listing of each disk partition showing its number, name, starting block address, block length, user type, and comment field.

For each partition you wish to back up (copy) to tape, type its partition number and press RETURN. The utility adds each partition number to a backup list, which it updates and displays each time you add a new number. Continue by typing the corresponding entry number and pressing RETURN for each partition you wish to copy to the bootable tape.

When you have entered all desired partition entry numbers, place the cursor on the second menu entry, Make Bootable (Labelled) Tape, and press RETURN. The utility copies the partitions whose entry numbers you specified onto the tape.

NOTE: If you select a partition of function type pb (page) for the Make Bootable Tape menu entry, a partition table entry is created but no partition data is written to tape.

If all the partitions cannot be placed on the first tape, you are prompted for another tape. This continues until all the partitions have been backed up. On each tape, make a note of the order of the reels.

If the backup requires multiple reels, each tape will have a tape volume label (including a partition table). The first tape will have a listing for all partitions backed up. The tape label on each subsequent tape will consist of complete partitions on it and the tapes that follow. For example, if 7 partitions were backed up requiring 3 tapes, the labels would be as follows:

- Tape one's label will list partitions 1 through 7, but the tape consists of partitions 1 and 2 and part of partition 3.
- Tape two's label will list partitions 4 through 7, but the tape consists of the remainder of partition 3, all of partitions 4 and 5, and part of partition 6.
- Tape three's label will list partition 7, but the tape consists of the remainder of partition 6 and all of partition 7.

NOTE: To ensure a good bootable tape backup, you should verify the partitions.

Restore Bootable Tape Utility

4.17.3 The Restore Bootable (Labelled) Tape utility enables you to restore the contents of a bootable tape to a disk. Use the procedure described below to restore partitions from a bootable tape (the procedure assumes you will boot GDOS from tape):

NOTE: In restoring a single partition from a multiple-partition multiple-reel backup, it is best to determine which tape the partition is on. Display the tape label of each tape, starting with the last tape, and look for the first occurrence of the partition name. This is the tape you should use to start the Restore Bootable Tape utility.

1. Insert the tape into a tape drive on the system.
2. Boot or reboot the system:
 - a. If the system is off, turn it on. This automatically boots the system.
 - b. If the system is already on, you can reboot the system by cycling power (turning the main power switch off, then on again). As the system self-tests run, messages indicating the test results scroll onto the video display. When the self-tests are complete, the system displays specific slot number and device information similar to the following, depending on system configuration.

```
Slot 0   CPU TESTING SYSTEM :
Slot 0   CPU Passed
Slot 2   NPI Passed
Slot 3   CPU Passed
D=Default load, M=Menu load, R=Retest, E=Extended tests :
```

Make a note of the slot number for the Controller board (in the example above, it is slot number 2) so that you can type it in at Step 8.

3. Press G to boot GDOS. The system displays a list of available load devices along with the slot number of the disk controller and each logical unit number. Make a note of this information so that you can type it in at Step 8. Each available load device is also identified by an associated letter. An asterisk denotes the default drive.

```
Available load devices

* A = Slot 2 disk 00
  B = Slot 2 tape 06

Select load device:
```

NOTE: When restoring a partition of function type pb (page), GDOS creates an entry in the disk partition table but does not transfer any partition data.

4. Choose the tape drive containing the bootable tape by pressing its corresponding letter.

After GDOS is booted (from tape, booting takes about 3 minutes), the GDOS Top-Level Menu is displayed (Figure 4-3). The cursor is on the first item in this menu, Loop on All Noninteractive Diagnostics.

5. Use the Up and Down Arrow keys to place the cursor on item number 3, Enter Menu for Extended-Interactive Diagnostic Mode, and press RETURN. The Extended-Interactive Diagnostic Mode Main Menu is displayed (Figure 4-4).

Figure 4-3 GDOS Top-Level Menu

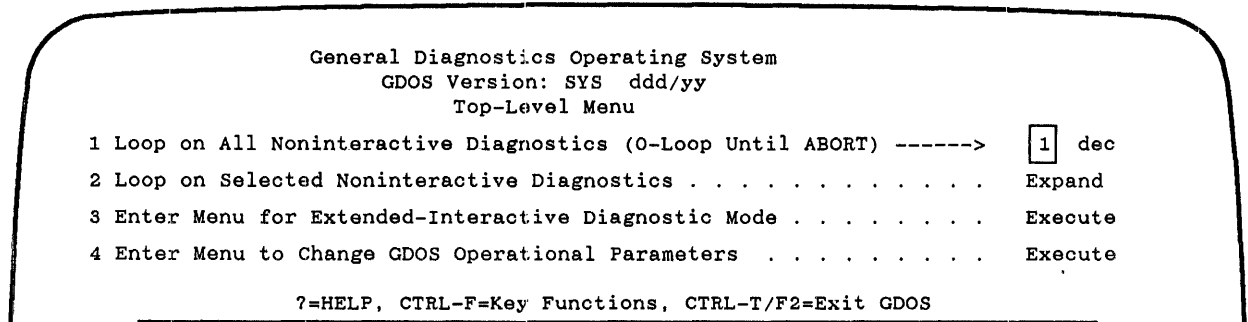

Figure 4-4 GDOS Extended-Interactive Diagnostic Mode Menu

GDOS		
Extended-Interactive Diagnostic Mode Menu		
1	Load a Diagnostic by Menu or Name and Show Its Main Menu ----->	Menu
2	Load a Diagnostic by Menu or Name	Menu
3	Display Main Menu of Loaded Diagnostic	Execute
4	Display GDOS and Diagnostic Memory Information	Execute
5	Display System Information	Execute
6	Display Slot Information	0 dec
7	Enter Debug Menu	Execute
8	Enter Backup/Restore and Edit Label Utility	Execute
9	Enter Batch Menu	Execute
10	Enter Menu to Print the Online Manual	Execute

?=HELP, CTRL-F=Key Functions, CTRL-B/F1=Previous Menu, CTRL-T/F2=Top Menu

6. When this menu is displayed, move the cursor to item number 8, Enter Backup/Restore and Edit Label Utility, and press RETURN. The Backup/Restore and Edit Label Utility menu is displayed. It contains the following entries:

Backup/Restore and Edit Label Utility

1	Display/Edit Disk Label or Display Tape Label ----->	Expand
2	Make Bootable (Labelled) Tape	Expand
3	Verify Partition(s)	Expand
4	Restore Bootable (Labelled) Tape	Expand
5	File Backup/Restore - TAR Format	Expand

7. When this menu is displayed, the cursor is on the Expand option in the first menu entry. Place the cursor on the Expand option in menu entry 4, Restore Bootable (Labelled) Tape. Press RETURN. (For detailed information about any of the menu entries in the Backup/Restore and Edit Label Utility, refer to the online help information.) The following sub-entries appear under the expanded Restore Bootable (Labelled) Tape menu entry:

4	Restore Bootable (Labelled) Tape	Execute
	Tape Slot Number (0-F hexadecimal)	2 hex
	Tape Logical Unit Number (0-F hexadecimal)	6 hex
	Disk Slot Number (0-F hexadecimal)	2 hex
	Disk Logical Unit Number (0-F hexadecimal)	0 hex
	Selectively Restore Partitions?	Yes

8. Place the cursor on the appropriate subentries and enter the correct slot numbers and logical unit numbers, as appropriate. Use the TAB key or the Left and Right Arrow keys to toggle a Yes or No response to the *Selectively Restore Partitions?* option; then, press RETURN.
 - If you selected *yes* for the *Selectively Restore Partitions?* option, prompts appear during the operation of this utility asking if you wish to restore the specific partitions on tape, that is, GDOS partition, DIAG partition, and so forth, as follows:

Do you want to restore partition *partitionname* of type *typenumber*?

Table 4-1 lists the defined user types that are displayed in the *typenumber* field. Refer to the NuBus License Identifiers Specification, TI Part number 2549287-0001, for additional information.

Table 4-1

Defined User Types

Typenumber	User Types
0000	Explorer I
0001	NuMachine
0002	System 1500 — 68020 processor
0003	Terminal Concentrator
0005	Explorer II
0006	Compact Lisp Machine (CLM)
0007	NuBus Peripheral Interface
0008	MSC
0009	Communications Carrier
000A	System 1500 — 68030 processor
0013	System 1505 — 68030 processor
0014	System 1507 — 68040 processor
0015	System 1500-anchor
FC00	TI Lisp
FC02	DIAG
FC02	System V
FFFF	Generic

If you type *y* (yes) at each prompt, the utility looks for that partition on disk. If a partition with the same name, user type, function type, and size is found (where the tape partition size is equal to or smaller than the disk partition size), the following prompt is displayed:

Partition *partitionname* of type *typenumber* already exists.
Do you want to restore over it? (Press *y* or *n* and RETURN.)

If you type *y* (yes), the partition on tape is restored over the existing partition on disk. If you type *n* (no), the partition on tape is restored to free space on disk if there is room. You then have two partitions with the same name on the disk.

- If you selected *No* for the *Selectively Restore Partitions?* option, the utility automatically restores all partitions to free space on the disk if there is room.

NOTE: If the tape is one of a multiple-reel bootable backup and part or all of the partition is not on the present tape, you will be prompted to insert the next tape.

After the partitions have been restored, the utility automatically updates the partition table, if appropriate, and prompts you for the necessary data if you wish to add a page partition. For the System 1500 the page partition name is `swap` and will be of user type 0002.

NOTE: If you are performing the Restore procedure on a newly formatted disk, responding with `No` to the `Selectively Restore Partitions?` menu entry restores the entire tape to the disk in the same order that the partitions reside on the tape.

9. When the Restore operation is complete, the system prompts with the message:
 Tape and disk utility successfully completed.

**Verify Tape
 Partition(s)
 Utility**

4.17.4 The Verify Tape Partition(s) utility enables you to verify or compare a selected partition on tape with a partition on disk, or to verify all partitions. The procedure described below assumes that GDOS has been booted and that the GDOS Top-Level Menu is displayed.

NOTE: Verification of a partition of function type `pb` (page band) is not a valid operation.

Use the following procedure to verify partition(s):

1. Insert the tape containing the partitions you wish to verify against disk partitions. In the GDOS Top-Level Menu, move the cursor to the third menu item, Enter Menu for Extended-Interactive Diagnostic Mode, and press the RETURN key.
2. When the Extended-Interactive Diagnostic Mode Menu appears, move the cursor to menu entry number 8, Enter Backup/Restore and Edit Label Utility, and press the RETURN key. The Backup/Restore and Edit Label Utility menu is displayed.

Backup/Restore and Edit Label Utility

```

1 Display/Edit Disk Label or Display Tape Label -----> Expand
2 Make Bootable (Labelled) Tape . . . . . Expand
3 Verify Partition(s) . . . . . Expand
4 Restore Bootable (Labelled) Tape . . . . . Expand
5 File Backup/Restore - TAR Format . . . . . Expand
    
```

3. When this menu is displayed, the cursor is on the first menu entry — Display/Edit Disk Label or Display Tape Label. Place the cursor on the third entry — Verify Partition(s) — and press RETURN to expand the menu entry. (For detailed information about any of the menu entries in the Backup/Restore and Edit Label utility, refer to the online help information.) The following subentries appear under the expanded Verify Partition(s) menu:

```

3 Verify Partitions . . . . . Execute
   Tape Slot Number (0-F hexadecimal) . . . . . 2 hex
   Tape Logical Unit Number (0-F hexadecimal) . . . . . 6 hex
   Disk Slot Number (0-F hexadecimal) . . . . . 2 hex
   Disk Logical Unit Number (0-F hexadecimal) . . . . . 2 hex
   Verify All Tape Partitions? . . . . . No
    
```

4. Place the cursor on the appropriate subentries and enter the correct slot numbers and logical unit numbers, as appropriate, or accept the default numbers. Next, use the TAB key to toggle between the Yes or No responses for the Verify All Tape Partitions option. Press RETURN. A numbered listing of the tape and disk partitions is displayed.
 - If you select the Yes parameter for the Verify All Tape Partitions entry, the utility checks all partition names, lengths, attributes, and partition comment fields when making its selection for the partitions to compare. The starting address block will not be compared.

The utility lists any partitions that cannot be correctly verified.

- If you select the No parameter for the Verify All Tape Partitions entry, the utility displays a numbered listing of all tape and disk partitions and prompts you for the number of the tape partition and the disk partition you wish to verify.

After you type the disk partition number and press RETURN, the Verify utility will execute.

NOTE: If the tape is one of a multiple-reel bootable backup and part or all of the partition is not on the present tape, you will be prompted to insert the next tape.

Display/Edit Disk Label or Display Tape Label Utility

4.17.5 This GDOS utility enables you to either display or edit a disk label or to display a tape label (a tape label cannot be edited). Steps 1 through 4 of the procedure below describe how to display either a tape or a disk label; steps 5 through 9 describe how to edit a disk label. It is assumed that GDOS has been booted and that the GDOS Top-Level Menu is displayed.

1. In the GDOS Top-Level Menu, move the cursor to the third menu item, Enter Menu for Extended-Interactive Diagnostic Mode, and press the RETURN key (if you wish to display a tape partition, make sure that a tape has been installed in the tape drive).

2. When the Extended-Interactive Diagnostic Mode Menu appears, move the cursor to menu entry number 8, Enter Backup/Restore and Edit Label Utility, and press the RETURN key. The Backup/Restore and Edit Label Utility menu is displayed.

Backup/Restore and Edit Label Utility

```

1  Display/Edit Disk Label or Display Tape Label ----->  Expand
2  Make Bootable (Labelled) Tape . . . . .  Expand
3  Verify Partition(s) . . . . .  Expand
4  Restore Bootable (Labelled) Tape . . . . .  Expand
5  File Backup/Restore - TAR Format . . . . .  Expand

```

3. When the menu is displayed, the cursor is on the first menu entry, Display/Edit Disk Label or Display Tape Label. Press RETURN to expand this menu entry. (For detailed information about any of the menu entries in the Backup/Restore and Edit Label utility, refer to the online help information.) The following subentries appear under the expanded Display/Edit Disk Label or Display Tape Label menu entry.

```

1  Display/Edit Disk Label or Display Tape Label . . . . . Execute
    Display/Edit Partition and Label . . . . . Display
    Device Slot Number (0-F hexadecimal) . . . . . 2 hex
    Device Logical Unit Number (0-F hexadecimal) . . . . . 0 hex

```

4. Place the cursor on the first subentry, Display/Edit Partition and Label, and use the TAB key to select Display. Next, place the cursor on the other subentries and enter the correct slot number and logical unit number for the tape or disk whose partitions you wish to display.

NOTE: To get a printed listing of the partition table, the `Select Trace Level to Print` option must be set to the `AllMsgs` parameter in the Operational Parameters Menu. This parameter must be set BEFORE you execute the Display/Edit Disk Label or Display Tape Label utility. To set the `AllMsgs` parameter, press the F4 key to call the Operational Parameters Menu. Move the cursor to the `Select Trace Level to Print` menu entry. Use the TAB key to select the `AllMsgs` parameter. Now, turn the printer on and press the F1 key to return to the Backup/Restore and Edit Label Utility menu.

5. Press RETURN to execute the utility. A numbered listing of the tape or disk partition table is displayed. It shows each partition name, starting block address, block length, user type, and comment field. After the disk partition table is displayed, the cursor returns to the Display/Edit Disk Label or Display Tape Label menu entry.
6. If you wish to edit a disk label, move the cursor to the subentry, Display/Edit Partition and Label, and use the TAB key to select Edit. Next, place the cursor on the other subentries and enter the correct slot number and logical unit number for the disk whose partitions you wish to edit.

CAUTION: It is recommended that you obtain a printed record of your editing operation to assist you in tracing errors should any occur. To get a printed listing of your editing operation, you must set the AllMsgs parameter in the Select Trace Level to Print menu entry of the GDOS Change Operational Parameters Menu. This parameter must be set BEFORE you execute the Display/Edit Disk Label or Display Tape Label utility. To set the AllMsgs parameter, press the F4 key to call the Operational Parameters Menu. Move the cursor to the Select Trace Level to Print menu entry. Use the TAB key to select the AllMsgs parameter. Now, turn the printer on and Press the F1 key to return to the Backup/Restore and Edit Label Utility menu.

7. Press RETURN to execute the utility. A numbered listing of the disk partition table is displayed and printed. It shows each partition name, starting block address, block length, user type, and comment field, and is similar to the following example (your display will differ depending upon the files on your particular disk):

```
Sys:, MAX-140,
LABL version 2, DISK
1024 bytes per block, 26 bytes per sector,
32 sectors per track, 15 heads,
917 cylinders, 920 sectors for defects
Volume comments:
(comment)
18 partitions, 12-longword descriptors:
  Name      Start  Length  User  Comments
1  *  LABL v1  0       2      FFFF
2  *  PTBL pt  2       3      FFFF
3    SAVE sb  5       3      FFFF
4    FMT  fp  8       9      FFFF
5    TZON tz 17      122   FFFF
6  *  unx1 lb 139     1024  0002
7    unx2 lb 1163    1024  0002
8    unx3 lb 2187    1024  0002
9  *  cfg1 cb 3211    17     FFFF
10   cfg2 cb 3228    17     FFFF
11   cfg3 cb 3245    17     FFFF
12  *  root fb 3262    8192  FC02
13   usr  fb 11454   32768 FC02
14   src  fb 44222   32000 FC02
15  *  swap pb 79020   30789 0002
16   GDOS lb 76222    300   0002  GDOS 320/86 RELEASE 1.2.0
17   DIAG fb 76522   2048  FC02  DIAG 320/86 RELEASE 1.2.0
18   S15A lb 78570    150   0002  S15A 320/86 RELEASE 1.2.0

Enter number of entry to edit:
(NOTE: An entry number of 0 indicates a desire to edit the
actual label information as opposed to the partition table.)
```

8. Type the number of the disk partition you wish to edit. (For the example below, assume that partition number 18, S15A, is selected.) Press RETURN. The partition edit screen is displayed. It contains a numbered list of the partition parameters that can be edited.:

```

1 Partition name      S15A                2 Function type load, 00000000X
3 Starting Block     78570              4 Length in blocks 150
5 User type          0002
   Partition properties (items 6-13)
6 Expandable ?      No                  7 Contractable?      No
8 Delete protected? No                  9 Logical partition? No
10 Copy protected?  No                  11 Default indicator? No
12 Diagnostic use?  Yes                 13 Reserved?         Yes
14 Comments S15A 320/86 RELEASE 1.2.0
15 Create new entry in front of this entry
16 Create new entry after this entry
17 Delete this entry
00 Write partition table to disk

```

Enter number of sub-entry to edit.

9. Type the number of the subentry you wish to edit as requested by the prompt. For example, if you wish to edit subentry number 4, Length in blocks, type the number 4 at the Enter number of sub-entry to edit prompt and press RETURN. The utility then displays the following prompt:

Enter the new value (in decimal) and RETURN.

10. Type the new value for length in blocks and press RETURN. For example, if you wish to specify 200 blocks, type the decimal value 200. The utility replaces the old value 150 with the new value 200 and redisplay the partition edit screen with the new value.
11. Use the same sequence to specify each parameter you wish to edit. With each selection, the utility prompts you for the new value. When you type the new value and press RETURN, the utility replaces the existing value with the new value you have specified.

If you make a mistake, use the backspace key to delete alphanumeric characters to the left of the cursor. If you discover a mistake after pressing the RETURN key, reselect the subentry and enter the correct value. All new values are stored temporarily in a buffer until you write them to the disk.

- To exit without writing any values to the disk, press CTRL-C or the appropriate ABORT key sequence for your computer. The utility returns you to the Backup/Restore and Edit Label Utility menu.
- To write the new values to the disk, enter 00 (zero, zero) at the Enter number of sub-entry to edit prompt. The utility writes the new parameters to disk and returns you to the Backup/Restore and Edit Label Utility menu.

BOOT PROBLEMS

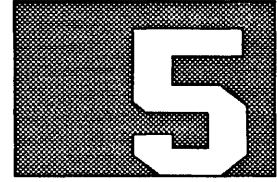

Highlights of This Section

5.1 This section describes some of the problems that can arise when you boot the system or load the General Diagnostic Operating System (GDOS):

- Power-up testing
- Boot error codes
- Fault indicator light-emitting diodes (LEDs)

System Testing During Power-Up

5.2 When you boot the System 1500, each of the system's intelligent boards executes a set of read-only memory (ROM)-based self-tests. After these tests have run, system control is given to the system test boot master (STBM), which automatically runs additional ROM-based interface diagnostic tests.

If a board fails this power-up test procedure, the system displays a message indicating which board has failed. You may not be able to load TI System V software or the diagnostics software until that board is repaired or replaced. Refer to Section 1 for instructions on rerunning the ROM-based power-up tests after a board failure has been indicated.

Initial program loading and execution of the diagnostics under GDOS can proceed even if the following failures occur:

- The communications carrier board and option boards can fail and still permit GDOS operation, because GDOS does not require the network.
- One or more processor board(s) in multiprocessor systems can fail as long as at least one processor board passes all tests. The processor board that has the lowest slot ID and passes all tests becomes the STBM.

For detailed descriptions of the system self-tests and the interface diagnostic tests, refer to the *Field Maintenance* manual for the System 1500, TI part number 2534849-0001.

Reading Boot Error Codes

5.3 During boot operations, most errors are reported by one or more self-explanatory messages such as:

No online device

Program not found

In some cases, however, the processor is not able to relate an error to an appropriate textual message and instead returns numeric error codes. Numeric error codes generally are displayed in the following form:

DEVICE ERROR: nnnnnnnn

where:

nnnnnnnn is a hexadecimal error number listed in Table 5-1.

Table 5-1

Boot Error Codes	
Error ID	Description
00000004	Memory board is unavailable. The processor could not find a memory board that passed all the self-tests.
00000005	NUPI error. The processor received a NuBus peripheral interface (NUPI) error while executing Diagnostic Engine (DE) code in a device driver. (DE is the programming language used to program the system self-tests.)
00000006	Command time-out. The NUPI device driver did not complete a command block before the maximum time allotted for this operation elapsed.
00000009	Network is down. Ethernet is disconnected, shorted, or open.
00000014	Device access error. The load device returned a bad status.
00000015	Invalid volume label. The first word of block 0 did not contain the string LABL.
00000016	Invalid volume partition table. The first word of the partition table did not contain the string PRTN.
0000000A	Invalid unit number for the load device.
0000000B	Local Area Network (LAN) 802.3 option board failed to initialize properly.
6nnnnnnn	NUPI command status. These error codes are returned by the NUPI device driver; the code is a copy of the status field of the NUPI command block.

Reading Fault Indicator LEDs

5.4 Fault indicator LEDs on the processor board, the communications carrier board, and the NUPI board supplement the standard boot error messages that the system displays during the boot procedure. The boot utility switches on LEDs for each board during power up. Then, the subsequent ROM-based power-up tests, if successful, switch the LEDs off.

These LED indications are particularly useful in cases where the processor board or the NUPI board is unable to display textual or hexadecimal messages. For example, if a faulty connection exists between the processor board and the system maintenance terminal, making it impossible for the processor to print an error message to the monitor, the red fault indicator LED confirms the existence of the error.

The fault indicator LEDs are located near the bottom of each board. To view these indicator LEDs on the 7-slot chassis system, open the outer front door on the system enclosure and look through the appropriate slot on the inner door as shown in Figure 5-1. To view the LEDs on the 16-slot, remove the front trim panels as shown in Figure 5-2. Table 5-2 lists the fault indicator LED errors. The S1505 LED locations and descriptions are shown in Figure 5-3 and Figure 5-4.

Figure 5-1

Location of Fault Indicator LEDs — 7-Slot Chassis

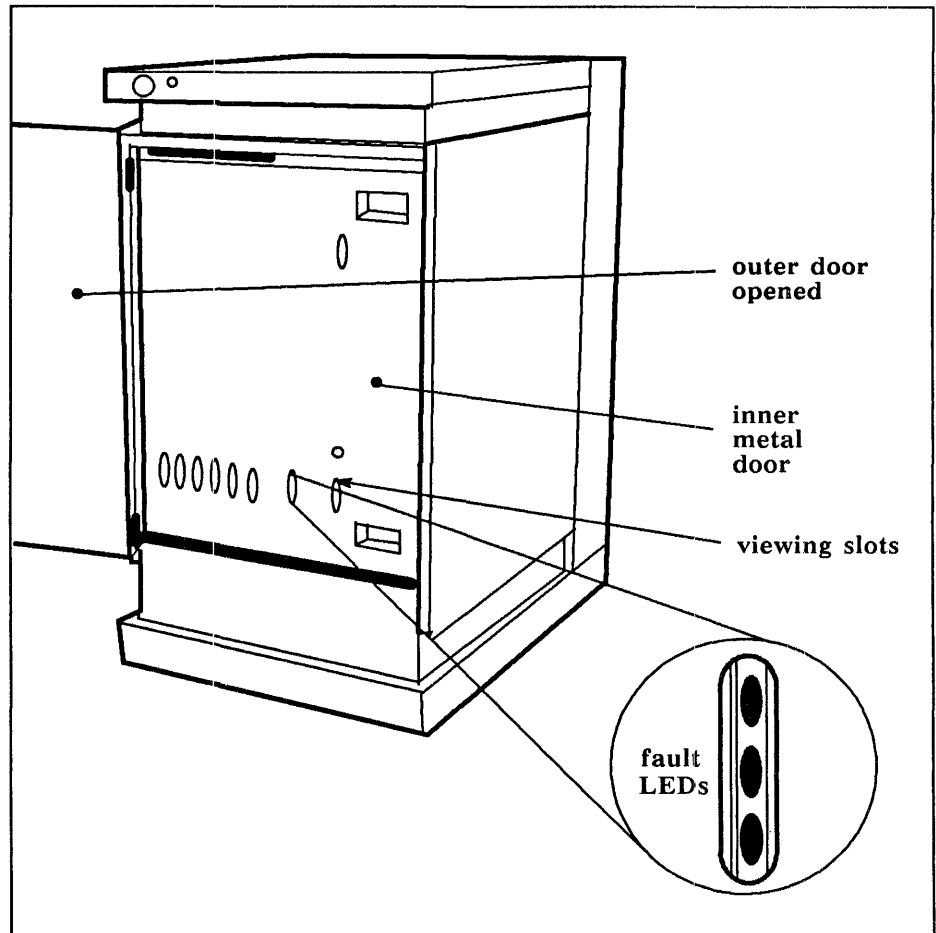

WARNING: Do not open the inner door; safety interlocks on the door power down the enclosure when the door is opened.

Figure 5-2 Location of Fault Indicator LEDs — 16-Slot Chassis

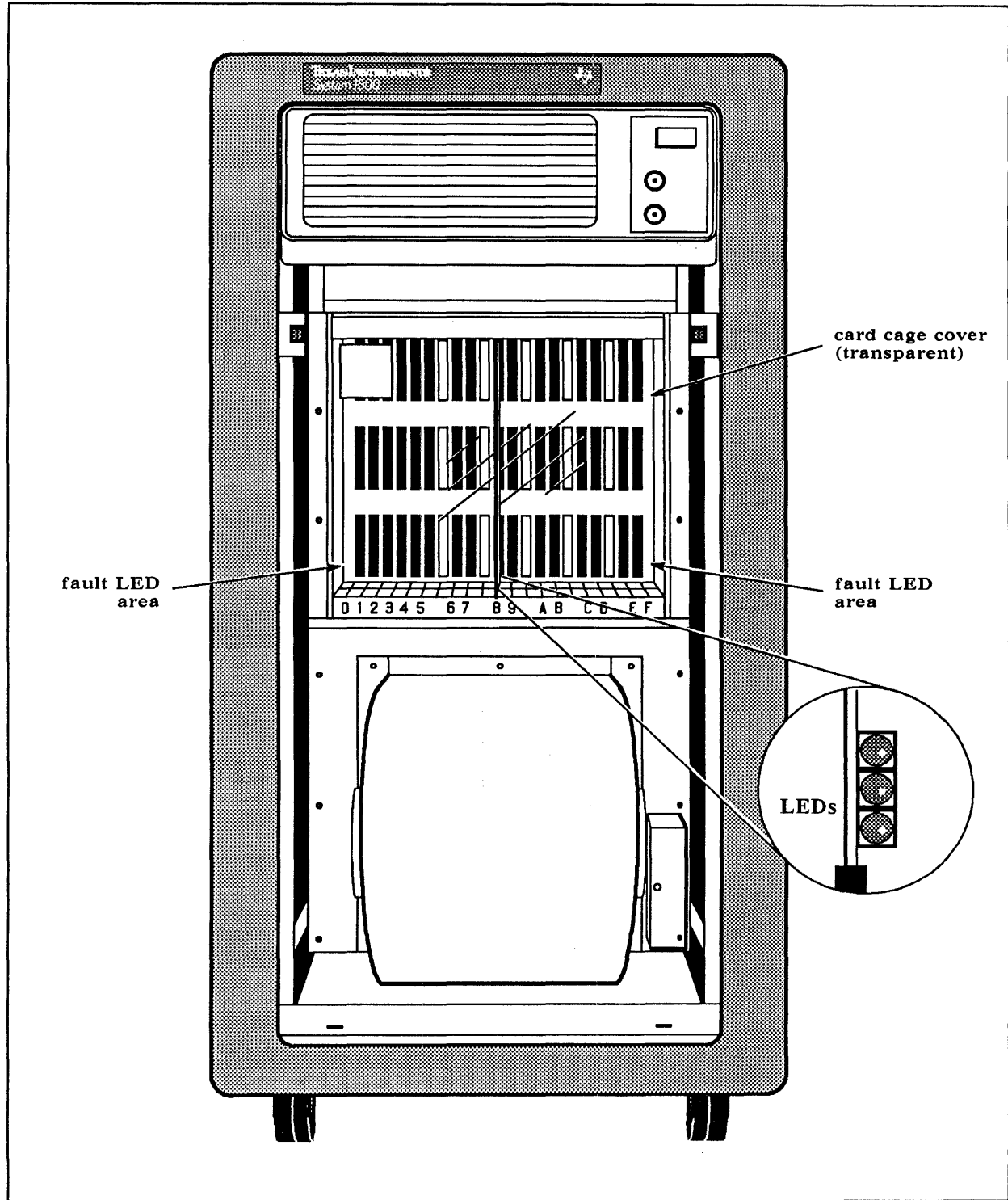

The color and the location of fault indicator LEDs is significant. In general, if a red fault indicator LED is on, an unrecoverable error has occurred. You may need to reboot the system and rerun the diagnostics, or you may need to replace the board. If a yellow fault indicator LED is on, it usually means a recoverable error has occurred. Run diagnostic tests for the specific board in order to isolate and identify the problem.

Figure 5-3

Location of LEDs on the S1505 — Front

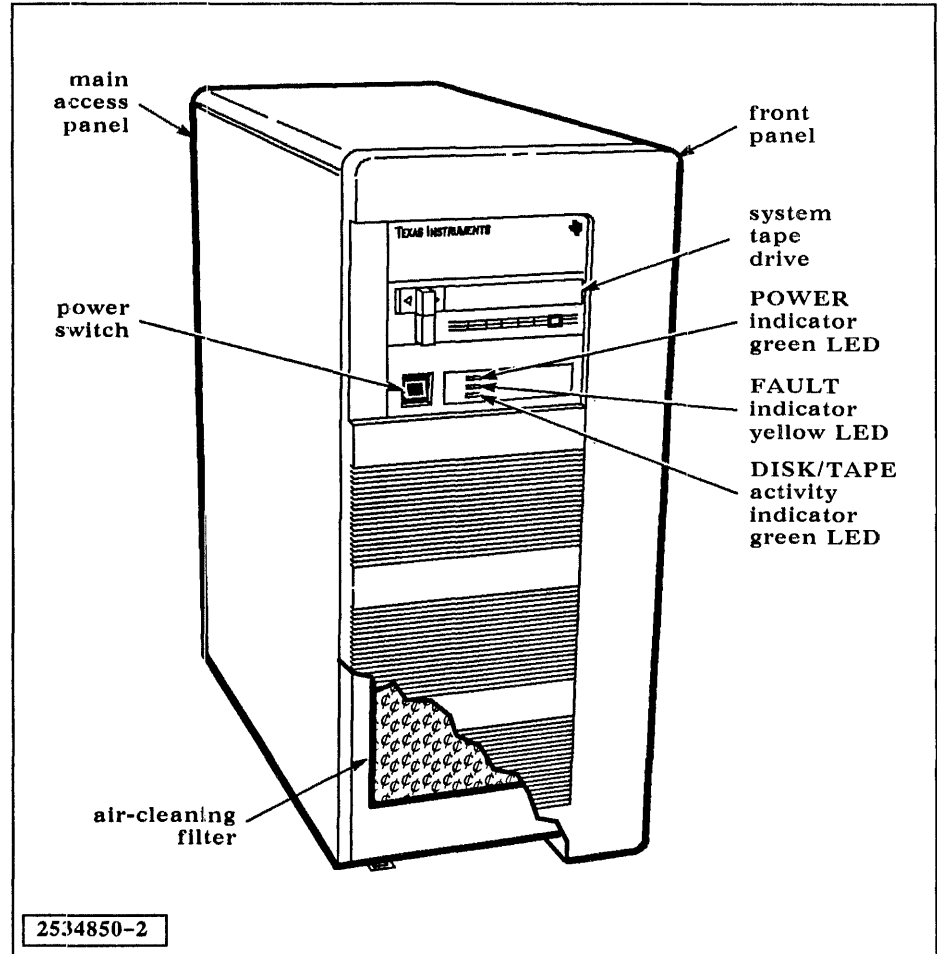

Figure 5-4 Location of LEDs on the S1505 – Back

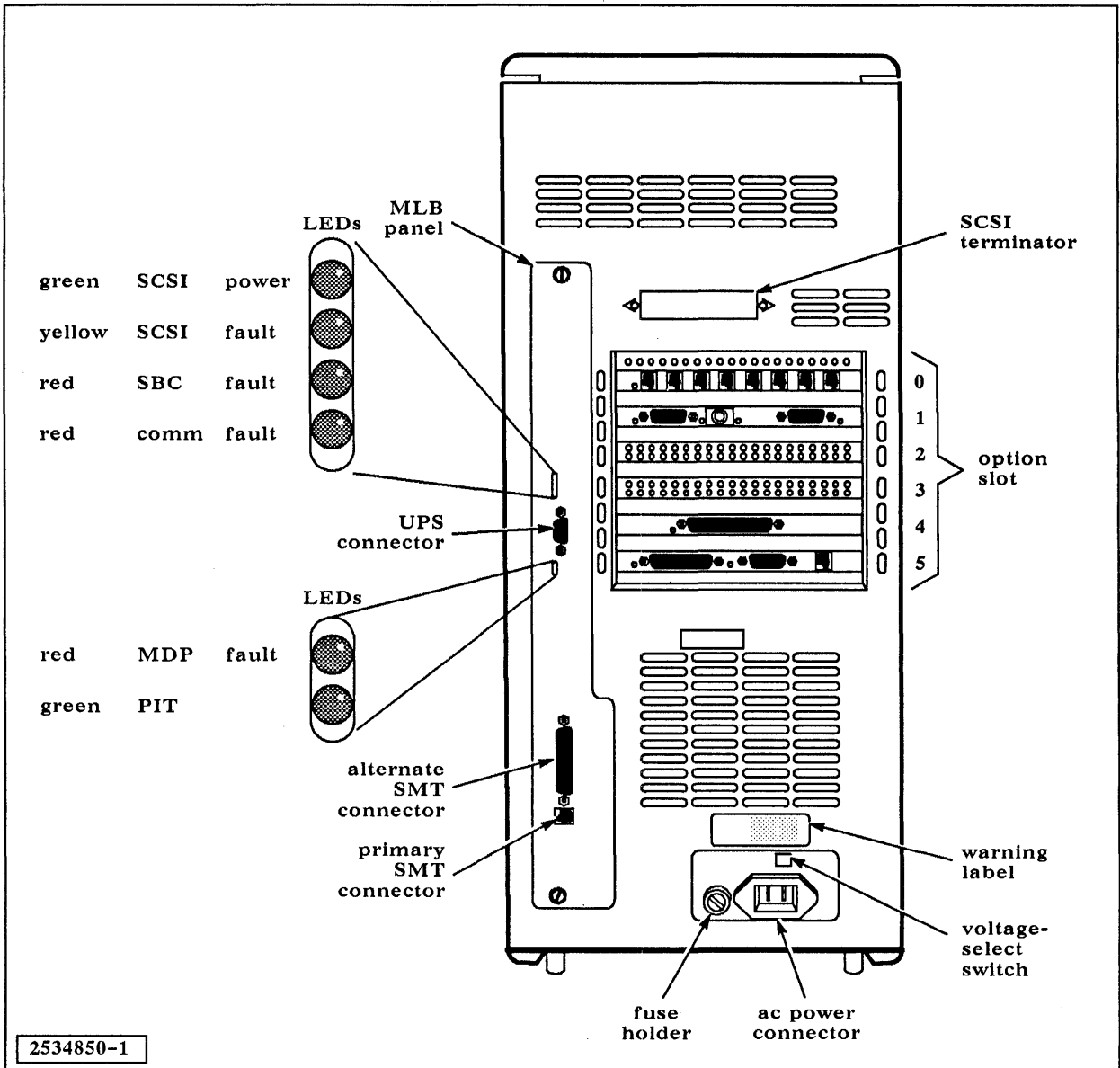

Table 5-2

Fault Indicator LED Error Listing		
Board Name	Position of LED	Explanation
68020 Processor Board	Top	Correctable memory error
	Center	Uncorrectable memory error
	Bottom	Board fault
68030 Processor Board	Top	PI/T Overrun (normally on)
	Second	Correctable memory error
	Third	Uncorrectable memory error
	Bottom	Board fault
16- and 32-Megabyte Data Buffer Board	Top	Correctable memory error
	Bottom	Uncorrectable memory error/ Board fault
NUPI Board	Top	Small computer system interface (SCSI) channel fault
	Bottom	Board fault
Mass Storage Controller (MSC) Board	Top	Storage Module Drive (SMD) channel fault
	Top Center	SCSI channel fault
	Bottom Center	Board fault
	Bottom	Fault
Communications Carrier Board (CCB)	Top	Port 0 fault
	Center	Port 1 fault
	Bottom	Board fault
NUPI-2 Board	Top	SCSI channel fault
	Center	Board fault
	Bottom	Fault

Other Problems

5.5 If the display freezes during power-up testing, an unknown intermittent error may have occurred. Reboot the system. If the problem was a temporary one, the system may boot properly.

NUBUS MULTIPROCESSOR TESTS

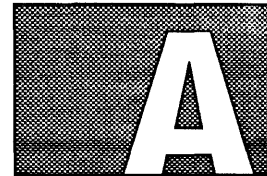

Introduction

A.1 The NuBus and Multiprocessor diagnostic program is designed to test the interaction between multiple System 1500 processor boards (68020, 68030, or both) over the NuBus.

To run the NuBus and Multiprocessor diagnostic program, you must load the General Diagnostics Operating System (GDOS) on all System 1500 processor boards in the system.

The following paragraphs explain how to load GDOS on all processors in multiprocessor System 1500s and how to get to the NuBus and Multiprocessor diagnostic program. For information about other GDOS tests or the standalone S15A processor board tests, see Sections 1 through 5 in this manual.

Loading NuBus and Multiprocessor Diagnostics

A.1.1 Be sure that you read through the following steps before loading the NuBus and Multiprocessor diagnostics. You must respond to certain prompts before you can finish the text accompanying that step. If you are loading from a tape, be sure that you have inserted the tape prior to performing any of the steps that follow.

1. Boot or reboot the system. Refer to Section 2.1 for instructions on booting the system. The system self-tests run automatically during the boot process. As the self-tests complete, messages containing the test results scroll onto the video display.

Upon successful completion of the self-tests, the system load menu is displayed:

D=Default load, M=Menu load, R=Restart, E=Extended tests:

2. The option you should take at this point is *not* listed. Press the N key, specifying a Name load. The Name load allows you to identify the diagnostics band that you want to load *by name*. You have approximately 15 seconds to press the N key after the system load menu appears.

If you do not choose an option in time, the system performs its default system initialization procedure. If default initialization does occur, simply reboot.

If you press the N key in time, the system displays the following prompt:

System load band name :

3. Type unx1, which is the name of your TI System V load band (unx1). The following prompt appears:

Configuration band name :

4. Type cBUS to identify the NuBus and Multiprocessor diagnostic program.

5. The system now displays a list of disk drives or tape drives that are available and a prompt requesting that you select a load device. The following example illustrates a display that might appear on your screen, depending upon the configuration of your system:

AVAILABLE LOAD DEVICES:

```
A= Slot 0 Enet 00
*B= Slot 2 Disk 00
C= Slot 2 Tape 08
```

Select load device :

If one of the disk or tape drives is not listed as an available load device, check the power switch on the drive, and check all cables and connections. You may have to reboot.

6. The drive denoted by an asterisk (*), drive B in the previous example, is the default drive. If you wish to accept the default drive, simply press RETURN. The system attempts to find the NuBus and Multiprocessor diagnostics on the default drive. If the diagnostics are stored on a different drive, type the letter associated with that drive. If you do not know where the diagnostics are stored, try the default drive first.

If you select a drive that does not have the diagnostic files on it, the following message is displayed:

```
Program not found
```

```
D=Default load, M=Menu load, R=Retest, E=Extended tests :
```

Press the N key again and proceed through the same steps until you can enter an alternate load device by typing the letter associated with that device.

If the error message continues to appear with each listed load device you try, it is possible that the loadable diagnostics are not installed. Refer to the *System 1500 Diagnostics Release Notes*, TI part number 2549447-0001, for instructions on how to install GDOS on your disk.

NOTE: To stop GDOS from loading after you choose a load device, press the ABORT key. On the TI 931 terminal, pressing the ESC key twice or pressing the CTRL-C key sequence performs the abort function when you are in GDOS. On the TI 924 and TI 928 terminals, pressing the CTRL-C key sequence performs the ABORT function.

7. After you select a drive on which GDOS is installed, the following GDOS prompt appears, which permits terminal-type selection when GDOS is booted:

```
Enter Terminal Type (0=TI-931, 1=TI-928, 2=TI-924, 3=TI-924
in 931 mode)
```

Enter the corresponding number:

A TI restricted rights notice appears; then, the GDOS Top-Level Menu appears. (See Figure 2-1.) At this time, you are asked to answer whether the time and date are correct.

If the time and date are correct, press Y and RETURN; to enter a new date and time, press N and RETURN.

The next two prompts ask you to enter the military time and the date. Then you are asked if you observe Daylight Saving Time (DST).

You are also prompted for the number of hours your time zone is from Greenwich Mean Time. If you are west of Greenwich, England, you should use a positive number. If you are east, use a negative number. For example, if you live in the Eastern Standard Time zone, enter 5. The default is 6 for Central Standard Time.

You can also change the time and date by entering the Operational Parameters menu.

Figure A-1 GDOS Top-Level Menu

```

General Diagnostics Operating System
GDOS Version: SYS ddd/yy
Top-Level Menu

1 Loop on All Noninteractive Diagnostics (0-Loop Until ABORT)-----> 1 dec
2 Loop on Selected Noninteractive Diagnostics . . . . . Expand
3 Enter Menu for Extended-Interactive Diagnostic Mode . . . . . Execute
4 Enter Menu to Change GDOS Operational Parameters . . . . . Execute

      09:23:49 08/16/88
Is this time correct (Y/N)? N
Enter military time (hhmmss): 092500
Enter date (MDDYY): 081688
Do you observe Daylight Saving Time (Y/N)? Y
Hours from Greenwich Mean Time (default=6;CST): 5
      09:25:00 08/16/88
Is this time correct (Y/N)? Y

      ?=HELP, CTRL-F=Key Functions, CTRL-T/F2=Exit GDOS

```

8. Next move the cursor to menu entry number 3 — Enter Menu for Extended-Interactive Diagnostic Mode — and press RETURN. The Extended-Interactive Diagnostic Mode Menu is Displayed (Figure A-2):

Figure A-2 GDOS Extended-Interactive Diagnostic Mode Menu

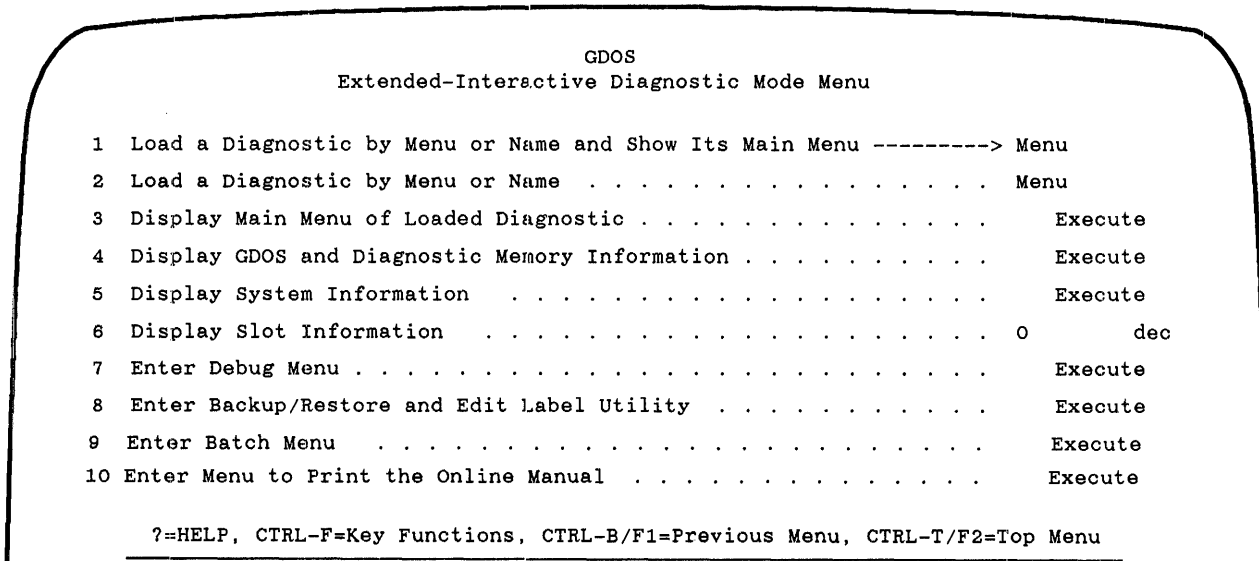

9. There are four ways to select the NuBus and Multiprocessor diagnostic when you are in the Extended-Interactive Diagnostic Mode Menu:

- Place the cursor on menu entry 1 — Load a Diagnostic by Menu or Name and Show Its Main Menu — and press RETURN. The Diagnostic Load Menu appears with a list of the diagnostic programs that are available for your system. Place the cursor on the NuBus and Multiprocessor Diagnostic menu entry and press RETURN. The system loads the NuBus and Multiprocessor diagnostic and then displays its main menu (Figure A-3).
- Place the cursor on menu entry 1 — Load a Diagnostic by Menu or Name and Show Its Main Menu. Use the TAB key to change the selection option from Menu to Name and press RETURN. A prompt appears requesting the name of the diagnostic program you wish to load. Type bustst and press RETURN. The system loads the NuBus and Multiprocessor diagnostic and then displays its main menu (Figure A-3).
- Place the cursor on menu entry 2 — Load a Diagnostic by Menu or Name — and press RETURN. The Diagnostic Load menu appears with a list of the diagnostic programs that are available for your system. Place the cursor on the NuBus and Multiprocessor Diagnostic menu entry and press RETURN. The system loads the NuBus and Multiprocessor diagnostic and then redisplay Extended-Interactive Diagnostic Mode menu (Figure A-2). You can now perform other tasks from the Extended-Interactive Mode menu, or you can display the NuBus and Multiprocessor Diagnostic Main menu by selecting menu entry 3 — Display Main Menu of Loaded Diagnostic. When you

press RETURN, the loaded diagnostic's main menu is displayed (Figure A-3).

- Place the cursor on menu entry 2 — Load a Diagnostic by Menu or Name. Use the TAB key to change the selection option from Menu to Name and press RETURN. A prompt appears requesting the name of the diagnostic program you wish to load. Type `bustst` and press RETURN. The system loads the NuBus and Multiprocessor diagnostic and then redisplay the Extended-Interactive Diagnostic Mode menu (Figure A-2). You can now perform other tasks from the Extended-Interactive mode, or you can display the NuBus and Multiprocessor Diagnostic Main menu by selecting menu entry 3 — Display Main Menu of Loaded Diagnostic. When you press RETURN for menu entry 3, the loaded diagnostic's main menu is displayed (Figure A-3).

Figure A-3 NuBus and Multiprocessor Diagnostic Main Menu

```

                                NuBus and Multiprocessor
                                Version BUSTST ddd/yy
                                Main Menu

1 Test All Available Processors With All Noninteractive Tests ----> Execute
2 Select Processors to Test . . . . . Execute
3 Enter Menu to Display and Set Test Execution Parameters . . . . . Execute
4 Execute Noninteractive (NonI), Interactive (I), or All Tests . . Non-I
5 Loop on All Tests (0 - Continue Until ABORT) . . . . . 1 dec
6 Enter Menu to Execute Selected Tests . . . . . Execute
7 Enter Menu to Loop on Selected Tests . . . . . Execute
8 Return to GDOS . . . . . Execute

?=HELP, CTRL-F=Key Functions, CTRL-B/F1=Previous Menu, CTRL-T/F2=Exit GDOS

```

You can now begin performing NuBus and Multiprocessor diagnostic tests, or return to the Extended-Interactive Diagnostic Mode main menu to load other GDOS diagnostics or run GDOS utilities, as described in sections 1 through 5 of this manual.

NOTE: For information about specific GDOS diagnostic menus and menu entries, use the online help facility. Online help messages are available for every entry in all GDOS diagnostic menus. For more information about accessing the online help messages, refer to Section 1 in this manual.

GLOSSARY

d

- device** A disk drive or tape drive.
- diagnostic** A group of programs (tests) that test the operation of an entire board or subsystem.
-

g

- General Diagnostics Operating System (GDOS)** A control program that furnishes the means for running the loadable diagnostics, including the menus, online help information, and processing of errors found by the diagnostics. GDOS also provides utilities for formatting disks, transferring the contents of a tape to a disk, and printing the online help information.
-

i

- information message window** The bottom portion of the video display, which displays help information, error messages, and prompts when running GDOS.
- interactive diagnostic program** A diagnostic program that requires user input during execution. The interactive diagnostic program usually provides one or more prompts that tell you what actions to perform to complete or continue running the diagnostic. Such actions include pressing the RETURN or ENTER key, moving the mouse, pressing a mouse key, or removing a tape cartridge from the tape drive. Contrast with *noninteractive diagnostic program*.
-

l

- loadable diagnostic test** A diagnostic test that is stored on an external mass-storage device, usually a disk drive, and provides extensive hardware testing and error reporting. To run a loadable diagnostic, you must load it into memory from the mass-storage device.
-

m

- menu window** The top portion of the video display, which displays the menu title and all of the entries in the menu when you are running GDOS.
-

n

noninteractive diagnostic test A diagnostic test that does not require user input during execution. To run a noninteractive diagnostic test, you press ENTER to start the diagnostic. No further input is required. Contrast with *interactive diagnostic test*.

O

online help information Descriptions of each menu entry and diagnostic test. The online help information describes test functions and provides instructions on how to run the tests and utilities. In GDOS and the loadable diagnostics, you can access the help information by pressing the HELP key or by printing the information using the GDOS Print Manual Utility. In the standalone S15A processor board diagnostic tests, you can access the help typing a ? (question mark) and the number of the menu entry.

operational parameters Options that allow you to change the way GDOS handles the output from a diagnostic program. When you change an operational parameter, it affects all of the diagnostic tests in the program.

S

selected Boards or devices chosen for testing. When you load a diagnostic program, all of the associated boards and devices are automatically chosen (selected) for testing. For example, if you load the communications carrier board diagnostic program and two CCBs are installed on the system, both are automatically selected for testing. No devices are selected because no devices are directly associated with the CCB.

You can use the appropriate menu entries in the main menu for the diagnostic program to isolate specific boards for testing.

self-test A diagnostic test that is stored in the read-only memory (ROM) hardware on the board that it tests. Usually, a self-test provides less comprehensive testing and error reporting than a loadable diagnostic.

standalone diagnostic program A loadable diagnostic program that cannot be run under the general diagnostic operating system. Standalone diagnostic programs must be loaded separately from the loadable diagnostics under GDOS.

status line The bottom line of a menu. Displays key functions, system prompts, and status messages.

t

test	A program or a segment of a program that checks the operation of part of a hardware board or subsystem. Same as diagnostic tests.
test execution parameters	Options that allow you to change the way a test or group of tests run. Test execution parameters affect only one diagnostic program or one test in a diagnostic program.
test zone (TZON)	A partition on the disk that is reserved for diagnostic testing. TZON contains a read-only portion and a read-and-write portion. The read-only portion contains a set of test patterns that the disk diagnostics use to test disk access.
title block	The top three or four lines on any menu that display the title of the menu.

v

video sense	The state of the video display — either normal (black characters on a white background) or reverse (white characters on a black background).
--------------------	--

ACRONYM AND ABBREVIATION LIST

The acronyms listed below are used throughout this Diagnostics User's Guide and the Diagnostics Online Manual.

a

ASYNC Asynchronous

b

Bi-sync Bisynchronous
BAUD Bits Per Second
BOP Bit-Oriented Protocol

c

CCB Communications Carrier Board
COB Communications Option Board
CPO Communications Peripheral Option
CRC Cyclic Redundancy Check

d

DE Diagnostic Engine
DMA Direct Memory Access
DMAC Direct Memory Access Chip
DPB Deposit Byte
DUART Dual Universal Asynchronous Receiver/Transmitter

e

ECC Error Correcting Code
EIA Electronic Industries Association

f

FPU Floating Point Unit

g

GCVF	Garbage Collector Volatility Fault
GDOS	General Diagnostic Operating System

i

ICC	Interrupt Controller Chip
IC	Integrated Circuit

l

LAN	Local Area Network
LCC	Local Communications Controller
LDB	Load Byte
LED	Light Emitting Diode

m

MCR	Machine Control Register
MHZ	Megahertz
MIB	Macroinstruction Buffer
MISCOP	Miscellaneous Opcode
MPEC	Multiprotocol Controller Chip
MMU	Memory Map Unit
MSC	Mass Storage Controller

n

NET	Network
NMI	Non-Maskable Interrupt
NRZI	Non-Return to Zero Inverted
NTC	Network Terminal Concentrator
NUPI	NuBus Peripheral Interface
NUPI-2	NuBus Peripheral Interface 2
NVRAM	Nonvolatile Random Access Memory

p

PCA	Peripheral Cable Adapter
PDL	Push Down List
PI/T	Parallel Interface/Timer

R

RAM Random Access Memory
ROM Read-Only Memory

S

SCB System Control Block
SCSI Small Computer System Interface
SMD Storage Module Drive
SMT System Maintenance Terminal
SPA Software Protection Adapter
STBM System Test Boot Master
SYNC Synchronous Option Board

t

TZON Test Zone

u

UART Universal Synchronous/Asynchronous Receiver-Transmitter

v

VDT Video Display Terminal
VMA Virtual Memory Address

INDEX

A

- aborting
 - GDOS tests, 2-6
 - S15A tests, 2-11
- Asynchronous Communications Board diagnostic, 4-4

B

- Backup/Restore and Edit Label utility, 4-7
- backup, multiple-reel, 4-16
- Batch Menu utility, 4-8
- boot error codes, 5-2—5-3
- booting GDOS, 2-3—2-4
- booting the system, 2-3—2-5

C

- changing operational parameters
 - GDOS, 3-4—3-6
 - S15A, 2-12
- code prefixes, error, 3-13
- Communications Carrier Board diagnostic, 4-3
- control keys, 3-2—3-4
- cursor-movement keys, 3-4

D

- date and time
 - prompt, 2-7
 - setting/displaying, 2-7, 3-6
- default system initialization procedure,
 - suspending, 2-5
- defect list, 4-9
- DIAG partition, 1-3
- diagnostics
 - Asynchronous Communications Board, 4-4
 - Communications Carrier Board, 4-3
 - Disk, 4-2
 - loadable, 1-3
 - Local Area Network Board, 4-3
 - menu structure, 3-6—3-11
 - NuBus and Multiprocessor, 4-4, A-1—A-5
 - S15A Processor Board, 4-5—4-6
 - standalone, 1-3, 1-7—1-8
 - Synchronous Communications Board, 4-4
 - Tape, 4-3
- disk
 - diagnostic, 4-2
 - display label, 4-22—4-25
 - edit label, 4-22—4-25

- format/verify procedure, 4-9—4-15
- media, 4-7

- Disk Format/Verify utility, 4-9—4-15
- Disk Media utility, 4-7
- Display/Edit Disk Label or Display Tape Label utility, 4-22—4-25

E

- edit disk label, 4-22—4-25
- editing operation, printing listing of, 4-24
- error
 - code prefixes, 3-13
 - reporting, 3-12—3-13
- error codes
 - boot, 5-2—5-3
 - diagnostic, 3-12—3-13
- error messages
 - printing, 3-12—3-13
 - sample, 3-12—3-13
 - sending to log file, 3-12
- error reporting, 3-12—3-13
- extended-interactive diagnostic mode, 2-9
- extended interface diagnostic tests, 1-2—1-3
- extended mode, interface diagnostic tests in,
 - 2-4
- extended tests, 1-2

F

- failure, self-test, 5-2
- fault indicator LEDs, 5-3—5-8
- FMT partition, 1-4, 4-9
- format partition, 1-4
- formatting a disk, procedure, 4-9—4-15
- function keys, 3-2—3-4

G

- GBUS partition, 1-4
- GDOS. *See* General Diagnostic Operating System
- General Diagnostic Operating System (GDOS)
 - booting, 2-3—2-4
 - loading, 2-5
 - loading from tape, 2-12
 - partition, 1-3
 - running tests and utilities, 4-2

H

Help

- GDOS online, 1-6
- key function, 1-6, 3-3
- printing the help information, 4-8
- S15A online, 1-8

I

- interactive tests, 4-2
- interactive vs. noninteractive test execution, 1-7, 2-8
- interface diagnostic tests, 1-2—1-3
 - extended, 1-2—1-3
 - extended mode, 2-4
 - retesting, 2-4

K

keys

- control, 3-2—3-4
- cursor-movement, 3-4
- function, 3-2—3-4
- Help, 1-6

L

- LEDs, fault indicator, 5-3—5-8
- load devices, 2-6
- loading, S15A Processor Board diagnostic, 2-10—2-11
- loading GDOS, 2-5—2-8
 - from tape, 2-12
- Local Area Network Board diagnostic, 4-3
- looping
 - on all installed boards, 2-4—2-5
 - on selected boards, 2-5—2-11

M

- Make Bootable Tape utility, 4-15—4-17
- manual, Print Online Manual utility, 4-8—4-9
- menu
 - Execute Selected Tests, 3-6
 - Loop on Selected Tests, 3-7
 - main, 3-6
 - Test Execution Parameters, 3-6
- menu entries, 1-6
- menu structure, 3-6—3-11
- menu windows, 1-5
- multiple-reel tape backup, 4-16
- Multiprocessor diagnostic, NuBus and, 4-4
- Multiprocessor system, A-1—A-5

N

- name load, 2-10
- noninteractive vs. interactive test execution, 1-7, 2-8
- NuBus and Multiprocessor diagnostic, 4-4, A-1—A-5

O

online help information

- GDOS diagnostics, 1-6
- S15A diagnostics, 1-7—1-8
- summary of key functions, 1-6, 3-3
- online manual, printing, 4-8—4-9
- operational parameters, changing
 - GDOS, 3-4—3-6
 - S15A, 2-12

P

parameters

- TI 924 terminal, 2-2—2-3
- TI 931 terminal, 2-2—2-3
- parameters, operational
 - GDOS, 3-4—3-6
 - S15A, 2-12
- partition table, printing listing of, 4-23
- partitions, 1-3—1-4
 - DIAG, 1-3
 - FMT, 1-4, 4-9
 - GBUS, 1-4
 - GDOS, 1-3
 - S15A, 1-4
 - TZON, 1-4, 4-2
 - Verify, 4-21—4-22
- pausing at error messages, 3-5
- power-up self-tests, 1-2
- Print Online Manual utility, 4-8—4-9
- printer, serial, connecting to an Aux port, 2-12
- printing
 - error messages, 3-12—3-13
 - help information, 4-8
 - online manual, 4-8
- printing listing of editing operation, 4-24
- printing listing of partition table, 4-23

R

- Restore Bootable Tape utility, 4-17—4-21
- restoring single partition from multiple-reel backup, 4-17
- restoring tape to disk, 4-17—4-21
- ROM-based diagnostic tests
 - interface diagnostic tests, 1-2, 2-4—2-5
 - looping option, 1-2, 2-4—2-5
 - power-up self-tests, 1-2
 - retest option, 1-2, 2-4
 - selected boards, 2-5—2-11

S

- S15A partition, 1-4
- S15A Processor Board diagnostic, 1-3, 1-7—1-8
 - changing operational parameters, 2-12
 - list of tests, 4-5—4-6
 - loading, 2-10—2-11

S15A Processor Board diagnostic (continued)
 running, 2-11—2-12
 stopping execution, 2-11
 self-tests
 failure, 5-2
 power-up, 1-2
 standalone diagnostics, 1-3, 1-7—1-8
 structure, menu, 3-6—3-11
 Synchronous Communications Board
 diagnostic, 4-4
 system testing, 1-2, 5-2

T

Tape Diagnostic, 4-3
 Tape utility, Restore, 4-17—4-21
 terminal parameters, setting, 2-2—2-3
 test execution
 changing parameters, 3-4—3-6
 GDOS, 1-7
 interactive tests, 4-2
 noninteractive versus interactive, 1-7, 2-8
 S15A, 1-8
 test zone partition, 1-4
 tests, looping, 3-7

TI 924 terminal parameters, 2-2—2-3
 TI 931 terminal parameters, 2-2—2-3
 time and date
 prompt, 2-7
 setting/displaying, 2-7, 3-6
 trace levels, 3-5
 TZON partition, 1-4, 4-2

U

user types, 4-20
 utilities
 Backup/Restore and Edit Label, 4-7
 Batch Menu, 4-8
 Disk Format/Verify, 4-9—4-15
 Disk Media, 4-7
 Display/Edit Disk Label or Display Tape
 Label, 4-22—4-25
 Make Bootable Tape, 4-15—4-17
 Print Online Manual, 4-8—4-9
 Restore Bootable Tape, 4-17—4-21
 Verify Tape Partition, 4-21—4-22

V

Verify Tape Partition utility, 4-21—4-22

SYSTEM 1500 DIAGNOSTICS RELEASE NOTES

Introduction

This document describes new features, changes, special notes, and installation information for Release 2.4.0 of the General Diagnostics Operating System (GDOS). Table 1-1 lists each test included in the 2.4.0 release of GDOS and its most recent version.

Table 1-1

GDOS Contents

Name	Version
SYS (GDOS)	057/90
DSKEXE (Disk diagnostic)	057/90
XTCTST (Tape diagnostic)	057/90
CCB (Communications Carrier Board diagnostic)	238/88
CPO (Communications Peripheral Option diagnostic)	057/90
SYN (Synchronous Communications Option Board diagnostic)	057/90
ASY (Asynchronous Communications Option Board diagnostic)	057/90
LAN (Local Area Network Option Board diagnostic)	057/90
CK2 (CK202 Communications Option Board diagnostic)	057/90
DSAUTL (Disk Surface Area utility)	057/90
BUSTST (Multiprocessor and NuBus™ diagnostic)	097/89
S15A (System 1500 Processor Board diagnostics)	057/90

NOTE: GDOS Release 2.4.0 or greater is highly recommended to load TI System V Release 3.2.0.

NuBus is a trademark of Texas Instruments Incorporated.

New Features

Release 2.4.0 of GDOS features the following enhancements:

- GDOS
 - Support of 68030 Single Board Computer, S1505.
 - Support of NuBus Peripheral Interface 2 (NUPI-2) board.
 - Support of 150-megabyte tape.
- DSKEXE
 - Support of small computer system interface (SCSI) peripheral controller (SPC).
 - Support of NUPI-2 board.
- XTCTST
 - Support of SPC.
 - Support of NUPI-2 board.
 - Support of 150-megabyte tape.
- CPOTST — Support of Communications Peripheral Option (CPO) board.
- SYNTST — Support of multifunction option board on CPO.
- ASYTST — Support of 8-channel asynchronous option board on CPO.
- LANTST — Support of local area network (LAN) option board on CPO.
- CK2TST — Support of multidrop option board on CPO.
- DSAUTL
 - Support of SPC.
 - Support of NUPI-2 board.
- S15A
 - Added error-correcting code (ECC) enable/disable function to Memory Array board operational parameters.
 - Added the Column Address Test and Block Move Test items to the Memory Array Board Menu.
 - Added memory utilities to the Memory Array Board Menu. Functions include display, write, and verify memory.

Changes

Release 2.4.0 of GDOS features the following modifications:

- **GDOS** — The GDOS partition has been increased from 400 blocks (for releases prior to 2.4.0) or 300 blocks (for releases prior to 2.0.0) to 1024 blocks (for Release 2.4.0 and later). The DIAG partition has been increased from 2048 blocks (for releases prior to 2.4.0) to 5120 blocks (for Release 2.4.0 and later). You must use a special procedure when installing this partition on a disk unit that has an older release of GDOS. Refer to the Installation paragraph of this document to correctly restore the partition.
- **DSKEXE**
 - Modified test 90 to reset all boards at once and verify status on each board after 60 seconds.
 - Restored disk parameters to original after diagnostics have completed.
 - Added soft error counter of disks.
 - Added sense verification of soft errors on SCSI drives for error reporting.
- **DSAUTL**
 - Added user pattern shift enable/disable for fixed pattern retries in the Test Execution Parameters Menu.
 - Clarified byte sequence for user input patterns in the Test Execution Parameters Menu.

Special Notes

The following information affects the operation of Release 2.4.0 of GDOS:

- Depending on defect quantity and location, the GDOS format/verify function may timeout before completing a format of a 760-megabyte disk drive. As a general rule, 760-megabyte disk formats are discouraged. However, if you must format one of these drives, the following procedure may be used:
 1. Go to the GDOS Operational Parameters Menu.
 2. Verify `Halt on Errors` is set to `off` and `Pause on Errors` is set to `on`.
 3. Go to the Format/Verify Utility Menu.
 4. Execute the format/verify function.
 5. When the timeout message is displayed, wait until the drive activity LED goes out indicating format complete, then press any key to continue. The verify function should now commence execution.
- When you are in the information window and you are prompted for input, the cursor may not go away after you press the RETURN key. Be sure to press the RETURN key firmly, and only once, when you are finished with your input.
- Before you boot from a multiple-tape backup, all boot partitions must completely reside on one tape. If the boot partitions are on more than one tape, those tapes cannot be used as boot media.
- The GDOS Restore Bootable Tape utility obtains partition space on the disk by contracting the page partition or by using unallocated disk space. If the page partition is less than 15,000 blocks, GDOS reports the error `SYS2011 - Insufficient space remains on disk for proper restoration`. Avoid this error by using the GDOS Display/Edit utility to delete the page band before you add partitions with the GDOS Restore Bootable Tape utility. You can recreate the page band using the original partition name and user type after all partitions are restored.
- The Select Trace Level to Log File entry in the Change Operational Parameters Menu is valid only if GDOS is booted from a disk unit. This option is not valid if GDOS is booted from tape.
- The TAR Format option of the Backup/Restore and Edit Label utility is valid only if GDOS is booted from a disk unit. This option is not valid if GDOS is booted from tape.
- Because of the tape capacity of the CT2000, Tape Diagnostic Tests 2 and 3 can take approximately 8 hours to run.
- When you run Tape Test 4 on the CT2000, allow enough time for the CT2000 to return to the online condition after you write-protect the media and before you continue the test by pressing RETURN as directed. The CT2000 is online when the green LED is illuminated. The error message `Error 4052 - Media change condition not detected correctly` may be displayed if you do not allow enough time for the CT2000 to return online.

- The EPROMS on the mass storage controller must be greater than revision -0006 or the code greater than revision *D to ensure that the reassigning of the last block on an storage module drive disk is handled correctly. To display the revision, execute the Display Slot Information option in the Extended-Interactive Diagnostic Mode Menu.

Installation

Your System 1500 is shipped with formatted disks, with GDOS and TI System V software already installed. However, you may need to reformat a disk at some point and reinstall the GDOS software on it. Refer to the *Diagnostics User's Guide* for information on using the Disk Media utility for formatting a disk, and for information on using the Backup/Restore and Edit Label Utility for making a bootable tape, restoring a bootable tape to disk, verifying a restore operation, displaying a tape/disk partition, and editing a disk partition.

Update your disk using one of the following methods:

- If you are updating from Release 1.x.x (where x.x is the release number of your software) and you do not have batch files to be saved, skip step 1 in the following procedure, and complete steps 2 through 4 to update your disk.
- If you are updating from Release 2.x.x (where x.x is the release number of your software) and you have not created batch files, skip step 1 in the following procedure, and complete steps 2 through 4 to update your disk.
- If you are updating from Release 2.x.x (where x.x is the release number of your software) and you *have* created batch files, use the following procedure to update your disk.

2. Save batch files — If you are updating your diagnostics and have created a batch stream of files, you first need to save the files. Save the files as follows:

1. From the Extended-Interactive Diagnostic Mode Menu, select the following option:

```
8 Enter Backup/Restore and Edit Label Utility
```

2. Select item number 5 from the Backup/Restore and Edit Label Utility menu. The following menu is displayed:

```
5 File Backup/Restore - TAR Format -----> Execute
   Select File Archive Operation . . . . . Backup
   Tape Slot Number (0-F hexadecimal) . . . . . 2 hex
   Tape Logical Unit Number (0-F hexadecimal) . . . . 6 hex
   Selectively Restore File(s)? . . . . . YES
   Rewind Tape After Command? . . . . . YES
```

3. Set the options as follows:

- Set Select File Archive Operation to Backup.
- Set Tape Slot Number to the slot number of the tape drive.
- Set Tape Logical Unit Number to the logical unit number of the tape drive.
- Set Selectively Restore File(s) to YES.
- Set Rewind Tape After Command to YES.

4. After you set all entries, press RETURN. The following messages are displayed:

```
Insert a tape in the tape drive and press the space bar when
ready.
GDOS Tape and Disk Utility in progress.
```

5. Insert a tape in the tape drive, and press the Space bar when ready.
6. Enter /batch as the directory to back up, and then press RETURN. When the copy is complete, the following is displayed:

```
Archive /batch/filename(s)  number Blocks
Enter the file/directory to be copied
Press RETURN to halt the program.
```

3. Update your disk — Update your disk with the latest diagnostics, as follows:

1. Insert the diagnostics release tape into a tape drive on the system.
2. Boot the system from tape. (Refer to the *Diagnostics User's Guide*, if necessary.)
3. Select a disk drive to restore the diagnostics. Refer to the *Diagnostics User's Guide*, if necessary, for information on how to display the disk label.
4. Look for a partition named GDOS of user type 0002 and/or 000A. If the partition is 400 blocks long or less (for releases prior to 2.4.0), rename the partition. Refer to the *Diagnostics User's Guide*, if necessary, for information on how to edit the disk label.
5. Look for a partition named DIAG. If the partition is 2048 blocks long (for releases prior to 2.4.0), rename the partition. Refer to the *Diagnostics User's Guide*, if necessary, for information on how to edit the disk label.
6. Restore the release tape to disk. Refer to the *Diagnostics User's Guide*, if necessary, for information on restoring a bootable tape.

4. Reboot the system from the disk drive that contains the diagnostics.
5. Restore your batch files — If you saved a batch stream, restore the batch stream as follows:

1. From the Extended-Interactive Diagnostic Mode Menu, select the following option:

```
8  Enter Backup/Restore and Edit Label Utility
```

2. Select item number 5 from the Backup/Restore and Edit Label Utility menu. The following menu is displayed:

```
5 File Backup/Restore - TAR Format -----> Execute
   Select File Archive Operation . . . . . Restore
   Tape Slot Number (0-F hexadecimal) . . . . . 2 hex
   Tape Logical Unit Number (0-F hexadecimal) . . . . . 6 hex
   Selectively Restore File(s)? . . . . . YES
   Rewind Tape After Command? . . . . . YES
```

3. Set the options as follows:
 - Set select File Archive Operation to Restore.
 - Set Tape Slot Number to the slot number of the tape drive.
 - Set Tape Logical Unit Number to the logical unit number of the tape drive.
 - Set Selectively Restore File(s) to YES.
 - Set Rewind Tape After Command to YES.
4. After you set all entries, press RETURN.
5. Insert the tape that contains the batch stream in the tape drive, and press the Space bar when ready.
6. Enter `/batch` as the directory to be restored, and then press RETURN. When the copy is complete, the following message is displayed:

```
Extract /batch/filename(s) number Blocks
```

SYSTEM 1500 DIAGNOSTICS RELEASE NOTES

Introduction

This document describes new features, changes, special notes, and installation information for Release 2.7.0 of the General Diagnostics Operating System (GDOS). Table 1-1 lists each test included in the 2.7.0 release of GDOS and its most recent version.

Table 1-1

GDOS Contents

Name	Version
SYS (GDOS)	087/91
DSKEXE (Disk diagnostic)	120/91
XTCTST (Tape diagnostic)	018/91
CCB (Communications Carrier Board diagnostic)	150/90
CPO (Communications Peripheral Option diagnostic)	150/90
SYN (Synchronous Communications Option Board diagnostic)	150/90
ASY (Asynchronous Communications Option Board diagnostic)	150/90
LAN (Local Area Network Option Board diagnostic)	150/90
CK2 (CK202 Communications Option Board diagnostic)	150/90
DSAUTL (Disk Surface Area utility)	120/91
BUSTST (Multiprocessor and NuBus™ diagnostic)	097/89
S15A (System 1500 Processor Board diagnostics)	338/90

New Features

Release 2.7.0 of GDOS features the following enhancements:

- GDOS
 - Support of DB160 disk drive
 - Support of CT525 tape drive
- DSKEXE — Support of DB160 disk drive
- DSAUTL — Support of DB160 disk drive
- XTCTST — Support of CT525 tape drive

NuBus is a trademark of Texas Instruments Incorporated.

Changes

Release 2.7.0 of GDOS features the following modifications:

- DSAUTL -- Fixed bug in unknown drive handling.

Special Notes

The following information affects the operation of Release 2.7.0 of GDOS:

- GDOS — The GDOS partition has been increased from 400 blocks (for releases prior to 2.4.0) or 300 blocks (for releases prior to 2.0.0) to 1024 blocks (for Release 2.4.0 and later). The DIAG partition has been increased from 2048 blocks (for releases prior to 2.4.0) to 5120 blocks (for Release 2.4.0 and later). You must use a special procedure when installing this partition on a disk unit that has an older release of GDOS. Refer to the Installation paragraph of this document to correctly restore the partition.
- When you are in the information window and you are prompted for input, the cursor may not go away after you press the RETURN key. Be sure to press the RETURN key firmly, and only once, when you are finished with your input.
- Before you boot from a multiple-tape backup, all boot partitions must completely reside on one tape. If the boot partitions are on more than one tape, those tapes cannot be used as boot media.
- The GDOS Restore Bootable Tape utility obtains partition space on the disk by contracting the page partition or by using unallocated disk space. If the page partition is less than 15,000 blocks, GDOS reports the error `SYS2011 - Insufficient space remains on disk for proper restoration`. Avoid this error by using the GDOS Display/Edit utility to delete the page band before you add partitions with the GDOS Restore Bootable Tape utility. You can recreate the page band using the original partition name and user type after all partitions are restored.
- The Select Trace Level to Log File entry in the Change Operational Parameters Menu is valid only if GDOS is booted from a disk unit. This option is not valid if GDOS is booted from tape.
- The TAR Format option of the Backup/Restore and Edit Label utility is valid only if GDOS is booted from a disk unit. This option is not valid if GDOS is booted from tape.
- Because of the tape capacity of the CT2000, Tape Diagnostic Tests 2 and 3 can take approximately 8 hours to run.
- When you run Tape Test 4 on the CT2000, allow enough time for the CT2000 to return to the online condition after you write-protect the media and before you continue the test by pressing RETURN as directed. The CT2000 is online when the green LED is illuminated. The error message `Error 4052 - Media change condition not detected correctly` may be displayed if you do not allow enough time for the CT2000 to return online.

- The EPROMS on the mass storage controller must be greater than revision -0006 or the code greater than revision *D to ensure that the reassigning of the last block on an storage module drive disk is handled correctly. To display the revision, execute the Display Slot Information option in the Extended-Interactive Diagnostic Mode Menu.

- In the DSKEXE test 70, the following message:

```
To test device "XXXX", logical unit number XX slot XX,  
Tab to the Desired Option in Entry 1, Enter Values in  
the Address, Count, and Loop Count Entries, and Press  
RETURN.
```

should read as follows:

```
Testing device "XXXX", logical unit number XX slot XX.
```

Also note that the slot number mentioned is usually incorrect.

- If a disk without a disk label is accessed in the Make Bootable (Labelled) Tape, Verify Partitions, Or Restore Bootable (Labelled) Tape entries (all found in the Backup/Restore and Edit Label Utility menu), GDOS will crash. You can verify that the disk has a label by expanding the Display/Edit Disk Label or Display Tape Label entry. If the disk does not have a label, see the Disk Media utility to write out a label.
- GDOS can be booted from tape on either a CT60, CT150 or CT525 tape drive, but not from a CT2000 tape drive.

Installation

Your System 1500 Series computer is shipped with formatted disks included, with GDOS and TI System V software already installed. However, you may need to reformat a disk at some point and reinstall the GDOS software on it. Refer to the *Diagnostics User's Guide* for information on using the Disk Media utility for formatting a disk, and for information on using the Backup/Restore and Edit Label Utility for making a bootable tape, restoring a bootable tape to disk, verifying a restore operation, displaying a tape/disk partition, and editing a disk partition.

Update your disk using one of the following methods:

- If you are updating from Release 1.x.x (where x.x is the release number of your software) and you do not have batch files to be saved, skip step 1 in the following procedure, and complete steps 2 through 4 to update your disk.
- If you are updating from Release 2.x.x (where x.x is the release number of your software) and you have not created batch files, skip step 1 in the following procedure, and complete steps 2 through 4 to update your disk.
- If you are updating from Release 2.x.x (where x.x is the release number of your software) and you *have* created batch files, use the following procedure to update your disk.

1. Save batch files — If you are updating your diagnostics and have created a batch stream of files, you first need to save the files. Save the files as follows:

1. From the Extended-Interactive Diagnostic Mode Menu, select the following option:

8 Enter Backup/Restore and Edit Label Utility

2. Select item number 5 from the Backup/Restore and Edit Label Utility menu. The following menu is displayed:

```
5 File Backup/Restore - TAR Format -----> Execute
      Select File Archive Operation . . . . . Backup
      Tape Slot Number (0-F hexadecimal) . . . . . 2 hex
      Tape Logical Unit Number (0-F hexadecimal) . . . . . 6 hex
      Selectively Restore File(s)? . . . . . YES
      Rewind Tape After Command? . . . . . YES
```

3. Set the options as follows:

- Set select File Archive operation to Backup.
- Set Tape Slot Number to the slot number of the tape drive.
- Set Tape Logical Unit Number to the logical unit number of the tape drive.
- Set Selectively Restore File(s) to YES.
- Set Rewind Tape After Command to YES.

4. After you set all entries, press RETURN. The following messages are displayed:

```
Insert a tape in the tape drive and press the space bar when
ready.
GDOS Tape and Disk Utility in progress.
```

5. Insert a tape in the tape drive, and press the Space bar when ready.

6. Enter /batch as the directory to back up, and then press RETURN. When the copy is complete, the following is displayed:

```
Archive /batch/filename(s) number Blocks
Enter the file/directory to be copied
Press RETURN to halt the program.
```

2. Update your disk — Update your disk with the latest diagnostics, as follows:
 1. Insert the diagnostics release tape into a tape drive on the system.
 2. Boot the system from tape. (Refer to the *Diagnostics User's Guide*, if necessary.)
 3. Select a disk drive to restore the diagnostics. Refer to the *Diagnostics User's Guide*, if necessary, for information on how to display the disk label.
 4. Look for a partition named GDOS of user type 0002 and/or 000A. If the partition is 400 blocks long or less (for releases prior to 2.4.0), rename the partition. Refer to the *Diagnostics User's Guide*, if necessary, for information on how to edit the disk label.
 5. Look for a partition named DIAG. If the partition is 2048 blocks long (for releases prior to 2.4.0), rename the partition. Refer to the *Diagnostics User's Guide*, if necessary, for information on how to edit the disk label.
 6. Restore the release tape to disk. Refer to the *Diagnostics User's Guide*, if necessary, for information on restoring a bootable tape.
3. Reboot the system from the disk drive that contains the diagnostics.
4. Restore your batch files — If you saved a batch stream, restore the batch stream as follows:
 1. From the Extended-Interactive Diagnostic Mode Menu, select the following option:

```

8  Enter Backup/Restore and Edit Label Utility
          
```
 2. Select item number 5 from the Backup/Restore and Edit Label Utility menu. The following menu is displayed:

```

5  File Backup/Restore - TAR Format ----->  Execute
      Select File Archive Operation . . . . . Restore
      Tape Slot Number (0-F hexadecimal) . . . . . 2 hex
      Tape Logical Unit Number (0-F hexadecimal) . . . . . 6 hex
      Selectively Restore File(s)? . . . . . YES
      Rewind Tape After Command? . . . . . YES
          
```
 3. Set the options as follows:
 - Set Select File Archive Operation to Restore.
 - Set Tape Slot Number to the slot number of the tape drive.
 - Set Tape Logical Unit Number to the logical unit number of the tape drive.
 - Set Selectively Restore File(s) to YES.
 - Set Rewind Tape After Command to YES.

4. After you set all entries, press RETURN.
5. Insert the tape that contains the batch stream in the tape drive, and press the Space bar when ready.
6. Enter /batch as the directory to be restored, and then press RETURN. When the copy is complete, the following message is displayed:

Extract /batch/*filename(s)* *number* Blocks

System 1000 Series, System 1500 Diagnostics User's Guide Customer Response

Your comments and suggestions
help us improve our products.

Your computer type _____ Date _____

Your name _____

Company name/department _____

Telephone () _____ Address _____

City _____ State _____ Zip _____

ABOUT YOUR SYSTEM. . .

Size of memory (RAM) _____ Type of display _____

Other options _____

Check if you have:

One diskette drive

Two diskette drives

Winchester disk

YOUR RESPONSE CONCERNS. . .

Software

TI Part No. _____

Manual

Version No. _____

Did you run diagnostics? Yes No

Serial No. (if any) _____

Error code or message _____

YOUR COMMENTS. . .

If your comments concern a manual, please include applicable page numbers.

Have you attached additional comments? Yes No

Date received by TI _____

TAPE EDGE TO SEAL

FOLD



NO POSTAGE
NECESSARY
IF MAILED
IN THE
UNITED STATES

BUSINESS REPLY MAIL

FIRST-CLASS PERMIT NO. 7284 DALLAS, TX

POSTAGE WILL BE PAID BY ADDRESSEE

TEXAS INSTRUMENTS INCORPORATED
INFORMATION TECHNOLOGY GROUP
ATTN: SUSTAINING
P.O. BOX 149149 M/S 2201
AUSTIN, TEXAS 78714-9149

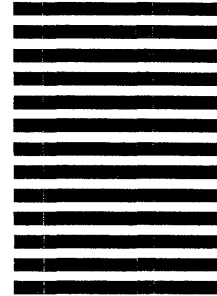

FOLD

Information Technology Group - Austin Documentation Questionnaire

System 1000 Series, System 1500 Diagnostics User's Guide

Do you use other TI manuals? If so, which one(s)?

_____	_____
_____	_____
_____	_____

How would you rate the quality of our manuals?

	Excellent	Good	Fair	Poor
Accuracy	_____	_____	_____	_____
Organization	_____	_____	_____	_____
Clarity	_____	_____	_____	_____
Completeness	_____	_____	_____	_____
Overall design	_____	_____	_____	_____
Size	_____	_____	_____	_____
Illustrations	_____	_____	_____	_____
Examples	_____	_____	_____	_____
Index	_____	_____	_____	_____
Binding method	_____	_____	_____	_____

Was the quality of documentation a criterion in your selection of hardware or software?

- Yes No

How do you find the technical level of our manuals?

- Written for a more experienced user than yourself
 Written for a user with the same experience
 Written for a less experienced user than yourself

What is your experience using computers?

- Less than 1 year 1-5 years 5-10 years Over 10 years

We appreciate your taking the time to complete this questionnaire. If you have additional comments about the quality of our manuals, please write them in the space below. Please be specific.

Name _____ Title/Occupation _____

Company Name _____

Address _____ City/State/Zip _____

Telephone _____ Date _____

TAPE EDGE TO SEAL

FOLD



NO POSTAGE
NECESSARY
IF MAILED
IN THE
UNITED STATES

BUSINESS REPLY MAIL
FIRST-CLASS PERMIT NO. 7284 DALLAS, TX

POSTAGE WILL BE PAID BY ADDRESSEE

TEXAS INSTRUMENTS INCORPORATED
INFORMATION TECHNOLOGY GROUP
ATTN: PUBLISHING CENTER
P.O. BOX 149149 M/S 2146
AUSTIN, TEXAS 78714-9149

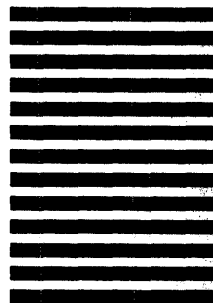

FOLD

JOIN TIMIX*, YOUR TI CONNECTION



TIMIX is an organization for users of TI computers and peripherals.

Would YOU like to know:

- How to make the most efficient use of your computer system?
- What TI's latest innovations in computer technology are and how they can help you?
- What third-party software and hardware products are available for upgrading your system?
- How other users solve their computer problems?

Benefits of TIMIX Membership

- Your direct link to Texas Instruments and to over 12,000 other TI computer users
- Monthly DirectIons magazine, with feature articles on TI's complete product line
- Annual TIMIX International Symposium — The leading conference and trade show for users of TI-based computers and peripherals
- Regional user group affiliation
- TIMIX Buyer's Guide — A complete listing of software, hardware, services, and supplies for TI computer users

One-year TIMIX membership — \$85

Subscription to DirectIons only — \$40

Above rates are for the U.S. only. If you live outside the U.S. add the following postage costs:

- Canada — \$30 per individual
- Central America — \$20 per individual
- All others — \$25 per individual

To start YOUR membership immediately, or to receive additional information on TIMIX, please complete this postage-paid form and mail today.

Your name: _____

Company: _____

Address: _____

City: _____ State: _____ Zip: _____

Telephone: (____) _____

Country: (if outside U.S.) _____

I wish to receive additional information on TIMIX.

I wish to join now and include my credit card information below.

[] Visa [] MasterCard [] American Express

Account No. _____ Exp. Date _____

Authorized Signature _____

* TIMIX is an independent contractor, not affiliated with Texas Instruments Incorporated. All information contained herein, including the prices and benefits of ownership, is subject to change by TIMIX without further notice.

TAPE EDGE TO SEAL

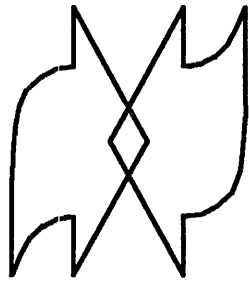

TIMIX
Your TI
Connection

FOLD

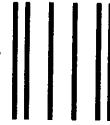

NO POSTAGE
NECESSARY
IF MAILED
IN THE
UNITED STATES

BUSINESS REPLY MAIL

FIRST-CLASS PERMIT NO. 6333 AUSTIN, TX

POSTAGE WILL BE PAID BY ADDRESSEE

TIMIX

P.O. Box 201897
Austin, Texas 78720-9990

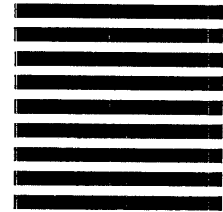

FOLD