

4153

CPD-1302

SERVICE MANUAL

US Model
Canadian Model

Chassis No. SCC-A08A-A



MULTISCAN

August, 1986

SPECIFICATIONS

Picture tube	Super Fine Pitch Trinitron color tube 13-inch picture tube measured diagonally 90 degree deflection Anti-glaring dark screen Useful screen 274mm x 207mm Phosphor P22 Phosphor pitch 0.26mm
Resolution	900 x 560 dots
Scanning frequency	Vertical sync signal frequency: 50-100 Hz Horizontal sync signal frequency: 15.0-34.0 kHz
Input	RGB input (D-sub 9 pin) (Analog and TTL available)

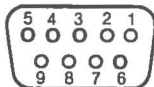

Pin Connection

Pin No.	1	2	3	4	5	6	7	8	9	Horizontal Frequency (kHz)	Vertical Frequency (Hz)	
NORMAL	GND	GND	R	G	B	GND	-	HD	VD	15.0 - 34.0	50 - 100	
D2	D2-1	GND	GND	R	G	B	Yi	-	HD	VD	15.0 - 17.0	50 - 100
	D2-2	GND	r	R	G	B	g	b	HD	VD	17.0 - 27.0	55 - 100
	D2-3	GND	GND	-	-	-	Yi	G	HD	VD	17.0 - 27.0	50 - 55
	D2-4	GND	r	R	G	B	g	b	HD	VD	27.0 - 34.0	50 - 100
D1	GND	GND	R	G	B	Yi	-	HD	VD	15.0 - 34.0	50 - 100	

GND: Grounded R: Red signal G: Green signal
B: Blue signal -: No connection HD: Horizontal drive signal
VD: Vertical drive signal Yi: Intensity signal
r: Separate red signal for EGA g: Separate green signal for EGA
b: Separate blue signal for EGA

- ANALOG
- SYNC ON GREEN are automatically available.
- When ANALOG is selected, Pin 8 is available for both positive and negative computer sync signals.

- TTL
 - TTL signal is available for NORMAL, D1, and D2.
 - HD and VD are available for both positive and negative.
 - D2-3 can be used for green monochrome monitor.
- Vertical size
 - When vertical frequency changes, the vertical size can be manually adjusted. (except D2)

Power requirements	120V AC, 50/60 Hz
Power consumption	96 W (maximum)
Dimensions	370 x 330 x 415 mm (w/h/d) (14 ⁵ / ₈ x 13 x 16 ³ / ₈ inches) including projecting parts
Weight	14.5 kg (32 lb)
Supplied accessory	AC power cord (1)

Optional accessories

Monitor cable (9-pin ↔ 9-pin)

SMF-512
SMF-513
SMF-514

Display stand

SU-535

Design and specifications subject to change without notice.



TRINITRON® CHARACTER
DISPLAY
SONY®

Timing Charts (for approximate reference)

1 D2-1 (IBM CGA compatible)

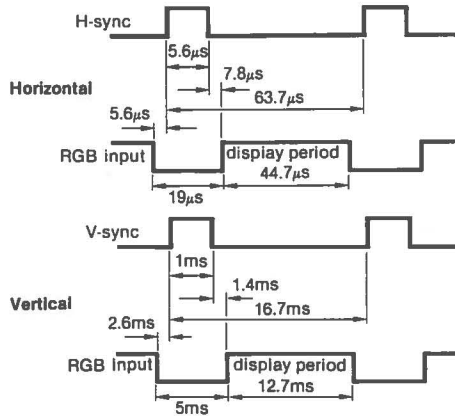

The indicated values apply when the line period is 63.7 μs and the field period is 16.7 ms.

2 D2-2 (IBM EGA compatible)

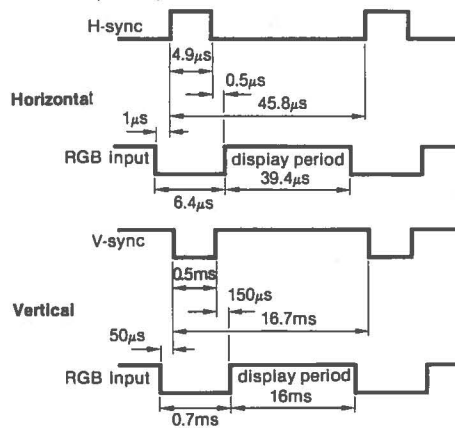

The indicated values apply when the line period is 45.8 μs and the field period is 16.7 ms.

3 D2-3 (IBM MDA compatible)

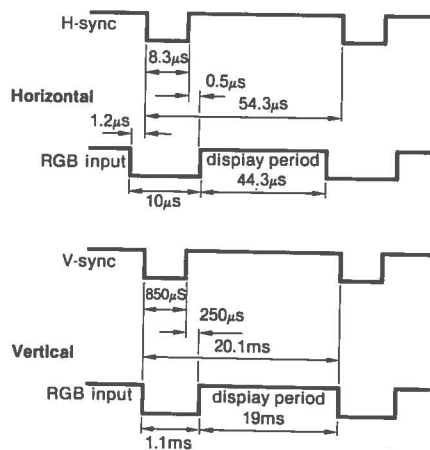

The indicated values apply when the line period is 54.3 μs and the field period is 20.1 ms.

Note

The picture may be biased or the picture size may be changed depending on the timing of the connected equipment.

INFORMATION

This equipment generates and uses radio frequency energy and if not installed and used properly, that is, in strict accordance with the manufacturer's instructions, may cause interference to radio and television reception. It has been type tested and found to comply with the limits for a Class B computing device in accordance with the specifications in Subpart J of Part 15 of FCC Rules, which are designed to provide reasonable protection against such interference in a residential installation. However, there is no guarantee that interference will not occur in a particular installation. If this equipment does cause interference to radio or television reception, which can be determined by turning the equipment off and on, the user is encouraged to try to correct the interference by one or more of the following measures:

- Reorient the receiving antenna
- Relocate the equipment with respect to the receiver
- Move the equipment away from the receiver
- Plug the equipment into a different outlet so that equipment and receiver are on different branch circuits.

If necessary, the user should consult the dealer or an experienced radio/television technician for additional suggestions. The user may find the following booklet prepared by the Federal Communications Commission helpful:

"How to identify and Resolve Radio-TV Interference Problems." This booklet is available from the U.S. Government Printing Office, Washington, DC 20402, Stock No. 004-000-00345-4.

A shielded interface cable such as the SMF-series recommended on page 6 must be used with this equipment.

WARNING !!

AN ISOLATION TRANSFORMER SHOULD BE USED DURING ANY SERVICE TO AVOID POSSIBLE SHOCK HAZARD, BECAUSE OF LIVE CHASSIS. THE CHASSIS OF THIS RECEIVER IS DIRECTLY CONNECTED TO THE AC POWER LINE.

SAFETY-RELATED COMPONENT WARNING !!

COMPONENTS IDENTIFIED BY SHADING AND MARK  ON THE SCHEMATIC DIAGRAMS, EXPLODED VIEWS AND IN THE PARTS LIST ARE CRITICAL TO SAFE OPERATION. REPLACE THESE COMPONENTS WITH SONY PARTS WHOSE PART NUMBERS APPEAR AS SHOWN IN THIS MANUAL OR IN SUPPLEMENTS PUBLISHED BY SONY. CIRCUIT ADJUSTMENTS THAT ARE CRITICAL TO SAFE OPERATION ARE IDENTIFIED IN THIS MANUAL. FOLLOW THESE PROCEDURES WHENEVER CRITICAL COMPONENTS ARE REPLACED OR IMPROPER OPERATION IS SUSPECTED.

ATTENTION AUX COMPOSANTS RELATIFS À LA SÉCURITÉ!!

LES COMPOSANTS IDENTIFIÉS PAR UNE TRAME ET PAR UNE MARQUE  SUR LES SCHÉMAS DE PRINCIPE, LES VUES EXPLOSÉES ET LES LISTES DE PIÈCES SONT D'UNE IMPORTANCE CRITIQUE POUR LA SÉCURITÉ DU FONCTIONNEMENT. NE LES REMPLACER QUE PAR DES COMPOSANTS SONY DONT LE NUMÉRO DE PIÈCE EST INDIQUÉ DANS LE PRÉSENT MANUEL OU DANS DES SUPPLÉMENTS PUBLIÉS PAR SONY. LES RÉGLAGES DE CIRCUIT DONT L'IMPORTANCE EST CRITIQUE POUR LA SÉCURITÉ DU FONCTIONNEMENT SONT IDENTIFIÉS DANS LE PRÉSENT MANUEL. SUIVRE CES PROCÉDURES LORS DE CHAQUE REMPLACEMENT DE COMPOSANTS CRITIQUES, OU LORSQU'UN MAUVAIS FONCTIONNEMENT EST SUSPECTÉ.

SAFETY CHECK-OUT

(US Model only)

After correcting the original service problem, perform the following safety checks before releasing the set to the customer:

1. Check the area of your repair for unsoldered or poorly-soldered connections. Check the entire board surface for solder splashes and bridges.
2. Check the interboard wiring to ensure that no wires are "pinched" or contact high-wattage resistors.
3. Check that all control knobs, shields, covers, ground straps, and mounting hardware have been replaced. Be absolutely certain that you have replaced all the insulators.
4. Look for unauthorized replacement parts, particularly transistors, that were installed during a previous repair. Point them out to the customer and recommend their replacement.
5. Look for parts which, though functioning, show obvious signs of deterioration. Point them out to the customer and recommend their replacement.
6. Check the line cord for cracks and abrasion. Recommend the replacement of any such line cord to the customer.
7. Check the condition of the monopole antenna (if any).
Make sure the end is not broken off, and has the plastic cap on it. Point out the danger of impalement on a broken antenna to the customer, and recommend the antenna's replacement.
8. Check the B+ and HV to see they are at the values specified. Make sure your instruments are accurate; be suspicious of your HV meter if sets always have low HV.

LEAKAGE TEST

The AC leakage from any exposed metal part to earth ground and from all exposed metal parts to any exposed metal part having a return to chassis, must not exceed 0.5 mA (500 microamperes). Leakage current can be measured by any one of three methods.

1. A commercial leakage tester, such as the Simpson 229 or RCA WT-540A. Follow the manufacturers' instructions to use these instruments.
2. A battery-operated AC milliammeter. The Data Precision 245 digital multimeter is suitable for this job.
3. Measuring the voltage drop across a resistor by means of a VOM or battery-operated AC voltmeter. The "limit" indication is 0.75 V, so analog meters must have an accurate low-voltage scale. The Simpson 250 and Sanwa SH-63Trd are examples of a passive VOM that is suitable. Nearly all battery operated digital multimeters that have a 2V AC range are suitable. (See Fig. A)

HOW TO FIND A GOOD EARTH GROUND

A cold-water pipe is guaranteed earth ground; the cover-plate retaining screw on most AC outlet boxes is also at earth ground. If the retaining screw is to be used as your earth-ground, verify that it is at ground by measuring the resistance between it and a cold-water pipe with an ohmmeter. The reading should be zero ohms. If a cold-water pipe is not accessible, connect a 60-100 watts trouble light (not a neon lamp) between the hot side of the receptacle and the retaining screw. Try both slots, if necessary, to locate the hot side of the line, the lamp should light at normal brilliance if the screw is at ground potential. (See Fig. B)

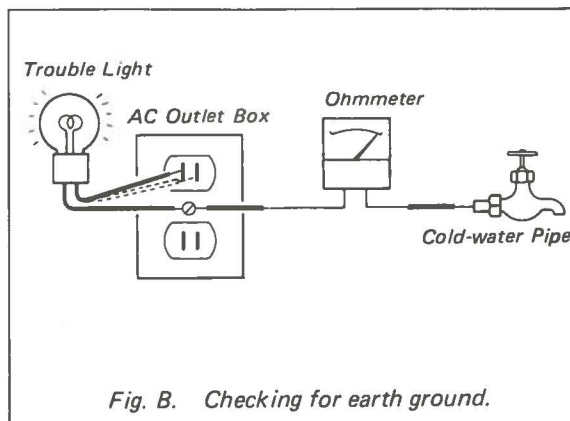
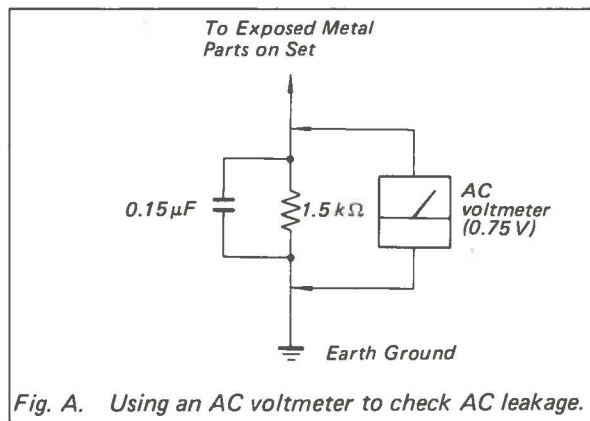

TABLE OF CONTENTS

<u>Section</u>	<u>Title</u>	<u>Page</u>	<u>Section</u>	<u>Title</u>	<u>Page</u>
1. GENERAL			4. DIAGRAMS		
1-1.	Location and Function of controls	5	4-1.	Block Diagram	13
1-2.	Connections	6	4-2.	Circuit Boards Location	17
1-3.	Use of a Display Stand	6	4-3.	Schematic Diagrams	17
			4-4.	Printed Wiring Boards	25
2. DISASSEMBLY			4-5.	Wave Form	33
2-1.	Cabinet Removal	7	4-6.	Semiconductors	35
2-2.	Checking for BA board Up	7	5. EXPLODED VIEWS		
2-3.	Checking for G and F Boards Up	8	5-1.	Picture Tube	36
2-4.	Checking for BA board Up	8	5-2.	Chassis Assy.	37
2-5.	Checking for CA board Up	9	6. ELECTRICAL PARTS LIST		36
2-6.	Checking for H and BB boards Up	9			
2-7.	Picture Tube Removal	10			
3. SAFETY RELATED ADJUSTMENT		11, 12			

SECTION 1 GENERAL

1-1. LOCATION AND FUNCTION OF CONTROLS

On the front panel

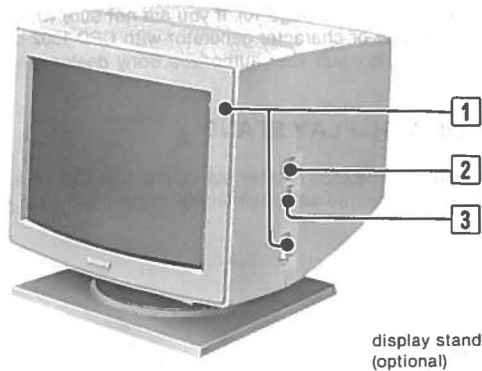

- 1 POWER switch and indicator (green)**
To turn on the power of the unit, press this switch to ON. The indicator will light up. To turn off the unit, press towards OFF.

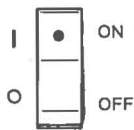

- 2 PICTURE control**
Adjusts the contrast. Turn downwards to increase contrast, or upwards for less contrast.
- 3 BRIGHTNESS control**
Normally keep this control at the center detent position. For a brighter display, turn this knob downwards, or for a darker display, turn it upwards.

On the rear panel

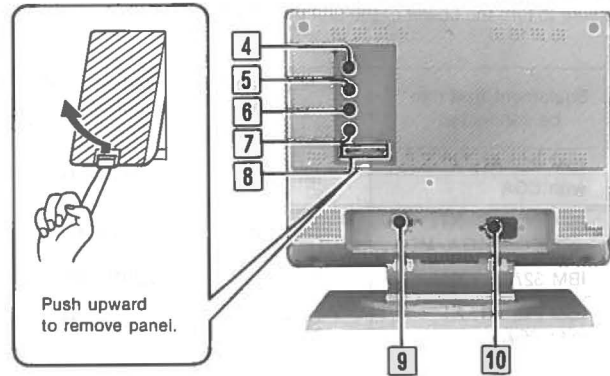

- 4 H SHIFT (horizontal shift) control**
Turn this control to center the displays of microcomputers, character generators, etc. that are shifted toward the left or right side of the screen.
- 5 V SHIFT (vertical shift) control**
Turn this control to eliminate any shifting in the vertical direction.
- 6 H SIZE (horizontal size) control**
Turn this control to adjust the horizontal size.
- 7 V SIZE (vertical size) control**
Turn this control to adjust the vertical size.
- 8 RGB input selectors**
Depending on the RGB output of the equipment you have connected, set these switches to one of the following four positions.

ANALOG: For microcomputers having analog RGB output, such as those using the PGA card. The position of the left switch has no effect when the right switch is set to ANALOG.

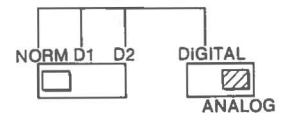

NORM-DIGITAL: For microcomputers having TTL RGB output, such as the IBM 3270.

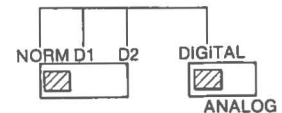

D1-DIGITAL: For microcomputers having TTL RGB and I signal output, such as the IBM PC, AT and XT using the standard color graphics card.

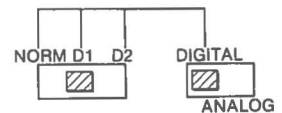

D2-DIGITAL: For TTL graphics cards on the IBM PC, AT and XT. (automatic adjustment between EGA, CGA and MDA)

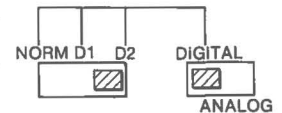

- 9 RGB IN (input) connector (9-pin D-sub)**
Allows a microcomputer having either analog or digital RGB output to be connected. Refer to page 8.
- 10 AC IN connector**
Connect to the AC outlet with the supplied AC power cord.

1-2. CONNECTIONS

Use an appropriate optional color monitor cable with 9-pin D-sub connectors shown in the table. Be sure to turn the power of the unit off before making any connections.

Equipment that can be connected	Monitor cable (optional) to be used	Position of RGB input selectors of the CPD-1302
IBM PC, AT, XT with CGA	SMF-512	D1-DIGITAL
IBM PC, AT, XT with EGA, CGA, MDA	SMF-512	D2-DIGITAL
IBM 3270	SMF-514	NORM-DIGITAL
IBM PC, AT, XT with VGA	SMF-513	ANALOG

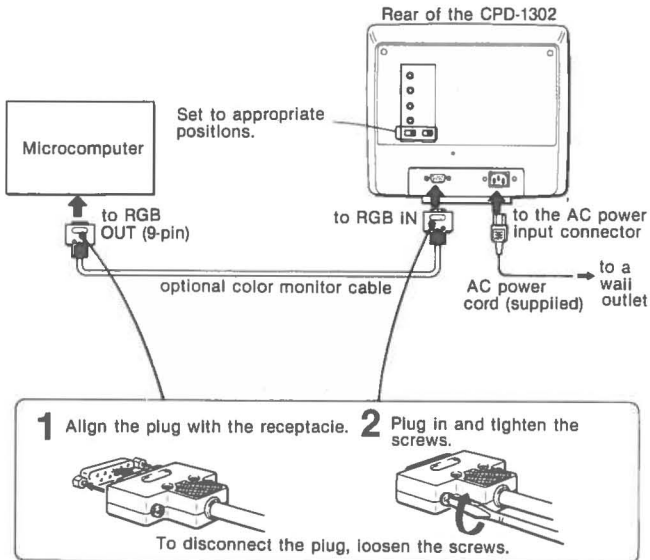

Note

The monitor cable should arrange the RGB output signals of the connected equipment so that they match the signal assignment of the RGB IN connector of this unit (See page 10). If you are not sure whether you can use your computer or character generator with CPD-1302 or which monitor cable to use, consult your authorized Sony dealer.

1-3. USE OF A DISPLAY STAND

With the optional Sony SU-535 display stand, this unit can be adjusted to be viewed at your desired angle within 90° horizontally and 15° vertically.

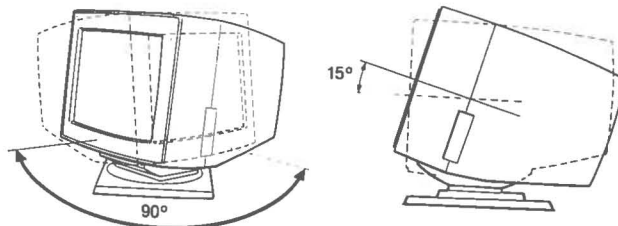

For details, read the instructions of the display stand.

SECTION 2 DISASSEMBLY

- Follow the disassembly procedure in the numerical order given.

2-1. CABINET REMOVAL

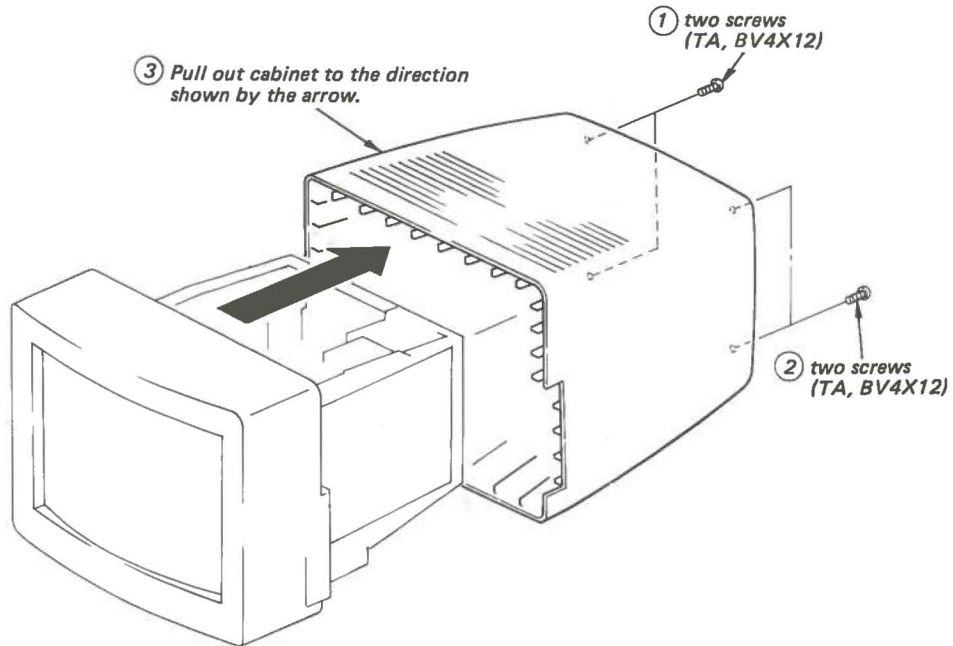

2-2. CHECKING FOR BA BOARD UP

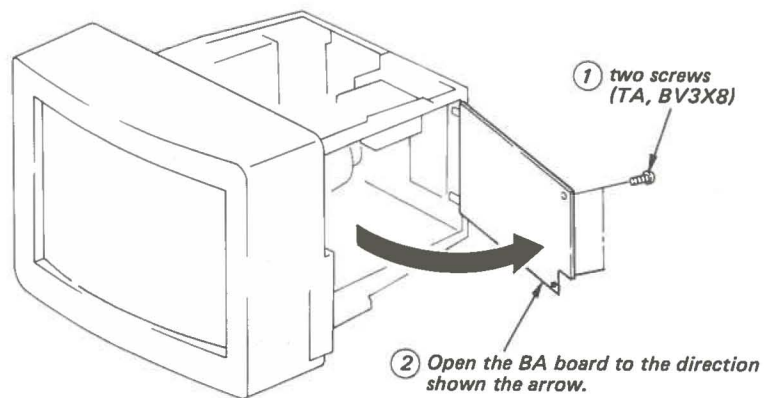

2-3. CHECKING FOR G AND F BOARDS UP

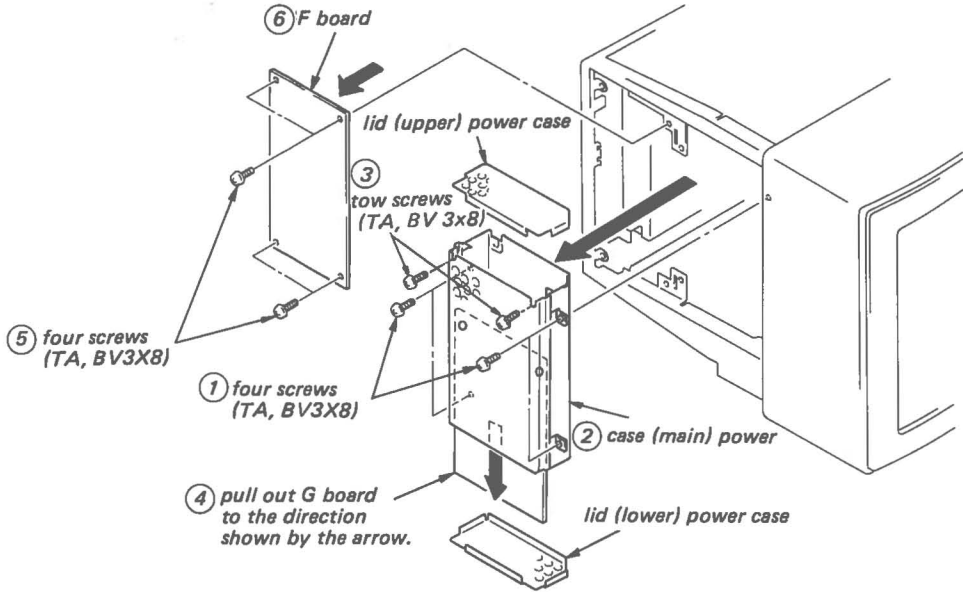

2-4. CHECKING FOR D BOARD UP

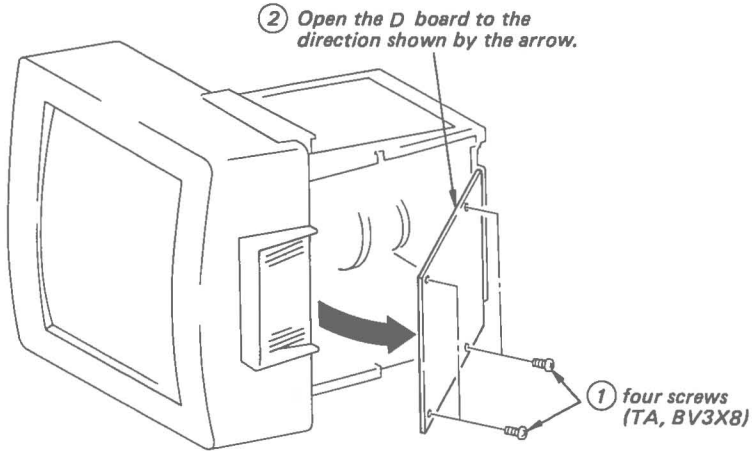

2-5. CHECKING FOR CA BOARD UP

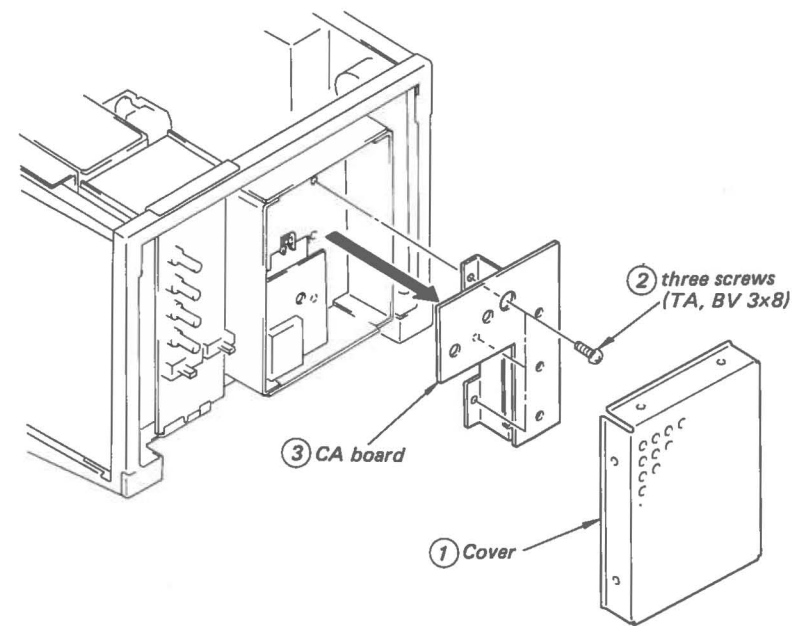

2-6. CHECKING FOR H AND BB BOARDS UP

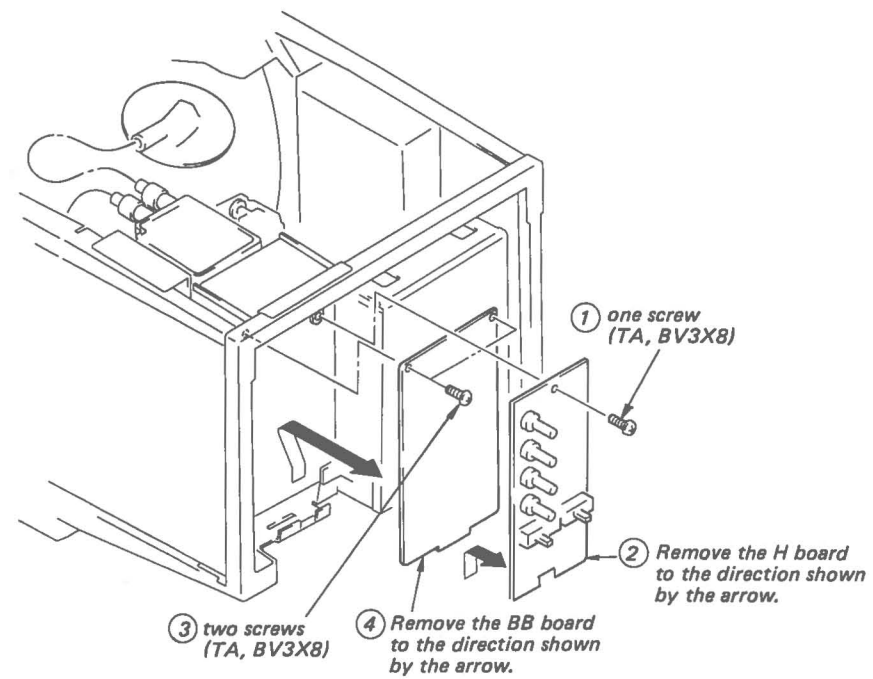

2-7. PICTURE TUBE REMOVAL

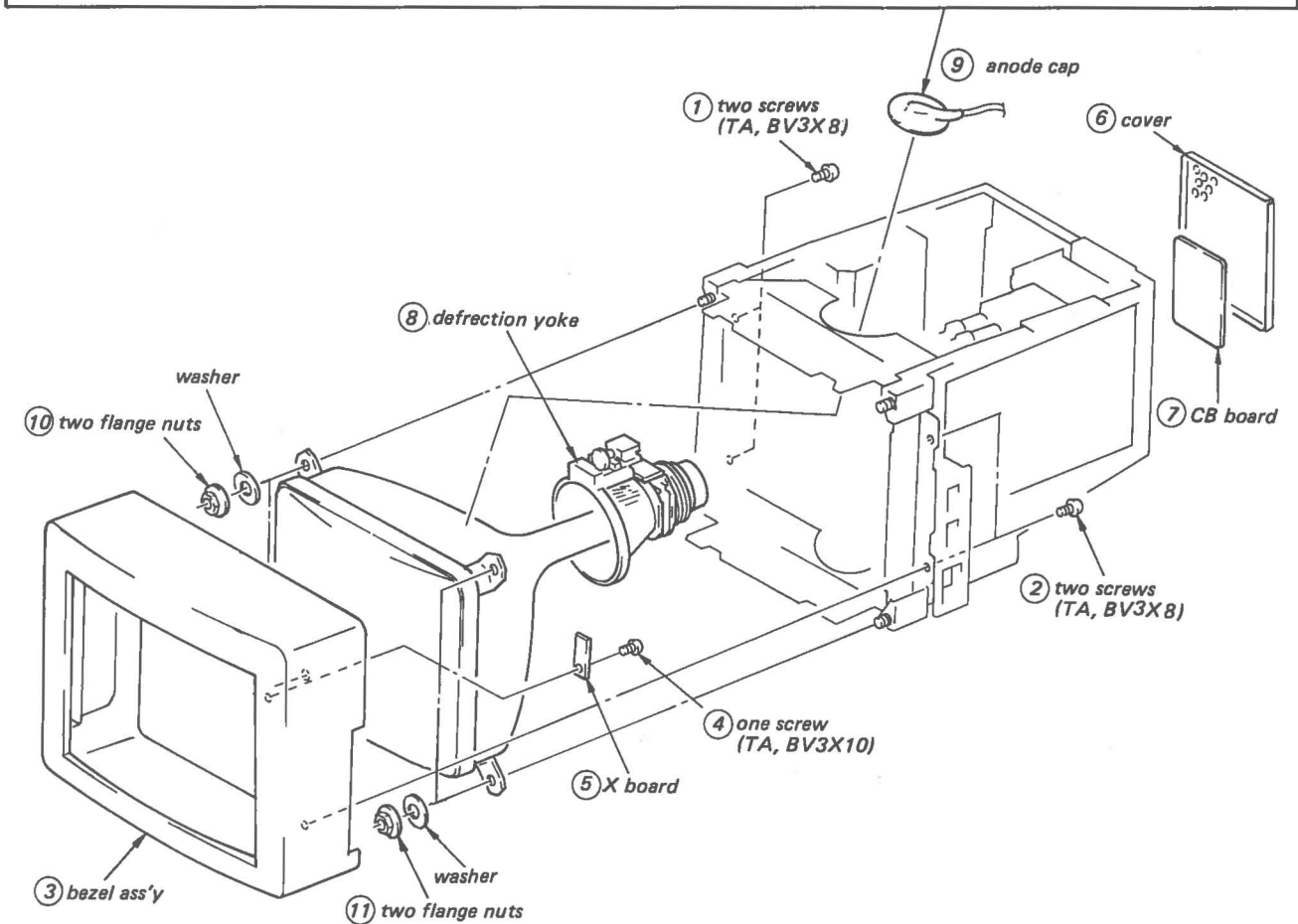
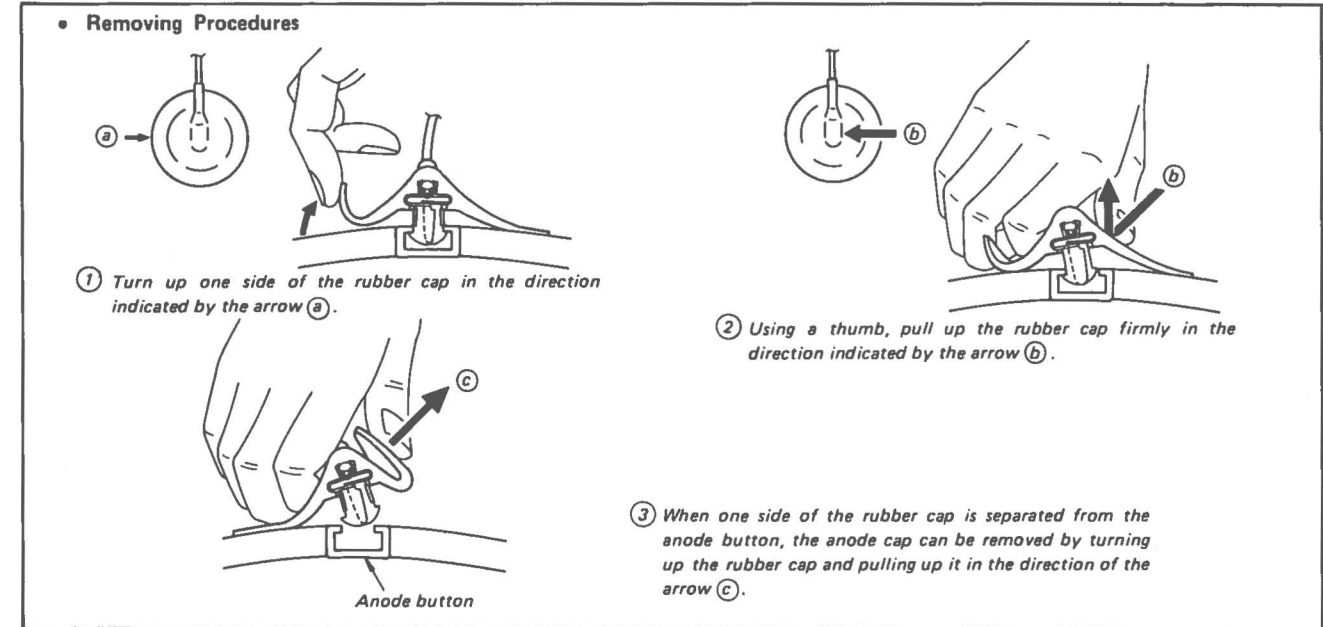

SECTION 3 SAFETY RELATED ADJUSTMENT

NOTE:

(1) TEST EQUIPMENT REQUIRED

1. Voltmeter (VOM)
2. Digital multimeter
3. DC POWER SUPPLY.
4. SONY Microcomputer SMC-70

+B MAX (R416, R489)

Be sure to perform the following adjustment after replacing the parts below. (Marked on the schematic diagram)

(G board) Q653, R658, R659, T653

(BA board)

IC401, IC404, IC405, Q409, R409, R410, R411, R412, R413, R414, R415, R416, R417, R418, R419, R424, R425, R448, R479, R480, R489, R488.

1. Input a dot signal and set PICTURE, BRIGHT to minimum.
2. Turn +B VR (RV403) to maximum.
3. Observe BA board to connector pin ① BA-1 on the digital multimeter.
4. Set SMC-70 output to fH = 15.734 kHz and confirm that the +B line is less than 62.0V dc.
5. Set SMC-70 output to fH = 18.4 kHz and confirm that the +B line is less than 72.8V dc.
6. Set SMC-70 output to fH = 21.8 kHz and confirm that the +B line is less than 86.0V dc.
7. Set SMC-70 output to fH = 25 kHz and confirm that the +B line is less than 97.8V dc.
8. Set SMC-70 output to fH = 31.5 kHz and confirm that the +B line is less than 124.5V dc.
9. If the specification is not met, adjust R416, R489 and repeat steps 1 and 3 until satisfied.

digital multimeter

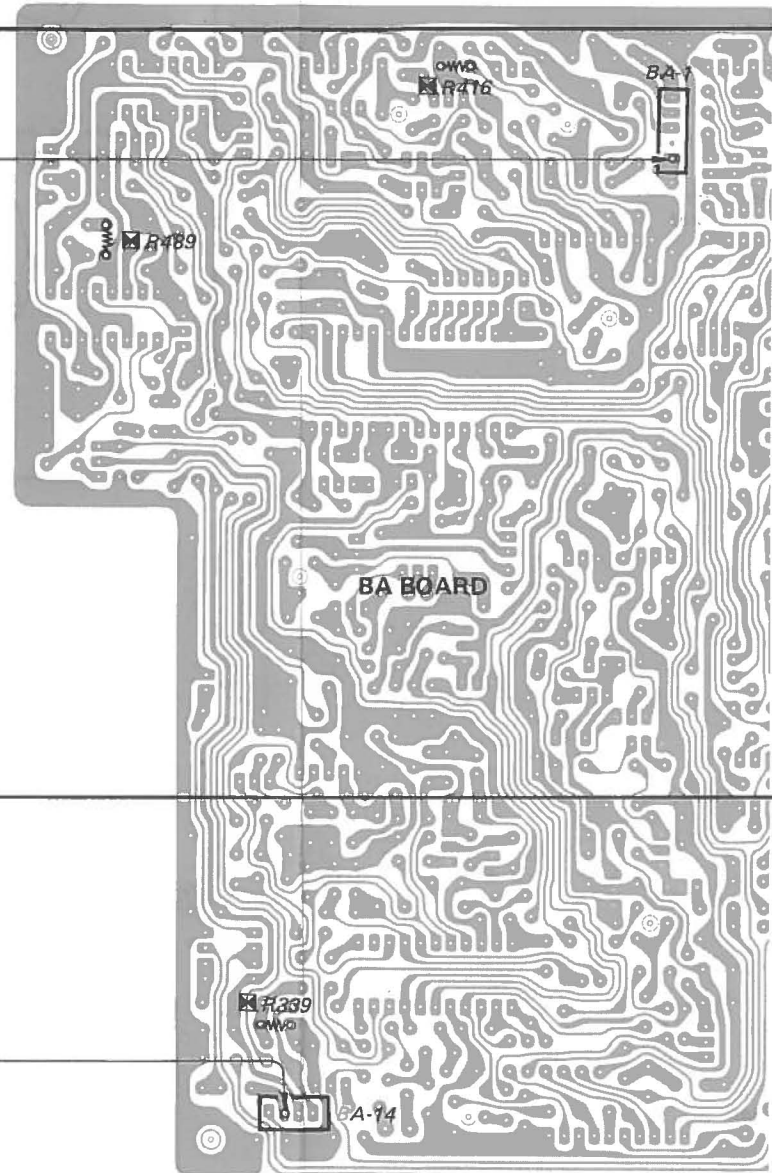
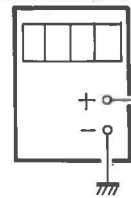

HOLD DOWN ADJUSTMENT (R339)

Be sure to perform the following adjustment after replacing the parts below. (Marked on the schematic diagram).

(BA board)

IC301, IC302, D304, R301, R302, R335, R336, R337, R338, R339, R340, R341, R342.

(D board)

R565, R566

1. Set the PICTURE and BRIGHTNESS control to maximum.
2. Input the dot pattern signal.
3. Set SMC-70 output to fH = 21.8 kHz and confirm that the BA board to connector pin ② BA-14 is less than 7.3±0.8V dc.
4. Set the PICTURE and BRIGHTNESS control to minimum and supply is less than 8.95V dc, confirm that HV HOLD DOWN operates.
5. Adjust ABL current to 400±20 μA with PICTURE and BRIGHTNESS controls.
6. Confirm that there is less than 8.70V dc whereby the raster disappears during operation of hold-down circuit. Note: If the hold-down circuit starts operating in the above case, switch OFF the POWER of the set immediately.
7. If above steps is not satisfied, select resistance valve of R339 and repeat above steps 1 through 6.

digital multimeter

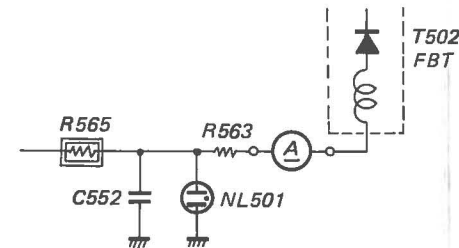
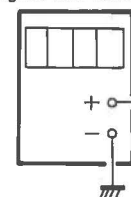

CONFIRMATION WHEN REPLACING H.V.R. (HIGH VOLTAGE REGISTER)

The following adjustments should always be performed with reference to whether an X-ray radiation control circuit is connected or not, when replacing H.V.R.

* This check is to be performed when H.V.R. only is replaced, and has no relation to the hold-down circuit readjustment for replacement of parts marked on the schematic diagram. (Connection Confirmation)

1. Turn the POWER switch ON, and receive white signals and set the PICTURE and BRIGHTNESS controls to MAX.
2. When the set is operating normally with 120V AC supply, confirm the voltage of the connection point for connector ② pin BA-14 is 7.3±0.8V dc.

ammeter
1.0mA dc
range

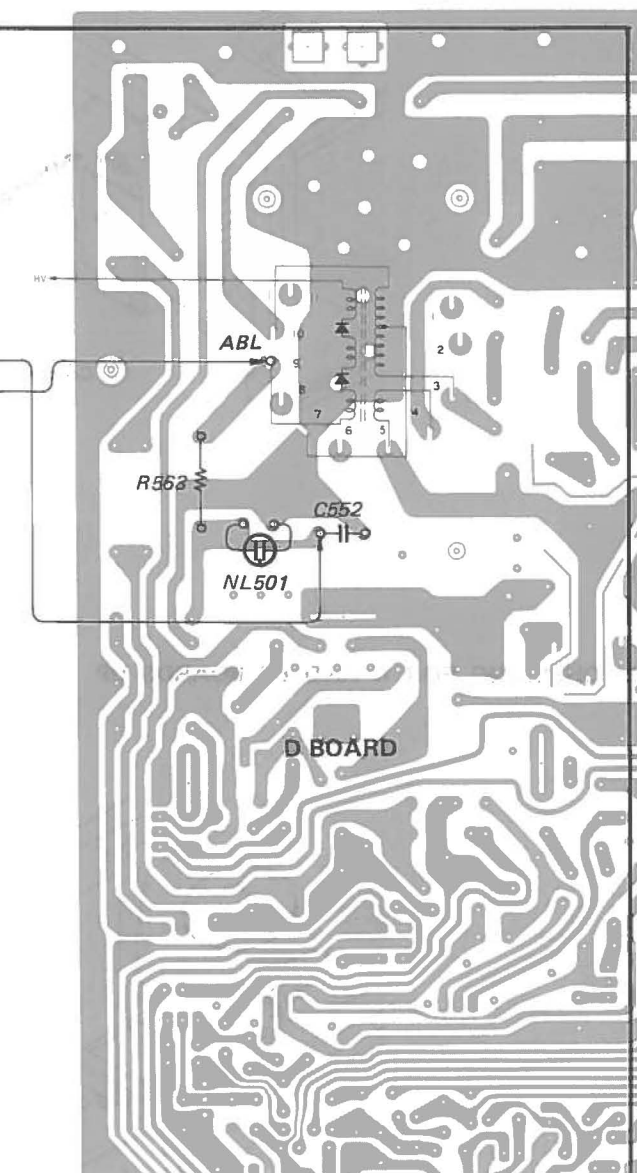
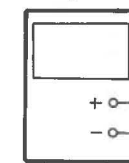

SECTION 4
DIAGRAMS

4-1. BLOCK DIAGRAM

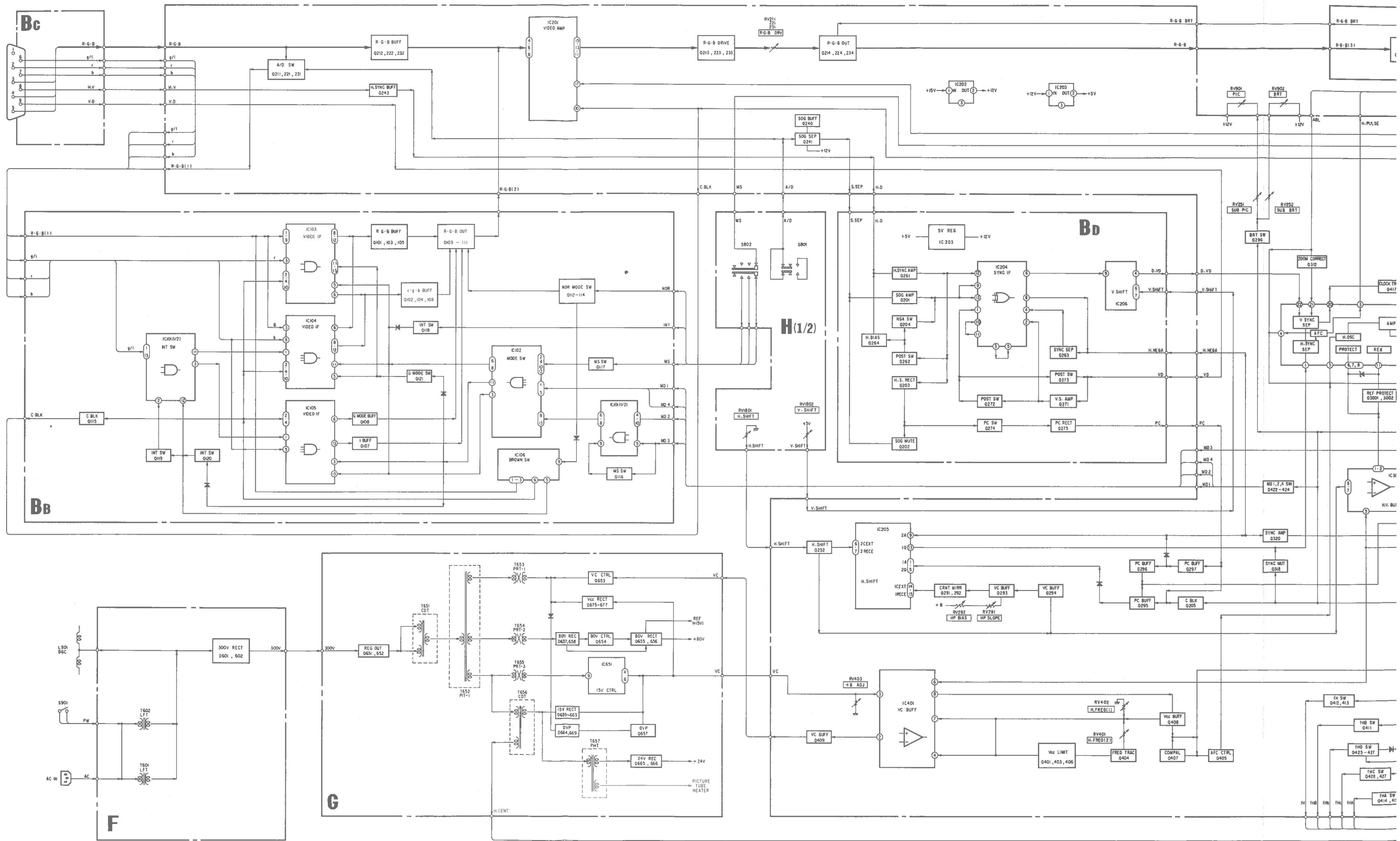

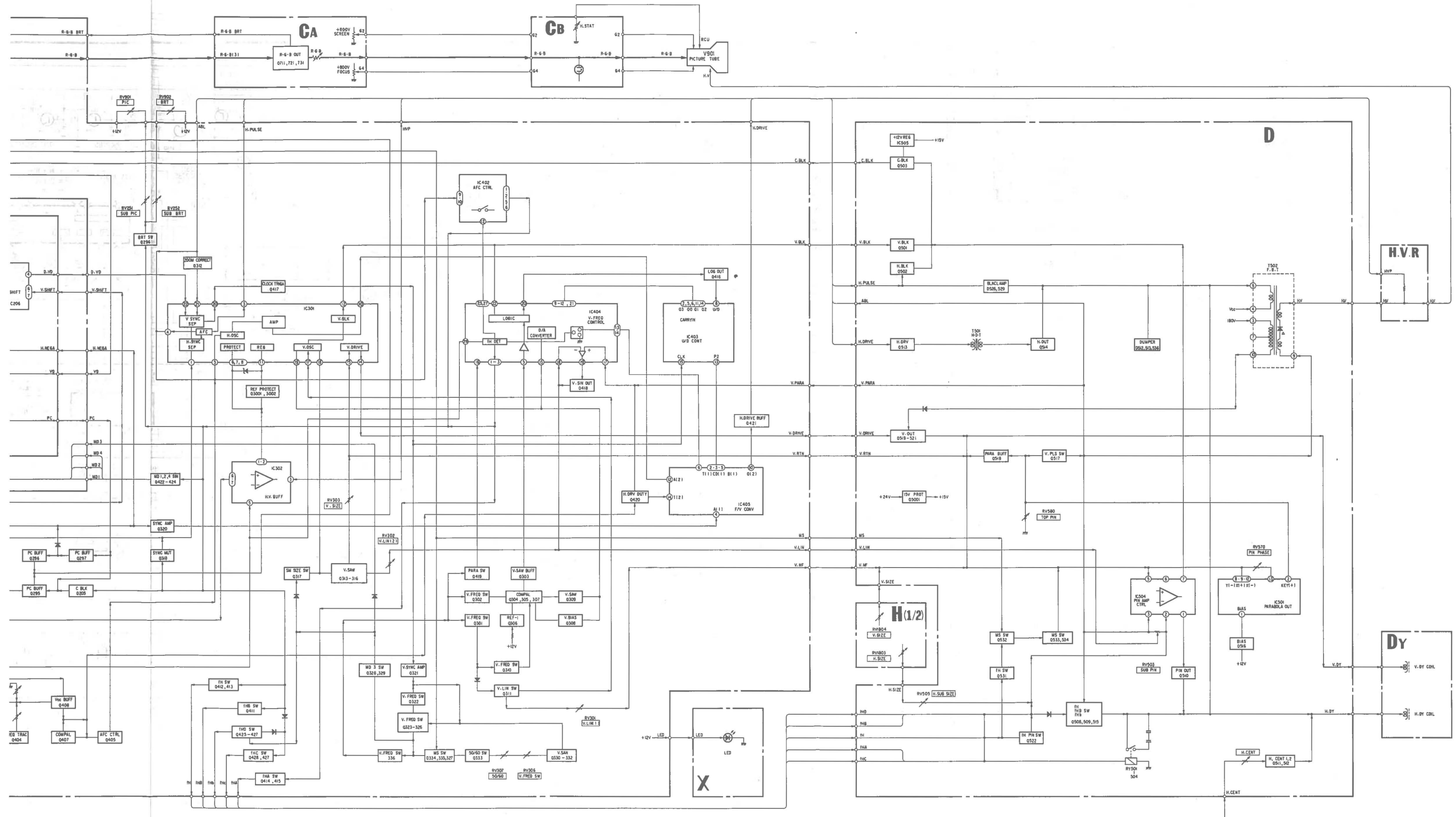

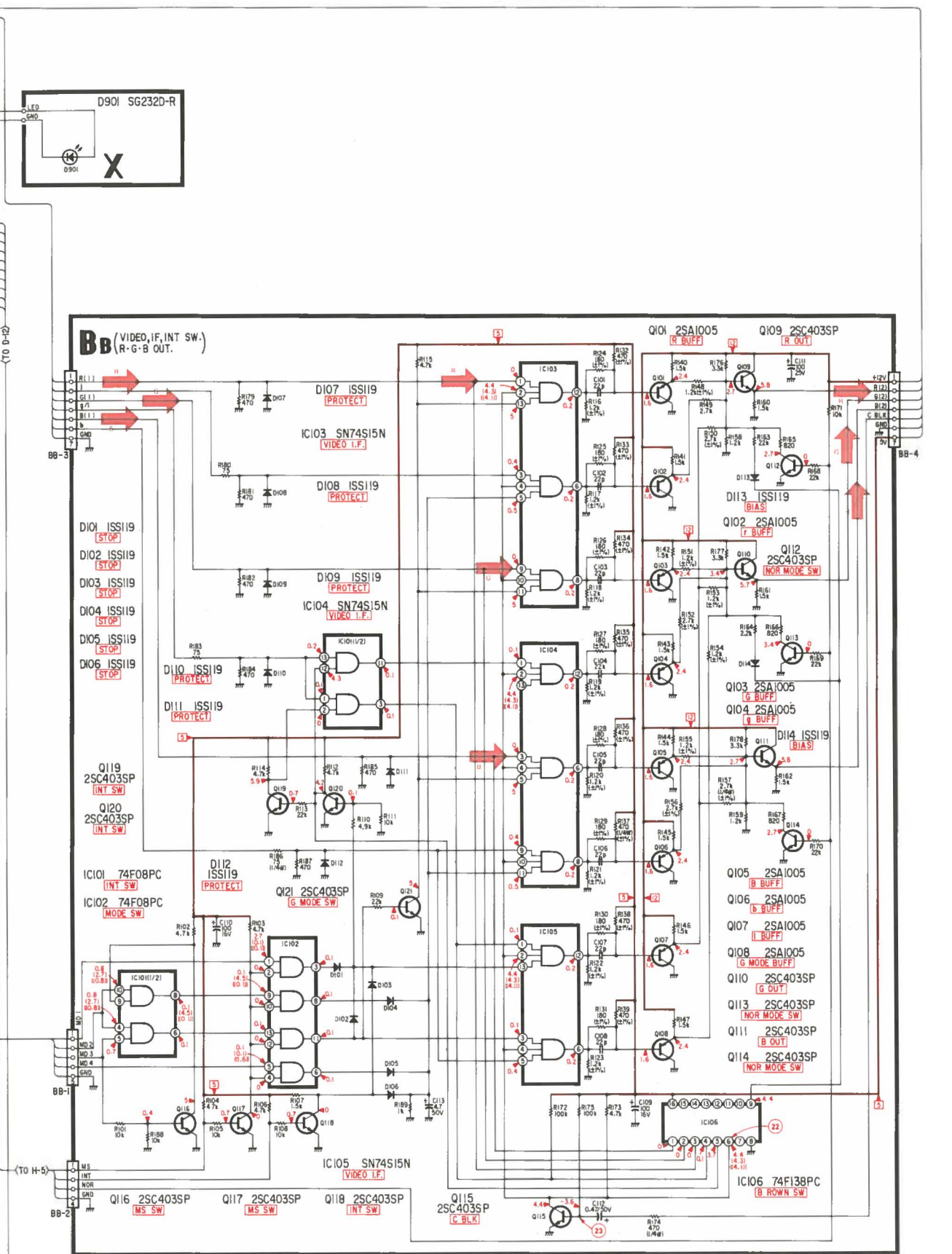
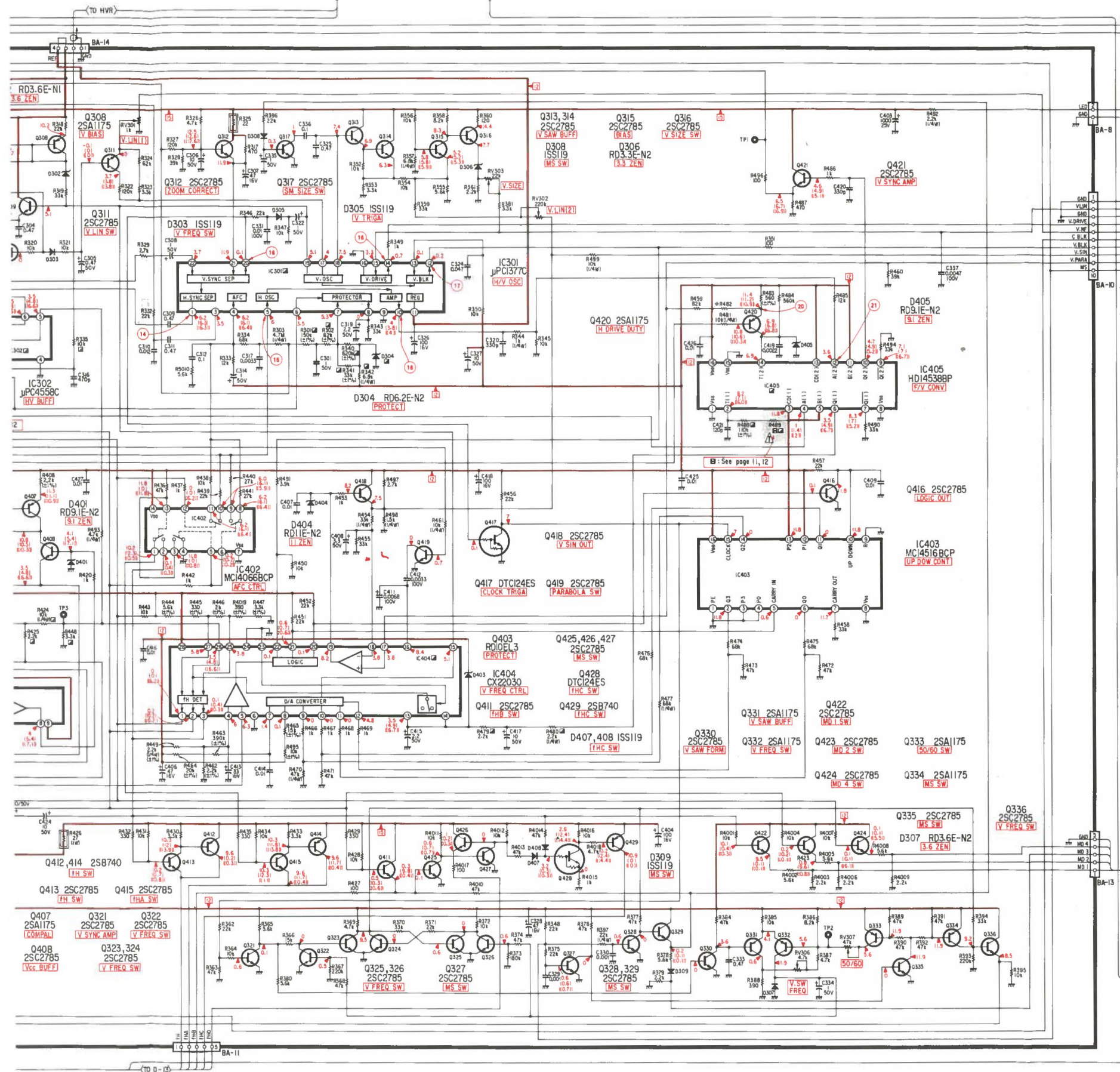

4-2. CIRCUIT BOARDS LOCATION

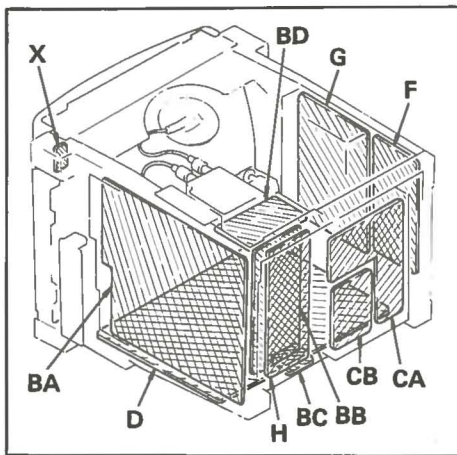

Note: The components identified by shading and mark are critical for safety. Replace only with part number specified.

Note: Les composants identifiés par une trame et par une marque sont d'une importance critique pour la sécurité. Ne les remplacer que par des pièces de numéro spécifié.

Note:

- All capacitors are in μF unless otherwise noted. p : μF 50WV or less are not indicated except for electrolytics.
 - All resistors are in ohms, 1/6W unless otherwise noted. k : 1000 Ω , M : 1000k Ω .
 - : nonflammable resistor.
 - All variable and adjustable resistors have characteristic curve B, unless otherwise noted.
 - : fusible resistor.
 - Δ : internal component.
 - : panel designation.
 - * : selected to yield optimum performance.
 - The components identified by in this manual have been carefully factory-selected for each set in order to satisfy regulations regarding X-ray radiation. Should replacement be required, replace only with the value originally used.
 - When replacing components identified by mark the necessary adjustments indicated. If results do not meet the specified value, change the component identified by and repeat the adjustment until the specified value is achieved. (Refer to R339, R416, R489 adjustment on page 11, 12.)
- When replacing the part in below table, be use to perform the related adjustment.

Part replaced ()	Adjustment ()
(G Board) Q653, R658, R659, T653 (BA Board) IC401, IC404, IC405, Q409, R409, R410, R411, R412, R413, R414, R415, R416, R417, R418,, R419, R424, R425, R448, R479, R480, R488, R489.	R416, R489 (+B MAX)
(BA Board) IC301, IC302, R301, R302, R335, R336, R337, R338, R339, R340, R341, R342, D304	R339 (HV HOLD DOWN)
(D Board) R565, R566	

- Voltages are dc with respect to ground unless otherwise noted.
- Readings are taken with a 10 M Ω digital multimeter.
- Voltage variations may be noted due to normal production tolerances.
- Readings are taken with a color-bar-signal input. (SONY SMC-70)
- : adjustment to repair.
- no mark: with 15.73kHz color-bar signal received.
- () : with 21.8kHz color-bar signal received.
- () : with 30.12kHz color-bar signal received.
- : signal path.

4-3. SCHEMATIC DIAGRAMS

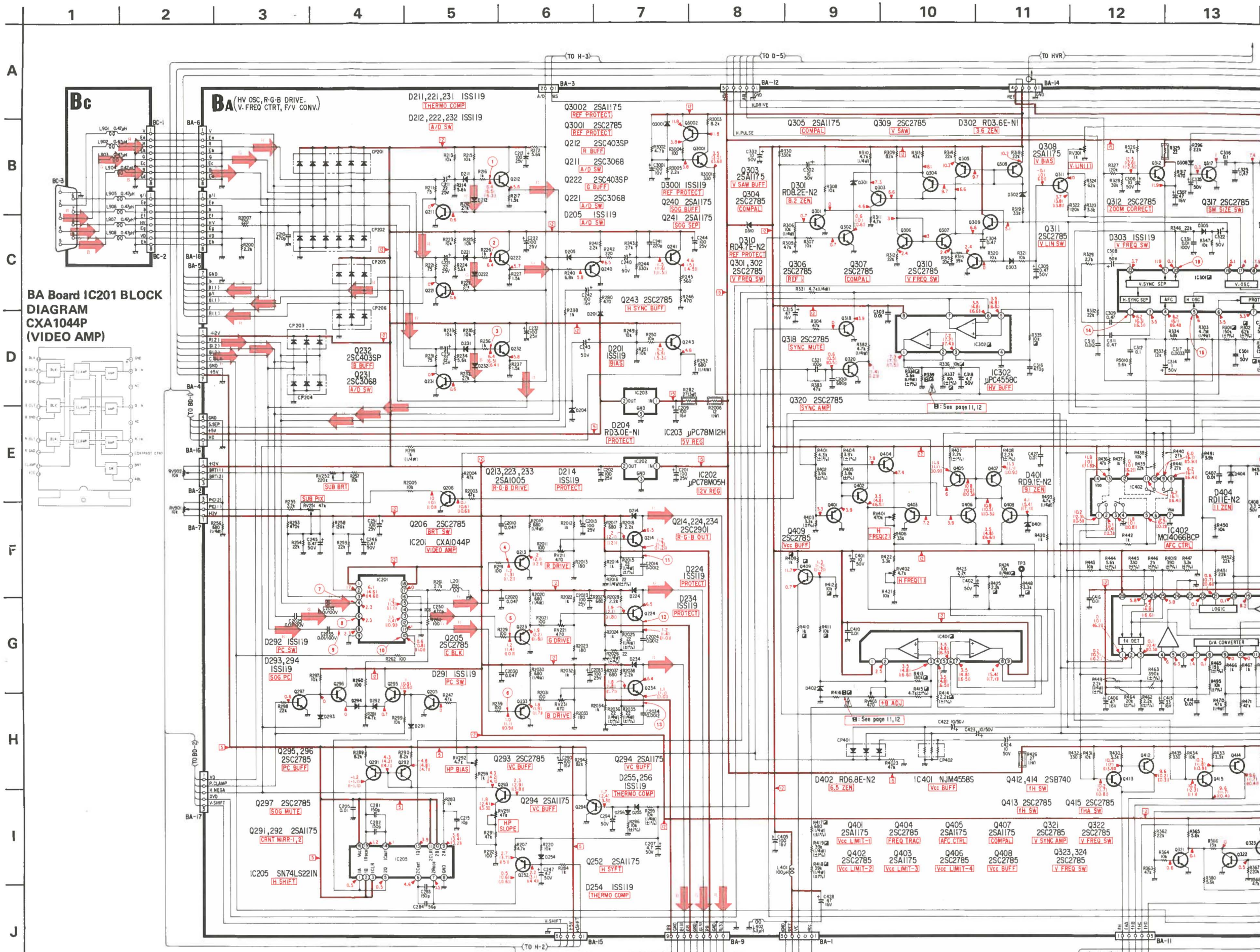

BA Board IC201 BLOCK DIAGRAM CXA1044P (VIDEO AMP)

44. PRINTED WIRING BOARDS

BA [HV. OSC, R-G-B DRIVE, V. FREQ CRT, F/V CONV.]

BB [Video, IF, INT SW., R-G-B OUT.]

BC **X**

1 2 3 4 5 6 7 8 9 10 11 12 13 14 15 16 17

- BA Board -

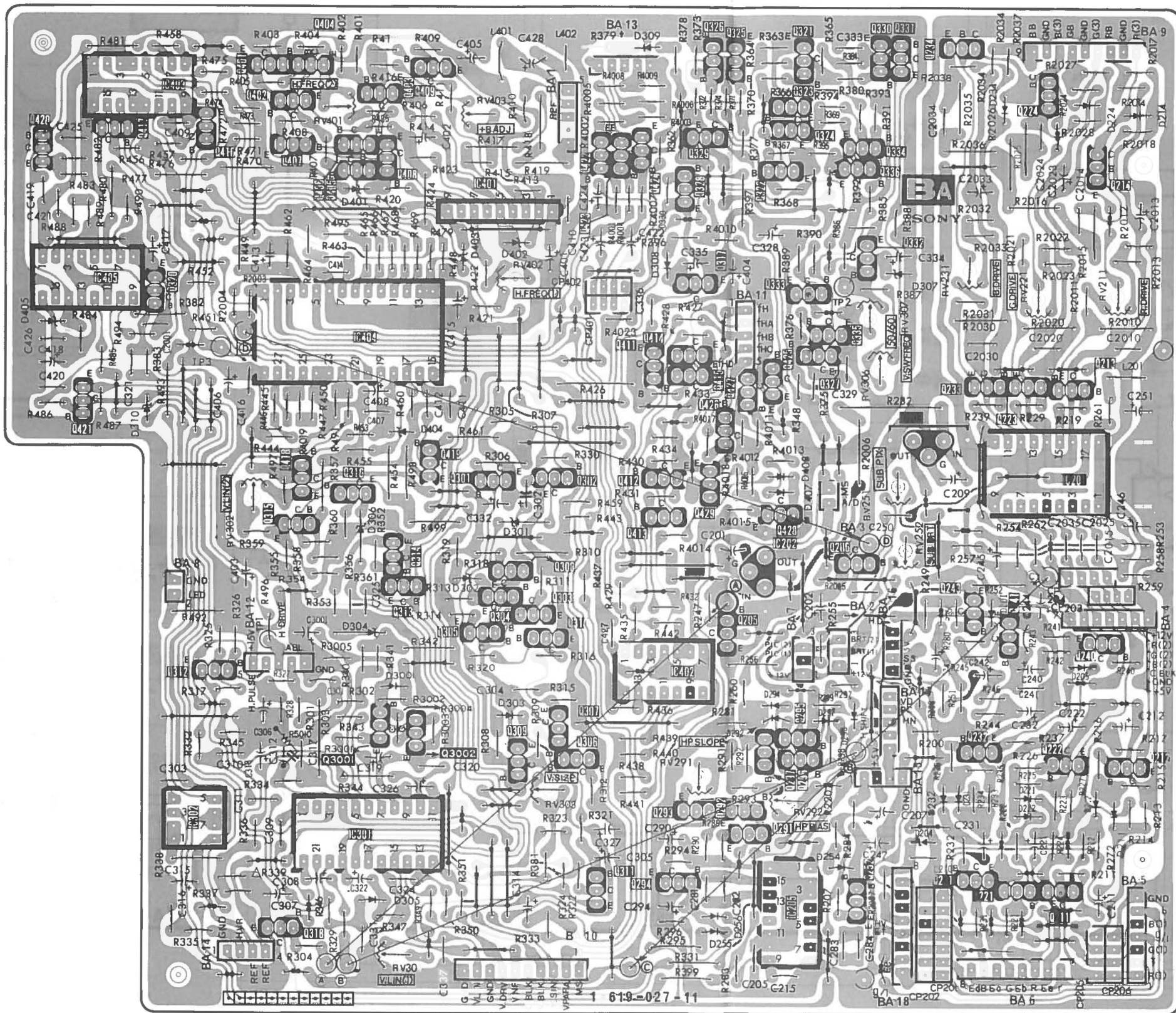

IC, Q	D	ADJ
326		
401 409 325 234	309	
404 403 321		
402 330 224		
331		
IC403	224	RV401
420, 417 329 323	234	RV403
416 324	214	
407, 406 422, 334		
408 423, 336		
405 424 214		
322		
328	401	
IC401		
320	402	
	403	
332	308	
IC405	307	RV402
317		RV231
333		RV221
	405	RV211
IC404		RV307
411 335		
414, 425		
415, 427		
233		
223	310	
213		
421	404	
426		
419 IC203		
418 IC201	408	RV302
412	407	
316, 301		RV251
302 428	306	
413		
314	206	RV252
308 IC202	302	
313		
303		
304 243	201	
305 310, 205, 241		
240	304	
312 IC402	205	
	3001	
	294	
	293	
3001 307	303	
3002 297	292	
306 295, 232	291	
309 296 222		RV303
212		RV291
	232	
	231	
	222	
IC302 293	221	RV292
IC301 292	211	
291	204	
	254	
311 IC205 231	305	
294 252 221	256	
318 211	255	
		RV301

- BB Board -

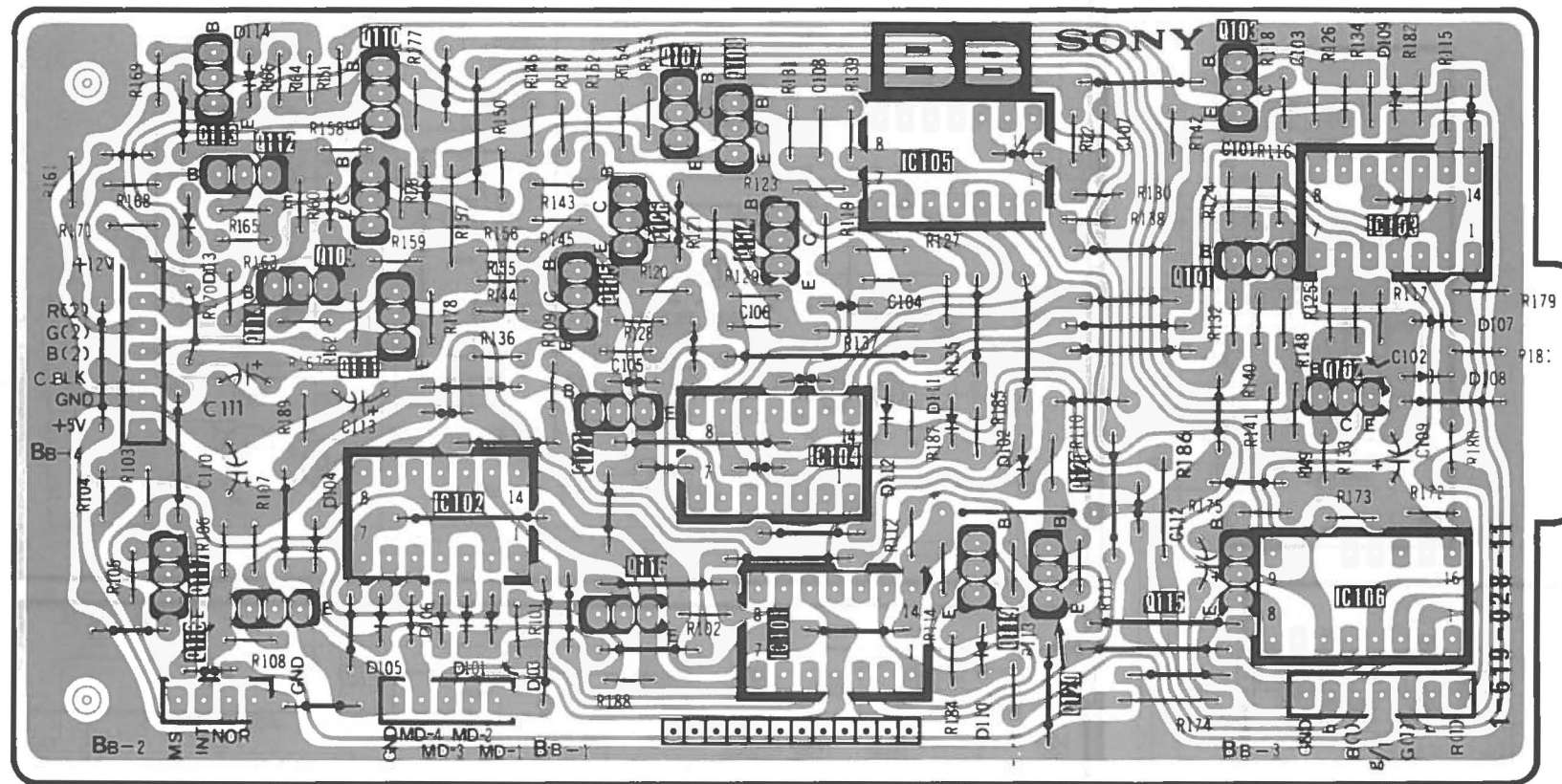

- BC Board -

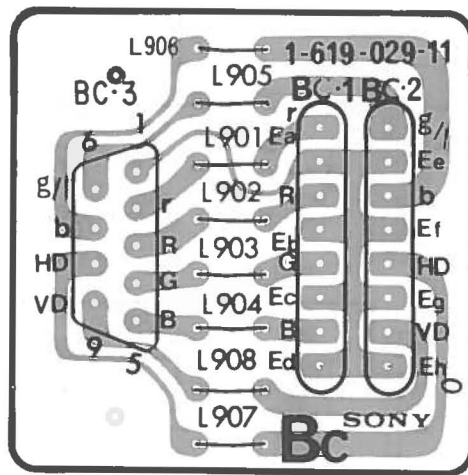

- X Board -

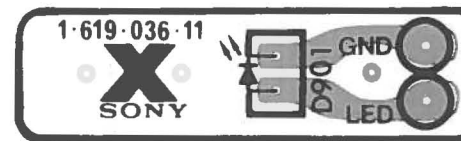

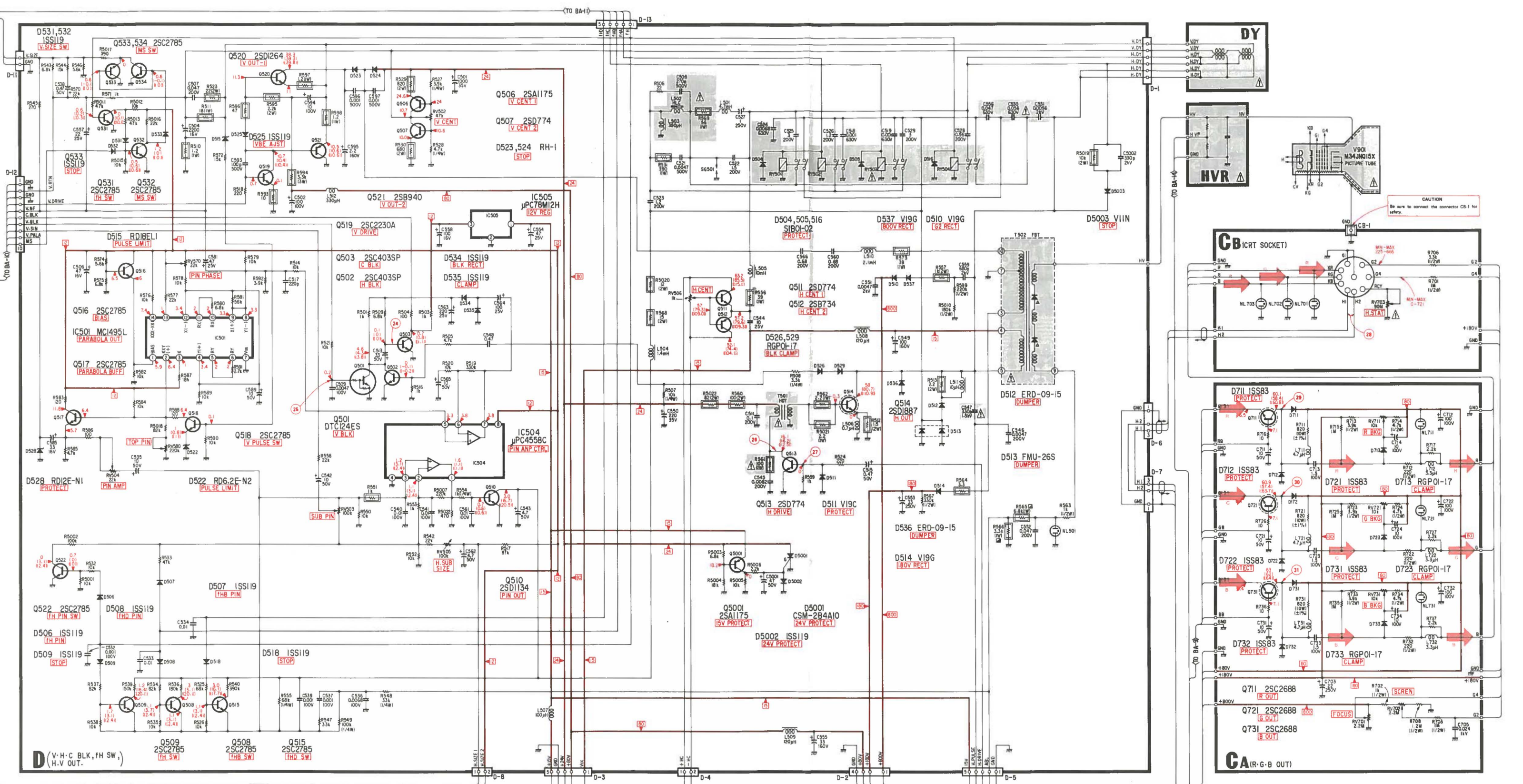







BA BOARD



1 2 3 4 5 6 7 8 9 10 11 12 13 1

Note: The components identified by shading and mark  are critical for safety. Replace only with part number specified.

Note: Les composants identifiés par une trame et par une marque  sont d'une importance critique pour la sécurité. Ne les remplacer que par des pièces de numéro spécifié.

te:
 All capacitors are in μF unless otherwise noted. p : μF 50WV or less are not indicated except for electrolytics.
 All resistors are in ohms, 1/6W unless otherwise noted. k : 1000 Ω , M : 1000k Ω .
 : nonflammable resistor.
 All variable and adjustable resistors have characteristic curve B, unless otherwise noted.
 : fusible resistor.
 : internal component.
 : panel designation.
 * : selected to yield optimum performance.

The components identified by  in this manual have been carefully factory-selected for each set in order to satisfy regulations regarding X-ray radiation. Should replacement be required, replace only with the value originally used.
 When replacing components identified by  mark the necessary adjustments indicated. If results do not meet the specified value, change the component identified by  and repeat the adjustment until the specified value is achieved.
 (Refer to R339, R416, R489 adjustment on page 11, 12.)
 When replacing the part in below table, be use to perform the related adjustment.

Part replaced ()	Adjustment ()
Board) Q653, R658, R659, T653 A Board) 401, IC404, IC405, Q409, R409, R410, R411, 112, R413, R414, R415, R416, R417, R418,, 119, R424, R425, R448, R479, R480, R488, 189.	R416, R489 (+B MAX)
A Board) 301, IC302, R301, R302, R335, R336, R337, 338, R339, R340, R341, R342, D304	R339 (HV HOLD DOWN)
Board) R565, R566	

Voltages are dc with respect to ground unless otherwise noted.
 Readings are taken with a 10 M Ω digital multimeter.
 Voltage variations may be noted due to normal production tolerances.
 Readings are taken with a color-bar-signal input. (SONY SMC-70)
 : adjustment to repair.
 no mark: with 15.73kHz color-bar signal received.
 () : with 21.8kHz color-bar signal received.
 (()) : with 30.12kHz color-bar signal received.

 : signal path

A
B
C
D
E
F
G
H
I
J

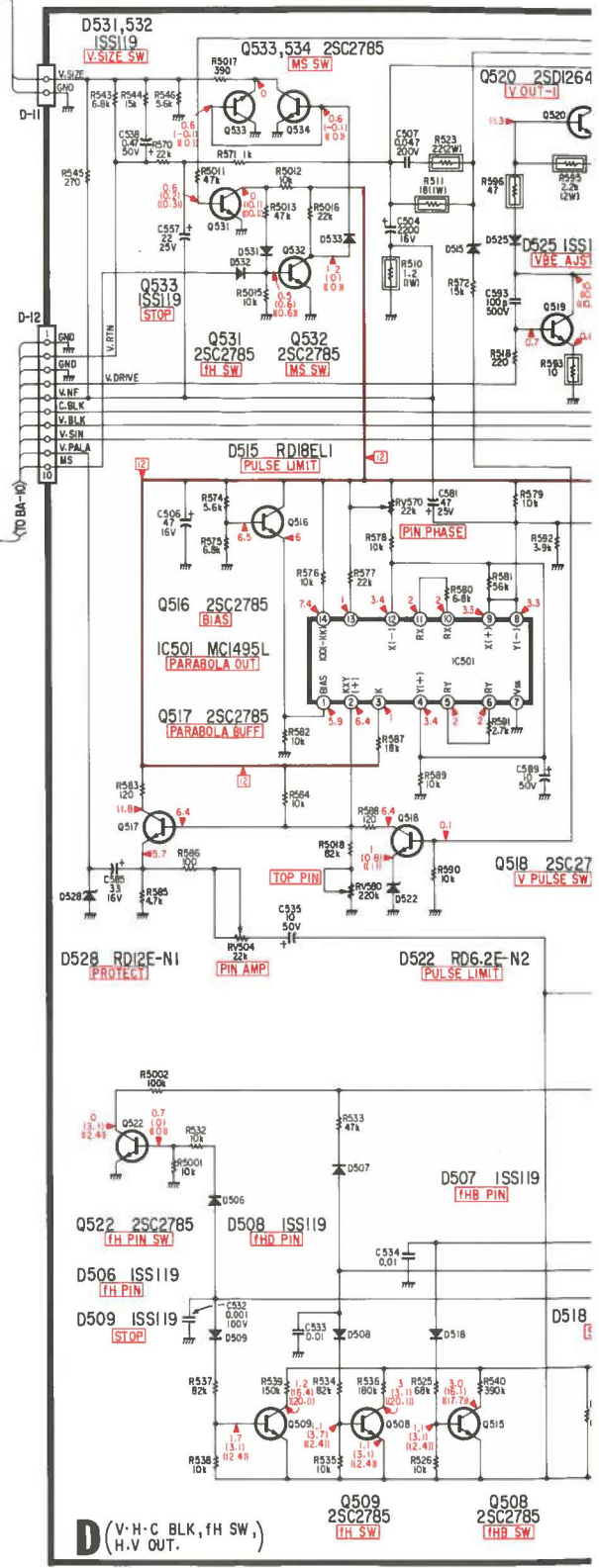
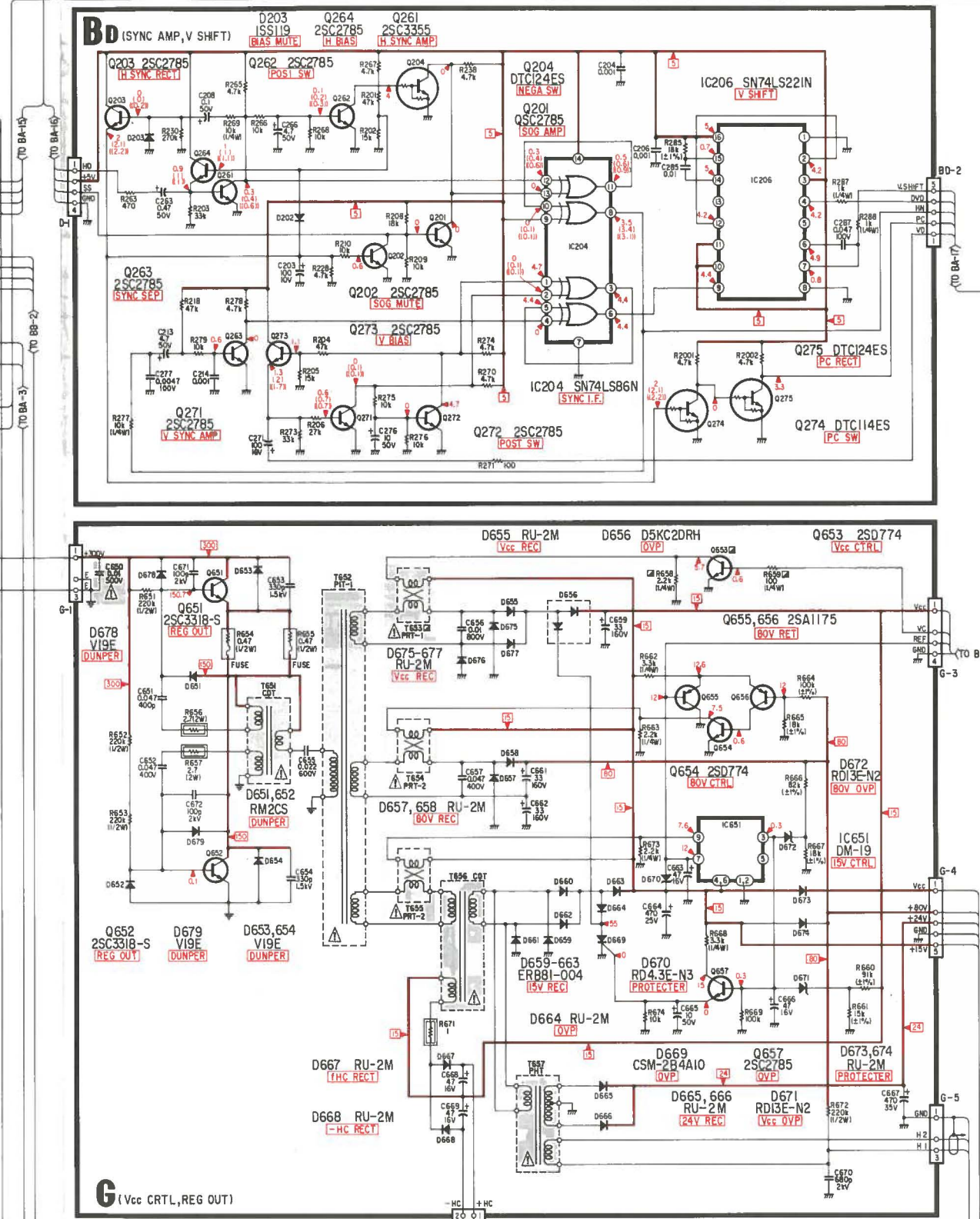
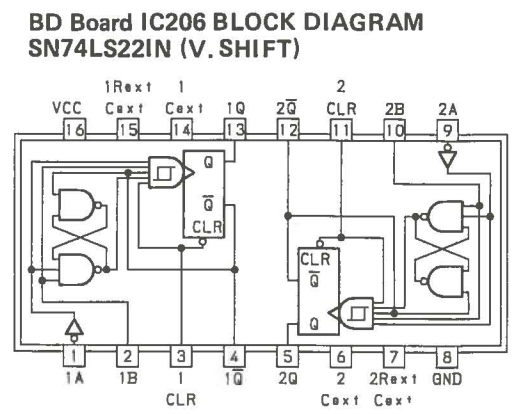
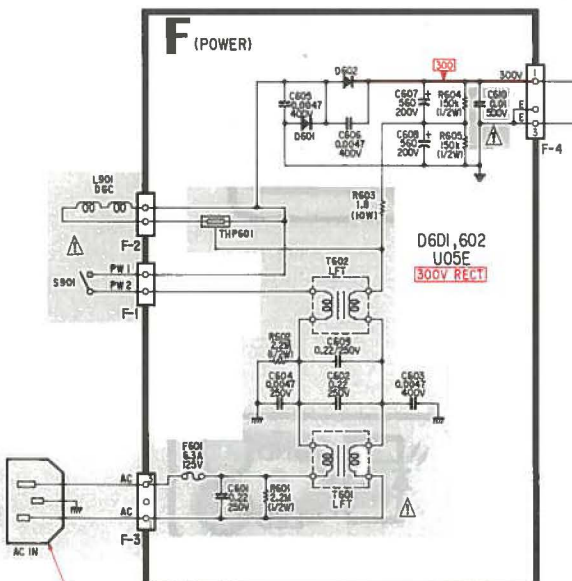
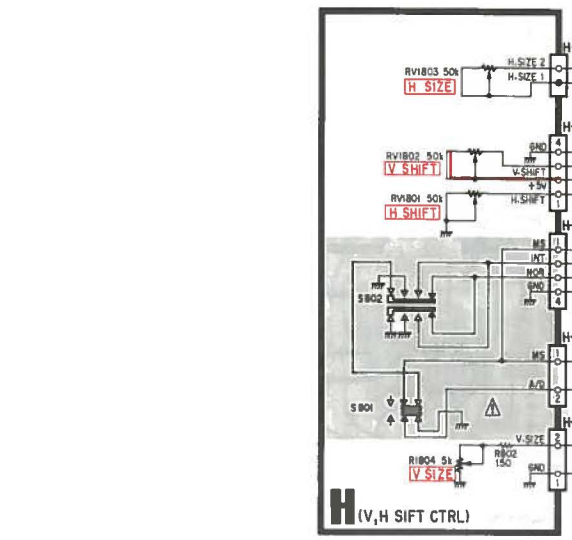

D [V.H.C BLK, FH SW,
H.V OUT.]

H [V, H SIFT CRTL.]

G [Vcc CRTL, REG OUT]

CB [CRT SOCKET]

BD [SYNC AMP, V SHIFT.]

F [POWER]

CA [R.G.B OUT]

1 2 3 4 5 6 7 8 9 10 11 12 13 14 15 16 17

- D Board -

A
B
C
D
E
F
G
H
I
J

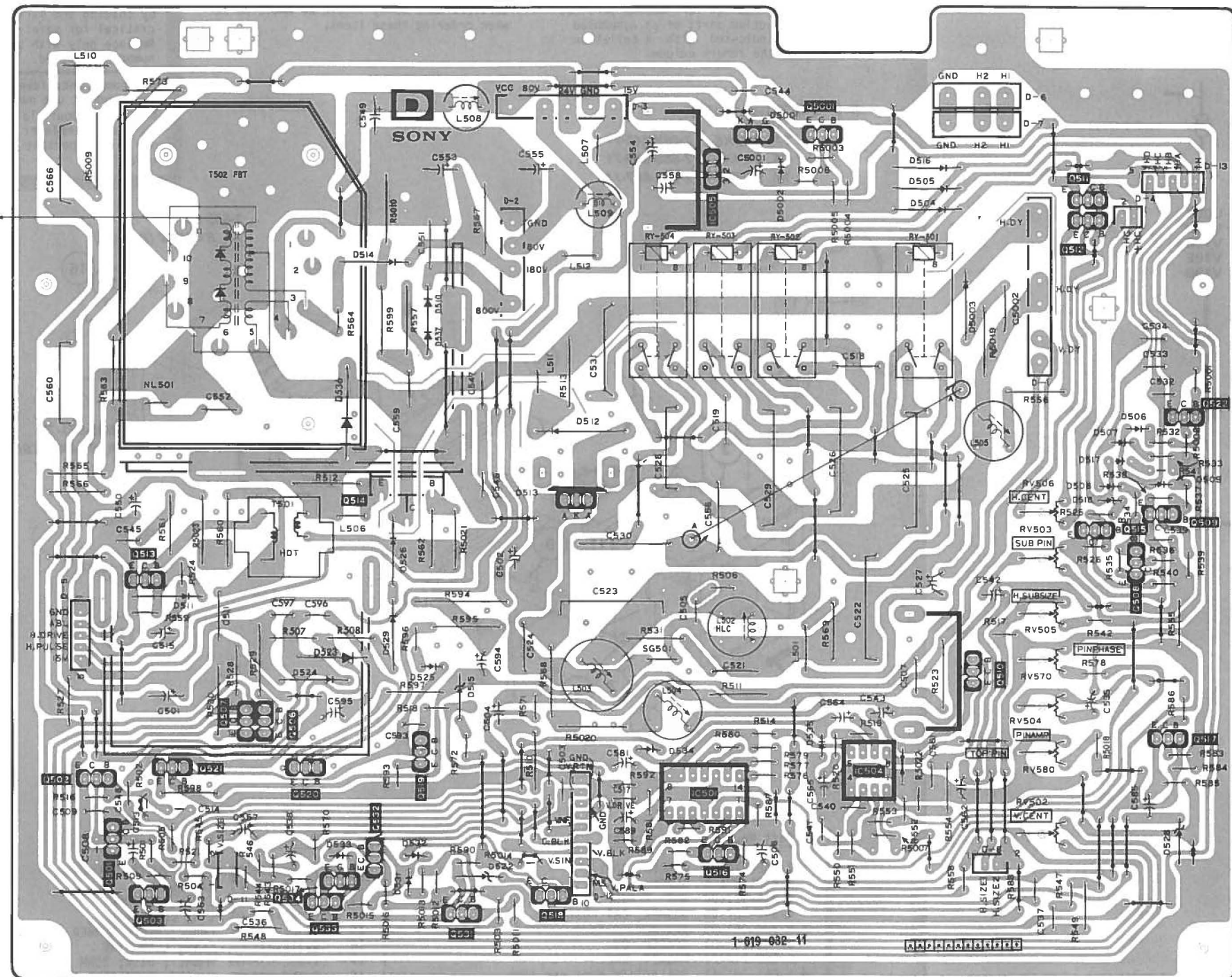

IC, Q	D	ADJ
5001	5001	
IC505	516	
511	5002	
512	505	
	504	
	514	
	5003	
	510	
	522	
	536	
	506	
	512,507	
	517	
	509	
514	508	RV506
509	513	
515	526	
513		RV503
	511	
	529	RV505
	523	
	525	RV570
	510	
	524	
	515	RV504
507		
506		
	517	RV580
519	535	
IC504	534	
521		
502		
520		
IC501		RV502
	528	
501	533	
532	532	
516	531	
534		
503		
533		
518		
531		

- H Board -

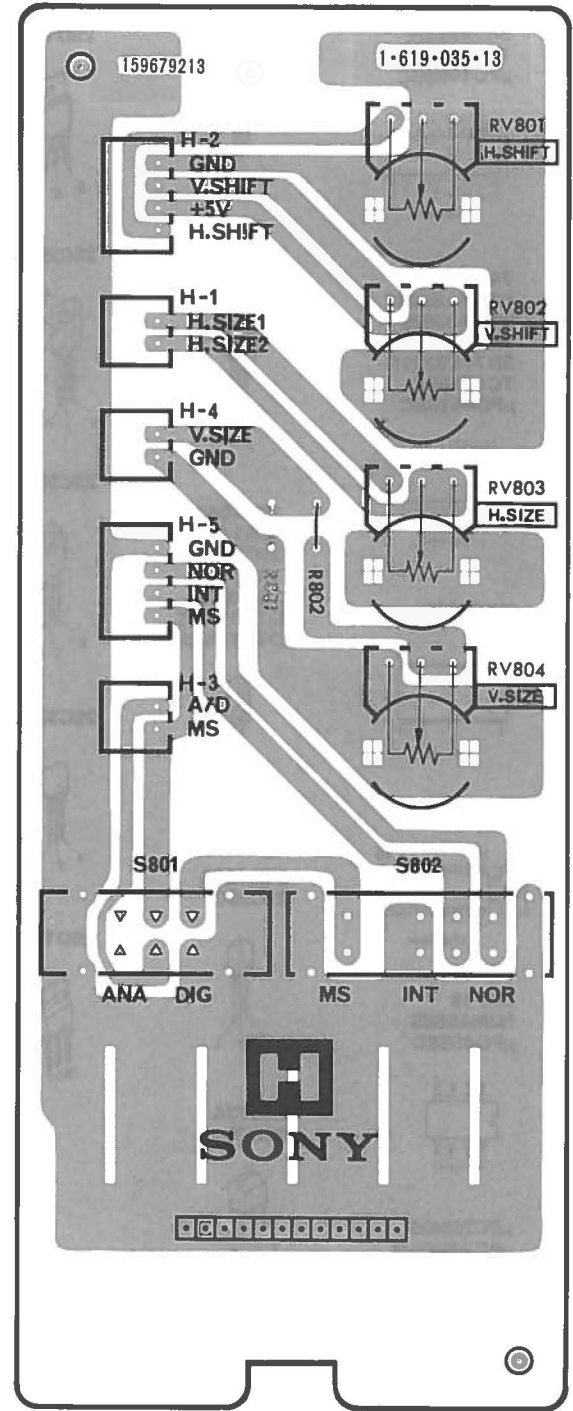

- G Board -

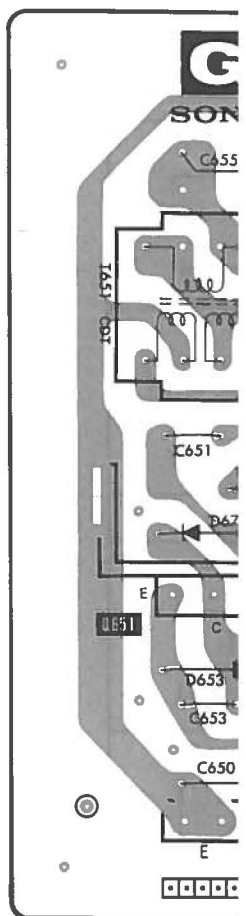

- F Board -

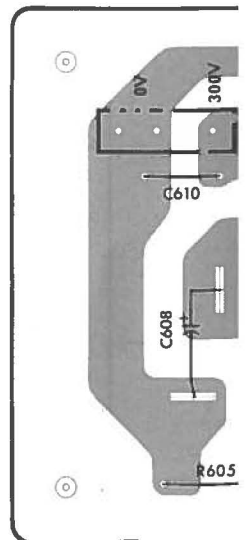

F [POWER] **CA** [R-G-B OUT]

15 16 17 18 19 20 21 22 23 24 25 26 27 28 29 30 31

- G Board -

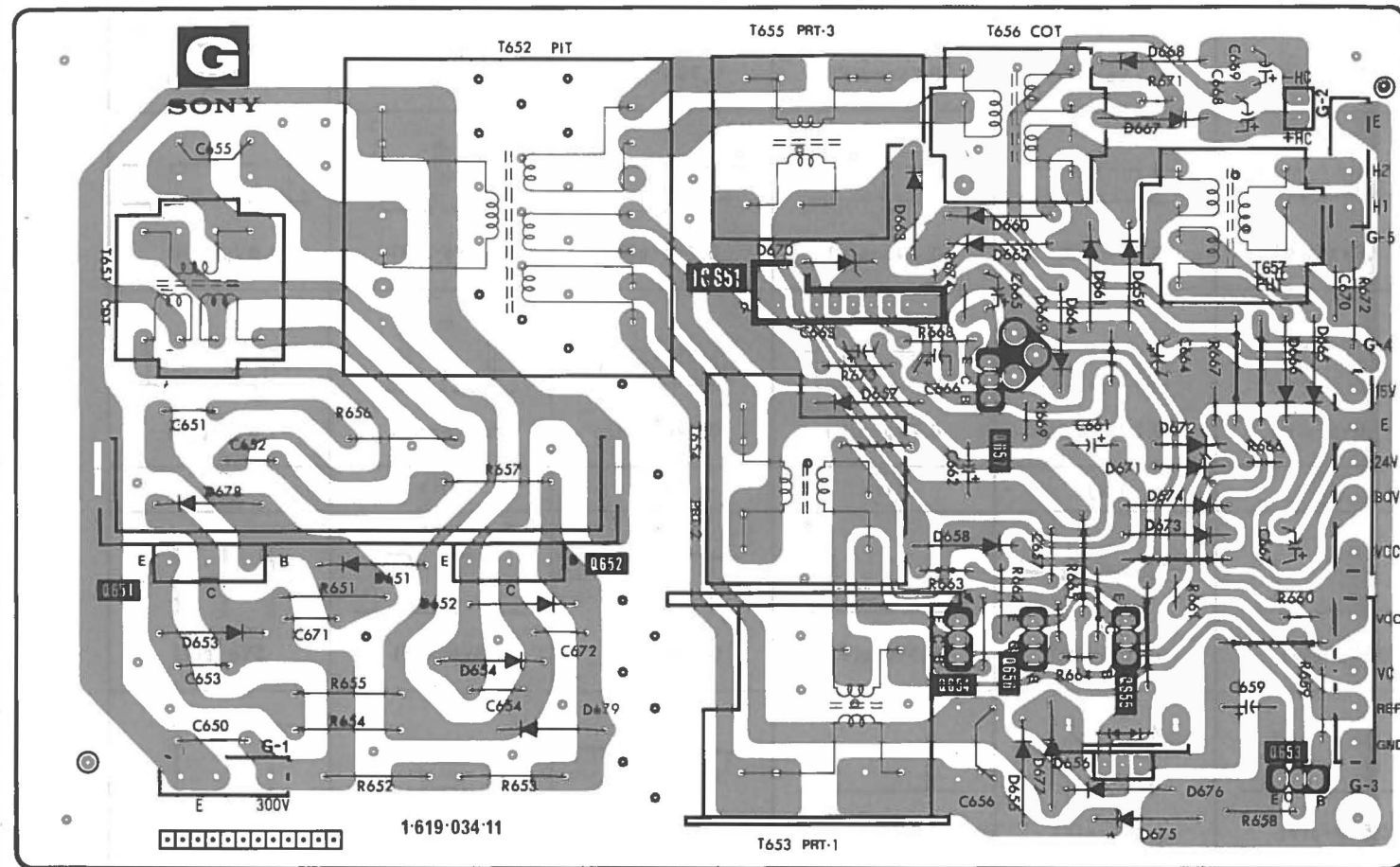

- CB Board -

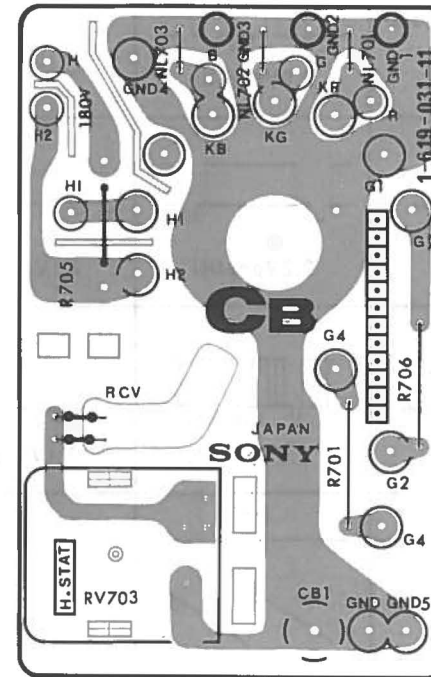

- BD Board -

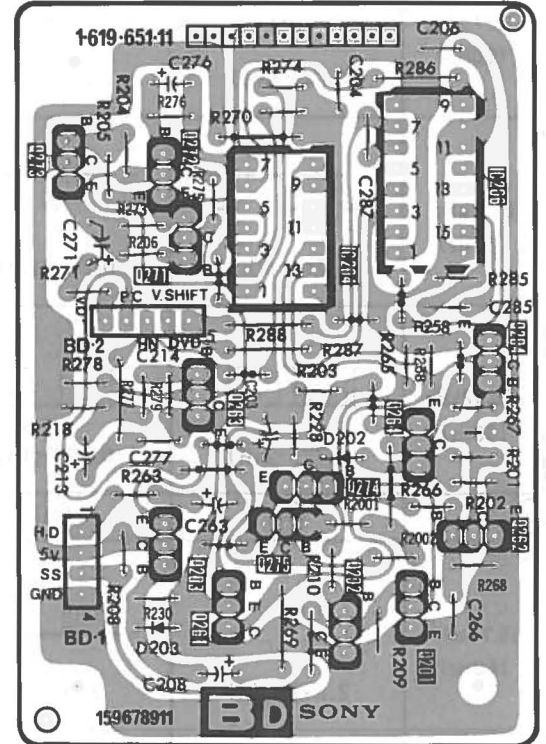

- F Board -

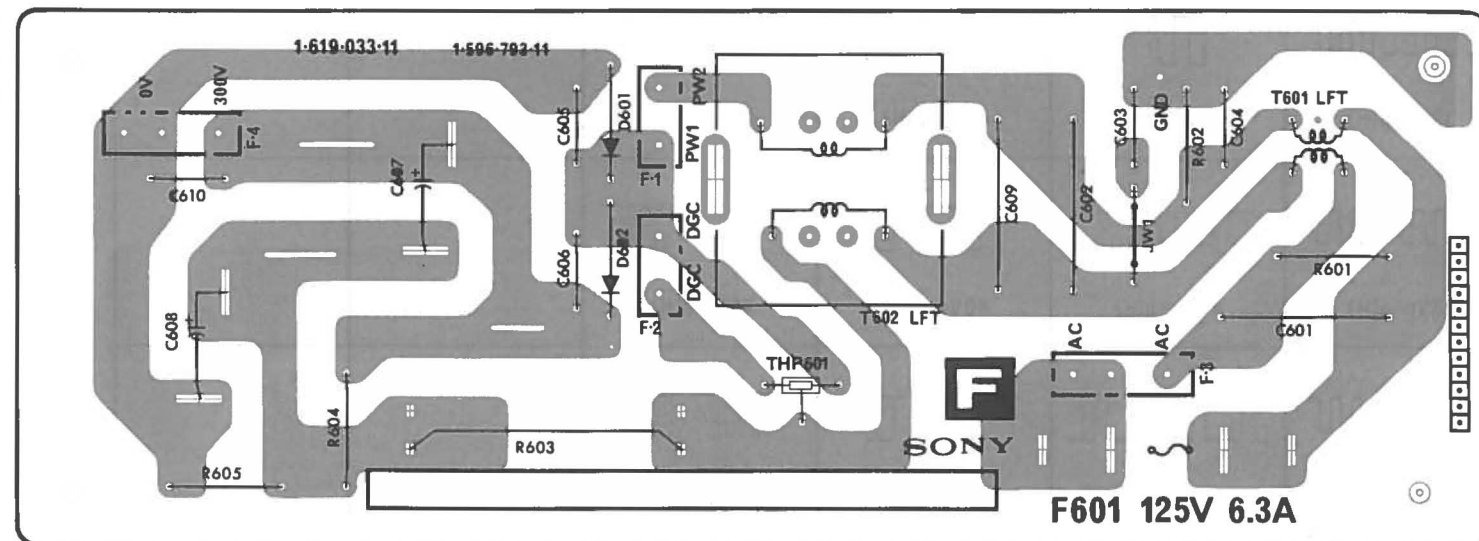

- CA Board -

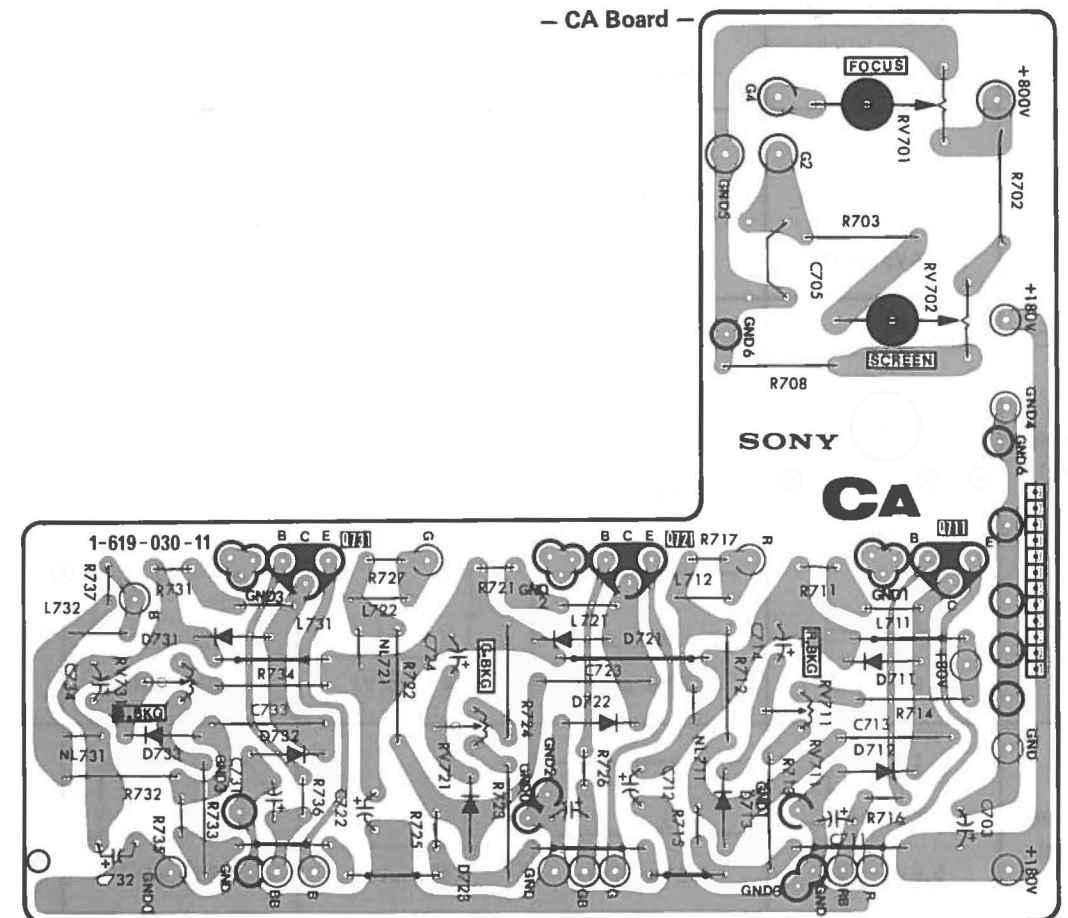

4-5. WAVE FORM

	①	②	③	④	⑤	⑥	⑦	⑧	⑨	⑩	⑪
15.73kHz (60Hz)	0.7Vp-p(H)	0.7Vp-p(H)	0.7Vp-p(H)	2.8Vp-p(H)	2.8Vp-p(H)	2.6Vp-p(H)	0.7Vp-p(H)	0.7Vp-p(H)	0.7Vp-p(H)	5.4Vp-p(H)	2.2Vp-p(H)
21.8kHz (60Hz)	0.7Vp-p(H)	0.7Vp-p(H)	0.7Vp-p(H)	2.2Vp-p(H)	2.1Vp-p(H)	1.8Vp-p(H)	0.7Vp-p(H)	0.7Vp-p(H)	0.7Vp-p(H)	5.4Vp-p(H)	1.8Vp-p(H)
30.12kHz (60Hz)	0.7Vp-p(H)	0.7Vp-p(H)	0.7Vp-p(H)	2.2Vp-p(H)	2.1Vp-p(H)	1.8Vp-p(H)	0.7Vp-p(H)	0.7Vp-p(H)	0.7Vp-p(H)	5.4Vp-p(H)	1.8Vp-p(H)
	⑫	⑬	⑭	⑮	⑯	⑰	⑱	⑲	⑳	㉑	㉒
15.73kHz (60Hz)	2.2Vp-p(H)	2Vp-p(H)	0.48Vp-p(H)	4Vp-p(H)	8.8Vp-p(H)	10.5Vp-p(V)	1.8Vp-p(V)	10.5Vp-p(V)	0.7Vp-p(H)	8Vp-p(H)	5Vp-p(V)
21.8kHz (60Hz)	1.6Vp-p(H)	1.5Vp-p(H)	0.4Vp-p(H)	4Vp-p(H)	8.8Vp-p(H)	10.5Vp-p(V)	1.8Vp-p(V)	10.5Vp-p(V)	0.7Vp-p(H)	8Vp-p(H)	5Vp-p(V)
30.12kHz (60Hz)	1.6Vp-p(H)	1.5Vp-p(H)	0.3Vp-p(H)	4Vp-p(H)	8.8Vp-p(H)	10.5Vp-p(V)	1.8Vp-p(V)	10.5Vp-p(V)	0.7Vp-p(H)	8Vp-p(H)	5Vp-p(V)
	㉓	㉔	㉕	㉖	㉗	㉘	㉙	㉚	㉛		
15.73kHz (60Hz)	5.6Vp-p(V)	5.6Vp-p(V)	7.4Vp-p(V)	32Vp-p(H)	1.6Vp-p(H)	13Vp-p(H)	40Vp-p(H)	40Vp-p(H)	40Vp-p(H)		
21.8kHz (60Hz)	5.6Vp-p(V)	4.8Vp-p(V)	7.4Vp-p(V)	30Vp-p(H)	1.6Vp-p(H)	13Vp-p(H)	40Vp-p(H)	40Vp-p(H)	40Vp-p(H)		
30.12kHz (60Hz)	5.6Vp-p(V)	4.2Vp-p(V)	7.4Vp-p(V)	28Vp-p(H)	1.6Vp-p(H)	13Vp-p(H)	40Vp-p(H)	40Vp-p(H)	40Vp-p(H)		

4-6. SEMICONDUCTORS

74F08PC
MC1495L
MC14066BCP
SN74LS88N
SN74S15N
TC4068BP
μPD4066BC

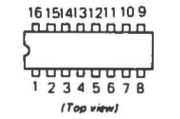

74F138PC
HD74LS221P
HD14638BP
MC14616BCP
SN74LS221N
TC4616BC
μPD4616BC

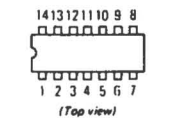

CX22030

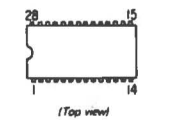

CXA1044P

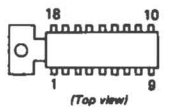

DM-19
NJM4658S
μPD4658C

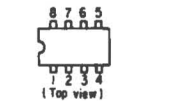

μPC78M05
μPC78M05H
μPC78M12
μPC78M12H
μPC1377C

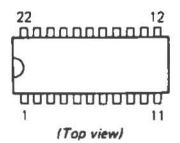

4-6. SEMICONDUCTORS



74F08PC
MC1495L
MC14068BCP
SN74LS86N
SN74S15N
TC4068BP
μPD4068BC

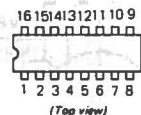

74F138PC
HD74LS221P
HD14538BP
MC14516BCP
SN74LS221N
TC4516BC
μPD4516BC

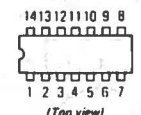

CX22030

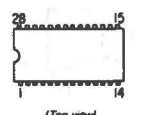

CXA1044P

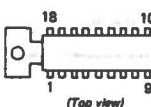

DM-19
NJM4558S
μPD4558C

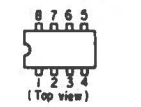

μPC78M05
μPC78M05H
μPC78M12
μPC78M12H
μPC1377C

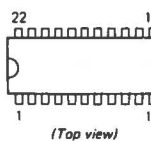

2SA564
2SA933S
2SA1005
2SC1740
2SC3068



2SA1175
2SC2785



2SA1048
2SA1115
2SC403SP
2SC2458
2SC2603
DTC114ES
DTC124ES



2SA1206
2SC2901



2SB734
2SD774



2SB740
2SC2230A
2SD789



2SB940
2SB940P
2SD1134
2SD1264
2SD1264P

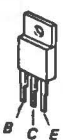

2SC2688



2SC3318-S



2SC3355



2SD1887



1SS83
1DE2
11E2
ERB12-02
ERB12-02V1
ERD09-15
ESIF
RD3.0E-N1
RD3.0F-NIT
RD3.0E-N2
RD3.1E-N1
RD3.1E-N2
RD3.3E-N2
RD3.6E-N1
RD3.6E-N2
RD4.3E-N2
RD4.3E-N3
RD4.3E-N3T
RD4.7E-N2
RD6.2E-N2
RD6.8E-N2
RD8.2E-N2
RD9.1E-N2
RD10E-L2
RD10E-LZ
RD10-E-L3T
RD11E-N2
RD12E-N1
RD12E-NIT
RD12E-N2
RD13E-N2
RD18E-L1
RD18E-L1T
RGP01-17
RGP01-17PKG23

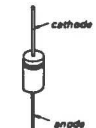

ISS119
ISS133
ISS148

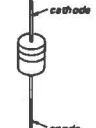

CSM2A4A10
CSM2B4A10

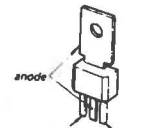

D5KC20RH

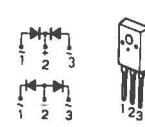

FRB81-004
EMU-26S
RH-1
RM28C
RU-2M
SIB01-02
SIB01-02V1



U05E
V11N
V19C
V19E
V19G



SG232D



SECTION 5
EXPLODED VIEWS

NOTE:

- Items with no part number and no description are not stocked because they are seldom required for routine service.
- The construction parts of an assembled part are indicated with a collation number in the remark column.

- Items marked "★" are not stocked since they are seldom required for routine service. Some delay should be anticipated when ordering these items.

The components identified by shading and mark **▲** are critical for safety. Replace only with part number specified.

Les composants identifiés par une trame et une marque **▲** sont critiques pour la sécurité. Ne les remplacer que par une pièce portant le numéro spécifié.

5-1. PICTURE TUBE

- : TA, BV3X8 7-685-646-71
- : TA, BV4X10 7-685-660-71
- ▲: TA, BV3X10 7-685-647-71

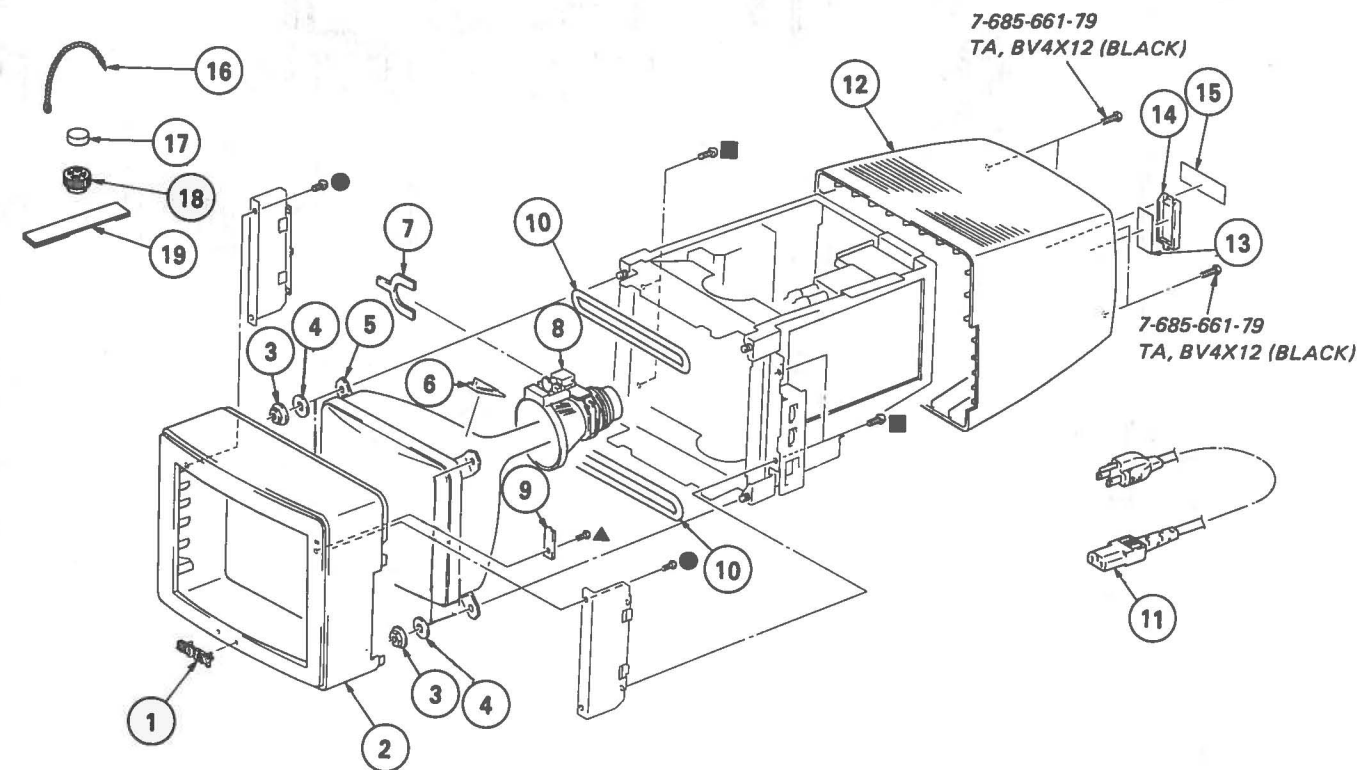

No.	Part No.	Description	Remark	No.	Part No.	Description	Remark
1	*3-668-914-31	EMBLEM, SONY		11	▲1-558-377-11	CORD, POWER	
2	X-4381-801-1	BEZEL ASSY		12	4-381-820-01	CABINET	
3	4-304-511-00	NUT, FLANGE		13	4-381-826-01	LABEL, CONTROL	
4	4-348-567-00	WASHER, CRT POSITION		14	4-381-817-01	LID, CONTROL	
5	▲8-738-251-05	CRT M34JNQ15X		15	*4-381-812-01	LABEL, MODEL NUMBER (SMALL)	
6	3-703-961-01	SPACER, DY		16	4-316-015-01	CLIP, LEAD WIRE	
7	1-452-146-21	MAGNET, BMC		17	1-452-032-00	MAGNET, DISK; 10MM φ	
8	▲1-451-291-11	DEFLECTION YOKE (SY-175)		18	1-452-094-00	MAGNET, ROTATABLE DISK; 15MM φ	
9	*1-619-036-11	X BOARD		19	X-4309-608-0	PERMALLOY ASSY, CONVERGENCE	
10	▲1-426-283-11	COIL, DEMAGNETIZATION					

5-2. CHASSIS ASSY

- : TA, BV3X8 7-685-646-71
- : TA, BV4X10 7-685-660-71
- ▲ : TA, BV3X10 7-685-647-71

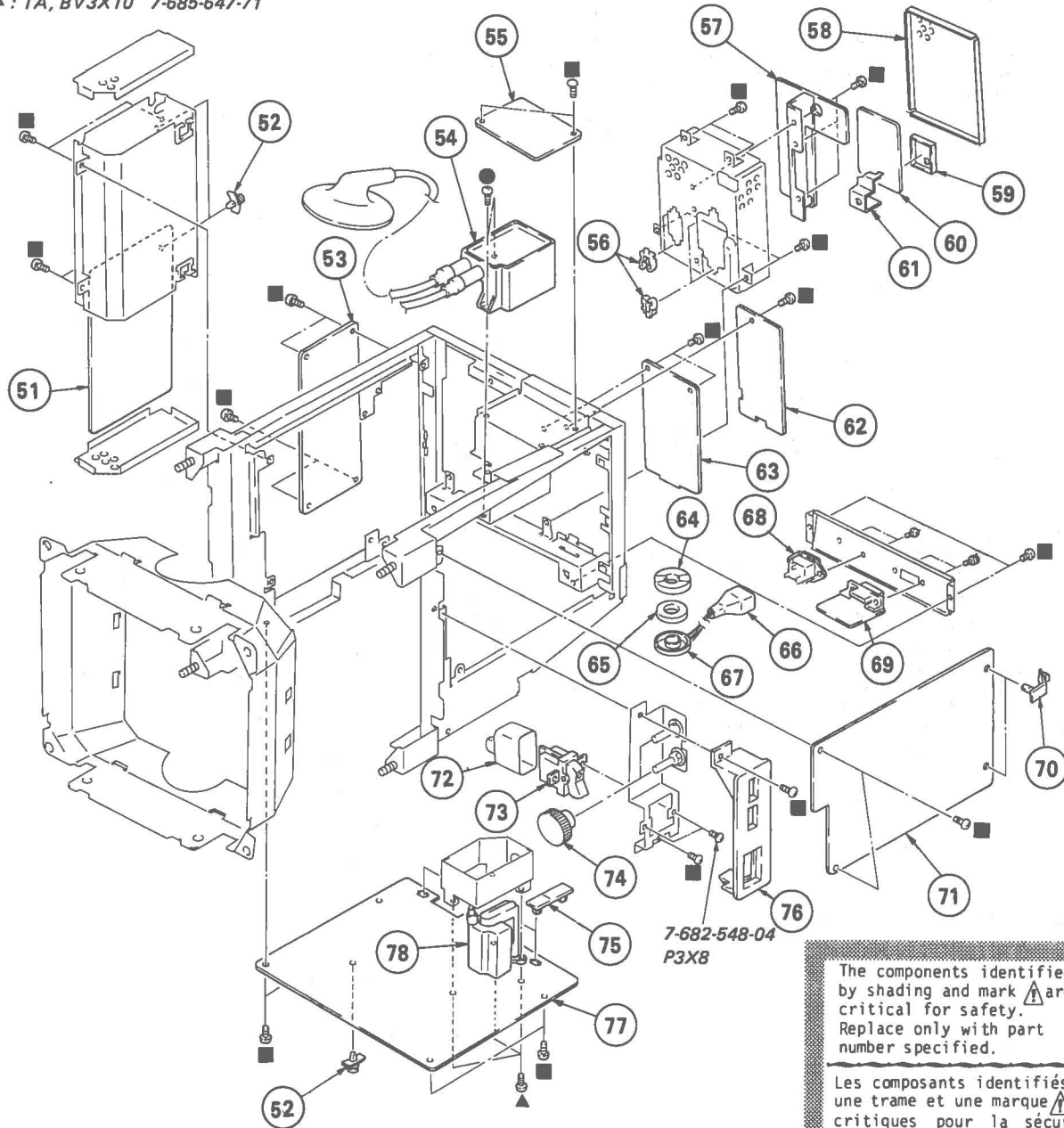

The components identified by shading and mark ▲ are critical for safety. Replace only with part number specified.

Les composants identifiés par une trame et une marque ▲ sont critiques pour la sécurité. Ne les remplacer que par une pièce portant le numéro spécifié.

No.	Part No.	Description	Remark	No.	Part No.	Description	Remark
51	*1-619-034-11	G BOARD		65	1-543-179-00	CORE, RING	
52	*3-703-961-01	SPACER, SUPPORT		66	*4-601-466-11	COVER, 3P INLET	
53	*1-619-033-11	F BOARD		67	*4-361-124-01	COVER (A), CORE	
54	▲1-230-666-11	RESISTOR ASSY, HIGH-VOLTAGE		68	▲1-509-546-11	3P INLET	
55	*1-619-651-11	BD BOARD		69	*1-619-029-11	BC BOARD	
56	4-343-123-00	RETAINER, AC CORD		70	*3-701-832-00	HINGE, CIRCUIT BOARD	
57	*1-619-030-11	CA BOARD		71	*A-1135-387-A	BA BOARD, COMPLETE	
58	*4-377-601-01	COVER		72	*4-381-806-01	COVER, SWITCH	
59	*4-370-995-01	COVER (LOWER), H.STAT		73	▲1-554-953-31	SWITCH, SEESAW (AC POWER)	
60	*1-619-031-11	CB BOARD		74	4-372-107-01	KNOB, ROTARY	
61	*4-370-996-01	COVER (UPPER), H.STAT		75	*4-313-732-00	CLIP, HINGE, CIRCUIT BOARD	
62	*1-619-035-11	H BOARD		76	*4-381-828-01	PANEL, SWITCH	
63	*A-1130-489-A	BB BOARD, COMPLETE		77	*A-1340-829-A	D BOARD, COMPLETE	
64	*4-361-125-01	COVER (B), CORE		78	▲1-439-390-11	TRANSFORMER ASSY, FLYBACK	

BB

SECTION 6 ELECTRICAL PARTS LIST

NOTE:

The components identified by shading and mark are critical for safety. Replace only with part number specified.

Les composants identifiés par une trame et une marque sont critiques pour la sécurité. Ne les remplacer que par une pièce portant le numéro spécifié.

- Items marked " * " are not stocked since they are seldom required for routine service. Some delay should be anticipated when ordering these items.
- All variable and adjustable resistors have characteristic curve B, unless otherwise noted.

CAPACITORS

- MF : μ F, PF : μ MF

RESISTORS

- All resistors are in ohms
- F : nonflammable

COILS

- MMH : mH, UH : μ H

When indicating parts by reference number, please include the board name.

Ref.No.	Part No.	Description	Remark	Ref.No.	Part No.	Description	Remark
*A-1130-489-A	BB BOARD, COMPLETE	*****		Q105	8-729-110-52	TRANSISTOR 2SA1005-L	
CONNECTOR				Q106	8-729-110-52	TRANSISTOR 2SA1005-L	
BB1	*1-564-441-11	PLUG, CONNECTOR (2.5MM) 5P		Q107	8-729-110-52	TRANSISTOR 2SA1005-L	
BB2	*1-564-440-11	PLUG, CONNECTOR (2.5MM) 4P		Q108	8-729-110-52	TRANSISTOR 2SA1005-L	
BB3	*1-564-443-11	PLUG, CONNECTOR (2.5MM) 7P		Q109	8-729-603-30	TRANSISTOR 2SC403SP-3	
BB4	*1-564-443-11	PLUG, CONNECTOR (2.5MM) 7P		Q110	8-729-603-30	TRANSISTOR 2SC403SP-3	
CAPACITOR				Q111	8-729-603-30	TRANSISTOR 2SC403SP-3	
C101	1-102-959-00	CERAMIC 22PF 5% 50V		Q112	8-729-603-30	TRANSISTOR 2SC403SP-3	
C102	1-102-959-00	CERAMIC 22PF 5% 50V		Q113	8-729-603-30	TRANSISTOR 2SC403SP-3	
C103	1-102-959-00	CERAMIC 22PF 5% 50V		Q114	8-729-603-30	TRANSISTOR 2SC403SP-3	
C104	1-102-959-00	CERAMIC 22PF 5% 50V		Q115	8-729-603-30	TRANSISTOR 2SC403SP-3	
C105	1-102-959-00	CERAMIC 22PF 5% 50V		Q116	8-729-603-30	TRANSISTOR 2SC403SP-3	
C106	1-102-959-00	CERAMIC 22PF 5% 50V		Q117	8-729-603-30	TRANSISTOR 2SC403SP-3	
C107	1-102-959-00	CERAMIC 22PF 5% 50V		Q118	8-729-603-30	TRANSISTOR 2SC403SP-3	
C108	1-102-959-00	CERAMIC 22PF 5% 50V		Q119	8-729-603-30	TRANSISTOR 2SC403SP-3	
C109	1-124-445-00	ELECT 100MF 20% 16V		Q120	8-729-603-30	TRANSISTOR 2SC403SP-3	
C110	1-124-445-00	ELECT 100MF 20% 16V		Q121	8-729-603-30	TRANSISTOR 2SC403SP-3	
C111	1-124-478-11	ELECT 100MF 20% 25V		RESISTOR			
C112	1-124-902-00	ELECT 0.47MF 20% 50V		R101	1-249-429-11	CARBON 10K 5% 1/6W	
C113	1-124-927-11	ELECT 4.7MF 20% 50V		R102	1-249-425-11	CARBON 4.7K 5% 1/6W	
DIODE				R103	1-249-425-11	CARBON 4.7K 5% 1/6W	
D101	8-719-911-19	DIODE 1SS119		R104	1-249-425-11	CARBON 4.7K 5% 1/6W	
D102	8-719-911-19	DIODE 1SS119		R105	1-249-429-11	CARBON 10K 5% 1/6W	
D103	8-719-911-19	DIODE 1SS119		R106	1-249-425-11	CARBON 4.7K 5% 1/6W	
D104	8-719-911-19	DIODE 1SS119		R107	1-249-419-11	CARBON 1.5K 5% 1/6W	
D105	8-719-911-19	DIODE 1SS119		R108	1-249-429-11	CARBON 10K 5% 1/6W	
D106	8-719-911-19	DIODE 1SS119		R109	1-249-433-11	CARBON 22K 5% 1/6W	
D107	8-719-911-19	DIODE 1SS119		R110	1-249-425-11	CARBON 4.7K 5% 1/6W	
D108	8-719-911-19	DIODE 1SS119		R111	1-249-429-11	CARBON 10K 5% 1/6W	
D109	8-719-911-19	DIODE 1SS119		R112	1-249-425-11	CARBON 4.7K 5% 1/6W	
D110	8-719-911-19	DIODE 1SS119		R113	1-249-433-11	CARBON 22K 5% 1/6W	
D111	8-719-911-19	DIODE 1SS119		R114	1-249-425-11	CARBON 4.7K 5% 1/6W	
D112	8-719-911-19	DIODE 1SS119		R115	1-249-425-11	CARBON 4.7K 5% 1/6W	
D113	8-719-911-19	DIODE 1SS119		R116	1-215-423-00	METAL 1.2K 1% 1/6W	
D114	8-719-911-19	DIODE 1SS119		R117	1-215-423-00	METAL 1.2K 1% 1/6W	
IC				R118	1-215-423-00	METAL 1.2K 1% 1/6W	
IC101	8-759-904-81	IC 74F08PC		R119	1-215-423-00	METAL 1.2K 1% 1/6W	
IC102	8-759-904-81	IC 74F08PC		R120	1-215-423-00	METAL 1.2K 1% 1/6W	
IC103	8-759-910-15	IC SN74S15N		R121	1-215-423-00	METAL 1.2K 1% 1/6W	
IC104	8-759-910-15	IC SN74S15N		R122	1-215-423-00	METAL 1.2K 1% 1/6W	
IC105	8-759-910-15	IC SN74S15N		R123	1-215-423-00	METAL 1.2K 1% 1/6W	
IC106	8-759-917-52	IC 74F138PC		R124	1-215-403-00	METAL 180 1% 1/6W	
TRANSISTOR				R125	1-215-403-00	METAL 180 1% 1/6W	
Q101	8-729-110-52	TRANSISTOR 2SA1005-L		R126	1-215-403-00	METAL 180 1% 1/6W	
Q102	8-729-110-52	TRANSISTOR 2SA1005-L		R127	1-215-403-00	METAL 180 1% 1/6W	
Q103	8-729-110-52	TRANSISTOR 2SA1005-L		R128	1-215-403-00	METAL 180 1% 1/6W	
Q104	8-729-110-52	TRANSISTOR 2SA1005-L		R129	1-215-403-00	METAL 180 1% 1/6W	
				R130	1-215-403-00	METAL 180 1% 1/6W	
				R131	1-215-403-00	METAL 180 1% 1/6W	
				R132	1-215-413-00	METAL 470 1% 1/6W	
				R133	1-215-413-00	METAL 470 1% 1/6W	
				R134	1-215-413-00	METAL 470 1% 1/6W	



Ref.No.	Part No.	Description	Quantity	Unit	Remark
R135	1-215-413-00	METAL	470	1%	1/6W
R136	1-215-413-00	METAL	470	1%	1/6W
R137	1-214-721-00	METAL	470	1%	1/4W
R138	1-215-413-00	METAL	470	1%	1/6W
R139	1-215-413-00	METAL	470	1%	1/6W
R140	1-249-419-11	CARBON	1.5K	5%	1/6W
R141	1-249-419-11	CARBON	1.5K	5%	1/6W
R142	1-249-419-11	CARBON	1.5K	5%	1/6W
R143	1-249-419-11	CARBON	1.5K	5%	1/6W
R144	1-249-419-11	CARBON	1.5K	5%	1/6W
R145	1-249-419-11	CARBON	1.5K	5%	1/6W
R146	1-249-419-11	CARBON	1.5K	5%	1/6W
R147	1-249-419-11	CARBON	1.5K	5%	1/6W
R148	1-215-423-00	METAL	1.2K	1%	1/6W
R149	1-215-431-00	METAL	2.7K	1%	1/6W
R150	1-215-431-00	METAL	2.7K	1%	1/6W
R151	1-215-423-00	METAL	1.2K	1%	1/6W
R152	1-215-431-00	METAL	2.7K	1%	1/6W
R153	1-215-431-00	METAL	2.7K	1%	1/6W
R154	1-215-423-00	METAL	1.2K	1%	1/6W
R155	1-215-423-00	METAL	1.2K	1%	1/6W
R156	1-215-431-00	METAL	2.7K	1%	1/6W
R157	1-214-739-00	METAL	2.7K	1%	1/4W
R158	1-247-833-00	CARBON	1.2K	5%	1/6W
R159	1-247-833-00	CARBON	1.2K	5%	1/6W
R160	1-249-419-11	CARBON	1.5K	5%	1/6W
R161	1-249-419-11	CARBON	1.5K	5%	1/6W
R162	1-249-419-11	CARBON	1.5K	5%	1/6W
R163	1-249-433-11	CARBON	22K	5%	1/6W
R164	1-247-839-00	CARBON	2.2K	5%	1/6W
R165	1-247-829-00	CARBON	820	5%	1/6W
R166	1-247-829-00	CARBON	820	5%	1/6W
R167	1-247-829-00	CARBON	820	5%	1/6W
R168	1-249-433-11	CARBON	22K	5%	1/6W
R169	1-249-433-11	CARBON	22K	5%	1/6W
R170	1-249-433-11	CARBON	22K	5%	1/6W
R171	1-249-429-11	CARBON	10K	5%	1/6W
R172	1-249-425-11	CARBON	4.7K	5%	1/6W
R173	1-249-425-11	CARBON	4.7K	5%	1/6W
R174	1-247-708-11	CARBON	470	5%	1/4W
R175	1-249-441-11	CARBON	100K	5%	1/6W
R176	1-249-423-11	CARBON	3.3K	5%	1/6W
R177	1-249-423-11	CARBON	3.3K	5%	1/6W
R178	1-249-423-11	CARBON	3.3K	5%	1/6W
R179	1-247-823-00	CARBON	470	5%	1/6W
R180	1-247-804-00	CARBON	75	5%	1/6W
R181	1-247-823-00	CARBON	470	5%	1/6W
R182	1-247-823-00	CARBON	470	5%	1/6W
R183	1-247-804-00	CARBON	75	5%	1/6W
R184	1-247-823-00	CARBON	470	5%	1/6W
R185	1-247-823-00	CARBON	470	5%	1/6W
R186	1-247-104-00	CARBON	75	5%	1/4W
R187	1-247-823-00	CARBON	470	5%	1/6W

Ref.No.	Part No.	Description	Quantity	Unit	Remark
R188	1-249-429-11	CARBON	10K	5%	1/6W
R189	1-249-417-11	CARBON	1K	5%	1/6W

*A-1130-510-A BD BOARD, COMPLETE					

CONNECTOR					
BD1	*1-564-440-11	PLUG, CONNECTOR (2.5MM)	4P		
BD2	*1-564-441-11	PLUG, CONNECTOR (2.5MM)	5P		
CAPACITOR					
C203	1-124-443-00	ELECT	100MF	20%	10V
C204	1-102-074-00	CERAMIC	0.001MF	10%	50V
C206	1-101-004-00	CERAMIC	0.01MF		50V
C208	1-123-607-00	ELECT	0.1MF	20%	50V
C213	1-124-927-11	ELECT	4.7MF	20%	50V
C214	1-101-001-00	CERAMIC	0.001MF		50V
C263	1-124-902-00	ELECT	0.47MF	20%	50V
C266	1-124-927-11	ELECT	4.7MF	20%	50V
C271	1-124-445-00	ELECT	100MF	20%	16V
C276	1-124-907-00	ELECT	10MF	20%	50V
C277	1-108-622-91	MYLAR	0.0047MF	10%	100V
C285	1-106-196-00	MYLAR	0.01MF	10%	100V
C287	1-106-212-00	MYLAR	0.047MF	10%	100V
DIODE					
D202	8-719-911-19	DIODE 1SS119			
D203	8-719-911-19	DIODE 1SS119			
IC					
IC204	8-759-900-86	IC SN74LS86N			
IC206	8-759-902-21	IC SN74LS221N			
TRANSISTOR					
Q201	8-729-178-54	TRANSISTOR 2SC2785			
Q202	8-729-178-54	TRANSISTOR 2SC2785			
Q203	8-729-178-54	TRANSISTOR 2SC2785			
Q204	8-729-900-36	TRANSISTOR DTC124ES			
Q261	8-729-104-80	TRANSISTOR 2SC3355			
Q262	8-729-178-54	TRANSISTOR 2SC2785			
Q263	8-729-178-54	TRANSISTOR 2SC2785			
Q264	8-729-178-54	TRANSISTOR 2SC2785			
Q271	8-729-178-54	TRANSISTOR 2SC2785			
Q272	8-729-178-54	TRANSISTOR 2SC2785			
Q273	8-729-178-54	TRANSISTOR 2SC2785			
Q274	8-729-900-80	TRANSISTOR DTC114ES			
Q275	8-729-900-36	TRANSISTOR DTC124ES			



Ref.No.	Part No.	Description	Remark
<u>RESISTOR</u>			
R201	1-249-437-11	CARBON 47K 5% 1/6W	
R202	1-247-859-00	CARBON 15K 5% 1/6W	
R203	1-249-435-11	CARBON 33K 5% 1/6W	
R204	1-249-437-11	CARBON 47K 5% 1/6W	
R205	1-247-859-00	CARBON 15K 5% 1/6W	
R206	1-249-434-11	CARBON 27K 5% 1/6W	
R208	1-249-432-11	CARBON 18K 5% 1/6W	
R209	1-249-429-11	CARBON 10K 5% 1/6W	
R210	1-249-429-11	CARBON 10K 5% 1/6W	
R218	1-249-437-11	CARBON 47K 5% 1/6W	
R228	1-249-425-11	CARBON 4.7K 5% 1/6W	
R230	1-247-889-00	CARBON 270K 5% 1/6W	
R238	1-249-425-11	CARBON 4.7K 5% 1/6W	
R263	1-247-823-00	CARBON 470 5% 1/6W	
R265	1-249-425-11	CARBON 4.7K 5% 1/6W	
R266	1-249-429-11	CARBON 10K 5% 1/6W	
R267	1-249-425-11	CARBON 4.7K 5% 1/6W	
R268	1-249-429-11	CARBON 10K 5% 1/6W	
R269	1-247-725-11	CARBON 10K 5% 1/4W	
R270	1-249-425-11	CARBON 4.7K 5% 1/6W	
R271	1-249-405-11	CARBON 100 5% 1/6W	
R273	1-249-435-11	CARBON 33K 5% 1/6W	
R274	1-249-425-11	CARBON 4.7K 5% 1/6W	
R275	1-249-429-11	CARBON 10K 5% 1/6W	
R276	1-249-429-11	CARBON 10K 5% 1/6W	
R277	1-247-725-11	CARBON 10K 5% 1/4W	
R278	1-249-425-11	CARBON 4.7K 5% 1/6W	
R279	1-249-429-11	CARBON 10K 5% 1/6W	
R285	1-215-451-00	METAL 18K 1% 1/6W	
R286	1-247-713-11	CARBON 1K 5% 1/4W	
R287	1-247-713-11	CARBON 1K 5% 1/4W	
R288	1-247-713-11	CARBON 1K 5% 1/4W	
R2001	1-249-425-11	CARBON 4.7K 5% 1/6W	
R2002	1-249-425-11	CARBON 4.7K 5% 1/6W	

*A-1135-387-A BA BOARD, COMPLETE

Ref.No.	Part No.	Description	Remark
<u>CONNECTOR</u>			
BA1	*1-564-441-11	PLUG, CONNECTOR (2.5MM) 5P	
BA2	*1-564-354-00	PLUG, CONNECTOR (2.5MM) 3P	
BA3	*1-564-353-00	PLUG, CONNECTOR (2.5MM) 2P	
BA4	*1-564-443-11	PLUG, CONNECTOR (2.5MM) 7P	
BA5	*1-564-443-11	PLUG, CONNECTOR (2.5MM) 7P	
BA6	*1-564-444-11	PLUG, CONNECTOR (2.5MM) 8P	
BA7	*1-564-354-00	PLUG, CONNECTOR (2.5MM) 3P	
BA8	*1-564-353-00	PLUG, CONNECTOR (2.5MM) 2P	
BA9	*1-564-445-31	PLUG, CONNECTOR (2.5MM) 9P	
BA10	*1-564-446-11	PLUG, CONNECTOR (2.5MM) 10P	
BA11	*1-564-441-11	PLUG, CONNECTOR (2.5MM) 5P	

Ref.No.	Part No.	Description	Remark
BA12	*1-564-441-11	PLUG, CONNECTOR (2.5MM) 5P	
BA13	*1-564-441-11	PLUG, CONNECTOR (2.5MM) 5P	
BA14	*1-564-440-11	PLUG, CONNECTOR (2.5MM) 4P	
BA15	*1-564-440-11	PLUG, CONNECTOR (2.5MM) 4P	
BA16	*1-564-440-11	PLUG, CONNECTOR (2.5MM) 4P	
BA17	*1-564-441-11	PLUG, CONNECTOR (2.5MM) 5P	
BA18	*1-564-444-11	PLUG, CONNECTOR (2.5MM) 8P	
<u>CAPACITOR</u>			
C201	1-124-127-91	ELECT 100MF 20% 25V	
C202	1-124-478-11	ELECT 100MF 20% 25V	
C205	1-101-004-00	CERAMIC 0.01MF 50V	
C207	1-124-927-11	ELECT 4.7MF 20% 50V	
C209	1-123-973-00	ELECT 100MF 20% 16V	
C210	1-102-114-00	CERAMIC 470PF 10% 50V	
C211	1-124-481-11	ELECT 22MF 20% 25V	
C212	1-124-478-11	ELECT 100MF 20% 25V	
C215	1-102-947-00	CERAMIC 10PF 5% 50V	
C221	1-124-481-11	ELECT 22MF 20% 25V	
C222	1-124-478-11	ELECT 100MF 20% 25V	
C231	1-124-481-11	ELECT 22MF 20% 25V	
C232	1-124-478-11	ELECT 100MF 20% 25V	
C240	1-124-903-00	ELECT 1MF 20% 50V	
C241	1-102-978-00	CERAMIC 220PF 5% 50V	
C242	1-124-445-00	ELECT 100MF 20% 16V	
C243	1-124-903-00	ELECT 1MF 20% 50V	
C244	1-124-478-11	ELECT 100MF 20% 25V	
C245	1-124-902-00	ELECT 0.47MF 20% 50V	
C246	1-124-902-00	ELECT 0.47MF 20% 50V	
C247	1-124-927-11	ELECT 4.7MF 20% 50V	
C250	1-102-114-00	CERAMIC 470PF 10% 50V	
C251	1-124-478-11	ELECT 100MF 20% 25V	
C281	1-102-500-00	CERAMIC 150PF 5% 50V	
C282	1-102-500-00	CERAMIC 150PF 5% 50V	
C283	1-102-500-00	CERAMIC 150PF 5% 50V	
C284	1-102-492-00	CERAMIC 56PF 5% 50V	
C290	1-124-445-00	ELECT 100MF 20% 16V	
C294	1-124-903-00	ELECT 1MF 20% 50V	
C301	1-124-271-00	ELECT 1MF 20% 50V	
C302	1-124-907-00	ELECT 10MF 20% 50V	
C303	1-101-004-00	CERAMIC 0.01MF 50V	
C304	1-136-173-00	FILM 0.47MF 5% 50V	
C305	1-124-902-00	ELECT 0.47MF 20% 50V	
C306	1-124-907-00	ELECT 10MF 20% 50V	
C307	1-124-475-11	ELECT 470MF 20% 16V	
C308	1-124-903-00	ELECT 1MF 20% 50V	
C309	1-136-173-00	FILM 0.47MF 5% 50V	
C310	1-108-627-91	MYLAR 0.012MF 10% 100V	
C311	1-136-173-00	FILM 0.47MF 5% 50V	
C312	1-136-165-00	FILM 0.1MF 5% 50V	
C314	1-124-903-00	ELECT 1MF 20% 50V	
C315	1-123-332-00	ELECT 47MF 20% 16V	
C316	1-102-114-00	CERAMIC 470PF 10% 50V	



Ref.No.	Part No.	Description	Remark	Ref.No.	Part No.	Description	Remark
C317	1-110-201-00	MYLAR	0.0033MF 5%	50V	C2020	1-101-006-00	CERAMIC 0.047MF 50V
C318	1-124-927-11	ELECT	4.7MF 20%	50V	C2023	1-124-127-91	ELECT 100MF 20% 25V
C319	1-124-904-00	ELECT	2.2MF 20%	50V	C2024	1-102-118-00	CERAMIC 0.0012MF 10% 50V
C320	1-102-112-00	CERAMIC	330PF 10%	50V	C2025	1-106-196-00	MYLAR 0.01MF 10% 100V
C321	1-102-973-00	CERAMIC	100PF 5%	50V	C2030	1-101-006-00	CERAMIC 0.047MF 50V
C322	1-124-903-00	ELECT	1MF 20%	50V	C2033	1-124-127-91	ELECT 100MF 20% 25V
C324	1-108-812-91	MYLAR	0.047MF 5%	50V	C2034	1-102-118-00	CERAMIC 0.0012MF 10% 50V
C325	1-136-173-00	FILM	0.47MF 5%	50V	C2035	1-106-196-00	MYLAR 0.01MF 10% 100V
C326	1-124-445-00	ELECT	100MF 20%	16V	C3001	1-124-443-00	ELECT 100MF 20% 10V
C327	1-124-907-00	ELECT	10MF 20%	50V	C3002	1-136-165-00	FILM 0.1MF 5% 50V
C328	1-123-332-00	ELECT	47MF 20%	16V	<u>DIODE</u>		
C329	1-102-074-00	CERAMIC	0.001MF 10%	50V	D201	8-719-911-19	DIODE 1SS119
C330	1-102-074-00	CERAMIC	0.001MF 10%	50V	D204	8-719-102-49	DIODE RD3.0E-N1
C331	1-106-196-00	MYLAR	0.01MF 10%	100V	D205	8-719-911-19	DIODE 1SS119
C332	1-124-907-00	ELECT	10MF 20%	50V	D211	8-719-911-19	DIODE 1SS119
C333	1-136-173-00	FILM	0.47MF 5%	50V	D212	8-719-911-19	DIODE 1SS119
C334	1-124-038-00	ELECT	1MF 20%	50V	D214	8-719-911-19	DIODE 1SS119
C335	1-124-903-00	ELECT	1MF 20%	50V	D221	8-719-911-19	DIODE 1SS119
C336	1-136-165-00	FILM	0.1MF 5%	50V	D222	8-719-911-19	DIODE 1SS119
C337	1-108-622-91	MYLAR	0.0047MF 10%	100V	D224	8-719-911-19	DIODE 1SS119
C401	1-124-907-00	ELECT	10MF 20%	50V	D231	8-719-911-19	DIODE 1SS119
C402	1-124-903-00	ELECT	1MF 20%	50V	D232	8-719-911-19	DIODE 1SS119
C403	1-124-557-11	ELECT	1000MF 20%	25V	D234	8-719-911-19	DIODE 1SS119
C404	1-124-445-00	ELECT	100MF 20%	16V	D254	8-719-911-19	DIODE 1SS119
C405	1-124-445-00	ELECT	100MF 20%	16V	D255	8-719-911-19	DIODE 1SS119
C406	1-123-332-00	ELECT	47MF 20%	16V	D256	8-719-911-19	DIODE 1SS119
C407	1-102-129-00	CERAMIC	0.01MF 10%	50V	D291	8-719-911-19	DIODE 1SS119
C408	1-124-905-11	ELECT	3.3MF 20%	50V	D292	8-719-911-19	DIODE 1SS119
C409	1-101-004-00	CERAMIC	0.01MF 50V		D293	8-719-911-19	DIODE 1SS119
C410	1-101-004-00	CERAMIC	0.01MF 50V		D294	8-719-911-19	DIODE 1SS119
C411	1-106-192-00	MYLAR	0.0068MF 10%	100V	D301	8-719-102-84	DIODE RD8.2E-N2
C412	1-108-620-91	MYLAR	0.0033MF 10%	100V	D302	8-719-102-58	DIODE RD3.6E-N2
C413	1-124-896-00	ELECT	33MF 20%	16V	D303	8-719-911-19	DIODE 1SS119
C414	1-102-129-00	CERAMIC	0.01MF 10%	50V	D304	8-719-102-74	DIODE RD6.2E-N2
C415	1-124-904-00	ELECT	2.2MF 20%	50V	D305	8-719-911-19	DIODE 1SS119
C416	1-101-004-00	CERAMIC	0.01MF 50V		D306	8-719-102-56	DIODE RD3.3E-N2
C417	1-124-907-00	ELECT	10MF 20%	50V	D307	8-719-102-58	DIODE RD3.6E-N2
C418	1-124-445-00	ELECT	100MF 20%	16V	D308	8-719-911-19	DIODE 1SS119
C419	1-106-180-00	MYLAR	0.0022MF 5%	50V	D309	8-719-911-19	DIODE 1SS119
C420	1-102-112-00	CERAMIC	330PF 10%	50V	D310	8-719-102-65	DIODE RD4.7E-N2
C421	1-102-530-00	CERAMIC	120PF 5%	50V	D401	8-719-102-87	DIODE RD9.1E-N2
C422	1-124-907-00	ELECT	10MF 20%	50V	D402	8-719-102-78	DIODE RD6.8E-N2
C423	1-124-907-00	ELECT	10MF 20%	50V	D403	8-719-101-76	DIODE RD10E-L2
C424	1-124-907-00	ELECT	10MF 20%	50V	D404	8-719-102-94	DIODE RD11E-N2
C425	1-101-004-00	CERAMIC	0.01MF 50V		D405	8-719-102-87	DIODE RD9.1E-N2
C426	1-101-004-00	CERAMIC	0.01MF 50V		D407	8-719-911-19	DIODE 1SS119
C427	1-101-004-00	CERAMIC	0.01MF 50V		D408	8-719-911-19	DIODE 1SS119
C428	1-123-332-00	ELECT	47MF 20%	16V	D3001	8-719-911-19	DIODE 1SS119
C2001	1-102-116-00	CERAMIC	680PF 10%	50V	<u>IC</u>		
C2010	1-101-006-00	CERAMIC	0.047MF 50V		IC201	8-752-030-45	IC CXA1044P
C2013	1-124-127-91	ELECT	100MF 20%	25V	IC202	8-759-170-12	IC UPC78M12H
C2014	1-102-118-00	CERAMIC	0.0012MF 10%	50V			
C2015	1-106-196-00	MYLAR	0.01MF 10%	100V			

BA

Ref.No.	Part No.	Description	Remark	Ref.No.	Part No.	Description	Remark
	*4-314-225-00	HEAT SINK, (A); IC202		Q311	8-729-178-54	TRANSISTOR 2SC2785	
IC203	8-759-170-05	IC UPC78M05H		Q312	8-729-178-54	TRANSISTOR 2SC2785	
	*4-314-225-00	HEAT SINK, (A); IC203		Q313	8-729-178-54	TRANSISTOR 2SC2785	
IC205	8-759-902-21	IC SN74LS221N		Q314	8-729-178-54	TRANSISTOR 2SC2785	
IC301	8-759-100-60	IC UPC1377C		Q315	8-729-178-54	TRANSISTOR 2SC2785	
IC302	8-759-145-58	IC UPC4558C		Q316	8-729-178-54	TRANSISTOR 2SC2785	
IC401	8-759-700-08	IC NJM4558S		Q317	8-729-178-54	TRANSISTOR 2SC2785	
IC402	8-759-000-49	IC MC14066BCP		Q318	8-729-178-54	TRANSISTOR 2SC2785	
IC403	8-759-000-73	IC MC14516BCP		Q320	8-729-178-54	TRANSISTOR 2SC2785	
IC404	8-752-203-00	IC CX22030		Q321	8-729-178-54	TRANSISTOR 2SC2785	
IC405	8-759-345-38	IC HD14538BP		Q322	8-729-178-54	TRANSISTOR 2SC2785	
	<u>COIL</u>			Q323	8-729-178-54	TRANSISTOR 2SC2785	
L201	1-407-717-00	MICRO INDUCTOR 1MMH		Q324	8-729-178-54	TRANSISTOR 2SC2785	
L401	1-407-705-00	MICRO INDUCTOR 100UH		Q325	8-729-178-54	TRANSISTOR 2SC2785	
L402	1-408-403-00	MICRO INDUCTOR 3.3UH		Q326	8-729-178-54	TRANSISTOR 2SC2785	
	<u>TRANSISTOR</u>			Q327	8-729-178-54	TRANSISTOR 2SC2785	
Q205	8-729-178-54	TRANSISTOR 2SC2785		Q328	8-729-178-54	TRANSISTOR 2SC2785	
Q206	8-729-178-54	TRANSISTOR 2SC2785		Q329	8-729-178-54	TRANSISTOR 2SC2785	
Q211	8-729-800-10	TRANSISTOR 2SC3068		Q330	8-729-178-54	TRANSISTOR 2SC2785	
Q212	8-729-603-30	TRANSISTOR 2SC403SP-3		Q331	8-729-117-54	TRANSISTOR 2SA1175	
Q213	8-729-110-52	TRANSISTOR 2SA1005-L		Q332	8-729-117-54	TRANSISTOR 2SA1175	
Q214	8-729-190-12	TRANSISTOR 2SC2901		Q333	8-729-117-54	TRANSISTOR 2SA1175	
Q221	8-729-800-10	TRANSISTOR 2SC3068		Q334	8-729-117-54	TRANSISTOR 2SA1175	
Q222	8-729-603-30	TRANSISTOR 2SC403SP-3		Q335	8-729-178-54	TRANSISTOR 2SC2785	
Q223	8-729-110-52	TRANSISTOR 2SA1005-L		Q336	8-729-178-54	TRANSISTOR 2SC2785	
Q224	8-729-190-12	TRANSISTOR 2SC2901		Q401	8-729-117-54	TRANSISTOR 2SA1175	
Q231	8-729-800-10	TRANSISTOR 2SC3068		Q402	8-729-178-54	TRANSISTOR 2SC2785	
Q232	8-729-603-30	TRANSISTOR 2SC403SP-3		Q403	8-729-117-54	TRANSISTOR 2SA1175	
Q233	8-729-110-52	TRANSISTOR 2SA1005-L		Q404	8-729-178-54	TRANSISTOR 2SC2785	
Q234	8-729-190-12	TRANSISTOR 2SC2901		Q405	8-729-117-54	TRANSISTOR 2SA1175	
Q240	8-729-117-54	TRANSISTOR 2SA1175		Q406	8-729-178-54	TRANSISTOR 2SC2785	
Q241	8-729-117-54	TRANSISTOR 2SA1175		Q407	8-729-117-54	TRANSISTOR 2SA1175	
Q243	8-729-178-54	TRANSISTOR 2SC2785		Q408	8-729-178-54	TRANSISTOR 2SC2785	
Q252	8-729-117-54	TRANSISTOR 2SA1175		Q409	8-729-178-54	TRANSISTOR 2SC2785	
Q291	8-729-117-54	TRANSISTOR 2SA1175		Q411	8-729-178-54	TRANSISTOR 2SC2785	
Q292	8-729-117-54	TRANSISTOR 2SA1175		Q412	8-729-374-02	TRANSISTOR 2SB740	
Q293	8-729-178-54	TRANSISTOR 2SC2785		Q413	8-729-178-54	TRANSISTOR 2SC2785	
Q294	8-729-117-54	TRANSISTOR 2SA1175		Q414	8-729-374-02	TRANSISTOR 2SB740	
Q295	8-729-178-54	TRANSISTOR 2SC2785		Q415	8-729-178-54	TRANSISTOR 2SC2785	
Q296	8-729-178-54	TRANSISTOR 2SC2785		Q416	8-729-178-54	TRANSISTOR 2SC2785	
Q297	8-729-178-54	TRANSISTOR 2SC2785		Q417	8-729-900-36	TRANSISTOR DTC124ES	
Q301	8-729-178-54	TRANSISTOR 2SC2785		Q418	8-729-178-54	TRANSISTOR 2SC2785	
Q302	8-729-178-54	TRANSISTOR 2SC2785		Q419	8-729-178-54	TRANSISTOR 2SC2785	
Q303	8-729-117-54	TRANSISTOR 2SA1175		Q420	8-729-117-54	TRANSISTOR 2SA1175	
Q304	8-729-117-54	TRANSISTOR 2SA1175		Q421	8-729-178-54	TRANSISTOR 2SC2785	
Q305	8-729-117-54	TRANSISTOR 2SA1175		Q422	8-729-178-54	TRANSISTOR 2SC2785	
Q306	8-729-178-54	TRANSISTOR 2SC2785		Q423	8-729-178-54	TRANSISTOR 2SC2785	
Q307	8-729-178-54	TRANSISTOR 2SC2785		Q424	8-729-178-54	TRANSISTOR 2SC2785	
Q308	8-729-117-54	TRANSISTOR 2SA1175		Q425	8-729-178-54	TRANSISTOR 2SC2785	
Q309	8-729-178-54	TRANSISTOR 2SC2785		Q426	8-729-178-54	TRANSISTOR 2SC2785	
Q310	8-729-178-54	TRANSISTOR 2SC2785		Q427	8-729-178-54	TRANSISTOR 2SC2785	
				Q428	8-729-900-36	TRANSISTOR DTC124ES	
				Q429	8-729-374-02	TRANSISTOR 2SB740	



Ref.No.	Part No.	Description	Remark	Ref.No.	Part No.	Description	Remark
Q3001	8-729-178-54	TRANSISTOR 2SC2785		R272	1-247-849-00	CARBON 5.6K 5%	1/6W
Q3002	8-729-117-54	TRANSISTOR 2SA1175		R280	1-247-823-00	CARBON 470 5%	1/6W
<u>RESISTOR</u>				R281	1-249-425-11	CARBON 4.7K 5%	1/6W
R200	1-247-839-00	CARBON 2.2K 5%	1/6W	R282	1-216-471-11	METAL OXIDE 27 5%	3W
R207	1-249-425-11	CARBON 4.7K 5%	1/6W	R283	1-249-417-11	CARBON 1K 5%	1/6W
R211	1-247-804-00	CARBON 75 5%	1/6W	R284	1-249-417-11	CARBON 1K 5%	1/6W
R212	1-249-434-11	CARBON 27K 5%	1/6W	R289	1-247-853-00	CARBON 8.2K 5%	1/6W
R213	1-249-429-11	CARBON 10K 5%	1/6W	R290	1-247-853-00	CARBON 8.2K 5%	1/6W
R214	1-247-849-00	CARBON 5.6K 5%	1/6W	R291	1-249-437-11	CARBON 47K 5%	1/6W
R215	1-249-429-11	CARBON 10K 5%	1/6W	R292	1-249-405-11	CARBON 100 5%	1/6W
R216	1-249-417-11	CARBON 1K 5%	1/6W	R293	1-249-417-11	CARBON 1K 5%	1/6W
R217	1-249-419-11	CARBON 1.5K 5%	1/6W	R294	1-249-440-11	CARBON 82K 5%	1/6W
R219	1-249-405-11	CARBON 100 5%	1/6W	R295	1-214-753-00	METAL 10K 1%	1/4W
R220	1-249-429-11	CARBON 10K 5%	1/6W	R296	1-215-445-00	METAL 10K 1%	1/6W
R221	1-247-804-00	CARBON 75 5%	1/6W	R297	1-249-429-11	CARBON 10K 5%	1/6W
R222	1-249-434-11	CARBON 27K 5%	1/6W	R298	1-249-433-11	CARBON 22K 5%	1/6W
R223	1-249-429-11	CARBON 10K 5%	1/6W	R299	1-249-429-11	CARBON 10K 5%	1/6W
R224	1-247-849-00	CARBON 5.6K 5%	1/6W	R301	1-215-473-00	METAL 150K 1%	1/6W
R225	1-249-429-11	CARBON 10K 5%	1/6W	R302	1-215-464-00	METAL 62K 1%	1/6W
R226	1-249-417-11	CARBON 1K 5%	1/6W	R303	1-202-727-00	SOLID 4.7M 10%	1/2W
R227	1-249-419-11	CARBON 1.5K 5%	1/6W	R304	1-249-437-11	CARBON 47K 5%	1/6W
R229	1-249-405-11	CARBON 100 5%	1/6W	R305	1-249-437-11	CARBON 47K 5%	1/6W
R231	1-247-804-00	CARBON 75 5%	1/6W	R306	1-247-725-11	CARBON 10K 5%	1/4W
R232	1-249-434-11	CARBON 27K 5%	1/6W	R307	1-249-429-11	CARBON 10K 5%	1/6W
R233	1-249-429-11	CARBON 10K 5%	1/6W	R308	1-249-429-11	CARBON 10K 5%	1/6W
R234	1-247-849-00	CARBON 5.6K 5%	1/6W	R309	1-249-440-11	CARBON 82K 5%	1/6W
R235	1-249-429-11	CARBON 10K 5%	1/6W	R310	1-247-721-11	CARBON 4.7K 5%	1/4W
R236	1-249-417-11	CARBON 1K 5%	1/6W	R311	1-249-425-11	CARBON 4.7K 5%	1/6W
R237	1-249-419-11	CARBON 1.5K 5%	1/6W	R312	1-249-433-11	CARBON 22K 5%	1/6W
R239	1-249-405-11	CARBON 100 5%	1/6W	R313	1-247-870-00	CARBON 43K 5%	1/6W
R240	1-247-851-00	CARBON 6.8K 5%	1/6W	R314	1-249-433-11	CARBON 22K 5%	1/6W
R241	1-247-839-00	CARBON 2.2K 5%	1/6W	R315	1-247-862-00	CARBON 20K 5%	1/6W
R242	1-247-815-00	CARBON 220 5%	1/6W	R316	1-247-869-00	CARBON 39K 5%	1/6W
R243	1-249-434-11	CARBON 27K 5%	1/6W	R317	1-247-823-00	CARBON 470 5%	1/6W
R244	1-247-891-00	CARBON 330K 5%	1/6W	R318	1-249-433-11	CARBON 22K 5%	1/6W
R245	1-249-414-11	CARBON 560 5%	1/6W	R319	1-249-435-11	CARBON 33K 5%	1/6W
R246	1-247-823-00	CARBON 470 5%	1/6W	R320	1-249-429-11	CARBON 10K 5%	1/6W
R247	1-249-437-11	CARBON 47K 5%	1/6W	R321	1-249-429-11	CARBON 10K 5%	1/6W
R249	1-249-429-11	CARBON 10K 5%	1/6W	R322	1-247-881-00	CARBON 120K 5%	1/6W
R250	1-249-429-11	CARBON 10K 5%	1/6W	R323	1-249-423-11	CARBON 3.3K 5%	1/6W
R251	1-249-429-11	CARBON 10K 5%	1/6W	R324	1-247-874-00	CARBON 62K 5%	1/6W
R252	1-247-711-11	CARBON 680 5%	1/4W	R325	1-249-397-11	CARBON 22 5%	1/6W
R253	1-247-895-00	CARBON 470K 5%	1/6W	R326	1-249-425-11	CARBON 4.7K 5%	1/6W
R254	1-249-433-11	CARBON 22K 5%	1/6W	R327	1-247-881-00	CARBON 120K 5%	1/6W
R255	1-247-839-00	CARBON 2.2K 5%	1/6W	R328	1-247-869-00	CARBON 39K 5%	1/6W
R256	1-247-711-11	CARBON 680 5%	1/4W	R329	1-249-422-11	CARBON 2.7K 5%	1/6W
R257	1-249-429-11	CARBON 10K 5%	1/6W	R330	1-247-891-00	CARBON 330K 5%	1/6W
R258	1-247-881-00	CARBON 120K 5%	1/6W	R331	1-247-721-11	CARBON 4.7K 5%	1/4W
R259	1-249-433-11	CARBON 22K 5%	1/6W	R332	1-249-433-11	CARBON 22K 5%	1/6W
R260	1-249-405-11	CARBON 100 5%	1/6W	R333	1-247-857-00	CARBON 12K 5%	1/6W
R261	1-249-422-11	CARBON 2.7K 5%	1/6W	R334	1-247-875-00	CARBON 68K 5%	1/6W
R262	1-249-405-11	CARBON 100 5%	1/6W	R335	1-249-429-11	CARBON 10K 5%	1/6W
				R336	1-249-429-11	CARBON 10K 5%	1/6W

BA

Ref.No.	Part No.	Description	Remark	Ref.No.	Part No.	Description	Remark
R337	1-215-445-00	METAL	10K 1% 1/6W	R390	1-249-437-11	CARBON	47K 5% 1/6W
R338	1-214-747-00	METAL	5.6K 1% 1/4W	R391	1-249-437-11	CARBON	47K 5% 1/6W
☒R339	△	METAL	1/6W	R392	1-249-437-11	CARBON	47K 5% 1/6W
R340	1-215-488-00	METAL	620K 1% 1/6W	R393	1-247-887-00	CARBON	220K 5% 1/6W
R341	1-215-457-00	METAL	33K 1% 1/6W	R394	1-249-435-11	CARBON	33K 5% 1/6W
R342	1-247-151-00	CARBON	6.8K 5% 1/4W	R395	1-249-429-11	CARBON	10K 5% 1/6W
R343	1-249-435-11	CARBON	33K 5% 1/6W	R396	1-249-433-11	CARBON	22K 5% 1/6W
R344	1-247-713-11	CARBON	1K 5% 1/4W	R397	1-247-163-00	CARBON	22K 5% 1/4W
R345	1-249-429-11	CARBON	10K 5% 1/6W	R398	1-249-417-11	CARBON	1K 5% 1/6W
R346	1-249-433-11	CARBON	22K 5% 1/6W	R399	1-247-713-11	CARBON	1K 5% 1/4W
R347	1-249-429-11	CARBON	10K 5% 1/6W	R401	1-215-436-00	METAL	4.3K 1% 1/6W
R348	1-249-433-11	CARBON	22K 5% 1/6W	R402	1-215-435-00	METAL	3.9K 1% 1/6W
R349	1-249-417-11	CARBON	1K 5% 1/6W	R403	1-215-433-00	METAL	3.3K 1% 1/6W
R350	1-249-429-11	CARBON	10K 5% 1/6W	R404	1-215-435-00	METAL	3.9K 1% 1/6W
R351	1-249-405-11	CARBON	100 5% 1/6W	R405	1-215-435-00	METAL	3.9K 1% 1/6W
R352	1-249-429-11	CARBON	10K 5% 1/6W	R406	1-249-435-11	CARBON	33K 5% 1/6W
R353	1-249-423-11	CARBON	3.3K 5% 1/6W	R407	1-215-429-00	METAL	2.2K 1% 1/6W
R354	1-249-429-11	CARBON	10K 5% 1/6W	R408	1-215-429-00	METAL	2.2K 1% 1/6W
R355	1-247-849-00	CARBON	5.6K 5% 1/6W	R409	1-249-417-11	CARBON	1K 5% 1/6W
R356	1-249-429-11	CARBON	10K 5% 1/6W	R410	1-249-417-11	CARBON	1K 5% 1/6W
R357	1-247-151-00	CARBON	6.8K 5% 1/4W	R411	1-249-429-11	CARBON	10K 5% 1/6W
R358	1-247-853-00	CARBON	8.2K 5% 1/6W	R412	1-249-429-11	CARBON	10K 5% 1/6W
R359	1-249-435-11	CARBON	33K 5% 1/6W	R413	1-247-885-00	CARBON	180K 5% 1/6W
R360	1-247-809-00	CARBON	120 5% 1/6W	R414	1-215-429-00	METAL	2.2K 1% 1/6W
R361	1-247-839-00	CARBON	2.2K 5% 1/6W	R415	1-215-437-00	METAL	4.7K 1% 1/6W
R362	1-249-433-11	CARBON	22K 5% 1/6W	☒R416	△	METAL	1/6W
R363	1-249-437-11	CARBON	47K 5% 1/6W	R417	1-214-725-00	METAL	680 1% 1/4W
R364	1-249-429-11	CARBON	10K 5% 1/6W	R418	1-214-767-00	METAL	39K 1% 1/4W
R365	1-247-849-00	CARBON	5.6K 5% 1/6W	R419	1-214-767-00	METAL	39K 1% 1/4W
R366	1-247-859-00	CARBON	15K 5% 1/6W	R420	1-249-417-11	CARBON	1K 5% 1/6W
R367	1-247-887-00	CARBON	220K 5% 1/6W	R421	1-249-429-11	CARBON	10K 5% 1/6W
R368	1-249-437-11	CARBON	47K 5% 1/6W	R422	1-249-423-11	CARBON	3.3K 5% 1/6W
R369	1-249-425-11	CARBON	4.7K 5% 1/6W	R423	1-247-839-00	CARBON	2.2K 5% 1/6W
R370	1-249-435-11	CARBON	33K 5% 1/6W	R424	1-247-725-11	CARBON	10K 5% 1/4W
R371	1-249-433-11	CARBON	22K 5% 1/6W	R425	1-247-839-00	CARBON	2.2K 5% 1/6W
R372	1-249-429-11	CARBON	10K 5% 1/6W	R426	1-216-423-11	METAL OXIDE	27 5% 1W F
R373	1-247-885-00	CARBON	180K 5% 1/6W	R427	1-249-405-11	CARBON	100 5% 1/6W
R374	1-249-437-11	CARBON	47K 5% 1/6W	R428	1-249-429-11	CARBON	10K 5% 1/6W
R375	1-249-433-11	CARBON	22K 5% 1/6W	R429	1-247-819-00	CARBON	330 5% 1/6W
R376	1-249-437-11	CARBON	47K 5% 1/6W	R430	1-249-423-11	CARBON	3.3K 5% 1/6W
R377	1-249-437-11	CARBON	47K 5% 1/6W	R431	1-249-429-11	CARBON	10K 5% 1/6W
R378	1-247-849-00	CARBON	5.6K 5% 1/6W	R432	1-247-819-00	CARBON	330 5% 1/6W
R379	1-247-839-00	CARBON	2.2K 5% 1/6W	R433	1-249-423-11	CARBON	3.3K 5% 1/6W
R380	1-247-849-00	CARBON	5.6K 5% 1/6W	R434	1-249-429-11	CARBON	10K 5% 1/6W
R381	1-249-423-11	CARBON	3.3K 5% 1/6W	R435	1-247-819-00	CARBON	330 5% 1/6W
R382	1-247-721-11	CARBON	4.7K 5% 1/4W	R436	1-249-437-11	CARBON	47K 5% 1/6W
R383	1-249-437-11	CARBON	47K 5% 1/6W	R437	1-249-417-11	CARBON	1K 5% 1/6W
R384	1-249-437-11	CARBON	47K 5% 1/6W	R438	1-249-429-11	CARBON	10K 5% 1/6W
R385	1-249-429-11	CARBON	10K 5% 1/6W	R439	1-249-433-11	CARBON	22K 5% 1/6W
R386	1-247-853-00	CARBON	8.2K 5% 1/6W	R440	1-249-434-11	CARBON	27K 5% 1/6W
R387	1-249-425-11	CARBON	4.7K 5% 1/6W	R441	1-249-434-11	CARBON	27K 5% 1/6W
R388	1-247-821-00	CARBON	390 5% 1/6W	R442	1-249-417-11	CARBON	1K 5% 1/6W
R389	1-249-437-11	CARBON	47K 5% 1/6W	R443	1-249-429-11	CARBON	10K 5% 1/6W

• The components identified by ☒ in this manual have been carefully factory-selected for each set in order to satisfy regulations regarding X-ray radiation. Should replacement be required, replace only with the value originally used.

The components identified by shading and mark △ are critical for safety. Replace only with part number specified.

Les composants identifiés par une trame et une marque △ sont critiques pour la sécurité. Ne les remplacer que par une pièce portant le numéro spécifié.



Ref.No.	Part No.	Description	Remark	Ref.No.	Part No.	Description	Remark
R444	1-215-439-00	METAL	5.6K 1% 1/6W	R493	1-247-721-11	CARBON	4.7K 5% 1/4W
R445	1-215-409-00	METAL	330 1% 1/6W	R494	1-249-435-11	CARBON	33K 5% 1/6W
R446	1-215-428-00	METAL	2K 1% 1/6W	R495	1-215-445-00	METAL	10K 1% 1/6W
R447	1-215-433-00	METAL	3.3K 1% 1/6W	R496	1-249-405-11	CARBON	100 5% 1/6W
R448	1-249-423-11	CARBON	3.3K 5% 1/6W	R497	1-249-422-11	CARBON	2.7K 5% 1/6W
R449	1-214-737-00	METAL	2.2K 1% 1/4W	R498	1-247-135-00	CARBON	1.5K 5% 1/4W
R450	1-249-429-11	CARBON	10K 5% 1/6W	R499	1-247-725-11	CARBON	10K 5% 1/4W
R451	1-249-433-11	CARBON	22K 5% 1/6W	R2003	1-249-437-11	CARBON	47K 5% 1/6W
R452	1-249-433-11	CARBON	22K 5% 1/6W	R2004	1-249-437-11	CARBON	47K 5% 1/6W
R453	1-249-417-11	CARBON	1K 5% 1/6W	R2005	1-249-429-11	CARBON	10K 5% 1/6W
R454	1-249-497-11	CARBON	33K 5% 1/4W	R2006	1-216-421-11	METAL OXIDE	12 5% 1W F
R455	1-249-435-11	CARBON	33K 5% 1/6W	R2007	1-247-815-00	CARBON	220 5% 1/6W
R456	1-249-433-11	CARBON	22K 5% 1/6W	R2010	1-247-711-11	CARBON	680 5% 1/4W
R457	1-249-433-11	CARBON	22K 5% 1/6W	R2011	1-249-405-11	CARBON	100 5% 1/6W
R458	1-249-435-11	CARBON	33K 5% 1/6W	R2012	1-249-417-11	CARBON	1K 5% 1/6W
R459	1-249-440-11	CARBON	82K 5% 1/6W	R2013	1-247-813-00	CARBON	180 5% 1/6W
R460	1-247-869-00	CARBON	39K 5% 1/6W	R2014	1-249-417-11	CARBON	1K 5% 1/6W
R461	1-247-725-11	CARBON	10K 5% 1/4W	R2015	1-214-092-00	METAL	22 1% 1/4W
R462	1-215-429-00	METAL	2.2K 1% 1/6W	R2016	1-214-092-00	METAL	22 1% 1/4W
R463	1-215-483-00	METAL	390K 1% 1/6W	R2017	1-249-415-11	CARBON	680 5% 1/6W
R464	1-215-452-00	METAL	20K 1% 1/6W	R2018	1-247-839-00	CARBON	2.2K 5% 1/6W
R465	1-215-449-00	METAL	15K 1% 1/6W	R2020	1-247-711-11	CARBON	680 5% 1/4W
R466	1-249-417-11	CARBON	1K 5% 1/6W	R2021	1-249-405-11	CARBON	100 5% 1/6W
R467	1-249-417-11	CARBON	1K 5% 1/6W	R2022	1-249-417-11	CARBON	1K 5% 1/6W
R468	1-249-417-11	CARBON	1K 5% 1/6W	R2023	1-247-813-00	CARBON	180 5% 1/6W
R469	1-249-417-11	CARBON	1K 5% 1/6W	R2024	1-249-417-11	CARBON	1K 5% 1/6W
R470	1-249-465-11	CARBON	47K 5% 1/4W	R2025	1-214-092-00	METAL	22 1% 1/4W
R471	1-249-437-11	CARBON	47K 5% 1/6W	R2026	1-214-092-00	METAL	22 1% 1/4W
R472	1-249-437-11	CARBON	47K 5% 1/6W	R2027	1-249-415-11	CARBON	680 5% 1/6W
R473	1-249-437-11	CARBON	47K 5% 1/6W	R2028	1-247-839-00	CARBON	2.2K 5% 1/6W
R474	1-247-875-00	CARBON	68K 5% 1/6W	R2030	1-247-711-11	CARBON	680 5% 1/4W
R475	1-247-875-00	CARBON	68K 5% 1/6W	R2031	1-249-405-11	CARBON	100 5% 1/6W
R476	1-247-875-00	CARBON	68K 5% 1/6W	R2032	1-249-417-11	CARBON	1K 5% 1/6W
R477	1-246-517-00	CARBON	68K 5% 1/4W	R2033	1-247-813-00	CARBON	180 5% 1/6W
R479	1-247-839-00	CARBON	2.2K 5% 1/6W	R2034	1-249-417-11	CARBON	1K 5% 1/6W
R480	1-247-717-11	CARBON	2.2K 5% 1/4W	R2035	1-214-092-00	METAL	22 1% 1/4W
R481	1-247-725-11	CARBON	10K 5% 1/4W	R2036	1-214-092-00	METAL	22 1% 1/4W
*R482	1-215-437-00	METAL	4.7K 1% 1/6W	R2037	1-249-415-11	CARBON	680 5% 1/6W
*R482	1-215-441-00	METAL	6.8K 1% 1/6W	R2038	1-247-839-00	CARBON	2.2K 5% 1/6W
*R482	1-215-445-00	METAL	10K 1% 1/6W	R3001	1-247-819-00	CARBON	330 5% 1/6W
*R482	1-215-453-00	METAL	22K 1% 1/6W	R3002	1-249-425-11	CARBON	4.7K 5% 1/6W
*R482	1-215-461-00	METAL	47K 1% 1/6W	R3003	1-247-853-00	CARBON	8.2K 5% 1/6W
*R482	1-215-469-00	METAL	100K 1% 1/6W	R3004	1-249-405-11	CARBON	100 5% 1/6W
R483	1-215-415-00	METAL	560 1% 1/6W	R3005	1-247-839-00	CARBON	2.2K 5% 1/6W
R484	1-247-897-00	CARBON	560K 5% 1/6W	R3006	1-247-893-00	CARBON	390K 5% 1/6W
R485	1-247-857-00	CARBON	12K 5% 1/6W	R4001	1-249-429-11	CARBON	10K 5% 1/6W
R486	1-249-417-11	CARBON	1K 5% 1/6W	R4002	1-247-849-00	CARBON	5.6K 5% 1/6W
R487	1-247-823-00	CARBON	470 5% 1/6W	R4003	1-247-839-00	CARBON	2.2K 5% 1/6W
R488	1-215-470-00	METAL	110K 1% 1/6W	R4004	1-249-429-11	CARBON	10K 5% 1/6W
☒R489 ▲		METAL	1/6W	R4005	1-247-849-00	CARBON	5.6K 5% 1/6W
R490	1-249-435-11	CARBON	33K 5% 1/6W	R4006	1-247-839-00	CARBON	2.2K 5% 1/6W
R491	1-247-845-00	CARBON	3.9K 5% 1/6W	R4007	1-249-429-11	CARBON	10K 5% 1/6W
R492	1-247-717-11	CARBON	2.2K 5% 1/4W	R4008	1-247-849-00	CARBON	5.6K 5% 1/6W

- * : Selected to yield optimum performance.
- The components identified by ☒ in this manual have been carefully factory-selected for each set in order to satisfy regulations regarding X-ray radiation. Should replacement be required, replace only with the value originally used.

The components identified by shading and mark ▲ are critical for safety. Replace only with part number specified.

Les composants identifiés par une trame et une marque ▲ sont critiques pour la sécurité. Ne les remplacer que par une pièce portant le numéro spécifié.



Ref.No.	Part No.	Description	Remark
R4009	1-247-839-00	CARBON 2.2K 5% 1/6W	
R4010	1-249-437-11	CARBON 47K 5% 1/6W	
R4011	1-249-429-11	CARBON 10K 5% 1/6W	
R4012	1-249-429-11	CARBON 10K 5% 1/6W	
R4013	1-249-437-11	CARBON 47K 5% 1/6W	
R4014	1-249-437-11	CARBON 47K 5% 1/6W	
R4015	1-249-417-11	CARBON 1K 5% 1/6W	
R4016	1-249-429-11	CARBON 10K 5% 1/6W	
R4017	1-249-405-11	CARBON 100 5% 1/6W	
R4018	1-249-425-11	CARBON 4.7K 5% 1/6W	
R4019	1-215-411-00	METAL 390 1% 1/6W	
R4023	1-249-437-11	CARBON 47K 5% 1/6W	
R5010	1-247-849-00	CARBON 5.6K 5% 1/6W	

VARIABLE RESISTOR

RV211	1-224-248-XX	RES, ADJ, METAL GLAZE 470	
RV221	1-224-248-XX	RES, ADJ, METAL GLAZE 470	
RV231	1-224-248-XX	RES, ADJ, METAL GLAZE 470	
RV251	1-224-254-XX	RES, ADJ, METAL GLAZE 47K	
RV252	1-224-256-XX	RES, ADJ, METAL GLAZE 220K	
RV291	1-224-254-XX	RES, ADJ, METAL GLAZE 47K	
RV292	1-224-251-XX	RES, ADJ, METAL GLAZE 4.7K	
RV301	1-224-249-XX	RES, ADJ, METAL GLAZE 1K	
RV302	1-224-256-XX	RES, ADJ, METAL GLAZE 220K	
RV303	1-224-253-XX	RES, ADJ, METAL GLAZE 22K	
RV306	1-224-251-XX	RES, ADJ, METAL GLAZE 4.7K	
RV307	1-224-254-XX	RES, ADJ, METAL GLAZE 47K	
RV401	1-224-134-XX	RES, ADJ, METAL GLAZE 470K	
RV402	1-224-251-XX	RES, ADJ, METAL GLAZE 4.7K	
RV403	1-224-248-XX	RES, ADJ, METAL GLAZE 470	

*A-1240-695-A F BOARD, COMPLETE

1-533-190-11 CLIP, FUSE

CAPACITOR

C601	Δ1-136-360-51	FILM 0.22MF 20% 250V	
C602	Δ1-136-360-51	FILM 0.22MF 20% 250V	
C603	Δ1-161-953-51	CERAMIC 0.0047MF 20% 400V	
C604	Δ1-161-953-51	CERAMIC 0.0047MF 20% 400V	
C605	1-161-953-00	CERAMIC 0.0047MF 20% 400V	
C606	1-161-953-00	CERAMIC 0.0047MF 20% 400V	
C607	1-125-295-00	ELECT(BLOCK) 560MF 20% 200V	
C608	1-125-295-00	ELECT(BLOCK) 560MF 20% 200V	
C609	Δ1-136-360-51	FILM 0.22MF 20% 250V	
C610	Δ1-102-050-51	CERAMIC 0.01MF 500V	

DIODE

D601	8-719-911-55	DIODE U05G	
D602	8-719-911-55	DIODE U05G	

Ref.No.	Part No.	Description	Remark
CONNECTOR			
F1	*1-508-786-00	2P PLUG (M)	
F2	*1-508-786-00	2P PLUG (M)	
F3	*1-508-765-00	3P PLUG (M)	
F4	*1-508-765-00	3P PLUG (M)	

FUSE

F601	Δ1-532-509-00	FUSE, GLASS TUBE 6.3A	
------	---------------	-----------------------	--

RESISTOR

R601	Δ1-202-723-51	SOLID 2.2M 10% 1/2W	
R602	Δ1-202-723-51	SOLID 2.2M 10% 1/2W	
R603	Δ1-205-741-11	CEMENTED 1.8 5% 10W	
R604	1-244-925-00	CARBON 150K 5% 1/2W	
R605	1-244-925-00	CARBON 150K 5% 1/2W	

TRANSFORMER

T601	Δ1-421-357-31	TRANSFORMER, LINE FILTER	
T602	Δ1-421-426-11	TRANSFORMER, FERRITE	

THERMISTOR

THP601	Δ1-806-214-21	THERMISTOR (POSITIVE)	
--------	---------------	-----------------------	--

*A-1316-059-A G BOARD, COMPLETE

*4-314-225-00 HEAT SINK, (A)
4-363-414-00 SPACER, MICA
*4-368-683-01 SPRING

CAPACITOR

C650	Δ1-102-050-51	CERAMIC 0.01MF 500V	
C651	1-136-060-00	FILM 0.047MF 5% 400V	
C652	1-136-060-00	FILM 0.047MF 5% 400V	
C653	1-102-327-00	CERAMIC 330PF 15% 1.5KV	
C654	1-102-327-00	CERAMIC 330PF 15% 1.5KV	
C655	1-130-661-00	FILM 0.022MF 3% 600V	
C656	1-136-239-11	FILM 0.01MF, 3% 1KV	
C657	1-136-060-00	FILM 0.047MF 5% 400V	
C659	1-123-024-00	ELECT 33MF 160V	
C661	1-123-024-00	ELECT 33MF 160V	
C662	1-123-024-00	ELECT 33MF 160V	
C663	1-124-035-00	ELECT 47MF 20% 16V	
C664	1-124-128-00	ELECT 470MF 20% 25V	
C665	1-123-875-91	ELECT 10MF 20% 50V	
C666	1-124-035-00	ELECT 47MF 20% 16V	
C667	1-124-900-11	ELECT 470MF 20% 35V	
C668	1-123-332-00	ELECT 47MF 20% 16V	
C669	1-123-332-00	ELECT 47MF 20% 16V	
C670	1-162-116-00	CERAMIC 680PF 10% 2KV	
C671	1-162-558-11	CERAMIC 100PF 10% 2KV	

The components identified by shading and mark Δ are critical for safety. Replace only with part number specified.

Les composants identifiés par une trame et une marque Δ sont critiques pour la sécurité. Ne les remplacer que par une pièce portant le numéro spécifié.



Ref.No.	Part No.	Description	Remark
C672	1-162-558-11	CERAMIC 100PF	10% 2KV
<u>DIODE</u>			
D651	8-719-301-18	DIODE RM2CS	
D652	8-719-301-18	DIODE RM2CS	
D653	8-719-901-93	DIODE V19E	
D654	8-719-901-93	DIODE V19E	
D655	8-719-302-00	DIODE RU-2M	
D656	8-719-500-25	DIODE D5KC20RH	
D657	8-719-302-00	DIODE RU-2M	
D658	8-719-302-00	DIODE RU-2M	
D659	8-719-982-04	DIODE ERB81-004	
D660	8-719-982-04	DIODE ERB81-004	
D661	8-719-982-04	DIODE ERB81-004	
D662	8-719-982-04	DIODE ERB81-004	
D663	8-719-982-04	DIODE ERB81-004	
D664	8-719-302-00	DIODE RU-2M	
D665	8-719-302-00	DIODE RU-2M	
D666	8-719-302-00	DIODE RU-2M	
D667	8-719-302-00	DIODE RU-2M	
D668	8-719-302-00	DIODE RU-2M	
D669	8-719-901-24	THYRISTOR CSM2A4A10	
D670	8-719-102-62	DIODE RD4.3E-N2	
D671	8-719-103-06	DIODE RD13E-N2	
D672	8-719-103-06	DIODE RD13E-N2	
D673	8-719-302-00	DIODE RU-2M	
D674	8-719-302-00	DIODE RU-2M	
D675	8-719-302-00	DIODE RU-2M	
D676	8-719-302-00	DIODE RU-2M	
D677	8-719-302-00	DIODE RU-2M	
D678	8-719-901-93	DIODE V19E	
D679	8-719-901-93	DIODE V19E	
<u>CONNECTOR</u>			
G1	*1-508-765-00	3P PLUG (M)	
G2	*1-564-353-00	PLUG, CONNECTOR (2.5MM) 2P	
G3	*1-508-766-00	4P PLUG (M)	
G4	*1-508-767-00	5P PLUG	
G5	*1-508-765-00	3P PLUG (M)	
<u>MODULE</u>			
IC651	1-235-449-11	POWER MODULE (DM-19)	
<u>TRANSISTOR</u>			
Q651	8-729-902-41	TRANSISTOR 2SC3318	
Q652	8-729-902-41	TRANSISTOR 2SC3318	
Q653	8-729-177-43	TRANSISTOR 2SD774	
Q654	8-729-177-43	TRANSISTOR 2SD774	
Q655	8-729-117-54	TRANSISTOR 2SA1175	
Q656	8-729-117-54	TRANSISTOR 2SA1175	
Q657	8-729-178-54	TRANSISTOR 2SC2785	

Ref.No.	Part No.	Description	Remark
<u>RESISTOR</u>			
R651	1-202-842-51	SOLID 220K	1/2W
R652	1-202-842-51	SOLID 220K	1/2W
R653	1-202-842-51	SOLID 220K	1/2W
R654	1-217-418-00	FUSIBLE 0.47	10% 1/2W F
R655	1-217-418-00	FUSIBLE 0.47	10% 1/2W F
R656	1-216-374-00	METAL OXIDE 2.7	5% 2W F
R657	1-216-374-00	METAL OXIDE 2.7	5% 2W F
R658	1-247-717-11	CARBON 2.2K	5% 1/4W
R659	1-247-700-11	CARBON 100	5% 1/4W
R660	1-215-468-00	METAL 91K	1% 1/6W
R661	1-215-449-00	METAL 15K	1% 1/6W
R662	1-247-719-11	CARBON 3.3K	5% 1/4W
R663	1-247-717-11	CARBON 2.2K	5% 1/4W
R664	1-215-469-00	METAL 100K	1% 1/6W
R665	1-215-451-00	METAL 18K	1% 1/6W
R666	1-215-467-00	METAL 82K	1% 1/6W
R667	1-215-451-00	METAL 18K	1% 1/6W
R668	1-247-719-11	CARBON 3.3K	5% 1/4W
R669	1-249-441-11	CARBON 100K	5% 1/6W
R671	1-249-381-11	CARBON 1	5% 1/6W F
R672	1-202-842-51	SOLID 220K	1/2W
R673	1-247-717-11	CARBON 2.2K	5% 1/4W
R674	1-249-429-11	CARBON 10K	5% 1/6W
<u>TRANSFORMER</u>			
T651	△1-421-704-11	CDT	
T652	△1-421-886-11	PIT	
T653	△1-421-888-11	PRT	
T654	△1-421-889-11	PRT	
T655	△1-421-889-11	PRT	
T656	△1-421-885-11	COT	
T657	△1-421-887-11	PHT	

	*A-1330-716-A	CB BOARD, COMPLETE	*****
	1-526-762-00	SOCKET, CRT	
<u>NEON LAMP</u>			
NL701	1-519-371-11	LAMP, NEON	
NL702	1-519-371-11	LAMP, NEON	
NL703	1-519-371-11	LAMP, NEON	
<u>RESISTOR</u>			
R701	1-202-719-00	SOLID 1M	10% 1/2W
R706	1-202-824-00	SOLID 3.3K	1/2W
<u>VARIABLE RESISTOR</u>			
RV703	1-230-798-11	RES, ADJ, METAL GLAZE 90M	

The components identified by shading and mark △ are critical for safety. Replace only with part number specified.

Les composants identifiés par une trame et une marque △ sont critiques pour la sécurité. Ne les remplacer que par une pièce portant le numéro spécifié.



Ref.No.	Part No.	Description	Remark	Ref.No.	Part No.	Description	Remark
*A-1340-829-A		D BOARD, COMPLETE *****		C552	1-108-429-00	MYLAR 0.047MF	10% 200V
*4-314-225-00		HEAT SINK, (A)		C553	1-123-949-00	ELECT 33MF	20% 250V
*4-323-833-00		HEAT SINK, PIN OUT		C554	1-124-477-11	ELECT 47MF	20% 25V
*4-323-833-00		HEAT SINK, PIN OUT		C555	1-123-024-00	ELECT 33MF	160V
4-363-414-00		SPACER, MICA		C556	Δ1-129-722-51	FILM 0.047MF	10% 630V
*4-381-827-01		HOLDER, TR		C557	1-124-481-11	ELECT 22MF	20% 25V
<u>CAPACITOR</u>				C558	1-124-445-00	ELECT 100MF	20% 16V
C159	1-162-116-00	CERAMIC 680PF	10% 2KV	C560	1-136-308-11	FILM 0.68MF	5% 200V
C501	1-124-448-00	ELECT 1000MF	20% 35V	C561	1-106-196-00	MYLAR 0.01MF	10% 100V
C502	1-124-932-11	ELECT 100MF	20% 100V	C562	1-124-927-11	ELECT 4.7MF	20% 50V
C504	1-124-556-11	ELECT 220MF	20% 16V	C563	1-124-120-11	ELECT 220MF	20% 25V
C505	Δ1-102-234-51	CERAMIC 270PF	10% 500V	C564	1-124-478-11	ELECT 100MF	20% 25V
C506	1-123-332-00	ELECT 47MF	20% 16V	C565	1-124-907-00	ELECT 10MF	20% 50V
C507	1-108-429-00	MYLAR 0.047MF	10% 200V	C566	1-136-308-11	FILM 0.68MF	5% 200V
C509	1-108-622-91	MYLAR 0.0047MF	10% 100V	C570	1-162-134-11	CERAMIC 470PF	10% 2KV
C511	1-108-433-00	MYLAR 0.1MF	10% 200V	C581	1-124-477-11	ELECT 47MF	20% 25V
C513	1-124-909-11	ELECT 33MF	20% 50V	C585	1-124-896-00	ELECT 33MF	20% 16V
C515	1-124-902-00	ELECT 0.47MF	20% 50V	C589	1-124-907-00	ELECT 10MF	20% 50V
C517	1-102-978-00	CERAMIC 220PF	5% 50V	C593	1-162-117-00	CERAMIC 100PF	10% 500V
C518	1-129-702-00	FILM 0.001MF	10% 630V	C594	1-123-640-00	ELECT 10MF	20% 100V
C519	1-129-702-00	FILM 0.001MF	10% 630V	C595	1-123-267-00	ELECT 2.2MF	20% 160V
C521	1-161-830-00	CERAMIC 0.0047MF	500V	C596	1-102-038-00	CERAMIC 0.001MF	500V
C522	1-136-179-00	FILM 1.5MF	5% 200V	C597	1-102-038-00	CERAMIC 0.001MF	500V
C523	1-136-053-00	FILM 1.2MF	5% 200V	C5001	1-124-910-11	ELECT 47MF	20% 50V
C524	Δ1-129-712-51	FILM 0.0068MF	10% 630V	C5002	1-162-115-00	CERAMIC 330PF	10% 2KV
C525	1-136-331-11	FILM 3MF	5% 200V	<u>CONNECTOR</u>			
C526	1-136-053-00	FILM 1.2MF	5% 200V	D1	*1-564-038-00	CONNECTOR PLUG, DY (MINI) 6P	
C527	1-123-943-00	ELECT 1MF	20% 250V	D2	*1-508-766-00	4P PLUG (M)	
C528	1-136-115-00	FILM 0.56MF	5% 200V	D3	*1-508-767-00	5P PLUG	
C529	1-136-331-11	FILM 3MF	5% 200V	D4	*1-564-353-00	PLUG, CONNECTOR (2.5MM) 2P	
C530	Δ1-129-723-51	FILM 0.056MF	10% 630V	D5	*1-564-441-11	PLUG, CONNECTOR (2.5MM) 5P	
C531	Δ1-136-089-11	FILM 0.0056MF	3% 2KV	D6	*1-508-765-00	3P PLUG (M)	
C532	1-108-614-91	MYLAR 0.001MF	10% 100V	D7	*1-508-765-00	3P PLUG (M)	
C533	1-102-129-00	CERAMIC 0.01MF	10% 50V	D8	*1-564-353-00	PLUG, CONNECTOR (2.5MM) 2P	
C534	1-102-129-00	CERAMIC 0.01MF	10% 50V	D11	*1-564-353-00	PLUG, CONNECTOR (2.5MM) 2P	
C535	1-124-907-00	ELECT 10MF	20% 50V	D12	*1-564-446-11	PLUG, CONNECTOR (2.5MM) 10P	
C536	1-106-192-00	MYLAR 0.0068MF	10% 100V	D13	*1-564-441-11	PLUG, CONNECTOR (2.5MM) 5P	
C537	1-106-196-00	MYLAR 0.01MF	10% 100V	<u>DIODE</u>			
C538	1-124-902-00	ELECT 0.47MF	20% 50V	D504	Δ8-719-901-02	DIODE SIB01-02	
C539	1-108-614-91	MYLAR 0.001MF	10% 100V	D505	Δ8-719-901-02	DIODE SIB01-02	
C540	1-106-196-00	MYLAR 0.01MF	10% 100V	D506	8-719-911-19	DIODE 1SS119	
C541	1-106-196-00	MYLAR 0.01MF	10% 100V	D507	8-719-911-19	DIODE 1SS119	
C542	1-124-907-00	ELECT 10MF	20% 50V	D508	8-719-911-19	DIODE 1SS119	
C543	1-124-192-00	ELECT 4.7MF	20% 50V	D509	8-719-911-19	DIODE 1SS119	
C545	1-108-691-81	MYLAR 0.0082MF	10% 200V	D510	8-719-918-77	DIODE V19G	
C546	1-108-688-91	MYLAR 0.0047MF	10% 200V	D511	8-719-901-93	DIODE V19E	
C547	Δ1-102-327-11	CERAMIC 330PF	15% 1.5KV	D512	8-719-973-95	DIODE ERD09-15	
C548	1-136-173-00	FILM 0.47MF	5% 50V	D513	8-719-302-59	DIODE FMU-26S	
C549	1-124-347-00	ELECT 100MF	20% 160V	D514	8-719-918-77	DIODE V19G	
C550	1-124-484-11	ELECT 220MF	20% 35V	D515	8-719-101-94	DIODE RD18E-L2	
C551	1-162-114-00	CERAMIC 0.0047MF	2KV	D516	Δ8-719-901-02	DIODE SIB01-02	

The components identified by shading and mark Δ are critical for safety. Replace only with part number specified.

Les composants identifiés par une trame et une marque Δ sont critiques pour la sécurité. Ne les remplacer que par une pièce portant le numéro spécifié.

Ref.No.	Part No.	Description	Remark	Ref.No.	Part No.	Description	Remark
D518	8-719-911-19	DIODE 1SS119		Q513	8-729-177-43	TRANSISTOR 2SD774	
D522	8-719-102-74	DIODE RD6.2E-N2		Q514	8-729-805-07	TRANSISTOR 2S01887-CA	
D523	8-719-300-76	DIODE RH1A		Q515	8-729-178-54	TRANSISTOR 2SC2785	
D524	8-719-300-76	DIODE RH1A		Q516	8-729-178-54	TRANSISTOR 2SC2785	
D525	8-719-911-19	DIODE 1SS119		Q517	8-729-178-54	TRANSISTOR 2SC2785	
D526	8-719-300-65	DIODE ES1F		Q518	8-729-178-54	TRANSISTOR 2SC2785	
D528	8-719-102-97	DIODE RD12E-N2		Q519	8-729-213-12	TRANSISTOR 2SC2230A	
D529	8-719-300-65	DIODE ES1F		Q520	8-729-401-21	TRANSISTOR 2SD1264-P	
D531	8-719-911-19	DIODE 1SS119		Q521	8-729-401-18	TRANSISTOR 2SB940-P	
D532	8-719-911-19	DIODE 1SS119		Q522	8-729-178-54	TRANSISTOR 2SC2785	
D533	8-719-911-19	DIODE 1SS119		Q531	8-729-178-54	TRANSISTOR 2SC2785	
D534	8-719-911-19	DIODE 1SS119		Q532	8-729-178-54	TRANSISTOR 2SC2785	
D535	8-719-911-19	DIODE 1SS119		Q533	8-729-178-54	TRANSISTOR 2SC2785	
D536	8-719-973-95	DIODE ERD09-15		Q534	8-729-178-54	TRANSISTOR 2SC2785	
D537	8-719-918-77	DIODE V19G		Q5001	8-729-117-54	TRANSISTOR 2SA1175	
D5001	8-719-901-24	THYRISTOR CSM2B4A10		<u>RESISTOR</u>			
D5002	8-719-911-19	DIODE 1SS119		R501	1-249-417-11	CARBON 1K 5% 1/6W	
D5003	8-719-901-19	DIODE V11N		R503	1-249-417-11	CARBON 1K 5% 1/6W	
<u>IC</u>				R504	1-249-405-11	CARBON 100 5% 1/6W	
IC501	8-759-014-95	IC MC1495L		R505	1-249-425-11	CARBON 4.7K 5% 1/6W	
IC504	8-759-145-58	IC UPC4558C		R506	1-247-791-00	CARBON 22 5% 1/6W	
IC505	8-759-170-12	IC UPC78M12H		R507	1-247-725-11	CARBON 10K 5% 1/4W	
<u>COIL</u>				R508	1-247-719-11	CARBON 3.3K 5% 1/4W	
L501	1-408-239-00	MICRO INDUCTOR 4.7MMH		R509	1-247-851-00	CARBON 6.8K 5% 1/6W	
L502	▲ 1-459-670-11	H.L.C		R510	1-216-350-11	METAL OXIDE 1.2 5% 1W	F
L503	▲ 1-459-671-11	COIL (WITH CORE)		R511	1-216-428-00	METAL OXIDE 180 5% 1W	F
L504	1-459-123-00	COIL, DUST CORE(PAC)		R512	1-216-371-00	METAL OXIDE 1.5 5% 2W	F
L505	1-459-104-00	COIL, DUST CORE		R513	1-216-373-11	METAL OXIDE 2.2 5% 2W	F
L506	1-407-365-00	COIL, CHOKE (HIGH FREQUENCY)		R514	1-249-429-11	CARBON 10K 5% 1/6W	
L507	1-421-421-00	COIL, CHOKE 100UH		R516	1-249-417-11	CARBON 1K 5% 1/6W	
L508	1-459-215-00	CORE COIL		R517	1-249-440-11	CARBON 82K 5% 1/6W	
L509	1-459-215-00	CORE COIL		R518	1-247-815-00	CARBON 220 5% 1/6W	
L510	1-459-454-00	COIL, FERRITE CHOKE		R519	1-247-891-00	CARBON 330K 5% 1/6W	
L511	1-421-329-00	COIL, CHOKE		R520	1-249-429-11	CARBON 10K 5% 1/6W	
L512	1-407-711-00	MICRO INDUCTOR 330UH		R521	1-249-429-11	CARBON 10K 5% 1/6W	
<u>NEON LAMP</u>				R522	1-215-882-00	METAL OXIDE 22 5% 2W	F
NL501	1-519-237-11	LAMP, NEON		R524	1-247-815-00	CARBON 220 5% 1/6W	
<u>TRANSISTOR</u>				R525	1-247-875-00	CARBON 68K 5% 1/6W	
Q501	8-729-900-36	TRANSISTOR DTC124ES		R526	1-249-429-11	CARBON 10K 5% 1/6W	
Q502	8-729-603-50	TRANSISTOR 2SC403SP		R527	1-247-145-00	CARBON 3.9K 5% 1/4W	
Q503	8-729-603-50	TRANSISTOR 2SC403SP		R528	1-247-721-11	CARBON 4.7K 5% 1/4W	
Q506	8-729-117-54	TRANSISTOR 2SA1175		R529	1-216-456-00	METAL OXIDE 820 5% 2W	F
Q507	8-729-177-43	TRANSISTOR 2SD774		R530	1-215-891-11	METAL OXIDE 680 5% 2W	F
Q508	8-729-178-54	TRANSISTOR 2SC2785		R531	1-216-430-11	METAL OXIDE 390 5% 1W	F
Q509	8-729-178-54	TRANSISTOR 2SC2785		R532	1-249-429-11	CARBON 10K 5% 1/6W	
Q510	8-729-313-42	TRANSISTOR 2S01134		R533	1-249-437-11	CARBON 47K 5% 1/6W	
Q511	8-729-177-43	TRANSISTOR 2SD774		R534	1-249-440-11	CARBON 82K 5% 1/6W	
Q512	8-729-103-43	TRANSISTOR 2SB734		R535	1-249-429-11	CARBON 10K 5% 1/6W	
				R536	1-247-885-00	CARBON 180K 5% 1/6W	
				R537	1-249-440-11	CARBON 82K 5% 1/6W	
				R538	1-249-429-11	CARBON 10K 5% 1/6W	
				R539	1-247-883-00	CARBON 150K 5% 1/6W	

The components identified by shading and mark ▲ are critical for safety. Replace only with part number specified.

Les composants identifiés par une trame et une marque ▲ sont critiques pour la sécurité. Ne les remplacer que par une pièce portant le numéro spécifié.



Ref.No.	Part No.	Description	Remark	Ref.No.	Part No.	Description	Remark
R540	1-247-893-00	CARBON	390K 5% 1/6W	R594	1-215-920-11	METAL OX IDE	3.3K 5% 3W F
R542	1-249-433-11	CARBON	22K 5% 1/6W	R595	1-215-894-11	METAL OX IDE	2.2K 5% 2W F
R543	1-247-851-00	CARBON	6.8K 5% 1/6W	R596	1-249-401-11	CARBON	47 5% 1/6W F
R544	1-247-859-00	CARBON	15K 5% 1/6W	R597	1-216-350-11	METAL OX IDE	1.2 5% 1W F
R545	1-247-817-00	CARBON	270 5% 1/6W	R598	1-216-350-11	METAL OX IDE	1.2 5% 1W F
R546	1-247-849-00	CARBON	5.6K 5% 1/6W	R599	1-202-842-51	SOL IO	220K 1/2W
R547	1-249-435-11	CARBON	33K 5% 1/6W	R5001	1-249-429-11	CARBON	10K 5% 1/6W
R548	1-249-497-11	CARBON	33K 5% 1/4W	R5002	1-249-441-11	CARBON	100K 5% 1/6W
R549	1-249-469-11	CARBON	100K 5% 1/4W	R5003	1-247-851-00	CARBON	6.8K 5% 1/6W
R550	1-249-429-11	CARBON	10K 5% 1/6W	R5004	1-249-432-11	CARBON	18K 5% 1/6W
R551	1-249-417-11	CARBON	1K 5% 1/6W F	R5005	1-249-429-11	CARBON	10K 5% 1/6W
R552	1-249-429-11	CARBON	10K 5% 1/6W	R5006	1-247-839-00	CARBON	2.2K 5% 1/6W
R553	1-249-417-11	CARBON	1K 5% 1/6W	R5007	1-247-887-00	CARBON	220K 5% 1/6W
R554	1-247-713-11	CARBON	1K 5% 1/4W	R5010	1-202-841-00	SOL ID	180K 10% 1/2W
R555	1-246-517-00	CARBON	68K 5% 1/4W	R5011	1-249-437-11	CARBON	47K 5% 1/6W
R556	1-216-424-11	METAL OX IDE	39 5% 1W F	R5012	1-249-429-11	CARBON	10K 5% 1/6W
R557	1-215-892-11	METAL OX IDE	1K 5% 2W F	R5013	1-249-437-11	CARBON	47K 5% 1/6W
R558	1-249-433-11	CARBON	22K 5% 1/6W	R5015	1-249-429-11	CARBON	10K 5% 1/6W
R559	1-249-417-11	CARBON	1K 5% 1/6W	R5016	1-249-433-11	CARBON	22K 5% 1/6W
R560	1-215-886-11	METAL OX IDE	100 5% 2W F	R5017	1-247-821-00	CARBON	390 5% 1/6W
R561	△1-215-863-51	METAL OX IDE	100 5% 1W F	R5018	1-249-440-11	CARBON	82K 5% 1/6W
R562	1-216-353-00	METAL OX IDE	2.2 5% 1W F	R5019	1-215-898-11	METAL OX IDE	10K 5% 2W F
R563	1-202-818-00	SOL IO	1K 1/2W	R5020	1-216-445-11	METAL OX IDE	12 5% 2W F
R564	1-249-387-11	CARBON	3.3 5% 1/6W F	R5021	1-216-353-00	METAL OX IDE	2.2 5% 1W F
R565	1-215-874-11	METAL OX IDE	6.8K 5% 1W F	R5022	1-247-823-00	CARBON	470 5% 1/6W
R566	1-215-872-11	METAL OX IDE	3.3K 5% 1W F	R5023	1-216-450-00	METAL OX IDE	82 5% 2W F
R567	1-244-933-00	CARBON	330K 5% 1/2W	VARIABLE RESISTOR			
R568	1-215-881-11	METAL OX IDE	15 5% 2W F	RV502	1-228-727-00	RES, ADJ, CERAMIC CARBON	47K
R569	△1-216-425-51	METAL OX IDE	56 5% 1W F	RV503	1-228-728-00	RES, ADJ, CERAMIC CARBON	100K
R570	1-249-433-11	CARBON	22K 5% 1/6W	RV504	1-228-725-00	RES, ADJ, CERAMIC CARBON	22K
R571	1-249-417-11	CARBON	1K 5% 1/6W	RV505	1-228-728-00	RES, ADJ, CERAMIC CARBON	100K
R572	1-247-859-00	CARBON	15K 5% 1/6W	RV506	1-228-720-00	RES, ADJ, CERAMIC CARBON	1K
R573	1-216-424-11	METAL OX IDE	39 5% 1W F	RV570	1-228-725-00	RES, AOJ, CERAMIC CARBON	22K
R574	1-247-849-00	CARBON	5.6K 5% 1/6W	RV580	1-228-729-00	RES, AOJ, CERAMIC CARBON	220K
R575	1-247-851-00	CARBON	6.8K 5% 1/6W	RELAY			
R576	1-249-429-11	CARBON	10K 5% 1/6W	RY501	△1-515-626-11	RELAY	
R577	1-249-433-11	CARBON	22K 5% 1/6W	RY502	△1-515-626-11	RELAY	
R578	1-249-429-11	CARBON	10K 5% 1/6W	RY503	△1-515-626-11	RELAY	
R579	1-249-429-11	CARBON	10K 5% 1/6W	RY504	△1-515-626-11	RELAY	
R580	1-247-851-00	CARBON	6.8K 5% 1/6W	SPARK GAP			
R581	1-247-873-00	CARBON	56K 5% 1/6W	SG501	1-519-063-XX	DISCHARGING GAP	
R582	1-249-429-11	CARBON	10K 5% 1/6W	TRANSFORMER			
R583	1-247-809-00	CARBON	120 5% 1/6W	T501	△1-437-164-11	HDT	
R584	1-249-429-11	CARBON	10K 5% 1/6W	T502	△1-439-390-11	TRANSFORMER ASSY, FLYBACK	
R585	1-249-425-11	CARBON	4.7K 5% 1/6W				
R586	1-249-405-11	CARBON	100 5% 1/6W				
R587	1-249-432-11	CARBON	18K 5% 1/6W				
R588	1-247-809-00	CARBON	120 5% 1/6W				
R589	1-249-429-11	CARBON	10K 5% 1/6W				
R590	1-249-429-11	CARBON	10K 5% 1/6W				
R591	1-249-422-11	CARBON	2.7K 5% 1/6W				
R592	1-247-845-00	CARBON	3.9K 5% 1/6W				
R593	1-249-393-11	CARBON	10 5% 1/6W F				

The components identified by shading and mark △ are critical for safety. Replace only with part number specified.

Les composants identifiés par une trame et une marque △ sont critiques pour la sécurité. Ne les remplacer que par une pièce portant le numéro spécifié.



Ref.No.	Part No.	Description	Remark	Ref.No.	Part No.	Description	Remark
*A-1371-187-A		H BOARD, COMPLETE *****		*A-1389-771-A		CA BOARD, COMPLETE *****	
1-619-035-11		PC BOARD, H		1-619-030-11		PC BOARD, CA	
		<u>CONNECTOR</u>		4-370-970-01		SPACER, TR	
H1	*1-564-450-11	PLUG, CONNECTOR (2.5MM) 2P		<u>CAPACITOR</u>			
H2	*1-564-452-41	PLUG, CONNECTOR (2.5MM) 4P		C703	1-123-948-00	ELECT 22MF	20% 250V
H3	*1-564-450-11	PLUG, CONNECTOR (2.5MM) 2P		C705	1-136-338-11	FILM 0.024MF	3% 1KV
H4	*1-564-450-11	PLUG, CONNECTOR (2.5MM) 2P		C711	1-124-907-00	ELECT 10MF	20% 50V
H5	*1-564-452-11	PLUG, CONNECTOR (2.5MM) 4P		C712	1-124-932-11	ELECT 100MF	20% 100V
		<u>RESISTOR</u>		C713	1-130-983-00	FILM 1.5MF	5% 100V
R802	1-247-811-00	CARBON 150 5% 1/6W		C714	1-124-928-11	ELECT 10MF	20% 100V
		<u>VARIABLE RESISTOR</u>		C721	1-124-907-00	ELECT 10MF	20% 50V
RV801	1-228-911-00	RES, VAR, CARBON 50K		C722	1-124-932-11	ELECT 100MF	20% 100V
RV802	1-228-911-00	RES, VAR, CARBON 50K		C723	1-130-983-00	FILM 1.5MF	5% 100V
RV803	1-228-911-00	RES, VAR, CARBON 50K		C724	1-124-928-11	ELECT 10MF	20% 100V
RV804	1-237-359-11	RES, VAR, CARBON 5K		C731	1-124-907-00	ELECT 10MF	20% 50V
		<u>SWITCH</u>		C732	1-124-932-11	ELECT 100MF	20% 100V
S801	Δ1-516-970-00	SWITCH, SLIDE		C733	1-130-983-00	FILM 1.5MF	5% 100V
S802	Δ1-553-111-00	SWITCH, SLIDE		C734	1-124-928-11	ELECT 10MF	20% 100V

*1-619-029-11		BC BOARD *****		<u>DIODE</u>			
		<u>CONNECTOR</u>		D711	8-719-901-83	DIODE 1SS83	
BC1	*1-564-444-11	PLUG, CONNECTOR (2.5MM) 8P		D712	8-719-901-83	DIODE 1SS83	
BC2	*1-564-444-11	PLUG, CONNECTOR (2.5MM) 8P		D713	8-719-300-65	DIODE ES1F	
BC3	1-563-301-11	SOCKET, CONNECTOR (D-SUB) 9P		D721	8-719-901-83	DIODE 1SS83	
		<u>COIL</u>		D722	8-719-901-83	DIODE 1SS83	
L901	1-410-314-11	MICRO INDUCTOR 0.47UH		D723	8-719-300-65	DIODE ES1F	
L902	1-410-314-11	MICRO INDUCTOR 0.47UH		D731	8-719-901-83	DIODE 1SS83	
L903	1-410-314-11	MICRO INDUCTOR 0.47UH		D732	8-719-901-83	DIODE 1SS83	
L904	1-410-314-11	MICRO INDUCTOR 0.47UH		D733	8-719-300-65	DIODE ES1F	
L905	1-410-314-11	MICRO INDUCTOR 0.47UH		<u>COIL</u>			
L906	1-410-314-11	MICRO INDUCTOR 0.47UH		L711	1-407-689-00	MICRO INDUCTOR 4.7UH	
L907	1-410-314-11	MICRO INDUCTOR 0.47UH		L712	1-407-687-00	MICRO INDUCTOR 3.3UH	
L908	1-410-314-11	MICRO INDUCTOR 0.47UH		L721	1-407-689-00	MICRO INDUCTOR 4.7UH	

1-619-036-11		X BOARD *****		L722	1-407-687-00	MICRO INDUCTOR 3.3UH	
		<u>DIODE</u>		L731	1-407-689-00	MICRO INDUCTOR 4.7UH	
D901	8-719-102-34	DIODE S6232D		L732	1-407-687-00	MICRO INDUCTOR 3.3UH	
				<u>NEON LAMP</u>			
				NL711	1-519-405-11	LAMP, NEON	
				NL721	1-519-405-11	LAMP, NEON	
				NL731	1-519-405-11	LAMP, NEON	
				<u>TRANSISTOR</u>			
				Q711	8-729-168-82	TRANSISTOR 2SC2688	
				Q721	8-729-168-82	TRANSISTOR 2SC2688	
				Q731	8-729-168-82	TRANSISTOR 2SC2688	

CA

Ref.No.	Part No.	Description	Remark		
<u>RESISTOR</u>					
R702	1-202-818-00	SOLID	1K		1/2W
R703	1-202-719-00	SOLID	1M	10%	1/2W
R708	1-202-720-00	SOLID	1.2M	10%	1/2W
R711	1-216-732-11	METAL	820	1%	10W
R712	1-202-557-00	SOLID	220	20%	1/2W
R713	1-244-887-51	CARBON	3.9K	5%	1/2W
R714	1-244-889-51	CARBON	4.7K	5%	1/2W
R715	1-247-903-00	CARBON	1M	5%	1/6W
R716	1-247-783-00	CARBON	10	5%	1/6W
R717	1-247-839-00	CARBON	2.2K	5%	1/6W
R721	1-216-732-11	METAL	820	1%	10W
R722	1-202-557-00	SOLID	220	20%	1/2W
R723	1-244-887-51	CARBON	3.9K	5%	1/2W
R724	1-244-889-51	CARBON	4.7K	5%	1/2W
R725	1-247-903-00	CARBON	1M	5%	1/6W
R726	1-247-783-00	CARBON	10	5%	1/6W
R727	1-247-839-00	CARBON	2.2K	5%	1/6W
R731	1-216-732-11	METAL	820	1%	10W
R732	1-202-557-00	SOLID	220	20%	1/2W
R733	1-244-887-51	CARBON	3.9K	5%	1/2W
R734	1-244-889-51	CARBON	4.7K	5%	1/2W
R735	1-247-903-00	CARBON	1M	5%	1/6W
R736	1-247-783-00	CARBON	10	5%	1/6W
R737	1-247-839-00	CARBON	2.2K	5%	1/6W

VARIABLE RESISTOR

RV701	1-226-114-00	RES, ADJ, METAL GLAZE	2.2M
RV702	1-226-063-00	RES, ADJ, CARBON	2.2M
RV711	1-224-252-XX	RES, ADJ, METAL GLAZE	10K
RV721	1-224-252-XX	RES, ADJ, METAL GLAZE	10K
RV731	1-224-252-XX	RES, ADJ, METAL GLAZE	10K

MISCELLANEOUS

△	1-230-666-11	RESISTOR ASSY, HIGH-VOLTAGE
△	1-451-291-11	DEFLECTION YOKE (SY-175)
	1-452-146-21	MAGNET, BMC
△	1-509-546-11	3P INLET
	1-543-179-00	CORE, RING
L901	△	1-426-283-31 COIL, DEMAGNETIZATION
RV901	1-230-536-11	RES, VAR, CARBON 10K
RV902	1-230-536-11	RES, VAR, CARBON 10K
S901	△	1-554-953-31 SWITCH, SEESAW (AC POWER)
V901	△	8-738-251-05 CRT M34JNQ15X

ACCESSORIES AND PACKING MATERIALS

Part No.	Description	Remark
△	1-558-377-11	CORD, POWER
	4-337-201-02	BAG, PROTECTION
*4-381-831-01		INDIVIDUAL CARTON
*4-381-832-01		CUSHION (UPPER) (ASSY)
*4-381-833-01		CUSHION (LOWER) (ASSY)
	4-482-265-21	MANUAL, INSTRUCTION
	4-491-213-22	INSTRUCTION

The components identified by shading and mark △ are critical for safety. Replace only with part number specified.

Les composants identifiés par une trame et une marque △ sont critiques pour la sécurité. Ne les remplacer que par une pièce portant le numéro spécifié.

CPD-1302

SONY SERVICE MANUAL

*US Model
Canadian Model*

Chassis No. SCC-A08A-A

January, 1987

No. 1

SUPPLEMENT

File this supplement with the service manual.

(SECTION ADJUSTMENTS)

MULTISCAN



MON

TABLE OF CONTENTS

<u>Section</u>	<u>Title</u>	<u>Page</u>
1. SETUP ADJUSTMENTS		
1-1.	Landing Adjustment	3
1-2.	Deflection Yoke Neck Adjustment	4
1-3.	G ₂ Adjustment	6
1-4.	Cut-off Adjustment	6
1-5.	White Balance Adjustment	6
2. SAFETY RELATED ADJUSTMENT 7		
3. CIRCUIT ADJUSTMENT		
3-1.	H.CENT, V.CENT Adjustment.	10
3-2.	Picture Distortion Adjustment.	10
3-3.	Adjustment of Horizontal Delay Sync Pulse	11
3-4.	Adjustment of Horizontal Oscillation Frequency.	11
3-5.	Horizontal Drive Pulse Width.	12
3-6.	Vertical Sync Frequency Identification Circuit	12
3-7.	+B Adjustment	12

Input a microcomputer (SONY SMC-70) signal.

Note: Micro Floppy Disk (SOFT) Part No. _____.

1. Input a Micro Floppy Disk on SMC-70.
2. Select the pattern signal. (F1~F5)
3. Select the Frequency. (SHIFT F1 ~ SHIFT F5)

SHIFT F-1	15.734kHz	60Hz
SHIFT F-2	18.4 kHz	60Hz
SHIFT F-3	21.8 kHz	60Hz
SHIFT F-4	25.0 kHz	60Hz
SHIFT F-5	31.5 kHz	60Hz

SECTION 1 SETUP ADJUSTMENTS

1-1. LANDING ADJUSTMENT

Preparations:

1. Face the set CRT surface toward the east or west in order to lessen the effect of geomagnetism.
2. Turn the set power switch on and degauss.

Adjustment:

1. Input an all white signal.
2. Perform rough adjustment of white balance, screen (G2), horizontal convergence and focus. The purity adjustment knob should be at the center position at this time. (Fig-1)
3. Set CA board R BKG VR (RV711) to maximum and G BKG VR (RV721) and B BKG VR (RV731) to minimum.
4. Move the deflection yoke back and adjust the purity magnet so that the entire picture is as shown in Fig-2.
5. Adjust so that the entire picture becomes red while moving the deflection yoke forward.
6. Use the G BKG VR (RV721) and B BKG VR (RV731) to check and adjust each color following steps 3 - 5.
7. When landing at the corners is not correct, perform magnet correction (Fig-3).
8. When the position of the deflection yoke is finalized, secure with the bracket.

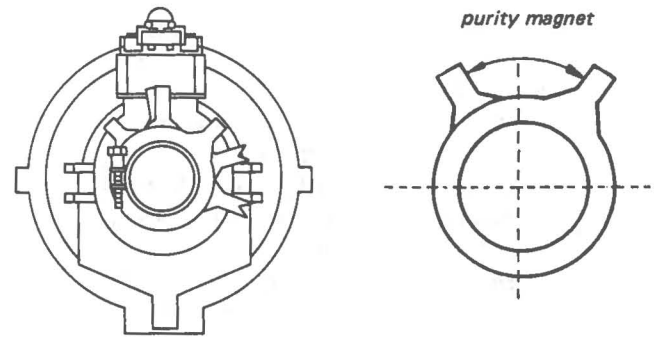

Fig. 1

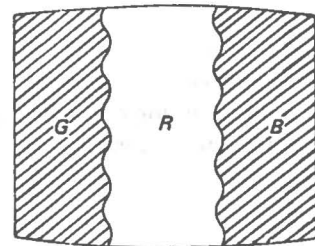

Fig. 2

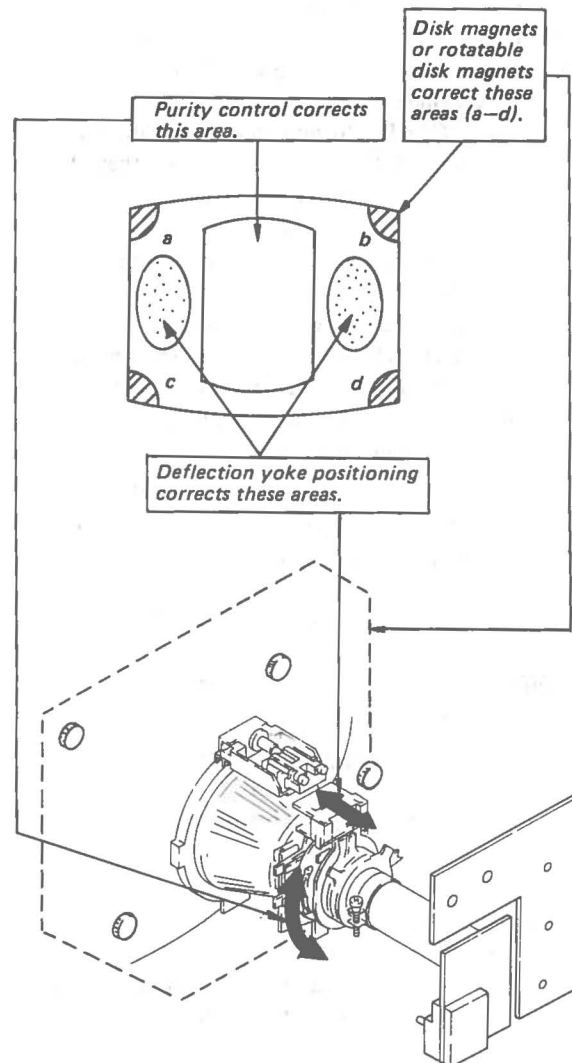
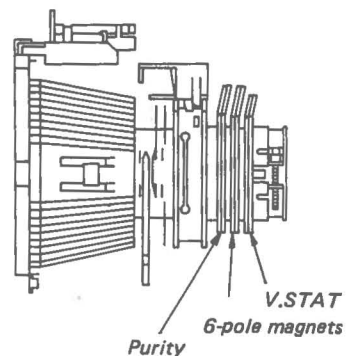
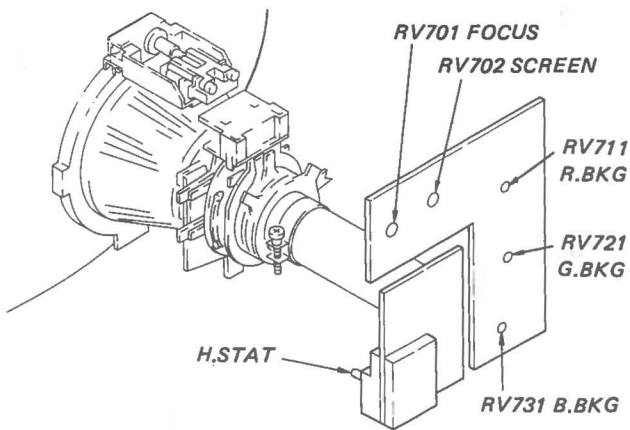

Fig. 3

1-2. DEFLECTION YOKE NECK ADJUSTMENT

Perform this adjustment when there is misconvergence and pincushion distortion at the top and bottom of the picture.

1. Tilt the deflection yoke up and down to adjust when the pincushion distortion is not the same at the top and bottom of the picture. (Fig-4)

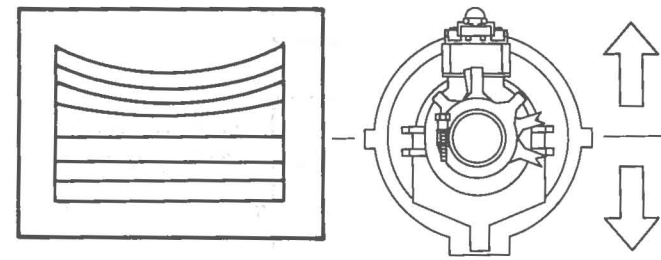

Fig. 4

2. When there is misconvergence at the top and bottom of the picture as shown in Fig-5, tilt the deflection yoke to the left and right to adjust.

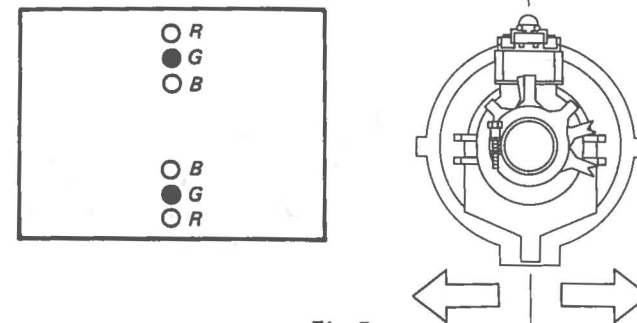

Fig. 5

- 1) Convergence Adjustment for Picture Center (H. STAT, V. STAT)

1. Input a dot signal, and with BRT at minimum, adjust for optimum picture with PICTURE.
2. Line up picture center and horizontal direction RGB dots with H. STAT VR (RV703).
3. Line up picture center and vertical direction RGB dots with V. STAT magnet.

- 2) Picture center horizontal direction asymmetrical misconvergence (HMC)
Picture center vertical direction asymmetrical misconvergence (VMC)

4. For HMC, move the six-pole magnet to adjust so that the R and B dots are symmetrical to the right and left of the G dot.
5. For VMC, move the six-pole magnet to adjust so that the R and B dots are symmetrical above and below the G dot.

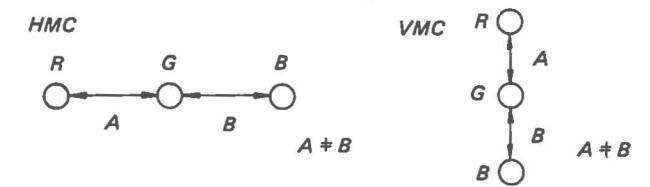

Dot Movement due to 6-pole Magnet movement

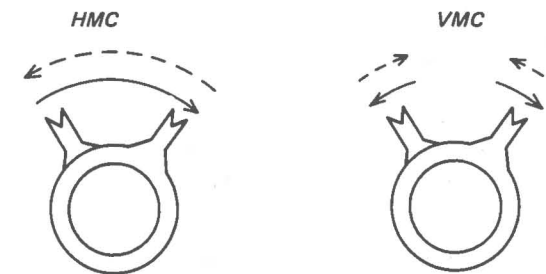
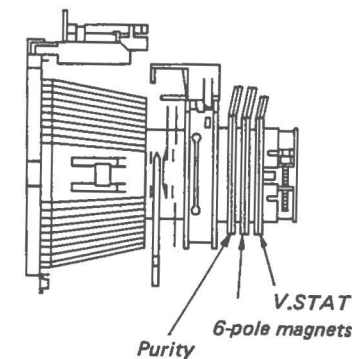
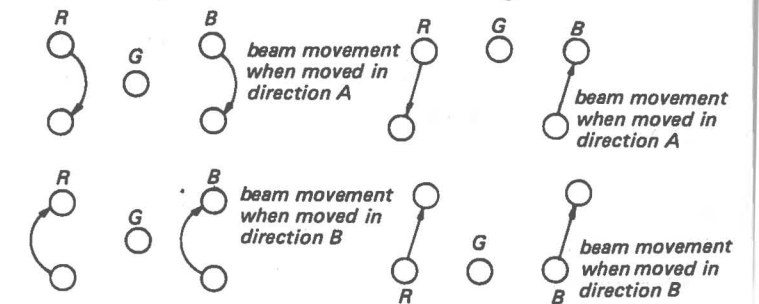

Fig. 6

Fig. 7



3) Picture Periphery Convergence Adjustment

1. For Y crosstalk, adjust with the Y crosstalk correction magnet.

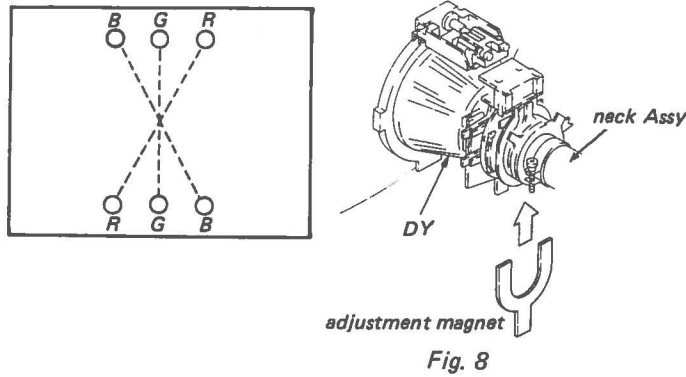

2. Adjust with the X crosstalk adjustment magnet when there is H TILT.

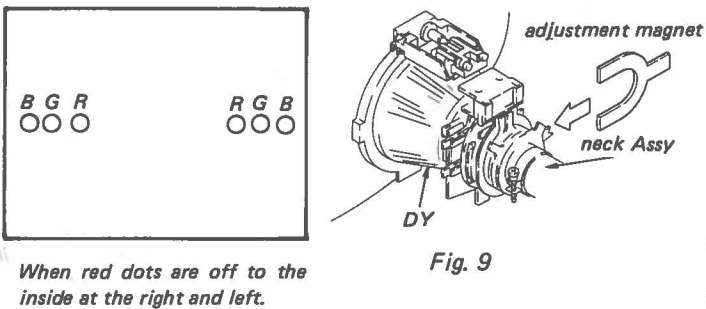

3. Adjust with the deflection yoke reactor correction coil when there is X crosstalk. (Fig-10)

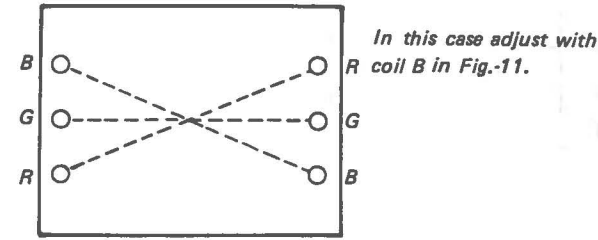
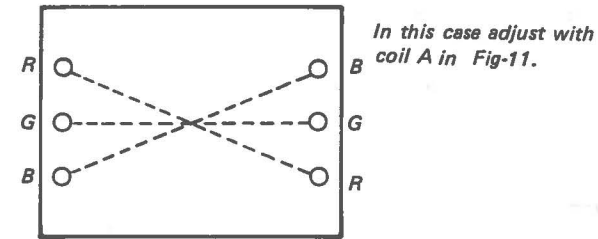
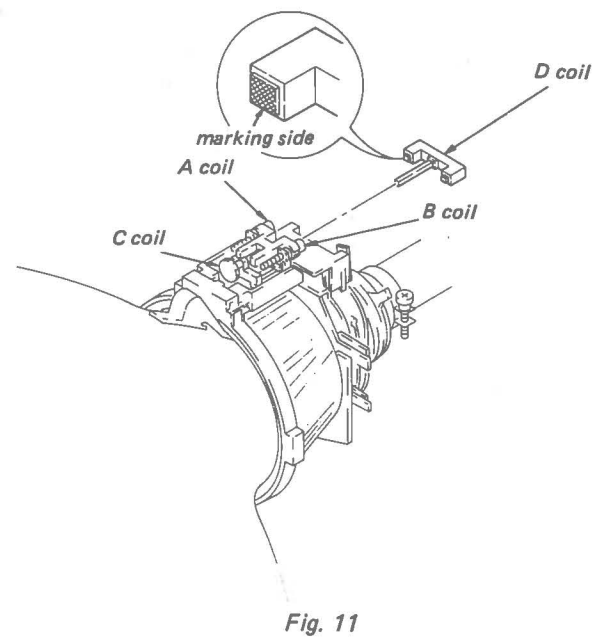
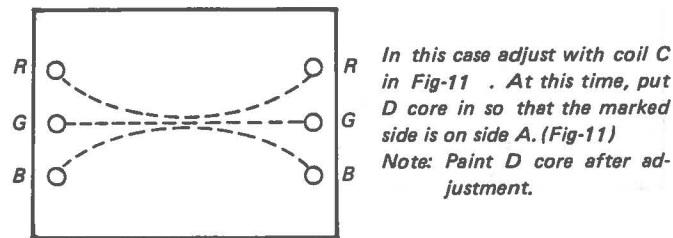

Fig. 10

4. Adjust with the deflection yoke reactor correction coil when there is X bow.



1-3. G₂ ADJUSTMENT

1. Cut off color check
 - (1) Receive a 21.8 kHz TTL H. V. separate SYNC signal.
 - (2) Set PICTURE, BRIGHTNESS (user controls), BA board SUB PICTURE VR (RV251) and SUB BRT VR (RV252) to minimum. Set R.G.B. BKG VR's (RV711, 721, 731,) to minimum.
 - (3) Brighten the entire picture with the screen VR, then gradually darken the picture and note which color remains glowing at the top of the picture.
2. G₂ Adjustment (RV702)
 - (1) Apply 140V DC to the cathode (CB board) of the color which remained glowing for cut off color check.
 - (2) Adjust the screen VR for optimum background over the entire picture.
 - (3) Set R.G.B DRIVE VR's (RV211, 221, 231) to maximum.

1-4. CUT OFF ADJUSTMENT

1. SUB BRT Setting
 - (1) Input an all white signal. (TTL H.V separate signal)
 - (2) Set PICTURE to maximum, and adjust BA board SUB PIX VR (RV251) so that the luminance meter set at the top of the picture is about 10 NIT.
 - (3) Perform white balance rough adjustment with the BKG VR's of the two colors which are not glowing as much.
 - (4) Set BRIGHTNESS to maximum, and adjust BA board SUB BRT VR (RV252) so that the brightness is 40 NIT brighter than the NIT value at this time.
2. 3 NIT Adjustment
 - (1) Set BRIGHTNESS at center click and PICTURE to minimum.
 - (2) Adjust an all white signal at 3 NIT to get white balance with the R.G.B. BKG VR's.

1-5. WHITE BALANCE ADJUSTMENT

1. Highlight Adjustment (during white peak)
 - (1) Input an all white signal. (TTL H.V separate signal)
 - (2) Set BRIGHTNESS and PICTURE to maximum.
 - (3) Adjust picture luminance to about 100 NIT with the BA board SUB PIX VR (RV251), then adjust highlight white balance with R.G.B. DRIVE VR's.

2. 3 NIT Adjustment
 - (1) Set BRIGHTNESS to center click and PICTURE to minimum.
 - (2) Adjust white balance with R.G.B. BKG VR's.
3. Tracking
 - (1) Repeat 2-3 times for white balance during highlight and 3 NIT.
4. MAX Luminance Adjustment
 - (1) Set BRIGHTNESS and PICTURE to maximum, and adjust BA board SUB BRT VR (RV252) for about 80 NIT.

BA BOARD

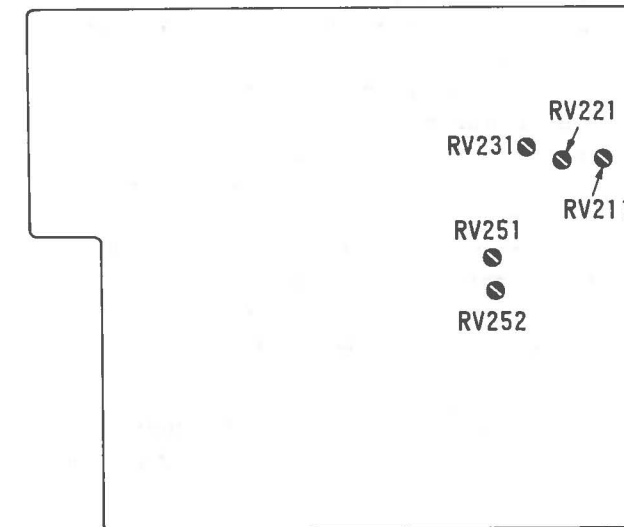

CA BOARD

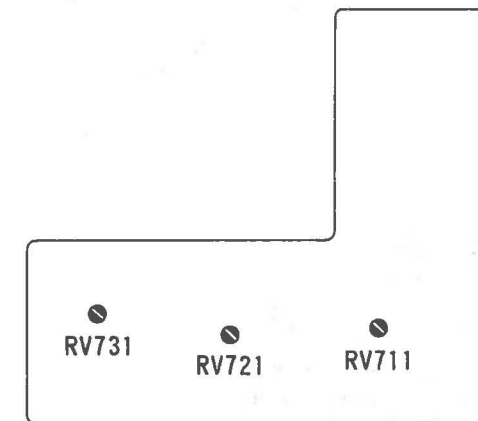

SECTION 2 SAFETY RELATED ADJUSTMENT

NOTE:

(1) TEST EQUIPMENT REQUIRED

1. Voltmeter (VOM)
2. Digital multimeter
3. DC POWER SUPPLY.
4. SONY Microcomputer SMC-70

+B MAX (R416, R489)

Be sure to perform the following adjustment after replacing the parts below. (Marked on the schematic diagram).

(G board) Q653, R658, R659, T653

(BA board)
IC401, IC404, IC405, Q409, R409, R410, R411, R412, R413, R414, R415, R416, R417, R418, R419, R424, R425, R448, R479, R480, R489, R488.

1. Input a dot signal and set PICTURE, BRIGHT to minimum.
2. Turn +B VR (RV403) to maximum.
3. Observe BA board to connector pin ① BA-1 on the digital multimeter.
4. Set SMC-70 output to fH = 15.734 kHz and confirm that the +B line is less than 62.0V dc.
5. Set SMC-70 output to fH = 18.4 kHz and confirm that the +B line is less than 72.8V dc.
6. Set SMC-70 output to fH = 21.8 kHz and confirm that the +B line is less than 86.0V dc.
7. Set SMC-70 output to fH = 25 kHz and confirm that the +B line is less than 97.8V dc.
8. Set SMC-70 output to fH = 31.5 kHz and confirm that the +B line is less than 124.5V dc.
9. If the specification is not met, adjust R416, R489 and repeat steps 1 and 3 until satisfied.

digital multimeter

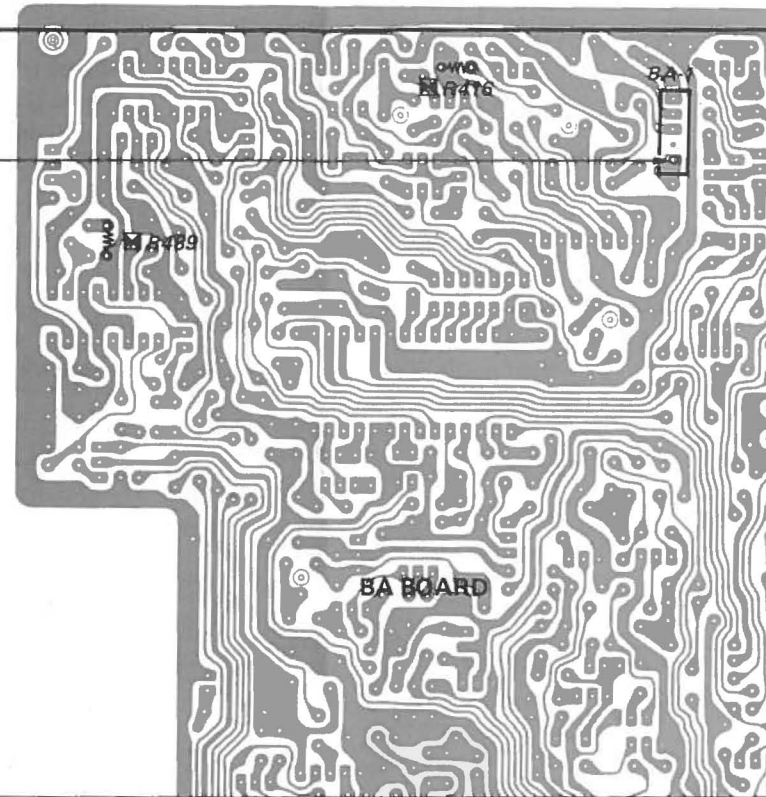
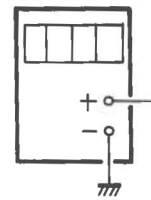

HOLD DOWN ADJUSTMENT (R339)

Be sure to perform the following adjustment after replacing the parts below. (Marked on the schematic diagram).

(BA board)
IC301, IC302, D304, R301, R302, R335, R336, R337, R338, R339, R340, R341, R342.

(D board)
R565, R566

1. Set the PICTURE and BRIGHTNESS control to maximum.
 2. Input the dot pattern signal.
 3. Set SMC-70 output to fH = 21.8 kHz and confirm that the BA board to connector pin ② BA-14 is less than 7.3±0.8V dc.
 4. Set the PICTURE and BRIGHTNESS control to minimum and supply is less than 8.95V dc, confirm that HV HOLD DOWN operates.
 5. Adjust ABL current to 400±50µA with PICTURE and BRIGHTNESS controls.
 6. Confirm that there is less than 8.70V dc whereby the raster disappears during operation of hold-down circuit.
- Note: If the hold-down circuit starts operating in the above case, switch OFF the POWER of the set immediately.
7. If above steps is not satisfied, select resistance value of R339 and repeat above steps 1 through 6.

digital multimeter

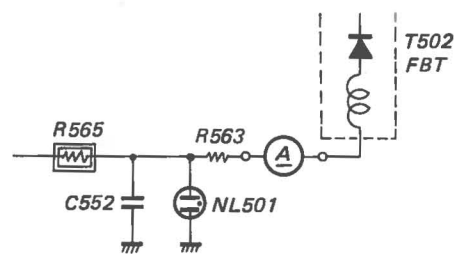
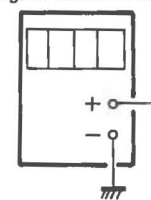

ammeter
1.0MA dc
range

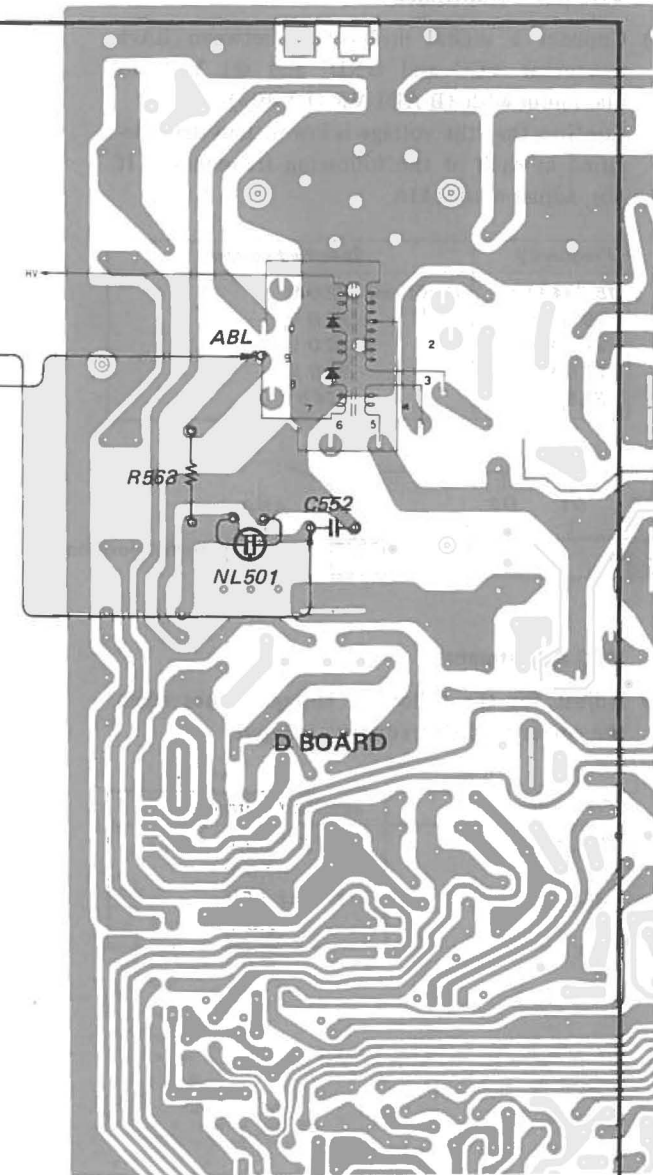
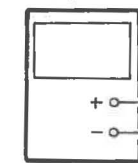

**CONFIRMATION WHEN REPLACING H.V.R.
(HIGH VOLTAGE REGISTER)**

The following adjustments should always be performed with reference to whether an X-ray radiation control circuit is connected or not, when replacing H.V.R.

* This check is to be performed when H.V.R. only is replaced, and has no relation to the hold-down circuit readjustment for replacement of parts marked on the schematic diagram.
(Connection Confirmation)

1. Turn the POWER switch ON, and receive white signals and set the PICTURE and BRIGHTNESS controls to MAX.
2. When the set is operating normally with 120V AC supply, confirm the voltage of the connection point for connector ② pin BA-14 is 7.3±0.8V dc.

SECTION 3
CIRCUIT ADJUSTMENTS

VCC Adjustment (R416)

Preparations:

- Set the switch on the set rear panel (H board) to NOR - DIG.
- Input a 21.8 kHz TTL RGB, H.V separate SYNC signal from a microcomputer.

1. VCC MAX Adjustment

- Connect a digital multimeter between BA-1 connector VCC and GND, and set VCC to maximum with +B ADJ VR (RV403).
- Confirm that the voltage is lower than that specified at each of the following frequencies. If not, adjust with R416.

Frequency	Specified voltage
15.734 kHz	(less than) 62.0 V
18.4 kHz	72.8 V
21.8 kHz	86.0 V
26.0 kHz	97.8 V
31.5 kHz	124.5V

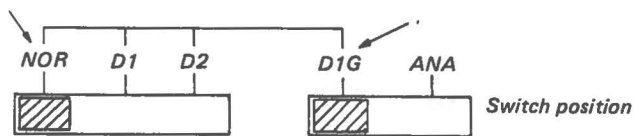

2. VCC Adjustment

- Adjust for the following voltage values when the corresponding frequency is input.

Frequency	Specified voltage
15.734 kHz	57.5 + 2.0 V -1.5 V
31.5 kHz	115.0 + 1.5V -2.0 V

BA BOARD

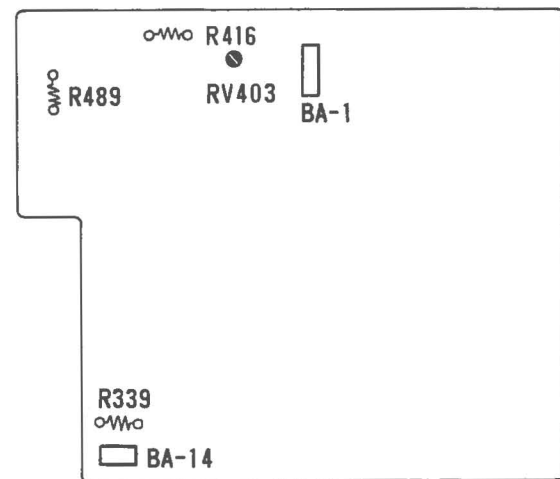

3-1. H.CENT, V.CENT ADJUSTMENT

1. Preparations

- LIN rough adjustment
Adjust top and bottom balance with V.LIN (1) for a 21.8 kHz signal. Balance center and top and bottom with V. LIN (2).
- Brighten the background with the screen VR and adjust H. CENT (RV506) and V.CENT (RV502) so that the background shown in the figure is at the center of the effective picture.
Note: Ignore raster blanking portion at this time.

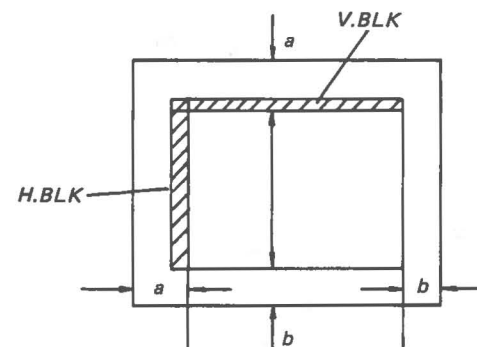

3-2. PICTURE DISTORTION ADJUSTMENT

1. Picture distortion adjustment

Input a signal equivalent to a crosshatch signal. (TTL H.V. separate SYNC signal)

PIN PHASE (RV570)



PIN AMP (RV504)

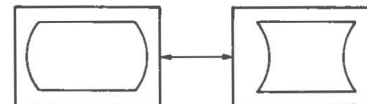

SUB PIN (RV503)



TOP PIN (RV580)

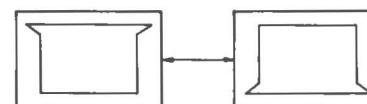

V. LIN (1) (RV301)



V. LIN (2) (RV302)



2. Picture Size

Input a TTL H.V. separate SYNC signal.

1. SIZE Adjustment

- Adjust picture to about 182mm with V. SIZE on the set rear panel.
- Set H. SIZE to maximum and adjust to about 244mm with D board H. SUB SIZE VR (RV505).
- Adjust to about 240mm with H. SIZE.

D BOARD

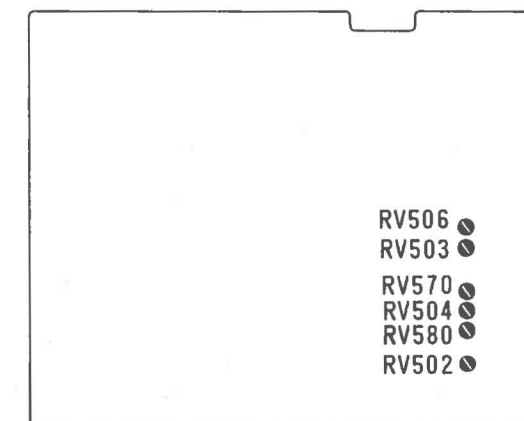

BA BOARD

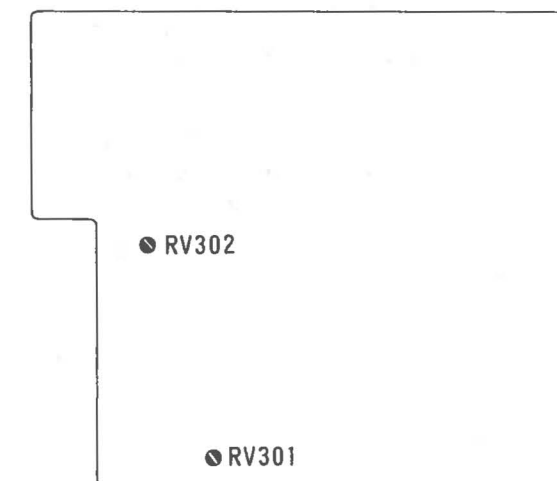

3-3 ADJUSTMENT OF HORIZONTAL DELAY SYNC PULSE

1. Signal
H: 15.734 kHz
V: 60 Hz
2. Measure the BA board IC205 pin 13 pulse waveform and adjust pulse width value as shown below.
 - (1) Turn HP BIAS VR (RV292) fully clockwise.
 - (2) Adjust pulse width to $6 \mu\text{sec} \pm 0.2 \mu\text{sec}$ with HP SLOPE VR (RV291).
 - (3) Adjust pulse width to $4 \mu\text{sec} \pm 0.2 \mu\text{sec}$ while turning HP BIAS VR (RV292) counterclockwise.
 - (4) Adjust pulse width to $5 \mu\text{sec} \pm 0.2 \mu\text{sec}$ with HP SLOPE VR (RV291).

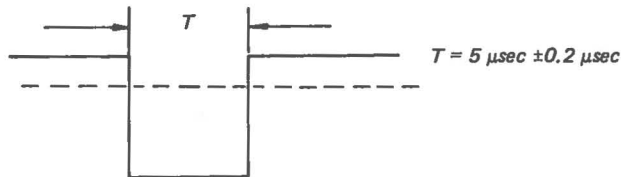

3. Signal
H: 30.12 kHz
V: 60 Hz
4. Confirm that BA board IC205 pin 13 pulse width is $3 \mu\text{sec} \pm 0.2 \mu\text{sec}$ at this time.

3-4 ADJUSTMENT OF HORIZONTAL OSCILLATION FREQUENCY

1. Signal
H: 15.734 kHz
V: 60 Hz
H: 21.8 kHz
V: 60 Hz
H: 30.12 kHz
V: 60 Hz
2. Mount a $10 \mu/16V$ chemical capacitor between BA board IC301 pin 1 and C307 negative side pin (GND).
3. Connect a frequency counter to IC405 pin 10.
4. Set H. FREQ (2) VR (RV401) to mechanical center.
5. Adjust H.FREQ (1) VR (RV402) so that the frequency counter reading is 30.12 kHz ± 300 Hz for the input signal (30.12 kHz).
6. Adjust H. FREQ (2) VR (RV401) so that the frequency counter reading is 21.8 kHz ± 300 Hz for the input signal (21.8 kHz).
7. Adjust H. FREQ (2) VR (RV401) so that the frequency counter reading is 15.734 kHz ± 100 Hz for the input signal (15.734 kHz).

8. With 30.12 kHz input signal again, adjust H. FREQ (1) VR (RV402) so that the frequency counter reading is 30.12 kHz ± 300 Hz.
9. Repeat the above adjustments so that the frequency counter readings are as specified above. Then remove the chemical capacitor mounted in step 2.

BA BOARD

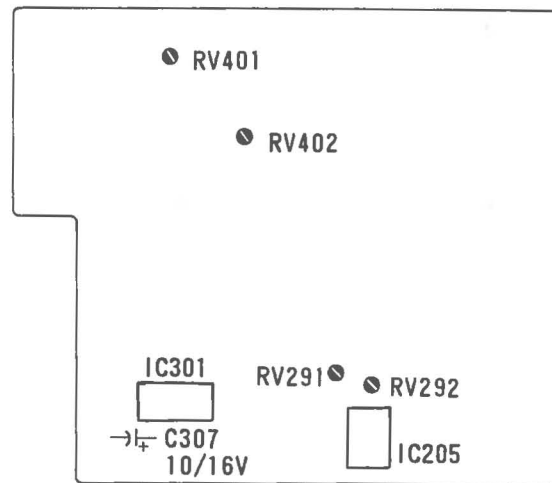

3-5. HORIZONTAL DRIVE PULSE WIDTH

1. Input signal H: 15.734 kHz
V: 60 Hz
2. Connect an oscilloscope to BA board IC405 pin 10.
3. Adjust with adjustment resistor R482 so that pulse widths is $24 \mu\text{sec} \pm 1.5 \mu\text{sec}$.

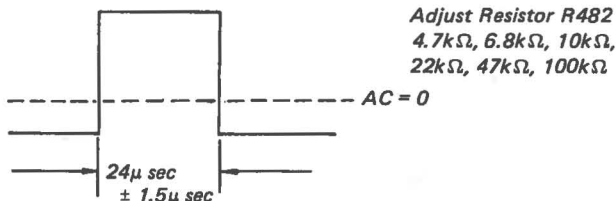

BA BOARD

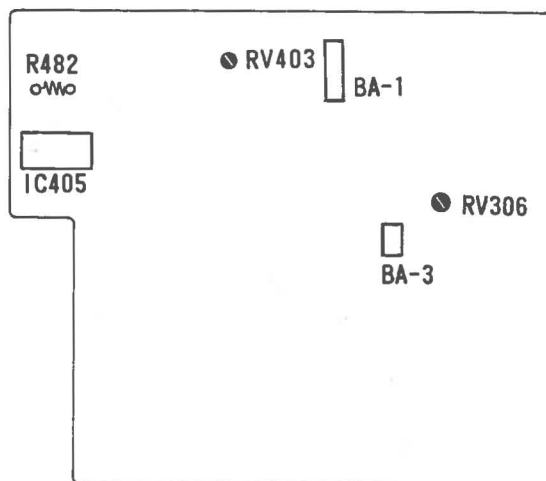

4. Check that the pulse width is $12.5 \mu\text{sec} \pm 1 \mu\text{sec}$ when input signal 30.12 kHz is input.

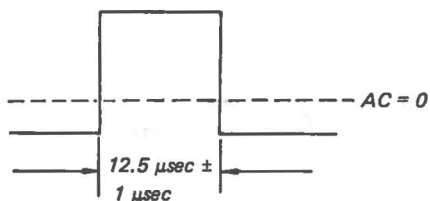

3-6. VERTICAL SYNC FREQUENCY IDENTIFICATION CIRCUIT

1. Input signal H: 15.734 kHz
V: 60 Hz
2. Connect a digital voltmeter to BA board Q332 base and adjust RV306 so that the voltage value is $5.6 \text{ V} \pm 0.05 \text{ V}$.
3. Short between BA-3 pin 1 (MS pin) and ground.
4. Adjust RV307 so that BA board Q332 base voltage value is $6.6 \text{ V} \pm 0.05 \text{ V DC}$.

3-7. +B ADJUSTMENT

1. Input signal H: 21.8 kHz
V: 60Hz
2. Connect a digital voltmeter to BA-1 connector pin 1 and adjust +B ADJ VR (RV403) so that the voltage value is $79.5 \pm 1 \text{ V DC}$.

CPD-1302

SONY® SERVICE MANUAL

*US Model
Canadian Model*

Chassis No. SCC-A08A-A

Serial No. 5,020,001 and later

Serial No. 5,021,501 and later

No. 2

SUPPLEMENT

SUBJECT : CIRCUIT MODIFICATION

File this supplement with the service manual.

MULTISCAN



INTRODUCTION

Contents of main modifications are as follows.

- BA board Addition: C203, R201, R300
Alteration: C402, C415
Deletion: R339 } (Serial No. 5,020,001 and later)
- BB board Alteration: IC106
- D board Deletion: C5001, D5001, D5002, Q5001, R5003~R5006 (Serial No. 5,020,001 and later)
Deletion: C505, C5002, D5003, R506, R5019 (Serial No. 5,021,501 and later)
Alteration : R513 (Serial No. 5,021,501 and later)
- Parts to be replaced.

BOARD	OLD		NEW	
BA	C402	1-124-903-00 ELECT 1MF 20% 50V	C203	1-102-119-00 CERAMIC 0.0015MF 10%
	C415	1-124-904-00 ELECT 2.2MF 20% 50V	C402	1-124-903-00 ELECT 10MF 20% 50V
	---	---	C415	1-124-904-00 ELECT 10MF 20% 50V
	---	---	R201	1-249-425-11 CARBON 4.7K 5%
	⊠R339	METAL 1/6W	R300	1-246-501-75 CARBON 15K 5%
BB	IC106	8-759-917-52 IC 74F138PC	IC106	8-759-917-52 IC SN74LS138N
D	C505	⊠1-102-234-51 CERAMIC 270PF 10% 500V	---	---
	C5001	1-124-910-11 ELECT 47MF 20% 50V	---	---
	C5002	1-162-115-00 CERAMIC 330PF 10% 2KV	---	---
	D5001	8-719-901-24 THYRISTOR CSM2B4A10	---	---
	D5002	8-719-911-19 DIODE 1SS119	---	---
	D5003	8-719-901-19 DIODE V11N	---	---
	Q5001	8-729-117-54 TRANSISTOR 2SA1175	---	---
	R506	1-247-791-00 CARBON 22 5% 1/6W	---	---
	R513	1-216-373-11 METAL OXIDE 2.2 5% 2W F	R513	1-216-369-51 METAL OXIDE 1 5% 2W F
	R5003	1-247-851-00 CARBON 6.8K 5% 1/6W	---	---
	R5004	1-249-432-11 CARBON 18K 5% 1/6W	---	---
	R5005	1-249-429-11 CARBON 10K 5% 1/6W	---	---
	R5006	1-247-839-00 CARBON 2.2K 5% 1/6W	---	---
	R5019	1-215-898-11 METAL OXIDE 12 5% 2W F	---	---

SECTION 4
DIAGRAMS

-  : deleted portion
-  : altered and added portion

4-1. BLOCK DIAGRAM : PAGE 15 ~ 16/Q5001 to be deleted (D board).

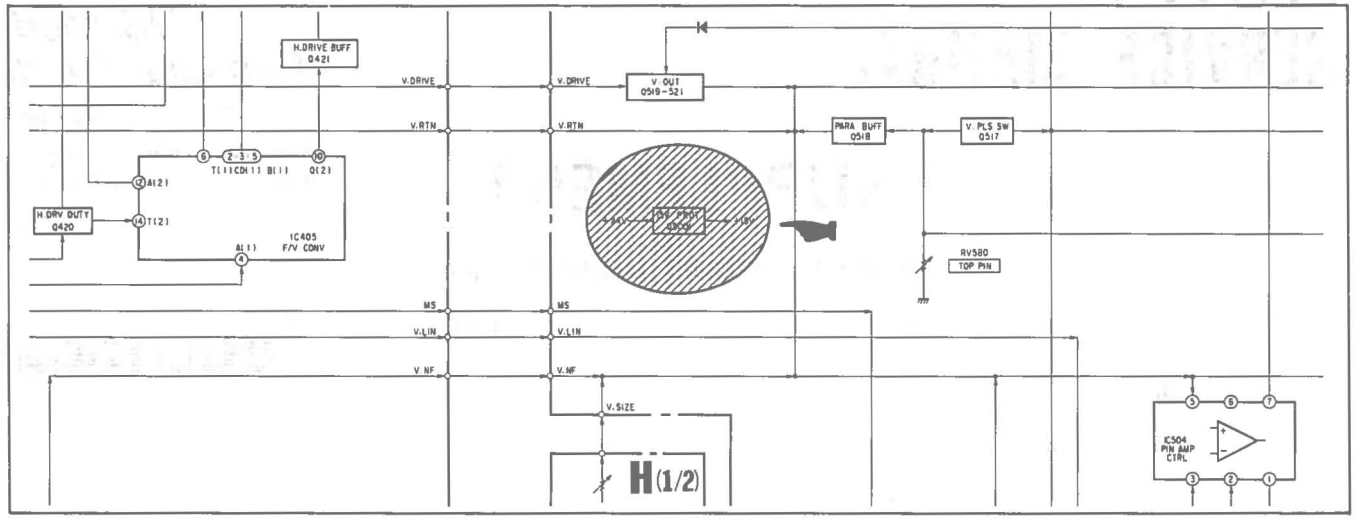

4-3. SCHEMATIC DIAGRAMS : PAGE 17 ~ 18/C203 and R201 to be added (BA board).

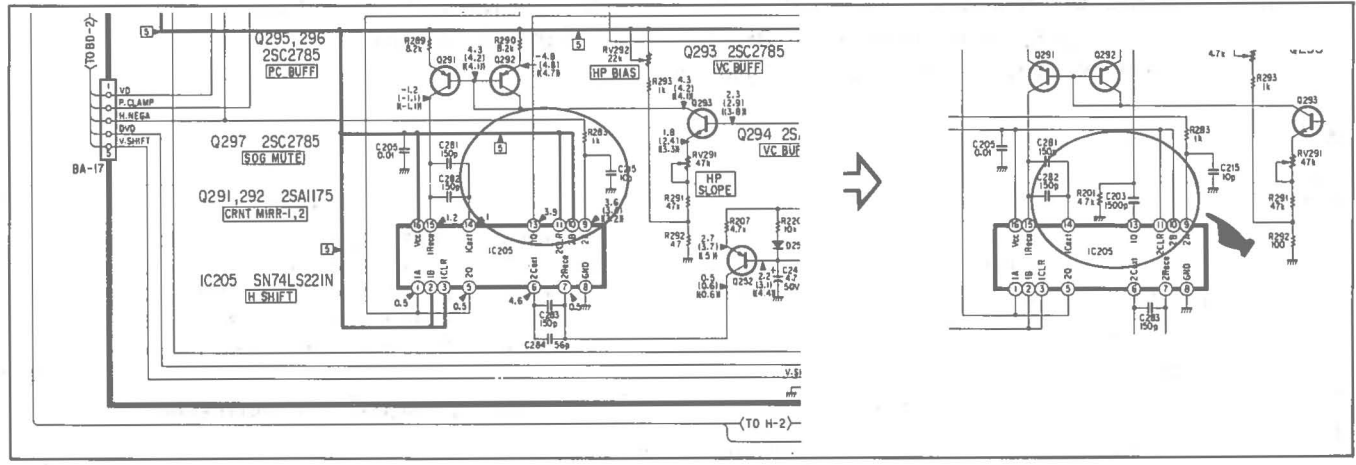

PAGE 18 ~ 19/R339 to be deleted and R300 to be added (BA board).

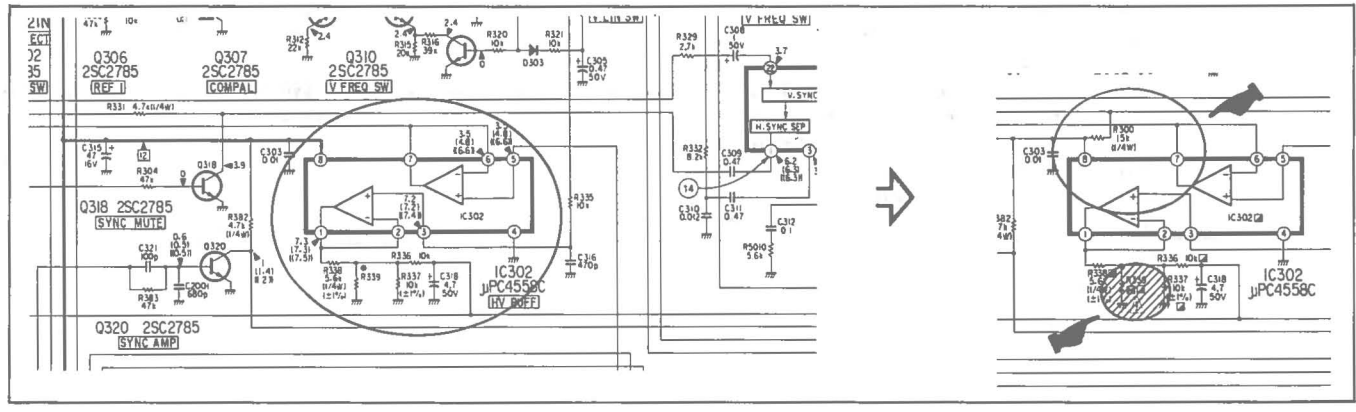

4-4. PRINTED WIRING BOARDS : PAGE 21 ~ 22/C203 and R201 to be added.
R339 to be deleted and R300 to be added (BA board).

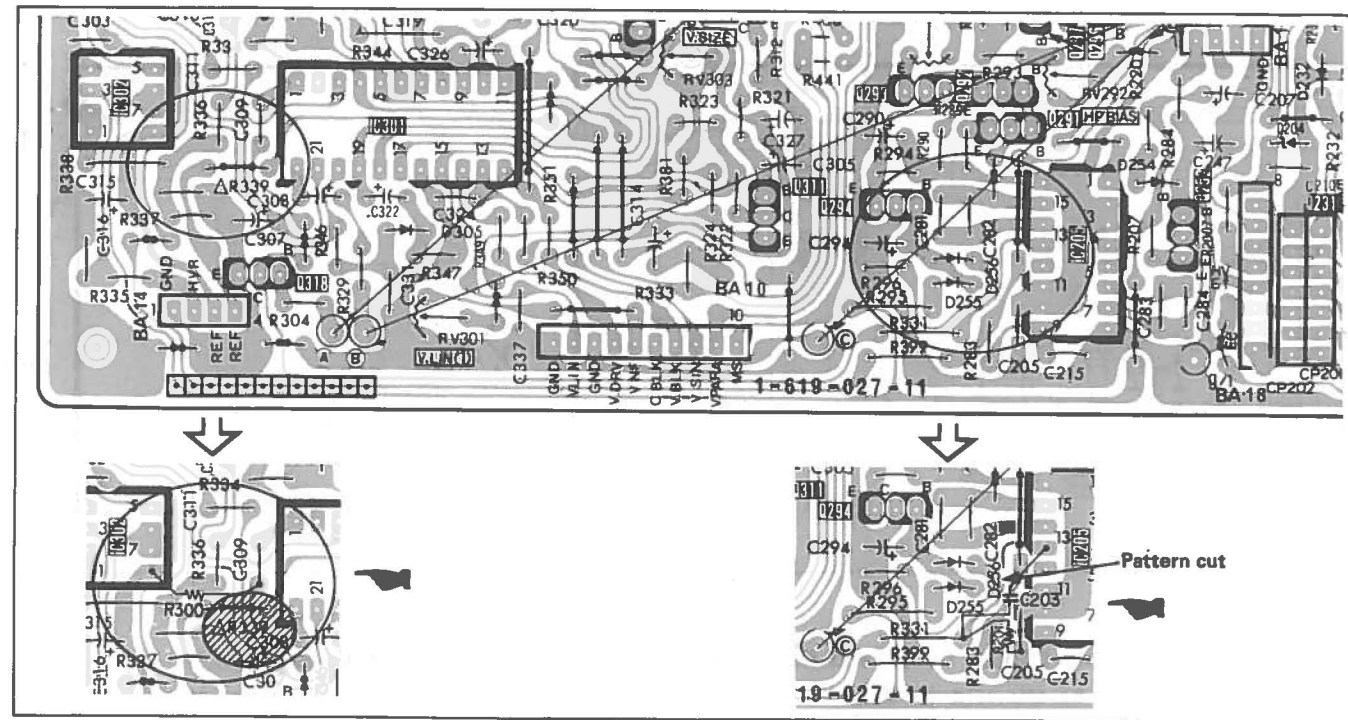

PAGE 29 ~ 30/C505, C5001, C5002 and D5001, D5002, D5003 and Q5001 and R506, R5003 ~ R5006, R5019 to be deleted (D board).

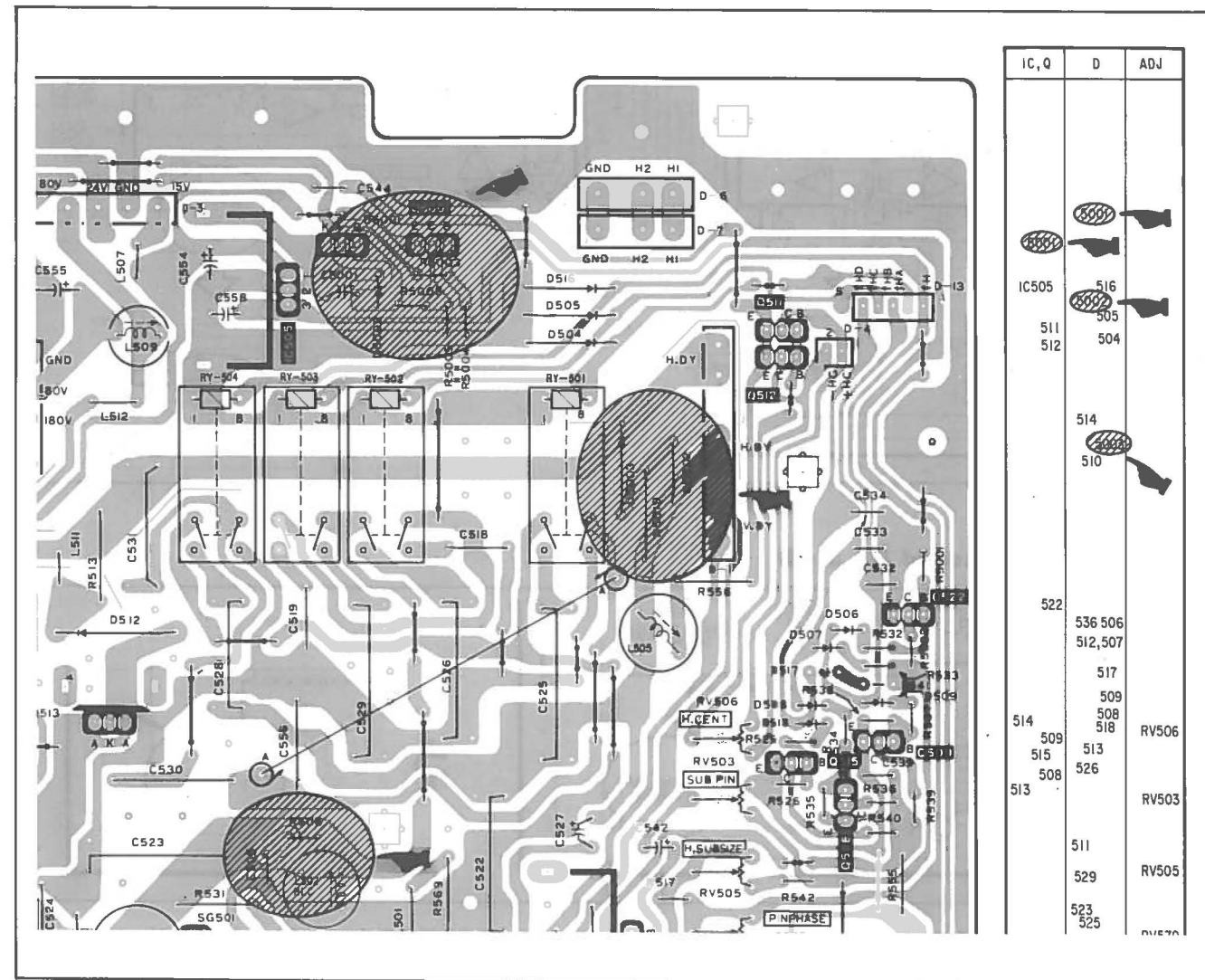

4-6. SEMICONDUCTORS : PAGE 35/SN74LS138N to be added and CSM2A4A10 to be deleted.

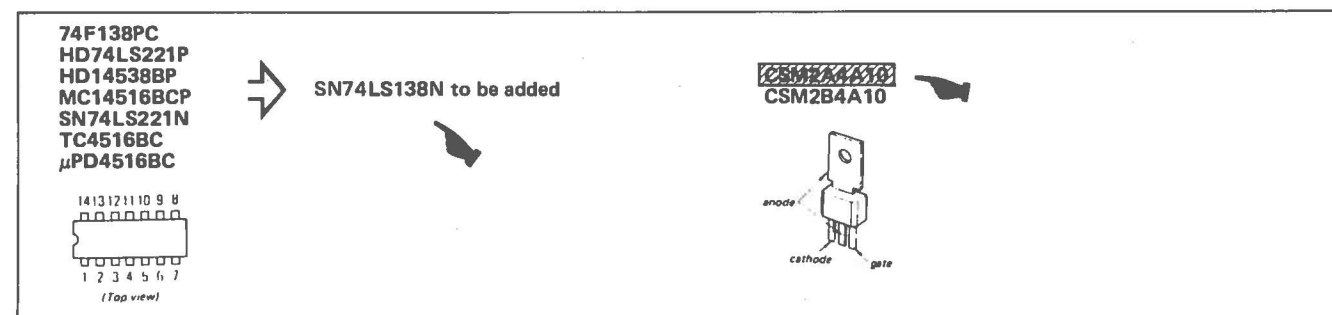

CPD-1302

SONY® SERVICE MANUAL

US Model
Canadian Model

Serial No. 5,500,001 and later
Chassis No. SCC-A08A-A

SUPPLEMENT-3

File this supplement with the service manual.

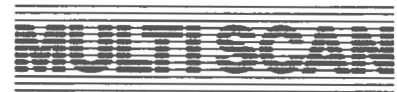

SPECIFICATIONS

Picture tube	Super Fine Pitch Trinitron color tube 13-inch picture tube measured diagonally 90 degree deflection Anti-glaring dark screen Useful screen 274mm x 207mm Phosphor P22
Resolution	900 dots x 560 lines
Scanning frequency	Vertical sync signal frequency: 50 - 100 Hz Horizontal sync signal frequency: 15.0 - 34.0 kHz
Input	RGB input (D-sub 9 pin) (Analog and TTL available)
Power requirements	120V AC, 50/60 Hz
Power consumption	96 W (maximum)
Dimensions	360 x 300 x 425 mm (w/h/d) (14 1/4 x 11 7/8 x 16 3/4 inches) including projecting parts
Weight	14.5 kg (32 lb)
Supplied accessory	AC power cord (1)

Optional accessories

Monitor cable (9-pin ↔ 9-pin)

SMF-512
SMF-513
SMF-514

Tilt/Swivel

SU-535 Display Stand

Design and specifications subject to change without notice.

Pin Assignment

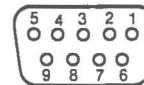

	1	2	3	4	5	6	7	8	9
ANALOG**	GND	GND	R	G*	B	GND	—	H/HV	V
DIGITAL	NORMAL	GND	GND	R	G	B	GND	—	H/HV
	D1	GND	GND	R	G	B	I	—	H/HV
	CGA	GND	GND	R	G	B	I	—	H/HV
	D2	MDA	GND	GND	—	—	I	G	H/HV
	EGA	GND	r	R	G	B	g	b	H/HV

(Input Selection)

GND: Ground R: Red Signal G: Green Signal
B: Blue Signal —: No connection
H: Horizontal Sync V: Vertical Sync
HV: Composite sync I: Intensity Signal
r: Secondary Red for EGA 64 colors
g: Secondary Green for EGA 64 colors
b: Secondary Blue for EGA 64 colors

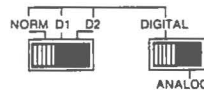

ANALOG

* Sync on Green automatic if horizontal or composite sync is not assigned at Pin #8

** IBM PGA should be connected with PGA Video cable (SMF-513)

DIGITAL (TTL LEVEL)

"Normal" is for 8 colors (R, G, & B)

"D1" is for 16 colors (R, G, B & I)

"D2" is for IBM Digital Color Graphic Boards (CGA, MDA, EGA) and there is no need to readjust anything among these cards.

SYNC

Composite sync is acceptable at Pin #8.

Every polarity is acceptable at Pin #8 & 9.

VERTICAL Size

Vertical size depends on vertical frequency and can be manually adjusted.



Timing Charts (for approximate reference)

1 D2-1 (IBM CGA compatible)

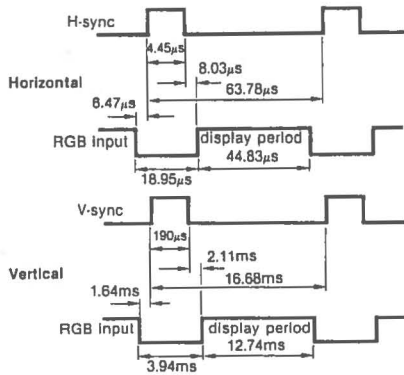

The Indicated values apply when the line period is 63.78 μs and the field period is 16.68 ms.

2 D2-2 (IBM EGA compatible)

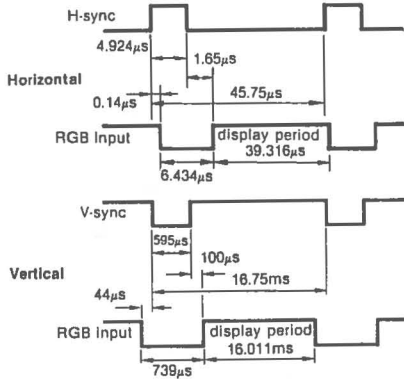

The Indicated values apply when the line period is 45.75 μs and the field period is 16.75 ms.

3 D2-3 (IBM VGA compatible)

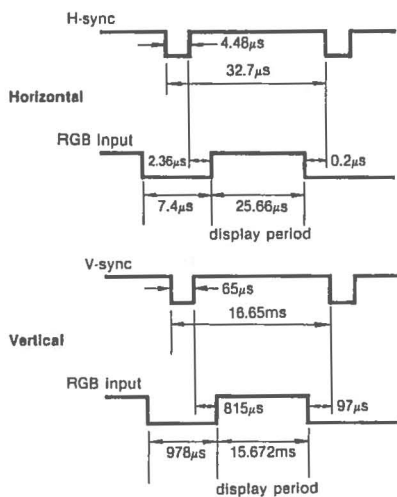

The Indicated values apply when the line period is 32.7 μs and the field period is 16.65 ms.

Note

The picture may be biased or the picture size may be changed depending on the timing of the connected equipment.

INFORMATION

This equipment generates and uses radio frequency energy and if not installed and used properly, that is, in strict accordance with the manufacturer's instructions, may cause interference to radio and television reception. It has been type tested and found to comply with the limits for a Class B computing device in accordance with the specifications in Subpart J of Part 15 of FCC Rules, which are designed to provide reasonable protection against such interference in a residential installation. However, there is no guarantee that interference will not occur in a particular installation. If this equipment does cause interference to radio or television reception, which can be determined by turning the equipment off and on, the user is encouraged to try to correct the interference by one or more of the following measures:

- Reorient the receiving antenna
- Relocate the equipment with respect to the receiver
- Move the equipment away from the receiver
- Plug the equipment into a different outlet so that equipment and receiver are on different branch circuits.

If necessary, the user should consult the dealer or an experienced radio/television technician for additional suggestions. The user may find the following booklet prepared by the Federal Communications Commission helpful:

"How to identify and Resolve Radio-TV Interference Problems." This booklet is available from the U.S. Government Printing Office, Washington, DC 20402, Stock No. 004-000-00345-4.

A shielded interface cable such as the SMF-series recommended on page 8 must be used with this equipment.

TABLE OF CONTENTS

<u>Section</u>	<u>Title</u>	<u>Page</u>
1.	CIRCUIT ADJUSTMENT	5
2.	DIAGRAMS	
2-1.	Printed Wiring Boards	6
2-2.	Circuit Boards Location	9
2-3.	Schematic Diagrams	9
2-4.	Semiconductors	21
3.	ELECTRICAL PARTS LIST	22

per
the
1.
2.
3.
4.
5.
6.
7.

WARNING !!

AN ISOLATION TRANSFORMER SHOULD BE USED DURING ANY SERVICE TO AVOID POSSIBLE SHOCK HAZARD, BECAUSE OF LIVE CHASSIS. THE CHASSIS OF THIS RECEIVER IS DIRECTLY CONNECTED TO THE AC POWER LINE.

SAFETY-RELATED COMPONENT WARNING !!

COMPONENTS IDENTIFIED BY SHADING AND MARK  ON THE SCHEMATIC DIAGRAMS, EXPLODED VIEWS AND IN THE PARTS LIST ARE CRITICAL TO SAFE OPERATION. REPLACE THESE COMPONENTS WITH SONY PARTS WHOSE PART NUMBERS APPEAR AS SHOWN IN THIS MANUAL OR IN SUPPLEMENTS PUBLISHED BY SONY. CIRCUIT ADJUSTMENTS THAT ARE CRITICAL TO SAFE OPERATION ARE IDENTIFIED IN THIS MANUAL. FOLLOW THESE PROCEDURES WHENEVER CRITICAL COMPONENTS ARE REPLACED OR IMPROPER OPERATION IS SUSPECTED.

ATTENTION!!

AFIN D'EVITER TOUT RISQUE D'ELECTROCUTION PROVENANT D'UN CHÂSSIS SOUS TENSION, UN TRANSFORMATEUR D'ISOLEMENT DOIT ETRE UTILISÉ LORS DE TOUT DÉPANNAGE. LE CHÂSSIS DE CE RÉCEPTEUR EST DIRECTEMENT RACCORDÉ À L'ALIMENTATION SECTEUR.

ATTENTION AUX COMPOSANTS RELATIFS À LA SÉCURITÉ!!

LES COMPOSANTS IDENTIFIÉS PAR UNE TRAME ET PAR UNE MARQUE  SUR LES SCHÉMAS DE PRINCIPE, LES VUES EXPLOSÉES ET LES LISTES DE PIÉCES SONT D'UNE IMPORTANCE CRITIQUE POUR LA SÉCURITÉ DU FONCTIONNEMENT. NE LES REMPLACER QUE PAR DES COMPOSANTS SONY DONT LE NUMÉRO DE PIÉCE EST INDIQUÉ DANS LE PRÉSENT MANUEL OU DANS DES SUPPLÉMENTS PUBLIÉS PAR SONY. LES RÉGLAGES DE CIRCUIT DONT L'IMPORTANCE EST CRITIQUE POUR LA SÉCURITÉ DU FONCTIONNEMENT SONT IDENTIFIÉS DANS LE PRÉSENT MANUEL. SUIVRE CES PROCÉDURES LORS DE CHAQUE REMPLACEMENT DE COMPOSANTS CRITIQUES, OU LORSQU'UN MAUVAIS FONCTIONNEMENT EST SUSPECTÉ.

8
9

Fig

SAFETY CHECK-OUT (US Model Only)

After correcting the original service problem, perform the following safety checks before releasing the set to the customer:

1. Check the area of your repair for unsoldered or poorly-soldered connections. Check the entire board surface for solder splashes and bridges.
2. Check the interboard wiring to ensure that no wires are "pinched" or contact high-wattage resistors.
3. Check that all control knobs, shields, covers, ground straps, and mounting hardware have been replaced. Be absolutely certain that you have replaced all the insulators.
4. Look for unauthorized replacement parts, particularly transistors, that were installed during a previous repair. Point them out to the customer and recommend their replacement.
5. Look for parts which, though functioning, show obvious signs of deterioration. Point them out to the customer and recommend their replacement.
6. Check the line cord for cracks and abrasion. Recommend the replacement of any such line cord to the customer.
7. Check the condition of the monopole antenna (if any).
Make sure the end is not broken off, and has the plastic cap on it. Point out the danger of impalement on a broken antenna to the customer, and recommend the antenna's replacement.
8. Check the B+ and HV to see they are at the values specified. Make sure your instruments are accurate; be suspicious of your HV meter if sets always have low HV.
9. Check the antenna terminals, metal trim, "metallized" knobs, screws, and all other exposed metal parts for AC leakage. Check leakage as described below.

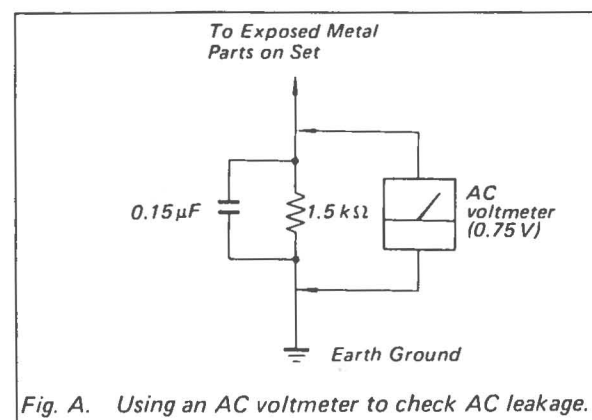

Fig. A. Using an AC voltmeter to check AC leakage.

LEAKAGE TEST

The AC leakage from any exposed metal part to earth ground and from all exposed metal parts to any exposed metal part having a return to chassis, must not exceed 0.5 mA (500 microamperes). Leakage current can be measured by any one of three methods.

1. A commercial leakage tester, such as the Simpson 229 or RCA WT-540A. Follow the manufacturers' instructions to use these instruments.
2. A battery-operated AC milliammeter. The Data Precision 245 digital multimeter is suitable for this job.
3. Measuring the voltage drop across a resistor by means of a VOM or battery-operated AC voltmeter. The "limit" indication is 0.75 V, so analog meters must have an accurate low-voltage scale. The Simpson 250 and Sanwa SH-63Trd are examples of a passive VOM that is suitable. Nearly all battery operated digital multimeters that have a 2V AC range are suitable. (See Fig. A)

HOW TO FIND A GOOD EARTH GROUND

A cold-water pipe is guaranteed earth ground; the cover-plate retaining screw on most AC outlet boxes is also at earth ground. If the retaining screw is to be used as your earth-ground, verify that it is at ground by measuring the resistance between it and a cold-water pipe with an ohmmeter. The reading should be zero ohms. If a cold-water pipe is not accessible, connect a 60-100 watts trouble light (not a neon lamp) between the hot side of the receptacle and the retaining screw. Try both slots, if necessary, to locate the hot side of the line, the lamp should light at normal brilliance if the screw is at ground potential. (See Fig. B)

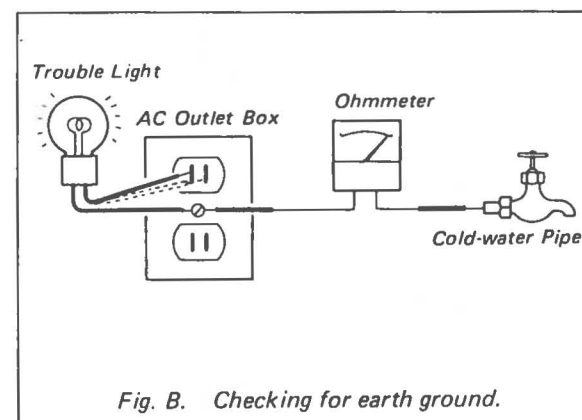

Fig. B. Checking for earth ground.

SECTION 1 CIRCUIT ADJUSTMENTS

V. SW. FREQ Adjustment

1. Input the EGA signal to the monitor.
2. Set the select switches position and VR adjustment.
 - 1) Digital voltage meter connect the probe between TP2 and ground on the BA board.
Note: CONTRAST MINIMUM (Right side of monitor)
 - 2) Set the switches of the back side.
Note: D2-ANALOG
 - 3) Adjust RV306 (V. SW. FREQ) for 6.10 V tolerance 0.02 V.
 - 4) Set the switches of the back side.
Note: D2-DIGITAL
 - 5) Adjust RV307 (50/60) for 6.80 V tolerance 0.02 V.
 - 6) After modification, adjust V. SIZE for VGA.

TP2 AND RV POSITION

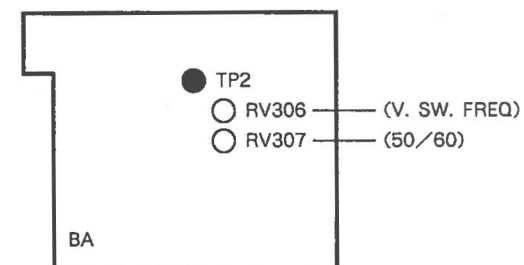

SW POSITION

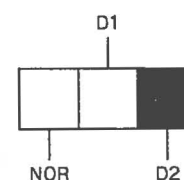

DIGITAL

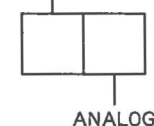

ELECTROCUTION
S TENSION, UN
R DOIT ETRE
E.
IT DIRECTEMENT
TEUR.

ELATIFS À LA

UNE TRAME ET
IAS DE PRINCIPE,
STES DE PIÈCES
QUE POUR LA
NE LES REM-
SONY DONT LE
ANS LE PRÉSENT
TS PUBLIÉS PAR
DONT L'IMPOR-
SÉCURITÉ DU
FIES DANS LE
DCÉDURES LORS
E COMPOSANTS
IS FONCTIONNE-

BA [HV. OSC, R-G-B DRIVE,
V. FREQ CTRT, F/V CONV.]

BB [Video, IF, INT SW.,
R-G-B OUT.]

BC **X**

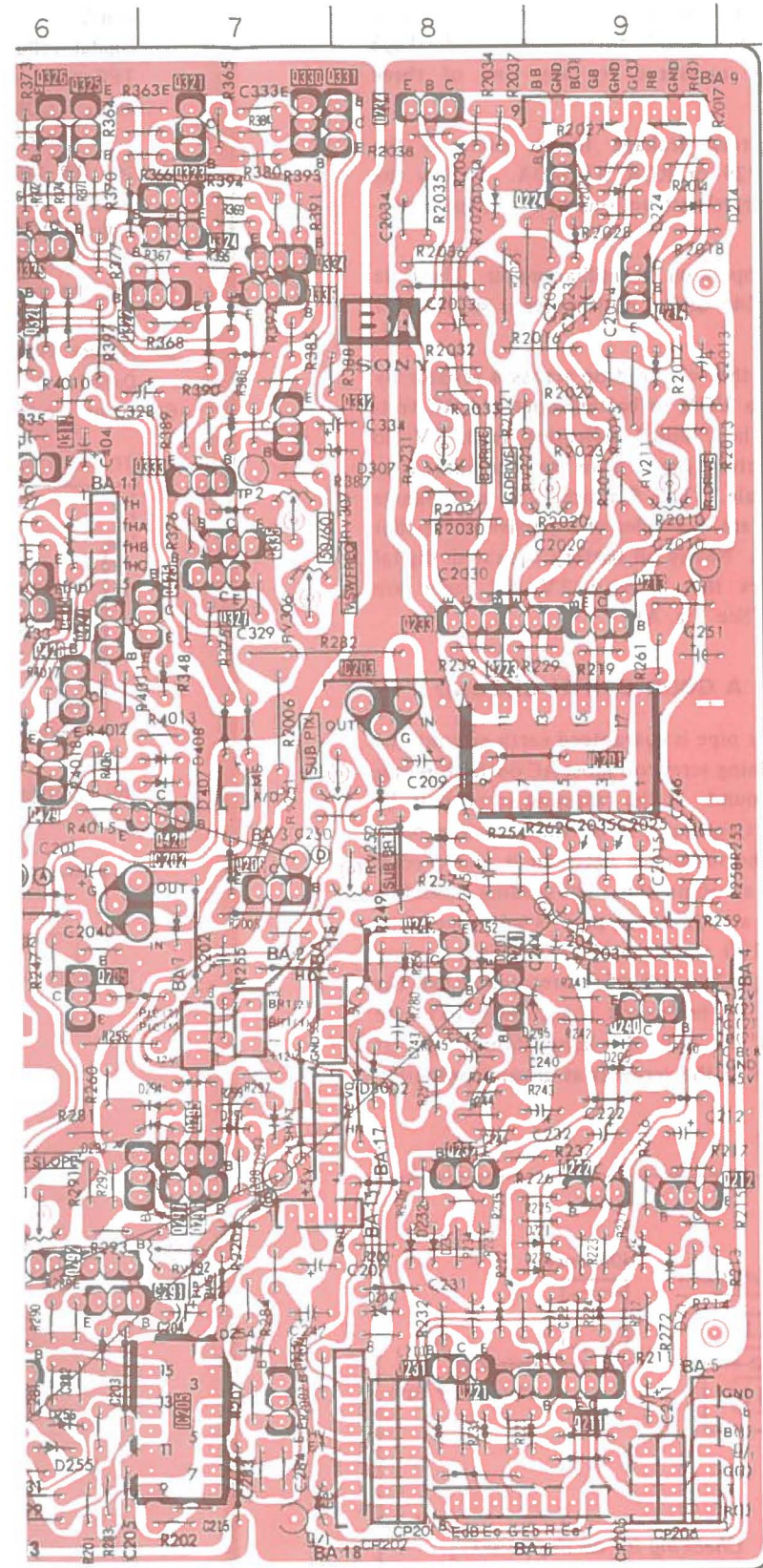

IC		Q408 B-3	
IC201	D-9	Q409	A-4
IC202	E-7	Q411	C-6
IC203	D-8	Q412	D-6
IC205	H-7	Q413	D-6
IC301	G-3	Q414	C-6
IC302	G-2	Q415	C-6
IC401	B-4	Q416	A-2
IC403	A-2	Q417	A-1
IC404	C-3	Q418	D-3
IC405	C-1	Q419	D-4
		Q420	B-1
		Q421	D-1
		Q422	B-5
		Q423	B-5
		Q424	B-5
		Q425	C-7
		Q426	D-6
		Q427	C-6
		Q428	D-7
		Q429	D-6
		Q440	F-6
		Q3001	F-3
		Q3002	F-4
TRANSISTOR		DIODE	
Q205	E-6	D201	E-8
Q206	E-7	D204	G-8
Q211	G-9	D205	F-9
Q212	F-9	D211	G-9
Q213	C-9	D212	G-9
Q214	B-9	D221	G-9
Q221	G-8	D222	G-9
Q222	F-9	D231	G-8
Q223	C-9	D232	G-8
Q224	A-9	D254	G-7
Q231	G-8	D255	H-6
Q232	F-8	D256	H-6
Q233	C-8	D291	F-7
Q234	A-8	D292	F-7
Q240	E-9	D293	F-7
Q241	E-8	D294	F-7
Q243	E-8	D295	E-9
Q252	G-7	D301	E-5
Q291	G-6	D302	E-4
Q292	G-6	D303	F-4
Q293	G-6	D304	E-3
Q294	G-6	D305	H-3
Q295	F-7	D306	E-3
Q296	F-7	D307	C-8
Q297	F-6	D308	C-6
Q301	D-4	D309	A-6
Q302	D-5	D310	D-2
Q303	E-5	D401	B-3
Q304	E-4	D402	B-4
Q305	E-4	D403	B-4
Q306	F-5	D404	D-4
Q307	F-5	D405	C-1
Q308	E-4	D407	D-7
Q309	F-5	D408	D-7
Q310	E-5	D3001	F-4
Q311	G-5	D3002	F-8
Q312	F-2		
Q313	E-4		
Q314	E-4		
Q315	E-3		
Q316	D-3		
Q317	C-6		
Q318	H-3		
Q320	C-2		
Q321	A-7		
Q322	B-7		
Q323	A-7		
Q324	A-7		
Q325	A-6		
Q326	A-6		
Q327	C-7		
Q328	B-6		
Q329	B-6		
Q330	A-7		
Q331	A-8		
Q332	B-7		
Q333	C-7		
Q334	B-7		
Q335	C-7		
Q336	B-7		
Q401	A-3		
Q402	A-3		
Q403	A-3		
Q404	A-3		
Q405	B-3		
Q406	B-3		
Q407	B-3		

- BB Board -

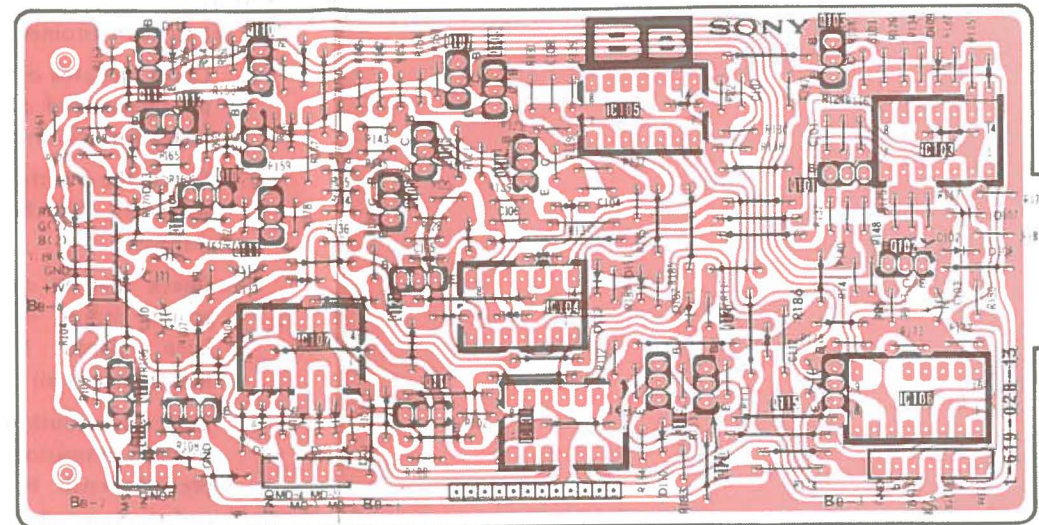

- BC Board -

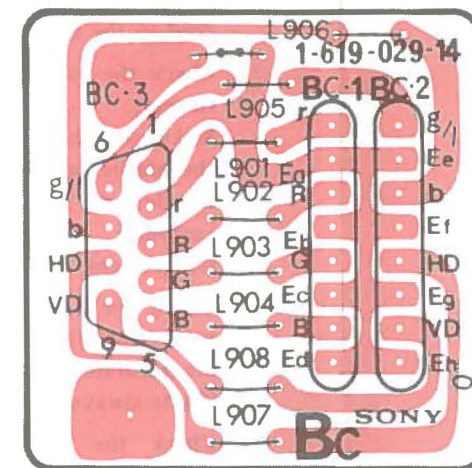

- X Board -

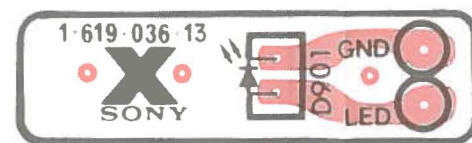

BA BOARD WAVEFORM

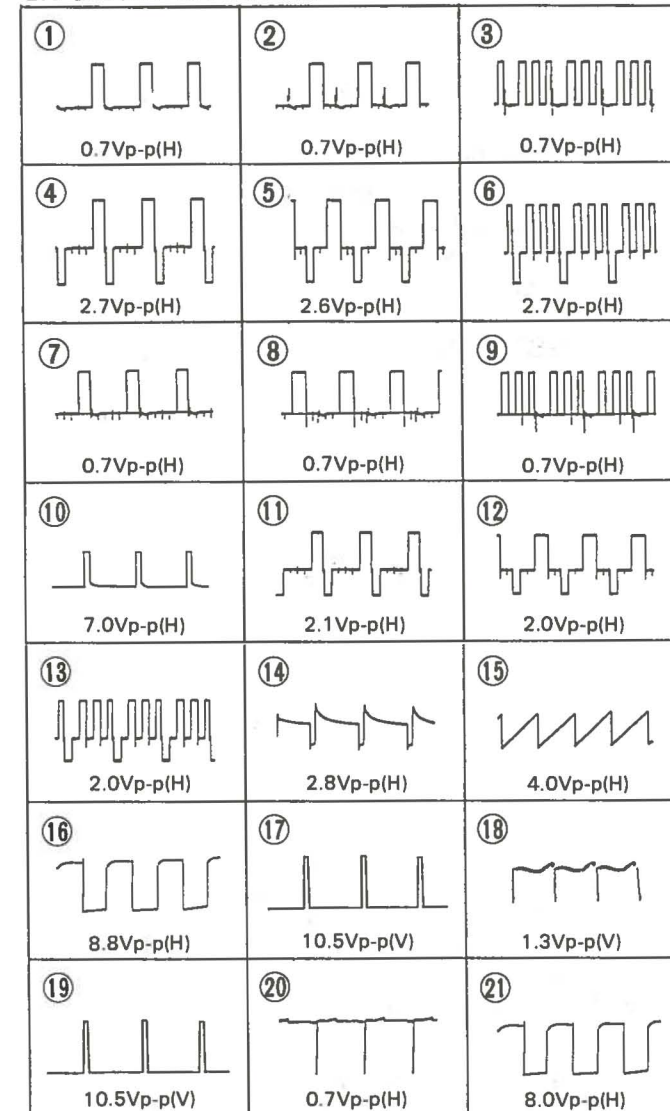

BB BOARD WAVEFORM

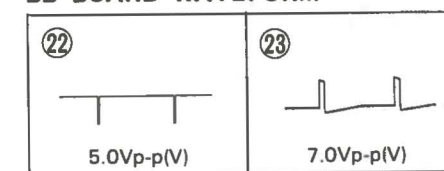

SECTION 2
DIAGRAMS

2-1. PRINTED WIRING BOARDS - Conductor Side -

- BA Board -

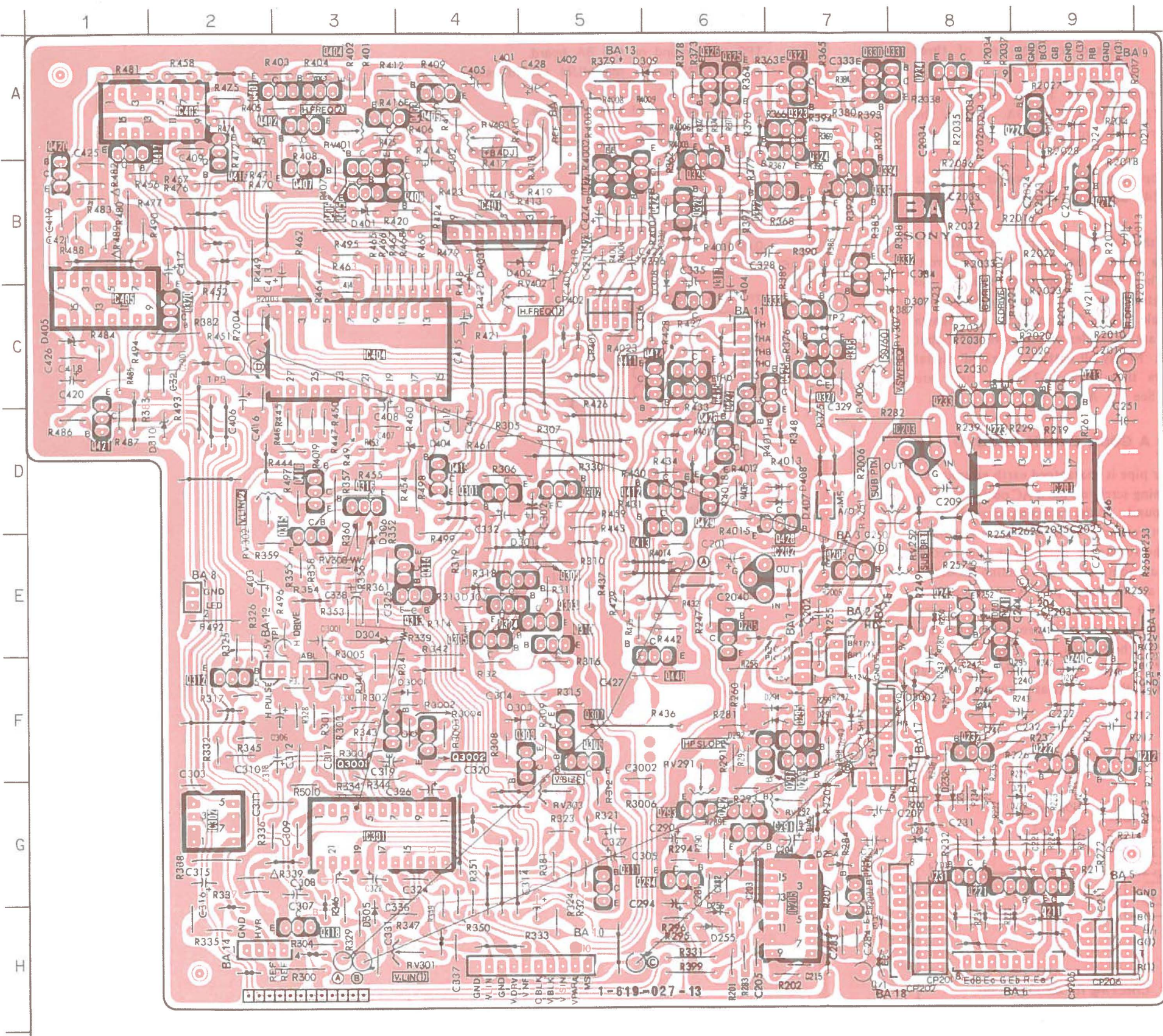

BA [HV. OSC, R-G-B DRIVE,
V. FREQ CTRT, F/V CONV.]

BB [Video, IF, INT SW.,
R-G-B OUT.]

BC **X**

IC		Q408 B-3	
IC201	D-9	Q409	A-4
IC202	E-7	Q411	C-6
IC203	D-8	Q412	D-6
IC205	H-7	Q413	D-6
IC301	G-3	Q414	C-6
IC302	G-2	Q415	C-6
IC401	B-4	Q416	A-2
IC403	A-2	Q417	A-1
IC404	C-3	Q418	D-3
IC405	C-1	Q419	D-4
		Q420	B-1
		Q421	D-1
		Q422	B-5
		Q423	B-5
		Q424	B-5
		Q425	C-7
		Q426	D-6
		Q427	C-6
		Q428	D-7
		Q429	D-6
		Q440	F-6
		Q3001	F-3
		Q3002	F-4
TRANSISTOR		DIODE	
Q205	E-6	D201	E-8
Q206	E-7	D204	G-8
Q211	G-9	D205	F-9
Q212	F-9	D211	G-9
Q213	C-9	D212	G-9
Q214	B-9	D221	G-9
Q221	G-8	D222	G-9
Q222	F-9	D231	G-8
Q223	C-9	D232	G-8
Q224	A-9	D254	G-7
Q231	G-8	D255	H-6
Q232	F-8	D256	H-6
Q233	C-8	D291	F-7
Q234	A-8	D292	F-7
Q240	E-9	D293	F-7
Q241	E-8	D294	F-7
Q243	E-8	D295	E-9
Q252	G-7	D301	E-5
Q291	G-6	D302	E-4
Q292	G-6	D303	F-4
Q293	G-6	D304	E-3
Q294	G-6	D305	H-3
Q295	F-7	D306	E-3
Q296	F-7	D307	C-8
Q297	F-6	D308	C-6
Q301	D-4	D309	A-6
Q302	D-5	D310	D-2
Q303	E-5	D401	B-3
Q304	E-4	D402	B-4
Q305	E-4	D403	B-4
Q306	F-5	D404	D-4
Q307	F-5	D405	C-1
Q308	E-4	D407	D-7
Q309	F-4	D408	D-7
Q310	E-5	D3001	F-4
Q311	G-5	D3002	F-8
Q312	F-2		
Q313	E-4		
Q314	E-4		
Q315	E-3		
Q316	D-3		
Q317	C-6		
Q318	H-3		
Q320	C-2		
Q321	A-7		
Q322	B-7		
Q323	A-7		
Q324	A-7		
Q325	A-6		
Q326	A-6		
Q327	C-7		
Q328	B-6		
Q329	B-6		
Q330	A-7		
Q331	A-8		
Q332	B-7		
Q333	C-7		
Q334	B-7		
Q335	C-7		
Q336	B-7		
Q401	A-3		
Q402	A-3		
Q403	A-3		
Q404	A-3		
Q405	B-3		
Q406	B-3		
Q407	B-3		
VARIABLE RESISTOR			
RV211	C-9		
RV221	C-9		
RV231	C-8		
RV251	D-8		
RV252	E-8		
RV291	G-6		
RV292	G-7		
RV301	H-3		
RV302	D-2		
RV303	G-5		
RV306	C-7		
RV307	C-7		
RV401	A-3		
RV402	C-4		
RV403	A-4		

- BB Board -

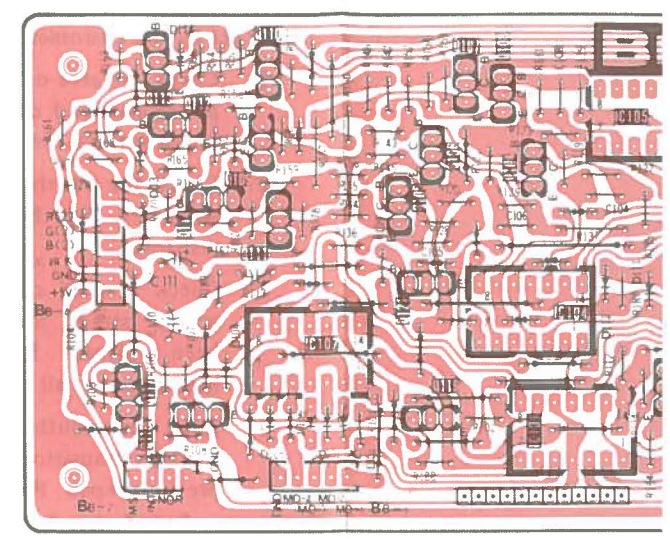

- BC Board -

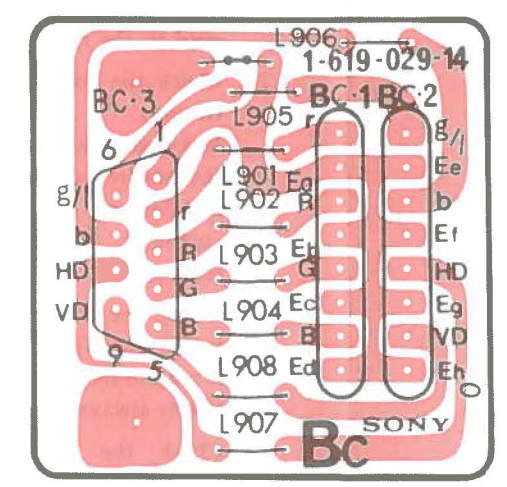

- X Board -

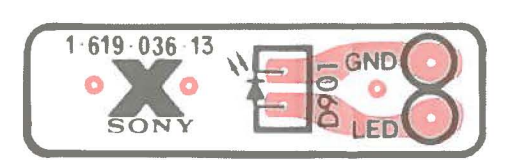

2-2. CIRCUIT BOARDS LOCATION

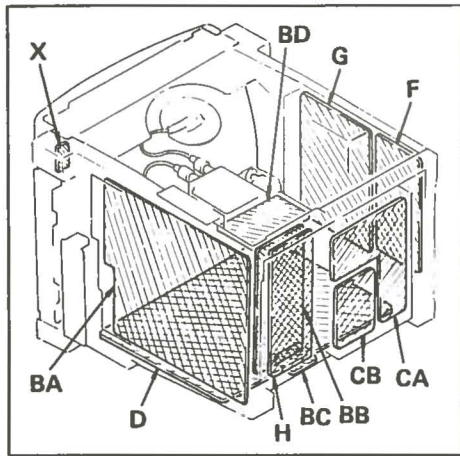

Note: The components identified by shading and mark are critical for safety. Replace only with part number specified.

Note: Les composants identifiés par une trame et par une marque sont d'une importance critique pour la sécurité. Ne les remplacer que par des pièces de numéro spécifié.

Note:

- All capacitors are in μF unless otherwise noted, p : μF 50WV or less are not indicated except for electrolytics.
- All resistors are in ohms, 1/6W unless otherwise noted, k : 1000 Ω , M : 1000k Ω .
- : nonflammable resistor.
- All variable and adjustable resistors have characteristic curve B, unless otherwise noted.
- : fusible resistor.
- : internal component.
- : panel designation.
- : selected to yield optimum performance.
- The components identified by in this manual have been carefully factory-selected for each set in order to satisfy regulations regarding X-ray radiation. Should replacement be required, replace only with the value originally used.
- When replacing components identified by mark the necessary adjustments indicated. If results do not meet the specified value, change the component identified by and repeat the adjustment until the specified value is achieved. (Refer to R339, R416, R489 adjustment on page 11, 12.)
- When replacing the part in below table, be use to perform the related adjustment.

Part replaced ()	Adjustment ()
(G Board) Q653, R658, R659, T653 (BA Board) IC401, IC404, IC405, Q409, R409, R410, R411, R412, R413, R414, R415, R416, R417, R418, R419, R424, R425, R448, R479, R480, R488, R489.	R416, R489 (+B MAX)
(BA Board) IC301, IC302, R301, R302, R335, R336, R337, R338, R339, R340, R341, R342, D304 (D Board) R565, R566	R339 (HV HOLD DOWN)

- Voltages are dc with respect to ground unless otherwise noted.
- Readings are taken with a 10 M Ω digital multimeter.
- Voltage variations may be noted due to normal production tolerances.
- Readings are taken with a color-bar signal input. (MULTI SCAN GENERATOR JIG)
- : adjustment to repair.
- no mark: with 15.76kHz (60Hz V) color-bar signal received.
- (): with 31.52kHz (70Hz V) color-bar signal received.

MULTI SCAN GENERATOR JIG VR POSITION

	FREQ	POSITION			
		(H)	(V)	(A)	(B)
NORMAL MODE	15.76kHz (60Hz)	2	3	7	F
2H MODE	31.52kHz (70Hz)	9	2	2	5

2-3. SCHEMATIC DIAGRAMS

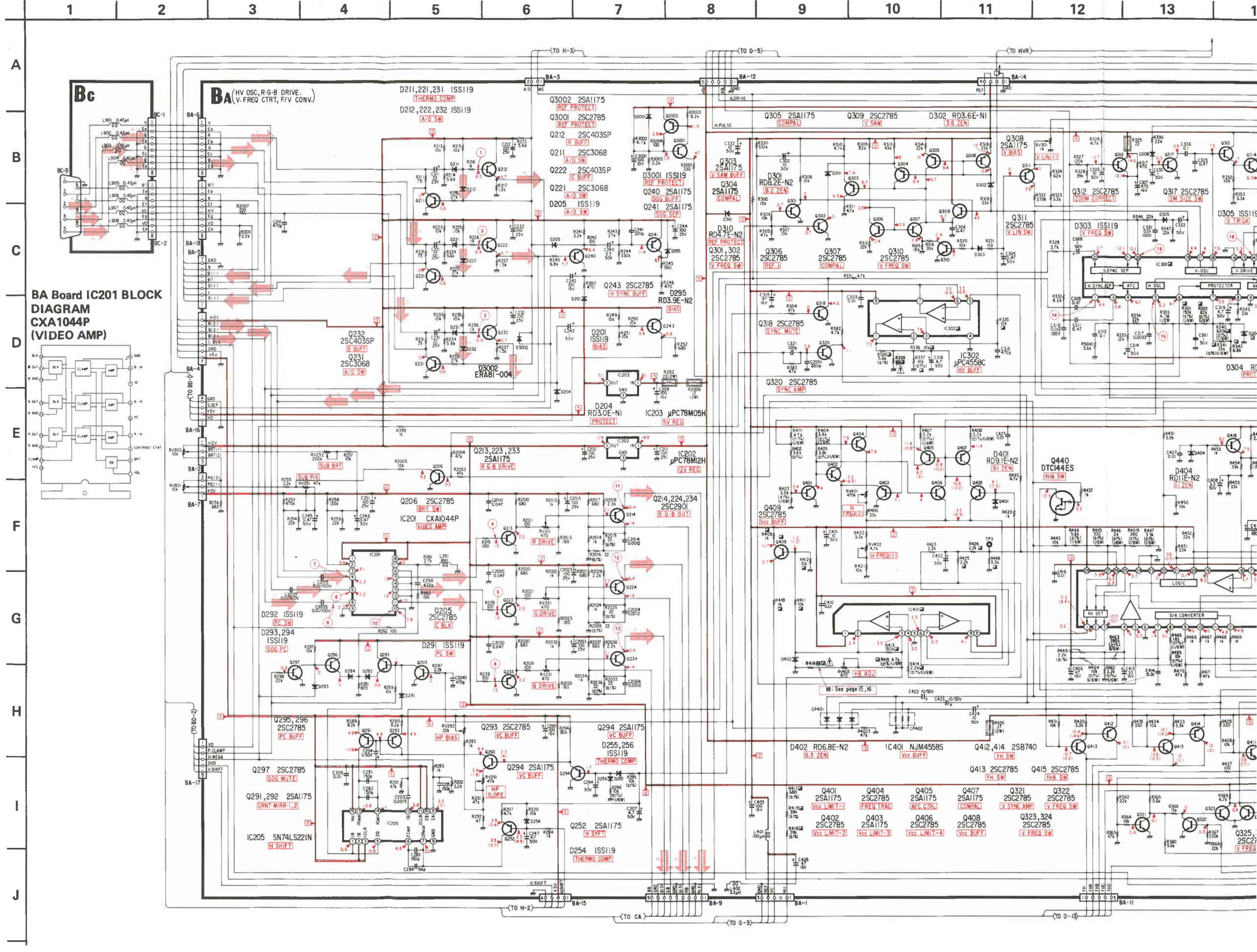

BA Board IC201 BLOCK DIAGRAM CXAI044P (VIDEO AMP)

11 12 13 14 15 16 17 18 19 20 21 22 23 24 25 26 27

A
B
C
D
E
F
G
H
I
J

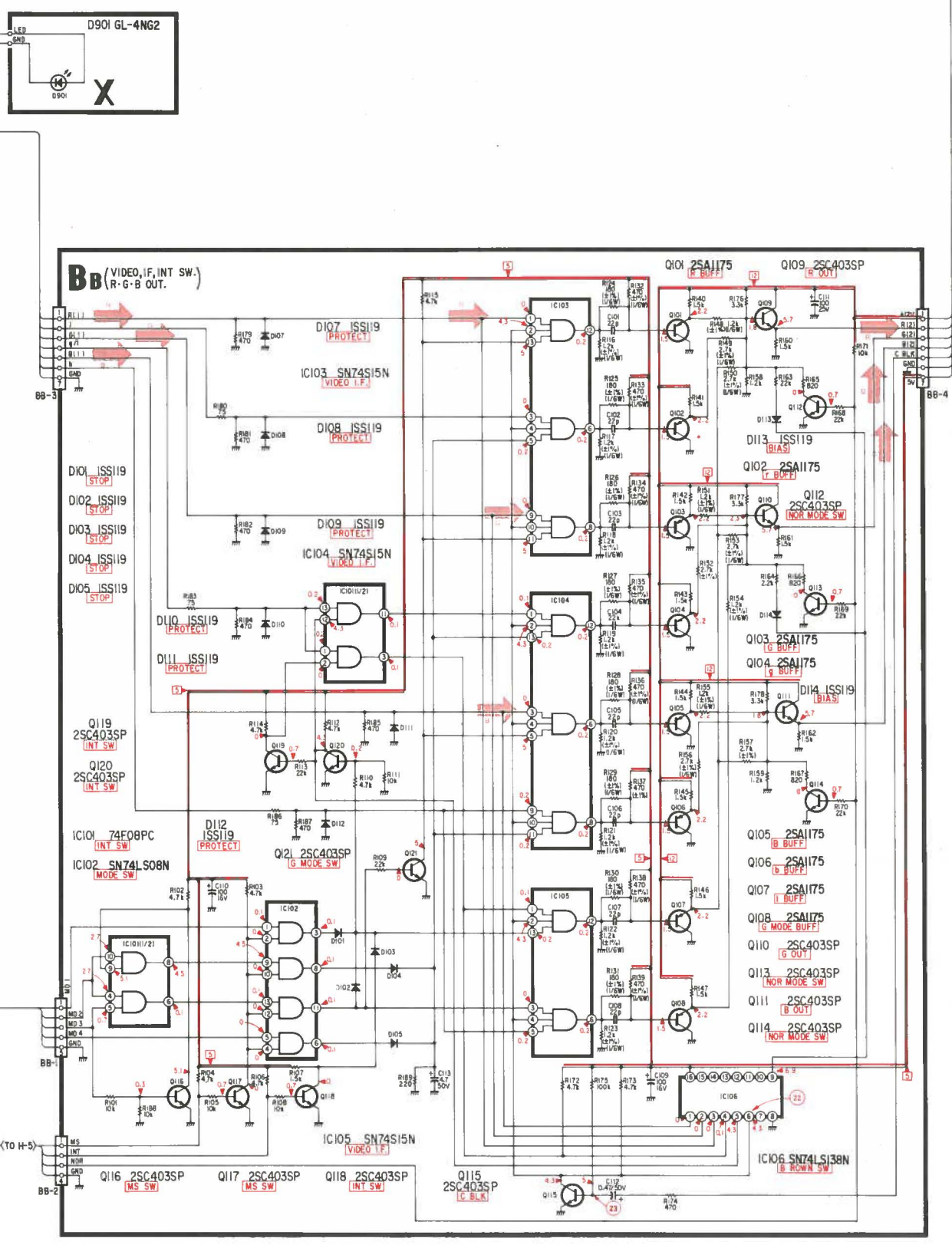
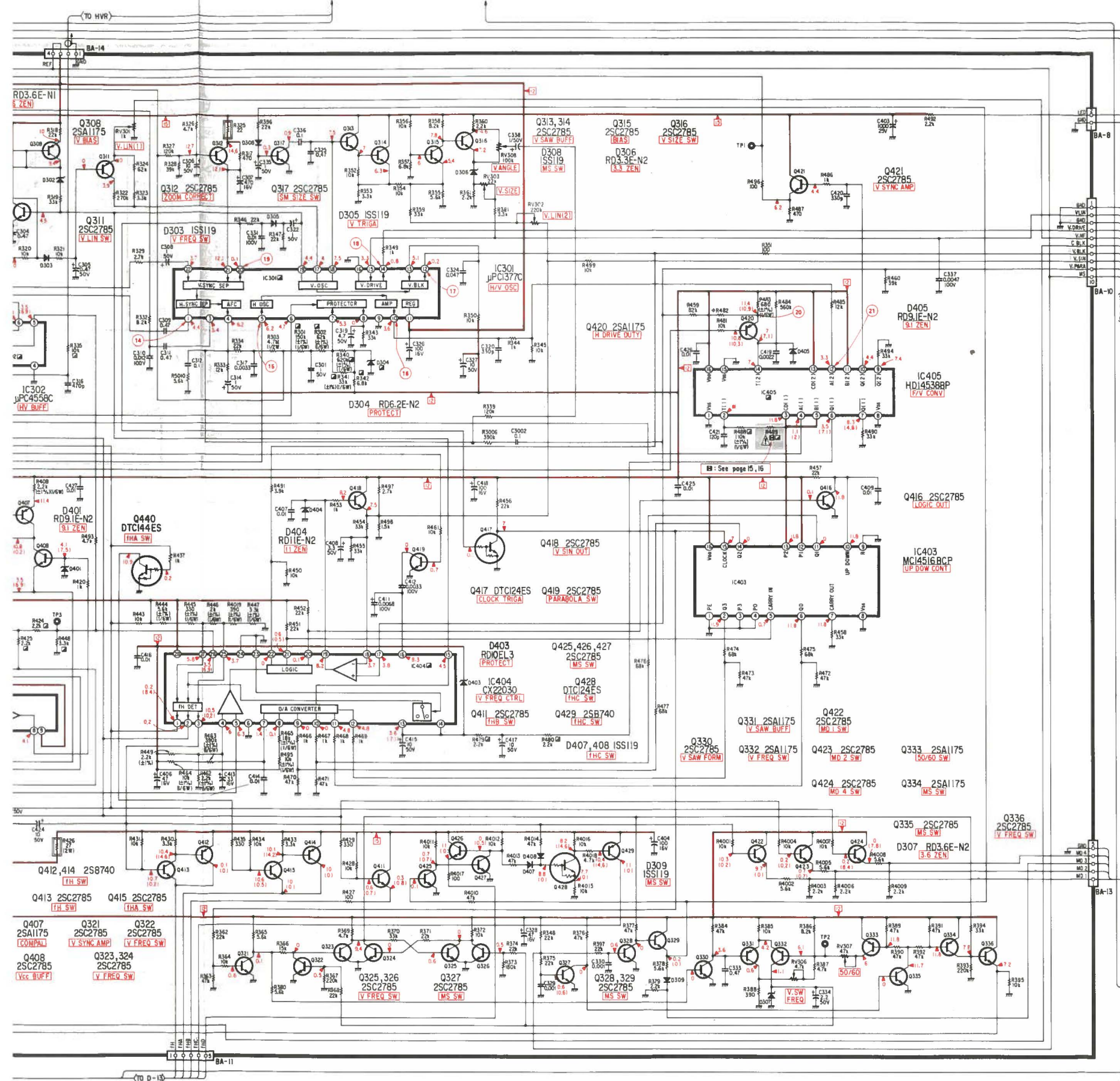

11 12 13 14 15 16 17 18 19 20 21 22 23 24 25 26 27

A B C D E F G H I J

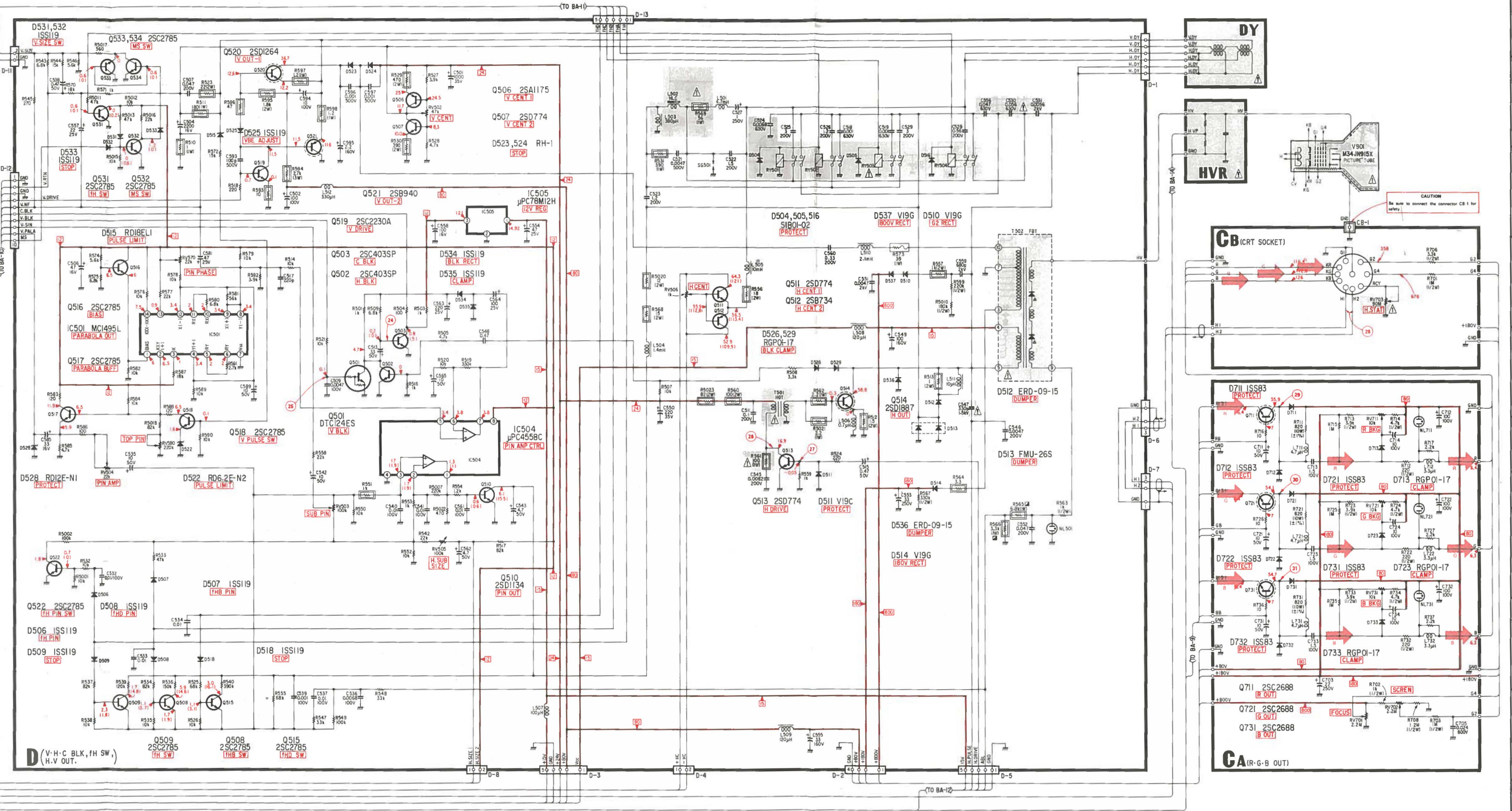

1 2 3 4 5 6 7 8 9 10 11 12 13 14

A
B
C
D
E
F
G
H
I
J

Note: The components identified by shading and mark Δ are critical for safety. Replace only with part number specified.

Note: Les composants identifiés par une trame et par une marque Δ sont d'une importance critique pour la sécurité. Ne les remplacer que par des pièces de numéro spécifié.

All capacitors are in μF unless otherwise noted. p : μF 50WV, r less are not indicated except for electrolytics.
 All resistors are in ohms, 1/6W unless otherwise noted. k : 000 Ω , M : 1000k Ω .
 \square : nonflammable resistor.
 All variable and adjustable resistors have characteristic curve B, unless otherwise noted.
 ∇ : fusible resistor.
 Δ : internal component.
 \square : panel designation.
 K : selected to yield optimum performance.

The components identified by \square in this manual have been carefully factory-selected for each set in order to satisfy regulations regarding X-ray radiation. Should replacement be required, replace only with the value originally used.
 When replacing components identified by \square mark the necessary adjustments indicated. If results do not meet the specified value, change the component identified by \square and repeat the adjustment until the specified value is achieved.
 Refer to R339, R416, R489 adjustment on page 11, 12.)
 When replacing the part in below table, be sure to perform the related adjustment.

Part replaced (\square)	Adjustment (\square)
Board) Q653, R658, R659, T653	
Board) Q1, IC404, IC405, Q409, R409, R410, R411, R413, R414, R415, R416, R417, R418, R424, R425, R448, R479, R480, R488, R489	R416, R489 (+B MAX)
Board) Q1, IC302, R301, R302, R335, R336, R337, R339, R340, R341, R342, D304	R339 (HV HOLD DOWN)
Board) R565, R566	

All voltages are dc with respect to ground unless otherwise noted. Readings are taken with a 10 M Ω digital multimeter. Voltage variations may be noted due to normal production tolerances.

Readings are taken with a color-bar signal input. (MULTI SCAN GENERATOR JIG)
 : adjustment to repair.

o mark: with 15.76kHz (60Hz V) color-bar signal received.
 : with 31.52kHz (70Hz V) color-bar signal received.

MULTI SCAN GENERATOR JIG VR POSITION

	FREQ	POSITION	
		(H)	(V)
NORMAL MODE	15.76kHz (60Hz)	A B A B	2 3 7 F
+ MODE	31.52kHz (70Hz)	9 2 2 5	

\rightarrow : signal path

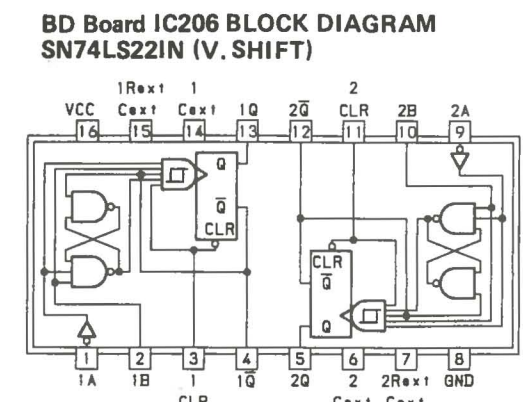
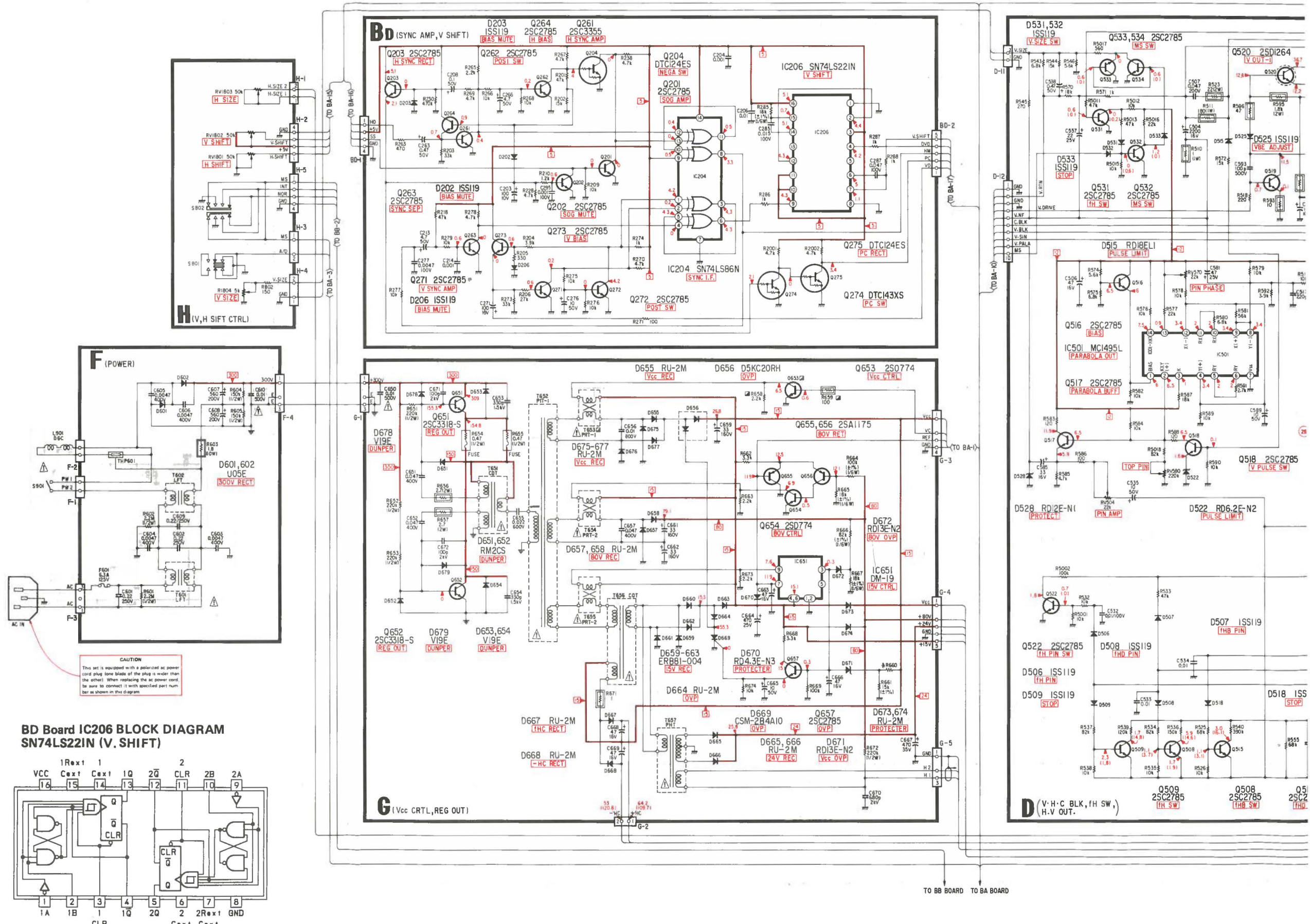

D [V·H·C BLK, fH SW,
H·V OUT.]

H [V, H SIFT CRTL.]

D BOARD WAVEFORM

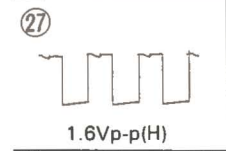
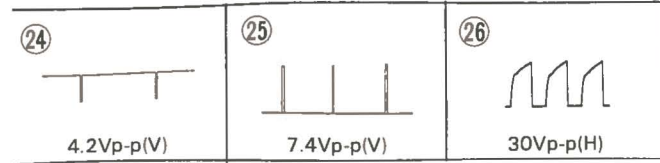

CB BOARD WAVEFORM

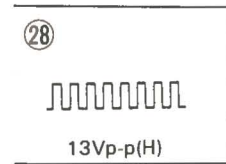

CA BOARD WAVEFORM

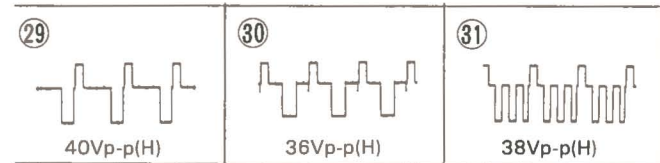

- D Board -

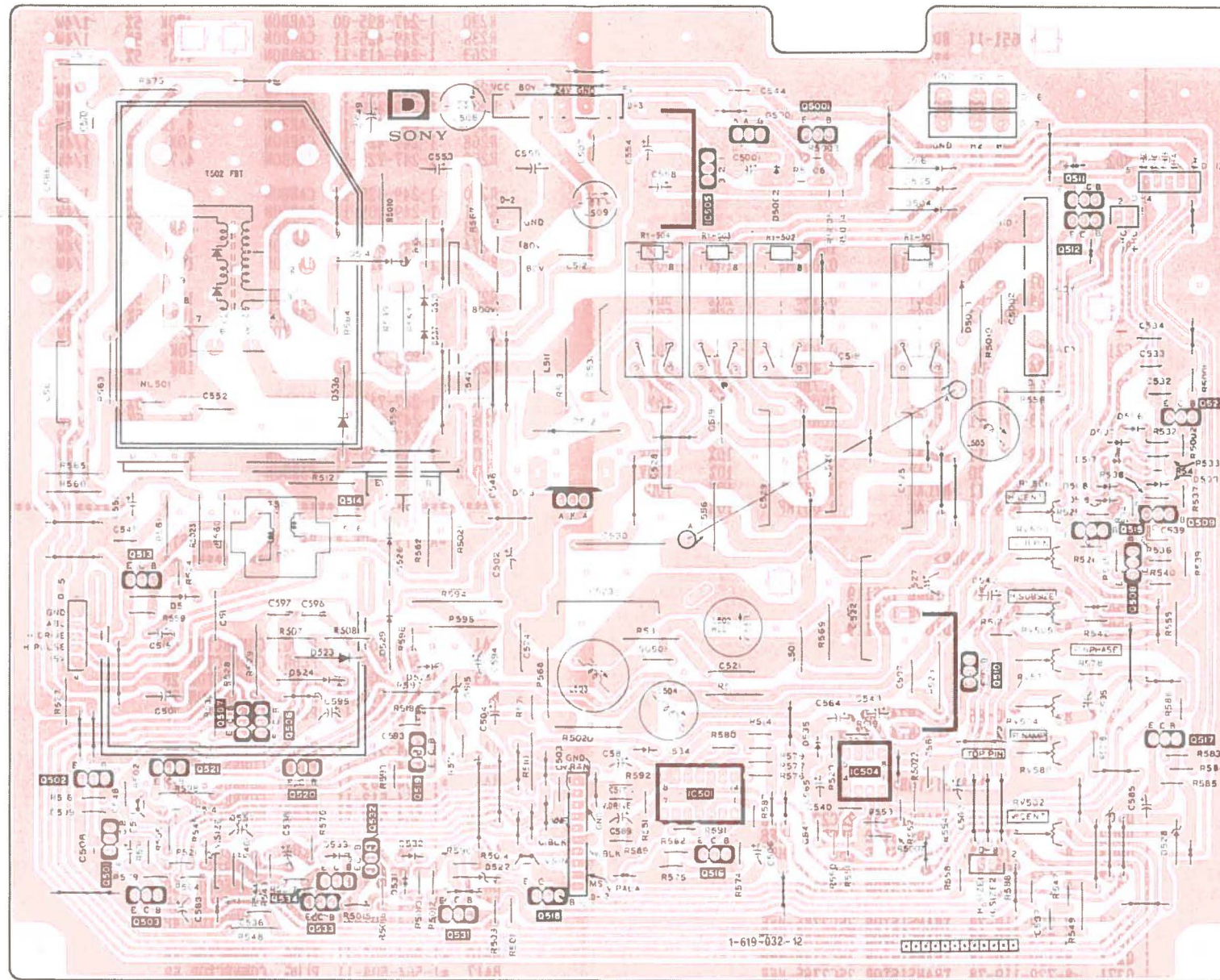

- H Board -

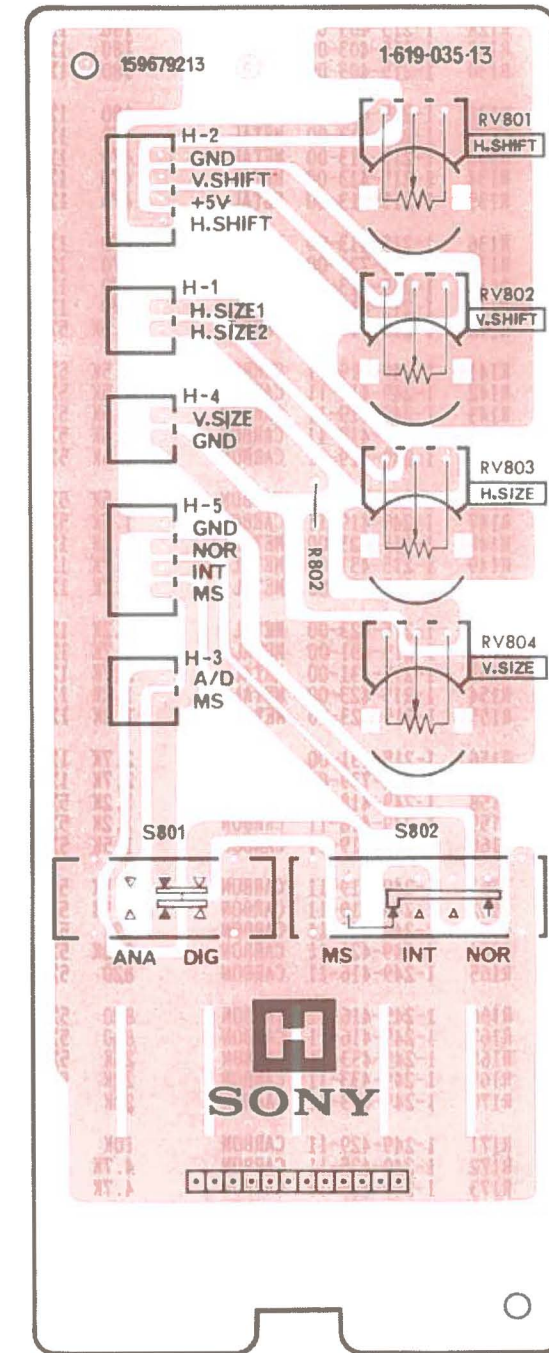

- G Board -

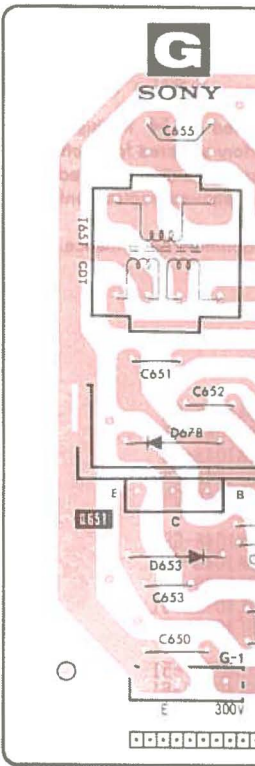

- F Board -

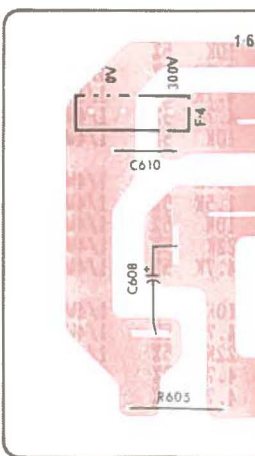

G [Vcc CRTL, REG OUT] **F** [POWER]

CB [CRT SOCKET] **CA** [R.G.B OUT]

BD [SYNC AMP, V SHIFT.]

— G Board —

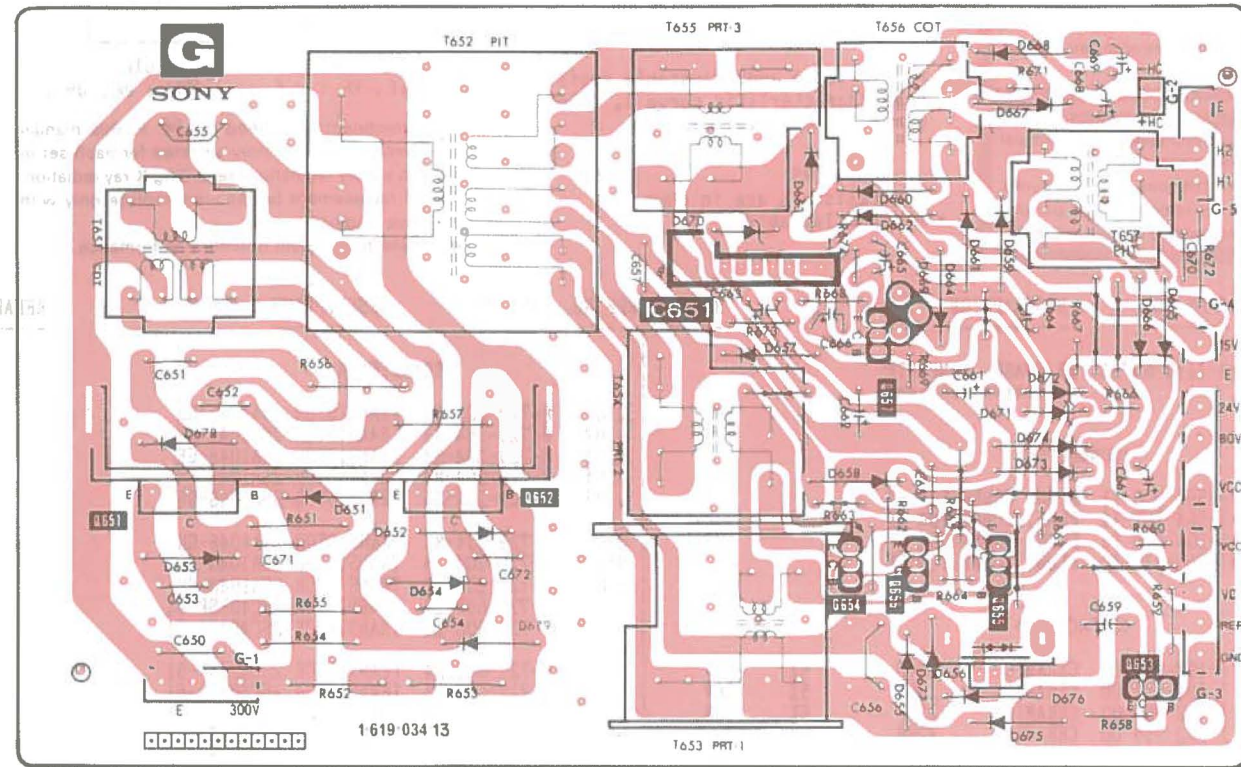

— CB Board —

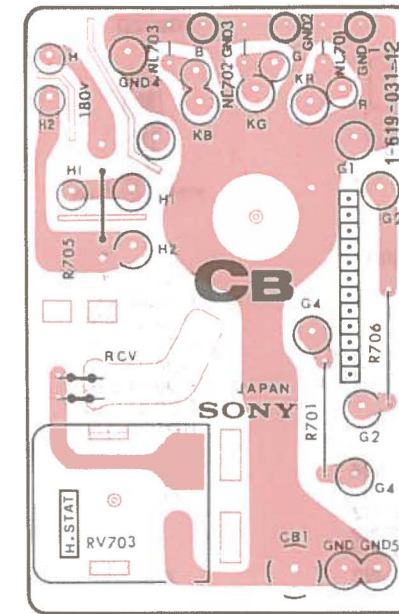

— BD Board —

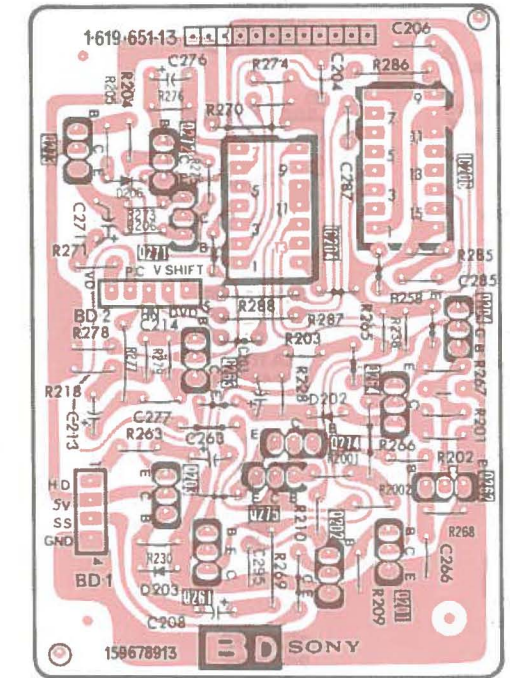

— CA Board —

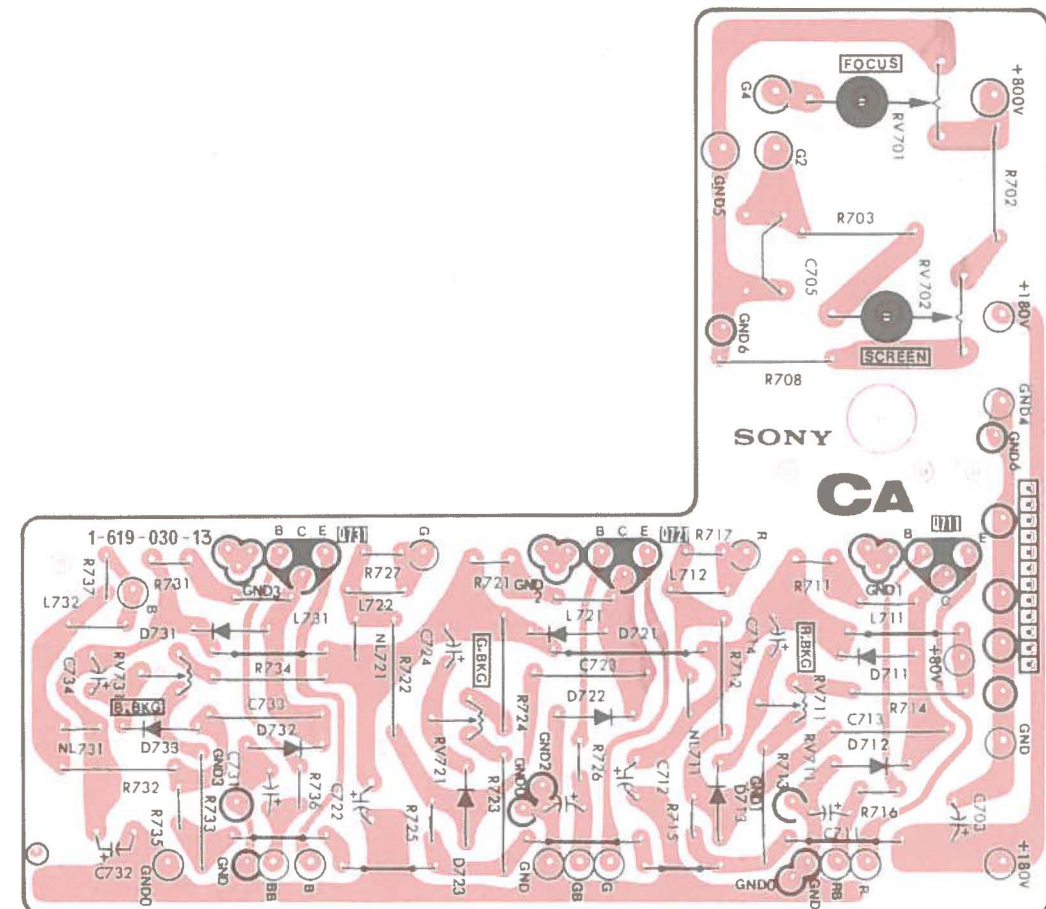

— F Board —

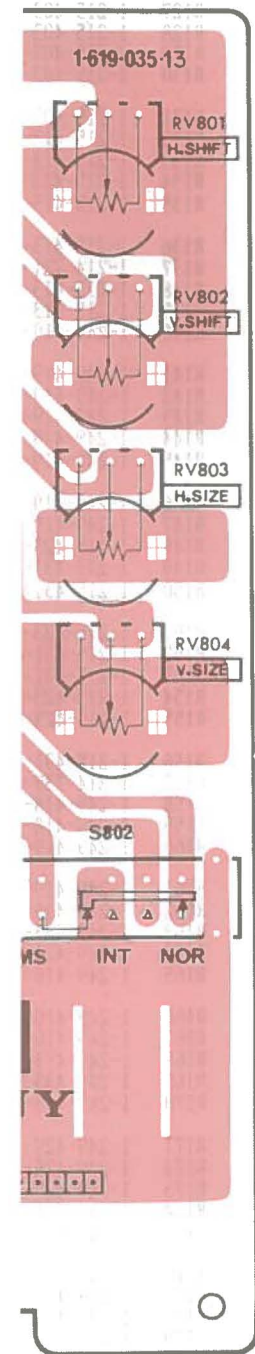
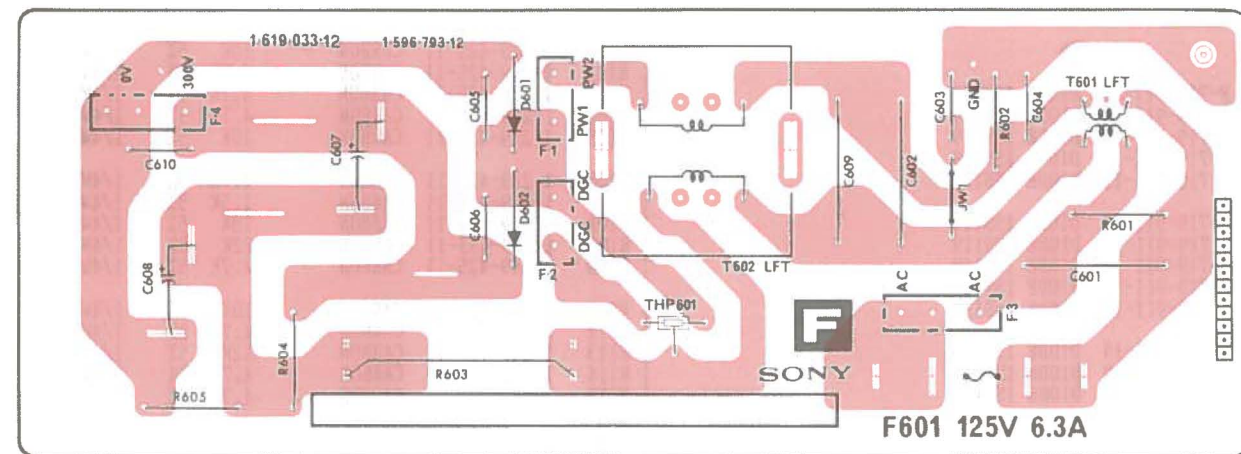

2-4. SEMICONDUCTORS

CXA1044P

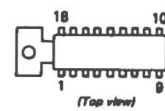

CX22030

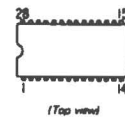

DM-19
NJM4558S
μPC4558C

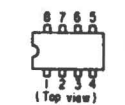

HD14538BP
MC14516BCP
SN74LS08N
SN74LS221N

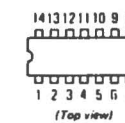

MC1495L
SN74LS86N
SN74LS138N
SN74S15N
TC4516BP
74F08PC
74F138PC

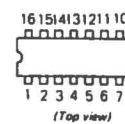

μPC78L12J



μPC78M05H
μPC78M12
μPC1377C

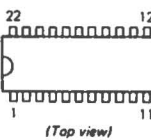

DTC114ES
DTC124ES
DTC144ES
2SA1048
2SC403SP



2SA1175
2SC2785



2SB734
2SD774



2SB740
2SC2230A



2SB940
2SB940P
2SD1134
2SD1264
2SD1264P



2SC2688



2SC2901



2SC3068



2SC3318-S



2SD1887



CSM2B4A10

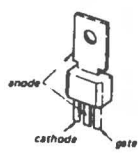

D5KC20RH

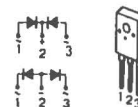

ERA81-004
ERD09-15
RD3.3E-N2
RD3.9E-N2
RD4.3E-N3
RD6.2E-N2
RD8.2E-N2
RD12E-N1
RD13E-N2
RD18E-L1
RGP01-17
RGP01-17PKG23
1SS83
10E2

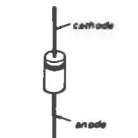

ERB81-004
FMU-26S
RH-1
RM2CS
RU-2M
SIB01-02

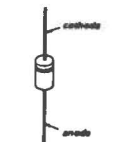

GL-4NG2
SG232D



RD3.0ES-B2
RD3.6ES-B1
RD3.6ES-B2
RD3.9ES-B2
RD4.7ES-B2
RD6.8ES-B2
RD9.1ES-B2
RD10ES-B3
RD11ES-B2
1SS119
1SS133

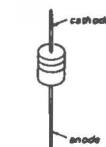

U05E
V19C
V19E
V19G



NOTE:

The components identified by shading and mark Δ are critical for safety. Replace only with part number specified.

Les composants identifiés par une trame et une marque Δ sont critiques pour la sécurité. Ne les remplacer que par une pièce portant le numéro spécifié.

• Items marked " * " are not stocked since they are seldom required for routine service. Some delay should be anticipated when ordering these items.

• All variable and adjustable resistors have characteristic curve B, unless otherwise noted.

RESISTORS
• All resistors are in ohms
• F : nonflammable

When indicating parts by reference number, please include the board name.

CAPACITORS
• MF : μF , PF : $\mu\mu F$
COILS
• MMH : mH, UH : μH
• The components identified by \boxtimes in this manual have been carefully factory-selected for each set in order to satisfy regulations regarding X-ray radiation. Should replacement be required, replace only with the value originally used.
• * : Selected to yield optimum performance.

REF. NO.	PART NO.	DESCRIPTION	REMARK	REF. NO.	PART NO.	DESCRIPTION	REMARK
*A-1130-697-A BB BOARD, COMPLETE *****				<TRANSISTOR>			
Q101	8-729-204-83	TRANSISTOR 2SA1048-GR		Q106	8-729-204-83	TRANSISTOR 2SA1048-GR	
Q102	8-729-204-83	TRANSISTOR 2SA1048-GR		Q107	8-729-204-83	TRANSISTOR 2SA1048-GR	
Q103	8-729-204-83	TRANSISTOR 2SA1048-GR		Q108	8-729-204-83	TRANSISTOR 2SA1048-GR	
Q104	8-729-204-83	TRANSISTOR 2SA1048-GR		Q109	8-729-600-24	TRANSISTOR 2SC403SP-51	
Q105	8-729-204-83	TRANSISTOR 2SA1048-GR		Q110	8-729-600-24	TRANSISTOR 2SC403SP-51	
<CONNECTOR>				<CAPACITOR>			
BB1	*1-564-508-11	PLUG, CONNECTOR 5P		C101	1-102-959-00	CERAMIC 22PF 5% 50V	
BB2	*1-564-507-11	PLUG, CONNECTOR 4P		C102	1-102-959-00	CERAMIC 22PF 5% 50V	
BB3	*1-564-510-11	PLUG, CONNECTOR 7P		C103	1-102-959-00	CERAMIC 22PF 5% 50V	
BB4	*1-564-510-11	PLUG, CONNECTOR 7P		C104	1-102-959-00	CERAMIC 22PF 5% 50V	
<DIODE>				<RESISTOR>			
D101	8-719-911-19	DIODE 1SS119		R101	1-249-429-11	CARBON 10K 5% 1/4W	
D102	8-719-911-19	DIODE 1SS119		R102	1-249-425-11	CARBON 4.7K 5% 1/4W	
D103	8-719-911-19	DIODE 1SS119		R103	1-249-425-11	CARBON 4.7K 5% 1/4W	
D104	8-719-911-19	DIODE 1SS119		R104	1-249-425-11	CARBON 4.7K 5% 1/4W	
D105	8-719-911-19	DIODE 1SS119		R105	1-249-429-11	CARBON 10K 5% 1/4W	
D107	8-719-911-19	DIODE 1SS119		R106	1-249-425-11	CARBON 4.7K 5% 1/4W	
D108	8-719-911-19	DIODE 1SS119		R107	1-249-419-11	CARBON 1.5K 5% 1/4W	
D109	8-719-911-19	DIODE 1SS119		R108	1-249-429-11	CARBON 10K 5% 1/4W	
D110	8-719-911-19	DIODE 1SS119		R109	1-249-433-11	CARBON 22K 5% 1/4W	
D111	8-719-911-19	DIODE 1SS119		R110	1-249-425-11	CARBON 4.7K 5% 1/4W	
D112	8-719-911-19	DIODE 1SS119		R111	1-249-429-11	CARBON 10K 5% 1/4W	
D113	8-719-911-19	DIODE 1SS119		R112	1-249-425-11	CARBON 4.7K 5% 1/4W	
D114	8-719-911-19	DIODE 1SS119		R113	1-249-433-11	CARBON 22K 5% 1/4W	
<IC>				<RESISTOR>			
IC101	8-759-904-81	IC 74F08PC		R114	1-249-425-11	CARBON 4.7K 5% 1/4W	
IC102	8-759-900-08	IC SN74LS08N		R115	1-249-425-11	CARBON 4.7K 5% 1/4W	
IC103	8-759-910-15	IC SN74S15N		R116	1-215-423-00	METAL 1.2K 1% 1/6W	
IC104	8-759-910-15	IC SN74S15N		R117	1-215-423-00	METAL 1.2K 1% 1/6W	
IC105	8-759-910-15	IC SN74S15N		R118	1-215-423-00	METAL 1.2K 1% 1/6W	
IC106	8-759-901-38	IC SN74LS138N		R119	1-215-423-00	METAL 1.2K 1% 1/6W	
				R120	1-215-423-00	METAL 1.2K 1% 1/6W	
				R121	1-215-423-00	METAL 1.2K 1% 1/6W	
				R122	1-215-423-00	METAL 1.2K 1% 1/6W	
				R123	1-215-423-00	METAL 1.2K 1% 1/6W	
				R124	1-215-403-00	METAL 180 1% 1/6W	
				R125	1-215-403-00	METAL 180 1% 1/6W	

Bb Bd Bd Ba

ts by refer-
se include

COILS
* MMH : mH, UH : μH

ad by in this manual
ry-selected for each set in
s regarding X-ray radiation.
quired, replace only with

timum performance.

REMARK

1048-GR
1048-GR
1048-GR
1048-GR
1048-GR

1048-GR
1048-GR
1048-GR
1048-GR

403SP-51
403SP-51

403SP-51
403SP-51
403SP-51
403SP-51
403SP-51

403SP-51

403SP-51

403SP-51

403SP-51

403SP-51

403SP-51

10K 5% 1/4W
4.7K 5% 1/4W
4.7K 5% 1/4W
4.7K 5% 1/4W
10K 5% 1/4W

4.7K 5% 1/4W
1.5K 5% 1/4W
10K 5% 1/4W
22K 5% 1/4W
4.7K 5% 1/4W

10K 5% 1/4W
4.7K 5% 1/4W
22K 5% 1/4W
4.7K 5% 1/4W
4.7K 5% 1/4W

1.2K 1% 1/6W
1.2K 1% 1/6W
1.2K 1% 1/6W
1.2K 1% 1/6W
1.2K 1% 1/6W

1.2K 1% 1/6W
1.2K 1% 1/6W
1.2K 1% 1/6W
180 1% 1/6W
180 1% 1/6W

REF. NO.	PART NO.	DESCRIPTION			
R126	1-215-403-00	METAL	180	1%	1/6W
R127	1-215-403-00	METAL	180	1%	1/6W
R128	1-215-403-00	METAL	180	1%	1/6W
R129	1-215-403-00	METAL	180	1%	1/6W
R130	1-215-403-00	METAL	180	1%	1/6W
R131	1-215-403-00	METAL	180	1%	1/6W
R132	1-215-413-00	METAL	470	1%	1/6W
R133	1-215-413-00	METAL	470	1%	1/6W
R134	1-215-413-00	METAL	470	1%	1/6W
R135	1-215-413-00	METAL	470	1%	1/6W
R136	1-215-413-00	METAL	470	1%	1/6W
R137	1-214-721-00	METAL	470	1%	1/4W
R138	1-215-413-00	METAL	470	1%	1/6W
R139	1-215-413-00	METAL	470	1%	1/6W
R140	1-249-419-11	CARBON	1.5K	5%	1/4W
R141	1-249-419-11	CARBON	1.5K	5%	1/4W
R142	1-249-419-11	CARBON	1.5K	5%	1/4W
R143	1-249-419-11	CARBON	1.5K	5%	1/4W
R144	1-249-419-11	CARBON	1.5K	5%	1/4W
R145	1-249-419-11	CARBON	1.5K	5%	1/4W
R146	1-249-419-11	CARBON	1.5K	5%	1/4W
R147	1-249-419-11	CARBON	1.5K	5%	1/4W
R148	1-215-423-00	METAL	1.2K	1%	1/6W
R149	1-215-431-00	METAL	2.7K	1%	1/6W
R150	1-215-431-00	METAL	2.7K	1%	1/6W
R151	1-215-423-00	METAL	1.2K	1%	1/6W
R152	1-215-431-00	METAL	2.7K	1%	1/6W
R153	1-215-431-00	METAL	2.7K	1%	1/6W
R154	1-215-423-00	METAL	1.2K	1%	1/6W
R155	1-215-423-00	METAL	1.2K	1%	1/6W
R156	1-215-431-00	METAL	2.7K	1%	1/6W
R157	1-214-739-00	METAL	2.7K	1%	1/4W
R158	1-249-418-11	CARBON	1.2K	5%	1/4W
R159	1-249-418-11	CARBON	1.2K	5%	1/4W
R160	1-249-419-11	CARBON	1.5K	5%	1/4W
R161	1-249-419-11	CARBON	1.5K	5%	1/4W
R162	1-249-419-11	CARBON	1.5K	5%	1/4W
R163	1-249-433-11	CARBON	22K	5%	1/4W
R164	1-249-421-11	CARBON	2.2K	5%	1/4W
R165	1-249-416-11	CARBON	820	5%	1/4W
R166	1-249-416-11	CARBON	820	5%	1/4W
R167	1-249-416-11	CARBON	820	5%	1/4W
R168	1-249-433-11	CARBON	22K	5%	1/4W
R169	1-249-433-11	CARBON	22K	5%	1/4W
R170	1-249-433-11	CARBON	22K	5%	1/4W
R171	1-249-429-11	CARBON	10K	5%	1/4W
R172	1-249-425-11	CARBON	4.7K	5%	1/4W
R173	1-249-425-11	CARBON	4.7K	5%	1/4W
R174	1-247-708-11	CARBON	470	5%	1/4W
R175	1-249-441-11	CARBON	100K	5%	1/4W
R176	1-249-423-11	CARBON	3.3K	5%	1/4W
R177	1-249-423-11	CARBON	3.3K	5%	1/4W
R178	1-249-423-11	CARBON	3.3K	5%	1/4W
R179	1-249-413-11	CARBON	470	5%	1/4W
R180	1-247-804-11	CARBON	75	5%	1/4W
R181	1-249-413-11	CARBON	470	5%	1/4W
R182	1-249-413-11	CARBON	470	5%	1/4W
R183	1-247-804-11	CARBON	75	5%	1/4W
R184	1-249-413-11	CARBON	470	5%	1/4W
R185	1-249-413-11	CARBON	470	5%	1/4W
R186	1-247-104-00	CARBON	75	5%	1/4W
R187	1-249-413-11	CARBON	470	5%	1/4W
R188	1-249-429-11	CARBON	10K	5%	1/4W
R189	1-249-409-11	CARBON	220	5%	1/4W

REF. NO.	PART NO.	DESCRIPTION			

	*1-619-651-11	BD BOARD			

<CONNECTOR>					
BD1	*1-564-507-11	PLUG, CONNECTOR 4P			
BD2	*1-564-508-11	PLUG, CONNECTOR 5P			
<CAPACITOR>					
C203	1-124-443-00	ELECT	100MF	20%	10V
C204	1-102-074-00	CERAMIC	0.001MF	10%	50V
C206	1-101-004-00	CERAMIC	0.01MF		50V
C208	1-124-463-00	ELECT	0.1MF	20%	50V
C213	1-124-927-11	ELECT	4.7MF	20%	50V
C214	1-101-001-00	CERAMIC	0.001MF		50V
C263	1-124-902-00	ELECT	0.47MF	20%	50V
C266	1-124-927-11	ELECT	4.7MF	20%	50V
C271	1-126-101-11	ELECT	100MF	20%	16V
C276	1-123-875-11	ELECT	10MF	20%	50V
C277	1-108-622-11	MYLAR	0.0047MF	10%	100V
C285	1-106-371-00	MYLAR	0.015MF	10%	100V
C287	1-108-634-11	MYLAR	0.047MF	10%	100V
C295	1-108-614-11	MYLAR	0.001MF	10%	100V
<DIODE>					
D202	8-719-911-19	DIODE 1SS119			
D203	8-719-911-19	DIODE 1SS119			
D206	8-719-911-19	DIODE 1SS119			
<IC>					
IC204	8-759-900-86	IC SN74LS86N			
IC206	8-759-902-21	IC SN74LS221N			
<TRANSISTOR>					
Q201	8-729-119-78	TRANSISTOR 2SC2785-HFE			
Q202	8-729-119-78	TRANSISTOR 2SC2785-HFE			
Q203	8-729-119-78	TRANSISTOR 2SC2785-HFE			
Q204	8-729-900-36	TRANSISTOR DTC124ES			
Q261	8-729-104-80	TRANSISTOR 2SC3355			
Q262	8-729-119-78	TRANSISTOR 2SC2785-HFE			
Q263	8-729-119-78	TRANSISTOR 2SC2785-HFE			
Q264	8-729-119-78	TRANSISTOR 2SC2785-HFE			
Q271	8-729-119-78	TRANSISTOR 2SC2785-HFE			
Q272	8-729-119-78	TRANSISTOR 2SC2785-HFE			
Q273	8-729-119-78	TRANSISTOR 2SC2785-HFE			
Q274	8-729-901-57	TRANSISTOR DTC143XS			
Q275	8-729-900-36	TRANSISTOR DTC124ES			
<RESISTOR>					
R201	1-249-437-11	CARBON	47K	5%	1/4W
R202	1-249-431-11	CARBON	15K	5%	1/4W
R203	1-249-435-11	CARBON	33K	5%	1/4W
R204	1-249-424-11	CARBON	3.9K	5%	1/4W
R205	1-249-411-11	CARBON	330	5%	1/4W
R206	1-249-434-11	CARBON	27K	5%	1/4W
R209	1-249-429-11	CARBON	10K	5%	1/4W
R210	1-249-418-11	CARBON	1.2K	5%	1/4W

REF. NO.	PART NO.	DESCRIPTION			
R218	1-249-437-11	CARBON	47K	5%	1/4W
R228	1-249-425-11	CARBON	4.7K	5%	1/4W
R230	1-247-895-00	CARBON	470K	5%	1/4W
R238	1-249-425-11	CARBON	4.7K	5%	1/4W
R263	1-249-413-11	CARBON	470	5%	1/4W
R265	1-249-421-11	CARBON	2.2K	5%	1/4W
R266	1-249-429-11	CARBON	10K	5%	1/4W
R267	1-249-425-11	CARBON	4.7K	5%	1/4W
R268	1-249-429-11	CARBON	10K	5%	1/4W
R269	1-247-721-11	CARBON	4.7K	5%	1/4W
R270	1-249-425-11	CARBON	4.7K	5%	1/4W
R271	1-249-405-11	CARBON	100	5%	1/4W
R273	1-249-435-11	CARBON	33K	5%	1/4W
R274	1-249-417-11	CARBON	1K	5%	1/4W
R275	1-249-429-11	CARBON	10K	5%	1/4W
R276	1-249-429-11	CARBON	10K	5%	1/4W
R277	1-247-725-11	CARBON	10K	5%	1/4W
R278	1-249-425-11	CARBON	4.7K	5%	1/4W
R279	1-249-429-11	CARBON	10K	5%	1/4W
R285	1-215-451-00	METAL	18K	1%	1/6W
R286	1-247-713-11	CARBON	1K	5%	1/4W
R287	1-247-713-11	CARBON	1K	5%	1/4W
R288	1-247-713-11	CARBON	1K	5%	1/4W
R2001	1-249-425-11	CARBON	4.7K	5%	1/4W
R2002	1-249-425-11	CARBON	4.7K	5%	1/4W

*A-1135-505-A BA BOARD, COMPLETE					

<CONNECTOR>					
BA1	*1-564-508-11	PLUG, CONNECTOR 5P			
BA2	*1-564-506-11	PLUG, CONNECTOR 3P			
BA3	*1-564-505-11	PLUG, CONNECTOR 2P			
BA4	*1-564-510-11	PLUG, CONNECTOR 7P			
BA5	*1-564-510-11	PLUG, CONNECTOR 7P			
BA6	*1-564-511-11	PLUG, CONNECTOR 8P			
BA7	*1-564-506-11	PLUG, CONNECTOR 3P			
BA8	*1-564-505-11	PLUG, CONNECTOR 2P			
BA9	*1-564-512-11	PLUG, CONNECTOR 9P			
BA10	*1-564-513-11	PLUG, CONNECTOR 10P			
BA11	*1-564-508-11	PLUG, CONNECTOR 5P			
BA12	*1-564-508-11	PLUG, CONNECTOR 5P			
BA13	*1-564-508-11	PLUG, CONNECTOR 5P			
BA14	*1-564-507-11	PLUG, CONNECTOR 4P			
BA15	*1-564-507-11	PLUG, CONNECTOR 4P			
BA16	*1-564-507-11	PLUG, CONNECTOR 4P			
BA17	*1-564-508-11	PLUG, CONNECTOR 5P			
BA18	*1-564-511-11	PLUG, CONNECTOR 8P			
<CAPACITOR>					
C201	1-123-333-00	ELECT	100MF	20%	25V
C202	1-124-478-11	ELECT	100MF	20%	25V
C203	1-102-119-00	CERAMIC	0.0015MF	10%	50V
C204	1-124-499-11	ELECT	1MF	20%	50V
C205	1-101-004-00	CERAMIC	0.01MF		50V
C207	1-124-927-11	ELECT	4.7MF	20%	50V
C209	1-126-101-11	ELECT	100MF	20%	16V
C210	1-102-114-00	CERAMIC	470PF	10%	50V
C211	1-126-233-11	ELECT	22MF	20%	25V
C212	1-124-478-11	ELECT	100MF	20%	25V
C215	1-102-108-00	CERAMIC	150PF	10%	50V

REF. NO.	PART NO.	DESCRIPTION			
C221	1-126-233-11	ELECT	22MF	20%	25V
C222	1-124-478-11	ELECT	100MF	20%	25V
C231	1-126-233-11	ELECT	22MF	20%	25V
C232	1-124-478-11	ELECT	100MF	20%	25V
C240	1-123-382-00	ELECT	3.3MF	20%	50V
C241	1-102-978-00	CERAMIC	220PF	5%	50V
C242	1-126-101-11	ELECT	100MF	20%	16V
C243	1-124-499-11	ELECT	1MF	20%	50V
C244	1-124-478-11	ELECT	100MF	20%	25V
C245	1-124-902-00	ELECT	0.47MF	20%	50V
C246	1-124-902-00	ELECT	0.47MF	20%	50V
C247	1-124-927-11	ELECT	4.7MF	20%	50V
C250	1-102-114-00	CERAMIC	470PF	10%	50V
C251	1-124-478-11	ELECT	100MF	20%	25V
C28					

REF. NO.	PART NO.	DESCRIPTION	REMARK	REF. NO.	PART NO.	DESCRIPTION	REMARK
C409	1-101-004-00	CERAMIC	0.01MF				50V
C410	1-101-004-00	CERAMIC	0.01MF				50V
C411	1-108-624-11	MYLAR	0.0068MF	10%			100V
C412	1-108-620-11	MYLAR	0.0033MF	10%			100V
C413	1-124-963-11	ELECT	33MF	20%			16V
C414	1-102-129-00	CERAMIC	0.01MF	10%			50V
C415	1-123-875-11	ELECT	10MF	20%			50V
C416	1-101-004-00	CERAMIC	0.01MF				50V
C417	1-123-875-11	ELECT	10MF	20%			50V
C418	1-126-101-11	ELECT	100MF	20%			16V
C419	1-108-796-11	MYLAR	0.0022MF	5%			50V
C420	1-102-112-00	CERAMIC	330PF	10%			50V
C421	1-102-816-00	CERAMIC	120PF	5%			50V
C422	1-123-875-11	ELECT	10MF	20%			50V
C423	1-123-875-11	ELECT	10MF	20%			50V
C424	1-123-875-11	ELECT	10MF	20%			50V
C425	1-101-004-00	CERAMIC	0.01MF				50V
C426	1-101-004-00	CERAMIC	0.01MF				50V
C427	1-101-004-00	CERAMIC	0.01MF				50V
C428	1-124-477-11	ELECT	47MF	20%			16V
C2001	1-102-116-00	CERAMIC	680PF	10%			50V
C2010	1-101-006-00	CERAMIC	0.047MF				50V
C2013	1-123-333-00	ELECT	100MF	20%			25V
C2014	1-102-118-00	CERAMIC	0.0012MF	10%			50V
C2015	1-108-626-11	MYLAR	0.01MF	10%			100V
C2020	1-101-006-00	CERAMIC	0.047MF				50V
C2023	1-123-333-00	ELECT	100MF	20%			25V
C2024	1-102-118-00	CERAMIC	0.0012MF	10%			50V
C2025	1-108-626-11	MYLAR	0.01MF	10%			100V
C2030	1-101-006-00	CERAMIC	0.047MF				50V
C2033	1-123-333-00	ELECT	100MF	20%			25V
C2034	1-102-118-00	CERAMIC	0.0012MF	10%			50V
C2035	1-108-626-11	MYLAR	0.01MF	10%			100V
C2040	1-102-114-00	CERAMIC	470PF	10%			50V
C3001	1-124-443-00	ELECT	100MF	20%			10V
C3002	1-136-165-00	FILM	0.1MF	5%			50V
<DIODE>							
D201	8-719-911-19	DIODE	ISS119				
D204	8-719-109-62	DIODE	RD3.0ES-B1				
D205	8-719-911-19	DIODE	ISS119				
D211	8-719-911-19	DIODE	ISS119				
D212	8-719-911-19	DIODE	ISS119				
D221	8-719-911-19	DIODE	ISS119				
D222	8-719-911-19	DIODE	ISS119				
D231	8-719-911-19	DIODE	ISS119				
D232	8-719-911-19	DIODE	ISS119				
D254	8-719-911-19	DIODE	ISS119				
D255	8-719-911-19	DIODE	ISS119				
D256	8-719-911-19	DIODE	ISS119				
D291	8-719-911-19	DIODE	ISS119				
D292	8-719-911-19	DIODE	ISS119				
D293	8-719-911-19	DIODE	ISS119				
D294	8-719-911-19	DIODE	ISS119				
D295	8-719-109-72	DIODE	RD3.9ES-B2				
D301	8-719-110-08	DIODE	RD8.2ES-B2				
D302	8-719-109-68	DIODE	RD3.6ES-B1				
D303	8-719-911-19	DIODE	ISS119				
D304	8-719-109-93	DIODE	RD6.2ES-B2				
D305	8-719-911-19	DIODE	ISS119				
D306	8-719-109-66	DIODE	RD3.3ES-B2				
D307	8-719-109-69	DIODE	RD3.6ES-B2				
D308	8-719-911-19	DIODE	ISS119				
D309	8-719-911-19	DIODE	ISS119				
D310	8-719-109-81	DIODE	RD4.7ES-B2				
D401	8-719-110-13	DIODE	RD9.1ES-B2				
D402	8-719-109-97	DIODE	RD6.8ES-B2				
D403	8-719-110-18	DIODE	RD10ES-B3				
D404	8-719-110-22	DIODE	RD11ES-B2				
D405	8-719-110-13	DIODE	RD9.1ES-B2				
D407	8-719-911-19	DIODE	ISS119				
D408	8-719-911-19	DIODE	ISS119				
D3001	8-719-911-19	DIODE	ISS119				
D3002	8-719-908-06	DIODE	ERA81-005				
<IC>							
IC201	8-752-033-27	IC	CXA1044AP				
IC202	8-759-604-39	IC	M5F78M12				
	*4-314-225-00		HEAT SINK, (A); IC202				
IC203	8-759-604-35	IC	M5F78M05				
	*4-314-225-00		HEAT SINK, (A); IC203				
IC205	8-759-902-21	IC	SN74LS221N				
IC301	8-759-100-60	IC	UPC1377C				
IC302	8-759-145-58	IC	UPC4558C				
IC401	8-759-981-95	IC	RC4558S				
IC403	8-759-245-16	IC	TC4516BP				
IC404	8-752-203-00	IC	CX22030				
IC405	8-759-345-38	IC	HD14538BP				
<COIL>							
L201	1-410-119-11	INDUCTOR				1MMH	
L401	1-408-080-00	INDUCTOR				100UH	
L402	1-408-403-00	INDUCTOR				3.3UH	
<TRANSISTOR>							
Q205	8-729-119-78	TRANSISTOR	2SC2785-HFE				
Q206	8-729-119-78	TRANSISTOR	2SC2785-HFE				
Q211	8-729-800-10	TRANSISTOR	2SC3068				
Q212	8-729-600-24	TRANSISTOR	2SC403SP-51				
Q213	8-729-204-83	TRANSISTOR	2SA1048-GR				
Q214	8-729-190-12	TRANSISTOR	2SC2901				
Q221	8-729-800-10	TRANSISTOR	2SC3068				
Q222	8-729-600-24	TRANSISTOR	2SC403SP-51				
Q223	8-729-204-83	TRANSISTOR	2SA1048-GR				
Q224	8-729-190-12	TRANSISTOR	2SC2901				
Q231	8-729-800-10	TRANSISTOR	2SC3068				
Q232	8-729-600-24	TRANSISTOR	2SC403SP-51				
Q233	8-729-204-83	TRANSISTOR	2SA1048-GR				
Q234	8-729-190-12	TRANSISTOR	2SC2901				
Q240	8-729-204-83	TRANSISTOR	2SA1048-GR				
Q241	8-729-204-83	TRANSISTOR	2SA1048-GR				
Q243	8-729-119-78	TRANSISTOR	2SC2785-HFE				
Q252	8-729-204-83	TRANSISTOR	2SA1048-GR				
Q291	8-729-119-76	TRANSISTOR	2SA1175-HFE				
Q292	8-729-119-76	TRANSISTOR	2SA1175-HFE				
Q293	8-729-119-78	TRANSISTOR	2SC2785-HFE				
Q294	8-729-204-83	TRANSISTOR	2SA1048-GR				
Q295	8-729-119-78	TRANSISTOR	2SC2785-HFE				
Q296	8-729-119-78	TRANSISTOR	2SC2785-HFE				
Q297	8-729-119-78	TRANSISTOR	2SC2785-HFE				
Q301	8-729-119-78	TRANSISTOR	2SC2785-HFE				
Q302	8-729-119-78	TRANSISTOR	2SC2785-HFE				
Q303	8-729-204-83	TRANSISTOR	2SA1048-GR				

The components identified by shading and mark Δ are critical for safety.

Replace only with part number specified.

Les composants identifiés par une trame et une marque Δ sont critiques pour la sécurité.

Ne les remplacer que par une pièce portant le numéro spécifié.

The components identified by \boxtimes in this manual have been carefully factory-selected for each set in order to satisfy regulations regarding X-ray radiation. Should replacement be required, replace only with the value originally used.

CPD-1302

BA

REF. NO.	PART NO.	DESCRIPTION	REMARK	REF. NO.	PART NO.	DESCRIPTION	REMARK
R293	1-249-417-11	CARBON	1K 5% 1/4W	R357	1-247-723-11	CARBON	6.8K 5% 1/4W
R294	1-249-440-11	CARBON	82K 5% 1/4W	R358	1-249-428-11	CARBON	8.2K 5% 1/4W
R295	1-215-753-00	METAL	10K 1% 1/4W	R359	1-249-435-11	CARBON	33K 5% 1/4W
R296	1-215-445-00	METAL	10K 1% 1/6W	R360	1-249-421-11	CARBON	2.2K 5% 1/4W
R297	1-249-429-11	CARBON	10K 5% 1/4W	R361	1-249-421-11	CARBON	2.2K 5% 1/4W
R298	1-249-433-11	CARBON	22K 5% 1/4W	R362	1-249-433-11	CARBON	22K 5% 1/4W
R299	1-249-429-11	CARBON	10K 5% 1/4W	R363	1-249-437-11	CARBON	47K 5% 1/4W
R300	1-249-460-11	CARBON	15K 5% 1/4W	R364	1-249-429-11	CARBON	10K 5% 1/4W
R301	1-215-473-00	METAL	150K 1% 1/6W	R365	1-249-426-11	CARBON	5.6K 5% 1/4W
R302	1-215-464-00	METAL	62K 1% 1/6W	R366	1-249-431-11	CARBON	15K 5% 1/4W
R303	1-202-727-00	SOLID	4.7M 10% 1/2W	R367	1-247-887-00	CARBON	220K 5% 1/4W
R304	1-249-437-11	CARBON	47K 5% 1/4W	R368	1-249-433-11	CARBON	22K 5% 1/4W
R305	1-249-437-11	CARBON	47K 5% 1/4W	R369	1-249-425-11	CARBON	4.7K 5% 1/4W
R306	1-247-725-11	CARBON	10K 5% 1/4W	R370	1-249-435-11	CARBON	33K 5% 1/4W
R307	1-249-429-11	CARBON	10K 5% 1/4W	R371	1-249-433-11	CARBON	22K 5% 1/4W
R308	1-249-429-11	CARBON	10K 5% 1/4W	R372	1-249-429-11	CARBON	10K 5% 1/4W
R309	1-249-440-11	CARBON	82K 5% 1/4W	R373	1-247-885-00	CARBON	180K 5% 1/4W
R310	1-247-721-11	CARBON	4.7K 5% 1/4W	R374	1-249-433-11	CARBON	22K 5% 1/4W
R311	1-249-425-11	CARBON	4.7K 5% 1/4W	R375	1-249-433-11	CARBON	22K 5% 1/4W
R312	1-249-433-11	CARBON	22K 5% 1/4W	R376	1-249-437-11	CARBON	47K 5% 1/4W
R313	1-247-870-11	CARBON	43K 5% 1/4W	R377	1-249-437-11	CARBON	47K 5% 1/4W
R314	1-249-433-11	CARBON	22K 5% 1/4W	R378	1-249-426-11	CARBON	5.6K 5% 1/4W
R315	1-215-451-00	METAL	18K 1% 1/6W	R379	1-249-421-11	CARBON	2.2K 5% 1/4W
R316	1-215-459-00	METAL	39K 1% 1/6W	R380	1-249-426-11	CARBON	5.6K 5% 1/4W
R317	1-249-413-11	CARBON	470 5% 1/4W	R381	1-249-423-11	CARBON	3.3K 5% 1/4W
R318	1-249-433-11	CARBON	22K 5% 1/4W	R382	1-247-721-11	CARBON	4.7K 5% 1/4W
R319	1-249-435-11	CARBON	33K 5% 1/4W	R383	1-249-437-11	CARBON	47K 5% 1/4W
R320	1-249-429-11	CARBON	10K 5% 1/4W	R384	1-249-437-11	CARBON	47K 5% 1/4W
R321	1-249-429-11	CARBON	10K 5% 1/4W	R385	1-249-429-11	CARBON	10K 5% 1/4W
R322	1-247-889-00	CARBON	270K 5% 1/4W	R386	1-249-428-11	CARBON	8.2K 5% 1/4W
R323	1-249-423-11	CARBON	3.3K 5% 1/4W	R387	1-249-425-11	CARBON	4.7K 5% 1/4W
R324	1-247-874-11	CARBON	62K 5% 1/4W	R388	1-249-412-11	CARBON	390 5% 1/4W
R325	1-249-397-11	CARBON	22 5% 1/4W	R389	1-249-437-11	CARBON	47K 5% 1/4W
R326	1-249-425-11	CARBON	4.7K 5% 1/4W	R390	1-249-437-11	CARBON	47K 5% 1/4W
R327	1-247-881-00	CARBON	120K 5% 1/4W	R391	1-249-437-11	CARBON	47K 5% 1/4W
R328	1-249-436-11	CARBON	39K 5% 1/4W	R392	1-249-437-11	CARBON	47K 5% 1/4W
R329	1-249-422-11	CARBON	2.7K 5% 1/4W	R393	1-247-887-00	CARBON	220K 5% 1/4W
R330	1-247-891-00	CARBON	330K 5% 1/4W	R394	1-249-435-11	CARBON	33K 5% 1/4W
R331	1-247-721-11	CARBON	4.7K 5% 1/4W	R395	1-249-429-11	CARBON	10K 5% 1/4W
R332	1-249-428-11	CARBON	8.2K 5% 1/4W	R396	1-249-433-11	CARBON	22K 5% 1/4W
R333	1-249-430-11	CARBON	12K 5% 1/4W	R397	1-249-462-11	CARBON	22K 5% 1/4W
R334	1-249-433-11	CARBON	22K 5% 1/4W	R399	1-247-713-11	CARBON	1K 5% 1/4W
R335	1-249-429-11	CARBON	10K 5% 1/4W	R401	1-215-437-00	METAL	4.7K 1% 1/6W
R336	1-249-429-11	CARBON	10K 5% 1/4W	R402	1-215-434-00	METAL	3.6K 1% 1/6W
R337	1-215-445-00	METAL	10K 1% 1/6W	R403	1-215-433-00	METAL	3.3K 1% 1/6W
R338	1-214-747-00	METAL	5.6K 1% 1/4W	R404	1-215-435-00	METAL	3.9K 1% 1/6W
\boxtimes R339 Δ		METAL		R405	1-215-435-00	METAL	3.9K 1% 1/6W
R340	1-215-488-00	METAL	620K 1% 1/6W	R406	1-249-435-11	CARBON	33K 5% 1/4W
R341	1-215-457-00	METAL	33K 1% 1/6W	R407	1-215-429-00	METAL	2.2K 1% 1/6W
R342	1-247-723-11	CARBON	6.8K 5% 1/4W	R408	1-215-429-00	METAL	2.2K 1% 1/6W
R343	1-249-435-11	CARBON	33K 5% 1/4W	R409	1-249-417-11	CARBON	1K 5% 1/4W
R344	1-247-713-11	CARBON	1K 5% 1/4W	R410	1-249-417-11	CARBON	1K 5% 1/4W
R345	1-249-429-11	CARBON	10K 5% 1/4W	R411	1-249-429-11	CARBON	10K 5% 1/4W
R346	1-249-433-11	CARBON	22K 5% 1/4W	R412	1-249-429-11	CARBON	10K 5% 1/4W
R347	1-249-433-11	CARBON	22K 5% 1/4W	R413	1-247-885-00	CARBON	180K 5% 1/4W
R348	1-249-433-11	CARBON	22K 5% 1/4W	R414	1-215-429-00	METAL	2.2K 1% 1/6W
R349	1-249-417-11	CARBON	1K 5% 1/4W	R415	1-215-437-00	METAL	4.7K 1% 1/6W
R350	1-249-429-11	CARBON	10K 5% 1/4W	\boxtimes R416 Δ		METAL	
R351	1-249-405-11	CARBON	100 5% 1/4W	R417	1-214-725-00	METAL	680 1% 1/4W
R352	1-249-429-11	CARBON	10K 5% 1/4W	R418	1-214-767-00	METAL	39K 1% 1/4W
R353	1-249-423-11	CARBON	3.3K 5% 1/4W	R419	1-214-767-00	METAL	39K 1% 1/4W
R354	1-249-429-11	CARBON	10K 5% 1/4W	R420	1-249-417-11	CARBON	1K 5% 1/4W
R355	1-249-426-11	CARBON	5.6K 5% 1/4W	R421	1-249-429-11	CARBON	10K 5% 1/4W
R356	1-249-429-11	CARBON	10K 5% 1/4W				

- The components identified by in this manual have been carefully factory-selected for each set in order to satisfy regulations regarding X-ray radiation. Should replacement be required, replace only with the value originally used.
- * : Selected to yield optimum performance.

Les composants identifiés par une trame et une marque sont critiques pour la sécurité. Ne les remplacer que par une pièce portant le numéro spécifique.

The components identified by shading and mark are critical for safety. Replace only with part number specified.

REF. NO.	PART NO.	DESCRIPTION	REMARK	REF. NO.	PART NO.	DESCRIPTION	REMARK
R422	1-249-423-11	CARBON	3.3K 5% 1/4W	R485	1-249-430-11	CARBON	12K 5% 1/4W
R423	1-249-421-11	CARBON	2.2K 5% 1/4W	R486	1-249-417-11	CARBON	1K 5% 1/4W
R424	1-247-717-11	CARBON	2.2K 5% 1/4W	R487	1-249-413-11	CARBON	470 5% 1/4W
R425	1-249-421-11	CARBON	2.2K 5% 1/4W	R488	1-215-470-00	METAL	110K 1% 1/6W
R426	1-216-447-00	METAL OXIDE	27 5% 2W F	R489 <input checked="" type="checkbox"/>	METAL		1/6W
R427	1-249-405-11	CARBON	100 5% 1/4W	R490	1-249-435-11	CARBON	33K 5% 1/4W
R428	1-249-429-11	CARBON	10K 5% 1/4W	R491	1-249-424-11	CARBON	3.9K 5% 1/4W
R429	1-249-411-11	CARBON	330 5% 1/4W	R492	1-247-717-11	CARBON	2.2K 5% 1/4W
R430	1-249-423-11	CARBON	3.3K 5% 1/4W	R493	1-247-721-11	CARBON	4.7K 5% 1/4W
R431	1-249-429-11	CARBON	10K 5% 1/4W	R494	1-249-435-11	CARBON	33K 5% 1/4W
R433	1-249-423-11	CARBON	3.3K 5% 1/4W	R495	1-215-445-00	METAL	10K 1% 1/6W
R434	1-249-429-11	CARBON	10K 5% 1/4W	R496	1-249-405-11	CARBON	100 5% 1/4W
R435	1-249-411-11	CARBON	330 5% 1/4W	R497	1-249-422-11	CARBON	2.7K 5% 1/4W
R437	1-249-417-11	CARBON	1K 5% 1/4W	R498	1-247-715-11	CARBON	1.5K 5% 1/4W
R443	1-249-429-11	CARBON	10K 5% 1/4W	R499	1-247-725-11	CARBON	10K 5% 1/4W
R444	1-215-439-00	METAL	5.6K 1% 1/6W	R2003	1-249-437-11	CARBON	47K 5% 1/4W
R445	1-215-409-00	METAL	330 1% 1/6W	R2004	1-249-437-11	CARBON	47K 5% 1/4W
R446	1-215-428-00	METAL	2K 1% 1/6W	R2005	1-249-429-11	CARBON	10K 5% 1/4W
R447	1-215-433-00	METAL	3.3K 1% 1/6W	R2006	1-216-445-11	METAL OXIDE	12 5% 2W F
R448	1-249-423-11	CARBON	3.3K 5% 1/4W	R2007	1-249-409-11	CARBON	220 5% 1/4W
R449	1-214-737-00	METAL	2.2K 1% 1/4W	R2010	1-247-711-11	CARBON	680 5% 1/4W
R450	1-249-429-11	CARBON	10K 5% 1/4W	R2011	1-249-405-11	CARBON	100 5% 1/4W
R451	1-249-433-11	CARBON	22K 5% 1/4W	R2012	1-249-417-11	CARBON	1K 5% 1/4W
R452	1-249-433-11	CARBON	22K 5% 1/4W	R2013	1-249-408-11	CARBON	180 5% 1/4W
R453	1-249-417-11	CARBON	1K 5% 1/4W	R2014	1-249-417-11	CARBON	1K 5% 1/4W
R454	1-247-726-11	CARBON	33K 5% 1/4W	R2015	1-214-092-00	METAL	22 1% 1/4W
R455	1-249-435-11	CARBON	33K 5% 1/4W	R2016	1-214-092-00	METAL	22 1% 1/4W
R456	1-249-433-11	CARBON	22K 5% 1/4W	R2017	1-249-415-11	CARBON	680 5% 1/4W
R457	1-249-433-11	CARBON	22K 5% 1/4W	R2018	1-249-421-11	CARBON	2.2K 5% 1/4W
R458	1-249-435-11	CARBON	33K 5% 1/4W	R2020	1-247-711-11	CARBON	680 5% 1/4W
R459	1-249-440-11	CARBON	82K 5% 1/4W	R2021	1-249-405-11	CARBON	100 5% 1/4W
R460	1-249-436-11	CARBON	39K 5% 1/4W	R2022	1-249-417-11	CARBON	1K 5% 1/4W
R461	1-247-725-11	CARBON	10K 5% 1/4W	R2023	1-249-408-11	CARBON	180 5% 1/4W
R462	1-215-429-00	METAL	2.2K 1% 1/6W	R2024	1-249-417-11	CARBON	1K 5% 1/4W
R463	1-215-483-00	METAL	390K 1% 1/6W	R2025	1-214-092-00	METAL	22 1% 1/4W
R464	1-215-445-00	METAL	10K 1% 1/6W	R2026	1-214-092-00	METAL	22 1% 1/4W
R465	1-215-451-00	METAL	18K 1% 1/6W	R2027	1-249-415-11	CARBON	680 5% 1/4W
R466	1-249-417-11	CARBON	1K 5% 1/4W	R2028	1-249-421-11	CARBON	2.2K 5% 1/4W
R467	1-249-417-11	CARBON	1K 5% 1/4W	R2030	1-247-711-11	CARBON	680 5% 1/4W
R468	1-249-417-11	CARBON	1K 5% 1/4W	R2031	1-249-405-11	CARBON	100 5% 1/4W
R469	1-249-417-11	CARBON	1K 5% 1/4W	R2032	1-249-417-11	CARBON	1K 5% 1/4W
R470	1-249-465-11	CARBON	47K 5% 1/4W	R2033	1-249-408-11	CARBON	180 5% 1/4W
R471	1-249-437-11	CARBON	47K 5% 1/4W	R2034	1-249-417-11	CARBON	1K 5% 1/4W
R472	1-249-437-11	CARBON	47K 5% 1/4W	R2035	1-214-092-00	METAL	22 1% 1/4W
R473	1-249-437-11	CARBON	47K 5% 1/4W	R2036	1-214-092-00	METAL	22 1% 1/4W
R474	1-249-439-11	CARBON	68K 5% 1/4W	R2037	1-249-415-11	CARBON	680 5% 1/4W
R475	1-249-439-11	CARBON	68K 5% 1/4W	R2038	1-249-421-11	CARBON	2.2K 5% 1/4W
R476	1-249-439-11	CARBON	68K 5% 1/4W	R3001	1-249-411-11	CARBON	330 5% 1/4W
R477	1-249-467-11	CARBON	68K 5% 1/4W	R3002	1-249-425-11	CARBON	4.7K 5% 1/4W
R479	1-249-421-11	CARBON	2.2K 5% 1/4W	R3003	1-249-428-11	CARBON	8.2K 5% 1/4W
R480	1-247-717-11	CARBON	2.2K 5% 1/4W	R3004	1-249-405-11	CARBON	100 5% 1/4W
R481	1-247-725-11	CARBON	10K 5% 1/4W	R3005	1-249-421-11	CARBON	2.2K 5% 1/4W
*R482	1-215-427-00	METAL	1.8K 1% 1/6W	R3006	1-247-893-11	CARBON	390K 5% 1/4W
*R482	1-215-429-00	METAL	2.2K 1% 1/6W	R4001	1-249-429-11	CARBON	10K 5% 1/4W
*R482	1-215-431-00	METAL	2.7K 1% 1/6W	R4002	1-249-426-11	CARBON	5.6K 5% 1/4W
*R482	1-215-433-00	METAL	3.3K 1% 1/6W	R4003	1-249-421-11	CARBON	2.2K 5% 1/4W
*R482	1-215-437-00	METAL	4.7K 1% 1/6W	R4004	1-249-429-11	CARBON	10K 5% 1/4W
*R482	1-215-441-00	METAL	6.8K 1% 1/6W	R4005	1-249-426-11	CARBON	5.6K 5% 1/4W
*R482	1-215-445-00	METAL	10K 1% 1/6W	R4006	1-249-421-11	CARBON	2.2K 5% 1/4W
*R482	1-215-453-00	METAL	22K 1% 1/6W	R4007	1-249-429-11	CARBON	10K 5% 1/4W
*R482	1-215-461-00	METAL	47K 1% 1/6W	R4008	1-249-426-11	CARBON	5.6K 5% 1/4W
R483	1-215-417-00	METAL	680 1% 1/6W	R4009	1-249-421-11	CARBON	2.2K 5% 1/4W
R484	1-247-897-11	CARBON	560K 5% 1/4W	R4010	1-249-437-11	CARBON	47K 5% 1/4W

The components identified by shading and mark Δ are critical for safety. Replace only with part number specified.

Les composants identifiés par une trame et une marque Δ sont critiques pour la sécurité. Ne les remplacer que par une pièce portant le numéro spécifié.

BA **F** **G**

REF. NO.	PART NO.	DESCRIPTION	REMARK
R4011	1-249-429-11	CARBON 10K 5% 1/4W	
R4012	1-249-429-11	CARBON 10K 5% 1/4W	
R4013	1-249-437-11	CARBON 47K 5% 1/4W	
R4014	1-249-437-11	CARBON 47K 5% 1/4W	
R4015	1-249-429-11	CARBON 10K 5% 1/4W	
R4016	1-249-429-11	CARBON 10K 5% 1/4W	
R4017	1-249-405-11	CARBON 100 5% 1/4W	
R4018	1-249-425-11	CARBON 4.7K 5% 1/4W	
R4019	1-215-411-00	METAL 390 1% 1/6W	
R4023	1-249-437-11	CARBON 47K 5% 1/4W	
R5010	1-249-426-11	CARBON 5.6K 5% 1/4W	
<VARIABLE RESISTOR>			
RV211	1-224-248-XX	RES, ADJ, METAL GLAZE 470	
RV221	1-224-248-XX	RES, ADJ, METAL GLAZE 470	
RV231	1-224-248-XX	RES, ADJ, METAL GLAZE 470	
RV251	1-224-254-XX	RES, ADJ, METAL GLAZE 47K	
RV252	1-224-256-XX	RES, ADJ, METAL GLAZE 220K	
RV291	1-224-254-XX	RES, ADJ, METAL GLAZE 47K	
RV292	1-224-253-XX	RES, ADJ, METAL GLAZE 22K	
RV301	1-224-249-XX	RES, ADJ, METAL GLAZE 1K	
RV302	1-224-256-XX	RES, ADJ, METAL GLAZE 220K	
RV303	1-224-253-XX	RES, ADJ, METAL GLAZE 22K	
RV306	1-224-251-XX	RES, ADJ, METAL GLAZE 4.7K	
RV307	1-224-254-XX	RES, ADJ, METAL GLAZE 47K	
RV308	1-228-997-00	RES, ADJ, CARBON 100K	
RV401	1-224-134-XX	RES, ADJ, METAL GLAZE 470K	
RV402	1-224-251-XX	RES, ADJ, METAL GLAZE 4.7K	
RV403	1-224-248-XX	RES, ADJ, METAL GLAZE 470	

*1-619-033-11	F BOARD	*****	
1-533-190-11	CLIP, FUSE		
<CAPACITOR>			
C601	1-136-360-51	FILM 0.22MF 20% 250V	
C602	1-136-360-51	FILM 0.22MF 20% 250V	
C603	1-161-953-51	CERAMIC 0.0047MF 20% 400V	
C604	1-161-953-51	CERAMIC 0.0047MF 20% 400V	
C605	1-162-599-12	CERAMIC 0.0047MF 20% 400V	
C606	1-162-599-12	CERAMIC 0.0047MF 20% 400V	
C607	1-125-457-11	ELECT (BLOCK) 560MF 20% 200V	
C608	1-125-457-11	ELECT (BLOCK) 560MF 20% 200V	
C609	1-136-360-51	FILM 0.22MF 20% 250V	
C610	1-102-050-51	CERAMIC 0.01MF 500V	
<DIODE>			
D601	8-719-911-55	DIODE U05G	
D602	8-719-911-55	DIODE U05G	
<CONNECTOR>			
F1	*1-508-786-00	PIN, CONNECTOR (5MM PITCH) 2P	
F2	*1-508-786-00	PIN, CONNECTOR (5MM PITCH) 2P	
F3	*1-508-765-00	PIN, CONNECTOR (5MM PITCH) 3P	
F4	*1-508-765-00	PIN, CONNECTOR (5MM PITCH) 3P	
<FUSE>			

REF. NO.	PART NO.	DESCRIPTION	REMARK
R601	1-532-509-11	FUSE, GLASS TUBE 6.3A/125V	
<RESISTOR>			
R601	1-202-723-51	SOLID 2.2M 10% 1/2W	
R602	1-202-723-51	SOLID 2.2M 10% 1/2W	
R603	1-205-741-11	WIREWOUND 1.8 5% 10W	F
R604	1-214-917-00	CARBON 150K 5% 1/2W	
R605	1-214-917-00	CARBON 150K 5% 1/2W	
<TRANSFORMER>			
T601	1-421-357-31	TRANSFORMER, LINE FILTER	
T602	1-421-426-11	TRANSFORMER, FERRITE	
<THERMISTOR>			
THP601	1-806-214-12	THERMISTOR, POSITIVE	

*A-1316-079-A	G BOARD, COMPLETE	*****	
*4-314-225-00	HEAT SINK, (A)		
4-363-414-00	SPACER, MICA		
*4-368-683-01	SPRING		
<CAPACITOR>			
C650	1-102-050-51	CERAMIC 0.01MF 500V	
C651	1-136-060-00	FILM 0.047MF 5% 400V	
C652	1-136-060-00	FILM 0.047MF 5% 400V	
C653	1-102-327-00	CERAMIC 330PF 15% 1.5KV	
C654	1-102-327-00	CERAMIC 330PF 15% 1.5KV	
C655	1-130-661-00	FILM 0.022MF 3% 600V	
C656	1-136-239-11	FILM 0.01MF 3% 1KV	
C657	1-136-060-00	FILM 0.047MF 5% 400V	
C659	1-124-494-00	ELECT 33MF 160V	
C661	1-124-494-00	ELECT 33MF 160V	
C662	1-124-494-00	ELECT 33MF 160V	
C663	1-124-126-00	ELECT 47MF 20% 16V	
C664	1-126-104-11	ELECT 470MF 20% 25V	
C665	1-123-875-11	ELECT 10MF 20% 50V	
C666	1-124-126-00	ELECT 47MF 20% 16V	
C667	1-126-104-11	ELECT 470MF 20% 35V	
C668	1-124-477-11	ELECT 47MF 20% 16V	
C669	1-124-477-11	ELECT 47MF 20% 16V	
C670	1-162-116-00	CERAMIC 680PF 10% 2KV	
C671	1-162-558-11	CERAMIC 100PF 10% 2KV	
C672	1-162-558-11	CERAMIC 100PF 10% 2KV	
<DIODE>			
D651	8-719-301-18	DIODE RM2CS	
D652	8-719-301-18	DIODE RM2CS	
D653	8-719-971-20	DIODE ERC38-06	
D654	8-719-971-20	DIODE ERC38-06	
D655	8-719-300-33	DIODE RU-3AM	
D656	8-719-500-25	DIODE D5KC20RH	
D657	8-719-300-33	DIODE RU-3AM	
D658	8-719-300-33	DIODE RU-3AM	
D659	8-719-981-00	DIODE ERC81-004	
D660	8-719-981-00	DIODE ERC81-004	
D661	8-719-981-00	DIODE ERC81-004	

* * : Selected to yield optimum performance.



Les composants identifiés par une trame et une marque Δ sont critiques pour la sécurité. Ne les remplacer que par une pièce portant le numéro spécifique.

The components identified by shading and mark Δ are critical for safety. Replace only with part number specified.

REF.NO.	PART NO.	DESCRIPTION	REMARK
D662	8-719-981-00	DIODE ERC81-004	
D663	8-719-981-00	DIODE ERC81-004	
D664	8-719-200-02	DIODE 10E2	
D665	8-719-300-33	DIODE RU-3AM	
D666	8-719-300-33	DIODE RU-3AM	
D667	8-719-300-33	DIODE RU-3AM	
D668	8-719-300-33	DIODE RU-3AM	
D669	8-719-913-64	THYRISTOR CSM2B4A10	
D670	8-719-109-75	DIODE RD4.3ES-B2	
D671	8-719-110-36	DIODE RD13ES-B2	
D672	8-719-110-36	DIODE RD13ES-B2	
D673	8-719-300-33	DIODE RU-3AM	
D674	8-719-300-33	DIODE RU-3AM	
D675	8-719-300-33	DIODE RU-3AM	
D676	8-719-300-33	DIODE RU-3AM	
D677	8-719-300-33	DIODE RU-3AM	
D678	8-719-971-20	DIODE ERC38-06	
D679	8-719-971-20	DIODE ERC38-06	
<CONNECTOR>			
G1	*1-508-765-00	PIN, CONNECTOR (5MM PITCH) 3P	
G2	*1-564-505-11	PLUG, CONNECTOR 2P	
G3	*1-508-766-00	PIN, CONNECTOR (5MM PITCH) 4P	
G4	*1-508-767-00	PIN, CONNECTOR (5MM PITCH) 5P	
G5	*1-508-765-00	PIN, CONNECTOR (5MM PITCH) 3P	
<MODULE>			
IC651	1-235-449-11	POWER MODULE (DM-19)	
<TRANSISTOR>			
Q651	8-729-904-23	TRANSISTOR 2SC3318-S	
Q652	8-729-904-23	TRANSISTOR 2SC3318-S	
Q653	8-729-177-43	TRANSISTOR 2SD774	
Q654	8-729-177-43	TRANSISTOR 2SD774	
Q655	8-729-204-83	TRANSISTOR 2SA1048-GR	
Q656	8-729-204-83	TRANSISTOR 2SA1048-GR	
Q657	8-729-119-78	TRANSISTOR 2SC2785-HFE	
<RESISTOR>			
R651	1-202-842-11	SOLID 220K 10% 1/2W	
R652	1-202-842-11	SOLID 220K 10% 1/2W	
R653	1-202-842-11	SOLID 220K 10% 1/2W	
R654	1-207-451-00	WIREWOUND 0.1 10% 1/2W	
R656	1-216-374-00	METAL OXIDE 2.7 5% 2W	F
R657	1-216-374-00	METAL OXIDE 2.7 5% 2W	F
R658	1-247-717-11	CARBON 2.2K 5% 1/4W	
R659	1-247-700-11	CARBON 100 5% 1/4W	F
*R660	1-215-469-00	METAL 100K 1% 1/6W	
*R660	1-215-470-00	METAL 110K 1% 1/6W	
R661	1-215-449-00	METAL 15K 1% 1/6W	
R662	1-247-719-11	CARBON 3.3K 5% 1/4W	
R663	1-247-717-11	CARBON 2.2K 5% 1/4W	
R664	1-215-469-00	METAL 100K 1% 1/6W	
R665	1-215-451-00	METAL 18K 1% 1/6W	
R666	1-215-467-00	METAL 82K 1% 1/6W	
R667	1-215-451-00	METAL 18K 1% 1/6W	
R668	1-247-719-11	CARBON 3.3K 5% 1/4W	
R669	1-249-441-11	CARBON 100K 5% 1/4W	
R671	1-249-381-11	CARBON 1 5% 1/4W	F

REF.NO.	PART NO.	DESCRIPTION	REMARK
R672	1-202-842-11	SOLID 220K 10% 1/2W	
R673	1-247-717-11	CARBON 2.2K 5% 1/4W	
R674	1-249-429-11	CARBON 10K 5% 1/4W	
<TRANSFORMER>			
T651	Δ.1-421-704-11	CDT	
T652	Δ.1-421-886-11	PIT	
T653	Δ.1-421-888-11	PRT	
T654	Δ.1-421-889-11	PRT	
T655	Δ.1-421-889-11	PRT	
T656	Δ.1-421-885-11	COT	
T657	Δ.1-421-887-11	PHT	

*1-619-031-11	CB BOARD	*****	
1-526-762-00	SOCKET, PICTURE TUBE		
<RESISTOR>			
R701	1-202-719-00	SOLID 1M 10% 1/2W	
R706	1-202-824-00	SOLID 3.3K 10% 1/2W	
<VARIABLE RESISTOR>			
RV703	Δ.1-230-798-21	RES, ADJ, METAL GLAZE 90M	

*A-1341-067-A	D BOARD, COMPLETE	*****	
*4-314-225-00	HEAT SINK, (A)		
*4-323-833-00	HEAT SINK, PIN OUT		
4-363-414-00	SPACER, MICA		
*4-381-827-01	HOLDER, TR		
<CAPACITOR>			
C501	1-126-105-11	ELECT 1000MF 20% 35V	
C502	1-123-605-00	ELECT 100MF 20% 100V	
C504	1-124-556-11	ELECT 2200MF 20% 16V	
C506	1-124-477-11	ELECT 47MF 20% 16V	
C507	1-108-700-11	MYLAR 0.047MF 10% 200V	
C509	1-108-622-11	MYLAR 0.0047MF 10% 100V	
C511	1-108-704-11	MYLAR 0.1MF 10% 200V	
C513	1-124-917-11	ELECT 33MF 20% 50V	
C515	1-124-902-00	ELECT 0.47MF 20% 50V	
C517	1-102-978-00	CERAMIC 220PF 5% 50V	
C518	1-129-702-00	FILM 0.001MF 10% 630V	
C519	1-129-702-00	FILM 0.001MF 10% 630V	
C521	1-161-830-00	CERAMIC 0.0047MF 500V	
C522	1-136-541-11	FILM 1.5MF 5% 200V	
C523	1-136-569-11	FILM 1.2MF 5% 200V	
C524	Δ.1-129-712-51	FILM 0.0068MF 10% 630V	
C525	1-136-598-11	FILM 3MF 5% 200V	
C526	1-136-569-11	FILM 1.2MF 5% 200V	
C527	1-124-634-11	ELECT 1MF 20% 250V	
C528	1-136-115-00	FILM 0.56MF 5% 200V	
C529	1-136-598-11	FILM 3MF 5% 200V	
C530	Δ.1-129-723-51	FILM 0.056MF 10% 630V	
C531	Δ.1-136-089-11	FILM 0.0056MF 3% 2KV	
C532	1-108-626-11	MYLAR 0.01MF 10% 100V	
C533	1-102-129-00	CERAMIC 0.01MF 10% 50V	

The components identified by shading and mark Δ are critical for safety. Replace only with part number specified.

Les composants identifiés par une trame et une marque Δ sont critiques pour la sécurité. Ne les remplacer que par une pièce portant le numéro spécifié.

REF. NO.	PART NO.	DESCRIPTION	REMARK	REF. NO.	PART NO.	DESCRIPTION	REMARK
C534	1-102-129-00	CERAMIC	0.01MF 10% 50V	D512	8-719-973-95	DIODE ERD09-15	
C535	1-123-875-11	ELECT	10MF 20% 50V	D513	8-719-302-59	DIODE FMU-26S	
C536	1-108-624-11	MYLAR	0.0068MF 10% 100V	D514	8-719-971-20	DIODE ERC38-06	
C537	1-108-626-11	MYLAR	0.01MF 10% 100V	D515	8-719-101-94	DIODE RD18E-L1	
C538	1-124-902-00	ELECT	0.47MF 20% 50V	D516 Δ	8-719-200-02	DIODE 10E2	
C539	1-108-614-11	MYLAR	0.001MF 10% 100V	D518	8-719-911-19	DIODE 1SS119	
C540	1-108-626-11	MYLAR	0.01MF 10% 100V	D522	8-719-109-93	DIODE RD6.2ES-B2	
C541	1-108-626-11	MYLAR	0.01MF 10% 100V	D523	8-719-300-76	DIODE RH-1A	
C542	1-123-875-11	ELECT	10MF 20% 50V	D524	8-719-300-76	DIODE RH-1A	
C543	1-124-045-00	ELECT	4.7MF 20% 50V	D525	8-719-911-19	DIODE 1SS119	
C545	1-108-691-11	MYLAR	0.0082MF 10% 200V	D526	8-719-300-65	DIODE ES1F	
C546	1-108-688-11	MYLAR	0.0047MF 10% 200V	D528	8-719-110-31	DIODE RD12ES-B2	
G547 Δ	1-102-327-11	CERAMIC	330PF 15% 1.5KV	D529	8-719-300-65	DIODE ES1F	
C548	1-136-173-00	FILM	0.47MF 5% 50V	D531	8-719-911-19	DIODE 1SS119	
C549	1-124-347-00	ELECT	100MF 20% 160V	D532	8-719-911-19	DIODE 1SS119	
C550	1-124-484-11	ELECT	220MF 20% 35V	D533	8-719-911-19	DIODE 1SS119	
C551	1-162-114-00	CERAMIC	0.0047MF 10% 2KV	D534	8-719-911-19	DIODE 1SS119	
C552	1-108-700-11	MYLAR	0.047MF 10% 200V	D535	8-719-911-19	DIODE 1SS119	
C553	1-123-949-00	ELECT	33MF 20% 250V	D536	8-719-973-95	DIODE ERD09-15	
C554	1-124-477-11	ELECT	47MF 20% 25V	D537	8-719-971-20	DIODE ERC38-06	
C555	1-124-494-00	ELECT	33MF 160V				
C556 Δ	1-129-722-51	FILM	0.047MF 10% 630V				
C557	1-126-233-11	ELECT	22MF 20% 25V				
C558	1-126-101-11	ELECT	100MF 20% 16V				
C559	1-162-116-00	CERAMIC	680PF 10% 2KV				
C560	1-108-965-11	MYLAR	0.33MF 10% 200V				
C561	1-108-626-11	MYLAR	0.01MF 10% 100V				
C562	1-124-927-11	ELECT	4.7MF 20% 50V				
C563	1-124-120-11	ELECT	220MF 20% 25V				
C564	1-124-478-11	ELECT	100MF 20% 25V				
C565	1-123-875-11	ELECT	10MF 20% 50V				
C581	1-124-477-11	ELECT	47MF 20% 25V				
C585	1-124-963-11	ELECT	33MF 20% 16V				
C589	1-123-875-11	ELECT	10MF 20% 50V				
C593	1-162-117-00	CERAMIC	100PF 10% 500V				
C594	1-124-667-11	ELECT	10MF 20% 100V				
C595	1-124-267-00	ELECT	2.2MF 20% 160V				
C596	1-102-038-00	CERAMIC	0.001MF 500V				
C597	1-102-038-00	CERAMIC	0.001MF 500V				
<CONNECTOR>							
D1	*1-564-038-00	CONNECTOR PLUG, DY (MINI) 6P					
D2	*1-508-766-00	PIN, CONNECTOR (5MM PITCH) 4P					
D3	*1-508-767-00	PIN, CONNECTOR (5MM PITCH) 5P					
D4	*1-564-505-11	PLUG, CONNECTOR 2P					
D5	*1-564-508-11	PLUG, CONNECTOR 5P					
D6	*1-508-765-00	PIN, CONNECTOR (5MM PITCH) 3P					
D7	*1-508-765-00	PIN, CONNECTOR (5MM PITCH) 3P					
D8	*1-564-505-11	PLUG, CONNECTOR 2P					
D11	*1-564-505-11	PLUG, CONNECTOR 2P					
D12	*1-564-513-11	PLUG, CONNECTOR 10P					
D13	*1-564-508-11	PLUG, CONNECTOR 5P					
<DIODE>							
D504 Δ	8-719-200-02	DIODE 10E2					
D505 Δ	8-719-200-02	DIODE 10E2					
D506	8-719-911-19	DIODE 1SS119					
D507	8-719-911-19	DIODE 1SS119					
D508	8-719-911-19	DIODE 1SS119					
D509	8-719-911-19	DIODE 1SS119					
D510	8-719-971-20	DIODE ERC38-06					
D511	8-719-971-20	DIODE ERC38-06					
<IC>							
IC501	8-759-014-95	IC MC1495L					
IC504	8-759-145-58	IC UPC4558C					
IC505	8-759-982-26	IC RC78L12A					
<COIL>							
L501	1-408-239-00	INDUCTOR 4.7MMH					
L502 Δ	1-459-670-12	H.L.C					
L503 Δ	1-459-671-11	COIL (WITH GORE)					
L504	1-459-123-00	COIL, DUST CORE (PAC)					
L505	1-459-104-00	COIL, DUST CORE					
L506	1-407-365-00	COIL, CHOKE (HIGH FREQUENCY)					
L507	1-421-421-00	COIL, CHOKE 100UH					
L508	1-459-215-00	CORE COIL					
L509	1-459-215-00	CORE COIL					
L510	1-459-454-00	COIL, FERRITE CHOKE					
L511	1-421-329-00	COIL, CHOKE					
L512	1-408-092-00	INDUCTOR 330UH					
<NEON LAMP>							
NL501	1-519-108-XX	LAMP, NEON					
<TRANSISTOR>							
Q501	8-729-900-36	TRANSISTOR DTC124ES					
Q502	8-729-600-24	TRANSISTOR 2SC403SP-51					
Q503	8-729-600-24	TRANSISTOR 2SC403SP-51					
Q506	8-729-204-83	TRANSISTOR 2SA1048-GR					
Q507	8-729-177-44	TRANSISTOR 2SD774-5					
Q508	8-729-119-78	TRANSISTOR 2SC2785-HFE					
Q509	8-729-119-78	TRANSISTOR 2SC2785-HFE					
Q510	8-729-313-42	TRANSISTOR 2SD1134					
Q511	8-729-177-44	TRANSISTOR 2SD774-5					
Q512	8-729-140-97	TRANSISTOR 2SB734-34					
Q513	8-729-177-44	TRANSISTOR 2SD774-5					
Q514	8-729-805-07	TRANSISTOR 2SD1887-CA					
Q516	8-729-119-78	TRANSISTOR 2SC2785-HFE					
Q517	8-729-119-78	TRANSISTOR 2SC2785-HFE					
Q518	8-729-119-78	TRANSISTOR 2SC2785-HFE					

D

Les composants identifiés par une trame et une marque Δ sont critiques pour la sécurité. Ne les remplacer que par une pièce portant le numéro spécifique.

The components identified by shading and mark Δ are critical for safety. Replace only with part number specified.

REF. NO.	PART NO.	DESCRIPTION	REMARK	REF. NO.	PART NO.	DESCRIPTION	REMARK
Q519	8-729-213-12	TRANSISTOR 2SC2230A		R560	1-215-886-11	METAL OXIDE 100 5% 2W	F
Q520	8-729-401-21	TRANSISTOR 2SD1264-P		R561 Δ	1-215-863-51	METAL OXIDE 100 5% 1W	F
Q521	8-729-401-18	TRANSISTOR 2SB940-P		R562	1-216-353-00	METAL OXIDE 2.2 5% 1W	F
Q522	8-729-119-78	TRANSISTOR 2SC2785-HFE		R563	1-202-818-00	SOLID 1K 10% 1/2W	
Q531	8-729-119-78	TRANSISTOR 2SC2785-HFE		R564	1-249-387-11	CARBON 3.3 5% 1/4W	F
Q532	8-729-119-78	TRANSISTOR 2SC2785-HFE		R565	1-215-874-11	METAL OXIDE 6.8K 5% 1W	F
Q533	8-729-119-78	TRANSISTOR 2SC2785-HFE		R566	1-215-872-11	METAL OXIDE 3.3K 5% 1W	F
Q534	8-729-119-78	TRANSISTOR 2SC2785-HFE		R567	1-214-925-00	CARBON 330K 5% 1/2W	
<RESISTOR>				R568	1-215-881-11	METAL OXIDE 15 5% 2W	F
R501	1-249-417-11	CARBON 1K 5% 1/4W		R569 Δ	1-216-425-51	METAL OXIDE 56 5% 1W	F
R503	1-249-417-11	CARBON 1K 5% 1/4W		R570	1-249-432-11	CARBON 18K 5% 1/4W	
R504	1-249-405-11	CARBON 100 5% 1/4W		R571	1-249-417-11	CARBON 1K 5% 1/4W	
R505	1-249-425-11	CARBON 4.7K 5% 1/4W		R572	1-249-431-11	CARBON 15K 5% 1/4W	
R507	1-247-725-11	CARBON 10K 5% 1/4W		R573	1-213-074-00	FUSIBLE 39 5% 1W	F
R508	1-247-719-11	CARBON 3.3K 5% 1/4W		R574	1-249-426-11	CARBON 5.6K 5% 1/4W	
R509	1-249-427-11	CARBON 6.8K 5% 1/4W		R575	1-249-427-11	CARBON 6.8K 5% 1/4W	
R510	1-216-349-00	METAL OXIDE 1 5% 1W	F	R576	1-249-429-11	CARBON 10K 5% 1/4W	
R511	1-216-428-00	METAL OXIDE 180 5% 1W	F	R577	1-249-433-11	CARBON 22K 5% 1/4W	
R512	1-216-371-00	METAL OXIDE 1.5 5% 2W	F	R578	1-249-429-11	CARBON 10K 5% 1/4W	
R513	1-216-369-00	METAL OXIDE 1 5% 2W	F	R579	1-249-429-11	CARBON 10K 5% 1/4W	
R514	1-249-429-11	CARBON 10K 5% 1/4W		R580	1-249-427-11	CARBON 6.8K 5% 1/4W	
R516	1-249-417-11	CARBON 1K 5% 1/4W		R581	1-249-438-11	CARBON 56K 5% 1/4W	
R517	1-249-440-11	CARBON 82K 5% 1/4W		R582	1-249-429-11	CARBON 10K 5% 1/4W	
R518	1-249-409-11	CARBON 220 5% 1/4W		R583	1-249-406-11	CARBON 120 5% 1/4W	
R519	1-247-891-00	CARBON 330K 5% 1/4W		R584	1-249-429-11	CARBON 10K 5% 1/4W	
R520	1-249-429-11	CARBON 10K 5% 1/4W		R585	1-249-425-11	CARBON 4.7K 5% 1/4W	
R521	1-249-429-11	CARBON 10K 5% 1/4W		R586	1-249-405-11	CARBON 100 5% 1/4W	
R523	1-215-882-00	METAL OXIDE 22 5% 2W	F	R587	1-249-432-11	CARBON 18K 5% 1/4W	
R524	1-249-409-11	CARBON 220 5% 1/4W		R588	1-249-406-11	CARBON 120 5% 1/4W	
R525	1-249-439-11	CARBON 68K 5% 1/4W		R589	1-249-429-11	CARBON 10K 5% 1/4W	
R526	1-249-429-11	CARBON 10K 5% 1/4W		R590	1-249-429-11	CARBON 10K 5% 1/4W	
R527	1-247-720-11	CARBON 3.9K 5% 1/4W		R591	1-249-422-11	CARBON 2.7K 5% 1/4W	
R528	1-247-721-11	CARBON 4.7K 5% 1/4W		R592	1-249-424-11	CARBON 3.9K 5% 1/4W	
R529	1-215-890-11	METAL OXIDE 470 5% 2W	F	R593	1-249-393-11	CARBON 10 5% 1/4W	F
R530	1-216-454-11	METAL OXIDE 390 5% 2W	F	R594	1-216-483-11	METAL OXIDE 2.7K 5% 3W	F
R531	1-216-430-11	METAL OXIDE 390 5% 1W	F	R595	1-216-458-11	METAL OXIDE 1.8K 5% 2W	F
R532	1-249-429-11	CARBON 10K 5% 1/4W		R596	1-249-401-11	CARBON 47 5% 1/4W	F
R533	1-249-437-11	CARBON 47K 5% 1/4W		R597	1-216-350-11	METAL OXIDE 1.2 5% 1W	F
R534	1-249-440-11	CARBON 82K 5% 1/4W		R598	1-216-350-11	METAL OXIDE 1.2 5% 1W	F
R535	1-249-429-11	CARBON 10K 5% 1/4W		R599	1-202-842-11	SOLID 220K 10% 1/2W	
R536	1-247-883-00	CARBON 150K 5% 1/4W		R5001	1-249-429-11	CARBON 10K 5% 1/4W	
R537	1-249-440-11	CARBON 82K 5% 1/4W		R5002	1-249-441-11	CARBON 100K 5% 1/4W	
R538	1-249-429-11	CARBON 10K 5% 1/4W		R5007	1-247-887-00	CARBON 220K 5% 1/4W	
R539	1-247-881-00	CARBON 120K 5% 1/4W		R5010	1-202-841-00	SOLID 180K 10% 1/2W	
R542	1-249-433-11	CARBON 22K 5% 1/4W		R5011	1-249-437-11	CARBON 47K 5% 1/4W	
R543	1-249-427-11	CARBON 6.8K 5% 1/4W		R5012	1-249-429-11	CARBON 10K 5% 1/4W	
R544	1-249-431-11	CARBON 15K 5% 1/4W		R5013	1-249-437-11	CARBON 47K 5% 1/4W	
R545	1-249-410-11	CARBON 270 5% 1/4W		R5015	1-249-429-11	CARBON 10K 5% 1/4W	
R546	1-249-426-11	CARBON 5.6K 5% 1/4W		R5016	1-249-433-11	CARBON 22K 5% 1/4W	
R547	1-249-435-11	CARBON 33K 5% 1/4W		R5017	1-249-414-11	CARBON 560 5% 1/4W	
R548	1-247-726-11	CARBON 33K 5% 1/4W		R5018	1-249-440-11	CARBON 82K 5% 1/4W	
R549	1-249-469-11	CARBON 100K 5% 1/4W		R5020	1-216-445-11	METAL OXIDE 12 5% 2W	F
R550	1-249-429-11	CARBON 10K 5% 1/4W		R5021	1-216-353-00	METAL OXIDE 2.2 5% 1W	F
R551	1-249-417-11	CARBON 1K 5% 1/4W	F	R5022	1-249-413-11	CARBON 470 5% 1/4W	F
R552	1-249-429-11	CARBON 10K 5% 1/4W		R5023	1-216-450-00	METAL OXIDE 82 5% 2W	F
R553	1-249-417-11	CARBON 1K 5% 1/4W		<VARIABLE RESISTOR>			
R554	1-247-714-11	CARBON 1.2K 5% 1/4W		RV502	1-228-727-00	RES, ADJ, CERAMIC CARBON 47K	
R555	1-249-467-11	CARBON 68K 5% 1/4W		RV503	1-228-728-00	RES, ADJ, CERAMIC CARBON 100K	
R556	1-216-446-00	METAL OXIDE 18 5% 2W	F	RV504	1-228-725-00	RES, ADJ, CERAMIC CARBON 22K	
R557	1-215-892-11	METAL OXIDE 1K 5% 2W	F	RV505	1-228-728-00	RES, ADJ, CERAMIC CARBON 100K	
R558	1-249-433-11	CARBON 22K 5% 1/4W		RV506	1-228-720-00	RES, ADJ, CERAMIC CARBON 1K	
R559	1-249-417-11	CARBON 1K 5% 1/4W					



Les composants identifiés par une trame et une marque Δ sont critiques pour la sécurité. Ne les remplacer que par une pièce portant le numéro spécifié.

The components identified by shading and mark Δ are critical for safety. Replace only with part number specified.

REF. NO. PART NO. DESCRIPTION REMARK

<RESISTOR>

R702	1-202-818-00	SOLID	1K	10%	1/2W
R703	1-202-719-00	SOLID	1M	10%	1/2W
R708	1-202-720-00	SOLID	1.2M	10%	1/2W
R711	1-216-995-11	METAL	820	1%	10W
R712	1-202-557-00	SOLID	220	20%	1/2W
R713	1-247-759-11	CARBON	3.9K	5%	1/2W
R714	1-247-760-11	CARBON	4.7K	5%	1/2W
R715	1-247-903-00	CARBON	1M	5%	1/4W
R716	1-249-393-11	CARBON	10	5%	1/4W
R717	1-249-421-11	CARBON	2.2K	5%	1/4W
R721	1-216-995-11	METAL	820	1%	10W
R722	1-202-557-00	SOLID	220	20%	1/2W
R723	1-247-759-11	CARBON	3.9K	5%	1/2W
R724	1-247-760-11	CARBON	4.7K	5%	1/2W
R725	1-247-903-00	CARBON	1M	5%	1/4W
R726	1-249-393-11	CARBON	10	5%	1/4W
R727	1-249-421-11	CARBON	2.2K	5%	1/4W
R731	1-216-995-11	METAL	820	1%	10W
R732	1-202-557-00	SOLID	220	20%	1/2W
R733	1-247-759-11	CARBON	3.9K	5%	1/2W
R734	1-247-760-11	CARBON	4.7K	5%	1/2W
R735	1-247-903-00	CARBON	1M	5%	1/4W
R736	1-249-393-11	CARBON	10	5%	1/4W
R737	1-249-421-11	CARBON	2.2K	5%	1/4W

<VARIABLE RESISTOR>

RV701	1-226-114-00	RES, ADJ, METAL GLAZE	2.2M
RV702	1-226-063-00	RES, ADJ, CARBON	2.2M
RV711	1-224-252-XX	RES, ADJ, METAL GLAZE	10K
RV721	1-224-252-XX	RES, ADJ, METAL GLAZE	10K
RV731	1-224-252-XX	RES, ADJ, METAL GLAZE	10K

MISCELLANEOUS

Δ 1-230-666-12	RESISTOR ASSY, HIGH-VOLTAGE
Δ 1-451-291-13	DEFLECTION YOKE (SY-175)
Δ 1-509-546-11	3P INLET
1-543-179-00	CORE, RING
L901 Δ 1-426-283-11	COIL, DEMAGNETIZATION
RV901	1-230-536-11 RES, VAR, CARBON 10K
RV902	1-230-536-11 RES, VAR, CARBON 10K
S901 Δ 1-554-953-31	SWITCH, SEESAW (AC POWER)
V901 Δ 8-738-251-05	PICTURE TUBE (M34JNQ15X)

ACCESSORIES AND PACKING MATERIALS

PART NO. DESCRIPTION REMARK

Δ 1-558-377-11	CORD, POWER
*4-337-201-02	BAG, PROTECTION
*4-381-831-01	INDIVIDUAL CARTON
*4-381-895-01	CUSHION (UPPER) (ASSY)
*4-381-896-01	CUSHION (LOWER) (ASSY)
4-482-265-21	MANUAL, INSTRUCTION

CPD-1302

SONY[®] SERVICE MANUAL

*US Model
Canadian Model*

*Serial No. 7,000,001 and later
Chassis No. SCC-A08A-A*

SUPPLEMENT-4

File this supplement with the service manual.

Introduction: the following parts change (Serial No. 7,000,001 and later)

Section 6. ELECTRICAL PARTS LIST
PAGE 52

<u>Part No.</u>	<u>Description</u>
*4-389-045-01	INDIVIDUAL CARTON
*4-389-039-01	CUSHION (UPPER) (ASSY)
*4-389-040-01	CUSHION (LOWER) (ASSY)
4-482-265-31	MANUAL, INSTRUCTION



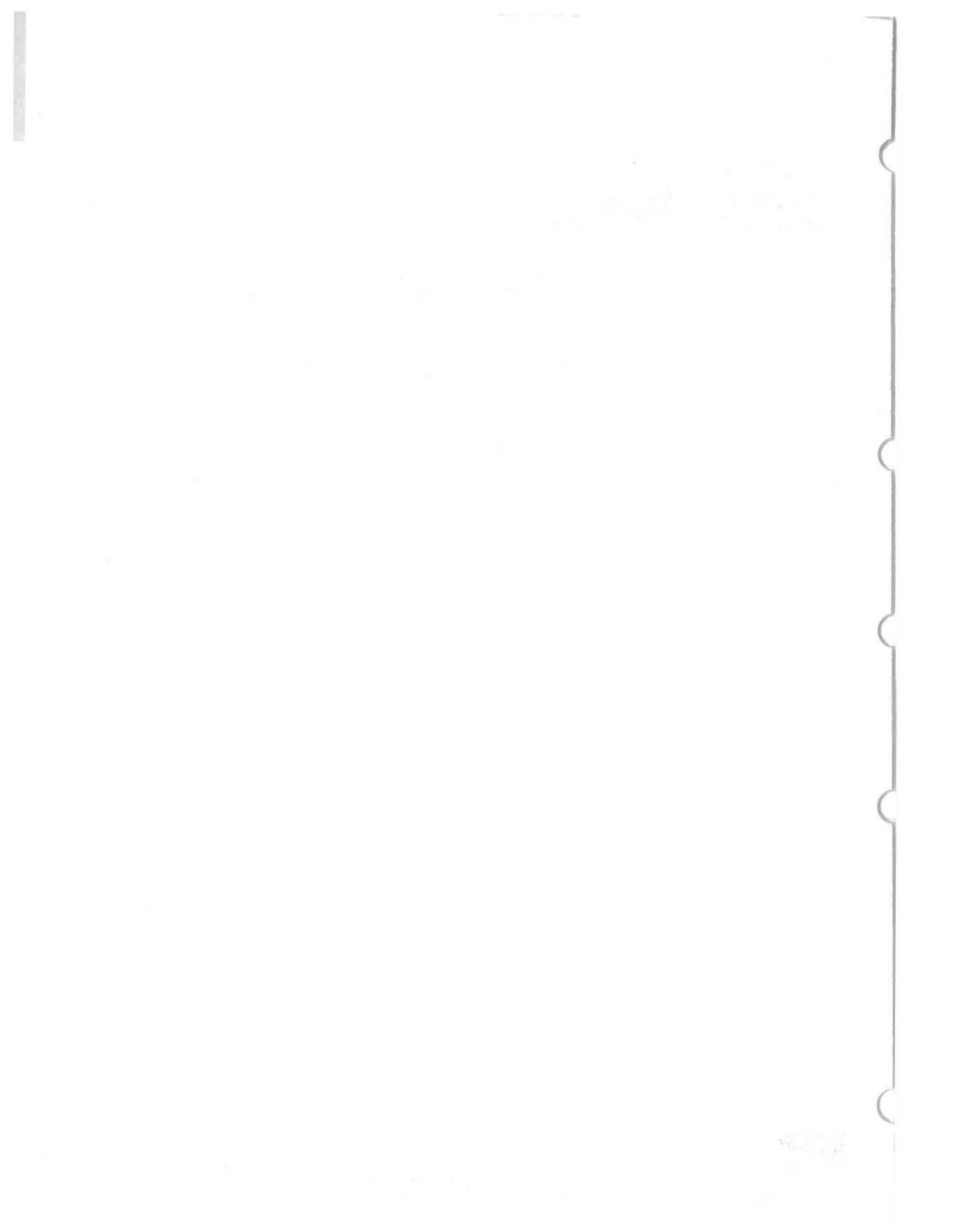

CPD-1302

SONY SERVICE MANUAL





US Model
Canadian Model
Chassis No. SCC-A08A-A

CORRECTION-2

Correct the service manual as shown below.
File this correction with the service manual and supplement-1.

 : indicates corrected portion

SECTION 3 (Service Manual), SECTION 2 (Supplement)
SAFETY RELATED ADJUSTMENTS

PAGE	INCORRECT	CORRECT
11 (Service Manual) 7 (Supplement)	<p>+B MAX ( R416, R489)</p> <p>Be sure to perform the following adjustment after replacing the parts below. (Marked on  the schematic diagram).</p> <p>(G board) Q653, R658, R659, T653 (BA board) IC401, IC404, IC405, Q409, R409, R410, R411, R412, R413, R414, R415, R416, R417, R418, R419, R424, R425, R448, R479, R480, R489, R488.</p> <ol style="list-style-type: none">1. Input a dot signal and set PICTURE, BRIGHT to minimum.2. Turn +B VR (RV403) to maximum.3. Observe BA board to connector pin ① BA-1 on the digital multimeter.4. Set SMC-70 output to fH = 15.734 kHz and confirm that the +8 line is less than 62.0V dc.5. Set SMC-70 output to fH = 18.4 kHz and confirm that the +8 line is less than 72.8V dc.6. Set SMC-70 output to fH = 21.8 kHz and confirm that the +8 line is less than 86.0V dc.7. Set SMC-70 output to fH = 25 kHz and confirm that the +8 line is less than 97.8V dc.8. Set SMC-70 output to fH = 31.5 kHz and confirm that the +8 line is less than 124.5V dc.9. If the specification is not met, adjust R416, R489 and repeat steps 1 and 3 until satisfied.	<p>+B MAX ( R416, R489)</p> <p>Be sure to perform the following adjustment after replacing the parts below. (Marked on  the schematic diagram).</p> <p>(G board) Q653, R658, R659, T653 (8A board) IC401, IC404, IC405, Q409, R409, R410, R411, R412, R413, R414, R415, R416, R417, R418, R419, R424, R425, R448, R479, R480, R489, R488.</p> <ol style="list-style-type: none">1. Supply 130±3V AC to with variable auto-transformer.2. Input a dot signal and set PICTURE, BRIGHT to minimum.3. Turn +8 VR (RV403) to maximum.4. Observe 8A board to connector pin ① BA-1 on the digital multimeter.5. Set SMC-70 output to fH = 15.734 kHz and confirm that the +8 line is less than 62.0V dc.6. Set SMC-70 output to fH = 18.4 kHz and confirm that the +8 line is less than 72.8V dc.7. Set SMC-70 output to fH = 21.8 kHz and confirm that the +8 line is less than 86.0V dc.8. Set SMC-70 output to fH = 25 kHz and confirm that the +8 line is less than 97.8V dc.9. Set SMC-70 output to fH = 31.5 kHz and confirm that the +8 line is less than 124.5V dc.10. If the specification is not met, adjust R416, R489 and repeat steps 1 and 3 until satisfied.

PAGE	INCORRECT	CORRECT
<p>12 (Service Manual) 8 (Supplement)</p>	<p>CONFIRMATION WHEN REPLACING H.V.R. (HIGH VOLTAGE REGISTER)</p> <p>The following adjustments should always be performed with reference to whether an X-ray radiation control circuit is connected or not, when replacing H.V.R.</p> <p>* This check is to be performed when H.V.R. only is replaced, and has no relation to the hold-down circuit readjustment for replacement of parts marked \blacktriangle.</p> <p>(Connection Confirmation)</p> <ol style="list-style-type: none"> 1. Turn the POWER switch ON, and receive white signals and set the PICTURE and BRIGHTNESS controls to MAX. 2. When the set is operating normally with 120V AC supply, confirm the voltage of the connection point for connector ② pin BA-14 is $7.3 \pm 0.8V$ dc. 	<p>CONFIRMATION WHEN REPLACING H.V.R. (HIGH VOLTAGE REGISTER)</p> <p>The following adjustments should always be performed with reference to whether an X-ray radiation control circuit is connected or not, when replacing H.V.R.</p> <p>* This check is to be performed when H.V.R. only is replaced, and has no relation to the hold-down circuit readjustment for replacement of parts marked \blacktriangle.</p> <p>(Connection Confirmation)</p> <ol style="list-style-type: none"> 1. Supply 120V AC to with variable auto-transformer. 2. Turn the POWER switch ON, and receive white signals and set the PICTURE and BRIGHTNESS controls to MAX. 3. Set SMC-70 output to $fH \pm 21, 8kHz$ and confirm the voltage of the connection point for connector ② pin BA-14 is $7.3 \pm 0.8V$ dc.

SECTION 4 (Service Manual)
4-3. SCHEMATIC DIAGRAM

PAGE	INCORRECT	CORRECT
<p>28</p>	<p>24 25 :</p>	<p>24 25 :</p> <div style="border: 1px solid black; padding: 5px; margin-bottom: 10px;"> <p>CAUTION</p> <p>When replacing HVR be sure to check the HOLD DOWN check point voltage value. Refer to the Safety Adjustment Section of the Service Manual.</p> </div>

INCORRECT

5-1. PICTURE TUBE
 ■ : TA, BV3X8 7-685-646-71
 ● : TA, BV4X10 7-685-660-71
 ▲ : TA, BV3X10 7-685-647-71

No.	Part No.	Description	Remark	No.	Part No.	Description	Remark
1	*3-668-914-31	EMBLEM, SONY		11	▲1-558-377-11	CORD, POWER	
2	X-4381-801-1	BEZEL ASSY		12	4-381-820-01	CABINET	
3	4-304-511-00	NUT, FLANGE		13	4-381-826-01	LABEL, CONTROL	
4	4-348-567-00	WASHER, CRT POSITION		14	4-381-817-01	LID, CONTROL	
5	▲8-738-251-05	CRT M34JN15X		15	*4-381-812-01	LABEL, MODEL NUMBER (SMALL)	
6	3-703-961-01	SPACER, DY		16	4-316-015-01	CLIP, LEAD WIRE	
7	1-452-146-21	MAGNET, BMC		17	1-452-032-00	MAGNET, DISK; 10MM Ø	
8	▲1-451-291-11	DEFLECTION YOKE(SY-175)		18	1-452-094-00	MAGNET, ROTATABLE DISK; 15MM Ø	
9	*1-619-036-11	X BOARD		19	X-4309-608-0	PERMALLOY ASSY, CONVERGENCE	
10	▲1-426-283-11	COIL, DEMAGNETIZATION					

CORRECT

5-1. PICTURE TUBE
 ■ : TA, BV3X8 7-685-646-71
 ● : TA, BV4X10 7-685-660-71
 ▲ : TA, BV3X10 7-685-647-71

No.	Part No.	Description	Remark	No.	Part No.	Description	Remark
1	*3-668-914-31	EMBLEM, SONY		11	▲1-558-377-11	CORD, POWER	
2	X-4381-801-1	BEZEL ASSY		12	4-381-820-01	CABINET	
3	4-304-511-00	NUT, FLANGE		13	4-381-826-01	LABEL, CONTROL	
4	4-348-567-00	WASHER, CRT POSITION		14	4-381-817-01	LID, CONTROL	
5	▲8-738-251-05	CRT M34JN15X		15	*4-381-812-01	LABEL, MODEL NUMBER (SMALL)	
6	3-703-961-01	SPACER, DY		16	4-316-015-01	CLIP, LEAD WIRE	
7	1-452-146-21	MAGNET, BMC		17	1-452-032-00	MAGNET, DISK; 10MM Ø	
8	▲1-451-291-11	DEFLECTION YOKE(SY-175)		18	1-452-094-00	MAGNET, ROTATABLE DISK; 15MM Ø	
9	*1-619-036-11	X BOARD		19	X-4309-608-0	PERMALLOY ASSY, CONVERGENCE	
10	▲1-426-283-11	COIL, DEMAGNETIZATION		20	▲4-381-813-01	BRACKET, BEZEL	

PAGE **INCORRECT**

37

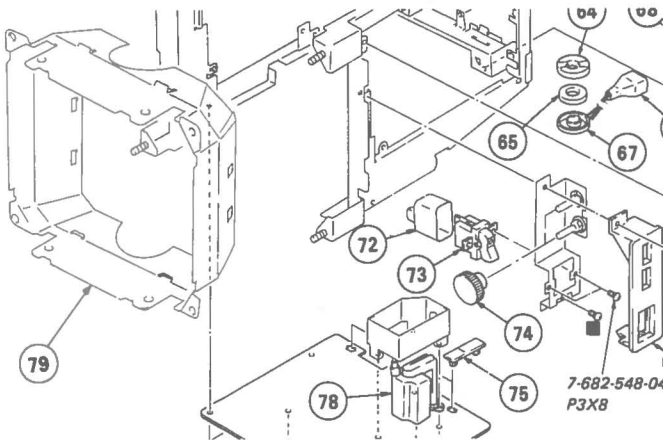

The components identified by shading and mark **▲** are critical for safety. Replace only with part number specified.

Les composants identifiés par une trame et une marque **▲** sont critiques pour la sécurité. Ne les remplacer que par une pièce portant le numéro spécifié.

No.	Part No.	Description	Remark	No.	Part No.	Description	Remark
51	*1-619-034-11	G BOARD		65	1-543-179-00	CORE, RING	
52	*3-703-961-01	SPACER, SUPPORT		66	*4-601-466-11	COVER, 3P INLET	
53	*1-619-033-11	F BOARD		67	*4-361-124-01	COVER (A), CORE	
54	▲ 1-230-666-11	RESISTOR ASSY, HIGH-VOLTAGE		68	▲ 1-509-546-11	3P INLET	
55	*1-619-651-11	BD BOARD		69	*1-619-029-11	BC BOARD	
56	4-343-123-00	RETAINER, AC CORD		70	*3-701-832-00	HINGE, CIRCUIT BOARD	
57	*1-619-030-11	CA BOARD		71	*A-1135-387-A	BA BOARD, COMPLETE	
58	*4-377-601-01	COVER		72	*4-381-806-01	COVER, SWITCH	
59	*4-370-995-01	COVER (LOWER), H.STAT		73	▲ 1-554-953-31	SWITCH, SEESAW (AC POWER)	
60	*1-619-031-11	CB BOARD		74	4-372-107-01	KNOB, ROTARY	
61	*4-370-996-01	COVER (UPPER), H.STAT		75	*4-313-732-00	CLIP, HINGE, CIRCUIT BOARD	
62	*1-619-035-11	H BOARD		76	*4-381-828-01	PANEL, SWITCH	
63	*A-1130-489-A	BB BOARD, COMPLETE		77	*A-1340-829-A	D BOARD, COMPLETE	
64	*4-361-125-01	COVER (B), CORE		78	▲ 1-439-390-11	TRANSFORMER ASSY, FLYBACK	
65	1-543-179-00	CORE, RING		79	*X-4381-802-1	SHIELD ASSY, CRT	
				80	*A-1465-149-A	HV BLOCK ASSY	

PAGE **CORRECT**

37

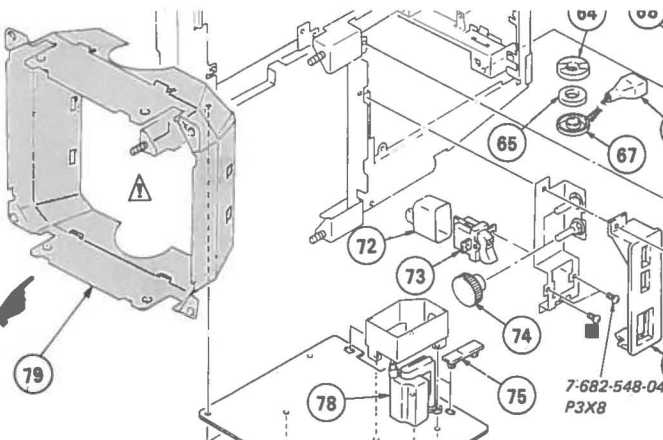

The components identified by shading and mark **▲** are critical for safety. Replace only with part number specified.

Les composants identifiés par une trame et une marque **▲** sont critiques pour la sécurité. Ne les remplacer que par une pièce portant le numéro spécifié.

No.	Part No.	Description	Remark	No.	Part No.	Description	Remark
51	*1-619-034-11	G BOARD		65	1-543-179-00	CORE, RING	
52	*3-703-961-01	SPACER, SUPPORT		66	*4-601-466-11	COVER, 3P INLET	
53	*1-619-033-11	F BOARD		67	*4-361-124-01	COVER (A), CORE	
54	▲ 1-230-666-11	RESISTOR ASSY, HIGH-VOLTAGE		68	▲ 1-509-546-11	3P INLET	
55	*1-619-651-11	BD BOARD		69	*1-619-029-11	BC BOARD	
56	4-343-123-00	RETAINER, AC CORD		70	*3-701-832-00	HINGE, CIRCUIT BOARD	
57	*1-619-030-11	CA BOARD		71	*A-1135-387-A	BA BOARD, COMPLETE	
58	*4-377-601-01	COVER		72	*4-381-806-01	COVER, SWITCH	
59	*4-370-995-01	COVER (LOWER), H.STAT		73	▲ 1-554-953-31	SWITCH, SEESAW (AC POWER)	
60	*1-619-031-11	CB BOARD		74	4-372-107-01	KNOB, ROTARY	
61	*4-370-996-01	COVER (UPPER), H.STAT		75	*4-313-732-00	CLIP, HINGE, CIRCUIT BOARD	
62	*1-619-035-11	H BOARD		76	*4-381-828-01	PANEL, SWITCH	
63	*A-1130-489-A	BB BOARD, COMPLETE		77	*A-1340-829-A	D BOARD, COMPLETE	
64	*4-361-125-01	COVER (B), CORE		78	▲ 1-439-390-11	TRANSFORMER ASSY, FLYBACK	
65	1-543-179-00	CORE, RING		79	*X-4381-802-1	SHIELD ASSY, CRT	
				80	*A-1465-149-A	HV BLOCK ASSY	

SONY®

color tv Service Bulletin No.294

Technical Department
Sony Service Company
A Division of Sony Corporation of America
Sony Drive, Park Ridge, New Jersey 07656

Model: CPD-1302

Subject: Picture Distortion (Pincushion)

Date: July 15, 1987

Symptom:
(133)

Picture distortion.

01162

Solution:

1. Change the value of capacitors.

C402 from $1\mu\text{F}/50\text{V}$ \longrightarrow $10\mu\text{F}/50\text{V}$ \longrightarrow 1-123-356-00

C415 from $2.2\mu\text{F}/50\text{V}$ \longrightarrow $10\mu\text{F}/50\text{V}$ \longrightarrow 1-123-356-00 (BA Board)

BA Board

2. Circuit Change:
 - *Cut the pattern between ⑬ IC205 and R331.
 - *Attach $1500\text{p}/50\text{V}$ (1-102-119-00) across the cut pattern.
 - *Add 4.7K ($1/6\text{w}$) between R331 and ground on soldering side.
 - *Add 15K ($1/4\text{w}$) between IC302 and C309 on soldering side.

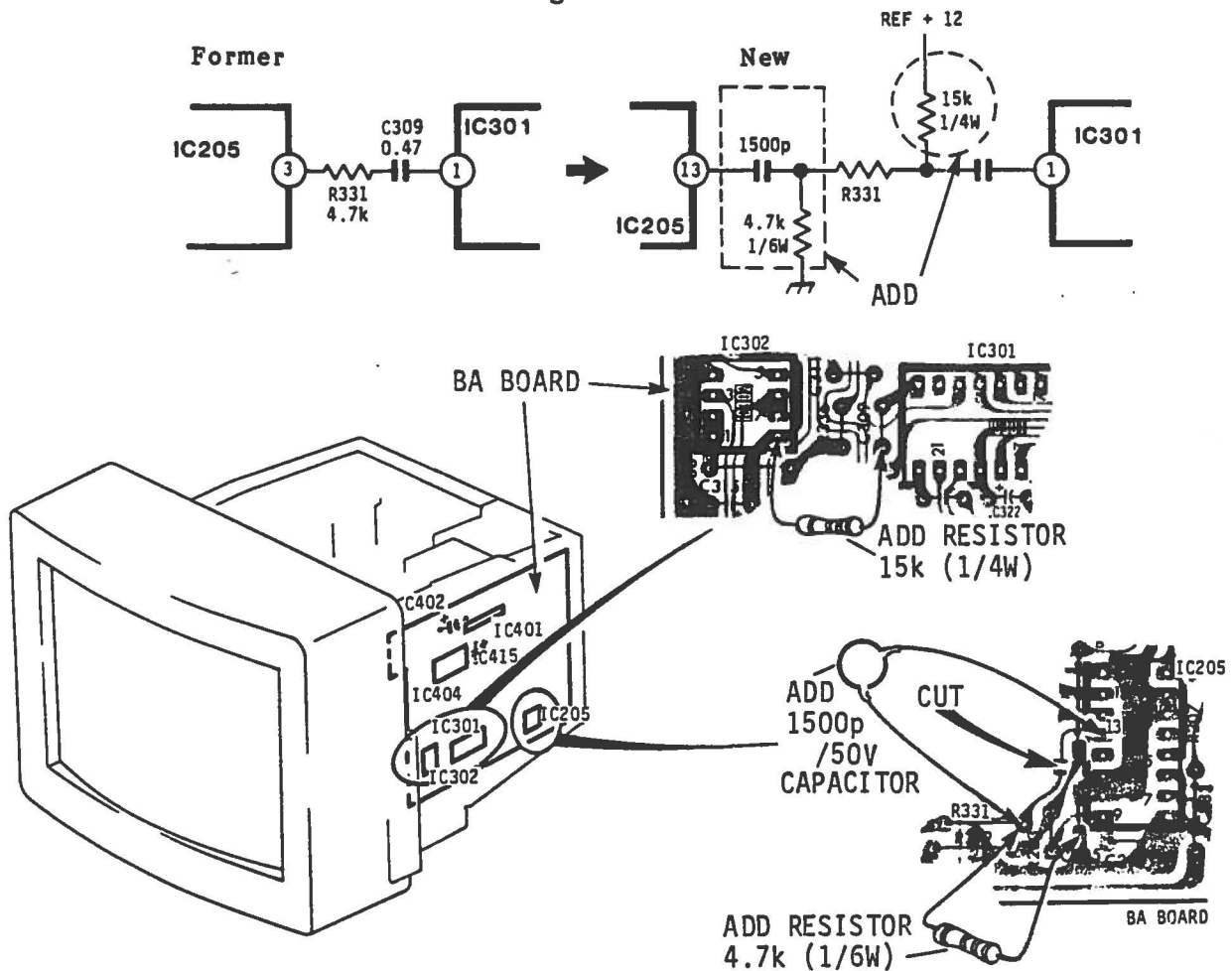

SONY®

color tv Service Bulletin No.303

Technical Department
Sony Service Company
A Division of Sony Corporation of America
Sony Drive, Park Ridge, New Jersey 07656

Model: CPD-1302

Subject: Only Green Text Displayed Or
Muted Picture

Date: October 9, 1987

Symptom:
(22)

01162

Using EGA Card only green text is displayed or occasionally no display at all when the vertical frequency is 55-57Hz. The 50/60Hz switching circuit does not respond correctly to the incoming signal.

Solution:

3-6. Vertical Sync Frequency Identification Circuit.

1) Preliminary CPD Generator Setting

1. Input signal H: 15.734KHz → H: ② ③
V: 60Hz → V: ⑦ ⑧

2. Set switch position to D1.

3. Connect a digital voltmeter to BA board Q332/BASE and adjust RV306 so the voltage value is $5.6V \pm 0.05V$ DC.

4. Set switch position to D2 (or short between BA-3 pin 1 (MS pin) and ground).

5. Adjust RV307 so the "BA" board Q332/BASE voltage value is $6.6V \pm 0.05V$ DC.

2) Precise CPD Generator Setting For V: 55.13Hz Switch-Over Frequency

1. Input signal H: 18.41KMz → H: ④ ③
V: 55.13H → V: ⑤ ⑥

2. Set switch position to D2 (Green Bars should appear on screen).

3. Connect a digital voltmeter to "BA" board Q332/BASE and very slowly increase the voltage with RV307 until relay CLICK is heard and GREEN BARS change into COLOR BARS. The voltage would be approximately in 6.7-6.8V range.

(Continued)

4. Confirm 55.13Hz switch-over point by changing position of VB switch within (B) (C) (D) range: CLICK + GREEN TO COLOR BARS CHANGE should take place.

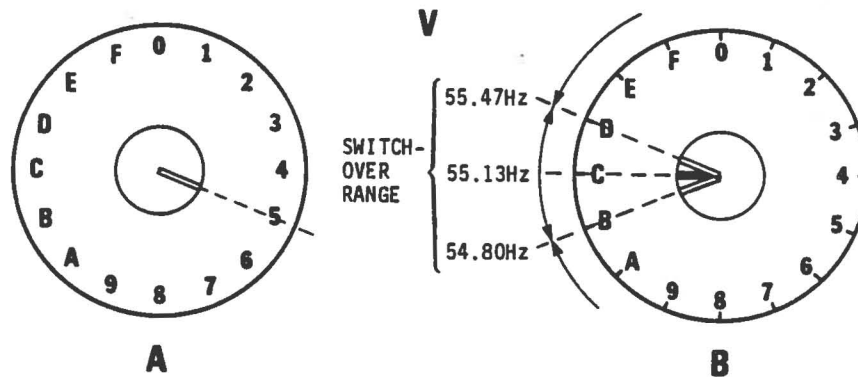

If the range is slightly different touch up RV307 until desired result is obtained. Monitoring Q332/B voltage while doing so provides helpful reference.

Settings For 18.41KHz//50Hz ~ 60Hz Combination

H		
A	B	f(KHz)
4	3	18.41

V		
A	B	f(Hz)
5	0	51.44
	1	51.30
	2	52.02
	3	52.31
	4	52.61
	5	52.91
	6	53.22
	7	53.53
	8	53.84
	9	54.16
	A	54.48
	B	54.80
	C	55.13
6	D	55.47
	E	55.80
	F	56.14
	0	56.49
	1	56.83
	2	57.19
	3	57.55
	4	57.91
	5	58.27
	6	58.65
	7	59.02
	8	59.40
	9	59.79
A	60.18	
B	60.57	
C	60.98	
D	61.38	
E	61.79	
F	62.21	