

**SDC-RXV31
Floppy Controller
Manual**

**SDC-RXV31
Floppy Controller
Manual**

**Sigma Information Systems
Anaheim, Calif.
June, 1983**

Contents

SECTION 1 - GENERAL INFORMATION

1.1	INTRODUCTION	1
1.2	GENERAL DESCRIPTION	2
1.3	COMPATIBILITY	2
1.4	LOGICAL TRACK FORMAT	3
	1.4.1 Sector Header Field	3
	1.4.2 Data Field	5
	1.4.3 CRC - Cyclic Redundancy Check	5
1.5	RECORDING SCHEME	6
1.6	SPECIFICATIONS	6

SECTION 2 - INSTALLATION

2.1	CONTROLLER JUMPER CONFIGURATIONS	7
	2.1.1 Device and Vector Address Selection	8
	2.1.2 Device Interrupt Priority	9
	2.1.3 Bootstrap	10
	2.1.4 Write Precompensation	10
	2.1.5 Write Current Control	11
	2.1.6 Drive and Side Selection	22
	2.1.7 Drive Step Rate	12
	2.1.8 22-Bit Addressing	12
2.2	DRIVE CONFIGURATIONS	12
2.3	CABLING	20
2.4	CONTROLLER INSTALLATION	22
2.5	INITIAL CHECKOUT	22

SECTION 3 - OPERATION

3.1	GENERAL INFORMATION	25
3.2	BOOTSTRAPPING	25
3.3	FORMATTING	26
3.4	FILL/WRITE OPERATION	27
3.5	READ/EMPTY OPERATION	29
3.6	OPERATION USING RT-11	29

SECTION 4 - PROGRAMMING

4.1	GENERAL INFORMATION	31
4.2	COMMAND AND STATUS REGISTER - RXVCS (177170)	32
4.3	DATA BUFFER (177172)	33
	4.3.1 Data Buffer Register (RXVDB)	34
	4.3.2 Trace Address Register (RXVTA)	34
	4.3.3 Sector Address Register (RXVSA)	34
	4.3.4 Word Count Register (RXVWC)	34
	4.3.5 Bus Address Register (RXVBA)	35
	4.3.6 Error and Status Register (RXVES)	35
	4.3.7 Bus Address Extension Register (RXVBAE)	36

4.4	EXTENDED STATUS REGISTERS	37
4.5	COMMAND PROTOCOL	38
4.5.1	Fill Buffer (000)	38
4.5.2	Empty Buffer (001)	39
4.5.3	Write Buffer (010)	40
4.5.4	Read Sector (011)	40
4.5.5	Set Media Density (100)	41
4.5.6	Read Status (101)	42
4.5.7	Write Deleted Data Sector (110)	42
4.5.8	Read Error Code (111)	42
4.5.9	22-Bit Mode	43

Figures

1.1	LOGICAL TRACK FORMAT	4
2.1	JUMPER LOCATIONS INDICATING FACTORY SET JUMPERS/ETCHES	8
2-2	DRIVE/CONTROLLER CABLING	20
2-3	CONNECTOR PIN DEFINITIONS	21
3-1	FORMAT SUBROUTINE	26
3-2	WRITE DATA SUBROUTINES	27
3-3	READ DATA SUBROUTINES	28

Tables

1-1	ADDRESS MARKS	5
2-1	FACTORY SET PARAMETERS	7
2-2	DEVICE/VECTOR ADDRESS JUMPERS	9
2-3	PRIORITY LEVEL CONFIGURATIONS	9
2-4	BOOTSTRAP CONFIGURATIONS	10
2-5	WRITE PRECOMPENSATION CONFIGURATION	10
2-6	WRITE CURRENT CONFIGURATIONS	11
2-7	DRIVE/SIDE CONFIGURATIONS	11
2-8	3ms STEP CONFIGURATION	12
2-9	22-BIT ADDRESSING CONFIGURATION	12
2-10	CONFIGURATIONS FOR SHUGART SA800/801	13
2-11	CONFIGURATIONS FOR SHUGART SA850/851	14
2-12	CONFIGURATIONS FOR SHUGART 860	15
2-13	CONFIGURATIONS FOR QUME (DATA TRAK 8) AND VE-DATA (YD-174)	16
2-14	CONFIGURATIONS FOR QUME TRAK 242	17
2-15	CONFIGURATIONS FOR MITSUBISHI M2896-63	18
2-16	CONFIGURATIONS FOR TANDON 848	19
3-1	DENSITY/SIDE COMMANDS	26

Section 1 - General information

1.1 INTRODUCTION

This manual provides the information needed to install and operate the SDC-RXV31 floppy disk controller manufactured by Sigma Information Systems, Anaheim, California. The SDC-RXV31 supports one or two dual density, single or double sided floppy disk drives. The single dual-wide module is software and media compatible with the DEC* RXV21/RX02, and features an on-board bootstrap and diskette formatting capability.

The material in this manual is arranged into the following sections:

Section 1 - GENERAL INFORMATION. This section contains a brief description of the SDC-RXV31, its logical track format, recording scheme, and a list of specifications.

Section 2 - INSTALLATION. This section explains the requirements and procedures for equipment installation. Alternate jumper selectable options and cabling are described.

Section 3 - OPERATION. This section explains the controller operation, including bootstrapping and formatting.

Section 4 - PROGRAMMING. A description of the SDC-RXV31 control registers and programming features are presented to aid the user in programming the controller.

*Registered trademark of Digital Equipment Corporation.

1.2 GENERAL DESCRIPTION

The SDC-RXV31 is a dual density floppy disk controller compatible with the DEC RX01/RX02. When connected to a Shugart-type drive, it replaces the RXV21 subsystem. The controller provides either single density encoding compatible with IBM 3740 devices, or double density encoding. The controller provides 512K bytes of storage on a single diskette. When two floppy drives are used, each drive may operate at a different density.

The SDC-RXV31 is a single dual-wide module that plugs directly into any standard Q bus* slot and interfaces through a 50-conductor ribbon cable to a Shugart compatible drive. The controller is factory preset for the standard device address 177170 and interrupt vector 264. The interrupt level is factory preset to level 4. Alternate addresses and interrupt vectors are jumper selectable. Features include:

- Transparent firmware bootstrap that automatically boots double density diskettes (jumper selectable).
- Write precompensation to reduce bit shift for greater data integrity.
- Power fail protect to inhibit write sequence while the controller completes sector currently being written.
- Write current control for tracks greater than 43.
- Jumper selectable 4-level interrupt priorities compatible with LSI-11/23 or LSI-11/2.
- Supports 22-bit addressing with appropriate software changes.

1.3 COMPATIBILITY

The hardware, software and media compatibility with DEC's RXV21 system is provided to aid the user in data interchange with foreign systems.

HARDWARE. The controller is compatible with the LSI-11, LSI-11/2 and LSI-11/23 CPUs. The single dual-wide module plugs directly into any standard LSI-11 backplane. Alternate address selection and a 4-level device interrupt priority scheme allows expanded system configurations. Shugart 800/850-compatible drive logic is interfaced through a 50-pin ribbon connector.

SOFTWARE. The SDC-RXV31 is completely compatible with DEC's RXV21 register definition and command protocol. The SDC-RXV31 will operate, with no modification, with operating systems and diagnostics designed for the RX02.

MEDIA. Media (either preformatted or blank soft sector diskettes) for the SDC-RXV31 is compatible with the IBM 3740. Recommended media are IBM single or double density, or DEC RX01/RX02.

1.4 LOGICAL TRACK FORMAT

Figure 1-1 defines each track format. The sector header field of each sector contains information describing both the sector and track number. All fields are recorded in FM except as noted in the following sections.

1.4.1 Sector Header Field

The header field consists of 7 bytes of information preceded by a field of 6 bytes of "zero" data for synchronization.

- Byte 1 ID ADDRESS MARK. A unique mark consisting of 1 byte of FE (hex) data with 3 missing clock transitions using a C7 (hex) clock pattern. This mark is decoded by the controller and indicates the start of the sector header.
- Byte 2 TRACK ADDRESS. This byte indicates the absolute (0-114 octal) track address. Each sector contains this track information to locate its position on one of the 77 tracks.
- Byte 3 "ZERO"
- Byte 4 SECTOR ADDRESS. This byte indicates the absolute (0-32 octal) sector address. Each sector contains this information to identify its position of the track.
- Byte 5 "ZERO"
- Byte 6,7 CRC. This is the 16-bit cyclic redundancy character and is calculated for each header from the first 5 bytes of information. Calculation, using the IBM 3740 polynomial, is defined in Section 1.4.3.

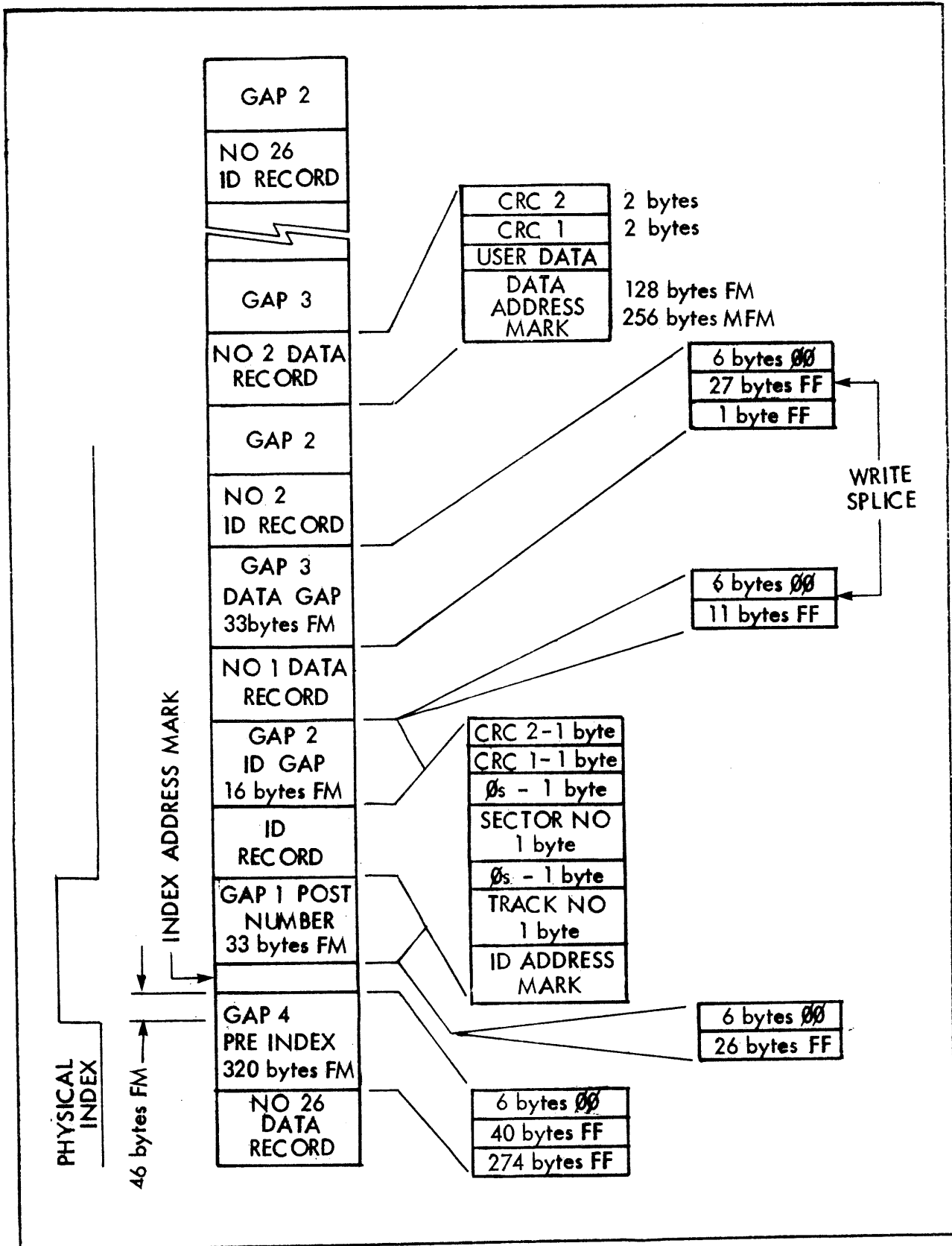

FIGURE 1-1: LOGICAL TRACK FORMAT

1.4.2 Data Field

The data field consists of either 131 or 259 bytes of information (depending on recording method) preceded by 6 bytes of "zero" data for synchronization.

The preamble and data address mark are written in FM. The user data and CRC character are written in either FM or modified MFM, depending on the formatted diskette density.

Byte 1 DATA ADDRESS MARK. This byte is a unique mark consisting of a data byte with three missing clock transitions using a C7 (hex) clock pattern as defined in Table 1-1. This byte is written in FM and is decoded by the controller to indicate the start of the data field, FM vs MFM recording method, and deleted data field indication.

ADDRESS MARK	INDICATED DENSITY	DATA
INDEX	N/A	FC
ID	N/A	FE
DATA	FM MFM Modifield	FB FD
DELETED DATA	FM MFM Modified	F8 F9

TABLE 1-1: ADDRESS MARKS

Bytes 2-257 FM (BYTES 2-129) OR MODIFIED MFM (BYTES 2-257). This field is recorded in either FM or modified MFM. Either 128 or 256 bytes of information can be stored, depending on the encoding scheme.

Bytes 130-131 or 258-259 CRC. This 16-bit cyclic redundancy character is calculated for each data field from the first 129 or 257 bytes of information using the IBM 3740 polynomial as defined in Section 1.4.3. These bytes are recorded with the same encoding scheme as the data field.

1.4.3 CRC - Cyclic Redundancy Check

Each sector header field and data field has a 2-byte (16-bit) CRC character which is the remainder that results when dividing the data bits (represented as a polynomial $M(x)$) by a generator polynomial $G(x)$. The polynomial used for IBM 3740 is $G(x) = x^{16} + x^{12} + x^5 + 1$. Data bits include bytes 1-5 for the sector header, bytes 1-129 for an FM data field, and bytes 1-257 for an MFM data field.

1.5 RECORDING SCHEME

Double frequency (FM) and DEC modified Miller code (MFM) recording schemes are used by the SDC-RXV31. FM, used for single density recording, is compatible with IBM 3740 or DEC RX01 media. Modified MFM, used for recording double density, is compatible with the RX02 system.

1.6 SPECIFICATIONS

Power Requirements: 5VDC at 2.5A (from LSI-11 backplane)

Bus Load: 1

Priority Level: 4-level compatible with LSI-11/23 CPU
(Selectable alternates)

Interrupt Vector: 264 (Selectable alternate at 270)

Device Address: 177170 (Selectable alternate at 177174)

Interface: Shugart compatible

Media: RX01/RX02 compatible

Recording Method: DEC modified MFM (Double density compatible
RX02) or optional FM (single density compatible
with IBM 3740)

Cable: Requires standard 50-conductor 3M-type ribbon
cable - not supplied.

Temperatures: 0 C to 45 C

Humidity: 10% to 95% noncondensing.

Section 2 - Installation

2.1 CONTROLLER JUMPER CONFIGURATIONS

The SDC-RXV31 is shipped configured with DEC standard operating parameters as defined in Table 2-1.

PARAMETER	SELECTION
Control Address	177170
Vector Address	264
Interrupt	Level 4
Firmware Bootstrap	Enabled
Write Precompensation	Enabled
Write Current Control	Enabled
Drive Select	Double Sided
22-Bit Address	Disabled

TABLE 2-1: FACTORY SET PARAMETERS

Options are etched to the most often used operation. Etches must be cut before alternate jumpers are inserted. Several of the options are selectable by using AMP 530153-2 pin jumpers or, alternately, No. 30 wire wrap. Refer to Figure 2-1 for jumper locations. Notice that certain jumpers are dedicated for factory test only. Jumpers 11-12, 13-14, 19-21 and 20-21 must NOT be removed.

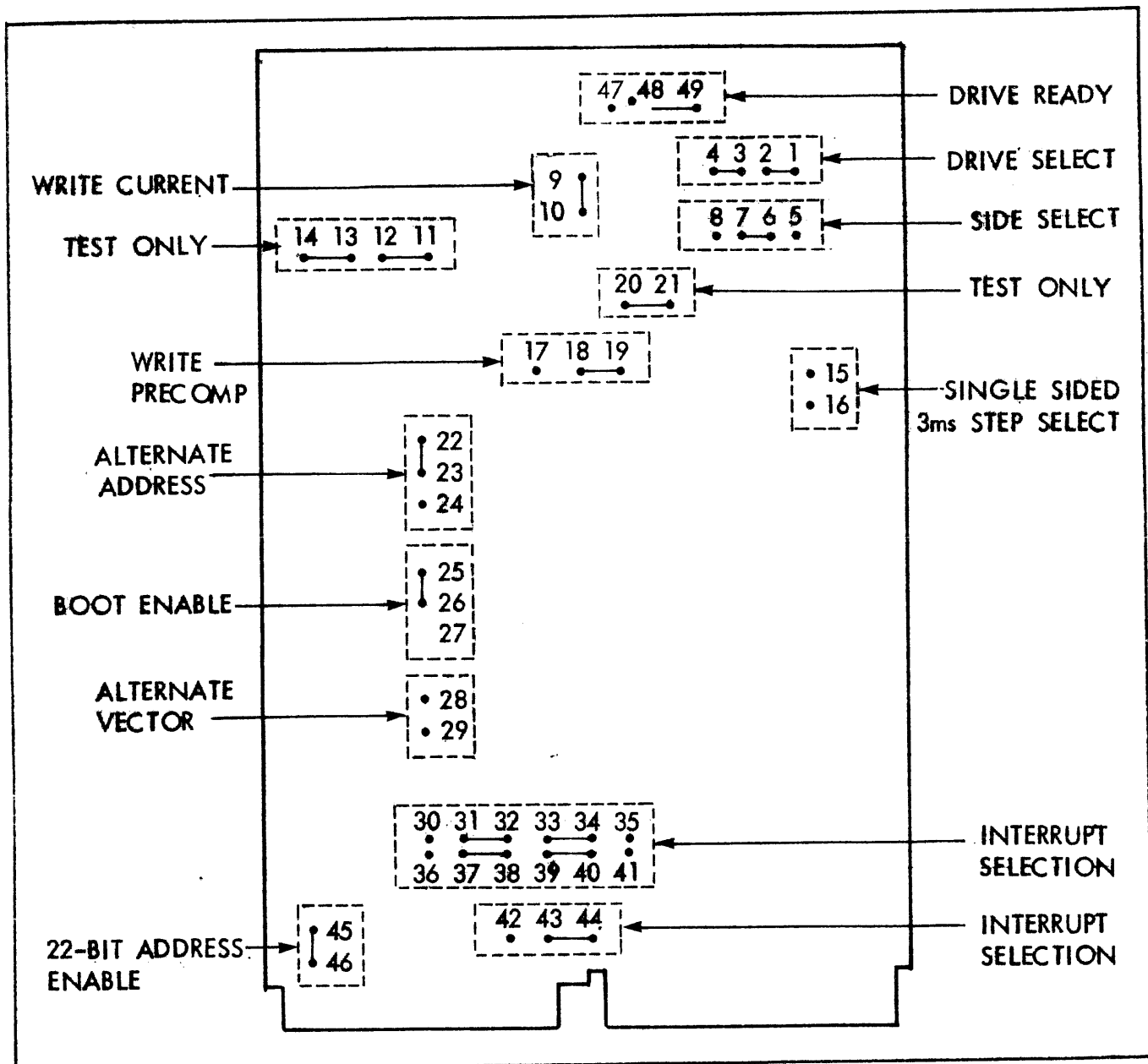

FIGURE 2-1: JUMPER LOCATIONS INDICATING FACTORY SET JUMPERS/ETCHES

2.1.1 Device and Vector Address Selection

The controller is shipped with the DEC standard device and vector addresses preset to 177170 and 264 respectively. Any change in these addresses requires a change in system software. The alternate device and vector addresses are selectable and are defined as 177174 and 270 respectively. These alternate addresses are typically used for systems with more than two drives where two controllers are required. To configure the second controller for address/vector assignments, cut the etch between W22 and W23; then jumper W23-W24 and W28-W29 as shown in Table 2-2.

OPTION	JUMPERS		
	22-23	23-24	28-29
Standard Device (177170) Vector (264) Addresses*	IN	OUT	OUT
Alternate Device (177174) Vector (270) Address	OUT	IN	IN

*Factory Preset

TABLE 2-2: DEVICE/VECTOR ADDRESS JUMPERS

2.1.2 Device interrupt Priority

The SDC-RXV31 supports the 4-level device interrupt priority scheme compatible with the LSI-11/23. The controller asserts interrupt requests and monitors higher level request lines during interrupt arbitration. The level 4 request is always asserted by the controller, regardless of its priority, to maintain compatibility with the LSI-11 and LSI-11/2 CPUs.

The interrupt priority is factory preset to level 4. If an alternate interrupt level is desired, the following etches must be cut: W31-W32, W33-W34, W37-W38, W35-W40, and W43-W44. Refer to Table 2-3 for the jumper installation for the desired priority level.

PRIORITY LEVEL	ASSERT LEVEL	MONITOR LEVEL	JUMPERS									
			W30 W31	W31 W32	W33 W34	W34 W35	W36 W37	W37 W38	W39 W40	W40 W41	W42 W43	W43 W44
4*	4	5,6	OUT	IN	IN	OUT	OUT	IN	IN	OUT	OUT	IN
5	4,5	6	OUT	IN	IN	OUT	IN	OUT	OUT	IN	OUT	IN
6	4,6	7	IN	OUT	OUT	IN	OUT	IN	IN	OUT	IN	OUT
7	4,6,7	NONE	IN	OUT	OUT	IN	IN	OUT	OUT	IN	IN	OUT

*Factory Preset

TABLE 2-3: PRIORITY LEVEL CONFIGURATIONS

2.1.3 Bootstrap

The controller module contains a transparent firmware bootstrap which is initiated whenever program execution is started at location 173000, homing both drives to track 0. Track 1, sector 1 of unit 0 is then read and diskette density is determined. For single density diskettes sectors 1, 3, 5 and 7 are loaded into memory starting at location 0. If the diskette is double density, sectors 1 and 3 are loaded. Program execution is then transferred to location 0.

BOOTSTRAP	JUMPERS	
	W25-W26	W26-W27
Enable*	IN	OUT
Disable	OUT	IN

*Factory Jumpered

TABLE 2-4: BOOTSTRAP CONFIGURATIONS

NOTE

Only one bootstrap should be enabled in a system for proper operation. If a second bootstrap exists in the system, it must be disabled before enabling the SDC-RXV31 bootstrap.

2.1.4 Write Precompensation

The SDC-RXV31 controller provides hardware write precompensation to reduce bit shift. The controller is shipped with write precompensation enabled. It is recommended that, for reliable operation, this feature not be disabled. However, if write precompensation must be disabled, remove the etch W18-W19 and insert jumper W17-W18 as shown in Table 2-5.

WRITE PRECOMPENSATION	JUMPERS	
	W17-W18	W18-W19
Enable*	IN	OUT
Disable	OUT	IN

*Factor Jumpered

TABLE 2-5: WRITE PRECOMPENSATION CONFIGURATION

2.1.5 Write Current Control

The SDC-RXV31 provides the necessary signal to reduce the write current for tracks greater than 43. This signal is available at pin 2 of the 50-pin connector. Write current jumper configurations are shown in Table 2-6

WRITE CURRENT	JUMPER W9-W10
Enable*	IN
Disable	OUT

*Factory preset

TABLE 2-6: WRITE CURRENT CONFIGURATIONS

2.1.6 Drive and Side Selection

The SDC-RXV31 controller has jumper options for both drive and side selection. Side select can be disabled, allowing operation on single sided drives only. The controller can be configured for either single or double sided drives. Jumpering allows one double sided drive to be addressed as two drives, where side 0 appears as drive 0 and side 1 appears as drive 1.

The controller is factory configured for either single or double sided drives. If double sided drives are used, write current control should be enabled. Before selecting alternate options, etch W6-W7 must be cut and then jumpers inserted as shown in Table 2-7.

DRIVE/SIDE SELECT	JUMPERS					
	W1-W2	W1-W4	W3-W4	W5-W6	W6-W7	W6-8
Single Sided Drive	IN	OUT	IN	OUT	OUT	IN
Single or Double Sided Drive*	IN	OUT	IN	OUT	IN	OUT
Double Sided Drive Drive 0 = Side 0 Drive 1 = Side 1	OUT	IN	IN	IN	OUT	OUT

*Factory preset

TABLE 2-7: DRIVE/SIDE CONFIGURATIONS

2.1.7 Drive Step Rate

The SDC-RXV31 floppy disk controller is designed to automatically select step rate of 3ms or 6ms. An assumption is made that all double-sided floppy disk drives step at 3ms, and all single-sided drives step at 6ms. If a 3ms step is required for a single-sided drive, install jumper W15-W16 as shown in table 2-8.

STEP RATE SELECT	W15-W16
Single-side 3ms All others	IN OUT

TABLE 2-8: 3ms STEP CONFIGURATION

2.1.8 22-Bit Addressing

The SDC-RXV31 is designed to allow 22-bit addressing. By removing jumper W45-W46 the controller will respond to 22-bit addressing as shown in Table 2-9.

ADDRESSING CAPACITY	W45-W46
18-bit 22-bit	IN OUT

TABLE 2-9: 22-BIT ADDRESSING CONFIGURATION

2.2 DRIVE CONFIGURATIONS

For proper operation the floppy drive(s) must be configured correctly. The controller uses radial drive selection and the drive(s) must be set up with this in mind. When two drives are used, the first drive is denoted 0 and the second drive 1. A particular drive is selected and remains selected after a function is complete, thus allowing the controller to poll drive status. A separate head load signal is provided by the controller read and write functions on the diskette. The "in use" logic of the drive is configured as a function of head loading. Since the drives are homed without loading the heads during an initialize command, the drive is configured to provide stepper motor power independent of head loading. Strapping configurations are shown in the following tables for some of the most common configurations..

Table 2-10 Shugart SA800/801
 Table 2-11 Shugart SA850/851
 Table 2-12 Shugart 860 (Slimline)
 Table 2-13 Qume Data Trak 8 and VE-Data YD-174
 Table 2-14 Qume Trak 242 (slimline)
 Table 2-15 Mitsubishi M2896-63 (slimline)
 Table 2-16 Tandon 848 (slimline)

DESCRIPTION	SHUGART JUMPER	DUAL DRIVES		SINGLE DRIVE 0
		DRIVE 0	DRIVE 1	
Drive Select 1	DS1	IN	OUT	IN
Drive Select 2	DS2	OUT	IN	OUT
Drive Select 3	DS3	OUT	OUT	OUT
Drive Select 4	DS4	OUT	OUT	OUT
Radial Head Loading Option	A	IN	IN	IN
Radial Head Loading Option	B	IN	IN	IN
Head Load Option	C	IN	IN	IN
In Use Option	D	OUT	OUT	OUT
Radial Head Loading Option	X	OUT	OUT	OUT
Inhibit Write When Protected	WP	IN	IN	IN
Allow Write When Protected	NP	OUT	OUT	OUT
Stepper Power from Drive Select	DS	IN	IN	IN
Stepper Power from Head Load	HL	OUT	OUT	OUT
In Use from Drive Select	Z	OUT	OUT	OUT
In Use from Head Load	Y	IN	IN	IN
Ready Output	R	IN	IN	IN
Index Output	I	IN	IN	IN
Disk Change Output	DC	X	X	X
Sector Output	S	X	X	X
Sector Option Disable	800	IN	IN	IN
Sector Option Enable	801	OUT	OUT	OUT
-5V DC Bias	L	IN	IN	IN
Termination HL	51	OUT	IN	IN
Termination Drive Select	52	IN	IN	IN
Termination Direction	T3	OUT	IN	IN
Termination Step	T4	OUT	IN	IN
Termination Write Data	T4	OUT	IN	IN
Termination Write Gate	T6	OUT	IN	IN

TABLE 2-10: CONFIGURATIONS FOR SHUGART SA800/801 DRIVES

TRACE DESIG	DESCRIPTION	DUAL DRIVES		SINGLE
		DR 0	DR 1	DR 0
SE	Termination for multiplexed standard input	IN	OUT	IN
DS1	Drive select 1 input pin	IN	OUT	IN
DS2	Drive select 2 input pin	OUT	IN	N/A
1B,2B) 3B,4B)	Side select option-drive select	OUT	OUT	OUT
RR	Radial ready	IN	IN	IN
R1	Radial index and sector	IN	IN	IN
R*	Option shunt for ready output	IN	IN	IN
2S	Two-sided status output	IN	IN	IN
850/51	Sector option enable	IN	IN	IN
I*	Index output	IN	IN	IN
S*	Sector output	OUT	OUT	OUT
DC	Disk change option	OUT	OUT	OUT
HL*	Stepper power from head load	OUT	OUT	OUT
DS	Stepper power from drive select	IN	IN	IN
WP	Inhibit write when write protected	IN	IN	IN
NP	Allow write when write protected	OUT	OUT	OUT
D	Alternate input - in use	OUT	OUT	OUT
M	Multi-media option	IN	IN	IN
DL	Door lock latch option	OUT	OUT	OUT
A,B*	Radial head load	IN	IN	IN
X*	Radial head load	OUT	OUT	OUT
C	Alternate input - head load	IN	IN	IN
Z*	In use from drive select	OUT	OUT	OUT
Y	In use from head load	IN	IN	IN
S1	Side select option using direction select	OUT	OUT	OUT
S2	Standard side select input	IN	IN	IN
S3	Side select option using drive select	OUT	OUT	OUT
TS,FS	Data separation option select	OUT	OUT	OUT
IW	Write current switch	IN	IN	IN
RS	Ready standard	IN	IN	IN
RM	Ready modified	OUT	OUT	OUT
HLL	Head load latch	OUT	OUT	OUT
IT	In use terminator	OUT	OUT	OUT
HI	Head load or in use to in use circuit	OUT	OUT	OUT
F	Remove for MFM encoding	OUT	OUT	OUT
AF	Install for FM or MFM encoding	IN	IN	IN
NF	Install for M2FM encoding	OUT	OUT	OUT

*Shunt

TABLE 2-11: CONFIGURATION FOR SHUGART SA850/851 DRIVES

NOTE

For SA850/851 drives a 16-pin programmable shunt, location 4F, is provided for the eight most commonly used cut track options. These traces are usually shorted as shipped from the factory. The traces can be opened as follows:

Jumper Z-Open Pin 1 to Pin 16	Jumper HL-Open Pin 2 to Pin 15
Jumper A-Open Pin 3 to Pin 14	Jumper B-Open Pin 4 to Pin 13
Jumper X-Open Pin 5 to Pin 12	Jumper I-Open Pin 6 to Pin 11
Jumper R-Open Pin 7 to Pin 10	Jumper S-Open Pin 8 to Pin 9

TRACE DESIG	DESCRIPTION	DUAL DRIVES		SINGLE
		DR 0	DR 1	DR 0
U9	Terminations for multiplexed inputs	OUT	IN	IN
SI	Internal write current switch	IN	IN	IN
SE	External write current switch	OUT	OUT	OUT
TR	True ready output	IN	IN	IN
2S	Two-sided status output	IN	IN	IN
DC	Disk change option	OUT	OUT	OUT
S1	Side select option using direction select	OUT	OUT	OUT
S2	Side select input	IN	IN	IN
S3	Side selection option using drive select	OUT	OUT	OUT
1B,2B 3B,4B	Side selection option using drive select	OUT	OUT	OUT
D	Alternate input in use	OUT	OUT	OUT
MS	Motor on from drive select	IN	IN	IN
MO	Alternate input-motor on	OUT	OUT	OUT
MD	Motor off delay	OUT	OUT	OUT
R	Ready output	IN	IN	IN
RR	Radial ready	IN	IN	IN
DS1	Drive select 1 input	IN	OUT	IN
DS2,3 DS4	Drive select 2,3,4 input	OUT	DS2	OUT
PD	Stepper power down	OUT	OUT	OUT
WP	Inhibit write when write protected	IN	IN	IN
NP	Allow write when write protected	OUT	OUT	OUT
TS	Data separation option select	OUT	OUT	OUT

TABLE 2-12: CONFIGURATION FOR SHUGART 810/860 FLOPPY DRIVES

QUME JUMPER	DESCRIPTION	DUAL DRIVES		SINGLE
		DR 0	DR 1	DR 0
DS1	Drive Select 1	IN	OUT	IN
DS2	Drive Select 2	OUT	IN	OUT
DS3	Drive Select 3	OUT	OUT	OUT
DS4	Drive Select 4	OUT	OUT	OUT
A	Radial Head Load option	IN	IN	IN
B	Radial Head Load Option	IN	IN	IN
X	Radial Head Load Option	OUT	OUT	OUT
Z	In Use from Drive Select	OUT	OUT	OUT
HL	Stepper Power from Head Load	OUT	OUT	OUT
R	Ready Alternate Output Pad	IN	IN	IN
I	Index Alternate Output Pad	IN	IN	IN
C	Alternate Input Head Load	IN	IN	IN
D	Alternate Input in Use	OUT	OUT	OUT
DC	Alternate Output Disk Change	IN	IN	IN
2S	Alternate Output 2-Sided Disk Status	IN	IN	IN
DS	Stepper Power from Drive Select	IN	IN	IN
Y	In Use from Head Load	IN	IN	IN
DL	Door Lock Latch	OUT	OUT	OUT
RR	Radial Ready	IN	IN	IN
RR RI	Radial Index	IN	IN	IN
WP	Inhibit Write when Write Protected	IN	IN	IN
NP	Allow Write when Write Protected	OUT	OUT	OUT
D1,D2	Drive Address, Select Pads (up to 8 Drives)	OUT	OUT	OUT
D4,DDS				
(B1,B2	Two Headed Drive Select	OUT	OUT	OUT
B3,B4				
S1	Head Select Option	OUT	OUT	OUT
S2	Head Select Option	IN	IN	IN
S3	Head Select Option	OUT	OUT	OUT
1TM	Termination Resistor Pack	OUT	IN*	IN
2TM	Termination Resistor Pack	OUT	IN*	IN

*Termination resistor pack must be installed on drive 1 and removed from drive 0 on dual floppy systems. On single floppy systems, install the termination resistor on drive 0.

TABLE 2-13: CONFIGURATIONS FOR QUME (DATA TRAK 8) AND VE-DATA (YD-174) INTERFACE DRIVES

TRACE DESIG	DESCRIPTION	DUAL DRIVES		SINGLE
		DR 1	DR 1	DR 0
DS1-	Drive select address pins			
(DS4	(up to 4 drives)	DS1	DS2	DS1
A	Radial head load	IN	IN	IN
B,X	Radial head load	OUT	OUT	OUT
Z	In use from drive select	OUT	OUT	OUT
HL	Stepper power from head load	OUT	OUT	OUT
R	Alternate output ready pad	IN	IN	IN
I	Alternate output index pad	IN	IN	IN
C	Alternate input head load	IN	IN	IN
D	Alternate input in use	OUT	OUT	OUT
DC	Alternate output disk change	OUT	OUT	OUT
2S	Alternate output two sided disk	IN	IN	IN
Y	In use from head load	IN	IN	IN
DL	Door lock latch	OUT	OUT	OUT
RR	Radial ready	IN	IN	IN
RI	Radial index	IN	IN	IN
WP	Inhibit write when write protect	IN	IN	IN
NP	Allow write when write protect	OUT	OUT	OUT
D1,D2	Drive address select			
D4,DDS	(up to 8 drives)	OUT	OUT	OUT
B1-B4	Two, double-sided drive select	OUT	OUT	OUT
S1,S3	Head select option	OUT	OUT	OUT
S2	Head select option	IN	IN	IN
T40	Test track 40	OUT	OUT	OUT
HA	Test actuate head load	OUT	OUT	OUT
(4,6,8,10				
12,16	Alternate I/O pins	OUT	OUT	OUT
18,24				
SF	Switch filter	IN	IN	IN
SP	Stepper power (used with HL)	OUT	OUT	OUT

TABLE 2-14: CONFIGURATION FOR QUME TRAK 242 FLOPPY DRIVES

TRACE DESIG	DESCRIPTION	DUAL DRIVES		SINGLE
		DR 0	DR 1	DR 0
TM	Termination for muxed standard input	OUT	IN	IN
DS1	Drive select 1 input pin	IN	OUT	IN
DS2	Drive select 2 input pin	OUT	IN	N/A
1B,2B 3B,4B	Side select option-drive select	OUT	OUT	OUT
RR	Radial ready	IN	IN	IN
R1	Radial index and sector	IN	IN	IN
R	Option shunt for ready output	IN	IN	IN
2S	Two-sided status output	IN	IN	IN
DC	Disk change option	OUT	OUT	OUT
HL	Stepper power from head load	OUT	OUT	OUT
WP	Inhibit write when write protected	in	in	in
np	Allow write when write protected	OUT	OUT	OUT
D	Alternate input - in use	OUT	OUT	OUT
DL	Door lock latch option	OUT	OUT	OUT
A,B	Radial head load	IN	IN	IN
X	Radial head load	OUT	OUT	OUT
C	Alternate input - head load	IN	IN	IN
Z	In use from drive select	OUT	OUT	OUT
Y*	In use from head load	IN	IN	IN
S1	Side select option using direction select	OUT	OUT	OUT
S2	Standard side select input	IN	IN	IN
S3	Side select option using drive select	OUT	OUT	OUT
RS	Ready standard	IN	IN	IN
RM	Ready modified	OUT	OUT	OUT
HLL	Head load latch	OUT	OUT	OUT
HI	Head load or in use to in use circuit	OUT	OUT	OUT
IT	In use terminal	IN	IN	IN
I	Index output	IN	IN	IN
RFa	"Don't remove"	IN	IN	IN
RFb	"Keep open"	OUT	OUT	OUT
MD	Motor on from head load	OUT	OUT	OUT
MS	Motor on from drive select	OUT	OUT	OUT
BS0	"Don't cut"	IN	IN	IN
BS1	"Keep open"	OUT	OUT	OUT
V	Door lock from head load	IN	IN	IN

*Solder jumper in

TABLE 2-15: CONFIGURATIONS FOR MITSUBISHI HALF HEIGHT
M2896-63 FLOPPY DRIVE

TRACE DESIG	DESCRIPTION	DUAL DRIVES		SINGLE
		DR 0	DR 1	DR 0
TM	Termination for muxed standard input	OUT	IN	IN
DS1	Drive select 1 input pin	IN	OUT	IN
DS2	Drive select 2 input pin	OUT	IN	N/A
1B,2B 3B,4B	Side select option - drive select	OUT	OUT	OUT
RR	Radial ready	IN	IN	IN
RI	Radial index and sector	IN	IN	IN
R*	Option shunt for ready output	IN	IN	IN
2S	Two-sided status output	IN	IN	IN
I*	Index output	IN	IN	IN
DC	Disk change option	IN	IN	IN
HL*	Stepper power from head load	IN	IN	IN
DS	Stepper power from drive select	OUT	OUT	OUT
WP	Inhibit write when write protected	IN	IN	IN
NP	Allow write when write protected	OUT	OUT	OUT
D	Alternate input - in use	OUT	OUT	OUT
DL	Door lock latch option	OUT	OUT	OUT
A,B*	Radial head load	IN	IN	IN
X*	Radial head load	IN	IN	IN
C	Alternate input - head load	OUT	OUT	OUT
Z*	In use from drive select	IN	IN	IN
Y	In use from head load	OUT	OUT	OUT
S1	Side select option using direction select	OUT	OUT	OUT
S2	Standard side select input	IN	IN	IN
S3	Side select option using drive select	OUT	OUT	OUT
RM	Ready modified	OUT	OUT	OUT
M1	Spindle motor control option	IN	IN	IN
M2	Spindle motor control option	OUT	OUT	OUT
M3	Spindle motor control option	IN	IN	IN
M4	Spindle motor control option	OUT	OUT	OUT
MC1- MC4	Motor control select	OUT	OUT	OUT

*Denotes shunt

TABLE 2-16: CONFIGURATION FOR TANDON HALF HEIGHT
848 FLOPPY DISK DRIVE

2.3 CABLING

An optional 50-conductor ribbon cable connects the controller to a Shugart compatible drive. Connect the cable to the 50-pin connector located at the top of the controller board observing the alignment of pin 1 as indicated in Figure 2-2. The cable can be purchased from an independent source, or the following list of materials (or equivalent) will aid in the construction of the required cable.

<u>QTY</u>	<u>DESCRIPTION</u>	<u>MFG</u>	<u>P/N</u>
1	50-pin controller connector	3M	3425-3000
2	50-pin drive connectors	3M	3415-001
A/R	50-conductor ribbon cable	3M	3365/50

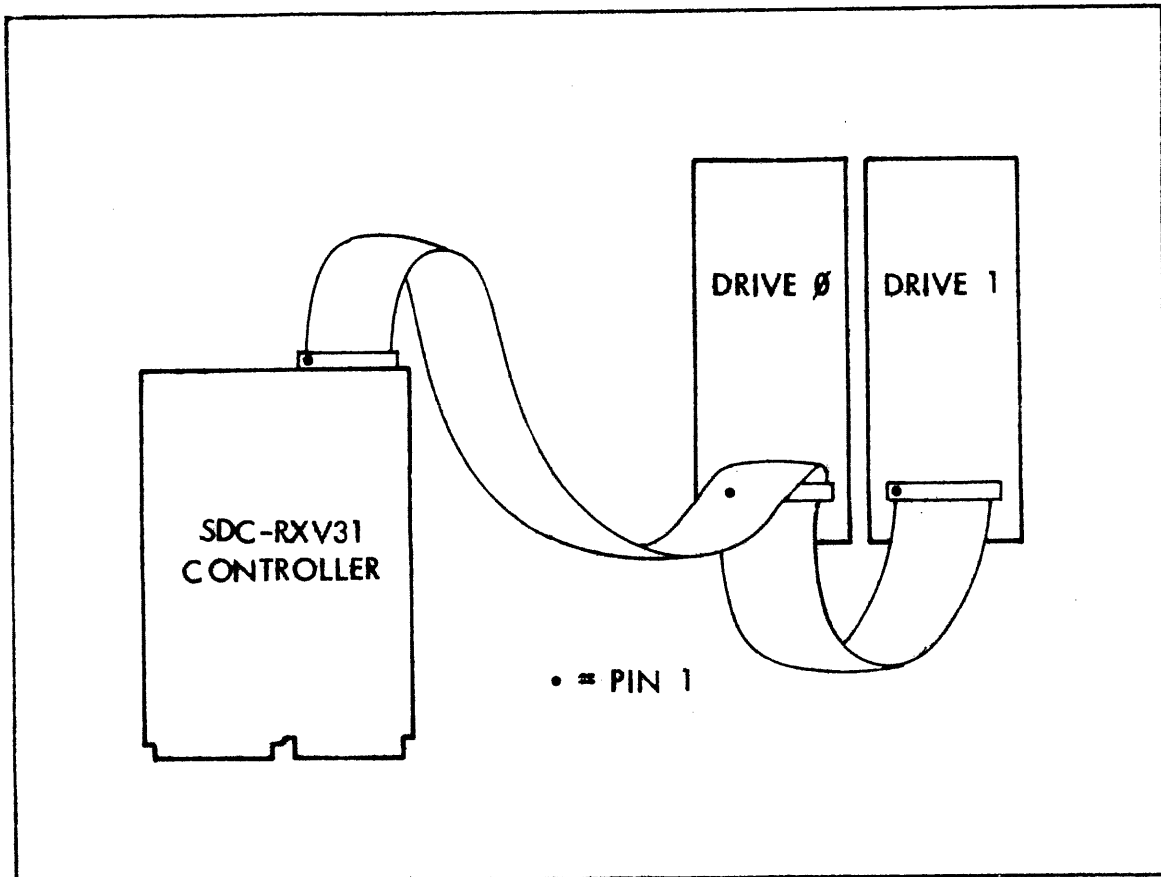

FIGURE 2-2: DRIVE/CONTROLLER CABLING

The connector pins illustrated in Figure 2-3 are compatible with Shugart-type 800/850 series interfaces.

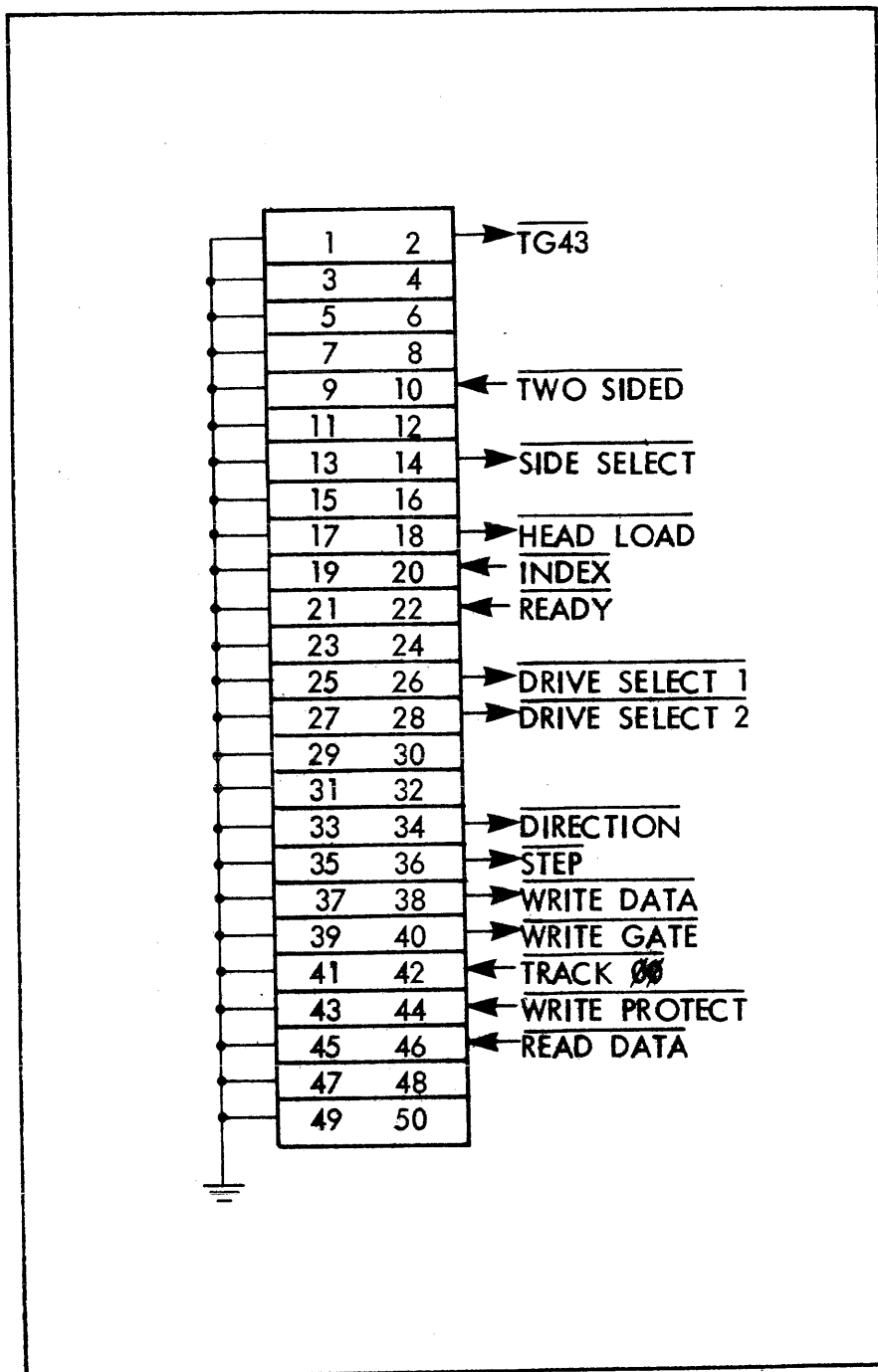

FIGURE 2-3: CONNECTOR PIN DEFINITIONS

2.4 CONTROLLER INSTALLATION

The SDC-RXV31 controller can be installed directly into any Q bus slot provided that interrupt and DMA continuity is maintained. These signals are daisy chained through the LSI-11 backplane and there should be no unused slots between the processor and the floppy controller. Priority sequences for the backplane can be found in the documentation accompanying the LSI-11 system. Note that when two interrupts of the same priority level are asserted, the device closer to the CPU receives the higher priority.

2.5 INITIAL CHECKOUT

After the controller jumpers and drive selection have been configured, initial checkout is performed using the following procedure.

NOTE

The bootstrap must be disabled
for the following procedure.

1. Apply AC and DC power to the drive(s). The spindle should begin to rotate. The "in use" indicators on both drives should be off.
2. Place the RUN/HALT switch on the CPU to the HALT position, and turn on the processor. An @ character on the terminal signifies that console ODT has been entered. First drive 1, then drive 0, will step the heads inward 10 tracks; then step the heads outward until the home signal is detected. If heads will not load and/or "in-use" indicators do not light, check cabling and drive power supplies.
3. Place a preformatted scratch diskette in drive 0.
4. If the standard address assignment is selected, open the Control Status (CS) register using ODT by typing 177170. The terminal will display 004040 (the contents of the CS register). Deposit a 40000 in the CS by typing 40000 <CR>. This command will initialize the controller. First drive 1, then drive 0 will calibrate for home position by stepping inward 10 tracks and then outward one track at a time until the drive indicates track 0 has been reached. After calibration the head on drive 0 is loaded. Sector 1 of track 1 is read into the controller buffer, as indicated by the in-use LED on drive 0. The LED will remain on for a short time after the read operation is complete.

If, after initializing, the drives do not calibrate or the LED does not light, check the cabling and power supplies.

5. Reopen the CS (177170) using ODT as described above. The contents of this location should be 004040. Examine the next location (177172) by using the linefeed key or by typing 177172</>, which should yield either 204 or 244. For a detailed description of register protocol and bit definition, refer to Section 4.
6. Either diagnostics or an operating system can now be booted.

Section 3 - Operation

3.1 GENERAL INFORMATION

This section provides the operating instructions for the SDC-RXV31 controller. Included are bootstrapping, formatting, fill/write, and read/empty operations. This section also reviews operation with an RT-11 operating system.

3.2 BOOTSTRAPPING

If the bootstrap is enabled, the SDC-RXV31 will respond to the standard bootstrap address 173000. The controller is booted by typing 173000G while in console ODT, causing a bus INIT and program execution transfer to 173000. An alternate method is to strap the LSI-11 CPU to power up in Mode 2, whereupon power-up the CPU automatically starts execution at 173000. Power-up strapping procedures for the LSI-11 processor can be found in the "Microcomputer Processor Handbook."*

To boot either a single or double density diskette, use the following procedure:

1. Place the diskette in drive 0.
2. If the processor is strapped for power-up Mode 2, operate the INIT (boot) switch or cycle DC power OFF and ON.
3. If the processor is not strapped for power-up Mode 2 while in console ODT, type 173000G.

*Published by Digital Equipment Corporation, Maynard, MA.

3.3 FORMATTING

The SDC-RXV31 is capable of formatting diskettes in a specified density. The formatting is accomplished on two passes. During pass 1, an index address mark is written on track 0 following the index hole. Twenty-six sector headers are written following the index address. Each of the remaining 76 tracks is written in the same manner. When track 76 is completed, pass 2 is initiated. The controller seeks track 0 and writes zero data field in sector 1 using the selected density. The remaining sectors are written in the same manner.

The format command selects diskette density, unit and side (for dual drives). Table 3-1 defines the command words.

DENSITY/SIDE	UNIT 0	UNIT 1
Single Density Side 0	11	31
Single Density Side 1	1011	1031
Double Density Side 0	411	431
Double Density Side 1	1411	1431

TABLE 3-1: DENSITY/SIDE COMMANDS

Figure 3-1 illustrates a format subroutine. The format command is loaded into TXVCS. When TRAN REQ is set, the keyword 222 is loaded into RXVDB. When the diskette is formatted, a return is made.

```

FORMAT:
    MOV #11, CMD           ;FORMAT
    BIS DENS, CMD         ;DENSITY
    BIS UNIT, CMD        ;UNIT
    BIS SIDE, CMD        ;SIDE
    MOV CMD, @#RXVCS     ;SELECT FUNCTION
    JSR PC, TRWAIT      ;WAIT FOR TR
    MOV #222, @#RXVDB    ;KEYWORD
    JSR PC, DNWAIT      ;WAIT FOR DONE
    TST @#RXVCS         ;ERROR
    BMI FRMERR          ;BR IF SO
    RTS PC

FRMERR:

```

FIGURE 3-1: FORMAT SUBROUTINE

Alternately, a diskette can be formatted using console ODT. Open the Control and Status (CS) register and deposit the appropriate command. Then deposit the format key word, 222, in the Data Buffer (DB) register. The following is an example of formatting unit 0 side 0 in double density:

```

177170      004040      411<LF>
177172      000000      222<CR>

```

3.4 FILL/WRITE OPERATION

Figure 3-2 illustrates subroutines to write data on a diskette by performing a Fill Buffer followed by a Write Sector operation.

```

FILLBF:

MOV    #1, CMD                ;FILL BUFFER
BIS    DENS, CMD              ;DENSITY
MOV    CMD, @#RXVCS          ;SELECT FUNCTION
JSR    PC TRWAIT             ;WAIT FOR TR
MOV    COUNT, @#RXVDB        ;WORD COUNT
JSR    PC, TRWAIT            ;WAIT FOR TR
MOV    #BUFOUT, @#RXVDB      ;BUS ADDRESS OF DATA
JSR    PC, DNWAIT            ;WAIT FOR DONE
TST    @#RXVCS               ;ERROR
BMI    ERFIL                 ;BR IF SO
RTS    PC

ERFIL:

WSECT:

MOV    #5, CMD                ;WRITE, SECTOR
BIS    DENS, CMD              ;DENSITY
BIS    UNIT, CMD              ;UNIT
BIS    SIDE, CMD              ;SIDE
MOV    CMD, @#RXVCS          ;SELECT FUNCTION
JSR    PC, TRWAIT            ;WAIT FOR TR
MOV    SECTOR, @#RXVDB        ;SECTOR
JSR    PC TRWAIT             ;WAIT FOR TR
MOV    TRACK @#RXVDB         ;TRACK
JSR    PC, DNWAIT            ;WAIT FOR DONE
TST    @#RXVCS               ;ERROR
BMI    WSERR                 ;BR IF SO
RTS    PC

WSERR:

```

FIGURE 3-2: WRITE DATA SUBROUTINES

3.5 READ/EMPTY OPERATIONS

Figure 3-3 describes subroutines to read data from a diskette. This is done by performing a Read Sector operation, followed by an Empty Buffer operation.

```

RSECT:

MOV    #7, CMD                ;READ SECTOR
BIS    DENS, CMD              ;DENSITY
BIS    UNIT, CMD             ;UNIT
BIS    SIDE, CMD             ;SIDE
MOV    CMD, @RXVCS           ;SELECT FUNCTION
JSR    PC, TRWAIT            ;WAIT FOR TR
MOV    SECTOR, @RXVDB        ;SECTOR
JSR    PC, TRWAIT            ;WAIT FOR TR
MOV    TRACK, @RXVDB         ;TRACK
JSR    PC, DNWAIT            ;WAIT FOR DONE
TST    @RXVCS                ;ERROR
BMI    RSERR                 ;BR IF SO
RTS    PC

RSERR:

EMPBF:

MOV    #3, CMD                ;EMPTY BUFFER
BIS    DENS, CMD              ;DENSITY
MOV    CMD, @RXVCS           ;SELECT FUNCTION
JSR    PC, TRWAIT            ;WAIT FOR TR
MOV    COUNT, @RXVDB         ;WORD COUNT
JSR    PC, TRWAIT            ;WAIT FOR TR
MOV    #BUFFIN, @RXVDB       ;BUS ADDRESS FOR DATA
TST    @RXVCS                ;ERROR
BMI    EREMP                 ;BR IS SO
RST    PC

EREMP:

```

FIGURE 3-3: READ DATA SUBROUTINES

3.6 OPERATION USING RT-11

The SDC-RXV31 controller requires a different handler than the single density controllers. This handler is configured to use the DMA transfer scheme of the controller. Also, diskette density is determined by the handler without system intervention, allowing the use of either single or double density diskettes interchangeably.

This handler (designated "DY") is available in RT11-V.3B and later revisions. Use the following procedure to create a DY-based system.

Using an RX01 (or equivalent) system, or a system which has an RX01 (or equivalent) peripheral device, copy the monitor file and other associated system files onto a single density diskette. These files can be obtained from the binary distribution media or by performing a SYSGEN and specifying DY as the system device. The following commands will initialize the diskette and copy the necessary files to Drive 1:

```
.INIT/NOQUERY DX1:  
.COPY/SYS SYS: SWAP.SYS DX1:  
.COPY/SYS SYS: DYMNXX.SYS DX1:  
.COPY/SYS SYS: TT.SYS DX1:  
.COPY/SYS: DIR.SAV DX1:  
.COPY SYS: PIP.SAV DX1:  
.COPY SYS: DUP.SAV DX1:
```

The bootstrap must then be copied from the monitor file to block 0 of the diskette. The following command will accomplish this on the diskette in drive 1.

```
.COPY/BOOT DX1: DYMNXX DX1:
```

This diskette can be used with the SDC-RXV31 controller, but it is single density. To build a double density diskette, first format a diskette to double density as explained in Section 3.3. Boot the single density system diskette in drive 0. Use the following commands to initialize the formatted diskette in drive 1 and copy the system software from drive 0 to drive 1.

```
.INIT/NOQUERY DY1:  
.COPY/SYS DY:*.DY1:
```

Finally, copy the bootstrap to block 0 of the diskette in drive 1.

```
.COPY/BOOT DY1: DYMNXX DY1:
```

The diskette in drive 1 can now be booted as a double density diskette.

Section 4 - Programming

4.1 GENERAL INFORMATION

This section defines device registers and command protocol for the SDC-RXV31.

Software control of the SDC-RXV31 is performed by means of two device registers: the Command and Status (RXVCS) register and a multipurpose Data Buffer (RXVDB) register with addresses 177170 and 177172, respectively. With few exceptions, the registers can be read or write using instructions referring to their addresses.

The RXVCS passes control information from the CPU to the controller and reports status and error information from the controller to the CPU. The RXVDB provides additional control and status information between the CPU and the controller. Information in the RXVDB is a function of the controller operation in progress.

The controller contains a sector buffer capable of storing a complete sector. For Read/Write operations the buffer is either filled before a Write command or emptied after a Read command under DMA control. During a Read, the desired sector is located, and the sector data are transferred to the buffer.

A detailed description of bit assignments are given for registers:

Command and Status	RXVCS	177170
Data Buffer	RXVDB	
Track Address	RXVTA	
Sector Address	RXVSA	
Word Count	RXVWC	177172
Bus Address	RXVBA	
Error and Status	RXVES	
Bus Address Extension	RXVBAE	

4.2 COMMAND AND STATUS REGISTER - RXVCS (177170)

Functions are initiated by loading the Command and Status register, when not busy (bit 5 = 1), with bit 0 = 1.

15	14	13	12	11	10	9	8	7	6	5	4	3	2	1	0
ERR	INIT	EXT	ADD	RX O2	22 BIT	HD SEL	DEN SEL	TR REQ	INT ENB	DN	UN SEL	FNCT SEL		GO	

where:

- ERR** ERROR. This bit is set by the controller if an error occurs during an attempt to execute a commands. Cleared by INIT or the initiation of a new command. When an error is detected the RXVCS is read into the RXVDB. Read only.
- INIT** INITIALIZE. This bit, set by the program, initializes the controller without initializing all the devices on the LSI-11 bus. Write Only.

CAUTION

Loading the lower byte of the RXVCS will
also load the upper byte of the RXVCS.

When set, the controller will negate DONE and move the head position mechanism of drive 1 (if two drives are available) to track 0. When completed, the controller will repeat the operation on drive 0. The controller then clears the Error and Status register, sets Initialize Done and Drive Ready, if drive 0 is ready. Finally the controller reads sector 1, track 1 of drive 0.

- EXT
ADD** EXTENDED ADDRESS. These bits define an extended bus address; bit 12 = MA16, bit 13 = MA17. Write Only.
- RXO2** RXO2. This bit, asserted by the controller, indicates an RXO2-type system. Read Only.
- 22-BIT** Written as 1 for 22-bit addressing, and written as 0 for 18-bit addressing. See section 4.5.9.
- HD
SEL** HEAD SELECT. This bit determines the side of the disk for execution of the desired function; bit cleared = side 0, bit set = side 1. Read/Write

DEN SEL DENSITY SELECT. This bit defines either single or double density operation. Bit cleared = single density, bit set = double density. Read/Write.

TR REQ TRANSFER REQUEST. This bit indicates the controller needs data or has data available. Read Only.

INT ENB INTERRUPT ENABLE. This bit, set by the program, enables an interrupt when the controller completes an operation and asserts DONE. Cleared by INIT. Read/Write.

DONE DONE. This bit indicates the completion of a function. It generates an interrupt when asserted if INT ENB is set. Read Only.

UN SEL UNIT SELECT. This bit selects one of two disks for execution of the desired function. Read/Write.

FNCT SEL FUNCTION SELECT. These bits define one of eight operations listed below and described in detail in Section 4.3.

000 = Fill Buffer
 001 = Empty Buffer
 010 = Write Sector
 011 = Read Sector
 100 = Set Media Density/Format
 101 = Read Status
 110 = Write Deleted Data Sector
 111 = Read Error Code

GO GO. Initiates a command to the controller. Write Only.

4.3 DATA BUFFER (177172)

This register is a general purpose data path between the SDC-RXV31 and the LSI-11. It represents one of six registers (RXVDB, RXVTA, RXVSA, RXVWC, RXVBA, and RXVES). These registers are addressable only under the protocol of the function in progress.

This register is Read/Write if the controller is not in the process of executing a command (i.e., it may be manipulated without affecting the controller). When the controller is executing a command, this register is Read/Write only if RXVCS, bit 7 (Transfer Request), is set.

4.3.1 Data Buffer Register (RXVDB)

All information transferred to and from the floppy media passes through the RXVDB register.

15 14 13 12 11 10 9 8 7 6 5 4 3 2 1 0

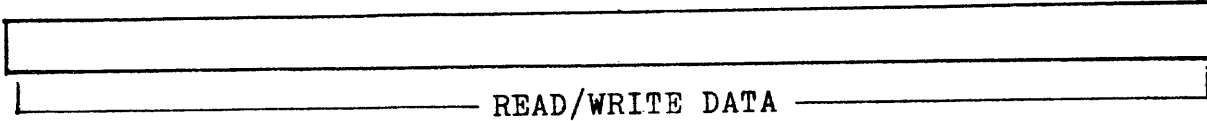

4.3.2 Track Address Register (RXVTA)

This register is loaded to indicate on which of the 115_8 (octal) - 77_{10} decimal - tracks a given function operates.

15 14 13 12 11 10 9 8 7 6 5 4 3 2 1 0

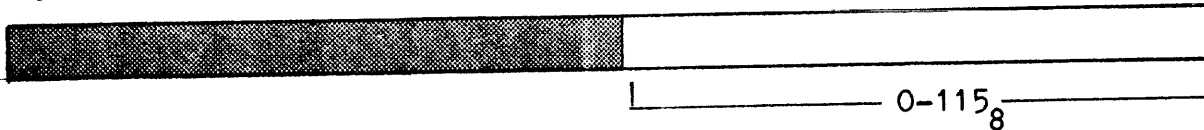

4.3.3 Sector Address Register (RXVSA)

This register is loaded to indicate on which of the 32_8 (octal) - 26_{10} decimal - sectors a given function operates.

15 14 13 12 11 10 9 8 7 6 5 4 3 2 1 0

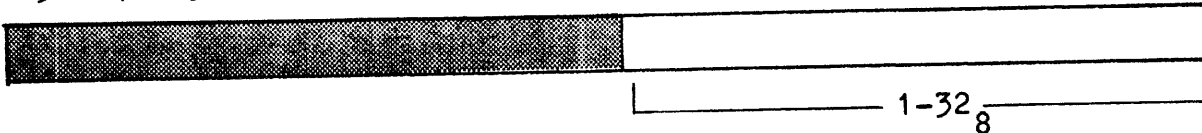

4.3.4 Word Count Register (RXVWC)

This 8-bit register is loaded with the number of words (128_{10} maximum) to be transferred. At the end of each transfer the Word Count register is decremented. When the contents of RXVWC are decremented to zero, transfers are terminated, DONE is set (RXVES bit 5) and, if enabled, an interrupt is requested. If the word count is greater than the limit for the density specified, the controller asserts WC OVF (RXVES bit 10).

15 14 13 12 11 10 9 8 7 6 5 4 3 2 1 0

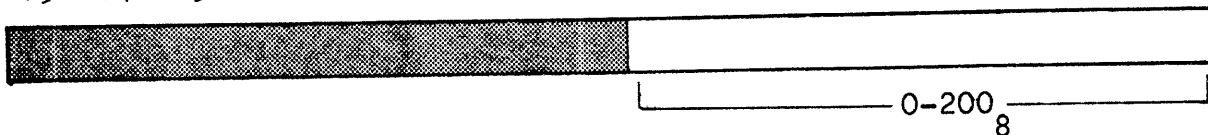

- DEL DELETED DATA. This bit indicates that, during data
DAT recovery, the identification mark preceding the data
 field was decoded as a deleted data mark.

- DRV DRIVE DENSITY. This bit indicates the density of the
DEN diskette in the selected drive. Bit cleared = single
 density, bit set = double density.

- DEN DENSITY ERROR. This bit indicates a density error was
ERR detected when information was retrieved from the data
 field of the diskette. A density error occurs when the
 density selected differs from that of the data field.
 Upon detecting this error the controller loads the RXVES
 into the RXVDB and asserts the Error and Done bits.

- AC AC LOW. This bit, set by the controller, indicates a
LO power failure.

- INIT INITIALIZE DONE. This bit indicates completion of the
DONE initialize routine, which can be caused by system power
 failure or by programmable LSI-11 bus initialize.

- SIDE SIDE READY. This bit is asserted by the controller when
RDY a double sided drive is selected, is ready, and has
 double sided media inserted. When asserted, this bit
 indicates that side 1 of the selected drive is available
 for Read and Write operations.

- CRC CRC ERROR. This bit indicates a cyclic redundancy check
 error was detected as information was retrieved from a
 data field of the diskette. Information stored in the
 buffer becomes invalid. Upon detection of this error the
 controller loads the RXVES into the RXVDB and asserts the
 Error and Done bits.

4.3.7 Bus Address Extension Register (RXVBAE)

This register is used to generate the six bus address extension bits in the 22-bit mode. Bit 10 of RXVCS must be written as a one to enable 22-bit mode of operation.

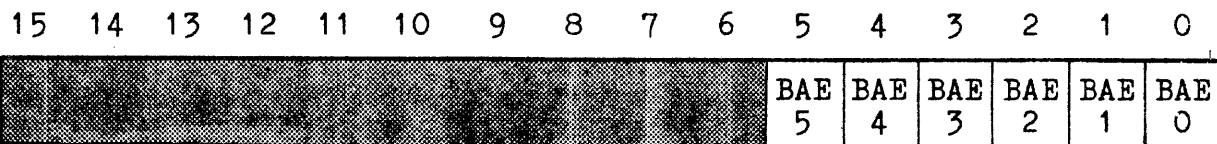

4.4 EXTENDED STATUS REGISTERS

The SDC-RXV31 controller has four internal status registers. These registers provide error information and drive status information. The registers can be retrieved by a read error code function as described in Section 4.5.8.

Word 1 <7:0> - Definitive Error Code

OCTAL	ERROR CODE DESCRIPTION
040	Attempt to access a track greater than 76.
050	Home found before desired track was reached.
070	Desired sector not found after investigating 52 headers (2 revolutions).
120	Preamble not found.
150	Header track address of a good header not comparable with the desired track.
160	Too many tries for an IDAM (identifies header).
170	Data AM not found in allotted time.
200	CRC error on reading the sector from the disk.
240	Density Error
250	Wrong key word for Set Media Density command.
260	Illegal Data AM.
270	Invalid POK during write sequence.
300	Drive not ready.
310	Drive write protected.

Word 1 <15:8> - Not Used

This register is always cleared by the controller.

Word 2 <7:0> - Current Track Address of Drive 0

This register (cleared during INIT to synchronize with actual track position) is updated with each Seek on drive 0 and maintains current track position.

Word 2 <15:8> - Current Track Address of Drive 1

This register (cleared during INIT to synchronize with actual track position) is updated with each Seek on drive 1 and maintains current track position.

Word 3 <7:0> - Target Track of Current Disk Access

If legal, the track specified for the last Read/Write command is saved in this register.

Word 3 <15:0> - Target Sector of Current Disk Access

The sector specified for the last Read/Write command is saved in this register.

Word 4 <15:8> - Track Address of Selected Drive

This register contains the track address read from the sector header of the desired sector during the last Read/Write command.

4.5 COMMAND PROTOCOL

Data storage and recovery using the SDC-RXV21 controller is accomplished by manipulation of the Control and Status (RXVCS) and Data Buffer (RXVDB) registers according to the protocol of the individual functions. The penalty for violation of protocol can be permanent loss of data. Each of the functions are encoded and written into the RXVCS, bits 1-3, as described in Section 4.2. The detailed protocol for each function is described below.

4.5.1 Fill Buffer (000)

This function is used to fill the controller buffer with data from the host CPU. The host specifies the number of words to be transferred. The command density bit determines the buffer size (64 or 128 words). The controller zero-fills the remaining buffer space. If the word count is too large for the density selected, the function is aborted, Error and Done are asserted and the Word Count Overflow bit is set in the RXVES.

The contents of the buffer may be written on the diskette with a subsequent Write Sector command or returned to the host CPU using an Empty Buffer command.

When the command is loaded, RXVCS, bit 5 (Done) is negated. RXVCS, bit 8 (DEN), must be set to define the buffer size. RXVCS, bits 1 and 13 (extended Address), must also be asserted to define the extended memory segment used with the buffer address yet to be specified, to form the absolute memory address of the data to be transferred. RXVCS, bit 4 (Unit Select) and bit 9 (Head Select), are ignored since no drive operation is required. When RXVCS, bit 7 (Transfer Request), is first asserted, the program must move the word count into the RXVDB, which will negate Transfer Request.

When the controller again asserts Transfer Request, the program must move the buffer address into the RXVDB. The controller then negates Transfer Request, initiates a DMA cycle and transfers the first word from the host to the controller buffer. At the end of the transfer the Word Count register is decremented, and the buffer address is incremented by two. This cycle is repeated until the Word Count register becomes zero. The controller zero-fills the remaining buffer space, sets the Done bit and, if enabled, causes an Interrupt Request. After Done is asserted, the RXVES is moved into the RXVDB.

During the data transaction, if any nonexistent memory is addressed, the controller will time out and abort the function. The Error and Done bits will be asserted, RXVES, bit 11 (NXM), will be set and the RXVES will be moved into the RXVDB. If enabled, an Interrupt Request will be generated.

4.5.2 Empty Buffer (001)

This operation transfers the contents of the controller to the host CPU which specifies the number of words to be transferred. The command density bit determines the maximum legal word count. If the word count specified is too large for the density selected, the function is aborted, Error and Done are asserted, and the Word Count Overflow (WC OVF) is set in the RXVES.

The contents of the buffer may be transferred to the host as many times as desired or may be written on the diskette with a subsequent Write Sector command. Unless a Fill Buffer or Read Sector command is issued, the controller buffer is not destroyed.

When the command is loaded, RXVCS bit 5 (Done) is negated, and bit 8 (Density Select) must be set to allow the proper word count limit. Bits 12 and 13 (Extended Address) must also be asserted to define the extended memory segment used with the buffer address (yet to be specified) to form the absolute memory destination address. Bit 4 (Unit Select) and bit 9 (Head Select) are ignored since no drive operation is required. When bit 7 (Transfer Request) is first asserted the program moves the word count into the RXVDB, which negates Transfer Request. When Transfer Request is again asserted, the program moves the buffer address into the RXVDB. The controller then negates Transfer Request, initiates a DMA and transfers the first word of the buffer to the host. At the end of the transfer the Word Count register is decremented and the Buffer Address register is incremented by two. This cycle is repeated until the Word Count register becomes zero.*

During DMA transactions, if any nonexistent memory is addressed, the controller will time out and abort the function. An Error bit will be asserted.*

*Error and Done are asserted, RXVES is moved into the RXVDB and, if enabled, an Interrupt Request is generated at this point.

4.5.3 Write Sector (010)

The Write Sector function locates a desired track and sector and writes the sector with the contents of the internal sector buffer. When RXVCS is loaded with this command, the RXVES is cleared and Transfer Request and Done are negated. When Transfer Request is first asserted, the program loads the desired sector address into the RXVDB, which negates Transfer Request. When Transfer Request is again asserted, the program loads the desired track address into the RXVDB, which negates Transfer Request. The controller then seeks the desired track and sector. The desired track and track field of the sector header are compared. If they do not match, the operation is aborted and Error is asserted.*

If the densities agree, but the desired sector cannot be located within two revolutions, the operation will be aborted and Error will be asserted.*

If the desired track and sector are located and the densities agree, the contents of the internal sector buffer are written followed by a CRC character in the selected density.* Note that the contents of the sector buffer are not destroyed by a Write Sector operation.

CAUTION

The contents of the internal sector buffer are lost during a power failure. However, after power is restored, a Write Sector command will cause the random contents of the buffer to be written on the diskette with a valid CRC character.

4.5.4 Read Sector (011)

This function locates the desired track and sector and transfers the contents of the data field into the internal sector buffer. When the RXVCS is loaded with this command, the RXVES is cleared and the Transfer Request and Done bits are negated. When Transfer Request is first asserted, the program loads the desired sector address into the RXVDB, which will negate Transfer Request. When Transfer Request is again asserted, the program loads the desired track address into the RXVDB, which will negate Transfer Request.

Transfer Request and Done bits remain negated while the desired sector is located. If after two revolutions the desired sector is not located, the operation is aborted and Error is asserted.

*Done is asserted, RXVES is moved into the RXVDB and, if enabled, an Interrupt Request is generated at this point.

When the desired sector is located, the desired track and the track field of the sector header are compared. If they do not agree, the operation is aborted and Error is asserted.

If the desired track and sector agree, the data address mark is read and diskette density is determined. If the diskette density does not compare with the function density, the operation is aborted and Error is asserted.

If a legal data address mark is located and the densities of the diskette and function agree, data from the sector is read into the internal buffer. If the data address mark indicates a deleted data field, RXVES bit 6 (Delete Data) is set. As data are stored in the internal buffer, a CRC is computed and the CRC bytes are recorded. A non-zero result indicates a Read Error. When a CRC error is encountered, RXVES bit 0 (CRC) is set.*

If the desired sector is located, the density of the diskette and function agree and the data are transferred with no CRC error, Done is asserted and, if enabled, an Interrupt Request is generated.

4.5.5 Set Media Density (100)

This dual purpose function can set media density of "reformat" a diskette. Media density is set by rewriting all the data address marks (single or double density) and writing zero data fields in the selected density. "Reformatting" the entire diskette is done by writing both the sector headers and the data fields. The data fields are written in the selected density preceded by the corresponding data address mark. Both commands are initiated by the Set Media function but differ in the keyword required to execute the command.

When the RXVCS is loaded with Set Media Density, the RXVES is cleared and Done is negated. When Transfer Request is set, the program responds with a keyword which must be deposited in the RXVDB to complete the protocol. When the controller recognizes this character, it begins executing the command. If an illegal keyword is used, the operation is aborted.*

If the keyword is 111, a Set Media Density operation is asserted. This operation starts at track 0, sector 1. Each sector header is located and a Write operation is initiated. A data field is written with zero data in the selected density. If an error occurs while reading any header, the operation is aborted.* If the operation is successfully completed, Done is set and, if enabled, the controller asserts an Interrupt Request.

*Error and Done are asserted, RXVES is moved into the RXVDB and, if enabled, an Interrupt Request is generated at this point.

If the keyword is 222, a Format operation is initiated. This function starts at the physical index of track 0. Each track is written first with an index address mark, then 26 sector headers are written sequentially about the track. When each track is written, Set Media Density is set as described above.

The following input string will format the selected unit in the desired density:

<u>777170</u>	004040	<u>XXX</u>	<u><LF></u>
<u>177172</u>	000000	<u>222</u>	<u><CR></u>

CAUTION

The Set Media Density operation takes about 15 seconds and the Format operation takes about 45 seconds. Do not interrupt these functions. If either operation is interrupted or an error occurs, an illegal diskette is generated, and the operation must be repeated.

4.5.6 Read Status (101)

This function, initiated by reading the command into the RXVCS, updates the drive status information. Done is negated and RXVES bit 7 (Drive Ready) is updated by sampling the drive ready status line. Drive density is updated by loading the head of the selected drive and reading the first data address mark. This operation requires about 250ms to complete.*

4.5.7 Write Deleted Data Sector (110)

This operation is the same as the Write Sector (010) operation except that the data address mark preceding the data is not the standard data address mark. A single or double density deleted data address mark is written according to the density of the function.

4.5.8 Read Error Code (111)

This function, initiated by loading the RXVCS with the command, retrieves the Extended Status registers. Done is negated. When Transfer Request is asserted the program loads the bus address into the RXVDB, which negates Transfer Request. Under DMA control one word at a time is assembled and transferred to memory starting at the specified address.

*Done is asserted, RXVES is moved into the RXVDB and, if enabled, an Interrupt Request is generated at this point.

If nonexistent memory is encountered during the transfer, the operation is aborted, and Error is asserted.*

When all four words are transferred, Done is set and, if enabled, an Interrupt Request is generated.

4.5.9 Command Protocol for 22-bit Mode

Bit 10 of RXVCS must be written as a one to invoke 22-bit mode of operation.

A change in command protocol applies only to Fill Buffer, Empty Buffer and Read Error Code commands; all other commands remain the same.

For the above commands one more Transfer Request is asserted by the controller to allow loading of the RXVBAE register by the program. After this transfer is completed Transfer Request is negated and the commands proceed as before with the Done bit asserted upon command completion.